

4076
C.M.T.B.W.

AMERICAN
CARPENTER AND BUILDER

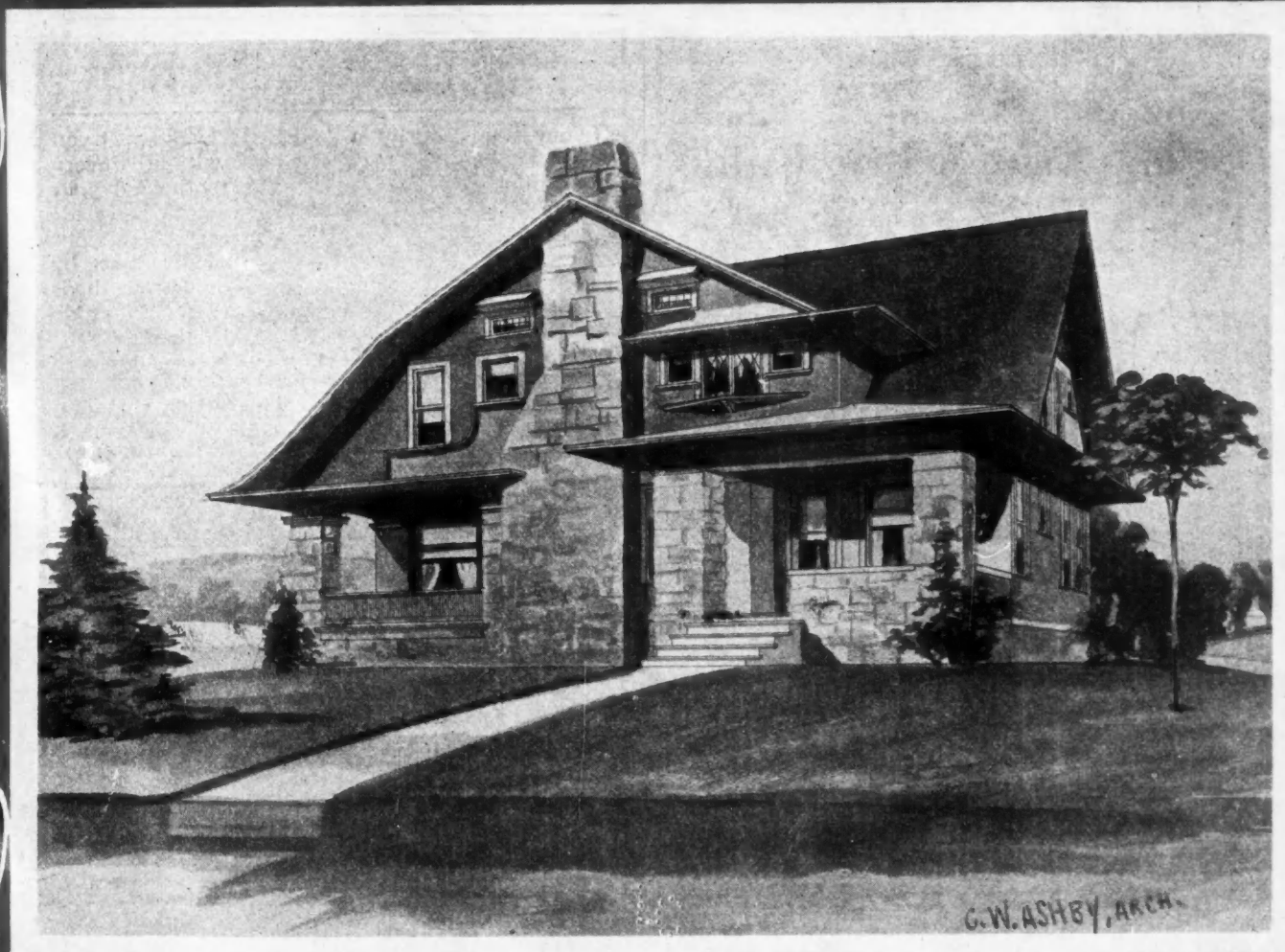

G.W. ASHBY, ARCH.

APRIL

1905



NO YOU DON'T! DON'T WHAT?

Don't buy **BUILDERS' Hardware** as cheap as we sell it. Not unless you are already one of our customers.

We give the contractor the advantage of the latest designs, finest material and lowest prices.

Write us and see.

SEND US YOUR HARDWARE LISTS

Write for our catalog and net price list. Free for the asking to contractors and builders.

REHM HARDWARE CO.
352 - 354 Blue Island Avenue
CHICAGO, ILL.

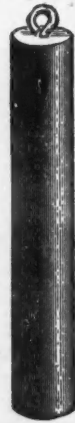
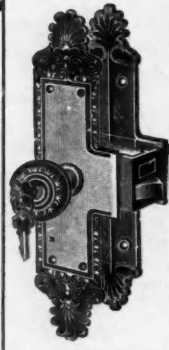

TH1
A25

MODERN FURNACE HEATING

A NEW BOOKLET FREE Tells how to plan the heating of a house, store, church, etc. How to locate the furnace—how to place the registers—how to arrange the pipes—how to ventilate—how to secure air supply—in fact, a complete instruction in the art of furnace heating.

It describes also the **LEADER STEEL FURNACE**, 1905 pattern, all riveted joints, lined casings, chain regulation, rocking grates, brick lining, evaporating pan, etc. Adapted to all fuels; six sizes, suitable for any work any furnace can do.

It outlines our new plan of selling and shipping *direct from factory to consumer*, and how we save you money. For instance, we offer our No. 45 Leader Steel Furnace, as above, for \$49.00, freight prepaid to your station, if east of Omaha. Send a sketch of your building and we will tell you what the whole equipment will cost, fitted and *guaranteed* and laid down at your door, freight prepaid.

References in Every State—Hundreds of Them. Drop a Card and Get a Booklet.

HESS WARMING & VENTILATING CO.
720 TACOMA BUILDING : : : CHICAGO

411 OF OUR \$25⁰⁰ Concrete Stone Outfits

Shipped on Trial during 1904
Only Three Returned

WHY?

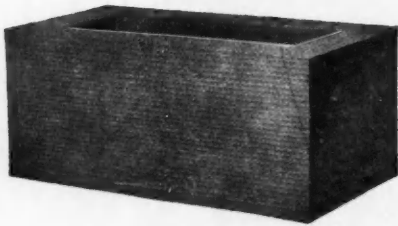

If we were selling **GOLD DOLLARS** at 90c each, we would have some dissatisfied customers

Our Record Proves Something

WHAT?

DON'T ARGUE. We pay the Freight When not Satisfactory

The Cement Working Machinery Co.
195 Lafayette Ave., : : DETROIT, MICH.

DO YOU USE ALL YOUR TEETH?

If your saw is set by a "SPECIAL" saw set you will use every tooth, and your work is made easy. If your saw is set by other methods three or four do it all.



If you will send in for a copy of our catalog you will learn all about this wonderful tool

CHAS. MORRILL 283 BROADWAY
NEW YORK

CUSTOM MADE FLY SCREENS

Our work is far superior to the usual output of local mills and has a style and finish not obtainable from those who do not make a specialty of screens.

For outside screens we use the identical finish of the outside of Pullman cars.

The best grades of Wire Cloth, enameled, galvanized, genuine bronze, etc. Fastened by tacks or by the "lock-strip" process.

Intending purchasers may have free by mail samples of woods, finishes and wire cloth and copy of catalog and price list. Agencies in many cities. Special terms to contractors and builders.

THE A. J. PHILLIPS CO. Fenton, Mich.
23 Years Experience. 3 1-2 Acres of Floors.



The Best and Most Practical Trade Journal for the Carpenter and Builder

American Carpenter and Builder

WILLIAM A. RADFORD, EDITOR.

Editorial Staff—FRANK E. KIDDER, FRED W. HAGLOCH, G. W. ASHBY,
ALFRED W. WOODS, WILLIAM H. SCHROEDER, J. A. F. CARDIFF,
I. P. HICKS, OWEN B. MAGINNIS, JULIUS KARPEN, IRA S.
GRIFFITH, HENRY H. NIEMANN, DWIGHT L.
STODDARD, WILLIAM REUTHER.

Published monthly by

American Carpenter and Builder Company

196 FIFTH AVENUE, CHICAGO.

O. F. BYXBEE, General Manager.

NEW YORK OFFICE, 253 BROADWAY
EGBERT DAYTON, Manager.

VOL. I. APRIL, 1905. No. 1.

The AMERICAN CARPENTER AND BUILDER is issued promptly on the first of each month. It aims to furnish the latest, and the most practical and authoritative information on all matters relating to the carpentry and building trades. Short, practical letters and articles on subjects pertaining to the carpentry and building trades are requested, and prompt remittance made for all acceptable matter.

SUBSCRIPTION RATES.

One year, \$1.00; six months, 50 cents; payable always in advance. Single copies, 10 cents.

SUBSCRIPTIONS may be sent by check, express or money order, or registered letter. Make all remittances payable to the American Carpenter and Builder Company. Postage stamps are not desirable, but if necessary to remit them, two-cent stamps are preferred.

OUR first cover page was specially designed and lithographed for the AMERICAN CARPENTER AND BUILDER by the Goes Lithographing Co., one of the leading firms in their line in the country. It is acknowledged by experts to be an unusually handsome, artistic and appropriate design. The American eagle is certainly well chosen for a publication that appeals to the needs of the entire list of American carpenters and builders, while at the same time the staunch old bird stands for strength and leadership. The predominance of red in the coloring gives character to the page, affording excellent contrast with the black and harmonizing nicely with the softer brown. The house design was drawn particularly for this issue and the floor plans are

shown on another page. It will be conceded that this is a very artistic residence, but, while the artistic effect is marked, it is none the less a practical and inexpensive house. This illustration will be changed monthly, but otherwise the cover will retain its present individuality.

This and Future Issues

Our first issue illustrates what may be expected in future numbers of the AMERICAN CARPENTER AND BUILDER—only it will naturally improve with age. That there is ample room for a publication of this character cannot be questioned, as there are half a million carpenters in the United States with only one or two magazines published solely in their interests.

It was a desire to meet the needs of these 500,000 carpenters that prompted the publication of the AMERICAN CARPENTER AND BUILDER. The primary thought in mind has been the securing of editors and contributors who are practical men—men who will not write “over the heads” of the tradesman, but men who will treat in an understanding, intelligent manner the various topics and questions that come within the experience of the carpenter.

Coupled closely with the interests of the carpenter are those of the builder—in fact, in most instances the carpenter and the builder are one and the same, only the builder is a carpenter who has advanced to the position of contracting carpenter. And there are more than 100,000 of these. The scope of the magazine will be widened sufficiently to cover the needs of every carpenter, whether he is handling the tools, or has the making of the building contract.

We have the names of every one of these 600,000 men, and we propose to make the AMERICAN CARPENTER AND BUILDER so interesting, so valuable, and so indispensable, that every one of them will feel that he cannot get along without it. In order to accomplish this we have made very thorough preparations—

preparations that cover fully a year and have involved the expenditure of several thousands of dollars—and with this issue we feel that we are giving our readers a publication of which we are justified in feeling proud.

On subsequent pages we show the faces of many of the editors and contributors to the AMERICAN CARPENTER AND BUILDER, and also brief sketches demonstrating their capability for the handling of the subjects of greatest importance to the readers of the magazine. Many of these men are well known as authors of hand books which have been shown to be most practical, and which are daily found in the hands of carpenters all over the land. Others are men of national and international reputation as authorities on particular subjects. We have selected this large corps of editors very carefully so that we are prepared to treat every subject that can interest or benefit the carpenter and builder in the most intelligent manner.

While we feel that this number of the AMERICAN CARPENTER AND BUILDER is as complete as the most exacting subscriber could expect, still we do not intend to be satisfied if future issues are no better, but will make it our purpose to improve the character and scope of the paper every month. Each month brings new problems and new achievements, and the AMERICAN CARPENTER AND BUILDER will make it a point to

keep in touch with all that is new, and will always be found abreast of the times.

Increase in Subscription Rate

Subscriptions beginning with the May number of the AMERICAN CARPENTER AND BUILDER will cost \$2.00 per year, as the rate will be increased at that time. We have printed an extra number of the April issue, so that we will be able to furnish the magazine to those who wish to begin with the first issue at the published rate of \$1.00 per year, but in order to take advantage of this price subscriptions must begin with this number and must be received before May 1.

IN this number we publish the first of a series of articles on cement construction, and in future issues will give considerable prominence to this subject, particularly to cement block houses. This form of building has advanced wonderfully during the past year or two, and the possibilities of the future are even more extraordinary. Carpenters are being asked continually for information regarding its good and bad features, and it is becoming more and more necessary that they should keep posted. Then, too, the use of cement blocks for house construction necessitates some important changes in the system of framing, and next month Mr. Hicks will give the first of a series of very instructive articles on this point.

Our Editors

BRIEF SKETCHES OF THE WELL KNOWN MEN WHO WILL WRITE FOR THE MAGAZINE, OUTLINING THEIR QUALIFICATIONS FOR THE PARTICULAR SUBJECTS THEY WILL COVER

No trade publication in the United States, Canada or England can boast of as large and capable an editorial staff as the AMERICAN CARPENTER AND BUILDER. The names of the best architects, and the best authorities and trade writers in the country are found at the head of its columns, and these noted men and authors, one or more of whose books are in the hands of almost every carpenter and builder in the United States, have been secured at considerable expense and will contribute regularly to the columns of the magazine. As this is our first issue we will no doubt be pardoned for devoting space to show their photographs and the following brief sketches:

FRANK E. KIDDER

Frank E. Kidder, although an extremely busy man, has consented to have a part in the editing of the AMERICAN CARPENTER AND BUILDER. Mr. Kidder is best known as a consulting architect, author and expert in matters pertaining to the strength and construction of buildings, and as a consulting architect his practice extends all over the United States and Canada. For nearly twenty years he has been actively

engaged in the practice of his profession, the greater part of the time residing in Denver, Colorado, where he has been prominently identified with the building up of the city. Mr. Kidder is a hard worker and close student of contemporary progress, as is evident by the vast amount of work he has accomplished. Aside from his writings and private practice, Mr. Kidder is consulting engineer for the largest reinforced concrete construction company west of the Missouri river and an enthusiastic believer in that material.

FRED W. HAGLOCH

Fred W. Hagloch, who will handle the subject of concrete building blocks and concrete construction in general for the AMERICAN CARPENTER AND BUILDER, is a consulting engineer in concrete construction whose practice reaches almost every nation and colony in the world, and his book on artificial stone is the standard authority on the subject in foreign countries as well as at home. His engineering practice is confined to artificial stone and concrete blocks, and in this field he directed the use of over 18,000 barrels of cement during 1904. Mr. Hagloch, although a young man, has



Oliver Bradford

AMERICAN CARPENTER AND BUILDER



G. W. ASHBY

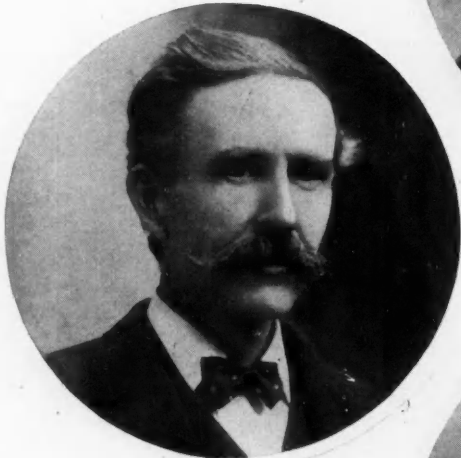

ALFRED W. WOODS



WILLIAM H. SCHROEDER

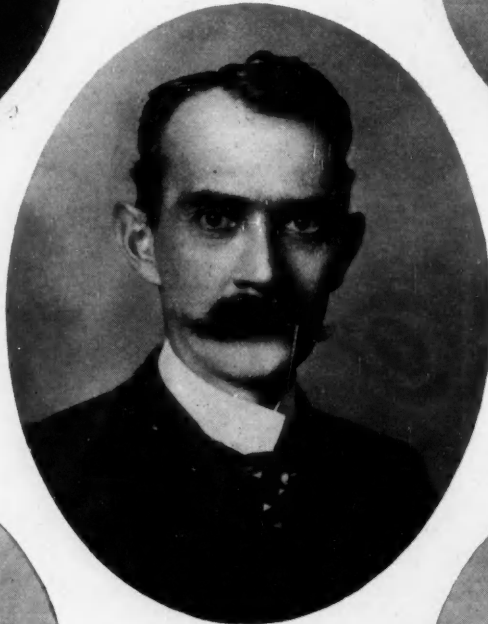

FRANK E. KIDDER



I. P. HICKS



OWEN B. MAGINNIS



DWIGHT L. STODDARD



FRED. W. HAGLOCH



J. A. F. CARDIFF



HENRY H. NIEMANN



O. F. BYXBEE
General Manager



S. C. KELLENBERGER
Manager Advertising Department



C. S. BADGER
Manager Business Department



WILLIAM REUTHER
Assistant to the Editor

had over twenty years' experience in the handling of artificial stone, and has superintended and made with his own hands every possible character of concrete construction.

G. W. ASHBY

"School Houses" will be one of the most important departments in the AMERICAN CARPENTER AND BUILDER, and the securing of Mr. G. W. Ashby to take charge of this department is a distinct advantage. Mr. Ashby has probably had a wider experience in the construction of school houses than any other architect in the country. To give an idea of the number he has built in the vicinity of Chicago, it might be cited that standing on the roof of one of these a person is able to see fourteen other school houses, all designed and built by him. In the last biennial report of the Cook County Superintendent of Schools, were published a number of school houses built in the county outside of the city of Chicago during the year, and five-sixths of the buildings were designed by Mr. Ashby. It must not be presumed that Mr. Ashby confines his work to school houses, however, as every month he produces large numbers of plans and specifications of dwellings and public buildings. Five of his houses appear in this issue and are described elsewhere.

ALFRED W. WOODS

Alfred W. Woods is too well known to the carpenters and builders of the country to need an introduction. For the past ten years he has made a special study of the steel square and its possibilities, and today has the most complete set of illustrations showing the application of that instrument to be found in this or any other country. It is upon this subject that he will write for the magazine. His writings have been largely copied, both in the United States and in foreign countries. Mr. Woods has had considerable experience in teaching architectural drawing in schools, and his "Key to the Steel Square" is meeting with a large sale.

WILLIAM H. SCHROEDER

In William H. Schroeder, who has consented to furnish a series of house plans, the AMERICAN CARPENTER AND BUILDER has secured a man who is in every way practical. He knows every detail of the practical construction of a house or other building, and is a man of exceptional ability. Besides being a licensed architect in the State of Illinois, he studied law in Chicago, where he was admitted to the bar; so that he not only knows how to make the plans for a house, but is well fitted to draw up specifications that preclude the possibility of legal disputes.

J. A. F. CARDIFF

J. A. F. Cardiff will be one of the editors of the AMERICAN CARPENTER AND BUILDER. He will fur-

nish a series of fully illustrated articles on the construction of a house from digging the cellar and the laying of the foundations to the painting of the exterior and the decoration of the interior. Mr. Cardiff is one of New York's prominent architects, and has written for and edited many of the principal architectural publications of the country. He gained his knowledge of the business by practical experience in the offices of various New York architects, combined with a course at Columbia University, and has been unusually successful in the practice of his profession.

I. P. HICKS

Readers of the AMERICAN CARPENTER AND BUILDER are thoroughly familiar with the name of I. P. Hicks, as the author of several very practical books on building, estimating, architectural drawing, etc. Mr. Hicks commenced work as a carpenter at the age of 20, four years later began contracting for himself. For the past twenty years he has been the leading architect at Omaha, Nebraska, and a prominent contributor to trade publications. He gained his knowledge of building through personal experience and enjoys the reputation of being a very conservative and practical man, and has acquired the art of making plans and drawings which are easily understood by the builder, and the ideas of the designer can be readily executed.

OWEN B. MAGINNIS

Every carpenter and builder in the country has read one or more of the practical books of Owen B. Maginnis, the well known New York authority on buildings of every description. He has written some of the best articles in the leading trade papers, and will now handle practical matters along the line of foundations and bricklaying for the AMERICAN CARPENTER AND BUILDER. Mr. Maginnis was born in Ireland and his successful life shows the result of devoting the leisure hours to attending night schools, reading on technical subjects and sticking without deviation to the one branch of industrial science. He has had successful practical experience in all branches of carpentry work, both inside and outside, and is at present Inspector of Buildings in New York City.

DWIGHT L. STODDARD

Dwight L. Stoddard was born and raised on a farm in Vermont. At the age of 15 he went to work at the carpenter trade, and has helped build many towns in Vermont, Iowa, Kansas, Colorado, Missouri, Ohio, Michigan and Indiana. He took a great interest in prisms in their early days and is reported to have installed every Luxifer prism in Indiana during the first five years of their use. He has always taken an active part in unions, his life's work being centered in his trade and his trade union. For the last fifteen years he has written articles for the carpenter to read, and last year wrote the "Steel Square Pocketbook," which is receiving much attention. It would be difficult to

find a man better fitted to handle the practical questions of carpentry.

JULIUS KARPEN

In this number appears the first of a series of articles on "Interior Decoration and Furnishing," by Julius Karpen, who is particularly qualified for this work. Mr. Karpen belongs to a family of furniture manufacturers, his father having been in the business before him. He is of an artistic temperament and an authority on interior decoration. He has designed furniture and interiors for the best buildings in the United States and for export to all countries of the world. The Pullman Palace Car Co. is using large quantities of furniture of his design on their finest trains.



JULIUS KARPEN



EGBERT DAYTON

HENRY H. NIEMANN

Practical men have been secured to conduct the various departments of the AMERICAN CARPENTER AND BUILDER, and Henry H. Niemann is no exception. For the past few years Mr. Niemann has been engaged in the designing of schools, public buildings, and particularly farm and live stock buildings of all classes, and in writing for the magazine he will give the greatest attention to the latter subject. Mr. Niemann has also had a wide experience in the designing of cold storage buildings, hotels, office buildings, and fire proof construction in general, and will from time to time contribute plans and descriptions of such structures.

IRA S. GRIFFITH

We expect to make the AMERICAN CARPENTER AND BUILDER of interest to all ages, and in order that the



IRA S. GRIFFITH

boys, whose fathers are subscribers to the magazine, may not be neglected, have made a particular effort to secure an editor who will look after their interests exclusively. Ira S. Griffith, whose first article appears in this number, is exceptionally well fitted for this work, as he comes in touch with hundreds of boys every day in his work as Director of Manual Training at Oak Park, Ill., and knows just what the boys want. Mr. Griffith's writings and drawings are in great demand, and he is frequently asked to make addresses along the very lines upon which he will write for this magazine.

Business Department

For looking after the business and advertising interests of the AMERICAN CARPENTER AND BUILDER, care has been taken to

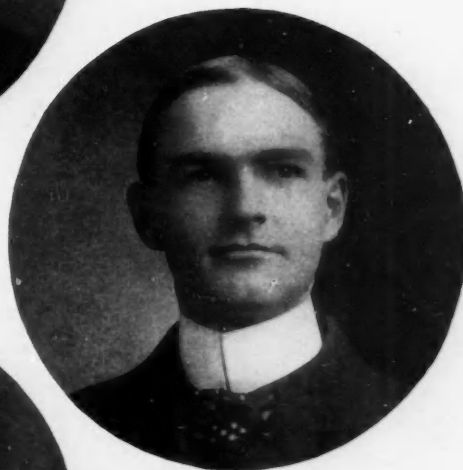

F. E. FRAME

secure men who could be relied upon to look after a large enterprise with satisfaction to both the publishing company and its patrons. Advertisers and subscribers alike may rest assured that nothing will be left undone that will add to the interest of the reader on the one hand, or

that will bring quick and adequate returns from the announcements in the advertising columns.

O. F. BYXBEE

O. F. Byxbee, the general manager of the AMERICAN CARPENTER AND BUILDER, has for eight years had charge of the department of "Newspaper Work," on the *Inland Printer*, the leading trade journal in the world in the printing and allied industries. For the past five years he has had the general management of the *Scranton (Pa.) Tribune*, the leading daily

newspaper of northeastern Pennsylvania. Mr. Byxbee's experience covers twenty years in the newspaper and printing business, and his connection with the *AMERICAN CARPENTER AND BUILDER* leaves no question as to the character of the magazine from a typographical standpoint, or to the ability of the paper to carry out any business contracts it may make.

EGBERT DAYTON

Egbert Dayton, who will have charge of the New York office of the *AMERICAN CARPENTER AND BUILDER*, is one of the most able advertising men in the trade paper line, and his experience and large acquaintance in the great cities of the East will furnish to the readers of this publication, articles and write-ups upon many new inventions and devices that are being placed upon the market by the American manufacturer. He attributes his success to having never made a promise to an advertiser that he could not fulfill, and has never left a man's office or workshop in a manner which would forbid his returning there

again, and by his good judgment in making suggestions to his advertisers has won for himself their generosity and confidence. Like all the others connected with the magazine Mr. Dayton is still a young man, having been born in a small village in New York state about thirty years ago.

H. E. FRAME

Horace E. Frame, who will have charge of the advertising of the *AMERICAN CARPENTER AND BUILDER* in Chicago and the West, is well qualified to handle this work, as he has a wide acquaintance with general advertising conditions throughout this territory. He attributes his success in the advertising business to courteous treatment and constant attention to the interests of his patrons. Mr. Frame is a thorough believer in the principles of advertising and is constantly studying the best means of securing the most satisfactory returns from it. His thorough knowledge of the business gives particular weight to any suggestions which he may offer.

Changes of a Quarter Century

DEVELOPMENTS IN BUILDING MATERIALS AND METHODS OF CONSTRUCTION DURING THE PAST TWENTY-FIVE YEARS
—EFFECT OF MACHINERY ON THE CARPENTERS' TRADE

By F. E. Kidder

The changes that have taken place in the method of building, the new materials introduced and the new applications of the ordinary building materials during the past twenty-five years have probably been greater than have occurred in any preceding century of the world's history. In many instances the new materials and methods have been so wonderful, and so quickly brought about that were it not for the equally wonderful progress that has been made in almost all of the industrial arts and sciences, they would be considered as little short of marvelous.



F. E. Kidder

This short period of time has seen the introduction and perfection of the rolled steel beam and other structural shapes, the invention of modern fireproof construction, the beginning and rapid development of skeleton construction—resulting in buildings which for height and practical utility are the marvel of the world—the application of electricity to lighting and power, the perfection of the modern elevator, the introduction of reinforced concrete as a standard building material, and the greatest expenditure of money for building enterprises that the world has ever seen.

With the invention of new materials and the abundant supply of capital, there has been a corresponding advancement in engineering knowledge, and in the methods of handling building operations, so that feats of construction have been accomplished of which the world affords no parallel. The most remarkable of

these have been exhibited in connection with the construction of tall buildings, and buildings of reinforced concrete.

Some of the most wonderful feats have been the methods by which buildings rising 300 to 400 feet above the ground have been supported, the underpinning of adjacent tall buildings, and the marvelous rapidity and economy with which these buildings have been erected.

In the matter of sanitation and provision for comfortable and luxurious living there has been nearly if not quite equal advancement. Modern plumbing is almost immeasurably superior to that of twenty-five years ago; the cottage of to-day being better plumbed than the mansion of 1880. Public water service, sewers, electricity in its many applications, inventions for the supply and control of heat and temperature, the modern elevator and numerous other small conveniences make the average residence or apartment of to-day a palace of luxury as compared with the mansions of our forefathers.

It is well to notice, however, that these developments have been mainly along practical and commercial lines; in fact, this has been an intensely practical generation, even the development of art being due probably more to a realization of its commercial value than to the actual pleasure which it produces.

Twenty-five years ago there was but one first-class architectural journal published in this country, but two schools of architecture and almost no American books

treating on architecture or building construction. Structural engineers and draughtsmen such as we have to-day were then unknown, and data for accurately estimating the strength of structural work, even for so simple a form as the wooden beam, very meagre and unsatisfactory.

In the matter of architectural design, while there has undoubtedly been an improvement in this country, at least over anything we had before, with the possible exception of four or five buildings, yet as compared with the architecture of Greece and Rome in their best days, or with the grand cathedrals of Mediaeval Europe, we can claim no advancement, and in certain methods of building we cannot perhaps hold our own with the great mediaeval builders. The marvelous vaulted roofs which they erected and which still stand for our admiration would daunt most of our modern architects and builders. In fact there are probably few stone masons of to-day that are so thoroughly masters of their craft as were the masons of the fifteenth and sixteenth centuries. And this may be also said of the carpenters. The buildings of the seventeenth and eighteenth centuries abounded in intricate carpentry and joinery and had some of the most wonderful staircases, the knowledge of which is becoming to a greater or less extent a lost art.

As this article will probably be seen mainly by carpenters and builders, they will undoubtedly be most interested in those developments and changes which most particularly affect their own work.

These may perhaps be classed as follows:

First, the introduction of machinery for doing a large portion of the work that was done by hand, bringing into existence the "mill man."

Second, the growing scarcity of timber, requiring a greater economy in its use.

Third, the introduction of other materials to take the place of wood; and,

Fourth, the demand for a better technical education.

The introduction of machinery has had a great effect upon the carpenters' trade, so much so that it has almost entirely driven out the "joiner" of a century ago. It is due mainly to this cause, undoubtedly, that few mechanics now learn the carpenters' trade thoroughly. Mechanics are now either "carpenters," "mill men," or "stair men," with a few cabinet makers—few if any attempting to master more than one branch of the trade—and the successful contractor is rather a good engineer or a business man than a mechanic.

Probably the greatest distinction between the building methods of to-day and those of a century ago is in the manner in which men go about the designing of a large building or an unusual piece of construction.

In those days timber was practically the only structural material, aside from stone and brick, and it was abundant (in this country), so that no particular economy was required for its use. The roof and floor

spans which could be provided were such as could be made of timber, and the process of proportioning the timbers was governed entirely by experience rather than exact knowledge, and this is probably true of all of the engineering work done previous to the nineteenth century. Every unusual problem called for careful comparisons with work already accomplished, and the judgment of the most experienced persons.

To-day all of this is changed. The mechanical principles by which framed structures are made to sustain their loads are well understood, and we have reliable data by which the strength of a given piece of material may be computed with a very close degree of accuracy. It is undoubtedly owing mainly to these two facts that the great structural feats, such as are shown in a twenty-five-story skyscraper, in roofs with spans of from 100 to 350 feet, and in the wonderful reinforced concrete constructions, have been accomplished. Without positive knowledge along these lines, such constructions could never have been even attempted, much less accomplished.

While steel has been an important factor in the accomplishment of these great structural feats, yet to a lesser degree the same facts hold good in wooden construction. Fifty years ago the master builder who had an unusual load to support, or a large room to span, had to feel his way, as it were, and to be guided mainly by his observation and judgment. To-day the young man, with ordinary technical knowledge, sets down to his drawing board, figures out the loads and stresses, and determines with exactness the size of the timber, rods and bolts required, and loses no sleep from anxiety. Without this technical knowledge, however, the architect or builder of to-day is handicapped more than was his predecessor of a generation ago, for then all were on about the same level—except in the matter of experience—while to-day those who are best equipped in technical knowledge are the ones who reap success.

To be a successful contractor or builder in this twentieth century one must be more than a good mechanic—he must be posted on all that pertains to building—the nature, utility and cost of materials employed, the most economical methods of construction, including the handling and placing of materials, and have some knowledge of the laws which govern the strength and stability of buildings. To attain to this he must keep in close touch with what is going on, through trade journals, books and builders' associations and conventions, as well as through observation and travel.

The writer believes that the present day offers to the man, who is ambitious and willing to work with his mind, opportunities that have never been exceeded in any age, but to grasp them he must not only be well equipped, but must keep well informed of every advancement that is made in his line, and be constantly pushing to the front.

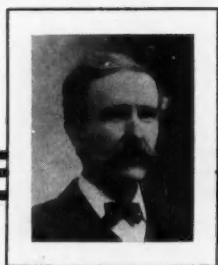

Steel Square

ALFRED W. WOODS

The Steel Square and Its Possibilities

THE FIRST OF A SERIES OF PRACTICAL ARTICLES ON THE USES OF THE STEEL SQUARE, ALL OF WHICH WILL BE FULLY ILLUSTRATED FROM ORIGINAL DRAWINGS BY THE WRITER

It is not definitely known who invented the square, or when it first came into use; however, while it is known to have been used in various forms for many centuries, it is only within comparatively recent years

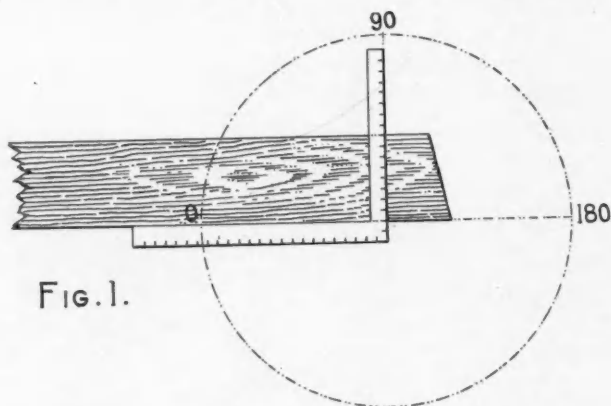

FIG. 1.

that the steel square has come into use as a general framing tool.

The steel square of to-day is a very different looking instrument as to finish and workmanship to what it was even thirty or forty years ago. Of course the standard scale of measurement remains the same, or is supposed to, on all squares, yet the square itself differs as to size and length of its members.

While the blades of most of these squares were twenty-four inches in length, the tongue ranged from twelve to eighteen inches. We believe the recognized standard square among most all classes of workmen to-day is one with a blade twenty-four inches in length by two inches in width, and with a tongue eighteen inches by one and one-half inches, with the inch divisions divided into eighths, twelfths and sixteenths. In addition to this most all squares have rules or formulas stamped on them for finding various measurements, such as board measure, brace measure, octagon and diagonal scale, etc., but as a rule these formulas are not understood and are more or less obsolete.

There are a number of patented squares on the market containing rafter tables and cuts for a limited number of roof pitches, but these, while they may give

correct answers, still leave the student in ignorance of the real cause and effect; besides their scope is limited and none can contain the general information to be found in the 90-degree angle and the inch division that is divided into twelfths found on the outer edge of the blade and tongue. We will, therefore, not take up space or time in describing the formulas given on the square, but will confine our remarks to the square itself and the twelfths scale found thereon. It is on these figures that we base our standard, and any square answers the purpose provided the angle is true and the markings correct.

Great as the steel square may be in the hands of the learned mechanic, it is only secondary to the compass. It simply steps in as an aid in defining what has already been determined by the compass and its divisions called degrees. Therefore, we cannot pass the compass by and the part it plays without giving it due credit.

It will be our aim as far as possible to illustrate the part each plays, thereby helping the student to more readily grasp the subject.

The old time masters, who set the recognized standard in architectural proportion, based their calculations upon the diameter of the circle and its divisions. Miters are governed by the divisions of the circumference of the circle, and not alone by the figures on the

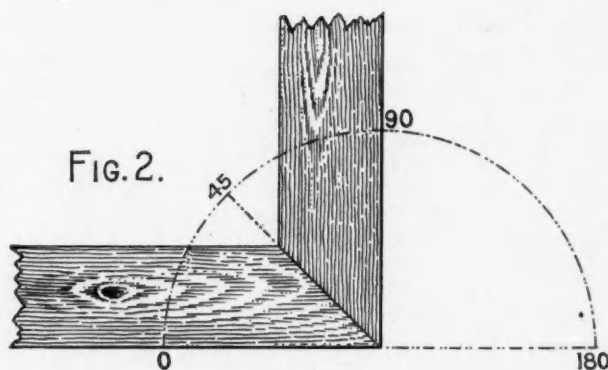

FIG. 2.

square. Therefore, to unlock the great fund of information contained in the arms of the square, it must be done by degrees. There are 360 contained in the circumference of the circle, and any of the regular

polygonal miters can be readily found by dividing 360 by the number of sides in the polygon, and the quotient will be the angle that the miters stand with each other, but in order to obtain the angle with the steel square it is only necessary to take one-half of the degrees contained in the circle, or 180, and this divided by the number of sides in the polygon will give the degrees to use on the square. The reader will notice that we use 12 on the tongue for all miters; the reason we do this is because 12 represents unity. It may represent one inch, one foot, one yard, or any other scale of measurement.

The casual observer sees nothing in the square beyond a simple measuring tool, or for squaring off the

miters. The former applies to polygonal corners, where the line of juncture is midway between the outer edge of the timbers, as shown in Fig. 2, and the latter to corners where the line of juncture does not rest midway between the outer edge of the timbers, as shown in the lower left hand corner in Fig. 3.

In this illustration we show both the regular and irregular miters for a square cornered frame, though it could be any polygonal corner. In this it will be seen that the regular miter is at 12 and 12 on the squares, and at 45 and 45 degrees from the edge of the timbers. In the irregular, the angle is at 58 and 32 degrees from the edge of the timbers, and on one of the squares it is at 12 and 19 5-24, and 12 and 7 1/2 on the other, but either of the squares give the same result as far as the miter is concerned.

In our next article we will show the degree line for any miter in connection with the steel square.

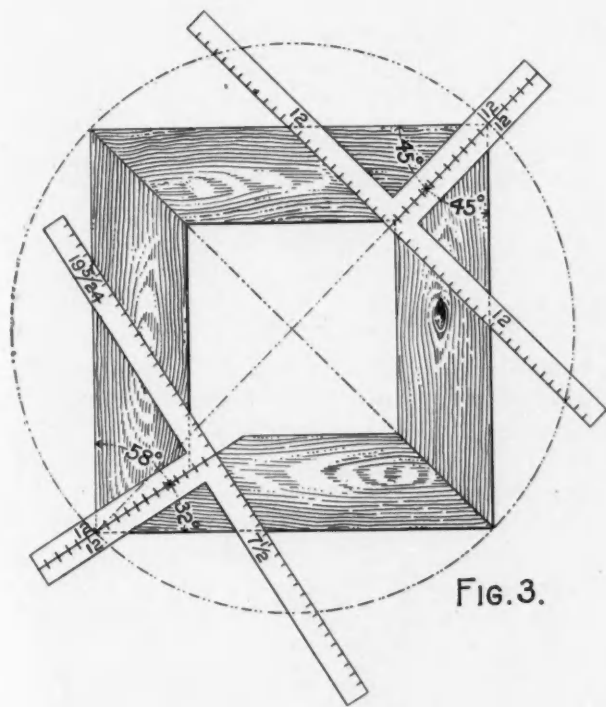

FIG. 3.

end of a board, which is the simplest of all the movements of the square. Yet as simple as it is, it is governed by the degrees, as will be shown in referring to Fig. 1.

In all cases a straight line, which may be the edge of a timber, represents one side of an angle from which the other side of the desired angle is reckoned, and in reality represents 180 degrees. Now, since the arms of the square set at an angle of 90 degrees with each other, just that much will it take from 180 degrees having the angle stand at 90 degrees as shown.

In Fig. 2 is shown the simplest of all miters, and it is used more than all others. The knowing ones give the definition of the word miter as, "Joining two timbers at an angle of 45 degrees," without reference to any other angle. This is contrary to general belief and we see no reason why it does not apply equally as well to any other angle, and will treat them as such, but dividing them into two classes, of regular and irregular

To Prevent Rotting

A cheap and effectual method of preventing the rotting of fence posts is said to be practiced by French farmers. The posts are piled in a tank and the whole thickly covered with quicklime, which is gradually slaked with water. Another plan, used in this country, is to char the posts to the depth of half an inch, and then dip them in coal tar, but the coal tar should be so used as to extend above the surface of the ground, when the posts are in place. While this may not prevent decay, yet it will prolong the period of durability of the posts.

Glass Houses

An Iowa architect has devised a method of using glass for the outer walls of houses. The glass resists fire and the buildings need no windows, but the inside treatment allows for marble or other wainscoting which goes half way to the ceiling. The cost for outer walls is said to be one-third less than for brick.

Impressions From the Prospectus

Below are a few unsolicited letters from those who saw copies of our prospectus, telling what we were planning to make the AMERICAN CARPENTER AND BUILDER:

Seneca Falls Manufacturing Co., Seneca Falls, N. Y.—We believe that you are arranging a paper along the right lines and trust that it will prove a success and a profitable advertising medium.

Wm. Penn & Co., Superior, Wis.—Your magazine appears to be very nicely gotten up and we think will be of great service to the trade at large.

Nicholls Manufacturing Co., Ottumwa, Iowa.—We believe you have a good field and are starting out in the right way.

Wm. Butler & Son, Huntley, Ill.—The magazine will be a grand thing for the contractors and builders, especially the young carpenters who are learning the trade.



Building Construction-

J. A. F. CARDIFF

Building a Home

A SERIES OF ARTICLES, FULLY ILLUSTRATED, COVERING THE DETAILS OF HOUSE CONSTRUCTION, FROM FOUNDATIONS TO COMPLETION

Under this heading will appear each month, profusely illustrated articles showing the various details of building construction met with in the erection of our American homes.

It is proposed to exhaustively cover every point in the order in which it would come up in the regular process of erection. The illustrations will show in the clearest and most comprehensive manner—first, the construction employed in the cottages of low cost; second, the improvements that can be made in the construction at a small additional expense; and third, the very best methods of construction used in the larger homes where expense is not an important consideration.

Every effort will be made to make the series the most complete ever published in any trade journal.

The illustrations of the two cottages are intended to serve as a basis from which the future detail drawings will be taken.

A ONE THOUSAND DOLLAR COTTAGE

A well-arranged floor plan has been the first consideration in the designing of this low-cost cottage. Good sized, well proportioned, and well lighted rooms, with every thought to the requirements of modest house-keeping, are provided throughout. Ample closet room has not been overlooked.

The keynote of the exterior design has been simplicity, depending for its artistic effect on its graceful lines and window grouping.

The materials of construction are, of course, owing to the limit of the cost, the cheapest servicable goods that can be obtained in the locality in which it is built. The foundations are of stone and the exterior covering of shingles, left natural.

A TWO THOUSAND DOLLAR COTTAGE

Larger and a little more elaborate than the previous design, this cottage should appeal to any home builder. Fine, large, well proportioned rooms, with ample closet space, are provided. The exterior, while following simple lines, as required by economical construction, presents a pleasingly picturesque effect that

would grace the finer locations. Two large rooms in the attic could be finished off at a small additional expense for anyone requiring more than the seven rooms provided.

FOUNDATIONS

Mr. Frank E. Kidder, C. E., in his "Architects' and Builders' Pocket-Book," defines the term "foundations" as, "used to designate all that portion of any structure which serves only as a basis on which to erect the superstructure."

The object of the foundation is to form a solid base, arranged to distribute the weight of the superstructure over a large area of ground and so reduce the inevitable "settlement" to a minimum and to provide for a uniform movement in settling, so that the framework will not be strained and the plaster cracked.

The method of constructing such foundations is largely determined by the nature of the soil and may be classed as follows:

Class I—Foundations where the soil is firm enough to bear the weight of the building.

Class II—Foundations on marshy grounds.

In Class I the foundation may be formed—

Firstly, by brick footings formed by spreading the wall by means of off-sets as shown in Figures 1, 2 and 3.

Secondly, by laying down rough thick stones of width equal to twice the thickness of the wall, and then forming brick off-sets to distribute the weight of the wall on the stones, as in Figure 4.

Thirdly, by concrete footings composed of Portland cement, broken stones and sand mixed together with water; a good proportion being, one part of cement, two of sand, and four or five of broken stone. The material thus produced becomes a solid mass as hard as stone. This method, as shown in Figure 5, is preferable to the preceding ones and is being generally adopted. The success of it depends upon the proportion of cement, sand and stone, as above given, being strictly adhered to, and care should be taken that the mixing is inspected, as the tendency is to economize on the cement to the detriment of the concrete.

In Class II, a solid bed is formed for the foundation



\$ 1000⁰⁰ COTTAGE.

J. A. CARDIFF, ARCHT.

by driving wooden piles into the marshy soil as shown in Figure 6. Oak, yellow pine, spruce and hemlock are the woods commonly used. The piles are driven

through the soft soil to the firm bed beneath. The heads are then cut off at a certain level and a timber capping put on them. This capping is commonly of



\$2000⁰⁰ COTTAGE.

J.A. CAEDIFF, ARCHT.

yellow pine and serves as a support for the foundation above and at the same time ties the piles together.

It frequently happens that the piles do not reach the firm soil owing to its great depth. In this case

the load is wholly supported by the friction of the earth on the sides of the piles; which, however, is generally found ample except in the case of large building and engineering operations.

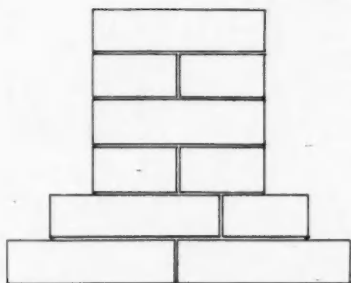

FIGURE 1.

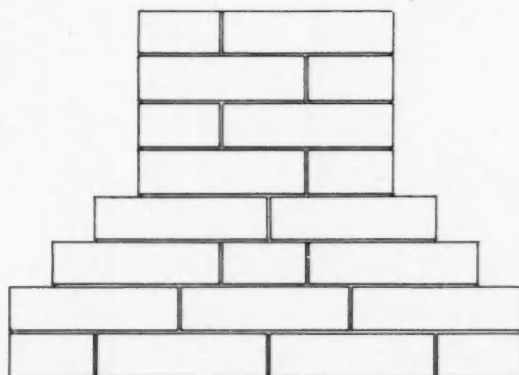

FIGURE 2.

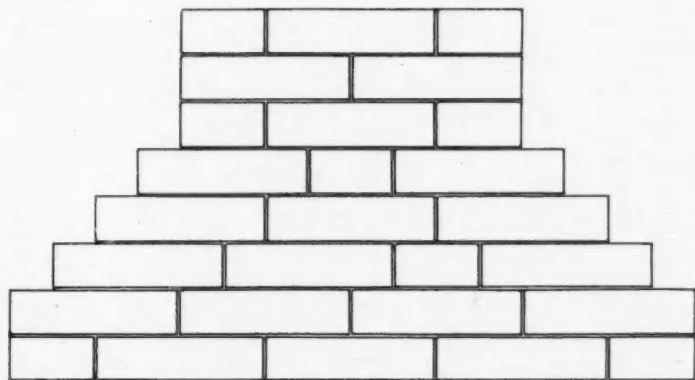

FIGURE 3.

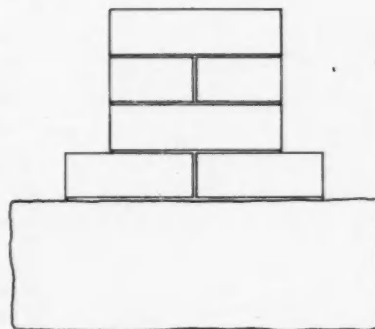

FIGURE 4.

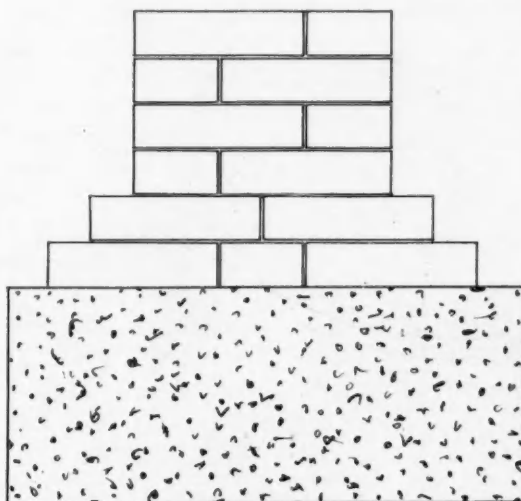

FIGURE 5.

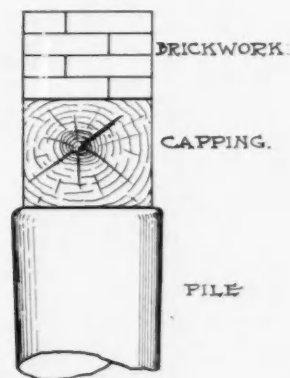

FIGURE 6.



PLATE III.

BUILDING CONSTRUCTION DETAILS

J. A. F. CARDIFF, Architect



Framing a House

I. P. HICKS

Constructive Details

INTERESTING AND INSTRUCTIVE POINTS ON PRACTICAL METHODS OF FRAMING, SHOWING THE RIGHT WAY AND ITS PRONOUNCED ADVANTAGES

Referring to the sketches, Fig. 1 represents a method of framing sills for light framing without gaining the joists into the sills. This method consists of using a 2 by 4 or 2 by 6 flat on the wall, and spiking a 2 by 8 or 2 by 10 on the face edge, as shown by A and B. This will allow the floor joists to be spiked through into the ends of the frame as shown. The floor joists are to be gained on the bottom to have a good bearing on the piece A, and should be cut to fit tight against the face piece B. After these two pieces are thoroughly spiked together then put on the third piece C and thoroughly spike the same. Allowances should be made in cutting the timbers so that they will work out right and bring the finish out flush with the wall, or as intended if otherwise shown. In most cases where houses are sheathed with seven-eighths sheathing it is best to keep the frame back one inch from the wall, so that when the sheathing is put on it will come flush with the wall, then there is nothing to project over the wall at the bottom but the outside base as shown.

This method of framing makes a very strong frame, and if well spiked it is fully as strong as solid timbers of the same dimensions. Two 2 by 8s and one 2 by 4 are just a little more than equal in cross section to a 6 by 6, and it is safe to say they are stronger than a 6 by 6 gained out to receive the joist. The built-up sill has much the advantage in making splices. In splicing, the joint can be so broken that when put together it will be like one continuous sill all around the building. The cut shows the sheathing, outside base, water table, siding and a double floor. Where double floors are laid the first rough floor should be laid diagonal, or stripped, before laying the finish floor. Where both floors are laid the same way the shrinking of the lower, or rough floor, is often enough to cause great cracks to appear in the finish floor. This is due to the fact that the rough floor boards are usually twelve inches wide and the finish flooring boards only about three inches wide, thus each twelve-inch board will take four of the three-inch boards, and the joint in the finish floor that comes nearly over the joint in the twelve-inch board below will draw apart very often

clear out of the matching, consequently the rough floor and the finish floor should never be laid parallel unless the first or rough floor is first stripped over the joists, and the finish floor laid on top of the strips. When this is done both floors may be laid the same way without any danger of the shrinking cracks as stated above. To lay the rough floor diagonal gives a much stronger job and as a rule a more even floor for the finish floor.

Fig. 2 shows the usual method of halving sills together at corners in framing, and of gaining floor joists into the sills as practiced in light framing. There is very little of the old fashion mortice and tenon framing any more. Principally the timbers are just halved together and spiked into place. When floor joists are gained into sills and girders they are usually gained into the sills or girders so that the joists have a bearing of two or two and one-half inches on the sills or girders, and the depth of the gain is usually two inches less than the width of the joist it is to take, and this two inches is cut out of the joist on the lower edge to let it come flush with the sill. This may be seen at A in Fig. 2. It is often the case that girders can be set below the sills in the center of buildings, and thus avoid the necessity of cutting gains in the girders. When this can be done it is better than to cut the gains, for it gives the full strength of the timber used.

Fig. 3 shows a simple and inexpensive way of making a good corner for ordinary house framing. Take two 2 by 4s and spike them together as shown, A and B, and on the inside corner spike on a 2 by 2 on each side to receive the lath. This will make a good solid corner for the lathing and has less lumber in it than the way some builders make corners, and is also better than the way some are constructed. The pieces C and D are only short blocks put in to make a nailing for the base in finishing. This is a matter that should never be overlooked in building a house. No mechanic can do a good job of putting down base unless there is something to nail it to. All the short blocks about a building can be utilized in a similar manner as shown in the sketch, to make nailing places for base corners and by the sides of doors, etc.

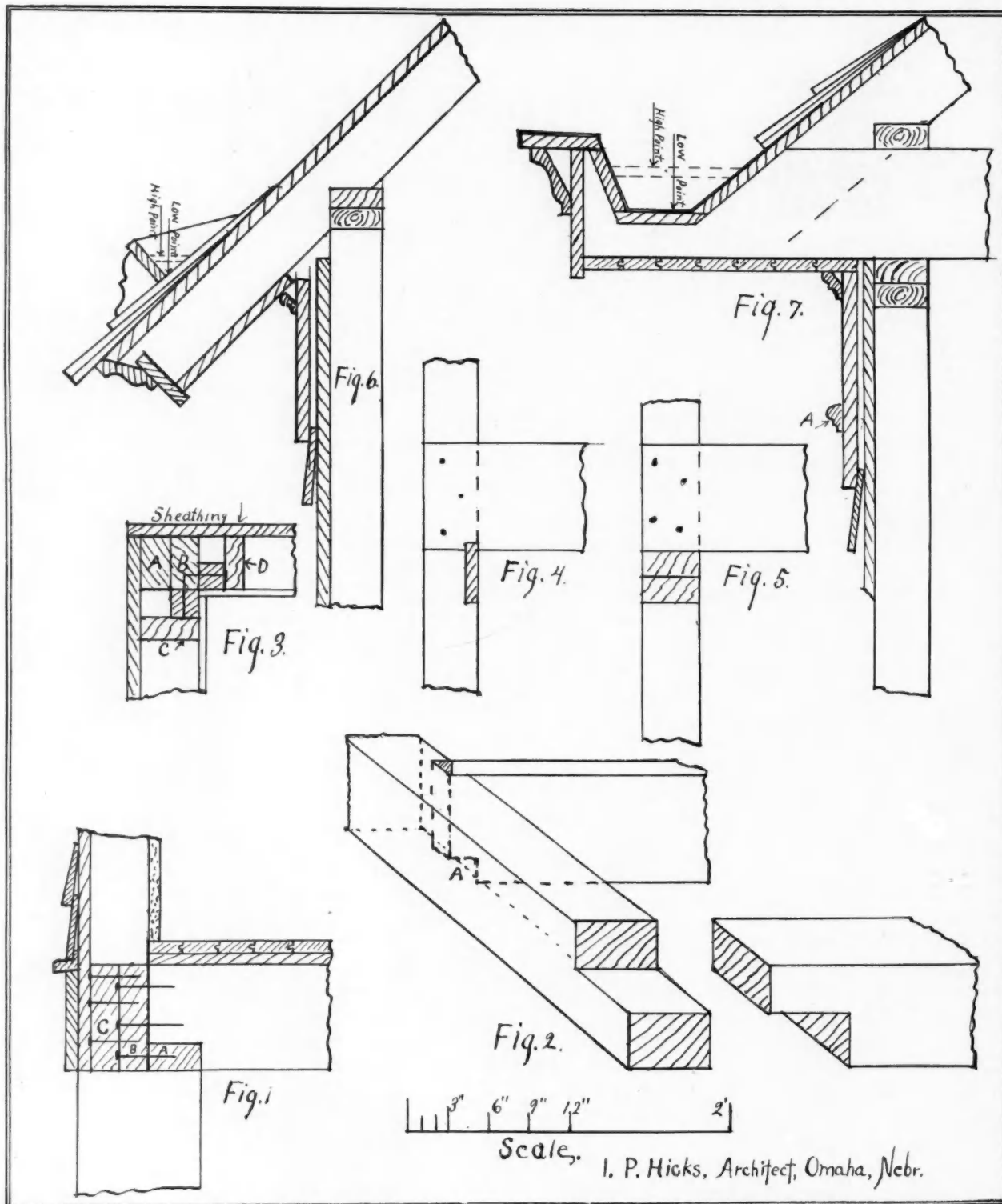

Fig. 4 shows the usual manner of framing a joist bearer for second floors in ordinary residences. A 1 by 4, or 1 by 6, is usually gained into the studding, and the joists are sized and notched out from one-half to three-quarters of an inch to set over it, and are then spiked to upright studding as shown. This method is not good on heavy work and for floors that are to sustain heavy loads; it makes the bearing on the joist too small and would cause the joist and ribbon board to

crush into one another to some extent if the loads placed upon them were very great.

Fig. 5 shows a better method. This method consists of putting a double plate around for the joists to rest on. The double plate makes a good bearing for the joists, one that will sustain any weight. By using the double plate it is much easier to keep the walls straight than with a ribbon board, which bends in and out at the slightest cause and is often hard to

get straight, and harder still to keep straight. Then again the double plate serves as a fire stop between stories. The double plate ought always to be used on houses that are full two stories in height; it is far better than the ribbon board, and it will result in giving a straighter and better job all around.

Fig. 6 shows a method of framing the foot of rafters for an ordinary square, plain cornice. On the average work there is probably more of this put on than any other kind. Double plates should always be used in order to bring the plate straight, even if it is not needed otherwise. This cornice provides for a frieze, plancier, fascia, crown and bed mold, as shown. The standing gutter shown on the roof should be placed either on the second or third course of shingle; the second course, unless for some cause it cannot be so placed. This gutter must be lined with tin and the tin should extend up under the shingles at least five inches. The first course of shingles starting from the gutter must be a double course, the same as starting from the bottom. The pitch in the gutter to run the water to the outlet is usually obtained by dropping the end, where the outlet is to be, down the roof a little. This is all right for short lengths, but for long runs it does not give sufficient fall to the gutters. When the fall or pitch is not enough it can be increased by putting tapering pieces in the bottom as shown.

Fig. 7. This is a large, square, box cornice, and is used quite extensively throughout the west, where a very wide cornice is desired, and particularly on two-story residences. The plancier is made of flooring or beaded ceiling and can be extended out to almost any width. Usually two to two and one-half feet is about the average. A double plate is used for the joists to rest upon, and the joists extend out to support the cornice and are cut out to form the gutter, cutting them deeper and deeper toward the outlet. Care should be taken to cut them to a true grade, so as to thoroughly drain the gutter. This can be arrived at the easiest and most accurately by striking a chalk line on the ends of the joists (before the fascia is put on), from the high point to the low point. This will show the proper depth to cut each joist to have a perfect grade. Care should be taken not to let the line sag, in striking the line.

The single plate above the joists supporting the rafters can be varied a little if necessary. For example, if a narrower gutter is desired, the plate can be thrown out some, say four inches or about, but if this is done it should be remembered in cutting the rafters, for if thrown out it widens the run of the rafters, and would necessitate cutting the rafters to meet the requirements in the case.

At A is shown a band mold broken around the frieze. This is usually placed about four and one-half inches above the frieze from the bottom of the mold, so that when window frames are set with the side cas-

ings up against the frieze, the part of the frieze below the mold forms the head casing for the frame and gives it a finished appearance.

Cellar Doors, Past and Present

Time was when cellar doors were all made of wood with iron strap hinges, each complete door consisting of a pair of wooden flap doors closing in the middle, to be thrown back on either side when the door was opened. A weather strip was nailed along the edge of one of these flaps.

Wooden cellar doors, either flat or inclined, are still to be found in countless numbers everywhere, and in cities as well as in the country. Plenty may yet be seen, for instance, in New York. But along much traveled business thoroughfares in cities wooden cellar doors were soon worn away and broken under the incessant scraping and trampling of many thousands of feet, and so in such situations wooden cellar doors were long ago largely supplanted by the cellar doors of iron, these not inclined but set level with the sidewalk, so that they would form no impediment to travel.

These were a wide departure from the old time wooden cellar door, but they have now been long familiar in such localities, and for a time it must have seemed, if anybody ever gave them a thought, that in them had been reached the limit in cellar door construction. But the really modern city cellar door is to them what they were to the ancient cellar door of wood.

The newest city cellar door, designed for use in crowded streets, one introduced within recent years, is built of steel, and galvanized and hung on heavy brass hinges. Of rigid construction in its own parts, and shutting into a rigid frame, this cellar door when closed is as firm a support to the feet as the surrounding sidewalk in which it is set, while the galvanizing of the door and the hanging of its parts on brass hinges preserve the door from rust and help to make it practically indestructible.

Posterity

The archaeologists were confounded. They had, in the year 4621, dug down to the ruins of a magnificent edifice, but were unable to determine whether it had been a government building, a place of religious worship, a private mansion or a temple of trade. After much wrangling and the airing of many theories, a grave and hairless professor said:

"We may be sure it wasn't a government building, anyhow."

"Why?" asked the others.

"The evidences are plain that the upper part of the structure was finished in less than 40 years after the laying of the foundations."

Thus the matter was at least simplified.

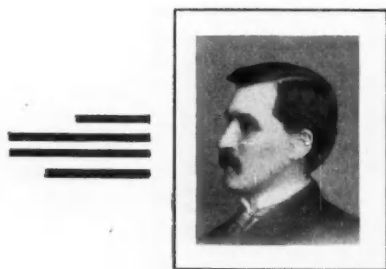

Cement Building Construction

FRED W. HAGLOCH

Artificial Stone

FIRST OF A SERIES OF ARTICLES COVERING THE USE OF ARTIFICIAL STONE FOR BUILDING PURPOSES—TOWER OF BABYLON COMPARED WITH THE PYRAMIDS OF EGYPT

That artificial stone is readily adapted to all styles of architecture we need but refer to the many residences built in Germany of this material since 1872, but the hollow block machines of this country have not yet passed the experimental stage and in the meantime the manufacturers of these machines have been carried away by the rock face fad. We find them unable to cope with classical architecture which is the direct cause of the American architect largely ignoring this material.

Many Americans, who have entered this field in the past few years, had little knowledge of building construction, but imagined that enormous profits could be realized, hence plunged into the industry with no regard to what would be the appearance of a building when completed, nor did they study the use of cement, hence the erection of many buildings which are unsightly in appearance and absorb water like a sponge, while the same amount of capital, placed in skilled hands, would have brought excellent results.

I am pleased to note that there were some skilled mechanics with knowledge in this industry in various localities, the products of whose hands have erected several buildings in Canada and the United States, that conclusively prove the assertion that artificial stone, when rightly made, is superior to the product of any natural quarry, in both appearance and durability, at a reduction of cost.

Artificial stone construction differs from natural in many ways, viz: Hollow walls are more expensive in natural stone, while solid walls are more expensive in artificial stone; any design can be produced in artificial stone at about one-fourth the expense of carving same in the natural product; artificial stone hardens with age, natural stone weakens with age. The tower of Babylon was built of natural stone, the Pyramids of Egypt were built of artificial stone; time has effaced the one and increased the durability of the other.

The best stone buildings of Europe are built of double walls, leaving air space between, which, in itself, proves the desirability of a hollow wall. Hence the popularity of the hollow concrete block, but like

all other articles, when introduced into general use it has been greatly misused.

To make a superior article of artificial stone, at the least possible cost, it will be found that the best formula is one part Portland cement, two to two and one-half parts sand, and one to three parts fine gravel or crushed stone that will pass through a screen of half an inch mesh, the exact proportions depending upon the strength of the cement and the fineness of the sand and aggregates (gravel and crushed stone) used.

Cement is used for two purposes, that of cementing particles together and filling the voids (air spaces). It is therefore plainly to be seen that any mixed sand, consisting of small and large grains, requires less cement to fill the voids and that the addition of one to three parts aggregates, while increasing the bulk, does not necessarily decrease the strength or the water proof qualities of the stone, unless the aggregates are an inferior article.

There are numerous high grade Portland cements on the market and owing to freight charges, locality will have much influence upon the brand selected, hence I will only outline the definite features of a high grade cement:

First—The finer a cement is ground, the stronger its bond, as cement, like glue, makes the most adhesive union when the least possible amount is used than can be uniformly distributed between two particles, except that a greater proportion of cement will show a higher test in the first sixty days to six months, but thereafter the first rule given will always apply.

Second—The higher degree of heat to which a cement has been burned the better, as it makes a firmer bond, besides cement is fireproof only to that degree of heat at which it was burned.

Third—A cement containing more than sixty-four per cent, or less than fifty-five per cent of lime, cannot be classed as a high grade cement. Several years ago the average Portland cement contained about sixty-eight per cent of lime, and to this reduction is due the fact that American Portland cements have increased in quality, but a cement recently put upon the market, containing fifty-two per cent of lime, was

found to be inferior for want of the proper amount of lime. Let the artificial stone maker, who is in the habit of adding lime to his cement, remember the foregoing facts.

Sand should contain as much silica as possible, but this cannot always be had, and we often find sand containing a small amount of dust when dry. Should this dust be of a loamy nature, it should not exceed one per cent of the sand; if of a clay nature, it may sometimes reach as much as three per cent of the whole and not be injurious, but if of a limestone nature, it may reach from eight to ten per cent without causing bad results. There is a vast difference between loamy sand and sand containing loam; the former is not sharp, while the latter is sharp, but has loam mingled with it; the former can never be used in concrete work or any kind, while the latter has often been successfully used.

In the selection of aggregate (gravel and crushed stone) the essentials are hardness, durability and size. Where fine finished work is desired, only small, if any, aggregates can be used, but in large and heavy work, the same rule applies to size as in sand, viz: Large and small size aggregates produce the same strength without increasing the proportion of cement. The hardness of aggregates has much to do with the strength of the finished product, and gravel and crushed granite have no equal. Limestone, which has been used for the past few years, owing to its hardness, is deceiving from the fact that it expands and contracts in absorbing and expelling moisture, thus crazing (small cracks or check marks) the surface. Blue flint stone is also a very desirable aggregate, as is also crushed furnace slag, but owing to its porous nature requires an increased portion of cement.

Our next article will dwell upon the mixing and seasoning (hardening) of artificial stone and concrete.

The "Stork's Nest"

This very appropriate and suggestive name has been given to a new row of flats erected by Edmund Beall, of Alton, Ill. He wants none but married couples with plenty of children as tenants. Mr. Beall is now being held up as a model landlord to those owners who threaten that evictions will follow an increase in the size of the families of their tenants. It is rumored that inducements are made to large families, and as the family increases the rent is decreased.

Private Theater on Elevator

A Paris millionaire has a private theater in his residence, built above the dining-room and so arranged as to go up and down like an elevator. After dinner the guests will retire to the smoking-room and the threshold will be no sooner crossed than the theater will replace the dining-room. When the performance is over the dining-room will reappear, with tables laid for supper.

CORRESPONDENCE

Our columns are always open for the discussion of trade subjects. Correspondents will please give their names and addresses, as we cannot publish anonymous letters. The names will not be used if we are requested to withhold them.

Measuring a Stream

Robert Chambers, Shoal Lake, Manitoba, Canada, writes: To find the distance across water, set a steel

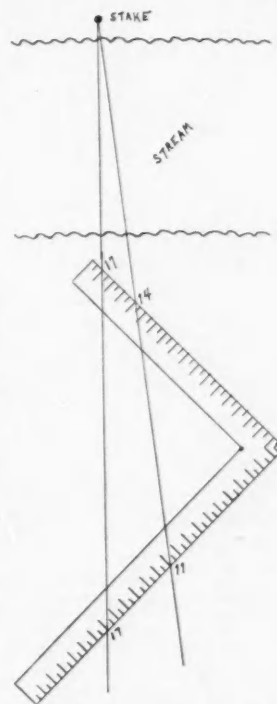

square as shown in the diagram, take any two figures, set two fine points at, say, 17 and 17, as shown, to strike stake, tree or other object on opposite bank; then set another point at any figure, say, 14, as shown, and a fourth point on opposite side of square wherever it comes when in line with the stake. Mark down your four figures, go on level ground and start a boy out with a stake, and when he has gone a sufficient distance to have the same four points strike the stake, the distance from the square to the stake will be the same as the distance across the stream. I have always used this method

and find it correct. It can be used anywhere where you can see an object on the opposite bank.

Building Without Wood

Two Baltimore architects have drawn plans for a building entirely without wood. It will be six stories, and will have a frontage of 41.5 feet. The entire structure is to be of re-enforced concrete and steel. Even the doors, trims, window sashes, and door jambs are to be of metal. The windows will be glazed with wire glass. The frames for the show windows will be of steel, into which the plate glass will be fitted. The side walls, columns, and rear walls, as well as the supporting columns of the front walls, will be of concrete. The floors will have a top dressing of cement one and a half inches thick. The stairs will be of concrete, with slate treads and wrought iron balustrades. The elevator shaft will be of concrete, as will also the inclosure around the stairway and the elevator hall. The cellar and roof are to be of cement. In order to eliminate all wood even the flagstaffs on top will be of steel.

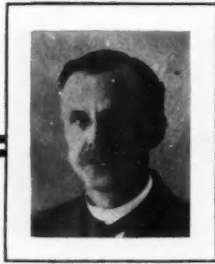

RESIDENCES

G. W. ASHBY

WM. H. SCHROEDER

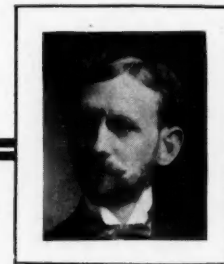

Low and Medium Priced Houses

ILLUSTRATIONS AND DESCRIPTIONS OF NINE HANDSOME DWELLINGS, INCLUDING FLOOR PLANS AND DIMENSIONS, WHICH MAY BE ERECTED AT SMALL COST

In this department each month will be shown several illustrations of practical houses, designed particularly for the man employed on a fixed salary who desires a home of his own, but cannot afford to expend a greater sum than his income will warrant his paying interest on. These illustrations will in all cases be accompanied by floor plans, giving the dimensions of all rooms, the estimated cost of construction, and a brief description of the attractive features.

The nine houses illustrated this month are particularly desirable and show a sufficient variety of cost and dimensions to suit the requirements of nearly all prospective builders. Any one of these would make a very comfortable and pretty home.

House No. 578 makes a cosy home and can easily be erected on a single fifty-foot lot for about \$2,800. The main feature of this house is the convenient, yet artistic, arrangement of the rooms. The living rooms are arranged to face the south and west, making them sunny and very pleasant. The sitting room has a direct entrance into the kitchen, thereby giving more privacy to the dining rooms, while the chambers are large and airy and are well equipped with clothes closets.

House No. 614 is a large and imposing residence, with all modern conveniences, and can be erected for about \$4,000. There is a cellar under the entire house which is equipped with coal bins and modern hot air furnace—or, if desired, hot water may be substituted—with pipes leading to all the rooms. The large porch running along the entire front of the house is not only a great convenience but adds very materially to the general appearance. The sitting and dining rooms have attractive window seats, while the library is very suitably arranged to hold a large collection of books. The second floor is nicely arranged into chambers containing spacious clothes closets, while facing the street is a pleasant sewing room.

House No. 615 is a very attractive, well equipped modern house. This will make a most suitable home for a moderately sized family, and while the rooms are not many in number, they are large and very attractive. There is a cellar under the entire house, making it

suitable for furnace or hot water heating. The second floor is well arranged into large and airy chambers and an extra closet, which is unusually large, can be put to several uses. The cost of this house would be about \$2,200.

House No. 691, as the plans and design here show, is a modern house, suitable for a fifty-foot lot and costing about \$2,600. The house is a combination of frame and cement work, making a very artistic looking dwelling. The heavy stonework used in the makeup of the porch gives it a massive and very attractive appearance. The living room is so located that it can also serve as a library.

House No. 692 is an ideal suburban home, while the large and attractive porch nearly surrounding the house gives it a very homelike appearance. The large living room with its open fire-place makes the interior as attractive in winter as the exterior is in summer. The cost of this house would be about \$4,000.

House No. 148 is a model square residence. A house of this kind gives more actual floor space than any other, as the rooms are all, to a greater extent, free from projections. The cost of this house, with all modern conveniences, would be about \$4,000.

House No. 152, which is an attractive home with all modern conveniences, would cost about \$3,300. One of the good features of this house is that all the rooms are well proportioned. The parlor and reception room contain fine mantels and open fire-places, while each of the chambers has a spacious clothes closet.

House No. 163 represents a moderate priced, well equipped home. It has many attractive features and can be erected on a fifty-foot lot for about \$1,200. The second floor is well arranged into bed chambers, closets, and bath room, while the large hall on the first floor gives the house a roomy appearance.

House No. 165 is an attractive, moderate priced, yet highly desirable home. It would cost about \$1,200 on a fifty-foot lot. One of the many good features about this house is the number and excellent arrangement of the rooms, making it a comfortable home for a good-sized family.

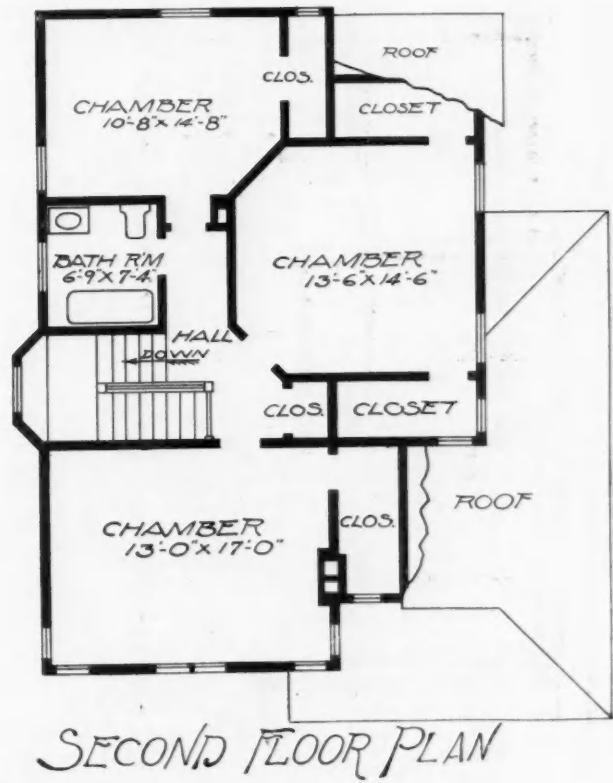
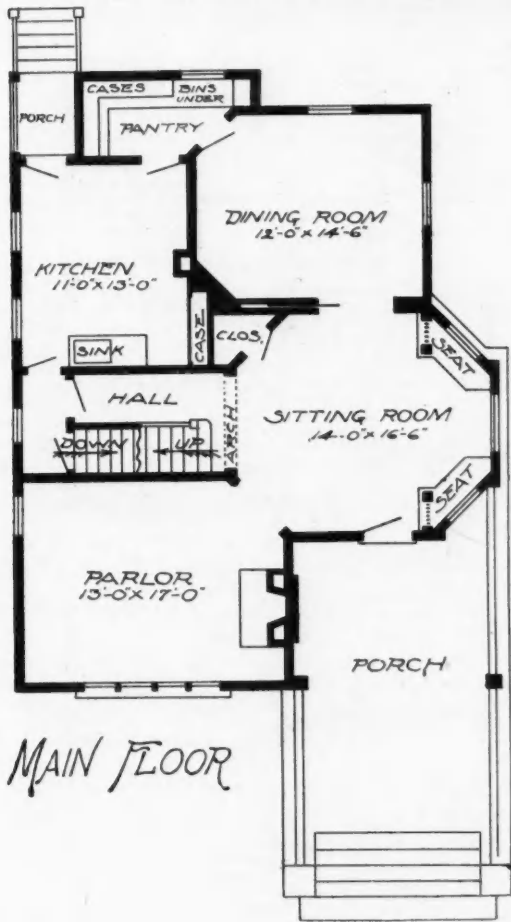
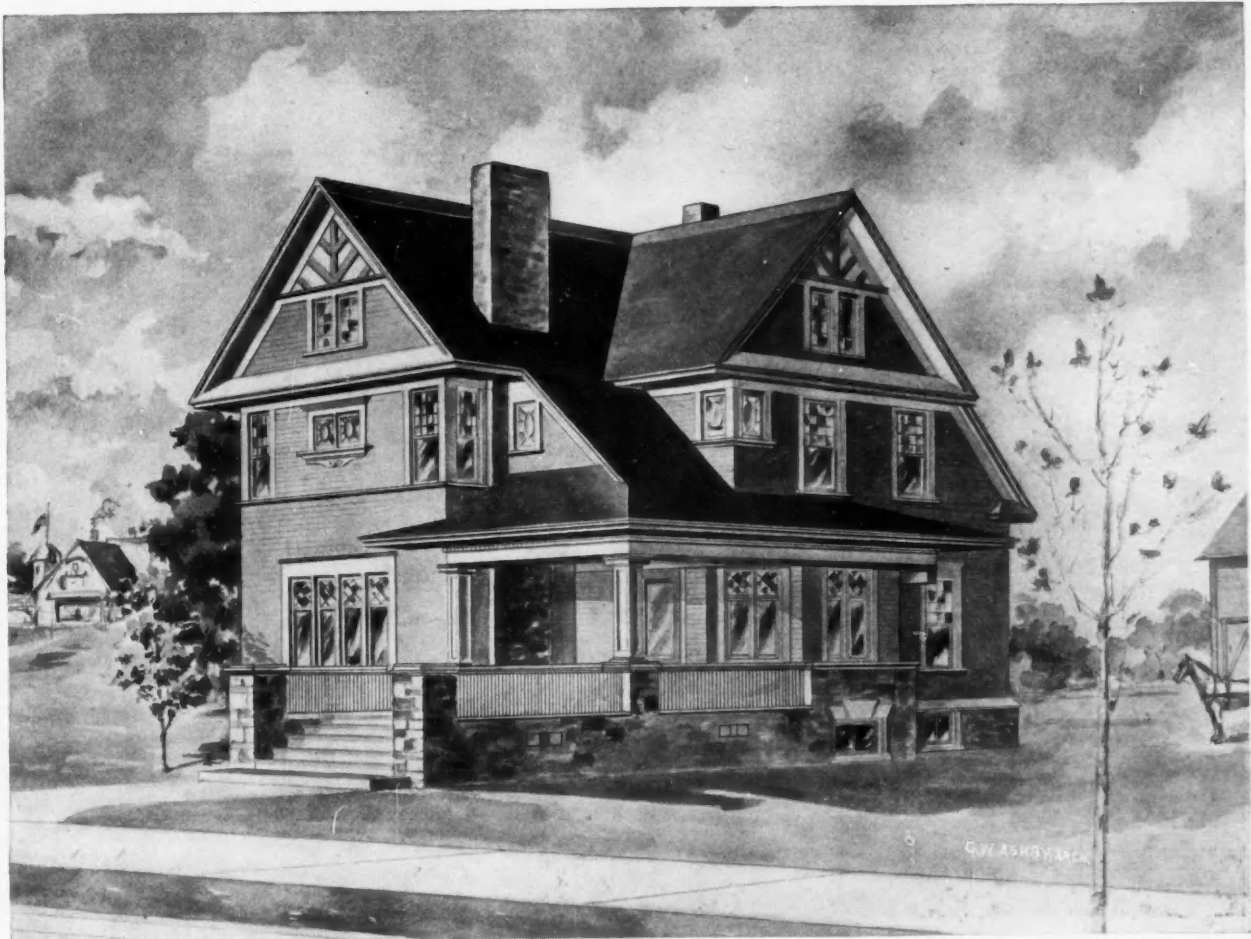

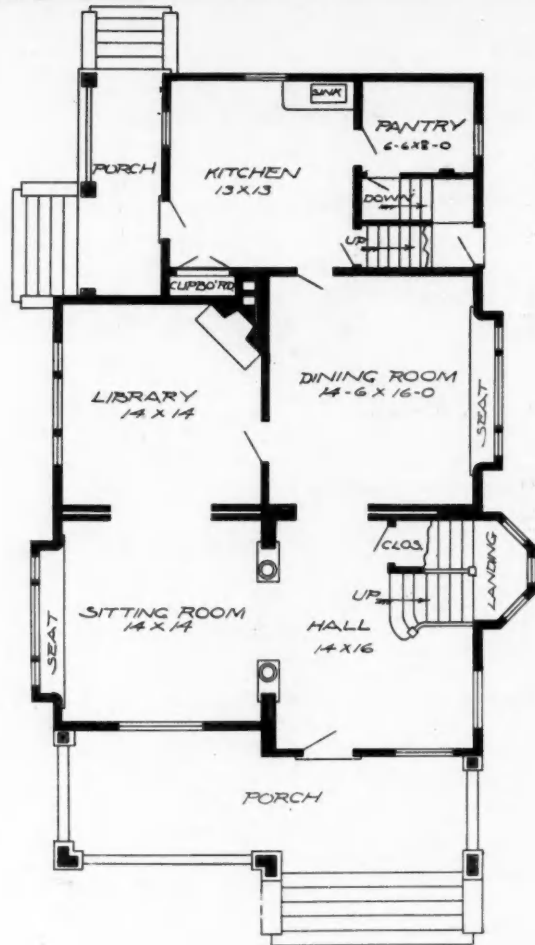
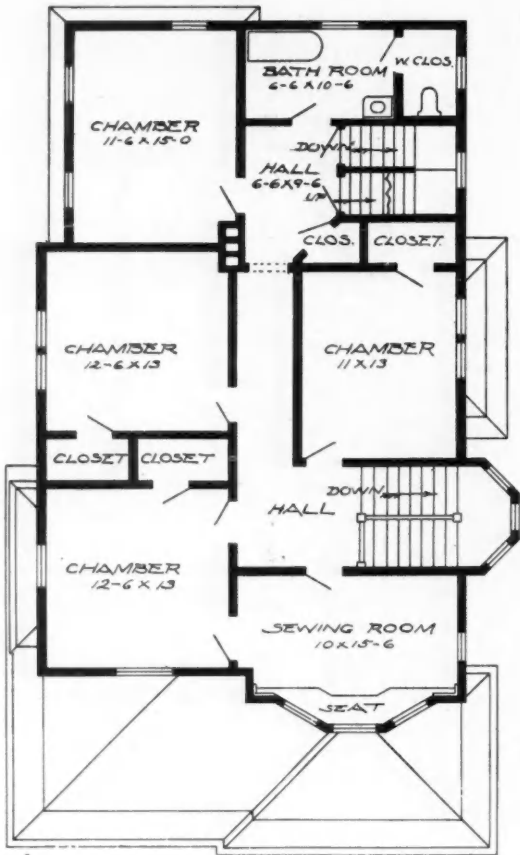

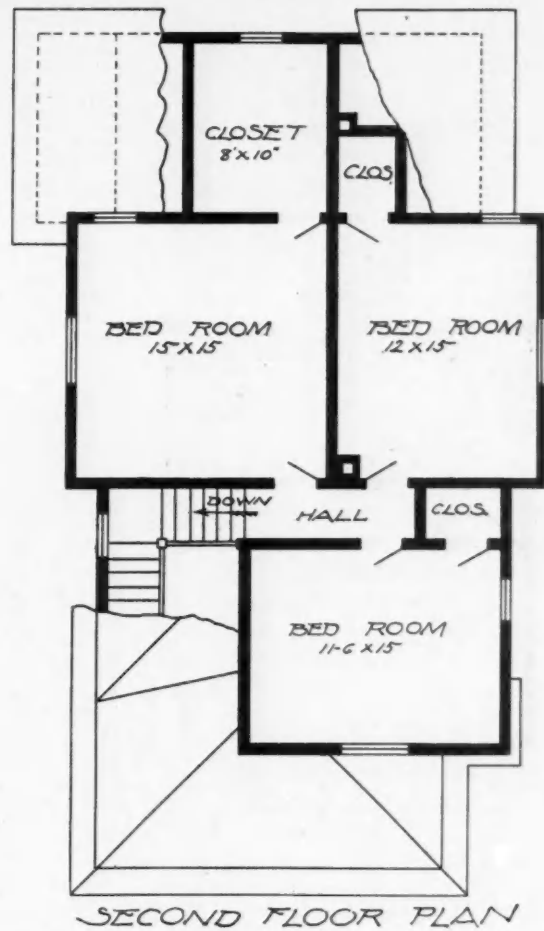
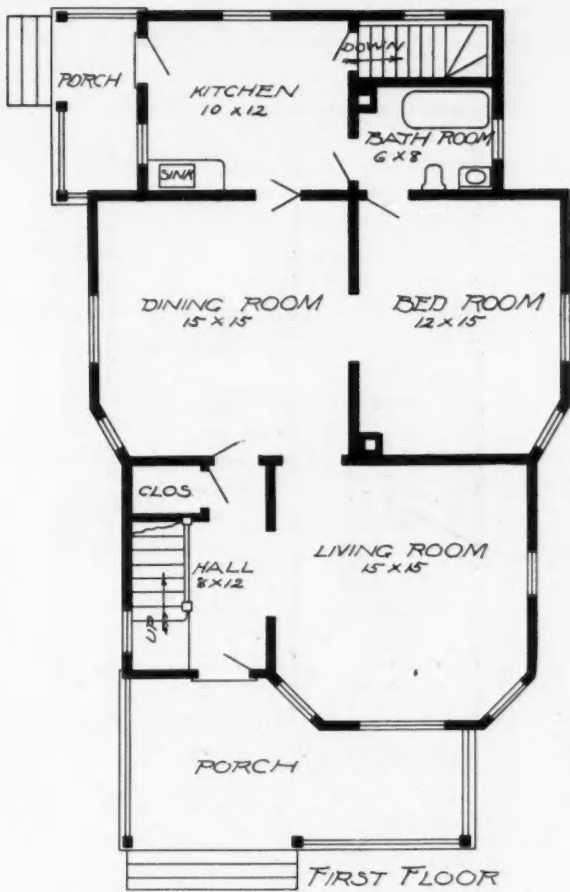

615

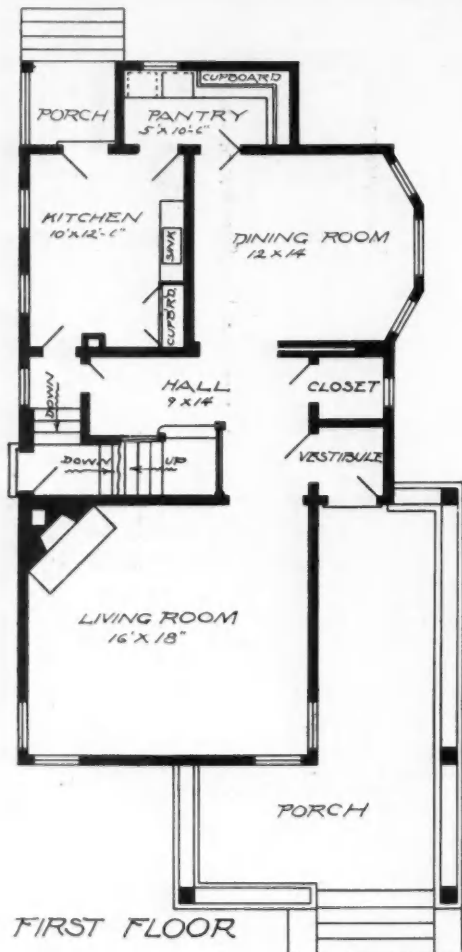

FIRST FLOOR

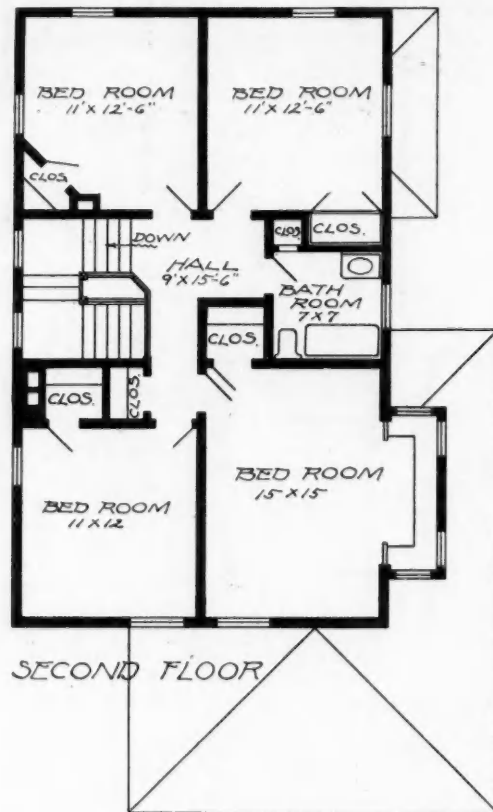

SECOND FLOOR

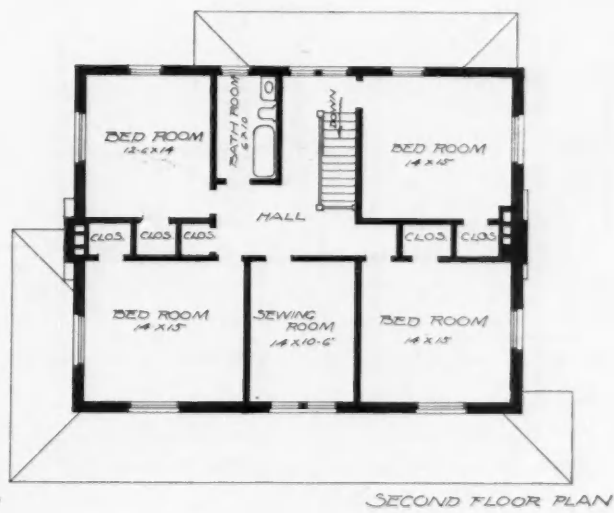
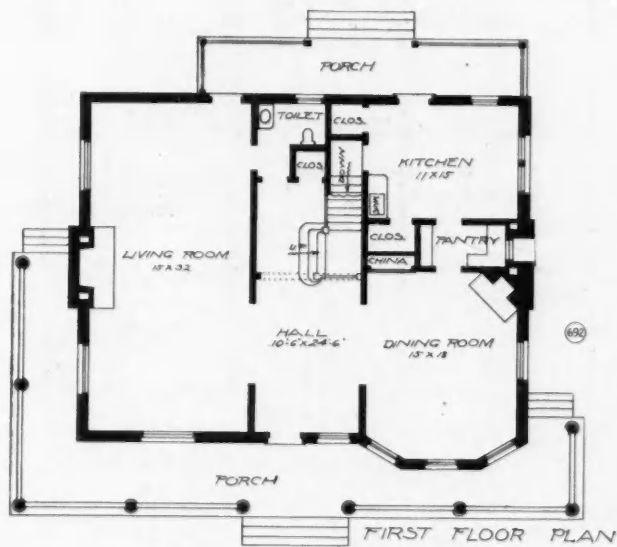

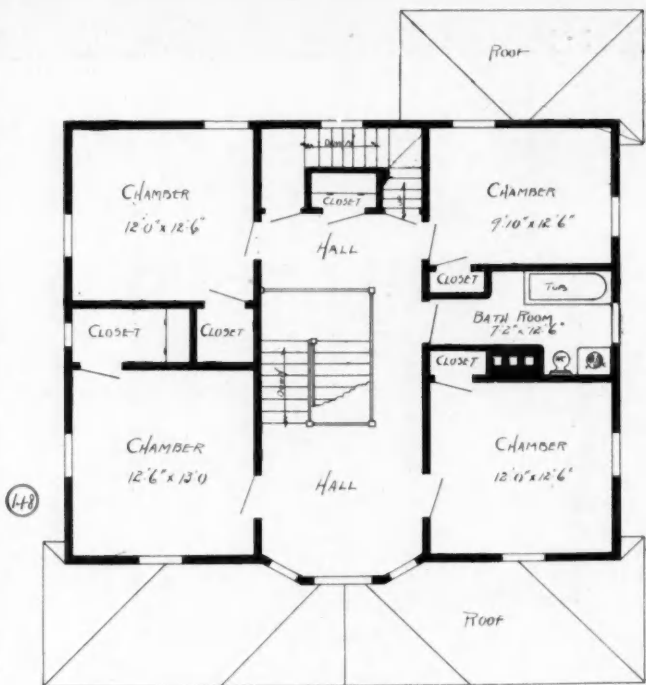
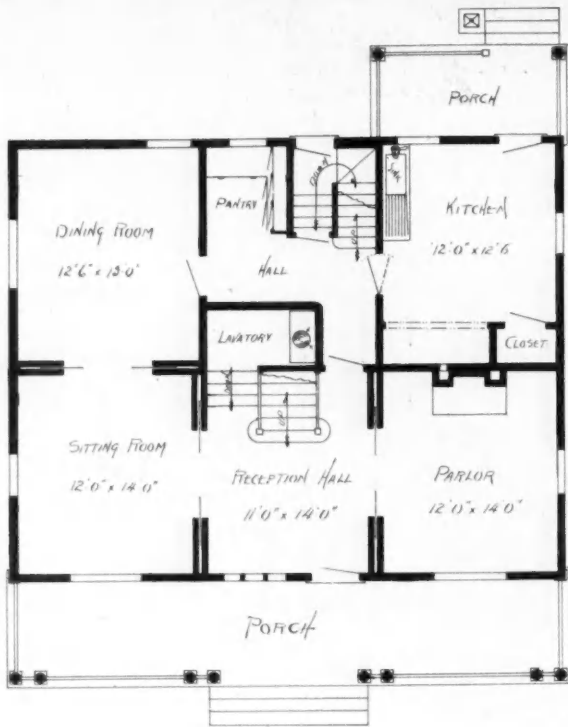

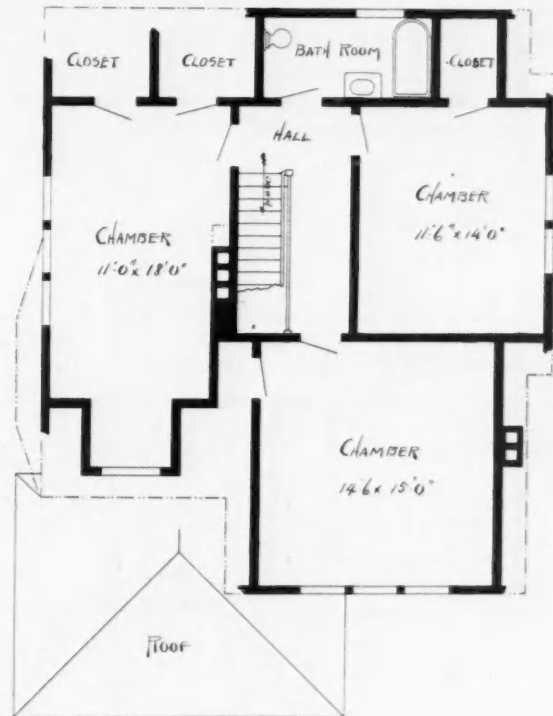
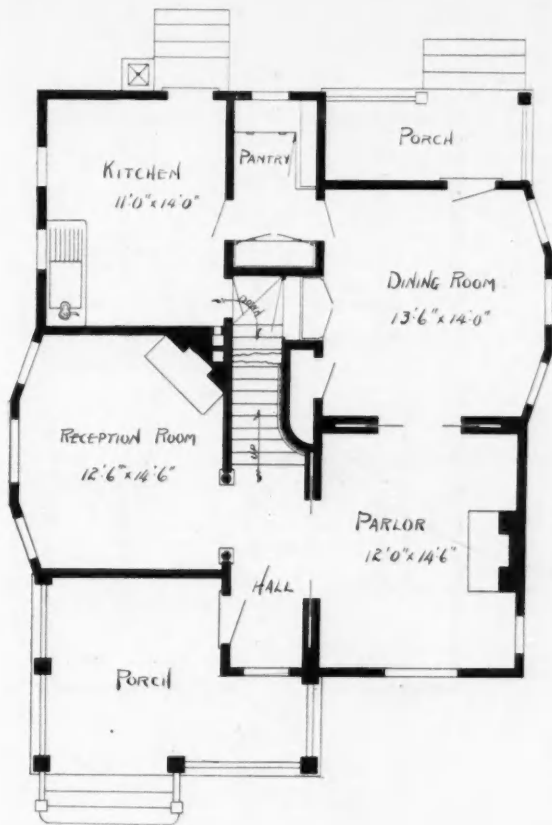

152

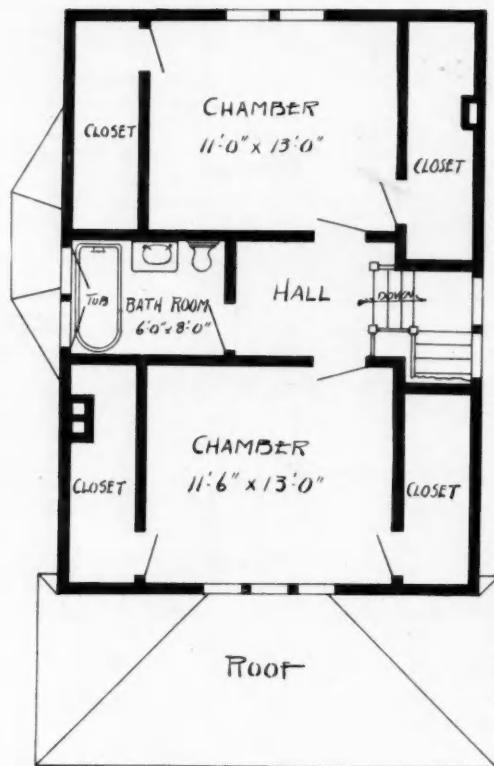
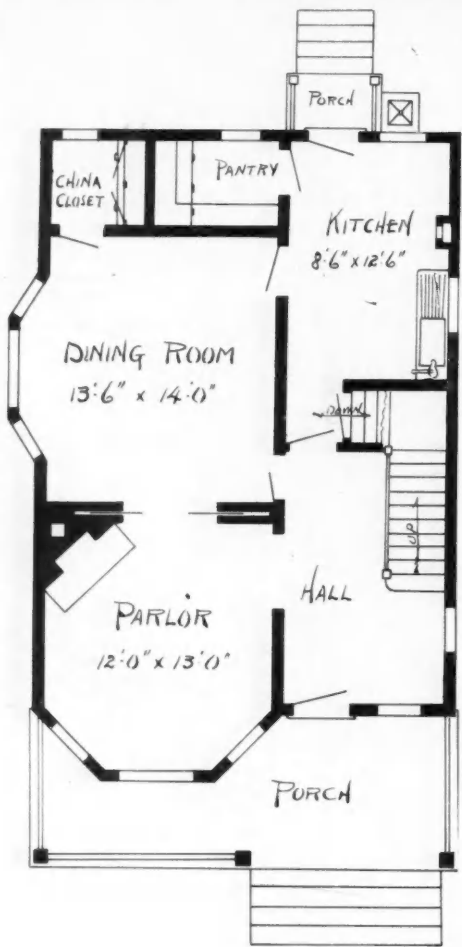

163

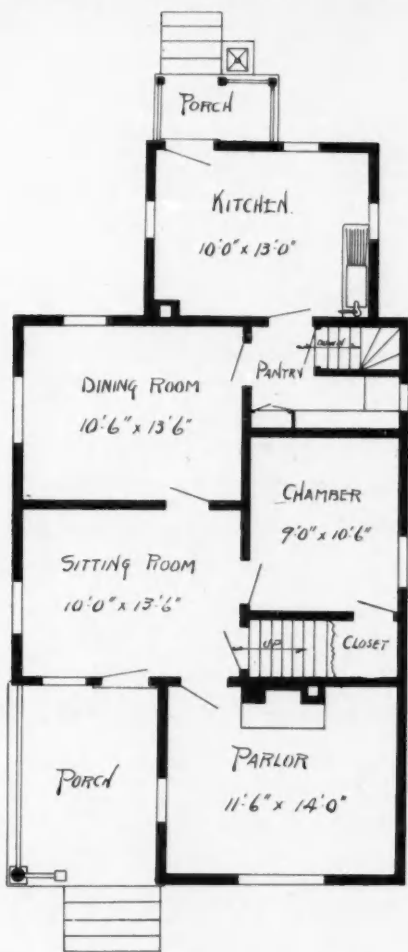

165



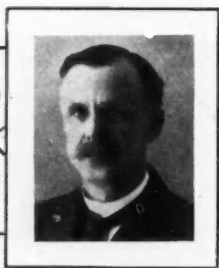

SCHOOL HOUSES

G.W. ASHBY

Model One-Room Country School

HAS BEEN BUILT IN MANY PARTS OF THE UNITED STATES AND ALL REPORTS ARE SATISFACTORY—TWO OTHER SCHOOLS OF ATTRACTIVE DESIGN AND DESIRABLE ARRANGEMENT

Under the head of "School Houses" will be published from time to time a number of school buildings, giving the cost and a short written explanation dealing with the main points in school house architecture, such as the ventilating, heating, lighting, material and construction and the cost. It must be understood that the cost of these buildings will differ somewhat in various localities, but the cost given will be based on material and labor in the vicinity of Chicago.

The small one-room country school, No. 105, has been published before, but it has been the most satisfactory of this size I ever designed. It appeared in the biennial report of the Cook County Superintendent of Schools, furnished by O. T. Bright, County Superintendent, as an "Ideal Country School."

This building has been built in many parts of the United States and the reports have been satisfactory in all cases, both in the estimated cost, design and perfect ventilation, heating and lighting. The reader will notice that every point was considered in the designing of this country school to make it complete in every respect, as well as keeping down the expenses. You will notice on the drawing that the fresh cold air is taken from the outside, coming in under the floor at a point just under heater, where the air passes between the metal jacket around heater into school room, forming a circulation of heat which is controlled by foul air vent at floor, which takes out all the low foul air from the room, giving the heated air a chance to fall to the floor. This foul air flue is heated by the smoke flue at its side. The heating of the foul air flue forms an artificial draft, which causes a circulation of the warm air.

This is a first-class country school system of heating and ventilating. The windows are placed on the left and rear, which makes a shadow impossible on the work. The transom lights over the side windows should be glazed with Florentine glass, as this gives a soft mellow light throughout the room. The curtain should be placed below the transom bar, by which the light could be adjusted by the teacher.

This building is frame on twelve-inch brick foundation wall. Shingled roof, cypress trim, D. S. A.

glass, ceiling twelve-inch in the clear. The bill of items is as follows:

30 cu. yds. of excavating for trenches.
 10 cords of rubble or field stone.
 22,000 Com. brick for foundation and chimneys (if brick).
 2,000 brick for chimney, if stone foundation.
 1 16x16 register for vent chimney.
 1 6-in. stove collar for stove pipe.
 149 lin. ft. of 8x10 in., for sills.
 38 2x10 in., 26 ft. long, 16 ins. o. c. (joist).
 38 2x8 in., 26 ft. long, 16 ins. o. c., ceiling joist.
 10 2x10 in., 14 ft. long, 16 ins. o. c., hat closet.
 10 2x10 in., 12 ft. long, 16 ins. o. c., tower.
 150 lin. ft. of 1x3 in. for cross bridging.
 70 2x6 in., 18 ft. long, 18 ins. o. c., rafters.
 24 2x4 in., 12 ft. long, 18 ins. o. c., rafters.
 280 2x6 in., 12 ft. long, 16 ins. o. c., studding.
 2,100 sq. ft. 8-in. ship lap, No. 1 quality.
 2,100 sq. ft. of building paper.
 2,100 sq. ft. of 3½-in. bevel siding, "C" quality.
 2,000 sq. ft. of roof sheathing, 1x6 in. d. i. s.
 1,500 sq. ft. of 5½-in. D. & M., No. 1 quality, flooring (rough floor).
 1,500 sq. ft. of 2¼-in. maple flooring, No. 1 quality.
 450 sq. ft. of narrow pine beaded ceiling (planceer).
 130 lin. ft. of stool and chalk rail, Georgia pine.
 130 lin. ft. of molding, under chalk rail, Georgia pine.
 106 lin. ft. of wainscoting cap, Georgia pine.
 236 lin. ft. of ¼ round, Georgia pine.
 900 sq. ft. of narrow Georgia pine ceiling, for wainscoting.
 3 ps. 12x1½ in., for front steps (treads).
 4 ps. 7x¾ in., for front steps (risers).
 4 5½x5½-in. pine, d. 4 s., with neat cap of posts.
 100 lin. ft. of 1½x1½ in., for balusters for porch.
 150 lin. ft. fascia moulding, 3 ins. wide.
 150 lin. ft. 1x3-in. gutters.
 150 lin. ft. 8x7/8-in., "C" quality, frieze.
 150 lin. ft. 2½-in. moulding for water table.
 22,000 shingles, 10-in. clear cedar.
 1 flag-pole, complete.

MILL WORK.

7 windows and frames, complete, 2 lts., 36x30 ins., 1¼ D. S. A.
 4 windows and frames, complete, 2 lts., 36x20 ins., 1¼ D. S. A.
 2 No. 1 doors and jambs, complete, 3 ft. x 7 ft. 6 in., 1¼ in., glazed.
 2 prs. of No. 1 double doors and jambs, 3 ft. x 7 ft. 6 in., 1¼ ins., glazed.
 1 transom, 6 ft. x 2 ft. 10 in., 1¼ ins., glazed, D. S. A.
 2 transoms, 3 ft. x 2 ft. 10 ins., 1¼ ins., glazed, D. S. A.
 1 book-case, complete with shelves, drawers and doors (built in wall).
 7 sides of Georgia pine trim., mill design.
 100 lin. ft. of blackboard cap moulding.
 130 ft. 2-in. picture rail.

HARDWARE.

2 kegs of 8 d. nails.
 1 keg of 10 d. nails.
 2 kegs of 20 d. nails.
 1 keg of shingle nails.
 ½ keg of finishing nails, 8 d.
 ½ keg of finishing nails, 10 d.
 11 sash locks, Ives make.
 22 sash lifts, Ives make.

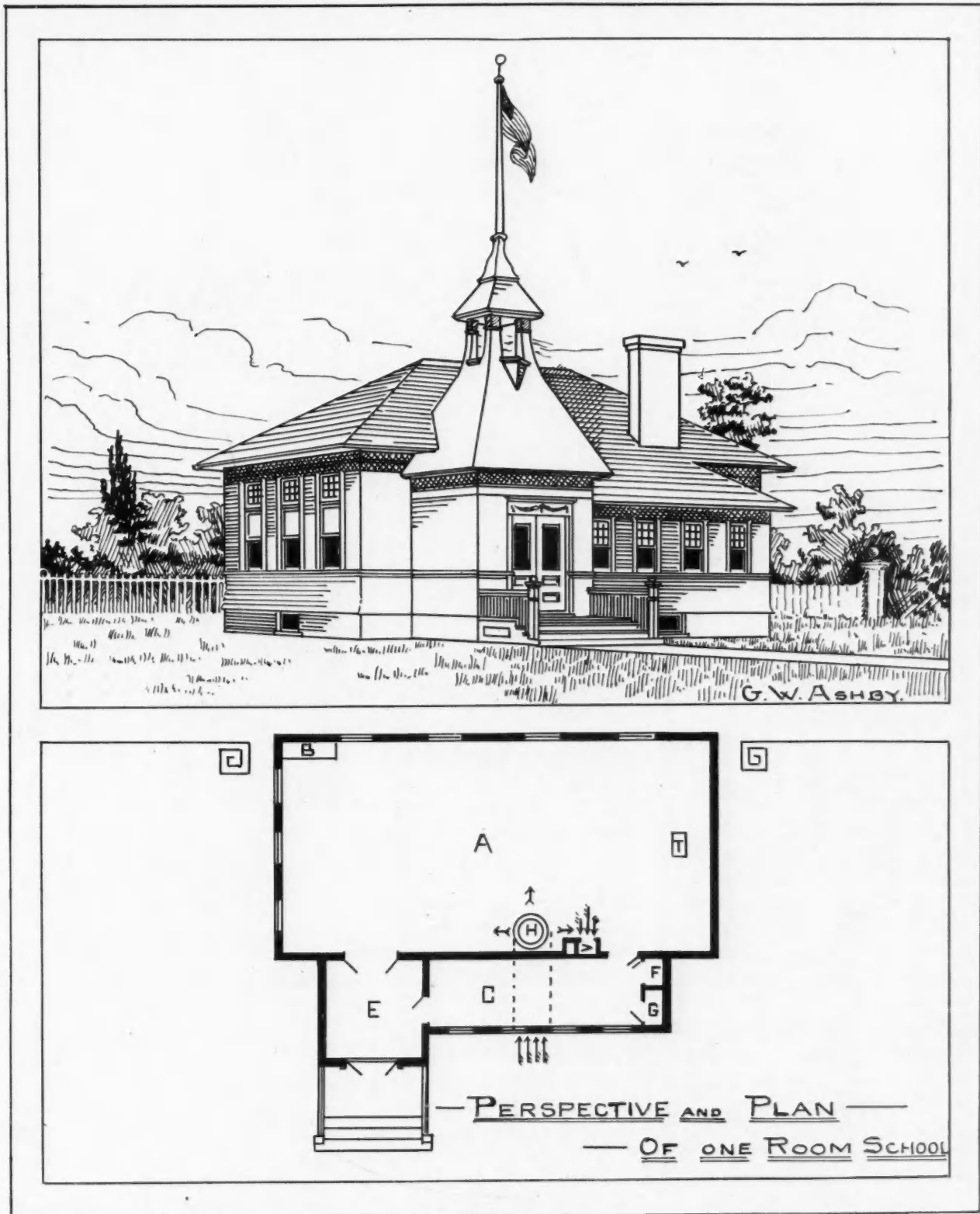

No. 105

60 extra heavy coat hooks, Japan.
 220 lin. ft. of sash cord.
 44 sash weights (see weight of sash).
 7 pr. of 4½x4½ Japan butts.
 3 mor. locks, brass face and bronze knobs, complete.
 1 outside front door lock, with store handles.
 2 check springs, complete.
 PLASTERING AND LATHING.
 380 sq. yds. of two coats of plastering.

TIN WORK.
 168 lin. ft. of 14-in. old style tin gutter and valleys.
 1 tin deck, 6x6 ft. sq. All tin painted both sides.
 Flashing for chimney.

PAINTING AND FINISHING.
 200 sq. yds. of two coat painting, lead and oil.
 80 sq. yds. of two coat oil finish, inside.

The above building on a careful estimate would cost



G.W. ASHBY
ARCHITECT.
RIVERSIDE, ILL.

PERSPECTIVE VIEW

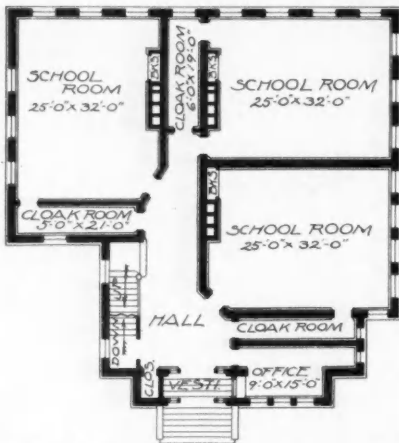

FIRST FLOOR PLAN



DESIGN No. 652
WIDTH OF BUILDING 67 FT.
LENGTH 68 FT. 4 IN.
BASEMENT CEILING 8 FT.
FIRST FLOOR CEILING 12 FT. 6 IN.
SECOND FLOOR CEILING 12 FT. 6 IN.

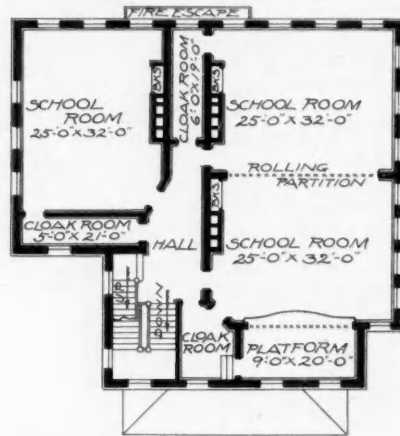

SECOND FLOOR PLAN

about \$1,275. This figure will vary in some localities.

Design No. 652 shows a six-room, brick and stone school building, which can be erected for about \$7,500. The basement is well equipped with a furnace and coal room, fresh air room, and boys' and girls' playrooms, in which toilet rooms can be built if desired. Every room is well supplied with a large cloak room and the halls are large and commodious so the students can make a hasty yet orderly exit in case of necessity. Two of the rooms on the second floor can be converted into one large assembly room by the use of rolling partitions, making it an excellent place for exercises of any kind. The vestibule in the lower hall has double storm doors, which afford ample protection during the winter.

One of the exceptionally fine features of Design No. 608 is the general appearance, which is modeled after the Spanish style of architecture. The entire

building is of brick, making it substantial and well protected from fire. The rooms and windows are so located that the students can be seated with the light coming over their left shoulders, which prevents the casting of a shadow, thereby resting their eyes and preventing headaches and nervousness. In each hallway are several wire screens with hooks attached for the students' wraps; this enables free circulation of air and also gives the teacher a full view of whatever is going on in the entire hallway. The windows in the school rooms are all square at the top, thereby letting in all the available light, and the curtain should be attached below the transom bar by which the light can be adjusted. The cost of this building will be from \$10,000 to \$15,000, depending on the interior finish and also the section of the country where it is to be built.

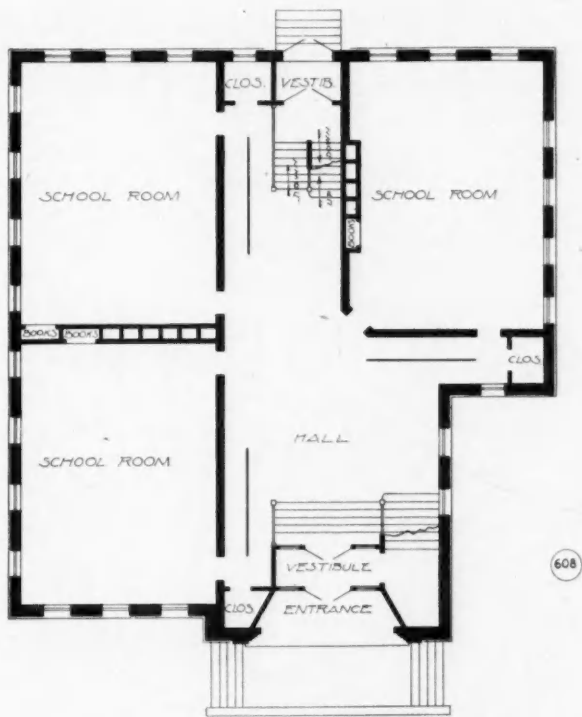
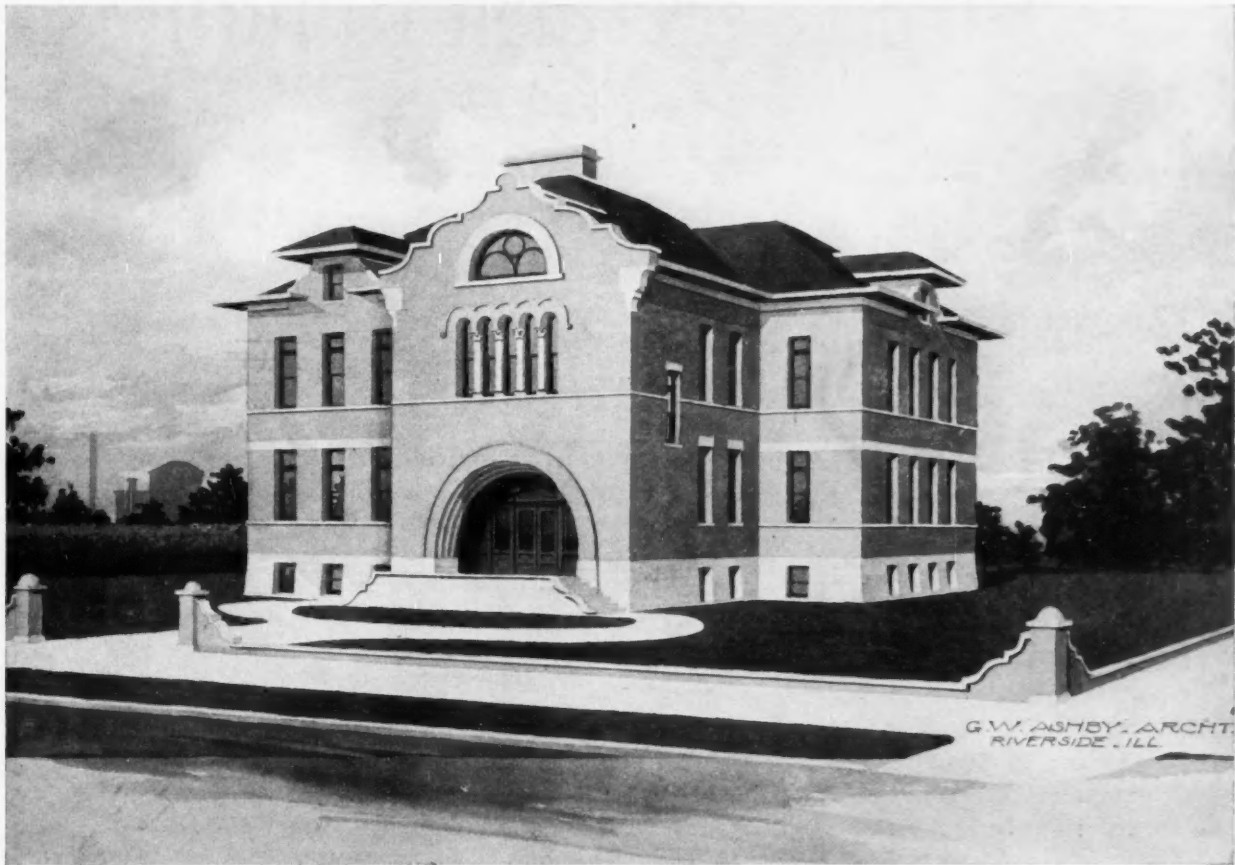

FIRST FLOOR PLAN

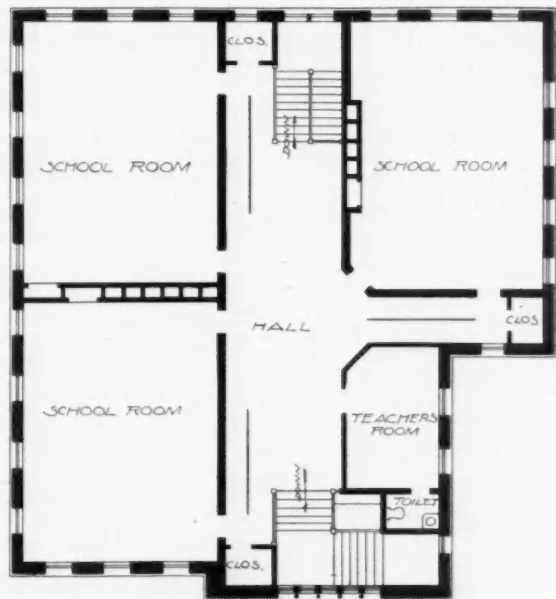

SECOND FLOOR PLAN

608

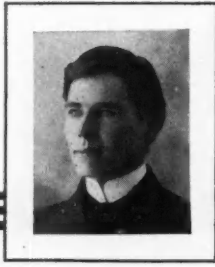

Barns and Farm Buildings..

HENRY H. NIEMANN

Two Barns Illustrated

ONE-DESIGNED FOR COWS AND THE OTHER FOR HORSES, EACH SO ARRANGED AS TO AFFORD EVERY CONVENIENCE, WITH SANITATION AND VENTILATION FULLY CONSIDERED

Although the circular barn construction, with the cattle, horses, fowl, sheep, and other live stock—as well as vehicles, implements, tools and all the various feed and bedding sheltered under one roof—is becoming very popular on account of its conveniences as well as economy in construction, it also has in most cases many disadvantages. In order to receive the greatest possible returns from a given piece of land it may become necessary to sub-divide this land, using each division for such a purpose as will be most profitable for that division. This or some other local condition often makes it advisable to have separate buildings for the various farm purposes, each located at the most convenient place for its particular use. For example, the corn crib should be located as near as practical to the corn field, the duck house near the creek or pond, the cow barn near the pasture, etc.

For this reason we will begin this series of designs with separate buildings for the different farm purposes.

The first illustration represents a cow barn for the accommodation of forty cows, having a middle feed alley of sufficient width to allow the feed trucks or wagons to pass through the entire length, entering the barn at one end and going out at the other, distributing the feed in the manger along both sides of the feed alley.

The mangers as well as the balance of the floor surface are built of concrete. As cows naturally feed from the ground level when in the pasture, the feed manger in the barn has only been elevated enough to make the bottom of manger three inches above the stall level; the manger being constructed of such a shape as to place all its contents within easy reach of the cow, and making the side nearest the cow almost vertical so no feed will be pushed over and become wasted among the bedding. The feed alley is elevated above the manger, so all feed can be swept back into the manger that may be pushed out by the cow, or spilled from the feed truck. The same manger is used for watering the cattle, having a faucet at each end and a drain and overflow in the middle.

The cows are fastened to stanchions built between the posts supporting the roof, which are spaced to

allow three stanchions between the posts. The manure gutters back of the cows are about sixteen inches wide, and from five to seven or eight inches deep, sloping down from each end to the middle, where they are connected with a bell trapped drain which carries away all liquids to a catch basin directly opposite the drain outside of the building, and from there the liquid can be disposed of into the manure pit or as may be desired.

In the sanitary conditions of the barn much depends on the disposal of manure, and for this reason too much can not be said on this subject. In order to obtain the best possible results from the type of construction here illustrated, one of the most vital points is to have the stalls of the proper length, so that when the cows are fastened in the stanchions all the droppings will fall in the manure gutter, thus keeping the bedding dry.

As cows vary in length, the stalls should be made longer at one end of the barn than at the other, by constructing the manure gutters at a slight angle with the mangers, instead of running them parallel, thus obtaining stalls of various lengths, using the shorter stalls for the shorter cows and the longer stalls for longer cows.

The floor of the stalls should have a slight slope down to the gutter, and if cement is used (as shown in this design) the finish should be made with a rough surface to prevent the cattle from slipping should the floor become wet.

The cleaning alley on each side should be of sufficient width for a truck or wheel barrow to be pushed the entire length to gather up all refuse, which is taken to a platform built at one end of the cleaning alley for dumping into a manure pit, which is built of stone or cement walls, with bottom and all walls well cemented and made water tight.

All side walls of the barn are filled in solid between the timbers with cement concrete to a height of two feet above the floor, and then finished with smooth cement plastering, making a perfectly sanitary finish and allowing the entire barn floor to be washed with hose and flooded with water without injuring any woodwork.

Very important features, but those very often neg-

COW BARN

SECTION THROUGH WALL

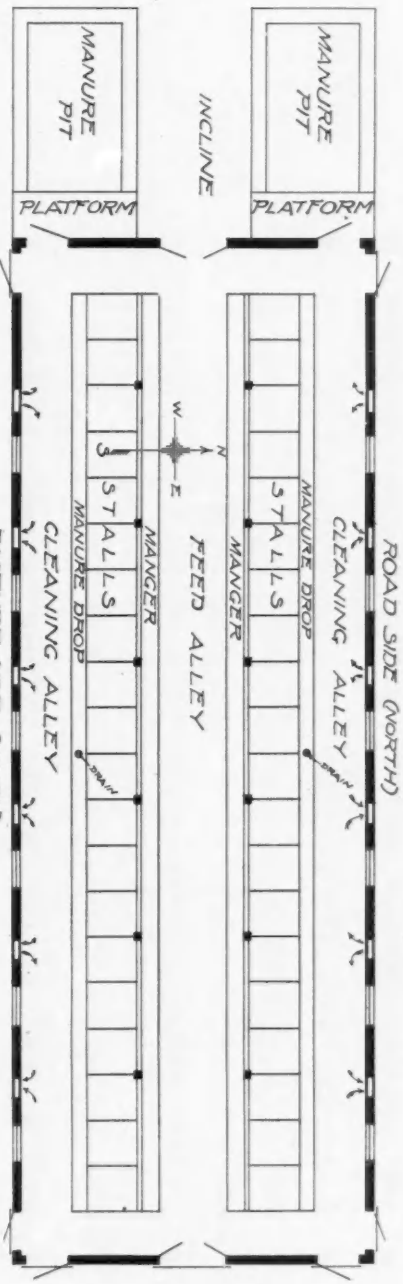
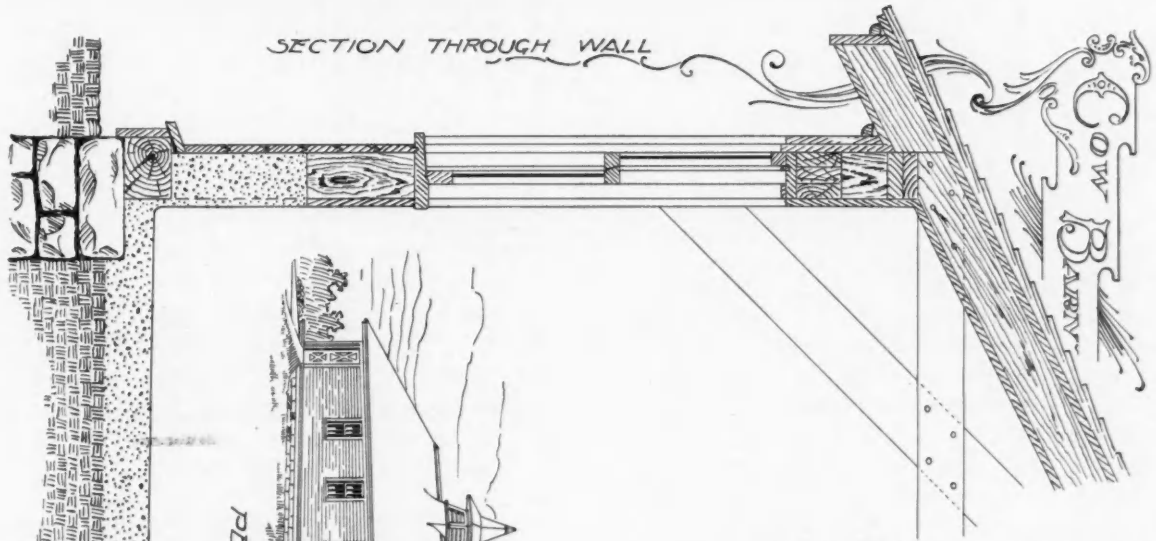

FLOOR PLAN

EXTERIOR DIMENSIONS
LENGTH 89 FT. WIDTH 32 FT.

PERSPECTIVE VIEW

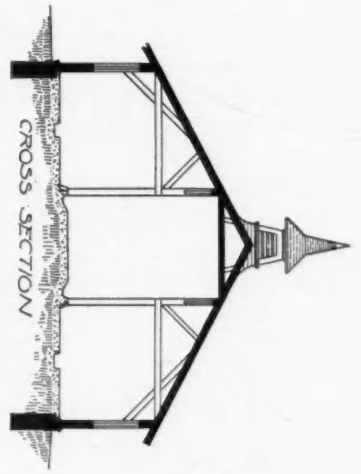
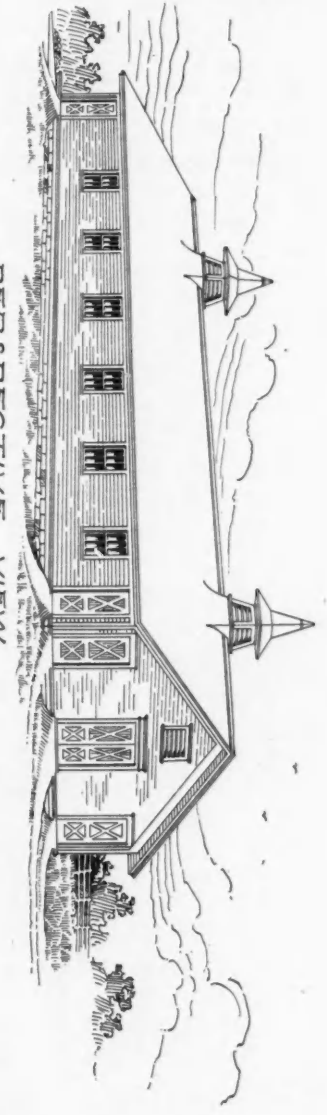

CROSS SECTION

T. H. NIEMANN, DEL.

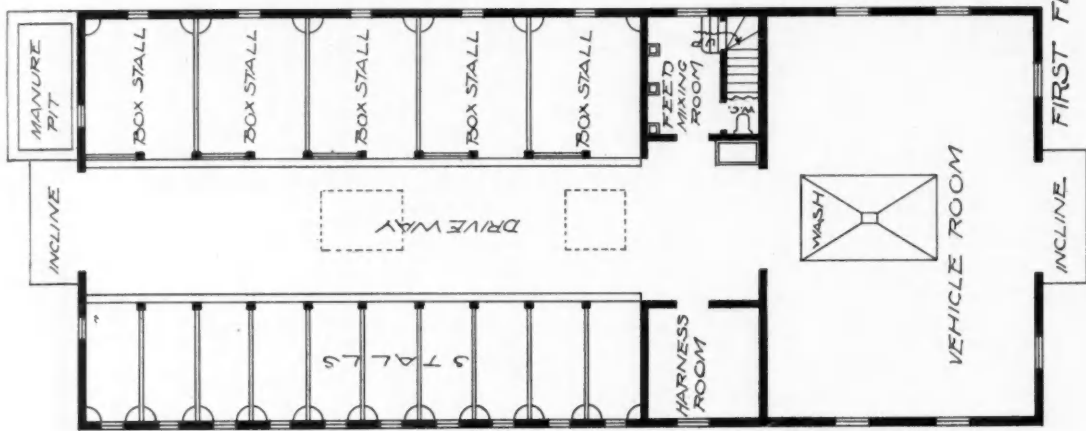

FIRST FLOOR PLAN

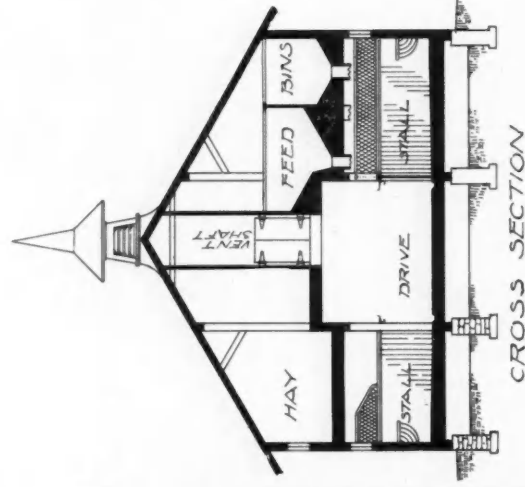

CROSS SECTION

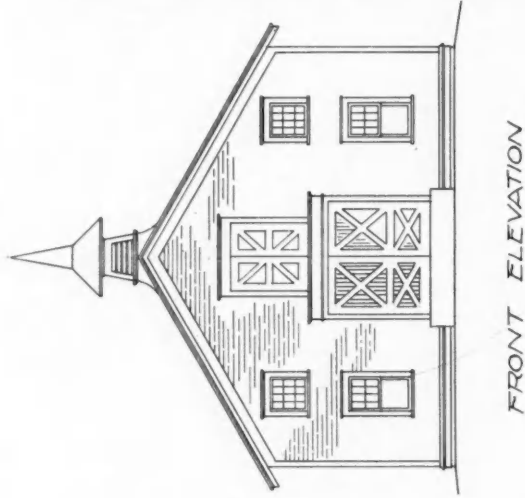

FRONT ELEVATION

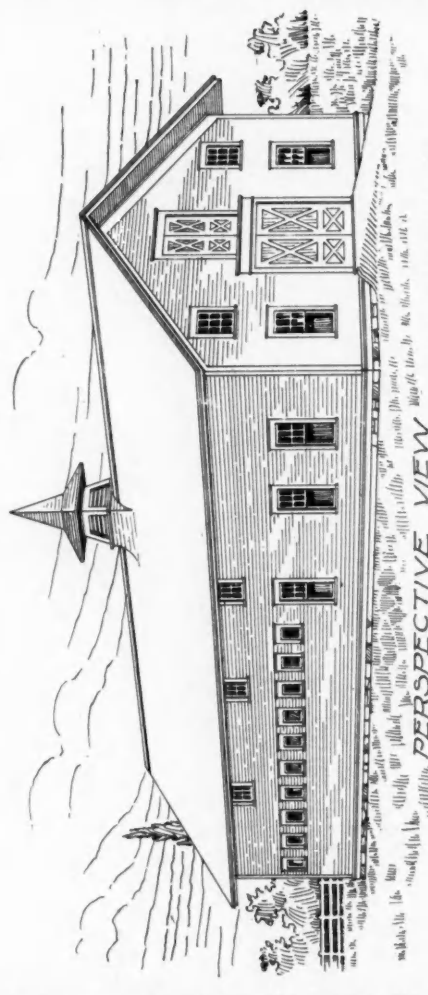

PERSPECTIVE VIEW

H. H. NIEMANN, DEL.

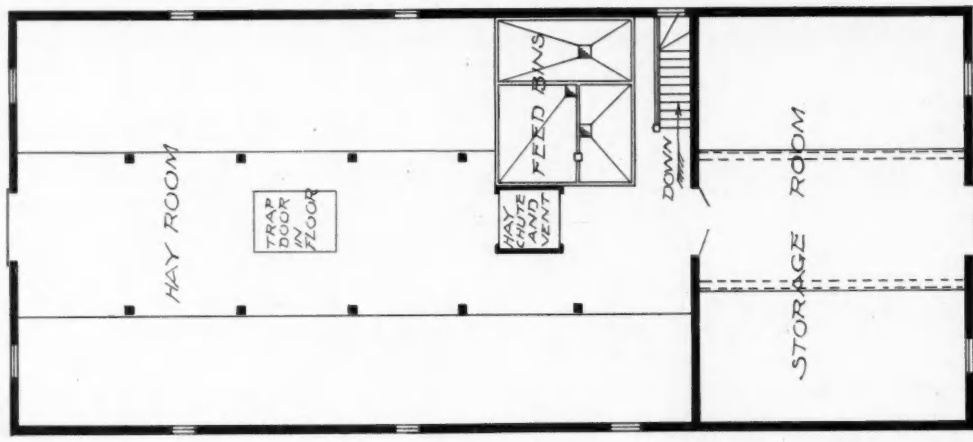

SECOND FLOOR PLAN

lected or entirely overlooked, are those of light, warmth and ventilation, which have been very carefully studied in this design. There is a large window to every three stalls, with sash hung on weights. These windows will allow an abundance of light and sunshine, which is Nature's best disinfectant, and also plenty of fresh air during the summer months.

This barn is equipped with ventilators and foul and fresh air shafts in the walls to supply a continuous flow of fresh air, which can be controlled by slides. The foul air enters the shafts near the floor, and rises up in the walls to the triangular vent duct under the ridge of the roof (see cross section). From this duct the air is exhausted through the slat ventilator towers shown on the roof. Eight hundred cubic feet of air is allowed for each animal.

The horse barn illustrated has been designed to accommodate fifteen horses, and has a large vehicle room, harness room, feed mixing room, feed bins, storage for hay, bedding, etc. The building is so constructed that an additional number of stalls can be added to the length when desired. It is set on a stone foundation, with two rows of stone piers supporting the floor joist and posts which run to purlin plates; the extreme width being thirty-seven feet and length eighty-six feet. There is a driveway through the middle the entire length of barn with large doors at each end; there is a large trap door in the ceiling of the horse stable, for the hoisting of hay or feed direct from the wagon, as well as for throwing down bedding, etc.; and there is a large vent shaft running up from stable ceiling, which has doors to the hay mow for throwing down hay or bedding and for ventilation, the latter being regulated with a damper. Feed can be hoisted up the ventilator shaft and conveniently thrown into the feed bins, which have hopper bottoms and spouts leading to the mixing room below. In the driveway at one side of the door to the mixing room is a watering trough for the stock, and with a hose connection the water is supplied to the vehicle wash which is in the floor of the vehicle room.

The stalls are floored with a double thickness of oak flooring, one and three-fourths inches thick, slightly sloping down to a cast iron gutter running the entire length of the stall room on each side of the drive. The first thickness of the stall floors is laid in hot tar, two thicknesses of tar roofing felt being well mopped over with tar and then covered with the upper thickness of oak one and three-fourths inch flooring. All stalls are provided with hay chutes from above, feed boxes and salt boxes. Each stall has a window for light and ventilation, above the horse's head, which swings out and is protected on the inside with heavy wire guards.

The vehicle room is thirty-six feet by twenty-four feet in the clear (without any posts), having a self supporting ceiling which forms the floor of a large storage room above. This storage room has large doors at each end and can be made practically dust

proof for the storage of light vehicles, tools, etc., when not used.

The hay mow has a large capacity, with a loading door and hay fork running from the outside to the vent shaft at the other end of hay mow.

Wind Bracing

Wind bracing is a system of steel connections, which in the body of a tall building serve a purpose similar to that of the interlacing muscles and tendons which bind together the bones of the human skeleton and enable it to act altogether, as a unit, in resisting forces tending to upset or crush it. In a scientifically constructed building the force of the wind pushing against the upper portion arouses a resistance which is transmitted downward from story to story, and distributed on all sides from member to member of the steel skeleton, until it is felt at the foundations, and thus the strength and weight of the lower portion of the building, lying in the shelter of the surrounding edifices, out of reach of the wind above, are brought into play for the common defense, very much as the effects of a push against a man's shoulders are distributed throughout his muscular system, down to his feet, and are thus resisted by his whole body.

German Building Limit

The German authorities place rigid restrictions on the height of buildings and the present limit is seventy-two feet. A petition asking permission to exceed that limit was recently refused in Berlin on the ground that the building would be above the level of the present water supply, and could not be kept clean and sanitary. Further reasons given were that it would put the upper stories beyond the protection of the fire department, and that it might lead to the dividing of the large buildings into a number of small departments, where many persons of both sexes and all ages would live "under conditions which are necessarily subversive to normal family life and prejudicial to public morals."

A New Idea in Building

C. E. Eastman of Des Moines, Iowa, has submitted plans for a most unique yet very attractive building, constructed entirely of wire glass. The building consists of a steel frame work, supported by brackets attached to the beams of the floors, the glass being set in the steel framework. The wall will resist fire to a practical degree and if necessary the glass could be easily replaced. The cost compared to stone, terra cotta, or brick would be from a quarter to one-third less for the outer walls. The inner construction of the building is similar to that in general use, either steel or masonry.

DETAILS OF
A COLONIAL PORCH

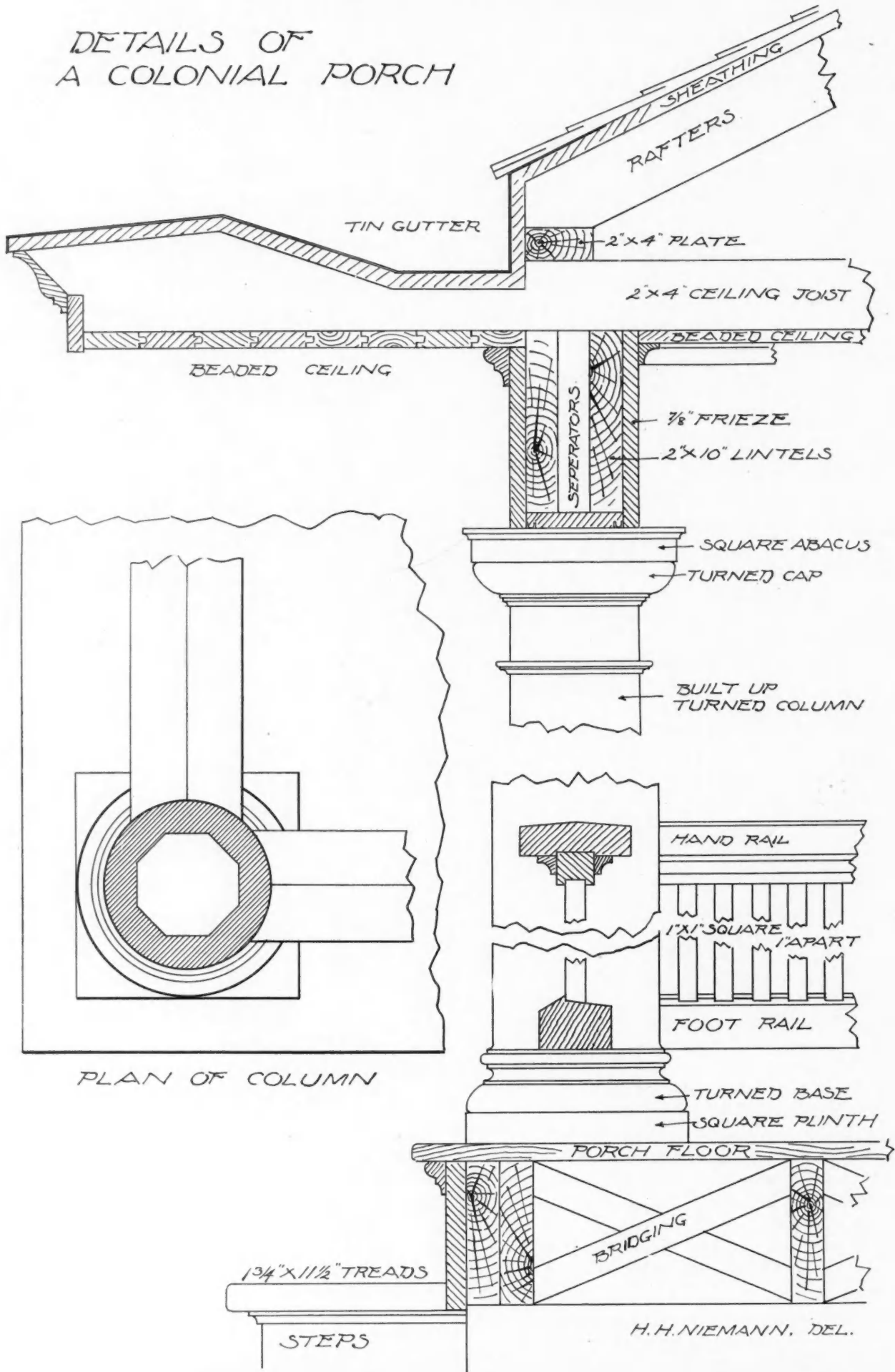

BEADED CEILING

TIN GUTTER

SHEATHING
RAFTERS

2"x4" PLATE

2"x4" CEILING JOIST

BEADED CEILING

7/8" FRIEZE

2"x10" LINTELS

SEPARATORS

SQUARE ABACUS

TURNED CAP

BUILT UP
TURNED COLUMN

HAND RAIL

1"x1" SQUARE
1' APART

FOOT RAIL

TURNED BASE

SQUARE PLINTH

PORCH FLOOR

BRIDGING

13/4" x 11/2" TREADS

STEPS

H.H. NIEMANN, DEL.

PLAN OF COLUMN



Foundations and Their Treatment

EXPERIENCES OF EARLY BUILDERS, SHOWING THE DEVELOPMENT OF PERMANENT FOUNDATIONS AND PRACTICAL DIRECTIONS FOR SECURING THEM

At the commencement of this article on a subject, which from the beginning of the world has been of the most vital importance to humanity, I would state that it is my intention to treat it entirely from its practical side, avoiding scientific data as secondary to the general treatment, because this detail of building construction is so tangible a one that it is only on the site of mother earth that the prospective building can be placed.

For this reason then I will ask readers to keep in mind that during the progress of the article only work which has actually been executed will be dealt with, and possible conditions likely to arise, with the proper procedure, will be explained and described.

With this introduction I will proceed to deal with the initiative and consider the subject in its most elementary stage, with a brief glance at past historical work.

In the primitive residences of man—being structures built of light materials, with the exception of the term embraced within the stone age, when the houses were built upon solid rock or gravel of which the stones were obtained—we find that foundations were a secondary consideration to the structures themselves, because the huts or leafy tents formed of the leaved branches of trees were so light that dryness of soil and a free drainage of the rain water away from the site were the first and only requisites.

Apart from the solidity of the ground necessary for the full stability of the structure, which was never really considered, the skin tents of the North American Indians and the arboreal huts and caves of our European forefathers, bear evidence and full testimony that, because the migratory nature of the aborigines and their transient residences while hunting or fishing for the necessities of life, it was impossible for them to stay for a fixed or lengthy period of time in one location. Only villages or settlements of natives for temporary dwelling places were built and were so light and inflammable as to be subject to destruction either by storm or fire.

The gradual increase of the intelligence of the people and the advancement of the mechanic arts made their tribes, races and communities become depend-

ent upon each other, not alone for defense, but also for the luxuries of food, clothing and the comfort of the body, which we find so essential to-day, and for social intercourse and the intermingling of the sexes.

With the permanent grouping and intermingling of races and peoples, a more stable and permanent form of buildings, both for war and habitation, became essential, and the ancients, notably the Asiatic and Southern Europeans, commenced to erect walls and houses of stone masonry for peace, well-being, and protection—not only from the elements, but from future destructive foes, or foreigners who by reason of their success or prosperity might through envy make war on them and menace their safety; or, in other words, the human race tired of its nomadic life, grouped and banded together for mutual safety and strength against a possible enemy. With a further alliance of families and nations permanent camps were indispensable, and these by a form of evolution of, or gradual improvements, worked through the series of centuries improving, step by step, up to the present centralizations or towns we now enjoy.

These improvements it would be superfluous for me to enumerate, as we all know and participate in them more or less in our modern houses, according to our means, so I will commence at the bottom and show you on what they all rest.

At the present day I would say that we, like our predecessors, if it can possibly be done, rest the foundations of our buildings upon a rock or rocks, thereby fulfilling the Divine law: "Upon a rock thou shalt build thy church," and the wisdom of this has been attested by years of experience in the remaining buildings of antiquity and their slight loss in value from the time they were originally built. So that I might state that the very best foundation for an edifice of any character, no matter how heavy or light, is the solid rock raised above the level of water, and of a close cohesive mass in its formation, free from fissures, quarry water, soft or rotten stoney spots, and far away of course from any possible springs and seismic or earthquake movements which might cause disintegration or collapse.

As to the quality of the bearing of the rock strata,

it is to be said that unfortunately it is not always suited for the purpose of the builder, even though the coherent mass of the material, or whatever the quality of the stone, be sound and capable of the fullest bearing capacity, and must be prepared for the footings of the future structure in a proper manner. For example, it is well known that the natural surface of rocks, as it is seen springing out of a grass or mossy bank, is rounded and smoothed off almost to a polished surface by the continued action of the wind and rain acting on it for ages, so that this surface being rounded, sloping and polished, is totally unfit to re-

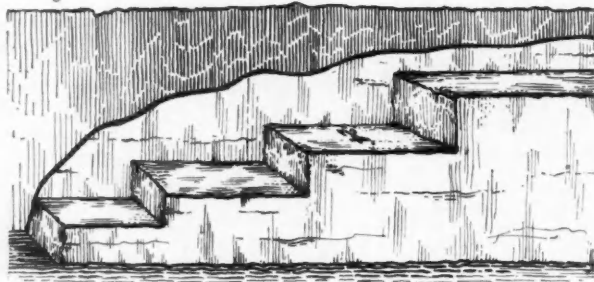

FIG. 1

tain the bottom surface of a material made up of such heterogeneous components as concrete or rubble masonry, so that it must be either hewn or blasted off throughout the entire surface to a level surface, or stepped off in shelves in the way which I represent in Fig. 1, here depicted.

All footings must be placed on a level bottom to be secure and free from all danger of slipping, so that it is absolutely imperative that they should be thus, no matter whether below or above the surface of the earth, and it is the paramount duty of every engineer, superintendent and inspector to make sure that this be always and surely done.

In the case of stepping, the writer might state that there are only two occasions when this might be omitted, and those are when the dip of the rock is so perpendicular as to leave the surface, after blasting or cleaning off, jagged or sloping back to the intersection of the angle of the perpendicular and horizontal; or, when it is so hard that a curved surface is developed of a convex and concave form, when it might be safely built upon, provided the concaved portion occurred at the corner or termination of the building or wall.

For very heavy structures, such as are erected in our modern American cities, the surface must be drilled or bored at specified close intervening distances, not only to ascertain the value of the strata beneath, but also to make certain that there is no detrimental existing agent, such as water, quicksands, fissures or any cause likely to make it insufficient in bearing capacity. Should the borings or excavations develop damp or rotten rock, or soft mud in shallow or deep pockets, then these must be scooped clean and filled in solid with a "grout-concrete."

I have purposely coined the last word to distinguish gravel-concrete from the regular concrete of one or two inch cube stone, also because I regard it as the very best composition for filling in doubtful cavities, fissures and crevices, invisibly buried in the earth, and consequently always a matter of serious moment to the engineer and architect.

This mixture has the virtue of being soluble and fluent, so that the particles being small it enters into all the interstices and renders the loose rock a comparatively solid mass. A notable instance of this method of rendering doubtful rock positive, which might be quoted, is the footings under the easterly apse of the Cathedral of St. John the Divine, at West One Hundred and Tenth street, Manhattan, New York City, where pockets and fissures were discovered of such vacancy and depth as to require the constant pouring in and puddling of concrete till it gradually rose to the surfaces and levels laid down by the engineers.

This also happens in many of the caisson foundations down town in New York and Chicago, where even on the surface within the caissons the fissures show plainly. The practice in these cases is to clean them out to the lowest possible depth and fill in with liquid concrete. The greatest of care and patience is also necessary in removing soft and rotten rock and rust, especially at the edges, and these detriments must in all cases be dug out with pickax or crowbar till the flinty ring of the steel betokens the full hardness essential for the setting of the base.

In setting foundations of this character the usual practice is to sink the caissons by the "O'Rorke" or other process, down through the clay strata till it rests on the rock, and to fill them in with concrete till they form, as it were, absolutely solid cylinders of this material.

Drawing Brickwork Details

PRACTICAL INSTRUCTIONS AND ADVICE FOR THE BRICKLAYER AND MASON IN LAYING OUT ORNAMENTAL FRONTS IN BRICK

By Owen B. Maginnis

Bricklayers and masons who do the actual work on the fronts of buildings are not, as a rule, gifted with a talent for drawing, and the following article will as-

sist them in making intelligible working drawings for the mechanics, either for repairs or any special details of new work.

At the outset I would recommend that the reader make a simple isometrical drawing of the oblo bricks shown in Fig. 1 of the sketches by using a 60-degree

on its long side on top of the square the top and bottom lines can be drawn, and the vertical lines, or ends, by placing the triangle on the tool forming a right angle with the same.

The shading of the second example, Fig. 2, demands very accurate pencil work as the light on the beads is fullest on the center, and the shadow darkens, as the round profile recedes from the eye, so that the shading lines at the top and bottom will be closest to-

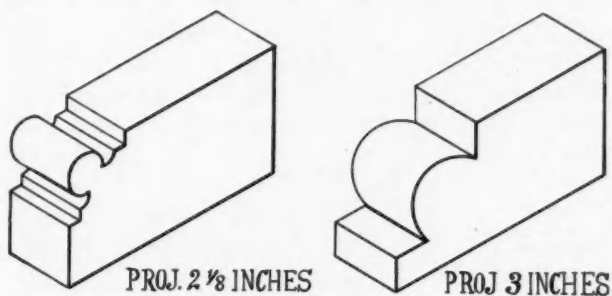
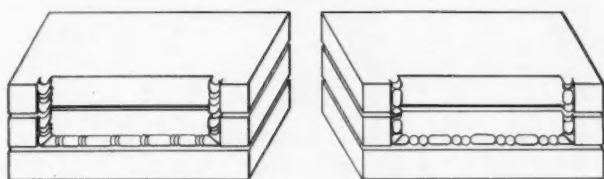

FIG. 1.



ROMAN PILASTER BRICK 4 X 1 1/2 INCHES PANEL 1/2 INCH DEEP.



PROJECTION 3/8 INCH RETURN MADE ANY SIZE UP TO 8 X 8 INCHES

FIG. 2.

triangle laid on a steel or T square on a drawing board, using a heavy black lead pencil. By laying the triangle

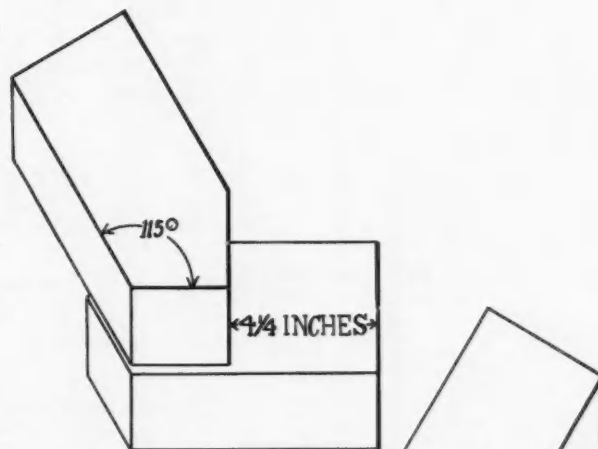

SPECIAL ANGLE BAY WINDOW BRICK.

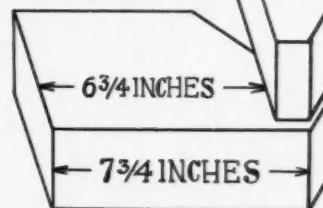

SPECIAL OCTAGON.

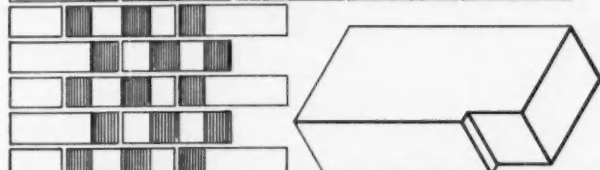
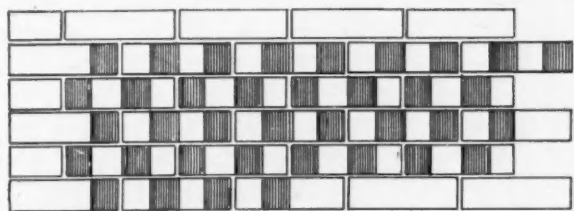

DEPTH OF CHECKER 3/8 INCH.

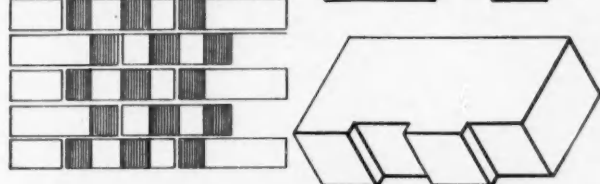
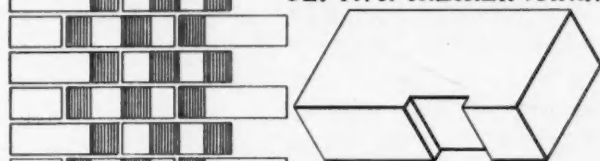

FOR VERTICAL AND HORIZONTAL CHECKER WORK.

FIG. 3.

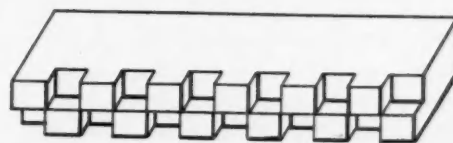

ROMAN CHECKER DEPTH 1/2 INCH.

FIG. 4.

gether and heaviest. Only continuous repetition will give proficiency in attaining the correct shadows. A little practice with these examples, drawing both the first projection and the reverse view, will materially assist the learner in the delineation of shaded surfaces.

Passing to the next engraving, Fig. 3, we find delineated a detail of front work of checker pattern, shaded out to show how the actual work will appear when built in the wall. This elevation or front view of the work involves much accurate measuring and drafting, so I would suggest that the draughtsman proceed slowly and carefully by laying out his work from a front brick which he can easily obtain at any

job, allowing three-sixteenths or one-eighth of an inch for the joints.

It would be advisable to reproduce this much larger than the engraving, about one inch to the foot, and when the lines of the joints and arises of the bricks are entirely set on the paper, to shade in the darkened or sunken parts. This is a tedious and prolonged task, but it has the valuable attribute of developing patience and accuracy of work in the hand and mind of the future draughtsman. The shading must be commenced at the top and carried down square by square until all are completed as shown in the illustration.

The projected drawings of the bricks which are

with the 8-inch plinths on either side, named "Plain Roman" bricks. Great care must be taken to get the curves of the flutes and moldings as near as possible to those in the engravings, and this can only be done by tracing them lightly with the pencil until they are accurately reproduced when they can be permanently heavily pencilled or inked in. The depths of the bricks with the recurring joints are seen in the projections of same, showing how many bricks of various profiles are required to make up the details of architectural designs, and it is for this reason that the bricklayer and mason should be able to draw details of construction before taking up the important subject of plans, etc.,

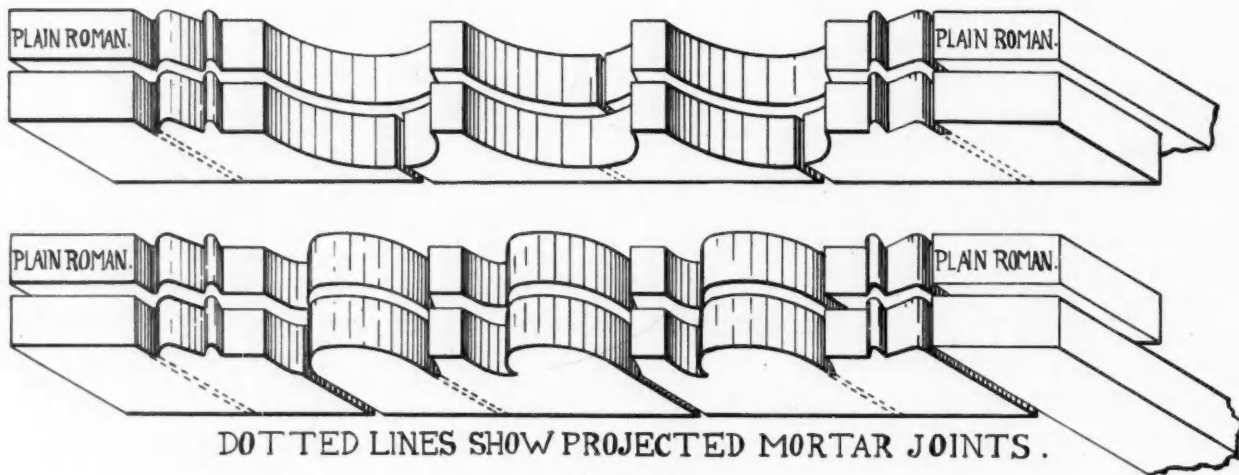

FIG. 5.

employed in making this class of ornamental brick-work are shown to the right on this engraving and should be drawn as depicted.

As a further example of the value of projection drawing I would refer the student to Fig. 4 and urge him to draw the bricks here represented to a scale of three inches to one foot, because when he becomes an adept at projection he will have a ready and convenient means of explaining how the work is carried out, the bricks placed, etc., and can, by sending sketches to others, show how he will require them to use up special or any materials.

Proceeding now to Fig. 5 readers will comprehend how drawing becomes more difficult, as the work to be indicated, or executed, increases in its details, so that in reproducing these two projected sections of brick pilasters more skill will be required than in anything the student has done heretofore.

The upper example being the simpler of the two it will be the first described. When built the pilaster will consist of three deep flutes with an O-G molding on both sides and square plinths. The three flutes are elliptic in form and must be drawn freehand to the curves shown to 1½-inch or 3-inch scale, with a flat plinth two inches wide between. To the right and left 3-inch plinths are drawn and next to these the bead and O-G curved moldings occur; the whole finishing

and leading him up by an interesting series of lessons from the simplest details to the most difficult, so that the ambitious student of drawing must not balk, stop or become discouraged if his efforts to reproduce the examples are not at first successful or an exact counterpart of the engravings, but plod on and practice doggedly until he finds himself becoming more proficient. To succeed in anything one must persevere and practice, going slowly and making himself master of one example at a time, and understanding each thoroughly. With a knowledge of drawing a better and longer memory is promoted, patience developed and the hand and eye trained to skill and accuracy, but only continuous application and steady handwork will give this knowledge.

With this digression and admonition I should advise students to endeavor to reproduce the second example in Fig. 5, and to draw six, eight or ten courses high in pencil to show how the shadows help the architectural effect. As these shadows are worked out by lines drawn parallel to the lines determining the moldings, they will only require delicate manipulation of the pencil or pen in reproduction.

Coming now to the subject of moldings, which are almost too well known to require much detailed description, I would request readers to make themselves thoroughly acquainted with the elements of mould-

ings illustrated in Figs. 6 and 7, where all the primaries are drawn in their full shape and outline, those in Fig. 6 being Grecian profiles, and those in Fig. 7

The application of freehand work, projection and mouldings to brickwork is delineated in the three isometrical samples of front bricks, Fig. 8, which the student must draw with his 60-degree triangle and T-square, making special effort to sketch in the egg and dart ornamental design shown in the one at the

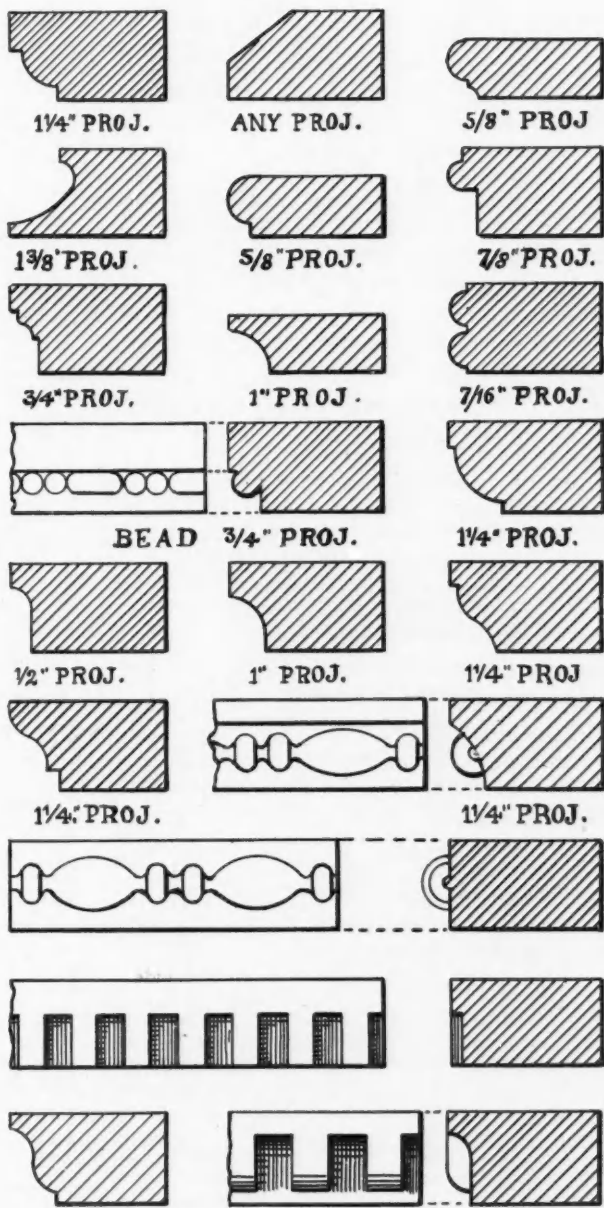

FIG. 6.

Roman. These should be carefully drawn in rotation, as shown in the engraving, using the compasses where necessary for curves and circles. All these profiles must first be done in pencil and afterwards inked in, to preserve their permanency. Let me here impress on those earnest students who really desire to make their drawing profitable, valuable and applicable, the extreme importance of becoming thoroughly familiar with mouldings by drawing and redrawing profiles until the hand is trained to such proficiency that any moulding can be struck out freehand with one sweep of the pencil, without having recourse to the instruments.

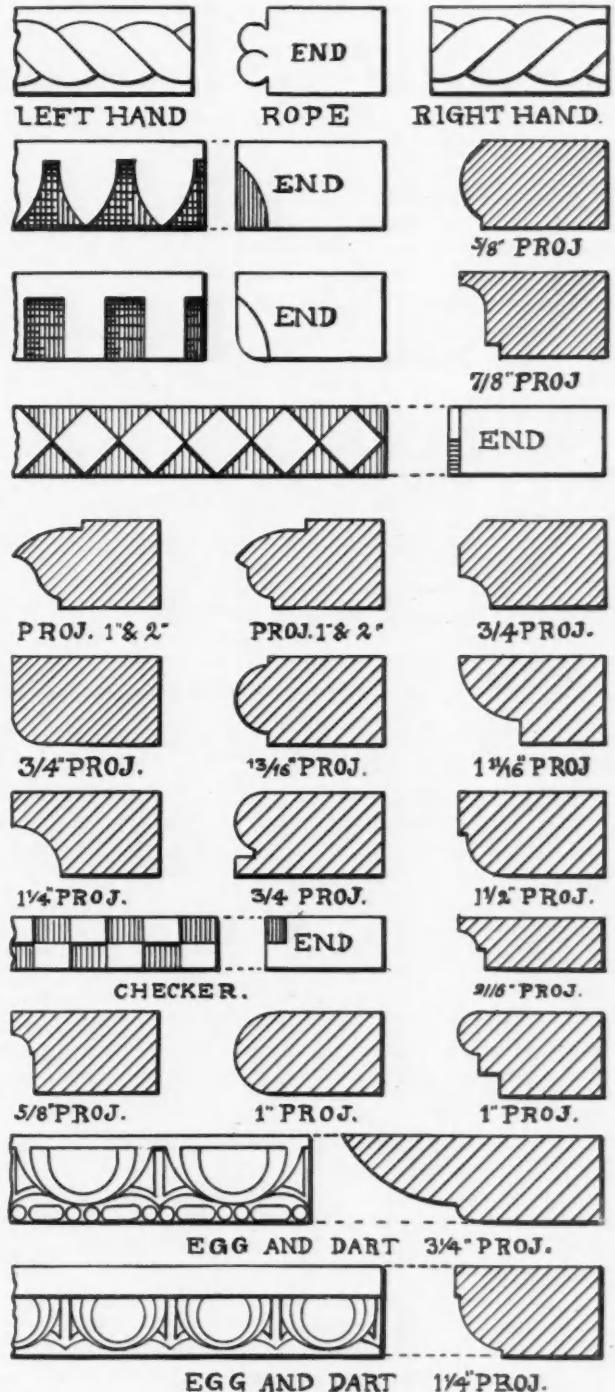

FIG. 7.

bottom. After the regular projection is laid down showing the bottom surface of the brick, the right and left curves of the ovolo are swept and a line drawn parallel to the bottom arris or corner to show the fillet or square on which the turned moulding is set.

Similarly a margin line is drawn across the top, and the curves for the decorative details lightly sketched in until the entire design is worked out. These three drawings should be made much larger than repre-

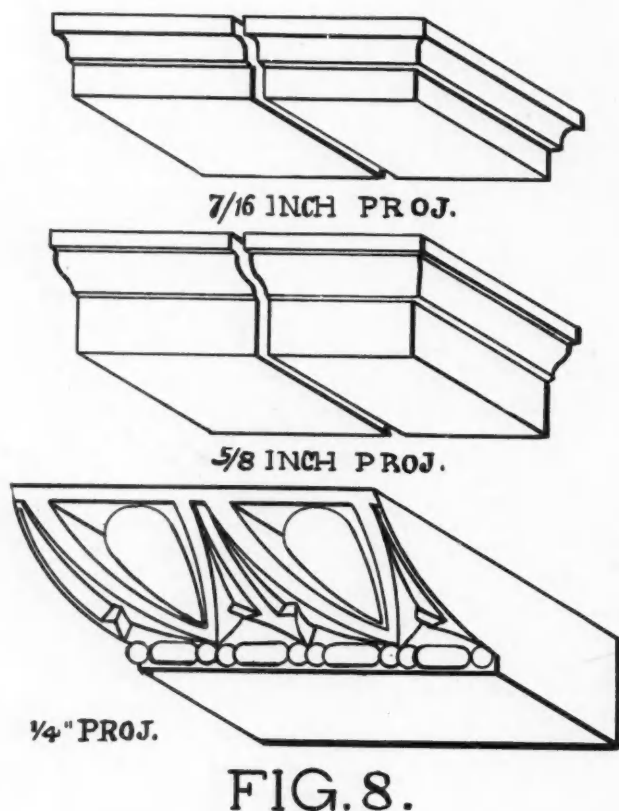

FIG. 8.

sented in the engraving, and the two top diagrams have their mouldings shaded by lines, to bring out their lights and shadows.

Hamlet Up to Date

The following anonymous contribution reached our office, and it is our custom to ignore anonymous communications. We regret that we do not know the name of the genius who has so cleverly cartooned in words by paraphrasing the immortal bard's soliloquy, which is a picture of the young Hamlet in business to-day:

To cut, or not to cut, that is the question.
 Whether 'tis not better in the end
 To let the chap who knows not the worth
 Have the work at cut-throat price, or,
 To take up arms against his competition,
 And, by opposing cut for cut, end it.
 To cut—and by cutting put the other cutter
 Out of business—'tis a consummation
 Devoutly to be wish'd. To cut—to slash—
 Perchance myself to get it in the neck—
 Ay, there's the rub; for when one starts
 To meet the other fellow's price, 'tis like as not
 He'll find he's up against it good and hard.
 To cut and slash is not to end the confusion.
 And the many evils the trade is pestered with;

Nay, nay, Pauline; 'tis but the forerunner
 Of debt and mortgage such course portends.
 'Tis well to get the price the work is worth
 And not be bullied into doing it
 For what So-and-So will do it for.
 Methinks I'll make the customer understand
 My work is It, the only It worth having;
 And having him on the string,
 I'll clinch the argument with fine specimens;
 Thus will I gather good business.
 Price-cutting doth appear unseemly;
 And fit only for the man who knows not
 What his work is worth, and who, ere long,
 By very stress of making vain comparison
 'Twixt bank account and liabilities,
 Will make his exit from the business.

—Rock Products.

According to Orders

To the Architect's office, the Millionaire
 Climbed merrily up by the winding stair.
 "I have found," said he, "by the shore of the sea,
 The jolliest place for house to be,
 On the edge of a picturesque jungle, O!
 I know how I want it—don't *you* interfere!
 A portico there and a chimney here—
 I'll make you a plan, Mr. Architect man,
 And then by my orders, as well as you can,
 You shall build me a sweet little bungalow!"

The Architect bowed—he was poor, though proud—
 And the house arose like a Summer cloud.
 But, at last, to visit the spot allowed,
 He tore his hair, did the Millionaire,
 And the language he used in his fierce despair
 Was innocent wholly of gilding, O!
 "What a horrible mess you have made!" he cried.
 "The roof is too low, and the chimney too wide!
 You can't get in and you can't get out—
 Pray, what in the world were you thinking about,
 To build such a botch of a building, O!"

Then the Architect hid, as architects may,
 The fiendish joy in his heart that lay;
 And, "Alas!" said he, "I am grieved to see
 Your dream is not all that a dream should be
 Of a house on the edge of the jungle, O!
 But as for me, I have done my best
 To follow your very unique behest:
 You made the plan, Mr. Millionaire man,
 And I think you'll admit that—as well as I can—
 I have built you a sweet little bungle, O!"
 —Margaret Johnson in *Architects' and Builders' Journal*.

Better Tenements for the Poor

The Sanitary Housing Company of Washington has demonstrated that it is a profitable investment to erect flats, with apartments of from four to five rooms, which rent from \$13 to \$20 a month, in place of the rattle-trap tenements which were a menace to the health and morals of the occupants. They are fitted with modern improvements, are attractive and easily rented, and have an influence in educating people in the higher ideals of living.



Practical Carpentry

DWIGHT L. STODDARD

Home-Made Furniture

HOW A HANDSOME BOOKCASE AND CABINET, WITH DRAWERS OF VARIOUS DEPTHS AND SIZES FOR SPECIAL PURPOSES, WAS MADE AT SMALL COST

There is nothing a mechanic can do to put in some odd out-of-work moments to a better advantage than to make some piece of furniture for a special purpose. It will be more convenient for special articles than any

anxious to get a place to put them as soon as possible, I got some wide quartered oak boards for sides and bottoms, and one enough wider to project at top, made the back of beaded ceiling, put in adjustable shelves and top so it could be changed if desired, though for the Encyclopaedias stationary shelves would have answered just as well; completed the doors and put in the glass and it was ready for the books.

The bottom was filled with drawers, the top ones for type, etc., and the bottom one large enough to hold the printing press.

It was as cheap and simple as a piece of furniture could be, considering the fact it was well made, with the very best material, as it was exceptionally fine quartered oak.

The plainness and simplicity just made the quartered oak just that much more beautiful, and I assure you it is far more beautiful than this hasty sketch of Fig. 1 would indicate.

Fig. 2 is the little plane I made when in my teens that I smoothed it up with, which is by far the best plane I ever used for that class of work, for the simple reason the bit is set at an angle of 60 degrees,

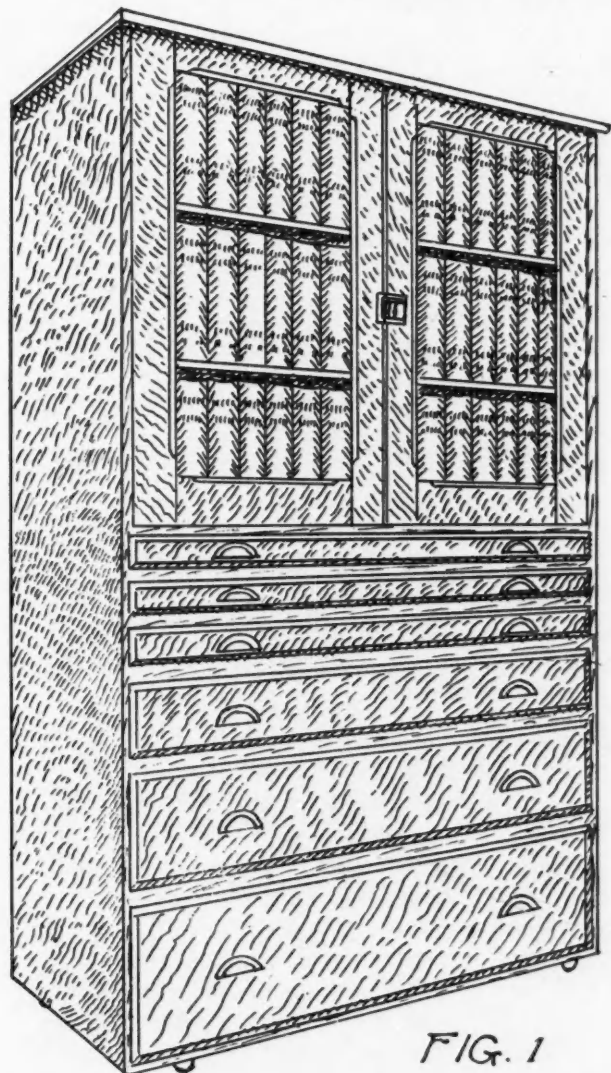

FIG. 1

ready-made furniture, and much more appreciated. The cost of material alone will make a very small outlay for quite a valuable piece of furniture.

I purchased a set of Encyclopaedia Britannica and a small printing press, etc., for my children, and being

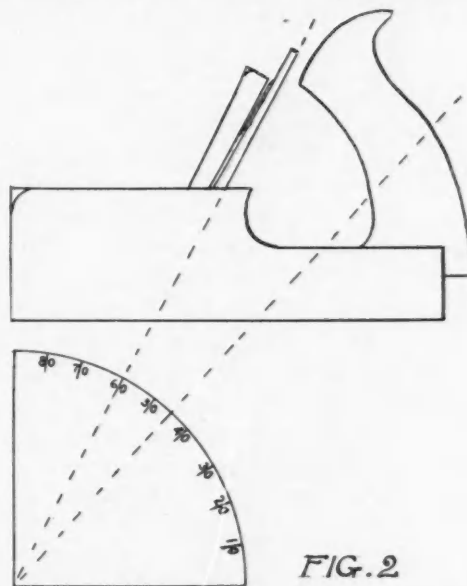

FIG. 2

while all ordinary smoothing planes are at about 45 degrees. If an ordinary plane goes against the grain

it will tear, and it takes much time to smooth it up with a scraper, and besides if it is a deep spot it is bound to be a hollow place when scraped out smooth; but a plane at this angle will go against the grain nearly as well as a scraper and therefore does not tear like an ordinary plane, and produces a smooth, nice even surface and leaves very little indeed to be finished with a scraper.

Then after it has been sanded down smooth, and the quartered oak grains all covered with white shel-

lac, so they will come out prominent when filled with dark filler, varnished and rubbed with pumice stone and polished with oil, it makes indeed a smooth piece of furniture.

While this is one of the simplest pieces of furniture of the many I have made, yet for the purpose intended it is valuable, and I hope this article will be of value enough to make some of the readers get at it and make their homes more convenient and cheerful.

Trestles

HOW A FEW PRACTICAL THOUGHTS IN THE CONSTRUCTION OF SUCH A SIMPLE NECESSITY AS A SAW HORSE ADD MATERIALLY TO ITS USEFULNESS

The reader may think it is foolish to take up space telling about a saw horse that any boy can make, but

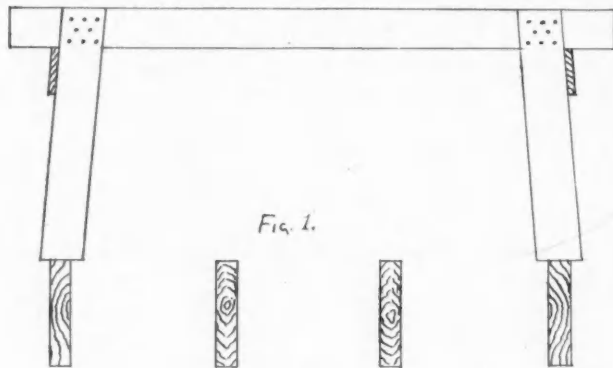

Fig. 1.

my experience has been that if we pay attention to the

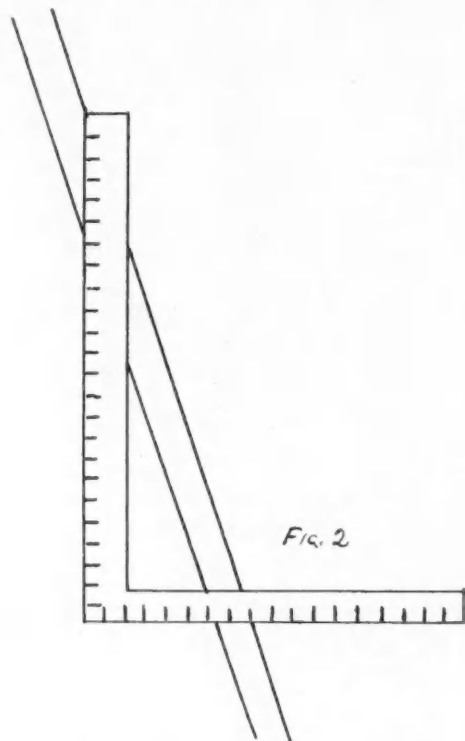

Fig. 2.

little, simple things and fully understand them as we pass along, that we gradually observe and learn until

the more difficult seem simple as we come in contact with them. In fact the mechanic that always pays attention to all little things never has anything too big for him to handle, but the mechanic that never considers small things stops completely when he comes in contact with something just a little difficult, and there he stands until the simple mechanic comes along

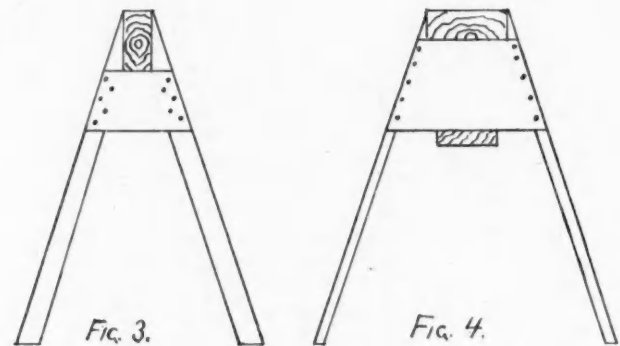

Fig. 3.

Fig. 4.

and shows him what a simple little thing has stopped him.

While it is practically true that any one can make a pair of trestles, yet it is indeed strange how few go at it with any mechanical knowledge of just what they

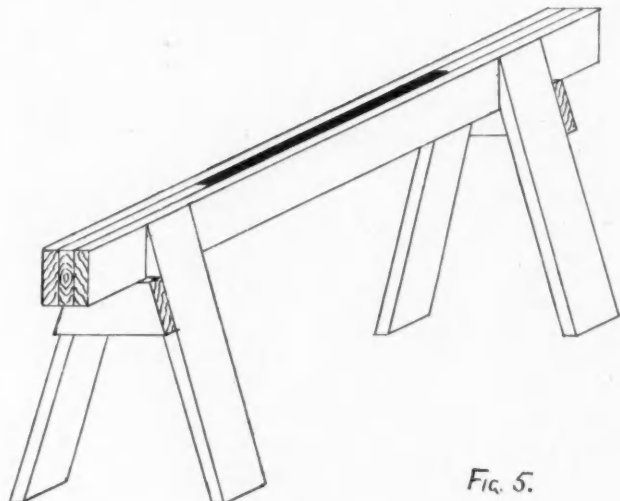

Fig. 5.

are driving at, or just exactly what kind of a pair of trestles they will have when finished.

Fig. 1. A very good trestle for ordinary use can be made with a 2x4 about five feet long, with two legs nailed on each end just four feet from center to center, as hundreds of times it is convenient to put a trestle on uncovered joist.

Fig. 2. If the legs are to be spread at the bottom to eighteen inches, place the two-foot square on eight inches on the tongue, and mark there for the bottom cut of legs, and end of blade for top cut. That gives cuts and length of legs if you wish them two foot high, which is a common height.

Fig. 3 shows end of trestle with a 1x4 nailed on and complete.

Fig. 4 shows one made with $\frac{7}{8}$ legs, with a 1x6

nailed on and a 2x6 laid flat, and with a 1x4 brace nailed on the bottom. This makes a very handy combination trestle, work bench and step ladder.

Fig. 5 is by far the best trestle I ever used for inside finishing, and is made entirely of $\frac{7}{8}$ pieces—scraps of flooring or anything can be used. The slot in the center makes the handiest kind of a vise to hold short pieces of base, etc., while sawing miters, and many other uses, especially handy many times as a tool rack to hold chisels, awls, etc. It makes a very neat, light and convenient all-around trestle for all kinds of light work.

I hope the readers of this simple article will grasp at least one good thought, and that they will show us other trestles, for there is nothing the carpenter uses much more, and he deserves the best.

Laying Out an Ordinary Stair

SIMPLE AND ACCURATE MANNER OF FIGURING TREADS AND RISERS FOR FLOORS OF ANY HEIGHT—HOW TO ACCURATELY ESTIMATE WINDERS AND LANDINGS

By Lewis R. Steinberg

Stair work on even the simple kinds of stairs is considered by many builders the most difficult part of the work encountered in a building, but it is really not much harder to lay out a stair than it is to fit and hang

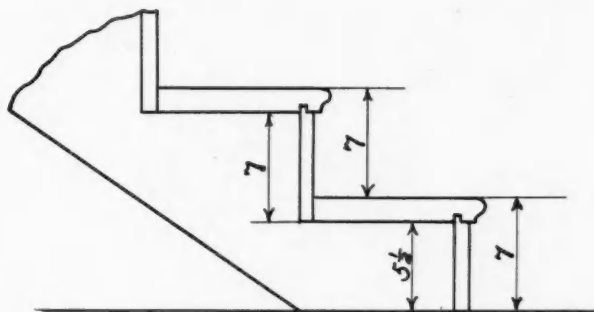

FIG. 1.

a door. If one is familiar with the fundamental principles so as to go at it understandingly, a stair for almost any conditions can be quickly designed.

Numerous tables of treads and risers, giving the treads and risers for any floor height or the run of the stairs for a given number of risers, have been published, but all the information necessary can be found by the little rule given below for any particular condition as quickly as by the use of a table.

It has been worked out from theory and found by practical experience that in the easiest stair twice the riser, plus the tread in inches, should equal from 23 to 25 inches. If the ratio is varied much from this the stair becomes harder to climb. No matter how steep or how flat the stair, by following this ratio it will always be the best stair for the place.

Someone will say, but you don't know what the

risers or treads are or how many there are to be. That can be quickly found. We will take first the case where the run of the stairs is not fixed. If it is a rear stair we can use a riser of 8 or even 9 inches, and a front stair 6 to 7 inches. Divide the floor height by the riser and we have the number of risers. Now from our rule we find that the tread equals 24 minus twice the riser, and as there are always one less tread than the number of risers, we have the run of the stairs.

Now we will take the case where the floor height and run of the stairs are both fixed. Here we take the floor height in inches, double it and add the run in inches. Divide this by 24 and we have the number of treads. Add one to the number of treads and divide the floor height in inches by this number and we have the exact riser height. Divide the run in inches by the number of treads and we have the height of the tread.

The result is the easiest possible stair which will fit the fixed conditions.

To make the explanation clearer we will make a practical application of the rule.

The floor is 12 feet and the run is 16 feet. Twice 12 feet in inches equals 288 inches; 16 feet equals 192 inches, and the sum is 480 inches. Divide this by 24 and we get the number of treads 20 and 21 risers. Twelve feet divided by 21 gives us a riser of $6\frac{7}{8}$ inches; 16 feet divided by 20 gives us a tread of $9\frac{5}{8}$ inches. Twice $6\frac{7}{8}$ inches, plus $9\frac{5}{8}$ inches, equals $23\frac{3}{8}$ inches, which is as near as we can get without using smaller fractions and near enough for all practical purposes.

Of course it is understood that the riser height is from top to top of tread, and the tread length from

face to face of the risers. In laying out the strings this must be taken into account. The string is laid out the same as the rise and tread lengths, with the exception of the first riser on which allowance must be made for the first tread. By referring to Fig. 1 this will be clearly understood. The foregoing has been with reference to straight run stairs, but a stair with landings or with winders can be treated in the same way. If the stair is one with landings but no winders it is simply a series of straight runs which can be laid out as given above. It must be remembered, however, that if the several runs are in one continuous stair the risers and treads should be the same throughout, for

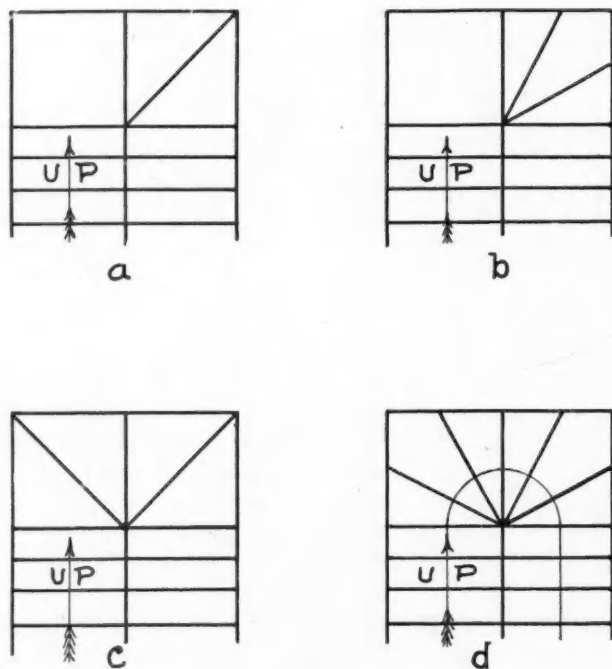

FIG. 2.

any change in the treads or risers will be a stumbling block to every one who uses the stairs.

Winders are not desirable if they can be avoided, but if the space available for the stair has been reduced to a minimum to make room for other things it becomes necessary to make use of them in order to reach the desired height without making the stair too steep. If a case of that kind comes up, first try it without the winders, and if it makes the stair too steep decide upon the number of more risers necessary to make the stair satisfactory. Where only one or two additional are required they are sometimes laid out in plan on one side only—see Fig. 2, (a) and (b)—making a kind of half landing or resting place. In (b) one more riser is used. In (c) the same number of risers have been laid out in a symmetrical manner, making a more continuous stair of it. These winders will have the same riser height as the common risers, but of course the tread length which is on the curve, as in (d) Fig. 2, varies with the number of winders. This is not

theoretically the correct way of planning winders, but for cheaper stairs it is the method used. When the stairs are elliptical or circular and of stone or iron the winder treads are worked out in the proper ratio to the riser. But as this would naturally fall into another article, which will come later, we will not go into detail here about the method of obtaining this ratio.

Theater Hewn Out of Rock

Probably the most novel theater in the world is that recently opened at Thale, in Germany. The theater is on the summit of a mountain, and is surrounded on all sides by steep rocks; the seats for the audience are hewn out of the rock and accommodate 1,000 persons, and the stage, which is also hewn out of the rock, is eighty feet long and fifty-four feet wide. No artificial scenery is used, but the background is formed by the dense forest, and by the outlines of the mountain in the distance. The dressing-room for the actors is close at hand in the forest, but completely hidden from the audience. The theater is fully protected from the wind, and its acoustic properties are so excellent that every word is heard.

Two of a Kind

A carpenter in a Kansas town sent the publisher of a trade paper a two-dollar bill in payment for his subscription. It was returned by the next mail with the following brief note:

"That bill you sent me was a counterfeit; please send another."

Several weeks passed before the publisher again heard from his subscriber, when he apologized for the delay, saying:

"I have been unable until now to find another counterfeit two-dollar bill, but hope the one now enclosed will suit, professing at the same time my inability to discover what the objection was to the other, which I thought as good a counterfeit as I ever saw."

Rufus the Roofer

"But to go back to this poor cuss of an architect. Nothing ever happens just the way he thought it would. His paint never mixes right. It must have been a new man bungled the job. And when he's getting ready to paint a roof the equinoxial always sets in too early, just in time to start the rust a-workin'. It did seem as though it must keep Providence busy just upsettin' his calculations. But it never was his fault.

"Now what I want to p'int out is this: That the man underneath the roof doesn't care a rap about any of these things. He'd rather pay a bigger bill for a sound roof, and cut out the tale of woe."—*Rufus the Roofer, in the Arrow.*



Manual Training

IRA S. GRIFFITH

Something the Boys Can Make

PRACTICAL INSTRUCTIONS FOR THE YOUNG CARPENTER, TELLING HOW TO BUILD USEFUL AND ORNAMENTAL PIECES OF HOUSEHOLD FURNITURE.

Before beginning the work of this department I want to have a talk with the boys of the AMERICAN CARPENTER AND BUILDER for whom it is intended. In most of the large cities, and many small ones, too, there is a subject taught in the public schools called



manual training. In some room of the school building will be found benches on which are complete sets of tools, such as the saw, plane, hammer, etc., for making articles of wood. Here sleds, boxes, tables and things of like kind are made by the boys for their own use. A teacher who has had special training and experience in handling tools has charge of the room and teaches the boys how to make the things he wants made. It is a good thing for the boys, and they enjoy the work, or play we would better call it, very much. I cannot stop to tell you all of the reasons that have made the men who have control of the public schools in many places willing to spend thousands of dollars for benches and tools "just for the boys," but they are good ones. The boys of the AMERICAN CARPENTER AND BUILDER have what is better than this; they have access to benches and tools at home. All that is necessary is for some one to tell them of some

good things to make and how to make them, and I am sure they will enjoy themselves as much as the boys I know who get to work in the school shop, and who beg to be allowed to come after school is out and work more. For the boys who do not get to do this kind of work this department will try to be a help in the making of things. For the boys who do get to make good pieces in school it will be a help in many ways I am sure.

As some of the boys will have used tools more or less and some will not have used them at all, I propose to tell each month hereafter how to make two things; the first to be for boys who want to learn how to use the different tools, and the other for boys who have had experience in handling them correctly. By making the thing first described each month a boy will have handled all the common tools by the end of the

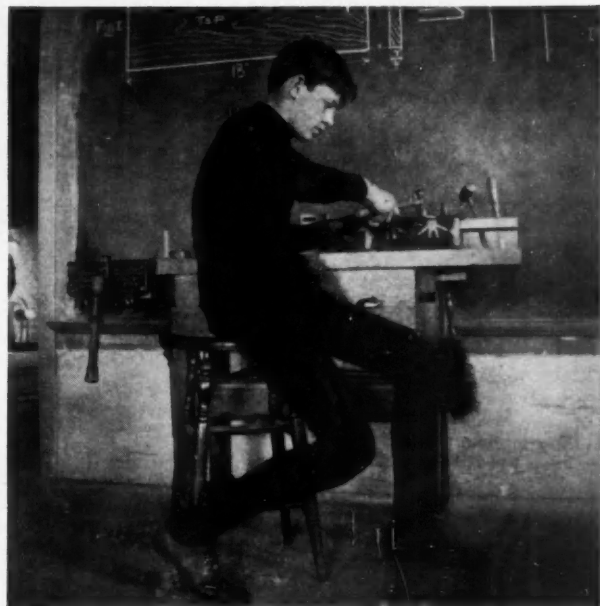

twelve months. By making the second article which will be described each month he will have made most of the common joints used in wood work.

Some of the best things I have for boys to make were suggested by the boys themselves. I shall be more than pleased to use any good suggestion sent me

by the boys of the AMERICAN CARPENTER AND BUILDER.

If the boys are not so fortunate as to have tools and benches of their own, I am sure their fathers would not object to letting them use their benches and some of their tools, if the boys will but know the place of everything they use and leave it there when they are

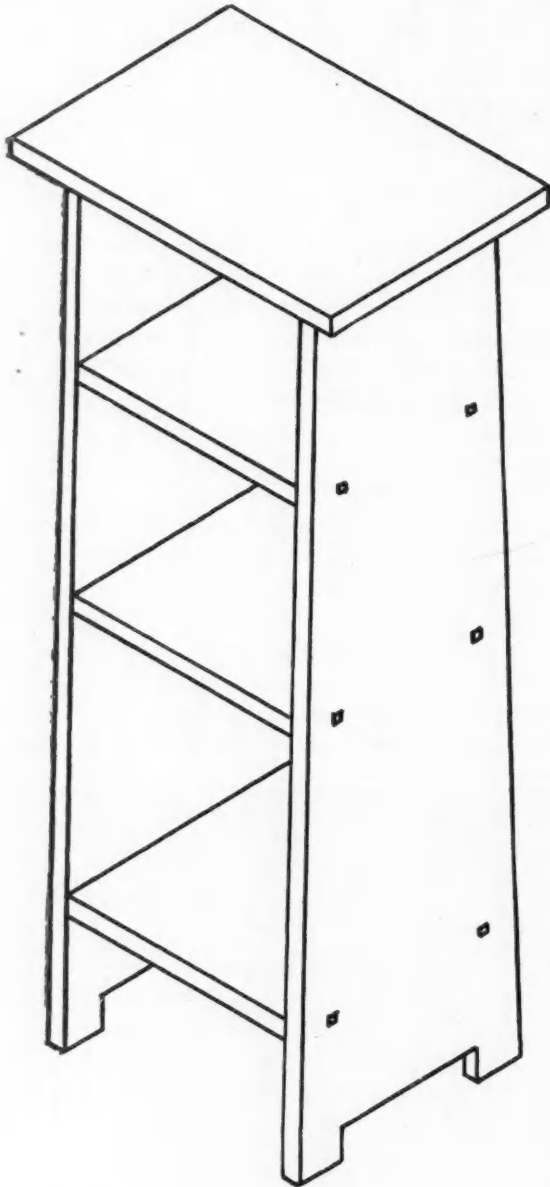

through with it. If they do not know how to use tools properly, they should learn first and avoid breaking them by pounding, prying, or scraping with them when they were not intended for that. No one can work with dull tools, nor would a boy's father want to find his tools dulled when he wants to use them after the boy has been using them. He must learn to sharpen such tools as the chisels and plane. His father will be glad to show him how to do it. If a boy will keep his tools sharp, handle them carefully, and leave them in order when he is through, and be careful, neat and try to be accurate in his work, and not wasteful of the

lumber, I am sure his father will be glad to let him have a place in the shop or mill.

The magazine stand which I am going to tell about this month is for boys who know how to handle tools and who know the meaning of such terms as stock, laying out, dressing down, squaring up, working face, joint edge, side edge, end, grain, etc. Next month I shall tell how to make something easy enough for beginners as well as something as difficult as the magazine rack.

First, determine the amount of lumber required by studying the figured drawing. The lengths are indicated by the numbers between the arrow points, the distances always being measured from point to point no matter which way the shaft of the arrow extends. Often the distances are not indicated directly on the plan, but short dash lines extend out a little way and the arrow points are placed on these. The numbers refer to the plan of course. The dotted lines indicate edges which cannot be seen when you look at the stand from the side which is towards you. Look at the drawing, now, and you will see that the side pieces or legs are to be thirty-seven and seven-eighths inches long, measured straight up. They are eleven inches wide at the bottom and nine inches at the top. The top piece is eleven inches wide and sixteen inches long. The upper shelf is nine and one-half inches wide and eleven inches long. The middle shelf is ten inches wide and eleven inches long. The bottom shelf is ten and three-quarter inches wide and eleven inches long. All of the stock or lumber is three-quarters of an inch thick. Get clean, well seasoned lumber, dressed or planed on two sides to the right thickness. Oak finishes up the prettiest, but soft woods can be stained to look well. Cut out the pieces roughly a little larger than is called for on the drawing. Square up the top first, then the shelves, being sure the grain of the wood runs the long way of the pieces or from leg to leg when they are in position. To lay out the side pieces, take a straight-edge, draw a center line down the mid-

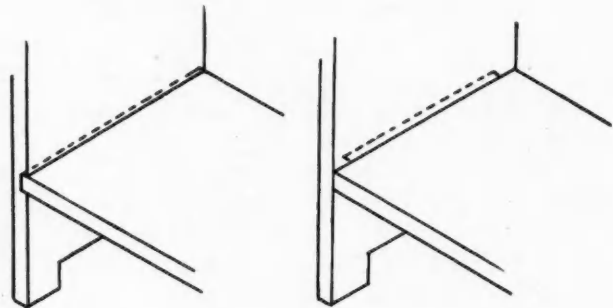

FIG. 1.

FIG. 2.

dle of the piece. Mark off on this line the length, thirty-seven and seven-eighth inches. Next, place the steel square so that one side lies along this center line, and the other makes a right angle to it, at the point

marked for an end. Mark out each way from this center line and repeat at the other end. Measure out from the center line, on these lines just drawn, each way one-half of the distance called for on the drawing. For example, the top of the leg is to be nine inches across, so measure four and one-half inches each way; on the bottom five and one-half inches. Connect with the straight-edge the two points on the same side of the center line. In this way the grain of the wood is kept extending up and down with reference to the

suitable, or common flat-head screws may be used, and covered with ornamental upholsterer's nails. When a dark finish is used a common lag screw and washer gives a fine effect. Bore the holes in the sides large enough to take in the screw easily; and, if oak is used, a hole large enough to take in the screw without the thread must also be bored in the shelves. Great care must be taken to get the holes in the shelves so that they will be in the right position with reference to those in the sides. A good way is to place a shelf in

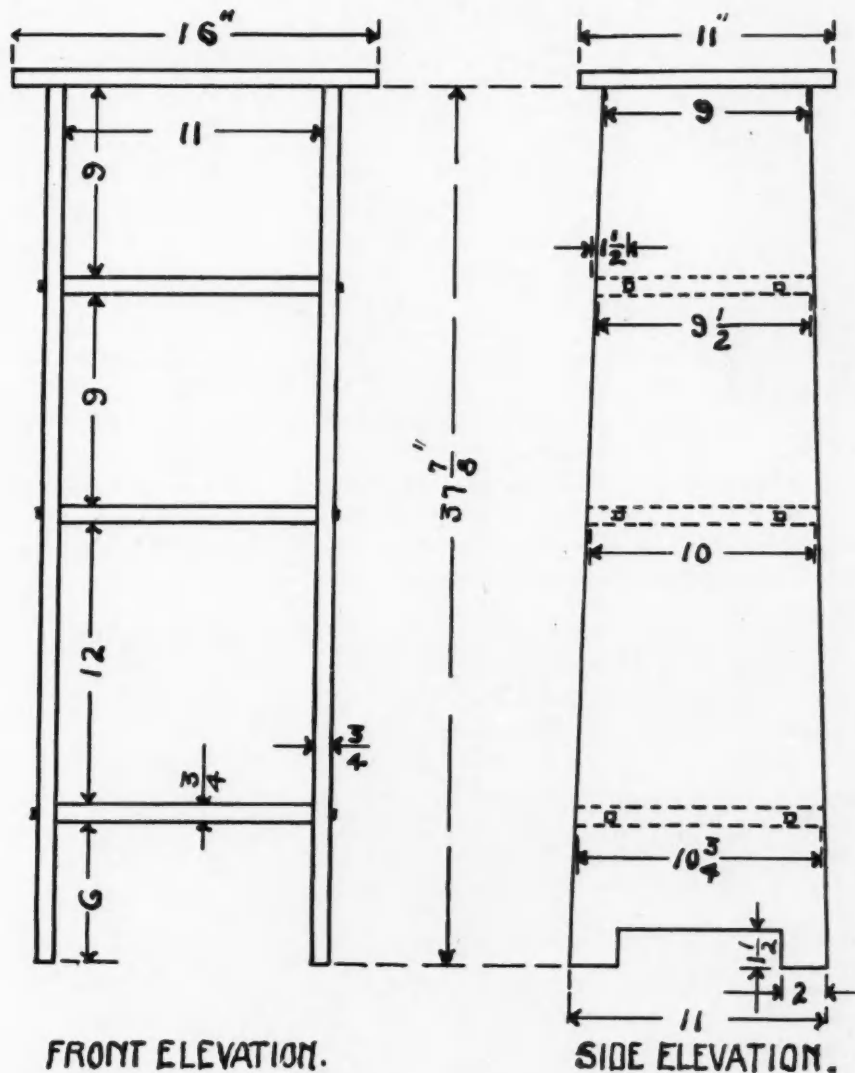

FRONT ELEVATION.

SIDE ELEVATION.

the vise, end up; place the side in position and mark through the holes in the side. Indicate in some way, such as numbering the holes in the shelf and the corresponding one in the side with the same number, so that no mistake occurs in putting the parts together. If the lag screw is used, one-quarter of an inch by three inches is a good size, using a one-quarter inch bit for the sides and a three-sixteenths inch for the shelves. Nails may be used if so desired. It will be well to look over the pieces now and see that the sides are alike; that the top and bottom of the sides square with the center line; that the shelves are of the same length and that the ends are square. Scrape and sandpaper all pieces well before putting together. Place the top shelf in the vise and secure the side to it, then the middle shelf and then the bottom in the same way. The stand can then be placed on the floor and the remaining side put on. The top can be nailed on. A better way would be to secure it by screws from underneath. Plane up a piece of stock one inch square and eight inches long, screw this fast to the

floor. The design at the bottom can be changed, though the simpler the lines the better the piece will look. Saw out and plane to the lines. To cut out the design on the bottom, bore holes near one corner, on the part which is to be cut out, and use a keyhole saw to start the cut across the grain. Lay out on the sides or legs the places for the shelves. This is done by measuring along the center line and placing the steel square as was done in marking off the ends of the legs. Measure and bore the holes for the screws. After one side has been bored a good way is to place both together in the vise and, placing the bit in the holes just made, bore the others. Round-head brass screws are

inside of the legs at the top and then screw through this piece into the top. Drill holes for the screws and countersink the heads. After the parts are in place touch up any unevenness with the plane and scraper.

The question of how to finish the pieces will be taken up from month to month. If oak has been used in making the magazine stand, a good finish, and one which is quite popular now, could be got by staining the wood with a brown water or oil stain, and after this has dried putting on a coat of ivory drop black Japan finish. Put the stain on evenly with a brush or sponge. Paint will not take the place of stain. Wipe off the drop black before it sets or begins to dry. This

gives a rich dull black which does not cover up the markings of the wood. For soft wood a weathered oak oil stain, such as is put up by paint making firms, put on with a brush and wiped off before it dries,

who are exceptionally good and experienced workers to use a joint such as Fig. 1, or better still, such as Fig. 2.

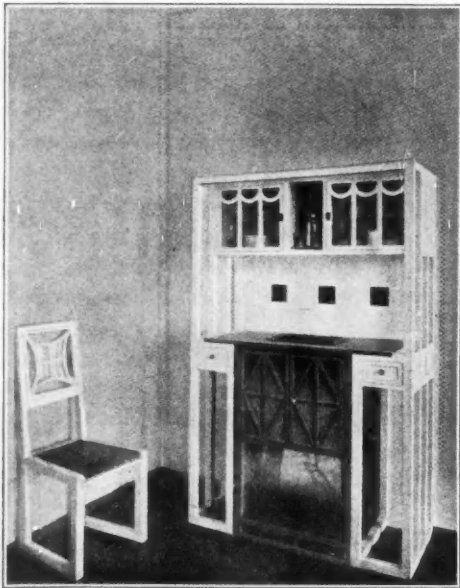

A Gas Heater and Cabinet Combined New German Art and Crafts

makes a good finish. This gives a very dark green color.

The joint which has been described is what is known as the square butt joint. I should advise those boys

He Got It

A manufacturer hired a boy. For months the only noticeable thing about the boy was that he never took his eyes off the machine he was running. One day the manufacturer looked down from his work to see the boy standing beside his desk.

"What do you want?" he asked.

"Want me pay raised," said the boy.

"What are you getting?"

"T'ree dollars a week."

"Well, how much do you think you are worth?"

"I t'ink I am worth \$4, and I've been t'inking so for t'ree weeks, but I've been so blame busv I haven't had time to speak to you about it."

About Boxing

A school teacher boxed the ears of a carpenter's son a few days ago. The boy told his mother, and the next day the teacher received the following note: "Nature has provided a proper place for the punishment of a boy, and it is not his ear. I will thank you to use it hereafter."



A Reception Hall in the Deutsche Kunst or New Art Style



Interior Decoration and Furnishing

JULIUS KARPEN

Mission Furniture

SIMPLICITY, CHARACTER AND DIGNITY DEPICTED IN THIS POPULAR STYLE—AN OUTCOME OF THE DESIRE FOR THE "SIMPLE LIFE"—IT HAS COME TO STAY

Much attention is being paid in the public prints at the present time to the exponents of the "Simple Life" and their teachings. Charles Wagner, the leader in this social movement, has become famous the world over.

Everywhere the attempt is being made to bring civilization nearer to nature, and where that has been impossible nature is being brought back to civilization and planted in its midst. In the city of Chicago great blocks of old and tumble-down buildings are being torn down to make way for the small city parks; transforming, in a few short months, a hideous wilderness of civilized ruins to beautiful parks with trees, flowers and shrubs. Never in the history of our country has there been so much attention paid to the study of natural phenomena and the beautifying of city homes by means of plants, flowers and shrubs.

It is but natural, therefore, that this longing for the plain, "Simple Life" should manifest itself in the furnishing of homes as well as in the out-door life of the people. If we are to seek the plain and "Simple Life" outdoors, why not surround ourselves in the home with furnishings which depend for their beauty only upon their simplicity of construction and plain and natural outline? Why not be close to nature within

as well as outside of the home?

The time is long past when it is considered necessary for beautiful furniture to be elaborately ornamented and carved. Intricate and costly designs are no longer considered necessary in making artistic furniture productions. "Beauty does not imply elaboration or ornament. On the contrary, simplicity and character and the dignity which comes of them are demanded alike of practicability and of art."

The desire on the part of the people for something substantial, thorough and honest, and which at the same time is designed with artistic skill, is responsible

for the extensive modern development of the Mission style. This is not a passing fad, but the manifestations of a public want long felt and come to stay. Its rapid development proves conclusively that the demand is not an artificial one, created by manufacturers, but rather that manufacturers are compelled to follow the public demand now that the movement has been

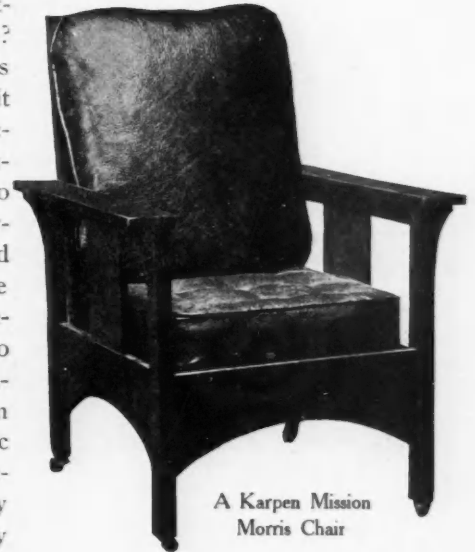

A Karpén Mission
Morris Chair

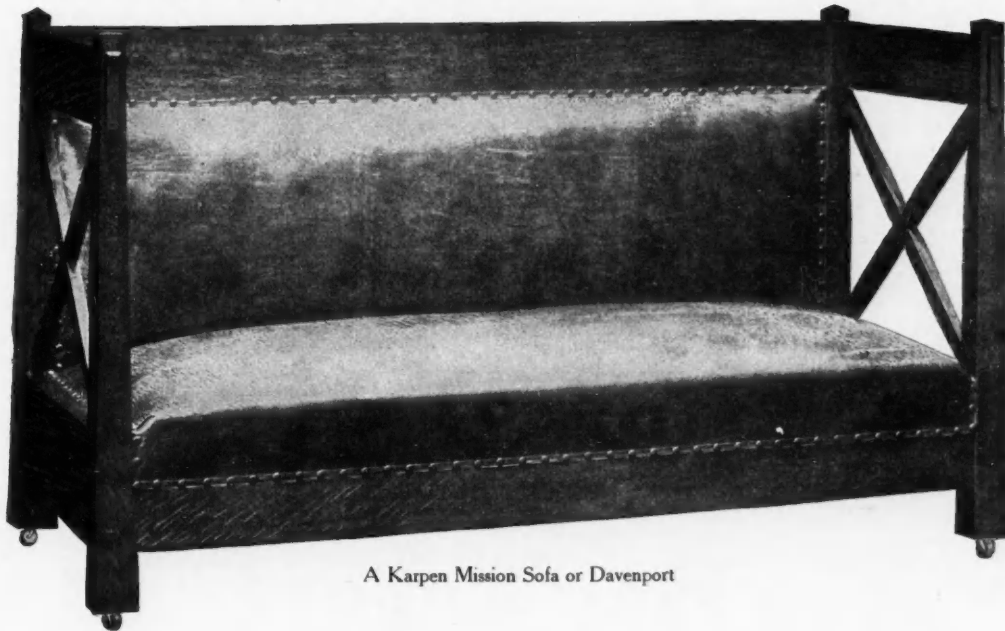

A Karpén Mission Sofa or Davenport

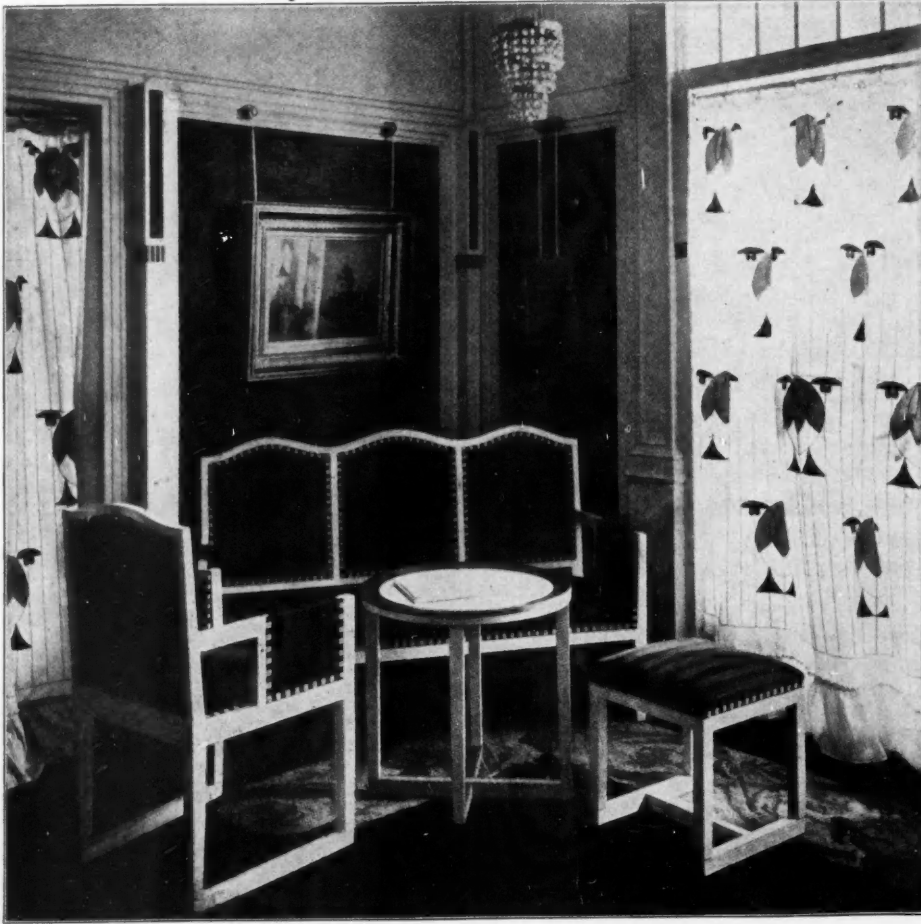

The Corner of a Sitting Room or Parlor New German Art

fairly started, and is popular in every walk of life.

The faith which close observers of furniture styles have in the permanency of the Mission or Arts and Crafts furniture is again shown by the fact that a number of the best equipped furniture factories in the United States turned over their entire productive force, attention and skill to the exclusive manufacture of Arts and Crafts furniture.

Mission furniture derives its name from the simi-

only from the Spanish Missions, but from Mediaeval Germany and the Tyrol, from France, Flanders and the England of Puritan times.

The life of a people is largely expressed in the furniture with which it fills its homes. Thus, during the reign of Louis XV, who was the most dissipated and spend-thrift king the world has ever known, there was developed the Louis XV style, which is the most extravagant and excessively ornamented of any of the

larity in rigidity of design and style of coverings to existing examples of furniture to be found in famous old Spanish missions. It is a mistaken idea, however, to suppose that all Mission designs are reproductions of designs found in missions founded by Spaniards. The words "Mission Furniture" have come to mean a distinctly new development of modern art and manufacture, which is destined to become as characteristic of our time as were the Louis XIV, Louis XV, Louis XVI, and Empire designs of the periods which they respectively represent.

Designers of Mission furniture must draw their inspirations from those historical periods when the people lived close to nature and rigidly followed plain and simple lives.

While their designs must appeal to modern taste they must seek their ideals not

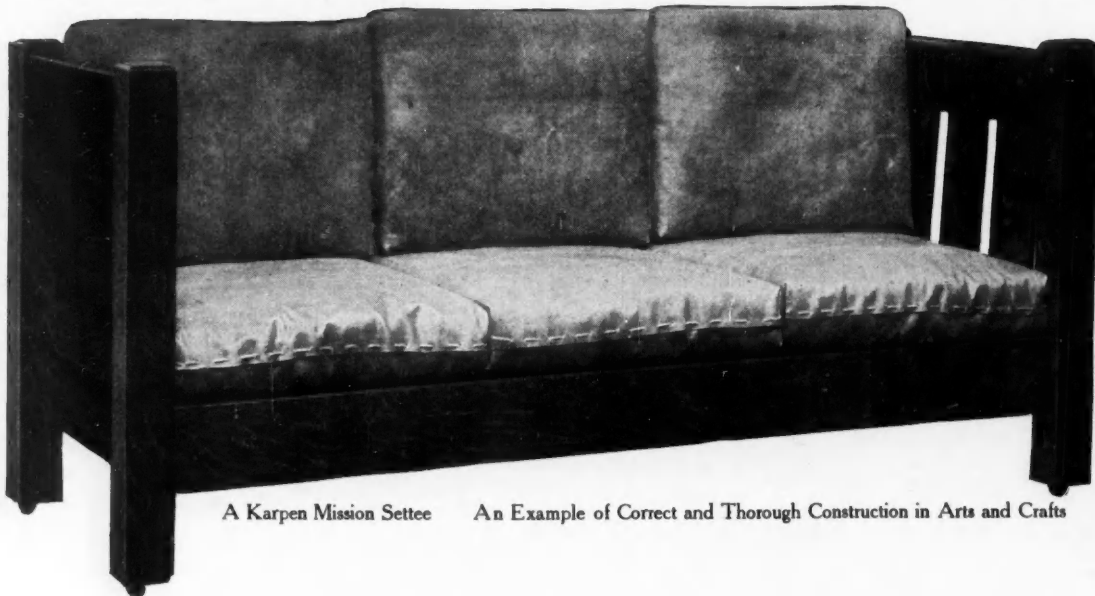

A Karpen Mission Settee An Example of Correct and Thorough Construction in Arts and Crafts

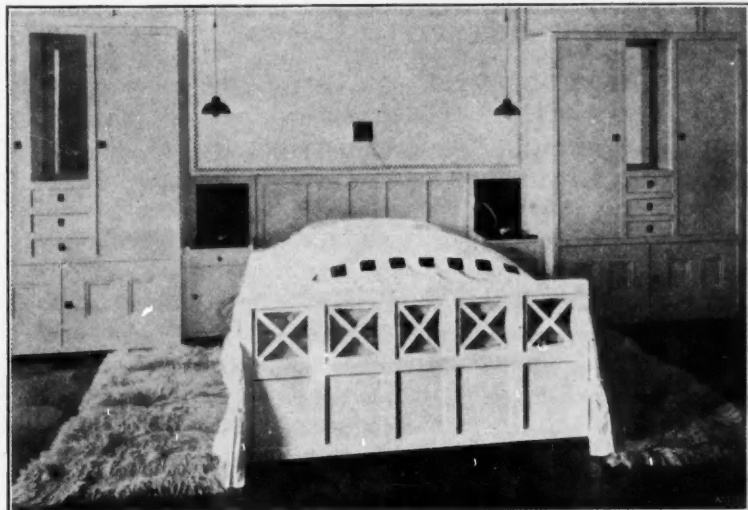

A Unique Bedroom in the German New Art Style

classical furniture styles. Therefore, it is proper that for simple styles of furniture we must seek examples in the times when the people were satisfied with furniture constructed with a view to usefulness and serviceability; when artists and designers preferred the rigid beauty of straight lines and simple outline and construction to curves, carvings and applied ornamentation.

In France L'Art Nouveau is making wonderful strides, and it is to nature that the artist must go for his inspirations in the creation of the L'Art Nouveau idea. "Art," it claims, "should be nature arranged and adorned."

Those who were fortunate enough to visit the German exhibit at the St. Louis World's Fair saw a most wonderful exhibition of productions in the new German style, there called "*Deutsche Kunst*." Some excellent examples of this new German style are shown in the illustrations accompanying this article.

A study of the German interiors shown discloses the resemblance and similarity between American Arts and Crafts and "*Deutsche Kunst*." The Germans have progressed much further than Americans in the development of this style. Not only are the furnishings of a room constructed in the new style, but the room itself is planned, built and decorated with a view of obtaining a harmony of design, color and beauty.

Americans have not been slow to see that in this harmony of interior furnishing lies the secret of successful and artistic results in the use of Mission or Arts and Crafts styles.

A talk about Mission or Arts and Crafts furniture would not be complete without saying something of the develop-

ment and progress made in the last five years in the decoration and finishing of leather. The leather most appropriately used on Mission furniture is popularly known as Spanish leather. It is well named, because it was in Spain that the decoration of leather in colors and designs was carried to its highest perfection, and the examples of decorated leather mural hangings to be found in art collections in Spain show a wonderful diversity of coloring and design, which it has been impossible for modern artists and craftsmen to imitate. Genuine Spanish leather is decorated and dyed by skilled artisans by hand. The result desired being a harmonious blending of the colors of the leather and the dark

finishes of the oak commonly used in the construction of Mission or Arts and Crafts designs.

Mission furniture is destined to become more popular as it is more thoroughly understood. It is a gradual substitution of the luxury of taste for the luxury of costliness. Utility and beauty go hand in hand, and it is the perfect combination of these two elements by which the ideal furniture is obtained.



A Fireplace and Wall Treatment Arts and Crafts Style

The Influence of the New Art on Decoration

HOW AMERICAN DECORATORS, NOT CONTENT TO COPY ENGLAND, GERMANY AND FRANCE, ARE LEARNING FROM THEM, HOWEVER, TO GO TO NATURE FOR INSPIRATION

By Edward Hurst Brown

During the past thirty years or so there has gradually been growing up an entirely new and distinct decorative style that bears little relation, either in form or spirit, to the period styles of the past. To-day by far the larger part of the decorative work that is done in this country is carried out in this new art, even though it does not show the exaggerated curves and the fantastic or grotesque features that have been associated with L'Art Nouveau in France or Germany, where the style has been pushed to an extreme.

At the great Centennial Exhibition in Philadelphia, in 1876, the Western World for the first time seemed to realize the beauty of Japanese art with its naturalistic conventionalism, so different from any of the European decorative styles. For a time our decorators attempted to imitate this Japanese style, but they failed to catch its spirit, and while we saw rooms decorated with cranes standing upon one foot or flying through the air, or with dragons of one kind or another, they were pictorial rather than conventional in treatment and were as stiff as the Eastlake Gothic, which had immediately preceded it. Then came the rage for the so-called "Queen Anne" style, which was very far indeed from the really graceful architecture and decoration that prevailed in England during the reign of that queen, but at any rate it was a striving after better things than the jig-sawed architecture and the pearl gray wall papers, with gilt flowers powdered on them, that had preceded. Meanwhile William Morris and his coterie of artist craftsmen, in England, catching and adapting the Japanese spirit, but not imitating its forms, were working out new ideas in art and decoration and carrying them out in their own shops. Their furniture and decorations were heavy and massive in their character, better suited for the monastery than the dwelling, but they were far superior to the red rep curtains and gilt cornices and other atrocities that had made the average English house of the early Victorian era hideous. The new ideas were taken up by a little coterie of faddists who pushed them to an extreme, and we were treated to the sight of English maidens dressed in flowing garments of a "greenery-yallery" tone and sickly looking men in knee breeches and pumps, carrying a lily or a sunflower lackadaisically before them as they strolled along Pall Mall or Picadilly. These were admirably caricatured in Gilbert and Sullivan's opera of "Patience," which was not one whit more absurd than the live English men and women who took up the aesthetic fad and endeavored to live up to it.

But although these extremists brought the new art into discredit with sensible people, the germ of truth was there and could not be destroyed by ridiculing

the faddists. Although the average decorator shunned the Morris school and stuck to the well-worn and threadbare period styles, passing by turns through the Italian, Rococo and Empire styles—or rather revivals of them—the leaven of the new spirit was working. In England, Morris was followed by Walter Crane, Shand Kydd and a number of others, who caught up the Japanese idea of going direct to nature for inspiration, and of reproducing the truth she tells us in a bold conventionalism. Decoration was gaining in strength and decorators were becoming accustomed to handling strong colors and to thinking in the mass rather than in detail. The English wall papers began to show great swirling leaves and masses of intertwining foliage done in tertiary colors. The prettinesses and the pettinesses of the days when bygone styles were blindly followed were being lost sight of and a new art was coming into existence.

Meanwhile the French and German decorators had caught the spirit of this decorative revival and began to recognize what the English seemed to be unaware of, that here at last was the new decorative style that art critics had been asking for and which they seemed to despair of. The Germans at once exaggerated it and made it grotesque, introducing as a characteristic feature of their designs, fantastic curves, which frequently served as the stems of plants or the bodies of animals; indeed they went as much as possible direct to nature for floral and animal forms, but almost invariably they exaggerated them. This German "Modern Art," as they termed it, was at first unsuited for American taste, and it is small wonder that our decorators were slow to copy it or to fall into its spirit. On the other hand, the English decorators are, as a rule, too gloomy or perhaps it is best to say too heavy in their color treatment to suit the average American taste, which demands lightness and airiness—or at least this is true of all the cities in the East where anthracite coal gives a clear and smoke free atmosphere, for it is a curious thing, well known in the wall paper trade, that the lighter decorative tones are always more in demand in the East, while in Pittsburg, Chicago and in other Western cities where soft coal is burned the people want strong, rich colorings. The French took up this new style, terming it "L'Art Nouveau," and refining it both in grace and delicacy of line and coloring. Seeing its capabilities, our American decorators and designers have also adopted and are using it more and more. They are departing from the narrow restrictions of the period styles and whether they recognize it or not they are working in the broader spirit of the new art.

One of the features of the new art in decoration is

breadth of treatment. The designer works with the whole room in his mind and adapts both color treatment and decoration to the purpose of the apartment. The walls are treated rather as backgrounds for the furniture, the pictures and the people who are to dwell in the rooms, than as surfaces to be filled with ornament regardless of the contents of the room. Flat colors, with the decoration, if there be any, executed in a barely discernable difference in color tone, are used for the walls, and what ornament there may be is applied to the frieze, and here the decorations are plant forms, broadly conventionalized from nature or are pictorial in the familiar poster style, which is a typical development of the new art. Our houses are ceasing to be museums for the display of bric-a-brac and are becoming habitable. The Rococo and the Empire styles might have been adapted for the periods of the French monarchy or the Empire, when pleasure was the chief business and men wore knee breeches and embroidered coats, but they are scarcely adapted as backgrounds for the average American business man, who does not want to wear a pink satin dressing gown in order to harmonize with the decorations on his walls—whatever his wife might be willing to do.

The influence of the new art is toward simplicity—toward a rational treatment of the decoration of our houses and public buildings. It is the spirit of individuality; the studying of the special need of the room to be decorated and adapting the color and the ornament to the use of the room and the quantity and character of the light it receives. The decorator who works in the spirit of the new art has ceased to be a mere copyist, repeating parrot-like the details of some past decorative style, but he is putting himself and his own best thoughts into his work. He is no longer content to be commonplace but he seeks to be original and at the same time he endeavors to cultivate a refined taste. This art of to-day is a living art, and the decorator who would be successful must live and grow with it, not content to copy what other men are doing in England, Germany, France, or even elsewhere in this country, but working in the same spirit, he must go to nature for his inspiration, and his work must express the impression which this study of nature makes upon him. This is the new art, and in the hands of our American decorators it is producing a decorative style that is typical of this twentieth century and truly expresses the spirit of the age.

Painting the New House

THE NATURE OF PAINT—PRACTICAL POINTS ON MIXING TO SECURE DURABILITY AND PROPER RESULTS THAT EVERY CARPENTER AND BUILDER SHOULD KNOW

By Edward Hurst Brown

By far the greater part of the painting that confronts the carpenter and builder is that of painting new houses, and this is an entirely different proposition from repainting an old house whose surface has already received at some previous time one or more coats of paint. The purpose of painting is primarily for protection of the wood against water, and secondarily for the purpose of ornament; although there are many who would rather reverse this statement and who regard the decorative as the primary purpose of painting.

Paint, properly speaking, is a mixture of a finely divided solid substance or some combination of substances, held in suspension in a liquid, which is termed the vehicle, and capable of being spread upon the surface to which it is to be applied, by means of a brush. This is a broad definition, which must be limited to some extent by the purposes and use to which the particular paint is to be applied. The different solids which are used in paint making are termed pigments. They do not become paints until they are mixed with the thinner or vehicle. Thus: white lead, zinc white, ochre, Prussian blue or Venetian red are all pigments, although they differ very materially from one another, but they do not become paints until they have been mixed with linseed oil, turpentine or such other vehicle as may be employed in making the paint.

The term "pure paint" is a misnomer. Pigments or oils may be pure or adulterated, but as no two painters or paint manufacturers will be found who will agree absolutely as to the exact composition of any paint, and as a paint may be made from one pigment in combination with a single thinner, or as it may be composed of a number of different pigments mixed with several liquids combined together, it will readily be seen that it is meaningless to speak of pure or impure paint. It is true that for the purpose of cheapening a paint manufacturer or a painter may load his paint with worthless material that has no value save as an extender, and which may be really harmful instead of beneficial to the house upon which it is applied, but he cannot be accused of using adulterated paint unless the specifications have clearly defined the composition of the paint, or have at least indicated that it is to be free from such make-weights or extenders. A knowledge of paints and their composition is therefore very essential to the architect and the builder who have regard for their own reputation, for no mechanical work about the house so soon shows the effect of time as the paint, nor in any other branch of building is poor workmanship and material so much in evidence. In fact the entire appearance of an otherwise well finished house may be marred by cracked, peeling or scaling paint.

No one thing is more essential than that a skilled and honest painter should be employed. Painting requires more judgment than almost any other trade, for the condition of the weather, the temperature and moisture, the nature and condition of the surface to which the paint is to be applied, the presence in the air of sulphur and other gases from manufacturing industries, or of salt from the adjacent sea coast, the proximity of foliage and the exposure to the sun, all exert a most important influence on the paint film when it is drying. In many parts of the country it is scarcely possible to use paint of exactly the same composition and to obtain the same results on two successive days, owing to varying weather conditions. Therefore, to secure the best results the proportioning of the paint must necessarily be left largely to the judgment of the experienced painter, although its general composition may be specified by the architect.

One of the most important things needed to secure a durable job of painting is that sufficient time should be allowed to elapse between coats to insure the under layer of paint being perfectly dry before another layer is applied. This does not mean mere surface drying—it does not mean that the paint shall not come off when touched by the finger, but that the paint film or layer should be dry throughout its entire thickness. Paint does not dry by evaporation, but largely by oxidation. The linseed oil, which is used as the vehicle, takes up oxygen from the air and forms a tough, leatherlike, gummy compound called linoxyn. It is this gum which gives linseed oil paint its waterproof qualities. If turpentine, benzine or other volatile liquids are used in the paint in order to make it work easier under certain conditions, or to hasten its drying, these evaporate, and only the oil and a very small part of the turpentine remain in the paint to act as a binder for the purpose of holding the particles of pigment together and causing them to cling to the wood. In order to hasten drying, it is the custom to add certain oxidizing agents to the paint, which exert a chemical action upon the linseed oil, but while these cause more rapid drying, they also introduce a destructive agency, and paint that is made to dry quickly by means of these "driers" is also quick to perish. This is another reason why the work of painting should not be hurried.

Paint may be either mixed by the painter, or it may be furnished by the manufacturer either in the form of a tinted paste, to which the painter adds thinners as his judgment dictates, or it may be obtained from the manufacturer thinned and ready for immediate application, and known as "mixed paint" or "ready-mixed." Good results can be obtained from any of these kinds of paint, provided they are adapted to the work on hand, but generally speaking the experienced painter prefers to mix his own paint because he can then more perfectly adapt it to meet the peculiar conditions of weather or surface that may confront him. However, much painting is done by men who do not

possess the requisite experience to mix paint properly, or who lack the color sense which is needed to produce the required tints from the usual pigment colors, and for men of this kind the paste or mixed paints are well adapted. It is also claimed by many paint manufacturers that the use of machinery in mixing the paint will produce more perfect and uniform results than when paint is mixed in a tub by hand in the ordinary fashion. But when it is considered that the painter does not grind his own pigments, but buys them ground in linseed oil in the form of a thick paste, it is evident that the claims in favor of machine mixing are rather a talking point than an actual advantage, and the painter, by using more time, can in all probability produce as uniform a paint as the manufacturer can by machinery.

There is undoubtedly much prepared or mixed paint on the market which is largely made up of make-weight and extenders, and which possesses little real paint value, but such paint is usually offered for sale at a low price and like all cheap things is apt to be of poor quality. In buying cheap paint or in hiring a cheap painter, the property owner must expect to get as poor results as he would obtain if he buys cheap clothing, in which cotton masquerades as wool. Good paint, like everything else that is good, commands a fair price and cannot be bought cheap. But because there are many cheap and nasty mixed paints on the market by no means condemns all of them, and properly used, over a suitable priming or foundation coat, good results can be obtained by first-class mixed paints and just as good results can be obtained by the shop-mixed paint of the experienced and honest practical painter. But the prepared paint and the painter's paint will differ materially in composition. The painter, as a rule, prefers a paint made of white lead and linseed oil, with the necessary tinting colors—for light tints—and such driers as may be required. The manufacturer finds it practically impossible to put up a pure white lead and linseed oil paint in cans ready for use, because such a paint will almost invariably become fatty or unfit for use after standing in stock for some time, and the result obtained from its use in that case would be anything but satisfactory. The use of forty per cent or more of zinc white in a mixed paint seems to prevent this tendency to grow fatty, and as its use may be defended on other grounds, it follows that prepared paints are all based to a greater or less extent on zinc white, some of them containing no white lead at all. The best prepared paints are made up of white lead and zinc white, with such colors as may be needed to produce the desired shade and contain no so-called inert pigments, although the use of as much as thirty per cent of barytes is strongly urged by many paint experts. What constitutes the best paint, and why, is something that we will discuss more fully later on.

By far the greater portion of the paint used for outside painting to-day is light in color—the strong, rich, dark colors being very little used—and these light col-

ors are made by the addition of a small proportion of strongly colored pigments to a white base. Where a dark colored paint is used, such as a bottle green, a Tuscan or Venetian red, or a rich brown or deep yellow, no white base is used, but the colored pigment is simply thinned with oil to the consistency required for painting.

The principal white base pigments are white lead and zinc white. Besides these there are several white pigments which are variously regarded as inert pigments or as extenders. Among these are barytes, whiting and gypsum.

White lead, one of the oldest known pigments, is the hydrate-carbonate of lead, and is of varying composition, no absolute formula being recognized, but the best white lead contains about twenty-five per cent of hydrate to seventy-five per cent of the carbonate. White lead may be made by the stack or so-called "old Dutch" process, which requires some one hundred days for corrosion, or by one of several so-called quick processes, wherein the principles of the Dutch process are applied to finely powdered or thin sheet lead, either contained in revolving vats or chambers or in some other suitable form of apparatus by means of which acetic acid, water and carbonic acid gas may be brought in contact with the metal lead. The lead made by these quick processes is usually whiter than that made by the old Dutch, due to the fact that the latter is apt to be more or less stained by the tan bark used to generate heat in the stacks. But as any white lead soon bleaches upon exposure to the sunlight, this is a matter of small importance. Whether there is any difference in covering power or durability between the quick process or the Dutch process lead is a mooted point. White lead unites with linseed oil to form an elastic, insoluble lead soap, and it is this property which gives it one of its greatest values as a pigment. It perishes by gradually powdering away on the surface, termed "chalking," so that a house painted with white lead may always be repainted without scraping or burning off. If the lead is poorly made, especially if it contains acetic acid which has not been washed away after corrosion, the chalking will be quite rapid and will be a serious objection.

Sublimed white lead, which is used to a considerable extent in mixed paint making, is not a true white lead, but is a lead sulphate that is white in color, and is produced by a fire process. It is chemically inert and does not unite with the linseed oil to form a soap. It has a tendency to correct the chalking of the ordinary white lead when mixed with it.

Zinc white, or the oxide of zinc, is made by blowing a current of air through molten zinc. It is comparatively inactive chemically, although it unites with oil to a certain extent to form a zinc soap. It is free from the poisonous qualities which render white lead objectionable for an indoor paint, and is not acted on by sulphur gases, which darken white lead. Zinc white spreads much more readily than white lead, but does

not cover so well, so that it will require four coats or even more of zinc white to hide a surface as well as three coats of white lead. Zinc white dries to form a hard and brittle paint film, and perishes by cracking, peeling and scaling, which are very objectionable unless neutralized by the addition of some other pigment. It is therefore very seldom used alone on exterior work, but almost invariably in combination with lead or some other white base.

Barytes, or sulphate of barium, is a native rock, which is very finely ground and is used as an inert extender of paint. It has no affinity for linseed oil and absolutely no covering power. Four coats of barytes mixed with linseed oil will not hide the surface to which it is applied and the film is practically transparent. The same is true of silica, which is another so-called inert pigment.

Whiting is lighter in weight than barytes and possesses a decided affinity for linseed oil. Mixed with oil in paste form it becomes putty. It has very little covering power in itself.

Linseed oil, the oil expressed from the seed of the flax, is remarkable from the fact that it unites with oxygen to dry to a waterproof film. It is this fact that it is a "drying oil" that gives it its great value in paint. There are some other drying oils, such as walnut oil and poppy seed oil, but they are not produced in sufficient quantities and are therefore too expensive to be of any interest to the house painter. Linseed oil is adulterated with various mineral oils (petroleum products), with rosin oil, with corn oil and with fish oil. The first named is the most likely adulterant.

Turpentine is the distilled sap of the long-leafed pine. It is used to make paint more fluid, and hence to make it spread easier. It dries by evaporation, leaving a slight gummy residue. Owing to its present high price it is apt to be adulterated with the lighter mineral oils. The source of supply of turpentine is decreasing and many efforts are being made to find something that will take its place. A so-called wood turpentine is being introduced, which is a product of the destructive distillation of pine trees. Very little as yet is known about the value of this turpentine. As it is a wood distillate somewhat akin to wood alcohol, it may possibly possess the poisonous property of this material, which affects seriously the nerves of the eye when inhaled to any great extent. It is therefore well to be cautious about wood turpentine until its nature is better known.

Benzine is also used as a diluent of paint and dries by evaporation without residue.

Driers are oxidizing agents introduced into paint to promote rapidity of drying. They are usually salts of lead, or salts of manganese. In this country they are usually used in liquid form, but in England paste driers are usually employed.

Having now considered generally the nature of paint, we will take up, in the next article, the subject of exterior painting as applied to the new house.

Ancient Architecture

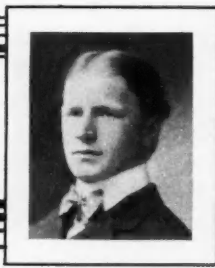

WILLIAM REUTHER

A Glimpse of Ancient Roman Architecture

GRAND AND MASSIVE STRUCTURES, AFFORDING SECURITY, CONVENIENCE AND PLEASURE, YET NOT BEAUTIFUL—HOW IN REALITY "ALL ROADS LEAD TO ROME"

The early Romans, who were noted for their great military achievements, can scarcely be said to have had an original architecture, but rather a modification of that of the Greeks and Etruscans.

It was noted for its solidity, massiveness and plainness, and is well described in a few words by Sir Henry Wotton, who says that the Roman architecture can be compared to a sturdy laborer in homely apparel.

The natural tendency of the Romans was to build walls and fortresses to aid them in the defense of their country, and we find an instance where Julius Cæsar, in the course of a few days, caused a wall to be built which was nineteen miles long and seventeen feet high, extending from Mount Jura to Lake Lemanus. This is astonishing to us at the present day and we can only account for it by the fact that the Romans were very robust

and enured to labor from infancy, and every individual considered the public weal as his own private affair.

Being very successful in their warlike career, they paid great homage to their military leaders in the form of triumphal arches, of which we have an excellent example in the arch erected in honor of the Emperor Titus, which represents him after the taking of Jerusalem. The trophies and captives are pictured in bas relief, showing the soldiers carrying the golden table which was in the Temple of Jerusalem, and others carrying great tablets upon which it is thought were written the names of the conquered cities.

The greater part of ancient history is taken from

the bas reliefs on these arches and pillars, and the fact that much ancient history is purely guesswork is due to the weather-beaten condition of the early structures.

A wise precaution taken by the early Romans in their building was to bind the several layers or courses of stone with plates of brass, and joining them to one another in a wall, which was done by making two holes upon a level in two stones, and letting the binders therein.

That wooden binders were also used is told us by an old Roman architect, Horatio Marco, who says: "In order to add some new ornaments to a monastery of nuns, situated in Nerva's Forum, we pulled down an old structure of four square stones, between every two of which stones there was a piece of wood drove in, cut on each side like a swallow's tail, and what was most to be wondered at, was that these pieces of wood were so hard and sound that they might have been used again."

Among all the works of the Romans, the most magnificent and most beneficial were their highways, aqueducts and common shores.

The first of these excelled the other two in grandeur when you consider their extent, their strength and firmness, and the immense sum of money expended in the making of them.

As to the aqueducts, how great and wonderful soever they were, yet were they confined within the boundaries of Rome and several surrounding cities, and the common shores within Rome only, whereas the highways reached from Rome through Spain and France, to the River Euphrates and even to the most southern part of Egypt.

The center of all these roads was a stone placed in the center of the city of Rome and called Milliarium Aureum, from whence the roads divided and passed through all parts of the great Roman Empire.

Isadorus, an ancient historian, says the Carthaginians were the first to pave the roads and that the Romans afterwards improved them for the convenience of traveling, rapid transportation of their armies, and partly to keep the people out of idleness.

The stones used in the construction of these roads were of an iron color and of a hardness that exceeds

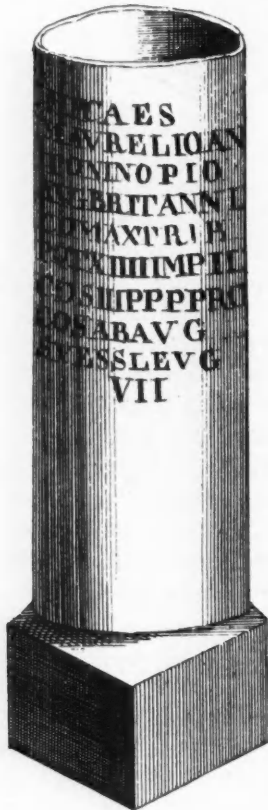

Roman Mile Post

marble. They were from one to two feet in length, hexagonal in shape and were so nicely joined together that in many places one could not force the blade of a knife between. Every mile was marked off

near Soissons, an English translation of the inscription being as follows: "Under the Emperor Cæsar Marcus Aurelius Antonius, the Pious, the August, the Britannick, the Greatest, in his fourteenth Tribun-



Reproduction of Steel Engraving from Father Montfaucon's "Antiquity Explained," printed in London in 1722.

by a post or pillar which stated how many miles one was from Rome or other important neighboring town, and also the name of the reigning emperor.

The illustration here given is of a mile post found

ate, with the title of Imperator the second time, Consul the third time, the Father of his country, Proconsul. The seventh league from Soissons."

While we must admire the grandeur and massive-

ness of the Roman structures we cannot say that they were beautiful. It was to the introduction of the arch that their triumphal edifices were indebted for their principal beauties; and without it their theaters and amphitheaters would have lost half their elegance.

While affording security, convenience and pleasure to the inhabitants, yet their architecture lacked the essential of beauty. With all the expense, with all the

fine marbles that were employed, with the bronze and gold lavished on the construction and decoration of the edifices erected, yet the richness of material did not compensate for the want of elegance in form.

The style of architecture found in Rome is exactly what one would expect in a country where brute force was at a premium and whatever beauty is found was brought there by some conquered nation.

Special Business Announcements

INTERESTING DESCRIPTIONS OF NEW AND IMPORTANT MACHINES AND MATERIALS THAT ENTER INTO HOUSE CONSTRUCTION IN ITS MANY PHASES AND DETAILS

Selling Heaters by Mail

Four years ago, the Hess Warming and Ventilating Company instituted, as an experiment, the selling of furnaces by mail. They prepared a new furnace expressly for this work, embodying all useful features now found in furnaces, but on



delivering the goods anywhere without additional charge, and to cap all, undertook to guarantee the successful operation of their apparatus, when so supplied.

This project was launched with some misgivings, some doubts, as to its success. After four years those doubts have disappeared. Successful beyond all anticipations, hundreds of pleased customers, all over the United States, are ordering and duplicating their orders, for the prices charged carry but one small profit, the middleman and his profit being eliminated. The company has now produced a new booklet, advertised elsewhere in this issue, which is in itself a valuable handbook of instruction in the heating of houses, and which should be in the hands of every builder.

It is prepared in the best manner, on enameled paper, profusely illustrated with copper half-tones. The subject of heating and ventilating is treated in a simple, intelligible manner, which enables anyone to fully comprehend the principles of heating. The concluding pages are devoted to a description of the "Leader Steel Furnace," the latest product of thirty years' experience in the making of heaters. Our readers are invited to apply for a copy (free) and we certainly advise a compliance with this invitation.

Bracket Hook for Scaffolds.

The Scaffold Bracket Hook Co., of 123 N. Winnebago street, Rockford, Ill., is putting out a practical scaffold hook that is guaranteed perfectly safe and strong. This hook has many advantages over other makes, chief among them being that you can commence lathing before siding is on, they are easy to put up, can be taken down without a ladder, and require very little storage space. Their cost is nominal, only

a plan so simple as to render the erecting of the furnaces an easy matter. They inaugurated a scheme for planning and supplying equipments of pipes and registers to accompany their furnaces, so that everything necessary to the heating outfit could be shipped in one lot, all fitted and ready to put up; they prepared plans showing all details of the work, for the guidance of purchasers in erecting the apparatus. They absorbed all freight charges,

\$3.00 per dozen, yet from \$10 to \$100 can be saved in a season through their use. A neat circular, giving full description and directions, will be sent upon application.

Foot and Hand Power Circular Saw.

We show in the accompanying cut the No. 5 "Union" combination self-feed rip and cross-cut saw, which is designed to meet the requirements of carpenters, builders, cabinet makers, and other wood workers, who do not have power. With this machine one man can rip soft wood up to 3½ inches thick, and hard wood up to 2 inches, doing as much work as could be gotten out by four men with hand saws in the same time. It is also useful for cross-cutting, mitering, etc., and, with extra attachments, may be employed for boring, scroll-sawing, edge-molding, beading, grooving, etc.

The iron frame, which is strong and rigid, has cold rolled steel shafts, with scraped babbitt metal lined boxes adjustable to take up wear. The table top is of wood and iron, 28 inches wide by 36 inches long, the center part (8½ x 36 in.) being of iron planed true. The table is hinged at the back and

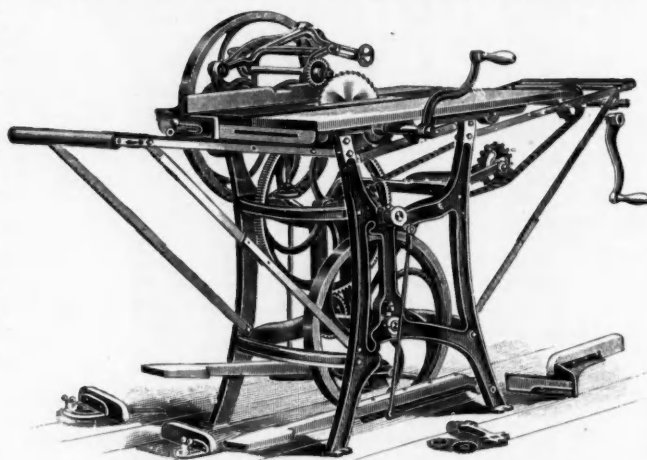

No. 5 "Union" Combination Self-Feed Rip and Cross Cut Saw

can be adjusted up or down by means of hand screw for rabbitting, grooving, dadoing, etc. The self-feed ripping device—which has three changes of speed—is self-adjusting for all thicknesses of wood, and is positive in its action, the power being transmitted by gears. It is easily detached when the table is required for cross-cutting, etc. By means of the extension rolls, the length of the table may be increased to 7 feet long, for ripping long stuff, but when not required, may be immediately folded down out of the way.

The machine has two hand powers, in employing either of which the operator is able to maintain a natural, upright, and therefore easy position. That at the rear (for one or two cranks) leaves the table entirely free for cross-cutting, etc. The foot power is, the manufacturers claim, as perfect as it

can be, power being transmitted entirely by automatic machine-cut chain gears and chain belts, doing away with any slipping or lost motion.

The fullest particulars as to price, etc., of this and many other foot and hand power wood working machines may be obtained by addressing the Seneca Falls Mfg. Co., 218 Water street, Seneca Falls, N. Y., U. S. A.

Morrill's Sawset

Morrill's sawsets are so well and favorably known among carpenters and have been the standard for so many years that it would seem as if the limit of improvement would have been reached years ago. But the seeming impossible has again been realized and Morrill's latest sawset, the "Special," has scored a greater success and been given a warmer welcome than any of its predecessors.

This sawset follows along the lines of the No. 95 Sawset with the advantages of the No. 1 Sawset, and has a great many features distinctly its own. The same anvil as in the No. 95 Sawset is used, but instead of placing it at right angles to

MORRILL'S NO. 95 SAWSET.



the axis of the plunger it is placed at an angle. This enables the point of the plunger to be made at less of an angle, thereby greatly lessening the chances of its breaking. The inclination of the anvil also enables the operator to see the angle at which his saw enters, so he can thereby better judge the set given the saw. The lever handle has been placed on the bottom of the sawset instead of at the top. This enables the sawset to be operated without wiggling the set, and lessens the likelihood of the tooth being broken. The placing of the handle on the bottom also enables the sawset to be made dirt and dust-proof. A lock-nut has been placed on the gauge-screw. This locks the screw firmly in place and is a great improvement over the former models.

The "Special" Sawset requires no expert to use it, but on the contrary can be used by any apprentice. All that is necessary is to know the number of teeth to the inch of the saw (this can be read off the saw-blade where it is stamped, near the handle), turn the gauge-screw up until the saw just passes through easily, lock the gauge-screw by means of the lock-nut; then setting the alternate teeth one way and the remaining teeth the opposite way, a perfect running saw is produced, one that will run true and easy, and will not require frequent sharpening.

Mr. Morrill invites any one who is interested in sawsets or sawsetting to send for a copy of his catalogue, which tells the whole story. Address, Chas. Morrill, 283 Broadway, New York.

Buying by Mail

It was only a few years ago that the contractor located in the small town was limited in buying his trim—mantels, hardware, etc.—to that carried by the dealers in or near the towns in which he was working. To-day all that is changed, and the entry of a reputable hardware house into the field has gradually but surely shown contractors the advisability of buying by mail, showing them the advantage it gives them in prices, in goods, and in the way the goods come to them.

We do not intend to convey the impression that any hardware house, solely because they happen to be located in a large city, can give better values than his smaller competitor in the smaller city, but when the hardware house in the large

city has the good reputation and the long experience that the Orr & Lockett Hardware Co., of Chicago, has, and makes the low prices they do, the contractor finds a great advantage in buying direct from the large center.

A catalogue is of course a great help in selecting hardware, especially when the cuts are photographs of the goods, as is the case in Orr & Lockett's catalogue. This enables a contractor to pick out exactly the article he wants and to know that the goods will be exactly as the catalogue shows them to be. Few catalogues are made this way, but Orr & Lockett have spared no expense to have theirs fitly represent them.

Orr & Lockett's advertisement on another page of this issue will give an idea of the prices they make to contractors.

The AMERICAN CARPENTER AND BUILDER requests that contractors who use builders' hardware mention this paper when they order the catalogue, so that Orr & Lockett may know where the request came from.

Framing Square and Mitre Box

The Nicholls Framing Square is the only square on the market on which there is a complete framing rule. It saves time, labor and brain work. Every young carpenter should use it, as it will save him years of study; the old carpenter should use it because it saves time and avoids mistakes. The Nicholls Common Sense Mitre Box has become a universal favorite among practical carpenters and builders, who report nothing but the most satisfactory results. Catalogue A, giving full description of these tools, will be sent upon application to the Nicholls Manufacturing Co., Ottumwa, Iowa.

A Good Concrete Block Machine

The accompanying illustration shows the Farmers' National Bank of Mangum, Oklahoma, a building made from concrete blocks moulded in the Normandin Concrete Block Machine, manufactured by the Cement Machinery Co., Jackson, Mich. The other picture is that of some of the concrete



blocks, showing the different forms of moulds. The subject of concrete construction is attracting greater attention as methods of cheaper building material become necessary. A large number of buildings throughout the country are now



being constructed entirely of concrete, and as an important feature of the work is the machine in which the bricks (or

blocks) are made, the necessity of having a first-class machine is manifest. The Cement Machinery Co. had an interesting display at the Louisiana Purchase Exposition at St. Louis in 1904, receiving the gold medal on the Normandin. This machine is taking a large part in concrete construction being done by the United States government, which highly recommends it. Your attention is called to the advertisement on the back cover of this issue in which an illustration of the machine appears. The manufacturers have published a handsome catalogue, giving in detail every feature of concrete construction, from the time of mixing to the laying of the stone, which they will be pleased to forward to your address upon application. Address, Cement Machinery Co., Jackson, Michigan.

The Parker Portable Derrick

The accompanying cut illustrates the Parker Portable Derrick, manufactured by the National Hoist & Machine Co., 460 W. 22d St., Chicago, as used by W. H. Phillips & Co., of Columbus, Ohio, for handling hollow concrete blocks, made



on the Normandin machine. Several of these derricks are used by this company, in their yards and on buildings.

These derricks are also used extensively to handle building material of all kinds, as well as concrete blocks. They are so constructed that by taking out one bolt the mast and boom are released, and the machine taken off the post, enabling two men to take it and set it any place, with ease. These derricks are patented.

Catalogue with full descriptions sent on request. The catalogue also contains cuts and descriptions of derricks of all kinds, also material elevators, hoists, and a general line of contractors' and builders' equipments. See advertisement in another column.

JOHNSON'S SCAFFOLD BRACKET HOOK

THE SIMPLEST, STRONGEST AND CHEAPEST DEVICE MADE FOR HOLDING UP SCAFFOLDING. Hook is ten inches long, made of best malleable iron, and saves its cost many times over in one season's work.



Easy to put on Bracket.

Easy to put Bracket on Building.

No wiggling or falling scaffolds where this hook is used.

Write for Circulars. Sold to builders with or without the folding brackets.

BRACKET HOOK CO., 123 N. Winnebago Street, Rockford, Ill.

Lumber Made More Durable

A method for making lumber more durable, consisting in brief of replacing the air in wood with a solution of beet sugar and removing the excess of water by a subsequent drying, has been perfected in England. It is claimed that the timber treated in this way is no longer porous, will not shrink or warp, and is stronger, heavier and more durable.

A Remedy for Dry Rot

A good remedy for dry rot is petroleum. The affected parts of the wood are painted with it, which causes the fungi to die, turn black and finally drop off. The best preventive of dry rot is plenty of draught. Another remedy is ordinary salt; it absorbs the moisture of the wood, whereby it is itself dissolved, thus gradually infusing the entire plank.

SLATE! SLATE!! SLATE!!!

Black Boards for Schools Roofing Slate for Houses

Are you going to build a home? I trust you are, and that you will put on it for a Roof (one of the most important things about a house) SLATE, which is always CLEAN, FIREPROOF and BEAUTIFUL. Write for prices, and I will tell you all about SLATE.

DAVID McKENNA, SLATINGTON, PA.

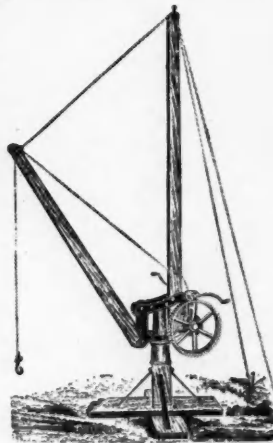

DERRICKS

of all descriptions, for all purposes, from . . \$35 up

Special derricks for handling

Cement Hollow Blocks

The finest derrick for this purpose made.

MATERIAL ELEVATORS

Chains, Sheaves, Tackle Blocks and Rope

Write for catalog and prices.

NATIONAL HOIST & MACHINE CO.

460 W. 22d St., CHICAGO, ILL.

GENUINE BANGOR UNFADING BLACK ROOFING SLATE, BLACKBOARDS

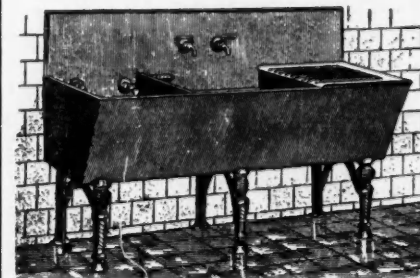

STRUC-TURAL SLATE

Mined and manufactured from the real Bangorquarry

The Bangor Slate Co. ALL ORDERS LOCK BOX 94 BANGOR, PA. PROMPTLY FILLED

We Wish to Get into Correspondence With Every Person Who Reads this Ad.

We Manufacture the INTROSTILE The only perfect door bottom appliance known to the building trade. It completely does away with thresholds, closes aperture underneath doors, and does not alter the appearance of the door a particle. You should know about it. Write for Catalogue A. **THE INTROSTILE & NOVELTY CO., Marietta, Ohio**

Strength of the Skyscraper

The tall buildings, or skyscrapers, as they are called, to be found in such cities as New York and Chicago, always interest visitors, and lead to much discussion as to their strength and durability. Such inquiry is inevitable, because office buildings of over twenty stories, shooting, as it were, up in the air from a foundation small in area, look fragile and destructible.

The inventive genius of man, however, has made these skyscrapers so strong and durable that it is now asserted by engineers and scientists that the natural life of modern steel structures is 5,000 years unless they are attacked by some unknown foe.

In the construction of these tall buildings it appears that there must be first of all foundations so formed as to prevent the possibility of moisture ever reaching the steel and iron trusses which form the base of the metal frame. There must be no possibility of settlement of the structure. The steel is protected from corrosion by moisture or acids by the use of concrete, cement and paint. Care is also taken that there shall be no leakage from electric wires. Besides this, every piece of steel is designed to support six times the stress that may be placed upon it.

"Can a tornado blow one of these tall buildings down?" is a question that experts generally answer in the negative. The structures are so strong that the editor of the Iron Age is quoted as expressing the opinion that, as they are deeply imbedded in the earth like an oak, if one of them tumbled it would go down lengthwise, not breaking, but falling as a tree would if uprooted by the wind. Engineers do not fear that the highest winds would affect them, but of course they are not so sanguine as regards the actions of a mild earthquake.

Salt Water Preserves Logs

We all know, or have heard, that water seasoning before drying lumber improves it, but it may be a new one to some to learn that salt water is regarded as specially good for logs or lumber. The mills on the seacoast say that it takes the place of decomposing matter in the wood, and acts as a sort of preservative after the moisture has been dried out, making ordinary lumber much more durable than it would be if just dried without a soaking in sea water.—*Wood-Worker.*

Inclined Planes for Hospital

A novel improvement to be made in the erection of the new Hahnemann Hospital, in San Francisco, Cal., is to have inclined planes throughout in place of stairways. This will be a great aid in removing patients. Other special features will be chute fire escapes, children's ward in the dome and deadened floors.

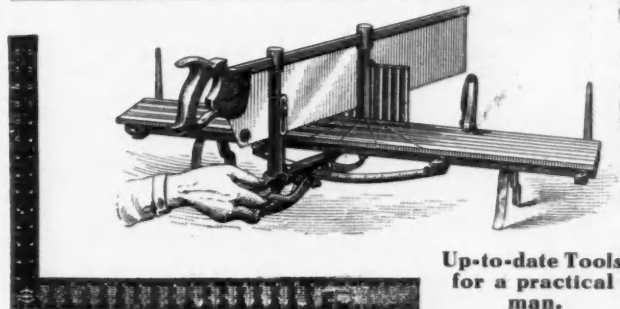

Up-to-date Tools for a practical man.

NICHOLLS' FRAMING SQUARE AND COMMON SENSE MITER BOX

NICHOLLS MFG. CO., Ottumwa, Iowa

FOR SALE

**GASOLINE ENGINE
GREAT BARGAIN**

**J. M. BACHERT
12 S. Water St. Room 3 CLEVELAND, O.**

ROOFING, GENUINE BANGOR BLACKBOARDS & STRUCTURAL SLATE

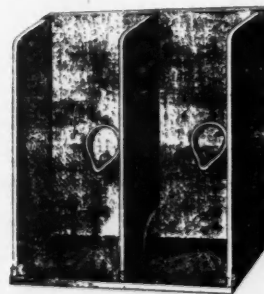

ALL ORDERS FILLED PROMPTLY

Order direct from the miners and manufacturers

HEADQUARTERS FOR SLATE BURIAL VAULTS, CATACOMBS, ETC.

**THE BANGOR STRUCTURAL SLATE CO.
LOCK BOX 48 BANGOR, PA.**



SAMPSON SPOT CORD

is warranted free from flaws. The colored spot is our trade-mark, used only in this extra quality cord.



SAMPSON CORDAGE WORKS, Boston, Mass.

YOU DON'T HAVETOWASTE SPOT CORD BY CUTTING OUT ROUGH PLACES



60c

FOR
COMPLETE
INSIDE DOOR
SET
IN EITHER
DESIGN



including one lock, one pair knobs and two escutcheons.

13 Other Designs at same price and others as low as 30c a set—shown in our new

BUILDERS' HARDWARE CATALOG No. 37

which will be sent *free* to any contractor on receipt of request from him showing his *business*, as well as name and address. The Catalog is full of just such bargains as those shown above. *Get it Today.*

If you use Tools send 20c to pay express on our 450-page Tool Catalogue.

ORR & LOCKETT HARDWARE CO.
Established 1872
71-73 RANDOLPH ST., CHICAGO

ARE YOU Going to Build?

THE FOSTER-MUNGER CO.

**GET THIS
800 PAGE BOOK
FREE**

If You Intend Building or Making Alterations of Any Kind You Should Not Fail to Get this Great Book.

Send ten 2-cent stamps to pay postage and we will mail you at once our 800-page official 1904 book, with plans, photographs, plates and 8000 designs of everything entering into the construction of **any building**. It covers every department. Stairs, interior finish, mantels, grilles, wood carpet, sash, doors, blinds, art glass, columns, porch work, hardware, etc. etc. Send today for book No. 88.

THE FOSTER-MUNGER CO.,
20th and Sangamon Streets, CHICAGO.

"BALL-BEARING" GRAND RAPIDS All-Steel Sash Pulleys

Are sold DIRECT to Builders, Contractors and Mills at prices under the common ordinary goods

PATENT PENDING





If you make ten or ten thousand window frames, we can save you money and give you a superior sash pulley. We are the largest sash pulley makers in the world. We ship direct, or through dealers and jobbers everywhere. Write for catalog and free samples and prices on half-gross, gross, barrel, or any quantity. Direct from the makers to you. Inquiries welcome.

Grand Rapids Hardware Co.
33 Pearl Street Grand Rapids, Mich.

MARSTON'S

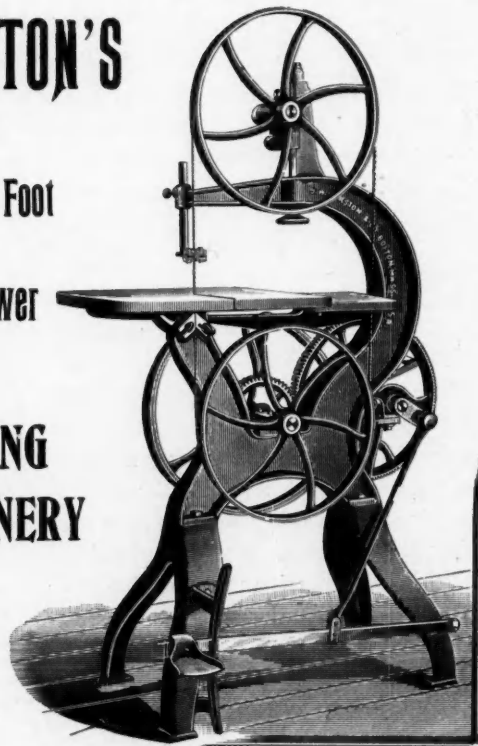
Patent
Hand and Foot
and
Steam Power
**WOOD
WORKING
MACHINERY**



20-inch Hand and Foot Power Band Saw.

J. M. MARSTON & CO.
205 Ruggles St., Boston, Mass., U. S. A.

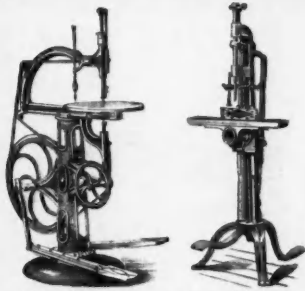

"Victor" Scroll Saw. "Diamond" Mortiser.

FOOT, HAND AND POWER

WOOD-WORKING MACHINERY

For Carpenters, Builders, Cabinet-Makers, and
Other Wood-Workers

BUILT FOR HARD WORK, ACCURATE WORK AND LONG SERVICE

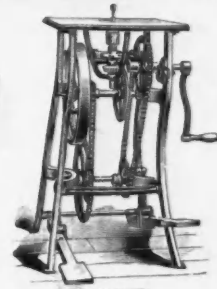

"Rex" Moulder.

ONE MAN with one of these machines will do the work of four to six men using hand tools; will do it easier, will do it better.

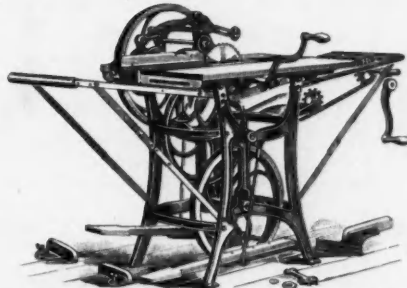

No. 5 "Union" Combination Self-Feed Rip and Cross-Cut Saw.

WE GUARANTEE each machine to be thoroughly practical and accurate. Machines sent on trial, and if not found entirely satisfactory, may be returned at our expense.



No. 8 "Union" Power Saw.

Enterprising mechanics are quick to see the superior merits of our machines. It will pay you to investigate these advantages.

SEND FOR CATALOG "A"

The Seneca Falls Manufacturing Co.

218 Water Street, Seneca Falls, N. Y., U. S. A.

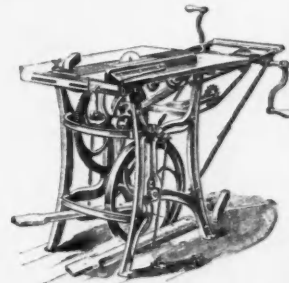

No. 6 "Union" Combination Saw. (96)

Remington Fame

RESTS UPON *Quality*

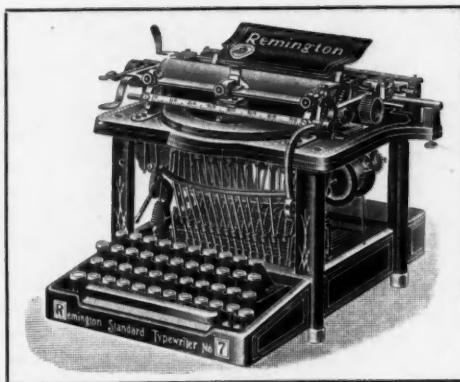

OUTSELLS ALL OTHERS

OUTWEARS ALL OTHERS

OUTLIVES ALL OTHERS

Remington Typewriter Co.

154 Wabash Avenue
CHICAGO

WHEN WRITING ADVERTISERS PLEASE MENTION THE AMERICAN CARPENTER AND BUILDER.

The Normandin Machine and its product received the Highest Awards for Superior Excellence at the Universal Exposition, 1904.

The Normandin Machine and its product are adopted and used by the U. S. Government Engineers—"they must be right."

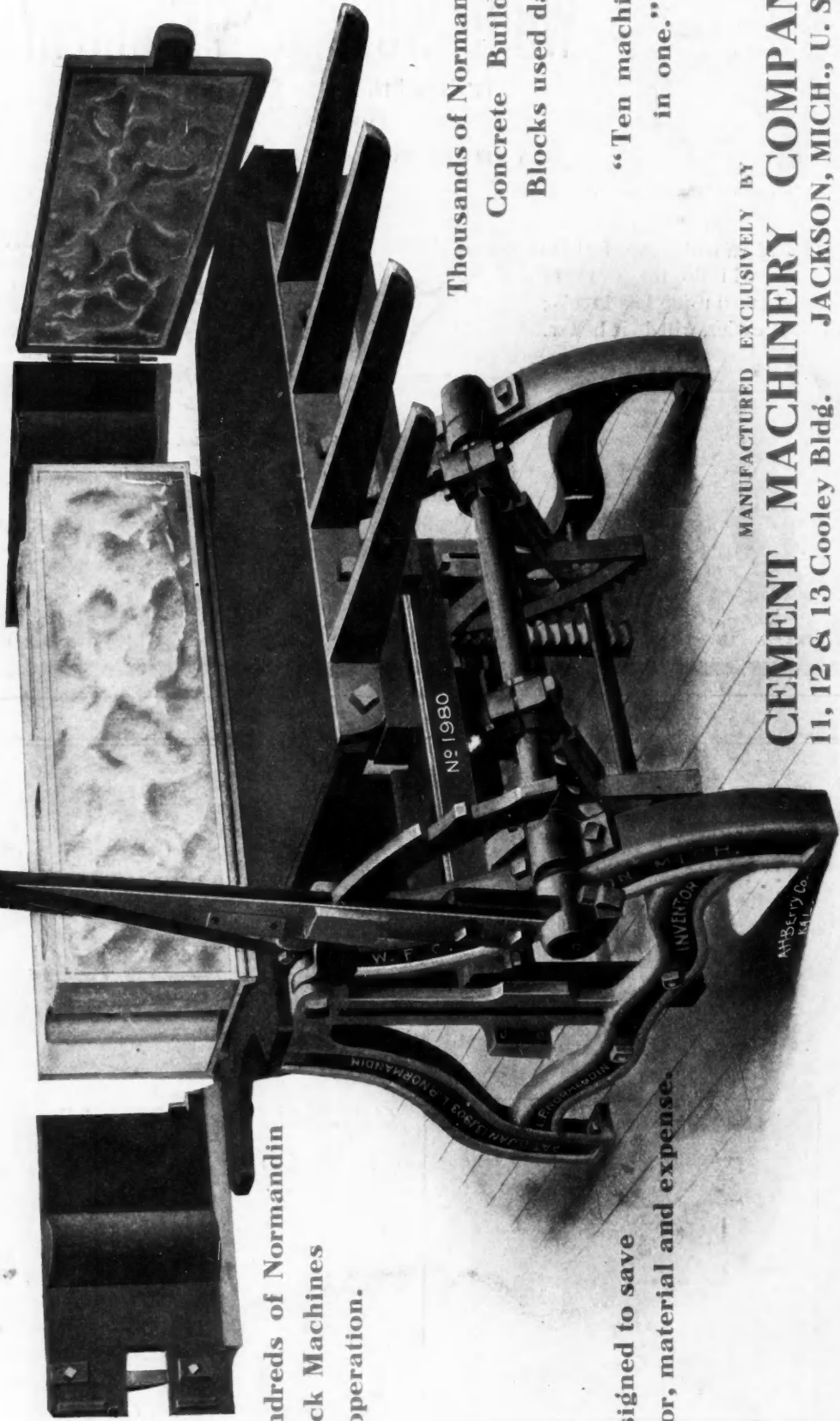

Hundreds of Normandin Block Machines in operation.

Thousands of Normandin Concrete Building Blocks used daily

Designed to save labor, material and expense.

"Ten machines in one."

MANUFACTURED EXCLUSIVELY BY

CEMENT MACHINERY COMPANY

11, 12 & 13 Cooley Bldg. JACKSON, MICH., U. S. A.

THE NORMANDIN CONCRETE BUILDING BLOCK MACHINE AND ITS PRODUCT