

Print Div.

UNION OF CARPENTERS
JUN 4
1905
PERIODICAL DIV.

AMERICAN CARPENTER AND BUILDER

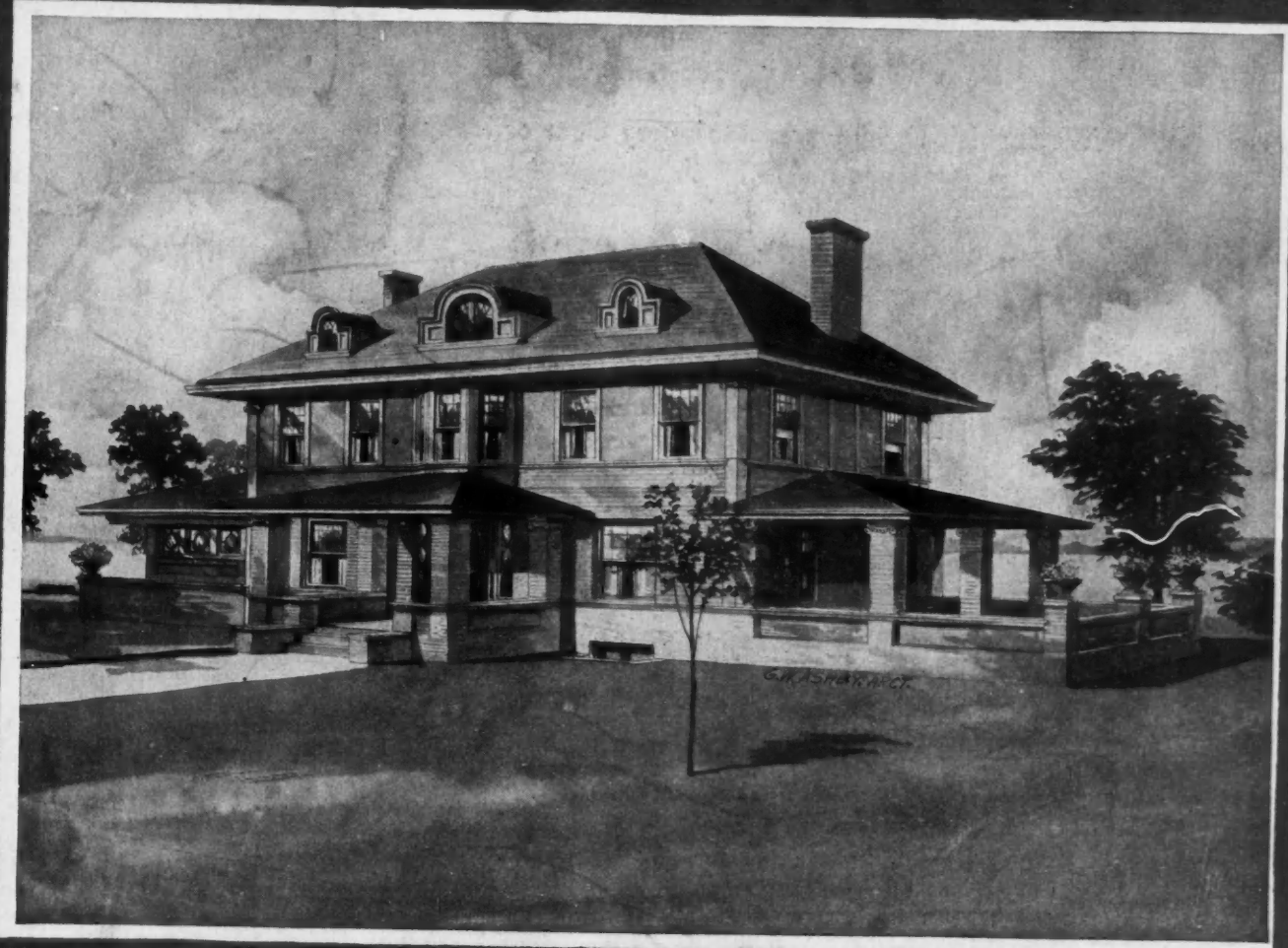

JUNE, 1905

Price 20 cents

WHEN WRITING ADVERTISEMENTS PLEASE MENTION THE AMERICAN CARPENTER AND BUILDER

Block Built with our \$35 Mold Outfit



Built by W. & H. McSween, Leamington, Ontario

We furnish Draw Core, Stationary Core or Drop Core as desired



OPEN—BLOCK REMOVED

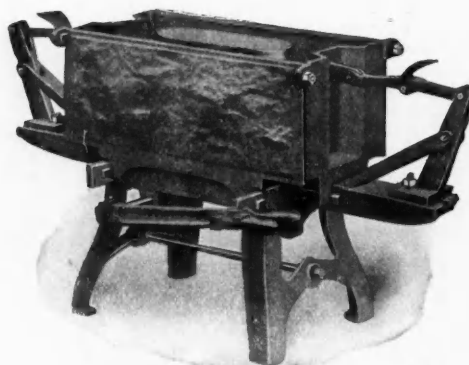

CLOSED FOR FILLING

Catalogues, Prices and Discounts on Application

We solicit your correspondence. Our line of Cement Machines
merits your investigation. Write

The Knickerbocker Company

Liberty Street, near Union Depot

JACKSON, MICHIGAN

No. 5 "Union" Combination

Self-feed Rip and Cross-Cut SAW

(Almost a complete workshop in one machine.)

THIS MACHINE is suitable for various kinds of work—ripping (up to 3 1/2" thick), cross-cutting, mitering, etc., and with additional attachments, rabbetting, grooving, dadoing, boring, scroll-sawing, edge-moulding, beading, etc.

The heaviest, most substantial, accurate and easiest running machine of its kind on the market.

ADVANTAGES: Large adjustable combination wood and iron table, 28x36"; folding extension rolls for long work; two hand powers, one for self-feed ripping and the other for cross cutting, etc., arranged at the rear of machine, leaving table free and allowing operator a natural, upright and easy position; our patent foot power with walking motion; three changes of speed; three changes of feed; no lost motion, power being transmitted entirely by chain-belt and accurate machine-cut gears; steel shafts and babbit metal lined boxes, adjustable for wear; easy and quick to change machine from one operation to another.

WE BUILD a complete line of Foot, Hand and Power Wood-working Machinery, and guarantee each machine and attachment to be thoroughly practical and accurate, and if they fail to give you entire satisfaction, may be returned at our expense.

Machines sent on trial. Send for Catalog "A."

The Seneca Falls Mfg. Co.

218 Water St., Seneca Falls, N. Y., U. S. A.

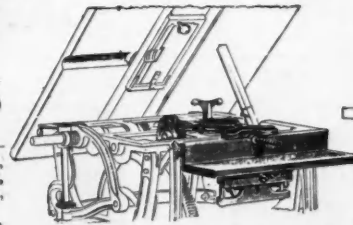

"Union" Boring Attachment.

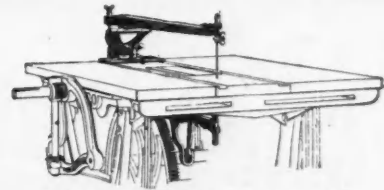

"Union" Scroll Saw Attachment.

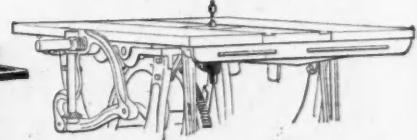

"Union" Moulding Attachment.

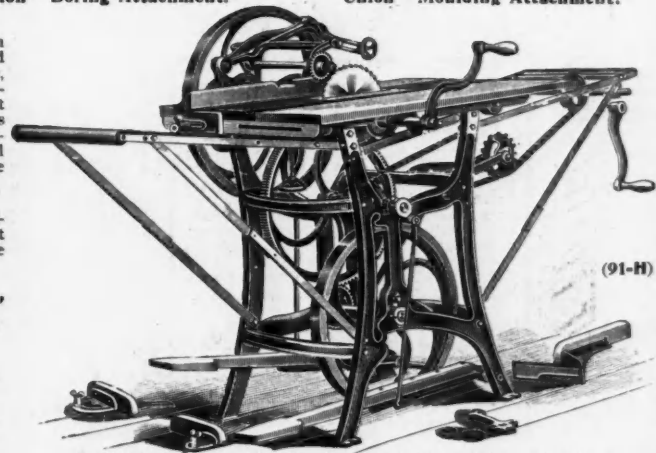

(91-H)

No. 5 "Union" Combination Self-Feed Rip and Cross-Cut Saw.

"Yankee Tools"

The newest, cleverest and most satisfactory in use, and the first to be offered at so reasonable a price that every up-to-date mechanic could buy tools of their quality and character.

Other tools are very good tools, but "Yankee" tools are better.

"Yankee" tools are sold by all leading dealers in tools and hardware everywhere. Ask your dealer to see them.

Our "Yankee" Tool Book tells all about these and some others, and is mailed free on application to—

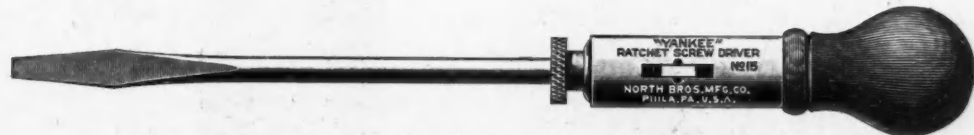

No. 15. "Yankee" Ratchet Screw Driver, with Finger Turn on Blade.



No. 30. "Yankee" Spiral-Ratchet Screw Driver, Right and Left Hand.



No. 44. "Yankee" Automatic Drill, Eight Drill Points in Handle, and Adjustable Tension to Spring.



No. 50. "Yankee" Reciprocating Drill for Iron, Steel, Brass, Wood, etc.

North Bros. Mfg. Co.
PHILADELPHIA, PA.

ARE YOU
Going to Build?



New Universal Square

Made in three sizes

No.	Inches	Price
1	6	\$0.65
2	10	1.00
3	13	1.50

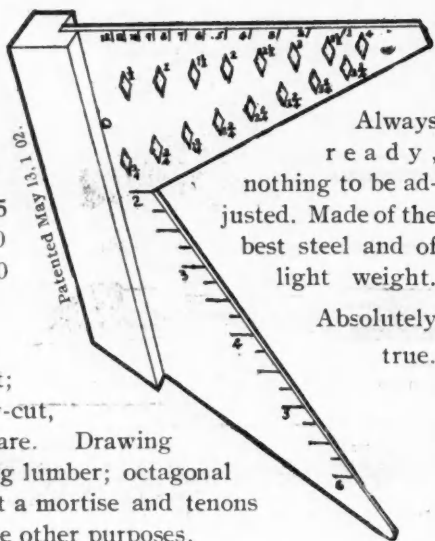

Always ready, nothing to be adjusted. Made of the best steel and of light weight.

Absolutely true.

Combination Tri; Pitch-cut; Hip and Valley-cut, and Mitre Square. Drawing circles; gauging lumber; octagonal cuts; laying out a mortise and tenons and innumerable other purposes.

For sale at all first class tool dealers.

The Duby & Shinn Mfg. Company, (Inc.)

19 PARK PLACE,

Nelson Building

NEW YORK CITY

THE FACE PLATES

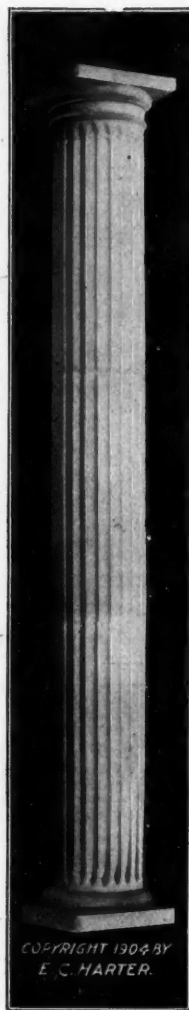

of our \$25.00 concrete Stone Outfit are all interchangeable. The stone made by it are just as artistic of design and as practical for building buildings as those made on the more expensive machines. We ship to responsible parties on ten days' trial. 411 machines shipped on trial during 1904; only three were returned. If we were selling gold dollars for 90 cents each we could scarcely hope to beat this record. Don't

argue—we pay the freight when not satisfactory. Send for our book of instructions for making concrete stone.



CEMENT WORKING MACHINERY CO.

195 LA FAYETTE AVE., DETROIT, MICH.

**We Guarantee
the Reliability of
Our Advertisers**

None but reliable advertisers will be admitted to the columns of THE AMERICAN CARPENTER AND BUILDER.

We will not knowingly accept advertising from firms which will not give full value to our subscribers.

Great care is exercised in investigating the standing of all firms whose announcements are admitted to our pages, and no questionable advertising will be accepted.

If you fail to get from an advertiser what you were led to believe you would get by his advertisement, write us about it and we will see that he does as he agreed to do.

If we find that our confidence in an advertiser has been misplaced, we will do all in our power to rectify matters.

American Carpenter and Builder

E
S
T
A
B.

1
8
7
2



Greatest Value Ever Offered in Hardware!

60c.

For a Complete Inside Door Set in Either Design and in 13 Others

The set includes 1 lock, 1 pair knobs, and 2 escutcheons, all for 60c—and the special contractors' discount (which applies to all goods shown in our **BUILDERS' HARDWARE CATALOG No. 37**) makes this ridiculously low price still lower.

This price is not a special bargain—we sell this set the year round at this price—but is a **specimen price**. The catalog is full of just such good things as this. **No up-to-date contractor can afford to be without it. Get it today. And REMEMBER THIS:**—When any other hardware man offers you goods that may even look a little like the cuts of our goods, at a lower price you are not getting the same goods. There are many goods—made in imitation of reliable goods—that are too unreliable for us to handle. You cannot afford to use shoddy goods.

E
S
T
A
B.

1
8
7
2



BATH ROOM FITTINGS

Finest line in the country. Designs exclusively ours. Get catalog 370. Set shown in cut \$25.00 complete. Others \$20.00 - \$15.00. Single articles in any quantity.

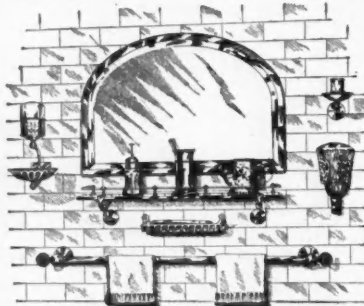

Butt Chisel—1 1/4 in.—leather tipped—delivered anywhere for 60c.

If you use Tools send 20c to pay expressage on our 425 page Tool Catalog No. 037. Nothing like it ever before compiled.

ORR & LOCKETT HARDWARE CO.
71-73 RANDOLPH STREET, CHICAGO

ESTABLISHED 1872

STEEL CEILINGS AND SIDE WALLS

We have added complete designs in steel ceilings and sidewalls to our already large line of Sheet Metal Building Material, and our special ceiling catalog, when completed, will interest you.

Send us your inquiries accompanied by drawings of rooms and we will send you a carefully prepared drawing with illustrations showing just how the ceiling will look when finished.

Our designs and prices are attractive and we want an opportunity to quote you.

The Edwards Manufacturing Co.

"THE SHEET METAL FOLKS"

121-129 Sycamore St.
CINCINNATI, OHIO.

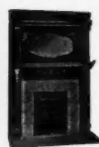

HARD WOOD MANTELS From \$5 Up.

With tile and grate complete. We ship direct to you from our factory on approval. Will save you 1/2 of the dealer's price for the same goods. Or it will enable you to secure from us a coal and wood burning grate guaranteed to heat good sized room in *Zero Weather*.

FREE—Write us to-day for free descriptive catalogue J. We pay the freight to your city, and allow special discounts to the building trade.

Address Dept. J.

HEITLAND GRATE AND MANTEL CO.

Factory, Front and Main Sts. Office, 817 Main St.
QUINCY, ILL.

Do You Own A Good Bench Stop?

MORRILL'S NO 1 BENCH STOP.

People who use them tell us there is

None Better Made Than Our Nos. 1 and 2



The only fault we have to find with them is they last too long. That's the carpenter's gain.

CHAS. MORRILL
283 Broadway New York

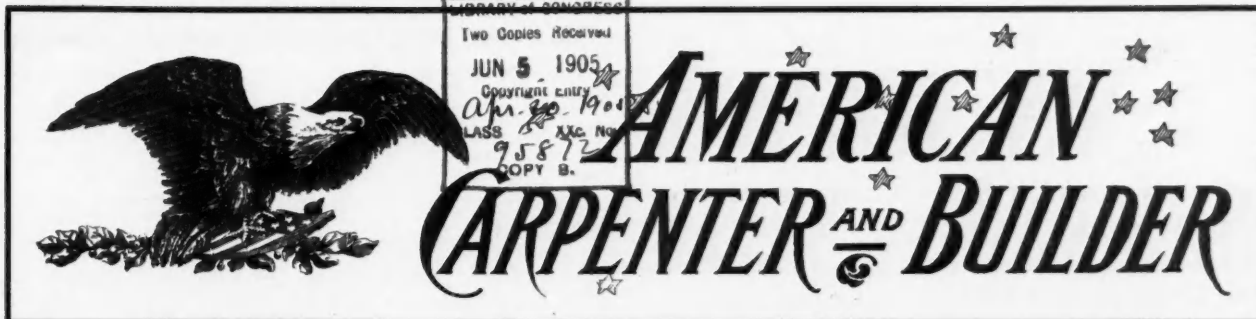

The Largest, Best and Most Practical Trade Journal in the World for the Carpenter and Builder

American Carpenter and Builder

(Application made for entry at the Chicago Postoffice as second-class matter.)

WILLIAM A. RADFORD, EDITOR.

Editorial Staff—FRANK E. KIDDER, FRED W. HAGLOCH, G. W. ASHEY,
 ALFRED W. WOODS, WILLIAM H. SCHROEDER, J. A. F. CARDIFF,
 I. P. HICKS, OWEN B. MAGINNIS, JULIUS KARPEN, IRA S.
 GRIFFITH, HENRY H. NIEMANN, DWIGHT L.
 STODDARD, WILLIAM REUTHER, LEWIS R.
 STEINBERG, W. R. MARSHALL,
 J. CROW TAYLOR.

Published monthly by

American Carpenter and Builder Company

196 FIFTH AVENUE, CHICAGO.

O. F. BYXBEE, General Manager.

NEW YORK OFFICE, 253 BROADWAY
 EGBERT DAYTON, Manager.

VOL. I. JUNE, 1905. No. 3.

The AMERICAN CARPENTER AND BUILDER is issued promptly on the first of each month. It aims to furnish the latest, and the most practical and authoritative information on all matters relating to the carpentry and building trades. Short, practical letters and articles on subjects pertaining to the carpentry and building trades are requested, and prompt remittance made for all acceptable matter.

SUBSCRIPTION RATES.

One year, \$2.00; six months, \$1.00; payable always in advance.
 Single copies, 20 cents.

SUBSCRIPTIONS may be sent by check, express or money order, or registered letter. Make all remittances payable to the American Carpenter and Builder Company. Postage stamps are not desirable, but if necessary to remit them, two-cent stamps are preferred.

FEW men care to push a good thing along. They grab for it and try to nail it down.

THE tendency of the American citizen to-day is for greater luxury. This is reflected by the fact that residences and all personal surroundings are designed more elaborately, for greater show, comfort and convenience.

WHEN making specifications for any contract or bid it is money saved to make them clear, even though it is necessary to go minutely into details. It makes no difference whether you are the contractor or

the engineer, it is to the interest of both that the specifications be such that there can be no room for misunderstanding.

SOME men incapable of creative art attempt to break down, in their ignorance, structures that they lack sufficient brains to conceive.

THERE was a time when the best talker could get the best job, but the talk act is no longer of any value, it is the work that does the talking these days.

TO CHEAPEN anything one does is to cheapen one's self. No man ever succeeded who continued to keep a cheap product on the market, masquerading it as a good one.

IF YOUR plans do not come up to your expectations, don't expect your customer to be pleased with them. He may not know a set of plans when he sees it, but he is all ears while you are explaining.

ANY man who does things differently from others, or who attempts to do anything new, is looked upon with a sort of amused contempt, unless he successfully markets some invention, whereupon he is pronounced lucky.

Inspection of Standpipes

THE recent fire in the Stock Exchange building, Chicago, should serve as a warning to other cities. The hose which was supposed to be connected with the standpipe was found to be simply fastened into the wall and had no connection with the standpipe whatever. Although the fire was readily extinguished a serious catastrophe might have resulted. The broken connections served one good purpose for they aroused the officials of the building department, who after a rigid inspection are said to have found many imperfect connections. It would be wise for authorities in other cities to look after this matter as it is a menace

to the lives of those who work in the so-called fire-proof buildings, and who rely upon the fire extinguishing apparatus which according to law should be ample protection in case of emergency.

Force Landlords to Admit Babies

THE aldermen of New York City have endorsed a resolution making it a misdemeanor to exclude families with children from flats and tenement houses. No more will the angry landlord banish the rising generation because "Johnny scratches up the walls," or "Mary is learning to play the piano," for the law has stepped in and declares Johnny needs exercise and Mary must practice. The landlord in the future will forget his antagonism toward children and undoubtedly become a family man himself and be a credit to the nation.

Color for Skyscrapers

THE high building is essentially American. It is a new proposition and requires more originality to solve than a problem where some historic example from the old world may be taken as a prototype. Would it not seem as if these requirements might best be met by the clever application of colors? If some one could use bright colored terra cotta, for example, omitting large projections, but with a handsome sky line, and make a beautiful building he would indeed deserve the thanks of the community. The Egyptian, Greek, Roman, Romanesque and Gothic architects all felt the want of color and used it, and, although color had perhaps better not be suggested by an architect until he is quite sure that he will be employed, it seems to be a subject for serious consideration.

Colored Woods for Furniture

THE colored-wood industry began in Italy in the seventeenth century, and wood-coloring works came to Sweden during the Thirty Years' War, but until quite recently the method was used on a very small scale, and at first only dry wood was colored. Now, by the method invented by the Austrian, Joseph Phister, in 1901, the wood is colored when fresh. The tree is cut while the sap is in action, and in the coloring process the dye is forced under heavy pressure into the wood and replaces the sap. Until recently the non-poisonous colors and "aniline" have been used, but those colors fade a little. Now the manufacturers can color to a length of 13 feet. Birch, beech, alder, maple, elm, and basswood are the best kinds of wood for the purpose; oak is not good on account of the tannic acid, and in spruce and pine the color cannot be made uniform.

The wood looks best when polished and when it is given a gay color. The prices are yet comparatively high on account of the amount of waste, but improve-

ments may follow; and with cheaper prices and more extensive use, it is considered that colored wood will give Sweden an important income. It can be used in furniture, panels and doors, also in outside work in order to avoid painting. It is especially good for fitting ships and tram cars, and also for elegant and modest furniture. During 1903 and 1904 many works for such wood have been built.

A Concrete Arch Bridge

THE largest reinforced concrete arch bridge is Gurenwald bridge over the Isar, near Munich, Bavaria, which was opened for traffic towards the close of last year. It has two main spans constituting three-hinged arches, and a number of small girder spans, all of reinforced concrete. The two main spans are each 230 feet, with a rise of 42 feet, and a width of 26.2 feet from center to center of hinges. The five girder spans are each 28 feet in the clear. The roadway is 30 feet wide. The total length of the bridge is about 720 feet. The structure is a highway bridge, and was designed for a live load of 82 pounds per square foot uniform, and a 22-ton steam road roller. The hinges of the main arches are of steel castings with a convex-concave rolling surface. The "open spandrel" style of construction has been adopted, to reduce the dead load as much as possible. The thickness of the arch ring (which at the crown is only 30 inches, at the springing lines 36 inches, and at the thickest portion—about the quarter points—but 48 inches deep) defines results which have barely been reached with stone.

Progress in Concrete Construction

THE entire country is awakening to the fact that concrete construction is no longer an experiment but has established itself as a permanent factor. Neither is it restricted to one locality or to one class of material, but is used for an increasing variety of purposes and over an increasing scope of territory. The greatest progress and the one of most value to the building world is along the line of concrete building blocks, and the praise is mostly due to the progressiveness and enterprise of the American engineers. Although they may have borrowed their original ideas from the European engineers, they have so improved on them that the original has been lost sight of and the new American ideas are the standard.

A commendable feature of the work is the exchange of ideas which is brought about by the literature on the subject, thereby establishing a greater uniformity in the work besides bringing out the very best methods. It is well for all interested in concrete work to read the literature on the subject and although there may be bushels of chaff, a few grains of wheat will always be found in its midst.

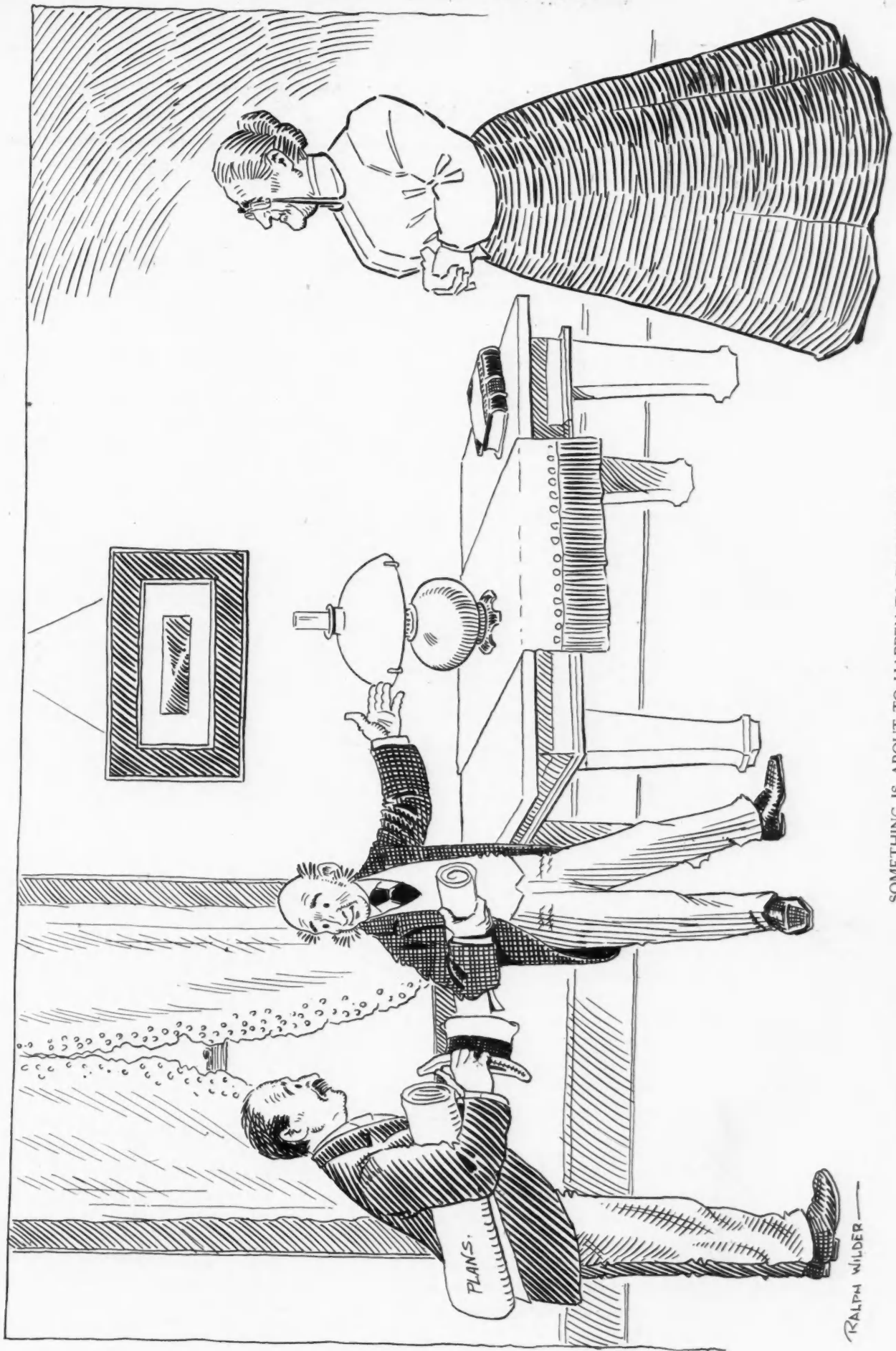

SOMETHING IS ABOUT TO HAPPEN TO THE PLANS
Mr. Henpeck, Aided by the Architect, has Finally Decided on the Plans for His House. They are About to Show the Result to Mrs. Henpeck.

RALPH WILDER

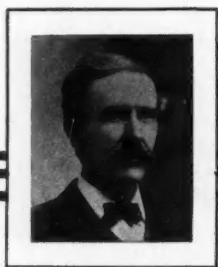

Steel Square

ALFRED W. WOODS

The Steel Square and Its Possibilities

III. SHOWING THE ANGLES IN CONNECTION WITH THE PENTAGON, AND HOW TO CONSTRUCT ORNAMENTAL DIAGRAMMS BY THE USE OF THE STEEL SQUARE

IF WE place the steel square on a board with the figures that give the miter for the pentagon, as shown in Fig. 9, and cut out that part covered by the blade and tongue, the two end pieces would form a miter with a right angled corner as shown in Fig.

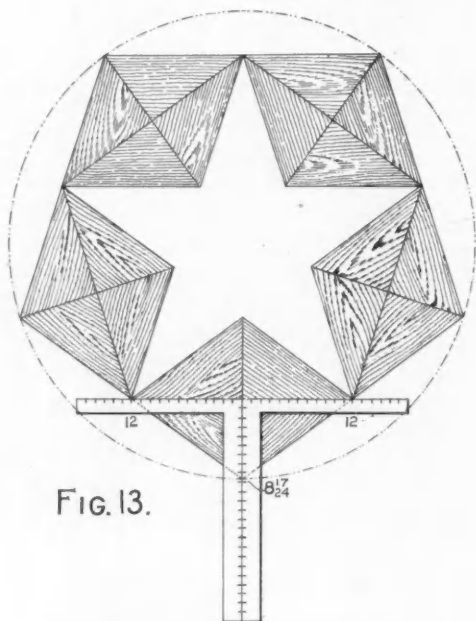

FIG. 13.

10. If four blocks the shape of that cut from the board be placed together, as shown in Fig. 11, they will form a perfect square frame. This would occur regardless of any miter used on the square as far as this figure is concerned, but if the figures on the square for any of the polygonal miters are used for cutting these triangular blocks, they will form when placed together, the figure that represents their miter as shown in Fig. 12. If they are laid with their short and long cuts matching each other, and with points touching, as shown in Fig. 13, they will still tell the part, though cast aside, that they helped to make. They may be arranged differently but the telltale remains of the part they once occupied.

A very ornamental diagram of the pentagon may be formed with the steel square alone, as shown in Fig. 14, by laying a square on a level surface and marking around the same, letting 12 on the tongue remain at

the center and 8 17-24 be the intersecting point on the blades. After ten movements of the square has been completed, it will be seen that portion of the blade below 8 17-24 helps to form the sides of a true pentagon and the intersecting lines from the blades forms the five pointed star. The dotted lines are thrown in to show the accuracy of the work. A very pretty diagram can also be made by reversing the figures on the steel square; in other words, let 12 on the blade be the center and 8 17-24 by the intersecting figures on the tongue, as shown in Fig. 15. However, there are much simpler ways of laying out the star with the aid of the steel square than shown in the above illustrations, some of which we will take up in our next article.

For the above illustrations we have taken the pentagon, but the rule is just as applicable to any of the other polygons and in fact some of the others with more corners would make more attractive illustrations, but for the present we thought best to use one with

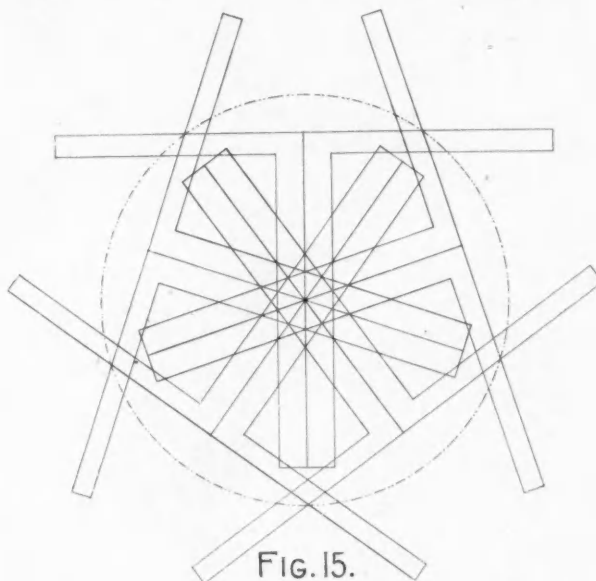

FIG. 15.

few corners and later on we will take up other polygons with more sides. From these illustrations it will be seen that the whole make up of these designs are formed by triangles and their dimensions, base, altitude and hypotenuse are the proportions taken on

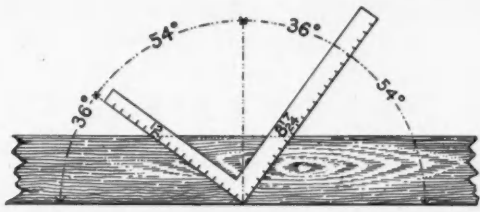

FIG. 9.

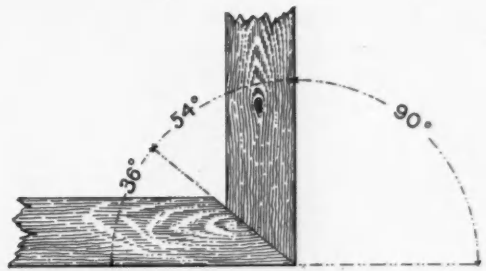

FIG. 10.

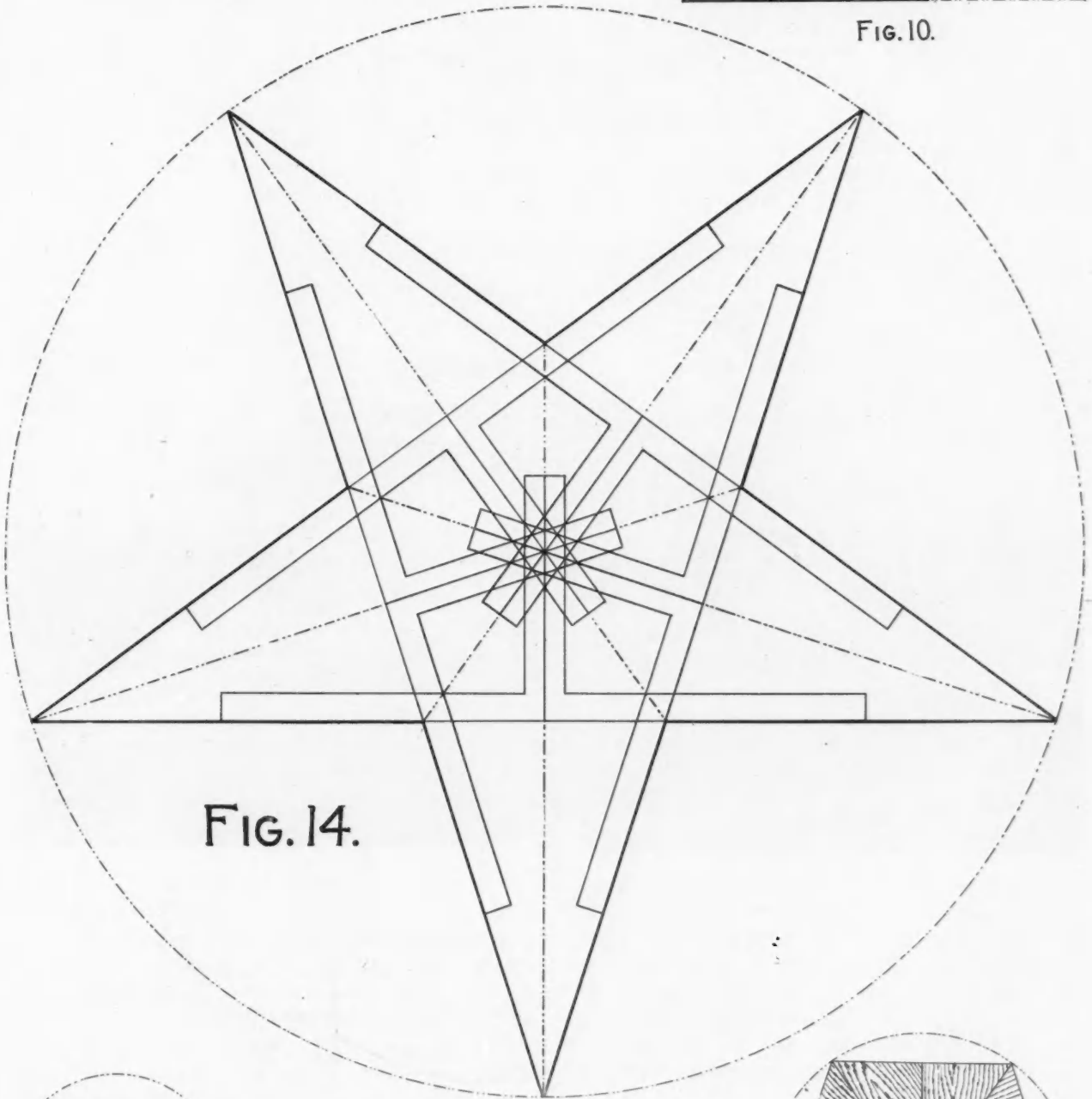

FIG. 14.

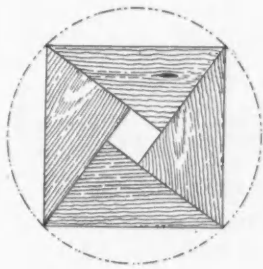

FIG. 11.

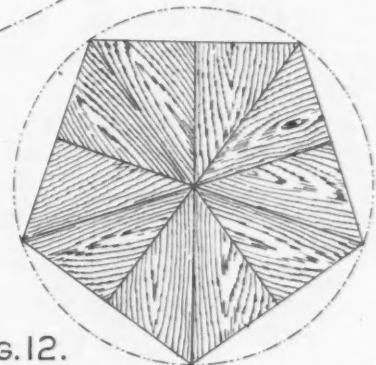

FIG. 12.

the steel square to obtain all of the angles, cuts and bevels required in framing roofs, hopper work, etc., all of which we will take up in due time and fully illustrate.

The reader will notice that in all of these illustra-

tions in connection with the pentagon we have used but one set of figures on the square. Of course other figures can be used but they must be to the proportions given in these illustrations and as described in Fig. 4 of our last article.

Attractive Club House

A LARGE, ARTISTIC STRUCTURE, HAVING ALL THE REQUISITES OF A MODERN, UP-TO-DATE CLUB-HOUSE —
LARGE AUDITORIUM CAN BE DEVOTED TO VARIOUS PURPOSES

By G. W. Ashby

THIS club house has been designed for a suburban town and meets all the requirements necessary for a building of its kind. Added to the commodious and artistic interior is the pleasing and well

and the necessary pantries, kitchen, etc., besides a parlor and an open balcony.

The basement has a bowling alley, toilet rooms, storage rooms, heating apparatus, etc.

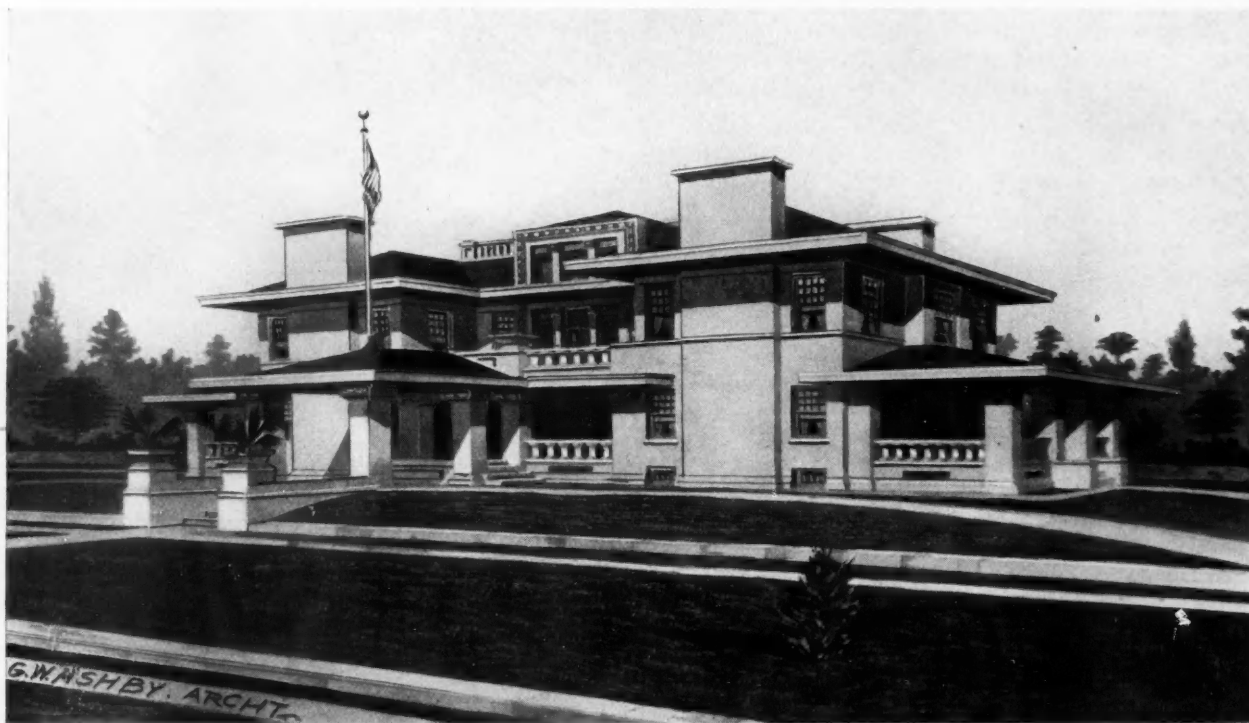

designed exterior. The large and shady porches give it a cool and inviting appearance in the summer, and the large chimneys for the fireplaces give a comfortable and cosy look to the exterior as well as interior during the winter.

In the reception hall opposite the main entrance is a large fireplace with seats on both sides, forming a comfortable nook by the main staircase, which runs around it.

The billiard room and parlor are entered from the reception hall through large openings, having ornamental columns.

The auditorium has a large stage for concerts, etc., and this auditorium can be cleared for a ball room when desired or it can be rented for entertainments, there being an independent entrance and vestibule with ticket office.

The second story contains a large banquet room

A Large Contract

He was a very young clergyman, and on this, his first day at his first appointment, he showed evident nervousness. The story is vouched for by Bishop Tuttle, whose stories are, of course, famous. After reading the service the young clergyman faltered the following announcement: "Services will be held at 10 A. M. next Sunday at the north end, and in the afternoon at the south end at half-past three. Infants will be baptized at both ends."

A project is on foot in Pittsburg, Pa., to erect a large arcade market and office building on the site of the present market houses on Diamond square. The proposed building is to be nineteen stories high and nearly 200 feet square. One entire floor is to be used as an auditorium with a seating capacity of 7,500.

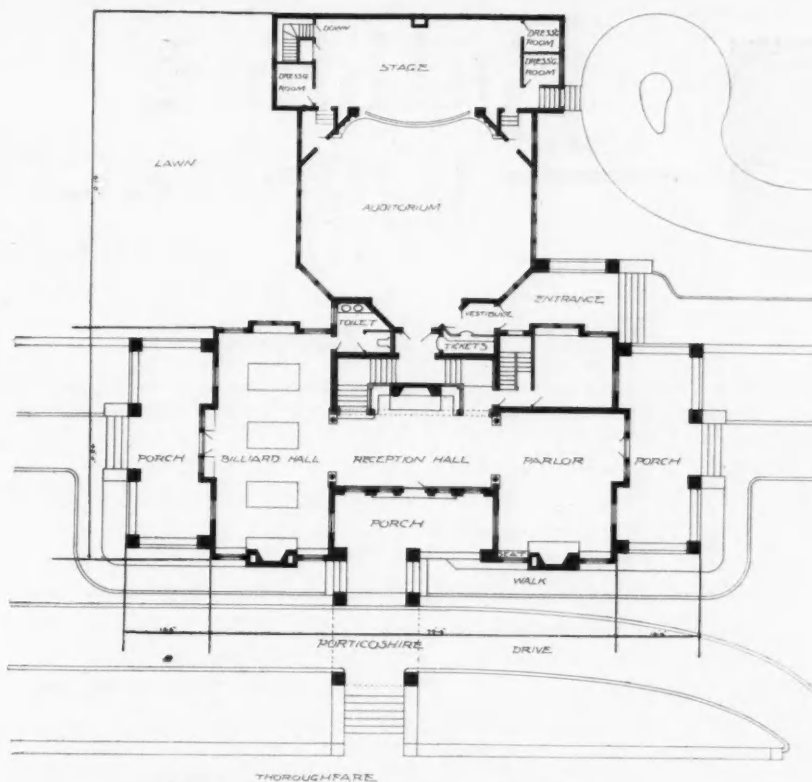

PLAN OF GROUND FLOOR

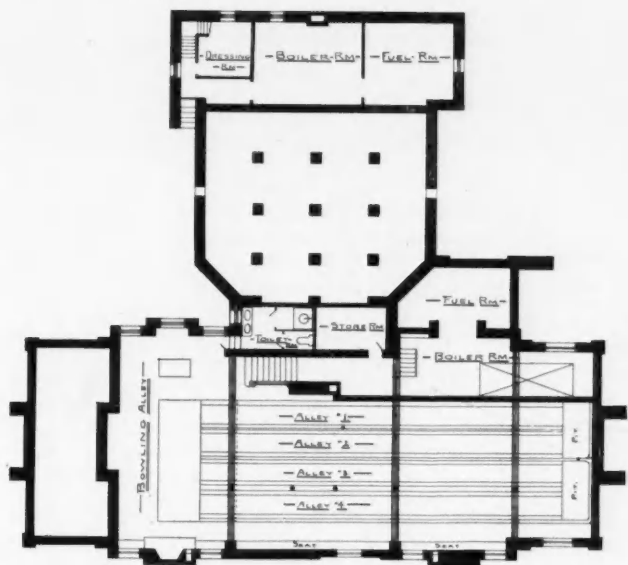

PLAN OF BASEMENT

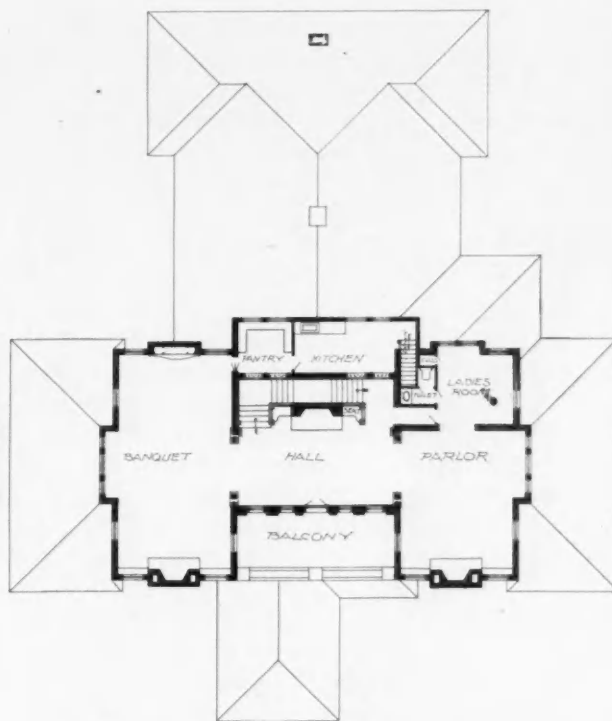

PLAN OF SECOND FLOOR



Building Construction-

J. A. F. CARDIFF

Building a Home

III. INTERESTING DESCRIPTION OF THE DIFFERENT FORMS OF BRICK ARCHES, WHAT MATERIAL TO USE IN CONSTRUCTING THEM AND WHERE BEST USED IN A BUILDING

AN ARCH is the arrangement of bricks, stone or other materials to span an opening. They are named from the outline of their soffits, as segmental (Figure 15), semicircular (Figure 16), or flat (Figure 17). The terms of the various parts of the arch are shown in Figure 23. The soffit or under side of the arch is also called the intrados. The back or upper side is also called the extrados. The pieces marked "B" of which the arch is composed are called voussoirs. The skewback is also known as the springing line.

Semicircular and segmental arches are the best as far as strength is concerned and are the simplest to construct. Other forms such as flat, Dutch, elliptical, and three-centered arches are used only where the architectural style of the building makes them preferable.

Figure 15 shows the two-row-lock arch used in common work. The bricks are laid on edge in two concentric rings extending through the wall.

Figure 16 shows a segmental arch. Ordinary bricks rubbed or cut to the required shape are used and form a perfect bond.

Figure 17 shows the flat arch which also requires the use of rubbed or cut bricks. Arches of this form should have a rise or camber equal to about one-eighth of an inch for every foot of span, in order to prevent it from sagging when the arch settles. The skewback is usually made to an angle of 60°. Arches of this kind only appear on the exterior face of the openings; the inner part of the wall being carried on a wooden lintel as shown in Figures 18 and 19. On top of the lintel is formed a rough brick relieving or discharging arch; the object of which is to prevent collapse in case of the destruction of the wooden lintel by fire or rot. The brickwork on top of the lintel and under the relieving arch is called the core (Figure 18). The construction when this core is omitted is shown in Figure 19.

Figures 20 and 21 illustrate the temporary wooden structure required to support the bricks of an arch while the arch is being built. The upper surface of a center corresponds in outline to the soffit of the arch. They consist of two parallel boards cut to the required

curvature and covered with narrow wooden strips called "lags" for supporting the bricks. The centers are supported on wooden uprights with wedges as shown. These wedges can be eased when necessary. The centers should never be removed before mortar has properly set.

Figure 22 illustrates the Dutch arch, which, as it is of weak construction, is suitable only for openings of narrow span.

The "Building Inspector"

When ground is broken on the site
For your new church, some busy wight
Is certain to assume the right
To pose as chief inspector.
He deems it quite the thing that he
Should represent the laity,
And watch the builder's work and see
He doesn't cheat the rector.

Of course, the whole thing's badly planned,
He tells you, and you understand
How good it is that he's at hand
To check some greater blunder.
The mortar's bad. He breaks a crumb
Between his finger and his thumb,
And shakes his head and murmurs "Bum!
Who sold 'em that, I wonder?"

Thus after mass each Sunday morn,
With mingled pity, grief and scorn,
He goes about on his forlorn,
Grim duty of inspection.
But, no, not every Sunday though,
That statement's not exactly so—
Some Sundays you take up, you know,
The building fund collection.

Breaking it Gently

The contractor was leaning over some plans, busy figuring out the cost of material. The new office boy slipped up and poked a note into his hand. The surprised contractor opened it and read:

"Honored Sir: Yer pants is ripped."

"Pull" may get you a job, but it usually takes push and merit to hold on to a good one.

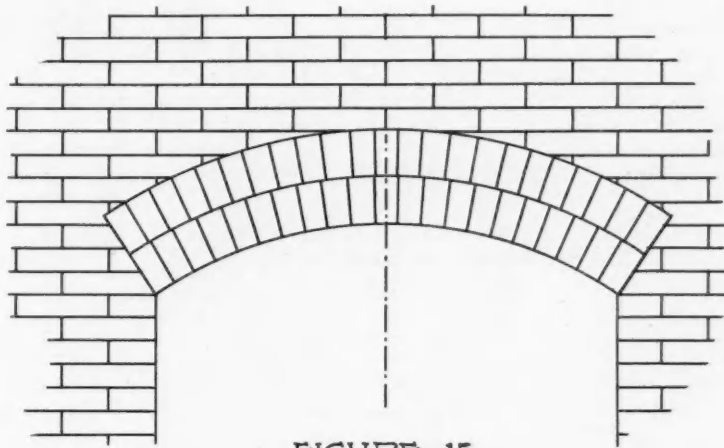
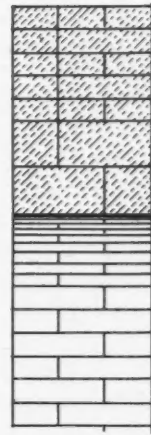

FIGURE 15.



SECTION.

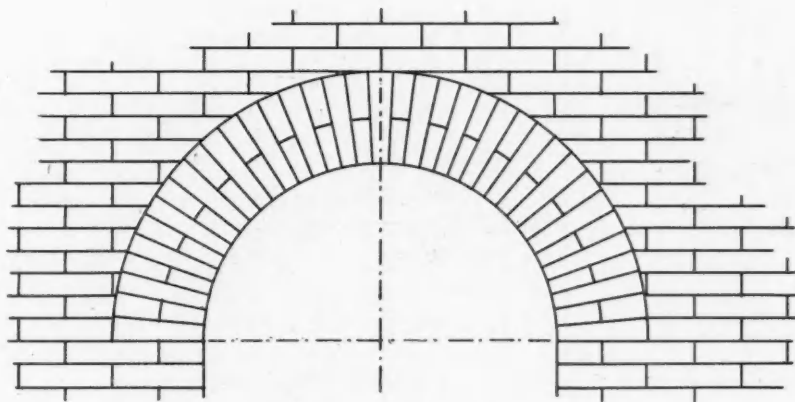
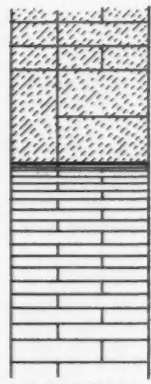

FIGURE 16.



SECTION.

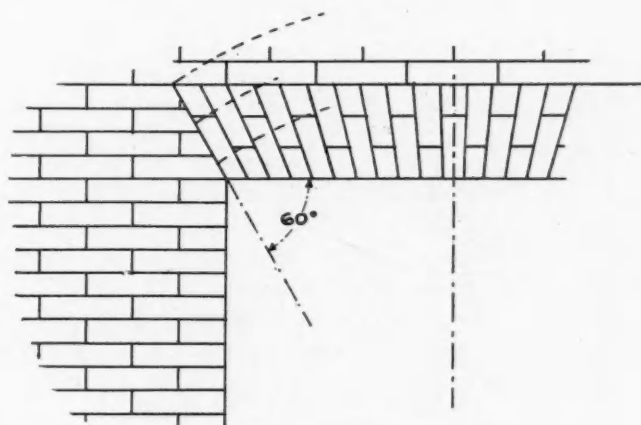
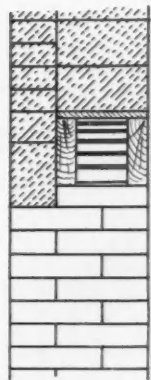

FIGURE 17



SECTION.

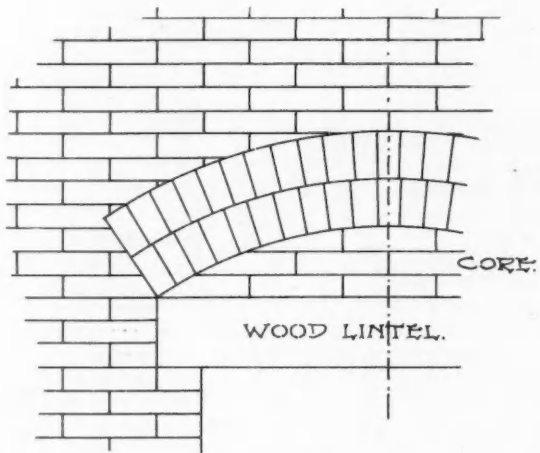

FIGURE 18.

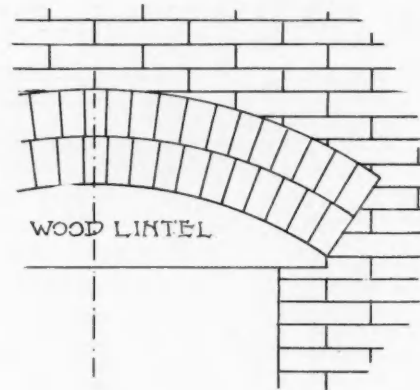

FIGURE 19.

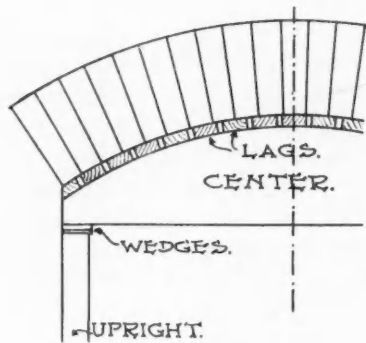

FIGURE 20.

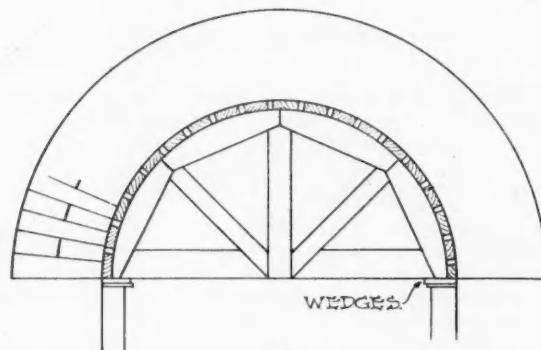

FIGURE 21.

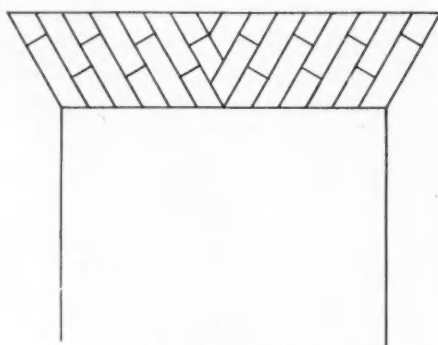

FIGURE 22.

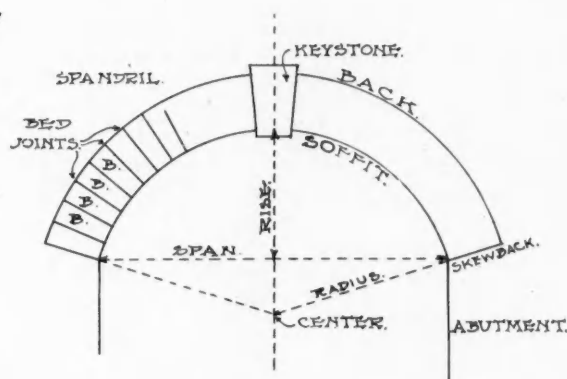

FIGURE 23.



Framing a House

I. P. HICKS

Constructive Details

HOW TO PREVENT HOUSES FROM SETTLING NEAR THE CENTER DURING CONSTRUCTION—THE USE AND IMPORTANCE OF PIERS IN BRACING UP THE CENTER OF THE HOUSE

WE HAVE a subject of special interest to lay before the readers of the AMERICAN CARPENTER AND BUILDER. Why do so many houses settle in the center? In all probability there are thousands of contractors who have had the experience of having houses settle in the middle or near the center during the construction of the building or very soon thereafter. In fact this state of affairs is by far of too frequent occurrence. Of course there is a cause for it but not one contractor in five hundred ever stops to investigate and figure out the cause and apply the proper remedy for this growing evil. Contractors are too apt to neglect certain portions of foundation work, not particularly because they want to beat somebody, but more because they are in a hurry just at that time and want to push the work along as fast as possible just at a certain time, and in so doing piers which are to support the center of some building are sadly neglected and overlooked. Piers are frequently built up after the outside walls are up and floor joists are in place, just some temporary support being put in the middle to hold up a girder while the pier is being built under it. This is very poor practice and nearly always you will find buildings constructed in this way low in the center.

As there is more weight concentrated on a pier, causing a greater weight per square foot of bearing surface than there is per square foot of outside walls, too much care can not be exercised in building the piers. When it is fully understood what a support a good healthy pier is to a building it will be plainly seen why they require as much care and attention as the main walls and even greater care. Faulty piers that have weights to support in a building are a very bad thing, and it is generally supposed that all piers are designed to carry some weight, else it would not be necessary for a pier at all.

As a rule contractors never have anything like a correct idea of what the weight will amount to that is to be carried on a pier. In speaking of contractors we mean in this case contracting carpenters who do more or less building from home-made plans. Still it may be truthfully stated that some architects do not

give the matter of piers in the ordinary house the proper amount of consideration.

We will give a diagram or sketch and a few figures to show why piers should be given careful attention and in no case neglected. In the sketch we show a foundation 24x30 with a girder running lengthwise through the center supported on the end outside walls

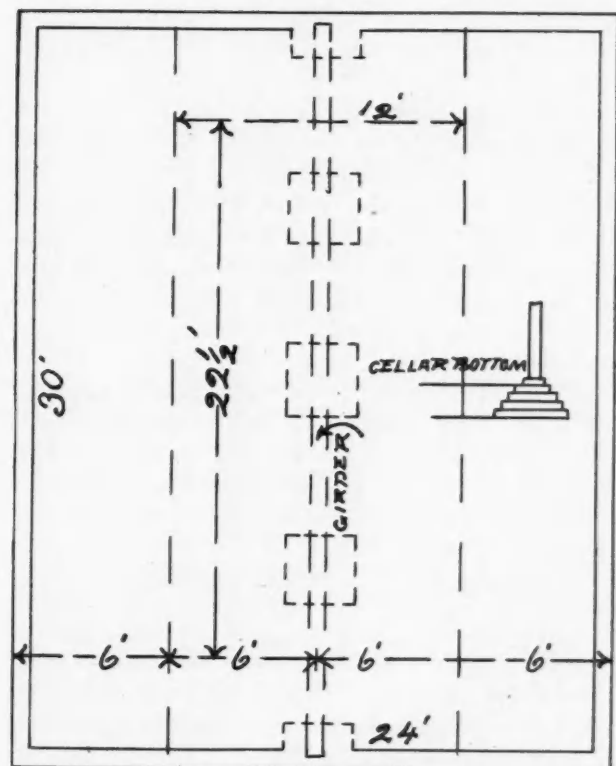

and three piers in the center. This makes the piers $7\frac{1}{2}$ feet apart from center to center.

Now let us figure approximately the weight carried on the outside wall and the weight carried on the piers. We will say that the outside walls are 18 feet high and that there is a first and second floor, ceiling and roof to provide for. We will first figure the approximate weight to be carried on the 30-foot side of the outside wall. The sheathing, studding, lath, and plaster on the outside wall, to say the least, will be 12 lbs. per square foot; thus $18 \times 30 \times 12 = 6,480$ lbs. The

building being 24 feet wide one-half of the floor weight will be borne by the outside walls, thus leaving a floor space 6x30 feet for weight bearing on the wall. The first floor will weigh 10 lbs. per square foot, hence $30 \times 6 \times 10 = 1,800$ lbs. weight of first floor on outside wall.

On account of lath and plaster the second floor will weigh more than the first; this we place at 16 lbs. per square foot, thus $30 \times 6 \times 16 = 2,880$ lbs. weight of second floor on outside wall. Now we have the ceiling over the second floor which we place at 7 lbs. per square foot and we have $30 \times 6 \times 7 = 1,260$ lbs. weight of ceiling on outside wall. Next comes the roof which we will suppose to be carried by the outside walls, one-half of which will be carried on a side and we will put the weight at 7 lbs. per square foot of roof. We will say the rafter length is 17 feet, then $17 \times 30 \times 7 = 3,570$ lbs. weight of roof to be carried on one outside wall. We now have $6,480 + 1,800 + 2,880 + 1,260 + 3,570 = 15,990$ lbs. weight to be carried on one of the outside walls 30 feet long. We will say it is an 8-inch wall with a two-brick footing with offsets of 2 inches to the course on each side; this will make the wall have a footing 16 inches wide. 16 inches equals 1 1-3 feet width of footing $30 \times 1 \frac{1}{3} = 40$ square feet of bearing surface on the foundation soil for the outside wall. 40 square feet has to carry 15,990 lbs. which equals $399 \frac{3}{4}$ lbs. per square foot. This is so close to 400 lbs. even that we will call it 400 lbs. per square foot on the outside wall. We will now find approximately the weights carried by the three piers, then we can tell how large or what size the footing of them should be to approximately carry the same weights per square foot of bearing surface as the outside walls.

Through the center there are four spaces. One-half of each end space will be carried by the end outside wall, leaving a length of $22 \frac{1}{2}$ feet to be carried on the piers. The width of floor carried on the piers is 12 feet, hence we have a floor space of $22 \frac{1}{2} \times 12$ feet to be carried on the piers.

First floor equals $22 \frac{1}{2} \times 12 \times 10 = 2,700$ lbs.
 Second floor equals $22 \frac{1}{2} \times 12 \times 16 = 4,320$ lbs.
 Ceiling to second floor. $22 \frac{1}{2} \times 12 \times 7 = 1,890$ lbs.

Total 8,910 lbs.

We now have 8,910 lbs. to be carried equally on three piers which equals $8,910 \div 3 = 2,970$ lbs. on each pier. We found that the weight on the outside wall was practically 400 lbs. per square foot, hence $2,970 \div 400 = 7.425$ square feet, almost $7 \frac{1}{2}$ square feet. The size of the footing to contain $7 \frac{1}{2}$ square feet should be about 2 feet and 9 inches, hence the pier footings should be 2 feet 9 inches square, or 31 inches square, to make the bearing weight about equal per square foot of the bearing surface on the soil. We trust now that anyone will be able to see why a pier built in the ordinary way with only a 16 or 20 inch footing is wholly inadequate for the weight it has to

carry and this uneven distribution of the weight is what causes buildings to settle in places.

In our figures we did not count the weight of the wall, which would have to be counted in very particular work. Our chief object in this is to show that pier footings are nearly always cut far too short for the purpose they are intended to supply in the building. Do not put in a pier with a 16x16 inch footing where one 30x30 is required, if you do some one will sooner or later be disappointed in the results.

The softer the ground the more essential it is to have piers with broad footings. If the broad piers are objectionable in the cellar, then dig down below the cellar bottom so that when the pier is stepped up to a level with the cellar bottom it will then only be the proper size wanted, or not large enough to be in the way. Taper them up from the bottom as shown in the sketch. With a proper bearing surface on the bottom and properly stepped up the pier will be all right and will support the weight intended for it, but do not put in weak and insufficient piers and expect them to stand for they never will, and your work will show it, and in many cases even before you get it off your hands.

Another point we wish to mention is about girders. Do not put in 6x6 girders; they are not strong enough for any kind of a girder. The latter day 6x6 is only $5 \frac{1}{2} \times 5 \frac{1}{2}$ and a very frail thing. Don't use it any place where strength is necessary. No girder ought to be less than $5 \frac{1}{2} \times 7 \frac{1}{2}$, and then ought to have a bearing every 8 feet at least. Make your girders $5 \frac{1}{2} \times 7 \frac{1}{2}$, $7 \frac{1}{2} \times 7 \frac{1}{2}$ or $7 \frac{1}{2} \times 9 \frac{1}{2}$ and with proper supports under them about every 8 to 9 feet you will have solid jobs and jobs that will be a credit to the builder. Circumstances alter cases and sometimes you can give one girder a longer span than others, but consider the weights to be carried and put in one large enough; be on the safe side always.

Some Furnishing Don'ts

Don't overload your rooms with furniture or pictures.

Don't imagine that plentitude of furniture means a well-furnished house. It does nothing of the sort.

Don't choose elaborately designed curtains, hangings or tablecloths for a room with a floral paper.

Don't waste your money on an accumulation of cheap bric-a-brac, so called. It only helps to gather dust and dirt.

Don't choose plain curtains with a plain carpet and wall paper.

Don't choose a blue paper and white paint for a room with a cold aspect—i. e., northern aspect.

Don't buy a carpet with a big pattern for a little room.

A man's greatest inspiration is the knowledge that he needs the money.

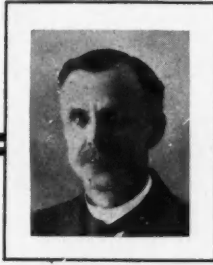

RESIDENCES

G. W. ASHBY



WM. H. SCHROEDER.



Houses Affording Comfort and Convenience

ILLUSTRATIONS AND DESCRIPTIONS OF TEN COMFORTABLE, MODERATE PRICED HOUSES, SUITABLE FOR HOMES FOR LARGE OR SMALL FAMILIES—DIMENSIONS AND FLOOR PLANS ALSO GIVEN

THE houses illustrated this month are of a pleasing variety, ranging in price from \$850 to \$6,000. The floor plans and dimensions of the rooms, together with a brief description showing the commendable features of each house, are also given.

House No. 735 is an elaborate home with all modern conveniences. The first floor is well arranged, having the dining room, reception hall and living room almost in line, making them appear larger than they really are. The terrace at one end and the large porch at the other, add very materially to the comfort and appearance of the house. Large open fireplaces are in both the dining and living rooms and in the den, which is off from the dining room and opens onto the terrace. The second floor is divided into four large bedrooms and a bath room. Each bedroom has a clothes closet in connection, and two of them have fireplaces, making them cosy and home-like. The entire house has a look of grandeur about it that makes it very attractive. The cost of this house is estimated at \$6,000.

House No. 550 is desirable for a good-sized family. There is a cellar under the entire house and place for a furnace or hot water heating plant. The first floor has a large living room, which is connected with the hall by sliding doors; dining room, which has a china closet on one side, and a kitchen and pantry. The kitchen is well located, having easy access to the pantry and cellar. The second floor is divided into three bedrooms, a bath room and an alcove, which is large enough to be used as a bedroom. The estimated cost of this house is \$3,200.

House No. 149.—In this design we have an admirable plan of a medium cost house, that has on the first floor a very nice square reception hall with an open stairway, a large sitting room with an open fireplace and dining room adjoining, so arranged that it virtually becomes a part of the sitting room when not in use for its special purpose. The room at the rear can be either used as a sleeping room or study, and the kitchen, pantry and cellar stairway are very conveniently arranged. The large porch and the side en-

trance make this a very desirable design for a corner lot. On the second floor, there are three large sleeping rooms and bath room centrally located. There is also a linen closet and plenty of clothes closets and also dressing room in connection with front bedroom. This house can be built for about \$1,800. The size, exclusive of porches, is 29½ by 37½ feet.

House No. 733 is a good home for a large family. The entire house has a solid, cosy, home-like appearance. There is a cellar under the entire house, making it convenient to have either furnace or hot water heating. The first floor has a living room, dining room and kitchen. The large hall has a stair leading to the second floor and a cosy hall seat. The second floor has four bedrooms and a bathroom, which is well situated, being at the end of the hall. Closets are found in every bedroom, which adds to their convenience. The estimated cost of this house is \$3,000.

House No. 736 is a pleasant home for a good-sized family. There is a cellar under the entire house, which can be used in many ways. The first floor is very nicely arranged, having a side entrance, opposite which is the stairway leading to the second floor. The living room, dining room and kitchen are on the first floor and attention is called to the kitchen, which is especially well equipped with a kitchen closet, pantry, cupboard and place for the ice-box. It can also be entered direct from the hall, which gives more privacy to the other rooms. The second floor is divided into five bedrooms and a bath room. The bedrooms are all of good size and are fitted up with clothes closets. The entire house has a comfortable and home-like appearance, which is aided by the two porches at either end of the house. The cost of this house is estimated at \$3,000.

House No. 146.—The exterior, while perfectly plain, is sufficiently broken in its outline to accomplish a very pleasing effect. The interior arrangement is very desirable and admirably adapted for a good-sized family, there being four sleeping rooms, each having a large closet. The first floor is conveniently arranged, all the rooms being large and well propor-

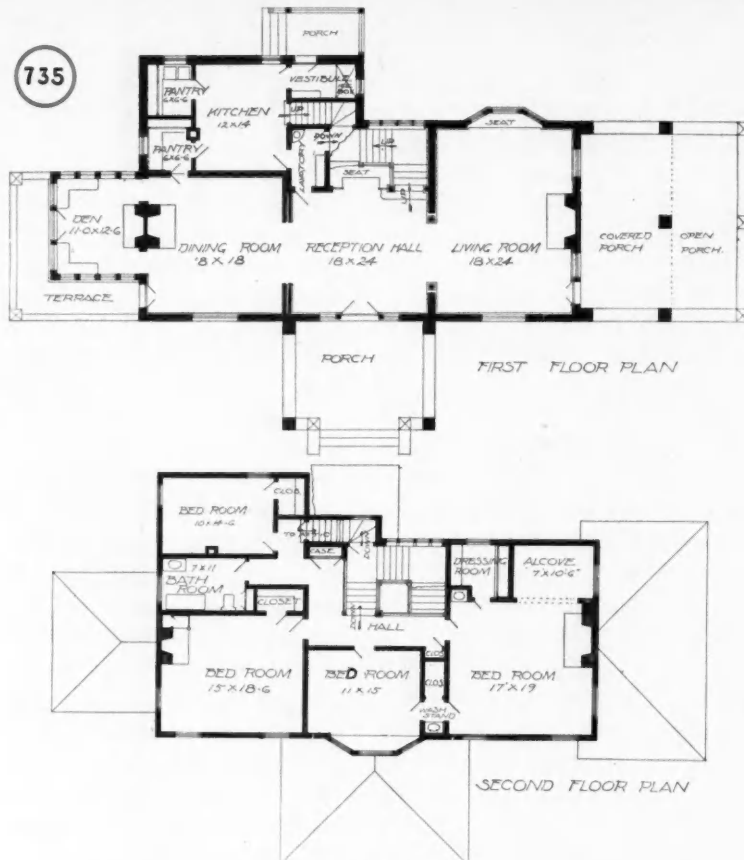
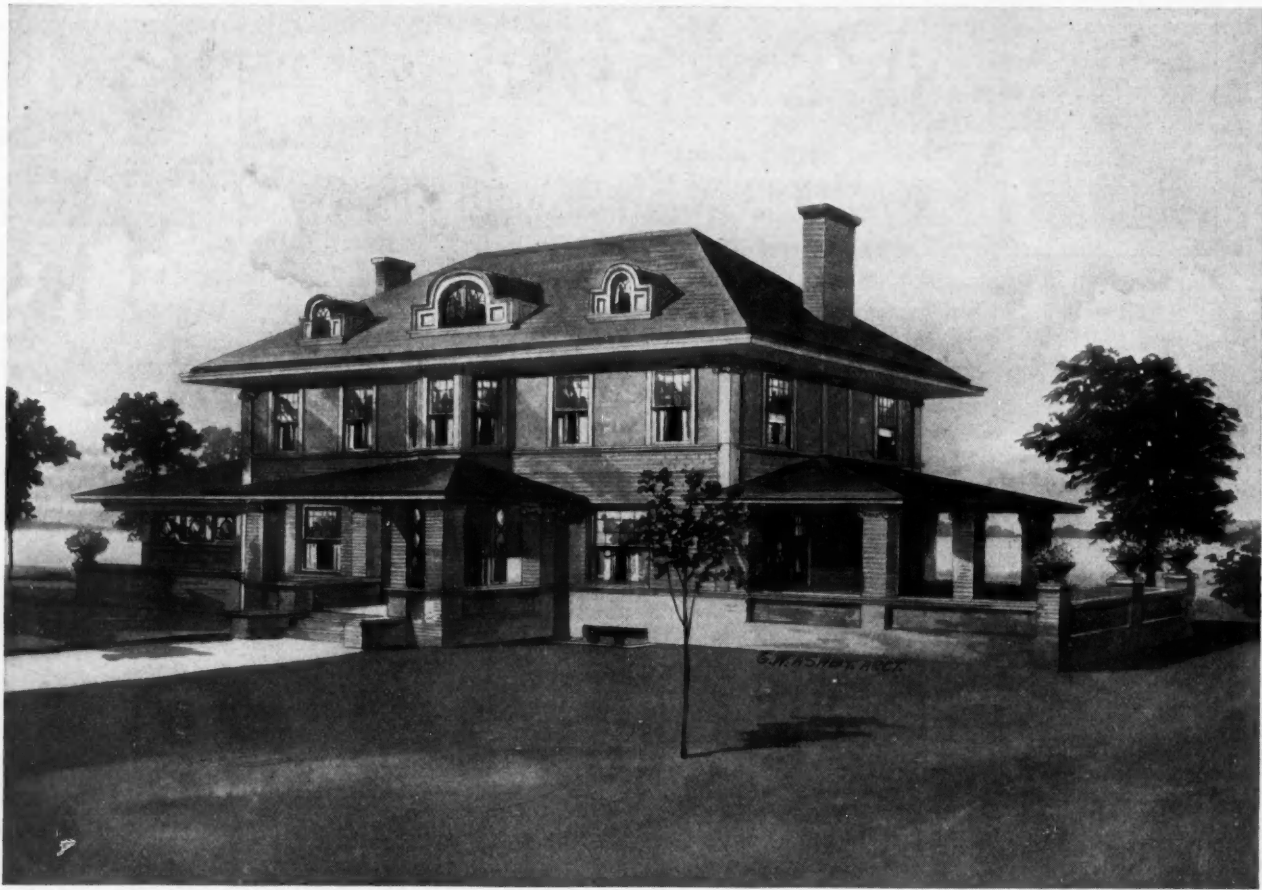

House Design No. 735. Estimated Cost, \$6,000. See Page 149.

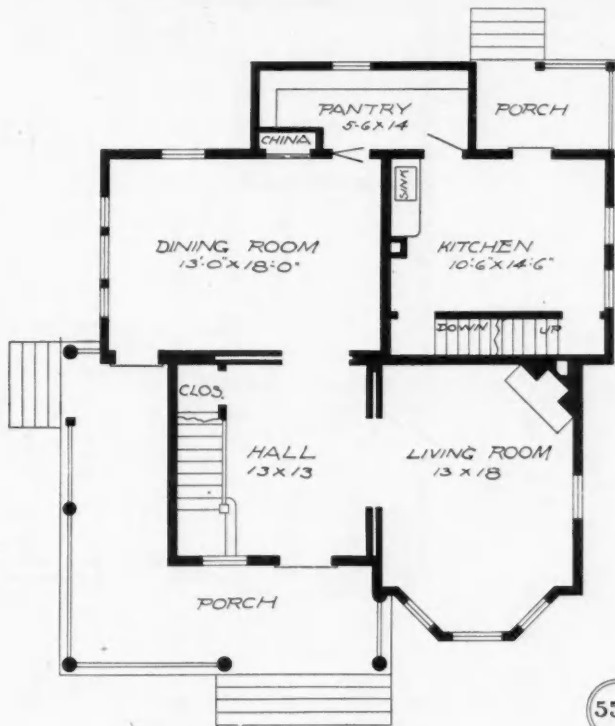

FIRST FLOOR PLAN

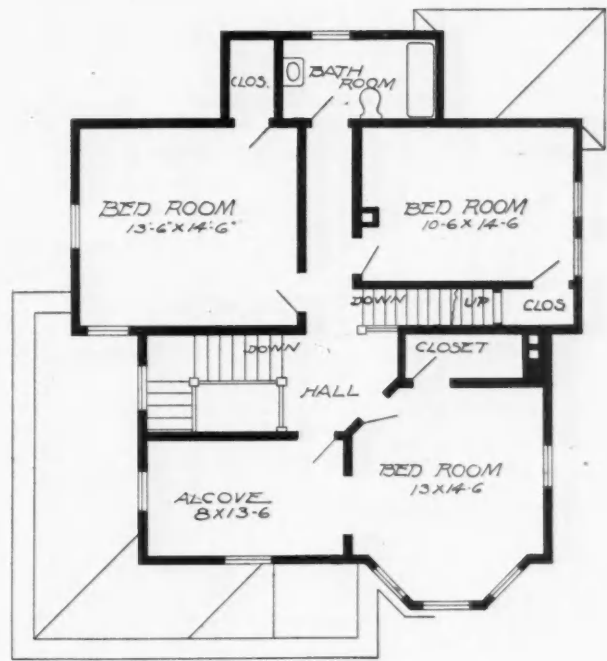

SECOND FLOOR PLAN

550

House Design No. 550. Estimated Cost, \$3,200. See Page 149.

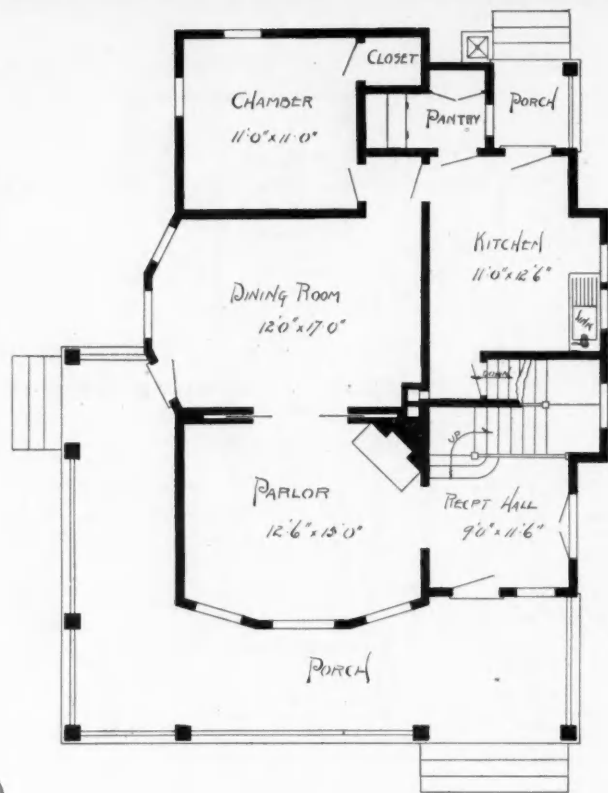
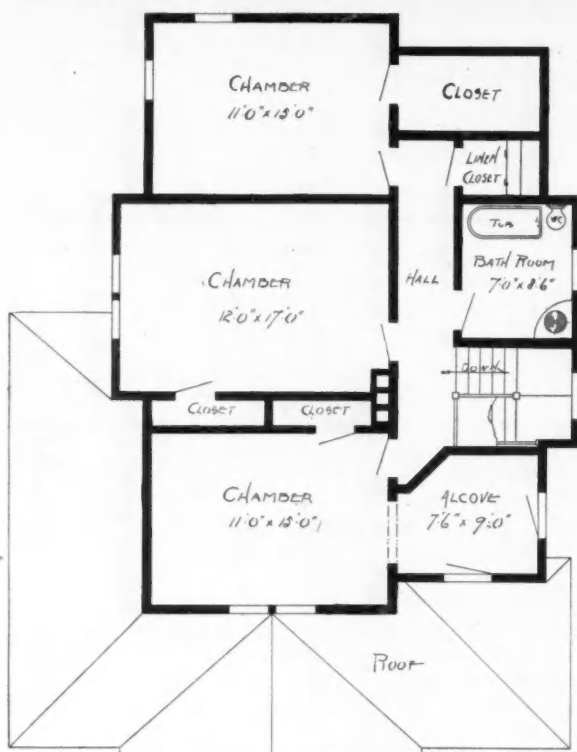

149

House Design No. 149. Estimated Cost, \$1,800. See Page 149.

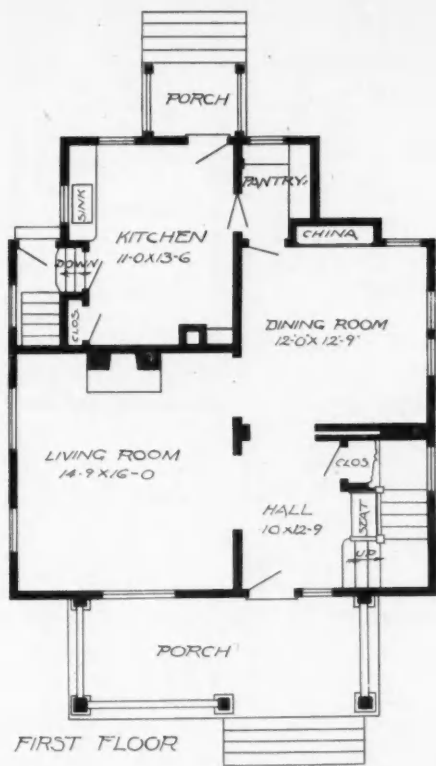

733

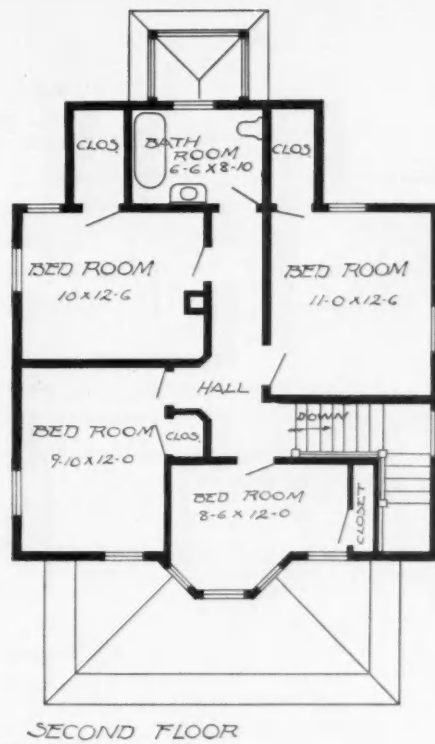

House Design No. 733. Estimated Cost, \$3,000. See Page 149.

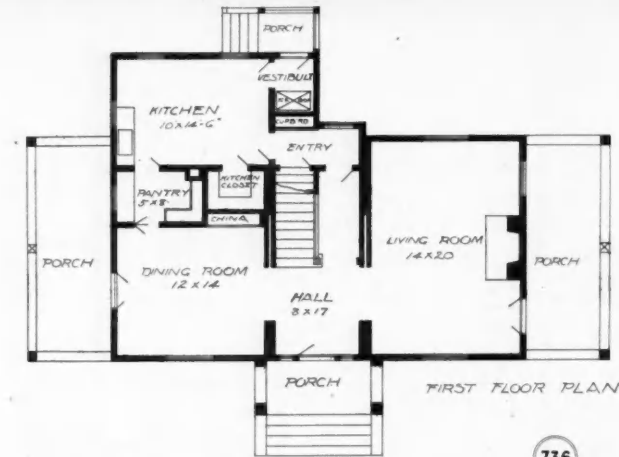
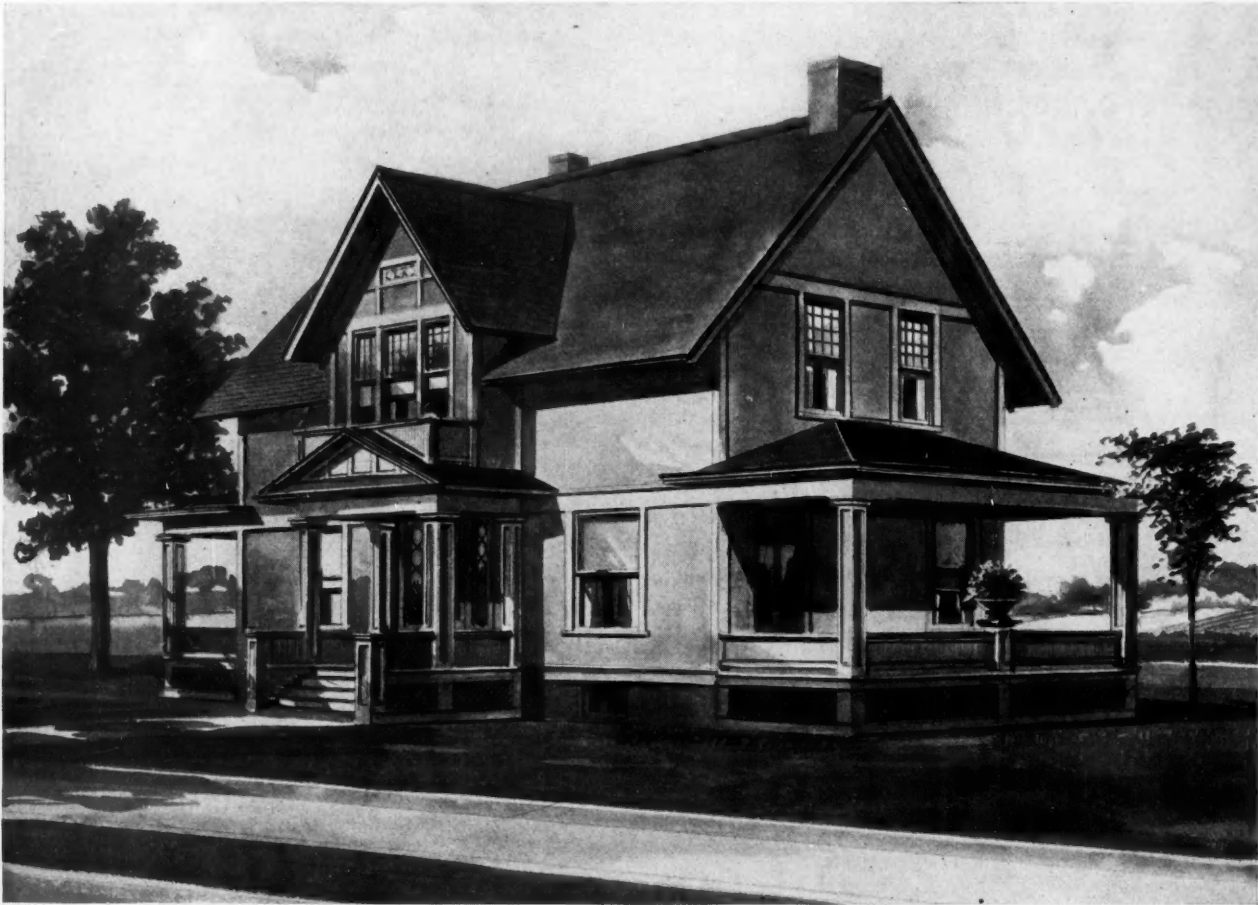

House Design No. 736. Estimated Cost, \$3,000. See page 149.

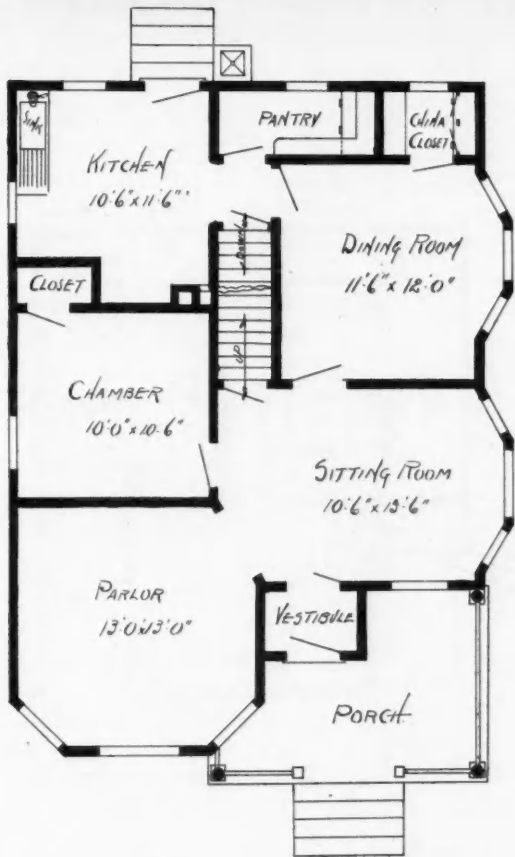

146

House Design No. 146. Estimated Cost, \$1,200. See Page 149.

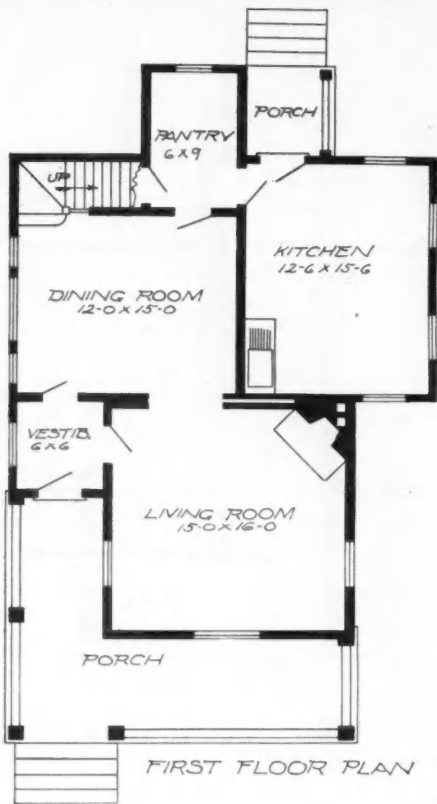

731

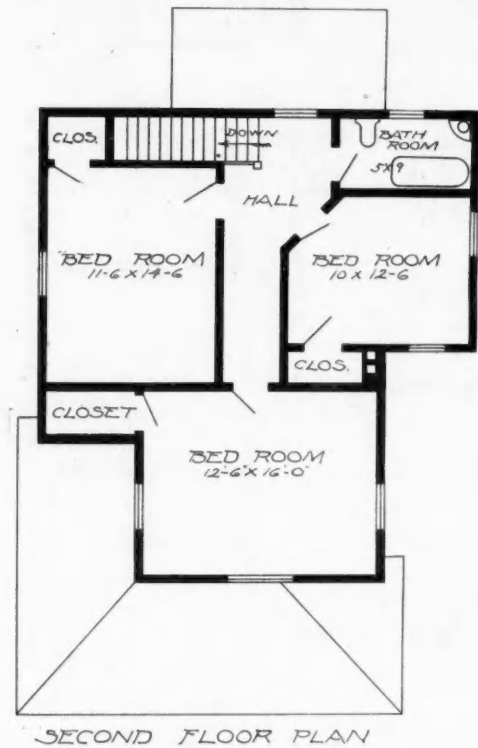

House Design No. 731. Estimated Cost, \$1,500. See Page 159.

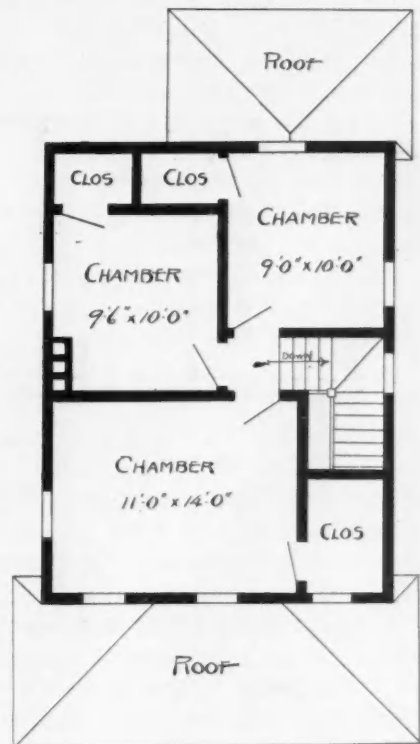
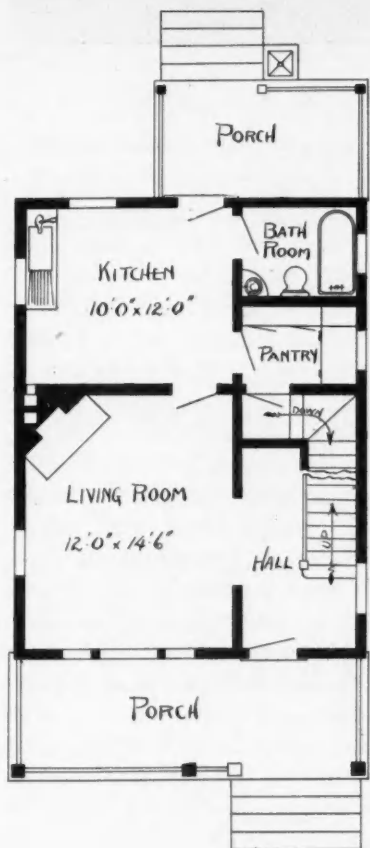

153

House Design No. 153. Estimated Cost \$850. See Page 159.

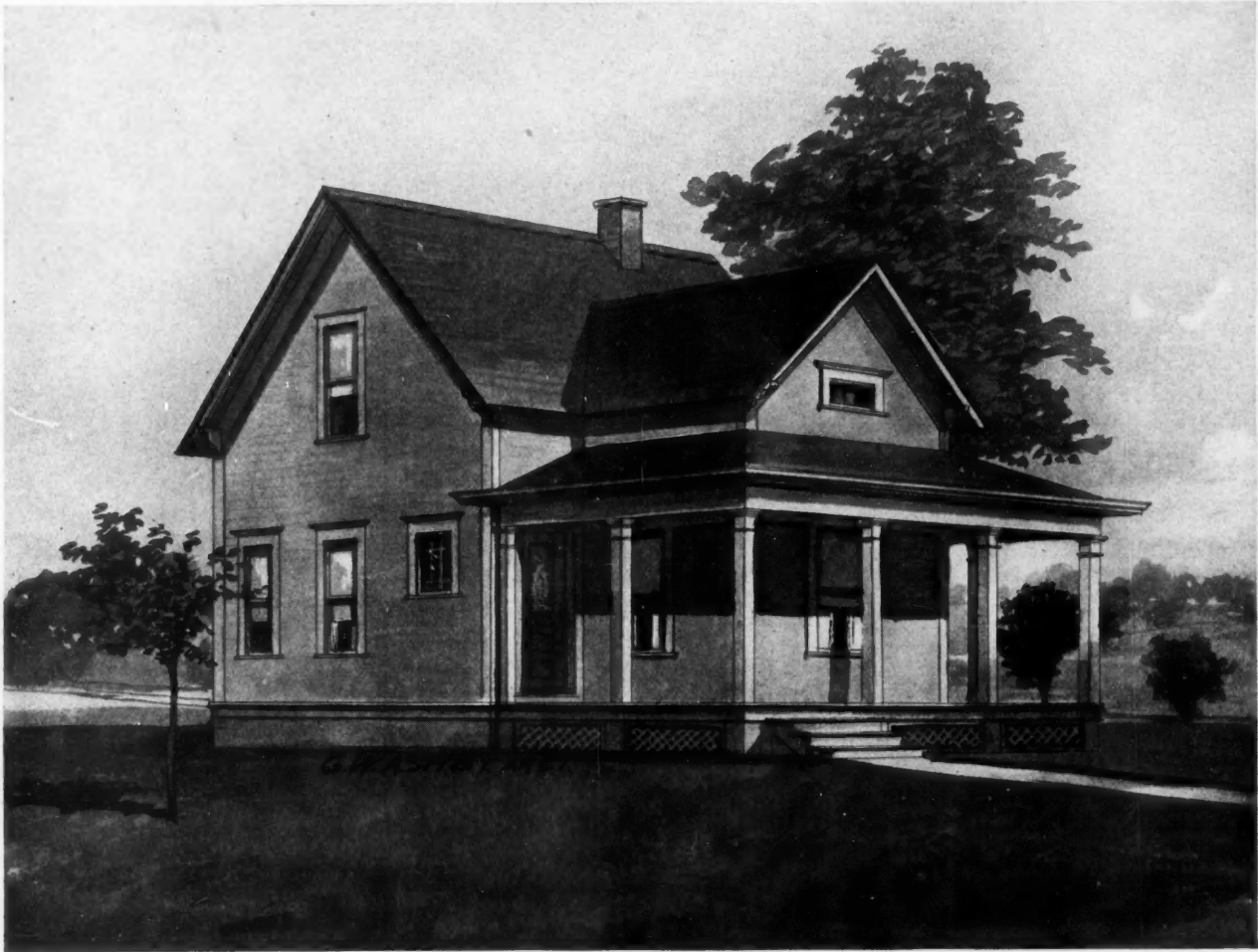

732



House Design No. 732. Estimated Cost, \$850. See page 159.

tioned; the parlor, sitting room and dining room having bay windows. A good-sized pantry and china closet, together with a well lighted kitchen, are also provided, leaving nothing to be desired in the line of comfort or convenience. The size of this house is 27½ by 26 feet, and can be built for about \$1,200.

House No. 731 is an elegant home for a moderate-sized family. A cellar extends under the entire house and can be used very advantageously. The first floor has a living room, dining room, kitchen and pantry. A fine heavy porch extends around the front of the house and adds to its appearance. The second floor has three large bedrooms and a bath room. Each bedroom is supplied with a clothes closet. The estimated cost of this house is \$1,500.

House No. 153.—This is a remarkably compact and conveniently arranged design. The body of the house is 20 feet wide and 25½ feet long and contains five large well proportioned rooms, also plenty of closets, pantry and bath room. The open stairway in hall and fireplace in living room make these rooms very pleasant and homelike. The large front and rear porches add considerable to the comfort and appearance of this house. The plans provide for cellar under entire house, and could be built for about \$850 complete.

House No. 732 is a three-room home for a small family. It affords many conveniences, having a large porch which partly surrounds the house, giving it an attractive appearance. The house has a large dining room, bedroom, kitchen and pantry. All the rooms are well lighted, making them very pleasant to live in. The estimated cost of this house is \$850.

Hardwood Supply in the Southwest

The greatest area of hardwood forest and the largest supply of hardwoods in the United States are in the region comprising the Southern Appalachian mountains and the country lying between them and the Mississippi river. For the last two or three years the Bureau of Forestry has been carefully studying this region, which is rich in commercial species, especially yellow poplar, white, red, black and chestnut oak, chestnut, white pine and hemlock.

For market value and amount of standing timber, yellow poplar and white oak are the two most important trees of the region. These species were formerly found throughout almost the entire region in merchantable quantities, but they have been cut so extensively where there are transportation facilities that it is now usually necessary to go back a long distance into the woods to find first-class stands of either of them. Poplar attains magnificent size in the coves of the mountain districts and in the rich river bottoms of central Tennessee and Kentucky, but its development is reached in the higher mountains of Tennessee and North Carolina. White oak reaches its best development in the river valleys of Tennessee and Kentucky. While poplar always forms a small proportion of the

timber of the area, it very often forms a large proportion of the merchantable timber. White oak is present in very much greater numbers than poplar over the region as a whole, and occasionally forms over 50 per cent of the stand.

Lumbering has had a serious effect on the reproduction of both poplar and white oak. When the white oak is cut, as a general rule, it is partially replaced by inferior species, as the red and black oaks. Thus in many cases where the virgin stand contained over 50 per cent of white oak the second crop contains less than 10 per cent. Often when poplar has been lumbered only the best trees have been cut, and as these were comparatively few in number and occurred at irregular intervals, the forest has not been opened up enough to let in sufficient light to allow young poplars to start growing. In addition poplar seedlings are very easily injured by fire; even slight ground fires kill them. Fires have been very common throughout the region, and thus successful reproduction of poplar has often been greatly hindered.

Hemlock occurs over a small portion of the region and white pine over a still smaller part; both confine themselves to the mountainous sections. As a rule hemlock has not been considered merchantable because it is generally impossible to log and sell it in Northern markets in competition with hemlock from Michigan and Pennsylvania. The little remaining white pine is lumbered in a few localities on a large scale, and the supply will soon be exhausted.

Chestnut is very abundant. It forms a large proportion of the stand in the mountain districts, but decreases in quantity westward until it practically disappears in western Tennessee and Kentucky. Mature chestnut is damaged more severely by fire than any of the other species of the region. A considerable part of its mature timber is defective for this reason. Much of the timber is also wormy. In the past but little chestnut has been cut for lumber, but the output is now increasing. A new use for chestnut, which has developed very rapidly in the last few years, is for making tannin extract. For this purpose all grades and sizes of chestnut above five inches in diameter are used. There are a number of factories making the extract, one of which consumes 150 cords of this wood daily. This industry makes possible the utilization of the limbs and tops and the defective chestnut which would otherwise be wasted, and materially assists by conservative management in making this timber more valuable and cleaner logging practicable.

Chestnut oak is abundant in the mountains, its stand decreasing westward. It is confined chiefly to the ridges, and in most sections is short-bodied and of little value for saw-logs. It is usually expensive to lumber because of its inaccessibility. The chief value of chestnut oak in this region has been for tan-bark, for which purpose in some places it has been extensively cut.



SCHOOL HOUSES

G.W. ASHBY

Three Well Equipped Schools

SHOWING ATTRACTIVE BRICK STRUCTURES RANGING IN COST FROM \$8,000 TO \$20,000—TWO-ROOM SCHOOL WITH A FOUNDATION AND EQUIPMENT FOR A FOUR-ROOM BUILDING

UNDER this head three large attractive schools are shown, varying from two to eight rooms. They are especially adapted for high schools or for enterprising towns, and the cost varies with the size of the building and the interior finish desired.

Design Lincoln is an eight-room school house very desirable for a high school or ward school. The foundation is of stone, while the building proper is constructed of pressed brick. A slate roof covers the building. The basement is equipped with boys' and girls' toilet and play rooms, and a large furnace and fuel room. The rooms are all well lighted, having windows on two sides and are 25 by 32 feet with a height of 12 feet. The corridors are well supplied with wire partitions for hats and coats, and the large office for the teachers in the upper corridor is a very great convenience. The estimated cost of the building is \$20,000.

Design No. 403 is a four-room school, very appropriate for smaller towns. The foundation is constructed of heavy stone while the building proper is pressed brick. The basement is well equipped with boys' and girls' toilet and play rooms, also a large furnace and coal room. The first floor has two good-sized rooms which are well lighted and have two entrances into the hall. This results in more order as the pupils can march through the cloak room and get their wraps on their way out. The rooms on the second floor are exact duplicates of those on the first and afford similar advantages. A teachers' office is also located at the head of the stairs on the second floor which can be used as the principal's office. The cost of this building was \$13,000 and was recently constructed at Homewood, Ill.

Design No. 204 is the school built at Maywood, Ill., and illustrates a plan which it would be well for other smaller towns to follow. The town not needing a large school and not wishing to erect a cheap wooden structure, built part of a large building which can be added to as necessity demands. The design shows the completed two rooms of the school; two more of which can readily be added as shown in design No. 400, published in the May issue. The basement is well arranged and well equipped with a large model-

ing and furnace room, boys' and girls' toilet and play rooms and two fresh air rooms. The first floor has two large well-lighted rooms, each of which has also a good place for books. The school and cloak rooms open into a large hall which is nearly as large as the rooms, making it a great aid in case of fire or other cause demanding a hasty exit. The cost of this building, which includes its excellent foundation, was \$8,000.

SEATS IN SCHOOL HOUSES

A matter of extreme importance, and one very little considered, is the placing of the seats of the children in the country schools. In the cities where each grade has a separate room and the size of the seats are nearly uniform, this does not apply, but where children of all sizes are placed in one or two rooms with probably two sizes of seats grave injury is sure to result. Seventy-five per cent of the children in ungraded schools have desks too large for them. The seats are so high that they cannot place their feet flatly on the floor, and the desks are so high that they cannot write without twisting their shoulders and backs out of shape. Either of these conditions is very injurious to health as the children are obliged to remain in these unhealthy positions for five or six hours daily during the greater part of their growing years and it is not to be wondered at that they are sometimes deformed and nearly always restless and weary.

Almost all manufacturers of desks make them in six sizes, from No. 6, the smallest, to No. 1, the largest. In nine out of ten of the ungraded schools, only the four lowest sizes should be used. Desk No. 1 is made only for high schools, and No. 2 for high schools and for the largest pupils in graded schools. The desks should be single in any school. The difference in expense is trifling, while the effect on the order of the school and the independence and studiousness of the children more than repays the additional expense.

In placing the desks only those of the same size should be placed in any one row. This is imperative. The idea that the smallest desks should be in front and the sizes increase to the largest at the back comes from the false notion that "it looks better that

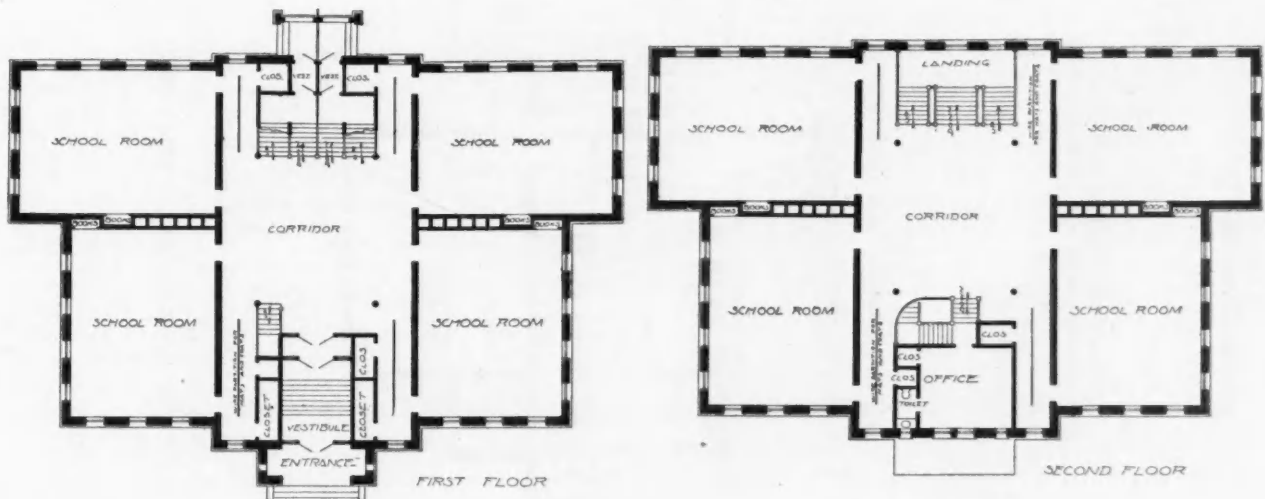
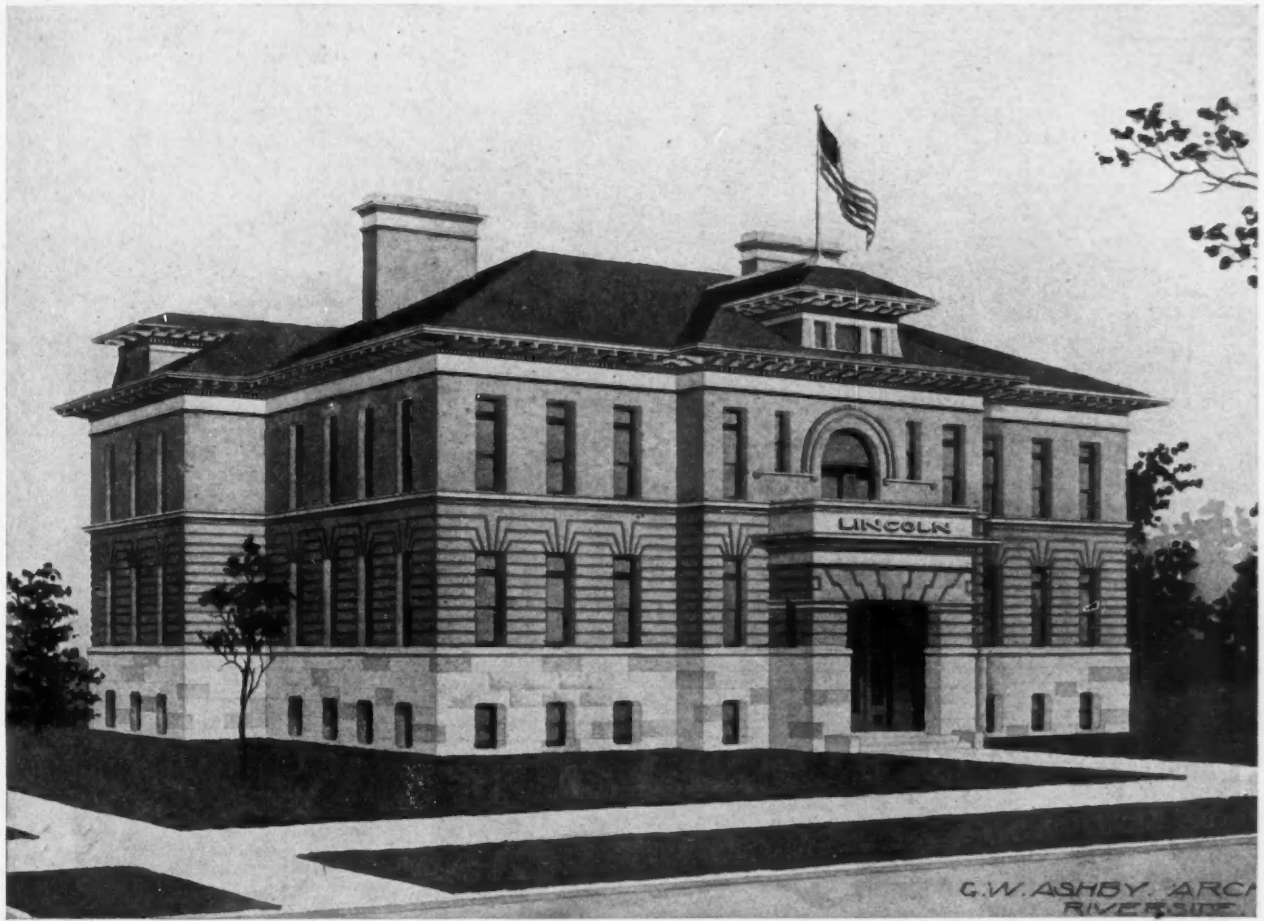

School House Design Lincoln. Estimated Cost, \$20,000. See Page 160.



G.W. ASHBY, ARCHT.

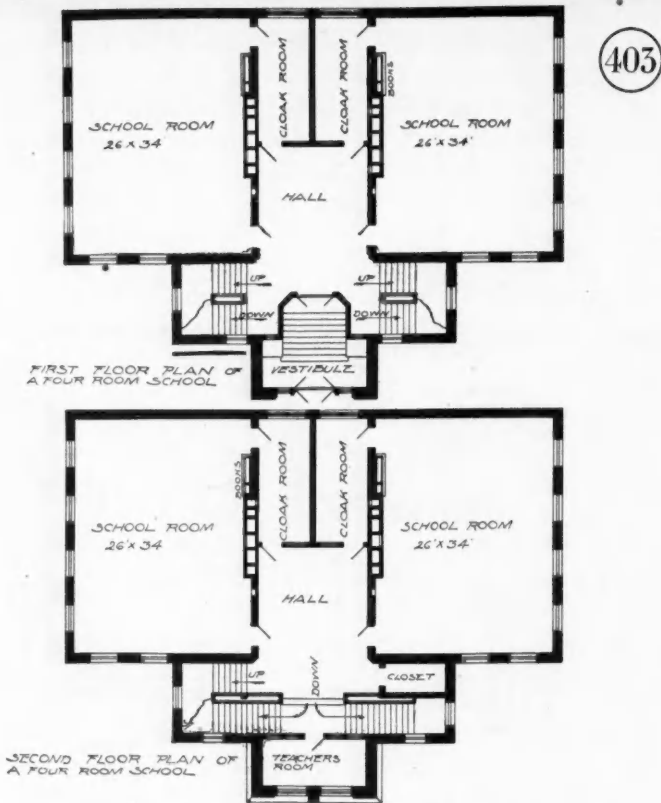

School House Design No. 403. Estimated Cost, \$13,000. See page 160.

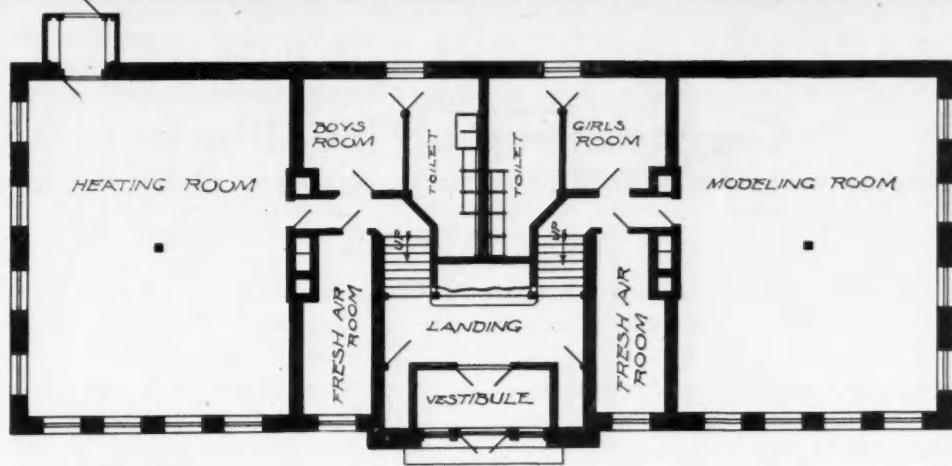
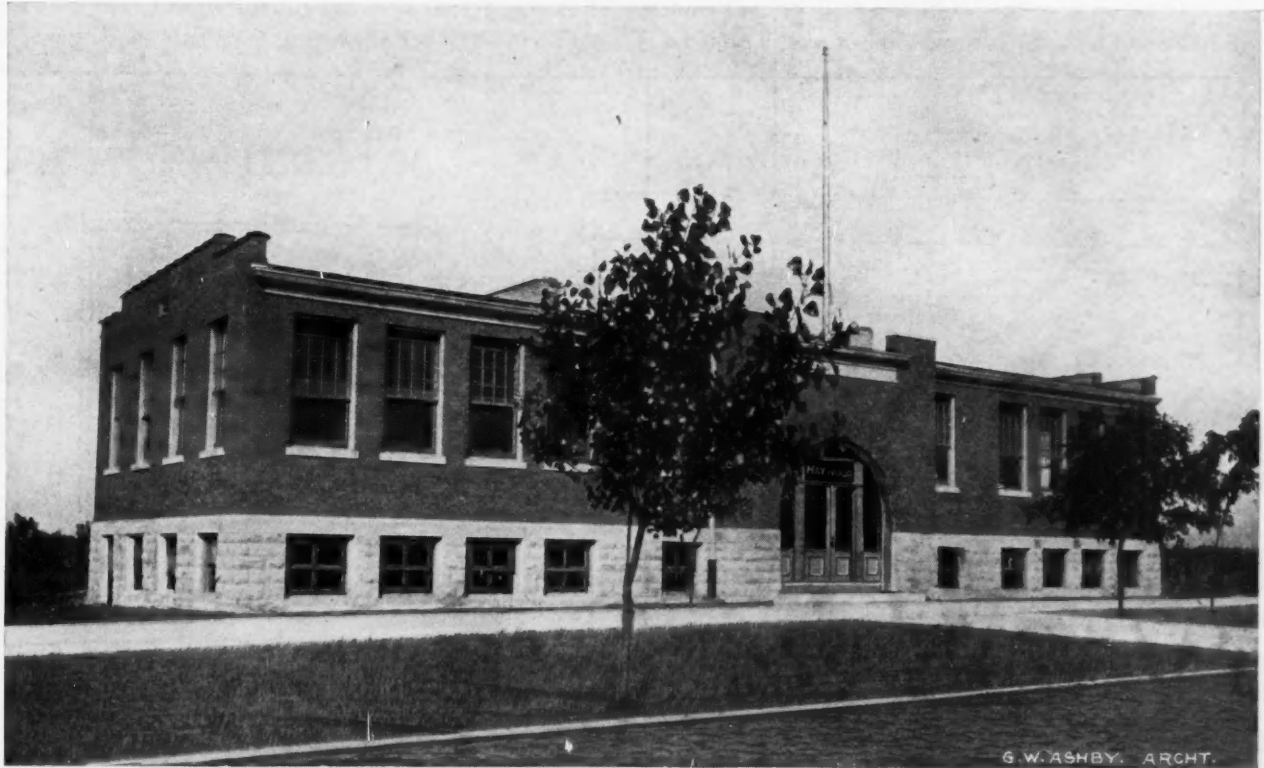

BASEMENT PLAN

204

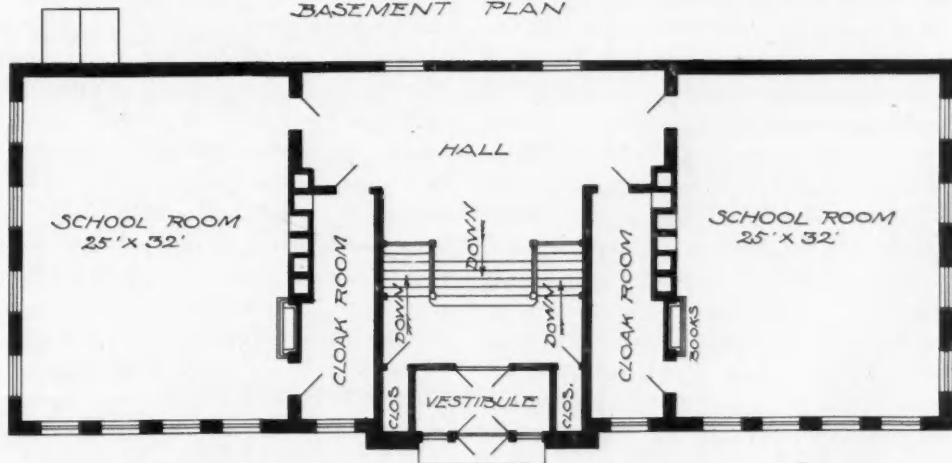

FLOOR PLAN

School House Design No. 204. Estimated Cost, \$8,000. See Page 160.

way." The error in this method is that the tall student in back will have a desk one size too small, or if he is

it is best arranged for the comfort and health of the children. The accompanying diagrams show the right

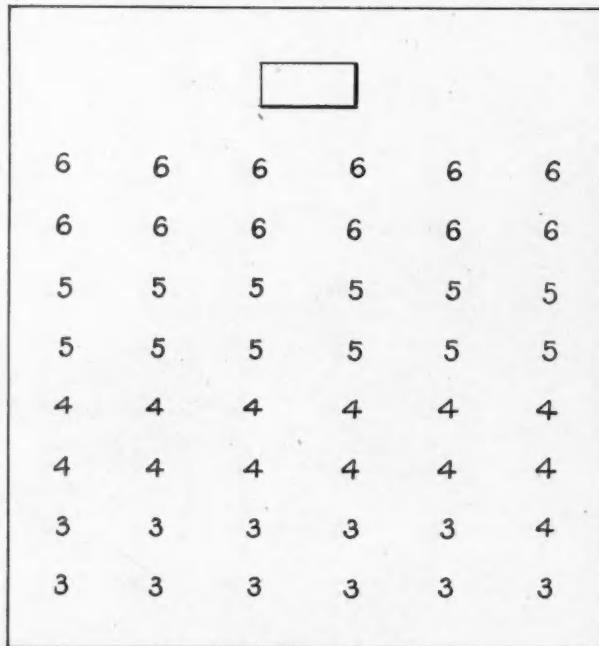

Wrong.

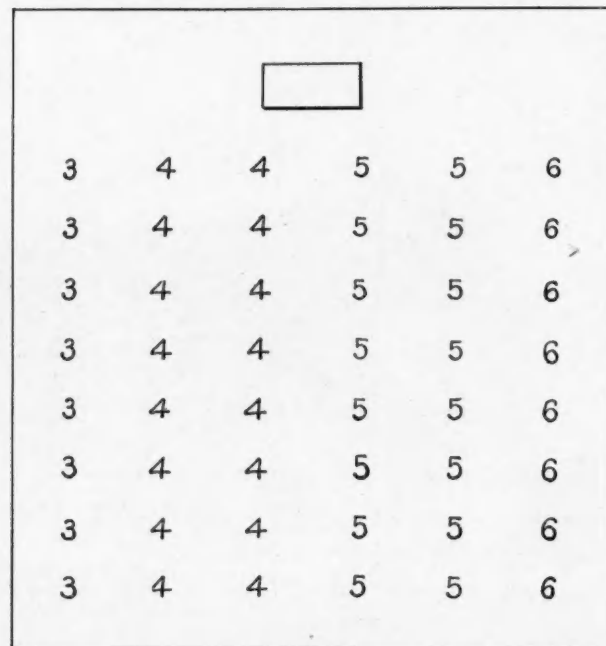

Right.

given a larger desk the seat will be too high for the student in front. The school room looks right when

and wrong way of arranging seats, the figures representing school desks of that number.

Constructing a Fire-Place

COMPLETE DESCRIPTION WITH DRAWINGS SHOWING CONSTRUCTION AND DIMENSIONS FROM THE BASEMENT TO THE ROOF, ALSO TELLING THE KINDS OF MATERIAL TO USE

By A. W. Woods

IN ANSWER to an inquiry sent in by Mr. Christ Moe, of Hanska, Minn., with regard to the construction of a fire-place, the following method is given: In the illustration herewith two flues are shown, one to extend to the basement floor and is for use of stoves in adjoining rooms. While we have shown four openings to this flue there are not supposed to be more than two stoves in use at the same time, otherwise the draft is liable to be overtaxed, as the flues have designed calls for only one brick square opening, or from 64 to 70 inches, according to the size of the brick. When thimbles are put in to make connection with adjoining rooms, the brick work should be corbled out to the full thickness of the wood partition, and a long thimble used to extend through the brick work, being careful not to let the thimble protrude into the flue space. At sketch A another way of widening the brick work at the thimble is shown, which is simply to cut in a cross piece between the studding, and on this build the extra brick work with all joints well filled with mortar. In all cases the thimbles should be set at the time of building the chimney, being careful that all joints are well filled and tuck pointed on both sides, and in addition to this it would be well to plaster on the inside of the flue from bottom to top.

In the illustration we have shown an ash pit beneath the fire-place where the ashes may be dumped and taken out later. This pit should have a vent into the flue so that when the ash dump is opened a downward draft will be created which will prevent the ash dust from flying back into the room. For supporting the hearth we use iron bars made of $\frac{1}{2}$ by 2 iron, and on this lay brick edgewise, leaving a space of three or four inches for concrete on which to lay the tile hearth. The fire-place should be lined with fire brick with the upper part of the brick slanted toward the front and carried up a few inches above the top of the opening, as shown in the cross section. The arch in front should be supported on a segment made of $\frac{3}{8}$ by 3 inches wrought iron set back from the front so that it will not show. If a straight top opening is desired then use a 3 inch by 3 inch angle iron with the flange on the inside of the brick work.

The dotted lines show the position of the flue for the fire-place and will require the opening or throat to draw over to it, but it should start straight from the fire-place and gradually draw over to its position as shown. The face of the brick work should carry up to the ceiling of the first story and this gives ample space to make the proper bend in the flue. The flues should

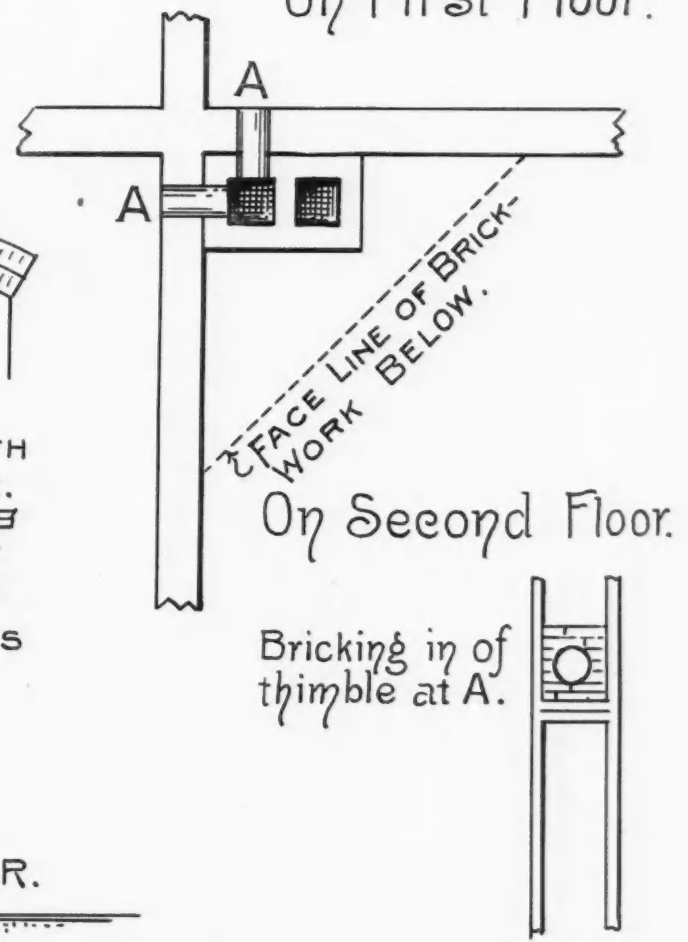
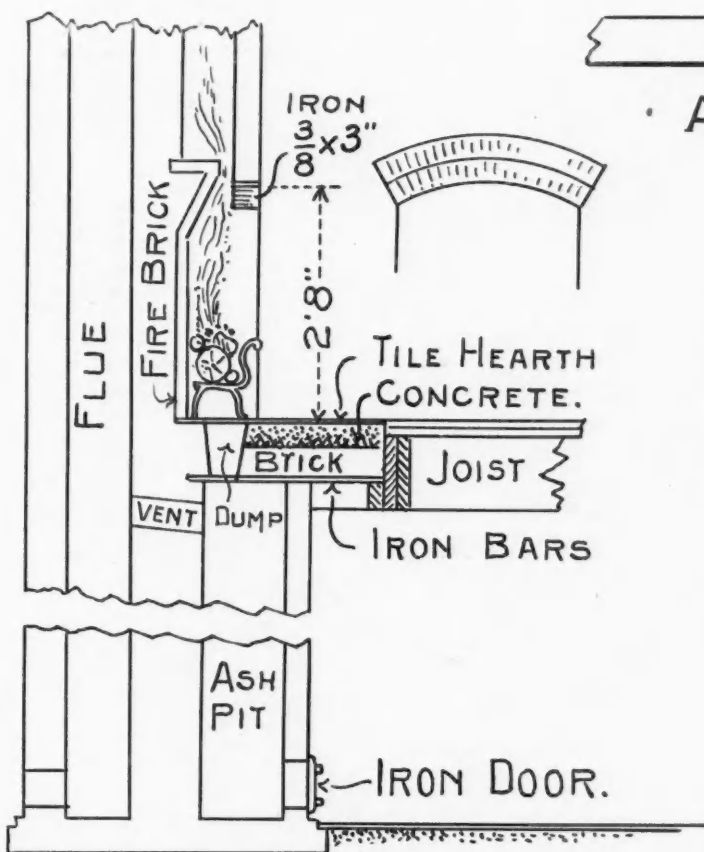
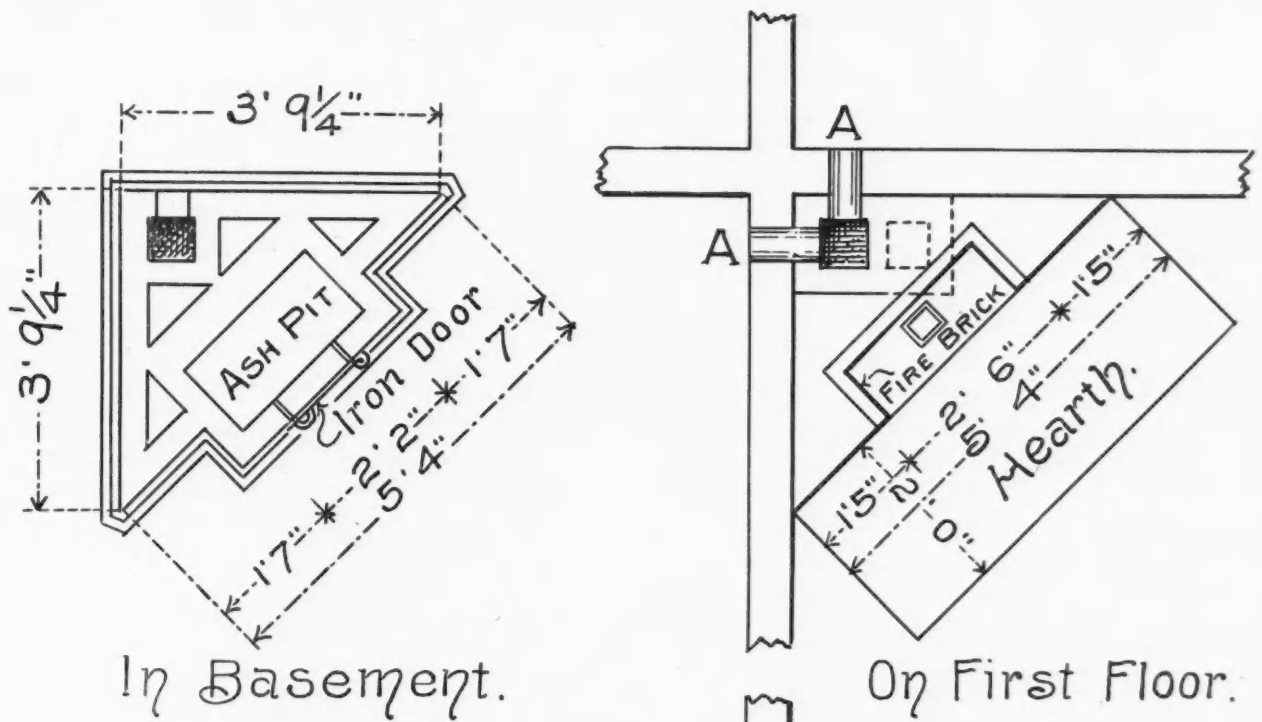

Section through Fire Place.

be independent from other openings. Cast iron hoods with damper attachment are quite often used to form the top of open fire-places and are set in place at the

time of building the chimney. The top should be capped with Portland cement or with a 3 or 4 inch flat stone with openings cut to fit the flue openings.

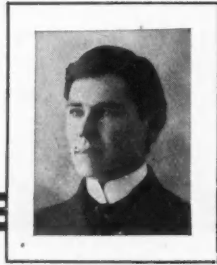

Barns and Farm Buildings..

HENRY H. NIEMANN

Grouping Farm Buildings

RESPECTIVE LOCATION OF EACH AND ADVANTAGES DERIVED FROM PROPER GROUPING — MODEL FARM AT HINDSDALE, ILL., SHOWN AND DESCRIBED

THE illustration presented herewith represents a bird's-eye view of the Geo. B. Robbins farm, which is located near Hinsdale, Ill., and shows the grouping of the buildings.

most convenient and at the same time the most artistic arrangement. While the buildings may have been planned very carefully and be perfect individually, the entire scheme can be very easily spoiled by their

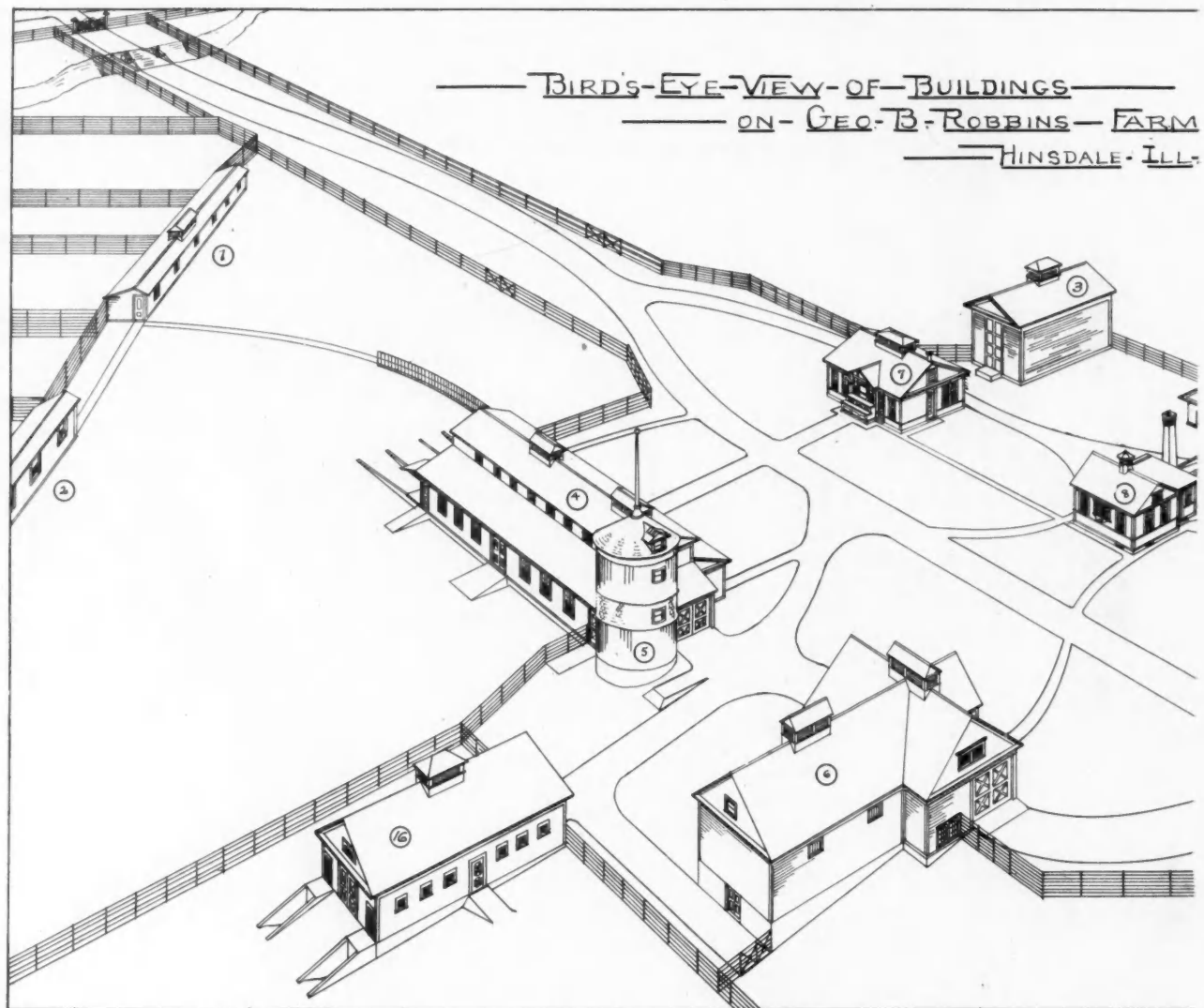

Although the buildings of no two farms can be grouped alike and at the same time give the best possible results, on account of the variation of local conditions and requirements, there are certain rules which can be followed in most cases in order to obtain the

being built in the wrong location for practical use, and too much study cannot be given to insure proper location. In most cases the buildings are not all built at the same time, and in constructing the first buildings but little thought is given to future improve-

ments, but they are located for the convenience and conditions of the present, and when additional buildings are necessary they are located with reference to the old, which may have to be abandoned within a few years and replaced with new ones.

At the time improvements were begun on the farm herein referred to, there were five buildings on the site, but the location of these was not taken into consideration. The farm was very carefully surveyed to secure the exact slopes of the ground, and with reference to this and the location of the public roads and river the new buildings were carefully located. The best advantages for future use were thereby obtained, regardless of the location of the old buildings. With the exception of the farm house and feed barn, which could not have been located to better advantage, all the other old buildings were moved aside for temporary use during the construction of the new build-

No. 3 is the ice house, which for the convenience of handling the ice by gravity is located directly opposite the ice doors of the refrigerator in the creamery, No. 7.

No. 4 is the cow barn and No. 5 the silo. The cow barn has a driveway through the middle of its entire length, which is a continuation of the driveway through the hay and feed barn, No. 6, which is equipped with dumping scales, grain elevating machinery, traveling hay forks, etc., for the handling of all kinds of feed and grain by electric power from the electric light, power, pumping and heating plant, represented by No. 8.

This building is centrally located and may be called the heart of the farm, as it furnishes all the buildings with electricity for light and power, with steam for heating and sterilizing, with hot and cold water, soft water from large cisterns for washing, etc., and deep

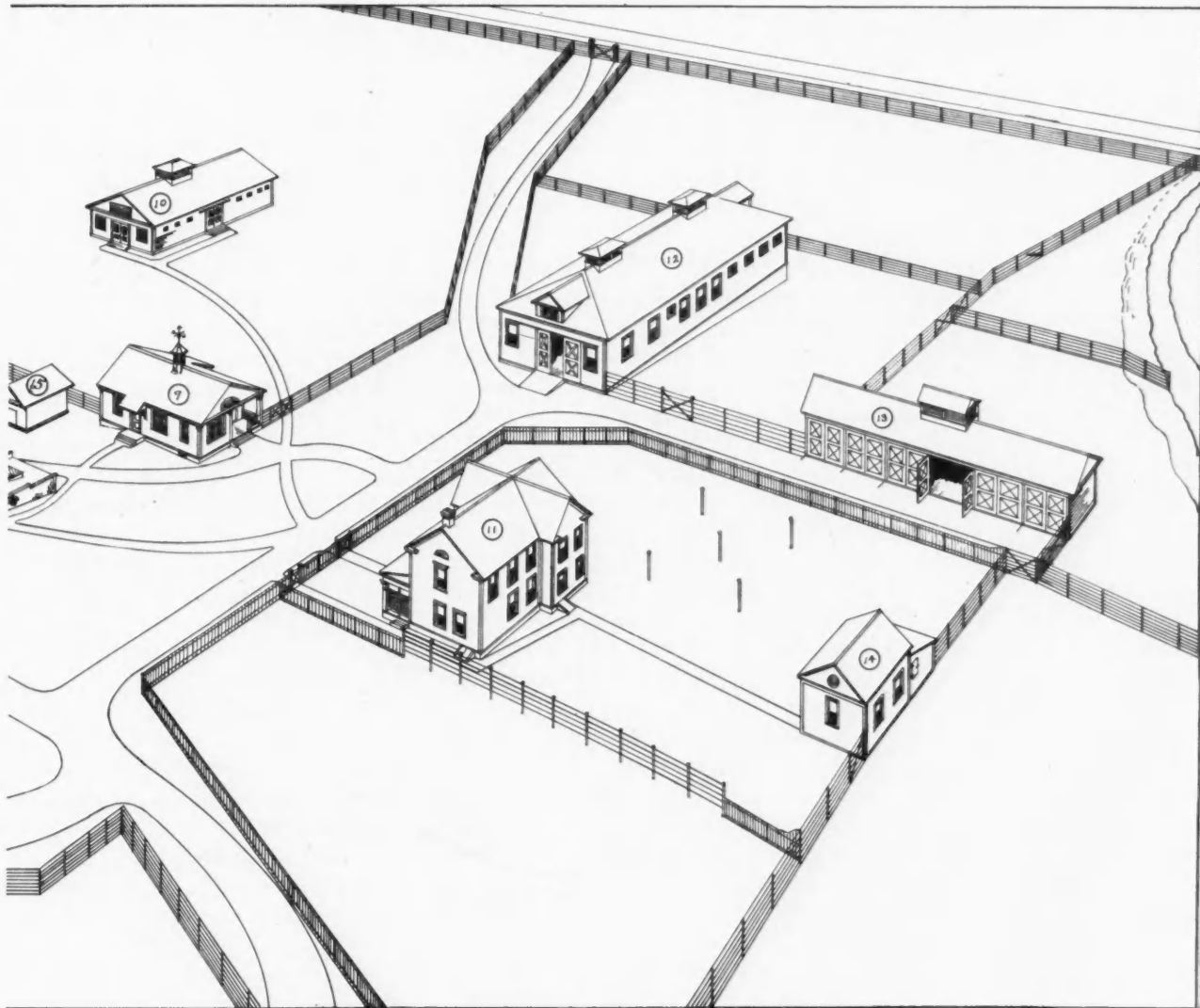

ings. The buildings shown in the illustration, according to the numbers thereon, are as follows:

No. 1 is the chicken house and No. 2 the duck house. These have scratching yards running down to the creek, which supplies the fowl with running water.

well water for general use. For lack of space we cannot go very far into detail concerning the mechanical equipment of this building, but will explain its various uses in articles to follow. The water is supplied to the various buildings by pressure obtained in

pumping it into large pneumatic storage tanks, which are located in the basement of building No. 9. This building contains the blacksmith shop, repair shop, office and a manual training room.

No. 7 is the creamery and is located opposite to the cow barn, so the milk can be taken from the middle door of the cow barn to the receiving vat in the creamery by means of an overhead trolley.

No. 10 is the sheep barn.

No. 11 is the farm house.

No. 12 is the horse barn, having a driveway through its entire length, a large vehicle room in front and stalls in the rear.

No. 13 is the implement shed for shelter of all farming implements, tools and machines.

No. 14 is a storage shed.

No. 15 is a fireproof storage house for gasoline, oils, etc., and No. 16 is the young stock barn.

There are also smaller buildings, such as hospital stalls, etc., which are not shown, as their locations do not form part of the general grouping scheme.

This article will be followed by others, describing each of these buildings individually, and will be accompanied by architectural drawings and photographs where necessary to more completely explain their construction and utility.

Construction of Stone Silos

CARE TO BE TAKEN IN USING STONE IN THE CONSTRUCTION TO PREVENT AIR REACHING THE SILAGE—THE KIND OF INTERIOR FINISH TO USE TO PREVENT ACTION OF ACIDS FROM SILAGE ON THE MORTAR

STONE is one of the most suitable and durable materials for the construction of silos, and in localities where it can be obtained without much expense it is preferable to wood construction. The walls must, however, be built with great care and well protected on the inside against the mortar coming in direct contact with the silage, which is generally done by coating the inside of the walls with an acid proof composition. Nothing but the best of materials should be used in the construction of silo walls, and all joints and interstices must be thoroughly filled with good live mortar, making the whole, when completed, one homogenous mass.

The walls should extend down to a solid sub-soil of hard clay, sand, gravel or rock, to prevent uneven settlement, which would cause the walls to crack and thus admit air to the contents of the silo; and in all cases the walls should be built below frost.

As explained in the previous article it would be advantageous to excavate the entire area to the depth of the foundation walls, thus greatly increasing the capacity. A depth of from three feet six inches to four feet below the ground can, in most cases, be made; and if the convenience in removing the silage will permit, it may be made much deeper.

In case there is danger of the ground becoming saturated with water, a drain tile should be placed around the outside of the bottom of the walls, as shown in the cross section, and after the wall has been completed the trench above the drain tile should be filled up to within one foot of the surface with gravel or cinders. This filling should be well tamped in solid against the wall all around so as to counteract the outward pressure caused by the silage.

The walls below the surface should be plastered on the outside with cement mortar, composed of one part cement and three parts sand. The walls should start on a large stone footing course in order to spread the weight of the wall over a larger area; first spreading a layer of good mortar in the bottom of the trench,

then setting the stone in place with a stone hammer so as to settle it well in place. The walls below the ground should be at least two feet thick and laid up in cement mortar to a height of two feet above the ground, so as to prevent moisture from creeping into the wall. It is preferable to lay the entire wall in cement, but in localities where lime is much cheaper it may be used where the walls do not come in contact with much moisture.

For large stone silos, where the outward pressure of the silage against the walls is greater than the safe tensile strength of the masonry, it becomes necessary to reinforce the wall with iron anchor rods or hoops bedded in the walls. These rods should not be less than one-half inch in diameter for the upper rods and increasing their diameter for the lower hoops where the pressure is the greatest. There should be at least one set of rods between all doors.

The entire interior surface of the wall should be plastered with a good rich coat of Portland cement and clean sand plaster, mixed in a proportion of about one part cement to two parts sand, and applied as soon as mixed and troweled to a smooth surface. In order to prevent the acids of the silage from dissolving this plaster it must in some way be protected by an acid proof coating. A coat of asphalt varnish is very effective and durable for this purpose and also closes up all the very fine shrinkage cracks in the walls which may not be discovered and would admit enough air to start decay in the silage.

The action of the acid can also be overcome by going over the cement plaster surface with a coat of cement whitewash, made of fresh Portland cement, adding enough water so it can be applied with a brush. This method, however, is not so satisfactory as it not only must be repeated each year for the protection of the wall but the action of the cement will spoil all the silage which is in direct contact with the wall, causing it to turn black and making it unfit for food.

DESIGN OF A STONE SILO

H. H. NIEMANN

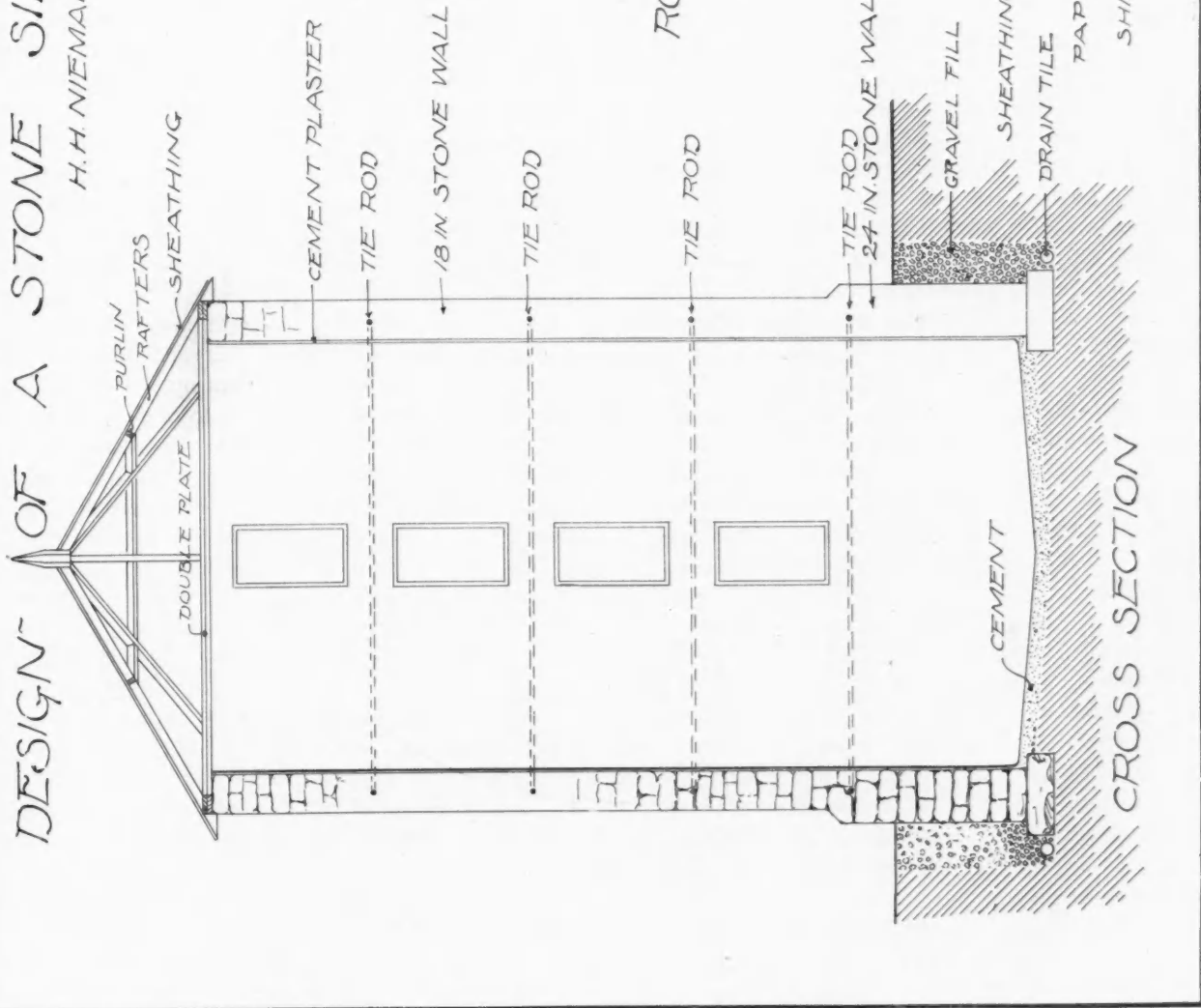



Foundations and Their Treatment

II. BEST SOIL FOR FOUNDATION TO REST ON—TREATMENT TO GIVE POOR SOIL TO MAKE IT SECURE AND PREVENT MALARIAL GASES AND DISEASE GERMS

PASSING now to the next best bottom on which foundation footings may be placed, we find it to be rock reduced by the evolution of the earth's crust to gravel or shale, which are sufficiently dense in their composition to sustain a weight of 200 pounds to the square foot, when grouped in large masses or retained in place by surrounding ledges of rock. The mass, however, being composed of small particles liable to move when unconfined, must in all cases be of a depth and area to warrant its mobility when weighed.

As to its treatment. I would again recommend a good spread of concrete, extended over the necessary length and width in layers of not less than four inches in thickness, and confined between boards until the entire mass has thoroughly set and is impervious to the impact of blows administered with a twenty-eight-pound sledge. Portland should always be used for foundation work, especially at the bottom or under ground, where the footing or base may be continuously wet or damp. Water pools or pockets are a dangerous feature sometimes existing in these bottoms and the space directly under the walls or future piers; so the ground must be carefully probed with a crowbar every two feet square to make sure there are no sand holes, quicksand formations, or any soft clayey or chalky material, which, not having sufficient bearing capacity or being compressible might be liable to sink and consequently cause the superstructure to subside, twist or fracture.

The presence of quicksand is perhaps the only really serious danger likely to develop, especially downtown in Manhattan. In the writer's experience he has met with one case in which the quicksand ran out so fast from under the footing of an old adjacent building when the trenches of the new building alongside were being dug, that it was only by wetting the running sand with a hose that it was solidified and the wall saved from collapse. Wetted quicksand, however, is not a secure material to set foundations on and it would be better to cofferdam this, if the pocket be limited in size, and either dig or pump it out with a suction pump or water jet.

Good, dry, hard sand or even damp, hard sand of a

close and compact kind, is as good a material on which a foundation can rest when running rivulets, springs, or tidal creeks are absent. Should any of these be revealed in the excavation they must either be bridged or dammed and the trench or pier footing carried down deep enough to guard against any possible danger of being mined by the running water. A very unusual and difficult solution of a bottom made up of the three elements described was met with recently in a district in which the topography revealed the presence of rock, sand, clay and marsh, making a most difficult problem for the builder and inspector. He combined a filling composed of loose clay, and large stones, a mixture hitherto unmet with in the writer's experience, covering a period of twenty-five years.

Each element was possessed of a different bearing capacity, decreasing in value from the front to the rear, necessitating that those of lesser worth and deficient in required strength must be treated in order to render them capable and fully competent to sustain the loads to be put upon them. The building in this particular case was to be seven stories high and used for stores and lofts, the latter being reserved for the storage of dry goods, cloth goods, etc. It followed that both the footings and foundations must be constructed so as to be absolutely strong and reliable. Other features which added to the difficulty of the work was the fact that the entire site was enclosed on three sides by three five-story brick tenement buildings, the extreme area of the building, measuring 20 feet front by 100 feet deep, and the depth required for the excavations, which ran from 10 feet below the curb line at the building line to 27 feet below at the rear southeasterly corner.

In the treatment a sloping rock was simply stepped off with the wedge and hammer in the way I illustrated in the first diagram, and this stepping gradually led down to the natural clay strata, which was carefully tested with an iron bar driven down by the arms of a strong laborer till it would not penetrate further than three inches. This was deemed strong enough, being adjudged able to carry a working load of eight tons to the square foot. The next material encountered was the filling in, which was found to be a useless mix-

ture of all sorts of ashes, cans, clay and stones indiscriminately dumped in the lot to fill it in on top of the marsh and water about twenty years before, and of course unfit to build on. It was decided that the only way to get to a good bottom was to take out the miscellaneous filling and get down to the firm sand beneath.

In doing this, however, the likelihood of undermining the adjoining foundations cropped up, and the surrounding walls had then to be shored, or perhaps needled, an exceedingly difficult undertaking, because the bottom being soft no solid bases could be obtained for the uprights. What, then, was to be done? After consultation with the architect and engineer it was decided to place spreaders tightly wedged across the lot from two opposite walls of the north and south buildings, to prevent them from settling down, it having been concluded that the walls must spring outwards before settling, and if kept free from jarring or bulging that the upward thrust of the beams would effectually prevent any danger of fall or break.

Subsequently the wisdom of this calculation was verified for when the concrete footings of the old contiguous buildings were undermined the walls above never moved, cracked, nor bulged, but remained fixed and immovable, even though the soil and sand underneath were taken out in sections of an average of ten feet at a time. Another testimony of the cohesiveness of the concrete was evinced during the removal, because its inherent strength was so great that it never once dropped, though virtually hanging for a span of ten feet.

Having gotten down to the bottom of the filling in, the mud and springs were discovered and it was here small cofferdams became necessary to keep the water out of the trenches to allow the men to dig out the mud; these consisted of small rectangular bottomless boxes, nailed together from two to three feet high, made of $1\frac{1}{2}$ or 2 inch plank battened together edge to edge. When excavated down to the solid black sand they were filled in with Portland cement concrete, mixed one, two and four, and set in layers of six inches thick to a depth of two feet and a spread of from four to six feet. Where the spring occurred (there is generally one spring larger than the rest in a marshy bottom) the concrete was bridged, allowing the water to run without stoppage or hindrance under footings and draining the site as before.

In connection with this matter of marshy and soft mud bottoms I would state that there are many blocks of buildings built over such stratas as this, but they are so far below the filling in that they are forgotten or ignored, but the marshy, malarial ground is still there, in fact it can't be taken away or improved, as all know, and the fumes and vapors which malarial maladies exude naturally rise up from the bottom and permeate and poison the

healthy oxygen of the atmosphere and promote chills and fevers. I could quote one district in the city of New York where the houses of the very best architecture are built on a filling in of the most varied description, placed on top of a swampy land filled in with decaying grasses, dead fish, eels, and other fetid matter, the effluvia of which is so detrimental to human health that 150 doctors obtain splendid livings and emoluments from the general unhealthiness of the residents who tenant the houses. Again, strange to say, the most prominent hospital in the greater city is situated on the brow of a hill north of the unhealthy locality I have mentioned. Readers will understand that I take the topography of all land as it originally was before the erection of the buildings at present standing on it, and some are possibly acquainted with many parts of the city of New York, which in their original state were totally unfit for building sites or foundations. By filling in the value of the land was gradually increased and rendered fit for the real estate market. Need I ask, would anyone recommend such sites for healthy homes, considering the subject from a hygienic standpoint, or would anyone if he were aware that such conditions existed under the foundations of houses, rent, lease or purchase them? Doctors, those shrewd men of science, whether or not they are aware of the nature of the bottoms, immediately on the first complaint of liver or malarial troubles, order the patient to go away at once to Europe, the mountains, or perhaps to the seaside, out of the city air; with the result that the house is immediately vacated and the vast mansion or city residence, which cost perhaps hundreds of thousands of dollars, becomes the abiding place of a poor old man or woman caretaker in the basement, for the upper stories of the building are closed and locked to him or her, and by and by the undertaker's wagon comes along and closes the chronicle by carting the bodies off to Potter's Field or an unknown grave. As the family never returns to the house lest ill-health should menace the safety of any member, it is offered for sale, and on account of its elegant location and appearance purchased by another uninformed aspirant to social pretensions and the tragedy recommences.

I hope that my readers will not think me pessimistic in this statement or mentally accuse me perhaps of exaggerating the conditions, but believe me, when one goes down into a caisson, as I have done, and at a depth of 56 feet below the curb line, finds all the germs necessary to develop a first-class case of typhoid fever, and then ascertains from a doctor next door that the general health of the neighborhood is poor, it is not a very intricate problem to think out the reason why. It is an error to my mind to take it for granted that because fetid matter is covered, it is no longer dangerous; and mark you, this stuff is not entirely covered, as I don't consider a covering

consisting of large stones dumped indiscriminately into a lot and full of voids, a sure preventive of insidious disease.

Therefore I trust that it will be understood that all foundations to be healthy must be placed on dry,

hard ground, and on a stratum sufficiently thick to resist all danger of injurious vapors penetrating or percolating through the layer of material immediately under the footings, and likely to place the health or lives of the inhabitants in danger.

Thickness of Rings in Arches

BEARING CAPACITY OF ARCHES SPANNING WINDOW AND DOOR OPENINGS—KINDS OF STONE TO USE IN THE CONSTRUCTION AND TABLE SHOWING FULL THICKNESS OF RINGS

By Owen B. Maginnis

IT IS a question whether an architect or builder really considers or calculates the bearing capacity of the arches or lintels which span window and door openings. They mostly take it for granted that a two-rolock arch will carry the brickwork inside the stone lintel on a 12 or 16 inch wall, from the wood

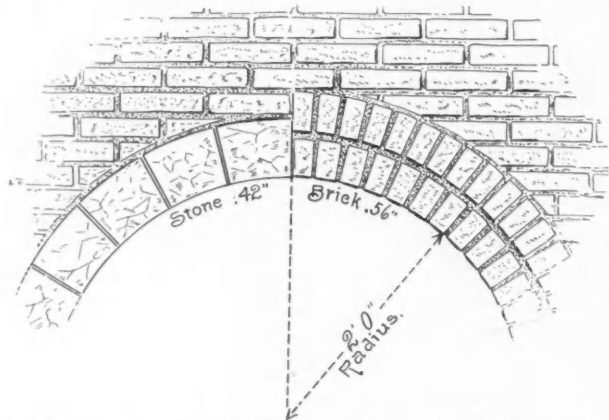

the joints of the voussoirs are made parallel, with beds straight and level, and the workmanship of the very best kind. Reference to the diagram that accompanies this will explain the practical application of the figures.

Taking the first figure two feet radius shown in the diagram it will be found that the thickness of the stone in the ring is .42 of one foot or slightly less than six inches, .50 being six inches, so that it would be about 5½ inches, which is near enough for all practical purposes. Again, to the right is shown the thickness of the brick ring which is given in the table, .56 of one foot, or slightly more than six inches, but as bricks come in 3½ or 4 inch width modern masons make the arch a little stronger than necessary and use two rolocks which make it concur with the table.

center up to the window sill of the story above. In warehouse buildings, for openings not more than three feet in the clear of the reveals, they use a three-rolock arch laid in cement mortar; or omit the arch entirely and set I beam lintels over the openings resting on bluestone or castiron templets with a relieving arch over same, thus giving a square top and soffit from the inside of the window opening.

As there are no stated sizes given by any authorities on building construction as to the full thickness of the rings of arches, we submit for the benefit of our readers the following tables and we would state though not common in modern practice, they are still sufficiently reliable and can be used with safety; but it would be advisable always to increase the thickness to the full value of 25, 50, or 100 per cent of the decimal given in the appended table.

For ordinary dwelling houses, office or loft buildings, the tables will be found very useful and can be easily approximated with the standard market sizes of bricks. The stone arches according to the sizes given herein will need stone of a non-compressible nature, but the figures given will safely apply to any stone of fair compressive value from Indiana lime stone to granite.

In submitting the table we of course assume that

Radius of Curvature	Stone Arches	Brick Arches	Radius of Curvature	Stone Arches	Brick Arches
Feet	Feet	Feet	Feet	Feet	Feet
2	.42	.56	24	1.47	1.96
4½	.47	.63	25	1.50	2.00
4	.52	.68	30	1.64	2.19
5½	.56	.75	35	1.78	2.37
5	.60	.80	40	1.90	2.53
6½	.64	.85	45	2.01	2.68
27	.67	.90	50	2.12	2.83
38½	.71	.94	55	2.22	2.97
39	.74	.98	60	2.33	3.10
2	.80	1.06	65	2.42	3.22
1	.85	1.13	70	2.51	3.35
0	.90	1.20	75	2.60	3.46
1	.95	1.26	80	2.68	3.58
1	1.00	1.33	85	2.77	3.69
1	1.01	1.38	90	2.85	3.80
3	1.08	1.44	95	2.92	3.90
14	1.12	1.50	100	3.00	4.00
15	1.16	1.55	110	3.15	4.20
16	1.20	1.60	120	3.29	4.38
17	1.24	1.65	130	3.42	4.56
18	1.27	1.70	140	3.55	4.73
19	1.32	1.74	150	3.67	4.90
20	1.34	1.79	160	3.80	5.06
22	1.41	1.88	170	4.18	5.58

Where good finish is an object, the cheapest planer is generally the most expensive.

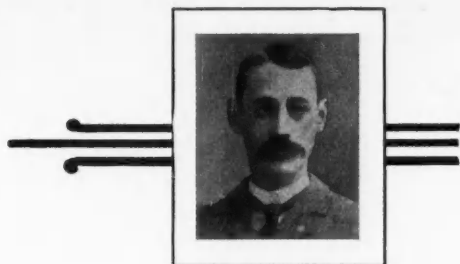

Practical Carpentry

DWIGHT L. STODDARD

Grinding Tools

HOW TO PROPERLY GRIND TOOLS TO OBTAIN BEST RESULTS—FIGURES SHOWING THE CORRECT AND INCORRECT METHOD—USEFUL ATTACHMENTS FOR A GRINDSTONE

TO THE builder who really earns his "bread by the sweat of his brow," it matters not how good a mechanic he may be or how difficult a job he may be able to do with poor or dull tools, if he cares anything at all about his muscle, nerve or general constitution he cannot afford to be without good tools, and have them in good condition.

I am only too sorry to know that at this very moment there are hundreds, yes, thousands, of plane bits and chisels that too nearly resemble Fig. 1, which shows a tool somewhat dull.

Fig. 2 shows one just ground in pretty good shape, better ground than the average, as many are not held firm and are somewhat rounding when they leave the grindstone, and by the time they are sharpened on an oil stone a few times are just like Fig. 1.

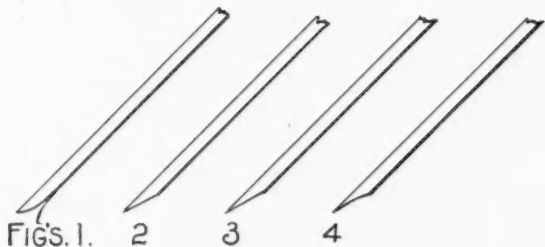

Fig. 3 shows one held firm on a large grindstone, and therefore is slightly hollow ground.

Fig. 4 shows one well ground on a smaller stone.

Fig. 5 shows how nice a small stone will grind a plane or chisel.

Fig. 6 shows a chisel well sharpened by being ground perfectly square across.

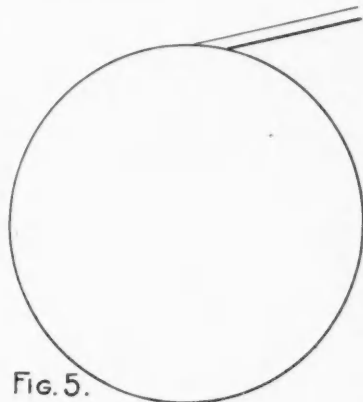
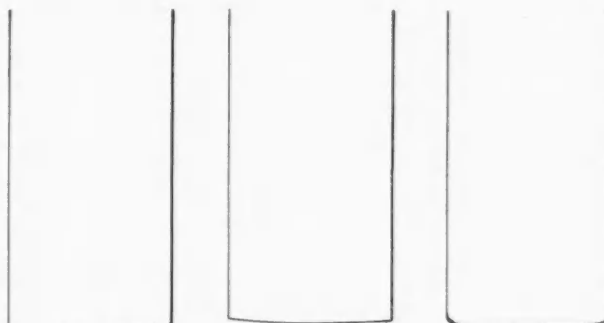

Fig. 5.

Fig. 7 shows a plane bit ground rounding as they should be, only this cut is somewhat to the extreme, for very slightly indeed should they be rounding. Planes for different work should be properly shaped on the grindstone.

Fig. 8 shows a very good way to grind a smoothing plane for general use.

Fig. 9 shows a very common grindstone with a



Fig's 6.

7.

8.

rack, which is simply a board nailed on both sides with holes bored in. This can be sprung apart to admit a cross-piece which holds chisels firmly to properly grind them. Another piece can be arranged to put into this and hold plane bits.

A little simple thought, and a few moments' tinkering can fix up an old (practically good for nothing) grindstone in such a convenient manner that it is not only a pleasure to grind on it but a pleasure to use the

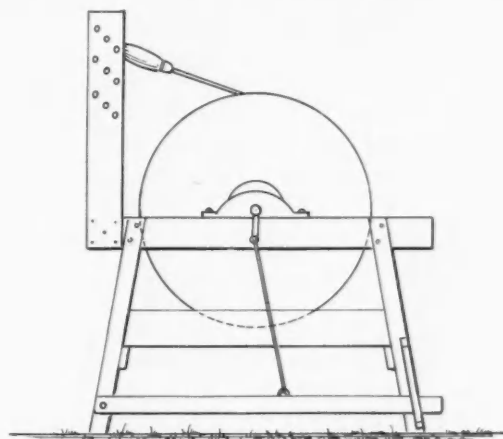

Fig. 9.

tools after they are sharpened, and change one's life from worry, vexation and drudgery, to ease, comfort and happiness.

Siding

DIFFERENT KINDS OF SIDING USED AND THE BEST WAY OF PUTTING IT ON THE HOUSE—ALSO A FULL DESCRIPTION OF HOW IT IS CUT AND OTHER DETAILS

IF THE human eye should travel this country from one end to the other and glance at the outside walls of every home, it would undoubtedly see more siding than any other one article, or material, and pos-

sibly more than all others combined. Considering the fact there is so much of it in house construction it is truly deserving of a passing thought. Common siding which has been used for ages to be distinguished from

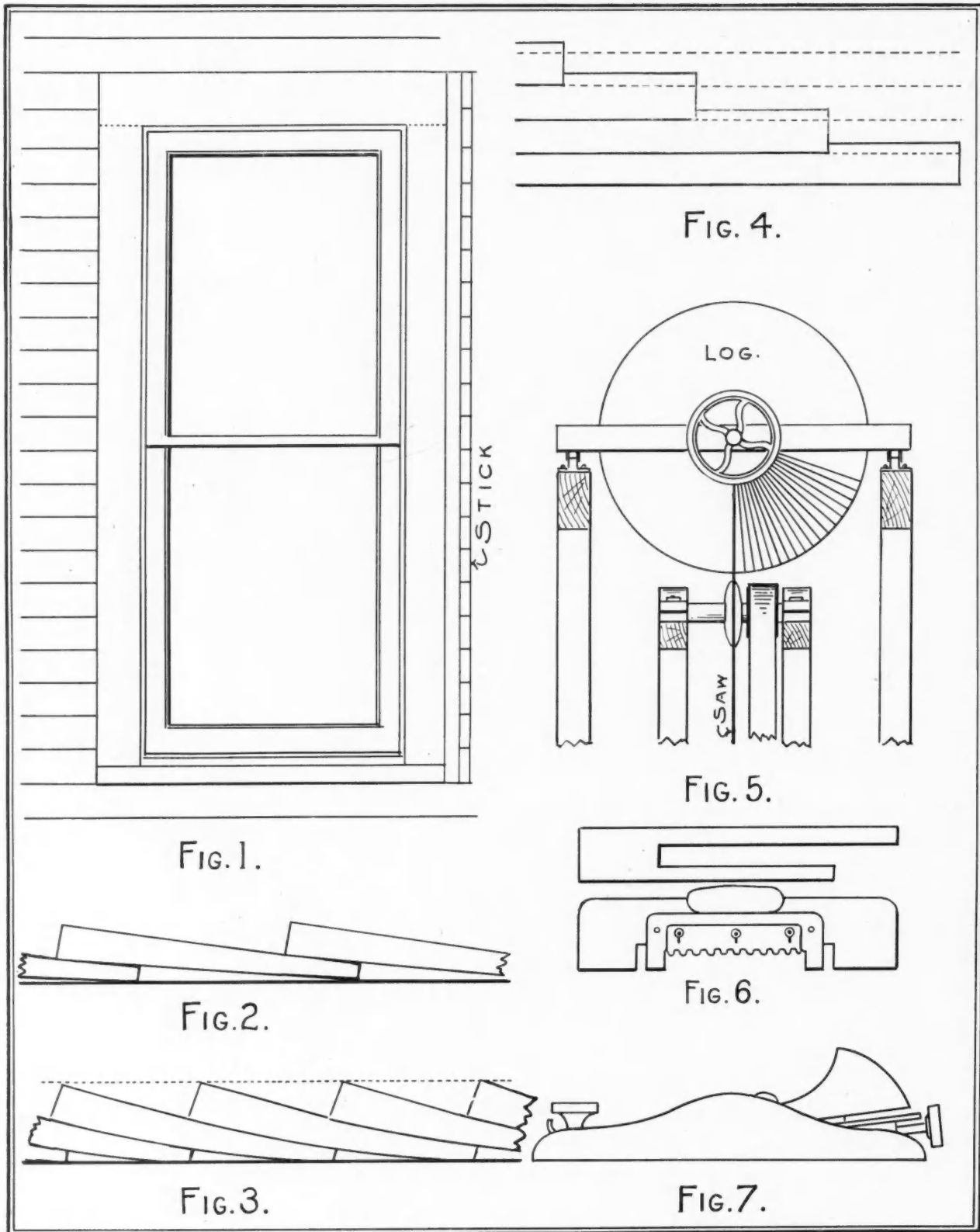

later combinations, and imitations of drop siding, etc., is often called lap siding, while many have always called it clapboards and others weatherboards.

Some contractors think the only thing necessary is activity, energy, and perspiration and plenty of it, just so the wall is covered as soon as possible, gauged the width it is to show to the weather and slapped on regardless of windows, doors, cornice, or anything else. But that is not the mechanical way.

Siding should run level and be put on straight, and as near as possible come up even under the window and come out even at the top and space up to the cornice. To get all spaces just the same height all around the house I have never found as good, quick, or easy a way as to cut a stick as shown in Fig. 1, just the length of the window, and space it off. Then with that, mark the edges of every window casing all around the building

Fig. 2 is an end view showing how it is lapped, while Fig. 3 shows it lapped so as to be double all over the building. Many years ago this was a style much used in many localities. Most of this double lap style was put on many years ago before the days of the planer for siding was here, and are therefore just as it came from the saw.

Fig. 4 shows it being laid on the building. While this illustrates it in a general way, it particularly shows it as I first learned to put it on, by snapping lines and running several courses same as shingles, but this siding was all only six feet long and both ends cut off perfectly square with little circular saws at the mill where it was made. This same style is still made in

many mills at Mill Brook, Vermont, and as it may seem somewhat novel to many western builders I will describe it very briefly.

The logs are drawn twelve feet long, taken into the mill and cut in two, making two six-foot logs. They are put into a turning lathe and turned. Then they are put into a carriage. Fig. 5 is merely suggestive so as to give the reader a clearer idea. The carriage runs over a buzz saw that cuts it through the bottom and gigs over the thickness of the thick edges of the siding and the saw goes through it again, and so on until the log is all cut up into siding. The siding can be easily pulled off and leaves a round fence post. Then it is stacked and seasoned, and run through a planer made for that purpose, and butted with cut-off saws as I mentioned before.

Fig. 6 shows two very common siding markers. Perhaps the most common one is simply a piece of siding with a notch cut in it, but really the worst trouble with most of the common markers is that they must be held with one hand while you mark with the other.

Stanley's patent is the best I have ever seen and the one I continue to use as it can all be done with one hand, therefore easily and rapidly.

Fig. 7 illustrates the best block plane for siding, because it is small, light and condensed, and the bit lies flat, making it a nice cutter and a wonderful improvement over the old style planes.

If it was not for making the article too long it would be hard to tell where a person would stop on a subject about which so much could be said, but I will leave the balance unsaid, hoping others will take up the subject.

The Making of a Practical Carpenter

II. A FULL DESCRIPTION OF DIFFERENT KINDS OF POLYGONS COMMONLY USED IN CARPENTRY—ALSO A COMPLETE EXPLANATION OF MATTERS PERTAINING TO THE CIRCLE

By Frank F. Addison

POLYGONS.—A polygon is a portion of a plane terminated on all sides by straight lines. A regular polygon has all its sides and angles equal and an irregular polygon has its sides and angles unequal. Polygons are named according to the number of their sides or angles, as follows:

A triangle is a polygon of three sides. See Fig. 6.

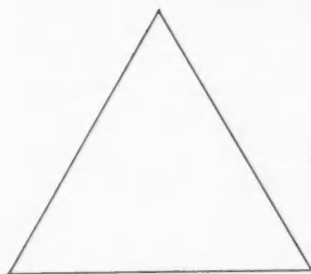

Fig. 6.

A square is a polygon of four sides. See Fig. 7.

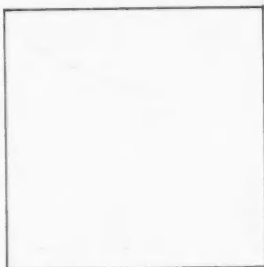

Fig. 7.

A pentagon is a polygon of five sides. See Fig. 8.

A hexagon is a polygon of six sides. See Fig. 9.

A heptagon has seven sides. See Fig. 10.

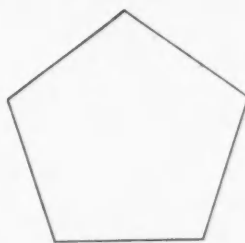

Fig. 8.

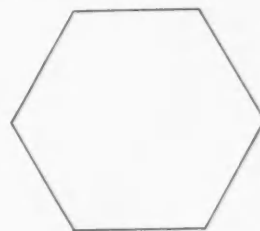

Fig. 9.

An octagon has eight sides. See Fig. 11.

A nonagon has nine sides. See Fig. 12.

A decagon has ten sides. See Fig. 13.

An undecagon has eleven sides. See Fig. 14.

A dodecagon has twelve sides. See Fig. 15.

Figures having more than twelve sides are generally designated polygons or many-angled figures.

A circle is a plane figure bounded by one uniformly

curved line, called the circumference, every part of which is equally distant from a point within called the center.

The radius of a circle is a straight line drawn from

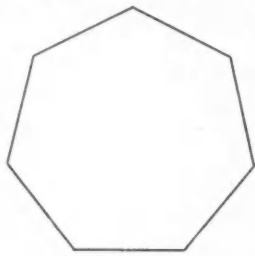

Fig. 10.

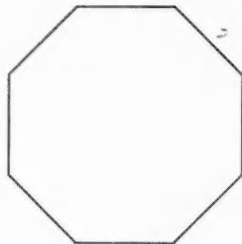

Fig. 11.

the center to the circumference; hence all the radii of a circle are equal.

The diameter of a circle is a straight line drawn through the center and terminated on each side by the circumference; consequently the diameter is exactly twice the length of the radius.

A chord of an arc is any straight line drawn from one point in the circumference of a circle to another,

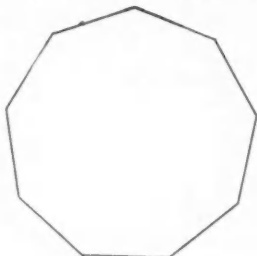

Fig. 12.

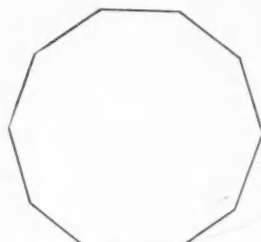

Fig. 13.

joining the extremities of the arc, and dividing the circle either into two equal or unequal parts. If into two equal parts, the chord is also the diameter, and the space included between the arc and the diameter on either side of it is called a semicircle. If the parts cut off by the chord are unequal, each of them is called a segment of a circle, but unless otherwise stated it is always understood that the smaller arc or

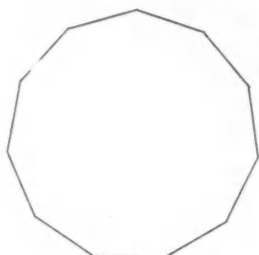

Fig. 14.

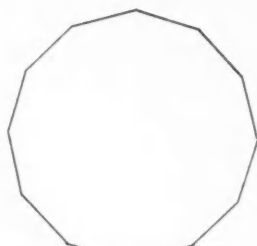

Fig. 15.

segment is spoken of. A tangent is any straight line which touches the circumference of a circle in one point, which is called the point of contact, as in Fig. 16.

Concentric circles are circles within circles, described from the same center; consequently their circumferences are parallel to each other.

Eccentric circles are those which are not described from the same center; eccentric circles may also be

tangent circles; that is, such as come in contact in one point only.

Altitude. The height of a triangle or other figure is called its altitude. To measure the altitude, let fall a straight line from the vertex or highest point in the figure, perpendicular to the base or opposite side.

An inscribed polygon is one which like A B C D E in Fig. 17, has all its angles in the circumference. The circle is then said to circumscribe such a figure.

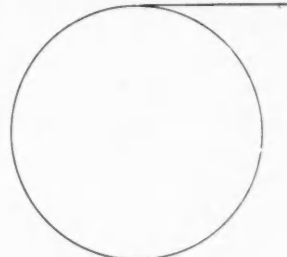

Fig. 16.

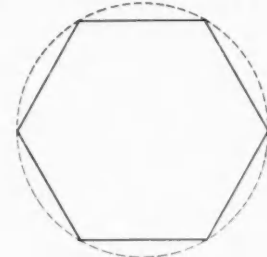

Fig. 17.

We have now described all the figures we shall require for the purpose of thoroughly understanding all that will follow in the series of articles; but we would like to say right here that the student who has time should not stop at this point in the study of geometry, for the time spent in obtaining a thorough knowledge of this useful science will bring in better returns than if expended for any other purpose.

In the next article we will begin to explain how the figures we have described can be constructed. There are several ways of constructing each figure we produce, but the simplest and therefore the best method has been selected in almost every case.

Explains Confusion at Babel

"Among ignorant persons," said Frank E. Wallis, secretary of the Architectural League of New York, "there is a belief that architects are useless—that a builder is enough of an architect for all practical purposes. I attended a session of court not long ago when an architectural case was being heard. A young architect was put on the stand, and, after he had given his testimony, the lawyer for the opposition began to cross-examine him. The questions ran like this:

"'You are a builder, I believe?'

"'No, an architect.'

"'Builder or architect, architect or builder, it is much the same thing, isn't it?'

"'No, not at all.'

"'What is the difference?'

"The young man explained what the difference was, and the lawyer, with a sneer, said:

"'Oh, very well. That will do. And now, after your very ingenious distinction without a difference perhaps you can inform the court who was the architect of the Tower of Babel?'

"'There was none,' he answered, 'and hence the confusion.'"

Constructing an Ordinary Stair

III. DIFFERENT WAYS OF MITERING TREADS AND RISERS—FULL DESCRIPTION OF FASTENING NOSINGS AND MANY OTHER DETAILS

By Lewis R. Steinberg

IN AN open stair, and especially one in which the treads project over the face of the string, it is desirable to have the work rather well finished in order to present an attractive appearance, one that will harmonize with its surroundings. In the modern dwellings of to-day the front hall or the stair hall is made larger than is necessary to accommodate merely the stair. The reception hall and stair hall are combined and appropriately so, but it is necessary then to finish the room more elaborately than if it were used as a stair hall only.

The details described last month as to joining treads and risers apply also to the work we are now taking up. In fact the two stairs are similar with the exception of the face string and the ends of the treads and risers adjoining.

The object in the stair we are now taking up is to avoid having the end of any piece of wood show. In order to accomplish this in the riser, the rise in the string is mitered and the end of the riser is cut on the same miter.

In Fig. 1 the different ways of mitering are shown. At (a) is a miter of forty-five degrees cut on both the string and the riser. This is the simplest method and the one more often used because of the saving in time. In (b) the riser has a shoulder to fit against

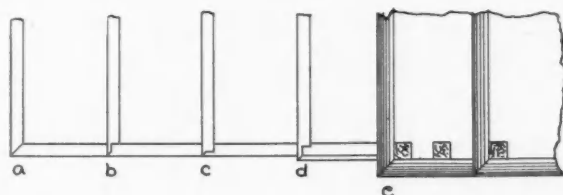

FIG. 1.

the string and only the outside is mitered. This makes a more rigid joint. In (c) the miter is cut at the front as in (b) and the string is cut out to receive the remainder of the riser. Here the riser gets a stronger bearing upon the string, while in (b) only the front of the riser gets a bearing.

Where it is desired to make the face of the string more ornamental, a thin bracket is placed against the string, as shown in Fig. 3 at (g). When this is done, the riser must be longer than the thickness of the bracket where no bracket is used. This is necessary because the bracket is mitered to the riser. The cove under the nosing is placed upon the bracket just as it is returned upon the face of the string in the case where the bracket is not used. The lower front part of the bracket rests upon the returned nosing of the tread. In the best grade of work the brackets are

glued upon the string, but ordinarily they are nailed on with brads, which are then set and the holes filled with putty.

The return nosing is mitered at the front of the tread to fit the nosing over the riser. At the back of the tread, a return is cut as seen at (m) in Fig. 3, which is a plan of (h) in Fig. 3.

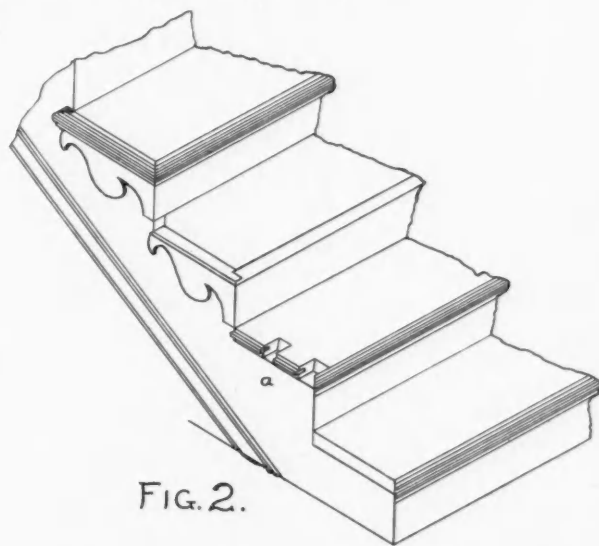

FIG. 2.

After the balusters are in place the return nosing is nailed to its proper place and nail-holes filled with putty or a groove may be cut into it, as shown in Fig. 4. On the end of the tread, as seen in Fig. 2 at (a), a similar groove is cut and a thin piece of wood or tongue glued into the groove in the end of the tread. This tongue should properly have the grain of the wood run in the same direction as the grain in the tread. The return nosing is then fastened into place by glueing the tongue and the groove and driving the nosing to a tight fit.

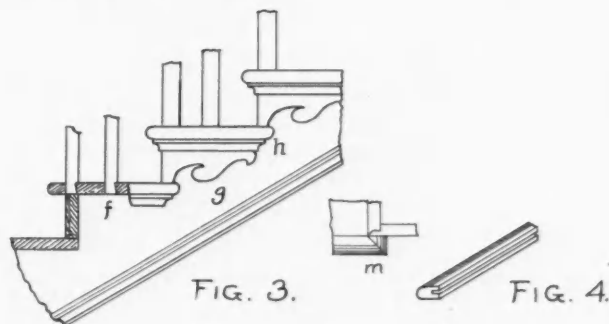

FIG. 3.

FIG. 4.

Another way to fasten the nosing is to cut notches on the underside of the tread and putting wood screws through into the return nosing.

A glance at Fig. 1 and 2 will show how the balusters are dove-tailed into the tread. The outside of the

baluster should be flush with the face of the string and where a bracket is used this must be considered the face of the string.

Next month we will take up more fully the details in relation to the balusters and rail of a straight stair, stairs of one run and also stairs with landings in them.

The Carpenter and the Gasoline Engine

MANY USES TO WHICH IT CAN BE PUT ON A SMALL SCALE—CARE MUST BE TAKEN TO KEEP WITHIN BOUNDS, AS IT IS USELESS TO COMPETE WITH LARGE MANUFACTURERS

By J. Crow Taylor

THERE is probably nothing in the way of mechanics or machinery that has opened the way to more possibilities and opportunities for the village carpenter than the gasoline engine. That is, the gasoline engine as it is to-day, and as it promises to be in the future. Some of the earlier gasoline engines were accompanied with a very trying element of uncertainty, and consequently were rather expensive, not only in the item of first cost, but, what was worse, in the item of maintenance. At the present time, however, the gasoline engine appears in a very materially improved state. This improvement does not mean, either, that it has had a lot of complex features added to it, but it is the other way around. The engine has been made more simple, less expensive, both as to first cost and as to the cost of operating, until to-day for a small power unit there is nothing better than the gasoline engine except the electric motor, and that generally costs more to operate and is not always practical in country villages, because of the lack of electric power stations to start with.

THE LONG SOUGHT SMALL POWER UNIT

It is the small power unit the village carpenter has been wanting right along, something small and inexpensive that would serve to drive a turning lathe, rip saw, scroll saw or other similar machines with light power requirements. In times past many have resorted to hand and foot power for the operation of certain light machines of this kind, but now there is no longer any need of this, for the gasoline engine can be had of almost any size from one and even one-half horse power up to fifty. The question is open for argument as to whether or not it is advisable to use the gasoline engine when ten horse power or more is wanted, and the deciding factor depends largely on local conditions, but what the average carpenter wants is a little three or four horse power engine, and it is remarkable what an aid to business this kind of an engine is. It not only furnishes driving power, and thereby the means for doing certain kinds of special machine wood working called for at various times in the life of every carpenter, which would either have to be ordered by local freight from some city, or else laboriously made by hand, but it goes further than this; it makes a carpenter shop a sort of local factory, a place where during bad weather and through the winter when building operations are at a standstill, the village carpenter can turn out a remarkably wide range of woodwork that he

will likely need for the busy spring season. The opportunities do not stop here either, but the institution may be expanded into the doing of quite an extensive line of cabinet wood work, the manufacture of wood novelties and almost an endless line of work, depending much on the ingenuity and enterprise of the man himself, and the prosperity and taste of the community. In fact, the field of opportunities that opens up is so great that apparently no enterprising village carpenter should be without one of these small gasoline engines in his shop, and their usefulness is not by any means confined to the village carpenter either, for even the city carpenter can find a remarkable amount of work that can be done to advantage in the shop if he has a little power and a few light machines. But the gasoline engine does not as a rule appeal to the city carpenter as much as to his brother in the country villages from the fact that should a city carpenter want power at any time, all he has to do is to put in a little electric motor and he can use power from one of the local power companies and pay them according to the amount used. This, as a rule, is a little more expensive than the use of the gasoline engine, but it has certain other advantages to commend it in the city.

OPPORTUNITY AND THE MULE

The one thing the average carpenter must guard against in taking up the idea of the small gasoline engine for operating a few wood-working machines is the tendency to go too far with this matter. I have frequently had occasion to remark that an opportunity, these things which the gasoline engine opens the way to so many of, frequently bears pretty close resemblance to a mule. This translated into plain English means an opportunity properly handled can and will do lots of good work for you, but if it is not handled right, it is likely to buck and kick and do all sorts of contrary things, and when overloaded it is a foregone conclusion that it will balk. That is what a man is likely to do when he starts in at machinery wood work, he is likely to go too far and overload the thing until it balks. It is, of course, a little difficult to point out clearly just where the line should be drawn and the distinction made between a carpenter shop and a planing mill. Quite a lot naturally depends on local conditions and each man must figure out for himself how much power he ought to have and about how many different machines he can operate to advantage.

There was once a village blacksmith who thought he saw an opportunity in the shape of a small band saw. Then he had a little talk with a local livery stable man who sometimes had idle horses during the winter season which were in absolute need of exercise, and this local livery man, too, had ideas about a wood yard and a power cross-cut saw that he wanted to work out, so between the two they figured out that what was in sight was an opportunity that it would be a sin to miss. That of course was before the days of the perfected gasoline engines, else this story would be a little different. They bought a band saw, a cordwood saw, a small horse power rig for driving them, one to which might be attached either two or four horses. The whole plan looked especially nice because of the fact that plenty of good oak and hickory lumber could be had in the community for almost any price and could be paid for with blacksmithing and wagon making. The plan so far as the blacksmith and wagonmaker was concerned was to saw his own wagon felloes, hounds and other special shaped pieces of wagon wood work. It was found, however, when they got to work that the power was not steady enough for as delicate a machine as a band saw, and while it did very well for a cordwood saw and proved a success as far as the livery stable man was concerned, the blacksmith became discouraged with the results at his end of the deal, so he applied the brakes to his ambition and stopped. If he had just gotten hold of one of the little modern gasoline engines the story would have been so different, but as he did not have, and could not get a smaller unit of power in a satisfactory manner he gave it up.

AN IDEA THAT GOT TOP HEAVY

Now, to complete the story and draw the moral I am after, it will be necessary to tell about another wagonmaker and blacksmith who got this same idea into his head, except it had grown some by the time he had had it worked over to his notion, and it had included within its boundaries nearly every kind of wagon woodwork. His idea grew some more, too, under the genial influence of the machinery salesman when he went to the city to buy the necessary machines to put it into practice, till, in the end, instead of having a nice little band saw and a few other special machines that would materially serve to assist him in his business, both by reducing the cost of manufacture and increase his capacity, he had the equipment of a complete industry in itself that was bigger by far than his original wagon and blacksmith shop. He had a sawmill and complete spoke factory, band saw and 25 horse power boiler and engine, and a lot of other special machines, which loaded him with a burden of debt he was never able to shake off, and besides the thing never would have proven a success anyway if he had not become involved in the original purchase, for his idea had grown until it was

top heavy. Of course it solved the problem of his wagon woodwork, for he had machinery to make everything he needed from axles up to stakes, but the requirements of his own wagon shop did not furnish enough outlet to take care of a day's run of this factory in the course of a year. Oh, yes, he had figured that he would have a surplus, but he knew he had had to pay a very good price for this material which he had once been buying but was now making, so figured that he could readily dispose of all he could manufacture at a good profit—and that is where he fell down. He first tried going to other wagonmakers, but found they gave him the cold shoulder and would rather pay more for the same material to well-known institutions who made a specialty of doing this class of woodwork than try his. Then he turned to the supply men who make it a business to buy and sell stock of this kind and found them ready to deal all right, but he was astonished at the difference between what they offered him and what he had been paying for the material. In fact, this difference was so wide that it wiped out all the profit margin, and then, to clap the climax, when the inspectors came to pass on his stuff, what they did to him was a plenty, but it only helped to hasten his footsteps toward the inevitable end—failure.

THE MORAL OF A STORY

This is not a blacksmith story for the benefit of the blacksmiths as much as it is a story with a moral that every carpenter will do well to keep in mind when he begins flirting with the idea of taking up machine woodworking. Just what the moral is in words it does not matter. We might say it is "Be careful and don't bite off more than you can chew," or various other expressions might be used that would fit the case reasonably well, but the point to it can be seen by any intelligent carpenter without the use of a microscope or anything of that kind. It is practically impossible to point out just where to draw the line and say this far we can go with success, but no farther, because quite a lot hinges on local conditions. Generally speaking, we can assume, however, that a man has no business getting an idea in his head about manufacturing sash and doors of standard sizes, no matter where he is situated, because the successful manufacturer of this kind of stock depends on making the business a specialty. In other words, it is an industry of its own to-day, and while a man might make fair headway under certain local conditions, as a rule it would prove to be the same kind of a burden the blacksmith had on his hands. The same thing applies also to everything that is made in quantities and kept in stock at the leading lumber yards and sash and door houses, because as a rule what a man requires of these things can be purchased cheaper than they can be made when you consider the investment to be made in the way of machinery and the consumption of material in any one country

locality. There are many items of expense entering into the manufacture of these articles that are liable to be overlooked.

THE MOST NEEDED MACHINES

Ordinarily, if I should start out to fit up a carpenter shop in a country town with a small power and some woodworking machines, I would say the power equipment should be about a three or four horse power gasoline engine, a rip saw, a small band or scroll saw, a turning lathe, a small planer, either a top smoother or some light panel planer, and then I would stop. In fact, I might even stop at first with getting a small rip saw, a lathe and a light scroll saw. However, as I have said before, much depends on local conditions. And this applies not only to local conditions in the way of requirements, but also to supplies. If there should be a regular planing mill in town, I would omit the planer part entirely. But generally where there is no planing mill the village carpenter can save an enormous amount of hand planing by having either a top smoother or a panel planer. The lathe you can hardly omit under any conditions, for there is a chance to utilize almost anything in the shape of waste in the turning lathe, and especially between a turning lathe and scroll saw. You can turn corner blocks out of scraps; you can also turn an almost endless variety of special decorative woodwork, to say nothing of the various wood novelties in the way of kitchen utensils that may be made out of these same scraps during the dull winter season, or when a rainy day comes and you can't work outside.

GREAT POSSIBILITIES OF A TABLE SAW

It is a peculiar fact though, that for the simplicity and generally innocent looks of the machine, you can get more different kinds of work and more good generally out of a common table saw than out of almost any other woodworking machine. There are, I know, certain combination machines made, such as a top smoother which is combined with a saw and boring machine, and forty-seven different combinations of these machines by which you can make almost anything in the line of woodworking, and there is no question but what in many instances a machine of this kind is worth having in such a shop, in fact, would be a good investment. But there are some of these plain, wooden-top table saws that don't look like more than thirty cents and don't cost more than about thirty dollars that can be made to do lots of work in the hands of a man who knows how to take advantage of their curves. In the first place, a rip saw is one of the most convenient things in the world, because there is really more ripping, if we include the sizing of various parts, than anything else, especially where a carpenter uses rough framing. Then, by changing saws you can convert this rip-saw into a cross-cut, and by adjusting the extension of this saw up through

the table you can perform quite a lot of work that you generally have to take a hand saw to. You can cut in gains, tennon shoulders, laps and all sorts of things of that kind. And, by putting on a bunch of saws or a dado head you can cut out the gains, rabbit and do various other things. You can, too, by putting on a saw of a thickness and getting it the right cut, rig your slide gauges up and do a very respectable job of grooving flooring, and then turn around, put on two saws, and make a tongue on the other side to match the groove. You can put a slide form on for cutting shapes, cut the ends of rafters, cut miters, cut joist bridging, make wedges. In fact, there is hardly any limit to the possibilities of a rip saw table when it is in the hands of a man of ingenuity, especially if he will go to the small expense of providing a variety of saws and cutters to be used on the mandrils. You can even get a small plainer head with bits and turn it into a top smoother or jointer.

GREAT IDEA IF PROPERLY HANDLED

But, to go back to the general idea of a carpenter doing machine woodworking—it is great. One can get small gasoline engines for a modest sum which will generally give fair satisfaction and call for very little attention. These little engines have really made the greatest opening that has ever been before the average country carpenter, and the man who expects to continue in the carpenter business is standing in his own light if he does not equip his shop with one, for it is only a matter of time when someone else will, if he does not, and then he will begin to lose work and prestige, too. It furnishes an opportunity to make the carpenter business not merely of a short season but one at which a man can be profitably employed all the year around. For when he is not busy outside, he can be doing things in the shop. The idea is an inspiring one, too, and once you let it take a good hold on you, it will require some effort, some curbing to keep it from running away with you. That is the one thing you should keep in mind all the time and guard against. If you invent a new wooden novelty and think there is money in it, enough to equip a factory and make it for general distribution, all right, make sure your figures are right and then go after it, but don't, whatever you do, allow the idea to run away with you to the extent of manufacturing general woodwork in competition with larger mills and factories, for nine times out of ten you will land into trouble, and the tenth time you will likely get into the habit of neglecting your carpenter business, so there is not much chance for you to win in a game of that kind. Still, with the brakes properly applied against this danger, there is no cause whatever to curb enthusiasm, and the more we have of it the better, not only for the carpenter trade but for the country in general, because it means the adding of more architectural beauty to country houses and the adding of more profits to the village carpenter.

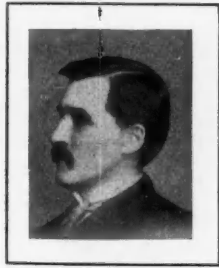

Cement Building Construction

FRED W. HAGLOCH

Artificial Stone

BEST COMBINATION OF COLORS—EFFECT OF AIR DRAFTS AND SUNLIGHT ON THE COLOR OF STONE WHILE HARDENING—FORMULAS TO FOLLOW IN MIXING TO OBTAIN CERTAIN COLORS

IN ARTIFICIAL stone the subject of color has much to do with the appearance of the finished product, and the demand for a variety of colors is much the same as it was in the brick industry. Before the average American builder had fully learned how to make a good brick in the natural color of the material, many strove to produce fancy and colored goods much to their own injury.

As no two materials have the same effect upon cement, the color proposition is somewhat difficult in artificial stone, and I suggest that small samples be first made so that the maker will soon learn by experience what his needs are better than any writer can describe. Practice and good formulas, together with a brief description of the effect of the various coloring materials, is the most successful way of becoming an expert in coloring artificial stone.

Some colors may be obtained (without the use of coloring matter) by the use of the proper colored cement, sand, etc. A blue cement that is strong is also strong in color and when used with a light-colored sand will produce a beautiful steel blue stone; a greenish cement mixed with red sand often produces a fine brown stone color, and a light-colored cement when mixed with a very dark sand often produces a gray stone effect that no mixture of colors can equal. Actual trials with your materials can produce your color, and after having once obtained a desirable color you need only use the same proportions as well as the same method of seasoning (curing).

In using colors I have had but limited experience and cannot give as broad a description as I would like, but will outline what I know can be depended upon.

Always use a color in its dry (powdered) state and mix with the cement before adding the courser materials.

Always mix by the same method if a uniform color is desired, as like proportions mixed by hand often produce a different shade of color than when mixed with a power mixer.

A colored stone hardened in air drafts and sunlight, will be much lighter in color than one of the

same mixture made indoors, even though each has been kept moist for the same number of days.

Blue. Light-colored cement can be blended to produce a beautiful blue, by the addition of seven pounds of ultra marine blue to every barrel of cement, but as no two cements are of the same shade, a variation of the proportion is sometimes necessary.

Gray. Two pounds of Germantown lamp-black to every barrel of light cement and sand will produce an elegant gray stone, but lamp-black will greatly reduce both crushing and tensile strength of the product; on the other hand, it is a protector against the elements, and when properly mixed with slag cement, prevents disintegration which is common with blocks made of slag cement.

Black. To every barrel of cement add from thirty to thirty-five pounds of peroxide of manganese.

Lake Superior Red Sandstone. The color of sand and aggregates has much bearing on the quantity of violet oxide of iron required to imitate the product of Lake Superior quarries, about twenty pounds per barrel of cement being the average.

Buff. In obtaining this color, ochre is used which greatly reduces the strength of the stone; ten to fifteen pounds of yellow ochre per barrel of cement is sufficient.

Brown Stone. Use brown ochre, twelve pounds per barrel of cement.

As color material reduces strength, it is very essential that sand and aggregates in color work be washed clean, which also insures uniformity of color. Spots in colored stone are due, first, to uneven sprinkling, air drafts and sunlight, while streaks are mostly due to improper mixing of materials.

Hardening stone by steam has gained prominence the past six months, and I have several tests now on, a full report of which will be given in the next issue, and I might add that I have already sufficient evidence that temperature above 90 degrees F. is unfit for properly curing cement products.

Stamped sheet zinc is rapidly coming into use for ceilings in places where wood has heretofore been used.

Plumbing

WM. R. MARSHALL.

Plumbing and Its Development

THE FIXTURES AND SYSTEMS OF TEN YEARS AGO ARE TO-DAY BRANDED AS ANTIQUITIES—NECESSITY OF PERFECT HOUSE DRAINAGE AS A HEALTH SAFEGUARD

THAT the plumbing proposition, during the past decade, has reached its most remarkable development in the construction of perfected systems of sewerage, house drains, ventilation and fixtures, is due to several causes.

In the first place, the manufacturers of plumbing material, in their pursuit of commercial supremacy, employ a large number of sanitary experts and engineers, who by experimenting and careful investigation, have perfected systems and fixtures which are

rest of the house, should be as carefully applied to the sewer, ventilation, bath and toilet rooms, and their furnishings.

Modern knowledge and refinement have taken the place of ignorance and neglect, and the fixtures and systems, which ten years ago were thought good enough, are to-day branded as old, on account of their not being a proper safeguard against disease. Every builder should weigh these facts well, and make himself familiar with the dangers arising from putting in

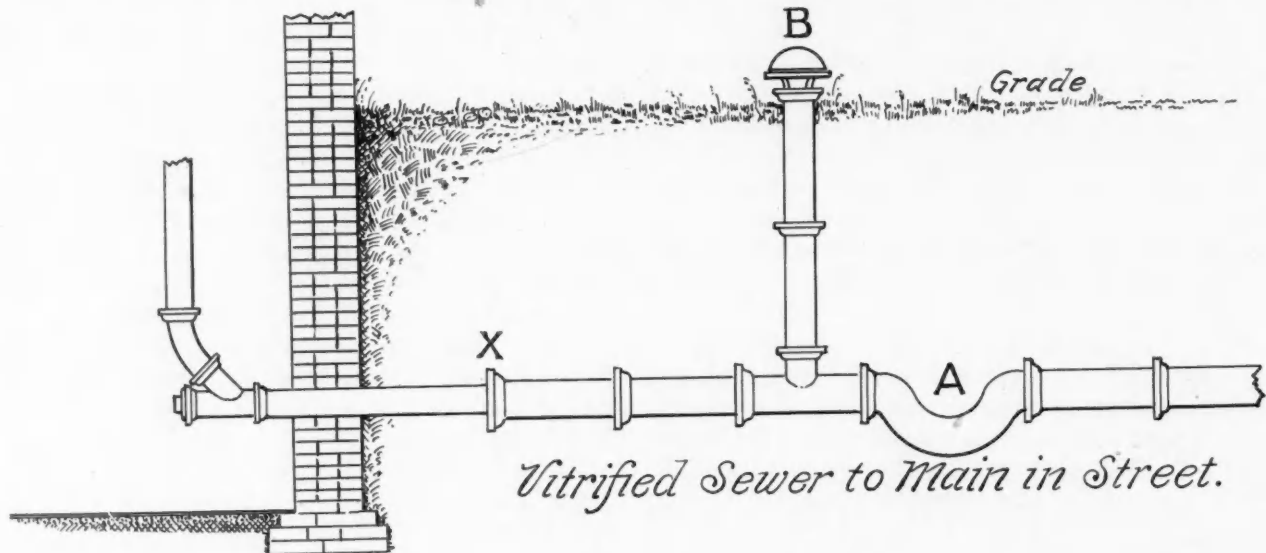

as safe and sure a preventative against the dangers of sewer gas and their subsequent results, such as typhoid, scarlet fever, dysentery, etc., coming as it frequently does from no apparent cause, as modern science has permitted.

Secondly, good and safe plumbing has ceased to be a luxury with the poor man. Its protection against the above mentioned diseases, and its safeguard to good health, have made it a necessity. Heretofore many earnest well-meaning gentlemen, not appreciating the importance of correct drainage and plumbing, were inclined to sacrifice this vital factor in their buildings, and even to-day we too often hear the remark of some builder, to the effect that the balance of the house has cost so much more than they originally intended, that they cannot afford to spend any more than is absolutely necessary for the plumbing. This is putting the "cart before the horse." The same art, which is employed for the decoration of the

a poor system, as even the smallest leak will cause sickness and often death.

The first subject to be taken up in the plumbing line, of course, is the house drain, which are the pipes which carry from the house the liquid and soil refuse. The accumulated waste from food, clothing, bathing, and other simple acts of daily existence, tends to decay, which naturally becomes offensive, and must be removed promptly and properly, or disease will result. The sewer which conveys the matter from dwellings, must be absolutely perfect. In all cases, the sewer pipe within the foundation wall, should be extra heavy cast-iron pipe, coated inside and out with hot asphaltum, and should run through the foundation wall, and the connection should be made to the vitrified sewer at least ten feet outside of the building wall. The connection between the iron and vitrified soil pipe should be carefully made at "X" and cemented tight with a good grade of "Portland" cement. A very good

idea is to incase this connection in a block of concrete, which will prevent the breaking of the joint at this point.

In the drawing we have an installation which is commonly used by a great many plumbers, but which has many disadvantages. The trap at "A," which is placed in the "connecting" sewer, to prevent the ingress of foul gases from the main sewer, is in a poor location, on account of its inaccessibility. The vent opening to the fresh-air inlet at "B" ventilates the house system of drain pipes. This vent is often placed between the sidewalk and the curb, or in the front yard. The vent bonnet is very liable to become loose or broken, which will permit of dirt, stones, and sticks falling into the opening so left, and choke the

sewer, which necessitates digging down to the bottom to clean it out. Another objection to placing a vent in a position such as this, is that grass and other vegetation is liable to close up around and into it, thereby destroying its efficiency. When a main disconnecting trap must necessarily be located outside of the building and underground, there should be built a brick manhole around it for easy access. The manhole for this purpose, should be two feet and five inches in diameter at the base, and closed on the top with a limestone cover, three inches in diameter, with an eighteen-inch round cast-iron lid, which should have a one-inch bearing on the stone all around.

In our next article, we will give you a more modern and efficient installation.

To the Front in One Bound

WHAT THE AMERICAN CARPENTER AND BUILDER HAS ACCOMPLISHED IN TWO MONTHS — SUBSCRIBERS DELIGHTED AND ADVERTISERS SAY THEY NEVER BEFORE RECEIVED SO MANY INQUIRIES

IT IS a safe assertion that no trade paper was ever established which leaped to the front with one bound as the AMERICAN CARPENTER AND BUILDER has done. Two months ago it was unknown—to-day it leads all competitors and has 23,000 subscribers, all paid in advance for one year. And 21,000 of these were secured within practically thirty days from the date of first issue.

It seems impossible that a new publication could thus spring into popularity. After an examination of its pages, however, the reason is apparent—the AMERICAN CARPENTER AND BUILDER is different from any other magazine; it contains more reading matter that is of interest to the trade; it is written in a practical yet not technical vein; it thoroughly covers every matter that would interest the carpenter and builder; it is more fully illustrated than any other trade publication—in fact, the interest of the reader is always placed above the interest of the editor.

Previous to April 1, the date of the first issue, 1,877 subscribers were secured. The number enrolled from April 1 to May 15 was as follows:

April 1.....	250	April 24.....	1,205
" 3.....	235	" 25.....	1,067
" 4.....	61	" 26.....	1,688
" 5.....	72	" 27.....	1,737
" 6.....	35	" 28.....	1,833
" 7.....	32	" 29.....	1,476—17,558
" 8.....	56	May 1.....	2,698
" 10.....	162	" 2.....	805
" 11.....	354	" 3.....	535
" 12.....	308	" 4.....	259
" 13.....	243	" 5.....	188
" 14.....	242	" 6.....	123
" 15.....	287	" 8.....	173
" 17.....	509	" 9.....	114
" 18.....	699	" 10.....	140
" 19.....	618	" 11.....	105
" 20.....	555	" 12.....	130
" 21.....	592	" 13.....	142
" 22.....	544	" 15.....	183— 2,897

These figures show that the total number of subscribers to May 15 to be 22,332, as follows:

Total subscribers to April 1.....	1,877
Number received during April.....	17,558
Number received between May 1 and May 15.....	2,897
	22,332

Since May 15 the average has exceeded 100 per day, and the indications are that this record will continue for some months, as the magazine is continually coming to the attention of those who have not seen it—and to see it is to subscribe.

To handle a business which has grown so rapidly requires careful system and a large force of employes, at times as many as 125 clerks being actively engaged in the work. We show herewith views of three of the departments of the work, which will give readers a little idea of what is required to publish a magazine of the character of the AMERICAN CARPENTER AND BUILDER and handle its large list of subscriptions. The three illustrations show only three departments of the work. In the larger picture is shown the force of clerks, handling the necessary correspondence and records of subscriptions, advertising and general business. The mailing department gives an idea of the work required to promptly mail the magazine, and the drafting department shows where sketches and pictures are made for the magazine and for use in answering the questions of subscribers.

As an indication of the way the magazine is being received by subscribers we append just a few of the many hundred expressions of appreciation received:

Riverside Planing Mill, Danville, Ill.—We are all well pleased with your first issue, and wish you every success, for this is the kind of a journal we have long been looking for.

G. V. Jett, Edgewood, Mo.—Your magazine fills a long felt want with me, and it is the best thing in the line that I have ever seen. I am fully satisfied with my outlay and consider it money well spent.

Frank Hoffman, Lemont, Ill.—I appreciate a publication of

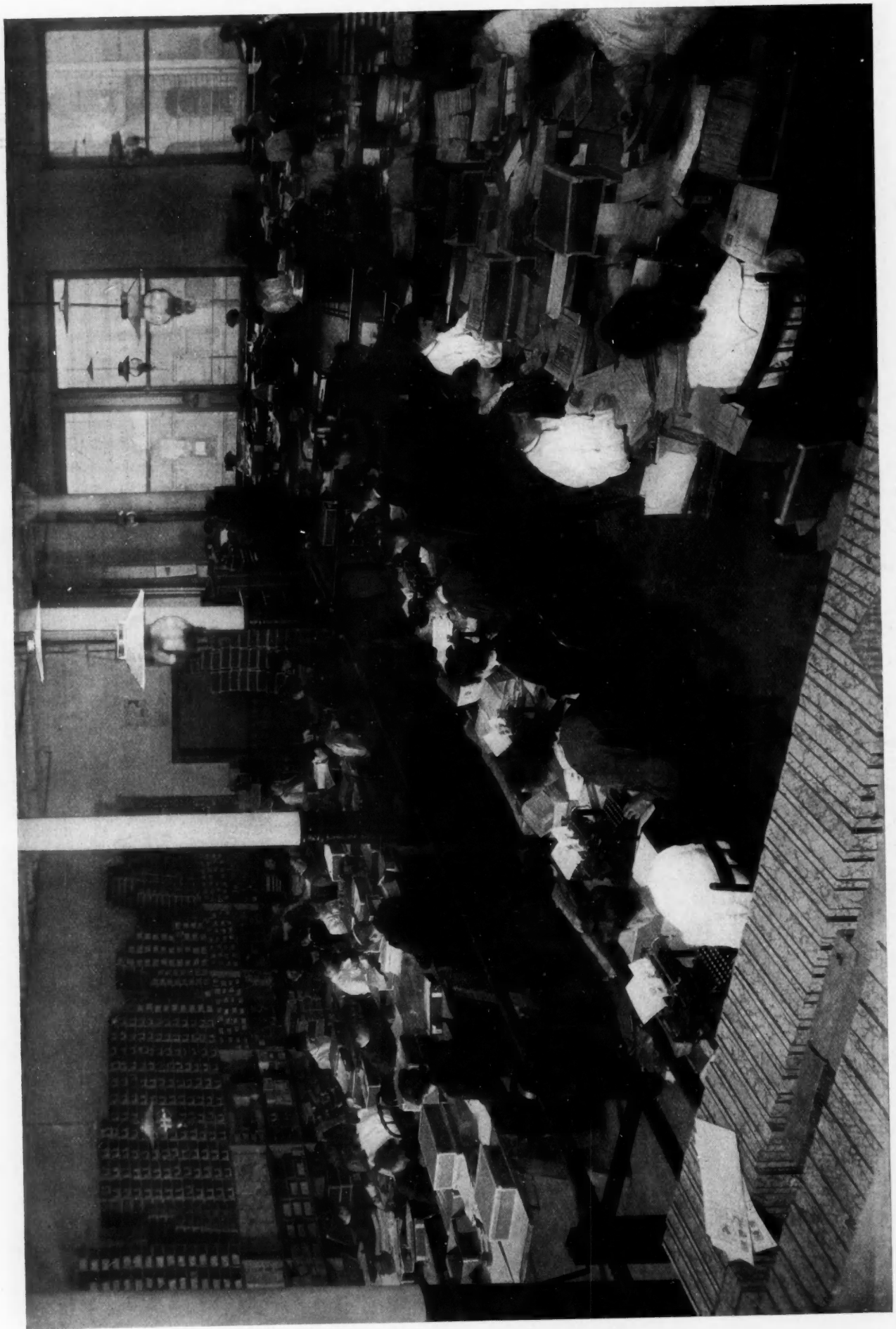

Business Office — Subscription, Advertising and Correspondence Departments



Mailing Department.



Art and Drafting Department.

this kind. It will educate the younger class and practically give them a college at home. The *AMERICAN CARPENTER AND BUILDER* must be in my home in the future.

F. I. Gardiner, manager Lane-Moore Lumber Company, Paton, Iowa.—The only kick we've got is because you didn't start your campaign twenty years earlier.

W. J. Wright, Edmore, Mich.—I wish to congratulate the management on the neatness of the first number of the *AMERICAN CARPENTER AND BUILDER* and its general practicability. I consider the first number worth the price of a year's subscription.

T. B. Farmer, Exeter, Neb.—Just what I have wanted for years.

W. A. Damon, Washington, Kan.—The journal is the finest of its kind published. I would not be without it, for it is a help to the American carpenter.

The newspapers and magazines have had nothing but words of congratulation for the *AMERICAN CARPENTER AND BUILDER*, one editor expressing his conviction that there was no more practical trade publication issued in any line. In addition to all these words of encouragement, letters are being received almost daily from advertisers expressing surprise at the unprecedented returns they are receiving from their announcements. We append a few of these letters which indicate how widely the magazine is circulated and how thoroughly it reaches the trade:

Detroit, Mich.

The results from your paper are surprising. We have had to buy stamps in larger quantities since our ad. has come out in your paper. You may increase our space to half a page instead of a quarter. CEMENT WORKING MACHINERY CO.

Chicago.

We have never had any such returns from any trade paper as we get from yours. We do not think it necessary to expand on this statement, but give it to you flat, without comparison or comment. It is far and away the best thing we have ever had. ORR & LOCKETT HARDWARE CO.

Chicago.

We have run our ad. in several of the old journals, and will state that not one of them has brought as many inquiries as the *AMERICAN CARPENTER AND BUILDER*. They come from all parts of the United States and Canada. It has brought us two sales—one from Massachusetts and one from Michigan—inside of thirty days from the first issue. We feel now that our ad. in your paper will prove more profitable for the investment than any we have ever placed.

NATIONAL HOIST & MACHINE CO.

Rockford, Ill.

We are getting better results from your paper than anything we have ever tried yet. SCAFFOLD BRACKET HOOK CO.

Jackson, Mich.

The page that we are carrying with you has proven very satisfactory indeed from a result standpoint. Our mails are flooded with, "We saw your ad. in *AMERICAN CARPENTER AND BUILDER*." By actual count from the record we have of the key to our ad. we have received up to May 1st, 48 inquiries; from May 1st to 10th, 23. CEMENT MACHINERY CO.,

Seneca Falls, N. Y.

To May 10 we have received 79 inquiries as a result of our advertisement in the *AMERICAN CARPENTER AND BUILDER*.

SENECA FALLS MANUFACTURING CO.

It is extremely gratifying to the publishers of the *AMERICAN CARPENTER AND BUILDER* to have their ef-

forts crowned with such success, and to have the magazine received with such enthusiasm. Readers may rest assured that the same standard of excellence will be maintained, as efforts are constantly being made to improve the magazine wherever possible, by the securing of additional writers and by the adding of new, interesting and practical features designed particularly for the carpenter and builder.

Largest Concrete Block Building

The largest concrete block building in the world will be that of the W. W. Sly Manufacturing Company's works, now under construction at Cleveland, Ohio, and the following notes will be of interest to our readers:

The entire plant is being built of hollow concrete blocks which are made on the building site, of a mixture of one part cement, three and three-quarters parts lake sand and from one to two parts gravel.

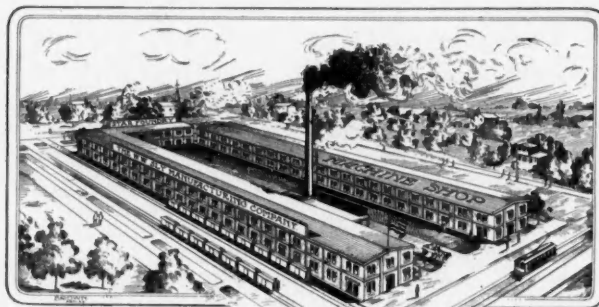

All walls will be thirty feet high and eight inches thick and strengthened with eight by sixteen pilasters every nine feet.

All floors will be of concrete steel of the multiplex patent.

The roof will be of the protected steel type. The interior construction will be of structural steel.

While the work is being pushed as rapidly as possible it will require about three years to complete it, which includes a twenty-foot fill of a valley through the building site.

The Standard Sand & Machine Co., Cleveland, Ohio, furnished the machinery used in the construction of the building.

Brier Hill and Struthers furnace (puzzalon) cement is used in constructing the foundation, and Diamond Portland cement is used in making the hollow concrete blocks.

The building was designed by Fred W. Hagloch, who is personally overseeing its construction.

More anger is created in the minds of fools by the success of others than sympathy for misfortune in the hearts of men.

We can't all be bosses, but it won't hurt any workman to acquire the qualities necessary to fit him for bossing.

Correspondence.

Stair to Fit Circular Wall.

To the Editor:

Lake Charles, La.

I enclose a plan of a stair with turn-out at the bottom to fit around a circular wall, and would like to know how to lay the string out so as to fit around the wall.

ROBERT WILLIAMS.

Answer: Measure the curve of the wall as from A to B taken at the floor line, as shown in Fig. 1, and this length will correspond with the natural run, as from A to C. To

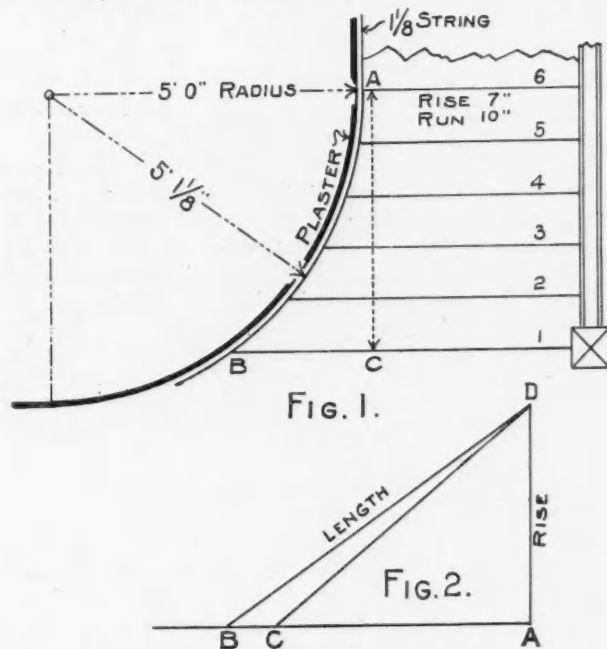

this set up the rise of the stairs, which in this case would be $6 \times 7 = 42$ inches, as from A to D in Fig. 2, and D to B will be the required length of the string. The back of the string can then be kerfed same as for the ordinary base, but the kerfs must be cut parallel with the risers.

These diagrams should be laid off full size, from which accurate measurement can be taken. A. W. Woods.

What Constitutes a Mechanic

To the Editor:

Johnsonburg, Pa.

That the workman is known by his chips is an axiom of long standing, and in my judgment beyond controversy it is equally true that the finished product from which he has whittled the chips bears stronger evidence of the efficiency or inefficiency of the workman than even the chips themselves. However many and beautiful the chips, they are but chips after all and have really no tangible affinity to the product itself as turned out in the finished condition and ready for the use for which it was made. It must follow that the first and last factors of consideration are the beauty, strength and perfection of the product itself, and by that alone we can establish the state of the creator.

There are many workmen, but there are few mechanics; a

man may be an excellent workman, but still remain a workman; he can cut, form, carve and finish and build many beautiful things, but back of this are the ear marks and the finger prints of the mechanic who made the lines, established the bevells and set the workman in motion. A workman lays off his cares and worry and responsibility when he lays down his tools at night and he only resumes them again when the whistle blows in the morning. He will do a piece of work today and forget how it was done by to-morrow; he knows that a proper application of the square will give the plumb and level cuts of a hip, a valley or a jack rafter, but he cannot make that application even after long and steady working at the trade.

No matter what his craft or how large or small the establishment in which he works, there will come some time when some one must take a bold initiative and carry for the time being the entire responsibility of the plant on his shoulders; and at such a time the man who can most quickly grasp the situation and restore order and set the wheels going right is the man who has not laid off his sense of responsibility with his apron. The emergency may not be in his particular line, yet he can see a solution to it, and the mechanical energy stored within him soon sets all things right. A mechanic may or may not be a skilled workman with his tools, but he is always onto his job, and while he may get into trouble, still he can always find or make a way out of it, and is wiser by his experience. He also pulls off his overalls and locks up his box when the whistle blows, the same as the other men, but he takes his job home with him and away from the hum and roar of the shop and there plans, pictures and mentally constructs his work. This may wear on him and not be duly appreciated by the financial end of the concern, still he is building better than he knows, and some day that man will be wanted and then he draws his first cash dividend on his brain investment which he started after the whistle blew. He not only gains financially but also gains the habit of industry and thought which will grow and expand and broaden his everyday life, adding to his enjoyment and self esteem and detracting from the temptations which would otherwise beset him.

I once had a boy come to me who wanted to be a carpenter; he was green, awkward and a cripple. I put him to work and he stayed. Soon he began to ask questions about this and that and I took time and pains to answer them. Later he brought drawings in the morning which he had made the night before and left them with me for correction. I took an interest in him and he trusted to my judgment in all things pertaining to his craft, even to the selection of his tools. I lent him books and he studied at home. That boy stayed with me three years and then went to the city, where he worked for a contractor, under whom he soon became foreman, and later a contractor, and at the present time is superintendent of a large cement company. About a year ago I talked with him and he said, "I thank you for my success. You taught me never to get so tight into a place that I would become a fixture, in other words never to give up." Yes, I taught him that, and many others, who have not profited by their lessons.

In my twenty-seven years of busy life in the construction business I am proud to say that I have not once failed to

work out to a finish any piece of erection, moving or repairs entrusted to my charge and have never caused the owner one dollar breakage during the progress of the work.

No matter what work you undertake, always make a careful study of the problem in hand, keep a cool head and have a will of your own that formulates a plan of procedure and stays by it regardless of suggestions or advice of any one else, and you will work out many knotty problems of the trade and become possessed of the prime factors of the successful mechanic who is the man whom the job hunts in place of him hunting the job.

C. J. CASE.

Cutting Rafters

To the Editor: Wellington, Texas.
I would like to add a small item which may set right some of the younger members of the craft and a few of the older

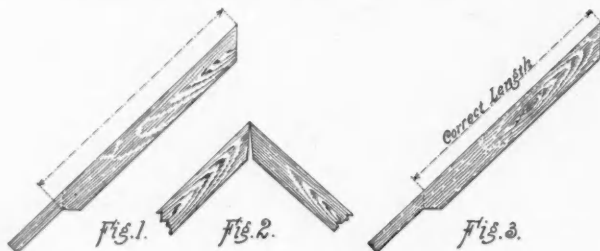

heads who never paid any attention to it; in fact, I saw a contractor cut the rafters on a three thousand dollar house in the same faulty way. It is in the manner of adding the projection for cornice. Fig. 1 is the wrong way and makes the rafters too short, causing the ridge joint to open as shown in Fig. 2. The right way is shown in Fig. 3.

A. BUERGER.

Building Construction

To the Editor: Hinton, W. Va.
Here is a business house 33 feet by 135 feet, five stories high. The first, second and third stories will be used for a furniture store, fourth story for a ball room, fifth story for a lodge room. Now will 3 inch by 14 inch pine placed 12 inches on center, which will be 9 inches between, with four rows of bridging, carry the weight, bridging to be 2 inches by 4 inches, nailed with two 12 penny nails in each end of the bridge?

H. B. HOUCINS.

Answer: The size 3 by 14 placed on 12 inch centers will be sufficient to carry the loads the floors will be subject to, but would recommend that the timbers be cut full size, and as these timbers will probably have to be sawed to order it would be well to have them gotten out several months in advance of using, so they will be seasoned so as to avoid shrinkage after being placed in the building. The joists should be sized to even depths with a camber of at least 1 inch. Four rows of 2 by 4 bridging is all right. Would also recommend laying a rough floor diagonally with the finished floor, the latter to be laid after all the plastering and rough work is done. Do not let the plumbers knotch into the joists further out than 3 feet from the ends of the joists.

A. W. WOODS.

How to Find Length of Hip Rafters

To the Editor: Winder, Ga.
Please give me the best way to get the length of hip rafter, cut on any degree.

H. E. ETRIDGE.

Answer: Take its run for 1 foot, which is always 17 on the tongue of the square, and the rise given the common rafter on the blade. The length from these figures measured across

the angle of the steel square will be the length per foot run of the common rafter. These figures on the square also give the seat and plumb cuts of the hip. To get the side cut of the hip take 17 on the tongue and the length of the hip for a 1 foot run, as described above, on the blade and the blade will give the cut.

A. W. WOODS.

Seat and Plumb Cut of Hood Rafters

To the Editor: Lake Park, Iowa.
What is the rule for cutting hood rafters for a barn if the lower cut is 20 inches and the upper cut is 14 inches? What will be the bevel cut on the upper end of the hood rafter, the pitch of the barn to be 9 inches to 12 inches?

GEO. F. REED.

Answer: The seat and plumb cut of hood rafters is identical with that of the common rafter. In other words, if the cuts of the common rafter are 20 and 14, as stated, then the same would give like cuts for the hood rafters, but the pitch would be $8\frac{3}{8}$ to 12 instead of 9 to 12, as stated. Consequently $8\frac{3}{8}$ and 12 would give the same result as 20 to 14.

A. W. WOODS.

Side Cut of the Hip

To the Editor: Madera, Pa.
Will you give me the rule to get the side cut of the hip?

JAMES N. ALEXANDER.

Answer: When the seat of the hip or valley rests at an angle of 45 degrees with that of the common rafter the rule is this: Take the length of the seat or run on the tongue and the length of the hip on the blade and the latter will give the cut; or taking the scale of one foot it is 17 on the tongue and the length of the hip for a one foot of the gable on the blade:

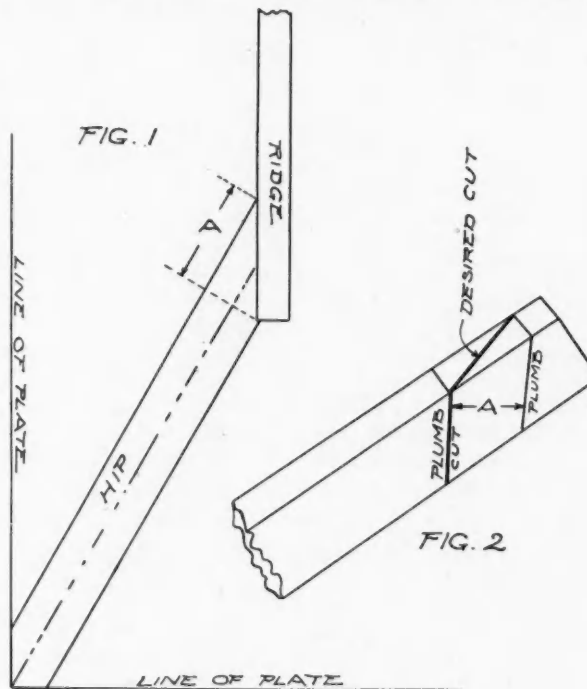

the blade will give the cut across the top of the unbacked rafter. The answer to the question asked would be 17 on the tongue and $20\frac{3}{4}$ on the blade—blade gives cut. When the seat of the hip does not rest at an angle of 45 degrees it can be had as shown in the inclosed diagram. Explanation of diagram: Side cut of hip, when the seat of the hip does not rest at an angle of 45 degrees. Fig. 1 shows the position of the hip. Square across the back as at A and lay off this same

amount from the plumb cut as at A in Fig. 2, and the diagram line across the back will be the proper angle.

A. W. Woods.

Measuring Inaccessible Distances

To the Editor: Jamestown, N. D.

I would like to submit the following method of measuring inaccessible distances by the use of the steel square:



Lay a steel square on some firm plane surface, such as a new board, with the outer edge of the tongue exactly pointed at the object whose distance you wish to measure. Draw the point of a short pen-knife held close and plumb against each outer corner of the blade making two perfect right angles. Reverse the square and place the heel corner of blade exactly in corner of triangle formed by outer corner of blade in the former position of square. Draw a small right angle on outer corner of blade and you will notice you have two similar triangles B X A and X B C. Measure c d in fractions of 1-100 of inches or treated as a decimal. I made a trial observation and found c d of my distant object to be .22 inches. Then in similar triangles we have c d:A B (both in inches)::A B:X (both in feet). Substituting we have .22 inches : 24 inches :: 2 feet : X. Reducing we have 48 divided by .22 equals 218 2-11 feet, which I found in this example to be correct to within six feet.

F. A. BENNETT.

Strength of Beams

To the Editor: Kahoka, Mo.

Will a beam, made by spiking seven 2 by 8's together equal 14 inches by 8 inches, 50 feet long, supported in the center by post, sustain a tar and gravel roof with joists 2 feet on center and hay loft of 10 feet high with hay? Two loft posts in sum of 50 feet, the two loft posts stand out from center post 8 feet on each side.

JAMES M. SHOCKELFORD.

Answer: You do not state the width of your building, but presume the joists are not over 24 feet. The construction you indicate would be rather weak in case of a full mow of hay and the possible chance of a heavy snow on the roof. Would suggest that you use five 2 by 14's, well spiked together; this will give you a girder of about 9 by 14 and not much more lumber.

A. W. Woods.

Cement Block Construction

To the Editor: Walkerton, Ind.

As I am in the cement block business and also lay them, I have an Ideal machine, size 8 by 8 by 16; and a man here is going to build a cement block building, but he thinks my blocks are too light in width; he thinks he ought to have a heavier wall in width. Now I would like to have your opinion on this so I could show him. His building will be 60 feet and one story high.

WM. H. NIXON.

Answer: I am now erecting a large manufacturing building the first section being 60 by 240 feet and two stories high, first story being 16 feet and the second story 12 feet, thus requiring a 30 foot wal! built of hollow concrete blocks. The

thickness of this wall is 8 inches, with a 16 inch pilaster every 18 feet, and I feel confident that even the vibration of the many machines which will be operated in this building will not affect the walls. I will suggest that you use pilasters every 20 feet, as this will adapt the building for increasing its height in the future and add to the outside appearance. With your Ideal machine you are equipped to build pilasters with 16 inch face and 8 inch projection with ease.

FRED W. HAGLOCH.

Facts About Doors

To the Editor: Collinsville, Ill.

I have several questions I would like to have answered: 1. How should double sliding doors be fastened in center to prevent sliding farther than they should? 2. What kind of stop should be used? 3. Which is the most proper way to put on corner block, with grain running vertical or horizontal?

JOHN U. ROEHL.

Answer: 1. The sliding is prevented by overhead track that door slides on, and also by rollers. If it is a pair of sliding doors, it should have a knuckle joint or astragal, although some sliding doors are banded, making it unnecessary to use either knuckle or astragal. 2. It is customary to use 3/8 or 1/2 inch stop, depending on the width. 3. Corner blocks should have the grain running horizontal, so it will match with the casing.

EDITOR.

Constructing "Saw Horses"

To the Editor: Glenburn, N. D.

I read with interest the article of Mr. Stoddard on "Saw Horses" and will send you my way of making heavy ones. I use 4 by 4, 4 1/2 feet long, and gain in on each side 1 inch on top to nothing at the bottom. This gives about the right slope to the legs at the bottom. I use 2 by 4 for legs and a brace of 2 by 6 cut between them just underneath the top; then cut a wedge 2 by 6 and 1 foot long and nail fast against the cross piece and on under side of the top. All the rest is pinned with hardwood pins to prevent dulling of saws when you happen to cut into the horse. I find for heavy work the above will stand almost any amount of strain.

F. R. MARRS.

Constructing Concrete Fence Posts

To the Editor: Hazel Dell, Ill.

I would like to have you give me reliable information how to make artificial stone fence posts, giving the best method and a description thereof.

MARTIN O. HENRY.

Answer: Cement (concrete) fence posts are best made by reinforcing them with wire (barb or plain), some of which

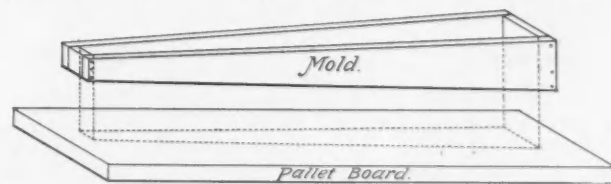

are patented, but many good systems do not require patent rights, as such have been made many years ago. Concrete for posts need not have as large a proportion as for hollow blocks, as waterproofing is no object for posts, hence the following will make a good article:

Cement one part, fine sand (sharp) two parts, coarse sand three parts, and gravel or crushed stone that will pass a 3/4 inch screen two parts; mix same as for hollow blocks on the dry tamped process.

Molds are best made of 2 inch planks, as shown in sketch,

the mixture being tamped in mold same as hollow blocks and the wire placed during the operation.

The most practical size for posts seems to be 4 to 5 inches square at the base and 2½ to 3½ inches square at the top.

Owing to the fact that wire is placed near the surface, galvanized wire is preferred, but in posts sufficiently large, such as corner and gate posts, I recommend common wire, as concrete adheres best to it.

The placing of wood strips in the post for the purpose of nailing boards thereto is now being tried, but I cannot give any evidence as to its success.

By the use of granulated furnace slag instead of sand, nails can be driven into the post anywhere the same as wood, but the withdrawing of the nail is almost impossible.

FRED W. HAGLOCH.

From Dwight L. Stoddard's Father

To the Editor:

Indianapolis, Ind.

Dwight Stoddard started at fifteen,
As by the April number seen;
The reason why is not so bad—
He took first lessons from his Dad.

Now Dwight is forty years of age;
The scenes have shifted on the stage—
The father now at seventy-one
Is taking lessons from the son.

D. S. STODDARD.

Fred W. Hagloch Explains

Cleveland, Ohio.

To the Artificial Stone Trade: There seems to be an impression among some of the dealers and manufacturers of machines and supplies for the trade that I am personally interested in one or more concerns to which I show special favors, while the facts are as follows: I was connected with the Rose Company of this city, which sold its entire business over a year ago, and since then I have not been personally interested in any machine company, nor do I expect to enter that line again, as my practice in the engineering line is now larger than I can well care for. I am, however, interested in eight artificial stone companies, among which five distinct machines are used; besides I am employed as engineer on other buildings which cover the use of nine other makes of hollow block machines, and I have never failed to use the product of each machine to the best advantage of the builder, to the best of my judgment.

I always make my decision plain and blunt, with as few words as possible, and never knowingly give out a statement that can be read in more than one way or drawn out to have an indefinite close, and I believe the readers of my articles and letters which have been before the builders the past eighteen months will bear me out in this statement.

All that I have to regret is that I had not long ago asked those who know nothing of practical building to either let the artificial stone business alone or interest some practical builder with them; for as it is, entirely too many inexperienced hands are in the field, which will sooner or later bring a reaction that will require much hard work on the part of the good and practical worker to overcome.

FRED W. HAGLOCH.

New Experiment in Turpentine

The old method of boxing Southern pine trees for the production of turpentine and resin has very greatly reduced the pine timber wealth of the Southern States. Three years ago the Bureau of Forestry determined that something should be done to eliminate

so destructive a method of procuring naval stores. Its three years of experiments toward this end have demonstrated that a new system of turpentine, which requires the use of earthen cups and metal gutters, not only greatly conserves the life of the timber tapped, but also gives an increased yield of resin, and therefore a greater profit than is possible by boxing.

While the new system is not yet in use by all turpentine operators, its application is extending as rapidly as the necessary equipment can be secured. At present there is but one company supplying the kind of cups and gutter iron required. It is hoped, since the demand for this material is very great, that in the near future the supply will be sufficiently increased to enable turpentine operators to procure the needed equipment.

While, in the work just completed, the Bureau of Forestry has performed an important service to the turpentine industry, it feels that a still more conservative method of turpentine can be found, which, consistent with a maximum yield of turpentine, will inflict the smallest possible injury upon the trees. With this in view, the bureau has begun an entirely new line of field experiments, in order to determine to what extent the wound now made in tapping the trees can be lessened.

Through the public spirited and cordial co-operation of the Hillman-Sutherland Land Company, of Jacksonville, Fla., a stand of about 40,000 pine trees in Clay county, Florida, with other facilities, have without cost to the government, been placed at the disposal of the bureau for experimental purposes.

The principal experiments now set on foot comprise the practical working of a number of different turpentine crops. One set of trees will be used to determine the best width of face to be cut on trees of different diameters.

Another set of trees will be used to demonstrate the rate in height at which weekly chippings should proceed, in order to stimulate a full flow of resin. It is believed that the weekly chipping now practiced cuts away in height, at one time, too much of the living wood. At present this upward chipping amounts to about eighteen inches every year, and it is thought that this can be reduced at least one-half or two-thirds. Such a saving in face height will permit a considerable increase in the number of crop years, which should give a much increased total yield of resin, as well as reduce the demand upon the area of pine forests. There will also be an economy for operators in not having to move their equipment from one set of trees to another as frequently as is the case at present.

Still another set of trees will be devoted to finding out how deep toward the center of the tree, each streak should be chipped. Under the present practice, it is believed that an unnecessarily deep cut is made, thereby greatly reducing the vitality of the tree and consequently its capacity to produce resin.



Manual Training

IRA S. GRIFFITH

Something the Boys Can Make

GIVING A FULL AND DETAILED DESCRIPTION OF HOW TO MAKE A HAT-RACK AND A HALL CLOCK, TELLING WHAT MATERIAL TO USE AND HOW BEST TO USE IT

IT WOULD not be possible to describe the manner of making any but the very simplest things without the aid of drawings. The hat rack will be described quite fully and by looking at the accompanying drawings as you read you will find it easy to understand any simple mechanical drawing. Look at the drawing and you will see that there are two views or pictures; one, the way the hat rack would look if you should hold the face or broad side in front of you; the other, the way it would look if you should hold the narrow side directly in front of your eyes. These two views are connected by short dash lines to show that

they belong to the same object. Between these short dash lines is a long dash line in which is the number eighteen. A number in a long dash line with arrow points show the distance between the points. In this case the length of the hat rack is eighteen inches. Two little dashes above and to the right of a number indicate inches, one dash similarly placed indicates feet. These dashes may be omitted where there is no chance for misunderstanding. Extending from the ends of the two views are short dash lines also, and between



holes bored through the piece at each end. The dotted lines of the edge view show us that these holes are bored entirely through the piece. All lines which represent edges which cannot be seen when looking from a given side are dotted. These holes are bored with a three-sixteenth inch bit. The corners of the rack are rounded by using a one-half inch radius. The places at which the hooks are fastened are indicated by the crosses; and the numbers in the long dash or measurement lines which lie between the short dash or extension lines show that one hook is placed in the middle of the broad side and one each six inches to the side.

When a problem in arithmetic is to be solved, there are certain rules by which it is done. Every piece of woodwork is a problem and woodworkers have certain rules by which they solve their problems. One of the commonest problems is how to square up a piece of rough stock in the quickest way and get the best results. To square up a piece of stock means to reduce a piece of sawed or rough lumber to one having smooth, flat sides at right angles to each other, and of definite length, width, and thickness. Since very few things are made of wood without having this problem, it will be necessary to learn well the solution if good results are to be expected. Commonly, the stock that

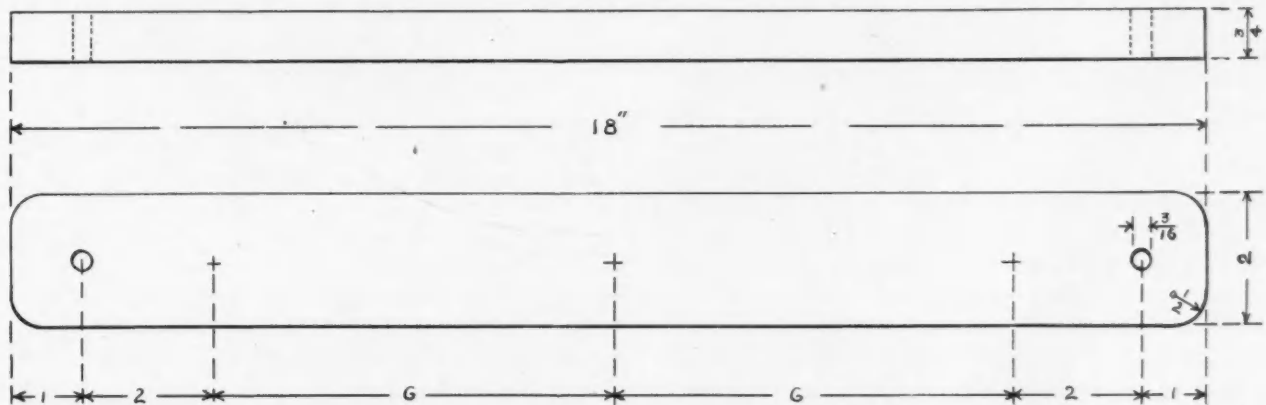

carpenters use is dressed or planed on two sides to the thickness they require. The directions which follow are for stock wholly in the rough. The piece of soft wood you are going to use for the

them long dash lines with arrow points. From the numbers on these long dash lines we see that the width of the rack is two inches and the thickness three-quarters of an inch. Looking again, we see that there are two

hat rack should be a little longer, wider, and thicker when in the rough than the numbers on the drawing call for as those numbers represent the dimensions of the piece after it has been squared up. Last month, in making the plant support you were told how to square up the four sides at right angles to one another, but no attention was paid to the width or thickness. The problem of the hat rack, therefore, is going to be more difficult.

First, plane up one of the broad surfaces smooth and level for a working-face; second, secure a joint edge by planing one of the narrow edges straight and at right angles to the working-face. Mark both of these

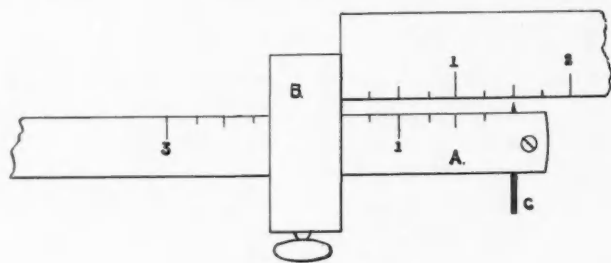

FIG. 1.

surfaces X X. Third, set the marking gauge to the required width, two inches. The gauge stick A, Figure 1, is graduated like a rule into inches and fractions of an inch, beginning at the steel marking point. It is safer in setting the gauge to use your rule as indicated in Figure 1, rather than to depend upon these markings for they are not always reliable. Gauge for the width, holding the gauge block B, Figure 1, against the joint edge and making the mark on the working-face. In gauging, hold the gauge block in the right hand tightly against the edge of the board, and place the thumb of the same hand directly behind the spur E, Figure 1. This spur should be kept sharp like the point of a knife, and so placed that the cutting edge will be in front when the gauge is pushed from you. It should project one-sixteenth of an inch, but the depth of the cut should be lessened ordinarily by tipping the gauge away from you. Fourth, plane the narrow surface which is in the rough carefully to this gauge line, testing with the try-square frequently as you approach it so that the narrow surface shall be square with the working-face when you have reached the line. Fifth, set the gauge for the thickness, three-quarters of an inch; and, holding the gauge block against the working-face, gauge a line on both of the narrow surfaces just planed. Sixth, plane the remaining rough surface carefully to these lines, testing with the try-square turned upside down to see that the surface is level. Seventh, square knife lines around the four smoothed sides as near the end as possible. Figure 2 shows the manner of holding the try-square. Remember to keep the beam of the try-square always against either the joint edge or working-face. Eighth, block plane this end to these knife lines. In block planing great care must be taken not to split the wood.

This splitting can be avoided by planing a little over half way from one edge, then reversing the stick and planing in the same way from the other edge. Use the try-square frequently as you near the lines. If properly done, the end should square up with both the joint edge and the working-face. Ninth, measure from this end the length required and square knife lines around as in the eighth step. If this line is more than an eighth of an inch from the end of the piece, saw very close to the knife lines and block plane as in the eighth step.

The block plane is used to plane at right angles to the grain so that it differs from the other planes in that no cap iron is needed to break off the shavings. The plane iron is placed with the bevel up instead of down as in other planes.

Having squared up the piece properly, set the dividers to one-half an inch between the points and mark the corners. The position of the filed prong or leg can be got by squaring across the face with the try-square, one-half an inch from the end and measuring one-half an inch from either edge along this line. The small curve is to be smoothed with the wood rasp, rasping in the direction of the curve and towards the end of the piece. Test the surface of the curve from the working face, with the try-square. Lay off the points for the location of the three hooks and also for the holes at the ends. With the scratch-awl, make holes into which to start the screws. Bore the holes in

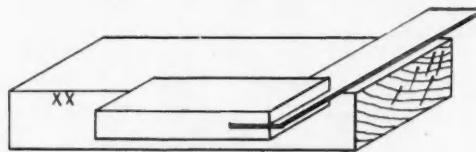

FIG. 2.

the end. Erase all pencil marks, and stain with any good oil stain. Do not mistake painting for staining. Stain shows up the beauty of the grain, paint covers it up. Mahogany stain looks well, but you do not want to use it unless it harmonizes with the other colors in the room. Put the hooks in place when the stain has dried and your hat rack is ready to be fastened to the wall.

HALL CLOCK

It is very important that straight-grained, well-seasoned oak should be used in making the hall clock. Begin by squaring up the sides of the posts to an inch and three-quarters each way. Time and much labor is saved by getting a plank planed on two sides to an inch and three-quarters. Then, all you need do is to straighten and square one edge; gauge and rip and square up the remaining edge. Repeat until you have the four posts. The mill marks can be easily taken off when you scrape them just before putting together. Miter the tops to forty-five degrees on the four sides and plane smooth. Measure the length, seventy-eight inches, and square off the lower ends. These ends are shaped on every side one-eighth of an inch back and

four and one-half inches up. The cross bars can be got out of the one and three-quarter inch plank as were the posts by setting the gauge to one and one-eighth inches. There will be eight of these bars fifteen inches long and eight of them eleven inches long. The clock frame will not go together well unless the ends of these pieces and the sides of the posts are squared up perfectly. Too great care cannot be taken with this part of the work. The slats can best be got out

occupy relative to one another, placing the best pieces where they will show most. Then, as you usually mark the better surfaces XX when you are squaring up the pieces, you ought to be able to get the best surfaces where they will show most by placing the XX marks forward and out. With the four posts marked so you can tell where they are to go, as back-left, back-right, front-left, front-right, place them side by side with the forward faces up. With the square, even the top ends. Begin at the topmost point of one of them and measure down three and three-eighths inches and square a line across the four posts; measure from this line sixteen and three-fourths inches and square a line across all four posts; measure again thirty inches and repeat; then, twenty-two inches and repeat. If the measuring has been correctly done and the posts are of the right length, there should remain five and seven-eighths inches. Now place the posts side by side as before but have the outer side surfaces, instead of the forward surfaces, up. Even the

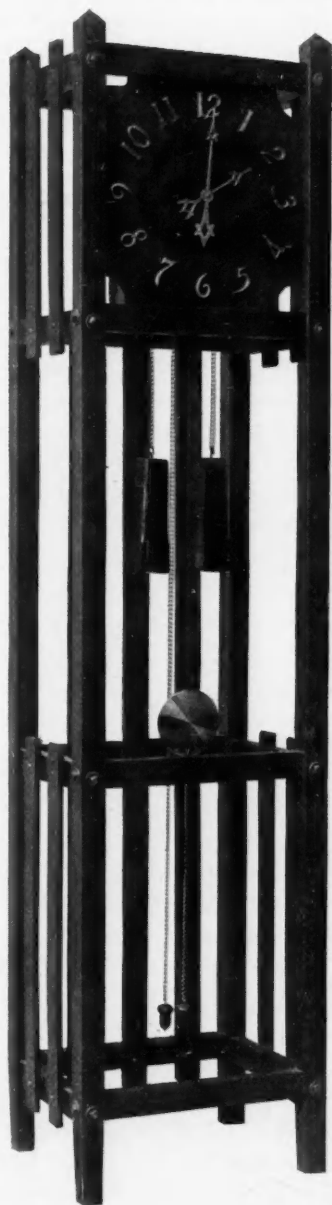

of lumber planed on two sides to three-eighths of an inch thick. There should be three pieces fifty-five and three-fourths inches long by two inches wide; four pieces twenty-five and three-fourths inches long by two inches wide; and four pieces twenty and one-half inches long by two inches wide. After the ends of these pieces have been squared up, the corners may be cut off measuring down on the narrow edge and back on the ends one-quarter of an inch each.

Place the four posts in the positions they are to

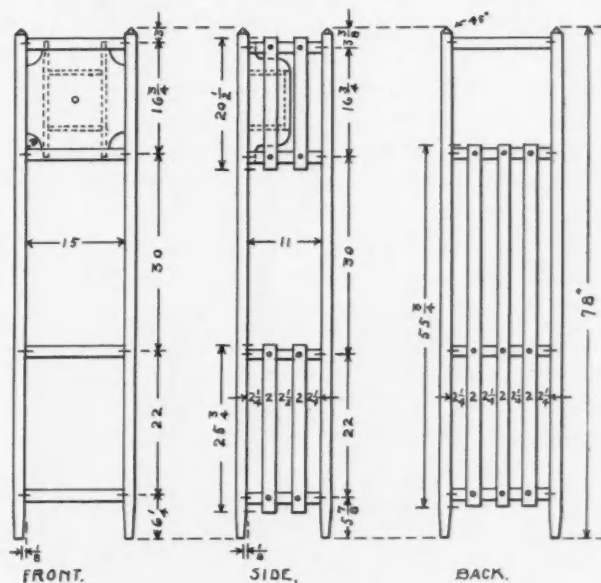

ends with the square so that the lines you have just placed on the posts are square across. This time, measure three inches beginning at the point and square a line across the four posts; the other measurements being as before except the remainder at the bottom which will be six and one-fourth inches instead of five and seven-eighths. Set the gauge to one-half the width of the posts and gauge on each line for the middle. Be careful not to gauge so far that the bolt head will not cover. Bore all of these holes with a three-eighths inch bit. The front bars will be three-eighths of an inch higher than the corresponding side bars in order to allow the lag screws to pass each other. Gauge the ends of the cross bars to find the center, or draw two diagonals, and bore two inches deep into the ends with a quarter of an inch bit. Carefully scrape and sandpaper the posts and cross bars and put the frame work together using lag screws three-eighths of an inch by four inches. Use washers. Care should

be taken not to pull the threads off the wood by continuing to wrench after the bolt is as tight as it need go. A cross bar can be held in the vise while the screw is being put into it by beginning the work at one end of the post and working towards the other. The slats are to be fastened to the cross bars with three-quarters by one-eighth inch round-head brass screws. Holes large enough to allow the screw to pass through easily should be drilled in the slats. On the longest slats, measure one and seven-eighths inches for the first hole; then, thirty inches from this for the next; and twenty-two inches from this for the bottom one. On the four slats next in length, measure from one end one and seven-eighths inches; then, from this twenty-two inches. On the four shortest slats, measure from one end one and seven-eighths inches; then, sixteen and three-quarters inches. After boring, scrape, sandpaper, and put in place as indicated on the drawing.

The face of the clock requires a piece of clear lumber dressed on two sides to one-half an inch. It is better to fit the face to the framework than to try to square it up to the correct size independently. Get the width first, by planing one edge then holding in position and marking the other. Plane to this line, putting the piece in place occasionally to see that you get a good fit. Hold the face in position and, with the knife point, carefully mark both ends. Saw, plane and fit these ends. The corners are marked by setting the dividers to two inches, and are sawed with the turning saw. Scrape and sandpaper all the mill marks off, and fasten four small metal buttons on the back so they will catch the cross bars and keep the face from falling forward. The box which holds the movements is fastened to the cross bars and keeps the face from falling backward.

The box which is to contain the movements is made of half-inch poplar dressed on two sides. The sides should be made long enough to reach from cross bar to cross bar. The size of the box will depend upon the kind of movement put in. The usual size would be six inches deep; six inches high, inside measurement, and eight inches wide. The holes for the chains, pendulum, etc., should be put in by the one who sets the movement. Unless you are experienced in such things you would better get some older person to assist you in setting the movements. With the size of the box given above, the gong should be fastened on the outside of the back, the striker being bent so as to extend through an opening. The back of the box should be put on with screws so it can be easily taken off.

The figures for the face come with the movements and have soft brass pins soldered to the back, by means of which they are fastened to the face. Take a piece of heavy paper and make a pattern of the face of the clock, full size. With your compass mark a circle using a radius of six and three-quarters inches.

Divide this circle into twelve parts. An easy way to do this is to draw a horizontal and a vertical line through the center; then, using the same radius as that of your circle place successively one point of the compass where these lines cut the circle and allow the other point to mark the circle where it will. Draw lines through opposite points and they will be found to pass through the center of the circle and divide it into twelve parts. Place the figures in position on the paper, pushing the pins through the paper when in position. Notice the arrangement of the figures in the picture, the three and the nine being the ones at which the change is made. Place this pattern on the wood and drill holes for the pins. Do not put the figures on until all wood finishing has been done.

A good finish for the clock can be obtained by staining with brown Flemish water stain diluted about one-fourth with water, and filling with Wheeler's No. 5 filler. The directions for using the filler are on the can. When thoroughly dry, apply one or two coats of prepared wax.

Greatest Beam in the World

Prominent architects and engineers of Los Angeles, who have witnessed many wonderful feats in engineering and building, watched with intense interest, as workmen knocked away timber after timber that formed the underpinning of one of eight of the longest concrete beams in the world. This beam is 102 feet long and there are only seven more in the world as long as this and these are in the same building.

This building is entirely of concrete. The walls are of concrete blocks made on the ground where the new warehouse is in course of erection. The roof is of the same material, four inches thick. The front of the building is of pressed brick, but this will soon be covered over with concrete and there will be no vestige of any other building material.

To one uninitiated in the mysteries of building this beam and the concrete columns at the sides of the building, on which it rests, seem curiously inadequate to support their portions of the heavy roof. While the beam is of such immense length, it is less than two feet in thickness, while the columns at the sides are only two feet three inches wide on the outside face, two feet thick and twenty-four feet high. These beams are reinforced by six iron bars running their entire length. The concrete blocks, from which the walls of the building are constructed, are curiously shaped. They have one flat surface with projections on the other side that loosely dovetail into other blocks. Some space is left in this dovetailing process and this is filled with cement.

These wonderful beams are now doing about half the work required of them in supporting the heavy roof. Iron hooks and other conveniences have been built into the beams and to these will be attached a suspended gallery.

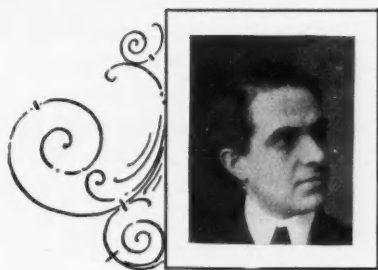

Interior Decoration and Furnishing

JULIUS KARPEN

Furnishing a Six-Room House

II. THREE IMPORTANT ROOMS AND HOW THEY SHOULD BE FURNISHED—PRACTICAL SUGGESTIONS TO BE FOLLOWED IN MAKING SELECTIONS FOR DINING ROOM, KITCHEN AND BEDROOM

"O, hour of all hours, the most bless'd
Upon earth, the blessed hours of our dinners!"

A COMFORTABLE and restful dining room, furnished in simple good taste, adds to the pleasure of eating and is a considerable aid to digestion.

Although comparatively little time is spent in the



A good round table for a "square meal."

dining room, and its necessary furnishings are few, care should be exercised in selecting them. Pure and simple designs are much to be preferred to those complicated by applied ornaments which increase their cost, while they detract from their beauty and utility. Rounded and curved shapes are more restful to the eye than stiff, square corners and angles. This accounts in some respect for the popularity of the round dining-room table. The round table also adapts itself more readily to the varying shapes of a dining room, and is more easily served. It is at a round table that we are most likely to enjoy a "square meal." A good round table, like the one illustrated, can be purchased for \$14, and when we add to this a buffet at \$24 and six dining chairs for \$21, the cost of a dining room

furnished in a most substantial and artistic manner is limited to an expenditure of \$59.

The dining chairs should, of course, match the design of the table as closely as possible. A red leather seat on a finely finished oak chair, produces a most effective harmony and combination of colors. Comfortable seating quality is, of course, the chief and most important consideration.

The style of buffet illustrated is of a type best adapted to general use and is preferable to the older style sideboard, and if desired a serving table to match can be added to the furnishing of this room.

The kitchen is necessarily a most important room and deserves careful consideration.



A buffet instead of a sideboard.

"We may live without friends; we may live without books;
But civilized man cannot live without cooks."

A whole volume might be written about the modern kitchen. Recent inventions have done much to lessen



A strong, substantial diner.

the labors of the kitchen and have added much to the pleasures of cooking.

A combination table and kitchen cabinet is a household necessity and a convenience beyond the wildest dreams of the housewife of ten years ago. A good one like that illustrated costs but \$9 and will many times repay its cost in time and labor saved. Heretofore system has been thought of only in business. With a kitchen cabinet, system may be introduced in the kitchen with considerable profit and pleasure.

A stove, such as shown, for \$22 and three kitchen chairs and a refrigerator for \$15.50, complete the furnishings of a modern up-to-date kitchen at a total cost of \$46.50.

Where gas is obtainable, a gas range is more desirable than the older style of a coal stove. The most recent and improved construction in gas ranges provides the oven above the stove, which permits of its



A kitchen cabinet and table combined.

use without stooping and in an erect, natural and comfortable position.

One-third of our life is spent in bed, therefore let it be spent in a room where one can obtain the great necessity for a happy and long life—perfect rest. It is with this one idea only, that our bedrooms should

be furnished. The colors should be light green, yellow or blue, because they are most restful to the eye. They are the most common colors in nature, and where art follows nature no error can be made.

Metal beds are more economical, more lasting and more sanitary than wooden bedsteads. A good metal bed can be purchased for \$15. A woven wire spring is to be avoided. In addition to sagging, it often rusts, and does not yield to the tired muscles of the body like a good spring bed of coiled springs.

A good elastic felt mattress is preferable to one filled with cheap hair. Mattress, springs and pillows can be supplied at a cost not exceeding \$22 and the



A kitchen stove.

addition of a neat dressing table and light rocker completes the furnishing of a bedroom at a cost of \$63.

In the furnishing of a second bedroom, the same rules should be followed, and a less expensive outfit for a servant's room can be installed at a nominal cost.

Unconsciously the furnishings of our homes influence our habits and have much to do with our views of life and our daily thoughts. Continuous contact with things that are pleasing to look upon and which have character in their design and construction is reflected in our mode of life. Care exercised in the beginning, therefore,

in the selection of only beautiful and useful things, is in the nature of a permanent investment for a comfortable and happy life.



A well constructed refrigerator.

Painting the New House

II. HOW MANY COATS SHOULD BE USED—QUALITIES THE BEST PAINT SHOULD POSSESS—BLISTERING AND BLACKENING PAINT

By Edward Hurst Brown

HAVING considered the priming coat, let us now take up the question of the subsequent or finishing coats of paint; how many coats are needed and what is the best paint to use.

It is well understood that no coat of paint should be applied over another until the under coat has become thoroughly dry. Nor should any painting be done while the carpenter has any scaffolds nailed fast to the house or resting against it. Wherever there is a brace nailed against the siding, the paint will form a little dam or ridge, and no matter how many coats of paint may be applied over this spot, the outline of the brace will always show upon the finished house. If the priming is done before all

not only gets the wood in better condition for painting, but permits the painter to do his work to greater advantage, because he can work from ladders and swinging staging, unhindered by scaffolds. Leaving the painting until the woodwork is completed does not permit the carpenter to cover up defective lum-



An oak dressing table preferable to a dresser where one cannot have both

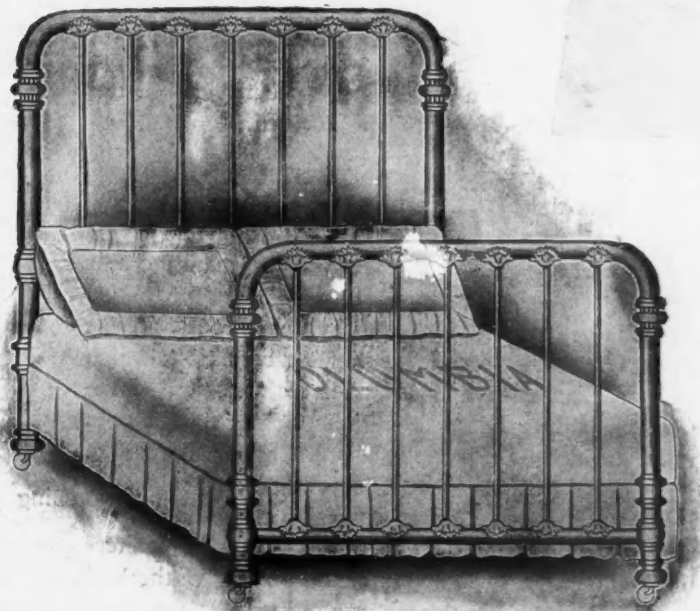

A simple but effective design of metal bed

ber and poor workmanship, and hide it from the eyes of the owner and architect—which is often the reason for immediate priming, but it is far better to make the woodwork right in the first place, rather than to expect the painter to be the scapegoat for the sins of the carpenter.

the woodwork is completed, the carpenter should first remove his scaffold, allowing all the painting to be done from ladders, and if necessary, the scaffold can be rebuilt. The simplest plan, however, and as was explained last month, the best from the standpoint of the durability of the paint, is to allow the woodwork to remain unpainted until the carpenters have entirely finished their work before even beginning the priming. This

In the desire to build as cheaply as possible and to make as big a show as can be made for the money, many architects have fallen into the habit of specifying two coats of paint on new work, generally calling for heavy coats. And where only two coats of paint are to be given, necessity compels the painter to mix his second coat very stout and to apply it without much rubbing out, in order to make it cover. But no greater mistake could be made. If economy compels the use of but two coats—and it is very questionable economy at best—the second coat should be mixed of such a consistency as to spread well, and should be thoroughly brushed out, regardless of the fact that the surface will be poorly covered, and this should be considered as the basis for a subsequent painting of not less than two coats, which should be given to the house the following spring. Indeed

this is by no means a bad plan to pursue, even when economy is not the first consideration, because it permits the first two coats of paint to get thoroughly dry before the final coats are applied, and is in the end most economical. Where only two coats are used and the second coat is the usual heavy one, there is an unavoidable tendency to blister. For a first-class house, and indeed in any case where economy rather than mere cheapness is the first consideration, three coats of paint should be given—the priming coat followed by two subsequent coats. For the best class of work four coats are sometimes specified, but it is better practice to wait for several months and then repaint with one or two coats. Too much paint is a detriment rather than an advantage and almost invariably produces blistering and peeling, no matter what material the paint is composed of.

WHAT IS THE BEST PAINT?

What is the best paint? This is a question which has provoked almost unlimited discussion and is far from being solved. Of course every manufacturer will contend that his particular pigment, or mixed paint, is best, but it is safe to say that there is no one paint that is best for all the varying conditions which paint is compelled to meet. The composition of the paint should be adapted to the special circumstances under which it is applied and the conditions of weather and climate that it is compelled to meet. It is a well-known fact that a pure white lead and linseed oil paint, which is generally favored by painters in most sections of the country, does not give the best results when used in the towns along our Atlantic seaboard, nor does it seem well adapted to the peculiar climatic conditions and the yellow pine lumber of the far south, perishing rapidly in either case. Let us consider then, briefly, what is required of an ideal paint in order that we may have some basis to decide what is the best paint for the particular case in which we may be interested.

First, it should spread readily—or, in other words, it should be capable of being spread out in a thin film over a large area with comparatively little muscular exertion. On a good surface, a gallon of good quality paint should spread over an area of from seven to eight hundred square feet. Or one gallon should cover from 350 to 500 square feet, two coats. This quality of spreading differs essentially from another important requisite of a good paint: It should cover well. By the covering capacity of paint is meant its ability to hide the surface to which it is applied. A paint might have the maximum of spreading capacity, yet cover very poorly. For example, a mixture of whiting and oil has a fairly good spreading capacity, yet when applied upon a board, in one, two or even three coats, the wood will not be hidden in the slightest—in other words, it has absolutely no covering power. The same is true of barytes and oil and also of ground silex and oil, yet all these three

substances are frequently used as constituents of mixed paints. In such cases their lack of opacity is counterbalanced by the admixture of some pigment of great covering quality. Next, the paint should adhere well to metal or wood when mixed with pure, raw linseed oil and spread on in the form of a paint film. The pigment should be ground exceedingly fine so that it will remain in suspension in the oil after it is mixed ready for use, and not settle constantly to the bottom of the pot. This is essential, as otherwise the coating would lack uniformity. The paint film should have sufficient elasticity to expand and contract with the wood or metal to which it is applied and not peel or flake off. It should be fairly durable. It is expected that any outside paint will in time require renewal, but a good paint should have a reasonably long life before repainting becomes necessary. And when renewal is required the paint surface should be in such a condition that no expensive burning off, scraping or other special preparation should be required. Lastly, but by no means least, the paint should be economical. A paint is not economical no matter what its first cost if it lasts five or six years and then perishes in such a way that the old paint requires to be burned or scraped off before repainting is possible. True paint economy is determined not by first cost nor even by the durability of the first painting. It is measured by the cost of keeping the house in good condition for a series of years.

MIXING THE IDEAL PAINT

Having considered what is requisite of an ideal paint, let us see how the leading white pigments, upon which all light-colored paints are based, satisfy these conditions. Remember, we are considering only those coats of paint that are to be applied after the priming, which we have seen should be composed either of pure white lead, or of a mixture of white lead and a good quality of ochre.

White lead spreads readily and possesses the maximum opacity of any white pigment, hence the greatest covering capacity. When the color of the paint is modified by dark pigments this is not so great an advantage as when the work is to be finished in white. It perishes by chalking or powdering, and when the white lead is not well made (for example, if there is an excess of acetic acid left in it after the process of corrosion), this chalking off occurs within a comparatively short time and the property owner has just cause for complaint, although it is no fault of the painter, for two batches of white lead made by the same manufacturer may be very different in regard to the quantity of acetic acid which is left in the lead. The fact that white lead perishes by chalking makes it very easy to repaint, needing only dusting off to fit it for a new coat, the oil from which, will unite with the powdered lead on the surface and closely bind the new coat of paint to the old surface. White lead darkens by exposure to sulphur fumes or to gases

containing sulphuretted hydrogen, but this is a negligible quantity in exterior painting, except in the neighborhood of sulphuric acid works or coke ovens.

Zinc white spreads much further than white lead but has less covering power. It is said that five coats of pure zinc white are required to cover as well as three coats of white lead. Zinc white perishes by cracking, followed by flaking and peeling from the surface. Paints containing a large proportion of zinc white, especially when mixed with one of the so-called inert pigments, like barytes, first crack across the grain of the wood and then peel off in large flakes, an inch or two across, while other portions of the paint will cling so tightly to the wood that it can be removed only by scraping or burning, making renewal of the paint not only expensive but difficult. As a rule, the perishing of zinc white paint is slower than a pure white lead paint, since the surface is much harder, and a zinc paint will generally last longer than white lead, but long before the paint has so badly perished as to make repainting necessary, minute cracks may be seen in the paint surface, which are clearly observed under a magnifying glass.

A TEST OF DURABILITY

In general it may be said that white lead is too soft to form a durable paint and zinc white is too hard and brittle. Taking these facts into consideration, manufacturers of the best mixed paints combine the two pigments, and upon the proper proportioning of the two will depend the maximum durability and economy of the paint. A mixed paint must be judged by two things—first, its average life, or the length of time which experience has shown it will require before renewal under the conditions existing in that particular locality; and second, by the manner of its perishing. If the manufacturer has succeeded in producing a paint which will powder, or at any rate, which will flake off in such minute particles as to practically powder or chalk, then it is safe to use, and will probably prove to be economical, but if it peels in large flakes, then it is well to let it severely alone. Of late years a great improvement has been made in some mixed paints by the use of sublimed lead, which is not a hydrate-carbonate but an oxy-sulphate, made by a fire process. This is said to possess all the good qualities of white lead with a harder surface, that wears away by gradual attrition and shows none of the cracking tendency of zinc white. As yet this sublimed lead has not been put on the market, ground in oil for house painters' use, but has been sold only in large quantities to the paint manufacturers.

The trouble with most mixed paints is that the proportion of zinc white is too large to obtain the best results. The reason for this has already been explained in the statement that it is impossible to keep a mixed paint containing a large percentage of white lead in good condition, owing to the chemical affinity which this material has for linseed oil, and the conse-

quent tendency for such a paint to grow fatty in the cans and valueless for painting. Where the painter is not prejudiced against the use of zinc white (and a good many painters are) very good results are undoubtedly obtained by mixing with the last coat of paint about ten to fifteen per cent of French zinc white. This hardens the paint and corrects the tendency to excessive chalking, while at the same time there is not enough zinc white to cause flaking. It will be noted that French zinc is mentioned. By this is not necessarily meant zinc white that is made in France, but that which is made from the metal zinc or spelter. The cheaper American zinc, that is used by the mixed paint manufacturers, is made direct from the zinc ore.

PREVENTING PREMATURE CHALKING

The foregoing statements apply particularly to white paints. In general, white lead is very satisfactory, when mixed and applied by a practical painter, except for its tendency to premature chalking or powdering. Perishing by surface powdering is desirable in a paint, provided it is not too rapid, because it leaves the paint always in condition for renewal without expensive scraping or burning off. The tendency of white lead to premature chalking may be corrected by the addition of a small percentage of French zinc to the last coat. But it may also be corrected by the addition of almost any of the colored pigments that are used to produce tints, hence this rapid chalking is noticed in tinted or colored paints only when the white lead is of exceedingly poor quality or when the color is produced by the addition of a very small percentage of staining color. Ochre, umber, sienna, Venetian and Indian reds, and lamp black all have a very decided tendency to correct the chalking of white lead paint and to prolong its durability, and these colors are very largely employed for tinting. According to figures presented in a paper read at the convention of the New Jersey State Association of Master Painters and Decorators, held at Jersey City, January 31, 1905, the cost of a pure white lead and zinc white paint, containing about 13 per cent of French zinc and 87 per cent of white lead, mixed with pure raw linseed oil, is about \$1.13 per gallon, exclusive of the cost of mixing. That of a pure white lead paint is slightly less. A tinted paint will cost from five to ten cents per gallon in excess of these figures, according to the color used for tinting. It might be said, then, in summing up, that where a skilled painter is employed, that the results obtained from shop-mixed paints made from pure white lead with just enough zinc white or tinting colors to correct the tendency to excessive chalking, will be found generally satisfactory. But where the services of skilled mechanics are not obtainable, probably better results will be obtained by the use of a mixed paint of the best quality, taking care to select

one that experience has demonstrated perishes by powdering instead of by cracking and flaking.

Pure raw linseed oil should be used in mixing paints for exterior use, with only so much turpentine as may be necessary to slightly deaden the gloss on the second coat. The last coat should be left with full gloss—no turpentine being added unless weather conditions make it necessary, and then only the least amount that will cause the paint to spread as freely as may be required. For winter painting more turpentine is required as the oil has a tendency to become thicker in cold weather. Boiled oil will cause paint to shrivel up, or "alligator," as the painters term it, from its resemblance to an alligator's hide.

Where strong, dark colors are used, such as dark greens, reds, browns or yellows, of course no white base is used in mixing the paint, but the paint is made by thinning the pure colors down with raw linseed oil until they are of the proper consistency for use. The greatest economy is obtained by using the best quality of colors that can be secured, as they will cover much more surface. Many second grade colors are sold that are largely adulterated with barytes. Although they are offered at a low price, they are by no means economical, because barytes is much heavier than almost all the pigment colors, and is far less oil absorbent. The cost of barytes is only about one cent a pound, so it can readily be seen that when a manufacturer adulterates a color selling for twenty-three cents with fifty per cent of barytes, and sells the mixture for eighteen cents a pound, that the painter instead of saving five cents loses about six cents a pound. Barytes is chiefly used because it does not affect the color of the mixture, although it diminishes its tinting strength and its covering capacity very materially. In paints, probably more than in any other

item of building material, the axiom holds good that the best is the cheapest in the end.

Blistering of paint, which is a trouble frequently met with, is caused by the presence of moisture, either in the paint, or as is more usual in the surface to which the paint is applied. The thicker the paint film the greater the tendency to blister. If an impure and non-drying oil, such as corn oil, fish oil or mineral oil, is used in the priming, the paint is almost sure to blister where it is exposed to the sun. In many cases blisters are caused by water that comes from a leaky gutter, or some similar place, and finds its way down back of the siding, wetting the boards from the back. The heat of the sun will draw the moisture toward the surface of the board, where it is held imprisoned by the paint skin. This, being elastic, is raised up in a blister. If the paint is of a brittle nature, these blisters will cause flaking off. The fact that blisters are caused by moisture may frequently be demonstrated by pricking them with a knife point, when water will come out.

Blackening of paint is often caused by smoke or dust lodging on the freshly painted surface. When this is the cause it may be cured by scrubbing with soap and water or by washing with water alone. Many cases of blackening that the painter is unjustly blamed for are traceable to locomotive or factory smoke. Another cause of blackening, especially where the house is surrounded by foliage, is mildew. This is a minute water plant, which finds a root in the fresh paint and grows with great rapidity, often covering the entire side of a house in two or three days, especially if the weather be damp. Mildew can also be scrubbed from the surface and will not reappear or it can be avoided by painting in winter time, if the location of the house causes a tendency to mildew.

Selection of Wall Hangings

KINDS OF PAPER MOST DESIRABLE—SELECTION SHOULD BE MADE WITH REGARD TO THE FURNISHINGS, THE PICTURES AND THE PEOPLE

By James H. Hall

IN SELECTING wall paper or fabric hangings for a room, the fact must not be lost sight of that the real object of wall decorations is not so much the adornment of the walls themselves, as the development of an effective and artistic background against which the furnishings, the pictures, and even the people in the apartment are to be viewed. Too many people, in selecting wall papers, think of them only for themselves and choose them for their mere prettiness, as they appear in the sample book or when thrown over the display rack in the dealer's store, with a result that is sure to be disappointing after the paper is hung upon the wall and the room is furnished. How many times have we seen papers that are as dainty in their design and printing as a water color painting,

yet which are simply impossible backgrounds for the pictures that one wants in the room. On the other hand, some of the English wall papers whose designs are made up of intertwining leafy scrollage in dull colors, are really much more effective on the wall than they appear in the piece, and form an agreeable background for both pictures and furniture. Two-toned papers, in stripes or figured patterns having the effect of fabric, are as a rule very desirable, especially when used for the lower part of a two-thirds treatment. In this case a picture moulding is run round the room about three feet below the ceiling, the upper portion of the wall being hung with a paper that is more decorative or even pictorial in its treatment than the lower part of the wall. The picture frieze is by no means

objectionable, and, indeed, is very attractive, provided it is flat and decorative and not naturalistic in its treatment. Some very charming friezes of this character are made by some of the English wall paper manufacturers, intended to be used in connection with wall treatments of plain cartridge papers, with grass cloths or burlaps. Such effects are very pleasing in halls, dining rooms, libraries or dens.

The use of fabrics for wall hangings, such as burlaps, buckrams and two-toned tapestry in jute or linen, marks a distinct advance in decoration, since these materials give an agreeable background that harmonizes well with pictures or furnishings of any character. It is specially adapted to the modern furniture in the Mission or craftsman styles that is becoming so popular.

The greatest difficulty in choosing wall paper from the sample books in which it is shown at the average dealer's, is the fact that it is almost impossible, even for the decorator of some experience, to judge of the effect of the pattern, when repeated a great number of times upon the wall, by the small section which is shown in the sample book. A pattern which is very pleasing in the book may develop into something positively disagreeable when seen on the wall. We all know how some designs seem to invite the beholder to follow up the intricacies of their lines until one's head positively aches with the effort, yet this peculiarity cannot always be detected in the small sample. On the other hand, the real beauty of large patterns often cannot be discovered until several breadths are seen side by side. Sometimes a paper will develop a peculiar spottiness that is very objectionable. What effect will it have on the wall? is the question which the purchaser should ask before deciding on a pattern that pleases in the sample book. As a general rule the patterns that are the most modest and unobtrusive in the sample book are the most pleasing on the wall.

It is almost impossible to judge from the sample book what the color effect will be in the room, where the light is entirely different from that in the dealer's store. A paper that appears fairly light in the pattern book may make the room look dark. Moreover, the reflected light from the ceiling will very materially modify the apparent color of the sidewalls of the room. This is something that the average person scarcely realizes, and they fail to understand why the wall paper which has been hung seems to be of a different color from that which they selected. A white ceiling will lighten the tone of the side wall and the same color on the ceiling and on the walls will appear lighter on the ceiling. A ceiling of a different color will modify the sidewall color. These facts must be constantly kept in mind in selecting wall papers or hangings.

The monkeywrench is one of the best tools ever invented, and it is also about the most sadly abused of the list.

Tallest Office Buildings in the World

A comparison of some of the most recent skyscrapers with a few of the earlier ones shows how much more audacious are the builders of to-day than those of a few years ago. As soon as the theory of the steel skeleton for tall structures was discovered, about twenty years ago, it was used to construct buildings of great size, which were regarded at that time as marvels of the builder's art. These structures, however, spread more than they towered. The Produce Exchange, erected in 1881, which was the first large steel cage building erected in New York, covers more land than any other office building in the city. Its total ground area is 57,350 feet. Its height, not including its tower, is 120 feet. With the tower it is 225 feet high. In striking contrast with the Produce Exchange building, is the Trinity building, now in the course of construction at 111 Broadway. It shows how the present-day builder piles up his structure, instead of spreading it out. Although its topmost office floor is nearly two and one-half times higher than that of the Produce Exchange, it stands on a plot having an average width of 42 feet, or one-fifth as wide as the Exchange. The building almost completed at 60 Wall street, which runs through to Pine street, has an office floor 330 feet above the street, or higher than that of any other towerless building in the world. This is the twenty-sixth floor, and the roof above is 346 feet from the curb. The Park Row building, which, with its towers, reaches a height of 380 feet, higher than that attained by any other building in New York or elsewhere, has a floor area twenty-six times greater than that of the first story.

Fire Protection in German Theaters

The Berlin police authorities have ordered that the following rules, containing instructions to the public as to how to act in case of fire, shall be displayed in illuminated letters between the acts on the drop curtains of the Berlin theaters:

(1) Leave the theater quietly; (2) proceed to the nearest exit; (3) do not scream and do not push; (4) do not stop at the cloakroom as you go out; (5) do not stand about near the exits; (6) obey all the orders of the theater attendants.

Among the precautions taken at Freiburg since the terrible Iroquois disaster at Chicago a year ago last December, are: An extra corps of firemen and police have been stationed all over the opera-house during each performance; the public is requested to make itself familiar with all exits; and the large iron curtain is lowered during each long pause, so that the audience can have ocular proof and demonstration that the main curtain is in good and proper working condition.

Some men never make a mistake because they never make a move.

New Tools for the Carpenter and Builder

INTERESTING DESCRIPTIONS AND ILLUSTRATIONS OF IMPORTANT MACHINES AND MATERIALS THAT ENTER INTO HOUSE CONSTRUCTION IN ITS MANY PHASES AND DETAILS

Warm Air and Hot Water Heating

The accompanying cut illustrates a Combination Heating Plant in a twelve-room residence. The radiators in the three front rooms have valves so that the heat can be shut off from either or all of them. The rear rooms have the overhead system and the heat can only be shut off from middle radiator. The six central rooms are heated with warm air, supplied through modern side wall registers.

The use of hot water attachments in connection with furnaces is made necessary, not because furnaces when properly constructed and properly installed are unsatisfactory, but because a furnace has its limitations.

water in kitchen tank. With hot water attachments the kitchen can be heated and an abundant supply of hot water secured, without additional cost for fuel.

A combination plant has its advantages over a straight hot water plant; the principal one being that it gives a constant supply of fresh air. Other advantages are, reduced cost for installation, smaller consumption of fuel, and a greatly reduced cost for repairs and general maintenance.

Mantels for China

A day or two after Christmas a large freight car was started west from Chicago with a consignment of forty-five mantels for the United States legation, Pekin, China. The contents

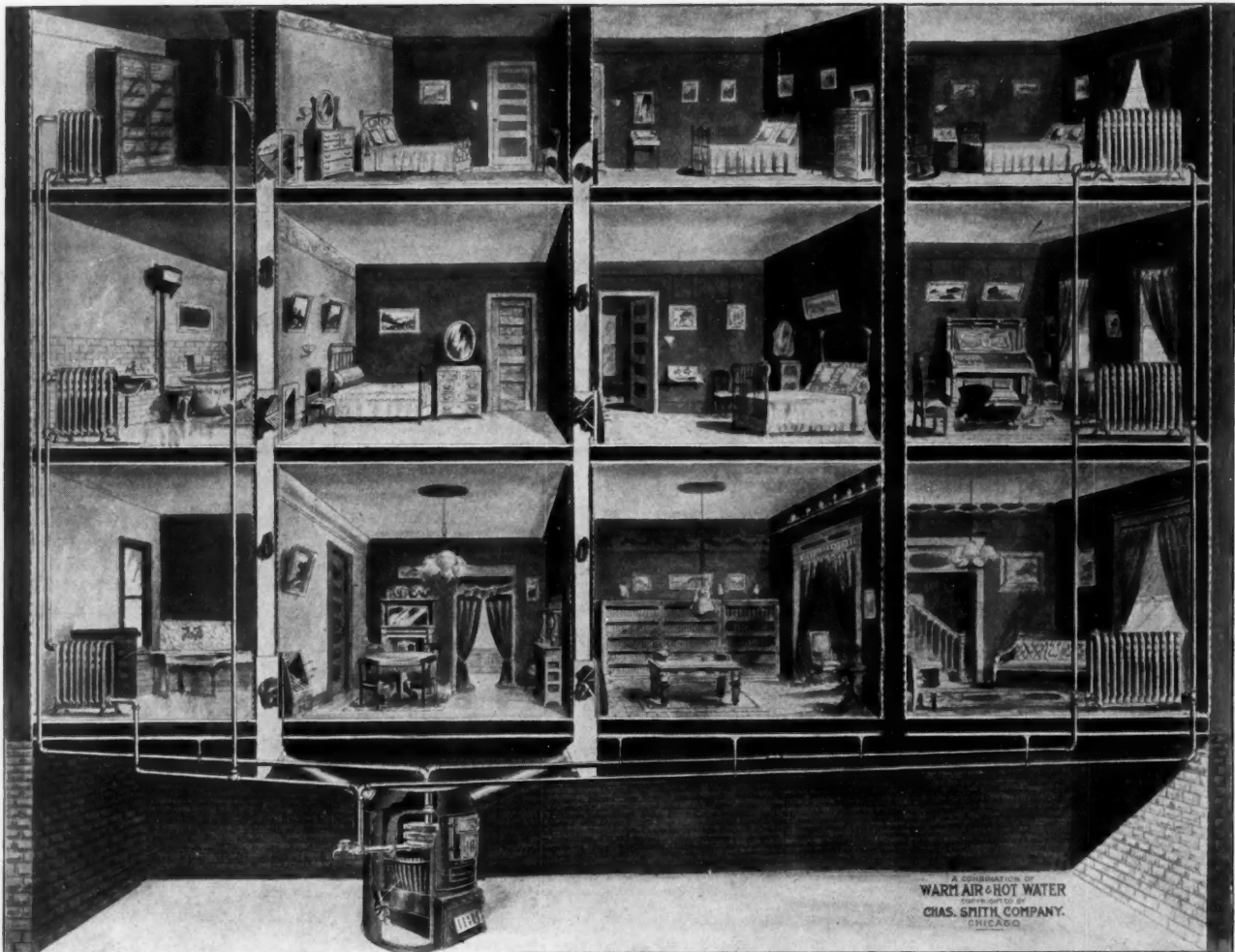

A COMBINATION OF
WARM AIR & HOT WATER
HEATING SYSTEM
BY
CHAS. SMITH COMPANY
CHICAGO

Many owners of large residences have found it necessary to install an extra furnace in order to heat all parts of the building satisfactorily. They may, by using hot water attachments, dispense with this extra furnace, and save the cost and labor of running it.

A hot water radiator insures a temperature that is pleasant and satisfactory, and in the front hall has a wonderful effect in moderating the temperature of the rooms on each floor opening into the hall.

Many store buildings have offices or apartments above the store, all of which can be heated with hot water, and the store floor with warm air.

Residences in which the gas range has displaced the coal range have no satisfactory way of heating the kitchen or the

of this car was unloaded at Seattle and placed aboard a United States transport, bound for Pekin, China.

When the Boxers in 1898 attacked the hated foreigners at Pekin and destroyed many of the buildings belonging to the different countries, it probably never entered their heads that they were doing a mantel company over in Chicago a good turn, but that was just what happened, for Charles F. Lorenzen & Co., Inc., 243 North Ashland avenue, Chicago, in spite of the competition of many other big companies, received the order for forty-five mantels for the United States legation buildings at Pekin, China.

These mantels were selected by Minister Conger from the Lorenzen catalogue and are of the Mission and Colonial styles. The entire order was gotten out in thirty days. When

it is remembered that any work or material furnished for the United States Government must stand the closest inspection, must be right in every respect, and that every one of these mantels had special finish, made to match the different trims, the reader can get an idea of what the company filling this order can do.

The mantels will be placed in Minister Conger's house, the chancery, first and second secretary's buildings, etc. They will go into the smoking rooms, reception halls, drawing rooms, large dining rooms and bedrooms.

The mantel made for the chancery hall is an exceptionally beautiful and artistic piece of work, and it is safe to say that when the buildings are completed, the mantels furnished by this hustling Chicago firm will receive more than their share of praise.

Charles F. Lorenzen & Co., 243 North Ashland avenue, sell their mantels and grille work direct to the consumer. Building people who have not already secured their finely illustrated catalogue should write for it.

Sand-Cement Brick Machines

A. D. Mackay & Co., 86 Washington street, Chicago, are placing before the readers of the AMERICAN CARPENTER AND BUILDER the Helm Hand Power Sand-Cement Brick Machine, which, it is claimed, has a capacity of 10,000 bricks in 10 hours, with only seven men. This machine exerts a pressure of 80,000 pounds, which makes the bricks stronger than ordinary bricks, and eliminates the danger of chipped edges. The machine is giving the best of satisfaction, and should be investigated. Write for catalogue.

Key to the Steel Square

This title is given a new framing device which is meeting with popular favor among carpenters and builders throughout the country. It is three inches in diameter, on either side of which, pivoted at the center, is a disk, one side giving the lengths and cuts for the common rafter, having a rise from 1 to 24 inches to the foot, also the corresponding lengths,



cuts, and bevels for the octagon hip or valley, and for the common hip or valley for roofs of equal pitch; while on the other side are given all the cuts for rafters and braces having a rise from one to ninety degrees. By turning the disk till the slot in same rests opposite the pitch desired, only the lengths and cuts for that pitch will be exposed, thereby preventing errors.

The illustration shows the instrument set for the one-third pitch.

Mr. Woods is one of the editors of the AMERICAN CARPENTER AND BUILDER and has prepared hundreds of fine illustrations showing the possibilities of the steel square, many of which will be published for the first time in this magazine. Those of our readers who are interested in the subject should

not fail to refer to the advertisement on another page and obtain one of these little instruments and apply it to the illustrations given from month to month in this paper.

An Implement for Many Uses

A few of the claims for the "Universal Square" are that the end of its utilities are never reached, and it is certain to supersede all others. The "Universal Square" covers all the ground the steel square does, and has the additional advantage, because of its shape, of permitting it to be placed into short corners, and hooks and crooks everywhere. The mechanic has but to see the tool and he realizes its virtues at once. There is not a cut of any description which you cannot make without any reckoning, and in one-half the time it can be marked out with the ordinary squares. A carpenter or other mechanic using the "Universal Square" for a short time

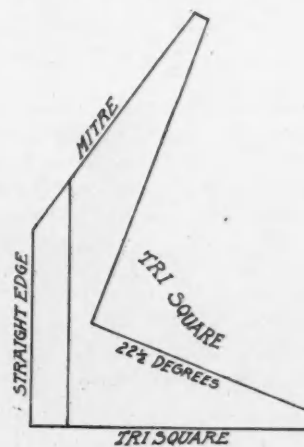

becomes acquainted with its advantages and very readily sees that with a tool in which he has a true square, a true mitre, a true pitch-cut and hip and valley-cut scale, he can accomplish any maneuver. Then, too, you must not overlook the fact that it gives you a gauge, a compass, the octagon and hexagon, the bevel, the mortise and tenons, tri-square and straight-edge, all without any adjusting whatever. It is made of the best steel, light, and guaranteed to be absolutely true. Notice the interesting price.

Complete circulars can be had from any first-class tool dealer, or address, The Duby & Shinn Mfg. Co., Inc., 19 Park Place, New York City.

Setting Glass for Store Windows

We call the attention of our readers to the new device whereby glass for store windows can be set from the street side of the window. This gives more room for handling the glass than if it had to be set from the inside. While some store fronts have been arranged for glass to be set from the outside it was always done in heavy construction, having heavy corner posts or mullions to set the glass in, but the rapid strides made in the last few years in perfecting show windows almost eliminated division bars, which has brought the builder face to face with a perplexing proposition. When mullions or division bars have been reduced to small size they present such a weak support that it practically is no support at all. The wood warps and twists in every direction, thereby causing a strain on the glass. Therefore the minds of a great many students in architecture and building have been exercised toward making a division bar which would combine the two virtues of making as little obstruction against the light and at the same time retain as much strength and rigidity as possible. Of all the devices so far that have been tried, one, known as the Columbus corner post and division bar, invented by L. Von Gerichten, Columbus, O., is very successful. It makes a neat looking

corner post and division bar, not exceeding 3 inches for the largest size made. Very large plate glass windows can be set in the 2-inch size. After the glass is set in this mullion and covered with brass or copper covering, it presents an artistic appearance.

This post is also made with special reinforcement, so heavy awnings can be fastened on it without bending the bar, thus removing any possible danger that the glass can break from the bending of the division bar. Write directly to the Columbus Corner Post Co., Columbus, Ohio, for further particulars.

A New Steel Square

A new and improved steel square is being placed upon the market by Sargent & Company, the well known manufacturers of hardware, an illustration of which is shown in the advertising columns.

This new square enables the carpenter to lay out all kinds of work and to calculate quantities with an ease and accuracy never before known.

It is made of the very best double refined steel, is true, accurately marked by an entire new system, and very nicely finished, and is being supplied to all the hardware stores throughout the country. They are also getting out a book on the steel square which is a practical treatise in itself, and will send a copy without charge to anyone writing to them and mentioning the AMERICAN CARPENTER AND BUILDER. Address Sargent & Co., 114 E. Leonard street, New York City.

Be Your Own Brick Maker

E. W. Seamans, of Grand Rapids, Mich., has patented and is placing on the market a simple and effective hand cement-brick machine, the advertisement of which, with illustrations, will be found in the advertising columns. This machine can be operated by two men, who can easily turn out 5,000 cement bricks (including mixing) per day.

In most localities these cement bricks made in the Seamans machine are much cheaper and more durable than ordinary bricks, which are not always perfect. With the molds furnished, ornamental as well as plain-shaped bricks can be made, and with careful handling no danger of ragged edges is to be feared.

The company has issued a catalogue showing the machine in operation and describing the manufacture from the time the cement is mixed until the bricks are turned out complete. For further information and catalogue, address E. W. Seamans, 23 Fountain street, Grand Rapids, Mich.

Ives Patent Window Ventilating Lock

The H. B. Ives Co., New Haven, Conn., John H. Graham & Co., No. 113 Chambers street, New York, selling agents, are placing upon the market the Ives window ventilating lock. It is a simple device that requires neither mortising nor the boring of holes to apply, it being fastened by screws. Being a permanent fixture, it affords extra security, in addition to the usual sash fastener, and also safety for ventilating rooms. It is a sure safeguard, quickly applied and operated, insuring sure protection against intruders; children are kept in and burglars are kept out; and, therefore, it should be used on all windows in flats as well as sleeping apartments. That this old established firm manufactures this and other specialties for windows is a sufficient guarantee of the utility of the article mentioned. A miniature forty-page catalogue of window hardware specialties will be mailed free upon application.

Concrete Facts

About a dozen years ago, as an experiment, a small number of Chimney Caps of the National Chimney Co.'s make, were placed on different houses to see how they would stand

weather and gases. The test proved them thoroughly dependable. They can be seen to-day as good as new, while their cost to the owner has been saved a dozen times over.

Years of hard work and experiment have perfected the original idea, until now they can say that in simplicity of construction and beauty of design they have a modern chimney terminal that meets the approval of architects and masons.

These capstones and caps are made of a concrescible mixture, molded from patterns and cast in sand. Besides their value as a chimney protector they add a handsome finish to public or private buildings. Write them for special information.

C. F. Pritchard, a member of the firm, is the inventor of the original "American Chimney Cap," which is made by this concern, the National Chimney Co., of New Britain, Conn.

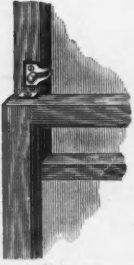

Children
Kept In.

**THE IVES
WINDOW
VENTILATING
LOCK**

A safeguard for ventilating rooms. A lock, quickly applied and operated. Affording sure protection against intruders.

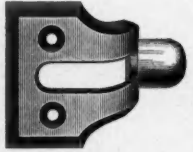

Burglars
Kept Out.

Patented.

ADDITIONAL PROTECTION TO THE WINDOW

The H. B. Ives Co., New Haven, Conn., U. S. A.

Working Model with Catalogue Mailed Free.



A. WOOD
B. STEEL
C. GLASS
D. RUBBER
E. METAL COVERING.

**PLATE
GLASS**

SET FROM THE
OUTSIDE

Simplest and strongest corner post and transom bar on the market. Made to size and sent all over the world by the inventors.

**THE COLUMBUS CORNER
POST CO., Columbus, Ohio**

FACTORY, 549-557 S. HIGH STREET

JOHNSON'S SCAFFOLD BRACKET HOOK

THE SIMPLEST, STRONGEST AND CHEAPEST DEVICE MADE FOR HOLDING UP SCAFFOLDING. Hook is ten inches long, made of best malleable iron, and saves its cost many times over in one season's work.



Easy to put on Bracket.

No wiggling or falling scaffolds where this hook is used.

Write for Circulars. Sold to builders with or without the folding brackets.

Easy to put Bracket on Building

BRACKET HOOK CO., 123 N. Winnebago Street, Rockford, Ill.

A Scarlet Dining Room

A dining room in white and scarlet is exceedingly beautiful. This dining room scheme boasts a flat white paneled wall with touches of scarlet in the frieze, with its chairs of oak and upholstered in good scarlet leather, with dark brown axminster carpet or brown rugs and scarlet damask curtains.

Nervous Old Lady (on seventh floor of hotel)—Do you know what precautions the proprietor of the hotel has taken against fire? Porter—Yes, mum; he has the place insured for twice what it's worth.

WANTED—Situation by a first-class finishing man, good all around carpenter, will go anywhere, west preferred. Address, L. HALVERSON Estherville, Iowa.

The Chicago Improved Cube Concrete Mixer

"It Has No Insides"

It is a well known fact that mixers having inside blades pocket and separate the material as it enters, and require constant attention by frequent flushing and scraping, also pounding at short intervals on the outside of drum to dislodge the material which is constantly attaching itself to the inside mechanism, not only causing the material to ball, but greatly decreasing the life of the machine, as these accessories, by reason of their resistance, not only wear out rapidly but largely increase the strain on the gears, frame, etc. Our CUBE MIXER, with ordinary use, is guaranteed not to clog.

The Best By Test



Made in seven sizes. Output 4 to 80 cubic yards per hour. Mounted on skids or on wheels. Steam power, gasoline or electricity. Send for Catalog No. 43.

MUNICIPAL ENGINEERING & CONTRACTING CO.

General Offices: 607-9-11 Railway Exchange

CHICAGO, ILLINOIS, U. S. A.

NEW YORK OFFICE: 150 NASSAU STREET

THE STRINGER CEMENT BLOCK MACHINE

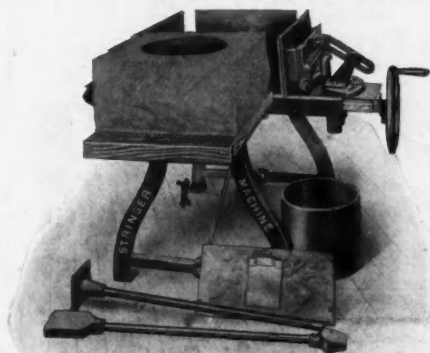

Latest Improved, Handiest, Quickest Adjusted

Will make blocks any size from brick up. Water tables, sills, angles and gables—HOLLOW OR SOLID. Sewer blocks and fence posts.

STRINGER MACHINE CO.

120 W. Trail Street, Jackson, Michigan

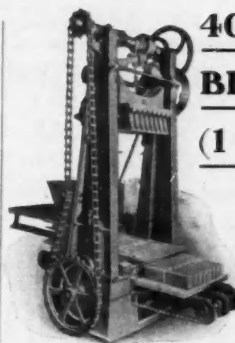

40,000 SAND-CEMENT BRICK or 5,000 BLOCK (18 x 24) PER DAY

Only TAMPING principle power machine made.

We also make an up-to-date mixer.

Write for Catalogue.

CONCRETE MACHINERY CO.

950 Majestic Building, DETROIT, MICH.

SLATE! SLATE!! SLATE!!!

Black Boards for Schools . . . Roofing Slate for Houses
Are you going to build a home? I trust you are, and that you will put on it for a Roof (one of the most important things about a house) SLATE, which is always CLEAN, FIREPROOF and BEAUTIFUL. Write for prices, and I will tell you all about SLATE.

DAVID McKENNA, SLATINGTON, PA.

**"BALL-BEARING" GRAND RAPIDS
All-Steel Sash Pulleys**

Are sold **DIRECT** to Builders, Contractors and Mills at prices under the common ordinary goods

PATENT PENDING



If you make ten or ten thousand window frames, we can save you money and give you a superior sash pulley. We are the largest sash pulley makers in the world. We ship direct, or through dealers and jobbers everywhere.
Write for catalog and free samples and prices on half-gross, gross, barrel, or any quantity. Direct from the makers to you. Inquiries welcome.

Grand Rapids Hardware Co.
33 Pearl Street Grand Rapids, Mich.

COLT'S CLAMPS

Steel bar any length desired.
QUICK ACTING. TIME SAVING.

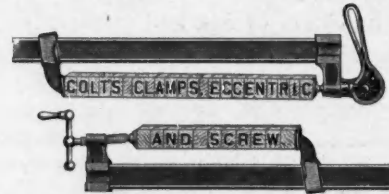

Ask for Catalogue No. 124

BATAVIA CLAMP CO.
57 Center St., BATAVIA, N. Y.

**Genuine Bangor Unfading
Black Roofing Slate, Black-boards, Structural Slate**

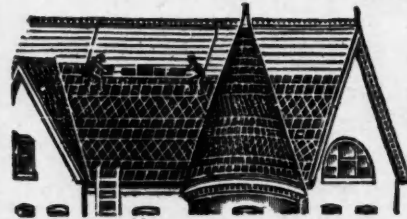

Mined and manufactured from the real Bangorquarry

The Bangor Slate Co. FILED
Lock Box 94 BANGOR, PA. PROMPTLY

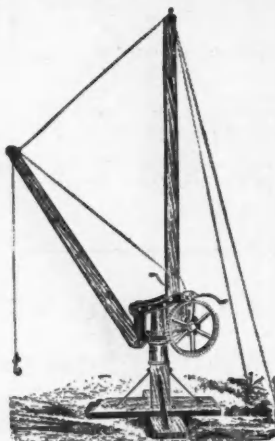

DERRICKS

of all descriptions, for all purposes, from . . \$35 up

Special derricks for handling
Cement Hollow Blocks
The finest derrick for this purpose made.
MATERIAL ELEVATORS
Chains, Sheaves, Tackle Blocks and Rope

Write for catalog and prices.
NATIONAL HOIST & MACHINE CO.
469 W. 22d St., CHICAGO, ILL.

**CUSTOM MADE
FLY SCREENS**

Our work is far superior to the usual output of local mills and has a style and finish not obtainable from those who do not make a specialty of screens.

For outside screens we use the identical finish of the outside of Pullman cars.

The best grades of Wire Cloth, enameled, galvanized, genuine bronze, etc. Fastened by tacks or by the "lock-strip" process.

Intending purchasers may have free by mail samples of woods, finishes and wire cloth and copy of catalog and price list. Agencies in many cities. Special terms to contractors and builders.

THE A. J. PHILLIPS CO. Fenton, Mich.
23 Years Experience. 3 1-2 Acres of Floors.

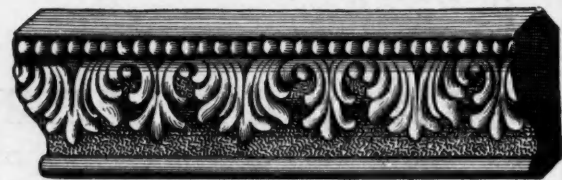

Embossed and Plain Mouldings

Balusters and Stair Work

**Columns, Interior Caps
and Raised Carvings**

Chicago Embossed Moulding Co.
598 AUSTIN AVENUE, CHICAGO, ILL.

Send for Our New 1905 Catalogue





"TEN MACHINES IN ONE."

Style "C" Norman n Block Machine—(Closed)
the only durable machine on the market.

Absolutely the Best.

NORMANDIN HOLLOW CONCRETE BLOCK MACHINE

and its product, is universally recognized by the leading architects, contractors, engineers, builders, railroads and cement workers **AS THE STANDARD.**

Hundreds of Normandin machine plants in operation. The Hollow Block business is permanent and profitable, broadening in extent every day. It's not a question of material but it is a question of machine. The Normandin is what you want, take no substitute. **INVESTIGATE** for yourself, in fact "look before you leap," get value for your money. **Don't get a machine because it's cheap** and be handicapped when you get a contract for an up-to-date building, because you can't make the blocks wanted—Normandin Blocks are standard.

The Normandin machine is "ten machines in one," designed to save labor, material and expense. *Adopted and used by the United States government engineers.* "The Normandin must be right." The most practical machine ever manufactured. Has won over all competitors. **We are pioneer block machine manufacturers, and have just the machine you want. We know what the trade demands, consequently we build our machines right.** Thousands of Normandin Blocks being used daily. Send for full printed matter to-day.

Styles and Variety of Stone Unlimited.



Style "C" Normandin Block Machine—(Open)
and its Product. **HIGHEST AWARDS** Universal Exposition, St. Louis, 1904, for superior excellence.

WE LEAD; OTHERS FOLLOW.

CEMENT MACHINERY CO., Jackson, Mich.

OFFICE
11, 12 and 13 Cooley Building

LORENZEN

The
"Sandoval"
LORENZEN MANTELS
AND GRILLES

Also Contractors for Ceramic Mosaic and Tiles, Interior and Decorative Marbles, also manufacturers of Improved Scagliola for Bathrooms, Vestibules and Interior of Lobbies and Corridors in Banks, Libraries, Hotels and Public Buildings.

To Carpenters & Builders
FREE

We will mail our large, handsome, 96 page (10x22) Catalogue, the largest Mantel and Grille book ever published, which cost us nearly 50 cents. Send us your business card and we will show you a way to make money by becoming our sales agent for your territory. **Write to-day.**

We have just shipped a carload of our Mantels and Interior Finish to the United States Legation Buildings, Pekin, China.

CHAS. F. LORENZEN & CO., Inc.
243 North Ashland Avenue, CHICAGO



LORENZEN
PAYS THE
FREIGHT

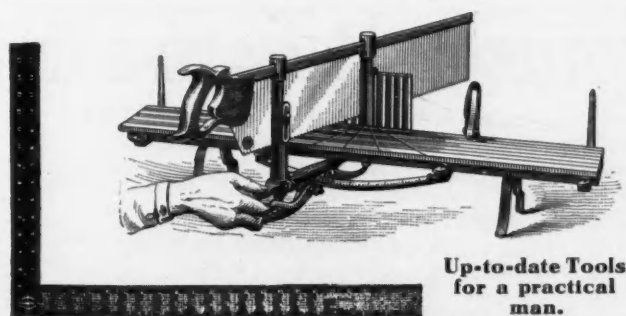

**Up-to-date Tools
for a practical
man.**

**NICHOLLS' FRAMING SQUARE AND
COMMON SENSE MITER BOX**

NICHOLLS MFG. CO., Ottumwa, Iowa

The Successful Builder

Is the one who conducts his business on systematic principles. Estimating the cost rapidly and correctly is the first step to success.

A simple, rapid and practical method for estimating the cost has been prepared by a successful builder, who has used same in his business for years.

Based on actual experience, not theory. Saves risk of omissions often made by customary methods of estimating.

A \$2,000 Residence Estimated in 30 Minutes.

Invaluable for repair work, which is so hard to estimate exactly. First edition nearly sold out in 60 days. This phenomenal sale allows us to sell the course for 50c. post paid.

Bradt Publishing Co.
1260 Michigan Ave. JACKSON, MICH.

FAR AHEAD for smooth, easy work and holding edge will be YOUR VERDICT ON TRYING
CHAPLIN'S IMPROVED PLANES

Patented Feb. 14, 1899; Oct. 30, 1900; Dec. 24, 1902.

*We invite the
 Severest
 Comparative
 Tests*

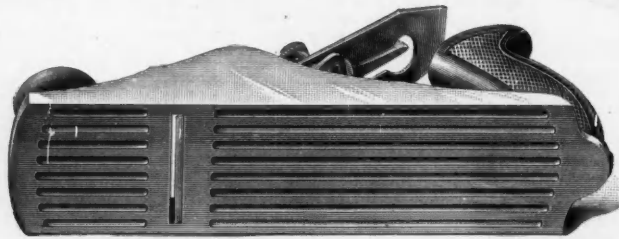

We want you to have a copy of our booklet

"A 'Plane' Talk About a Good Plane!"

We want you to have a copy, for it is a booklet you really need in your business. We'll gladly send you this booklet with our compliments, promptly upon receipt of your request.

Tower & Lyon Company, 95 Chambers Street, New York

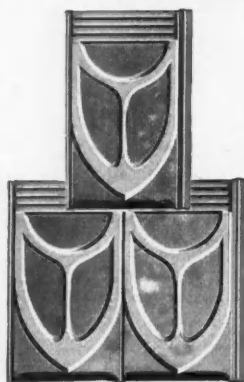

THE
CHAMPION
 Lock Joint
Metal Shingle
 FOR
Roofs, Gables
 AND
Dormers

MADE ONLY BY

J. H. ELLER & CO.
 CANTON, OHIO

ALSO MAKERS OF

Metal Ceilings, Cornice, Sky-lights, Tin Plate, Eaves Trough, Roofing, Etc.

MARSTON'S

Patent
 Hand and Foot
 and
 Steam Power

**WOOD
 WORKING
 MACHINERY**

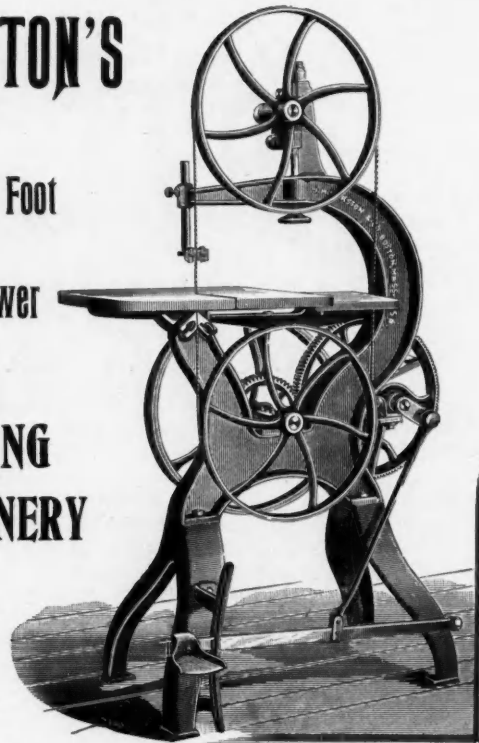

20-inch Hand and Foot Power Band Saw.

J. M. MARSTON & CO.

227 Ruggles St., Boston, Mass., U. S. A.

Facts Concerning the

HARTWICK AUTOMATIC CONCRETE BLOCK MACHINE



All working parts tool finished, so a perfect Block guaranteed.
 Makes all forms of Solid or Hollow Blocks.
 Makes all sizes from 2 inches to 16 inches in width and fractional lengths to 24 inches.
 Has fewer parts and works easier than any other machine.
 Simplicity and durability its strong points.
 No spring—no wheels—no cogs.
ONE BOTTOM PLATE for all kinds of work.
EITHER WOOD OR IRON pallets.
DON'T FAIL TO INVESTIGATE before you buy.

Write for Catalogue B.

HARTWICK CONCRETE BLOCK MACHINE CO. 228 Washington St. JACKSON, MICH.



We Move the Machine NOT THE BLOCKS

Saves labor of off bearing, loss by damage; obviates necessity for heavy and expensive iron pallets. Reduces cost of plant and cost of operation. Every one knows that concrete should not be disturbed after it is molded or while it is setting, but this is the only machine by which this is possible. The blocks cost 6 cents to make—sell for 18 cents. One man can make 200 blocks per day. Whole outfit costs \$125.00. Figure the profits.

Competition simply demonstrates the superiority of the Pettyjohn machine. Unlimited guarantee. SENT ON TRIAL.



THE PETTYJOHN COMPANY

156 Fifth Ave., CHICAGO, ILL. 533 N. 9th Street, TERRE HAUTE, IND.

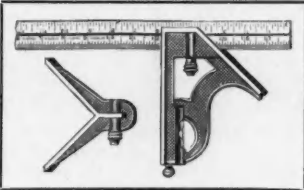

STARRETT

COMBINATION SQUARE

THE ORIGINAL : : THE MUCH IMITATED
Send for free Catalogue No.176, of Fine Tools for all kinds of mechanics.

The L. S. STARRETT CO., Athol, Mass., U. S. A.

**ROOFING, GENUINE BANGOR
BLACKBOARDS & STRUCTURAL**



THE BANGOR STRUCTURAL SLATE CO.
LOCK BOX 48 BANGOR, PA.

SLATE

ALL ORDERS FILLED PROMPTLY

Order direct from the miners and manufacturers

HEADQUARTERS FOR
SLATE BURIAL VAULTS,
CATACOMBS, ETC.



PAT. MAY 22, 1894.

GENERAL OFFICE

A FIRE RESISTANT

SUPERIOR TO WOOD OR METAL LATH IN THE
CONSTRUCTION OF PLASTERED

WALLS AND CEILINGS

NAILED DIRECTLY TO STUDDING AND FINISHED WITH PLASTER

Walls and Ceilings constructed with this Plaster Board are economical, light, durable and will not fall. Its use saves weeks of time in construction, as the light finishing required dries quickly. Warmer than lath and cleaner in application. Send for booklet and sample.

Sackett Wall Board Company, 17 Battery Place, New York

Builders Hardware

FREE Illustrated catalogue and net price list mailed to contractors and building material men on request. Our prices are right and goods are as represented.

Send for catalogue and be convinced.

REHM HARDWARE CO.
350 and 354 Blue Island Ave. CHICAGO, ILLS.

GRILLES

Beautiful Designs
Moderate Prices



PATENTED Catalogue Free

**BERTELSEN
ADJUSTABLE
GRILLE CO.**
308 S. Clinton Street, Chicago



CEMENT BRICK

BE YOUR OWN BRICK MAKER

LARGE CAPACITY — 5,000 BRICK PER DAY
SKILLED LABOR UNNECESSARY. SIMPLE AND INEXPENSIVE

Seaman's Cement Brick Machine Co.

23 Fountain Street Grand Rapids, Michigan

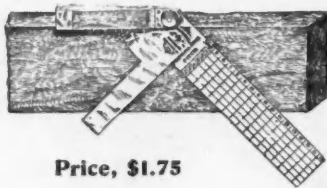

Price, \$1.75

TOPP'S FRAMING TOOL.

A PERFECT TOOL and the only Tool for the purpose ever invented.

Saves from 3 to 24 hours in laying out a single roof. Saves time for the skilled mechanic, and enables the ordinary workman to frame the most difficult roof with absolute certainty.

IT DOES ALL THIS. It is accurate, thus preventing all mistakes. It gives angles for any pitch. It gives lengths for any rafters. It gives cuts for principals, jacks, hips, valleys and cripples. Saves time for the skilled mechanic, and enables the ordinary workman to frame roofs with absolute certainty.

Write for circular. Address the manufacturers,

G. A. TOPP & CO., Indianapolis, Ind.



SAMSON SPOT CORD

is warranted free from flaws. The colored spot is our trade-mark, used only in this extra quality cord.

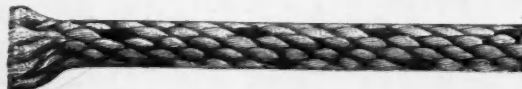

SAMSON CORDAGE WORKS, Boston, Mass.

**YOU DON'T
HAVETO WASTE
SPOT CORD BY
CUTTING OUT
ROUGH PLACES**

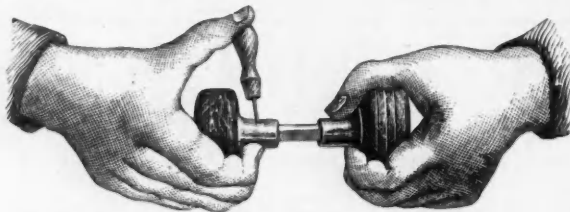

ROBERT'S SCREWLESS SPINDLE DOOR KNOB

Strength (tested to 400 lbs.) No Screw or Washer. Self adjusting. Fits any thickness of door. Any Standard Escutcheon. No tool required, an Awl or Small Wire Nail will answer. A Great Labor and Time Saver, at a Price of the Ordinary Capped Shank Knob. Every Knob Guaranteed. It cannot work loose.

MANUFACTURED BY

LAANNA MANUFACTURING CO.

Factory, Laanna, Pa. Office, 3614 HOWELL ST., PHILADELPHIA, PA.

Ask for **Millers Falls Co.'s
Bit Braces**

Series Nos. 30	31	32	33
14	12	10	8 inch sweep

There are no other braces made which match them in merit and beauty of finish.

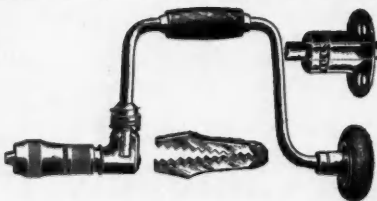

Our name appears on all genuine goods. Look for it before you buy. If your dealer does not keep Miller's Falls Braces then write to us.

Millers Falls Company
28 Warren Street, New York, N. Y.

KEY TO THE STEEL SQUARE

By ALFRED W. WOODS

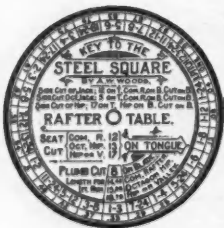

It is a wonderful instructor. It instantly gives the figures to use on the common steel square for the lengths, cuts and bevels for all rafters. It also gives the figures to use for all polygonal miters, hopper cuts, etc. Size, three inches in diameter, complete with book of instruction, all in morocco case suitable for the pocket. Can be consulted at a moment's notice.

Price, post paid, \$1.50

Send express or money order to

ALFRED W. WOODS

198 FIFTH AVENUE

CHICAGO

Our New Steel Square

Aside from excellence of material and workmanship, the greatest difference between the best Carpenters' Steel Square and the old iron square of the blacksmith, consists of the scales and markings on the improved tool. Our square, as recently improved, enables the carpenter to lay out all kinds of work and to calculate quantities with an ease and accuracy never before known.

Our Steel Square Book, describing the new tool, is a veritable PRACTICAL TREATISE ON THE STEEL SQUARE and we will send a copy, without charge, to anyone who in writing us will mention the American Carpenter and Builder

SARGENT & COMPANY

1149 Leonard Street

NEW YORK

**CHICAGO &
ALTON
RAILWAY**
"THE ONLY WAY"

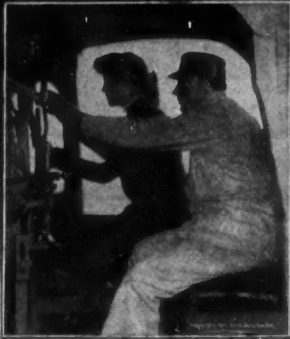

THE CHICAGO & ALTON
runs the largest passenger engines
in the world
They keep the trains on time
Between Chicago,
St. Louis,
Kansas City and
Peoria

GEO. J. CHARLTON, General Passenger Agent
CHICAGO, ILL.

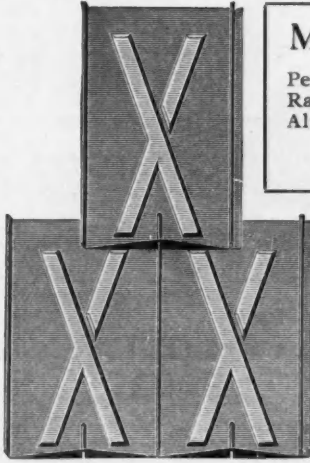

Metal Shingles
Perfect Side Lock.
Rain and Snow Proof.
Always Give Satisfaction.
Write for Prices and
Catalog "S."

For—
Architectural
Sheet Metal
Work,
Galvanized and
Copper Cornice,
Roof Gutters,
Curved Mouldings, Skylights, Finials,
Ventilators, all styles Roofing and Sid-
ing, Conductor Pipe, Eave Trough, Etc.

Write for prices and Catalog "G G".

Art Metal Ceilings and Sidewall.
Exclusive and Artistic Designs. Perfect Fitting Plates.
Write for Prices and Catalog "D-D".

KANNEBERG ROOFING AND CEILING CO.
CANTON, OHIO. MANUFACTURERS.



**The
Helm
Hand
Power**

Sand-Cement Brick Machine
Exerts a pressure of 80,000 pounds. Capacity 10,000 per day 10 hours, 7 men
Every brick a pressed brick. Dies for plain and ornamental brick
furnished with machine. Output of 2 factories to meet present demand.

A. D. MACKAY & CO. 86 Washington St. CHICAGO

**DRAWING MATERIALS
SURVEYING INSTRUMENTS**

Drawing and Blue Print Papers, Archi-
tects' and Builders' Level, Drawing In-
struments, T Squares, Triangles, Scales,
Inks, etc. Steel and Metallic Tapes.
Builders' Levels. Repairing promptly
executed. :: :: :: :: :: :: :: ::

**BLUE PRINTS, BLACK PRINTS
and BLUE ON WHITE PRINTS OUR SPECIALTY**

CHICAGO BLUE PRINT PAPER CO.
Room 550, 160 Adams St., Rand-McNally Bldg.
Telephone Main 3891 CHICAGO

Awarded Gold Medal, World's Fair, St. Louis
Highest Award World's Columbian Exposition

CONCRETE CHIMNEY CAPS

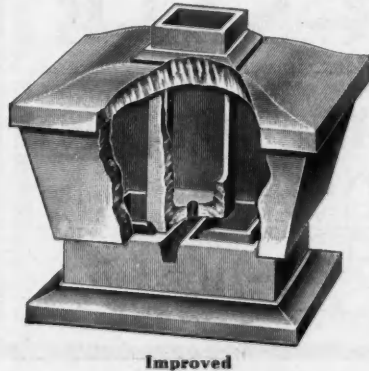

Improved

Useful, Durable, Inexpensive

Architects recognize and specify
on their merits.

We want to send you a leaflet
telling about them. Write.

We want a man to handle our
ware in Chicago. Write.

National Chimney Co.
NEW BRITAIN, CONN.

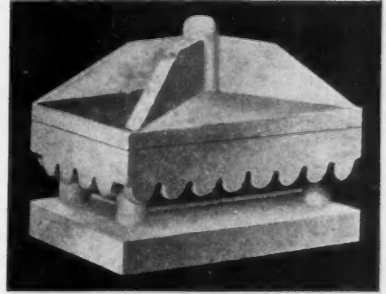

Old Style

WHEN WRITING ADVERTISERS PLEASE MENTION THE AMERICAN CARPENTER AND BUILDER

PARKER VISES

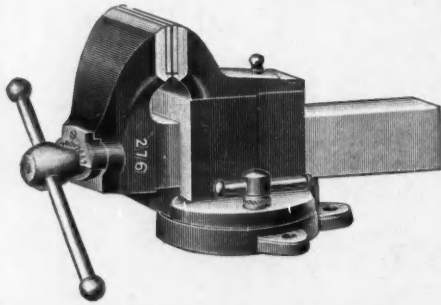

MADE
ESPECIALLY
FOR WOOD
WORKERS.

FOR SALE BY
DEALERS.

SEND FOR
CATALOG.

CHAS. PARKER CO.
MERIDEN, CONN.

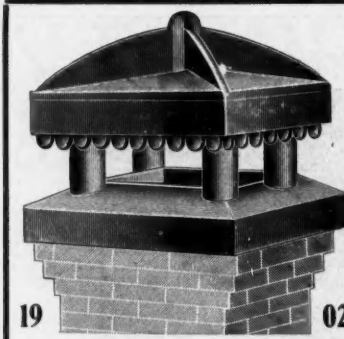

**Quigley's
American
Brand**

They save your chimney.
Give you a better draft.

Write for price list and
descriptive booklet.

19 02

MANUFACTURED BY

The American Artificial Stone Co.
NEW BRITAIN, CONN.

Remington Fame

RESTS UPON *Quality*

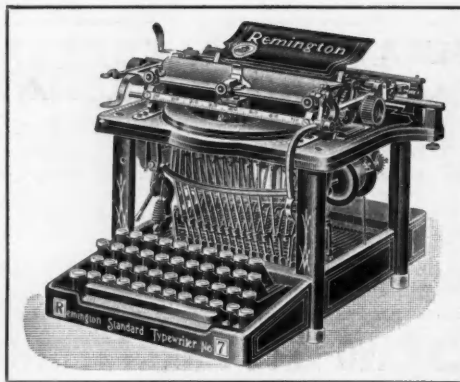

OUTSELLS ALL OTHERS

OUTWEARS ALL OTHERS

OUTLIVES ALL OTHERS

Remington Typewriter Co.

154 Wabash Avenue
CHICAGO

The Standard Sand & Machine Co.

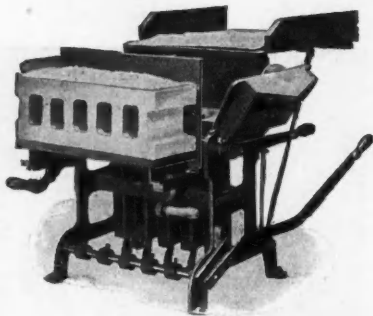

BEST in the world.
No experiment.
Been on the market
since 1903 and success-
fully stood the test.
Ask for catalog "A"
and prices.

The Standard Sand & Machine Co., Cleveland, Ohio.

FOR SALE

GASOLINE ENGINE

GREAT BARGAIN

J. M. BACHERT

12 S. Water St. Room 5 CLEVELAND, O.

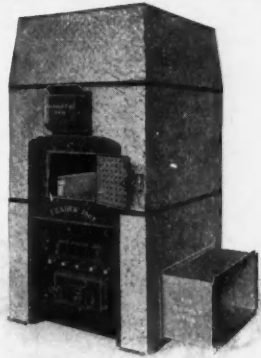

If You Are Building

IF YOU WANT A FURNACE

**IF ONE OF YOUR FRIENDS
WANTS A FURNACE**

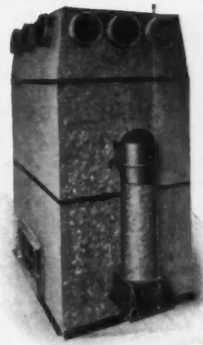

Send for Our New Book on Furnace Heating

This book is FREE. It is a COMPLETE GUIDE to the heating of houses, stores, churches, etc., profusely illustrated, by which any handy man can plan the successful heating of such buildings and install the apparatus as well as any mechanic.

It describes our 1905 LEADER STEEL FURNACE, made in six sizes, adapted to all fuels and suitable for any work that any furnace can do.

It describes our CIRCULATING ROOM HEATERS, for stores, assembly rooms, etc., where the heater may stand in the room it heats.

It describes our NOVEL PLAN OF SELLING, by which we put our goods STRAIGHT FROM OUR FACTORY INTO YOUR HANDS, with a small manufacturer's profit only, added to cost. Under this plan, WE PAY THE FREIGHT; we MAKE A PLAN of your house, showing every detail of the furnace work to be done; we GUARANTEE SUCCESS or money refunded; we SAVE YOU MONEY. For instance: Our No. 45 Leader will heat an eight room house in Chicago latitude, or store or small church. The price of this heater, with lined galvanized casing, rocking grates, chain regulated check-draft, water evaporating pan, etc. etc., is \$49.00 FREIGHT PREPAID to any station east of Omaha. Pipes and registers are not included; but if you will send us a rough sketch of your house we will tell you what the complete equipment will cost, made to your measures and fitted with plan and full directions for setting and operating, laid down at your station, and its SUCCESS FULLY GUARANTEED.

Send your name, NOW, for the booklet. It will interest you. A postal will do.

HESS WARMING AND VENTILATING CO.

720 Tacoma Bldg., CHICAGO.

Concrete Blocks! The Clipper Block Machine Produces Them

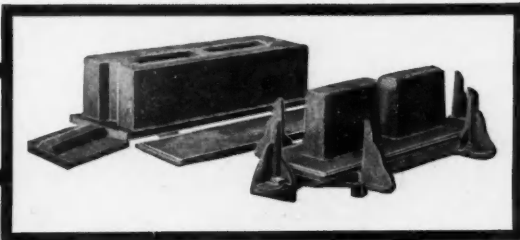

The Clipper Block Machines are simple, durable, light, strong, accurate, and will produce a great variety of shapes and sizes in hollow blocks, veneering blocks, chimney blocks, pier blocks, circular blocks.

ALL FACE BLOCKS TAMPED WITH THE FACE DOWN.

Rock faced, plain faced, panel faced.

Continuous air space, damp and frost proof.

Machines on the installment plan.

Write for particulars.

THE CLIPPER MACHINE CO.

Address Dept. "A"

Dows, Ia.

STANLEY CHUTE BOARD



A VERY IMPORTANT TOOL FOR ALL WOOD WORKERS

Will hold any shaped work to be planed, at any angle from 0 to 90 degrees.

The Plane Iron is fitted with a lateral adjustment, and a cut giving any ordinary draft to a pattern can be made.

Sold by all Hardware Dealers.

Stanley Rule & Level Co.

New Britain, Conn., U. S. A.

THE NEW HERO

IS THE BEST FOR
COUNTRY RESIDENCES, LARGE BUILDINGS and COMBINATION HEATING

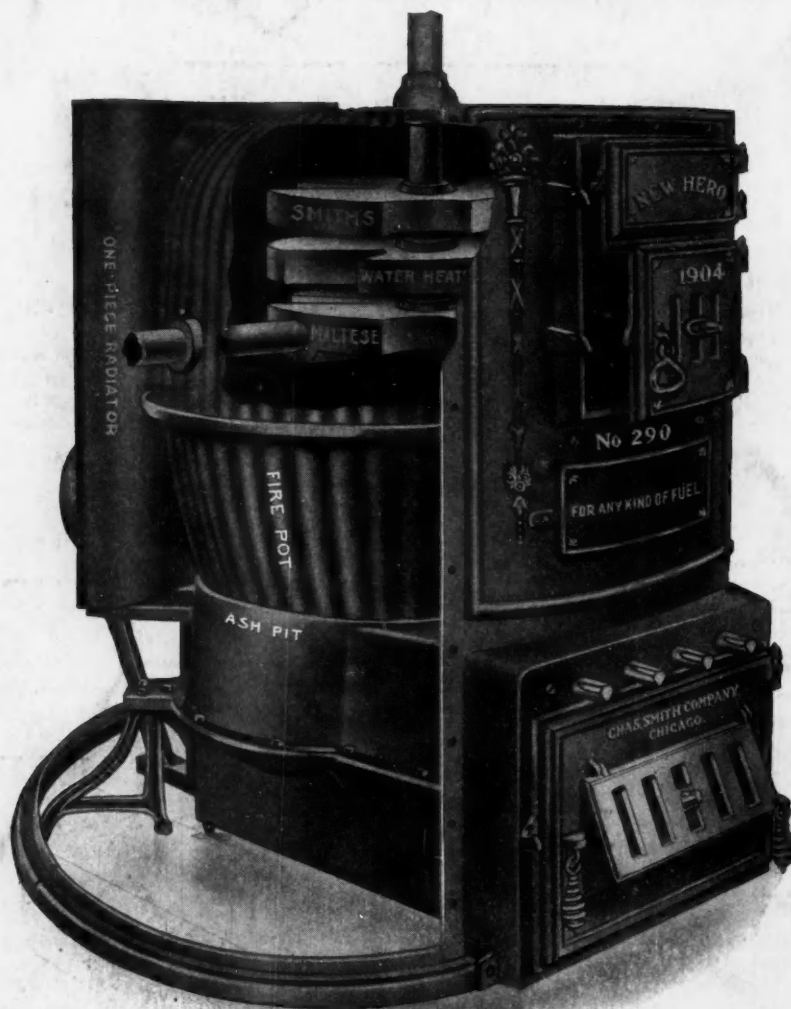

All Cast
Iron

Portable or
Brick Set.
Four Sizes.

Warm Air Only, or Combination of Warm Air and Water.

It has a **DEEP ASH PIT** with **TRIANGULAR GRATE BARS.**

No COG WHEELS or **BOLTS.**

The **DEEP CORRUGATIONS** of **FIRE POT** and **DOME** increase the radiating surface fifty per cent, and double the strength of the casting.

The **LARGE FEED DOORS** are a great convenience.

The **DOME** and **RADIATOR** are each made in one piece. They cannot leak gas.

This is not a cheaply constructed furnace. It can't be made better. Will last a life time.

Send us your plans and we will tell you what it will cost to heat your building by the most approved method.

Chas. Smith Company, Manufacturers

40 Dearborn Street, CHICAGO