

AMERICAN CARPENTER AND BUILDER

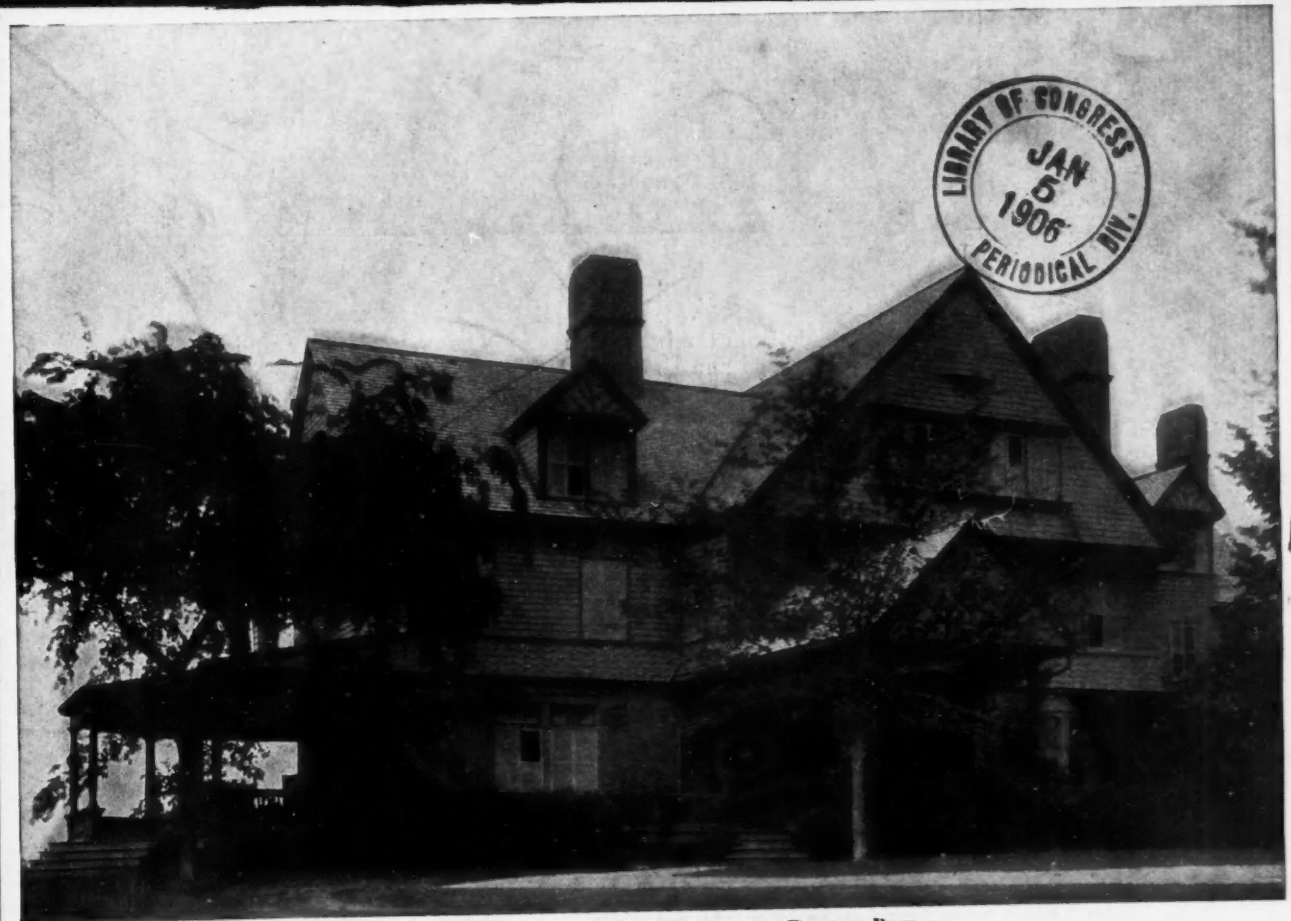

President Roosevelt's Home at Oyster Bay

Impervious

SHINGLE STAINS

*The best made for durability
and permanency of color.*

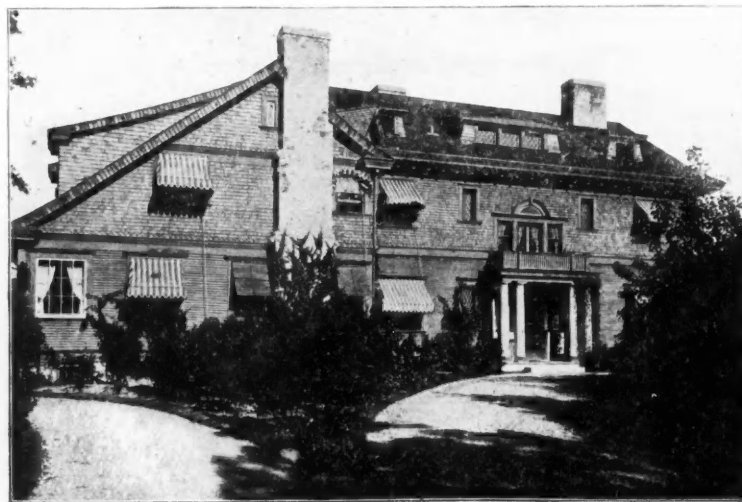

These Stains are made from the best permanent German colors, ground in Linseed Oil, **Creosote** and Drying Oil. Made expressly for modern style of houses. A surface treated with these Stains will prolong the life of the shingles and protect them from dry rot and keep them from warping. They bring out the beautiful shading of the grain of the wood which cannot be obtained with paint. The cost, compared with paint, is about one-half. If interested, send for color samples on wood of twenty-one different tints and colors.

Manufactured by

VILAS BROTHERS

Quincy and Fifth Avenue

::

Chicago, Illinois

Established 1877

Great Prize Contest

REMARKABLE interest has already been manifested in the AMERICAN CARPENTER AND BUILDER'S Great Prize Contest, the first announcement of which was made last month.

If the contest were to close today, Lorin Turner, of Paintsville, Ky., who has secured ten subscriptions, would be entitled to the Remington typewriter for having the largest number, also \$25.00 for having the largest number in the Southern Central States, two special prizes for each five subscriptions, and cash commissions of \$5.00.

There are great possibilities for new contestants in each group of states. The leader in the North Atlantic States has only four subscriptions, in the Western States only six, with practically no second, while in the South Atlantic States and Miscellaneous sections the lists are practically open.

The full list of contestants, with the number of subscriptions secured to Dec. 20, is given below:

State.	Town.	Contestant.	Subscriptions.	
Illinois.	Table Grove	E. F. Davis	1	
	Upper Alton	L. N. Willis & Co.	4	
	Wataga	O. M. Elder	1	
	Waterloo	Theo. P. Lindbeck	1	
	Kansas.	Waterloo	C. W. Hutton	1
		Argentine	George Paine	1
		Ellsworth	J. O. Knowles	1
		Greensburg	B. R. McBride	1
		Highland	W. G. Bingham	5
		Lacygne	R. Flesher	1
Wisconsin.	Newton	A. G. McQuiddy	2	
	Oakland	Nels Swank	1	
	Parsons	Paul Sharp	1	
	Knapp	A. C. Peters	1	
	Plymouth	J. A. Kuster	5	
	Thorp	Patrick Finnegan	1	
	Ohio.	Barberton	Wm. H. Snyder	1
		Cleveland	E. Holder	1
		Portsmouth	W. C. Bussa	1
		Rittmann	A. R. Deneke	1
Sidney		S. H. Love	1	
Steubenville		A. A. Arnold	2	
Wadsworth		A. K. Houseworth	2	
Westerville		J. F. Bunn	1	
Youngstown		C. C. Phelps	1	
Indiana.		Carmel	A. G. Stanley	1
	Decatur	J. E. Dentner	1	
	Hamilton	Levi B. Brown	1	
	Hammond	W. Baumgart	1	
	Indianapolis	Burnett & Lewis	1	
	Knights town	O. J. Reddick	1	
	Lowell	J. Claude Rumsey	1	
	Sedalia	W. H. Cokayne	1	
	North Dakota.	New Rockford	Chas. F. Culp	1
		Minot	A. Hangse	1
Munich		Chas. F. Bitterling	1	
Nebraska.	Wales	Chas. Richardson	1	
	Farwell	Alfred Lang	1	
Iowa.	Geneva	W. A. Hosack	2	
	Humboldt	J. W. Graham	1	
	Bedford	E. Golding	1	
Michigan.	Tiffin	George Osborne	1	
	Wilton Junction	Julius B. Schmidt	1	
	Alpena	Grant B. Freer	1	
Minnesota.	Bloomington	C. J. Lawson	1	
	Holland	A. Potsma	1	
	West St. Paul	Frank Reibe	1	
Missouri.	Everton	E. D. Wrightsman	1	
	Desloge	W. G. Manson	1	
	Kahoka	L. W. Dumas	1	
South Dakota.	Middlebrook	Geo. Gassman	1	
	Monroe City	Mack Green	1	
	Doland	Chas. Schaff	1	
Kentucky.	Highland	J. H. Cox	1	
	Paintsville	Larin Turner	10	
	Dyersburg	E. E. Maynard	1	
	Tennessee.	Greenwood	W. J. Lacouer	3
		Jackson	C. J. Harper	1
		Leakesville	C. A. Hillebrand	1
	Mississippi.	Tupelo	R. A. Moreland	1
		Clarendon	E. T. Boals	1
		Conway	John A. Herbert	1
	Arkansas.	Fort Smith	W. M. Roach	1
West Hartford		C. C. Brown	1	
White Castle		J. T. Williams	7	
Louisiana.	Holdenville	K. B. Weist	1	
	El Paso	E. J. Ogle	1	
Indian Territory.				
Texas.				
Southern Central States.				
Kentucky.	Paintsville	Larin Turner	10	
	Dyersburg	E. E. Maynard	1	
	Greenwood	W. J. Lacouer	3	
Mississippi.	Jackson	C. J. Harper	1	
	Leakesville	C. A. Hillebrand	1	
	Tupelo	R. A. Moreland	1	
Arkansas.	Clarendon	E. T. Boals	1	
	Conway	John A. Herbert	1	
	Fort Smith	W. M. Roach	1	
Louisiana.	West Hartford	C. C. Brown	1	
	White Castle	J. T. Williams	7	
	Holdenville	K. B. Weist	1	
Indian Territory.				
Texas.				
Western States.				
Colorado.	Durango	August Brinkman	1	
	Lamar	P. S. Lynch	6	
	Longmont	Fred H. Thompson	1	
California.	Long Beach	J. A. Kirkpatrick	1	
	Madera	C. J. Hall	1	
	San Francisco	James Gilchrist	1	
Oregon.	Halsey	J. W. Rector	1	
	Phoenix	E. T. Shaffer	1	
	Butte	C. M. Prentice	1	
Montana.	Ephraim	T. Brainholt	1	
	Olympia	Clarence D. Gray	1	
	Washington.	Pomeroy	Wm. Waugh	1
Arizona.	St. Johns	H. Coverson	1	
Miscellaneous.				
Canada.	Perth	W. A. McLenahan	1	
	Regina	Andrew Menzies	1	
	Truro	D. Henderson	1	

North Atlantic States.

State.	Town.	Contestant.	Subscriptions.	
Pennsylvania.	Barnesboro	John F. Bee	1	
	Berwick	T. J. Ray	1	
	Berwick	J. C. Smethers	2	
	Claysville	S. A. Bane	1	
	Center Valley	Frank A. Weaver	1	
	Columbia	G. T. Emon	1	
	Dorrancton	H. L. Poust	1	
	Honesdale	J. A. Hurd	1	
	Kushequa	Harry Eshbaugh	1	
	Lebanon	R. J. Yoder	1	
New York.	Lilly	A. J. Yingling	3	
	McKeesport	M. E. Davis	1	
	Sheffield	F. A. Stover	1	
	Shiremanstown	H. L. Huntsberger	1	
	Tarantum	Howard E. Brown	1	
	Wyalusing	V. H. Brown	1	
	Brooklyn	E. Nelson	1	
	Dansville	E. J. Rauber	4	
	Fairground	Geo. W. Sweezy	1	
	Fairport	L. E. Rowell	1	
Connecticut.	Jamaica	Henry W. Bangert	1	
	Medina	Carl A. Smith	1	
	Rochester	H. C. Ball	1	
	Rochester	Geo. M. Grover	1	
	Stamford	C. L. Murdock	1	
	Tottenville	W. E. Joline	1	
	Tully	W. T. Bailey	1	
	Massachusetts.	Bristol	Geo. H. Saxton	1
		Greenwich	Geo. R. Murray	2
	New Jersey.	Norwood	F. L. Colton	1
Quincy		Herman G. Olsen	1	
New Hampshire.	Cranford	E. A. Thompson	1	
	East Nutley	W. G. Fitting	1	
	Phillipsburg	G. L. Greveling	1	
Maine.	East Acworth	Geo. E. Symonds	1	
	Exeter	Geo. W. Lane	1	
	Camden	R. E. Richards	1	

South Atlantic States.

Maryland	Baltimore	J. E. Kaiser, Jr	1
North Carolina.	Elkin	J. W. Nelson	1
	Hendersonville	U. M. Orr	1

Northern Central States.

Illinois.	Barrington	E. E. Ernst	3
	Benton	W. W. Munday	1
	Buffalo	E. Stubbs	1
	Carrollton	A. Postlewait	2
	Chebanse	G. E. Scott	9
	Colfax	D. L. Hamilton	1
	Dewey	J. W. Fink	1
	Evanston	H. B. Doose	1
	Exeter	H. C. Ward	2
	Harvard	F. W. Moore	1
Kewanee.		Frank Ahlman	2
		Jacob Gedelman	1
		Ole Randall	1

Complete Description of Contest

For the benefit of those subscribers who are not familiar with the rules of this great contest, a full description is given in the following pages. On page 702 a full list of the rewards and prizes will be found, together with the rules governing the contest.

Date _____

Contest Editor,
AMERICAN CARPENTER AND BUILDER,
196 Fifth Avenue, Chicago.

DEAR SIR:
Enclosed find \$1.50 for the subscription of

Name of New Subscriber _____
Address of New Subscriber _____

Please enroll my name as a contestant in your Subscription Contest, and send subscription blanks at once.

Subscriber's Name _____
Address _____

This Coupon must be used to insure your participation in the contest.

This Subscription to be counted in the distribution of all prizes.

[SEE OTHER SIDE]

Description of Grand Rewards to Subscribers

(SEE PAGE 601.)

Remington Standard Typewriter No. 7

In selecting Grand Rewards and Special Prizes to be given to its great family of subscribers, as described on page 702, the AMERICAN CARPENTER AND BUILDER has endeavored to secure none but the very best. The Remington Typewriter is so well known that our readers do not need to be told of its excellent points. We are so well convinced of its superiority that we have twenty-five of these machines in daily use in our correspondence department. The subscriber who secures this Grand Reward absolutely free will have not only one of the most useful articles ever produced, but will have something to be extremely proud of. It will be sent all express charges prepaid. Value \$100.00.

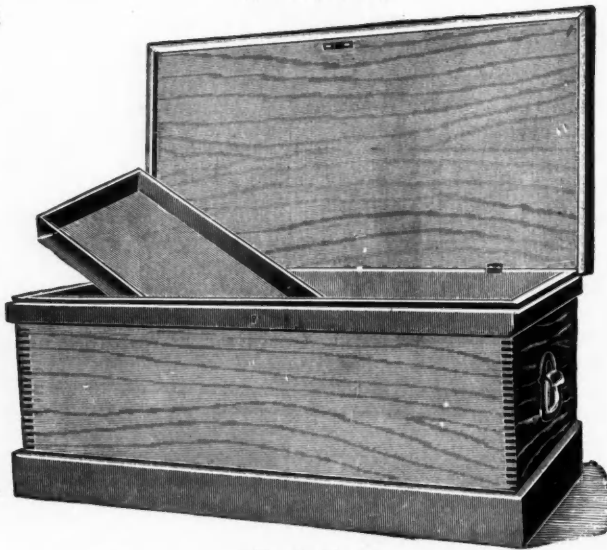

Tool Chest

To be filled with a complete set of carpenter's tools, over 100 pieces of the very highest quality.

Complete Chest of Tools

Following the same idea regarding the best of everything, we have arranged with the Orr & Lockett Hardware Co. to furnish us with one of their Tool Chests of the largest size, to be packed full of every conceivable tool that the carpenter or builder could use, everything to be of the very best. This Chest is 32 inches long, 18 inches wide, 16 inches deep, and has sliding trays. We show on this page the empty chest. When filled it will contain the following:

Orr & Lockett Tool Chest.
Bedrock Smooth Plane, 2-inch Cutter.
14-inch Bedrock Jack Plane, 2-inch Cutter.
22-inch Bedrock Jointer Plane, 2 $\frac{3}{8}$ -inch Cutter.
Bailey Iron Block Plane.
Bailey Rabbit and Fillester Plane.
26-inch Bishop Cross Cut Saw.
26-inch Bishop Rip Saw.
12-inch Bishop Back Saw.
1 Set No. 12 Bishop's Nest of Saws.
Jones Cable Coping Saw.
3x6 Orr & Lockett Cabinet Scraper.
Morrill's Special Saw Set.
1 Set Buck Bros. Socket Chisels, Bevelled Edges, $\frac{1}{4}$ -inch, $\frac{1}{2}$ -inch, $\frac{3}{4}$ -inch, 1-inch, 1 $\frac{1}{2}$, 1 $\frac{3}{4}$ -inch.
1 $\frac{1}{2}$ -inch Buck Bros. Tang Butt Chisel.
Straight Claw Hammer.
5 $\frac{1}{4}$ -inch Cut Barton Hand Axe.
Millers Falls Ratchet Brace, 10-inch Sweep.
Yankee Automatic Drill, with 8 Drills.
1 Set Russell Jennings Auger Bits, in case, 3 $\frac{1}{4}$ Quarters, $\frac{1}{2}$ -inch to 1-inch—13 bits.
Large Steers Expansive Bit, to cut $\frac{3}{4}$ -in. to 3-in.
1 Set Syracuse Twist Bits for Wood, from 3-32-inch to 12-32-inch.
Clarks Countersink.
Yankee Automatic Screw Driver.
6-inch Champion Screw Driver.
Orr & Lockett Screw Driver Bit.
30-inch Stratton Brass Bound Mahogany Level.
4-foot White Enamel Zigzag Rule.
Eclipse Folding Square.
8-inch Stanley Try Square.
8-inch Eureka T-Bevel.
Stanley's Universal Spoke Shave.
Wilkinson Folding Handle Drawing Knife.

Pair 8-inch Single Leg Cook's Dividers.
Assortment Knurled Handle Nail Sets.
Mortise and Marking Gauge.
Stanley Butt Gauge.
Lignum Vitae Mallet.
Russwin Monkey Wrench.
Pair 7-inch Carpenter's Pinchers.
Wells Special Steel Oilers.
"Oils-Here" Oil Stone, with one 8-inch Combination India Oil Stone.
1 Dozen Orr & Lockett Carpenter's Pencils.
1 Dozen 5-inch Black Diamond Saw Files.

This complete set consists of more than 100 pieces, and combined with the Tool Chest has an actual value of more than \$65.00. It would require four pages to illustrate the different articles.

NOTE.—The carpenter securing this valuable reward may make any changes in the contents desired, providing the changes do not materially increase the cost.

Dearborn Roll-Top Office Desk

The beautiful desk shown in the illustration is made by the Dearborn Desk Co., who are constantly shipping desks in large quantities all over the country. It is 54 inches wide, 33 $\frac{1}{2}$ inches deep, 53 $\frac{1}{2}$ inches high, and weighs 300 pounds. These



Roll-Top Office Desk

dimensions alone show that it is an exceptionally fine and heavy piece of office furniture. It is made of beautifully figured oak, polish finish, three-ply writing bed and panels, well grained oak front wood filing boxes, two upright spaces reserved for books, two extension slides, drawer in center, four drawers right and left which lock and unlock automatically by action of curtain; all drawers have carved handles and work easily. This desk is equipped with a patent smooth outer surface, dust-proof roll curtain, showing an unusually attractive grained effect, and also has heavy chilled-steel ball-

USE THIS SIDE IF YOU CANNOT SECURE YOUR FIRST SUBSCRIPTION AT ONCE

Date _____

Contest Editor,

AMERICAN CARPENTER AND BUILDER,
196 Fifth Avenue, Chicago.

DEAR SIR:

Please enroll me as a contestant in your liberal Subscription Contest. Send full information, and subscription blanks at once.

Name _____

Address _____

This Coupon must be used to insure your participation in the contest.

bearing casters. Absolute satisfaction is guaranteed by the manufacturers. Value \$50.00.

German Silver Drawing Instruments

The set of Drawing Instruments offered as a fourth Grand Reward is one of the best and most complete made. They are of high grade, superior quality and the set includes 13 pieces: 5½-inch Compass, Attached Needle Point, with Pencil and Pen Points, Lengthening Bar, 5-inch Divider with Hair Line Spacing Attachment, 3½-inch Compass, Attached Needle Point with Pencil

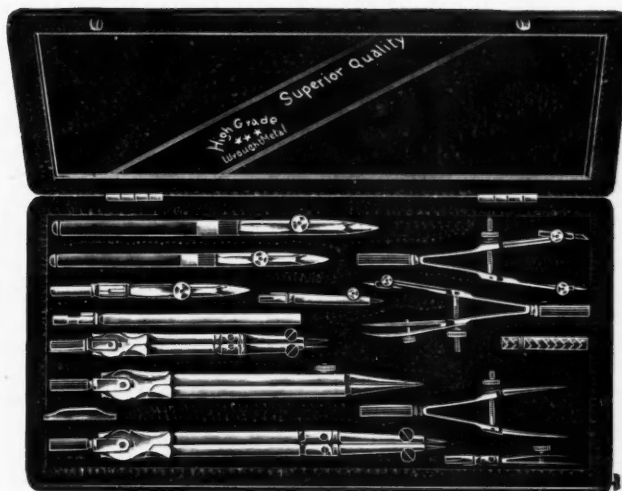

and Pen Points, Spring Bow Pen, Spring Bow Pencil, Spring Bow Divider, two Spring Back Ruling Pens, 4½ and 5 inches, Box of Leads and Key. Value \$13.50.

SPECIAL NOTICE

The illustrations and descriptions above cover only four of 38 Grand Rewards and Territorial prizes to be given absolutely free to subscribers. Read all of page 702 carefully, and then prove yourself one of the most interested members of our great family, by using the coupon at once.

Special Prizes for Each Five Subscriptions

ONE OF THESE USEFUL AND VALUABLE PRIZES WILL BE GIVEN ABSOLUTELY FREE TO EACH CONTESTANT FOR EVERY FIVE SUBSCRIPTIONS SECURED.

IN addition to participating in the distribution of the "Grand Rewards" and "Territorial Prizes," and also in addition to the liberal cash commission paid for each subscription, the contestant is entitled to select one of the following "Special Prizes" every time he secures five subscriptions:

1. "Bed Rock" Smooth Plane No. 603

This plane is of a design which allows of the combination of the utmost solidity and rigidity, with a wider range of adjustments than heretofore placed on iron planes.



Bedrock Smooth Plane, No. 603

The advantages of this design are made possible by the extreme nicety of their manufacture. Among the novel points in this plane are: A frog with a machined face; a frog so designed that the entire bottom of the frog rests solidly on a seat formed in the plane body; a frog so designed that its sides conform to guides formed in the plane body, which guides lend accuracy of adjustment to the frog as well as prevent any possibility of its wobbling; a reliable adjustment for the width of throat opening. This plane is 8 inches in length, with 1¾-inch cutter.

2. "Bed Rock" Jack Plane, No. 605

All that has been said in describing the Smooth Plane applies also to the Jack Plane. It is 14 inches in length, with 2-inch cutter.



Bedrock Jack Plane, No. 605

3. Bishop's Rip or Cross Cut Saw, No. 90

These saws are highly polished and fully warranted in every respect. They are hand made from purest steel, perfect in temper, full taper ground and highly finished blade, carved



Bishop's Rip or Cross Cut Saw, No. 90

and polished applewood handle, improved nickel screws, full skew back, teeth hand filed to diamond point, set ready for use. Length, 26 inches.

4. Disston's Acme Rip or Cross Cut Saw, No. 120

This saw is made of extra London spring steel, warranted, carved and polished apple handle, skew back. A fast, smooth-cutting saw, particularly adapted for fine cabinet work, sawing mitres, and in all instances where rapid, smooth cutting is desired. Either a rip or cross cut saw will be furnished, 26 inches in length.

5. Jennings' Chisel Set, No. 702

This is a set of 6 No. 02 Beveled Edge Chisels in canvas chisel roll. There is one each ¼, ½, ¾, 1, 1¼ and 1½ inch, with Cocobolo handles. The blades average about 3½ inches long from shoulder, with sockets and handles in proportion.

6. Barber Improved Ratchet Brace, No. 32

These braces possess the following points of superiority: The sweep is made from steel, the jaws are forged from steel, the wood handle has brass rings inserted in each end so it cannot split off, and the chuck has a hardened steel anti-friction washer between the two sockets, thus reducing the wear. The head has a bearing of steel balls, running on hardened steel plates, so no wear can take place, as the friction

is reduced to the minimum. The brace is heavily nickel plated and warranted in every particular. No. 32 has a 10-inch sweep.

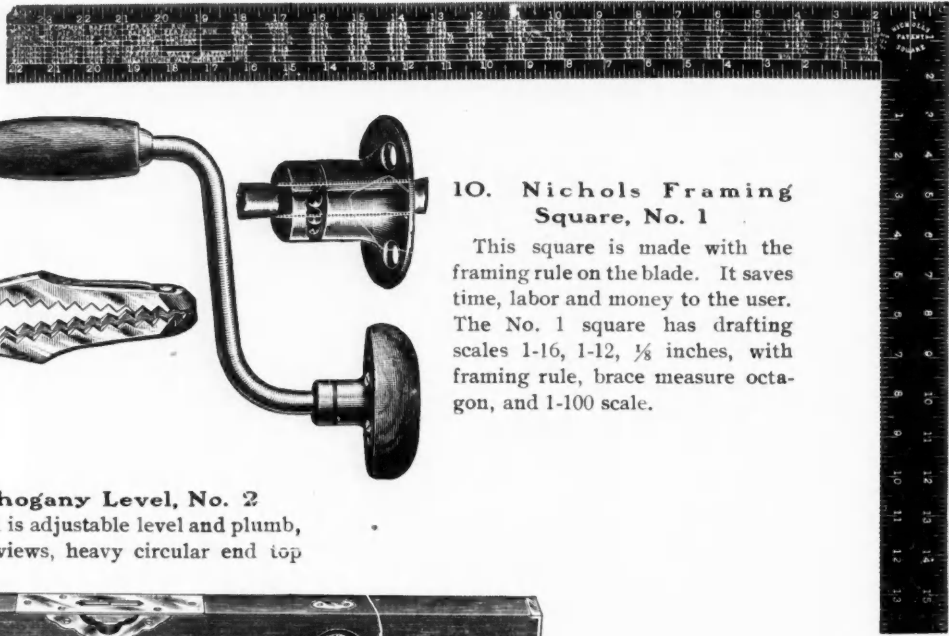

10. Nichols Framing Square, No. 1

This square is made with the framing rule on the blade. It saves time, labor and money to the user. The No. 1 square has drafting scales 1-16, 1-12, 1/8 inches, with framing rule, brace measure octagon, and 1-100 scale.

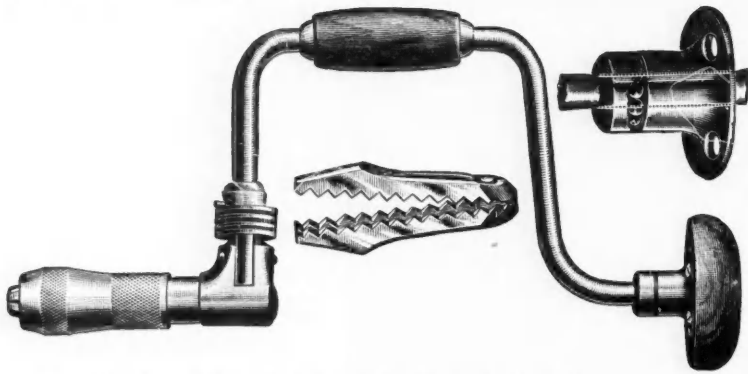

7. Stratton Bros.' Mahogany Level, No. 2

This excellent mahogany level is adjustable level and plumb, has two ornamental brass side views, heavy circular end top



11 Carpenters' Shoulder Tool Chest, No. 20

This is a portable tool chest and can be easily carried on the shoulder. It is made of chestnut with locked dovetailed corners; has lock, brass elbows to support lid when open, drop handles and rack for holding saws. No. 20 is the largest size. Its inside dimensions are 32 inches long, by 8 inches wide, by 8 inches deep. A smaller size, 25 inches long, may be had if preferred.

plates, solid brass end plates, polished. Can be had in either of three lengths, 26, 28 and 30 inches.

8. "Rival" Steel Measuring Tape, No. 243

This steel tape line is enclosed in a nickel plated steel case

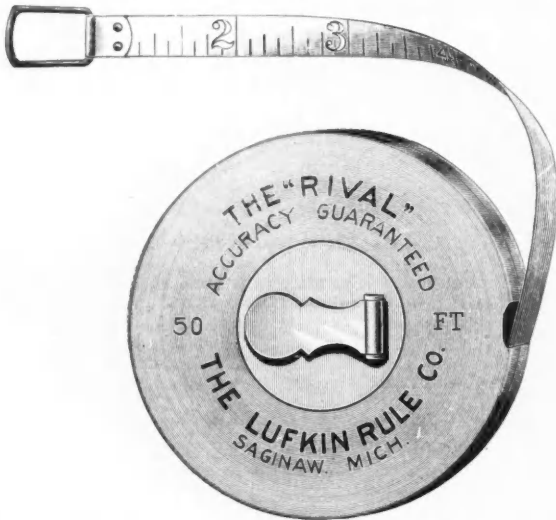

with flush handle. It is a 3/8 inch tape, marked one side only in feet and twelfths (inches and eighths).

9. Eclipse Adjustable Folding Square

This square is designed to meet the wants of those desiring a more convenient tool than the ordinary carpenter's square. It can be folded and packed in a small chest, and can be adjusted at right angles ready for instant use when required. It does away with cutting holes in the top or sides of small chests, can be shipped more readily on cars when traveling from place to place, and is protected from being bent and rusted when left standing or exposed to the weather. The illustration is a miniature reproduction of the square when closed.

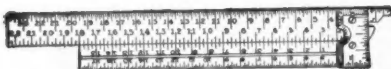

Eclipse Folding Square—Closed

12. Set of Drawing Instruments, No. 2076

This is an excellent set of German silver instruments. It contains 8 pieces: 5 1/2-inch compass, attached needle point,

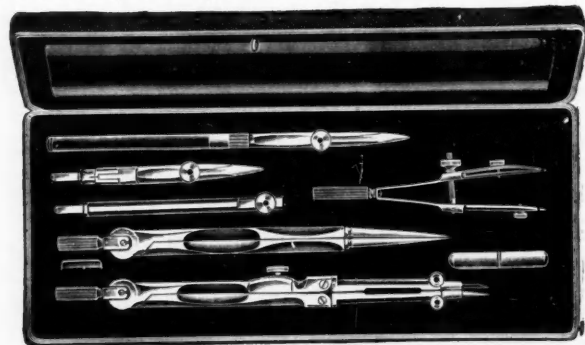

with pencil and pen points, lengthening bar, 5-inch divider, spring bow pen, 5-inch ruling pen, box of leads and key.

13. Set of Drawing Instruments, No. 2015

This is a set of nickel plated instruments, designed especially



for the young carpenter. It contains 9 pieces: 4 1/2-inch compass, pen and ruling points, lengthening bar, dividers, ruling pen, spring bow pen, box of leads and key.

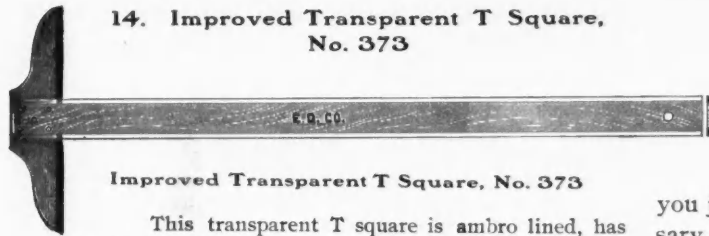

14. Improved Transparent T Square, No. 373

Improved Transparent T Square, No. 373

This transparent T square is ambro lined, has maple blade and black walnut head. It can be had in any length desired: 18, 24, 30, 36, 42 or 48 inches.

Special Notice.— If the subscriber should fail to find in this list an article that he desires, we will be glad to substitute any other tool or article of merchandise of equal cost. Write to the "Contest Editor," stating just what you would like to secure, and he will tell you just how many new subscriptions will be necessary to secure it free. There is no reason why any subscriber should not secure any article he desires.

Special Prizes for Three Subscriptions

In order that every subscriber entering this contest shall be fully paid for the work accomplished, we have decided to offer a limited list of Special Prizes to those who may not be able to secure more than three subscriptions. These prizes will be given absolutely free and entirely additional to the cash commission of 50 cents on each subscription.

1. Stanley Steel Jack Plane, No. 105

This is an exceptionally fine plane and is one of the carpenter's most handy tools. It is adjusted by a lever and is especially adapted for working on soft woods. It is 14 inches in length and has a 2 1/8-inch cutter. Smaller planes, 9 inches in length with 2 1/8-inch cutter, or 8 inches in length with 1 3/4-inch cutter, may be had if desired.

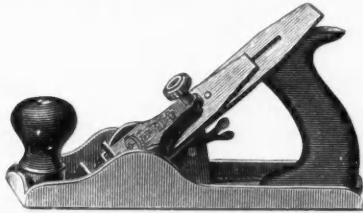

2. Hammond's Mechanic's Pride Hammer, No. 175

This is one of the most expensive hammers made. It is nickel plated, has hickory ebonized handle, and octagon neck.



Hammond's Mechanic's Pride, No. 175

Its weight, exclusive of handle, is one pound. Any other make, size, or style of hammer may be had if preferred.

3. Yankee Automatic Drill, No. 44

This drill has an adjustable tension. The cap on top has a screw attached to it, by revolving which the spring is made longer or shorter, thereby making it weaker or stronger. The tool is made of brass, nickel plated and finely finished, the material and workmanship throughout being of the best. Eight



Yankee Automatic Drill, No. 44

drills are furnished with each tool. The chuck is of new and approved design, and will hold drill points absolutely tight and rigid. The entire length of tool, inclusive of drill, as in illustration, is 10 3/4 inches.

4. Set Syracuse Wood Drills, No. 16

This set contains nine instead of seven drills, as shown in the illustration. It is put up in a neat, strong box, and contains one each of the following sizes: 3/8", 7/16", 1/2", 9/16", 5/8", 3/4", 7/8", 1", and 1 1/8". An attractive prize.

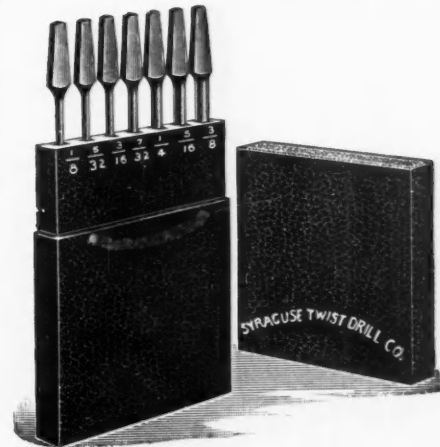

Syracuse Wood Drills, No. 16

5. German Silver Dividers, No. 2231

These dividers are made of the best German silver and have steel points and high finish. They have pivot point, with set screws, straightening device, hair-line spacing attachment, 5 inch.

Four Prizes For Every Contestant

GREATEST OFFER EVER MADE TO AMERICAN CARPENTER AND BUILDER SUBSCRIBERS—GREAT FAMILY OF READERS TO SHARE PROFITS—READ ALL OF PAGE 702

EVERY energetic contestant can hardly fail to secure four separate and distinct prizes if he takes an active interest in the work:

First—A cash commission of 50 cents on every subscription.

Second—A "Special Prize" when he secures either three or five or more subscriptions.

Third—A "Territorial Prize" if he secures the largest or second largest number of subscriptions in the group of states where he is located.

Fourth—One of the leading "Grand Rewards," if he finishes among the first 26.

It Should Be Remembered

That the securing of one of these prizes does not

prevent participation in the distribution of the other three. The contestant is paid for every subscription secured, an additional payment for the securing of

three or five, and also may secure two additional prizes through participating in the distribution of thirty-eight other rewards for special merit.

Details of Rewards and Conditions

HOW THE VALUABLE REWARDS AND CASH PRIZES WILL BE DIVIDED AMONG AMERICAN CARPENTER AND BUILDER SUBSCRIBERS THROUGH ITS GREAT CONTEST

BELIEVING that our "great family" of 25,700 subscribers would be most interested in our wonderful success, and would wish to see that success continue, this Great Prize Contest was inaugurated. We want them to share in the profits of the AMERICAN CARPENTER AND BUILDER, and will reward them liberally for adding new names to the "great family."

Grand Rewards

To those subscribers securing the most yearly subscriptions before March 1, 1906, the following Grand Rewards will be given:

For the largest number, Remington Standard Typewriter, No. 7, value.....	\$100.00
For the second largest number, Complete Chest of Carpenter's Tools, value.....	65.00
For the third largest number, Dearborn 54-inch Roll-Top Office Desk, value.....	50.00
For the fourth largest number, Complete Set of Drawing Instruments, value.....	13.50
For the fifth and sixth largest numbers, Cash, each, \$10.00, total.....	20.00
For the next five largest numbers, Cash, each \$5.00, total.....	25.00
For the next fifteen largest numbers, Cash, each, \$1.00, total.....	15.00

There are twenty-six (26) prizes in this list, with a total value of \$288.50.

Territorial Prizes

In addition to participating in the above distribution of Grand Rewards, Territorial Prizes will be awarded as follows:

For the largest number of subscriptions from the North Atlantic States, First prize.....	\$25.00
Second prize.....	10.00
For the largest number from the South Atlantic States, First prize.....	25.00
Second prize.....	10.00
For the largest number from the Northern Central States, First prize.....	25.00
Second prize.....	10.00
For the largest number from the Southern Central States, First prize.....	25.00
Second prize.....	10.00
For the largest number from the Western States, First prize.....	25.00
Second prize.....	10.00
For the largest number from Canada, etc., First prize....	25.00
Second prize.....	10.00

This makes an additional twelve (12) prizes, bringing the total value of these two lists up to almost an even \$500.00.

Special Prize for Each Five Subscriptions

In addition to participating in both of the above, each contestant securing five subscriptions, and for every five subscriptions secured, will be entitled to a choice of the prizes enumerated on pages 699, 700 and 701.

Special Prizes for Three Subscriptions

Where a contestant is unable to secure five subscriptions, but does secure three subscriptions, he will be entitled to a choice of prizes enumerated on page 701.

Cash Commissions

In addition to participating in the Grand Rewards, Territorial Prizes and Special Prizes, each contestant is entitled to a liberal cash commission on every subscription secured.

Conditions

These offers are made to AMERICAN CARPENTER AND BUILDER subscribers only.

The prizes are divided into four classes: "Grand Rewards," "Territorial Prizes," "Special Prizes," and "Commissions."

Each contestant sending three or more subscriptions will participate in all four of these classes.

Send us your new subscriptions and the payment for each subscription as soon as you get it.

As soon as a subscriber has sent in five new subscriptions the "Special Prize" should be ordered.

The "Special Prize" for three new subscriptions is only intended for those who are unable to secure five or more subscriptions.

How to Enter

Any subscriber or reader of the AMERICAN CARPENTER AND BUILDER may become a competitor for these valuable prizes and rewards by filling out and signing the coupon on page 697, and sending us one new subscription.

If one new subscription cannot be readily secured, use reverse side of coupon, on page 698.

Territorial Prizes

These prizes are entirely additional to all other rewards and prizes. The list of states included in each division follows:

North Atlantic States—Maine, New Hampshire, Vermont, Massachusetts, Rhode Island, Connecticut, New York, New Jersey, Pennsylvania.

South Atlantic States—Delaware, Maryland District of Columbia, Virginia, West Virginia, North Carolina, South Carolina, Georgia, Florida.

Northern Central States—Ohio, Indiana, Illinois, Michigan, Wisconsin, Minnesota, Iowa, Missouri, North Dakota, South Dakota, Nebraska, Kansas.

Southern Central States—Kentucky, Tennessee, Alabama, Mississippi, Arkansas, Louisiana, Oklahoma, Indian Territory, Texas.

Western States—Montana, Wyoming, Colorado, New Mexico, Idaho, Utah, Arizona, Washington, Oregon, Nevada, California.

Miscellaneous—Alaska, Cuba, Philippine Islands, Canada, and all Foreign Countries.

Commissions

Every contestant will be well paid. In addition to participating in the "Grand Rewards," "Territorial Prizes," and "Special Prizes," a commission of 25 per cent (50 cents) will be paid on every subscription secured. In addition to this liberal commission, those who participate and are most successful will have a share in all three of the other classes of rewards for special merit.

Renewals

Renewals of subscriptions already on our books will count as new subscriptions.

For every subscription secured, whether new or old, the contestant must send us \$1.50.

How to Send Money

There are four ways in which money may be sent by mail at our risk—by Postoffice Money Order, Express Money Order, Bank Draft, or Registered Letter.

Stamps may be sent in payment for subscriptions, but one or two cent stamps must be used.

The expense of sending money must be borne by the person sending it.

Money must be sent with all subscriptions—we cannot open subscription accounts with any one.

We will be pleased to furnish sample copies and subscription blanks—as many as you can use—free.

Contest closes March 1, 1906.

Tools for the Boys

THE CARPENTER'S SON

has one great and creditable ambition—to have tools of his own, like Father has, and do the same work that Father does.

The Carpenter's Boy and the Boy in the Manual Training School need and should have tools of their own, which they can use at home.

We carry a complete line of every tool that is used by the carpenter in sizes suitable for the boy. They are all equally good in quality with the larger tools.

Tool Cabinets, with sets of tools \$5.00 to \$28.00

Tool Chests, with sets of tools, \$3.50 to \$50.00

MANUAL TRAINING CATALOGUE FREE

Send a postal for our special Manual Training Catalogue, 370B, giving accurate illustrations and full descriptions of everything for manual training schools and for the carpenter's boy.

Or send 25 cents for copy of our 450 page Tool Catalogue No. 37B, showing tools for 40 trades.

ORR & LOCKETT

HARDWARE CO.

71-73 Randolph St.

CHICAGO

Star Haying Tools

THE BUILDER AND CONTRACTORS' LINE

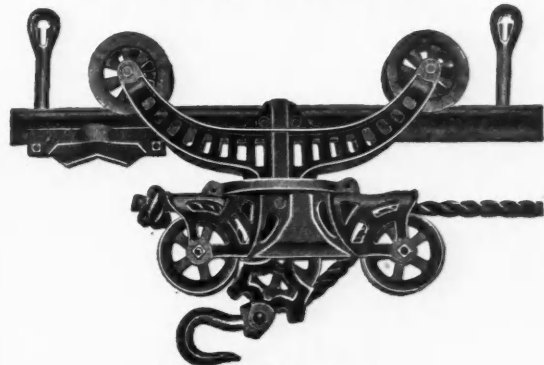

STAR HAY CARRIERS.

both fork and sling are the strongest and simplest on the market.

STAR HAY CARRIER TRACK.

stronger by actual test than any other Hay Carrier Track made. No tools required to erect this Track in the barn, except a wrench and hammer. The hangers are movable and will fit the rafters at any point. Write us for full information.

HUNT, HELM, FERRIS & CO.

MANUFACTURERS

HARVARD, ILL.

\$13.00
Delivered

42 in. Long
24 in. Deep
38 in. High

Roll Curtain
To Paper
Cabinet



No. 5 DEARBORN JUNIOR CABINET

DO YOU KNOW? DEARBORN CABINETS?

Will save your stenographer's time, improve quality of work and save YOU money. Made of Select Oak, golden finish.

Guaranteed the most complete Typewriter Cabinets ever sold anywhere near the price. Shipped on approval, to any point east of Rocky Mountains, freight prepaid. Return at our expense if not satisfied. What more can we offer.

Remember you take no risk. Could we make such an offer if there was any doubt of goods proving satisfactory?

Write today for new Catalog of Office and Typewriter Desks sent free on request.

DEARBORN DESK CO.

Alexander A. Samuel, General Manager.

512 Fisher Building, CHICAGO, U. S. A.

\$6.50 Delivered

Typewriter base
26 in. High

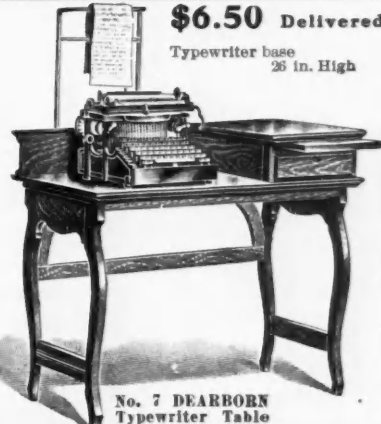

No. 7 DEARBORN
Typewriter Table



Important to Contractors and Builders

We want agents in all parts of the country to send us lists of all new or remodeled buildings in their towns, or of any one needing new fixtures. For all information, if we get the job, we will pay a good commission. If you will send us the names we will do the rest, and you get a commission on all goods shipped to your town as long as you send us reports. We manufacture a full line of Bank, Store and Office Fixtures. We draw plans, make sketches, and submit prices, free of charge. Our factory is equipped with the latest machinery, and our goods are all up-to-date. Write us for information.

Bloomington Store Fixture Company

BLOOMINGTON,

::

::

ILLINOIS

FOOT, HAND AND POWER
WOOD-WORKING MACHINERY
 For Carpenters, Builders, Cabinet-Makers, and
 Other Wood-Workers
BUILT FOR HARD WORK, ACCURATE WORK AND LONG SERVICE



"Victor" Scroll Saw. "Diamond" Mortiser.



"Rox" Moulder.

ONE MAN with one of these machines will do the work of four to six men using hand tools; will do it easier, will do it better.



No. 8 "Union" Power Saw.



"Union" Combination Self-Feed Rip and Cross-Cut Saw.

WE GUARANTEE each machine to be thoroughly practical and accurate. Machines sent on trial, and if not found entirely satisfactory, may be returned at our expense.



No. 6 "Union" Combination Saw. (96)

Enterprising mechanics are quick to see the superior merits of our machines. It will pay you to investigate these advantages.

SEND FOR CATALOG "A"

The Seneca Falls Manufacturing Co.
 218 Water Street, Seneca Falls, N. Y., U. S. A.

MARSTON'S

Patent
 Hand and Foot
 and
 Steam Power

**WOOD
 WORKING
 MACHINERY**

20-inch Hand and Foot Power Band Saw.

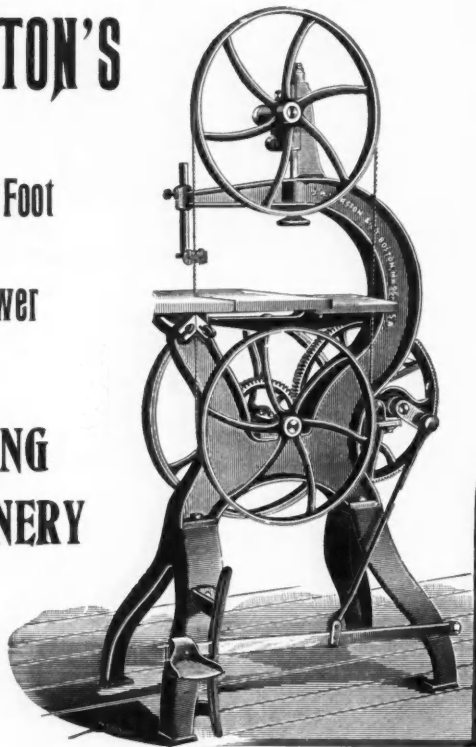

J. M. MARSTON & CO.

227 Ruggles St., Boston, Mass., U. S. A.

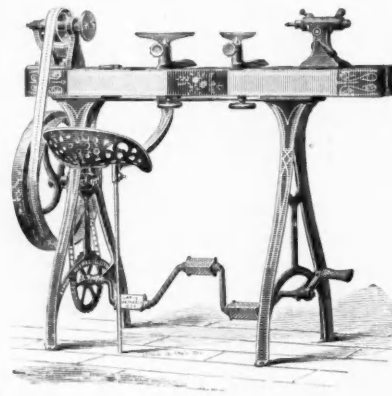

COMPLETE OUTFIT

Hand and Foot-Power
MACHINERY

Our **No. 3 Wood Turning Lathe** can be speeded from 1,000 to 2,000 revolutions a minute with perfect ease. Stopped or reversed at will of operator.

Write for particulars

W. F. & Jno. Barnes Co. 74 RUBY ST.,
 Rockford, Ill.

Crescent Jointers Always Give Satisfaction

You may be in a hurry for a job and crowd a **CRESCENT JOINTER** to the limit of capacity, and get just as good work as though you had not crowded the machine at all.

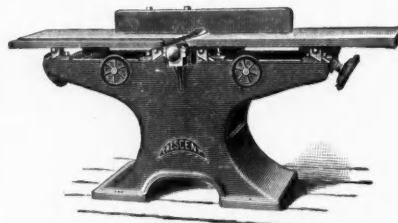

Every fellow fortunate enough to own a **CRESCENT JOINTER** is so perfectly satisfied that when any of his friends want a jointer he tells them on the spot to order a **CRESCENT**.

You will do the same when you get one.

Catalog describing our elegant line of **BAND SAWS, SAW TABLES and JOINTERS** mailed on request.

SEND FOR IT NOW

THE CRESCENT MACHINE CO.

224 Main Street, - - - LEETONIA, OHIO

The New Universal Square

Made in Three Sizes

No. 1—6-in. - \$0.65 | No. 2—10-in. - \$1.00 | No. 3—13-in. - \$1.50

Always Ready—Nothing to be Adjusted

Made completely of best steel and of light weight. **Coppered**, then oxidized or nicked as desired. **Can't rust.** Guaranteed absolutely true.

For sale by all first-class tool dealers. Write for descriptive circular.

The Duby and Shinn Manufacturing Co.

Incorporated.

NELSON BUILDING
19 Park Place :: 16 Murray Street
NEW YORK

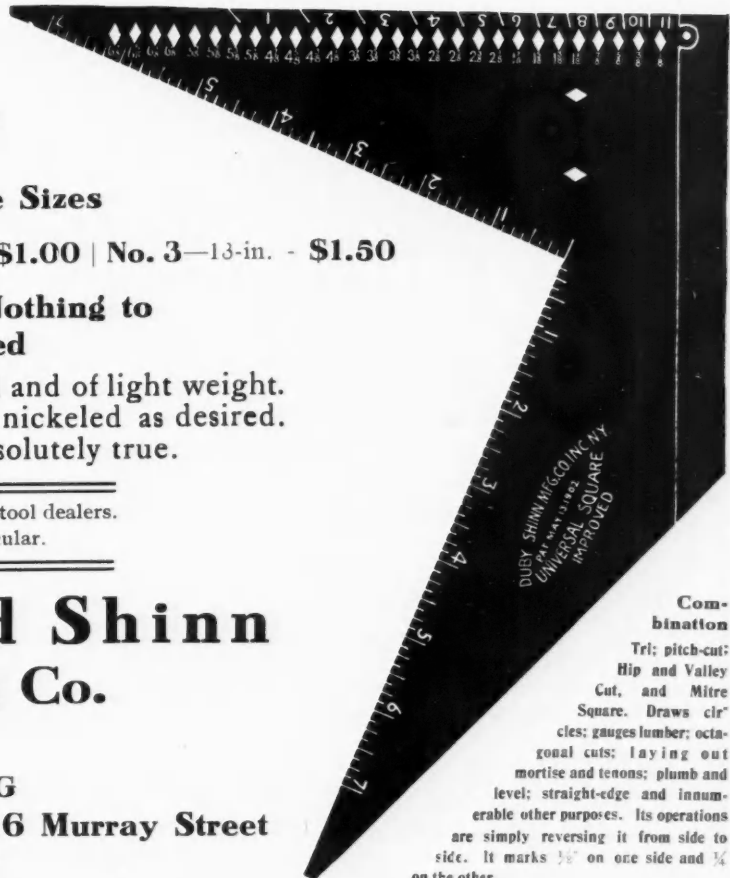

Combination
Tri; pitch-cut; Hip and Valley Cut, and Mitre Square. Draws circles; gauges lumber; octagonal cuts; laying out mortise and tenons; plumb and level; straight-edge and innumerable other purposes. Its operations are simply reversing it from side to side. It marks $\frac{1}{2}$ " on one side and $\frac{1}{4}$ " on the other.



The Gold Medal, at World's Fair, St. Louis

For Superiority of
Wood Working Machinery

Send for
600 page catalog of
150 Machines for
WORKING WOOD

H. B. Smith Machine Co.
SMITHVILLE, N. J., U. S. A.

Branches:
New York Boston Chicago



Cut of No. 195-A, Panel Raiser.

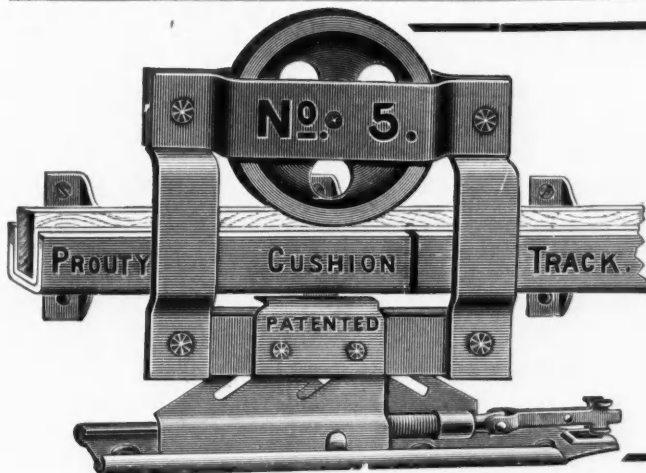

Desirable Points in a Parlor Door Hanger

Noiselessness, Strength and Easy Running

These qualities are all embodied in the

Prouty No. 5 Cushion Track Hangers.

Felt compression washers on shaft each side of wheel and the felt lining in rail absorb all sound vibrations. Our adjustment is positive, as it locks after door is in place and door plate is removable without disturbing the adjustment.

Be sure that you get the **Prouty No. 5 Cushion Track Hanger**, as there are numerous substitutions on the market.

T. C. PROUTY CO., Ltd.
P. O. Box 237. ALBION, MICHIGAN

WIVANCO TOOL CABINETS

Cabinet No. 15

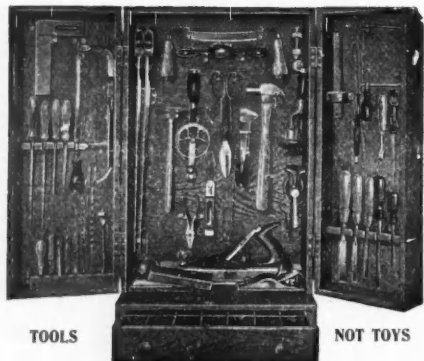

Our Tool Cabinets

are equipped with all the tools needed about the house, shop, or farm, and the use of such an outfit will result in a substantial saving as well as the great convenience of having the little repair jobs done without hiring a carpenter. These cabinets are substantially made of handsome polished quartered oak with brass trimmings, and have two-keyed cylinder locks. The drawer contains a full assortment of screws, screw eyes, tacks, and nails for any kind of work. Prices according to assortment of tools, from \$10 up. Catalogue of cabinets, work benches, and lists of tools sent anywhere without charge upon request.

600 PAGE CATALOGUE FREE TO AMERICAN CARPENTER AND BUILDER READERS

We have just issued a Big Catalogue of over 600 pages illustrating and describing 20,000 articles for house, shop, and farm. The prices quoted are as low as our 90 years in this business make possible—and no house anywhere can beat them. Our location in New York makes shipping by express, freight, or mail easier, quicker, and cheaper than anywhere else. Although our book costs us 75c. we send it to you free if you live anywhere except Chicago or New York City; but we send our tool cabinet catalogue to anyone anywhere. **Oldest Mail Order House in America. Established 1816.**

WHITE, VAN GLAHN & CO.

No. 28 CHATHAM SQUARE :: :: NEW YORK CITY

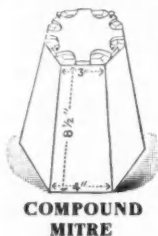

**SAW COMPOUND AS
WELL AS PLAIN MITRES
ANY WIDTH WITH A
BACK SAW 4 INCHES
WIDE ON**

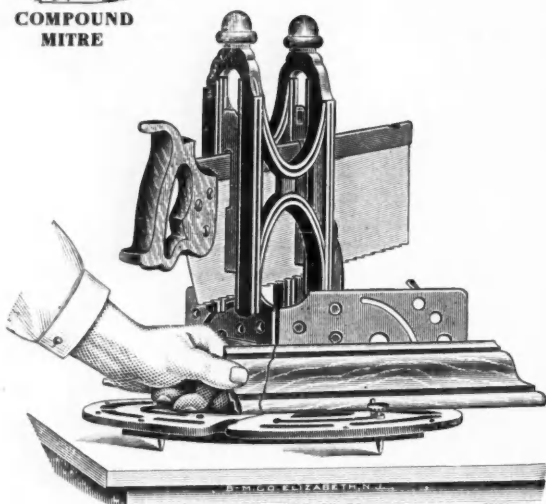

DORN'S REVOLVING MITRE BOX

SEND FOR BOOKLET

Manufactured By **Braunsdorf - Mueller Co.**
1091 E. Grand Street Elizabeth, N. J.

When
You Build

Beautify
Your Home

By Using

Polygon Pipe
It Excels

all conductors in

Beauty, Strength and
Durability.

Address Dept. C.

THE AMERICAN ROLLING MILL CO.
MIDDLETOWN, OHIO.

"Yankee Tools"

The newest, cleverest and most satisfactory in use, and the first to be offered at so reasonable a price that every up-to-date mechanic could buy tools of their quality and character. Other tools are very good tools, but "Yankee" tools are better. "Yankee" tools are sold by all leading dealers in tools and hardware everywhere. Ask your dealer to see them.

Our "Yankee" Tool Book tells all about these and some others, and is mailed free on application to—



No. 15. "Yankee" Ratchet Screw Driver, with Finger Turn on Blade.



No. 30. "Yankee" Spiral-Ratchet Screw Driver, Right and Left Hand.



No. 44. "Yankee" Automatic Drill, Eight Drill Points in Handle, and Adjustable Tension to Spring.

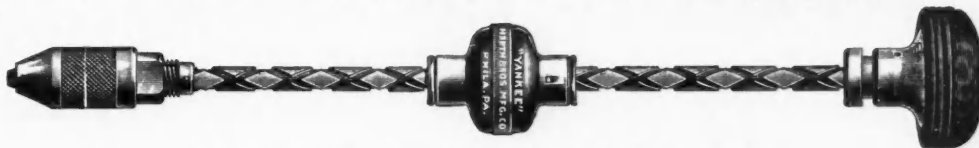

No. 50. "Yankee" Reciprocating Drill for Iron, Steel, Brass, Wood, etc.

North Bros. Mfg. Co.
PHILADELPHIA, PA.

"FORSTNER" BRACE AND MACHINE BITS FOR FINE CARPENTER, CABINET AND PATTERN WORK



giving a true polished surface. It is preferable and more expeditious than chisel, gouge, scroll-saw, or lathe tool combined, for core-boxes, fine and delicate patterns, veneers, screen work, scalloping, fancy scroll twist columns, newels, ribbon moulding and mortising, etc.

Specially Adapted for Hardwood Working.

The Forstner Labor-Saving Auger Bit, unlike other bits, is guided by its *Circular Rim* instead of its centre; consequently it will bore any arc of a circle and can be guided in any direction regardless of grain or knots, leaving a true polished surface.

Manufactured by

THE PROGRESSIVE MFG. CO., Torrington, Conn.

Enquire of your Hardware Dealers or write us direct.

Supplied in sets.

Write for Catalogue.

To thoroughly introduce this high grade tool among carpenters, pattern makers, and others, we will mail to any reader of THE AMERICAN CARPENTER AND BUILDER upon receipt of 50 cents any bit we make from one quarter inch to one inch in size.

PARKER VISES COLT'S CLAMPS

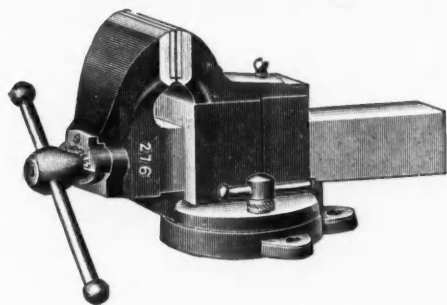

MADE ESPECIALLY FOR WOOD WORKERS.

FOR SALE BY DEALERS.

SEND FOR CATALOG.

CHAS. PARKER CO.
MERIDEN, CONN.

Steel Bars Any Length Desired

Quick Time Acting. Saving

Eccentric and Screw.

Ask for CATALOGUE No. 124.

BATAVIA CLAMP CO.
57 CENTER ST., Batavia, N. Y.

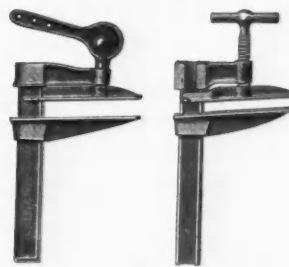

WHEN WRITING ADVERTISERS PLEASE MENTION THE AMERICAN CARPENTER AND BUILDER.

...WITH THIS...

Corner Brace

...YOU CAN...

Bore a Hole Anywhere

By simply adjusting the supporting handle to one of its eight positions and turning the sweep.

ASK YOUR DEALER ABOUT

Our Catalogue May Be Had for the Asking

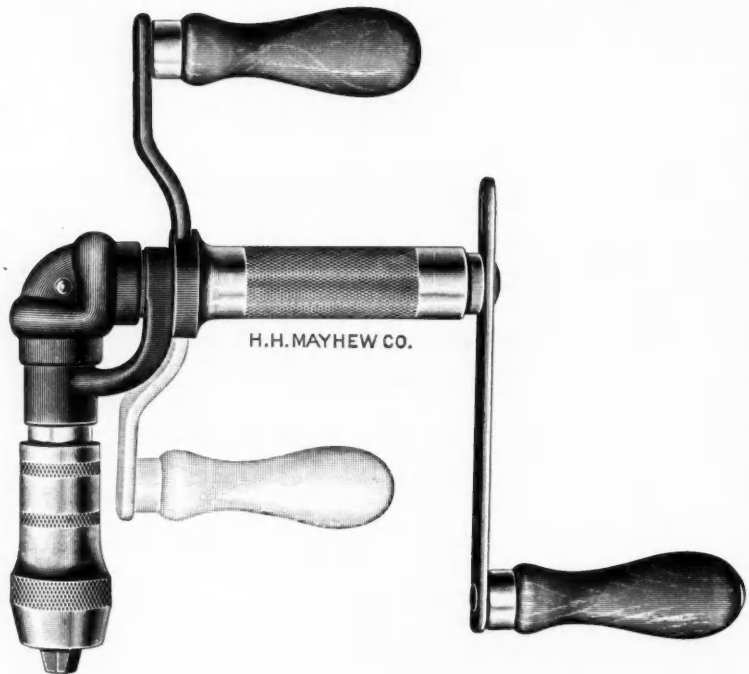

H. H. MAYHEW COMPANY
SHELBURNE FALLS, MASSACHUSETTS

FAR AHEAD for smooth, easy work and holding edge will be YOUR VERDICT ON TRYING

CHAPLIN'S IMPROVED PLANES

Patented Feb. 14, 1899; Oct. 30, 1900; Dec. 24, 1902.

We invite the Severest Comparative Tests

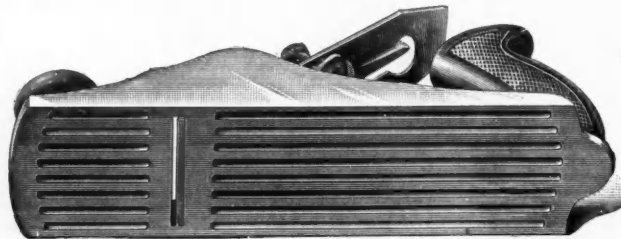

We want you to have a copy of our booklet

"A 'Plane' Talk About a Good Plane!"

We want you to have a copy, for it is a booklet you really need in your business. We'll gladly send you this booklet with our compliments, promptly upon receipt of your request.

Tower & Lyon Company, 95 Chambers Street, New York

30 DAYS' TRIAL MONEY REFUNDED

BEST PLANE IN THE WORLD.

ONLY SELF-SETTING PLANE MADE.

HAS AN ADJUSTABLE IRON THROAT

Sets Instantly with Minute Accuracy.

Every bit warranted to stand hemlock knot to user's satisfaction. Works easy.



If plane is returned at

Our Expense

To introduce our planes where not sold, we will for 2 months sell them to CARPENTERS at DEALERS' PRICE.

Write for particulars.

GAGE TOOL CO.
Vineland, N. J.

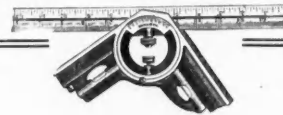

New Starrett Protractor

One of the most useful tools a carpenter ever had. See full description in free Catalogue No. 176. With this tool in your chest you can give away half a dozen or more which it will render back numbers

The L. S. Starrett Co., Athol, Mass., U.S.A.

Books for Carpenters and Builders

THE BOOKS MENTIONED BELOW ARE PRACTICAL, RELIABLE, AND DESCRIBE UP-TO-DATE METHODS. ANY BOOK SENT POST-PAID ON RECEIPT OF PRICE. YOUR MONEY BACK IF YOU ARE NOT PLEASED.

The Steel Square Pocket Book. A practical and handy treatise, giving the best and simplest methods of using the carpenter's steel square. By D. L. Stoddard, 109 pages, 112 illustrations, pocket size, neatly bound in cloth. . . . **50c**

The size of this book enables it to be carried in the pocket, hence the carpenter can always refer to it for the method of finding the different cuts used in carpentry.

This book is thoroughly original, every cut is new and specially made for it.

Concrete By Frank Jay. 94 pages, illustrated by 38 engravings. . . . **25c**

The extensive use of concrete at the present time makes this little manual "fill a long felt want." It is written by an expert of many years' experience in concrete work.

How to Frame a House. A practical treatise on the latest and best methods of laying out, framing and raising timbers for houses, making a handy and easily applied book for carpenters, builders, foremen and journeymen. By Owen B. Maginnis. 96 pages, large 8vo. Cloth. . . . **\$1.00**

Roof Framing Made Easy. A practical and easily comprehended system of laying out and framing roofs adapted to modern building construction. By Owen B. Maginnis. 164 pages, 8vo., 98 illustrations, cloth. . . . **\$1.00**

This book gives simple, practical methods for laying out and framing roofs of various forms. Simple and practical.

How to Measure up Woodwork for Buildings. By Owen B. Maginnis, 79 pages 161 illustrations, 12mo., cloth **50c**

This book was written so as to place in handy and concise form reliable directions to enable builders and mechanics to measure up the quantities of woodwork for brick and frame houses accurately and without hesitation, figuring either from plans or on the work. Its use saves blunders.

Handy Lumber Tables. Containing board measure, plank measure, scantlings reduced to board measure with other useful data and memoranda, 24 pages, 12mo., paper. . . . **10c**

The American Homes. Contains designs of 100 low and medium-priced houses, 8vo., over 200 pages, cloth, ornamented. . . . **\$1.00**

The Ideal Homes. Contains 100 designs of houses entirely different from those illustrated in the American Homes, 110 large 8x11 inch pages, ornamented cloth. . . . **\$1.00**

The plans of the houses illustrated in these books have been drawn by licensed architects.

Great care has been taken to have these plans practical as well as artistic. Every available foot of space is used to the best advantage.

The cost of the houses illustrated varies from \$300 to \$4,000; from a two-room house up to ten rooms.

Considering the number of plans given, these are the cheapest books of designs ever got out.

We can also furnish the complete plans (blue prints) and specifications of any design illustrated in these books at an average price of only \$5.00 per set. These plans and specifications will save builders the time and labor of drawing plans or employing an architect to do so.

Send for our CATALOG OF BOOKS RELATING TO THE BUILDING TRADES, which describes over 300 books for Architects, Draftsmen, Contractors, Masons, Carpenters, Stairbuilders, Plumbers, Steam Fitters, Tin Smiths, Painters, etc.

Industrial Publication Co., 14 Thomas St., New York



HENRY SANDERS CO., 70-80 Weed St., CHICAGO, ILL.

Western Manufacturers of

Koll's Patent Lock Joint Columns

We make Columns and Pilasters of all sizes and woods for exterior and interior use, and general line of porch work.



PACIFIC COAST:
AUG. J. KOLL, Los Angeles, Cal.

EASTERN FACTORY:
HARTMAN BROS. MFG. CO.
Mt. Vernon, N. Y.

Send for Catalogue

LUFKIN STEEL TAPES and RULES

ARE INDISPENSABLE FOR ACCURATE WORK

MADE BY THE LUFKIN RULE CO. SAGINAW, MICH., U. S. A. NEW YORK LONDON

For Sale Every where. Send for Catalogue.

JOIST HANGERS

For Concrete Blocks, Wood or Iron Beams.

Many Sizes in Stock.

Special Shapes to Order.

STEEL POST CAPS, WIRE FLOOR CLIPS, STRAPS, BOLTS, PIN ANCHORS.

CHAS. MULVEY MFG. CO. CHICAGO.
15 So. Jefferson Street.

TAYLOR CLAMPS

They Last a Lifetime

The grip is positive and instantaneous. No other clamp is half so quick, or so strong.

This One Takes 10,000 lbs. Clamping Strain

No. 25 THE TAYLOR

We make other styles. Get our catalogue

JAMES L. TAYLOR MFG. CO. : Bloomfield, N. J.

STANLEY MITRE BOX

On the edge of the Solid Metal Base, (where they will always remain correct) degrees are accurately graduated.

As the Swivel will automatically lock at any point, the operator can quickly set the Saw to cut the angle needed.

For duplicating work, a stock guide can be screwed in a threaded Plate, inserted in base board, making a perfect length gauge.

With these new features, the Stanley Mitre Box is more than ever a necessity to all wood-workers.

For full description, sizes, and prices, write for Catalogue No. 34.

Sold by all Hardware Dealers.

Stanley Rule & Level Co.
New Britain, Conn., U. S. A.

AT RIGHT PRICES BUILDERS' HARDWARE AND TOOLS.....

REHM HARDWARE COMPANY
352 BLUE ISLAND AVE., CHICAGO, ILL.

Illustrated Builders' Hardware catalog and net prices mailed only to contractors and builders on request.

Tracings received by express in morning
shipped same day with prints.

Electric Light Prints



SAVE INKING YOUR TRACINGS

Draw your carpenters' and masons' details, plans, elevations, etc., on "Monarch" Tracing Paper, with No. 2 "Ortole" Pencils and we will make Black or Blue Prints from these **PENCIL TRACINGS** that will answer all requirements.

SOLE LICENSEE FOR PUBLICATIONS OF A. I. A.
UNIFORM CONTRACTS

When in need of

DRAWING MATERIALS

send to Headquarters at

SOLTMANN'S

125 E. 42nd St. New York, N. Y.
Next to the Grand Central Station

Write for Price Lists and Samples of Papers

REAL SLATE BLACKBOARD

NEVER NEED REPAIRING
NEVER WEAR OUT

IT PAYS TO GET
THE BEST GRADE

PRICES LOWER THAN EVER

ALSO UNFADING BLACK
ROOFING SLATE

M. H. E. BECKLEY, 260 Wabash Ave., Chicago

DISTRIBUTOR

DRAWING MATERIALS SURVEYING INSTRUMENTS

Drawing and Blue Print Papers, Architects' and Builders' Level, Drawing Instruments, T Squares, Triangles, Scales, Inks, etc. Steel and Metallic Tapes. Builders' Levels. Repairing promptly executed. :: :: :: :: :: :: :: :: ::

BLUE PRINTS, BLACK PRINTS OUR SPECIALTY
and BLUE ON WHITE PRINTS

KEYSTONE BLUE PAPER COMPANY

910-912 FILBERT STREET
PHILADELPHIA, PA.

Awarded Gold Medal, World's Fair, St. Louis

Highest Award World's Columbian Exposition

Ask for
Millers Falls Co.'s Bit Braces

Series Nos.	30	31	32	33
	14	12	10	8 inch sweep



There are no other braces made which match them in merit and beauty of finish. Our name appears on all genuine goods. Look for it before you buy. If your dealer does not keep Millers Falls Braces then write to us.

Millers Falls Company
28 Warren Street New York, N. Y.

BEST MADE

GENUINE MARSHALSTOWN
TROWEL.

Plasterer's Mitering Trowels, Aluminum Hawks and Darbies, Hand-Forged Brick Hammers and Brick Layer's Scutch. Beading Tools for Stone Range and Cement Block Work.



Catalogue on Plasterer's Tools.

Marshalltown Trowel Works

801 East Church St., Marshalltown, Iowa.

GRILLES

Beautiful
Designs

Moderate
Prices

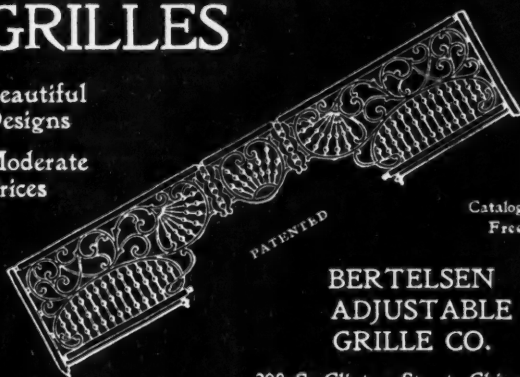

Catalogue
Free

**BERTELSEN
ADJUSTABLE
GRILLE CO.**

308 S. Clinton Street, Chicago

NORTHWESTERN GRILLE WORKS



Send for our catalogue, which contains a large number of attractive and modern designs of Grilles.

OFFICE AND FACTORY
1452 Milwaukee Ave., CHICAGO.
CHRISTENSON BROS., Props.

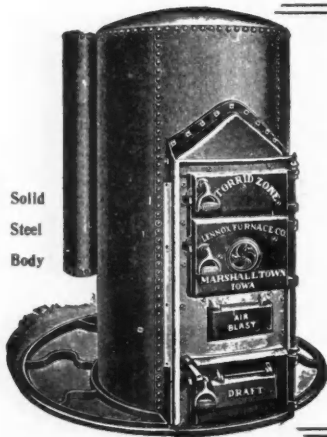

Solid Steel Body

The Furnace for the Builder

Because of its simplicity, its scientific heating principles and its success. Because it is as easy to set as a stove. The pioneer of all steel furnaces—riveted like a boiler, dust tight and gas proof. No packed joints or cracked fire pots to leak gas into the air chamber. Being of steel it radiates heat quickly and the indirect radiator doubles its radiating capacity. Investigate the

LENNOX TORRID ZONE FURNACES

and send for a 40 page illustrated catalog and submit pencil sketch of plans for an estimate from our heating engineer. TORRID ZONE hot air furnaces are now sold from Pittsburg to Denver and from Canada to Texas. We sell direct to the contractor or consumer where we do not have agencies established

THE LENNOX FURNACE COMPANY, Marshalltown, Iowa

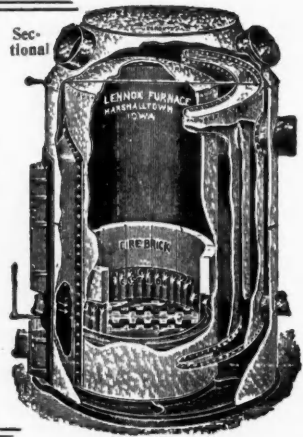

Sectional

\$49
LEADER
Steel Furnace



THIS No. 45 Leader Steel Furnace will heat uniformly a 7 or 8 room house, a good sized store, a school, or small church. It is durable, strong, compact. Has steel body with galvanized iron casing. Works easily with coke, hard or soft coal or wood. Has brick fire box. It costs \$49, freight paid east of Omaha. We furnish also plans of your house so you yourself can set up the furnace with its pipes, registers, smoke pipe, etc. Hundreds of people have done it—you can. Write for our new illustrated instruction book on furnaces, "Modern Furnace Heating." It's free. It's valuable. Do it now.



HESS WARMING & VENTILATING CO.

720 Tacoma Building, CHICAGO, ILLINOIS.

CUSTOM MADE FLY SCREENS

Our work is far superior to the usual output of local mills and has a style and finish not obtainable from those who do not make a specialty of screens.

For outside screens we use the identical finish of the outside of Pullman cars.

The best grades of Wire Cloth, enameled, galvanized, genuine bronze, etc. Fastened by tacks or by the "lock-strip" process.

Intending purchasers may have free by mail samples of woods, finishes and wire cloth and copy of catalog and price list. Agencies in many cities. Special terms to contractors and builders.

THE A. J. PHILLIPS CO. Fenton, Mich.
23 Years Experience. 3 1-2 Acres of Floors.

PLUMBERS' SUPPLIES AT WHOLESALE



If you need anything in my line, and wish to

SAVE

20 to 40 Per Cent

on every article, write for my free illustrated Catalog. Shipments promptly made from a very complete stock of guaranteed goods.

Small orders are as carefully handled as large ones.

B. B. KAROL, 233 W. Harrison St., Chicago, Ill.



PAT. MAY 22, 1894.

GENERAL OFFICE

A FIRE RESISTANT

SUPERIOR TO WOOD OR METAL LATH IN THE CONSTRUCTION OF PLASTERED

WALLS AND CEILINGS

NAILED DIRECTLY TO STUDDING AND FINISHED WITH PLASTER

Walls and Ceilings constructed with this Plaster Board are economical, light, durable and will not fall. Its use saves weeks of time in construction, as the light finishing required dries quickly. Warmer than lath and cleaner in application. Send for booklet and sample.

Sackett Wall Board Company, 17 Battery Place, New York
Grand Rapids Plaster Co., Grand Rapids, Mich.

FOR 36 YEARS OUR CONSTANT EFFORT HAS BEEN TO MAKE THE

Best Spirit Levels on the Market

Our Goods Talk For Us



SOLD BY DEALERS

Catalogue for Asking
Stratton Bros.

R. O. STETSON, Prop.,
Greenfield, Mass.

THERE IS NO SUBSTITUTE FOR A LEVEL
NEITHER IS THERE A SUBSTITUTE FOR

Cannot be thrown
out of
ADJUSTMENT
by a FALL or JAR.
HAVE THE
BEST



WOOD
IRON
ALUMINUM

COOK'S PATENT LEVEL

FOR CARPENTERS, MACHINISTS, MASONS EVERY LEVEL WARRANTED

OF ALL DEALERS, OR
CATALOGUE ON REQUEST

DAVIS & COOK

13 HIGH STREET
WATERTOWN, N. Y.

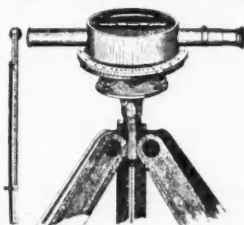

THIS LEVEL, INCLUDING
LEVEL ROD

\$22.50

WEBER'S "ECONOMIC" ARCHITECT'S AND BUILDER'S LEVEL

FOR LEVELING FOUNDATIONS, SETTING MACHINERY, FLOOR TIMBERS, Etc.
FOR ASCERTAINING THE HEIGHT OF SPRINGS, WATER-FALLS, Etc.

Manufacturers and
Importers of **DRAFTING SUPPLIES**

Sole Agents for Riefler's Round System Drawing Instruments, Ott's Planimeters and Pantographs.

Drawing Tables, T Squares, Triangles, Drawing and Tracing Papers, Tracing Cloth, Blue Print, and Blue Line and Black Print Papers. Large assortment of School Supplies.

Manufacturers of Drawing Instruments
of Every Description

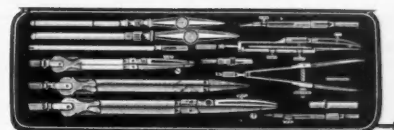

SEND FOR CATALOG 263

Mention Amer. Carpenter & Builder.

BRANCHES { BALTIMORE
ST. LOUIS

F. WEBER & CO. Philadelphia, Pa.

THE UP-TO-DATE STAR EXPANSION BOLT



With the STAR you can fasten things to brick and stone about as easily as to wood and much more firmly.



Write to us for samples and information.

STAR EXPANSION BOLT COMPANY
Cor. Cedar and Washington Sts., New York City.

Farrington Expansion-Bolt



A New Device of Unlimited Utility.

Is the simplest, most effective and least expensive of all anchor or expansion bolts in common use. It depends for its expansive qualities upon the flexibility of a coil of wire, engaging the thread of a common wood screw.

Write for Circular and Sample

Inventor and Manufacturer
HARVEY FARRINGTON
45 Broadway, N. Y. City

General Sales Agents
LOCKE & SMITH CO.
103 & 105 W. 37th St., N. Y. City



VICTORIA SHINGLE

CORTRIGHT



METAL SLATE

Carpenters:—Do you know the only difference to you in laying Cortright Shingles and wood shingles is that you make more money on the former? Let us explain.

CORTRIGHT METAL ROOFING CO., Philadelphia and Chicago

The "WEATHERPROOF" Shingle Nails. Made from GENUINE SWEDES CHARCOAL IRON. The kind GRANDFATHER used.

WHY DO YOU shingle your house **five** times while **Grandfather** shingled the old homestead **once**?

BECAUSE you use a cheap steel or common iron nail, the life of which is short owing to the combined action of acids and the elements.

GRANDFATHER used a nail made from genuine **SWEDES CHARCOAL IRON**, which we are reproducing. Some of these nails were recently taken from the Old South Church in Boston when reshingling and were in good condition, although driven before most of us were born.

WHEN shingling your roof insist on having "**WEATHER-PROOF**" nails because you get the genuine **SWEDES IRON** in every nail.

MADE ONLY BY

Henry J. Miller's Sons & Co.

BRIDGEWATER, MASS.

We have NOW READY our NEW ILLUSTRATED CATALOGUE devoted exclusively to

WOODWORKERS' TOOLS

CONTAINING 250 PAGES
1,100 ILLUSTRATIONS

Handsomely printed on heavy paper, it makes a convenient and useful book for ALL WOODWORKING MECHANICS.

Sent to any address on receipt of Ten Cents Postage, if you mention American Carpenter and Builder.

WM. P. WALTER'S SONS
1233 Market St., Philadelphia

SHELF SUPPORTED ON PINS.

JOHNSTON'S

PATENT

SHELF PIN.

1 DOZ 15¢ 1 GROSS 25¢

THESE PINS ARE USED FOR SUPPORTING MOVEABLE SHELVES IN BOOK CASES.

CANNOT FALL OUT OR SAG DOWN. THE BEST SHELF PIN MADE. EASILY PUT IN PLACE BY ANY ONE.

SEND FOR FREE SAMPLE TO J.D. Johnston NEWPORT, R.I.



FRONT FULL SIZE

FULL SIZE PIN SIDE VIEW.

This Shelf Pin is neat in appearance, strong, easily put in place, easily removed, without the use of any tool, not liable to sag down or drop out of place. I have a neat model which I will send to Architects.

It will support all kinds of movable shelves in all kinds of cases, or cupboards, or cabinets.



Monroe's Horizontal Wood Rolling Partitions

Successfully close and clear any sized opening.

Dividing Class Rooms and Sunday School Rooms in such a manner that they can all be thrown together when occasion requires.

Also used in Schools, Libraries and Public Buildings, where it may be desirable at times to shut off part of the room.

Your correspondence and investigation solicited.

Monroe Screen, Blind and Partition Co.

Lock Box 8
LIMA, OHIO

Rain proof Durable

Shingles that last Rust proof Ornamental

The National Sheet Metal Roofing Co.

WALTERS' SHINGLES — Jersey City N. J. — WALTERS' TILES

Write for Catalogue, Samples and Prices

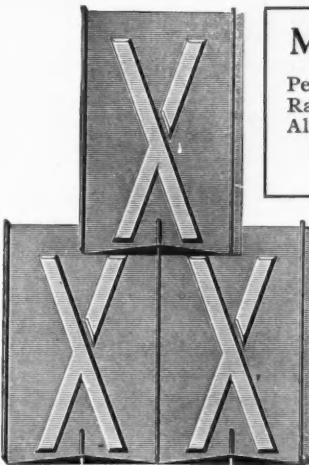

Metal Shingles
 Perfect Side Lock.
 Rain and Snow Proof.
 Always Give Satisfaction.
 Write for Prices and Catalog "S."

For—
 Architectural Sheet Metal Work,
 Galvanized and Copper Cornice,
 Roof Gutters,
 Curved Mouldings, Skylights, Finials,
 Ventilators, all styles Roofing and Siding,
 Conductor Pipe, Eave Trough, Etc.

Write for prices and Catalog "G G".

Art Metal Ceilings and Sidewall.
 Exclusive and Artistic Designs. Perfect Fitting Plates.
 Write for Prices and Catalog "D-D".

KANNEBERG ROOFING AND CEILING CO.
 CANTON, OHIO. MANUFACTURERS.

If you could visit the mill where



PITTSBURGH

"APOLLO BEST BLOOM"

Galvanized Sheets

are made, and watch our expert sorters examine every sheet for flaws; weigh it for gauge; bend it to prove its softness; and test it to see that it does not scale, there'd be no question in your mind as to what is the best brand.

A flaw as large as a pin-head on the black sheet, or in the coating, condemns the whole to the scrapheap—We'd rather lose in manufacture than lose the name which "Apollo" Sheets have held so long.

For your own sake, specify "Apollo" whenever you need galvanized sheets, and write us for a weight card if you desire information regarding gauges and weights.

AMERICAN SHEET & TIN PLATE COMPANY.

FRICK BUILDING PITTSBURGH, PA.

ARTISTIC ROOFING

Endorsed by leading architects.
Storm and Fire Proof.
 Can be put on by Carpenters.
 Especially adapted for
 Residences, Churches, Schools,
 And all Buildings with Pitched Roofs.



Our Galvanized Shingles do not require painting or after care.

Testimonials, Prices and Catalogue showing seven different designs, free.

Durable, Medium Weight.

Moderate in Price.

MONTROSS METAL CO., 19 Erie Avenue, CAMDEN, N. J.

SLATE SLATE
 GENUINE BANGOR



Roofing
 Blackboards
 Structural

Write us before ordering elsewhere.

The Bangor Slate Co.
 Miners and Mfgs. BANGOR, PA.

The CHAMPION Lock Joint METAL SHINGLE
 for ROOFS, GABLES and DORMERS



Made only by
J. H. ELLER & CO.
 1160 East Fifth Street
 CANTON, OHIO

Also Makers of
 Metal Ceilings, Cornice, Skylights, Tin Plate, Eaves Trough, Roofing, Etc.



DIXON'S FRAMERS, 558

DIXON'S CARPENTERS PENCILS

**LAST THE LONGEST
 BREAK THE LEAST
 MARK THE CLEARST**

Send 16 cents for samples and our special circular 182 J.

JOSEPH DIXON CRUCIBLE CO.,
 JERSEY CITY, N. J.

**YOU NEED
OUR
CATALOG
OF
TOOLS**



This Butt Chisel, leather tipped, costs you (delivered at our expense):

1 1/4 inch - 60c 1 1/2 inch - 65c
1 3/4 " - 70c 2 " - 75c

OUR NEW TOOL CATALOG

Contains 425 pages, showing nothing but Tools, and is the most complete catalog of Tools ever issued. We make a specialty of the unusual tools—the ones you have some trouble to find.

Send 25 cents to help pay expressage and get a copy of Tool Catalog No. 370.

We sell more **Builders Hardware** of quality than any other concern in the country. If quick shipments, good treatment and low prices are worth anything to you, get our

BUILDERS' HARDWARE CATALOG No. 37

and get acquainted with us.

ORR & LOCKETT HARDWARE CO.

Established 1872.

**71-73 Randolph Street,
CHICAGO**

**BOMMER
SPRING HINGES**

are quality goods,

but cost no more than inferior kinds.

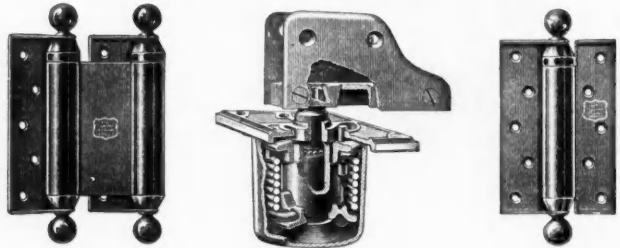

DON'T ERR IN JUDGMENT when buying spring hinges, which of all hardware perform the hardest work. Bommer Spring Hinges never fail to give satisfaction and have withstood the test of time. "PRACTICALLY UNBREAKABLE" says the World's Fair Award, Chicago, 1893.

Gold Medals—St. Louis, 1904—Buffalo, 1901—Paris, 1900

**Your Hardwareman can supply them. Kindly
but firmly refuse all substitutes.**

BOMMER BROTHERS, Mfr's, Brooklyn, N. Y. Est. 1876.

A HOUSE
Lined with
MINERAL WOOL

As shown in these sections, it is warm in Winter, cool in Summer, and is thoroughly deaired. The lining is vermin proof, neither rats, mice nor insects can make their way through or live in it. MINERAL WOOL checks the spread of Fire, and keeps out dampness.

Vertical Section. Cross Section Through Floor.

Samples and Circular Free. Correspondence Solicited.

MINERAL WOOL

FOR HOUSES

SEND FOR
SAMPLE

U. S. MINERAL WOOL CO.

STANHOPE, N. J.

Grandfather's Fire Place

was a great success in furnishing healthful heat and ventilation for his family; and for burning the surplus wood while clearing the farm.

Our Economy Fire-Place Heater

—See sectional cut—will give same ventilation and more heat from one-tenth the amount of fuel. It will burn any kind of fuel and suit any fire-place and mantel. Its cost is saved in fuel during one season's use. Free catalogue "J" in full explanation.

HEITLAND GRATE & MANTEL CO.
Address Dep't "J".
Quincy, Ill.

IF YOU CAN'T BUY THE "SPECIAL" IN YOUR TOWN WE WILL SEND YOU

THE "SPECIAL" SAW SET



MY TRADE MARK ON ALL MY GOODS

ONE UPON RECEIPT OF \$1.00

WRITE IN FOR COPY OF CATALOGUE

**Chas. Morrill, 283 Broadway
NEW YORK**

The NEW MARSH-LANGDON and IMPROVED MITER BOXES

All have Corrugated Metal Bed Plates—same are ground true, and cannot warp and split like thin Wooden Plates. Made in 4 sizes and 40 numbers. Ask your dealer to show you one, and if he does not carry them in stock, ask him to order one for you, for you want the best. Write for circulars and prices.

Manufactured only by
H. C. Marsh
606 Race Street
Rockford, Illinois



Copyright, 1905, by American Carpenter and Builder Company.



AMERICAN CARPENTER and BUILDER

LIBRARY OF CONGRESS
One Copy Received
JAN 5 1905
Copyright Entry
Apr 30 1905
CLASS 4 XXc. No.
93-879

The Largest, Best and Most Practical Trade Journal in the World for the Carpenter and Builder

American Carpenter and Builder

Entered as second-class matter July 1, 1905, at the postoffice at Chicago, Ill. under the Act of Congress of March 3, 1879.

WILLIAM A. RADFORD, EDITOR.
WILLIAM REUTHER, ASSOCIATE EDITOR.

Published monthly by

American Carpenter and Builder Company

196 FIFTH AVENUE, CHICAGO.

O. F. BYXBEE, General Manager.

NEW YORK OFFICE, 253 BROADWAY
EGBERT DAYTON, Manager.

VOL. I. JANUARY, 1906 No. 10

The AMERICAN CARPENTER AND BUILDER is issued promptly on the first of each month. It aims to furnish the latest and the most practical and authoritative information on all matters relating to the carpentry and building trades.

Short practical letters and articles on subjects pertaining to the carpentry and building trades are requested.

SUBSCRIPTION RATES.

One year, \$2.00; six months, \$1.00; payable always in advance. Single copies, 20 cents.

SUBSCRIPTIONS may be sent by check, express or money order, or registered letter. Make all remittances payable to the American Carpenter and Builder Company. Postage stamps are not desirable, but if necessary to remit them, two-cent stamps are preferred.

IMPORTANT TO SUBSCRIBERS—Do not fail to notify us promptly if you wish your magazine forwarded to another address than that originally ordered. We will not guarantee to furnish missing numbers in cases where subscribers have neglected to inform us of their change of residence. We will be pleased to change the address of any subscriber at any time, but have no means of knowing that they have moved unless they notify us of the fact. The postoffice authorities will not forward newspapers or magazines from one address to another unless extra postage is paid by the subscriber. Write us as soon as you move, giving your new address, and we will correct our mailing list and there will be no delay in your getting your magazine.

ADVERTISING RATES.

Furnished on application. The value of the American Carpenter and Builder as an advertising medium is unquestioned. The character of the advertisements now in its columns, and the number of them, tell the whole story. Circulation considered, it is the cheapest trade journal in the United States to advertise in. Advertisements, to insure insertion in the issue of any month, should reach this office not later than the twentieth of the month preceding.

Work for Winter Months

THE question of vital importance to the carpenter and builder every year is what to do during the winter months. Active building is at a standstill in many parts of the country, and it is impossible and not advisable for most carpenters to move to a warmer climate for these few months. It is therefore essential for them to find work in their own localities. This can be done in several ways: one was described in last month's magazine, but was especially for those

who had acquired small machines in their shops and would therefore not apply to the large majority. A good way for those who have only the regular carpenter's outfit is to have small cards printed telling their friends what they are capable of doing. For example, making screens, storm doors, storm sashes and even book cases, putting in glass lights, hardwood floors, re-shingling roofs, making new sinks, repairing furniture and scores of other jobs. If these things are done well and promptly, charging reasonable prices, there is no reason why the carpenter should have one idle moment during the entire winter. The scope of the work is only limited by the ability of the carpenter to handle it. The numberless break-ages which occur in every household will keep them busy until spring comes, when the real harvest of the carpenter begins.



Carpenters as Business Men

WHILE one of the essential factors in a carpenter's work is good workmanship, a fair share of attention should be given to the financial end of his business. This is often sadly neglected by him with a financial loss as a natural result. He receives many calls with reference to his work which should be promptly attended to, as it may lead to new business. This is a very important point, for it is not the work in hand which is worrying the carpenter so much as the getting of new business. Another thing which is overlooked is good advertising, not necessarily a newspaper display, but by letting your friends know what you are doing. If you are putting up a fine residence or school building, tell them about it and invite them over to inspect your work. If you are making the living room in that particular house the largest room in it, tell them about it and why you are doing so. Show them the advantages in the arrangement of the rooms and tell them everything along that line that you know will be of interest to them, and of value to you to have them know. It will not be amiss to go still further and explain all about some things upon which you may realize you are not an authority, for a little "bluff" often helps a great deal. Above all things bear in mind that you must keep your name and occupation before the people all of the time and then if your work is good the business will follow.

Mr. Bugg's Taste in Architecture and His Pocket Book Get Together

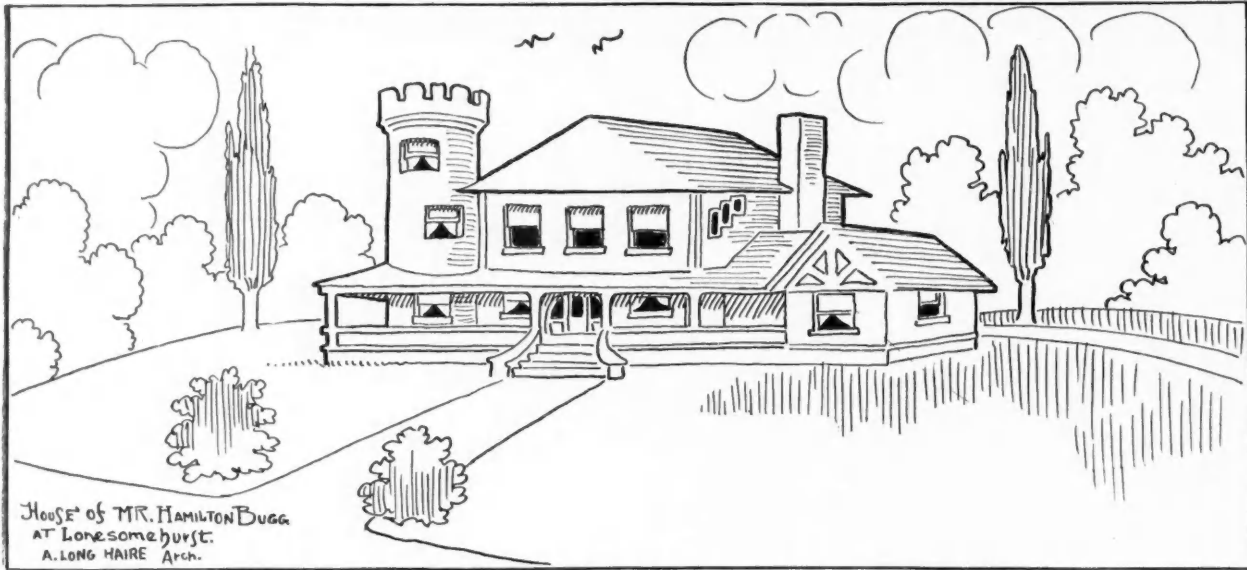

June 1, 1905. Mr. Haire, Archt., Dear Sir:—Drawing received. It is exactly what I want, but the price is a little too much. We could get along without the tower. How would it look then? Yours, Hamilton Bugg.

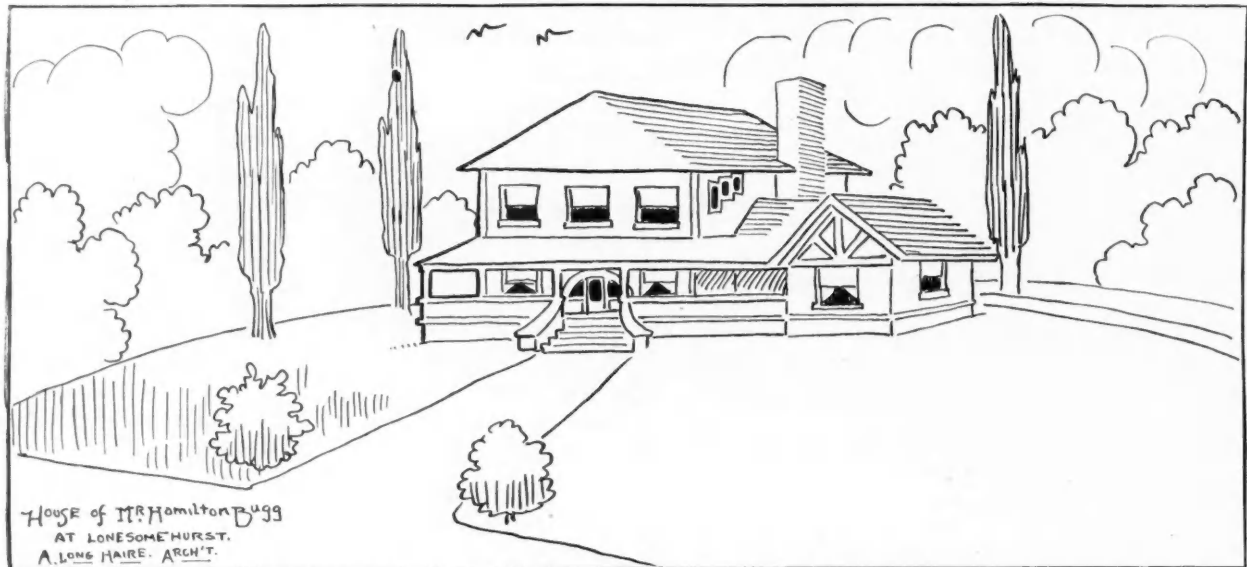

Sept. 10, 1905, Dear Haire:—I note what you say about high prices; but we must have a house. How much would it cost if the left end was left off? Yours, Ham. Bugg.

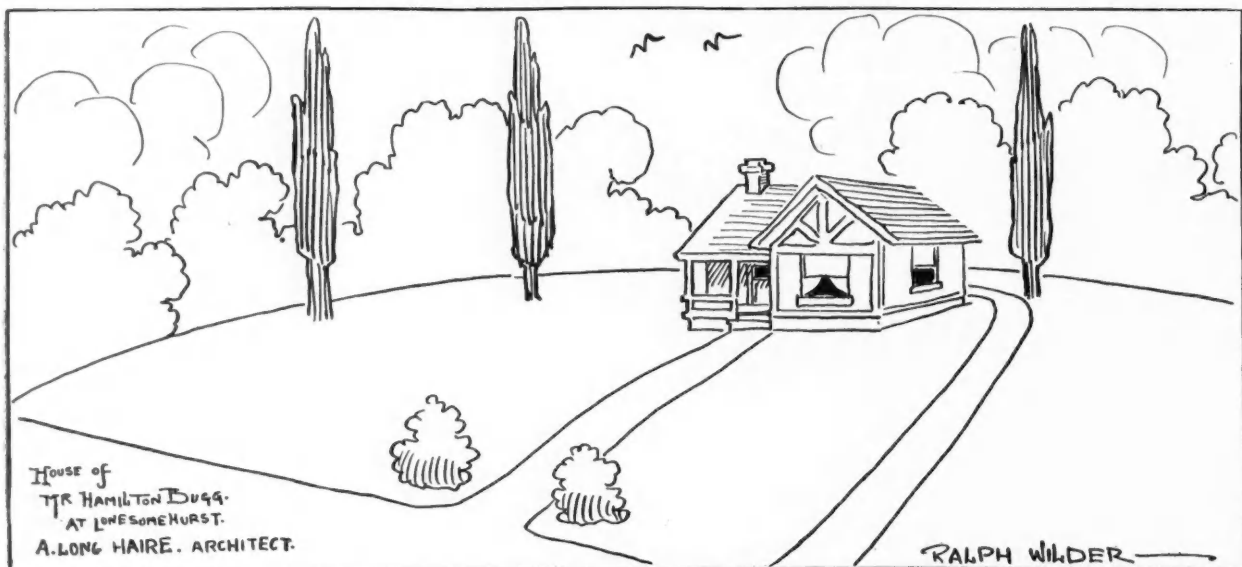

Oct 9, 1905. Dear Haire:—My wife thinks this is "just too cute"! As our lot is only 20 feet wide, perhaps it will be better to have a small house, so let's go ahead. Would it cost much more to have another tree? Yours, Ham.

Uncle Rural on Practical Co-operation

BY J. CROW TAYLOR

THE more he thought about it, the more J. B. felt convinced that the idea of forming some kind of a club or association of carpenters and builders of the community was a good one. He did not stop at thinking for himself on the subject, however, but sought the opinions of others who had had experience in association work of one kind and another, making personal visits in some instances and investigating by correspondence in others, in which he sought not only personal expressions, but also information, together with the rules and regulations governing the workings of various industrial associations, together with an outline of results that had been accomplished in each case. After making a thorough study of the entire subject in this way, and consulting at various times with Uncle Rural

other end, usually presided over by Aunt Cynthia, J. B. had fortified himself with writing material and quite a collection of personal letters on the subject of associations and numerous by-laws, rules, regulations, etc., in pamphlet form, and when we were all seated and made comfortable it was J. B. that set the ball to rolling.

"Gentlemen," he said, "one of the things I have had impressed on my mind ever since I have been big enough to do much thinking for myself is that at the beginning of every new year we should look back over the past year's efforts and garner from it the fruits of knowledge. That is, the lessons that we have learned during the year to guide and assist us on our way in the new year, and then when we turn and start into the new year we should make up our mind



Uncle Rural occupied his regular place at the end of the table

and others of his acquaintance with whom he came in contact from day to day, he finally arranged for an informal meeting of as many of the local carpenters and builders as could be gotten together at Uncle Rural's one evening.

There were about a dozen present, including, of course, Uncle Rural, Mosby and Lefty, who were among the closer acquaintances of J. B., and embracing with the others in attendance probably three-fourths of the representative carpenters and builders of the community; men who made the work of carpentering and building their main vocation in life. Aunt Cynthia had lengthened out the dining-room table, put an empty punch bowl in the center, with a bowl of fruit on one side and a bowl of cracked walnuts on the other, and with this and other preliminary arrangements for comfort of the visitors she had left the room for the evening. Uncle Rural occupied his regular place at the end of the table, while at the

to accomplish more and better things, and to that end should seek to formulate some new idea, some new line of work, or some new thought of some kind to be developed. I don't mean by this that we should stop at one idea, but we should never go into the new year without at least one new thought or idea of progress of some kind and should naturally, in the course of events, follow this up with as many new ones as come to our share. Now, my one new thought, the starting one for this year, is the association idea. Just what we can make out of this idea is an unknown quantity yet, and evidently depends largely on ourselves. I find the association idea prevailing generally in the industrial world and taking various forms. Sometimes it is purely a social club idea, business matters not entering in any way whatever, and the only purpose of the club being to bring together the members of not only one industry in the locality for social evenings now and then, but they

may in this way come to know each other better, and in the end meet in a business way in their every-day life on more friendly and intimate terms. In other words, the good to the business end is brought about indirectly through the development of more intimate acquaintance and personal regard by social meetings. Of the business associations, pure and simple, there are two distinct branches—one is what is termed close and the other open association work. The close association idea is one in which there is involved the getting together of the various members of the trade, specially the competitive members, and entering into secret contracts and agreements of business methods, especially relating to prices. Between the extreme point of this idea and the open association work on the other hand there may be found various combinations in which part of the work might be termed open and part of it close. What is in some respects the broadest association idea of all is that of open association, where there are no secret meetings or agreements, but the meetings are wide open, the deliberations and actions are given general publicity in every detail. This open association idea is gaining ground right along, too, in all industrial lines, and even where there is a desire to reduce competition it is found that the meeting together of the people concerned and talking over in a free and outspoken manner of all the different features of the trade results in competing members who meet there having more consideration for each other, and really getting closer together and working more in harmony than they would if they were tied up in secret contracts and agreements. Now, while I have no special plan to offer for the forming of an association of carpenters and builders, I somehow feel that we ought to try and develop something original and unique, because among all the good points of all the associations there is an undefined something lacking. They all do good, but their results sometimes fall short of what is expected of them, and, in short, they never develop as much good as it looks like they ought to in return for the efforts put forth. What I would like to hear is an expression from every one present, and suggestions as to how it is possible for a community of carpenters and builders to get the most and the best results out of an association."

Instead of anybody answering immediately in reply to this invitation, practically everybody looked toward Uncle Rural, until seeing that it was up to him to make the first suggestion, he cleared his throat, started to talk and then stopped, looked at Mosby, who was nearest the center of the table, in reach of the punch bowl, and said, "Mosby, lest the subject get a little dry, suppose you fill our glasses out of the punch bowl."

Mosby made a move as if to comply with the request, and then stopped, stared with surprise at the punch bowl for a minute, and then turned to Uncle Rural with a questioning look in his eye, hesitated.

hummed and hawed a little as if what he felt called on to say was difficult, then laughed a little and said, "Uncle Rural, there is nothing in the punch bowl."

Instead of Uncle Rural looking embarrassed, as Mosby seemed to expect, he smiled a little and said, "Certainly, I know that, and that being its condition it is perfectly logical to assume that you can't get something out of it without first putting something into it. You see I was fixed for you boys, for I knew this question of how to get good out of the association would come up, and I wanted to give you a sort of every-day illustration of the fact that if you expect to get anything out of an effort of this kind you must first put something in it."

"Now," he said, "suppose each one of you go bring a glass of water and put in the bowl. Then, Mosby, if I should tell you to dish out a glass of the contents to each one present, what would you get out of it?"

"Water, of course," said Mosby, "just what was put in; that's simple."

"Well," replied Uncle Rural, "that's simple all right, of course, but there are some things about this idea I want to illustrate that are not so simple as all that. If we all put water in it or any other single ingredient we may stir it up all we please and dish it out and it is nothing but water. But there are other things." Then Uncle Rural went to the sideboard, fished out some lemons, possessed himself of Aunt Cynthia's sugar bowl and before continuing his talk proceeded to make a punch bowl full of lemonade. Then, after Mosby had helped all those present to a glass Uncle Rural went back to his seat and continued. "You have probably gathered from what I have just said and done that by the combining of different elements into a common body you can produce what we might term new elements. By using water, lemons and sugar we have a delightful drink, but, on the other hand, had we combined with this water some unpalatable agent, the result, instead of being an improvement on the original element of water would have destroyed its palatable qualities and rendered it unfit for use. You can no doubt get the idea out of this little homely parable without any elaboration on my part, and, anyway, it's not my purpose to elaborate. What I want to do here and now is not to do your thinking and planning for you, but simply to point the way and encourage you to do your own thinking. I think, too, I have said enough now to set you all thinking, and I would suggest that instead of seeking to complete your plans for an association tonight that each of you take home with you the thought that what you can get out of an association depends not only on the amount you put in it, but also on the kind of substance and the skill you make use of in combining the different elements. And then, each of you do some thinking for yourselves and come back here again next week prepared either to put something into this purpose or to suggest a combination of things that will be refreshing and beneficial to all."

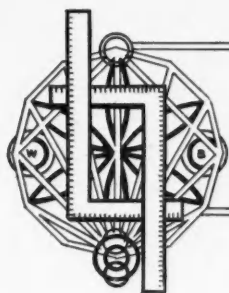

Steel Square

ALFRED W. WOODS

How to Use the Steel Square

THE FIRST OF A SERIES OF ILLUSTRATED ARTICLES ON GENERAL ROOF FRAMING, SHOWING HOW THE CUTS, LENGTHS AND BEVELS CAN BE OBTAINED WITH THE AID OF THE COMMON STEEL SQUARE.

WE NOW come to that part of our subject in which the large majority of woodworkers are most interested—that of roof framing.

The articles that have appeared in previous numbers dwelt more particularly on miters and angles. They also have their part in roof framing and we will have occasion to refer to them in this work. In this, it is

The span has reference to the width of the gable, or that part of the building to be roofed which may be covered with a pair of rafters resting opposite each other.

The run has reference to the length taken on a level line directly under the space covered by a single rafter. In other words, it is to the rafter as the base is to the triangle.

The rise has reference to the space taken on a perpendicular line directly under the comb or highest point on the measurement line of the rafter to the level of the plate on which it rests. Its height is reckoned by the proportion of the span as one-quarter, one-third, one-half, etc. It is to the rafter as the altitude is to the triangle.

The pitch has reference to the slope given the roof and is to the rafter as the hypotenuse is to the triangle. Therefore, the run, rise and pitch constitute a right angled triangle.

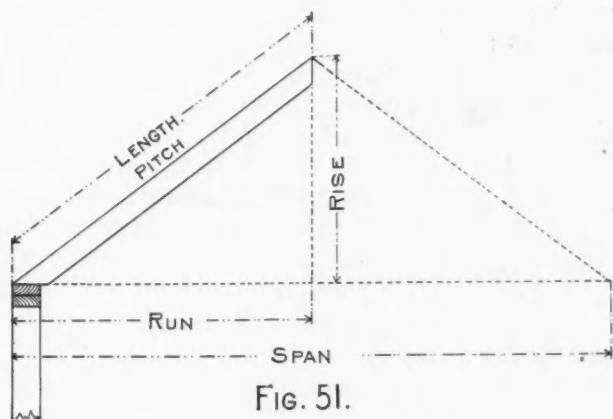

FIG. 51.

not the intention to follow the beaten path, but to cut loose from the common roof diagrams as are in general use for finding the various cuts, etc.

It will be our aim to say what we have to say in as plain words as possible, omitting all high sounding terms, thus giving to the reader the subject matter in its simplicity, with illustrations especially prepared for the work.

We do not question that there are many ways of illustrating roof framing, but after all they must conform to the fundamental rule of unity. In this, we let 12 on the tongue of the square represent unity. It may represent one foot or one inch, as the case may be. It represents the starting point from which all of the measurements and angles are reckoned, as will be seen by referring to previous numbers of this magazine, but the work heretofore has been on the level plane which has its preparatory work for the roof; in other words, the base from which to start. Now we must, so to speak, go up in the air, but before going it might be well to define the principal terms used in roof work as follows:

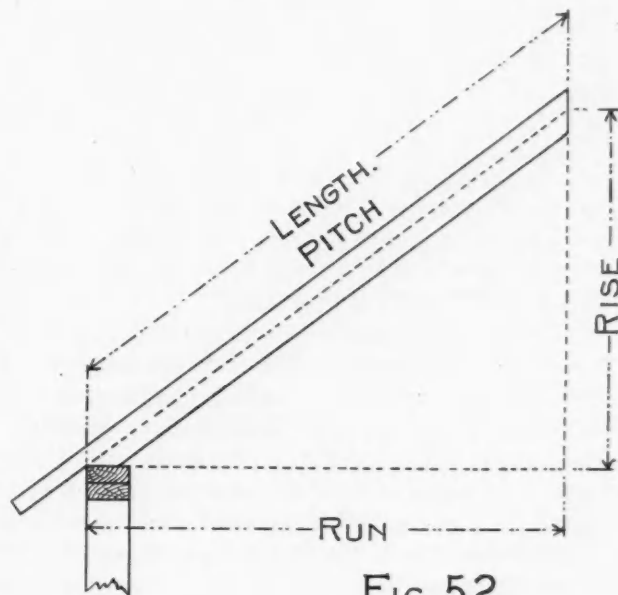

FIG. 52.

The blade and tongue of the steel square represents the base and altitude and these applied to the straight edge of a timber may be made to represent the third side or hypotenuse. . These are the three factors by

which all of the cuts, bevels and lengths are obtained. We can explain this point better by referring back to Figs. 11, 12 and 13 of the June number where it will be seen that the part removed to form the miter is a right angled triangle.

In Fig. 51, all of the above terms are illustrated in connection with a rafter set in position. This is the simplest form of a rafter and the cuts are just the same as for a brace.

In Fig. 52, is shown another form of getting the measurement of the rafter and while the cuts are the

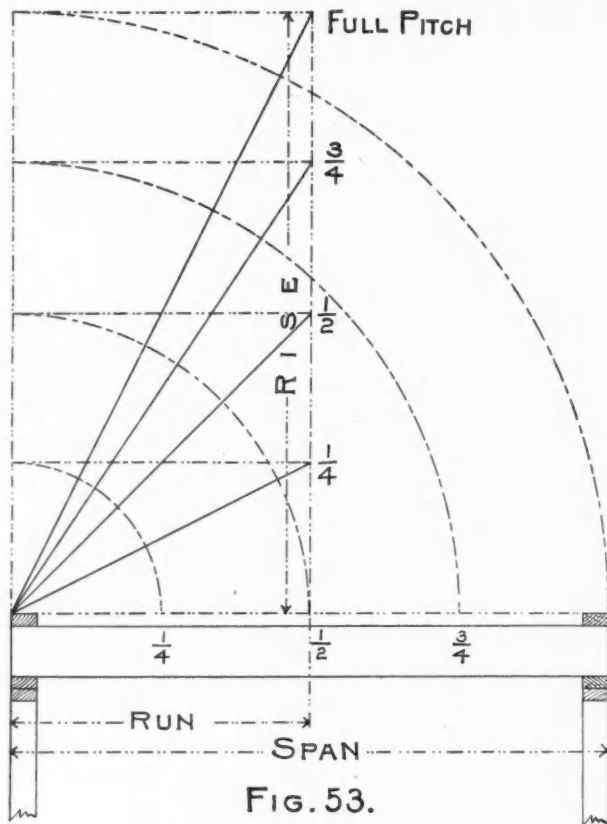

same as in Fig. 51, the measurement line is taken at the side of the rafter as shown by the dotted line. This line is usually taken at the depth of the seat cut or at a point where it will intersect the outer edge of the plate when the rafter is in position.

The base and altitude represent the seat and plumb cuts of the rafter while the hypotenuse represents the pitch. Here is a point in regard to the pitch that should not be overlooked. The point in question is this, that while the miter cuts are determined by the degrees contained in the circle as we have before described, the slope or pitch given the roof is reckoned by the proportion of the rise to that of the span as before described. Thus, when the rise is equal the span it is then a full pitch as shown in Fig. 53. Consequently the slope of the roof when reckoned by the span will not coincide with same when reckoned by the degrees, with the exception of the one-half pitch which remains the same in either case.

Probably the reason that the pitches are not reck-

oned by the degrees is because it avoids fractions in the rise when applied to the standard measurement as given on the steel square. By referring to Fig. 4 of the May number it will be seen, only the 45-degree pitch results without fractions besides it would require an instrument to first find the degree. In our next article we will continue on the subject of pitches with comparative illustrations of the two methods.



Some Rare Woods

Old and well-seasoned oak is hard to get and harder to work. There is no great quantity of old oak furniture in the market, and old pieces that would supply large enough lumber for important work are seldom found. New kiln dried oak is uncertain, being liable to warp and crack. Paneled articles can be made of such material with some safety, but large solid articles are likely to give a bad account of themselves at the end of a winter in a steam-heated house.

Rosewood, also, the best cabinet makers distrust. This wood has a peculiar oily quality that makes it unsafe when glued. For this reason rosewood is used chiefly as a veneer. Thin sheets lose much of their oil and take glue satisfactorily.

Native walnut is no longer a favorite with the cabinet makers. This wood was in effect exhausted a quarter of a century ago or more, and is now as expensive as mahogany and by no means so beautiful.

Chestnut is a good deal prized, not for furniture, but for wainscotting and for doors. It is sometimes put up in the rough with good effect, and sometimes oiled and polished when it is remarkably beautiful considering the cost.

Gulf cypress is used with great effect in like fashion, and when filled and oiled it makes one of the most beautiful woods for inexpensive interior decoration.

Cherry was the old substitute for mahogany, and is still a favorite wood with the furniture makers. It is, however, not easily obtained in a properly seasoned condition, for proper seasoning makes it expensive. The fact is that with cherry, as with oak and mahogany, the seasoning is an important element of cost. The cabinet maker who must sink his capital for two or three years in wood that is undergoing the process of seasoning, finds it hard to compete with those who use kiln dried material.

Mahogany is the favorite wood with the best cabinet maker. There is a vast amount of seasoned mahogany to be had from ruinous old articles made in the last century, when the rage for mahogany was well developed; and while the new mahogany is less beautiful than the old, purchasers of furniture seem to have learned that it is worth while to have the new wood well seasoned.



Business is warfare—in a sense, a hard, constant fight to the finish. Advertising is the business man's most modern, most effective, weapon.

Drawing Lessons for the Carpenter

PLAIN INSTRUCTIONS ON HOW TO COMBINE THE VARIOUS PARTS THAT MAKE UP A FLOOR PLAN
—THINGS TO BE GUARDED AGAINST

By A. W. Woods

IN THE previous lesson we illustrated the various parts of a residence. In this we will combine some of these parts into floor plans for a four-room cottage. The accompanying illustration shows the floor and foundation plans in position on the draughting board. The first thing is to decide on the size and number of rooms desired, and we might here add keep in mind the desired cost of the building. Always plan

the foundation and even a second and third floor can be drawn opposite the first floor.

The T square will accurately delineate the measurements from the first floor for one way. The other way can be scaled, or the better way is to take a strip of paper and lay across the floor plan and take the measurements on same, then lay where wanted and mark the same on the drawing paper and draw accordingly.

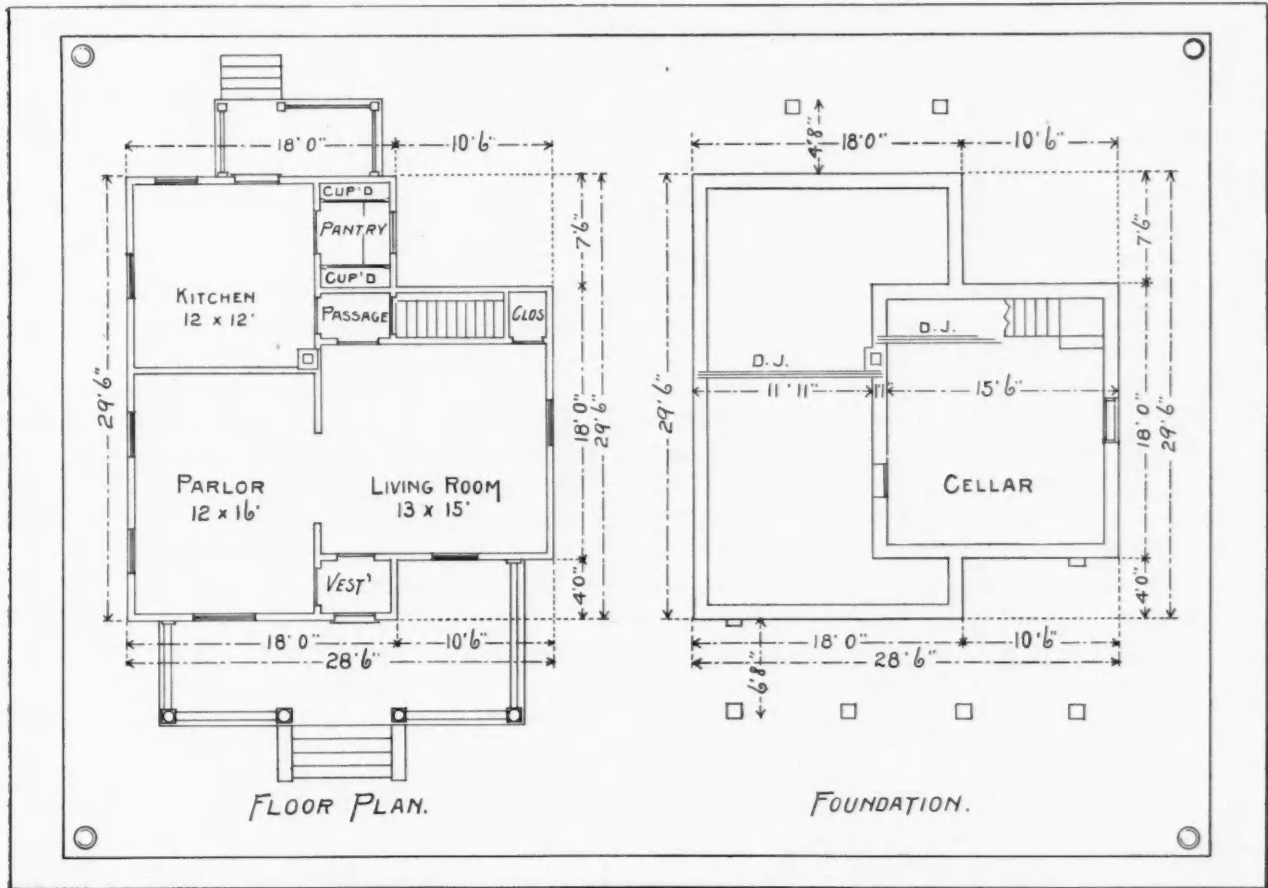

to work the lumber to the best advantage so as not to cut to waste.

The sizes of lumber vary somewhat, but the walls, when 2 by 4 studding are used, will finish up about six inches in thickness. Therefore, 16-foot joist will make a 15-foot room in the clear. Arrange the doors and windows to show up the exterior to the best advantage, but in so doing do not let this predominate to the detriment of the interior arrangements.

Another point that should not be overlooked from the start is how the whole arrangement is going to roof up, and plan accordingly.

After the first floor arrangements have been settled on, the foundation may then be laid out. Now, this is where a large drawing board comes in good play, as

Thus the student has the plans constantly before him and he can easily refer from one to the other.

All parts should be drawn to the same scale, and the dimensions of all particular parts should be given in figures, as shown on the dotted lines. In copying this would recommend using the scale of 1/4-inch to the foot. In the next lesson we will take up other parts of this building and continue until the full set of plans are completed.



Got What He Looked For

I am very much pleased with your magazine and I have at last got what I have looked for the last twelve years.—W. N. Stahl, Geneva, Ind.

Building Construction

J. A. F. CARDIFF



Building a Home

A SERIES OF ILLUSTRATED ARTICLES COVERING CONSTRUCTION DETAILS IN THE ERECTION OF OUR AMERICAN HOMES
—FROM THE LAYING OF THE FOUNDATION TO THE DELIVERY OF THE HOUSE TO THE PAINTER

WITH this number we will consider two special methods of constructing double hung sash windows. The first, shown in illustrations on Plate 19, is a window so constructed as to permit the use of mosquito screen, and blinds with swivel slats outside of the sashes. This is accomplished by putting the outside casing "D," over the sheathing boards "C," which makes a wider box for sash weights and allows the piece "A" to be set for mosquito screen. The space between mosquito screen and blind "B" is required for blind fasteners.

Fig. 78 is a section through the window head. The ground "G" serves as a gauge for plastering and as a nailing for the trim and should always be used in the best work.

Fig. 79 is a section through the jamb of the window. The stop bead "F" should never be less than one and three-fourths inches wide so as to allow proper space for the window shades. At "P" a pocket is formed in pulley style for access to sash weights.

Fig. 80 is a section through the sill of the window. The sill should be grooved out three-eighths of an inch for pulley style.

In all good work a back mould "H" should always be provided. This mould has a beveled edge which may be planed off to fit the unevenness of the plaster work.

Figs. 81 and 82 are respectively interior and exterior elevations of the window.

Plate 20 illustrates a somewhat better method of construction than any previously shown. The advantage of having mosquito screen and blinds outside of sashes is secured in this case by using four by five-inch studs. The construction is known as a "box frame," the back casing "A" forming the box and insuring a rigid pulley style and consequently accurately fitting sashes. The window sill forms the bottom of the weight box, and is grooved out three-eighths of an inch for the pulley stile.

Fig. 83 is a section through the head of the window.

Fig. 84 is a section through the jamb of the window. The use of the strip of wood "B," dividing

the weight box, is an improvement used only in the best grade work.

Fig. 85 is a section through the sill of the window, and shows the use of the moulded panel back under the window in place of the stool and apron finish.

Fig. 86 is an interior elevation of the window.



Sand-Lime Brick

A wonderful industry which was to revolutionize the manufacture of brick in this country has in recent years been frequently described in the newspapers and trade journals. The claim has been made that brick suitable for all purposes could be made from sand with a small addition of lime, at a cost far less than that of ordinary brick. Time has not yet proved the truth of this statement; nevertheless the sand-lime brick industry seems to have established itself and to have a promising future in certain sections of the United States. Where clay of good quality is not available, but comparatively pure sand is abundant, the manufacturers of sand-lime brick may reasonably hope for success.

There are in this country at present about fifty plants, with a total capacity of approximately 1,000,000 bricks a day. The experience of these plants indicates that sand-lime brick can usually be manufactured at a cost below that of common clay brick. When, however, a sand-lime brick is desired equal to the fine clay front brick, the cost of production is naturally increased beyond that of common clay brick. Sand-lime bricks have been in use long enough, both in this country and in foreign countries, to prove that when properly made, they have sufficient strength and water-resisting qualities to make them a safe building material.

The sand-lime brick of to-day is the natural outcome of the improvements made in the old mortar brick, which has been known for years. This mortar brick was at first never more than a molded mixture of lime and sand mortar which was allowed to harden in the air.

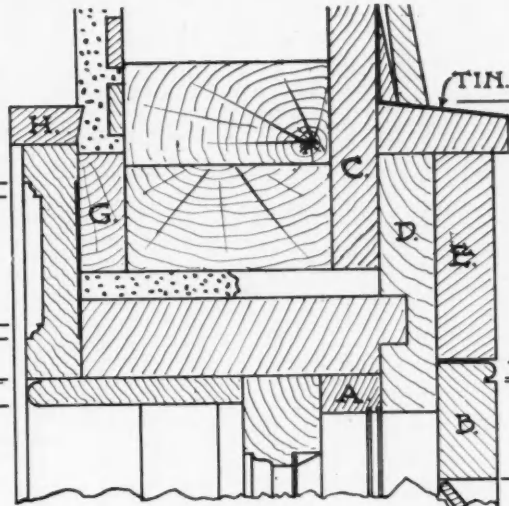

FIG. 78.

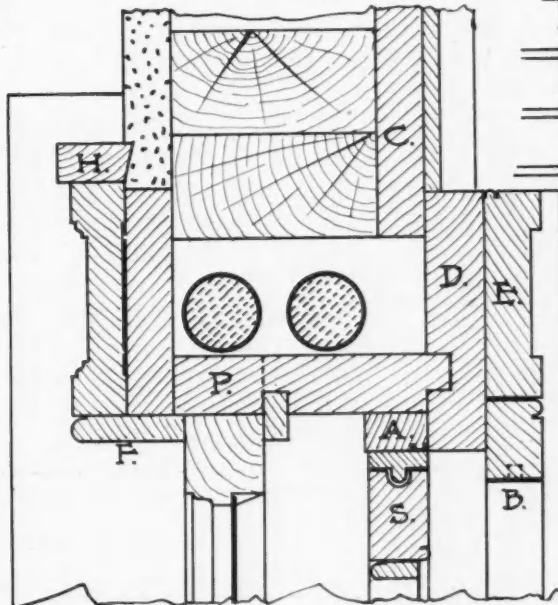

FIG. 79.

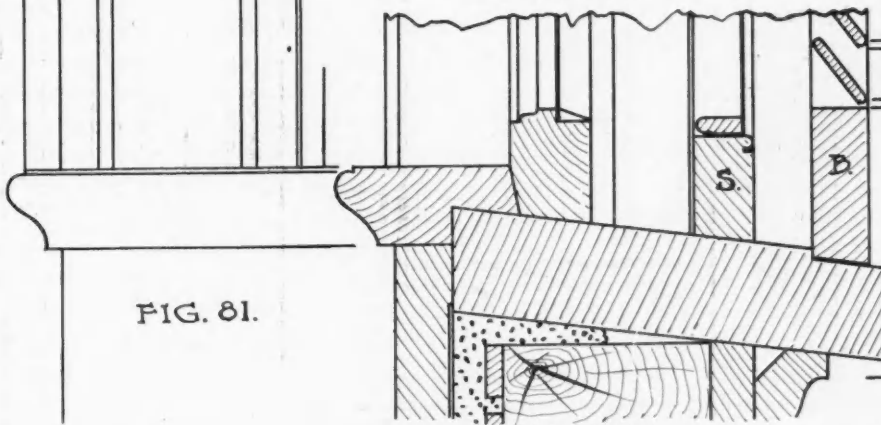

FIG. 81.

FIG. 80.

FIG. 82.

PLATE XIX.

WINDOWS.

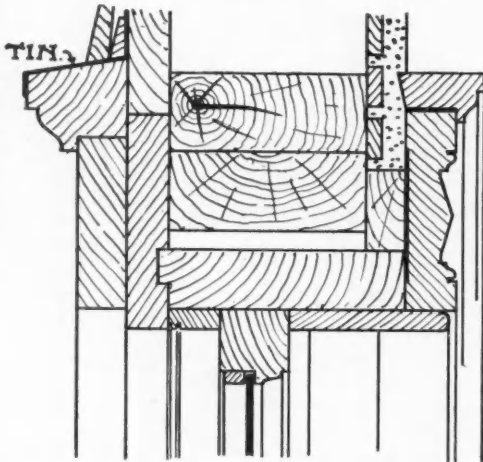

FIG. 83.

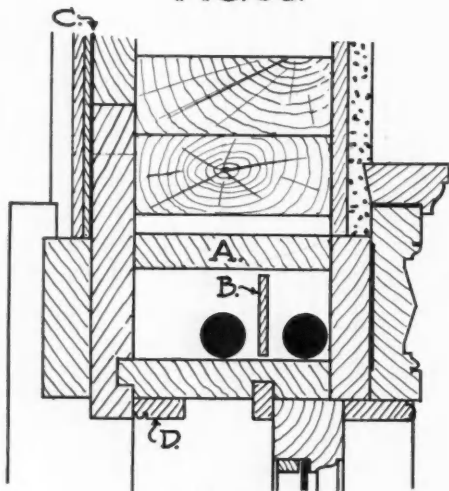

FIG. 84.

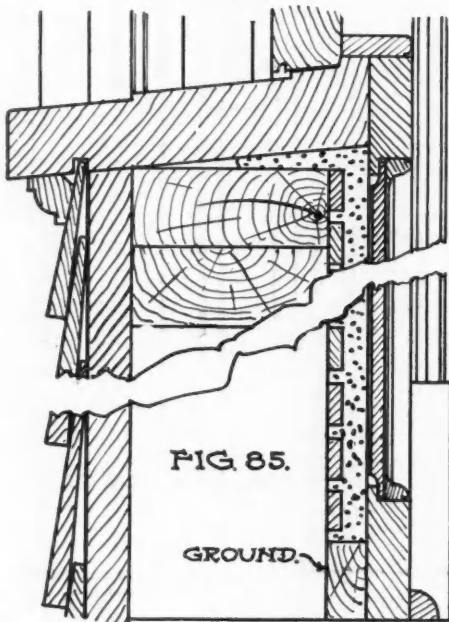
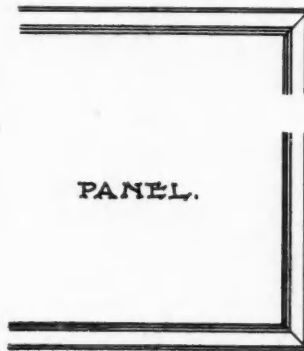
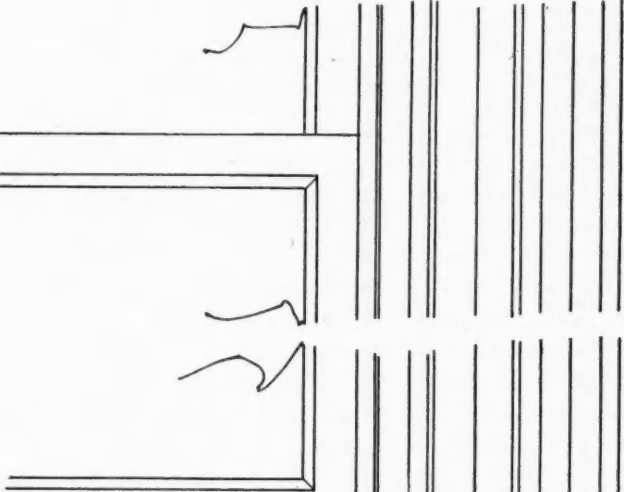
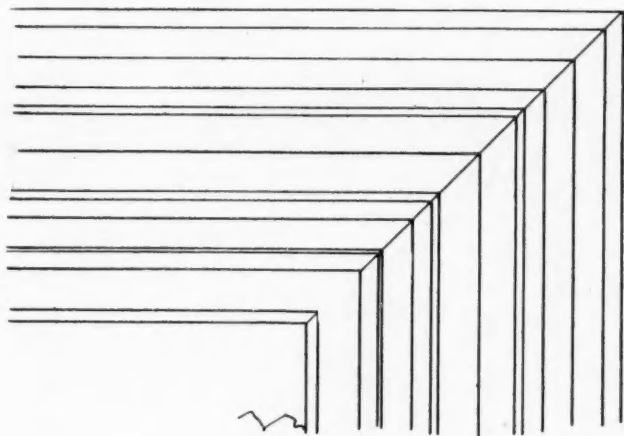

FIG. 85.

GROUND.



PANEL.

BASE
BLOCK.

PLATE XX.

FIG. 86.

WINDOWS.

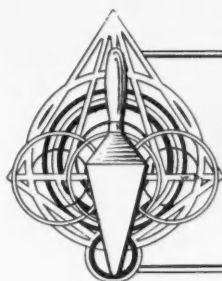

Cement Building Construction

FRED W. HAGLOCH



Waterproofing and Coloring Concrete

EFFECT OF COLORING ON THE WATERPROOF QUALITIES—WHAT MATERIALS TO USE—HOW TO REMOVE STAINS FROM CONCRETE

OWING to the general desire to make stone waterproof from the mold we devote this lesson to this subject, also to waterproof with coloring matter.

Before proceeding we wish the reader to remember that we have not yet seen a stone made waterproof that successfully passed every test required of a good building stone, but as there are certain uses wherein same can be successfully adapted we give a description of the process, as our course of instruction would be incomplete without it.

Perhaps the oldest and most successful method of manufacturing artificial stone that resists moisture is the alum and soap composition, the general formula being three pounds of soap dust, one and one-half pounds pulverized alum per barrel of Portland cement, mixed dry before using. The soap and alum hardens upon the addition of water, therefore no time should be lost in placing in the mold, besides it apparently reduces the time of setting of the cement and reduces the strength of the stone, as the closing of the pores prevent the interior of the block from receiving sufficient water during hardening (curing) to obtain a full crystallization of the cement.

Temporary Work

Another method of making waterproof stone is one pound soda, one-half pound potash, one pound alum, all pulverized and mixed dry to each barrel of cement. This composition sets hard in a very short time. Sidewalks made with it are ready for traffic in from five to ten hours, depending much upon the nature of the cement, as high grade Portland cements vary greatly when used with the above mixture. This formula is to be used only in temporary work, such as exposition grounds and buildings, where durability for a single year is sufficient, as potash will soon destroy the strength of the cement.

However some work has stood good usage for three seasons. In constructing work with this formula no time should be lost as water is of no benefit to the cement almost after the first wet mixing. In considering the lasting and wearing qualities of both the soap and alum and the soda, potash and alum formulas we have no practical tests, therefore we must compare with tests and usages of similar compositions

which can best be comprehended by descriptions of such instances.

A lawn vase made of sand and cement, alum and soap in 1903 was waterproof after two weeks old, but badly discolored the first season, which was easily removed with ammonia preparation, same as is used in cleaning wall paper. This spring (1905) the sharp edges began to crumble and could not be repaired, as cementing to the crumbled surface would result in further crumbling, the concrete having the appearance of work in freezing temperature. We attribute this to the fact that the alum and soap prevented complete setting just as freezing temperature will do, hence in another year or two the work will be worthless.

The Use of Lye Water

Perhaps the best practical example of potash on concrete was the use of concrete in a soap works, where it was discovered that lye water made a harder concrete in much less time than pure water and used in laying several thousand feet of concrete flooring, which wore well for two years, which crumbling in spots began. In two years more the daily sweepings consisted largely of concrete until the four inches of concrete was entirely swept away in those spots. The owners believed it to be caused by certain acids used in manufacturing soap, but the theory that it was due to an overdose of lye water in making the concrete for those particular spots looks more plausible, as the original floor made of clear water is to-day without a blemish, but is so located as to be less subject to the acid and chemicals used in the manufacture of soap, but sufficiently to show slight defects were the owners' theory correct.

The theory that coloring matter increases the waterproof qualities of artificial stone is correct to a limited degree, but not as much as a few color manufacturers would make us believe, but different colors act differently, therefore a separate description of each is necessary.

In coloring artificial stone to a gray the use of one pound of Germantown lampblack mixed with cement dry and one pound of salt previously dissolved to every ten gallons of water greatly assists to waterproof the product, but it must be remembered that it does not make an absolute waterproof stone, however

increasing the lampblack will make it less absorbent, but it will also darken the color and affect the durability.

To produce a black stone we have two distinct materials, either by adding Per Oxide of Manganese to the cement at a proportion of twelve to fifty pounds per barrel of cement, which is governed by the color of the sand and cement, or by adding from two to four pounds Excelsior Carbon Black per barrel of cement.

The Manganese in a measure prevents the absorption of water, but the Excelsior Carbon does not; the first reduces strength and the latter has little or no effect upon the durability or strength of the product.

The use of any waterproofing in making black stone will badly discolor the surface. In producing a waterproof blue stone we find the best success is obtained by using five pounds of Ultramarine blue, one pound pulverized alum, and one pound soda mixed dry with the cement. This produces a very sound product less subject to moisture than perhaps any natural quarry product.

Red artificial stone made either of Oxide of Iron or Pompeian Red will not mix well with any waterproofing compound, and we are of the opinion that to reduce the absorbing qualities can be done only after the colored product has hardened. In making brown or buff stone we use Ochre, which, in a measure, prevents moisture, but is so detrimental to strength and durability that we prefer to exclude these colors from the artificial stone field. In connection with the study of this lesson we wish to give a few methods for removing stains, blotches and discolorations from stone.

To remove stains from colored stone without injuring the color requires care and can best be done with a solution of ten parts gasoline, two parts ammonia and two parts soda; apply with a sponge and wash with cold water and brush.

The use of muriatic acid affects some colors, but its use should be confined to natural (uncolored) products.

Deep stains cannot be removed without affecting the color, even in natural products (bricks and natural cement), and can best be done by dissolving one-half pound of Oxalic Acid in a gallon of water and add sufficient plaster of paris to make a stiff paste. Apply heavy and let remain twenty-four hours; remove with cold water and scrubbing brush.

When Plaster of Paris hardens too soon, use wheat flour.

Making Wall Waterproof

To the Editor: Winchester, Ohio.

Can you tell me what will make my basement wall waterproof?

Answer: Select a time when the walls and floor are reasonably dry and cover with a coat of paint made of one part liquid shellac, ten parts refined coal tar, six to eight parts Portland cement, and sufficient turpentine to admit its application on the wall with a flat brush.

This will produce a black surface, but can be coated with plaster before the paint has become dry.



National Association of Cement Users

The National Association of Cement Users, which was organized at Indianapolis last January, will hold their second annual meeting in Milwaukee, Wis., January 9-12, 1906. At their first meeting they had an attendance of six hundred, which promises to be doubled at the Milwaukee convention. The following excellent program has been given out by the committee:

"Concrete Block Architecture," by Louis H. Gibson of Indianapolis, Ind.

"Manufacture of Artificial Stone from Slag," by Paul Davis of Reading, Pa.

"General Uses of Cement," by R. H. Bowen of Keokuk, Ia.

"The Choice of Cement for Concrete Blocks," by Richard L. Mead.

"Concrete Aggregates," by Sanford E. Thompson.

"Concrete Mixers," by E. B. Kelley of New York City.

"Cement in Fireproof Construction," by Edwin T. Cairns of Chicago, Ill.

"Air Tamping of Concrete Blocks and the Conveying of Blocks," J. P. Sherer of Milwaukee, Wis.

"Testing and Uses of Natural and Portland Cements," by E. S. Larned of Boston, Mass.

"Building Regulations Regarding Concrete Blocks," by W. J. Scutt of Chicago, Ill.

"Use of Cement and Concrete for Farm Purposes," by S. W. Woodward of United States Department of Agriculture, Washington, D. C.

The above program shows that the convention will be one of vital interest to all users of cement and it promises to be very successful from every standpoint.



Convention of Cement Users

A convention of the Northwestern Cement Products' Association will be held in Minneapolis, Minn., January 17-19, 1906. Committees have been appointed to look after all features of the convention, and the program committee announces that the speakers will be among the ablest in the United States in their respective lines. The topics to be discussed will be those that will interest contractors, builders and cement men generally. The exhibit committee has already received a large number of applications for space, and as the convention occurs immediately after the national convention at Milwaukee most of the exhibits will be brought to Minneapolis from there.

They extend a cordial invitation to all those interested to be present. For information with regard to exhibit space, applications are made to the president, O. U. Miracle, or the secretary, Geo. A. Hughes, 1401 Hennepin avenue, Minneapolis, Minn.



Most Valuable Paper

Your paper is without a doubt the best and most valuable journal in print.—S. O. Forslund, Chanute, Kan.

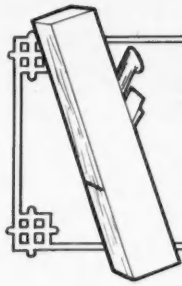

Practical Carpentry

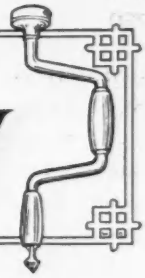

Properly Filing Saws

BEST METHOD OF FILING SAWS TO BE USED IN VARIOUS KINDS OF WORK—DIFFERENCE IN FILING A RIP SAW AND CROSS CUT SAW

By Dwight L. Stoddard

AS THERE have been several questions asked in regard to saws, and as they have been of such a general nature, I have decided that the best way to answer them is to write a brief article covering the entire subject. I will try and be as brief



FIG. 1.

as possible and cover the subject, although I fully realize it is a large one and a great deal should be written to fully give it justice.

As the saw is by far the most important of any of the carpenter's tools, yet how often we see a carpenter almost work his very life out of himself with



FIG. 2.

a saw in bad shape, and yet not do even a fair day's work; again, how often we see mechanics leave an inside job (where the lumber was dry) with their tools in good order and go to framing course, wet, cross-grained lumber. Their saws would cut fine until they got in a little ways, and then, as they would not be set enough for that kind of lumber the saw would bind and it would be almost impossible to continue to push it until the piece was cut, simply be-

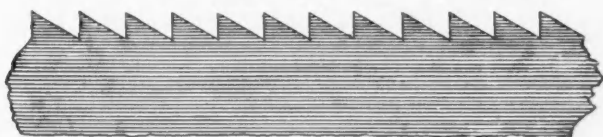

FIG. 3.

cause there did not happen to be a set on the job.

How easy these hard, unsatisfactory days could have been made by simply laying the saw down on some studding or joist on the trestles as shown in Fig. 1, and set with a common nail set, which would practically not dull it at all.

A common nail set makes the best saw set I know of to meet the emergency just mentioned. Many claim a hammer set is the only perfect set, while I find for general use the latest hand sets much more convenient. The ornamental nib on point of saw I am glad to say is not put on many of the best saws of to-day.

Fig. 2 shows the set in a saw which should always be just as little as possible and have the saw run free.

Fig. 3 is a rip saw, which should be filed square across for all ordinary work. The set gives all the bevel the teeth need, as rip saw teeth should march

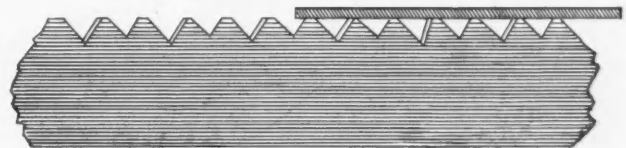

FIG. 4.

one after the other just like little chisels and cut clear across the tooth and not simply cut on the outside edge as a cross-cut saw, which acts more like jack-knife blades on each side of the saw.

Fig. 4 shows the jointing of a saw which is generally done with a flat file. A cut-off saw should be jointed rounding, while a rip saw should be jointed

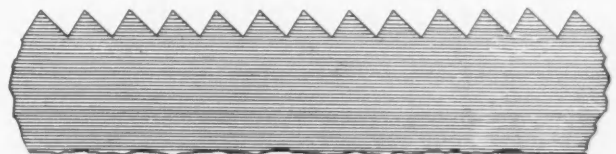

FIG. 5.

perfectly straight, although many of them are jointed rounding, and some joint them hollowing.

Fig. 5 illustrates a good way to file a cut-off saw that has gotten into very bad shape. After the teeth are all made even and the same pitch (or rake), then give it proper bevel.

Fig. 6 shows a saw filed with about the right pitch and bevel for ordinary hard wood.

Fig. 7 shows the proper pitch, bevel and fleam, which is the bevel on the back of the tooth, for ordinary soft wood. It also shows the file, which as you

will note should point towards the point of the saw. Not only is that my opinion but all the best authorities I have ever read on the subject give it the same way; still I am free to admit many good mechanics file just the other way.

Fig. 8 shows the groove in a cut off saw. A needle

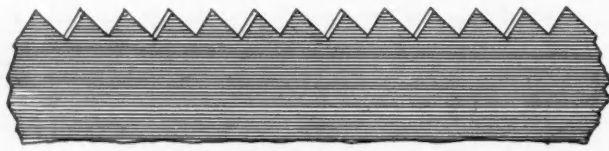

FIG. 6.

should run down this groove the full length of the saw if it is well filed. To prove this statement I just tried my father's old course saw which is not very sharp and has had many kinks in its day. The needle went to full length. If an old saw about 40 years old, filed by a man nearly twice that proves the statement, new saws by young mechanics surely ought to.

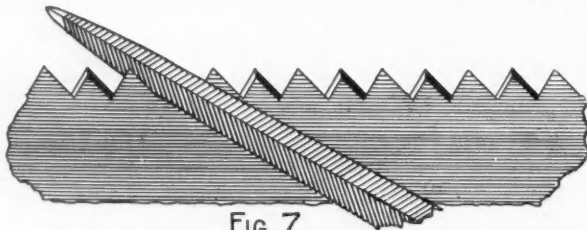

FIG. 7.

Fig. 9 gives the degree of pitch. Tooth and the dotted lines show that the rip saw tooth should be on the square or at an angle of 90 degrees. I used to file even just a little sharper than that. Tooth 2, which is 60 degrees, is right for a general cut-off saw. If you wish the saw to cut fast, though possibly not quite as smooth, file it 70 degrees, or more like Tooth

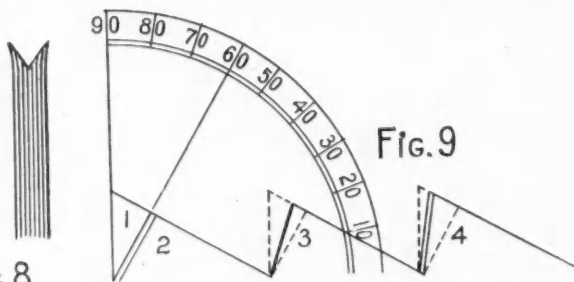

FIG. 9

FIG. 8.

3, while 4 shows a tooth 80 degrees or over, which is about right for a compass saw that rips as much as it cuts off or any similar saw, such as a rip saw for cross-grained hard wood where it has to do some cutting across the grain, or a cut-off saw for sawing diagonal sheathing, or rafter cutting, which is as much ripping as cutting off.

Fig. 10 is looking right down onto the edge of the saw and shows that the rip saw should be filed square across or at an angle of 90 degrees with the saw, while a strictly cut-off saw at an angle of 45 degrees, and for the different classes of work the file should swing at different points between 90 degrees and 45 degrees.

Fig. 11 shows how the file should be held level

for rip saws, and some even hold it level for all saws, and others drop the handle so the point is raised to

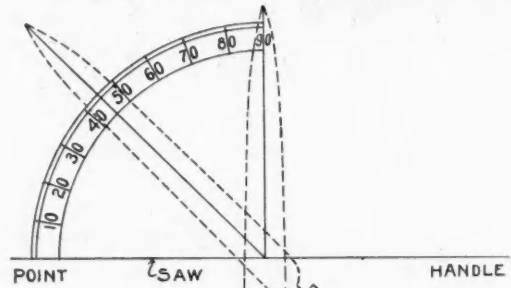

FIG. 10.

about 30 degrees. I seldom raise the point of my file more than 10 degrees.

Anyone who is willing to give the time required to keep a saw in good order (and that time is time well

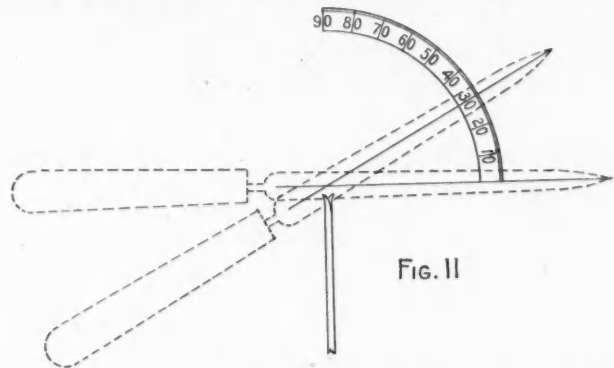

FIG. 11

spent) ought to be interested enough in his saw to secure a good one, even if it does cost a little more. A cheap saw is a poor investment at any price, for the files and time it takes to keep it in order would soon pay for the very best.

While there have been no radical changes in saws

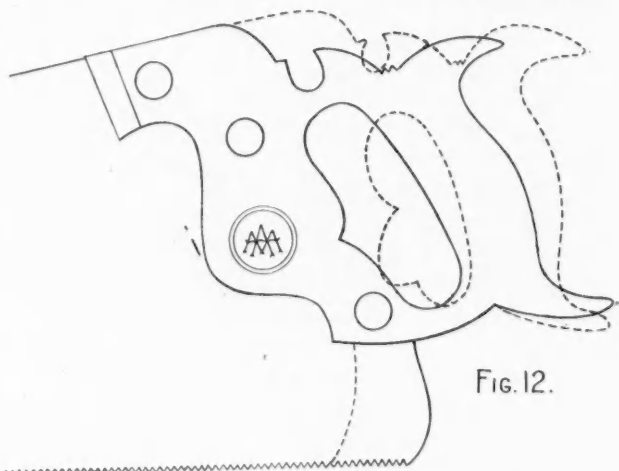

FIG. 12.

in my time, yet there have been some improvements, the main improvement being in the perfecting of the

the section of the rail on the respective bevels and taking off the width along the bevel, the same as was done in Fig. 1, except that in Fig. 1 the pitch line was the bevel while in Fig. 2 there is a different bevel for each end. The width found on the bevel RT will be the width of the mould at M, and the width found on the bevel JS will be the width of the mould at N.

In the figures here shown much more is drawn in

than would be done in actual practice so as to make the problem more easily understood. When the stair-builder desires to lay out his rail he takes the pitch-board or lays out the pitch line and measures the distances required on his plan, applying them directly to the pitch-board or his layout of the pitch line. In this way he arrives at the desired result with drawing but a very few lines.

Making of a Practical Carpenter

GIVING THE METHODS OF CONSTRUCTING THE VARIOUS ROOFS—RULES FOR ASCERTAINING THICKNESS OF TIMBERS

By Frank F. Addison

IN our article last month we gave the carpenter an idea regarding the principles of roof construction, and we will proceed to describe the methods of constructing them.

The form of roof known as the king-post roof is practically the beginning of all trusses, which are complete framings in themselves, spanning from wall to

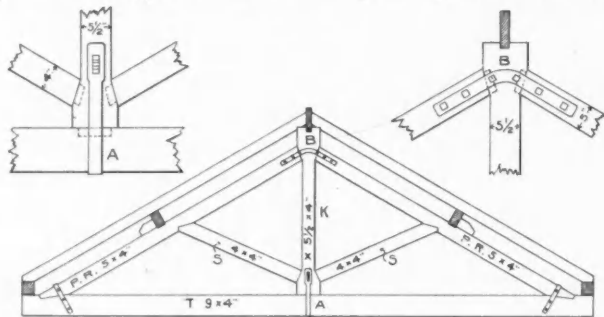

FIG. 39.

wall, and doing duty for the cross walls. They support, in their turn, the ridge and purlins, which require a bearing every eight or ten feet. Trusses should be no more than eight or nine feet apart, and have a nine-inch bearing on each wall.

Fig. 39 represents a king-post roof-truss. P R is the principal rafter, five inches deep and four inches thick; T the tie-beam, nine by four inches; S the struts, four by four inches; and the king-post K is five and one-half by four inches at X; the cuts to give a bearing for the struts are also shown.

Flat-pitched roofs are not so strong as those that

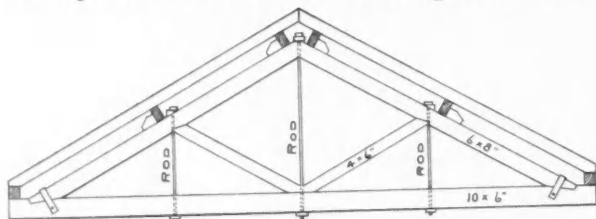

FIG. 40.

are pitched higher. The nearer to the perpendicular that wood is fixed the stronger it is. This is shown by the fact that the horizontal thrust of a pair of rafters is proportionate to the length of the oblique line drawn, at right angles from the foot of the rafters, to the perpendicular dropped from the apex.

The joints of a king-post truss, in fact, all consist of mortises and tenons entering but a short distance into the timbers; and they have all beveled shoulders, which ought, whenever possible, to be at right angles to the incline of the roof. At B is the joint between king-post and principal rafters at the apex supporting the ridge, a pair of two and one-half by three-eighths-inch wrought-iron straps, bolted from side to side, completing the joint; or in practice a through-bolt from A to B will answer the same purpose, though not so good. At A is the joint between king-post and struts at the base. King-post trusses are suitable for spans up to thirty feet.

Fig. 40 represents the common "A" truss suitable for spans from thirty to thirty-six feet.

Queen-post trusses are used for spans over thirty feet, and contain two perpendiculars to brace up the tie-beam spanning the walls.

Fig. 41 is a "queen-post truss" for a thirty-two-foot span. The same form is suitable up to about forty-

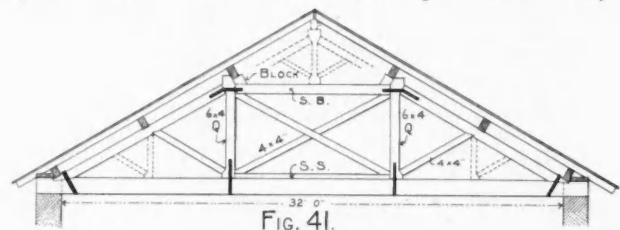

FIG. 41.

two-foot span, and beyond that size princesses, or intermediate posts and struts, have to be inserted between the queens and the heels of the roof, as shown by the dotted lines. It is sometimes necessary to frame a small king-post truss (also shown on the figure by dotted lines) above the straining beam S B, to support the ridge. S S is the straining sill, and Q the queens. The other members are known by the same names as in other trusses.

A good rule to ascertain the thickness of queen-post trusses is as follows: Divide the span by eight, and the quotient will be the required thickness (in inches) making up for odd parts by adding another inch for heavy-tiled roofs, and omitting such fractions for slates.

Taking the tie-beam for thirty-two feet span at eleven inches deep, the principal rafters at six inches,

by adding one inch for every five feet additional span, we can arrive at their depth for the different roofs.

In Fig. 42 we show a roof that is at once strong

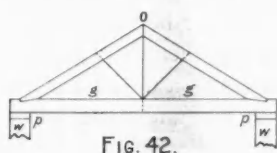

FIG. 42.

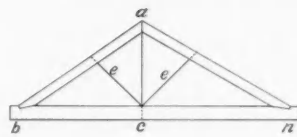

FIG. 43.

and cheap for spans from twenty to thirty feet. pp shows the wall plates, w the wall, o the ridge and head of suspending rod; g and g show where the suspending rods may be placed if the span exceeds twenty-five feet.

Fig. 43 shows a roof with unequal sides. ac shows the suspending rod. ee may be braces of wood or rods

of iron; b and n are resting points. This is suitable for a span from twenty to thirty feet.

Fig. 44 is suitable for a roof with a deck, and where the span is not more than twenty-five feet. It is also suitable for a small bridge crossing a creek, where the

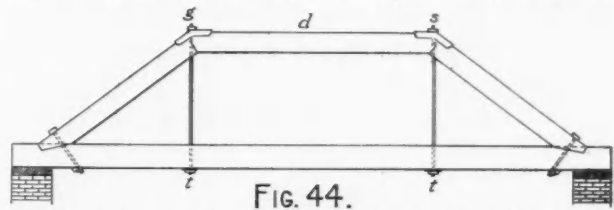

FIG. 44.

span is not more than sixteen to twenty-two feet. The deck is shown at d; gt, st, show the suspending rods.

In our next article we will give a table showing the estimated pressure on a roof, for the purpose of appor-tioning the proper sizes of timber to be used.

Use of Metals in Modern Building Construction

VARIOUS USES TO WHICH METALS ARE BEING PUT IN BUILDING—USED IN BOTH INTERIOR AND EXTERIOR WORK—ODD COMBINATIONS MADE

By George H. Melrose

THE increased use of iron and other metals in the design and construction of modern buildings was specially noticed by your correspondent while recently traveling. In fact, the development of the metal industry in connection with parts for brick, stone and wood buildings, has been one of the features of the trade for some years. Six years

ago I commenced my travels and visited different sections of the world. In practically all foreign countries I observed that the masons were using framework designs of metal, the frame to be filled in with the composition of which the building was composed. During the past year I traveled in the United States. The attached illustrations are sketches that I made of specially interesting designs of metal compositions for service in connection with wall work, ceiling, etc. That in Fig. 1 represents a sectional building of iron



Fig 1

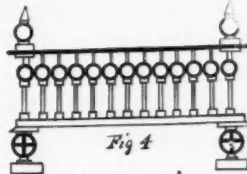

Fig 4

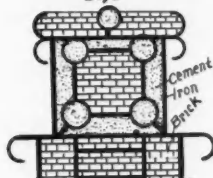

Fig 2

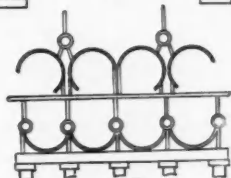

Fig 5

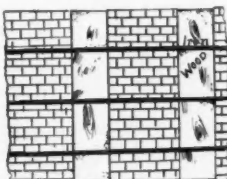

Fig 3

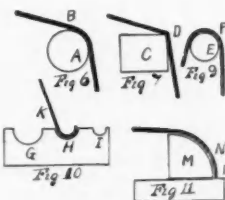

Fig 6

Fig 7

Fig 9

Fig 10

Fig 11

ago I commenced my travels and visited different sections of the world. In practically all foreign countries I observed that the masons were using framework designs of metal, the frame to be filled in with the composition of which the building was composed. During the past year I traveled in the United States. The attached illustrations are sketches that I made of specially interesting designs of metal compositions for service in connection with wall work, ceiling, etc. That in Fig. 1 represents a sectional building of iron

framework. The dark portions represent the iron. The pattern is wrought out in the shop of the metal worker from flat pieces of wrought iron. These pieces as a rule are about one-third the width of the common brick, and about three-eighths of an inch in thickness. Some are made of heavier material and some of lighter. The parts forming the squares are set up and shaped as exhibited, with a view of adjusting the masonry in between, thus forming a solid wall of considerable strength and elasticity. When made of a bronze-like metal, the artistry of the pattern is improved. I saw some of these combinations in brass framework for interior settings. For getting an ornamental effect in iron, bronze substance, brass or other metal, the design shown in Fig. 2 is made. I saw this in a western building in course of erection. A number of these patterned metal settings were calculated for use at objective points in the design of the building. There was one over each window, I noticed. A larger style fitted into the masonry work over the main entrance. The interior hall walls were also provided with kindred patterns in metals at each end and at passages. In addition to the filling of brick or stone, sometimes cement is employed and the surfacing finished off in a presentable manner to correspond with the surroundings. In one case the cement bed was furnished with bits of broken colored glass and offered quite a novel effect. Again I saw filings of the iron foundry used and the "rusty" iron effect offered was novel if nothing else. The making of these metal frames in which there are considerable numbers of ovals, rings, scrolls, etc., in the pattern, is a little difficult except in works where particular attention is given to this line of business. I was shown models of metal frames intended for use in new building construction and had to acknowledge

that it was quite inferior in design and manufacture. Then again I saw some very substantial and beautiful designs wrought out by the makers of the frames. A great deal depends upon the amount of money the builder intends to put into the project. If the cheaper forms of combinations are to be used, the results will not be satisfactory, as the plain iron fittings will look too modest.

If the workmen are to adjust some artistically designed patterns into the walls, in which bronze imitation or brass metals are used, and if these metals are kept polished for interior service, the results will not only be attractive, but pleasing. Still, some of the work is very plain and businesslike of necessity. For example, I observed that some wallwork of a manufacturing plant was in course of building simply with a view of strength. Beauty was not one of the requirements. Fig. 3 is a drawing of the detail used. Wood posts were introduced at intervals of four feet, and through the frontals of the posts the strips of quarter-inch metals of iron were passed as represented by the dark lines crossing the beams. The metal strips were arranged to fit snugly into grooves mortised into the beams at proper junctures. The work of putting in the brick followed and the combination made as sketched.

Fig. 4 is a drawing of another style of metal noticed by the writer. This was made to work into the walls of a library, over the fireplace. There was no mirror to be placed in its usual position. The entire fireplace scheme was altered. The wall was made solid with this frame of blackened metal put in. Small stones were used to fill in the intervals and a liberal supply of cement held them in place. In this instance the width of the strips employed in the design were made about half an inch wider than customary and this additional width was permitted to project beyond the common level of the surfacing of stone, cement and brick. The brick used were enameled. The finished black metal frame did not satisfy and finally the metal was gilded. In this condition it remains.

One of the best designs I saw in this line of work is exhibited in Fig. 5. This is a model of a brass design intended to fit about the lower portion of a room, set into the rough, unfinished wall. The height is about three feet. The line between the floor level and the top of the brass design is packed in with brick and mortar of the plainest form. No attempt is made at a fine presentation. The pattern extends entirely around the room. Although there were many finely finished apartments in this residence, this particular room seemed to be the attraction. But one must have a servant to maintain a room like this. I was told that the brass work had to be gone over every day. The brass presentation and the contrast of the crude, unfinished mortar and brick surfaces make a combination that one does not see often. As to the forming of these designs which are now called for, the work

is usually done at the metal working establishments. Still in the back shop-rooms of architects and builders, masons and stone people, I discovered occasional evidence of thrift and ingenuity along these lines. In one man's back room was an outfit for bending metals cold. He buys the strips and shapes them, so as to get his design complete and this serves as a model for the regular metal workers. He had a round metal piece fixed to a bench like shaft a, Fig. 6, about which the metal strip could be bent as at b. Another form c, Fig. 7, is for bending the strip d at an angle.

For a horseshoe effect the piece f is bent over a smaller shaft e, as in Fig. 9. The metal form, Fig. 10, is a handy block, which is placed upon the bench, and with the round-nose hammer, the strips can be shaped to groove g, h, or i, as represented at k. Or, perhaps, a full bend with muscular force is needed, in which case the wood form, Fig. 11, is employed. The strip for bending is marked n and its lower end fits into a hole at p, so that a brace can be secured while the process of bending is going on.



Sea-Grass Furniture

A large trade is being built up along the lower Chinese coast in furniture made from bamboo and a certain sea-grass which the Chinese have used for centuries in many ways, but which has heretofore not been used for furniture. Considerable of the trade is with the United States, chiefly by way of Hongkong. The manufacture of chairs and small tables from this material was commenced by two American citizens from the Pacific Coast. They began making the well-known rattan furniture, and exported much of it to the United States. Casting about for new and novel materials, they hit upon this coarse grass and after considerable experimenting they found that upon suitable bamboo frames they could make a fairly substantial and very pretty article. The natives imitated their work, and now it may be said to be an industry common to many points along the coast. The grass is secured in the salt water marshes along the lower coast, especially below Swatow, and ranging toward Canton. It can be had in abundance, almost without limit, in fact, and its pliability and strength are such as to make it available for not only furniture but for other purposes. It is greenish yellow, maintains its color and strength, and might be used to advantage in other industries.



Hanging a Door

The hanging of a door is a comparatively simple task, and yet it does not seem to ever have been mastered to any great extent into the future behavior of the door, for if there is any other one thing about a house that gives more trouble than the doors, it has not yet been discovered.



"Saw wood. There's horse sense at the woodpile."



PLANING MILLWORK

J. CROW TAYLOR

Care of Small Band Saws

WHAT TO DO WHEN SAW BREAKS OR CRACKS—HOW TO BRAZE THEM SUCCESSFULLY—COMPLETE INSTRUCTIONS GIVEN AND MATERIALS TO USE

THE small band saw, as has been pointed out heretofore, is one of the most useful machines that can be put into a machine carpenter shop, but at times the pleasure of its manifold uses is marred somewhat when the saws begin to break and the task of brazing and refitting confronts a man who is not old in the practice. For this reason, and for the other reason that there are confusing technicalities involved in the care and maintenance of larger band saws, serves to give an air of mystery to the uninitiated, it is in order to have a little plain, every-day talk on the subject of brazing small band saws. First, I would say to those who are new to the work, get your mind entirely free from this idea of confusing technicalities, because we can get along without them very well in this work, and so will make it a point to avoid them and not use them. The first plain fact that will confront you when a saw breaks or cracks, and it becomes necessary to break it and reweld it, is that you want to get the two ends of your saw fastened together again, the lap reduced to the same thickness of the body of the saw and the back of the saw kept straight. Usually a band saw will give notice to the observant operator before it breaks in two, for the minute a crack starts either in front or back, the saw begins to jump and jerk in its work, and when this happens the thing to do is to stop the machine immediately, look it over for the crack and take it off the machine before it breaks in two and does some damage to the rubber on the wheels or else kinks itself up more or less when it flies off the machine while in operation. It is seldom that an operator is hurt from the saw breaking; in fact, I never knew a case of serious hurt to an operator from a small band saw breaking, because the guides and guard blocks usually retain it, but they frequently do damage to the rubber on the wheels and nearly always make some kinks in the saw blade, so it is best to be on guard and take them off when cracks start and lay them away for brazing.

There are several methods of brazing spoken of in technical works on the subject of brazing band saws, but the only general method worthy of consideration in this work is really a soldering and not a brazing process, in which you chamfer and lap the two ends of the saw blade, place between them a piece of thin silver solder and effect the joining of the ends by

using a pair of hot brazing tongs. The equipment necessary for brazing is simple and inexpensive and needs no lengthy description here, as it consists of a small cast iron brazing vice or clamp and a pair of brazing tongs, both usually being furnished along with the new band saw machines just like oil cans and wrenches are furnished with some other machines. The silver solder for brazing these saws comes in ribbon form and can be had from almost any mill supply house, costing usually about \$1.50 for a one ounce roll. Other incidentals to the brazing equipment consist of a small bottle of muriatic acid for cleaning the solder and the saws and a little powdered borax.

When with this equipment you start in to brazing a saw the first question that will confront you is, how long to make the lap. On this point practice differs a little, the variations going from one-quarter to three-quarters inches. In this you can be governed somewhat by the lapping of the saw teeth, which naturally must match, even though it becomes necessary to trim off a little of the end of the saw. The next problem will be that of filing the lap. That is, chamfering the ends of the broken saw blade so that they will lap together and leave the thickness of the saw the same after the brazing is done. Generally the brazing clamp itself can be made use of as a holding vice for filing, and the filing of the lap is really not a very tedious or burdensome job, but calls for the exercising of some care so that you may file it square across the blade and not leave a lump in the center, and to get a good job of it will require some fitting together and refiling after trying and seeing where the lumps are. Some instructions on this point say that you should not file to a feather edge on the end, but should leave a little shoulder to the lap in the back for the end to fit into, but while this may be all right in theory, in practice it will be found better to file to a feather edge, for the average small band saw blade is too thin for the making of other than straight bevel laps unless a man is unusually skilled in the work and has an excellent equipment at hand, and besides the feather edge lap probably gives the best results.

Having filed and prepared your lap, the next step in the preparation for brazing consists of putting your saw into your brazing vice with the lap in the center space provided for the inserting of brazing tongs.

Now see that the back of your saw is straight. Usually the back of the brazing clamp is planed to a straight line and answers very well as a straight edge in this work, but it is well to take the precaution of sighting along the blade, for one can generally distinguish with a fair degree of certainty whether or not it lays straight on the back. This is a very important feature, because if it is not, it will not only make the saw run badly on the wheel, but puts a heavy strain on the short edge of the blade and causes it to break again. Cut a piece of silver solder large enough to cover the entire space of the lap and extend a little on all sides, just enough to make it flush will do, but it is better to have too much than not enough. Before going further with this preparation you should see to the matter of heating the brazing tongs, and this sometimes is a deciding factor in where the brazing shall be carried on. The most convenient place all around to do band saw brazing is at the blacksmith shop, or somewhere where there is a forge and vise available, because your tongs must be brought to a good red heat, not a welding heat, but a good light red, which means, of course, hotter than a cherry red, and the best place to obtain the heat desired is at the forge. It is possible, of course, to heat them in a stove in the carpenter shop, or even in an open fire outside, but it generally takes quite a time, and besides the result frequently is the use of tongs not hot enough. Every man, of course, will have to be governed in this matter by his surroundings, but where it is available the blacksmith shop is the best place to do the brazing.

When the tongs get warm, and before you are ready to use them, see that they fit together nicely so that they will come down on the braze evenly all over, clean the scales off of the inner face with an old file and then while your tongs are getting the right heat on them go back to your brazing and finish your preparations. With a feather or small swab of some kind dipped in the muriatic acid clean off the surface of the lap and also of the piece of silver solder, sprinkle a pinch of powdered borax on the lower face of the lap, put on the solder, sprinkle a little more powdered borax on top of it, lay the other half of the lap on carefully, fasten your saw firmly, see that the back is straight and the teeth match and you are ready for your tongs. Take your hot tongs, clamp them firmly over the lap, covering carefully all parts of the brazing, keep an eye on the solder and as soon as it melts good release the tongs and let the braze cool. Be sure, however, that your solder melts and don't mistake the early curling of the exposed edges for melting, but wait till it begins to run and you are sure it is melted inside the lap—then release and let cool.

Now, while the directions given up to this point are reasonably clear and as nearly completed as you generally find printed instructions, the chances are that no matter how carefully you may think you are carrying them out, your first efforts at brazing will result unsatisfactorily unless you do quite a lot of thinking

on your own account. Probably the main cause of failure will be due to disturbing the braze in releasing the brazing tongs. When you try it once you will find that it is rather difficult to unclasp the heavy brazing tongs from the lap without disturbing it and causing it to come apart, and at other times there will be a natural tendency to come apart after it is released and before the metal has become hardened. To avoid disturbing the braze with the tongs in releasing a good practice is to slip a thin piece of flat iron or something under the bottom half of the tongs, which may be used as a lever to support the tongs and keep them from bagging down with their own weight. This will serve to materially assist you also in releasing and withdrawing the tongs by helping steady them. To further safeguard against the lap coming apart, it is a good idea to have a pair of cold pliers or tongs at hand so that immediately after releasing the brazing tongs you can clamp the braze with a cold pair of tongs and hold it together while it cools. The quick cooling that will come from the applying of cold tongs will also help in restoring the temper to that part of the blade which has been made soft by the heat of the brazing tongs.

Sometimes, especially where very small saws are being brazed, it is advisable to change the method a little, even though the change may suggest unprofessional work. If you have trouble with brazing light saw blades, instead of beveling the lap to a feather edge, just brighten the blade a little and don't file the lap at all, but lap and braze the blade full thickness. This, of course, gives you a joint twice as thick as the normal blade, but after the brazing is made you can then by careful work file off this surplus thickness from the outside, dressing each lap end down to a feather edge on the outside after the brazing is made instead of on the inside before making the braze. This may not sound right, and it is objected to by the more skilled workers, but still it is well worth trying on small saws, and that it can be done successfully and made give good results, I can give personal testimony, because I have not only occasionally but frequently resorted to it myself in days gone by. Anyway, try it once just for the sake of seeing what you can do, and then be guided by the results.

After your braze is made if you have other saws to braze lay the first one aside to cool and continue until through with brazing, then take them up and proceed to dress the outside of the lamp and straighten up the saw. Most of the advice given on this point is that you should not hammer on a saw, but—forget it. Get to a nice smooth anvil surface of some kind after first dressing the lap until the thickness in the joint is no thicker than the body of the saw, and take the kinks and crooks out of your saws, just the same as you would take them out of a piece of hoop steel. Don't do any unnecessary hammering and don't be rough about it.

Residences

Three Well Planned Houses

COMPLETE PLANS AND DETAILS OF A VERY DESIRABLE HOME—SPECIAL FEATURES ABOUT EACH HOUSE LOCATED IN VARIOUS SECTIONS OF THIS COUNTRY

TOO little thought is often given by architects and builders to the very important point of designing the house to exactly suit all the local conditions of its proposed location. The plan of the building itself may be ever so good as far as its interior arrangements are concerned; if it is not properly located in respect to the points of the compass, direc-

er direction by members of the family, and as the view in this direction is just as pretty as that to the front, it became necessary to make the rear elevation just as attractive as the front, and this has been done by making both ends of the house practically alike.

As to arrangement, this house has been designed to have all living rooms and all bedrooms face the south,



FRONT ELEVATION.

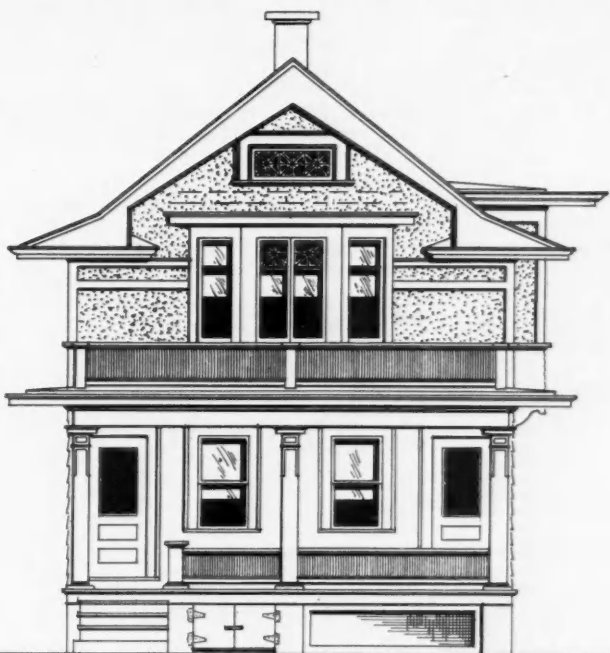

REAR ELEVATION.

tion of approach, location of the thoroughfare and its relative position to the neighboring houses, as well as to other local conditions, the entire scheme may be blurred. The writer, therefore, wishes to emphasize that this house has been designed to suit a certain location and the needs of a certain family, which should be the case with all residences.

With these thoughts in view, this house has been designed for a suburban lot having a street frontage on the west of 35 feet, a street frontage on the south of 125 feet, an alley on the east and party line on the north. The west street, being a very prominent thoroughfare, made it essential to face the house west. The way to the depot, school and business part of the suburb lies to the east; hence the house will be approached from the southeast more than from any oth-

er direction because the south in this case is a very pleasing view, but also to give sunlight in all the rooms, which should be the case in all houses. How often, unfortunately, is sunshine barred out of living rooms to prevent the fading of cheap decorations, but with the results of a gloomy and very unhealthy house.

The first story consists of the hall, living room, dining-room and kitchen, besides the smaller compartments, such as entry way, toilet room, pantry, vestibule, etc. The hallway, which is entered from the front porch, has doors leading to the dining-room, toilet room and kitchen; has an opening or archway leading into the living room, and also contains the stairways leading to the second story and basement. The kitchen is entered indirectly from the hall through an entryway which forms two doors to prevent odors

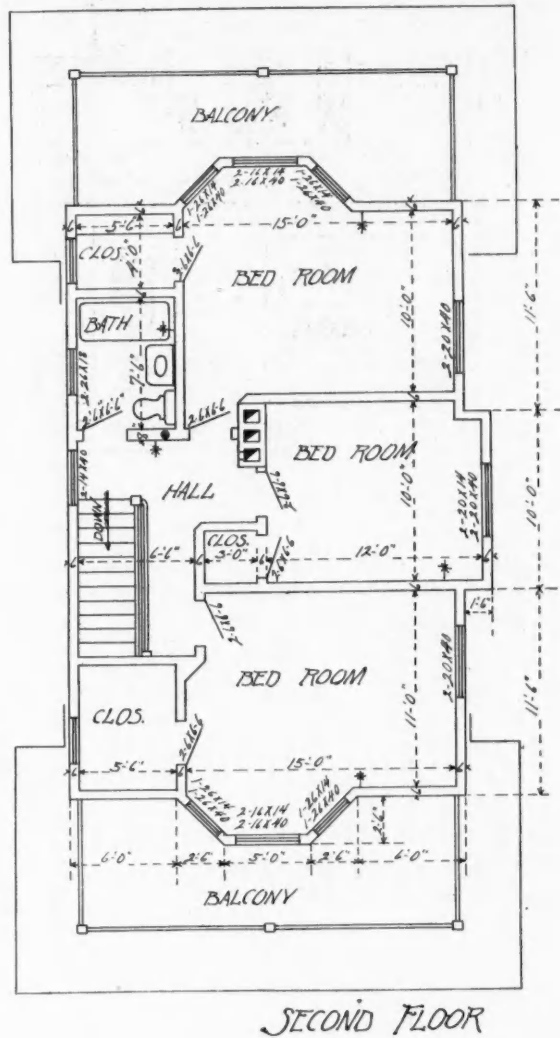
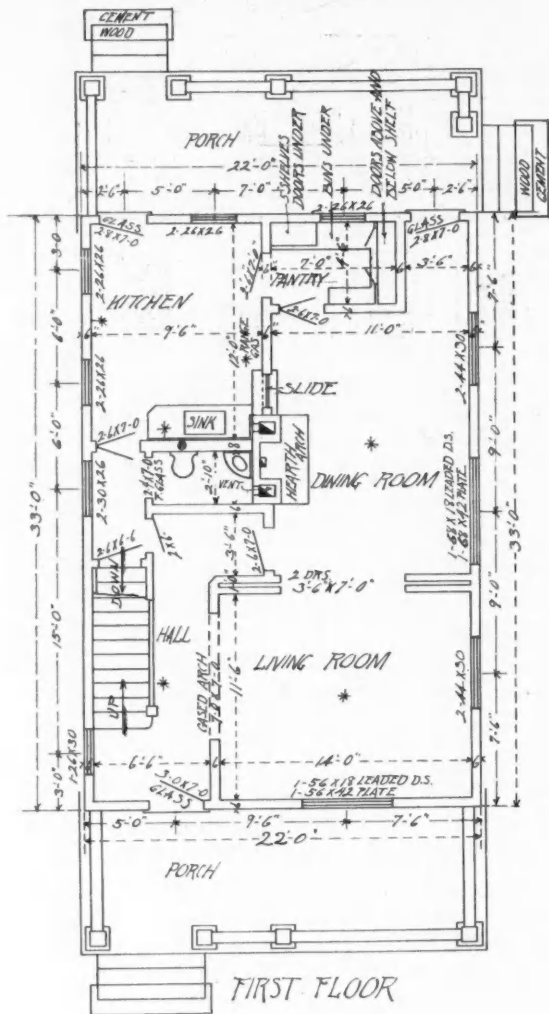

from the kitchen from entering the hall. This entryway also connects the kitchen with the cellar stairs and the toilet room. The kitchen sink is located on

placed directly from the dining-room table onto the drain board of the kitchen sink, thus avoiding all unnecessary steps of the housewife. The doors to the



SOUTH ELEVATION

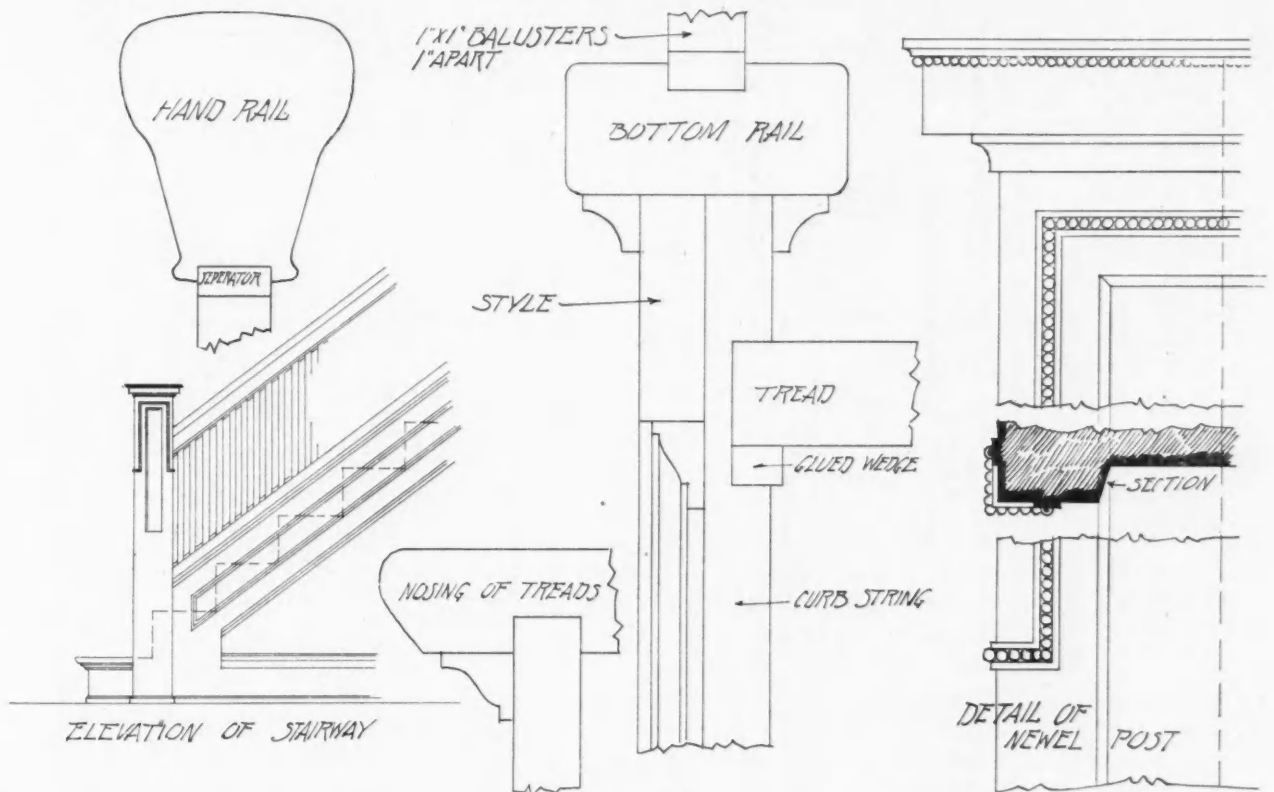

the toilet room partition, not only to concentrate the plumbing pipes and to get the sink on an inside wall to prevent freezing of water pipes, but also for convenience, as dishes can be returned from the dining-room to the kitchen through the slide (see plan), and

dining-room from the kitchen through the pantry are so arranged that it is not necessary to turn one step out of the way, thus making it as convenient as a direct door from dining-room to kitchen and at the same time having the advantage of the two doors to

prevent odors. The pantry is large, light and well equipped with shelves, bins, drawers, cupboard and work table.

The dining-room is very homelike, and has a pretty

is necessary to give convenient entrances to the three bedrooms and bathroom. These bedrooms are all of commodious dimensions, having been carefully planned as to location of doors and windows in reference to the location of furniture, light and ventilation. All these rooms have extra large closets; two of these closets have windows. As before mentioned, all bedrooms have south light and are protected from the cold north by the closets and hall. The bathroom is located conveniently near to all the bedrooms, and also so as to make the plumbing directly over the plumbing on first story. As the writer is limited to space, let it suffice to say in regard to the interior woodwork that the hall, living room and dining-room are trimmed in oak and balance of house in birch. All inside trim is of a tasty design, and at the same time very inexpensive for the fact that the same planer knife will cut all the various members, as will be seen by the illustrations.

The building is piped for gas and wired for electric

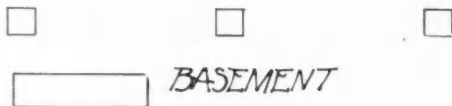
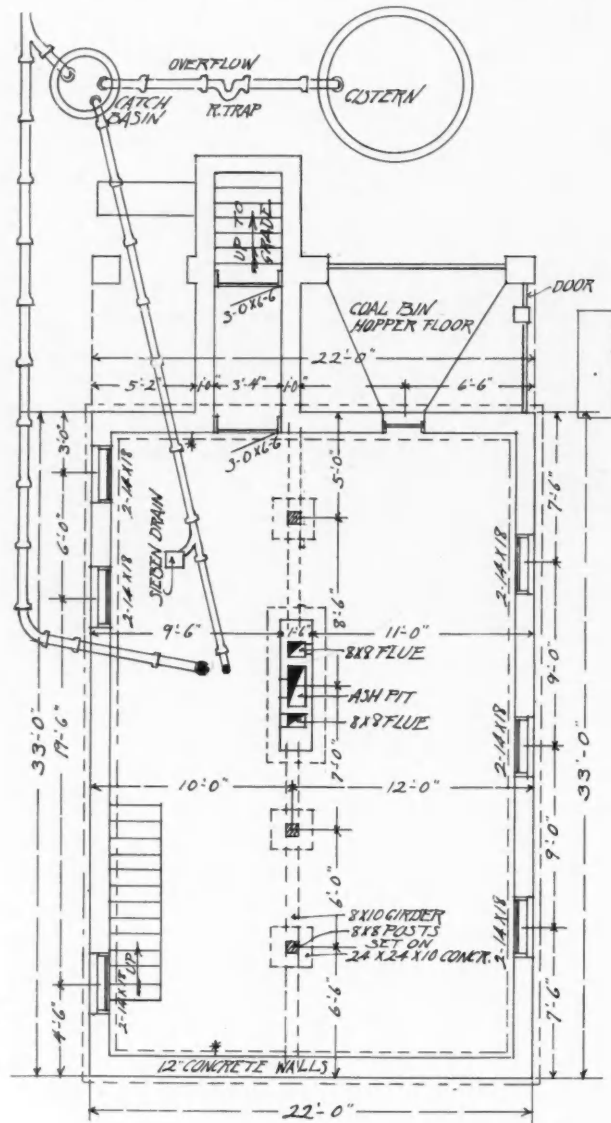

fireplace, which gives cheerfulness to the room and adds greatly to the ventilation. This fireplace is of a special design, being in harmony with the decorations of the room. Over the moss-green tile fireplace is a wide weather oak shelf and cabinet, which forms a sort of sideboard and bears the very appropriately carved inscription, "May the gifts we offer here, graces from thy favor take."

The dining-room has a vestibule leading to the east porch for the convenience of the family, and has large sliding doors to the living room.

The second story hall has no more floor space than

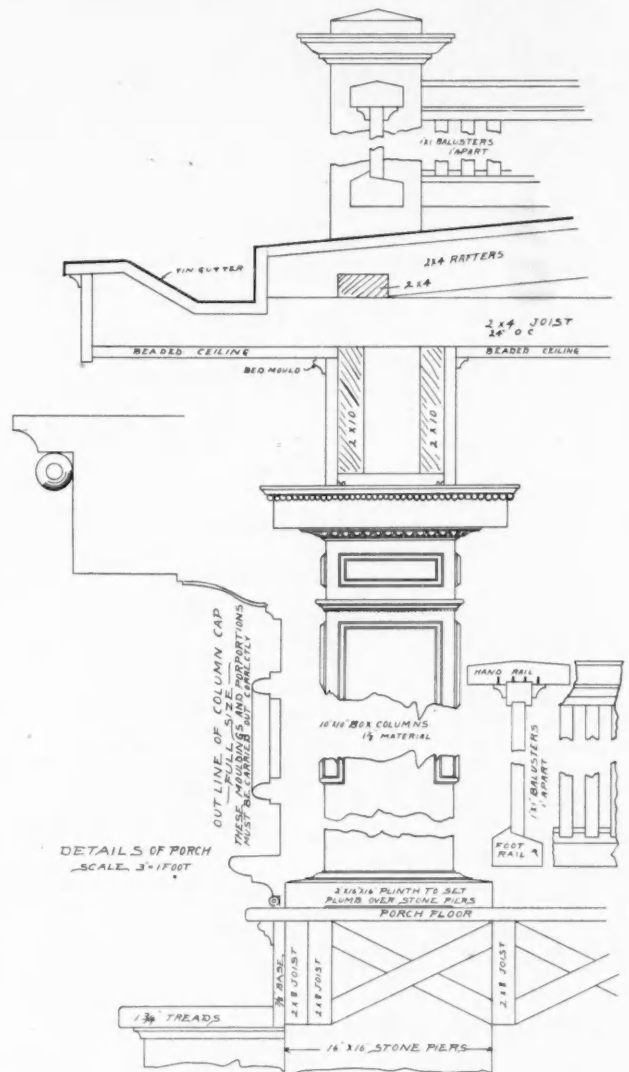

lights. All plumbing fixtures are supplied with hot and cold city water and soft water from cistern.

It has hot water heat and special attention has been

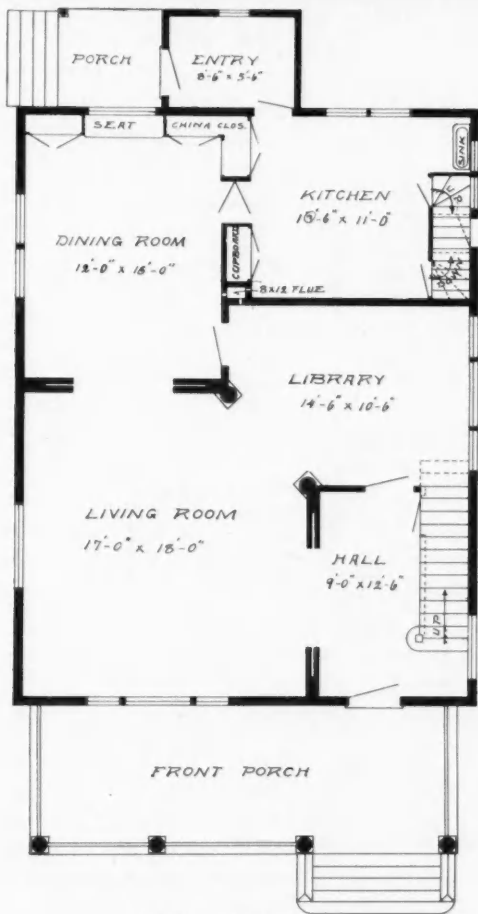

FIRST FLOOR PLAN

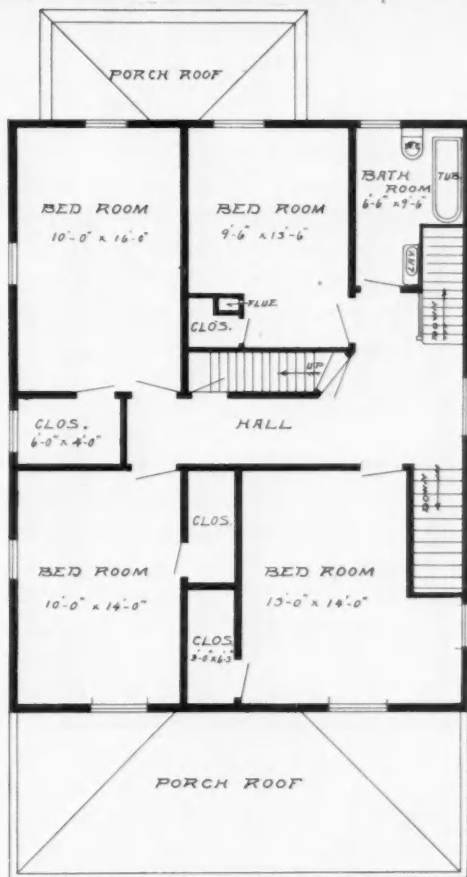

SECOND FLOOR PLAN

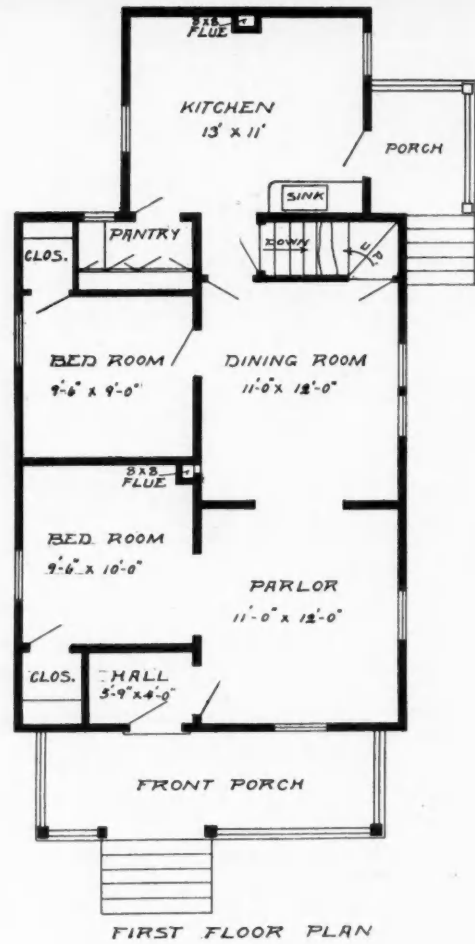
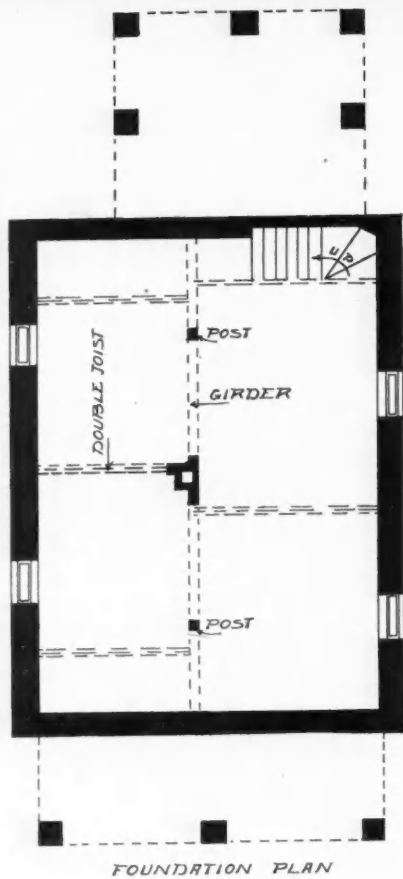
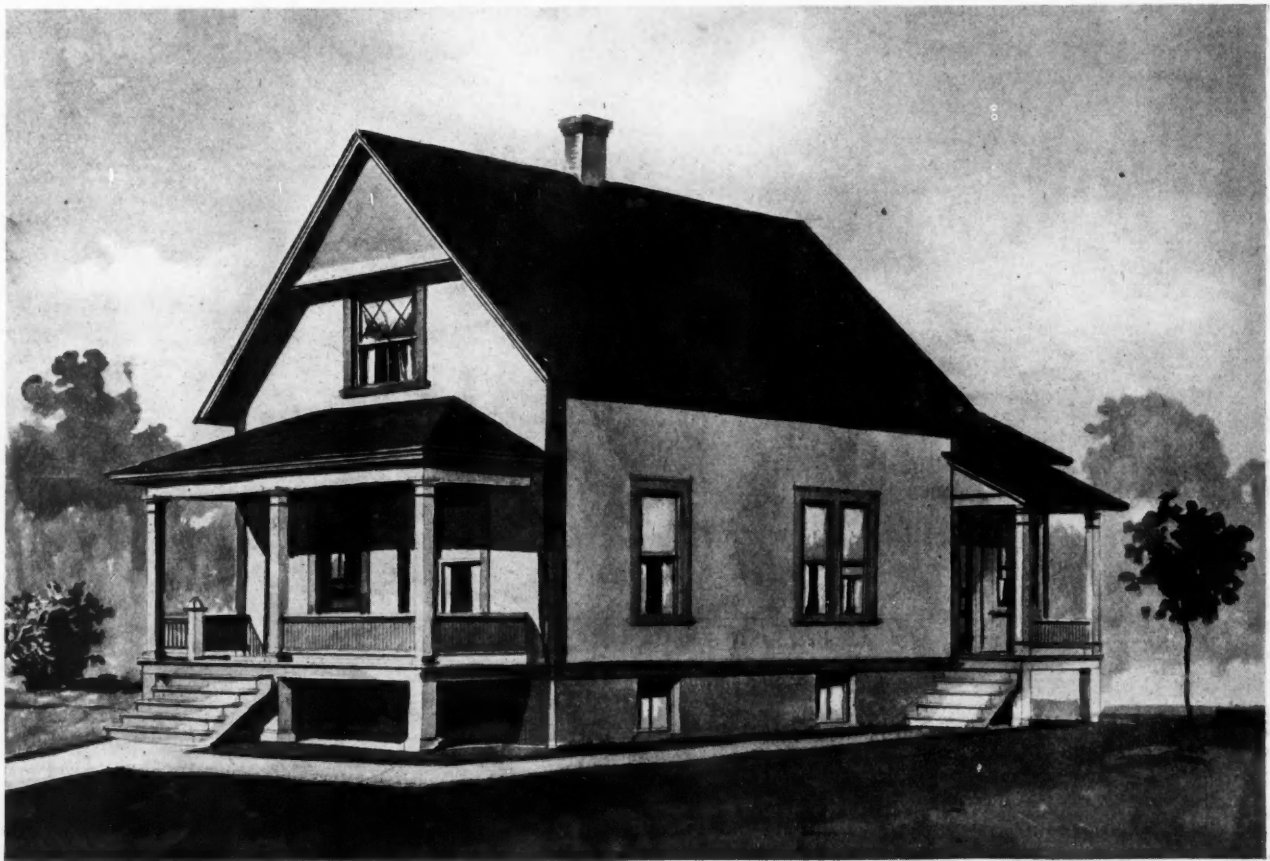

given to ventilation, each room being equipped with baseboard registers to draw out all foul air, while fresh air is admitted through a duct in basement having an indirect radiator. The cost of the building is \$1,900.

Well Constructed House

The house on page 741 was designed and constructed by Geo. Issenhuth in Huron, South Dakota. The basement wall is constructed of cement blocks and the rest of the house is frame. The cellar extends under the back half of the building and is equipped

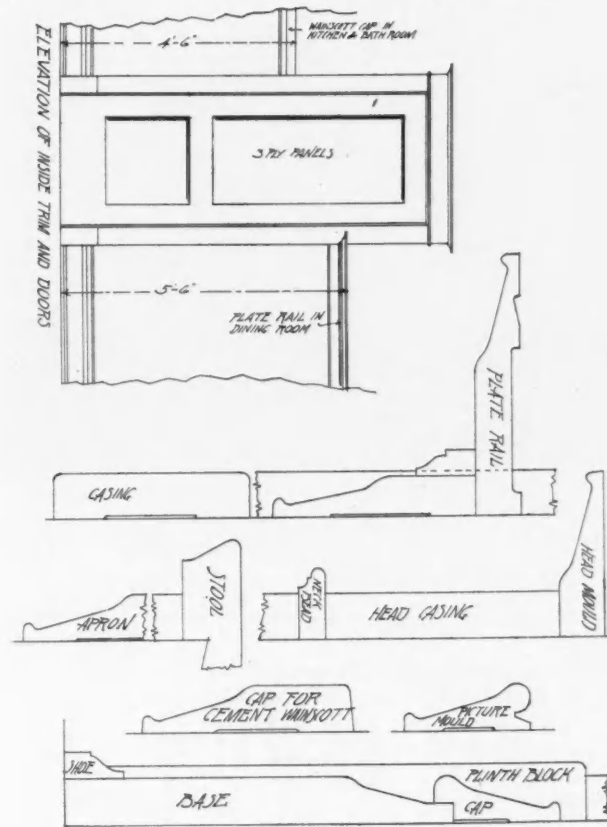

with a hot water heating plant. The first floor is divided into the living room, dining-room, library and kitchen. The living room is the largest room in the house and is divided from the library by means of drop curtains and from the dining room by a double door. The dining-room is twelve and one-half by fifteen feet and is equipped with a good-sized china closet. The kitchen has a large cupboard and has a stairway leading to the cellar and one leading upstairs. The main stairway to the second floor is in the large front hall. The second floor is divided into four large bedrooms and a bathroom. The bedrooms all open directly into the hall and all have large clothes closets. The floors, with the exception of the kitchen and bathroom, are laid with clear kiln dried southern pine. The kitchen and bath room are laid with dry select first fenced flooring. The entire outside finish of the house is of pine. The porch ceiling is of matched clear yellow pine. The entire inside finish

on both floors is of smoothed southern yellow pine, prepared for oil finish. The entire cost of the house, including hot water heating and plumbing, was \$4,000.

Another Practical House

The house illustrated on page 742 was designed by Simon Fluor and has met with great favor, as it is inexpensive, attractive and very practical. There is a basement under the entire house, and the arrangement is shown in the foundation plan. There are four windows in the cellar, which makes it light and also assures good ventilation. The first floor is divided into the parlor, dining room, kitchen and two bedrooms. The rooms are all nearly square, thereby making use of all the available space. The kitchen is arranged as a small addition to the main part of the house, but is very conveniently located with regard to the dining room, pantry and stairway to the cellar. Both bedrooms are equipped with large closets which is a great convenience. The second floor can be arranged into one or two bedrooms, as there is a large window in the front part of the house, otherwise it can be used as a storage room.



Chicago's Leaning Towers

A peculiar condition has been developed in connection with the tall buildings in Chicago, according to the investigations of James N. Hatch, a civil engineer of that city. He asserts that many of the tall buildings of the Windy City are veritable leaning towers of Pisa, and that a remarkable feature of the matter is that they all lean toward the east. "This," he says, "may be due to the prevailing west winds which sweep across the level prairie. That this wind pressure is no insignificant item may be realized when it is known that on a building the size of the Masonic Temple, wind blowing at the rate of 80 miles an hour would exert a pressure of 700 tons. This would bring a pressure on the foundations of the east side of the building exceeding that of the west side by a very considerable amount."

The inference drawn by Mr. Hatch is that this great wind pressure has caused the foundations on the east side of the buildings to be subjected to a much greater pressure than the west side and, therefore, the east side has shown an inclination to sink. Mr. Hatch doesn't expect to witness any great disasters as a result of this condition, but merely presents it for the consideration of builders who may hereafter be constructing Chicago foundations.



A Great Educator

"The AMERICAN CARPENTER AND BUILDER is doing a great work along educational lines for mechanics. We could not afford to be without it."—Gurley Bros., Grant, I. T.

Farm Buildings

HENRY H. NIEMANN

A Model Dairy Barn

LOCATED NEAR THE COW BARN FOR GREATER CONVENIENCE—VARIOUS DEPARTMENTS IN THE SAME—
CONSTRUCTION AND MATERIALS USED

THIS month we illustrate the dairy building of the Geo. B. Robbins farm, which is located directly west of the cow barn and so arranged that the milk can be brought from the west door of the cow barn directly to the receiving vat in the dairy building. The milk cans are unloaded from the truck on to a plat-

form, from which the milk is poured into the receiving vat from the outside of the building, thus avoiding the opening and closing of outside doors, which is very essential in order to maintain a uniform temperature in the building and to prevent the admittance of any impure air. From the receiving vat the milk flows by gravity through the various machines and apparatus without having to be handled by any hands until it is sealed in bottles, not only for economical, but more especially for sanitary reasons.

through the cooler and into the bottling machine, which is located in a pit in the center of the milk room. The filled and sealed bottles are then placed into wooden delivery boxes for immediate delivery, or else are stored in the refrigerator ready for use when necessary.

In order to obtain a purely sanitary milk much de-



WEST ELEVATION OF DAIRY HOUSE

From the receiving vat the milk flows into the separator and after the milk has been separated from the cream it is again mixed together and then flows

depends on the care and cleanliness of the various receptacles, therefore too much emphasis cannot be placed on the washing and sterilizing. All the bottles are thoroughly washed by machines, which can do the work very thoroughly and rapidly by revolving brushes, etc., and after a thorough washing they are set into the sterilizing oven, which is equipped with steam coils and steam jets.

The butter room is located to the left of the milk room and is well equipped with the most up-to-date churns and also contains the testing machine and other apparatus. The refrigerator is divided into compartments, and is of the most approved construction, but

as we are here limited to space the writer will in a future issue of this magazine go further into the detail of its construction with illustrations of the same.

on the outside. Between these is placed a double thickness of heavy building paper. The space between the studding is filled with mineral wool and the in-

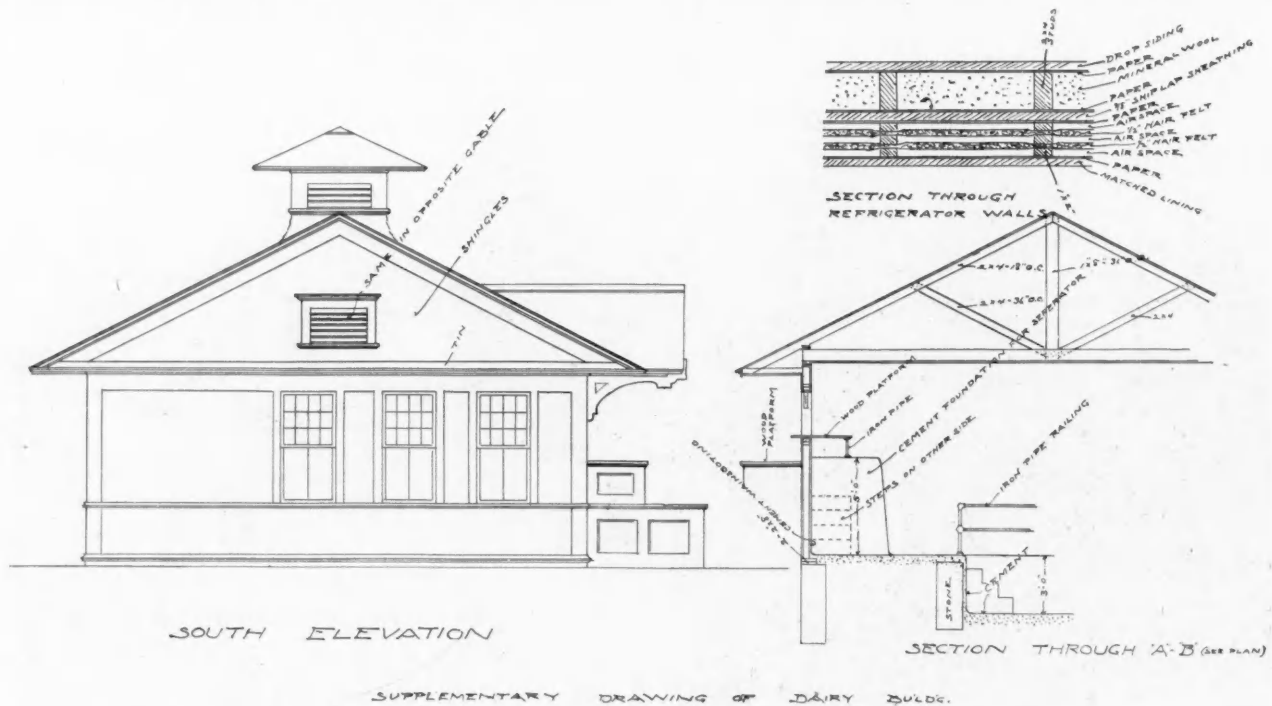

The construction of this building is of the usual balloon type, having a stone foundation under walls of 2 by 4-inch studding, which are sheathed and sided

side surface of walls and ceilings are lathed and plastered with Portland cement. All the floors are also of cement, which admits the free use of the hose.

Six-Room School

PERSPECTIVE AND FLOOR PLANS SHOWING THE ARRANGEMENT OF THE ROOMS—KINDS OF MATERIAL TO USE IN CONSTRUCTION

THIS month we are showing the perspective and floor plans of a six-room school. It is designed for a corner site and has a diagonal entrance. The style of architecture is known as the Mission style and is very desirable for school buildings.

The building is constructed of stone to the first story window sills, above this paving brick is used. The roof is of Spanish red tile and the trim is of white cut stone.

There is a basement under the entire building and is divided into the furnace room, fuel room, boys' and girls' playrooms and toilet rooms.

The first floor has three large class rooms, each twenty-five by thirty-two feet and have a seating capacity of forty-five to fifty students. Each room has a large cloak room attached, through which the children can march in going to or coming from the school room and can get or leave their wraps in an orderly manner. A teacher's room fifteen by eighteen feet is at the end of the first floor corridor and is a great convenience to the teachers.

There is a large vestibule at the entrance which is a good feature, as it protects the stairway from ice and

snow in winter, and also prevents drafts in the corridor.

The second floor is the same as the first except that in place of the teacher's room there is a library and a large office for the principal is above the vestibule.

The idea of having a library in a school is a good one and should be encouraged, as the teachers can in this way train the children to read good books. If left to their own resources the children would read the sensational and trashy books, but if led in the right channel they will acquire the habit of reading books which are of help to them. With the large amount of good literature which is being published there is no necessity for children reading books which cannot help having a bad influence over them.



Proud of the Journal

I am very proud of the AMERICAN CARPENTER AND BUILDER and would not do without it.—F. I. Hager, Longtown, Mo.



Business success needs three things—knowledge, push and good advertising.

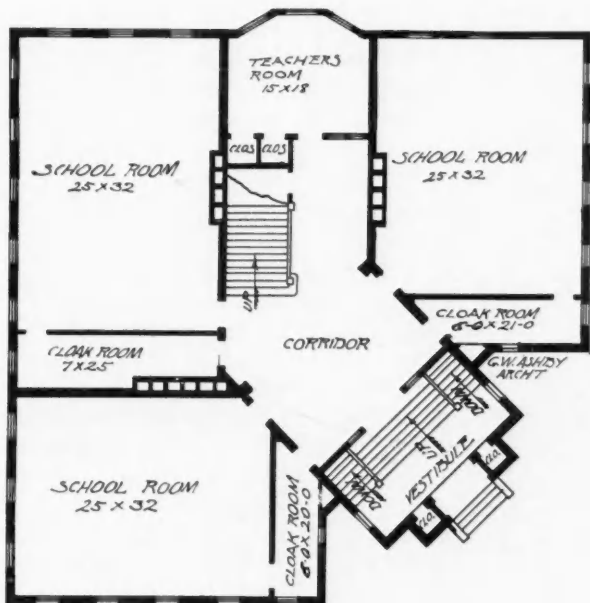

FIRST FLOOR PLAN

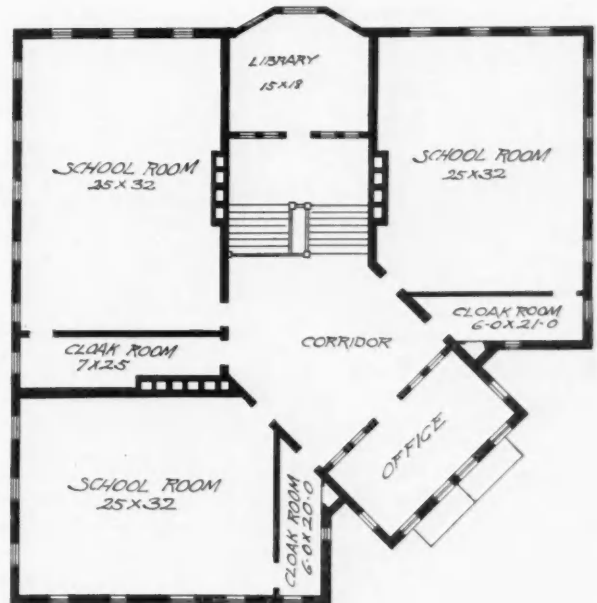

SECOND FLOOR PLAN



Traps for Plumbing Fixtures

DIFFERENT KINDS OF TRAPS IN USE—WHERE USED TO THE BEST ADVANTAGE—WORKING OF EACH AND REASON FOR SAME

A TRAP is a device or fitting used to allow the free passage through it of liquids and solids, and still prevent the passage of air or gas in either direction. There are two kinds of traps used on plumbing fixtures known as syphon traps and anti-syphon traps. The simplest trap is the syphon trap—a horizontal pipe bent as shown in Fig. 1. This forms a pocket which will retain enough liquid to prevent air

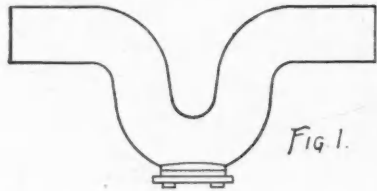

or gas from passing. The dip or loop is called the seal, or, speaking more plainly, the distance between points "A" and

"B" is called the seal, and should never be less than one and one-half inches. This type of trap is what is known as a running-trap. This is not a good trap to use, as it is only capable of withstanding a very low back pressure.

The trap most generally used is what is known as the "S" trap, as shown in Fig. 2. When this trap is subjected to a back-pressure, the water backs up into the vertical pipe, and naturally will withstand a greater pressure than the running-trap type—about twice as much.

The trap shown in Fig. 3 is what is known as a "P" trap, and in Fig. 4 as three-quarters "S" trap, and has the same resisting power as the "S" trap.

A trap may lose its seal either by evaporation, self-

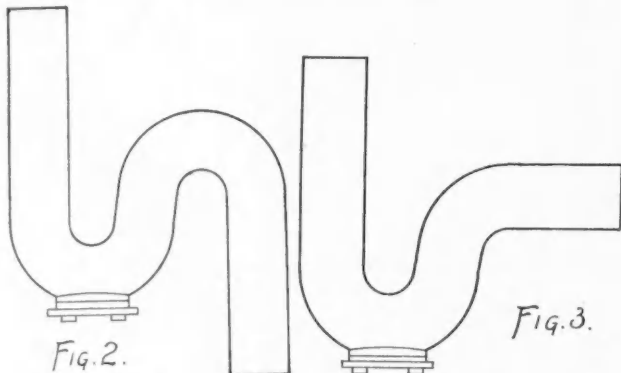

syphonage or by suction. There is no danger of a trap losing its seal in an occupied house from evaporation, as it would take a number of week's time, under

ordinary conditions, to evaporate enough water to destroy the seal.

A trap can be syphoned when connected to an unvented stack, and then only when the waste pipe from the trap to the stack extends below the dip, so as to form the long leg of the syphon, as in Fig. 5.

When two fixtures are installed one above the other, with unvented traps and empty into one stack, the lower trap can be syphoned by aspiration. The water emptying into the stack at the higher point in passing to the trap inlet of the lower fixture, creates a partial vacuum which sucks the water out of the trap at the lower point. To prevent this, what is known as back-venting is resorted to; back-venting not only protects the trap against syphonage, but relieves the

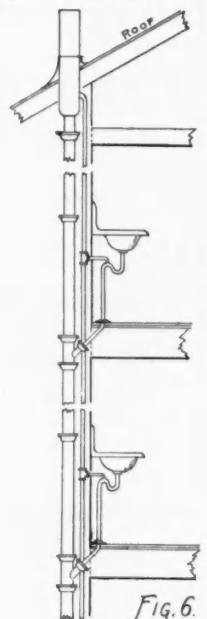
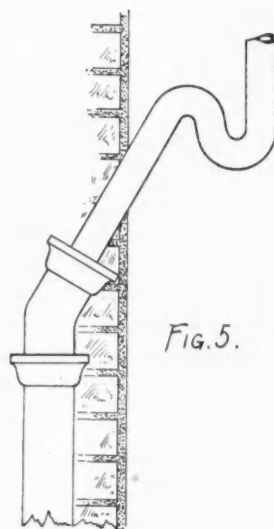
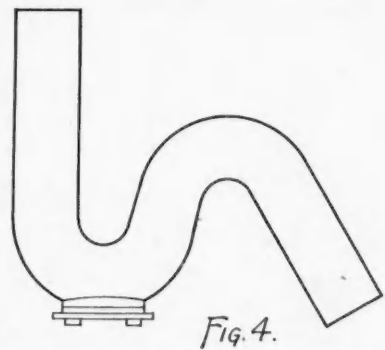

seal from back-pressure, by equalizing the pressure on both sides of the seal. All vent pipes must be connected to vent pipes at such a point that the vent

opening will be above the level of the water in the trap.

In Fig. 6 we show two basins connected to soil pipe with "S" traps and back, or reverted into the vent

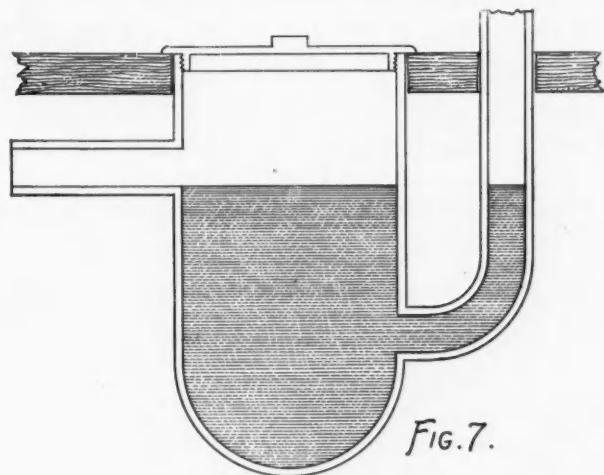

FIG. 7.

pipe, both connecting into the attic into an increaser, which projects through the roof. We give this sketch simply to illustrate the proper back-venting to prevent syphonage of basin traps, and when it is necessary

to run separate stacks for wash basins, such as are sometimes installed in bedrooms, the main waste stack must be two inches in diameter and the vent pipe one and one-half inches—either cast iron or galvanized wrought iron.



FIG. 8.

Non-syphon traps are those in which the seal cannot be broken under any reasonable conditions. Some water can be syphoned from the best of non-syphon traps made, but not enough to destroy their seal. The commonest non-syphoning trap is known as a drum trap, which is four inches in diameter and ten inches deep. Sufficient water always remains in this trap to maintain its seal, even when subjected to the severest of syphonic tests.

Fig. 7 shows the trap which is the type generally

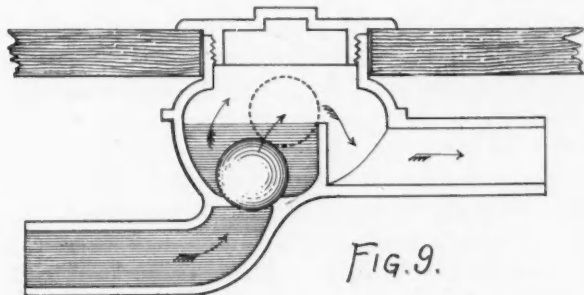

FIG. 9.

used to trap the bath tub. This trap is provided with a brass trap-screw top for clean-out purposes, made gas and water tight against a rubber gasket. A trap

of this kind would not be suitable for a lavatory, its principal fault being that owing to the enlarged body they are not self-cleaning, affording a fouling place for the depositing of sediment.

The non-syphon trap to be used is one in which the action of the water is rotary, as it thoroughly scours the trap and keeps it clean, such as is shown in Fig. 8. This trap depends upon inner partition to effect this rotary movement, and is so constructed that its seal cannot be broken by syphonic action and is permitted by health and sanitary departments, where it is impossible to run a separate vent pipe to the roof.

One of the oldest traps is the Cudell trap, as shown in Fig. 9. The rubber ball being of slightly greater specific gravity than water rests on the seat and forms a seal when the water is not flowing through the trap. This ball prevents the seal of the trap being forced by back-pressure, and acts as a check against back flow of sewerage should drain stop up, and provides a seal if water is evaporated.

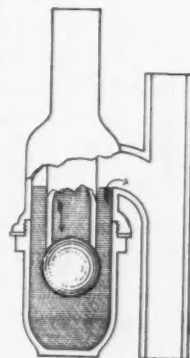

FIG. 10.

In Fig. 10 we have the old Bower trap. The water seal is maintained by the inlet leg, extending down into the body below the outlet, the rubber ball advantages being described in a previous chapter. The bottom of this trap is glass, brass or lead, whichever is desired, and can be unscrewed from trap and thoroughly cleaned.



Cement in South Africa

It may be of interest to some readers to learn that there is a fair prospect of manufacturing Portland cement, of the highest grade, to the British standard specification, in the South African colonies. An old-established Portland cement manufactory in England has succeeded in finding deposits of the necessary raw materials lying in close proximity to each other in the neighborhood of Kroonstad in the Orange River Colony and on the main line of railway from Bloemfontein to Johannesburg, and it is intended to erect works there. The importance and value of manufacturing Portland cement in the South African colonies has long been known, but, up to the present, the necessary raw materials for producing first-class Portland cement have not been found in proximity to each other nor in suitable positions for cheap transit. A recent trade conference held at Bloemfontein, recognizing the importance to the colony for establishing the manufacture of Portland cement, recommended the Orange River Colony Government to offer a bounty to the first works established. It is stated in reference to the foregoing that the sea transit and railway carriage from the coast to Johannesburg amount to four times the prime cost of Portland cement in England.

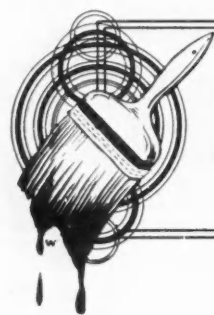

PAINTING

EDWARD HURST BROWN

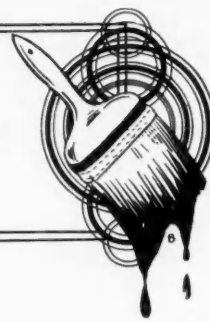

Painting the New House

GUMS USED IN THE MANUFACTURE OF VARNISHES—DIFFICULTY IN SECURING THEM—DANGER IN USING SHELLAC CONTAINING WOOD ALCOHOL

THE resins used in the manufacture of oil varnishes are known to the trade as copals or gum copal and are distinguished by the locality from which they are obtained.

The hardest of the varnish resins is the Zanzibar copal, which comes in small flat pieces, having a surface resembling gooseskin, and hence is known as goose skin copal. Next come the Sierra Leone, the Gaboon and the Angola copals, all of which, like the Zanzibar, are fossil resins found in Africa.

The copal which is chiefly used by American varnish manufacturers, is the kauri copal, found in New Zealand, and named from the kauri tree, of which it is a fossil product. Great forests of the kauri trees still grow in the island, and some of the lumps of fossil resin are found deep in the ground beneath these trees, but by far the larger part is found in portions of the island where no kauri trees have existed within the memory of man. The kauri tree is probably the most slow growing plant known. A sapling planted by the government in Auckland was still a sapling a hundred years later, and some of the great trees in the forests now standing were undoubtedly in existence long before the pyramids of Egypt were built. As in the case of many other trees a resinous substance exudes from the kauri tree, chiefly at the junction of the main branches with the trunk and under the forks of some of the large branches. But it is almost impossible to realize how slowly this lump of gum grows. Not less than a hundred years would be required for the formation of a lump the size of a man's head. But fossil lumps are found occasionally which weigh a hundred pounds or even more, to produce which ages must have elapsed. The fossil gum has come from trees that centuries or perhaps thousands of years ago either perished of old age or from which branches were torn off by storms, carrying with them the lumps of gum that clung to them. The wood decayed and became a part of the soil, but the gum remained covered with the earth and grew harder as centuries passed, until it has become exactly what the varnish maker of to-day needs. The gum diggers are mostly outcasts of society, both men and women, who have failed to earn a living in other occupations and have turned to gum digging as a last resort. The earth is

prodded with a long spear of peculiar shape to detect lumps of gum which are often concealed several feet below the surface, and the experienced digger can detect by the feeling of the object struck whether it is the desired gum or merely a stone or piece of charred wood from some forest fires of ages past. More than two million dollars worth of gum, thus collected, is shipped from New Zealand every year, the greater part of it coming to New York, and although the exhaustion of the supply has been predicted frequently, it still seems to be sufficient for a long time to come. Varnish made from the kauri copal is not as durable as that made from the African copals and does not equal it in other respects.

Manila and Borneo copals are also much used in varnish making but are inferior to the kauri, being much softer. The West India and South American copals are little used in the United States and are soft and of inferior quality.

Common rosin, or colophony, is the residue remaining in the still after the spirits of turpentine has been distilled off from the crude turpentine. This latter is the sap of the long-leafed pine of the South Atlantic states. It is probable that the crude turpentine is chemically decomposed in the still and is broken up into two parts, one of which is the spirits of turpentine or the "turpentine" of the painter, and the other part is rosin. Rosin is much used in varnish making. The addition of a small percentage to an oil-resin varnish of the better grade will often make it ready for use earlier than it would be by a simple aging process. The addition of not more than from three to five per cent of rosin to a copal varnish cannot necessarily be regarded as an adulteration. But when it is added in larger quantities, as it frequently is, it is done solely for the purpose of reducing the cost of the varnish. When added in large quantities it is injurious to the varnish, causing it to crack. The cheap varnishes used in the factories where low-priced furniture is made are almost entirely made from rosin, and such varnish will crack and peel in a manner that is very disheartening. The same result may be expected when rosin varnish is employed for finishing the woodwork of a house. Unfortunately there are many unscrupulous painters who care little for

the quality of their work and ask only for cheapness in the purchase of the materials which they use. Such painters will invariably use cheap rosin varnishes, even though better grades have been specified, and as such varnishes can be made so that they will dry with great brilliancy, the fraud is not detected until after the painter has received his pay. But the varnish will soon begin to lose its luster and before very long will crack and peel, leaving a surface that it is almost impossible to refinish over satisfactorily. The cheap painter thus always proves to be the expensive man in the end. Indeed, in no other department of painting is the advantage of paying a fair price for honest work and materials so great as it is in hardwood finishing. It pays to give a good price for a varnish and to get the best for the purpose that can be bought. Of course, by this, it is not meant that it is necessary to pay a high price to buy a varnish that is very light in color, when a dark wood is to be varnished. This light color is obtained by sorting the lumps of gum for their color, before they are melted, since the light colored gum will produce varnish of greater paleness, but otherwise the quality will be no different from that made from the same kind of gum, only darker. Extra light or pale varnish always commands a much higher price than that made from the general run of the gum. Of course it is essential, when finishing such woods as white holly or when mixing white enamels, but for ordinary work, where extreme lightness of color is no object there is no advantage in using an extra light varnish.

For exterior work a special exterior varnish should always be specified. Each different manufacturer calls his exterior varnish by a special name, but the fact that it is intended for outside use and is expected to stand severe exposure is always indicated by the name. Exterior varnishes are also known as spar varnishes, because they are largely used for coating the spars and exposed woodwork of ships. They are higher in price than the corresponding grades of interior varnish because it is necessary to use the harder and more expensive copals in their manufacture. But although the gums used are hard, exterior varnishes must dry with more elasticity than is necessary for interior varnishes, since they must stand greater changes of temperature.

Interior varnishes are of two classes, those that are adapted for rubbing to a dead surface or to a polish and those which cannot be rubbed but will roll up under the action of the pumice stone. Left in their natural gloss, these latter varnishes would remain in good condition as long as a rubbing varnish. When a dead surface is required a rubbing varnish should be specified. Within the past few years, a class of varnishes has been introduced that dry with a dull gloss, somewhat resembling the effect of rubbed work. These varnishes can be used for the last coat where this dull effect is desired and where the owner is will-

ing to use a substitute in order to save money. They are probably as durable as a rubbed finish, but they lack the smoothness and beauty of a dead finish produced by rubbing. Moreover a little more gloss is left than is found in the rubbed surface.

Furniture varnishes are usually inferior to first-class architectural varnishes and should not be specified where good work is desired.

Floor varnishes are specially made to stand the hard wear that a floor gets. They are made so as to dry fairly quick—some of them drying over night—and as a rule will stand considerable wear. Floor varnishes are generally made with less body than other finishes, and will consequently spread over a larger surface, leaving a thinner film of varnish. This is one thing that makes them dry quicker than the ordinary varnish, and thin coats on a floor are less liable to mar from heel marks; but in spite of the claims of the manufacturers it is impossible to produce any varnish that will not sooner or later mar badly from foot marks.

There is no such thing as a thoroughly satisfactory general purpose varnish, and the architect in writing a specification for hardwood finishing should be careful to select only such grades of varnish as are adapted for the work in hand and should not make the mistake of specifying a special grade of varnish for work it is not intended to do. But there are objections to specifying brands of varnish that have better grounds than similar objections for any other class of materials. As has been before stated, experience counts for a great deal in varnish making. No two manufacturers will produce a product that is exactly alike in every particular. Probably no other painting material is more tricky than varnish and until a painter has had considerable experience in handling any particular make and grade of varnish, he will not know how to use it in order to get the best results. While a given varnish, in the hands of a man who has become used to its peculiarities, may be all that is desired, in the hands of a man who has not learned how to use it, it may turn out entirely wrong and may cut up any of those "deviltries" for which varnish is proverbial. Therefore, if the architect or builder has confidence in the honesty and ability of the painter who has the contract for the work, it is much better to permit him to use the varnish he has grown accustomed to, instead of requiring him to use a brand that he is unfamiliar with and whose peculiarities he does not understand.

Spirit Varnishes

The two spirit varnishes most generally employed by painters are shellac and gum damar. Shellac is dissolved in alcohol, or "cut" with alcohol as the painters say, to produce shellac varnish and gum damar is dissolved in turpentine with the addition of some absolute alcohol to produce damar varnish.

Shellac, when pure, is one of the most valuable materials used by the painter. Not only does it pro-

duce a hardwood finish of a beauty difficult to surpass, and of great durability when not exposed to the influence of moisture, but it is almost essential as a sap and knot killer under paint. Unfortunately a great deal of shellac has been placed on the market that has been largely adulterated with rosin for the purpose of cheapening it. Not only has the shellac varnish been so adulterated, but even the gum shellac has been adulterated in the East Indies where it is produced. Until recently there has been practically no way to detect such adulteration, but about a year ago, Dr. Iangmuir, the chemist of a well known firm of shellac importers in New York City, perfected a test by which adulterated shellac can be detected almost instantly by its effect in darkening the testing reagent. Pure shellac, on the contrary, causes no discoloration.

Shellac may be cut with either grain or wood alcohol. The grain alcohol shellac is much superior in every way, flowing freer under the brush and not showing laps, something difficult to avoid in using wood alcohol shellac. Moreover recent investigations have shown that wood alcohol, which has long been known to be a deadly poison, when taken internally, also has a very injurious effect on the human system when used in confined locations where the vapors rising from it are apt to be inhaled by the person using it. Within the past few months there have been two well authenticated cases of blindness caused by the

use of wood alcohol, either as a solvent for varnish which it was desired to remove or as a solvent for shellac with which varnishing was being done. One of these was in Chicago, the other in Lynn, Massachusetts. No one knows how many similar cases may have occurred where the cause of the injury has been attributed to something else. For this reason, if for no other, the use of wood alcohol shellac should be avoided.

In making grain alcohol shellac, one gallon of the alcohol will cut about four pounds of shellac. With grain alcohol at \$2.50 per gallon and shellac at 45 cents or more a pound, it stands to reason that much of the shellac sold as pure grain alcohol shellac cannot be anything but deodorized wood alcohol shellac—this being indicated by the price.

Damar varnish is mostly used in making enamels or in varnishing over enameled woodwork. Mastic varnish is used for coating oil paintings. Sandarac varnish is used for polishing.

Amber varnish is sometimes referred to but is practically never met with in any ordinary wood finishing. It is believed that the varnish used by the celebrated Italian violin makers was made by fusing amber. Amber is so difficult to fuse, that it is possible only to make a few ounces of amber varnish at a time, this fact precluding its use in modern times when, in order to make any profit, all manufacturing operations must be carried on upon a large scale.

Suggestion for a Hall Decoration

KINDS OF COLOR TO USE TO BRING ABOUT DESIRED EFFECT—DRAPERIES AND FURNITURE TO USE TO BLEND WITH THE GENERAL SURROUNDINGS

By Sidney Phillips

THE hall of a country house is paneled for some six feet high with large flat panels, having a narrow molding and broad flat stiling. This woodwork is all of quartered oak, the stiles and rails being finished with a gray stain or dye, and the panels being stained with a transparent sealing wax red. This staining should preferably be done with water or spirit stains and the wood afterward finished with wax, which gives a soft velvety effect impossible to obtain with varnish. At the intersections of the stiles and rails are large headed blued iron nails, giving a massive appearance. Above the dado, a narrow English wall paper border is used, a Dutch landscape design, in broad flat tones of greens and blue grays, showing winding streams flowing through grassy meadows, with distant windmills and church towers and softly rounded foliage. Above this, the wall is hung with a soft gray burlap that runs to the deep beamed ceiling. The quaint doorway has an upper sash panel glazed with heavy thick greenish glass, and is trimmed with heavy strap hinges and a lock and kick plate of blued iron. The door and window casings are broad and flat with a delicate stencil design

in red, put on underneath the wax. A slight amount of stenciling is also used on the cornice, between the beams and on the panels of the ceiling. The floor is of oak, the central portion being treated with a red stain and the border being gray.

In another hall, where the wainscoting was finished in white enamel rubbed to a dead finish, a stencil design of a light tracery pattern was executed in gold size japan and afterward gilded with leaf gold.

In still another house, where oak paneling was used in a small reception room, the woodwork was gilded on the unfilled wood, the gilders' brush being used to force the gold leaf into the open grain of the oak, and thus relieve the garish effect which would otherwise have been produced by large masses of gold on a plain smooth surface. Of course, in this apartment the draperies were necessarily in heavy dark colorings and the furniture was of Flemish oak upholstered in dark red velours.



Advertising isn't an art; it's just applied common sense.

MANUAL TRAINING

IRA S. GRIFFITH

Something the Boys Can Make

HOW TO MAKE THE VARIOUS PARTS OF A STOOL—FINISH TO GIVE TO THE DIFFERENT PARTS—MANNER OF WEAVING THE SEAT

IN THE November number of the AMERICAN CARPENTER AND BUILDER a description of how to make a blind mortise and tenon was given in connection with the making of a settle. There are several ways of making the tenon and mortise; and, as it plays such an important part in carpentry and cabinet making, several pieces of furniture will be described having one or more of the various modifications of this joint before proceeding to another kind.

gauging from an XX side of course. Plane the unsmoothed surface to the gauge line. Repeat until the four legs have been gotten out.

Now square up one end of each leg remembering to keep the beam of the try-square against each of the two XX sides. Measure from this end sixteen inches and with pencil and try-square place a line around the four smoothed sides at this point. Set the bevel, or bevel-square as it is sometimes called, so

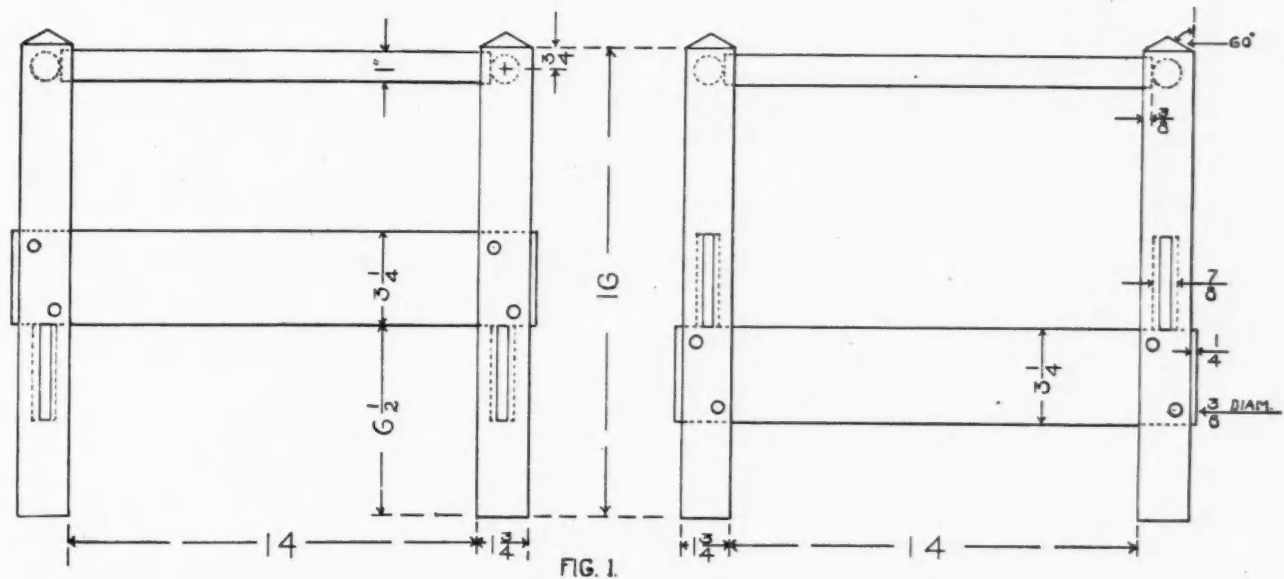

The seat, Fig. 1, has been found simple enough in its construction for any boy of fair ability to make easily. It contains a through tenon and mortise.

For the legs, get a piece of stock seventeen inches long by eight inches wide, preferably oak, of sufficient thickness to dress to an inch and three-quarters. Plane one surface just enough to get it smooth and level. Joint up one edge so that it shall be straight and square to the surface just planed. Set the gauge to one and three-quarters inches and gauge from this jointed edge. Rip off this piece allowing a little margin for smoothing up. Mark the two planed surfaces XX, one for working-face and the other for joint-edge. Plane to the gauge mark just made. Without changing the setting of the gauge mark so as to have the piece of the same thickness as width,

that its blade shall make an angle of sixty degrees with the handle, Fig. 2.

Place the bevel along the sides of the leg so as to lay off lines as shown in Fig. 2. Place similar lines on the side opposite the one just marked. Saw along and plane carefully to these lines. This leaves the top of the leg like a house roof with two gables. Now locate the middle of the ridge and connect this point with each of the four corners, drawing the lines on the sloping surfaces. Cut to these lines and the top will then slope from each of the four sides to a point. The bevel can be used to test the slope while planning.

Square up the four rails from stock that will dress to a thickness of seven-eighths of an inch. They should be three and one-quarter inches wide by eighteen inches long each. If stock dressed to seven-

eighths of an inch at the mill is used, the mill marks should be planed, the plane bit being set very shallow. One-inch dowel rods are to be used for the top rails.

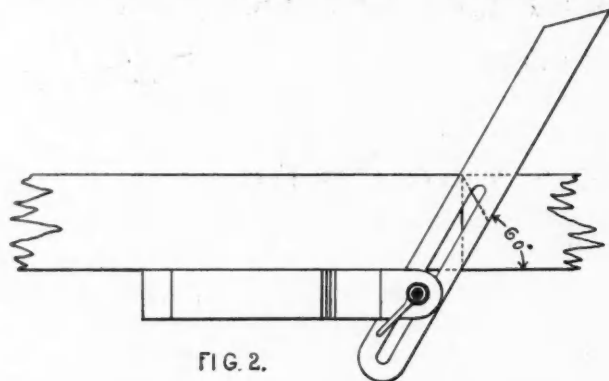

FIG. 2.

They are to be cut to fourteen and three-quarters inches in length.

Too great care cannot be taken in the laying out of the mortises. The positions which the legs are to occupy relative to one another must be kept constantly in mind. Stand the legs upright so that the XX surfaces shall face outward and place pencil marks approximately where the mortises are to be cut.

Lay the legs side by side on the bench and even the ends by means of the square. Measure from the bottom of one of the legs six and one-half inches

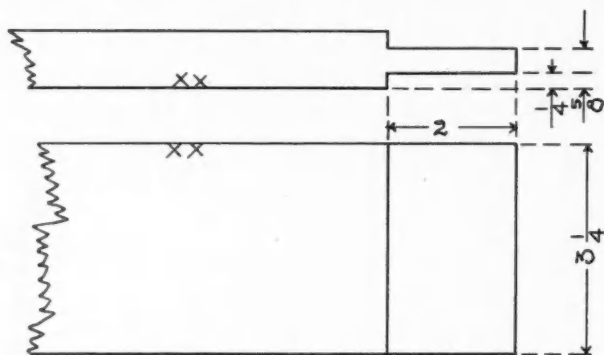

FIG. 3.

and square a sharp pencil line across the four pieces. With try-square and pencil carry this line entirely around each leg.

Now measure up three and one-quarter inches from this mark to locate the upper ends of the higher mortises and, on an adjacent side, measure down the same distance to locate the lower ends of the lower mortises. Since the mortises are to extend entirely through the leg these lines must be laid off on the opposite sides also.

To locate the sides of the mortise, Fig. 4, set the gauge to eleven-sixteenths of an inch and gauge, being careful not to allow the gauge marks to cross the pencil marks at the ends of the mortise. All gauging must be done from the XX surfaces. Remember that the mortises on the same leg are at right angles to each other, or are on adjacent sides, and that one passes through just below the other. The second side

is located similarly, the gauge being set to one and one-sixteenth inches.

Two methods of cutting a mortise are described in this department in the November number. As this mortise is small it will be better to do no boring, but to select a chisel just the width of the mortise and, beginning at the middle of the mortise work out to each end. Cut half way through the leg, then turn it over and cut through from the other side. No trimming of the sides of the mortise is necessary but care must be taken to stand at the end of the mortise while cutting so as to be able to sight the chisel plumb with reference to the sides.

The holes for the dowel pins are laid off one-half an inch from the sides of the legs and one-half an inch from the ends of the mortise, Fig. 4. They are

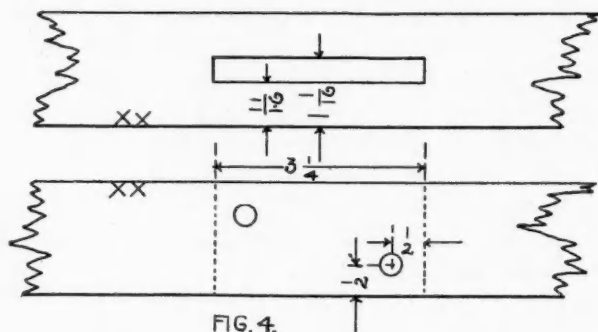

FIG. 4.

bored entirely through the legs but not until the tenons are in place.

The holes for the large rods which support the seat are bored in the middle of the legs, three-quarters of an inch from the lower edge of the slope to the center. There are but two of these in each leg and

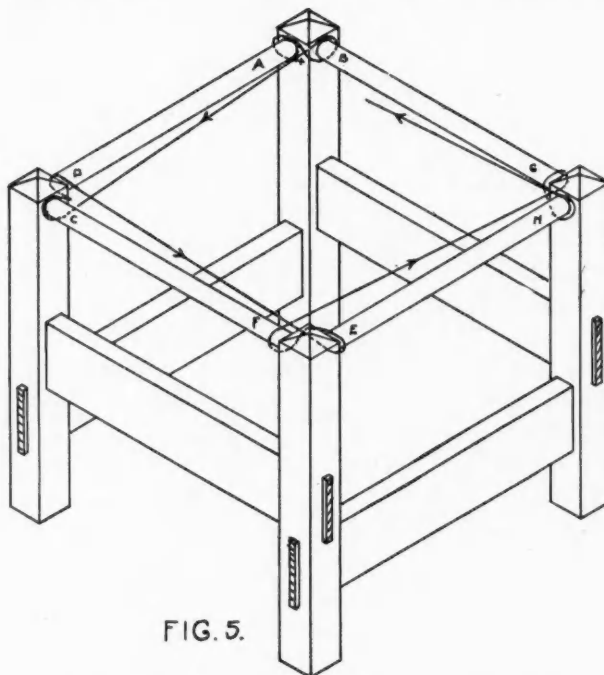
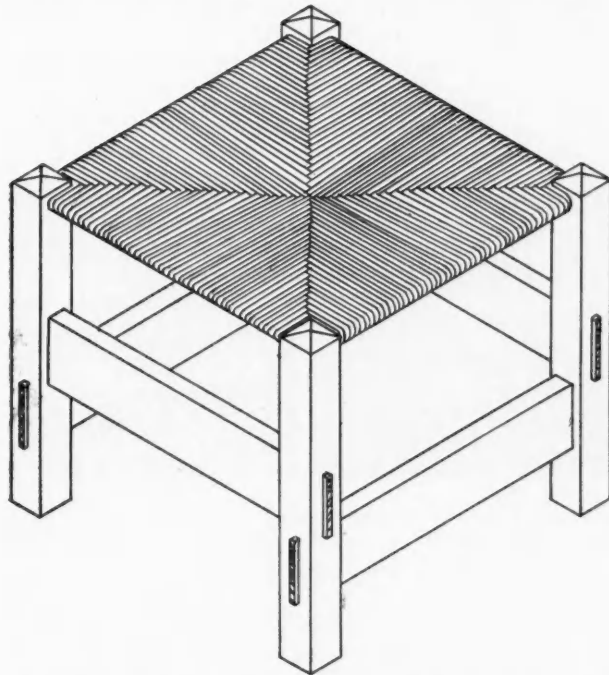

FIG. 5.

they are on the sides not marked XX. A one-inch bit is used, the holes being bored to a depth of three-eighths of an inch.

To make the tenons, measure from the end of each rail two inches and square a sharp pencil line on the four sides, Fig. 3. From this line measure fourteen inches and repeat. There should remain two inches of rail for the second tenon. Set the gauge to one-fourth of an inch and gauge from the working-face on both edges and also on the ends of each rail. Now set the gauge to five-eighths of an inch and gauge as before. This lays off a tenon of the same width as the rail with a thickness of three-eighths of an inch and a length of two inches, with shoulders on two sides.

Rip carefully to the gauge lines with the tenon-saw and cross-cut to the pencil lines. Bevel the ends of the



tenons slightly to insure their entering the mortises easily.

Fit the tenons into the mortises, marking each as soon as fitted in such a way that no two tenons shall be fitted to the same mortise. A good way is to letter a tenon AA and its mortise AA, another BB, etc., keeping the XX faces out and up while fitting.

Scrape and sandpaper well, then put two sides of the frame together using cabinetmaker's clamps to hold the legs in place until the three-eighths-inch holes for the dowel pins have been bored and the pins driven in place. Glue is not necessary with this construction. Place the remaining rails and rods in place and fasten as just described.

A good finish may be obtained by filling with golden oak paste filler, applying one coat of thin shellac, followed with two coats of prepared wax. No stain is necessary prior to the filler, for a filler can be got which contains sufficient coloring matter. Allow the filler and shellac each to dry over night. Rub the wax well after each application with a flannel cloth.

The most satisfactory thing for the seat is obtained by taking a ball of cord of about one-eighth of an inch in diameter and weaving it around the dowel

rods as shown in Fig. 5. Begin by fastening one end of the cord to the post as at A. Carry the cord around the nearest dowel rods as at A, Fig. 5, carrying it under, then over. Now carry it around the adjacent rod as at B, Fig. 5, passing it under, then over, the rod. Next, carry the cord entirely across the stool to the opposite rod passing it under, then over, as at C, Fig. 5. Pass it around the adjacent rod as at D. Now carry it entirely across the stool to E. Continue in this way until the seat is completed. Always pass the cord under from the inside, then over the rod. Keep the strands pressed closely to the legs in starting, and against one another.

A leather seat may be made by cutting thongs one-half an inch wide and weaving them with the common cross weave.

Other ways of making the seat will suggest themselves.



An Artist's Unique Bill

An old church in Belgium decided to repaint its properties and employed an artist to touch up a large painting. Upon presenting his bill the committee in charge refused payment unless the details were specified, whereupon he presented the items as follows:

To correcting the Ten Commandments.....	\$ 5.12
Embellishing Pontius Pilate and putting new ribbon on his bonnet.....	3.02
Putting new tail on the rooster of St. Peter and mending his comb.....	2.20
Repluming and gilding left wing of Guardian Angel....	5.18
Washing the servant of the high priest and putting carmine on his cheeks.....	5.02
Renewing heaven, adjusting the stars and cleaning up the moon.....	7.14
Touching up purgatory and restoring lost souls.....	3.06
Brightening up the flames of hell, putting new tail on the devil, mending his left hoof and doing several odd jobs for the damned.....	7.17
Rebordering the robe of Herod and adjusting his wig..	4.00
Taking the spots off the son of Tobias.....	10.30
Retouching Balaam's ass and putting one shoe on him..	5.70
Beautifying Adam's lost rib.....	5.26
Putting a new stone in David's sling, enlarging the head of Goliath and extending Saul's leg.....	6.13
Decorating Noah's ark, putting a head on Shem and cutting Ham's hair.....	4.31
Mending the shirt of the prodigal son and cleaning his ear.....	3.39
	<hr/>
	\$77.00



A feeling of importance is a good thing for a man to be afflicted with, until he gets so severe a case of it that it results in affecting the size of his cranium, and then it is time to take a course of training to reduce weight in the head and chest.



Once in awhile we hear some old fellow saying, "I have never advertised and am still doing business at the old stand." He means that he is doing business at the old standstill.

Correspondence

Lime Concrete Houses

To the Editor:

Ulman, Mo.

It will probably be of interest to the readers of your journal to know how we build lime concrete houses in this section of the country. When we wish to build we make a pit near the bank of some creek or branch. This pit is about six to eight feet in diameter and usually ten to twelve feet wide and two feet deep, and is dug out through the bank to the open about five feet above the bed of the creek. This being done they haul limestone rocks from the adjacent hills and at the pit they are broken with a sledge hammer into small pieces from four to six inches in diameter. These are dumped into the pit until it is filled. Then comes the process of firing, which lasts from three to five days and nights. This is done with wood which is burned in the channel or trench at the bottom. After firing the required length of time the fire is drawn and the pit allowed to cool off. The limestone has turned into a flour like dust. This is then stored in a dry place. Now comes the process of concreting. The forms are usually made about a foot wide and fourteen inches high. We now take about six parts coarse gravel and two of sand, and the lime which had been slacked the evening before is now made thin with water and is poured upon the gravel while the turning process is going on until it becomes tough and plastic, and it is then ready for casting into the molds. After the forms are filled they remain until the next morning, when they are renewed. This concrete work can be done only in dry, hot weather, as it sets very slowly in cool or damp weather. After the walls of the building made from these blocks are seasoned they are generally plastered on the exterior and stenciled, which adds greatly to their appearance. The action of this lime is entirely different to any I have ever seen. As soon as it is cool and taken from the pit it is white and almost as fine and smooth as flour, and never heats in coming into contact with water, but has a strong fiery taste like that of lye. It makes a very plastic mortar for laying stone and brick and makes a good plaster. This lime concrete is used in the construction of churches and large business houses, none of which are reinforced. I do not recommend this concrete, however, as I do not think it so satisfactory as cement. This is the only part of the country I have ever seen it used. I hope this may be of interest to some of your readers.

O. H. HICKMAN.

Novel Method of Moving

To the Editor:

Campbellton, N. B.

As it might be interesting and instructive to the readers of your paper to know how I moved a thirty-five by fifty-foot two-story house one and one-half miles by water, I will try and explain how I did the work. I raised the building about two feet with jack screws and placed pieces of spruce ten by ten-inch timber under the building. Under these I placed two timbers ten by twelve inches and fifty-two feet long. I used eight-inch hardwood rollers about three and one-half feet

long and used them every fourteen feet. I made a track of timbers and four-inch birch deals, and then in the ordinary way I moved with the capstan and heavy block and tackle. I took the building down quite a steep incline to the shore. This I did in about six days. I here made a wharf by placing barrels filled with gravel on the shore. On these I placed timbers and deal blocking. This had to be done at low



tide and the building was swung out on the same. When the tide was high it came up to the top of the blocking, and we had about five feet of water in front of the building. We then ran our two lighters in and secured them in place with heavy ropes side by side about eighteen inches apart. When the tide went out they settled down on the level ground which I had prepared at low tide. I then moved the building onto the lighters and put wedges between the rollers and spiked a few braces to the lighters from the side of the house. These lighters were eighteen by sixty-four feet and five feet deep, built of timber. The sides were well corked and tarred the same as a boat. When the high tide came in it raised the building and we then attached an eight-horse power gasoline boat to the lighters and towed the house one and one-half miles in about one hour. We then made the building fast to a temporary wharf which I had previously built, and then pulled several plugs from the lighters and they slowly filled with water and settled down on a nearly level shore. The next day we moved the house from the lighters onto the wharf and about two hundred feet from the high water mark. The house was in as good condition when we had finished as when we started, and while it was a rather unusual way of moving the building it undoubtedly was the most rapid. I trust this will be of interest to some of the readers of your paper.

W. H. WALLACE.

Hanging Doors

To the Editor:

Alliance, Ohio.

I read an article in the AMERICAN CARPENTER AND BUILDER for December which said that fitting, hanging and locking three doors was a day's work. I think the party who wrote the article must have been referring to very heavy doors with complicated locks. I think that a first-class carpenter should fit, hang and lock one door every hour, that is, ordinary pine doors one

and three-eighths inches thick. For my part I would be glad to take one door per hour for my day's work. I am not boasting when I say that I can put on a mortise lock in fifteen minutes and can do it in eleven minutes if I try hard. In trying to see how many I could hang, I fitted, hung and locked eight doors in five hours and five minutes. These doors were pine and hung on oak jambs. Three of these doors were 2 feet 4 inches by 6 feet 8 inches, one 2 feet 6 inches by 6 feet 8 inches, and four 2 feet 8 inches by 6 feet 8 inches; all of them being 1 3/8 inches thick. I have more than once put up twelve of these doors in ten hours. I am a contractor and would not pay a man full wages if he could not put up more than three doors in a day, although there are more carpenters who will put up less than six doors in a day than there are who will put up more than six.

C. C. MUMBERT.

Trestles

To the Editor:

Fossum, Minn.

Figs. 1 and 2 show a high trestle—Fig. 2 shows half of trestle, side view. It is very handy when placing second floor joists, painting or where any low scaffolding is needed. By placing the ladder and board on top of trestles it makes quite a staging. The 2-inch cleat is about 18 inches long. The 4-inch cleat, 20 inches. End cut of cleats about 2 1/2

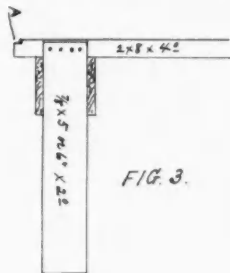
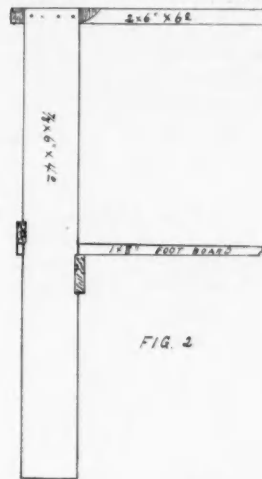
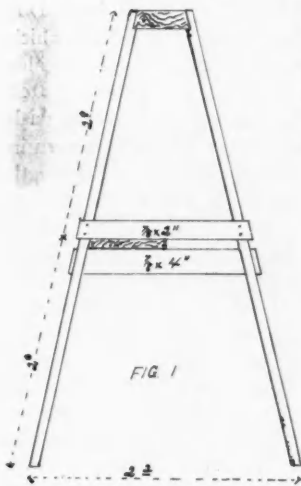

and 12 on the square. The 8-inch footboard is 6 feet long, and fastened close to legs on one side. Do not make trestle too wide at bottom; about 2 feet 2 inches is wide enough. The cleats are gained in about one-quarter of an inch deep. The outer ends are beveled—about five-sixteenths each side, to conform with legs. Fig. 3 shows the low trestle, and how braced. Braces might be let into legs the same as in Fig. 2; but it makes more work. Notch, A, in Fig. 3, is cut clear across, about one-half an inch wide and one-quarter inch deep, to steady ends against when ripping short pieces.

A. O. STIEN.

Connecting a Water Front to Boiler

To the Editor:

Meeker, Colo.

In making connections from a water front in a range to boiler for heating water, which is the better way to have same, the top pipe from front to top of boiler, or to opening about one-third above bottom of boiler? Have read of both

ways being the "only proper" way, and hence would like to have your opinion.

H. A. WILDHACK.

Answer: The only proper way to connect a water front in range to a boiler is to connect it to the opening in side of boiler. If the boiler is connected to a gas heater, the proper way is to connect to the top of boiler, as in this way you will get hot water immediately. In other words, you can heat just as much hot water as you want without heating the entire contents of the boiler. Of course, you can readily understand this would be impractical if connected to a range as the fire in the range is burning all the time, and it would not give you a sufficient amount of water above inlet to insure a perfect circulating job.

W. R. MARSHALL.

Making a Tool Chest

To the Editor:

Ray, N. D.

I herewith enclose a sketch of my tool chest and workbench combined. It is the most useful and handiest I ever had. It is 12 feet long, 2 feet 6 inches wide and 2 feet 10

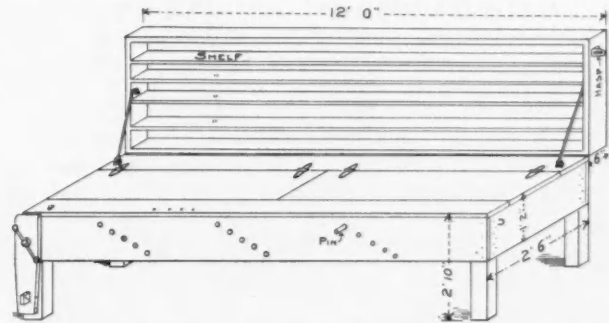

inches up to cover, which is 6 inches high and divided into shelves as shown. The sides and ends are covered with flooring to a depth of 1 foot 2 inches with the front reinforced back of the pin holes. The bottom of the chests are made of flooring and to the full depth of the sides. I have them divided into compartments to suit the tools. The top of bench is of 1-inch select lumber. The cover is of 1/2-inch lumber and covered with galvanized iron and hinged to bench with heavy strap hinges. A hasp and staple is provided at each end so that the cover can be locked with padlocks.

M. C. OSTER.

Roofing a Store Building

To the Editor:

Blyth, Ontario.

I have a flat roof to put on a double store building. Each store is twenty-one feet wide and sixty-four feet long with a center wall dividing them. I would like to have you advise as to which is the best way to put on a low pitched roof. Would you run all of the rafters to the center wall

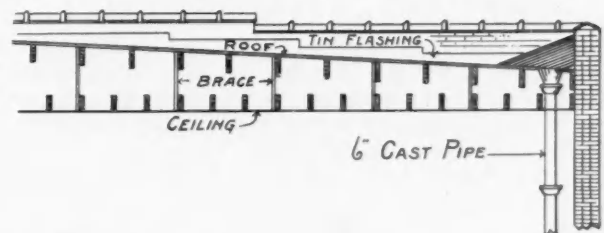

or to the outer walls? A cut of this roof in your next journal will be greatly appreciated.

J. A. McDONAGH.

Answer: The common way to roof a building of this kind is to slant the roof to the rear, giving a fall of about five-eighths of an inch to the foot, which in this case would be a fall of forty inches in the length of the building. Each joist is put on level but set enough higher than the ad-

jacent one to give the required fall. The gutter is usually a hanging one, but may be objectionable in Mr. McDonagh's section of the country on account of ice formed from melting snow. In that case it is better to run the water to one place and empty into an internal down pipe as shown in the illustration.

EDITOR.

Shingling a Circular Roof

To the Editor:

Chanute, Kan.

Please give best method of shingling a circle roof and how to run the chalk line. Also is paint considered better than shingle stain and how should it be applied?

S. O. FORSLUND.

Answer: Trim the shingles so that their edges will be in line with the center or peak. This can be done with a sharp hatchet at the time of laying. As to the chalk or gauge line, this can be had with a pole pivoted at the peak as shown in the illustration and with a marker set at the desired spacing, each circle can be easily described as needed. Or after the first course is laid, the spacing may be had with a gauged hatchet as shown in either the May or July numbers of this magazine. Opinions widely differ as to whether paint or stain is the better shingle preservative. In either case the butts of the shingles should be dipped to a depth beyond where the second lap will be. Most dipping as a rule is simply a farce. The object seems to be not how much, but how little covering. We have seen dippers take a handful of shingles and dip

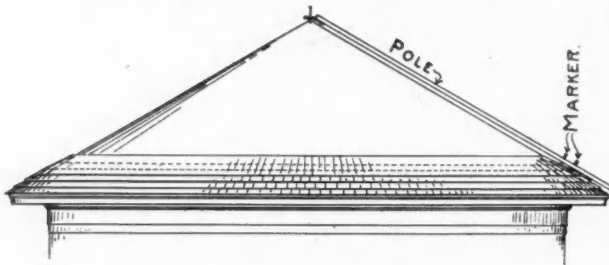

them five or six inches deep as though they were practicing a sleight-of-hand performance, not giving the stain time to properly penetrate the wood. After they were laid bright wood at the joints were exposed. Thus the place which most needed protection had none at all. As a protection to the wood we prefer dipping in boiling linseed oil, dipping not more than three shingles at a time with each separated between the fingers, giving two or three seconds' time to each dip.

EDITOR.

Which is the Stronger

To the Editor:

Stacyville, Ia.

Which is the stronger for a barn, 2 by 6 studding set on 4-foot centers or two 2 by 6 spiked together placed on 8-inch centers?

E. B. TYLER.

Answer: Would prefer placing the studding on 4-foot centers. It is true the two studs spiked together would more than double the strength at that point, but in doing so the space between is robbed in carrying strength for the hay load. The load, however, remains the same in either case, but where the carrying supports are on the lesser span the weight is more equalized.

EDITOR.

Hip Roof Framing

To the Editor:

Hollidaysburg, Pa.

I thought it would be interesting and helpful to your readers to give them the benefit of my experience on hip roof framing which I find very practical. It is done as follows:

Draw the straight line A C, which is the center of a building provided it is square, or if it is a rectangle it would be the vertex of the hip. Then draw A B perpendicular to A C, which is the rise of the roof. Next draw B C, which will

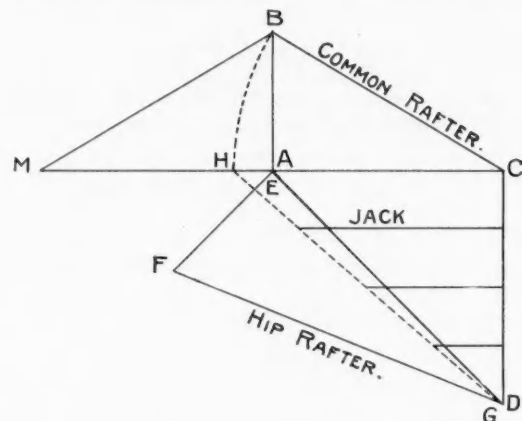

give the length of the common rafter. Draw C D at right angles to A C, which is the same as A C. Then draw D E, which is the hypotenuse of A C, C D. Square from D E and raise the same distance E F as A B. Draw F G, which will be the length of the hip rafter. Set the point of a divider in C D, draw the dotted line B H, from which draw dotted line H B. Space the rafters on C D as far apart as you wish them in the roof. Squaring with C D, draw lines as shown in the sketch, touching dotted line H A, which will be the length of the jacks. The bevel on dotted line in jack will be the cut on side of hip, and the plumb cut on common rafter will be the plumb cut on the jack. This can be used on open cornice as well as on box cornice by putting projections on from C to D.

J. A. MARTZ.

Bricks Turn White

To the Editor:

Albany, Oregon.

I have built a residence with a fireplace. The brick work is exposed on the outside. I used best grade common brick laid with black joints. After about two weeks the bricks have turned nearly white. What is the cause?

ANDREW TAUCHER.

Answer: It is simply the alkali in the brick coming to the surface. It can be washed off, but it will appear again and disappear according to the condition of the weather. Aside from its looks it does not seem to be injurious.

EDITOR.

Dry Versus Wet Process

To the Editor:

Denver, Colo.

We received a copy of your December number, and note with astonishment the answer which is made to Mr. Brogdon's inquiry on page 641. It is evident that your correspondent is not informed relative to the later developments in processes and machines for manufacturing concrete blocks, as architects and engineers are unanimous in the opinion that to make thoroughly good concrete blocks it is necessary to have, in proper proportions, a coarse aggregate tending to secure great density and strength, an amount of water sufficient to cause thorough crystallization, the application of uniform and instantaneous pressure resulting in thorough condensation of the mass, scientific methods of facing by which no line of cleavage remains between the face and the body of the block, such shape of blocks and such arrangement in laying that an indestructible bond will obtain, and that decrease in heat conductivity and increase in water resistance, which is only obtained by a continuous horizontal air space throughout the wall. You will

recognize that the above essentials are necessarily absent in the dry tamped process which your correspondent recommends, and we beg to say that the correctness of the comparison between the one and two-piece systems, as stated in our catalogue, has been thoroughly established by the awarding of the first and second prizes of the *Engineering News* contest to papers advocating our system, while the practical value of these principles is evidenced by the use of our blocks in such important structures as the Nebraska State Normal School, the large power house of the Chicago Drainage Canal and the Carnegie Library in connection with the Syracuse (N. Y.) University.

THE AMERICAN HYDRAULIC STONE CO.

To Square a Tapering Timber

To the Editor: Bedford, Ind.
Thinking the enclosed design as being of value to many readers of your most excellent journal I submit same, stating that the idea is original with me, though it may have been used by carpenters for many years. But in 35 years' experience at the trade I have never seen the principle employed by

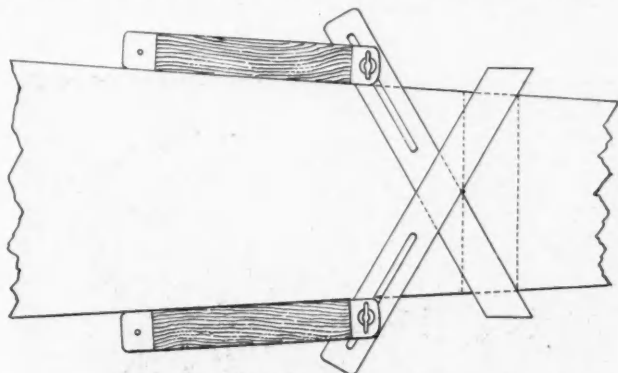

anyone. It relates to the squaring the end of a tapering piece of board or timber as shown, using the common T bevel. Setting the same so that the blade will reach diagonally across face and mark along the edge of the blade. Note the center of the line and reverse the bevel to the other side and set to same. Set bevel blade to these centers and the timber can be squared around on all four sides as easily as if it was a square timber.

H. M. DRAPER.

Remedy for Damp Walls

To the Editor: Pittsfield, Ill.
I noticed in the November number of your magazine that one of your subscribers wanted a remedy for damp walls in the basement. Here is my experience with a brick wall that had been plastered with cement. I took strips one by two inches and, putting them sixteen inches on centers, I covered the entire wall. I then got a plasterer to lath and plaster the wall. You will not find a nicer and cleaner basement than it is to-day. The walls are papered and neither dampness nor mold is to be found.

BEN JOHNSON.

Length of Sides of an Octagon

To the Editor: University Place, Neb.
In your August number on page 314 you say "length of the sides may be found by multiplying the radius by the decimal 9.18, which equals 5 feet 10 3/8 inches." Kindly explain operation, as I can't see it that way.

J. M. KELLER.

Answer: The length 5 feet 10 3/8 inches represents the sides of an octagon in a circumscribed diameter of 15 feet 4 inches (15.33) and is found by multiplying the decimal 4.59 by 15.33

equals 5 feet 10 3/8 inches, but inasmuch as the complete circle does not appear in the illustration given with the article in question, we take the radius or one-half of 15 feet 4 inches, which is 7 feet 8 inches (7.66), and double the decimal 4.59 equals 9.18 and this multiplied by 7.66 equals 70.35+ inches or 5 feet 10 3/8 inches, as shown.

A. W. Woods.

Scaffold Brackets

To the Editor: Girard, Ill.
Thinking probably some of the craft might be interested in the most successful scaffolding (to my idea) in use, I herewith enclose a sketch of same. The arms are made of 2 by

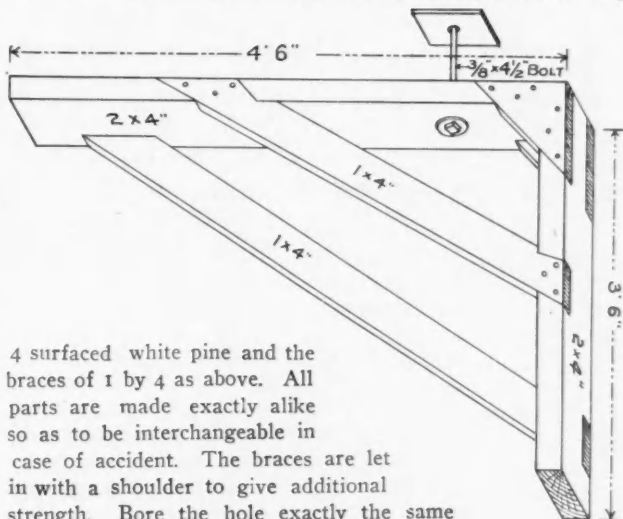

4 surfaced white pine and the braces of 1 by 4 as above. All parts are made exactly alike so as to be interchangeable in case of accident. The braces are let in with a shoulder to give additional strength. Bore the hole exactly the same distance from the heel and see that the bolt fits tight to prevent turning. Use a large washer under the head of bolt. These brackets can be bolted to Byrnett sheathing the same as on the common sheathing, or can be stood on the ground with the short arm turned to the wall and make a good scaffold for siding. I have mine painted, which adds to durability and appearance.

CHAS. M. GATES.

Preventing Leaky Window Frame

To the Editor: McCracken, Kansas.
I wish you would explain with an illustrated sketch the proper way to make a window frame, for an ordinary frame building, to gain into the sill or into the jamb so as to prevent leak.

CHAS. B. KINNAMON.

Answer: The most satisfactory way we have found is to gain the jamb into the subsill, leaving the end of this sill

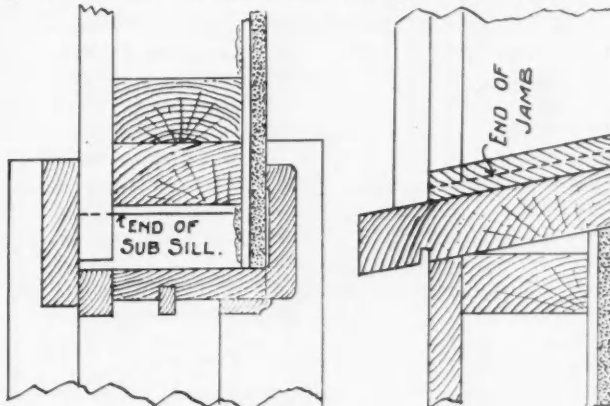

project same as for the window sill, and only notch out enough of the back corners to fit nicely in opening for the window as shown by the sectional drawing. The joints should be set in white lead, and well painted on the outside.

A. W. Woods

PRACTICAL TRADE APPLIANCES

Five Dollars for the Best Letter

The Bradt Publishing Company of Jackson, Mich., whose advertisement is running in our magazine, offers \$5.00 to the person sending them the best letter of endorsement of their book on estimating. They also offer a year's subscription to the American Carpenter and Builder for the three next best letters. This offer will remain open to old and new purchasers of their book on estimating until Feb. 1, 1906.

Weatherproof Shingle Nails

Henry J. Miller's Sons & Co., of Bridgewater, Mass., are advertising a "Weatherproof" shingle nail. They ask the pertinent question: "Why do you shingle your house five times while grandfather shingled the old homestead once?" and answer, "Because you use a cheap steel or common iron nail, the life of which is short, owing to the combined action of acids and the elements."

This firm is advertising a weatherproof shingle nail made from genuine Swedes Charcoal Iron. This is a nail that the carpenters have been trying to get for several years, but have been unable to do so, as the mills in Sweden would not take the work on, but they have at last obtained it after working four years for it. Readers who believe in doing their shingling with the best materials should write to Henry J. Miller's Sons, who will be pleased to furnish further information.

The Farrington Expansion Bolt.

The Farrington Expansion Bolt depends for its expansive qualities upon the flexibility of a coil of wire, engaging the thread of a common wood screw, or for larger and heavier work on the taper of the mandrel of a screw bolt, specially threaded. It can be used most effectively wherever an expansion bolt is required, and can be removed and replaced as frequently as a common bolt with nut, without its expansive qualities being lessened. It is practically made up of two parts, the screw and coil of wire (the jacket covering the coil merely distributing the pressure over a greater area); the metal contained in the jacket offers little resistance to the great power of the expansion coil.

In its practical operation it requires to be driven into a hole in hard material with slight force until the head of the screw comes in contact with the object to be held, then a few turns only of the screw will permanently and efficiently hold the fixture in place. It distributes the pressure equally on all sides of the hole in which it is inserted, and owing to the hardness of the wire, has no tearing or stripping effect, as in devices using soft material. It may be used not only as an expansion bolt, but in place of ordinary standard bolts with an embedded nut, such as is ordinarily used to unite the various parts of portable objects, like beds, chairs, tables, small buildings, etc. Its field of operation is practically unlimited.

Palmer Rights are Selling

There is no diminution in the demand for machinery to equip plants for making hollow concrete building blocks, and the H. S. Palmer system continues to be prominent in the concrete block industry. On a recent trip, H. S. Palmer of the Harmon S. Palmer Hollow Concrete Building Block Company of Washington, D. C., sold exclusive rights to his

system in Lackawanna county, Pennsylvania, and three machines; one of the purchasers being A. T. Trautwene of the Carbondale, Pa., Machine Works. He also sold rights to Camden county, New Jersey, and two machines to George A. Aldrich of Philadelphia. These sales indicate that the H. S. Palmer system is continuing to be recommended to those who think of entering into the new industry and who investigate the Palmer patents.—*Manufacturers' Record.*

Artificial Stone

No class of manufactured building material has ever so quickly attained popularity generally throughout the country as has this reliable product. Many hundred plants for the manufacture of concrete building blocks have been established

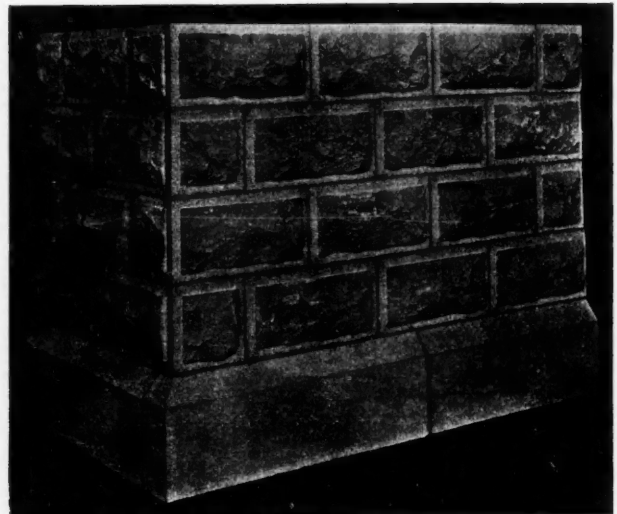

throughout the country and thousands of structures of various kinds have been erected of the blocks. There is, however, another and more advanced field of work which cannot be reached by the concrete block maker using machines to produce his blocks by the semi-dry process, as there is a demand for a higher class of manufactured stone for trimmings and enrichments, and which will not have an artificial appearance when used in high class buildings, and having more the texture and finish of natural stone. This particular branch of the industry necessitates an entirely different treatment of this valuable material, using a much better class of aggregates than is furnished by ordinary sand and compelling the manufacturer to use crushed marble, granite, etc., and in order to produce a stone which follows in detail the plans of the architect and which can be tooled and carved after the stone has matured. In this field the work of the Standard Stone Co. of 1 Madison avenue, New York, seems to be practically without a rival, and the fine specimens of work turned out by the licensees of this company are attracting the attention of the trade generally. This company control what is known to the trade as the McClenahan process of casting the stone in "treated sand molds," and are rapidly installing plants in various portions of the country, many of which are under control of parties who are already engaged in the concrete block business, but find it necessary to be able to turn out the higher class of work, for

Johnson's Electric Solvo

"A Perfect Remover of all Finish from Wood, Metal and Glass"

Eight Points of Superiority

1. Softens old finish so that surface may be wiped clean in three minutes.

2. Has no objectionable odor.

3. Will not injure the hands.

4. Does not raise the grain.

5. Does not change color of wood.

6. Very economical, as one gallon is sufficient to remove the finish from 350 to 400 square feet.

7. The old finish, after being softened, will not harden again for five or six hours.

8. Anyone can easily use it.



This preparation is the most effective, most economical and easiest applied softener of paint, varnish, enamel, shellac, wax or any finish on wood, metal or glass. It will not harm the finest wood, but will quickly and thoroughly soften the finish so that anyone can remove it with an ordinary painter's putty knife. The old finish will remain soft for three hours. Solvo is fine for softening putty in window sashes and for cleaning paint and varnish brushes.



Johnson's Electric Solvo is sold by all dealers in paint.

Pint Cans	. . .	\$0.40
Quart Cans75
Gallon Cans	. . .	2.50

Special FREE Offer. If you do not regularly use Johnson's Electric Solvo and will send us your paint dealer's name, we will send you a sample absolutely FREE. Don't miss this offer.

Send for FREE Book. We have just published a new edition of the interesting, practical book, "The Proper Treatment for Floors, Woodwork and Furniture," that we will send you free on request. It is illustrated from life and written by a wood finishing authority with over 23 years' experience in this line of work. Contains many ideas for your business. Write us now. Mention edition ACB 1.

S. C. JOHNSON & SON
Racine, Wis.

"The Wood-Finishing Authorities"

which there is a large demand, in competition with the natural stone and terra cotta. The rock face ashler produced by the "casting in sand" process is especially striking, as the stone is rock faced after it leaves the mold, thus producing no two stones alike. Many large structures are now being erected of this new material, chief among which is a machinery hall at the college in Syracuse, New York. The accompanying cuts but partially illustrate the beauty of this product. The Standard Stone Co. of 1 Madison avenue, New York, have a finely illustrated catalogue, which is sent to the trade upon request, which contains much valuable information regarding this process. Write to them for catalogue and mention AMERICAN CARPENTER AND BUILDER.

Cement Brick Manufacture Made Easy.

Although the cement industry is in a most healthy condition and although it is destined to a most prosperous future, the Miracle Pressed Stone Company do not lessen their efforts in the least. They have recently added to their very good list of cement machines a most practicable one for the manufacture of cement brick.

The machine is destined to an enormous sale—in fact, we are informed that the sales already surpass the supply, and it is selling solely upon its merits. In designing it, the Miracle Company has in mind the five following facts which impress them so strongly that to feel right about it, they were fairly forced to place on the market their new machine. The facts are:

- Pressed brick has been used successfully for years.
- Good brick will always be in demand.
- Cement brick is one kind of good brick.
- Cement brick is better than pressed brick.
- Cement brick costs less to produce.

Although these five facts seem most logical, the Miracle Pressed Stone Company have recently published a booklet which analyzes them and very clearly demonstrates their truth. The public will be thoroughly thankful to this progressive firm, because they did take advantage of these five facts and were able to produce a successful machine for making cement brick.

The simplicity of the machine is what appeals to us most strongly. Unlike other machines, it is strictly a one man machine, and as the result of experiment it is found that one man with the Miracle machine and with his material mixed and delivered, can make more brick in one day than three men can on any other machine yet produced. The average capacity is 3,000 bricks a day. The mechanism is most perfect, fitting at all parts, and producing a most perfect brick of standard size, $8\frac{3}{4} \times 4\frac{1}{8} \times 2\frac{3}{8}$ inches, weight 5.2 pounds.

It is very evident that such a machine will prove to be a decided boon to the already prosperous industry, concrete construction.

We wish to congratulate the Miracle boys in their success, not only with their new machine, but also in the success of their general line of business pertaining to the cement industry, and we also hope for a continuation of the same.

Value of Good Tools

Pretty nearly everybody knows how valuable tools are. In a general way they know the part tools play in building the home, in the making of furniture and doing hundreds of other useful things. In fact, the home that has not constant use for a saw or an axe or a tool of some sort hardly exists. Notwithstanding the general knowledge of the utility of tools, few people seem to realize what a lot of money can be saved by having a tool chest in the home. Shelves can be put in cupboards, furniture that is damaged can be fixed and lots of improvements can be made. The best of it all is, very little experience is needed to give any one a good working knowledge of how to use tools. Ordinarily, buying tools is largely a matter of guesswork. If you want an axe

you go to the nearest hardware store and ask for "an axe." If it turns out to be a good one you are lucky. If it turns out to be a poor one you have to make out with it or buy another. In other words, it is all a matter of luck. However, it is very simple for any one—even a child—to buy a tool of any kind and be positive that it will be the finest tool that can be made, and that it will give satisfaction in every respect. You say "How?" By simply asking for the Keen Kutter brand. For the name Keen Kutter covers a complete line of tools, this brand being the only complete line of tools to receive the Grand prize at the St. Louis Exposition. Keen Kutter tools have been the standard of America for thirty-six years, and are without doubt the finest tools it is possible to produce. Every Keen Kutter tool is made under the mark and motto that "The recollection of quality remains long after the price is forgotten." Yet Keen Kutter tools cost but a trifle more at first than inferior kinds, and in the long run are much more economical. If your dealer does not keep Keen Kutter tools, write the Simmons Hardware Co., St. Louis, Mo., mentioning the AMERICAN CARPENTER AND BUILDER, and this firm will see that you are supplied.

The "Economic" Level

The leveling instrument portrayed here contains the rare qualities of simplicity, efficiency and compactness at an extremely moderate cost. The essential features are the ease with which it can be adjusted and its accuracy proven right on the spot. These features commend themselves to the thinking and the wise because it saves time and insures confidence. The advantages of a level like this to the builder and contractor are so numerous that they will be apparent at the first thought of its many uses, such as for leveling foundations or setting machinery, floor timbers and sills, leveling lines of shafting, for ascertaining the height of springs, water falls, etc., for laying off drains, ditches, irrigation canals and laterals, in fact, any and all the uses to which a level can be put. This level is constructed entirely of brass, highly lacquered and finished, has a graduated circle divided into 360 degrees, numbered from zero to 90 degrees in both directions, giving zero points on opposite sides of the circles, and clamping screw for holding in any position. It has a ground level vial, which makes the instrument very sensitive and accurate. The telescope is achromatic, giving a clear field. The cross hairs are set in the eye piece and cannot be dislodged or destroyed except through carelessness. A neat leveling rod is given with each instrument. The rod is hardwood, five feet when closed and extending to nine and one-half feet, has sliding target and is graduated to feet, inches and one-fourth of an inch. This is not done by any other manufacturer. Write to F. Weber & Co., Philadelphia, for further information.

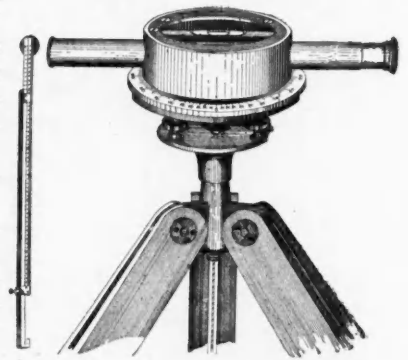

The Great Prize Contest

Every carpenter and builder who uses tools of any kind should be interested in the Great Prize Contest. Read the first six pages of this month's magazine and send in the coupon to-day. If you can send in your first subscriber at once it will be so much gained.

SPECIAL OFFER TO CARPENTERS
BUILDERS AND OWNERS OF HOMES



Ives Patent Window Ventilating Lock, a Safe-Guard for Ventilating Rooms, Pure Air, Good Health and Rest Assured.

To introduce this article, Four Ventilating Locks in Genuine Bronze, Brass or Antique Copper Finish will be mailed to any address prepaid for One Dollar. Will include a forty page Hardware Catalogue and Working Model to Carpenters who wish the agency to canvass for its sale. Address,



PATENTED.

THE H. B. IVES CO.
 NEW HAVEN, CONN., U. S. A.

PAYNE'S MODERN HOMES



IS A NEW BOOK OF DESIGNS JUST OFF THE PRESS (JAN. 1906)

240 pages, 7 x 10 inches, heavy enameled paper. It may contain just the Home you desire. Views, floor plans, costs and descriptions with each design. Over 200 designs, many styles and costs ranging from \$500 to \$10,000, many under \$2,000, a few elaborate ones costing up to \$20,000. Also shows a selection of Stables, Schools, Churches and Business Buildings.



It Will Help You When You Build.
 PRICE, \$1.00 POSTPAID.

Book of 25 Cottages costing \$500 to \$1,200, 25c.
 Small book of 42 miniature designs, 10c.



We have aided thousands to build satisfactory homes—we would like to aid YOU when you build. Plans and specifications from \$5 upwards.

GEO. W. PAYNE & SON, Architects,
 Box A, Carthage, Illinois.

Why Not Increase YOUR Earnings?

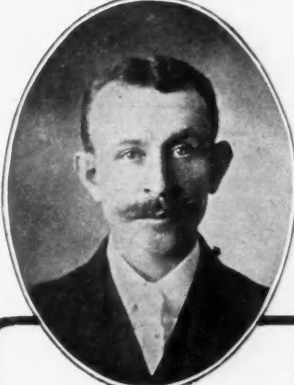

Mr. William Weber, Contractor and Builder, of Beaumont, Texas, whose picture appears above, says:

"When I enrolled, I was a bricklayer, earning a bricklayer's wages. I am now a contractor and builder, and the volume of my business is over \$200,000 a year. All of this success I owe to the I. C. S."

This proof is merely one of thousands which we have to show that we can help any ambitious man, no matter what his circumstances are, to gain a better position and increase his earnings. If YOU want to gain a better position, write us today, stating the occupation you wish to rise in, and we will explain how you can better yourself without loss of time from your present work or paying more than you can afford.

INTERNATIONAL CORRESPONDENCE SCHOOLS
 Box 910, Scranton, Pa.

"Best" Cement Sidewalk Tools



Brass Rollers, Bronze Edge Groovers and Center Groovers, Spring Tempered Edge Groovers and Center Groovers, Step Finishing Tools, Iron Tampers, etc.

SEND FOR 1906 CATALOGUE AND PRICE LIST
 The Most Satisfactory CEMENT SIDEWALK TOOLS in the World
THE WOODHOUSE HARDWARE MFG. CO.
 2618 So. 13th Street, St. Louis, Mo.

STRUCTURAL DRAFTSMEN

desiring to fit themselves for better paying positions should send for 200-page handbook (FREE) describing our Structural Drafting course, and over 60 others, including Architecture, Electrical, Mechanical, Steam and Civil Engineering, Mechanical Drawing, Telephony, Textiles, etc.

American School of Correspondence, Chicago, Ill.

SLATE! SLATE!! SLATE!!!
 Black Boards for Schools - - - Roofing Slate for Houses

Are you going to build a home? I trust you are, and that you will put on it for a Roof (one of the most important things about a house) SLATE, which is always CLEAN, FIREPROOF and BEAUTIFUL. Write for prices, and I will tell you all about SLATE.

DAVID McKENNA, SLATINGTON, PA.

Saw Filer, Clamp and Vise Complete,
 to file your own saws. All who see it buy it with joy and file with pleasure. For illustrated circulars and testimonials address

G. H. ROTH NEW OXFORD, PA.

READ ABOUT THE GREAT PRIZE CONTEST IN THE FIRST SIX PAGES.
 WHEN WRITING ADVERTISERS PLEASE MENTION THE AMERICAN CARPENTER AND BUILDER.

A B A R G A I N

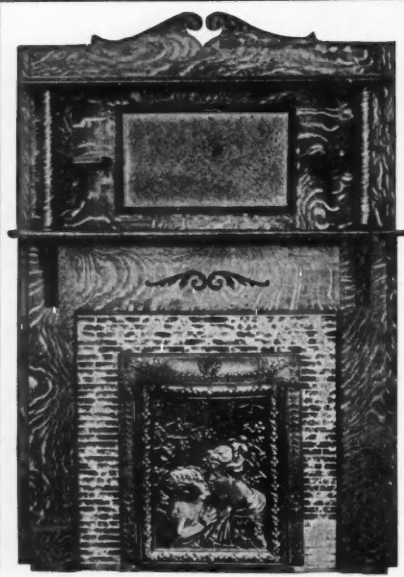

Oak Mantel, handsomely figured with veneered quartered oak columns, beveled *plate* mirror, polished and rubbed finish, tile facing (slabbed) and steel summer front, delivered anywhere.

\$18.00

Other designs and woods at equally low prices.

We carry a stock of over 200 mantels in 50 designs, in all kinds of woods.

Send *to-day* for our 40 page Catalogue.

Address,
Department "M"

THE A. W. BURRITT CO.,
"The Mantel Folks,"
349-473 Knowlton Street, BRIDGEPORT, CONN.

LORENZEN

• MANTELS •

are not designed to meet the requirements of persons who are satisfied with ordinary common-place designs so universally offered. They are exclusive in pattern, workmanship and material, because no other maker has the workmen, the woods, or even the inclination to make them as thoroughly good—inside and out—as the makers of

Lorenzen Mantels, \$10 upward

Our Craftsman, Modern Mission and Colonial designs embody the acme of artistic achievement. Nowhere in the world will you find the careful wood selections, the elegance of form and finish, the skilled workmanship.

To Carpenters and Builders Free

We will mail our large, handsome, 96 page (10x22) Catalogue, the largest Mantel and Grille book ever published, which cost us nearly 50 cents. Send us your business card and we will show you a way to make money by becoming our sales agent for your territory. **Write today.**

CHAS. F. LORENZEN & COMPANY
220 N. Ashland Ave., Chicago, U. S. A.

Fifty Lorenzen Mantels were recently purchased by the U. S. Government and shipped direct from our factory to Peking, China, for use in new buildings of the U. S. Government

Legation. After a thorough test of all other makes the government chose the Lorenzen Mantel as superior in attractiveness, workmanship and durability.



**PHOENIX
SLIDING
BLIND
CO.**

Phoenix, N. Y.

**HIGH GRADE
VENEERED DOORS**

**HALE &
BENJAMIN'S
PATENTED
AUTOMATIC
BLIND HINGES**

Flush and surface for wood and brick building. Easy to put on, strong and durable. Warranted. Also combination awning hinges. With these hinges blinds will not slam or blow off. They are the only hinges adapted to bay or mullion windows, as they require no other fixtures. Testimonials on request from dealers, contractors and people who have used them several years. We are the sole owners of these two patents. If your dealer does not keep them write to

PARKER WIRE GOODS CO.

Manufacturers
General and Special Wire Hardware
Worcester, Mass.



MALLORY'S

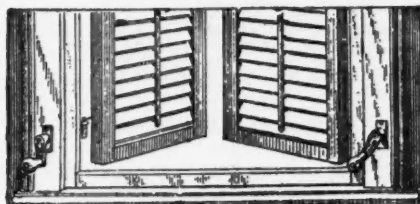

**Standard
Shutter
Worker**

New and improved patterns and designs.

Opens and closes the blinds without raising the window. Automatically locks the blinds in any position desired. Made of gray and malleable iron. The best and most durable blind hinge. Incomparable for strength, durability and power. Can be applied to old or new houses of brick, stone or frame. Send for Illustrated Circular. If your hardware dealer does not keep them, send direct to

FLEMINGTON, NEW JERSEY.

The BUILDER or ARCHITECT

Who fails to learn about



BURLINGTON

Venetian and Sliding Blinds is losing a splendid opportunity for himself and his clients. We are telling the public, through the popular magazines every month, how unequalled Burlington Blinds are for beauty, simplicity, service and economy. The inquiries we are getting from interested people more than prove the big need there is for our perfect blinds.



We earnestly solicit the correspondence of architects and builders everywhere, and will take pleasure in going into every desired detail, and quoting prices.

Burlington Venetian Blind Co.
950 Lake Street, Burlington, Vermont.

Gasoline Engines

1½, 2, 3 and 5 H. P., and one 3 H. P. with pumping jack-- 25 per cent. cheaper than other prices.

J. M. BACHERT, Room 5,

12 So. Water St., :: Cleveland, Ohio

The "Zimmermann" Iron Base

FOR WOOD COLUMNS

"The Column Never Rot"

All sizes for Round or Square Columns. Thousands in use. Send for Circular "Z"

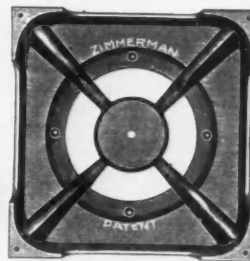

C. E. ZIMMERMANN, : Syracuse, N. Y.

Powers Fireproofing Company

Manufacturers of all kinds of Clips, Anchors and Hangers for Carpenters, Lathers, Plasterers and Builders. Estimates furnished.

343 East 63rd Street :: New York City

Buch's Stable Fixtures

are just what you need to equip your new stable or the one you are remodelling. They are handsome, durable, convenient, cheap, sanitary. None better. None nicer.

ETC.

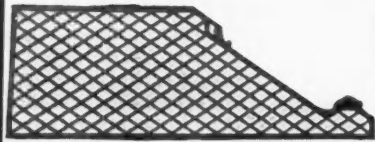

Wrought Iron Stall Guard



Wrought Iron Hay Rack



Steel Water Trough



Steel Feed Trough

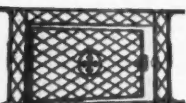

Wrought Iron Cellar Gate

We manufacture a complete line of modern, up-to-date Stable Fixtures, such as Steel and Wrought Iron Stall Guards, Mangers, Feed and Water Troughs, as well as Cellar Grates, etc. Everything we make is of the well-known Buch quality, while our prices will save you some money. Write for new stable fixture booklet and prices. Don't buy until you hear from us. We want you to know the value and labor-saving features of Buch's line.

A. BUCH'S SONS CO.
Elizabethtown, Pa. U. S. A.

KEY TO THE STEEL SQUARE.



This is it.
The Key,
Book of
Instruction
and
Morocco
Case.
Full Size
4x5 inches.

It tells the whole story of how to use the common steel square for all kinds of framing.

Get it now. Price, postpaid, \$1.50.

ALFRED W. WOODS
198 Fifth Avenue, - CHICAGO.

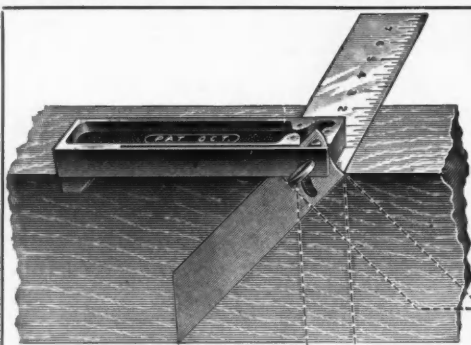

SOMETHING NEW
Ideal Bevel Try Square

With one stroke of pencil you get both square and bevel cut without changing tools.

Send for particulars

NICHOLLS MFG. CO., Ottumwa, Iowa

Our New Steel Square

Aside from excellence of material and workmanship, the greatest difference between the best Carpenters' Steel Square and the old iron square of the blacksmith, consists of the scales and markings on the improved tool. Our square, as recently improved, enables the carpenter to lay out all kinds of work and to calculate quantities with an ease and accuracy never before known.

Our Steel Square Book, describing the new tool, is a veritable PRACTICAL TREATISE ON THE STEEL SQUARE and we will send a copy, without charge, to anyone who in writing us will mention the American Carpenter and Builder

SARGENT & COMPANY

1149 Leonard Street NEW YORK

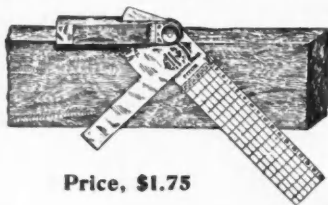

Price, \$1.75

TOPP'S FRAMING TOOL.

A PERFECT TOOL and the only Tool for the purpose ever invented.

Saves from 3 to 24 hours in laying out a single roof. Saves time for the skilled mechanic, and enables the ordinary workman to frame the most difficult roof with absolute certainty.

IT DOES ALL THIS. It is accurate, thus preventing all mistakes. It gives angles for any pitch. It gives lengths for any rafters. It gives cuts for principals, jacks, hips, valleys and cripples. Saves time for the skilled mechanic, and enables the ordinary workman to frame roofs with absolute certainty.

Write for circular. Address the manufacturers,

G. A. TOPP & CO., Indianapolis, Ind.

For a First-Class Strip for Door Bottoms.

BUILDERS NEED NOT SEARCH FURTHER

O-K METAL WEATHER STRIP

Its efficiency, durability, and handsome appearance are unequalled. Keeps out every bit of draft, dust and water. Every carpenter and contractor should have a supply on hand now. Cannot fail to satisfy. Fine profits. It is made in two non-rustible finishes.

Write for full particulars, prices and terms.

THE INTROSTILE & NOVELTY COMPANY,

MARIETTA, OHIO

THESE CUTS SPEAK FOR THEMSELVES, No. 4 CHICAGO, 1906 MODEL

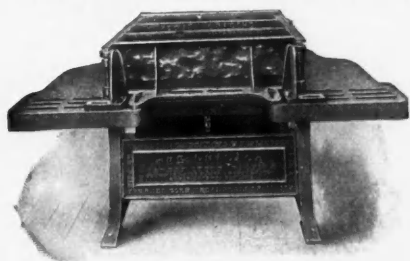

□ Rear view. Set to mould 3-8x32 inches at one mould. Adjustable to 60 in. long x30 in. wide. Cores down. Back brace shows patent dates and gold medal award.

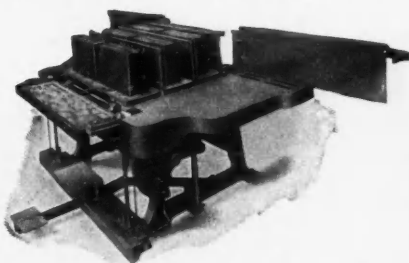

Front and end view. Set to mould 3-8x32 inches. Cores raised, pallets and divisions in position. Mould box ready to close. Name stamp on one division.



3 blocks moulded 8x32 inches. Mould box open ready to off bear blocks. See pallets and divisions. Cores are withdrawn by stepping on compound lever.

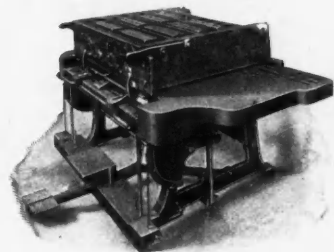

□ Set to mould 4-6x32 inches. Machine is closed. Cores are raised and locked automatically by stepping on lever.



Cores withdrawn, divisions removed, Machine open, front and back plate shown. See slotted end doors for divisions.

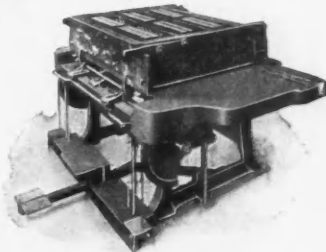

Closed, Cores raised. Divisions in position ready to fill and tamp. Blocks can be made any design face.

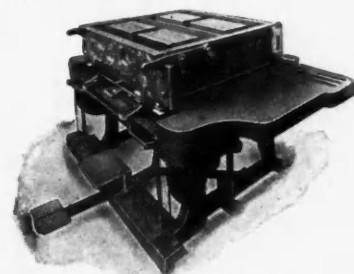

Set to mould two blocks, 14x32 inches. Cores raised. Divisions ready to fill and tamp. Cores are raised and lowered with foot lever.



2-14x32 inches. Blocks moulded. Cores withdrawn. Division shown in center. Front block is carried away first. Moulded block in rear.

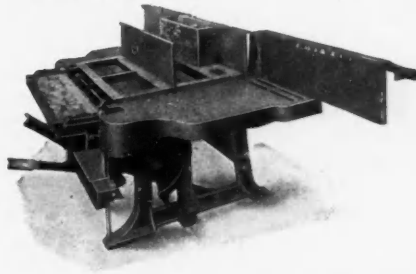

Open. Set for 1-10x32 in. straight and 1-10x32 in. corner. Rock face inside angle, plain division. Use rock face division and rock face end to rock face outside angle.

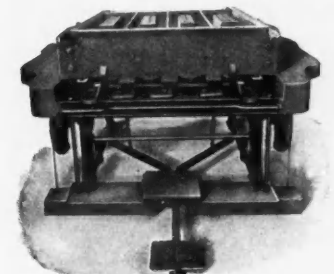

Front. Set to mould 4-8x24 inches. Any designs can be used. Four blocks can be moulded as quickly as one in a common mould.

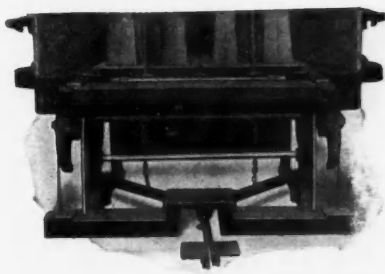

Open. Cores raised. Pallets in position. Center division not in. Has two sides of any design wanted.

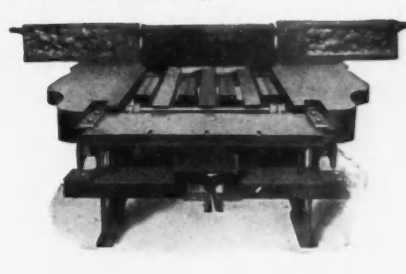

Open. Cores withdrawn. Divisions removed 24-inch rock face doors shown. The No. 4 Chicago is the only perfect adjustable machine.

COUPON

Cut out this coupon and write today for what you want. Enclosed find \$1.00 for sample of waterproofing and coloring sufficient to cover 300 sq. ft. of wall. State color wanted when writing.—Enclosed find 15c in stamps for descriptive catalogue containing cuts and descriptions of machinery and buildings built of cement blocks. Be sure and pin coupon to letter and address

SALES DEPARTMENT, CEMENT MACHINERY MANUFACTURING COMPANY, BURLINGTON, IOWA

The above cuts show our 1906 model No. 4 Chicago Machine set in several different ways. Blocks from 32 inches long up to 60 inches long are moulded lengthwise of the machine. Blocks from 18 inches long up to 28 inches long are moulded crosswise of the machine. We guarantee twice the capacity of any other machine, and that blocks moulded on the No. 4 machine will not be 1-64th part of an inch out of square or plumb.

We build twenty different styles of block machines, ranging in price from \$15.00 up to \$450.00, depending on the equipment. We are the largest exclusive manufacturers of cement working machinery.

We were awarded the Highest Prizes at the World's Fair. We build machines, not crude, cast boxes. See our machines before buying. Every part of the No. 4 machine is machined and interchangeable. There is no design that we cannot furnish, unless under cut, to work on the No. 4. The cores are raised and withdrawn with compound foot-lever, and being counterbalanced, a boy can draw 8 cores at a time or raise them to position. Cores lock automatically when raised and are released with handle bar in front. We build the No. 1, No. 2, No. 3, No. 4, Junior No. 2, Junior No. 3, and Junior No. 4 Chicago machines. The Junior No. 3 is the same as the No. 3 except cores are drawn from top. The Junior No. 4 is the same as the No. 4 except cores are drawn from top. We have the strongest patents but do not sell territory or patent rights. We manufacture special moulds from drawings. We make patterns for block machines. We carry a stock of pallets for every standard machine and can make prompt shipment. We manufacture every class of cement working tools and moulds. Write us for anything you want. We have more than 2,000 users of Chicago machines, all satisfied. We have shop capacity of 5 machines per day and can ship promptly. We will gladly furnish you a list of users of our machines. We furnish all repairs for one year from date of sale free of charge. We have the best face down machines on the market. We will show you 40 different styles of machines if you will visit us. If we cannot please you, we do not expect you to buy.

If you are intending to purchase cement working machinery, we agree to pay your transportation if you will visit us, or we agree to ship one of our No. 4 machines to any point in the United States, freight prepaid, and send our representative to start it. If machine is not satisfactory, we remove it at our expense. We will take old machines of any make made of iron in exchange for our new models. We will build you a No. 4 with special equipment just as you want it at less than you can buy a crude mould box. We want every plant to be a success; tell us where you are located and we will tell you what equipment to buy. Don't buy a large outfit if a small one will do; we build them all sizes and we want to sell you only what you have use for. We agree to ship on approval or to pay your expenses to visit us; it will be more satisfactory for you to visit us and see all the different makes and choose just what you want. Last of all, don't buy territory or patent rights. Buy the best machine you can find. Write us today. Cut out coupon, pin to your letter, and address to SALES DEPARTMENT, CEMENT MACHINERY MANUFACTURING CO., BURLINGTON, IOWA.

A Model Cement Block Machine For 1906

To the Public and Purchasers of Cement Machinery:

We offer you this, our model block and sill machine, as the BEST general purpose cement machine to be had at a reasonable price; easy and quick in operation, substantial, durable and strong; and will mold everything necessary for the construction of a modern building within itself.

Commence communicating with us AT ONCE, that we may be able to supply your demands with promptness and dispatch.

Keep this ad in mind, it may not appear again.

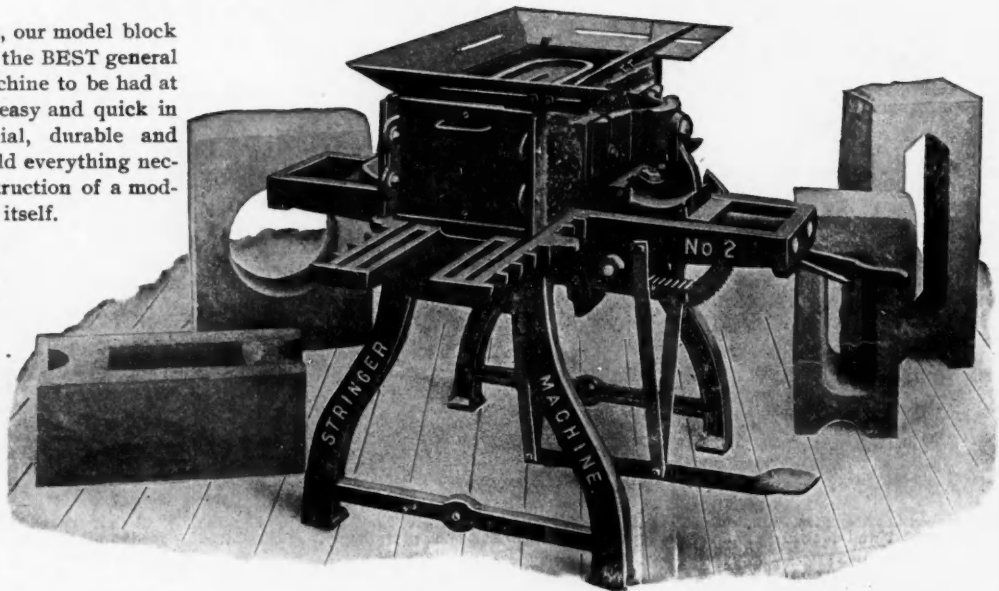

ADDRESS

STRINGER MACHINE CO., Jackson, Mich.

On the High Wave of Popularity

The Ideal Hollow Concrete Block Machine

Not a New Machine. Tried and Tested Over Two Years. Satisfied Users Everywhere. Interchangeable to Various Widths. Adjustable to Sixteen Lengths.

No wheels, cogs, gears, chains or cranks.

Nothing to clog, break or get out of order.

Simplicity, rapidity, adaptability, durability.

Face formed in bottom of the mould.

Cores withdrawn horizontally by lever.

Guaranteed Capacity—two men, 10 hours, 200 blocks.

Portable—Can be carried by two men Over 200 in use in the state of Indiana alone. The only machine by which can be accomplished the facing of blocks by the Borst System.

A business proposition to the maker of blocks. An appeal to the common sense judgment of the builder. In correspondence with us we make our business your interests.

Ideal Concrete Machinery Co.

SOUTH BEND, INDIANA



\$29.75

The R. B. Coltrin Block Mold
With Eleven Doors

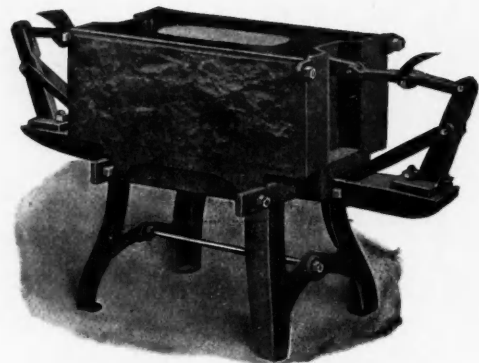

Patented April 12, 1904

Manufactured Exclusively By

The Knickerbocker Co.

JACKSON, MICHIGAN

That Hercules Cement Stone Machine

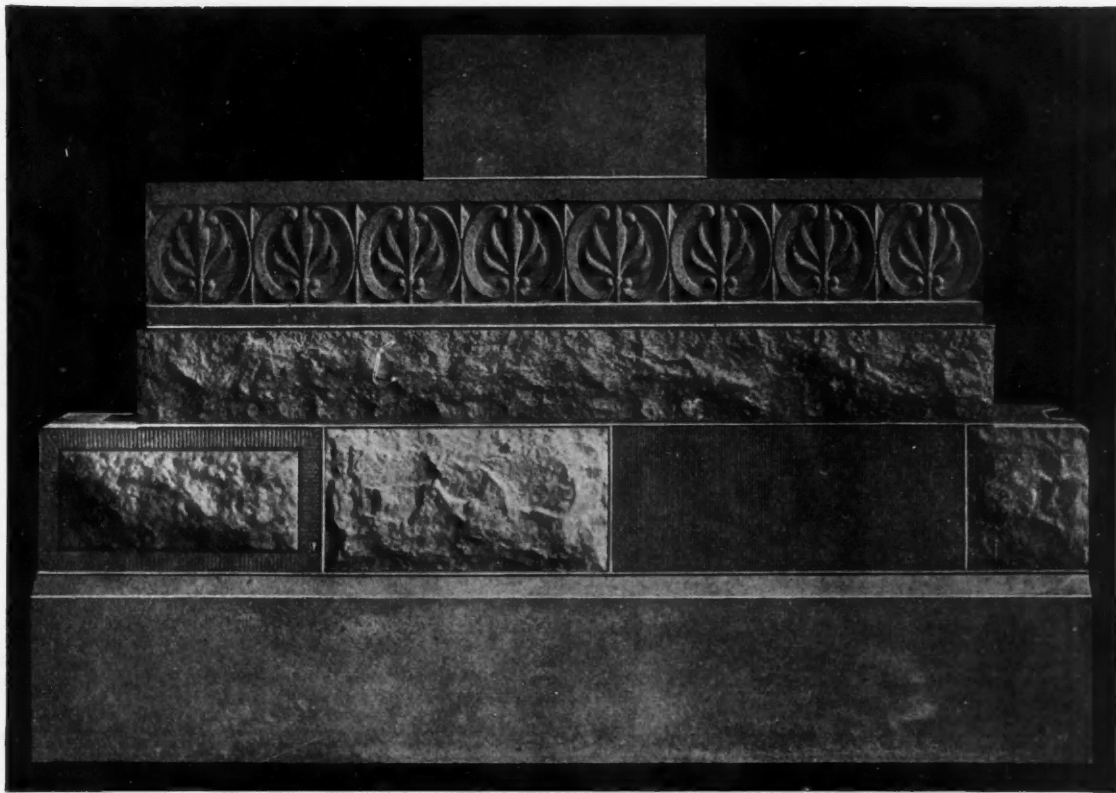

Taken Directly From Stone, Made On One Hercules Machine

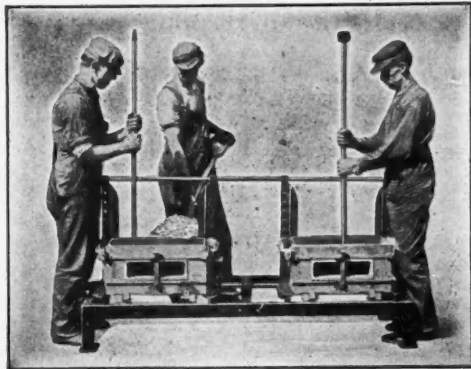

Showing Method of Making Two Stone at One Operation

reducing the cost of labor to a minimum, saving you the expense of purchasing two machines—important item, this.

Reason No. 3. "That tamp on the face method" guarantees a perfect reproduction of the face plate, which means stone that has the appearance of natural stone,—that bold, sharp appearance,—allows 2 to 1 composition for facing and 5 to 1 for backing—great saving in material, this, and insures a face on the stone that will be durable. By this method you may make your mixture more wet, guaranteeing perfect chemical action and a stronger stone.

Knowledge is Based on Reason

You may SUPPOSE that an artificial stone machine is superior, but if you would know, you must have reasons. We KNOW the superiority of

"That Hercules Machine"

Here Are Some of Our Reasons:

Reason No. 1. "That large variety," which means supplying the architects and builders with that class of stone essential for all building purposes. It is the only machine in the world that can make, in addition to hollow blocks of all shapes and sizes, water tables, sills, lintels, coping and ornamental work, up to 6 feet long, all on the one machine.

Reason No. 2. "That double operation feature" permitting two stone to be made at one operation, doubling your capacity and reducing the cost of labor to a minimum, saving you the expense of purchasing two machines—important item, this.

For Accuracy, Strength and Simplicity of Construction and High Class Work, "That Hercules Machine" is Without a Peer. Send for Beautifully Illustrated Catalogue X, With More Reasons

Century Cement Machine Company, 173 W. MAIN STREET, ROCHESTER, N. Y.

Get the best

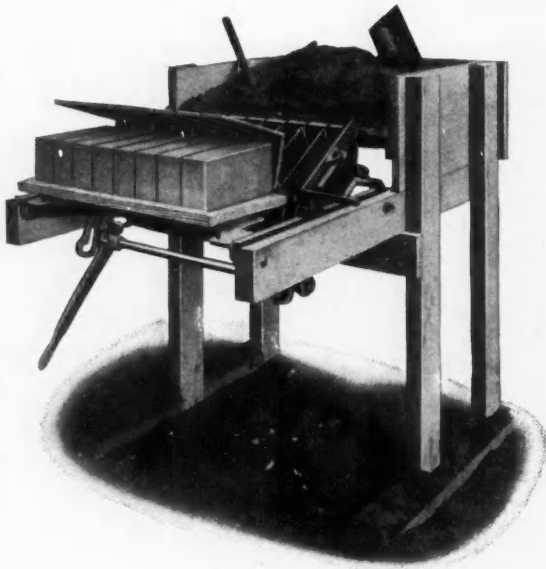

*To the conservative business man
To the man who wants value received for his money*

we present for his consideration and investigation this new

Boos Automatic Cement Brick Machine

confident that on examination it will demonstrate its superiority over any brick machine on the market. Compare its merits with its competitors, the rapidity of its work, the quality and uniform size of its product, the simplicity of its construction, and you will readily admit that we do not exaggerate in our statement when we say that one man can readily turn out 2,000 brick in ten hours, and in presenting the Boos Automatic Brick Machine to the public, we feel we are presenting for your consideration a high grade, practical machine that will be appreciated by those who want the best.

Manufactured and sold by

COLTRIN MANUFACTURING COMPANY
140 W. Main St., Jackson, Mich.

The Architectural Mold Co.

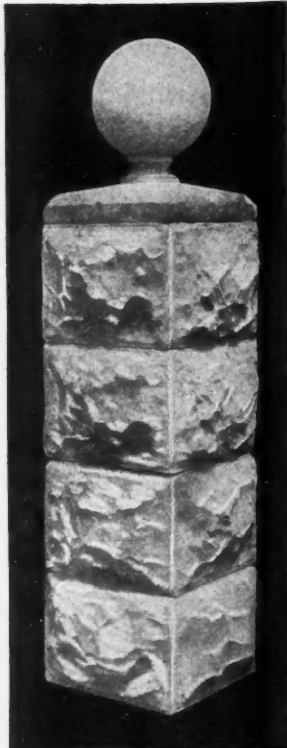

This cut illustrates results obtained from our

Balluster and Base Ball Cap Molds

Photographed direct from the cement products. Size of Balluster blocks $8\frac{3}{4} \times 12 \times 12$, base of cap 12×12 in., diameter of sphere 9 in.

These molds have our corner locks, which easily and rapidly adjust the molds to their proper position. You will be interested in our Broken Ashler and Course Building Block Molds.

Let us supply your needs in this line also.

Full particulars and prices furnished upon application

THE ARCHITECTURAL MOLD CO.
1174 Theodore Street DETROIT, MICH.

SUPERIOR THE BEST CONCRETE BLOCK MACHINE



The **SUPERIOR** makes the stone with the face down or in the bottom of the flask, which permits of the use of fine rich material for the face and coarser, cheaper material for the main body of the block.

It is manufactured by
T. O. EICHELBERGER COMPANY
DAYTON, OHIO

who will gladly tell you all about it. Write them.

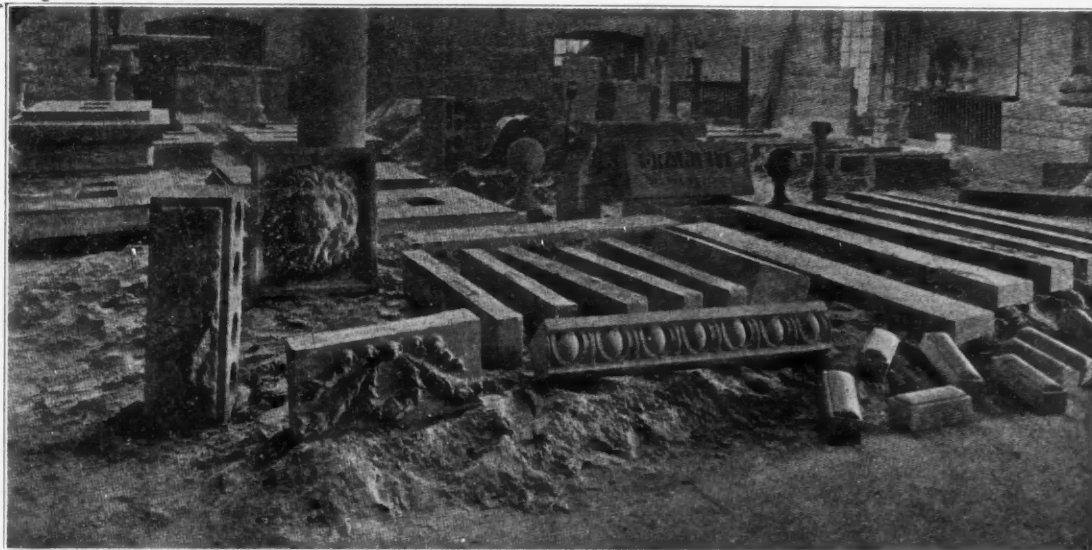

Granite manufactured by the McClenahan process

CONTRACTORS and builders are amazed at the perfection of this product. Highly approved by architects everywhere.

DURABILITY UNQUESTIONED LESS ABSORBENT THAN NATURAL STONE
ABSOLUTELY FIRE-PROOF

Every detail of architect fully carried out. Our Licensees are not compelled to compete with the owners of \$25.00 hollow block molds. Parties with capital should write for illustrated catalogue.

STANDARD STONE CO. OF AMERICA (Sole owners of McClenahan patents) No. 1 Madison Ave., New York City

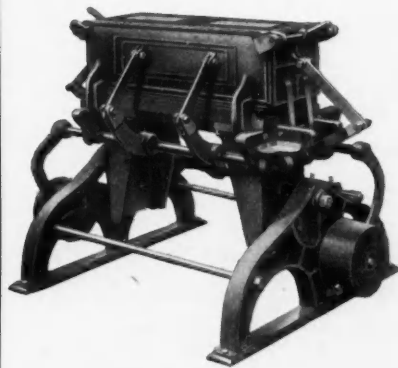

The "Runyan"

Is the only machine that will make concrete building blocks of any description, pavement blocks, window and door caps and sills, BRICK and curbing. The only combination brick and block machine ever invented. One movement of the lever through an arc of 55 degrees, forms the mould and places the cores in position; a reversed motion will release the mould and remove the cores; less than a second's time required; A CHILD CAN DO IT. Cheapest machine on the market, capacity considered.

C. M. RUNYAN & CO.
ELYRIA, OHIO



Strong, Simple, Durable
Capacity limited only by what can be fed into it. It's doing business all the time. Operated by 3 H. P. gasoline engine, the entire machine when equipped weighs but 1,700 lbs.

The GRANT

The Mixer that Mixes
Dry Concrete, for it is not a revolving drum or cube

It has the dry and wet mix of our famous CONNOLLY and, of its character, is the lowest priced concrete, cement and mortar mixer equipped with power on the market.

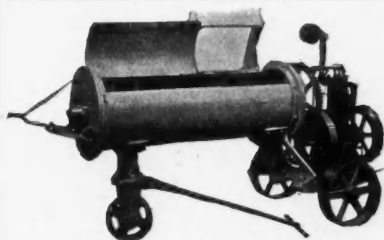

The rapid and peculiar motion of its 23 paddles attached to the center (mixing) shaft, making 62 revolutions a minute, throwing the material over itself and giving it lateral and edgewise thrusts, the entire product gets a thorough and absolutely perfect mix.

We make and try to keep in stock our Special Type of Grant with mixing cylinder 10 ft. in length and equipped with 53 paddles, a superb mixer designed for dry concrete. This we sell with or without power, stationary or on wheels, and is essentially a machine for block and all kinds of artificial stone work.

Make no mistake but send for Booklet "G" and prices.



Ready for Shipment

U. S. CONCRETE MACHINE Co., Majestic Bldg., Detroit, Mich., U.S.A.

Well! Well! Get in Line!



HOW?

By using the Coryell Cement Block Machine. When we ask you to get in line, we mean get in line with a block that will make a hollow wall, so that when your customer asks you if you can build a hollow wall, you will not have to evade the question by saying: Our or my machine makes a hollow block. A hollow block is all right as far as it goes, but they will not make a hollow wall. Now if you want to avoid trouble with moisture and frost, use the Coryell Block, which is better than all, for it makes a hollow wall.

Our catalogue can be had for the asking.

Write, The Kells Foundry & Machine Co.
82 N. Main St. WHO MANUFACTURE AND SELL THE MACHINE ADRIAN, MICH.

ROAD TO SUCCESS

LEARN THE REAL ESTATE BUSINESS

Our course teaches you the Real Estate, General Brokerage and Insurance business, fitting you to successfully establish yourself without interfering with your present employment. We list with you choice salable properties and investments, help you secure customers, cooperate with and assist you to a quick success.

Thousands of real estate men earn from \$3,000 to \$10,000 a year. Don't spend the best days of your life working for others when you can make an independent fortune for yourself. Real estate offers better opportunities than any other business to men without capital.

One of our correspondents writes: "I have learned more from your lessons than I could have possibly picked up in five years in the ordinary way." Another says: "For concise statements and comprehensive instruction I know of nothing better for the wide-awake real estate man." Hundreds of others make similar statements. Write for particulars and **Free Booklet**. It will interest you.

Be A
Business
Man

H. W. CROSS & Co.
890 Tacoma Building, CHICAGO

Be Your
Own
Boss

It is always safe to be first

CONCRETE Construction Taught BY MAIL

**Artificial Stone Making
Concrete Steel Construction
and Hollow Block Building**

3 Practical Courses by 3 Practical Instructors

Send for Catalogue and be
the first in your locality

College of Construction
Cleveland, Ohio

THE FACE PLATES

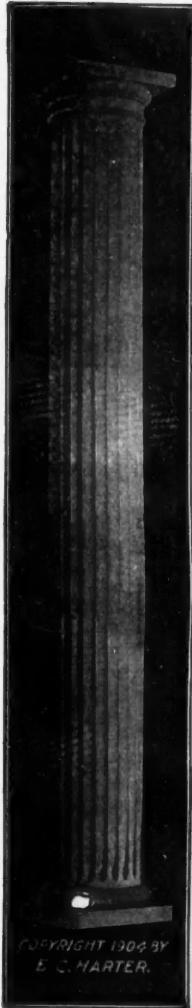

COPYRIGHT 1906 BY E. C. HARTER.

of our \$25.00 concrete Stone Outfit are all interchangeable. The stone made by it are just as artistic of design and as practical for building buildings as those made on the more expensive machines. We ship to responsible parties on ten days' trial. 411 machines shipped on trial during 1904; only three were returned. If we were selling gold dollars for 90 cents each we could scarcely hope to beat this record. Don't

argue—we pay the freight when not satisfactory. Send for our book of instructions for making concrete stone.



CEMENT WORKING MACHINERY CO.

195 LAFAYETTE AVE., DETROIT, MICH.

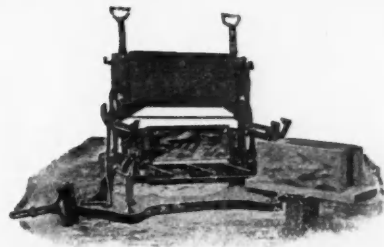

THE IMPROVED "MILES"

CONCRETE BUILDING BLOCK MACHINE

MOLDS ALL BLOCKS FACE DOWN

Makes circles, octagons, gables and water table blocks for hollow, solid or veneer walls.

Write us today for circulars and descriptive matter

THE P. B. MILES MFG. CO.

Suite 23, Dwight Bldg.
JACKSON, MICH.

Concrete Blocks! The Clipper Block Machine Produces Them

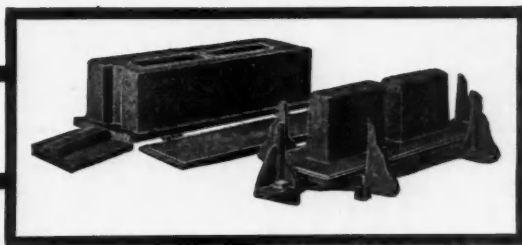

The Clipper Block Machines are simple, durable, light, strong, accurate, and will produce a great variety of shapes and sizes in hollow blocks, veneering blocks, chimney blocks, pier blocks, circular blocks.

ALL FACE BLOCKS TAMPED WITH THE FACE DOWN.

Rock faced, plain faced, panel faced. Continuous air space, damp and frost proof. Machines on the installment plan.

Write for particulars.

R. T. FROST, Exclusive Agent
Address Dept. "A" Dows, Ia.

Notice to Architects Contractors and Builders



THOUSANDS of hollow concrete houses were built this last year and ten times as many are being arranged for this coming year. While such buildings are comparatively new, yet the oldest buildings and work in the world are concrete material. We have had twenty years experience in concrete work, but as every new invention and discovery has difficulties and defects to overcome, we had an expert engineer travel and examine buildings that have been built of Hollow Concrete Blocks. He found lintels, sills and blocks cracked. As you readily understand, a solid block is much stronger than one with a large percentage removed. We experimented, made tests and invented a wire reinforcement which we patented. This strengthens blocks, lintels, etc., so they would not crack and would stand any strain. Tests show they would stand 1500 feet high before bottom block would commence to crumble. 40,000 of these were placed in the sewerage pumping station where the strain of the powerful machinery required the strongest construction. By using this reinforcement in the blocks they can be made so much lighter that one man can make and lay same, being a great saving in labor and material. Foundations, basements and even the first stories of frame buildings can be made of Hollow Concrete Blocks as well as lintels, sills, etc. Our machines make blocks face down. The face can be made one-fourth inch thick, any color, the balance of the block ordinary concrete. We make machines any size, from a hand machine that can be moved instead of the blocks, to a machine that turns out five blocks at one time. Write us and get full particulars regarding machines, cost, etc. We also furnish forms, shapes and moulds for all kinds of ornamental concrete work.

National Hollow Concrete Machine Co.
Department K No. 921 F Street, N. W. Washington, D. C.

Rebekah's Well
WOULD BE STANDING TO-DAY IF IT HAD BEEN
MADE OF **Frost Cement Blocks.**

**WE SELL THE
MACHINE,
YOU MAKE THE
BLOCKS**

**WE HAVE A
PROPOSITION TO
MAKE YOU RIGHT NOW
IT WILL INTEREST YOU**

Write us. You cannot afford not to.
Our catalogue illustrates our
machine, which is practically 40
machines in one.

Write us today, not tomorrow

FROST CONCRETE STONE CO.

607 Commercial Avenue :: :: WATERLOO, IOWA

Waterloo Concrete Brick & Block Mach. Co.



ONE movement of the lever operates the **ENTIRE** machine, consuming the least time for operation of any machine. Two men will make 250 blocks per day.

Our block is patented. Has double, a vertical and horizontal air space.

The brick attachment makes 18 brick as easily as a block. No gears or chain to clog or break.

Write for catalogue "B." **O. H. SWEENEY, Sec.**
Agents Wanted. 101 E. 4th St. WATERLOO, IOWA.

Southern Agents, SILVERA & GADSDEN, Savannah, Ga.
Agents for the Pacific Coast, C. J. TALLON & CO., 618 Bailey
Building, Seattle, Wash.

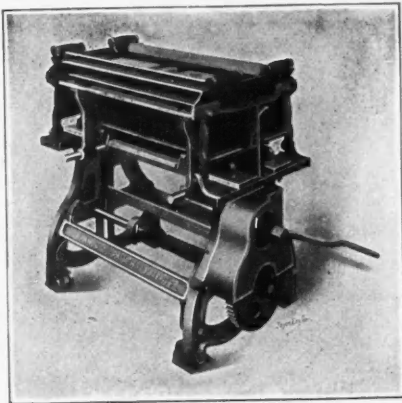

**Only
Machine that
can make
Water-Proof
Work**

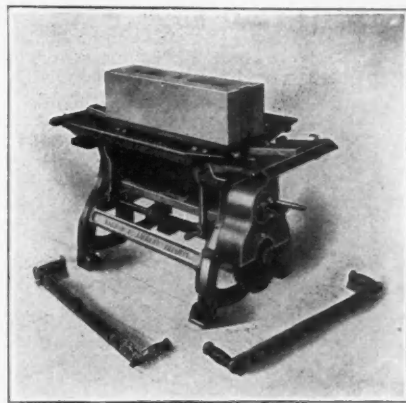

The original inventor's latest production in Hollow Concrete Building Block Machines; advancing the industry one hundred per cent

**Harmon S. Palmer's
Self-Closing-Automatic-Adjustable**

The Crystallization of Every Merit in the industry to date. Blocks of every size, length, angle, height and contour produced with astonishing ease and rapidity. Also brick. A marvel of ingenious attachments to the machine which has made more buildings than all infringers and imitators combined. We gave the world the Hollow Concrete Block Industry, the first machine and the first practical block. In the race for advancement and business, we are still in the lead.

Two Highest Awards at St. Louis Exposition. Adopted by the United States Government and Panama Canal Commissioners.

Wanted!—Live Agents, Good Factories and Local Lawyers

We agree to prosecute infringers. Many already enjoined. Many suits pending.

**Write for Catalogue "A."
Washington, D. C.**



CEMENT BRICK

BE YOUR OWN BRICK MAKER

**LARGE CAPACITY — 5,000 BRICK PER DAY
SKILLED LABOR UNNECESSARY. SIMPLE AND INEXPENSIVE**

Seaman's Cement Brick Machine Co.

23 Fountain Street

Grand Rapids, Michigan

Do You Need a Concrete Mixer?

If so you certainly need the best one obtainable—one that is strictly up to date. It will cost no more than old-style machines of same capacity—will save you more money and give better satisfaction.

THE AMERICAN MIXER

is the up-to-date machine. It mixes any kind of material in the most thorough, uniform and perfect manner—feeds while running, taking the materials in any order—discharges instantly and is self-cleaning. Less time is required to mix a batch than with any other machine and the concrete is within full view of the operator while being mixed. Furnished without power or with any kind of power required—several sizes. Catalog No. 5 upon request.

Manufactured by

The International Fence & Fireproofing Co., Columbus, O.



THE CROUCH SYSTEM

THE SAND PALLET BEATS THEM ALL

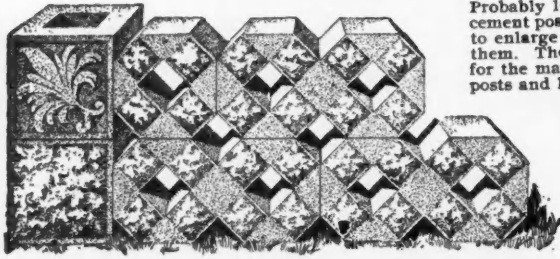

Probably 10,000 persons contemplate engaging in the manufacture of cement posts or cement building blocks this year. Many more propose to enlarge their plants or perfect their equipment. You are one of them. The cost is an item of importance. Before buying a machine for the manufacture of cement building blocks, porch blocks, fence posts and hitching posts, write for my new catalog and learn about the Sand Pallet and the economical system of making them.

By using the Sand Pallet you cut out the cost of wooden or metal pallets. This item alone will save you \$200 to \$500 on a small outfit to make 150 blocks per day. This amount is more than I ask for an outfit to make 25 varieties and sizes of stone, posts, lattice and piers. Besides this, the other kind of machine costs more than mine. You will be right when you adopt the Crouch System.

J. M. KEITH, 1190 West 4th Street, Des Moines, Iowa.

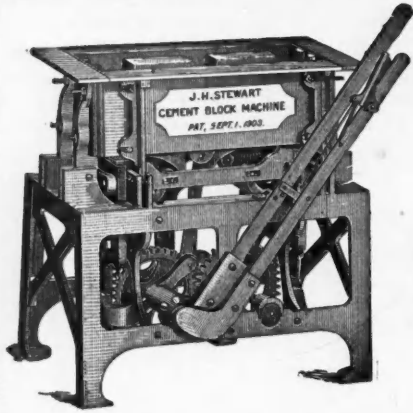

GET A MACHINE THAT WILL DO THE BUSINESS

The cut of the church shows what can be done with the Stewart Machine, as this church was erected of blocks made on a Stewart. You can make blocks in any old box, but if you want to make good blocks,

GET A STEWART

Write for catalogue to the

STEWART CEMENT BLOCK MACHINE CO.

888 Lafayette Block, WATERLOO, IOWA

The OHIO CERAMIC ENGINEERING CO., Cleveland, Ohio
Agents east of Wisconsin, Illinois and the Mississippi River.

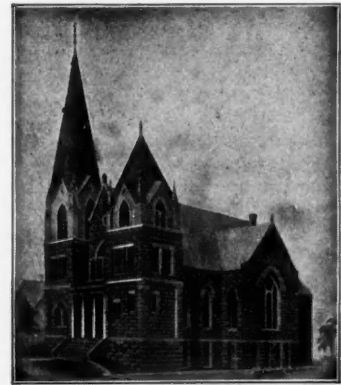

CONCRETE STONE

MADE BY NATIONAL BUILDING BLOCK MACHINERY CO.

MILWAUKEE, WIS.

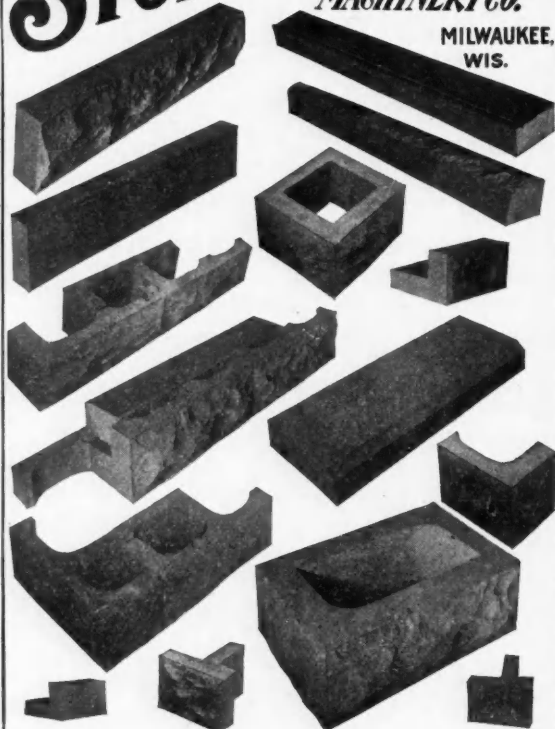

211 GRAND AVE., MILWAUKEE, WIS.

ONLY CONCRETE BLOCK MACHINE

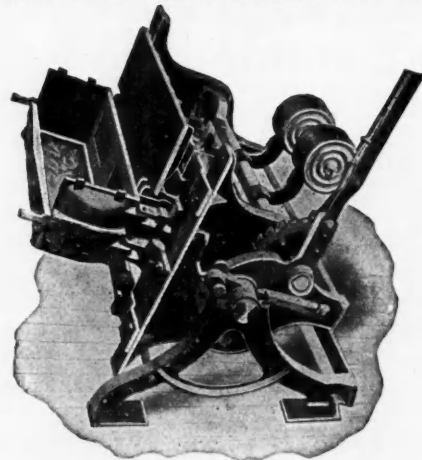

(Showing Face Down Position)

To receive an award at the Portland Exposition was THE "WINGET 1906 MODEL"

The judges quickly recognized its superiority over all others.

This is called a Universal machine because it combines completely all the three standard kinds of machines into one machine, and does the work of them all most perfectly and quickly.

Up to this time the purchaser of a concrete block machine must choose either an upright machine, a face down machine or a two piece block machine separately. Now if he buys a "WINGET" he gets them all in one, and to his great advantage all the movements are quickly and easily operated by one simple automatic lever.

As an upright machine it has never been equaled in wide range of adjustments, speed, economy and ease of operation. As a face down machine it far excels others in convenience of operation, but more notably in its great advantage of being the only face down machine that gives finished molded surfaces to all sides of the block, all other machines leaving a rough, irregular troweled surface on one side. As a two piece block machine it has the advantage that it makes two of these blocks at once. For full particulars regarding the Winget System of Concrete Machinery, address the Columbus office or branches, New York Chicago St. Louis Los Angeles Greensboro, S. C.

IT'S A HOOSIER



AN
IDEAL
FACE-
DOWN

CONCRETE BLOCK MACHINE

PRICED COMPLETE, including Iron Pallets that will not warp, split or have to be replaced.

PRICE Well, this is attractive and will interest you.

ADDRESS

Hoosier Mfg. Company
Auburn, Ind., U. S. A.

THE GENERAL PUBLIC

is not educated as to the degree of perfection to which Block Machines have attained, many believing the cheap machines will do the work, as it is nothing more than an experiment.

However, this idea is wrong, and experimenting with an inferior machine will invariably prove a failure.

The Block business is permanent, and the trade demands that the machine prove its efficiency before it becomes a fixture on the market.

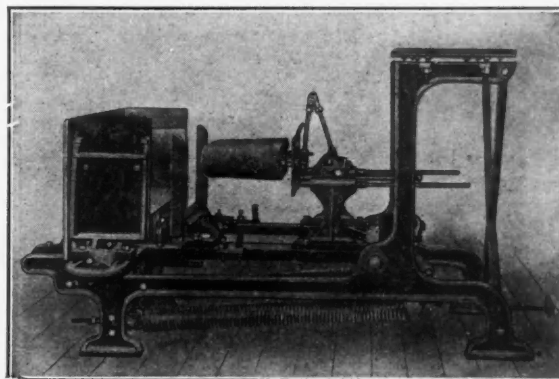

The success of our machine is established, and it is classified as permanent and invaluable because of its many superior features.

Its speed is unlimited, and you are assured of the very best results in quality and appearance of blocks, because of the fact that they are moulded with the face down. Write us for descriptive catalogue J.

AUTOMATIC BUILDING BLOCK MACHINE CO.
126 Liberty Street, Jackson, Mich.

Bedford Stone

BUFF AND BLUE

Sawed, Planed, Turned
Cut Ready to Set

Estimates promptly made for stone delivered to any point. Plans sent for estimate, promptly returned.

Bedford Steam Stone Works
Bedford : : Indiana

—ASTRALITE—

Makes Concrete Blocks Absolutely Waterproof

It is applied with a brush
It is used cold : It does not discolor the blocks
It is lasting : It costs one cent for seven square feet

Trial Gallon \$1.00

ASTRAL MOULD WASH

Is painted on the block mould and keeps it free from concrete

A Gallon Costs \$2.00

Pays for itself in a week and lasts two months

ASTRAL DRIER CO.

828 West Washington Street INDIANAPOLIS, IND.

ROOFING, GENUINE BANGOR BLACKBOARDS & STRUCTURAL SLATE

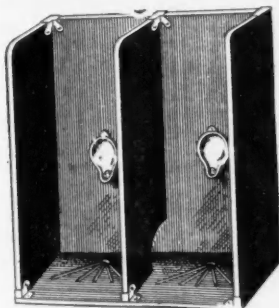

ALL ORDERS FILLED PROMPTLY

Order direct from the miners and manufacturers

HEADQUARTERS FOR
SLATE BURIAL VAULTS,
CATACOMBS, ETC.

THE BANGOR STRUCTURAL SLATE CO.
LOCK BOX 48 BANGOR, PA.

KEEP OUT DAMPNESS

PAINT YOUR CONCRETE BUILDINGS WITH

R. I. W. PAINT

"REMEMBER IT'S WATERPROOF"

Sold in Barrels, \$1.25 per gallon; 5-gallon cans at \$1.35 per gallon; 1-gallon can, \$1.50 per gallon; all F. O. B. Chicago.

PROOF AGAINST WATER, ACID, FUMES OR ALKALI
Special Elastic Compound for Each Specific Purpose.

THE GARDEN CITY SAND CO.

Dealers in All Kinds of Building Materials

1201 SECURITY BUILDING, CHICAGO.

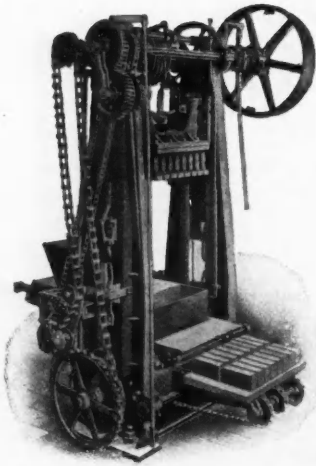

40,000 SAND-CEMENT BRICK or 5,000 BLOCK (8 x 24) PER DAY

Only *TAMPING* principle power machine made.

We also make an up-to-date mixer.

Write for our Catalogue of power machines, also of our perfect bond, damp-proof block wall. (Hand moulds.)

CONCRETE MACHINERY CO.

950 Majestic Building, DETROIT, MICH.

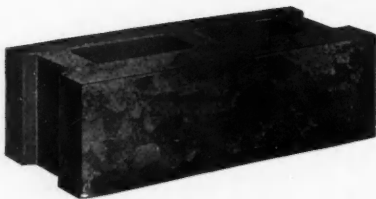

We Move the Machine NOT THE BLOCKS

Saves labor of off bearing, loss by damage; obviates necessity for heavy and expensive iron pallets. Reduces cost of plant and cost of operation. Every one knows that concrete should not be disturbed after it is molded or while it is setting, but this is the only machine by which this is possible. The blocks cost 6 cents to make—sell for 18 cents. One man can make 200 blocks per day. Whole outfit costs \$125.00. Figure the profits.

Competition simply demonstrates the superiority of the Pettyjohn machine. Unlimited guarantee. SENT ON TRIAL

THE PETTYJOHN COMPANY

634 No. 6th Street, TERRE HAUTE, IND.



FACTS CONCERNING THE HARTWICK AUTOMATIC CONCRETE BLOCK MACHINE

All parts are machine finished and every block guaranteed perfect. Makes all forms, **Solid or Hollow Blocks**. Has fewer parts and works easier than any other machine. **No Springs—No Cogs—No Wheels**. Simplicity and durability its strong points. Either **Wood or Iron Pallets** for all kinds of work.

THE SCHEIFFLER, Continuous Automatic Proportioning Mixer

The only Mixer that will automatically proportion in any amounts from 1 to 2, to 1 to 10, and **will not clog with Cement**. Made in all sizes; any kind of power required. Used for all kinds of **Street and General Contract Work**. Hand Machines are fitted with pulley power—can be attached. Are especially adapted for **Concrete Block Manufacture**.

HARTWICK MACHINERY CO.

228 Washington Street

::

JACKSON, MICHIGAN

Masons' and Builders' Concrete Block Machine A Complete Machine for the Price of a Mould

Makes Hollow, Solid or Veneer blocks in all lengths and from 2 inches to 12 inches in width. Different Designs

Price **\$35.00**

WHY PAY MORE? WRITE FOR CATALOG.

W. E. DUNN & CO.

:: 353 West Fullerton Ave.

:: CHICAGO, ILL.

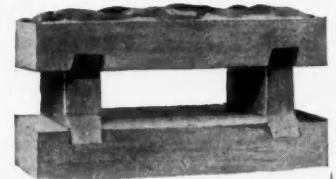

THIS MANTEL \$24.00

Golden Oak, 82 inches high, 5 feet wide. Includes enameled tile hearth and facing, 20-inch oxydized finish combination grate with summer front.

Catalogue E Free—Mantels \$20.00 up. Our handsome large 172 page Catalogue for 10c postage.

CALHOUN MANTEL & TILE CO.

KANSAS CITY, MO.

Tile Floors AND Bath Rooms

Send Sketch of
Space for Prices

WHEN WRITING ADVERTISERS PLEASE MENTION THE AMERICAN CARPENTER AND BUILDER.

High Grade Concrete Block, Brick, Post and Mixing Machinery

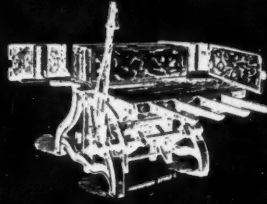

"WE HAVE THE LEADERS. 'THE BIG 7'"

1. Normandin Concrete Block Machine (Face Side)
2. Peninsular Concrete Block Machine (Face Down)
3. Cemaco Concrete Block Machine (Face Side)
4. Champion Concrete Veneer Block Machine (Face Down)
5. Favorite Sand Cement Brick Machine
6. Systematic Concrete Mixer.
7. Universal Cement Line, End and Brace Post Machine.

GIVE YOU THE BEST VALUE FOR YOUR MONEY. WRITE US. DON'T DELAY. GET STARTED. Concrete posts, blocks and brick ARE IN DEMAND. We solicit your trade because we can please you. Our machines are standard; ADOPTED TWICE BY THE UNITED STATES GOVERNMENT. Highest awards Universal Exposition, St. Louis, 1904, and Portland Exposition, 1905.

CEMENT MACHINERY COMPANY, JACKSON, MICHIGAN U. S. A.

LEARN REAL ESTATE—Business at home. Taught by mail. Pays \$2,000 to \$5,000 a year. Catalog free. W. H. CLAWSON & CO., 1721 Grand Avenue, Kansas City, Mo.

THE REED CEMENT BLOCK MACHINERY

Is superior to all others because of its rapidity, simplicity, cheapness and large range of adjustments. All others take the machines from the blocks after being manufactured. On the Reed machines the blocks are raised or turned out of the machines. All sizes of blocks produced.

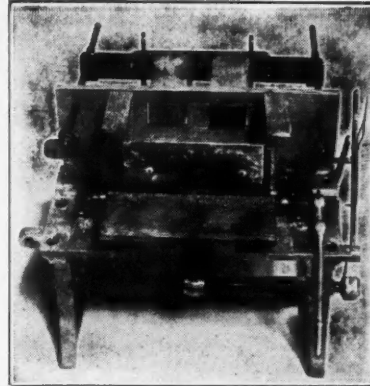

Side Face Machine

Capacity in Ten Hours:
 Side face machine, capacity - - 600 blocks
 Down face machine, capacity - - 350 blocks
 Brick machine, capacity - - 6,000 brick
 Absolutely Perfect Blocks Produced. No Cogs or Gears to Clog.
 Write for circulars today. Reliable agents wanted. The Wichita Coal & Material Co. WICHITA, KANSAS

The Standard Sand & Machine Co.

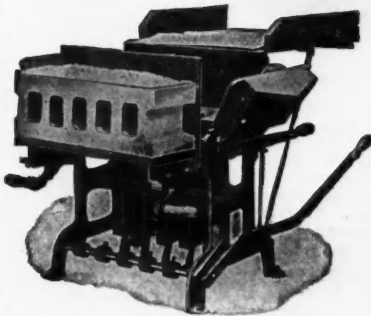

BEST in the world. No experiment. Been on the market since 1903 and successfully stood the test. Ask for catalog "A" and prices.

The Standard Sand & Machine Co., Cleveland, Ohio.

Don't fail to read about the Great Prize Contest

SLATE WE HAVE WHAT YOU WANT

*In Roofing Slate, Slate Blackboards
 Structural and Plumbers' Slate*

SATISFACTION GUARANTEED IN QUALITY AND PRICE

ASK FOR DELIVERED PRICES

J. K. HOWER, Station C., Slatington, Pa.

H. J. KICHLINE, Sales Agent



Shingle Roof being covered with our Standing Seam Roofing.

STEEL ROOFING AND SIDING

Cheaper than tin, slate or reshingling. Cooler in summer; warmer in winter. Saves insurance and danger from fire.

LLOYD IRON ROOFING & PAINT CO.

100 West Monroe St., CHICAGO, ILL.

Manufacturers of Metal Ceilings and Sidewalls, Corrugated and Crimped Iron, Steel and Galvanized Iron Roofing, Roofing Paints and Cement

ARCHITECTURAL DRAFTSMEN

desiring to fit themselves for better paying positions should send for 200-page handbook (FREE) describing our Architectural course, and over 60 others, including Electrical, Mechanical, Steam and Civil Engineering, Mechanical Drawing, Structural Drafting, Telephony, Textiles, etc.

American School of Correspondence, Chicago, Ill.

GOODELL MITRE BOX

MADE ENTIRELY OF STEEL. NO MORE BREAKING
 FIRST IN QUALITY AND IMPROVEMENTS

AUTOMATIC STOPS FOR HOLDING UP SAW. CORRUGATED BACKS. GRADUATED GAUGE FOR DUPLICATE CUTS and many other features.

If you want the best you will take no other. Send for Circular C.

GOODELL MFG. CO., Greenfield, Mass.

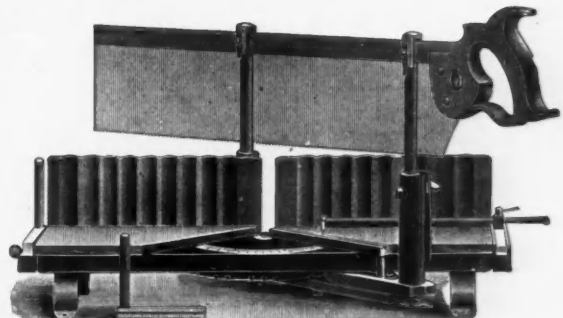

**Dumb Waiters
Hand Power Elevators**

Let us quote you our low delivered prices on Dumb Waiters and Hand Power Elevators.

We ship them complete, ready for erection.

Tell us what you want and we'll quote you prices that will please you.

Ask for Catalog 99.

**Eaton & Prince
Co.**

CHICAGO

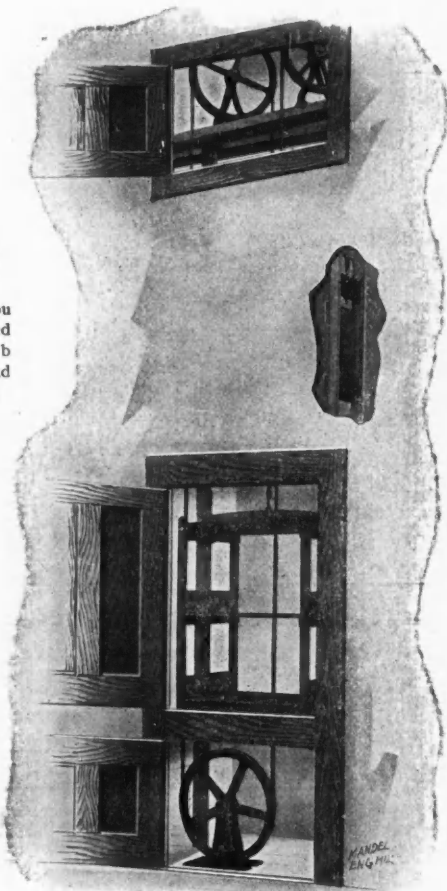

**"BALL-BEARING" GRAND RAPIDS
All-Steel Sash Pulleys**

Are sold DIRECT to Builders, Contractors and Mills at prices under the common ordinary goods

PATENT PENDING

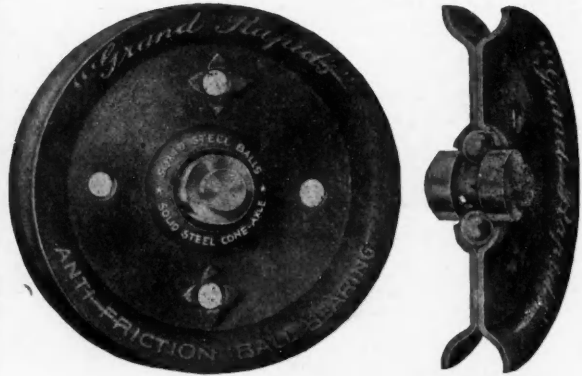

If you make ten or ten thousand window frames, we can save you money and give you a superior sash pulley. We are the largest sash pulley makers in the world. We ship direct, or through dealers and jobbers everywhere. Write for catalog and free samples and prices on half-gross, gross, barrel, or any quantity. Direct from the makers to you. Inquiries welcome.

Grand Rapids Hardware Co.
33 Pearl Street Grand Rapids, Mich.

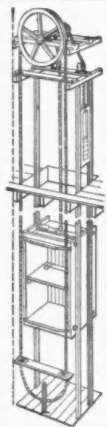

**AUTOMATIC
DUMB WAITERS
—AND—
HAND ELEVATORS**

of latest design and most improved construction

Carriage Elevators, Trunk Lifts,
Side-walk Elevators, Invalid Lifts,
Freight Elevators, Hatchway Hoists

SEDGWICK MACHINE WORKS,
84-88 Carrol St., Poughkeepsie, N. Y.
NEW YORK SALESROOMS, 128 LIBERTY ST.

Send for Catalogue on application.

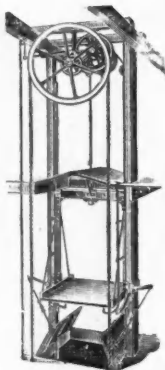

DUMB WAITERS

The "COLUMBIA" or "JUMPER" always leads. Shall we send you descriptive matter that tells all about them?

HAND and POWER **ELEVATORS**
SIDE-WALK or CELLAR **HOISTS**

J. G. SPEIDEL

Send for Catalogue "A" **READING, PENNA.**

*New Ideas and Clever
DRAWINGS*

*To Illustrate a
Point*

Manz Engravings have furnished a standard of excellence for years.

Manz Drawings have a life, snap, dash and attractiveness that make advertising do its work most effectively.

Write us about the new ideas and drawings. Quite probable that we can help you. We have ideas, as well as artists to execute them; and for any business.

J. Manz Engraving Company

Photographers, Designers, Engravers,
Electrotypers and Printers

195-207 Canal Street, CHICAGO



Stays on.

HIGH IDEALS IN PAINTS.

MONARCH PAINT. 100% PURE.

Made of Carbonate of Lead, Oxide of Zinc, and pure Linseed Oil. *Guaranteed and sold subject to Chemical Analysis.* Introduced 21 years ago.

We are the oldest and the largest manufacturers of an absolutely pure Paint in the United States.



Dries hard.

SENOUR'S FLOOR PAINT.

The Original and Best on the Market.

Made specially to walk on. Dries hard over night. High lustre. Wears like iron.



Stands the wear.

SENOUR'S E. Z. FLOOR AND FURNITURE STAIN.

Easy to Apply. Quick to Dry.

For Floors—does not chip or mar white. Washable. For Furniture—does not obscure the grain of the wood. High polish finish for high-grade work.

SENOUR MFG. CO.
CHICAGO. SOLE MAKERS. MONTREAL.

PENNSYLVANIA PAINT & GLASS CO.

Wholesale Dealers in

Paints Varnishes Brushes Colors
 Painters' Supplies Plate Skylight Mirrors
 Ornamental Window Glass

Exclusive Distributors for
 Acme White Lead and Color Works' Products

890-902 SECOND AVENUE, PITTSBURGH, PENNSYLVANIA



Design No. 44
 Estimated Cost, \$2,000

SPECIAL OFFER
 Complete plans and specifications of this design

\$10.00

Concrete Block Houses

The details of this beautiful Concrete Block house are given in my Folder containing 8 Concrete Block house designs. Price of Folder, 25 cents.

My "Portfolio of Houses" contains the above Concrete Block house designs, together with 40 other designs in Frame, Brick and Plaster, ranging in cost from \$500 to \$7,500. Price of Portfolio, \$1.00, postpaid.

Complete working drawings and specifications furnished of any of the designs at low cost.

SPECIAL PLANS PREPARED

H. WITTEKIND, ARCHITECT. Dept. A, 28 E. Jackson Blvd., CHICAGO, ILL.

FREE

SEND YOUR NAME
For Our Beautiful Catalogue

WE ARE THE WORLD'S LARGEST MANUFACTURERS OF

FREE

ORNAMENTAL
GLASS

**GLASS
SIGNS**

In Chipped
Gold and Sil-
ver for Store
Fronts, Office,
e.t.c., Name
Plates and
Number
Plates for res-
idences, Name
Plates for Of-
fice Desks.

Sand Blast
and Chipped
Glass for Office
Doors and Bank
Fixtures, Jew-
eled Electric
Signs, Col-
ored Glass
Signs for Store
Windows, Lod-
ges, etc.

Glass Signs
are most dur-
able. They are bril-
liant at night as
well as day,
and, having a
perfectly smooth
front surface, are
easily kept clean.
We furnish full
size designs free
of charge.

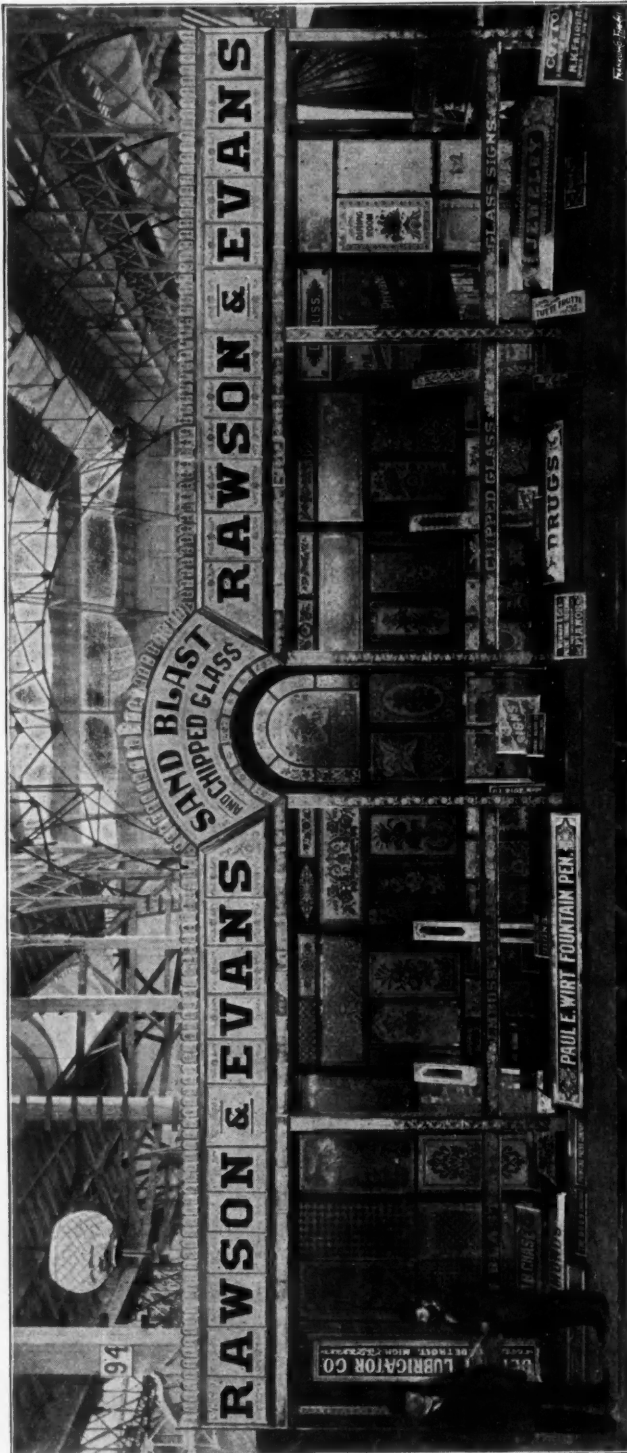

Ornamental
Sand Blast
and Chipped
Glass, Plain
and Mirrored
Reveled
Plates
Leaded Art
Glass and all
other orna-
mental glass
for use in doors,
front windows
and transoms of
residences.

**Enameled
Glass** (clear
and obscure).
Single and
Double pro-
cess Chipped
Glass, Plain
Sand Blast
Glass, Ge-
ometric
Chipped
Glass, Col-
ored Glass
ornamented
in Sand Blast
and Chipped
effects;
Leaded Art
Glass, Stained
Glass, Church Win-
dows, Mirrors
of all kinds.

Our Great Exhibit at the World's Fair. We received highest Awards Covering Every Point of our Exhibit.

We issue **TWO CATALOGUES—PLEASE MENTION CATALOGUE YOU WANT**

ORNAMENTAL GLASS CATALOGUE—This catalogue is 10x6, containing 44 pages and cover, profusely illustrated with very fine, large cuts, showing what we manufacture in sand blast, chipped, embossed, ground and enameled glass, also chipped glass signs.

GLASS SIGN CATALOGUE—This catalogue is 10x6½, containing 40 pages and cover, showing full page illustrations of chipped, ground, enameled and embossed glass signs of all descriptions.

RAWSON & EVANS Union St. and Washington Blvd. **CHICAGO, U. S. A.**

ALL KINDS OF **GLASS** FOR BUILDING PURPOSES

IF YOU WANT GOOD GLASS, PROMPT SHIPMENTS, FAIR TREATMENT

DEAL WITH US
OUR STOCK IS ALWAYS COMPLETE

Don't buy before getting our price, and save money

SHARP, PARTRIDGE & CO.
10 to 20 Union Place, Chicago

DO YOU USE GLASS IN YOUR BUILDINGS?

Send for our **ART BOOK** and Special Designs



FREE! Write Today

Place Pictures of Art on Glass in Your Doors

If you intend building or are in need of GLASS OF ANY KIND, you should write for catalogues of designs and prices today. Our ART GLASS glazed in metal (coppered) is the most perfect in design and workmanship.

The above cut is a photograph from a finished light made by our NEW PROCESS in SAND BLAST. Our designs are equal to steel engravings and half tones, and are inimitable in the ORIGINALITY of design, softness in EFFECT, and high grade QUALITY of WORK. TAKE OUT your plain glass, DECORATE your entrance and welcome cheerfulness as such little extra cost. ASK US HOW! Write for special catalogue on sand blast door designs.

THE SUESS ORNAMENTAL GLASS CO.
Throop and 21st Streets, Dept. C. CHICAGO.

ADJUSTABLE PLATE GLASS TOWEL SHELF

WITH PLATE GLASS TOWEL BAR COMBINED

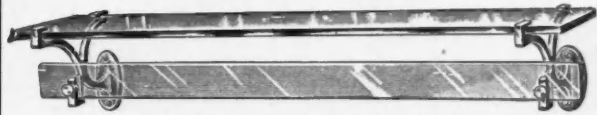

Nickel Plated Bronze Brackets and Screws
No. 6.—Shelf 24 inches long and 6 inches wide, price each \$4.00

ADVANTAGES OF OUR FLAT GLASS TOWEL BARS

ARE

- The Towels never slip*
- Water, hot or cold, has no effect*
- Need no cleaning*
- Never wear out or show use*
- All edges are ground and polished*
- They are entirely antiseptic*

OUR TOWEL SHELVES

Are so made that there are no holes required in the glass, thereby reducing breakage to a minimum. All shelves made so glass cannot fall out, but are adjustable.

Geo. H. Anderson & Co.

MANUFACTURERS OF MIRRORS
BEVELERS AND POLISHERS OF PLATE GLASS

Send for Complete Catalogue
281 to 291 West Superior St.
CHICAGO

TO OUR FRIENDS AND PATRONS:
WE PROMISE
Best of Glass in all sizes of single and
Some sizes of double,
also QUICK SHIPMENTS.

WINDOW GLASS
MACHINE MADE
IN HIGH FAVOR
 Brilliant in Surface
 Even thickness
 Superiorly annealed
 Easily cut
 Little breakage

MANUFACTURED BY
AMERICAN WINDOW GLASS CO.
 PITTSBURG PA.

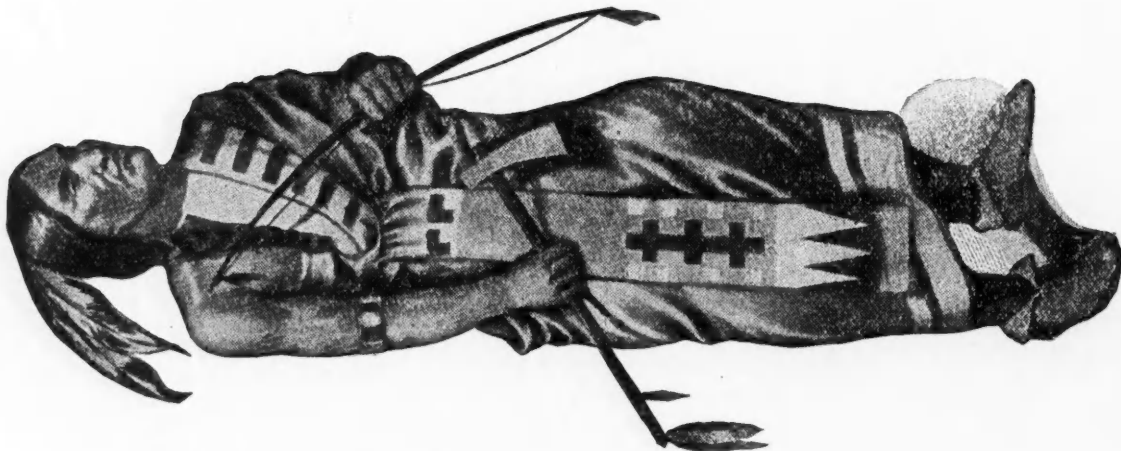
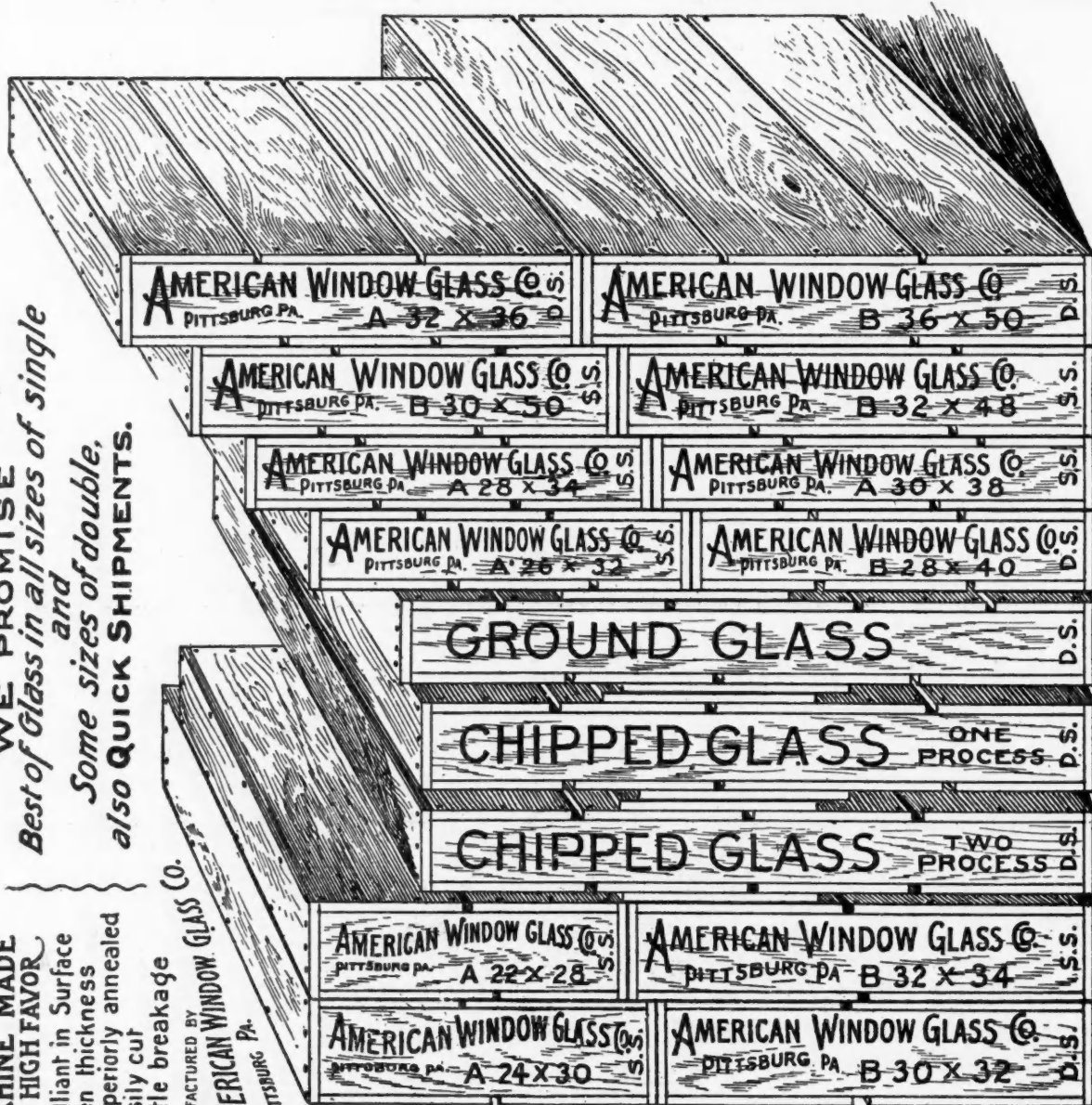

WHEN WRITING ADVERTISERS PLEASE MENTION THE AMERICAN CARPENTER AND BUILDER.

STEEL CEILINGS AND SIDE WALLS

We have added complete designs in steel ceilings and sidewalls to our already large line of Sheet Metal Building Material, and our special ceiling catalog, when completed, will interest you.

Send us your inquiries accompanied by drawings of rooms and we will send you a carefully prepared drawing with illustrations showing just how the ceiling will look when finished.

Our designs and prices are attractive and we want an opportunity to quote you.

The Edwards Manufacturing Co.

"THE SHEET METAL FOLKS"

121-129 Sycamore St.
CINCINNATI, OHIO.

ARTISTIC STEEL CEILINGS

We wish to announce that we have added to our Steel Ceiling Catalog, **Supplement "A,"** which we have just received from the printers.

In addition to the fine line of ceilings shown in our catalog, we illustrate in Supplement "A" a variety of new and up-to-date designs which we have recently finished.

We are desirous of procuring a good, reliable party in each city or town to handle our ceiling material, a party that is in position to have it put up in buildings requiring metal ceilings or side-walls.

We can make interesting prices, and are glad to submit designs in answer to all inquiries, giving figured dimensions for rooms.

Acme Sheet Metal Co.
MARTINS FERRY, O.



You don't have to waste Spot Cord by cutting out rough places

SAMSON SPOT CORD

is warranted free from flaws. The colored spot is our trade mark, used only in this extra quality cord



SEND FOR CATALOG "A" AND SAMPLES

SAMSON CORDAGE WORKS, BOSTON, MASS.



CORNER POST

THE "PETZ" CORNER POST AND TRANSOM BAR

GLASS IS SET FROM THE OUTSIDE WHICH MAKES GLAZING EASY

Used in up-to-date Display Windows and Store Fronts. Does not obstruct the light. Gives use of every inch of window for display. Its adaptability and utility will be grasped by every merchant. Send for descriptive circular No. 77.

Address, 491 FORT ST., DETROIT.

Made only by DETROIT SHOW CASE COMPANY, DETROIT, MICHIGAN

For sale by PITTSBURGH PLATE GLASS COMPANY at its various warehouses.

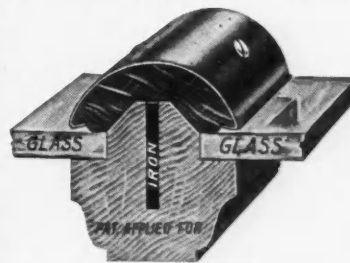

TRANSOM BAR

BUILDERS EVERYWHERE

SAVE MONEY
ON ALL KINDS OF
MILL WORK.

DIRECT FROM THE MILL
AT LOWEST MILL FIGURES

SASH DOORS FRAMES
PLAIN AND
EMBOSSED **MOULDINGS**
FINE INTERIOR FINISH.
PERFECT WORK PROMPT SHIPMENT.

TRY SEND FOR ESTIMATES TRY
PRICES AND CATALOGUE.

FOLEY M'FG. Co.
FACTORY AND LUMBER YARD
474-498 & 475-495 W. 21ST. PLACE
OFFICE
471 W. 22 ND STREET-
CHICAGO
ALSO BEST MATERIALS FOR
GREENHOUSES AND CONSERVATORIES.
SEND FOR CATALOGUE



Embossed and Plain Mouldings

Balusters and Stair Work

**Columns, Interior Caps
and Raised Carvings**

Chicago Embossed Moulding Co.
598 AUSTIN AVENUE, CHICAGO, ILL.
Send for Our New Catalogue

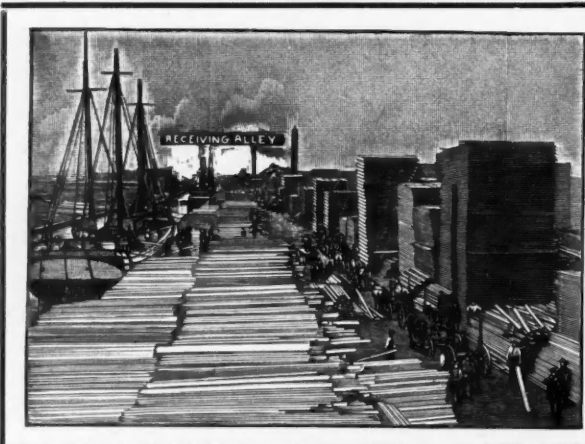
S. A. Spry, Pres. George E. Spry, Treas.

**We Manufacture Lumber, Lath,
Shingles, Sash, Doors, Blinds
and Everything in Mill Work**

**WE SELL DIRECT TO THE CONTRACTOR IN
ANY QUANTITY AT WHOLESALE PRICES
AND GIVE WHOLESALE GRADES**

Our maple and oak flooring is considered superior in quality and manufacture to any in the market. Give us a trial on this fine end-matched, polished and bored flooring, and send in your lists for figures on anything in Mill Work, Sash, Doors, Blinds, Etc.

JOHN SPRY LUMBER CO.
Yard and Offices
1100 to 1300 S. Ashland Av. CHICAGO, ILL.

DO YOU WANT
MILLWORK
AT ROCK-BOTTOM PRICES

?

Let us send you our 200-page catalogue of
**SASH, DOORS, BLINDS, MOULDINGS, GRILLES,
MANTELS, STAIRWORK, ETC.**

All prices are net. We make special prices to
contractors and builders. Book free if you
write on letter-head or send business card.

DEPT. "A"
SCHALLER-HOERR CO.
420 Blue Island Ave., CHICAGO, ILL.

MR. CONTRACTOR?

Are you satisfied with your method of estimating? Do you know how much profit you are going to make? Are you sure you get everything figured in? And do you know the exact cost of each separate part of the work? Is your method rapid and practical? Is it simple and reliable? Do you know that "The Lightning Estimator" solves these problems and is making more successful builders than any other method heretofore sold? Are you going to continue guessing when you can get this method for a 50-cent money order?

Particularly adapted to residence and repair work.

First edition sold out in 3 months. Second edition now ready. A table of 4600 rooms, giving square yards in each, given with each course.

A LEADING MAGAZINE SAYS OF IT:
"A wonder of terseness, compactness, and comprehensiveness."
—National Builder.

WRITE NOW
BRADT PUBLISHING CO.
1260 Michigan Ave.
JACKSON, MICH.



8x8 - 8 ft.

\$2.50

1 1/4" Stave
Lock Joint

CHICAGO MILLWORK SUPPLY CO.

Manufacturers

*Buy
Direct
and
Compete*

**FROM
MANUFACTURER
DIRECT**

*We
Save
you
Money*

**Mailed
Free
Catalogue
No. 12**

This valuable book—200 pages—2,000 designs, with **exact, net prices** plainly marked on all goods illustrated—Doors, Windows, Mouldings, Blinds, Frames, Porch Work, Art Glass, Mantels, Stair Work, Grilles, Wood Carpet, etc., etc.

Mailed to **Contractors and Builders** on application. Estimates on Millwork submitted.

Write today for Book No. 12

239-245 W. 22nd St.

CHICAGO, U. S. A.

WANTED!

CARPENTERS AND BUILDERS

to send in their lists of **Lumber, Sash, Doors and Millwork** requirements for delivered estimates. We are quoting low prices and it will pay you to write us at once. Buy direct, cut out dealers' profits.

If not already in possession of our STOCK CATALOGUE, drop us a line; we will mail you a copy by return mail

GEORGE GREEN LUMBER CO.

22d and Grove Streets

CHICAGO

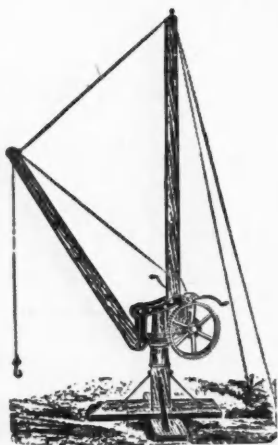

This Means U

U cannot afford to put up that building without a **PARKER DERRICK**.

WHY?

Because it is worth more to you than one good man.

EXAMPLE:

If it takes six men, at \$15.00 per week, six weeks to erect a building without the derrick, at a cost of \$90.00 each, or \$540.00; five men with this derrick (which will cost, complete with rope, \$45.00) will do the same job much easier at a cost of \$450.00, thus saving you \$90.00, or a saving of \$45.00 above the cost of the machine. The machine will last for years, and at any time you can use it for any of the following purposes.

Elevators, Erecting Steeples. Also used for handling Heavy Articles, Machinery, Stone, Cotton, Cane, Grain, Baled Hay and Straw, Broom Corn, Erecting Towers for Windmills and Tanks. It has the power of 24 horses in moving small buildings.

WITH ONE QUARTER THE HELP AND TIME IT WILL

raise and place a tank on its tower easier than by any other method now used by sheet iron tank builders. The No. 1— $\frac{1}{2}$ derrick with car is especially useful in handling timbers, logs, piles, posts, ties, etc.

ONLY PRACTICAL MACHINE FOR HANDLING CONCRETE BLOCKS.

Let us send you our catalogue, also the address of some one near you for references. These machines are used near you, and we want you to know how those who are using them, like them.

We also make derricks, cranes, and hoists of all sizes for all purposes. State your special requirements. We can build what you need.

PARKER HOIST & MACHINE CO.

520 Ashland Block, CHICAGO, ILL.

AN UNPARALLELED OFFER

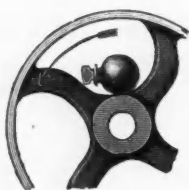

To every manufacturer using wood-working machinery of any description, who will tell us he saw this ad in the American Carpenter and Builder, we will send **free of charge** one of our

VAN DUZEN LOOSE PULLEY OILERS

They do not waste or throw oil—can be used on almost every size and speed of pulley. Tried and tested 15 years. 7 sizes, all brass. Ask for price list 26Z.

THE E. W. VAN DUZEN CO., CINCINNATI, OHIO

DERRICKS Union Elevator & Machine Co.

"The Manufacturing House"

144-146 Ontario Street, CHICAGO

Prices F.O.B. Chicago.
We Ship Promptly.

SALAMANDERS

DERRICKS

Irons only

Drum 6 in diam. x 42
in. long.....\$32.00 each.

Drum 6 in. diam. x 48
in. long.....\$36.00 each.

SALAMANDERS

With grates

No. 16 Gauge \$2.00 each
" 18 " 1.75 "
" 20 " 1.50 "



The Cement Worker's Hand-Book.

By W. H. BAKER. :: Second Edition.

A practical treatise on Cement and its Uses in Construction. Cloth bound. Over 30,000 words. $\frac{1}{2}$ In five chapters. One each on *Commercial Cements, Mortars, Concretes, Cast Masonry, and Practical Notes, Indexed.* The tables and formulas are reliable, and are alone worth the cost. Sold to the Amateur Workman, the Mason, the Engineer, the Railroads, and to the U. S. Government, and in all parts of the English-speaking world. Sent to any address for 50 cents.

Address,

W. H. BAKER, Seville, Ohio

WHEN WRITING ADVERTISERS PLEASE MENTION THE AMERICAN CARPENTER AND BUILDER.

JACK HENDERSON SERIES

Mirthful Books in Up-to-Date Slang



JACK HENDERSON

A Series of Books by Benj. F. Cobb, written in the catchy slang vein which to-day is so prevalent. These books are the best issued, and fairly blossom with wit and humor. Bound in cloth, gilt top, with seven half-tone illustrations. Price 50 cts. each, postpaid.

- Jack Henderson Down East
- Jack Henderson Out West
- Jack Henderson Down South!
- Jack Henderson on Matrimony
- Jack Henderson on Tippln
- Jack Henderson on Experience

The six books would cost you \$3.00. There are seven stories in each book and seven laughs in each story. Nothing like it for driving away the blues and keeping down doctor bills.

If you can not find these at your book dealer's, write to

Hurst & Company
Publishers
395 Broadway, N. Y.



THE GIRL LOOKED CONFUSED

Smokers

CAN NOW BUY THEIR CIGARS DIRECT FROM FACTORY

BY SAVING JOBBERS' AND DEALERS' PROFIT YOU CAN BUY A CLEAR HAVANA CIGAR FOR 2½c.

100



\$2.50

OUR PROPOSITION:—Send us express, P. O. order or check for \$2.50, and we will deliver to your address, prepaid, 100 Little Dream Panetellas. Guaranteed to be clear long Havana hand made, same size as above cut. You may smoke 10 of the cigars and if not suited, return balance of them to us and we will return your money without a word, or you may return them C. O. D. to us.

We refer you to any bank or mercantile agency in Chicago. *You run no risk.*

Write To-day. Let Us Show You

TRIUMPHIA MFG. CO., Wilson Building, CHICAGO

It costs them less

Contractors say, to furnish the Perfection Barrel Swings than to fit up the broad shelf in the old way, and their customers are pleased with the improvement. Your Hardware Dealer will supply them.

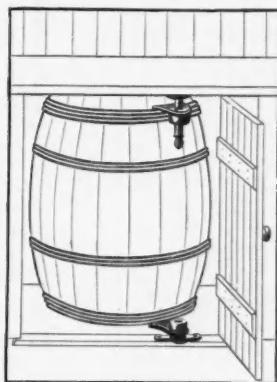

Perfection Barrel Swings

**THE LEAVITT
MACHINE CO.**
ORANGE, MASSACHUSETTS

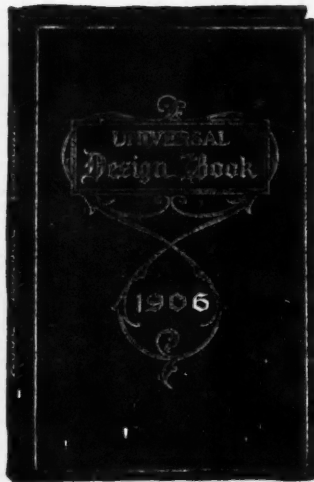

UNIVERSAL Design Book

416 Pages—Handsomely Bound in Cloth—1500 Illustrations.
Official Lists Throughout—Size of Page, 7x10½

\$1.25 POSTPAID.

The phenomenal success of our large Design Book throughout the United States, the many testimonials we have received as to its usefulness, is assurance the book is all its name implies, viz: "Universal." Corrected to date, it contains all the Official Lists, including Window and Plate Glass, Mouldings, Corner, Head and Base Blocks, New Sash and Door List, etc. Almost invaluable to the Architect, Contractor, Builder, Jobber and Manufacturer, alike. A book of ready reference, and referred to constantly. Special care having been taken in its compilation by the best authorities, assuring accuracy and judgment, and nothing listed that cannot be obtained at all times without annoyance and delay.

Handsomely bound in cloth, lettered in white and gold, beautiful enamel stock, with Art Glass, Parquetry Flooring, Painted and Grained Doors, illustrated in seventeen colors—a work of art, a Design Book that no office is complete without. Send for one while the edition lasts.

We also publish and keep in stock the following Official Lists:

96 Page Sash and Door List—232 Page Sash and Door List

THE ABOVE IN VEST POCKET SIZE.

OFFICIAL MOULDING BOOK—WINDOW AND PLATE GLASS LIST—ART GLASS CATALOGUE

SEND FOR SAMPLES AND PRICES.

Shattock & McKay Co. PRINTERS AND PUBLISHERS **Chicago**
180-182 MONROE STREET

ARE You Going to Build?



HIGH-CLASS ARCHITECTURAL WORK

Secure an Architect who can combine style and dignity in DESIGN with practicability and economy in construction

ARTISTIC HOMES

This handsome 1905 Edition-de-Lux will be sent for \$1.00, post-paid. It is the largest and best-printed book of moderate-cost house plans

—PUBLIC BUILDINGS—

NOTE.—If you take an interest in "A City Beautiful" send me full particulars of any important buildings which are to be built in your city in the near future.

I have designed churches, schools, libraries, theatres, stores, hotels, banks, etc., all over the U.S., and have a special department for the planning of residences. Book of 32 Churches, 25c.

HERBERT C. CHIVERS
—CONSULTING—
216 N. 7th ARCHITECT St. Louis

Home Study and Success



THE DRAKE SERIES OF HOME STUDY BOOKS

Never before has such an opportunity been given to men and boys the world over to make themselves thorough masters of all the leading mechanical and scientific trades and professions, and the avidity and eagerness with which so many are availing themselves of this unique chance to obtain, by so direct and easy a method, this practical and invaluable knowledge is the most potent testimonial to the high merit of the works that public sentiment can accord. The prices for these valuable works have been marked at a phenomenally low figure with a view to place them within the reach of everybody—ambitious men and boys of the narrowest means as well as their more prosperous co-workers.

They are Practical, Omitting Nothing Essential and Containing Nothing Irrelevant

From the Home Study Series of Books has been eliminated everything which can in the remotest degree divert the student's mind from the essentials of the subjects treated; thereby providing him with the necessary and useful knowledge by the most direct route and shortest cut and saving him many hours of misspent study.

Designed for employes of mills, factories, offices, the farm, etc., the Home Study works present all the rules, formulas, and principles of practical science, describing processes, machinery, tools, etc., in such a manner as to enable the student to put in practice what he learns—in short, these works make a practical operator of the student, and not an eloquent theorist, as is too often the case with the product of modern schools. The books are technical only within indispensable limitations, and in such instances care has been observed not to confuse the student with terms which to an untrained reader might appear ambiguous or obscure.

DRAKE'S SELF-TEACHING BOOKS

Each volume is a complete modern treatise—written so you can understand it.

Practical Treatise on the Use of the Steel Square. By Fred T. Hodgson. Two large volumes. 560 page. 500 illustrations. Cloth. Price\$2.00

Modern Estimator and Contractors' Guide. For pricing all builders' work. By Fred T. Hodgson. 300 pages. Fully illustrated. Cloth. Price\$1.50

Modern Carpentry and Joinery. A practical manual. By Fred T. Hodgson. 250 pages. 200 illustrations. Cloth. Price\$1.00

Easy Lessons in the Art of Practical Wood Carving. By Fred T. Hodgson. 320 pages. 300 illustrations. Cloth. Price.....\$1.50

The Up-to-Date Hardwood Finisher. By Fred T. Hodgson. 320 pages. 117 illustrations. Cloth. Price\$1.00

Common Sense Stair Building and Handrailing. By Fred T. Hodgson. 200 pages. 200 illustrations. Cloth. Price\$1.00

Twentieth Century Stonemason's and Bricklayer's Assistant. By Fred T. Hodgson. 320 pages. 400 illustrations. Cloth. Price\$1.50

Builders' Architectural Drawing Self-Taught. By Fred T. Hodgson. 300 pages. 300 illustrations. 18 large double folding plates. Cloth.\$2.00

Modern Locomotive Engineering. With questions and answers. Twentieth Century Edition. By Calvin F. Swingle, M.E. 650 pages. 400 illustrations. Full leather. Gold edges. Pocket-book style. Price.....\$3.00

The Twentieth Century Hand-Book for Steam Engineers and Electricians. Second Revised and Enlarged Edition. By Calvin F. Swingle, M.E. 650 pages. 300 illustrations. Full leather. Pocketbook style. Gold edges. Price.....\$3.00

Steam Boilers: Their Construction, Care and Operation. With questions and answers. By C. F. Swingle, M.E. 200 pages. Fully illustrated. Price.....\$1.50

The Calculation of Horse-Power Made Easy. Tells how to calculate the power of steam engines, gas and oil engines, and electric motors. By L. E. Brookes M.E. 50 pages. Fully illustrated. Cloth. Price.....75c

Modern Air Brake Practice: Its Use and Abuse. With questions and answers. Treats on both Westinghouse and New York systems. By Frank H. Dukesmith. 400 pages. 150 illustrations, with five large folding plates. Cloth. Price\$1.50

The Practical Gas and Oil Engine Hand-Book. A manual on the care, maintenance and repair of gas and oil engines. By L. E. Brookes, M.E. 160 pages. Fully illustrated. Cloth. Price.....\$1.00

The Automobile Hand-Book. Giving the care, construction, and operation of gasoline and electric automobiles. By L. E. Brookes, M.E. 320 pages. 118 illustrations. Full leather.....\$1.50

Farm Engines and How to Run Them. The Young Engineer's Guide. By James H. Stephenson. This book is used as a textbook in nearly every Agricultural College in the United States and Canada. 230 pages. 75 illustrations. Cloth. Price\$1.00

Practical Telephone Hand-Book and Guide to Telephonic Exchange. How to construct and maintain Telephone Lines. By T. S. Baldwin. 12 mo. Cloth. Price\$1.00

Telegraphy Self-Taught. A complete manual of instruction. By Theo. A. Edison. 160 pages, fully illustrated. Cloth. Price\$1.00

Handy Electrical Dictionary—Vest-Pocket Edition. 4,800 words, terms, phrases. By W. L. Weber. 224 pages. Illustrated. Cloth. Indexed. Price..\$0.25

Modern Wiring Diagrams and Descriptions. By V. H. Tousley and H. C. Horstmann. The Standard Authority on Electric Wiring of all kinds. 160 pages. 200 illustrations. Full leather. Price\$1.50

Electricity Made Simple. By C. C. Haskins. Just the book for beginners. 233 pages. 108 illustrations. Cloth. Price..\$1.00

Dynamo Tending for Engineers, or Electricity for Steam Engineers. By Horstmann & Tousley. 200 pages. 116 illustrations. Cloth. Price\$1.50

Modern Electrical Construction. By Horstmann & Tousley. Treats entirely on Practical Electrical Work. 250 pages. 100 illustrations. Full leather. Price..\$1.50

How to Make Them. A book for beginners. By L. P. Dickinson. 220 pages, fully illustrated. Cloth. Price\$1.00

The Up-To-Date Electroplating Hand-Book. A complete treatise on Electroplating in all its branches. By Jas. H. Weston. 192 pages. 50 illustrations. Cloth. Price\$1.00

Modern Blacksmithing. By J. G. Holmstrom. A complete up-to-date Manual for Home Study. 200 pages, fully illustrated. Cloth. Price\$1.00

Correct Horseshoeing. A standard work, adapted to the demand of Veterinarians, Farriers, and the Amateur Horseshoer. By J. G. Holmstrom. 160 pages, fully illustrated. Cloth. Price..\$1.00

Pattern Making and Foundry Practice. By L. H. Hand. A practical, up-to-date treatise. 160 pages. 120 illustrations. Full leather. Price\$1.50

Picture Making for Pleasure and Profit. A treatise on the Modern Processes of Photography. By T. S. Baldwin. 280 pages, fully illustrated. Cloth. Price..\$1.25

Bookkeeping Self-Taught. A standard work for self-instruction. By Phillip C. Goodwin. Cloth. Price\$1.00

The Home Law School Series. By Chas. E. Chadman, LL.D. In 12 large, carefully-prepared volumes. Price per set, half law sheep binding, only.....\$18.00

For further descriptions to these books sent for our Large Illustrated Catalogue. Sent free.

Any of the above volumes sent all charges paid upon receipt of price. Remember that all our books are sold on a guarantee to be as represented, and worth many times the price asked. Write for complete (1906) catalogue of Modern Mechanical Books sent FREE. Address

Frederick J. Drake & Co., 225-228 E. Madison St. CHICAGO

THE TWO MIRACLES

Concrete Specialists

Miracle

STAGGERED
AIR
SPACE
BUILDING
BLOCK
MACHINE
EXHIBIT
"A"

and their Big Four Concrete Products

CONCRETE, THE BIG, NEW INDUSTRY, CAN MAKE
MONEY FOR YOU.

Four branches to this profitable business are now open to you. No proposition of the present day can equal it for profits earned on capital invested. Each branch is working wonders in concrete construction, and has much larger possibilities. The demand for concrete is growing every day, and the best thing for any contractor or builder to do is to be prepared at least to meet that demand. Many men are making thousands of dollars yearly from concrete construction. Those who get started first set the profits and market value in your territory. We can get you started exclusively in your territory if you will let us.

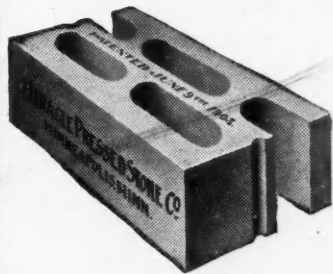

"THEY ALL LIKE OUR BLOCK."

It therefore behooves you to talk to us before installing any other kind.

NO OTHER CEMENT BRICK MACHINE

on the market with two men operating can do the work ours can with only one man. And it costs less to install. Our booklet will tell you more. Send for it.

ALL OTHER SEWER PIPE AND TILE MOLDS

require a big investment because they cannot be removed until the cement is set. Ours is different. New patented mechanism makes it possible for one mold to be kept busy all the time. It is boosting the industry.

OUR SIDEWALK TILE MACHINE

has done service for years, and not a one returned. Every purchaser is making good money. These are reasons which are worth considering.

We will make it worth your while to correspond with us.



The New Miracle Cement Brick Machine

WRITE FOR CATALOG K.

Miracle Pressed Stone Co.
MINNEAPOLIS

Miracle

ONE
MAN
CEMENT
BRICK
MACHINE
THE
MOST
PRACTICAL

Miracle

CEMENT
SEWER
PIPE
AND
TILE
MOLDS
PERFECT
MECHANISM

Miracle

CEMENT
SIDEWALK
TILE
MACHINE
—
AN
EXCELLENT
SIDE
LINE

The Improved Hero Furnace

100 SERIES



Is an ALL CAST furnace with the DEEPEST ASH PIT made.

The GRATE BARS have no COG WHEELS or BOLTS. You don't have to shake a clean bar to clean a dirty one. The DEEP CORRUGATIONS of fire pot and dome DOUBLE the RADIATING SURFACE. It has LARGE DOUBLE-FEED DOORS.

It is a **Gas Tight** **Durable** Furnace

It is ECONOMICAL with any kind of fuel. Easy to MANAGE; easy to FEED; easy to CLEAN. You can't buy a better furnace.

Send us plans or pencil sketch and we will tell you what it will cost to heat your building by the most approved method

Chas. Smith Company
Manufacturers 40 Dearborn St., Chicago

*Our WATER ATTACHMENTS can be used in any furnace.
Send for SPECIAL CATALOG*

The La Salle Pressed Brick Co.

La Salle, Ill.



Manufacturers of pressed brick in Buff, Red, Brown, Gray, and Mottled Colors. Standard, Roman and Norman size. Also Ornamental Brick.



Brick Mantels

A Specialty

