

AMERICAN CARPENTER AND BUILDER



THE WORLD'S GREATEST BUILDING PAPER

Better Building

—and What It Means To You



WHAT is needed today in this country is a revival of the Quality Idea in building. There are too many skimped jobs, too much second-rate material and too much rushed work. Building in general, and residence work in particular, is suffering from the Blight of Cheapness.

Carpenters and Builders, you can change all this, if you will. The Opportunity is yours to bring about a new order—an era of Better Building that will be much to your advantage.

Do you ask, How?

The Carpenter and Builder occupies the strategic position in the building world to-day. The man who is going to build looks to his carpenter-contractor as an Authority on all methods and materials. Advise him toward Better Building. A personal word from you will have more real influence than any quantity of advertising booklets and circulars. Advise him to use high grade materials; they cost but very little more. Advise him to build well. By so doing you do him a good turn and benefit yourself as well.

It is impossible to do satisfactory work with cheap materials. A cheap job satisfies neither the workmen nor the owner, and the building is a poor investment when it is done. Nobody wants it. The worst of it is too, that for a very little more, first quality building and finishing materials could have been used—if the owner had only known it.

Let every carpenter and building contractor point this out in every case. Let us all enroll in a Nation-Wide Campaign for Better Building. Let us all use, as far as possible, nothing but Good Quality Materials.

Urge and Recommend them.



BRAIN OR BRAWN

You earn your bread with brain and skill rather than with muscle. Otherwise you would be a laborer with pick and shovel, instead of a mechanic with a kit of fine tools.



One day two husky laborers were told to remove a few yards of paving brick between street-car tracks. They began hammering them to pieces with sledges. Hard work—slow work. Not until they were shown, did they think of loosening the bricks with bars and pulling them out. ALL BRAWN—NO BRAIN.

mering them to pieces with sledges. Hard work—slow work. Not until they were shown, did they think of loosening the bricks with bars and pulling them out. ALL BRAWN—NO BRAIN.

You use your brain to save your brawn, to save time, to save mistakes, to save you money. And you never make a more profitable use of your brain than in the selection of the saw, for it is the tool that you use most—the tool requiring most energy and most skill in handling.

Atkins ^{Silver} _{Steel} Saws

These saws are fully abreast of the times. They embrace the latest and most scientific ideas in saw making. They are so constructed that they run easier than any other saw, and the SILVER STEEL used in the blades will receive that keen, sharp, cutting edge that you high-class mechanics want—and hold it.

How to Get Them

Go to your dealer and tell him that you are a progressive mechanic and you want tools that will save you time and strength. Select a saw with the words SILVER STEEL on the blade. Then you'll be sure of getting a saw representing the highest achievements in saw making. If your dealer does not sell them he will order for you from his wholesale house. If he won't do this then let us know. We'll help you get the finest saw if you want it.

You Run No Risk

We stand back of every SILVER STEEL SAW with a guarantee so strong that you risk nothing—not one cent. If the next saw you buy is an Atkins Saw and if the words SILVER STEEL are on the blade, remember that it is guaranteed to run easier, cut faster and hold its edge longer than any other saw. If it is not absolutely satisfactory, you are authorized to take it back to your dealer and get your money back or a new saw. If he won't refund your money; let us know.

OFFER TO CARPENTERS. We are compiling a list of high-class mechanics and if you will send us your name, we'll mail you our book on saws free of charge. If you'll send us ten cents to pay postage, we'll forward you free a strong, durable nail apron, our Saw Sense book, monthly time book, and a whole lot of useful information about high grade saws.

E. C. Atkins & Co., Inc.
Indianapolis, Ind.

ARE YOU ALIVE

to the fact that with this Portable Saw Rig on your job, or in your shop, you can do all of your millwork. This outfit is a complete and economical operating mill which requires no line shafts nor large amount of floor space.

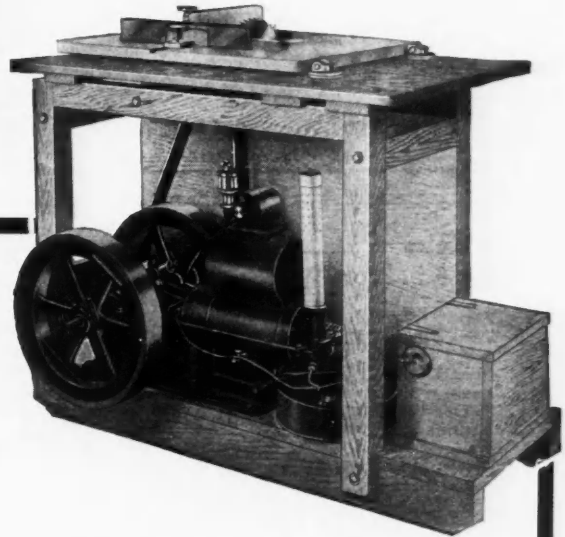

A Power Plant Guaranteed to Make You No Trouble

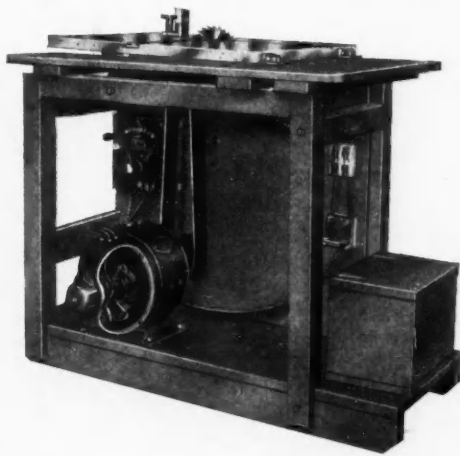

Designed and built to run continuously under full load. Cuts hours to minutes, cuts cost to pennies. Cuts out the wear and tear on muscles. Does away with the man-killing hand saw.

Nine Machines in One

The three horse power water hopper cooled engine pulls 8 inch saws, ripping up to 2 inch lumber and cross cutting 3 inch lumber.

Guaranteed for Life

Write for our attractive folder and testimonials, which give valuable information on our different sizes of Portable Saw Rigs.

GEORGE D. SMITH

814 FISHER BLDG.,

CHICAGO, ILL.

The American Floor Surfacing Machine

IS NO EXPERIMENT. Its work since 1903 has established a standard for finely surfaced and polished floors. It is the only machine whose work is specified by leading architects and used in the best government buildings and will surface and polish any kind of a floor from common pine to the finest parquetry. **IT IS THE ORIGINAL** and only two-roll, self propelled, dust collecting machine, that surfaces close to the wall and can be used in small rooms. Anyone can operate it. **ITS WORK IS RAPID, regular smooth and even** because the power that drives the rolls, also propels the machine at the same ratio of speed. It has surfaced and polished millions of square feet of the finest floors in America and Europe.

GET A MACHINE that does first class work and in paying quantities, that is fully guaranteed and sold on its merits.

Write for Our Free Book, "Surfacing Floors as a Business."

Manufactured By **The American Floor Surfacing Machine Co., TOLEDO, O.**



We Make Panels of any Thickness and Any Kind of Wood — Curved or Flat.

FOR
Wainscoting
Ceiling
Mantels
Doors
Counter Tops
Partitions
Cabinets
Shelving
Drawer Bottoms

Our products excel in Quality and Durability, because we concentrate our best efforts in their manufacture. We specialize in Panels and have the facilities for producing best results. Try us with your next order. Send us your specifications and ask for our prices.

AMERICAN VENEER CO.

Specialists and Manufacturers of Built-up Veneer Panels
We appreciate small orders as well as large ones

12 Market St., KENILWORTH, N. J.

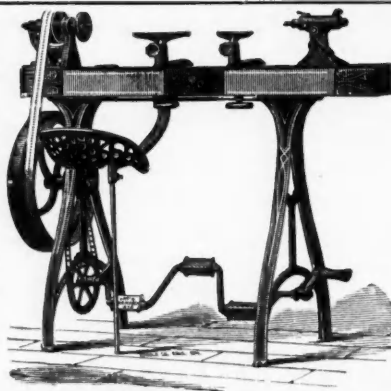

COMPLETE OUTFIT

Hand and Foot-Power MACHINERY

Our No. 3 Wood Turning Lathe can be speeded from 1,000 to 2,000 revolutions a minute with perfect ease. Stopped or reversed at will of operator.

Write for Particulars

W. F. & Jno. Barnes Co. 74 RUBY ST., Rockford, Ill.

Do Your Next Job of Floor Scraping at Our Expense with a

Little Giant Floor Scraper

Sold only on its merits. A request brings it to your door, freight prepaid. Try it out, if you are convinced it is the best floor scraper on the market, pay for it. If not, return it at our expense.

The **Little Giant** has scraped millions of square feet of floors. Cuts right up to the baseboard and into every corner. Easy to operate. Will scrape floors quicker, cleaner, and cheaper than any other machine on the market.

Ask us for our special price on this machine.

Hurley Machine Company

31 S. Clinton St
CHICAGO

NEW YORK: 1011 Flatiron Bldg.

DETROIT: 246 Woodward Avenue.



Woodworking Machinery

H.B. SMITH MACHINE COMPANY SMITHVILLE, N.J.

Saw and Dado Machine

THIS combination machine for operating cross cut, rip saw or dado head in which the saw is brought into work by a foot treadle, leaves the operator free to use both hands in handling the material, thus greatly increasing the capacity of both workman and machine.

The Head Stock which carries the saw arbor, is mounted on rollers having ball bearings, causing it to move easily and accurately on the ways, reducing the friction, and consequent wear on the machine.

The ways are adjustable for depth of cut, and the counter-shaft is equipped with a tight and a loose pulley permitting the use of an endless belt so as to run smoothly. Further details will be furnished gladly upon request. Our guarantee protects you.

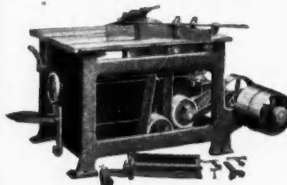

OFFICES:
New York Chicago Atlanta Memphis

Smith of Smithville
H.B. SMITH MACHINE COMPANY, SMITHVILLE, N.J.

79-2061

Head and Shoulders Above All Others

Why? Because it does perfect work. But—to convince yourself, ask any user. He will tell you that—with or against the grain—the Weber never fails to please the owner. That it saves time, trouble and money, and enables the user to underbid all others and make up the difference in speed.

The WEBER DOUBLE ACTING Floor Scraper

is the result of years of concentrated effort, brought to present perfection by a practical floor worker and contractor of wide experience and is rigidly guaranteed to suit you.



**Cannot
Chatter
nor
Leave
Waves**



**FREE
TRIAL
5 to 10 DAYS**

Send for the Weber.
Try it 5 to 10 days' free. Give it the hardest kind of actual working test. If its work isn't the best you've ever seen, send it back at our expense.

Write Today

John F. Weber, Pres.

WEBER MFG. CO.

670 71st Ave.

West Allis, Wis.

*Bear
This
Name
in
Mind*



The WEBER Scrapes Both Ways

You Should Accept This Offer

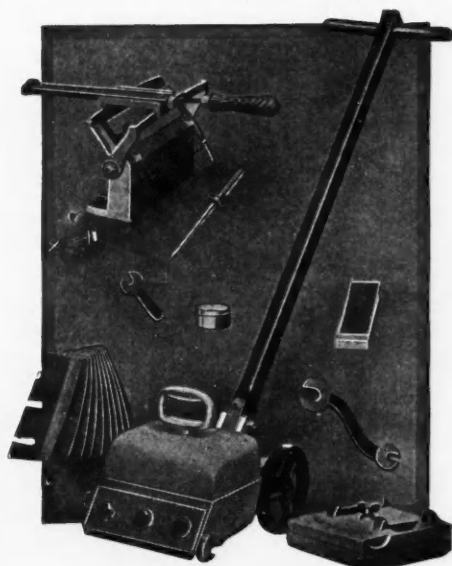

The Acme Floor Scraping Outfit.

for it means many dollars in your pocket during the year. This is a fact and I am ready to prove it to you by offering to ship to your address the complete **Acme Floor Scraping Outfit** on one week's free trial at my expense.

Thousands of carpenters and contractors have accepted this offer during the past four years and they are saving thousands of dollars yearly on their floor scraping work.

Let me send you full details of my proposition. Write for them to-day.

JOSEPH MIOTKE

247 Lake Street

MILWAUKEE, WIS.

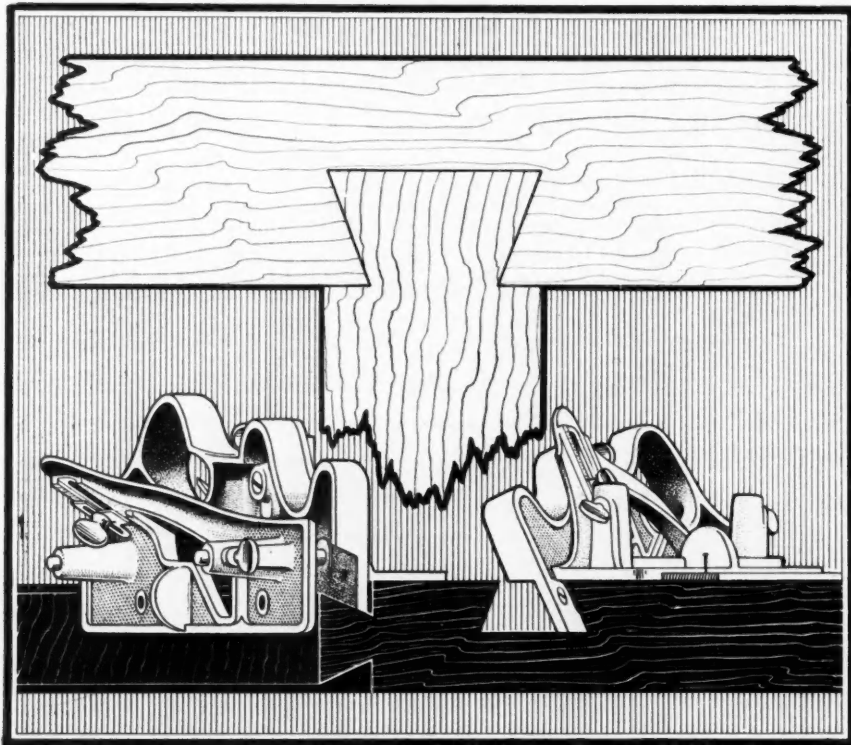

Stanley Tools

"444"

A COMBINATION DOVETAIL TONGUE AND GROOVE PLANE

Something entirely new. A Plane that will at one setting cut a dovetail groove, and in the other setting a dovetail tongue to match.

The operation is simple and the accurate and perfect fitting joints obtained both parallel and tapering, will convince the workman of the utility of this unique and original tool.

A most valuable addition to the kit of pattern makers, cabinet makers, carpenters and wood workers in general.

SEND FOR COMPLETE DESCRIPTION

STANDARD
THE WORLD
OVER

Stanley Rule & Level Co.
NEW BRITAIN, CONN. U.S.A.

EVERY
TOOL
GUARANTEED

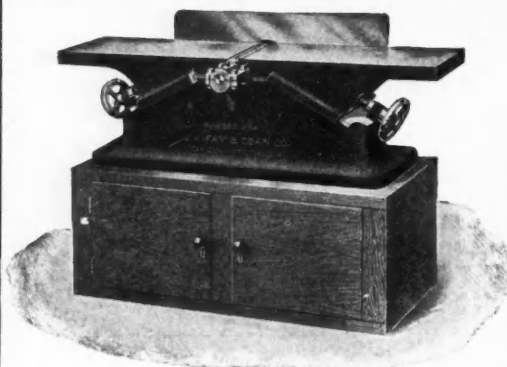

No. 254 Bench Hand Planer (Pat'd 3-28-11)

Money-Makers

FOR CARPENTERS
AND BUILDERS

Are these Two Small Shop Tools

Take up small space, require little power. Pay for themselves in a short time as the first cost is low.

Write for our Catalogue of
Small Shop Tools

J. A. FAY & EGAN CO.

545-565 W. Front St., Cincinnati, Ohio

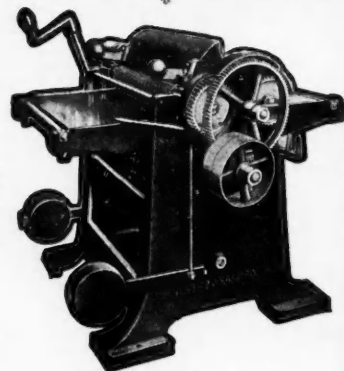

No. 2 Centennial Surfacer

CONTRACTORS

These Two Machines Will Do Your Work.

[Save time used in making changes on light inferior machines, known as "Wood Workers."]

MACHINE No. 1

Chicago No. 5 Combination Saw Table

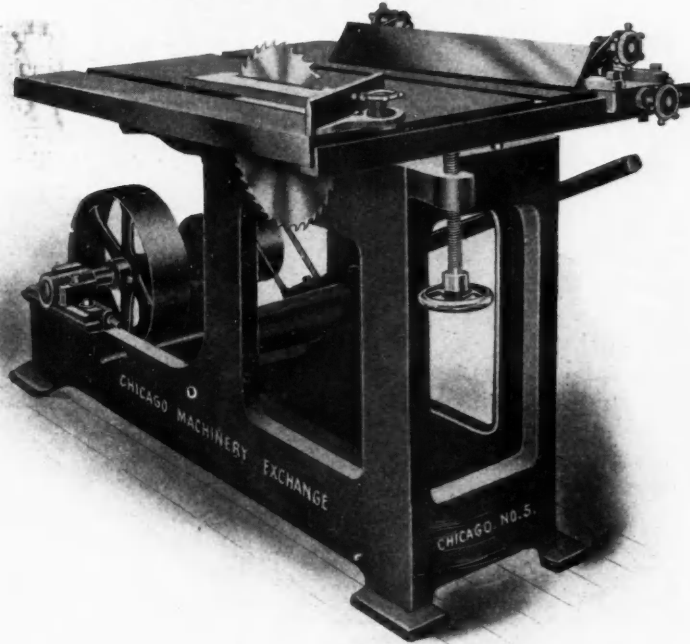

Send for our Free Special Catalogue today. We issue a catalog of machines especially adapted to Contractor's and Builder's use.

Used for Cutting Off, Ripping, Mitering, Grooving, Boring, Tenoning, Etc.

MACHINE No. 2

Chicago 12' Jointer and Planer

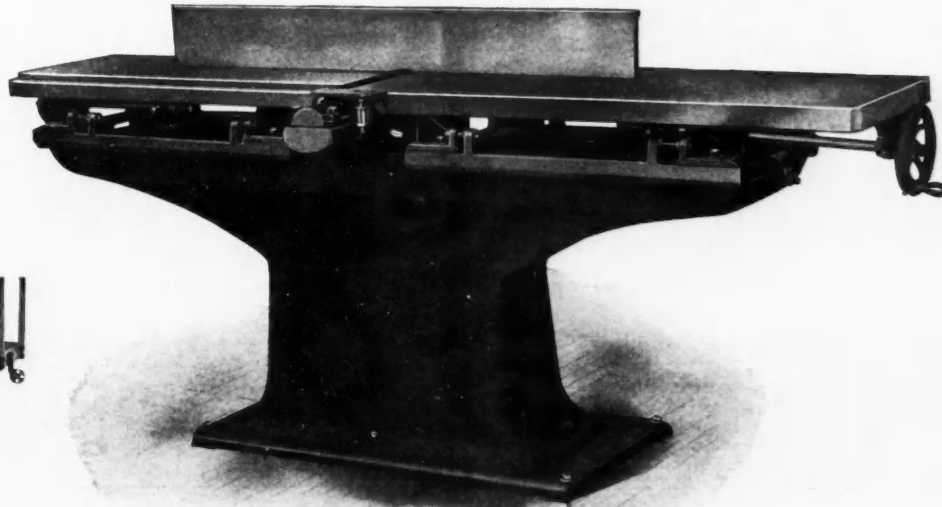

Used for Planing, Jointing, Shaping, Matching, Rabbeting, Grooving, Chamfering, Beading and Making Mouldings.

These Two Machines for \$170.00, including belt for saw arbor, countershafts, 1 14" rip saw, 1 14" cut off saw, 5 boring bits— $\frac{1}{4}$ ", $\frac{5}{16}$ ", $\frac{3}{8}$ ", $\frac{1}{2}$ ", $\frac{3}{4}$ " and 1 pair of jointer knives. Ask for price on one if you cannot use both.

Chicago Machinery Exchange 1219-1227 Washington Boul.
CHICAGO, ILL.

Big, Practical, Up-to-the-Minute Book

For Contractors, Builders, Cement Men

"Cement and How to Use It" is a big, practical, up-to-the-minute book for the cement manufacturer, dealer and user, as well as the architect, draftsman, construction man, contractor, builder, carpenter and prospective home owner. This book contains the boiled-down essence of all the accurate information on the subject of "Cement and How to Use It" possible to obtain. It is indispensable to the man who in any way has anything to do with construction or the use of cement in any one of its multitude of applications.

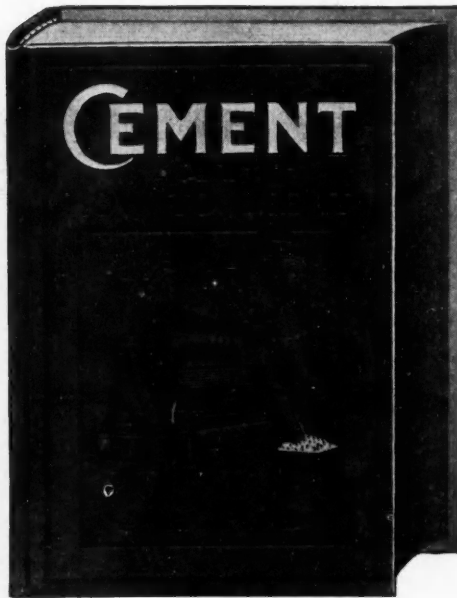

"Cement and How to Use It" is the largest book of its kind ever published. It consists of 370 pages, 6x9 inches, and is printed from large, clear type on a high-grade book paper. It is illustrated with over 250 drawings, diagrams, details, etc., including many pages of full-page plates reproducing architects' original drawings and details of construction.

Two thousand topics relating to cement are discussed in this great, new book. No book attempting to treat this important subject has ever before so successfully covered the ground.

370 Pages—350 Illustrations—2,000 Topics

Every phase, part and use of this wonderful twentieth century building and paving material is treated fully and completely, with details showing each step to be taken.

This book contains only practical information. By practical is meant information that can be successfully applied to the every-day work of the average builder, contractor and cement user. The book presents and solves problems as they have been met and worked out by well known architects and the man on the job.

"Cement and How to Use It" is written so that any reader can understand every page, every term used and every detail shown. It is entirely free from technicalities and yet its pages are full of instructions for all classes of cement users. It shows the easiest and most common-sense way to do the work. Its methods, formulas and tables can be relied upon to be absolutely correct.

FREE WITH ONE YEAR'S SUBSCRIPTION TO
CEMENT WORLD
"THE WORLD'S GREATEST CEMENT PAPER."

USE THIS COUPON—PIN \$1.00 TO IT—AND MAIL TODAY.

CEMENT WORLD CO., 241 So. 5th Ave., Chicago.

Gentlemen:—Enclosed find \$1.00 for which enter my subscription to the **Cement World** for one year, and send me, absolutely free, postage prepaid, one copy of the big, new 370 page book, "CEMENT AND HOW TO USE IT."

Name

A. C. B. 9-11.

Post Office

State

AN OFFER OF QUALITY

PLAIN TO BE SEEN

12 INCH
JOINTER
AND
PLANER

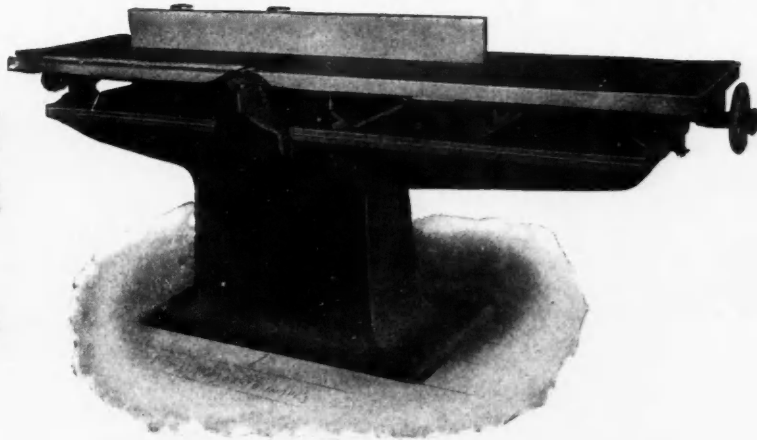

AND
THINK
OF THE
PRICE

BOTH MACHINES FOR \$185.00

Tilting Table, Saw Table
with Raising and Lowering
Arbor and Boring Arbor

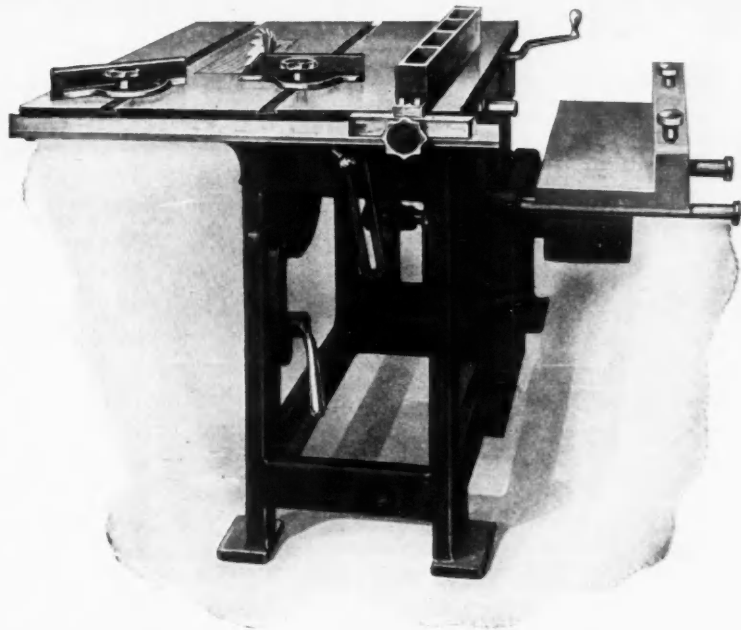

THEY

Rip	Mitre	Gain
Joint	Match	Chamfer
Bore		Cross Cut
Rabbit	Bevel	Plane
Groove	Shape	Mould

We include in the above price countershafts, one pair Jointer Knives, one 14-inch Rip Saw, one 14-inch Cut-off Saw. All Gauges shown in picture.

It will pay you to get our price on any machine.

UNITED MACHINERY COMPANY

136 LIBERTY STREET NEW YORK CITY

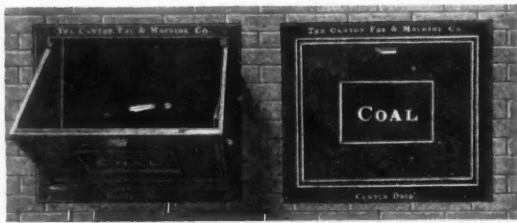

No building is up-to-date without a Coal Chute. They are necessary for sanitary reasons—for the time and labor they save—and for looks.

The Canton Improved Coal Chute

is made to last and at the same time be practical and ornamental. It is burglar proof, locking automatically when closed, but can be opened from the outside by special key furnished with it, when the owner wishes to avoid crawling over his coal pile. There is no more excuse for blackened walls, soiled and battered window frames and sash, littered walks and lawns.

MADE IN VARIOUS SIZES

Write Dept. B for catalogue of Contractor's and Builder's accessories.

THE CANTON FOUNDRY & MACHINE CO.
CANTON :: :: OHIO

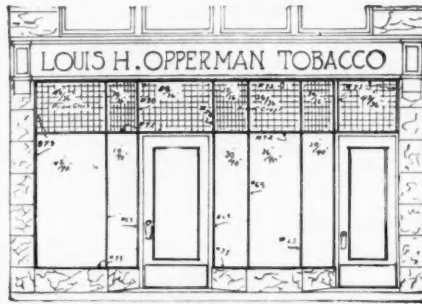

This Bar is No Experiment

The Petz Bar for modern store front construction has proved its superiority. You don't have to use it on our "say-so". It has "made good" in thousands of cases, and shown itself to be safe, strong, and sure.

It is easy to install, is stylish and artistic in appearance, will not break the glass, and gives perfect ventilation. It is the bar to use if you want to be sure of satisfactory results.

Write for our new booklet on "Modern Store Front Construction", or explain in detail your requirements, and we will gladly give complete information about the different styles of Petz Bars.

DETROIT SHOW CASE CO.,
491 West Fort Street :: DETROIT, MICH.

NOTE—Our Special brand Clamps, have notches on the bottom of the bar, instead of on the top.

Per pair, 1 foot.....	\$2 70
" 1 1/2 feet.....	2 85
" 2 ".....	3 00
" 2 1/2 ".....	3 75
" 3 ".....	4 00
" 4 ".....	4 50
" 5 ".....	5 00
" 5 " heavy.....	7 50
" 6 ".....	8 50
" 7 ".....	9 50
" 8 ".....	11 00
" 9 ".....	12 50
" 10 ".....	14 00

These clamps have steel bars and screws and malleable iron parts.
The New Adjustable and Perfection Clamps are made in the following lengths and sizes:
2, 3, 4 and 5 foot have... 1 1/2 x 1/2 inch bars.
5, 6, 7, 8, 9 and 10 foot have 1 1/2 x 1/2
Joiners' Clamps—1, 1 1/2, and 2 foot have hand-wheels for rapid work, 1 1/2 x 3-16 inch bars.
In ordering parts always make sketch, to avoid delay.

Write for circular Dept. H.

Hargrave's New Adjustable SPECIAL Clamp.



Hargrave's Perfection SPECIAL Clamp.



Hargrave's Joiners' SPECIAL Clamp.



THE CINCINNATI TOOL CO., CINCINNATI, O., U. S. A.

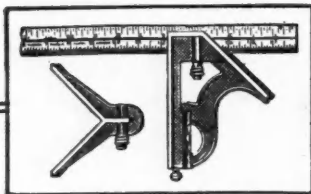

STARRETT

COMBINATION SQUARE

THE ORIGINAL :: THE MUCH IMITATED
Send for free Catalogue No. 186, of Fine Tools for all kinds of mechanics.

The L. S. STARRETT CO., Athol, Mass., U. S. A.

Straight-grained cedar that cuts like cheese; smooth, tough leads that make clean-cut, strong marks—that's the way Dixon's Carpenter Pencils are described. Send 16c for generous sample lot 183J.

JOSEPH DIXON CRUCIBLE CO.
JERSEY CITY, N. J.

A Free Copy

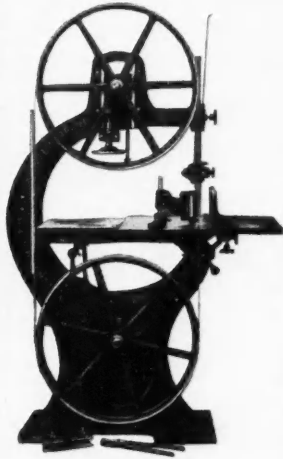

Secrets of Successful Band Sawing by

Mr. Charles E. Wright,
The Acknowledged Exponent on
Band Saw Talk.

Would be mailed free. Send for a copy before our supply is exhausted.

We illustrate fifteen new model machines. **Here is one, \$95 net**, complete with all improvements as shown in cut. If you want a

machine to show economy in the general wear and breakage of saws **here you are**. Our catalog will tell you all about it.

The Chas. E. Wright Co.
317 Boulevard, Kenilworth, N. J.

THE FOLDING DRAW KNIFE

These are handles that are rigid
On a blade that's always keen.
They are set at any angle;
Why, it's sold as soon as seen.



If your hardware dealer does not keep it, we will send it to your address postage paid. : :

A. J. WILKINSON & CO., 180 to 188 Washington St., BOSTON, MASS.

The Only Self-Setting Plane

Over 25 years ago we commenced to make the Self-Setting Planes. They are shovled in every state and Canada. Thousands of carpenters use them doing work easier, better, quicker, saving time, trouble and temper.

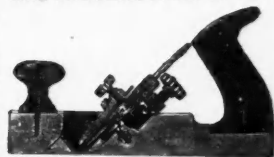

Every issue of this paper has had our ad. in it. If not sold in your town, we will send you a Beech wood plane on trial on receipt of one dollar less than list price, and if you return it at our expense within 30 days of receipt we will refund your money. If you want more than one we will allow you dealers' discount.

In writing, if you mention this paper and send us the addresses of 10 plane users—no matter where they live—we will send you a carpenters' hard tough pencil. If you send us a 2-cent stamp we will send you two pencils. Remember this trial will cost you nothing if you return the plane at our expense, as per circular. We will not knowingly send to consumers where our planes are being sold. This offer is good while this ad. appears. This paper guarantees that the Gage Tool Co. will do as their advertisement states.

GAGE TOOL CO., Vineland, N. J.

Power and Durability

with

Lightness

and

Compactness

combine to make our

No. 111

Automatic Screw Driver

the greatest tool of its kind on earth

Ask your dealer to show it to you, you can appreciate a light handy tool with all the power of other styles.

Better get a catalog.

Goodell-Pratt Company

Toolsmiths

GREENFIELD :: :: MASS.



MAYHEW 60° MITRE BOX

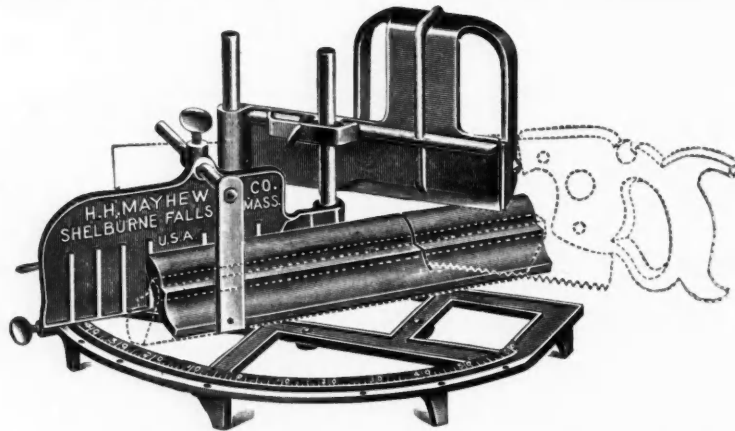

This box embodies more distinctive features than any other made
 Designed for Simplicity, Accuracy, and Durability.
 Strictly a right hand tool for mitering.
 Box embodies a new feature in reversing the principle commonly used on other boxes.
 Any of three saws may be used — Panel — Hand or Back saw.
 Saw guide adjustable for any thickness of saw.

Extreme mitre to 60° without makeshift. May be used as a stationary or pivot box by use of the pin posts.
 In mitering duplicate cuts there is no restriction on length.
 Will cut compound mitre.
 Parts take down into space 10x10x4 inches.
 Weight 15 lbs. complete.
 Box contains full directions for use.

PRICE EACH, \$10.00

H. H. MAYHEW COMPANY, SHELBURNE FALLS, MASS.

GOODELL MITRE BOX

Made of STEEL - Cannot Break

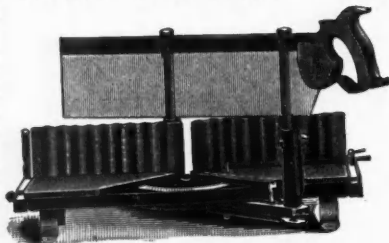

First in Quality and Improvements
 Automatic Stops for holding up saw.
 Corrugated Backs Graduated.
 Gauge for duplicate cuts and many other features
 Send for Circular "C"

GOODELL MFG. CO., Greenfield Mass.

"SEAVEY" MITRE BOX

Cuts Any Angle

Meets Every Requirement

Special Offer

On return of this "Ad" and \$2.00 one of these Mitre Boxes will be shipped to any reader of "Carpenter & Builder." Offer good for 30 days from date of issue.

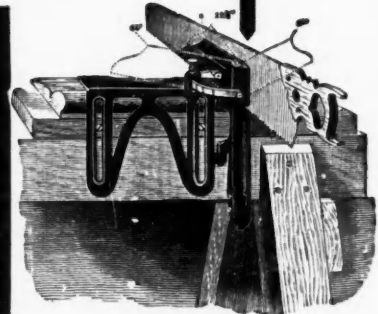

Portable — Can be carried in the Tool Kit

Weights

2

Pounds

SMITH & HEMENWAY CO.
 150-152 Chambers St. New York City

LUFKIN Tapes & Rules

are Standards of Accuracy, Durability and Workmanship.

SEND FOR CATALOG

THE LUFKIN RULE CO.

SAGINAW, MICH.

NEW YORK LONDON, ENG. WINDSOR, CAN



The information about Horse-power required for driving the different machines should be especially valuable to you. It tells all about our line of Band Saws, Saw Tables, Shapers, Jointers, Variety Wood Workers, Planers, Swing Saws, Disk Grinders, and Bores. We have a copy all ready to be sent to you and it will go forward on receipt of your name and address.

The Crescent Machine Company

224 Main Street
LEETONIA :: OHIO

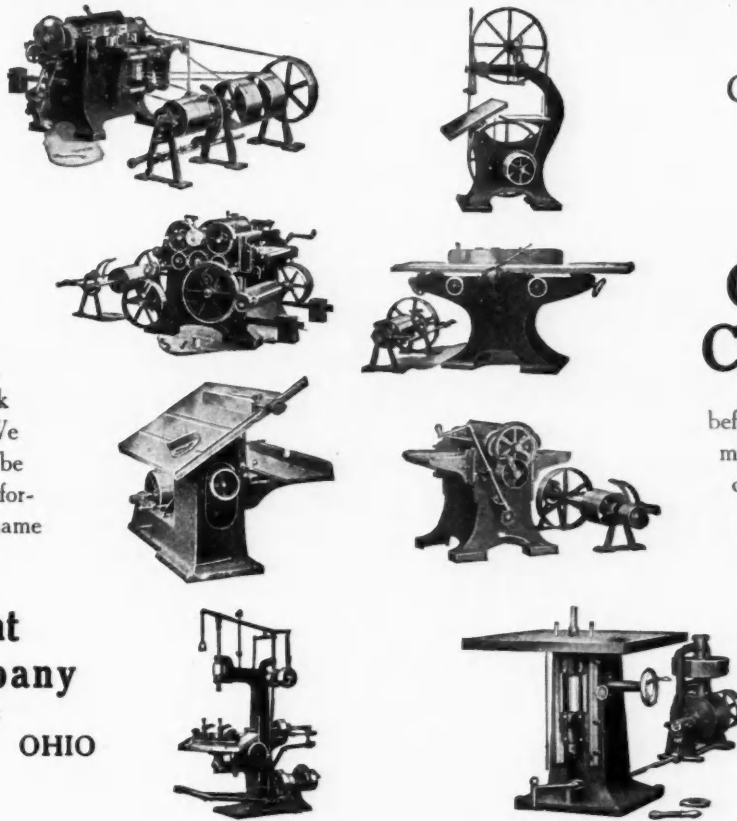

Get a Copy
of the
**1912
Crescent
Catalogue**

before you buy wood working machinery. The book contains 112 pages of information of interest to every user of wood working machinery.

The GRIMM WOODWORKER
PORTABLE



Type "A" with 4 H. P. Gasoline Engine, showing Rip Saw. Weight equipped for work 350 lbs.

NINE MACHINES IN ONE

Grimm Mfg. Co.,
Gentlemen:—Just received the extra saws and Panel-raiser, thank you for same. I find the GRIMM WOODWORKER the cheapest man in my shop.

Respectfully Yours,
(Signed) Wm. P. Jones.

Write for descriptive booklet and selling plans.

Grimm Manufacturing Co.
46 Erie Street - - - - - BUFFALO, N. Y.

**In This Improved
Swing Saw
Machine the
Saw Arbor
Travels in
a Perfectly
Straight Line**

**PRYIBIL No. 5
Parallel Swing Saw**

Also for grooving,
gaining, rabbeting,
tenoning, etc. Send
for prices and catalog.

P. PRYIBIL
520 W. 41 St.
**NEW
YORK**



This Machine Cuts (Parallel with Table)

IN AND OUT SCREW DRIVER

NUMBER 41

This is the kind of tests to which Millers Falls tools are subjected. This reversible screw driver was tested with a mechanical device against a resistance equal to driving in a 1½ inch screw. One hundred thousand movements were made, and there was **not a sign of wear** at the end. How long do you think such a tool is likely to last you? Its sensible construction is responsible for this remarkable wear, for in designing it, every effort was made to avoid the defects which other reversible screw



drivers were known to possess. In this reversible screw driver **one of the grooves is cut deeper than the other**, and in that simple, sensible manner the tool is made without any intersecting points of grooves at all; hence the remarkable wear it gives. The operation, too, is simple and easy, and if desired, the spiral can be locked instantly and the tool used as an ordinary screw driver at different lengths. This tool has proven one of the popular tools that we make. With each tool we supply three bits, two of them double end.

Send for free book "TOOL PRACTICE"

MILLERS FALLS CO.

28 WARREN STREET,

NEW YORK, N. Y.

Don't Ask the Dealer for Sash Cord. Ask for

"SILVER LAKE"

and see that he gives it to you. It is impossible to



substitute, as our name is stamped on every foot of cord. Silver Lake Sash Cord is the Original Solid Braided Cotton Sash Cord, and has been the standard since 1868. No other is just as good.

\$95.00

BUYS
3 Machines

A SAW BENCH
An 8-INCH JOINTER
A MORTISER AND BORER

This combination machine is the best value ever offered. It is made of solid cast iron and is furnished complete with necessary tools, belt, etc. Each machine is distinct from the others, and can be operated without interference with them. You should send at once for literature. It tells all about this new machine. WE SELL GASOLINE ENGINES.

THE TANNEWITZ WORKS,
42 S. Front St.,
Grand Rapids, Mich.

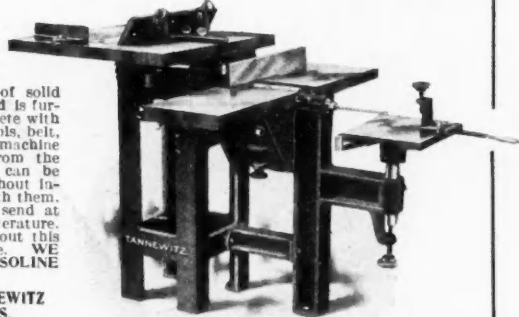

Practical Art Metal Ceilings



Quickly and easily applied. We are the only manufacturers who cut the heads in the dies after casting. Result—Square and accurate plates—which will save you time and labor in cost of erection.

Send for Catalogue No. 2 which shows 200 new and original designs.

Manufactured by
Wm. Foster & Son Co., Inc.
Springfield, Illinois

Also manufacturers of Radiator Shields, Fire Proof Window Frames and Sash, Galvanized Iron Fronts, Hip Shingles, Cornices, Skylights

Steel-Bound Columns

(Cunnius Patent)

Cannot come apart, bulge, split or crack. A heavy steel wire, placed inside, every 15 inches, solves the problem. Every column guaranteed.

Send for Circulars
and Price List

Fitzgerald-Speer Co.

Sole Manufacturers
Pen Argyl - Pa.
Agents Wanted Everywhere

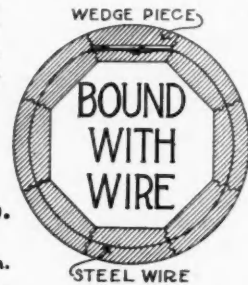
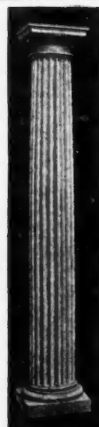

The **FAMOUS** Universal Woodworker Does **Sixteen** Different Kinds of Work

No. 1 OPERATION: JOINTER, TWO SIDE EDGER AND MOULDER

With this attachment stock as wide as 12 inches can be joined, two side edging can be accomplished with good results, and various kinds of small mouldings can be made. All this work can be done on the FAMOUS Woodworker in every way as rapid and as good as on a machine that does nothing else.

But the FAMOUS can be used as fifteen other machines as well. Think it over. Then send for the new catalog.

THE SIDNEY TOOL CO.
Sidney, - - - Ohio

- Toronto**
The A. R. Williams Machinery Co.
Front Street.
- Montreal**
Williams & Wilson
320-326 St. James Street.
- Winnipeg**
The A. R. Williams Machinery Co.
260 Princess Street.
- Vancouver**
The A. R. Williams Machinery Co.
57-61 Alexander Street.

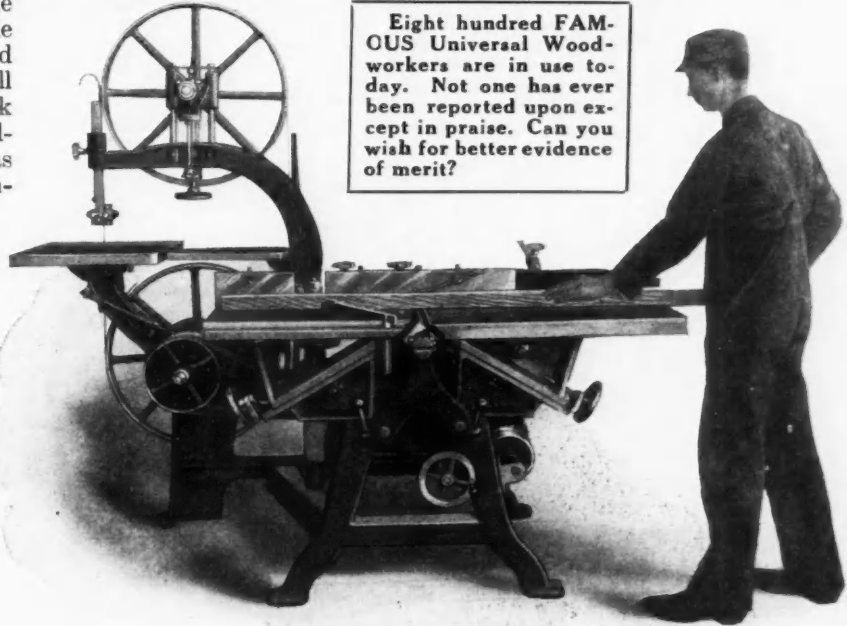

Eight hundred FAMOUS Universal Woodworkers are in use today. Not one has ever been reported upon except in praise. Can you wish for better evidence of merit?



"A Bit Of Utility"

Guided by its circular rim—instead of its centre—the Forstner Labor-Saving Auger Bit will bore any arc of a circle, and can be guided in any direction.

Doesn't matter how hard the wood is, no consequence whether it is full of knots, or the grain awkward to negotiate. The Forstner Bit works with equal smoothness under any condition and leaves a true polished surface on every job.

Unequaled for Delicate Work

Supersedes chisels, gauges, scroll-saws, or lath tools combined, for all kinds of delicate work. Cabinet and pattern makers and carpenters are enthusiastic because they do more work than other bits and cost no more.

We can offer something special in the matter of price on sets packed in a sensible box. Send today for particulars and catalog.

The Progressive Mfg. Co.
Torrington, :: :: :: :: Conn.

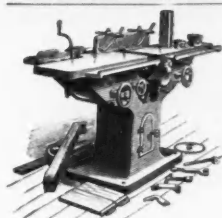

CORDESMAN, MEYER & CO.
Manufacturers of
WOOD WORKING MACHINERY
41-45 CENTRAL AVE., CINCINNATI, OHIO

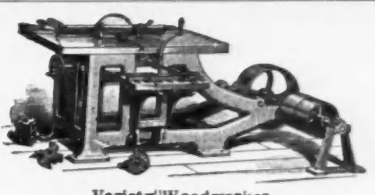

Write for Catalog Showing Our Line of Machinery for Universal Woodworker. Carpenters and Builders.

WHEN WRITING ADVERTISERS PLEASE MENTION THE AMERICAN CARPENTER AND BUILDER

Another New

“YANKEE”

“Quick Return” No. 130

Same as the No. 30, but with a Spring in the Handle that drives the Spindle back, ready for the next push. A great advantage for overhead work or where only one hand can be used. Takes all the Attachments used in the No. 30.



Have You Seen the “YANKEE” Line?

There are 35 Styles and 75 Sizes each a Labor Saver. Our New Yankee Tool Book tells about them. A postal brings it.

Your Hardware Dealer Sells the “Yankee”

North Bros. Mfg. Co.

(Department A)
PHILADELPHIA, PA.



**“GRAND RAPIDS”
ALL STEEL
SASH PULLEYS**

**No Nails No Screws
Just Bore 4 Holes**

The time saved by the “Grand Rapids” will actually pay for the pulleys.

You can't afford to use old style pulleys.

Write for free samples and prices.



Grand Rapids Hardware Co.
Manufacturers
158 11th Street, GRAND RAPIDS, MICH.

This fastening is more secure than any number of screws or nails could make it. Saves about 15 per cent, too. **S C R E W S COST MONEY**

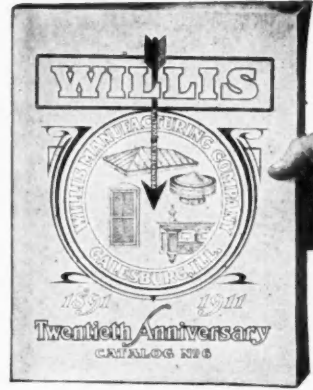

WILLIS MANUFACTURING CO.
GALESBURG, ILL.

WE take the pleasure of offering to Architects and Builders our Catalog No. 6, just received from the printer, containing 180 pages, which fully describes and illustrates the most complete line of Architectural Sheet Metal Building Material.

**Cornices, Store Fronts, Steel Ceilings, Deck!
Railings, Crestings, Etc.**

WILLIS MANUFACTURING CO.
GALESBURG, ILL.

Manufacturers of the FAMOUS Willis Skylights and Ventilators



We Want a Builder In Every Town

We Have An Attractive Proposition For One Carpenter Or Builder In Every Community To Take Orders For Our Widely Advertised

Edwards' Metal Spanish Tile

ARE EASILY SOLD BY OUR AGENTS
Home Owners Everywhere Are Reading Our Advertisements In The Leading Magazines

Edwards' Interlocking Metal Spanish Tile

ARCHITECTS EVERYWHERE SPECIFY THIS ATTRACTIVE ROOFING

Edwards' Metal Tile are stamped out of the highest quality Worcester Grade Terne Plate, size 10 x 14 inches, furnished either painted or heavily galvanized. They are provided with our patented interlocking device, which conceals all nails, makes it possible to get a perfectly moisture proof roof without soldering and without danger of having the tile crack open in extremely cold or hot weather. Edwards Metal Spanish Tile looks exactly like the best Terra Cotta Tile. They have the decided advantage of being much lighter, easier to apply, longer lived and cost much less.

Write us today about your territory. Here's an opportunity you should not miss. Many carpenters and builders have been so successful taking orders and laying out Metal Spanish Tile that they now devote their entire time to this business. Others have made big profits selling and laying our metal tile roofing "between jobs." We show you how to build up an independent, profitable business in your own community. Write for our proposition today. The territory is going fast. Don't be too late. Send a postal right now.

The Edwards Manufacturing Company

"THE SHEET METAL FOLKS"

401-417 Eggleston Avenue

Cincinnati, Ohio

THE WORLD'S LARGEST MANUFACTURERS OF METAL ROOFING, METAL SHINGLES AND METAL CEILINGS

CONSOLES Columns and Grilles



In quality and price our work is not surpassed

You will make no mistake in writing us before ordering elsewhere.

Send for 36-page Catalog
— No. 16 —

It contains many fine designs of modern Grilles, Columns and Consoles.

Northwestern Grille Works

Incorporated
CHRISTENSEN BROS., Managers. 1820-26 Milwaukee Ave., Chicago

ASK FOR AN H. & B. The Carpenter's Hammer

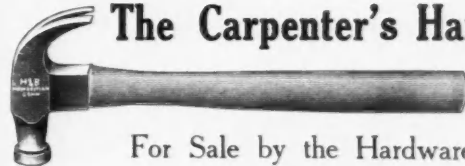

For Sale by the Hardware Trade

HUMASON & BECKLEY MFG. CO.
NEW BRITAIN, CONN.

G. RUHLING, Chicago Representative
57 WEST LAKE STREET. - - CHICAGO, ILL.

SALAMANDER

FOR DRYING PLASTER

With or Without Brick Lining
Has Dumping Grate

Write for Circular and Prices
The S. M. HOWES CO.
40-46 Union Street
BOSTON

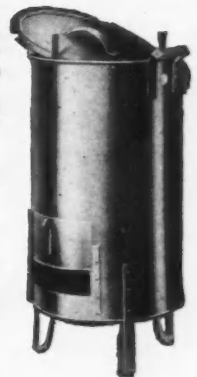

The Improved Perfection Mortiser

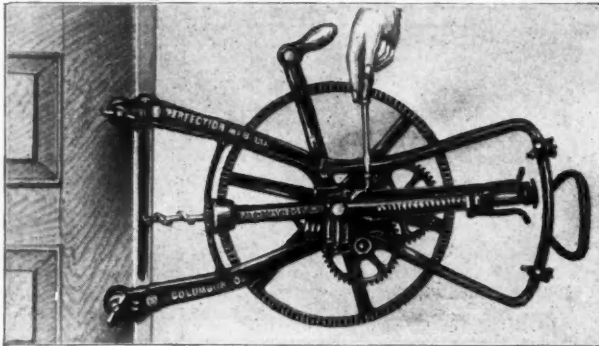

One bit moves up and down while working.

For Door Locks, Sash, Sash Pulls, Screen Frames and Cabinet work. Instantly changed from round hole to ANY size mortise up to 6 1/2 in. Finished perfect WITHOUT THE USE OF BRACE OR CHISEL. Made of Malleable. Automatic and ball bearing.

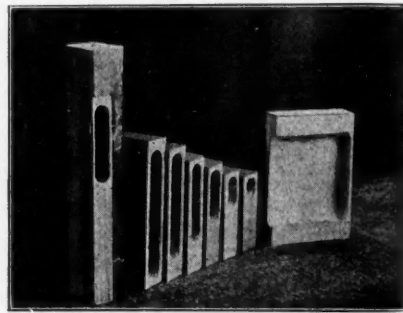

MANUFACTURED BY **PERFECTION MFG. CO.**
COLUMBUS, OHIO

Write for prices and full details.

INVESTIGATION OF ALL ROOFINGS EMPHASIZES G F T SUPERIORITY

When discriminating buyers want a roof that never fades—never wears out—never needs any preservative and never absorbs any water, they always insist on getting

'GENUINE FRANKLIN TUNNEL SLATE'

THE EXPERIENCE OF MORE THAN 59 YEARS HAS PROVEN THAT THEIR COST PER YEAR OF SERVICE IS LOWER THAN ANY OTHER ROOFING. Our 72-page Slate Book tells a score of facts which should be known to everybody living under a roof. IT POINTS THE WAY TO IMMENSE ROOF SAVING

Write for the book *To-Day*. It is sent FREE

Slatington Slate Co. Established 1852 **Slatington, Pa.**

PHOENIX INSIDE SLIDING BLINDS

WILKES BARRE, PA.

The Phoenix Sliding Blind Co. Enclosed find my check for blinds. I am pleased with them and sorry I did not have them put throughout the whole house. C. W. BURT.

Comfort!
Economy!
Convenience! PHOENIX SLIDING BLIND CO.
BRIDGE & CANAL STS. PHOENIX, N. Y.

The lately improved springs and corrugated steel rods put the "PHOENIX" far in lead of less improved styles. Write for Catalogue "C" and free samples, showing construction.

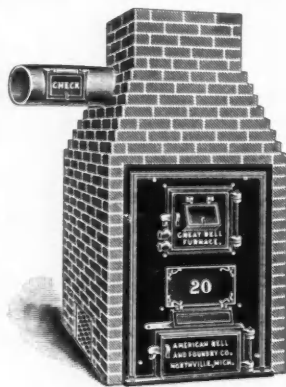

A HOT AIR FURNACE

For Less than \$50 Complete

For 5 and 8 Room Dwellings

An unheard of Price and a most Remarkable and Indestructible Furnace

No Pipes No Lost Heat

AMERICAN BELL AND FOUNDRY CO.

NORTHVILLE - MICH.

ASHLAND Folding Scaffold Bracket

Best and strongest bracket made. Used on any kind of siding. Adjusts to any space studding or pitch of roof instantly. Just the thing for carpenters, tinners, painters, and brick masons. Folds instantly. No pins or bolts used in adjusting. One bracket easily carries 1000 pounds put up on 4-10d nails. No contractor can afford to be without a set. Every man who uses them orders again. Pay for themselves on first two jobs in time and material. For prices and information, write.

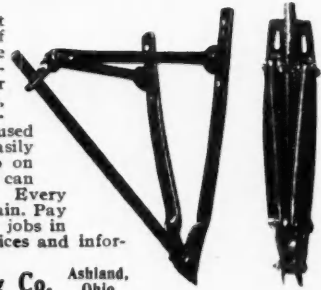

Elite Manufacturing Co. Ashland, Ohio

PATENTS

Secured in the United States and foreign countries. TRADE-MARKS registered. Investigations, opinions and advice in regard to patentability and infringement.

WATSON & BOYDEN

Patent Law and Soliciting 918 F St. N. W. WASHINGTON, D. C

Universal Sash Bar

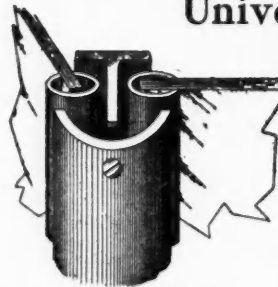

Glass set from the outside

The Bar that holds with a grip of iron yet with a touch of velvet.

Makes any and all angles without cutting or fitting. Holds the glass in a strong wind and under adverse conditions.

50 times safer than wood frames.

The only flexible setting for Plate Glass

VOLTZ MANUFACTURING COMPANY

Get our Catalogue

St. Joseph, Mo.

NEW SETS

RUSSELL JENNINGS AUGER BITS

Are Now Put Up in Five Sets:

	32½ qrs. - - 13 bits	
	22½ qrs. - - 11 bits	
	20½ qrs. - - 9 bits	
	18 qrs. - - 9 bits	
	17½ qrs. - - 7 bits	

The set of 11 bits (22½ qrs.) contains standard bits ¼ to ¾ inch inclusive and two quick-boring bits ½ and ⅝ inch. This set is particularly adapted to door mortising, etc.

Ask Your Dealer for Full Information, Prices, Etc.

RUSSELL JENNINGS MFG. CO.
CHESTER, CONN., U. S. A.

21-41

Use **KEROSENE** Engine **FREE!**

Amazing "DETROIT" Kerosene Engine shipped on 15 days' FREE Trial, proves kerosene cheapest, safest, most powerful fuel. If satisfied, pay lowest price ever given on reliable farm engine; if not, pay nothing

GASOLINE GOING UP!

Automobile owners are burning up so much gasoline that the world's supply is running short. Gasoline is 9c to 15c higher than coal oil. Still going up. Two pints of coal oil do work of three pints gasoline. No waste, no evaporation, no explosion from coal oil.

Amazing "DETROIT"

The "DETROIT" is the only engine that handles coal oil successfully; uses alcohol, gasoline and benzine, too. Starts without cranking. Basic patent—only three moving parts—no cams—no sprockets—no gears—no valves—the utmost in simplicity, power and strength. Mounted on skids. All sizes, 2 to 20 h. p., in stock ready to ship. Complete engine tested just before crating. Comes all ready to run. Pumps, saws, threshes, churns, separates milk, grinds feed, shells corn, runs home electric-lighting plant. Prices (stripped), \$29.50 up. Sent any place on 15 days' Free Trial. Don't buy an engine till you investigate amazing, money-saving power-saving "DETROIT." Thousands in use. Costs only postal to find out. If you are first in your neighborhood to write, we will allow you Special Extra-Low Introductory price. Write!

DETROIT ENGINE WORKS, 495 Bellevue Ave., DETROIT, MICH.

Cement Columns in One-half the Time

The Simple and Perfect Cement Column Form Clamp

EASY TO APPLY—a common laborer does five times the work of an expensive Carpenter. Placed in a minute, a tap on the wedges, and the greater the pressure the tighter they clamp. Takes the place of two by fours and nails—nothing to lose or get out of order—adjustable to any size column—will last for years. Write for circular.

1119 McGee St.
Carroll Column Clamp Co. KANSAS CITY, MO.

Next machine you buy, order a— **Rothmotor**

to drive it individually. You will be pleased. You will be gaining some profitable experience in economy.

Ask
ROTH BROS. & CO.
1422 West Adams Street,
CHICAGO, ILL.

NEW YORK OFFICE:
136 Liberty Street

RICHARDS-ROYAL HOUSE DOOR HANGER

Solves all your hanger troubles. Our catalog should be your guide to handle any sliding door proposition.

Shall we send it?

Richards-Wilcox Mfg. Co.
Aurora, Illinois

PERFECTION ELEVATORS

The Best Value for the Money in the World
—Mechanically Correct—

Dumb Waiters, Carriage and Store Elevators, Sidewalk Hoists, Etc., Etc.

Our Elevators are noted for their EASY RUNNING and SERVICE-ABLE QUALITIES. They are practically self-contained, and can be erected by any carpenter in a few hours. We furnish plans for erecting.

The Low Cost Will Surprise You

State your requirements, giving capacity, size of platform and number of feet to travel and we will name our lowest money saving estimate.

SIDNEY ELEVATOR MFG. COMPANY, SIDNEY, OHIO

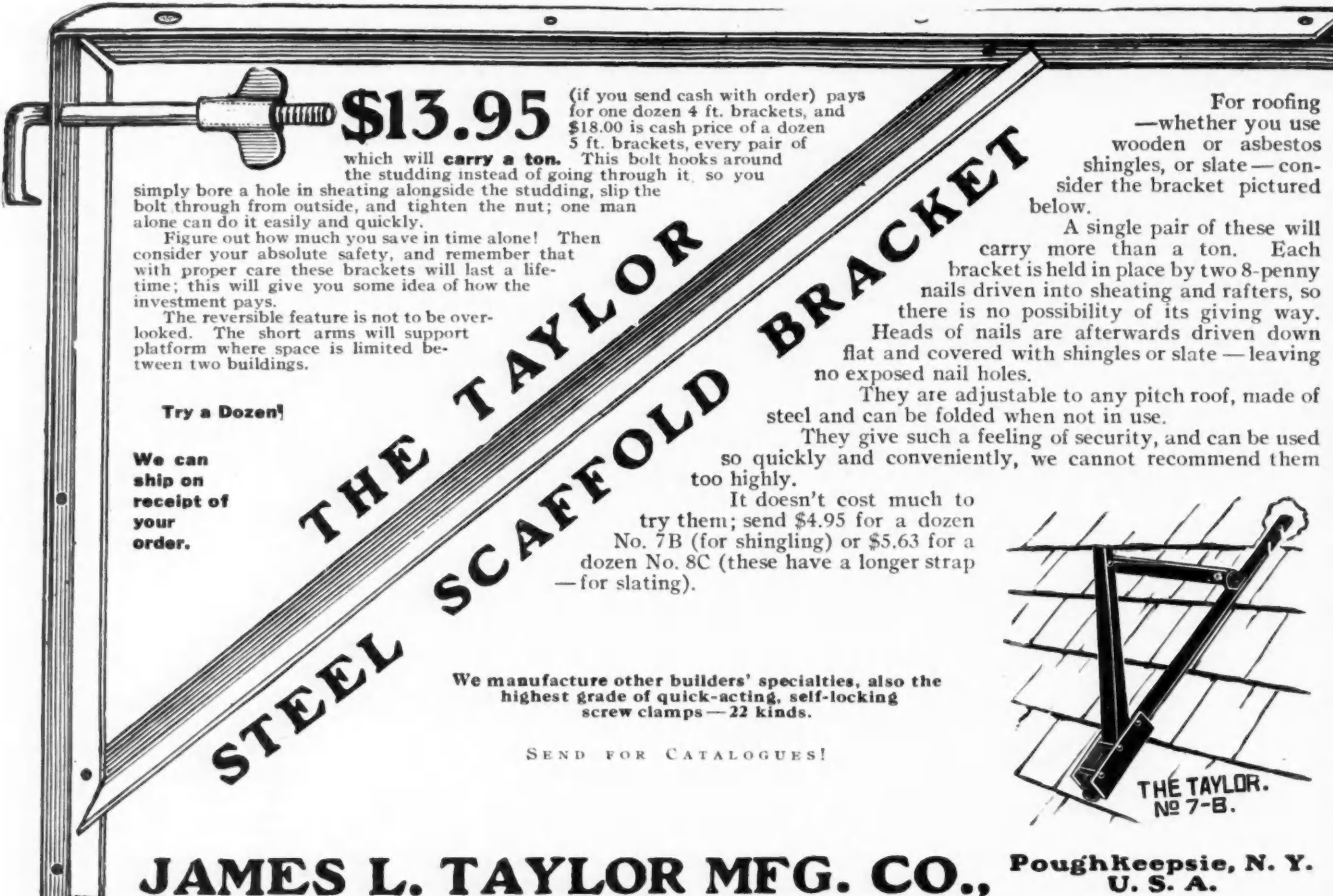

\$13.95 (if you send cash with order) pays for one dozen 4 ft. brackets, and \$18.00 is cash price of a dozen 5 ft. brackets, every pair of which will carry a ton. This bolt hooks around the studding instead of going through it, so you simply bore a hole in sheathing alongside the studding, slip the bolt through from outside, and tighten the nut; one man alone can do it easily and quickly.

Figure out how much you save in time alone! Then consider your absolute safety, and remember that with proper care these brackets will last a lifetime; this will give you some idea of how the investment pays.

The reversible feature is not to be overlooked. The short arms will support platform where space is limited between two buildings.

Try a Dozen!

We can ship on receipt of your order.

THE TAYLOR STEEL SCAFFOLD BRACKET

For roofing—whether you use wooden or asbestos shingles, or slate—consider the bracket pictured below.

A single pair of these will carry more than a ton. Each bracket is held in place by two 8-penny nails driven into sheathing and rafters, so there is no possibility of its giving way. Heads of nails are afterwards driven down flat and covered with shingles or slate—leaving no exposed nail holes.

They are adjustable to any pitch roof, made of steel and can be folded when not in use. They give such a feeling of security, and can be used so quickly and conveniently, we cannot recommend them too highly.

It doesn't cost much to try them; send \$4.95 for a dozen No. 7B (for shingling) or \$5.63 for a dozen No. 8C (these have a longer strap—for slating).

We manufacture other builders' specialties, also the highest grade of quick-acting, self-locking screw clamps—22 kinds.

SEND FOR CATALOGUES!

JAMES L. TAYLOR MFG. CO., Poughkeepsie, N. Y. U. S. A.

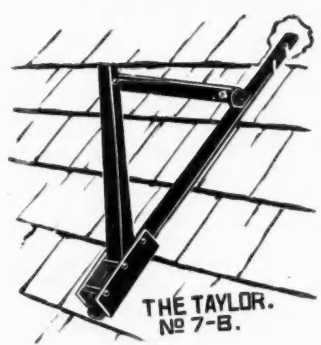

THE TAYLOR. No 7-B.

Dumb Waiters

Some builders buy a Dumb Waiter Outfit and then build the enclosure to fit it. Others build the enclosure and then build or buy the Dumb Waiter to fit the enclosure.

The Sedgwick Machine Works carry in stock catalogue sizes of Dumb Waiter and Hand Power Elevator Outfits for prompt shipment (within twenty-four hours of receiving order) and make up promptly special sizes when stock sizes cannot be used. They sell complete outfits or any dumb waiter material wanted and every builder should keep their catalogue for ready reference, as it contains much valuable information resulting from their fifty years' experience as specialists in Dumb Waiters and Hand Power Elevators. Catalogue "K" sent free on request to Sedgwick Machine Works, 128 Liberty Street, New York.

BLAKE QUICK ACTING VISE

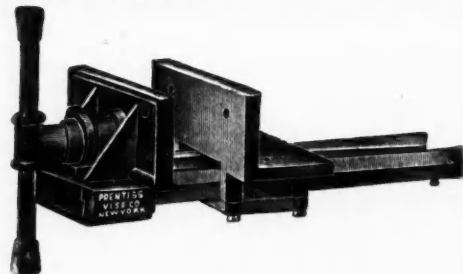

For Cabinet Makers and Wood Workers. Simplest—Strongest —Cheapest—Best
Send for Catalogue of all kinds of Vises
PRENTISS VISE COMPANY, MAKERS
106-110 La Fayette St., New York, U. S. A.

The American Combined Level and Grade Finder



All progressive and up-to-date Carpenters, Contractors and Mechanics should have one of our levels and grade finders. An instrument with which at one glance you can get the true slant on any line or grade, either in degrees, inches or percentage, or all at one time, and will at once give the exact distance needed to plumb up to a true level.

The most practicable, durable and convenient instrument of the day. In addition to ordinary mechanical work the American Combined Level and Grade Finder will prove serviceable in cutting off rafters, laying off and leveling buildings, getting height of any object and is useful in dozens of ways.

The longitudinal recess shown in cut is well worth the low price of the instrument.

Write at once for large list of testimonials and special introductory price given only to first applicants with privilege of taking agency.

American Level & Grade Finder Co., Railroad, Pa.

Let us send you this book for
FIVE DAYS FREE TRIAL

SEND no money—just mail us your name and address. Your book will reach you by return mail. Keep it 5 days—use it—then either send one dollar or return the book.

STANDARD HANDBOOK OF ESTIMATING DATA
EVERY MAN IN THE BUILDING TRADE NEEDS IT

Name.....
Address.....

The Builders' Auxiliary Co.
325 Old South Building, BOSTON, MASS.

Disston Saws, Files and Tools



For fifty-six years we have been making Disston Crucible Steel. It is made under the exclusive Disston process. The long life and cutting properties of Disston Saws are due to Disston Crucible Steel and the treatment it undergoes in our shops.

The Disston establishment is the *only one* making steel for its full line of saws and tools—

one reason why Disston Saws are uniformly durable and efficient.

Disston Saws are hardened and tempered by the exclusive Disston process.

It pays to buy Disston Saws and Tools. For any and every kind of work Disston Saws, Files and Tools are the most reliable.

We have been making saws for over 71 years.

HENRY DISSTON & SONS

Incorporated

Keystone Saw, Tool, Steel and File Works

PHILADELPHIA, PA.

BRANCHES: Chicago, Cincinnati, Boston, New Orleans, Memphis, San Francisco, Seattle, Portland, Spokane, Vancouver and Toronto

CUSTOM MADE Fly Screens



Our work is far superior to the usual output of local mills and has a style and finish not obtainable from those who do not make a specialty of fine screens.

Our screens are made from kiln dried lumber and have waterproof coped joints and the frames are weather proofed before finishing coats are applied.

Best grades of Wire Cloth, enameled, galvanized, genuine bronze, fastened by the most approved method.

A. J. PHILLIPS & CO., FENTON, MICH.
28 YEARS' EXPERIENCE 3 1-2 ACRES FLOOR SPACE

The New Gun Metal Finish

Makes the

"STERLING" Builder's Levels



By far the most durable instrument in existence. 1912 models now on sale.

Write to-day for CATALOGUE and SPECIAL PRICES

ISZARD-WARREN CO., Inc.
136 N. 12th St., Philadelphia, U.S.A.

CALDWELL SASH BALANCE

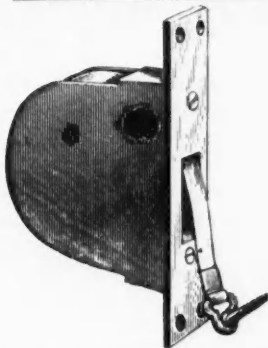

Does away with weights and cords, and VASTLY more durable.

Makes sashes work perfectly.

Permits greater window space in new work, as box frames are not necessary.

May be applied to old windows without altering sashes or frames.

Write for circular to the
Caldwell Mfg. Co.
15 Jones Street, Rochester, N. Y.



No Dust
Dirt
Smoke
Cinders

Travel Over the Road of Good Service

THE GREATEST INTERURBAN SYSTEM IN THE WORLD . .
THE MCKINLEY LINES
EXPRESS SERVICE AT FREIGHT RATES!

GEO. H. BISHOP & CO., Lawrenceburg, Indiana, U.S. A.

Makers of

Fine Hand Made Hand Saws

The Purest of Quality Our "GREYHOUND" Hand Saw



IN introducing our "GREYHOUND" brand of Saws to the trade, we have departed from our usual custom in naming instead of numbering the saw. This saw will be known as our "GREYHOUND" and will be the only Bishop Brand of saw known by name.



We have had a Chemist experimenting for years to originate a purity of steel with a fine grain and tough body that would stand up under such a fearless warranty as we place on our "GREYHOUND" brand of saws. We now have it. We know its worth as well as its value. As workers of steel we understand it. We had to name it and we have christened it Bishop's Refined "GREYHOUND" Steel, associating our trade mark with its name. We have in this "GREYHOUND" Saw blade a purity of steel that is tough, tempers accurately and even—together with the special way it is made—enables us to guarantee that this "GREYHOUND" brand of Saws will cut faster and run easier in all kinds of wood, hold its sharpness and set longer than any other makes of good Saws in the world. We Refund the Money if 30 days' trial does not prove our guarantee. Our pride is quality with an honest opportunity for the purchaser to judge. Each Saw is tagged with our warranty on it. No expense has been spared to make this Saw the most perfect in the world. We invite correspondence with anyone who has our "GREYHOUND" brand of saws in use.

Made in both straight and skew back. Packed One in a Box.

In workmanship this saw possesses all the skilled mechanical features known to the art of saw making. The hang of the blade has been carefully studied and adjusted, to suit the fancy of the most critical.

If this saw cannot be found in the Hardware Store and they will not order it for you, write to us. Price for 28 in. saw, \$3.00 delivered. We make anything in Carpenters' Saws.

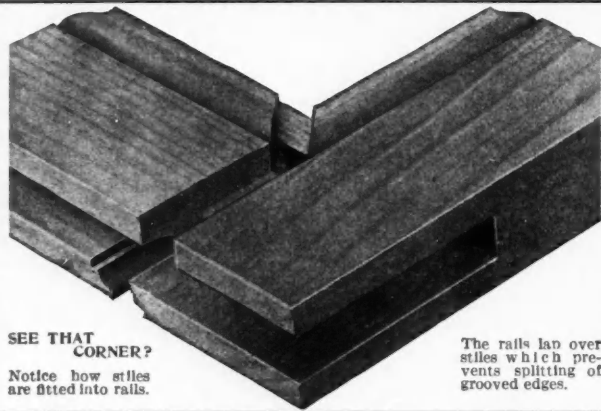

SEE THAT CORNER? Notice how sills are fitted into rails.

The rails lap over sills which prevents splitting of grooved edges.

MADE TO ORDER FLY SCREENS AND SCREEN DOORS

For Residences, Apartment Houses, Hotels, Clubs, Hospitals, Schools, etc., no order too large or none too small, from a single screen or door to a thousand.

We use the best grades of wire, black enamel, galvanized, pearl and copper bronze, fastened by the improved Standard Shoulder Strip Method, which makes the wire drum tight and firm, can not sag nor pull away.

Dealers, Carpenters, Contractors and Builders, write for a free copy of our 1911 illustrated catalog.

STANDARD SCREEN CO., 1848-50 W. 14th St. CHICAGO, ILL.

Our screens are all mortised, tenoned, joined with waterproof glue and pinned with steel pins, will last a life time.

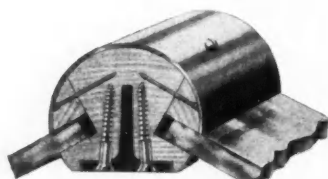

COULSON CORNER POST

MODERN STORE FRONTS ARE OBTAINED BY USING
The Coulson Patent Store Front Construction

WRITE FOR CATALOGUE E-800, AND FOR PAMPHLET DESCRIBING THE COULSON DRAINAGE SILL.

J. W. COULSON & CO.

Office and Factory, 234-236 N. Third St., COLUMBUS, OHIO

ranch Office, 202 Builders' Exchange, Dallas, Texas

WHEN WRITING ADVERTISERS PLEASE MENTION THE AMERICAN CARPENTER AND BUILDER

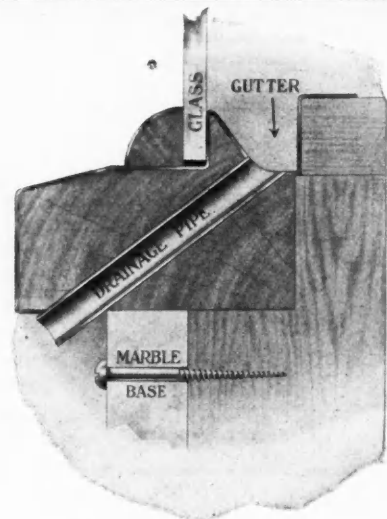

COULSON DRAINAGE SILL



One view of our exhibit room.

Wood Mantels, Grilles, Colonnades, Fireplaces,

Why Not Save Money by Buying Direct from the Manufacturer

Mosaics also Rookwood Tiles and Faience

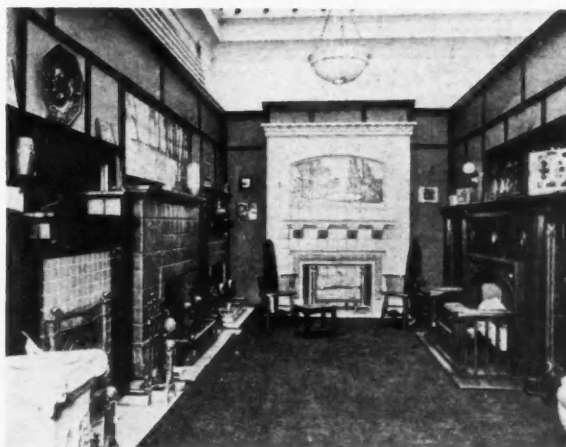

Another view of our exhibit room.

CATALOGS AND DESIGNS ON APPLICATION
SEND FOR OUR 100 PAGE CATALOG

CHAS. F. LORENZEN & COMPANY

GENERAL OFFICES AND SHOW ROOMS
701-709 N. Sangamon St.

CHICAGO

Down Town Office and Tile Display Rooms
128 REAPER BLOCK
Cor. Clark and Washington Sts.

Sold by Mail Only



Patented.
Steel Points can be moved up or down
to suit pencil.

The Peerless Scriber

Broad Point for Plaster, walls, etc. Sharp Point for Quirks and Mouldings. Will hold any shape pencil equally well. This scriber will hold a framer's pencil, thus doing away with breaking of pencil point. Adapted for extra close scribing. Made in 3 and 5 inch. Prices given are for 3 inch. For 5 inch size add 15c.

Polished Steel, 30 cts.
Nickel-Plated, 35 cts.
Five cents extra with Oval Pencil.

The peerless flexible-bit gauge when it comes in swift contact with the wood will not mark the wood or slip upwards, or interfere with chips as other bit-gauges do. The only gauge which can be used successfully for boring mortise locks. Just the thing for dowels. Made of steel spring wire, flexible, twenty turns to the inch.



Patented.
Nickel-Plated - 30 Cents.

Mail Orders promptly filled on receipt of price. Postage stamps accepted by
POTTER BROS., Specialty Mfrs., 612 West 110th Street, New York City

"Last a Lifetime and Give Satisfaction To the End"

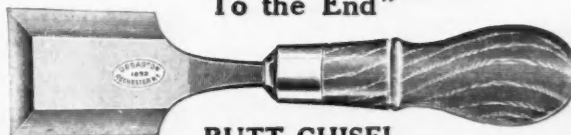

BUTT CHISEL

TRADE MARK



The celebrated Barton Planes and Edge Tools for carpenters and all other woodworkers are unequaled by any other made for keen, hard smooth cutting edges. If your hardware dealer does not handle

THE CELEBRATED BARTON TOOLS

Send direct for catalogue and our free story book. True Stories. Be sure to specify "CARPENTER'S CATALOGUE."

MACK & COMPANY, 20 BROWN'S RACE, ROCHESTER, N. Y.

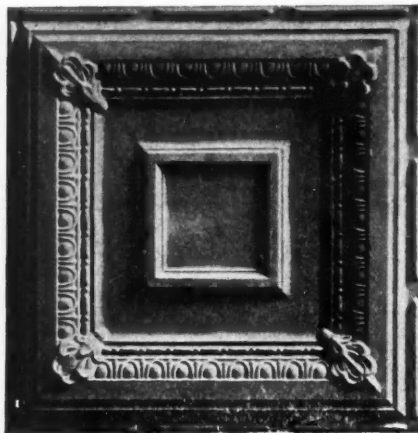

Colonial Plate 7004E.

METAL CEILING AND SIDEWALL

LARGE VARIETY OF CLASSIFIED DESIGNS

Easily erected. Plates resquared. Perfect Fit.
Material the Best. Prices Right.

WE MAKE QUICK SHIPMENTS.

Suggestions Plans Estimates Free.

ALL STYLES OF METAL ROOFING.

Catalog Dc for Ceiling.

Catalog Gc, Roofing.

THE KANNEBERG ROOFING & CEILING CO.

1002 Robin Street, CANTON, OHIO

ROOF SLATES BLACKBOARDS

E. J. JOHNSON

38 Park Row, New York

Quarry Operators

BLACK, GREEN, PURPLE, RED

Booklet, Samples and Prices on Application

Huther Bros. Patent Groover or Dado Head

Will save it's cost in three days' time

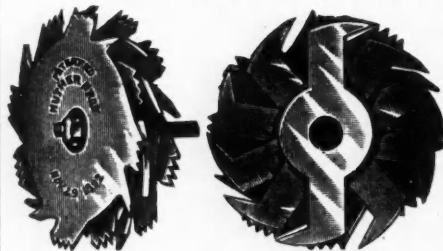

Showing Arrangement of Cutters

Can be used on any Circular Saw Mandrel
For cutting any width groove from 1/8" to 2" or over. Will cut a perfect groove, either with or across the grain, and leave edges smooth. Will ship to any responsible firm on ten days' approval; if not satisfactory you are at liberty to return at our expense. We also make a specially cut: Grooving Saws for all kinds of special work; Lock Corner Cutters Concave Saws, etc.

Try our Scraper Blades and you will use no others.

HUTHER BROS. SAW MFG. CO.

1000 University Ave. ROCHESTER, N. Y.

BOVEE FURNACES at Manufacturer's Prices

SAVES 50 PER CENT OF COST; 40 PER CENT OF FUEL
Most Durable, Most Economical Furnace Sold



Has a perfect ventilating system for every part of the building

RESIDENCE HEATING PLANT

Hot air registers in five rooms; cold air return in two rooms; 40-in. Furnace, 20-in. Fire Pot, 28-in. Combustion Chamber, 10,000 cubic feet Heating Capacity.

Special Price, \$65

CHURCH AND SCHOOL HEATING PLANT

One large hot air, two cold air registers, 54-in. Furnace, 32-in. Fire Pot, 40-in. Combustion Chamber, 40,000 cubic ft. Heating Capacity.

Special Price, \$95

Horizontal Furnaces with large doors or larger furnaces and more piping at proportionately low prices.

Bovee Grinder & Furnace Works, 50 8th St., Waterloo, Ia.

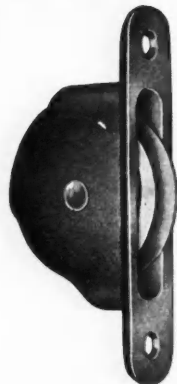

Headquarters For Sash, Door and Blind Makers' Supplies and Special Machines

WINDOW PULLEYS (Cast and Sheet Steel). All sizes and finishes. Write for Catalogue.

ENTERPRISE PULLEY MORTISER. Equipped with Four Bits. Cuts Full Stile in same time required for single mortise

ENTERPRISE POCKET CUTTER. Makes a Pocket both wind and water tight.

PIONEER MOULDING SANDER. Finishes Mouldings and Interior Trim equally as well as handwork, and at one-tenth the cost.

Sash Cord and Chain, Glazier's Points (Standard and Machine), **Blind Staples, Wood Screws, Wire Nails and Dowels.**

125 Broad St., Boston, Mass.

AUSTIN & EDDY

805 Tacoma Bldg., Chicago, Ill.

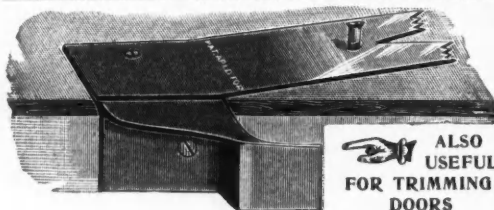

ALSO USEFUL FOR TRIMMING DOORS

WHIPPLE'S CARPENTER COMBINATION BENCH HOOK

The Handiest Little Tool Ever Manufactured
ARE QUICKLY ADJUSTED TO A TEMPORARY BENCH
EVERY CARPENTER SHOULD OWN ONE

45c Postpaid

45c Postpaid

Sent postpaid on receipt of price.

R. P. WHIPPLE & CO., 275 Main Street, SPRINGFIELD, MASS.

See our Ad in back of this Magazine.

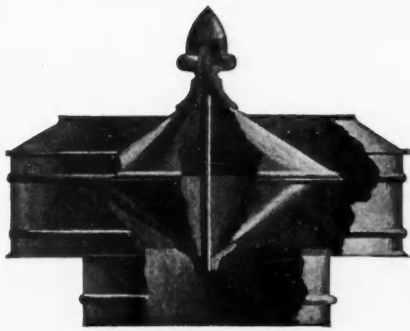

Ventilators THAT VENTILATE

**Improved Metal Ceilings
with Punched Nail Holes
and Repressed Beads**

Those particular features that saves so much time in the erection and increases your profits. They produce a nicer job.

METAL SHINGLES

in two sizes, 10 x 14 inches and 19 x 26 inches.

Metal Hip Shingles Sheet Metal Goods

of all kinds for interior and exterior of buildings.



The Canton Art Metal Co.

"Quality Products"

CANTON, OHIO.

ADDRESS, FACTORY No. 1

EASTERN BRANCH
Cor. 11th Ave. & W. 25th St.
New York

WESTERN BRANCH
No. 206 South 3rd Street
Minneapolis



TEN DAYS' FREE TRIAL

If you will take this ad to your hardware dealer and ask him to comply with this offer he will gladly do so, or if he does not handle our squares and will not order one for you, write us, giving your bankers' and grocer's names as reference. We will ship you one, express prepaid.

Guaranteed Accurate and to Remain So

The main feature of our new Take-Down Square is that it will always stay true. It is so constructed that the tongue is held down into beveled bearings by a spring, and these bearings are made so as to take up the constant wear which comes in taking square apart and putting it together, thereby producing constant accuracy. Rust-proof canvas case with each square.

	Polish	Ox. Copper	N. Plated on Copper
No. 3 Standard.....	\$2.50	\$2.75	\$3.00
No. 100 Standard.....	2.75	3.00	3.25
No. 100R Framing.....	3.00	3.25	3.50
No. 100A Framing.....	3.25	3.50	3.75

Add ten cents to the price of the No. 100R and 100A if 1 1/2 inch tongue is desired.

Mr. Hardware Dealer—

Knowing that our new Take-Down Square is so constructed that it will remain true, we are willing to allow you the privilege of putting this square out on TEN days' trial. We will make good all squares returned to you, but all squares that come back to you must be returned to us through the jobber from whom you purchased these squares.

We are in no wise responsible for squares not returned or bad accounts herewith contracted.

NICHOLLS MFG. CO.

Ottumwa, Iowa

The Builder Who Knows: vs The Builder Who Guesses

It is easy to tell which wins out. Stop guessing. Learn to estimate safely and rapidly.

The New Sixth Edition of

THE LIGHTNING ESTIMATOR

shows you how

SIMPLE **RAPID** **ACCURATE** **RELIABLE** **PRACTICAL** **SYSTEMATIC**

* Easily adjusted to any locality. Based on experience not theory. Amply Illustrated and Bound in CLOTH. This is your Opportunity to get on to the road to Success. Don't let it go by, but send \$1.00 TO-DAY, for a copy of this interesting book.

BRADT PUB. CO.

1260 Michigan Ave.

::

JACKSON, MICH.

50c FOR THIS Clamp Fixture

*It is Unequaled for Strength—
Quick Action and Last-
ing Qualities*



Write for Catalog of Sheldon's Clamps and Vises.

E. H. SHELDON & CO.

84 N. May Street

::

::

CHICAGO, ILL



A SUGGESTION

Do you specify a spring hinge with distinctive features which will appeal to your client and assure you of satisfaction to all concerned?



Chicago "Triplex" Spring Butts offer this advantage to you. The appearance, durability and finish of this article is unsurpassed, and in consideration of prices that are conservative in respect to value, the up-to-date builder cannot afford to risk his reputation with goods that are unsatisfactory.

Send for Catalogue C 26. It illustrates and describes the most complete line of Spring Hinges manufactured.

Chicago Spring Butt Company.

CHICAGO  NEW YORK



SIX INCH SOLID LAP

A six inch lap is better than a three inch lap. It gives better protection against leaks and permits nailing down on the under sheet only, so that no nail heads appear on the surface. Otherwise this is the same Granite Roofing that we have sold for 26 years for use on great factories. It is immune from damage by coal smoke or cinders, and it has a sea grit surface which makes painting entirely needless. Behind it is a reputation that has Passed the Quarter Century Mark.

EASTERN GRANITE ROOFING CO.
 19 Battery Place, New York Pittsburgh

Chicago

GIVEN AWAY!

Our new book telling you how to joint, file and set your saw.

Send postal for copy of **"SAW POINTS"**

CHAS. MORRILL, 271 Broadway, New York

THE TALKING POINTS OF THE
Fale's Patent Variable Bench Plane
ARE AS MANY AS ITS VARIOUS ATTACHMENTS

It is the original combination plane. Highest in Quality, Lowest in Price.

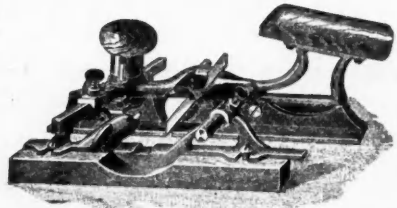

Ask Your Dealer or write for circulars and prices to

OTIS A. SMITH, : Rockfall, Conn.



CARPENTERS PREFER THE POPULAR

Marsh Ayer Miter Box

Because:

- It is absolutely accurate.
- It is so convenient to use.
- It is built to last.
- It has an unusually large capacity.
- The price is right.

Let us send you our illustrated circular.

H. C. Marsh Company
 606 Race Street :: :: ROCKFORD, ILLINOIS

Copyright 1911 by American Carpenter and Builder Company



The
**World's Greatest
Building Paper**

Important Notice

When your subscription expires, renew at once, using the blank enclosed in your final copy. If it expires with this issue your renewal must reach us before September 25 to avoid missing the October number. Use P. O. or Express Money Order if possible, but bills or 2-cent stamps may be sent at our risk.

The
**World's Greatest
Building Paper**

American Carpenter and Builder

Entered as second-class matter July 1, 1905, at the postoffice at Chicago, Ill. under the act of Congress of March 3, 1879.

Published on the first day of each month by

AMERICAN CARPENTER AND BUILDER COMPANY
178 W. JACKSON BOULEVARD, CHICAGO

NEW YORK OFFICE, 178 FULTON STREET

EDITORIAL DEPARTMENT

WILLIAM A. RADFORD, EDITOR-IN-CHIEF
BERNARD L. JOHNSON, B. S., EDITOR
WILLIAM REUTHER } ASSOCIATE
ALFRED W. WOODS } EDITORS
ALFRED S. JOHNSON, M. A., PH. D. }

BUSINESS DEPARTMENT

WM. A. RADFORD, PRESIDENT AND TREASURER
H. M. RADFORD, SECRETARY
E. L. HATFIELD, BUSINESS MANAGER
H. W. WALKER, ADVERTISING MANAGER
E. B. WOLFROM EASTERN REPRESENTATIVE

VOL. XI SEPTEMBER, 1911. No. 6

SUBSCRIPTION RATES

One Year, \$2.00; six months, \$1.00; payable always in advance
Single Copies, 20 cents. Canadian Subscriptions, \$2.50.
Foreign Subscriptions, \$3.00.

ADVERTISING RATES

Furnished on application. The value of the AMERICAN CARPENTER AND BUILDER as an advertising medium is unquestioned. The character of the advertisements now in its columns, and the number of them, tell the whole story. Circulation considered, it is the cheapest trade journal in the United States to advertise in. Advertisements, to insure insertion in the issue of any month, should reach this office not later than the 20th of the month preceding.

WHILE Doubt stands still Confidence erects a skyscraper.

DON'T cry over spilled milk. What's the use?
Go after another can.

Anything to Suggest?

WITH the beginning of the fall season we want the readers of the AMERICAN CARPENTER AND BUILDER to feel that these columns belong more than ever to them. So many fine ideas and suggestions have come from the readers in times past that we have been able to make this magazine, editorially, just what you want it. Will you help us keep this up?

There is an old saying, and a very true one, that "Two heads are better than one." So let's all get together and make the columns of the AMERICAN CARPENTER AND BUILDER our exchange forum for asking questions and offering advice on all matters pertaining to building construction.

Maybe there are some parts of the work that you would like special help on. Perhaps there are some building problems we can help you solve. Write to us anyway about them, and if our corps of experts can't find the right answer, probably some one of the "Brothers" can.

Just to begin, why not let's start one of the good old-fashioned controversies?

For instance, how many doors do YOU hang in a day?

FAILURE is not the worst thing in the world; the very worst is not to try.

ACRITIC is a fellow who can tell better how a thing ought to be done than he can do it himself.

Welcome News for the Carpenter

WE read with interest the reports now going the rounds in lumber circles that a wide campaign is soon to be undertaken to restore public confidence in wood as to structural material.

It seems that lumbermen generally are now awake to the fact that they have been "asleep at the switch"—that during the past seven or eight years, while they have been sitting back contentedly relying on the past reputation of lumber as the natural and logical building material, the manufacturers of the competitive substitutes for wood have been very busy urging and persuading old friends and customers not to use any more lumber.

Unlike the promoters of the competitive materials, the lumbermen have never advertised in such a way as to reach the actual consumer. The carpenters know only too well what the result has been. Gradually, but steadily, they have seen their field of operations cut down. Some have even been almost convinced them-

selves that the material they work with and on which they depend for their bread and butter is as "flimsy," "unreliable" and "short-lived" as they see it stated.

Carpenters will be glad to know, therefore, that a movement is now on foot for a broad campaign of energetic, intelligent and persistent advertising to teach the general public that wood cannot and will not be superseded, and that its use is unlimited for all time to come.

At the last annual meeting of the National Lumber Manufacturers' Association a committee was appointed to look into this matter and recommend what should be done. This committee has now made its report, advising that the work be taken up, under the direction of a central bureau composed of one representative each from the five great divisions of the lumber industry; namely, the West Coast, Yellow Pine, White Pine and Hemlock, Hardwood and Cypress. This is to be the "executive committee on advertising," and is to have full authority to establish and maintain an advertising bureau and to secure the ablest and best qualified council or agent to direct the work, and to employ the necessary assistants for the purpose of "following up" the public interest developed. The funds for carrying out this educational and publicity program are to be raised by an assessment of 1 cent per thousand feet on the annual cut of the mills having membership in the affiliated lumber associations.

We note from the report of the committee that during the past seven or eight years, the volume of advertising of the competing substitutes for lumber has been continually growing until it now reaches the astounding aggregate of more than \$3,000,000 a year. "At the same time," quoting from the report, "wood, 'the natural and historic building material' and 'mankind's instinctive reliance' was complacently allowing itself to be shouldered out, without even a protest, or a contest or an argument. Your committee regrets to believe that the result is now a much harder fight to 'come back' than should have been necessary; but we are absolutely convinced that it can be done. Advertising has done equal tasks for others and can be made to do it for us."

All this is welcome news to the carpenter and the carpenter contractor. They will watch the progress of this educational campaign with interest and will do all that they can to help it along. They are in a position to do first hand missionary work along the lines of informing prospective builders as to the comparative merits of the various forms of building materials. They will welcome any new arguments the lumbermen may have to offer in behalf of timber.

IT is hardly fair to charge all the disastrous fires to wood used in construction. Often the burning of a wooden house is directly due to inferior work in the building of a brick chimney.

Do You Do Your Share of Furnace Business?

AT this season of the year the furnace question becomes a live issue. Work is being rushed on the heating plants in all new work so that they will be in working order before snow flies. And, in addition to this, there are a great many people who come to the conclusion at the last minute, so to speak, that their old furnace will hardly pull them through another winter safely; and so a new one must be had at once. Also, there are the large number, and their number is increasing every year, who decide to get in line with the times and discard the old stove heating contraptions and install furnace heat.

A live question to-day among the building trades is: How much of this work ought the carpenter and builder to undertake? In the larger cities, of course, there are the special furnace contractors and furnace workers who, by right, tend to all of this business. But throughout the country generally, in the smaller towns and rural communities, the carpenter and builder is very often the only one there is who can undertake this work.

The country carpenter, strange as it may seem to his city brother, is called on for *everything* connected with building construction, from the work of putting in the concrete foundation to laying and painting the tin roof. Also, he has to be depended on to install the plumbing, if any; and he would disappoint the owner sorely if he declined to handle the heating plant as well.

Undoubtedly, this is not just exactly as it should be, yet it bears striking testimony to the all-around usefulness and importance of the carpenter and builder in the scheme of things as now organized.

How is it with you? Do you go after the furnace work and get your share of it, or do you think it ought to be left to the special furnace men?



Equitable to Try Home-Building Policy

THE Equitable Life of New York has decided to make a preliminary test of its proposition of life insurance and home-buying, based upon the system popular in England. The tests will be made in five representative cities of the various sections—New York, Cleveland, Des Moines, San Francisco and Birmingham, Ala. Loans will be made for the acquirement of homes, to be repaid in monthly payments at a low rate of interest and on long time, the payments being regulated to cancel the loans in 10, 15 or 20 years. The monthly payments include premiums on life insurance for an amount equal to the amount of the loan, so that the death of the borrower prior to the termination of the contract will pay up the contract, returning the difference to the widow. On maturity of the loan it is cancelled and the life insurance may be continued if desired.

HARDWOOD DOOR MAKERS SEEK WIDER FIELD

**Leading Manufacturers Put Best Product
Within Reach of All**

OUR READERS TO HELP

**Importance of Carpenter-Contractors Recognized;
Cooperation Sought in Big Campaign
for Better Building**

"Away with the cheap pine door. The door of the future is to be of hardwood. With the assistance of the carpenter-contractors we will put hardwood doors into every building."

This is the slogan just announced by certain of the foremost door manufacturers.

And they back it up with some pretty interesting arguments, not only about the merits and advantages of modern, high-grade hardwood doors, but also concerning their cost as compared with those of ordinary soft wood.

It comes with something of a shock to those who are not watching the millwork situation pretty closely to learn how small the difference now is between the cost of hardwood and softwood doors.

The lumbermen understand the reason for this well enough. They know that our extravagant and prodigal lumbering methods brought about this great change. As it happened, the soft woods were most abundant in the early days. Their easy working qualities, the seeming limitlessness of the supply and the inherent cheapness of the product all combined to establish softwood doors and millwork as the logical material for general building.

The pine forests of Michigan and Wisconsin were the wonder of the lumbering world in those days. They seemed boundless in extent. The prediction was confidently made that here was a supply of timber that never could be exhausted. Yet where are those forests now? The woodman's axe and the forest fire have done their destructive work, and the once cheap and plentiful white pine has, because of its scarceness, become one of the most expensive of woods.

The hard woods were more difficult to work; hence, they withstood the onslaught of the early forest butcher, and, thanks to the scientific forestry methods now in use by the hardwood lumbermen, furnish today an abundant supply.

Softwood doors, in spite of their many shortcomings, came into general use in the early days because of their cheapness. The hardwoods were difficult to work—almost too much for the early mill machinery—so that hardwood doors were expensive, to be afforded only by the aristocrats.

Hardwood doors still have the aristocratic look. Yet, through this strange process of change the cost of hardwood doors has been brought lower and lower, while, at the same time, the cost of the softwood doors has constantly increased.

So quickly and silently has this change been brought about that the general public knows nothing of it. They continue to use the softwood doors through force of habit.

"No, we can't afford hardwood doors," they say, "We must economize. Father and grandfather always used pine."

Yes, they did, but not at the prices you have to pay for it to-day.

Carpenter-Contractor the Pivotal Man

The carpenter-contractors know the value of hardwood doors; they have worked with them; they have seen them tested on many jobs; they know their beauties of grain and finish, their stability and strength. There is no fooling practical builders when it comes to the matter of the relative merits of hard and soft wood doors and interior trim. They know exactly the situation and can understand it. The general public does not know it.

It is for these reasons that certain of the foremost door manufacturers now desire the active co-operation of the readers of the AMERICAN CARPENTER AND BUILDER in their wide campaign for better building.

It is a source of gratification that the importance in the building world of the carpenter-contractor is thus recognized. The carpenter-contractor holds the strategic or pivotal position in the building world, midway between the manufacturers of building materials and the consumers. With their expert knowledge of methods and materials their advice and opinion are sought by those who are going to build. Just a word from a practical builder carries more weight than a whole mail-sack full of brightly illustrated catalogues and circulars. Even the architects, we have noticed, pay attention to what their contractors say and somehow the specifications usually call for what they recommend.

For these reasons the announcement by some of the largest producers of hardwood doors in the world that their product is now within the reach of all and that they are seeking a wider field for hardwood doors will be welcomed by carpenter-contractors with special interest. It is very significant, too, that these great manufacturers are coming direct to the carpenter-contractors, asking their co-operation and support in getting their high-grade product before the notice of the building public.

If everyone knew the facts about hardwood doors as well as the carpenter-contractors know them—their excellencies and beauty, their methods of construction and manufacture and their low cost—there would be no need for a campaign of education. Hardwood doors would soon be in universal use; we would see nothing else, since home builders would have nothing else.

The campaign is for better building, and every carpenter and building contractor can help by a few words of personal advice on every job.

Your Interest in Hardwood Doors

Every carpenter-contractor is anxious to build up for himself a reputation for good work. He realizes it is money in his pocket to be known as a man who handles the best contracts. There is a satisfaction in doing fine work, for then everyone is satisfied. Owner, architect, contractor and workmen are all satisfied. And besides—there are bigger profits in that kind of work.

But for good workmanship good materials are necessary. It is a trait of human nature that it is almost impossible to do careful work on cheap materials. For instance, a house finished in soft wood is usually thrown together. The workmen don't take the interest they should in doing careful work; and they can hardly be blamed as it is probably known generally as "a cheap job."

The progressive carpenter-contractor doesn't like that kind of work. It doesn't satisfy either him or the owner; there is no money in it for him and it doesn't help his reputation.

How different it is with a nice hardwood job. Even though the material costs no more, the men handle it carefully. They have been trained through years of work to put their very best efforts onto hardwood finish. Hardwood doors are carefully hung, and when the painter comes to finish them he works like an artist giving the last loving touches to his masterpiece.

With work of this kind the owner is sure to be satisfied and the carpenter-contractor finds himself very well repaid for the kindly regard he took in the interests of the owner in pointing out to him that he should, by all means, have hardwood doors and trim in his new house.

Great Field to be Developed

If one could take a trip through the planing mills and factories of these hardwood door manufacturers,

where the modern hardwood doors are made, one would be astonished at the enormous size of the plants, the perfection of the huge woodworking machines, so strongly made that they handle the tough hardwood as easily as the soft cork Pine used to be worked in the early days, the machines that turn out the hardwood doors so economically. Seeing the output of hardwood doors from these factories—carload after carload in almost endless procession of finished doors—one would say this must certainly supply the entire demand, leaving no room even now for the softwood door.

Such, however, is far from being the case.

It is only in the cities that home builders generally have realized the opportunity to have fine hardwood doors and finish in their houses. The great broad stretches of our land—the smaller towns and prosperous rural districts—still cling to the old softwood door, even though it has become so expensive.

So really today, in spite of the magnificent size and importance of these hardwood door interests, the field has only just been scratched as yet. What is needed is a good broad campaign of education toward better building, that will get clear down to the sub-soil of our national life and will influence our building construction so that everyone, even away in the remotest hamlet, will realize the economy of using hardwood doors and other substantial high-grade building materials.

These leading manufacturers of hardwood doors are to be congratulated that they have so wisely chosen the means by which they will effectively reach all prospective builders in all parts of the country. The carpenter-contractor is the pivotal man and he alone can do this good work.

It is not too much to predict that in ten years the use of hardwood doors and other satisfactory high-grade building materials will become almost universal in this country through the good efforts of progressive carpenters and building contractors.

Why Use Hardwood Doors?

Carpenter-contractors who have had experience with hardwood doors can give you more good reasons why they should be used than would fill this page. Space permits us only a few.

The chief consideration to the man who is going to build is, of course, their beauty and richness of appearance. Hardwood doors give a tone to the entire house that cannot be secured in any other way. The atmosphere of opulence clings to them; they look "aristocratic." The charge was sometimes brought against hardwood doors in the old days that they would warp. Modern hardwood doors are scientifically built-up of softwood laminated cores and hardwood veneer—absolutely preventing warping or twisting of the door and keeping it always in place. They take an enduring finish. They are strong; they are permanently satisfactory.

Hardwood Trim the Best Investment

Did it ever occur to you what an excellent investment the small amount of extra money is which is needed to put hardwood doors and trim into a house? Actual instances have come under the writer's personal observation where an extra expenditure of \$50.00 secured fine hardwood doors and finish throughout for a residence; in place of the cheap appearing soft wood, and immediately the selling value of the property advanced \$500.00.

A pretty good percentage. What?

Speculative builders and real estate operators have learned this lesson well. You will find their houses almost invariably finished with hardwood. Those buying homes want the hardwood doors and trim; they insist on them.

Money can be borrowed much more readily on a house finished with hardwood and where hardwood doors are used, than on the other kind.

These points simply go to indicate the long-headedness of the man who pays a trifle extra for permanent quality and satisfaction by equipping his building with hardwood doors. It testifies to his wisdom and goes to show why it is that the carpenter-contractor does his client a favor by calling his attention to the facts concerning the present millwork situation.

Modern Hardwood Built-Up Veneered Doors

The construction of modern hardwood doors is in itself an interesting study. In the old days the hardwood doors, what few there were of them, were solid hardwood slabs or made in two thicknesses and screwed together. They were very heavy and hard to work, with a tendency to warp. Modern manufacturing skill and ingenuity have changed all this. The modern hardwood doors are built up in such a way that warping is impossible. Veneering of the finest grain and most beautiful figure is reserved for the outside surface of the door. The construction is so thorough that these doors are enduring for long service, even through rough treatment.

There are many interesting points connected with modern hardwood veneered door manufacture and construction that the contractor ought to know all about.

Let us all take up this CAMPAIGN FOR BETTER BUILDING and do all that we can to bring about the general use of the higher grade building materials. As has been pointed out, the carpenter-contractor is in the strategic position where a personal word from him will decide the question with the owner in each particular case.

Contractors who are alive to their own interests will study up this question, especially in regard to hardwood doors, so that they will know all about it and can talk intelligently.

For the benefit of these, the AMERICAN CARPENTER AND BUILDER is taking up the matter and will present a very interesting series of instructive articles on the subject in all its various phases.

These will begin next month. Watch for them.

IMPORTANT NOTICE!

Without doubt many of our readers have had interesting experiences with hardwood doors and trim or have observed instances where the selling value of property has been greatly increased through the use of a small extra expenditure for this purpose. Will you write us a personal letter about this?

This is a live subject. Are you with us in this Better Building Campaign? Editor.



New Test for Building Materials

The cutting and wearing power of a stream of blown sand, long since utilized for various purposes, has been employed for testing building materials at the Gross-Lichterfelde institute in Germany. Granite, pine wood, linoleum, and other substances used in the construction and furnishing of buildings are subjected for about two minutes to the action of a blast of fine quartz sand, under a pressure of two atmospheres. The results show the resisting powers of the substances tested to the effects of wear. This form of test is applicable to road building materials.



Why a Granite Statue Was Rejected

There has frequently been comment on the *naivete* often revealed by the ancient artists and stone carvers. There is not a Gothic cathedral but furnishes ludicrous examples, and paintings are treasured in the old churches that would call out nothing but laughter were it not for the earnestness and childlike devotion of the artists. One scarcely expects to see this same delightful *naivete* in modern work, but an instance is furnished by a recent granite job at Barre, Vt. A few weeks ago there was completed at one of the sheds on an order from a woman at Buffalo, N. Y., a life-sized statue in granite of the Virgin and child. The work was shipped, but was returned, as the woman who gave the commission objected to the Van Dyke beard on the child in the arms of the Virgin. The reason for a beard and mustache on the Christ child is not known, and the head of the firm would say nothing on the subject. It was rumored, however, that the firm received the order for a statue of the Virgin with the Christ child in her arms and workmen carved the face of the Christ as they had seen it in pictures, with a full beard, although the body is that of an infant. The statue is of excellent workmanship and worth in the vicinity of \$1,000, but it will probably take a little work with a chisel on the beard before a ready purchaser is found.

The Sage Foundation "Model Village"

FOREST HILLS GARDENS, LONG ISLAND, THE MADE-TO-ORDER SUBURB THAT IS TO BE AN OBJECT LESSON TO ALL HOME BUILDERS AND REAL ESTATE MEN

As every newspaper reader knows, Russell Sage left a colossal fortune to his widow. She, being interested in the welfare of humanity, created the Russell Sage Foundation for the proper handling and distribution of the fortune. Most of the Foundation's activities are frankly charitable. But the "model village" of the Sage Foundation Homes Company at Forest Hills, Long Island, where a million and a quarter dollars is being spent in improvements, is not.

This is a suburban town site laid out and developed with a distinct educational purpose—namely to demonstrate to practical real estate men that the "advanced" village planning ideas pay and that both the buyer and seller can win in a legitimate real-estate transaction. Seeing that beauty of design, the use of indestructible building materials and an abundance of playground space are not inconsistent with fair profits, it is expected that companies with tens of millions of capital may be expected to adopt similar enlightened policies.

From the start the idea has been to make every feature of the development a model which it will be safe

for any practical real-estate man to follow. The services of experts in every line of community development has been enlisted. The landscape architect is Frederick Law Olmsted, the architect of buildings is Grosvenor Atterbury.

Forest Hills Gardens—such is the name of the company's settlement—contains one hundred and forty-two acres. It is on the main line of the Long Island Railroad, nine miles from the Pennsylvania-Long Island terminal station in the heart of Manhattan Island. The running time from the station, by the tubes under the East River, is about sixteen minutes.

If the village does prove successful unquestionably its success will be chiefly due to this—that the experts engaged in the venture constantly worked together. Cooperation has been the watchword. The financial plan, the landscape plan, the building plan all depend one upon the other.

Visitors from Europe often express surprise at the haphazard manner in which houses of widely varying designs are jammed against one another in the streets of an American City. Things are not done that way abroad, they tell you. The reason is that there the

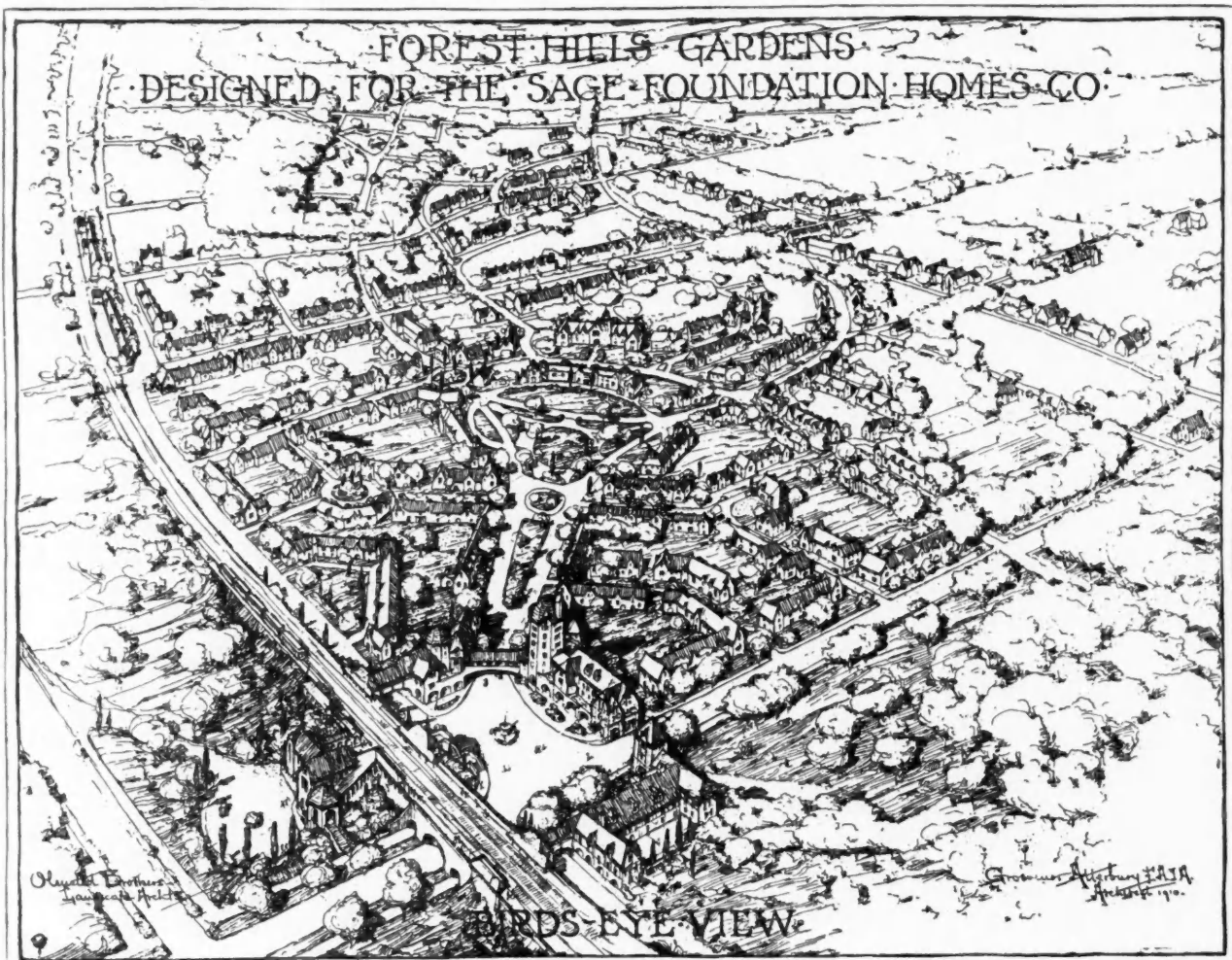

five
with
to
city
are
far
son
gra
laic
roa
from
ind
win
asp
In
pars
sett
econ
shor
the

municipal authorities exercise some control over design, while here, as far as the law is concerned, almost any architectural enormity is possible. But at Forest Hills Gardens the European critics cannot complain of lack of harmony. Not only do the houses "go" well together—they fit into their surroundings.

Beginning at the railroad on one side of the property, two broad avenues, parallel and four hundred yards apart, run off to Forest Park on the other side. In addition to these, two other avenues, almost as broad and gently curving, radiate from Station Square and these also reach Forest Park. Along the edge of the Park (a public reserve containing more than five hundred acres) is a boulevard one hundred and twenty-

value of adjacent property than the cost of the plots so set aside. Thus the Foundation Homes Company is not chasing a rainbow when it plans a public green. In the words of the projectors, this will form the "residential focus" of the community. The size of the whole open space where the green is located is about three and a half acres; in addition there is reserved a school site, with space for school playground and school gardens.

The business center of Forest Hills Gardens will be the plaza known as Station Square. Here are the railroad station and its approaches, shops, offices, restaurant and small non-housekeeping apartments. The Square, too, like the rest of the settlement, is



five feet wide. It is the "cross streets," however, that will be of most interest to the man who is accustomed to the right-angled scheme of the typical American city. The streets not necessary for general traffic are laid out so as to discourage their use as thoroughfares. They are not straight, and they are narrow; some curve more, some less, according to the topography of the neighborhood. The landscape architect laid them out to have a cozy domestic character. The roadways being narrow more room will be left for front gardens. Every little local street will have an individuality; it will not be simply one of a hundred wind-swept, dead straight stretches of macadam or asphalt.

In many suburban developments the managers are parsimonious with playground space. They regard the setting aside of land for purposes of recreation uneconomical—a yielding to sentiment. But this is a short-sighted view, for it has been demonstrated that the devotion of plots to such a use adds more to the

designed as a unit. Merely because it is given up to trade it is not to be neglected in its artistic phases. The buildings will harmonize with each other.

The most revolutionary idea of the developers, however, is that of having what they call "block playgrounds," spaces out of sight of the streets and occupying the interior part of some of the blocks. To effect this lots are provided of less than the ordinary depth, the area thus saved being free to the smaller children, not yet lusty and obstreperous enough to venture upon the public green. Gates will open into this common property from the back yards. The slice taken off the back yard is small, while the advantages of this safe and quiet playground will be considerable.

For those who want lots of the regular New York depth, however—lots a hundred feet deep—the landscape architect has laid out blocks on the more conventional pattern.

In telling of his plans of the buildings Mr. Atterbury has explained why it is that the homes at Forest



Hills cannot be adapted to the so-called laboring man, or the lower-paid mechanic. The tract is too accessible from the heart of New York City—in short, it is too valuable—to permit of its use for very low-priced houses. If they were built and let out at rents which the laboring man would pay the venture would cease to be a business venture; it would become simple charity, and that is what the managers of the Foundation wish most to avoid.

About a million and a quarter dollars is to be spent on the first building operation, which includes the houses around Station Square and residences on the more expensive parts of the property. Most of these will be contiguous, or block houses. This may seem strange to the person who thinks of Forest Hills Garden as offering an opportunity to "get back to the land." But it must be remembered that, as far as accessibility is concerned, the dweller here is actually within the city; he is far nearer the busy shopping and hotel district than if he lived up on Washington Heights in Manhattan. Furthermore, he has the benefit not only of the public green and the interior play-

grounds, but of Forest Park, which will remain a free and open reserve for all time.

It is in keeping with the general character of the undertaking that the buildings should be of indestructible materials. This too, is regarded as unduly lavish by a great number of suburban developers, because the original cost is somewhat greater than if destructible materials were used. But the more enlightened real-estate men of today have come to recognize that fact that permanent fireproof construction is a real economy over a period of years. The saving in repairs, the lack of necessity for repainting, the smaller insurance premiums, the qualities of retaining heat (decreasing the consumption of coal in winter)—these advantages of a fireproof house more than compensate for its greater original cost as compared with a house of wood.

The architect made an elaborate study of various materials before making his choice. So important was this question considered that the Foundation Homes Company built an experimental station—a laboratory—in New Jersey and there carried on extensive tests.



The different materials were subjected to varying degrees of heat, and exact records of the effects of heat were kept. The result was that Mr. Atterbury selected hollow terra cotta tile for the structural parts of the houses of Forest Hills Gardens. These tile are practically the same that are employed for the protection of the steel frames of business buildings—cubical blocks consisting of an outer web and of interior webs that separate the hollow spaces. In the walls and partitions they are laid end on end, the hollow space forming continuous chambers perpendicularly. In the floor they are laid flat between concrete beams. When the structural work is done the terra cotta is hidden from view; surface flooring of wood or other material is placed on top of the tile and concrete, and plaster and stucco are applied to the interior and exterior surfaces of the walls. The coloring is optional with the architect or owner.

Naturally the location of the high-priced and low-priced homes is determined by economic conditions. Around Station Square are to be three and four-story buildings, close together. From the square out to Forest Park the houses are planned with the value of the lots in view. Some contain ten or twelve rooms, others four or five. In the sections more remote from the railroad detached houses, or smaller groups, prevail.

Finally, after the planning and the building comes the sale of the property. Here the company proposes to introduce economies that will be of great benefit to the home seeker. While there will be property for the man who wants to pay all in cash, there will also be homes for those who can pay a little at a time. And this latter class will be protected from the accidents of fortune by the establishment of a system of moderate payments. Though the managers are correct in denying that the scheme is a charity, yet it is undeniable that their motives are somewhat different from the motives of those interested in a purely commercial enterprise. They want to show how both buyer and seller can win in a legitimate real-estate transaction. In short, the Forest Hills project may be described (with the help of a sometimes overworked phrase) as a lesson in "enlightened self-interest."



Plan a 150-Foot Fence for "Privacy of Home"

New York, Aug. 5.—Plans for a fence 150 feet high have been filed with the New York City building department by J. M. Francolini, a banker, who expects thus to maintain the privacy of his uptown residence, despite the encroachments of apartment houses in the neighborhood.

"I learned a few days ago," said the banker, "that a nine-story apartment house was going up shortly on the lot to the west of my home. Already a tall building blocks me to the east.

"I decided to protect the privacy of my home, which my family has occupied for more than seven years, and the only way seemed to be a fence high enough to shut off all the curious eyes of my apartment house neighbors. The fence will be of ornamental brick and as artistic as possible under the circumstances."



Why English Workmen Went on Strike

Perhaps some explanation of the strikes which recently caused riot and bloodshed and paralyzed industry in England may be found in the following comparative table of weekly wages paid in England and the United States in the same vocations:

	England	United States
Bricklayers	\$9.85	\$30.42
Stone masons	9.57	26.77
Carpenters	9.57	21.90
Joiners	9.57	21.90
Plasterers	10.14	29.00
Plumbers	9.67	27.37
Painters	9.12	20.60
Hod carriers	6.57	16.73
Laborers (masons)	6.57	16.73
Fitters	8.76	18.13
Pattern makers	9.25	22.30

These figures are for the year 1909 and are furnished by the United States Government. Since then there have been advances both here and abroad, but the ratio remains the same. It may also be noted that the hours of labor per week in England average about ten per cent more than in the United States.

These statistics have been quoted in newspaper and magazine articles to show why English workingmen emigrate to the United States, but may they not be equally eloquent in demonstrating why those who do not or cannot emigrate resort to the strike to better their condition?

Recent investigations prove that, except possibly in the items of rent and clothing, the cost of living is as high in England as in the United States. In fact, if English workingmen should insist upon the same style of living as that to which their American brethren are accustomed to it would be higher. With very few exceptions all kinds of meat products are higher abroad than here. This is natural, because the vast bulk of England's meat supply is imported.

This is also true as to fruits and vegetables, with the result that articles of food which American workingmen consider necessities are in England regarded as luxuries only to be enjoyed upon rare occasions.

The increase in the cost of living has created no end of agitation and discontent in the United States, but it is easily demonstrated that it has not caused anywhere near the hardship and suffering here that it has abroad, not only in England but in continental countries.

Development of Gasoline Engines

By Joseph C. Riley

Assistant Professor of Mechanical Engineering, Mass. Inst. Tech.

(Portions of a Paper Presented before the Congress of Technology.)

THE development of the gasoline engine has been more rapid than any other form of motor, not even excepting the steam turbine. We all recollect, not many years ago, with what curiosity we regarded the new horseless carriages upon our streets, and how we wondered whether the noisy little engines which left a smell of half-burned gasoline behind them, would ever become really desirable motors. As late as 1896, a prominent engineer wrote, in his work on the gas engine, that he had recently examined one of the strangely designed vehicles then attracting attention in France, and that in his opinion, ingenious as the carriage was, it would not come into general use unless the gasoline engine with which it was equipped were replaced by a heavy-oil engine. That was only fifteen years ago.

The first part of this period of development saw radical changes in the design of these motors, but the use of light-oil had come to stay. Although dangerously inflammable and five times as dear as the heavier grades of petroleum burned in larger oil engines, the cleanliness of gasoline and the ease with which it can be prepared for combustion, are alone sufficient to dictate its use. The original methods of mixing, introducing and firing the explosive charge were soon changed in order to secure more reliable operation throughout a greater range in speed and load. Cylinders and valves were designed to give more power. Ball-bearings and gears of a degree of perfection previously unknown were introduced, to minimize friction. But the most noticeable changes in the last few years have been largely in the nature of improvements in material and processes of manufacture, tending toward a general improvement of the engine as a machine and a simplification of its construction.

New alloys of aluminum and methods of cooling them locally in the mould have brought about light, yet rigid and durable castings for frames. New steels have provided stronger shafts and connecting rods. Machine moulding from wax or metal patterns has produced better castings of more uniform thickness and yet at lower cost than could have been produced by hand. The art of moulding the thin walls and coring the irregular jackets of cylinders, and then casting them in iron, has indeed been revolutionized. Castings which a few years ago would have attracted general attention as remarkable specimens of good workmanship are now so common that we pass them by without notice. The use of special jigs for holding work during cutting operations and the application of semi-automatic tools for machining or grinding to precise dimensions have not only produced better fitted

surfaces and fully interchangeable parts, but have also reduced the time and cost of production.

The gasoline engine has profited by the general rapid advance in all branches of mechanical work. Its own special improvements have been, for the most part, such as would naturally come from the thousands of ingenious designers, skillful mechanics and experienced drivers, who have tested and tried it under all possible conditions of service, on the road, on the water, and in the air. As a result, advancing by process of trial and error, the engine has reached a fair degree of perfection in two points at least. It has been made to develop greater power per unit weight than any other form of prime mover; and in reliability it has been advanced to the stage which warrants its use even for such exacting service as propelling a life-boat or driving a fire-engine.



Work of Boy's Carpentry Class

The accompanying illustration, which is reproduced here by courtesy of the *Manual Training Magazine*, shows the work of boys between the ages of eleven and fifteen years, being taught practical carpentry work by the students of the Manual Arts Department, of the State Normal School, Wayne, Nebr.

This work, even though it is on such a small scale, is of a quality that deserves the respect and admiration of even skilled carpenter craftsmen.

According to the signs on these little buildings, the boys who made the various pieces are as follows: Granary made by F. Roe; Hip-roofed house made by R. Moeller; Hog house made by G. Webber; Storage tank and machine shop by R. Bohnert; Wind mill and repair shop by E. Young; Corn crib by H. Thomas and Barn by C. Schroer.

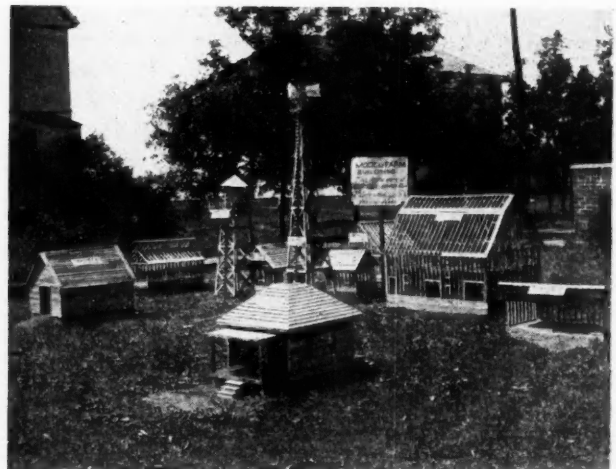

Model Farm Buildings—the Work of Eight Boys Between 11 and 15 Years Old—State Normal School, Wayne, Nebr.

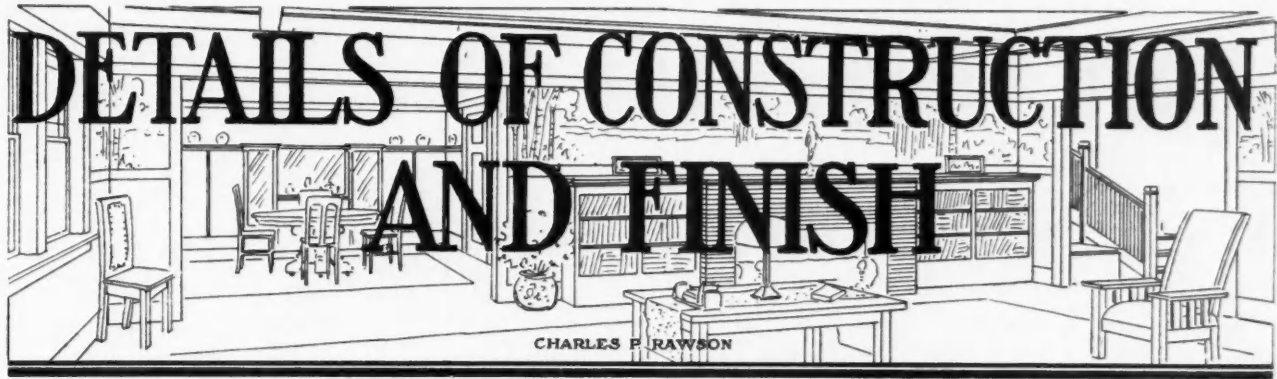

Styles of Interior Trim

FIRST OF A SERIES OF ARTICLES ILLUSTRATED WITH FULL PAGE WORKING DETAIL PLATES DEALING WITH THE VARIOUS POPULAR STYLES OF STANDING FINISH—COLONIAL TRIM—MISSION OR CRAFTSMAN FINISH

ALL the finished woodwork which is an integral part of a building and which is put up after the building is plastered, is generally included under the heading of "interior finish." This may be divided into "standing finish," including all that is affixed to the walls, as casings, baseboards, wainscoting, beams, cornices, etc., and "fittings," which include cases, cupboards, drawers, shelves, etc. It is with the former division which the present series of articles will illustrate, including also doors and sash.

As the primary object of the standing finish is to cover up the rough work and make a finish where the plaster joins the frames, or else to protect the plaster walls, an ornamental appearance is the chief requirement of the work; and to this end smooth surfaces—free from knots, sap or other defects—close joints and freedom from warping and shrinking are necessary, rather than strength and durability.

The character and quality, and usually the cost of the inside finish depends greatly upon whether it is to be soft or hard wood, and whether it is to be painted or varnished. The soft woods are commercially classified as those belonging to the conifers, while the hard wood come from the broad-leaved trees. Carpenters, however, usually classify whitewood (poplar), redwood and cypress as soft woods, while hard pine is frequently, but incorrectly, called a hard wood.

For finish of any kind the soft woods are always cheaper than hard woods, even when the price of the lumber is the same. This is principally for the reason that the soft woods (and here we include redwood and cypress) can be used in the solid for making doors, sash, etc.; the greater ease with which these woods can be worked also effects the price, although not to a very great extent.

Painted work also costs, as a rule, less than varnished work, for the reason that cheaper grades of lumber may be used, and the same care is usually not exercised in putting it up and keeping it clean.

The first consideration for wood that is to be painted is that it shall stand well, and next to this come freedom from knots and pitch, and then low cost. These conditions are most fully found in white pine, and whitewood (poplar). The latter is extensively used in some localities, particularly for carved work, columns and mantels and for shelving, etc., as it can be obtained in large dimensions and remarkably free from knots: its softness and uniform grain make it also well adapted for carving that is to be painted. This wood, however, does not stand wear as well as pine. In a great many localities hard pine is cheaper than white pine, but it contains too much pitch to take paint well.

For interior work that is to be stained or finished, the color or grain of the wood most influences the selection when the cost is not a controlling feature.

Its hardness also is a very important quality, as the softer woods mar and get dented easily. It is for this reason that soft pine, whitewood, redwood and cypress are inferior to oak, ash, beech or maple, although otherwise they make a very attractive finish when properly treated. Redwood, moreover, is very brittle, and the edges break easily.

The various woods used for finishing rank as to cost, in about the following order, commencing with the cheapest, the relative cost varying somewhat with the locality: whitewood, hard pine, clear white pine, cypress, redwood, ash, chestnut, butternut, red oak, white oak, beech, birch, maple, bird's-eye maple, cheery, mahogany and walnut.

Aside from the cost, the last eight woods are usually considered the handsomest, and most desirable, although for certain rooms the other woods are nearly, if not equally, as well adapted.

All woods should always be kiln-dried just before they are sent to the building, but it is not the custom in some localities to kiln-dry woods that are to be painted.

The various woods to be used in finishing the differ-

(Continued to Page 41)

FULL PAGE PLATES SHOWING COMPLETE DETAILS ARE PRESENTED ON THE TWO PAGES FOLLOWING

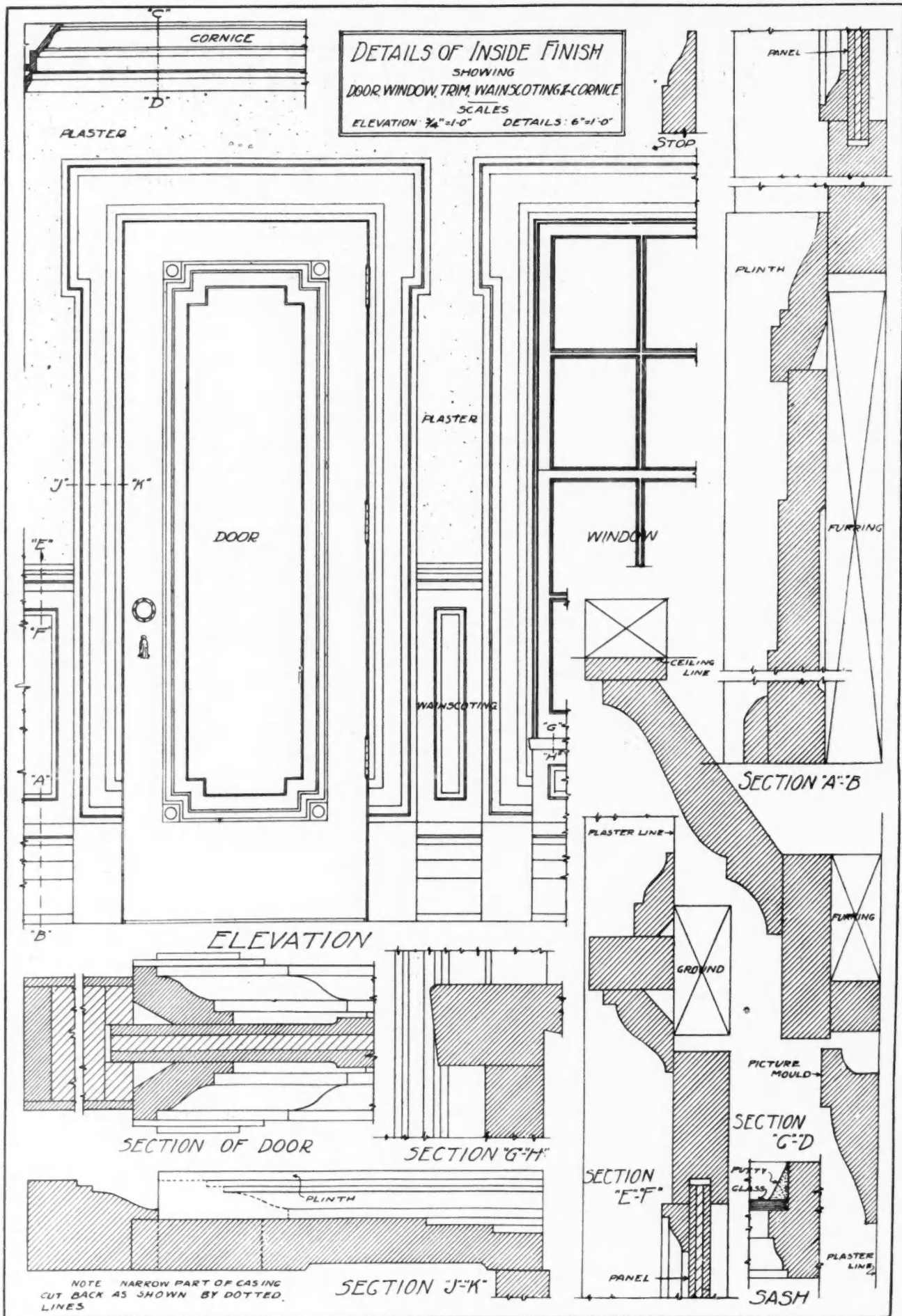

ELABORATE COLONIAL TRIM

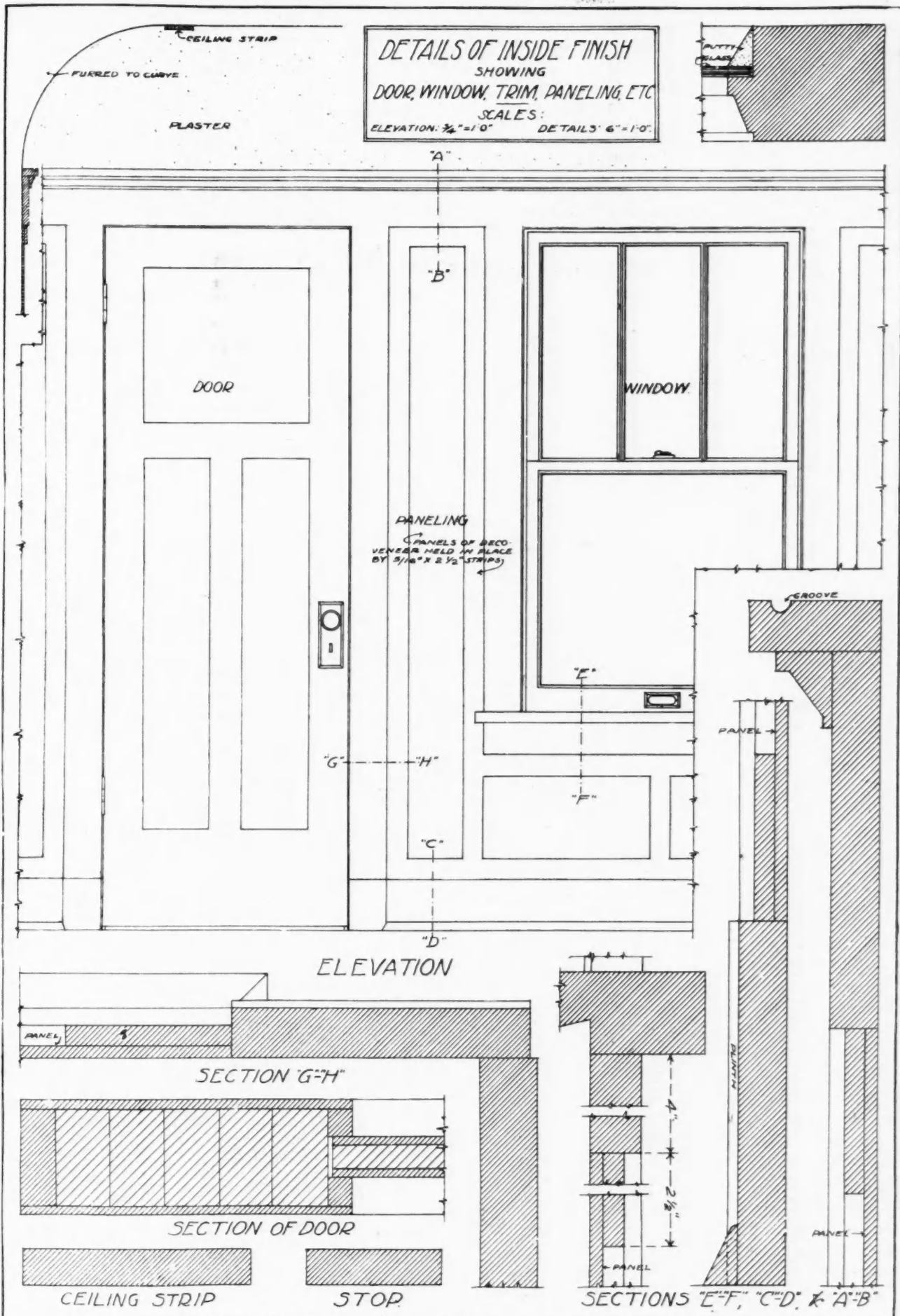

CRAFTSMAN STYLE, INTERIOR FINISH

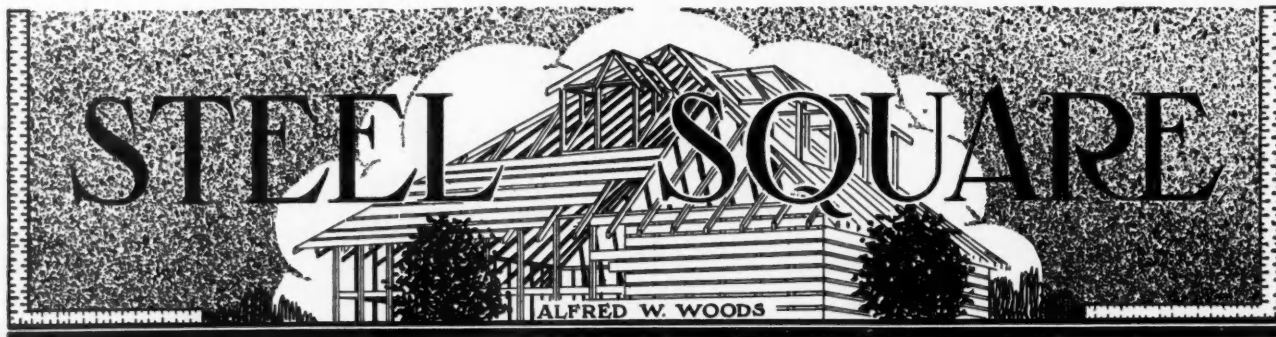

Framing Uneven Pitches

THE SUBJECT SIMPLIFIED AND EXPLAINED WITHOUT USE OF TECHNICAL TERMS—STEEL SQUARE RAFTER FRAMING

THE last few articles we devoted to unequal pitches using a universal rule that applies to all kinds of roofs, whether regular, cornered or of equal or unequal pitches, illustrating the parts that go to make up the proportions to take on the steel square to obtain the lengths, cuts, etc. In this article we are go-

ing to omit all technical terms and present the subject in a plain straight-forward manner, letting the illustration do practically all of the talking—and in such a way that the reader will not have to annihilate the greater part of the alphabet for illustrative purposes.

So we are going to cut it all out this time—say little and do much. The illustration shows a plan of an unequal pitched roof showing the runs of all of the jacks. The common rafters are erected on their respective sides and right here we wish to call attention to the fact that a jack is a fraction of the common rafter of the respective side to which it belongs. Therefore its seat and plumb cut are the same as that of the common rafter.

Its run is shown at Fig. 1 in the plan and the dotted lines from the intersection at the hip to the elevation of the common rafter as shown at Fig. 1 shows what part of the common rafter it is. What is true of this is true of all of the others. Here we have the length of the common and all

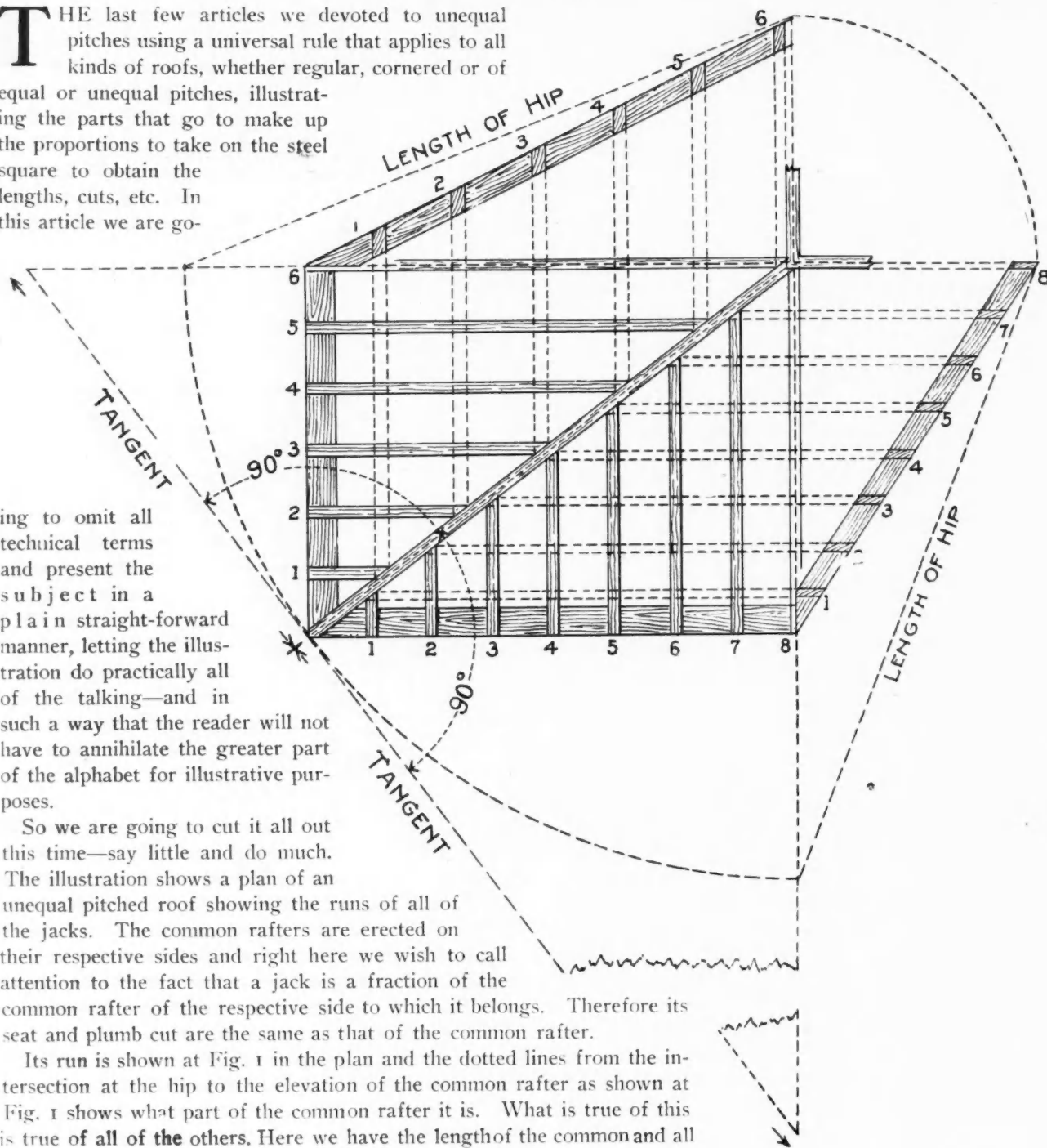

of the jack rafters laid on top of one another, each in their respective place ready to set in place in the roof.

The side cut of the jack may be found by taking the distance from the corner of the plate to the seat of the common rafter on one arm of the square and the length of the common rafter on the other; and the side on which the latter is taken will give the cut. Or take the distance from the corner to the seat of any of the jack rafters and its length (the jack's) and the result will be the same. In the case of the even pitched roof both sides, of course, are alike, but when one side is steeper than the other then the length and cuts are determined from their respective sides; but the formula remains the same.

In this we have shown the length and pitch of the hip in comparison with that of the common rafters. Its individual run and rise give its seat and plumb cuts same as for any other rafter; and its side cut is found by taking its tangent for its respective side as shown and the hip's length to scale on the square, the latter will give the cut across the top of the unbacked hip. If the hip is first backed then the same proportions as used for the side cut of the jack for that side applied to the backing will give the same result.

In framing roofs of this kind it is better where it can be done, to frame the ceiling joists so that they will project over the plate so as to form the plancher and on these nail a plank on which to rest the foot of the rafters. This will avoid the uneven heights of the plates and greatly simplify the work. In case of heavy roofs, standards should be set up over the plates to relieve the weight on the projecting joists at the eave or cornice line.

Styles of Interior Trim

(Continued from Page 37.)

ent portions of the building should be explicitly specified before describing the character of the finish.

Except occasionally in wainscoting and in inlaid work, all the exposed finish in a room, including the door frames and doors and the inside of the sashes, should be of the same wood.

We show this month two complete schemes for interior finish. Each scheme is illustrated by an elevation of a door and window together with accompanying trim, wainscoting, cornice, etc., drawn to the scale of three-quarters of an inch equals one foot; and by details of each important part of the finish drawn to the scale of six inches equals one foot.

The first plate shows an elaborate "Colonial" finish. Work of this kind is preferably painted white, with the doors, sash and shoe-strip of mahogany.

The second plate shows a finish in the "Mission" or "Craftsman" style. As all walls are covered with wood to the top of the door and windows, the style would only be appropriate for a living room, den or dining room. The wood should be stained dark and the plaster ceiling tinted or painted in a light color.

Some Oddities in Joints

By W. D. Graves

Visiting a friend, the writer's attention was engaged by a number of jointures which, while they would hardly appeal to the operator of a full equipped wood-working plant, are all thoroughly practical—however odd—and might well be used by any one lacking the equipment necessary for the expeditious making of more conventional ones.

That shown in Fig. 1 was in a screen door corner, and was very secure.

The stock was mitered, a wire W carried around the corner, through holes as shown by the dotted lines, and the ends passed through a hole in the brace B, through a washer C, and secured in a common nut by

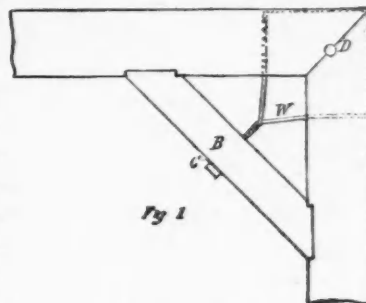

Joint for a Screen Door

pouring the hole full of solder. Turning the nut twisted the wire and drew the joint tight. The pin, or dowel, D served to keep the parts from sliding out of place while the wire was being tightened.

Figs. 2 and 3 are self-explanatory, being merely adaptations of the miter and dovetail combined. Fig. 4 is a joint on essentially the same principle but was

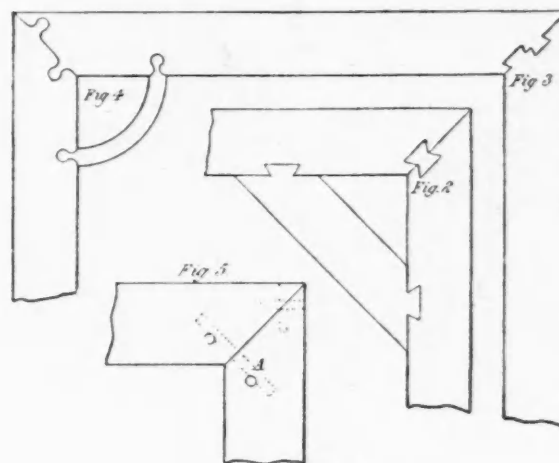

Joints for Picture Frames

made by tacking adjoining pieces together, one on top of the other, but otherwise relatively in their final positions, and sawing through both with a band saw; the table of the machine being tilted to an amount equaling the thickness of the saw kerf in twice the thickness of the stock. Fig. 5 is a doweled miter, the holes for the long dowel A being bored before the parts were put together, and the others afterward. All these joints, except that shown in Fig. 1, were in flat frames for pictures, and, the contiguous parts being of wood of different shades, the effect was striking. —*Scientific American.*

BRICK AND TILE WORK

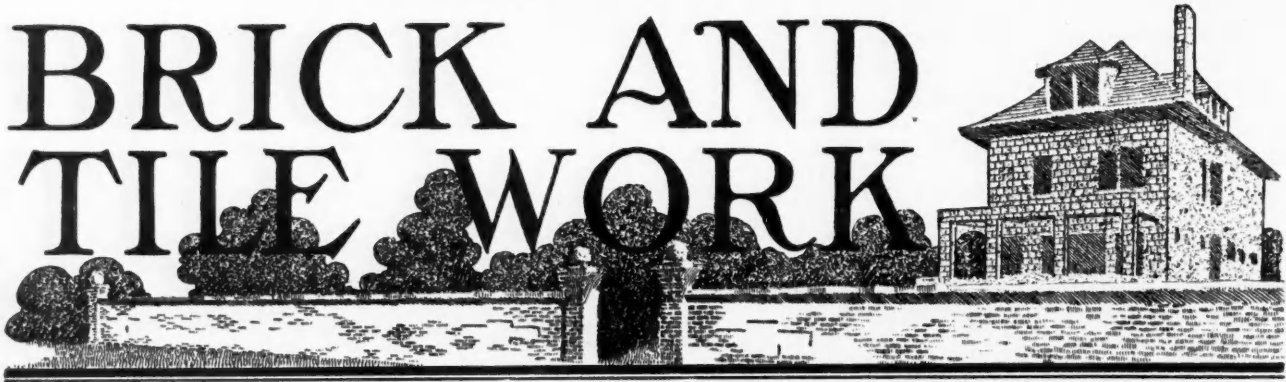

The "Brick Revival"

HOW IT HAPPENS THAT THE CONTRACTORS AND BUILDERS OF TODAY ARE INTERESTED IN BRICK AND BRICK CONSTRUCTION

BRICKS and brickmakers are coming again into their own. They have weathered a period of unpopularity that might have proved fatal to anything less meritorious. And now, after years of misunderstanding, ignorance and misrepresentation, when bricks were considered from a purely utilitarian standpoint, we are said to be on the eve of a "renaissance in brickwork," and such phrases as "artistic brickmakers" and "the art of brickmaking" are common enough in the trade.

During what may be termed the "dark age" of the

semblance to their real selves.

But times have changed. Ideas of beauty have undergone a transformation, and people have begun to ask themselves whether, in their anxiety to cover up their bricks, they haven't been gilding refined gold or painting the lily. And the conclusion has been reached that this and other countries have been suffering from a "blight of perfection," and that what we have been calling perfection was "merely a degradation of the imagination, a blindness of the eyes and a forgetting that individuality was the very corner-stone of art achievement."

An Ancient and a Modern Art

Brick making is now regarded as an art, and the most beautiful effects in form and color are obtained from the product of the worker in burnt clay, just as they were in the olden days, as is evident from the wonderful brick architecture to be found in the famous churches, palaces and other notable structures of the old world. And it would not be surprising—though the ancients knew the value of bricks, as they did that of most things that could be used to produce beautiful effects—if present-day brickmakers could teach them something of the possibilities of this wonderful art.

An industry as old as brickmaking must be a great

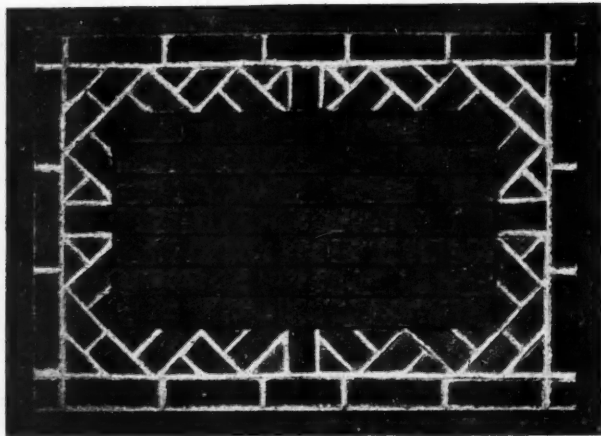

Decorative Brick Panel

brick industry in this country, to speak of "artistic brickmakers" would be to invite a laugh. The work of the brickmaker was low down in the scale of employment. Clay, a very lowly substance, was the essential constituent of his product. He resembled it in appearance and ate his portion of it with his daily bread. He was of the earth, earthy. An artist? Hardly. Just a maker of bricks.

And bricks? Substantial and enduring as building materials, but plebian and homely. The problem of the builder and the decorator was to hide their objectionable features as much as possible. They must not be exposed to the public gaze in all their glaring ugliness. No effort must be made to give them an artistic arrangement. But they must be covered with English ivy, or painted and cemented out of all re-

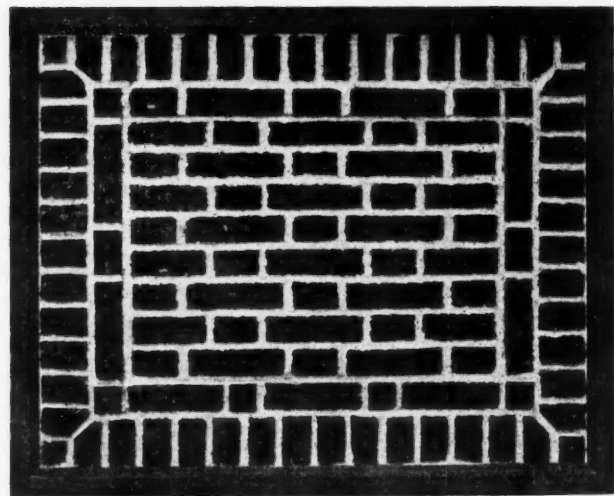

Panel with One-half Inch White Mortar Joint—Bricks in Shades of Red, Brown and Green

industry. There were brick kilns in Egypt, and the children of Israel were toilers among them. The Greeks knew the art, and Pliny mentions at least three kinds of bricks used in their buildings. But it remained for the Romans to bring the manufacture and use of burnt clay to a point little short of perfection.

England has always been noted for excellence in the manufacture and use of brick. In fact, it may be said that without this material England would not be the England that we know, for brick has always been,

to America from England and Holland as ballast in the holds of returning vessels.

The brick architecture of the early Victorian period, when, with the mastery of machines, vanished all the artistic beauty that "the inconstant, uncalculating inspiration of the human mind gives to the product of the hands," has been described as "the antithesis of everything good." "Civilization became ridden by a passion for mechanical accuracy," says the *Craftsman*, speaking of this period. "It was then that the second-



Beautiful Residence of John J. Cain, Columbia, S. C., Built of Rough Texture Brick with Wide Mortar Joints

and still is, the staple vehicle there, for building. From the Roman wall which used to surround London in the far distant past, to Bentley's magnificent Westminster Cathedral in the immediate present, the history of England is written almost without a break in brick architecture, which, while it never achieved that high point of art attained in Italy, never suffered degeneration.

Up to a few years ago there was nothing worthy of name of brick architecture in the United States, excepting, perhaps, the architecture of the Colonial period, which was an echo of the architecture of the Gregorian period in England. The bricks were brought

hand stores were flooded with soft-finished, substantial old mahogany, and parlors were furnished with parlor sets whose surfaces would have made excellent substitutes for mirrors."

The Blight of Perfection

The brickmaker's ideal—for he did not escape the infection of this mania for accuracy, for uniformity in size and shape and color, for polish and brilliancy—was brick of a single shape and size, a surface of the proverbial Yankee "slickness," and a color like a firecracker. And the ideal of the bricklayer was to arrange these uninteresting units in a uniformly monotonous manner, concealing the headers by clipping and

suppressing the joints as much as was humanly possible. The aim was to produce a brick wall that should be as smooth as a billiard table and as interesting as a piece of tin painted a dull, uniform red.

Beauty into the Discard

To produce this result required bricks of the most uniform size and shape and color. In the process of selection, therefore, the bricks which had burned to strange rich violets and blues, and dull, deep purples, or which were irregular in size or shape, were thrown into the dump and used to fill up discarded clay pits in the brickyard. They were thought to be worthless, until the late Stanford White rescued them and used them in producing wonderfully artistic chimneypieces and decorative exterior brickwork. Then manufacturers "began to save these outcasts of the kiln, and the interest of the effects which they saw produced led them to experiment and to study the brickwork of the ancients, the beauty of which had been attributed to remote and lost processes."

And so we have the beautiful rough texture bricks and numerous other wonderfully artistic effects in the brickwork which is coming more and more to distinguish modern American architecture. More and more people are coming to believe that the beauty of a house should lie in the structural features and the material from which it is made. Some of the most beautiful brick buildings owe their decorative interest solely to the varying arrangement of the bricks; the proportion of headers—that is, bricks laid with the narrow end out—to the stretchers, those laid lengthwise. And with the wonderful colors which can be secured with skillful burning, the possibilities of beauty in brick-work are only beginning to be realized.

Modern Rough Texture Brick

One of the most beautiful things in the evolution of artistic brickwork in this country is the rough texture brick. A wall built of this kind of brick shows the soft shades and delicate tones of a fine old Persian rug. It has no glaring high lights, no pronounced colors, no extreme contrasts. Starting from Indian reds the colors run through coppers, olive greens and purple browns to deep blue. With another clay is produced a light brownish gray, running into cream and coffee shades, deep russets and tobacco brown, giving in the mass the effect of old ivory. Still another clay gives a series of rich old buffs, ranging from a soft delicate chamois color to a deep golden brown.

One of the distinguishing features of this class of brick is the almost infinite number of its intermediate shades and the absence of violent, glaring contrasts so offensive to refined taste.

Dull finishes and rough textures are sought for beauty in sheltered interiors. It is only a step to apply this artistic principle to exterior effects, and that is what all the makers of brick have done. It has a peculiar rough texture which detracts from its

reflecting power and prevents the high lights which mar the conventional brick wall.

A rough brick gives the weathered effect which makes it not only artistic, but logical as a material for exterior construction. By the selection of the proper shades of brick and the proper mortar joints, a new wall can be made to take on the appearance of great age, if the builder so desires, or by the use of other shades, properly blended, can be made to sparkle with life.

The brick is burned to the hardness of iron and is practically non-porous. It is not a colored brick, in the ordinary sense of the word, for it is produced without the aid of artificial coloring matter. Its wonderful and peculiar shadings are due to the skillful selection and blending of natural clays and the expert application of intense fire. It is thus alone that nature's great range of color tones can be reproduced in brick.

This beautifully colored material gives character to a building, the broad mortar joints and varying shades reminding one of the famous castles and cathedrals of the old world.

And so the home builder of today, in considering the use of brick as a building material, is no longer balked by the old libel: "Bricks are unsightly." This prejudice was well founded a quarter of a century ago. Today it is different. There are now fashions in brick as well as in women's clothes. The conventional uniformity of color and shape and narrow mortar joint has been abandoned and today a brick facade is a work of art, and the various styles of brick laying offer themselves to unending variety of architectural treatment.

To the home builder, of course, the question of cost is an important consideration, and the idea prevails that on this ground the man of average means is debarred from the enjoyment of the beautiful effects of artistic brick construction. But as a matter of fact, the difference in first cost between frame or concrete and good brick construction is not so great as might be imagined.



City Lacks Power to Screen Houses

The "swat the fly" campaign which has been in progress in many of our cities throughout this summer recently received a setback in Chicago.

An ordinance had been proposed to compel all tenement house owners to place screens at all doors and windows to protect the dwellers from flies. The city law department stopped this, however, with a legal opinion that the proposed ordinance "cannot be sustained under any grant of power to the city unless the city can show it is not an experimental ordinance, but is reasonably certain to prevent the spread of diseases definitely attributable to the fly."



THE man of good judgment is like a pin—his head prevents his going too far.

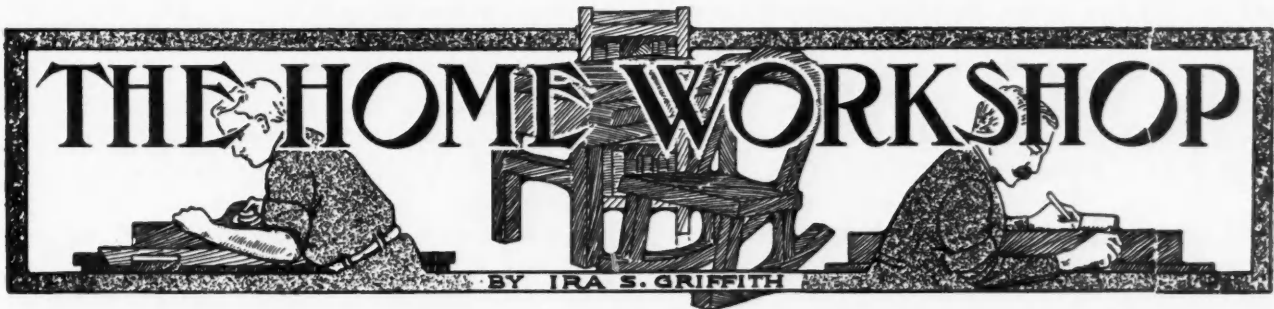

Something the Boys Can Make

COMPLETE DIRECTIONS FOR MAKING AND FINISHING A NECKTIE RACK AND SOME ORNAMENTAL WOOD TEA POT MATS

IT has been quite a while since simple pieces, such as small boys can make, have been offered. This month we describe two such pieces.

How to Make a Tea Pot Mat

The making of a teapot mat is a problem in woodwork of exceeding simplicity, and, when given a decoration in simple color, makes a rather attractive piece of work. The accompanying illustration shows shapes into which it may be made.

To make any of them secure first a piece of soft wood of three-fourths or seven-eighths of an inch thickness with a width and length of about eight inches each. With a smooth plane remove the mill-marks, the little hills and hollows made in machine planing the board at the mill.

For the square mat, plane a face-edge, after having selected and marked a faceside. Gauge for width seven and one-half inches, and plane the second edge to the gauge line. Plane one end square to the face-side and face-edge, testing frequently with the try-square. Measure the length and score a knife line across the face-side, using the knife and try-square. Saw within one-sixteenth of an inch of the line, then plane to the line carefully.

Lay off with pencil the chamfer of one-quarter inch on face-side and edges and ends, and then plane to these lines.

Sandpaper the surfaces and chamfers carefully,

using a block of wood on the sandpaper so as not to round off the arrises. Sharp arrises signify good workmanship. After the edge has been made to coincide with the line and square across, lay off as if to make a quarter inch chamfer, but, instead of making a chamfer, make a round arris extending a quarter inch on edge and on face-side.

To make the eight-sided mat, square up the stock just as if the mat were to be square. Next, with something having a straight edge, connect the corners C and D; and B and A, as in Fig. 1. These lines are

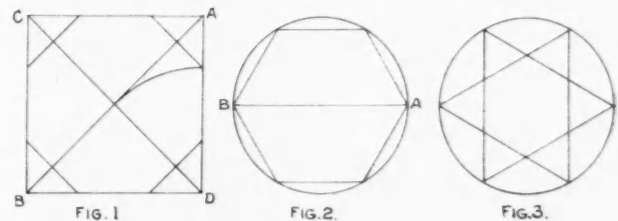

called diagonals. Measure the distance from a corner to the center, the place where the diagonals cross, and with this distance measure from each corner each way along the edges carefully. Connect these with lines across the corners, as shown. Saw and plane to those lines, and the result will be an octagonal mat. Lay off and work a quarter inch chamfer as on the square mat.

For the six-sided or hexagonal mat, describe a circle as for the circular mat. Draw the line A-B, Fig. 2, through the center of the circle and parallel or along

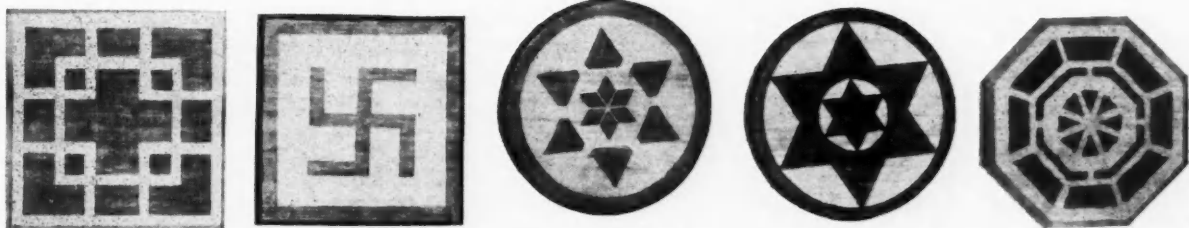

Wood Tea Pot Mats Ornamented With Simple Geometric Designs

using a block of wood on the sandpaper so as not to round off the arrises. Sharp arrises signify good workmanship.

The circular mat is laid off by means of a pair of dividers set to a radius of three and three-fourths inches. Saw the outline, using a compass saw or turn-

ing the grain of the wood. Using the same setting of the dividers as was used in making the circle, place one point at A and cut the circle on either side. Repeat at B, and connect these points with straight lines. Saw and plane to these lines and put on the quarter inch chamfer in the usual manner.

For decorative design, simple geometric designs look better and are more within the ability of the average boy than fancy ones. The designs for the square mat are not in need of description. The circular mats have the hexagonal star, and this may seem difficult to get. It is not, however. All that is necessary is to describe and point off the circle just as would be done in making a hexagon, but, instead of connecting each point with the point next to it with straight line, con-

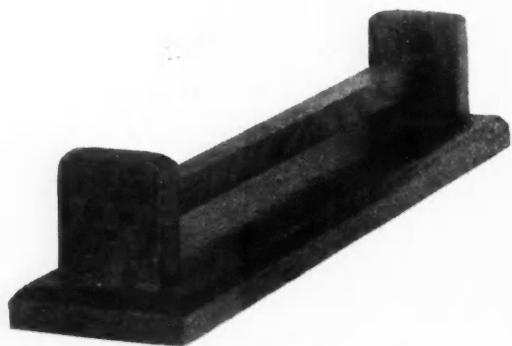

Necktie Rack to be Fastened to Wall

nect every other point—skipping a point each time, Fig. 3.

The construction of the design of the octagon is evident, the lines following the outline of the octagon itself.

To apply the design in color, first file a nail so that it has a chisel-shaped edge. With this tool go around the outline of the design, making a groove just deep enough to break the grain of the wood. This prevents the color from running from one part to another adjacent part. With a small brush put on a spirit stain

How to Make a Necktie Rack

The rack shown in the accompanying illustration is intended to be fastened to the wall. It may be made of any kind of wood. For a beginner, chestnut is a very satisfactory wood. Being coarse grained, it takes a fine finish, and being soft in fibre it is easily worked.

The following pieces will be needed for the tie rack: Back, 1 piece, 3/4 by 3 1/2 by 18 1/2 inches, mill planed on the two broad surfaces to the thickness specified; Ends, 2 pieces, 3/4 by 2 1/4 by 3 inches, surfaced on two sides; Support, 1 piece, 3/4 by 1 by 16 inches, surfaced on two sides.

As this bill specifies all the pieces to be mill-planed on two surfaces, in squaring them to size, the steps would be (1) Plane a face-edge on each piece, (2) Gauge for the width specified, (3) Plane carefully to the gauge line, keeping the edge square to the face-side as the line is approached. Use the try-square in making this latter test. (4) Plane one end square to the face-side and face-edge, (5) Measure the length from this squared end and score a knife line across the face-side at the point so located, (6) Saw close to this line and then plane to it accurately. As the pieces are already the correct thickness, it is only necessary to plane off the mill-marks.

The groove joints should be laid out and cut before the chamfer is put on the back. Measure and locate these grooves carefully, then remove the waste wood by means of the chisel. They are each one-fourth of an inch deep. Use the try-square and knife point and the gauge in laying off the sides of the grooves. Not only is a pencil line not accurate enough, but it provides no groove into which the chisel can be set in making the final cuts, as does the knife line.

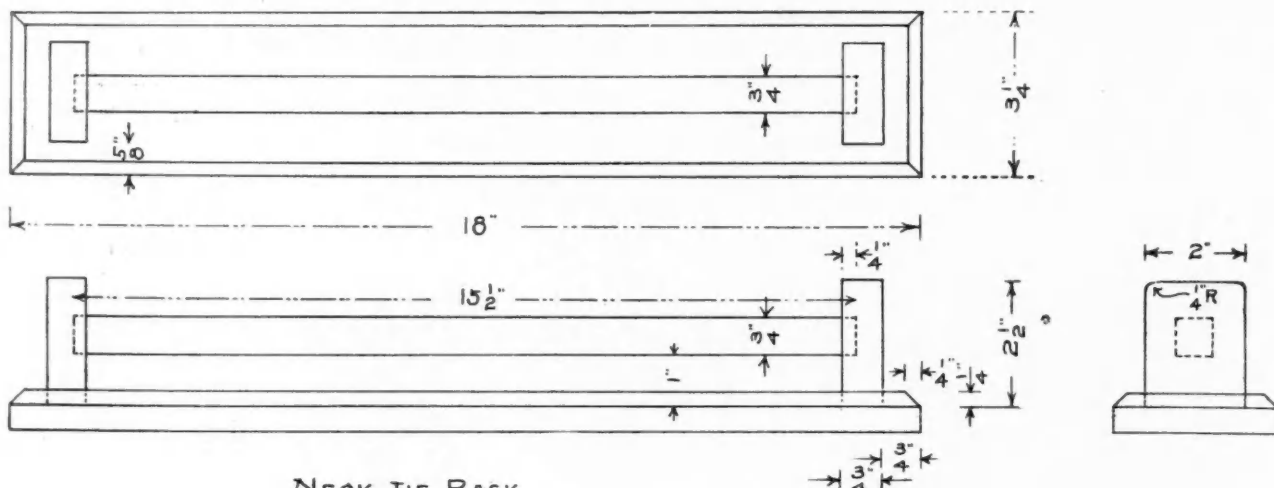

NECK TIE RACK.

of the colors wanted. Follow this with several coats of furniture or floor wax.

At suitable points on the design drive in brass-headed tacks, escutcheon pins, and allow the heads to stand above the surface of the wood slightly, so that the pot shall not touch the wood but will rest upon these heads.

In chiseling, it is not wise to make the vertical cuts directly on the line the first time. When this is attempted, the pressure of the wood against the bevel side of the chisel forces the chisel over the line and the groove is, therefore, made larger than is wanted. Instead, cut inside the lines and about one-sixteenth of an inch away from them. Cut the groove to depth,

testing by placing the rule in it as the final cuts are being made, and after the depth has been obtained go back and pare or chisel the sides accurately to the lines. The chisel is not forced over the line this time for the sixteenth inch waste wood breaks off before any wedging can be done.

After the chiseling and fitting of the parts, the chamfer is to be laid out and planed on the back piece. The parts are to be fastened together by means of flat head screws from the back of the back piece. It is much easier and a better job will result if the finish of filler is applied before the parts are fastened together.

Sandpaper all the parts clean, taking care to keep the arrises sharp; sharp arrises are the signs of good workmanship, and are obtained by using a block of wood upon the paper and holding it carefully.

From the paint store secure a small can of paste filler of a color desired. Thin this with turpentine until it becomes like thick paint and coat all the wood with it. After ten minutes, or after the gloss has disappeared, rub off this filler that remains on the close-grained wood, using excelsior and then polish with a rag. The purpose of the filler is to fill up the pores of the wood. Being wiped off the close grain and remaining in the open grain a very contrasty effect is produced, the grain of the wood being made to show up beautifully.

After this filling the parts may be put together. Allow the filler time to harden, over night will be sufficient time, then apply a thin coat of shellac with a brush. When the shellac has hardened, say twelve hours, apply a coat of floor wax. This wax can be got at the paint store in small cans. Apply it very thin, using a rag, and allow it to stand about five or ten minutes, then polish it with a cloth, rubbing briskly just as you would polish your shoes. In an hour put on a second coat in a similar manner.

Bore two holes in the back and through these fasten the rack to the wall in some convenient place.



To Clean Woodwork

To wash painted woodwork, use good baking soda dissolved in warm water. If it is very dirty, rub some soda over the spots until the dirt seems loosened then wash it off with warm soda water. This will not remove the paint.



The Retort Courteous

The other-people's-business man persisted in trying to extract information from a prosperous-looking elderly man next him in the Pullman smoker.

"How many people work in your office?" he asked.

"Oh," said the elderly man, getting up and throwing away his cigar, "I should say, at a rough guess, about two-thirds of them."—*Everybody's*.



DON'T grunt; do your stunt.

Nameless

An architect remarked to a lady that he had been to see that great nave in the new church. The lady replied, "Don't mention names; I know the man to whom you refer!"—*Sacred Heart Review*.

Long-Legged Heirlooms

"An heirloom, my son," explained the farmer's wife to her twelve-year old boy, "is something handed down from father to son, and in most cases is highly prized."

"I'd prize these heirlooms I got on, a good deal more," replied the youngster, "if they wasn't so long in the legs."

Explained at Last

Uncle John: "My goodness, Tommy, you eat an awful lot for such a little fellow."

Tommy: "I s'pect I aren't so little as I looks from the outside."—*Woman's Home Companion*.

Never Feazed Dugan

Dugan, the roofer, was sent to a millionaire's palatial home to try to find a leak in the roof.

As he entered the front hall, the butler whispered to Dugan:

"You are requested to be careful of the hardwood floors as you go upstairs, they've just been polished."

"Sure, there's no danger av me slippin' on thim," Dugan replied. "Oi hov spikes in me shoes."

A Vacation Memory

He was a good builder, but knew as little about fishing as the average man knows about building a house. He "fell for" a railroad summer resort circular and went after fish.

A shiny new department-store steel rod and fishing reel went along with him.

After hours of waiting he hooked a little fish. With rod held straight ahead he slowly reeled in. Presently the fish was directly below the end of the rod. Did he stop? Not much! He kept on reeling.

Pretty soon the fish's head touched the ring on the very top of his rod!

Just then the builder saw a man watching him in astonishment. "What shall I do now?" called the builder.

"Damfino—unless you climb your rod and grab him!"

IDEAS FOR HOME BUILDERS

Some Essentials In House Building

FEATURES THAT ADD HOMELIKE CHARACTER AND INCREASE SELLING VALUE—REAL AND FALSE ECONOMIES IN HOME BUILDING

By Edward Hurst Brown

REAL estate dealers and speculative builders, in the larger cities and in the suburban towns, have long realized that every dollar spent in making more attractive the interior of the houses, that they have to offer, will come back tenfold in the increased selling price that can be obtained or the larger rental that can be asked. This is something which the home builder, who has but a limited amount to invest, or the builder in the smaller towns, does not always realize. Indeed, it really pays better, in the end, to cut down the size of the house, if it should become necessary to economize, rather than to omit any features which add to the selling value of the property.

One may say that he is building a home for himself; that he has no intention of selling, but expects to live in the house for the rest of his life, and can do without the frills, if only the house is big enough to accommodate the actual needs. What, therefore, is the necessity of considering selling or rental value?

To Increase Renting and Selling Value

There's an old and very true proverb that "Man proposes but God disposes," and though a man may be building a home, circumstances may, in time, arise that make the sale or renting of the house imperative, and every feature which adds to its selling or rental value will be doubly appreciated. Death may make it necessary to sell the house in order to settle the estate; business reasons that cannot be foreseen, often compel a man, much against his inclinations, to move to some distant part of the country, and I have found out, by personal experience, that there is nothing more unsatisfactory, as an investment, than real estate, which is so far away that the owner cannot see for himself whether repairs asked for by the tenant are really needed or not, but must be compelled to depend upon the word of the real estate agent, whose interests seem, often, to be rather with the tenant than with the landlord. At such a time the owner realizes that anything which, by catching the eye and the fancy of the prospective purchaser, makes a house

sell more readily, is something decidedly to his advantage.

Pennywiseness

The man who is compelled to borrow money, in order to build his house, usually endeavors to keep the sum that he borrows down to the lowest possible notch, and will cut down, wherever he can, in order to accomplish this object. But it is possible to carry this pruning too far. To the man, unfamiliar with the cost of building, the things which appear to be most expensive are those items of interior finish and decoration which add the touch of elegance and refinement to the house. For the sake of saving from one to five hundred dollars, and often nearer the former figure than the latter, he will omit such items as fireplaces, mantels, built-in china closets, or attractive stair finish.

He thinks, perhaps, that after the mortgage has been paid off he will add these features that he has omitted. But he forgets that it will cost very much more to add them later than to put them in at the time of building, to say nothing of the fact that those things which we put off till another time, are very apt to be left undone.

It would be far wiser to cut down in some of the hidden features that he may regard as essential, rather than to omit those which show upon the surface, and which make the difference between a box-like barracks and a home. When you stop to figure the matter out, the two or three hundred dollars additional, which a man will need to borrow, in order to include those items which will make his home attractive, will at most add eighteen or twenty dollars a year to the interest charges which he will have to pay, while they will add fully a thousand dollars to the price he can realize for the house, or five dollars a month—perhaps more—to the amount of rent he could get for it.

Some Possible Economies

Attractive wallpapers, while adding much to the selling value of the house that is erected as a real

estate speculation, especially when chosen with the good taste and artistic feeling that is now possible to command, even with low cost papers, can be better left for the future than any other item which the home builder needs to consider. Wallpaper must be renewed every few years at best, and the paper hangers are no more objectionable to have about the house than the scrub women, that seems to be an inevitable part of the spring and fall house cleaning.

Gas or electric features are another item that can, if necessary, be postponed till some time in the future, provided the house is piped or wired for them, because there is no need for extensive or disturbing mechanical work in placing them in position; but it is the poorest kind of economy to omit the necessary piping or wiring, according to the custom of the locality, or both, in those towns where both gas and electricity are installed.

Features That Can't be Added

But those features which are built into the house, and which form an essential part of the construction or the finish, should never be put off till a more convenient season, because the mechanical difficulty and the expense of adding them later will prevent them from ever being put in. The seat at the bottom of the stairs, and which forms a part of the paneling, should be built at the same time the stairs are, and made an essential feature of the design. And the same thing is true of the built-in china closets in the dining-room. Things like this are furniture, as well as part of the architectural finish.

Have a Fireplace

Every room needs, in its planning, some central architectural feature to catch the eye at the first glance, which should be the keynote, as it were, to the room. From the earliest days of building, the fireplace, with its accompanying mantel shelf, has served as that feature in every country whose climate has made artificial warmth a necessary thing in winter. Even though we have provided for the actual warming of the house by means of the hot air furnace or the steam heater, there is a sentiment that makes the open fireplace the center of the home circle. "Aha; I am warm; I have seen the fire," was the cry of the old idolator who warmed his hands over the blazing chips that were left after he had carved his graven image, and even to-day, in this more prosaic age, there is a sense of warmth in the sight of the fire that does not belong to the steam radiator or the grated hole in the wall or floor through which a stream of over-heated air is pouring.

The fireplace must be planned for in building the house, or we must do without it, but even in the old house its place can be partially filled by the gas log, which should, if possible, be fitted with some means of carrying off the products of combustion. A simple terra cotta pipe that need not be more than

three or four inches in diameter, or a double pipe of galvanized iron, with an air space between the two, or preferably a wrought iron pipe, with an asbestos pipe covering, is sufficient chimney for an ordinary gas log, and will serve as an excellent means for ventilating a room. It must never be forgotten that the fireplace is one of the most effective, as well as one of the simplest means of providing that ventilation which is so essential to health. It is practically automatic in its action, for even when no fire is burning, there is an almost constant upward current of air through the chimney.

Wood Mantels from Stock

The selection of the mantel is something deserving careful consideration. Wood mantels will naturally be chosen for the dwelling house of average cost, because the trim of the windows and doors is made of wood, and the mantel, made of the same material and finished in the same color, will harmonize with the general decorative scheme of the room far better than one made of any other material. The architect will naturally desire mantels made from his own designs and expressive of his own individuality, but this will cost more than a mantel selected from the catalogue of some manufacturer who makes a specialty of mantels and who effects a considerable saving on the cost of the individual mantel by making up each pattern in considerable quantities. Were it possible, nowadays, to obtain only those clumsy and ugly patterns that were found in the best catalogues a dozen years or so ago, there might be some necessity for having specially designed mantels in your house, but the same evidence of the progress of good taste is to be found in the present day factory mantels that will be found in up-to-date furniture. Nobody thinks, nowadays, of going to a cabinetmaker and having him make our tables, chairs, bedsteads or chiffoniers to order. Instead, we visit the furniture store, where we will find in stock, or will be shown photographs in the catalogues, artistic and well-made furniture of every period style, as well as in the modern so-called New Art or Craftsman types. In the same manner, we can select our mantels, having a wide range of choice, so that every individual taste can be satisfied. Besides the usual hardwood mantels, I have found, at the dealers, many beautiful Colonial mantels, some of them being faithful copies of old examples, while others have been designed in the spirit of the old work. There are also to be had faithful copies of the French period styles, which would find fitting place in a parlor that is decorated in the popular Louis Fifteenth or Sixteenth styles. These mantels are usually furnished with a priming coat of white paint and may be finished by the painter in flat white or in enamel, to correspond with the rest of the woodwork of the room.

In addition to the economy that is secured by purchasing ready made wood mantels another point is the excellence of finish, for the mantel factories use

the same processes and methods as the furniture factories and produce the same grade of work. Varnished surfaces should always be finished in dust-free rooms that are kept at practically uniform temperature and free from currents of air. These are possible in the factory, but not in the house under process of construction, where the painters are often obliged to varnish while carpenters and other workmen are filling the air with dust, and where it is impossible to keep the temperature anything near uniform. For this reason, the factory made mantel almost invariably presents a better appearance than one made by the planing mill and finished by the painters at the same time as the trim. The mantel, being the chief feature of the room, should naturally have a finer finish than the rest of the woodwork.

“New England” Framing and the Quality Idea

WHEN pinned right down to action no building owner wants a cheap job on his house. If cheap work is accepted by the owner it is usually because he is incompetent to judge. Inferior workmanship and materials a little under the best grades look all right to him, and the poorly built job goes through; but inferiority is bound to show up later on.

Most architects are loyally and energetically trying to get good work on every building they design, whether a \$3,000 house or a \$3,000,000 office building. Most contractors take pride in building up a reputation for honesty and integrity—sincere, earnest, conscientious methods of doing business, which are as much in the interests of architecture as in their own.

There is no excuse for cheap work. Every inferior job is occupying space which would be better utilized by a building of enduring construction. It endangers surrounding buildings, depreciates the entire architectural profession and contracting trade by conveying false ideas of cost to building owners, and hurts reputations of architects, builders and owners.

Even in real estate work, houses built to sell bring no profit in the long run to owners through whose hands they pass unless they are honestly built. On the other hand, most reputable real estate operators have proved time and time again that well-built, attractively designed houses yield larger profit, although the first cost may be much greater than for houses flimsily built.

When it comes to frame houses the best is none too good, as a frame structure is under greater stress of wear and tear than any other, by reason of the perishable quality of the material.

New England Frame Houses

Down in New England is the place to see good work in frame construction. With century old houses to follow, New England builders have right at hand ex-

Screens for Doors and Windows

In every section of the country where mosquitoes make life miserable in the summer time, provision should be made in the planning for screens for windows, doors and porches. The mouldings should be so designed that screens will fit properly, and where possible, they should be so made that the windows may be opened either from the top or the bottom. The writer lives in the mosquito belt, and in this section of the country the owner invariably furnishes the screens, although the tenant is expected to put them in position in the spring, take them out in the fall and store them and repair the screen wire that may rust out. No one would rent an unscreened house, so that screens must always be considered as a part of the initial expense, when building.

cellent examples of the best. This practical exhibit of honest, careful construction has taught builders the value of good work.

New England houses are built on the complete, self-supporting skelton frame idea brought from England in the days of early colonial development. In modern houses the frame has a solid, one-piece sill, usually 4x6 or 4x8 inches. At each corner of the building and at intermediate points on the sides (if the house be a long one) are 4x8 inch posts, extending from the sill to plate. These are usually mortised into sill and plate and frequently pinned with oak pins. Cut in between the upright posts are 4x6-inch horizontal girts for the support of the second floor joists.

Ordinary 2x4 or 2x6 inch studding is used for the remainder of the wall construction from sill to plate and for inside partitions, and outside walls are wind-braced by diagonal 3x4 inch pieces, extending from the sill up against the corner posts.

In glancing at one of these New England frames one is much impressed with its stability. Honest construction and practical utility are expressed in every line. Any man would be willing to guarantee long wear and freedom from excessive repairs where such construction is used if the danger of fire could be entirely eliminated.



Mechanics Lien for Broken Glass

A materialman is held in *Pittsburgh Plate Glass Company v. Leary* (S. D.) 31 L. R. A. (N. S.) 746, not to be entitled to a lien for glass furnished the contractor for use in a building if it was broken before any attempt was made to use it in the building, so that it became worthless, where, under the statute, the lien depends not upon the owner's contract, but upon the incorporation in the building of the material for which the lien is claimed.



An Original Decorative Scheme

MAKING THE DECORATION OF A CLUB ROOM PAY FOR ITSELF

“OF the making of decorative schemes there is no end,” are the words written in the Twenty-third Book of the Wisdom of the Foolish, although even that becomes a short and fleeting pastime compared to the making of estimates. But even so, he is either a brave or a hardy man who springs into the arena with an “original” decorative scheme. That is: an original one now. They were all original once—a good while ago.

But, although we may know no new way to cut out leaves or to paste on angels, relates Mr. S. C. Singleton in *The Painters Magazine*, to which we are indebted for the privilege of presenting this interesting article, we demand the spotlight while we tell of the room we did, that paid a good round sum to the decorator and yet left the buyer richer by as large a sum as was paid. This treatment was a real “scheme”—decorative, financial and (let us say it, humbly, lest some other Jay arise and put us in the Dr. Cook class) original.

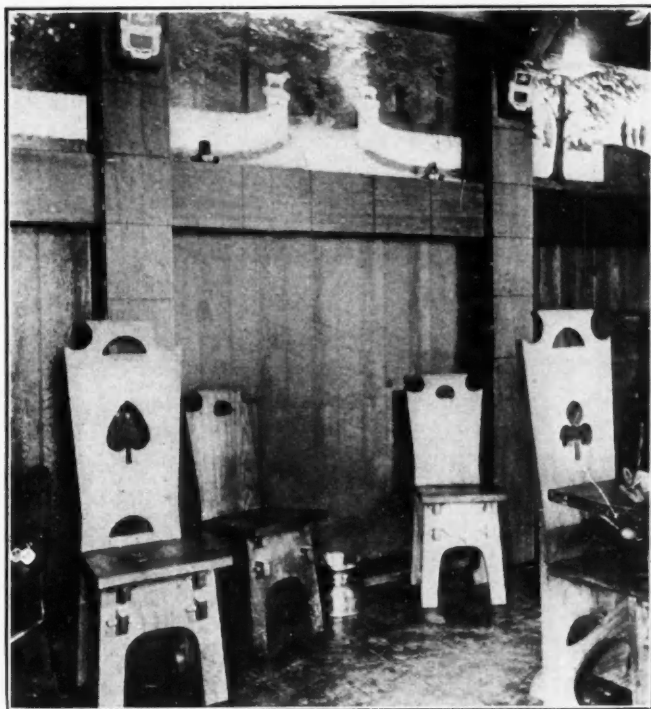

The Lockers Made the Profit

The lucky buyer was a political club, whose members thirsted—for immortality and fame, and, well, they had a thirst for decoration, too.

A small room in the back of the building was set aside as a card room, and being the least attractive room in the house, the decorative instinct was strong to make the most of it. It was one of those oppor-

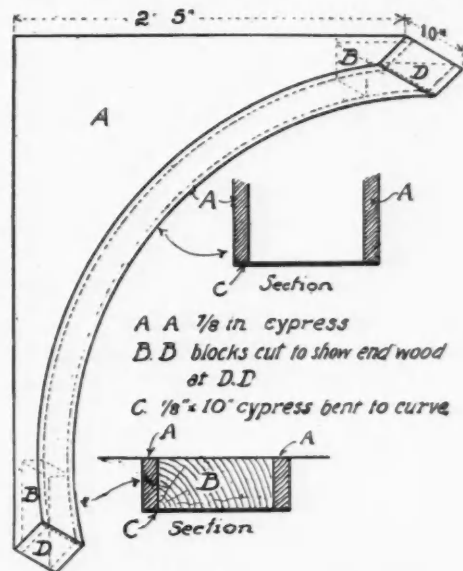

Sketch Showing Construction of Brackets

tunities—would there were more of them—where the specifications were brief and concise and summed up, simmered down to the order, “Fix her up.” And so the room grew, not into the realization of a carefully thought out and dried up plan, but into a real work, an evolution and a joy to the workman and the beholder.

Heavy (looking) false beams of cypress were put across the ceiling, and the ceiling itself was done in a lincrusta, which showed a raised grain, and took the same stain as did the cypress, and took it beautifully. This same lincrusta formed the wainscoting. Each beam was supported by a cypress upright, 8 by 10 inches, outside measurements, and connecting upright and ceiling beam, was a knee—massive looking but easily constructed as shown in the sketch. Running around the room, five feet from the floor, was another 8 by 10 cypress beam form-

ing a plate rail (constructed like the others of $\frac{7}{8}$ -inch stock.)

The panels thus formed above the plate rail were stippled rather roughly with Muralo, then painted and finished with a coat of enamel. On the ground thus formed were painted in flat oil colors (Marvelo was used for this), sketches of bits of local scenery. Beautiful as are the decorative scenes that come to us from Holland, England and France, the writer has always felt that, with a camera, a sketch book and a seeing eye that decorator is strangely situated who cannot, within ten miles of home, find decorative

begun, a matter for regret, as the distribution of strong notes of color over the cypress was a distinct addition to the success of the room.

In place of the landscape painting this treatment could be very successfully carried out with the landscape borders that are now obtainable, especially if a different pattern were used in each panel.

A World Wide Competition

The Minister for Home Affairs for the Commonwealth of Australia, Melbourne, has issued a memorandum in connection with the designs for the Federal capital city, to be constructed in a federal district which will be the permanent seat of government of the Commonwealth of Australia, where all Commonwealth legislation will be conducted and where the governor-general will have his official residence. The invitation to the competitors embodies the conditions of competition, historical and introductory matters relating to the district of Yass-Canberra and its selection as the federal district, and the requirements for the consideration of designers, the location of appropriate areas embracing sites for twenty-eight buildings. These include a house of parliament, governor-general's residence,

court houses, public offices for all departments, and other building necessary.

A description of the site selected is also given, and a model of the city site on a horizontal scale of 400 feet to one inch with a vertical scale of about 100 feet to one inch has been prepared, and a cast of the model will be sent to each of the centers of distribution for inspection. Copies of the invitation to competitors can be secured by application to either the British Embassy, Washington, or the British Consulates in New York and Chicago.

A feature of this world-wide competition contemplates that immediately after the announcement by the minister of the adjudication of the premiums, which will be made at Melbourne within two months of the date of receipt of designs, it is intended to publicly exhibit in Melbourne for a reasonable period all designs admitted in competition. Should the competitors desire on their own behalf to arrange a second exhibition in London or elsewhere, the minister will, if requested, supply as exhibits, reproductions from the originals of the premiated designs only.

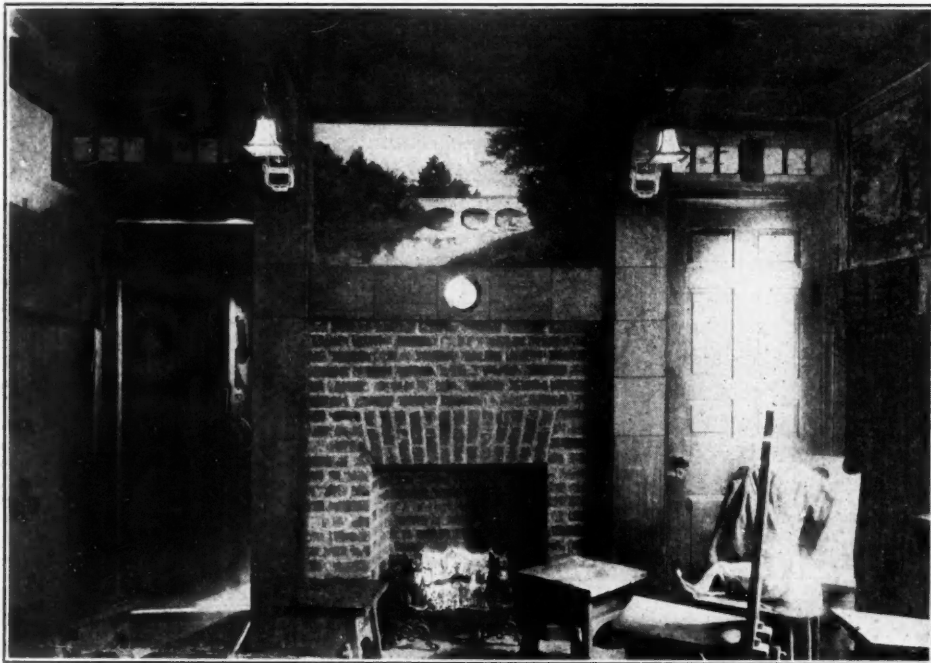

View of Decorated Club Room

schemes just as beautiful and with the charm of home that no importations can possess.

The coat of arms of the club was emblazoned on each cypress knee, in strong, bright colors, which were reflected in the color scheme of the landscapes and the lettering on the lockers.

Then (here comes that financial scheme, for the sake of which you have waded through the foregoing) the cypress plate rail and the uprights were divided into lockers, each with its individual key, and the members of the club, upon payment of a sum which was small considering that posterity is scheduled to come and gaze reverently upon this galaxy of names, were entitled to possess, in perpetuity, a locker, and to have carved and emblazoned thereon, in color, their names. As the lockers were quickly taken and there were eighty-four of them, any one who has an adding machine can figure up that after the decorator got his there were left several pounds of "iron men" for the club. Behold the scheme! Can you beat it? The accompanying photographs, while they show the lockers, were taken before the carving of the names was

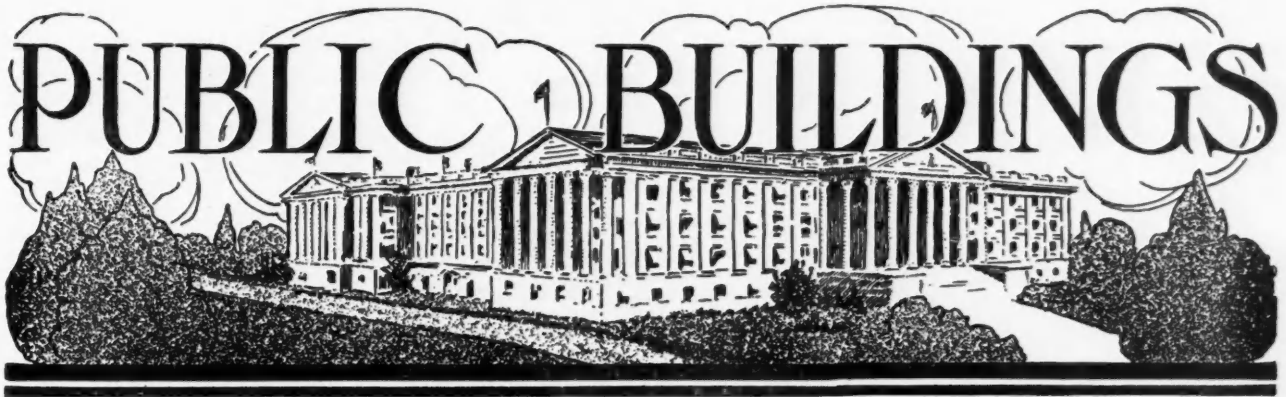

New Berwyn, Ill., Grammar School

ARCHITECT'S PERSPECTIVE AND FLOOR PLANS OF FOUR-ROOM SECTION TO BE BUILT IMMEDIATELY—
DESIGN PROVIDES FOR FUTURE ADDITION

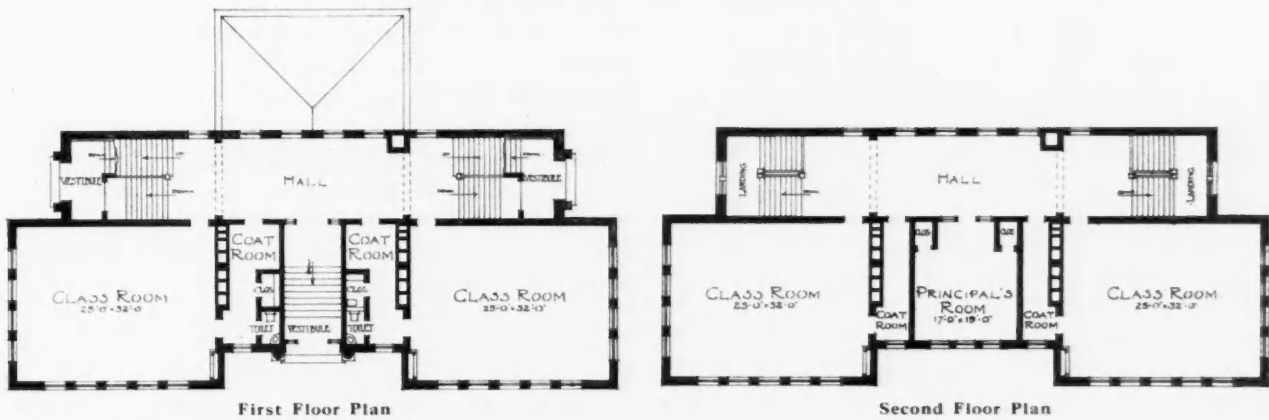

First Floor Plan

Second Floor Plan

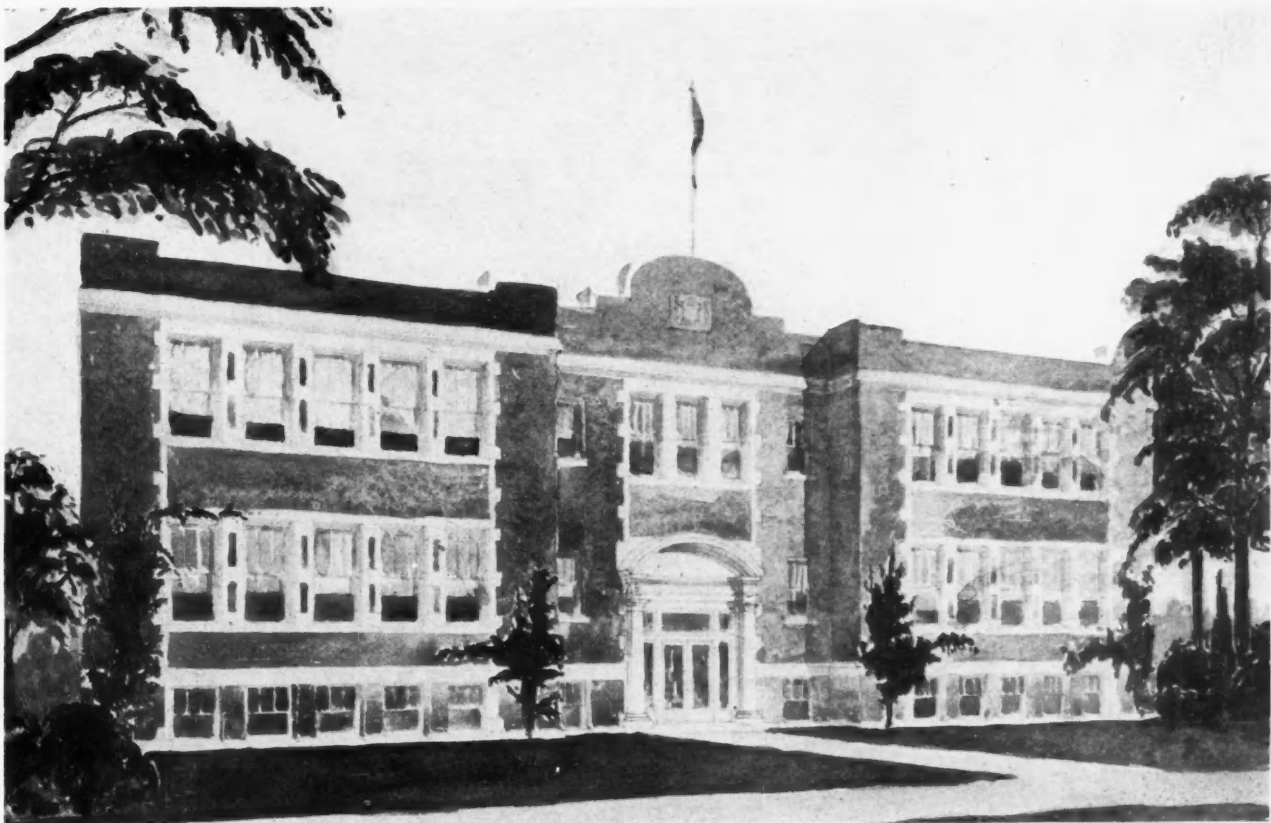

New La Vergne Grammar School, Berwyn, Ill. G. W. Ashby, Chicago, Architect

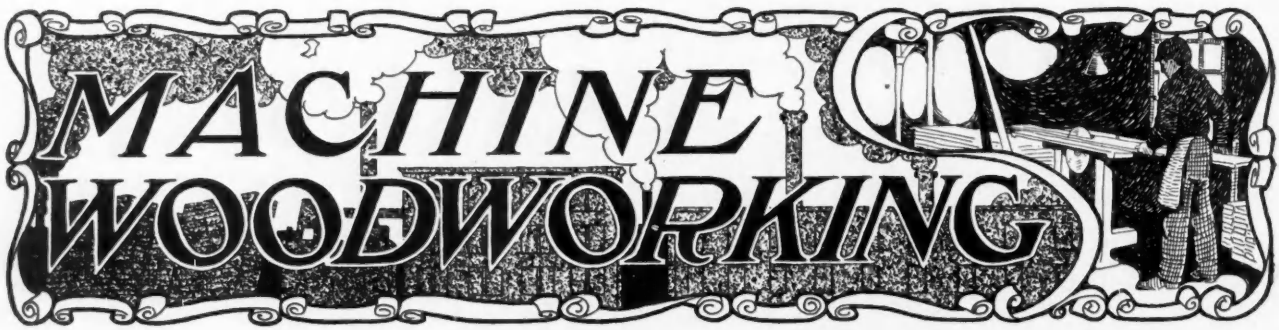

Operating the Scroll Band Saw

By Chas. Cloukey

THIS paper is intended as a supplement to that one treating of the care of the scroll band, and while it might not be exceedingly instructive to the man of long experience, it is sure to be of interest to such carpenters and mechanics as are putting band saws into their shops as adjuncts to hand and bench work.

As will have been seen by the foregoing article, there is a good deal of "know how" about keeping the machine and saws in shape, and it is even so with the operation of the band saw. It is a fact that almost anyone can make cutting marks on the face of the boards and then run them up against the saw, but there is at least one wrong way to do work, even if there may be more than one right way.

We will suppose that the proper selection of a saw has been made and that the proper strain has been put upon the blade and all the other preliminaries, such as the adjustment of the guides, leveling of the table and clearing away for foot room, and that the required pattern has been marked on the stock to be sawed. The next step for the novice is to determine where to begin his cut, which cuts to make first so as to avoid all unnecessary backing out of the cuts, and which side of the mark he will cut out, for a really good sawyer does not cut out all of the mark, but will leave about half of it on the board.

A variation of the width of a pencil mark does not seem to be enough to worry about, but if the saw runs from one side of the mark to the other without even leaving it at any place, the deviation from a true curve or straight line will be so marked that "bum" is the only word for such a job. Generally speaking, it is better to run the saw on the side of the mark away from the pattern to be cut so as to leave a smoother surface on the edge of the finished stock.

The sawyer should practice working his feed with a slight pressure against the side of the blade as this helps to steady the work and keep the side of the cut at the middle of the mark. In order to do this it is nearly always necessary to turn the work being sawed somewhat at an angle with the line of advance, but as this comes naturally when one tries to feed to the mark

and at the same time gives the pressure against the saw, it is not such a difficult matter to accomplish. However, this trick, like all other good things, may be carried too far, and the thicker the stock and the harder the lumber, the less pressure may be placed against the side of the saw and still preserve a square cut straight down through the stock.

If one wants to make a perfectly square cut with a band saw, he must first select a blade that has been properly fitted to run straight, and he can test it for this quality by crowding the feed on a thin board, say not more than 1½ inches thick. If it runs straight with a crowded feed, it will run straight through a thick piece if it is fed slowly enough so

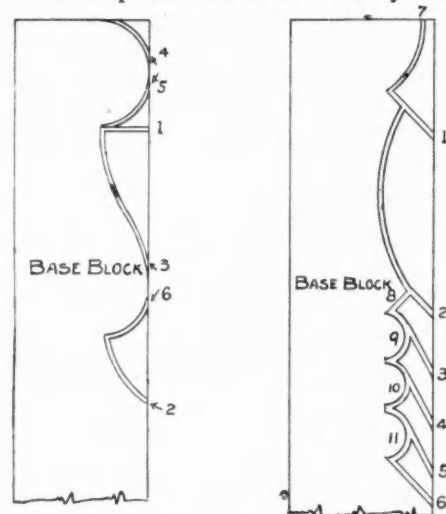

FIG. 1
FIG. 2
Direction of Cuts and Order in Which They are Made in Ornamental Sawing.

that the teeth will chamber the dust properly. The guides must be carefully adjusted for the thick material, for it often occurs that when the upper guides are pushed up high they lose their alignment with the lower set. This is caused by the post to which the upper guides are attached not being in alignment with the saw when under its working strain. Of course the lower and frequently the upper guides have a lateral motion so that the two sets of guides may be kept in line, but the point is that in some machines

one or the other set has to be changed whenever it is necessary to do thick work.

But to return to the actual work of sawing. Figs. 1, 2 and 3 show something of the way the band sawyer should go at his work. The cuts are numbered consecutively and after some experience the operator will be able to tell at a glance about what is the proper move to make.

Fig. 4 shows how to determine whether a certain blade will make a given turn or not; and it is a poor policy to try to crowd a blade around too short a turn. If the curve is on the outside of a piece it may be cut with safety by slashing off the surplus

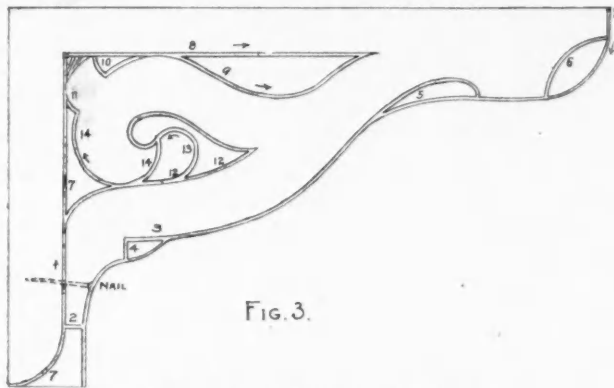

Sawing Out an Ornamental Bracket

stock close to the mark and then make a finishing cut.

Cutting or ripping long stuff on the common scroll band is one of the most particular feats for the beginner, and he need not be discouraged if he does not get his feed to track with his fence the first time tried. In the first place it is the exception to find a scroll band blade which has been fitted so as to run absolutely straight under a maximum feed, and like the sawing of thick material, should really run straight; but if the saw runs off to one side, the guide or fence against which the stock is fed should be turned to such an angle as will let the saw cut freely and at the same time permit the stock to run easily against the fence. If the fence is too far one way the board will draw away from it, and if it is too far the other way the board will wedge in between the saw and the fence. In this latter case the machine should be shut down at once as the blade may be strained or even broken if it is allowed to go too far.

The band sawyer in a carpenter shop will find that he has almost as great a range of work as does the man in the planing-mill and factory; for while he does not have as many different patterns of some things, he has to match up many pieces which are no longer turned out regularly by the factories. Where the factory makes its blocks with a special machine or buys them by the car load, the carpenter's saw must make up his sorts in his own shop or he buy them at a loss. It is the same way with brackets, balusters, table legs, porch circles, rails, ramps, goosenecks and a thousand and one things the contractor would have

to buy as extra expensive material if it were not for the band machine in his shop.

When it comes to the sawing of table legs, balusters, or any four-sided pattern, it will be necessary for the sawyer to mark the stock on two adjacent sides, and if the pattern is such that the offcut will be in more than one piece, the side will have to be marked after the first two cuts are made. If the offcut is in one piece it may be fastened back on the stock with a brad or two and the other cuts made as before.

When designs are to be made for original work and it is not necessary to preserve them, it is the more economical way to draw the pattern directly upon one piece of the stock which will save the work of transferring it from a paper or thin piece of board. If the design is a balanced one, having the same lines each side of the middle, a great deal of time may be saved by drawing one side and sawing it out and then using this half pattern to mark both sides of another piece of stock so as to get a complete pattern. The trick may often be turned on simple patterns by using the outside piece cut off for a pattern to mark the other half, by laying it on the stock in the proper position. This does away with the hardest part of drafting balanced designs, which is to get the two sides to look exactly alike.

When using the tilt of the table for pattern drafting, that is, sawing the slight bevel required for drawing the patterns out of the sand, the sawyer will have to use his judgment for the requirements of each individual job, for it will not do to put the table at the same slant for all patterns one is required to saw.

The sawing of rake brackets is another thing, and

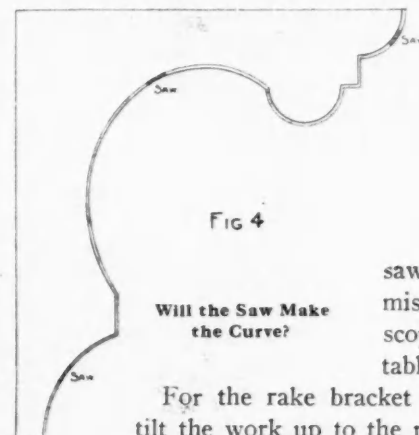

while one might think at first sight that they could be sawed by means of the tilted table, the very first trial will convince the sawyer that he has misapprehended the scope of the tilting table.

For the rake bracket it is necessary to tilt the work up to the required angle and then saw it on a level table, which will bring all of the face cuts parallel with the cut of the rake under which the brackets are designed to stand. The sawyer can easily rig up a little holder which will support the stock to be sawed out and at the same time not be in the way of the cut. The same is true of the sawing out of stair crooks. The sawing of easings and ramps is classed with the plain work of the sawyer, and the stock is cut out of lumber the same thickness as the width of the rail to be matched.

(To be continued in October American Carpenter and Builder.)

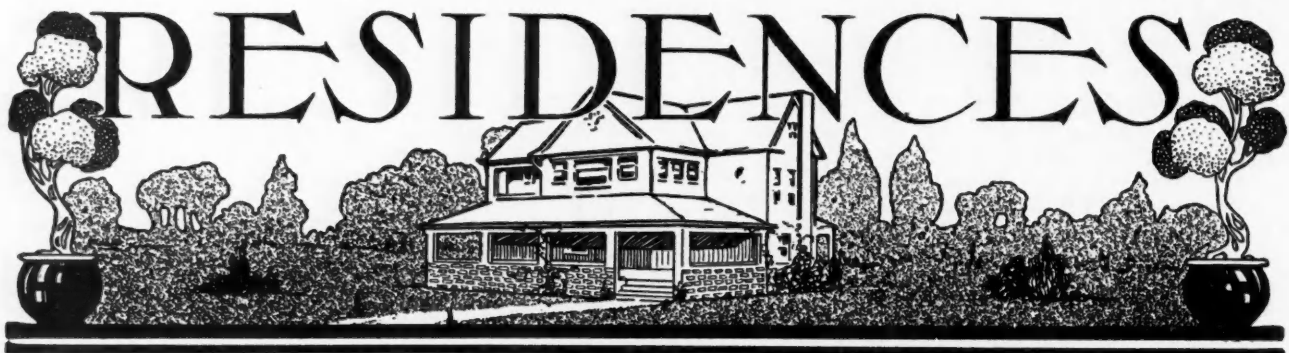

Plans for Substantial Brick Bungalow

COMPLETE SET OF ARCHITECT'S DRAWINGS FROM WHICH THE ATTRACTIVE MODERN SIX-ROOM BUNGALOW ILLUSTRATION ON THIS PAGE CAN BE BUILT

ADWELLING of the kind shown herewith is always very popular with those who intend to build a home of their own. The great majority of people would like to have a bungalow, and it is only after they get right down to the point of figuring comparative costs that they usually give up the idea and go back to the more conventional style of dwelling. The expensive feature of a building of this kind is the large-sized lot that it requires. With this bungalow, for instance, the width is 50 feet, over all, which is a good deal more than the average building lot will accommodate nicely. Still, if one has

acre property and can afford it, there is no question concerning the attractiveness and convenience of a home laid out on bungalow lines.

So, although this design is not one that could be adopted generally for town or city building, it contains a number of points of special interest which make it worthy of consideration.

The first thing noticeable in the floor plan is the beauty and spaciousness of the two rooms with connecting reception hall occupying the front portion of the house. The living room is 20 feet 9 inches long by 16 feet 9 inches wide. A large bay window forms

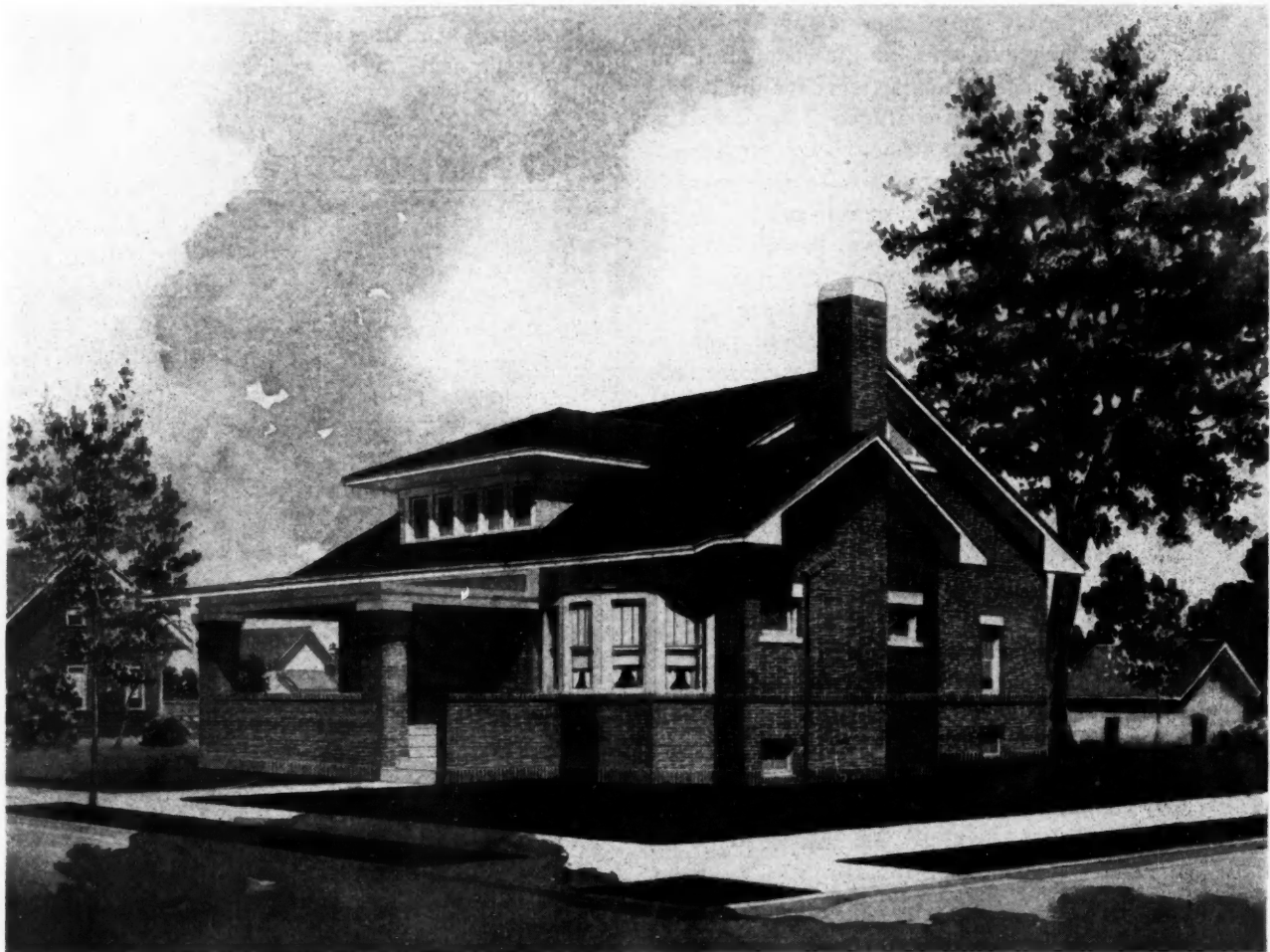

Brick Veneer Bungalow to be Built for Mr. Chas. Kramer, Chicago, Ill.
COMPLETE WORKING DRAWINGS FOR THIS HOUSE ARE PRESENTED ON THE 5 PAGES FOLLOWING.

the entire front side of this room; a fire-place, with built-in book cases on either side, fills the side of the room opposite the door. The door into the reception hall is a wide cased opening. At the other side of the hall is the dining room with bay window and

built-in seat, beautiful built-in side-board, etc. This room, as well as the living room, has a simple beamed ceiling.

The next point of interest, rather unusual in bungalow design, is the fact that three good-sized, well-lighted and ventilated bed-rooms are provided, all of them well away from the main part of the house. There is an abundance of closet space. Everything

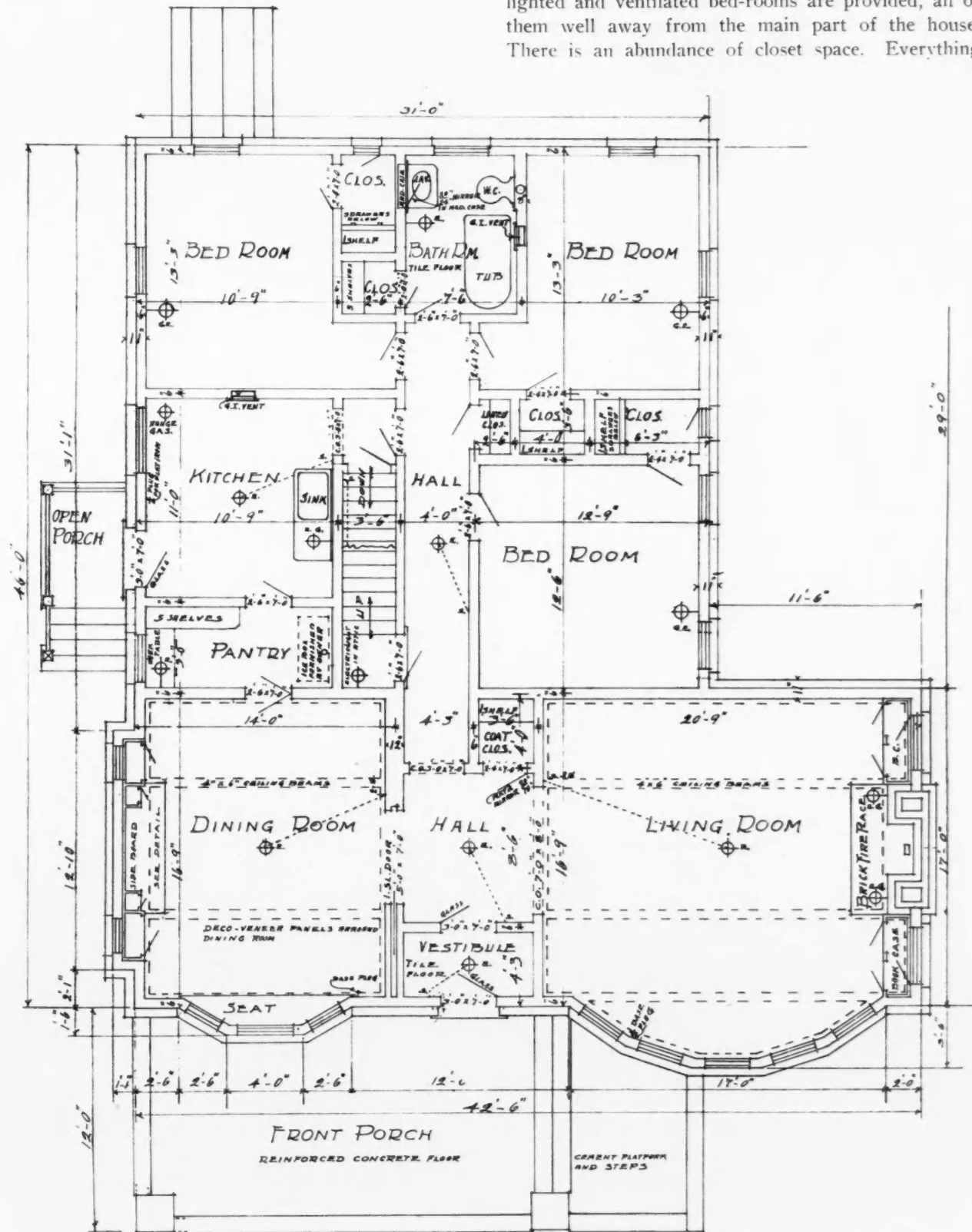

FIRST FLOOR PLAN

House Shown on Page 56

is conveniently arranged for ease of house-keeping. The second floor furnishes a large, light space for

storage, or for extra sleeping rooms, if needed.

This house is of brick veneer construction. The perspective drawing gives a good idea of the actual appearance as it will look when completed.

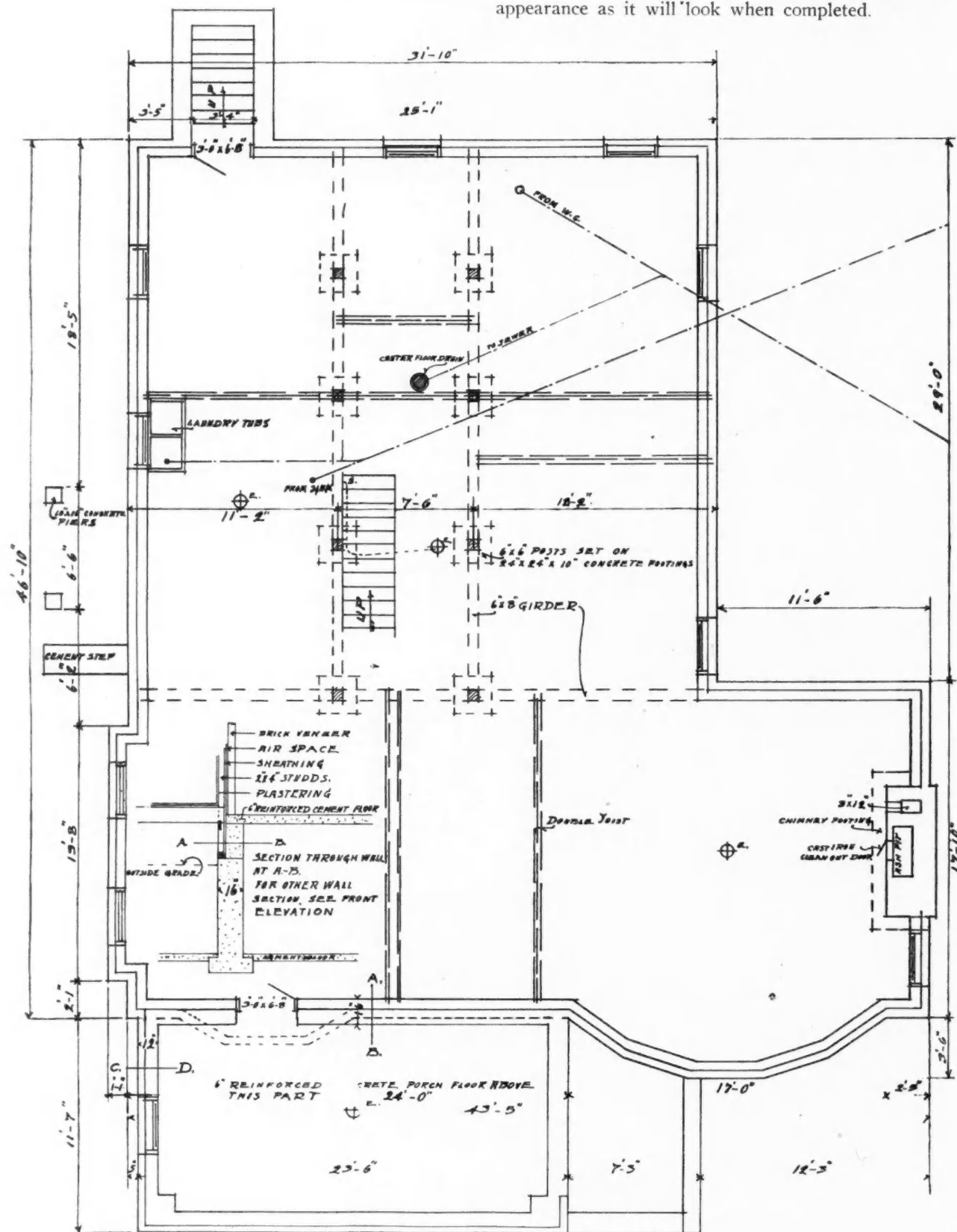

BASEMENT AND FOUNDATION PLAN

House Shown on Page 56.

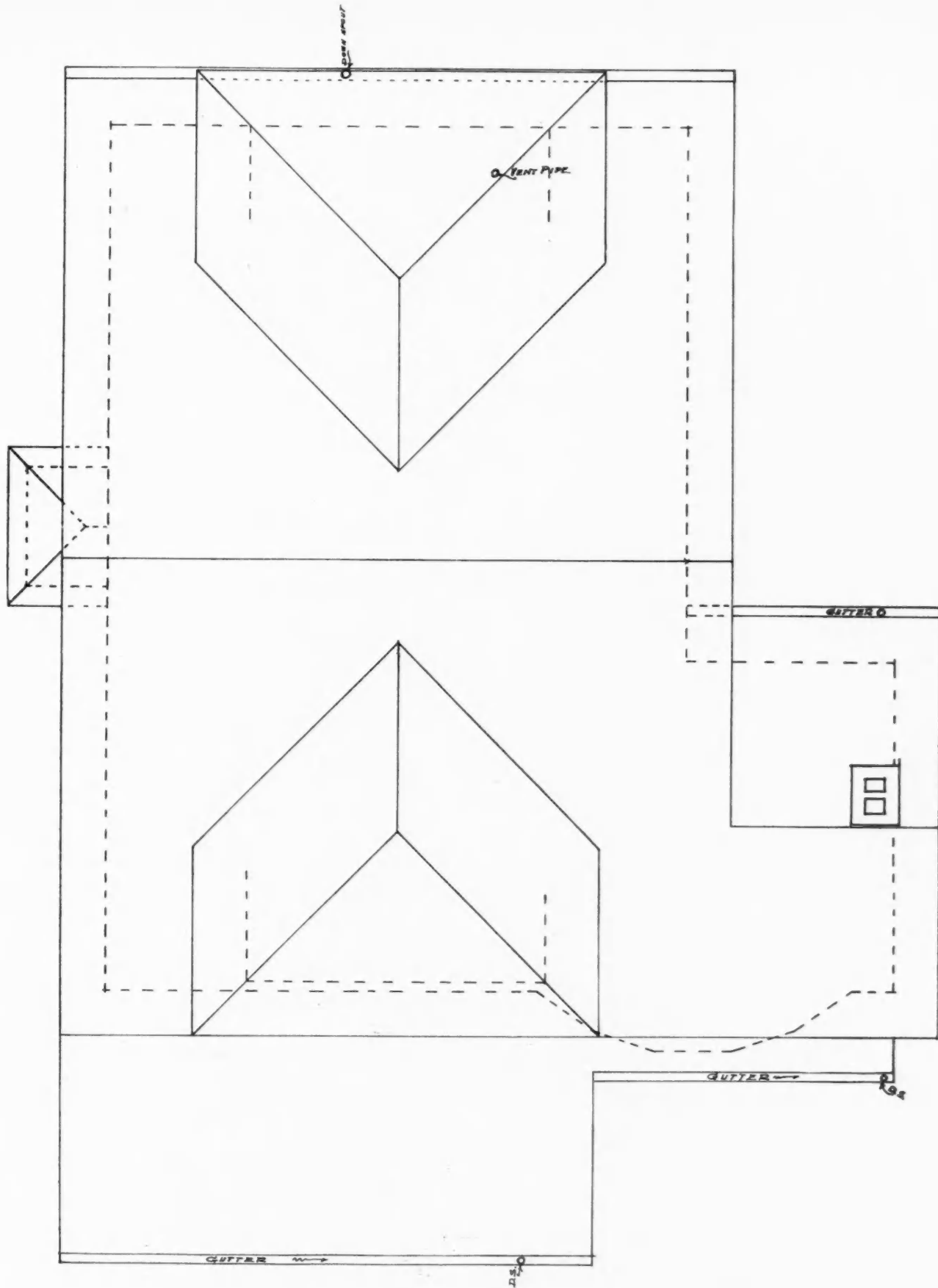

ROOF AND ATTIC PLAN

House Shown on Page 56.

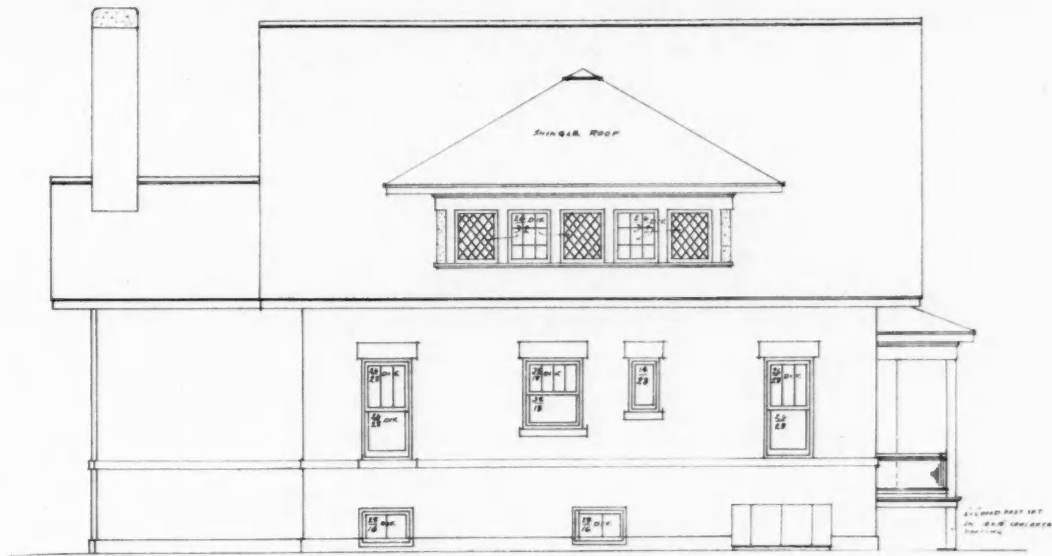

REAR ELEVATION

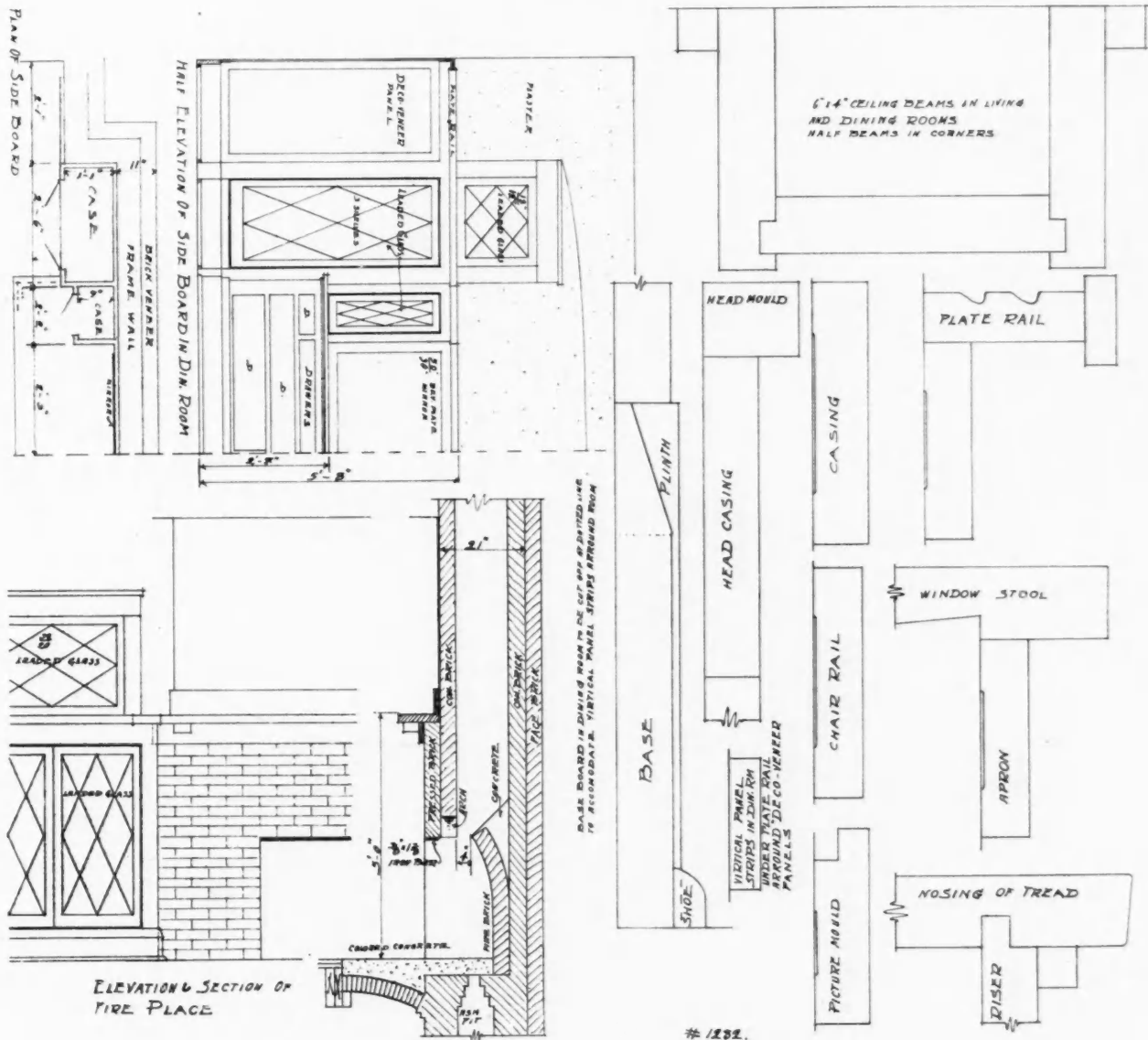

DETAILS OF INTERIOR FINISH

House Shown on Page 56

1232.



Our Readers are Requested and Urged to Make Free Use of These Columns for the Discussion of all Questions of Interest to Carpenters and Builders

How to Build a Log House

To the Editor:

Danville, Pa.

I see one of your subscribers wants details of how to construct a log cabin. I would say about all of the details needed is the style of locking or building of the corners. I herewith present a plan which I think is the best of any that I have seen.

First square off the sills on four sides and frame them for joists and lay them on the wall, then square off two pieces on three sides and cut the saddles as shown in the diagram. A good man should be at each corner to cut the saddles so that they will be plumb, while other men should be stationed at the middle of the sides to hold it in place, while the corner men cut the saddles. Enough help should be on hand to make the work easy.

After the walls are built they then cut in the windows and doors, allowing room to admit a 2-inch plank on each side spiked or pinned to the ends of the logs. Then slip in the frames.

The plates should be squared and the end ties and rafters should be framed into the plates.

At each corner have a 2-inch hole about 18 inches deep into which drive a good hardwood pin.

In selecting timbers to be flattened get as nearly one size as possible, and remove all of the bark; care should be

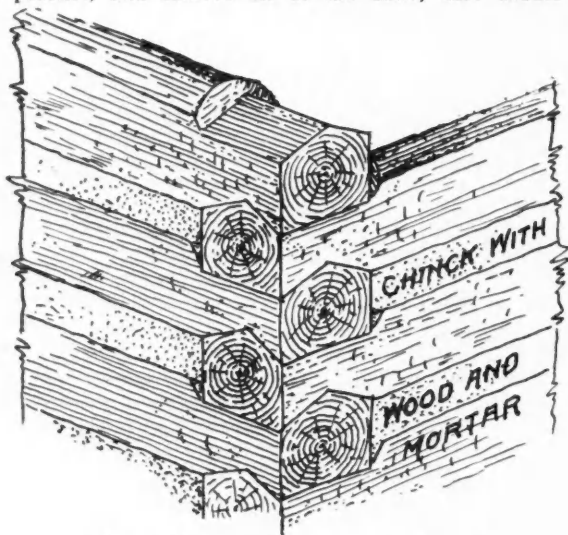

OLD STYLE OF LOCK CORNER.

taken to keep the walls level by selecting logs for that purpose. By changing the ends about it is an easy matter to keep true and level.

After the building is up chink between the logs with wood and fill in with mortar. About all of the tools required are as follows: A good chopping ax, a broad ax, a square and a cross-cut saw. When I learned my trade the saw mills

and planing mills were very scarce and we had to score and hew all of our timbers; many a day I have followed six and seven good scorers with a broad ax six days a week from sun to sun. We did all of our surfacing by hand, made all of our panel doors and sash, also worked out our mouldings by hand. In hewing timbers care should be taken not to score too deep so that the same will show after the surfacing is done. The hewer wants to trace his line three or four feet and cut down plumb; then score back and hew; then the second side should be hewed; care should be taken so as to have the top and bottom the same width. In getting out barn timbers, etc., make a 1/2-inch gauge the size required. This will allow for taking the timber out of wind. I have hewed many thousands of feet of timbers in my time and the larger the timbers the better it suits me.

JAMES F. WELLIVER.



About Veranda Railing

To the Editor:

Leonard Bridge, Conn.

Will you kindly tell me in the Correspondence Department next month at what point it is customary to connect the

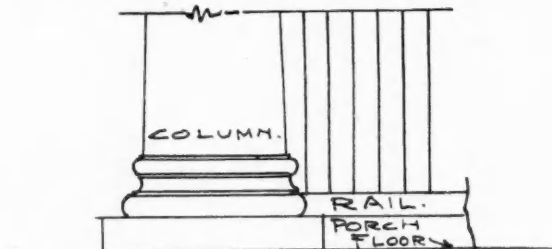

How the Bottom Rail Should Meet the Column Base

lower veranda rail to round porch columns, whether at the top of the base block, or on top of the square part of base?

E. E. CAPLES.

Answer: The accompanying drawing illustrates the point in question and shows correct placing for the lower veranda rail. It rests directly on the base block and is membered closely to fit the lower member of the column moulding.

EDITOR.



Help Wanted

To the Editor:

St. Johns, Ariz.

About one year ago I put down A No. 1 California pine (quarter sawed) dance floor. I oiled it thoroughly, but now some of the boards are wearing more than the others. I wish you or some one through your paper would give me the best way to finish or cover the floor—kind of oil, wax, etc., and how to apply it so it would be like a good hard finish that will stand hard wear.

H. C. OVERSON.

Tool Box

To the Editor:

La Cross, Mo.

Enclosed find a sketch of my tool box with the front cut away so as to show interior construction. Fig. 1 shows the top till; it has a lid; the tills slide and can be taken out. A in Fig. 1 slides on A in the box.

I use the bottom for heavy tools such as planes, mallets, miter box, etc. In the rack on the right end I keep my ham-

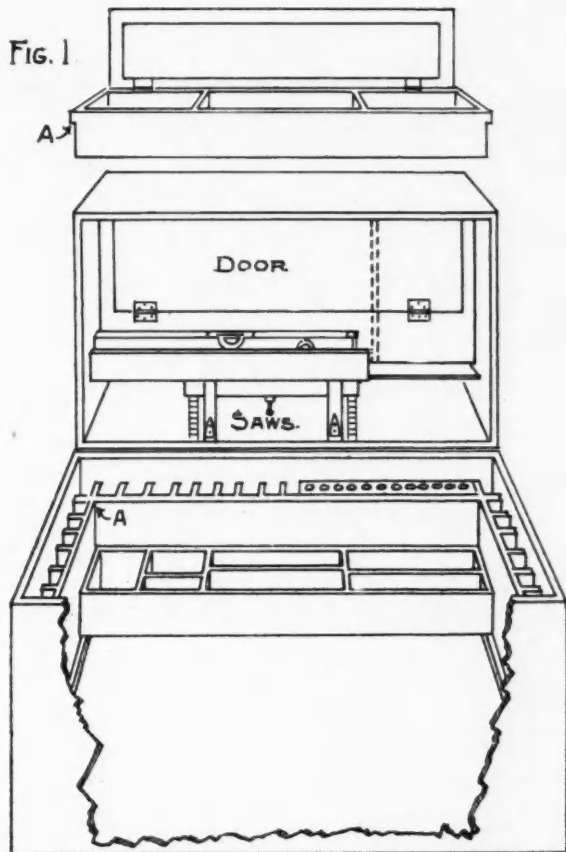

Tool Chest. Cut Open to Show Interior

mers, hatchet, pincers, etc. I put my screwdrivers, automatic drill and bevel squares on the rack. The back holds my auger bits and chisels. The saw rack is in the lid. Above the saws I keep my level and back of that is an apartment where I keep light stuff such as sandpaper, plans, plan books, catalogues, etc. I have my bit, brace, adze, draw knife, hand ax and squares against the front of the box (not shown).

I intend to make a shoulder box to fit in in front of the tills, and will use it to hold the tools that I use during the day and save the trouble of putting them away at night. I think this box is hard to beat for general use.

W. H. GWIN.

Lining the Roof for Shingles

To the Editor:

Milford, Del.

Will you kindly tell me how to line off a roof where the length of the rafters are the same on both sides, so that the shingle courses will come out exactly even at the ridge, using three courses to the foot and give a lap of two inches on one side at the ridge.

HARRY L. DAVIS.

Answer: If the rafters are of the same length there is no reason why the shingle courses should not work out evenly at the ridge as it is simply a matter of even spacing. Years ago it was quite the custom to lay the shingles to a

straight edge, that is to tack a straight edge board or strip and place the butts of the shingles against this before nailing, then later the chalk line came into use. Some struck off two lines at a time and then ran two courses across the roof before striking two more lines. This was thought to be going some, but nowadays, and especially in the larger cities, there are professional shinglers, men that make a specialty of shingling at so much a square or by the thousand. The chalk line method is too old foggy and slow-going for them—though it would be a great credit to their work if they would use it. They use a gauge on their hatchet blade for the spacing, while others trust to the eye alone, and we have known some to become very proficient in skill and workmanship.

EDITOR.

A Roof Plan

To the Editor:

Romney, Ind.

I am sending you herewith a drawing of a house we are going to build and would like your idea of the best way to frame the roof. Would like the roof hipped; do not want gables.

CHAS. BARNHART.

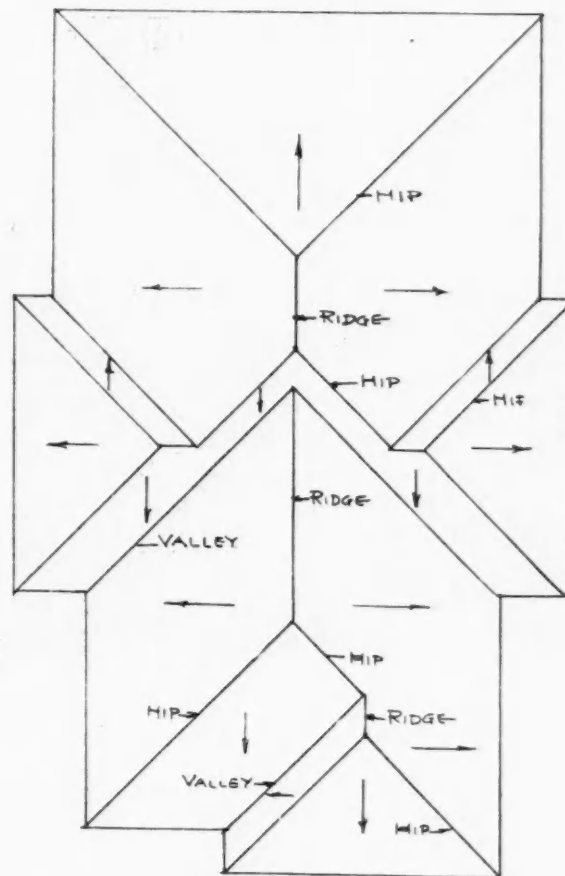

Suggested Roof Plan

Answer: The accompanying drawing shows the outline of the house with the hips and valleys indicated. This is the simplest way to roof a house of this outline; and as for gables, it would be a pretty hard job to have any and still have the roof look right.

EDITOR.

More Light

To the Editor:

Needham Heights, Mass.

In your June number was a question concerning screen door hanging—which side out to hang the screen. An old saying is "best side to (insert name of your city, town or vil-

lage)." Now look at your front door, or rear door for that matter, and put the best side out. Make the other work to correspond and you are likely to be correct, to show good artistic judgment.

The bench vise question is easily answered. Make the vise leg shorter and mortise up through the bench top, and you will have no more trouble of the kind mentioned.

D. S. PICKETT.

Steel Bridge Builders, Too!

To the Editor:

Wymore, Neb.

The accompanying photograph shows a steel span railroad bridge that I have just put up near here. I have been a bridge builder for eleven years; thought you might be interested to know that you have builders of steel bridges

as the seeding time comes in its season, a time to plant and a time to harvest; and if this is done in the proper season and with intelligent cultivation and care, the harvest may be looked forward to as a reasonable certainty of bounteous returns. But if the seeding time is neglected, no matter how much time and labor is spent in the preparation, the development time has been passing by, and the laborers who slept in the morning of life just because it seemed more pleasant to slumber than to labor are sure of disappointment. They let the preparation time pass by and chose the heyday of life for the beginning—a time when the harvest should be maturing. Summed up in a few words this is a late start, unseasonable weather and a poor harvest.

Father Time waits for no man. He moves on schedule time, bringing with him the bright sunshine, the invigorating

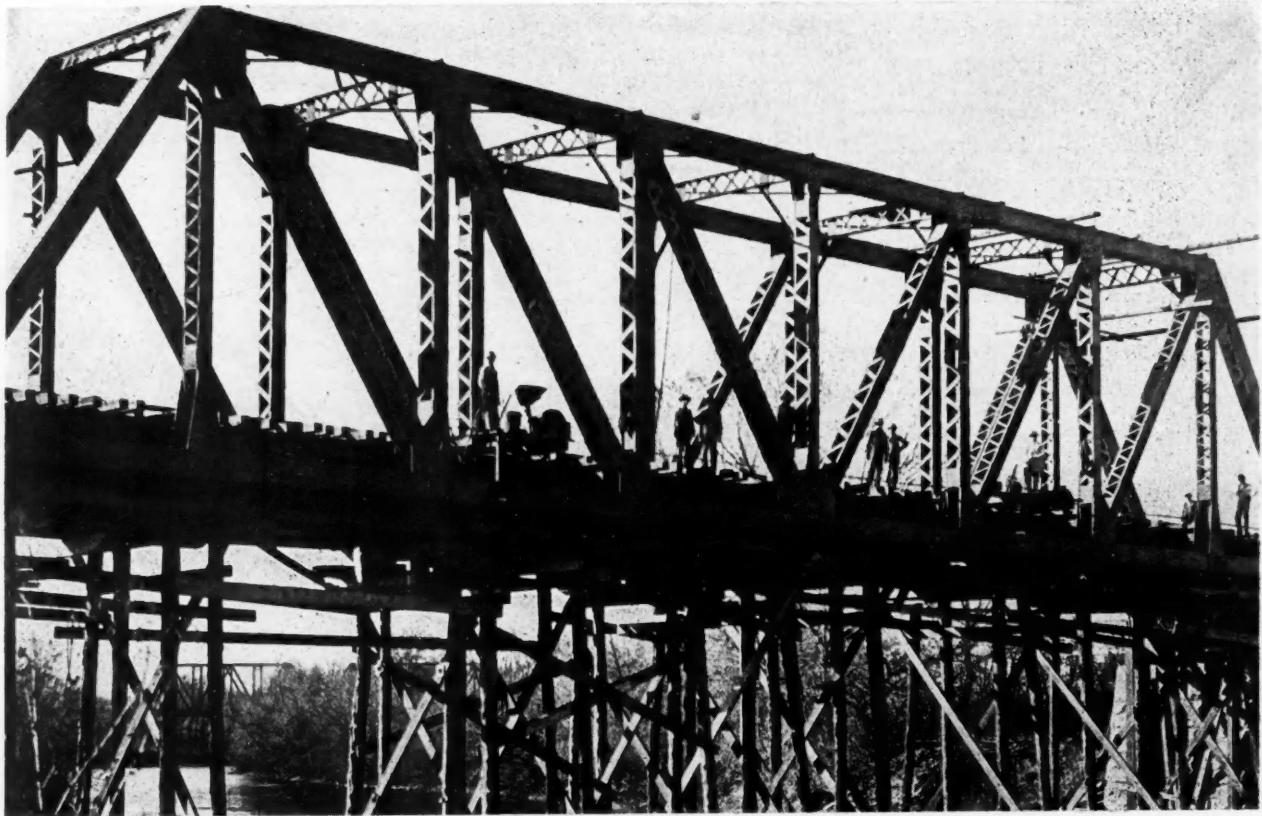

Steel Bridge Built by Our Subscriber, Mr. T. Hutson, Wymore, Nebr.

among your subscribers, and might like to see a picture of some of their work.

Will say that I get many fine ideas from reading the AMERICAN CARPENTER AND BUILDER. T. HUTSON.

Opportunity—(or Be Seasonable)

To the Editor:

Lincoln, Neb.

I have read with pleasure the article Stop! Look! Listen! by H. Lynn Staley, published in the last number of this magazine. It contains a whole lot of good meat which should be wholesome to the appetite of all seeking the easy road in life's journey.

The trouble is there are dyspeptics in all lines or professions. They partake of all that is set before them, in fact they bite off more than they can chew; they do not masticate as they should, and the result is, they do not get the proper assimilation of the nutritious parts that go to build up a strong system of being able to do things right and at the right time.

There is a time to prepare for life's battles just as surely

air and the refreshing showers so necessary in the spring-time of life for the proper germination; and in the midday of life he passes the meridian; the changing time in life's scales from the developing period to the maturing. In the afternoon he brings the sunshine suitable for the ripening of the golden harvest and before the sun goes down the industrious laborer gathers in the harvest for the long winter's supply. But the late planter's harvest is nipped in the bud because he planted out of season, his sun goes down on a harvest ungathered.

WM. D. SPRINGER.

Two Questions

To the Editor:

Smithland, Ky.

Will some of the readers of your valuable paper please answer the following questions:

In a square hip roofed building for a church or school house, where the ceiling cannot be supported as in a ridge roof from crown of rafter, how should the ceiling joist be framed and supported?

Also how can the shingling of a hip roof be best accomplished with any width of shingles?

J. A. THOMPSON.



Results of a Kansas Tornado

To the Editor: Hiawatha, Kansas.
 You may have heard that we sometimes have cyclones out here in Kansas. On April 16th last there was a good little



Wreck of Frame House, Home of H. Zimmerman



Cellar of Vanbuskirk House Where Five Lives Were Saved

one about four miles and a half southeast of here that did a lot of damage. A great many houses were completely wrecked. We have all been very busy since the storm rebuilding and repairing.

It is interesting to us who make a business of building



Brick House Wrecked by Tornado

houses to see the effect one of these cyclones has on even the strongest built house. The pictures will show how some of the houses looked the morning after the storm.

WILLIAM ASKEY.



Veranda Design

To the Editor: Regina, Sask., Canada.
 Will you please let us have a design for a veranda to extend across the front of a house, 20 feet wide. The gable end of the building faces the road; the house is built with 14-foot studs and one-half pitch roof. The veranda should have no return ends. The design required must be plain, but to include a handrail.

We should also like to know of a suitable moulding to use at the junction of siding and shingles on a gable end where the gable is shingled.

E. VENNING.

Answer: The accompanying drawings will show one idea for a porch or veranda to meet the requirements you name. It is attractive, yet inexpensive.

The detail at one side shows a cross section through the outside wall where siding and shingles come together, as in the case you mention. A special moulding something like that detailed should be used, both for appearance sake and to make a weather-proof joint.

EDITOR.

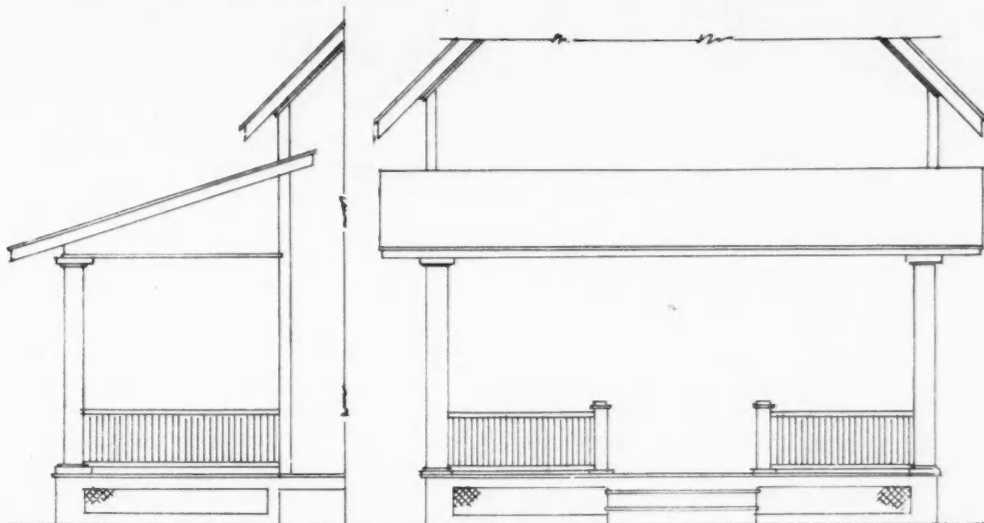

Suggested Design for Front Veranda

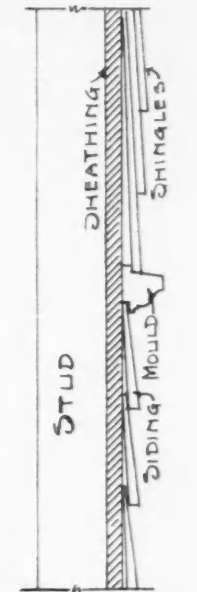

Detail of Gable Wall

A Handy Vise

To the Editor: Cheboygan, Mich.
I am a charter subscriber of your valuable paper and I see

for about twenty years and I find it very handy as it is adjustable. It can be raised above the top of bench, which is very handy in using a draw knife

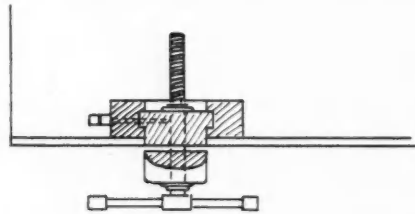
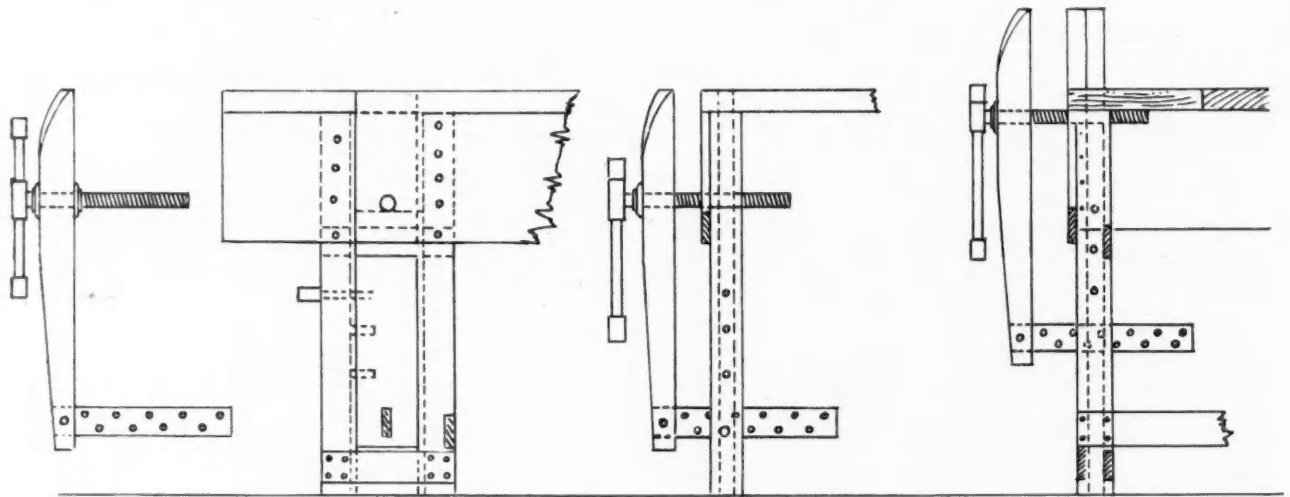

Arrangement for Wood Bench Vise

in the June, 1911, number that Mr. Venning would like a little information as to how to build a bench vise. I herewith inclose a sketch of one that I have used in shop work

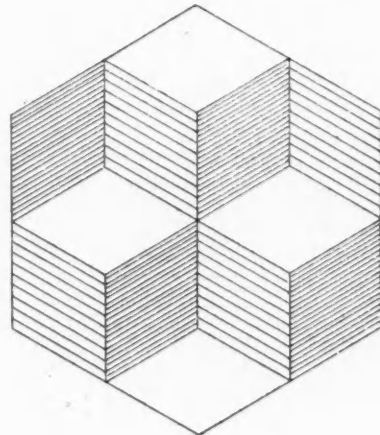

THE TRICK CUBES

If you think this is worth publishing you are welcome to same. I also am sending a diagram of some trick blocks which you may also publish if you care to do so.

ALBERT E. JEWELL



Another Roof Plan

To the Editor: Wood River, Ill.
I am enclosing you an outline of the ground plan of a cottage and would be glad to have you give through the columns of your paper the best method of drawing the roof.
M. F. PILKINGTON.

Answer: The accompanying drawing will show the best method of roofing a house of this kind. EDITOR.



A Rafter Framing Method

To the Editor: Ashley, N. D.
I am sending you drawings, showing an easy and simple way to obtain the lengths and cuts for all rafters required in roofs intersecting with unequal pitches. This method may be used for roofs having equal pitches as well. Fig. 1 is the plan of a roof in which the ridges are on same level, the span of one part being 12 feet and the other 16. The

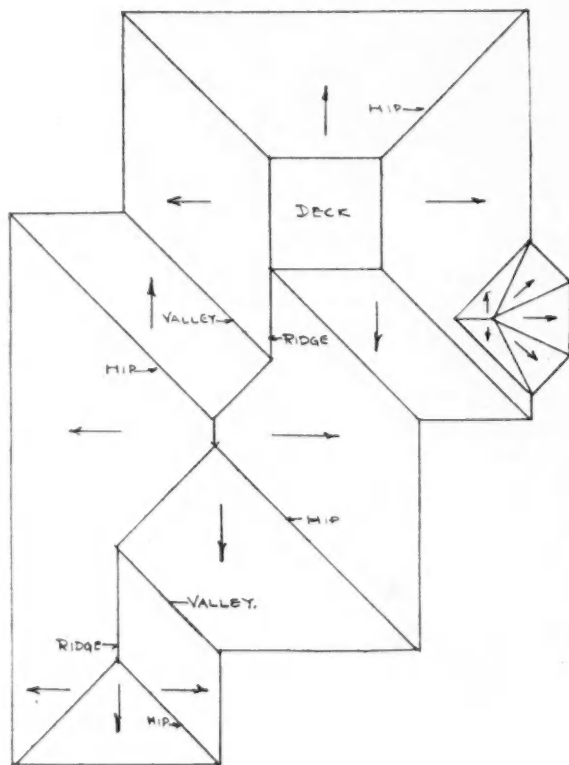

Suggested Plan for Bungalow Roof

ridge of the 12-foot span is indicated by the line AB and that of the 16-foot by the line AE. The roof of the 12-foot span is assumed to have a 12-inch rise per foot and both parts to have a 12-inch eave projection measured square back from walls. Parts in Fig. 2, similar to those in Fig. 1, are illustrated by like letters and figures.

In making the diagram Fig. 2, first draw the ridge lines AB and AC at right angles to each other (see Fig. 1). The complete roof plan as shown in Fig. 1 is not essential in practice, but is shown as an explanation to the diagram Fig. 2. The plate lines DD and DD are drawn next, each to be parallel with its respective ridge and at a distance from same equal to one-half the required span. The cornice lines EE and EE are drawn parallel to DD and DD, the distance between being the same as that of cornice projection. Connect A with E (intersection of cornice) and line AE will give the run of valley rafter. The lines FE and GH are next in order, giving the run of a common rafter for each of the 12 and 16-foot spans, respectively.

It often happens that the last two common rafters next to a valley are set at unequal distances from same. The spacing for jack rafters is continued along the ridges from the last common at the required distance on centers. The run of the jack rafters is obtained by drawing lines perpendicular to ridges and intersecting the run of valley, the lines being drawn from the spacing before mentioned. The next step is to obtain the lengths of the different rafters. As before stated, the roof of the 12-foot span is assumed to be one having a rise of 12 inches per foot. Any other rise or differently proportioned spans might have as well been taken. It was thought that if definite rise and spans were taken, the explanation might be made more clear.

In this case the total rise will be 7 feet above toe of rafters at projection ends. Draw the line AI, 7 feet long, square

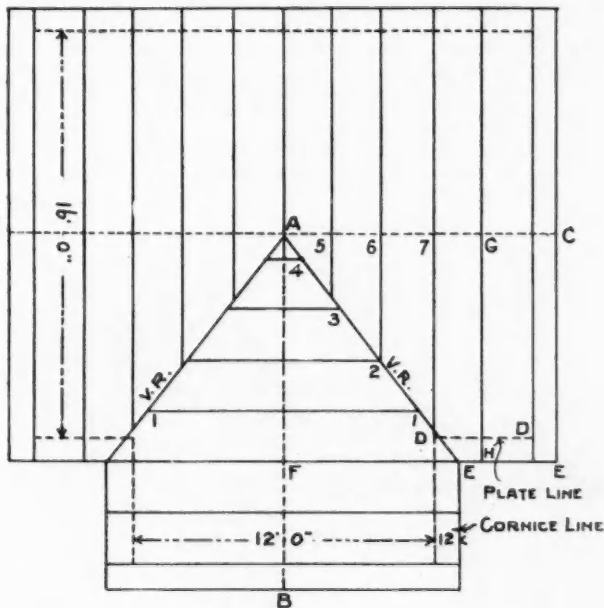

FIG. 1.
Plan of Roof and Rafters

back from run of valley and connect I and E. IE is the length of valley rafter. The length of the common rafter FE is obtained by measuring off the total rise (7 ft.) along ridge from F to B, and joining BE, the line BE giving the length. Proceed in like manner to get the length of rafter GH. Make C 7 feet from G. CE is the length required.

To get the lengths of the jack rafters meeting at ridge AB, draw lines 1 and 1, 2 and 2, 3 and 3 and 4 and 4, all parallel with ridge line AB. The lengths of the jack rafters is

found along the line BE: B4 giving the length of jack 4, B3 length of jack 3, etc. Lengths of jack rafters meeting at ridge AC are found in like manner; C5 being the length of jack 5, etc.

In order to readily understand the method shown in Fig. 3 for obtaining the side cuts of valley and jack rafters, it should be remembered that if the rafters shown in roof plan, Fig. 1, were entirely level and the roof without pitch, the side cuts for the jacks 1, 2, 3 and 4 could be taken from the angles as at O and those of the jacks 5, 6 and 7 from the angles as at P. Also the side cut of the valley rafter

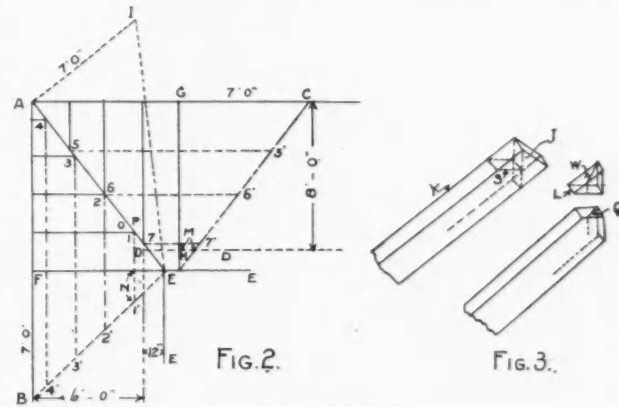

FIG. 2.
Hip of Unequal Pitches

would be the same as the angles it forms with the ridges AB and AC, the left hand cut being on the left hand side and the right hand cut on right side. Of course side cuts for all rafters in flat roofs of equal span would be an angle of 45 degs., or 12 and 12 taken on the square. The next step is to secure the block Y on which to mark the bevel. This is preferably the same width and thickness as the rafter for which we are to get the cut, or the end of the piece from which the rafter is to be made may be used. First saw the plumb cut J and square back from J, S, making the triangular block L. Take, (as before explained) the angle which would be used in flat roofs and transfer it to the horizontal cut on block as shown at Q, marking the location where it touches face of block, then replace triangular block L and draw a line upward from the marked location parallel with the plumb cut. Draw the line W as shown which gives the side cut sought.

The jacks for the roof in question are cut in pairs—one right and one left. All jacks should be cut one-half the thickness of valley short, measured square back from bevels and valleys one-half thickness of ridges. All measurements for jack, valley or hip rafters should be taken along center of top edges. The plates must be made of different heights, the difference being equal to the difference in the rise of the two pitches in width of cornice. Take the difference in the length of lines M and N for difference in height of plates, the steeper roof having the higher plate.

The plumb and foot cuts for the common and valley rafters may be readily found in the usual diagram way, the jack rafters having, of course, the same foot and plumb cuts as the common rafters. The diagram Fig. 2 should be carefully drawn to a scale of one inch or more to the foot. All the principles used in this method for obtaining lengths and cuts are of ancient origin, yet a part of the manner of their application is, so far as I know, new.

Now, Mr. Editor: if you think this article of sufficient merit to deserve publication, and it should prove to be a help to some brother chips, perplexed when constructing unequal pitched roofs I will feel well repaid for my trouble.

CHAS. J. MOORE.

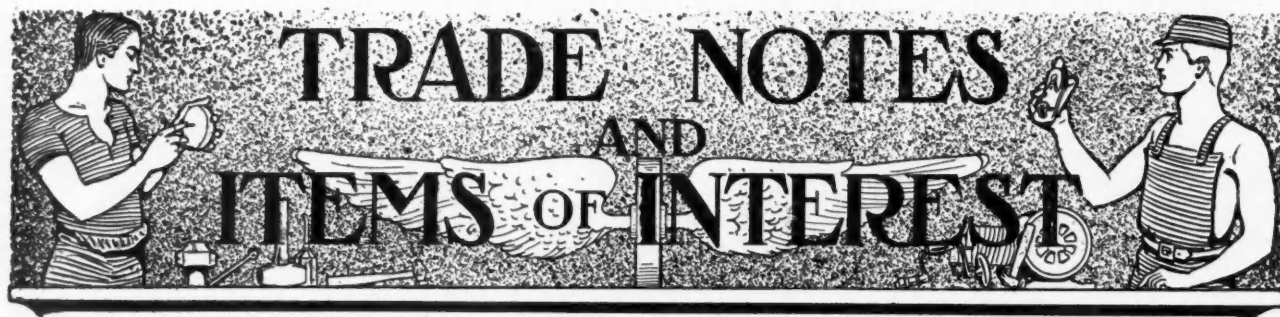

Hollow-Wall Concrete Houses at Low Cost

For the past four years, W. N. Britton, a well-known real estate operator, contractor, and builder, of Rochester, N. Y., has been erecting hollow-wall concrete houses. These houses are now being put up in the so-called "Britton" subdivision, in Rochester, a tract of about 132 acres lying along three streets, each a mile long, running west from Lake Avenue, just south of the plant of the Eastman Kodak Company. Seventy houses of this type are being built by Mr. Britton this summer.

Naturally, the erection of these concrete houses involves the use of a patented device—known as the "Van Guilder" hollow-wall machine. Mr. Britton first experimented with this device four years ago, when, by rather laborious methods, he erected several hollow-wall concrete houses. From the start, these houses were a success, as they were easily sold or rented. The second year, about 10 houses were erected; last summer Mr. Britton built 18 more concrete houses; this season, he is putting up 70, and even at that cannot supply the demand. When the houses were first built, Mr. Britton actually figured at renting them for less than frame houses; they are now renting for \$26 per year more than frame houses of the same layout and dimensions, and, when sold, bring from \$400 to \$1,000 more than the latter. It should also be stated that the demand for houses in this locality is steadily increasing, as they are built to sell and to rent to operatives in the Eastman Kodak Company's plant.

The houses under construction this summer are all the same size, 25 by 27 feet, outside dimensions, containing full basement, three rooms and hall downstairs, four bedrooms and bath upstairs, and a large attic. The concrete houses

sell for about \$3,200, and rent for \$5.50 per week (all houses in Rochester rented by the week); frame houses of equivalent accommodations sell for about \$2,800, and rent for \$5.00 per week.

Mr. Britton's enterprise has been going on practically unnoticed by outside contractors for nearly four years. The

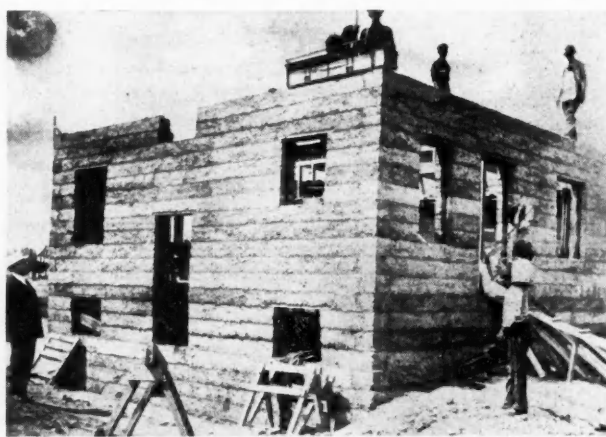

Walls Under Construction for House on Avis St., Rochester, N. Y. Basement and First-Story Walls are Complete. Photo Clearly Shows the Air-Space in Walls, also the Rough Exterior, to which Stucco or Other Finish is Easily Applied

houses he has erected of concrete have stood the test; the walls are stronger than ever; the occupants are enthusiastic; and the demand for the houses cannot now be filled. Mr. Britton is undoubtedly a pioneer in construction work of this



Row of Six Hollow-Wall Concrete Houses on Pullman Ave., W. N. Britton Addition, Rochester, N. Y. Finished Outside in Various Styles, but Built at Same Figure, \$1,971.50—See Itemized Bill of Costs for Materials and Labor

kind, and he has carried it past the experimental stage. Furthermore, that the building of these concrete hollow-wall houses is a money-maker is surely attested by Mr. Britton's statement that he would not take \$20,000 for his profits on the work this summer.

The cost figures given in the accompanying tabulated list of itemized costs are the actual amounts expended by Mr. Britton for these hollow-wall concrete houses, as well as for the frame houses. In outside dimensions, the concrete houses, as already stated, are 25 by 27 feet; and the frame houses, 24 by 26 feet. The inside dimensions are alike for both types of house, the difference being due to the necessarily thicker walls in the concrete construction. Both houses are the same height, the foundations being 7 feet, and the superstructures 18 feet high. Both frame and concrete houses have frame

at an actual saving in first cost over frame. While it is true that these Rochester houses are built to rent or to sell and hence are not given the finishing architectural touches that they might have, the essential features of good concrete construction are attended to. The writer went through some of the houses that have been up three years. No sign of wall cracks was noticeable. The tenants and owners assert that the inside walls are perfectly dry. Paper applied to the direct plastering has shown no sign of dampness or discoloration.

It may be interesting to add that Mr. Britton has also built by the Van Guilder hollow-wall system a storage warehouse, on his property. This warehouse has two 4-inch walls, with 2½-inch air-space, and carries from 100 to 200 tons of cement. This well illustrates the strength of the walls.



Hollow-Wall Concrete Houses at Bellaire Park, Long Island, New York City
Unfinished Porch Foundations Show the Hollow-Wall Feature

roofs, shingled. The cost of excavating the cellar and footing is not included in the figures below, as it is the same for both houses, and depends entirely upon local conditions.

Relative Costs of Hollow-Wall and Frame Construction

	Concrete	Frame
Concrete Work		
Man to operate machine, 14 days, at \$3.50 per day	49.00	
3 laborers, 14 days each, at \$1.75 per day	73.50	
Concrete mixer, including gasoline, 14 days at \$1.00 per day	14.00	
Cement, 41 bbls., at \$1.20 per bbl., car-load lots	49.20	
Gravel, 56 loads, at \$1.00 per load (on property)	56.00	
Ordinary stucco finish outside	40.00	
Wire reinforcement and ties	5.00	
Total cost of concrete	\$ 286.70	
Lumber bill	300.00	\$ 456.00
Lath, 6,000 for concrete; 8,000 for frame	30.00	40.00
Carpenter labor	230.00	315.00
Plaster, 5 tons, at \$6.00 per ton	30.00	30.00
Brick, 1,500, at \$8.00 per thousand	12.00	12.00
Flue lining, 22, at 30 cents each	6.60	6.60
Mason and helper	60.00	60.00
Lather	15.00	20.00
Inside trim, chestnut	350.00	350.00
Plumbing	250.00	250.00
Furnace (concrete house two sizes smaller)	100.00	120.00
Hardware	30.00	30.00
Paint and painter, inside and out	90.00	160.00
Tinning, nails, and incidentals (saving for concrete house principally in nails)	135.00	150.00
Window frames, 22, at \$2.10 each	46.20	46.20
Building paper, 6 rolls for frame house, at 80 cents per roll		4.80
Solid concrete foundation walls for frame house		140.00
Total cost for both houses	\$1,971.50	\$2,190.60

From these figures it is apparent that in any city where building material prices approximate those of Rochester, seven room houses of uniform floor plan can be built of concrete

The machines used in the construction work described in this article are manufactured and sold by the Van Guilder Hollow Wall Co., 720 Chamber of Commerce Building, Rochester, N. Y.

A catalogue and full particulars can be obtained by addressing the company.

The Finest of all Flooring

When one familiar with the subject of flooring hears someone inquiring for or asking what is the finest of all flooring, his thoughts instantly turn to quartered oak. Oak in any form is claimed to be best of all wood for flooring, and when oak is quartered the acme of perfection is said to be reached both in point of finish and durability and stability of the floor.

In quarter sawing oak, that is, in sawing from the heart to the sap across the rings of growth, there is brought out that beautiful figure known in the cabinet world as the splash line. Sometimes it is very conspicuous. At other times it is more subdued, but always it is attractive, takes a high polish, and is very desirable. Moreover, flooring with the quartered face presented not only polishes easily and shows more beauty of figure than can be presented in any other way, but it also wears longer, gives more service and better service.

Quartered oak flooring is manufactured in the same general widths as plain oak, and by the leading oak flooring manufacturers, into two general thicknesses, the standard 1¾-inch and the thin stock of ¾-inch. The 1¾-inch can either be laid on or without a sub-floor, depending on whether or not one intends to lay in border or paving effects.

With the different manufacturers the price differential varies between $\frac{3}{16}$ -inch stock and $\frac{3}{8}$, probably a fair average differential is 35 per cent cheaper for the $\frac{3}{8}$ stock. Some do not make this much difference, because they claim it takes the same work in manufacturing a thousand feet and there is more loss in trimming, but others figure differently.

There is one point about all flooring, where a man is seeking to get the best, which has not been touched on very extensively heretofore and needs attention right now. And that is, quality in flooring depends to quite an extent on quality in manufacture. That is, on the expert knowledge of handling and matching that comes only through study and experience at the work. Any man can take good oak and make a serviceable flooring out of it with a flooring machine and a dry kiln, but to get the highest quality in appearance and in service requires special equipment and expert attention from the time it comes into the mill. In the first place it must be so thoroughly dried that there is not a vestige of moisture left in it. This on its face looks simple, because it is only a matter of applying heat, but it is not so simple as it looks for the very fact that in obtaining this thorough dryness it must be done without in any way injuring the structure or body of the wood. If it is dried carelessly or recklessly there develop checks and what is termed honeycomb in the wood until it is neither beautiful nor serviceable.

After the drying the same painstaking care must be exercised in ripping, preparing and matching the lumber. It is not only a matter of finishing the face and getting it in uniform thickness and widths, but it must be neatly and carefully matched so that the joints will not only fit up smooth and neat, but the tongue and groove must fit together snugly so as to give strength at the joints and where the end matching comes. The manufacturers who are experienced in this work are very careful in their measuring and in adjusting their machines and frequently resort to microscopic measurements and keep very careful standards so that the flooring will be of uniform width and thickness and will match up right. Therefore, it is well to add that in offering to your customer the finest of all flooring that you not only seek oak for quality, and quartered oak for the highest quality of all, but there must go with it an equally high order of work in preparing and manufacturing, and generally the place to get this is with well known and reliable manufacturers who make oak flooring their special business.

Sidewalk Doors

The sidewalk doors manufactured by The Canton Foundry & Machine Co., Canton, Ohio, and illustrated herewith, are made in nearly fifty different sizes and in cast iron checkered, checkered steel, and illuminated tops. These doors have been constructed with a view of meeting general requirements and, at the same time, furnishing something that has a good appearance.

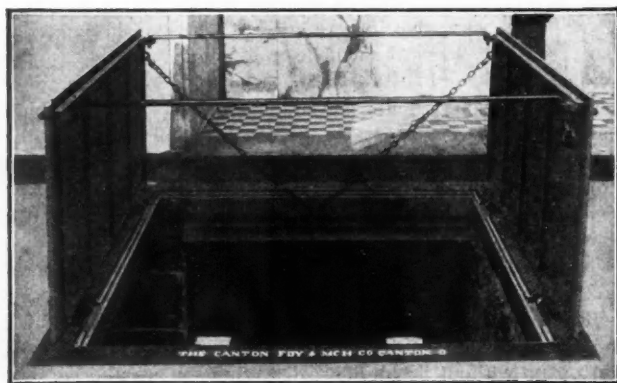

Sidewalk Doors Open

You will notice from the cut that these doors are entirely flush. There is no obstruction or projection to interfere with the free walking of pedestrians. Every builder has, no doubt, in his own experience stumped his toes on many a brass hinge which probably was the only projecting feature of an otherwise very good door.

These doors are made as near water-proof as it is possible for a sidewalk door to be made. The illustration shows the groove on the frame underneath the door which carries the water to a low point and then conducts it through a small pipe to the gutter. The solid door when open is protected in a manner that will avoid accidents to passersby. It can also be locked from either side; and to be unlocked from the outside requires a special key which accompanies it.

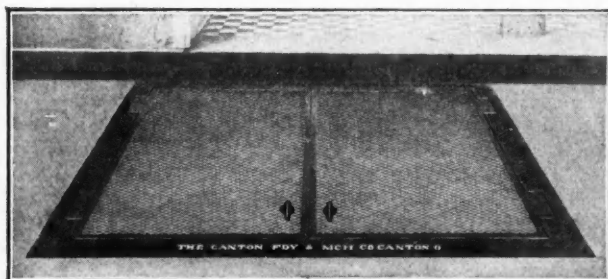

Sidewalk Doors Closed

The illuminated door also sets flush with the sidewalk and owing to its weight, must, of course, be opened and closed with a ratchet attachment, operated by a worm gear, connected with a T handled key operated from the cellar floor. This key is made in various lengths to suit different requirements. The prisms and lights are furnished in various styles from a plain square glass diffusing the light directly below, to various forms of prism lights which cast the rays of light back into the basement.

In addition to the sidewalk doors this concern make a large line of building accessories such as self-locking coal chutes and doors, cast iron conductor connections and boots, sidewalk gutter boxes and wheel guards, cast iron columns to suit different requirements, coal hole rings, solid or illuminated, as well as a self-locking square coal hole frame with cover, the latter being either solid, ventilated or illuminated. They also make a complete line of street contractors supplies, viz. Catch basins, manholes, channel boxes, etc.

Our readers are interested in some or all of these lines and should write at once to The Canton Foundry & Machine Co., Canton, O., for catalog and price list.

Antifriction Ball Tip Butts

The new Antifriction Ball Tip Butts being offered by the McKinney Manufacturing Company, Pittsburg, Pa., and illustrated in their advertisement on page 72, embody features of interest to every carpenter and builder on the lookout for things of merit. These butts are made of special metal which this company have developed and perfected after a long series of experiments and severe tests. They are fitted with this company's antifriction washers.

There are no delicate parts to these butts to become deranged or lost. They require no adjustment and need no oiling. The claim is made that they permit the heaviest doors to swing easily, freely and noiselessly.

All sizes are equipped with the new non-rising pin, which is another patented feature, eliminating all troubles incident to partially lifted pins.

The McKinney Manufacturing Company make these butts in all standard finishes. They also make strap and T hinges, barn-door hangers and tracks. These items are fully described in their new 1911 catalogue which will be mailed to those interested, on request. Address the Company, Department 4, Pittsburg, Pa.

Timber Construction "Coming Back"

Those interested in timber construction note with approval the reports now going the rounds in lumber circles that a wide and carefully planned educational campaign is soon to be undertaken to emphasize and further develop public confidence in wood as a structural material.

The excellent record of properly designed "mill-construction" (of wooden beams or both beams and columns, even in structures externally of brick or stone) has begun to impress manufacturers, architects and builders with wood's really surprising value as a fire-resistant as compared with unprotected or partially protected steel.

The financial section of the New York *American* recently contained a most interesting interview on this subject with John Bemer Crosby, who is probably the best authority in the country on general market extension for lumber as a whole. In forecasting a revival of wood construction Mr. Crosby said:

"It looks as though wood as a structural material has an increasingly good chance to 'come back.' It is a fact, little known, that fire-resistant wood interior construction for manufacturing can be insured at a lower rate than unprotected or partially protected steel. An early instance affording a comparison occurred in Arlington, N. J., three or four years ago. They were one steel 'I' beam short, and to save time put in a wood beam. A fire shortly after twisted and sagged the steel beams and merely charred the wooden one, which remained the only straight and true thing in the place. When they rebuilt, they used 'slow-burning' wooden mill construction.

"Another case recently was the great sawmill at Bogalusa, La., the largest plant of its kind in the world. It was all steel and concrete, and no insurance was thought necessary. A fire threw it into ruins, and they had to dynamite the debris at a cost of \$5,000.00 to clear the site for rebuilding, which they did with wood.

"Wood is still good for something besides nutmegs, tooth-picks and wooden legs, though concrete enthusiasts may aspire to include those in their market. There is business enough for both materials, but neither can expect to get its share of public dependence and public favor unless its manufacturers care enough about their market to go after the consumer, himself, who in the last analysis is the only real market for anything."

After reading Mr. Crosby's interview the AMERICAN CARPENTER AND BUILDER investigated the Bogalusa saw mill case referred to and found it a very illuminating instance which may well carry a valuable lesson to many manufacturers wrestling with the factory-building problem.

We understand that the mill was 450 by 125 feet, of steel construction, thought to be fire-proof and so carried no (or very insufficient) insurance. It held 35 machines, electric-driven. The fire was attributed to a paper friction pulley.

When they rebuilt they made it of wood (650 by 140 feet). It is said to be the largest saw mill in the world. They make lumber and now they believe in it themselves.

It is an interesting fact that probably a great many powerful, successful and broad-minded lumber manufacturers have given singularly little study to many of the side angles of wood's usefulness. They may have taken too much for granted and not have realized that many remote details really were, and are, absolutely vital to the stability of their market.

The present writer knows keen, brilliant and important lumber manufacturers who confess their lack of knowledge of the principles and economies of mill-construction as against steel, and if the makers of a product do not realize its merits how can they expect the consuming public to do so?

We have had many appreciative expressions from heavy lumber operators complimenting us on our article on mill-construction in the AMERICAN CARPENTER AND BUILDER for February, 1911, and their statements of the value to them of

the authoritative information and detail drawings therein shown.

This magazine will acknowledge their appreciation by further earning their confidence and respect, and has in preparation other articles of similar character and of the highest technical value.

Unlike the promoters of the competitive materials, lumbermen as a class have never called the attention of the real consumers to the merits of their product but have been content to take what business came to them as a matter of course. One of the brilliant exceptions recently called this habit "fatalism" and urged that his fellow lumbermen get busy and do something for themselves. The carpenters know only too well what the result of this passive and illogical course has been.

They will be glad to know, therefore, that a movement is now on foot for a broad campaign of energetic, intelligent and persistent advertising to teach the general public that wood cannot be surpassed as a structural material, nor equalled by any of its substitutes for hundreds of uses, and further that its use is unlimited for all time to come. There is plenty of wood left—untold millions upon millions—the misinformed public belief to the contrary notwithstanding.

A member of the "Committee on Advertising" of the National Lumber Manufacturers' Ass'n., who is one of the most important figures in the lumber industry and is known as a strong though cautious supporter of the general publicity appeal, said in a recent address, "The *Red Gum and Cypress* manufacturers have been advertising long enough, in various publications, to prove beyond all doubt that this is the right method to pursue." He said further, that he was led into consideration of it by the success of the two kinds of wood whose producers had been, and still are, doing the demonstrating. "Their results have been very remarkable because their campaign has been in the hands of a first-class advertising agent and their follow-up work gotten up by an expert, and there is no place I know of where money can be wasted so easily and quickly as in ill-advised advertising."

As the AMERICAN CARPENTER AND BUILDER is carrying the famous *Cypress* advertising we are glad to concur in the above judgment and to have had our part in contributing to signal results in a case of public education which exacted the broadest experience and a careful though daring handling because of there being no precedents in advertising history to serve as guides.

The general determination to "restore wood (as the committee reports) to its rightful position as a worthy contestant in the war for business" is welcome news to the carpenter and the carpenter contractor. They will watch the progress of this educational campaign with interest.

This magazine will also further the cause of its readers by important articles from time to time, each with some special and permanent value for reference.

Parks' Portable Saw Table

The Parks' Ball-Bearing Machine Co., Cincinnati, Ohio, are offering their Nos. 205 and 405, portable Circular Rip and Cross-Cut Saw Machine illustrated on page 72 (shown mounted with gasoline engine). The engine mounting with angle steel base extending to and including engine base shows their method of mounting engine with any of their combination saw machines. This angle steel base with heavy angle steel frame with overlapping corners, strongly braced and securely bolted together makes an unbreakable, yet portable machine of great steadiness with a long, solid, stiff and rigid foundation of most compact substantial character, while distributing strain over more floor space.

Table top is hinged in the back to raise and lower, adjusting the depth of cut, with opening for a 14-inch saw, which will cut 5 inches deep. Height, 34 inches; width, 23¼ inches

(overhanging base left side, 7 inches); length, 3 feet.

Base—2 inches by 10 inches by 4 feet long (not including engine base).

These machines are made in two sizes, and require 2 and 3 horsepower engines.

Attachments that can be added to No. 205 or No. 405—3 in. Moulder or Jointer; 6 in. Jointer; Tilting Guide; Rabbet-

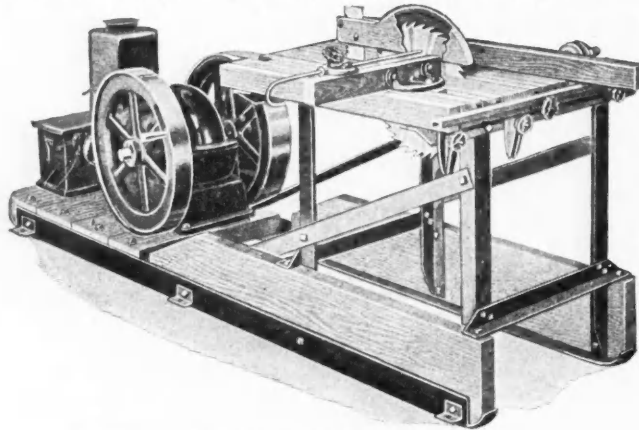

Parks' Portable Saw Table

ting attachment; Boring attachment; Groover and any style head for the great variety of work.

All readers of AMERICAN CARPENTER AND BUILDER are urged to write the Parks' Ball-Bearing Machine Co., Cincinnati, O., for full particulars and prices on these machines.

Getting at the Facts in Regard to the Merit and Value of Ready Roofing

"If twenty samples of 2-ply rubber roofing, each made the same day at twenty different mills, were laid before you, could you pick out the one that would be most durable?"

The above question was submitted to a number of roofing manufacturers and their answer, without exception, was—"No."

This fact is more or less unfortunate as it practically deprives the buyer of the use of his judgment in purchasing roofings. How then is a user of roofing to know when he is buying a dependable, durable roofing? And this question is of the greatest importance for it is absolutely remarkable the durability and satisfactory service a Prepared Roofing will give when made of the right materials—while an unsatisfactory roofing is an "abomination forever."

Probably no commodity has ever been marketed surrounded with so much "mystery" and "bunco" as the

so-called Rubber Roofings—they look like rubber, but everyone knows they contain no rubber.

Few contractors and builders or even the best posted architects understand fully the difference between Asphalt, Asphaltum, Asphaltene, and the various trade terms used by manufacturers in describing their products, and very few of the ultimate users of roofings even understand the difference between Asphalts and Coal-tar or Pitch.

The Northwestern Lumber Dealers' Association, realizing the lack of authentic information and believing that there was no "mysterious" or "secret process" necessary to the production of these goods, which the retailers, and the consumers too, were not entitled to know, appointed a committee to visit all the important roofing factories in the United States to get at the actual facts. The committee not only visited the leading factories, but investigated the Felt Paper Mills, Rag Sorters, Rag Importers, Wholesale Dealers in native and foreign Asphalts, Jobbers and Brokers in so-called home and foreign Pitches; also the sellers of Fluxing Oils and finally investigated the machinery used in making roofing felts and in saturating and coating these felts.

The facts disclosed by this investigating committee are of the greatest value and interest to Architects, Engineers, Contractors, and all prospective users of roofing and waterproofing materials, particularly in view of the unbiased source of the investigation.

The Lumbermen have certainly accomplished a work that will be greatly appreciated and that will result in greatly increasing the sale of ready roofing, for where the public has some way of knowing that they are purchasing durable roofing made from durable materials they will not hesitate to use it in innumerable cases—its low cost and ease of application recommend it.

The report has been published in illustrated form and is now ready for free distribution. An advertisement on page 87 of this issue by the General Roofing Mfg. Co., York, Pa., Marseilles, Ill., East St. Louis, Ill., Minneapolis and San Francisco, announces that they will gladly send a copy to anyone interested, without charge.

Morrill's Saw Points

Useful Little Book Telling How to Joint, Set and Sharpen Saws

That a knowledge of the principles upon which his tools are constructed and operated and a further knowledge of how to keep them in the best working condition is desirable will be admitted by every user of a tool.

This knowledge enables him to do better work in an easier manner and to prolong the life of his tools.

From the long experience of years in making saw-sets,



ANTIFRICTION BALL TIP BUTTS

(Patent Pending)

Strongest, Best and Cheapest Antifriction Butts Made

GUARANTEE OF QUALITY
STAMPED ON EVERY BUTT



FURNISHED IN ALL
STANDARD FINISHES

Makers of Strap and T Hinges, Barn Door Hangers and Track

McKINNEY MFG. COMPANY
WRITE FOR NEW 1911 CATALOGUE DEPT 4 Pittsburgh, Pa.





Where the Big Bargains Come From

Out from these great concrete warehouses come the greatest millwork and lumber bargains that the American market affords.

Our whole business revolves around the bargain idea. The present building season finds us better equipped than ever before to save money for contractors and builders. You will be amazed to see the big reductions on staple millwork and lumber of highest guaranteed quality.

New Bargain Catalog Ready

This catalog is in itself an immense exhibit of the finest building material on the market. It offers an almost unlimited variety of the latest styles in millwork of every description. Doors in all regular sizes and in scores of new and beautiful patterns and in various woods—veneered doors in Colonial, Mission, Craftsman and other popular styles—art glass doors in exquisite designs and colors—doors for every purpose. Windows to correspond with every style of door. Mouldings, inside finish, flooring, mantels, stair and porch material—everything that goes into any home, down to the very last detail. A bargain price and a guarantee of quality, safe delivery and satisfaction on every item. Send for the catalog and see for yourself.

New Plan Books—Just Out

The new Gordon-Van Tine Book of Plans, prepared at a cost of over \$5,000, is now ready for free distribution to carpenters and contractors. A complete and practical work that gives 32 designs for city, suburban and country residences, cottages and bungalows costing from \$600 to \$6,000. Also 12 plans for barn, dairy and cattle barns and other outbuildings. **This book keeps cost within original estimates**, for every plan has been proved again and again by actual construction.

The Plan Book will be mailed free on receipt of 10 cents in stamps or a dime to cover cost of packing and mailing.

You Are Invited to Visit Our Vast New Millwork and Lumber Plant

Although we conduct our business entirely by mail, we like to have carpenters and contractors visit our plant. Hundreds of them do this every year. Our warehouse is the busiest place in Iowa. Come and see us loading 22 cars at a time from our loading platforms, extending the entire length of the plant. Meet personally the men who stand behind this gigantic enterprise. The latch string is always out.

We Can Save You Hundreds of Dollars This Season

Why pay middlemen's double prices for millwork, lumber and other building material? Save several hundred dollars this season by buying at net wholesale prices direct from

GORDON-VAN TINE COMPANY

589 Federal Street

Davenport, Iowa

WHEN WRITING ADVERTISERS PLEASE MENTION THE AMERICAN CARPENTER AND BUILDER

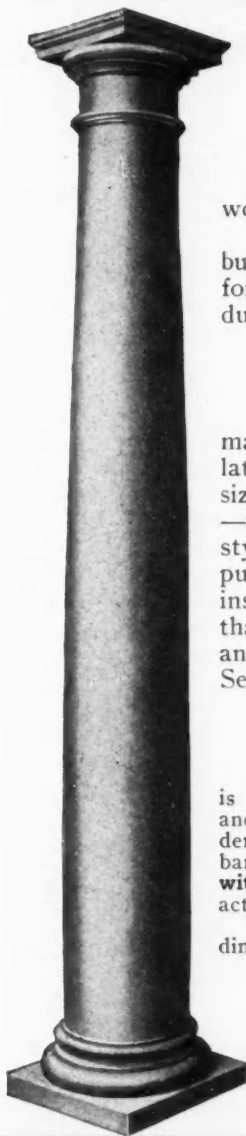

No. E 322—Colonial Built-up Column; Cypress, Plain Cap.

\$163

Dealer's Price, \$3.25

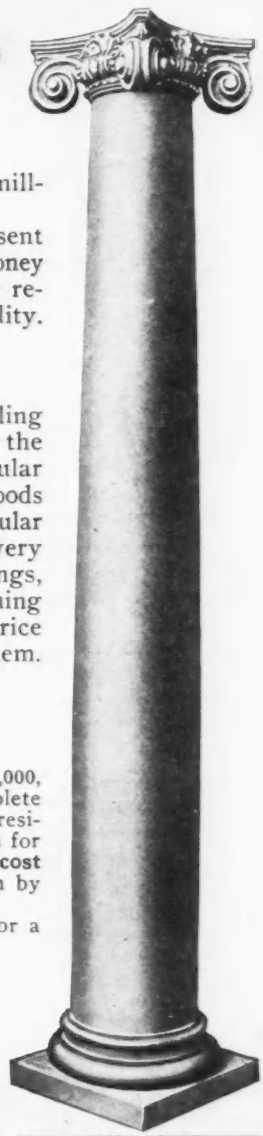

No. E 323—Colonial Built-up Column; Cypress, Fancy Cap.

\$222

Dealer's Price, \$4.75

**You Can Bid Lower and Still
Make Money if You Use an
"AMERICAN"
SAW BENCH**

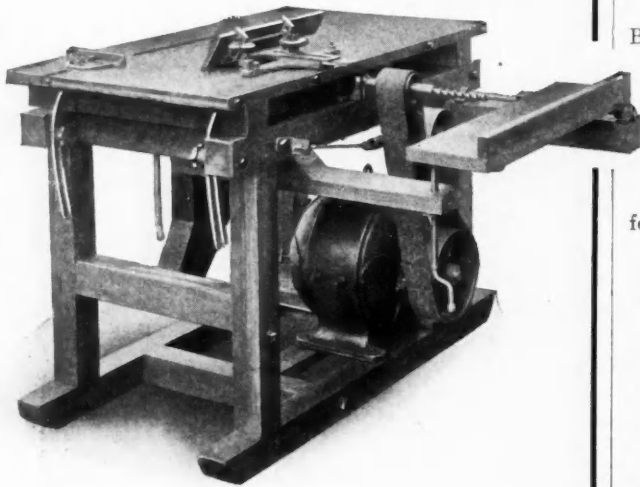

There's no use delaying longer. You've got to have an "American" Portable Saw Bench to meet competition these days.

When you have one of these time-and-labor-saving machines, you can shave off the little expenses which would otherwise throw the contract to your competitor.

If you have an "American" Bench and "the other fellow" has none at all, you have a tremendous advantage over him.

If your competitor has "some other" saw bench and you have an "American", you can still win out; for the "American" Bench has a larger capacity than any other.

Think it over. Go over your last figures and see how an "American" Bench would have cut your estimate of costs.

Then write to us for full information, stating your needs.

**AMERICAN SAW MILL
MACHINERY CO.**

82 Main Street
HACKETTSTOWN,
NEW JERSEY

1655 Hudson Terminal
NEW YORK CITY
NEW YORK

which are today the world's standard, Charles Morrill, 271 Broadway, New York, is well qualified to write with authority on the subject of the proper treatment of saws.

This little booklet "Saw Points" has, therefore, been written under the supervision of Mr. Morrill to give the users of saws some definite practical information on this important subject. This book will be mailed free of charge to any of our readers who will write Charles Morrill, 271 Broadway, New York, asking for a copy of it.

**Winners in S. C. Johnson & Son's Prize
Contest**

In the April number of the AMERICAN CARPENTER AND BUILDER S. C. Johnson & Son, manufacturers of artistic wood finishes, Racine, Wis., advertised a cash prize contest—\$150.00, to be distributed among the 41 painters who would send in the best letters (of not more than 150 words), telling why they use and recommend Johnson's Wood Dye and Under-Lac.

They now wish us to announce the winners, which are as follows:

FIRST PRIZE, \$25.00.

Mr. H. R. Brunell, 916 Bloomfield St., Hoboken, N. J.

SECOND PRIZE, \$10.00 each.

Stanley Sivers, 606 Third St., Albany, N. Y.

F. B. Carter, Gen. Del., Portland, Ore.

F. P. Connolly, 151 So. Water St., York, Penn.

Albert Borchardt, Monticello, Arkansas.

H. W. Richards, 164 Oak St., Elgin, Illinois.

THIRD PRIZE, \$5.00 each.

Christopher T. Sullivan, 46 Stewart St., Fall River Mass.

Thomas A. Cooper, 308 McClellan St., Schenectady, N. Y.

Joseph Denno, Alpena, Michigan.

R. F. Flannery, 325 Poole Ave., Long Branch, N. J.

J. N. Humble, 816 E. Cachela Poudre St., Colo. Springs, Colo.

Elmer Rosengren, 404 Anson St., Marshalltown, Iowa.

J. White, 6121 Sangamon St., Chicago, Illinois.

H. Edwards, Jupiter, Fla.

H. A. Baldwin, Box 589, Austin, Texas.

Jesse J. Jackson, Box 37, Teague, Texas.

FOURTH PRIZE, \$1.00 each.

J. P. Rowden, 313 E. 4th St., Texarkana, Arkansas.

George Voss, Benson, Nebraska.

Charles F. Hoefler, 122 Mystic Ave., Medford, Mass.

C. Churchill, 148 W. 16th St., Erie, Penn.

R. T. Hill, 3117 Forest Ave., Chicago, Ill.

E. G. Myers, 41 Elm St., Plattsburgh, N. Y.

J. W. Rainsford, 3704 Park Ave., Nashville, Tenn.

Anton Hoffstadt, 3212 Addison Ave., Chicago, Ill.

H. A. Struebing, 2739 Lafayette Ave., St. Louis, Mo.

Richard Holle, Jr., 708 8th Ave., Clinton, Iowa.

J. H. Clark, 412 E. Main St., Bradford, Penn.

Wm. Van Valkinburgh, 1221 Watt St., Schenectady, N. Y.

R. McEwartson, c/o G. Wallace, 6610 Hartwell Ave., Chicago.

Everett March, 217 Somerset St., Plainfield, N. J.

Richard Smith, 3 So. Central Avenue, Wollaston, Mass.

H. Laycock, 77 Southgate St., Worcester, Mass.

D. W. Edwards, Box 1140, Twin Falls, Idaho.

Frank Gordon, 127½ Stockton St., Brooklyn, N. Y.

E. C. Monroe, Berlin, N. J.

H. C. Faber, Monongah, W. Va.

Elmer Hahn, 71 Main St., Hudson Falls, N. Y.

Fred Bennis, 319 Spies Ave., Menominee, Michigan.

A. S. Joynes, Fortress Monroe, Virginia.

In one of the early Fall publications they will have another advertisement quoting the replies which have won the prizes.

Put It At Work In Your Shop

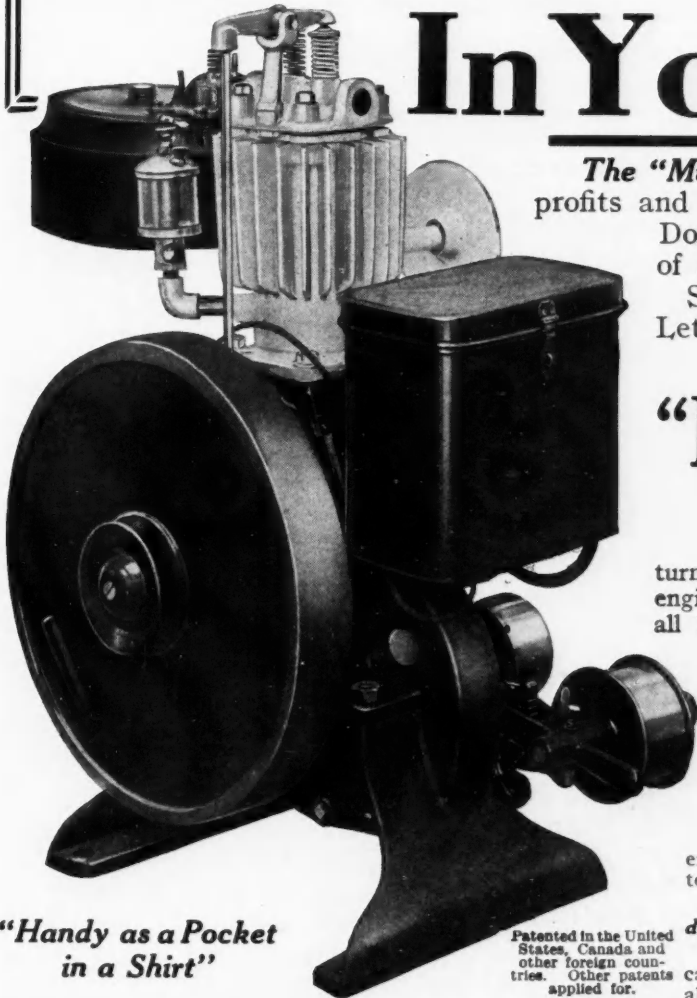

*"Handy as a Pocket
in a Shirt"*

Patented in the United States, Canada and other foreign countries. Other patents applied for.

The "Multimotor" Shop Engine increases your profits and keeps down the size of your pay-roll. Does the work of three men at an expense of *less than a cent an hour.*

Stop pedal-pushing and crank-turning! Let the

Fuller & Johnson "Multimotor" Shop Engine

turn the wheels in *your* shop. This wonderful engine is small in size but a giant in power. Runs all hand-power or foot-power machines—jig saws, lathes, emery wheel, grindstone, drills, etc. Just the thing for carpenters, contractors and owners of small workshops.

Perfectly Simple Absolutely Safe

Simplest, neatest, strongest, most reliable little engine ever built. Comes to you *complete*—nothing to add but gasoline.

Easily moved anywhere. For *indoor* use has *out-door* fuel tank, insuring perfect safety.

Important working parts protected by dust-proof case. Needs no attention while running. Works steadily all day on a few cents' worth of grocery-store gasoline. It is air-cooled, fool-proof, cannot freeze or overheat.

The "Multimotor" in design, material and construction equals the best automobile engines. Every engine is thoroughly tested before leaving the factory, and is *guaranteed!*

Fuller & Johnson Farm Pump Engine

Practically the same as "Multimotor," with pumping gears added. Can be hooked up to any pump in 15 minutes. Needs no belts, arms, jacks or special platform. Pumps 400 to 1,500 gallons every hour. Perfectly adapted to farm and suburban use.

Engine Book Sent Free!

Book, giving full information about "Multimotor" and Farm Pump Engine, sent FREE on request. Let us tell you more about these amazing little power-producers. Let us send you the name of the nearest dealer, who will show you the engine and *explain* what it can do. (264)

If interested in larger engines, ask for Catalog of Fuller & Johnson's Famous Double-Efficiency Engines.



Fuller & Johnson
"MULTIMOTOR"
Works Like Ten Men

FULLER & JOHNSON MFG. CO. 9 Ames Street (Established 1840) **Madison, Wis., U. S. A.**

Come to Roofing Headquarters

We Sell Direct From the Factory Every Dependable Grade and Kind of Prepared

SLATE SURFACED ROOFING AND SIDING.

SEND FOR FREE SAMPLES.

\$225 Per Roll

RED SLATE ROOFING

Proof against action of fire, snow, ice, lightning and wind. Cannot crack, warp, split or decay. Made without tar. Impervious to water, cold and heat.

Can be laid over old shingles or tin if desired. The heavy coating of natural colored red or gray crushed slate is firmly imbedded in a 3/4-ply fabric of long fiber felt, from 10 to 15 per cent heavier than any other rubber felt roofing manufactured. In its composition, weight, thickness and quality it is the same superior fabric we have sold for years and which has been tried and proven in every climate from Alaska to Texas. But the surfacing of slate in permanent colors is better than any surfacing heretofore produced, as durable and handsome as slate tile.

Substitute This Better Roofing for Shingles and Double Your Profits.

The illustration shows our Modern Home No. 144, roofed with Red Slate Surfaced Roofing and the second story sided with Gray Slate Surfaced Roofing. Cost of roofing for the second story and roof of this house, \$47.25; cost of labor for laying, \$6.30; total cost, \$53.55.

A Grade Cedar Shingles for the roof and second story of this house would cost \$73.50; cost of laying shingles, \$31.50; total cost, \$105.00. Remember, our Red or Gray Slate Roofing will out-wear shingles.

Total saving, \$51.45.

We will furnish all the material to build this six-room house, consisting of lumber, lath, shingles, mill work, ceiling, siding, flooring, finishing lumber, building paper, pipe, gutter, sash weights, hardware and excepting only cement, brick and plaster. **FOR \$711.00**

MODERN HOME No. 103



This is a popular design two-story house with dormer, affording a great deal of room for the amount of money required to build it. An open stairway in the reception hall with cased opening between the reception hall and living room and cased opening between living room and dining room. Two large bedrooms, four large closets and bathroom on second floor.

Artistic front door glazed with sand blast design glass. Five-cross panel yellow pine interior doors, clear yellow pine trim for both first and second floors. Clear yellow pine flooring for entire house and porches.

Painted two coats outside, choice of color. Varnish and wood filler for interior finish.

Excavated basement under entire house, 6 feet 6 inches from floor to joists. First floor 9 feet from floor to ceiling; second floor, 8 feet 6 inches from floor to ceiling.

For floor plan refer to the Book of Modern Homes. Mailed free on request.

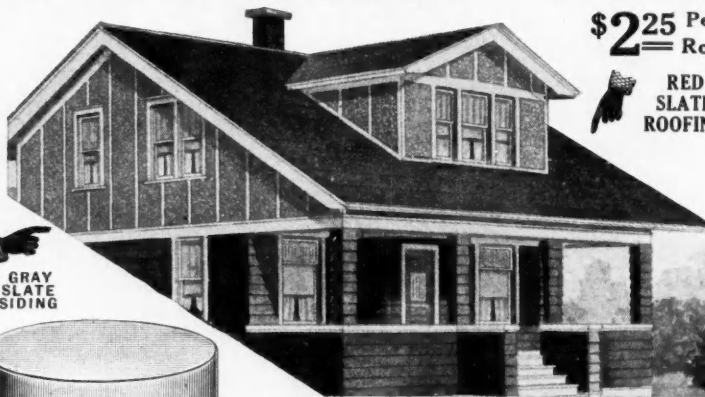

GRAY SLATE SIDING

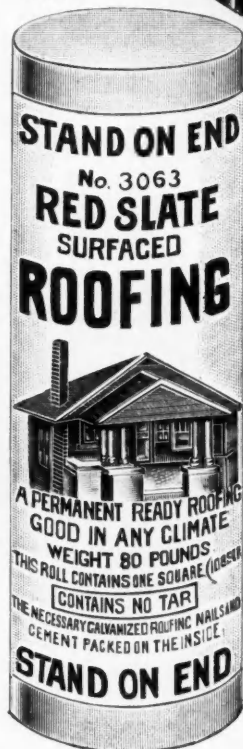

Price, per roll, 108 square feet, Gray \$2.25 Red \$2.25 Weight, 80 pounds.

Fireproof. Not to be Painted. Guaranteed for Twelve Years. Send for Free Samples.

FOR \$1,260.00

We will furnish all the material to build this eight-room house, consisting of lumber, lath, shingles, mill work, flooring, ceiling, finishing lumber, building paper, pipe, gutter, sash weights, hardware, mantel and medicine case, and excepting only cement, brick and plaster.

MODERN HOME No. 163



This two full stories and attic. Stair hall contains open oak stairway to second floor, under which is an inside cellar stairway; also a stairway from kitchen leading to second landing of the main stairs. Outside cellar stairs under rear porch. Colored leaded Art Nouveau sash at each landing and half way up the stairs; also in vestibule at front door. Mantel in dining room.

Beautiful front door, veneered oak, 3x7 feet, glazed bevel plate glass. Two-panel veneered birch interior doors; clear birch casing, baseboard and trim throughout the house. Two bevel plate glazed front doors on second floor, one opening from each chamber on to balcony. Clear oak flooring for main rooms on first floor; maple flooring for kitchen, pantry and second floor. Varnish and wood filler for two coats of interior finish.

Built on concrete foundation with cement blocks above grade line. Frame construction, sided with stonekote and roofed with cedar shingles.

See the Book of Modern Homes for detailed description of this and over 100 other up to date residences.

Have You Sent for This Book Yet?

Our Building Material and Mill Work Catalog will enable you to make lower bids for contracts and at the same time to earn larger profits on your work. Our control of the timber supply,

our immense factory facilities and our direct shipment to you from the factory enable us to sell our materials at prices lower than most dealers pay.

What Our Building Material and Mill Work Catalog Contains:

Front Doors. 140 kinds and sizes of Oak and Birch Front Doors, 325 kinds and sizes of Soft Wood Front Doors, 126 kinds and sizes of Painted and Grained Sash Doors, 312 kinds and sizes of Four and Five-Panel Doors in cypress, white pine, yellow pine, etc.

960 kinds and sizes of Fancy and Plain Windows and Sash, also Storm and Hotbed Sash.

A complete line of Fancy and Plain Glass.

Window and Door Frames, for frame, stone, cement block, or brick buildings, including 600 kinds and sizes.

Moldings of every description. We carry the largest stock of Moldings of any concern in the country, all of which are illustrated in our Special Building Material and Mill Work Catalog.

Hard and Soft Wood Flooring.

Porch Materials. Columns, Newels, Rail, Balusters, Spindles, Gable and Eaves Brackets, etc.

Outside Trimmings, Gable Ornaments, Gable Drapery, Roof Cresting, Finishing Lumber.

Stairwork, Newels, Rail, Balusters, String Board, Treads, Risers, etc.

Arch Grilles of the very latest designs. **Siding and Ceiling** furnished in cypress, yellow pine, white spruce pine and red wood.

Steel Roofing, Steel Siding and Ceiling, Steel Brick Siding, Steel Rough Stone Face Siding, Roofers' Tools and Supplies, Fireproof Partitions, etc.

Asphalt Roofing and Building Paper, Plaster Board, Deadening Felt, Tarred Roofing Felt, Roofing Nails, Caps, etc.

SEARS, ROEBUCK AND

WHEN WRITING ADVERTISERS PLEASE MENTION THE AMERICAN CARPENTER AND BUILDER

and Save 30 to 50 Per Cent

Felt and Metal Roofing at ONE-PROFIT Prices and Guarantee Satisfaction

Our Roofing Catalog describes the largest line of Roofings carried by any one Supply House in the country including Gravel Bur-lap, Marble Coat, our famous Best-of-All, Flint Surfaced Asphalt and Century Tarred Roofings, Pressed Stand-ing Seam, Crimp, Cor-rugated Steel Roofing, as well as building and sheathing papers, dead-ening felt, plaster board, metal lath, eaves trough, conductor pipe, metal shingles, siding, etc.

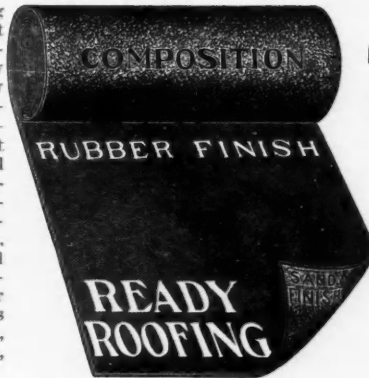

75c
Per Roll
of
108
Square
Feet,
32
Inches
Wide.

COMPOSITION ROOFING

Flint Sand Coated Rubber Roofing.
Unequaled Value at Our Low Price.

Many a roll of Composition Roofing identical in quality with ours has been sold by others under some fancy label at two and three times our price.

While our Composition Roofing has not the durability or the handsome appearance of our Slate Surfaced Roofing and other more expensive grades, it will fully meet the requirements of the builder who desires only a temporary roofing to last for a few years. Our Composition Roofing is made of standard felt, saturated with an asphaltic composition and is finished on one side with a smooth asphalt rubber coating and on the other side is coated with fine sand. It may be used with either side exposed to the weather.

One-Ply. Weight, 34 pounds. Per roll.....\$0.75
Two-Ply. Weight, 44 pounds. Per roll..... .90
Three-Ply. Weight, 54 pounds. Per roll..... 1.05

Steam and Hot Water Heating Systems of Guaranteed Efficiency



We sell the best Home Heating Plants in the country. Estimates are furnished free. We guarantee our plants to heat the homes for which we furnish them and furnish a two-year written guarantee with each plant we sell. We do not question your word regarding the ability of the plant. You are the sole judge and jury. If at any time during the two years you desire to return the plant, we will ask no questions but return your money, together with the transportation charges you have paid.

We issue a Special Heating Catalog devoted entirely to heating, and we will be glad to send this to you on receipt of a postal card requesting the same. If you will kindly make us a rough sketch of the building you intend to order a heating plant for, we will be pleased to furnish you an estimate on the boiler, radiators, all fittings, pipe and accessories for the complete installation of a steam or hot water heating plant.

\$200.00 is what you would pay elsewhere for a high class guaranteed steam heating plant for the six-room house shown on opposite page as our Modern Home No. 103. We equip this residence with a complete steam heating plant, equal to any plant made in economy of fuel consumption and in heating capacity, for only \$125.80, or we furnish this same building with a complete hot water heating plant for only \$158.36.

For the big eight-room house, also shown on opposite page and designated as our Modern Home No. 163, we furnish a complete steam heating plant for \$193.64, or a complete hot water heating plant for \$238.07.

We will make you the same proportionate saving on heating plants for the buildings you are erecting, no matter what their size.

Warm Air Furnaces \$25.11 and Up

Send us your blue prints. Let us figure on your furnace needs. We will gladly abide by the result of your price and quality comparisons.

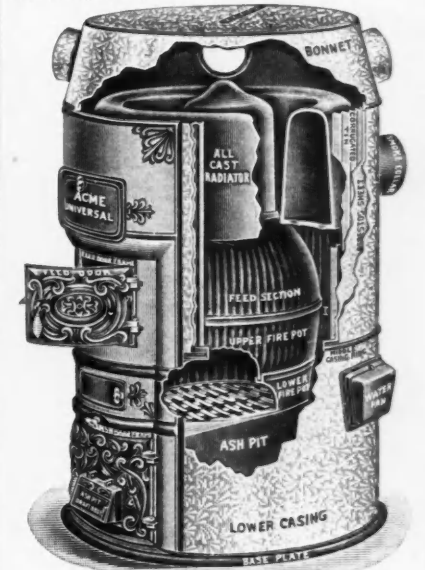

So large is our business in heating plants that we are able to maintain a corps of heating and ventilating engineers whose services are at your command without cost.

As a mere suggestion of the savings we can effect for you we call your attention to Modern Home No. 103, illustrated on opposite page of this advertisement. We equip this six-room house with a complete Warm Air Heating Plant for soft coal for \$61.55 and for hard coal for \$64.55.

A complete soft coal Warm Air Heating Plant for Modern Home No. 163, also pictured on opposite page, is sold by us for \$85.41, while the same plant designed for hard coal costs only \$88.79.

Figure for yourself the savings we make you and remember we guarantee absolute satisfaction or your money back on any furnace you buy from us.

Have You Got Our September Lumber List?

Do you know we can save you \$100.00 on a carload of lumber and furnish you absolutely the best grades, grades far better than are now furnished by your dealer?

Give us a trial. Write for this Wholesale Lumber List. Let us ship a car on approval with the understanding that we save you all we claim, and our quality surpasses the kind you are now buying. MAILED FREE ON REQUEST.

THIS IS OUR WHOLESALE LUMBER PRICE LIST

We Publish Special Lumber Price Lists Quoting "Delivered Prices" to Every City in the United States.

Let Us Send You a List Showing Our Delivered Prices (Freight Prepaid) to Your Station. Mailed Free on Request.

If you cannot wait for our delivered Lumber Price List, SEND US YOUR LIST, we will gladly meet you on bid pricing. We our prices on your entire bill of lumber or mill work. The prices, however, will be exactly the same as the prices printed in our wholesale price list.

TWO MILLS: SOUTHERN ILLINOIS to contractors living east of the Mississippi River. NORTHERN LOUISIANA to contractors living west of the Mississippi River.

CO., CHICAGO, ILLINOIS

WHEN WRITING ADVERTISERS PLEASE MENTION THE AMERICAN CARPENTER AND BUILDER

Machine Equipment for the Shop

It gives us pleasure to welcome a new company into our woodworking machinery circle, United Machinery Company, 136 Liberty Street, New York. They have landed on both feet as though they mean to stay, as may be seen by their advertisement on another page.

They say that after this introductory offer has made a goodly number of new friends for them, they will have a three machine offer for new shops.

Their first offering is their "No. 5 New Type Saw Table," and their 12" Hand Planer—two machines that make an ideal equipment for the carpenter shop.

The No. 5 Saw Table is described as follows:

The frame is cast in one solid piece making it very rigid and strong. The countershaft is attached to the frame and is adjustable to take up the stretch in the belt.

The arbor is made of the very best grade of spindle steel and is 1 7/16 in. in bearings turned down to 1 inch where the saw goes on. It is extended on the saw end to take on 2 in. dado heads, also extended on boring end to receive 1/2 inch straight shank boring bits when the boring attachment is used. The arbor raises and lowers by means of hand lever assisted by heavy coil spring, making it very easy to adjust the arbor in any position. The same is clamped firmly by eccentric wrench. The bearings are lined with bab-bitt and are self-oiling.

The table is also cast in one piece, heavily ribbed, and planed perfectly true; tilting to an angle of 45 degrees, and same can be clamped to any desired position, enabling the operator to cut at any or all bevels. The table is equipped with

one straight ripping gauge, one straight cut-off gauge and one miter cut-off gauge. The table is also constructed with an opening around the saw, with a wooden detachable throat,

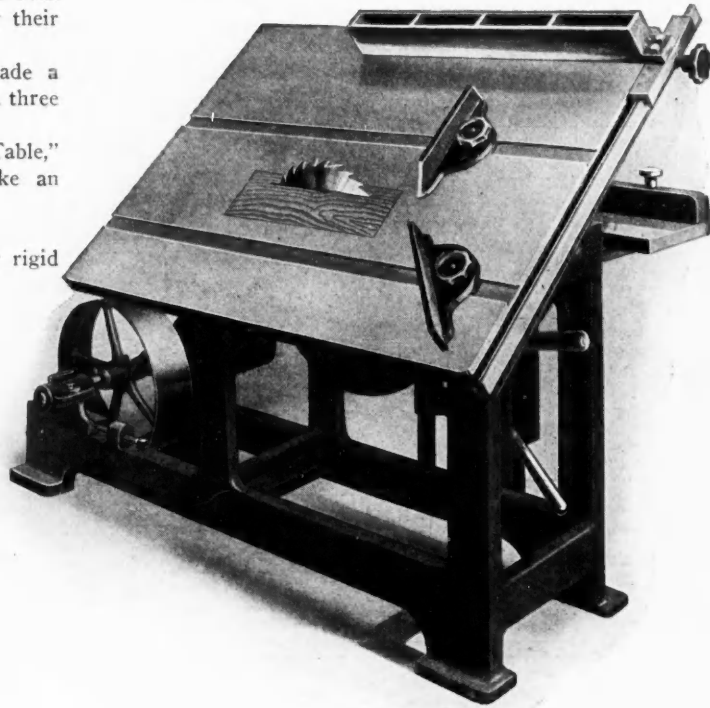

United Machinery Co.'s No. 5 New Type Saw Table.

MAJESTIC FOUNDATION COAL-CHUTE

Protects the Building Just where the Protection is Most Needed ABOVE THE OPENING

The heavy wrought steel Hopper is non-breakable, and when not in use lies in the bottom of the chute, and allows a full ray of light to shine in through the 1/4-in. Wired Glass.

Locks automatically open or closed, making it positively Burglar Proof, made in two sizes.

Write for Full Description

Majestic Furnace & Foundry Co.
995 to 1001 Sixth Ave.
Huntington, Indiana

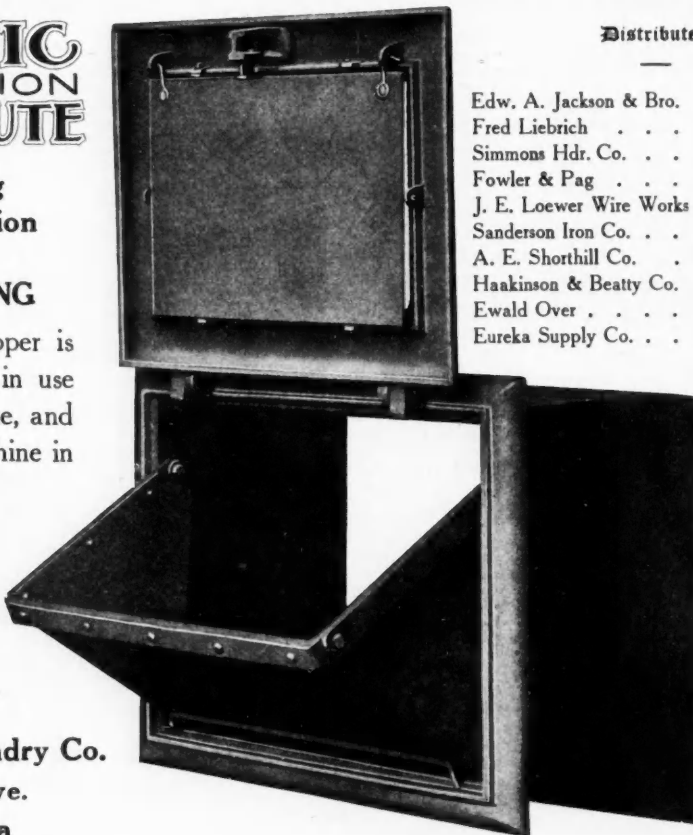

Distributors

- Edw. A. Jackson & Bro. New York
- Fred Liebrich Chicago
- Simmons Hdr. Co. St. Louis
- Fowler & Pag Minneapolis
- J. E. Loewer Wire Works Kansas City
- Sanderson Iron Co. Omaha
- A. E. Shorthill Co. Marshalltown, Ia.
- Haakinson & Beatty Co. Sioux City
- Ewald Over Indianapolis
- Eureka Supply Co. Chattanooga

Stratton & Terstegge Co. Louisville, Ky.

I. J. Kohler Supply Co. Seattle

Honeyman Hardware Co. Portland

Donley Bros. Cleveland

T. B. Rayl Co. Detroit

Down Draft Furnace Co. Galt, Ont.

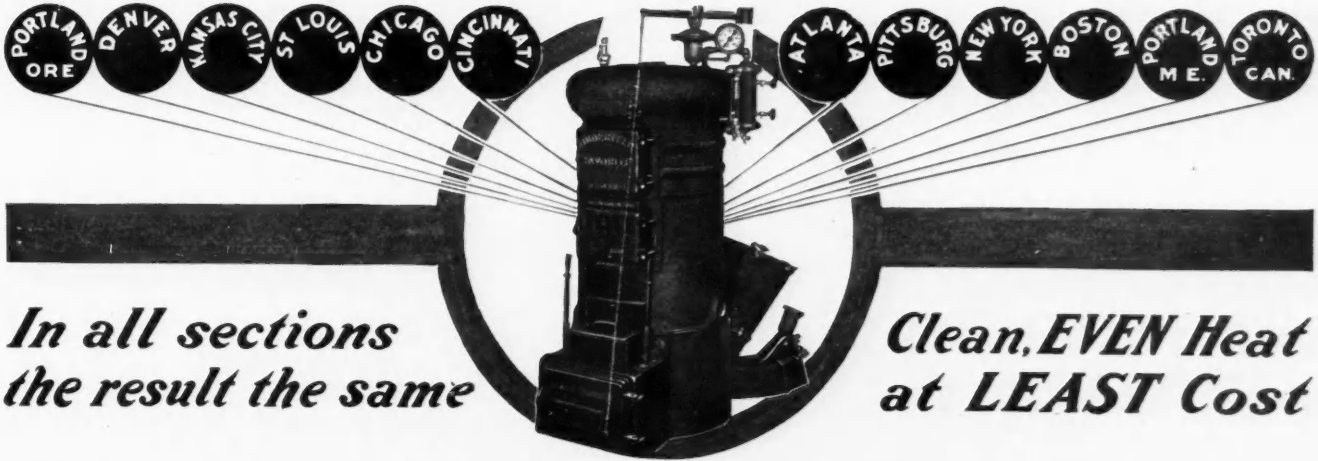

UNDERFEED

UNDER *all* conditions and in all sections, underfeed results are happily the same — *clean, even* heat at *least possible* cost. Builders and contractors everywhere recognize the oft-proved truth because of the vast saving in the “coal fed from below” plan the Underfeed ADDS to the renting and selling value of *any* building. The true test of house-value in cold weather lies in its successful heating. The Underfeed makes possible a saving of 50% to 66 $\frac{2}{3}$ % in cost of fuel. Just imagine heating a ten-room house in Michigan for \$25. This is all it cost I. A. Rees, 227 Twelfth Avenue, Grand Rapids, to operate his Underfeed Boiler all

last winter. And he adds: “It is very easy to take care of, thoroughly consumes coal and makes very few ashes.” Following the municipal example of Minneapolis in heating her shelter houses, New York has also installed Underfeed boilers in Zoological Garden Buildings, because Underfeed heat is *cheapest* and *best*. Even in Saskatchewan, Manitoba and farthest-North Canadian provinces, despite freight and duty, the great economy of Underfeed maintenance has earned for it recognition as the *most profitable heating investment*.

The Peck-Williamson Underfeed HEATING SYSTEMS WARM AIR STEAM-HOT WATER FURNACES - BOILERS

Save $\frac{1}{2}$ to $\frac{2}{3}$ of Coal Bills

The Underfeed Furnace, with casing removed, cut away to show how coal is forced up under fire, which burns on top.



In big houses and little houses—residences, apartments, business stores, public halls, churches, armories—Underfeed Heating Systems offer the opportunity of suitable choice and the same delightful exclusive degree of *economy* in maintenance.

Building contractors are urged to look into Underfeed heat. Write TODAY for YOUR copy of the Underfeed Furnace Booklet or Underfeed Boiler Catalog. Let us send you facsimiles of letters from those who KNOW by practical, joyful and saving experience.

Heating Plans of our Engineering Corps are FREE.

THE
PECK- **WILLIAMSON CO.**
436 W. Fifth Street
CINCINNATI - OHIO

Furnace Dealers, Plumbers and Hardware Dealers are invited to Write TODAY for new Selling Plan.

The Underfeed Boiler

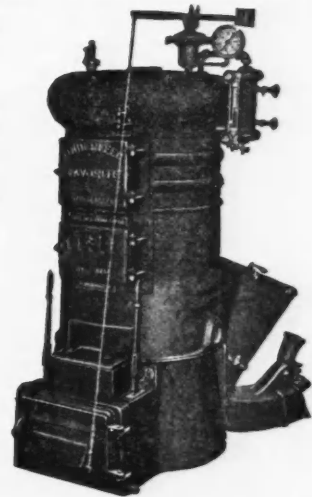

being accurately fitted, giving ample room for changing the saws, and the using of dado or grooving heads.

This machine can also be furnished with a boring attachment bolted to the frame, which is adjustable up and down with screw and hand lever. It slides on planed, gibbed ways, assuring perfect accuracy in boring.

A hand planer is now considered an indispensable tool in any workshop; for planing out of wind and making glue

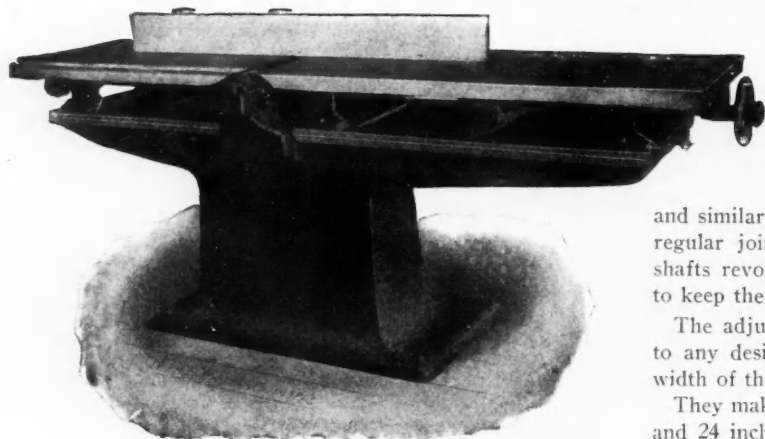

United Machinery Co.'s Hand Planer.

joints it has no equal. It will also perform various other operations, such as rabbetting, grooving, chamfering, squaring up, beading, making circular mouldings, etc.

The frame of this hand planer is cast hollow, strongly braced and ribbed. The base bears on the floor on all four sides, insuring freedom from jar and vibration.

The tables are planed true, arranged for rabbetting and made

extra long, the extreme length from out to out being 7 feet 3 inches. Both tables are mounted on inclines and have independent adjustments for the different depths of cuts, this movement being accomplished by means of a convenient wheel and screw. They can also be drawn back from the head without interfering with their relative heights, permitting the operator to have free access to same, and also to use moulding cutters working in larger circle than the knives.

Provision is also made for re-adjusting the inclines in case the tables should get out of line by accident or otherwise.

The cylinder head is a solid crucible steel forging. It is accurately turned, ground and provided with lips to strengthen the edges of the knives. It is made to carry four cutters at once, two sides being slotted, hence beading, rabbetting and similar flat mould cutters may be used in connection with regular jointer knives. The bearings in which the cylinder shafts revolve are unusually large and have patent reservoirs to keep the journals constantly flooded with oil.

The adjustable fence can be angled to 45 degrees, adjusted to any desired position, and material can be planed the full width of the machine without its removal.

They make four sizes of these jointers as follows: 12, 16, 20, and 24 inches wide.

H. J. Rosenkranz, who has for some time been associated with the Chas. E. Wright Co., of Kenilworth, N. J., has joined the sales force of the United Machinery Co., 136 Liberty St., New York. Mr. Rosenkranz is well known in the wood working machinery trade.

The United Machinery Co., 136 Liberty St., New York, is in a position to quote prices on any kind of woodworking machinery required and solicits inquiries along this line.

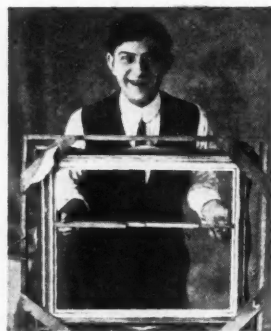
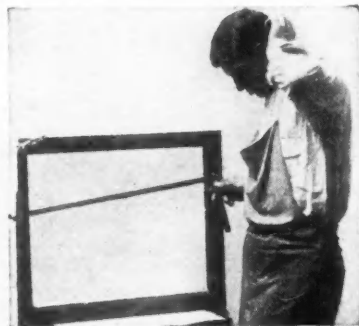

Illustration shows the Master Slide Rule in use for inside measurements. The Master Slide Rule shows exact dimensions without figuring or calculations. No guess work.



This illustration shows the ordinary carpenters' rule in use for measuring inside window trim. No exact measurements can be taken this way.

CARPENTERS AND BUILDERS, GLAZIERS, SHADEMEN, PLUMBERS AND EVERY KIND OF MECHANIC!

You will find that once using the



(Patented Dec. 13, 1907)

MASTER SLIDE RULE

illustrated on this page, you will always use it, as it is the only practical rule for **inside measuring** of doors, windows, etc., as indicated in the accompanying illustrations, and it will become absolutely indispensable to you thereafter. For speedy operation there is no other rule made that can compete with the **MASTER SLIDE RULE**. A five or six foot rule can be extended to full length in one or two movements and closed in two movements. When opened, it is kept in place rigidly by strong steel springs and cannot get out of order.

One side of the **MASTER SLIDE RULE** is marked for **inside measurement**. The reverse side of the rule is the same as any ordinary rule but is particularly valuable for quick measurement of ceilings and walls, etc. It is made in lengths of from two to six feet.

Ask your nearest hardware dealer for the rule or write direct to us for particulars and price list. Send us the name of your nearest hardware dealer.

DAHL MANUFACTURING COMPANY
1 East 42nd Street, NEW YORK CITY

AGENTS WANTED

You may never use a varnish brush, but you ought to know the best varnish.

The way to know is by this label.

When you recommend Berry Brothers' varnishes to your customers, you are not only giving them good advice, but you are insuring the permanent beauty and protection of your handiwork.

Good carpentry and cabinet work deserves good finishing with the best varnish you can get.

Berry Brothers' Architectural Varnishes

MEET ALL REQUIREMENTS FOR HIGHEST GRADE FINISHING IN BUILDINGS

TRADE
LIQUID GRANITE
MARK

For finishing floors in the most durable manner possible. Its quality has made it the best-known and most widely used of all varnishes. There is no substitute.

WOOD
LUXEBERRY
FINISH

For the finest rubbed (dull) or polished finish on interior woodwork. It has for years been the standard to which all other varnish makers have worked.

ELASTIC INTERIOR
FINISH

For interior woodwork exposed to severe wear and finished in full gloss, such as window sills and sash, bathroom and kitchen woodwork, and stands the action of soap and water to an unusual degree.

ELASTIC OUTSIDE
FINISH

For front doors and all other surfaces exposed to the weather. Dries dust free in a short time and possesses great durability under the most trying weather conditions.

SEND FOR OUR FREE BOOKLET:
"NATURAL WOODS AND
HOW TO FINISH THEM."

BERRY BROTHERS, Limited

Established 1858.

Largest Varnish Makers in the World.
Factories: Detroit, Mich., and Walkerville, Ont.
Branches: New York, Boston, Philadelphia, Baltimore,
Chicago, Cincinnati, St. Louis, San Francisco.
Dealers: Everywhere.

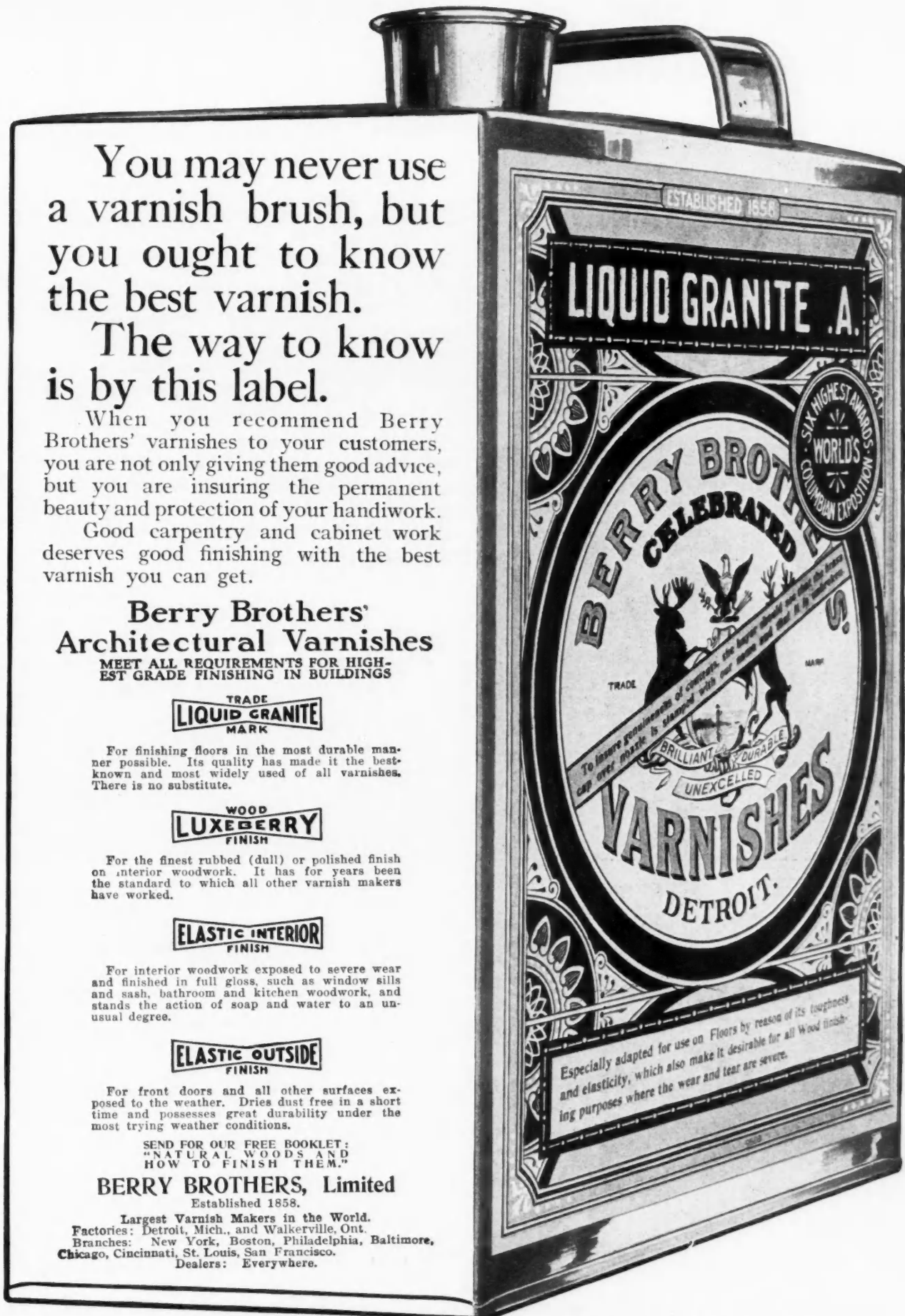

PAINÉ LUMBER CO., LTD.

OSHKOSH, WISCONSIN, U. S. A.

These Plants Produce TWO THIRDS of All the S



We Make Everything in Milwaukee

OUR SPECIALTY

Korelock Veneered Doors

Cost but a little more than Pine

WRITE FOR CATALOGUE A

Whenever You See a Korelock Joint Think P

P. PAINE LUMBER CO., LTD.

OSHKOSH, WISCONSIN, U. S. A.

The Standard Veneered Doors Used in the World

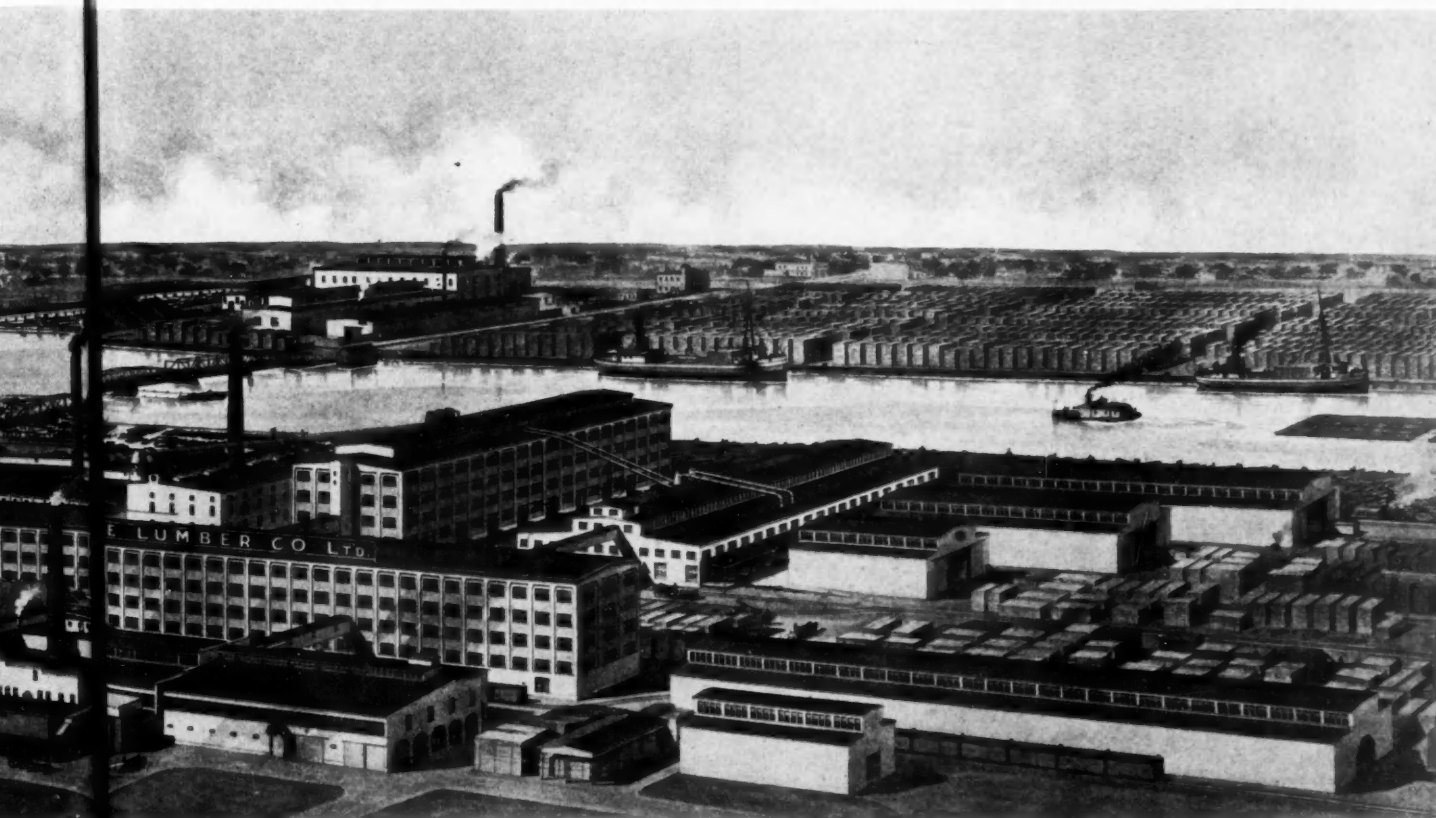

Work in Any Kind of Wood

OUR SPECIALTY

Korelock Veneered Doors

Birch and Oak Doors Ready to Ship

WRITE FOR CATALOGUE A

Think Paine Lumber Co.—The Originators

A Satisfactory Plasterer's Stove



The Salamander (Plaster-drying stove) here illustrated is an improved style brought out by The S. M. Howes Co., Boston, Mass.

The driving draft slide regulates the fire and being attached to stove is in its place when wanted.

This stove is made in one size, 16 in. diameter, furnished either lined with fire brick or unlined; is equipped with strong handles, also openings for running bar through for carrying; provision is made for flue connections.

The S. M. Howes Company solicit inquiries from the readers of the AMERICAN CARPENTER AND BUILDER.

The Majestic Chute

A chute for unloading coal, vegetables, etc., into the cellar is now considered an indispensable part of any first-class residence. Properly made, it is burglar proof and will last as

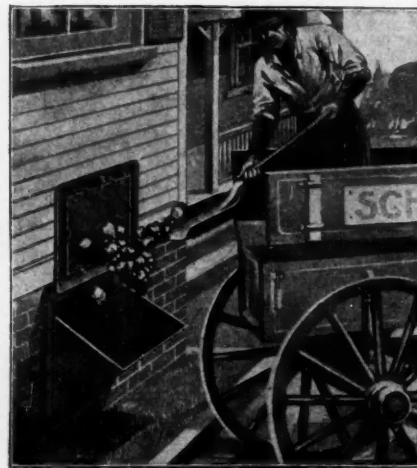

Majestic Chute in Use

long as the building itself. The advantages of such a chute are that it protects the building from damage by the careless unloading of coal, wood or other articles, deposits the load

Quality Is
Economy

*It may not be in
other building materials
it Is in Varnish*

You lower the building cost by using cheap materials of other kinds.

You do not lower the cost, you increase the cost, by using cheap varnishes.

Murphy Varnish gives you the Best Possible Finish with enough fewer gallons and enough less labor actually to reduce the cost.

The Varnish
That Lasts
Longest

Murphy Varnish Company

FRANKLIN MURPHY, President
Associated with Dougall Varnish Company, Limited, Montreal, Canada

NEWARK,
N. J.
CHICAGO,
ILL.

ANNOUNCEMENT

A year ago we commenced work on a portable saw rig, feeling sure, after talking with many contractors, both large and small, that this would fit the builders' work exactly—and overcome the drawbacks found in other portable rigs, such as lack of power, quality, attachments, service and ability to stand up under the most severe working conditions.

We have designed this superior rig with all the labor saving devices and none of the defects found in others. We are building them in the most modern and up-to-date factory, so well equipped in every way that it allows us to make an exceptionally low price on our rigs. We have so much confidence in them that we will sell you one on the following conditions:

IF NOT SATISFACTORY RETURN AT OUR EXPENSE

No charge for these attachments:

10-inch Ripsaw

10-inch Crosscut Saw

12-inch Jig Saw

Boring Outfit

10-inch Sander

6-inch Dado Head

2½-inch Jointer Head

Miter Device

6-inch Emery Wheel

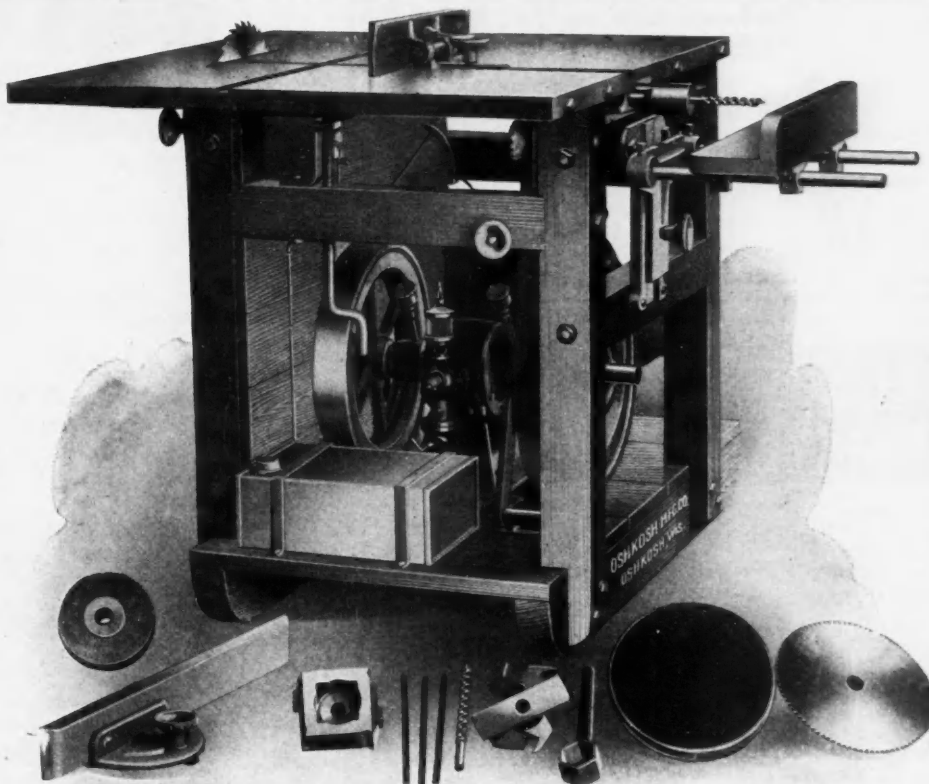

THE OSHKOSH EVEREADY—Guaranteed for Life

Write for Attractive Price and Folder

ESTABLISHED 1843

Oshkosh Manufacturing Company

Formerly The Oshkosh Logging Tool Co.

316 S. Main Street

Oshkosh, Wis.

Color Schemes Suggested On Request

LET us help you in the selection of up-to-date and appropriate color harmonies for exteriors and interiors. Hundreds of color schemes have been proved pleasing, practical and successful by users of

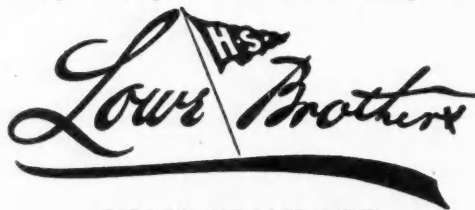

HIGH STANDARD Liquid Paint

and other Lowe Brothers paint products. We will gladly furnish you latest color fashions and give helpful advice about finishes for any particular purpose. It will pay you to learn about the "High Standard" line in paint, enamel, stain and varnish—all carrying the "Little Blue Flag." Its extra spreading capacity—greater hiding power, longer wear and beauty of finish save money and protect you.

WRITE FOR PARTICULARS.

The Lowe Brothers Co.

450-452 E. Third St., Dayton, Ohio
Lowe Bros., Ltd., Toronto

Boston
New York



Chicago
Kansas City

This Kerosene Engine Cuts Your Expenses 75%

YOU should not even consider engines that operate on gasoline only. The rapidly rising price of gasoline, now 6 to 16 cents higher than kerosene, absolutely makes operation on this fuel too expensive. The Perfection Kerosene Engine operates on any engine fuel. When you purchase it you are on the safe side—proof against all fluctuations of the market. You can always run this engine at a great fuel saving and get the greatest amount of work done. The Perfection vaporizes its own kerosene and so makes it as efficient as gasoline—something other engines cannot do.

The Perfection is very light, portable, has only three moving parts, runs everything about the place, is lower in price than any other engine of its capacity on the market.

PERFECTION KEROSENE ENGINE Sent You on 15 Days FREE TRIAL

See your dealer at once and ask him to let you have a copy of our **Free ENGINE BOOK** which shows the sizes and styles of the "Perfection" and explains this very attractive offer. Your dealer will send any "Perfection" engine to your farm for 15 days and let you return it if you are not satisfied. Ask him about it. If he does not carry the "Perfection" write to us and we will send you our **Free Engine Book** direct.

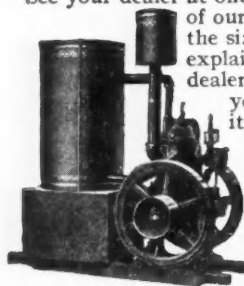

QUICK SHIPMENT GUARANTEED
The day we get your order we will ship your engine. No delays at this time of the year—a man wants his engine and wants it quick. We have ready right now the very engine you require. Get your order in quick.

CAILLE PERFECTION MOTOR CO.
233 Second Ave. DETROIT, MICH.

just where it is wanted, and can be closed securely when not in use.

The Majestic Furnace & Foundry Co., of Huntington, Ind., are the manufacturers of the Majestic Chute here illustrated.

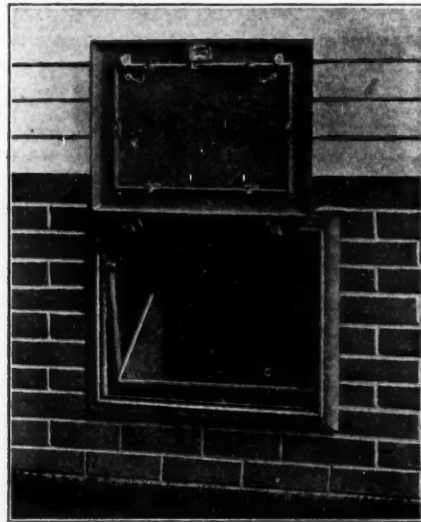

Style "B" With Hopper and Without Glass

As shown in the engraving this chute is built into the cellar wall and becomes a permanent part of the building. It can only be opened from the inside, and when closed it locks automatically. It is furnished with or without a wire glass, so that if desired it becomes both a chute and a window. The chutes are made in three styles, style "A" with 1/4-inch wire glass, style "B" without glass, and style "C" with glass but without hopper. The door and frame are of cast iron, the hopper is of 12 gauge boiler plate and the chute is made of heavy steel. The hopper is so made that when not in use it falls to the bottom of the chute, permitting the light to shine in through the window without obstruction. Similarly, the glass in the door is protected when the chute is in use by a steel shield which hangs in front of it.

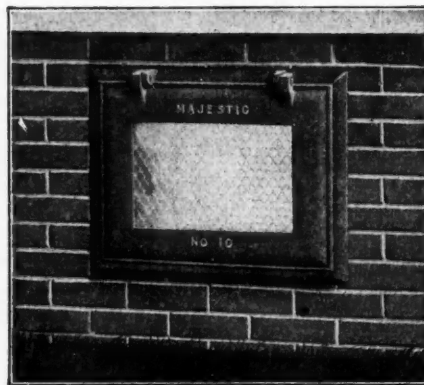

Style "C" With Wire Glass and Without Hopper

Style "C" represents the chute without hopper but with wire glass window. For ordinary purposes this chute is all that is required. The window is opened, a wagon chute is inserted and the coal is thus delivered into the basement without the use of the window hopper. The latter, however, is desirable where it is desired to deliver coal from bags, baskets or wheelbarrow.

The Majestic Chute is made in two sizes, one for residence use and a larger size for schools and public buildings. An attachment can be put onto the chute which will permit of

“Manufacturers of Roofing should realize they are making a product as staple as shingles”

**— Extract from Report Entitled —
READY ROOFING
MISTS AND MYSTERIES**

Issued by N. W. Lumbermen’s Association

Every Architect, Contractor and prospective user of Roofings vitally interested in facts disclosed by this report

¶What do you know about the comparative merit and value of the thousand and one brands on the market?

¶Is there any “secret compounds” or mysterious process necessary to the production of this commodity?

¶The Report says “there has been much ‘fake’ in the Roofing business.”

¶They “show up” many of the ridiculous claims, used as selling arguments.

¶They visited every plant of consequence in the U. S.

¶They say “Roofing is a staple” —that high grade goods can be produced at a reasonable price.

¶They found low grades being made—they say “common straw is especially detrimental though still used by a very few.”

¶The “General” wants the truth known, for we have always claimed that our **Weather Compo-Rubber Roofing** is the most durable roofing that can be made regardless of the fact that it is sold at prices way below the prices charged for other brands.

¶Our enormous facilities result in **high grade goods** at low cost.

¶Our policy “make the price right and increase the use of Ready Roofings.”

¶Remember the brand “Weather-proof Compo-Rubber Roofing”—handled by thousands of dealers in the U. S. and foreign countries.

¶You will be greatly interested in reading this report—you’ll see that some manufacturers dodged—they didn’t want the truth known.

¶Do a little investigating yourself before you buy another supply of Rubber Roofing—Investigate Us.

Write our nearest office for copy of the Lumbermen’s Report—IT’S FREE

Illustrations Used in the Report

The Report says—“Retailers have been told—“Our Roofing is made from PURE Wool Felt” etc.—how the Investigating Committee caused this greatest lie in captivity to disillusionize is well illustrated by the cartoonist’s story of the Mermaid and the Mouse.



Some Manufacturers Claims

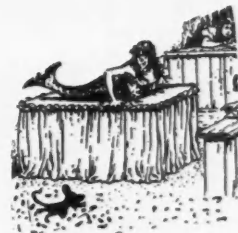

The Investigating Mouse



What was Disclosed

General Roofing Mfg. Co.

The World’s Largest Manufacturers of Roofing and Building Papers

Mill No. 3
YORK, PA.

MINNEAPOLIS

Mill No. 2
MARSEILLES, ILL.

Mill No. 1
E. ST. LOUIS, ILL.

SAN FRANCISCO

opening it without going into the bin. This consists of a chain and gravity latch which can be operated from another part of the basement. The Majestic Chute is intended to fulfill all the requirements of a first-class installation of that kind. It is more fully described in the company's catalogue. In writing them, please mention AMERICAN CARPENTER AND BUILDER.

Reducing the "Overhead Expense"

It is a well-known axiom of modern business practice that the profits of an institution come in largest measure from the saving effected in the overhead expense, and along this line the higher cost of living, which in a large measure is the principal overhead expense of the individual family, can be materially reduced by cutting down the daily outlay for car fare.

Nothing is more suited to this purpose than the bicycle, and it is, perhaps, surprising to learn that for an investment of from \$18 to \$30, depending upon the style desired, it is possible to secure a brand new, high grade bicycle completely equipped and thoroughly guaranteed, that will not only carry the carpenter or contractor to and from his work but is sturdy enough in construction to carry in addition a large kit of tools or other necessary baggage.

The use of an automobile is, of course, beyond the income of many, and a horse and buggy has an overhead for feed, etc., that is likewise prohibitive. In and around the suburbs of our larger cities it is astonishing to note the increasing number of mechanics and contractors who use the bicycle to go to and from their work.

The Mead Cycle Company, Department P-122, Chicago, U. S. A., will be pleased to send a catalogue of their latest

model 1912 bicycles, also a catalogue of sundries, showing a complete line of clever attachments for the bicycle for any and all purposes, to any reader of the AMERICAN CARPENTER AND BUILDER, free of charge.

This Will Interest Concrete Workers and Contractors

One of the foremost manufacturing concerns of concrete machinery are going to do what thousands of cement workers and builders have been anxiously awaiting, and that is—make a special offer on a high-grade, standard, guaranteed concrete mixer.

The Raber & Lang Mfg. Co., Kendallville, Ind., are going to do this, and the offer will be restricted, positively, to within a 30-day limit. They are making their announcement on another page of this issue. Mr. O. P. Raber, president of the concern, says that he would like to extend this big offer longer, but that the low price will prevent it. He states further that if he were not sure that this special offer would be of extreme benefit to the firm in an advertising way, the offer would never be made.

This certainly would be appreciated by the many concrete workers, who do not own a mixer, or at any rate, a good reliable and dependable machine. This will be a rare chance to get one of these world-famed mixers.

It is generally conceded, and proven to be a fact, that the day has come when the concrete mixer is the determining factor of the cement workers' success.

This firm has also gained nation-wide renown by the extensive work it has done in establishing the profitable cement pipe and tile industry, as well as the cement brick business. "Crescent" pipe and tile molds and Vertical tamping brick machines are known favorably the world over.

WHAT GOOD REASON HAVE YOU FOR NOT USING A TRUCK IN YOUR BUSINESS?

Just a moment, Mr. Contractor or Builder! We want to KNOW, and we think we have the right to know, why YOU have never considered the great possibilities of a motor Truck in your business—for hauling your lumber, cement, stone, brick, lime, or any other kind of material or heavy hardware.

Probably you've never been told or had occasion to figure it out for yourself how much time, labor and MONEY could be actually saved by the use of a truck. Undoubtedly you did not know that in six months' time a hard-working motor truck would easily pay for itself and for the three extra men you had been paying at least \$2 a day to.

The Schacht 3 to 4 Ton Truck

will be the biggest paying proposition you ever invested your money in and it can SHOW YOU! With it you will be able to handle twice

This is the 3 to 4 Ton Schacht Truck

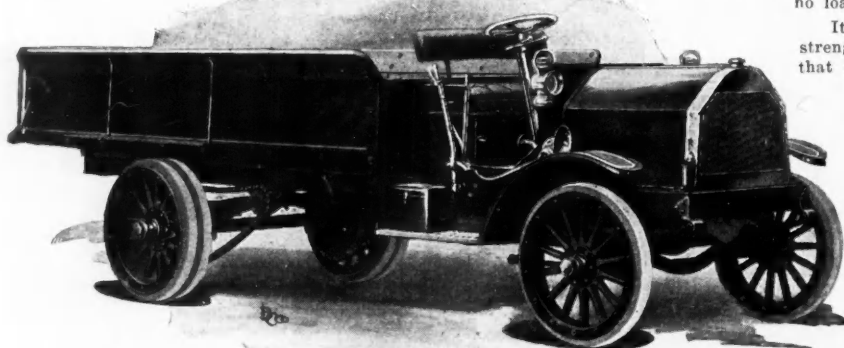

the work you are handling with teams and wagons. More trips—five to one—can be made with the SCHACHT; more material carried; more satisfaction given everyone of your buyers and more profits naturally will follow this additional business and that means a greater success.

With the SCHACHT 3 to 4 Ton Truck you have an untiring, work-all-the-time employee that costs materially less to handle than your horse, requires practically no attention, is far less trouble and care than two or three horses, is much more powerful and dependable, don't grow old and worn out, will carry the heaviest loads to the farthest suburb or section of town in any kind of weather—good or bad—and one man can run the SCHACHT at a salary of \$2 per day and do much more work than your three teams and drivers could, although each one of them was costing you from \$1.75 to \$2 a day. And, of course, this does not include feed for horses.

The SCHACHT is built especially for heavy duty service. There's no load it can't safely deliver quicker than teams.

It is powerfully constructed—a forty horse-power strength that's ready to work for you all the time—that is SCHACHT SATISFACTION.

If you are interested, please write us and request further information and catalog.

The Schacht Motor Car Co.

2846 Spring Grove Ave.

CINCINNATI :: OHIO

VENEERED DOORS

Do You Know That  Doors Are the Best

Here are a few points about Max Royal Doors:

Max Royal Doors are made with White Pine core for both stiles and rails. They weigh from two to four pounds less than other Veneered Stock Doors.

Max Royal Stock Doors are furnished in three styles, one panel, two panel and five cross panel. (There are more five cross panel doors sold than all other patterns put together).

Max Royal Doors are made with B. & C. solid sticking, which is and has been considered standard for the past twenty years.

Max Royal Doors with wide bottom rails are made with special construction which insures their remaining perfectly straight.

Max Royal Doors have thick Veneers and are made with laminated panels which effectually prevents warping.

Our one light doors with long glass opening like Nos. 253 and 254 are made with metal strip covering the top of bottom rail which prevents the water from soaking into the Core or behind the Veneers. It doubles the life of the Door.

We also use a stool or water table on doors like our No. 189 which passes entirely through the door covering the rail below, so that no water can drip down into the Core of the door or behind the Veneer. This has the same effect as the metal strip used on doors where there is no water table.

The designs we refer to above are found in our Catalogue No. 27, which is yours for the asking, and they say it is well worth seeing.

Now the Doors are just as good as the illustrations in the book, and we want you to know it, so we say, "If for any reason they are not satisfactory, send them back at our expense."

THE R. McMILLEN CO.

OSHKOSH, WIS.

Branch Offices

NEW YORK
N. Y.

WASHINGTON
D. C.

CHICAGO
ILL.

SAN ANTONIO
TEXAS.

LOS ANGELES
CAL.



*Beauty
Endurance
Economy*

These are the three great factors entering into the present success and the future of

Chehalis Fir Doors

Architects specify them; builders ask for them; all dealers alive to opportunities handle them. They cost less—keep in stock better—are better made than other doors, are moreover adaptable to practically all hardwood finishes. Chehalis Fir Doors are made of Old-Growth Yellow Fir and nothing else. They are built with vertical stiles and rails and slash grain panels—the only doors where the grain of wood in all five panels is picked to match.

STRENGTH—UNIFORMITY—BEAUTY
A perfect match for yellow pine trims.

Don't delay in finding out all about these doors. It will cost you one penny to investigate. The penny may save you many dollars. Send the card requesting catalog **F** tonight.

IT'S FREE

CHEHALIS DOOR CO.
CHEHALIS, WASHINGTON



Asbestos "Century" Shingle Roof—Residence of George Jacka, Calumet, Michigan; Architect, Paul Humphrey MacNeil, Calumet, Michigan; Contractor, Edward Ulseth, Calumet, Michigan.

Asbestos "Century" Shingles

"The Roof that Outlives the Building"

Every cent your client puts into an Asbestos "Century" Shingle roof buys wear and service—protection against fire and weather—insurance against bills for repairs and painting.

You can't say as much for any other roofing on the market.

Asbestos "Century" Shingles are practical, lightweight shingles of reinforced concrete—made of hydraulic cement reinforced with interlacing asbestos fibers.

They are absolute: Indestructible by weather, time and fire. No repairs—no painting.

You can get Asbestos "Century" Shingles in three colors—Newport Gray, (silver gray) Slate (blue black) and Indian Red—in numerous shapes and sizes. Write for booklet "Everlasting" 1911.

The Keasbey & Mattison Company, Factors
AMBLER, PENNSYLVANIA

Branch offices in principal cities in the United States, and London, Eng.

Steam or Hot Water Heat at Low Cost

Modern steam and hot water heating systems are now numbered foremost in the list of comforts, conveniences and economies for all progressive homes. Builders generally have recognized the merits and advantages of these forms of heating, but have not adopted them as widely as they should because of the notion that is generally current that they are very expensive forms of heating; rather too "fancy" for the man of moderate means. Many who really wanted steam or hot water heating systems in their houses have given up the idea and changed to something else because they did not want to be held up for the high prices demanded by the local steam fitters.

All such will be interested at once in the proposition of Mr. M. J. Gibbons, Dayton, Ohio. He is putting out a substantial grade of plumbing and heating supplies that he can positively guarantee, and at reasonable prices. He prepares working drawings covering the installation of the boiler, all pipings and radiation for each job, working everything out so clearly that the work can be easily done.

Both the prices and methods of Mr. Gibbons are a surprise and shock to some of the "old timers," but if he is able to help them to cut down the "high cost of building" in any substantial way, builders in general will not object.

A very interesting catalogue has been prepared illustrating and explaining this proposition in detail. It will be sent to all who will write to Mr. Gibbons, 20-22 West Third St., Dayton, Ohio, mentioning the AMERICAN CARPENTER AND BUILDER.

Stanley Dovetail Tongue and Groove Plane

A new and novel tool has been placed on the market by the Stanley Rule and Level Co., which accomplishes a result sought for many years by wood workers in general, namely: to form a dovetail tongue and groove with one hand tool.

This result was reached by designing a plane which at one setting cuts a groove with a cutter having a *horizontal* edge guided by an *oblique* fence, and in the other setting cuts a

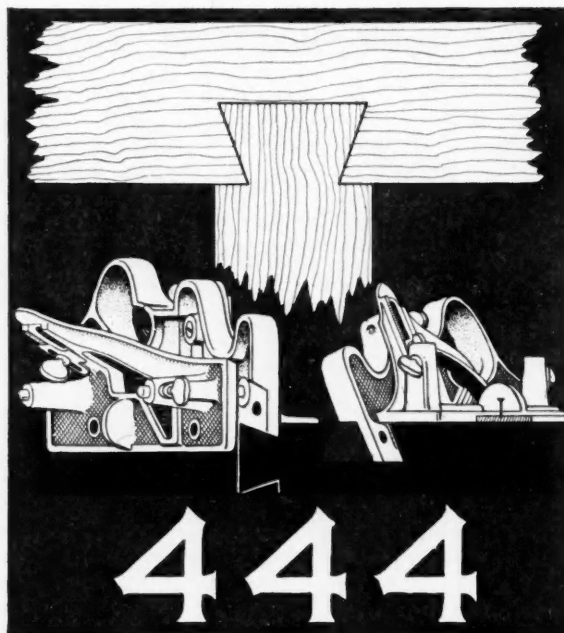

New Stanley Plane for Dovetailing and Some of Its Work

tongue with a cutter having an *oblique* edge of the same angle guided by two fences at right angles to each other, one being parallel to one side of the cutter.

The operation of the plane is simple, and the accurate and



10 years ago
this house
was lined
with

LAFAYETTE, IND.

About 10 years ago in rebuilding my home, I finished four rooms and a half-round bay window with Compo-Board, and two years ago built two new rooms and used Compo-Board again for interior finish and also a hall partition, which speaks my appreciation of same.

Geo. E. Jenks

Compo-Board
THE MODERN WALL LINING

Mr. Contractor:

How many houses do you know of that were lined with lath and plaster ten years ago, which have not been patched and mended, or perhaps replastered. The above experience of Mr. Geo. E. Jenks is typical of thousands of other cases where the permanent reliability of Compo-Board has been put to tests of from five to twelve years of actual service as a wall lining.

Compo-Board is quicker to put on, and it lasts longer. It introduces no moisture into the building. It cannot sag or fall off like plaster. When you finish a job with Compo-Board, you are through with it. You do not have to go back a little latter and repair.

COMPO-BOARD WILL HELP YOU GET BUSINESS

Time is the essence of many contracts. In nearly every building put up, you are urged again and again to complete it as soon as possible. Compo-Board will actually help you get business you might otherwise lose, because it will enable you to complete the work quicker than other contractors who might be figuring on lath and plaster. Read this experience from a Philadelphia Contractor:—

"I commenced a job this morning which I got although I was the highest bidder. My bid was accepted on account of being able to complete the work fifteen days sooner than the other contractor, because I am going to use Compo-Board. I have used Compo-Board on cold damp walls and it has given entire satisfaction."

JOHN B. WALLS,
Philadelphia, Pa.

You can work with Compo-Board in all kinds of weather, winter or summer. It enables you to do quick, clean and satisfactory jobs with very little labor expense.

HOW COMPO-BOARD IS MADE

Compo-Board is a composition board. From the illustration of the border of this advertisement, you will see that it has three principal parts, the surface of heavy paper, the wooden core and cement. The paper is special extra hard paper, non-porous, and a non-conductor of heat. The cement is of very great strength, and permanently holds the paper to the slats. The wooden core is made of thoroughly dried slats 1" wide, and put in indiscriminately as to grain, to prevent warping. The whole, after the parts are assembled, is subjected to very heavy pressure and intense heat. It is $\frac{1}{4}$ " thick and will take the place of 1" lumber anywhere. It can be sawed with an ordinary hand saw. It comes in strips 4 feet wide and from one to eighteen feet in length.

SEND FOR SAMPLE AND BOOKLET. You ought to know just what Compo-Board is and how it is made, its surface, its strength, and its adaptability in many ways in which it will save you a great deal of time and secure for you a great many jobs. Send for sample and booklet.

NORTHWESTERN COMPO-BOARD COMPANY

5777 LYNDAL AVE. NORTH,

MINNEAPOLIS, MINN.

Strength, Beauty and Service

The three necessary elements required in a material of *Quality*
For ROOFING and SIDING

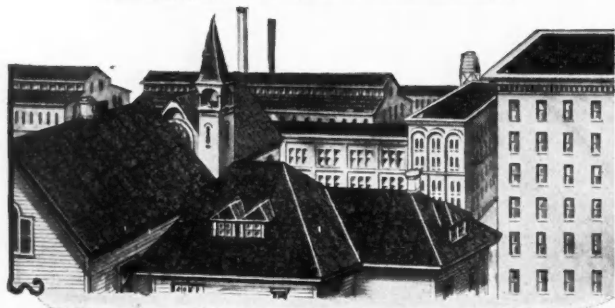

Buildings of any kind of construction—be they new or old, are combined to the greatest extent in

Ready-To-Lay **Burmite** (REG. U. S. PAT. OFF.)



A Flexible-Cement-Burlap Inserted Material for all who **Talk and Want Quality.**
 It positively makes good and is **Guaranteed for 10 years without Coating or Painting.**

We couldn't afford to make this statement were it not a fact, any more than you can afford to recommend or use an inferior article for a customer of yours. We know that it is an **honest value for discriminating people**, and invite your closest and most critical investigation of our claims and severest test of "Burmite" made to meet **Extreme Weather Conditions** in two separate and distinct surfaces. i. e.,

Bird-Sand and "Twolayr" Slate Chips

Lasts longer than shingles—costs less, lays smoother, looks nicer—requires no paint to preserve it.

Cheap roofing is expensive at any price—must be painted at least three times in the course of from seven to ten years. "Burmite" requires no paint—hence is the most economical to buy. It can be used in any climate—does not dry out—remains flexible always.

LET US SEND YOU THIS SET OF SAMPLES and our **BOOKLET**, so that you can compare it with other roofings you've handled—apply your own tests in your own way and then let us explain our **SPECIAL SERVICE TO BUILDERS** which will help you to introduce it in your locality.



Illustrated with buildings beautifully printed in colors showing effect of "Burmite" applied as a roofing and siding on Residences, Summer Homes, Cottages, Bungalows, Garages, Barns, etc. Mailed **FREE** of all charges and obligations—**WRITE FOR THEM TODAY.**

BERMINGHAM & SEAMAN CO., Roofing Manufacturers

General Offices: 1208-26 Tribune Bldg., **CHICAGO**
 Plant: 56th, Armitage and Grand Avenues

Distributors of **BEAVER BOARD**

USE THIS COUPON

BERMINGHAM & SEAMAN CO., Tribune Bldg., Chicago

Mail to my address, as above, Samples and Booklet. This places me under no obligations. A. C. & Bldr. 9-11.

Name _____

No. and St. _____

Town _____

State _____

WHEN WRITING ADVERTISERS PLEASE MENTION THE AMERICAN CARPENTER AND BUILDER

perfect fitting joints obtained, both parallel and tapering, will convince the operator of the utility of this unique and original tool.

Below are shown some of the numerous kinds of Dovetail Tongue and Groove Joints that can be made with its use.

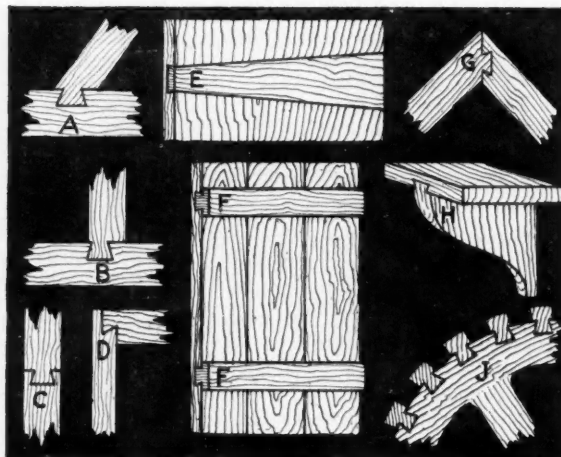

Work of Stanley Dovetail Tongue and Groove Plane

A is a dovetail tongue and groove joint with the groove cut in the regular manner, and the tongue cut on a bevel, used for supports.

B is a dovetail tongue and groove joint with unequal shoulders or a joint with a regular groove, but where the tongue is offset.

C is a dovetail tongue and groove joint as can very often be conveniently used when one is forming an end to end timber match.

D is a dovetail tongue and groove half joint, frequently used by carpenters to a very great advantage in concealed nail work.

E is a dovetail tongue and groove joint as applied to a flush key batten, where used in strengthening wide thin boards across the grain.

F is a dovetail tongue and groove joint as it is very often used to construct a batten on doors made of several boards, etc.

G is a dovetail tongue and groove joint where both the groove and tongue are cut on a beveled surface, making a strong corner.

H is a dovetail tongue and groove joint shown in one of its most useful applications, that of a bracket supporting a shelf.

J is a dovetail tongue and groove joint as applied to the setting of gear teeth around the outer rim of any gear pattern.

The manufacturers of this unique tool have issued a very attractive circular containing a detailed description, as well as complete instructions for operating, and will be glad to send same to anyone interested. Address Stanley Rule & Level Co., New Britain, Conn.

Pullman Mfg. Co. Issue New Catalog

New catalogue No. 10 has just been issued by the Pullman Manufacturing Company, makers of hardware specialties, Rochester, N. Y. This is a catalogue that every reader of the AMERICAN CARPENTER AND BUILDER should have on hand for his own information and for reference. It covers a most interesting line of hardware specialties, including the well known "Unit Sash Balances" that are making this company famous.

This catalogue is very attractively gotten out, nicely illustrated and is of convenient size for reference. It will be mailed on request to all those desiring a copy.

Its third year—and Hupmobile demand unabated

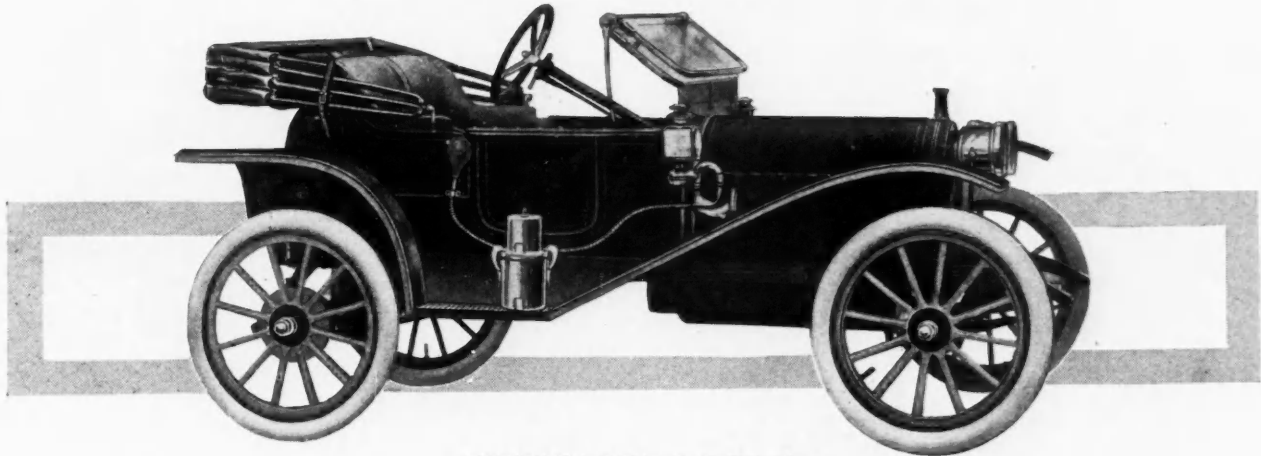

RUNABOUT—\$750 F. O. B. Detroit.
Equipment includes top, windshield, gas lamps and generator, three oil lamps, tools and horn. All types have 20 H. P. 4-cylinder motor, sliding gear transmission, Bosch magneto.

RUNABOUT
Fully Equipped
\$750 F. O. B.
Detroit

Hupmobile
GUARANTEED FOR LIFE

TOURING CAR
Fully Equipped
\$900 F. O. B.
Detroit

Now, in its third year—amid a bewildering distraction of new models and new prices—the Hupmobile is bought as eagerly as it was in its first season.

Then it was a sensational novelty—a car unheard of at a price unheard of.

Today its place is firmly fixed. Its hold has grown stronger and stronger upon those level-headed buyers who always ask and always get the most for their money.

Hupmobile demand has been steady and consistent through two seasons and well into its third.

Public confidence was gained at the outset, and has been held through the keeping of faith and the giving of generous value.

For weeks our factory has been under the supreme test of working day and night in order to produce cars rapidly enough to keep pace with the volume of orders.

The Hupmobile occupies this unique position because it has been true to itself and true to the people.

It has gone on being better and better until now—with more than \$100 added in improvements and almost as much more in equipment—it is as extraordinary a car as it was three seasons ago.

At this time we wish to call attention particularly to the Hupmobile Coupe—which has been aptly termed a "baby grand limousine."

It has gone a long way toward displacing the old idea that an enclosed car is restricted to town use.

It was only recently that three residents of Elgin, Ill., toured in a Hupmobile Coupe, from Chicago to Minneapolis, via Mankato, Minn.—more than 500 miles—without trouble of any sort and showing an average of 25 miles per gallon of gasoline over country roads and hills. Last November a physician of Hammond, Ind., drove his coupe home from the factory in Detroit.

Hupp Motor Car Company, 1255 Jefferson Avenue, Detroit, Mich.

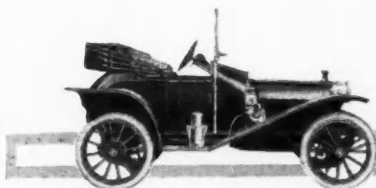

Torpedo—\$850 F. O. B. Detroit, with special torpedo top and windshield and other equipment same as Runabout.

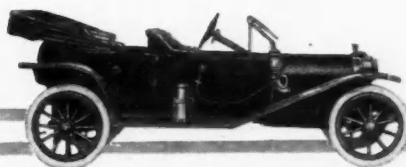

Touring Car—\$900 F. O. B. Detroit, with same equipment as Runabout, shock absorbers in front, 31x3½-inch rear tires.



Coupe—\$1100 F. O. B. Detroit, with five electric lamps outside, dome light, folding dash seat for third passenger, shock absorbers in front, 31x3½-inch rear tires.

WHEN WRITING ADVERTISERS PLEASE MENTION THE AMERICAN CARPENTER AND BUILDER

Pryibil Woodworking Machinery

A special catalogue has been received from P. Pryibil, 520 W 41st St., New York City, illustrating and describing their Band Saw Machine No. 7. This is a machine that is especially adapted to the needs of the general wood-working shop and is for that reason of special interest to our readers.

Pryibil's large catalogue "A," showing their full line of woodworking machinery will be sent immediately upon request, as will also this special Band Saw Catalogue, to readers of the AMERICAN CARPENTER AND BUILDER.

The Engine for Carpenters and Contractors

The Gray Motor Company, the well known marine engine builders of Detroit, Michigan, are now putting on the market a complete line of 2-cycle and 4-cycle stationary engines.

Although they have been catering to this trade for some little time past, it is only recently that they began building 4-cycle engines.

They have been builders of 2 cycle engines exclusively for a number of years but in supplying the trade with stationary engines it was found to be a better plan to have both 2-cycle and 4-cycle engines as there are many cases where a 4-cycle is better adapted to the work than a 2-cycle and vice versa.

Take the carpenter for instance, who has a small work shop of his own with some of the smaller wood working machines that are best adapted to the use of the carpenter; the gasoline engine has proved to be his one salvation and a 4-cycle engine such as the one manufactured by the Gray Motor Company, has been found to be particularly well adapted to this kind of work. They are reasonably low in first cost, the upkeep is very slight and the gasoline engine today is so perfected that if a reliable one is purchased there is very little danger of annoyances from unsatisfactory engines. In fact it will

be found that the purchaser really takes no chances at all, as a reliable firm guarantees their product and as it is only a question of selecting your engine from a concern who are known to be well advertised and financially able to look after the needs of all their customers.

The 4-cycle engine, which we illustrate here, is one of the latest models of the Gray Motor Company and is particularly well adapted to carpenter shops, etc. The illustration is of a 4 H. P. size and is a very complete power plant. It is water cooled and mounted on substantial well seasoned wood skids with battery box attached to the skids. The gasoline tank is in the base of the engine and the cylinder and hopper are cast in one piece of the best grey iron preventing any

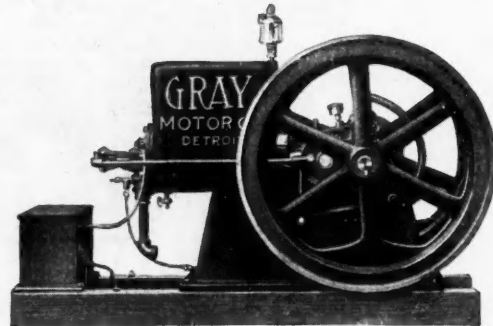

4 H. P., 4 Cycle "Gray" Carpenter Shop Engine

possibility of leaking joints. The engine is very simple and accessible, has a very sensitive automatic governor which takes care of any variation in the load very quickly and automatically, also cuts off the supply of gasoline and electric current when the engine is running on a light load making the engine a very economical one to operate. Normal speed of the engine is 350 to 400 R.P.M. Can be instantly increased

The Way to a Good Steel Ceiling Business, Better Profits, Increased Prestige---

"BERGER'S"
Classik
METAL CEILINGS

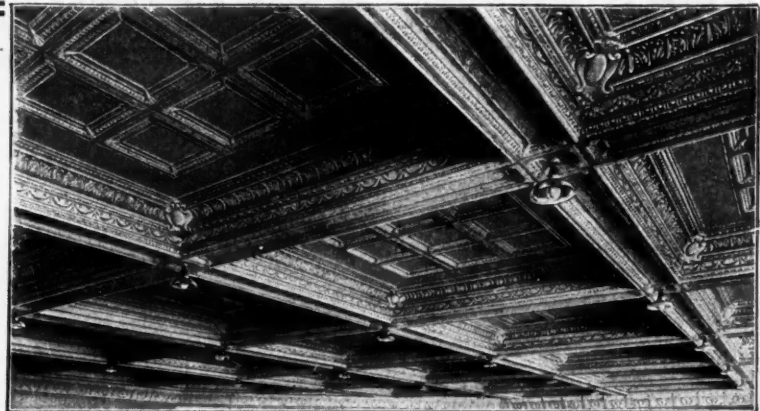

BERGER'S "Classik" Steel Ceilings offer the most complete selections of artistic, embossed steel ceilings.

They comprise eleven distinct classes of architecture. Each of these eleven classes is made in a variety of design, making possible the arrangement of hundreds of beautiful combinations.

A good selection for your customer to choose from makes easy sales for you.

Berger's "Classik" Steel Ceilings are easy to erect—every man who handles them will tell you so. Easy erection means time saved—money saved—better profits for you.

Berger's "Classik" Steel Ceilings have a prestige that wins trade—wins profits—wins dollars. They will win these for you.

The nearest Berger Branch will give you full particulars—a handsome catalogue, too. Write today.

The Berger Mfg. Co., Canton, Ohio

New York

Chicago

Philadelphia

Boston

St. Louis

Atlanta

Minneapolis

San Francisco

We also manufacture Black, Galvanized and Painted Roofings, Tin Plate, Metal Lath, Prong Lock Studs and Furring, Metal Tile, Eaves Trough, Hangers, and Conductor Pipes, Brick and Stone Siding, etc.

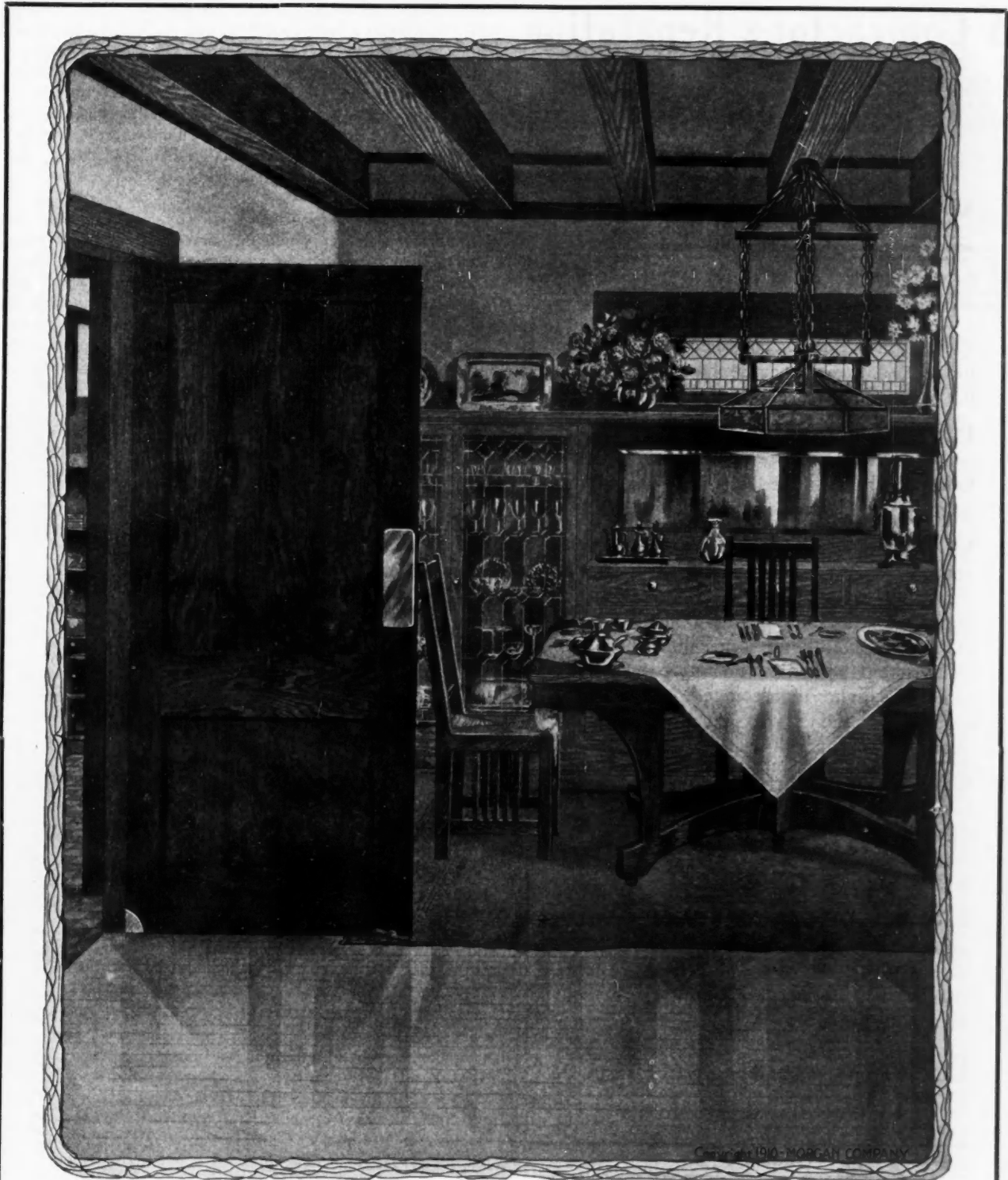

Look Into the Door

the works. The works of a door are just as important to its

Did you ever stop to think just why some doors stick, warp, shrink, open at the joints and are always causing trouble? You would not buy a watch without looking at the works of a watch.

Morgan Doors

are beautiful and durable—they are constructed so that they will never warp, twist, open at the joints, stick or cause any door trouble—they are not heavy or unwieldy—they are beautiful on the outside and have durability built into them.

Write today for our handsome illustrated book, "The Door Beautiful," showing some of the details of the honest construction and beauty of design of Morgan Doors.



The word Morgan is our Guarantee of Perfection—the Manufacturer's Pledge of Quality in Hardwood Veneered Doors.

Morgan Company,

Dept. O. H., Oshkosh, Wisconsin

Distributed by:—Morgan Sash and Door Company, Chicago, Ill.
Morgan Millwork Company, Baltimore, Maryland.

A Contractor's Reputation

AND



CORTRIGHT METAL SHINGLES

¶ Many a builder or contractor has had his bid turned down because he had acquired the reputation of using poor quality material.

¶ This may not always be his fault, for the competition may be so keen, or the owner's funds may be so limited, as to necessitate some sacrifice in the quality of materials.

¶ **Cortright Metal Shingles** are economical enough in cost to enable you to meet competition with superior instead of inferior quality, and at the same time possess so many obvious advantages over other forms of roofing that even should your bid, including them, run somewhat higher than competitors, you have arguments in their favor so convincing as to overcome any such differences.

¶ Another reason **Cortright Metal Shingles** would help you on competitive work is that they are so constructed that any of your own workmen can lay them, saving you the otherwise necessary expense of skilled roofers.

¶ We have an unusually attractive proposition to offer contractors and builders. Write us today, or just simply sign and mail the attached coupon, and learn how to get your share of these increased profits.

Cortright Metal Roofing Co.
Philadelphia and Chicago

COUPON

Cortright Metal Roofing Co., Philadelphia, Pa.:

Gentlemen: You may send me your special proposition for Contractors and Builders advertised in American Carpenter and Builder for September.

Name

Street Address

City

Business

or decreased between 300 and 500 R.P.M. The starting handle is situated conveniently in the fly wheel closing up automatically when the engine starts. The engine is painted a light green, skids and battery box a dark red; will operate on kerosene, alcohol, distillate or gas as well as gasoline.

Just to give you an approximate idea of how cheaply one of these engines will do your work the following data may be interesting: Engine consumes about 1/2 pint of gasoline per H. P. per hour. 4 H. P. engine running all day under full load will consume approximately 20 pints or 2 1/2 gallons of gasoline which at 16 cents a gallon would be 40 cents. Of course a general user would undoubtedly average not more than 4 hours a day and the work would therefore be turned out for an expenditure of about 15 or 20 cents a day for fuel. These figures, of course, are only to give an idea of what a gasoline engine will accomplish under normal conditions, different conditions and different kinds of work naturally could be expected to increase or decrease the cost, depending entirely upon time and amount of work being accomplished. Any carpenter or builder desiring information regarding gasoline engines should write to the Gray Motor Co., for their catalog and we are also sure you will find them not only willing but well prepared to answer any questions of a technical nature that you may put up to them.

A Mark and Its Meaning

Making good tools is a good deal like making anything else. It takes the best of material and the best of skill. The best material in the world can be easily ruined by carelessness or indifference, and no amount of skill can put quality into inferior metal or wood.

Sometimes men are permitted to guess that their finished work will prove itself by use. Too often the result is the contrary because the care that should accompany the smallest motion has been carried only to a certain point and then abandoned.

When a product passes through numerous hands before completion, and each man slights some detail that he may consider unimportant, the final result is apt to be far short of quality.

Keen Kutter tools, made by the Simmons Hardware Company of St. Louis, are the expression of real quality from every point of view. The one great purpose back of every manufacturing effort is satisfaction to the user and to the dealer. That brings satisfaction to the Simmons Company, and makes friends of all customers.

Keen Kutter tools have been a final definition of the word quality for more than forty years. The Keen Kutter trade mark was designed as a positive guarantee that every tool or implement that bears it is of first quality, and that all claims made for them are backed by the Simmons money-back plan. This method is the same in effect as a written agreement. The fact that the Keen Kutter trade mark is stamped on the metal or attached to the wooden handle of any tool is all that is required for a quick refund or a new tool, if not as represented.

The Keen Kutter trade mark makes tool buying a matter of certainty, instead of a matter of chance. Keen Kutter means real tool insurance.

Every workman needs good tools for shop or field. He cannot afford to experiment with nameless tools that have no guarantee. If he uses that sort he often finds himself in a bad fix in the midst of a job that he cannot leave, because some tool has gone wrong or broken under a little unusual strain.

For his workshop, the farmer needs Keen Kutter carpenter's tools, and for his work of cultivation he needs scythes, hay knives, grass hooks, hoes, rakes, forks, corn knives and other garden tools. His wife, scissors, shears, a food chopper

**Boost Your Own Reputation, Mr. Contractor, By Telling Your Customers
—“Put a Stop to Depreciation—Build with Cypress at First”**



is the “LIFE-SAVER” of an HONEST CONTRACTOR’S REPUTATION

Here is a letter just received from a builder who **knows** by experience. Probably you feel the same way. Why not **CUT OUT TROUBLE?**

Contractor and Builder, _____ Street,
PITTSBURG, PA., Mar. 22, 1911.
Southern Cypress Manufacturers’ Association,
New Orleans, La.

Gentlemen:—Please send me information about Cypress lumber. Have about a dozen frame houses, from two to 16 years old, which I never get through repairing. Window frames, sash, siding, sills, etc., become rotten in a few years, and *the contractor gets a bad name* (as if it was his fault!)
Yours respectfully,

This is a bona fide letter—“hot off the bat.” The facts are all too true. **HE WILL BE A CYPRESS MAN FOREVER. HOW ABOUT YOU?**

We say it again—that by honest and intelligent advice on **woods** we are not only saving losses to people who are going to **build anyhow**—but we are also **CAUSING MORE PEOPLE TO BUILD.**

This is going to be of more and more benefit to **you** month by month. It is **up to you** to intelligently take advantage of this by **learning for yourself** that **CYPRESS** is not only the **ONE BEST OUT-DOOR WOOD** for the owner—but also the **ONE BEST WOOD FOR YOU.** Cypress “**makes good.**” That helps your reputation. Cypress is easy to work—that’s **good for your tools.**

We are giving away complete working plans and specifications for **THIS SHINGLE HOUSE.** Many thousands of people **ALL OVER THE U.S.** are writing for them. **THEY WILL HAVE TO GET YOU TO DO THE WORK.**

THEY WILL INSIST on CYPRESS

It will be **MONEY IN YOUR POCKET TO HELP THEM GET JUST WHAT THEY WANT.**

CYPRESS is the “**comer**” in **YOUR** territory.

LISTEN FOR IT

Why not FIND OUT what CYPRESS can do for YOU, NOW? WRITE US—ASK YOUR OWN QUESTIONS—about your own needs, big or little. You can rely on detailed and reliable **CYPRESS** information if you address our “**BUILDERS’ HELPS DEPT.**” We will recommend **CYPRESS ONLY FOR USES WHERE IT IS THE BEST WOOD TO USE.**

Southern Cypress Manufacturers’ Association
1216 HIBERNIA BANK BUILDING, NEW ORLEANS, LA.

We are *producing* CYPRESS—and *talking it*—but *not retailing it.* **BUY IT NEAR HOME.** ASK your lumber man if he sells CYPRESS; if he does not, ask him **WHY.** Then **WRITE US.** We will tell you where you **CAN** get CYPRESS.

WHEN WRITING ADVERTISERS PLEASE MENTION THE AMERICAN CARPENTER AND BUILDER



and kitchen cutlery. His personal needs include a razor and pocket knife.

All these are of the best quality obtainable if they have the Keen Kutter trade mark, and the Keen Kutter guarantee.

Many farmers have bought Keen Kutter tool cabinets equipped with Keen Kutter tools; just enough for the ordinary requirements of the home or a complete set that includes all the tools used by a journeyman carpenter. The cabinets are beautifully made from selected woods and present a very handsome appearance.

Your hardware dealer carries a complete line of Keen Kutter tools for shop, home or farm—or he will get any

Schacht Motor Truck

It is stated by those who are in a position to know that every contractor and builder will eventually use nothing but motor trucks for his heaviest hauls and longest trips. The day of heavy horse trucking is past, and that of the big, powerful, never-tiring motor truck is here. More and more of these machines are being sold every day to men who have come to the conclusion that they can't afford any longer to keep and maintain such large numbers of teams and wagons.

The logic of this becomes evident when you consider that a three or four-ton Schacht motor-truck, as illustrated herewith, will do the work of three teams, or six horses, and more than that, it reaches the remotest sections and suburbs much more quickly than the teams did, delivers the goods safely and returns for another load. Distant trips which in the past have meant all-day hauls to the horse-drawn trucks have been reduced to two-hour trips by the Schacht truck. The truck never tires, never ails or fails; it is always on the job and whether it is worked three hours or twenty-four hours a day, it will always give the same unflinching service. Costs nothing for maintenance when not in operation.

A prominent lumber dealer, speaking of his experience with Schacht motor trucks, states that he now makes four long hauls and gets back exactly the same time it took him to do it with his three teams and wagons. This is his daily average for one truck. One man now handles the Schacht truck.

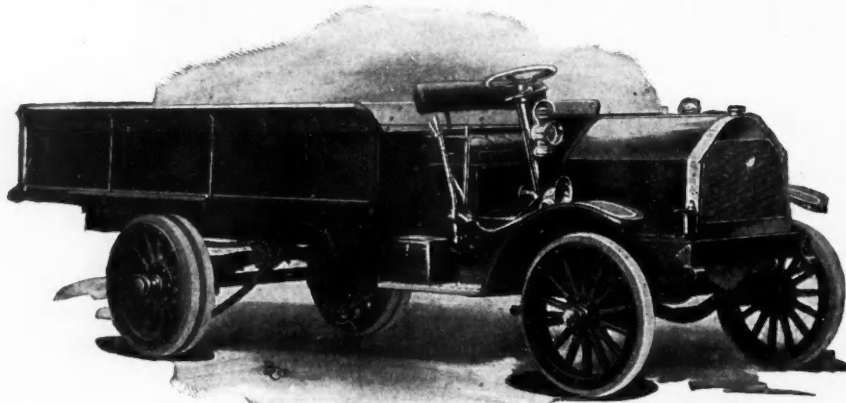

Heavy Duty Schacht Truck for Contractors' Hauling

Keen Kutter piece you want. If not, write to the Simmons Hardware Company, St. Louis, Mo.

Save 1/2 Your Lumber Money

Builders, Contractors and Carpenters who buy their lumber from the
Peter J. Seippel Lumber Co.

have greater advantages in wide selection and low price than if they owned a lumber yard of their own.

Every stick of lumber we sell is a double bargain—a bargain in price and a bargain in quality. We sell you everything straight from the mill—we don't job anything. We have our own forests, saw mills, planing mills, etc., and make everything needed for building, from foundation to roof. The price you pay us is based on the actual cost of production. We

Cut Out All Middlemen's Profits and Save You **25% to 50%**

Your local dealer can't buy his own stock to any better advantage anywhere than you can buy from us. And our quality is so much higher than his that if you use much lumber you can get all the No. 1 you need by resorting our No. 2 stuff. This way you can get your No. 1 for 25% to 50% less than No. 2 is now costing you. Whenever you need a car of lumber, get on the train and come to Dubuque. We will pay your fare both ways and you can select every stick of your order personally from a stock as big as 200 or 300 local yards combined. Send small orders by mail and get the advantage of our low prices on all the lumber you use. We guarantee satisfaction on every order and a saving worth while. On all your buildings where a prepared roofing is specified, you will find our DUX-BAK Roofing the most profitable and satisfactory you can use. Contains no tar, won't run, crack, peel or taint water. Works perfectly on flat or steep roofs. These prices and guarantee periods will convince you.

1 ply, 35 lbs. per square, only \$1.15 per square.	Guaranteed for 5 years.
2 ply, 45 lbs. per square, only \$1.40 per square.	Guaranteed for 10 years.
3 ply, 55 lbs. per square, only \$1.70 per square.	Guaranteed for 15 years.

We make a specialty of handling builders' orders promptly. Send us your next order and see how much we save you. Write for free catalog and builders' price list. Special estimates furnished promptly on your buildings at any time.

Peter J. Seippel Lumber Co.,
 Dept. 24, - - - - - **DUBUQUE, IOWA.**

ANDREWS HOT-WATER HEATING



**WE SAVED THE OWNER
\$160**

**CONTRACTORS, There's
Good Money for You
Putting in My ANDREWS
HOT WATER HEATING
SYSTEMS in Your Houses**



**THEY ARE SENT YOU "KNOCK-DOWN"
READY TO SCREW TOGETHER**

T HIS SYSTEM is the easiest for you to handle, as I do all the work of planning, cutting and fitting —yes, and take the risk of the plant's success. I know the Andrews Systems are the best that can be produced in every way. Your Carpenter's helper can easily set up the plant, following my complete and simple directions. It will pay you to investigate my proposition which enables you to make the profit that would otherwise go to the heating contractor. Send me a rough sketch for an estimate on your next job. I will quote you a net price or quote price to your customer, allowing you a commission. Let me help you increase your profits.

Andrews Steel Boilers

are more efficient and require from 25% to 50% less fuel than cast boilers. They are made of the strongest steel plate like big power boilers. There are no cast-iron sections, nothing to break or crack, no leaky joints to pack and, given ordinary care, the boiler is as durable as the building itself.

Regurgitating Safety Valve

makes your radiators one-half hotter in very cold weather. It makes Andrews Hot Water System heat up your house as quickly as steam without any steam plant disadvantages; stops "boiling over". It is simple, automatic, safe.

Temperature Control

Andrews Thermostat keeps the whole house at 70 degrees or any other point you wish. It watches the fire and operates the dampers, saving you all bother. Accurate, absolutely dependable. Guaranteed for life.

Our Hot-Water Engineers

are famous. From your rough sketch or architect's plans they design your complete hot water system, make it complete in my factory and ship it to you "knock down" with such complete and simple directions that you, your carpenter's helper or any handy man can put it in.

How to Get An Andrews System

First send us a rough sketch or architect's plans of the house to be heated, giving size of rooms, windows, height of ceilings and construction, and get our free estimate of cost complete. The plant is then made complete in our factory and shipped "knock down" either to you or to your customer, as you may prefer. We pay freight and furnish a 360 Days Free Trial Guaranty Bond. For your services we allow a very liberal commission.



**SOLD ON 360
DAYS FREE TRIAL
Guaranteed by Bond**

Our Big Factory

has capacity of 3,000 Systems per year. It is equipped with special tools and labor saving devices which reduce cost and furnish much better plants. We sell direct from jobbers' and middlemen's

HEATING—PLUMBING—WATER-SUPPLY—SEWAGE DISPOSAL AND GASOLINE LIGHTING SYSTEMS

**Buy Direct
and take the
Middleman's
Profit**



**Free Estimate and 72 Page Heating Book
Coupon. Fill in and Mail Us To-Day**

**We
Pay the
Freight

Old
Houses
Easily
Heated**

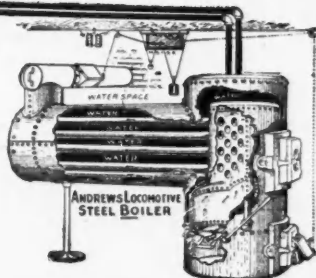

ANDREWS HEATING CO., 1197 Heating Bldg., Minneapolis, Minn.

I enclose herewith rough sketch or architect's plan of house for which please furnish me a Free Estimate of Hot Water Heating System, Complete. Also your Big Book on Heating, Plumbing, Water Supply, Sewage Disposal and Gasoline Lighting.

NAME

ADDRESS

I enclose also two names of parties who might buy.

1197 Heating
Building

ANDREWS HEATING CO.

Minneapolis,
Minn.



**"I NEVER
HAVE HAD TO
ASK A DEALER
FOR MY
MONEY BACK
SINCE I HAVE
BEEN USING
SIMONDS
HAND
SAWS"**

That's what one carpenter said when writing about his experience with Simonds Hand Saws.

It would be entirely too broad a claim to say that none of them ever did come back, but we believe that dealers have to give "money back" on fewer Simonds Saws than any other brand of Hand Saws.

Here's what one dealer in a large city in Pennsylvania writes: "The saws I return you by express are the only ones to my knowledge returned for exchange in all the years I have bought your line. We have less exchanges on Simonds Saws than on any other brand, and sell twice as many of them."

A carpenter in Cairo, N. Y., writes: "Five years ago I bought two Simonds Hand Saws, one Rip and one Cutoff. They are certainly the nicest running saws I have ever used. The dealer said if they were not better than any other make I ever used to bring them back. I never took them back."

Ask your hardware dealer for Simonds Hand Saws or write us about the kind of a saw you are wanting.

**Simonds
Manufacturing
Company**



Fitchburg, Mass.
Chicago, Ill.
New York City
New Orleans
San Francisco
Portland, Ore.

whereas three men, all drawing \$2.00 a day, formerly drove the teams.

Those who have investigated the matter claim that the Schacht three or four-ton truck actually can show you that it is a money-maker, a time saver and a necessity. It is a necessity for any construction man—lumberman, builder, contractor—who is shrewd enough to know that the purchase price of any proven business builder is a secondary consideration if more business can be handled and greater results secured.

The statement is made that Schacht trucks are now daily making new business for hundreds of level-headed men. There isn't a motor truck user in the country today who would go back to the old horse-drawn methods. They couldn't afford to.

You will be interested in investigating this matter for yourself. Write at once to the Schacht Motor Car Co., 2846 Spring Grove Ave., Cincinnati, Ohio, requesting their interesting catalogues on motor trucks and inspection cars. Tell them what your trucking problems are.

New Catalog on Universal Woodworkers

One of the most complete pieces of literature ever prepared on woodworkers is the catalog describing the "Famous" line which has just been received by us. Most of our readers are acquainted with this class of woodworking machinery through the advertisements of the Sidney Tool Co., who build the Famous Universal Woodworker; but for real first-hand information it is necessary to refer to the above mentioned catalog.

Of a handy pocket size, the catalog is well written and illustrated and covers every possible feature connected with woodworkers. The fore part explains how economic conditions have made a combination machine necessary and how the necessity was foreseen and provided for. It explains how one machine is made to take the place of sixteen, besides

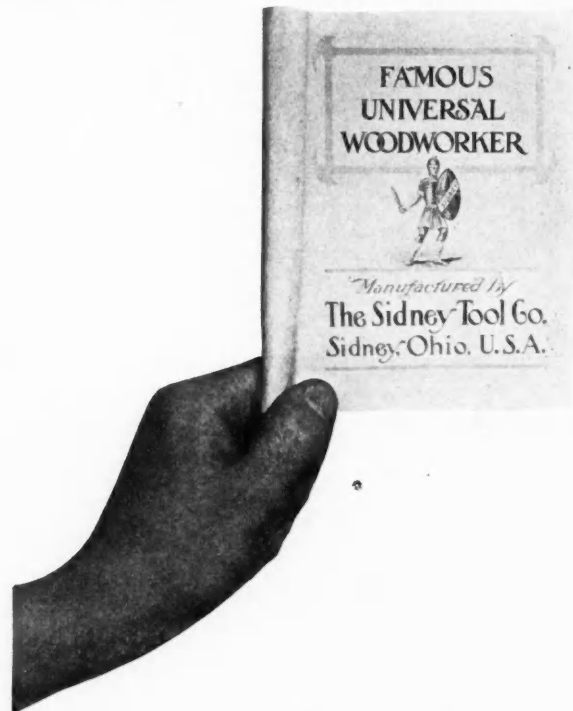

effecting an economy in labor, time and floor space.

Over half the catalog is descriptive of the woodworker itself. Its construction and operation in general is described and the construction and operation of the various parts are also explained thoroughly. One is struck by the absolute simplicity of the whole machine and the ease by which the adjustments for the different operations are made. Full in-

Glidden

Green Label

Varnishes,

Stains and

Specialties

THEY are specified by Architects for the finishing of the finest interior trim in private residences, banks, office buildings, etc.

We will gladly send you a beautiful panel frame showing our Endurance Wood Stains in fourteen different color effects and the stains finished with our best interior varnishes. We maintain a special department devoted exclusively to reproducing any color scheme you may care to suggest. You are welcome

to avail yourself of the services of this department *without cost*.

Glidden's Endurance Wood Stains

These are the ultimate wood stains—the stains you will specify once you know them. Those who have used them, declare that they are so far superior to any other stains that there is no comparison.

They enhance the natural beauty of all woods. They penetrate *without raising the grain*, and all the colors are permanent.

Specify our Stains and Varnishes and we will see that they are used.

Demonstrating Samples and Literature free on request. See Sweet's Index.

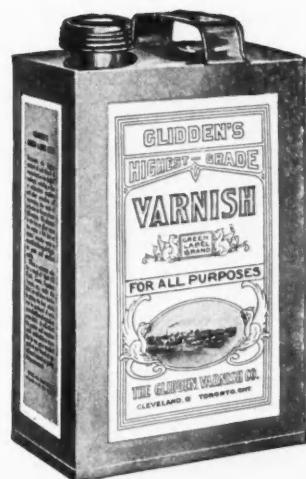

The Glidden Varnish Co.

Factories:
CLEVELAND, U. S. A.
TORONTO, CAN.

Branch Warehouses:
NEW YORK
CHICAGO

B. M.

formation on the various models is given, explaining how the requirements of practically every woodworking business is arranged for.

If proof of the success the machine has met with by contractors, carpenters, etc., be needed it lies in the fact that over eight hundred machines have been sold in a little over two



Shingled with "Eastlake" Shingles in 1889—Not One Cent for Repairs Since

years, and that not one has ever been returned or reported upon adversely.

Our readers would do well to write to the Sidney Tool Co., Sidney, Ohio, for this catalog as it is sent free upon request.

Montross Metal Shingles

The question of the "best" roofing material has always been one that has brought out many arguments. The manufacturers of metal shingles and metal roofing make the statement that metal is the best material for roofing when properly put on; they say that it is used on almost every building, either as an entire covering, or in connection with slate and wood shingles, or in the most critical parts, such as valleys and gutters.

The illustration printed with this article shows St. Paul's Episcopal church, at Tidioute, Pa. In 1889 this church congregation purchased of the Montross Metal Shingle Co., 102 Erie St., Camden, N. J., a supply of Eastlake shingles, and shingled the church with them. Not a cent for repairs has been made on the roof since, except the purchase of some paint. This is surely a good recommendation for Montross Eastlake metal shingles.

The Montross Metal Shingle Co., make the claim that these shingles will last double the time the same metal would, put on the old way, as there is no strain on the metal by contraction or expansion. These shingles are provided with this company's telescope storm-proof sidelock. They are thoroughly secured along their lower edge by cleats of heavy metal and are held in place permanently. Hammer and shears are the only tools required to lay them.

The Montross Metal Shingle Co. manufacture Eastlake, Octagon and Victor shingles, Gothic and Diamond tiles, metal brick siding and various roofing sundries. The illustration, page 104, shows the Octagon shingle, laid 66 shingles per square. Three figures are stamped on each

CARBORUNDUM Sharpening Stones

*You Can Tell a Good Workman
By the Condition of His Tools*

That is why so many **GOOD** carpenters use **Carborundum Sharpening Stones**—the stones that keep all edge tools keen and smooth cutting; that never become "slicked" over. **Carborundum Stones** are distinctly different; they cut the steel quickly and easily, leaving a fine, fast-working edge. Other stones merely rub. For general bench tools, the **Carborundum Round Combination Stone** is most practical and convenient; the shape allows for the rotary motion required in sharpening chisels, plane bits, etc.; for tools requiring an extra fine edge, there is the extra hard, extra fine stone. A bottle of **Carborundum Temperoil** will complete the outfit nicely.

No. 107. Round Combination Stone	-	\$1.00
No. 156. Extra Hard, Extra Fine	-	1.00
No. 108. Oblong Combination	-	1.25



From Your Dealer or Direct

The Carborundum Company
Niagara Falls, New York

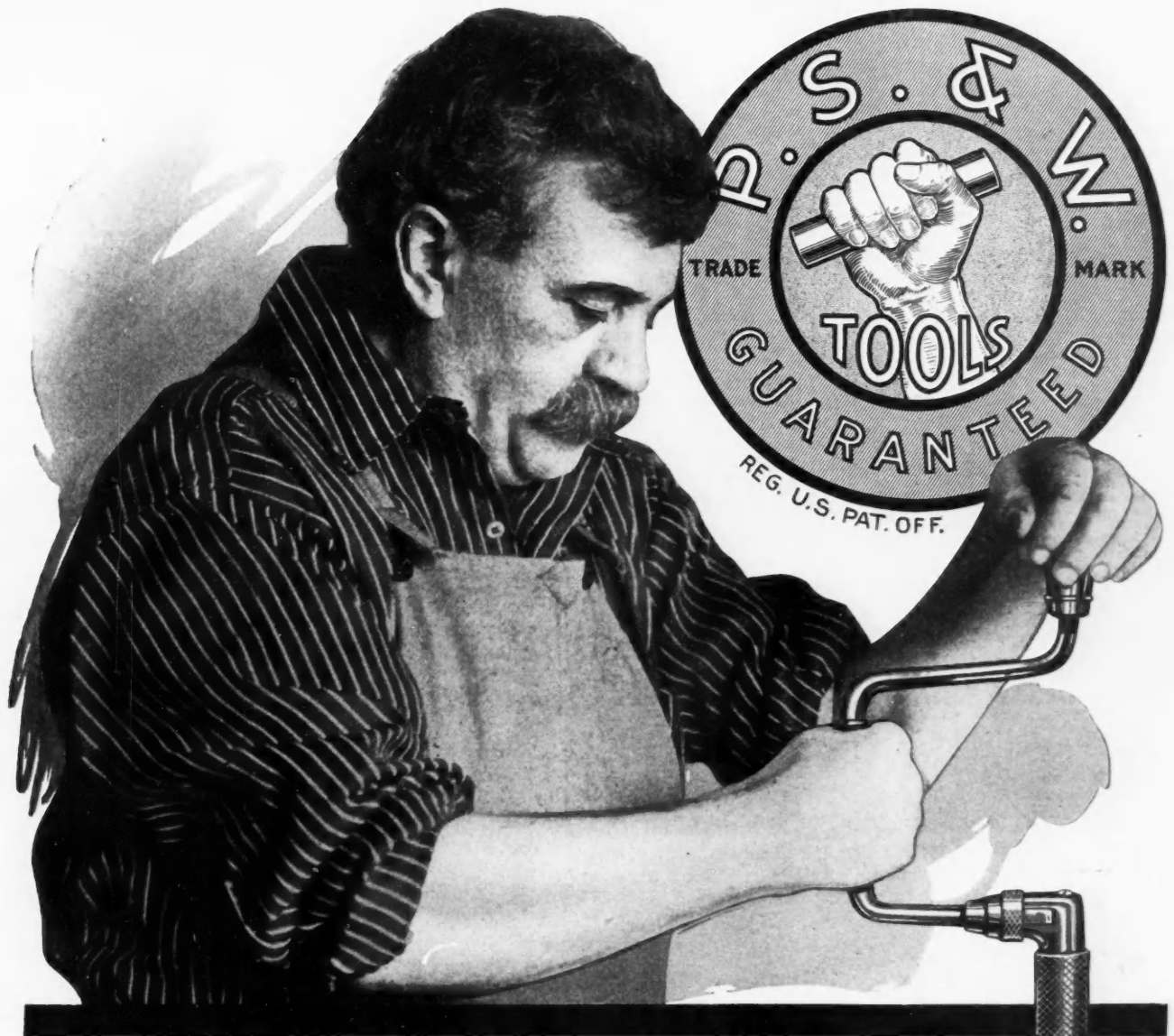

GOOD service for many years in the hands of skilled mechanics is the best standing advertisement of the SAMSON Brace and other items in the large line of P. S. & W. Carpenters' Tools.

Look for The MARK of the MAKER; it is branded on our highest-grade tools, and is an absolutely dependable guarantee of excellence.

The P. S. & W. Samson, or "Big Chuck" Brace has a ball-bearing chuck which grips tighter and releases more easily than any other ever made. It has also a steel-clad, lignum vitae head with dust-proof ball-bearings; a forged steel alligator jaw; solid steel sleeves; coco bolo center, etc.

Other P. S. & W. Tools for Carpenters include the largest line of braces and auger bits, and the most complete line of chisels and gouges on the market. Also highest grade drawing knives, squares, calipers, hammers, hatchets and many other carpenters' tools. These are all superior in finish, workmanship and fitness for their several uses.

Write today for our 165-page "Mechanics' Handy List." It contains 35 pages of valuable shop information and a catalog of over 200 tools. Sent free at your request.

Our four large Lines of Guaranteed Hand Tools for Electricians, Machinists, Tinsmiths and Carpenters are sold by leading dealers in the United States and Canada, or can be ordered by them from any hardware jobber. Insist on The MARK of the MAKER and accept no substitute.

The Peck, Stow & Wilcox Company

MANUFACTURERS of the Largest Line of Mechanics' Hand-tools Offered by Any Maker

Est. 1819 Address correspondence to 22 Murray St., NEW YORK CITY 5 Large Factories

WHEN WRITING ADVERTISERS PLEASE MENTION THE AMERICAN CARPENTER AND BUILDER

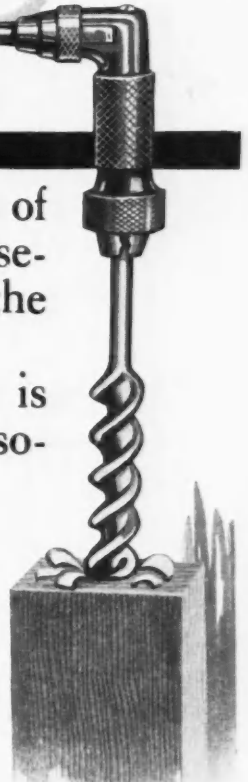

WANTED.

PARTNER WANTED with 10 to 20 thousand dollars to start a lumber business in South Brazil. There is a good field for the same. Welcome to full information. L. H. American Carpenter and Builder, New York Office

- BOOKLETS**
1. Shop saws—power equipment.
 2. Portable rip and cut-off outfit.
 3. Engines on hand trucks.

ELLIS ENGINES
USE

Valuable Information Free
Check One Needed

KEROSENE

SAVE LABOR—TIME—EXPENSE

Always On the Job

AT THE SHOP AT THE BUILDING
AT THE YARD AT THE MILL

More power, gallon for gallon. Hundred less parts. Catalog Free—Tells How. Force feed lubricator. Automobile muffler. Starts instantly. No pre-heating, no crank. Experience unnecessary. Vibration eliminated. Comes complete.

FREE TRIAL
No obligation till satisfied. 10-Year Guarantee.
"Engine Facts" free, write for it now.

ELLIS ENGINE CO.
69 Mullett St., DETROIT, MICH.

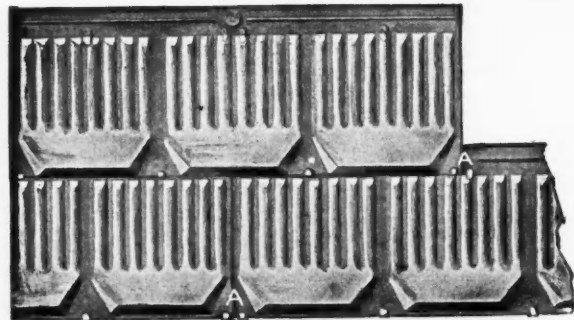
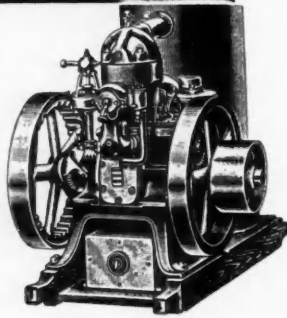

Montross Metal Shingle Co's. "Octagon" Style

shingle. Both Eastlake and Octagon styles are designed for churches, residences, barns, grain elevators, sheds and all buildings where moderate-priced, reliable, durable, ornamental, medium weight, fire and storm-proof roofing is desired.

A handsome set of blotters showing buildings of various styles in colors, on which Montross shingles have been used, has been prepared by this company. Write to the Montross Metal Shingle Co., 102 Erie St., Camden, N. J., for a set of these blotters and for their literature.

Two Interesting Appliances

Carpenters, builders, glaziers, shademen, plumbers, in fact any one in the building trades that ever has use for a folding rule, should be interested in the Dahl Master Slide Rule, made by the Dahl Mfg. Co., 1 East 42nd St., New York. This rule is illustrated herewith, right side up, ready for inside measurement. The arrow indicates the exact inside dimensions.

As can be seen this rule is particularly desirable for measuring the inside dimensions of doors, window trim, etc. When closed the rule measures 8 inches.

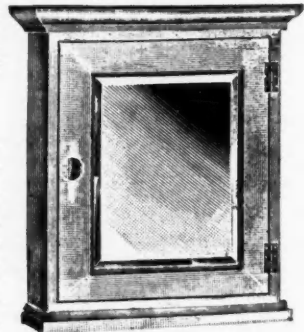

Dahl White Finish Metal Medicine Cabinet

To take the exact inside measurement, say, of a window case, hold the rule with the left hand, right side up, as shown in the accompanying cut, and with the right hand extend one slide at a time, beginning with the lower one until the two extreme points of the rule touch the object measured between, and you then have the exact measurement shown at all times as indicated by the arrow. For ordinary measurement use the reverse side.

The Dahl Master Slide Rule, when opened full length is perfectly rigid, and, is kept in place by springs that cannot get out of order. In this way the rule is particularly suitable for measuring height of ceilings, etc. The rule is made in lengths from 2 to 6 feet. Measurements are indicated to 1/16 of an inch.

The Dahl Mfg. Co. also manufactures a full line of white finish sheet metal medicine cabinets and metal shelving. The cabinets, as illustrated, are furnished with glass knob for doors, nickel plated trimmings, bevel French mirrors of good

(Patented Dec. 13, 1907)



Dahl Master Slide Rule

quality and two glass shelves. The metal shelves made by this company are of various designs, fireproof, neat in appearance and low in cost. They are particularly suitable for the building trade including especially hospitals, apartment

Let SANDOW Run It!

WONDERFUL WORK ENGINE

Farmers and Shop Owners, Stop Sweating! A few dollars gets this grand little work engine, complete and ready to run Cream Separators, Corn Shredders, Grist Mills, Feed Mills, Dynamos, Printing Presses, etc., etc. Gives a lifetime of steady service! All Sizes: 2 to 20 h.p. No cranking! No cams! No gears! Only 3 moving parts. Finest construction. Thousands in use. Guaranteed 5 years. Write for special introductory proposition.

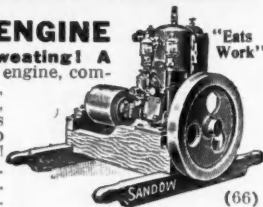

DETROIT MOTOR CAR SUPPLY CO. 196 Canton Ave., Detroit, Mich.



MOTOR TRUCKS
Three Chassis Models
2-ton, Stake Body \$2,950
4-ton, Stake Body \$3,500
6-ton, Stake Body \$4,000
Estimates will be furnished upon request for equipping Speedwell Trucks with any style body required.

Speedwell Motor Car Co., 610 Essex Ave., Dayton, O.

Are You Ever in Need of a Large Number of ? BLUE PRINTS ?

If so, write us sizes and quantity, and we will quote you prices that will surprise you!—Small orders at the rate of 2 cents sq. ft. All orders filled same day as received
THE POWER WALLACE CO., 1219 Arch St., PHILADELPHIA, PA.

CARPENTERS' TOOL SATCHEL



Carpenters' Tool Satchel.

Especially adapted for jobbing trips. Made of heavy canvas with steel frame for lock and key, leather handles and strap. Contains 5 saw pockets, bit and chisel rolls. Can't rip. Durable and convenient.
Send for Catalog showing our line of Mechanics Tool Bags

EXCELSIOR BAG & MFG. CO., Inc.
TROY, N. Y.

You SAVE \$15 or More

on every frame house you build with

WHEELER SAFETY SCAFFOLDS

Use no lumber or nails—Save their cost on two jobs—Last a life-time—Self-locking—Safe—Fold compactly—Convenient to handle—Self-adjusting—No loose parts to get lost—Always ready for use—They carry 1500 lbs.

Write today for our trial offer.

AMERICAN STEEL SCAFFOLD CO., 66 McGraw Bldg., DETROIT, MICH.

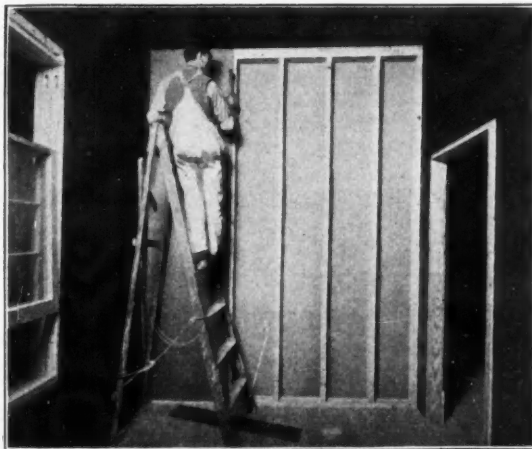

We Want to Send You a Sample

We want every carpenter and builder and home owner in America to know about and to have a sample of

Utility Wall Board

It is to your interest to have this sample and to become thoroughly familiar with this remarkable material.

Utility Wall Board marks the greatest advancement that has been made in interior building construction in a hundred years.

It is made of fibre—very hard and tough and durable. It is waterproofed on both sides. Being a non-conductor, it is largely heat and cold and sound proof.

It is very easily put on—nailed right to the studding and takes the place of both lath and plaster.

It is the only wall board on which you can safely use wall paper. At the same time it lends itself admirably to tinting and stenciling or other forms of decoration.

Made in various widths and lengths to meet all requirements of interior finishing.

**Write today for the Sample—
and for the new book of interiors**

**UTILITY WALL BOARD is Sold Through
Dealers in Builders Supplies Everywhere**

THE HEPPE'S COMPANY

4503 Fillmore St., Chicago, Ill.

THE IVES PATENT WINDOW STOP ADJUSTER

Prevents dust, drafts

and window rattling

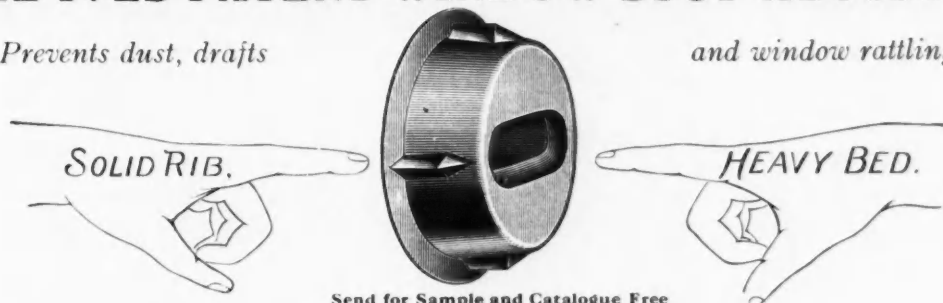

Send for Sample and Catalogue Free

1 piece of metal, will not cup, bend or turn in tightening screw.

THE H. B. IVES CO., Sole Mfrs. New Haven, Conn. U. S. A.

houses, etc., and the company will be glad to quote prices in large quantities.

Write to the Dahl Mfg Co., 1 East 42nd St., New York, for their circulars and prices. This company is also looking for carpenters and builders to act as agents in all parts of the United States and are in a position to make a good proposition along this line.

Mass. The original building, constructed entirely of concrete blocks made on Hercules machines, was over 250 feet long, 112 feet wide, and 50 feet high. It required over 30,000 blocks, and blocks of the same type will be used in the enlargement. An idea as to the size of the building can be realized from the fact that it contains 12 large boilers and over 150 carloads of machinery.

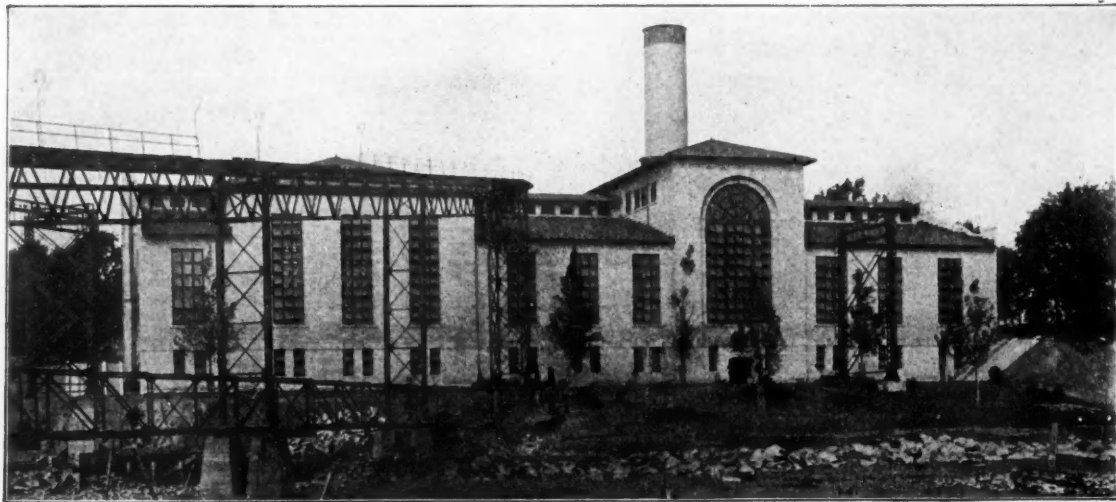

Concrete Block Power House of New York, New Haven & Hartford Railway at Cos Cob Conn. Now being enlarged. Over 30,000 blocks used in original structure, all made on "Hercules" machines.

Railroad Power House of Concrete Blocks

The New York, New Haven & Hartford Railway power house at Cos Cob, Connecticut, shown in the accompanying view, is to be enlarged, the contract for the work having been awarded to Fred T. Ley & Company, of Springfield,

The blocks used are 10 inches high, 12 inches wide, and 24 inches long. Work on the new addition will be commenced at once, the necessary Hercules machines and equipment having already been installed by the Century Cement Machine Company, of Rochester, N. Y.

Best for Churches, Public Buildings, Residences, Factories, Mills Montross Metal Shingles

The permanent roofing. Fire-proof; lightning-proof; storm-proof. Won't leak, crack, rattle or blow off. Lighter than slate or tile. Easily laid, no soldering. Architects and builders everywhere recommend them. Write for illustrated catalogue, testimonials and prices.

"Used Montross Galvanized "Victor" Shingles on the State Buildings here. They were put on in 1903, and have given good satisfaction."

*John Wheeler
Construction Co.
Geneva, Ill.*

*Per John Wheeler,
Pres. and Treas.*

Illustration shows section of Administration Building, State Training School for Girls, Geneva, Ill.

Live wire representatives make big money selling Montross Metal Shingles. Some very attractive territories now open. Write for particulars regarding our exclusive agency proposition.

**MONTROSS METAL
SHINGLE CO.**

102 ERIE STREET, CAMDEN, N. J.



6 Months' Free Trial

Hand and Foot Power

Don't take our word that this tool grinding, buffing and polishing outfit will save money for you. We offer you 6 months' absolutely free use of this outfit in your own work on your own tools, and let you prove for yourself that it is a money-saving and money-making outfit for any tool user. Use it a whole half year free, and if you don't find it a money-maker for you, send it back. The half year's use will not cost you a cent. If you want to make your own work and the work of the men you hire count for the most profits, how can you neglect this liberal offer? Return the coupon at bottom of page for 6 months' free trial offer.



Mechanics' Special—
will not draw temper

Luther Tool Grinders

6 times faster than emery wheels
25 times faster than grindstones
Built like a high grade lathe

Special attachments enable inexperienced persons to sharpen Chisels, Twist Drills, Etc.



The genuine Carborundum wheels will not draw temper from tools; no need of cooling with water—all your tools will last longer, which means that much money saved. The wheels cut hardest steel, as emery does soft copper—it is only a moment's work to do any job of tool sharpening, so easy in fact that tools are always kept razor-keen and that means more work accomplished with less effort, which means more money saved. The wheels outwear any number of emery wheels and that means another money-saving.

11 Tools in One

consisting of Mechanic's Special, built like a high-grade lathe, with steel and malleable construction, machine cuts spur gears, bronze bearings in oil bath, etc., and the following accessories: rough Carborundum wheel, fine Carborundum wheel, 1 chisel attachment, and 1 twist drill attachment by which inexperienced persons can sharpen chisels and twist drills, 1 polishing spindle, 1 buffer, 1 polisher, 1 oil stone, 1 Carborundum hone in leather case, 1 Carborundum scythe stone, 1 foot-power attachment.

Return this Coupon for 6 Months' Free Trial Offer

■ This perfected sharpening, polishing and buffing Mechanic's Special Outfit is a business and labor economy—can you afford to neglect our liberal offer? Return this coupon for 6 Months' Free Trial Offer, and free booklet reprinting the story of Carborundum as it appeared in McClure's Magazine.

LUTHER GRINDER MFG. CO.
18 Madison St. MILWAUKEE, WIS.

COUPON

LUTHER GRINDER MFG. CO.
18 Madison St., Milwaukee, Wis.

Please send me free and prepaid your free Carborundum booklets and 6 months' free trial offer on Mechanic's Special Outfit.

Name

Address

Dealer's name

Address

Oshkosh Manufacturing Company

A notable example of American enterprise is the way in which certain old established manufacturing concerns keep watch of the changing conditions of industry and adapt themselves and their product to meet the new demands.

During the past few years the portable saw-rig and variety woodworking machine has been, first the novelty of the building world, and next the money-making necessity for progressive builders. When the first awkward attempts were made toward the portable saw-rig for building contractors there were those who scoffed, deriding the idea and saying that it would never be practically feasible nor generally adopted.

Not so, however, with the Oshkosh Manufacturing Company. There was an old established concern, started way back in 1843, and with an established reputation for the manufacture of dependable logging and woodworking machinery, whose officers were keenly alive to the changing demands of modern business as applied to building construction. These men saw in the portable saw-rig and variety woodworker a piece of equipment, which was destined to revolutionize carpentry contracting. When perfected they saw that it would be in demand by all builders.

Accordingly, they began investigating actual working conditions. They talked

with many contractors, both large and small, to find out just exactly what kind of a machine would best suit their needs. They made up their minds that in their machine there would be found no draw-backs, such as lack of power, quality, attachments, service or ability to stand up under the most severe working conditions.

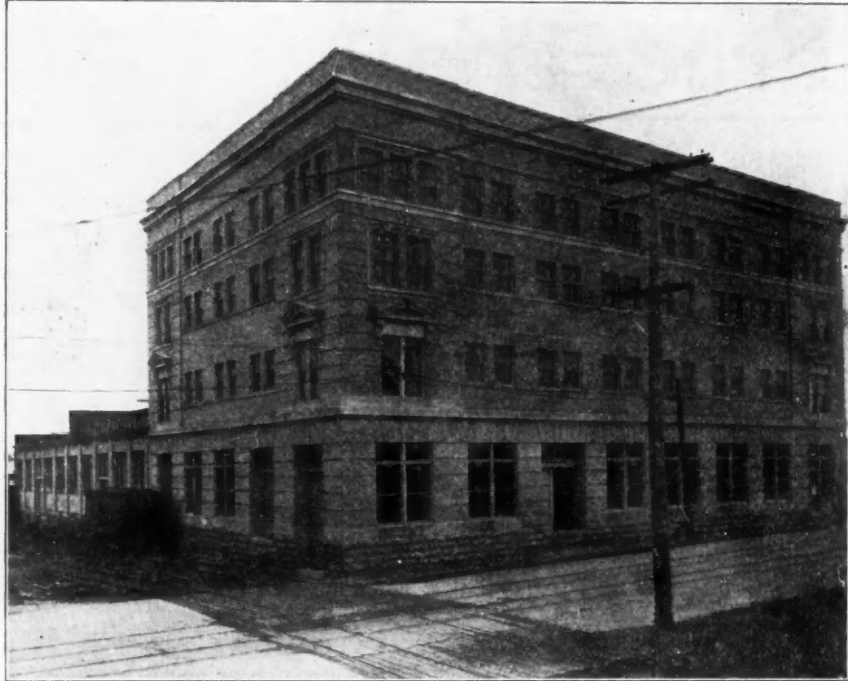

Large Modern Plant of Oshkosh Mfg. Co., where the "Oshkosh Portable Saw Rigs" are Made.



OAK FLOORING

Beautiful :: Economical :: Durable

Every builder, owner and investor should insist on OAK FLOORING, because it possesses all the qualities that tend to make it known as the rightful **King of flooring**.

Any truthful landlord will tell you that OAK FLOORING increases the **renting and selling values** of any building. It is **rich and cheerful** in color, and will harmonize with any kind of trim.

A home is half furnished when laid with OAK FLOORING. It imparts an air of refinement and elegance to a home.

OAK FLOORING $\frac{3}{4}$ " thickness by $1\frac{1}{2}$ " or 2" faces can be laid over old floors in old homes or over a cheap sub-floor in new homes, at a very low cost. It is cheaper than carpets or Pine Flooring. When laid, it has all the appearance of a heavy floor. It is **sanitary**, and requires but little care to keep in perfect condition.

OAK FLOORING is made in four grades, and is adapted to the humblest of homes or a palace. Use **Clear Plain** (first grade) OAK FLOORING for high class residences, hotels, apartment houses, churches, and club houses.

Write us for further information

THE OAK FLOORING BUREAU, 842 Hammond Bldg., DETROIT, MICH.

WANTED—A GOOD FIRST-CLASS CONTRACTOR and BUILDER IN EVERY TOWN

to take the Agency of the Celebrated

M & O-LINE of "WOOD AND TILE" MANTELS

We issue a catalogue of our extensive line and offer special inducements to the right party — We want reliable agents.

Write today to **MOORMANN & OTTEN,** 611-613 Main
CINCINNATI, OHIO



A Much Better Wall Can Be Built

with *Sackett Plaster Board* than with lath. Wood lath absorb moisture when the wet plaster goes on, and swell. Then they afterwards dry out and contract, pulling away from the plaster. The result is a loose wall—liable to crack, and is neither fireproof nor soundproof. If such a wall or ceiling happens to be made of lime mortar and gets wet, the plaster loosens and falls—there is no strength in it.

Sackett Plaster Board

on the other hand, is fireproof and does not swell or buckle under any conditions. It is composed of alternate layers of calcined gypsum and strong fibrous felt, cut into sheets 32x36 inches—every one uniform—and about as thick as ordinary wood lath. Sackett is nailed direct to the studding, furring or joists, just the same as any other lathing material, and makes a firm, even surface for the plaster coat. If U. S. Gypsum Plaster goes on, the wall becomes a monolith, as solid as a rock—fireproof and soundproof

Do not spoil a good house with poor walls. Use SACKETT Plaster Board, the Nation's best lathing material, instead of lath. For full particulars write or call on us.

UNITED STATES GYPSUM CO.

New York CHICAGO Cleveland
Minneapolis Kansas City San Francisco



SHINGLING HATCHETS

With Positive Gauge

Gauges by $\frac{1}{4}$ inches from 4 $\frac{1}{4}$ inches to 5 $\frac{1}{2}$ inches
Full Polished, Solid Tool
Steel, Extra Quality

L. A. SAYRE & SON
8 Oliver St., Newark, N. J.

SLATE WE HAVE WHAT YOU WANT

*In Roofing Slate, Slate Blackboards
Structural and Plumbers' Slate*

SATISFACTION GUARANTEED IN QUALITY AND PRICE
ASK FOR DELIVERED PRICES

J. K. HOWER, Station, C., Slatington, Pa.
R. J. KICHLINE, Sales Agent

YOU MR. CARPENTER



No doubt are looking for hinges that are the easiest and quickest applied and that will also give the best satisfaction to the builder.—Here they are—The Shelby "Chief," the original and only genuine double-acting ball-bearing surface floor hinge, and the Shelby Double and Single Acting ball-bearing Spring Butts. Insist on using these hinges. Ask your dealer, or write us to tell you more about them.

THE SHELBY SPRING HINGE CO., - - Shelby, Ohio

The Chief Floor Hinge
Spring Butt

WHEN WRITING ADVERTISERS PLEASE MENTION THE AMERICAN CARPENTER AND BUILDER

Finally they developed the machine they are now offering to the building public. The machine is compactly constructed, with sturdy gasoline engine power. It has a 10-inch rip-saw, 10-inch cross-cut saw, 12-inch jig-saw, a boring outfit and a 10-inch sander. It also has a 6-inch dado-head, a 2½-inch jointer head and a mitre device.

These machines are manufactured in the modern, up-to-date factory establishment illustrated on page 108. The equipment is complete in every way so that these machines can be turned out economically. For this reason their price is said to be extremely low.

The "Oshkosh Everready" is the name of this portable woodworking machine. It is guaranteed for life. Those interested should write at once for interesting catalogue and other information, addressing the Oshkosh Mfg. Co., 414 So. Main St., Oshkosh, Wis.

Bertolith System of Building Construction

Readers of the AMERICAN CARPENTER AND BUILDER should be interested in a new system of concrete construction, especially suitable for ease, rapidity and economy in the building of cottages, bungalows, stables, garages, stores, warehouses, shops, etc. This is known as the Bertolith System and is said to cost 25 per cent less than enclosing walls of usual timber frame structures.

The Bertolith System has been very successfully used in the vicinity of Philadelphia. The accompanying illustration shows an addition to the Baptist chapel, at Bryn Mawr, Pa., recently erected by this method. This addition is 10x16 ft., and 8 ft. high, with a solid concrete base. The outside frame was put up in one day and the entire structure fully completed in two days.

Naturally the use of concrete for walls and partitions pro-

duces a building that is firm, also fire- and weather-resisting. The Bertolith System, moreover, plans to produce buildings with hollow, fireproof walls by the most effective use of labor and materials, without delays and waste. No high priced or skilled labor is necessary and no special materials are used.

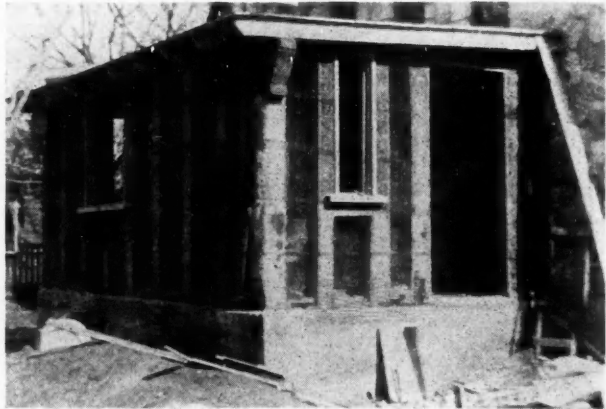

Addition to Baptist Chapel, Bryn Mawr, Pa. Erected by Bertolith System—Partially Completed; Ready for Outside Finish.

Detail plans for buildings proposed to be constructed by this system, or for its adaption to plans of buildings drawn for usual methods of construction, so that any intelligent contractor or builder can estimate and do the work, can be obtained by addressing the Bertolith System, Bryn Mawr, Montgomery Co., Pa. Terms for the use of these plans are said to be very moderate and builders are asked to write for full information and data.

Look for the trade-mark—the genuine is stenciled



PITTSBURGH

A sheet user writes—"I have been using Apollo Sheets for years and find them all right." They have to be right to be Apollo.

Apollo Best Bloom Galvanized Sheets are always uniform, soft, pliable and easily formed—specially adapted to shop and construction work. Gauges 10 to 30. Write for full information and quotations on Sheet and Tin Mill products of every description.

American Sheet and Tin Plate Company

General Offices: Frick Building, Pittsburgh, Pa.

DISTRICT SALES OFFICES: Chicago Cincinnati Denver Detroit New Orleans New York Philadelphia Pittsburgh Portland San Francisco St. Louis

STANLEY'S Wrought Steel Butts and Hinges

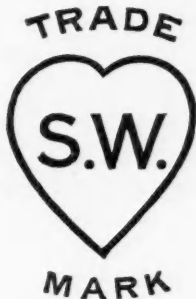

The Guaranty

of Quality

By hanging the doors of your buildings on hinges whose quality is guaranteed by this Trade Mark printed on the labels and stamped on the goods, you insure the satisfaction of the owner, and protect your reputation as a builder against inferior goods.

Upon application we will send you an attractive booklet showing a number of our lines of Wrought Steel Hardware.

THE STANLEY WORKS
Department A. New Britain, Conn.

BURLINGTON VENETIAN BLINDS

Improve any House

Not only in appearance, but in increased advantages, they will add value to the building. Give privacy, when put up on windows or porches, yet permit a perfect ventilation. They match any wood or finish and require no pockets.

Burlington Venetian and Sliding Blinds, Screens and Screen Doors "keep out the sun but let in the air."

Write for our special price list and catalogue for carpenters and builders.

Burlington Venetian Blind Company
341 Lake Street, Burlington, Vermont

Framing for ANY ROOF PITCH of 100 marked in 5 MINUTES on Timbers with the New PARKHILL PITCH GAUGE

This Gauge excels all other tools or rules in simplicity and facility of operation. Any one may use it and mark length per foot run and both cuts of com. rafter in 6 seconds. Same for hip, also backing in 7 seconds; and in 17 seconds all the following—side bevel on jack; both bevels on fascia, plancher, and sheathing. And a hip joining unequal pitches. Others with equal ease. The Parkhill Pitch Gauge also has no superior as a stair and brace gauge. Is as accurate as a square—on which it is used. Small in size and cost. Steel nicked. Sent you prepaid in U. S. with illustrated directions for \$1.50, with privilege of returning it inside 30 days and get your money back.

Address

JOHN PARKHILL, Rochester, Minn.
Reference: 1st Nat. Bank.



**Fire
Will
Not
Burn**
Any Roof
Covered
With

**WALTERS' or COOPER'S
METAL SHINGLES**

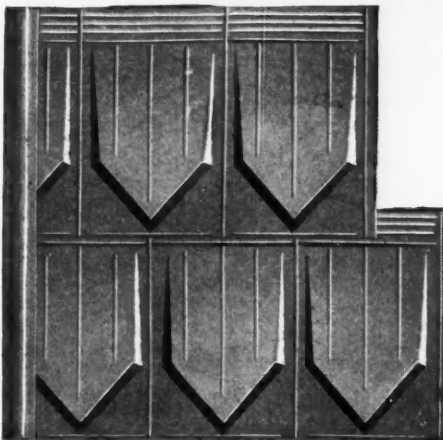

PROTECT YOURSELF FROM FIRE

THE house on EACH SIDE of the burned one shown above was roofed with our Metal Shingles! THEY COULDN'T BURN! Photo of this house badly burned, taken in Macon, Ga., which DID NOT have our Shingles. Not only are they wear-and-moisture-proof but FIRE-PROOF! One of our latest patterns (Cooper's Diamond Tile) shown here on the left. AN INEXPENSIVE SHINGLE, A TIME AND FIRE DEFYING SHINGLE! Write for NEW CATALOG giving ALL information. Also free samples

NATIONAL SHEET METAL ROOFING COMPANY
JERSEY CITY, NEW JERSEY
THE FIRST PEOPLE TO MAKE METAL SHINGLES

WHEN WRITING ADVERTISERS PLEASE MENTION THE AMERICAN CARPENTER AND BUILDER

Of Interest to Floor Finishers

A new bulletin describing the "Adjustable" floor scraper has just been issued by Mr. H. P. Didriksen, of South Bend, Ind. This should be of special interest to any building contractor who contemplates any floor scraping or refinishing work, for the "Adjustable" is a practical machine and is said to have many features of advantage over anything of its kind that has yet appeared upon the market.

The wide range of adjustable features make it readily adaptable to any kind or condition of floor, whether hard or soft, old or new wood. A strong feature, and one in which it differs from all others, is the movable weight, by which it is claimed absolutely uniform work can always be obtained.

This weight may be so adjusted as to give any desired pressure upon the blade, and this pressure remains fixed until the adjustment is again changed, thus insuring a *true*, even cut by the blade. This may be a deep or a thin cut, as may be desired, but it will always be true, something that cannot be claimed for any machine where the pressure upon the blade is governed by the operator lifting upon the handle.

A striking feature about this machine is the fact that the user never lifts upon the handle in operating it, and as a result its operation is very easy, for it is only necessary to adjust the weight over the blade to the desired degree of

pressure, adjust the handle to the convenience of the operator, and then simply push and pull it forward and backward in an easy, natural way.

This machine is sold strictly on its merits, and will be

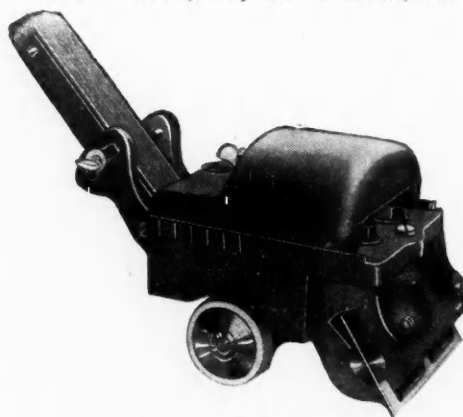

"Adjustable" Floor Scraper

shipped to any responsible builder on approval, with the privilege of returning it if not found perfectly satisfactory.

Address all communications to H. P. Didriksen, South Bend, Ind.

CARPENTERS!!! STOP!! LOOK!! LISTEN!!



PAT. APPLIED FOR

MANUFACTURED BY BRAUNSDORF-MUELLER COMPANY

THIS NEW NAIL SET with the round knurled body WILL NOT ROLL AWAY! Both ends are hardened, and the SQUARE HEAD of soft steel prevents the HARD CENTRE from crystallizing and flying. It will not mushroom and is easy to find in your pouch. Tell your dealer and friends about it.

THIS IS GOOD—WE ARE THE ORIGINATORS—
LOOK OUT FOR THE IMITATORS

ELIZABETH, NEW JERSEY

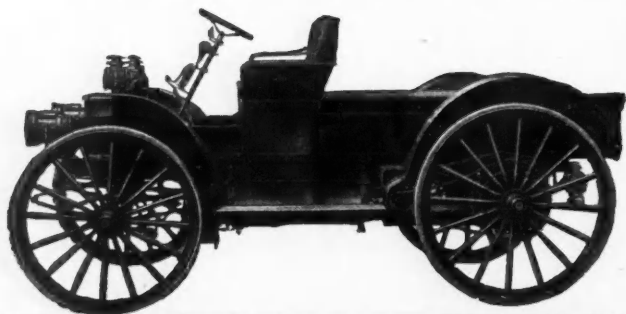

Where Haste Makes Money

The International Commercial Car is a great convenience in its prompt and reliable delivery of the numerous "little things" which are so essential to quick work. Tools, finishings, light materials are often needed at critical times, and their absence means delay and money lost.

International Commercial Cars

save this vexation and expense. They can be depended on in all weathers, over all roads. The simplicity of the power plant insures its satisfactory handling by the average driver. Its power and capacity are not secured at extra fuel expense as we shall be glad to demonstrate. Solid rubber tires are proof against punctures and blow-outs; the wheels are sufficiently high to give perfect clearance; the air-cooled engine will not freeze, and its all-around economy, reliability, and service have made many friends for this car among progressive and wide-awake merchants.

Let us tell you all about the International Commercial Car.

International Harvester Company of America

(Incorporated)

70 Harvester Building

CHICAGO U S A

Van Guilder Hollow Wall Concrete Machine—A Continuous Air Chamber from Cellar to Roof

Steel Reinforcement Throughout

Completely revolutionizing building methods. We manufacture and build with one operation; saving manufacturers profits, transportation charges and half the labor cost, producing a more durable and up to date building. Only one machine needed for each job.

Van Guilder Houses Costs Less Than Wood and Sell Quick at a Wonderful Advance

They have stood the test for over three years and are long past the experimental stage.

This superior construction was immediately approved by the building department of the city of New York, one of the most severe and conservative boards in the world.



SILLO WALLS

Our curved silo machine produces a silo which is water-proof and frostproof, greatly improving the quality of the ensilage. The most economical and durable construction in the world.

Send for Booklet

VAN GUILDER HOLLOW WALL CO.

720 Chamber of Commerce Bldg. Rochester, N. Y.

ASK YOUR DEALER TO SHOW YOU AN AKRON LEVEL

Don't merely ASK for an Akron level, but INSIST on having one. Your dealer CAN supply you if he WILL. When you see an Akron level and recognize the great advantage of their quick reading, durability and adjustable features, you'll instantly realize why they are the choice of expert workmen. Write for catalog showing 33 styles and sizes for every purpose.

The BAKER, McMILLEN CO., Dept. E, Akron, Ohio



Interior and Exterior CAPITALS AND ORNAMENTS



DETROIT DECORATIVE SUPPLY CO. Limited

810 14th Avenue, : : DETROIT, MICH. Most Complete Catalog Ever Issued

OLDS DIAPHRAGM PUMP

For pumping, excavations, cofferdams, trenches, etc.

Handles 3000 gallons per hour on one pint of gasoline.

It is a money saver every minute.

Engine can be removed and used for other purposes and easily replaced.

Construction the most durable possible.

We also make a full line of gasoline engines, pumps and hoists. Write for catalog.

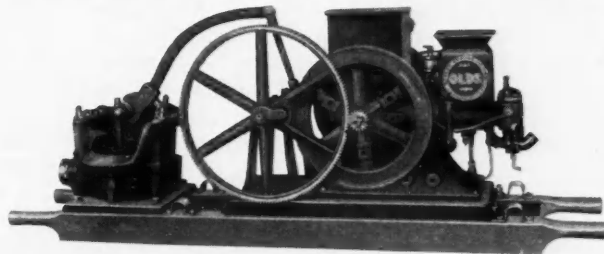

L-687

SEAGER ENGINE WORKS

Lansing Michigan

Olds Gas Power Co.,

2112 Central St., Kansas City

1007 Farnum, Omaha

204 N Los Angeles St., Los Angeles

65 Beverley St., Boston

THE WINTHROP SOLID TAPERED ASPHALT SHINGLES

ARE OF A COOL, GRAY SLATE COLOR

And have all the Durability of Asphalt—the Fine Appearance of Slate and the Light Weight and Low Cost of Wood Shingles. Laid with regular Shingle Nails, the same as Wood Shingles. NEVER REQUIRE PAINTING.

Write for Free Booklet and

SPECIAL INDUCEMENTS TO THOSE WHO APPLY

FIRST ROOF IN EACH TOWN

Winthrop Asphalt Shingles are Fire-resisting, Water-proof, Wind and Sun-proof, and never Crack, Break or Fall Off.

WINTHROP ASPHALT SHINGLE CO. 1101 1/2 The Temple CHICAGO, ILL.

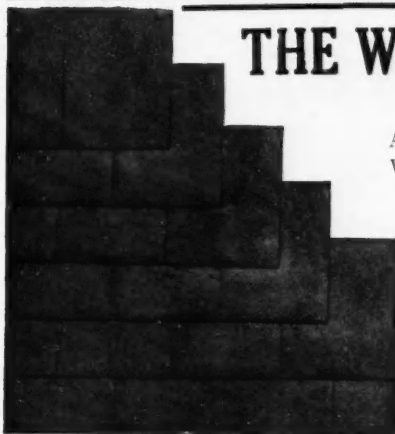

YOU KNOW

from the picture that the

ADJUSTABLE

Is a Practical FLOOR SCRAPER



I will send you one on approval and let you give the machine a chance to speak for itself in your own hands.

If not more than pleased with its work, ship it back at my expense. If perfectly satisfied, remit \$40.00, the price to everyone, payment in full.

I will make one profit the day the sale is made, but you will make a profit every day you use it.

H. P. DIDRICKSEN

943 Riverside Drive

SOUTH BEND, IND.

"H & B" Hammers

Good hammers, with the "H. & B." trade mark, as illustrated herewith, have been made for many years by the Humason & Beckley Mfg. Co., New Britain, Conn. This firm have made a specialty of manufacturing hammers for carpenters and machinists who want good tools and have established a reputation for goods of this class.

The hammer illustrated is made from the best hammer steel, forged in the bar, and has an exceptionally good claw that will easily pull large, and small nails equally well. It



is furnished with a clear, all-white, well finished hickory handle. The face of the hammer has the best of temper and is made to stand the hardest kind of service without cracking or chipping off.

A special new feature in hammers that the Humason & Beckley Mfg. Co. is now offering is a corded handle, made to prevent the hand from slipping. This handle is meeting with great favor among carpenters in general. All the Humason & Beckley Mfg. Co. hammers can be recognized by the "H. & B." trademark.

Ask your hardware dealer to show you an "H. & B." hammer. If he does not happen to have it, readers of the AMERICAN CARPENTER AND BUILDER can obtain the address of the nearest dealer handling this line by writing to the Humason & Beckley Mfg. Co., New Britain, Conn.

Here's a Building Paper that Has Strength and Fibre and Body to it

A Building Paper that is easy to put on—and that stays put—

Amafibre
BUILDING REG. U.S. PAT. OFF. 08. PAPER

is just what its name implies—a fibre paper wonderfully light in weight—and yet the **strongest**, most durable building paper you ever saw.

Amafibre Building Paper is water-proof, wind-proof, insect-proof—and largely sound-proof. Being tough and light, it is extremely easy to put on. It does not stretch nor tear and is readily handled. It is made of pure sulphite and comes in regular size rolls, 36 inches wide.

We want to send a Free Sample of Amafibre to every Builder and Contractor in America—Will you write today for yours? Your name on a postal will do.

WELT & SONS PAPER COMPANY
DETROIT, MICH.

TAYLOR PORTABLE STEEL DERRICK
2000 Pounds Capacity

Adjustable capacity and speed to three ways. One man operates both cranks and can hoist with ease 700 pounds. Weight 160 lbs. Made in two sections. A man can climb a ladder with either section. Beam section connects to post by tipping in a vertical position. Consider the durability of a derrick constructed of malleable iron and steel, and that of Wood, more compact, more powerful. Roller bearing circle swing. Clears side wall of building three feet. With special platform attachable to side of railroad gondola car for unloading water-pipe, etc. Price of derrick with three way block, brackets, and bolts for attaching to building, **\$40.00** F. O. B. Chicago.



Manufacturer
John L. Taylor
 1036 W. Lake St. CHICAGO
 Telephone Monroe 3086



**Ornamental
 Theatres**

Plaster Relief Decorations
Theatres Designed Everywhere

Write for illustrated Theatre Catalog. Send us Sizes of Theatre for Special Designs.

—The—
Decorators Supply Co.
 2525 Archer Ave., CHICAGO, ILL.



DECORATE
 Your Home and Church

With F. & B. Co.'s
ART WINDOWS
 Designs and Estimates on Application Without Charge.
 Beveled Plate, Metal Sash, Memorial Figure Windows and Residence Work Our Specialty

Grand Prize Awarded Louisiana Exposition. Established 1883.

The Flanagan & Biedenweg Co.
 Office, Studio and Salesroom,
 312 to 318 W. Illinois St., near Franklin
 CHICAGO, ILL. Tel. North 218

ORR & LOCKETT'S CABINET MAKERS' BENCH



PRICE As shown in cut.....\$10.50
 With 10" Rapid Action Vise, \$14.00

THIS illustration shows our regular Cabinet Makers' Bench. This bench is made entirely of maple. The top is made of 2 1/2 inch strips glued together to prevent its warping. The working top of this bench measures 78 inches long and 24 inches wide. We also make a smaller size, 66 inches long and 20 inches wide. These dimensions do not include the screws. **Both 34 inches high.**

NOTE—We furnish with this bench our Continuous Screw, Rapid Action Roller Nut Vise. The simplest and best screw vise on the market. Jaws 10 inches wide, 4 inches deep, opening 12 inches.

ORR & LOCKET HARDWARE CO.
 ESTABLISHED 1872
 14-16 W. Randolph St., CHICAGO



SAMSON SPOT SASH CORD

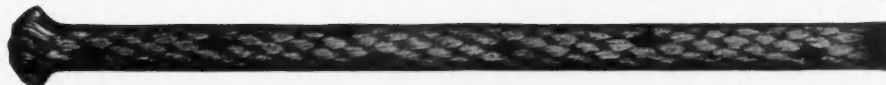

TRADE MARK Be sure that the cord you buy has **SAMSON AND THE LION** on the label, and that the braid is marked with the **COLORED SPOT**. You may be sure you'll get the best.

WE'RE GLAD TO SEND SAMPLES AND FULL INFORMATION.

SAMSON CORDAGE WORKS, BOSTON, MASS.



NOTICE

We are going to make a "never before and never again" offer for

30 DAYS ONLY
on our world-famed

Crescent Continuous Mixers

This will be a chance of a life-time, and positively, will not be extended or repeated. It will pay you handsomely to find out all about this **amazing offer, AT ONCE.**

Don't delay for one moment getting in touch with us, as it may be all over with, before you know it. Let us send you also our free literature on the following big money-getters:

"Crescent" Sewer Pipe and Tile Molds, used the world over, and by Uncle Sam in his reclamation work. All sizes 4" to 48". We have over 500 patterns that are used in making pipe and tile molds alone.

"Crescent" Vertical Tamping Brick Machine, the only machine of its kind. Our 1912 Model has a new feature that revolutionizes brick machines—the automatic stripper and finisher. You will want it if you see it.

Don't fail to write us at once

RABER & LANG MFG. CO.
810 Mill St. KENDALLVILLE, IND.

JUST SAY "SPECIAL OFFER"

An Advertising Campaign That Means Business for You

For several years past the AMERICAN CARPENTER AND BUILDER has watched with a great deal of interest the advertising of Asbestos "Century" Shingles; and especially the methods adopted by the Keasbey & Mattison Company to interest the consumer in this indestructible roofing.

The advertising is appearing in *Country Life In America*, *Town and Country*, *House and Garden* and *Keith's Magazine*—all of which appeal to property owners and prospective property owners, who may be expected to be interested in securing the most durable and all around satisfactory roofing on the market.

It is easily the most forceful roofing campaign now before the general public—convincingly written, well displayed, and beautifully illustrated with photographs of buildings of all types roofed with Asbestos "Century" Shingles.

It is so notably successful that Two Hundred Million of these Shingles were sold in 1910—the largest majority of which left an interesting profit in the pockets of the building and roofing trades on their way to the consumer.

As to the Asbestos "Century" Shingles themselves, we need hardly speak at length here. We simply refer our readers to Keasbey & Mattison Company's series of advertisements in the pages of this magazine.

Every progressive member of the trade knows that these shingles are made of concrete reinforced with interlacing asbestos fibers; that they come in numerous shapes and sizes; and three colors; and that they are indestructible by weather, fire and time.

The point that we wish to make here is, that this advertising campaign is a distinct trade-building asset to every one of our readers who goes after his part of the business it is creating.

Bought a Coltrin Mixer Three Years Ago

READ what they say about it NOW
AND DO A LITTLE THINKING FOR YOURSELF

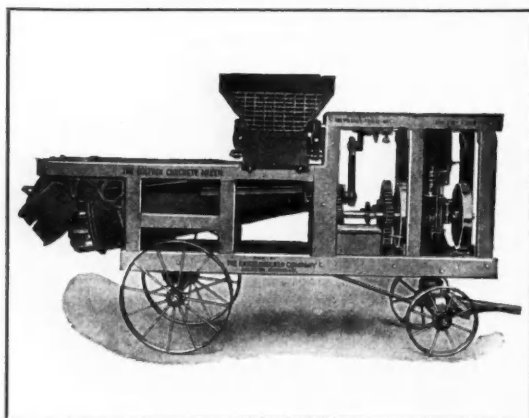

No 12 COLTRIN
With Automatic Proportioning Feed

Grand Rapids, Wis., July 21, 1911.

The Knickerbocker Co.,
Jackson, Michigan.

Gentlemen:

Ship us a set of blades for our No. 6 Mixer. Our old ones are nearly worn out. It works fine. We mixed 69 yards of concrete in 7 hours and we worked only about 4 hours out of the seven. For mixing you have anything beat on the market. We will want another next year.

Very truly yours

Bossert Bros. & Co.

*Just another unsolicited proof of the
merit and staying qualities of*

The Coltrin Concrete Mixers

SIZES 8 SIZES

Shipped anywhere on 5 days' trial

THE KNICKERBOCKER CO., Jackson, Michigan

WRITE FOR 1911 CATALOG

Announcement of Awards In Cash Prize Contest

IN the April issue of this publication we offered \$150.00 in cash prizes to those giving us the best reasons why they use and recommend Johnson's Wood Dye and Johnson's Under-lac. There were forty-one prizes: First prize, \$25.00; five second prizes of \$10.00 each; ten third prizes of \$5.00, and twenty-five fourth prizes of \$1.00 each. The answers had to be in by June 15th, 1911.

The scores of replies received show to what an extent Johnson's Wood Dye and Johnson's Under-lac are depended on by men who look upon every job they do as a standing advertisement and part of their reputation.

Johnson's Wood Dye

is recommended by these men and thousands of others because it is more than an ordinary stain. It is a genuine deep-seated dye that penetrates the wood, giving a rich, permanent color without raising the grain in the slightest. It is easiest to work with, too, and most economical, because it goes farther than any other coloring. It is made in 15 artistic shades, and by lightening or darkening, or blending certain colors, over a hundred beautiful effects can be obtained.

Johnson's Under-lac

is the choice of careful painters and finishers because it is far superior to any varnish, both in results and in working qualities. It is not thick and sticky like varnish, is much more easily applied, and dries in half an hour. Better than any kind of shellac, and easier to work with.

Let the Prize Winners Tell You

If you had before you the stack of letters we received in this contest you could hold no further doubts of the advantages to you of using nothing but Johnson's Finishes in your work.

The two letters we have space to print here will give you the facts from your own point of view—from the standpoint of the man who does the work and must abide by the results. Read these letters, then if you have not tried Johnson's Wood Dye and Johnson's Under-lac

Send for Free Samples and Prove Their Worth Yourself

We want you to know the superior merit of these Johnson's Finishes. We want you to know, at our expense, that with them you can do better work with less labor. Send us your name and address and name of dealer from whom you purchase supplies. We will see that you get, free, and without obligation, samples of Johnson's Wood Dye and Johnson's Under-lac. Also ask for copy of our free book—"Specifications and Instructions for Finishing New Wood-work and Floors"—Edition No. ACB-9. Address

S. C. Johnson & Son, Racine, Wisconsin

"The Wood Finishing Authorities"

H. R. Brunell Hoboken New Jersey Wins First Prize

To Mr. Brunell was awarded the First Prize of \$25.00 for his direct reasons for using and specifying Johnson's Wood Dye and Under-lac. We give below the reasons and some experiences with these finishes which Mr. Brunell sent us at the same time.

Gentlemen: I will give you a few experiences with your Dye and Under-lac. I am foreman for a New York firm, and have used your Dyes for the past five years. I used your No. 129 Dark Mahogany on Mr. Walker's house in Montclair. He is an architect and has one of the finest constructed houses there. This winter we did quite a large job in the Greenwich Bank Building at 35th Street, corner 6th Avenue, the offices of the American Undergarment Co. We have landed two jobs on account of them. I think without a doubt these offices are the finest in New York City. I could write you a score of such places where we use your Dyes. Three years ago at the Chapter House in Hoboken and Scottish Rites Temple, Jersey City.

I will now give you my reasons for specifying your Dyes from a mechanic's point of view: I find your dyes are easily applied, there is no sediment to them and mix well together, when so needed. But the beauty of them is this: They have such a rich, clean color, give the depth, bring out the figure and all the details of the wood, do not raise the grain and can make a perfect job with either your Wax or Under-lac. Your Under-lac I like for these reasons: It works freely, does not run, dries very hard over night, gives a first-class effect of rubbing, and is very easily kept clean. Just give a light rub with cheese cloth. Your Dyes and Under-lac are both very durable.

A Second Prize Winner

Mr. Stanley Sivers, 606 3rd St., Albany, N. Y., has been awarded a \$10.00 prize for the following:

My reasons for recommending your Under-lac are: 1st—For its good body. 2nd—Amount of surface it will cover. 3rd—Does not mar or chip. 4th—Will not raise grain of wood. 5th—Good drying. 6th—Better than shellac.

My reasons for recommending your wood Dye are: 1st—For richness of color. 2nd—Penetrating the hardest of wood. 3rd—For not raising the grain of the wood. 4th—Will not mar or scratch. 5th—Is transparent and does not cloud. 6th—For long service. 7th—Can produce better work. 8th—Because I can satisfy people who know what they want and are willing to pay for it.

Other winners of Second Prizes, getting \$10.00 each, are:

Mr. F. P. Connolly, 151 S. Water St., York, Pa.
Mr. F. B. Carter, Portland, Oregon.
Mr. Albert Borchardt, Monticello, Arkansas.
Mr. H. W. Richards, 164 Oak Street, Elgin, Illinois.

List of Third Prize Winners

\$5.00 awarded to each:

C. T. Sullivan, 46 Stewart St., Fall River, Mass.
T. A. Cooper, 308 McClellan St., Schenectady, N. Y.
Joseph Danno, Alpena, Mich.
R. F. Flannery, 325 Poole Ave., Long Branch, N. J.
J. N. Humble, 816 E. Cabela Poudre, Colorado Springs, Colorado.
Elmer Rosengren, 404 Anson St., Marshalltown, Ia.
J. White, 6121 Sangamon St., Chicago, Illinois.
H. Edwards, Jupiter, Fla.
H. A. Baldwin, Box 589, Austin, Texas.
Jesse J. Jackson, Box 37, Teague, Texas.

List of Fourth Prize Winners

J. P. Rowden, 313 E. 4th St., Texarkana, Ark.
George Voss, Benson, Nebraska.
Charles F. Hoefner, 122 Mystic Ave., Medford, Mass.
C. Churchill, 148 W. 16th St., Erie, Pa.
R. T. Hill, 3117 Forest Ave., Chicago, Ill.
E. G. Myers, 41 Elm St., Plattsburgh, N. Y.
J. W. Rainsford, 3704 Park Ave., Nashville, Tenn.
Anton Hoffstadt, 3212 Addison Ave., Chicago, Ill.
H. A. Struening, 2739 Lafayette Ave., St. Louis, Mo.
Richard Holle, Jr., 708 8th Ave., Clinton, Iowa.
J. H. Clarke, 412 E. Main St., Bradford, Pa.
Wm. Van Valkenburgh, 1221 Watt St., Schenectady, N. Y.
R. McEwartson, care of G. Wallace, 6610 Hartwell Ave., Chicago, Ill.
Everett March, 217 Somerset St., Plainfield, N. J.
Richard Smith, 3 South Central Ave., Wollaston, Mass.
H. Laycock, 77 Southgate St., Worcester, Mass.
D. W. Edwards, Box 1140, Twin Falls, Idaho.
Frank Gordon, 127 1/2 Stockton St., Brooklyn, N. Y.
E. C. Monroe, Berlin, N. J.
H. C. Faber, Monongah, W. Va.
Elmer Hahn, 71 Main St., Hudson Falls, N. Y.
Fred Bennis, 319 Spies Ave., Menominee, Mich.
A. S. Joynes, Fortress, Monroe, Va.

FOR CANVAS ROOFS



Order the Scientifically Prepared—

**BAYONNE
ROOF AND DECK
CLOTH**

Easiest to lay—
Lasts longest.
Requires but
ONE COAT OF
PAINT. The
treatment per-
meates the
fabric and pre-
serves the fibre.

BEST FOR PIAZZA ROOFS AND PORCH FLOORS

Ask for Sample Book A 6 and Prices

JOHN BOYLE & CO., 112-114 Duane Street New York
70-72 Reade Street ST. LOUIS
202 and 204 Market Street, ST. LOUIS

The Standard Brand of White Canvas
All Widths—All Weights—Any Quality

Our co-operative department gives complete
instruction for laying

BAYONNE or GULF STREAM

John Boyle & Co.'S Awning Stripes have
been the Standard for fifty years



New Roofing Catalogue

The American Sheet and Tin Plate Company, of Pitts-
burgh, have just issued a catalogue dealing with their brands
of corrugated roofing, "Apollo" and "American," and their
other sheet iron products.

In addition to the ordinary catalogue features, which are
handled most worthily in this publication, there is included
also much valuable information relative to the weights and
gauges of various types of sheets, approved methods of
construction, standard measurements, etc. All of this material
is nicely indexed for ready reference. A copy of this
catalogue will be gladly mailed to any of our readers who
are interested in it.



INVESTIGATE SAVE MONEY

Lignine Wood Carvings

Free Sample Free Catalog

WRITE

ORNAMENTAL PRODUCTS CO.

Fourteenth Ave., Detroit, Mich.

The Gale Wall Safe

It makes your Valuable papers,
Jewelry and Silver secure against
Porch Climbers, Petty Thieves,
Fire, etc.

No Home or Apartment house
complete without one. It has a
combination lock. Write for
descriptive matter today.
FRED LIEBRICH, Agt. for Cook Co.,
1102 Monadnock Bldg., Chicago, Ill.



WILLIS MFG. CO.

Galesburg, Ill.

The Best That Is Offered

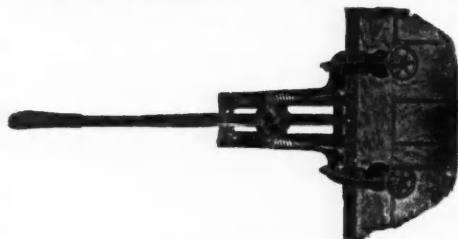

Two Minutes

**TWO MINUTE
LEVER LOCK MORTISER**

The Greatest Time and Labor Saver.

Does the complete job the quickest. The easiest to
operate. Cuts in any kind of wood. Any length or
depth of mortise. No exaggeration in our statements.
Send for descriptive circular.

Our Butt Mortiser and Rule Gauge are handy little devices. Sent for 75c.

A. W. MILLER MFG. CO.

Riverside, Calif.

Cincinnati, O.



**"Victor" Scroll-Saw
FOR FOOT AND POWER**

Suitable for carpenters, pattern and cabinet makers and all wood-workers requiring accurate work, also for
sawing soft metals. Will cut up to 3 inches thick, swings 24 inches, has powerful tread motion, cuts rapidly
and is easy to operate. Has adjustable tension spring on upper spindle, dust blower, drill attachment, iron
tilting-table, etc. Will furnish tight and loose pulleys for power in place of treadles when desired.

This is acknowledged to be in all respects the most complete foot-power scroll saw made.

We make a complete line of Foot, Hand and Light Power Wood-Working Machinery, suitable for
Carpenters, Builders, Cabinet Makers and other Wood-Workers. It will pay you to investigate their merits.

SEND FOR CATALOG A

THE SENECA FALLS MFG. CO.

218 Water Street, SENECA FALLS, N. Y., U.S.A.

263

Electric Weld

Combination Boiler and Gas Water Heater

The self-contained storage system. Illustration shows arrangement of enclosed Heating Chamber, Vent, and parts.

The advantages of this Type are many, in addition to the maximum efficiency thus obtained. Adapted to Large or Small requirements, without change in design of fixture or method of installing.

Widest choice as to location of fixture.

Economy of space.

Absence of delicate or intricate parts.

No special Meters or Service pipes required.

Lowest possible maintenance cost.

Moderate initial cost.

Minimum cost of operation (service considered.)

Double Circulation.

Primary Circulation equal to other types.

Secondary Circulation equal to thirty-five per cent. of total efficiency—altogether absent in other types.

Automatic or Intermittent Service optional, without adjustment of parts or breaking connections.

Range or Furnace Connections provided for.

Auxiliary Steam Coil, for High or Low Steam Pressure, if desired.

This type represents one-twentieth of total number of Gas Water Heaters in service, and is essential if water heaters are to be popularized.

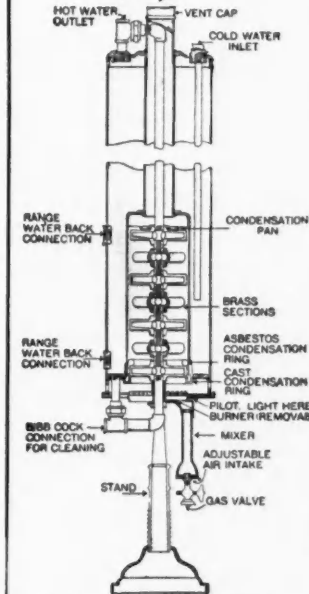

JOHN WOOD MFG. CO.
CONSHOHOCKEN, PA.

Branches Throughout United States



ARE you in doubt, or do you know that there are better things ahead?

Doubt never raised a man's salary—confidence makes many fortunes.

The purpose of the International Correspondence Schools is to give a man confidence in himself by training him in the line of work he prefers. With this equipment he goes to any employer with confidence in his ability to fill the position he seeks.

A man with I. C. S. training applies to such concerns as Baldwin's Locomotive Works, Cramp's Shipyard, Westinghouse Electric Company, the great Railroad Systems, or any other branch of industry, with the confidence that he will have an opportunity not offered to the untrained man.

Doubt or Confidence

To learn about the I. C. S. it is only necessary to mark and mail the attached coupon. For example, if you desire to become a Civil Engineer you put a cross opposite that occupation. Or, if you desire to become a Mechanical Draftsman, Electrical Engineer, Architect, Advertising Man, Stenographer, Bookkeeper, or fill any other occupation mentioned, you simply mark the position you prefer.

Mark and mail the coupon and the I. C. S. will show you exactly how to accomplish what you desire and will place at your disposal the best industrial training that can be given to any man—young or old.

Mark and Mail the Coupon TODAY

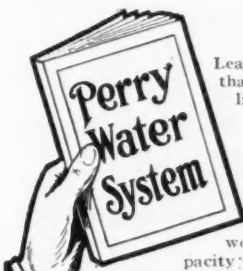

Send for This Book

Learn all about the only system of water supply that eliminates the storage of water. That delivers water fresh from the well. The

Perry Water System

provides all the conveniences of a city water works system. It is designed for large or small capacity: is easy to install in any old or new building—operated by any kind of power—economical and practically indestructible. Has more advantages than any other system of water supply. Every reader of this publication should write for copy of our illustrated catalogue. Address

UNITED PUMP & POWER CO.

495 Old Colony Building, CHICAGO

SEND
POSTAL
TO DAY

PARKS' No. 620 and 622

Combination Circular Saw, 6-inch Jointer, Band Saw, Reversible Spindle Shaper with Boring or Mortising and Rabbeting attachments.

Six Machines in One and all in Plain Sight No unbolting or bolting is necessary before you can see, or use all the attachments. Economical, cheap, and a constant money maker for Carpenters and Contractors.

Write for Circular and Prices. Parks' Ball Bearing Machine Co. Fergus & C. H. & D. Ry. Cincinnati, Ohio

Originators of the Circular Saw, Band Saw, and Jointer Combination, also Foot and Hand Power Machine.

Canadian Agent, BOURNIVAL & CO., 335 Notre Dame East Montreal, Que.

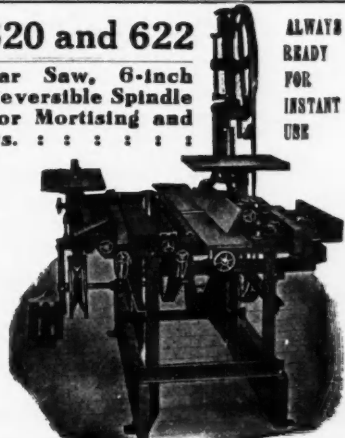

ALWAYS
READY
FOR
INSTANT
USE

International Correspondence Schools

Box 910, SCRANTON, PA.

Please explain, without further obligation on my part, how I can qualify for a larger salary and advancement to the position, trade, or profession before which I have marked X.

Architect	Estimating Clerk	Automobile Running
Arch'l Draftsman	Civil Engineer	Foreman Machinist
Contract'g & Build.	Surveying	Sh.-Met. Pat. Drafts.
Building Inspector	Mining Engineering	Textile Manufact'g
Structural Engineer	Mechanical Engineer	Bookkeeper
Structural Draftsman	Mechanical Drafts.	Stenographer
Plum. & Heat. Con.	Stationary Engineer	Advertising Man
Supt. of Plumbing	Electrical Engineer	Window Trimming
Foreman Steam Fit.	Electric Lighting	Commerci'l Illustrat'g
Plumbing Inspector	Electric Railways	Civil Service Exams.
Heat. & Vent. Eng.	Concrete Construct'n	Chemist

Name _____

Street and No. _____

City _____ State _____

**THE COAST LINE
TO
MACKINAC**



THE LUXURY OF A LAKE TRIP

Where will you spend your summer vacation? Why not enjoy the charms of our Inland Seas, the most pleasant and economical outing in America?

Daily service is operated between Detroit and Cleveland, Detroit and Buffalo; four trips weekly between Toledo, Detroit, Mackinac Island and way ports; three trips weekly between Toledo, Cleveland and Put-in-Bay.

A Cleveland to Mackinac special steamer will be operated two trips weekly from June 15th to September 10th, stopping only at Detroit every trip and Goderich, Ont., every other trip.—Special Day Trips Between Detroit and Cleveland, During July and August.—Railroad Tickets Available on Steamers.

Send 2 cent stamp for Illustrated Pamphlet and Great Lakes Map.

Address: L. C. Lewis, G. P. A., Detroit, Mich.
Philip H. McMillan, Pres. A. A. Schantz, Gen'l Mgr.
Detroit & Cleveland Navigation Co.

New Large Size "Peerless Scriber"

The sale of the Peerless scriber has been so successful that the manufacturers, Potter Bros., 612 W. 110th St., New York, have decided to furnish this tool in a larger (5 inch) size. It has heretofore been made in the 3 inch size only. This scriber has a broad point for plaster, walls, etc., and a sharp point for quirks and mouldings. It will hold any shape pencil equally well and is adapted for extra close scribing. Potter Bros. also manufacture the Peerless flexible bit gauge which is said to be the only gauge that can be successfully used for boring mortise locks. It is made of steel spring wire and is flexible. Write to Potter Bros. for quotations on the scriber and the bit gauge. They have already sold over 1,000 dozen of these devices.

The new 5-inch scriber is said to be far superior to the ordinary compass. Orders sent by mail will have prompt and careful attention.

The BERTOLITH SYSTEM of Concrete Construction

for ease, rapidity and economy in building Cottages, Bungalows, Stables, Barns, Garages, Stores, Warehouses, Shops, and any other structure of moderate height. Simple, permanent and fire proof. Costs 25 per cent less than enclosing walls of usual timber frame structure. No specialties required, uses only materials purchasable everywhere in open market. Full detail plans and specifications, with instructions and the right to use the system at very moderate terms, by addressing

THE BERTOLITH SYSTEM

(Patent Applied for.) Bryn Mawr, Mont'g Co., Pa.

THE BEST ON THE MARKET

"DWIGHT SPECIAL" thin hardwood flooring can be laid over any floor with very little expense. Manufactured in $\frac{7}{16} \times 2"$ and $\frac{3}{4} \times 2"$ quartered oak, plain oak, white maple and red birch. It is much stronger than the ordinary thin flooring, as the tongue is longer and is backed up thus securing the nail.

Sold by all Dealers. If Yours Does Not Carry It, Write us for Samples

DWIGHT LUMBER COMPANY
DETROIT, MICHIGAN

Wentworth Institute

Boston, Mass.

DAY and EVENING Courses in
CARPENTRY and BUILDING

Both Practice and Instruction in Principles

**ADVANCED WORK FOR MEN WHO
WISH TO BECOME FOREMEN**

TUITION FEE, \$6.00 PER TERM
Write for Catalogue and Particulars

Train Yourself for the Highest Grade of Work in Your Trade

DECO-VENEER

The handsomest and most effective material on the market for

—PANEL WORK—

WAINSCOTS, SHOW-WINDOWS, Etc.

Made in all sizes from 25 varieties of
FOREIGN AND DOMESTIC WOODS

**It will not Warp or Twist
A Permanent Decoration
Easily and Quickly Installed
Half the Cost of Ply Veneer
Endorsed by Architects and
Contractors**

Write for Catalogue and Details

Deco-Veneer Co.
INDIANAPOLIS



Exquisite Architectural Effects

are evident in every piece of Mullins Sheet Metal Cornices, Capitals and Tympanums.

This is also true of our entire line, which includes Sheet Metal Statuary, Finials, Building Fronts, Skylights, Fireproof Windows, Metal Tile Roofing, Steel Ceilings, Wrought Iron Grilles, Architectural Ornaments, etc.

Mullins Fireproof Windows positively deflect the severest flames and heat. Frames, Sills and Sashes are riveted and lock-seamed together—no soldered joints.

Buildings that are equipped with Mullins Fireproof Windows have lower insurance rates because Mullins Fireproof Windows are manufactured under the supervision of the Underwriters' Laboratories, Inc., according to the latest specifications of the National Board of Fire Underwriters. Every one of these windows is inspected, approved and labeled with the official approval of that board.

State particular line you wish to know more about and catalogues will be sent at once. Mullins prices are attractive. Equal care and attention is given both large and small orders. Estimates quickly submitted on special jobs. Send your letter now.



The W. H. Mullins Co.

214 Franklin St. : SALEM, O.

Makers of Everything in Sheet Metal

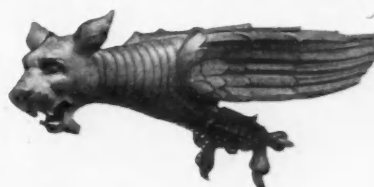

SHULTZ'S MODERN Store Fronts
 of Steel and Brass CORK BEDDED
 CORNER POSTS, MULLIONS AND TRANSOM BARS

Handsome, Strongest and Most Practical Bar on the Market. Long Life—Nothing to rot out. Glass bedded on Spanish Cork preventing cracking or crushing of glass. No putty, yet Absolutely Water and Dust proof.

Simple, incomparable with old fashioned styles. They add immensely to the Beauty, Utility and Rental Value of Buildings.

ARE LOW IN COST
 Architects, Contractors and Owners are invited to write me for descriptive literature, prices or estimates.

All Steel Cork Bedded and Ventilated Bottom Bar.

Also Shultz Patent Burglar Proof Coal Chute.

C. H. SHULTZ, MANUFACTURER, ST. JOSEPH, MO.

ALL-STEEL BURGLAR-PROOF COAL CHUTE



The Neatest, Strongest and Most Convenient Coal Chute Made. Prices also Lowest. No modern residence complete without it. Locks itself when closed up. Can only be opened from inside. Architects, Contractors and Owners are invited to write for descriptive circular.

C. H. SHULTZ, Manufacturer, St. Joseph, Mo., U. S. A.

This is the inner radiator of the **HESS STEEL FURNACE**. It's all steel and contains the fire, with its gas, smoke and dust. Radiator leakage in other furnaces sends gas and dust to the rooms, but never in the **HESS**, for every joint and seam in a **HESS** radiator is sealed tight WITH MELTED STEEL. EVERY JOINT IS WELDED AND STAYS TIGHT FOREVER. Inferior furnaces are not built that way. Cemented radiators always open after a while and give trouble. It's impossible with the **HESS**.

HESS Sent on Approval FURNACE

You can buy our furnace direct from our factory, at the factory price, and test it 60 days in winter weather. If not pleased, return it at our expense for freight both ways and pay us nothing.

This offer and lots of good furnace information will be found in our free 48-page furnace booklet. Ask us for one. A postal card will do.

HESS, 916 Tacoma Bldg. - CHICAGO

Just Off the Press

ASHBY'S

Designs of Schools and Libraries

display a composition of utility, durability and good, pure architecture without any "gingerbread."

No buildings are too large or too small for our personal and prompt attention.

We develop your own ideas into a practical set of plans and specifications which can be executed to the smallest details into a building that can be built within your means and to your entire satisfaction.

Ashby's "Designs of Schools and Libraries" will be sent to parties interested in the erection of a school building or library for which plans have not yet been procured.

G. W. ASHBY—ARCHITECT
 11th Floor, Medinah Bldg.
 CHICAGO, ILL.

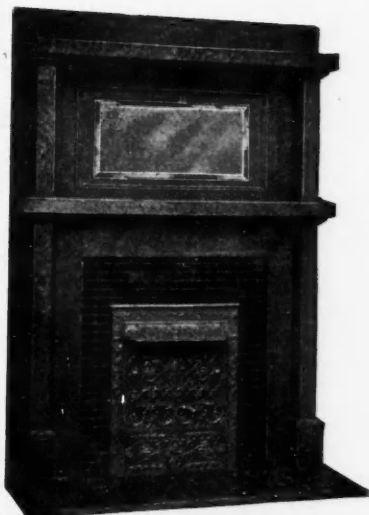

'Reputation and Quality Count'

columns, full length or double as shown in cut. Dealer's price not less than \$40.

\$25.85

For this elegant, massive, selected oak or birch, mahogany finished mantel.

"From Factory to You"

Price includes our "Queen" Coal Grate with best quality enameled tile for facing and hearth. Gas Grate \$2.50 extra. Mantel is 82 inches high, 5 feet wide. Furnished with round or square

CENTRAL MANTELS

are distinctive in workmanship, finish and style. Twenty years' experience enables us to know and satisfy the needs of those who want mantels of quality, different from the rest. We build all styles—Colonial to Mission.

CATALOGUE FREE—Will send our 112 page catalogue, the finest ever issued, free, to carpenters, builders, and those building a home.

CENTRAL MANTEL COMPANY

1247 Olive Street, St. Louis, Mo.

Low Prices : Quality : Quick Shipments
(Our Headliners)



CYPRESS Colonial Column 8 in. x 8 ft. \$2.10 With cap as shown add 65c.

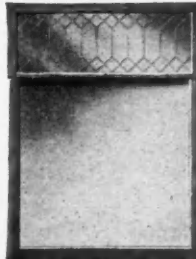

COTTAGE WINDOW 1 1/2 in. Thick. Glazed Clear - - \$3.75 With Leaded Top - - 4.50



FRONT DOOR 2-8 x 6-8 1 1/2 in. thick. Glazed, \$3.97

SURROUNDED

By EXTRAORDINARY Bargains which are only a few of the many Money Savers shown in our new Catalog of High Grade Sash, Doors, Frames, Blinds, Mouldings, Inside Trim, Grilles, Colonnades, Stair and Porch Work, Mantels, Grates, Tiling, Art Glass, Roofing and Building Papers, Wall Boards, Hardware, Paints, Hardwood and Parquetry Flooring, Rolling Partitions, Screens, Steel Ceilings, Gutters, Shingles, etc.

Write Today for Free Copy

The Huber Builders Material Co.

45-49 Vine St., Cincinnati, O.



Front Door Set Antique Cop - per \$1.60 Inside Door Set, 49c



CASING—Yellow Pine 4 1/2 in. \$1.89 per 100 lin. ft.



BASE Yellow Pine 1 1/2 x 7 1/2 in. \$2.77 per 100 lin. ft.

CLEAT Yellow Pine 1 1/2 x 1 1/2 in. 35c per 100 lin. ft.



Quarter Round Yellow Pine, 1/2 in. 38c per 100 lin. ft.

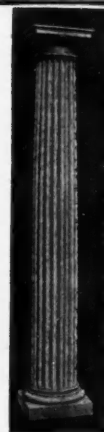

THE PRACTICAL SIDE OF THE PERGOLA

The growing popularity of the formal garden has aroused an increased interest in the pergola. Many means of supporting the overhead work has been used but none so successful as those built with our patent lock joint column.

Contractors and carpenters can make money by recommending them and putting them up themselves. We own the largest factory devoted to such work. Let us tell you more of the artistic use of the pergola.

A new and complete catalogue of pergolas and our patent lock joint columns will be sent upon request. Ask for H-40.



Hartman-Sanders Company

Sole Manufacturers of KOLL'S PATENT LOCK JOINT COLUMNS 2155-2187 ELSTON AVENUE, CHICAGO Eastern Office: 1123 Broadway, New York City The best columns for porches, pergolas or interior use.



The Myers New-Way Adjustable Tandem Door Hanger

Is adjustable to and from buildings and permits the door to be raised or lowered as desired. This is a very important feature in cold weather when the ground is frozen and heaved up. It is absolutely dust proof and can be adjusted to keep out all snow and rain. Owing to its construction it will carry a heavier load than any other style tubular track. Another very important feature is its flexibility which permits the door to pass over uneven surfaces.

Write us for information and catalog.

F. E. MYERS & BRO.

ASHLAND, OHIO

Corrugated Iron Roofing
Galvanized and Painted

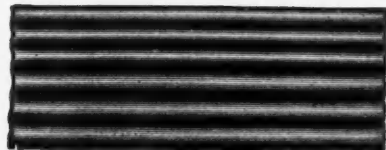

The Jersey City Galvanizing Co.

MAIN OFFICE 107 John Street :: NEW YORK

Wrought Iron Grilles, Railings, Stairs, Guards, Gratings, Etc.



Manufactured by McLaren Brothers, 337 THE ARCADE, CLEVELAND, O.

Architectural and Ornamental Iron and Wire Work

SARGENT'S IMPROVED STEEL SQUARE

The difference between good and indifferent Carpenters' Squares lies in something more than excellence of material and workmanship, which are, of course, among other "Sargent" features—it is in the qualities that increase its all-round efficiency. That is why the practical "Sargent" Standard Steel Square is the universal favorite wherever Squares are used. Our latest model has the scales and markings which enable the carpenter to lay out all kinds of work and to calculate quantities with an ease and accuracy never before thought possible. "A practical treatise on Steel Square" is what several recipients have declared our little publication. Copy free simply by mentioning your Carpenter and Builder.



Sargent & Company
1149 Leonard Street **New York**

C. E. JENNINGS
 TRADE

ARROW → HEAD
 MARK

AUGER BITS No. 1 1/2

Beat the World :: Try Them and See for Yourself :: Fully Warranted



These Bits are universal in scope. They will bore equally well in hard or soft wood, with the grain or against the grain. They combine our single skip Auger twist with our extension lip. No pressure is required to make them bore. They draw themselves in—they are the easiest boring bits made.

INSIST ON HAVING GENUINE C. E. JENNINGS

Arrow



Head

Accept No Substitute
 Order by Name and Number

If you cannot purchase of your dealer we will furnish direct in sets of 13 in leather roll or hardwood case at \$6.00 per set.

C. E. JENNINGS & CO. :: 42 Murray Street :: NEW YORK

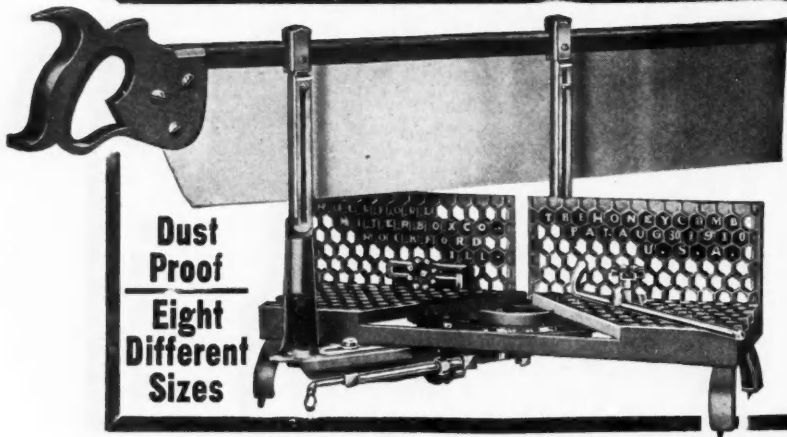

Dust Proof
Eight Different Sizes

HONEYCOMB MITRE BOX

Combines greatest strength with extreme lightness. Back Detachable—the only way in which boxes can be made mechanically perfect for all time. Lever can be adjusted off square if necessary for filing or other exceptional requirements. There is an intermediate gib to take up the wear, thus keeping THE GIB ALWAYS FLUSH WITH THE BED PLATE. The index is conveniently placed for accurate adjustment. THE LEVER LOCKS AT ANY DEGREE OR FRACTION OF DEGREE. The lock is positive, working on the principle of an eccentric—no springs used. As shown in cut, the length and clamp gauges are subject to thousands of variations, always assuring a perfect clamp on the material. Easily moved from place to place, and will stand securely without fastening. ALL BREAKABLE PARTS MADE OF MALLEABLE STEEL. Special prices to Contractors and Carpenters in Localities where our Tools are not handled.

Rockford Mitre Box Co., Rockford, Illinois

1810 THE JAMES SWAN COMPANY 1911

SEYMOUR, CONN.
 Manufacturers of

Mechanics' Tools. Augers. Auger Bits, Draw Knives, Chisels, Hollow Augers, Gimlets, Boring Machines, Gouges, Screw Drivers, etc.

Send for Catalogue



TRADE MARK

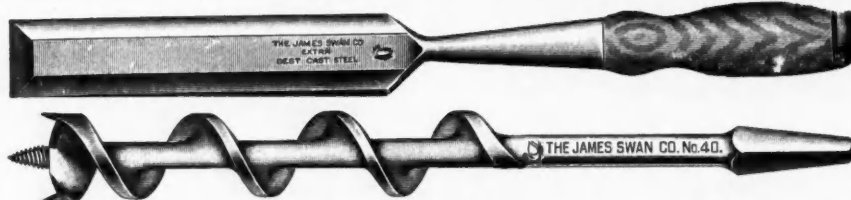

When looking for quality buy goods with the "Swan" trade mark.

RUSSELL & ERWIN MFG. CO., Sale Agents, **NEW BRITAIN NEW YORK** **SAN FRANCISCO CHICAGO**



To Prove to you the high, standardized construction and composition of Carey's Roofing, we want to send to you Booklet and Sample FREE and give you practical information regarding Carey's Roofing based on 25 years' actual time-proved tests. Carey's Roofing is equally adapted to flat or steep surfaces, wood-sheathing, tile or concrete. Whether your contract is large or small, we want to show you the advantage of using a standardized roofing material.

THE PHILIP CAREY MFG. CO.
58 Wayne Avenue 50 Branches Cincinnati, O.

"FAMOUS FOR DURABILITY"

**WHIPPLE'S
AUTOMATIC
BLIND HINGE**



Write Today
For Full
Particulars

Reasons Why
**THEY ARE
THE BEST**

Cannot slam or blow off.
No fastening required.
No blinds to trim or catches to interfere.
Will hold blind—open, half open, or closed.

We also manufacture a flush hinge, constructed on same principle
Two styles, for brick or wood buildings.

R. P. WHIPPLE & CO.,
275 Main Street :: :: SPRINGFIELD, MASS.

**PLUMBERS' SUPPLIES
AT WHOLESALE**

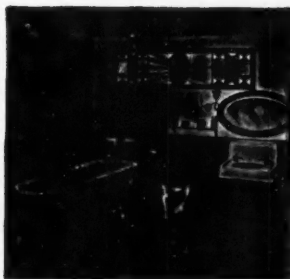

When in the market for Plumbing Supplies and you wish to

**SAVE
20 to 40 Per Cent**

on every article write for my free illustrated Catalog. The only house that sells first class guaranteed goods at wholesale prices direct. Shipments are promptly made from a very complete stock.

Small orders are as carefully handled as large ones.

B. B. KAROL, 768-772 W. Harrison St., Chicago, Ill.

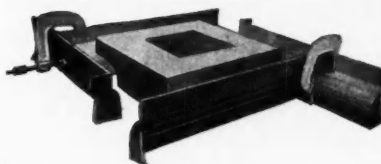

**If You
Don't Say
This Mold**

Is the best value you ever bought you can send it back at the end of six months and we'll return your money.

We can't say anything more emphatic than that; or anything more convincing. It will make 476 different sizes of blocks; and you'll be surprised to see how many different places you can use it.

Adjustable from 2 to 24 inches in width, and from 2 to 24 inches in length.

Send for a catalogue. Don't overlook this because you ought to realize and know the value of a mold like this to you **\$10.00**

W. E. DUNN MFG. CO.
4132 Fillmore St., CHICAGO

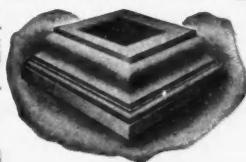

Trained Men Wanted

Every year thousands of *good jobs* are seeking *trained men* through the daily press. You won't have to look for a good job if you have the necessary training to fill one —*the job will look for you*—the "Help Wanted" columns in every daily paper prove this.

Read this special proposition
which the American School of
Correspondence has decided
to offer every ambitious man:

If you lack the time and money to stop work and take a course in training, the American School will *lend you the cost of the training you need* and let you make your own terms about repaying us.

This is the greatest offer that has ever been made to men who have "got it in them to make good." We have studied this matter carefully and know that there are thousands of men who are capable and ambitious, but simply lack the money necessary to pay for their training. They are the men we want to help.

Check the coupon and send it to us today, so we can explain fully our "*Deferred Tuition Plan.*"

The American School is an educational institution. It does not employ agents, representatives or collectors. Signing the coupon will not place you under any obligations whatever or bring an agent to your door. All business will be carried on privately—by correspondence.

AMERICAN SCHOOL OF CORRESPONDENCE
CHICAGO, U. S. A.

Opportunity Coupon

American School of Correspondence, Chicago, U. S. A.

Please send me your Bulletin and advise me how I can qualify for the position marked "X." Am. Carp & Bldr. 9-II.

- | | |
|-------------------------------|---------------------------|
| ... Aviator | ... Fire Insurance Eng'r |
| ... Draftsman | ... Telephone Expert |
| ... Architect | ... Moving Picture Op'r |
| ... Building Contractor | ... Book-keeper |
| ... Structural Engineer | ... Stenographer |
| ... Civil Engineer | ... Accountant |
| ... Electrical Engineer | ... Cost Accountant |
| ... Elec. Light & Power Supt. | ... Cert'f'd Public Acc't |
| ... Master Mechanic | ... Auditor |
| ... Steam Engineer | ... Business Manager |
| ... Reclamation Engineer | ... College Preparatory |

NAME.....
ADDRESS.....
OCCUPATION.....

OSHKOSH, WIS.
CHICAGO, ILLS.
DULUTH, MINN.
BALTIMORE, MD.



OSHKOSH, WIS.
CHICAGO, ILLS.
DULUTH, MINN.
BALTIMORE, MD.

WE SELL TO DEALERS ONLY

Ask Your
Dealer for
Radford
Millwork

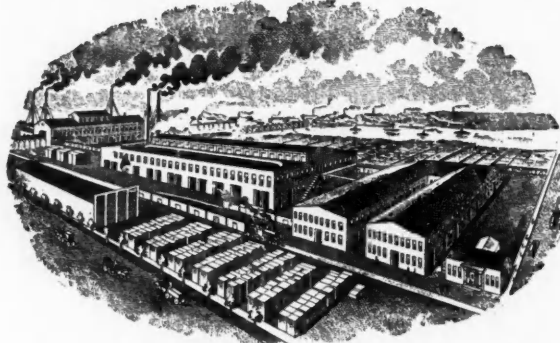

Ask Your
Dealer for
Radford
Millwork

Factory, Saw Mill and Lumber Yard, Oshkosh, Wis.

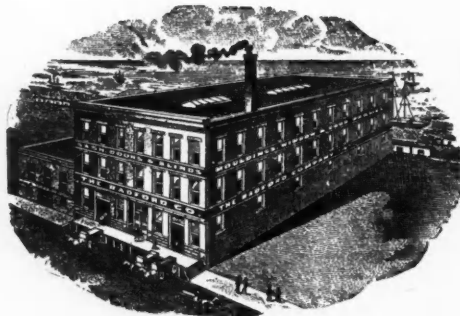

Duluth Office and Warehouse
110-112-114-116 East Michigan Street

Always Ask For
Radford
Guaranteed
Goods

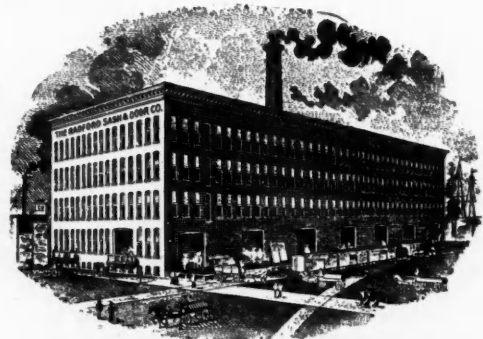

Chicago Office and Warehouse
845 West 22d Street, Near Halsted Street

MANUFACTURERS

Sash, Doors & Blinds

And All Kinds of Mill Work

We take no little pride in manufacturing goods that are just a little bit better than those turned out by our competitors, especially along lines that we make a specialty of. Every article is inspected carefully before we ship, and the greatest care is taken in packing, to prevent damage in transit.

EVERY PIECE OF WORK WE MANUFACTURE IS GUARANTEED
Ask for "Radford Guaranteed Goods"

Radford Bros. & Co.
OSHKOSH, WIS.

The Radford Co.
DULUTH, MINN.

The Radford Sash and Door Co.
CHICAGO, ILL.

Radford Millwork Co.
BALTIMORE, MD.



No Rubbing Needed for a Beautiful Flat Finish

Johnson's Flat Wood Finish, applied with a brush, produces the soft, velvety effect of the hand-rubbed finish at one-third the cost for labor. All that is necessary to obtain this beautiful flat finish on any woodwork, new or old

is to brush on a coat of Johnson's Flat Wood Finish. It dries in an hour without a suggestion of gloss.

Architects, Contractors, Painters and Home Owners everywhere are enthusiastic over the results obtained with it and the big saving it makes possible.

Johnson's Flat Wood Finish

is a liquid — an easy spreading preparation, manufactured especially for finishing interior woodwork of new residences and buildings — as well as furniture — and equally valuable for re-finishing old surfaces.

This flat wood finish opens a new field for the painter. He can now give his customers the beautiful, artistic, flat, hand-rubbed effects that have always been so high priced on account of the labor — at prices that are within the reach of everyone.

By the use of Johnson's Flat Wood Finish, you can make figures on hand-rubbed effects that will land the contract every time — give your customer perfect satisfaction — and make you a good profit besides.

For giving this rubbed effect to new woodwork, apply Johnson's Flat Wood Finish over Wood Dye, Paste Wood Filler, or Varnish — for old woodwork or furniture having a gloss or varnish finish, simply apply a coat of Johnson's Flat Wood Finish. It is not necessary to remove the old finish before applying the new — and one coat *thoroughly brushed in* is sufficient.

Prices of

Johnson's Flat Wood Finish

Gallons	\$3.00
Half Gallons	1.60
Quarts85
Pints30

One Gallon is sufficient for 500 square feet

FREE Let us send you free a test can of Johnson's Flat Wood Finish and a copy of our Instruction Book. Edition A. C. B-9. We want every painter — you — to know all about this most important development in wood finishing materials. We will send you a free sample so you may try it yourself at our expense and be convinced. Write today or fill out coupon for sample of Johnson's Flat Wood Finish and panels of wood finished with it.



COUPON
for free sample of Johnson's Flat Wood Finish and panels of wood finished with it.

Name

Street and Number

City and State

S. C. Johnson & Son, Racine, Wis.
The Wood Finishing Authorities

MONITOR SASH LOCKS

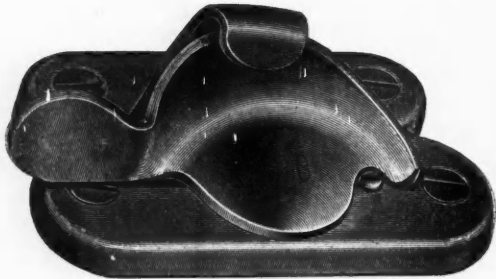

(PATENTED)

NEVER BREAK

BECAUSE THEY ARE MADE OF VERY HEAVY GAUGE METAL AND PERFECTLY CONSTRUCTED.

If the upper plate drops, the Monitor "Never Break" Sash Lock will pick it up from a lower point than any other, adjust the sashes perfectly, prevent all vibration and lock securely, so it cannot be opened from the outside.

MADE IN TWO SIZES AND ALL FURNISHED BY

The Champion Safety Lock Co.
Geneva, Ohio

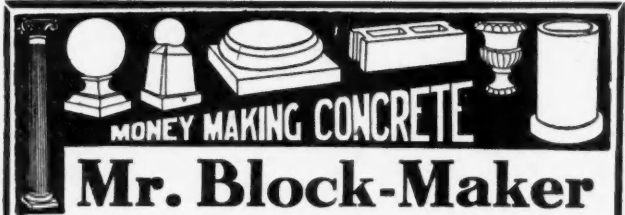

MONEY MAKING CONCRETE

Mr. Block-Maker

Wet Process is Right.
Face down is Right.
Three blocks at a time is Right.
Triple Tiering is Right.
Damp Curing is Right.

The Mogul Invincible Block Machine

COMBINES ALL THESE

IT IS RIGHT

It is 46 inches long and will make three 16" or two 24" blocks at one operation. It makes sills, caps, copings, rails and steps, faster and better than a special sill machine. It has every adjustment that any other machine has and many that no other machine has.

PRICE—Machine and Outfit, \$75.00

WRITE FOR CATALOG

THE PETTYJOHN COMPANY

634 No. 6th St., TERRE HAUTE, IND.

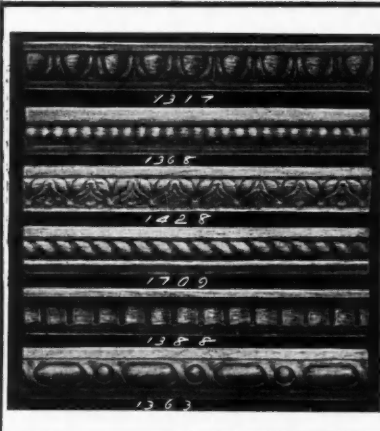

Wood Carvings for Interior Finish

Our beautiful Catalogue No. 21 will be sent upon receipt of 15 cents in stamps. Our product is of the highest grade, and too large to list here.

Write today

Waddell Mfg. Co.

Corner of Taylor and Coldbrook Streets
Grand Rapids, Michigan

Builders' Hardware and Specialties



No. 5493 Old Copper Steel Sash Lock.
Per dozen.....\$0.50

FREE—Our illustrated catalog and net price list to contractors and material men. Please state whether you are a contractor, carpenter, or builder.

We do not sell to contractors or carpenters in Cook County

REHM HARDWARE CO., 1501 Blue Island Ave.
Chicago, Ill.

4 H.P. Kerosene or Gasoline Engine \$79.50

Greatest value ever offered in 4 H. P. water cooled stationary engine. Just the thing for carpenters and builders. Pays for itself in a short time. Runs any kind of wood working machinery—band saws—boring machines—planers—combination wood workers, etc. Also great engine for running cement mixers or can be used around the home for pumping water—running ice cream freezers—electric light outfits, etc. Very simple, easy to operate and very economical, best material and workmanship, made to last a life time. Every engine shipped complete all ready to run, nothing to do but fill the fuel tank, put in some water and start up. No extras to buy. Absolutely guaranteed by a big responsible concern.

1 1/2 H. P. for \$49.50

Write for catalog today and ask about
30 DAY TRIAL OFFER
GRAY MOTOR CO.
961 U. S. Motors Bldg.
Detroit : Mich.

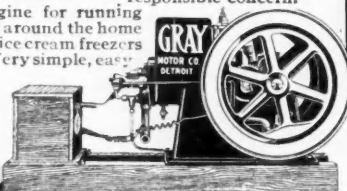

HESS MEDICINE SANITARY LOCKER CABINET

The Only Modern, Sanitary STEEL Medicine Cabinet



or locker, finished in snow-white, baked everlasting enamel, inside and out. Beautiful beveled mirror door. Nickel plate brass trimmings. Steel or glass shelves.

Costs Less Than Wood

Never warps, shrinks nor swells. Dust and vermin proof, easily cleaned.

Should be in Every Bath Room
Four styles—four sizes. To recess in wall or to hang outside. Send for illustrated circular.



HESS, 920L Tacoma Bldg., CHICAGO
Makers of Steel Furnaces Free Booklet The Outside Steel Cabinet

The MAN Who Stood Still!



You can't afford to be **The Man Who Stood Still**. You don't want to stick to the plane, the saw and the hammer all **your** life. You don't want to continue to work for the next twenty or thirty years just as you do now. You must want to advance, and you can advance by studying

Radford's Cyclopaedia of Construction CARPENTRY, BUILDING AND ARCHITECTURE

Twelve great, big, massive volumes. More thorough, more complete, more exhaustive than anything before even attempted. Over four thousand pages, thousands of illustrations, diagrams, charts, plans and working drawings, made especially for this set of books, including three complete volumes on cement and concrete construction, the only thing of the kind in existence. Practical carpentry, steel square, framing, roof construction, and even manual training, painting, glazing and decorating are thoroughly treated in addition to the bigger work, such as masonry and steel construction, heating, ventilation and plumbing, reinforced concrete, contracts and specifications. And all this explained thoroughly without the use of a single square root sign or algebraic equation, or the use of anything but simple arithmetic. **Practical information from start to finish.**

Free Set of Blue Prints and Book of Plans

ONE-QUARTER PRICE BARGAIN
Delivered to you at bare cost of manufacture merely to introduce the set. Privilege of examination free. We pay transportation both ways if you don't keep the books. One dollar with your order and two dollars a month pays for the books. Order on the coupon below and get all the benefits of the One-quarter Price Offer—\$23.80 instead of \$79.00.

Free Five-Day Offer Sent For Only \$1.00

Including year's subscription to the **American Carpenter and Builder** and one extra large Portfolio size volume of three hundred pages of all kinds of plans, perspective views and floor plans, selected for their excellence, economy of design and popularity among the building classes.

SMALL LIST OF CONTENTS

To Realize their Tremendous Scope, You Must See the Books

- | | | | | |
|-----------------------------|-----------------------------|-----------------------------|-----------------------------|-------------------|
| Carpentry | How to test Cement | Walls and Foundations | Use of Tiles | Invaluable to the |
| Stair Building | Standard Specifications for | Steps and Stairs | Ventilation and Plumbing | house owner or |
| Steel Square | Concrete Blocks | Concrete on the Farm | Heating—Steam, Hot Air, | prospective |
| Test Questions, Practical | Establishing a Concrete | Roofings, Chimneys, etc. | Hot Water, Furnace | home |
| Problems, Reviews | Block Business | Reinforced Concrete Bridges | Steam Fitting, Gas Fitting, | builder |
| Framing | Concrete Block Systems | Railroad Work, Concrete | etc. | |
| Roof Construction | Proportions—Sand, Stone, | Ties, Abutments, Culverts | Architecture, Mechanical, | |
| Strength of materials | Gravel and Water | Concrete Dams | Free Hand and Perspec- | |
| Foundations, Retaining | How to Overcome Concrete | Retaining Walls | tive Drawing | |
| Walls, etc. | Troubles | Reinforced Concrete | Rendering in Pen and Ink | |
| Piles and Caissons | Curing Stone by Steam | Various System, Tables | and Wash | |
| Sewers and Drains | Color of Concrete Blocks | Showing How to Reinforce | Lettering | |
| House Drainage and Sani- | Waterproofing | Cement Ornamentation | Practical Problems in | |
| tation | Cement Plaster Work | STEEL CONSTRUCTION | Mensuration | |
| Estimating and Superinten- | Cement Mortar | This subject is handled | Water Color | |
| dence | Monolithic Concrete Con- | thoroughly | Effects | |
| Laws of Building Contracts | struction | General Principles | The Five Orders | |
| Painting and Glazing | Sidewalks, Pavements and | Practical applications | | |
| Blue Printing | Floors | Practical Problems in Con- | | |
| Specifications for Portland | Expansion Joints | struction | | |
| Cement | Concrete Floors | Fireproofing | | |

ONE-QUARTER PRICE COUPON

Radford Architectural Co. Medinah Bldg. Chicago

Please reserve your 13 volume Cyclopaedia of Construction for me for five days' examination. I enclose \$1.00 deposit which you agree to return if I decide not to buy the books. If I keep the books I will pay \$2.00 a month until the special price, \$23.80, is paid, including year's subscription to Am. Carp. and Bldr.; otherwise I will notify you within five days after receipt of them. You also agree to furnish set of blue prints, if ordered within two months after acceptance of books.

RADFORD ARCHITECTURAL CO.
Medinah Building, Chicago, Ill.

Name _____
Address _____
Employer _____

IMPERIAL "SPIRAL" "AMERICAN" INGOT IRON LATH

THE MOST SUPERIOR RUST-RESISTING

Government Approves It---Architects Specify It, Contractors Demand It.

RUSTPROOF

Made From
**"AMERICAN
INGOT IRON"**

The Attainment
of the
Highest Purity
in Iron

99.94% PURE

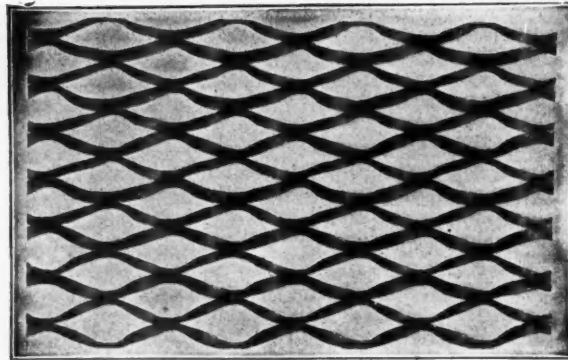

Imperial "Spiral"

FIREPROOF

Equal Distribution
of the Metal
Giving Maximum
Rigidity

Is unequalled by any expanded lath made, NOTE that "Spiral" Twist
SAVING of THREE to FOUR cents Per Yard IN labor AND Plaster.

MADE IN ALL GAUGES, ONE STANDARD SIZE 16½ INCHES x 96 INCHES

Samples and Prices Furnished on Request.

WRITE DEPT. R. C.

THE AMERICAN ROLLING MILL CO. - Middletown, Ohio

SYKES METAL LATH

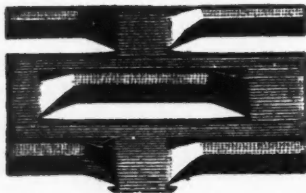

that can be plastered on either side—cannot be applied wrong because both sides are alike.

We make two kinds—Sykes Expanded Cup Lath, and Sykes Trough Lath. Both are supreme for their own purpose.

The top illustration shows Trough Lath, bottom cut depicts Cup Lath.

NO PICKLED LATH

Sykes Lath is absolutely guaranteed not to have been pickled in an acid bath. This means that the weight and thickness is not reduced and is less susceptible to rust. Requires no furring out from studs because it is self furring.

It has been approved by U. S. Government and by leading architects, carpenters and builders throughout the country. In fact, when we say it is the best ever made we are simply stating a proven fact.

Samples and prices mailed upon request.

Sykes Metal Lath & Roofing Co.

NILES, OHIO

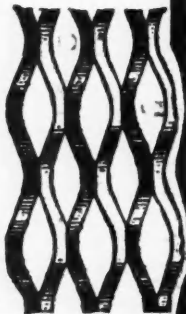

The lath that is positively different to anything else made; different because it combines more good features.

Cup lath is the only Expanded Metal Lath that can be plastered on either side—cannot be applied wrong because both sides are alike.

WIRE LATHING

The Secret of the durability of the woven wire lathing is owing to the fabric being completely embedded in the mortar, and thus secured from the corrosive action of the atmosphere; and also to the fact that rust will not attack the smooth round wire as it does the thin cut edges of a metal fabric.

"Why not use the proper kind of lath that lasts?"

Before building, write for our Booklet No. 6 A and Prices

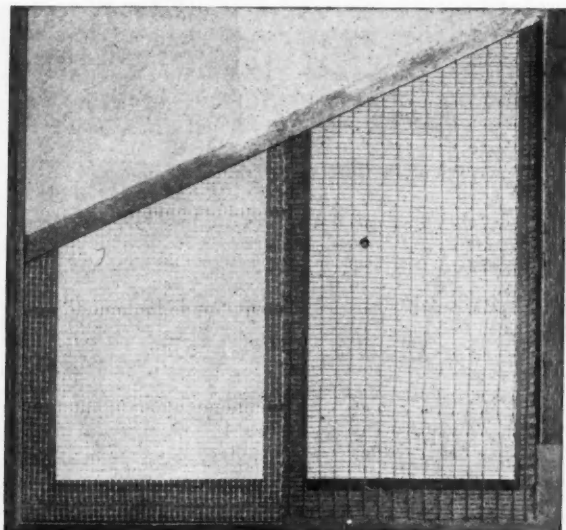

Grimm's Galvanized Corrugated Wire Lathing
"Patent applied for"

Greening's Patent Trussed Steel Wire Lathing

BUFFALO WIRE WORKS CO., BUFFALO, N. Y.



Little Wonder
Concrete Mixer

Concrete Machinery, Tools and
Molds of all kinds. Gasoline
Hoists, Builder's Derricks,
Cranes and Material Elevators

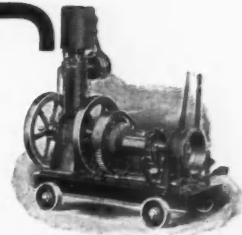

Polygon
Gasoline Hoist

THE GREAT POLYGON LINE THE LITTLE WONDER LINE

Waterloo Cement Mach'y Corp'n

103 Vinton Street WATERLOO, IOWA

Stone Crushers, Sand and Stone Screens and Elevators. Send
today for descriptive Literature

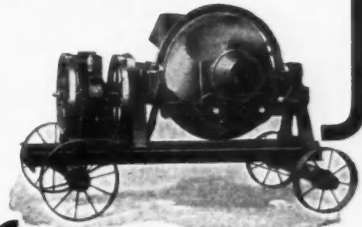

Polygon Junior
Concrete Mixer



Made in all
sizes and
styles, for
use with
brick or
concrete
block walls
or with
wooden or
steel beams

TRUS-CON Joist Hangers

Avoid cutting away and weakening of timbers
and walls—save labor, time and money.

Trus-Con Joist Hangers are made from open
hearth steel plates, and are proven by actual test
to be the strongest on the market. Note the bulb-
shaped reinforcement at upper angle.

We also furnish Post Caps Post Bases, Wall
Plates and Base Plates made in rolled steel, mal-
leable iron, or cast iron.

Write for catalog and prices

TRUSSED CONCRETE STEEL CO., 344 Trussed Concrete Bldg., Detroit, Mich.

Trus-Con Pressed Steel Inserts for Supporting
Shaft Hangers in Con-
crete Buildings

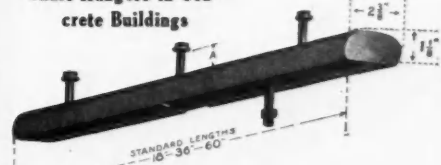

Trus-Con Pressed Steel Inserts are im-
bedded in the concrete during con-
struction, saving expensive drilling after com-
pletion of the work. The long slots allow a
wide variation in position. Special washers pre-
vent bolts from turning in the slots. Write for
details and prices.

DOW
Wire & Iron Works
(Incorporated)
LOUISVILLE, KY.

IRON LINTELS
Beams, Angles, Anchors, Hangers.
Ornamental Cast Iron Fronts and Stairways.

GENUINE BANGOR

Roofing Slate
Structural Slate
Blackboards

Large Facilities, Prompt Deliveries

EAST BANGOR CONSOLIDATED SLATE CO.

East Bangor, Pa.

Stair Building



Made Easy

A PRACTICAL TREATISE FOR CARPENTERS BY

David Mayer

127 PAGES (5x7 inches)
111 ILLUSTRATIONS
Handsomely bound in cloth

PRICE 50 CENTS

Sent postpaid on receipt of price. Your money back if you are not pleased.

A COMPLETE and clear description of the art of building the bodies, carriages and cases for all kinds of stairs and steps, together with illustrations showing the manner of laying out stairs, forming treads and risers, building cylinders, preparing strings; carriages for common platform, dog-leg and winding stairs; also the method of setting out stairs, laying out strings, plans of stairs, pitch-boards, construction of steps, line of nosings, housing strings, placing balusters, finishing ends of wall strings, trimmers and joists, lower newel finish, well hole finish, straight platform stairs, planning stairs, dog-leg stairs, close string stairs, continuous stairs, geometrical stairs, carriages of stairs, story rod, dancing the treads, double platform stairs, straight flights and winders, solid newels, all winders, etc., etc.

This work takes hold at the very beginning of the subject, and carries the student along by easy stages until the entire subject of Stair Building has been unfolded, so far as ordinary practice can ever require.

SEND FOR OUR CATALOG OF BOOKS ON BUILDING
Industrial Book Co. 178 Fulton St. NEW YORK

Concrete Building Block

for the simple, low cost building and block for the elaborate high-class structure may be made on the same block machine—**IF YOU HAVE THE RIGHT ONE.**

To be successful a block manufacturer should be equipped with a machine that will make anything from an 8x8x16 block to a six foot sill.

The **only** machine that will fill this bill is

The Hercules Block Machine

The **HERCULES** is built upon one solid frame six feet long. If your demand is just for 8x8x16 inch blocks, you only need the mould box for that size—as your trade increases, add new plates to be attached to your original machine.

No need to buy a complete new outfit every time you have to add to the variety of your output.

There are many other points connected with Hercules machines you ought to know. We have just issued a little book full of information. **SEND FOR IT TODAY.**

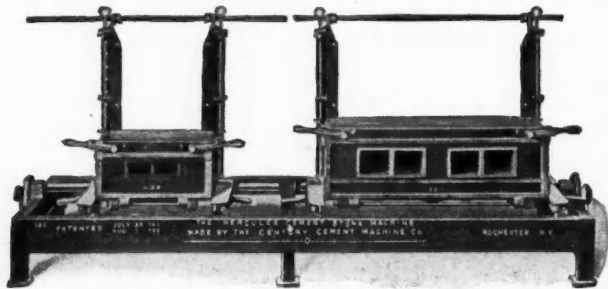

CENTURY CEMENT MACHINE CO.
279-289 St. Paul St., ROCHESTER, N. Y.

NOTICE IMPORTANT



Owing to increased manufacturing facility we have tripled our output and reduced the cost of manufacture materially. On and after Aug. 20, 1911.

PEERLESS BRICK MACHINES

will be sold at an **enormously reduced price.**

Our 1912 Model now ready meets every requirement—tamps brick uniformly; makes them face-down and is the only economical and successful machine on the market.

THE CUT IN PRICE IS GREAT

Write us regarding it.

Peerless Brick Machine Company
19 NORTH 6th ST. MINNEAPOLIS, MINN.

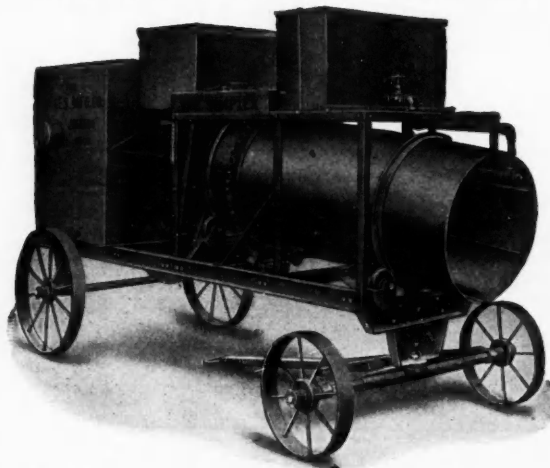

THE MILES SIMPLEX MIXER

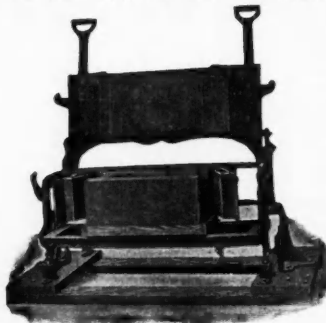

Continuous Feed, Batch Mix, Low Down Steel Frame, 3 Hoppers, Positive Feed, Attractive Price

"The Miles" No. 5, Down Face, Wet Concrete Block Machine

Makes Stone in Lengths, 4", 6", 8", 10", 12", 16", 18", 20", 22", 24"; in Width, 4", 6", 8", 10", 12"; in Height, 4", 6", 8". Also Angle Stone, Circle Stone, Cable Stone, Hollow or Solid Stone.

The Contractor's Friend, Simple, Strong and Rapid. Lowest in price.

WRITE FOR NEW 1911 CATALOGUE

THE MILES MFG. CO., Inc. 307 E. Franklin St. JACKSON, MICHIGAN

CONTENTS FOR SEPTEMBER, 1911

About Veranda Railing.....	62	How to Make a Necktie Rack.....	46	Results of a Kansas Tornado.....	65
Another Roof Plan.....	66	How to Make a Wood Tea Pot Mat.....	45	Roof Plan.....	63
Anything to Suggest?.....	27	Ideas for Home Builders.....	48	Sage Foundation "Model Village".....	32
Brick and Tile Work.....	42	Lining the Roof for Shingles.....	63	Slivers.....	47
Brick Revival, The.....	42	Machine Woodworking.....	54	Some Essentials in House Building.....	48
City Lacks Power to Screen Houses.....	44	Mechanics Lien for Broken Glass.....	50	Some Oddities in Joints.....	41
Correspondence.....	62	Modern Rough Texture Brick.....	44	Something the Boys Can Make.....	45
Craftsman Style Interior Finish.....	39	More Light.....	63	Steel Bridge Builders, Tool.....	64
Details of Construction and Finish.....	37	New Berwyn, Ill., Grammar School.....	53	Steel Square.....	40
Development of Gasoline Engines.....	36	"New England" Framing and the Quality Idea.....	50	Styles of Interior Trim.....	37
Do You Do Your Share of the Furnace Business?.....	28	New Test for Building Materials.....	31	To Clean Woodwork.....	47
Editorial.....	27	Operating the Scroll Band Saw.....	54	Tool Box.....	63
Elaborate Colonial Trim.....	38	Opportunity—(or Be Reasonable).....	64	Trade Notes and Items of Interest.....	68
Equitable to Try Home-Building Policy.....	28	Original Decorative Scheme, An.....	51	Two Questions.....	64
Framing for Uneven Pitches.....	40	Painting and Wood Finishing.....	51	Veranda Design.....	65
Handy Vise.....	66	Plan a 150-Foot Fence for "Privacy of Home".....	35	Welcome News for the Carpenter.....	27
Hardwood Door Makers Seek Wider Field.....	29	Plans for Substantial Brick Bungalow.....	56	Why a Granite Statue Was Rejected.....	31
Hardwood Trim the Best Investment.....	31	Public Buildings.....	53	Why English Workmen Went on Strike.....	35
Help Wanted.....	62	Rafter Framing Method.....	66	Wood Mantels from Stock.....	49
Home Workshop, The.....	45	Residences.....	56	Work of Boy's Carpentry Class.....	36
How to Build a Log House.....	62			World Wide Competition.....	52
				Your Interest in Hardwood Doors.....	30

INDEX TO ADVERTISEMENTS, SEPTEMBER, 1911

American Bell & Foundry Co.....	18	Gage Tool Co.....	11	Peck, Stow & Wilcox Co.....	103
American Floor Surfacing Machine Co.....	4	General Roofing Mfg. Co.....	87	Peck-Williamson Co.....	79
American Level & Grade Finder Co.....	20	Glidden Varnish Co.....	101	Peerless Brick Machine Co.....	132
American Rolling Mill Co.....	130	Goodell Mfg. Co.....	12	Perfection Mfg. Co.....	18
American Saw Mill Machinery Co.....	74	Goodell-Pratt Co.....	11	Pettyjohn Co., The.....	128
American School of Correspondence.....	125	Gordon-Van Tine Co.....	73	Phillips Co., A. J.....	21
American Sheet & Tin Plate Co.....	110	Grand Rapids Hardware Co.....	16	Phoenix Sliding Blind Co.....	18
American Steel Scaffold Co.....	104	Gray Motor Co.....	128	Potter Bros.....	23
American Veneer Co.....	4	Grimm Mfg. Co.....	13	Power-Wallace Co., The.....	104
Andrews Heating Co.....	99	Heitman & Co., Lewis.....	104	Prentiss Vise Co.....	20
Ashby, G. W.....	122	Hartman-Sanders Co.....	123	Progressive Mfg. Co.....	15
Atkins & Co., E. C.....	2	Heppes Co., The.....	105	Raber & Lang Mfg. Co.....	116
Austin & Eddy.....	24	Hess Warming & Ventilating Co.....	121-128	Prybil, P.....	13
Baker-McMillan Co.....	113	Howar, J. K.....	109	Radford Architectural Co.....	129
Barnes Co., W. F. & Jno.....	4	Howes Co., S. M.....	17	Radford Sash & Door Co.....	126
Berger Mfg. Co.....	94	Huber Builders Material Co.....	123	Rehm Hardware Co.....	128
Birmingham & Seaman Co.....	92	Humason-Beckley Co.....	17	Richards-Wilcox Mfg. Co.....	19
Berry Bros.....	81	Hupp Motor Car Co.....	93	Rockford Mitre Box Co.....	124
Bertolth System, The.....	120	Hurley Machine Co.....	4	Roth Bros.....	19
Bishop & Co., Geo. H.....	22	Huther Bros. Saw Mfg. Co.....	24	Russell Jennings Mfg. Co.....	19
Bovee Grinder & Furnace Co.....	24	Illinois Traction System.....	21	Samson Cordage Works.....	115
Boyle Co., John.....	118	Industrial Book Co.....	132	Sargent & Co.....	124
Bradt Publishing Co.....	25	International Correspondence Schools.....	119	Sayre & Son, L. A.....	109
Braunsdorf-Mueller Co.....	112	International Harvester Co. of America.....	112	Schacht Motor Car Co.....	88
Buffalo Wire Works Co.....	130	Iszard-Warren Co.....	21	Seager Engine Works.....	113
Builders Auxiliary Co.....	20	Ives Co., The H. B.....	105	Sears, Roebuck & Co.....	76-77
Burlington Venetian Blind Co.....	111	Jennings & Co., C. E.....	124	Sedgwick Machine Works.....	20
Caille Perfection Motor Co.....	86	Jersey City Galvanizing Co.....	123	Seippel Lumber Co., The.....	98
Caldwell Mfg. Co.....	21	Johnson, E. J.....	24	Seneca Falls Mfg. Co.....	118
Canton Art Metal Co.....	25	Johnson & Sons, S. C.....	117-127	Shelby Spring Hinge Co.....	109
Canton Foundry & Machine Co.....	10	Kanneberg Roofing & Ceiling Co.....	24	Sheldon & Co., E. H.....	25
Carborundum Co., The.....	102	Karol, B. B.....	125	Shultz, C. H.....	121
Carey Mfg. Co., The Philip.....	125	Keasbey & Mattison Co.....	90	Sidney Elevator Mfg. Co.....	19
Carroll Column Clamp Co.....	19	Knickerbocker Co., The.....	116	Sidney Tool Co.....	15
Cement World.....	8	Lowie Bros. Co., The.....	86	Silver Lake Co.....	14
Central Mantel Co.....	123	Lufkin Rule Co.....	12	Simmons Hardware Co.....	135
Century Cement Machine Co.....	132	Luther Grinder Mfg. Co.....	107	Simonds Mfg. Co.....	100
Champion Safety Lock Co.....	128	McKinney Mfg. Co.....	72	Slatington Slate Co.....	18
Chehalis Fir Door Co.....	90	McLaren Bros.....	123	Smith, George D.....	3
Chicago Machinery Exchange.....	7	McMillan Co., R.....	89	Smith Machine Co., H. B.....	4
Chicago Spring Butt Co.....	26	Mack & Co.....	23	Smith & Hemenway Co.....	12
Cincinnati Tool Co.....	10	Marsh Co., H. C.....	26	Smith, Otis A.....	26
Cordesman-Meyer Co.....	15	Majestic Furnace & Foundry Co.....	78	Southern Cypress Mfrs. Asso.....	97
Cortright Metal Roofing Co.....	96	Mastic Wall Board & Roofing Mfg. Co.....	134	Speedwell Motor Car Co.....	104
Coulson & Co., J. W.....	22	Mayhew, H. H.....	12	Standard Screen Co.....	22
Crescent Machine Co.....	13	Miles Mfg. Co., P. B.....	132	Stanley Rule & Level Co.....	6
Dahl Mfg. Co.....	80	Millers Falls Co.....	14	Stanley Works, The.....	111
Decorators Supply Co.....	115	Miller Mfg. Co., A. W.....	118	Starrett & Co., L. S.....	10
Deco-Veneer Co.....	120	Miotke, Jos.....	5	Swan Co., Jas.....	124
Detroit & Cleveland Navigation Co.....	120	Montross Metal Shingle Co.....	106	Sykes Metal Lath & Roofing Co.....	130
Detroit Decorative Supply Co.....	113	Morgan Co., The.....	95	Tannewitz Co., The.....	14
Detroit Engine Works.....	19	Moorman & Otten Co.....	108	Taylor, John L.....	115
Detroit Motor Car Supply Co.....	104	Morrill, Chas.....	26	Taylor Mfg. Co., James L.....	20
Detroit Show Case Co.....	10	Mullins Co., W. H.....	121	Trussed Concrete Steel Co.....	131
Didreksen, H. P.....	114	Murphy Varnish Co.....	84	United Machinery Co.....	9
Disston & Sons Co., Henry.....	21	Myers & Bro., F. E.....	123	United Pump & Power Co.....	119
Dixon Crucible Co., Jos.....	10	National Mfg. Co.....	136	United States Gypsum Co.....	109
Dow Wire & Iron Works.....	131	National Sheet Metal Roofing Co.....	111	Van Guilder Hollow Wall Mfg. Co.....	113
Dunn & Co., W. E.....	125	Nicholls Mfg. Co.....	25	Voltz Mfg. Co.....	18
Dwight Lumber Co.....	120	North Bros. Mfg. Co.....	16	Waddell Mfg. Co.....	128
East Bangor Consolidated Slate Co.....	131	Northwestern Compo-Board Co.....	91	Waterloo Cement Machinery Corp.....	131
Eastern Granite Roofing Co.....	26	Northwestern Grille Works.....	17	Watson & Boyden.....	5
Edwards Mfg. Co.....	17	Oak Flooring Bureau.....	108	Weber Mfg. Co.....	5
Elite Mfg. Co.....	18	Ornamental Products Co.....	118	Welt & Sons Paper Co.....	114
Ellis Engine Co.....	104	Orr & Lockett Co.....	115	Wentworth Institute.....	120
Excelsior Bag & Mfg. Co.....	104	Oshkosh Mfg. Co.....	85	Whipple & Co., R. P.....	24-125
Fay & Egan Co., J. A.....	6	Paine Lumber Co.....	82-83	Wilkinson & Co., A. J.....	11
Fitzgerald-Speer Co.....	14	Parkhill, John.....	111	Willis Mfg. Co.....	16-118
Flanagan & Biedenweg Co.....	115	Parks Ball Bearing Machine Co.....	119	Winthrop Asphalt Shingle Co.....	113
Foster & Sons Co., Wm.....	14			Wood Mfg. Co., John.....	119
Fuller & Johnson Mfg. Co.....	75			Wright Co., Chas.....	11

NOTICE TO ADVERTISERS

Forms for the October number of the American Carpenter and Builder will close promptly on September 20. New Copy, changes and orders for omissions of advertisements must reach our business office, 178 West Jackson Boulevard, Chicago, not later than the above date. If new copy is not received by the 20th of the month preceding date of publication the publishers reserve the right to repeat last advertisement on all unexpired contracts. AMERICAN CARPENTER & BUILDER CO.

BISHOPRIC WALL BOARD AND SHEATHING

BISHOPRIC Wall Board is cheaper and better than lath and plaster. It is the **ONLY** Wall Board **COMBINED WITH LATHS** and Asphalt Mastic. Laths are necessary in a Wall Board, just as they are in plaster walls, to prevent warping and to insure solid, rigid, stiff, substantial

WALLS AND CEILINGS



Bishopric Wall Board Easily Applied

Bishopric Wall Board also is the only Wall Board with a water-proof body. The Asphalt Mastic in which the laths are imbedded affords absolute protection against dampness. Does away with delays in building. Applied winter or summer. Is nailed to studding dry, ready for immediate application of paper, paint, burlap or any other kind of decoration.

Bishopric Wall Board is made of kiln-dried, dressed laths imbedded in hot Asphalt Mastic, surfaced with sized cardboard and cut in the factory into 4 x 4 feet sheets. Shipped in crates ready for immediate nailing to studs. It is guaranteed not to swell, shrink, warp, crack, flake or blister. It is clean, sanitary and odorless; proof against moisture, cold, heat and vermin; saves fuel and keeps out summer heat; also deadens sound.



Applied Dry Winter or Summer

Shows Construction of Bishopric Wall Board

It is suitable for dwellings, factories, new partitions in old buildings, finishing attics, porches, laundries, cellar ceilings, garages, etc.

PRICE OF WALL BOARD AND SHIPMENT—Crate of 16 sheets, covering 256 sq. ft. of surface, \$6.40 per crate, or \$2.50 per 100 sq. ft., f. o. b. New Orleans, Cincinnati, or Alma, Mich. We ship from nearest point.

T. W. Hanes, Carpenter and Contractor, Mounds, Ill., wrote August 15: "I have used 13 crates of Bishopric Wall Board, and the waste could be put in a hat."

Wm. Cooper, Taxidermist, Milo, Me., March 9 wrote the Philadelphia Farm Journal: "Your interesting paper has been a real bonanza to me. I wanted a cheap, warm method of lining my new work room. An advertisement in your paper gave me the very idea and material at a price that suited my pocket. I wrote to two firms who advertised with you, but selected 15,000 ft. of sheathing from the Bishopric Wall Board Mfg. Co. of Cincinnati. If the stuff was made on purpose, it could not suit me better; and a most prompt, obliging firm they are, too."

Bishopric Sheathing is Cheaper than Lumber; saves 75% in Labor; does away with Building Paper

BISHOPRIC SHEATHING

Ideal Material for Cement Buildings or Stucco Exteriors. Proof against Dampness, Heat and Cold

Bishopric Sheathing is made of same materials as Wall Board, but finish is not necessarily so fine, therefore costs less. It is of uniform thickness, insuring a perfectly even surface when applied.

Bishopric Sheathing is nailed to studs, with lath and asphalt side exposed. Over laths weather boards are nailed or cement applied.

Bishopric Sheathing makes a more solid and substantial wall than lumber. There are no gaping joints; no widening cracks due to shrinkage; no knot holes.

The Asphalt Mastic in Bishopric Sheathing is a non-conductor, moisture cannot penetrate it. It is proof against vermin. The pests cannot bore through the tough, gummy Asphalt Mastic. In applying weather-boards over laths, dead air space is left between the laths; forming splendid insulation. Does away with the expense of building paper and cost of its application.

An Ideal Bishopric Home



Ideal home showing Weather-boards over Bishopric Sheathing, lath side exposed, also Bishopric Roofing over Bishopric Sheathing. (smooth side of sheathing exposed)

The cost of applying Bishopric Sheathing is but \$2.50 per 1,000 feet—A **SAVING OF ABOUT 75 PER CENT.** Furthermore, 1,000 square feet of wood sheathing covers but 750 feet of surface, 20% less being due to tongue and groove. In Bishopric Sheathing 1000 sq. ft. covers 1000 square feet of space.

Bishopric Sheathing insures comfort during the construction of the building. As soon as the building is closed in with Bishopric Sheathing, the men may work in comfort on the inside during bad weather, finishing the outside on suitable days. This insures continuous work, without loss of time, enabling the contractor to hold his men and complete the work in the least possible time.

Bishopric Sheathing is used with equally splendid results under flooring and as a substitute for roofing boards. Used under floors, it serves as a sound deadener and keeps out dampness; used under the shingles, it keeps out cold and summer heat.

ITS MANY USES—Bishopric Sheathing also is used with excellent results as a lining for dairy barns, ranch houses, poultry houses, driving stables or any out-door building where protection from the elements, Summer or Winter is desired.

PRICE OF SHEATHING AND SHIPMENT—Crate of 16 sheets covering 256 square feet of surface, \$6, or \$2.35 per square of 100 square feet, f. o. b. New Orleans, La., Cincinnati, or Alma, Mich. We ship from nearest point.

BISHOPRIC ROOFING SELF-PROTECTING

The materials used in Bishopric Roofing are self-protecting. Other roofings require protection in the way of paint or coatings to prevent drying out, cracking or rotting. Bishopric Roofing requires no paint. The Asphalt itself in this patented Roofing is toughened and perpetuated by an exclusive process. Carbonate of Lime is mixed with pure asphalt, making one homogeneous mixture, which stands a pressure of 500 pounds to the square inch. This is a positive guarantee against breaks and cracks. Asphalt Mastic may be exposed direct to the weather in any climate without danger of softening, drying out, cracking or crumbling. Write for free sample and literature.

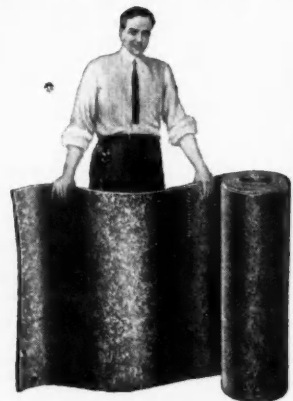

Write for Descriptive Booklet and Samples—all Sent FREE. Dealers Write for Proposition.

THE MASTIC WALL BOARD AND ROOFING MFG. CO., 24 E. Third St. Cincinnati, O.



K 6558
3 Blades
Size 3 3/4 in.
\$1.25

K 4078
3 Blades
Size 3 3/4 in.
\$1.00

K 343
3 Blades
Size 3 1/4 in.
\$2.00

The Knife That Takes a Keen Edge And Keeps It

Many an ordinary knife becomes useless in a short time, because of repeated grindings to keep its edge in condition.

KEEN KUTTER

knife blades are all alike—of the same even quality and uniform hardness. A Keen Kutter edge will cut a string or a rope, whittle a match or shape a leather washer, and *stay* sharp longer than the best ordinary knife you've ever seen. Keen Kutter knives are put together to *last*. Every part is quality—to the little rivets that hold the blades. Right in spring, in strength and finish, Keen Kutter knives are all they ought to be, all that you *expect*. Guaranteed as promised, or your money back.



"The Recollection of Quality Remains Long After the Price is Forgotten."
Trademark Registered. —E. C. SIMMONS.

If not at your dealer's, write us

SIMMONS HARDWARE COMPANY, Inc.
St. Louis and New York, U. S. A.

We Initiate—Never Imitate

A Good Tip

**Exclusively
“National”**

The tip is threaded and
screws into the Butt

It is also slotted for a
screw driver making it
easy to remove the tip and af-
fords ready access to the pin

The slot also indicates instantly
which is the bottom of the Butt

Good selling features and of
practical value to the carpenter

Send for booklet “Ornamental
Ideas” and give dealer’s name

***National Mfg. Co.,
Sterling, Illinois***

*The Greatest
Improvement
In Butt Con-
struction in
Recent
Years*

