

AMERICAN CARPENTER AND BUILDER

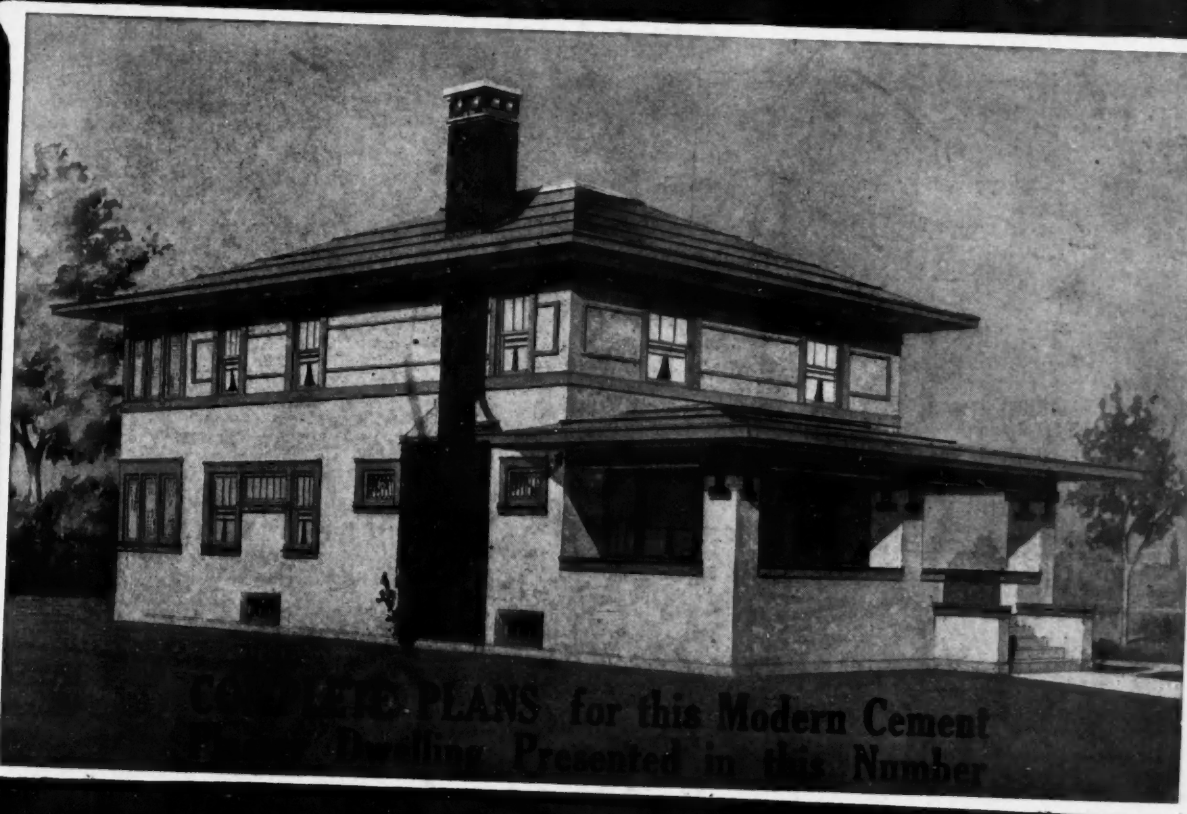

THE WORLD'S GREATEST BUILDING PAPER



PLANS for this Modern Cement
Building Presented in this Number

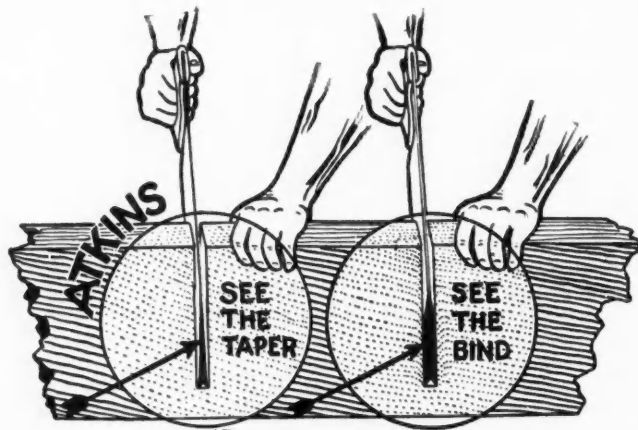

Look Here, Mr. Carpenter!

See the big difference between the ordinary "thin-back" saw and the Atkins "taper-ground" saw! It's easy to see why the Atkins cuts faster, easier and straighter.

The ordinary "thin-back" saw has a little bevel along the back to make it *look* thin.

The rest of the blade is of uniform thickness, except that the teeth are spread out ("set") so as to cut a path wider than the blade.

If you don't give the teeth plenty of "set," the blade doesn't have elbow room, and sticks in the wood.

But the more "set" the teeth have, the harder the saw runs. And there you are!

With the Atkins, it's different.

The blade is thickest at the tooth-edge and thinnest at the back. And it tapers *all the way* from tooth-edge to back.

Almost no "set" on the teeth is needed, because the tooth-edge is the widest part of this tapering blade.

The result is that wherever the teeth go, the rest of the blade follows without a struggle. No "bucking!" No "binding!"

You can easily see why the Atkins ought to be just what it is—

The easiest running, fastest cutting, easiest guided saw you ever put through a board!

The Atkins Perfection Handle makes it still easier. Takes the strain off the wrist and gives your whole body an easier position. But you can have the old-style handle if you prefer.

Better Than Razor Steel

Silver Steel is our own secret formula, and it is gas-tempered by our own secret process. Both these secrets

have been carefully guarded in the Atkins factory for over 50 years.

No such steel was ever used in any other make of saw, the world over. It's better steel than you'll find in most of the high-grade razors.

And it's a peculiar steel. Holds its sharp edge longer than any other, needs less filing, and yet files very easily. Doesn't rust easily, either!

ATKINS Silver Steel SAWS

Trial Order

Go to your dealer and select an Atkins Silver Steel Saw. Be sure the blade says "Silver Steel"—that's our best saw. Take that saw and try it! If it isn't the best saw you ever touched, take it back

to the dealer and he will refund your money.

Now, Mr. Carpenter, if you want to know which is really the best saw, there's the way to find out, without risking a cent.

FREE To Carpenters

Write us today (enclosing 10 cents in stamps to cover postage), and we will send you free a good strong Nail Apron, our Carpenter's Time Book, and another mighty handy booklet, "Saw Sense." Address our Carpenter's Department.

E. C. Atkins & Co., Inc. Indianapolis, Indiana

Largest Exclusive Saw Manufacturers in the World

If your dealer doesn't handle Atkins Saws, or hasn't the particular saw you wish, ask him to order it for you from the wholesale house. He should be glad to do this—it's no trouble—and he will do it promptly if you make the request.

WE ARE THE
PIONEERS
In the Manufacture of
PORTABLE SAW RIGS

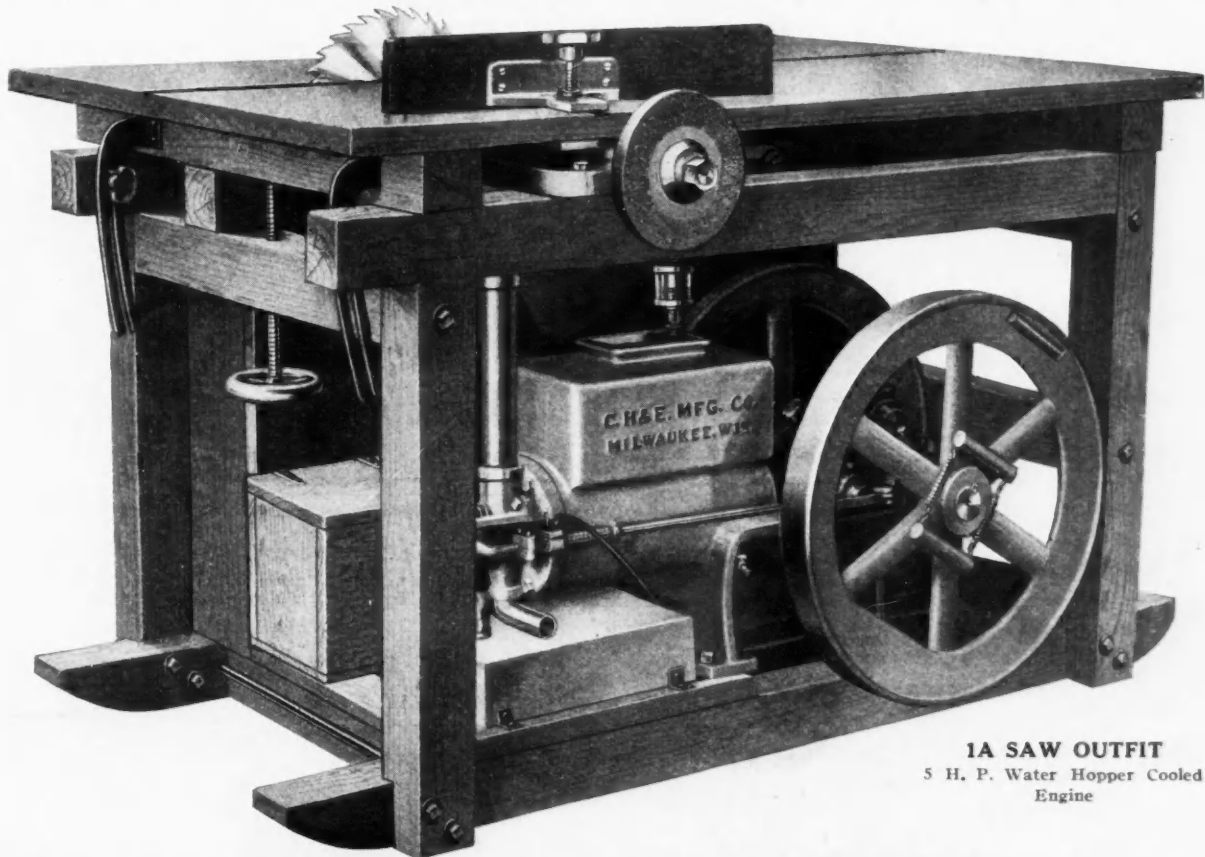

1A SAW OUTFIT
 5 H. P. Water Hopper Cooled
 Engine

MORE C. H. & E. Portable Saw Rigs now on the market than all our competitors combined. Our descriptive folders will help you solve the problem in comparing the expense of operating our Portable Saw Rigs at twenty cents a day as against the high wages which you pay your men. We are manufacturers of Contractors' Equipment and make Portable Saw Rigs in four different sizes, as well as a Builders' Hoist, Material Elevator, Hand Derrick, Centrifugal Pumping Outfit, Power Driven Trench Pump, Concrete Chute, Column Clamp, Mortar Mixer, Gravel Heater, etc.

WRITE FOR OUR ATTRACTIVE FOLDER
FOR OUR ATTRACTIVE PRICE

C. H. & E. Manufacturing Co., Inc.

322 - Mineral Street : : : : : Milwaukee, Wis.

When Writing Advertisers Please Mention the American Carpenter and Builder.

The American Floor Surfacing Machine

IS NO EXPERIMENT. Its work since 1903 has established a standard for finely surfaced and polished floors. It is the only machine whose work is specified by leading architects and used in the best government buildings and will surface and polish any kind of a floor from common pine to the finest parquetry. **IT IS THE ORIGINAL** and only two-roll, self propelled, dust collecting machine, that surfaces close to the wall and can be used in small rooms. Anyone can operate it. **ITS WORK IS RAPID, regular smooth and even** because the power that drives the rolls, also propels the machine at the same ratio of speed. It has surfaced and polished millions of square feet of the finest floors in America and Europe. **GET A MACHINE** that does first class work and in paying quantities, that is fully guaranteed and sold on its merits. Don't be fooled with an imitation.

Write for Our Free Book, "Surfacing Floors as a Business."

Manufactured By **The American Floor Surfacing Machine Co., TOLEDO, O.**



We Make Panels of any Thickness and Any Kind of Wood - Curved or Flat.

FOR
Wainscoting
Ceiling
Mantels
Doors
Counter Tops
Partitions
Cabinets
Shelving
Drawer Bottoms

Our products excel in Quality and Durability, because we concentrate our best efforts in their manufacture. We specialize in Panels and have the facilities for producing best results. Try us with your next order. Send us your specifications and ask for our prices.

AMERICAN VENEER CO.

Specialists and Manufacturers of Built-up Veneer Panels
We appreciate small orders as well as large ones

12 Market St., KENILWORTH, N. J.

COMPLETE OUTFIT PRICE \$15.00 HAND AND FOOT-POWER MACHINERY

Our No. 7 Scroll Saw is warranted to be made of good material and workmanship, and to saw pine 3 inches thick at the rate of one foot a minute.

Send for Catalogue.

W.F. & Jno. Barnes Co.

74 Ruby St. ROCKFORD, ILL.



These Two Machines for \$170.00

MACHINE No. 1
Chicago No. 5 Combination Saw Table

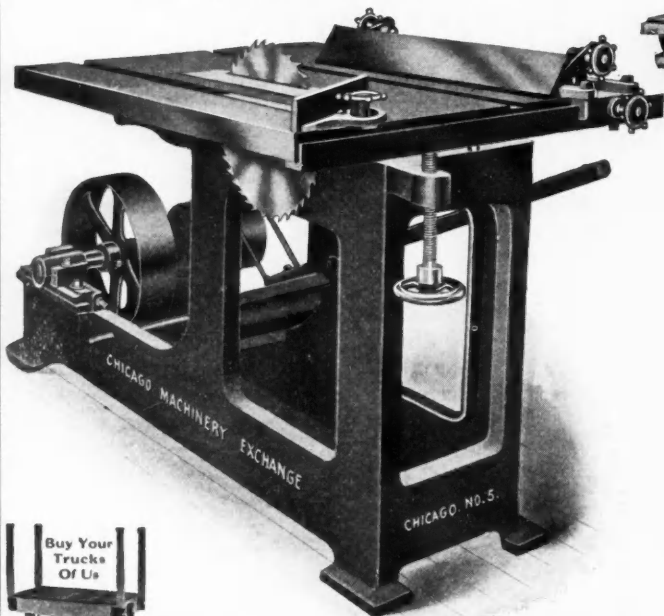

Used for Cutting Off, Ripping, Mitering, Grooving, Boring, Tenoning, Etc.

MACHINE No. 2
Chicago 12-Inch Jointer and Planer

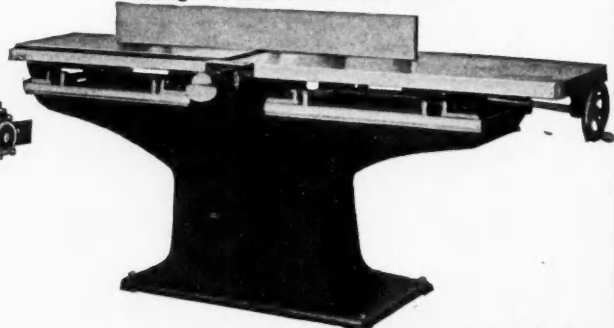

Used for Planing, Jointing, Shaping, Matching, Rabbeting, Grooving, Chamfering, Beading and Making Mouldings.

Read What Contractors Think of Our Machines

Charleston, Ill.
July 13th, 1911.

Chicago Machinery Exchange, Chicago.

Dear Sirs:

Your saw table which I bought of you last fall is a complete success, the best I ever saw for the money, and I worked in a good mill for ten years. You can refer anybody to me in regard to your saw table No. 5.

Yours, CLARENCE B. MUCHMORE

Ask for Price on One if You Cannot Use Both

Send for our Free Special Catalogue to-day. We issue a catalogue of machines especially adapted to Contractor's and Builder's use.

CHICAGO MACHINERY EXCHANGE, 1219-1227 W. Washington Blvd., CHICAGO, ILL.

When Writing Advertisers Please Mention the American Carpenter and Builder.

OVER \$100,000.00

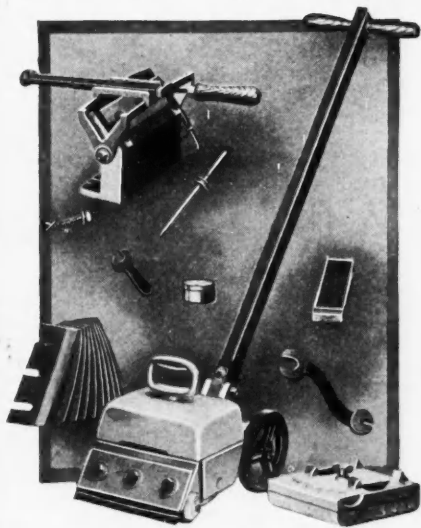

**Has
been
SAVED
by
USERS
of the**

Acme Floor Scraping Outfit

during the past five years. Thousands of machines are now in daily operation, and every mail brings letters from users commenting upon the satisfactory work their outfits are doing and the vast amount of labor expense they are saving.

Now, Mr. Contractor, you do not have to rely upon what I say regarding the merits of my machines, but I want you to let me send an outfit to you on **one week's free trial**, and you can then let the machine demonstrate on your own work just what they can do. If, after working with the equipment for one week, you are not convinced that the same will save you many dollars, and do your floor scraping better than it was ever done before, just pack up the machines, return them to me, and you will owe me nothing.

Write to-day for booklet and full details of my proposition.

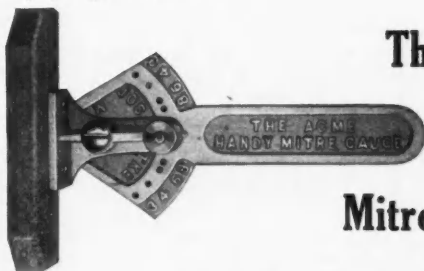

**The Acme
Handy
Mitre Gauge**

is another labor saving tool. It is absolutely accurate, can be set at any angle and fits in the pocket where it is always ready for instant use. If your dealer does not carry them in stock, then write to me for circular describing this wonderful little tool.

JOSEPH MIOTKE
247 Lake Street : : Milwaukee, Wis.

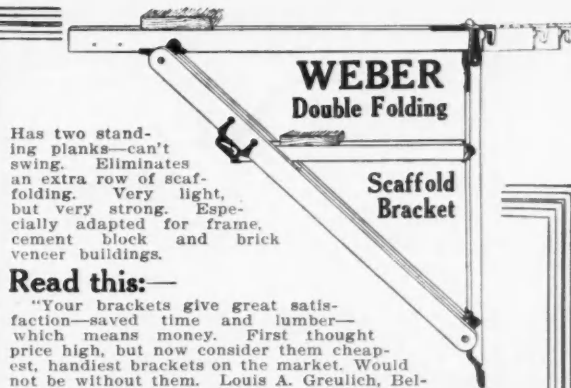

**WEBER
Double Folding
Scaffold
Bracket**

Read this:—

"Your brackets give great satisfaction—saved time and lumber—which means money. First thought price high, but now consider them cheapest, handiest brackets on the market. Would not be without them. Louis A. Greulich, Bellevue, O."

The WEBER DOUBLE ACTING Floor Scraper

works forward or backward, saving time and energy. Try it for five days. If its work isn't the best you ever saw, return it at our expense. Postal brings details of offer and descriptions and prices of all Weber inventions.

JOHN F. WEBER

Pres. Weber Mfg. Co.

670 71st Ave.

WEST ALLIS, WIS.



**Five Days
Free Trial**

DON'T BUY A FLOOR SCRAPER

of any kind until you have tested the

LITTLE GIANT

at our expense. Sold only on its merits. Shipped to you prepaid for a free trial. If not satisfactory in every particular, return it to us, at our expense.

Easy to operate. Will scrape your floors rapidly, perfectly and economically.

Ask for special price on the **LITTLE GIANT**



The Thor Electric Home Laundry Machine



permanently solves the laundry problem in the home. More than 34,000 now in use. Sizes, designs and prices to meet every requirement. Free trial. Easy payments.

Write for full particulars.

Hurley Machine Company
1008 Flatiron Building NEW YORK 37 So. Clinton St. CHICAGO

PAINÉ LUMBER CO., LTD.

OSHKOSH, WISCONSIN, U. S. A.

These Plants Produce TWO THIRDS of All the

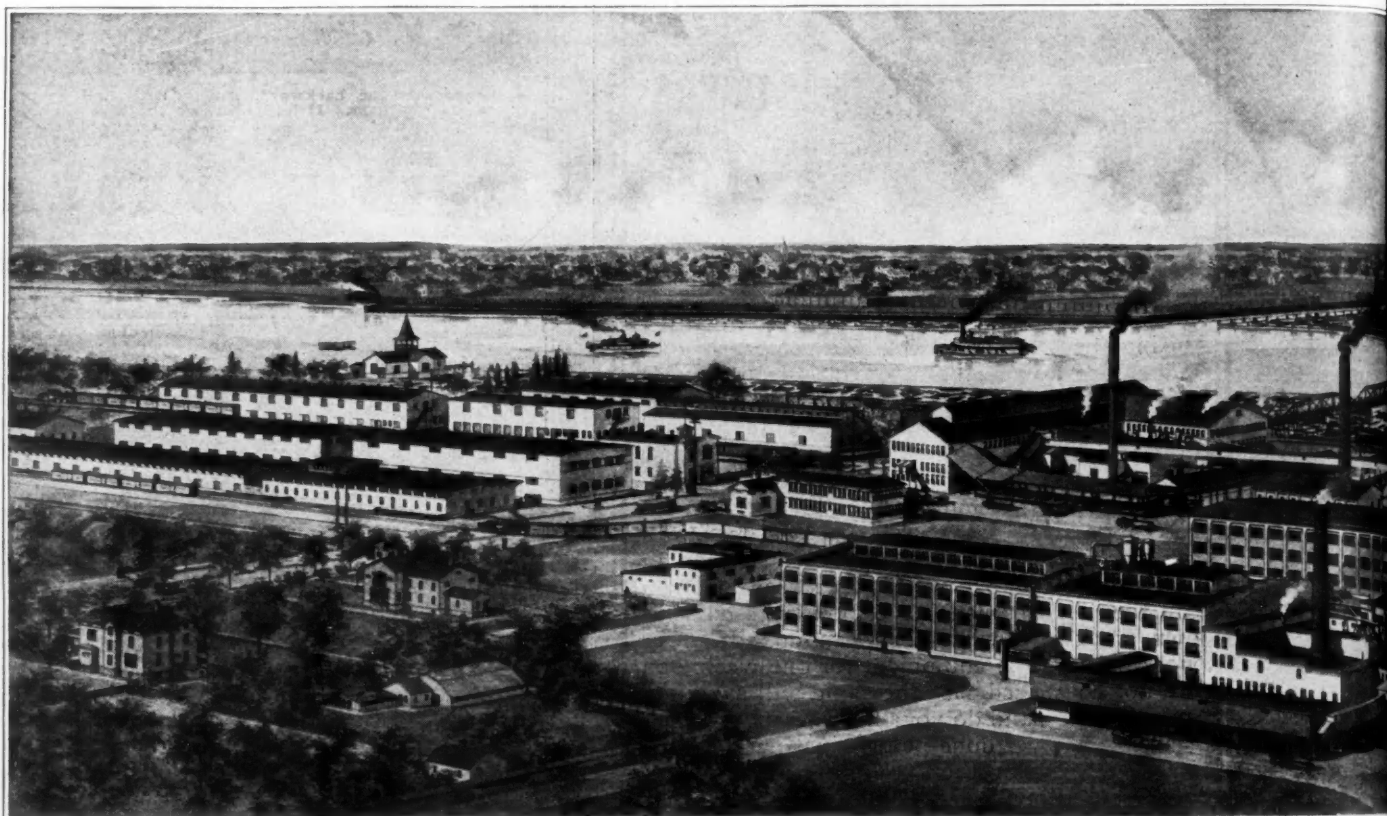

We Make Everything in Mill

OUR SPECIALTY

Korelock Veneered Doors

Cost but little more than Pine

WRITE FOR CATALOGUE A

Whenever you See a Korelock Joint Think of

When Writing Advertisers Please Mention the American Carpenter and Builder.

PAINE LUMBER CO., LTD.

OSHKOSH, WISCONSIN, U. S. A.

f All the Standard Veneered Doors Used in the World

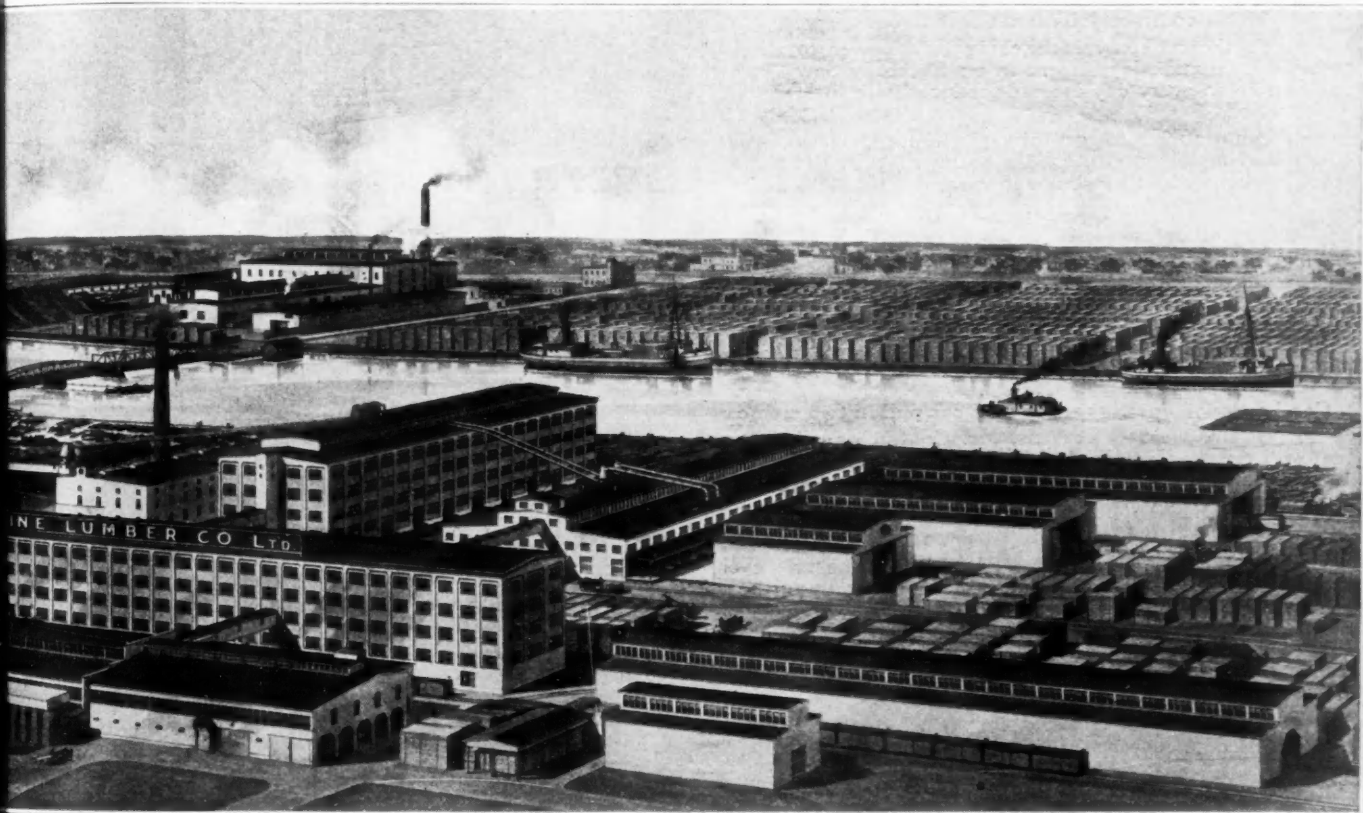

Mill *Work in any Kind of Wood*

OUR SPECIALTY

Korelock Veneered Doors

Birch and Oak Doors Ready to Ship

WRITE FOR CATALOGUE A

think of Paine Lumber Co.—The Originators

When Writing Advertisers Please Mention the American Carpenter and Builder.



Profits depend on good shop management. Time-eating methods of turning out contract jobs must be cut out.

Where's the economy in hitching man power to saws when a small investment in an Eveready Saw Rig will be an every day income-producer with little depreciation.

You can't afford to get along without such a compact, simple, easy-to-handle outfit as this. It takes up little room in your shop.

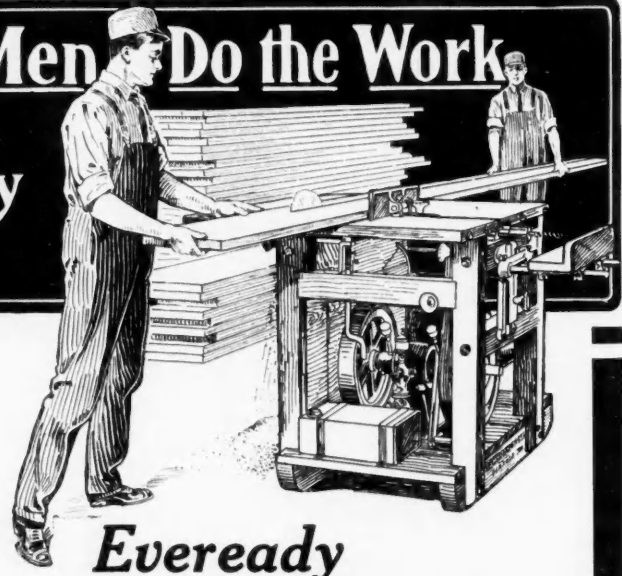

TRADE MARK
OSHKOSH

SAW RIG

Guaranteed for Life

Can be moved anywhere, one man can pull it; two men can lift it, and your wagon can take it to any job.

These are weighty reasons, Mr. Contractor. A few minutes figuring will convince you that a machine that will do all your jig-sawing, dadoing, mitering, beveling, ripping, boring, sanding, etc., for 25c for 10 hours is a mighty profitable proposition.

Histfuls of letters from enthusiastic contractors—big and little—prove our claim. The

Oshkosh Eveready Saw Rig is "Guaranteed For Life"

Operating Cost 2c per hour.—Never tires—never stops because of hot weather—neither perspiration nor sunshine has any effect on it—always good natured—always on the job—will work overtime.

It pays for itself in a surprisingly short time. When not in use it doesn't cost a cent. But there is scarcely a day you'll not use it at a profit.

The Engine and Frame.—It's a quick actor—a snap of your finger! a twist of your wrist! and off she goes with a merry hum. It is a 4 H. P. of the valveless type which gives double the power of 4

cycle styles and has no complicated parts. The bearings are large, will stand unusual strain and are enclosed, away from grit and dust. A highly sensitive governor insures steady movement under any load. The table, frame and skids are of very best rock maple air and kiln seasoned. Will never warp.

Write for prices. Then work your pencil for 5 minutes comparing your present costs and that of operating an Eveready. The big chance is that you'll order—for you'll conclude as others have proven that—

It Will Increase Profits On Your Contracts

You Run No Risk

Return this Rig at our expense—after six days' trial in your own shops—if it is not exactly as represented. Every one is sold under our steel-riveted guarantee—hand signed if you ask it.

Send for Literature

Giving complete description of the Eveready, price, etc., at once and commence to save money.

All These Attachments Free

Jointer Head.—This works on exactly the same principle as an up-to-date planer. Produces a smooth, even job with no deep cut as the material leaves the jointer head. 2½ inches in size.

Boring Attachment.—A high class attachment. Guaranteed absolutely accurate. Extra long boxes insure easy long-running qualities on the guides. Bits, standard size.

Jig Saw.—Not a cheap one, but the best 12-inch jig we can make. All joints reinforced with steel, equipped with brass bushings. Once use it and you won't part with it.

Sander.—The best one yet—a great time and money saver over old methods in change and economy of paper. Our method of holding paper will not blister as do many others. 10 inches in diameter.

Saw Gauge and Mitre Device.—Saw Gauge of best gray iron, 18 inches long, adjustable to any level. Mitre Device adjustable to any angle and can be used as a cross cut gauge.

Dado Head.—Our own special design. Does smooth, even work with or across the grain. Makes window frames, dados, etc.

Emery Wheel.—A 6-inch wheel made for grinding tools is also furnished with this rig.

Free Attachments



We will exhibit at Chicago and New York Cement Shows

OSHKOSH MFG. CO., 316 S. Main St. Oshkosh, Wis.

When Writing Advertisers Please Mention the American Carpenter and Builder.



Economy Double Headed Nail
 (PATENTED DEC. 20th, 1910)
 (PATENTED MAY 31st, 1910)

A Labor and Lumber Saver
 For concrete forms, staging and other temporary lumber construction these nails are invaluable. Because: The second head has an area of four or five times as great as the ordinary nail. This means that these nails can be driven home four or five times as hard as the ordinary nail.

Ask for sample. Orders shipped promptly.

The F. A. NEIDER CO., Inc.
 AUGUSTA, KENTUCKY

Taylor Portable Steel Derrick



Tested at factory, is hoisted and swung a complete circle 1900 lbs. Shipped ready to operate. No wrench or tools required to set derrick on job. Made in two sections. Beam section connects post by tipping in a vertical position and objects at such an angle to clear side wall of building and has sufficient height to hoist wheel-barrows, window frames and timbers. One man can climb a ladder with either section. Consider the durability of a derrick constructed entirely of malleable iron and steel and that of wood, more compact, more powerful.

Derrick complete with three way block, channel steel brackets, bolts for attaching to building, price \$40.00, and four and one-half cents per ft. for crible steel cable attached. Drum capacity 300 ft.

Special platform and chains for attaching derrick to gondola railroad cars, price \$15. Chains for hoisting wheel-barrows, price \$2.

JOHN L. TAYLOR, Manufacturer
Taylor Portable Steel Derricks
 Phone Monroe 3066 1034 W. Lake St., Chicago

Carpenters, Builders, Cabinet Makers and Every Kind of Mechanic!



Do Not Forget That the Master Slide Rule

This illustration shows the Master Slide Rule in use for inside measurements. The Master Slide Rule shows exact dimensions without figuring or calculations as indicated with pencil. No guess work.

is the only practical rule in the world for inside measuring of doors, windows, etc. Will become absolutely indispensable after once using it. For speedy operation no other rule can compete with the MASTER SLIDE RULE. Can be extended and closed instantly. When opened, is kept in place by strong steel springs and cannot get out of order. One side of rule is marked for inside measurement. Reverse side of rule is the same as any ordinary rule, but is particularly valuable for quick measurement of ceilings and walls, etc. Made in lengths from 2 to 6 ft.

Ask your hardware dealer, or write us for particulars and price list. Send name of hardware dealer. Agents wanted.

Send 15c per lineal ft. for 4, 5 or 6 ft. rule, which will be sent you prepaid. Remittance by money order or cash preferred.

Dahl Manufacturing Co.
 Childs Building, 1 East 42nd St.
 NEW YORK



Showing lower slide extended 2 1/2 inches — Making distance between extreme ends 10 1/2 inches.

NOTE—Our Special brand Clamps, have notches on the bottom of the bar, instead of on the top.

Per pair, 1 foot	\$2 70
1 1/2 foot	2 85
2 "	3 00
2 1/2 "	3 75
3 "	4 00
4 "	4 50
5 "	5 00
5 " heavy	7 50
6 "	8 50
7 "	9 50
8 "	11 00
9 "	12 50
10 "	14 00

These clamps have steel bars and screws and malleable iron parts. The New Adjustable and Perfection Clamps are made in the following lengths and sizes: 2 1/2, 3, 4 and 5 feet have 1 1/2 x 1/2 inch bars. 6, 7, 8, 9 and 10 feet have 1 1/2 x 1 inch bars. Joiners' Clamps—1, 1 1/2, and 2 foot have hand-wheels for rapid work, 1 1/2 x 3-16 inch bars.

In ordering parts always make sketch, to avoid delay.

Hargrave's New Adjustable SPECIAL Clamp.



Hargrave's Perfection SPECIAL Clamp.

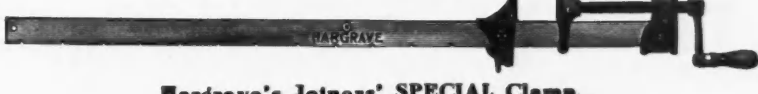

Hargrave's Joiners' SPECIAL Clamp.



Write for circular Dept. H.

THE CINCINNATI TOOL CO., CINCINNATI O., U. S. A.

The Best That Is Offered



Two Minutes

TWO MINUTE LEVER LOCK MORTISER

The Greatest Time and Labor Saver.

Does the complete job the quickest. The easiest to operate. Cuts in any kind of wood. Any length or depth of mortise. No exaggeration in our statements. Send for descriptive circular.

Our Butt Mortiser and Rule Gauge are handy little devices. Sent for 75c.

A. W. MILLER MFG. CO.

Main Office and Factory: Riverside, California
 Eastern Office and Shop: Cincinnati
 For special information address, Riverdale, Calif.

When Writing Advertisers Please Mention the American Carpenter and Builder.

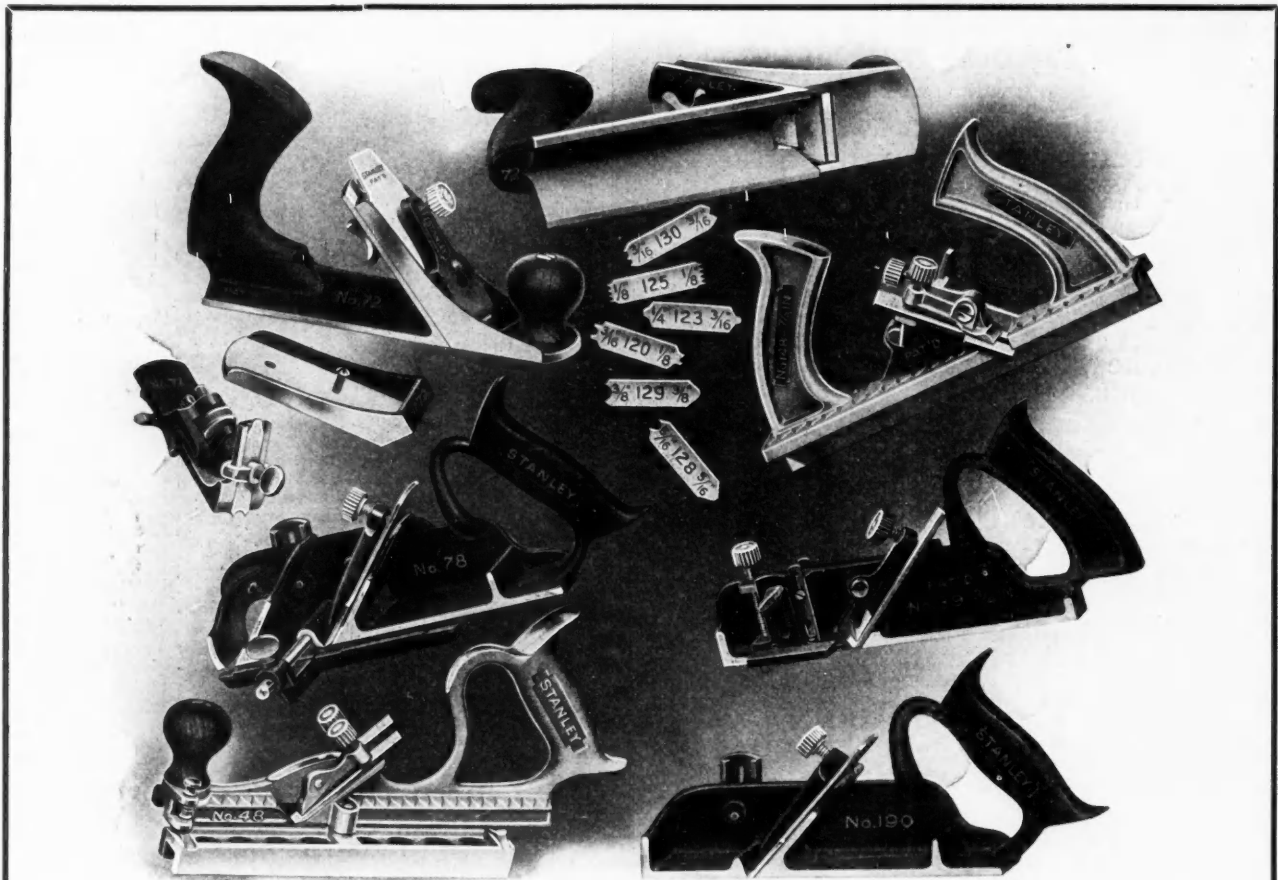

Copyrighted 1909 by the Stanley Rule & Level Co

Stanley Tools

The Planes illustrated above can be used for many kinds of work, such as Rabbeting, Matching, Chamfering, Tonguing and Grooving, etc.

Send for Catalogue No. 34 which contains a complete description of these Planes as well as many other tools of interest to Carpenters.

STANDARD
THE WORLD
OVER

Stanley Rule & Level Co.
NEW BRITAIN, CONN. U.S.A.

EVERY
TOOL
GUARANTEED

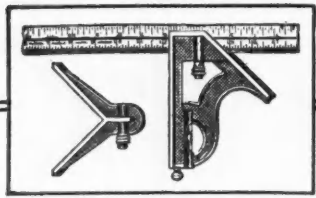

STARRETT

COMBINATION SQUARE

THE ORIGINAL : : THE MUCH IMITATED
Send for free Catalogue No. 186, of Fine Tools for all
kinds of mechanics.

The L. S. STARRETT CO., Athol, Mass., U. S. A.

Straight-grained cedar that cuts like cheese; smooth, tough leads that make clean-cut, strong marks—that's the way Dixon's Carpenter Pencils are described. Send 16c for generous sample lot 183J.

JOSEPH DIXON CRUCIBLE CO.
JERSEY CITY, N. J.

When Writing Advertisers Please Mention the American Carpenter and Builder.

Low Prices : Quality : Quick Shipments
(Our Headliners)



CYPRESS
Colonial
Porch
Columns
8 in. x 8 ft.
\$1.33
shown add
50c net.

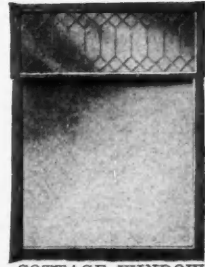

COTTAGE WINDOW
1 3/4 in. Thick.
Glazed Clear.....**\$3.75**
With Leaded Top.... **4.50**



FRONT DOOR
2-8 x 6-8 1 3/4 in.
thick. Glazed
\$3.67



Front Door Set
Antique Copper
\$1.60 Inside
Door Set, 49c

SURROUNDED
By Extraordinary Bargains
which are only a few of the
many Money savers shown
in our new Catalog of High
Grade Sash, Doors, Frames,
Blinds, Mouldings, Inside
Trim, Grilles, Colonnades,
Stair and Porch Work,
Mantels, Grates, Tiling, Art
Glass, Roofing and Building
Papers, Wall Boards, Hard-
ware, Paints, Hardwood and
Parquetry Flooring, Rolling
Partitions, Screens, Steel
Ceilings, Gutters, Shingles,
etc.

Write Today for Free Copy.
The Huber Builders Material Co.
45-49 Vine St., Cincinnati, O.



BASE
Yellow Pine
1 3/16 x 7 1/4 in.
\$2.77
per 100 lin. ft.

CLEAT
Yellow Pine
3/8 x 1 1/8 in.
35c
per 100 lin. ft.



CASING—Yellow Pine
4 3/4 in.
\$1.89 per 100 lin. ft.



Quarter Round
Yellow Pine.
7/8 in., **30c**
per 100 lin. ft.

Are You Paying DOLLARS
For work that you should buy
for CENTS, and figuring profits
in CENTS That you ought to
figure in DOLLARS? 🍀 🍀

If you are paying men to fit up fancy sash by hand, while your competitor does the same work much better and in a great deal less time on an

AMERICAN SASH TRIMMER

the [chances are pretty good that you are.

To fit up
fancy sash
like this by
hand takes
from three to
five times as
long as it
does to do it
our way.

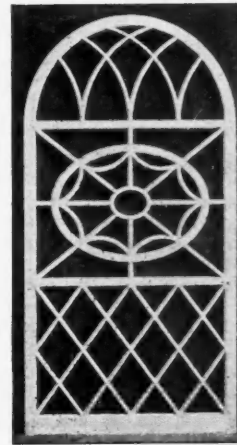

Joints made
on the Amer-
ican are
made right
the first
time trying
and need no
fixing up
afterwards.
Further
information
given with
pleasure and
perhaps with
profit to you.

**The Heald
Machine
Company**

**Worcester
Mass.
2 New Bond St.**



This is the "Excelsior" Brad Set

A tool that will *drive* and *set* brads and finishing nails in places inaccessible without it, and indispensable to the Carpenter, Pattern Maker, Picture Framer, Electrotyper; in fact, all who use small brads, finishing nails or tacks. The tool is made in four sizes. No. 1 takes No. 20 and No. 18 brads up to 3/4-inch long; No. 2, No. 16 brads 3/4-inch long; No. 3, No. 14 brads, 3/4-inch long, and No. 4, No. 14 brads and finishing nails up to 2-inch long. Nos. 1, 2 and 3 retail for 25c each, and No. 4 for 50c. If your retail hardware dealer does not carry these tools in stock, they can be procured at the prices above given from

The Standard Tool Supply Co., 42 West 15th St., NEW YORK CITY

**FOOT, HAND AND LIGHT POWER
WOOD-WORKING MACHINES**



"Victor" Scroll Saw



"Diamond" Mortiser

Carpenters, Builders, Cabinet-Makers and other wood-workers can successfully compete with large shops by using our labor saving machinery. Save for yourself some of the profits you have been paying to the mills. With our machines one man will do as much work as four to six men using hand tools; will do it easier; will do it better.

Send for Catalog "A"
describing our complete line

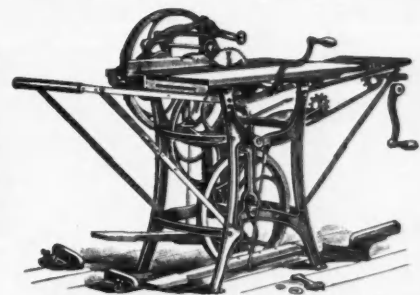

No. 5 "Union" Self Feed Rip and Cross-Cut Saw

THE SENECA FALLS MFG. CO.
218 Water Street - SENECA FALLS, N. Y., U. S. A. (249)

When Writing Advertisers Please Mention the American Carpenter and Builder.

MAYHEW 60° MITRE BOX

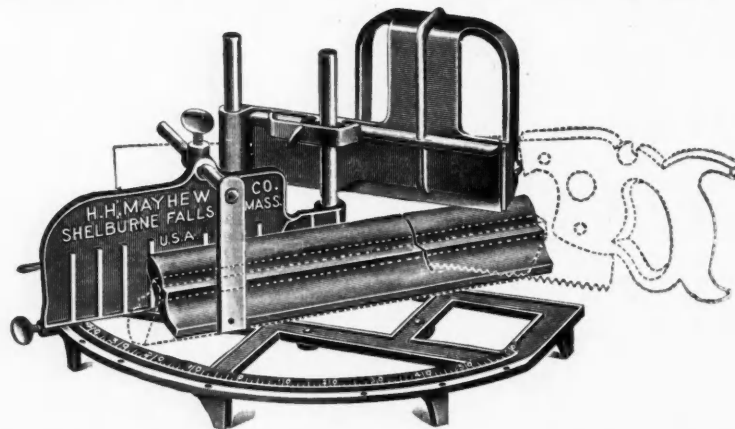

This box embodies more distinctive features than any other made
 Designed for Simplicity, Accuracy, and Durability.
 Strictly a right hand tool for mitering.
 Box embodies a new feature in reversing the principle commonly used on other boxes.
 Any of three saws may be used — Panel — Hand or Back saw.
 Saw guide adjustable for any thickness of saw.

Extreme mitre to 60° without makeshift. May be used as a stationary or pivot box by use of the pin posts.
 In mitering duplicate cuts there is no restriction on length.
 Will cut compound mitre.
 Parts take down into space 10x10x4 inches.
 Weight 15 lbs. complete.
 Box contains full directions for use.

PRICE EACH, \$10.00

H. H. MAYHEW COMPANY, SHELburne FALLS, MASS.

GOODELL MITRE BOX

Made of STEEL - Cannot Break

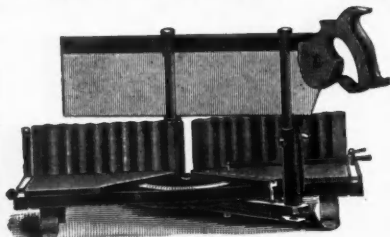

First in Quality and Improvements
 Automatic Stops for holding up saw.
 Corrugated Backs Graduated.
 Gauge for duplicate cuts and many other features
 Send for Circular "C"

GOODELL MFG. CO., Greenfield Mass.

"Red Devil"
 Carpenter's Tools
 Glaziers' Tools
 Electricians' Tools
ARE THE BEST TOOLS MADE

"Red Devil" Seavey Mitre Box

Cuts any Angle

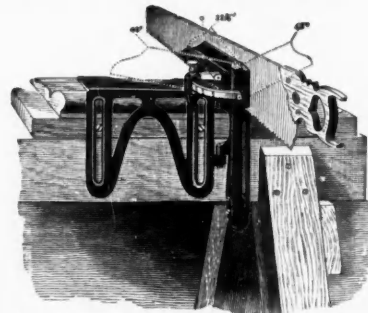

Weights 2 Pounds

Portable — can be carried in the Tool Kit.

Special Offer On return of this "Ad" and \$2.00 one of these Mitre Boxes will be shipped to any reader of "Carpenter & Builder." Offer good for 30 days from date of issue

—We Make—
 Pliers Hack Saw Frames, and all "Red Devil" Tools.

Smith & Hemenway Co.

150-152 Chambers Street
 NEW YORK CITY

LUFKIN
 Tapes & Rules

are Standards of Accuracy, Durability and Workmanship.

SEND FOR CATALOG

THE LUFKIN RULE CO.

SAGINAW, MICH.

NEW YORK
 LONDON, ENG.
 WINDSOR, CAN.



When Writing Advertisers Please Mention the American Carpenter and Builder.

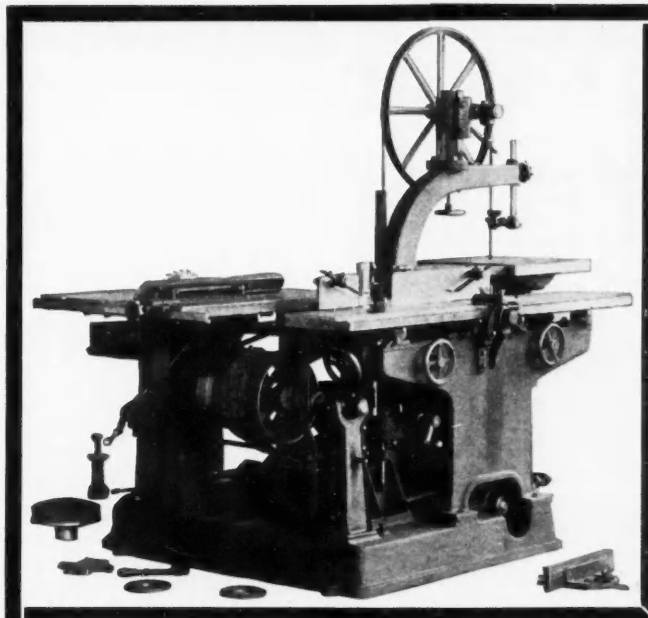

CARPENTERS! CONTRACTORS!

This Machine
**WILL SAVE
YOU MONEY!!!**

With the No. 51 CRESCENT UNIVERSAL wood worker in your shop, you have a complete planing mill instantly available. It is a machine that will save you money and that will give you a complete wood working outfit at a very moderate cost. The number 51 CRESCENT UNIVERSAL wood worker combines a shaper, 26" band saw, 8" jointer, saw table, boring machine. Regular equipment includes, resaw attachment, tenoning attachment, panel raiser, pole rounder, hollow chisel mortising attachment, disk grinder, knife grinder, emery grinder.

This machine fills the demand for a BETTER equipment for small shops, and will place them on an equal basis with the larger factories for getting their work out quickly, accurately and economically. If you are rushed for a job, you can operate the band saw, the jointer, saw table, and borer all at one time. This means that four men can work on the machine at one time without interfering with one another. There is no other wood worker on the market with which you can compare this tool. The machine is substantial, well built, durable, and is distinctly in a class by itself.

The machine is portable and is instantly adaptable for being moved from one place to another without the aid of crowbars or rollers. The countershaft is self-contained with the machine.

Each machine can be operated independently of the other. It is not necessary to stop all the machines when you want to stop one, and if you want to start one machine you do not have to operate any other.

You carpenters and contractors who want the best equipped shops owe it to yourselves to send for our special circular describing this splendid machine as this is the machine you will eventually buy.

In addition to this machine we build an elegant line of band saws, saw tables, jointers, shapers, planers, planers and matchers, disk grinders, swing saws, borers, and on receipt of your name we will forward our catalogue.

THE CRESCENT MACHINE CO.

224 MAIN ST.

LEETONIA :-: OHIO

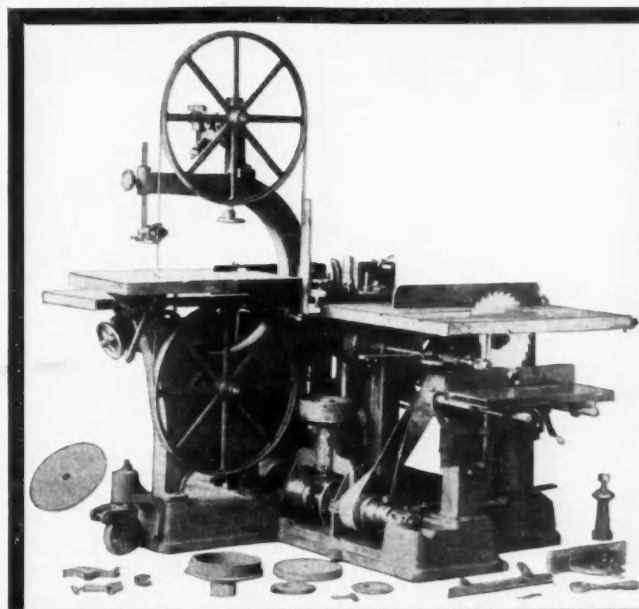

When Writing Advertisers Please Mention the American Carpenter and Builder.

**FOR
PERFECT
MITRES**

**LANGDON
ACME MITRE BOX**

These Mitre Boxes, when supplied with back saws fitted by ourselves, are warranted to give better service than any similar tool on the market.

There are a dozen improvements over the ordinary mitre box in the LANGDON ACME that insure quicker and more perfect work than any tool of its kind.

Some of the advantages over other models are: In longer guides, which hold the saw steadier, and these guides are provided with elevators to hold the saw stationary, when desired, above the work; In a graduated arc showing the various angles commonly used;

- In supporting guides, to hold the work in place;
- In an appliance for quicker adjustment of extension lever;
- In a length gauge for duplicate lengths. There are other improvements—impossible to describe because of lack of space—which are explained in our catalog.
- These boxes are made in three sizes and put up with varying sizes of saws, ranging from 22x4 inches to 30x5 inches.

Send for the FREE Book, "Tool Practice."

MILLERS FALLS CO.,
28 Warren St. New York City

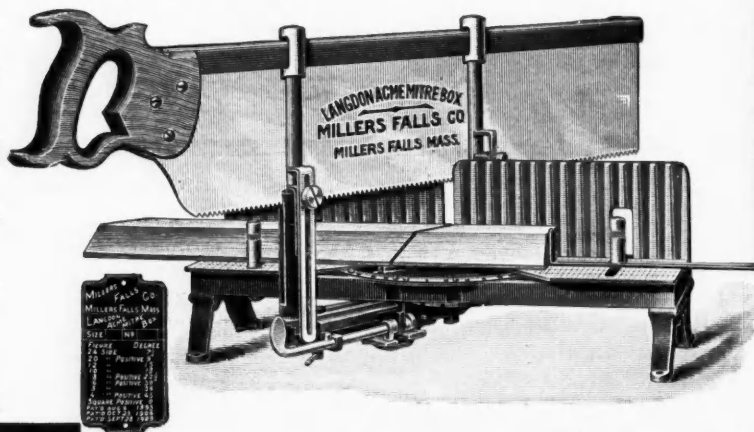

"A Bit of Utility"

Guided by its circular rim—instead of its centre—the Forstner Labor-Saving Auger Bit will bore any arc of a circle, and can be guided in any direction.

Doesn't matter how hard the wood is, no consequence whether it is full of knots, or the grain awkward to negotiate. The Forstner Bit works with equal smoothness under any condition and leaves a true polished surface on every job.

Unequaled for Delicate Work

Supersedes chisels, gauges, scroll-saws, or lath tools combined, for all kinds of delicate work. Cabinet and pattern makers and carpenters are enthusiastic because they do more work than other bits and cost no more.

We can offer something special in the matter of price on sets packed in a sensible box. Send today for particulars and catalog.

The Progressive Mfg. Co.
Torrington, Conn.

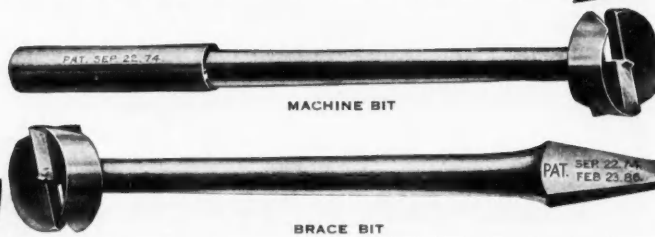

The Marvel locks shut automatically, is burglar proof, and ornamental. Is made of heavy wrought steel plates.

Circular for the asking.

INTERSTATE MFG. CO.
OSKALOOSA IOWA



When Writing Advertisers Please Mention the American Carpenter and Builder.

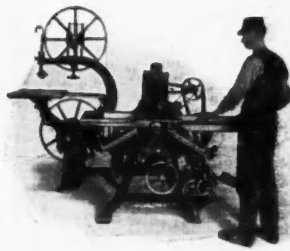

FAMOUS Universal Woodworker operated as Power Feed Planer.

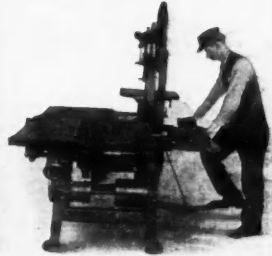

FAMOUS Universal Woodworker Operated as a Hollow Chisel Mortiser.



FAMOUS Universal Woodworker operated as Drum Sander.

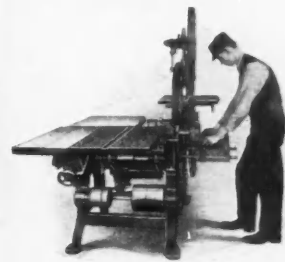

FAMOUS Universal Woodworker operated as Knife Grinder.

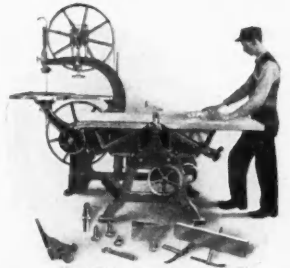

FAMOUS Universal Woodworker operated as a Saw Table.

FAMOUS UNIVERSAL WOODWORKER

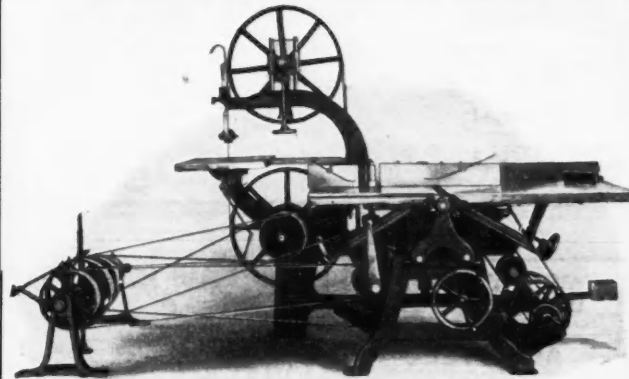

FAMOUS Universal Woodworker operated as a Disc Sander.



FAMOUS Universal Woodworker operated as Felloe Rounder.

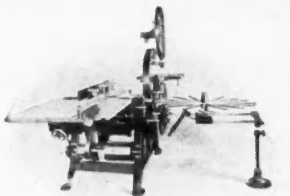

FAMOUS Universal Woodworker operated as a Spoke Tenoner, Rim Borer and Wheel Equalizer.

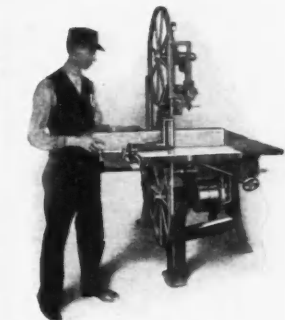

FAMOUS Universal Woodworker operated as a Re-Saw.

Instead of Buying Sixteen Wood-working Machines Buy ONE
 machine—buy a FAMOUS Universal Woodworker which combines the working qualities of sixteen and is a complete planing mill in itself.
 All the machinery a carpenter or contractor needs is combined in this one machine. It can be adjusted for the different operations almost instantly and permits of a number of men working at one time. It is the original and **only practical woodworker** on the market today.
 The accompanying illustrations show thirteen different operations—and there are three more besides. For multiplicity of work, ease of operation and absolute economy the FAMOUS is supreme. Write for catalog.

THE SIDNEY TOOL CO.
 SIDNEY : : : : OHIO



FAMOUS Universal Woodworker operated as Single End Tenoner.

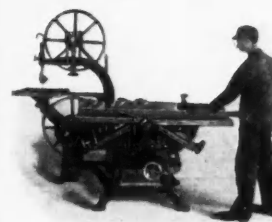

FAMOUS Universal Woodworker operated as Jointer, Two Side Edger and Moulder.

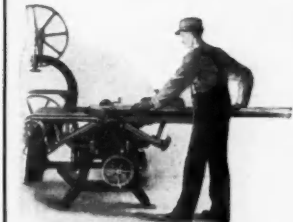

FAMOUS Universal Woodworker operated as a Pole Rounder.



FAMOUS Universal Woodworker operated as Single Spindle Shaper.

When Writing Advertisers Please Mention the American Carpenter and Builder.

Take Another Look at this

"YANKEE" Push Brace No. 75.

Bores $\frac{3}{4}$ " holes in any kind of wood in half the time of a Bit-Brace and does it easier. Drives and draws screws---takes all the small tools and works in close quarters where a Bit-Brace cannot be used. Bearing down on the Handle drives it with that quick and easy motion of the "Yankee" Spiral Driver.

Have You Seen the "YANKEE" Line?

There are 35 Styles and 75 Sizes each a Labor Saver. Our New Yankee Tool Book tells about them. A postal brings it.

Your Hardware Dealer Sells the "Yankee"

North Bros. Mfg. Co.

(Department A)
PHILADELPHIA, PA.





No. 12
GRAND RAPIDS

"GRAND RAPIDS" ALL STEEL SASH PULLEYS

No Nails No Screws
Just Bore 4 Holes

The time saved by the "Grand Rapids" will actually pay for the pulleys.

You can't afford to use old style pulleys.

Write for free samples and prices.



STEEL PUNCH
"Grand Rapids"

This fastening is more secure than any number of screws or nails could make it. Saves about 15 per cent, too.
SCREWS COST MONEY

Grand Rapids Hardware Co.
Manufacturers
158 11th Street, GRAND RAPIDS, MICH.

In This Improved Swing Saw Machine the Saw Arbor Travels in a Perfectly Straight Line

**PRYIBIL No. 5
Parallel Swing Saw**

Also for grooving, gaining, rabbeting, tenoning, etc. Send for prices and catalog.

P. PRYIBIL
520 W. 41 St.
NEW YORK



This Machine Comes (Parallel with Table)

When Writing Advertisers Please Mention the American Carpenter and Builder.

J-M BUILT-UP ASBESTOS ROOFING

An Imperishable Mineral Roofing

This roofing is built up on the roof of Asbestos Felts (made of mineral fibers) cemented together and coated with Trinidad Lake Asphalt—Nature's indestructible waterproofing.

It needs no mineral surface to protect it from the destructive influence of the sun's rays. Asbestos felts are mineral and will not rot or decay like organic felts.

The Asphalt saturant and coating is positively stable. It will not lose 1 per cent of its essential oils when subjected to 325 degrees F. for seven hours, therefore it does not become brittle or lose its waterproofing qualities as do other saturants and cements.

The smooth-coated surface of J-M Built-Up Asbestos Roofing makes easy inspection of leaks which may be caused by damage.

Our finished roofing weighs only 125 pounds per 100 square feet, or less than one-third as much as the ordinary built-up roofing.

J-M Built-Up Asbestos Roofing is applied only by our own workmen. We assume all responsibility and stand back of it in every respect. This gives positive protection, impossible to secure where the responsibility is divided between the producer of the material and the roofer, who may be financially irresponsible.

Write our nearest branch for Booklet.

H. W. JOHNS-MANVILLE CO.

MANUFACTURERS OF
ASBESTOS AND MAG-
NESIA PRODUCTS

ASBESTOS ROOFINGS,
PACKINGS, ELECTRICAL
SUPPLIES, ETC.

Baltimore
Boston
Chicago
Cleveland
Dallas

Detroit
Kansas City
Los Angeles
Milwaukee

Minneapolis
New Orleans
New York
Omaha

Philadelphia
Pittsburgh
San Francisco
Seattle
St. Louis 1523

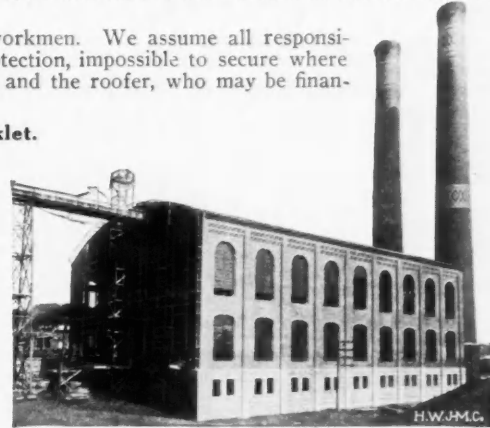

For Canada:—THE CANADIAN H. W. JOHNS-MANVILLE CO., Limited
Toronto, Ont. Montreal, Que. Winnipeg, Man. Vancouver, B. C.

\$1,000,000 Power Plant of Metropolitan Electric Co., Reading, Pa. Covered with J-M Built-Up Asbestos Roofing over Concrete. Muhlenberg Bros., Architects, Reading, Pa.

CONSOLES

Columns and Grilles

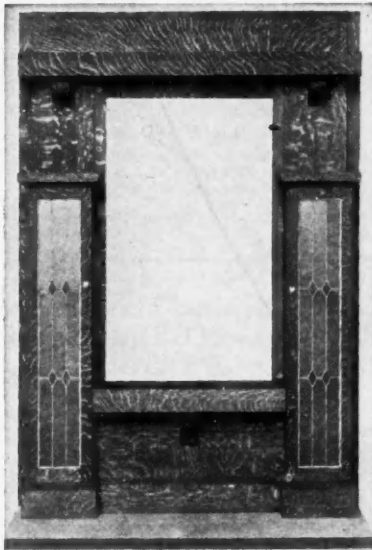

In quality and price our work is not surpassed

You will make no mistake in writing us before ordering elsewhere.

Send for 36-page Catalog
— No. 16 —

It contains many fine designs of modern Grilles, Columns and Consoles.

Northwestern Grille Works

Incorporated
CHRISTENSEN BROS., Managers, 1829-26 Milwaukee Ave., Chicago

Don't Ask the Dealer for Sash Cord. Ask for
"SILVER LAKE"

and see that he gives it to you. It is impossible to



substitute as our name is stamped on every foot of cord. Silver Lake Sash Cord is the Original Solid Braided Cotton Sash Cord, and has been the standard since 1868. No other is just as good.

SALAMANDER

FOR DRYING PLASTER

With or Without Brick Lining
Has Dumping Grate

Write for Circular and Prices
The S. M. HOWES CO.
40-46 Union Street
BOSTON

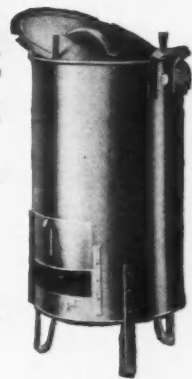

When Writing Advertisers Please Mention the American Carpenter and Builder.

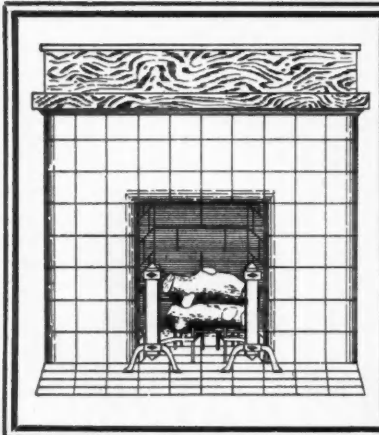

Do You Want our handsomely illustrated MANTEL-CATALOG?

We show the most complete and up-to-date line of
Mantels, Grates and Tilings at the Lowest Prices.

Catalogue free upon application

MOORMANN & OTTEN, 611-613 Main Street
CINCINNATI, OHIO

INVESTIGATION OF ALL ROOFINGS EMPHASIZES G F T SUPERIORITY

When discriminating buyers want a roof that never
fades—never wears out—never needs any preservative
and never absorbs any water, they always insist on getting

'GENUINE FRANKLIN TUNNEL SLATE'

THE EXPERIENCE OF MORE THAN 59 YEARS
HAS PROVEN THAT THEIR COST PER YEAR OF
SERVICE IS LOWER THAN ANY OTHER ROOFING
Our 72-page Slate Book tells a score of facts which should
be known to everybody living under a roof. IT POINTS
THE WAY TO IMMENSE ROOF SAVING

Write for the book To-Day. It is sent FREE

Slatington Slate Co. Established 1852 **Slatington, Pa.**

Use **KEROSENE** Engine **FREE!**

Amazing "DETROIT" Kerosene Engine
shipped on 15 days' FREE Trial, proves
kerosene cheapest, safest, most powerful fuel.
If satisfied, pay lowest price ever given on
reliable farm engine; if not, pay nothing.

GASOLINE GOING UP!

Automobile owners are burning up so much
gasoline that the world's supply is running
short. Gasoline is 9c to 15c higher than
coal oil. Still going up. Two pints of coal
oil do work of three pints gasoline. No
waste, no evaporation, no explosion from
coal oil.

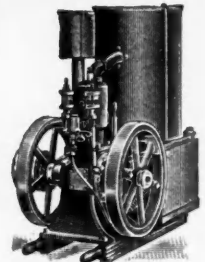

Amazing "DETROIT"

The "DETROIT" is the only engine that
handles coal oil successfully; uses alcohol,
gasoline and benzine, too. Starts without
cranking. Basic patent—only three moving parts—no cams—no
sprockets—no gears—no valves—the utmost in simplicity, power and
strength. Mounted on skids. All sizes, 2 to 20 h. p., in stock ready
to ship. Complete engine tested just before crating. Comes all
ready to run. Pumps, saws, threshes, churns, separates milk, grinds
feed, shells corn, runs home electric-lighting plant. Prices (stripped),
\$29.50 up.

Cylinders cannot
carbonize.

Sent any place on 15 days' Free Trial. Don't buy an engine till
you investigate amazing, money-saving, power-saving "DETROIT."
Thousands in use. Costs only postal to find out. If you are first in
your neighborhood to write, we will allow you Special Extra-Low
Introductory price. Write!

DETROIT ENGINE WORKS 495 Bellevue Ave., **Detroit, Mich.**

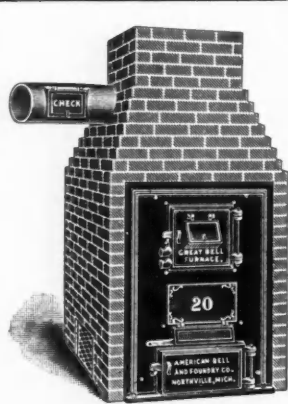

A HOT AIR FURNACE

For Less than
\$50 Complete

For 5 and 8 Room Dwellings

An unheard of Price and
a most Remarkable and
Indestructible Furnace

No Pipes No Lost Heat

**AMERICAN BELL AND
FOUNDRY CO.**

NORTHVILLE - MICH.

PHOENIX INSIDE SLIDING BLINDS

WIKES BARRE, PA.

The Phoenix Sliding Blind Co.
Enclosed find my check for blinds. I am pleased with them
and sorry I did not have them put throughout the whole house.
C. W. BURT.

Comfort!
Economy!

Convenience! **PHOENIX SLIDING BLIND CO.**
BRIDGE & CANAL STS. PHOENIX, N. Y.

The lately improved springs and corrugated
steel rods put the "PHOENIX" far in lead of
less improved styles. Write for Catalogue "C"
and free samples, showing construction.

Reason It Out! Individual Motor Drive with ROTHMOTORS will Save Money.



Only the machines that
are in actual operation
consume power. Over
25 other advantages.

Let us act as your en-
gineers. We will save
you money.

Roth Bros. & Co.
1422 W. Adams St., Chicago
New York: 243 Canal St.

When Writing Advertisers Please Mention the American Carpenter and Builder.

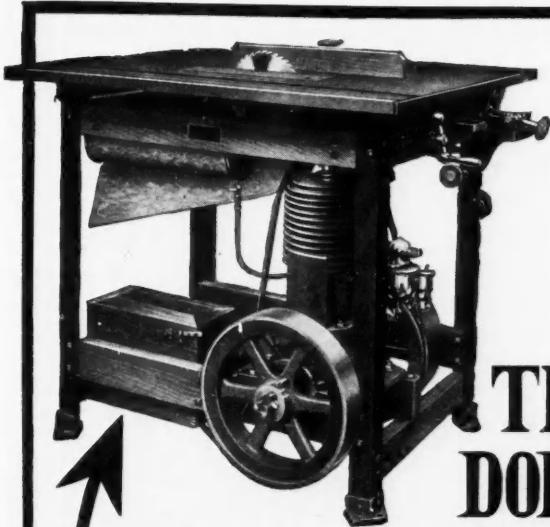

THE MACHINE THAT DOES THE WORK OF A WHOLE PLANING MILL AND A LITTLE MORE

The Grimm Woodworker Combines maximum utility with minimum simplicity and weight.
Does the Work of 5 Men—Nine Machines in One

Each Grimm Woodworker has the following adjustments:

- | | |
|-------------------------------------|----------------------------|
| 8-inch Rip Saw | 4-inch Jointer |
| 8-inch Cross Cut Saw | 10-inch Sander |
| 6-inch Dado Head | Moulder, (18 pairs knives) |
| Boring Machine (7 Bits) | Jig Saw, (3 blades) |
| Square and Round Faced Emery Wheels | |

Here Are Some of the Things It Will Do:

rip, size, cut off, joint, plane, plow, jig saw, bore, mould, shape, rabbet, mitre, mortise, tennon, and sand.

The Grimm Woodworker is constructed of steel and wood, combining strength and rigidity with compactness and least weight so that it can be easily moved to any part of any shop, house or wherein needed. The Gasoline Engine or Electric Motor which furnishes the power is **built into the machine.** No loss in transmission of power; added weight of engine makes machine rigid. Does not have to be bolted to floor. Sold under a positive guarantee.

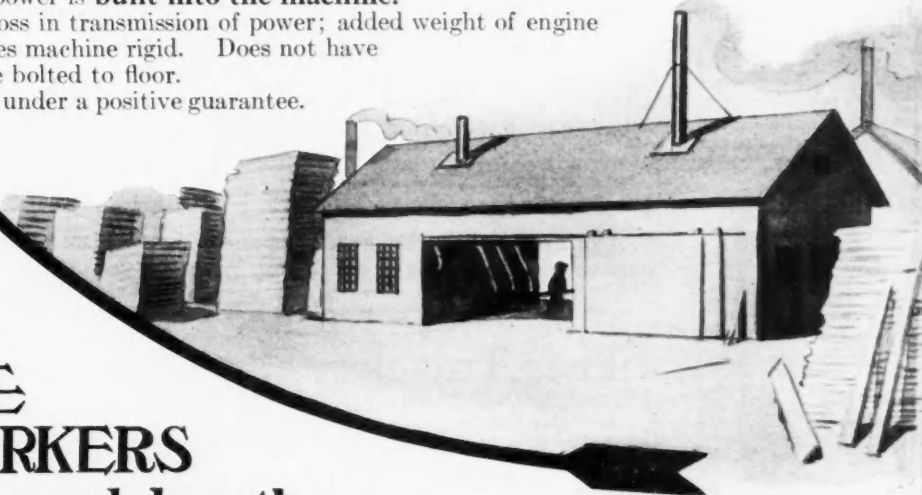

**"GRIMM"
PORTABLE
WOODWORKERS**
 Manufactured by the
GRIMM MANUFACTURING COMPANY
 46 ERIE ST. BUFFALO, N.Y.

When Writing Advertisers Please Mention the American Carpenter and Builder.



Tired Out!

IT sometimes happens that a woman, on the death of her husband, is left without any means of support. Her duties have not fitted her to meet the problems of making a living for herself and her children, and she has to fall back upon her skill with a needle. Such skill is so poorly paid that poverty and privation stare her in the face.

No man has any excuse for subjecting his wife to such a future. Whatever he earns, a part of it should be used to guarantee her against it.

The **Travelers Insurance Company** in its Guaranteed Low Cost Monthly Income Policy has the best safeguard ever devised for just this emergency.



The Travelers Insurance Company HARTFORD, CONN.

Please send me particulars regarding the Guaranteed Low Cost Monthly Income Policy

Name _____ Business Address _____

Date of Birth _____ City _____ State _____
A. C. B.

When Writing Advertisers Please Mention the American Carpenter and Builder.



Roenius Wood and Coal Chutes

**A NECESSITY TO EVERY MODERN HOME
NO MORE DAMAGED CASINGS OR SASH**

Roenius Chutes are equally desirable for houses of low or high cost.

Nearly 20,000 in Use

Safe from outside tampering or entrance and weather-proof. Are easily opened and locked.

*Write for Catalog and Our
Special 1912 Offer*

Grand Rapids Foundry Co.
High Street - Grand Rapids, Wis.

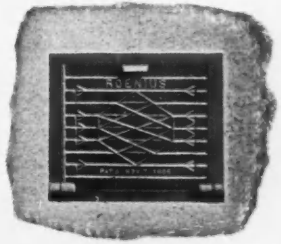



PERFECTION ELEVATORS

The Best Value for the Money in the World
Mechanically Correct

Dumb Waiters, Carriage and Store Elevators, Sidewalk Hoists, Etc., Etc.

Our Elevators are noted for their EASY RUNNING and SERVICE-ABLE QUALITIES. They are practically self-contained, and can be erected by any carpenter in a few hours. We furnish plans for erecting.

The Low Cost Will Surprise You

State your requirements, giving capacity, size of platform and number of feet to travel and we will name our lowest money saving estimate.

SIDNEY ELEVATOR MFG. COMPANY, SIDNEY, OHIO

THIS SMITH PREMIER \$26! Standard Typewriter—Yours for

For more years than you probably can remember, the Smith Premier Typewriter has been recognized as *One of the Two Leaders* among standard \$100 typewriters.

The Model No. 2, shown here, writes 76 characters, including the alphabet in capitals and small letters, figures, punctuation marks, etc. It has 76 finger-keys, "A key for every separate character." Hundreds of thousands of this model are in use to-day.

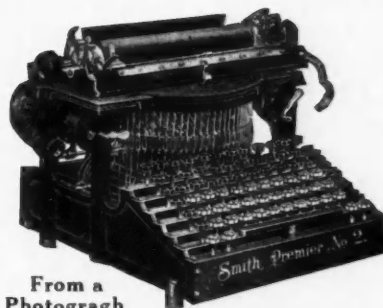

From a Photograph

For practical use, year in and year out, there is no other typewriter that will give you better service than the Smith Premier.

"American Factory Rebuilt"

The Smith Premier typewriter we offer you has just gone through our Newark factory. Our expert workmen have dismantled the entire machine, examined it thoroughly, and replaced every worn or defective part with a new part.

Thoroughly reconstructed, realigned and readjusted, this typewriter performs like new. Refinished and re-nickeled it looks like new. We fully guarantee it for one year.

Free Trial

Sign the coupon below and mail at once—no obligation, no expense to you—and we will write you how you can examine and try this typewriter in your own home—to prove to your satisfaction that it is exactly as we say. Promptness will be wise, for there are only a limited number of these typewriters for sale.

Your Opportunity

to purchase this famous typewriter for practically one-fourth the makers' price is due to the new Visible Writing Smith Premiers, for which No. 2 Models were accepted as part payment.

By an exclusive purchase we got all of the turned-in No. 2 machines, and are thus enabled to offer the best of them (some but little used) at this unheard-of low price.

Your Guaranty

of satisfaction in the typewriter you buy from us is this seal—placed on the machine itself—equivalent to the makers' original guaranty.



The Other Fellow's Impression

When you receive a *pen-written* letter from a business or professional man in these days, don't you immediately lower your opinion of the sender's importance?

Then how can you afford to send out scribbled correspondence—bills of account—estimates—reports—orders—(whatever your need for writing may be) to represent your business or yourself.

Typewriting Easily Learned

Anyone can operate a Standard Typewriter. You can learn all you need to know about the machine in one evening and finish by writing a letter.

Speed comes with use; a novice can soon write as fast as a rapid pen-writer (20 to 30 words a minute), and an ordinary stenographer easily typewrites TWICE AS FAST AS pen-writing.

AMERICAN WRITING MACHINE CO.,
345 Broadway, New York.

Please mail me full particulars of the Free Trial Offer of a Smith Premier Typewriter for \$26.00, without any obligation or expense on my part as advertised in the American Carpenter and Builder.

Name

Address

When Writing Advertisers Please Mention the American Carpenter and Builder.

A BENCH HAND PLANER

For any WOOD-WORKING SHOP, whether large or small. It does a great variety of



small work, occupying small space, and using very little power. Invaluable to the pattern and cabinet shops, contractors and carpenters. If you use wood at all you need a No. 254 HAND PLANER. Write for details, prices, etc.

J. A. FAY & EGAN CO.

Manufacturers of the Lightning Line of Wood Working Machinery
545-565 W. FRONT ST. CINCINNATI, OHIO

INTRODUCTORY TRIAL OFFER

If the SELF-SETTING PLANES are not sold in your town and you write us saying, "I saw your trial offer in A. C. & B.," we will send you particulars, a carpenter's pencil and our \$1.00 Certificate, which we will receive as \$1.00 in payment for a SELF-SETTING PLANE as stated in our \$1.00 Certificate, and if this S. S. Plane is unsatisfactory and returned to us at our expense, we will send you \$1.00 more than you sent us, as the \$1.00 Certificate says.

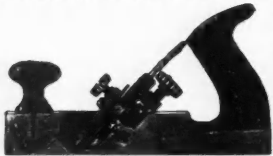

As this paper guarantees we will do as our advertisement says, you know the plane must be O. K.

ALL WE ASK is to have you TRY the SELF-SETTING PLANE on your own bench, in your own way, with or against the grain, on the WORST cross-grained, eaty, knurley, knotty, hard or soft wood you can find, THAT IS FREE FROM SAND OR DIRT.

If it is not worth to YOU, OR YOUR MEN, TWICE ITS COST, return it at our expense as above stated.

If you send us the addresses of ten carpenters, no matter where they live, we will send you another hard, tough carpenter's pencil.

Give the SELF-SETTING PLANE a chance to PROVE ITS WORTH, if it FAILS, return it and we will return your money.

Carpenters' Hard, Tough Pencils, 30c per dozen, postage prepaid.

GAGE TOOL CO., Vineland, N. J.

THE FOLDING DRAW KNIFE

It's the Draw Knife that's the seller
Right up to the Draw Knife law;
It's the workman's prize and treasure,
And the Draw Knife that will draw.



If your hardware dealer does not keep it, we will send it to your address postage paid. : :

A. J. WILKINSON & CO., 180 to 188 Washington St., BOSTON, MASS.

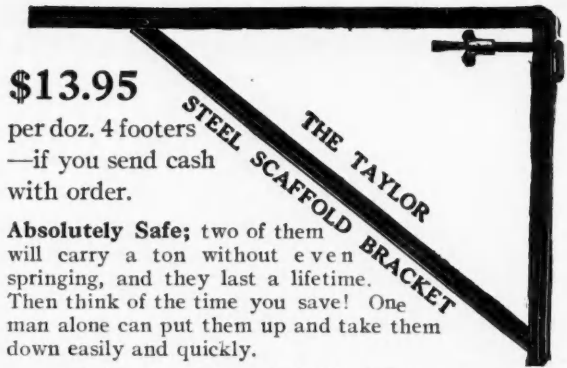

\$13.95

per doz. 4 footers

—if you send cash with order.

Absolutely Safe; two of them will carry a ton without even springing, and they last a lifetime. Then think of the time you save! One man alone can put them up and take them down easily and quickly.

Write for Catalog of Builders' Specialties!

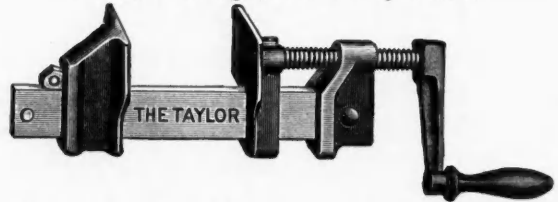

About clamps—the sliding jaw on each of ours can be moved in an instant **DIRECTLY AGAINST** the work operated on, so that half a turn of the fine specially threaded screw will apply the power.

Think of the time this saves!

The grip is positive, and special grade of steel in the bar more than doubles the strength of the clamp.

Our No. 10 catalogue shows some very interesting price reductions on four of the most wanted styles. It will pay you to write for it at once.

James L. Taylor Mfg. Co.

Poughkeepsie, N. Y., U. S. A.

DUMB WAITERS

Did you ever have any complaints about the Dumb Waiters or Hand Power Elevators you have installed. We want more complaints.

The Sedgwick Machine Works, of 132 Liberty St., New York, manufacture Hand Power Elevators and Dumb Waiters for all purposes and are seeking criticisms.

If you have ever used any of their outfits and were not pleased in every respect they will thank you for letting them know about it.

If you have not used their goods, write for catalogue and when your customers call on you for a Dumb Waiter or Hand Power Elevator you will be in a position to sell him a good one.

BLAKE QUICK ACTING VISE

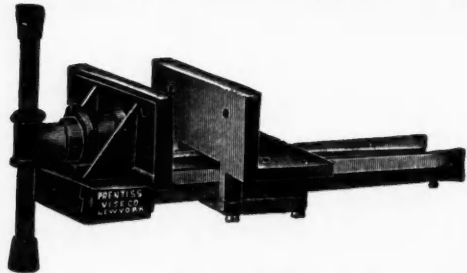

For Cabinet Makers and Wood Workers. Simplest—Strongest

—Cheapest—Best

Send for Catalogue of all kinds of Vises

PRENTISS VISE COMPANY, MAKERS
106-110 La Fayette St., New York, U. S. A.

When Writing Advertisers Please Mention the American Carpenter and Builder.

ASK, AND A POCKET CATALOG WILL BE SENT TO YOU

This catalog will be a handy size that will just fit your side pocket. It will be devoted entirely to labor-saving tools for carpenters and mechanics.

304 Pages of Tools

Every one of our own make and of a quality and workmanship which has made our name synonymous with good tool making throughout the world. You need this book, SEND NOW.

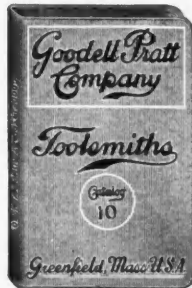

Goodell-Pratt Company

Toolsmiths

Greenfield, Mass., U. S. A.

THE PRACTICAL TOOL

One Used Every Day

Not
a
Toy

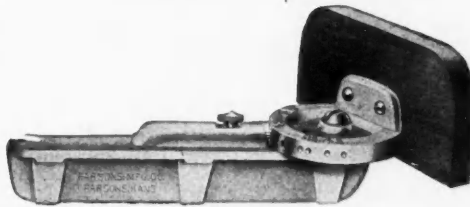

Milks Pocket Miter Box

**Weights 7 oz.
Guaranteed
Accurate**

You will keep it in your pocket. Send a \$1.00; try it. If not satisfied, return it and get your \$1.00 back.

The Parsons Tool Mfg. Co.

21st & Corning Ave.

Parsons :- :- :- Kan.



Woodworking Machinery

Saw and Dado Machine

THIS combination machine for operating cross cut, rip saw or dado head in which the saw is brought into work by a foot treadle, leaves the operator free to use both hands in handling the material, thus greatly increasing the capacity of both workman and machine.

The Head Stock which carries the saw arbor, is mounted on rollers having ball bearings, causing it to move easily and accurately on the ways, reducing the friction, and consequent wear on the machine.

The ways are adjustable for depth of cut, and the countershaft is equipped with a tight and loose pulley permitting the use of an endless belt so as to run smoothly. Further details will be furnished gladly upon request. Our guarantee protects you.

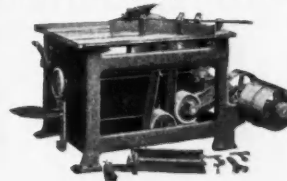

OFFICES:

New York Atlanta
Chicago San Francisco

H. B. SMITH MACHINE CO.
SMITHVILLE, N. J.

When Writing Advertisers Please Mention the American Carpenter and Builder.



Don't Miss This Opportunity

We Want One Carpenter or Builder in Every Community to Demonstrate, Take Orders for and Apply Our EDWARDS METAL SPANISH TILE ROOFING on a Liberal Commission.

Here is a chance to build up an independent, profitable business for yourself right at home. Many carpenters are now devoting their entire time to selling our metal roofing. Others have made big profits simply devoting part of their time to selling and laying our Metal Spanish Tile.

Edwards Metal Spanish Tile

Is being advertised in the leading magazines and is now known to thousands of home builders and owners everywhere. Wherever it has been used it has made a decided "hit" because it shows off to good advantage on the roof and has numerous points of superiority over any other style of roofing.

Architects are specifying Edwards Metal Spanish Tile, for they know it will do away with roofing "troubles." Builders like it because of the finished appearance it gives any house on which it is used.

Our Metal Tile are stamped out of the highest quality Worcester terra plate in exact imitation of the most expensive Terra Cotta Spanish Tile. They come either "dip" painted or heavily galvanized size 10 x 14 inches. Our patented interlocking side lock makes it possible to make a perfectly moisture-proof roof without soldering. Edwards Metal Spanish Tile afford the fireproof advantages of Terra Cotta Tile, but are much lighter in weight, cost but a trifle more than ordinary roofing and will last a lifetime.

WRITE US TO-DAY ABOUT YOUR TERRITORY. Our business is growing so rapidly that it is necessary to have an agent in every community. The territory is going fast. One day's delay may mean that some one else will be given your territory. DON'T DELAY. WRITE TO-DAY FOR OUR SPECIAL AGENTS' PROPOSITION.



Note the construction of patented interlocking device, protecting nail heads from weather and providing perfectly for expansion and contraction of the metal.

The Edwards Manufacturing Co.

"THE SHEET METAL FOLKS"

401-417 Eggleston Ave. - - CINCINNATI, OHIO

THE WORLD'S LARGEST METAL ROOFING, METAL SHINGLES AND METAL CEILING MANUFACTURERS



CUSTOM MADE Fly Screens



Our work is far superior to the usual output of local mills and has a style and finish not obtainable from those who do not make a specialty of fine screens.

Our screens are made from kiln dried lumber and have waterproof coped joints and the frames are weather proofed before finishing coats are applied.

Best grades of Wire Cloth, enameled, galvanized, genuine bronze, fastened by the most approved method.

The new "Ironwood" screen is the cheapest good custom made screen yet produced. Intending purchasers may have free, by mail, samples of woods, finishes, wire cloth and a copy of catalogue. Agencies in nearly all large cities. Agents wanted in smaller cities. Special terms to contractors and builders.

A. J. PHILLIPS & CO., FENTON, MICH.
28 YEARS' EXPERIENCE 3 1-2 ACRES FLOOR SPACE

The New Gun Metal Finish

Makes the

"STERLING" Builder's Levels



By far the most durable instrument in existence. 1912 models now on sale.

Write to-day for CATALOGUE and SPECIAL PRICES

ISZARD-WARREN CO., Inc.
136 N. 12th St., Philadelphia, U.S.A.

CALDWELL SASH BALANCE

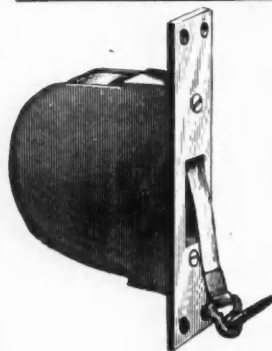

Does away with weights and cords, and VASTLY more durable.

Makes sashes work perfectly.

Permits greater window space in new work, as box frames are not necessary.

May be applied to old windows without altering sashes or frames.

Write for circular to the

Caldwell Mfg. Co.
15 Jones Street, - Rochester, N. Y.



No Dust
Dirt
Smoke
Cinders

Travel
Over the
Road of
Good
Service

THE GREATEST INTERURBAN SYSTEM IN THE WORLD . .
THE MCKINLEY LINES
EXPRESS SERVICE AT FREIGHT RATES

When Writing Advertisers Please Mention the American Carpenter and Builder.



One view of our exhibit room.

**Wood Mantels,
Grilles,
Colonnades,
Fireplaces,**

Why Not Save Money by Buying Direct from the Manufacturer

Mosaics
also
Rookwood Tiles
and **Faience**

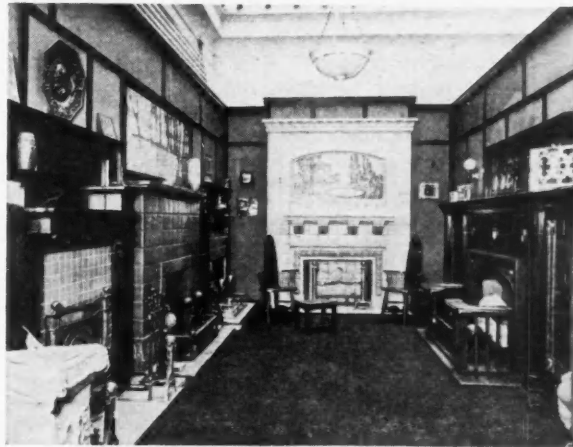

Another view of our exhibit room.

CATALOGS AND DESIGNS ON APPLICATION
SEND FOR OUR 100 PAGE CATALOG

CHAS. F. LORENZEN & COMPANY

GENERAL OFFICES AND SHOW ROOMS
701-709 N. Sangamon St.

CHICAGO

Down Town Office and Tile Display Rooms
128 REAPER BLOCK
Cor. Clark and Washington Sts.

PLUMBERS' SUPPLIES
AT WHOLESALE



When in the market for Plumbing Supplies and you wish to

SAVE
20 to 40 Per Cent

on every article, write for my free illustrated Catalog. The only house that sells first class guaranteed goods at wholesale prices direct. Shipments are promptly made from a very complete stock.

Small orders are as carefully handled as large ones.

B. B. KAROL, 768-772 W. Harrison St., Chicago, Ill.

"Last a Lifetime and Give Satisfaction To the End"

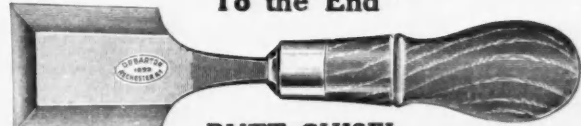

BUTT CHISEL

TRADE MARK



The celebrated Barton Planes and Edge Tools for carpenters and all other woodworkers are unequalled by any other made for keen, hard, smooth cutting edges. If your hardware dealer does not handle

THE CELEBRATED BARTON TOOLS

Send direct for catalogue and our free story book. True Stories. Be sure to specify "CARPENTER'S CATALOGUE."

MACK & COMPANY, 20 BROWN'S RACE ROCHESTER, N. Y.

When Writing Advertisers Please Mention the American Carpenter and Builder.

GEO. H. BISHOP & CO., Lawrenceburg, Indiana, U.S. A.

Makers of

Fine Hand Made Hand Saws

The Purest of Quality Our
"GREYHOUND" Hand Saw



IN introducing our "GREYHOUND" brand of Saws to the trade, we have departed from our usual custom in naming instead of numbering the saw. This saw will be known as our "GREYHOUND" and will be the only Bishop Brand of saw known by name.

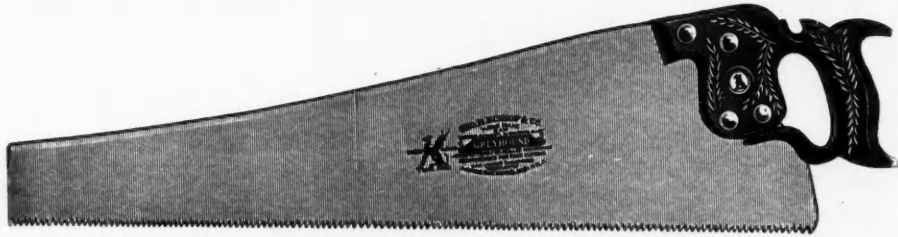

We have had a Chemist experimenting for years to originate a purity of steel with a fine grain and tough body that would stand up under such a fearless warranty as we place on our "GREYHOUND" brand of saws. We now have it. We know its worth as well as its value. As workers of steel we understand it. We had to name it and we have christened it Bishop's Refined "GREYHOUND" Steel, associating our trade mark with its name. We have in this "GREYHOUND" Saw blade a purity of steel that is tough, tempers accurately and even—together with the special way it is made—enables us to guarantee that this "GREYHOUND" brand of Saws will cut faster and run easier in all kinds of wood, hold its sharpness and set longer than any other makes of good Saws in the world. We Refund the Money if 30 days' trial does not prove our guarantee. Our pride is quality with an honest opportunity for the purchaser to judge. Each Saw is tagged with our warranty on it. No expense has been spared to make this Saw the most perfect in the world. We invite correspondence with anyone who has our "GREYHOUND" brand of saws in use.

Made in both straight and skew back. Packed One in a Box.

In workmanship this saw possesses all the skilled mechanical features known to the art of saw making. The hang of the blade has been carefully studied and adjusted, to suit the fancy of the most critical.

If this saw cannot be found in the Hardware Store and they will not order it for you, write to us. Price for 26 in. saw, \$3.00 delivered. We make anything in Carpenters' Saws.

HESS MEDICINE SANITARY LOCKER CABINET



The Recessed Steel Medicine Cabinet

The Only Modern, Sanitary STEEL Medicine Cabinet

or locker, finished in snow-white, baked everlasting enamel, inside and out. Beautiful beveled mirror door. Nickel plate brass trimmings. Steel or glass shelves.

Costs Less Than Wood

Never warps, shrinks nor swells. Dust and vermin proof, easily cleaned.

Should be in Every Bath Room. Four styles—four sizes. To recess in wall or to hang outside. Send for illustrated circular.

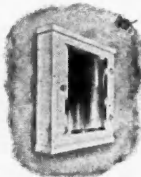

HESS, 920L Tacoma Bldg., CHICAGO

Makers of Steel Furnaces

Free Booklet

The Outside Street Cabinet

BUILDERS

SAVE TIME and SAVE MONEY

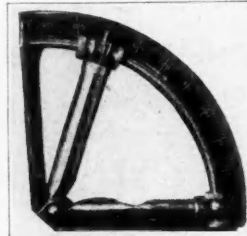

By using this Adjustable Level you can do the work of two men and do it quicker. For all jobs requiring leveling, plumbing or grading it has no equal.

There are no conditions to the guarantee, money returned if not satisfactory.

Price by mail \$1.00

J. D. WEAVER, Jacksonville, Ill.

The Standard Portable Combination Woodworker

FOR BUILDERS AND CONTRACTORS

NINE MACHINES in One

Equipped with 6 H.-P. ENGINE

Large Facilities. Prompt Deliveries.

Send for illustrated catalogue A.

Atlantic Engine Co.,

67 Mercer Street, MEADVILLE, PA.

Canadian Office: BRIDGEBURG, ONT.

ROOF SLATES BLACKBOARDS

E. J. JOHNSON

38 Park Row, New York

Quarry Operators

BLACK, GREEN, PURPLE, RED

Booklet, Samples and Prices on Application

When Writing Advertisers Please Mention the American Carpenter and Builder.

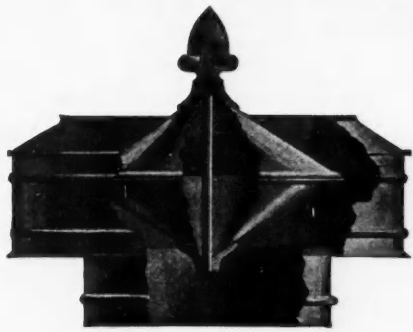

Ventilators THAT VENTILATE

**Improved Metal Ceilings
with Punched Nail Holes
and Repressed Beads**

Those particular features that saves so much time in the erection and increases your profits. They produce a nicer job.

METAL SHINGLES

in two sizes, 10 x 14 inches and 19 x 26 inches.

**Metal Hip Shingles
Sheet Metal Goods**

of all kinds for interior and exterior of buildings.



The Canton Art Metal Co.

"Quality Products"

CANTON, OHIO.

ADDRESS FACTORY No. 1

EASTERN BRANCH
Cor. 11th Ave. & W. 25th St.
New York

WESTERN BRANCH
No. 206 South 3rd Street
Minneapolis



FREE

OUR LITTLE BOOK

telling how to get the lengths and cuts for Common, Hip, Valley and Jack Rafters for seventeen different pitches of roof.

This rule we put on our rafter framing squares and our No. 100-A has the Octagon Roof Framing Rule on back of body.

We manufacture the only practical *Take-Down Square*, guaranteed to remain true.

Don't be a jack-knife carpenter. Send today for this little book.

NICHOLLS MFG. CO., Ottumwa, Iowa

THE CROWN SAW GAUGE

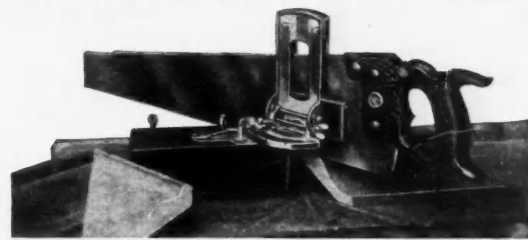

The most convenient Miter-box ever invented. Unsurpassed for sawing all kinds of miters, also compound miters, hopper cuts, weatherboarding, etc. Instantly adjusted to any desired cut. Compact, Portable, weighs two pounds, takes small space in tool-box.

Sent on receipt of \$2.50

Gem Mfg. Co., L. R. Bender, Mgr., Elizabethville, Pa.

50c FOR THIS Clamp Fixture

*It is Unequaled for Strength—
Quick Action and Lasting
Qualities*

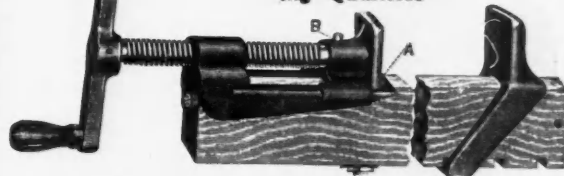

Write for Catalog of Sheldon's Clamps and Vises.

E. H. SHELDON & CO.

84 N. May Street CHICAGO, ILL

When Writing Advertisers Please Mention the American Carpenter and Builder.



The Baby Grand "RUNS LIKE A WATCH"

No matter what kind of concrete work you do, a continuous mixer will serve you best. The BABY GRAND has a mechanical proportioning and feeding device which eliminates guess-work and makes mistakes impossible. Our general catalogue describing our complete line of Concrete and Mortar Mixers will be mailed upon request. We will ship any machine to any part of the United States on five days trial. Don't purchase a machine until you get our prices.

Hall-Holmes Manufacturing Co.
427 Oak St. JACKSON, MICH.



The Simple, Little, Light, Handy and Substantial NORTHFIELD MIXER

will save you big money on every job. Conservative Capacity: 90 Cu. Yds. per day. It can always be set to discharge direct into Forms, cutting out 1/2 the wheelers. It saves you 3/4 the Transportation charges and all repair bills, as compared with any other mixer.

No man's business is so big, nor no job so small but what it will pay to have this little Money, Time and Worry Saver on the Work.

New Principle: Plows, Hoes, Stirs, Mixes Mortar, Plaster or Concrete. Insures a thorough mixture under all conditions. The only satisfactory color blending machine.

IS NOT A MAN-KILLER

Operates by either Engine, Motor or Hand Power. Most reasonable priced good mixer on the market.

*Sold on trial. Satisfaction Guaranteed.
Write at once for FREE Catalogue, Price and Terms.*

Manufactured by
NORTHFIELD IRON COMPANY
402 Water Street : : : Northfield, Minn.

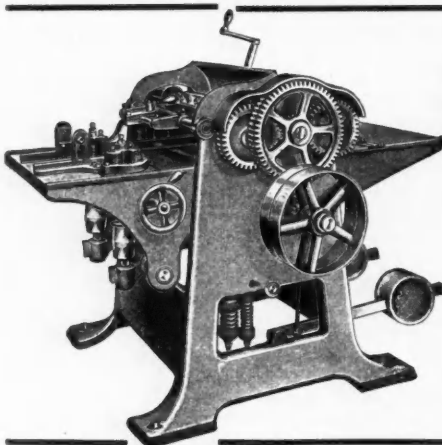

A high grade modern

WOOD WORKING MACHINE

for Contractors, Builders, Planing Mills and general use.

Many exclusive features

Send for Catalog and get posted. It will pay you.

CORDESMAN, MEYER & CO.
41-45 Central Ave. CINCINNATI, O.

Huther Bros. Patent Groover or Dado Head

(Will save it's cost in three days' time

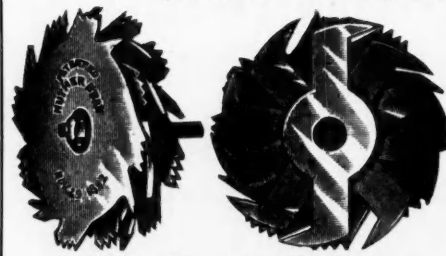

Showing Arrangement of Cutters

Can be used on any Circular Saw Mandrel

For cutting any width groove from 1/4" to 2" or over. Will cut a perfect groove, either with or across the grain, and leave edges smooth. Will ship to any responsible firm on ten days' approval; if not satisfactory you are at liberty to return at our expense. We also make a specialty

of concave ground smooth cutting circular Mitre Saws, for either rip or cross cut; Grooving Saws for all kinds of special work; Lock, Corner Cutters Concave Saws, etc.

Try our Scraper Blades and you will use no others.
HUTHER BROS. SAW MFG. CO.
1000 University Ave. ROCHESTER, N. Y.

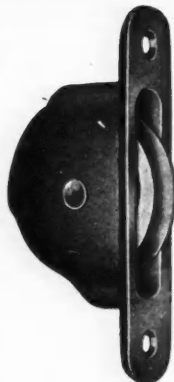

Headquarters For Sash, Door and Blind Makers' Supplies and Special Machines

WINDOW PULEYS (Cast and Sheet Steel). All sizes and finishes. Write for Catalogue.

ENTERPRISE PULLEY MORTISER. Equipped with Four Bits. Cuts Full Stile in same time required for single mortise

ENTERPRISE POCKET CUTTER. Makes a Pocket both wind and water tight.

PIONEER MOULDING SANDER. Finishes Mouldings and Interior Trim equally as well as handwork, and at one-tenth the cost.

Sash Cord and Chain, Glazier's Points (Standard and Machine), **Blind Staples, Wood Screws, Wire Nails and Dowels.**

125 Broad St., Boston, Mass.

AUSTIN & EDDY

805 Tacoma Bldg., Chicago, Ill.

When Writing Advertisers Please Mention the American Carpenter and Builder.

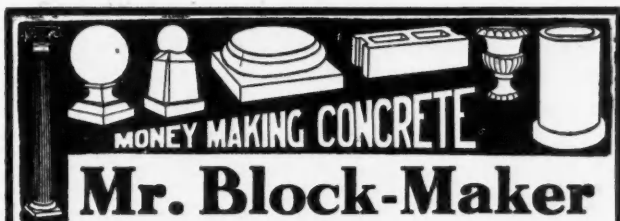

Mr. Block-Maker

Wet Process is Right.
Face down is Right.
Three blocks at a time is Right.
Triple Tiering is Right.
Damp Curing is Right.

The Mogul Invincible Block Machine

COMBINES ALL THESE

IT IS RIGHT

It is 46 inches long and will make three 16" or two 24" blocks at one operation. It makes sills, caps, copings, rails and steps, faster and better than a special sill machine. It has every adjustment that any other machine has and many that no other machine has.

PRICE—Machine and Outfit, \$75.00

WRITE FOR CATALOG

THE PETTYJOHN COMPANY

634 No. 6th St., TERRE HAUTE, IND.

WHY THE Hercules Concrete Block Machine

is the **BEST** for **YOU** to buy

The man who is about to take up the manufacture of concrete blocks, should exercise the greatest care in selecting a block machine. The biggest mistake to make is to buy a small machine that will always remain a small machine. Why not buy a machine large enough for your immediate needs and capable of being expanded to make more and larger blocks as your business expands.

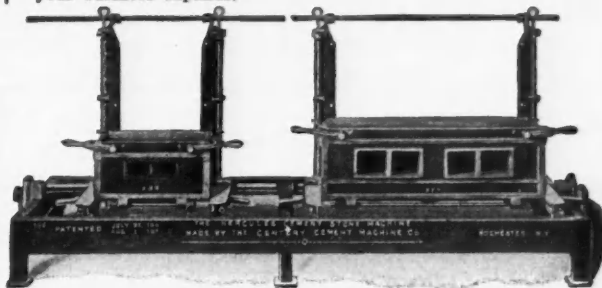

You can buy a HERCULES equipped to make whatever size of block you need when you start. Parts for other sizes are added as you require them. Your machine is a plant in itself. When you expand you don't have to throw away old equipment—you merely add at small cost to what you have.

There are many other important points connected with Hercules Machines that you ought to know. We have just issued a little book full of information. Send for it today.

CENTURY CEMENT MACHINE CO.
290-300 St. Paul St. ROCHESTER, N. Y.

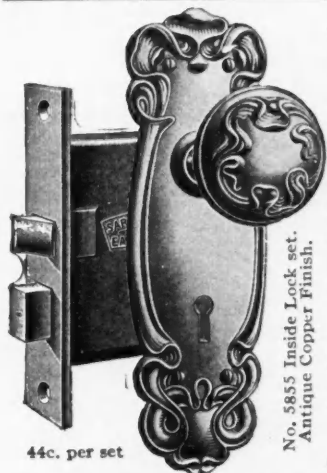

44c. per set

No. 5855 Inside Lock set. Antique Copper Finish.

Do You Know

What it means to buy Builders' Hardware at the right prices?

Send for our No. 5 illustrated catalog and net price list free to contractors and material men.

When sending for catalog state whether contractor, carpenter, or material man.

We do not sell to contractors, carpenters or material men in Cook County.

Rehm Hardware Co.
1501 Blue Island Avenue, CHICAGO, ILL.

The Myers New-Way Adjustable Tandem Door Hanger

Is adjustable to and from buildings and permits the door to be raised or lowered as desired. This is a very important feature in cold weather when the ground is frozen and heaved up. It is absolutely dust proof and can be adjusted to keep out all snow and rain. Owing to its construction it will carry a heavier load than any other style tubular track. Another very important feature is its flexibility which permits the door to pass over uneven surfaces.

Write us for information and catalog.

F. E. MYERS & BRO.
ASHLAND, OHIO

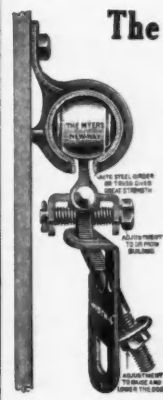

Made in all sizes and styles, for use with brick or concrete block walls or with wooden or steel beams

TRUS-CON Joist Hangers

Avoid cutting away and weakening of timbers and walls—save labor, time and money.

Trus-Con Joist Hangers are made from open hearth steel plates, and are proven by actual test to be the strongest on the market. Note the bulb-shaped reinforcement at upper angle.

We also furnish Post Caps Post Bases, Wall Plates and Base Plates made in rolled steel, malleable iron, or cast iron.

Write for catalog and prices

TRUSSED CONCRETE STEEL CO., 344 Trussed Concrete Bldg., Detroit, Mich.

Trus-Con Pressed Steel Inserts for Supporting Shaft Hangers in Concrete Buildings

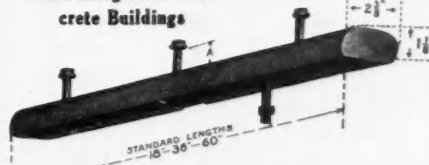

Trus-Con Pressed Steel Inserts are imbedded in the concrete during construction, saving expensive drilling after completion of the work. The long slots allow a wide variation in position. Special washers prevent bolts from turning in the slots. Write for details and prices.

A NEW METAL TILE

ABSOLUTELY WATER TIGHT—PERFECT FITTING

OF THE WELL KNOWN

KANNEBERG QUALITY

Best Roofing in the World. Also Various Artistic Designs in Metal Ceiling

Catalog Ec for Metal Tile, Catalog Dc for Ceiling

Kanneberg Roofing & Ceiling Co.
Canton, Ohio

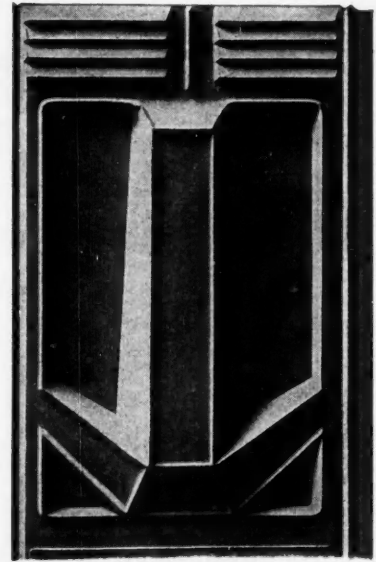

PEARSON'S AUTOMATIC SHINGLE NAILER



Works well on any pitch roof. Gloves or mittens can be worn and nails driven faster than by the old way. Throw nails in by the handful—holds about 600 nails—start nailing. Nails can be driven through tin or quite heavy sheet iron.

PAYS ITS COST ON ONE JOB



Made in two sizes:
The **BLUE** Nailer for 3d common No. 14 gauge wire nails.
The **RED** Nailer for 3d galvanized No. 13 gauge 1 1/4 inch wire nails.

Order through your dealer or sent prepaid for \$5.00.

Money refunded if not as represented
PEARSON MFG. CO.
Robbinsdale, Minn.

SEE THAT NAIL



DECORATE

Your Home and Church

With F. & B. Co.'s

ART WINDOWS

Designs and Estimates on Application Without Charge.

Beveled Plate, Metal Sash, Memorial Figure Windows and Residence Work Our Specialty

Grand Prize Awarded Louisiana Exposition. Established 1883.

The Flanagan & Biedenweg Co.

Office, Studio and Salesroom,
312 to 318 W. Illinois St., near Franklin
CHICAGO, ILL.

Tel. North 21 8

TRADE



MARK

Height of Cut . . . 6"
Width of Cut . . . 12 1/2"
Size Bed . . . 18"x39"
Weight . . . 420 lbs.
Price . . . \$90.00
F. O. B. Grand Rapids

Bench and Floor Type

'Universal' Wood Trimmers

To Meet Every Demand

Height of Cut . . . 4"
Width of Cut . . . 8"
Size Bed . . . 7 1/2"x17 1/2"
Weight . . . 32 lbs.
Price . . . \$22.50
F. O. B. Grand Rapids



4-A Universal Wood Trimmer

EVERY PATTERN SHOP, INTERIOR FINISH MILL, FURNITURE FACTORY, and others doing work requiring **perfect glue joints** and **angles** should have our Trimmers or Miter Machines to produce the best results.

WRITE TODAY FOR COMPLETE CATALOG OF OUR TOOLS

FOX MACHINE CO.

22 N. Front Street
GRAND RAPIDS, MICHIGAN

30 Church Street, New York
J. B. STONE & CO.,
135 Finsbury Pavement, E. C.

6-E Universal Wood Trimmer

When Writing Advertisers Please Mention the American Carpenter and Builder.

How You Can Buy The Best Roofing For Less Money

CERTAIN-TEED ROOFING

Guaranteed 15 Years

Made in Shingles as well as Rolls

The General Says:—

"I realize that there are so many brands of Roofing and so many different qualities, that Roofing buyers cannot be sure of what they are getting.

To relieve the buyer of worry on these matters, I will in future, paste the Certificate shown below, on all of my **First Quality** Roofings, whether sold under my Weatherproof Compo-Rubber Brand, or Jobbers' private brands."

The CERTAIN-TEED Label of Quality Protects You from Paying Double What Roofing is Worth

Back of this Certificate is the General's experience of nearly a quarter of a century in mining and refining asphalts, also manufacturing roofings. This is why he has outstripped all competitors and today owns and operates the three largest roofing plants in the world.

The General's three million dollar mills enable him to produce a splendid roofing at a low cost and place the local dealer in a position to sell it to you at a price so attractive you can't afford to use any other material.

*Don't make any mistake—buy from your local dealer—when it comes to price, quick delivery and service, he has them all beat. But when you buy, see that our Certificate of Quality is pasted on each roll—you will not only save money, but you will be entitled to the **15-year guarantee.***



Before you buy another square foot of roofing—or if you have never used ready roofing—at least investigate—send today for our Free Book (XI), just off the press, "**How to build for less money,**" in contains facts and figures you should know—it will save you money—write today to the nearest point.

General Roofing Manufacturing Co.

YORK, PA. MARSEILLES, ILL. E. ST. LOUIS, ILL.
MINNEAPOLIS, MINN. SAN FRANCISCO, CAL.

The World's Largest Manufacturers of Roofing and Building Papers

FREE BOOK COUPON

If you will send me your free book (XI), "**How to build for less money,**" I will read it.

Name

Street

State

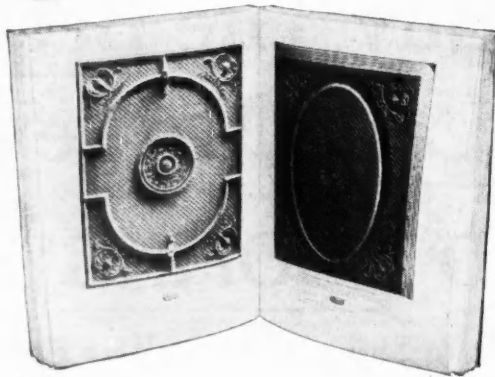

Let our catalog help you

The biggest help you can have in selling steel ceilings is the Berger catalog of "Classik" Ceiling designs and combinations.

In this catalog are steel ceilings to suit every taste and fancy—a ceiling for every building and every purpose. They range from the plain and inexpensive to the most elaborate.

"BERGER'S"
Classik
METAL CEILINGS

are good sellers. Their well-earned reputation for high quality and beauty of design has created a well-defined demand, and building owners are quick to appreciate these good qualities.

Every building owner will find in the Berger catalog a steel ceiling that will exactly suit him and suit his building.

Every Berger "Classik" Steel Ceiling you sell will net you a good profit—and will likely sell another Berger Ceiling for you.

Write today to the nearest Berger Branch—get the Berger "Classik" Steel Ceiling catalog.

THE BERGER MFG. CO.

CANTON, OHIO

New York Philadelphia Minneapolis
St. Louis Boston
San Francisco Atlanta Chicago

We also manufacture Tin Plate, Black, Galvanized, and Painted Roofings, Metal Tile, Brick and Stone Siding, Ridge Roll, Cornices, etc.

Does Slate Rust?

Neither Does Copper
Clad Steel

Nails made of it will hold a slate roof in place forever.

Galvanized nails let go, and the roof leaks.

Then there's trouble.

TRADE MARK



WELD CLAD

Duplex Metals Company

Main Office and Works

CHESTER, PENNSYLVANIA

Western sales office

PEOPLES GAS BUILDING, CHICAGO, ILL.

P. S.—Your dealer can get them for you.

OLDS HOISTS

OLDS GASOLINE CONTRACTORS' HOISTS are built in all sizes, 3 H. P. to 12 H. P. and in several types to meet all requirements.



Do not buy without first getting our printed matter and prices.

Gasoline Engines 1½ H. P. to 100 H. P.

SEAGER ENGINE WORKS
LANSING, MICHIGAN

Olds Gas Power
2112 Central St.
Kansas City

Olds Gas Power
1007 Farnum
Omaha

Olds Gas Power
204 N. Los Angeles St.
Los Angeles

Seager Engine Works
65 Beverley St.
Boston

When Writing Advertisers Please Mention the American Carpenter and Builder.

**THE APPEARANCE OF AN ARTICLE OF UTILITY
QUICKLY CARRIES TO THE MIND A
CONVICTION OF ITS EFFICIENCY**

The demand for the **DISSTON BRAND SAWS, TOOLS and FILES**
has been steadily increasing since 1840

HENRY DISSTON & SONS
INCORPORATED
KEYSTONE SAW, TOOL, STEEL AND FILE WORKS
PHILADELPHIA



**Dull Kote the Best
for EVERY Room**

And
This
is the
Label



Why? Should not every room be clean? Sanitary? Attractive? Of course they should not all look alike. The living room demands a more artistic treatment than the kitchen; the bedroom calls for the quiet restful effects; the dining room for more pronounced coloring—each room should harmonize with its purpose and its furnishings.

The one and only wall finish that fully and satisfactorily meets all these requirements is

Johnston's Dull Kote Paint

It has the soft beautiful finish of undressed kid, without a trace of brush marks or laps. Artistic patterns can be stencilled in borders or panels, while the 24 tints or colors obtainable admit of the widest range of treatment, from the plain to the most elaborate. And it can be washed with soap and water like tile. It never chips or peels, contains no poisonous pigments, and, unlike paper, it will not harbor disease germs.

Can you conceive of a more desirable, economical and sanitary wall covering than this for your rooms?

Send for color card. Sold by dealers everywhere, or by

The R. F. Johnston Paint Co.
Pearl and Main Streets Cincinnati, Ohio

"It Works Like a Plane"

The Boss Floor Scraper

The "Boss" is the only Floor Scraper made that will plane a floor without leaving a square cut where knife first starts cutting. Why? Because the "Boss" is made with a gauge on front, to which is attached a pear-shaped wheel which raises when machine is pulled and lets the knife down gradually.

The "Boss" can be set for any thickness of shaving, it also can be set for any shearing cut right or left up or down to suit the kind of Lumber.

It is guaranteed to give absolute satisfaction.

G. J. KEPPLINGER

Main Office: - DWIGHT, ILL.

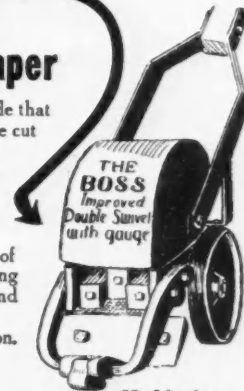

Mnfd. also
in Canada.

THE WINTHROP SOLID TAPERED ASPHALT SHINGLES

ARE OF A COOL, GRAY SLATE COLOR

And have all the Durability of Asphalt—the Fine Appearance of Slate and the Light Weight and Low Cost of Wood Shingles. Laid with regular Shingle Nails, the same as Wood Shingles. **NEVER REQUIRE PAINTING.**

Write for Free Booklet and

SPECIAL INDUCEMENTS TO THOSE WHO APPLY

FIRST ROOF IN EACH TOWN

Winthrop Asphalt Shingles are Fire-resisting, Water-proof, Wind and Sun-proof, and never Crack Break or Fall Off.

WINTHROP ASPHALT SHINGLE CO. 1101 1/2 The Temple CHICAGO, ILL.

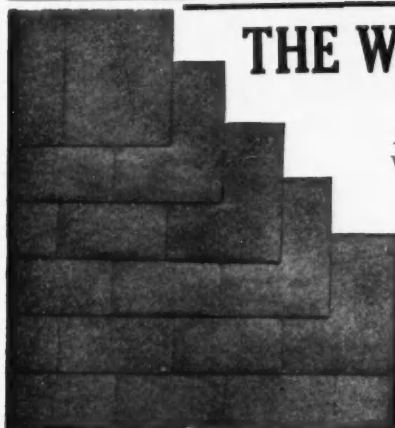

When Writing Advertisers Please Mention the American Carpenter and Builder.

TRADE MARK
CHICAGO
MARK

A SUGGESTION

Do you specify a spring hinge with distinctive features which will appeal to your client and assure satisfaction to all concerned?

Chicago "Triplex" Spring Butts

offer this advantage to you. The appearance, durability and finish of this article are unsurpassed, and in consideration of prices that are conservative in respect to value, the up-to-date builder cannot afford to risk his reputation with goods that are unsatisfactory.



Send for Catalogue C 26. It illustrates and describes the most complete line of Spring Hinges manufactured.

Chicago Spring Butt Company

CHICAGO  NEW YORK

BOMMER
SPRING HINGES

ARE

Quality Goods

BUT COST NO MORE THAN THE
SUBSTITUTES

This trade mark



THE BOMMER SPRING HINGE

Reg. U. S. Pat. Office
on every genuine
Bommer Hinge

Durable—Neat—Reliable

BOMMER
SPRING HINGES

ARE THE BEST

Bommer Bros., Mfrs., Brooklyn, N. Y.

MORRILL'S

**Saw Set
Soap Urn
Nail Puller
Bench Stop**

Morrill's Specialties are scientifically constructed of the finest materials, fully warranted. They are best for reliability, best for the satisfaction of your customers, best for your reputation and best for profit. Send for our export catalog No. 9 and special C. I. F. prices.



CHAS. MORRILL
277 Broadway NEW YORK CITY

— Our Claim —

Superior Tools at Lowest Prices



Fales' Patent Variable Bench Plane

Ask Your Dealer or Write

Otis A. Smith - Rockfall, Conn.

Specialties
Combination Bench Plane
Countersinks
Butt Gauges
Clapboard Markers
Adjustable Countersink

CARPENTERS PREFER THE POPULAR

Marsh Ayer Miter Box

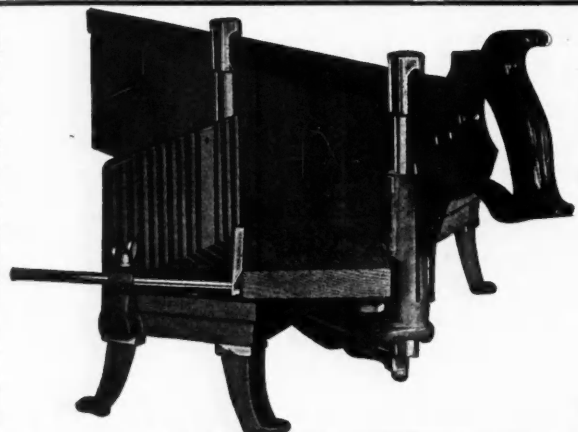

Because:

- It is absolutely accurate.
- It is so convenient to use.
- It is built to last.
- It has an unusually large capacity.
- The price is right.

Let us send you our illustrated circular.

H. C. Marsh Company
606 Race Street :: :: ROCKFORD, ILLINOIS

When Writing Advertisers Please Mention the American Carpenter and Builder.



The
**World's Greatest
Building Paper**

Important Notice

When your subscription expires, renew at once, using the blank enclosed in your final copy. If it expires with this issue your renewal must reach us before February 25 to avoid missing the March number. Use P. O. or Express Money Order if possible, but bills or 2-cent stamps may be sent at our risk.

The
**World's Greatest
Building Paper**

American Carpenter and Builder

Entered as second-class matter July 1, 1905, at the postoffice at Chicago, Ill. under the act of Congress of March 3, 1879.

Published on the first day of each month by

AMERICAN CARPENTER AND BUILDER COMPANY
178 W. JACKSON BOULEVARD, CHICAGO

EDITORIAL DEPARTMENT

WILLIAM A. RADFORD, EDITOR-IN-CHIEF
BERNARD L. JOHNSON, B. S., EDITOR
WILLIAM REUTHER
ALFRED W. WOODS } ASSOCIATE
ALFRED S. JOHNSON, M. A., PH. D. } EDITORS

BUSINESS DEPARTMENT

WM. A. RADFORD, PRESIDENT AND TREASURER
H. M. RADFORD, SECRETARY
E. L. HATFIELD, BUSINESS MANAGER

New York Office, 178 Fulton Street

E. B. WOLFROM, EASTERN REPRESENTATIVE

VOL. XII. FEBRUARY, 1912. No. 5

SUBSCRIPTION RATES

One Year, \$2.00; six months, \$1.00; payable always in advance. Single Copies, 20 cents. Canadian Subscriptions, \$2.50. Foreign Subscriptions, \$3.00.

ADVERTISING RATES

Furnished on application. Advertisements, to insure insertion should reach our Chicago office not later than the 20th of the month preceding date of publication.

Axioms that Made a Millionaire

THE life of R. T. Crane, "The Ironmaster," who died recently at his home in Chicago, will long serve as an inspiration and encouragement to young men who are poor yet plucky. Beginning in the very lowest ranks in the industrial world he rose entirely through his own efforts to wealth and prominence. A short time before his death he authorized the publication of the following working rules or "Axioms" for the man who is ambitious to achieve success:

- Money comes to the man who knows.**
- If you want to lead you must first learn.**
- Learn your business thoroughly and you can get to the head today, as well as men could fifty years ago.**
- The only place to learn a business is in the business.**
- To make a success today a man must know a great deal**

more than in the old days—therefore, begin to learn early.

The big men in business today were poor boys of yesterday. The big men of tomorrow are to be found among the poor boys of today.

There is always room for capable men—big employers can never find enough of them.

To be poor is no bar—a poor boy can enter the trades, and at 26 have acquired the knowledge on which to base a fortune.

Lack of college training is no handicap.

Get right into the business and learn from the bottom up. I don't know of any man who has made a success in any other way.

To develop a perfect organization a man must have a thorough knowledge of the line he is to manufacture, of the best machinery, processes, factory locations and constructions, raw material, men, wages, merchandising, manufacturing costs, improvements, business growth, panics and other trade conditions.

License Builders and not Their Plans

Brooklyn Official Believes This Action is Necessary in Order to Check the Erection of Cheap Structures

THE report of Superintendent of Buildings John Thatcher, of Brooklyn, raises a novel question. In order to check the spread of cheap building, of the sort which occasionally results in a disaster, Mr. Thatcher recommends that builders should be licensed before they be permitted to engage in the business.

Mr. Thatcher's argument is that men who know nothing about the business are tempted into building by the hope of profit. They buy the cheapest possible material; and the result is a lot of structures so badly built as to be a danger to the community.

There is little question about the premises. "Jerry" building has been an evil for years. The authorities have sought to check it by stringent regulations regarding the approval of plans and the like, but the mischief still goes on, and Brooklyn—like every other city—is cumbered with houses and tenements which ought never to have been put up at all. Now Mr. Thatcher wants to go to the root of the matter by approving the builders instead of their plans, and compelling them to submit to an examination before securing licenses.

The suggestion is novel, and it seems to fly in the

(Continued to Page 37)

What Makes the "High Cost of Building"?

PORTIONS OF AN ADDRESS BEFORE 22ND ANNUAL MEETING OF THE NORTHWESTERN LUMBERMEN'S ASSOCIATION JAN. 17TH, AT MINNEAPOLIS

By J. R. Moorehead

I COULDN'T come to a lumberman's meeting without making a speech about lumber first. . . . A week ago, I got a letter from a lumber journal man, who said I had been in the business so long that I ought to know something about the high cost of lumber, and that I ought to know the reason of it and be able to tell him so that he could publish it, and I wrote him a letter, which I have here with me today. I am going to read it to you, as there is so much truth in it, and it ought to be read and re-read, talked about and reiterated and possibly be printed and sent to all the lumbermen, so that when



His grandfather didn't have the things he did

a man comes in your place and ask you to figure a bill for a modern house, then wonders why it costs so much more to build one now than it did when his grandfather built one, you can show him why he can't get his modern house at the price his grandfather got a house that did not have so many conveniences. His grandfather didn't have the things he did. I am going to read you what I wrote:

Why Buildings Cost More

Replying to yours of recent date as to "why" the high cost of building in these days, when the lumbermen are being charged with all kinds of high crimes, I want to give you some figures showing just where the "high cost" comes in. This is a concrete case. The house was erected in this city [Lexington, Mo.] during 1911, and is an eight-room modern house. The contract price was \$3,700.00. If this house had been erected in this town 26 years ago, when I first went into business, or if it had been erected in the country last year on a good Lafayette County farm, which

has been doubled and many times trebled in value in the last ten years, the following items of cost would not have been added to the original cost for the reason that most of the items were not then a part of a home or would not now be a part of an average country house.

To original contract.....	\$3,700.00
By difference in excavating all of basement instead of cellar only.....	25.00
By extra on brick foundation by reason of excavation entire basement.....	75.00
By heating plant instead of stoves bought as furniture	250.00
By sewer connection (none used in country or 26 years ago in town).....	50.00
By gas pipe and connections (none used in country or 26 years ago in town).....	25.00
By electric fixtures and wiring instead of coal oil lamps	175.00
By bathroom outfit, not in use generally then or on farm now.....	250.00
By six closets built in house instead of wardrobe bought at store	150.00
By kitchen cabinet and china cupboard bought at store	80.00
By sub-floors in house not formerly used.....	70.00
By hardwood floors, finishing, etc., extra cost over pine floor	60.00
By extra size of porches, formerly not large or at all necessary	150.00
By extra cost of hardwood interior finish and oak stairway	40.00
By extra hardware, front door locks, etc.....	25.00
By veneered front door and art glass side lights	40.00
By boxing and paper on outside of house, including work	85.00

Total\$1,550.00

Total cost of extras in this house not absolutely necessary to its construction, and which would not have



When the lumbermen are being charged with all sorts of high crimes

been necessarily added to the cost of a house 26 years ago, or to the farm house of today, \$1,550.00, deducted from the original contract, leaves \$2,150.00 as the cost of this same house without the above deductions.

I think the above answers the question as to the high cost of this particular house; and this example is but an illustration of what are facts in all modern house building.

Again, if this house is erected without all the closets and bathroom, there will be an additional large sleep-



"It shows that the 'high cost of building' in these days is due to the demands of modern life for modern conveniences"

ing room, for all of these things take up one room at least in most all modern houses. But the most startling fact which I have discovered in this investigation is the following:

I agreed to furnish the bill of lumber for this house as erected, not including the interior hardwood finish, stairway and front door, for \$900.00. I lost the bill; for my competitor took it for less. I went back to my old day book for 1886 and figured this bill as nearly as I could on the same grades of lumber used then and the same profits, and the price was \$803.28, and my competitor sold this bill at a price much nearer the latter figure than \$900.00, which I asked for it.

This example shows several important facts.

It shows first, that lumber is being sold today, and at a profit, for less than 10 per cent over what it sold for twenty-six years ago.

It shows second, that at the price of \$900.00 for this bill, the lumber cost less than one-fourth the price of the original cost of the house.

It shows third, that lumber has advanced less than any other item of general use.

It shows fourth, that the "high cost of building" in these days is due to the demands of modern life for modern conveniences which are now considered necessities instead of luxuries, and not to the high cost of lumber.

It shows fifth, that a substantial farm house can be erected today at practically the same price it would cost twenty-six years ago.

It shows sixth, that the labor bill upon the modern house is not so much more than it was when labor received smaller wages, for the following reasons: At the present time lumber of every kind that goes into a house is more nearly prepared for immediate use than it was formerly. The framing lumber is all sized and ready to put up without extra work by the carpenter; in fact, it comes cheaper sized ready for use than if it were rough and unsized, owing to the saving in freight. The finishing lumber is all ready with but very little work to "put up in place," and only requires cutting to lengths. In the making of frames, finish, cornice and such items, the modern planning mill has largely taken the place of the carpenter and very much reduced the number of "days' work" by the carpenter on the modern house. Therefore, the labor bill, especially the carpenter work, is not increased as much as some would have us believe.

It shows seventh, that the retail lumbermen are the worst lied about set of merchants in the country.

Respectfully,

Lexington, Mo.

J. R. MOOREHEAD.

License Builders and Not Their Plans

(Continued from Page 35)

face of the American idea, that any man may take up any line of trade to which he takes a fancy, and that if he makes a mess of it the result is his own affair. But we have had to abandon that theory in those cases where the man's incompetence was found to injure other people more than it injured himself, which is precisely the case of the incompetent builder. If he were building a house to live in himself he might be let go his way, because he would have to pay the penalty of his cheap building in repairs. But when he puts up a building to sell or to rent, so that its fall will injure tenants or workmen employed in it, then the community has a right to call a halt on his greed in the interest of public safety.

Set Up a Job on Them. I once worked in a planning mill that used a large Corliss engine, with wide, long belt. Well, you know how blue flames (electricity) will arc between your fingers and a large running belt. Well, the annoyance caused by this was from the kids in the neighborhood and other curious people continually coming in to "get a shock," so the engineer ran a small wire around on top of the rail that enclosed the driving wheel pit, and arranged the end of the wire just far enough under the big belt to get the current. Well, say! he stopped the *influx* (that word is a new one on me) of visitors; they got suspicious.—WM. C. JASBURY.

BETTER BUILDING

WHY AND HOW



Where Cheapness is Folly

(Paints and Varnishes)

As has been truly said "Quality is Economy in painting." In no other part of a builder's work does good quality pay such big dividends on the investment as in the use of paints and varnishes. Nowhere else does the best grade of material, properly applied, add half so much, dollar for dollar, in renting or selling value, or half so much to the occupant's pleasure and the builder's reputation.

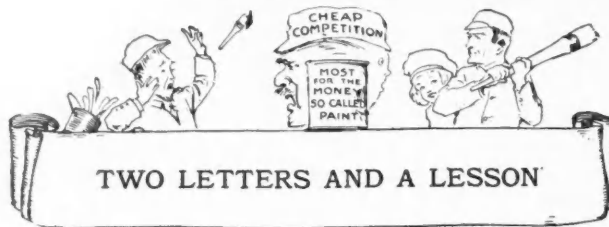

AS recorded in a recent number of "The Dutch Boy Painter," that bright little publication of the National Lead Co., two letters have come to them from two contracting painters in one of the south middle states of the Union, though from different towns. The letters are on the same subject, but so different in tone that, considered together, they seem to teach quite an important lesson regarding "Better Building" as it applies to painting materials.

One of the men writes that his business has declined steadily for three years and that the season just past has been the poorest in his experience. He is not only discouraged but disgusted. Cheap painters have invaded his place with low bids. He has lost contract after contract to men who know only enough to brush on what is in the pail and who couldn't mix lead and oil to save their lives.

The other painter writes also about sharp competition of the low-priced variety. He says that when he came to the town as a white-leader three years ago, the wise ones reckoned that a single season would wind him up. Cheap paint and cheap painters were so entrenched that the people didn't know they wanted anything better. His first year was rough sledding. House-owners could not see why they should pay a hundred dollars for a job of repainting for which they were accustomed to pay from fifty to seventy-five dollars. He kept talking high grade work wherever there was a prospect, and the first contract he got fairly spread himself in an effort to turn out the finest piece

of painting he had ever done. That helped him enormously. It was a standing advertisement for him. He was careful to see that everybody who was likely to paint knew about this sample job of his. This letter closes by saying that three of the five painters who were in the town three years ago have moved away. One has turned carpenter and the other is becoming a white-leader as an employee of his former competitor.

Now please note that the conditions in the two towns appear to have been quite similar so far as the painting business went. The problem of cheap competition confronted both of these painters. One of them yielded to it, the other downed it.

Every good painter in the country faces the same conditions. His business is menaced by the low-priced bidder who relies for his profit on inferior materials and slighted work.



"He kept talking high grade work"

The cheap painter has no idea of establishing a permanent business and thinks only of present profits. He relies not at all on repeat orders, for he knows that his work doesn't deserve them. His one inducement is low price. As long as he can so magnify cheapness as to blind customers to the poor quality of his work, he gets orders. When his welcome in one neighborhood wears out, he goes to another or else tries his hand at a different trade. That, of course, is his weak point. He doesn't last and he would not be a serious competitor if there were not so many of him.

The outcome for the two painters who wrote those

two letters depended for the most part on how they looked at cheap competition.

The timid one apparently felt that the longer he held out the poorer off he would be. The thing that looked big to him was the resistless force in the low price argument. Had he been less conscientious he might have joined the price cutters himself. It is to his credit that he quit instead. But that he could successfully combat such competition did not seem to him possible.

The other painter must have looked at the cut price competition in a different and a stouthearted way. He knew as well as anybody that the cheap work would be unsatisfactory and that the house-owners who were buying it would learn their lesson in time. But his idea was, "If they can learn it now and from me, so much the better, for both them and me.

Beginning with three or four prospects whom he thought most likely to appreciate quality, he talked the virtues of pure white lead and pure linseed oil applied with a view to the particular needs of the house to be painted. He showed how knowledge of conditions, material and methods gave character and beauty to the work, while the longer wear reduced the average cost per year.

This kind of talk took, though it gained slowly at first. Every house he painted continued his earnest appeal for better work. His customers were all well pleased and of their own accord praised the good work to their friends. The painter himself kept his name and his business before the community by means of newspaper advertisements and distribution of quality painting literature supplied him by the manufacturers. Little by little white-leading became the established custom, for Painter Stoutheart had so raised the standard that poor painting in this neighborhood is now decidedly out of style. The fight was won with skill, backbone and good paint, but it paid.

"Better Building" Campaign Endorsed

Up Against a Tough Proposition

Pittston, Pa.

Editor AMERICAN CARPENTER AND BUILDER:

Replying to your esteemed favor of Dec. 7, 1911, I am pleased to say that your letter was read at our discussion. The prevailing opinion was that you have a tough proposition on hand.

The question was laid on the table, and the secretary requested to reply.

My reply will be brief. Your campaign of education is sadly needed. As I view the question, you have undertaken a gigantic task. I have been on the firing line in the building business for over forty years; and I believe that you should concentrate your effort in educating the average builder up to the proper standard rather than the owner. Good material is proper, poor material or inferior material should be avoided.

Please tell me how can a *poor* contractor or carpenter construct a *good* house, even with the best materials the market affords?

Is it not a fact that every town and city has its full quota of unlearned and unskilled contractors competing for work with the man of skill, brains and integrity, and usually getting the job away below the contractor of responsibility?

Could the cheap-John builder be educated up to a higher standard of ability and honesty, it would mean a better class of work in every town and city in the country.

PITSTON BUILDERS' EXCHANGE,
B. GRIFFIN, Secretary.

"Better Building" Endorsed by Toledo Builders' Exchange

Toledo, O.

Editor AMERICAN CARPENTER AND BUILDER:

Your communication of Dec. 7, 1911, was read at the meeting held Jan. 3d and I was instructed to answer same by assuring you that the Toledo Builders' Exchange is in sympathy with your campaign for Better Building, and that we are with you in it.

Believing much good can be accomplished by a campaign of this kind and assuring you our hearty support, we are,

Respectfully yours,
THE TOLEDO BUILDER'S EXCHANGE,
By W. J. Albrecht, Sec.

Better Building Kink for Drying Plaster

To the Editor:

Batavia, Ill.

In my experience in building in the winter I have found it very difficult to dry plaster. Several years ago I tried leaving the plaster off below the base ground until after the house was hard finished and then plastered it one coat.

I find that you can dry a house in half the time in this manner, the cold, damp air coming down and circulating instead of soaking into the sheeting, paper and siding.

The majority of houses are painted at the time the plastering is being done. This prevents the moisture from striking through into the siding and causing paint to peel as you can readily see. Oftentimes it is not the fault of the paint or the painter, but this damp condition of the building after plastering.

I think this would be a benefit to the builders and I ask to have you insert it in your paper. W. J. DRAKE.

Wood Butchers and Mullet Heads

To the Editor:

Valley Springs, S. Dak.

Well, here I am, 58 years old. Been shoving the plane since I was a boy. Haven't earned 50 dollars in 6 months. Dry times, poor crops, everything dead. "Corn plow" carpenters and other plug wood butchers get the work. I think I am about to the end of my string. There are too many plugs; the west is overrun with them. And the people are a set of mullet heads; don't know the difference between an old trained workman and a common scrub. For instance, a fellow here put in a platform stair with first run 7-inch treads except last one to platform, which he made 6 inches from platform to upper floor. All were 8-inch risers. Oh, Lawd, think of it! WARREN RILEY.

Ambition to Be First

*If I were a cobbler, I'd make it my pride
The best of all cobblers to be;
If I were a tinker, no tinker beside
Should mend an old kettle like me.
But whether a tinker, or whether a lord,
Whatever my station may be,
Determined to play second fiddle to none,
I'll climb to the top of the tree;
Let who will be second, the first I'm determined to be.*

—Thayer's "The Way to Succeed."

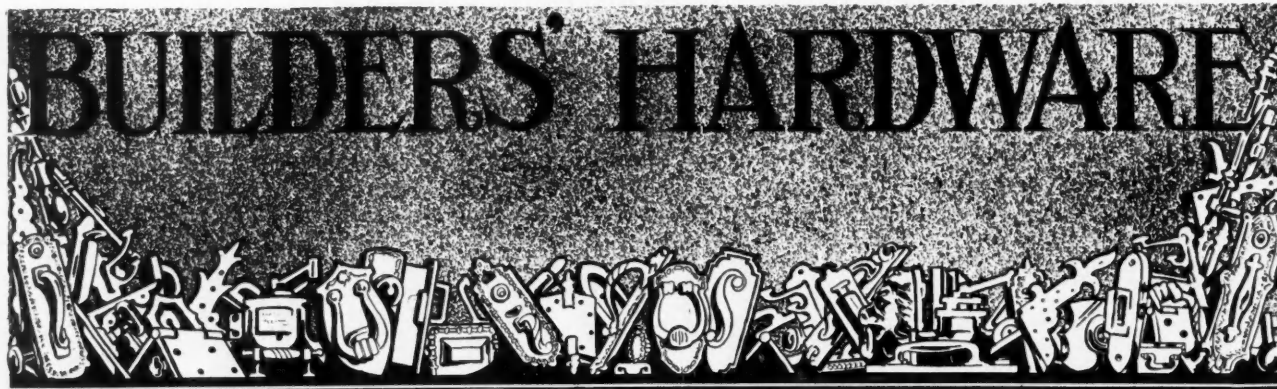

THE great bugbear of the builders' hardware men is specially detailed millwork which no standard hardware fixtures will fit. Many architects seem to have a mania for detailing casement windows, French windows, double doors, etc., in some peculiar style of their own invention, with the result that the hardware trimmer has all kinds of trouble putting on the hardware, for the reason that the standard hinges, locks, and adjusters do not fit. In this series of articles, our Hardware Expert is showing recommended standard practice for the several varieties of doors and windows, showing how the hardware people want these parts made.—Editor.

Make Your Millwork to Fit the Hardware

By Our Hardware Expert

THE builders hardware man is usually bald headed. He is also a man who uses cuss words. The architect is blamed for this condition. Many times you may see him with both hands tearing the few remaining locks from his head.

The Yankee is a good guesser; but not all hardware trimmers are Yankees.

The hardware editor will not have lived in vain if the suggestions in this and succeeding numbers of the AMERICAN CARPENTER AND BUILDER are adopted by the architect and millmen.

The details shown are of vital importance to the hardware man, because if every one of them is used he will be enabled to select, what in his best judgment, are the best articles of builders hardware, to do the work required for them.

The reader will note that particular pains are taken to impress on the architects the necessity of showing on the original set of plans details of the lock stiles of the double doors, double French windows, and double casements. They must be shown on the original set of plans, because these are the plans from which the trimmer makes up his schedule of hardware. Usually the order for hardware on any sizeable job is already in the works before the full size details are drawn by the architect.

It is the usual practice of the hardware trimmer, in making up his schedule of items, to begin with the front entrance door. This is especially true in trimming a residence. His aim should be, to place the knob and escutcheon as nearly as possible on the middle of the lock stile.

Detail No. 1 shows the standard cylinder front lock applied to the right hand leaf of a double door. The T astragal is almost universally used on double doors because the flat front lock is reversible; and if it is desired to put the lock on the left hand door the lock can be reversed by the carpenter on the job. A lock having a front which is not beveled can be successfully applied by the carpenter to a door, beveled $\frac{1}{8}$ to 2 in., which is now accepted as the standard. These scale drawings are made half full size, and are designed to show the locks in place on the narrowest stiles on which the standard lock can be applied to the best advantage. The above suggestions apply to the single front door as well as to the double.

Detail No. 2 shows the same standard lock applied to the reverse right hand leaf of a double door. It should be the usual practice of the carpenter to attach the T astragal to this door, to protect the bolts of the lock from being tampered with. The writer earnestly urges the architects to comply with this detail

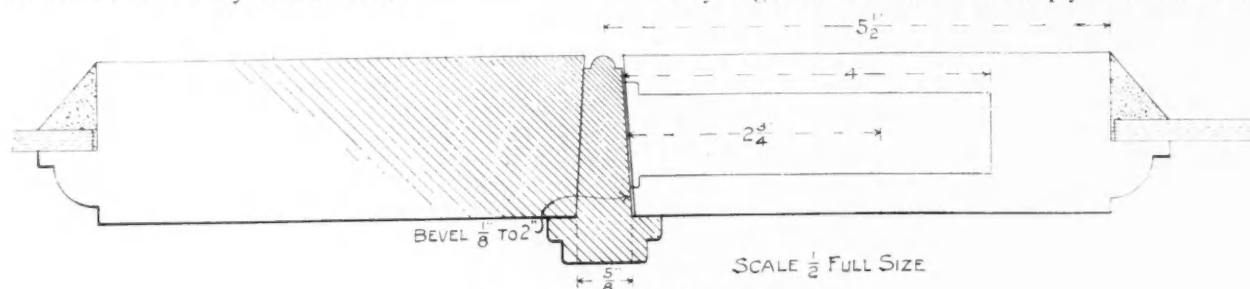

Detail No. 1, 1 1/2" Double Door, Open in

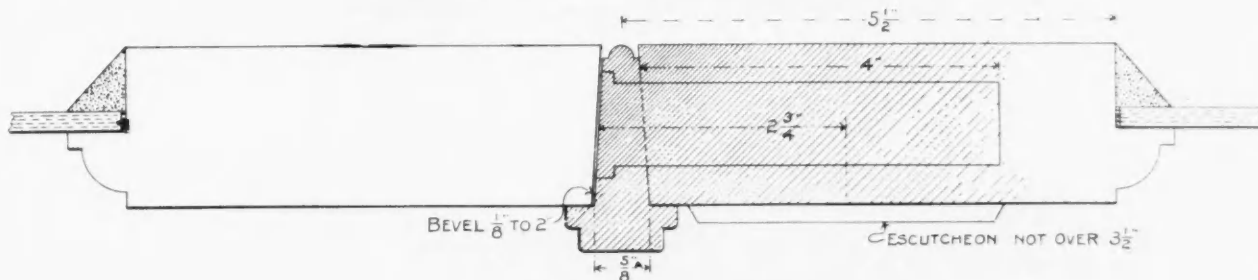

SCALE $\frac{1}{2}$ FULL SIZE

Detail No. 2. 1 1/2" Double Door, Open Out

for double doors opening out, so there can be no misunderstanding by the hardware trimmer of what is required. This is the first trouble he encounters. If he is not a mind reader, he sure goes wrong and furnishes trimmings which cannot be applied to the best advantage.

Note—on the outside of a door opening in, an escutcheon plate four inches wide can be applied.

the architect and the millman give him stiles of sufficient width on which a cylinder lock and its trimmings can be applied. If the trimmer must apply a narrower backset lock than 1 3/4 in., he has to sacrifice the appearance of the rosette for the lever and omit the rosette surrounding the cylinder.

Detail No. 4. Suggestions set forth about Detail Number 2 relative to T astragal apply to this detail.

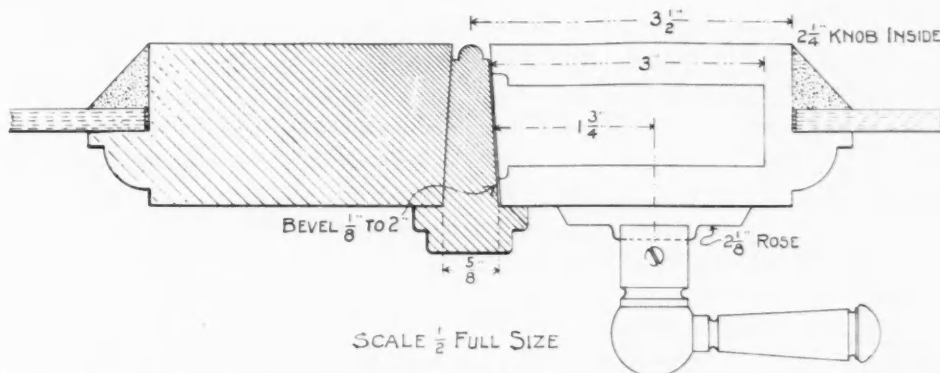

SCALE $\frac{1}{2}$ FULL SIZE

Detail No. 3. 1 1/2" Double Door, Open in, on Which the Narrowest Cylinder Front Door Lock Can Be Used

One can readily see that the widest escutcheon plate or door pull plate which can be applied to doors opening out is three and one half inches. A lock having a deeper backset than 2 3/4 in., can be had. It must be made up special at an advance in price. It is also a great expense, in loss of time completing the work.

Detail No. 3 will be of interest to the architect who has contracted the habit of the Colonial school of architecture. It will be of greater interest to the hardware trimmer because it is up to him to see that

Suggestion relative to the appearance of the trimmings made about Detail Number 2 also apply to this detail. It is good practice to use a 2 1/4 inch knob in combination with the lever, because the spindle is smaller than the hole in the lock hub and the knob on one side will make the lever stand at right angles to the edge of the door, whereas a pair of levers will usually not be at right angles to the edge of the door,

Detail No. 5 shows the narrowest practical width of stile to which a lock of sufficient strength should be applied. Architects must be cautioned by the hard-

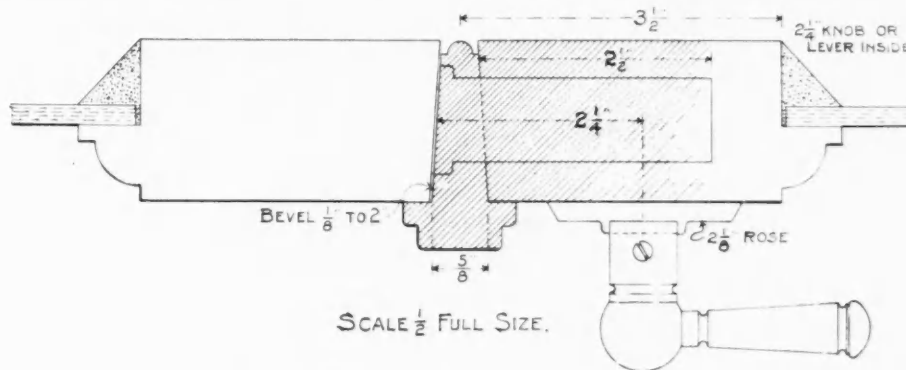

SCALE $\frac{1}{2}$ FULL SIZE.

Detail No. 4. 1 1/2" Double Door, Open Out, on Which the Narrowest Cylinder Front Door Lock Can Be Used

ware man that narrower stiles than these here shown for French windows are not good practice. Locks can be had having 1 inch backset; but they are not of proper strength to do what is required of them and trimmings can not be had, on the narrow space of woodwork, to match up with the design of hardware adjacent to it. Architects must be impressed with the

the Appellate Division declaring that in Greater New York all permanent encroachments over the building line, including front stoops, show windows, porticos, permanent awnings or other structures are illegal and alleging that no municipal body has the right to permit them.

The court says that when such obstructions exist in New York City no permit from the Park Department or other municipal body can legally authorize their maintenance.

Adjoining owners may bring a suit in equity to compel their removal or may move for a mandamus to compel the city officials to perform their duty and remove the obstruction. In the latter case the courts hold that it is immaterial that the obstructions have been in existence for a long time, and that the relator and his predecessor in interest

have not complained before, for no prescriptive right to occupy the streets can be gained as against the public and no adjoining owner can legalize such obstruction by acquiescence.

Where it appears that the obstructions have existed for a long time the writ of mandamus should direct the proper authorities to remove them or in their discretion compel the owner or lessee to remove them and with all reasonable speed. It is well understood that the Borough President and the Commissioner of Public Works of Queens will promptly prosecute any

cases as to existing encroachments upon the complaint of adjacent property owners or others who are injured by such projections over the street lines.

As to new buildings no permits will be given for bay windows, store windows, stoops or steps, in any section of the borough. This is such a radical change from the past policy of the city authorities, of granting privileges for projections

such as the above named, that the new order of things is felt to be a great hardship by property owners in all parts of the city. It is said that in residence streets especially, traffic was not at all impeded by such projection and conditions are entirely different in Queens from those existing in the crowded avenues of Manhattan.

Under the new order buildings will have the use of only about 90 or 95 feet depth of lot besides stoops and other projections and on 25 feet corner lots the width must be reduced to 20 feet for building purposes. Builders say that this will mean a loss of millions of dollars to them.

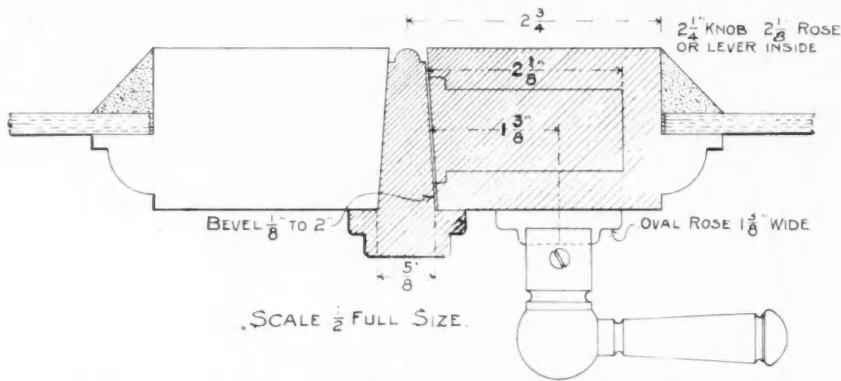

Detail No. 5, 1 1/4" Double French Window, Open In, Bit Key or Thumb Bolt Lock

necessity of making the lock stiles at least 2 1/2 inches from edge to glass rabbet so that a lock having a case 2 1/8 inches can be applied by the carpenter. The auger bit used, has a worm at least 1/4 inch long and the mechanic will not mortise for this lock on narrower than 2 1/2 inch stiles for fear of breaking the glass.

Detail No. 6. Remarks relating to Detail Lumber 4 apply to this detail—with this exception, that a pair of levers should be used, because, insufficient space of wood on the inside forces the use of the same

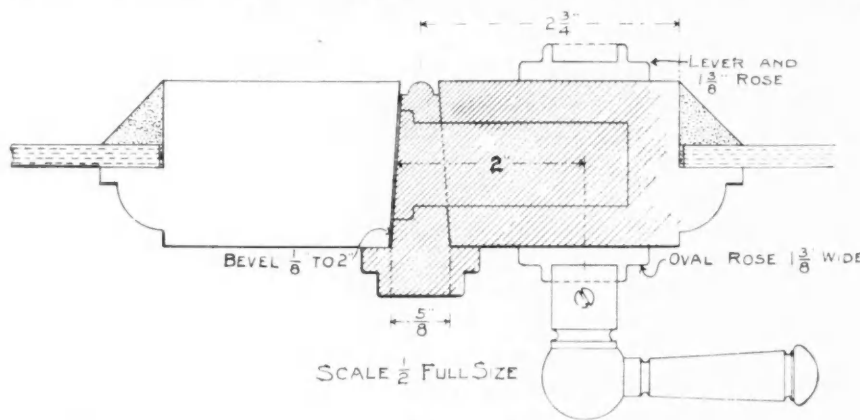

Detail No. 6, 1 1/4" Double French Window, Open Out, Bit Key or Thumb Bolt Lock

oval rosette as used on the outside.

Note.—Nearly all makers of hardware now furnish for French windows, a thumb bolt lock. This is preferable to a bit key lock as there is not sufficient security in this type of lock. A thumb bolt lock is as secure as the high priced cylinder lock applied to the front entrance doors.

Court Upholds New York Building Line Law

The New York Court of Appeals has recently rendered a decision affirming the sweeping judgment of

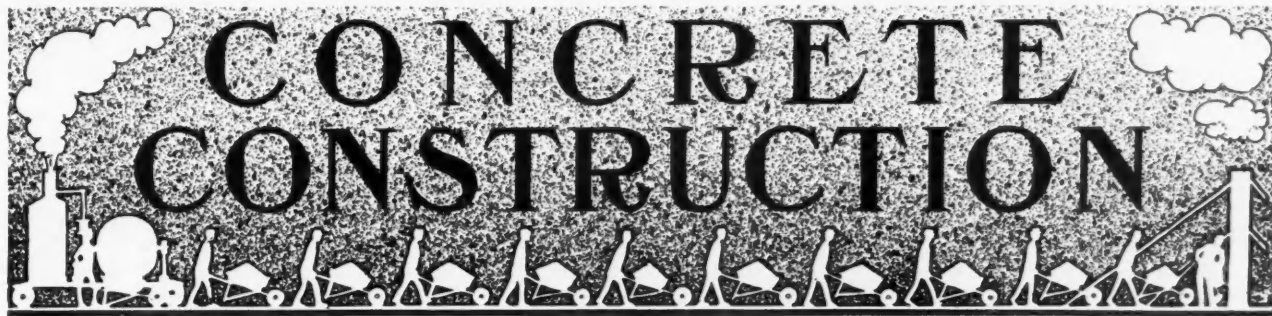

Concrete Pavements as a Community Peacemaker

HAS A PSYCHOLOGICAL VALUE BASED ON ITS COMPARATIVE CHEAPNESS AS A PAVING MATERIAL TENDING TO ALL-AROUND SATISFACTION OF PROPERTY OWNERS

IN Davenport, Iowa, they have discovered that concrete when used for street paving has proved to be a neighborhood peacemaker, for the reason that in localities in which automobile owners and other progressive citizens have been confronted with the objection of neighbors who did not enjoy wheeled transportation, concrete has come to the rescue by reason of the fact that it would not cost much more than half as much as other forms of street paving.

The discovery of this psychological benefit from concrete paving is somewhat new; and yet, to those communities in which concrete paving is familiar, it is apparent that the ethical merit in this form of street improvement is a real one. The small town of Remsen, Ia., for instance, is paving its main street this year 70 feet wide at a cost of 89 cents per square yard, because concrete made of local gravel is being used. The difference in cost for this improvement to the property owners of Remsen means a saving of \$3,700 for each city block of street improvement; and it means in effect, that hereafter no small town in Iowa is too small to afford a substantial and durable street pavement at a cost such as at Remsen of \$3,000 for each city block when paved 70 feet wide, or \$1,300 when paved 30 feet wide. In fact, it has been demonstrated at Osage, that in the residence districts, street pavements 24 feet wide are fully adequate, and if constructed at the Remsen price, would cost not much in excess of \$1,000 per city block of street improvement.

If distributed over twelve town lots, and assessed on a seven-year assessment plan, people living in any village can live on paved streets at a cost of \$10 to \$15 per year per town lot, wherever there is a deposit of local gravel such as to make possible the Remsen price.

Not only is this true for the residents of villages, but the owners of \$150 farm land enjoying the luxury of automobiles can live on paved highways five and ten miles from town, with pavements extending the entire distance from their mail boxes to the village store, at a cost of \$750 per quarter-section of land; and, if distributed on a county road bond issue over twenty years with interest, this would cost less than \$35 per

annum for each quarter-section of \$150 land. In other words, the price of one new automobile tire paid each year for twenty years by the owner of each quarter-section abutting a paved highway extending five to ten miles into the country, would pay for such highway improvement wherever concrete could be used at the Remsen price. Thus, not only is concrete the neighborhood peacemaker as discovered at Davenport, but it is eventually to become the universal peacemaker for rural improvements as well.

Reinforcement for Expansion Joints

Expansion joints in concrete pavements are usually located at intervals of 20 to 25 feet extending across the road. Frequently chipping of the concrete occurs along the edges of the joint, which, under continued traffic, develops into unsightly and even

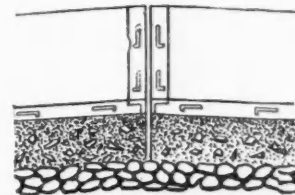
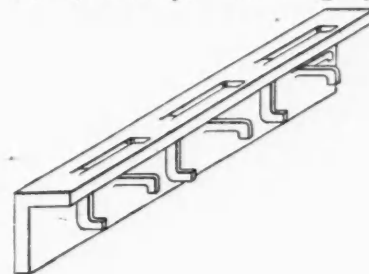

Armor-Plate for Expansion Joint in Concrete Pavement, and Method of Using Same.

dangerous holes or hollows. An armor-plate designed to reinforce the concrete at the joint and prevent the trouble referred to, has recently been invented. The accompanying diagram explains its essential features.

+

Reinforced Concrete Road Bridge

The accompanying illustration shows a 56-foot concrete bridge in Webster County, Nebraska, with piers 2 feet wide and 20 feet long. The two middle piers

are set on red cedar piling driven 6 feet below the bed of the stream, with an extreme length of 22 feet; and the center span of the bridge is 18 feet between the piers. The floor is 12 inches thick, reinforced with ten 8-inch I-beams 20 feet long weighing 18 pounds to the foot.

It is of interest to note that the floor also is reinforced with 6-inch stay hog wire placed 2 inches from



Reinforced Concrete Bridge in Webster County, Nebraska

the bottom between the beams, with another layer crossways above the beams.

The bridge has an arched balustrade 3.2 feet high and 8 inches thick, with a hand-rail 12 inches wide, reinforced with $\frac{3}{8}$ -inch rods. The concrete was mixed 1:6 in the piers and 1:5 in the floor and hand-rail.



Unit Cost of Concrete Buildings of Various Types

Lockwood, Greene & Co., architects and engineers for industrial plants, Boston and Chicago, estimate the approximate unit costs of reinforced concrete buildings of various types as per the figures in the table below. These figures coming from a firm that has had such an extensive experience in this line are of more than usual value.

Coal pockets above 300-ton capacity cost from \$6.00 to \$7.50 per ton. Reinforced concrete stand pipes above the foundations cost from 2½ to 3 cents per gallon.

Type of Bld.	Dimens.	Live Load per sq. ft.	Cost sq. ft.	above fdn. Cu. ft.	Costs sq. ft.	Inc. fdn. Cu. Ft.
Mch. Shop	120x50 4 sto.	150 Lb.	\$1.05	\$0.08	\$1.17	0.09
Mch. Shop	220x100 1 sto. sawtooth skylights		1.65	0.09	1.75	0.10
Cartridge Factory	223x56 2 sto.	300 Lb.	1.40	0.09	1.55	0.10
Cotton Mill	550x129 2 sto.	75 Lb.	0.99	0.07	1.06	0.075
Weave Shed	341x231 1 sto. sawtooth skylights	125 Lb.	1.66	0.064	1.79	0.07
Power House	90x62		2.53	0.115	2.67	0.12
Store House	181x56 4 sto.	150 Lb.	1.08	0.065	1.15	0.07
Store House	256x100 12 sto.	150 Lb.	0.90	0.09	0.98	0.105
Store House	223x56 2 sto.	300 Lb. and 1000 Lb.	1.20	0.08	1.35	0.09

Advantages of Cement Mortar

Cement nowadays enters so largely into building operations that it is surprising to find so few architects and engineers who specify walling to be constructed in cement mortar. In the case of light piers, or piers designed to carry heavy loads, the value of cement is readily recognized, and these sections of the work are marked out for special treatment. When the structure is in course of erection, the difficulty naturally arises as to unequal settlement—an anxiety which could easily be avoided by carrying out the whole of the work in cement. The material is now manufactured to such a high standard that it may safely be relied on, and if it be recollected that brickwork will bear twice the compressive strain when in cement, as compared with the load it can bear when in lime mortar, and that the difference in gross cost is at most 20 per cent, the actual saving incurred by using the latter material is not as substantial as is generally imagined. Building in cement, under normal conditions, frequently obviates the use of piers, and work can be proceeded with more expeditiously, while the elimination of settlement enables the vertical dimensions of any steelwork required to be calculated at once, and ordered directly the contract is signed, without the fear of having to make some readjustments at the last moment. Moreover, the walling is more durable and weatherproof. It would, therefore, seem a practical step to adopt cement mortar generally, except, perhaps, in those instances where everything has to be sacrificed to keep initial expenditure within the most strict and meagre limits.



Cobblestone Coated Cement Post

The street corners in a fashionable district of Hollywood, California, are ornamented with 15-foot col-



Ornamental Post of Cobblestone and Cement Construction

umns of cobblestones, of unique and original design, reminding one of the decorative exhibits of apples or oranges that one sees at county fairs. The shaft is supported on six courses of large cobblestones, and is surmounted by a large sphere composed of smaller ones which seemingly defy the law of gravity. Of course, a reinforcement of iron, and plenty of reliable cement, keep them together.

+

Concrete Railroad Switchmen's Houses

The accompanying illustration shows the novel type of concrete shelter for switchmen, telephone booths, etc., recently developed by Claude H. Witt for the Erie Railroad.

These reinforced concrete houses are constructed of an economical round rod frame, covered on the outside with wire mesh. The window and door frames are placed in position, and the entire frame as thus made is placed inside of a wooden frame mould, which has previously been lined with galvanized metal and slightly greased. The concrete mixture is 1:2:4, using crushed stone not over $\frac{1}{2}$ inch in diameter.



Erie Railroad Switchman's House. Monolithic Reinforced Concrete Construction.

The ventilator at the top of the house is used for a smokestack in the case of watchmen's houses, and is used for a ventilator in the case of double closets, also for a ventilator in the case of telephone booths. These telephone booths are used in connection with automatic signals.

The watchmen's houses are used at grade crossings through cities. The construction is of such form that

the houses are readily picked up by an ordinary wrecking or other crane, and unloaded by the same machine. The walls do not exceed $3\frac{3}{4}$ inches in thickness, and are lighter at the panels. The roof is of the same thickness, and is waterproof.

The cost of these reinforced structures is as follows:

Telephone Booths	\$42.00
Switchmen's Houses	62.00
Double Water Closets	72.00

It is of interest to note that the door and window frames are made of white pine, and are secured in place by having the reinforcing fabric fastened to them with staples, and by having $2\frac{1}{2}$ -inch screws partially screwed into the wood, leaving the heads project about 1 inch into the concrete. The doors and windows are hung in the usual manner—with hinges.

+

Move to Organize National Association of Builders' Exchanges

Ohio State Association Indorses Idea at Recent Convention

Ready support was given to the movement to organize a national association of builders' exchanges at the convention of the Ohio State Association of Builders, held in Springfield the week of January 14th. The convention voted to send Secretary Roberts to St. Louis to attend a national meeting, to be held on January 30, at which representatives from the various exchanges of the large cities of the country will assemble to consider this subject. The movement already has the backing of the leading exchanges in the Eastern cities, and is receiving favorable attention from many of the Western state and local organizations. The primary objects of the national organization will be to protect the interests of the builders in matters of legislation and building regulations, as well as to promote a friendly feeling among the builders of the different cities and the other branches of the building industry.

The state convention was well attended, every exchange in Ohio being represented by delegates. Those who were present from Cleveland were Vice President Rutherford, Ira S. Gifford, R. L. Queisser and Secretary Roberts.

It was decided that membership in any of the individual exchanges should be regarded as entitling the holder to the privileges of all other exchanges in the state, thus increasing the benefits of each organization to its members. A committee was appointed to co-operate with the state lumber dealers and other branches of the building industry in efforts to obtain an improved lien law for Ohio.

On invitation of the Cincinnati exchange it was decided to hold the next convention in that city at a time to be selected by the executive committee.

The following officers were elected for the ensuing year: President, C. A. Schuster, of Springfield; first vice president, J. C. Skeel, of Cleveland; second vice president, C. Taylor Handman of Cincinnati; third vice president, John W. Boren, of Dayton; secretary and treasurer, E. A. Roberts, of Cleveland.

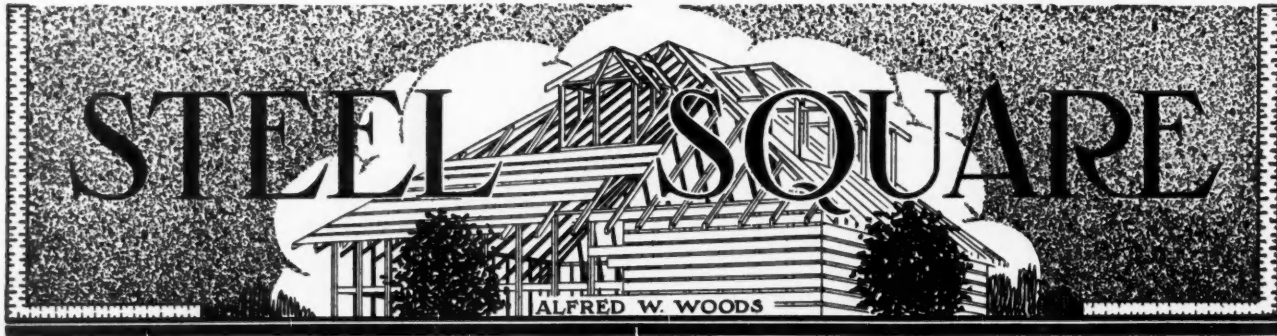

Practical Uses of the Steel Square

SHOWING THE RELATIVE PARTS ON THE STEEL SQUARE FOR EACH CUT AND WHAT DETERMINES THEM

HERE is a strictly steel square problem and we propose to give it on the square. Of all of our writings, we have no hesitancy in saying that we never handed out anything better in the way of illustrating why certain parts are taken on the square to obtain the cuts. Each square is made to represent its individual part that it occupies in the problem, and by a simple change of position of two of the squares the diagram is made to show the parts to take on the square for any shape the building may have.

Suppose we lay down five squares as shown. (Fig. 1.) The first three according to their numbers are to remain stationary but the last two are movable, and are made in connection with the others to define the parts to take for all of the cuts, as follows:

Square No. 1 represents the plan; the shaded part covered by same shows the shape of the plan that is under consideration. It has a 45 degree angle and therefore represents the square cornered building; and the figures on the square are 12 and 12. These proportions give the miter for a square corner.

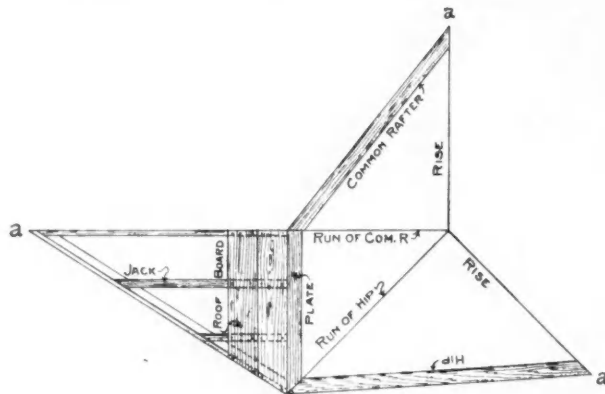

FIG. 2.

Square No. 2 represents the run and rise of the common rafter. Figure 12 on the tongue represents the run and is an arbitrary number and therefore remains unchangeable; but the figures to use on the blade represent the rise to the foot run, and are therefore anything that may be desired.

In the illustration, we have chosen the $\frac{5}{8}$ pitch or 15 inch rise to the foot. Therefore 12 and 15 will

give the seat and plumb cuts of the common and jack rafters.

Square No. 3 shows the parts to take for the side cut of the jack and the face and miter cut for the roof boards. 12 is used on the tongue because it represents the distance that the common rafter, in proportion to its run, rests from the corner of the building. (In this case it is equal the run). 19 5-24 is used on the blade because it is the length of the common rafter, as indicated by the dotted arc from square No. 2. The blade gives the side cut of the jack while the tongue gives the face cut across the roof board, as shown. Now, as the roof boards are square edged, we lay off a line at right angles from the foot of the pitch of the common rafter to a point directly under the rise, as shown. This length transferred to the blade of No. 3 will give the edge or miter cut of the roof boards; the tongue giving the cut.

Square No. 4 represents the run and rise of the hip. This is a movable square; just suppose that the heel is pivoted at 12 on the tongue of No. 1 and at heel of No. 2; and, being placed for the square cornered building, 17 on the tongue intersects at 12 on the blade of No. 1 and same number on tongue of No. 3. 17 represents the proportionate run for the hip in comparison with one foot run of the common rafter, the same number (15) is taken on the blade. The length of a line from 17 to 15 is $22\frac{5}{8}$ and represents the proportionate length of the hip; these figures (17 and 15) give the seat and plumb cuts, as shown. NOTE the arc from 15 on No. 4 intersects 19 5-24 on No. 3.

Square No. 5 is also a movable square and represents the parts to use to obtain the side cut of the unbacked hip. (If the hip has been backed, the same proportions as used for the side cut of the jack, as shown on square No. 3, will give the cut; the blade giving the cut.) 17 on the tongue is used because it is the length of a line at right angles from outer point of the seat cut of the hip to a point in line with the run of the common rafter. In the case of a square cornered building this line is equal to the run of the hip; but, this does not occur in any other angled building. $22\frac{5}{8}$ is used on the blade because it is the

length of the hip. The blade will give the cut, as shown.

The foregoing covers all of the cuts contained in a square cornered building; but suppose we wish to change the diagram so that it will work for an octagon corner. All that is necessary is to take hold of the blade of No. 4 and swing it to the left until the tongue of same rests in line with $22\frac{1}{2}$ degrees and at the same time square No. 5 will slide along the tongue of No. 4 with its heel resting at the edge of the blade, of No. 1, the figures at the intersecting points caused by the changing of the squares 4 and 5 will be the proportions to use and the changes will be found to be as follows:

Instead of 12 on the blade of No. 1 and tongue of No. 3 it will be 5; instead of 17 inches on the tongue of No. 4 and blade of No. 5, it will be 13 and instead

of 17 on the tongue of the latter, it will be 5 5-12. The other figures will remain, as shown, unless the pitch is changed.

In connection with square No. 1 is shown the degree pitch and in this example it is shown that a pitch of 15 inch rise falls in between 51 and 52 degrees; the exact pitch in circular measure being 51 degrees and 21 minutes. In this connection, we wish to call attention to the fact that none of the pitches when reck-

(Continued to Page 49)

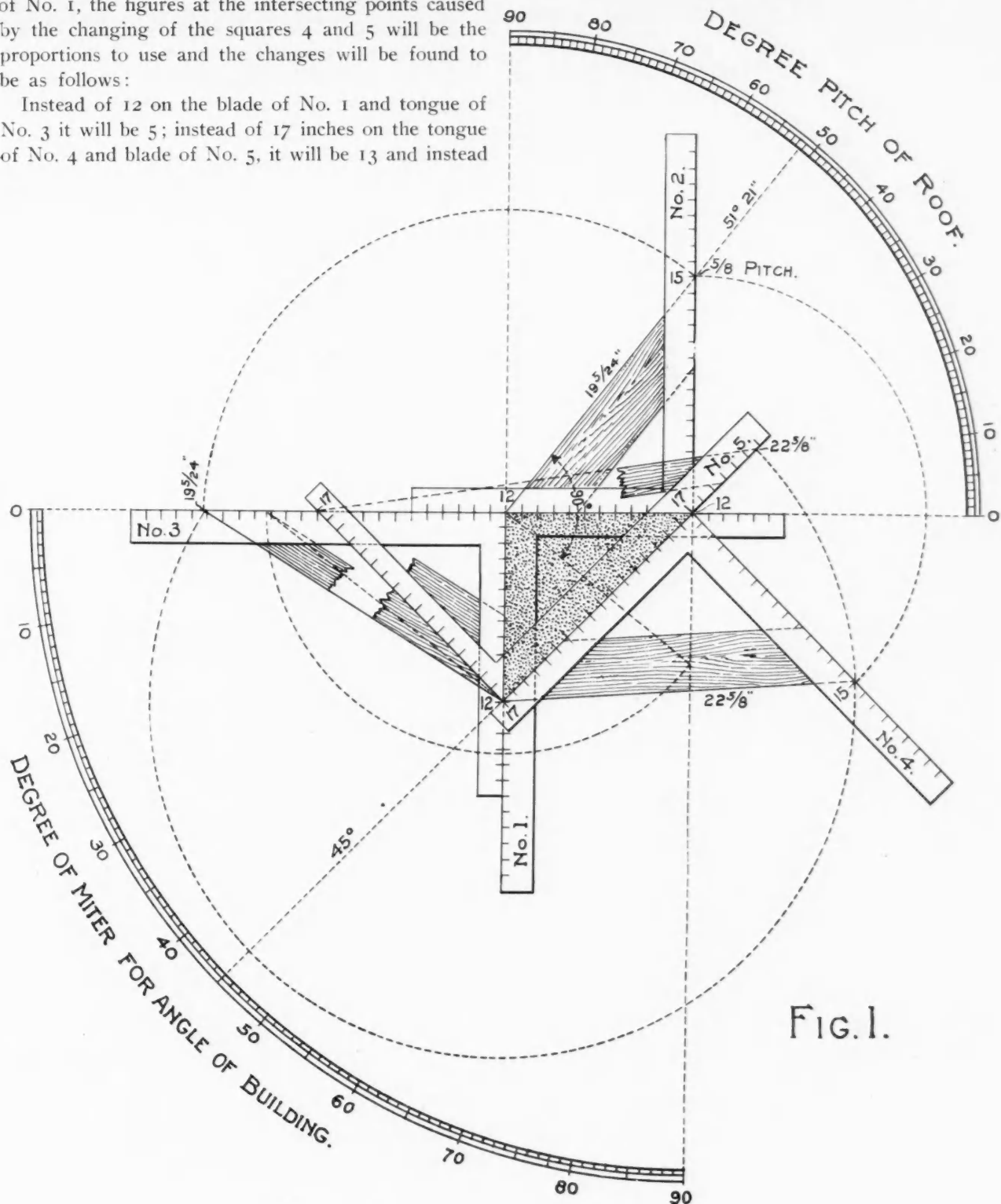
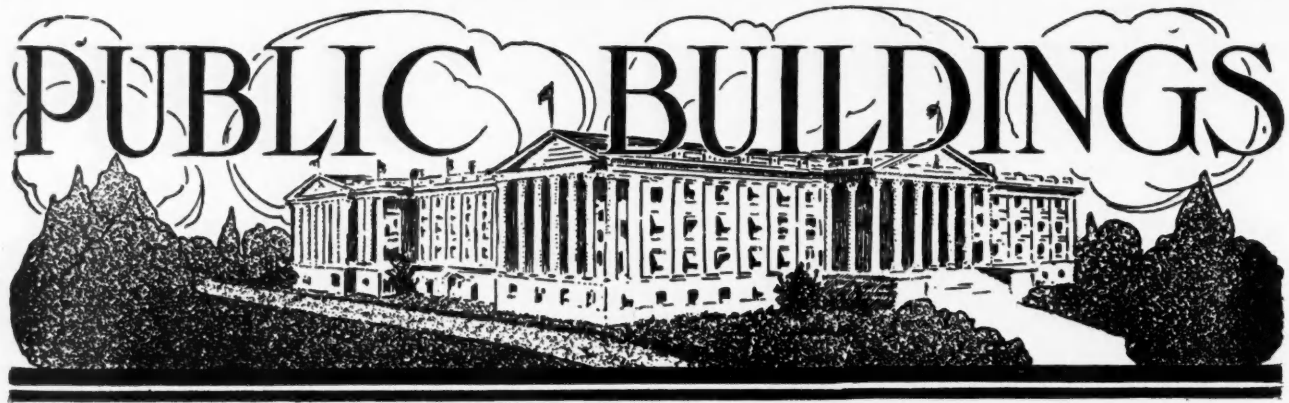

FIG. 1.



Model High School Building

ARCHITECT'S PERSPECTIVE AND FLOOR PLANS FOR NEW WEST HAMMOND, ILLINOIS, HIGH-SCHOOL;
BIDS FOR CONSTRUCTION OF WHICH ARE TO BE RECEIVED ON OR BEFORE FEBRUARY,
FOURTEENTH, NINETEEN HUNDRED AND TWELVE

THE well known schoolhouse architect, G. W. Ashby, of Chicago, has been called upon by the Board of Education, School District No. 155, Cook County, Illinois, of which John J. Brehm is President, and Fred Siegrist, Secretary, to prepare plans for a two-story brick school building to provide for all present-day high school requirements.

The finished design, as prepared by Mr. Ashby, is illustrated herewith. The exterior of the building is all that could be desired in the way of dignity and beauty. A glance at the floor plan diagrams will show how well the architect has taken into consideration the special needs of the modern public school.

The main entrance in front leads into a wide vestibule and hall, from which five large, well lighted class rooms open. Each of these class rooms on the main floor is provided with a cloak room of ample size, all very well ventilated and lighted.

On the second floor there is a large assembly room to the left extending the full width of the building from front to back. This assembly room is provided with a platform or stage and necessary anterooms, so that student theatricals or other entertainments can be satisfactorily presented. A set of rolling partitions about two-thirds of the way back in the assembly room divide this room into two nice class rooms when occasion requires. Each room then has its own separate entrance from the main hall.

To the right upon the second floor the space is given over to the physical and chemical laboratories, including the supply rooms. This part of the building is one of the special high school requirements which is seldom handled in the very best way except by an architect who thoroughly understands schoolhouse planning. The library, principal's office and four class rooms are also provided on this floor.



New High School Building for West Hammond, Ill. Designed by G. W. Ashby of Chicago

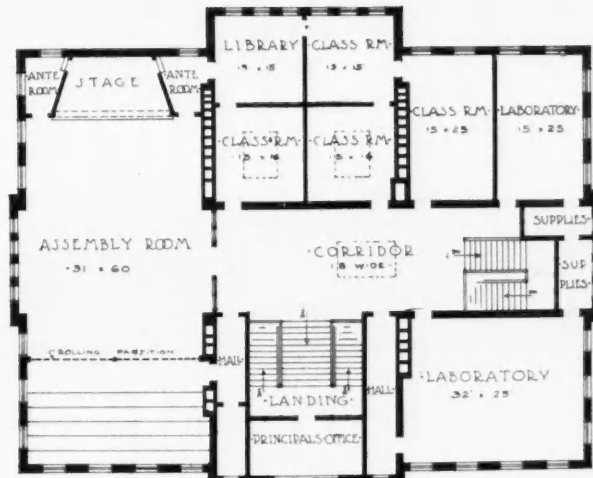

Second Floor Plan

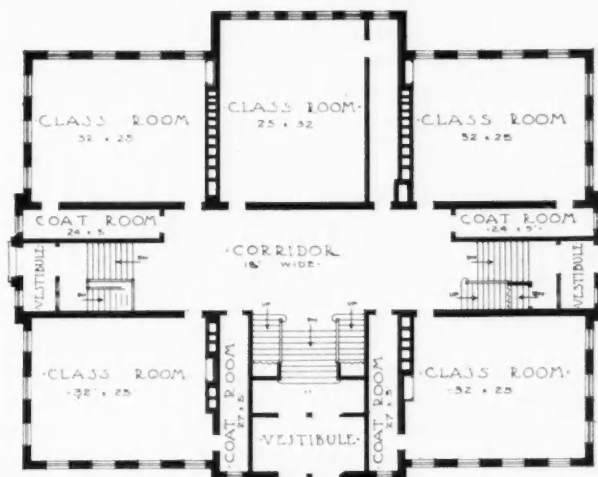

Main Floor Plan

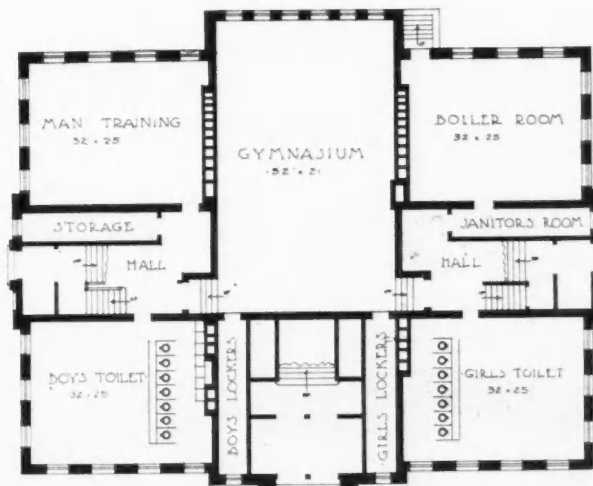

Basement Plan

In the basement we find a large gymnasium, manual training room, toilet and locker rooms, also the heating plant. The basement is entered by way of the two side doors, one at either end of the building.

Sealed proposals for the erection of this schoolhouse have been advertised for and are to be in the hands of the secretary on or before 8:30 p. m., February 14th, 1912, at West Hammond School.

Practical Uses of the Steel Square

(Continued from Page 46)

oned as so many inches to the foot run, are without fractions in the degree, save for the 12 inch rise, or one-half pitch; the corresponding degree pitch is 45. On the other hand when the pitch is reckoned as so many degrees to the foot run, it will result in fractions where the degree line intersects the blade, save for the half pitch, as mentioned above. The degrees pass off the blade when 12 on the tongue is used as a center, at 63 degrees and 26 minutes. The degrees as shown in connection with square No. 1 are for the purpose of showing the degree of the miter for angle of building, or in other words angle of the plan.

All of the regular polygonal angles fall below 45 degrees, except for the triangle, which is at 60 degrees. The degree angle for any of the regular polygonal angles may be readily found by dividing 180 by the number of sides contained in the polygon and the quotient will be the degree angle on the square to lay off the miter, or lay off the plan, as shown in the diagram. Thus the angle for a four sides building would be found as follows:

$180 \div 4 = 45$; for a five sides building, the angle would be 36; for a six sided, it would be 30, etc.

But the beauty of this formula is that it applies to any angle, regular or irregular. To successfully frame the rafters to cover any angled corner, the carpenter must know the dimensions of the plan before he can begin the work and knowing the plan, he can lay it out to a scale, say one inch to the foot and proceed as here described.

Before we quit, we want to show one more illustration in connection with this diagram. Not that we think we have failed to make the subject clear, but because the subject is such a good one we cannot resist the temptation to show up the kindergarten part of it—well, we don't care if you do holler "Oh! you old kid." But here is a diagram covering the same problem as shown in Fig. 1. It represents the lay out of the rafters. If this figure was trimmed to the outer lines and then folded on the run lines and the outer edge of the plate so that all the points, as a, a, a, would come together in such a way that all of the printed matter would show on the outside, we would have a complete model of that part of the roof, or one-half of the rafters for one corner of a square building; and eight of these models put together would show a complete miniature roof.

Last month we talked about the discarded tell-tale blocks and what may be determined from them. In this illustration, we have such a block. Suppose we cut a jack rafter with a 15 inch rise to fit against a hip and then say we cut off the point on a line at right angles from the plumb cut and we would have identically the same shaped block, as shown in Fig. 2, and from this block alone all the cuts as illustrated in Fig. 1 can be obtained by manipulation of same by placing it on the timber and marking along its various edges.

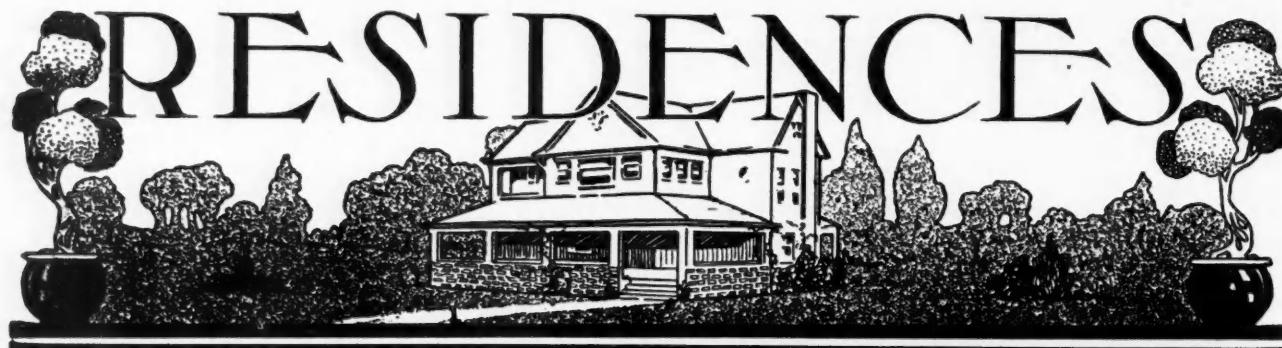

Complete Plans for Modern Cement Plaster House

ARCHITECT'S DRAWINGS REPRODUCED TO SCALE SHOWING ARRANGEMENT AND CONSTRUCTION OF THE ATTRACTIVE EIGHT-ROOM CEMENT PLASTER HOUSE ILLUSTRATED

WE present this month, on this and the seven pages following, rendered perspective and complete set of working drawings for a model residence. The building is of the square hip-roof style that is now so much in demand. The total width of the building is 31 feet; the depth, exclusive of front porch, 45 feet.

This dwelling is planned on the most up-to-date lines to meet all modern requirements. The first floor has a large living room and dining room opening together, giving a very spacious effect. At the rear there is a broad porch opening from both the dining room and kitchen. The kitchen end of the house is

well arranged for convenience and there is plenty of pantry and cupboard space.

On the second floor are three large, well-lighted bedrooms and a sewing room. There is also a sleeping porch, eight feet in width, extending the full width of the house at the rear. Double, glazed doors open onto this sleeping porch from each of the two back bedrooms. An exceptional amount of closet space is provided.

This fine residence is estimated to cost \$5,000 if constructed of high grade materials throughout and fully equipped with basement heating plant, plumbing, electric lighting, etc.

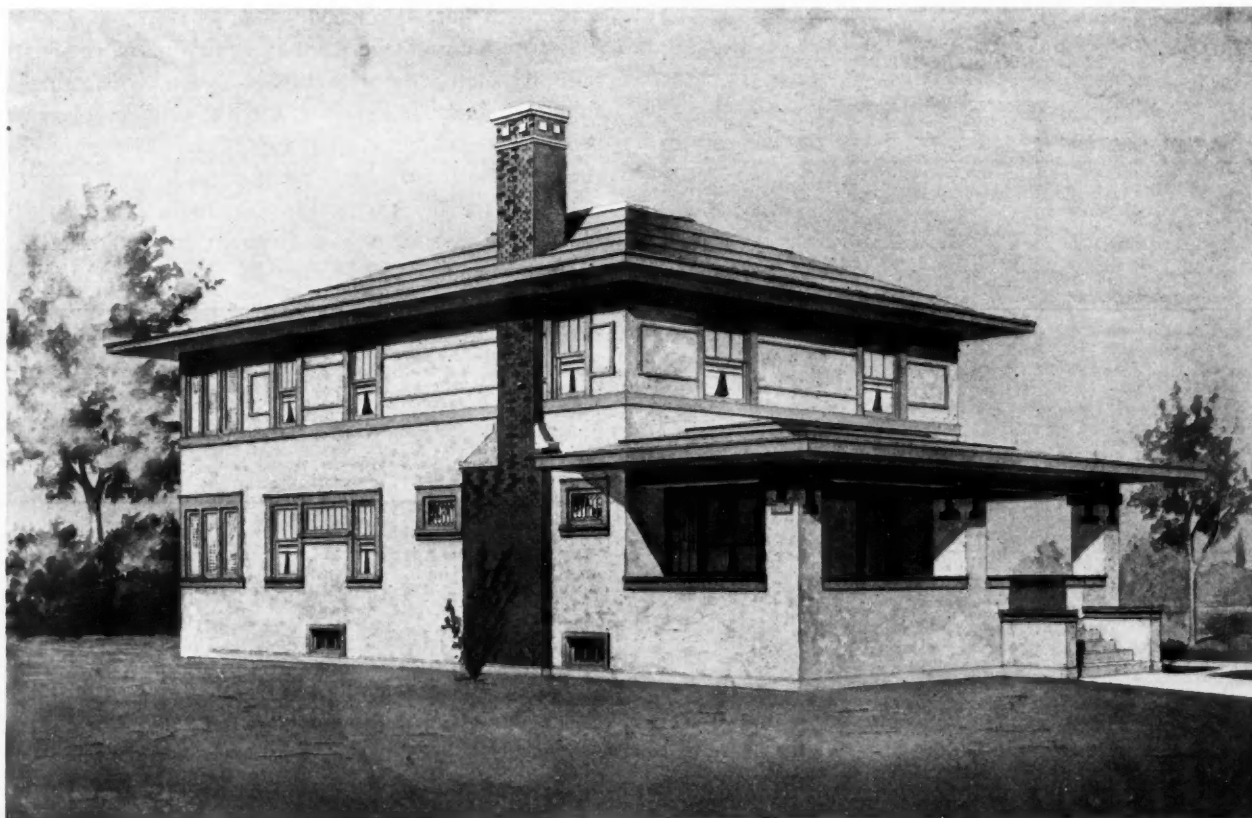

Cement Plaster House of Strictly Modern Design and Arrangement. Planned for J. M. Borrowdale, Chicago
COMPLETE WORKING DRAWINGS FOR THIS HOUSE ARE PRESENTED ON THE 6 PAGES FOLLOWING

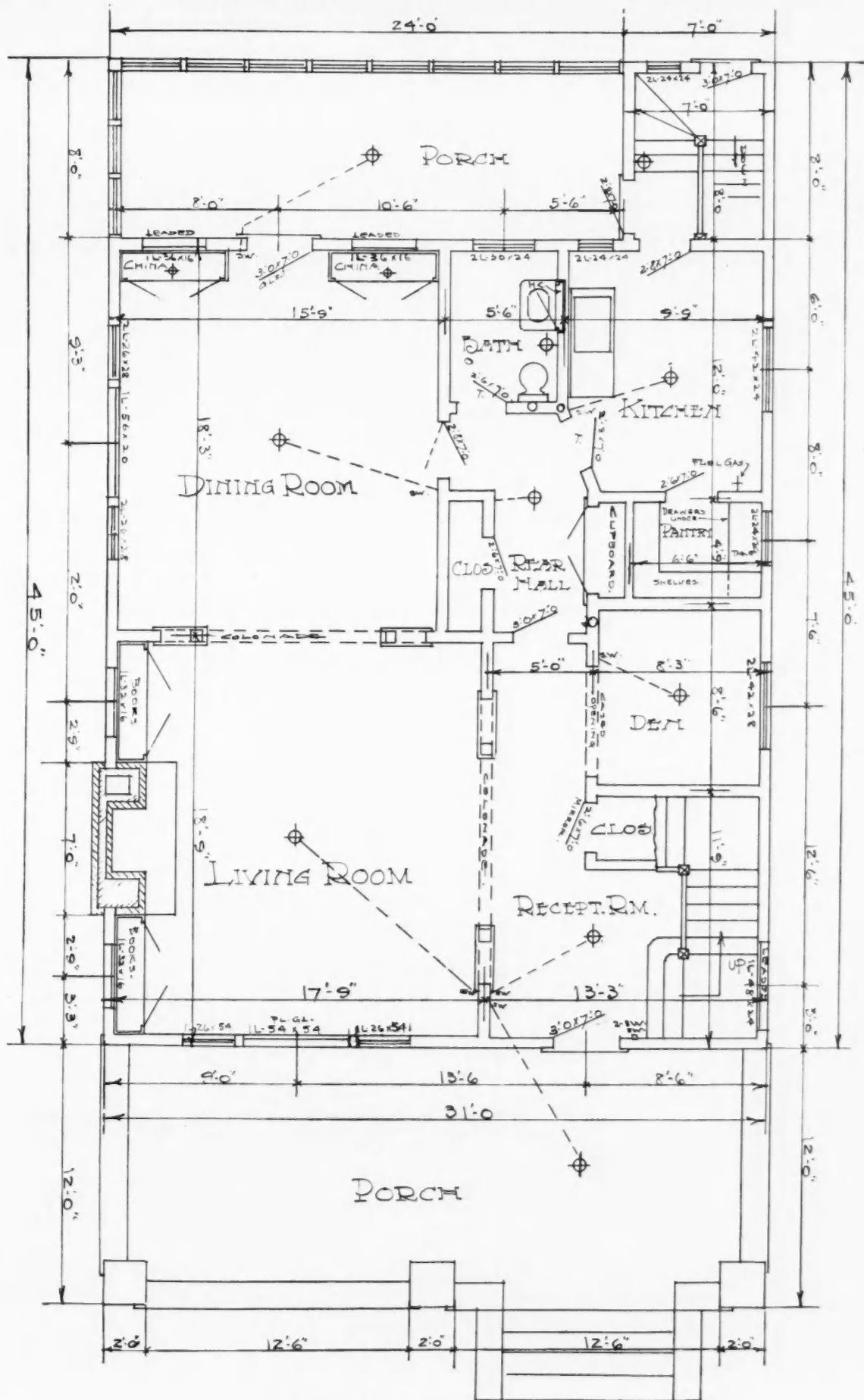

FIRST FLOOR PLAN
(House Shown on Page 50)

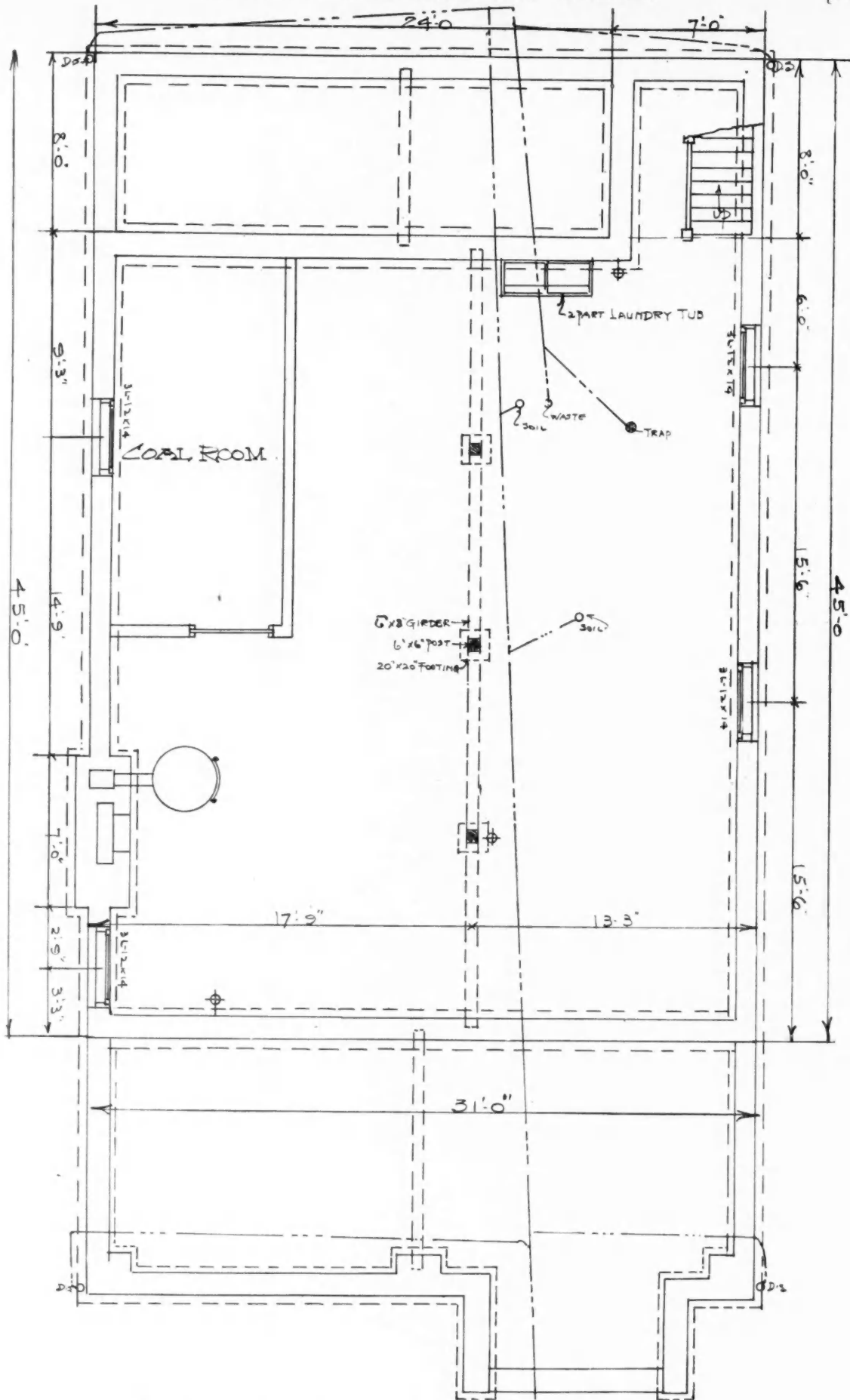

BASEMENT AND FOUNDATION PLAN
(House Shown on Page 50)

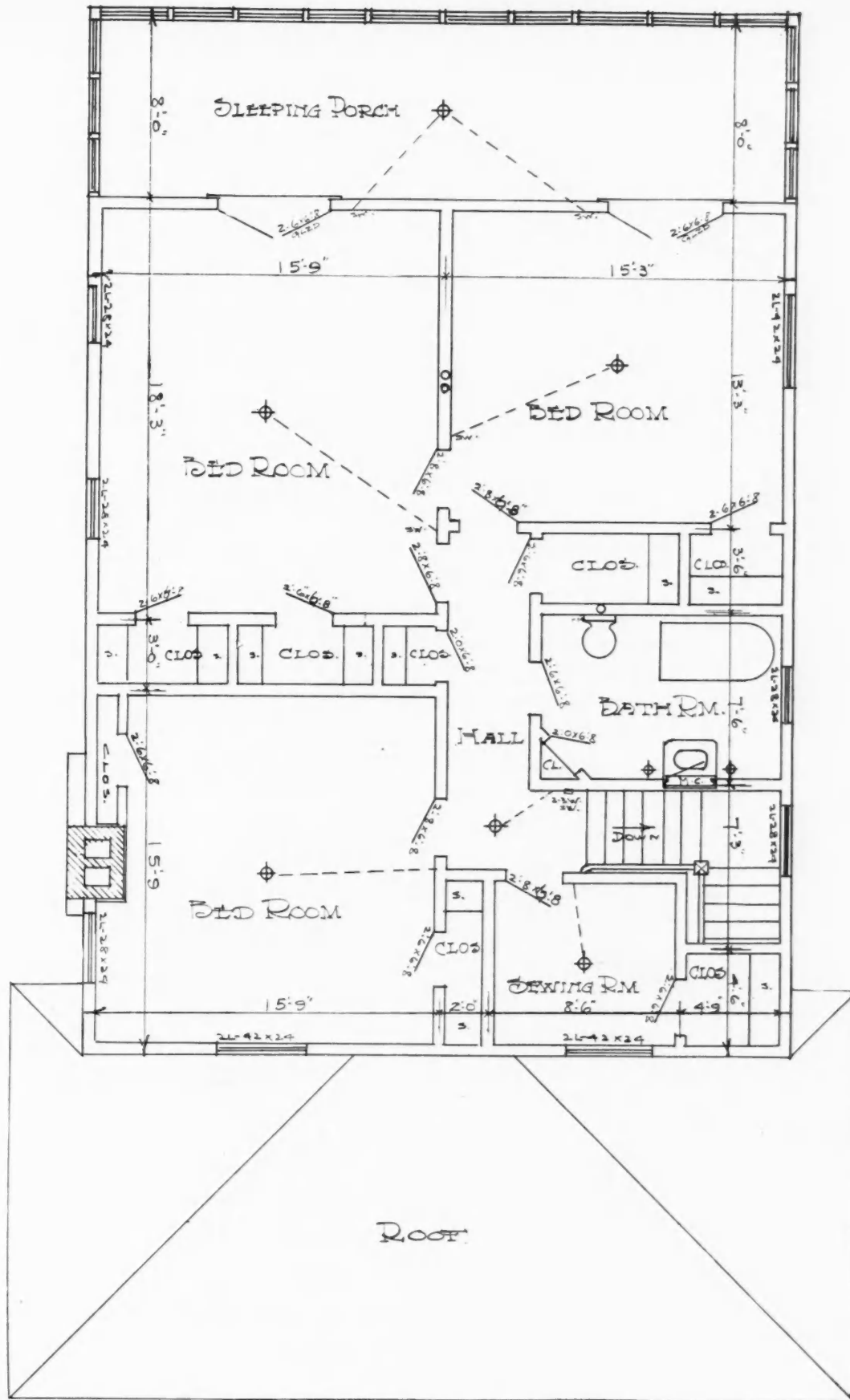

SECOND FLOOR PLAN

(House shown on Page 50)

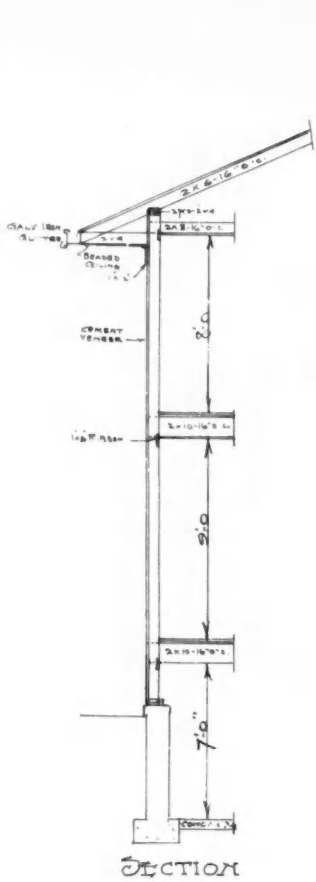

FRONT ELEVATION



SIDE ELEVATION

RIGHT SIDE ELEVATION

(House Shown on Page 50)

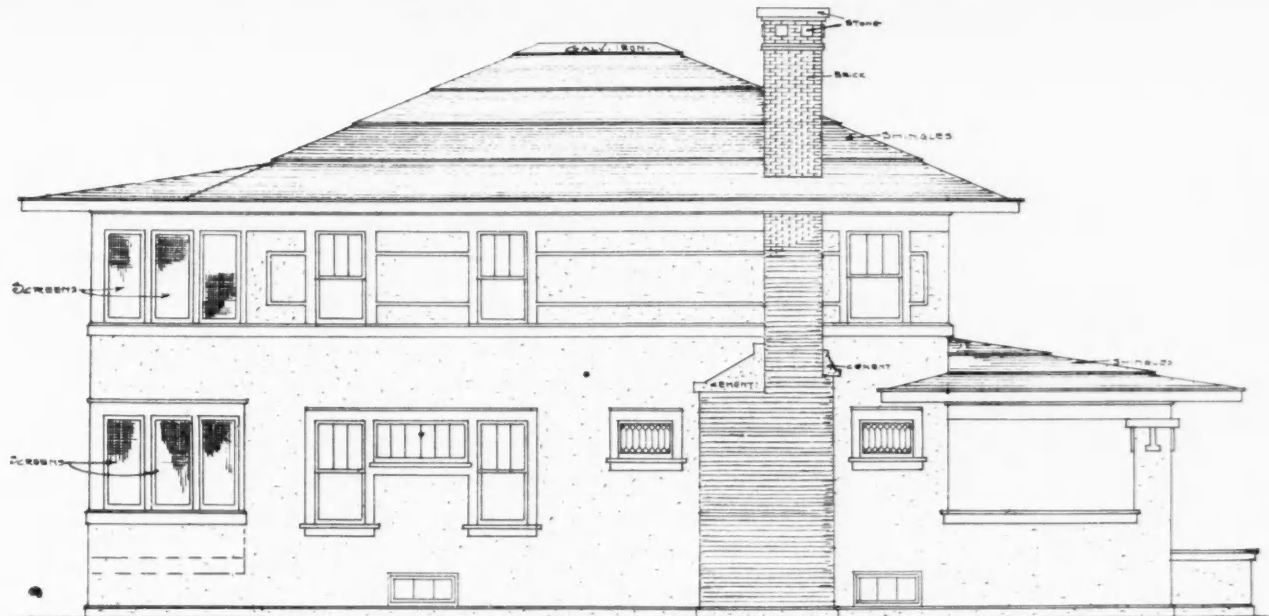

LEFT SIDE ELEVATION

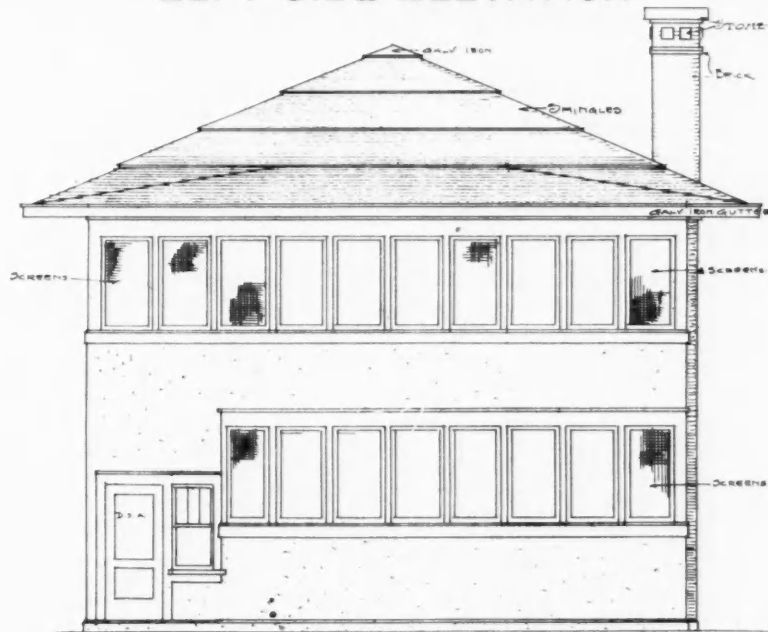

REAR ELEVATION

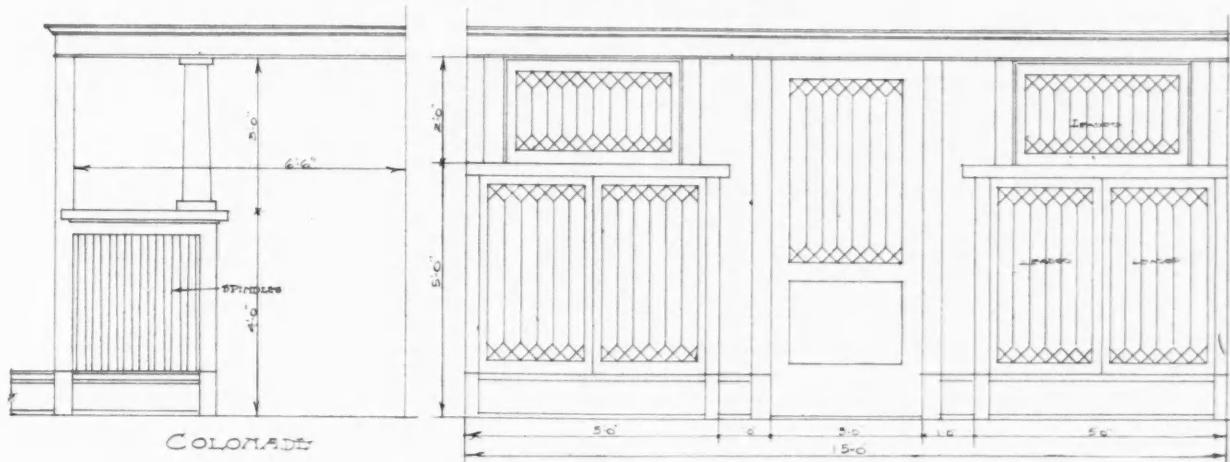

ELEVATION OF REAR WALL OF DINING ROOM
DETAILS OF INTERIOR FINISH

(House shown on Page 50)

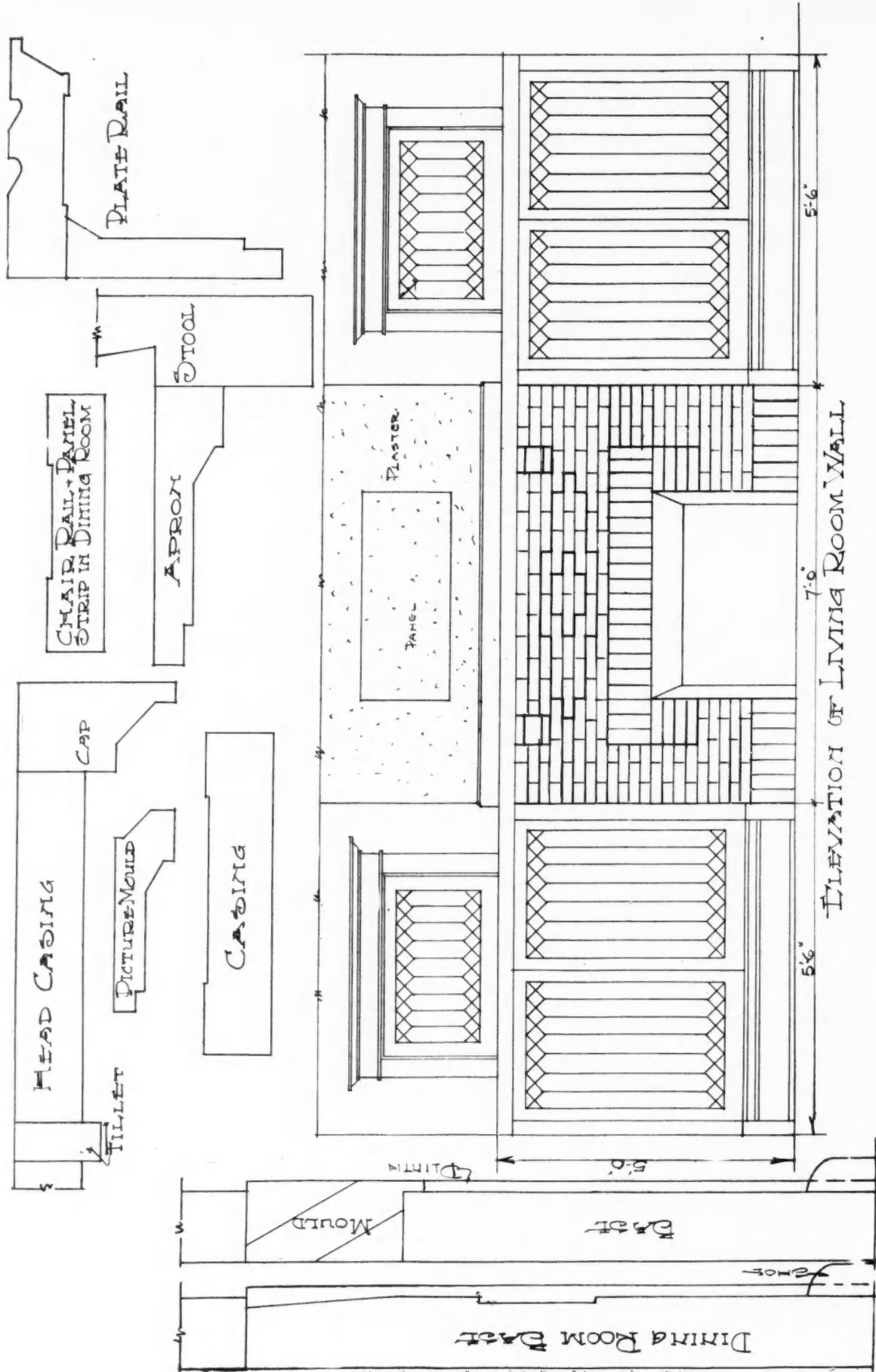

DETAILS OF INTERIOR TRIM
 (House Shown on Page 50)



Essentials to Satisfaction in House Painting

THE PRACTICAL BUILDER'S PAINT PROBLEM—WHAT COLORS TO USE DEPENDING ON STYLE AND SIZE OF BUILDING—CONDITIONS GOVERNING PAINTING SUCCESS

By Edwin L. Shuey

EVERY home owner desires an attractive house, one that will wear well, will have a charm at the beginning and will not lose it with years of use—a house that will please his neighbors as well as himself, and that will add to the beauty and attractiveness of the community in which he lives. He wants this beauty along with protection to his house from the ravages of decay, for men are beginning to understand that protection against weather is more important than against fire.

The practical builder's problems therefore, as far as paint is concerned, are two—to secure beauty and assure protection, and he wants both to last as long as possible. The good taste and judgment which are necessary in securing beautiful effects are the result of education and experience, not of large expense. Quality of product is essential to proper protection as well as to attractiveness of color.

In securing an attractive home much more is needed than a house plan, however good that may be. The trouble with most homes is that there is a lack of harmony in the grounds, the house and its coloring and the interior. Even good architects may fail to understand how to accomplish this harmony. It is not money alone that makes a beautiful house. A small cottage may be as attractive as a mansion and far more homelike. The wise builder, therefore, studies the many practical booklets made by manufacturers of house products, as well as magazines intended to teach the principles of harmony in building.

To make the house appear as if it really belonged upon the ground where it is built is not so easy as it seems, yet this is the first essential to good building. Appropriateness of design to the location is often forgotten in planning a home. Artistic effect is possible without added cost, the necessary elements being taste and judgment.

None the less must care be taken in painting the house, for often colors are chosen without regard to their fitness or their adaptation to the style of architecture. Colors that appear well on one house may be disappointing on another. One house may look well with contrast of body and trim, while the next should

be of one color or have but slight differences in the color used.

A few things must be remembered by the contracting builder in planning the painting which is to do so much to make his work satisfactory to the owner: Simplicity in painting is the evidence of good taste and the assurance of beauty. Strong colors, particularly in contrasts, should be avoided. When a light and a dark color are brought together, the light color appears lighter and the dark darker than it really is. When red and green, for example, are placed side by side, the red seems much redder and the green much greener than is actually the case. This explains the disappointment that often occurs to builders and owners when seemingly appropriate colors have been used.

Buildings in the country or on large village lots with an abundance of shrubbery, generally look best in a light color than a dark. Among the most satisfactory of these colors are cream, colonial yellow, sandstone and ivory. Gray and drabs are associated in the mind with slate and stone, and therefore give to any structure painted with them a solid appearance. Warm gray, pale gray and freestone among the lighter tones and silver gray or French gray among the darker are almost sure to give good results. Browns in various tones are particularly good for city buildings.

It should be remembered also that a trimming color darker than the body makes the house look smaller and that one lighter makes it look larger. A plainly built house usually appears best when painted with one color, depending upon the painting of the roof, the sash and the doors to break the monotony of the single color. The main thing to be avoided is patchiness.

Painting, from an industrial standpoint, may be considered as a process of weather-proofing or water-proofing; but to secure a covering that will give satisfaction against the weather through a term of years is not a simple protection. The builder needs a paint that will withstand the expansion and contraction of the surface, caused by climatic changes, without crack-

ing or wrinkling, presenting a smooth, hard outer surface that will wash clean by rainfall and that will fail by gradual wear and not by disintegration, leaving the surface in good condition for repainting when in the course of years that may become necessary. This may seem to the average paint user an easy task until he takes into consideration the extreme thinness of a coat of paint (or even three coats—the number generally used in good painting work), the immense range of temperature from 100 or more degrees above zero in midsummer to 20 or more degrees below in midwinter, and the large quantities of poor material which paint is called upon to cover.

To secure the right paint not only is it necessary to consider the materials to be used, but the method of making. The best paint makers and paint users through long experience have learned that in addition to the high quality of their materials, thoroughness of mixing and fineness of grinding which can be accomplished only with highly specialized machinery,



A popular suburban house, which looks best in light first story and dark shingled second story.

are the important elements in a paint that is to cover well and protect thoroughly. It follows that with equal quality of materials, that paint which is made most carefully with the best machinery will give best results.

It is this important feature that gives to the prepared paint of reputable manufacturers the great advantage in durability, which modern tests of skilled painters have proved that they enjoy, for the manufacturer can give to his product a quality that cannot be obtained in any other way. In this case, as in all building, the reputation of the maker is an important factor, and just as the builder buys his lumber or his hardware from men with a good reputation, so he should realize that there are good paints and poor paints for the finishing, and should be satisfied only with those of the best makers. Naturally their products will cost more per gallon, but the finished work and the years of wear are the real criterion of paint cost.

The builder should never lose sight of the fact that a combination of conditions must be considered when he looks for results in painting, for these results depend—

1. Upon the kind and conditions of the surface to which the paint is applied.
2. Upon the location of the structure to which it is applied.
3. Upon the quality of the paint, especially the character of the primer.
4. Upon weather conditions when the paint is applied.
5. Upon the workmanship of the painter.
6. Upon the number of coats applied.
7. Upon the time allowed to elapse between coats.

How fully faith in men is essential will be realized when these factors are studied; and good results are gained only through constant vigilance. Indifference as to material to be covered; dampness or unfavorable weather when the work is done; careless workmanship and too great haste in applying the paint; one or two coats when three should be used; the use of cheap paint or orchres and similar products for primer—any one of these may destroy the work and cause decay and dissatisfaction. Often a dollar or two saved in the cost of the paint means large loss to the owner, years of difficulty in correcting the error, and consequent discounting of the work of the builder.

The conscientious builder, therefore, will give special attention to the foundation, or filler, or priming coat as the most important, for upon it all succeeding coverings must stand. It is to be regarded as preservative, not as protective, as are the upper coats. Under no circumstances should the priming coat be slighted because it is hidden. The paint for it is frequently made of the cheapest materials, whereas if the best materials were used for priming coats and the cheaper for finishing coats (if cheaper must be used) in the end money would be saved. As a rule it is best to use the same paint for all coats, only changing for each coat the character and quantity of the thinners as conditions may indicate. In this connection one caution is important to the contractor. Do not permit the owner to hurry the painting. The priming coat may be put on before the plaster is done, but the second and third coats should never be put on until the plaster is perfectly dry. One of the most common causes of paint failure is putting on the finishing coats too soon.

Two good coats at least, well brushed out, should be put over the priming coat for all new work. The three coats will give no more protection than is needed, for they will not be over 1/150 of an inch in thickness, but three coats drying together and forming one solid substance impervious to air and moisture, make a tough layer that will preserve and protect for a good number of years.

The numerous details required to secure satisfactory results in painting are important, and every builder should study them carefully in order that he may know why good paint sometimes fails and what steps are needed to avoid failure.

All these things enter so fully into the satisfaction of the house owner and his neighbors, that no builder can afford to forget them, for the owner's satisfaction is the essential element to the prosperity and success of the contractor and builder.

Dayton, Ohio, Jan. 19, 1912.

Combined Colonnade and China Closet

COMPLETE WORKING DRAWINGS TO SCALE FOR THIS NOVEL AND ATTRACTIVE FEATURE—SUITABLE FOR BUNGALOWS

By Charles P. Rawson

A REQUEST has come for complete working details of a colonnade between a living room and dining room containing china closets opening in the latter. Such a design is wanted as might be used in a five or six room bungalow. While this arrangement is somewhat out of the ordinary we present herewith such a scheme.

The idea is subject to considerable development and can be used with a few changes in other locations. It could also be used in the same location with the cases opening into the living room, and used for books. This would necessitate changing only the glass panel in the end of the cases to a wooden panel, the substitution of wood for glass shelves, and the omission of the electric lights in the top of the cases.

It will be noticed that in order to give some decorative features to the rooms, the top of the cases has been extended around the dining room in the form of

a plate rail with strips forming panels below the same. This room also has cornice and a picture moulding.

In the living room the head casing of the opening is made a continuous feature about the room; and, of course, it would be necessary to have all other doors and windows in this room lined up at the top in order that the continuous trim be used.

The wood used for the exterior trim in both of these rooms should in all cases be the same and should be finished in the same manner by the painter.

We show herewith elevations of the colonnade illustrating both sides, two sections and two plans all drawn to the scale of three-quarters of an inch equals one foot. We also show complete details of all portions of the construction drawn to the scale of six inches equals one foot. The colonnade is designed in the style which is appropriate to the usual bungalow and should make an attractive feature.

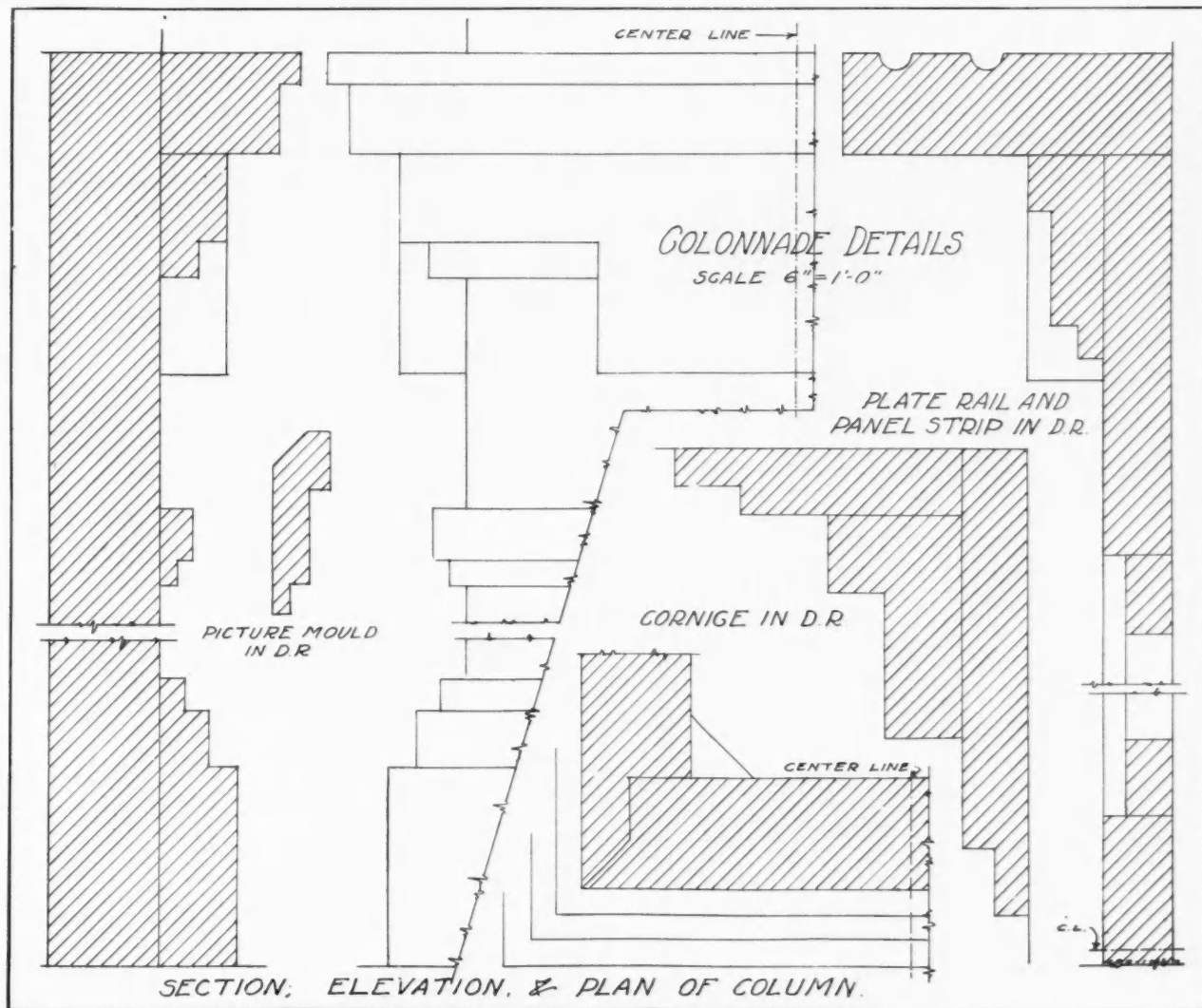

FULL PAGE PLATES SHOWING COMPLETE DETAILS ARE PRESENTED ON THE TWO PAGES FOLLOWING

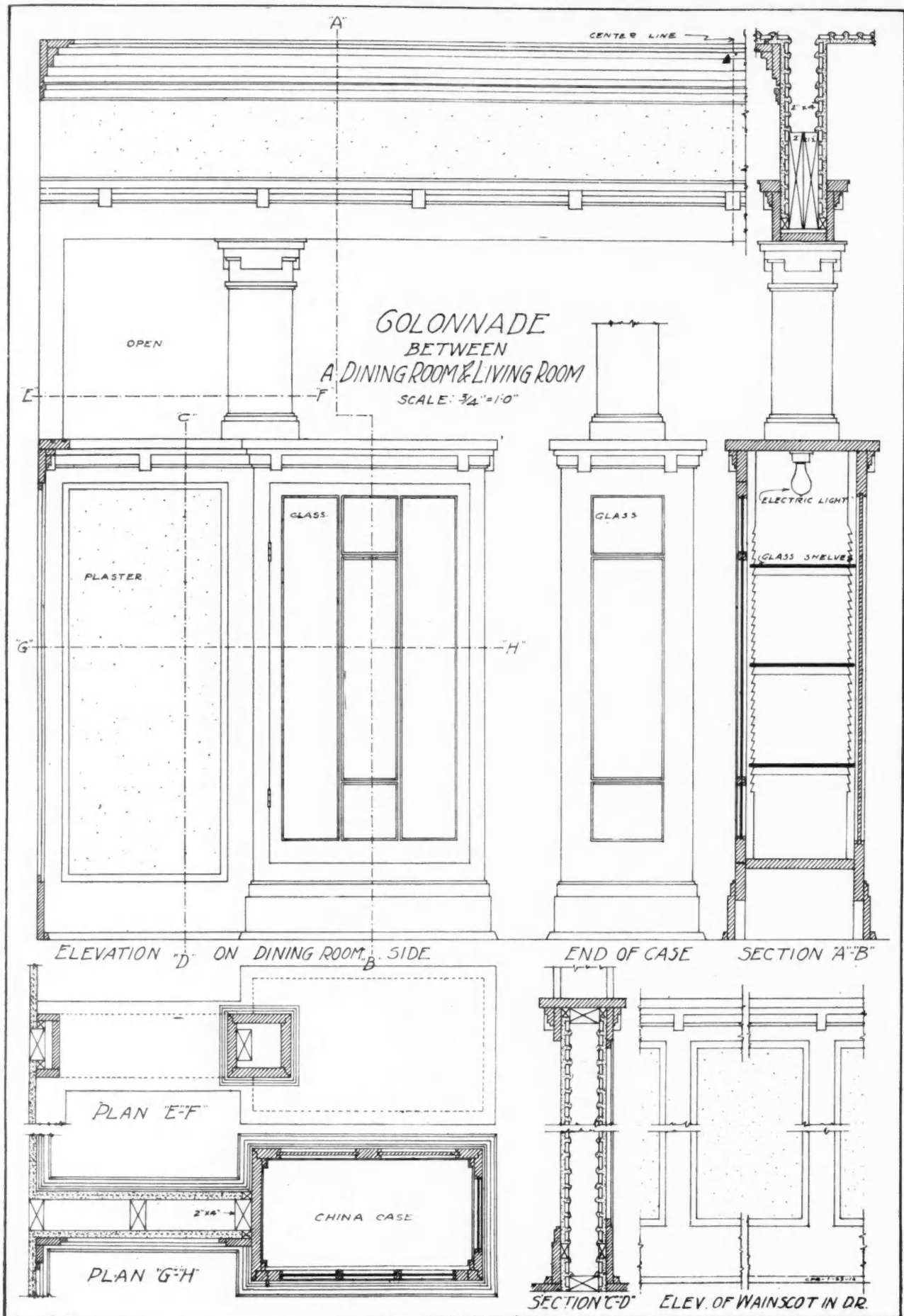

COMBINED COLONNADE AND CHINA CLOSET

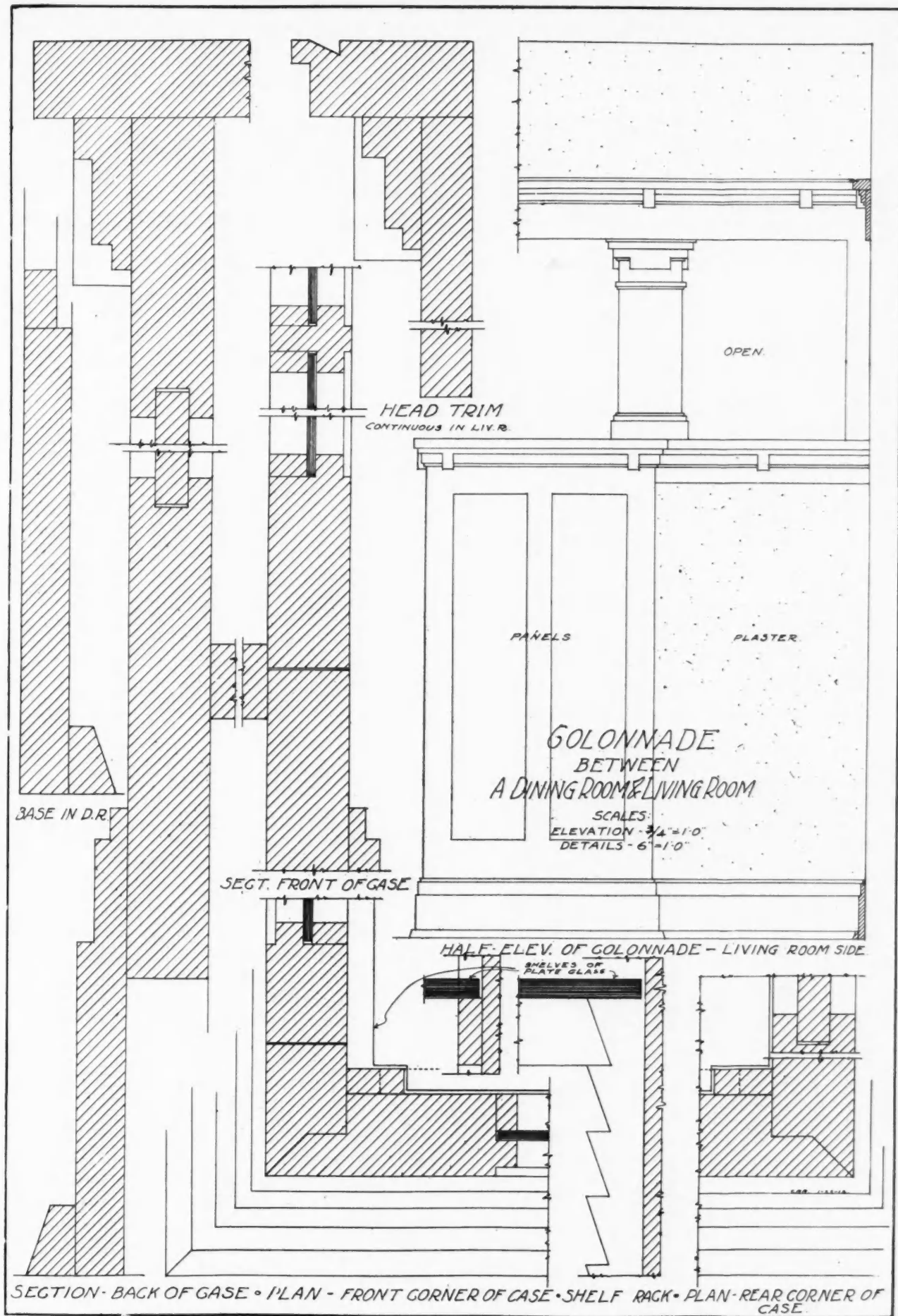

COMBINED COLONNADE AND CHINA CLOSET

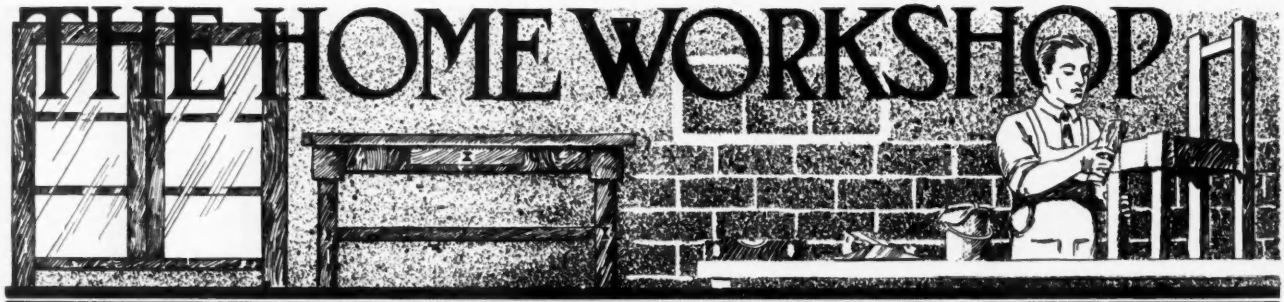

Two Interesting Pieces of Work

HOW TO MAKE AN ELECTRIC CHANDELIER—HOW TO MAKE A SETTLE OR DAVENPORT—COMPLETE WORKING DRAWINGS AND DIRECTIONS FOR MAKING THE "PROJECTS" ILLUSTRATED

By Ira S. Griffith

THE first piece offered this month, the Electric Chandelier, is one in which the woodwork is exceedingly easy. There will be required five blocks squared up in the usual manner with chamfered edges and a cross piece for supporting the globes and shades.

In the picture shown the metal work was all of it made by the craftsman himself. If the worker does not care to work out the metal parts, he may without difficulty purchase suitable fixtures, chains, etc., and apply these to his woodwork.

There will be needed pieces as follows:

1 piece, $\frac{7}{8}$ by $4\frac{1}{4}$ by $4\frac{1}{2}$ inches, S-2-S.

4 pieces, $\frac{7}{8}$ by $6\frac{1}{4}$ by $6\frac{1}{2}$ inches, S-2-S.

2 pieces, $1\frac{3}{4}$ by 4 by $26\frac{1}{2}$ inches, S-2-S.

Oak will look well. Select a wood that will harmonize with the other furnishings of the room. No great

dimensions are indicated in the accompanying drawing. It will be necessary to bore holes, thru which to put the screws used to fasten the blocks to the ceiling. The center block will need a hole, thru which to drop the electric wire.

Now square up the sides of the cross arms. Lay out the slopes at their ends, and work them. Lay

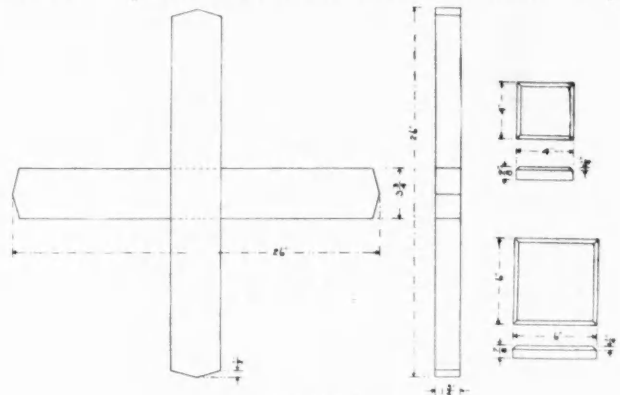

out and cut the cross lay joint at the centers. This may be fastened with glue or simply with screws from the top side. On the top side of the arms should be made grooves in which the wires may be run, or holes from each end of the cross arms. After the vertical holes are bored these holes on the ends of the pieces may be plugged in such a manner as not to show where the boring took place.

For a finish, apply a stain of a color suited to the rest of the room, after having scraped and sandpapered all parts clean. On this stain, after it has dried over night, apply a filler—if the wood is coarse grained, rubbing it into the pores and then off of the high-lights in the usual manner. Allow the filler to harden over night, sand it lightly with number 00 paper then apply a very thin coat of shellac. Sand the shellac lightly and apply several coats of some good dull drying varnish. The dull drying varnish is rather a new production and is guaranteed to give a dull gloss without the tiresome hand rubbing usually required.

How to Make a Settle or Davenport

The large settee or davenport will best be made of

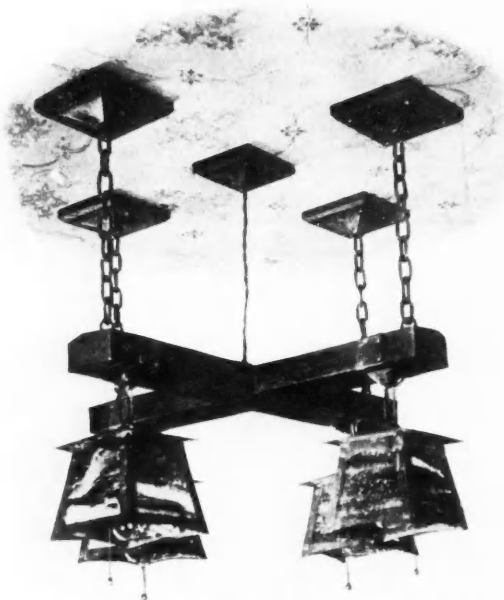

Out-of-the-Ordinary Electric Lighting Fixture

strength is required and there will be little opportunity for the parts to become marred thru usage so that a soft wood will serve the purpose just as well as a hard one, if a soft grained wood is needed to fit in with other woodwork.

Square up the ceiling blocks first. The proper

some hard wood. The following stock is needed:

STOCK BILL FOR DAVENPORT.

- 4 posts, 3/4 by 3/4 by 36 1/2 inches, S-4-S.
- Rails, 2 pieces, 7/8 by 7 1/4 by 76 inches, S-2-S.
- Back rail, 1 piece, 7/8 by 11 by 76 inches, S-2-S.
- End rails, 2 pieces, 7/8 by 5 1/4 by 29 inches, S-2-S.
- End rails, 2 pieces, 7/8 by 4 1/4 by 29 inches, S-2-S.
- Slats, 1 pieces, 3/8 by 3 1/4 by 24 inches, S-2-S.
- Cleats, 2 pieces, 7/8 by 3 1/4 by 72 1/2 inches, S-2-S.
- Seat slats, 18 pieces, 1/2 by 3 1/4 by 27 inches, S-2-S.

Begin by squaring the posts to length. Their widths and thicknesses are specified in the stock bill exact. The lower end should have the arrises slightly rounded or chamfered to prevent their splintering. The top ends have a rather long chamfer as shown in the drawing. After the posts have been worked to length, plane up the rails and slats to the desired widths.

Stand the posts upright in the positions they are to occupy relative to one another and mark roughly the locations of the intended mortises. Place them side by side on the bench, even the ends by means of the square and proceed to lay off the ends of the mortises by accurate measurement. Gauge the sides of the mortises. Remember to keep the gauge head against the face side and face edge. The work should be so planned that the faces shall be turned in; face sides are more likely to be true than other surfaces and therefore more likely to make for good fitting joints.

Cut the mortises then lay off the tenons on the rails and saw them to size.

In making the mortises for the ends of the slats,

If the worker wishes to give the joints additional strength, he may bore and pin the tenons to the mortises.

After the glue has set on the end parts, the side rails may be fitted and then glued and clamped. Make sure that the frame is square before leaving it. Measure the two diagonals by means of two sticks. If necessary, adjust a clamp along a diagonal to bring that diagonal to a length equal to the other.

The seat may be made up in one of two ways: It may be made by placing webbing and spiral springs,

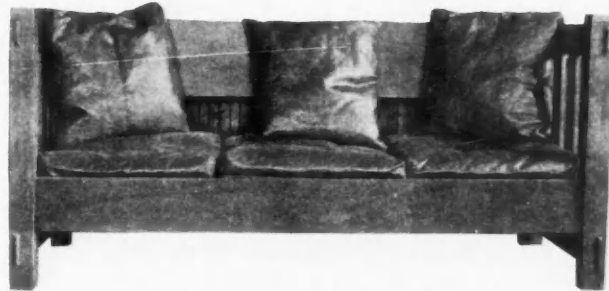

Big—Comfortable—Solid—Easily Made

with suitable covering; or it may be made by simply placing slats at frequent intervals. The heavy upholstered pillows will serve to make the seat comfortable, though not as comfortable, of course, as the pillows with the spring seat. These pillows may be purchased ready made or they may be made up by the amateur.

After the glue has hardened scrape all the parts thoroughly and sandpaper them. The manner of fin-

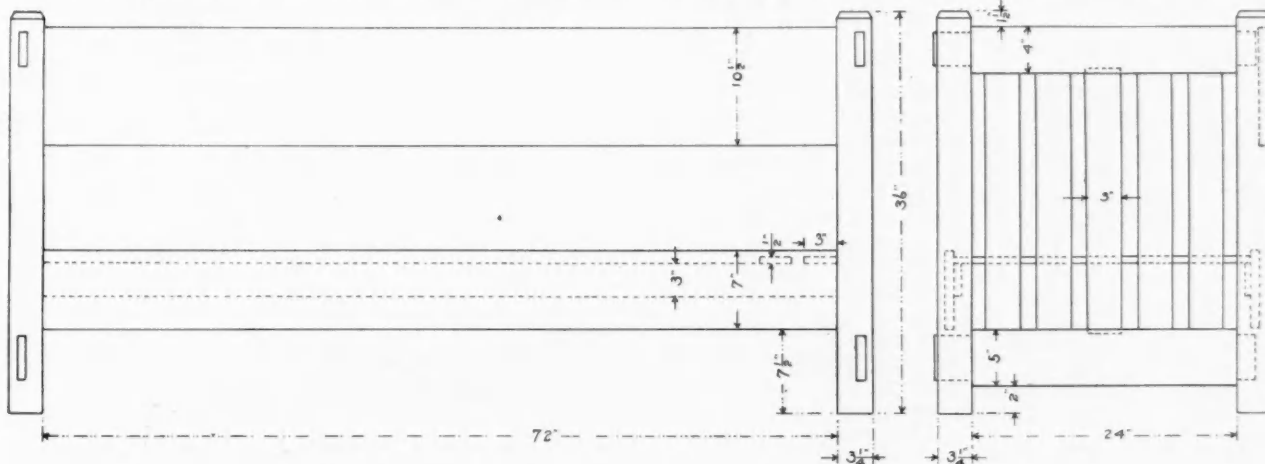

SETTLE OR DAVENPORT

the easiest way to secure good fitting joints is to make mortises that will allow the whole ends of the various slats to be inserted. Of course this means that the sides of the mortises must be accurately cut.

The ends of the davenport should be assembled first. To make sure that all will be well when the glue is applied, put the parts together dry. After this they may be separated and the glue applied with some assurance that the glue will set before the parts can be assembled and the champs be adjusted properly.

ishing may be quite similar to that described for the electric cluster light.

The two pieces shown were made by boys attending the high school, Urbana, Illinois.

From Cover to Cover

To the Editor: I think your paper fine. Whenever I receive it I generally read it all through from cover to cover before I quit.

Aguilar, Colo.
FRANK L. PERRY,
 Contractor and Builder.

The Knock-Down Boat Business

WHAT IT IS AND HOW IT MAKES SATISFACTORY BOAT BUILDING EASY FOR CARPENTERS—WORKING DRAWINGS SHOWING DESIGN AND CONSTRUCTION OF 27 FT. SPEED BOAT

THE knock-down boat business has reached that stage of development which places it among the standard industries of this country. It places in the hands of the amateur, handy with tools, the means of building his own boat, at his own home, successfully, whether it be a 12-ft. row boat or a 50-ft. cruiser. When he wants to build a boat he can write to some well-known company for catalogs, which enable him to select the size and style boat that suits his taste and requirements. He can buy the finished frame alone or the finished frame and all other material cut to shape to finish the hull and build the cabin.

The frame of an established boat company is the product of an experienced, up-to-date boat designer, which insures a perfect model. Every part of the frame is shaped from perfect templates, by experienced boat builders. The shaftlog is constructed and fastened to the keel, the rabbets cut and all beveling done. The keel with shaftlog bored and fastened to it, stem and stern timbers are then set up on blocks. The mould ribs which are carefully bent to conform to the mould templates are crosspawled and stayed so as to hold them to shape and are then set up on the keel and ribbands are tacked over the mould ribs. After this is done all other ribs are fastened to place and temporarily fastened to the ribbands. By looking over the frame at this stage of its construction, the least variation in the lines or construction will be quickly noticed and corrected. The floor timbers are then fastened to the ribs, holes bored through them for permanent fastenings and keelson is fitted. The frame has thus been entirely finished at the factory, just as it would be if the boat were there to be constructed throughout. The parts are inspected, marked and numbered before being taken down for shipment.

Upon receipt of the frame by the purchaser, it is only a matter of about three hours' time, depending upon the size of frame, to reassemble the frame and put in permanent fastenings. With each frame the makers furnish specifications, instructions, illustrations and a set of full-sized planking patterns. The instructions are written in an open clear manner so as to avoid ambiguity, and the subjects relating to construction are in the order that the different parts of the work are to be done. So complete in fact are the instructions that any one with any idea of a boat should be able to build from them, but the manufacturers do not stop there. They send a typewritten, detailed set of instructions which each boat, which

describes every piece of wood that is necessary for one to buy; every nail, bolt and screw is listed in the quantity required, and in case there is liable to be difficulty with any little detail not made clear in the General Instructions, it is fully described in the typewritten instructions.

So simple in fact has this work been made by the leading knock-down boat companies that not only have amateurs availed themselves of the advantages so offered, but many small boat builders throughout the country obtain their material and stock from these companies and build boats for sale by this means.

The business-like manner in which the various knock-down

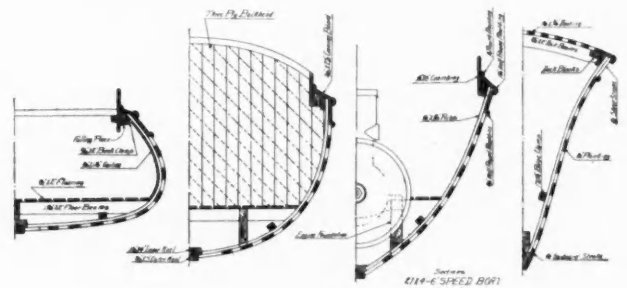

Half Cross Sections

boat manufacturers throughout the country are conducting this industry today is the best possible guarantee one can have of the quality of their goods. One who has never seen would be surprised if he were to visit one of those up-to-date plants in operation, where a large number of the boat frames are being built by experienced boat men with every possible facility that an up-to-date shop can afford the workmen, before the frames are taken down and packed for shipment to the various parts of the country.

The knock-down boat business has become a big factor in the motor boat industry. It has grown very rapidly because there is a great demand for satisfactory motor boats at a reasonable price.

Any one who has ever attempted the preliminary work necessary to creating or imitating a model by which a set of boat frames is to be gotten out, will appreciate the saving of

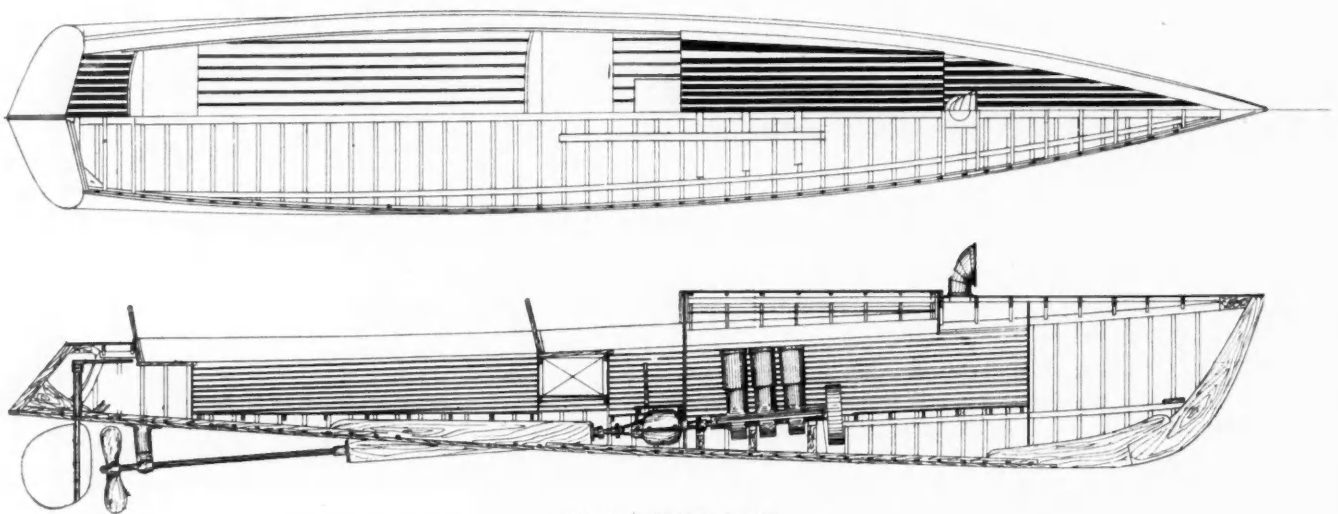

27' x 4' 6" SPEED BOAT
Plan View, Both Above and Below Flooring; Also Side View Showing Construction

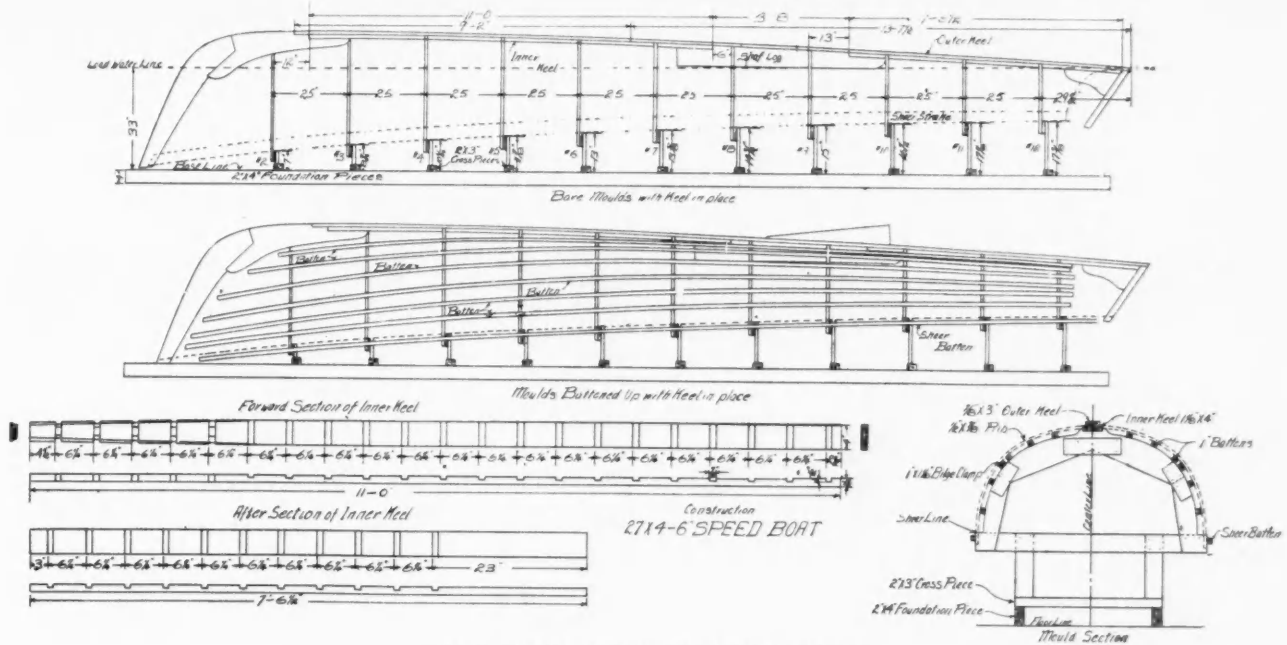

Some Details of Motor Boat Construction

time and labor it is to buy the finished boat frame—one that has been set up so as to insure perfect lines and construction.

Some of the largest boat companies when supplying the knock-down boat furnish the planking cut to exact shape, making the claim that it is unnecessary expense to furnish it further fitted, giving as a reason that the proper time to cut the bevels on the planking is when the boat is being planked, which work is a simple matter to do at that time, as each plank can be tried up to the frame. The same rule applies to other parts in the finishing of a boat, as the frame acts as a guide for the part to be fitted to it, and the instructions are so plain that unexperienced persons have no difficulty in doing the work in a first-class manner.

As to the quality of material furnished by such companies, it follows that first quality of material must be supplied to their customers for the reason that the parts are neither

painted nor otherwise covered. Therefore, defects cannot be hidden. All the material is in full view of the customer when taken from the crates, and any material not up to the standard would tend to bring all kinds of trouble to the manufacturer.

The freight rate on a completed boat is necessarily high. Perhaps so much so as to prevent many people from having the ready made product shipped to them, but the compact manner in which the knock-down frame and all other material is shipped reduces the expense of freight to a small item.

A part of the large size working drawings of a new 27-ft. speed boat of the Valley Boat and Engine Co., are reproduced. These will give some good ideas as to motor boat lines and method of framing; and will also show what trim, clean-cut work carpenters may expect to be able to turn out at boat building during dull seasons through the assistance of the knock-down boat experts.

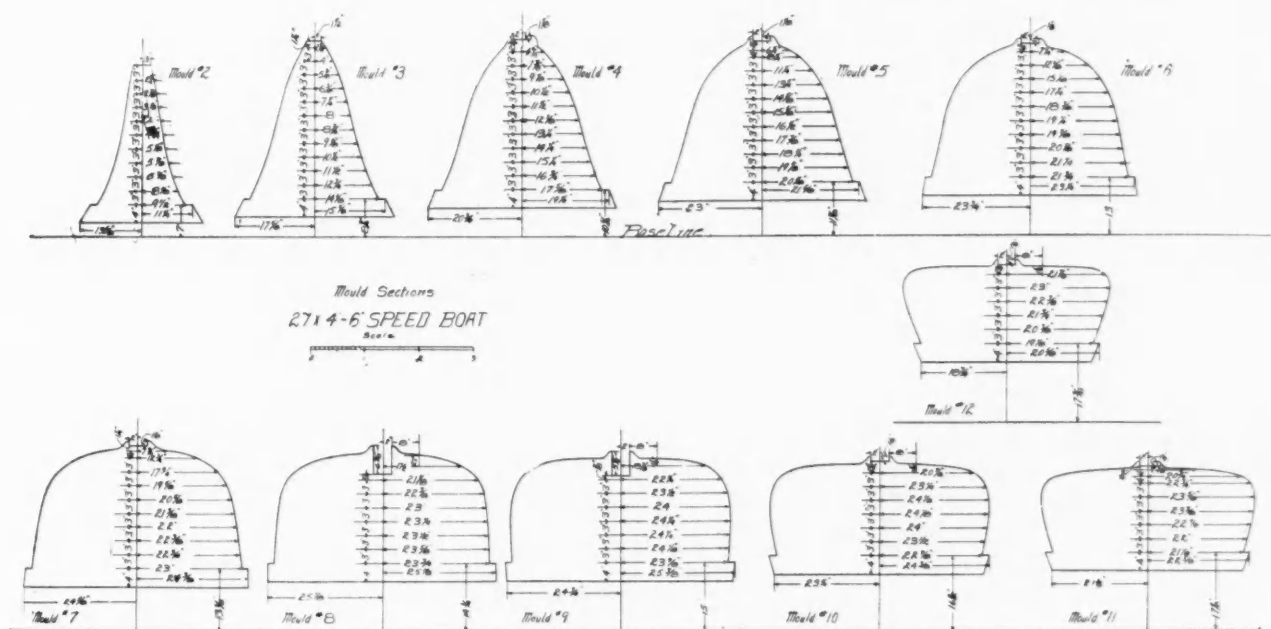



Our Readers are Requested and Urged to Make Free Use of These Columns for the Discussion of all Questions of Interest to Carpenters and Builders

"Carpenters," Speak Up!

To the Editor: Honolulu, Hawaii.
Will some of the readers of your publication inform us through the columns what incentive there is for a boy to learn the carpenter trade?

We know of none ourselves. Have never met any millionaires who have followed it, and if we see one in an automobile even, upon inquiry we are likely to be informed it is not his, but belongs to some man he names, who could not do a day's work at the carpenter trade to save his life.

Please let the respondents bear in mind we are not including contractors. We mean actual carpenters following the trade; what are the prospects for making an independent millionaire (?) of himself by hard work, skill thrown in, as a "workman"—an actual "carpenter"?

A Subscriber, C. H. CORNELL.

Substantial End Cleat

To the Editor: Milton, Oregon.
I have followed shop work for some time and have made a great deal of furniture. I have had more or less trouble in cleating the ends of boards but have at last solved the problem.

I first V out the end to be cleated and then make a wedge

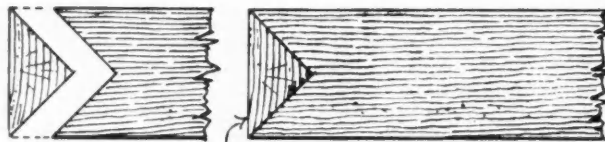

CLEAT SET IN PLACE.

Neat and Strong End Cleat for Boards

shaped piece to fit into the V and glue it on, same as for veneering, but will be much stronger and at the same time it is much easier for shop men to make. The V should extend clear out to the edge of the board, as shown in the sectional drawing, then when the cleat is put in, the joint can scarcely be noticed. In flat grain work, the face of the cleat should also show the flat grain side, as it improves the looks.

DAVID W. OLINGER.

Acid for Marking Tools

To the Editor: Bushnell, Ill.
Some time ago I saw in your paper to use nitric acid for cutting letters in steel, such as tools. I tried this by coating the tool just with wax, as directed, also using the best nitric acid that could be got, but it failed to do the work.

Now, I know there is an acid that will cut steel, and have seen it; but have never been able to learn what kind it was.

J. B. ROBERTSON.

Answer: Nitric acid is the proper one to use, and the reason it did not work well for you is probably because you used it too strong. If you will dilute it with water, you

will find that it will do the business all right.

When you see the little bubbles rising from the steel, you may know that the etching is taking place. EDITOR.

He Urges Good Proportion

To the Editor: Silvertown, Ohio.
I read with much interest what Mr. Woods said in the January number in answer to a question as to the proper way of framing porch soffits, and I hope that it has been read and will be put in practice by all, especially those who have heretofore constructed work in the careless, slipshod manner as described by Mr. Woods.

I have observed time and again porch work where the soffit did not center over, or in line with the neck of the column, being off all the way from $\frac{1}{2}$ to $1\frac{1}{2}$ inches; and in some cases even more, notwithstanding the fact that the work was erected under the supervision of men with years of

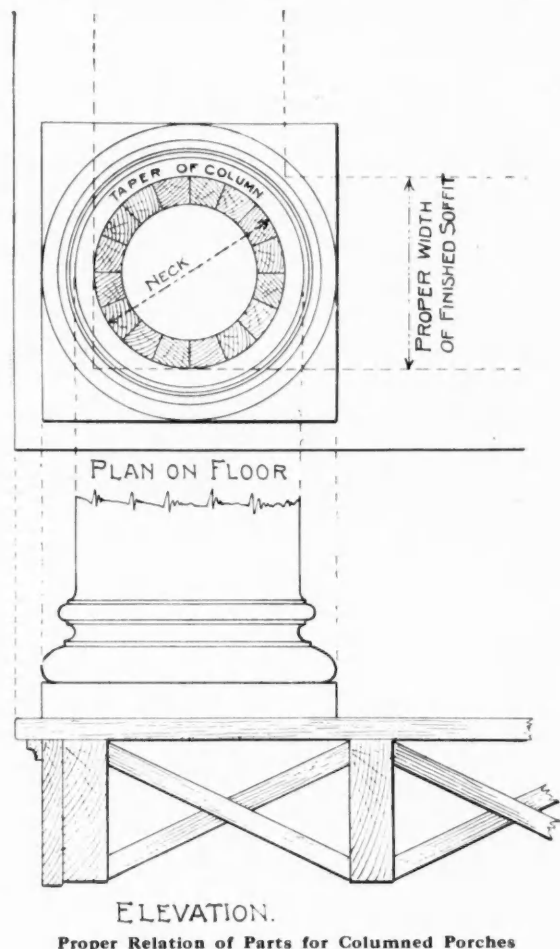

Proper Relation of Parts for Columned Porches

experience and rated as first class builders. It is true, the average person does not notice a deficiency of this kind, but nevertheless such work does not represent the work of a finished workman, or a careful foreman, but more that of a bungler.

Knowing the size of the column, at the neck and base, it is an easy matter to properly frame and erect the porch soffit and have it line up with the columns; and, as stated by Mr. Woods, the soffit should be same width as the neck of the column and to make it clearer, I might further add, make the face of frieze both in and out line up with neck of column.

I always built my porches that way and I remembered many years ago, while yet in my teens, how I went about it to frame my first porch soffit, supported by large tapering columns. The result was a correctly executed piece of work, and I prided myself that I had accomplished what many a grey-beard had failed to do, as their work bears witness. Still it was nothing new, as many others before me had done, and many others at the present time could accomplish, with a little fore-thought and the simple method of procedure that I use, which is a little different method from that shown by Mr. Woods, but gives the same result:

First, get size of column at base and lay off same on porch floor, full size; locate outside of base so as to set flush, or plumb, over porch base; then locate size of the column at neck directly over the center of base. Having the neck of the column so located, the correct location and lengths of the soffit are clearly shown, as they will appear when placed in position over the columns.

G. J. SHUSTER.

NOTE.—As the method described by Mr. Shuster is very practical, requiring no figures to arrive at a correct result, thereby greatly simplifying the problem for many, we have thought best to submit an illustration showing the method, as described.

EDITOR.

Wants Paint for Wool Deadening Felt

To the Editor:

Almyra, Arkansas.

I have never before asked a favor through your columns, but have been keeping in touch with the answers to the other questions that appear from time to time.

I would like to know if there is any fluid in the form of a stain or paint that may be used for a body color or stencil work over wool deadening felt, so as to make a finish without putting wall paper over the felt.

I note this felt is used very extensively in the south instead of canvas; and thought possibly there was some way to make a finish without papering over it. Will be glad if some one will give me the information and also where such material may be obtained.

I am a reader of this noted paper of yours, and is is an *idea spreader*. Would be lost without it.

R. M. JACKSON.

Ironing Board Closet

To the Editor:

Nampa, Idaho.

I received the book of "Details," and think it will be a great help to me in my work.

We are putting in a convenience in some of the houses that we build here that I think a great deal of; and as I have not seen it published anywhere, am herewith submitting a sketch of same and hope it will appeal to you enough to publish it in your magazine. It is an ironing board closet.

Trim out the same as you would for a window for either an inside or outside wall, and place jambs so that when the back is ceiled it gives same margin for plaster as for all other frames; case up same as for other openings. Hang

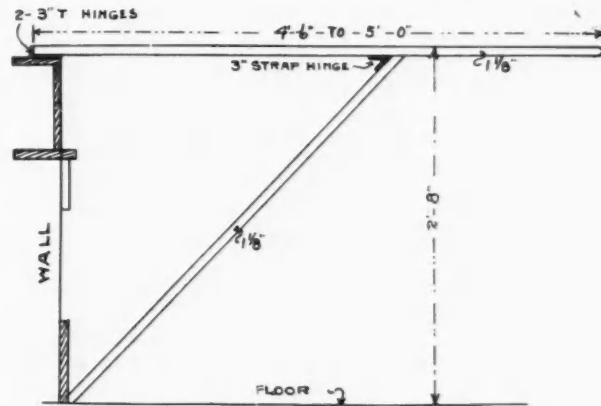
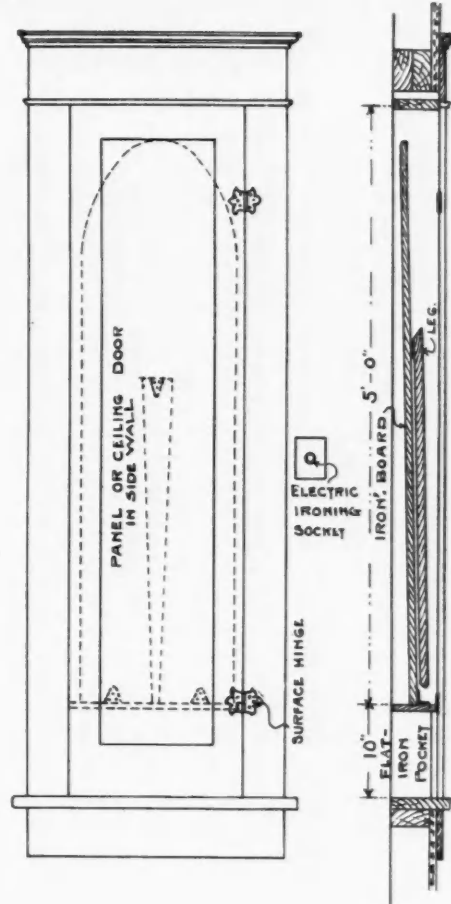

IRONING BOARD CLOSET.

the door with surface hinges. Leave a pocket at the bottom, as shown, for the flat irons. Place a cross piece at proper height, so that when the ironing board is let down, it will be at least 3 inches above the floor. Boards are made in all kinds of shapes, and should be of not less than 1 1/8-inch stuff that is not apt to warp badly. The leg or support, when let down, can either be straight or on a slant as shown in sketch. The board should be level while in use and should be about 16 inches wide.

Where an electric iron is used, a 2 by 4 studding does not make enough room for the pocket. So in that case, the wall can be furred out at that point to give the required room.

We have installed quite a number of these closets and wherever they are used, they are praised very highly.

ED COLLINS.

Jasbury Should Have Known Better

To the Editor: Highland, Kansas.
I have received my paper regularly since I subscribed, and look forward to its coming as a source of information. I have also received "Details of Building Construction," and think it the best work of its kind published, and at the conditions under which you offer it, no workman should be without it, whether he be an apprentice of a week's experience or the shrewdest mechanic; for it is so simple and plain that the one can understand it, and yet so complete and mechanical that the other is benefited.

Since receiving this book, I have had occasion to use "Design and Details," page 12, in constructing an oak stair in a house I am just finishing. I built the entire stair—newels, balustrade and hand rail, of $\frac{7}{8}$ -in. and $1\frac{1}{4}$ -in. material; and everyone who sees it is delighted with its artistic beauty. For my part, I am only jealous of the designer, as he left little room for improvement.

Now, as your paper seems to be open for all kinds of discussions in construction, I wish to call the attention of the readers to the article by Wm. C. Jasbury, in January, on stair building. I would not advise any inexperienced workman to house out a wall string with the wedges to be driven from the top, unless he has more material on the job to make others in the right way—with the wedges driven from the bottom or back side! In the first place, it is never necessary to drive wedges from the top and if it was it would be impossible to do it, and I am surprised that the author would make such a mistake.

His method of finding length of newel is good, and if "original" he is an "old man," and should know better than to get out a stair string like the one just mentioned! I have used his method for some time, and in fact I know of no other way; and yet he might have made it a little plainer, because the riser does not always come in the center of the newel.

E. D. SAUNDERS,
Contractor and Builder.

Two Answers and a "Call Down"

To the Editor: Aurelia, Iowa.
In your "shop kinks" by Wm. C. Jasbury, I think he has made quite a "kink" in his article on stairs where they are plastered underneath.

Now, any man that has ever built stairs knows that it is impossible to drive the wedges from the front. In the first place, the housing only reaches to the front of the step, and the wedge would start in on an angle and would not do much good. You might possibly wedge the riser, but to get a wedge under the step you would have to cut a hole through the riser.

I have worked at the trade seventeen years, starting when I was eighteen years old. I always prefer to build my own stairs, ordering newells, railing and balusters, and getting out the rest of the stuff myself.

I much prefer panel work underneath my stairs, so I have lots of room to work. If I have it plastered underneath, it is usually the upper run and usually short. This I put together and wedge tightly, using hot glue; then slip the whole run in the hole and nail it to the wall.

In answer to Mr. A. J. Metzger, St. Paul, Minn, "What makes the bay window leak?" I find quite often the leak is higher up, sometimes around an upstairs window and sometimes through a shaky siding. The water gets in and follows the outside lining down, and shows up on the plastered ceiling of the bay window. The leak may be six feet above where you expect to find it.

In answer to Mr. Wm. Vreeland, Durand, Mich., I would

say that three inches in eight feet is too much pitch for a porch floor. About one and one-half inches is plenty. Where I use a wooden base I cut the first piece until it sets level; then mark my column with a gauge and cut it off square and it usually fits the first time on.

FRANK R. WELCH,
Contractor and Builder.

Some Swift Shingling

To the Editor: Elgin, Iowa.
I note in the November number of the AMERICAN CARPENTER AND BUILDER, of some rapid work in shingling which I doubt very much can be done, and done properly. That is, for two persons to lay one and one-half thousand in an hour. My helper and myself nailing have put on ten thousand in eight hours and I have not yet met a man that could put on more, quality of work considered.

I use a straight edge and have it four inches wide and drive a nail in the edge to the width I wish to lay the shingles. That enables me to see the shingles in the last course. If I chance to split one, I can then see if it split directly over a joint; if so, I remove it and place another shingle.

Another thing, I break joints on both rows, as shown in Fig. 1, so that should a shingle split, it will not leave a crack extending across three courses, as shown in Fig. 2. I split

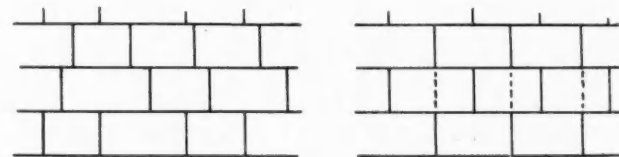

FIG. 1.

FIG. 2.

shingles over ten inches wide and place three or more nails, that is, when using redwood shingles.

There is little danger of nailing redwood shingles too much. A pine shingle over ten inches wide should be split and never have more than two nails; otherwise when they buckle, they will split at the center nailing. Redwood shingles will buckle but very little, as will be seen by testing them in water for a few days.

Perhaps these swift shinglers do their work on large roofs with little or no breaks and not over one-fourth pitch, and have spiked shoes and a cushioned seat, also with spikes (we mean on the under side to catch the roof), thereby avoiding the use of a scaffold, and with gauge on the hatchet, can put on one and one-half thousand in an hour, but I am—well, not from Missouri, but next to it.

Now, Mr. Editor, this letter is rather lengthy, but as you request discussion in the columns of the Correspondence Department, I was prompted to do it.

ALEX PAGAN.

He Likes the Old Way Best

To the Editor: Fort Atkinson, Wis.
As to making better roofs, I think the old way of using a chalk line the best. Many use a straight edge and nail in the roof, which leaves a hole to begin with. Then again some nail the staging to the shingles, so that when they take it off, they leave exposed all nail holes, which greatly impair the roof. Now, I take a shingle about four inches wide and nail it to a 2 by 4 with the point down, then flat it over and nail in place, leaving the 2 by 4 below the line, so that a saw can be used. When the roof is done, I saw off the ends and release the 2 by 4 pieces and there will be no nail holes in the roof.

H. L. OMEALY.

Better Building and Better Men

To the Editor:

Baldwin, Kansas.

In regard to Mr. Kane's "Hot Shot About the 'Big Stick,'" I see no cause for alarm. To be sure there was a great noise, and much smoke in the air. But noise and smoke, terrible as they are, do not compensate for accuracy.

He suggests that I have had some experience with the "Big Stick" and quotes me as saying, "I for one will not have any more of it," when what I really said was "I for one wish no more stringent and arbitrary authority over me." In regard to the advice which he says that I gave him, I wish merely to call his attention to the fact that my former article was addressed TO THE EDITOR. If I had any advice to give him I would suggest that he put away his old scattering musket-type of shot gun, get a modern rifle and indulge in a considerable amount of target practice for the sake of accuracy.

As to his contention for four-penny galvanized nails as a cure for leaky roofs it is my observation that three-penny nails are long enough to reach through the shingles and sheathing, also that most houses in these parts are plastered so that longer nails are not serviceable for hat hooks, and as added length does not add to the life of the roof it is simply a matter of poor economy to waste more steel on the length of the nail. And while there may be a supposed standard for the size of wire used in making three penny nails; it is a fact that nails for shingling purposes are made of various sizes of wire. Therefore, if an architect wished to be specific about the size of wire to be used in making the nail he should specify not only the length of the nail but also the No. of wire to be used in making the nail.

But after he has looked after these things he has still omitted the very essential point relative to the life of the nail—that is the materials used in galvanizing. If, as has been contended, it is necessary for the architect to look after the numerous details of a building instead of trusting to the honesty and judgment of the builder, he would here be burdened with specifying not only the length of the nail but also the No. of wire used in manufacturing the nail, and the quality of material used in galvanizing the nail.

But thanks to the advance made in modern commerce and industry, when a reliable firm puts an article on the market, that article, generally speaking, can be trusted as to its honesty and efficiency. And should an architect, of our locality, prepare plans and specifications including all these and like details and expect those plans to be rigidly followed, in another locality, it would absolutely be out of the question to construct the building with speed and economy.

For example, a large per cent of the specifications call for hemlock for different stuff. We never use hemlock here. In fact to the best of my knowledge and recollection I never saw a piece of hemlock timber.

Indeed it is not of choice but of necessity that modern institutions, if they are to exist, have to be founded upon confidence and integrity. No longer are the mandates of the ancient despot executed under the iron rule of compulsion. No longer do we hear the cry of the old pedagogue in the schools "More lickin', more learnin'." Nor is it common for neighbors to settle their disputes in courts of law. With the more general application of the Christian principal of confidence and integrity to business have come the possibility of greater things. How could the great mail order business of the day exist with out honesty on the part of the merchant and public, and confidence by all concerned.

Are we carpenters and builders as a class ready to admit that we are less competent, less reliable and less ready to shoulder our part in the progress of civilization than the

public at large. It is true that while the general public is trusted as men we must call for the authority of the architect to make us be men? No by all means no.

And if Mr. Kane will think carefully and think calmly he will find that I and he have no cause for controversy. True he called for "Better building" under the old method of compulsion. I too call for "Better Building," Better Methods and Better Men.

BURR GUNSAULLUS.
Contractor and Builder.



Non-Dust Catching Head Trim

To the Editor:

Kansas City, Mo.

As a charter subscriber to your valuable magazine I consider myself one of your family and in the front row, and I am going to acknowledge with some shame that this is the very first line of encouragement or congratulations I have offered to the Editor for his wonderful advancement and success with this valuable magazine.

With the exception of three or four copies I have all my magazines and consider it a very valuable part of my library. How many of our charter members can put their hands on the May 1905 number of the AMERICAN CARPENTER AND

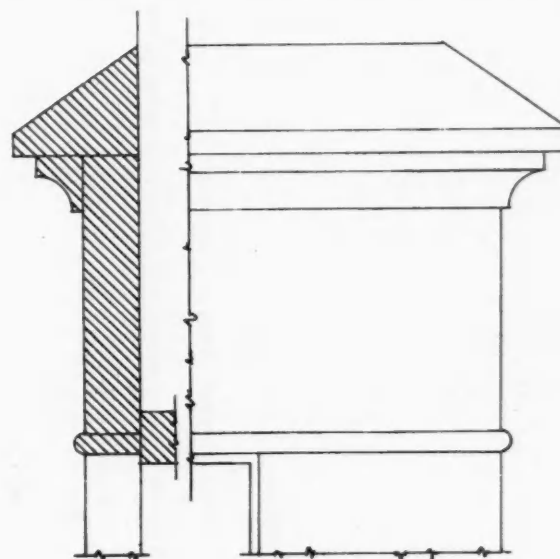

Beveled Door or Window Head

BUILDER and look at the building on the front cover and say they bought the plans and have built that house? I can.

I am enclosing a detail of a sanitary window and door head for inside trim, this is original with me and to my knowledge has never been used except on a few of my buildings. I would like to hear some comments on this. My idea is to get away from the flat top so generally used, as they are, as we all admit, a dirt catcher. Wishing you continued success I am with you to the end.

JOHN C. SNODDY.

Architect and Engineer

Answer: Your method is by no means new, having been used round and about Chicago for some time back. Builders here, however, are getting away from it, now since they find that it does catch some dust and, moreover, whatever dust is caught, shows.

EDITOR.



Wants Instantaneous Hot Water

To the Editor:

Will you kindly ask Mr. C. A. Eddy or some other of the heating experts if they will give me a detail drawing of

how to connect a range boiler so the water will always be hot at the bath room on the second floor. I now have to draw about five quarts of water before I get hot water. I have heard that there is a way by which you can get hot water as soon as you open the cock. But I have never seen any place fixed that way and so I thought perhaps you would be able to give me a detail in your paper.

BENJ. R. BUSH.

What's Best for Leaky "Rubber Roof"

To the Editor: Sunnyside, Wash.

What is the most satisfactory method for repairing "rubber roofing" after it once starts to leaking?

I have been using tin patches by first painting the leaky spot then applying the tin and nailing well with shingle nails. Then painting it again. The tin I find nails closer than the paper patches.

R. LEE EHMER.

To Remove Paint from Cement Walk

To the Editor: Sioux City, Iowa.

I am a member of the High School of this city. Somebody painted the club name on the sidewalk in red enamel. It is up to us to get this enamel off or get out of school. We tried hydrochloric acid but failed. I wonder if you have any suggestions.

C. B.

Answer: We want to say that we are going to keep you boys in school if the best modern cement practice offers anywhere a way out of the difficulty; and we believe it does. We have been in consultation with two of the members of our corps of experts: Chas. E. Paul, S. B., of the Armour Institute of Technology, and Dr. A. S. Johnson, M. A., Ph. D., of the University of Toronto. And the following course of treatment is now suggested:

First apply ordinary paint remover to the red enamel paint on the cement sidewalk. This will loosen up quite a bit of it so that it can be scraped off; but the spots will still be left smudgy and discolored. Bleach these out with oxalic acid, full strength. Even after this, some slight discoloration may remain, but this will disappear in a short time due to the ordinary wear which the cement sidewalk will receive. By rubbing these spots which remain with pumice stone and water they can be cleaned up quickly; this process being in effect the same as the natural wear on the sidewalk concentrated to a few minutes of time. A carborundum block or rubbing brick could be used in place of the pumice stone.

This method was used with very good results at the Armour Institute recently after some of the boys had been up to mischief and had painted their class numerals on the cement sidewalk about the campus.

We sincerely hope that you will be able to use this with equally good success so that you will be able to continue your school work.

EDITOR.

Leaky Bay Windows and How to Make Them Water Tight

To the Editor: Omaha, Neb.

In answer to A. J. Metzger of St. Paul, Minn., I send the following explanation. No doubt many have had experience with bay windows that leak and have defied almost every effort at making them rain proof. Almost every bay window of the kind referred to has a window over it on the second story, and it is this that causes most of the leaks. In a driving rain enough water will get in where the siding joins this frame to run down back of the siding to show a leak on the ceiling below. Water running down is turned up from the roof of the bay. It is not because the tin is not turned up far enough but because the water

gets back of the tin. If the tin extends up 2 inches it is far enough, but before setting a frame over a bay, put tar paper under each side casing from top to bottom, all one piece, and let this paper always lap on the outside of the tin turned up from the bay roof. Same way in siding above the entire bay, be sure that the paper laps over the tin on the outside, this will run the water out on the roof should any chance to get in. This is a sure preventative if it is followed with ordinary intelligence and discretion.

I. P. HICKS.

Remedy for Crawling Varnish

Sydney Mines, Cape Briton, N. S.

To the Editor:

Would like to know if you can give a remedy for creeping varnish? Have a large arched ceiling, covered with half inch spruce and finished with half inch Georgia pine; paper between. A coat of oil stain and one coat of hard oil varnish were applied with no difficulty. When the second coat of varnish was commenced, then the trouble began. Heat was then applied steady for eight days and nights at a temperature of 78 degrees, with little results.

JOHN C. McMILLAN.

Answer: Creeping of varnish will occur in the presence of cold and heat alike, and the remedy in either case is the same, coat the surface over with benzine, just as if you were applying a coat of paint, though be sure there is no open fire about when you do it. Paint, stain or varnish, applied over this will not creep or crawl. Another remedy is vinegar, which may be used if there is any danger of fire; but the benzine is to be preferred if there is no danger to be apprehended from fire. The cause of the crawling of the varnish is found in the glossy surface of the previous coating, to which the new coat cannot attach itself. The benzine or vinegar leaves a film on the glossy surface which, as the artists say, gives tooth, or a surface that will permit the coating to hold by. Varnish is easier to apply in the presence of heat, say at 78 deg., Fahr., and the varnish itself should be near the same temperature.

A. ASHMAN KELLY.

How to Kerf Crown Mould

To the Editor:

Allen, Neb.

Will you tell me through your paper how to cut crown mould so that the same can be sprung around a circle? This refers to the common crown mould—not the square backed mould.

D. A. ROBERTS.

Answer: Unless the radius is very large, it is not practical to try to make a finished job of circular crown mould out of the common splayed back moulding. The mould being set on a level, kerfs should be cut vertically and, being of such shape does not admit of kerfing without showing on the face. And then again the mould being wider, would require a

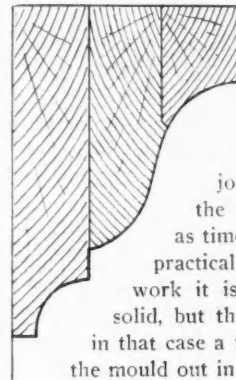

very deep kerf; and to have the same close up tight would necessitate the kerfs being cut in a concave wedge shape. Even though the work may be done in the best workmanlike manner, the joints or kerfs are there on part of the face only to show up more and more as time goes on. So that it cannot be counted practical from any point of view. For good work it is better to have them run out in the solid, but this is not always readily to be had and in that case a fairly good job may be had by working the mould out in strips, as shown in the illustration, and putting them up separately.

A. W. WOODS.

Mr. Woods Makes a Correction About Degrees

To the Editor: Lincoln, Neb.
 Under the above caption, we answered in last issue, Mr. James Wilson's question in regard to degree of miters, but when it came back to us in cold print, we were surprised to see that we had made a slip of the tongue, or pencil rather, and said what we did not mean to say. It was in reference to the length of tangents for a polygon having 360 sides. What we meant, and should have said, was 180 sides and the calculation as given would be correct.

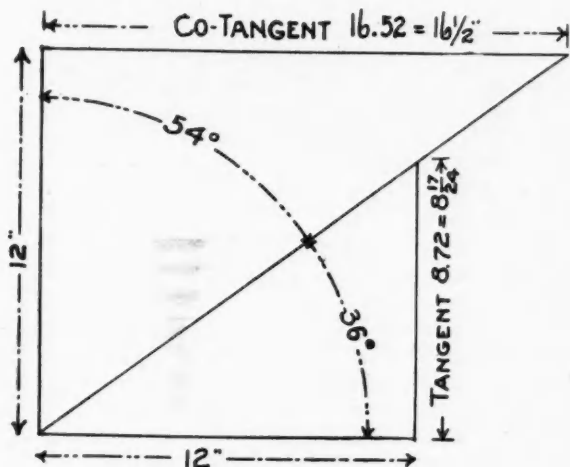

FIG. 1.

Now carrying out the same calculation for the 360 sided polygon, the tangent would be $.10476 = \frac{3}{32} +$ and represents the length of the sides, as per foot of the inscribed diameter and the co-tangent would be 1375.068 inches, or equal to 114 feet $7\frac{1}{12}$ inches. Therefore, 12 and $\frac{3}{32}$ will give the miter, also 12 and 114 feet $7\frac{1}{12}$ inches will give the same thing. But this, of course, is far-fetched and is only used here for illustration purposes, but it must be remembered that this rule holds good regardless of the number of sides that the polygon may have.

Now coming down to the pentagon, the degrees are 36 and 54 and the tangents are equal to 8.72 ($8\frac{17}{24}$) and 16.52 ($16\frac{1}{2}$) as shown in Fig. 1, respectively. The smaller triangle is equal to one tenth of the area of a pentagon when its inside diameter is 24 inches and the larger is equal to one tenth of a pentagon when its sides are equal to 24 inches.

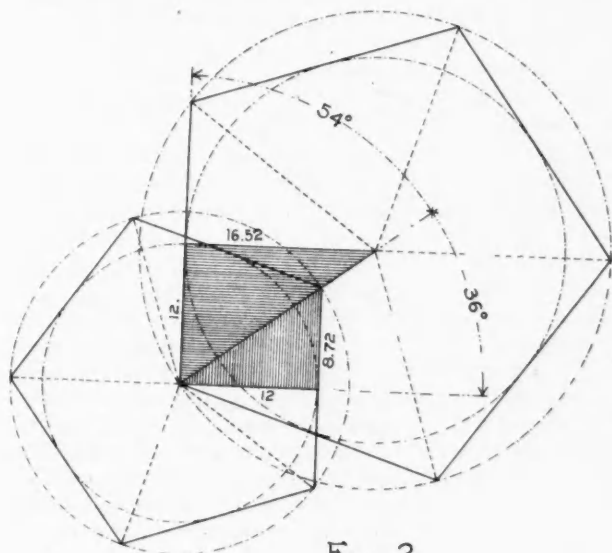

FIG. 2.

This we can probably illustrate better by referring to Fig. 2. The shaded part represents the parts as mentioned above, shown in their respective place. A. W. Woods.



That Sliding Door Question

To the Editor: Oakfield, Wis.
 I have had the pleasure of reading your magazine for the past three years and have enjoyed the correspondence columns very much, but up to the present have never ventured to take part in it.

I notice in the last number that a brother carpenter wants to know if there is a way to put on stops for sliding doors without cutting out for escutcheons. I agree with him that it makes an unsightly job to notch out so as to allow the raised escutcheon to pass by. This may be overcome by putting a pair of projecting sliding door astragals on the front edge of the doors and then continue the projecting part clear around the door, both sides. Do the same for a single door, but let the face of the astragal be plain. This leaves an opening wide enough between the stop to allow the escutcheon to pass without interfering. On the top, I put in a false piece of jamb and reduce the width of the opening to about $\frac{3}{4}$ of an inch. I find by this method that the doors

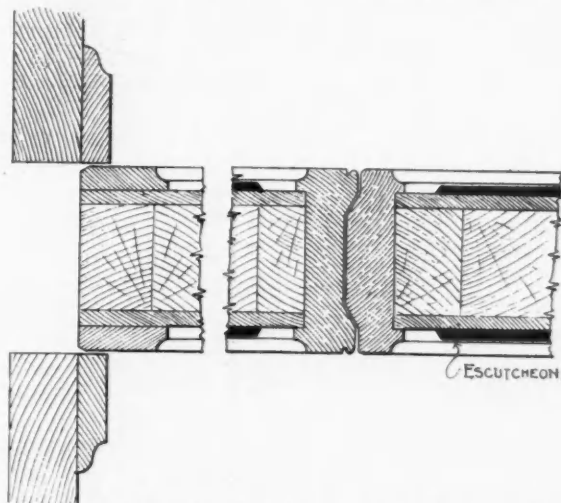

Section Through Double Sliding Doors Showing Proper Trim

when working are not apt to rub against the stops. I also bevel the back side of the stops so there will be no sharp corners to strike the back side door banding in closing the doors.

I am enclosing a sketch and shall be pleased to see it published in the AMERICAN CARPENTER AND BUILDER.

THEO. P. SCHULTZ.

NOTE:—As Mr. Guy Fowler, of Brookings, So. Dak., and Mr. H. L. Omealey, of Fort Atkinson, Wis., submitted answers to the above along the same lines as described by Mr. Schultz, it is unnecessary to print their letters. However, we appreciate their efforts, which shows the interest they are taking to help make the correspondence department of real worth to all concerned. EDITOR.



He Wants to Know Why

To the Editor: Camas, Mont.
 In the next number of the AMERICAN CARPENTER AND BUILDER, I wish you would state why the proportions D E and D C give the side cut on the unbacked hip rafter for the pentagon roof, Fig. 3. "Practical Uses of the Steel Square," December number. BERT ROBERTS.

Answer: To begin with, let it be remembered that the formula is not confined to the pentagon but applies to any

other kind of a corner as well, and that is the beauty of the rule. It is one of the unseen things that exist in all hip and valley roofs and to know them is the key to the whole situation. In short, the same individual parts, that is, the tangent and length of rafter will give the side cut of the jack and hip, but of course being different rafters necessarily these parts are of different lengths.

With this system, it does not matter what shape the building may have because as we said before, it applies to all alike, but for illustration purposes, we will answer the question by illustrating that for the common square corner.

Now, for instance, we take a building 12 feet wide. The hip for same becomes the common rafter for a building 17 feet wide with the same rise as for the 12 foot building, as far as the seat and plumb cut is concerned. In other words, the diagonal of a building 12 feet square is 17 feet (practically) and letting that represent the width of another building the common rafter would show, as at D A (run) A C' (rise) and C' D (length). The same parts also answer for the hip for the building 12 feet wide, as is clearly shown in the illustration, while A B (run) A C (rise) and B C (length) represent the parts of the common rafter for the same building.

Now we are right up against Mr. Robert's question. Listen! B D (tangent) and B C (length of common rafter) will give the side cut of the jack for the 12 foot building. The side of the square on which the length is taken will give the cut. In other words, it is the distance from the corner and the length of the rafter. These same proportions will give the side cut of the hip for the same width building, provided it has been backed and the square applied to the backing plane.

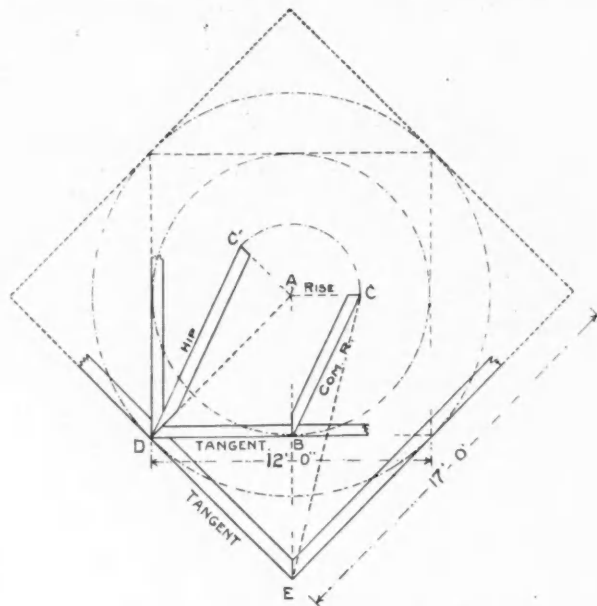

Getting Side Cut of Unbacked Hip Rafters

For the corresponding side cut of the unbacked hip, it is D E (tangent) and D C' (length of hip); and the cut will be on the side of the square on which the latter is taken.

A. W. WOODS.

Go to It

To the Editor:

Vale, Ore.

Enclosed please find \$2.00 renewing yearly subscription to the AMERICAN CARPENTER AND BUILDER, commencing May 1st. I have your book on Framing and like it very much. My wife and I couldn't keep house with out the AMERICAN CARPENTER AND BUILDER.

I would like to answer some questions in regard to shing-

ling and nails. First I would say to Mr. Newcomber in November issue that line or straight edge shingling is too far behind the times to talk about, likewise cut nails. To Mr. Kane in same issue, get out of the rut, use 3 penny blue steel nails and save the wear and tear on your mouth. Go to it Gunsaulus you are all right. FRANK W. MCGUIRE, Shingling and Lathing Contractor.

+

Rapid Method for Miter Siding

Ventura, Calif.

To the Editor:

I have never contributed anything to the Correspondence Department to help my fellow carpenters, but if the following sketch will aid any one, they are welcome to it.

It is our California rapid method of putting on mitered siding. We run up either side as at A or B, letting the ends project beyond the corner enough to allow good sawing. Then we tack on a straight edge on top of siding and the thickness of the siding beyond the outer face line of the studding; then with saw against the straight edge and on line C-D we cut clear down the whole side and the result will be a true miter and correct bevel to work to from the outer side. A corner stud may be easily inserted after cutting down the side, as above described.

F. L. MARTIN.

+

Three Good Questions

To the Editor:

Longmont, Colo.

I want to ask three

questions through the AMERICAN CARPENTER AND BUILDER:

First. What is the proper way to figure the cost of a stairway?

Second. Is there such a thing as a standard bevel for door and window sills? If there is, what is the bevel or pitch?

Third. I am running a small planing mill with electric power. I want to build a small dry kiln in connection, say 8 or 10 ft. wide, 10 ft. high and 18 ft. long, or long enough inside to receive 16-ft. lumber. Of course I have no steam plant to heat the dry kiln, and can not afford to build a steam plant and put in a hot air fan for so small a kiln. Now, what I want to know is, can I heat such a kiln and dry lumber successfully with a common hot air furnace, or hot water plant, such as is used in a residence? If so, can you give sketch showing how such a dry kiln should be built. If the Editor of the AMERICAN CARPENTER AND BUILDER can not answer this, I should be very glad to hear from any one who has had experience with a dry kiln.

CHAS. E. NOWELS.

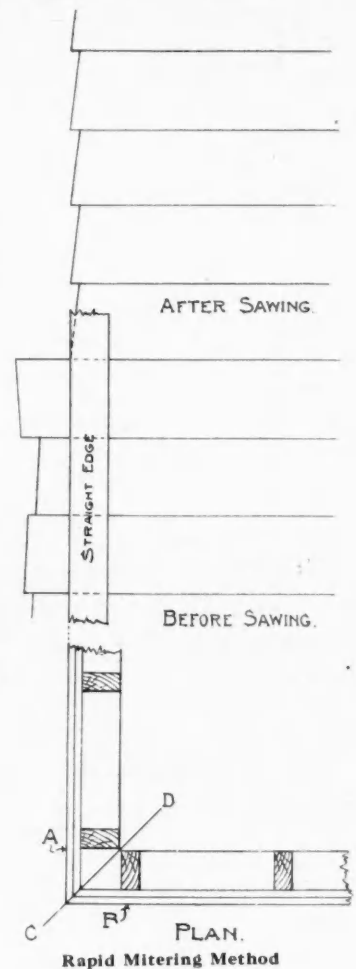

Handy Tool Case

To the Editor:

Elizabethville, Pa.

As I have been a charter member of your valuable paper and obtained much useful information from it, I will send you the photographs of a tool box I made about six years ago.



Fig. 1. Bender's Case Closed

Fig. 1 shows the tool box as it appears closed ready to carry. Fig. 2 shows it open and the inside arrangement. There is a rack on hinges in the lid for three saws, the lower apartment is for planes, hatchet, hammer, miter box, etc.

The upper part has two swinging drawers for chisels, screw driver and miscellaneous tools; the other side has a place for a bit brace, coping saw, oil can, whetstone; also a swinging augur box for a full set of bits, and a place for punches, counter sink, reamer, etc. The steel square is placed diagonally in the box after the drawers are shut and occupies a position between the drawers and lid when closed.

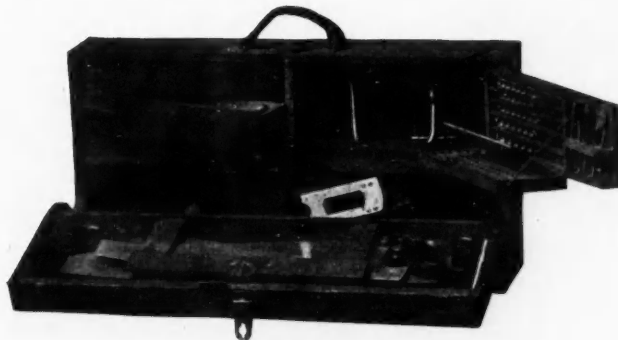

Fig. 2. Bender's Case Opened

The tools are thus snugly tucked away and can be reached instantly when wanted. It is very convenient to carry, and will hold all the tools needed by a carpenter.

This tool box is not patented and any of the readers of the AMERICAN CARPENTER AND BUILDER are welcome to make one. It is 32 inches long, 17 inches high and 8 inches wide, it is made of poplar or any light wood, the back and front is 3/8 in. thick, 17 in. wide; the top, bottom and ends are 3/4 in. thick and 8 in. wide. The lid is 13 in. wide and 2 1/2 in. deep, for saw rack.

L. R. BENDER.

Another Tool Chest

To the Editor:

Vesper, Wis.

In the January number of the AMERICAN CARPENTER AND BUILDER, and to which I am a well pleased subscriber, I note that Mr. Clark of Red Wing, Minn., wants some ideas on a light, strong and convenient tool chest. I present herewith a sketch of a tool chest which I designed and made for myself some time ago, and which I find not only much lighter than the ordinary tool chest, but more convenient and adaptable in every respect.

The size of the chest of course will depend largely on the amount of tools a carpenter wishes to carry. I made mine 34 inches long, 12 inches wide and 18 inches high. The end pieces are of 1/2 inch and the remainder of 7/8 inch stuff, and all of white pine. The saw tray, or rack, marked F is a feature which one will find well worth while to arrange for in this tool chest, as it keeps the saws in perfect shape, being entirely apart from the other tools. I have used the old style lid tool chest for a number of years, but find that I can get more tools in this one, as illustrated, than in the old style twice as large.

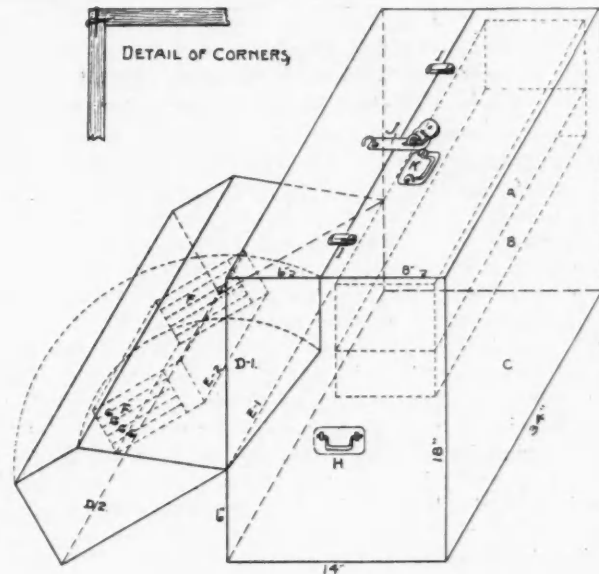

CARPENTERS TOOL CASE.

A—Tray for small tools, B—Tray for small tools, C—Open space below trays, if desired, or put in more trays, D—1, Hinged side cover, D—2, Hinged side cover, as it appears opened. E—1, Hinges on cover, E—2 Hinges on saw rack (size to suit owner) F—General appearance of saw rack, H—Handles, I—Suit case snaps, J—Hasp with all screws covered when locked, K—Handle on top, if desired.

I will be pleased to answer any inquiries in regard to this chest as far as is in my power. F. G. ROCKWOOD.

Fireproof School Building

To the Editor:

Grand Forks, N. D.

I am sending a photo of a schoolhouse, now nearly complete, at Chisholm, Minn. I think it is pretty good one. It is 170 by 90 feet and, with little exception, of fireproof construction. The floors are tile slab and reinforced concrete with wood floor on top. Stairs also of reinforced concrete and tile slab with slate steps for finish. It has steam heat and good fan system; oak finish. Has been erected in about



New School Building at Chisholm, Minn.

6-7 months. The architects are C. Bell, Tirie and Chapman, Minneapolis, Minn., and the contractors are Northern Construction and Engineering Co., Grand Forks, N. Dak.

T. BRINING.

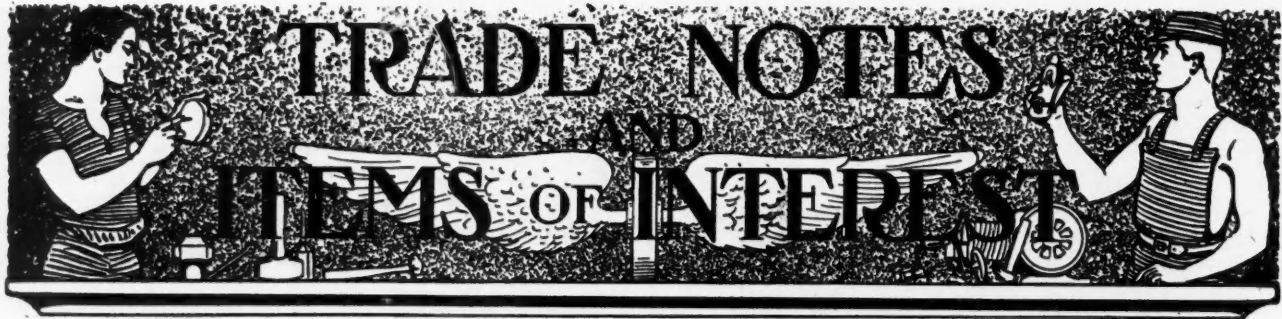

Suggestions for the Use of Cast Iron Columns in Construction Work

By Leo. H. Pleins, Architect and Engineer

Experience extending over a large number of years has demonstrated that there can be found no better material for columns in buildings than cast iron. Such columns, that have been in use for years, are in as good condition today as when first put in place. It is true, of course, since the introduction of steel in construction work that columns of this material are used, but there are a great many points of advantage possessed by cast iron over steel. Cast iron columns are neater in appearance than columns of angles, channels, or I-beams. Provided with a neat base and cap plate, they add greatly to the appearance of the finished work. Again, cast iron is not as much affected by the corrosive action of rust, even under the most unfavorable conditions, as is steel.

It is an established fact that cast iron water pipe buried in the ground will last indefinitely, whereas, similar pipe of wrought iron or steel, quickly corrodes. What is true of conditions below ground is true above ground, and it has been proven that when steel is used in construction work, it must be thoroughly painted and then enclosed in some form or other, by cement, concrete or tile, so as to prevent rust. Such preventative measures are not necessary with cast iron—merely a coat of paint, as much for decorative purposes as any other value, is all that is required.

Today, wherever durability is kept in mind, constructional parts of cast iron are extensively used; not only for columns, but also for door and window lintels, sills, curbs, base plates for steel columns, and so on without limitation, proving that experience has demonstrated that no better material can be found.

It being true that the quality of lumber does not compare with what it was years ago, and, the cost of same practically double, it should be the aim of the architect and builder to supplant it by material far better, and everything considered, no more expensive. In years past it was customary to use 6x6 in., 6x8 in., or larger wooden posts in basements, residences, store buildings, etc. Today, to do this would not only be a mistake, but would lay the architect or builder open to criticism. Everyone will agree that cast iron columns are greatly superior for this work. They can be obtained regularly in diameters of 5 in., 7 in., and 9 in., with plain or ornamental base and cap plates and in lengths varying from 6 ft. to 12 ft. No one can help but admit that their use in place of wood is extremely desirable, and if, then, cast iron columns are suitable for basement use, they are as well adapted for upper floors and certain types of buildings such as stores, stables, garages and the enumerable kinds of buildings, from one to several stories in height, where good construction is intended to be used.

Citing a case in point where in the opinion of the writer cast iron columns would be admirably suited to peculiar conditions, is to replace wooden posts in localities such as the Peninsula of Florida and other points on the Gulf and Eastern and Western coasts where, owing to the low sea level, residences and a great many other buildings cannot be pro-

vided with basements. Such buildings are usually set up on wooden posts, and owing to the rapid decay of the wood, it is necessary to replace such posts, whereas, if cast iron columns had been used in the first instance, they would have lasted indefinitely. A similar condition exists in the case of supporting posts for porches and verandas. Instead of building up piers of brick or concrete, it would be cheaper to use cast iron posts of proper size, extending these down into the ground and supported on the concrete footing, at proper depth. Constructed in this way, these supports would be much neater in appearance, less expensive and more durable.

There is really no limit to the use of cast iron columns and posts, and it depends entirely upon the architect or builder to advocate their use, if he should truly desire to give his clients the best and most permanent construction work.

By referring to page 81 you will find more information on the subject.

Corbin Door Check and Spring-1911 Model

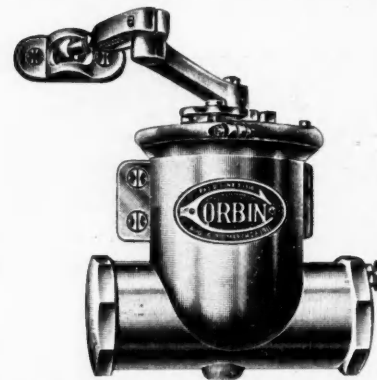

This model is adaptable for right hand and left hand doors without change.

It is supplied with or without the hold-back attachment. The hold-back attachment can be adjusted to stop the door at any point.

The spring used is long and resilient, reducing the crystallization to a minimum

and giving a quick, live action, which is highly desirable.

The spindle has a lower bearing which absolutely prevents side pressure or friction and gives rigidity to the check.

The rack and pinion in the check give control to the door at all points from wide-open to the closed position. The movement in closing is steady, without shock or jar at any point.

The parts are few and strong, easily accessible and quickly replaced.

The liquid used is one which has been carefully compounded with a view to securing immunity from changes due to difference of temperature. It is non-freezing and not affected by extreme heat.

The checking pressure is confined to the cylinder. There is no pressure at the spindle, so that the liquid is not forced upward and the check will not leak.

The brackets used are the same as used with other models of the Corbin check.

Six sizes are made to swing all doors from the lightest screen door to the heaviest doors made.

P. F. Corbin, New Britain, Conn., will send illustrated booklet telling all about this new door check to all those writing for it.

New Tools for Contractor and Builder

We take pleasure in illustrating herewith a few new machines,—the production of J. A. Fay & Egan Company of Cincinnati, Ohio. Like all other machines they put on the market, they are modern in every respect, nothing having been left undone that would tend to make them perfect.

These machines are of great value to the carpenter, contractor and builder, as they will do a great amount of work, and produce a revenue sufficient to pay for themselves in a very short time.

Figure 1 shows the No. 2 Planer, Matcher and Molder, designed for general work in small mills and jobbing shops.

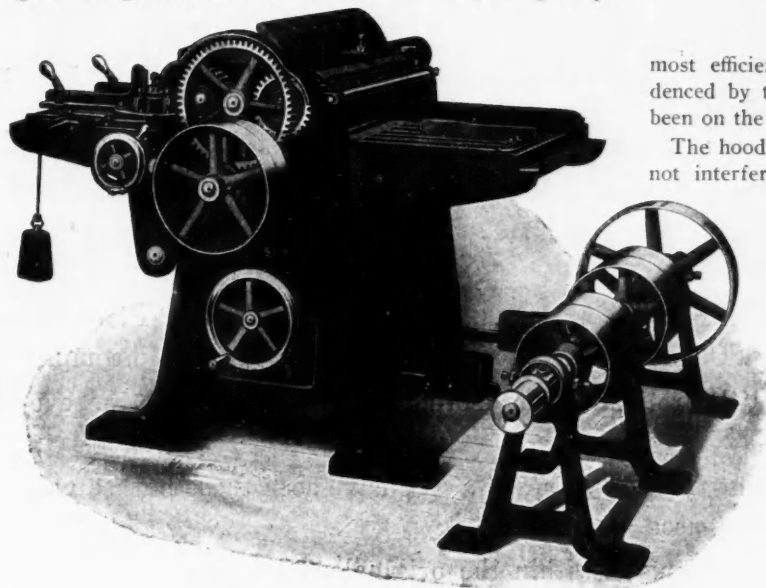

Fig. 1.—No. 2 Planer, Matcher & Molder

It planes material 24 inches wide and 6 inches thick, and matches 12 inches wide. The manufacturers have given special attention to the building of the frame, which is of strong castings,—heavy and free from vibration. The table is carried in wide dovetail slides, securely gibbed with take up for wear. It raises and lowers by hand wheel shown at side of machine.

Their No. 110 Self-feed Rip Saw, shown in Fig. 2, meets the requirements of any shop for a medium size self-feed rip saw. It rips 18 inches between saw and fence, and up to 4½ inches thick. The Saw Mandrel is made of the best grade of crucible steel, and carries a 16-inch saw. It has a space of 3½ inches between stationary and loose collars for the purpose of using more than one blade when it is desired to saw lath stock.

Fig. 3 is a saw guard made of aluminum, a new idea from the J. A. Fay & Egan Co. That this guard is the

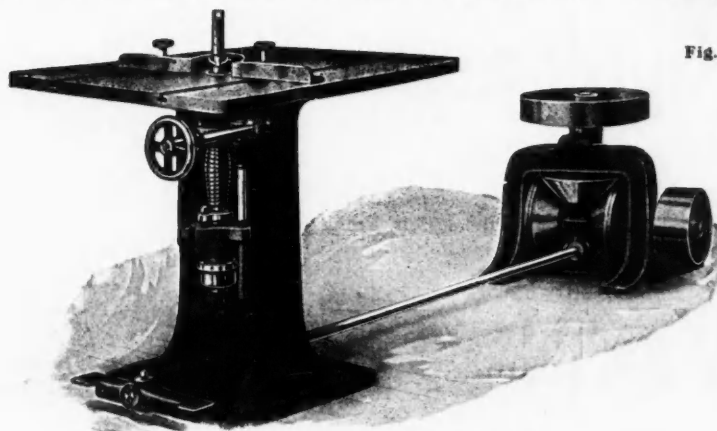

Fig. 4.—No. 252 Single Spindle Shaper

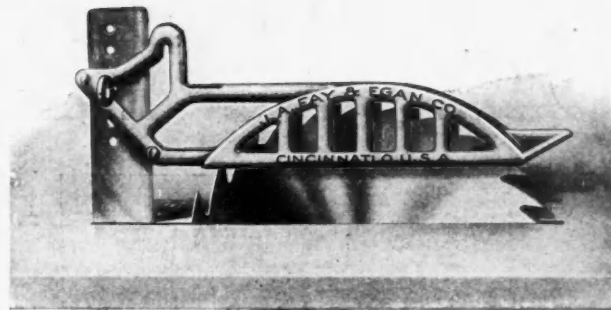

Fig. 3.—Aluminum Saw Guard

most efficient safety device made for circular saws is evidenced by the large number already in use, although it has been on the market only a few weeks.

The hood being made of aluminum, is very light, and does not interfere with the operation of the saw, nor mar the work in any way. Neither will it damage the blade should the hood by some accident be forced against it. The protection afforded is perfect, the guard complying with all safety appliance laws in every respect.

The guard is mounted on a steel standard set into a plate which is countersunk into the table. The standard is easily removed, while the hood is quickly set for various thicknesses of stock or can be thrown back when not required.

This guard affords protection not only to the operator but to the manufacturer as well. The laws of practically every state now make it obligatory to use saw guards and where

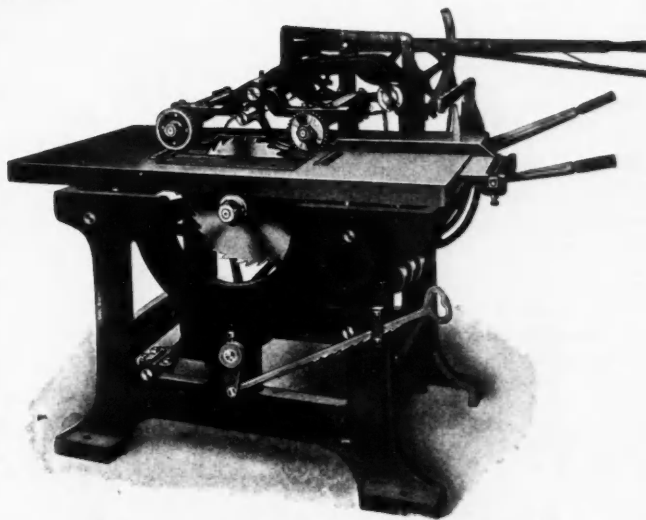

Fig. 2.—No. 110 Self-Feed Rip Saw—For Medium Work

none are provided there is no defense against an action for damages for injuries sustained by the operator.

Another new machine which has been added to this well known line of woodworking machinery (shown in Figure 4), is a single spindle shaper, designed for general use in furniture, carriage, wagon, chair, bracket and picture frame factories, manual training schools, etc.

For further information concerning these machines, or any other machine of their up-to-date line, write J. A. Fay & Egan Company, 545-565 West Front Street, Cincinnati, Ohio.

Our 1912 Plan Book



Free to Carpenters and Contractors

The Standard Authority on Home Architecture. Every Plan Proven Practical Over and Over Again by Actual Construction.

Send the Coupon on opposite page for your copy of the Gordon-Van Tine 1912 Plan Book. Contains over 50 designs of Town and Country homes costing from \$600 to \$6,000 to complete.

Gordon-Van Tine Plans are not "theoretical"—not mere "pictures" to catch the eye—leaving you to "guess" at the cost.

Each home has actually been built at the figures stated. We have seen these houses go up and we have furnished all the materials used.

Our Plan Book keeps the cost of new houses within the original estimates.

Beautiful Houses, Cottages and Bungalows

The 1912 Book of Plans shows all styles of modern homes—frame, Stucco, Combination Brick and Stucco, etc., etc.—each design embodying distinctive ideas. The book is a veritable treasure house of modern Home Architecture.

Owing to the increasing popularity of Bungalows, we offer an unusual variety of bungalow plans, based on our study of 200 fine California bungalows.

Plans and Specifications Complete, \$2.50

We furnish a complete set of working drawings and blue prints, with all details and drawings plainly marked, drawn to the scale of one-quarter inch to the foot, also Specifications and Bill of Materials.

Front Elevation,	Showing front view of house.
Right Side Elevation,	Showing right side view of house.
Left Elevation,	Showing left side view of house.
Rear Elevation,	Showing rear view of house.
Basement Plan,	Giving information with reference to excavation, foundation, etc.
First Floor Plan,	Giving size of rooms, partitions, location of rooms, doors, etc.
Second Floor Plan,	Giving size of rooms, partitions, location of rooms, doors, etc.

Save \$25.00 to \$100.00 Architect's Fees By Building From Gordon-Van Tine Plans

Why pay an architect from \$25.00 to \$100.00 for a set of plans, with the possibility of expensive errors, when for \$2.50 you can get **better plans**, that have been proved out?

If you buy the material from us, we refund the price of the plans. Our architects will advise you, without charge, and will make any changes you may wish, for a trifling sum.

GORDON-VAN TINE CO.

When Writing Advertisers Please Mention the American Carpenter and Builder.

Plan Service Plus Millwork Service



WE CAN SHIP ALL THE MATERIALS FOR A COMPLETE HOUSE WITHIN 48 HOURS

We furnish all the materials to build any of the splendid, modern homes shown in our Plan Book.

We sell immense quantities of Millwork and Lumber of highest guaranteed quality, direct to Carpenters and Contractors, at about 50 per cent saving over local dealer's prices. We save our customers over a million dollars a year. We undersell everybody.

We can ship materials for a complete house within 48 hours after we receive the order. Quality, safe delivery and satisfaction guaranteed or money refunded.

5000 Bargains in Guaranteed Building Material

These 5000 items include everything used in the construction of modern buildings. Note these sample prices:

- Complete Flight of Stairs, Y. P.—\$23.93.
- 4-Panel Doors, 2 ft. 6 in. by 6 ft. 6 in.—\$1.11 each.
- Oak Flooring, $\frac{3}{8} \times 1\frac{1}{2}$, per 100 lineal ft.—52 cts.
- 4 lt. Ck. Rail Windows, glazed, 10x16—70 cts. each.
- 2 lt. Pantry Ck. Rail Windows, glazed, 12x20—65 cts. each.
- Red Oak Colonnade—\$11.50.
- Transoms, 2 ft. 6 in. by 10 in.—33 cts. each.
- Outside Blinds, 2 ft. 4 $\frac{1}{2}$ in. by 3 ft. 11 in.—per pr., \$1.08.
- Hot Bed Sash, Cypress, 6-inch glass—\$1.69.
- Y. P. Quarter Round, per 100 lineal ft.—25 cts.
- Y. P. Door and Window Stops.
- Y. P. Pilaster Casings, per 100 lineal ft.—\$1.69.
- Corner blocks, each 2 cts. Head blocks, base blocks, 4 cts. each.
- Gable Ornaments, 4 ft., price each, 75 cts.
- Screen Doors, 2 ft. 6 in. by 6 ft. 6 in., each, 90 cts.
- O. S. Window Frames—\$1.18 each.
- O. S. Door Frames—\$1.79 each.
- Cypress Colonial Built-up Columns, 6 by 6 in. by 8 ft., each, \$1.83.

Use Our Complete Service Double Your 1912 Profits

You can double your profits in 1912 by using the wonderful facilities and service of this company. Send the coupon for our Catalog and Plan Book and let's get together.

MAIL THIS TODAY

Gordon-Van Tine Co., 599 Federal St., Davenport, Iowa

Please send to address below, your
**BUILDING MATERIAL CATALOG,
BOOK OF PLANS** (Enclose 10c for postage on Plan Book.)

Name

Address

599 Federal St., Davenport, Iowa

When Writing Advertisers Please Mention the American Carpenter and Builder.

Dull Kote on Wall Boards

By R. F. Johnston

Wall boards are a comparatively new factor in building construction, and in building remodeling and maintenance. They are considered by many as an improvement over lath and plaster rather than as a substitute therefor. Wall boards are cut in sheets and are well adapted for application to any class of buildings, from "sky-scrapers" to school houses, public buildings, churches and homes.

Many merits are advanced in behalf of this class of material. It is nailed on the studding in panels with ease and convenience, without muss, dirt, litter or confusion. It cuts readily with a saw. It is easily put up by any mechanic or by anyone who possesses a little mechanical skill. The seams are covered by wide or narrow strips of wood, decorated or painted, as one's taste may dictate. The effect is both pleasing and artistic. The strips of wood may be finished in harmony with the decoration applied to the panels, or in a dozen different finishes by way of contrast.

Penetrating wood stains are used for such purpose, as also varnish stains and enamels or paint in simple oil gloss.

The Wall boards can be decorated and finished speedily and effectively.

With plastered walls the feature of drying out is necessary before any finish or decoration is practicable. This requires a "right smart" period.

With wall boards it is different. The finish and decoration may be applied at once.

Any kind of a finish can be produced on wall boards with perfect results. However, the handsomest, most artistic, most satisfactory, most durable, decoration is paint in flat effects.

Experience fully proves that Johnston's "Dull Kote" paint is one of the best decorative and protective finishes for wall

boards, either with or without stencil ornamentation. There is no end to the range of decorative opportunity with wall boards where Johnston's "Dull Kote" paint is used.

In this connection it is to be carefully borne in mind, that while the several makes of wall board are designed for a single purpose (that is, in building construction), they are vastly different in the constituent parts which enter into their composition as an integral. For example, one wall board is made entirely of wood, by a process which assures great strength and availability; another wall board has a base of dressed laths imbedded in asphalt and surfaced with heavy cardboard; another is two thicknesses of heavy paper, with a core of wooden slats between, all securely cemented together; still another is fibrous boards, compressed and waterproofed; and there are others made under still different methods.

The R. F. Johnston Paint Co. has no financial interest whatever in any brand of wall board—but they are highly concerned in their painting and decorating possibilities.

In the painting and decorating of wall boards, slightly varied methods of procedure in the first coats are necessary in order to perfectly meet diversity in the materials which enter into the varied processes of manufacture.

Specifications which cover the painting and decorating features of all standard brands of wall board have been carefully prepared and will be mailed to any reader of the AMERICAN CARPENTER AND BUILDER who will write the R. F. Johnston Paint Co., Cincinnati, Ohio.

The Carpenter Laying Oak Flooring

By W. L. Claffey

At this season of the year when outside millwork is somewhat slack for the carpenter, a splendid opportunity presents

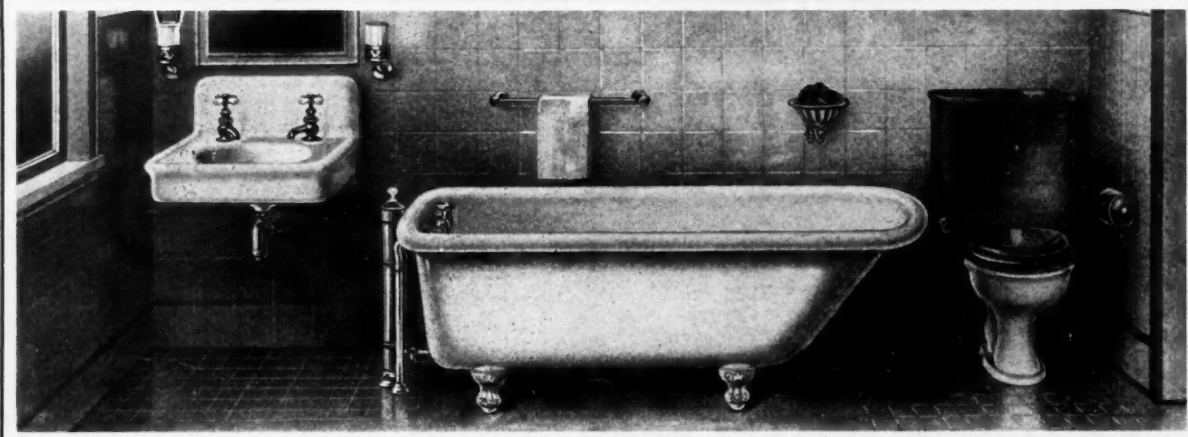

The rent agent calls attention to the Wolff Plumbing Fixtures as the best guarantee to the prospective tenant of the high grade of the plumbing system—indeed, the type of the whole building is many times inferred from the use of WOLFF material throughout.

The worries from "assembled" plumbing, contrasted with the perfect service of the all-built-by-one-house Wolff Plumbing, makes it easy for the architects to use Wolff specifications.

L. WOLFF MANUFACTURING COMPANY

MANUFACTURERS OF

PLUMBING GOODS EXCLUSIVELY

The Only Complete Line Made by Any One Firm

General Offices
601-627 W. Lake St., Chicago
Trenton, N. J.

Showrooms
111 N. Dearborn St., Chicago
Denver, Colo.

Branch Offices:

Omaha, Neb.
Minneapolis, Minn.

St. Louis, Mo.
San Francisco, Cal.

Cleveland, Ohio
Washington, D. C.

Kansas City, Mo.
Cincinnati, Ohio

Buffalo, N. Y.
Dallas, Texas!

When Writing Advertisers Please Mention the American Carpenter and Builder.

Put It At Work In Your Shop



*"Handy as a Pocket
in a Shirt"*

Patented in the United States, Canada and other foreign countries. Other patents applied for.

The "Multimotor" Shop Engine increases your profits and keeps down the size of your pay-roll. Does the work of three men at an expense of *less than a cent an hour.*

Stop pedal-pushing and crank-turning! Let the

Fuller & Johnson "Multimotor" Shop Engine

turn the wheels in *your* shop. This wonderful engine is small in size but a giant in power. Runs all hand-power or foot-power machines—jig saws, lathes, emery wheel, grindstone, drills, etc. Just the thing for carpenters, contractors and owners of small workshops.

Perfectly Simple Absolutely Safe

Simplest, neatest, strongest, most reliable little engine ever built. Comes to you *complete*—nothing to add but gasoline.

Easily moved anywhere. For *indoor* use has *out-door* fuel tank, insuring perfect safety.

Important working parts protected by dust-proof case. Needs no attention while running. Works steadily all day on a few cents' worth of grocery-store gasoline. It is air-cooled, fool-proof, cannot freeze or overheat.

The "Multimotor" in design, material and construction equals the best automobile engines. Every engine is thoroughly tested before leaving the factory, and is *guaranteed!*

Fuller & Johnson Farm Pump Engine

Practically the same as "Multimotor," with pumping gears added. Can be hooked up to any pump in 15 minutes. Needs no belts, arms, jacks or special platform. Pumps 270 to 2,450 gallons every hour. Perfectly adapted to farm and suburban use

Engine Book Sent Free!

Book, giving full information about "Multimotor" and Farm Pump Engine, sent FREE on request. Let us tell you more about these amazing little power-producers. Let us send you the name of the nearest dealer, who will show you the engine and *explain* what it can do. (264)

If interested in larger engines, ask for Catalog of Fuller & Johnson's Famous Double-Efficiency Engines.



Fuller & Johnson
"MULTIMOTOR"
Works Like Ten Men

FULLER & JOHNSON MFG. CO. 2 Ames Street (Established 1840) **Madison, Wis., U. S. A.**

When Writing Advertisers Please Mention the American Carpenter and Builder.



Your tool is your helper. It's on your pay-roll, just as truly as any two-legged human helper.



The head with noiseless ball bearings, of steel, not shot—made split-proof by a steel cap.

You won't give a poor helper room, whether the helper goes to supper or into a tool box when the whistle blows.

If you want a tool that will produce—for yourself and the boss—you'll get the

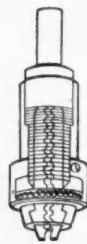

This is the chuck that the weakest wrist tightens as tight as strongest vise—**instantly.**

P. S. & W. SAMSON BRACE

THE BRACE WITH THE BALL-BEARING CHUCK

The same master workmanship and integrity goes into P. S. & W. Guaranteed Chisels. Behind them, as behind all P. S. & W. Tools, is 93 years of honorable tool making.

P. S. & W. Chisels are made of the best tool steel, tempered and hardened by special process; they are sharpened before they leave the factory; and the handles are turned and sandpapered until they fit the extra-long sockets exactly.

P. S. & W. Tools for Carpenters include the largest line of braces and auger bits, the most complete line of chisels and gouges, highest grade drawing knives, squares, calipers, hammers, hatchets and many other tools.

Write today for our 170-page "Mechanics' Handy List." It contains 35 pages of valuable shop information and a catalog of over 200 tools.

The Peck, Stow & Wilcox Co.

MFRS. of the largest line of mechanics' hand-tools offered by any maker

Address correspondence to 22 Murray St., New York City
Established 1819 Five Large Factories

When Writing Advertisers Please Mention the American Carpenter and Builder.

itself in the laying of 3/8-in. thickness oak flooring over old floors in old residences. A little canvassing by the carpenter to some of the old homes that were built before the advent of hardwood flooring will secure agreeable and profitable jobs. This line of work is being carried on by a great number of carpenters during the winter season. In fact it is the best time of the year for the laying of oak flooring in old homes, for the reason that the rooms are heated, making the old floors dry and in good condition to receive the thin oak flooring.

The average carpenter requires no special training to lay oak flooring. It is necessary, however, that he should acquire a full knowledge of all the grades, thicknesses and faces in the plain and quartered oak flooring, as well as prices from the local dealer before estimating any jobs.

It brings to the writer's mind how a progressive carpenter in a small town in Michigan, who, having a few days leisure time, went around and secured jobs for the laying of oak flooring in old homes. It proved so agreeable and profitable that he is now what is termed "a professional floor-layer." The dealer in his town would not supply all the different kinds of oak flooring that he required, so he was obliged to make arrangements with an oak flooring manufacturer, who now supplies his needs. Today he is securing jobs within a radius of a hundred miles of his home town, and employs about ten men the year around.

It seems to be the general impression that in order to make a successful hardwood flooring job, one must be a professional floor-layer. This is not true. Any ordinary carpenter with any judgment at all can lay oak floors. After the floor is laid, the process of scraping is necessary to make a good job. On the finer jobs a hand scraper is recommended, but in places where there is a large surface, there are many types of power machines on the market that will do this work cheaper and easier. Sometimes No. 1 sandpaper is used after the scraping process.

The finishing of an oak floor is a matter of taste. It is always best, however, to apply a good liquid floor filler first, and then a coat of pure white shellac. This gives a firm base for the final finish, which is usually wax or one of the numerous finishes offered by different paint companies. Any of the large paint concerns will send complete information on the finishing of oak floors upon request.

Carpenters can secure from their local dealers, a catalog issued by the oak flooring manufacturers, or can find out from them where it can be secured. This book gives complete and valuable information on all the different kinds of oak flooring, thicknesses and faces; besides it tells how to lay, the kind of nails to use, how to estimate and other pertinent information that the carpenter should have knowledge of before undertaking jobs of this nature.

Jig Saw Attachment for Luther Grinders

One of the attachments for the new Luther Grinder and one that is extremely valuable in carpenter's work and in pattern making is their jig saw attachment. It is used on the same frame as the head for the grinding wheels, another cap being supplied for the regular cap that is used in grinding.

Every carpenter has more or less use for a jig saw. For scroll work and pattern making it is indispensable. This jig saw is heavily built and although a large range of work can be done on it the necessary power can be easily developed by foot. It can take work up to two inches in thickness.

A particularly valuable feature in certain classes of work, and which comes in handy in almost any sawing, is the adjustable table. By means of this, work can be done at any angle and the same angle rigidly maintained throughout.





You have probably taken your Simonds saw in just this same way and displayed it to the admiring gaze of some friend.

Like the fellow in the picture you probably said—"Simonds I tell you it's a great saw."

No the Simonds Hand Saw isn't a very old product—even though The Simonds Co. has been in business eighty years. We made other kinds of saws for a great many years before we yielded to the demand for a Simonds hand saw.

Ten years on the market has proved the Simonds Saw, has tested it, has shown the undoubted call for an extra high quality saw. The story of public approval is shown by public demand.

Every Simonds saw is fully warranted. Ask your Hardware Dealer. Tell your friends about this saw—send for a free copy of Simonds carpenter Guide. If your Dealer doesn't sell Simonds Saws write us saying what kind of a saw you want.

Simonds Manufacturing Company

Fitchburg, Mass.
New York City
Portland, Ore.
Vancouver, B. C.

Chicago, Ill.
New Orleans, La.
San Francisco, Cal.
Lockport, N. Y.

Montreal, Que.
Seattle, Wash.
London, Eng.
St. John, N. B.



The Use of Waterproof Flat Finishes For Composition Wall Boards

By Frank P. Foster Jr.

In view of the fact that composition wall boards are gaining a vogue everywhere among builders, it is of more than ordinary importance that architects, builders, contractors, interior decorators and painters should become acquainted with the best means for finishing such materials to the greatest advantage. In this connection it is interesting to note that the Glidden Varnish Company of Cleveland, Ohio, has devoted unusual attention to the development of special materials for the perfection, protection and decoration of modern structural work, including concrete and steel structures and that among the numerous products evolved as a result of their laboratory research and exhaustive practical tests are a series of special waterproof flat finishes especially adapted to the protection and decoration of composition surfaces such as the wall boards which are so rapidly becoming more and more popular. The finishes in question are made in light pink, light blue, pearl gray, cream, medium buff, golden yellow, light green, medium green, green toner, yellow toner, red toner, brown toner and also in white which may be tinted in any shade desired. Besides being of special value for use upon wall boards and other composition surfaces from a protective and decorative view point they are also used to great advantage in interior work on old or new plastered surfaces, whether rough, smooth or sand finished, and for metallic ceilings and wainscotings. They produce a beautiful, soft flat finish and one that is perfectly sanitary inasmuch as it may be washed repeatedly without injury.

A sand-finished surface treated to one coat of Glidden's Waterproof Flat Finish over a coat of Glidden's Alkali Proof Wall Size has been found to produce very good results. On the highest class work it is advisable to use two or three coats and to allow from two to three days between coats, according to weather and temperature conditions. These waterproof flat finishes have been found to have excellent brushing properties and covering capacity and to flow out with a full, even surface, free from brush marks. When they are applied over the alkali proof wall size on interior wall work they produce especially beautiful effects. Under ordinary conditions their covering capacity is approximately five hundred square feet to the gallon.

In applying these waterproof flat finishes they should be brushed well out over the surface so as to obtain uniform covering properties and it is essential that the surfaces over which they are applied should be dry, clean and well seasoned. Where an inexpensive yet satisfactory job is desired, it is well to use for the first coat a mix of half alkali proof wall size and half waterproof flat finish in the desired color, followed by a second coat of straight waterproof flat finish. When the waterproof flat finishes are applied upon rough or sand finished plaster the material should be worked well into the pores of the surface. Upon smooth white plaster finish a priming coat composed of three parts of alkali proof wall size and one part of the color of flat finish to be used, gives good results. Where two or more coats are desired, one should use the flat finish just as it comes from the package, allowing plenty of time between coats for thorough drying.

A large, soft black stock brush should be used for applying the wall finishes and the material should be well incorporated by thorough stirring before application. When applying these finishes to wood and metallic surfaces no priming coat is required. All that is necessary

When Writing Advertisers Please Mention the American Carpenter and Builder.

Mr. Builder:

It Pays to Deal with Practical Lumbermen



Nearly 10,000,000 feet in sight. This cut shows our big Southern Illinois Plant, situated where 27 Trunk Lines and 3 Interurban and Traction Systems have their terminals. Our customers get as prompt service as they could from their home lumber yard, and many other advantages which the local yard cannot offer them.

We do not claim to know anything but lumber—lumber and mill work. We handle nothing else—but in **lumber** and **mill-work** we are **experts**, and we can give you material of selected quality at rock-bottom prices, that even to the closest buyers are **simply amazing**. Send the free coupon today and investigate.

It took us 11 years to work up from lumber jacks to mill owners—then followed 20 years of actual experience in the lumber business, in which we are today. During all this time not a foot of our selected stock has been shipped out without our personal inspection—and every shipment has been made at the very lowest rock-bottom figure. This is the way we have built up our tremendous business.

Increase Your Profits

Send free coupon below for our big history-making lumber and mill work book listing hundreds of astounding bargains—bargains that will mean a **tremendous increase in your profits**. Remember, these prices are quoted on material that is selected by expert lumbermen, and **absolutely guaranteed in every respect**. These prices are **rock-bottom** and are absolutely the lowest **figures** ever offered to bona fide builders. Remember, our material is absolutely guaranteed to be strictly of the **highest grade**. We ship to your customers without any money down, thus assuring them of the best quality, since they may unload the car and examine before paying.

Our Big Helps to Builders—Carpenters—Contractors

We offer all of the facilities (and more) of the local lumber yard. We offer the highest grades of lumber—a great stock to select from—the lowest prices, because of our enormous capacity and the man who engages you to build has the opportunity never before offered.

Our whole plan is to help you—the builder—the carpenter—the contractor. We want you to bear in mind that we are doing something more than just **selling** lumber. We are **lumbermen**—we are in the lumber business and the lumber business **alone**. We don't deal in anything **but** lumber, and, as we told you once before, we don't know anything **but** lumber, but we know **THAT**. We want you to write us.—if you want to deal with out and out lumbermen whose enormous stumpage and far-reaching facilities enables you to buy just as if you stood right in our lumber yards.

BIG BOOK of Bargains FREE

Send for it today. There is everything in this catalog—bargains in doors—gable ornaments—windows—transoms—cellar sash—attic sash—barn sash—stall sash—wall board—porch columns—newels—spindles—brackets—rails—balusters—mouldings—battens—lattice—nosing—wainscoting—window stools—casings—base blocks—head blocks—stair rails—grilles—everything—positively **everything** and at right down rock-bottom prices. You can find anything in lumber and mill-work in this book—anything to build a house from cellar to garret.

Send COUPON Now

No matter what you are going to *build*—write to us and let us give a *Lumberman's Delivered Estimate*—positively free and postage prepaid. Write your name and address on the free coupon and mail it to us *today—now*. We want to give you an estimate on any bill of lumber you want—a positively free estimate. **Get our Free Catalog at once.**

Barrows & Donnellan Lumber Co.

TRADE BUILDING, Dept. 2662
CHICAGO ILLINOIS

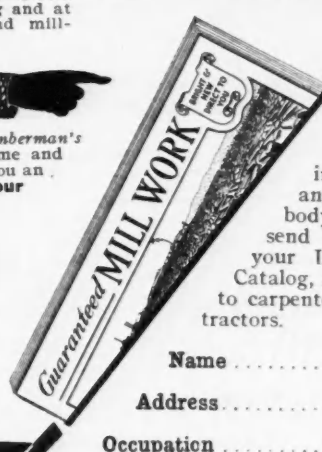

Barrows & Donnellan Lumber Co., Trade Building, Dept., 2662, Chicago, Ill.

With the understanding that I am not buying anything or paying anybody for anything you may send me free and prepaid your Lumber and Millwork Catalog, and explain your helps to carpenters, builders and contractors.

Name

Address

Occupation

When Writing Advertisers Please Mention the American Carpenter and Builder.

is to use the material as it comes from the package, after having taken proper precautions to insure the surface upon which it is to be applied being dry, clean and free from rust, grease and other foreign matter. Before applying the wall finishes to woodwork, one should see that all knots or sappy places are given a coat of pure white shellac. These flat finishes have also been used over colored wall paper with excellent results—two coats of waterproof flat finish over one coat of alkali proof wall size. Pure turpentine is used for reducing purposes.

Preparing Walls for Tinting

All walls that are to be tinted should first be washed clean with soap, all cracks and crevices filled with plaster of Paris. When mixing the plaster of Paris it is well to add a small amount of vinegar to the mix in order to prevent it setting too rapidly. As soon as the wall is dry, after washing, it is ready for sizing.

To prepare walls that have been painted with kalsomine, or water paints of any kind they should be washed with warm water and made thoroughly clean. The most satisfactory method of accomplishing this is by means of a large paste brush or kalsomining brush, for wetting the surface, and then sponging the walls after they have been thoroughly soaked. After the walls have been thoroughly cleaned, in the manner described, is the proper time to fill all cracks and crevices with plaster of Paris mixed with water and a small amount of vinegar or paste. The vinegar is used to temper the plaster of Paris and to obviate too rapid setting.

The proper treatment for walls that have been white washed, in order to prepare them for tinting, is to scrape off all whitewash by means of a steel brush, and, after the wall is perfectly clean, it should be well sanded and

one coat of vinegar applied. After this has been done, all cracks and crevices should be filled with plaster of Paris, after which the walls are ready for sizing.

Frequently new walls require special treatment owing to the fact that they are often very hot, having a strong absorbent tendency that practically amounts to suction. In cases of this kind, if one will see that the surface is given a strong coat of vinegar before proceeding with the sizing, no further special treatment will be required.

Changes in the L. S. Starrett Organization

The L. S. Starrett Company, which has the largest manufacturing establishment of fine mechanical tools in the world, has recently increased its capital stock to \$3,500,000, of which \$1,500,000 is to be six per cent cumulative preferred stock and \$2,000,000 common stock.

The officers of the company are: L. S. Starrett, president; F. A. Ball, vice president; F. E. Wing, treasurer and secretary; W. G. Nims, assistant treasurer; with a board of nine directors consisting of the officers named and M. B. Waterman, Augustus P. Loring, John A. McGregor, J. H. Drury, and W. B. McSkimmon. The last four named are officers of the Union Twist Drill Co., the second largest machine factory in Athol. The Union Twist Drill Co. becomes a stockholder of the L. S. Starrett Company and as such has representation on the board of directors, which is increased from five to nine.

The L. S. Starrett Company was incorporated in 1900, succeeding to the business established by L. S. Starrett in 1880 and conducted by him individually up to the time of its incorporation. The capital stock of the incorporation was \$100,000 in 1900, since which time the business has increased far out of proportion to the original capital. L. S. Starrett continues in active control of the business.

What becomes of your spare time? Why not turn it into money?

Many of your patrons spend their summers near the water and they all want boats. Why don't you offer to supply them? With Niagara frames you can construct as good a boat as was ever built.

You will have an actual advantage over the average boat builder, as we furnish you with Naval Architects plans to show your customer and you can guarantee results. We will help you close your sales.

\$350 BOAT FOR \$140

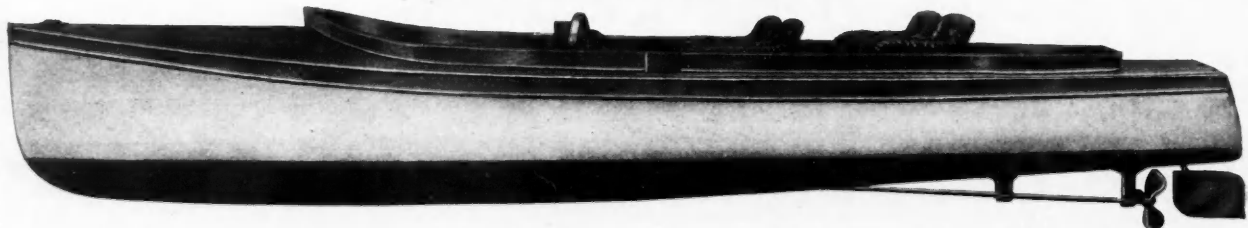

The above price includes every stick and fastening for this boat including brass fittings, auto steering wheel, rudder, gasoline tank and cushions. If you have on hand odd lots of material left over from former contracts, it will not be necessary to purchase all of the material. You get patterns for all parts not ordered with the frame. Complete instructions for building are also furnished.

You will find Niagara boats far in advance of others who furnish the same old models year after year. Start one of these boats now. It will prove interesting work for you in your spare time and a chance for extra money.

Cruisers Speed Boats Runabouts

Send five cents postage for handsome 48 page catalogue showing 40 new designs

Would you like to see Plans?

NIAGARA MOTOR BOAT CO., 225 Sweeney St., North Tonawanda, N. Y.

When Writing Advertisers Please Mention the American Carpenter and Builder.

Glidden

Challenges Comparison

We challenge any painter, builder or contractor to send us a sample of any exterior varnish, foreign or American (that is not a Glidden varnish) that equals Glidden's M. P. Durable Exterior in durability, elasticity, body and flowing properties.

We challenge any painter, builder or contractor to send us any interior varnish, foreign or American (that is not a Glidden varnish) that equals Glidden's M. P. Durable Interior in elasticity, durability, and flowing and brushing properties.

We challenge any painter, builder or contractor to send us a sample of any floor varnish, foreign or American (that is not a Glidden varnish) that equals Glidden's M. P. Durable Floor in durability, hard and quick drying properties and elasticity, that is more impervious to water and that will withstand harder usage.

By this proposition we invite Trouble, knowing that Trouble will not accept our invitation.

Talk is cheap—brag is cheap. Comparison proves facts. We challenge comparison.

Get busy. Send in your samples. We will test them.

Be as skeptical as you like when you read this advertisement, but be honest to yourself. Put us to the test.

The Glidden reputation was not built in a day, but it might be lost in an hour, and we are taking no chances.

We know that Glidden's Green Label Varnishes have no equal.

We are merely seeking an opportunity to prove it to you. In the meantime let us send you Demonstrating Samples and Literature. Use the attached coupon.

AC&B
The
Glid-
den
Varnish
Company,
Cleveland,
Ohio:

Gentlemen:
Send us Dem-
onstrating Samples of
your M. P. Durable Ex-
terior, M. P. Durable In-
terior and M. P. Durable
Floor and Literature, free of
charge.

The Glidden Varnish Company

FACTORIES: CLEVELAND, OHIO - TORONTO, CANADA
BRANCHES: NEW YORK - CHICAGO - LONDON

When Writing Advertisers Please Mention the American Carpenter and Builder.

LUMBER, LATH AND SHINGLES



VIEW OF PLANT IN ILLINOIS.

THE WHOLESALE AND RETAIL MERCHANTS BUY LUMBER FROM THE PRODUCING MILLS, WHY DON'T YOU?

We Are Producers and Can Save You \$100.00 on the Average House Bill of Lumber

You save lumber dealers' profits when you order from us. Better still, we give you a finer grade of material than the average dealer carries. Furthermore we can insure delivery in a few days. We are now operating two immense lumber plants, one in Louisiana, another in Illinois. Our Louisiana plant is located in the great lumber forests with saw mills, dry kilns, log trains, planing mills, etc., in connection, permitting us to control our costs and grades and enabling us to sell you the finest lumber manufactured for all building purposes at strictly manufacturer's prices. Our Illinois plant is located on the two largest and fastest freight railroad systems in the North with direct connections to over twenty different railroads. We make a specialty of prompt shipment from this point to the Central and Eastern States, reducing the time in transit from weeks to days. Whether you want a single carload of lumber or twenty carloads, we can make shipment in record breaking time. Remember, our prices to you are strictly manufacturer's wholesale prices, in most instances a saving of from \$5.00 to \$10.00 per thousand feet.

EVERY MAN THINKING OF BUILDING SHOULD HAVE THIS PRICE LIST

THIS IS OUR WHOLESALE LUMBER PRICE LIST
 We Publish Special Lumber Price Lists Quoting "Delivered Prices" to Every City in the United States.

Let Us Send You a List Showing Our Delivered Prices (Freight Prepaid) to Your Station. Mailed Free on Request.

If you cannot wait for our delivered Lumber Price List, SEND US YOUR LIST, we will gladly mail you our bid quoting you our prices on your entire bill of lumber or mill work. The prices, however, will be exactly the same as the prices printed in our wholesale price list.

THE OPPOSITE PAGE SHOWS WHAT WHOLESALE PRICES WILL DO

ASK FOR LUMBER LIST 205AC.

930 DIFFERENT DESIGNS AND SIZES OF BUILDING LUMBER for all building purposes. Do you realize what it means to have such a large stock of this great big assortment of lumber located at a nearby plant, every piece of it guaranteed to be strictly up to grade and which can be purchased at a saving of about \$100.00 on the average order? We pay the freight to your station when you order from our Wholesale Lumber Price List, which you can have for the asking, and which quotes delivered prices on yellow pine and cypress finishing lumber, yellow pine and fir flooring, yellow pine ceiling, siding, partition, dimension lumber, shiplap, plain boards, bevel cribbing, joists, lath, cypress and red wood siding, cypress and red cedar shingles, etc., so that you can tell to a penny what a carload of lumber will cost you. Do not buy lumber of any kind until you get this list. It will pay you to make an intelligent comparison of prices. Architects, construction companies, contractors, carpenters all unite in praising the quality of our lumber. In our lumber list we print letters from people from Connecticut to Colorado who have bought lumber from us, giving facts and figures that will surprise you, and proving beyond a shadow of a doubt all we have claimed in regard to saving, quality and quick service.

If you are thinking of building even a small size house you will need about 9,500 feet of lumber, 14,000 shingles and 10,000 lath. This will make a carload of 30,000 pounds. If you have a barn or any other outbuildings to put up you can safely figure on requiring a minimum carload. If you only require a few thousand feet, perhaps your neighbor has some building to do and can order his lumber with yours. It will pay you both handsomely to make up a club order and secure our wholesale carload delivered prices.

Do not forget that we are producers of lumber, operating two big plants. You can purchase lumber from us for the same money that your local dealer pays for his supply. Write for our Wholesale Lumber Price List today.

THE PRICES shown on this page are for the purpose of giving you some idea of what our prices are F. O. B. our Southern mill (without freight added). Write for our Wholesale Lumber Price List. It names you these same items, also our full assortment, with freight to your station added.

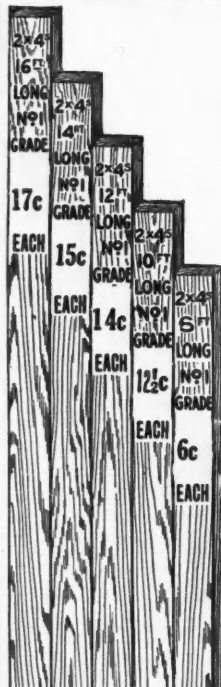

VIEW OF PLANT IN LOUISIANA.

ADDRESS ALL ORDERS TO **SEARS, ROEBUCK AND CO., CHICAGO, ILLINOIS**

WHICH ONE OF THESE HOUSES INTERESTS YOU?



TO EVERY CARPENTER AND BUILDER
Here's a Gift of \$20⁰⁰
 PLUS A SAVING OF NEARLY ONE-HALF.

We can now furnish plans for 110 modern homes, all of which we illustrate and describe in our new Book of Modern Homes. We will send this book free and postpaid to every reader of the American Carpenter and Builder. Write for it. Read about the wonderful bargain on this page which we offer you for February. We practically make you a present of \$20.00, but remember that even at our regular price the materials which we furnish for Modern Home No. AC194 for only \$599.00 is worth fully one-third more.

Note the sketches of the different houses on this page. They will give you some idea of the splendid assortment of designs shown in our Book of Modern Homes. If you are interested in any of these houses just cut out the little picture, paste it on your letter and ask us for any information regarding it you may think necessary. We will be glad to answer your inquiries without any obligation whatever on your part.



Ask for Catalog AC196.

\$599⁰⁰ IS OUR REGULAR **LOW PRICE** || OUR FEBRUARY **PRICE IS** **\$579⁰⁰**

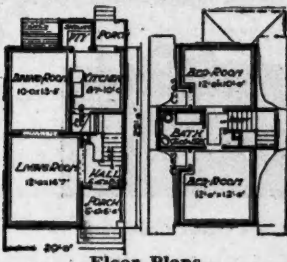

Floor Plans.



Modern Home No. AC194

Here is a five-room house that can be built complete for \$1,250.00. We furnish all of the material, consisting of lumber, lath, shingles, siding, finishing lumber, building paper, pipe, gutter, sash weights, hardware and painting material for \$579.00. After February 29th our price will be \$599.00. If we receive your order at any time before March 1st we will ship the material whenever you get ready to start building up to June 1st at this low price. Look into the merits of this house, send for the plans and examine them thoroughly. We expect to sell 100 Modern Homes No. AC194 during this sale, and we are willing to sacrifice our own profit for the advertising these 100 houses will bring us.

Do You Know Why We Can Save You So Much Money on a House? The Opposite Page Tells the Story. READ IT.

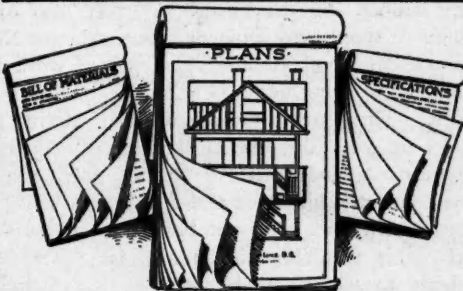

TAKE THESE PLANS FOR 50 CENTS.

We have never before offered a set of plans for less than \$1.00, but in order to show you what a big bargain we are offering you in Modern Home No. AC194, we will sell you during February, the complete blue prints, specifications and an itemized bill of materials for only 50 cents. Order now and save half a dollar.

THE ORIGINAL TRACINGS FOR OUR HOUSES COST US \$100.00 A SET. The architectural service, which usually costs a builder from \$100.00 to \$200.00, we offer you practically free. Get the plans for Modern Home No. AC194, study them if you like, but if you want to take advantage of a free gift of \$20.00 be sure to get your order for the material to us before March 1st. You do not have to start building before June 1st and we will make shipment at any time before that date to suit your convenience.

Would you like to see reproductions of actual photographs of houses built according to our plans and with our material in all sections of the country? You can see them in our Book of Modern Homes, together with letters from the builders, telling of substantial saving, high quality and good service.

When you are writing for our Book of Modern Homes enclose 50 cents in stamps or money order and ask us to send you the plans for Modern Home No. AC194. **BETTER DO IT TODAY. THE BOOK OF MODERN HOMES IS FREE.**

OUR NEW BUILDING MATERIAL AND MILL WORK CATALOG IS NOW READY.

Our 1913 edition of our big Building Material and Mill Work Catalog is now ready, containing many new items, new illustrations, new cover design and filled from the first to the last page with the greatest building bargains it is possible to secure. We will send it to you free with the plans for Modern Home No. AC194, or if you do not want the plans



Ask for Catalog AC143.

No. 63AC7136
 Two - Light Window, 2 ft. 4 in. by 5 ft. 2 in.; 1 1/2 in. thick.
 Price...89c
 Worth \$2.00.

No. 63AC6877
 Four - Panel Yellow Pine Door, 2x6 ft., 1/2 in. thick.
 Price...95c
 Worth \$1.50.

\$1.00 WORTH OF MOLDINGS FOR 30 CENTS.
 COVE MOLD. Yellow Pine. Size, 1/2 x 1/2 in.
 No. 63AC7817
 Price, per 100 lineal feet30c

75 CENTS WORTH OF QUARTER ROUND FOR 25 CENTS.
 Size, 1/2 x 1/2 in. Clear soft wood.
 No. 63AC7784
 Price, per 100 lineal feet.....25c

\$4.00 WORTH OF CASING FOR \$1.63.
 Size, 1 1/2 x 1 1/4 inches. Clear soft wood.
 No. 63AC7594
 Price, per 100 lineal feet.....\$1.63



ADDRESS ALL ORDERS TO **SEARS, ROEBUCK AND CO., CHICAGO, ILLINOIS**

HARDWOOD VENEERED DOORS

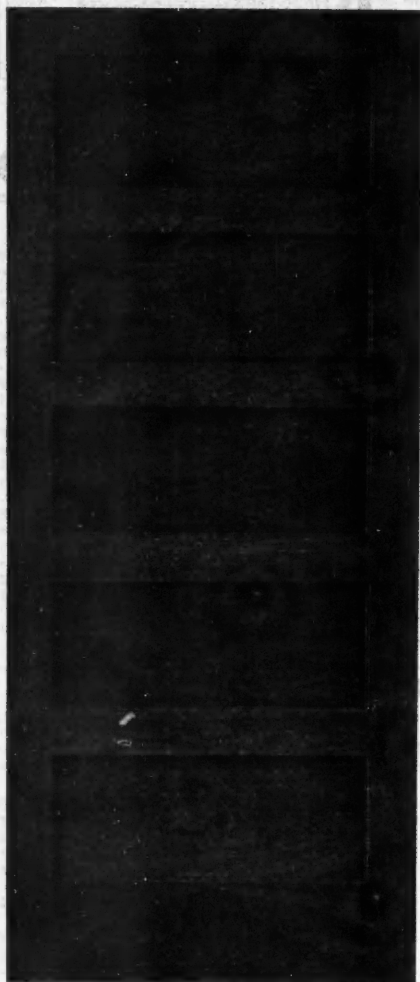

M. & G. 519

Unselected Birch and Plain Red Oak

Our plant is well equipped with the latest Machinery. Our goods cannot be excelled in workmanship or quality.

We make everything in the millwork line and will submit estimates at all times.

Write for our Catalogue

Moore & Galloway Lumber Co.
FOND DU LAC, WIS.



Money-Making Recreation

We are in receipt of a new catalogue from the Niagara Motor Boat Company of North Tonawanda, N. Y., covering their line of knock-down boats. It does not require much imagination to see how this proposition will prove immensely interesting to carpenters and builders.

At certain seasons of the year the carpenter finds himself with a certain amount of spare time on his hands. He has passed through his busy season and his time and skill have commanded a good money return. Taking into account, however, the periods of inactivity between seasons, the average day's wages for the year are reduced. Right here is where this boat proposition will prove of vital interest.

The suggestion is that the spare time be spent building one or more boats. That this is a most feasible plan will be proven.

The Niagara Motor Boat Company make a business of furnishing boat frames from which amateurs can build their own boats. Thousands of them have done it—doctors, lawyers and the like with absolutely no knowledge of tools have been



Most Carpenters Are Great Boatmen

enabled to construct for themselves high class boats at less than half the cost. If an unskilled amateur can do this, how very easy it would be for the skilled mechanic, with his tools and knowledge of construction.

It is interesting to note how this very complete system is worked out. The first thing considered of course, is design. Faulty design in a boat may lead to disastrous results, both for the builder and the buyer. A great deal of time and large sums of money are expended each year on Niagara designs. Competent naval architects are put to work in the Fall of each year to bring out a new line of models, for the coming Spring. This assures the purchaser of getting a boat which will be up with the times. Better yet, it assures a perfectly comfortable and seaworthy craft. After the naval architect has completed his plans and figures, one each of the new models is built and tried out before being listed as a stock model. This fact alone is an absolute protection for those who build to sell. It enables the builder to go to his prospective customer and say, "Here, Mr. Boatman, I can furnish you with this boat and moreover I can absolutely guarantee the design, seaworthy quality and speed. Here are naval architect's plans. Look them over and see for yourself just what you will be getting." The builder knows he can do these things as he is furnished with the naval architect's plans and backed up by a guarantee. This puts the carpenter builder ahead of even the local boat builder, who has never plans to show and can offer no assurance of success.

The method of furnishing Niagara boat frames and material is as follows: We will suppose an order has come in for say, a 28-ft. boat of a certain model. This order is treated as a special job, the first step being to work out the keel, stem, stern, post, transom, etc., which are completely finished and all properly bolted together. These are put in place and the frame completely set up, as shown in the illustration, page 90. Each rib is put into position and properly bent and beveled, after which the sheer strake is fastened into place. This makes a complete skeleton of the boat, ready for the planking. The parts are all carefully fitted and each one given a number after which the frame is taken down and securely crated for shipment. It is only the work of from

When Writing Advertisers Please Mention the American Carpenter and Builder.



The UNDERFEED

CUTS COAL BILLS $\frac{1}{2}$ to $\frac{2}{3}$

and Insures Clean Even Summer Heat in Zero Weather



WHEN winter's blasts are fiercest the UNDERFEED best proves its superiority over other systems in producing clean, EVEN heat at LEAST cost. It is this truth, easily demonstrated, which gives the Underfeed the exclusive advantages over all other heating systems. The Underfeed, because of the saving qualities, soon pays for itself. Then it keeps on saving for the householder.

The Underfeed ADDS to the RENTING or SELLING Value of ANY building. Adapted for ALL buildings—large or small—residences, halls, offices, apartments, churches, etc.

Architects and Builders will find it to their lasting advantage to send for the Underfeed Booklet and learn WHY coal bills will be reduced ONE-HALF to TWO-THIRDS by the installation of

The Peck-Williamson Underfeed HEATING SYSTEMS WARM AIR FURNACES-BOILERS STEAM-HOT WATER

This illustration shows the Underfeed Boiler



The principle of Underfeed coal-burning is right. Coal is fed from below. All fire is on top. Smoke and gases wasted in other heaters, must pass up through the fire in the Underfeed, are consumed and converted into heat. Soft coal stack, which would smother fire in other furnaces and boilers, and pea and buckwheat sizes of hard and soft coal yield as much heat in the Underfeed as highest priced coal in furnaces and boilers of the ordinary type. The few ashes are removed by shaking the grate bar as in other furnaces and boilers.

Illustration shows furnace without casing, cut away to show how coal is forced up under fire, which burns on top.



We will send many fac-simile letters of enthusiastic users of Underfeed heaters. Plans of our Engineering Corps are FREE. Write for FREE booklets today, using Coupon.

THE PECK-WILLIAMSON CO., 436 W. Fifth St. CINCINNATI, O.

Mail Coupon To-day and Learn how to CUT YOUR COAL BILL $\frac{1}{2}$ to $\frac{2}{3}$

THE PECK-WILLIAMSON CO., 436 W. Fifth Street, Cincinnati, Ohio

I would like to know more about how to cut down the cost of Coal Bills from one-half to two-thirds. Send me—FREE—

UNDERFEED Furnace Booklet..... Boiler Booklet..... (Indicate by X Booklet you desire)

Name..... Street..... Postoffice..... State..... Name dealer with whom you prefer to deal.

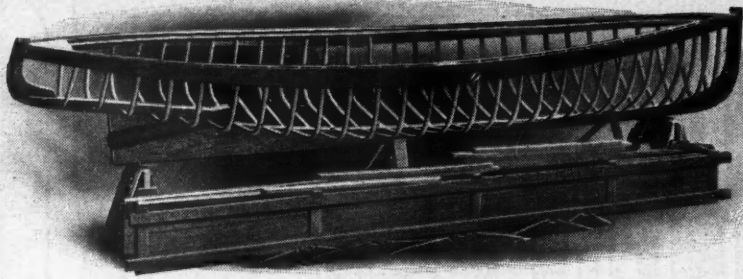

Niagara Motor Boat Co. Boat Partially Done.

four to six hours to set this frame up again and be ready to start the planking. Those desiring to purchase all material with which to complete the boat may do so. However, this is not necessary for those who prefer to buy the material locally, for a complete set of patterns is always furnished free of charge for parts not ordered.

A complete system of instructions for finishing the boat is also included. These instructions take up in common everyday language each step in the work and are illustrated by special drawings and photographs.

The "Money-Making Recreation" comes in right here. Take for instance, the handsome runabout shown on page 88. She is 28 feet long by 4 feet 10 inches beam, and the complete hull, including all the polished brass fittings, but without the motor, is easily sold for \$550.00 The Niagara Motor Boat Company will furnish every stick and fastening for this boat, including fittings, for less than one-third this price. This, of course, includes one of the Niagara frames described above. This is an actual comparison but is merely used as an example to show the margin of profit for those who wish

to turn their spare time into hard cash. Many of the carpenters or builders who have their own shops, and will doubtless have lying about odd amounts of good material which have been left over from former contracts. This being the case, the full bill of material need not be purchased, but this material which otherwise would be wasted, could then be used to good advantage.

The building of one or more of these boats will be a recreation. It will be something new and different from every-day grind. At the same time something really worth while would be accomplished, bringing a good return for the spare time which otherwise would not add to the income.

The Niagara Motor Boat Company maintain a designing department which readers of *AMERICAN CARPENTER AND BUILDER* are invited to make use of. Advice will be given, plans and estimates furnished and all questions answered cheerfully and promptly. There is no charge for this service and it offers an excellent opportunity for expert and accurate advice. A mention of the fact that you are a reader of *AMERICAN CARPENTER AND BUILDER* will assure you of a prompt reply to all your communications.

Chance to Make Money

It is rather a startling fact, when you come to think of it, that with all the progress that has been made in sanitation and in the matter of household conveniences of other kinds, there has been no improvement for the great majority of families in the matter of bathing facilities.

Most people are still obliged to use the same crude appli-



GARAGE TYPE—MADE IN ALL SIZES.

Pruden System Buildings are used for Garages, Stores, Cottages, Warehouses, Engine Houses, Implement Shelters, etc.

A big new field is opened up to the contractor by the Pruden System. Take automobile garages alone. You know the widespread demand for Fireproof garages, both in and out of fire limits. You can now meet this demand quickly, efficiently and at low cost. The profits are large compared to other contracting work. Why not get your share?

Don't form any opinion of the Pruden System based on anything you have ever seen or heard of, for there is nothing like it. It's absolutely original with us. We own the patents and are the only manufacturers. Thousands are now in use all over the country. This wonderful new fireproof construction is an established, proven success. Learn ALL about it. Send for catalogs, pictures, and our proposition to contractors.

THE METAL SHELTER CO.

9-90 WEST WATER ST.

ST. PAUL, MINN.

COTTAGE TYPE

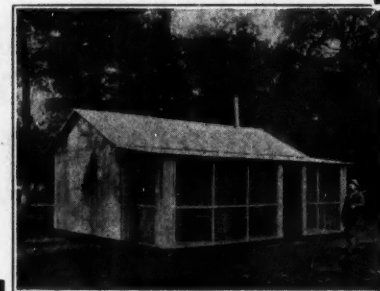

You Can Put Up the "Pruden System" Portable Fireproof Buildings Quickly—

—many times in a few hours. No high cost labor— one ordinary helper is all you'll need. No foundation or framing. You don't have to bother with plans. Everything is shipped to you in completely finished unit sections all ready to be set up. The sections interlock into a self-supporting, strictly fireproof building, that is strong enough, durable and handsome enough to *rank with solid masonry*, but costs only one-third as much, often less.

When Writing Advertisers Please Mention the American Carpenter and Builder.

The "ABC" of BEAVER BOARD Construction

A series of talks to carpenters about the practical use of *Beaver Board*, the pure-wood-fibre wall and ceiling material that is durable, economical, artistic; has none of the disadvantages of lath, plaster and wall-paper; and is appropriate to any type of building new or old.*

Beaver Board is essentially a proposition for Carpenters and Builders.

CHAPTER II

BEAVER BOARD for Residences

The carpenter or builder who is looking for business—and profits—that will keep him busy no matter what the weather, will find big business opportunities in *BEAVER BOARD'S* use in residences.

Whether the house is new or old, *BEAVER BOARDING* is *inside* work. Unlike plaster, *BEAVER BOARD* can be successfully applied in *any* season, onto *bare studding* or *over old lath and plaster*.

Things to be kept in mind in *BEAVER BOARDING*.

Any carpenter can put up *BEAVER BOARD*, but there are a few little things—just a few—he must keep in mind.

He shouldn't drive a nail until he has had every detail of the job thoroughly worked out, or had us work it out for him. As in anything else, you must *plan* if you're going to *BEAVER BOARD* right.

We are willing—and anxious to help. Our Architectural Department will plan the whole job for you if you wish it; and give you estimates, too.

Your problem, if it is only that of *BEAVER BOARDING* to best advantage a 10x12 room will be given just as serious and careful attention as the other fellow's 12-story office building job.

Some *BEAVER BOARD* "Dont's"

Don't paper or plaster over *BEAVER BOARD*.

Don't put up *BEAVER BOARD* immediately if it has become damp in transit; let it dry out—flat.

Don't paint *BEAVER BOARD* until it has been well sized.

Don't put on decorative strips until *BEAVER BOARD* has been painted.

BEAVER BOARD'S endless possibilities for all kinds of uses are fully described in our free booklet "*Beaver Board and its Uses*" with many pictures of different interiors. Write for it today.

BEAVER BOARD

PURE-WOOD-FIBRE
WALLS & CEILINGS



Look for this mark on the back of every panel

If it is a new house, earn the plastering money yourself.

Once you've tried *BEAVER BOARD*, you're primed for convincing the house-owner that he needn't wait for better weather before plastering, and, indeed, needn't think of plaster at all.

Win him over to *BEAVER BOARD*, save him the delay and trouble and litter and the greater expense of plastering, and create for yourself more work more profit.

If it is an old house—

Why, there's a new, virgin field for you. Talk *BEAVER BOARD* walls and ceilings to the owner whose walls need re-plastering or re-papering.

BEAVER BOARD advantages argue its own case. These are:

BEAVER BOARD is economical to handle, suits any kind or sort of building, retards heat, cold and sound, doesn't crack check or deteriorate with age.

*This is the second of a series of twelve advertisements written with a view of acquainting the carpenter with *BEAVER BOARD* and its more-business possibilities. The first appeared in the January number. We will be glad to send you back chapters you miss.

The *BEAVER COMPANY* of BUFFALO

432 Beaver Road, Buffalo, N. Y. U. S. A.

The *BEAVER COMPANY, LIMITED*

372 Beaver Avenue, Ottawa, Canada.

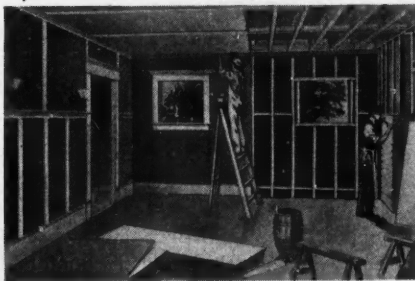

How *BEAVER BOARD* is applied to a room in a new house. Note the absence of litter.



A sample of *BEAVER BOARD*, showing its pebbled surface, which lends itself to painting.



A *BEAVER BOARD* living room, is shown in a model bungalow at the Memphis Tri-State Fair.

When Writing Advertisers Please Mention the American Carpenter and Builder.



**DO
YOU**
Consider
**The COST
of GRINDING**

WHEN BUYING EDGE TOOLS? Did You ever stop, consider and *FIGURE* that *TIME, MONEY, and PATIENCE* SPENT on *INFERIOR TOOLS* requiring continual sharpening is greater than the purchase price? Do you add the grinding expense to the price paid for your tools, or do you make the mistake of judging the cost only by the price you pay the dealer?

Save Money BY LESS GRINDING Make your first cost the last cost. Buy *WHITE'S Edge Tools* and they'll save enough in grinding to pay for themselves. They're **GUARANTEED PERFECT** in *quality, shape, material and temper*, for any wood, any job, at any time, always ready, sharp, accurate and perfect. The **BEST TOOLS** for **BEST WORK**. It'll pay you to buy **White's Edge Tools**. If not at your dealer, furnish us his name and secure our latest catalogue.

The L. & I. J. WHITE CO
143 Perry Street, Buffalo, N. Y.

LOOK FOR IT
DEMAND IT
ACCEPT NO
OTHER



ances that were used hundreds of years ago. For everyone knows the sorrowful fact that modern bathrooms are possible only where there is running water, supplied either by public water works or private water pressure systems, and then only at great expense.

The vast number of people living in small communities or in rural districts where water pressure systems are unknown still have to rely on the old bothersome and unsatisfactory utensils of long ago.

Any one who has experienced the inconvenience of carrying water to pour into a tub or basin, the nuisance of slopping water, to say nothing of the incompleteness of the old cleansing process, will appreciate at once the wonderful advantages of a simple equipment now offered by the Allen Mfg. Co., 3470 Allen Bldg., Toledo, O.

This apparatus has proved so efficient in operation, so simple in construction and so easily used, at the same time being extremely moderate as to cost, that its use is quickly spreading throughout all parts of the country. It is now stated that after having been thoroughly tested throughout a considerable period of years, a quarter of a million of these portable bath outfits have been sold.

M. Fritter, Sec. and Treas. of The Allen Manufacturing Company is now making a very attractive offer to readers of the *AMERICAN CARPENTER AND BUILDER* to act as district agents for the Allen Portable Bath Apparatus. It will pay you to drop him a line requesting details of their agency plan and information concerning the apparatus itself. You will find this very interesting and well worth investigating.

Grimm Portable Woodworker

Inventive mechanical genius and skill are constantly devising and introducing valuable time, labor and money saving machines and machinery of all kinds.

In the present instance we would direct attention to the Grimm Woodworker, a truly wonderful invention, which is meeting with a demand that shows fully how well its merits and efficiency are appreciated by woodworkers everywhere.

A word concerning the Grimm Woodworker may be of interest to our readers.

This machine is of a very simple design and construction, its different saws and attachments can each be set in position in a moment. It has no delicate or complicated parts to get out of order and those who have tested its working and efficiency say that this invention is certainly a wonder.

The Grimm Woodworker is a portable mill on four legs, and generating its own power. It is but 650 pounds in weight, including all attachments, and is always ready to size, rip, plane, joint, cut off, mould, jig-saw, bore tennon, sand, mortise, shape, rabbet and mitre. Moreover it can be moved anywhere, for it requires no special foundation, nor does it need to be fastened to the floor, so that it may be taken to any job and returned to the shop when the work is finished. Thus the contractor has the advantage of a fire-class planing mill with all wood working machinery at hand at all times, and this is a great saving of time and money to him. This machine is the invention of a man who has had fifteen years' experience in the planing mills, as well as more than five years' experience as a contractor and builder, so that his machine is designed along practical lines and meets just the requirements of this class of work.

The motive power is supplied with a 4 H. P. "air-cooled" gasoline engine, built in the Grimm Manufacturing Company's plant, and designed especially for this machine. Or if the contractor has power of his own he might buy one of these machines equipped with countershaft with tight and loose pulley or the machine can be equipped with an electric motor as the purchaser desires. For further information address Grimm Mfg. Co., 46 Erie St., Buffalo, N. Y.

When Writing Advertisers Please Mention the American Carpenter and Builder.

ABC
 Run this adv. in Carpenters, Builders, as it stands in Carpenters' papers just appreciate the general public - J.E.W. (Note below)

WHO SAID ALL THIS ABOUT CYPRESS?

THE WOOD ETERNAL

THE WOOD ETERNAL

(Here's a part of the good things they said:)

"CYPRESS is put to almost every use as an interior trim for houses.....natural color or stained.....contains little resin.....thus affords a GOOD SURFACE FOR PAINT, WHICH IT HOLDS WELL..... popular.....for kitchens, where it is subjected to dampness and heat..... shrinks, swells or warps but little..... For the parts of houses exposed to the weather it serves equally well. AS SIDING IT PRACTICALLY WEARS OUT BEFORE IT DECAYS.....made into porch columns it retains its shape, holds paint, and has sufficient strength.....It is placed as cornice, gutters, blinds.....and railing, and is much used for Porch Floors and steps..... Much CYPRESS lumber is employed in the construction of SILOS..... The FARMER puts the wood to many uses..... ITS LASTING PROPERTIES FIT IT WELL for curbs..... Resistance to decay fits it for stable floors and timbers near the ground, as well as for.....gates, and especially for fence posts.....one of the best available woods for picket fences, because it shows paint well and holds it for many years, but lasts a long time without it.....widely used for this purpose.....in regions remote from its range..... It is PRE-EMINENTLY FITTED for (greenhouse construction).....where it is called upon to resist dampness, excessive heat, and all the elements that hasten decay.....sash, frames, benches, boxes, and practically all else.....the builder needs.....Agricultural implement manufacturers make seed boxes of it, wagon makers.....for beds.....carriage builders and automobile makers work it into panels for fine bodies..... Its slight tendency to warp has caused its employment for incubators.....freight-car siding.....many builders of gasoline launches are said to be using Cypress exclusively for hull planking.....makes handsome church pews.....Telephone boxes and switchboards of CYPRESS are coming into use.....spools.....beehives;.....seine floats;.....tables.....curtain poles;.....patterns;.....shelving and counter tops;.....shims;.....tool boxes. CYPRESS has been substituted for white oak for wine barrels.....The same.....freedom from taste is claimed for it by pump makers, who recommend it for that reason." (etc.)

(Here's who said it—) a reprint from:

U. S. GOVT. REP., Bulletin 95, June 30, 1911, pp. 44-46.



WHEN YOU BUILD (palace, cottage or pasture fence) Why not "Stop Depreciation Before it Begins—Use CYPRESS At First!"



WHEN "FIXING UP" (big new porch or little backsteps) "Why Replace Rotten Wood with Wood that Will Rot?" (Use CYPRESS, of course.)

WRITE TODAY for VOLUME ONE of the CYPRESS POCKET LIBRARY, with Full Text of OFFICIAL GOVT. REPT. Also Full List of 32 Other Volumes. (FREE on request.)

Let our "ALL ROUND HELPS DEPARTMENT" help YOU. Our entire resources are at your service with Reliable Counsel SOUTHERN CYPRESS MANUFACTURERS' ASSOCIATION 1216 HIBERNIA BANK BUILDING, NEW ORLEANS, LA.

INSIST ON CYPRESS AT YOUR LOCAL DEALER'S. IF HE HASN'T IT, LET US KNOW IMMEDIATELY.

The best Carpenters are more and more favoring Cypress because it is easy to work, easy on edged tools and is such a luster that owners are pleased, and that's a good thing for the reputation of the builder who put him wise - J.E.W.

When Writing Advertisers Please Mention the American Carpenter and Builder.

Myers' Calendar

We have received from F. E. Myers & Bro., Ashland, Ohio, their 1912 Poster Calendar. We have become familiar with this particular style of calendar, having received one for a number of years. We are told that for 30 years back the Myers have been using this style, illustrating their complete line of pumps, and they tell us it has become so familiar that many of their dealers set aside a special nail on which to hang their Myers' Calendar.

This calendar is being mailed to about 30,000 dealers and friends of F. E. Myers & Bro. It will pay all of our readers to write for one of them.

Catgut is from the Caterpillar

There may be still some who, misled by the name, think the domestic cat is sacrificed for the necessity of the fisherman. As a matter of fact, catgut, which combines in so remarkable a way the qualities of strength, lightness and inconspicuousness, is made from the silkworm. The chief seat of its manufacture is the Island of Procida, in the Bay of Naples. Most of the silk worms used are reared near Torre Annunziata, at the foot of Vesuvius. When the caterpillars are about to spin, they are killed and the silk glands are removed. These are pickled in some way, which is a trade secret, and drawn out into the familiar threads.—*Scientific American.*

Loss of Heat by Painting Radiators

It is generally believed that there is a great loss in efficiency from painting radiators. We do not agree with this opinion, however, says "The Locomotive," and it has long been our custom to require piping and radiators to be painted in colors appropriate to the finish of the rooms in which they are placed. Professor C. L. Norton, of Boston, Mass., made a long series of experiments upon the transmission of heat through and from painted surfaces. His results are highly interesting, and are recorded in the nineteenth volume (1898) of the *Transactions of the American Society of Mechanical Engineers*. They have seemingly never attracted the attention they deserve. Taking the amount of heat radiated from a new pipe as 100, Professor Norton obtains the following relative values for the heat radiated, under similar conditions, from pipe treated as indicated:

LOSS OF HEAT AT 200 POUNDS PRESSURE FROM BARE-PIPE

New pipe	100
Fair condition	116
Rusty and black	119
Cleaned with caustic potash, inside and out.....	116
Painted dull white	120
Painted glossy white	100.5
Cleaned with potash again	116
Coated with cylinder oil	116
Painted dull black	120
Painted glossy black	101

It appears from the foregoing results that the color of the pipe has little or no effect upon the radiation of heat, though the condition of the surface with respect to glossiness or dullness has quite a sensible influence. Thus a dull surface, whether it be white or black, has a radiative power of 120, and a glossy surface, whether white or black, has a corresponding power of only about 101. These results accord well with our experience, which is to the effect that there is no loss in efficiency through making pipes and radiators harmonize with the general color scheme of the rooms in which they occur, provided glossy finishes are avoided.

MONARCH METAL WALL PLUG

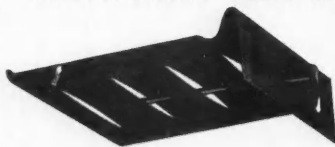

The lowest priced, standard plug on the market. Has a positive grip on the nail, and a definite key in the mortar. *Sample Free.*

Monarch Mfg. Co.
202 Shepard Bldg. Grand Rapids, Mich.

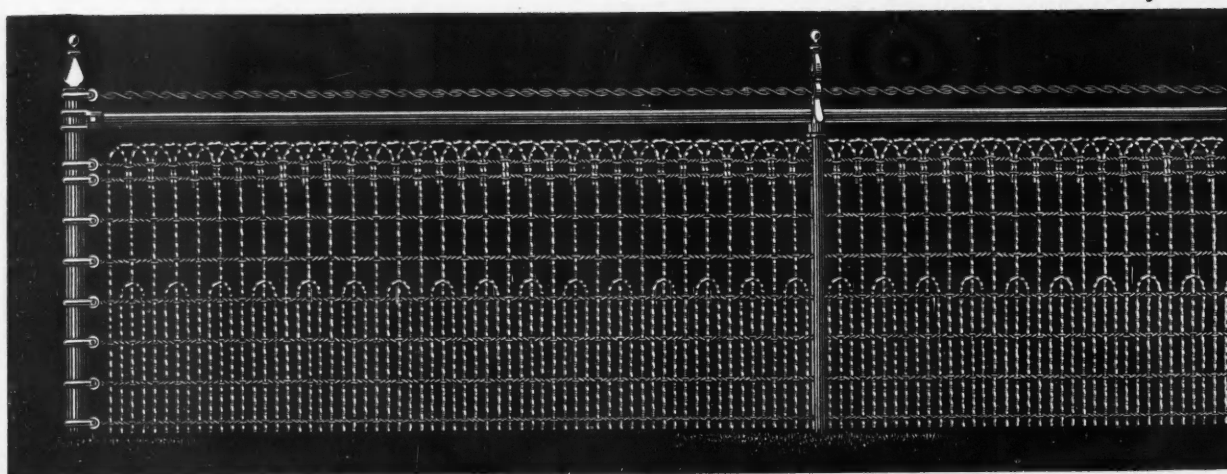

CYCLONE LAWN FENCES

are designed for beauty—built for service. Simplicity and strength generally go together. In Cyclone Lawn Fences they are combined with beauty, making them the most practical, economical and most widely used Lawn Fence on the market.

We manufacture a large assortment of styles and heights for residences, schools, factories and cemeteries, any of which will go up smooth, straight and tight on wood or steel posts and once up your fence troubles and expenses are ended. Ask for our catalog.

CYCLONE FENCE CO. - Dept. AC. - Waukegan, Ill.

When Writing Advertisers Please Mention the American Carpenter and Builder.

LINOFELT = Weatherproof

Linofelt made from Flax Fibre

LINOFELT
Linofelt made from Flax Fibre

for
1912

" I feel that the company that produces an article like Linofelt owes it to the citizenship of our country to tell them what the conditions in their houses really are and how they can be remedied."

—Extract from recent letter from leading material man in Duluth.

The conviction expressed above heads our good resolutions for the New Year. In discharging this, our debt to the citizenship of our country, we must have **your** aid—to **your great profit**. Write us today.

UNION FIBRE COMPANY



ABOUT the most puzzling problem you have with residences is that of **weatherproofing** the walls and roofs. You know that building-paper is nothing more than a wind-break at the best, that tarred felts and such add expense to little or no effect.

What you want is **SOMETHING** that will keep the heat and cold each on their own side of the wall, just as any opaque substance separates light and darkness. But perhaps you have never heard of any such material.

That's our fault—but it won't continue to be. In 1912 we're going to tell the public—**your** public—**all** about Linofelt. And if satisfied customers—walking, **strutting** advertisements—mean anything to **you** we're going to put big round dollars into your pockets as was never done before.

Sure, there's such a material. By hundreds of **actual** and **laboratory** tests **LINOFELT—**

—stops the passage of heat and cold more effectively than **40** thicknesses of standard building-paper.

—cuts **one-third** off **your** customer's fuel bill **every** winter.

—keeps his house **cooler in summer** than you or he ever dreamed possible.

—deadens sound from **200** feet through wood to **2** feet through Linofelt **and**

—adds no more than one per cent to cost of building at most.

Linofelt is made from flax fibres, specially treated and steam-cooked in chemicals. After drying it is made into batts a quarter-inch thick and quilted between 2 sheets of rosin-sized building-paper on the largest sewing-machine in the world.

Linofelt is used just like building-papers. It comes in 18 different styles to meet any particular use or problem which may arise.

Remember that only separated dead air-cells stop heat and cold. Live air is the best transmitter known—and that's what your so-called "dead" air space is. Linofelt contains **more** separated **dead** air cells than any other substance capable of use in building.

Write us **today** for our booklet and all the information you want. Send us the wall and roof dimensions of any residence you have in work and let us estimate it for Linofelt. There's no "corner-coupon" here; we want you to write us a **personal** letter.

There is money in it for both of us—write us **now**.

Union Fibre Company

Union Avenue

Winona, Minnesota

When Writing Advertisers Please Mention the American Carpenter and Builder.



CHOOSE

IT'S up to you to be the man at the top instead of the man with the dinner pail.

Don't hesitate to grasp this opportunity to win success, for there's always room at the top for the man who knows how.

The LIGHTNING ESTIMATOR

stops worry, lying awake nights, over or under estimating and guessing—in fact, by showing you how to estimate the cost correctly, it spells the word **Success** for you. Don't do yourself an injustice by passing up the greatest opportunity ever offered to Carpenter, Contractor or Builder.

The New Sixth Edition of the LIGHTNING ESTIMATOR

will teach you: How much time and material involved in each part of your work; how to figure on unfamiliar work; how to estimate quickly and correctly on a large job; how to estimate on time, material and prices in all parts of the country.

This Book is written by a man who has made good in this profession, and is based on hard, solid facts, secured by the knocks of experience, making it an invaluable guide to any one engaged in or those about to enter the building business.

If you are just starting out, here is your chance to get a firm foot hold. If you are an old timer and getting a little behind the times, here's your chance to brighten up and get some new ideas.

This Edition is bound in cloth, profusely illustrated—a feature not found in other books of this kind. The price, \$1.00. Don't delay. Send for it today.

BRADT PUBLISHING CO.

1260 Michigan Avenue

JACKSON, MICH.

Prudential Steel Shelters

The buildings illustrated show two new designs by C. D. Pruden & Company, Baltimore, Md., for buildings of steel construction. One is a store building, the other a garage or shed. In both the ornamentation is quite unusual.

As is probably well known to our readers, Prudential Steel Shelters are made of galvanized sheet steel, a very durable rust-proof and fire-proof steel so formed that no founda-

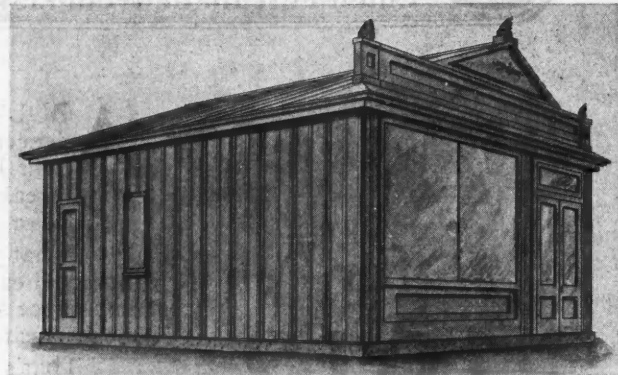

Prudential Steel Store Building

tion of frame wood work is required in erecting them. The point is made concerning them that they afford perfect protection and are thoroughly water proof and comfortable. For hot or cold climates the walls and ceilings can be lined with asbestos board or embossed ceilings and side walls. When so lined they are perfect for the forest, shore, plain, or mountain, and are most attractive in appearance. They are free from insects or vermin and are sanitary.

Prudential Steel Shelters are made in a variety of styles and sizes for garages, work shops, implement shelters, storage sheds, boat houses, outing cottages, hunting lodges, settlers' cabins, moving picture booths, and for innumerable

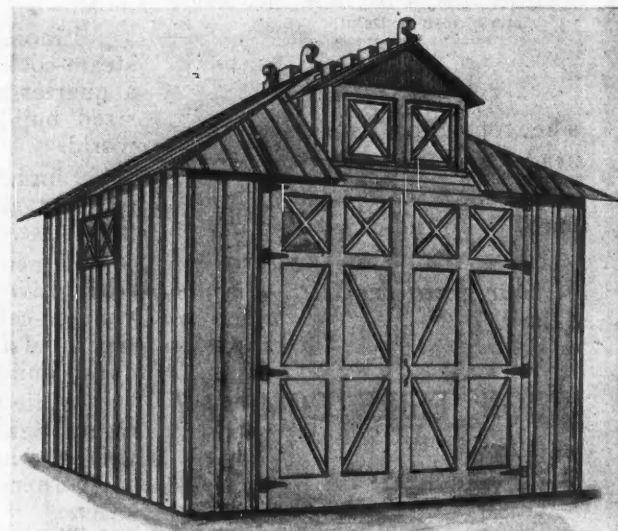

Prudential Steel Garage

other purposes. They are shipped in the knock-down in a compact case with full instructions how to erect them. Any one can put them up without previous experience, and they may be taken down and re-erected many times without damage.

We are assured that there is a large opportunity for readers of the AMERICAN CARPENTER AND BUILDER in representing C. D. Pruden & Co., in their own neighborhood. Write at once for full information, including photographs, designs and plans and details of construction.

When Writing Advertisers Please Mention the American Carpenter and Builder.

YES, YOU CAN!

You can get all you want of it! Just put a "MUST" on your order—and don't let anybody sell you any other lumber when you know that what you WANT is WHITE (or Norway) PINE! "Put a MUST on it."



SOME PEOPLE HAVE THE FACTS BACKWARDS

Many hold the very erroneous belief that WHITE PINE, "the People's Lumber since the Pilgrims landed," no longer exists in commercial quantities(!), or is not easily available at comparatively low cost. They do not know that our annual cut of White and Norway Pine is 1,250,000,000 feet.

THIS IS TO SET THEM RIGHT

and head them straight for WHITE PINE and NORWAY PINE—"THE RELIANCE OF YOUR FOREFATHERS," THE MOST UNIVERSALLY USEFUL WOOD GROWN and the,

"Leader in the Markets for 250 Years" (U. S. Government Report Bulletin 99, October, 1911)

You may rely on us to see that through WIDE AWAKE RETAILERS EVERYWHERE, YOU may secure this "staple American lumber" with the same prompt *certainty* and the SAME QUALITY ADVANTAGES ENJOYED BY YOUR ANCESTORS (They knew White Pine, and Why.)

WRITE US before you BUY ANY LUMBER. Inform yourself. This question of "what wood to use" is deeper than many realize. We will reply promptly and CANDIDLY. (Ask for "Why—When—WHITE PINE" book. Sent for a postal.)

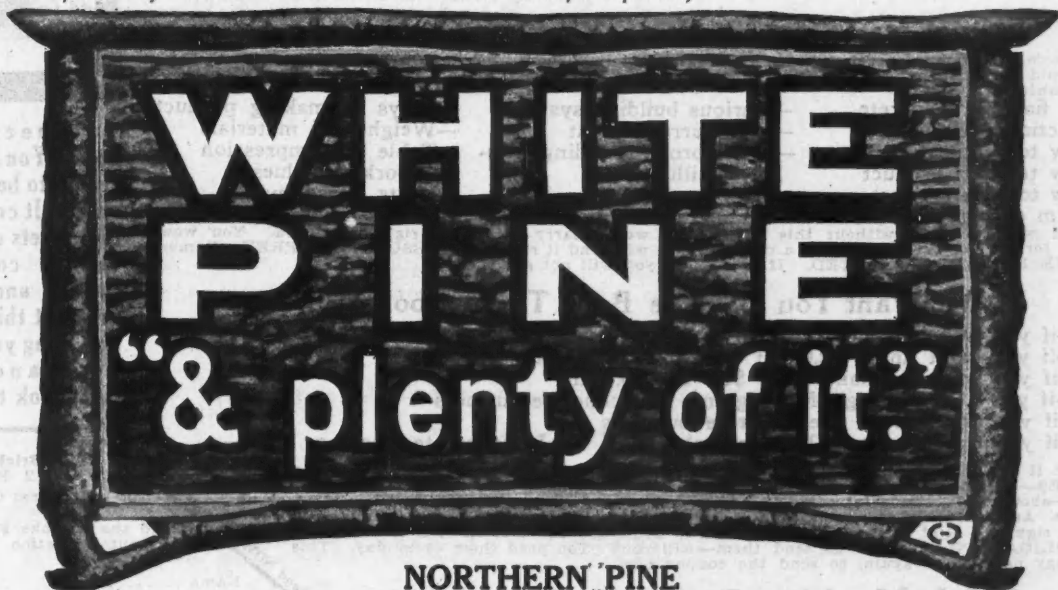

NORTHERN PINE

Manufacturers' Association

1118 Lumber Exchange Minneapolis, Minnesota

When Writing Advertisers Please Mention the American Carpenter and Builder.

The Double Claw Hammer

The utility of the double claw hammer is so clear that the illustrations hardly need any comment. As one of the first carpenters who bought one said, "Don't explain it, I see what it is, and it's a mighty good thing too." But we are going to tell here what the manufacturers of this new tool claim for it.

They claim that the double claw hammer will pull the nails out straight, and so straight that they can be immediately

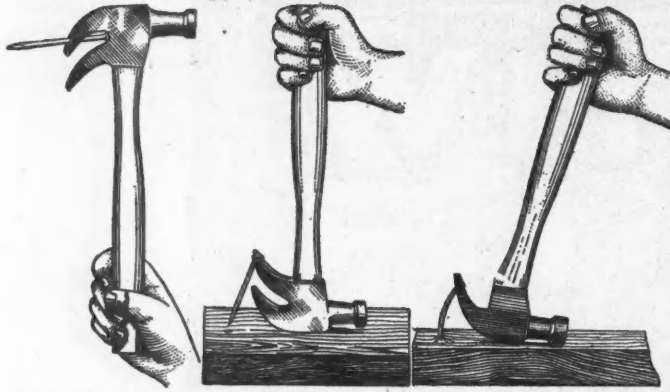

For High Nailing The New Way The Old Way

driven right back again. For "finishing work" this hammer is a great aid, as 10 to 15 per cent of all finishing nails start wrong and must be withdrawn.

The carpenter can hold on with his left hand while pulling with his right without fear of a loose block dropping away if the nail comes out with a jerk. The nail is drawn out straight instead of making a fish hook out of it, as with the old style hammer. The center of gravity, in driving with the double claw hammer, lies exactly between the two claws. Thus, it has a more powerful drive than if too much of the weight were at the extreme end.

The manufacturers have learned that it costs at least three times as much to make a hammer in two pieces and weld these together than to make the ordinary hammer. That is only one of the many reasons why it is worth every cent asked for it. Their advertisement in this number quotes the prepaid price for one hammer. Better steel, better handle, better finish and the better mechanic uses it.

The hammer is made of the finest hammer steel, properly tempered, and while there has been the standing offer to return the price if not satisfactory, the makers, The Double Claw Hammer Company, Broadway and Hewes street, Brooklyn, N. Y., advise us that they have not been asked to take a single hammer back.

Rustless NAILS

A Chain is no Stronger Than
It's Weakest Link

Insure Your Roof
A Good Roof is Often Ruined by a Poor Shingle Nail.

Solid Zinc Nails are Rust-Proof
Rustless Nails Cost But Little More Than Others—
ARE FAR SUPERIOR

W. H. MAZE & CO.,

TRADE MARK
ON EVERY HEAD

PERU, ILL.

SEND FOR THIS BIG FREE BOOK TODAY

Merely Sign
the Coupon

**IT WILL TELL YOU HOW TO MAKE
\$20 TO \$50 A DAY IN CONCRETE**

Many report daily profit of \$20 and upwards. Some as high as \$50. One reports \$2,430 made in 90 days. Another secured \$90,000 U. S. government contract after product was placed in severe tests. Learn all about it in this **BIG FREE BOOK**. Tells how you can do it, how simple it is, the equipment needed, explains it completely. The most thorough book on concrete ever printed.

Also Get the Latest Hand Book on Concrete Free

Recommended by concrete men as the best thing published. You would pay a dollar for it before you would return it, but we give it to you without a penny's cost. Can you afford not to know about these subjects?

- | | | |
|-------------------------|---|--------------------------------------|
| —The field for concrete | —Various building systems | —Ways of making product |
| —Selecting materials | —Plant arrangement | —Weights of materials |
| —How to proportion them | —Waterproof building system illustrated | —Table of compression working values |
| —How to form product | —How to estimate | —Hints on selling |
| —How to cure product | —Comparative tests | —Profits in concrete |
| —Steam curing | | |

You would not be without this data. You would carry this book right with you. You would keep it for years. You cannot buy a copy, but we will send it right now **ABSOLUTELY FREE**. Remember **THE EDITION IS LIMITED**. If you delay you will not get a copy.

We Want You to Have Both These Books Free

- if you want to know how to make sand worth \$6.00 a yard
- if you want about \$2.00 of that to be **YOUR** profit
- if you want to make from \$10. to \$50. daily
- if you are thinking of going into the concrete business
- if you are now in the concrete business
- if you want to know how to make **DRY WALL** concrete blocks or brick—

But if not, then we would not even sell you these books or desire to tell you about **HELM PRESSES**—how they are built in different sizes—for hand or power—combined for brick and blocks—about their wonderful capacity and pressure, or their labor saving and profit making features. As a reader of this paper you are entitled to a copy of each of these valuable books, so just sign and send the coupon **RIGHT NOW** while you think of it. **NO EXPENSE** and **NO OBLIGATION**. Just let us send them—will you? You need them every day. This offer may not appear again, so send the coupon now.



You need this book. You cannot afford to be without it. It contains the secrets of successful concrete making and selling. Let this coupon bring you this book and the Handbook too.

Helm Brick Machine Co.
472 Bank Bldg.
Traverse City, Mich.

Send the 2 books **FREE** prepaid without obligation.

Helm Brick Machine Co.

472 Bank Building
Traverse City, Mich.

Send NOW for your Copy

Name

Address

Business

When Writing Advertisers Please Mention the American Carpenter and Builder.

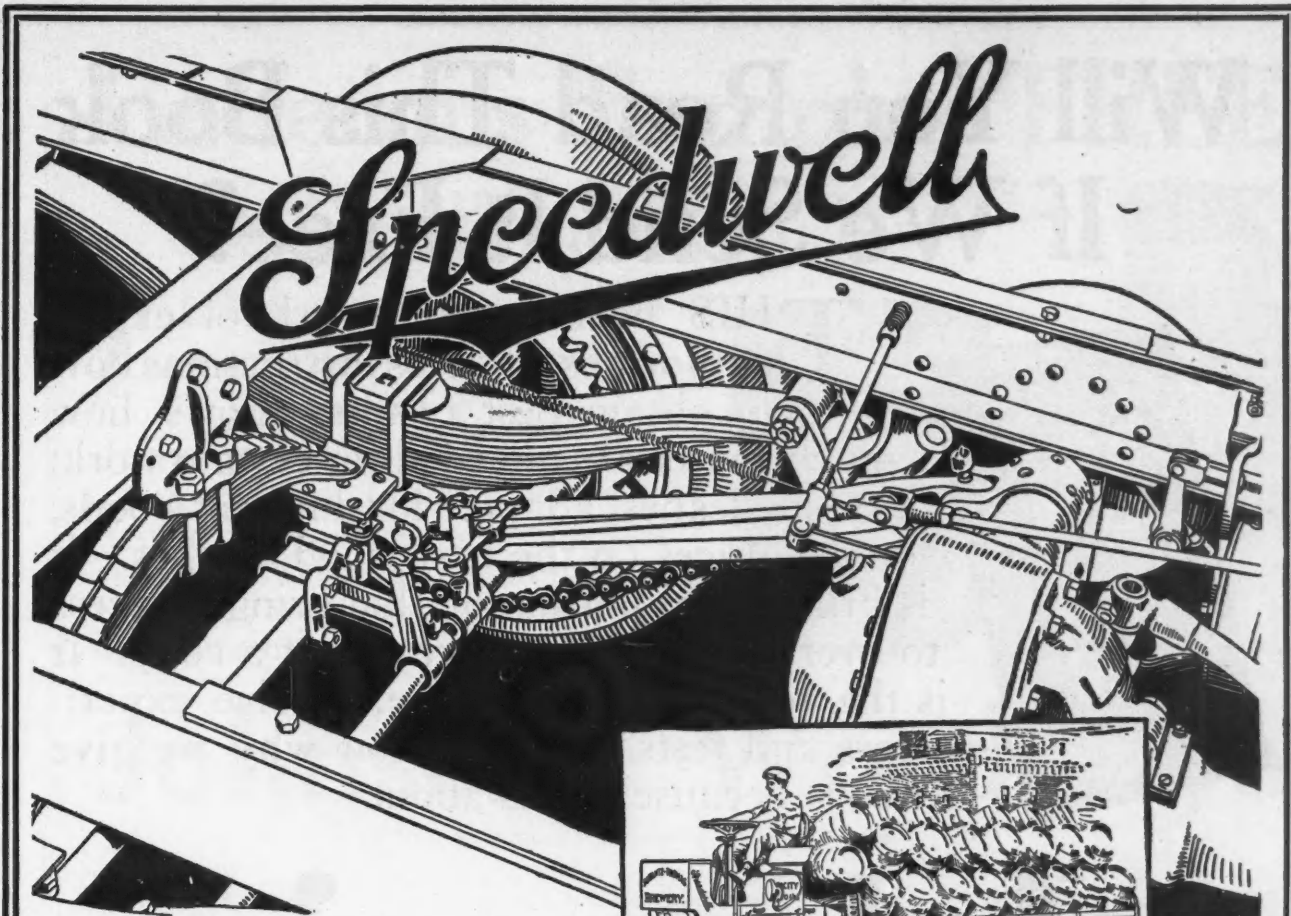

The above illustration shows details of rear axle and adjacent members of the Speedwell four-ton truck. Note the simplicity and staunch appearance of every member.

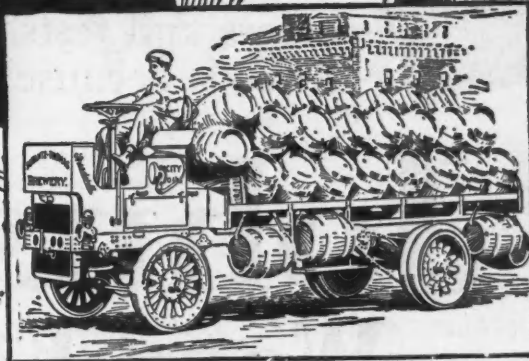

Go Over Speedwell Trucks Point by Point You'll Not Find a Single Mechanical Weakness

The key-note of the standing of the motor truck is of necessity, efficiency.

The truck must prove its greater economy over other forms of delivery.

With this and this only in view, Speedwell Trucks are built heavier in all important members than other trucks of the same load capacity.

The tires are larger, the frame members and axles stronger, the power greater.

There are scores of features in Speedwell design that are showing their worth in the daily performance of Speedwell Trucks now in service.

On a basis of efficiency the Speedwell Truck demands your attention.

*Our latest truck catalog, just off the press,
will interest you*

The Speedwell Motor Car Co.
610 Essex Avenue, Dayton, Ohio.

When Writing Advertisers Please Mention the American Carpenter and Builder.

Will You Read This Book If We Send It Free?



THIS book is the work of expert authorities. It gives instructions how to obtain best results; shows how much material is needed for certain work; lists shades best adapted for different woods; quotes prices on the best wood finishes. It is brimful of information that brings success to every reader. Be sure to get a copy. It is the result of 30 years' expensive experiments and tests. The reason why we give it free is because it tells about

Johnson's Wood Finishes

We want every painter to know all about our wood finishing materials and try them at our expense, so with the booklet we give you generous samples of Johnson's Wood Dye and Flat Wood Finish.

**Over \$200,000 Worth of Experience Is
Behind This Book—Ask For Your Copy**

We have been manufacturing Wood Finishes for over 25 years and know just what painters and decorators need. Our book and samples will bring you the information you want. Get them today.

S. C. Johnson & Son,

*"The Wood Finishing
Authorities"*

Racine, Wisconsin

When Writing Advertisers Please Mention the American Carpenter and Builder.

Generous Samples FREE

To Painters, Builders, Architects, Contractors

LET us send you free samples of Johnson's Flat Wood Finish and Johnson's Wood Dye, also a copy of our Instruction Book. Architects, Contractors, Painters and Home Owners are enthusiastic over the results obtained and the big saving made possible with them.



Johnson's Wood Dye

is made in 15 popular shades as follows:

- No. 126 Light Oak
- No. 123 Dark Oak
- No. 125 Mission Oak
- No. 140 Early English
- No. 110 Bog Oak

- No. 128 Light Mahogany
- No. 129 Dark Mahogany
- No. 130 Weathered Oak
- No. 131 Brown Weathered Oak
- No. 132 Green Weathered Oak

- No. 121 Moss Green
- No. 122 Forest Green
- No. 172 Flemish Oak
- No. 178 Brown Flemish Oak
- No. 120 Fumed Oak

Gallons \$3.00—Half-Gallons \$1.50

Test samples on any work you have in hand. Note how quickly Johnson's Wood Dye dries, so that dust and dirt have no chance to settle in the finish. Observe how it penetrates and brings out all the beauty of the grain without raising it in the slightest degree. In addition to this, the fastness of color, ease of application and practical economy will also appeal to you.

Johnson's Flat Wood Finish

is a liquid—an easy spreading preparation, manufactured especially for finishing interior woodwork of new residences and buildings—as well as furniture—and equally valuable for refinishing old surfaces.

This flat wood finish opens a new field for the painter. By the use of Johnson's Flat Wood Finish, you can make estimates on hand-rubbed effects that will land the contract every time—give your customer perfect satisfaction—and make you a good profit besides.

Don't fail to secure Instruction Book No. A.C.B. 2 and samples at once. If your dealer isn't supplied, write us and we will send them direct on receipt of postal or coupon.

S. C. Johnson & Son, Racine, Wis.

"The Wood Finishing Authorities"

ACB 2

S. C. Johnson & Son, Racine, Wis.

Please send me free samples of Johnson's Flat Wood Finish and Wood Dye Shade No. Also Instruction Book A.C.B.2

My Dealer's Name is.....

His Address.....

My Name.....

Address

When Writing Advertisers Please Mention the American Carpenter and Builder.

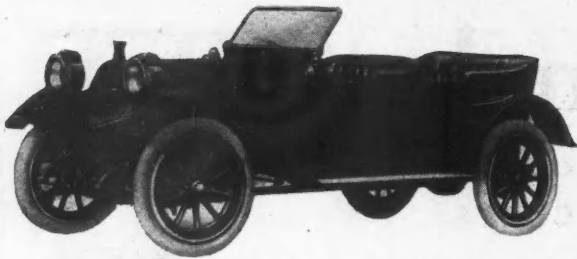

Hupmobile Long-Stroke "32" Five-Passenger Touring Car, \$900 F. O. B. Detroit, including equipment of windshield, gas lamps and generator, oil lamps, tools and horn. Three speeds forward and reverse; sliding gears. Four cylinder motor. 3 1/2-inch bore and 5 1/2-inch stroke. Bosch magneto. 106-inch wheel-base. 30x3 1/4-inch tires. Color—Standard Hupmobile blue.

**Not an ordinary \$900 car
but a \$900**

Hupmobile

Not an ordinary \$900 car either outwardly or inwardly—as the picture and the summary of special features will quickly disclose.

A car of infinite refinement, which proves conclusively that a low price need not be accompanied by crudity of construction.

The product of a plant which has always looked higher than its own price for inspiration—which has always sought to give the most in merit; not merely the least in price.

A result made possible by a skilled organization held intact since its inception under the leadership of E. A. Nelson, who designed the original Hupmobile; by shop-generalship of the highest order, striving continuously to surpass its own previous ideals.

Hupp Motor Car Company

1255 JEFFERSON AVENUE, DETROIT, MICH.

\$2500 Features in the \$900 Hupmobile

Small-bore, long stroke motor.
Cylinders cast en bloc.
Valves enclosed.
Three-bearing crankshaft.
Bronze bearings lined with Babbitt.
Transmission gears large enough for 40 H. P. car.
Full-floating rear axle of extreme strength.
Multiple disc clutch with 13-inch plates.
Imported Coventry chain to drive camshaft and magneto.
Hyatt and F. & S. Imported Annular High Duty roller bearings in the transmission.
Bower High Duty roller bearings on the wheels.
Standard Imported Bosch magneto.

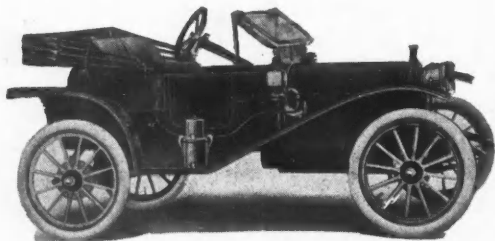

Hupmobile Runabout \$750 F. O. B. Detroit

Including top, windshield, gas lamps and generator, three oil lamps, tools and horn. Four cylinders, 20 H. P., sliding gears, Bosch magneto.

Simplex Nail Display Hanger

The H. B. Sherman Manufacturing Co., Battle Creek, Mich., has just been distributing among its friends in the trade a display hanger illustrated below, calling attention to its Simplex Nail.

One of these hangers is included in every shipment of



Simplex Nails, so that the recipient may so display it upon the wall or elsewhere as to be readily seen. It is of a nature to serve as an excellent medium for directing attention to the merits of the Simplex Roofing Nail.

Choose Between Success and Failure

When estimating on a job some builders simply look at the plans and say, "That job is worth so much," while others sit down and go carefully over the plans and specifications, measure up and take a few notes of some of the things that will be required. The former are taking great risks, which do not pay, and the latter are adopting very unsatisfactory methods. Now, a builder should give his whole attention to reading off, measuring up and writing down everything required, even if it takes longer time than anticipated.

The question is, can he afford the time to do it? Consider the value of the many hours and days contractors spend in taking off quantities, the neglect of other work, which requires all their attention, the doubtful chance of obtaining the contract, the sleepless nights spent in trying to come to a satisfactory conclusion in their efforts to figure out what it ought to be, and a hundred and one other worries which help to shorten this brief span of life.

Slipshod estimating and guess work have ruined many a good man. A builder is anxious to get the work and may have inside information that his efforts will be fruitful, but even so, he is liable to overlook something or many things. His familiarity with a particular class of work makes him overconfident. He sends in his tender and is accepted. Perhaps his was not the lowest, but he honestly believed that he gave a fair, reasonable offer to do the work with a marginal profit. When the work commences and as it advances he discovers that he overlooked the ceiling joists, or didn't reckon on the strapping, or some other items. If only one item be omitted, however small, he is that much the loser. "But," he may say, "what does it matter? I have allowed sufficient elsewhere to cover that." Thus he cuts a piece off the top of his pants to make them longer at the bottom.

No man can be a success until he can make a reliable estimate of the actual cost of everything required in the job and do it quickly. Then, and then only, can he tell how much he will gain, and only a systematic method will enable him to do this, and place him in a position to do good work to the satisfaction of the owner, the architect and all concerned. He then impresses the architect with his sincerity and ability, increases his clientele, and improves his banking account, building up a reputation and obtaining a lasting ad-

When Writing Advertisers Please Mention the American Carpenter and Builder.

BUILT FOR HEAT AND COMFORT

**"HOLLAND FURNACES
MAKE WARM FRIENDS"**

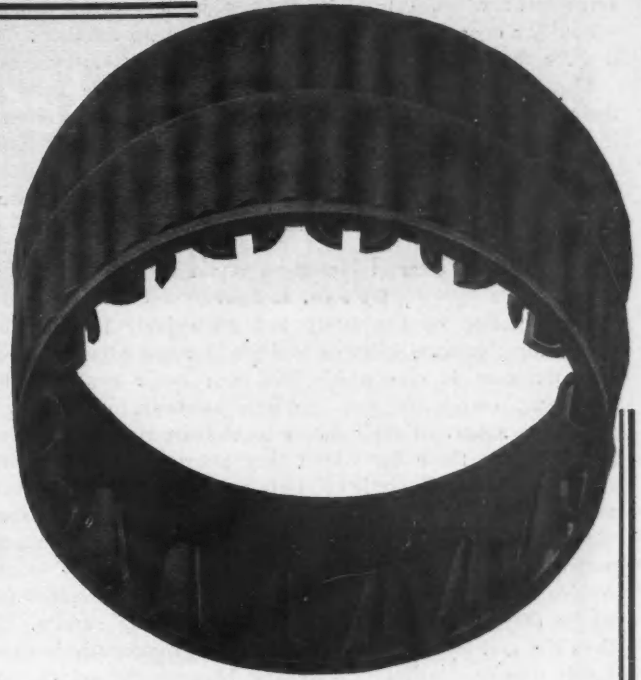

The Fire-pot, the all important feature in any furnace, is the best part in the construction of the "Holland." The following features of our patented always air admitting Fire-pot put the "Holland" in a position excelled by none.

First—This furnace means *economy*, for it will burn anything combustible, with the least waste.

Second—The gases and soot are *burned* thus making the "Holland" *clean* and *healthy*. No internal explosions and puffing can occur, which open joints; to repair them is costly.

Third—All cast iron construction, and the fact that *all* castings are heated uniformly, makes the "Holland" the best and most durable furnace in existence.

Send us your floor plans and let our heating engineers submit you correct plans for heating, together with cost of outfit complete. This service is free.

You will never regret, if you buy a "Holland."



HOLLAND FURNACE COMPANY

HOLLAND
MICH.

When Writing Advertisers Please Mention the American Carpenter and Builder.

vertisement which cannot be secured by any other means.

Rapidity doesn't mean so much in making an estimate; but it gives the builder more time for looking after his business.

The Bradt Publishing Company emphasize these facts in their ad. this month and offer a solution of these problems to those sending for the last edition of the Lightning Estimator.

We might say this concern has advertised in every issue of this journal and we know them to be reliable.

Lighting Rural Homes with Acetylene

By Jno. T. Earl

The question of adequately and attractively lighting the home, church, store, hotel or building devoted to other business purposes is one which has been much neglected by architects, carpenters and builders, although, naturally, it should be a part of their duties to at least suggest this improvement to those for whom they prepare plans and construct buildings. There is certainly no other one improvement they can possibly recommend which will do more to enhance the comfort of their clients or add to the attractiveness and permanent value of the property, or for which they would receive a greater measure of praise from their customers for whom they might install a dependable lighting service. In the cities and larger towns the problem is comparatively easy, for it usually consists of choosing between the service offered by the coal gas company and that tendered by the company that furnishes electricity.

In the smaller towns, the farming communities and the nearer-to-nature resorts the problem is not so simple, since it involves not only a choice between illuminants, but also between devices that will produce light.

It seems a fair assumption that for properly lighting homes, no matter how isolated, kerosene lamps are inefficient and will soon become a part of the historic past. They are heat-

ing, throw out a disagreeable odor, deplete the air of its vitalizing element, require much time for their care and are the source of greatest danger to life and property.

Acetylene is the youngest of the illuminants and has made



Farm Home of Mr. and Mrs. Robert Boston, Rollo, Illinois. Lighted for the past seven years by a Davis Acetylene Lighting System.

rapid strides in public favor. The light is of a soft white yet powerfully penetrating nature, the latter property causing its adoption by American and foreign governments for lighthouse service. It rivals electricity in non-heating quality, does not asphyxiate and is ready for instant use at all hours and in all portions of a building. The gas is also useful as a fuel for cooking. It may be piped from a single plant to any number of buildings. It is popular for church use, and is highly regarded for lighting primary schools and colleges. Crude apparatus of any kind is faulty, and the acetylene generators made by tinsmiths and other unscientific inventors,

ADD TO YOUR BUSINESS THE AGENCY FOR Montross Metal Shingles

There's Money In It.

Carpenters and builders all over the United States and Canada are learning this every day. Montross Metal Shingles are fire, storm and lightning proof. Most durable and most economical roofing made. Easily laid—no soldering.

Send for our proposition, price list, catalogue, etc. You'll be surprised at the generous margin of profit.

And with this you are giving your customer the best shingle, at lower rates than he could possibly get elsewhere. One roofing job will convince you.

Use Montross on your operation work, for barns, garages and all other buildings that require a dry, durable, economical roofing of the best kind. Hundreds of testimonials given.

"Schenectady, N. Y."
"Twenty years ago I built my house in Albany, N. Y., and covered the roof with Montross Metal Shingles and the shingles are in excellent condition at the present time.

"Chas. A. Heldrich,
"Architect,

Montross Metal Shingle Co.
132 Erie St. CAMDEN, N. J.



Douglass County Court House,
Roseburg, Oregon.

ALBANY, ORE.

Gentlemen:—I used the Victor Shingle on two Court Houses and for a good metal roof at small cost, it is the best I have been able to get.

In this land of "rain" a roof is put to a severe test, and what "Victor" I have used has stood the storms. I have specified "Victor" for another Court House for which the contract will soon be let.

Respectfully yours,

CHAS. H. BURGGRAF, Architect.

When Writing Advertisers Please Mention the American Carpenter and Builder.

Northwestern Modern Concrete Machinery

The entire Line is shown in Books now ready for distribution

THESE 1912 CATALOGS contain the entire line of NORTHWESTERN CONCRETE MACHINERY, including Mixing Machines, Block Machines, Moulds and Tools, with beautiful halftone illustrations taken from actual photographs and complete detailed description of everything in concrete machinery. These catalogs are encyclopedias of what you ought to have and at the prices you ought to pay. They are extremely valuable as a guide and reference whether you buy machinery or not, and anyone interested in concrete in any way should have copies of these publications.

Special Northwestern Concrete Mixer Catalog

Our Special Mixer Catalog contains a complete line of mixing machines of every size and description from the smallest type of hand mixers up to the largest power mixing machines made. This catalog shows a complete new line of Rotary Drum Mixers built in all sizes, from 7 ft. up, with combination of features that are the most attractive ever included in mixing machines. Special Sidewalk Mixers, Continuous Mixers, Block Plant Mixers and Hand Mixing Machines are shown, fully described and beautifully illustrated, many full page pictures showing exactly the details of construction. Be sure and write for this book.

Wholesale Prices

Block Machines, \$10 to \$250.
Brick Machines \$22.00 to \$75.
Mixers, \$24 to \$1,000.
Porch Column and Baluster Outfits, \$15 to \$75.
Cap and Sill Moulds, \$12 to \$35.
Lawn Vases, \$15 to \$25.

Ball Moulds, \$2 to \$17.
Grave Stone Moulds, \$7 to \$69.
Well Curbing Moulds, \$4 to \$7.
Drain and Sewer Tile Moulds, \$6 to \$83.
Block Cars, \$11 to \$17.
Fence Post Moulds, \$7 to \$12.
Silo Moulds, \$14 to \$150.

Coping Moulds, \$18.
Hitching Post Moulds, \$20.
Baluster Moulds, \$6 to \$18.
Jardinieres, \$12.
Special Gate Post Moulds, \$10 to \$30.
Newel Post Moulds, \$14.
Grave Markers, \$7.
Burial Vaults, \$90.

COMPLETE LINE OF Cinder Crushers, Rock Crushers, Sand and Gravel Elevators, Sand Screens in both Revolving and Stationary Type, Motor Gauges, Wheelbarrows, Jointers, Groovers, Edgers, Corner Tools, Curb and Gutter Tools, Corrugating and Radius Tools, Roller Jointers, Brick Tong, Curb Clamps, Curbing Edgers, Hawks, Floats, Line and Indentation Rollers, Tampers, Rammers, Name Stamps, Indentation Letters, Wall Plugs, Expanded Metal and Water Proofing, Flower Pots, etc.

We can save everyone from 10 to 50 per cent on their purchase. We make no charge of fancy prices on account of patents, territory rights, etc.

We are Concrete Machinery Experts

In addition to the NORTHWESTERN Line we manufacture the complete lines of several large concrete machinery concerns, and we are in the market for manufacturing propositions of this kind at any time. Owing to our immense manufacturing facilities, we are naturally in position to negotiate for large contracts because of our ability to turn out the goods at much lower cost than factories not so adequately equipped.

We Make Quick Deliveries

We are distinctly manufacturers and operate the largest factory of its kind in existence. We own and operate our own Brass Shops, Foundries, Machine Shops, Pattern Works, and build the entire line from start to finish, including gasoline engines. Large stocks are always carried on hand, enabling prompt shipment and quick delivery.

Our Guarantee

Every machine is sent out with the distinct understanding that if not entirely satisfactory it can be returned within ten days and not only the full purchase price refunded, but the return freight charge paid by us. Our immense business has been built up on the satisfaction of Northwestern Concrete Machines and our liberal trial offer, and they are now used in every civilized country in the world.

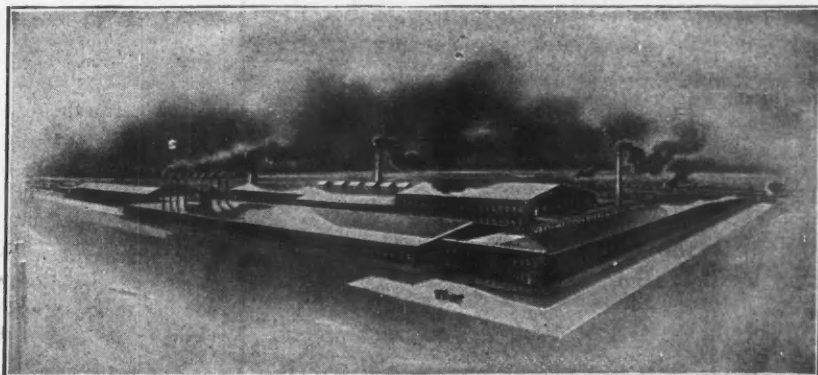

The Largest Factory in the World Devoted to the Manufacturing of Concrete Machinery.

Write for Wholesale Catalogs. We want everyone interested in concrete machinery to have copies of these catalogs. Send us your name and address and advise what particular machines or moulds interest you. Any one or all catalogs sent on request. It will pay you to get our prices before making your purchases.

Northwestern Steel and Iron Works, 998 Spring St., Eau Claire, Wis.

When Writing Advertisers Please Mention the American Carpenter and Builder.



More Durable, More Beautiful than Plastered Walls

IDEAL WALL BOARD is not a substitute for plaster.

It is vastly better than plaster. It is more permanent, more beautiful, more sanitary, more convenient to apply.

Its decorative possibilities are almost unlimited—and, with all its advantages, it costs less than lath and plaster,

Ideal Wall Board

is helping to bring the day when plastered walls will be used no more.

It is far more sensible because it is nailed to the studs—either in a new building or in the old one, right over the plaster.

It can be used—and is being used—in all sorts of buildings—residences, garages, churches, office buildings, etc., etc.

You, as a progressive dealer, ought to know about Ideal Wall Board.

You should be able to suggest and recommend it to your clients.

We shall be glad to send you a sample and our booklet if you will write us.

THE ROBERDS MFG. CO.
MARION, IND.

through their unsafe and faulty operation, have done much to injure the industry in the minds of those not thoroughly informed. Incidentally the standard machines have had to force their way to deserved recognition, which they have secured solely on the ground of merit. The National Board of Fire Underwriters have passed the correctly-made type and they may be installed anywhere without increasing insurance rates.

Architect C. E. Schermerhorn, of Philadelphia, says, in a booklet entitled "House Hints for Those Who Build": "The best types of acetylene generators now on the market are simple in construction, positive and reliable in operation and modest in cost."

Architect Wm. H. Hoover, Jr., of Elizabeth, N. J., designed the Tarrytown, N. Y., postoffice building, which is lighted by an acetylene plant, city coal gas and electricity, and he avers that the postmaster, his assistant and the whole staff of clerks, carriers and others use the acetylene lights almost exclusively, and that it is a gratifying circumstance since it results in reducing the monthly bills for lighting—"giving better light for less money."

Architects, builders, contractors and their clients should investigate thoroughly acetylene illumination before deciding on a lighting system, and should give especial attention to the details of generator construction so as to make no error in failing to install a machine that is economical and dependable in operation and that generates gas in its purest condition.

Wide-awake and progressive contractors and builders are beginning to realize that the furnishing of an acetylene lighting plant for the buildings they erect is a legitimate part of their business, from which a satisfactory additional profit can be secured, and are, therefore, arranging to sell and install such apparatus. In fact many of them do not confine themselves to the equipment of new buildings only, but during the winter months or other dull seasons are selling and installing them in homes and other buildings already erected, thus giving them a remunerative business and oftentimes creating a sufficient demand for the outfits as to justify them in giving the business their entire time and attention. This is more than possible where the system installed is one which has proven its quality by years of service.

In another column the Davis Acetylene Company, 90 Crawford Street, Elkhart, Ind., invites our readers to investigate their proposition, and offer acetylene lighting apparatus proven by more than twelve years of use in every section of the country.

The Lumber of Your Fathers

With all the timber of the original primeval forests from which to make a selection, the settler chose White Pine. This selection was made because White Pine possessed nearly every merit of nearly every other wood. The principal exceptions were that it was not so hard nor was it so strong as certain other kinds of timber.

Its advantages were lightness, low cost of preparing for use, the excellent service it gave wherever used, and that it seasoned quickly, did not subsequently shrink, lasted whether or not it was protected by paint and that an abundant supply was to be had.

For these reasons White Pine became the lumber of your daddies.

It is obtainable today. Considered from volume of product it is the wood of the third importance today. Considered as a material for building, factory use, etc., it still holds first rank. In point of quantity yellow pine comes first, fir second, white pine third.

White Pine, the lumber of your forefathers, is available today and if consumers do not use this premiere wood it is

When Writing Advertisers Please Mention the American Carpenter and Builder.



Get the Best

The standard doors of America, made in the special Morgan way from special woods by special machinery. Morgan doors are specified and recommended by all leading architects. Built of separate layers of kiln dried wood with the grain running in opposite directions. Shrinking, warping or swelling is impossible.

Each door is stamped "MORGAN" which guarantees quality, style, durability and satisfaction. Be sure your doors bear the "MORGAN" stamp.

Send for a copy of our elegant new catalog "The Door Beautiful"—just out—full of page illustrations of interiors and attractive exteriors in all styles, showing Morgan Doors and their surroundings—tells why it is the best kind of economy to use Morgan Doors throughout your building.

Write for Your Copy Today

Morgan Company

Dept. E.
Morgan Doors are handled by Dealers who do not substitute



Oshkosh, Wisconsin

Distributed by
MORGAN SASH & DOOR CO., Chicago
MORGAN MILLWORK CO., Baltimore, Md.

When Writing Advertisers Please Mention the American Carpenter and Builder.

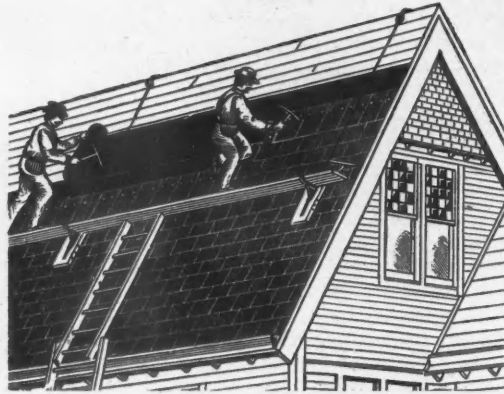

TAKE UP SLATE ROOFING

Carpenters and Builders: Take up slate roofing in unoccupied territory everywhere. It's a money maker. Only a few simple, inexpensive tools and small capital necessary. Slatting is easy to learn. Very much like laying shingles. Can be carried on in connection with your present line with no extra trouble or expense and will give good returns. A profitable, growing slate roofing business can be established anywhere. Besides the new work that comes up every year there are simply hundreds of worn-out shingle, metal, tin and composition roofs in every locality that must soon be replaced.

Sea Green or Purple Slate Roofs

OUTLAST ANY BUILDING

They can't wear out, rust, warp or decay. Are fire and spark proof. Reduce insurance rates. Afford clean cistern water. Don't require constant repairs and attention. Your neighbors are tired of paying good money for short-lived roofing—high-priced shingles that soon decay—tin and metal roofs that cause frequent and costly paint bills—composition and the "olds" roofing that disintegrate. Furnish them with handsome, sanitary, fire-proof Never-Wear-Out Sea Green or Purple Slate Roofs that last forever.

Carpenters and Builders: Take up slate roofing this Spring. You will make good money and please your customers. Write to us at once for delivered prices on slate, tools and supplies and Free book of instructions. Don't Delay. Write To-day.

NOTE—This special proposition does not apply to any territory now covered by a Slate Roofer.

American Sea Green Slate Co.

Box 125
GRANVILLE, N. Y.

because they doubtless have listened to the false prophets who have predicted the end of White Pine production for the last score of years. In reality the end is not yet in sight.

The cut is diminishing, it is true, but many of the mills of Minnesota have a sufficient timber supply to keep them in operation for fifteen years longer. This fact should serve to convince the dealer and consumer that he can secure White Pine if he wants it, and he wants White Pine if he wants the best.

"The Pine Cone" is a breezy little publication which will be issued each month and distributed free of charge to those who desire copies by the Manufacturers of Northern Pine Lumber. All those of our readers who would like to receive this little magazine each month should write Northern Pine Manufacturers' Association, 1119 Lumber Exchange, Minneapolis, Minn.

The Kahn System Idea

One of the most attractive calendars of the year is that of the Trussed Concrete Steel Company, Detroit. Mr. S. M. Fecheimer, their Publicity Manager, has expressed in definite form what the "Kahn System Idea" is. This decorates the calendar: "To make the best products we know how—to improve these products continually and to cheerfully discard old methods for advanced ideas—to provide the most studied designs to insure the scientific use of these products—to spread broadcast the knowledge of our advantages without exaggeration or bluster—to be broad-minded in our attitude toward all, so that we may live up to the greatness of our organization—to realize that permanent success is founded on merit only—and finally and above all, to have our company always represent our own highest ideals as men—that is the Kahn System Idea."



SUPERIOR SHINGLE STAIN

Represents quality both in color and durability. We use only the very best elastic and preserving oils, thoroughly mixed by the latest improved machinery.

COVERING CAPACITY

One gallon will cover 150 square feet when applied with a brush. Dipping requires 2 gallons for 1000 shingles.

GUARANTEE

Superior shingle stain is sold under our absolute guarantee never to crack, scale, peel or flake off as paint does, and to retain its color as well or better than any stain on the market.

Write Dept. S. for color card.

NORTHWESTERN MFG. CO.,

135½ So. Illinois St. INDIANAPOLIS, IND.

ORNAMENTAL IRON WORK

Manufactures all kinds of iron and steel work for Ornamental, Architectural and Light Structural Purposes. Lowest prices and best quality prevail.

SPECIALISTS IN

Fire Escapes	Jail Work	Fencing	Lawn Seats	Stairs	Balconies
Wire Work	Shutters	Brackets	Iron & Steel Doors		Railings
Window Guards	Write for illustrated catalogue, free on application				Grilles Etc.

THE MACK IRON & WIRE WORKS COMPANY

Warren St., Sandusky, Ohio

When Writing Advertisers Please Mention the American Carpenter and Builder.

ANDREWS HOT-WATER HEATING

\$198

Average Price

14 Andrews Heaters in One Block



Geo. C. Andrews

Profit for the Contractor

We have made lots of money for other contractors who read this paper and we'd like to make some for you. It is a great advantage to you to include Andrews' Heating and Plumbing Systems in your contracts, and we assure you that there are no systems which give such general satisfaction. They are the easiest for you to handle, too, for we do all the estimating for you and make the plant complete, all ready to screw together, so one of your carpenter's helpers can erect it. You can make a nice profit without much work.

The Man Who Does It Right in 44 States.

360 Days Free Trial Guaranteed by Bond

We take all the risk of the plant's success. Also the financial risk providing you want us to bill your customer direct and pay you a commission. Let us give you a free estimate on your next job and you'll see the advantage of doing business with us.

Special Free Thermostat Offer

In order to give your end of the business a good start, we will give you or your customers one of our famous "Hired Man" Thermostats, providing you write us within 30 days and order an Andrews Plant or Boiler during 1912. This Thermostat regularly sells for \$20, is guaranteed for life and should be a good inducement for your customers to contract with you right away for their heating plants.

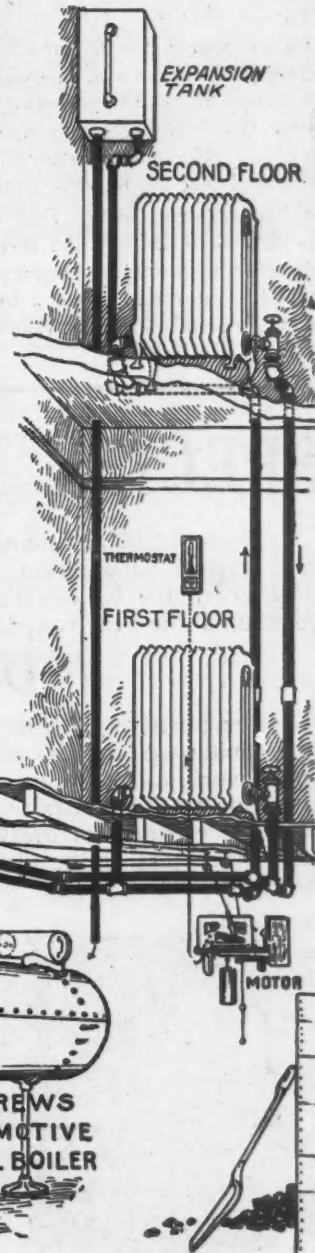
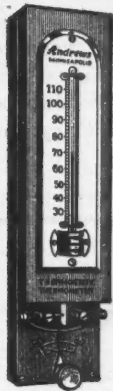

SEND FOR ANDREWS BIG BOOK On Heating, Plumbing, Water Supply, Sewage Disposal, Lighting

Plumbing

The Andrews Plumbing line is complete of the very best material. Complete plans and instructions for erecting accompany each order. Pipes are cut to fit, threaded, etc., so that any handy man can easily erect. Write for estimate.



Andrews Steel Boilers

The two styles of Andrews Steel Boilers, vertical and locomotive, are the highest types of hot-water boilers. They are made of steel-plate like power boilers and their very large fire travel together with the close proximity of fire and water make them heat quicker than any other boilers on much less fuel. A child can clean either style in a few minutes. Average annual cost of coal \$3.00 to \$5.00 per room. Our catalog also shows cast iron boilers.



Sewage Disposal

The Septic Tank is one of Mr. Andrews' own inventions. A small steel tank placed under ground just outside the basement treats the sewage in such a manner that it becomes purified and passes off into a drain bed. An almost indispensable device for any home not having sewer connections. Cheap and lasts forever. State size of house and grounds when writing for estimate.



Gas Lighting

The very best gasoline gas system made makes finest gas for cooking, lighting and gas-engine use. Entirely safe, lasts a life time, easily operated, more economical than city gas and gives more light and heat.



Write for estimate, giving sizes and number of your rooms.

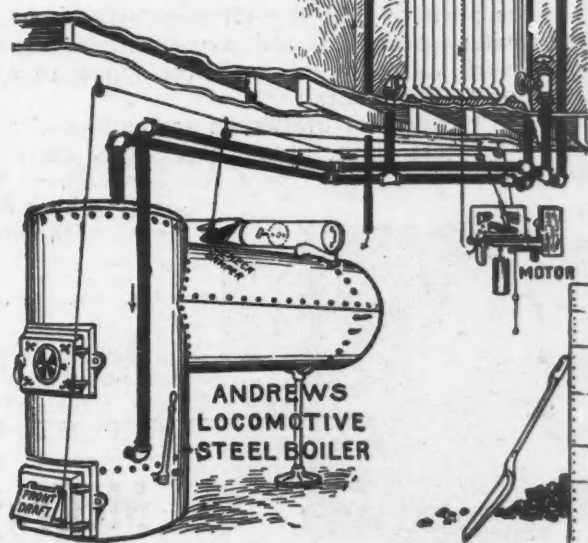

1239 Heating Building

ANDREWS HEATING CO.

Minneapolis, Minn.

Monarch Continuous Concrete Mixer

The Monarch Manufacturing Company, 308 Shepard Building, Grand Rapids, Mich., have perfected a concrete mixer which they claim saves its cost in 680 hours of work. They are confident that a Monarch mixer will get any contractor using one business, for the reason that people who have work to do know that machine mixed concrete is the best, and they wait for the up-to-date man who has a concrete mixer.

The Monarch Manufacturing Company issue an illustrated circular giving complete details concerning this machine and its equipment. This will be sent to all readers of the AMERICAN CARPENTER AND BUILDER who will write for it.

One Woodworking Machine-not Sixteen

On another page of this magazine will be found the advertisement of the "Famous" Universal Woodworker, a remarkable achievement of combining the working qualities of sixteen machines into one in such a manner that practically all the woodworking machinery a carpenter or contractor needs can be obtained from the one investment.

From the economic standpoint it is claimed that everything is in favor of such a machine over a number of machines. In addition to the enormous saving in first cost is the saving in power transmitting equipment, saving in floor space and depreciation. The latter feature is doubly apparent when it is considered that the builders guarantee it for life.

The builders—the Sidney Tool Co.—were the originators of this class of machinery and their sixteen-in-one Universal Woodworker is pretty convincing proof that they mean to maintain their position. Over a thousand of these machines—that is "Famous" Universal Woodworkers—are now in use;

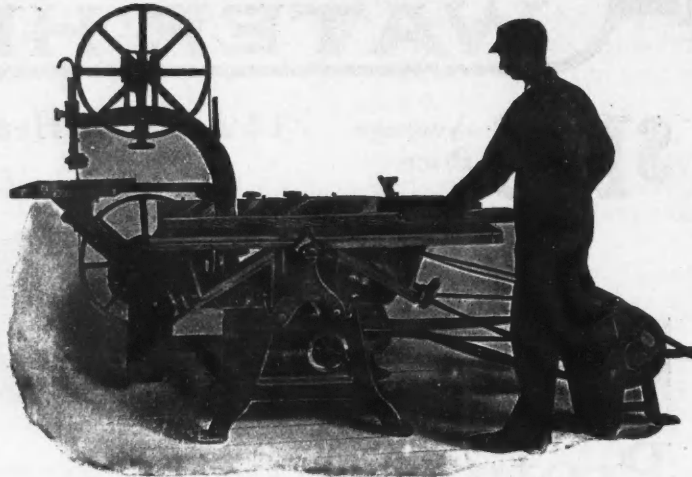

"Famous" Universal Woodworker

and of this number it is claimed not one has ever been reported upon unfavorably. Such a record is sure to be a great factor in the plans of prospective users of woodworking machinery.

The sixteen machines comprised are: 27 inch Band Saw, 12 inch Jointer Saw Table (with raising or lowering arbor), Single Spindle Shaper, Borer, Pony Planer, Tongue and Pole Rounder, Hollow Chisel Mortiser, Single End Tenoner, Drum Sander, Disc Sander, Knife Grinder, Emery Grinder, Band Re-Saw, Spoke Tenoner, Rim Borer and Wheel Equalizer. Adjustable Felloe Rounder. Full particulars of this machine, together with information on their Portable Woodworker, will be sent free upon request. Address the Sidney Tool Co., Sidney, Ohio.

SPECIFY McCRAY REFRIGERATOR

The kind of refrigerator for you to recommend to the home builder is one which will always give perfect satisfaction. McCray Refrigerators are known for quality the world over because they are made by experts of long experience in the business and because they are advertised constantly the year round.

Dozens of Superior Features

The positive cold, dry air circulation, the outside icing arrangement, the absence of all odors, the sanitary cleanliness and convenience of the linings, the ice-saving insulation, the beauty of the wood work, all make an irresistible appeal to your clients, who will thank you for calling their attention to the McCray.

Our refrigerator draftsmen are employed to co-operate with you in drawing up specifications of refrigerators of the proper capacity to meet the requirements of the home on which you are working. Simply send us a rough sketch of the floor plan with proper dimensions, and we will gladly submit designs and blue prints so you may take the matter up with the owner.

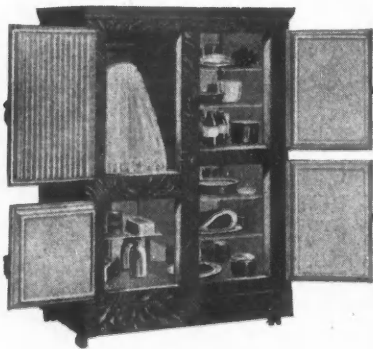

McCray Quality

McCray Refrigerators are made for all purposes. Send for free books: No. A. H. Built to order for Residences, No. 88 stock sizes for Residences, No. 67 for Grocers, No. 59 for Markets, No. 48 for Hotels, Clubs and Institutions, No. 72 for Florists.

McCray Refrigerator Company
306 Lake Street : : Kendallville, Ind.

When Writing Advertisers Please Mention the American Carpenter and Builder.



2250

Carpenters Have Become

434
Contractors

431
Draftsmen

296
Foremen

111
Managers

418
Proprietors

293
Architects

160
Superintendents

37
Inventors

70
Pres. and Other Professions

Through I. C. S. Training

Two Thousand Two Hundred Fifty Carpenters have voluntarily written to us that the International Correspondence Schools opened to them the door to increased pay, promotion and prosperity in new positions and occupations. But this is not all: 1,616 more letters came from other men who, from other or no occupations, have become carpenters, architects, and contractors through I. C. S. training. This is the very best evidence of results accomplished by I. C. S. students.

These men are making their spare time increase their wages, build homes, and win independence. If you are not one of them, you are neglecting a great opportunity—neglecting your duty to yourself and those dependent upon you.

The I. C. S. have taken thousands upon thousands of men and fitted them for larger and better-paying positions. What we have done for others, we can do for you. I. C. S. Courses are adapted to meet your particular need, for by a Course you can rise to a larger and more prosperous career.

Mark and mail the coupon. It will bring to you, without cost or obligation, full information about the promotion you wish to secure.

Send the Coupon NOW

International Correspondence Schools

Box 910, SCRANTON, PA.

Please explain, without further obligation on my part, how I can qualify for a larger salary and advancement to the position, trade, or profession before which I have marked X.

Architect	Estimating Clerk	Automobile Running
Arch't Draftsman	Civil Engineer	Foreman Machinist
Contract'g & Build.	Surveying	Sh.-Met. Pat. Drafts.
Building Inspector	Mining Engineering	Textile Manufact'g
Structural Engineer	Mechanical Engineer	Bookkeeper
Structural Draftsman	Mechanical Drafts.	Stenographer
Plum. & Heat. Con.	Stationary Engineer	Advertising Man
Supt. of Plumbing	Electrical Engineer	Window Trimming
Foreman Steam Fit.	Electric Lighting	Commerci'l Illustrat'g
Plumbing Inspector	Electric Railways	Civil Service Exams.
Heat. & Vent. Eng.	Concrete Construct'n	Chemist

Name _____

Street and no. _____

City _____ State _____

Present Occupation _____

When Writing Advertisers Please Mention the American Carpenter and Builder.

**ANY MAN CAN
GET \$1,000.00
Who Joins Fritter's \$1,000 Class**

For goodness sake
listen to me.

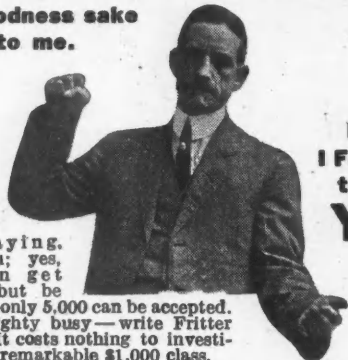

Reader,
I Fritter, am
talking to
YOU!

—Am saying,
that you; yes,
you, can get
\$1,000; but be
warned—only 5,000 can be accepted.
So get mighty busy—write Fritter
today. It costs nothing to investi-
gate this remarkable \$1,000 class.

5,000 Men Will Get \$1,000 Each

You, by acting now—today—can get the thousand allowed to your section. This money—\$1,000 or more, per man—goes to mechanics, clerks, farmers, preachers, doctors, lawyers, teachers—people from all walks of life—any man, anywhere—up to 5,000, who is willing to join Fritter's \$1,000 class. Nobody barred. Not a fairy tale, fake or humbug; for listen—it's going on dally—hundreds have received their thousand—some many thousands. If you can use \$1,000—real money—payable \$35 to \$75 weekly—say so—don't hesitate—don't delay a minute; but get the thousand-dollar hustle—get your first \$1,000—first start, first taste of real independence—power, influence, luxuries—get these through Fritter, just as hundreds have done. Poor men joining his wonderful \$1,000 class

Without Capital—Without Experience

—starting with only their nerve—finishing with thousands; yes, thousands of dollars. You, if willing to join hands with Fritter, can easily enjoy same abundant prosperity. Knowing the reason dispels all doubt—creates confidence—enthusiasm.

Class Getting Over \$2,000.00 Per Man

Korstad (Minn. farmer) received \$2,212.13 in 2 weeks; Zimmerman (Ind. farmer) \$3,856 in 30 days; Stoneman (Nebr. photographer) \$3,841.68 in 60 days; Rasp (Kansas agent) \$1,685 in 73 days; Juell (Canada clerk) \$6,800; Oviatt (Iowa minister) \$4,000; Hart (Va. farmer) \$2,000; Wilson (Ky. cashier) \$3,000 in 30 days; Beem (Kans.) averaged \$164.25 weekly for 3 months; Langley (Dak.) liveryman) \$115 first day. No wonder these men bless the day they joined Fritter's \$1,000 class. Reads like fiction, yet it's the gospel truth. Proven by sworn statements—investigation—personal interviews.

**10 MINUTES' WORK
\$6.50 CASH, PRESTO!**

IT'S SOLVED. The long-desired, much wanted, universal bathroom has come. Requires no plumbing, no water-works—no water systems. 10 minutes to install—\$6.50 to buy. The equivalent of any \$200 bathroom. Self-heating—hot or cold running water facilities. Cleansing, friction, massage and shower baths in any room. No tubs to clean, bowls or buckets to fill. Simple, durable, handsome, sanitary. The dream of millions come true. Modern homes, modern bathing facilities within the easy reach of every man, woman and child in the land. No experiment. Used by U. S. Government. Over 200,000 delighted customers. With such an article, with exclusive selling rights, with Fritter's help and your nerve you're bound to make from \$1,000 to \$5,000 this year. It's not a question of ability, location or capital (for we give credit to active workers) but whether you act quick enough to get into Fritter's \$1,000 class. Once in you're good for \$1,000 anyhow. Reese solicited 60 people—sold 55; MacDaniels 20—sold 19; Lodewick 41—sold 39—17 orders in one day; Hart "16 in 8 hours;" Wilson, "102 in 14 days."

Address Fritter personally today—make him prove his claims and above all that you too can get \$1,000. Don't accept anything without proof. First get Fritter's entire proposition—it's free. Then decide. Just a postal will do.

**M. FRITTER, Secretary and Manager
ALLEN MFG. CO., 3470 Allen Bldg., Toledo, O.**



The Window Chute

The window chute is a window and a coal chute all in one. When open it is a strong and satisfactory coal or vegetable chute with cast-iron frame and a hopper having a continuous heavy sheet steel bottom which completely covers and absolutely protects the glass below it from breaking. When closed and locked, however, this becomes a fine, unobstructed basement window.

The window chute is useful every day of the year for light, or as a chute. It saves the price on extra window frame and sash.

Coal chutes have become a modern convenience, without which no building is really up-to-date. The Holland Furnace Company, Holland, Mich., have done the trade a good turn

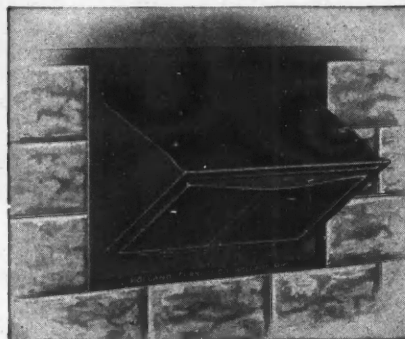

The Window Chute Open

in developing this window chute. We understand that they are now further improving this chute, offering a design which they call their Improved Recess Chute.

The point is made concerning these window chutes of the Holland Furnace Company that they are absolutely burglar-proof. The window chute cannot be opened except from the inside. The window chute is made to last and for practical utility and service is said to have no equal. With

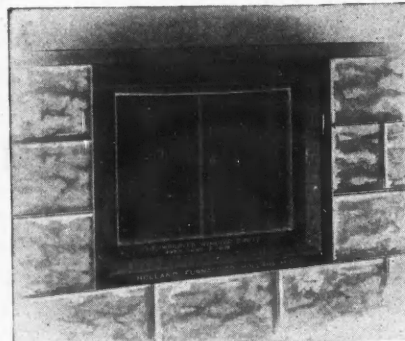

The Window Chute Closed

a fixture of this kind obtainable, and at such a reasonable price as they ask for it, there is no longer any excuse for unsightly, soiled and blackened walls, battered frames and sash, littered walks and grass plats, always found where coal and wood are put through a basement window.

These chutes are equally suitable for frame, brick, stone and concrete walls and for new or old buildings. For complete information our readers should address the Holland Furnace Company, Holland, Mich.

Woman Architect Enters Brick Bungalow Competition

Marion Griffin, Chicago's only woman architect and a firm believer in equal suffrage, is working on a plan which she hopes will be a step toward solving the problem

When Writing Advertisers Please Mention the American Carpenter and Builder.

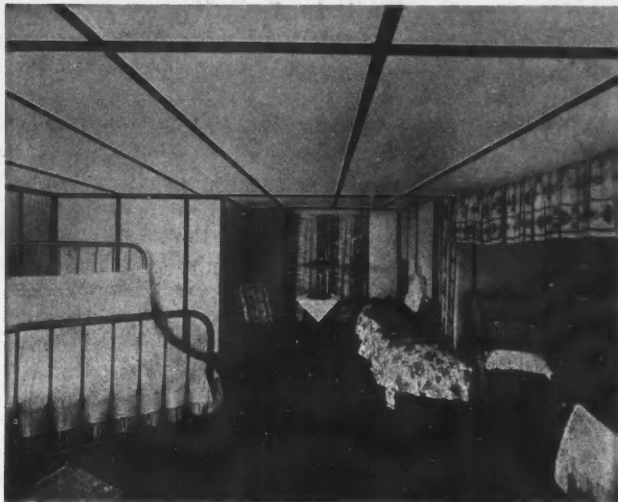

Attic Room Finished Off with "Utility" Wall Board and made one of the Pleasantest Rooms in the House. Panels are Tinted Yellow and Wood Bands Stained Dark Brown

Utility Wall Board lends itself admirably to any type of house or style of decoration.

Use it in the bath room or kitchen and by decorating with white enamel paint secure a beautiful and lasting tile effect.

Use it in the living room or bed chamber, the parlor or hallway.

Use it to turn the bare attic into a cozy bedroom or nursery; line the laundry with it and add 100 per cent to its comfort and usefulness.

Use it for making closets or for partitions.

Use it in any type of construction either new or old—and you will find in every instance an easily put up job—a thoroughly satisfied customer—and a good profit for yourself.

As a Carpenter and Builder have you ever carefully investigated the possibilities of

UTILITY WALL BOARD

Do you realize that here is a comparatively new material that is practically revolutionizing interior construction?

Utility Wall Board does away entirely with the need of lath and plaster.

You put it right on over the studding.

It comes in sheets of various sizes and widths suitable for wall and ceiling use. It is as easy to cut and handle as a thin pine board—yet is so tough and durable that it gives much better service than lath and plaster.

You can put Utility Wall Board on at any time with out regard to weather. You don't have to wait for it to dry. There is no muss and dirt to contend with Utility Wall Board is very tough and durable—lasts longer than lath and plaster—is much more easily applied—makes a better looking wall and costs less.



We want to send you a free sample of Utility Wall Board together with our illustrated book of Interiors—Will you send us your name?

THE HEPPES COMPANY 4503 FILLMORE STREET CHICAGO, ILLINOIS

SOMETHING ENTIRELY NEW IN IRON PLANES

These planes are made on an entirely new plan, they positively will not clog, chatter, or tear out in the most difficult wood and are the quickest and simplest planes to adjust that have ever been offered.



Buckeye Smooth Plane

They are made in two sizes, 9 1/4" Smooth Plane, 2" iron, and 18" Fore Plane 2 1/4" iron, the Fore Plane can be adjusted to do the work of Jack Plane and Jointer without removing plane from the work, or the iron from the plane, thus doing the work of four planes of other makes, which makes two less planes to buy, two less to carry, and two less to keep in order.

Every plane guaranteed. Your money cheerfully refunded, if after giving them a trial, you are not convinced that they are the best planes you ever used. Ask your dealer to get them for you, or write us. We also manufacture a full line of Saw Vises, Foot-power Saw Set, Chain Drills, Hollow Augers, etc.

BUCKEYE SAW VISE CO. 2044-50 West 55th Street CLEVELAND, OHIO.

1853



BROS.

1912

Fine Beveled Edge Shank and Socket

Chisels



Butt Chisels

Plain and Beveled Edges

Send for illustrated Catalog

Buck Brothers, Millbury, Mass.

When Writing Advertisers Please Mention the American Carpenter and Builder.

which Thomas Mawson, a noted English architect, pointed out as confronting the people of that city. Mrs. Griffin is designing what she believes will prove the ideal low-cost home.

She is working on the plans of a five room brick bungalow in which is to be combined the merits of beauty, practicability and moderate cost. The plan is to be entered in the competition started by the management of the Clay Products and Permanent Home Exposition, to be held at the Chicago Coliseum, March 7 to 12.

"The idea of the architects throughout the country giving their combined efforts towards a solution of the low cost home problem appealed to me strongly," said Mrs. Griffin. "I agree with Mr. Mawson when he says that the modern American in a city is a cave-dweller. Flats are hideous and are anything but 'homey.'

"From among the hundreds of plans that will be made in this competition it is certain that there will be enough satisfactory ones to give variety to the home-builders and it should result in ultimate improvement in the appearance and comfort of residences in the suburbs."

Mrs. Griffin is a graduate of "Boston Tech." and was the second American woman to take up architecture as her pursuit in life. Miss Hayden, who won the prize at the Chicago World's Fair, was the only woman architect in the country when Mrs. Griffin got her degree.

"Architecture is essentially a woman's work," she declared. "The domestic quality of architecture indicates that. And you would be surprised to see how readily contractors are willing to accept the word of a woman architect when they find out that she knows her work."

Low cost home plans entered in the prize competition are to be sent to the editor of the Brick Builder at Boston, Mass.

New Catalogue of Grilles, Colonnades and Built-in Furniture

The Northwestern Grille Works, 1820-26 Milwaukee Ave., Chicago, have just issued their new catalogue for the year 1912, this being their Catalogue No. 17.

This is a large size, finely illustrated book showing attractive and modern designs for consols, built-in china closets and book-cases, archways, colonnades, spindle grilles, column caps, etc.

Carpenters and builders will find this a very useful book for them to have on hand. We are assured by Christensen Bros., Managers of the Northwestern Grille Works, that specially careful attention is given to small orders, their aim being to satisfy everyone dealing with them, as they know that a satisfied customer is their best advertisement.

The National's New Hanger and Rail

A barn door rail which requires no brackets and in itself forms a perfect housing, is the New Storm-Proof Rail now



Storm-Proof Rail

being placed on the market by the National Manufacturing Company, Sterling, Illinois.

This Rail is a new departure in barn door rail construction and is proving to be remarkably popular with the trade.

It is made of heavy gauge steel and has great carrying capacity.

CLAY PRODUCTS SHOW COLISEUM, CHICAGO

Your Home Can't Burn

"By Frost, Nor Fire. Nor Flood—Nor Even Time are Clays Destroyed."

The Ideal Home is not ideal unless it's Fire Proof and Sanitary. Both these features are only attainable through the use of Clay Products.

To show the wide variety and superiority of Clay Products a Clay Products Exposition will be given at the Coliseum, Chicago, March 7 to 12 this year.

To develop a low cost, fire proof and sanitary home the Exposition company is offering \$1,000 in prizes for the best plans of a moderate cost Clay Products Bungalow. Four Prizes, contest open to the United States. The prize Bungalow will be erected on a lot in Chicago and given free to some visitor at the exposition. You will be interested in these plans. They will be on display at the show. Look them over. Other souvenirs made of clay given daily to each visitor.

Beauty in Brick Mantels, Art in Clay Fireplaces. The country's foremost faience firms will show their most artistic offerings. Tableware of all countries and all ages. Walks of clay, walls of clay, lawn ornaments and window boxes of clay, in fact a complete education and revelation of the extent, variety and superiorities of the third largest mineral industry of the U. S.

Municipal Clay Products and Sanitation will be the scope of an entire department of the exposition including paving brick, sanitary sewer pipe, conduit, sanitary ware with best methods and means of using each.

Architects, Contractors, Builders, Municipal officials and the home owning public will find this the opportunity of years to study Burned Clay Products and their advantages. Clay Products are fireproof because they are burned for days in making.

The fire loss of the U. S. can be cut from \$400,000,000 annually to a fraction of that sum by the use of burned clay. The death rate from contagion can be cut in half by the use of Clay Sanitary ware.

The Exposition is put on solely for the benefit of the people of the United States. You are invited to take advantage of it.

CLAY PRODUCTS EXPOSITION CO. 815 CHAMBER OF COMMERCE BUILDING, CHICAGO, ILL. All Bungalow plans will be on display throughout the exposition. Inspection of plans invited.

1912 MARCH 1912						
SUN	MON	TUE	WED	THU	FRI	SAT
					7	8
10	11	12				

THIS IS YOUR SHOW
HAVE AN EXHIBIT
BE SURE TO ATTEND
GET OTHERS TO GO

When Writing Advertisers Please Mention the American Carpenter and Builder.

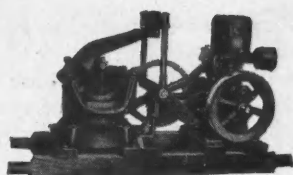

Novo Contractor's Trench Pump Outfit

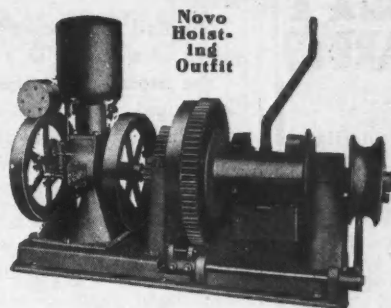

Novo Hoisting Outfit

Gives Better Service Than Steam or Electric Motor

**NO TANK
NO FAN
NO FREEZING TROUBLES**

The Novo has many advantages for hoisting or other contracting work over other means of power.

No licensed engineer is needed—anybody can run a Novo.

It occupies small space and is readily

moved—it's the lightest engine for power developed.

No expensive electric wiring has to be done—the Novo is self-contained.

No coal to buy—and be stolen.

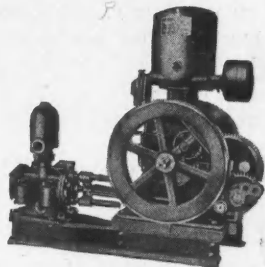

Novo Engine Direct Connected to Pump

NOVO ENGINE

Novo Contractor's Outfits include Novo Engines and Trench Pumps, Hoists, etc., Centrifugal Pumps—direct connected, or belted.

Novo Engine is adaptable to every contractor's needs within range of its horse-power. It is simple, reliable, exceptionally economical, and very compact. Working parts are enclosed against dirt and constantly lubricated by a splash system, even the main bearings. The Novo Cooling System is self-contained and guaranteed proof against freezing damage. Weather conditions do not effect the Novo Engine. 1 to 10 H. P.

Send for Novo Equipment Catalog and let us tell you the whole story. You'll find it an interesting one from your standpoint.

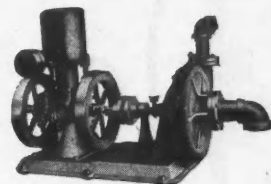

Novo Engine and Centrifugal Pump Outfit, Direct Connected

Novo Engine Co., 236 Willow St., Lansing, Mich.

CLARENCE E. BEMENT, Sec'y. and Gen'l. Mgr.

We can offer an exceptional proposition to dealers in new territory. Write for facts and figures.

"The Engine for Every Purpose"

THE
Fox Floor Scraping Machine

has satisfied over 8,000 American Carpenters and Builders.
Simple in construction, yet durable in every detail, has no parts to break, cuts into the corners right up to the base-board, will not chatter or leave waves.
Shipped on 5 days free trial. Freight charges prepaid. If it does the work as you want it done, send us \$25.00, if it does not, return it to us at our expense.
Weight, 85 pounds. Knife 3 x 9 inches.

Weight 85 lbs.

Price \$25.00

FOX SUPPLY CO., Mfgs.
1 East Main Street
Madison, Wisconsin

Wire Window Guards, Railings, Signs, Etc.

Manufactured by
McLaren Brothers,
337 THE ARCADE
Cleveland - Ohio

Architectural and Ornamental
Wire and Iron Work

Majestic Foundation Coal Chute



Protects the building just where most needed—above the opening.

The heavy steel hopper catches all the coal.

When not in use, the hopper lies in the bottom of the chute body.

The door locks automatically either open or closed. Strictly burglarproof.

With 1/4-inch wire glass or steel panel in door.

Write for circular and address of nearest dealer.

MAJESTIC FURNACE CO.

995 to 1001 Sixth Avenue

Huntington, Indiana

When Writing Advertisers Please Mention the American Carpenter and Builder.

ORR & LOCKETT

Established 1872 **L** HARDWARE CO.

Most Contractors and Builders doing business in Chicago or nearby towns know that Orr & Lockett's is the one best place to buy their hardware and supplies. But there are others who do not realize what an advantage it is to have the benefit of our service and long experience, and this advertisement is intended for them.

In the first place any contractor in buying from us is assured of the best and most suitable piece of hardware for each particular purpose. We very seldom fill an order with the goods of any one manufacturer exclusively, but are able to choose those pieces which are acknowledged to be the leaders in each manufacturer's line. Thus the entire order contains only the highest grade articles—not a weak link anywhere.

Then in the matter of packing our goods for shipment we employ only experienced men who sort and label each piece from the specifications, so that the workmen on the job lose no time in handling. Any contractor will realize the great advantage in receiving his hardware in this shape.

There are many other reasons why every Contractor and Builder will find Orr & Lockett's the most satisfactory place to deal, and we shall be glad to give these reasons to anyone interested.

SPECIAL NOTE for those attending the following conventions:

Illinois Lumber and Builder's Supply Association, Chicago, Ill., Sherman House, February 13, 14, 15.

Fifth Annual Cement Show, Coliseum, Chicago, February 21-28.

Clay Products Show, Chicago, March 7-12.

While you are in Chicago don't fail to visit this store and see our remarkable stock of Builder's Hardware and Supplies, Contractor's Tools, Supplies, etc. You will find that we carry the largest and most complete line in the country. Come in and ask all the questions you wish.

ORR & LOCKETT

Established 1872 **L** HARDWARE CO.

14-16 W. Randolph St. - CHICAGO

When Writing Advertisers Please Mention the American Carpenter and Builder.

It fits tight against the building and forms a continuous bracket.

The Rail is made in 4, 6, 8 and 10-foot lengths, packed two pieces of a length in a bundle.

The Storm-Proof Hangers for use with this Rail are made both rigid and flexible. The illustration below shows the No. 77 Flexible Storm-Proof Hanger. It is simply constructed and will carry great weight.

Each Hanger has two wheels, in tandem, with anti-friction roller bearings.

The Hanger has a flexible hinge joint. When the door hangs straight down there is no vibration in the hanger, but the hinged joint allows the door to swing out should any-

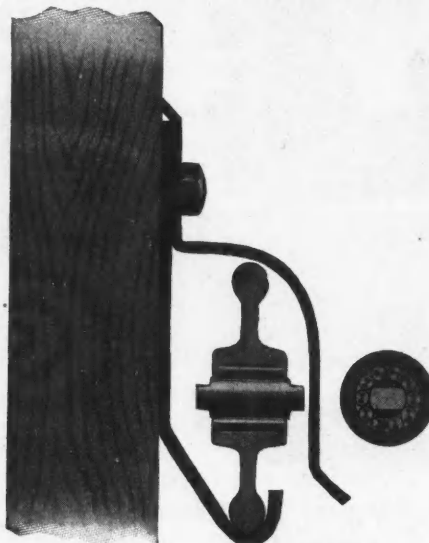

Cross Section of Hanger and Rail Showing Bearings

thing bump against it. This feature places this Hanger in a class with the "Big 4" Hangers and makes it a popular seller.

The No. 66 Storm-Proof Hanger is the same construction as the No. 77 except the flexible hinge joint.

The Hangers are packed one pair in a box with bolts for attaching the Hangers to the door; also lag screws, end-stops and cover-splice for the Rail. Each box also contains a set

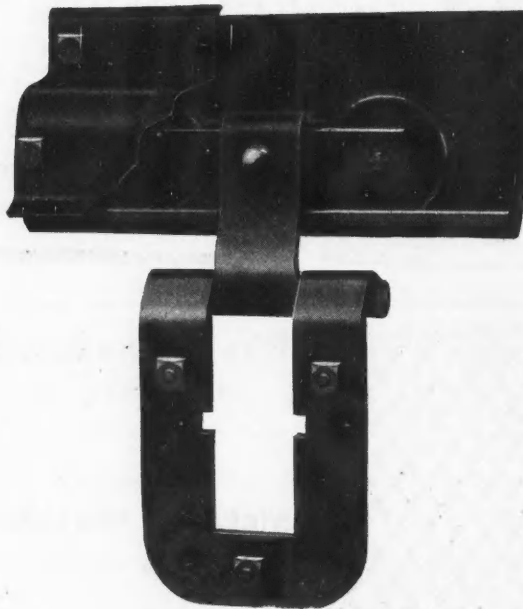

No. 77 Storm Proof-Hanger

of illustrated directions for attaching the Hangers and Rail. They are packed one dozen pairs in a case.

An illustrated descriptive circular will be mailed on request. Address the National Mfg. Co., Sterling, Ill.



STANLEY'S
No. 165
Ornamental
Surface
Butt
Beveled Edge
 Unequaled in Quality

Time and Labor Saved
And the Owner Satisfied

With these butts it is not necessary to mortise the door, as the ornamental leaf screws on the surface.

The Butts can be changed to either right or left hand by simply unscrewing the slotted tip and reversing the pin. A screw driver is enclosed with each box that fits the slot in the tip, and can afterwards be fastened on your key ring.

Write for a Handsome Booklet of Wrought Steel Hardware to Department "A"

THE STANLEY WORKS
 NEW YORK NEW BRITAIN CONN. CHICAGO



Drawing of the Residence on Bitter Root Stock Farm, Hamilton, Montana. Owner, Mrs. Marcus Daly.

THIS notably fine and pure example of modern colonial architecture is built of brick with white woodwork and roofed with **Asbestos "Century" Shingles**
"The Roof that Outlives the Building"

In a building of this kind, architectural fitness is the prime factor in the selection of a roof. Yet no property owner will ignore the fact that an Asbestos "Century" Shingle roof costs no more than any other first-class roofing. That it needs no repairs and no painting—that it is proof against fire—that it never "grows old."

Send for quotations, and booklet "Everlasting 1912".

Keasbey & Mattison Company, Factors
 Ambler, Pennsylvania
 Branch Offices in Principal Cities of the United States

THE "BEST"

The FUEL CHUTE for Every Home

A "Fuel Chute" is as necessary to a home as a heating plant. It protects the wall saves the sash and saves the glass.

Will save it's cost each year

The "BEST" fuel chute is made right. It sets flush with the outside wall. An over-lapping flange on the top of the door prevents rain from entering chute and rusting it out. The "BEST" is adapted for any kind of fuel. It is burglar-proof. It is the right kind to buy.

Neat—Practical—Durable

Made in three sizes

No. 1—18 in. x 18 in. No. 2—18 in. x 24 in. No. 3—20 in. x 26 in.

Easily Installed—Locks Open—Locks Shut

If your dealer don't handle them write us direct

STERLING FOUNDRY COMPANY

Sterling, Illinois



When Writing Advertisers Please Mention the American Carpenter and Builder.

Slate Sink Tops

The clear black sink tops made by the Slatington Slate Company, Slatington, Pa., seem to be growing in popularity from year to year. They are claimed to be the most sanitary and durable of any sink top made. They do not wear out, they last forever. They always retain their beautiful uniform black color, never becoming unsanitary.

The sink tops of the Slatington Slate Company are all hand-rubbed, and are made to order to fit any space. This

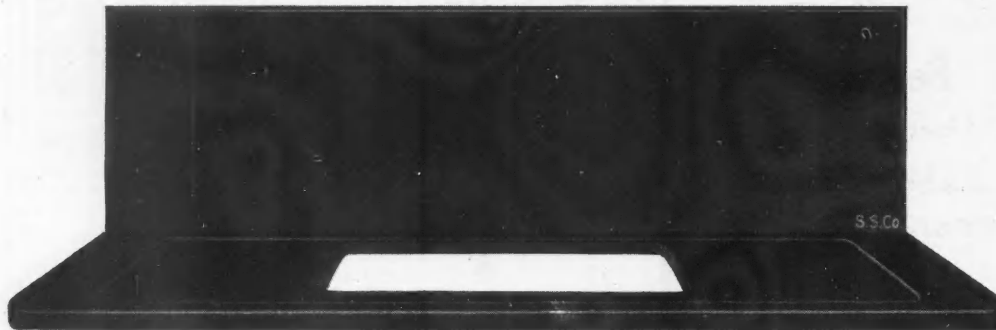

Clear Black Hand-Rubbed Sink Top from the Genuine Franklin Quarry.

company guarantee the workmanship and finish on their sink tops to be the very best. The one illustrated is for an open sink. They furnish them also for sinks built into walls, kitchen closets or cup-boards, etc.

The Slatington Slate Company, who quarry their slate from the Genuine Franklin Tunnel, issue a very interesting illustrated book and price list covering their entire line of roofing slate, slate black-boards, structural slates, etc. Write for a copy.

Emmert Universal Vises

Attention is called to the Universal Vise of the Emmert Manufacturing Company as being one of the best on the market for pattern and woodwork of all kinds. More than 40,000 of these vises in daily use prove the worth of this sterling tool as a time saver and convenience to the user.

This vise is so arranged that the jaws can be set at various angles so that the workman has no need of twisting or bending himself to suit his work. He just lets the vise turn the work to the position or direction which best suits his comfort, and the vise holds it there firmly.

Seven different pairs of jaws make up part of the equipment of this Universal Vise. With these any kind of work, no matter what its irregularity of form, can be satisfactorily held.

The Emmert Universal Vise is made in two standard sizes, differing in

weight and holding capacity, also in size of jaws, etc.

In the use of these tools *valuable time is saved, labor economized, skill manifested and profitable results obtained.*

This is a work-bench appliance that is well worth investigating. Address the Emmert Manufacturing Company, Department C, Waynesboro, Pa., and they will send you an illustrated pamphlet on the Universal Vise, giving full information including prices.

THERE'S A PLACE IN YOUR TOOL KIT FOR A CARBORUNDUM SHARPENING STONE

You will never know how quickly and easily you can bring your tools to a keen, smooth, fast-working edge until you use a Carborundum Stone. There isn't a sharpening stone like it—Carborundum is so totally different from and sharpening material—it is hard, sharp, durable—it cuts—cuts clean and quick, leaving the tool edge perfect—Carborundum simply gives a better edge in less time, with less effort.

Carborundum Round Combination Bench Stone, No. 107	-	\$1.00
Carborundum Oblong Carborundum Stone, No. 108	-	\$1.25
Carborundum Pocket Stone, No. 149	-	\$0.15

At Your Hardware Dealer's—Or Direct

THE CARBORUNDUM COMPANY
NIAGARA FALLS, N. Y.



When Writing Advertisers Please Mention the American Carpenter and Builder.

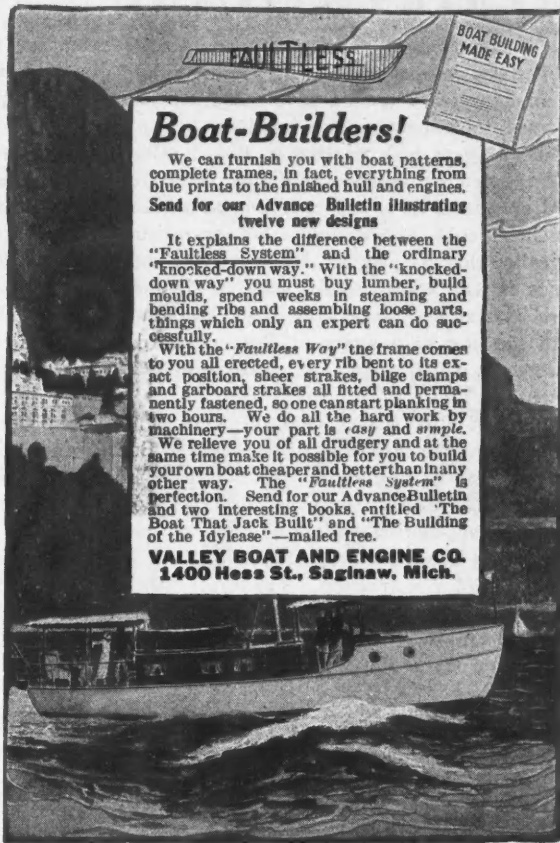

BOAT BUILDING MADE EASY

Boat-Builders!

We can furnish you with boat patterns, complete frames, in fact, everything from blue prints to the finished hull and engines. Send for our Advance Bulletin illustrating twelve new designs.

It explains the difference between the "Faultless System" and the ordinary "knocked-down way." With the "knocked-down way" you must buy lumber, build moulds, spend weeks in steaming and bending ribs and assembling loose parts, things which only an expert can do successfully.

With the "Faultless Way" the frame comes to you all erected, every rib bent to its exact position, sheer strakes, bilge clamps and garboard strakes all fitted and permanently fastened, so one can start planking in two hours. We do all the hard work by machinery—your part is *easy* and *simple*.

We relieve you of all drudgery and at the same time make it possible for you to build your own boat cheaper and better than in any other way. The "Faultless System" is perfection. Send for our Advance Bulletin and two interesting books, entitled "The Boat That Jack Built" and "The Building of the Idylise"—mailed free.

VALLEY BOAT AND ENGINE CO.
1400 Hess St., Saginaw, Mich.



A CEILING LIKE THIS

Metal Ceilings For Residences

To the Editor:—

We notice the article by "Observer" on page 47 of the January issue. He is quite right as to walls, but does not say much about ceilings. We recommend fabric or tinted walls and a Suitable Metal Ceiling, but be sure it is suitable. Do not use such as are commonly sold for Commercial Buildings and Barrooms. We have a number of designs sold only for residence work, Beam Ceilings in metal for Dining rooms, Tile patterns for Kitchens and Baths, and good modest modern patterns, not Greek or Gothic, for parlors and bed rooms, all durable and incombustible.

Northrop, Coburn & Dodge Co.,
No. 29 Cherry Street, New York City.



32 POUNDS COATING

ROOFING TIN

in the hands of a practical roofer assures both builder and property owner a roof that is light, clean, lasting, and thoroughly satisfactory. MF is the original Old Style, and is the most popular terne plate manufactured. Each plate is stamped with the weight of coating—32 pounds, which is an assurance to the purchaser that he is getting exactly what he is paying for. This is important—insist upon your plates being stamped with the weight of coating.

You hear complaints that Tin Roofs do not last as long as they did formerly. Why is it? Simply because there has been a tendency to buy cheap plates and then put them on the roof as cheaply as possible. You can buy as good or better plates today than ever before. MF if properly applied will last a lifetime, and is cheapest in the long run. We also manufacture other brands of Redipped Plates carrying from 20 to 40 pounds of coating. Write for full information.

American Sheet and Tin Plate Company

General Offices: Frick Building, Pittsburgh, Pa.

DISTRICT SALES OFFICES:

Chicago	Cincinnati	Denver	Detroit	New Orleans	New York	Philadelphia	Pittsburgh	St. Louis
---------	------------	--------	---------	-------------	----------	--------------	------------	-----------

Export Representatives: UNITED STATES STEEL PRODUCTS COMPANY, New York City
Pacific Coast Representatives: UNITED STATES STEEL PRODUCTS COMPANY, Los Angeles, Portland, San Francisco, Seattle

When Writing Advertisers Please Mention the American Carpenter and Builder.

THESE SHINGLES ARE FULLY GUARANTEED



THOUSANDS of buildings, homes, schools, churches, etc., are today covered with Reynolds Asphalt Shingles. Many of these have stood the heave of frost and the wear and tear of storm for 10 years and are in every way as good as when first laid.

Reynolds Asphalt Shingles have "made good"—they have stood the test. So satisfactory are they in durability and appearance that leading architects and builders are specifying them for new work on the best class of modern homes.

Reynolds Flexible Asphalt Slate Shingles

Reynolds Asphalt Shingles last. They are 8x12 1/2 in. and lay 4 in. to the weather. They are fire-resisting and weather-proof. Never split, warp nor rot. Cannot color rain water. These shingles are mineral surfaced and laugh at wind and weather. No better shingles are made than these. If you want to enjoy life, roof your home with Reynolds Asphalt Shingles and—"forget it." We also make strictly high grade granite surfaced roofing in rolls.

H. M. REYNOLDS ASPHALT SHINGLE CO.
(Original Makers of Asphalt Shingles)
180 OAKLAND AVENUE - GRAND RAPIDS, MICH.

READY-TO-LAY
Burmite

Reg. U. S. Pat. Off.

The Material of Strength, Beauty and Service FOR ROOFING AND SIDING

Residences, Factory and Business Buildings, Summer Homes, Cottages, Garages, Barns, etc., of Frame, Brick, Stone, Concrete, or other construction. It's different. Guaranteed for 10 years without coating or painting.

Practical—Durable—Artistic—Inexpensive.

It has perfect water-proofing qualities, and great resistance to all destructive agencies, INCLUDING FIRE.

To become acquainted with this up-to-date material, send for Samples and Booklet (A C and B).

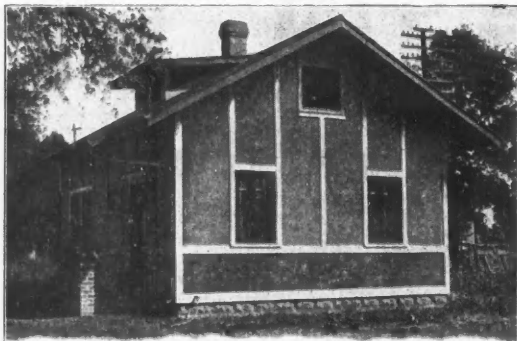

Bungalow of Mr. W. W. Kercher, Orchid Place, So. 7th St., Goshen, Ind.

Burmite Material (Slate-Red) for Roof and strip at bottom. "Stoddard" Slate-Green for balance of Siding. Ivory White Wood (4 in.) Panels.

BERMINGHAM & SEAMAN CO. ROOFING MFRS.
GENERAL OFFICES, 1208-1226 Tribune Building. CHICAGO
PLANT, 56th and Armitage and Grand Avenues
Distributors of BEAVER BOARD

Interesting Series of "Talks" about Beaver Board

The Beaver Board people, with an idea of extending the already very general use of this popular brand of wall board have inaugurated a unique advertising campaign of education addressed to carpenters and builders.

While a great bulk of Beaver Board sales originate from the carpenter or builder who has come to know Beaver Board excellence as a wall covering, as a home-beautifier, and as a heat, cold, shock and vibration-resistant, the Beaver Co. realize that its product, its properties and its possibilities are not as well known to the trade as they should be.

The AMERICAN CARPENTER AND BUILDER presented last month the first of a series of Beaver Board educational advertisements which are to run throughout 1912, twelve advertisements in all.

Readers of THE AMERICAN CARPENTER AND BUILDER are to be taken through each step of the Beaver Board proposition, in an endeavor to thoroughly acquaint them with the wonderful practical and decorative possibilities of Beaver Board, and its ease of application and profit-making features.

The series has very properly been labeled the "A B C" of Beaver Board construction. The first "talk" begins at the obvious beginning. The carpenter is told that Beaver Board is made of pure-wood-fibre in panels so conveniently sized that waste is practically eliminated; of its practical resistant quali-

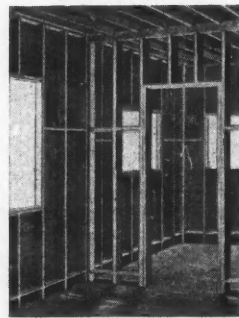

Room ready for Beaver Board construction. Studs evenly spaced and headers in correct position to suit panel design adopted.



Nailing up panels.



Before putting on decorative strips. Panels are painted at this stage.



The finished room, in use.

ties, its sanitary, and artistic and wearing qualities; and its adaptability for walls and ceilings of both old and new buildings (in which it can be nailed up over old plastering) and new buildings (where it is applied directly to the studding.)

All of these "talks" are to be illustrated by actual photographs, tending to make the simple text simpler. For instance, "chapter one" is illustrated by the photographs shown in this article. They show all four stages of Beaver-Boarding a room in a new residence from the bare-studding stage until

When Writing Advertisers Please Mention the American Carpenter and Builder.

THE IVES PATENT WINDOW STOP ADJUSTER

Prevents dust, drafts

and window rattling

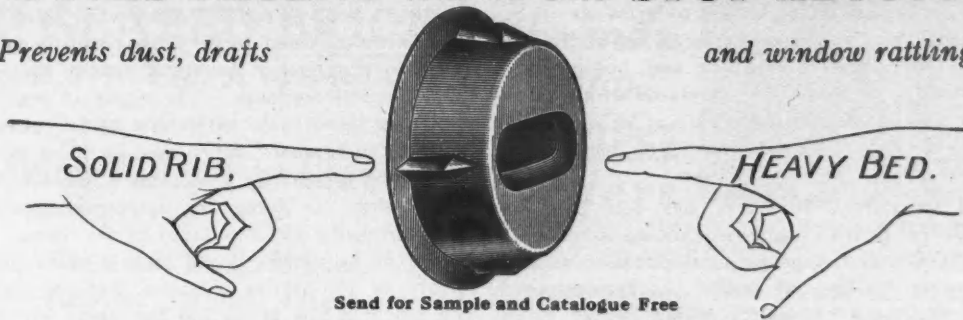

Send for Sample and Catalogue Free

1 piece of metal, will not cup, bend or turn in tightening screw.

THE H. B. IVES CO., Sole Mfrs. New Haven, Conn. U. S. A.

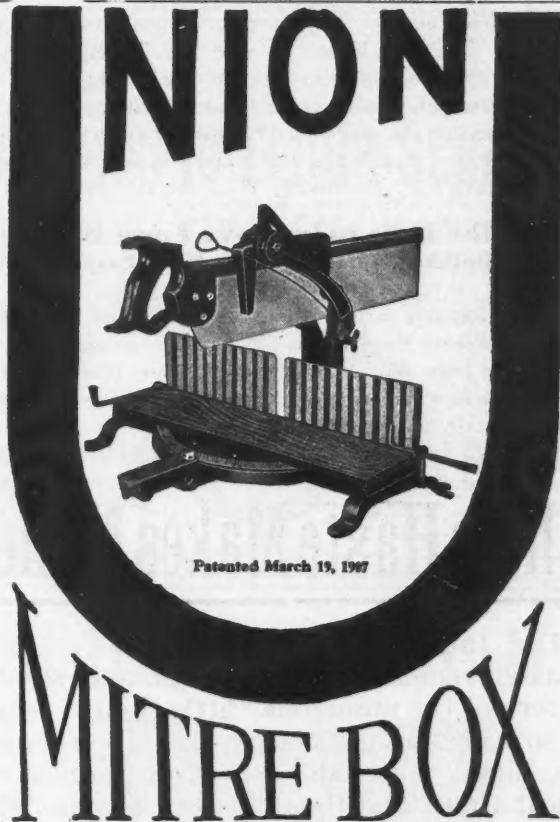

Patented March 19, 1907

Accuracy and strength together with simplicity, combining to make the best Mitre Box you can buy. The open front is only one of many strong features found only in the Union. To those who wish the most for the money, send for our Circular A. We also make a very simple and handy Floorscraper. Watch next issue for something new in your line.

DOSCH MFG. CO. -- Bridgeport, Conn.

Granite
TRADE MARK
ROOFING



SIX INCH SOLID LAP

A six inch lap is better than a three inch lap. It gives better protection against leaks and permits nailing down on the under sheet only, so that no nail heads appear on the surface. Otherwise this is the same Granite Roofing that we have sold for 25 years for use on great factories. It is immune from damage by coal smoke or cinders, and it has a sea grit surface which makes painting entirely needless. Behind it is a reputation that has Passed the Quarter Century Mark.

EASTERN GRANITE ROOFING CO.

Chicago 19 Battery Place, New York Pittsburgh

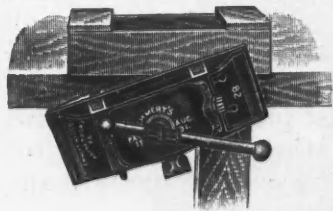

EMMERT UNIVERSAL VISES

are recognized as the greatest Time-Savers and conveniences ever offered the woodworker. Convenient and easy in operation. Will hold work in any desired position. More than 50,000 in use today. Sold on approval and guaranteed satisfactory.

Write for full description and prices.

EMMERT MFG. CO., Dept. C. WAYNESBORO, PA.

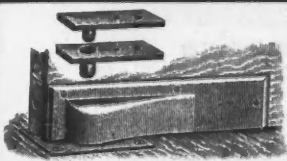
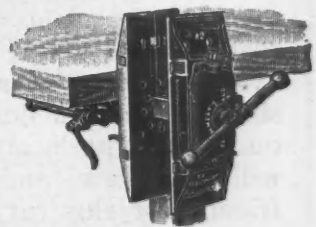

THE NEW SHELBY CHIEF FLOOR HINGE

The original Shelby Chief, Double-Acting Ball-Bearing Surface Floor Hinge, with valuable improvements, viz, attaching plate added which simplifies the hanging of a door. Deep beveled surface cover plates, which cover all defects in notching the door for hinge, and gives a very attractive finish to the door.

The Shelby Chief is guaranteed to give satisfaction. The carpenter is pleased with its ease of application. The builder is pleased with its good service.

The Shelby Chief costs no more than the so called "Just as good" kind. Beware of imitations. The original and only genuine surface floor hinge has "The Shelby Chief" stamped on the floor plate. Ask your dealer or we will tell you more about "The New Shelby Chief," and our line of builders hardware.

THE SHELBY SPRING HINGE CO.

SHELBY, OHIO

When Writing Advertisers Please Mention the American Carpenter and Builder.

the lady of the house has arranged her furniture and ornaments.

If Beaver Board popularity continues to grow as it has it won't be long before it will have displaced lath-and-plaster as a standard. Discriminating builders and house-owners have already refused to consider lath-and-plaster at all. Hundreds of homes and buildings that haven't a bit of lath or plaster in them—all Beaver Board—have been built during the past few years.

Beaver Board superiority, of course, has been primarily responsible for Beaver Board's popularity. A big factor, however, has been the Beaver Company's very extensive national advertising to owner, builder and dealer. As a consequence there are today thousands of dealers selling Beaver Board to carpenters, or to house-owners who are, in a great majority of cases, employing carpenters to put it up. The carpenter has been making good money in the process, the dealer has, and the house-owner has been saving it.

The Beaver Board people have always held that Beaver Board "is essentially a proposition for carpenters and builders."

"I Tell You It's a Great Saw"

A striking two-color sign or poster has been received from the Simonds Manufacturing Company, Fitchburg, Mass.—a character study of a carpenter holding a Simonds saw. He has a pleased, satisfied expression on his face and is evidently saying, "I Tell You It's a Great Saw." The Simonds saw held in his hand has the look of never yet having given disappointment.

This sign is 14 by 21 inches in size. We understand that it is being distributed to the hardware trade and to carpenters and builders who are well wishers of the Simonds saw.

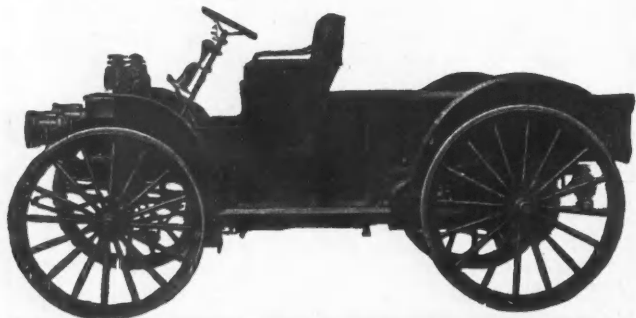

Where Haste Makes Money

The International Commercial Car is a great convenience in its prompt and reliable delivery of the numerous "little things" which are so essential to quick work. Tools, finishings, light materials are often needed at critical times, and their absence means delay and money lost.

International Commercial Cars

save this vexation and expense. They can be depended on in all weathers, over all roads. The simplicity of the power plant insures its satisfactory handling by the average driver. Its power and capacity are not secured at extra fuel expense as we shall be glad to demonstrate. Solid rubber tires are proof against punctures and blow-outs; the wheels are sufficiently high to give perfect clearance; the air-cooled engine will not freeze, and its all-around economy, reliability, and service have made many friends for this car among progressive and wide-awake merchants.

Let us tell you all about the International Commercial Car.

International Harvester Company of America

(Incorporated)

70 Harvester Building

CHICAGO U S A

When Writing Advertisers Please Mention the American Carpenter and Builder.

Morse Duplex Clamp

The Morse Duplex Clamp was primarily designed for supporting a door or sash on edges while being planed or having the hardware fitted to it. This clamp is found useful, however, in many other ways that readily suggest themselves to the practical mechanic. The clamp is readily attached to a porch or fence post or to any other convenient place that happens to be near. When used in fitting doors and windows the clamp is fastened onto some other door or window jamb and casing. In doing this the workman need have no fear that the casing will be marred by the clamp.

For fitting narrow doors, such as china closet or book-case doors, or for narrow windows, transom sash, etc., set them on top of a saw bench and the clamp will hold them accurately in position so that the workman does not have to go down on his knees to do the work, or else break his back bending over so far.

The Morse Duplex Clamp is made of good malleable iron so that it cannot be broken in use. As it weighs only 38 ounces, it does not add very much to the weight of the tool kit. Hundreds of satisfied carpenters and building contractors declare that it is the one device for the purpose ever invented that has proved really practical. Our readers should write Duplex Clamp Co., Reedsburg, Wis., for full particulars.

Now is the Time to Improve Farm Buildings New Building Materials Make Work Easy Right Through Winter

What! Improve farm buildings in winter time! Certainly—that is improve them inside. Make them air-tight and rat-tight. You have more time now than at any other season of the year—and the new building materials make it so easy that it is really a pleasure.

Maybe you haven't kept up with the new building materials

SALT GLAZED BRICK
THE BEST IN AMERICA

ARE MADE BY

The Hocking Valley Fire Clay Co.
 NELSONVILLE, OHIO

Light, Medium, Dark Shades
With Heavy, Smooth Glaze

Some Good Territory Unassigned. - - Write Us.
 Annual Capacity, 12,000,000

Be the man who gives orders



If you aspire to be one of the men who do things, to rise above the poorly paid class, and to be independent, you must have special training. You have the ability, but it is latent, it needs developing. By our practical and complete correspondence courses we can positively teach you to become proficient in **DRAFTING—Estimating, Plan Reading, etc., by Mail.**

In full or partial courses to fit your individual need. The courses cover every conceivable branch of the building trades. Conducted by a large and successful firm of Chicago architects;—your lessons are supervised by them. Blue-prints of buildings actually being erected in Chicago to study from. Courses are especially prepared for contractors, bricklayers, carpenters and all men in construction work. Low tuition, easy terms. No text books to buy. Send for instructive folder.

CHICAGO TECHNICAL COLLEGE, 654 Athenaeum Bldg., Chicago, Ill.

We also teach these same courses, including architectural, mechanical and structural drafting, at our Chicago School. Day and evening classes. If interested in the resident course ask for Catalog X.

ACB

THE RAPID FLOOR SCRAPER



Large Wheels—easy motion. Automatic brush, sweeps floor ahead of knife. Knives sharpened in machine. No bolts to loosen when knives are sharpened or changed. Scrapes hard or soft wood. Saves labor of 3 men. Does a finished job. With the **RAPID KNIFE SHARPENER (INCLUDED FREE) ANY MAN CAN SHARPEN KNIVES.**

MONARCH MFG. CO
 262 Shepard Bldg.
 GRAND RAPIDS, Mich.

SEND FOR CATALOG —AND— **FREE TRIAL OFFER**



Office Buildings, Stores, Schools, Churches, Public Buildings

¶ In the finishing of all buildings the question of sanitary, durable, economical and attractive wall coverings is most important. In large contracts it is customary to have *efficiency tests* of the various materials. *In every such test*

JOHNSTON'S DULL KOTE PAINT

leads them all. But that is only natural when you realize that DULL KOTE is the Best Sanitary paint that contains no white lead or other poisonous substance, does not rub, flake or peel off, is hard and elastic, and that can be cleaned with soap and water like tile. In appearance it has that *soft beautiful look of undressed kid*, without a trace of brush marks or laps.

¶ These are the qualities that make it so popular in the home—the same qualities are desirable in public buildings and business houses.

¶ Get our 24-color card and list of buildings using DULL KOTE. For sale by dealers everywhere, or by

The R. F. Johnston Paint Co.
 Pearl and Main Streets Cincinnati, Ohio



No can and the Label—Accept no other

This is a Small View of Our Line



A proof that we are the leading manufacturers of Mitre Boxes. Any style, shape, or size Mitre Box can be bought direct from us, or from our Dealers. Special prices to Carpenters and Builders in localities where our tools are not handled. Drop us a card for further particulars.

ROCKFORD MITRE BOX CO., ROCKFORD, ILL.

When Writing Advertisers Please Mention the American Carpenter and Builder.

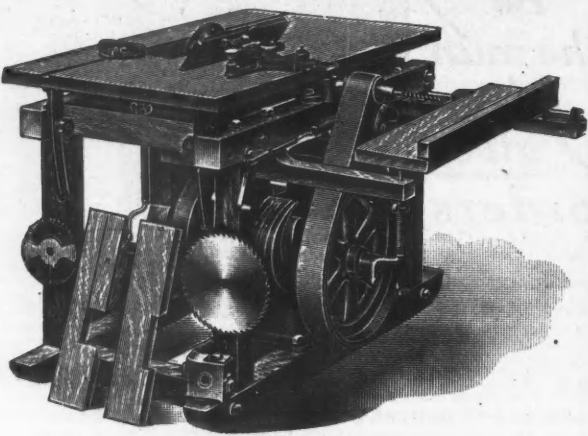

"AMERICAN" Portable Contractor's Saw Bench

Now is the time to prepare for spring business—and, first of all, look into the "American" Contractor's Saw Bench—the bench that pays for itself on its first job and then becomes a steady money-maker.

Of course, there are other portable saw benches—but only one "American" Bench, built by "American" methods, with the "American" experience and guarantee behind it, by the concern which has made the name "American" on saw mill machinery a guarantee of maximum satisfaction.

Write us for prices and full descriptive literature.

SEE IT AT THE CEMENT SHOWS
AMERICAN SAWMILL MACHINERY CO.
82 Main St., Hackettstown, N. J. 1655 Hudson Terminal, New York City

The Bessler Movable Stairway!



THE
BESSLER
STAIRWAY
IN
POSITION

Agents Wanted
In Every Town

A device combining usefulness, strength and convenience.

Saves Space!
Low Cost!
Strong and Durable!
Easy to operate!
Operates Automatically!
Adds Value to House!
Reduces Fire Risks!
Secures Good Ventilation!

Write for descriptive circular and price list to

— THE —
Bessler Movable Stairway Co.
AKRON, OHIO

and don't know how little they cost, and what labor they save. One of these is Bishopric Wall Board which takes the place of lath and plaster in the house, and is a fine thing for all farm buildings. It comes in sheets four feet square and $\frac{3}{8}$ -inch thick. Any man who can drive nails can put it on.

Bishopric Wall Board is made of Asphalt-Mastic (toughened asphalt), in which laths are imbedded. Surfaced with high-grade, sized cardboard. Asphalt-Mastic does not burn. It thus makes a fire-resisting wall. The laths hold it perfectly rigid, and flat, so that it can never warp nor twist even in a steamy kitchen.

The finest homes as well as cottages, are finished with Bishopric Wall Board. You can use it in your new buildings if you have any going up. You needn't wait for building weather, for this is a very good time to use it to improve in your present home.

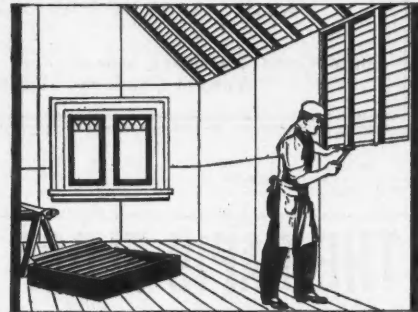

Applying Wall Board to Studding

You can make an extra room in the attic by inclosing it with this remarkable material. Many houses have attic bed rooms made of wall board that are just as cozy and just as handsome as any other bed rooms in the house.

This is because the Wall Board takes any kind of decoration. As soon as it is nailed onto the studding it is ready for paint, paper, burlap or any other decoration. In its own gray tint with Mission Panels—made by nailing strips of wood over the joining edges—it is a wall that satisfies artistic taste. You can close up your cellar, your back porch, your summer kitchen, and make them as warm as any other room.

You can build a workshop in any building where you can work in comfort winter or summer.

In farm buildings other than the walls of the house, some do not care for as fine a finish as the Wall Board.

For these Bishopric Sheathing is provided. It is made of exactly the same materials as the wall board, but not finished so smooth.

If you have a damp, cold room owing to moisture coming through the floors you can make them warm, dry and comfortable by nailing this sheathing to the joists under the floors. It will shut out all the dampness and cold from below.

You can use this sheathing in your stable, barn, corn crib, implement shed, carriage house, tool house, poultry house, milk house or any other farm building. It is easily handled in these sheets, four feet square, and you can nail it on in a jiffy. It seems inexcusable that any farm building should be open to rain, snow, sleet and rats, when this low-priced remedy is so easily obtained.

Why not do your remodeling now? You don't have to bring in the plasterers with their muss and litter. You don't have to pay for their high-priced time. You don't have to pay the high cost of lath and plaster. Just run the studding for a partition—a hallway or a room—and nail on the wall board. The manufacturers advise us that on request they will furnish any reader with a simple plan for finding just how much of these materials he needs.

They will also send a book explaining all the uses of Wall Board and a large sample of the material. Address The Mastic Wall Board and Roofing Mfg. Co., 340 Este Ave., Cincinnati, Ohio.

When Writing Advertisers Please Mention the American Carpenter and Builder.

Try It FREE

Why, compared with the grindstone or emery wheel, it is mere child's play to do the toughest job of grinding—and with the patent tool rests and attachments an apprentice can do any job of sharpening such as gumming saws, sharpening plane bits and twist drills as well as a high paid mechanic. Try it 30 days absolutely free—then if you don't want to keep it, return it at our expense.



A Workshop in Itself
Extra attachments convert the Luther "Hummer" tool grinder into jig and circle saw, lathe, force feed drill, forge, etc.—you can completely equip your workshop at very low cost—free book illustrates and describes extra attachments—16 in all. Write for Free Book today. Luther Grinder Mfg. Co., 505 Michigan St. Milwaukee, Wis.

Dimo-Grit Sharpening Stones
Ask your dealer for Dimo-Grit sharpening stones—the fastest, smoothest sharpening substance for steel. Look for name Dimo-Grit, on the stones.

Cuts Steel as Emery Does Copper

Dimo-Grit, the new artificial diamond abrasive, peels steel away in tiny shavings 25 times faster than grindstone, 10 times more efficient than emery—no need of water cooling, no danger of drawing temper. Will not glaze or wear lop-sided. Dimo-Grit is especially adapted for steel. Carborundum wheels supplied when wanted.

Luther Shop Tool Grinder

Foot and engine power—built completely of steel and iron, enclosed shaft drive like an automobile, dust-proof bearing—runs as easy as sewing machine—1000 revolutions per minute by foot power.

LUTHER GRINDER MFG. CO.,
505 Michigan St. MILWAUKEE, WIS.



14 Machines in One
1—Fine Dimo-Grit wheel. 2—Coarse Dimo-Grit wheel. 3—Universal toolrest. 4—Chisel and plane bit guide. 5—Dimo-Grit razor hone. 6—Dimo-Grit scythe stone. 7—Dimo-Grit saw gummer. 8—Felt polishing wheel. 9—Medium Dimo-Grit wheel. 10—Cloth buffing wheel. 11—Dimo-Grit oilstone. 12—Dimo-Grit pocket hone. 13M—Plane bit honing attachment. 14—Twist drill sharpening attachment.

40 Page Free Book

Shows all ways this machine saves and earns money and makes work easier—gives valuable pointers on tool sharpening. Prove this machine's value to you in your own work. Send for full information, then decide if you want to try the shop outfit for 30 days free. Don't delay. Write today.

PREMAX **PREMAX SASH CHAIN** **PREMAX**

IS IN EVERY WAY RELIABLE

Made in three weights of link, in bright steel or in electroplate of copper, brass or nickel.

Runs on our Niagara Pulley or on any other suitable pulley, with the greatest ease and smoothness.

NIAGARA FALLS METAL STAMPING WORKS
MANUFACTURERS OF HARDWARE SPECIALTIES
NIAGARA FALLS, NEW YORK, U. S. A.

Niagara Sash Pulleys and Steel Sash Fixtures, Niagara Wall Plugs, Wall and Veneer Ties, 12" Ties for Stone, Brick and Concrete Block Walls

Folder 57C will interest every Architect and Building Contractor. Samples mailed on request. 15 M

THE MORSE DUPLEX CLAMP

Patented June 21st 1910

Is the only device ever offered to carpenters that rigidly holds a sash or door while planing or fitting hardware, weighs thirty-eight ounces. Is practically unbreakable. Sold under a positive guarantee of satisfaction or money refunded. Send for circulars giving full description and price, enclosing a stamp.

DUPLEX CLAMP CO.
Agents Wanted, Reedsburg, Wis.

1½ H. P.—1½c—1½ Hrs.

THE greatest engine value on the market—*The Caille Perfection Special*—simplest in construction—most economical in fuel, kerosene or gasoline. Built by automobile men with automobile machinery, all parts of the highest grade materials, every moving part runs with the smoothness of perfect construction.

Caille Perfection Motor ONLY \$48

Delivered complete and ready to run. You will never need "finker" with this motor. Nothing about it that can get out of order. It delivers the service you need at all the times you need it—under all conditions.

15 Days' Free Trial

To prove to you its economy, reliability and unailing service. Write today for Free Book and Free Trial Offer.

Caille Perfection Motor Co.
317-2nd Ave., Detroit, Mic

When Writing Advertisers Please Mention the American Carpenter and Builder.

Cement Over-Coated Buildings for the Prairie Countries

The building constructed with an over-coating of cement or concrete seems particularly adapted to withstand the high winds and severe weather conditions of the prairie countries.

The accompanying illustration of the Kimball House at Kimball, South Dakota, is an excellent example of the type of building that withstands the elements, is practically fire-

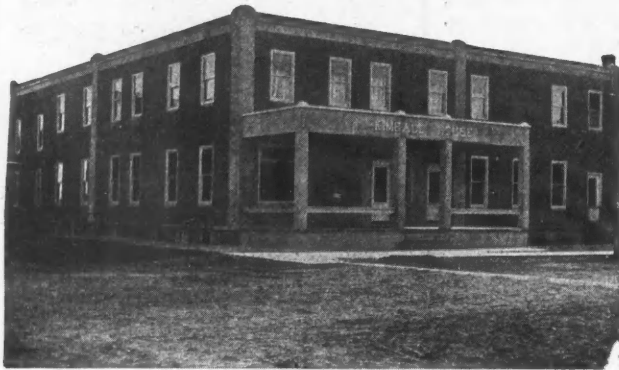

Kimball House, Kimball, Nebr., Cemented Over Berger's Diamond Mesh Lath.

proof, and considerably warmer than almost any other construction.

This Hotel is covered on the outside with Berger's Diamond Mesh Expanded Metal Lath, manufactured by the Berger Manufacturing Company of Canton, Ohio. After the Metal Lath was applied the whole building was given an over-coating of cement stucco. The result is a neat, snug, warm building that is practically proof against both wind and fire.

Even in the smaller towns and villages throughout the great Northwest this over-coated or stucco construction is becoming quite popular for residences, schools, store buildings, hotels and buildings of practically every class. This construction has many advantages over both wood siding and cement blocks and makes a most substantial and permanent building. Best of all it has those fireproof qualities which are so essential in every locality. Yet with all these advantages stucco or over-coated buildings are comparatively inexpensive to construct.

Old frame buildings can be renovated and greatly improved at small expense by covering the exterior with this Expanded Metal Lath and then applying the stucco cement. The improvement and change in the appearance of many of these buildings which have been refinished in this way is truly wonderful, and has well repaid the owners by the improvement in appearance alone without considering the additional fire protection.

BLOCK MACHINES

Face down. Fastest and best machine. Send for special price circular.

New-Departure Block Machine Co., Indianapolis, Ind.

INTROSTILE

is a door bottom which seals the crack; clears the floor of thresholds—not needed for any reason; renders doors tight from bottom to top—desirable for many reasons. Don't confuse the Introstile with clap-trap arrangements. It is not that kind of door hardware. It is ten years old and knows its business and does it and keeps doing it automatically, noiselessly, and out of sight. The Introstile is needed in every building where the best door and floor conditions are demanded. Write us.

INTROSTILE & NOVELTY CO.

Marietta, Ohio

The Roofing Problem

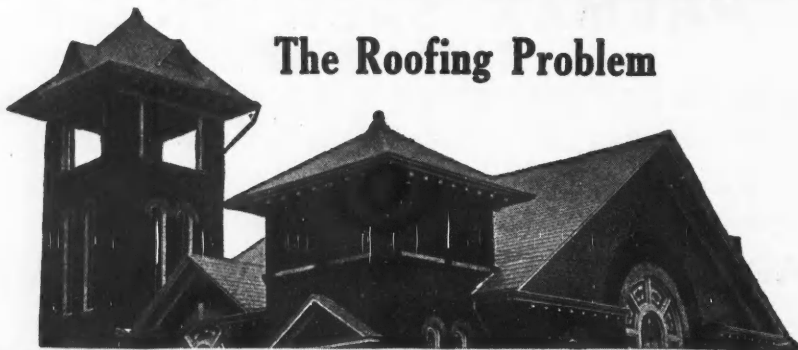

CORTRIGHT METAL SHINGLES

Will be confronting you Contractors and Builders again before long. Prospects for spring business are good, and the demand for CORTRIGHT METAL SHINGLES will be heavier than ever, for there is no question that they are supplementing the wood shingle in all progressive sections of the country.

They're fireproof, stormproof, handsome, easy to put on—yield a good profit to you, and last as long as the building itself without needing repairs.

Our special proposition to contractors and builders will interest you. Better write for it today.

CORTRIGHT METAL ROOFING COMPANY
PHILADELPHIA and CHICAGO

COUPON
Gentlemen: Please send me catalog "Concerning That Roof" as advertised in American Carpenter and Builder, Feb.

Name
Street Address
City
Business

When Writing Advertisers Please Mention the American Carpenter and Builder.



Mr. Contractor and Builder

Why not equip the home or other building you are erecting with

Acetylene Lighting?

You can greatly increase your income by selling Davis Acetylene Lighting Plants, for new buildings, and during dull seasons for buildings already erected.

Write us for cost of equipping a building and for our terms as salesmen.

Davis Acetylene Company
90 Crawford St., Elkhart, Ind.

This Tool Will "Pry" Into Anything

It has the strength and leverage for safely opening packing cases, taking up floors, removing scaffolding and other like jobs that carpenters, plumbers and electricians come up against every day. Sizes 14 and 23 inches. Drop

forged from special formula steel.

"BONNER" Pry Bars

are about the handiest things a mechanic or electrician can keep in his kit. They are the only tools that will do fast housewrecking and save lumber. The only Pry Bar that will pull a nail as high as a man can reach. Dealers make money handling Bonner Pry Bars.

C. E. BONNER MFG. CO., Champaign, Ill.



OAK FLOORING

Attracts Your Attention Immediately and Holds Your Admiration Permanently

Builders and owners will find it a clinching argument to say "It's floored with OAK FLOORING." It means that the tenant or the buyer will be glad to pay 10 to 15 per cent more. It is the biggest single feature to look for in any house or apartment building. It imparts an air of refinement and elegance. It is the modern flooring.

OAK FLOORING 3/4 inch thickness by 1 1/4 inch or 2 inch faces can be laid over old floors in old homes or over cheap sub-floors in new homes at a very low cost. It is cheaper than carpets or pine flooring. When laid it has all the appearance of a heavy floor.

There is a solid satisfaction and lasting pleasure in the substantial and dignified appearance of OAK FLOORING.

Contractors and carpenters find it very profitable to lay 3/4-inch stock over old floors in old homes during the Winter Season. A little canvassing is all that is necessary to secure jobs.

Write us for further information

THE OAK FLOORING BUREAU, 865 Hammond Bldg., DETROIT, MICH.

Best for all Walls

TAPESTROLEA
Burlaps and Canvases

Recommended by
Architects, Builders, Decorators, Owners

Beware of Worthless, Cheap and Unsatisfactory Imitations

Illustrated Booklet and Samples on Application

RICHTER MFG. CO.
Main Office and Works
TENAFLY, N. J.

SALESROOMS: New York, 20 E. 21st Street
Chicago, 6 W. Lake Street

SAVE \$100 to \$250
on a modern heating plant

Special working plans with every plant. Any one can install. Steam or hot water systems.

38⁹⁵ Buys this Complete Bath Room Outfit

Highest grade material. Satisfaction guaranteed or your money back

Running Water in Your Home for \$42

All the conveniences of city water at a reasonable cost.

WRITE TODAY FOR FREE BIG CATALOG FREE

Gasoline Engines. Electric lighting plants, \$300. Hydraulic Rams, Pumps, Pipe, Valves, Fittings at lowest prices. Farm Tanks, Gas and Electric Fixtures. Acetylene Plants. Buy from me and save 50 per cent. Write today to

M. J. GIBBONS DEPT. B
DAYTON, O.

When Writing Advertisers Please Mention the American Carpenter and Builder.

Prudential Portable Steel Shelters

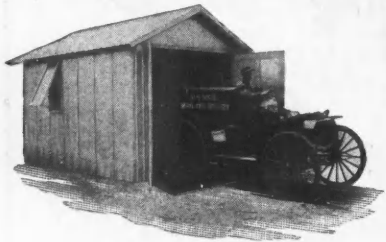

"Made in Baltimore"

Sheds, Boat Houses, Outing Cottages.

For Garages, Implement Shelters, Work Shops, Hunting Lodges, Storage

Anyone Can Erect Them

They require no frame, no woodwork, nor any foundation. When put up they are very rigid, sanitary, weather-proof and fire-proof. They will not rust and when dissembled occupy very compact space.

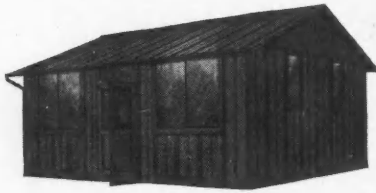

Contractors and Builders! The erection and sale of these buildings open a new and profitable field for you

Write for prices, catalogues and discounts.

C. D. PRUDEN & CO., SOLE MANUFACTURERS
BALTIMORE, MD., U. S. A.

Portable Derrick for Builders

The Taylor Portable Steel Derrick made by John L. Taylor, 1036 W. Lake St., Chicago., is constructed of malleable iron and steel. Weight 197 lbs. Base section weight, 88 lbs.; beam section weight, 109 lbs. Reach of beam 3 ft. 4 in. Height to block, 5 ft. Beam swings a complete circle and presses on two beveled cold rolled steel wheels that are mounted on prongs that project half around post, wheels roll on beveled flange on post. Beam is connected to post by tipping in a vertical position. Post is mounted on channel steel right angle base, braced with two angle steel braces that rivet to malleable castings that cuff around lugs on post that prevent shearing bolts that hold braces rigid. Flanges and bearings on post are turned accurately, post is reinforced with four ribs that project through its inner wall. Drum connects to beam. Drum is revolved by operating cranks that are so positioned one man can reach both cranks and pushes with one hand and pulls with the other; it is a muscular movement, hoists one-third more and it is

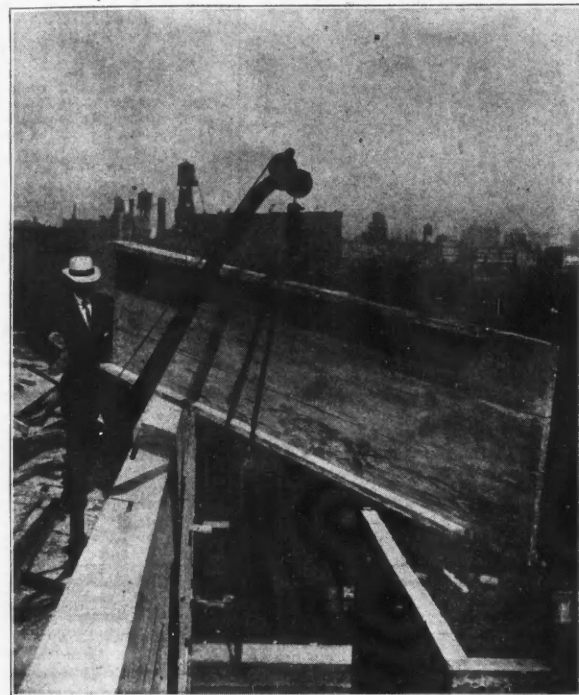

Taylor Portable Steel Derrick Projecting over fire wall on cement construction and hoisting cement post forms

faster and easier than operating one crank. Drum being placed over the post enables operator to reach both cranks when derrick is set to edge of wall of building.

Drum being placed on center over post cranks can be operated without causing beam to swing.

Cable is connected to a square steel shaft that projects through the drum and cable winds around the drum and threads through cast flanges on head of beam around sheaves mounted on cold rolled steel pins that are held by spring cotter keys and cable passes around sheave in three-way swivel hook block that is especially designed.

Cable attached to ball bearing swivel shackle that allows twist in cable to unwind. Roller in mounted on cold rolled steel pins that hold lower sheave, cable passes under roller and over top sheave, roller prevents wear on cable when dragging a load and holds cable from escaping off sheave. No wrench required to attach or remove derrick.

All those interested should write at once to John L. Taylor, 1036 W. Lake Street, Chicago, for catalog giving full information.



Nothing Else Matters

if the heating system is not right. Beautiful walls, fine floors or fancy fixtures will not make up for the discomfort of poor heating. That is why so many builders install only

GILT EDGE Furnaces and Boilers

They insure comfort and satisfaction with economy of fuel. Thirty five years of successful heating experience enables us to guarantee them in every particular. Write us for information or advice.

R. J. Schwab & Sons Co.,
295 Clinton Street
MILWAUKEE WIS.



When Writing Advertisers Please Mention the American Carpenter and Builder.