

AMERICAN CARPENTER AND BUILDER



THE WORLD'S GREATEST BUILDING PAPER

Big Special Feature This Issue—



We are proud of the work being done by the great family of American Carpenter and Builder Subscribers.

They are today in control of practically all building activity in every progressive and thriving city, town and rural community throughout our broad land.

HOW well they are living up to their responsibilities is forcibly demonstrated by the photos and plans presented in this issue, which illustrate some of the structures they have recently planned and built.



It is the "Taper Grinding" (not "thin back") that does it. They are of even gauge along the entire tooth edge, two gauges thinner on the back at the butt and from four to five gauges thinner on the back at the point.

THEY TAPER GRADUALLY

This reinforces the blade and makes it stiff. The kerf is wide enough to permit the blade to drop easily without binding. They run free, even in wet lumber and require but little set. **Atkins Taper Ground Hand, Rip and Panel Saws** will actually run easier and cut faster than any other.

SILVER STEEL

Then the Blades are made of ATKINS Exclusive SILVER STEEL (as fine as Razor Steel). It's the toughest hardest Saw Steel. Takes an even temper, holds its edge. A real Mechanic's Saw.

HOW TO GET THEM

Your regular dealer probably sells them, but if not, he will be glad to order for you from his wholesale house. Just tell him you want the Genuine ATKINS SILVER STEEL SAW with our name on the blade. If he won't supply you, then write to the nearest address below.

AN APRON FREE

Our offer to mechanics is still in force. Send us ten cents to pay postage and we will forward free of charge our fine Carpenter's Apron and full information in regard to ATKINS SILVER STEEL SAWS. Address

E. C. ATKINS & CO., Inc.

The Silver Steel Saw People

Home Office and Factory, INDIANAPOLIS, IND.

Also Branches in the following cities: Address E. C. ATKINS & CO.

Atlanta,
Chicago,
Memphis,

Minneapolis,
New Orleans,
New York City,

Portland, Oregon
San Francisco,
Seattle,

Canadian Factory—Hamilton, Ont.
Vancouver, B. C.
Sydney, N. S. W.

When Writing Advertisers Please Mention the American Carpenter and Builder.

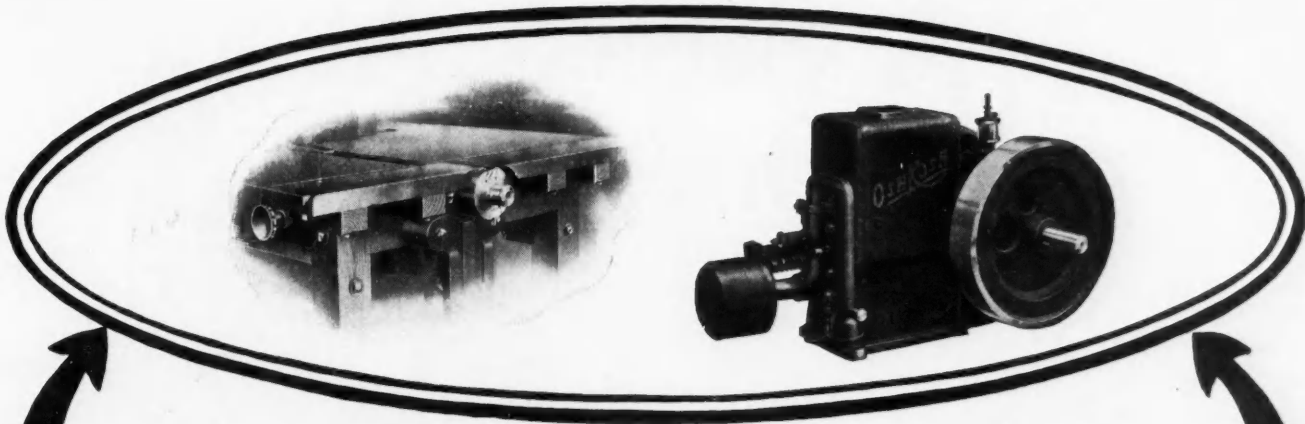

Two More Big Improvements

A LATER-MODEL, handier Jointer and a more powerful, better-balanced Engine, bring the Oshkosh "Eveready" Saw Rig just a little farther ahead of the times. Careful study of building problems continually reveals some new need, and this rig meets these needs more than half way. In time and quality of work, the new



"EVEREADY"
PORTABLE
SAW RIG

Saves More
Money Now
Than Ever

Higher-Grade Jointer

—Unlike the other one, this Jointer is attached to the saw arbor at opposite end from the saw; so both Saw and Jointer can be used at the same time. It is of improved cylinder type, 5 inches wide, fitted with two tool steel knives, and works between two semi-steel tables. This is a high grade jointer, made for long, hard service. There is none better made.

More Powerful Engine

—This new 4-cycle Engine is of our own design, built expressly for this rig. It is of 4½-inch bore and 6-inch stroke—guaranteed to develop over 4 h.p. Cast from semi-steel instead of gray iron, and as perfectly balanced as a high-grade auto engine. Special inlet-valve device effects great fuel saving. All parts are tightly enclosed from dust.

Try It One Week FREE

—We'll let you try the "Eveready" six days under any working condition and take it back if you don't want it. Write for descriptive folder and details of trial offer. Don't buy any rig till you do this. Remember—the price still includes the SEVEN FREE ATTACHMENTS.

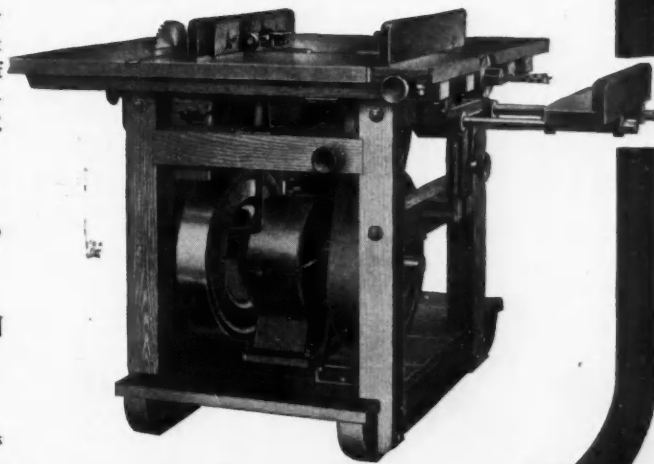

Oshkosh Mfg. Co.

316 S. Main Street

OSHKOSH

WISCONSIN

Chicago Office, 1452 Monadnock Block

DODGE & DODGE, Eastern Sales Agents
1133 Broadway New York

When Writing Advertisers Please Mention the American Carpenter and Builder.

A Success At Any One's Hands

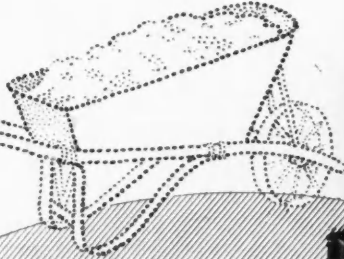

MIXER

YOUR men need not be graduates of a veteran mixer crew to get A-1 results out of the "Oshkosh." It is so simple any one can produce smooth, well mixed concrete that will pass the most exacting tests. We **guarantee** it. The "Oshkosh" loads easily, cleans easily, mixes, any material and requires little power. It contains fewer parts than any other mixer made; consequently it will last a lifetime without excessive breakdowns. A

Big Money Saver on Any Size of Job

Special Features: Quadruple or Four-Way mixing principle; that is, it turns, kneads, pours and flows four times to each drum revolution—efficient **Chain Drive**—Main Sprocket Drum Ring in sections; each instantly replaceable—**Discharge Lever** can be operated from all sides of mixer—**Combination Drive and Hoist**—heavy reinforced channel steel **Frame**—thick semi-steel **Drum** rotated on extra large rollers; can be stopped or started full or empty

—all parts standardized and fitted to interchange in the field with ordinary tools. In every size demanded: standard or batch hopper or power charger; steam, gasoline or electric power. High grade gasoline engine with multiple disc clutch. Fine horizontal steam engine instead of a cheap vertical. Electric motor of latest approved pattern. **Rigid Guarantee** of absolute satisfaction.

We also manufacture saw rigs and trench and centrifugal pumps.

WRITE FOR FOLDER AND PRICES

Oshkosh Mfg. Co., 316 S. Main St., Oshkosh, Wis.

Chicago Office:—1452 Monadnock Blk.

DODGE & DODGE, 1133 Broadway, New York

Eastern Representative

When Writing Advertisers Please Mention the American Carpenter and Builder.

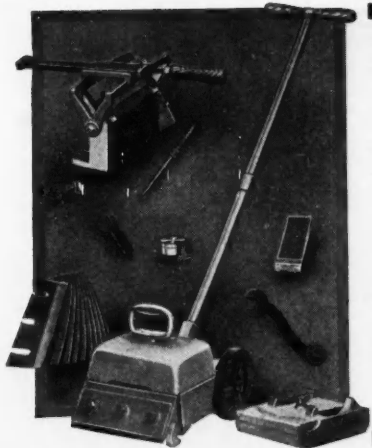

Try It—But Don't Buy It—

until you have convinced yourself, by actually working with the machines, that they are satisfactory in every particular. In order that you may know just what the

Acme Floor Scraping Outfit

can do on your own flooring, I want to send the same to you on a WEEK'S FREE TRIAL. Thousands of carpenters and contractors have accepted this offer and if you haven't done so, get busy and write for full particulars and catalog to-day.

JOSEPH MIOTKE 247 Lake St., Milwaukee, Wis.

\$25.85



You May Try This

Haven Planing Floor Scraper

at Our Risk



THE ADJUSTABLE TOOL

We will guarantee you absolutely against expense if you are not entirely satisfied with the Haven Planing Floor Scraper after keeping it for one week.

The "Haven" eliminates all the defects of other floor machines. Study this machine. Mark its simplicity. Raise the handles, draw them toward you and the work proceeds rapidly. Note the light-running carriage on the smooth trackway, the handle swinging on a pivot for a shearing cut and moving laterally in dressing the area within machine. It will appeal to your common sense because its tool is merely a scraping plane, such as you have always known. The angle of blade and thickness of cut are each regulated by a small screw in the usual way. Because the tool is a true plane, it prevents chattering, gouging and "waves." It planes and scrapes at the same time and all woods are alike easy. It also does away with the man-killing toil of pulling a heavy weight. The most simple, easy and rapid machine on the market and solves the problem practically and permanently. Saves its cost within five days.

Don't pay exorbitant prices for an inferior machine, when you can get the best on earth for \$25.85. Send for catalogue and complete particulars to learn how we can make this wonderful proposition on a guaranteed machine.

THE HAVEN MFG. CO.

:::

RACINE, WIS.

The Haven Planing Floor Scraper

You will never buy a better machine—
You will never get bigger value for you
money than in

An Adjustable Floor Scraper

Complete—\$22.50—Cash

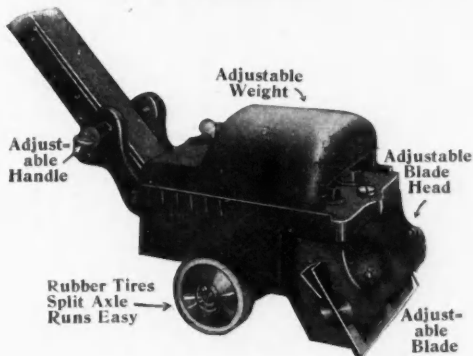

Money back in 30 days if not satisfied

H. P. Didriksen

11th & Jackson Sts. Anderson, Ind.

Scrape Your Floors With this LITTLE GIANT—

You Can Try It
At Our
Expense



A floor scraper is now a necessity with every builder. In this Little Giant you get a floor scraper you can always depend upon to do its work properly. It is easy to operate. Scrapes floors rapidly, perfectly and economically. We'll let you try this Little Giant before you buy it—a fair proposition—and you can prove to yourself just what it can do. Write us NOW for our special offer for YOU.

The THOR Electric Home Laundry Machine

should be in every home. This machine does away with all laundry troubles. Home owners and builders appreciate their convenience and usefulness and it is good policy on your part to install them for your clients. There are now more than 51,000 in use. Sizes, designs and prices to meet every requirement. Sold on liberal FREE TRIAL EASY PAYMENT Plan.

You ought to have our circular matter describing our Little Giant Scrapers and THOR Washing Machines. Write for this NOW.

Hurley Machine Company

New York 1008 Flat Iron Building

37 S. Clinton Street, Chicago



When Writing Advertisers Please Mention the American Carpenter and Builder.

The American Floor Surfacing Machine

IS NO EXPERIMENT. Its work since 1903 has established a standard for finely surfaced and polished floors. It is the only machine whose work is specified by leading architects and used in the best government buildings and will surface and polish any kind of a floor from common pine to the finest parquetry. **IT IS THE ORIGINAL** and only two-roll, self propelled, dust collecting machine, that surfaces close to the wall and can be used in small rooms. Anyone can operate it.

ITS WORK IS RAPID, regular smooth and even because the power that drives the rolls, also propels the machine at the same ratio of speed. It has surfaced and polished millions of square feet of the best floors in America and Europe.

GET A MACHINE that does first class work and in paying quantities, that is fully guaranteed and sold on its merits. Don't be fooled with an imitation.

Write for Our Free Book, "Surfacing Floors as a Business."

Manufactured By **The American Floor Surfacing Machine Co., TOLEDO, O.**



BUILDING CONTRACTOR AGENTS

to use and sell
the **RAPID FLOOR SCRAPER**

FREE TRIAL
USE IT
FIRST—
THEN
PAY
US



Saves its cost in 10 days.

Send for our special proposition and catalog.

MONARCH MFG. CO.
283 Shepard Bldg.
GRAND RAPIDS, Mich.

THE BOSS NO. 3

The wheels will adjust themselves to any uneven floor and not interfere with the scraping knife.

The Boss is the only Floor Scraper which leaves no mark where you start to scrape, or waves.

The Boss can be set by a Thumb Screw which is over the Gage to any thickness of shaving.

It can be set for any shearing cut right or left up or down to suit the kind of lumber.

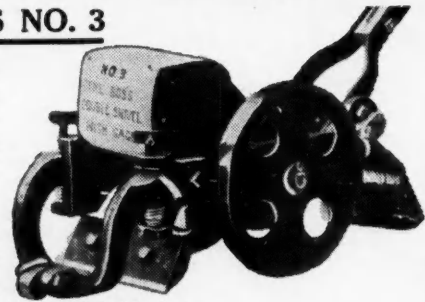

Write for Prices and Circulars to Dwight, Ill.

C. J. KEPPLINGER
FACTORIES: Dwight, Illinois and London, Canada

The Stern Floor Scraper

The handle and blade can be adjusted to a thousandths part of an inch.

Blades removed and replaced instantly by a turn of the hand.

No wrench necessary. No bolts or nuts to contend with.

Will hold any size blade up to 3 1/2"x7". No specially designed blade required. Every hardware store has a blade that will fit.

It is the last word in Floor Scrapers.

"Better than the kind you thought was best."



Simple—Accurate
—Rapid

Waved or Chattered Floors Impossible

Dealers Wanted in the Large Centres

Write us today for our price. You will be surprised at the small amount we ask.

Stern Manufacturing Co.

E. Walnut St. - Lancaster, Pa., U. S. A.

New York Representative

United Machinery Co., 88 Centre St., New York City

They all Boost for the Fox Floor Scraper

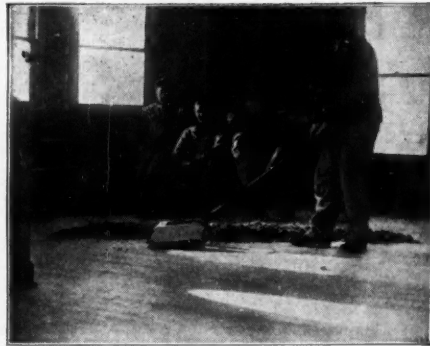

It saves Time, Labor, Money.
It pays for itself on a single job,
and lasts a lifetime.

Our new catalog is now ready. It shows the prize winning photos. Drop us a postal—ask for the catalog.

FOX SUPPLY CO.

Dep't. A

BROOKLYN :: :: WISCONSIN

When Writing Advertisers Please Mention the American Carpenter and Builder.

You Can Try **The WEBER DOUBLE ACTING Floor Scraper** **Five Days Free**

Give the Weber a thorough try-out right out on the job. Then if you don't want it, return it. Send for full details, also catalog showing the Weber Automatic Sharpening Device Folding Scaffold Bracket, Folding Saw Clamp, and Handy Cabinet Scraper

THE WEBER MFG. CO., 670 71st Avenue, West Allis, Wisconsin. Chicago Office, 704 Mortimer Building



SAMSON SPOT SASH CORD

Reg. U. S. Pat. Off.

Samson Cordage Works Boston, Mass.

Made of extra quality stock, carefully inspected, and guaranteed free from the imperfections of braid and finish which destroy common cords so quickly. The spots on the Cord, in any color, are our trade mark. Don't be misled by imitations. Samples and full information gladly sent.

WOOD



Made in three sizes: 8 x 18, 8 x 15 and 8 x 12 in. Flexible Roller. Edge Roller easily adjusted to either side.

FREE TRIAL

Perfect Results Are Easily Obtained By Using Schlueter Rapid Floor Scraper

This machine is built on the only correct principle. It is guaranteed to be the Best machine with which to produce an even, smooth surface on any kind of large or small wood floor, old or new, hard or soft, and in all buildings: Residences, Stores, Factories, Bowling Alleys, Roller Skating Rinks, Reception and Dance Halls, etc.

The Schlueter will remove all joints or warped edges, and oil, wax, lime stains, or the "muck" from skate wheels, in a most satisfactory manner. (Earning capacity \$20.00 to \$25.00 per day.)

Send for prices and **FREE TRIAL PROPOSITION.**

M. L. SCHLUETER, Chicago, Ill.
107 N. Canal St., Chicago N. Y. Office, 1001 Flat Iron Bldg.

CONCRETE



Rapid and Flexible Stone Floor Surfacer for Concrete with Terazzo, Mosaic Tile, Cement, etc.

You Should Know the Difference Between the Triple "A" Spring Driven and the Ordinary Hand Power Floor Scrapers



3 Machines in 1
A Floor Scraper
A Floor Sander
A Blade Sharpener

Write Now for Full Information.

Triple "A" Machine Company
1014 Chicago Opera House Bldg., Chicago, Illinois

It won't cost you anything to write in and find out. The TRIPLE "A" SPRING-DRIVEN does the work of three other machines and runs easier. For quality of work there is no other machine that begins to compare with the Triple "A."

It has 160 pounds of weight to keep the scraper from jumping and making waves. The weights are demountable and adjustable, so that the machine can always be used with just the proper amount of weight for the work at hand, as follows:

For scraping old and varnished floors at 160 lbs.
For scraping new floors at 135 lbs. (with top weight removed.)

No Carpenter could operate any other machine having that much weight, and that's the reason weight—the one essential for smooth work—has been sacrificed in other hand power machines.

Not so with the Triple "A."—The Spring does more than half of the work, and with all of its 160 lbs. of weight it is the easiest running floor scraper on the market.

Spring Power is a thing which can be used on every building. It requires no fuel or electricity and entails no power expense.

It's no trick for an average carpenter to scrape 1000 square feet of floors per day with a Triple "A."

You can't afford to waste time with a hand scraper or a dead-weight machine. Investigate the wonderful labor saving qualities of the Triple "A" Spring-Driven now, and then when the next job of floor scraping is ready you can begin to make some easy money—or, you can start right in now, anywhere, and contract to resurface old and varnished floors at a profit of from \$15.00 to \$30.00 per day. The Triple "A" is guaranteed to fulfill all claims and to do satisfactory work or money refunded.

Triple "A" Machine Co.,
1014 Chicago Opera House Bldg.
Chicago, Ill.

Please send full particulars concerning your Triple "A."

Name

Address

Send This Coupon or Write Postal or Letter TODAY

When Writing Advertisers Please Mention the American Carpenter and Builder.

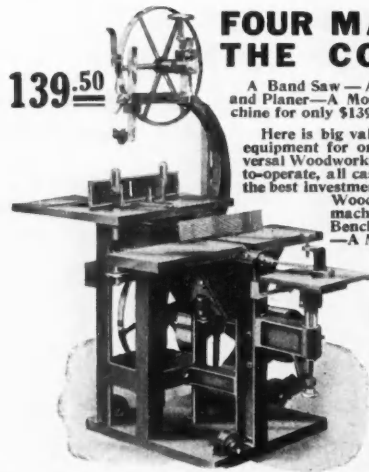

139.⁵⁰

FOUR MACHINES FOR THE COST OF ONE

A Band Saw—A Saw Bench—An 8 inch Jointer and Planer—A Mortiser and Borer—all in one machine for only \$139.50.

Here is big value for you. A real woodworking equipment for only \$139.50. This type "C" Universal Woodworker is a substantial, portable, easy-to-operate, all cast iron machine, that represents the best investment you can make. In this type "C" Woodworker you get FOUR distinct machines in ONE A Band Saw—A Saw Bench—An 8 inch Jointer and Planer—A Mortiser and Borer. Our type "C" Woodworker is equipped complete, including tools and belting. The heavy base is fitted with wheels—one of which swivels—making it very easy to move machine. Get our descriptive matter about this machine, also particulars about our 30 day trial selling plan. Drop us a line for full details right now.

THE TANNEWITZ WORKS
315 N. Front Street
Grand Rapids Mich.

Parks Portable Single and Combination Woodworking Outfits

This machine combines three of the most necessary tools to have on the job, namely Circular Rip or Cross-cut saw, 6" Jointer tilting guide and boring machine. Jig Saw, Band Saw and many other valuable attachments can be added.

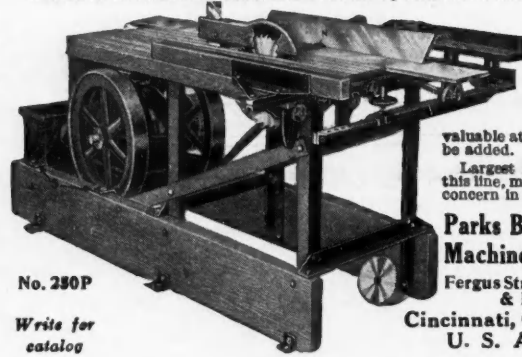

Largest assortment, in this line, made by any one concern in the world.

Parks Ball Bearing Machine Company

Fergus Street and C. H. & D. Ry.
Cincinnati, Ohio,
U. S. A.

No. 280P

Write for catalog



"Victor" Scroll-Saw FOR FOOT AND POWER

Suitable for carpenters, pattern and cabinet makers and all wood-workers requiring accurate work, also for sawing soft metals. Will cut up to 3 inches thick, swings 24 inches, has powerful tread motion, cuts rapidly and is easy to operate. Has adjustable tension spring on upper spindle, dust blower, drill attachment, iron tilting-table, etc. Will furnish tight and loose pulleys for power in place of treadles when desired.

This is acknowledged to be in all respects the most complete foot-power scroll saw made.

We make a complete line of Foot, Hand and Light Power Wood-Working Machinery, suitable for Carpenters, Builders, Cabinet Makers and other Wood-Workers. It will pay you to investigate their merits.

SEND FOR-CATALOG A
THE SENECA FALLS MFG. CO.
218 Water Street, SENECA FALLS, N. Y., U.S.A.

263

TRADE

FOX

MARK

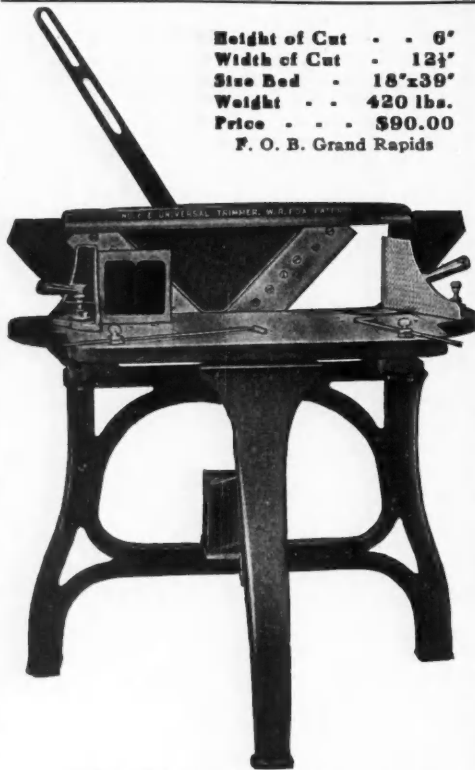

Height of Cut . . . 6"
Width of Cut . . . 12 1/2"
Size Bed . . . 18"x39"
Weight . . . 420 lbs.
Price . . . \$90.00
F. O. B. Grand Rapids

Bench and Floor Type

Universal Wood Trimmers

To Meet Every Demand



Height of Cut . . . 4"
Width of Cut . . . 8"
Size Bed . . . 7 1/2"x17 1/2"
Weight . . . 32 lbs.
Price . . . \$22.50
F. O. B. Grand Rapids

4-A Universal Wood Trimmer

EVERY PATTERN SHOP, INTERIOR FINISH MILL, FURNITURE FACTORY, and others doing work requiring perfect glue joints and angles should have our Trimmers or Miter Machines to produce the best results.

WRITE TODAY FOR COMPLETE CATALOG OF OUR TOOLS

FOX MACHINE CO.

22 N. Front Street
GRAND RAPIDS, MICHIGAN
30 Church Street, New York
J. B. STONE & CO.,
138 Flinbury Pavement, E. C.

6-E Universal Wood Trimmer

When Writing Advertisers Please Mention the American Carpenter and Builder.

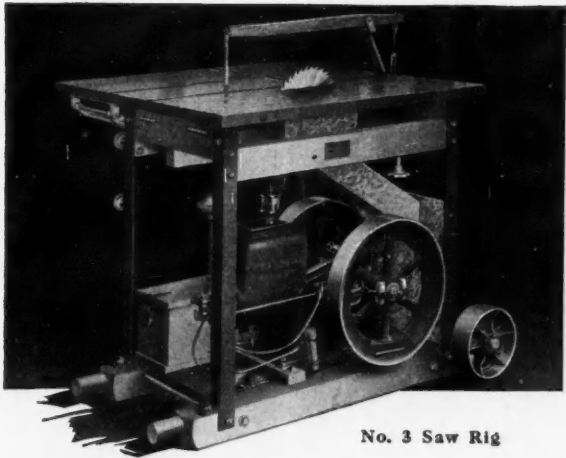

No. 3 Saw Rig

Portable Saw Rigs, Hoists, Elevators, Pumps, Engines.

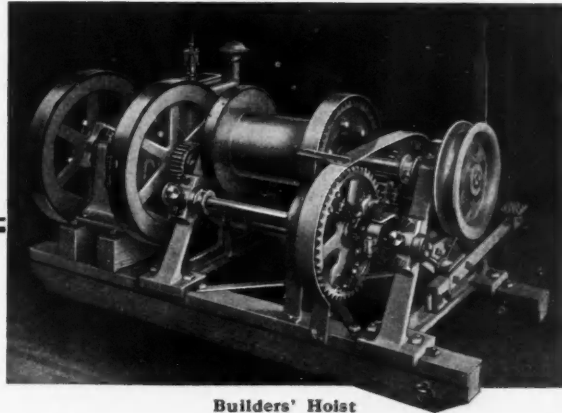

Builders' Hoist

**WRITE US FOR OUR
ATTRACTIVE
CATALOG JUST OFF THE
PRESS.**

C. H. & E. Manufacturing Co., Inc.

322 Mineral Street

Milwaukee, Wis.



SECTION OF MAIN FLOOR EXHIBIT AND SALESROOMS

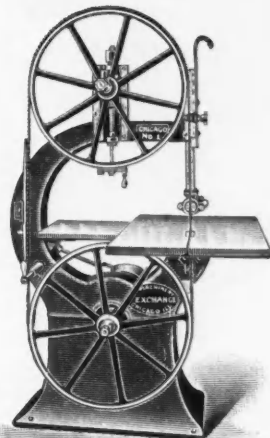

27-inch Chicago Band Saw

\$130.00 FOR BOTH
To Contractors and Builders

Ask for prices on one if you can't use both.
Used for Planing, Jointing, Shaping, Match-
ing, Rabbeting, Grooving, Chamfering,
Beading and making Mouldings.

Ask Us for Complete Catalogue

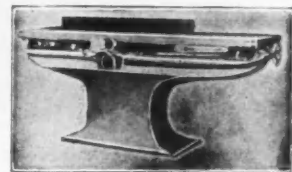

Chicago 8-inch Jointer.

Chicago Machinery Exchange

1215-1223 Washington Boulevard - - - - Chicago, Ill.

When Writing Advertisers Please Mention the American Carpenter and Builder.

"NOW I'M MAKING MONEY"



Are YOU making money? Or are you permitting planing mill bills and high labor costs to eat into your profits?

Over 1,700 Carpenters, Builders and Contractors have **cut production costs to the minimum**, and are giving their customers better service by installing **FAMOUS UNIVERSAL WOODWORKERS**. Now they are making more money than ever before.

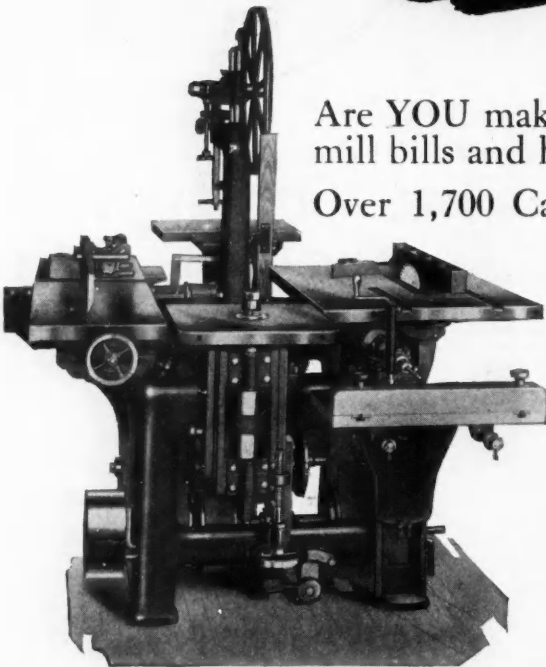

The illustration above shows an end view of our FAMOUS "30"—the most remarkable money-saving woodworking machine ever invented. It does sixteen different kinds of work, allows five men to work on it at the same time, and is guaranteed for life. **Does** more and **saves** more than any woodworker on the market.

We have styles and sizes of woodworkers to suit your needs. Write us about your requirements and we will gladly advise which is the most suitable machine for your particular needs.

You can do the same.

The illustration at side shows the FAMOUS "30" with motor drive. It also shows the compactness of the whole machine. Notice how all belts are located within the frame of the machine, entirely out of operators' way, and how little floor space is required.

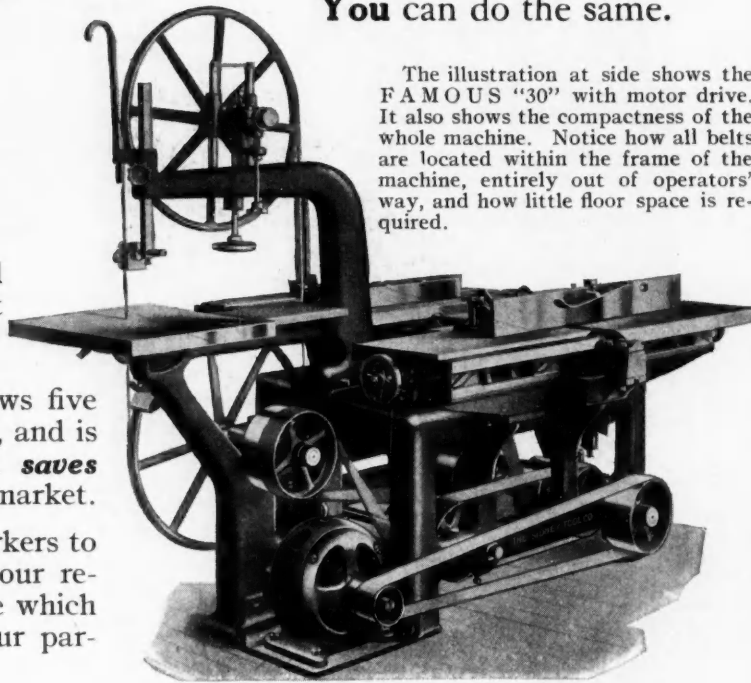

THE SIDNEY TOOL COMPANY

Chief Offices and Factories

SIDNEY, OHIO

U.S.A.

AGENCIES AND DISTRIBUTING CENTERS THROUGHOUT THE UNITED STATES AND ABROAD



When Writing Advertisers Please Mention the American Carpenter and Builder.

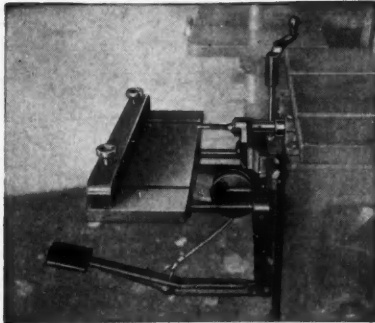

Hollow Chisel Mortiser

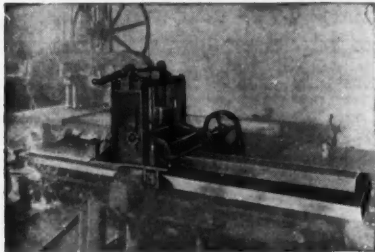

Planer

These Sixteen Machines are Combined in ONE

1. 27 inch Band Saw.
2. 12 inch Jointer.
3. Single Spindle Shaper.
4. Variety Saw Table (with raising and lowering arbor.)
5. Boring Machine.
6. Planer.
7. Disc Sander.
8. Drum Sander.
9. Hollow Chisel Mortiser.
10. Knife Grinder.
11. Emery Grinder.
12. Band Re-Saw.
13. Tenoner.
14. Tongue and Pole Rounder.
15. Adjustable Felloe Rounder.
16. Spoke Tenoner, Rim Borer and Wheel Equalizer.

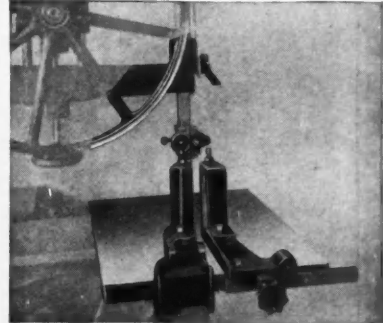

Band Re-Saw

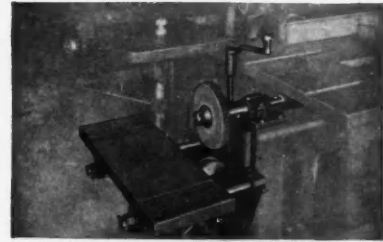

Emery Grinder

The FAMOUS "30" Universal Woodworker will make your business more profitable

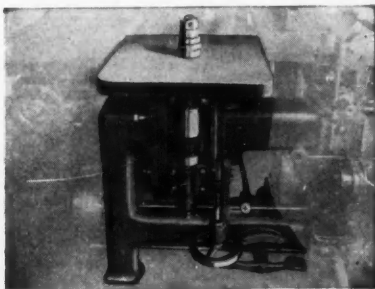

Shaper



Drum Sander

Don't be fooled into buying cheap, flimsy, unreliable woodworkers. The market is flooded with imitations of the FAMOUS line and we advise you—for *your own protection* to investigate our machine and our *guarantee*.

The FAMOUS is a permanent *investment* while other woodworkers are a permanent *expense*. Write for descriptions, prices and catalog No. 12 *today*.

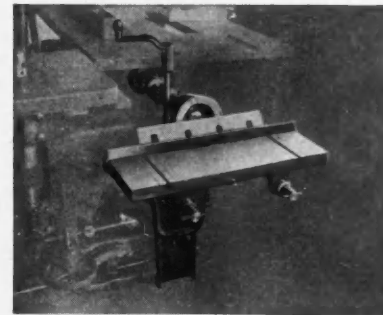

Knife Grinder

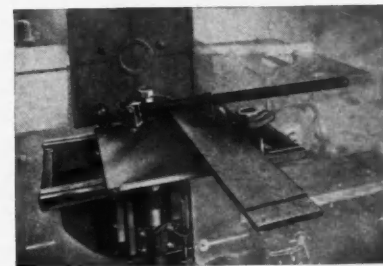

Tenoner

THE SIDNEY TOOL COMPANY
 Chief Offices and Factories **SIDNEY, OHIO** U.S.A.
 AGENCIES AND DISTRIBUTING CENTERS THROUGHOUT THE UNITED STATES AND ABROAD

When Writing Advertisers Please Mention the American Carpenter and Builder.

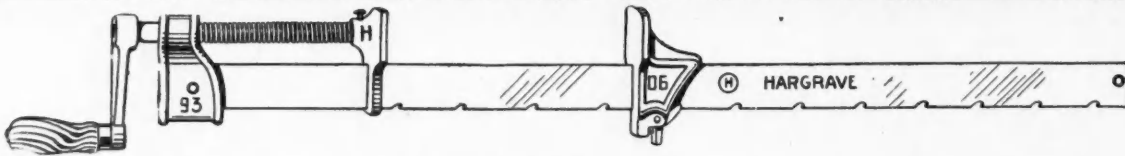

EXPERIENCE is the best teacher. We made and sold the first Steel Bar Clamp. We make three patterns and many lengths—a complete assortment.

SHOWN above is our SPECIAL PERFECTION CLAMP. The Screw is steel, carefully cut with heavy square thread and is securely keyed to malleable iron crank. Hardwood Handle turns easily, but will not break nor come off. Frame of malleable iron with plenty of bearing for screw to prevent thread stripping. Bar is made of springy steel which will not buckle nor bend out of line. On Clamps over 5 ft. long, we use an extra heavy bar. Tip is of malleable iron with plenty of bearing for Screw, and is so shaped that it will not bind on the bar. Slide is equipped with hardened forged steel dog, which will not wear out. Notches close together to give rapid work, but not so close as to weaken the bar.

ALL the Hargrave Tools are made just as carefully as this Clamp.

Made by **THE CINCINNATI TOOL CO.** Dept. H, NORWOOD, CINCINNATI, O.



The machine is portable, requires little space in the shop, and is equipped with electric motor or gasoline engine. Furnished with wood or iron frame.

building work in New York City has been installed and has given satisfaction. It is a great labor saving machine and we would not start another concrete job without having a saw of this description on the work.

We guarantee these machines in every respect. Write us today about them. Get our catalog "M."

BEACH MFG. CO.,

Save \$50.00 Per Day

This Double Arbor Rip and Cut-Off Machine does the cutting which formerly required the labor of from 12 to 30 men. This means a clear saving of at least \$50.00 per day—and we say nothing about the great saving in time. Read the accompanying letter—read the description of the machine—then write for literature.

See the Table Extension

The Beach Mfg. Co., Montrose, Pa.
Gentlemen: The Wood Frame No. 3 Double Arbor Rip and Cut-Off Saw which you recently furnished us for concrete work has been installed and has given satisfaction. It is a great labor saving machine and we would not start another concrete job without having a saw of this description on the work.
McHARG-BARTON COMPANY, 165 Broadway, New York.

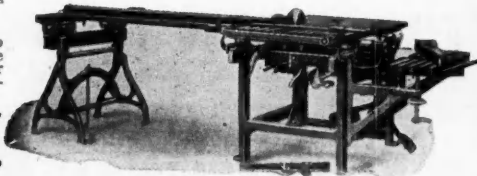

Montrose, Pa.

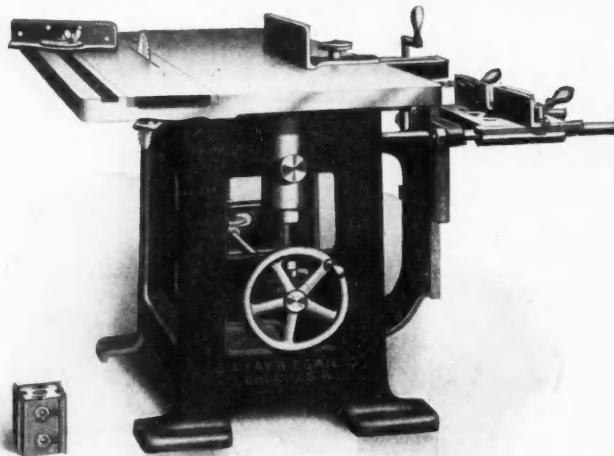

FAY-EGAN "Lightning" No. 76 Variety Woodworker

will rip, cross-cut, miter and bevel saw and raise panels to any depth. It will match both tongue and groove sides for boxes, bore, route, make rosettes and table slides. The table raises and lowers so that the operator on one side doesn't interfere with operator on other side:

A first class Woodworker at a Variety Saw Price

WRITE US TODAY

J. A. Fay & Egan Company

545-565 W. Front St. :: :: CINCINNATI, OHIO

Radically Different

From All Others

Merits the Claim, "The Best Endorsed Product Made in America." "Ask us for the Proof."

The HOOVER Suction Sweeper



sells and makes re-sales. Do you want our special Dealers' Proposition? It is also "different."

The Hoover Suction Sweeper Co.

Everywhere And New Berlin, Ohio

When Writing Advertisers Please Mention the American Carpenter and Builder.



"MORE PROFIT"

Can be made in your business
by putting in a

"Grimm Woodworker"

NINE MACHINES IN ONE

Here is a Letter From a User: Grimm Mfg. Co., 46 Keystone Street, Buffalo, N. Y.

Gentlemen:—I have been in fourteen states and went as far as Phoenix, Arizona, and took the GRIMM Woodworker along and have seen hundreds of machines, but none of them had the GRIMM beat one inch. In doing good work or being handy the GRIMM cannot be made better. I have not spent \$3.00 for repairs in the twenty months that I have had the machine, and work it every day. I have no shop and keep it out on the jobs. The GRIMM will do more work than the best five carpenters that you can hire, and pay them fifty cents per hour. I will not part with the GRIMM as long as I contract. The GRIMM will burn less gasoline than any other engine ever put on the market for sale, and saves all kinds of scrap lumber for you.

Very truly yours,

JOHN WOLTER, Box 414, De Pue, Illinois.

☐ The profit question then is important to you and is solved by you if you get one of these machines at once, because upon it you can do your own ripping, cross-cutting, dadoing, boring, jointing, moulding, sanding, jig sawing and grinding.

☐ There are thousands of our machines in use, giving complete satisfaction:

☐ "GRIMM" Woodworkers are built with gasoline engine drive for portable use, also with electric motor or belt drive for use in the shop or factory.

☐ Send for catalog and prices. "DO IT NOW!" before you forget it.

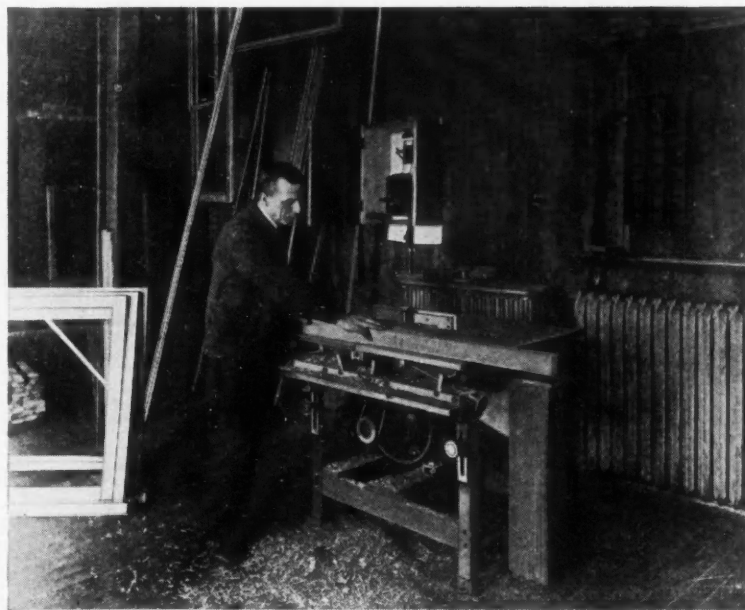

Grimm Manufacturing Co.

46 KEYSTONE STREET

BUFFALO, N. Y.

When Writing Advertisers Please Mention the American Carpenter and Builder.

STANDARD DOUBLE ACTING SPRING FLOOR HINGES

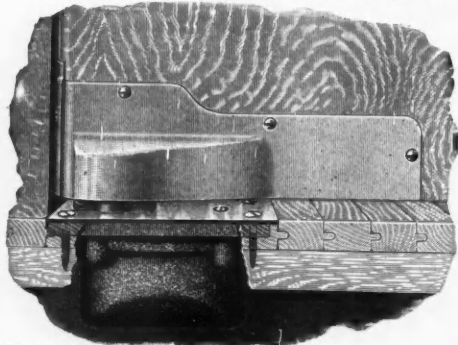

Patented Oct. 31, 1911. CHECKING

It is a door check and hinge combined. It automatically closes the door without a slam. It prevents children from being knocked down. It prevents injury to hands if caught when door is closing. It stops door exactly at center. It holds door open automatically when desired. It renders the action of door absolutely noiseless. It will outwear three of the spring hinges now in common use. Ask your dealer to show you a model or write us for information.

We also make pivot check for double-acting doors, as well as other hardware specialties

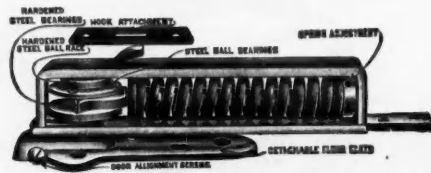

Patented Apr. 20, 1909. UNCONTROLLED KIND

Sold by all Hardware Dealers

THE STANDARD MFG. CO.
SHELBY, OHIO, U. S. A



Excelsior Dumb Waiters

The only Knock-Down Dumb-Waiter ever offered, shipped complete to a nail, with explicit directions for erecting, for **\$18.50**

Up-to-Date in Every Particular

Hardwood Car, Self Retaining Machine, Adjustable Weight, Guides, Ropes, Timbers and Hardware. Ropes joined by coupling. No Splicing. Will fit any ordinary opening up to 24" x 30"

Send for Printed Matter

R. M. RODGERS & CO.

74 Emerson Place - - Brooklyn, N. Y.

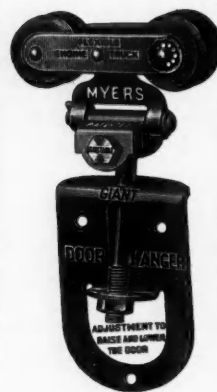

THE MYERS GIANT

ADJUSTABLE TANDEM DOOR HANGER

for TUBULAR GIRDER TRACK is adjustable to and from the building, and up or down as necessary. Has flexible engine truck with steel rollers revolving on steel roller bearings. The adjustable features prevent trouble from weather conditions or sagging of building. Storms, sleet or ice do not affect it, owing to complete protection afforded by the tubular track. Track and Hanger are constructed to carry and operate heavy doors easily.

This and other styles of Tubular and "Stayon" Door Hangers are shown in our Door Hanger Booklet. Copy mailed on request.

F. E. MYERS & BRO.
ASHLAND, OHIO

The "Blake Line" Elevators

Will pay for Themselves in a Short Time
Mechanically Correct—They Save
Hard Labor—They Save Time

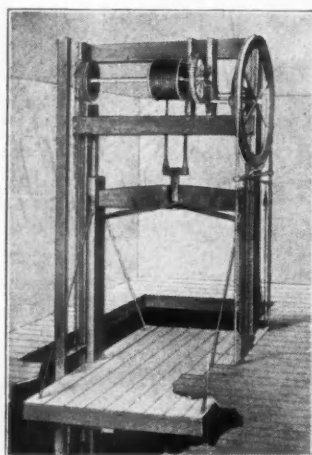

Dumb - Waiters, Carriage, Auto and Store Elevators.

Our Elevators are noted for their Easy Running and Serviceable Qualities. They are practically self-contained, and can be erected by any carpenter in a few hours. We furnish plans for erecting.

The Low Cost will Surprise You

State your requirements, giving capacity, size of platform and number of feet of travel and we will name our money-saving estimate.

SIDNEY ELEVATOR MFG. CO., SIDNEY, OHIO

TRADE Sedgwick MARK ELEVATORS AND DUMB WAITERS

— HAND POWER —

Standard of Quality the World Over

SEDGWICK MACHINE WORKS

82 Carroll St., Poughkeepsie, N. Y.

New York Office, 132 Liberty St.

Sasgen Poles and Setter Derricks

The Latest and Most Practical on the Market.

Sent on trial to Reliable Contractors.

Write for illustrated catalog No. 2 showing complete line of Builders Derricks.

We will exhibit at the Clay Products Exposition Coliseum, Chicago Feb. 26 to Mar. 8.

SASGEN BROS.
2053-57 Racine Ave., Chicago, Ill.

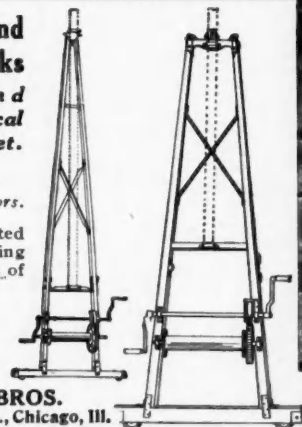

When Writing Advertisers Please Mention the American Carpenter and Builder.

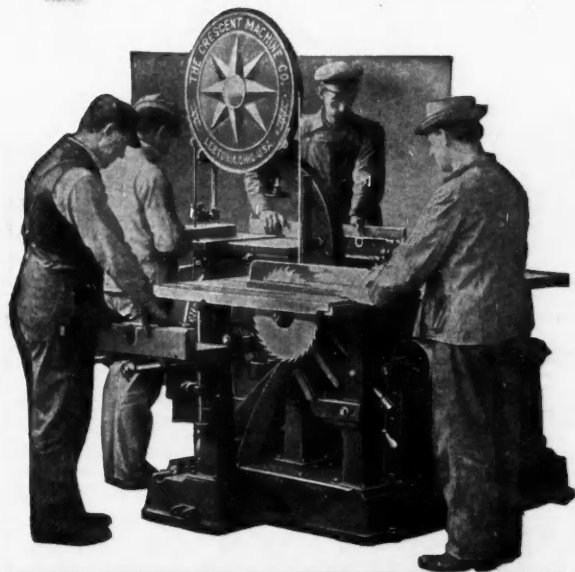

Get Ready to Make Big Profits This Season—NOW

Don't wait until you're right in the midst of a lot of work this Spring and then decide that if you had a wood worker you would be making more money in less time.

Start right this season—get a wood worker and have it in your shop and working before your rush begins. Be prepared to tackle any job and not have to "farm" part of it over to "some one else" and let them make the big profit. Do all the work and keep all the profit in your Own shop.

Our Crescent Universal Woodworker is just the sort of woodworking machine you want—and need—because it is practical in both construction and operation. The Crescent Universal gives you all the advantages of a fully equipped planing mill. It isn't just simply a combination wood worker.

Four men can work upon the Crescent at one time without in any way interfering with one another. In addition to its 5 separate units—the band saw; the jointer, the shaper; the table and borer—various attachments for panel raising, tenoning, mortising, tool grinding, knife grinding, sanding, dadoing, resawing, moulding making and pole rounding can be added.

With the Crescent each machine is entirely independent of the others—each can be started and run and stopped at will. It is compact. It is convenient. It is well built throughout—and is always ready for work. It is particularly suitable for the kind of work you have to do. It operates easily. Any average mechanic can handle it satisfactorily. We equip the machine with either a 26-in. or 32-in. band saw, and with either an 8-in., 12-in. or 16-in. jointer. We can also furnish the machine without the band saw.

Fill out this coupon and mail it to us to-day. We'll send you our new 128-page catalog FREE. It will explain to you fully just why the Crescent is the machine you want to get. Send in the coupon NOW.

The Crescent Machine Co.

224 Main Street

Leetonia, Ohio

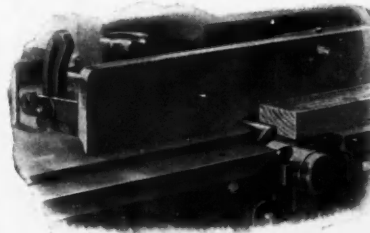

This shows how to do rabbeting on the jointer. You can't do this on every jointer. How it is done on a CRESCENT is fully explained in our latest catalog.

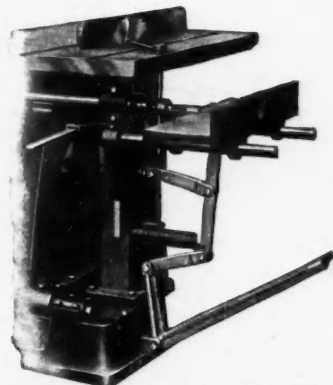

This attachment converts the borer into a hollow chisel mortiser, suitable for cutting mortises up to 5/8 inch square.

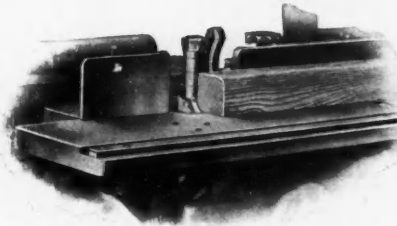

Poles and shafts can easily be rounded on the shaper spindle. This feature will appeal to the wagon and carriage builder. All you need to do this work are the special knives.

CRESCENT

The Crescent Machine Co.

Leetonia Ohio

Name

Address

City or Town

Gentlemen:
I am interested in your Crescent Universal Woodworker. Send me your latest catalog and all particulars FREE and without obligating myself.

When Writing Advertisers Please Mention the American Carpenter and Builder.



White 1½ ton Truck Owned by The Geo. A. Rutherford Co., Cleveland, Ohio

White Trucks for Builders and Contractors

This is what a well-known firm of building contractors say about a White Truck which they own:

"We don't know how we got along without it. We have practically eliminated such losses as occur when workmen are held up for lack of supplies, and we get the fullest use from our tools and equipment, being able to put such equipment where we want it quickly and without delay."

That company operates its own mill for the manufacture of sashes, doors, etc., and in the delivery of these articles, tools and other supplies to jobs, the truck is proving indispensable.

With a swift, reliable motor truck you get the fullest efficiency from both your equipment and your workmen, and you can give better service than you had ever imagined was possible without increasing your working force.

A great many concerns in your own line—and in related lines of business—are using White Trucks with great success.

White Trucks are made in two particularly convenient sizes for building contractors' use—¾ and 1½ tons, also in 3 and 5 ton sizes for heavy hauling.

Catalogs Sent Upon Request

The White  Company

Manufacturers of Gasoline Motor Cars, Motor Trucks and Taxicabs.
CLEVELAND OHIO

When Writing Advertisers Please Mention the American Carpenter and Builder.

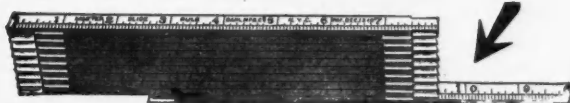

**USE THIS MASTER SLIDE RULE
and MAKE NO MEASURING MISTAKES**

Take any measurements—inside or outside—quickly and accurately. This rule is strongly built of selected boxwood—trimmed with brass plated steel. Kept rigidly in place when extended by strong steel springs. Opens or closes instantly. Marked both for inside measuring and similar to other rules.

As shown above the lower slide is extended $2\frac{1}{4}$ inches, making distance between the two extreme points of the rule $10\frac{1}{2}$ inches, as indicated by the arrow.

This rule costs but 15 cents per lineal foot for 4, 5, or 6-foot rule. Ask your dealer for it or send for one today for a Xmas present.

Our circulars, agency proposition particulars, etc., will be mailed to you FREE for the asking. Get them.

AMERICAN PATENT SALES COMPANY
417 Fifth Avenue NEW YORK CITY

GET THE ROOF THAT LASTS

—the kind that never fades, never wears out, never needs any painting, re-coating or repairing every few years and never absorbs any water.

GENUINE FRANKLIN TUNNEL SLATE

—the strongest, the most uniform in color the best hand-selected, made from the best slate deposits makes the "Roof that Lasts a Lifetime" and Guarantees Freedom from all Roofing Troubles.

Plan Now to roof Right. Begin by sending to-day for our new Catalogue. Just out. It points the way to immense roof saving. Write for your copy to-day. It is sent Free.

SLATINGTON SLATE CO. Sole Manufacturers **SLATINGTON, PA.**
G. F. T. Slate puts "The Finishing Touch" on any Building.

**"American"
Wrought Metal**

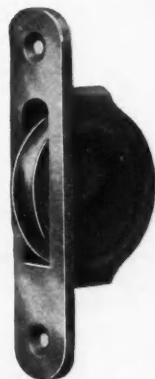

Ball-Bearing

**SASH PULLEYS
Electrically Welded**

Most up to date line on the market.

We make all kinds.

Our Famous Ball Bearing and Roller Bearing Pulleys are superior to all others. Wheels are made with combination groove for chain or cord.

Our Pressed Metal Pulleys are indestructible and are cheaper, lighter and better finished than cast pulleys and can be delivered promptly.

Send for Catalogue.

THE AMERICAN PULLEY COMPANY

OFFICE AND WORKS: PHILADELPHIA, PA.
Warehouses New York 208 Lafayette St. Boston, 169 Pearl St. Chicago, 124 S. Clinton St.

**How to Make a
Good Profit on
Fancy Sash**

Whittling the joints of fancy sash with a jack knife and chisel is slow and tedious work, and the profits from it are small.

**The American
Sash Trimmer**

makes the work of fitting curved and straight sash bar equally easy, and with this machine a man can fit up more fancy sash in one hour than he can in from three to five hours by hand, also producing better work.

Here Is the Proof

The Heald Machine Co., Worcester, Mass.

Gentlemen:—We have been using one of your "American Sash Trimmers" constantly for the last two and a half years, and are perfectly satisfied with its work.

It is a great labor saver, doing five times as much work as could be done in the old way, and doing it cheaper and better.

Yours very truly,
Mohawk Valley Lbr. Co.,
Fultonville, N. Y.

Here's How We Do It

Two or three downward strokes of that cutter will cut a piece of bar to the exact length required and shape the end to a perfect fit in a very small part of the time required to do a poor job by hand.

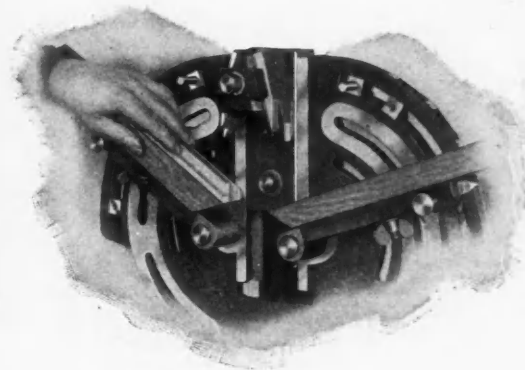

**Better Work
Results Less Cost
More Profit**

We guarantee the enormous saving of at least 75 per cent in cost over the old way of fitting up this work and the price of the machine being small, it soon pays for itself.

Can you not see how this machine would increase the profits from your sash department?

Machines sent on approval to responsible concerns.

The Heald Machine Company

2 New Bond Street, Worcester, Mass.

When Writing Advertisers Please Mention the American Carpenter and Builder.



An Automatic Boring Tool That Fits Your Pocket

This is a mighty handy, convenient tool. It is compact and when compressed can be carried in the pocket. But set it to work and you'll find it has all the good qualities of larger and more expensive borers.

STAR BORER No. 8

has cells in the handle holding eight drill points ranging in size from 1-16 inch to 11-64 inch, and numbered from 1 to 8. Cell No. 9 contains a small screwdriver to be used when the tool is compressed, with the plunger forced back into the handle and held there.

Look for the name — **MILLERS FALLS** —

Our book "Tool Practice" is FREE — if it.

MILLERS FALLS COMPANY

28 Warren Street

::

::

NEW YORK CITY

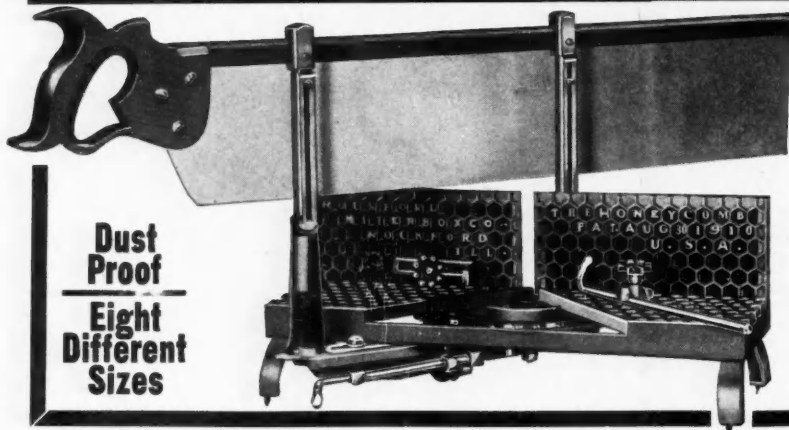
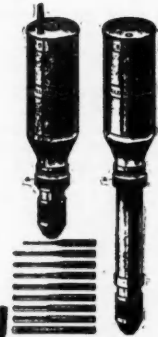

Dust Proof
Eight Different Sizes

AN OFFER TO CARPENTERS AND BUILDERS

We want one of our new improved Honeycomb Mitre Boxes in every community, and will sell one box at wholesale, to Carpenters and Builders where they are not handled by the dealers.

Combines greatest strength with extreme lightness.

Lever can be adjusted off square if necessary for filing or other exceptional requirements.

There is an intermediate gib to take up the wear, thus keeping the gib always flush with the bed plate.

The index is conveniently placed for accurate adjustment.

Easily moved from place to place, and will stand securely without fastening.

Base made of malleable steel and warranted not to break.

Write for descriptive circular and prices.

ROCKFORD MITRE BOX CO.

252 Mill St. Rockford, Ill.



"Red Devil"
Circular Glass
Cutter

"Twill cut a 2 inch or a 22 inch full circle a half circle or a straight cut in any kind of glass. It's a "Red Devil" tool. Its perfect in every detail. Thousands are in use all over the world. Your dealer has it on sale.

Ask for No. 263, "Red Devil."

The price is \$1.25 with 2 extra wheels.

That little 2 Lb. all metal mitre box that does it all with any saw. Over 130,000 sold and in use today. Your dealer has it on sale. Ask and insist on the "RED DEVIL." The price is \$2.00.

SMITH & HEMENWAY COMPANY

125 Chambers Street New York, U. S. A.
(Smith Hardware Co., Ltd., Montreal.)

"Red Devil"
(Seavy Patent)
MITRE BOX

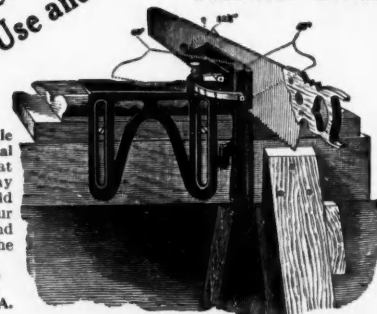

"RED DEVIL" Tools are sold by dealers everywhere. If your dealer can't fill your wants we will ship prepaid single samples at the above prices. But try your own dealer first. (They work smooth as butter — any "Red Devil" cutter — and we make 40 styles.)

"RED DEVIL" Specialties
You Use and Need

When Writing Advertisers Please Mention the American Carpenter and Builder.



Stair Work Made Easy

Starrett

Patent

Stair

Gage

This gage is to be used in connection with any carpenter's steel square, and can be adjusted to any pitch or angle desired. For cutting in rafters, braces, stairs, etc., it will soon pay its cost and prove one of the most valuable tools in a carpenter's kit.

The attachment is furnished either plain or graduated in inches, 4ths, 12ths, and 24ths.

It is made in the shape of a steel angle, $\frac{7}{8} \times \frac{3}{4}$, $\frac{1}{2}$ inch thick, ground straight and nickel plated.

Send for our catalog No. 196 and see what other time savers we make.

Our builders' combination tool will look pretty good to you.

PRICES.
 No. 110A Plain, 18 inch, nickel plated.....\$1.00
 No. 110B Plain, 28 inch, nickel plated.....\$1.50
 No. 110C Graduated, 18 inch, nickel plated.....\$1.50
 No. 110D Graduated, 28 inch, nickel plated.....\$2.25
 Sent plain unless otherwise ordered.

The L. S. Starrett Company
 ATHOL, MASS.

NEW YORK: 150 Chambers Street
 CHICAGO, ILL.: 17 No. Jefferson Street
 42-31



Over 3000 in Use
There's a Reason

WHITE'S
IMPROVED LEVEL

is guaranteed to give satisfaction or money back. Ask for catalog and special price—Ask today.

DAVID WHITE CO.
 419 E. Water St., Dept. C, Milwaukee, Wis.

The Yankee

Compound Level



A reliable instrument for simple leveling and laying off horizontal and vertical angles. Can be handled speedily and easily.

The Yankee is particularly adapted for Architects, Builders and Contractors use. The Yankee is made of high grade materials throughout. All complicated and costly unnecessary features have been eliminated. The Yankee is not an experiment. Yankees are in extensive use. They are giving thoroughly satisfactory service in every way. The Yankee is the BEST moderate cost instrument made. It is light and simple. The vernier on a circular plate saves the circle from springing elliptical in case the instrument falls. It is the only instrument where the plate levels are saved by quickly employing the telescope level. Before you buy any level write us for complete particulars concerning the Yankee Compound Level. Let us send you this information right NOW.

FROST & ADAMS CO., - 31 Cornhill, - BOSTON, MASS.

THE BEST CONCRETE BUILDINGS

are erected with the aid of a good instrument



None better than the
BECKMANN

Our high power telescopes are especially adapted for work of this nature and will show an error of $\frac{1}{8}$ inch in 300 feet. It will pay you to investigate our Levels.

Send for Circular Y.

The L. Beckmann Company, Established 1874
 500 Adams St., Toledo, Ohio

LEVEL WORK

Architects

Builders

Contractors



insure against mistakes in leveling by using our Architects and Builders Level. We make a specialty of this instrument. It will give positive, accurate service. Saves its cost in a short time.

We manufacture a complete line of surveying instruments in various sizes and at a wide range of price. Our circular No. 27 will explain our instruments to you in detail. It will pay you to get it before deciding upon any surveying instruments.

KOLESCH & CO.
 Surveying Instrument Makers. Established 1885.
 138 Fulton St. - NEW YORK

When Writing Advertisers Please Mention the American Carpenter and Builder.

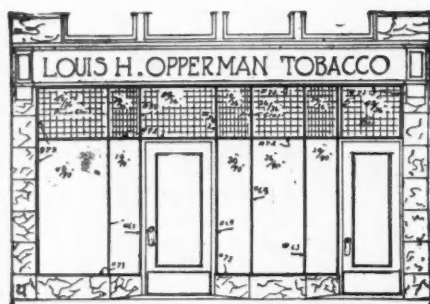

FRONT ELEVATION.

Investigate This Bar

That's all we ask. Get the facts about Petz Bars, consider the elements of safety, strength and beauty they will give to that new store front you are planning; compare them with others, and we will be satisfied.

Petz Bars insure handsome appearance, long life, perfect ventilation and absolute safety to your glass. Easy to install; permit the lowest rate of insurance.

Our booklet, "Metal Store Front Construction," gives you all the facts about the different styles of bars we make. A copy for your desk sent promptly on request.

Detroit Show Case Co.

Sole Makers

491 Fort Street, West :: Detroit, Mich.

Huther Bros. Patent Groover or Dado Head

(Will save 1/3 cost in three days' time)

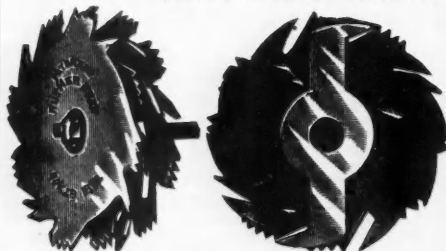

Showing Arrangement of Cutters

Can be used on any Circular Saw Mandrel

For cutting any width groove from 1/4" to 2" or over. Will cut a perfect groove, either with or across the grain, and leave edges smooth. Will ship to any responsible firm on ten days' approval; if not satisfactory you are at liberty to return at our expense. We also make a specialty of groove ground smooth cutting circular Mitre Saws, for either rip or cross cut: Grooving Saws for all kinds of special work; Lock, Corner Cutters, Convave Saws, etc.

Try our Scraper Blades and you will use no others.

HUTHER BROS. SAW MFG. CO.
1000 University Ave. ROCHESTER, N. Y.

STOP THE FLOPPING

of that Pantry Door. The everlasting "flip-flop" of the Butler's Pantry Door is not only very annoying, but is extremely dangerous. It pinches fingers, bumps heads and breaks dishes.

The RIXSON PANTRY CHECKING Floor Hinge

puts a stop to all these troubles. A perfect Floor Check at a low price.

THE OSCAR C. RIXSON CO.
544 W. Harrison St. CHICAGO

Makers of Sperry Casement Adjuster.

LUFKIN
Tapes & Rules
are Standards of Accuracy, Durability and Workmanship.

SEND FOR CATALOG

THE LUFKIN RULE CO.

SAGINAW, MICH.

NEW YORK
LONDON, ENG.
WINDSOR, CAN.



INTRODUCTORY TRIAL OFFER

If the SELF-SETTING PLANES are not sold in your town and you write us saying, "I saw your trial offer in A. C. & B., we will send you particulars, a carpenter's pencil and our \$1.00 Certificate, which we will receive as \$1.00 in payment for a SELF-SETTING PLANE as stated in our \$1.00 Certificate, and if this S. S. Plane is unsatisfactory and returned to us at our expense, we will send you \$1.00 more than you sent us, as the \$1.00 Certificate says.

As this paper guarantees we will do as our advertisement says, you know the plane must be O. K. ALL WE ASK is to have you TRY the SELF-SETTING PLANE on your own bench, in your own way, with or against the grain, on the WORST cross-grained eaty, knurley, knotty, hard or soft wood you can find, THAT IS FREE FROM SAND OR DIRT. If it is not worth to YOU, OR YOUR MEN, TWICE ITS COST, return it at our expense as above stated.

If you send us the addresses of ten carpenters, no matter where they live we will send you another hard, tough carpenter's pencil.

Give the SELF-SETTING PLANE a chance to PROVE ITS WORTH, if it FAILS, return it and we will return your money.

Carpenter's Hard, Tough Pencils, 30c per dozen, postage prepaid.

GAGE TOOL CO., Vineland, N. J.



GOODELL MITRE BOX

Made of STEEL - Cannot Break

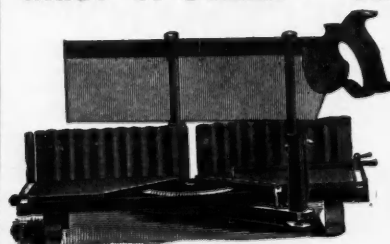

First in Quality and Improvements

Automatic Stops for holding up saw.

Corrugated Becks Graduated.

Gauge for duplicate cuts and many other features

Send for Circular "C"

GOODELL MFG. CO., Greenfield Mass.

When Writing Advertisers Please Mention the American Carpenter and Builder.

Are You Ready for the Spring Rush

Your tools should all be in the best of shape, ready to meet the rush of work that comes as soon as the frost is out of the ground. If your bits are not in good shape or if some sizes are missing you can't do better than to stock up with

Russell Jennings Auger Bits

They are the only bits made of genuine crucible steel. They outlast any other bit. They bore fast, clean, and true. Made with ordinary shank for ordinary brace chucks, or with the new Precision turned shank which never pulls out or wobbles in the Precision brace chuck. And don't forget the new Russell Jennings braces, expansive bits, etc. Any hardware dealer will show you the full line.

Russell Jennings Mfg. Co.
Chester, Conn. 21-108



USE Crescent Nails In Your Roofing Work

With Crescent Roofing Nails you can put on more roofing in less time than with the old style tin plate and nails—and Crescent Roofing Nails will last much longer.

The stems of Crescent Roofing Nails are riveted both sides of head and they cannot leak as they are in one piece. The heads are thicker than the tin plates, this prevents their rusting out.

The heads of Crescent Roofing Nails are large—they have more bearing on the roofing and this prevents it from tearing off.

Crescent Roofing Nails have a good true point, which enables the roofer to make straight laps. Their large head prevents them from being driven through the roofing as is the case with the old style roofing nail or wire ringheads.

Crescent Roofing Nails are being extensively used. Be sure YOU use them on your next roofing job—they will save you time and they will give you better satisfaction.

Crescent Roofing Nails are made 1 inch and 1 1/4 inches long.

You can get Crescent Roofing Nails from your supply man. If he should not have them write us for descriptive circular, samples and name of dealer in your locality from whom you can get Crescent Roofing Nails.

Crescent Brass and Pin Company
DETROIT, MICHIGAN

Every "Yankee" Tool is a Labor Saving Tool

And there are 17 varieties to say nothing of the 100 and more different tools comprising them.

*Here are
a few*



But you ought to get acquainted with the full line.

*Our Tool Book tells you.
A postal brings it.*

Your dealers sell the "Yankee"

North Bros. Mfg. Co.
Department A
PHILADELPHIA, PA.

PLANE GAUGES

333 NUMBERS 334

Iron Plane Gauge No. 333

Cut shows Gauge attached to a Plane

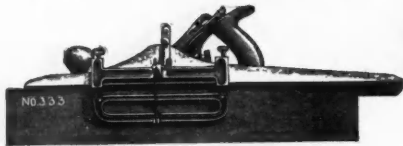

This tool can be readily attached to any Iron Plane and will enable the operator to accurately plane levels of any desired angle, or make an even joint and will do away with the continual use of a Bevel or Try Square.

Wood Plane Gauge No. 334

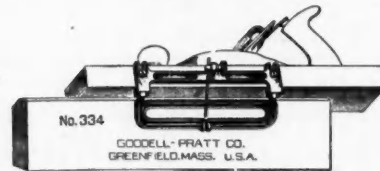

This tool is practically the same as our No. 333 except that it is intended for use on a Wooden Plane.

Both the 333 and 334 are made entirely from iron and steel fully nickeled.

If your dealer doesn't carry them in stock, write us direct. Our catalog showing over 1200 tools and devices sent Gratis upon request.

Goodell-Pratt's

Goodell-Pratt Company

Toolsmiths

Greenfield

Mass., U. S. A.

C. E. JENNINGS & CO.'S 42 MURRAY ST., N. Y., U. S. A.

TRADE  MARK.

Carpenters' New Hand Tool Case No. 340 With Tools

Patent Applied for
Made of select-
ed hard wood,
handsomely fin-
ished and with
paneled sides.
Furnished with
brass lock, leath-
er handle with
rings for strap to
pass over shoul-



der, metal clasps, metal corners, saw rack for holding four Saws (the Hand Saws narrow plate), hooks for Brace and Coping Saw, wood button of Try Square, partitioned tray for Bits, Chisels and small tools, space in bottom to hold Planes, Levels, etc.

	Length	Height	Width
Outside dimensions.....	31 1/4 in.	14 in.	6 in.
Inside dimensions.....	30 in.	12 3/4 in.	5 in.
Removable Tray, Inside.....	29 1/4 in.	1 in.	4 1/4 in.

Weight empty, about 14 lbs. Weight with tools, 18 lbs.
This Case is made to take our narrow plate Saws A7 1/2. The No. 340 contains one A7 1/2 Hand Saw, 26-inch; one A7 1/2 Rip Saw, 26-inch, and one Steel Square, No. 18B, a beautifully finished (Gun Metal Finish with Yellow Markings) Square, 18-inch body, 18-inch tongue. It is not made for wide plate Saws and large Square, but enables the mechanic to carry a lighter and smaller case than our No. 35, and a lighter kit of tools. Packed one or more in a crate.

THE CASE YOU WANT TO CARRY YOUR TOOLS IN



Get one of these cases for your tools. It is convenient and looks good. It is made strong. You'll find it a mighty handy part of your equipment.

Lorenz Fibre Tool Cases are made of 3-ply bass-wood covered with vulcanized fibre which will outwear any other material. Will not rust or tear. Light in weight. Brass corners and trimmings. Carried like a suit case. Compartment for saws, levels, planes, etc. Removable tray for chisels and bits.

Write for prices and FREE Catalog of Lorenz Guaranteed Cases and Tool Trunks.

WM. LORENZ TRUNK WORKS
107-109 Second-St. South - Minneapolis Minn.

Topp's Framing Tool

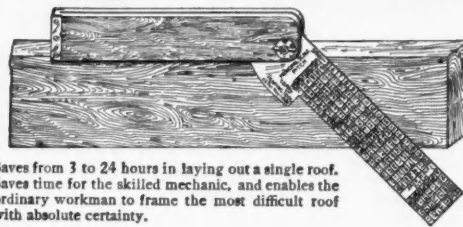

A Perfect Tool, and the Only Tool for the Purpose Ever Invented.

Price, \$1.75

Saves from 3 to 24 hours in laying out a single roof. Saves time for the skilled mechanic, and enables the ordinary workman to frame the most difficult roof with absolute certainty.

IT DOES ALL THIS { It gives angles for any pitch.
It gives lengths for any rafters.
It prevents all mistakes. It is accurate.
It gives cuts for principals, jacks, hips, valleys and cripples.

G. A. TOPP & CO., Indianapolis, Ind. See Tool at Your Hardware Dealer. Circular on request

When Writing Advertisers Please Mention the American Carpenter and Builder.

1853 **BUCK**  **BROS.** 1913

Fine Beveled Edge
Shank and Socket
Chisels

**Tang and Socket
Butt Chisels**

Plain and Beveled Edges
Send for illustrated Catalog
Buck Bros., Millbury, Mass.



**BARN DOOR
HANGERS**

That Cannot
Get Off the
Track

In Sizes for Both Light and
Heavy Doors

Send for complete Catalog show-
ing large variety suitable for
every requirement.

Lane Bros. Co.
Cherry St., Poughkeepsie, N. Y.



**MONITOR
SASH LOCKS**



(PATENTED)

NEVER BREAK

**BECAUSE THEY ARE MADE OF VERY HEAVY GAUGE
METAL AND PERFECTLY CONSTRUCTED.**

If the upper plate drops, the Monitor "Never Break"
Sash Lock will pick it up from a lower point than any
other, adjust the sashes perfectly, prevent all vibration
and lock securely, so it cannot be opened from the outside.

MADE IN TWO SIZES AND ALL FURNISHED BY

The Champion Safety Lock Co.
Geneva, Ohio

**Stanley
Tools**



No. 289

**Stanley Skew Cutter Filletster
and Rabbet Plane**

A Plane that is fast finding its way into the "kit" of every lover of good tools.

It has an extra wide cutter (1 $\frac{3}{4}$ inches) which is set on a *skew*.

It is provided with a *Fence* and a *Depth Gauge* which can be attached to either side, so that the Plane can be used equally well for right or left hand work.

Furthermore, the Fence is so hung that it slides under the bottom, enabling the user to regulate the width of the cut.

It has two adjustable spurs, one on each side, a valuable feature. By removing the Fence and Arm a very superior Rabbet Plane is obtained.

8 $\frac{1}{2}$ inches long, weighs 3 $\frac{3}{4}$ pounds.

List price, **\$1.75.**

Ask your Hardware Dealer
to let you see it.

Made by

Stanley Rule & Level Co.
NEW BRITAIN, CONN. U.S.A.

Bishops Refined "Greyhound" Steel Saw—A Masterpiece

Of the Saw Maker's Art. We are proud of its quality and guarantee it to cut faster and run easier in all kinds of wood, to hold its sharpness and set longer than any other good saws.

It's the Your-Money-Back-If-Not-Satisfied Saw

30 Days' Trial Will Prove Our Guarantee

The "Greyhound" is the result of years of experimenting to originate a purity of steel with fine grain and tough body.



Made in both Straight and Skew Back

Length	18	20	22	24	26	28 1/2	30 inches
Each	\$2.35	\$2.50	\$2.65	\$2.80	\$3.00	\$3.30	\$3.65 net

Packed One in a Box



GEO. H. BISHOP & COMPANY
LAWRENCEBURG, IND.

"A Bit of Utility"

Guided by its circular rim—instead of its centre—the Forstner Labor-Saving Auger Bit will bore any arc of a circle, and can be guided in any direction.

Doesn't matter how hard the wood is, no consequence whether it is full of knots, or the grain awkward to negotiate. The Forstner Bit works with equal smoothness under any condition and leaves a true polished surface on every job.

Unequaled for Delicate Work

Supersedes chisels, gauges, scroll-saws, or lath tools combined, for all kinds of delicate work. Cabinet and pattern makers and carpenters are enthusiastic because they do more work than other bits and cost no more.

We can offer something special in the matter of price on sets packed in a sensible box. Send today for particulars and catalog.

The Progressive Mfg. Co.
Torrington, Conn.

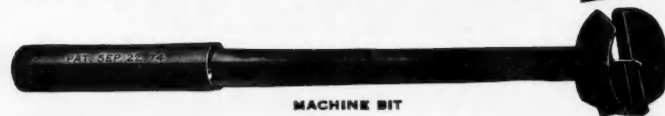

ROOF SLATES

STRUCTURAL SLATE BLACKBOARDS

E. J. JOHNSON
38 Park Row, New York
Quarry Operator

BLACK, GREEN, PURPLE, RED

Booklet, Samples and Prices on Application

When Writing Advertisers Please Mention the American Carpenter and Builder.



HERE IS A Can't Slip Screw Driver

It Is The Mayhew "Peerless" No. 510

As this Peerless Screw Driver will not slip from screw slot it prevents any marring of work

Any one who uses a screw driver—whether a good many times every day or just once in awhile—should try out a Mayhew "Peerless" Screw Driver.

You will find this No. 510 "Peerless" very easy to use, it is not tiring to hand or wrist, it is made thoroughly and of A No. 1 materials, and the special "Peerless" point prevents any slipping from screw slot.

No. 510 and No. 511 "Peerless" Screw Drivers have blades forged from fine tool steel and riveted through ferrule. Ferrule is drawn steel, nickel plated. Handle is hard wood, fluted. The blade extends slightly through handle end and allows pounding without damaging handle.

No. 510 comes in regular sizes from 2 to 12 inches
No. 511 comes in cabinet sizes from 2 1/4 to 12 1/4 inches

You will get complete satisfaction and thorough service from any Mayhew tools. We manufacture Drills and Braces, Breast Drills, Ratchet Drills, Bits, Gimlets, Counter Sinks, Reamers, Screw Drivers, Nail Sets, Punches, Awns, etc., etc.

The next time you buy any tool ask for a Mayhew. If your dealer does not handle Mayhew tools write to us and we will tell you the dealer of your locality who does

Why not drop us a line anyway for information about our tools?

H. H. MAYHEW COMPANY, Shelburne Falls, Mass.

THE BUSINESS END OF
A Peerless Screw Driver



An enlarged view of Peerless Screw Driver point. Note that point is non-slipping.

THE WORCESTER



Improved BLOUNT
DOOR
CHECK

The most certain,
durable and strong-
est door check built.

Worcester Mfg. Co.
10 E Worcester St.
Worcester : Mass.

CALDWELL SASH BALANCE

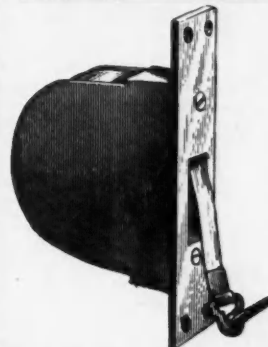

Does away with weights
and cords, and VASTLY
more durable.

Makes sashes work per-
fectly.

Permits greater window
space in new work, as box
frames are not necessary.

May be applied to old
windows without altering
sashes or frames.

Write for circular to the

Caldwell Mfg. Co.
15 Jones Street, Rochester, N. Y.

50c FOR THIS Clamp Fixture

It is Unequalled for Strength—
Quick Action and Last-
ing Qualities

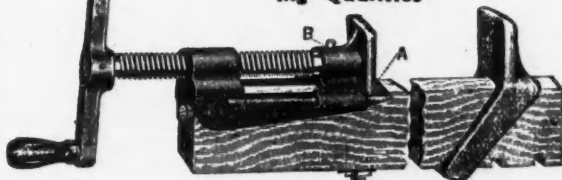

Write for Catalog of Sheldon's Clamps and Vises.

E. H. SHELDON & CO.
184 Nims Street " " MUSKOGON, MICH.

BLAKE QUICK ACTING VISE

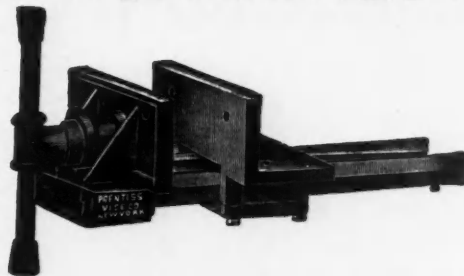

For Cabinet Makers and Wood Workers. Simplest—Strongest
—Cheapest—Best

Send for Catalogue of all kinds of Vises
PRENTISS VISE COMPANY, MAKERS
106-110 La Fayette St., New York, U. S. A.

When Writing Advertisers Please Mention the American Carpenter and Builder.

A Proven Success



What Do You Think

of a hand mixer that **will mix ninety cubic yards of concrete per day?** Can you imagine any convenience to a builder or contractor that would be more profitable?

The Northfield Batch Mixer

will do it. Speedy, handy, inexpensive, simply and durably constructed. Weighs only 300 lbs. Easily shifted to always discharge direct into forms. Saves half of wheeling time and labor, saves three-fourths transportation costs and repair charges, saves big money, time and worry on every job. Easy to operate—not a man-killer.

Thorough mixing principle that plows, hoes and stirs the entire mass many times per second.

SATISFACTION GUARANTEED

SOLD ON TRIAL

Operates by either Engine, Motor or Hand Power

NORTHFIELD IRON COMPANY

402 Water Street

NORTHFIELD, MINN.



MONEY MAKING CONCRETE

Mr. Block-Maker

**Wet Process is Right.
 Face down is Right.
 Three blocks at a time is Right.
 Triple Tiering is Right.
 Damp Curing is Right.**

**The Mogul Invincible Block Machine
 COMBINES ALL THESE
 IT IS RIGHT**

It is 46 inches long and will make three 16" or two 24" blocks at one operation. It makes sills, caps, copings, rails and steps, faster and better than a special mill machine. It has every adjustment that any other machine has and many that no other machine has.

PRICE—Machine and Outfit, \$75.00

WRITE FOR CATALOG

THE PETTYJOHN COMPANY
 634 No. 6th St., TERRE HAUTE, IND.

Buy The SIMPLEX 1913 Model MIXER



Combining the good features of both batch and continuous mixers in the one machine.

The best feature of the Batch Mixers is the rolling of the materials. The greatest advantage of the Continuous Mixer is the automatic measuring and feeding of the materials.

Only one machine combines these two features—the SIMPLEX. It's the happy medium between the two types of mixers, giving the points of advantage claimed by each, and eliminating the faults of both.

Write for New Complete Catalog.

The Miles Mfg. Co.
 309 E. Franklin St. JACKSON, MICH.

When Writing Advertisers Please Mention the American Carpenter and Builder.

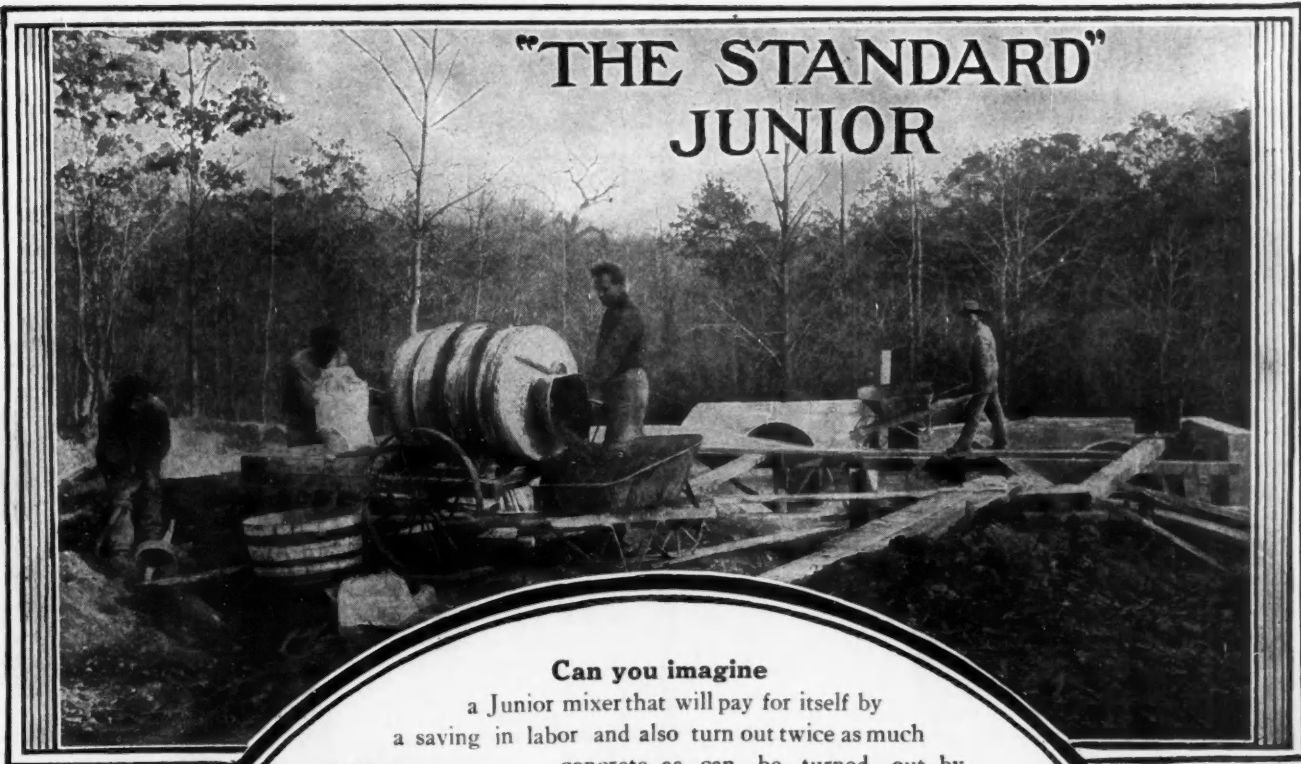

"THE STANDARD" JUNIOR

Can you imagine

a Junior mixer that will pay for itself by a saving in labor and also turn out twice as much concrete as can be turned out by hand mixing.

If you can't, better ask M. S. Boehm of Ravinia, Ill., who says that

"THE STANDARD" JUNIOR MIXER

paid for itself and doubled his profits on this job. The same time and money saving features of "THE STANDARD" Mixers are embodied in The Junior such as Low Charging Platform only 2 feet high and attached to the mixer. Semi-

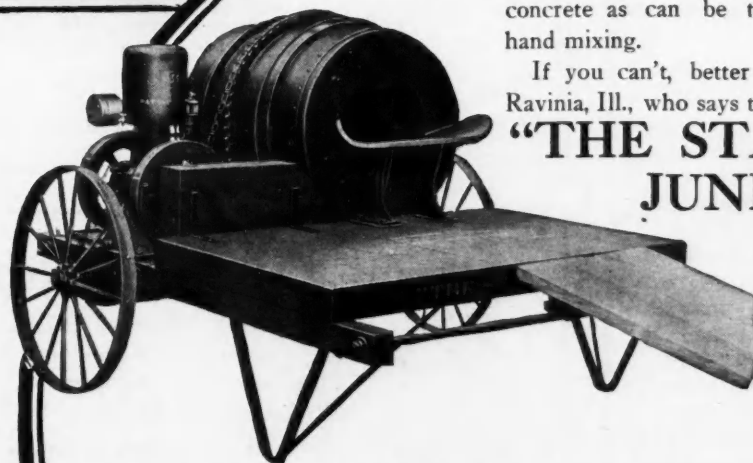

Automatic Discharge simplest, easiest and quickest on the market. Open Drum allowing the inspection of the batch also permitting being charged by shoveling directly into the drum.

The Junior is built mounted on two or four wheels with or without power, and will mix from 20 to 35 cu. yds. per day according to conditions.

THE STANDARD SCALE & SUPPLY CO.

Chicago
1345-47 Wabash Ave.

Pittsburgh
243-45 Water St.

New York
136 W Broadway

Philadelphia
35 S Fourth St.

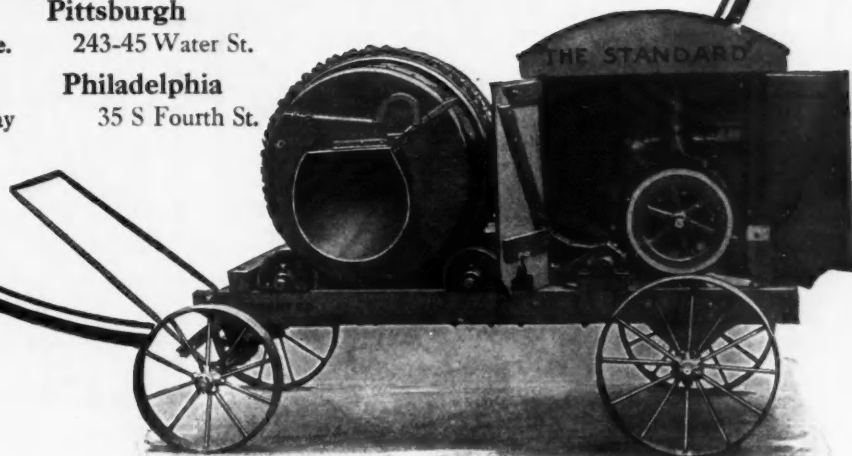

Our new catalog No. 144 J is now on the press and will be sent to you upon request.

When Writing Advertisers Please Mention the American Carpenter and Builder.

Here, Mr. Contractor---Read

What a Minnesota Contracting Firm Say about the Baby Grand Mixer



HAVREBERG & ELVERUM, Contractors and Builders
Jackson, Minnesota, March 8, 1912.

HALL-HOLMES MFG. COMPANY, Jackson, Mich.
Gentlemen:—The "Baby Grand" mixer we bought last year, we have used on different kinds of work and are very well satisfied with it. We find it is very accurate in proportioning and it mixes very thoroughly and being light in weight can be used in places where a heavier machine would be out of the question. We find it very easy for three men to mix four cubic yards an hour with this machine.

Yours respectfully,
HAVREBERG & ELVERUM (Signed.)

"The Baby Grand Runs Like a Watch"

Every Contractor who has had experience with any of our Baby Grand Machines will tell you they are the best mixers on the market. They are of the continuous type. They have a mechanical proportioning and feeding device. They eliminate guess-work and make mistakes impossible. No matter what kind of concrete work you do a Baby Grand Mixer can and will do better work and make more money for you.

We manufacture Baby Grand Mixers, also Hartwick Mixers, "the two trough mixers" in many various sizes and for any type of concrete construction work. Write for catalogues, prices, etc., and find out about our mixers—first hand—before buying any mixing machines. Learn what they are doing for others—they'll do as well for you.

Hall-Homes Manufacturing Co., 430 Oak St., Jackson, Mich.

HOW ABOUT YOUR MORTAR MIXING?

Costs you a good deal—and your plaster mixing does too—doesn't it?

Do you know we can stop all that needless expense and save you considerable time in both the mixing of your mortar and plaster with our Blystone Batch Mixer?

This Blystone Batch Mixer is a practical and economical mortar and plaster mixer as well as a concrete mixer. Read what Contractor Nagel has to say about it.

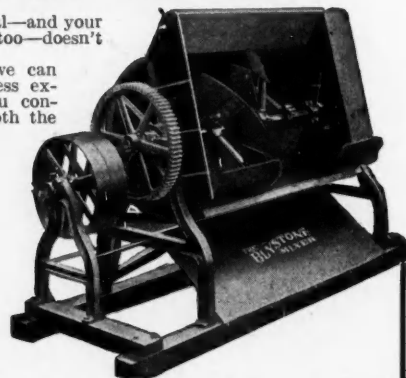

THE BUILDERS' EXCHANGE, 180-188 Jessie Street
Phone Kearny 4700 San Francisco, Cal., Nov. 1st., 1912.
Blystone Machinery Co.,
Cambridge Springs, Pa.

Dear Sirs:—After having used the Blystone Mixer to mix hard wall plaster, I can recommend it to any one who wants a mortar mixer. It not only mixes rapidly but perfectly, and is a saver of both labor and material and easy to clean.

Yours truly, W. L. NAGEL.

This Blystone can save you time, labor and material on every mortar and plastering job you do. It operates very easily. It is filled while in motion and material is discharged while machine is in motion. It mixes in full view insuring an absolutely accurate mix. The revers spiral paddle system of the Blystone mixes rapidly, turning over 40 times in ONE minute. Blystone mixers are furnished with gasoline engine power equipment or for belt driving. Mounted on skids or portable hand trucks.

Get our catalogs and other particulars explaining in detail how the Blystone can save you money—NOW.

This information will interest you.

THE BLYSTONE MACHINERY CO.
19 Carpenter St., CAMBRIDGE SPRINGS, PA.

Buy Your Own Concrete

AS the forests are cut, builders turn to concrete. Concrete construction is not difficult. It pays liberal profits. Hundreds of contractors are going into concrete every year. You can start with a small investment—some wheelbarrows, shovels, small tools and a

Smith Hand Mixer

IT is a batch mixer, guaranteed to mix a perfect batch in three slow, easy turns of the drum. Cranks easily—popular with the men. Batch capacity, 2½ cu. ft. Output, 25 to 30 cu. yards per day. Weight, 1000 lbs. Guaranteed fully by the biggest and oldest mixer concern in the United States.

The T.L. Smith Co.
1333 Majestic Building
Milwaukee, Wisconsin

Let us send you our guarantee and booklet No. 17

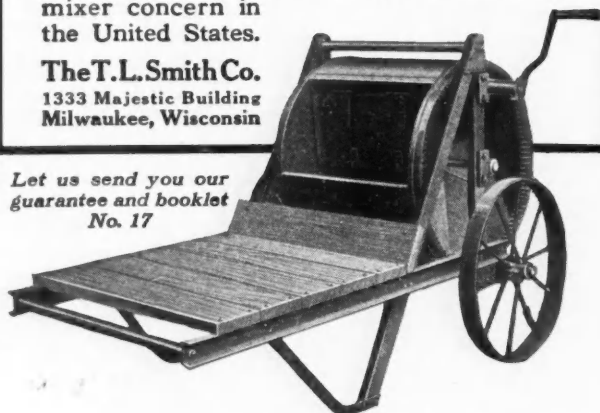

Mix with a Mixer

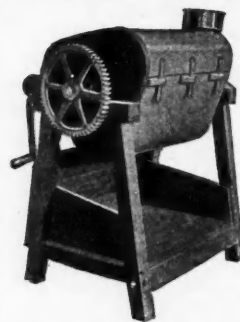

With mixers selling at the present prices, no one doing concrete work wants to be without one.

Hand mixing is slow, expensive and wasteful. Laborers are often hard to get.

Machine mixing is faster, cheaper and much more thorough.

Our hand mixers sell from \$24.00 (like cut) to \$75.00 each; three sizes.

Power Mixers (like cut) sell from \$300 up; five sizes. Equipped with side loaders, automatic water tanks, friction clutches, and all up-to-date conveniences. Capacity a batch a minute.

Our \$300 mixer is the ideal machine for the country contractor. Weight, 1500 lbs. Wide gauge. Can be moved anywhere. The only machine of its kind made.

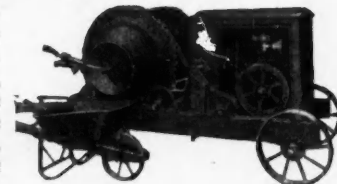

Ask about this machine when writing or come to the cement shows and see it on exhibit.

LANSING CO., 606 Cedar Street **Lansing, Mich.**
Agents Everywhere

It Pays For Itself Every 60 Days It Is In Motion

—HENRY E. ENGLSBY, Watertown, S. D.

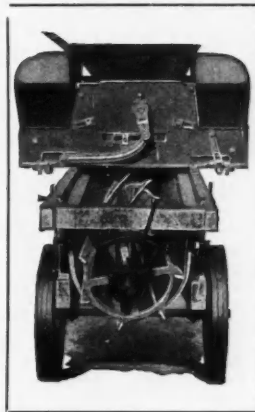

Watertown, S. D., Dec. 28, 1912.

The Knickerbocker Co., Jackson, Mich.

Gentlemen: Enclosed please find a broken casting that came off from my No. 12 Coltrin Mixer. It is so small there is no number on it but mail me one like it.

I have run my Coltrin steadily for two years and this is the first break have ever had. The mixer does not owe me one dollar. It pays for itself every sixty days it is in motion.

Yours truly,

HENRY E. ENGLSBY.

It Is the Ability to Save Money

In first cost operating cost and total cost when the work is finished that is proving to users of mixers the greater economy of the COLTRIN.

The Coltrin Continuous-Batch Mixers

Shipped anywhere on trial
Steam—Electric—Gasoline Engine—Stationary—Hand Power
Write for 1913 catalog

The Knickerbocker Company

Jackson, Michigan

When Writing Advertisers Please Mention the American Carpenter and Builder.

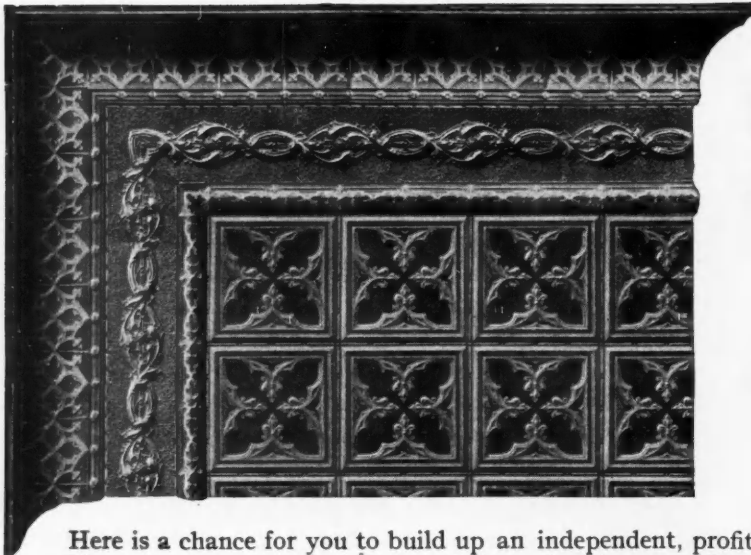

Edwards Metal Ceilings and Walls

Carpenters Contractors and Builders

Here is a chance for you to build up an independent, profitable business for yourself right at home. Many agents are now devoting their entire time to selling our Metal Ceilings. Others have made big profits simply devoting part of their time to selling and applying our Metal Ceilings and Walls. *Write us to-day about your territory.* Our business is growing so rapidly that it is necessary to have an agent in every community. The territory is going fast. One day's delay may mean that some one else will be given your territory. *Don't delay. Write today for our special agents' proposition and large handsome catalog of attractive designs.*

The Edwards Manufacturing Company, "The Sheet Metal Folks"
401-417 Eggleston Avenue, Cincinnati, Ohio

Largest Manufacturers of Metal Ceilings, Metal Shingles, Metal Roofing and Siding in the World
Eastern Representatives: The W. H. Daycock, Jr. Co., 81-83 Fulton Street, New York
Branch Office and Warehouse: 1625-1627 Pacific Avenue, Dallas, Texas. J. F. Agnew, Manager

BAYONNE ROOF AND DECK CLOTH

Windproof--Rainproof--Wearproof

Bayonne Roof and Deck Cloth, the result of years of manufacturing experience, is a specially treated canvas, requiring but one coat of paint. Easy to lay, wears longer and costs less than most roof and deck coverings.

Architects and Owners Recommend It

for porch roofs, porch floors and decks because it is both durable and economical. Write us your needs and we will send samples of Bayonne Roof and Deck Cloth, and give you full information regarding it. Write today.

John Boyle & Company, Inc.

112-114 Duane St. New York 70-72 Reade St.

Concrete Marble Decorative Concrete Composition Flooring Processes

FOR SALE, Shop, County or State Licenses.

No machinery used. Big Profits for Contractors and Builders. For literature write to

Art Stone Co.
Waynesboro, Pa.

Box A

Genuine Peach Bottom Slate

THE BEST ROOFING MATERIAL IN THE WORLD

It has been in actual use over 170 years. It will not fade, but grow darker with age. It is the toughest and strongest slate in the world. It is the cheapest slate to use. Little or no breakage in shipping, and when once on the roof practically speaking will need no repairs at all, as long as your building may stand.

FOULK JONES & SONS Manufacturers
SLATE HILL, PA. :::: DELTA, PA

When Writing Advertisers Please Mention the American Carpenter and Builder.

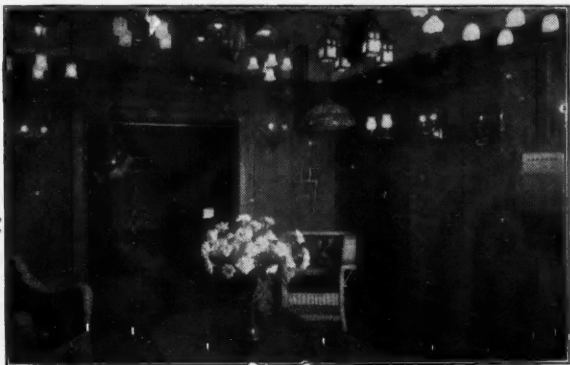

The above cut shows a corner in a display room finished with

DECO VENEER

It is not an imitation. It is made of natural wood of the best quality of both foreign and domestic timbers.

Panels furnished either finished or unfinished. Unfinished panels are sanded ready for the finish.

For wainscoting and similar construction, panels with strips, caps and base are furnished ready for installation. No mill work necessary.

Deco is used for wainscoting, window backgrounds, bank and bar fixtures, and all interior decorations where ply veneers are used.

Contractors and builders have found Deco a most satisfactory substitute for old style ply veneers and more economical.

We want agents in every city and town. Write for our agency proposition.

Illustrated catalog sent on request.

Deco Manufacturing Company
Indianapolis, Indiana

METAL CEILING

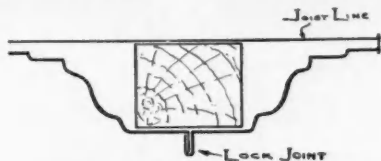

See that Joint?

The Acme of perfect construction. Don't nail or slip the joints. Lock them. Full information in catalogue E.

S. KEIGHLEY METAL CEILING & MFG. CO.
PITTSBURGH, PA.

We Make Panels of any Thickness and Any Kind of Wood - Curved or Flat.

FOR
Wainscoting
Ceiling
Mantels
Doors
Counter Tops
Partitions
Cabinets
Shelving
Drawer Bottoms

Our products excel in Quality and Durability, because we concentrate our best efforts in their manufacture.

We specialize in Panels and have the facilities for producing best results.

Try us with your next order. Send us your specifications and ask for our prices.

AMERICAN VENEER CO.

Specialists and Manufacturers of Built-up Veneer Panels

We appreciate small orders as well as large ones

12 Market St., KENILWORTH, N. J.

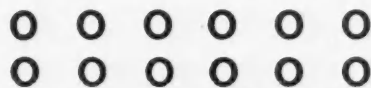

CANTON

Art Metal Co. Ceilings

Are the kind that have the famous Punched Nail Holes and Repressed Beads which save so much time on the job and increase your profits

Perfect Fitting Plates
Artistic Designs

Write today for our mammoth Art Metal book just fresh from the press for further information

THE CANTON Art Metal Co.

"Quality Products"

CANTON : : OHIO

Eastern Office and Wareroom
THE CANTON STEEL CEILING CO.

11th Ave. and W. 25th St.
NEW YORK CITY

Western Branch
THE CANTON STEEL CEILING CO.

206 S. 3rd St.
MINNEAPOLIS, MINN.

When Writing Advertisers Please Mention the American Carpenter and Builder.

Mullins Metal Tile Roofing

has won widespread and lasting favor because of its many superior qualities. Beauty, simplicity, durability—these are its salient characteristics. Absolutely storm-proof and water tight.

When put on according to directions, Mullins Metal Tile Roofing is guaranteed to keep in perfect condition for years. No other roofing can equal it for all-round satisfaction. Many of the finest buildings in this country are equipped with it.

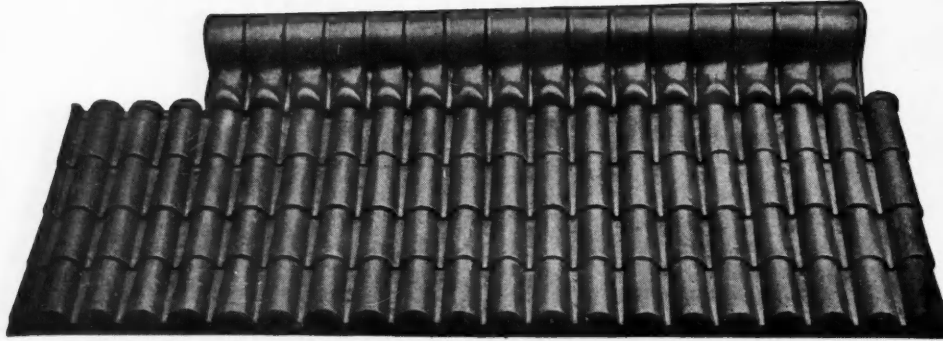

We also make Cornices, Building Fronts, Finials, Tympanum panels, Rosettes, Faces and other architectural ornaments. Many thousands of designs to select from.

Ours is the largest and best equipped factory of its kind in the world. We use

only the finest materials. Every artisan in our employ is a masterhand. Our prices are attractive, our services prompt. Glad to submit quick estimates on special jobs.

Catalogue along any desired line will be sent you by return mail.

The W. H. Mullins Co.

214 Franklin St.

SALEM, O.

Your Customers Want Artistic Up-to-Date Designs

AND

YOU Want A Price That Will Give YOU Big Profits



Get our ceiling catalog DA and discount and you will have this combination that will satisfy both YOUR CUSTOMERS and YOURSELF



The Kanneberg Roofing & Ceiling Co.

::

::

Canton, Ohio

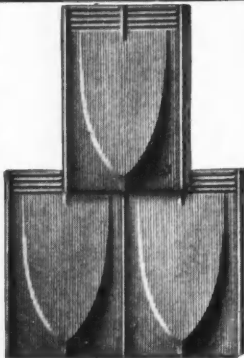

PLACE YOURSELF ABOVE YOUR COMPETITOR

AND SELL **"TITELOCK"** THE BEST

METAL SHINGLES made. They are business-getters and money makers. **FIRE, WATER AND LIGHTNING PROOF.**

Write for Samples and Prices

MILWAUKEE CORRUGATING COMPANY
MILWAUKEE, WIS. KANSAS CITY, MO.

Style "B" - Showing Method of Laying

When Writing Advertisers Please Mention the American Carpenter and Builder.

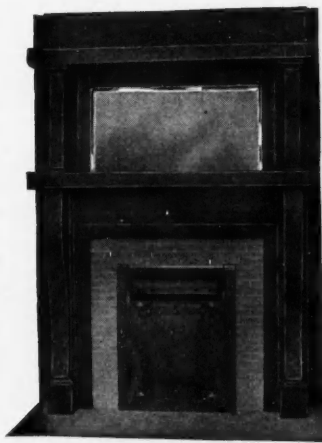

\$28.60

For this elegant massive, selected oak or birch, mahogany finished mantel. Beveled Mirror 18x36

"From Factory to You"

Price includes our "Queen" Coal Grate with best quality enameled tile for facing and hearth. Gas Grate \$2.50 extra. Mantel is 82 inches high, 5 feet wide. Furnished with round or square columns, as shown in cut. Dealer's price not less than \$40.00.

No. 875.

"Reputation and Quality Count"

Central Mantels

are distinctive in workmanship, finish and style. Twenty-five years' experience enable us to know and satisfy the needs of those who want mantels of quality, different from the rest. We build all styles—Colonial to Mission.

CATALOGUE FREE—Will send our 100 page catalogue, the finest ever issued, free, to carpenters, builders and those building a home.

CENTRAL MANTEL COMPANY

1247 Olive Street

St. Louis, Mo.

High Grade Mantels and Fireplaces

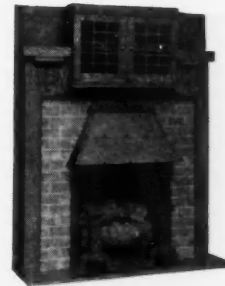

Our line of Colonial, Mission and Standard Mantels is the most complete in the country. All goods are guaranteed as to quality. Our large new catalogue, showing also brick mantels and a large selection of fireplace fixtures, consoles, colonnades, etc., sent free on request.

If building or remodeling be sure and write us.

CHAS. F. LORENZEN & CO.

701 N. Sangamon St. CHICAGO, ILL.

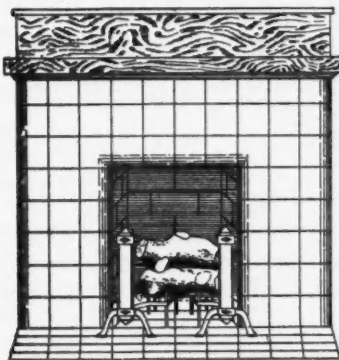

Do You Want Our Handsomely Illustrated MANTEL-CATALOG?

We show the most complete and up-to-date line of *MANTELS, GRATES and TILINGS* at the *LOWEST PRICES*.

Catalog free upon application

MOORMANN & OTTEN, 611-613 Main Street CINCINNATI, - OHIO

HESS MEDICINE SANITARY LOCKER

The Only Modern, Sanitary STEEL Medicine Cabinet



The Recommended Steel Medicine Cabinet

or locker, finished in snow-white, baked everlasting enamel, inside and out. Beautiful beveled mirror door. Nickel plate brass trimmings. Steel or glass shelves.

Costs Less Than Wood

Never warps, shrinks nor swells. Dust and vermin proof, easily cleaned.

Should be in Every Bath Room

Four styles—four sizes. To recess in wall or to hang outside. Send for illustrated circular.

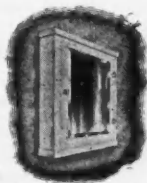

HESS, 920L Tacoma Bldg., CHICAGO

Makers of Steel Furnaces

Free Booklet

The Outside Street Cabinet

PLUMBERS' SUPPLIES

AT WHOLESALE

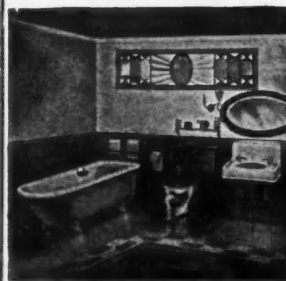

When in the market for Plumbing Supplies and you wish to

SAVE 20 to 40 Per Cent

on every article, write for my free illustrated Catalog. The only house that sells first class guaranteed goods at wholesale prices direct. Shipments are promptly made from a very complete stock.

Small orders are as carefully handled as large ones.

B. B. KAROL, 768-772 W. Harrison St., Chicago, Ill.

When Writing Advertisers Please Mention the American Carpenter and Builder.

Our First Public Message Means Profit for You

A CONTRACTOR'S greatest asset is a satisfied customer. You know that from your own experience, don't you? When you build a house that has particularly pleased Jones, almost invariably some friend of his wants a house "like Jones'."

And furthermore you know that no house can give as complete satisfaction as a brick house. Taking into account the saving in fire insurance, heating, repairs and painting, the brick house represents the lowest expenditure, after a few years. No other house compares with a brick house in beauty, comfort, durability and economy.

Then why not build your houses of the best brick and give the greatest satisfaction? Here are a few reasons why

Hy-tex Brick

is the best brick for you to use:

Our unexcelled facilities—with our twenty-two plants scattered across the country—for manufacturing every kind and variety of brick; our ability to deliver the same brick year after year; our rigid inspection; the distribution of our plants making for quick deliveries and low freight charges; the stability and reliability of our organization—all these factors make us the logical organization for contractors to ally themselves with.

**There's a Hy-tex Face Brick
in
Every Tint and Texture**

We also make a full line of Enameled Brick which we positively guarantee will not craze, scale or discolor.

No Order Too Large for Our Capacity or Too Small For Our Attention

*Get in touch with us—and let us co-operate with you.
Write now to our Contractors' Department at St. Louis.*

Hydraulic-Press Brick Company
St. Louis, Missouri

BRANCH OFFICES

BALTIMORE, MARYLAND, 11 E. Lexington Street
CHICAGO, ILLINOIS, Chamber of Commerce Building
CLEVELAND, OHIO, Schofield Building
INDIANAPOLIS, INDIANA, Board of Trade Building
KANSAS CITY, MISSOURI, Rialto Building

MINNEAPOLIS MINNESOTA, Security Bank Building
NEW YORK CITY, Fredenburg & Lounsbury, 381 4th Ave.
OMAHA, NEBRASKA, Woodman of the World Building
PHILADELPHIA, PENN., Real Estate Trust Building
TOLEDO, OHIO, Ohio Building
WASHINGTON, D. C., Colorado Building

When Writing Advertisers Please Mention the American Carpenter and Builder.



What do you Think of the Prize Competition?

WE feel pretty good about the Prize Competition. We promised you that even the average run of work being done by our Big Family of subscribers is something to be proud of, and that the photos and plans of the twenty-four prize winners would be well worth while studying.

Were we right?

When you have looked through this issue of Your Magazine, we wish you would write us a letter and tell us what you think of it.

There will be a lot of building this season; and you will have the chance to plan and build a good many residences. Show these prize winning house plans to your prospective customers. Any person who thinks at all of building will be interested in these prize ideas for planning and equipping modern homes.

One reason we like this Prize Competition so well and have been willing to go to the heavy expense—nearly \$400 for prizes—is that we believe our publication of these designs will really help you to do a bigger and better building business this season.

Eighth Anniversary Issue Next

MAYBE you think this is a good number of the AMERICAN CARPENTER AND BUILDER—Just wait till you see the next month's magazine!

Many of you know what our Anniversary Numbers are like. You wouldn't want to miss one of them, would you?

This eighth Anniversary number is a little more interesting—bigger and better, than any before. A good many of us have been hard at work for quite a time getting up some special stunts for this big eighth Anniversary Number, that will surprise and please you.

If you want to do us a favor and help some brother workman, some friend of yours, at the same time—show him this copy of the AMERICAN CARPENTER AND BUILDER and tell him

Contents for March, 1913

	Page
Atkins Pioneers Banqueted.....	89
Carved Oak Altar in St. James Church, St. Paul, Minn.....	70
Chicago Builders Elect Officers.....	89
Church of Christ at Seymour, Iowa.....	52
Colonial Interior; Also Glazed Porch.....	90
Combined Dining Room Side Board and Kitchen Cabinet.....	72
Convenient Coal Bin.....	97
Correspondence.....	96
Details You Can Use.....	90
Device for Stretching Screen Wire.....	99
Dimension Stuff.....	76
Discriminating as to Prospects.....	76
Driving Back the Arctic.....	89
Dumbwaiter that Speaks for Itself.....	100
Editorial.....	37
Editor's Drawer.....	89
\$14,000 Country Home at Princess Anne, Md.....	63
Good Work with Field Stone.....	74
Hammer with Triple Claws.....	89
Home Workshop.....	94
How to Make a Music Stand.....	94
How to Make Floor Leak Proof.....	99
Huge Bontecoe Dairy Farm Barn at Tillson, N. Y.....	55
Improvising a Gainer.....	76
Interesting Letter.....	98
Labor-Saving Wheelbarrow.....	89
Library Table with Inlaid Top.....	71
Magnificent House of Classical Design at San Antonio, Texas.....	48
Making Power Woodworkers Pay.....	81
Marble Stair Railing in Elk's Building, Denver, Colo.....	73
Masonry on Union Station at Great Falls, Mont.....	75
Model 9-Room Bungalow at El Paso, Ill.....	42
Model Small Woodworking Shop.....	96
Modern 8-Room Dwelling at Denver, Colo.....	40
Modern \$14,000 Residence at South Bend, Ind.....	65
More Shop Kinks.....	79
Motor-Cars and Cycles for Busy Builders	86
Motorcycle as an Investment.....	86
New Christian Church at Bowen, Ill.....	50
New Congregational Church at Vesper, Wis.....	54
Noon Hour Talks by the Boss Carpenter (Talk No. 8).....	84
North Carolina Builders Elect Officers.....	89
Popular Hip-Roof Brick and Stucco Residence at Davenport, Iowa.....	45
Practical School for a Small Town.....	83
Prize Winning Structures Planned and Built by Our Readers.....	38
Public Buildings.....	83
Quick to See the Joke.....	51
Responsibility of the Builder.....	37
Re-Working Form Stock.....	76
Round Dairy Barn at Beloit, Wis.....	58
\$75,000 Southern Mansion at Lebanon, Tenn.....	61
Sign Found in a Mine.....	51
Six-Room Stone Bungalow at Waterville, Conn.....	44
Steel Square Department.....	76
To Build Model Concrete Road.....	95
Trade Notes and Items of Interest.....	100
Two-Family Dwelling at Sedalia, Mo.....	68
Uncle Dan Comes to Life.....	97
Unique Dwelling for Business Street in San Francisco.....	47
Unusual Gothic Roof Barn at Johnson, Wash.....	59
Up-to-the-Minute Brick and Frame House at Mable, Minn.....	67
Value of Reputation.....	76
Watching Jimmie (Part IV).....	80
Will Curb Fire Loss.....	51
Woods Lays His Cornerstone.....	76
Yours for Safer Building.....	84

to "come on in." Tell him about the big Eighth Anniversary Number which comes next month and have him *subscribe now*, so that he can get this big number which begins Volume XV.

More Prize Competition Designs Next Month

We have only made a beginning at publishing the worth-while, interesting photos, plans and letters sent in by our readers for the big Prize Competition. Some more will be published in the April issue—one of the prize winners and several of the honorable mention designs. A good many of you will say that these Honorable Mentions are just as good as the prize winners. They are too.

Three Hundred Concerns Eager to Serve You

IT is plain to be seen that our subscribers are using, wherever they can, the goods made by our advertisers. Reading the letters sent in, describing the structures they have planned and built, we have been gratified at the many evidences of friendly business relationship between our subscribers and their friends, the AMERICAN CARPENTER AND BUILDER advertisers.

Look through the pages of this issue. You will find three hundred responsible concerns represented, each one offering you the very best that they have. They are your friends. They want your business. These manufacturers appreciate the importance of the work that Our Folks are handling in the small hustling cities and towns. They are anxious to work with you in developing this business. Take our advice and get on intimate terms with all of our advertisers. It will help your business and will make money for you.

Get the Habit

GO through the advertising pages and see what is new. Get the habit of looking into all of these things. Investigate the new propositions and likewise the new phases of the old and tried matters you think you know all about. We are just at the beginning of a record-breaking building season and builders should be thoroughly posted on everything they will need for their work this year.

And don't forget to write us what you think of the Prize Competition.

Cordially yours,
Editor AMERICAN CARPENTER
AND BUILDER.

CHICAGO SPRING BUTTS

REPUTATION

Do you specify a spring hinge with distinctive features which will appeal to your client and assure satisfaction to all concerned?

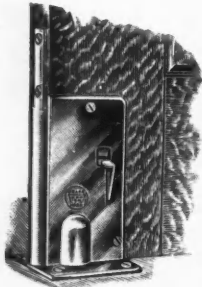

Chicago "Relax" Spring Hinges

are in great demand. They are substantial in construction and readily applied. The EXCLUSIVE FEATURE of spring action release, allowing the door to be placed at any desired position and automatically re-engaging when the door is closed,

is of recognized merit and utility.

Send for Catalogue C 29. It fully illustrates and describes the most complete line of Spring Hinges manufactured.

Chicago Spring Butt Company,

CHICAGO



NEW YORK

BOMMER SPRING HINGES

ARE

Quality Goods

BUT COST NO MORE THAN THE SUBSTITUTES

This trade mark

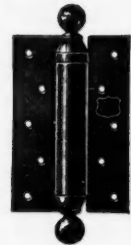
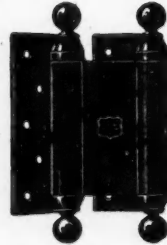

Reg. U. S. Pat. Office

on every genuine Bommer Hinge

Durable—Neat—Reliable

BOMMER SPRING HINGES

ARE THE BEST

Bommer Bros., Mfrs., Brooklyn, N. Y.

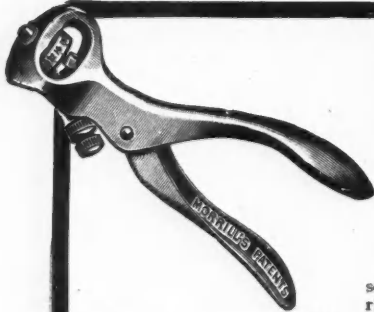

Morrill Saw Set

Mechanically perfect, made with a rotatable anvil that is gauged so as to set any Saw not over 16 gauge. It will take the wrong set out of a saw and put in the right set at one operation.

Send for Catalog No. 9 to-day

Chas. Morrill 275 Broadway New York

CABOT'S "QUILT"

Cold-Proof, Heat-Proof, Sound-Proof
40 Times Warmer Than Common Papers

THE many imitations of Cabot's Quilt are the best evidence of its wonderful efficiency and success. Quilt is sold on quality—the imitations are made to sell cheap! Quilt is rot-proof, vermin-proof and almost fire-proof. It will pay for itself in two winters in saving coal and will keep the house cool in summer as well. It is the only deadener that breaks up and absorbs sound-waves.

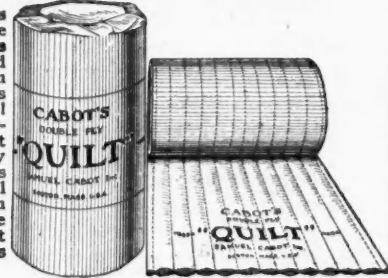

SAMUEL CABOT, Inc., Sole Mfrs., Boston, Mass. U.S. A.
1133 Broadway, New York. 350 Dearborn Ave., Chicago

The Marsh Miter Machine

Make picture frames and novelties during your dull season on a Marsh Miter Machine.

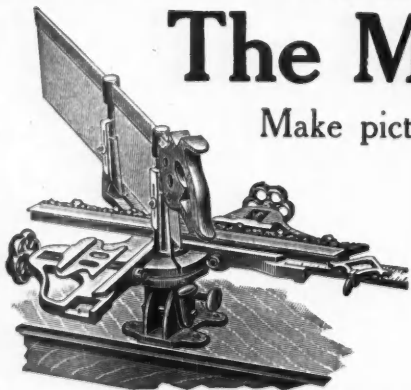

Cuts and joins perfect corners.

Over 50,000 in use.

Any one can operate it.

Send for circulars.

H. C. MARSH CO.

606 Race St.

ROCKFORD, ILL.

When Writing Advertisers Please Mention the American Carpenter and Builder.

Copyright 1913 by American Carpenter and Builder Company



The
**World's Greatest
Building Paper**

Important Notice
When your subscription expires, renew at once, using the blank enclosed in your final copy. If it expires with this issue your renewal must reach us before March 25 to avoid missing the April number. Use P. O. or Express Money Order if possible, but bills or 2-cent stamps may be sent at our risk.

The
**World's Greatest
Building Paper**

American Carpenter and Builder

Entered as second-class matter July 1, 1905, at the postoffice at Chicago, Ill. under the act of Congress of March 3, 1879.

Published on the first day of each month by
AMERICAN CARPENTER AND BUILDER COMPANY
178 W. JACKSON BOULEVARD, CHICAGO

EDITORIAL DEPARTMENT

WILLIAM A. RADFORD, EDITOR-IN-CHIEF
BERNARD L. JOHNSON, B. S., EDITOR
WILLIAM REUTHER
ALFRED W. WOODS } ASSOCIATE
ALFRED S. JOHNSON, M. A., PH. D. } EDITORS

BUSINESS DEPARTMENT

WM. A. RADFORD, PRESIDENT AND TREASURER
H. M. RADFORD, SECRETARY
E. L. HATFIELD, GENERAL MANAGER

New York Office, 178 Fulton Street
E. B. WOLFROM, EASTERN REPRESENTATIVE

VOL. XIV. MARCH, 1913. No. 6

SUBSCRIPTION RATES

One Year, \$2.00; six months, \$1.00; payable always in advance. Single Copies, 20 cents. Canadian Subscriptions, \$2.50. Foreign Subscriptions, \$3.00.

ADVERTISING RATES

Furnished on application. Advertisements, to insure insertion should reach our Chicago office not later than the 20th of the month preceding date of publication.

The Responsibility of the Builder

NO matter who draws the plans, it is the builder—the man on the job who is in personal consultation every day with the owner of the building—who has the final say-so.

The carpenter and builder, throughout the locality in which he operates, gets to be pretty strongly entrenched in that community's confidence and esteem. The builder is counted the *practical* man who knows all about building materials and building methods, knows just what is best from actual experience; and what he recommends usually goes.

This is a happy state of affairs for the builder; yet it carries with it a heavy obligation to be careful of advice; and, as nearly always as is humanly possible, to recommend wisely.

In looking over the photographs and building plans submitted in the Prize Competition, and reading the letters from our readers which accompanied them, we have been impressed more strongly than ever before with the power our

readers exert in the building world. It is evident that a large proportion of our carpenters and builders are not only builders, but also architects. They do their own planning. There is nobody else to do it. Their customers expect it of them; and we are very glad to know that our readers are so well qualified for this work.

Wherever there are architects located, the building contractors of course work in close harmony with them. There is much satisfaction in working after the carefully made drawings and specifications turned out by a professional architect, who understands his business. It often develops, however, that certain changes—perhaps small, often of some extent—have to be made as the building progresses and after the architect's work is done. The chances are that the owner is no longer in close communication with the man who drew up his plans and specifications. He is in close touch with his *builder*; and he looks to him for advice as to the carrying out of the plans and in respect to any changes that may be wanted.

When this occurs, you carpenters and builders who read this, must recognize first the opportunity offered you of strengthening your own position, and second the obligation of deciding according to the best interests of your client.

The changing of plans and specifications is an every-day occurrence. If the builder is working from his own drawings, he is very willing to modify them if so requested; and, if they were drawn by some outside party, considerable changing is pretty sure to develop before the building is done. A letter from one of our subscribers sent in with an entry in the Prize Competition illustrates this point.

“Adamstown, W. Va.

“Editor AMERICAN CARPENTER AND BUILDER:

“Enclosed are photos and floor plans of a residence I built for Samuel Powell in this suburb of Clarksburg. He had the plans drawn by a local man for a *brick veneer structure*. I changed the size and style of the house in a number of particulars; also changed the walls from brick veneer to 8-inch *hollow tile* plastered on the inside and stuccoed on the outside direct to tile. The architect was away all the time, so I was not able to consult him, *but I pleased my customer*. This is the first structural tile residence in this section.

“I cannot do without the AMERICAN CARPENTER AND BUILDER and wish you success. (Signed) I. W. THOMPSON.”

Many other similar instances could be cited. The builder is the man on the job, in close touch all the time with the owner; and the owner has all confidence in the builder's practical judgment and knowledge. In recommending changes be careful; keep thoroughly posted; and know what you recommend.

The manufacturers of building material are acting wisely in their present policy of taking particular pains to instruct and inform the carpenters and builders about their several materials.

PRIZE WINNING PLANNED AND BUILT

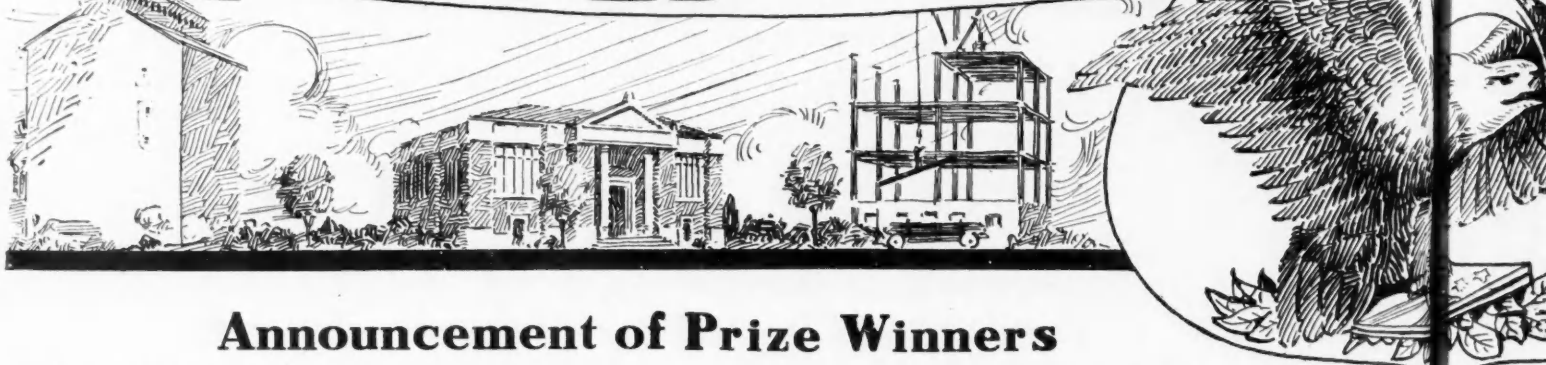

Announcement of Prize Winners

THE judging of this competition proved to be the most puzzling proposition the Editor ever tackled. In the first place, the number of entries was simply overwhelming. They began to come in about January 10th and by February 5th, the closing date, our editorial rooms were literally blockaded with photographs, plans and descriptions of structures planned and built by the Big Family; and we had to open and set aside a special office just to take care of them.

And, in the second place, practically every piece of work submitted had its good points. We keep pretty closely in touch with the building situation and know in a way of the work the AMERICAN CARPENTER AND BUILDER subscribers are doing; but we confess we were amazed at the quality, variety,

and magnitude of the work submitted in this competition. It has been a revelation of the importance of Our Folks in most communities, not only as builders, but also as practical architects and planners.

Of all those designs showing worth-while ideas and up-to-date features the number, for all seven classes of the competition, was finally narrowed down to 116. There should have been a prize for each one of these. As it was there were 21 Prizes; and then, through the generosity of Mr. Radford, three additional prizes were added for Class A—Best Designed Residences, to apply particularly to well-planned *small houses*. This made 24 Prizes, 8 Firsts, 8 Seconds, and 8 Thirds. The 24 prize winners and the 92 practical builders whose submitted work deserves Honorable Mention are as follows:

Winners Class A—Best Designed Residence Planned by a Reader of the "A. C. & B."

Small Houses

First Prize—Chas. M. Gates, Architect, Denver, Colo.
Second Prize—Jos. A. Riechel, Building Contractor, El Paso, Ill.
Third Prize—John S. Dixon, Waterville, Conn.

Large Houses

First Prize—Alfred J. Danielson, Contractor and Builder, Davenport, Iowa.
Second Prize—Edw. A. F. Carson, Carpenter and Builder, San Francisco, Cal.
Third Prize—B. Torres, Builder, San Antonio, Texas.

HONORABLE MENTION—CLASS A

Thos. L. Hickey, Designer with L. A. Hickey's Sons, General Contractors and Builders, South Bend, Ind.
W. Twilley Malone, Contractor and Builder, Allen, Md.
D. A. Haines, Mabel, Minn.
A. Kent Miller, Real Estate Builder, Somerset, Pa.
J. H. Starr, Contractor and Builder, Napa, Cal.
Michael Mikkelsen, Builder and Contractor, Pleasantville Station, N. Y.
C. M. Diller, Contractor and Builder, Akron, Ohio.
Leaton & Rawlins, Contractors and Builders, Goodhouse, Ill.
C. J. Waffle, Evert, Mich.
I. W. Thompson, Adamston, W. Va.
Albert Gonne, Highland, Mich.
J. L. Stiert, Carpenter and Builder, Benson, Mich.
M. M. Johnson, Courtland, Kans.
H. A. Taylor, "The Home Builder," Morris, Ill.
Edward Cuthbert, Contractor and Builder, Fulton, Mich.
Eycleshymer & Snyder, "Builders of Good Houses," Niles, Mich.
Edw. I. Barnes, Chanute, Kans.

Arthur T. L. Thompson, Rushmore, Minn.
W. W. Lupton, Winnipeg, Man., Canada.
Joseph F. Jahnel, Jr., Coon Valley, Wis.
R. E. Crook, Architect, Nelsonville, Ohio.
George W. Eddy, Contractor and Builder, Marysville, Kans.
A. M. Williams, Contractor and Builder, Portland, Ore.
D. A. Gardner, Contractor and Builder, Dyersburg, Tenn.
J. Hand & Son, Onsted, Mich.
I. P. Hicks, Architect, Omaha, Neb.
Howard Hollman, Warren, Ohio.
C. F. Malmbourg (2 Designs), Tonkawa, Okla.

Osborn Bros., General Contractors, Bloomington, N. Y.
Louis Beck, Moweaqua, Ill.
Herman Schnoor, Fortuna, Cal.
Elwyn R. McKinstry, Ottawa, Ont., Canada.
Geo. D. McCleery, Contractor and Builder, Lawrence, Kans.
Geo. C. Johnson, Dexter, Iowa.
J. E. Offer, Contractor and Builder, Hickman, Neb.
Robert Christman, Bethlehem, Pa.
M. C. Parker, Contractor and Builder, Normangee, Texas.

Winners Class B—Best Designed Church, School, or Business Building Planned by a Reader of the "A. C. & B."

First Prize—Phillip Nelson, Contractor and Builder, Bowen, Ill.
Second Prize—H. D. Le Suer, Contractor and Builder, Plano, Iowa.
Third Prize—F. G. Rockwood, Grand Rapids, Wis.

HONORABLE MENTION—CLASS B

Jas. Snelgrove, Builder and Contractor, Beaverton, Ont., Canada.
John J. Binet, San Francisco, Cal.
A. L. Weinberger, Contractor and Builder, Beach, No. Dak.
Oliver Woodward, Contractor and Builder, Park, Kans.
Frank S. Stroup, Architect and Builder, Carey, Ohio.

Winners Class C—Finest Dairy Barn or Other Farm Building Planned and Built by a Reader of the "A. C. & B."

First Prize—L. P. Clark, Carpenter and Builder, Tillson, N. Y.
Second Prize—M. T. Kellor, Beloit, Wis.
Third Prize—Wm. Stelner, Johnson, Wash.

HONORABLE MENTION—CLASS C

George Holt, Carpenter and Frammer, Ellsworth, Iowa.
Albert Gonne, Highland, Mich.
Levi Landkamer, Alexandria, Neb.
Northern Construction Co., Contracting and Consulting Engineers, Mason City, Iowa.
Chas. W. Williams, Contractor, Builder and House Mover, Ridgeway, Wis.
C. F. Miller, Contractor and Builder, Hanoverton, Ohio.
William M. Chapman, Greenback, Tenn.
Frank Balbough, Contractor and Builder, Ewen, Mich.
J. A. Putman, Dunnville, Ont., Canada.

Winners Class D—Largest and Most Costly Structure Built Complete by a Reader of the "A. C. & B."

First Prize—Robt. L. White, Carpenter and Contractor, Lebanon, Tenn.
Second Prize—W. Twilley Maloney, Contractor and Builder, Allen, Md.
Third Prize—L. A. Hickey's Sons, General Contractors and Builders, South Bend, Ind.

HONORABLE MENTION—CLASS D

Joseph Taylor, Canton, Ohio.

Winners Class E—Most Modernly and Completely Equipped Residence Planned and Built by a Reader of the "A. C. & B."

First Prize—D. A. Haines, Mabel, Minn.
Second Prize—J. C. Warren, Contractor and Builder, Sedalia, Mo.
Third Prize—Joseph Stephens, Contractor and Builder, Paris, Ill.

STRUCTURES

BY OUR READERS



Prize Winners (Continued)

HONORABLE MENTION—CLASS E
 C. J. Toellner, Jr., Carpenter and Builder, Bunceton, Mo.
 Chas. Tyte, Fort Worth, Texas.
 Joseph Stephens, Contractor and Builder, Paris, Ill.
 P. O. Andrews, Architect and Superintendent, Mt. Sterling, Ky.
 Nels Olsan, Minden, Neb.
 J. W. Packer, Contractor and Builder, Oneonta, N. Y.
 D. A. Haines (2 Designs), Mabel, Minn.
 H. J. Noyes, Newburyport, Mass.
 Emmett Markley, Donovan, Ill.
 B. Torres, Builder, San Antonio, Texas.

Winners Class F—Finest Piece of Carpentry Work or Cabinet Making Done by a Reader of the "A. C. & B."

First Prize—John F. Coxhead, Yankton, So. Dak.
Second Prize—William Quilliam, Washington, Ind.
Third Prize—Geo. H. Rabenberg, Britton, So. Dak.

HONORABLE MENTION—CLASS F
 Alfred Sanders, Hector, Minn.
 P. H. Heron, Aberdeen, So. Dak.
 Arthur B. Kestell, of Brieske & Kestell, Carpenter Contractors, Elkhart Lake, Wis.
 Richard Barr, Carpenter, Contractor and Builder, Ravine, Pa.
 Ernest L. Hulbert, Montague, Mich.
 O. B. Overholser, Architect and Builder, Riverside, Iowa.
 James C. Sackett, Carrollton, Ill.
 Isaac Hughes, Ridgefield, Wash.
 August Droge, St. Benedict, Kans.
 Louis Schemanski, Alpena, Mich.
 Arthur B. Congdon, Goulds, R. I.
 Leon Clyde, Traverse City, Mich.
 Albert Gonne, Highland, Mich.
 John McElivee, Mt. Carmel, Pa.
 W. R. Schmieding, Hartshorne, Okla.
 W. M. Moore, Melfort, Sask., Canada.
 J. E. Gryde, Waldville, Sask., Canada.
 Howard P. McLaughlan, Contractor and Builder, Perth, N. B.

Winners Class G—Most Extraordinary Piece of Work Pertaining to Building Not Usually Classed as

Carpenters' Work, Done by a Reader of the "A. C. & B."

First Prize—Walter Thomson, Denver, Colo.
Second Prize—Frank Klepach, Cedar Rapids, Iowa.
Third Prize—Jno. Jenkin, Weyburn, Sask., Canada.

HONORABLE MENTION—CLASS G

D. A. Gardner, Contractor and Builder, Dyersburg, Tenn.
 Alfred Larry, Manufacturer of Cement Products, Grafton, Ont.
 Jas. Snelgrove, Builder and Contractor, Beaverton, Ont., Canada.
 Mercer Lawing, Tucumcari, New Mex.
 John Kurtz, Elwood, Ind.
 Robt. A. Heim, Lockport, N. Y.
 R. Verbeke, Tryon, N. C.
 P. P. Wright, Lima, Ohio.
 Tom Davies, Carpenter and Contractor, Durban, Man., Canada.
 Walter L. Hill, General Building Contractor, Okmulgee, Okla.
 Chas. C. Hummel, Espy, Pa.
 Wm. L. Steele, Jr., Bellefonte, Pa.

The several Prizes as offered in our January issue will be shipped to the winners at once:

To each of the 8 First Prize Winners, one regular DeLuxe Edition set of "Radford's Cyclopaedia of Construction," 12 Volumes.

To each of the 8 Second Prize Winners, one regular DeLuxe Edition set of "Radford's Cement Cyclopaedia"—5 volumes.

To each of the 8 Third Prize Winners, one Seven Volume Builders' Plan Library.

THREE facts have been driven home and well clinched in the minds of all those who have had the privilege of carefully examining all the examples of builders' work submitted in this competition. First, we are building better today than ever before; second, our houses are planned with more thought for conveniences and comforts; and third, the men who are responsible for this—the carpenters and builders—are doing their work well and deserve great credit.

We are building better. The writer can easily remember back to the time when one thousand or two thousand dollars at most, built the average dwelling. But look what it was; four walls and a roof—just the beginning of a residence as we think today. You will hear some mourn for the "old days" and tell about how cheaply one could build a house then; but those houses didn't have hardwood floors and fine

hardwood trim; and instead of the modern high cemented basement, waterproofed and plastered and as large as the main floor plan, those wonderfully cheap old houses were set on posts or on a surface foundation of stone, and only a little pit at the center was dug out for a cellar. Stoves answered for heating; and kerosene lamps were all the lighting system required; and as for water supply and sewage disposal, the former wasn't supplied and the latter wasn't disposed of! Bath rooms with sanitary set fixtures were unknown; a wash tub placed before the kitchen stove of a Saturday night had to do for the family bath.

Our houses today have all modern appointments for comfortable, convenient and sanitary living. Nowhere else in the world do the homes of the people contain so many ingenious, worthy devices for making the housework easy and living enjoyable. It costs more today to build because more is required. Our readers



are evidently seeing to it that in the buildings they plan every good thing is provided for.

Looking over the great mass of photographs, and studying the plans of all these structures designed and built by AMERICAN CARPENTER AND BUILDER readers in every State and Province in America, we appreciate in a new way the value of the work they have done. First class architectural work and the use of modern improvements are not confined by any means to New York City or Boston. The so-called centers of culture have no corner on good residence architecture nor on good substantial building construction. And we must give the keen and wide-awake builders, operating in the smaller cities and towns, full credit for having kept fully abreast of the times, in spite of their handicaps. Their work, both in the designing of their buildings and in the execution of the contracts, will bear the closest inspection.

The carpenter and builder will usually give his

customer the sort of a structure that that customer (and his wife) want—as nearly as he can; and in this he is not so very different from his brothers of the city ateliers. But here is where the good work of the local carpenter and builder comes in, and we have to give him full credit for it. He is keeping himself informed in regard to the new and worth while things pertaining to the planning, building and equipping of present-day structures, and he is exerting his influence at every opportunity *so that his customers will want what he knows to be best for them.*

The good results of these "missionary" efforts are sometimes overlooked; but in the aggregate they are stupendous. The photos and plans sent us in this competition illustrate the average run of building activity throughout the country generally. A study of these will show how far carpenters and builders have been able to mould public opinion along advanced lines pertaining to building design and construction.

First Prize Class A—Best Designed Residence (Small) Planned by a Reader of the "A. C. & B."

Modern 8-Room Dwelling at Denver, Colo.

Designed and Built by Charles M. Gates, Architect and Real Estate Builder

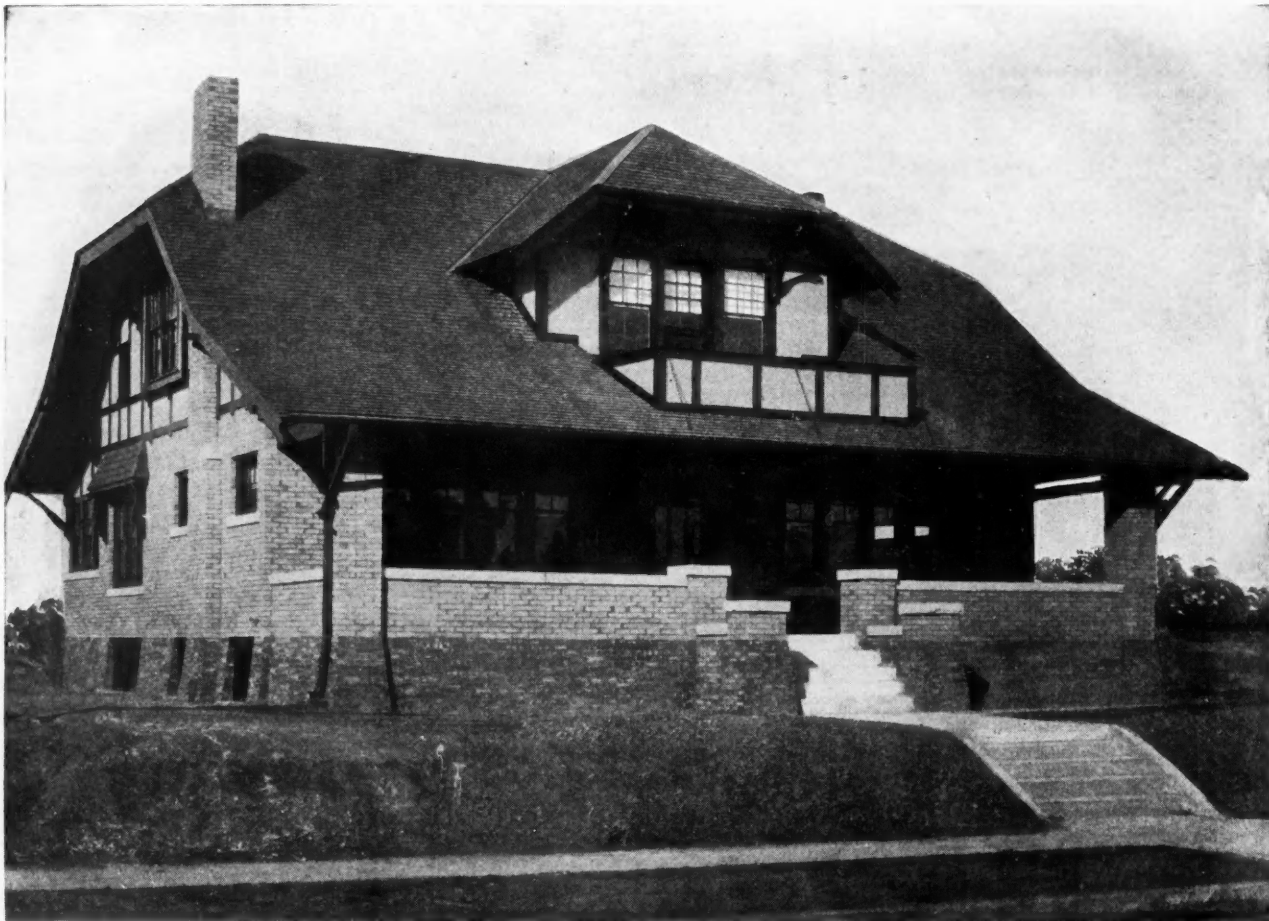

First Prize Small Residence; Substantial; Face Brick; 8 Rooms; Modern in Every Way; Designed by Chas. M. Gates and Built in Denver, Colo., for \$5,500



AWARD.—More than the ordinary amount of interest always attaches to a building design that is a prize winner. We may concur at once in the decision of the judging committee and find much to approve; or we may—and very often do—have quite different ideas about what is good design and convenient planning. But even as we quarrel with the jury we are sizing up the award—and generally find it to possess some worth-while points.

seemed unfair to judge modest three and four thousand dollar bungalows in competition with big residences costing five times as much—especially as it is well known that the successful small dwelling is the more difficult to design.

The announced requirements for Class A called for simply the *planning* of the residence. It is quite significant that the majority of the work submitted had been both planned and built by our subscribers.

The First Prize for the best designed small residence goes to Mr. Chas. M. Gates, a licensed architect of Denver, Colo., and Sec.-Treas. of The Gates Bros. Realty Co. Here is what he says of this house:

“In this plan you have several distinctive features—features that the housewife of the city home will appreciate. The front porch, being of the size it is and on the east, is an ideal living porch for the summer

PHONE MAIN 6204

CHAS. M. GATES
Architect
LICENSE No. 72
DENVER, COLORADO

Secretary-Treasurer of
THE GATES BROS. REALTY CO
SUITE 511 IDEAL BLDG.

Mr. Gates Is a Thorough Business Man

As practical men who are concerned every day with the actual planning and construction of buildings of various kinds it is likely that our point of view differs from that of the layman or of the art critic. We are interested in certain of the practical aspects of a house design: What is its cost? Could more be had for the same money, if laid out differently? Is the interior arranged for convenience? Is it a popular plan, which any household would approve of—permitting a ready sale, if desired? What of the exterior design?

afternoons; and the balcony over it converts the front bed room into an upstairs living room if you wish it.

“The dining and living room, connecting as they do, give the house an air of elegant roominess that is hard to better, besides being what is constantly asked for in our western metropolis. The room off the hall can be used as a living room or a ground floor bed room. It has a large closet as well as a sun parlor off, connecting with French windows. Having a bath up and

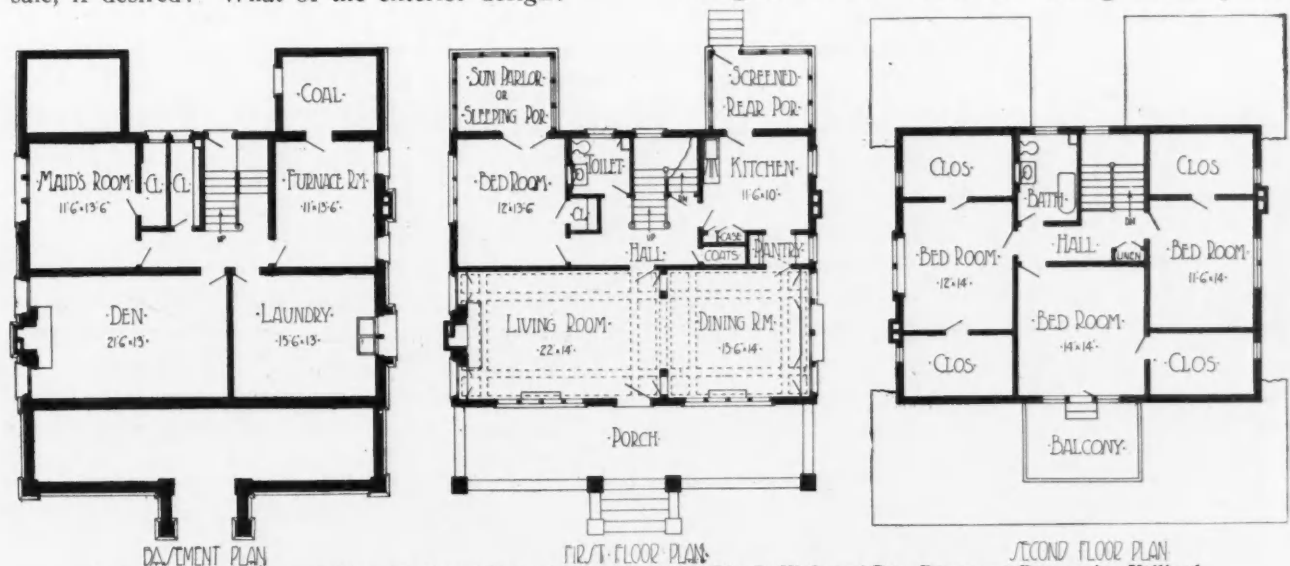

Basement Plan First-Floor Plan Second Floor Plan
Interior Arrangement of Chas. M. Gates' Bungalow; As Building Site Is High and Dry, Basement Rooms Are Utilized

These are about the order of importance of these several counts as they appeal to practical builders.

Class A of the Prize Competition is for the best designed residence. So many designs were submitted in this class—well-planned small houses and well-planned large houses—that it was decided to divide this class into two, and add three more prizes. It

one downstairs saves many a step for both mistress and maid.

“The den as well as the maid's room is in the basement. The entire basement is fully plastered and finished, giving it a finished, homey appearance. The upstairs has three good rooms with square ceilings, and four large closets.



"I built this house at a cost of \$5,500 here in Denver, using a \$25 pressed face brick, extra heavy footings, and building under very strict building restrictions. It is modern to the minute.

state that the owner sold it a year later, making a net profit of \$1,200.

Chas. M. Gates, Architect License No. 72.

Denver, Colo.

"To show how well this home is liked, will simply

Secretary-Treasurer of The Gates Bros. Realty Co."

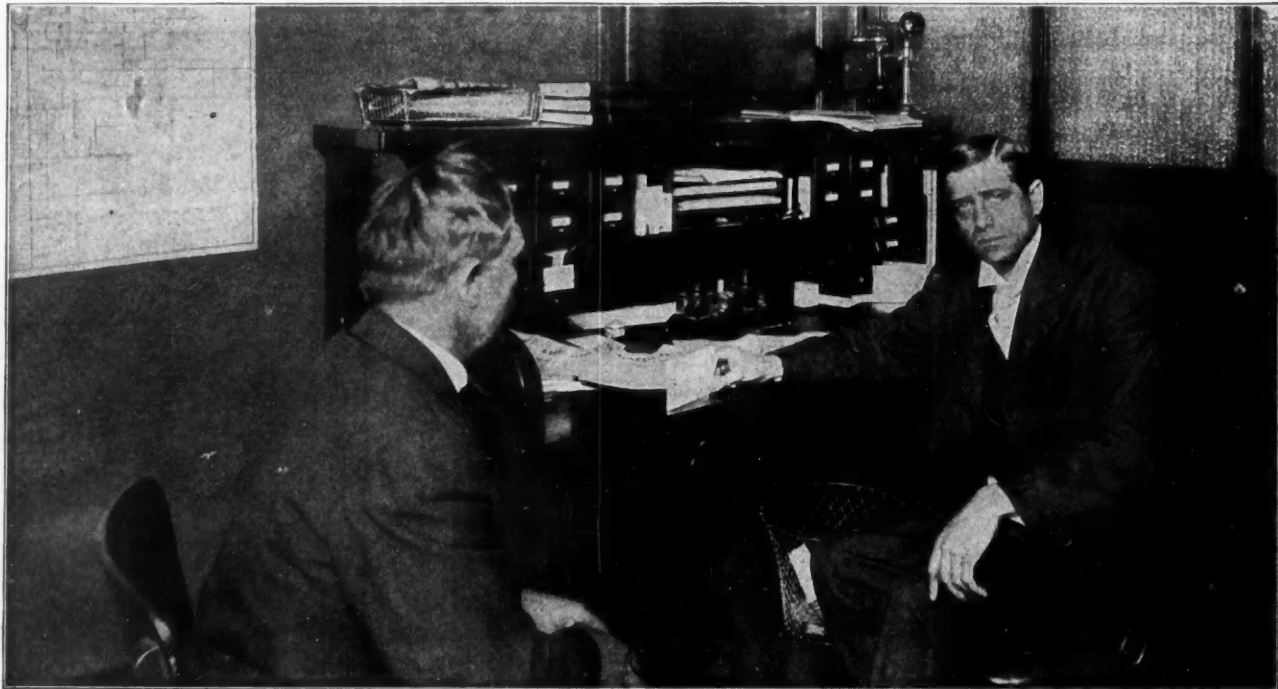

Chas. M. Gates in His Office—Note That He Keeps His Bound Volumes of the "A. C. & B." Close at Hand

We are glad to know that our old friends stay with us. Here is a photo received from Mr. Gates four years ago and published in our April, 1909, issue, correspondence column. This is what he wrote us then:
 "Enclosed find order for a renewal of my subscription. Just to show you what we of the Gates Bros. Realty Company think of the American Carpenter and Builder I want to say that the publications for the years 1905, 1906, 1907 and 1908 I have had bound into four volumes with the year of publication on each one. In the first volume, and as a fly leaf, I have had bound in my certificate of charter membership. I would not do without the volumes for twice what it cost to bind them. Am sending you an idea of how they look on my desk—1908 happened to be on my drafting table when the picture was taken.
 CHAS. M. GATES, Secretary."

Second Prize Class A—For Small Residence Planned by a Reader of the "A. C. & B."

Model 9-Room Bungalow at El Paso, Ill.

Designed and Built by Jos. A. Riechel, Building Contractor.

THE second prize for a small residence is awarded on the neat, attractive bungalow illustrated on the opposite page. Mr. Jos. A. Riechel, its designer and builder, writes of it:

"This bungalow has full basement, concrete floors,

concrete block foundation, concrete steps to porches, slate roof, pressed brick chimneys, siding in first story, shingles in gable ends. Double floors throughout. Living room, library and dining rooms have $\frac{3}{8}$ by $\frac{7}{8}$ -inch quarter sawed white oak floors, balance of floors are

BUILDINGS ERCTED RECENTLY

PUBLIC LIBRARY, ATLANTA, ILL.
 PUBLIC LIBRARY, EL PASO, ILL.
 CITY HALL, EL PASO, ILL.
 BAPTIST CHURCH, EL PASO.
 NUMEROUS RESIDENCES.

BLUE PRINT PLANS, SPECIFICATIONS AND ESTIMATES FURNISHED

JOS. A. RIECHEL,

BUILDING CONTRACTOR.

EL PASO, ILL..

El Paso is a Prosperous Hustling Town of 1,500 People, Mr. Riechel is the Building Authority There

$\frac{7}{8}$ by $2\frac{1}{4}$ -inch edge grain yellow pine. Finish in principal rooms is quarter sawed white oak, balance of house yellow pine, stained "mission" except bath and two first-story bedrooms are done in white enamel. Living

Colonade has book case pedestals. "Complete plumbing and hot air heating outfit included. Also vacuum cleaning machine in basement run by electric motor. "Cost complete, \$5,300.00."

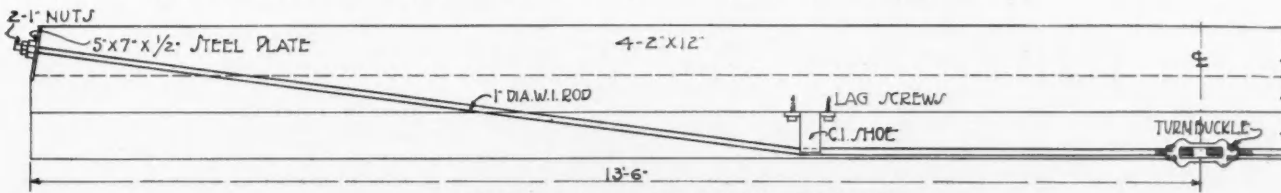

BELLY-ROD TRUSS FOR PORCH

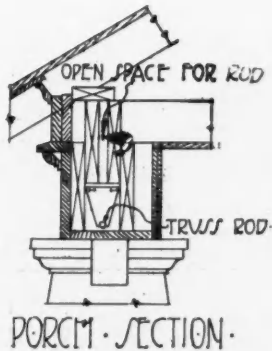

PORCH SECTION

and dining rooms have beamed ceilings, dining room has paneled walls below plate-rail. Walls in first story are sand finished and frescoed in various colors. Living room has Roman press brick mantel.

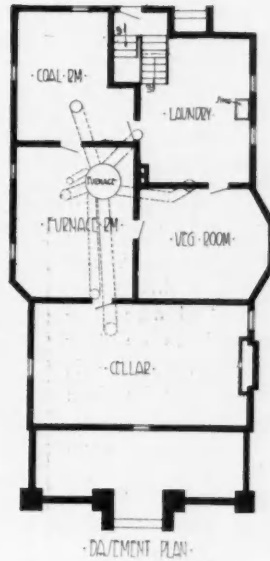

BASEMENT PLAN

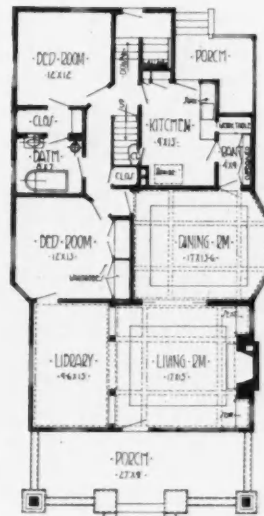

FIRST-FLOOR PLAN

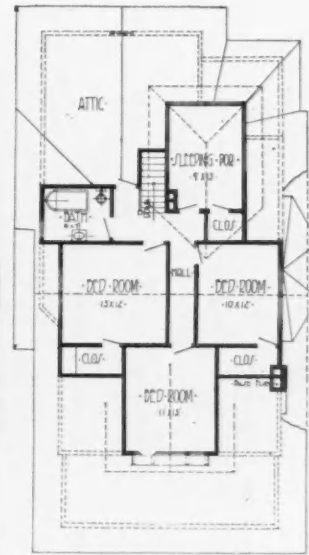

SECOND-FLOOR PLAN



9-Room Story and Half Bungalow Designed and Built by Contractor Riechel at El Paso, Ill., for \$5,300



Third Prize Class A—For Small Residence Planned by a Reader of the "A. C. & B."

A Six-Room Stone Bungalow at Waterville, Conn.

Designed and Built by John S. Dixon.

THE third prize for small residences is awarded on the stone bunaglow planned and built by John S. Dixon at Waterville, Conn., illustrated herewith. The cellar walls are of rough stone, 22 inches thick, and laid 6 inches below cellar floor. Exterior walls are 10 inches field stone, laid up in black cement, and backed with 4-inch brick to make a nailing for furring. All window and door openings are supported at top with angle irons. Veranda floor is cement reinforced with expanded metal, and troweled to a smooth finish. Chimney is of field stone with two

flues, one for kitchen range and boiler in cellar, and one for fire-place in den. Fire-place is of field stone run to ceiling (not plastered above metal). Outside woodwork is of Georgia pine painted two coats Carter's Pure White Lead. Roof is tight boarded, covered with asphalt roofing, and tiled with terra cotta tile furnished by Ludowici Celadon Co. of Chicago (weight, 36,000 pounds of tile). All rooms but den finished with N. C. pine. Den is finished with chestnut. Floors are of N. C. pine except den, parlor, and hall, these are quartered oak. Walls are plastered with Adamant plaster, white hard finish.

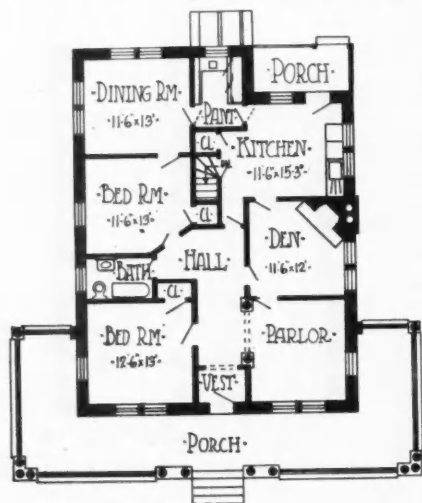

FLOOR PLAN

Pantry is fitted with flour bin, china closet with four drawers under, and small cupboard, also has six shelves and counter. Dining room fitted with plate rail, and has swinging doors on floor hinges leading to kitchen. House is equipped with hot water heat (Crawford boiler, made by Walker & Pratt Co., Boston, Mass.), with radiators in all rooms, including kitchen. Plumbing installed connected with cess pool, and building is piped with gas, and wired for electricity.

ESTIMATED COST

Mason work, including plaster	..\$2,080.00
Carpenter work 1,600.00
Tile roof, including laying 500.00
Plumbing and heating 426.00
Electric wiring, including fixtures 98.00
Total\$4,704.00

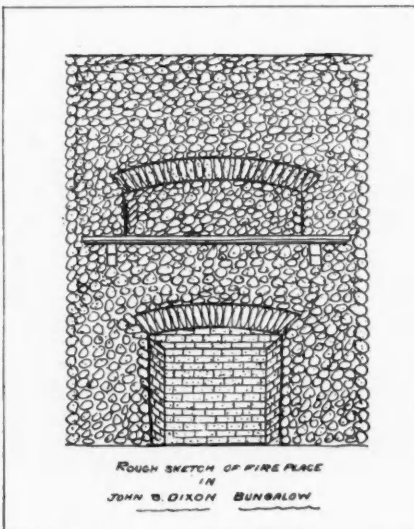

ROUGH SKETCH OF FIRE PLACE IN JOHN S. DIXON BUNGALOW



6-Room Stone Bungalow Designed and Built by Mr. John S. Dixon at Waterville, Conn., for \$4,704



First Prize Class A—Best Designed Residence (Large) Planned by a Reader of the "A. C. & B."

Popular Hip-Roof Brick and Stucco Residence at Davenport, Iowa

Designed and Built by

ALFRED J. DANIELSEN
Contractor and Builder

PHONE 2368-L

1736 Eola Street DAVENPORT, IOWA

ESTIMATES CHEERFULLY FURNISHED

THE judging of the large residences proved quite as difficult as the small. All the work submitted in this class seemed to have prize winning points; in fact, many of the Honorable Mention designs stand very close to the winners. These interesting Mention designs in all the Classes will be presented in these pages next month and thereafter.

The first prize for best designed large residence goes to Alfred J. Danielson, contractor and builder, of Davenport, Iowa, on the dignified, popular style, brick veneer and stucco residence shown on this and the next page.

He writes of this house:

"I am sending you photos and plans of a two-story, brick-veneer and stucco residence I built in 1912; built complete in four months with about four men, average.

"I drew the plans myself last winter in spare time. You will find my name on blue print. Cost about \$7,000.00. (The building looks a good deal better than it shows in the photo.)

"The pressed brick cost \$20.00 per M., mixed dark brown in color, with

a smooth white sand finish stucco above and green dipped shingles on roof; exposed rafters on main building dormers and porches and out buildings, and finish first floors quartered red oak; kitchen and pantry cypress finish maple flooring; second floor plain red oak finish and floors. There's a very pretty art glass grape design in dining



Floor Plan Diagrams and Front View of First Prize Large Residence Designed and Built by Contractor Alfred J. Danielson at Davenport, Iowa for \$7,000



Another View of Builder Danielsen's 1st Prize Winner. He States He Is Designing and Building Many Such Residences in Davenport, that Growing City of 45,000 People

room of building, also art glass in bath and library; fancy bevel plate glass in front transoms and vestibule side light and doors, and art glass in stairway landing, first floor. I make quite a point of fancy glass work and my customers like it.

"I am 25 years old, have been in business for two

years; built one house first year, same order as this only siding on entire house.

"Built three houses this year costing \$7,000.00, \$5,000.00, \$6,500.00, and other repair work, etc. Am ready to build six houses next year. I draw most of the plans of the houses I build myself."

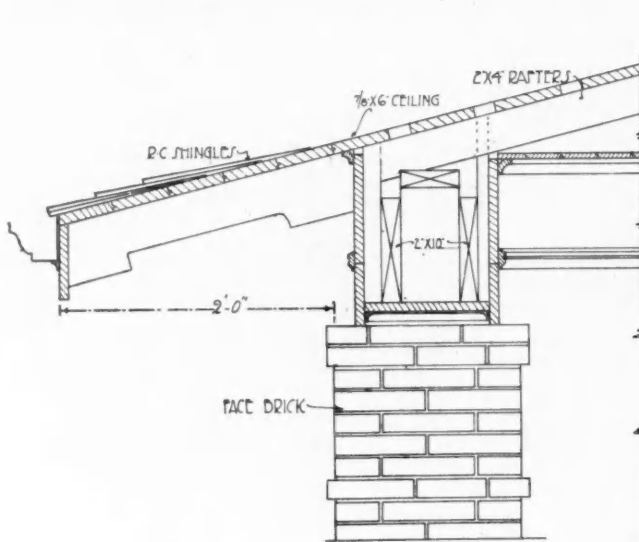

DETAIL OF FRONT PORCH CORNICE.

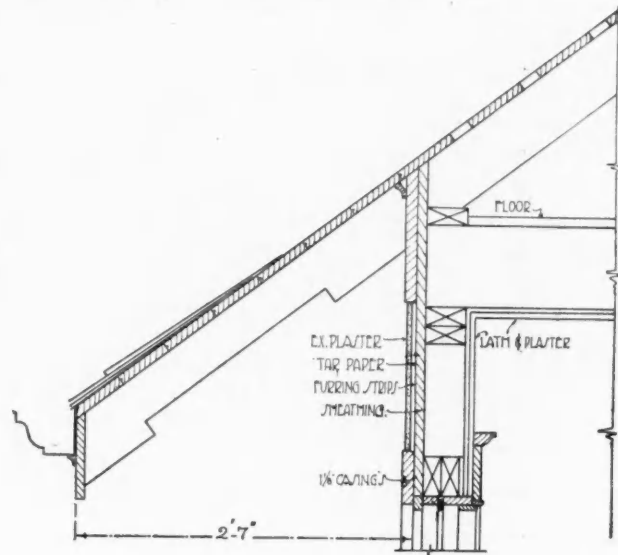

DETAIL OF MAIN CORNICE.

Showing Approved Construction Methods Used on Danielsen's Work



Second Prize Class A—For a Large Residence Planned by a Reader of the "A. C. & B."

Unique Dwelling for Business Street in San Francisco

Designed and Built by

THE second prize in this class goes to a structure which is rather unusual—a residence for a narrow lot where no light can be had from the sides. This is a problem often confronting city builders, where a building combining a store room or other business place on the first floor with living rooms above is wanted.

EDW. A. F. CARSON
Carpenter and Builder

PLANS AND ESTIMATES FURNISHED AT SHORT NOTICE

San Francisco,

This building illustrated on this and the next page was designed and built by Edw. A. F. Carson, carpenter and builder, of San Francisco, Calif. He has this to say for his work:

"I am enclosing under separate cover floor plans, elevation, detail sheet, specifications and photo of finished building, of a six room residence costing four



Clever Handling of a Hard Problem—An Attractive Dwelling on a Narrow Lot in a Closely Built Up City Street—Designed and Built by Edw. A. F. Carson, at San Francisco; Cost \$4,000



Floor Plans of Carson 6-Room Dwelling

thousand (\$4,000.00), dollars. The entire work of planning, tracing, detailing, and blue printing and erecting under contract was done entirely by me personally. I am an amateur; that you will see upon inspection of my drafting, the only knowledge I have in that line was gained from your valued journal, *THE AMERICAN CARPENTER AND BUILDER*, of the last 5 years I have been reading it. I have all the issues of your journal. Ideas gained from Radford's "Details of Building Construction" are used in building plans I am sending. I have a copy of this book and value it very highly. I receive great assistance from it.

"The plans I am sending are for a lot 24 feet 8 inches front-

age, with a building on either side, hence the light court. Most all San Francisco building lots are 25 feet frontage. The Building Laws here under the supervision of Board of Public Works, require plans, specifications and application filed in duplicate. One set of plans must be in cloth print, same returnable to builder at completion of building.

"This house is heated by two open fire-places; the climatic conditions here do not require furnace or steam heat. We do not show side and rear elevations excepting corner lots; on inside lots all side walls are blind walls. Sides have to be finished back on joist and moved out in place as a finished wall."

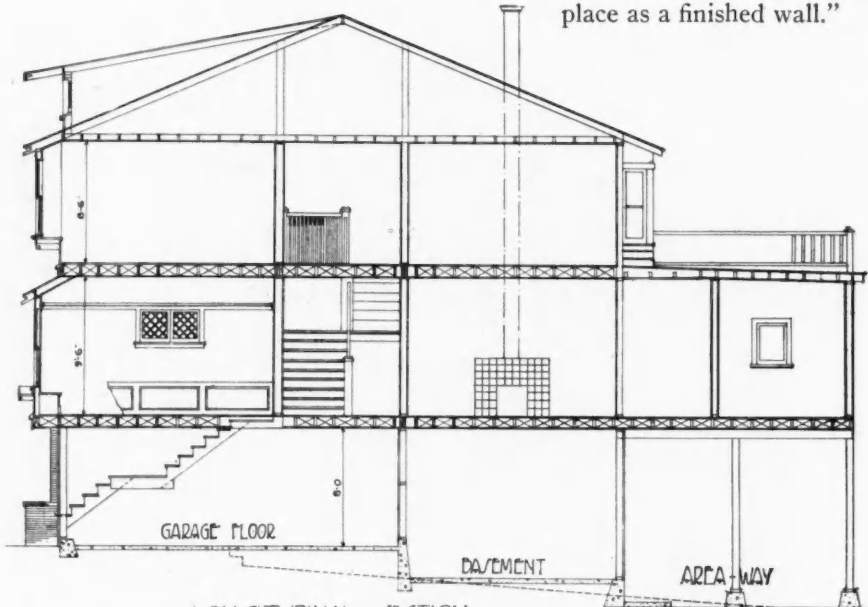

LONGITUDINAL SECTION

Layout of 2nd Prize Structure—See Page 47

Third Prize Class A—For Large Residence Planned by a Reader of the "A. C. & B."

Magnificent House of Classical Design at San Antonio, Texas

Designed by B. Torres, Contractor and Builder, Brownsville, Texas.

A RESIDENCE design of much distinction, a design typical of the dignity, splendor and hospitality of the South land called forth much favorable comment while the competition was being judged and is herewith awarded the third prize for best planned large house. Mr. B. Torres, a contractor and builder, of Brownsville, Texas, drew the plans for this. It was erected at San Antonio for Mr. W.

H. Daniel. The cost complete was \$6,500. This structure is illustrated on the opposite page.

This is a modern residence in all its appointments, and is elaborately finished, much paneled and turned woodwork being used. There is no basement. The floor plan diagrams show that the exterior of this place make good fully the promise of the exterior design.

PRIZE WINNING STRUCTURES
PLANNED AND BUILT BY OUR READERS

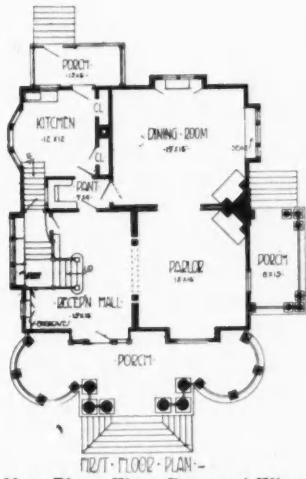

FIRST FLOOR PLAN
 Note Plans Were Reversed When House Was Built

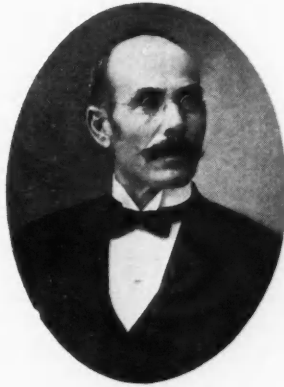

B. TORRES
 Contractor and Builder

Mr. Torres is "The Builder" at Brownsville, Texas, a Coming City Now of About 12,000 Inhabitants. His Reputation as a Builder is Spreading. It Reached Out in This Instance Clear to the City of San Antonio, Where This Important Commission Was Handled Satisfactorily by Him.



SECOND FLOOR PLAN
 Note Plans Were Reversed When House Was Built



Third Prize for Large Residence, Planned and Built by B. Torres, of Brownsville, Texas, for Mr. W. H. Daniel, at San Antonio, Cost \$6,500



First Prize Class B—Best Designed Church, School, or Business Building Planned by a Reader of the "A. C. & B."

New Christian Church at Bowen, Ill.

Designed and Built by

CLASS B of the competition proved something of a surprise. It is evident that our readers are great builders of churches. And we don't mean by this either that they neglect the other sorts of public structures, schools, libraries, town halls, etc.; not at all. It is simply that this competition brought out the church planning talent most strongly.

The first prize goes to Mr. Philip Nelson, contractor and builder, of Bowen, Ill., for the design and construction of the beautiful new Christian Church of that place. In writing of this he says: "This is a very neat, convenient and substantial brick veneered church building for a country village. It has cut

PHILIP NELSON
CONTRACTOR AND BUILDER
BOWEN, ILLINOIS

stone trim and pressed brick exterior. It is impossible to fully appreciate this building without a view of the interior which is very neat in design,—frescoed on a sand finished plastered wall. This was done by a first-class artist of Springfield, Ill., a German who learned his trade in his native country. The woodwork throughout the entire building was finished in yellow pine—stained to imitate mahogany and all doors built up in harmony with the style of exterior (English Gothic).

"The auditorium will accommodate, in the curved seats, about 170; and odd space for chairs will accommodate about fifty more; also the Sunday School



First Prize Church—The New Christian Church at Bowen, Ill.; Designed and Built by Contractor Philip Nelson. Cost \$12,000. Bowen is a Thriving Town of About 1,000 Population; Our Subscriber Is the Building Expert Throughout This Community.



Room, separated by rolling partitions, accommodates about seventy-five and Sunday School side room and extra room in choir space, also other spaces, accommodate fifty, making a total of 350 by using chairs.

"This building has a commodious basement—a large kitchen under Sunday School rooms with coat and cloak rooms; also has ample space for furnace and coal rooms. The side walls of basement were shaded with paint of light green color and ceiling of a light gray solid color. For floor in basement a drain tile was laid in the dirt surface and filled in with loose crushed stone, a little above level of the drain tile leading to the main drain tile—above this an ordinary cement finished floor was run in; which makes a good, dry floor. The main foundation and basement walls were built of poured concrete about 5 feet high and 18 inches wide above footing or to grade line. At this point a cut stone water table was set, receiving basement windows; from this point to top of basement windows and bottom of floor joist a dark paving brick rock faced for the outside course, backed up with a 13-inch wall of hard burned brick. Above water table belt course at top of basement windows, a good quality of Quincy red pressed brick was used with cut stone trim.

"All brick work around the heavy stone front en-

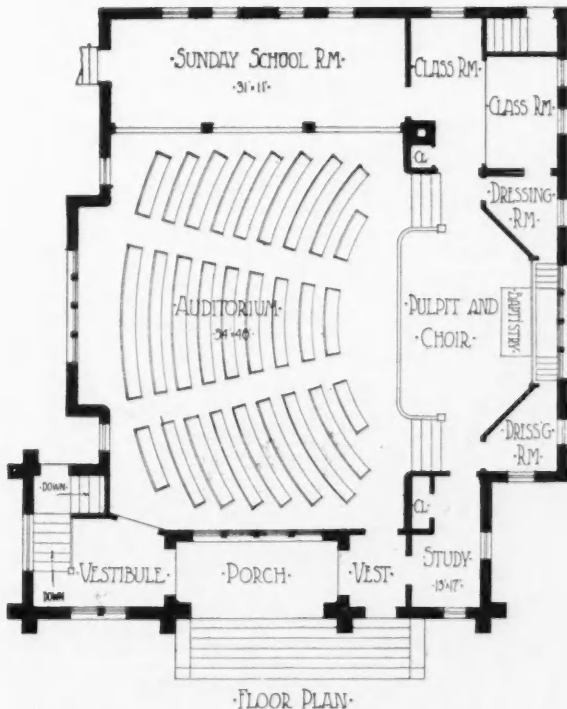

Convenient Arrangement of Bowen Christian Church

trance at front is solid brick work, reinforced with stay rods and I-beam. All windows are glazed with a very nice design of art glass; and seats of a very good design and quality. The roof is covered with Cortright Metal Slates, which I think is the best

obtainable on the market at the price today, considering the quality and looks. The building is heated throughout with steam generated by furnace in basement.

"Much more could be said about this building; how-



Another View of 1st Prize Church

ever, I have gone beyond the two hundred and fifty word limit and will close. The cost of this building was \$12,000.00 at Bowen, Ill."



Will Curb Fire Loss

THE Fire Prevention Commission of Philadelphia of which Mr. Powell Evans of the Merchant & Evans Co., is chairman, is actively engaged in reducing fire loss and danger in the Quaker City.

The commission plans a strict inspection of all buildings beginning immediately and continuing regularly hereafter. By this means the unsafe buildings will be discovered and proper protection insisted upon. A detail of firemen has been sent to New York City for a course of instruction under the Fire Prevention Bureau of that city.

The importance of this forward move must not be lost sight of as property loss by fire has been reduced in various cities as much as 90 per cent. There is no town, however small, that should be without a committee on fire prevention and Philadelphia's Commission through Chairman Evans aims to co-operate with every town and state to further the commendable work of decreasing the fire risk.



Quick to See the Joke

Traveling Inspector (to his host, the squire of the village)—"A most amusing thing happened today. I was questioning the class, and asked a boy, 'Who wrote Hamlet?' and he answered, tearfully, 'P-p-please, s-sir, it wasn't me.'"

Squire (after loud and prolonged laughter)—"Ha, ha! That's good. And I suppose the little devil had done it all the time."

A Sign Found in a Mine

Notice to all employes
 any Person or Persons that Mooves into A house Without
 my Consent shall be Put out Without enney Cemmony.
 Dam it I Must and Will have some Sistom.



Second Prize Class B—For Church, School, or Business Building Planned by a Reader of the "A. C. & B."

The Church of Christ at Seymour, Iowa

Designed and Built by

THE second prize in Class B also goes to a church builder, Mr. H. D. Le Suer, of Plano, Iowa—based on his new Church of Christ at Seymour, which is illustrated here.

H. D. LeSuer

Contractor and Builder

Planning, Drafting and Blue Printing

Plano, Iowa, *Jan 27th* 1918

called merely for buildings *planned* by our readers. Mr. Le Suer writes us as follows:

"I designed and built this church last summer for the members of The Church of Christ at Seymour, Iowa.

A noteworthy fact about this public building competition also—as in the residence class—all of the designers of the buildings proved to be likewise their contractors, although the requirements of the competition

The building is 64 by 70 feet in plan, with 18-foot studding. The foundation walls are built of cement blocks on concrete footings. The basement has cement floor; all walls are plastered; ceilings are



Second Prize Church—The New Church of Christ at Seymour, Iowa, Designed and Built by Contractor H. D. Le Suer of Plano. Plano is a small Town, about 300 inhabitants, but the center of a most prosperous Farming Community. It speaks well for the standing of our subscriber that he was called away to the neighboring city of 2,500 to plan and build this church



finished with metal ceiling and painted. The kitchen is provided with cupboards, sink, water, etc.; the dining room has china closet, and tables for 100 plates. The auditorium is 44 feet square with bowled floor, having

are glazed with Holly glass, also second story windows in belfry. All other windows are leaded art glass.

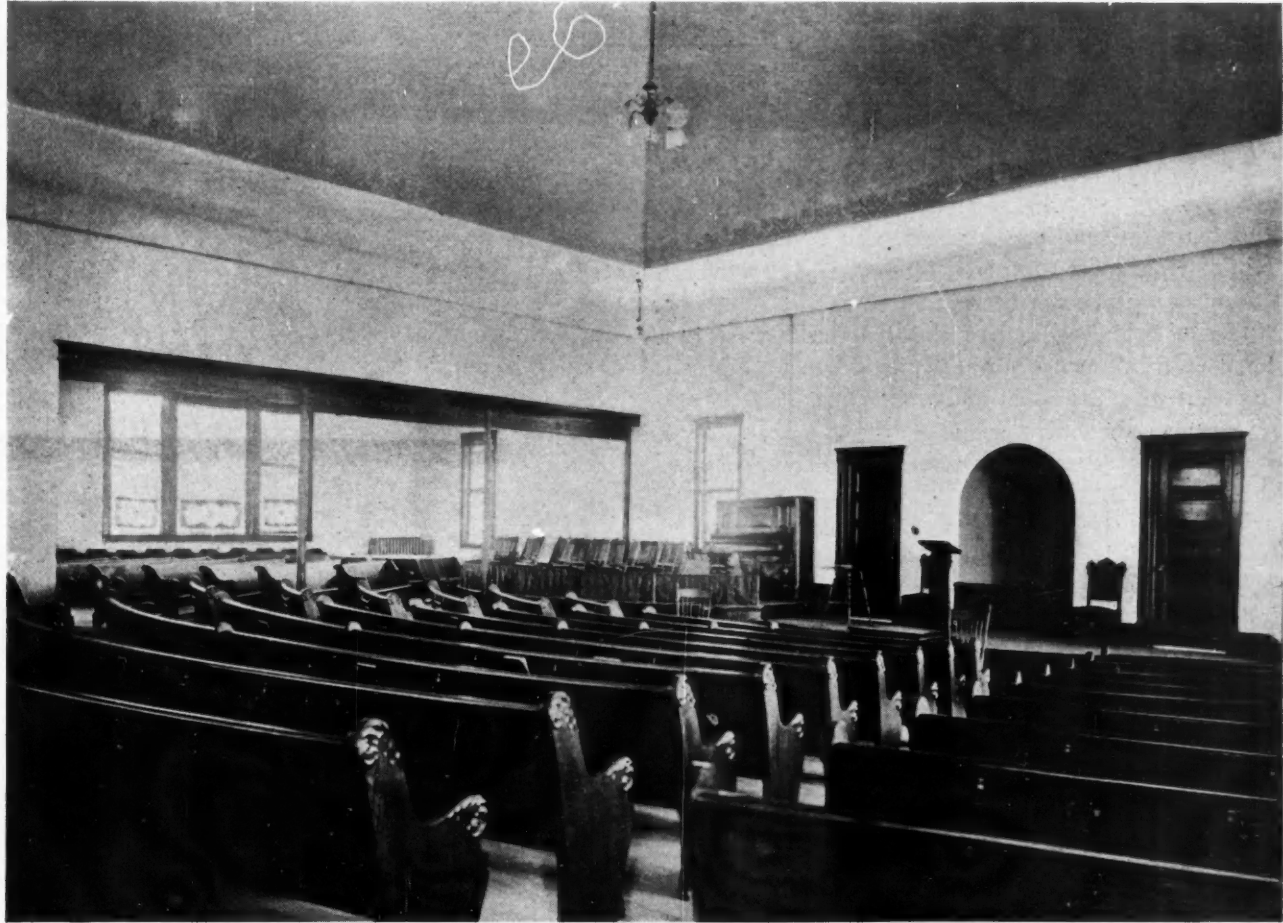

Attractive Interior of Church of Christ at Seymour, Iowa

a rise of 18 inches in 28 feet. The ceiling is in the form of an ellipse. The platform is 24 inches high. The choir loft is 8 inches higher than platform; the dressing room floors are on a level with platform. The bapistry is just back of platform and is provided with steps leading up to hall as shown.

"All walls and ceilings are plastered, having a float or sand finish which is tinted and decorated with Alabastine colors. The rooms are all finished with yellow

"The rolling partitions were installed by H. B. Dodge & Co., of Chicago. The building is heated with a double pipe steam heating system installed by a local firm. They also did the plumbing. The city did the wiring for the electric lights.

"I use power woodworking machinery right on the job and think it a paying proposition. I think the AMERICAN CARPENTER AND BUILDER a great paper and a valuable addition to any carpenter's library."

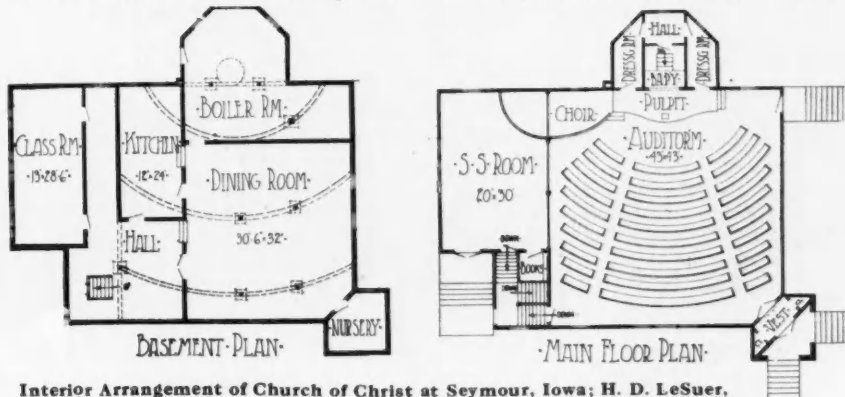

Interior Arrangement of Church of Christ at Seymour, Iowa; H. D. LeSuer, Plano, Iowa, Architect and Builder



Third Prize Class B—For Church, School or Business Building Planned by a Reader of the "A. C. & B."

New Congregational Church at Vesper, Wis.

Designed by Fred G. Rockwood, Contractor and Builder, Grand Rapids, Wis.

THE third prize in Class B is awarded to Mr. Fred G. Rockwood, of Grand Rapids, Wis. He writes about his entry as follows:

"I herewith send you a photo, also floor plans, of the Congregational Church at Vesper, Wis., for which I drew up the plans and specifications.

"About January 1st, 1912, the Board of Trustees of the Congregational Church Society announced that they were going to build a church. They set to work at getting subscribers enough to nearly pay for a church to cost about \$2,800.00. This they soon succeeded in doing.

"They then began to search for satisfactory plans for such a building. They received several sketches and a couple of sets of blue prints, but no estimates except mine as to the cost of erecting the church according to their plans.

"Some of these plans were very nice, but they were too costly.

"The congregation then decided to vote by written ballot as to whose plans they should accept. The

consequence was that my plans were accepted. Following is a note clipped from one of Vesper's papers

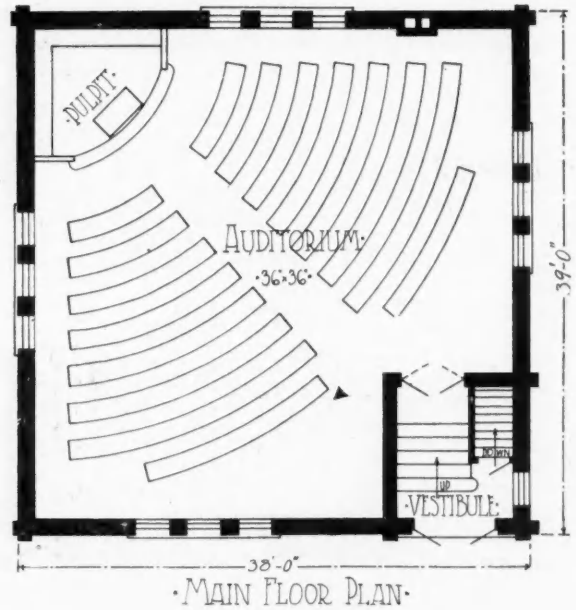

Congregational Church at Vesper, Wis. The Building Committee Went to Fred G. Rockwood, a Contractor and Builder Operating in and around Grand Rapids—A Bustling City of 6,500—for the Plans and Specifications.

regarding the plans:

"On Wednesday evening of last week the building committee having in charge the construction of the new Congregational Church, accepted the plans drawn by Fred Rockwood.

"By eliminating \$400 for the lots, the cost of the furnace and furnishings it brings the actual cost of the church a trifle over \$2,900, which is a very modest sum for so permanent a structure. There may be a few correction bills that will modify these figures, somewhat, but they are approximately correct.

"The contracts were awarded for the brickwork and carpenter work, etc.; and the work proceeded. The building is now completed and you may be sure that the people in Vesper are proud of this building."



First Prize Class C—Finest Dairy Barn or Other Farm Building Planned and Built by a Reader of the "A. C. & B."

Huge Bontecoe Dairy Farm Barn at Tillson, N. Y.

Planned and Built by L. P. Clark, Carpenter and Builder, Tillson, N. Y.

AMERICAN CARPENTER AND BUILDER subscribers have long been recognized as the country's foremost barn builders. Many of them live in the small and thriving farming center towns; and their fields of building activity naturally embrace all the surrounding farms. When any building is wanted the carpenter and builder in the nearby town is the logical man to handle it. He is looked upon as an authority on all building matters, and so has to keep

in close touch with what the manufacturers are all the time bringing out new for this class of work.

We are very pleased to award the first prize in the farm building contest to Mr. L. P. Clark of Tillson, N. Y. The immense modern sanitary dairy barn on

the Bontecoe Dairy Farm, which he planned and built, is the structure submitted which wins the prize. With reference to this structure and his work, Mr. Clark writes:

**L. P. CLARK,
Carpenter and Builder.**

High grade work a specialty.

Tillson, N. Y.

"CARPENTER AND BUILDER"—An Honorable Title in the Building World

"I am no expert drafts-

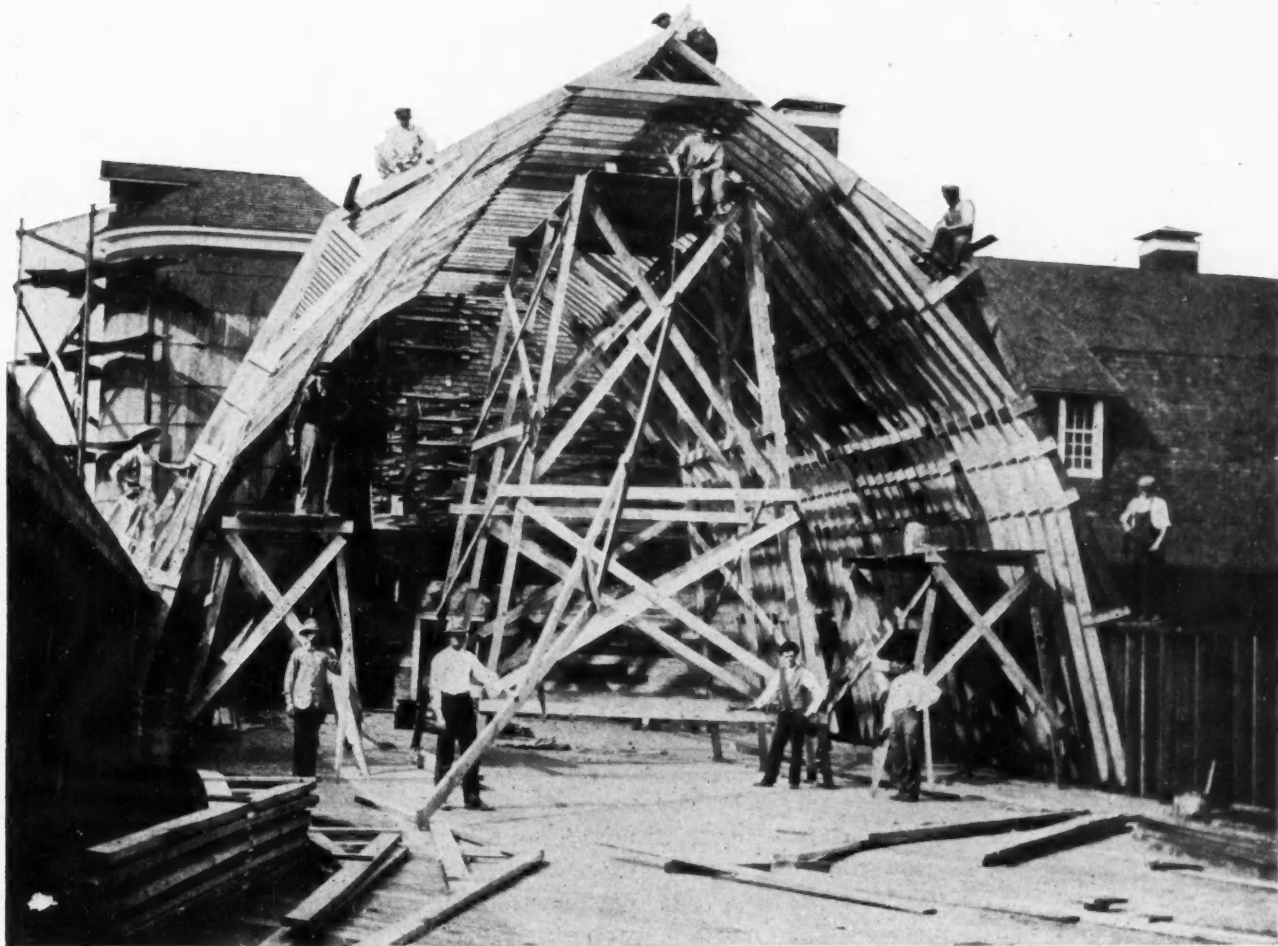

FRAMING THE ROOF OF SECOND SECTION OF HUGE DAIRY BARN AT TILLSON, N. Y.
The Barn is in the form of an L; and one Section was Built and Finished Complete before the other one was started

PRIZE WINNING STRUCTURES
 PLANNED AND BUILT BY OUR READERS

[March

man, but do all my own drawing and superintend all construction on a large farm, where the breeding of high-class Holstein cattle is a business.

"This barn was constructed in two sections, as you will see by photo. This was done to accommodate the

from approach to approach, with 22-foot posts was constructed, together with two silos, 16 by 40 feet. Later the second part, 40 by 130 feet, 14-foot posts, and silo, 12 by 20 by 40 feet, were added.

"The foundations and floors, gutters, mangers, etc.,

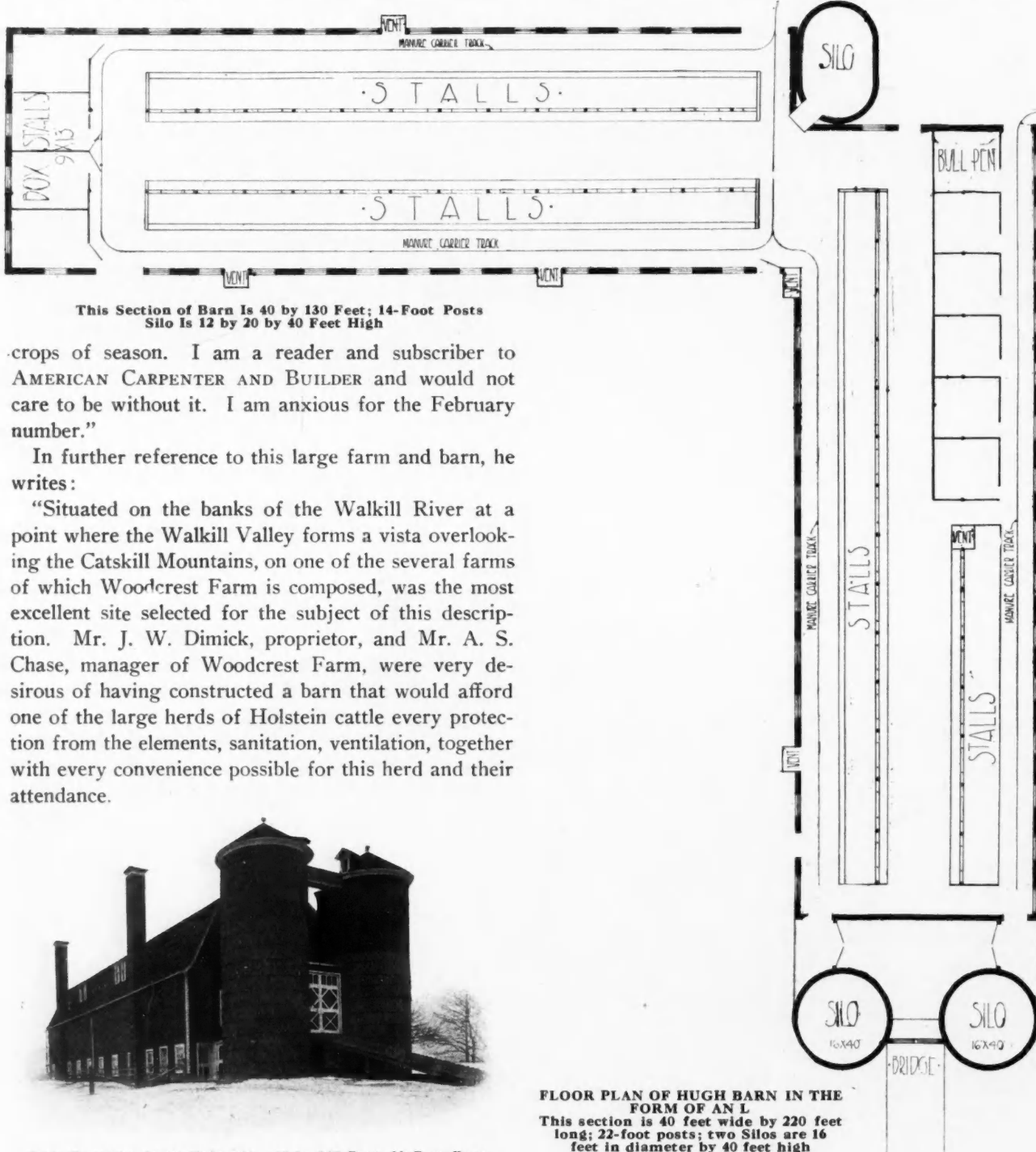

This Section of Barn Is 40 by 130 Feet; 14-Foot Posts
 Silo Is 12 by 20 by 40 Feet High

crops of season. I am a reader and subscriber to AMERICAN CARPENTER AND BUILDER and would not care to be without it. I am anxious for the February number."

In further reference to this large farm and barn, he writes:

"Situated on the banks of the Walkill River at a point where the Walkill Valley forms a vista overlooking the Catskill Mountains, on one of the several farms of which Woodcrest Farm is composed, was the most excellent site selected for the subject of this description. Mr. J. W. Dimick, proprietor, and Mr. A. S. Chase, manager of Woodcrest Farm, were very desirous of having constructed a barn that would afford one of the large herds of Holstein cattle every protection from the elements, sanitation, ventilation, together with every convenience possible for this herd and their attendance.



This Part Was Built First; Size 40 by 220 Feet, 22-Foot Posts

"The collecting of data and drawing plans for this structure, as well as superintending the construction, has been the source of much pleasure to the writer.

"It was found advisable to construct the barn in two sections due to season and conditions; consequently, as may be seen by one of the photos, a part 40 by 220 feet

FLOOR PLAN OF HUGH BARN IN THE FORM OF AN L
 This section is 40 feet wide by 220 feet long; 22-foot posts; two Silos are 16 feet in diameter by 40 feet high

are built of concrete; in fact, everything in concrete or galvanized iron up to the window sills. Sills, 6 by 10 chestnut; all studs, 2 by 10; entire building covered with shiplap, papered, and shingled with best R. C. shingles.

"The first story is used exclusively for cows and is



equipped with Louden galvanized stanchions, box stalls, etc. An automatic water system furnishes each cow fresh and clean water. The manure carrier track installed provides that a car can be run to any part of stable and run to a circular dump or shed not shown on plans.

use of hay fork and carrier.

"The 130-foot section has the eight feed bins and a clear loft, 40 by 60 by 30 feet. The creamery, 20 by 26 feet, has the modern equipment, as well as the Kewanee Water System, with engine boiler and tanks with a capacity sufficient



GENERAL VIEW OF COMPLETED BONTECOE DAIRY FARM BARN
L. P. Clark, Carpenter and Builder, Tillson, N. Y., writes: "The collecting of the data and drawing plans for this structure, as well as superintending the construction, has been the source of much pleasure."

The liquid manure is also collected at a large cistern, 12 by 20 by 12 feet. The entire lower part of barn is ceiled with $\frac{7}{8}$ by $7\frac{1}{2}$ pine ceiling and painted a light gray.

"The second story is provided with eight feed bins; each will hold a carload of feed, and so located that the feed carrier on lower floor can be filled conveniently. The longer section of barn has driveway all way through with appliances that hay may be unloaded on either side, in bay, as well as on a third story by

to supply the plant with plenty of water of the very best quality.

"The entire building covered with shingles that were dipped in creosote stain of a soft green shade and trimmed with white. As a whole, no pains or expense have been spared to make this plant one of the very best that planning, material and money could offer.

"As I wrote you, I am employed steady on this farm, and find your AMERICAN CARPENTER AND BUILDER one of the necessities of my shop."



Interior View of Dairy Stable Section. Manure Carrier Runs on Overhead Track to All Parts; Sanitary Metal Stanchions Provided; Interior Tight Ceiled



Second Prize Class C—For Dairy Barn or Other Farm Building Planned and Built by a Reader of the "A. C. & B."

A Round Dairy Barn at Beloit, Wis.

Planned and Built by M. T. Kellor of Maurer and Kellor, Beloit, Wis.

THE second prize in the farm building class goes to Mr. M. T. Kellor, of Maurer & Kellor, Beloit, Wis., who designed and built this round barn for Mr. W. J. Dougan. He writes that this barn is one of several units which form one of the best dairy farms in Southern Wisconsin.

"Barn is 64 feet in diameter, is built up 3 feet above cement floor of 10-inch concrete, remainder of 8 feet of basement is 2 by 8-inch studding, above basement 2 by 6-inch by 16-foot studding. All plates are formed by nailing 1 by 6-inch pieces together, forming a continuous plate about the whole structure.

"Rafters each form a truss, converging at center of silo. Silo extends 6 feet below floor of basement and runs up 52 feet, inside measurement. On top of this is 4 feet of wall 2 by 6 studding, sheated both sides,

and in which are located filling door and windows for lighting inside of silo.

"Ventilator shafts run up on either side of silo for ventilating basement, one of which forms silage chute. At regular intervals on outside of basement are fresh air intakes.

"Four square feet of light is provided for each of forty head of stock, for which barn is built.

"Eight feet above second floor on side on which is located silage chute, are the grain and other feed bins, with chutes running down into basement inside feed aisle in front of stock.

"Elevators are provided to elevate all feed to bins. The engine room is located on second floor of vestibule. Feed cutters and grinders are located conveniently between engine room and silo.



SECOND PRIZE—LARGE ROUND DAIRY BARN—A NOVELTY SHOWING MANY GOOD POINTS
This was Designed and Built by M. T. Kellor, Beloit, Wis. It has all modern appliances, even to a vacuum cleaner for removing flies from the cattle as they enter the door

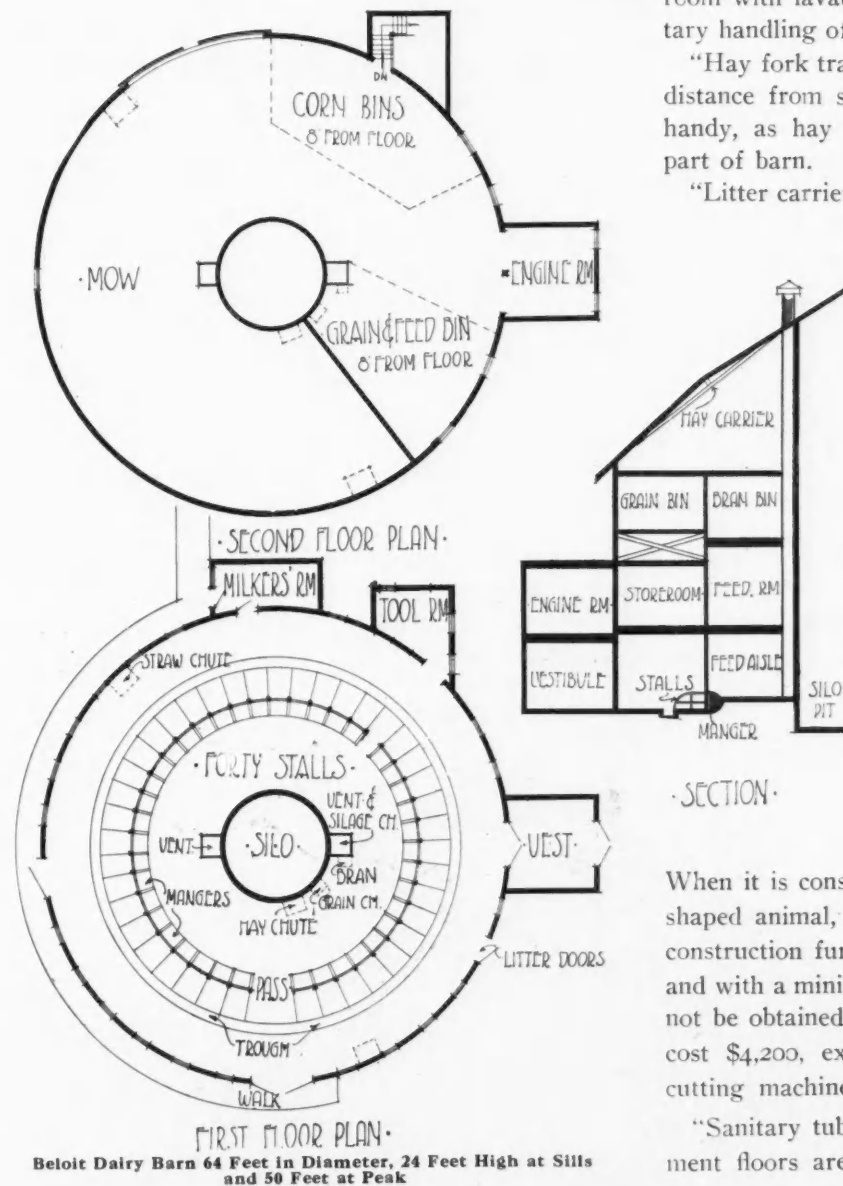

Beloit Dairy Barn 64 Feet in Diameter, 24 Feet High at Sills and 50 Feet at Peak

room with lavatories, etc., used in line with the sanitary handling of milk.

"Hay fork track is located under rafters about equal distance from side of barn and silo, making it very handy, as hay and fodder can be deposited in any part of barn.

"Litter carriers in basement run out in yard. Silage and feed trucks in feed alley next to silo enables all stock to be bedded and cared for by a short operation of one man, thus doing away with the services of two men in handling of stock in barn.

"The outside of barn is sided with drop siding and inside of basement is sheathed with matched lumber above cement wall. The roof is shingled with the best R. C. shingles; galvanized ventilators are provided in roof to carry off all foul air from basement, also a number of skylights in roof to light mow. The vestibule on side keeps out cold in winter and here are located the vacuum brushes for removing flies from stock coming into barn.

When it is considered that the dairy cow is a wedge-shaped animal, it can be readily seen that the round construction furnishes the ideal shape of stall for her and with a minimum space in front of stall, which cannot be obtained in any other construction. The barn cost \$4,200, exclusive of engine and grinding and cutting machinery.

"Sanitary tubular steel stanchions are used. Basement floors are all of cement, as are feed troughs.

Third Prize Class C—For Dairy Barn or Other Farm Building Planned and Built by a Reader of the "A. C. & B."

Unusual Gothic Roof Barn at Johnson, Wash.

Planned and Built by Wm. Steiner of Steiner Bros., Carpenters and Builders.

THE third prize, after considerable discussion, is awarded to Mr. Wm. Steiner, of Johnson, Wash., on the striking barn of unusual design illustrated. He writes regarding this:

"I am sending you a photo of a barn which shows our way of building them. This kind of barn is being built almost entirely in this section of the country. They look good and can't be beat for hay room. This one is the first one that Steiner Bros. have built of its

kind.

"In building one of these barns, first put up your frame work, and lay the upstairs floor. Mark a straight line, the width of your building, on the floor, then get the distance from the plate as you have it on your small plan. Nail a couple of 1 by 4's together, lay a 1 by 12 board down and mark off your pattern.

"Then mark the circle on the floor to nail your rafters together by. A good average height is about a

PRIZE WINNING STRUCTURES
PLANNED AND BUILT BY OUR READERS

foot less than two-thirds the width of the building. Rafters are made out of 1 by 12's, ripped down to not less than 6 inches at either end. With about four thicknesses nailed to-

Put a couple of guy ropes on your pole to brace it. Put a block and tackle on the top of the pole and raise one rafter at a time. When up, plumb it and brace it and move your

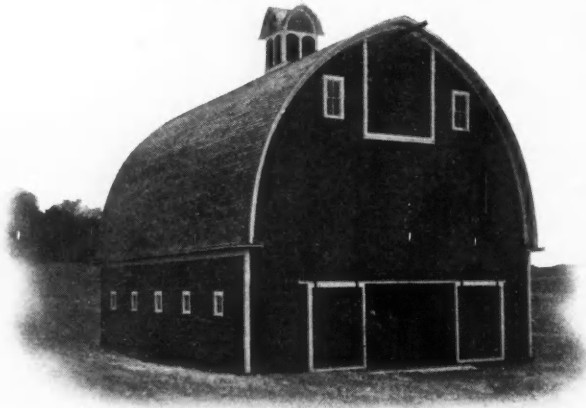

Completed Barn of Striking Design, Planned and Built by Wm. Steiner, Johnson, Wash.

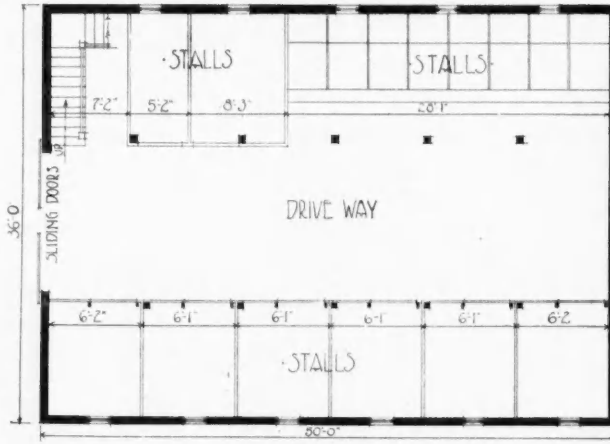

FLOOR PLAN

gether, and joints well broke, put your rafters about 6 to 8 feet apart. Make a long gin-pole, just long enough so your rafters will swing over the top of it.

pole to the next rafter. When your rafters are up put in your 2 by 4's lengthways, starting with the first one between the rafters. Gradually allow them to come out as you get higher, keep coming out till you



WM. STEINER AND MEN FRAMING GOTHIC ROOF BARN AT JOHNSON, WASH. Curved Rafters are Sawed Out 1 by 12's and Nailed four together.

have them on top of the rafters. Plumb your rafters as you go. Before you get too high with your 2 by 4's start your 1 by 4's up and down, as it might prevent the 2 by 4's pulling loose. Double them and brake joints.

"When on, put on your cornice; then you are ready



for sheeting. Build a rounding or a straight pitch eave to start shingles on. If needed, put braces between your rafters on the inside. And whatever you do, don't be afraid to use nails in one of these buildings."

First Prize Class D—Largest and Most Costly Structure Built Complete by a Reader of the "A. C. & B."

\$75,000 Southern Mansion at Lebanon, Tenn.

Built Complete by

THIS part of the competition brought out some wonderfully fine and magnificent examples of builders' work. It is certain, judging from these, that as general contracting builders, handling the entire building proposition, Our Folks are a great success.

Without hesitation we award the first prize in this class to Robt. L. White, carpenter and contractor, of Lebanon, Tenn., on his handling of the complete contract for the splendid residence of Mr. D. E. Mitchell of that place. The firm of Thompson, Gibel & Asmus, of Nashville, Tenn., were the architects.

Mr. White, the builder, writes concerning this job:

ROBT. L. WHITE

CARPENTER AND CONTRACTOR

*Interior Finish and Cabinet Work
a Specialty*

Lebanon, Tennessee

Lebanon has Only 3,600 Inhabitants but Some Worth While Building Work is Being Done There

"In addition to the main floor, diagram of which is shown, this house has the following on second floor: Six bedrooms, linen closet, sewing room, three bathrooms and hall and colonade in center. All wood-

work on this floor is finished in white egg-shell gloss; walls in rooms all finished in colors. First floor has one large hall and side halls and circular stairway, as shown by photograph.

"This finish is quartered white oak, hand rubbed. Dining room is finished same as hall; living room finished as hall; kitchen and breakfast room finished in white; library, as shown by photograph, finished in Philippine Mahogany. All brackets and hangers hand



\$75,000 Residence of Mr. D. E. Mitchell, Lebanon, Tenn. Designed by Thompson, Gibel & Asmus, Architects, Nashville, and Built Complete by Robt. L. White, Carpenter and Contractor, of Lebanon

PRIZE WINNING STRUCTURES
 PLANNED AND BUILT BY OUR READERS

[March

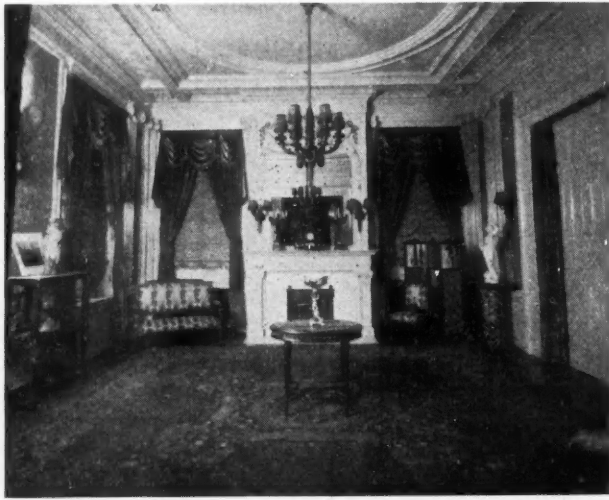

Drawing Room Finished in White and Hung With Embroidered Silk



Spaciousness and Elegance the Keypnote of This Residence

carved; marble mantle; the woodwork in this room was finished at a cost of \$7,000. The finish is a piano finish.

"Drawing room as shown by photograph is finished in white; the panels are embroidered silk. These rooms and hall have quarter-sawn white oak floors and satin



Main Hall and Stairway in Mitchell Residence, Finished in Quartered White Oak, Hand Rubbed



Library Finished in Philippine Mahogany, Hand Carved and Given Piano Finish. Cost of Finishing this Room was \$7,000. Robert L. White, Lebanon, Tenn., Carpenter and Contractor

finish. I finished the interior of these rooms with only one helper, from the simple fact there is only a very few who can do this class of work. It is all of best material and workmanship throughout. The home is built of native stone at a cost of \$75,000.00.

"Lebanon is a town of only 5,000 people, and this home is one of the prettiest in the South. You won't find a more classic home outside of New York, Chicago, or some large city. Wishing for the AMERICAN CARPENTER AND BUILDER the best year it ever had."

Second Prize Class D—For Large and Costly Structure Built Complete by a Reader of the "A. C. & B."

\$14,000 Country Home at Princess-Anne, Md.

Built Complete by

THE second prize is this class goes to W. Twilley Malone, contractor and builder of Allen, Md., on the work illustrated. He writes:

"In entering Class D of your Prize Competition I realize that I am going up against the 'big

W. TWILLEY MALONE
 CONTRACTOR AND BUILDER

ARCHITECTURAL DRAWING A SPECIALTY
 AGENCY FOR AMERICAN COLONIAL COLUMN AND
 EDWARDS SPANISH TILE

Allen, Md.

guns' in this contest; but it is the energy and enthusiasm with which the editor of our grand building paper is ever striving to enthuse us that causes me to enter this class.

"I am aware of the fact that a young man of 26 years is greatly

PRIZE WINNING
 PLANNED AND BUILT
 STRUCTURES
 BY OUR READERS

[March

handicapped in a contest of this kind in going up against 'seasoned timbers'; however, if we don't 'buck the line' we'll not accomplish anything; so here goes.

"My entry is the home of Mr. J. Charlton Rowers, situated on the Wicomico River, near Princess-Anne, Md., designed by Ernest A. Arend, New York, and built in 1911.

"The house is located on the crest of a small hill, which slopes away to the river, making a charming location. The river here is in the form of a crescent,

which blends beautifully with the landscape. The house is 50 by 49 feet, inclusive of verandas, and contains throughout the finest grades of materials the writer has ever seen.

"A concrete floored cellar extends under the greater part of the house and here are located heater room, fruit room, coal bins, etc.

"The main feature of the first floor is the large living room (20 by 28 feet), which, together with the open stair hall and dining room, make the larger part

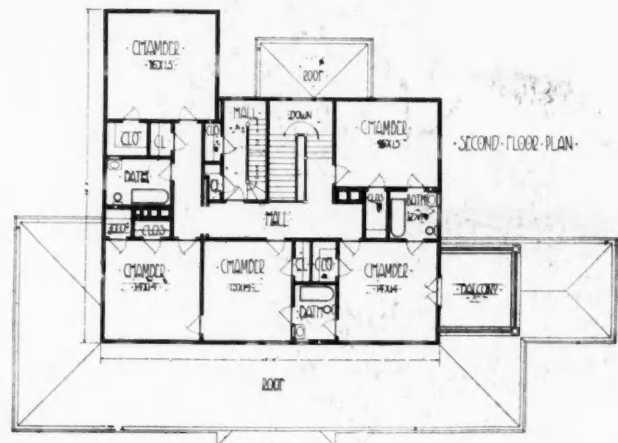

Ten Large Rooms, Well Laid Out and Having All Modern Equipment

giving a fine view from three sides of the house.

"Spacious verandas on all sides is an assurance of being able to enjoy the summer breezes at all times. The exterior is painted white with moss green roof,

of this floor almost as one room.

"The dining room is much larger than the average size, it being 17 by 20 feet 6 inches.

"At the back of dining room a large butler's pantry



Second Prize for Costly Residence, Built Complete by W. Twilley Malone, Contractor and Builder, Allen, Md. This is the Residence of Mr. J. Charlton Rowers at Princess-Anne, Designed by Ernest A. Arend of New York



GENERAL VIEW OF HOUSE AND GROUNDS AT PRINCESS-ANNE, MD.
This \$14,000 Modern Residence Built Complete by W. Twilley Malone, Contractor and Builder, Allen, Ind.

connects with the kitchen. The pantry is equipped with a sink and large dresser. The kitchen as shown on plan is very nicely arranged. The maid's porch is latticed and screened.

"The den contains a 'built-in' book case and open fire-place. It is finished in mahogany.

"The dining, living rooms and hall have a paneled wainscot 5 feet high and beamed ceilings in finely figured chestnut, stained a soft brown. Large open fire-places add the necessary finishing touch.

"On the second floor are five good sized bedrooms and three bathrooms. The baths are tiled and each contains a recessed cabinet. There is an abundance of closet space throughout. The entire second floor is finished in white enamel. The third floor contains two bedrooms and a bath. This floor is finished in gulf cypress, finished natural. The floors are edge grain yellow pine.

"The floors on first and second stories are quartered oak except servant's wing, first floor, which is finished in trim and floor the same as attic. First and second floors are double with Florian Deadening Felt between.

"Basement and foundation wall are constructed of best hardened brick laid in cement mortar. Frame long-leaf yellow pine, siding gulf cypress. All other outside material, such as base, cornice, columns, etc.,

is of best white pine. The house contains a hot-water heating plant, acetylene lighting plant and has an electric bell system throughout. The house was six months in building. Cost complete, \$14,000.00. I kept from four to six men (carpenters) on the job."

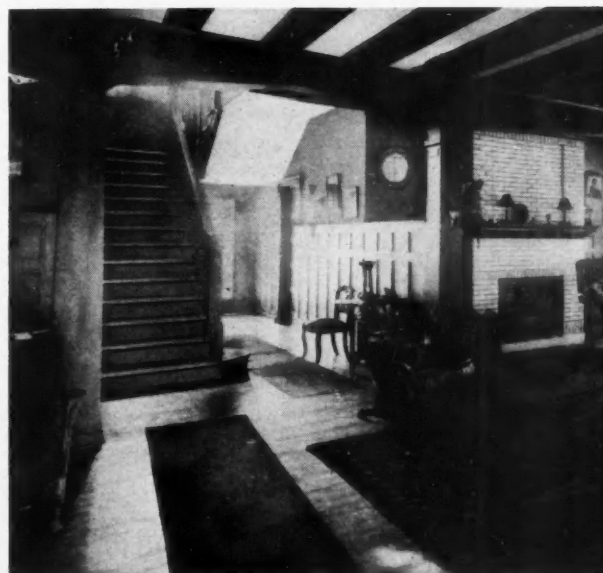

Interior View of Stair Hall and Ingle Nook in Malone House

Third Prize Class D—For Large and Costly Structure Built Complete by a Reader of the "A. C. & B."

Modern \$14,000 Residence at South Bend, Ind.

Built Complete by

THE third prize in this Class goes to Mr. Thos. L. Hickey of L. A. Hickey's Sons, General Contractors and Builders, South Bend, Indiana. The builders statement follows:

L. A. HICKEY'S SONS
GENERAL CONTRACTORS
AND BUILDERS
424 NORTH ST. LOUIS STREET
SOUTH BEND, INDIANA.

Influential Builders in This City of 54,000

Owner, Mr. C. A. Dolph; architects, Freyermuth & Maurer; contractors, L. A. Hickey's Sons; cost, including garage, \$14,000; six months in building.

This residence is finished throughout in quartered white

PRIZE WINNING STRUCTURES
 PLANNED AND BUILT BY OUR READERS



FIRST FLOOR PLAN SECOND FLOOR PLAN ATTIC PLAN
 Interior Arrangement of So. Bend House. Shows 13 Rooms and Many Good Ideas

oak, has billiard and dance hall on third floor. Exterior: first-story pressed brick; second-story, stucco over metal lath; roof, slate. Has complete vacuum cleaning outfit, with taps on each floor to which hose

may be attached.

The heating system is the Norwall Vacuum system, American boiler and radiator vacuum air valves and packless radiator valves.



Third Prize—Modern Queen Anne Style Brick and Plaster Residence of Mr. C. A. Dolph, So. Bend, Ind.; Designed by Freyermuth & Maurer and Built Complete by L. A. Hickey's Sons, General Contractors and Builders, for \$14,000.



First Prize Class E—Most Modernly and Completely Equipped Residence Planned and Built by a Reader of the "A. C. & B."

Up-to-the-Minute Brick and Frame House at Mabel, Minn.

Planned and Built by D. A. Haines, Mabel, Minn.

THIS building, which is awarded the first prize in this Class, is of brick and frame construction with a cottage style roof. It has a full basement with 12-inch brick foundation walls cemented on the outside below grade with Atlas Portland cement. The entire basement floor is also cemented with Atlas Portland cement. The basement is divided into a laundry, a vegetable cellar coal, bin, boiler and work

two 4-inch walls with a 2-inch air space between. All exposed brick are hard red—all other are common hard brick. Porch piers are also brick. The water table, sills and caps are gray Indiana Bedford rock.

The second story is frame construction, the dimension stuff is all No. 1 white pine. The outside walls are sheated with a No. 2 fence flooring, lined on the inside with Cabot's sheathing quilt, and on the outside



First Prize Modernly Equipped Residence—An 8-Room Brick and Timber House, Planned and Built by D. A. Haines of Mabel, Minn.

room, and toilet. The laundry is equipped with a three compartment stone laundry tray, laundry box with a clothes chute which extends up to the bath room on the 2nd floor, and a laundry stove. The vegetable cellar is partitioned off with an 8-inch brick wall, and is provided with a preserve cupboard for the reception of canned goods. The coal bin is sheated on the inside with No. 2 flooring, lathed and plastered on the outside, and provided with a Holland iron coal chute.

The first story walls are brick, 10 inches thick—

with 35 lb. red rosin paper, and covered with cedar shingles—5 to 2— as is the roof also. The exterior finish is C select white pine and given three coats of white paint trimmed in medium moss green. The shingles were stained to match the trimming. The porch floors are cypress.

The interior finish in all the rooms below is oak floors and trim, excepting the kitchen, pantry and entry which are maple floors and Y. P. trim.

The second story is oak floors and trim throughout.



-BASEMENT PLAN-

-FIRST FLOOR PLAN-

-SECOND FLOOR PLAN-

Interior Arrangement of First Prize Modern Residence, Designed and Built by D. A. Haines

All the wood work is finished with Johnson's Wood dyes, fillers and flat finish, excepting the floors are waxed. Morgan doors are used throughout.

The windows are all equipped with Caldwell's sash balances, excepting the basement sash are hung on loose pin butts. The plastering is all two coat work of Climax Wood Mortar, manufactured by the Grand Rapids Plaster Co. The hardware trimmings are wrought bronze, antique finish, manufactured by Sargent & Co. The colonnade, fireplace and tile hearth were manufactured by Chas. F. Lorenzen & Co. The sinks and bath room fixtures are white porcelain lined "Standard" make.

The building is heated with a Furman hot water boiler and American radiators. It is lighted with a combination electric and acetylene gas plant, using an Eagle gas generator, and equipped with Macbeth-Evans shades and globes.

Special Features and Equipment

- 1st.—Large library with a fireplace, built-in book cases and seats.
- 2nd.—Dining room with a built-in buffet, and a toilet.
- 3rd.—A good sized pantry with built-in sinks and cupboards.
- 4th.—Large kitchen with water sink, work table and cabinet.
- 5th.—Rear entry with refrigerator and storage room for coats, caps, etc.
- 6th.—Combination cellar stairs.
- 7th.—Enclosed sleeping balcony.
- 8th.—Clothes chute and well equipped laundry.
- 9th.—Water closet in basement.
- 10th.—Iron coal chute in coal bin.
- 11th.—Porte-cochere and cement drive.
- 12th.—Pleasing exterior appearance.

Second Prize Class E—Modern and Fully Equipped Residence Planned and Built by a Reader of the "A. C. & B."

A Two-Family Dwelling at Sedalia, Mo.

Planned and Built by

THE second prize is awarded to J. C. Warren, contractor and builder, of Sedalia, Mo. He writes:

"Editor AMERICAN CARPENTER AND BUILDER: I am one of your charter members. I have every number



J. C. Warren, Contractor ^{and} Builder

ESTIMATES MADE ON ALL KINDS OF BUILDINGS.
PLANS FURNISHED WHEN DESIRED.

Office 671 East Fifteenth Street.

Home Phone 315.

SEDALIA, MO.,

19

Go-ahead Builder of this City of 19,000 Inhabitants

of the AMERICAN CARPENTER AND BUILDER that has been published to date and want to say that what I now know about drafting and planning has been learned from the AMERICAN CARPENTER AND BUILDER and your books. The usefulness

PRIZE WINNING STRUCTURES
PLANNED AND BUILT BY OUR READERS



of this knowledge to me is beyond any attempt of placing a value on same.

The AMERICAN CARPENTER AND BUILDER and its books are worth their weight in gold to any carpenter that wants to gain knowledge in his craft.

"This is a two family modern residence which I planned, designed and built for C. E. Whitney of Sedalia, Mo., last year, at a total cost of \$6,105.00. As the plan indicates each apartment is entirely separated from the other from basement to attic. This design has attracted considerable attention since being built from its exterior appearance and from the interior arrangement. The building is heated by steam. The plumbing is modern and first class. The building

doors are 2 panel veneer. The foundation, concrete with cement blocks

above grade line to basement floors. Cemented first and second stories plastered with Acme hard plaster, finished in white. The attic was finished with "Utility" wall board nailed on rafters and floored with flat grain yellow pine 3 1/4 faced floor'ng.

The cost of this building was as follows:

Foundation and cement work.....	\$850.00
Plumbing and heating.....	900.00
Flues	90.00
Plastering	400.00
Electric wiring	95.00
Metal work	65.00
Painting	325.00



Interior Arrangement of Two-Apartment Residence at Sedalia, Mo.

is wired and lighted by electricity and plumbed for gas.

"The building as indicated by the plan is of balloon frame construction, the exterior and interior walls are 2 by 4. Floor beams 2 by 10, attic 2 by 8, rafters 2 by 4; all spaced 16 inches on centers, exterior walls are covered with 8-inch shiplap, building paper and narrow siding. The first and second floors were laid with 8-inch shiplap after plastering was done and all inside finish work was complete. These floors were finished with 2-inch strait grain yellow pine flooring, scraped and finished to match the other inside finish. Between the first floor one layer of Barretts deadening felt was used; between the second floor, one layer of Barretts deadening felt, also one layer of H. W. Johns-Manville quilted hair deadening insulator. A lath was laid on these felts then the finished floor.

The owner, Mr. Whitney, states that these floors are very near sound proof and is much pleased with the results. The inside finish throughout is yellow pine, of stock designs. The

Hardware	125.00
Lumber	1350.00
Mill work	350.00
Stairs	125.00
Carpenters labor, 35c per hour.....	875.00
Incidentals, 10 per cent.....	555.00
	\$6,105.00



Front and Right Side of Chas. E. Whitney's Apartment Residence; Designed and Built by J. C. Warren, Sedalia, Mo., Second Prize Winner



First Prize Class F—Finest Piece of Carpentry Work or Cabinet Making Done by a Reader of the "A. C. & B."

Carved Oak Altar in St. James Church, St. Paul, Minn.

Work Done by John T. Coxhead, of Yankton, S. D.

WE have always had a great fondness for fine carpentry work and cabinet making. This Class F of the Prize Competition proved a veritable joy in the great numbers of excellent and interesting pieces of work, photographs of which were submitted.

The very highest respect is due the man who has trained his hand and brain to the extent of producing such skillful work. Undeniably it takes high qualifications to draw plans and superintend construction and put through big building deals, but after all, it is the skill of the artisans who will actually do the work, on which the entire success depends.

All credit and honor to the skillful carpenters and cabinet makers in the Big Family! We are proud of the work they are doing. May they continue their painstaking and well-loved tasks, knowing that their

work is well done and their efforts appreciated. We are proud of them.

The first prize for a fine example of carpentry work or cabinet making goes to Mr. John T. Coxhead, Yankton, S. D. The altar in the St. James Church, St. Paul, Minn., is his work. Concerning this, Mr. Coxhead writes: "I enclose a photo of an altar I made just before Christmas for the St. James Church of St. Paul, Minn. The material is quartered-oak and it is finished with a paste filler and wax.

"Except for the aid of a band saw and hand planer and lathe, this work was done entirely by hand. The letters and emblems are all raised and the monogram on the center panel is hand carved.

"The chairs, partly shown on each side of the altar, were also made by me, this work having been done some months earlier."

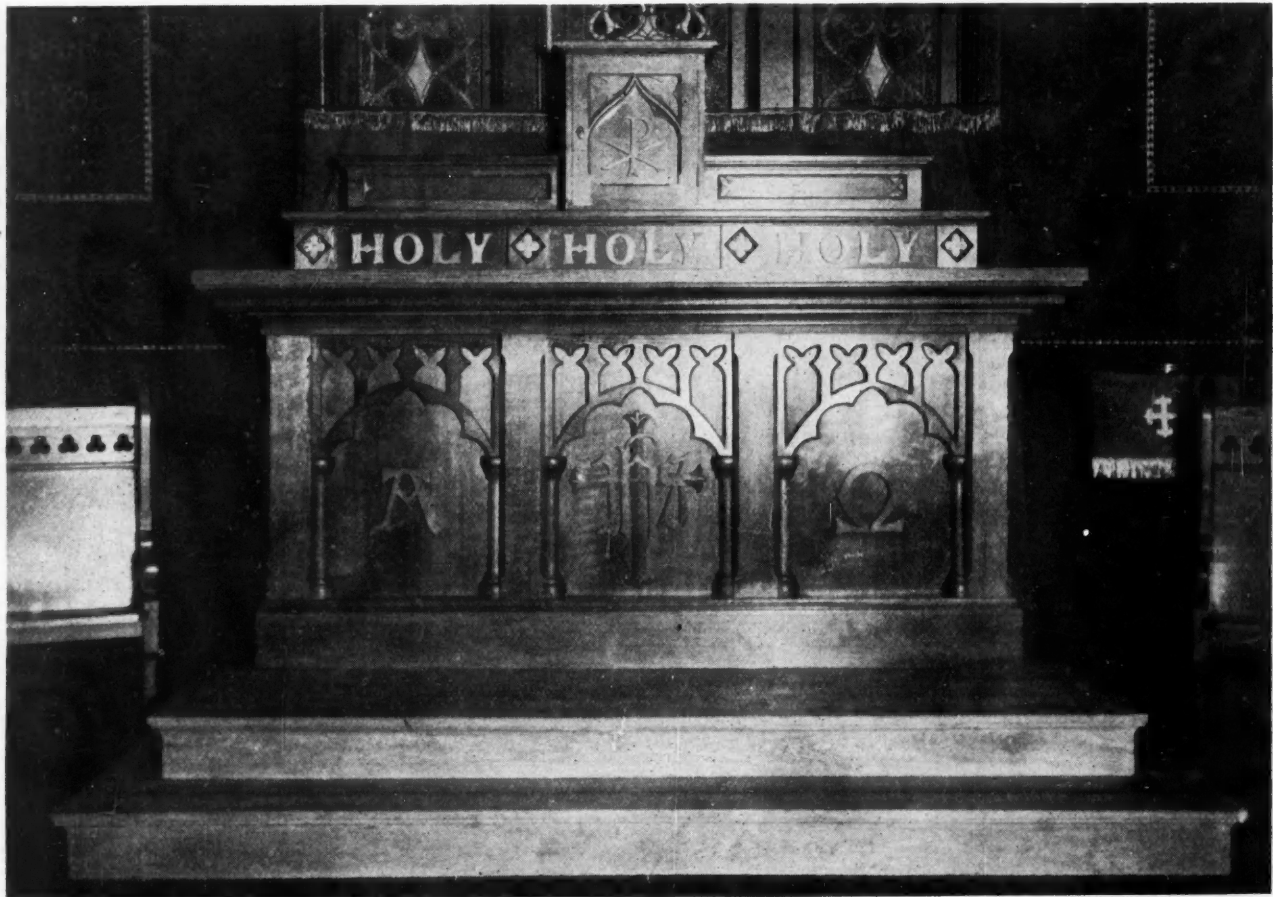

First Prize for Fine Carpentry Work—the Altar in St. James Church, St. Paul, Minn.; Worked in White Oak and Hand Carved by John T. Coxhead, Yankton, S. D.



Second Prize Class F—Fine Piece of Carpentry Work or Cabinet Making Done by a Reader of the "A. C. & B."

Library Table with Inlaid Top

Work Done by William Quilliam of Washington, Indiana.

THE second prize in Class F is awarded to Mr. William Quilliam, of Washington, Ind., who made the beautiful inlaid library table illustrated. He writes that it is his custom to do one hour's work of this kind each evening after supper. In this way, he has never lost one hour's time from his regular day's labor. It required seventy-eight hours of work to complete this table.

The top of this library table is twenty-eight inches wide by forty-two inches long. It is built up of nine different kinds of wood and contains over two-hundred eighty separate pieces. Every piece in it was worked out by hand "from small scraps," then glued and clamped.

Mr. Quilliam got a lot of fun out of doing this work and he has an elegant and unique piece of furniture to pay him for his trouble.



Massive Library Table with Beautiful and Unique Inlaid Top

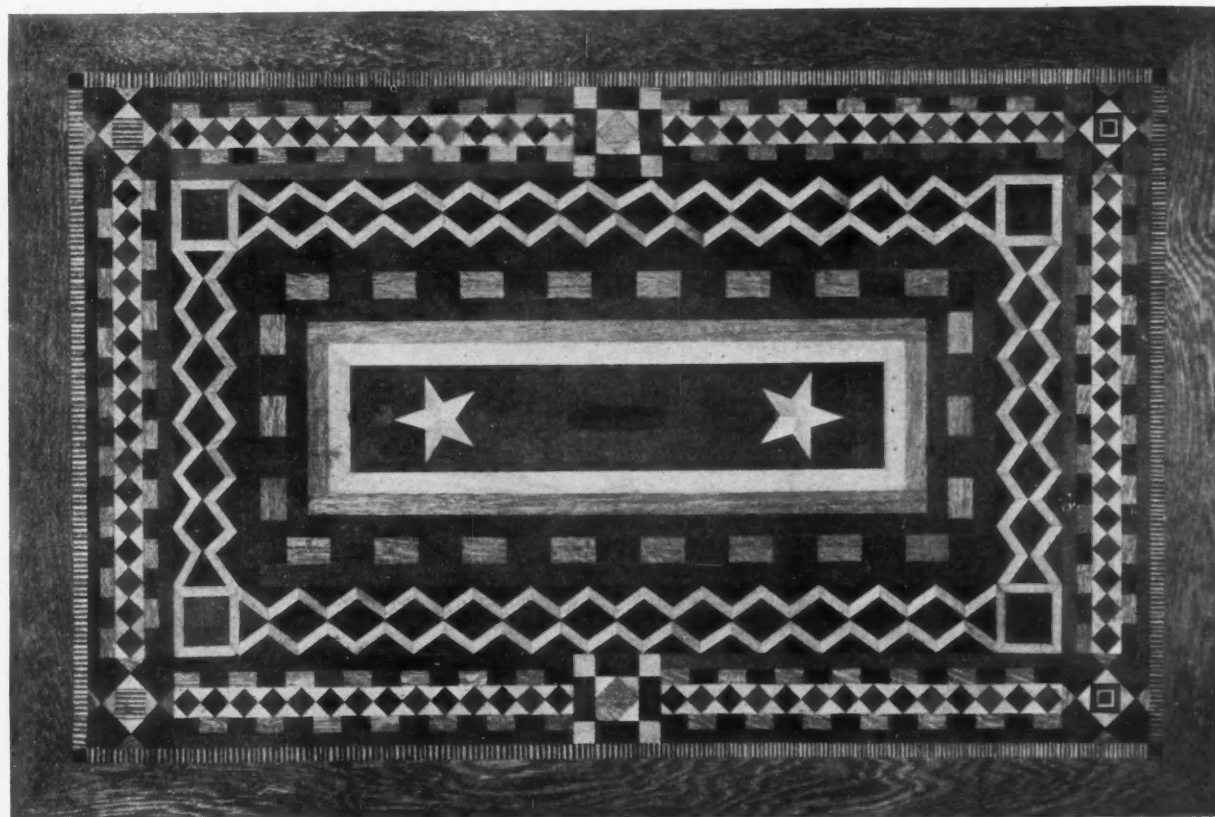

Detail of Table Top which is 28 by 42 inches and is Inlaid with over 2,800 Pieces of wood of Nine Different Kinds. This Table was made at Odd Times by William Quilliam of Washington, Ind., and is awarded 2nd Prize



Third Prize Class F—Fine Piece of Carpentry Work or Cabinet Making Done by a Reader of the "A. C. & B."

A Combined Dining Room Side Board and Kitchen Cabinet

Work Done by George H. Rabenberg of Britton, S. D.

THE third prize in this class is awarded to Mr. George H. Rabenberg, of Britton, S. D., for a very practical piece of carpentry work. There is nothing unusual about it. It is a problem that is met with in some sections of the country on fully half the residence jobs. This is a two-sided cupboard and cabinet built in the partition wall between a dining room and kitchen. The design is neat and attractive and makes a thoroughly satisfactory cupboard for this purpose. The work is well done.

Mr. Rabenberg writes that he built this cabinet out of yellow pine; constructed it entirely by himself and by hand, using an ordinary kit of carpenter's tools together with a combination No. 55 Stanley plow.

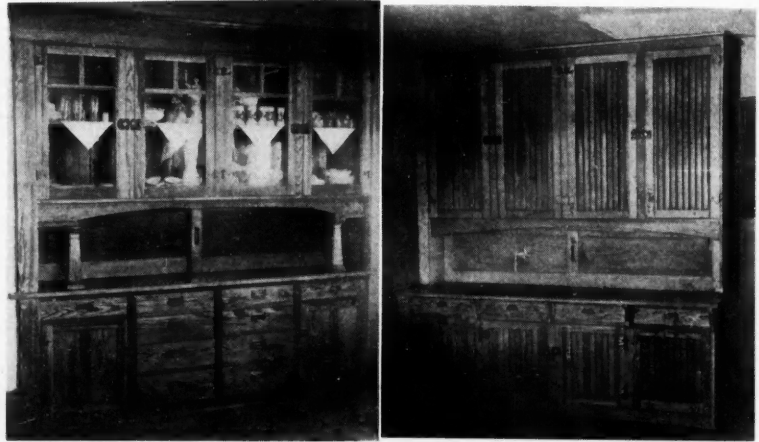

Dining Room Side Kitchen Side
Third Prize Fine Carpentry Work, by George H. Rabenberg, of Britton, S. D.

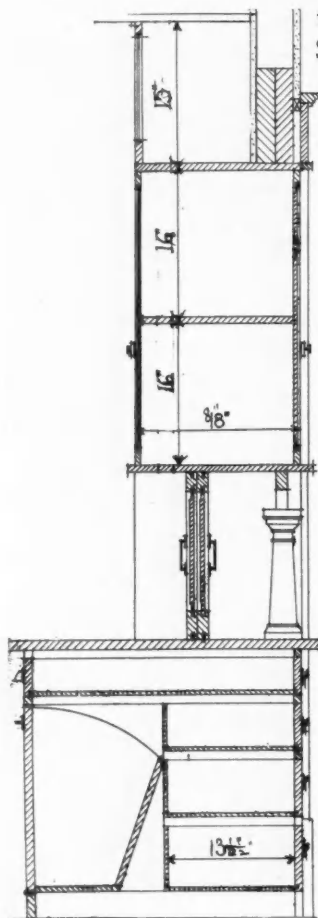

SECTION

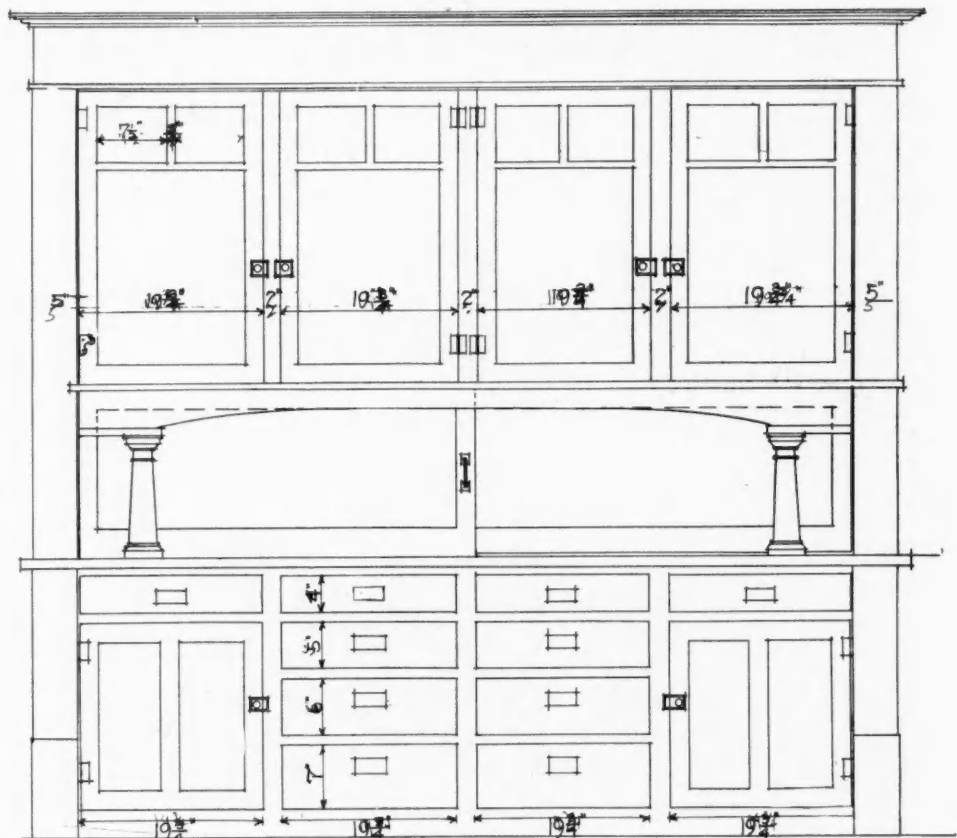

DETAIL OF CHINA CLOSET



First Prize Class G—Most Extraordinary Piece of Work

Marble Stair Railing in Elk's Building, Denver, Colo.

Work Designed, Detailed and Executed by Walter Thomson, of Denver, Colo.

AS we expected, Class G of the Prize Competition brought forth a most remarkably array of various interesting pieces of work pertaining to building. About the whole range of builders' activities is represented in these entries. We have examples of work handled by Our Folks ranging all the way from installing a vacuum cleaning outfit in a public library to detailing and superintending construction on a big reinforced concrete viaduct. The great diversity of material submitted in this class, made the choice of the three prize winners extremely difficult. Every example of work seemed just as interesting and worthy as any of the others. It will give us pleasure to illustrate all of these in coming numbers of the AMERICAN CARPENTER AND BUILDER.

The first prize in this class is awarded to Mr. Walter Thomson, of Denver, Colo., for his work in connection with the marble stair railing illustrated. This is in the new Elk's Building of Denver. Mr. Thomson is employed by the Eureka Marble Works, which had the contract for this work. He made the design of railing and newels to fit the marble steps already in place. His design was accepted; after which he drew up complete details, made patterns, etc.; after which he did all of the cutting (except the roughing out) and finally superintended the setting of the marble in place.

Mr. Thomson writes that he has been a subscriber to the AMERICAN CARPENTER AND BUILDER for a considerable time and would not want to be without it.

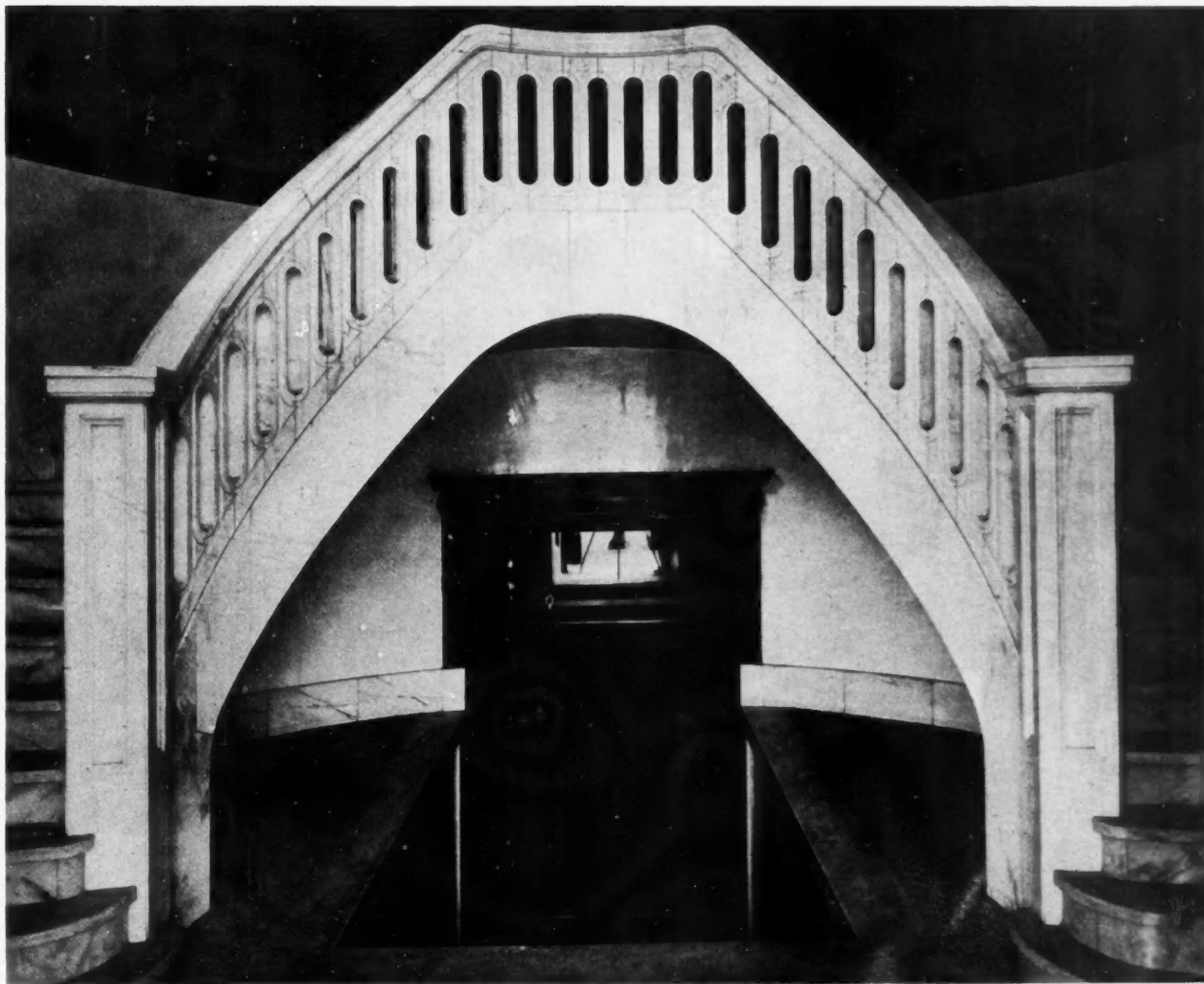

Marble Stair Railing Designed, Detailed, Cut and Set by Walter Thomson, of the Eureka Marble Works, Denver, Colo.



Second Prize Class G—Extraordinary Work Pertaining to Building, Not Usually Considered “Carpenters’ Work”

Good Work With Field Stone

Done by Frank Klepach, of Cedar Rapids, Iowa.

THE second prize in this part of the competition goes to Mr. Frank Klepach of Cedar Rapids, Iowa, for his work with field stone on the Ford residence in that city. In submitting his photos Mr. Klepach writes:

“I notice the splendid prizes offered. The AMERICAN CARPENTER AND BUILDER is certainly a help to the young mechanic; but it doesn’t need my praise. I am going to try for the first prize in (Class G). Enclosed find photos of a stone residence built for Mr. M. Ford, a paving contractor of this city.

“The material used was field stones or boulders

fireplace, arch and chimney. The chimney is 7 feet wide at roof line and tapers to 3 feet at top. The chimney cap is one piece of granite 3 feet by 3 feet by 8 inches with a 12 inch by 12 inch flue cut in center. The stone work continues up to the plate all around. The house also has a granite water table. The terrace walk in front has a granite coping and all

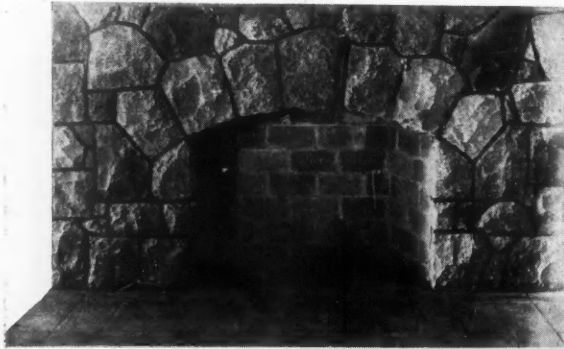

Stone Fireplace and Arch Laid Up by Frank Klepach

brought in from the field. The stones were drilled and broken to expose the color of the stone and then laid on edge clean face out.

“The pieces of work that I performed myself are,

piers have rubbed granite caps.

“My brother, John Klepach, was mason contractor on this residence. We are both devoted readers of the AMERICAN CARPENTER AND BUILDER.”



Striking Work With Field Stone on Residence of Mr. M. Ford, at Cedar Rapids. Chimney, Laid up by Frank Klepach, is especially good



Third Prize Class G—Extraordinary Work Pertaining to Building, Not Usually Considered “Carpenters’ Work”

Masonry on Union Station at Great Falls, Mont.

By Jno. Jenkin, Mason Contractor, of Weyburn, Sask.

THE third prize in Class G goes to Mr. Jno Jenkin, of Weyburn, Sask., Canada. Here are his letter and a photograph of one of his jobs:

“Weyburn, Sask., Canada, January 12, 1913.

“Editor AMERICAN CARPENTER AND BUILDER:

“It has taken no small amount of moral courage to enter the carpenter’s domain as a claimant for contracting honors. Inasmuch as I represent a different branch of the business, I trust that my views will be of interest to contractors other than carpenters—as well as to the great army of your readers.

“I have been impressed with the fact that almost invariably the general contractor has graduated from the carpenter. Why this should be so was for a long time a complete puzzle to me, but from my own observations I have come to the conclusion that a better opportunity presents itself to the carpenter than to any other building me-

our skyscrapers and our most beautiful public buildings? For the encouragement of those of us who are not carpenters, let us turn our attention to such buildings as one finds in a city, such as stores, banks, offices, etc., and the carpenter must make way for the mason as the chief operative.

“The problem which confronts the mason is: How to establish? From my own early experiences I am bound to admit that it is hard pulling. I commenced business as a subcontractor and was for some time subordinate to the carpenter contractor. But it was the start and I have held on with determination, endeavoring at all times to assimilate knowledge of other branches of building construction.

“I am successful as a builder of brick buildings, which includes railway passenger depots, stores, warehouses, garages, etc. I attribute my success principally to the knowledge I have gained through a well-known correspondence school. I have a small library of good books relating to the building trades and I always consider my money well invested, when I add to my collection. I am especially appreciative of the valuable information contributed every month by readers of the AMERICAN CARPENTER AND BUILDER as well as by its advertising columns. And but for the consciousness of receiving already more than value for the subscription price, I would ask for a page for the Mason Contractor.

“I enclose view of the Great Northern & Burlington Depot at Great Falls, Mont. I secured the contract for this in

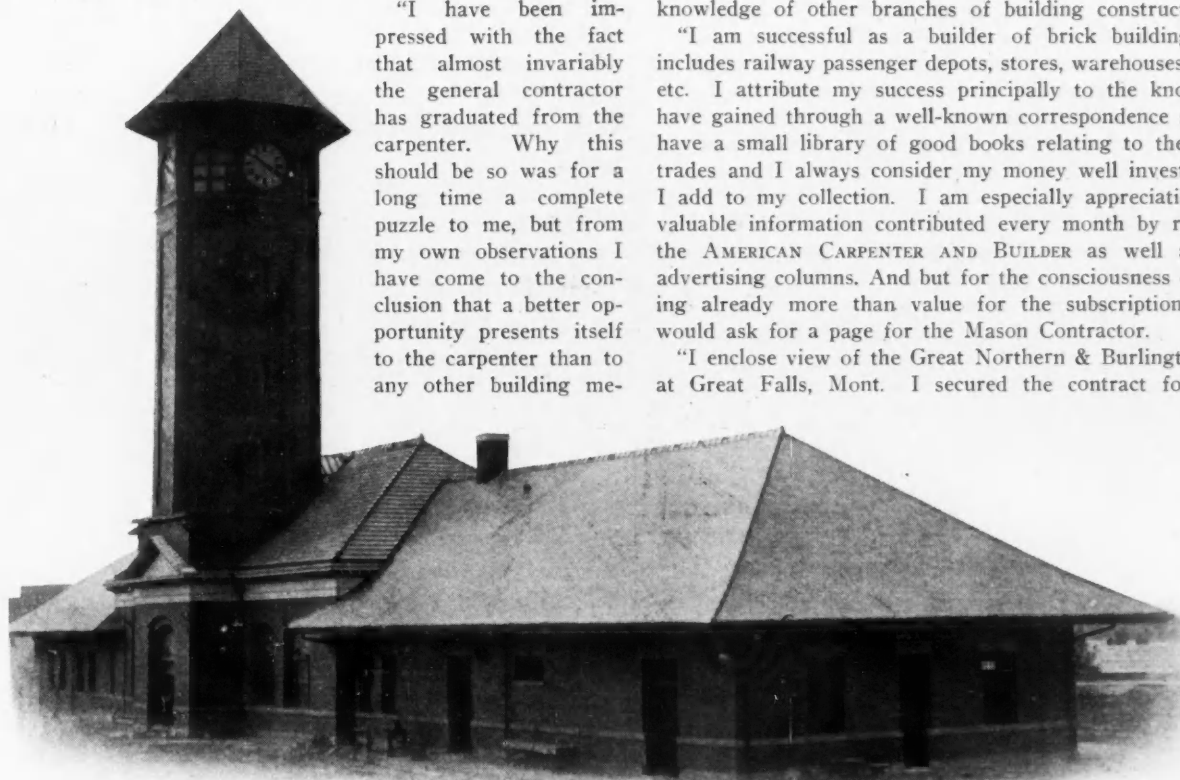

The Union Station at Great Falls, Mont.; One of the Important Masonry Structures Handled Recently by Contractor Jenkin

chanic. A commencement can often be made through the medium of small repair jobs and work which entails only a small outlay of capital. Other features favorable to the carpenter are that he is able to continue work in the winter time and that he is usually the last man to perform the finishing touches to the completed building.

“However, I shall endeavor in a spirit of friendly rivalry to show that the contracting field need not necessarily be confined to the carpenters. As a bricklayer and mason, let me draw attention to the greatness of the art of masonry. Who has not heard of the architectural glories of Rome, or the wonderful structures of the Egyptians, or, to return to the present day, is it not the wielders of the trowel who erect

February, 1910, and the building was occupied in September of that year. My contract was for the masonry only and included the erection of all brick, stone, steel, terra cotta, etc. The octagonal portion of the tower is 90 feet high. The building is approximately 300 feet in length by 70 feet wide at its widest dimension. A wainscot of white enameled brick 6 feet high circumscribes the waiting rooms. The exterior walls are of vitrified paving brick with trimmings of terra cotta and Kettle River sandstone. I trust that my remarks will not be considered a trespass on your columns and that they will be received with the generosity characteristic of the AMERICAN CARPENTER AND BUILDER.

Yours fraternally, JNO. JENKIN.

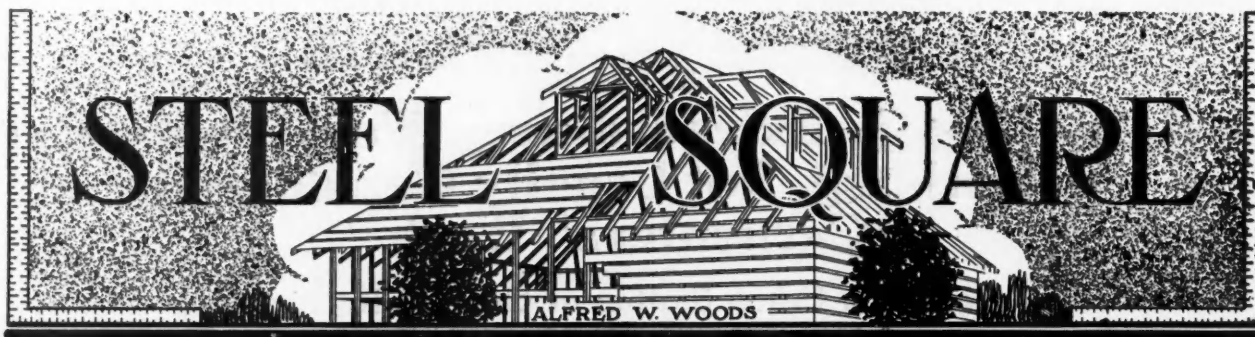

Woods Lays His Corner Stone

SHOWING HOW TO OBTAIN THE CUT FOR EITHER BUTT OR LAP JOINT WITH THE AID OF THE STEEL SQUARE, AND OTHER USEFUL INFORMATION PERTAINING TO SAME

WE have a letter from one of the readers, asking that we illustrate butt joints and how to obtain them with the steel square. We are glad to take advantage of the cue thus offered, although as a matter of fact, we have already covered the subject in the course of talking about other things. In looking over some of the back numbers, we find that we have pretty completely covered this subject; we refer to the articles under the following heads:

- “Hopper Cuts,” in the August, 1908, number.
- “Miter and Lap Joints,” July, 1908.
- “Possibilities of the Steel Square,” June, 1911, and

we know that we have indirectly touched on it in other numbers. We did it in the last number, but did not call attention to it, under the name of “Butt or Lap Joint.” In that article we referred to it as join-

January number) is in reality the same as a butt or lap joint.

We want to make the illustration so clear that it can not be forgotten, even though one tried to forget it. In driving a nail it should be hit squarely on the head every time, until it is sent home, and that is just what we want to do with this subject, and we want to give it such biffs in the right place to send it home to stay. To do that, we are going to present the subject with new illustrations and if possible, more to the point.

We believe in getting started off on the right foot and that too with the first step, and that is the foundation. We would not give a cent for a rule that is not self explanatory. This thing of saying so and so taken on the square will give the desired cut, without a why to it, is not worth

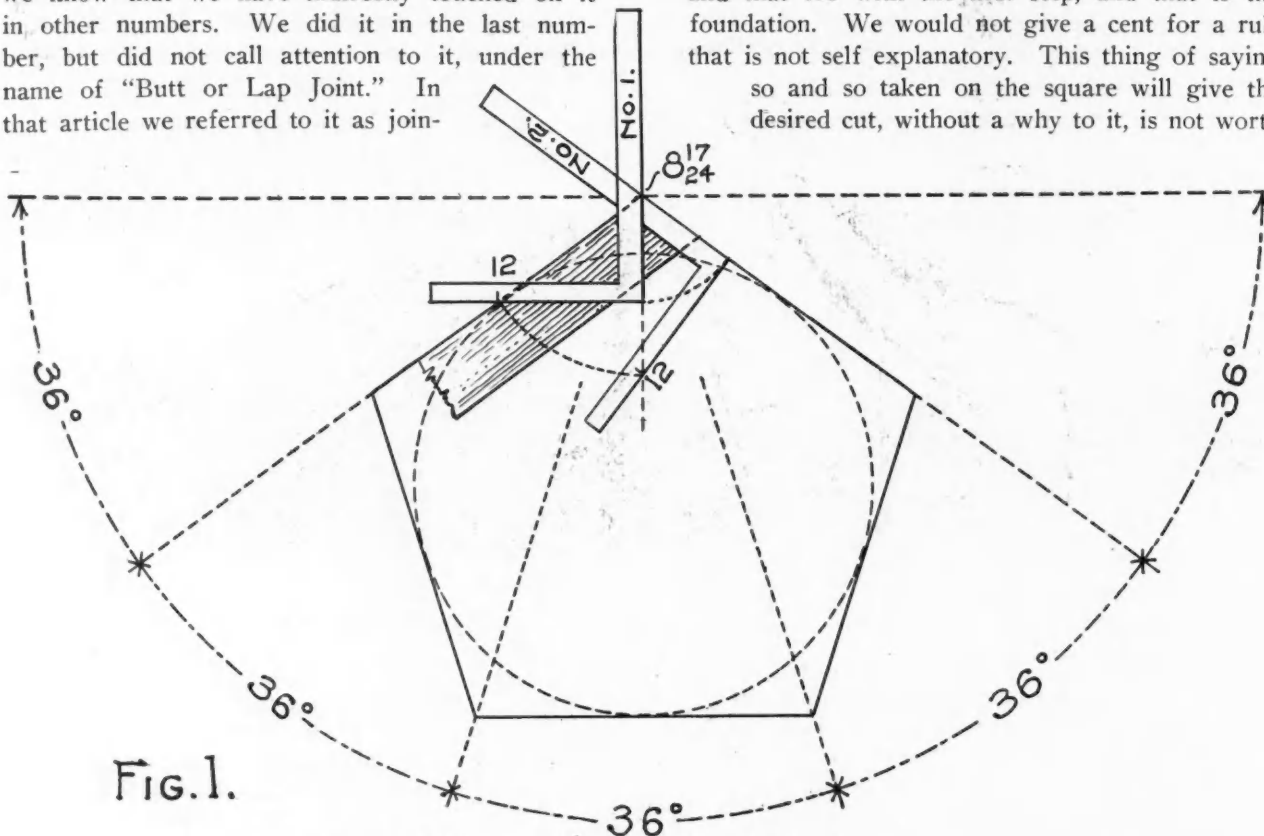

Fig. 1.

Explaining Miter Cut for Pentagon with Steel Square

ing one pitch to that of another. Now just stop and think a minute and see if that is not the case. The cutting of the rafters to fit on to another, or of the purlin post to fit against the purlin (given in the

trying to remember, because there is nothing there to stick. Better go to the fountain head and there take observations of the subject, branching out in all of its simplicity. Then it is a delight to follow

up the different forms and see the work unfold itself, at the same time exemplifying why it does so.

Now referring to the question in hand, what determines the figures to use on the square for lap joints? We will answer the question by first illustrating what determines the proportions to use on the square for the miter joint.

Say we wish to find the miter of the pentagon. Referring to Fig. 1, there is shown a semi-circle divided into five equal parts; and as there are 180 degrees in the semi-circle, each part represents 36 degrees. Then the angle of 36 degrees (twelve, and eight and seven-

We call to mind an instance where three-fourths of a true octagon, sixteen feet in diameter, was to go on a square corner of a building and to finish up in a true octagon above the roof. The mason foreman asked the carpenter foreman for a template in order to lay off the foundation and after waiting as long as he could, he laid off his men for a half day so that he might assist the carpenter foreman to lay off and build the template. They retired to a barn where they could have a nice level floor to lay it off full size, from which they could take the necessary measurements and they got it O. K. But Oh! how much easier it would have been to have done it thus: 16 times 4.97 equals 79.52

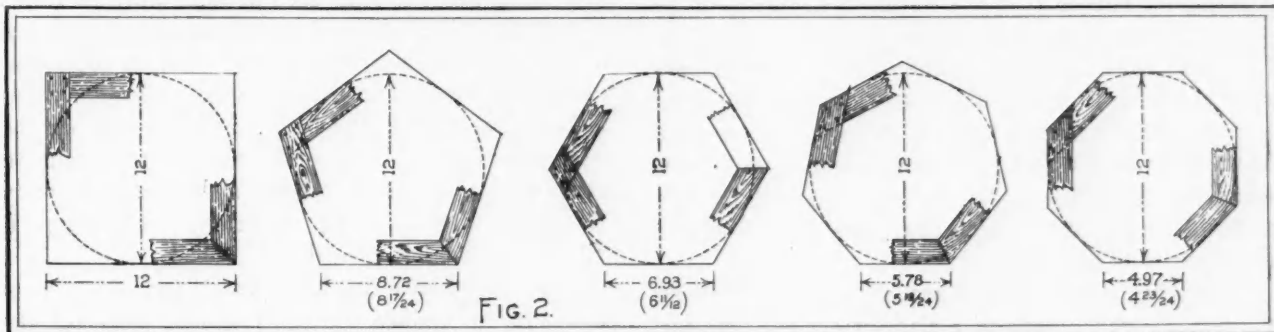

[Length of Sides of Polygons of Four to Eight Sides and Bases of Calculation with these Figures.]

teen-twenty-fourths), taken on the square, will give the miter for the pentagon, as shown by square No. 1. Since the miter is at the half way place, between the angle formed by the joining of the sides of the pentagon, the same figures applied to the miter line will complete the angle, as shown by square No. 2.

To make this point more clear, just suppose that eight and seventeen-twenty-fourths on square No. 1 is a pivoted point; then take hold of the blade and swing it to the left until its edge is in line with the side of the pentagon, and the twelve mark on the tongue will be found to be resting at the miter line. Therefore the same figures that give the miter for any regular polygon, applied to the miter will give the angle for either the butt or lap joint.

Now, while we are talking about polygons and their miters, we want to go just a little further and show some of the things that the figures used for the miter stand for.

In Fig. 2 are shown several polygons with an inscribed diameter of twelve inches, also the corresponding length of their sides. NOTE these figures are the same as those used to obtain the miter. They form the basis for calculation purposes; that is not generally understood. For instance, having the length of the side for one foot of the diameter, the length for any diameter may be found by simple multiplication. This is worth remembering, because problems of this kind often come up in octagon angles, which are quite commonly used.

We know of instances where the foreman on a job would gladly have given more than the subscription price of this Magazine to have known this simple rule.

inches (6 feet 7½ inches, answer). Nobody would have had to lay off and the contractor would have been several dollars to the good, if his foremen had only known what they did not know and which they thought they did.

Now, we have done a good deal of talking but in reality we have only commenced. In other words, we have only laid the cornerstone containing its treasures upon which to build; and though we have used a big batch of mortar to do it, it is there to stay. But we have not told of all of the treasures contained in that cornerstone. They are there for use, if you will only open it up and get them out. They will furnish the key for all of the cuts for all that goes on above and only quits when the finial is put on the topmost peak.

+

Earned It

WOMAN—"How did you get that Carnegie medal?"

TRAMP—"Heroism, lady. I took it away from a guy that was twice my size."—*New Orleans Times-Democrat.*

Force of Habit

BEGGAR—"Will you please, sir, give me ten cents for a night's lodging?"

PHILANTHROPIST—"I'll give you five cents if you raise the other five."—*Life.*

Half and Half

"Earlie, why don't you let your little brother have your sled part of the time?"

"I do, ma. I take it going down the hill, and he has it going back."—*New York Morning Telegraph.*

Dimension Stuff

By J. Crow Taylor

Discriminating as to Prospects

IF you can cultivate the faculty of discriminating between the triflers who come to you to figure on prospective building and those who really mean business—learn to gage the prospects and to avoid wasting time on those who are simply dreaming or playing. It will be worth a lot to you every year.

A popular builder can waste a lot of time to no purpose drawing plans for and estimating the cost of building houses that are never to be built—if he takes up keenly with every one that comes along. One man who has made a study of this subject says that he doesn't figure with more than a fourth of the people that come to him. This looks like the man is standing in his own light, but he claims not. His contention is that he has learned to gage prospects, and to discriminate between those who mean business and those who do not.

Some, he says, he feels are calculating on doing very cheap work, work of a class he doesn't care for, and simply want him to give them a start to drive a bargain with some one else; others have no money to build with and are just building air castles that they hope to realize on at some distant future day. He supports this theory with the assertion that he has kept an eye on the prospects he has passed up in this way and proven to his satisfaction that his judgment was good.

If this is true as a rule, that there are many who come for figure and estimate who do not mean business, it is certainly well for the builder to cultivate the faculty of discrimination so that he may conserve his time and energies for real work.

Improvising a Gainer

FOR work that is light enough to handle you can put a dado or gainer head on any one of a number of different machines and do very nicely. You may have one of those combination woodworkers that includes a gainer or dado attachment, and if so that puts you in good shape, especially for a variety of light work. If you have only a table saw you may put a head on this and by adjusting either the table or the saw for depth, do gaining just as you do grooving. If you happen to have a cross-cut rig, the carriage of which moves, you can handle pretty heavy stock on it over a gainer head.

Then there are some new things in swing cross-cuts that suggest great possibilities in the way of improvising gainers for heavy stock. There are swing frames that are so compounded in the hanging that the saw swings back and forth in a parallel line, just as if it were running on a straight, level track. With a bench underneath and a dado or gainer head on the mandrel instead of the regulation cross-cut saw, this

should make an ideal gainer for heavy work. It would be doing its cutting on top, in sight of the operator, while the stock could have a solid rest on the bench below. There are many ways to improvise a power gainer and thus eliminate a lot of expensive hand work.

Re-Working Form Stock

WHEN it becomes necessary to cut and rework stock that has been used as false work or forms for concrete, which is not by any means an uncommon occurrence, there is grit that is so hard on tools that it makes the workman grit his teeth. Get rid of as much of this as practical before starting to work the stock, and then, no matter whether you are going to cut it with a machine or hand saw, turn the gritty side down. This reduces materially the damage it will do to saws, but even then it is bad.

If you have a saw that has been set too wide, this is good stuff to reduce it on, as it will wear off the corners, so that when you file sharp again there will be less set. Avoid using fine toothed saws in this work; take the coarsest ones you have, and if they are a little dull already it won't hurt much, for if they are keen sharp they will soon be dull. If you have a newly filed saw on your machine, take it off and put on one that is slick, saving the sharp one for clean work, and in this way you can rework your form stock without it doing so much damage to your best saws.

The Value of Reputation

THERE is such a general impression today, especially in the larger towns and cities, that the majority of builders build only for outward appearance, and to sell instead of to stand, that more than the ordinary amount of value attaches to a reputation for doing good, honest work.

Recently a successful builder, who has been at the work only a few years, made the statement that the thing which is worth more to him today than all he has made, and more than his bank standing and record, which are both good, is his reputation for doing good work. He has made it a point to leave nothing but pleased customers behind him, and at times has used up his profits on a job to satisfy the customer. The result is that those he has built for are the means of getting him most of his new jobs; they do him more good than any of his advertising. People seek him with confidence that they will be treated right, and he gets lots of his work without competition though there are plenty of other builders around anxious for jobs, many of whom would do the work cheaper.

This is what makes consolation for and helps bring business to the man who knows his business and insists on doing his work right.

More Shop Kinks

HELPFUL IDEAS AND SUGGESTIONS FOR CARPENTERS, CABINET MAKERS AND MACHINE WORKERS

By Wm. C. Jasbury

HOW ABOUT THIS? While out measuring a new building for stairs recently (and in fact many times) have noticed carpenters trying to hold stuff while working it, not having a vise bench. I have seen them down on the floor going through contortions fearful to behold. I have often wondered and remarked why a good bench with a vise on each end would not be a time and labor saver, especially when putting stair rail together and such other work. Of course some builders have such conveniences; but it is not the rule.

SOMETHING ABOUT STAIR HAND RAILING. I am now going to dwell at some length on the complex and interesting topic of stair hand railing—that is, the kind that makes wrinkles and grey hairs. As I have said before, the larger part of the books on the subject are so full of square and cube root, high geometry and various heiroglyphics (Gee! but that is a big one) only found in College libraries, that the average mechanic who usually has to start to work before he can go to

of the string, and the string is $\frac{7}{8}$ inch thick, the baluster is plumb over the string with the outside edge of the baluster in the same vertical plane as the face of the string. Then, say the baluster is $1\frac{3}{4}$ by $1\frac{3}{4}$ inches square, measure $\frac{7}{8}$ inch from the face of the baluster; which will give the back of the string and also the center of the rail. Now in taking the measurements, there should be established some

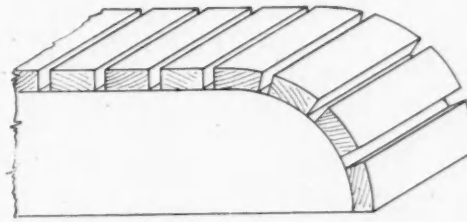

Bending Drum Cut to Shape

point from which to work; then stick to it.

Say we take the back of the string, which in this case is at the center of the rail, and this is the foundation. Now, there are some cases where the back of the string is not the center of the rail; it depends on the width of the baluster; if it is $1\frac{1}{4}$ by $1\frac{1}{4}$ inches, then measure in $\frac{5}{8}$ inch from the face of the baluster to get the center of rail. This does not line up with the string by $\frac{1}{4}$ of an inch, so always reckon from the center of rail unless fitting around a form or drum.

Now, say we want a piece of rail for a stair containing a curve, the radius to the center of the rail to be 4 feet and the balusters are $1\frac{3}{4}$ by $1\frac{3}{4}$ inches. Subtract $\frac{1}{2}$ of $1\frac{3}{4}$ which leaves $\frac{7}{8}$ of an inch, and this subtracted from 4 feet leaves 3 feet $11\frac{1}{8}$ inches from the face of string to radius point. This would also be the radius of the outside of bending drum, or sometimes called curb.

The drum is made thus: Take two pieces of

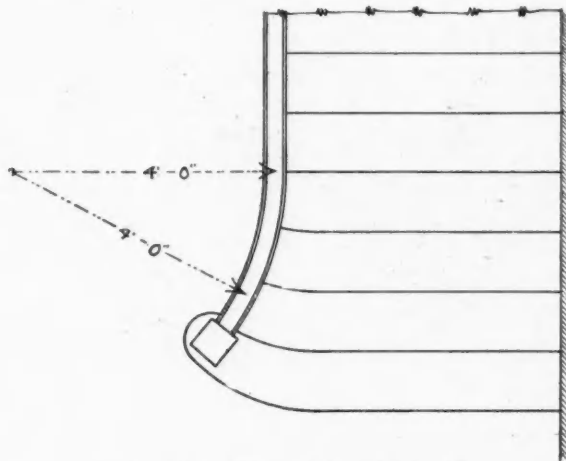

Piece of Rail Wanted for This Stair

College, can get nowhere at all with such works—in fact, I will sit in a pessimist's chair long enough to say such works are only aids to sanitariums, and furthermore would drive a man to strong drink. The book sent me by some good friend called "Dr. Grant's System of Spiral Stair Railing," is nearer what I think is a common sense thing; but of course he goes on so far that I get lost in his maze of description, because he has much more brains than I. But I want to say that my system of curved hand rail is along the same lines, and therefore I am about to tell how I have gotten out many jobs.

Any time I have a piece of curved rail (rake) to make, I first get the exact plan layout of the rail; that is, the level plan. For instance, if the ends of the treads project $1\frac{1}{4}$ inch over the outside edge



Wood Veneer or Canvas Glued on Holds Curved Shape

spruce, hemlock, yellow pine or any cheap wood, saw them out the right radius, minus the thickness of the slats, leaving some straight for where the spring line begins. The string is sprung to the form, as shown and clamped. I usually kerf a string and bend it before the housing or cuts are made. If the string bends in or out, I kerf and either glue wood veneer on over the kerfs or canvas, as shown.



MAKING POWER

Watching Jimmie

Part IV

I GET UP EARLY AND HELP TO DO SOME GOOD WOODWORKING STUNTS

By W. D. Graves

AS I expressed some doubt as to the availability of my old alarm clock Jimmie came over in the evening and brought his. It was one of these new fangled contraptions that ring a fellow up on the installment plan; and Jimmie so aroused my interest in its mechanism that I went to bed an hour earlier than usual and set it at 4:30. It worked fine.

The first time it rang, so Harriet says, I simply murmured "Hello"; but the next time I more than murmured—and left off the final o. At the first ring of which I have any clear recollection I leaped out of bed and made a patient search for the lever which shut the noise off. Failing to find this, I threw the thing out the window. As it still continued in audible evidence I so far lost my temper as to rush down stairs and out doors where, finding the clock hanging on the big lilac bush, I seized it in both hands, threw it in the snow drift alongside the path and jumped on it till the infernal noise was hushed. This done I suddenly came to realize that it was one of the coldest mornings of the winter, and that I hadn't even stopped to put my slippers on. Harriet says that she heard my teeth chatter, and I don't doubt it even though they are "store teeth" and were still in their bowl of water on the bedroom dresser. Considering my years I made almighty quick time getting into bed—and Harriet got out as quickly. Thus an early breakfast was assured.

Gas Engine Flywheel as Horizontal Borer

Arriving at the shop I found that Jimmie had his blocks there and that he and his father were making preparations to bore them. They were simply sections

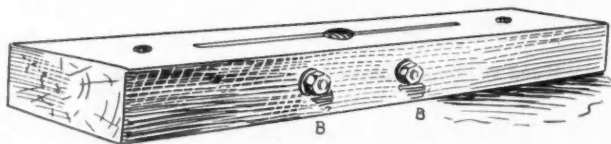

Fig. 1.—2 by 4 Oak Piece for Auger Holder

twenty inches long sawed off the end of a big maple log, and the intent was to bore them for a steel shaft and then turn them as large as the smallest would go which was about two feet in diameter. I called Jimmie's attention to the fact that, being yet green, they would check in seasoning.

"Yes," said he, "I expect them to check some; but

they are of curly grain and, with a three inch hole through the heart, I don't believe they will open up very badly. Anyway I'll use them till they show signs of weakness, or till they are seasoned, then hoop them."

"But as they shrink the hole will become smaller and they will stick fast on the shafts."

"I guess not. I'm going to bore them with a three-

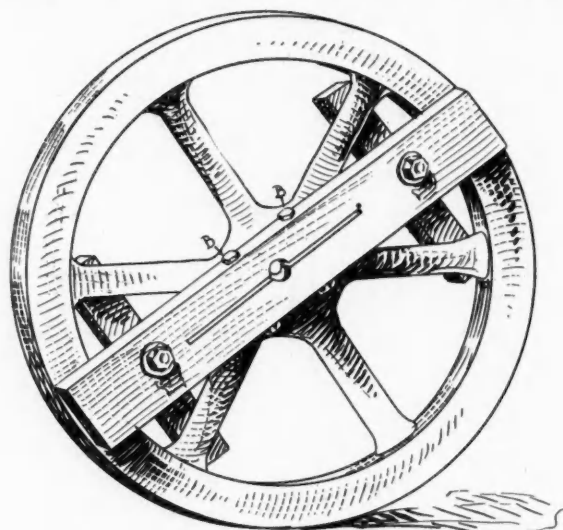

Fig. 2.—Gas Engine Fly Wheel With Auger Holder Attached

inch auger and use a $2\frac{7}{8}$ -inch shaft. A little play will do not harm."

It was Blaydell's intent to attach the auger to the center of the fly wheel of the little engine which drives Jimmie's machine. This was only about fourteen inches from the floor and Jimmie was tacking down some joists to serve as temporary guides for a roughly made table to slide on. To the front of this table, which was made in the simplest manner possible and of the most available material, was attached a board high enough so that the auger would bore through it and the end be steadied thereby when it was not in the work. Such a crude steady-rest would of course not serve for a permanent machine, but for the few holes in this job it did very well.

To attach the auger Blaydell made a "handle" of a piece of oak 2 by 4 as long as the outside diameter of the fly wheel. He didn't square the hole for the shank, but bored it an eighth of an inch smaller than

WOOD WORKERS PAY

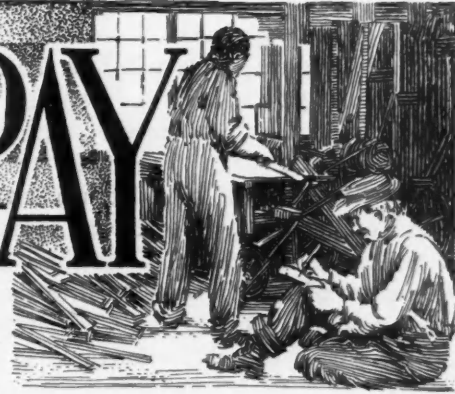

the diagonal of the square, cut through a saw kerf extending longitudinally about five inches each side of the center and put a couple of four-inch bolts close to either side of the hole, as shown in Fig. 1. He next fastened this "handle" to the fly wheel by means of bolts extending through its ends and through short strips placed against the back sides of the spokes, as shown in Fig. 2. The hole was carefully centered by pushing through it the bit with which it was bored and bringing the spur to bear in the center of the shaft. Before finally tightening the bolts its centrality was made absolute by turning the wheel by hand and tapping the "handle" into position with a hammer. The shank of the auger was now forced into position, the bolts B, B, tightened up; and, the wheels being again turned by hand, the shank sprung till the spur ran exactly true. Pressing the point of the spur against the front of the sliding table the engine was started, the auger running into its steady rest at the same time; and the boring machine was ready for business.

To Sharpen an Auger Bit

Before the auger was put in place, however, Jimmie got a lesson in so sharpening an auger or bit as to make it cut end wood without requiring much pressure. Blaysdell instructed him that it should be sharpened the same as for ordinary work except that boring end wood emphasized the need of sharply defined clearance on the under side of the lip. Augers and bits which have been much used—and even some of the cheaper ones when new—will be found to be rounded somewhat as shown, exaggerated, in Fig. 3. In order to do the cleanest and easiest work in any wood, and in order to work at all where the worm does not get a firm hold, it is necessary that the under side of the lip be filed in such a manner that the cutting edge will be the lowest point, i.e., the first to



Figs. 3 and 4

strike the wood. This condition should be the first thing noted and, before any other filing is done, the lower side of the lip should be brought to a true and straight surface which, when the tool starts work, will stand relatively to the surface of the wood about as c, d, is to a, b, in Fig. 4. Perhaps the angle need not be quite as great as is here shown but, however

small or great it is, it should be sharply defined. As

will be seen at a glance, when the lip is considered as a separate cutting tool, not much pressure will be required to force it into the wood.

Having the auger properly sharpened, Jimmie did the boring very easily alone; the only hitch being that his roughly constructed table didn't slide very freely on the wooden guides. He was going to oil them, but harkened to a suggestion that he rub on some hard soap instead, and, after trial, admitted that it was much better than oil would have been.

Turning Large Rollers With Buzz Saw

While the boring was being done Blaysdell was preparing the jigs for turning the blocks. The fact that he and I had in mind slightly different ways of doing the job led to a somewhat heated discussion as to which was the better, and to some personalities which would not interest the average reader—though

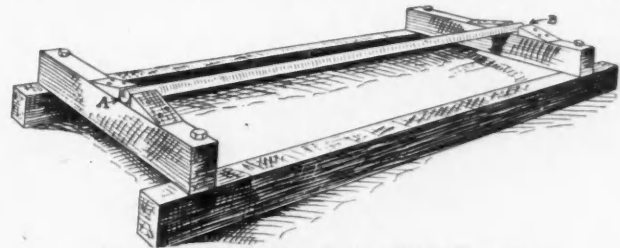

Fig. 5. Jig for Holding Rollers While Turning

Jimmie seemed to enjoy them hugely. As both methods called for the same jig we tried both, without coming any nearer to an agreement. As Jimmie wouldn't take sides (I think the scamp rather likes to see us at odds on mechanical matters) I'll leave it to the crowd.

Blaysdell took two pieces of 4 by 6, each 6 feet long and laid them on edge, parallel, about 2 feet apart. Across the ends of these, on top, he secured shorter pieces of the same; making sure that the distance between them was twice the length of the rollers plus the diameter of the saw he was going to use. On the top of each of these shorter pieces he nailed a couple of blocks far enough from each side of the center so that one of the pieces of shafting, A, B, which Jimmie proposed to use for the axles would just lie snugly between them; all as shown in Fig. 5.

Thus far he and I had agreed perfectly, but had to

draw lots to see whose method of using the device should have preference. I won, so the frame was placed on the saw table with the shaft directly over the saw and parallel with it; the whole being secured by means of lag bolts screwed into the under side, through blocks which bore under the edges of the table. The thickest available rip saw having been placed on the arbor, the table was adjusted so that the distance from the center of the shaft (A, B, Fig. 5) to the top of the saw was equal to the radius of the desired roller. One of the blocks was then slipped on the shaft; and then, the machine being started, pushed along its length; thus removing the surplus material for the width of the saw kerf. After push-

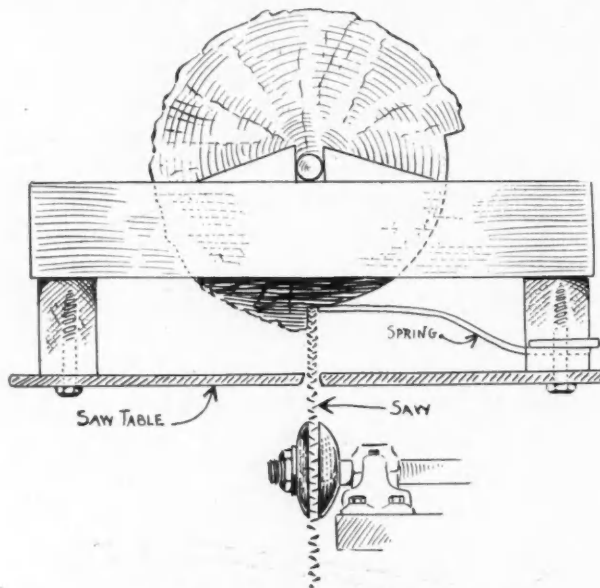

Fig. 6. Buzz Saw Used as Turning Lathe.

ing it back, with the saw running in the same kerf, it was turned to the left, the thickness of the saw cut, then pushed forward as before; and so on till it was practically round. Of course the work could have been considerably expedited by using a dado head and making the cuts wider. This, it is true, would have made the roller more noticeably polygonal, but if the flat surfaces were even as wide as $\frac{3}{4}$ inch it would not matter on a roller of this kind.

In order that the block might be readily turned just the right distance after, and before each cut, there was fastened to the right hand timber a flat spring with its end extending close to the front of the saw, as shown in Fig. 6, and in line with its right hand side, so the block had simply to be turned against it before each cut. In order to steady the block during the latter part of the cut a similar spring might be placed behind the saw, extending to the line of the other side thereof; but we found this needless.

Blaysdell's Way

Blaysdell's way was to place the same frame in a position at right angles with the one shown; that is, with the shaft directly above and substantially parallel

with the *saw arbor*, instead of the saw itself. He used the same spring stop, located the same *relatively to the saw*, and rotated the block continuously, making an helical cut like that of a Blanchard lathe. He claimed that this method held over the other in that it made the roller really round, avoiding the flat surfaces which I considered immaterial, and made it possible to cut gains, or rabbets, for rings around the ends. The latter he accomplished by lowering the table a quarter of an inch and clamping a block on the shaft to stop the roller when the gain was cut the desired distance from the end, 2 inches in this case. The table was then raised, the roller turned to within 2 inches of the other end, then lowered as before and the roller finished.

With Blaysdell's method it was necessary to use a cut-off saw, or a cut-off and rip saw of the same size put on the arbor together; and we found it necessary to skew the frame a bit in order to give clearance to the back teeth.

"Suppose," said Jimmie, "you wanted to turn rollers without a hole in the center, or with a very small one? I'm figuring on a job, now, that calls for a lot of 6-inch rollers 2 feet long with half inch gudgeons. A half inch rod 4 feet long wouldn't be stiff enough to support them while being sawed."

"If they were not to be bored at all," said Blaysdell, "the job would involve the rigging of a pair of centers like lathe centers, which probably wouldn't be worth while; but if they are to have gudgeons driven in it as simple as this, and much easier because lighter. You would drive your gudgeons in the squares and build your frame of light material, making it only as long, inside, as the rollers. Then, instead of sliding your roller on the shaft as we have done this time, you would slide both the roller and the frame either against the regular fence or against a temporary one rigged crosswise of the table, according to the method you prefer."

"Say, Dad, a fellow can do most anything with a buzz saw, can't he?"

"Yes," said Blaysdell, taking the words out of my mouth, "but one must be constantly on guard against getting too interested and wasting time on jobs that can be better done otherwise."

When I got home Jimmie's alarm clock was hanging behind the kitchen stove, evidently unharmed, and I think I heard Lorna giggle when I looked at it. Jimmie has been up after it every night, for a week now, but has forgotten to take it each time. He might as well take it along, for I don't want it any more.



Mistaken

FIRST COSTER (outside picture dealer's window)—
"Who was this 'ere Nero, Bill? Wasn't he a chap that was always cold?"

SECOND COSTER—"No; that was Zero; anuver bloke altogether."—*Tit-Bits*.

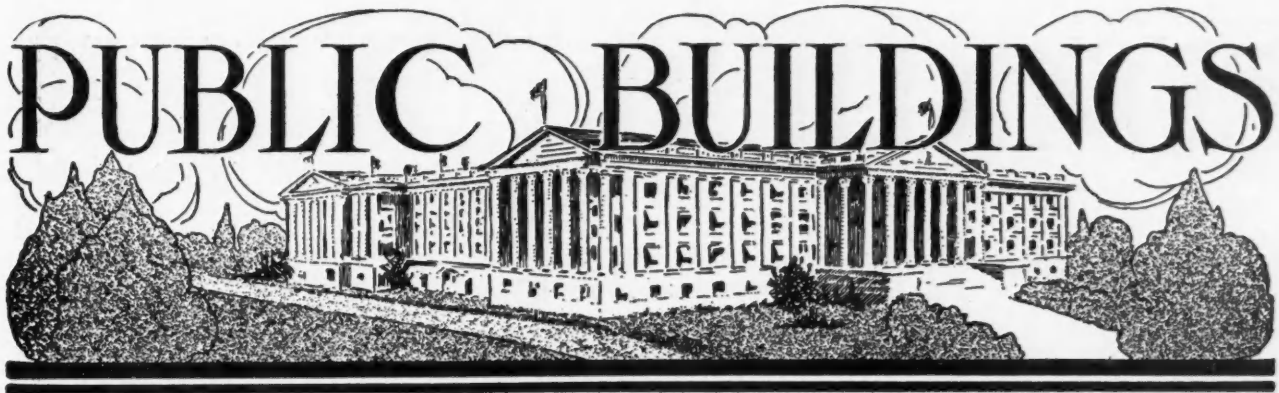

Practical School for a Small Town

One of the many artistic and practical schools designed by the well known schoolhouse architect, G. W. Ashby, of Chicago, is shown below.

The construction of this school house is of wide siding and cement plaster, combined with shingled roof. It is a one room school; and is especially suited to communities where a larger building is not needed. The entrances on each side of the front give upon vestibules from which open the cloak rooms—one for pupils of each sex. To the rear of the class room is provided a fuel room and teachers' private room. Special attention is called to the lighting. Windows are arranged along one side only. The light comes from these over the pupils' shoulders which is highly desirable in preserving the eyesight.

The building gives a beautiful effect, and ought to

find much favor over the common ordinary rural school.

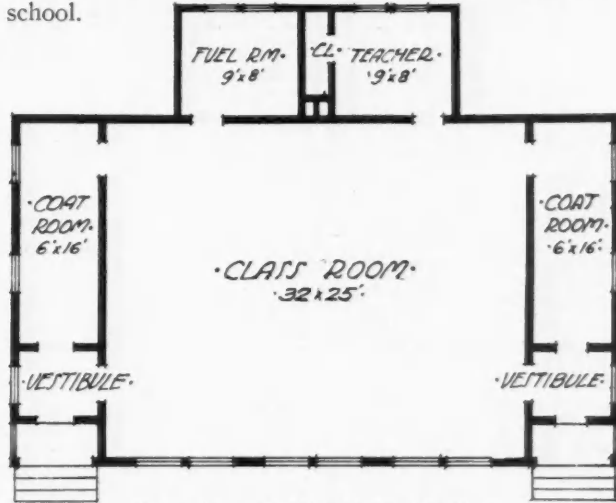

Floor plan embodying best principles.

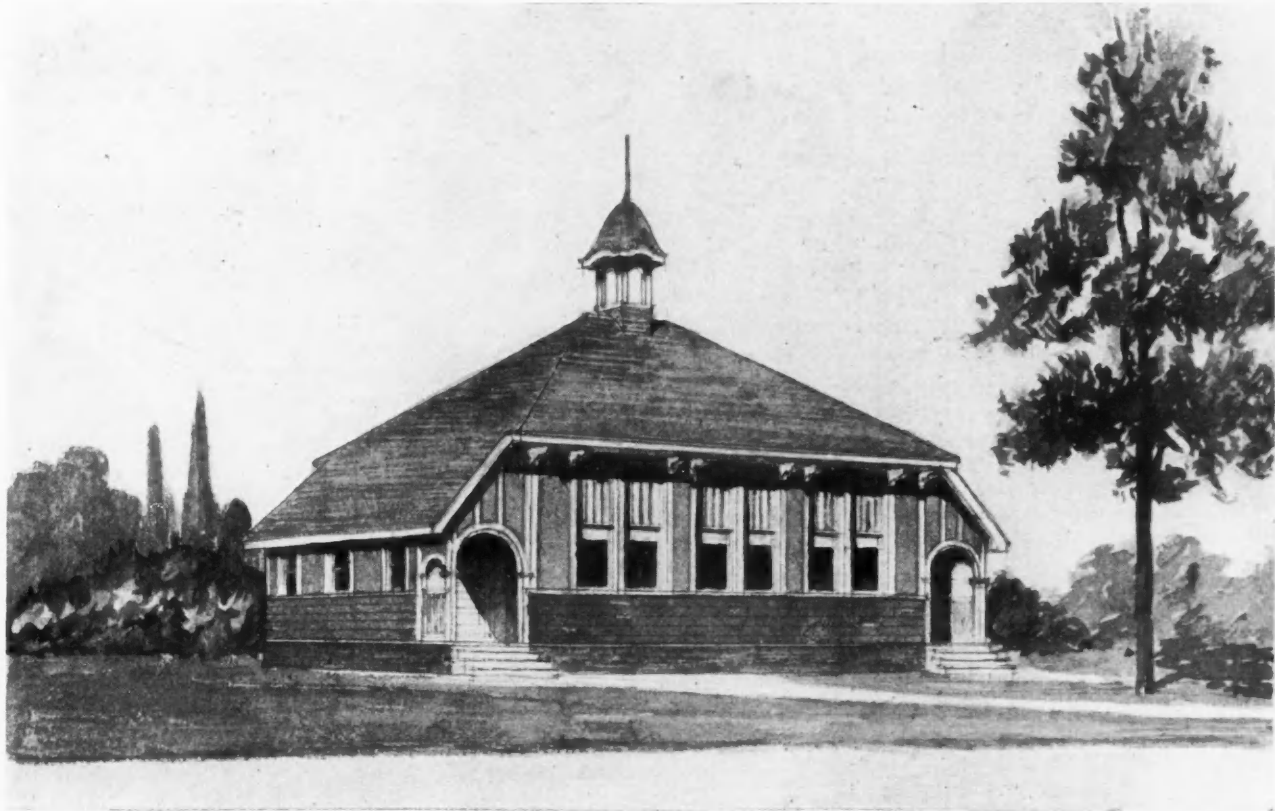

Design for Model One-Room School Building



Noon Hour Talks by the Boss Carpenter

Talk No. 8

THE BOSS EXPLAINS ABOUT THE EFFECT OF AN ECCENTRIC LOAD ON A SHORT COLUMN, AND SHOWS METHOD OF CALCULATION

WHEN the "calculating squad" assembled on the day following the talk on centrally loaded short columns, one of the men asked the Boss to turn back to the page in the log book which contained Figs. 12 and 13, and explain the condition present when the column carried a load which was *not* central.

"I can see," said the man, "that the unit stress will be uniformly distributed over the column cross-section when the load is central as in Fig. 12, but what happens *in* the material when the load is a little off-center? It would seem to me that one side of the column would be loaded a little bit heavier than the other."

"That is just exactly what happens," said the Boss, "and the point is to find out how much more one side feels the effect of the eccentric load than does the other side. Suppose that we look at Figs. 15 to 17

in order to get this matter clear."

The Boss then constructed Figs. 15, 16, and 17 in the "log book," and explained that while Figs. 15 and 17 were to illustrate instances where eccentric loading on short columns might occur, Fig. 16 was to show the *internal* stress conditions in the *column material* due to loads carried as shown in the other figures. The little arrows shown were made to represent the manner of distribution of the internal stress in the material when the load was applied at the top.

"Suppose," said the Boss, "that we had a load centrally applied on a short column, then the stress in the material will be uniform all over the column cross-section, as shown by the upper part of Fig. 16. Each of these little arrows are of the same length in order to represent this condition. Now suppose that we were to move this load a little way to the right as shown in the brick pier in Fig. 15. The pier or column would still have to carry just as much weight as it did before, and also would be subjected to an unbalanced action on account of the load being on one side of the center. The lower part of Fig. 16 shows this unbalanced effect. One set of arrows point in the same direction as formerly, but the other set point in the opposite direction, since the other side tends to tip up instead of crush down. Suppose that we call p , a compressive tendency, or a unit crushing action, then from the figure p_2 will add to this effect on the right-hand side of the column, and lessen the compression or crushing effect on the left-hand side.

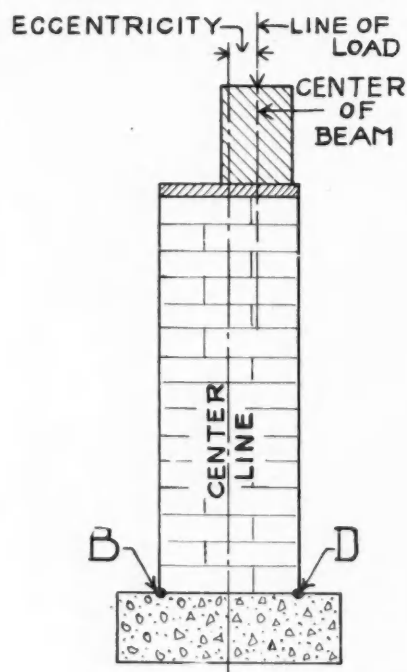

Fig. 15. Brick Pier with Eccentric Load, Due to Weight on Floor Beams

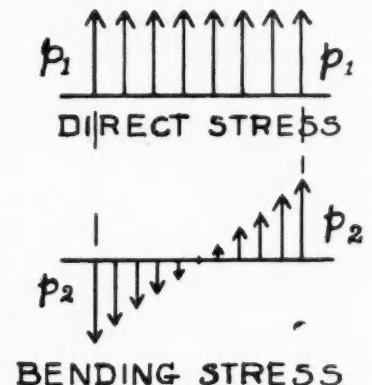

Fig. 16. A Graphical Illustration of the Unit Stress Conditions in a Short Column Loaded with an Eccentric Load

In fact, this difference in internal stress in the material may be so great, due to the distance of the load from the center, that there will be no crushing tendency at all on the left side of Figs. 15 or 17. The actual internal stress at *B* in Fig. 15 may be zero, or even may have a tension value. If a tension value was present, there would be a danger of the joints in the brickwork opening up, since mortar will stand little or no tensile or pulling stresses. This shows us that we must be careful in placing loads, and also in figuring members of this kind.

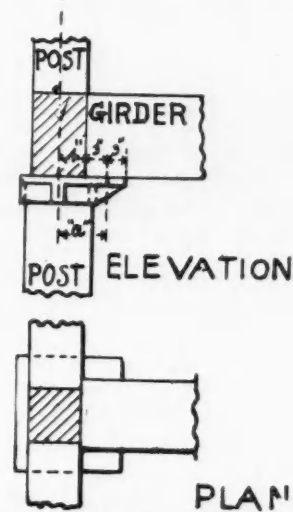

Fig. 17.—Short Post Loaded with a Floor Girder on a Side Bracket and Also Carrying Load from Another Post on Upper Floor.

“The formula that we will use for figuring eccentric loads on short columns is

$$C = \frac{W_1}{A} + \frac{W_2ae}{I} \quad (\text{Formula No. 6})$$

where *C* is the working unit compression stress in pounds per square inch for the material used; *W*₁ is the total load on the post or column in pounds; *A* is the area of the column cross-section in square inches; *W*₂ is the amount of the total load which is off-center, in pounds; *a* is the distance of the line of action of the eccentric load from the center line of the column, or the *eccentricity*, in inches; *e* is the distance in inches from the center of gravity of the cross-section of the column to the outer fiber on the compression side of the column or to the side nearest the load; while *I* is the moment of inertia of the column cross-section about an axis passing through the center of gravity of the section. Values of *e* and *I* for common shapes are given in a table in Talk No. 4. Values of *A* may be obtained by multiplying by 2 the values of the “half areas” given in a table in Talk No. 4. Values of *C* may be found by dividing by 4 to 6 the final crushing strengths given in the first column of the table in Talk No. 7, or from the values given for brickwork or stonework in the latter part of that article. *C* will be the combined values of *p*₁ and *p*₂ shown in Fig. 16.

“For an example, let us see what would be the difference in the unit stresses which would exist at the base of the brickwork pier shown in Fig. 15 if a load of 24,000 pounds was to be carried by the uniformly loaded beam which is supported at one end by the pier. The pier is 13 inches square and 7 feet high.

First, if the end load from this beam was central on the pier, the unit stress at *B* and *D*, and in fact all over the base of the pier, would be

$$\frac{24000}{2}$$

plus the weight of the pier itself, divided by the area of the pier. (See Formula No. 5). The weight of the brick pier would be

$$\frac{13 \times 13}{144} \times 7 \times 120 = 985 \text{ pounds}$$

where 144 is the number of square inches in a square foot, and 120 is the weight of a cubic foot of brick work.

“Then 12,985 pounds would be the entire weight on the base of the pier, and

$$\frac{12,985}{13 \times 13} = 77 \text{ lbs. sq. inch (nearly)}$$

from Formula No. 5. This value is seen to be safe according to the working value for brickwork given in Talk No. 7.

“Now let us put this same beam in the position shown in Fig. 15 and let the center line of the beam be placed 2 inches away from the center line of the pier. Then applying Formula No. 6 and using values of *A*, *I*, and *e* from Talk No. 4, we would have for the unit stress at *D*

$$C = \frac{12,985}{13 \times 13} + \frac{12,000 \times 2 \times 6\frac{1}{2}}{\frac{1}{12} \times 13 \times 13 \times 13 \times 13} = 77 + 65\frac{1}{2} = 142\frac{1}{2} \text{ lbs. per square inch.}$$

“Thus you see,” said the Boss, “that the unit stress in the material at *D* is almost doubled by placing this beam as shown in Fig. 15,, and the unit working stress for lime mortar would be exceeded.

“What would be the condition of affairs at the side *B*?” asked one of the men.

“I will tell you about that tomorrow,” said the Boss, “and I will show you how to figure a post which supports a side girder load and also a top load as shown in Fig. 17.”



MOTOR-CARS *and* CYCLES for BUSY BUILDERS



As motorcycles will continue to be more and more used by carpenters and builders, and no doubt each rider has at times encountered vexatious problems, the American Carpenter and Builder, will, beginning next month, devote necessary space to answering questions pertaining to motorcycles. Make your questions as brief as possible yet explicit. Address all inquiries to Motorcycle Editor, American Carpenter and Builder. Also write and tell him your experiences with motorcycles and enclose a photo.

The Motorcycle as an Investment

By Frank L. Valiant

DO you believe that the purchase of a motorcycle would prove a good investment for me?"

This was the question propounded to me by a very good friend not long ago. I will relate the circumstances that led up to the question and the experiences that followed, for the reason that no doubt there are many others persons in exactly the same position as my friend, Mr. P.

Mr. P. formerly lived in a small city of about 35,000 population. He was a carpenter by trade, but because of sickly children he moved into the country on a little farm about 12 miles out. Naturally there was not a great deal of building going on where he was located, so P. took the Civil Service examination and was appointed a rural carrier. He had a little money saved up and

bought a horse and wagon and began distributing mail over a route 18 miles in length with 86 boxes. He managed to get along very well, by means of doing a little trucking on the side, but it didn't take him long to figure out



C. A. Parker, a Denver, Col., carpenter, who recently made a tandem trip with his wife as passenger from Denver to Columbus, Ohio. He finds the motorcycle indispensable.

that the horse was eating up all the profits of the trucking business, and besides, it required the better part of the day for him to cover his route.

Mr. P. was a subscriber to the R. F. D. News and it was through reading of other carriers' experience with motorcycles that first caused him to become interested. Knowing that I was considered more or less an authority on the two-wheeled machines, having ridden motorcycles since 1900, Mr. P. asked me to come and see him.

Should he or should he not purchase a motorcycle? I advised him exactly as I would counsel any one else. I told him I believed a motorcycle would prove mighty profitable and named a half dozen leading makes, any one of which was recognized as one of the leaders. He mentioned a certain well advertised machine and asked my opinion. I urged him against the purchase of that particular machine for many reasons, one of my principal reasons being that it was impossible to

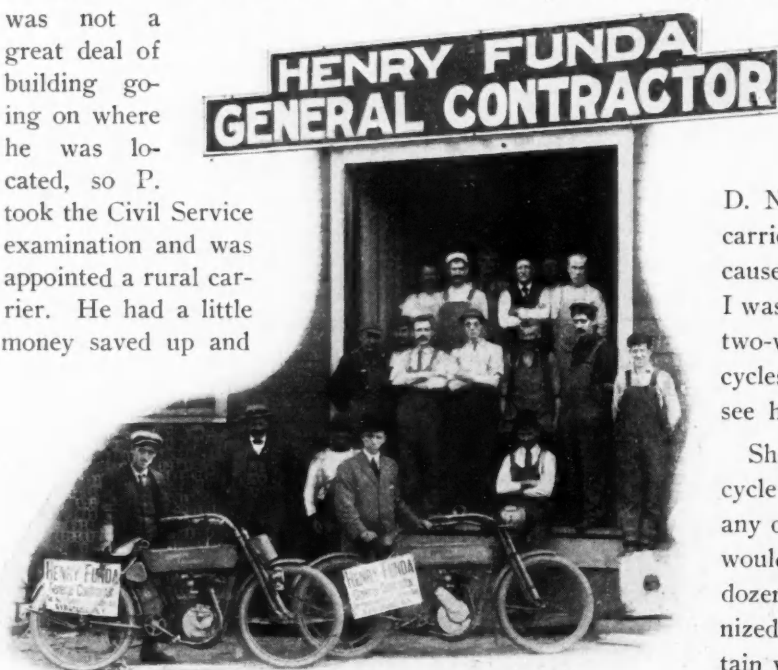

Henry Funda, Builder and General Contractor of Syracuse, N.Y., has worked up a big business through progressive energetic methods. He finds the motorcycle an absolute necessity in looking after the many branches of his work.

build a motorcycle and build it right at the price advertised.

Mr. P. thanked me and I thought nothing more about it. Three months later I happened to be in the neighborhood and motored out to my friend's house, only to find him in despair. Contrary to my advice he had purchased the cheap machine. Everything had gone along fine for the first month and then things began to happen. First it was a broken frame. Then the bearing chewed up, necessitating express to the factory and a delay of ten days. No sooner had the machine come back than the connecting rod crumpled up, in addition to a few minor mishaps. It wasn't the cost my friend objected to, as each damaged part had been replaced gratis by the factory, but it was the loss of time necessitated by the frequent trips back to the factory.



BUILDERS SUPPLY MAN "GETS THERE"

W. C. Cassidy, travelling salesman for the Contractors Supply Co., Springfield, Mass., finds the motorcycle a valuable aid to him in calling on contractors and builders. Frequently he finds contractors miles from the city on some job, and by means of the motorcycle he is able to call on them, where otherwise a delay of a day might be necessary.

By this time P. was willing to listen to reason, and acting on my advice, he sold the machine at a price considerably less than the original cost and purchased one of the most reliable motorcycles on the market, but at a figure \$65 higher than the original cost of his initial machine.

I got a letter from him the other day and a more enthusiastic motorcyclist would be hard to find. Not once has it been necessary to ship the motor back to the factory and my friend wrote me that not only has he paid for the machine twice over, but he has been enabled to pay nearly half the mortgage on his little farm, this in a period of fourteen months. Where it took him nearly all day previously to cover his route with a horse and wagon, he can now get through by ten or half past ten o'clock in the morning, leaving the remainder of the morning to work his garden. The



DELIVERS BUILDERS HARDWARE QUICKLY

W. C. Martin, Washington C. H., Ohio, would not be able to successfully transact his business but for a motorcycle. He repairs farm machinery, and being interested in a hardware store frequently is called upon to deliver building essentials miles in the country.

entire afternoon he devotes to doing odd jobs of carpenter work around the neighborhood, and so much work has come his way that he is considering resigning from the R. F. D. and devoting his entire time to his original trade. The farmers in the entire county have learned that they do not have to wait a week for a town carpenter—as Mr. P. can get "on the job" in a few minutes.

The above incident is a true story in every detail and is related because there are hundreds of persons just like Mr. P. who no doubt would be able to double their income by using a motorcycle.

From a carpenter's standpoint, the next question



SUPERINTENDENT OF CONSTRUCTION USES MOTORCYCLE
M. C. Schanck, Superintendent of the Street Department, Kings County Lighting Co., Brooklyn, N. Y. He finds the motorcycle a great time saver as well as an economical means of rapid transit.

arises. "What kind of a motorcycle should I purchase?" Every advertisement asserts that particular machine is the best made, and every dealer knows positively that you will get "stung" unless you purchase the machine he is selling. You then write for catalogs and forthwith are so smothered with printed blandishments that you may be pardoned for not knowing which direction to turn.

First of all, what will you require of a machine? Providing that this is your first experience with a motorcycle I would strongly urge the purchase of a single cylinder machine. There are a number of excellent singles on the market with engines rated at about 4 horsepower. A machine of this power is capable of traveling from four to forty miles an hour and will jog along all day, day in and day out, at a



Isaac Heckman is a builder at Middletown, Ohio. Not only is the motorcycle a great help to him in earning a living, but he uses it a great deal for pleasure. The photo was snapped just after he returned from a lucky turtle hunt. Heckman is an enthusiastic sportsman, and although working nearly all day he is able to get on his motorcycle and get in some shooting and fishing between times.

gait of 25 miles an hour. Most of the leading 1913 machines are fitted with luggage carriers without extra charge, and a large sized tool box may be carried on the rear without inconvenience and without an appreciable diminution in speed. The leading single cylinder motorcycles for 1913 range in price from \$200 to \$225. Whether to purchase a chain or belt drive is a point that could be argued from now until doomsday without arriving at a positive conclusion. The writer has ridden both belt and chain drive machines for the past thirteen years and must confess that he likes one as well as the other. I would, however, choose between a V-type belt or chain, as the flat belt has proved unsatisfactory, a fact proved by the fact that the leading manufacturers have, with few exceptions, discarded the flat belt.

If you reside in a hilly country or where the roads are not of the best, a twin cylinder machine of seven horsepower would perhaps suit the requirements better. A twin will carry you and your tools any place that any 40-horsepower automobile can go and a great many places that no automobile can travel. The prices

of 1913 twins range from \$250 to \$335, according to the type and make. For very hilly country or where the roads are unusually bad, a two-speed hub is recommended, and this year there has been put on the market a machine fitted with a self-starter and two-speed hub which makes a machine that will carry a rider any place with no physical effort whatever, as all the energy required to start the motor is to depress a small pedal with the left foot.

The cost of upkeep for a motorcycle naturally will vary with the machine, the rider and road conditions. The writer rides a six horsepower twin cylinder machine of the 1911 vintage and so far has covered upwards of 25,000 miles without two dollars' worth of expense outside of the money expended for tires and gasoline and oil. I have traveled over some of the finest roads in the United States and over some of the most execrable roads imaginable. I average about 75 miles to the gallon of gasoline and pint of oil—sometimes more and sometimes less, but 75 miles is a pretty fair average. My machine originally cost \$250 and I can sell it any day for \$150 or more, so at best there is a depreciation of only \$100 in two years. To have covered the same distance on a train would have cost at least \$625, to say nothing of the pleasure I would have lost.

I know a telephone company that formerly used ten horses and buggies and as many men. For the last year five motorcycles have done more work. For the entire year, accounting for depreciation, the cost per mile for the motorcycle was 1.1 cents, as against 4.2 per mile under the old method. Unquestionably the motorcycle is the cheapest method of transportation known to the present generation.

I have often been asked the question: "Why not buy a second-hand motorcycle to start with?" I can answer that question in a very few words. Buying a second-hand motorcycle by a person not familiar with the machines is about the same proposition as a blind man buying a horse. You can never tell how fast a horse can trot by its whinny, neither can you figure what the upkeep of a motorcycle will amount to by the smell of the exhaust. My advice is to purchase a new motorcycle, but if you are determined to get a second-hand one, then at least purchase it from a reputable dealer who has built up a profitable business through square dealing and who has a reputation to maintain.



After considerable experimenting, the best mixture for cement stucco for interior use is, according to the metal lath manufacturers, one part cement, 2½ parts clean, sharp sand and 1/10 part lime putty.

For best results in building, metal lath of No. 24 gauge weighing 3¼ pounds to the square yard should be used.



A Hammer With Triple Claws

For a hundred years or more, everybody worked along with the ordinary style hammers and seemed fully content. Their shortcomings were taken as a matter of course and nobody thought of the possibility of improving on the carpenter's hammer.

But of late, all this is changed. The carpenter's hammer is on the operating table and the doctors are making him over.

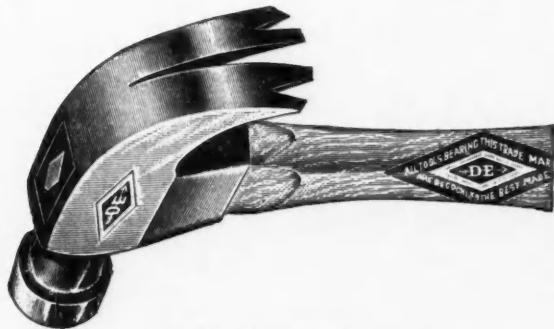

A New Idea in Claw Hammers

The newest development is the hammer with a triple claw. It has the ordinary heavy claw and two smaller ones away at the end. By means of these extra claws it is said that nails can be drawn that are impossible with the old style claw. With this tool, finishing nails can be drawn entirely out of the wood without putting a block under the head of the hammer and without bending the nail. Those who have used it, also say it will pull the nail straight and true without marring and crushing the finest wood work.

This triple hammer is made of one piece of drop forged crucible steel, carefully tempered and hardened. As it is one of a well known line of mechanics' tools, builders will certainly take an interest in it and give it a trial.

Atkins Pioneers Banqueted

The E. C. Atkins Co., of Indianapolis, Ind., manufacturers of the famous "Silver Steel" saws have in the "Atkins Pioneers" a unique fraternal organization. The present membership includes 129 men who have been employed by the E. C. Atkins Co. for periods ranging from twenty to fifty years.

The "Atkins Pioneers" gave their fourth annual banquet on Feb. 1st. The menus were cleverly arranged and pictures of Mr. John H. Wilde, Honorary President of the "Pioneers" were given as souvenirs. Mr. Wilde is the oldest Pioneer and has been retired on a pension. Dinner was followed by an excellent and entertaining program. The annual banquet is also made the occasion for the election of new officers and the reception of new members.

The advantage of such an organization as the "Pioneers" is great, fostering as it does that close family feeling among employes, which is so productive of the best cooperation. We

congratulate the E. C. Atkins Co. in having the services of such a fine lot of men as the Pioneers.

Chicago Builders Elect Officers

The Builders and Traders Exchange of Chicago held their annual election on January 20th. The voting was lively and the following officers elected by a considerable plurality—For President, John D. Corlett; First Vice-Pres., Thomas B. Roy; Second Vice-Pres., A. C. Jaeger; Treas., Joseph E. Lindquist. Out of twelve candidates for the offices of directors the following five were chosen, F. F. French, C. W. Jones, O. W. Jovien, A. Y. Reed, F. S. Shoemaker.

N. C. Builders' Exchange Elect Officers for Year

Raleigh, N. C., Jan. 22.—The North Carolina Builders' Exchange, in annual session just closed, elected H. A. Pfohl of Winston-Salem, president, to succeed J. A. Jones of Charlotte; John F. Underwood, vice-president, and D. T. Tinglye of Charlotte, secretary. The association established affiliation with the national association and heard an address by former Supreme Court Justice J. S. Manning.

Driving Back the Arctic

"If the Gulf Stream could flow unbroken past the Grand Banks of Newfoundland, where it now is broken and dissipated by the icy Labrador Current, climate changes would be effected that would double the land value of the Northern Hemisphere. Arctic winters would then be unknown," writes Carrol L. Riker in the issue of *Harper's Weekly* for September 28th. The author, who is an engineer of experience, claims that this can be accomplished by the construction of a jetty across the Grand Banks off Newfoundland at a cost of \$200,000,000.

A Labor-Saving Wheelbarrow

Builders are all the time on the lookout for anything that will help them do their work easier or better. An ingeniously contrived wheelbarrow is now on the market which looks like a winner for contractor's use. For handling of sand, gravel, mortar or concrete, it will be all right.

The hopper of this wheelbarrow is pivoted directly over the wheel. Pressing a lever at the handle unlocks the hopper, allowing it to tip forward dumping the load.

Suppose only a minute is saved on every dump—a minute of time and all of the labor of raising the load up and over; it doesn't take much figuring to compute a substantial saving in a day's work for a gang of men. With this barrow, the wheel is also placed farther back under the tray than ordinarily so that the bulk of the load is on the wheel bearings and less on the arms of the trundler. Another advantage is the accuracy in depositing the load just where desired.

This looks like a little piece of equipment worth looking up.

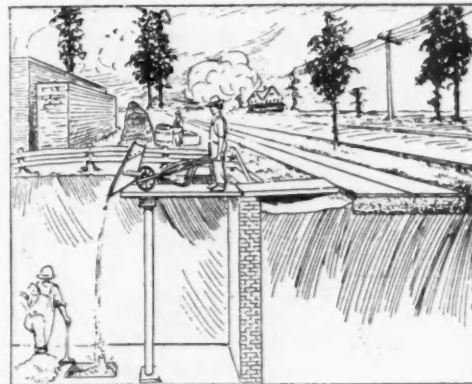

Material Dumped Easily and Just Where Wanted

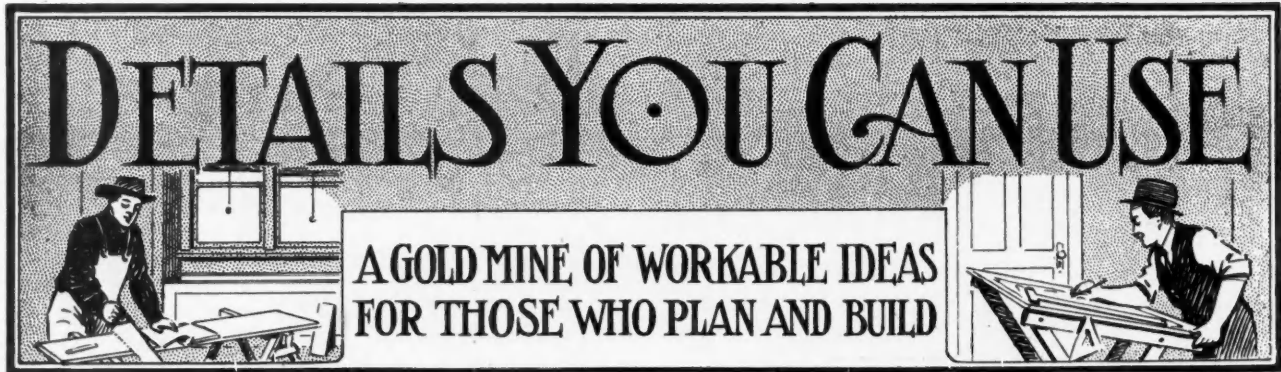

Colonial Interior; also Glazed Porch

THE whole idea these days seems to be for lots of light. Residences will have double the window area we used to consider plenty; and on the inside of the up-to-date house we find, in place of the solid sliding doors our fathers would have used, double doors that are practically all glass. Doors of some sort are needed to prevent drafts—but they must not cut off any light.

A gracefully designed pair of these glazed interior or French doors is illustrated. White enamel paneled wainscot in harmony is also shown. Details show how these features are proportioned and constructed. This is a dining room opening into living room.

The porch design presented on the opposite page is one that works in well very often. It is of colonial origin combined with something of the bungalow characteristics. This is a smallish porch—a side door sun parlor or screened summer sitting room. It is a feature that adds to the beauty of a place (so many of the built-on porches we see are anything but beautiful) and affords a cosy, enjoyable retreat at very little extra expense.

The drawings show the fine points of the design and construction so that house planners will have no trouble making practical use of the suggestions contained.

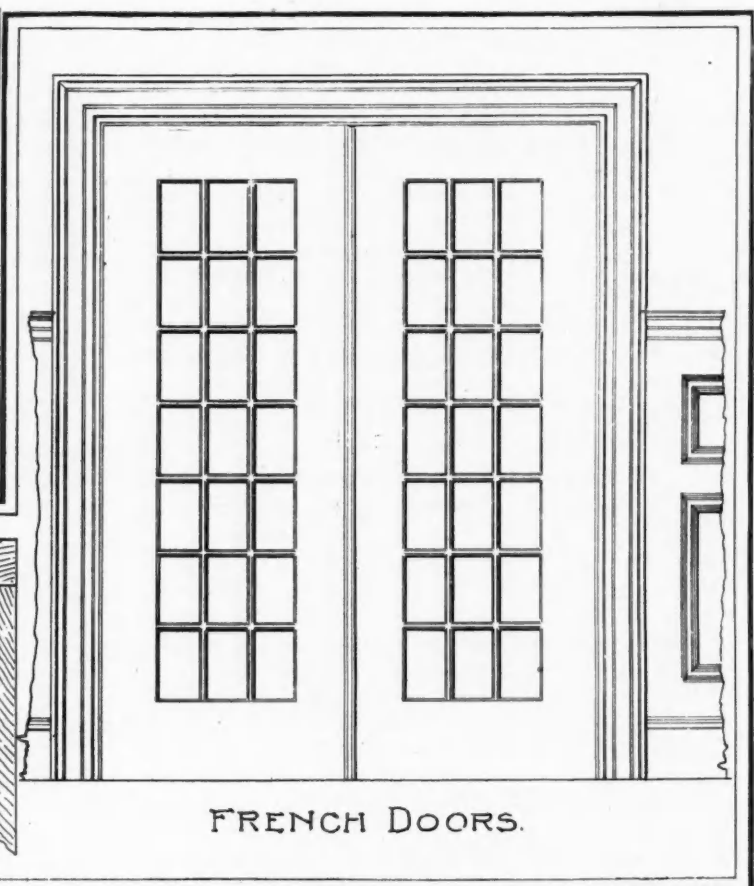
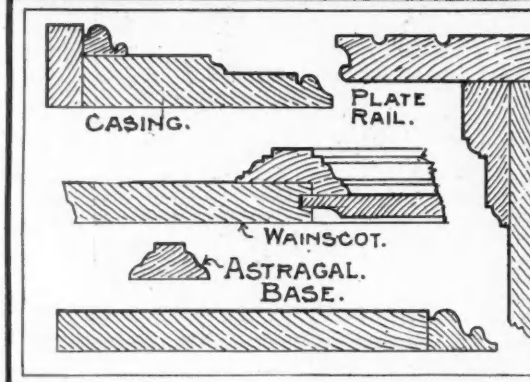
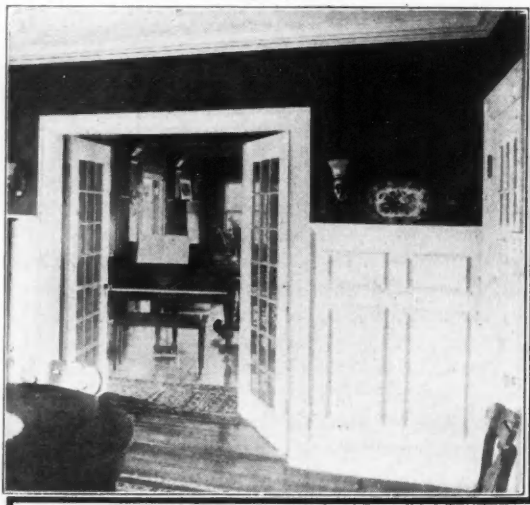

Photo and Working Drawings of Beautiful Colonial Interior—Paneled Wainscot and Double Glazed Doors in the Latest Fashion

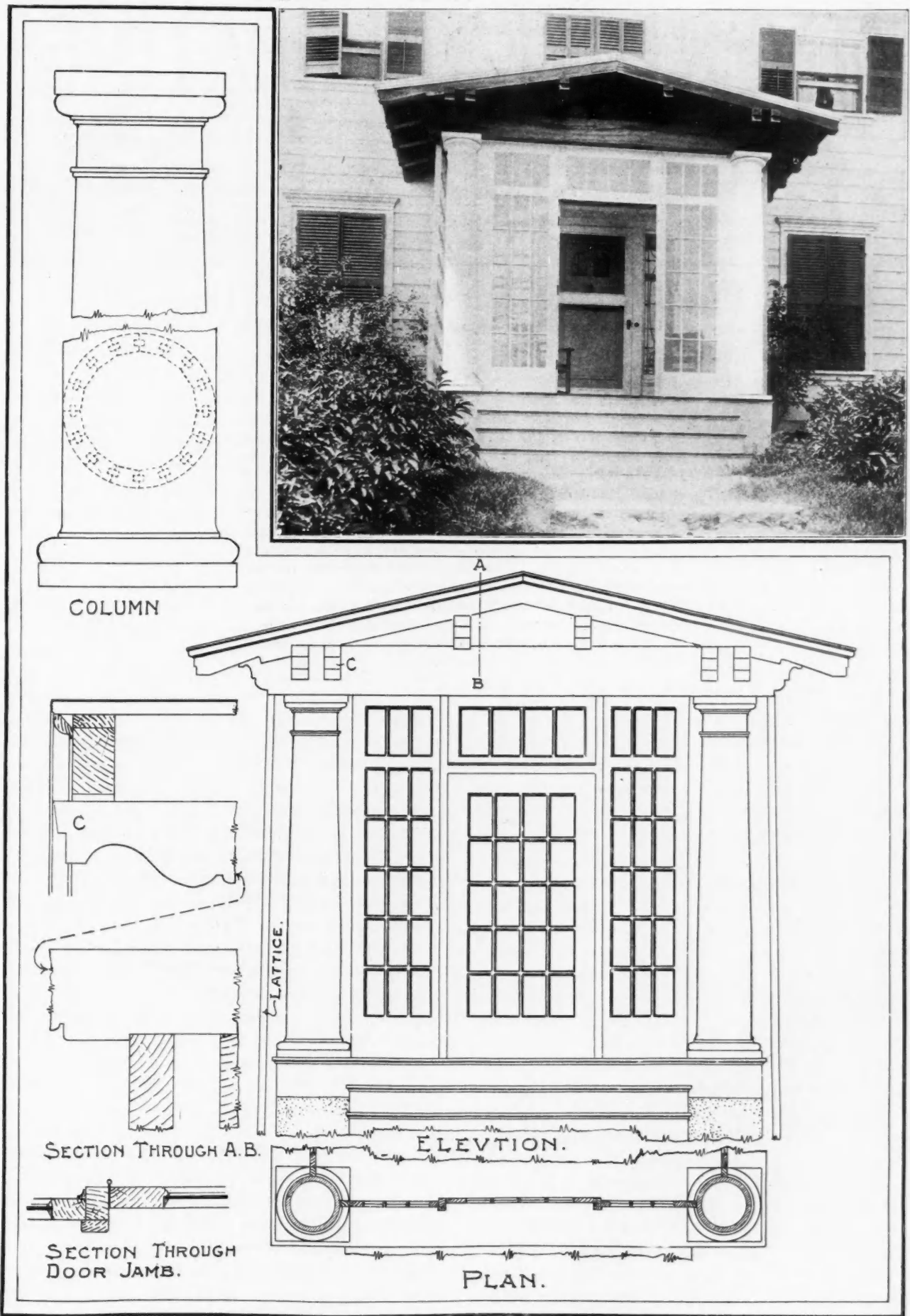

Photo and Working Drawings of Well Designed Glazed or Screened Porch



Builders Experiences in Handling Warm Air Furnace Work and Installing Steam and Hot Water Systems

Placing the Furnace Properly

IN THIS ADVENTURE NO. 1 THE OLD BUILDER TELLS HOW HE GOT INTO THE HEATING END OF THE BUSINESS—IMPORTANCE OF COLD AIR BOX

By Cecil F. Herington

AN old builder whose houses were noted far and wide for their general comfortableness and solidity of construction was asked recently to relate some of the reasons for his reputation and success in this line. What he said was so interesting and instructive that we believe our readers will be the gainers by careful attention to his remarks. Here is what he said:

"When I first began building houses I thought I knew all about them until I came to get some questions handed out to me which had to be settled then and there and which, much to my surprise, I found out I knew really very little about.

"You know when I started in to learn the carpenter trade I thought that a man was a pretty good carpenter when he could saw boards with square edges and drive nails without leaving hammer marks on the boards. Well, after I had been learning the trade for sometime I found out that a man who could do all this wasn't necessarily such a good man after all, unless he understood his work thoroughly enough to know not only when to drive a nail but just why it was necessary to be driven. In fact I discovered that a workman, be he ever so efficient, is a pretty expensive man to hire if you also have to hire a foreman to stand over him every minute in order to properly direct his efforts.

"And so, after I had been learning the trade for sometime, I made up my mind that I wasn't going to stop at being just a carpenter—that I wasn't going to stop at being even a *good* carpenter, and I determined to learn the why and wherefore so that gradually I might progress to the extent of becoming a builder. How well I have made good on that point it remains

This is the first of a series of articles by this practical builder and heating man to appear every month in the A. C. & B. We have hunted a long time for just the right authority to take up this heating subject and handle it in a way that would be both instructive and readable. We feel very much gratified in having secured the services of Builder Herington for this work. He will relate a series of actual experiences in handling warm air furnaces, steam heat and hot water systems in connection with his regular building work. Each of these incidents teaches clearly some important principle in handling this branch of the work. Write and tell us YOUR heating experiences; and ask questions. —Editor

for my customers to say, but I soon found that the same principle holds good among the builders which I discovered among the carpenters, only perhaps in a little bigger way. A builder may understand all about carpentry and all about lumber, he may be well up on painting, quite wise about masonry and know good plaster

when he sees it, yet still be a builder who, on account of ignorance on some other essential points, will be constantly running into obstacles which lead to his discomfiture if not his actual undoing. So when I got into the building line I at once struck a good many new things that would have helped me out had I known about them, and whenever it begins to turn cold it always makes me think of the way I got in over my head on the subject of heating one of the first houses that I tackled all by myself.

"This house was of the ordinary suburban type (such as you are perfectly familiar with) and I was building it for a family from some sketches they had made, and I was also trying to work in some ideas of their own. But I was badly perplexed before I started to build by having it put up to me to decide for the owner the most satisfactory kind of heat. Now of course you know that strictly by rights a builder is not required to advise an owner on such points as this, but there is a whole lot in keeping the man for whom you are working in a good humor; and oftentimes by helping him out on various points like this you get into his good graces so that he isn't inclined to be as unpleasant as he might be about some of your work which possibly may not quite meet with his approval.

"So when this question was put up to me I did a lot of scurrying around to find out something about heating and the deeper I got into it the more interest-

ing I found it. I believe now that the proper heating of a house is one of the most important items for every builder to consider. Of course on the ordinary residence there is not perhaps as much to the heating end as there is in the carpentry work, but it is an interesting subject all the same, and I was mighty well repaid for the time I spent looking it up. In fact I have been getting experience in heating ever since and I have a great many customers who are much better satisfied with my houses on account of their efficient heating apparatus than they would be had I allowed some heating contractor to go ahead and put in just as little as he possibly dared with the idea of making a bigger profit on the job."

On being questioned as to how he had handled his first heating proposition the Old Builder smiled reflectively and took a few extra puffs out of his pipe before he made reply. Finally he smiled again and said, "Well, you see, in consideration of the amount of knowledge on heating that I had myself *at that time* I thought it was much safer to look around and see what most of the other people had and, going on the principal that there was safety in numbers, to advise my owner to put in the same apparatus.

"Of course, in those days, heating was done almost exclusively by warm air furnaces (except where stoves were used), and even today, when all other things are considered, furnaces are about as satisfactory in the general run and for the amount of attention they require as any kind of heating apparatus used in residences. You want to remember though about furnace heating that its action is not all positive and it is liable to be disturbed seriously in high winds and on the exposed sides of a house. I don't suppose that many builders have even studied into the furnace subject far enough to tell how big a furnace pipe should be run up to this room where we are now sitting, or if the pipe would have to be the same size had the room been located on the opposite side of the house. You see the action of the hot air furnace is all natural; that is to say you start a fire in the fire pot which heats the iron castings around it, this heat being given off to the surrounding atmosphere just the same as with an ordinary parlor stove, the only difference being that the furnace is surrounded with some sort of a metal jacket which confines the surrounding air so that it can pass only in a vertical direction, either up or down.

"Of course when air is heated it expands a little, becomes lighter and has a tendency to rise, and the air surrounding the fire pot follows this general tendency and rises up into the hot air chamber at the top of the furnace from which the pipes are taken leading to the various rooms. Now these pipes are often installed improperly by careless furnacemen who sometimes run them in a perfectly horizontal direction from the furnace to where the pipe turns up to go either to a first floor register or into one of the wall flues going

up to the second floor. These pipes should one and all have an upward pitch from the point where they leave the furnace to the end of the horizontal run. This allows the air to rise slightly as it moves along and results in helping the flow of the hot air in the pipes. When these pipes are placed horizontal or worse yet with a slight drop as they leave the furnace you are giving the hot air no chance to rise and retard the flow considerably by this reason.

"Another thing about furnaces which often results in trouble is the location of the cold air inlet and quite likely you have seen a whole lot of furnaces where the cold air box has been omitted entirely and nothing but an opening left in the bottom of the furnace casing to supply this need. Now you can easily see that when the air around the fire pot becomes heated and rises you must admit other air to take its place, for if you do not there will be produced a vacuum which would prevent the hot air from rising and the furnace from operating in a proper manner. This is provided for by the opening in the bottom of the furnace casing through which new air is allowed to enter. So if you don't put in a cold air box the entering air will be taken out of the cellar which is liable to result in damp air, possibly with more or less of an odor to it, and in many places liable to be contaminated with sewer gas and full of dust. A proper furnace installation must by all means have a cold air box, which should be run

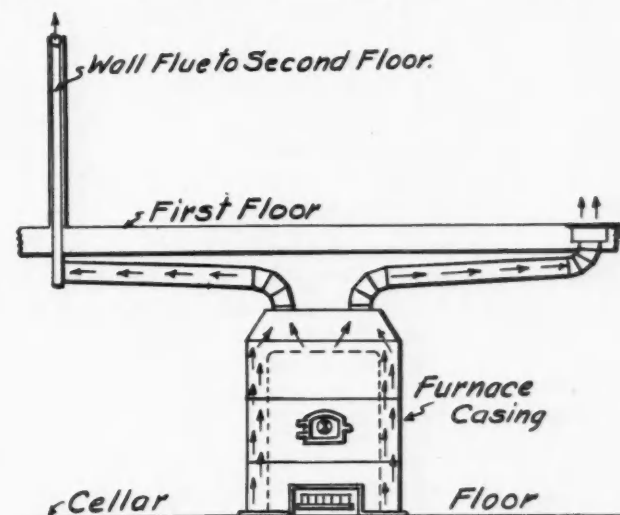

Sketch that the Old Builder made to illustrate the flow of air in a furnace and the proper way to pitch the horizontal pipes

to some cellar window or other outside connection to allow the incoming air to be taken from the outside direct, insuring a fresh and pure supply at all times.

"Why I knew a woman who bought a house at a *great bargain* and the first winter she did nothing but dust, dust, dust. Every time her husband coaled up she dusted off black dust and every time he cleaned out the ashes she dusted white dust and every time the cellar was swept the result upstairs was simply like a volcanic eruption. At last she came to me and

(Continued to Page 95)

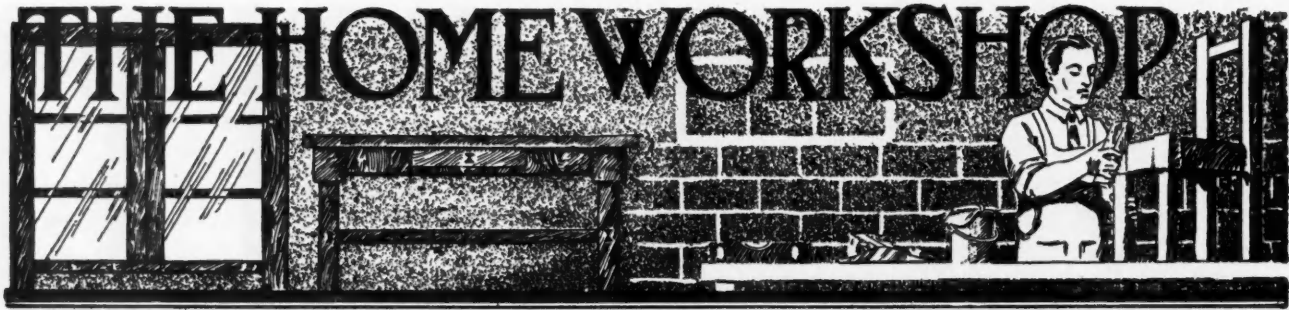

How to Make a Music Stand

COMPLETE DIRECTIONS WITH WORKING DRAWINGS FOR MAKING AND FINISHING THIS ATTRACTIVE PIECE OF FURNITURE

By Ira S. Griffith

THE music stand presented this month is from the home workshop of Mr. H. Geib of Chicago. The dimensions of the working drawing are not exactly like those of the original but the proportions will be found similar. The piece this month is made of quarter sawed white oak and is finished in a soft brown very pleasing to the eye.

STOCK BILL FOR MUSIC STAND

- Posts, 4 pieces, $1\frac{1}{2}$ by $1\frac{1}{2}$ by 48 inches, S-4-S.
- Shelves, 4 pieces, $\frac{3}{4}$ by 18 by 24 inches, S-2-S.
- Back rails, 4 pieces, $\frac{3}{4}$ by $3\frac{1}{4}$ by 25 inches, S-2-S.
- Side rails, 8 pieces, $\frac{3}{4}$ by $3\frac{1}{4}$ by 18 inches, S-2-S.
- Back panel, 1 piece, $\frac{5}{16}$ by $10\frac{1}{2}$ by 23 inches, S-2-S.
- Side panels, 2 pieces, $\frac{5}{16}$ by $10\frac{1}{2}$ by 16 inches, S-2-S.
- Slats, 4 pieces, $\frac{3}{16}$ by $\frac{3}{4}$ by $8\frac{1}{2}$ inches, S-2-S.
- Slats, 8 pieces, $\frac{3}{16}$ by $2\frac{3}{4}$ by $8\frac{1}{2}$ inches, S-2-S.
- Slats, 4 pieces, $\frac{3}{16}$ by $\frac{3}{4}$ by $10\frac{1}{2}$ inches, S-2-S.
- Slats, 8 pieces, $\frac{3}{16}$ by $2\frac{3}{4}$ by $10\frac{1}{2}$ inches, S-2-S.

Square the ends of the four posts, at the same time securing the correct length. Chamfer these ends slightly, both top and bottom. Square the rails to width and saw them to length. Lay off the lines which shall indicate the shoulder lines of the tenons and then gauge for the width and thickness of the tenons. The slats

may next be worked to width and length. These slats are not to be tenoned, however, the whole end being housed in the rail.

Stand the posts upright in the positions they are to occupy relative to one another in the finished piece and mark roughly, as with penciled circle, the approx-

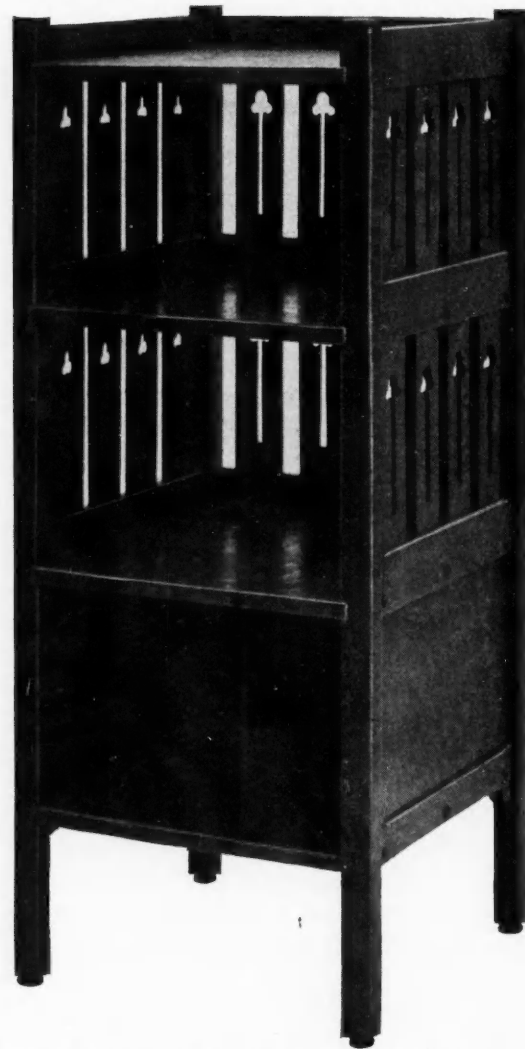

Completed Music Stand Equipped with Gliding Casters

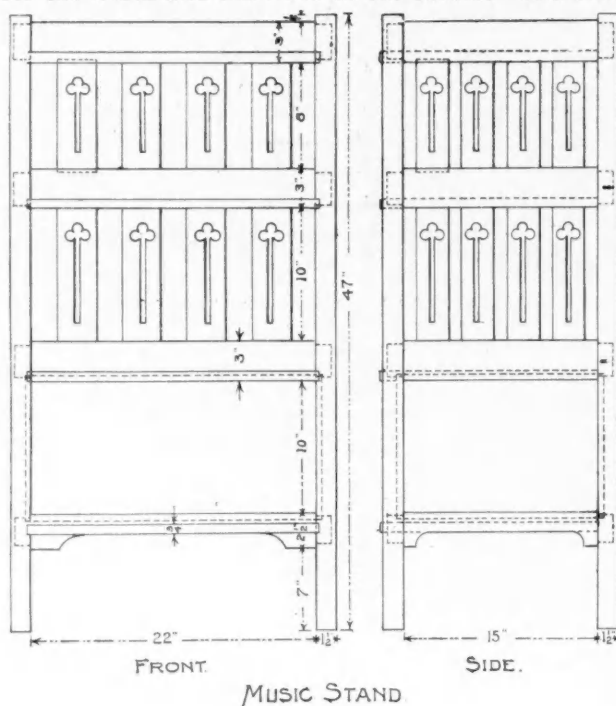

imate locations of the mortises. After this the pieces may be laid prone upon the bench and the ends of the mortises laid out accurately with knife and try-square without danger of misplacing any of the mortises.

Gauge the sides of the mortises and then work them.

The decorative ornament in the slats is suggestive. It may be modified or left out entirely as the worker may prefer.

Plow the rails for the paneling and then put the two sides of the stand together. Use good glue and plenty of clamps and see that the rails are square with the posts and the frame out of wind.

While the glue is hardening upon these parts, the shelves may be squared to size and the back panel, rails, and slats prepared. When the glue has hardened upon the sides, lay off and work the dados in the posts and fit the shelves. Having done this, set the shelves and place the back with its panel and slats.

How to Finish

A suitable finish is obtained as follows:

Thoroughly sandpaper all the parts leaving the surfaces smooth and clean. Apply a coat of stain of a color desired for the highlights. Sandpaper this lightly with number 00 paper and then apply another coat of the same stain diluted this time by the addition of an equal amount of the solvent. This second coat is to bring the grain into still higher relief. Upon this, when it has dried thoroughly, apply a thin coat of shellac. If the stain was dark an orange shellac may be used, otherwise, use white shellac. Sandpaper this shellac lightly with the fine paper and apply a coat of filler colored somewhat darker than the stain. If no dark filler can be purchased readily, a natural color of filler may be used and this darkened by the addition of coloring materials ground in oil. See that the filler is thoroughly cleared from the highlights and is not allowed to remain in the corners. A good piece of woodwork is easily spoiled by not properly cleaning off the filler before it hardens. Upon the filler, after it has hardened apply a coat of shellac. Upon the shellac apply several coats of some good rubbing varnish. Rub these first coats with hair cloth or curled hair and the last with powdered pumice stone and raw or crude oil. If a fine finish such as that given pianos is desired, it may be obtained by rubbing the last coat with pulverized pumice stone and water, and then with pulverized rotten stone and water instead of using the oil as specified just above. A still higher finish is obtained by further rubbing with a little pulverized rotten stone upon a flannel cloth upon which has been placed sweet oil and alcohol in equal amounts.



Adventures in Heating

(Continued from Page 93)

asked me to tell her what was the matter. So I went over, took one look, and—no cold air box.

"Another thing that should be taken into consideration is where you place your furnace in the cellar. This thing is of course governed somewhat by the arrangement of the house and the location of the chimney but as far as possible you should try and put

your furnace about at a central position between all of the points where your pipes turn up except that you should set it a little closer to the side from which the prevailing winds come in order to favor the registers on this side of the building.

"When you move your furnace towards the windy side of the house you lengthen out the horizontal runs in the cellar which go toward the sheltered side and shorten up the ones running to the exposed side; and the shorter your horizontal runs are the faster your air will go through the pipe and the greater will be the heating effect. This is owing to the fact that the air rubbing against the pipe produces a retarding effect (which is commonly called pipe friction), which results in slowing down the air so that in a shorter pipe, where less of this effect is experienced, the air will move more rapidly and you will get more heat in a room at the end of such a pipe than you will in one located at the end of a longer horizontal pipe of the same size.

"It took a long time for me to get furnace heating down to where I could reasonably depend on it. Next month I will tell you about the most successful heating plant I ever put in and just how I figured it out."



To Build Model Concrete Road

At the close of the recent Springfield Good Roads Convention, Mayor Thos. F. Doyle of La Salle, headed a delegation from that city, in conference with the Illinois State Highway Commissioners, on the question of building a permanent roadway from the Rock Island Depot at La Salle to a point one mile south.

Plans and estimates for the work were prepared by the State Highway Engineer and were laid before the La Salle Board of Highway Commissioners on Monday of last week, meanwhile, interest in the project was aroused, among the producers of roadway material in the state.

F. W. Renwick, President, Joliet Sand & Gravel Co., Chicago, considered the enterprise a laudable one and consented to furnish free, the gravel consisting of approximately 2800 tons or 95 carloads of this material. The Marquette Cement Mfg. Co. and the Chicago Portland Cement Co., Chicago, demonstrated similar interest and will jointly furnish without cost, the cement required amounting to 26 carloads. The American Sand & Gravel Co, also of Chicago, stands sponsor for 54 carloads of sand which will be shipped as required, from sand pits at Buda and Lincoln.

At a meeting of the La Salle Board of Highway Commissioners, held at La Salle on Wednesday, February 5th, letters were read from the donors and their respective offers formally accepted, the Board appropriating the sum of Five Thousand Dollars to defray the cost of labor and fuel, incidental to the work.

The Illinois Highway Commission at Springfield were then petitioned to supervise the building of the road and in granting this request, the State Highway Engineer, named May 1st as the date on which the work will proceed.

The specifications of the State Highway Engineer, call for a roadway nine-tenths of a mile long, twenty feet wide, with an average thickness of seven inches. It will replace the old road at a point where it is subjected to heavy traffic, La Salle being the most convenient market for the prosperous farming community, immediately south of the city and which must necessarily travel this highway.



Our Readers are Requested and Urged to Make Free Use of These Columns for the Discussion of all Questions of Interest to Carpenters and Builders

Model Small Woodworking Shop

To the Editor:

Varna, Ill.

As I have been a subscriber to your valuable magazine for three years or more, and only made use of your correspondence department once, I thought I'd send in a few notes, especially since you urge your subscribers to do so. I find the correspondence department a very valuable and highly instructive addition to the paper. I am surprised, for each succeeding copy seems to eclipse the previous one. I am sorry that it does not come twice a month instead of once.

I inclose herewith a rough and rather carelessly drawn plan of a carpenter shop, which, if you see fit, and worthy of it, you may publish in the AMERICAN CARPENTER AND BUILDER. Things are dull around here now and have been for some time, giving us a chance to collect ourselves, so to speak. I have been putting in most of my spare time

studying, among other things, "Radford's Cyclopaedia of Construction," of which I am fortunately a possessor.

I have also been reviewing the back numbers of your paper, and in doing so I find in the September number a plan of a model carpenter shop. I like the model real well, especially the overhead part, I do not like the engine in the same room, however. An engine to give good results with one or two machines should have at least five H. P. and one of that size, in the shop proper would be the next thing to a nuisance. For one thing, it takes up considerable room and then it causes more or less vibration, which is undesirable. A small room on the side of the shop is well worth what it costs. With such an arrangement, you can start the engine and close the door to the engine room and you will hear very little noise.

My engine is six H. P. and my saw is of the combination

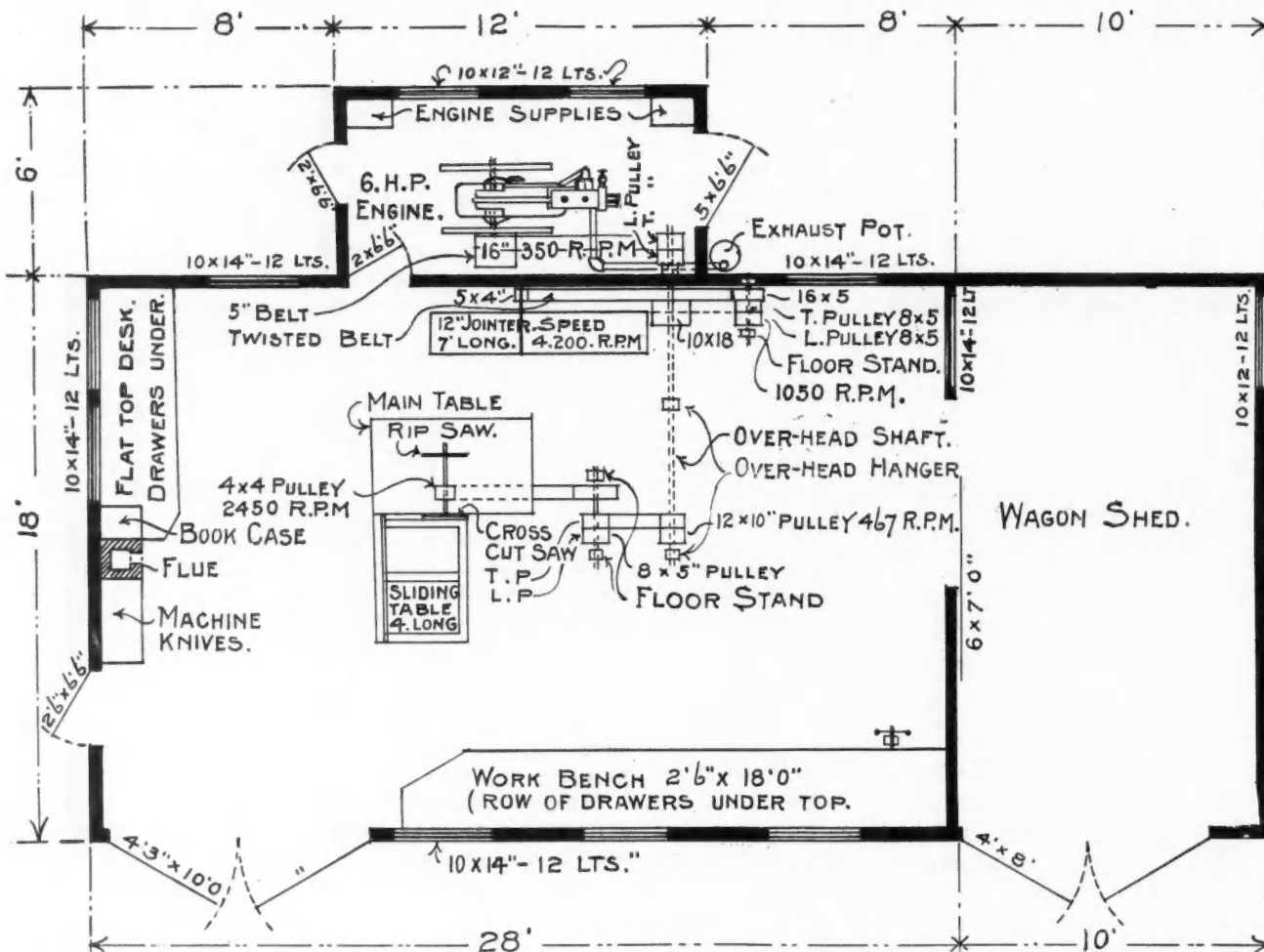

Contractor Extrom of Varna, Ill., Says this is the Best Way to Lay out a Small Power Woodworking Shop. Do YOU Agree?

class with jointer on one side. It is a very slick machine, the jointer is hard to beat on stuff not over ten feet in length. If longer it takes two men. My saw is not like the one shown on plan, but if I should buy a separate jointer, that would be a suitable saw. My shop is like plan with the exception of wagon shed. If I should build another shop for myself, I'd build shed up full height like rest of shop and gain storage room above. I'd make walls twelve feet high on entire building, and I'd drop ceiling joists below plate so as to have nine feet in the clear to floor, this only in the "shed end" extending back eighteen feet; and on these joists I'd lay a tight floor. In the gable end over shed I'd have a good sized door through which stuff could be taken in, and a small window on each side of door to let in light.

I would also have two small windows in opposite gable, one on each side of chimney, and in this end of shop I would place the crossies on top of plate, without any floor on them. Here I would build the moulding rack in the middle, and have a good place to put away all kinds of strips and rippings. Lumber could be piled on both sides of moulding rack. In this way lumber would be taken through gable door in shed end, and from the tight floor there, could be easily piled away in its proper place in other gable end of shop. By having cross ties on top of plate, in this end, one can build cupboards and other high things here, under the high ceiling. I have arranged the windows so that any ordinary length stuff can be worked, either way, both on saw and jointer. I have placed line shaft over head where it is out of the way. The two small counter shafts on the floor do not take up much room. The belts can be shifted from tight to loose pulley when it is desired to stop either machine. I have marked sizes and speeds of pulleys.

Now this is my idea of a good *small* shop, if one can afford same two feet wider, it will be still more serviceable. The floored part overhead can be used for storing many different things—window frames, windows, doors, mill work and little of everything—ropes, jack screws, rollers, etc.

OLIVER B. EXTROM,
Contractor and Builder.

✦
A Convenient Coal Bin

To the Editor: Emerson, N. J.
Enclosed you will find a sketch of what appears to be a

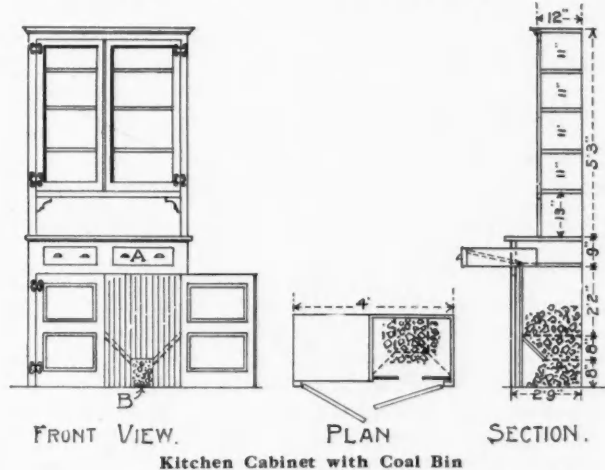

Kitchen cupboard but one-half of the lower part is used for a coal bin. It holds 15 hods of coal and is filled from the drawer "A" which has a slanting bottom and the coal is taken out from the hole at "B." This is a very clean arrangement and a space saver, especially in a kitchen where the room is limited.

NATALE LUCIA.

Drawing and Filing Cabinet

To the Editor: Dayton, Ohio.
For the benefit of the many readers of the AMERICAN CARPENTER AND BUILDER, I am sending my plan for a practical drawing table and filing cabinet.

Particular attention is called to the construction of this table. The size of the drawing board is 36 inches by 72

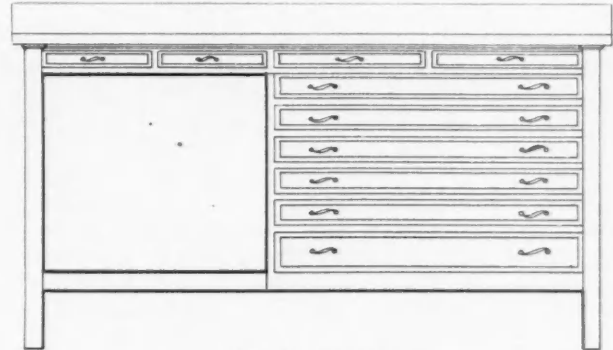

FRONT ELEVATION

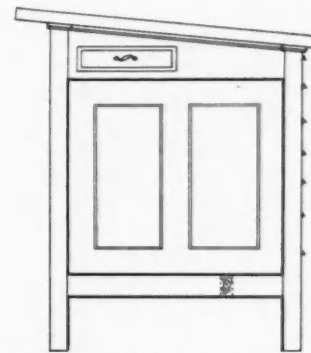

END ELEVATION

Drawing Table and Filing Cabinet

inches by 1½ inches. It is extra heavy and is not attached permanently to the table. When it is desired to remove the table from one room to another, it can be very conveniently done by removing the board first and then the cabinet, which is only 30 by 68 inches and will pass through any ordinary door.

Another good feature of this table is that the draftsman has a place to put his feet, also a good foot rest. The many large and small drawers in the cabinet can be used to suit one's convenience.

BYRON H. THOMAS.

✦
Uncle Dan Comes to Life

Ithica, New York.

Mr. Alfred W. Woods, Associate Editor:
This being my 53rd birthday and also the birthday of Thomas A. Edison, together with the fact that Mr. Edison is a great inventor, and other reasons prompts me to endeavor to kindle a confidential smile on your countenance.

A few months ago, you requested me not to conscript you and your steel square into service again and thus far I have respected the request, although the rays of humor gleaming through your articles in the AMERICAN CARPENTER AND BUILDER have tempted me to put in my penny at times. I have lots of confidence in a man who has good nature and sense enough to enjoy a good joke even if he pays for it himself.

In your editorial on the "Steel Square" in the current issue of the AMERICAN CARPENTER AND BUILDER you made Uncle Dan Jones do various stunts in the role of a laugh provoker, Uncle Dan did nobly, as I can testify, but he did

not like to be laughed at so now he retaliates by preferring charges against you of such a nature that if you cannot make it clear that your acts were not premediated or wilfully calculated to deceive, I fear you will have to be court-martialled.

He charged in substance, that in the afore mentioned article you gave a recipe for intersecting a steep roof with a low roof and that by the use of said recipe he cut the rafter about 2 1/16 inch too short. Then he wilted. Freshening up, he said it was that last sentence in that article (February AMERICAN CARPENTER AND BUILDER) which caused his downfall, but he is willing to settle on the terms that you furnish a good method of performing aforesaid intersection. The following is a suggestion which may be relevant:

The difference in the pitches, in this instance is 10/12 minus 4/12 equals 6/12, that is, the rate of divergence or convergence of the rafter lines. Now, by referring to your diagram, you will see that the plate which supports the high pitch is two feet above the one that supports the low pitch, also that the perpendicular distance to the plate of the high pitch from the rafter above is 40 inches minus 24 inches equals 16 inches; and as the rate of convergence is 6 inches to the foot, we will have to extend the run 16 inches times 2 equals 32 inches or 2 feet 8 inches, instead of 2 feet 6 inches to affect the point of intersection. This will make it right with "Uncle Dan."

15 and 3/4 cut the lap joint and 9 and 23 cut the joint at intersection of the roofs.

Sometimes mistakes are profitable, especially so if some good points are brought in consequence of them.

Allow me to express my appreciation of your Steel Square articles and other instruction which you have contributed to the AMERICAN CARPENTER AND BUILDER. Can you tell me where I can procure a copy of the "Universal Moulding Book"?

Hoping I have not caused you any pain, I am,
Your respectfully,

CHARLES GRAY.

Answer: Referring to the story of Uncle Dan, we left him at the river's brink and we thought he had passed over, but it appears we were mistaken as he seems to have turned up in New York. He has given us a knowing wink and a hunch that he is still on the job, which caused us to set up and take some notice.

In looking up the question, we find that it is true, we made a miscalculation in the length of the shed rafter, and while we regret the error, we are consoling ourself that we have good company in the person of Uncle Dan. By strange coincidence he gives the correct length, but in his analysis he is off. He is all right up to the point where he multiplies 16 by 2. Now, what does that 2 have to do with it? What he should have done when he found the difference in the two pitches per foot run to be 6 inches, was to divide 16 by 6, which would be 2 2/3 or 2 feet 6 inches, which in this case gives the same result; but suppose the main rafter has a rise of some other pitch, say 12 and 12; then the difference would be 8 and 16 ÷ 8 = 2; that is the necessary extension of the run, which would be two feet; but Dan's way would still make this measurement 2 feet 8 inches.

Then again, Dan. Did you notice that the measurement line on the shed rafter is given at the center of its side, while on that of the main rafter, the top edge is made the working line, See? This would necessarily make the net length of the shed rafter shorter than we both estimated, because the 16 inches represents the rise of the shed roof above the main plate, while the working line of the main rafter is 2 1/2 inches on a plumb line above the corner of the plate, provided the rafter is four inches wide and the seat cut extends to a center line, thus causing a reduction of 5 3/8 inches to lay on top of the main rafter. So after

all, we were nearer right than you were. Ha. Ha!! Those who laugh last laugh best.

Then again, Dan. How do you know that 9 and 23 would give the cut of the shed rafter to fit on to the top of the main rafter without first making a diagram to try out on and catch any old figures without fractions as in this case? In other words, what is your calculation basis, so that you can work it on any other pitch without first making a diagram?

We agree with you when you say "Sometimes mistakes are profitable" and I think we both got our profit and loss thrown in, in this deal. Shake.

As to where to get a copy of the Universal Moulding Book, Shattuck and McKay Co., of Chicago, are the printers from whom I presume you can get a copy; but if you will ask most any of the large planing mill men, they will give you a copy, provided you do not give them too much of a wink and a hunch. That is the way we get ours.

A. W. Woods.



An Interesting Letter

To the Editor: Providence, R. I.

I notice in a recent issue of the AMERICAN CARPENTER AND BUILDER Mr. Jas. A. Desell desires some information on making screens. Sometime ago, when instructor of cabinet making in a Massachusetts reform school, I had some 400 window screens and a number of screen doors to make. I had twelve inexperienced boys to do the work and we made them without the aid of a mortiser or tenoner.

First I had the boys rip up a lot of stock 1/8 inch wider than it was to finish. I then gave a boy the finished lengths to square off to a stop; another boy took these pieces to the jointer and planed 1/16 inch off one edge, the stiles and rails being kept separate.

A 5/16-inch Huther grooving saw was put on the arbor

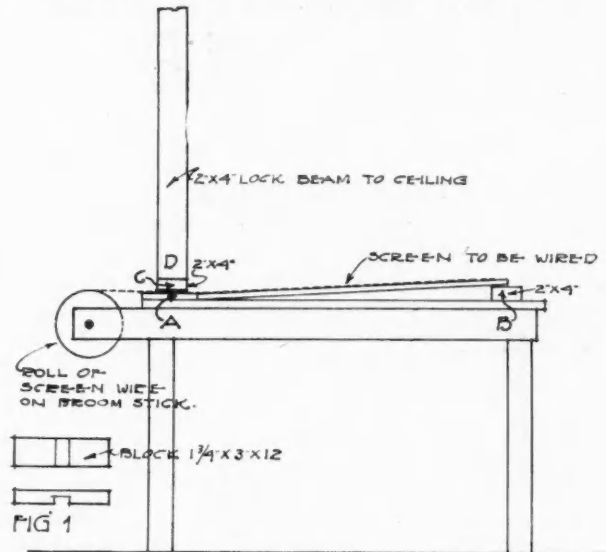

FIG. 2. ROUGH TABLE WITH PROJECTING SIDES FOR WIRING SCREENS

of the saw table and a board fastened to the ripping fence.

The board was to keep the cutters from striking the iron fence while making the tenons which I will describe later. I made a block, Fig. 1, about 1 3/4 by 3 by 12 inches with a groove cut in one side the size of the screen stock. This was put grooved side to the ripping fence and a spring fastened to the table to keep it in place, then a boy took the rails and grooved the ends the depth of the finished stock.

To make the tenons two of the 1/4-inch inside cutters from a Huther grooving saw were put on the arbor with a wood

spacing collar between them to give the thickness of the tenon. A wood throat piece was put in the table and the arbor run up leaving a piece between the cutters to keep the tenons from dropping down. Another block, Fig. 1, was made the same as before and the tenons cut the same as the grooves.

The block was never pulled away from the spring and was principally to keep the boy from cutting his fingers, but also served to keep the ends of the stock from splitting while making the tenons.

After they were machined they were glued together, jointed side in, squared with a stick and while in the clamp a $\frac{3}{4}$ -inch screw put in each joint and the clamps removed.

Some of them had a $\frac{1}{4}$ -inch dowel put in the joint but the screw was quicker and just as good.

The screens were then taken to the paint shop to be primed. While they were there we made a lot of half round in this way. After putting a pair of cutters on the jointer and a wood face on the fence two boys took a number of $\frac{1}{2}$ -inch W. W. boards and with a spring to keep them against the fence, pushed them by the jointer both edges leaving a nosing on them. While they were doing this two more boys were ripping the nosing off on the saw table. They kept this up until there was nothing left of the boards and we had a lot of nice half round.

Of course with a moulder one could use up a lot of waste strips, but we had neither the moulder or the strips. We then made four cheap tables, Fig. 2, with the side rails running by on one end, bored a hole in them and put a broom stick through to hold a roll of wire. A board, A, was nailed on the same end of the table top and the screw frame placed on the table with one end against this board A. The wire was then pulled up over the frame and tacked across the farther end. Now for stretching the wire.

The tacked end of the frame was raised up and a piece of 2 by 4, B, placed under it, while a piece of 2 by 4, C, the length of the width of the table and faced on one side, was put across the wire over board A. Another piece, D, was put from that to a beam overhead and driven tight. The end of the frame was then let down and the wire tacked all around and cut off, leaving it nice and tight. The half round was mitered and nailed on later and the edges cut off with a knife. The boys got so interested in putting on the wire that they got to racing, one boy holding the record of 45 seconds from the time the frame was put on the table until he had the wire cut off. Some of these were sliding screens and some hinging. For the sliding ones a $\frac{5}{16}$ -inch groove $\frac{1}{4}$ inch deep was put in one stile and $\frac{9}{16}$ inch deep in the other for the spring.

We also made screens that were rabbited for a flush moulding which took a little longer and required an inside cutter from a 1 inch smaller diameter Huther groover to make one shoulder on the tenon $\frac{1}{2}$ inch longer than the other. The screen doors were doweled together on the boring machine and $\frac{5}{8}$ -inch dowels used. An astrigal moulding was put on these in place of the half round.

In writing this I do not intend it as instruction to a novice but thought the experience of the boys might be of some interest to the readers. I am much interested in the AMERICAN CARPENTER AND BUILDER and believe it to be the best building paper published.

LESLIE K. CLARK,

Instructor of Cabinet Making,
R. I. Institute for the Deaf.



How to Make Floor Leak Proof

To the Editor:

Waldren, Mich.

I am building a house with a double deck porch. How can I make the upper floor so it will not leak and spoil the ceiling?

C. B. Jay.

A Device for Stretching Screen Wire

To the Editor:

Booth, Texas.

I am enclosing a rough sketch of my device for stretching screen wire. I do not think it needs much explanation as the pencil sketches show how it is made and any carpenter can make one. I use $1\frac{1}{2}$ by 6 inch stuff for the bed plate,

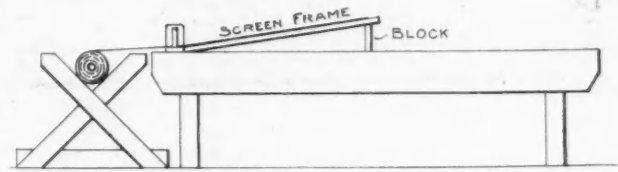

Side Elevation of Screening Bench

key and key blocks. First, get out all of the pieces as shown, then set key on the bed plate and place the key blocks over the key into the slots cut into the bed plate and fasten with $\frac{1}{4}$ by 6 inch bolt and it is ready to screw down to the bench, as shown. I have a rack to hold the roll of wire as shown, and I am now ready to proceed. I pass the end of the wire under the key to the upper end of the frame and tack the wire in place, then raise the upper end by placing a 6 inch block under same. Now roll back on the screen to get the slack out of the wire and then with a hammer,

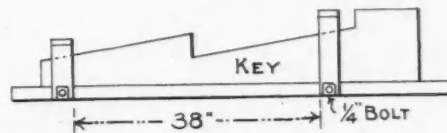

BED PLATE.



KEY BLOCK.

Device for Locking the Wire Tight

drive the key up tight to hold the wire and remove the block under the upper end and press the frame flat on the bench and you will be surprised to see how nice it is stretched ready to finish tacking and moulding. When through, the bed plate is easily removed, unscrewing same when it can be set aside ready for the next job.

M. MEEHAN.



Shingling Questions

To the Editor:

Battle Mountain, Nev.

Being a pre-amateur and having a small building to shingle I should be glad of a little advice.

1. Should all nail heads be covered by succeeding shingles? If so, where would you place the nails in 14-inch shingles, laying $4\frac{1}{2}$ -inch to the weather? It would seem, in this case, necessary to nail either very close to the edge or less than 5 inches from the top. 2. How do you make a strong and at the same time, water-tight job when crossing a change in pitch, as for instance, going from a quarter pitch verandah to a half pitch roof?

W. F. COLLINS.



How Many Gallons of Water?

To the Editor:

Havelock, Nebr.

I am submitting a problem that I would like to see some of the good brother solve for publication in the AMERICAN CARPENTER AND BUILDER.

Here it is,—A horizontal tank 18 feet in length and 6 feet in diameter is filled with water 30 inches deep and I want to know how many gallons of water is in the tank. I would like to see this worked out in full.

F. C. MCCOLLAN.

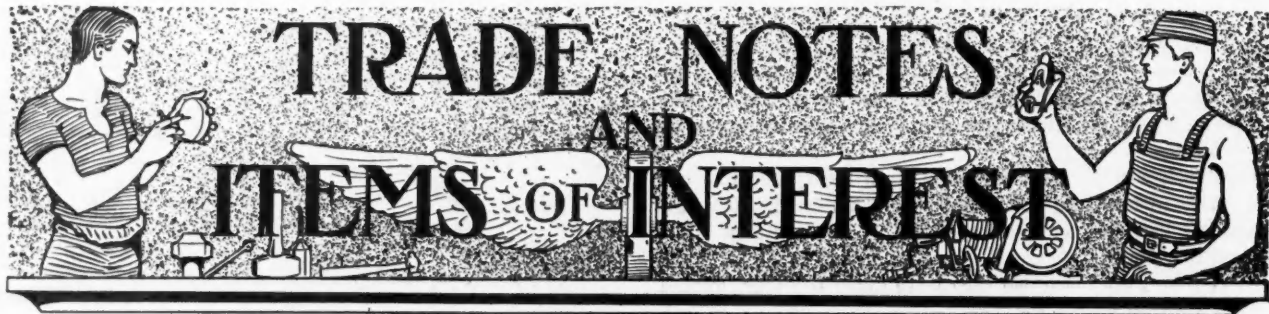

Through this department the editors aim to keep builders, contractors, carpenters and architects in touch with what their friends, the manufacturers, are doing for them in new or improved tools and machinery, methods and materials—pertaining to building. Items for these columns must have real news value; they are offered here as interesting information for our readers; they are not advertising. No matter will be printed here simply because some advertiser wishes it. Likewise, no matter will be excluded simply because the article described is not advertised in this magazine. Suggestions for the betterment of this department are requested of our readers.

Brick House Sent By Mail UNCLE SAM'S PARCEL POST GETS ITS HEAVIEST PARCEL

The management of the Chicago Clay Show is pulling off a novel stunt this year. Some 25000 brick manufacturers are each sending by Parcel Post a brick of local manufacture to be used in building a brick house at the Coliseum, Chicago, during the Clay Products Exposition, February 26th to March 8th. This house will be given away and re-erected after the exposition.

The idea was originated to test the merits of the Parcel Post system and it is certainly a novel one. A record will be kept of each brick from the time the brick is mailed until it is delivered in Chicago in order to see how speedily Uncle Sam can deliver a brick house by mail.

It is probable that Uncle Sam's mail carriers in Chicago will not be overly enthusiastic for this method of delivery of a brick house. Other mail carriers throughout the country will watch the experiment with interest and fear and trembling. While the brick fireproof home is becoming more and more popular because of its permanency, economy and superiority, it is not probable that they will be delivered by mail to any alarming extent.



The Brick Makers Are Sending to Chicago Bricks for a House by Parcel Post

A Dumb Waiter that Speaks for Itself

Dumbwaiters as a step-saving convenience have been in use for untold years in houses, stores, bakeries—in fact, in every building where there is the necessity of carrying things up or down stairs.

The great fault with the majority has been that they either bind in the shaft, rattle like the proverbial dish pan or wear out ropes as fast as they can be strung. A machine perfectly geared with wheels of the right diameter and constructed to

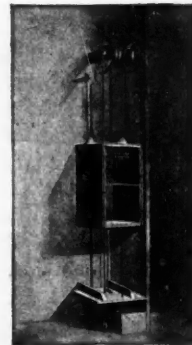

Number Two Pulley
Dumbwaiter

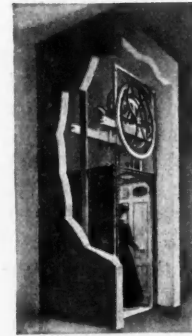

Number Seven Hand
Power Elevator

eliminate the undesirable features mentioned has been for some time past manufactured by the Chelsea Elevator Co., 330 West 26th St., New York City. Illustrations of the dumbwaiter and hand power elevator are shown. It will be in line for our progressive contractors and builders to get the instructive literature these people have issued describing their machines.



A New Book on Building

COPY FREE AT YOUR DEALERS

At a very great expense, the General Roofing Mfg. Company have prepared a book that will be of great help to those who are thinking of building any kind of building, from a chicken house to a skyscraper.

Many books on building are filled with such technical instructions and intricate working drawings that to understand them one has to take a course in building. But the book, "Modern Building Ideas and Plans," was prepared with the idea of giving suggestions and illustrating the newest and best ideas and plans to those who are considering building. The value of this book is in the suggestions which it gives for the selecting of the land for building, how to utilize every bit of the land, giving you an idea of the kind of house you want and enabling you to give definite instructions to your architect. In the bustle of building many things will be overlooked, and you are not apt to think of all the pitfalls to be avoided. This book tells you in simple terms and illustrations the many conveniences your building

can have without extra expense, and suggests many economies which may save you money.

The General Roofing Mfg. Company have spared no expense in making this book of supreme value to the builder, and the attractive illustrations found therein liven up the pages. In fact, the whole book is written in an interesting manner by a former architect. The illustrations and plans cover modern bungalows, city residences, apartments, warehouses, factories, garages, model farm houses, barns, poultry houses, silos, etc., and the description for each is very complete.

"We want a book that will be of real help to anyone who wants to build any kind of a building—one that will save the builder money." were the condensed instructions given for the preparation of the book by the General Roofing Mfg. Company.

This book is distributed through the many hardware, lumber and material dealers, free. If you write direct to the General Roofing Mfg. Company, East St. Louis, Ill., Marseilles, Ill., or York, Pa., it will be necessary to enclose 25c to help cover cost and mailing expense.

We recommend that you go to your local lumber, hardware or building material dealer who will gladly get you a copy of this book without cost to you—neither do you obligate yourself to buy anything of the dealer.



Steel Forms Prove Money Makers

Concrete in every form is making great forward strides. Poured concrete seems to be the easiest way of obtaining all the desired advantages of the material and, if the form problem can be solved, it is least expensive. The material itself is not expensive but when the cost of manufacture and erection, as in the case of blocks or bricks, is added it amounts to a considerable item.

When poured concrete is used forms are necessary and all builders know the nuisance of wood forms. Read & Morrill have placed on the market what they call the "Morrill System of Sectional Steel Moulds or Forms," which can be used



Morrill Steel Forms Used on the "Concrete City" at Nanticoke, Pa., for the D. L. & W. R. R. Co.

over and over again; when used these are a decided advantage in giving a smooth, compact re-inforced wall. These forms have proved practically water-tight, permitting a good wet mix thereby leaving a nice straight finished surface. The inexpensive and easy manipulation of these forms and the favorable results from using poured concrete ought to appeal to our readers.



Building Being Erected by the One-Day Process

D. L. & W. Railroad used these forms to build what they call their "Concrete City" at Nanticoke, Pa., and expressed great satisfaction with them. Illustration 1 shows a group of buildings in the "Concrete City." In figure two is shown a building being erected by the one-day process. Many large construction and development companies are finding the "Morrill" forms indispensable in eliminating the factors of time and expense.

We regret that space does not allow us to give a complete description of the forms as we know such information would be most acceptable to contractors and builders. However, we suggest that you get literature on the subject from Read and Morrill, Inc., 179 Joralemon St., Brooklyn, N. Y., and see if it won't revert to your advantage to buy these forms and go in for poured concrete building.



The Champion Mortiser

Everything possible is being done to aid the carpenter in executing his work with ease and dispatch. The cutting of mortises which looks like a small thing is really a difficult and painstaking job when done with brace, bit and chisel. And then the results are not always satisfactory.

A machine that will not only do the work well but per-

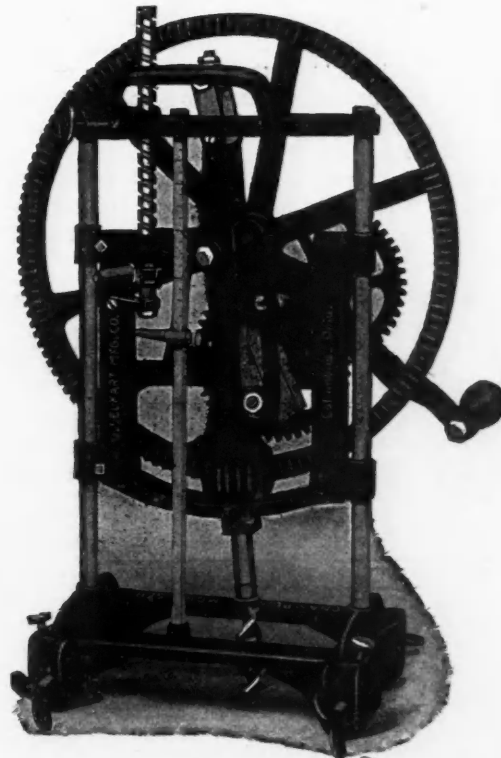

New Model Lock Mortiser

fectly ought to form a part of the busy man's equipment. The "Champion" mortise which we illustrate has been recommended as one which meets every demand for mortising. The special advantage is that it can be accurately gauged as to desired depth and width of slot, cutting clean through hard, soft or knotty wood, through dowel pins or panel ends, with or against the grain with equal facility. When the desired depth is reached the machine stops automatically. No other tool is necessary where the "Champion" is used. The ball bearing is in the end of the spindle relieving all friction. Automatic feed is operated with a cam and when the bit is at the top of the slot it will feed one-sixteenth of an inch and the same when at the bottom continuing until four and one-half inches for full depth.

The manufacturers—J. Leukart Mfg. Co., Columbus, Ohio, claim this machine will last a life time and all carpenters would be well repaid to write these people for more data on this machine.

After Plaster What?

The rapidly increasing cost of building material has led the attention of manufacturers into channels leading toward the production of substitutes which will not only take the place of the original but be improvements on them. Everything tending toward easier work, less expense, permanency and general good results has been carefully considered.

Despite the fact that many people claim "Our buildings are not as substantial as they used to be," we believe the builders are putting as good work and material into their buildings as they ever did. It's true that heavy framework for small buildings is no longer used and to the unanalytical mind this may look like an argument in favor of their claim that we put up flimsy structures.

They probably lose sight of the fact that our forefathers built when timber grew in abundance and could be had almost for the asking. Their facilities for whipping the material into proper shape were limited and in the light of present day development seem crude. Had they been able by the means of proper tools to saw out beams or studding or siding as we now do, they undoubtedly would have done it. The log house is no argument in favor of substantial construction. The builders were simply following the line of least resistance—taking the easiest way to make a shelter.

It is the spirit of evolution constantly working in the minds of men that has brought to their present state of perfection all the wonderful inventions that belong to this day and age. We are not only becoming more proficient mechanically but also more artistic.

The cave man had his cave; kings in olden days had rude fortresses of earth or stone; but there are no cave men these days and the kings have their magnificent castles and

the general run of humanity demands that everything about them be more beautiful and artistic.

From bare walls to animal skins hung on them was a big stride but infinitely greater was the change from animal skins to plaster, paint and wall paper. And yet greater is the change to a wall covering that does away with both lath and plaster.

In producing Wodwalboard the McHenry Millhouse Mfg. Co., of South Bend, Ind., seem to have made a great forward stride. This Wodwalboard is nothing more than wood reduced to a fibrous form which under immense pressure is made into sheets of various sizes uniformly thick. These people claim that this material will revolutionize interior finishing. Many excellent properties are attributed to it. The most important is the fact that it replaces lath and plaster and gives a uniformly smooth surface. Undoubtedly Wodwalboard is easy to apply coming as it does in sheets of all sizes and requiring no more work than the nailing of the sheets to the studding. 'Tis said that this board makes the house warmer in winter and cooler in summer and that age has no deteriorating effect as it will neither warp, chip nor crack. It can be applied at any season of the year without the delays consequent on waiting for the walls to dry, and once in place can be decorated in any manner as readily as plaster. The illustration shows a dining room finished in this material.

The catalogs of the McHenry Millhouse Mfg. Co., which we have received with great interest, depicts the use of their product in various buildings. It seems to be an ideal and economical material for transforming a bare attic into a pleasant room. Other advantages noted are that Wodwalboard can be used to finish summer cottages or bungalows

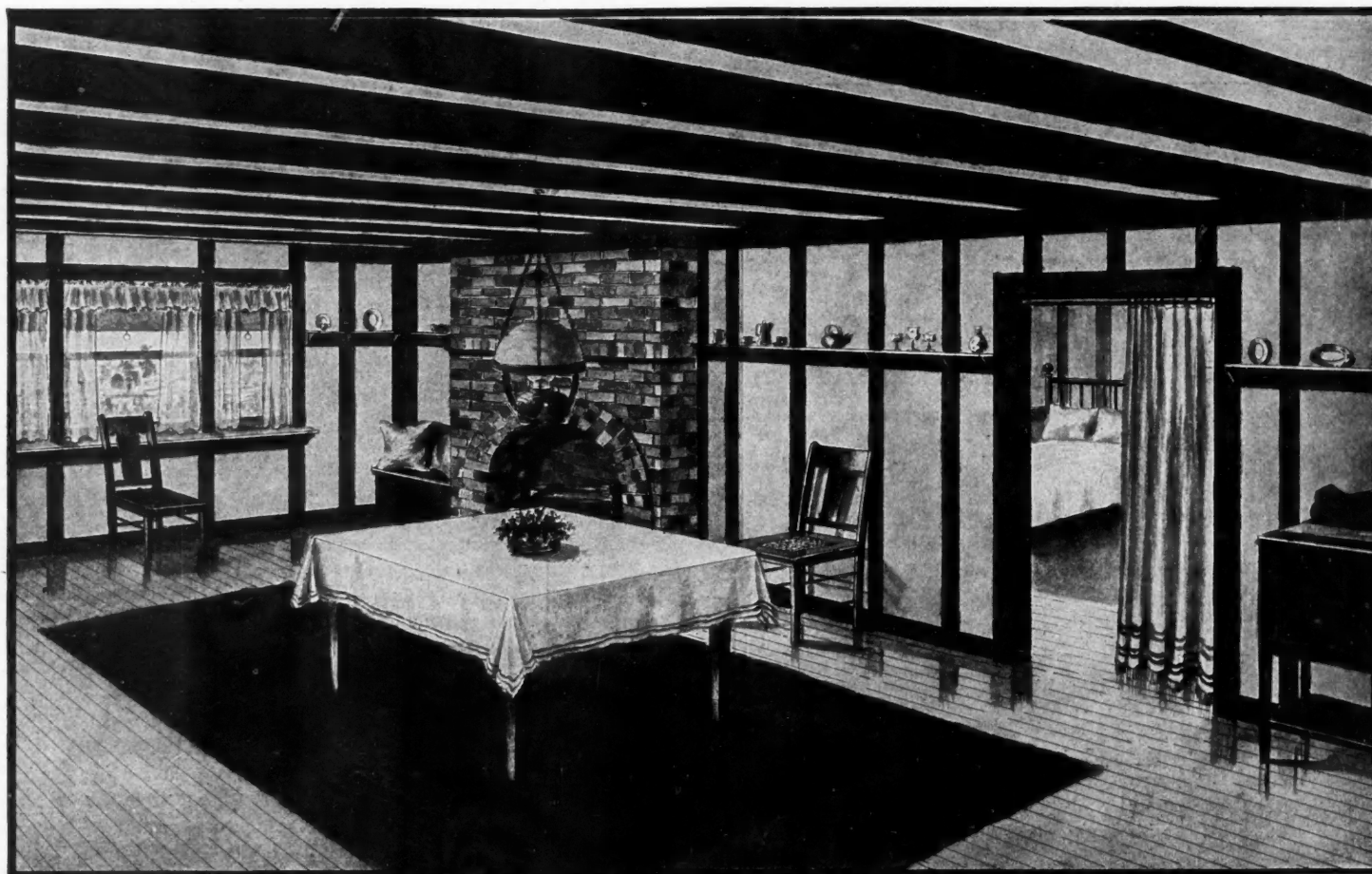

Dining Room Beautifully Finished with "Wodwalboard." This is Especially Adapted for Cottages, Bungalows, Etc.

and to make partitions wherever desired. The comparison of the cost of this material as against that of lath and plaster is interesting.

Another forward movement of this company has been in the manufacture of their Veribest Asphalt Shingles which unlike the pine shingle will not split, decay or warp. These shingles are specially prepared to resist the fury of the elements being fire-resisting and fadeless. They can be applied to any roof.

To those of our readers desiring enlightenment on these modern methods of treating roofs and walls we suggest writing to the McHenry Millhouse Mfg. Co., South Bend, Ind., for information which they will gladly send without charge.



Striking Brick Work

Show me a man's house and I will tell you his standing in the community in which he lives.

The best homes, especially in towns of reasonable size, are invariably constructed of brick. There is no building material known to the trade that has ever or ever will take the place of brick. Their fireproof qualities and their permanency make them an ideal material to use whether it is in the modest home, the more pretentious home, the public building, or the factory. Brick have been used for the past 4,000 years; and, while the finished product is to-day far superior to what it has ever been before, bricks that were made 3,000 years ago are still to be found in a good state



Latest Style Durable Residence, Built of Con-tex Brick

per cent higher. Taking into consideration the future up-keep of a house, lowered insurance rates, etc., it can be easily figured that a brick house costs no more than one of a good wooden construction.

Both the Continental and the Con-tex brick are thoroughly vitrified. This means that the bricks are absolutely non-absorbent. It means further that no efflorescence will ever occur; it means house satisfaction. It is to the interest of every reader of the AMERICAN CARPENTER AND BUILDER to look thoroughly into the brick proposition before advising wooden construction.

The house illustrated here, built with Con-tex brick, with red centers shade Number 820, is all that a house should be. It combines great beauty with enduring quality. It is a house that the owner would be proud to claim and one that will give the builder a permanent advertisement for high-class work.

If you want to know more about the qualities of Continental and Con-tex brick, write Mr. J. L. Buckley, General Manager of the Continental Brick Company, of Aledo, Ill., or write the S. S. Kimball Company, Chamber of Commerce Bldg., Chicago, who are the Chicago and vicinity selling agents for Continental and Con-tex brick.



Investigate Cal-Co-Craft

The finished building in every detail, represents the product of the architect's or builder's ideal. By his buildings he is judged. Moreover, the inside of any house is what must bear the closet scrutiny. It is that part of the home that constantly comes under the watchful eye of the owner. Hence the builder ought to give considerable attention to the decoration of the interior.

It is not always the most elaborate designing and coloring that produces the best result. Rich effects can often be obtained by simple and economical methods, providing harmony of line and color is preserved.

Now and for many years to come wood-paneling will lead in favor. It is something that lends itself to easy and pleasing combination with burlap, paint or paper. Wood-paneling is of course expensive and cannot be afforded for general use.

A printed representation of wood, applied in the same way as wall paper, proves to be a satisfactory substitute for the same combinations can be effected at little expense. The

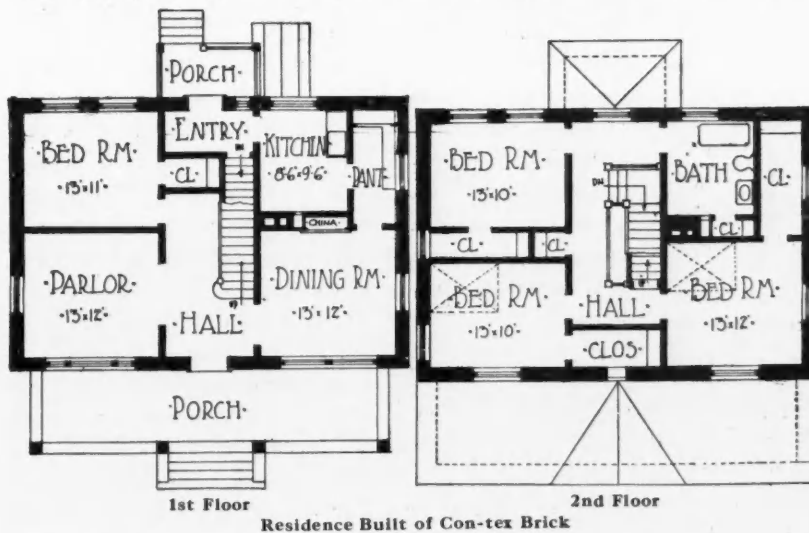

of preservation. The past decade has brought possibly more changes in the construction and the finish of brick than any other period in the history of brick.

Those of our readers who were fortunate enough to visit the Clay Products Exhibition in Chicago, this year—February 26 to March 8, were more than interested in our booth. This booth was erected by the Continental Brick Company of Aledo, Ill., their brick being used entirely in this exhibit. The bricks used in this Exhibit were the Continental and the Con-tex. This Company have a large assortment of colors in these two kinds of brick, ranging down through the Blacks, Blues, Greens, Purples, Red Centers, and light and dark reds.

It is a common impression that the cost of a brick house is almost prohibitive for the man who has not a great deal of money to spend on his home. This is absolutely an erroneous impression. A veneered brick house can be built at an average cost of 5 per cent over good wood construction. An 8 inch wall can be built at about 10 per cent over wooden construction, and a 12 inch wall costs not more than 12

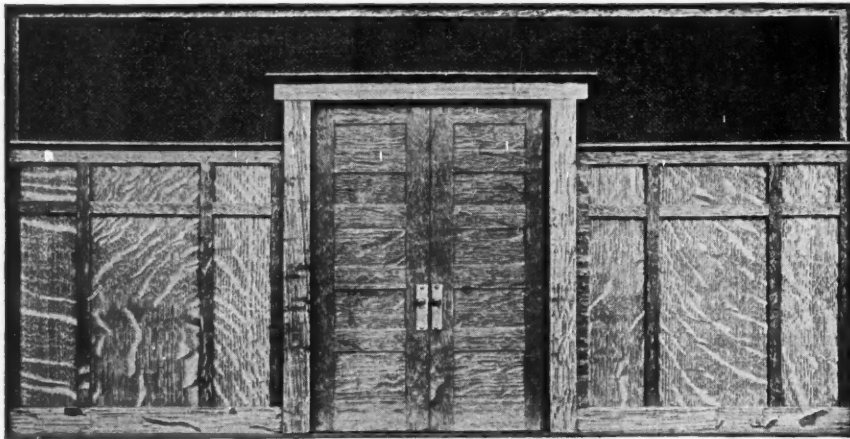

Artistic Paneled Wall, Using Cott-a-lap Co. Wall Coverings

strips of the imitation wood are used with battens and it is hard to tell the difference between the imitation and the real.

The Cott-a-lap Company of Somerville, New Jersey are large manufacturers of wall fabrics and show some fine specimens of their products. This company will gladly send full particulars to those desiring to acquaint themselves with the possibilities of these new wall coverings.



A Mixer Experience

One of our representatives has a friend who is a contractor. The other day this man phoned to our office: "Say old man I've started work on the concrete foundation for that new apartment building and have got a new mixer on the job. You ought to see the thing work. It's great. I think the readers of the AMERICAN CARPENTER AND BUILDER ought to know about this. Come on out and see it."

Ever alert for interesting news for our readers our man slipped into his overcoat and hurried off to where the contractor was at work. Arriving there his friend took him over to the machine. It seemed simple and sturdy and the way it chewed up the materials and delivered the mix was a caution. The mixer was working pretty fast and it kept those men hustling the concrete into the moulds. "Whose make is it?" our man asked. "Why that's the 'Low Down Concrete Mixer,' made by the Elite Mfg. Co., of Ashland, Ohio. Here's their catalog. I carried it with me as it contains some fine points on engine troubles and correct proportioning. Glad to say the machine is working without a hitch. That forced feed does the work," he replied.

An examination of the machine in action only convinced our representative that it should be an ideal one for every branch of the concrete business. The construction was excellent and the measuring device assured proper proportioning and mixing of the material in any condition. Instead of an ordinary intermittent feeder the material was forced into the mixing trough in an unbroken stream. The mixing trough was very long—about seven feet—and the contractor said this feature together with the forced feed insured not only a thorough mixture but a concrete uniform throughout. The best part of it was that the feeding and mixing was done in plain sight.

Our man came back to our office full of enthusiasm. He had a cut of the machine made from an illustration in the catalog, and now urges all subscribers to send for the catalog. Just drop a line to the Elite Mfg. Co., of Ashland, Ohio, and look over their machines before you decide to buy.

National Testing Laboratory Needed

EXTRACT FROM DISCUSSION ON
METAL LATH CONSTRUCTION

By H. M. McMaster, Commissioner
Associated Metal Lath Manufacturers

About three hundred of the leading Chicago architects were recently the guests of the Northwestern Expanded Metal Co. at a noonday luncheon at the Hotel La Salle. One point made by Mr. McMaster, the principal speaker, was concerning the need of a national testing laboratory for building materials.

"I want to dwell particularly upon one great lesson that was brought to all who had anything to do with those tests.

The superior fire-resisting value of cement mixtures was again well demonstrated, but regardless of findings of this character, however valuable to the building trades there was a thing impressed upon us through it all that should have the thoughtful consideration of every man in any way interested in building construction.

"Whatever of value may have been gotten from those tests can have official recognition only by the City of Cleveland, as the tests were under the direction of the Cleveland Building Department. If similar investigations were desired in Pittsburgh, or any other city revising its building laws, the effort and expense would have to be duplicated, if the State Building Code Commissions of Pennsylvania, Ohio, Illinois or Wisconsin, should want similar information, the process would have to be duplicated in each of those states, or they may continue to do as is now done. That is, manufacturers of building materials, electrical equipment or other devices, each with the arguments that may best advance the sale of their products, go before the Commission and tell their stories. Competitors are not always of one mind as to the way of presenting this data, and confusion in the minds of the men on a Commission is sure to follow. Some of these manufacturers are sure to have superior advocates and preference may be given where it is not always deserved.

"Some of the manufacturers may have gone to the expense of having their materials or devices tested by the Underwriters' Laboratories. The approval of this institution always

(Continued to Page 108)

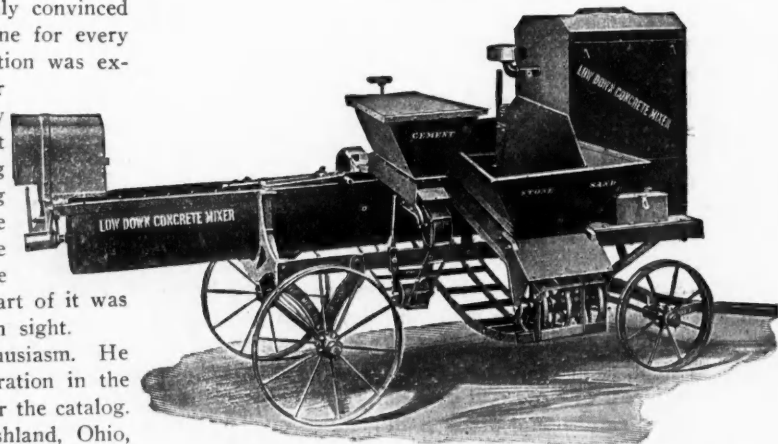

"Low Down Concrete Mixer" Made by the Elite Mfg. Co.

Make Every Furnace Job Net You a Friend!

**Kalamazoo Service
means easy installa-
tion for the Builder.**

**Kalamazoo Quality
means permanent
satisfaction for
the owner.**

**Good Profits
for the
Builder.**

A builder's future jobs depend largely upon the ones he is doing **now**. And the success of the ones he is doing now—whether he is to have pleased, satisfied, enthusiastic owners **plugging** for him to others who are going to build—depends largely upon the kind of heating plants he uses and the way they are installed.

The **installation service** that goes with every Kalamazoo Heating System—the **quality** that is guaranteed in every Kalamazoo plant—mean that by working with us, a builder can develop a satisfying and **profitable** furnace business.

Easiest to Install

The work of our expert Engineering Department is so thoroughly done that the builder's part in placing a Kalamazoo Heating System is easy and simple. Give us a sketch of the building, showing size and location of rooms, the way the house faces; tell us about prevailing winds in your locality. That's all. Then we turn these specifications over to our engineers. They study the plans and prepare blue prints showing every pipe in the system, every elbow, every fitting, every detail.

Installation from these complete directions is not only simple, but it is **right**. The owner will be pleased—you will get the credit for installing a fine system—and you will enjoy the best advertising in the world, the endorsement of a satisfied user. All this is yours when you handle the

Kalamazoo Furnace

Again, in placing a Kalamazoo you have all the advantage in **price**. There's a liberal profit for you, while making a big saving for your customer. **You and we** will make the sale—cutting out all the profits and expenses and interest and losses of retail dealers and jobbers. Much of this saving we put into Kalamazoo quality. You are well paid for your part of the work. We get a reasonable profit on top of manufacturing cost—and there it ends, with Kalamazoo **supremacy** and **economy** standing out as signs to success for both of us.

Kalamazoo Quality

We want to send you a Free Book that will show you plainly why we can back Kalamazoo **Quality** with the strongest claims. It proves the perfect air circulation—wholesome, uniform heat—big radiating surfaces—perfect insulation—economy of fuel—conservation of heat units—and all the other facts that make Kalamazoo Furnaces supreme.

Let us prove to you that when you put a Kalamazoo plant in a house you have taken on the easiest heating proposition you ever had anything to do with. Let us show you that you can make **more money—more friends**—can have more enthusiastic "boosters"—get more heating jobs and thus be helped to more building jobs by recommending and placing the Kalamazoo.

Drop us a letter or card **today** and you'll get complete details by return mail. Line up now for a better, a busier, a more profitable building season. Don't delay. Get Kalamazoo business and profits on **your** side during this spring of 1913. Ask for Catalogue No. 947.

**KALAMAZOO STOVE CO. KALAMAZOO,
MICHIGAN**

A Kalamazoo And
Trade Mark Registered **Direct to You** Gas
Stoves
Too



When Writing Advertisers Please Mention the American Carpenter and Builder.

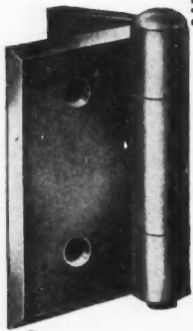

YOU'RE WASTING

If you are not using "National" Half-Surface Ornament door set and wedged into position, and the ornamental leaf a very simple one and saves fully half the time required to hang on the present high price paid carpenters, for this class of labor,

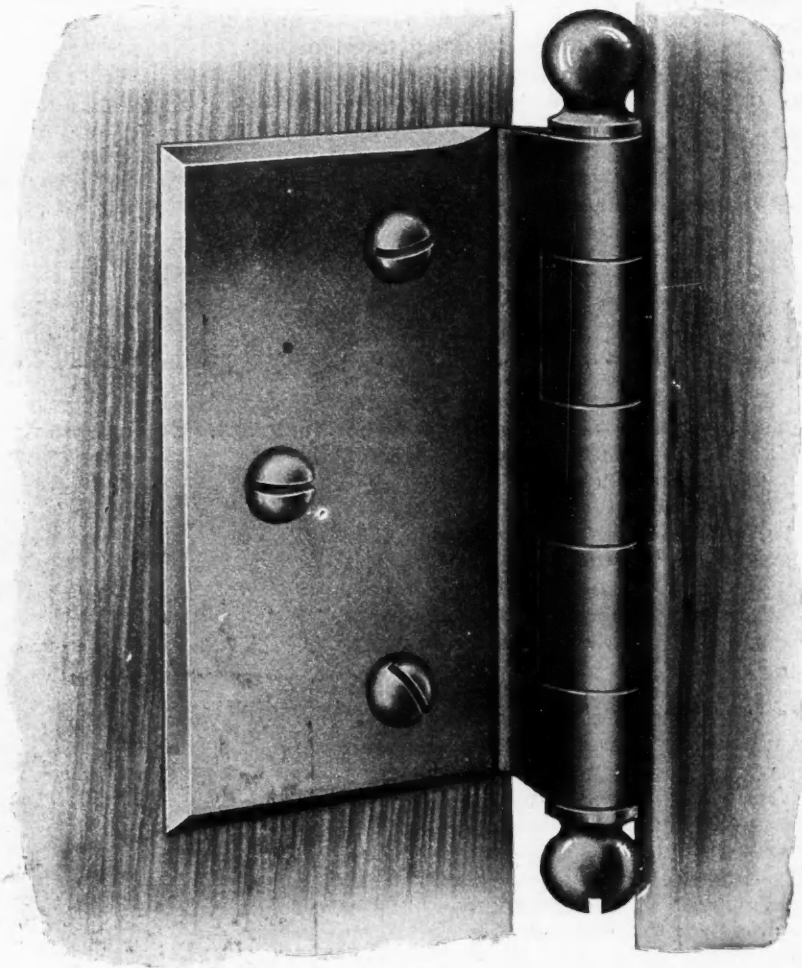

Style No. 450

The No. 450 Ornamental Butts here illustrated are made in all sizes from 1½" to 4" in size. These butts have beveled edges to match beveled escutcheon plates, are polished and double plated. Larger sizes packed one pair in a box. Smaller sizes, one half and one dozen pairs in a box, each pair in an envelope with screws. Any finish.

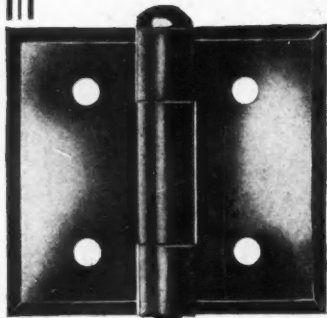

NATIONAL MANUFACTURING

When Writing Advertisers Please Mention the American Carpenter and Builder.

HALF YOUR TIME

al Butts. The butt part is mortised into the jamb, the screwed to the surface of the door. The operation is the door with the old style or common butts. The saving, based is sufficiently large to receive your most careful consideration.

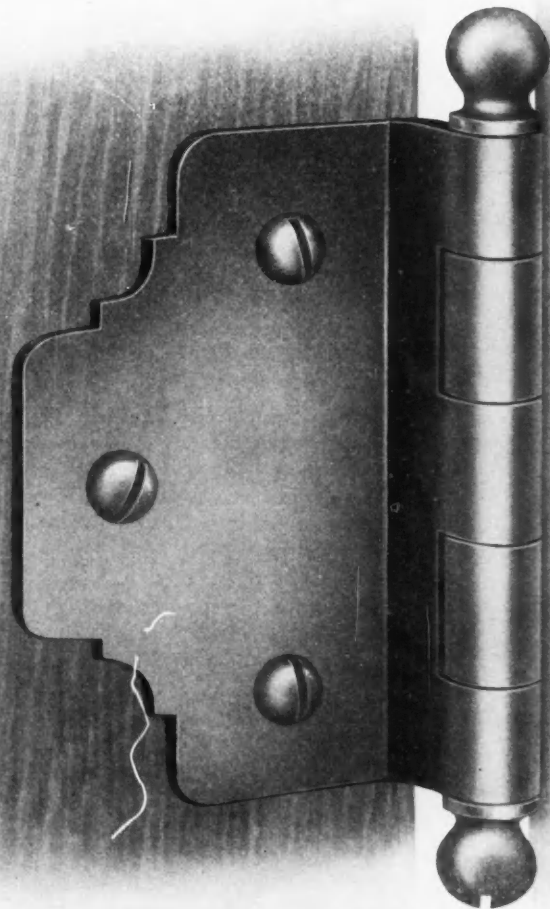
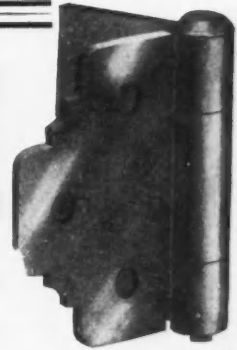

Style No. 400

The No. 400 Butts illustrated above are made in all sizes from 1½" to 4½" in size. The larger sizes are packed one pair in a box with screws. The smaller sizes are packed one-half and one dozen pairs in a box, each pair in a separate envelope with screws. Any finish.

If your dealer can't supply you, send us his name and we will see that you are supplied. Ask for "Ornamental Ideas." It's free and will interest you.

COMPANY, STERLING, ILL.

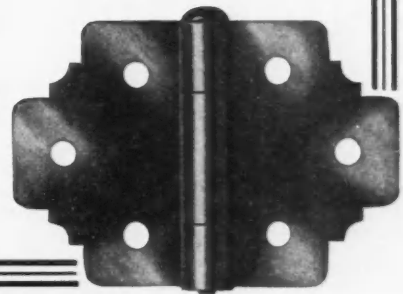

When Writing Advertisers Please Mention the American Carpenter and Builder.

This P. S. & W. Rafter-Square and Book Make Rafter-Framing Easy

YOU can get all the lengths of rafters—common, hip, jack and valley. You can get all the necessary cuts—top, bottom and side-cuts for rafters, and cuts for sheathing or shingles in the valley or on the hip, moulding, gable plancier, etc.

The square gives the figures; the book tells how to use them with speed and accuracy.

How to Use the P.S. & W. RAFTER FRAMING SQUARES

A complete set of brief, handy and really under-standable rules for every-day use

The Peck, Stow & Wilcox Co.
MADE IN U.S.A.
NEW YORK, N.Y.

Write today for free copy of the "Mechanics' Handy List," a book that lists over 200 tools for Carpenters, Machinists, Electricians and Tinsmiths.

Among other items it shows the most complete lines of chisels and gouges, drawing knives, braces and auger bits, steel squares, and pliers on the market. It also contains over 35 pages of handy reference tables and valuable information.

The PECK, STOW & WILCOX CO
Manufacturers of the Largest Line of Mechanic's Hand-Tools Offered by Any Maker
Southington, Conn., New York, N.Y., Cleveland, O.
Address Correspondence. 22 Murray St., N. Y. City

has much weight, as it should, but it is manifestly wrong in principle that a private concern should fix the standards or constants that are used and enforced by city, state and national governments.

"I am led to believe that the remedy is on the way, as I understand the Bureau of Standards has in its budget for the coming year an item of \$25,000.00 to carry on fire tests. A similar item was refused by the last Congress, but I am sure anyone who has anything to do with the marketing of building materials and devices will agree with me that there is but one place where those standards can properly be fixed and that is by some Bureau of the Federal Government.

"When this 'National Testing Laboratory' becomes operative, it will be only a question of time when we shall have uniform standards for every city and state. It is not reasonable to expect that any manufacturer having confidence in his material or devices would do other than wish to have the government determine its physical properties and give it official approval.

"There would be a tremendous saving of money by precluding the numberless duplications of effort and there would be no use for the bitter contentions which have characterized legislation on building codes at some points in the country."



"Better Buildings"

Quite a number of the leading manufacturers of building materials have adopted the policy of late of making their catalogs something more than mere price lists of materials. They have cared enough for the business of the contractors and builders to prepare their catalogs in a way that will really instruct and benefit those who receive them.

For instance, the new edition of the American Sheet and Tin Plate Company's book, "Better Buildings," which is now being distributed, is in reality a building plan book. It contains model designs of all kinds of structures on which corrugated iron roofing or sheathing can be used. There are designs for contractors' shops and warehouses, barns and farm buildings of all kinds both large and small, garages, store buildings, etc.

Altogether it is a book full of ideas and suggestions for builders. It illustrates best recommended practice for the use of sheet metal; also contains considerable miscellaneous information pertaining to this line of work. The Pittsburgh office of the American Sheet and Tin Plate Company will gladly send a copy of this book to any of our readers who will write them for it.



New Dixon Catalog

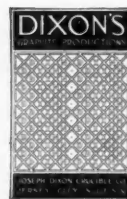

The largest and most complete production catalog ever issued by the Joseph Dixon Crucible Company, Jersey City, N. J., is now being mailed to the thousands of manufacturers, jobbers, purchasing agents and others interested in graphite, crucibles, paint, lubricants, pencils and the other productions of the Dixon Company.

Though over one hundred pages of type and illustrations are used, this catalog does not attempt to carry a full description of the entire Dixon line and only a few of the many hundreds of Dixon's American Graphite Pencils are listed.

The Dixon Company attach a peculiar value to their production catalog inasmuch as it serves to acquaint those who are already users of one form of graphite with its many other forms and uses. If you are particularly interested in graphite products you are invited to send for a copy of this catalog.

When Writing Advertisers Please Mention the American Carpenter and Builder.

FREE \$15⁰⁰ Drawing Outfit

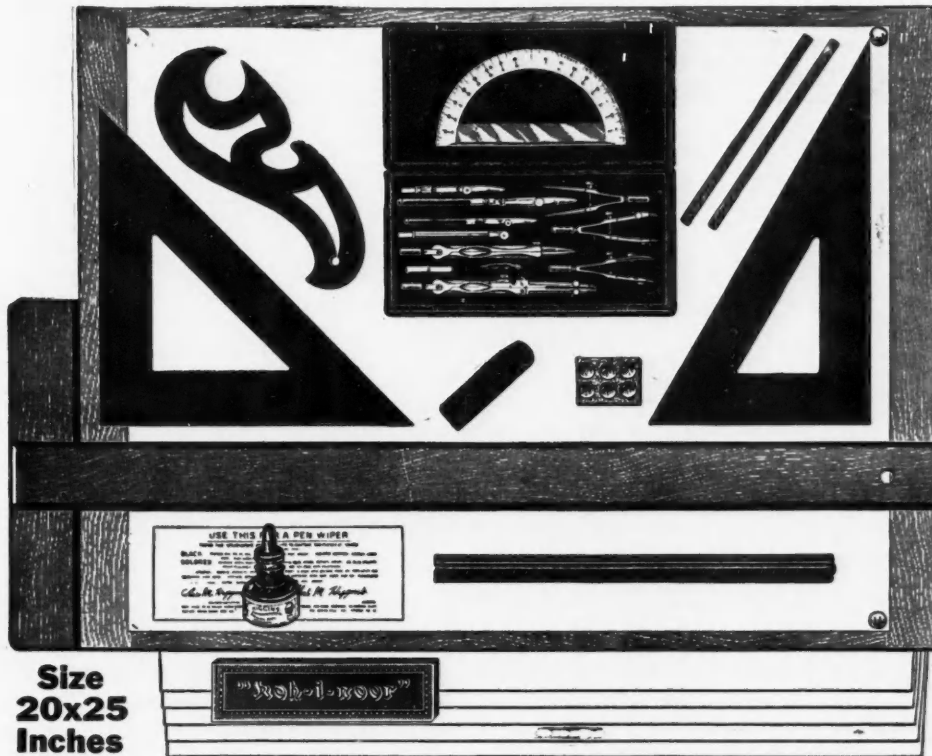

For You
TO
Draw
More
Money
Right
Away

Draw \$125 to \$175 Per Month

Chief Draftsman Will Instruct *You Personally*

A most wonderful opportunity for a limited and selected number of ambitious men! For over twenty years I have been doing the highest paying expert drafting work. I am **Chief Draftsman** of a large and well known company. Daily I see the urgent demand for practical, trained draftsmen and I apply my practical method for ambitious men whom I train personally. Each month the demand for practical trained draftsmen is growing.



I Guarantee
To instruct you *until competent* and placed in a position at a regular salary paying from \$125.00 to \$175.00 a month.



Get This Valuable Book FREE! **If You Write to Me AT ONCE**

As Chief Draftsman of a big engineering firm I know exactly the quality and quantity of **practical** training, knowledge and actual up-to-date experience (not school knowledge) you must have in order to obtain a good position and advance to highest salary. This is **NOT** a regular correspondence school course. I deal individually with each student and give you individual practical working plans (just as your ability and advancement requires) which fit your particular needs. Men who expect to be Superintendents, Mechanics, Engineers—must know practical Drafting as I teach it. What I want is the **right kind** of men. Don't bother about expense.

You Can Earn Big Money At Once **While Learning At Home**

Yes, my friend, \$5.00 to \$10.00 per day. I will pay you for your work that you can do for me, even while learning right at your home if you write to me at once.

Mail Free Coupon NOW

I will send my book to those who write at once absolutely free—also full particulars about my offer to a few ambitious men who want to make from \$2,500 to \$5,000 a year. No obligations on you whatever in sending this coupon.

ADDRESS
Chief Draftsman
Division 2663
Engineer's Equipment Co., [Inc.]
Chicago - Illinois

FREE COUPON

Chief Draftsman, Div. 2663
Engineer's Equipment Co., Chicago, Ill.

Without any obligation on me whatsoever, please mail your book, "Successful Draftsmanship," and full particulars of your liberal personal instruction offer to a few students. It is understood that I am obligated in no way whatever.

Name.....
Address.....

When Writing Advertisers Please Mention the American Carpenter and Builder.

A Good Trade Book to Have

Readers of the AMERICAN CARPENTER AND BUILDER should have a copy of The Willis Manufacturing Company's catalog No. 6, on Architectural Sheet Metal Work and affiliated lines, which contains 180 pages of reliable information.

This catalogue is issued for the express purpose of illustrating and pricing everything in the line of sheet metal building material which will assist contractors and builders in making estimates on contracts requiring sheet metal.

A large number of our readers are already well acquainted with the high standard of efficiency which this company have attained in constructing Willis skylights and ventilators.

The Willis fireproof metal windows have also attained a high standard of efficiency. These are made in all the standard types and are approved by the Underwriters' Laboratories and bear their label.

Any reader of our paper writing for catalogs or details will be furnished with the same promptly. Address Willis Mfg. Co., Galesburg, Ill.



Business From Abroad

What do you think of a magazine that reaches out and brings its advertisers inquiries from foreign countries? The AMERICAN CARPENTER AND BUILDER does it. Lately the United Pump & Power Co. received from Mr. C. F. M. Knudsen, Copenhagen, Denmark, a request for more information on the Perry Water System. The letter enclosed an ad clipped from our magazine.

Well, the Perry Water System is deserving of good attention. There's an old saying, "To save time is to lengthen life," and the Perry system does away with all needless pumping of water. Stored water is unfit for most uses, and the leaky space-taking storage tank has never been wholly

satisfactory. Consequently some one had to devise a method of delivering water fresh from the well. The Perry system has accomplished this by a method of storing air with which water is pumped direct from the source. Water can be drawn from more than one source, enabling the user to have both spring and cistern water in his home. The relative position of buildings and the source of supply makes no difference. The air-tank and compressor used in the Perry System occupy a space about 10 feet square; and, if greater capacity is needed, the change can be made without difficulty.

For those who desire the convenience of running water in their homes and the independent means of furnishing a supply, the Perry System ought to prove a good one. Contractors will find a profitable field in installing this water system and we'd suggest that our friends write for the free illustrated catalog to the United Pump & Power Co., 495 Old Colony Bldg., Chicago, Ill.



Birch and Hemlock Producers Meet

The Northern Hemlock and Hardwood Manufacturers' Association held their annual meeting on January 27th at the Fisher Hotel, Milwaukee, Wis.

Resolutions were adopted favoring their present advertising campaign and expressing satisfaction with the results obtained in furthering sales. The officers for the coming year will be Messrs. E. A. Hamar, Pres.; R. B. Goodman, Vice Pres.; G. E. Foster, Treas., and W. C. Landon, J. J. Lingle, A. R. Week, and A. C. Wills, directors. The personnel of the grading committee for the association is Messrs. M. J. Quinlan, C. A. Goodman G. W. Harder, J. T. Phillips, A. R. Owen and J. J. Ott. R. S. Kellogg, Wausau, Wis., is Secretary.

A review of the policies of the association for the past year and for 1913 created a lively interest.



Residence of Mrs. Clara F. Taylor, De Land, Fla., Roofed with J-M Transite Asbestos Shingles.



For the Artistic Fire-Proof Home



Residence of L. R. Hoff, Paterson, N. J. Roofed with J-M Transite Asbestos Shingles, Sided with J-M Stucco. F. J. Parsons, Architect, N. Y.

As it requires no additional planning and is more economical, why not make the roof not only as artistic as the rest of the building, but absolutely fireproof by using J-M Transite Asbestos Shingles. They are moulded into one solid, compact, homogeneous mass under tremendous hydraulic pressure from a composition of Asbestos and Portland Cement.

J-M TRANSITE ASBESTOS SHINGLES

never rot, warp, split, curl, crack or decay. And they never require painting to preserve them. Supplied in sizes and shapes to meet all requirements, in colors of slate, natural gray and Indian red. J-M Shingles are also furnished 1/4" thick with rough or irregular edges. This provides maximum durability and beauty.

Write nearest Branch for copy of interesting Booklet and our offer to dealers.

H. W. JOHNS-MANVILLE CO.

Albany
Baltimore
Boston
Buffalo

Chicago
Cincinnati
Cleveland
Dallas

Detroit
Indianapolis
Kansas City
Los Angeles

Louisville
Milwaukee
Minneapolis
New Orleans

New York
Omaha
Philadelphia
Pittsburgh

San Francisco
Seattle
St. Louis
Syracuse

For Canada—THE CANADIAN H. W. JOHNS-MANVILLE CO., LIMITED
Toronto Montreal Winnipeg Vancouver

1585



When Writing Advertisers Please Mention the American Carpenter and Builder.

Big Announcement

Direct-to-You Lumber from two new points

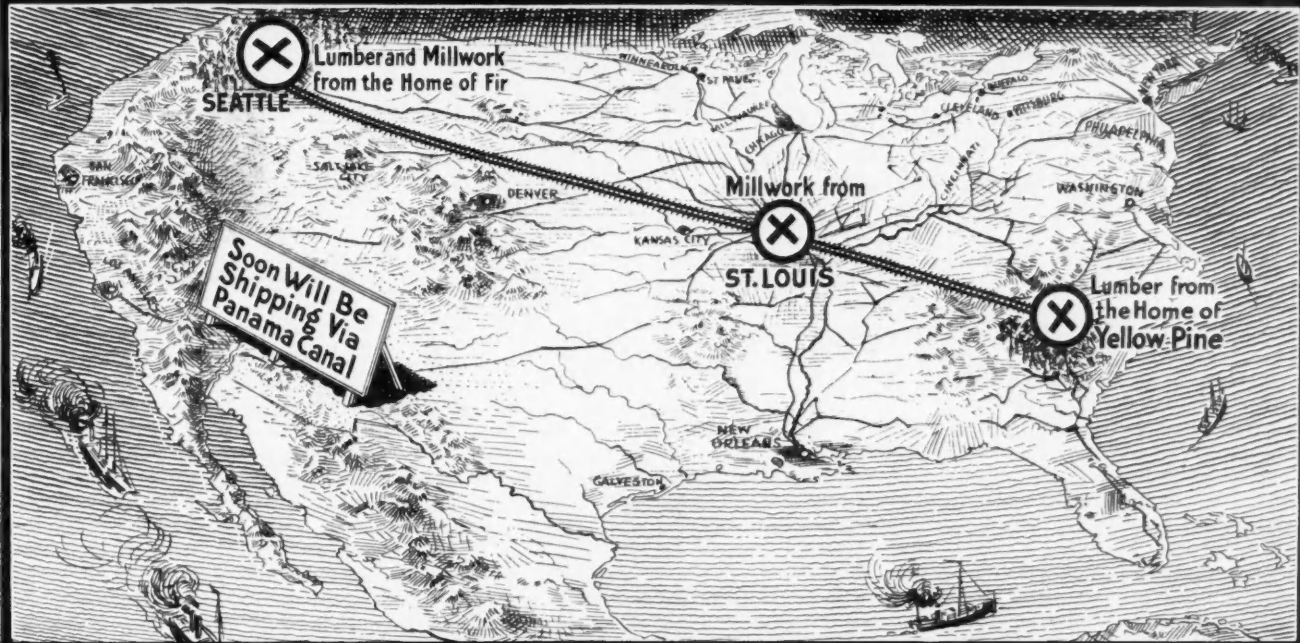

40% to 60% Saving for Eastern Lumber Users

Great news for lumber users! Sad news for the lumber combine! Hewitt-Lea-Funck Company have invaded the East! From our Western mills, shipping out of Seattle, we have been underbidding from 40% to 60% all competition in the territory west of the Mississippi. We now offer this same saving to lumber users in every part of the United States.

We Own Forests and Mills In addition to our vast holdings of Western timber, our large lumbering activities and our six great mills, we have now secured the control of two new mills—in order to free the East from the bondage of high prices.

Note the Lowness of these Prices

All f. o. b. Seattle

No. 1 Common fir, sized—	Per M
2x4, 12, 14, 16 ft.	\$12.50
2x6, 12, 14, 16 ft.	12.00
2x8, 12, 14, 16 ft.	12.00
2x10, 12, 14, 16 ft.	13.00
2x12, 12, 14, 16 ft.	13.50
1x6, No. 1 Common fir, S1S.	11.00
1x6, No. 2 Common fir, S1S.	9.00
1x4, No. 2 Clear and Better sial, grain flooring.	23.00
1x4, 1st Clear vertical grain fir flooring.	31.00
5-8x4, No. 2 Clear and Better fir ceiling.	19.00
1-2x6, "A" Clear red cedar bevel siding.	24.50
1x6, No. 2 Clear and Better fir drop siding.	20.00
1x4 1-4, Clear Bull Nose casing, per ft., 1 1-2c base, 2 1-2c	
2-8x6-8x1 3-8, 5 Cross Panel Fir Door, ea. 1.50	

SHINGLES—straight carload prices

5-2 16-in. Clear red cedar shingles.	\$2.20
6-2 16-in. Extra "A" red cedar shingles.	1.80

These Prices f. o. b. Southern Mill

No. 1 Common Yellow Pine, S & E—	Per M
2x4, 12, 14, 16 ft.	\$18.75
2x4, 10, 18, 20 ft.	21.75
2x6, 12, 14, 16 ft.	17.75
2x6, 10, 18, 20 ft.	18.75
2x8, 12, 14, 16 ft.	18.25
2x8, 10, 18, 20 ft.	20.25
2x10, 12, 14, 16 ft.	19.00
2x10, 10, 18, 20 ft.	20.50
1x8, 10 ft., No. 1 Common Yellow Pine.	20.50
1x8, 10 ft., No. 2.	17.75
1x4, B and Better Edge Grain Yellow Pine Flooring.	34.75
1x4, B and Better Flat Grain Yellow Pine Flooring.	24.75
1x10, B and Better Yellow Pine Finish.	31.50
4 ft. No. 1 Yellow Pine Lath.	2.95

Millwork From St. Louis—Lumber From the South

The St. Louis mill is noted for the quality of its millwork. The Southern mill is in the heart of the soft, short leaf yellow pine country. These two mills, in addition to our six Western mills, give every lumber buyer in the United States the chance to buy direct from the mill at small prices. Not one middleman gets a profit. You pay five profits when you buy from local dealers. Wholesalers, jobbers, commission men, salesmen and retailers all get a fat rake-off and you pay the whole bill. Our low prices enable you to underbid competition, get more business and at the same time deliver better quality.

Quick Delivery to Every Point in the U.S.A.

We have already told you of our great facilities in the West—our six mills which produce 20 to 30 carloads of finished materials each day; our filling of orders in from 24 to 48 hours; and the seven great transcontinental railways radiating eastward from Seattle, which rush materials to all points west of the Mississippi inside of two weeks.

Our two new mills are within a few days' freight haul to all points east of the river. Every town in the United States is now within easy shipping distance of our mills.

Lumber and Millwork of Highest Quality

The timber from our Western mills is famous for quality—sawed from huge forests of fir, spruce, cedar, hemlock and western soft pine. The fir is clean, straight, free from sap and knots and wonderfully lasting.

The yellow pine from our Southern mills comes from the famous Rose Mary belt. Unusually light and soft in texture. Makes best casing, base and interior finish. Works easily under saw. Takes

and holds paint well. Makes beautiful varnished finish. All stock of uniform thickness and width required by Association rules.

As to millwork, there is no better than ours. You'll be surprised at the wide variety we offer you and at the big saving it allows. Our St. Louis mill is exceptionally equipped to handle orders for cypress, yellow pine, oak and all kinds of doors.

Satisfaction Guaranteed

We guarantee you complete satisfaction in every way or your money refunded. More than that, we guarantee our materials to grade better than trusts and combine standard. You will surely make a hit with your customers, both as to quality and price.

One Estimate Will Convince You

Send us your material lists—your complete schedule of materials for work on which you are figuring. Get our prices. Find out what a real opportunity this is to reduce the cost of materials. We can figure on your requirements no matter what they may be. Don't miss this chance to increase your profits. If you haven't any material lists to send right now, at least

Mail the **COUPON TODAY** for Catalog and Price List

Hewitt-Lea-Funck Co.

623 First Ave., SEATTLE, WASH.

Kindly send me your catalog and list of prices on lumber and building supplies, laid down at my station.

Name _____

Business _____

Address _____

When Writing Advertisers Please Mention the American Carpenter and Builder.

Good Plaster

If It's Made by the Grand Rapids Plaster Co.—it is Good

Satisfy yourself—and the building owner—by using plaster that will last and won't crack. Our hard wall plaster is guaranteed to satisfy, and is made good enough to outlive even our guarantee.

If you have been using heavy, cracky lime mortars, change today to our Hard Wall Plaster and save on time, labor and material. The economy is positive.

Climax Wood Mortar

is a wood fiber plaster made of pure gypsum rock, and is admittedly the finest plaster ever marketed. The fiber adds about one-third to the bulk of plaster, making it cover a greater area with less weight and maximum solidity and tensile strength. Absolutely water and vermin proof. Is durable, flexible, pliable, adhesive, permanent and very easily applied. Doesn't contain any sand.

Hercules Wall Plaster

contains no chemicals, acids or vegetable matter. A pure gypsum-rock-hair-fiber plaster, and makes a wall that is dense, durable, hard and economical. Positively fireproof. Spreads easier and goes further than ordinary plasters, and dries quickly. We use the highest grade hair in its manufacture.

We Will Send You—

a set of books that cover the plaster question from A to Z. They explain just why you should use our Climax Wood Mortar, Hercules Wall Plaster, Superior Wood Fiber Plaster, Gypsum Wall Plaster and Sackett Plaster Board. In addition, we will send you our room measurement booklet which makes it easy for you to tell at a glance the number of square yards in a room. These are all free; ask for them.



"Remember the TRADE MARK"

GRAND RAPIDS PLASTER COMPANY
GRAND RAPIDS, MICHIGAN

N. B. We solicit inquiries from Michigan, Ohio, Indiana, Illinois, Wisconsin, Kentucky, Tennessee, West Virginia, and Pittsburgh districts, Pa., only. Freight rates will not permit shipment to other territory.

Grand Rapids Plaster Co.
Grand Rapids, Michigan



Oshkosh Boring Device for Heavy Timbers

Another great difficulty in building is now overcome—the boring of timbers for heavy construction work. The Oshkosh "Eveready" portable saw rig has just been fitted with a successful boring device that permits boring heavy beams and girders as they lie on the ground.

It is simply a matter of dragging the piece to be bored under the auger to the desired position. As the device can be quickly attached and detached, it does not interfere with the use of the saw rig in its many other capacities. The makers say it has been thoroughly tested out and is giving perfect satisfaction everywhere.

Further information can be had by dropping a card to Oshkosh Mfg. Co., 316 South Main St., Oshkosh, Wisconsin.

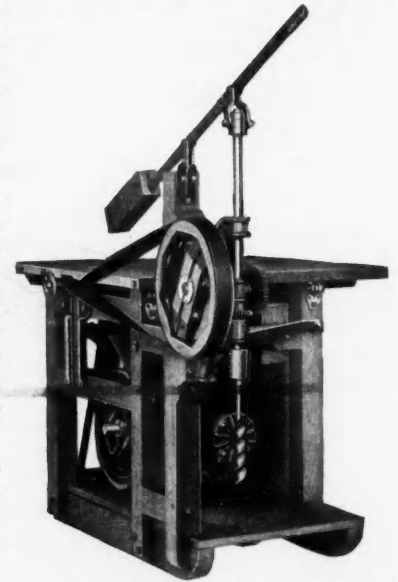

Oshkosh "Eveready" Saw Rig Equipped with New Heavy Timber Borer

Oak Flooring vs. Carpets

In recent years, the hardwood floor, especially oak flooring, is taking the place of carpets to such an extent that it is a very uncommon thing to see the old fashioned carpet that covers the entire floor. Carpets have had their day. The carpet is the champion collector of dust and germs. To keep a carpet thoroughly sanitary it would be necessary to wash it or steam it every week or two and, of course, this cannot be done so the best thing is to get rid of the carpet.

The ordinary home builder is often misled in regard to prices of oak flooring. Oak flooring is cheaper, and far better, than carpets. A yard of carpet is 27 inches wide by 3 feet in length, thus a yard of carpet contains 6¾ sq. ft. Carpet sells at from \$2.00 to \$9.00 per yard and a fair average, for a good quality, would be about \$3.00 per yard. Clear quartered (best grade), oak flooring ¾ inch thick by 1½ inches or 2 inches face can be bought, laid and polished for \$1.00 per carpet yard, with the price based in Cincinnati. This is about one-third the price of good carpet. Oak flooring tones up a house and exhibits more taste than any carpet that was ever made.

¾ inch thickness, after being laid, has all the appearance of thicker stock. A little more care is required to have the sub-floor even than when the 13/16 inch thickness is laid. In the ¾ inch only two widths are made, namely 1½ inch face and 2 inch face. Comparing the prices of the two thicknesses—¾ inch is about 40 per cent cheaper than 13/16 inch.

The ¾ inch thickness is used very extensively to cover old pine floors in old homes. All one needs to do is to rip off the quarter round trim, level off the sub-floor, and lay the ¾ inch oak flooring at right angles to the old floor. New bungalows and all classes of homes and apartment buildings are using ¾ inch thickness with marked success.

When one enters a home where oak flooring is used, his attention is immediately attracted by its handsome appearance. Its color is rich and cheerful and gives that dignified tone that is desired.

Builders and architects recognize that oak flooring attracts a better class of tenants and makes a vast difference in the

When Writing Advertisers Please Mention the American Carpenter and Builder.



The Shepherd Brooks Building

Locally known as the Monroe Building

Chicago, Ill.

HOLABIRD & ROCHE, Architects

Has Corbin Unit Locks and Hardware of the special gothic design shown. The building next to it on the left is the Illinois Athletic Club, and the next one is the Kesner Building. Both of these have Corbin Hardware throughout.

One good building trimmed with Corbin Hardware might be an accident; but when they come in rows, *there's a reason for it.*

P. & F. CORBIN

Division

The American Hardware Corporation
NEW BRITAIN, CONNECTICUT

P. & F. Corbin of Chicago

P. & F. Corbin of New York

P. & F. Corbin Division, Philadelphia

When Writing Advertisers Please Mention the American Carpenter and Builder.

renting and selling value. A striking example of this can be seen daily in our newspapers in the advertising section where homes are listed for sale or for rent. Oak flooring, if used, is always emphasized. The woman of today demands oak flooring.

Oak has always been taken as an example of strength and endurance and there is little doubt but that before the dawn of history, the oldest living trees to be found, were oaks, as they are today. Vitruvius, in a book that he published about B. C. 25, which bears his name, writes that oak floors were used and recommends that each board be nailed with two iron nails to every joist. This sounds very much like our own modern specifications inasmuch as there is a special Oak Flooring, at the present time, made with holes bored through the face for nailing.



Adaptability of Metal Spanish Tile

That Metal Spanish Tile is met with widespread, popular favor, is shown by the many different types of buildings on

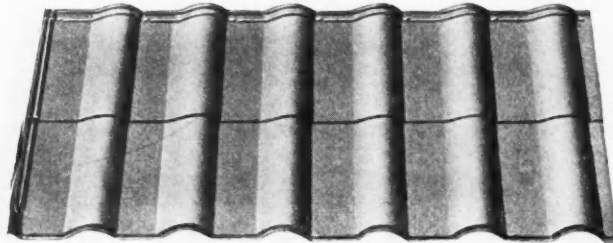

which it has been installed.

It came after years of study and experiment with a view of perfecting weather-proof tile roofing combining architectural beauty, light weight, ease of application, fire and lightning proof qualities and low maintenance cost; and the numerous

installations throughout the country indicate that The Berger Manufacturing Company of Canton, Ohio, has presented the building world with a product for which the need has long existed.

It offers a very handsome, durable roof at a moderate cost and adaptable for residences, stations, express offices, all

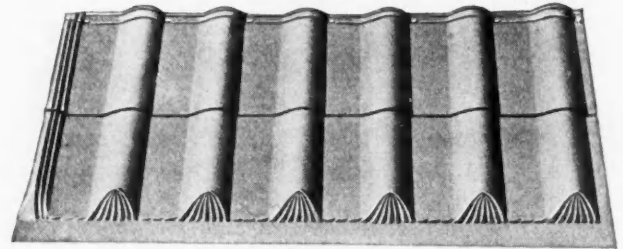

kinds of public buildings, and in the case of every installation up to the present time it has met with the entire approval of every one concerned.

There are also many features of construction which are worthy of note. The water guard of the tile is high and the

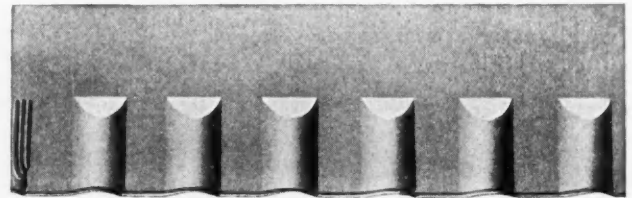

joints are perfect with ample provision for expansion and contraction under all climatic conditions.

The heavily embossed S shapes permit free circulation of

Everybody Can Afford Wolff Plumbing

Specify Plumbing Goods made by a firm of long established reputation, whose goods are of unquestioned value, rather than be tempted by price consideration into buying

substitutes which can only result in disappointment and loss. Our Suggestion Booklet shows a series of designs for bath rooms from \$60.00 upward. Sent upon request.

Branches and Branch Offices:

- | | |
|--------------------|---------------------|
| Denver, Col. | St. Louis, Mo. |
| Trenton, N. J. | Washington, D. C. |
| Omaha, Neb. | Cleveland, Ohio |
| Minneapolis, Minn. | Cincinnati, Ohio |
| Dallas, Texas | San Francisco, Cal. |
| Rochester, N. Y. | Kansas City, Mo. |

L. WOLFF MANUFACTURING COMPANY

Plumbing Goods Exclusively

MAIN OFFICE 601-627 W. Lake Street CHICAGO SHOWROOMS 111 N. Dearborn Street

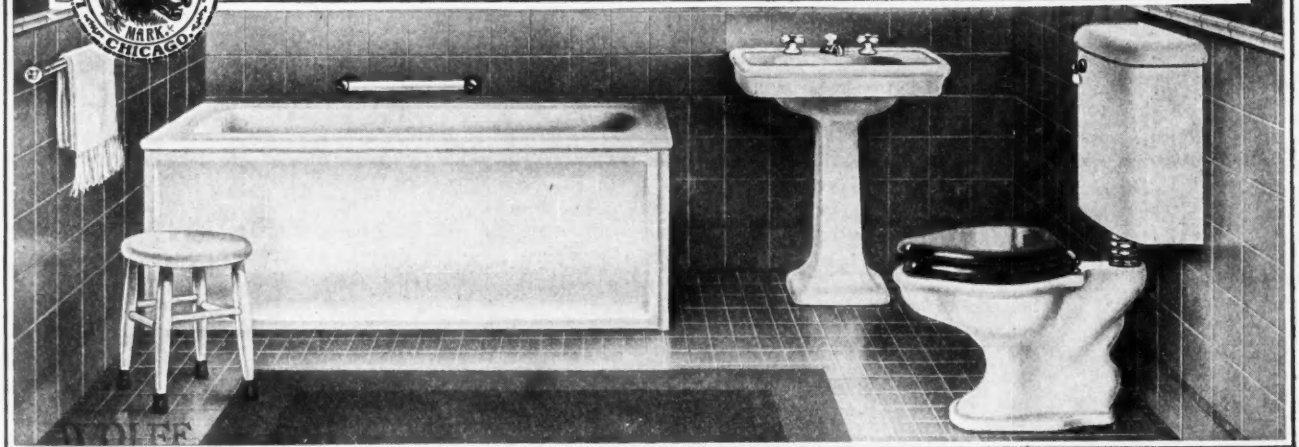

When Writing Advertisers Please Mention the American Carpenter and Builder.

Berger
ed the
s long

re cost
es, all

llation
oval of

ch are
nd the

n and
ion of



THE house of your creation must stand use and abuse. Complete satisfaction to client, is insured by specifying Pratt & Lambert "61" Floor Varnish for floors — the water and heel-proof kind — Vitralite, *The Long-Life White Enamel*, for perfect, porcelain-like white effects on wood, metal or plaster, and other Pratt & Lambert Varnishes for every conceivable varnish purpose.

Send for Booklets and Sample Panels.

See Pratt & Lambert Specifications, pages 1842-1843, 1913 Sweet's Index, before specifying wood finishes.

Pratt & Lambert-Inc., 110 Tonawanda Street, Buffalo, N. Y.

Vitralite
THE LONG-LIFE WHITE ENAMEL

When Writing Advertisers Please Mention the American Carpenter and Builder.

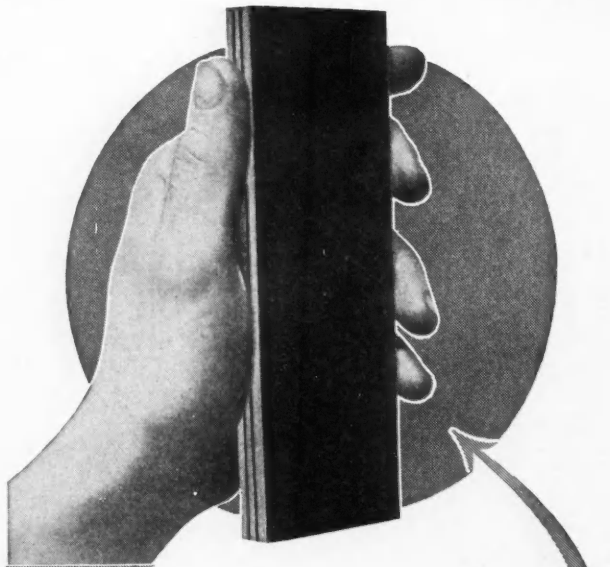

TAKE A PIECE OF CEIL-BOARD IN YOUR HAND

and examine its surface closely. See how compact and even the texture is—feel how smooth and firm; no high spots to catch the dust—no hollows to hold it and serve as breeding places for disease germs. Just a plain, flat, glossy hygienic surface.

Ceil-Board is constructed from materials of proven purity, in a manner that insures permanent, efficient and sanitary service on walls and ceilings under all conditions.

Try to break your sample—its toughness will surprise you, for Ceil-Board is no flimsy "soda cracker" material. Note the two layers of tempered asphalt. Ceil-Board is damp-proof, vermin-proof and fire retarding.

Decorate it any way you wish—with oil paint, water-paint, distemper, wall paper or burlap, or grain it to resemble wood. It takes them all perfectly and with the same pleasing results.

And Ceil-Board costs no more than inferior wall board, and can be applied as quickly, easily, and economically as any; practical men don't need to be told how much cheaper it is than lath and plaster.

Send a post-card for sample to test. Address Ceil-Board Dep't.

THE PHILIP CAREY COMPANY
LOCKLAND, CINCINNATI, OHIO.

Ceil-Board used
in a Factory.



Practical, Dur-
able, Strong.

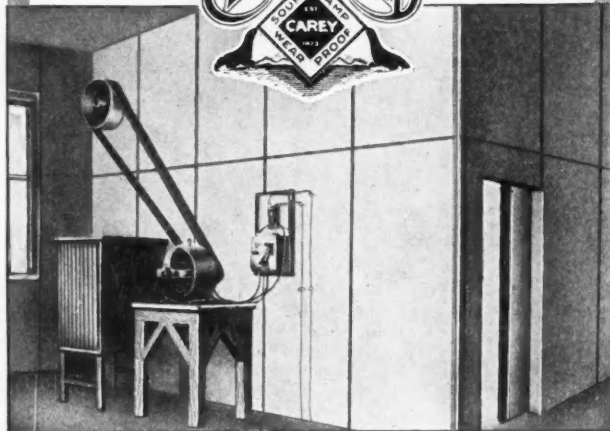

When Writing Advertisers Please Mention the American Carpenter and Builder.

air underneath the Metal Tile Roofing, keeping the underside of the tile roofing and the roof sheathing free from moisture.

This air space also acts as a perfect non-conductor of heat and cold.

That Metal Spanish Tile Roofing has come to stay is indicated by the thousands of inquiries which are pouring into the Berger office concerning this material, and by the many installations for which it is being specified.



Ventilating Fireplace

The fireplace as a home fixture is at last coming into its own again, and justly so. Here is the center of the family circle, here the radiation, cheeriness and comfort that should be a part of the home life—for what is more cozy in inclement weather than the glow of an open fire?

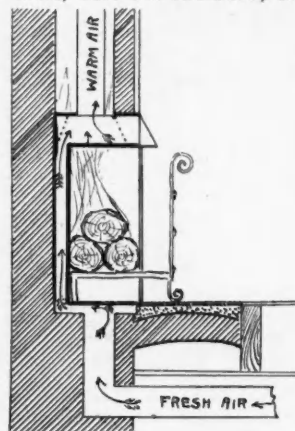

The vogue of fireplaces passed for a time because most people objected to the smoke and draft caused by an open grate. The firm of E. A. Jackson & Bro., 50 Beekman Street, New York City, evidently have overcome this difficulty in an economical and satisfactory manner. Their principle, which is the same as that of the furnace combined with the direct radiation of an open fire, should

provide a clean and economical method of heating, not only the room in which the fire burns, but overhead or adjoining rooms.

Their scheme involves a fresh air intake leading from the outside of the house to points directly back and over the lining of the fireplace. Here the cold air is warmed and carried up a pipe to the room above. There is a ventilating grate directly above the fireplace by means of which, when the damper in the pipe leading to the upper chamber is thrown across, the warmed air from outside can be directed into the room in which the fire is situated. In this way healthful ventilation without draft is secured. The accompanying diagram will serve to indicate the system more clearly. One might probably conceive the idea that the installation of such a heating system would be difficult and expensive. On the contrary it is said to be one which any mason can set. The actual fireplace can be fitted to any opening.

We have no doubt our readers will be greatly interested in ventilating fireplaces. Full details regarding this ingenious arrangement can be had by writing E. A. Jackson & Bro.



Valuable Book Free

Of considerable interest to our readers will be the latest issue of a valuable book size 6 by 9, containing highly interesting, important and valuable matter, that every reader of this paper should have.

A limited number of these books treating on architectural drafting will be sent free to those interested to learn drawing thoroughly and in a practical up-to-date and efficient manner. This book is issued by the Chief Draftsman of the Engineers' Equipment Co., who has for a long period of years given practical working instructions to a limited number of selected men.

Every carpenter and builder of the progressive and ambitious kind, should write for this book and special offer to furnish the student with a complete draftsman's working outfit free.

Pick of The Pines



Tasty Arkansas Soft Pine Interior of a Peoria (Ill.) Bungalow.

ARKANSAS SOFT PINE

Is the pick of the pines of the south. All of them are good; Arkansas Soft Pine is best, because of its

Soft, even texture,

Freedom from pitch,

Varied and pleasing figure,

Special fitness for all building and factory uses, and because

It can be secured in quantity and quality the user needs. It is not a one-purpose Wood, not a specialty, but is *suitable* and is *available* for all the requirements of the building and factory trades.

If your lumber comes from any of the mills listed you may be assured you are getting the best lumber now available.

Ask for a copy of "Arkansas Soft Pine Interior Trim," sent free upon request.

Ask your dealer: "Do you buy from the Arkansas Soft Pine group of mills?" If he does you will be supplied with the "Pick of the Pines," manufactured by:

Wisconsin-Arkansas Lumber Company, Malvern, Ark.
Arkansas Lumber Company, Warren, Ark.
Cotton Belt Lumber Company, Bearden, Ark.
Crossett Lumber Company, Crossett, Ark.
Eagle Lumber Company, Eagle Mills, Ark.
Edgar Lumber Company, Wesson, Ark.

Fordyce Lumber Company, Fordyce, Ark.
Freeman-Smith Lumber Company, Millville, Ark.
Gates Lumber Company, Wilmar, Ark.
Southern Lumber Company, Warren, Ark.
Stout Lumber Company, Thornton, Ark.

When Writing Advertisers Please Mention the American Carpenter and Builder.



AT CHALLENGE PRICES

Our big Southern Mills in Louisiana and our Assembling Yards in Illinois are especially well stocked right now with highest quality lumber, lath, shingles, etc., of all kinds. Millions of feet are ready for shipment.

Our customers advise our wholesale prices save them about \$100.00 on the average carload.

In order to get the benefit of the lowest carload rate of freight, it is necessary to order 30,000 lbs. or more of lumber, which can be made up of 10,000 ft. lumber, 14,000 shingles and 10,000 lath. An ordinary house or barn will require this amount.

Prices on these two pages are for carload lots of lumber, F. O. B. our plant in Southern Illinois and are guaranteed to March 31st, 1913. If you cannot order a carload and wish a smaller quantity, add 8 per cent to the above carload prices and we will ship any quantity you want by local freight. Mark your order "Lumber Department 56-A."

CROWN MOLDING. Cypress.

Will Be Shipped in Assorted Lengths.

Size, Inches	Price, per 100 Lineal Feet	Wt., per 100 Lineal Feet
13-16x2 1/2	\$1.10	40 pounds
13-16x3 3/4	1.35	45 pounds
13-16x3	1.45	52 pounds
13-16x4 1/4	1.74	60 pounds
13-16x4 3/4	1.95	68 pounds

BED MOLDING. Cypress.

Will Be Shipped in Assorted Lengths.

Size, Inches	Price, per 100 Lineal Feet	Wt., per 100 Lineal Feet
13-16x2	\$0.83	28 pounds
13-16x2 1/4	.94	31 pounds
13-16x2 3/4	1.10	38 pounds

DRIP CAP MOLDING. Cypress.

Will Be Shipped in Assorted Lengths.

Size, Inches	Price, per 100 Lineal Feet	Wt., per 100 Lineal Feet
1 1/2 x 1 1/2	\$1.17	28 pounds
1 1/2 x 2	1.46	34 pounds
1 1/2 x 2 1/2	1.76	42 pounds
1 1/2 x 3	2.09	52 pounds

COVE MOLDING. Cypress.

Will Be Shipped in Assorted Lengths.

Size, Inches	Price, per 100 Lineal Feet	Wt., per 100 Lineal Feet
3/4 x 3/4	\$0.37	13 pounds
13-16x1 1/2	.45	16 pounds

NOSING. Cypress.

Will Be Shipped in Assorted Lengths.

Size, Inches	Price, per 100 Lineal Feet	Wt., per 100 Lineal Feet
1 1/2 x 2	\$1.45	34 pounds

BRICK MOLDING. Cypress.

Will Be Shipped in Assorted Lengths.

Size, Inches	Price, per 100 Lineal Feet	Wt., per 100 Lineal Feet
1 1/2 x 1 1/2	\$1.17	28 pounds
1 1/2 x 2	2.40	30 pounds
1 1/2 x 2 1/2	2.40	55 pounds

SCREEN MOLDING. Cypress.

Shipped in Assorted Lengths.

Size, Inches	Price, per 100 Lineal Feet	Wt., per 100 Lineal Feet
3/4 x 3/4	\$0.37	13 pounds
7-16x3/4	.39	14 pounds

DOOR AND WINDOW STOP. O. G. Cypress.

Shipped in Assorted Lengths.

Size, Inches	Price, per 100 Lineal Feet	Wt., per 100 Lineal Feet
3/4 x 1 1/2	\$0.37	8 pounds
3/4 x 1 3/4	.41	9 pounds
1/2 x 1 3/4	.59	13 pounds
5-16x2	.66	15 pounds

LATTICE. Cypress. Shipped in Assorted Lengths.

Size, Inches	Price, per 100 Lineal Feet	Wt., per 100 Lineal Feet
5-16x1 1/2	\$0.31	8 pounds
5-16x1 3/4	.37	9 pounds
5-16x1 3/4	.50	12 pounds

PARTING STOP. Cypress.

Shipped in Assorted Lengths.

Size, Inches	Price, per 100 Lineal Feet	Wt., per 100 Lineal Feet
1/2 x 13-16	\$0.37	8 pounds

BLIND STOP. Cypress.

Shipped in Assorted Lengths.

Size, Inches	Price, per 100 Lineal Feet	Wt., per 100 Lineal Feet
13-16x1 1/2	\$0.55	21 pounds

QUARTER ROUND. Shipped in Assorted Lengths.

Size, Inches	Cypress Price, per 100 Lineal Feet	Yellow Pine Price, per 100 Lineal Feet
3/4 x 3/4	36c	26c
3/4 x 3/4	37c	
3/4 x 3/4	38c	

FLOORING. Yellow Pine. FLAT GRAIN.

Thickness, Inch	Width of Face	Grade	Weight, per 100 Square Feet	Price, per 100 Square Feet, Surface Measure
13-16	2 1/2 inch	Clear	200 lbs.	\$3.10
13-16	2 1/2 inch	No. 1	200 lbs.	2.85
13-16	2 1/2 inch	No. 2	200 lbs.	2.15
13-16	3 1/4 inch	Clear	210 lbs.	2.90
13-16	3 1/4 inch	No. 1	210 lbs.	2.65
13-16	3 1/4 inch	No. 2	210 lbs.	1.93
13-16	5 1/4 inch	Clear	220 lbs.	2.90
13-16	5 1/4 inch	No. 1	220 lbs.	2.73
13-16	5 1/4 inch	No. 2	220 lbs.	2.15

ORDER ENOUGH EXTRA TO ALLOW FOR TONGUE AND GROOVE.

Above prices are for assorted lengths. Specified lengths, 20 cents per 100 square feet, extra.

FLOORING. Yellow Pine. EDGE GRAIN.

Thickness, Inch	Width of Face	Grade	Weight, per 100 Square Feet	Price per 100 Square Feet, Surface Measure
13-16	3 1/4 inch	Clear	200 lbs.	\$4.10
13-16	3 1/4 inch	"C"	200 lbs.	3.32

ORDER ENOUGH EXTRA TO ALLOW FOR TONGUE AND GROOVE.

Above prices are for assorted lengths. Specified lengths, 20 cents per 100 square feet, extra.

FLOORING. Made Especially for Porch FIR, EDGE GRAIN. Floors.

Thickness, Inches	Width Face, Inches	Grade	Wood	Weight, per 100 Board Measure	Price, per 100 Board Measure
7/8	3 1/4	Clear	Fir	200 lbs.	\$4.70
1 1/4	3 1/4	Clear	Fir	220 lbs.	5.20

IN ORDERING ABOVE FLOORING ALLOW EXTRA FOR TONGUE AND GROOVE.

If 1 1/2-inch is ordered add 25 per cent to surface measure for quantity board measure.

CEILING. Yellow Pine.

Size, Inches	Clear Grade Price, per 100 Square Feet	No. 1 Grade Price, per 100 Square Feet	No. 2 Grade Price, per 100 Square Feet	Weight, per 100 Square Feet
1/2 x 3 1/4	\$2.32	\$2.15	\$1.50	110 lbs.
3/4 x 3 1/4	2.65	2.32	1.60	140 lbs.

Order extra to allow for tongue and groove.

YELLOW PINE PARTITION.

Size, Inches	Clear Grade Price, per 100 Square Feet	No. 1 Grade Price, per 100 Square Feet	No. 2 Grade Price, per 100 Square Feet	Weight, per 100 Square Feet
3/4 x 3 1/4	\$3.02	\$2.71	\$2.00	180 lbs.

FINISHING LUMBER. Surfaced Both Sides.

Size, Inches	Yellow Pine, Clear Grade Price, per 100 Lineal Feet	Yellow Pine, Select Grade Price, per 100 Lineal Feet	Cypress, Clear Grade Price, per 100 Lineal Feet	Cypress, Select Grade Price, per 100 Lineal Feet	Weight, per 100 Lineal Feet
1 x 3	\$0.90	\$0.76	\$1.18	\$0.90	65 lbs.
1 x 4	1.13	.95	1.49	1.06	85 lbs.
1 x 5	1.51	1.26	1.93	1.44	100 lbs.
1 x 6	1.66	1.40	2.30	1.72	125 lbs.
1 x 8	2.02	1.83	2.70	2.23	165 lbs.
1 x 10	2.52	2.53	3.87	2.39	210 lbs.
1 x 12	3.58	3.00	5.07	4.01	250 lbs.
1 1/4 x 4	1.55	1.33	1.93	1.41	114 lbs.
1 1/4 x 6	2.36	2.03	3.08	2.34	167 lbs.
1 1/4 x 8	3.17	2.72	4.03	3.05	220 lbs.
1 1/4 x 10	4.22	3.59	5.14	3.90	280 lbs.
1 1/4 x 12	5.00	4.26	6.69	5.37	335 lbs.
1 1/2 x 4	1.88	1.60	2.40	1.76	136 lbs.
1 1/2 x 6	2.80	2.20	3.70	2.84	200 lbs.
1 1/2 x 8	3.74	3.20	4.86	3.70	265 lbs.
1 1/2 x 10	5.01	4.27	6.24	4.77	336 lbs.
1 1/2 x 12	5.98	5.09	8.20	6.57	400 lbs.
2 x 4	2.52	2.16	3.40	2.55	178 lbs.
2 x 6	3.68	3.15	5.20	4.03	270 lbs.
2 x 8	5.09	4.28	6.87	5.31	365 lbs.
2 x 10	6.66	5.76	8.76	6.80	460 lbs.
2 x 12	7.90	6.70	11.33	9.22	550 lbs.

YELLOW PINE DROP SIDING.

Size, Inches	Clear Grade Price, per 100 Square Feet	No. 1 Grade Price, per 100 Square Feet	No. 2 Grade Price, per 100 Square Feet	Weight, per 100 Square Feet
3/4 x 5 1/4	\$2.88	\$2.65	\$2.10	175 lbs.

BEVEL SIDING.

Size, Inches	Kind of Wood	Grade	Price, per 100 Square Feet	Weight, per 100 Square Feet
1/2 x 3 1/2	Cypress	Clear	\$2.35	100 lbs.
1/2 x 5 1/2	Cypress	Clear	2.45	100 lbs.
1/2 x 3 1/2	Cypress	C	2.00	100 lbs.
1/2 x 5 1/2	Cypress	C	2.10	100 lbs.
1/2 x 3 1/2	Yellow Pine	Clear	1.95	100 lbs.
1/2 x 5 1/2	Yellow Pine	Clear	2.05	100 lbs.
1/2 x 3 1/2	White Pine	C Select	2.40	80 lbs.
1/2 x 5 1/2	White Pine	C Select	2.50	80 lbs.

FIR STEPPING FOR PORCH STEPS.

Surfaced both sides. Nerd and all ready.

Thickness, Inches	Width, Inches	Price, per 100 Lineal Feet	Weight, per 100 Lineal Feet
1 1/4	10	\$6.35	280 lbs.
1 1/4	12	7.90	320 lbs.

WINDOW FRAME STOCK.

Made for 1 1/2-inch windows unless otherwise ordered.

Size, Inches	Clear Grade Price, per 100 Lineal Feet	No. 1 Grade Price, per 100 Lineal Feet	Weight, per 100 Lineal Feet
13-16x4 1/4	\$1.95	\$1.60	90 lbs.

INSIDE DOOR FRAME STOCK.

Furnished in assorted lengths, 10 to 20 feet.

Grade	Price, per 100 Lineal Feet	Weight, per 100 Lineal Feet
Clear	\$2.05	120 lbs.
No. 1	1.65	120 lbs.

ORDER LUMBER ON THIS PAGE FROM SEARS, ROEBUCK & COMPANY, CHICAGO, ILLINOIS



Facts About Quality, Sizes and Grades

CONCERNING QUALITY. It is a well known fact among large contracting concerns and architects that cypress lumber for outside cornice work, finishing lumber and bevel siding, and yellow pine for dimension, joists, timbers, flooring, ceiling, partition, etc., are very superior in strength and lasting qualities to other kinds of woods, such as hemlock, tamarack, jack pine, etc. In most cases our yellow pine prices are lower than the prices charged by local concerns for cheaper woods, but frequently in the states and localities where hemlock, tamarack, etc., grow a slightly lower price is quoted on these woods than on yellow pine. In all instances, however, yellow pine and cypress will be the cheapest and most satisfactory woods in the end, for they will last much longer and make a more permanent building.

CONCERNING SIZES. The sizes specified on this and the opposite page for dimension lumber, timbers, boards, shiplap, dressed and matched, etc., are the even inch measurements into which lumber is always cut, green and rough. After allowing for the shrinkage of drying and for surfacing, this stock will finish a little scant in thickness and width. Our lumber is all finished and manufactured in standard or regular Association yellow pine sizes.

In ordering flooring, siding, ceiling, partition, shiplap, dressed and matched, be sure to order enough extra to allow for the tongue and groove. For instance, to make 4-inch lumber to make flooring with 3 1/4-inch face. The difference is taken up in the tongue and groove. Example: A room 10x10 feet requires 100 square feet plus 25 per cent, or 125 feet, the board measure quantity necessary to cover this room.

CONCERNING GRADES. All our clear finishing lumber,

flooring, ceiling, siding, etc., both in cypress and yellow pine, is made from thoroughly kiln dried stock, very carefully machined. This is the highest grade furnished, is commonly known as Clear grade and is intended for the very best class of work.

Our select grade finishing lumber is the next grade below the clear and will contain some defects which can be covered with paint. This is the grade usually used for outside finishing lumber.

No. 1 grade dimension and timbers are all sound, straight stock, and our No. 1 boards, flooring, siding, ceiling, etc., are equal to the No. 1 grades usually furnished and are better than are sold in many local territories. No. 1 grade is the highest grade in which timbers, dimension, sheathing shiplap and dressed and matched are manufactured, and this stock is recommended for the best class of work.

Our No. 2 grade boards, sheathing and shiplap are good serviceable stock, and are the grade in which this material is usually ordered in moderate and high priced buildings. Our No. 2 dimension, flooring, ceiling, etc., are equal to the No. 2 grades usually furnished, but should be ordered only for low priced construction.

Our No. 3 grade is the lowest grade we handle, but in many localities No. 3 boards, sheathing and shiplap are used almost entirely. This lumber will be used with some waste, and may be satisfactory for low priced buildings. Mark your Order "Lumber Dept., 56-A."

ALL PRICES
On These Two Pages Are Guaranteed
Only To March 31

DIMENSION. Yellow Pine.

Surfaced One Side and One Edge.				Surfaced Four Sides.			
Size, In.	Lgth., Feet	No. 1 Grade, Each Piece.	Wt., Lbs.	Size, In.	Lgth., Feet	Price, Each Piece.	Wt., Each Piece, Lbs.
2x4	6	10	10	4x4	10	\$0.32	47
2x4	8	14	13	4x4	12	.40	56
2x4	10	18	17	4x4	14	.46	65
2x4	12	22	20	4x4	16	.52	75
2x4	14	26	23	4x4	18	.58	84
2x4	16	30	27	4x4	20	.64	93
2x4	18	34	31	4x4	22	.70	103
2x4	20	38	35	4x4	24	.76	112
2x4	22	42	39	4x4	26	.82	122
2x4	24	46	43	4x4	28	.88	133
2x4	26	50	47	4x4	30	.94	144
2x4	28	54	51	4x6	10	1.13	152
2x6	6	14	15	4x6	12	1.19	168
2x6	8	19	20	4x6	14	1.25	184
2x6	10	24	25	4x6	16	1.31	200
2x6	12	29	30	4x6	18	1.37	216
2x6	14	34	35	4x6	20	1.43	232
2x6	16	39	40	4x6	22	1.49	248
2x6	18	44	45	4x6	24	1.55	264
2x6	20	49	50	4x6	26	1.61	280
2x6	22	54	55	4x6	28	1.67	296
2x6	24	59	60	4x6	30	1.73	312
2x6	26	64	65	4x6	32	1.79	328
2x6	28	69	70	4x6	34	1.85	344
2x6	30	74	75	4x6	36	1.91	360
2x8	8	26	27	6x8	12	1.17	168
2x8	10	33	33	6x8	14	1.37	196
2x8	12	40	40	6x8	16	1.55	224
2x8	14	47	47	6x8	18	1.73	252
2x8	16	54	53	6x8	20	1.91	280
2x8	18	60	60	6x8	22	2.09	308
2x8	20	67	67	6x8	24	2.27	336
2x8	22	73	73	6x8	26	2.45	364
2x8	24	80	80	6x8	28	2.63	392
2x8	26	87	87	6x8	30	2.81	420
2x8	28	94	94	6x8	32	2.99	448
2x8	30	101	100	6x8	34	3.17	476
2x10	8	34	35	6x8	36	3.35	504
2x10	10	42	45	8x8	12	1.55	224
2x10	12	50	52	8x8	14	1.81	261
2x10	14	57	61	8x8	16	2.08	299
2x10	16	65	69	8x8	18	2.34	336
2x10	18	72	78	8x8	20	2.61	373
2x10	20	80	87	8x8	22	2.87	411
2x10	22	87	95	8x8	24	3.14	448
2x10	24	95	104	8x8	26	3.41	485
2x10	26	102	110	8x8	28	3.67	522
2x10	28	110	116	8x8	30	3.94	560
2x10	30	118	125	8x8	32	4.20	597
2x12	8	42	42	8x8	34	4.46	634
2x12	10	52	52	8x8	36	4.72	671
2x12	12	59	62	8x10	12	2.02	310
2x12	14	67	73	8x10	14	2.36	360
2x12	16	74	83	8x10	16	2.70	400
2x12	18	82	94	8x10	18	3.03	455
2x12	20	90	104	8x10	20	3.37	510
2x12	22	98	114	8x10	22	3.70	565
2x12	24	106	125	8x10	24	4.04	620
2x12	26	114	130	8x10	26	4.38	675
2x12	28	122	140	8x10	28	4.72	730
2x12	30	130	150	8x10	30	5.06	785
2x12	32	138	160	8x10	32	5.40	840
2x12	34	146	170	8x10	34	5.74	895
2x12	36	154	180	8x10	36	6.08	950

No. 2 Dimension furnished when in stock for \$2.00 less per 1,000 feet.

SHINGLES. RED CEDAR AND CYPRESS.

Thickness, Inches	Length, Inches	Grade	Kind of Wood	Price, per 1,000	Weight, per 1,000
6-2	16	Star A Star	Red Cedar	\$3.65	160 lbs.
5-2	16	Extra Clear	Red Cedar	4.35	180 lbs.
5-2	16	Prime	Cypress	3.70	300 lbs.

LATH. CYPRESS AND YELLOW PINE.

Thoroughly dry. All 3/4 inch thick, 1 1/2 inches wide.

Length, Inches	Wood	Grade	Price, per 1,000	Weight, per 1,000
48	Yel. Pine	No. 1	\$3.15	500 lbs.
48	Yel. Pine	No. 2	2.60	500 lbs.
48	Cypress	No. 1	4.55	500 lbs.
48	Cypress	No. 2	3.70	500 lbs.

SHINGLE LATH, FURRING STRIPS AND GROUNDS AND BRIDGING.

Surfaced two sides and made from sound stock suitable for the purpose intended.

Thickness, Inch	Width	Kind of Wood	Price, per 100 Lineal Feet	Weight, per 100 Lineal Feet
13-16	1 inch	Yel. Pine	25c	20 lbs.
13-16	2 inch	Yel. Pine	40c	40 lbs.
13-16	3 inch	Yel. Pine	55c	60 lbs.

BRIDGING. YELLOW PINE. (Square Ends.)

Size, Inches	Price, per 100 Lineal Feet	Weight, per 100 lineal feet
1x2	40c	40 lbs.
2x2	75c	75 lbs.

DIMENSION SHINGLES. RED CEDAR.

5 inches wide. 16 inches long. Furnished in six different designs.

Diamond Butt.	Octagon Butt.	Half Circle Butt.	Segment Butt.	Cove Butt.	Square Butt.
CLEAR GRADE.					
Draw a circle around name of design you want shipped.					
Grade			Price, per 1,000		Weight, per 1,000
Clear			\$5.00		150 lbs.

Prices on this page are for carload lots only. F. O. B. our plant in Southern Illinois, and are subject to market change. We will always give you the lowest prices in effect at time your order is received.

YELLOW PINE BOARDS, SHIPLAP, AND DRESSED AND MATCHED.

Size, Inches	No. 1 Grade, Price, per M Square Feet	No. 2 Grade, Price, per M Square Feet	No. 3 Grade, Price, per M Square Feet	Weight, per 1,000 Square Feet
1x4	\$23.25	\$20.50	\$18.75	2,500 lbs.
1x6	25.50	21.50	18.75	2,500 lbs.
1x8	25.50	22.90	19.00	2,500 lbs.
1x10	26.00	23.00	19.00	2,500 lbs.
1x12	29.85	23.50	20.00	2,500 lbs.

Order extra to allow for shiplap or dressed and matched.

CYPRESS BARN BOARDS.

Strictly No. 1 Selected Stock. Surfaced Both Sides. Be Sure to Specify Length Wanted.

Size, Inches	Lengths, Feet	Price, per 1,000 Feet, Board Measure	Weight, per 100 Square Feet
1x8	12, 14, 16	\$29.00	250 lbs.
1x8	18, 20	30.00	250 lbs.
1x10	12, 14, 16	30.00	250 lbs.
1x10	18, 20	31.00	250 lbs.
1x12	12, 14, 16	36.00	250 lbs.
1x12	18, 20	38.00	250 lbs.

Above stock will be furnished in shiplap or dressed and matched for 15 cents extra per 100 square feet.

YELLOW PINE BARN BOARDS.

Select No. 1 Grade. Surfaced Both Sides. Be Sure to Specify Length Wanted.

Size, Inches	Length, Feet	Price, per 1,000 Feet, Board Measure	Weight, per 100 Square Feet
1x8	12, 14, 16	\$27.00	250 lbs.
1x8	18, 20	28.00	250 lbs.
1x10	12, 14, 16	28.00	250 lbs.
1x10	18, 20	29.00	250 lbs.
1x12	12, 14, 16	32.00	250 lbs.
1x12	18, 20	33.00	250 lbs.

Above stock will be furnished in shiplap or dressed and matched for 15 cents extra per 100 square feet.

BARN BATTENS.

Size	Kind Wood	Design	Price, per 100 Lineal Feet	Weight, per 100 Lineal Feet
3/4x3	Cypress	Flat	\$0.57	30 lbs.
3/4x3 1/4	Cypress	O. G.	.80	40 lbs.
3/4x3	Yellow Pine	Flat	.50	30 lbs.
3/4x3 1/4	Yellow Pine	O. G.	.75	40 lbs.

ORDER LUMBER ON THIS PAGE FROM SEARS, ROEBUCK & COMPANY, CHICAGO, ILLINOIS

Startling Watch Offer

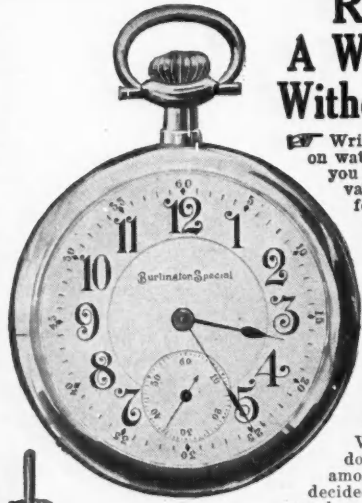

READ! A Watch Offer Without Parallel

Write for our FREE book on watches; a book that posts you on watches and watch values—explains reasons for our most remarkable rock-bottom-price offer DIRECT TO YOU on the highest grade Burlington.

IF YOU WANT a highest grade watch (ladies' or gentlemen's), or if you ever expect to own such a watch, write NOW for the FREE Burlington book. See coupon below.

We won't "knuckle down" to selling systems among dealers, so we have decided to make such a tremendous and wonderful offer direct to the public on a first-class time piece, that no trust, no dealers under contract will or can stop us. You too will seize this opportunity to get the "Burlington Special" direct on this wonderful offer.

You should not buy a worthless watch just because it is cheap. Nor need you pay trust prices now for a top-notch watch. The free Burlington book explains.

\$2.50 a Month at the Rock Bottom Price

\$2.50 a month for the world's most superb time piece! The easiest payments at the rock-bottom price—the Rock-Bottom price. To assure us that everybody will quickly accept this introductory direct offer, we allow cash or easy payments, just as you prefer.

No Money Down

We ship the watch on approval, prepaid (your choice of ladies' or gentlemen's open face or hunting case). Your risk absolutely nothing—you pay nothing—not one cent unless you want the great offer after seeing and thoroughly inspecting the watch.

Get the Free Burlington Book

THIS BOOKLET will quickly convince you too that you DO want an independent watch—made in the independent factory that is fighting the trust as best it can by giving better quality and superior workmanship throughout; we will quickly convince you that the Burlington watch, on which there is only one rock-bottom price (the same rock-bottom price everywhere), is THE watch for the discriminating buyer; that it is THE watch for the man or woman who wants, not the largest selling brand which everybody has, but the best watch, the watch bought by experts, THE watch that is absolutely perfect in its many points of superiority—the Burlington Watch. You will be posted on inside facts and prices when you send for the Burlington Company's free book on watches.

Now Write

for the free book. It will tell you what you ought to know before you even examine a watch. It will tell you the inside facts about watch prices, and will explain the many superior points of the Burlington over the double priced products. Just send your name and address today.

BURLINGTON WATCH CO.

Dept. 2663 19th and Marshall Boulevard

No Letter is Necessary
COUPON Will Do.

BURLINGTON WATCH COMPANY

Dept. 2663
19th & Marshall
Boulevard

CHICAGO ILLINOIS

CHICAGO ILLINOIS

Please send me (without obligations and prepaid) your free book on watches and copy of your \$1,000 challenge, with full explanations of your cash or \$2.50 a month offer on the Burlington Watch.

Name

Address.....

When Writing Advertisers Please Mention the American Carpenter and Builder.

The "Crescent" Machines Employ Special Features

Many commendable features are employed in the "Crescent" vertical tamping brick machine. Everything about it has been so constructed as to bring simplicity, strength and efficient operation to a high standard.

In a machine of this kind there must be no "give" or the repeated blows of the tamper will eventually cause a loosening or breakage of the parts. It also stands to reason that a heavy tamper if properly balanced produces the best brick. It is with these requisites in mind that the Raber & Lang Mfg. Co. make their machines. In the "Crescent" a steel hopper is placed over the moulding compartments which are all filled at the same time. Only two blows of the tamp are necessary. The hopper which is provided with handles is then drawn forward scraping off all surplus material. The bricks are made face down, but one pull on the lever delivers the ten bricks face up on the pallet. The operation is extremely simple and the machine is thoroughly warranted.

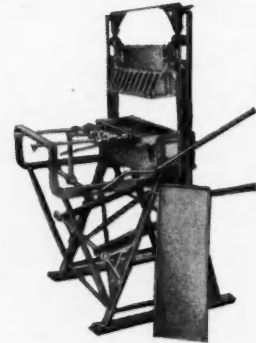

Brick Machine

The "Crescent" continuous concrete mixers are also worthy of our readers' attention. These have been built with a fine regard to lasting qualities. The proportioning by these machines is unique. It is accomplished by cupped cylinders one each for the sand, stone and cement. Each cylinder can be

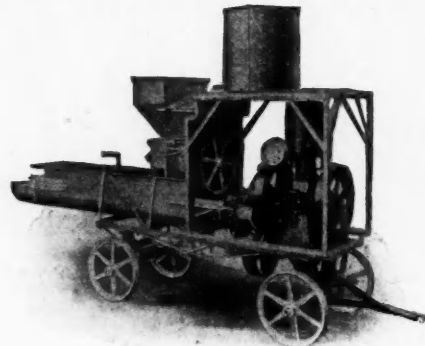

Continuous Mixer

so adjusted that any proportion may be obtained. For instance if the cup in the sand cylinder is 4 inches long and that in cement cylinder is 2 inches long the proportion will be 2 to 4 or 1 to 2. Its very plain. The hoppers, mixing trough and paddles are all specially designed to produce the best results.

We think you will be interested in the catalogs that the Raber & Lang Mfg. Co. of Kendallville, Ind., send free to all inquirers. Suppose you write them for some information regarding their machines.



New Disston Catalog

A valuable little catalog and price list that ought to be in the hands of every carpenter and mason, has been issued by Henry Disston & Sons, Philadelphia, Pa.

These people have achieved an enviable record for the integrity of the tools made by them. The Disston crucible steel saws are well known for the qualities that have held them on the market for over fifty years. There is an advantage in buying direct from the manufacturer that should not be overlooked and this company can be given the full confidence of our readers.

A Model Home



Residence of D. S. Pate (Geo. W. Maher, Architect), Highland Park, Chicago.

Mr. Pate is a lumberman of wide knowledge and experience, consequently when he built a residence in which to enjoy the leisure earned by many years of activity, he wisely decided upon a house in which the "homey" atmosphere would prevail. The result secured by Architect Maher is but partly shown in the above engraving. While the house is strictly modern in every detail, its simple lines and lack of useless ornamentation are particularly pleasing.

The **INTERIOR FINISH** on the first floor is of natural **BIRCH**, quarter-sawed oak, and mahogany, with beamed ceilings and built-in features to correspond with the trim. On the second floor, **BIRCH** is used throughout, stained to harmonize with the finish on the first floor.

BIRCH is an honest, versatile, durable wood which combines beauty and economy to a high degree. It does not mar easily like softer woods, while the peculiar richness of tone and figure pleases the most discriminating architect and builder.

Our illustrated **BIRCH BOOK "C,"** which shows how **BIRCH** is used in modern homes, apartments and office buildings, together with a sample of the wood in stained and natural colors will be sent postpaid to any reader of this magazine. Address—

The Northern Hemlock & Hardwood Manufacturer's Association

WAUSAU, WISCONSIN

When Writing Advertisers Please Mention the American Carpenter and Builder.

Big Lumber Firm Invades the East

HEWITT-LEA-FUNCK COMPANY ACQUIRES
TWO NEW MILLS

Our readers will be interested in learning that the Hewitt-Lea-Funck Company of Seattle, Washington, are now operating two new mills—both within a few days' freight haul to all points East of the Mississippi River.

This is in addition to the six great mills that are now turning out from 20 to 30 carloads of lumber and mill work a day in Seattle.

The Hewitt-Lea-Funck Company are in an enviable position today. They own vast tracts of timber in the Puget Sound region; do their own cutting, logging, railroading and operate their own mills.

Their success has been so phenomenal that they decided to offer the lumber buying public of the East and South the same opportunities of buying lumber and millwork as are now enjoyed by their thousands of satisfied customers throughout the West.

Our readers are doubtless familiar with the high quality of the timber from the Hewitt-Lea-Funck Company's huge forests of fir, spruce, cedar, hemlock and western soft pine.

Builders appreciate the wonderfully lasting qualities of their fir, which is clean, straight and free from sap and knots. Their customers will be glad to know that they can secure from the new Southern mills of the Hewitt-Lea-Funck Company, yellow pine that comes from the famous Rose Mary belt. This lumber is unusually light and soft in texture. It makes good casing, base and interior finish, and not only does it work easily under the saw, but it takes and holds paint well and makes a beautiful varnished finish.

From their St. Louis mill, they are now handling orders promptly for cypress, yellow pine, oak, all kinds of doors and millwork that is famous for its high quality.

A postal card to the Hewitt-Lea-Funck Company, Seattle, Washington, by a builder asking for catalog and price list, will be a first step towards putting in his own pocket the money that would otherwise go to the lumber combine.



A New Idea in Floor-Scrapers

It seems too good to be true that a floor scraper can be made without bolts or nuts and yet such a one has been



New Model Floor Scraper

placed on the market by the Stern Manufacturing Co. of Lancaster Pa. The adjusting of the handle and the removal or replacement of the blades is done by a simple turn of the

Paneling is More in Demand than Ever

Our Circassian Walnut Appeals to the Homebuilders—Contractors and Builders—Because it is Both Beautiful and Distinctive

¶ Paneling is being used more and more. It is popular with home owners and home builders for it gives a clean cut, attractive, substantial appearance to any room that is finished with it. Paneling is especially suitable for use in offices, stores, etc., and it is being used extensively in such work.

¶ Paneling offers you—Contractors and Builders—a big field among both new and old buildings. You can secure business through our Built-Up-Veneers. They give your work a certain standing. People see them—admire them—and want them.

¶ Paneling is not hard to install. It can be put into an old or re-modeling home, as easy as into a new building. And considering the added worth and effect paneling produces, it is not expensive.

¶ You can buy our Circassian Walnut Built-Up-Veneers at a really moderate figure. Our Circassian Walnut Built-Up-Veneers give a dandy effect, too.

¶ Note the accompanying reproduction of a Circassian Walnut Built-Up-Veneer. Note the distinctiveness of this panel—the perfect and pleasing effect.

¶ Our Built-Up-Veneers are made in many highly figured, also domestic and foreign solid effect woods. They are essentially different in their appearance and make-up than any other paneling manufactured. They represent quality all the way through. They are up-to-date in all respects.

¶ We are the largest manufacturers of paneling and Built-Up-Veneers. We can turn out paneling of almost any size desired up to 17 feet in length. Longer lengths are easily spliced.

¶ Send us your specifications and details and we will be pleased to quote and give you any information you may desire.

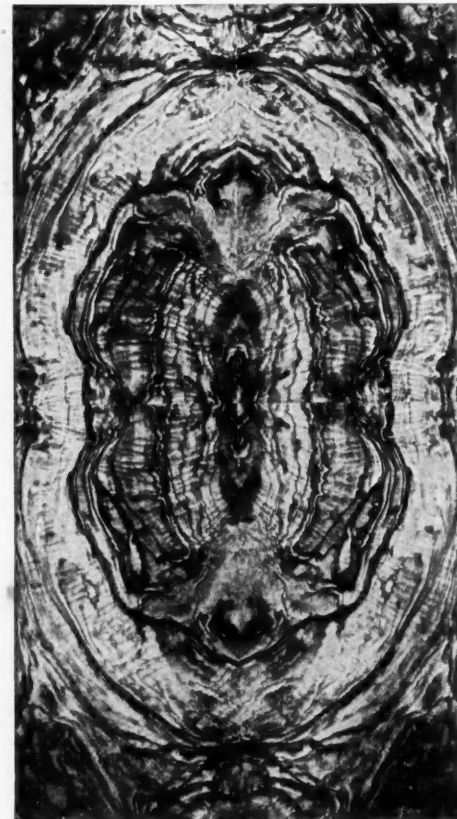

The F. Eggers Veneer Seating Co., TWO RIVERS, WISCONSIN

When Writing Advertisers Please Mention the American Carpenter and Builder.

Mr. Contractor, Mr. Builder:---

The Houses YOU have Built:

*Are you proud to point them out,
or are you ashamed of them?*

That depends largely upon the *wood* you use. You know that constant repair bills and depreciation will kill any good contractor's *Reputation*—and thereby his *Business*. *Cypress* "makes good" for you because it is *the one best wood for the owner*.

Cypress Resists Rot and Competition

Folks want it. "It" is CYPRESS.

Our advertising has seen to that.

Can you conceive of any reason why you shouldn't let them have it?

Can you imagine any excuse for laboriously arguing them out of it—and possibly antagonizing them? Why not recommend what will fall right in line with what our advertising has taught them? *They know they need CYPRESS. You (or your competitor) know it!* And your (or your competitor's) *pocket-book knows it*. Nuff Sed! We are "friends to our friends." *Go to it and boost CYPRESS.*

Write our Builders' Helps Department and ask us how we can help you.

Southern Cypress Manufacturers' Association

1216 Hibernia Bank Building :: :: NEW ORLEANS, LA.

Ask your Lumberman if he sells CYPRESS—if not, ask him *why NOT*.

When Writing Advertisers Please Mention the American Carpenter and Builder.

Steel Hot Water Heating Boiler

Capacity for 8-Room House

Only \$47.50

Other Material at Factory Prices

WE are making this special offer for a limited number. This "Simplex" Steel Boiler is especially adapted for burning soft coal but will also burn hard coal and other fuel. It has no flues nor compartments, and requires no cleaning. Built of plate steel like large power boilers, it is extremely durable and heats up quickly.

Our Special Offer is made to try out a selling idea. The Boiler has been given a good trial and proven a great success. During 1912 we sold more than we could deliver. Investigate and get your order in early. It is a real bargain, worth double the price. Send \$10 with order. Balance upon inspection. Money refunded if unsatisfactory. Galvanized Iron Expansion Tank free if full cash payment accompanies order.

Fully Guaranteed

Specifications :

RATING—750 sq. ft., Boiler Manufacturers' Standard.

SIZE—NO. 20.—Outside diameter, 23 in.; height, 66½ in.; diameter of firepot, 20 in.; depth of firepot, 16 in.; height of combustion chamber, 48 in.; diameter of smoke pipe, 8 in.; supply tappings—six 1½ in.; return tappings—six 1½ in. Other sizes also.

BOILER STEEL—These boilers are manufactured from 60,000 lbs. tensile strength boiler steel with shell and firepot ¼ in. thick and heads ¼ in. thick. They are machine-riveted throughout under 60 tons' pressure with ⅝ in. union cone head rivets and calked and tested under 80 lbs. hydrostatic pressure.

CASTINGS AND TRIMMINGS—Are of the soft gray iron and include heavy rocking and dumping finger grates of latest pattern, ashpit and firedoor frames and doors ground and fitted, adjustable check damper and special cast iron smoke connection.

TOOLS—Each boiler is furnished with complete set of fire tools, including shaker bar and clinker hook.

Read What a User Says:

"Your No. 20 Simplex Boiler installed in my residence two years ago has been very satisfactory in every way. I have burned \$49 worth of coal during the past severe winter, heating comfortably my entire 8-room house. For economy in fuel, ease of operating, together with self-cleaning feature of heating surfaces, I consider the boiler more than equal to the best on the market."—Baldwin Brown, Minneapolis.

For other styles of Famous Andrews Steel Boilers, Septic Tanks for Sewage Disposal without Sewer, Thermostats, Air-Pressure Water Supply Systems, Gasoline Gas Systems, etc., write today for our

**BIG FREE BOOK OF
FOUR SYSTEMS**

Andrews Heating Co.

1328 Heating Building Minneapolis, Minnesota

hand screws. The set of the blades, they say can be adjusted to the one-thousandth part of an inch by the twist of an ordinary screw driver in a slot in the center of the quadrant. The special feature to which attention is called is that floor scraper blades of any make can be used. The weight of the machine is about 125 pounds and each part is covered by a liberal guarantee.

The Stern Manufacturing Co. will gladly send details and price list to any of our readers.

Three "Yankee" Drills

The North Bros. Mfg. Co., of Philadelphia have recently added a few new "Yankee" tools to their already large line. Three of these are illustrated herewith.

The first is their No. 1500 which is equipped with a three jaw chuck, the same as used on the well known "Yankee" breast drill. The chuck body is of malleable iron, polished and nickel plated, 2¾ inches long by 1⅝ inches diameter. The three jaws are of tool steel. The chuck holds round shanks only up to ½ inch in diameter. This tool is 9¾ inches long and weighs 3¼ pounds. On this tool the taking up and releasing of the chain is done in a movement with a friction feed. When the chain is tight, the automatic feed operates by turning a small lever which can be relieved when desired depth is reached.

The "Yankee" chain drill have been subjected to long and severe trial for durability and strength as well as from the practical standpoint of convenience and rapidity with which they work. They have stood up to very requirement.

The "Yankee" No. 1455 is a plain breast drill, double speed with three jaw chuck. The jaws are of tool steel and hold round shank drills only up to ½ inch diameter. The large gear is 5 inches, small gear 1⅞ inches. All the gears have extra strong cut teeth. Extreme length of drill is 16½ inches.



New "Yankee" Models

Net weight 5½ pounds. Special attention is called to the quick, easy change in speed made by the small shifter on the main frame between the small gears. The side handle can be unscrewed and has screw driver bit to fit in drill. The frame is of malleable iron, spindle of steel turned and fitted.

The "Yankee" No. 1430 is a plain hand drill of single speed with three jaw chuck to hold round shank drills only up to 3/16 inch diameter. The large gear wheel is 3 1/18 inches in diameter. The wood handle is 4 inches long, 1½ inches diameter, and can be detached from frame by milled nut to use interior of handle as a magazine for drills. The thrust on spindle is taken by hardened steel bearing in lower end of frame.

When Writing Advertisers Please Mention the American Carpenter and Builder.

You, as a Carpenter and Builder realize the importance of a good roof

When your men are putting on a roof do you know for a certainty that it is the best roofing you can get?

Merely ordering "roofing" doesn't tell you the kind of a roof the building will have *after your work is completed*. You naturally want to be sure of pleasing your customers in every particular.

Cast all doubts aside—you can give the owner our written guarantee when you insist upon

Certain-teed Roofing

(Quality *Cert*-ified — Durability *Guaran-teed*)

in Rolls and Shingles

Guaranteed for fifteen years—lasts longer

There is a Certain-teed roof for every kind of building. The red, green and slate gray shingles make an artistic covering for a bungalow, residence, boat-house and garage. The rolls make an ideal, durable and low-

cost roof for barns, chicken houses and small buildings, and by following the Certain-teed specifications you can easily lay an extremely satisfactory built-up roof on big factories, warehouses, apartment buildings and skyscrapers.

We give this book away to help YOU



General Roofing
The World's
Largest Manufacturer of
Roofings
and Building Papers

This book, "Modern Building Ideas and Plans," illustrates the latest and most modern building ideas. Tell your customers they can get a copy Free from any hardware, lumber or building material dealers—and get a copy for yourself. It is easily worth a dollar, but as all the buildings illustrate the use of Certain-teed we give it free—at the dealer's. All requests to us must be accompanied with 25 cents to cover cost, wrapping and postage.



Used anywhere
-sold everywhere

Certain-teed Roofing is sold at reasonable prices by dealers everywhere—no exclusive agencies.

Valuable Book
FREE
at your dealer's

General Roofing Manufacturing Co.

E. St. Louis, Ill. York, Pa. Marcellus, Ill. Minneapolis San Francisco Winnipeg, Can.

Big Profit Laying Ready Roofing You can make a nice, clean profit laying Certain-teed roll and shingle roofing, also Certain-teed Specification roofing. Write today for full instructions and specifications

When Writing Advertisers Please Mention the American Carpenter and Builder.

A Simple Concrete Mixer

It is a recognized fact that the working value of any piece of mechanism depends on three things, viz.: The quality of the material entering into the making, few and simple parts and maximum efficiency in producing results. The Ballou

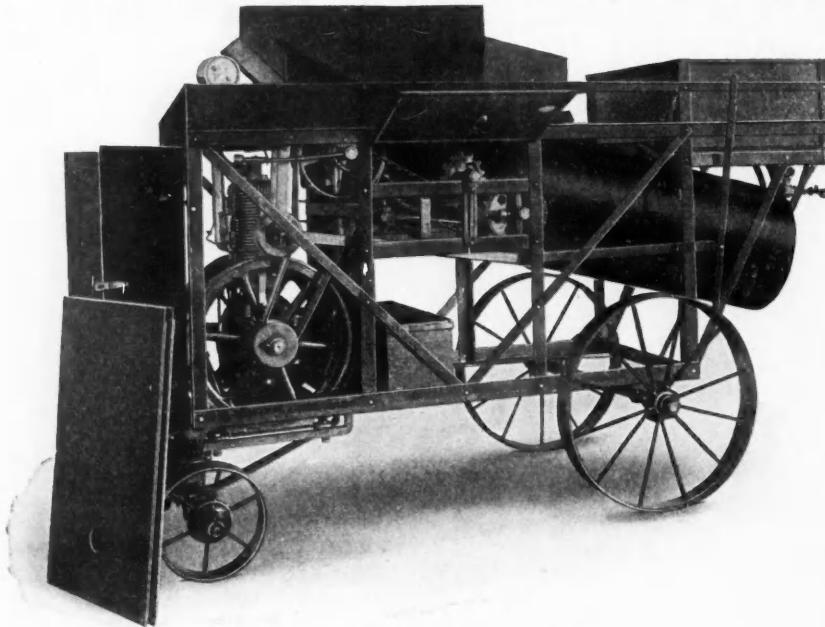

Continuous Mixer of Ballou Mfg. Co.

Mfg. Co., of Belding, Mich., seem to have followed these principles in manufacturing their concrete mixers.

Both their hand and power mixers embody many requisites

not usually found in machines of this type. Special attention has been paid to perfecting the proportioning and mixing devices and the wetting of the entire mix. Naturally the simple mechanism employed makes for ease in operation and the saving of considerable wear and tear on the machine.

This company feature three styles—the hand power (Model

A) and two engine power model B2 and B3, these last being equipped with two and three hoppers respectively. It is claimed that with a hand power mixer a man can turn out from 3 to 5 cubic yards per hour while the output of the power models ranges from 3 to 10 cubic yards in the same time according to adjustment of the feed gates.

Anyone who is at all interested in concrete mixers would do well to look over the catalog illustrating these machines. The Ballou Mfg. Co. are very glad to furnish these free on request.



Send for This One

An interesting catalog of hardware specialties has been issued by L. A. Sayre & Son, Newark, N. J. While the book is small and compact, it contains nearly one hundred pages of finely illustrated tools indispensable to our friends, the builders. The prices in our estimation are reasonable for articles of such excellent quality.

We should like you to have this catalog for we know you'll be pleased with it. L. A. Sayre & Son are glad to send it when requested.



Coal Bills Cut

1/2 to 2/3

BY THE UNDERFEED

Four Reasons Why

COAL in the Underfeed is fed from below and, like a candle, burns from the top down. Four big savings result—of interest to every wide-awake carpenter and builder. Write for Free Underfeed Furnace or Boiler Book, which explains everything. The Underfeed does MORE than cut coal bills $\frac{1}{2}$ to $\frac{2}{3}$; it produces in coldest weather, more heat, cleaner heat and more even heat than other heaters, and requires least attention in feeding, regulating and cleaning. Underfeed Heating Systems—warm air furnace or hot water and steam boilers—ADD to the RENTING or SELLING value of any building. February magazines and periodicals will lay before millions of readers the

Four Big Savings

Saving No. I—Burns Cheaper Coal

Cheaper grades of hard or soft coal—costing from \$1.50 to \$4 less per ton than more expensive grades—are pumped up into the firepot underneath the fire and burn perfectly, from the top down. The Underfeed produces more clean, even heat per ton from cheaper grades of coal than topfeeds from most expensive grades.

Saving No. II—Complete Combustion

Smoke and gases (25 to 40 per cent heat value in coal) pass up through the fire, are consumed and converted into useful heat; whereas in topfeed heaters, smoke and gases go to waste—up the chimney. Combustion being perfect in the Underfeed, no clinkers form and very few ashes.

Saving No. III—All Heat Utilized

Live coals in the Underfeed are on top—nearest the most effective radiating surfaces; whereas in topfeed heaters live coals are smothered by fresh coal, which forms a blanket between the fire and heating surfaces, checking the heat.

Saving No. IV—Self-Cleaning Feature

Since the Underfeed consumes smoke, there is no soot. The fire-glow is upon clean metal responsive to heat; whereas in topfeeds the "fire-shine" is upon deadened heating surfaces, coated with soot and grime-insulation. Topfeeds require frequent, troublesome cleaning; Underfeeds are self-cleaning.

THE PECK Williamson Underfeed FURNACES BOILERS

Adapted for ALL Buildings

Underfeed heaters are adapted for large or small homes, apartment houses, halls, churches, schools, etc. Installed in unit or battery form.

Send us your building plans and we will furnish FREE engineering plans, actual cost of installation and tell you where you can get your Underfeed.

Write TODAY, Mr. Carpenter and Mr. Builder, for FREE Booklets.

The WILLIAMSON CO.

436 Fifth Street

CINCINNATI, OHIO.

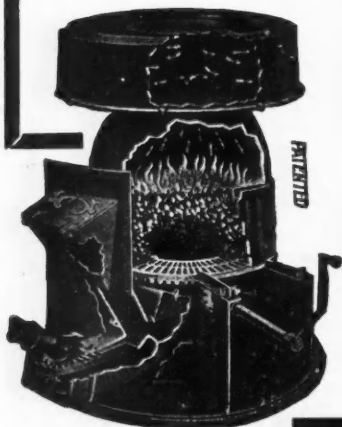

When Writing Advertisers Please Mention the American Carpenter and Builder.

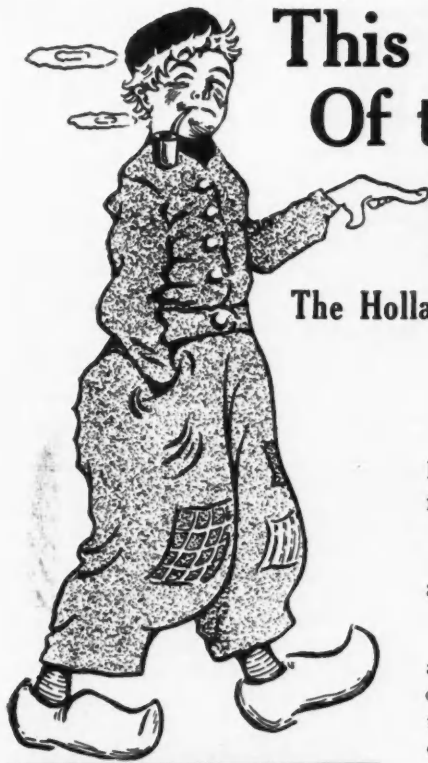

This Is the Heart Of the Holland—

The Holland Air Admitting Fire-Pot

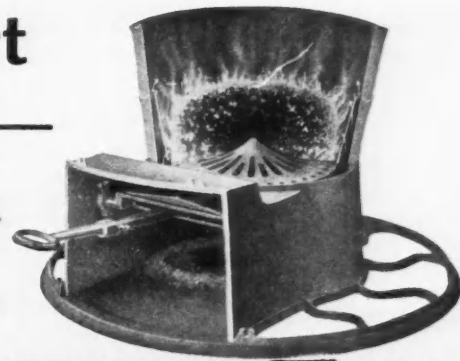

Do you know that old saying, "a chain is as strong as its weakest link," applies directly to every furnace. A furnace is as good as its fire-pot—and no better.

We have put a cracker-jack of a fire-pot in our Holland furnace—and it gives cracker-jack service at all times, too.

You want to give this fact your thorough consideration in your selection of any furnace. Remember the fire-pot is the important feature—the successful operation of the furnace depends upon the fire-pot—and you want to know positively that it is designed and built right. Further, be sure you know the general construction and quality of materials used throughout are A No. 1 in all respects.

Designing right and building right of the proper materials is the secret of the Holland success—and the Holland has certainly been successful. Last year we were oversold early in the Fall and had to wire our agents and salesmen not to accept any more orders. We simply couldn't handle the business, it came so fast.

We sold so many furnaces because Holland construction and operation—and Holland installing service—could not be improved upon. And that's why I ask you, before you definitely decide this season's furnace question, to give our Holland a regular grand jury investigation.

Get into all the facts about it. Note just what perfect continuous service it gives day and night—and you will look no further for furnaces.

Our Holland is in every sense a furnace built for heat and comfort. Our organization always stands back of every Holland. Our Holland furnace burns all the fuel—from the side and over the top—the natural and right way. It cuts coal bills in half because it burns everything combustible. It is always clean and is practically repair-proof. The Holland Cone Grate and the Holland One Piece All Cast Iron Radiator—besides the Holland Air Admitting Fire-pot—are exclusive features of Holland construction. They are a positive insurance of perfect operation and service.

With our Holland service any contracting builder can easily install a Holland furnace. You send us the floor plans—(with instructions as to which rooms are to be heated)—of any residence or building you are putting up. Then our heating engineers will submit to you detailed plans and specifications, prices, etc., covering the entire heating equipment. We make no charge for this service.

"Holland Furnaces Make Warm Friends"

I wish you would write us right now for our complete literature upon the furnace question, detailing in particular the many Holland advantages.

You won't obligate yourself in any way in asking for this material. Get in touch with us immediately and thoroughly satisfy yourself all about the Holland.



Holland Furnace Company
Holland Michigan

When Writing Advertisers Please Mention the American Carpenter and Builder.

B-U-S-T-E-D PRICES!!

**Lumber
Millwork
Mantels
Grilles
Colonades**

NOW IS THE TIME TO BUY BUILDING MATERIAL

NEVER before in the history of Lumber and Building Supplies have such remarkable bargains existed. Notwithstanding the fact that all prices on Lumber and Building Material have advanced, we still maintain our low, unequalled prices.

We advise you to give careful thought to the improvements you may need within the next few years, and especially in the purchase of Lumber and Millwork. Buy now while the opportunity to get in at a low price exists; later on, all this class of material will advance in price.

We have on hand a stock of Brand New Building Materials at prices so far below

what others are asking for goods of equal quality, that there is no possibility of any competition affecting us. This great 1913 announcement of ours is bound to quickly reduce our mammoth stock. Why not get in now and get the benefit of such bargain prices? Write us for facts.

**Shingles
Lath
Wallboard
Complete
Houses**

Lumber Prices Smashed

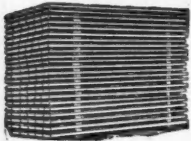

Yes, we mean smashed. Absolutely busted to pieces. That's our policy. We quote prices on lumber that will positively save you big money. If you will send your lumber bill we will send you a freight paid estimate that will mean a saving to you of from 30% to 50%. Every stick is absolutely first class, brand new and fully up-to-grade such as you would buy from any reputable house in the United States.

We have determined that the Spring of 1913 is going to be the **Banner Year** in our great lumber department. We have had on hand 20,000,000 feet of high grade lumber suitable for the construction of Buildings, no matter for what purpose intended. Come to our great yards in **Chicago** and let us show you this stuff actually in stock. No other concern in the world has a more complete stock of everything needed to build, whether Lumber, Shingles, Structural Iron, Plumbing, Heating, Doors or anything else that you may need. Do you know that lumber is getting scarcer and scarcer every year? Yet our prices are lowest and will continue so until our stock is gone. **WRITE TODAY.**

\$739 BUYS THE MATERIAL TO BUILD THIS HOUSE.

This is Our House No. 6A

A beautiful up-to-date full 2 story, 7 rooms and bath home. Has been sold over 400 times. Copied and imitated all over the U. S., but our price and quality cannot be equaled. The price is easily 25 per cent to 50 per cent below local dealer's prices. Immediate shipment right from our Chicago stocks, where you can come and see it loaded. **NO MONEY DOWN.** \$2.00 buys perfect Blue Print Plans, complete specifications and detailed descriptive material list, with a refund of \$1.50 if you do not like them.



Our House No. 6A.

ORIGINAL METHODS

We are the originators of a system of selling practically complete Houses direct to the consumer, at a great saving.

We eliminate all in-between profits. We sell and ship direct to you from our own stocks.

Great care and study has been given all our Plans. Economy is the watch-word both in materials and construction.

No Worry No Loss No Waste

Our Binding Guarantee both as to quality and quantity goes with every sale.

Write us for letters from people in your vicinity who have bought from us. We have thousands of unsolicited testimonials.

Special Information

If you intend building, you will lose money if you don't write us at once. Tell us what you want. We will answer you promptly and give you valuable information regarding building. Send rough pencil sketch showing the kind of house you want. We will make you a freight paid price that will save you big money on material necessary to build same. Every stick first class.

If you intend to make improvements, write us what they are, and we will help you to save money on your purchases.

HEATING PLANTS

For this great Spring Sale we are offering a warm-air heating plant large enough for the ordinary 5-room house, with all necessary blue print plans and complete instructions for installation of same for \$45. Send us your sketch and give us information as to the construction of your building and we will make you a quotation on any kind of heating plants—steam, hot-water or warm air. Every heating plant sold under a broad and binding guarantee of 365 days, free trial. Write for a copy of our Heating Catalog, containing information of priceless value.

Shingles at Big Saving

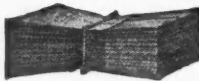

We have a special lot of 1,000,000 5 to 2 Common 6 to 8 in. Clear Shingles Coming in, on which we are making an exceptionally low price of **\$2.59**. Other grades at lowest prices.

This Door at 98c



Lot MS-39. Four panel painted door, size 2 ft. 6 in. x 6 ft. 6 in. 1200 in stock. A high quality door for the price. This is only one of our many special bargains. Our grand Building Material Catalog and Bargain Sheets will show a full line of **Inside Millwork** of all kinds.

Be Sure to

**Fill in
Coupon
at the
Right**

Best Quality Premier, Michaelson Ready Mixed House Paint, per gal. \$1.05



Our paint department is under the personal supervision of Mr. V. Michaelson, for 30 years the foremost paint man in America. His picture has appeared on over 8,000,000 cans, and his name is known from ocean to ocean. Paint of quality is his specialty. Every gallon has our strongest guarantee. Our Ready Mixed Barn Paint at 67c. per gallon will outlast any similar paint produced. If you want quality paint, write us; or write to Mr. Michaelson if you prefer. Finest, most valuable paint book ever published sent **FREE.**

Wire Nails Per Keg, \$1.50



10,000 kegs, put up in 100 lbs. to keg, mixed, all kinds, regular, such as made by factories. Lot 2-AD-33, per keg, \$1.50. 1,000 kegs of 10 penny-weight, regular new wire nails, 100 lbs. to keg, per keg, \$2.00, while they last.



Book of House and Barn Plans Contains 100 designs of different kinds of buildings and houses, from \$147.50 up. Also shows the latest style barns. It's free.



Building Material Catalog A 200 page book of bargains in Millwork, Lumber, Paints, Plumbing, Heating Apparatus, Hardware, etc. Just what you need. Write for it today.

CHICAGO HOUSE WRECKING CO.

Dept. 149 CHICAGO, ILLINOIS

When Writing Advertisers Please Mention the American Carpenter and Builder.

B-U-S-T-E-D PRICES!!

**Plumbing
Piping
Heating
Water
Systems**

TWENTY YEARS OF HONEST DEALINGS

THE Chicago House Wrecking Company was organized in 1893, and for twenty years has been well and favorably known to the buying public. Our transactions of the past have found an enviable place in the world's commercial estimation. Customers by the hundreds of thousands have learned to recognize our company as a safe place to buy their supplies.

Our guarantee is broad and binding and fully protects you. If you buy any goods from us that are not fully up to our representation in every way, or if they fail to come up to your expectations, then, at our expense, we will take back any such unsatisfactory merchandise or material and refund you the full purchase price. All we require is that you promptly advise us of any dissatisfaction upon receipt of the goods.

Our capital stock is \$2,000,000. We refer you to the publisher of this or any other paper, to any Express Company, to any Commercial Institution or any of the leading banks. Our responsibility is unquestioned.

**Roofing
Paints
Hardware
Structural
Steel**

Roofing Prices Smashed

**Galvanized Roofing
Fire, Water
and Lightning-Proof**

We have in stock 50,000 squares of corrugated painted roofing, which we offer at \$1.25 per 100 square feet. It is new, perfect and first-class in every respect, but light in weight. The sheets are 22x24 in. x 1 1/4 in. corrugation. Our price of \$1.25 is not freight prepaid, but f.o.b. cars Chicago. The material is not galvanized, but black, steel roofing.

\$1.25
per 100 sq. ft.
buys best
steel roofing

Order by Lot AD-700. Write for our

Freight Prepaid Prices

On our high-grade, brand new, galvanized roofing we are offering prices lower than ever before. Quotations range from \$2.50 per square up.

We can furnish corrugated, "V" crimped, standing seam, shingles, metal ceiling and everything in roofing, siding and ceiling. Samples free. Write for our Great Roofing Catalog.

75c Per 108 Square Feet Buys Best Rubber-Surfaced Ajax Roofing.

Here again we show a remarkable example of our "Price-Wrecking" methods.

We have in stock upwards of 40,000 squares of the very best Ready Roofing, same kind as is being sold regularly at very much higher prices.

75c. buys 108 square feet of our "Ajax" 1-ply Ready Roofing; 90c. for the 2-ply and \$1.05 for the 3-ply.

This roofing is not continuous in the roll, but contains three to five cuts to a roll.

We furnish, at this price, sufficient cement and nails to make the joints.

At this price we pay the freight in full to all points east of Kansas and Nebraska, and north of the Ohio River. Prices to other points on application.

We have 1,000 squares of Ready Roofing put up 108 square feet to the roll, with stone surface, extra durable, which we offer per roll \$1.06. This price is not freight prepaid, but f.o.b. cars Chicago. Our Great Roofing Catalog explains all about these different grades. Write for free samples.

We can furnish this roofing also continuous rolls at proportionate prices.



PLUMBING \$26.50 Buys This Complete Bath Room Outfit

Here is a saving to you of 50%; a high grade, perfect white enameled bath tub, 5 feet long, all nickel plated trimmings, including double bath cock for hot and cold water; lavatory of latest design, with high one piece back, all white enameled, big size, nickel plated basin cocks, nickel plated trimmings.



Closet is latest, most sanitary Syphon acting, vitreous closet bowl; hardwood seat and cover, nickel plated hinges; fitted with hardwood, copper lined, low down tank, latest style, easy working, noiseless working outfit. Easily worth \$50, but for this great Spring Sale we have literally cut the price in two. When you order this outfit, mention Lot 5-AD-100.

\$13 Buys Complete Bath Tub



White enameled, cast iron, one piece, heavy roll rim bath tub 5 feet long; fitted with latest style, nickel plated trimmings, including Fuller double bath cocks for hot and cold water, nickel plated waste and overflow, and nickel plated supply pipe. In ordering, mention Lot 5-AD-101.

\$6 Buys Complete Wash Stand

Finest enameled, cast iron, one piece lavatory built; graceful in shape; can be furnished either for straight wall or corner of room; trimmed with best nickel plated fittings. Lot 5-AD-104, price \$6.00. 40 other styles at proportionately low prices.



\$8.50 for a High Grade, Sanitary, Complete Closet

We have 200 of these outfits. Closet bowl latest sanitary construction, syphon acting, vitreous bowl, fitted complete with hardwood seat and cover, with nickel plated hinges. Low down, latest style, copper lined tank. Outfit is Lot 5-AD-105. Write for prices on other styles, also our Plumbing and Heating Catalog.



Enameled Sink at 75c

One piece, seamless Kitchen Sink, blue enameled inside and outside, size 18x30 or 18x36. Price includes strainer and collar to make connections. Lot 5-AD-106, price 75c. At \$14 we furnish you latest and most sanitary, white enameled, full length, one piece Kitchen Sink; back, drainboard and end piece all cast in one piece. Fitted with nickel plated faucets for hot and cold water and trap to floor. Finest outfit manufactured.



Write today for Free Plumbing Catalog. Fill in coupon below.



Roofing Catalog
A book covering this subject complete. Tells you how to select the best kind of roofing for general purposes; also describes our Siding and Ceiling. It's free. Write for it today.



Wire and Fencing Catalog
A complete description contained in this book of all our wonderful bargains in Woven Wire Fencing, Barb Wire, Nails, Bolts, etc.

High Grade Fencing 48 in. High, Per Rod 27c

A complete stock of all heights of Woven Wire Fencing for every purpose. Do not delay your order, but send it in at once, even if you are not ready to have it shipped. We will hold the material ready to deliver when you want it.

CHICAGO HOUSE WRECKING CO.

Dept. 149 CHICAGO, ILL.

FILL IN THIS COUPON

CHICAGO HOUSE WRECKING CO., Dept. 149, Chicago. Send me free of cost the following catalogs, (Place an X mark in square opposite the catalogs you desire).

- Catalog of 50,000 Bargains
- Roofing, Siding and Ceiling
- Plan Book of Houses and Barns
- Building Material
- Wire and Fencing
- Plumbing & Heating
- Paints

My Name is
My Address is
County State
E. E. P. O.

When Writing Advertisers Please Mention the American Carpenter and Builder.

Clow Cast Iron Specialties



A-2187
Ex. Hy. Cesspool, Long Outlet

Size of top.....In.	12x12	16x16	18x18
Depth.....In.	10	10	10
Size of outlet...In.	3	4	6
Length of outletIn.	10	10	10
Painted, net Each	3.09	3.58	7.15



A-2185
Extra Heavy Cesspool

Size of top.....Inches	16x16
Depth.....Inches	10
Size of outlet.....Inches	4
Painted, net.....Each	2.00

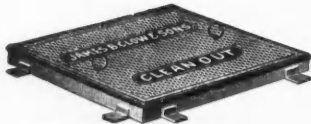

A-1700.
Cleanout Cover and Frame

Size.....Inches	27x27
Size of frame, outside.....Inches	27 1/4 x 27 1/4
Height of frame.....Inches	4
Price, Standard, net.....Each	\$ 9.00
Price, Extra Heavy, net, Each	18.00



A-2015
Grating with Loose Frame

Size, inches	8x8	10x10	13 1/4 x 13 1/4	18x18
Grate only net.	.60	.98	1.43	1.80
Grate and frame, net	.83	1.28	1.88	2.25

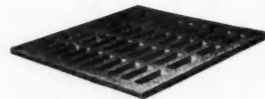

A-2020
Grating

Size, inches.....	9x9	13 1/4 x 13 1/4
Price, each, net.....	.75	\$1.13

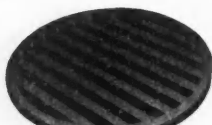

A-1945
Concave Grating

Concave, diam.	19 in., net, each	\$3.38
Convex, diam.	22 1/2 in., net, each	3.75

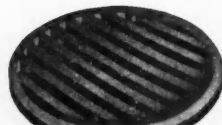

A-1950
Cast-Iron Grating

Diameter.....Inch	net	Each
.....14		\$1.88
.....16		2.06
.....18		2.25
.....20		2.43
.....21 1/2		2.81
.....23		3.19
.....28		3.56
.....30		3.94



A-1955
Cast Iron Bar Strainer

Diameter	4	5	6	7	8	9	10
Net, each.	.07	.09	.11	.18	.23	.28	.37



A-1710.
Cleanout Cover and Frame

Opening, diam., In.	18	24	34
Top, Outside, diam., In.	22	28	38
Price, net, ea	\$4.13	\$6.00	\$9.00

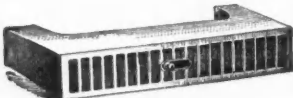

A-2200
Air Brick with Sliding Ventilator

Size.....Inches	8 1/4 x 5	17 x 2 1/2	17 x 5
Price, net...Each	2.59	2.59	5.17

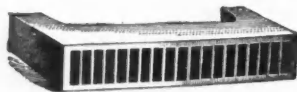

A-2201.
Air Brick

Size.....Inches	8 1/4 x 5	17 x 2 1/2	17 x 5
Price, net...Each	2.20	2.20	4.40



A-1720.
Cleanout Cover and Frame

Opening, diameter, inches...	18
Top, outside diam., inches...	22
Base, outside diam., inches...	28
Price, net, each.....	\$4.88

Send For Catalogue 39

James B. Clow & Sons

CHICAGO, ILL.

When Writing Advertisers Please Mention the American Carpenter and Builder.

A Space-Saving Arrangement

While home building along the most modern plans has progressed wonderfully, there seems to be one undesirable feature to which people still cling. We refer to the dark and dusty clothes closet. Heretofore in building, closets have been placed here, there and everywhere, because they were considered indispensable. People realize that closets take up a lot of space and cannot accommodate a quantity of clothing unless one article is hung on top of the other. This makes the clothing doubly inaccessible, and such inconveniences have been borne as no relief was offered.

It has remained for Mr. John Thomas Batts to offer a solution, with what is called the "Batts System" a wardrobe is built into the house instead of a closet and it is claimed ten per cent of the floor space is saved. The wardrobe set used consists of a telescopic extension attached to the inner top of the wardrobe and ranging in lengths from 19 inches upward to 48 inches. Upon the carrier are suspended clothes hangers. From 20 to 25 garments can be hung in a space 24 inches wide by 30 inches deep; the hangers used being suitable to either men's or women's garments. When an article of clothing is desired the extension rod may be pulled out so that each garment is in plain view and the one selected



Double Wardrobe With Two Carriers

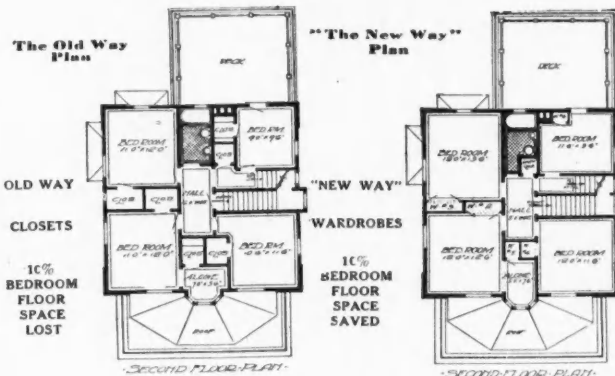

Comparison Showing Space Saved

without in any way disturbing the others.

The special feature that will interest our readers is the space saving. The above floor plan diagrams illustrate the difference between bedrooms equipped with clothes closets and those fitted with wardrobes.

There is some mighty interesting literature as well as detail drawings that can be had by writing Mr. John Thomas Batts, Grand Rapids, Mich. Mr. Batts also has a book of plans for houses ranging in price from \$1,260 to \$12,000. The "New Way Home Book" as he calls it shows the floor plan when wardrobes are used.



H. B. Crile Joins Canton Company

Mr. H. B. Crile, formerly with the Massillon Rolling Mill Company and who has been representing the Canton Art Metal Co., in Virginia and West Virginia has been transferred to the state of Pennsylvania and will call on the trade in that section. Mr. Frank Kiley who has been employed in the Canton, O., office of these well known manufacturers of high grade sheet metal products for several years, succeeds Mr. Crile in Virginia and West Virginia.

“ Demand ”

Wausau

Sandpaper—



because it is the best made. There's a difference between "good" and "best."

The best is **Wausau.**



A CARPENTER'S PENCIL AND BOOK OF SAMPLES FREE FOR YOUR DEALER'S NAME. SEE COUPON

Go to your dealer and say:—"Here, I want you to buy some Wausau Flint

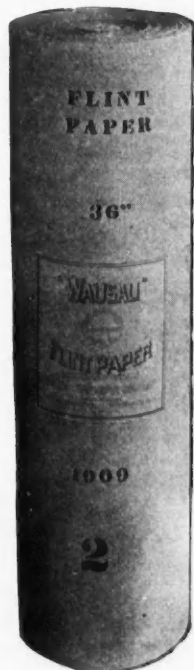

Paper and Garnet Paper so I can get it. It is a sheet 9x11 in., of the very highest quality all the way through, and they **guarantee** it."

For your own protection insist firmly on having the most economical and enduring—**Wausau.**

Send us your dealer's name and we will mail you **free** a good carpenter's pencil and a neat little sample book of our Flint Paper. Just clip the coupon before you forget and send it today.

Wausau Sandpaper Co.

WAUSAU, WISCONSIN

When Writing Advertisers Please Mention the American Carpenter and Builder.

SEND YOUR DEALER'S NAME AND GET THIS CARPENTER'S PENCIL AND BOOK OF SAMPLES — FREE

Wausau Sandpaper Co.,
Wausau, Wis.
Gentlemen:—My dealer's name and address is

For this send me FREE the carpenter's pencil and book of sandpaper samples you offer.

Name _____
Address _____
City or Town _____

"The Standard" Junior Mixer

"The Standard" Junior mixer is offered to contractors with confidence that it is one of the greatest small batch mixers on the markets, all the time and money saving features of "The Standard" low charging regular mixers are embodied in "The Standard" Junior.

"The Standard" Junior is built mounted on two or four wheels with or without power, gasoline or electric. The four wheel machine is mounted for side discharge, and is adapted to all regular work, while the two wheel mixer is built for rear discharge and is suitable for sidewalk and other special work.

The manufacturers constructed "The Standard" Junior as a help to the contractor and not a hindrance consequently designed it so it could be adapted to all classes of work. "The Standard" Junior will successfully mix (besides concrete), cement, mortar, plaster, Westrumite tar asphalt, Tarvia, etc.

"The Standard" Junior is adapted to small foundations, curbs and gutters, small bridges, culverts, sidewalks, street, repairing, and in fact to all work where a uniform high grade mixture is desired. Certain advantages of "The Standard" Junior make it especially adapted to sidewalk construction. The rear discharge two wheel mixers are especially designed for this purpose, as the wheels are far enough apart to permit them spanning the forms and allowing the concrete to be discharged directly into the forms. On small foundation work this machine can be supported by planks over the forms and the concrete discharged directly into the forms. "The Standard" Junior is built especially light and can be moved easily by one man.

The low charging platform is about 2 feet high and portable with the outfit and can be very easily removed. The mixer can be charged directly from the piles by means of shovels, when desired. The large opening in the drum allows the inspection of the batch while mixing, thus assuring a uniform high grade concrete, impossible to secure by hand mixing or any other method.

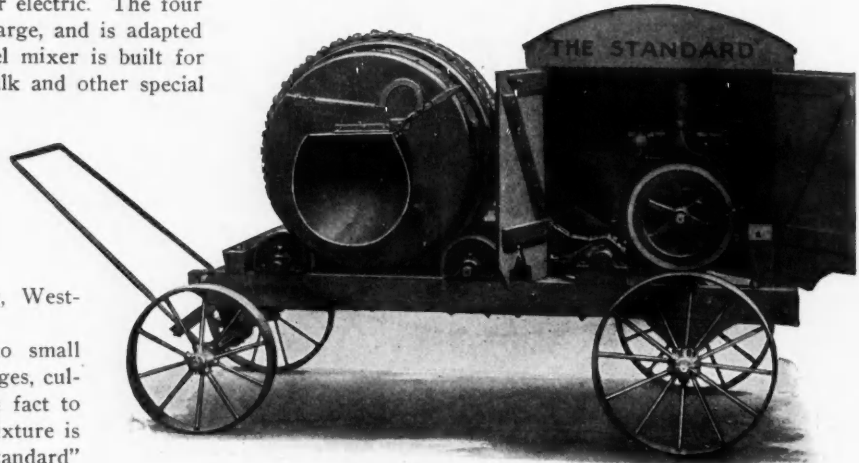

"The Standard" Junior Batch Mixer

"The Standard" Junior mixers are equipped with semi-automatic discharge. Neither the drum nor engine have to be stopped to discharge. "The Standard" Junior will mix twice the amount of concrete with half the labor that can be mixed by hand, also saving about 20 per cent in cement. The saving in labor alone will pay for the machine in a few weeks. "The Standard" drum and all parts are constructed

Bestwall Good News for Carpenters and Builders *Bestwall*

The steadily growing demands of many of you carpenters and builders for Bestwall Wall Board forced us to make plans to increase our output; and we have just finished installing machinery giving us double our former manufacturing capacity for

BESTWALL WALL BOARD

Having this added machinery you can count upon our co-operation at every point in promptly supplying you with a wall board that will not warp or shrink; that needs no strips to cover joints; and that can be papered, painted or calcimined with splendid effects.

Remember: you handle this fire resisting, non-inflammable mineral compound as you would a board; with hammer and nails; or with a saw—if you need small pieces for odd places.

For full particulars and catalogue write to

Bestwall Manufacturing Company

1247 First National Bank Building, CHICAGO

Warehouses: Cleveland, O.; St. Louis, Mo.; Kansas City, Mo.; Lincoln, Neb.; Louisville, Ky.; Stuttgart, Ark.

1922

When Writing Advertisers Please Mention the American Carpenter and Builder.

This \$1.00 Portfolio is FREE And You Need it in Your Business



EVERY up-to-date, wide awake contractor should have this Portfolio of Wood Panels. It shows the Johnson Finishes on oak, maple, birch, chestnut, pine, etc.

The portfolio gives full instructions, specifications and covering capacities. Any competent contractor can use Johnson's Artistic Wood Finishes with the minimum of labor and splendid results.

Johnson's Wood Dye

In 17 beautiful and harmonious shades such as Early English, Mission Oak, Three Shades of Mahogany, Flemish Oak, etc.

This Dye has nothing in common with the ordinary stain. It gives an artistic *natural* shade in just the tone desired—and does not raise the grain. Dries in 30 minutes.

Johnson's Flat Wood Finish

This easy-spreading liquid is made especially to enable you to get hand-rubbed effects with little labor and with extra profit.

S. C. Johnson & Son, Racine, Wisconsin

“The Wood Finishing Authorities”

\$1.25

\$1.25

Mr. Contractor: Upon receipt of this coupon, filled out by you, we will send you free and postpaid.

1—\$1.00 Portfolio of Wood Panels.

1—25c Book, “The Proper Treatment for Floors, Woodwork and Furniture.”

S. C. Johnson & Son, “Wood Finishing Authorities,” Racine, Wis.

Name _____ Address _____

City and State _____

I buy my paints of _____

A.C.B. 3

When Writing Advertisers Please Mention the American Carpenter and Builder.



On Our Material
Bill of \$969 Complete
Saved \$360

I furnished all the material complete, for this 8 room house for A. L. Clark, at Rochelle, Ill. Lumber, Lath, Shingles, Doors, Windows, Trim, Millwork, Guttering, Sash Weights, all Hardware, Nails, Paint and Varnish, (two coats inside and outside), everything complete, except masonry, for \$969. Dealer's price was \$1,329, an exact saving of \$360.



H. B. Munger, Pres.
 30 Yrs. Experience.

My two books, plan book (of 50 house plans) and building material catalog (of 8,000 illustrated bargains) mailed absolutely free and without obligation.

The books cost you nothing and show the way to big savings. In building and repair work they are a most valuable price guide.

GOING TO BUILD?



These Two Books Will Reduce Your Building Expense. NOW—Mail Coupon.

Doors of All Kinds

At Wholesale Prices
 Glass Doors \$1.99 Up
 Lock Sets \$1.00 Up



Wearwell Paint

Perfect guaranteed house Paint, only **\$1.20** per gal. in 5 gal. kits. We have all kinds of good paint at wholesale prices.

Economy Rubber Roofing
 2-Ply 45 pounds guaranteed 7 years, **\$1.35**
 3-Ply 55 pounds guaranteed 10 years, **\$1.60**



Clear Lattice 30c
 Per 100 Feet

Chicago Millwork Supply Co. 1422 W. 37th St. Chicago

Chicago Millwork Supply Company,
 1422 West 37th Street, Chicago, Ill.

Gentlemen: Please send your FREE Books, listed below to

Name

Address State

Catalog No. 43, Building Materials. Book No. 53, House and Barn Plans.

When Writing Advertisers Please Mention the American Carpenter and Builder.

from the best material obtainable and coupled with the work of the highest grade skilled mechanics.

Considering these advantages as well as the low first cost and low operating cost you cannot afford to be without "The Standard" Junior Mixer.

They have issued a new bulletin 144, giving in detail the construction and additional information regarding "The Standard" Junior and same will be sent to you upon request to the Standard Scale & Supply Co., Pittsburgh, Pa., New York City, Philadelphia, Pa., and Chicago, Ill.



Spot Cord Trade Mark Menaced

The following letter will no doubt interest our readers:
 Boston, Mass., Feb. 17, 1913.

The AMERICAN CARPENTER AND BUILDER,
 178 W. Jackson, Boulevard, Chicago, Ill.

Dear Sirs:

There seems to have been more misapprehension in the trade as to our Spot Cord Trade-Mark, and some of your readers may be interested to know that we brought suit against the manufacturer who had put out a cord with a mark so nearly like ours as to mislead users into thinking they were getting our best grade of cord, when actually they were getting that of another manufacturer. Although we were not successful in our suit in the Lower Court, we are advised by eminent counsel that the Court erred in its decision, and the question is now before the Court of Appeals and will come to a hearing just as soon as the Docket will allow.

The mark of the Spots on the Cord was established by us in 1893, and registered in the U. S. Patent Office in 1894. We have no doubt of the ultimate protection of the Courts in this case, and believe that the trade will, in fairness to users of cord, and to the manufacturers, and in their own interests, wait for that decision before handling an article which is to us such a manifest case of "unfair competition."

The mark is so nearly like ours that it is likely to be substituted where Spot Cord is specified. We know of one case where the imitation cord was substituted, the difference not being noticed by the architect until the cord was all put in. The builder then had to remove all the imitation cord, cut up in small pieces as it was.

We shall be glad to have you use this information in your reading matter if you can consistently do so.

We remain,

Yours very truly,
 SAMSON CORDAGE WORKS,
 H. G. Pratt.



Canton Builders' Exchange Gives Banquet

The banquet given by the Canton Builders' Exchange at the Courtland Hotel, Canton, Ohio, on Feb. 5th, was very much of a success in the promotion of policies for which the Exchange stands.

An address on "The Value of Organization" delivered by Mr. James M. Carter, Secretary of the Buffalo Builders' Exchange, was accorded much favor. The keystone of his talk was the government of the organization according to the same high ideals and character that prevail in home life. Mr. Charles R. Kumpf, Secretary of the Canton Branch, reviewed the work accomplished during the past year and outlined the work for 1913. The aim of the Exchange, according to Mr. Kumpf, is to create a demand for better buildings to protect the public from unfair work on the part of contractors and builders and to prevent friction between members of the trade. Worthy motives, all!

Nearly 200 builders and contractors including a delegation from the Alliance Builders Exchange, were greatly pleased with both the dinner and the speeches.



Send for Your Copy of This Free Book

HERE'S a book that every carpenter, contractor or builder should have: "Natural Woods and How to Finish Them." Written by an expert, and full of valuable information that you'll be mighty glad to have at hand.

Remember that the finish on a job is sometimes the principal factor in determining the satisfaction of the

owner. 55 years of varnish-making experience have gone into this book and there'll be many a time when you want to consult it.

Simply write us and say you want the book, and it will go forward at once.

BERRY BROTHERS' VARNISHES

BERRY BROTHERS

Established 1858.

Factories: Detroit, Mich., and Walkerville Ont.

Branches: New York, Boston, Philadelphia, Baltimore, Chicago, Cincinnati, St. Louis, San Francisco, London, England.



When Writing Advertisers Please Mention the American Carpenter and Builder.

Transportation for Builders

The motorcycle will prove a happy solution of the transportation problem for the builder whose work lies some distance from his home. The rapidity and ease in traveling to and from the job are worth considering.

The Miami Cycle & Mfg. Co. have sent us their 1913 catalog which we have read with great interest. These people are old and reliable manufacturers of cycles and have embodied some new and exclusive features in their "Flying Merkel." It is said to be the only motorcycle equipped with a self-starting and two-speed free engine gear. Special attention has been paid to perfecting the motor and carburetor. The spring frame insures easy riding. The beautifully illustrated catalog before us cleverly describes all the parts entering into motorcycle construction and is a great source of information. An excellent line of bicycles is also shown.

We'd like you to have this valuable and interesting catalog. The Miami Cycle & Mfg. Co. of Middletown, Ohio, will send it free of charge.



The "Monarch" Motorcycle

A very neat motorcycle—The Monarch—has been introduced by the Ives Motorcycle Corporation of Owego, Tioga Co., New York. This machine with single or double cylinders is fitted with the Monarch "Feather Bed" leaf spring seat suspension which makes easy riding. There has been some objection to motorcycles on the basis that they tire the rider. No such claim ought to be made against the Monarch.

Unsolicited testimonials from buyers indicate that this motorcycle is an excellent hill-climber, and the cost of repairs practically nothing. It may be safely said that a good hill-climbing machine is a trustworthy one for speed and en-

durance on level ground. A motorcycle as a means of "getting on the job" ought to be seriously considered by every builder. The claims made for the Monarch are worth your attention.

The manufacturers have just got out their new catalog in which the working parts of their machines are nicely shown. The book will be sent upon request.



Here's a Tip

We have a little message for our carpenters which will prove a happy suggestion. It's a small matter but with a little attention and no great effort may be turned into considerable profit.

Everyone admires the smooth polish of a hardwood floor but it's a mighty difficult thing to preserve when people slide chairs or other furniture on it, leaving behind a scar that mars the whole effect. The little tip we want to tell you about is simply a metal cap having three prongs. These are driven into each chair leg and behold, you have no chance of scratching the floor or tearing a rug. They're the easiest thing to

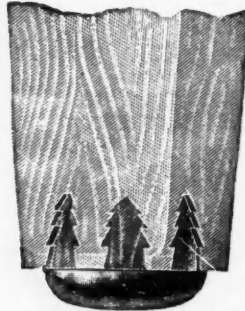

attach you ever saw.

The Evergrip Gliding Caster Co., 20 Warren St., New York City, want agents and distributors everywhere to sell these dandy casters. We thought we'd pass the knowledge along to you. They're so cheap and there's a neat little profit in it. Write these people for their proposition to carpenters. They also send a sample set free of charge.

Single 5
\$225

Monarch

Twin 10
\$275



America's Most Practical Motorcycle

In the *MONARCH* no expense or pains are spared to make it so.

All wearing parts are designed right and made large, weight is put where needed, but we have no superfluous weight.

Our *LEAF SPRING* shock absorber is the greatest device of its kind ever invented. Taken with our 60-inch wheel-base and large tires, it makes the *MONARCH* the most easy riding possible.

For further information address

— Sales Department —

IVES MOTORCYCLE CORP.

Owego

Tioga Co.

New York

NOVO
ENGINE
NO LANK
NO FAN
NO FREEZING
TROUBLE

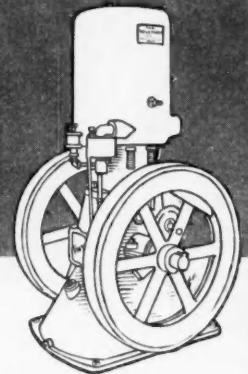

"Guaranteed against trouble from freezing."

Cracked cylinders, "The Engine for Every Purpose" because the cooling water has frozen, is a trouble never met with by owners of Novo Engines. They'll run in any weather. That's guaranteed.

The light weight, great durability and economy, perfect simplicity of design and lack of lateral vibration make the Novo, without question, the engine for running concrete mixers and similar portable machinery. Made in ten sizes: 1 to 15 h.p.

Send for Novo Equipment Catalog

and let us show you why the above is so. It also describes the Novo Hoisting and Centrifugal Outfits and other Novo Pumping Outfits, made in many sizes to fit all conditions

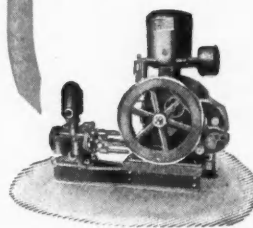

NOVO ENGINE CO.

Clarence E. Bement,
Secy. and Genl. Mgr.

236 Willow Street
Lansing - Michigan

When Writing Advertisers Please Mention the American Carpenter and Builder.

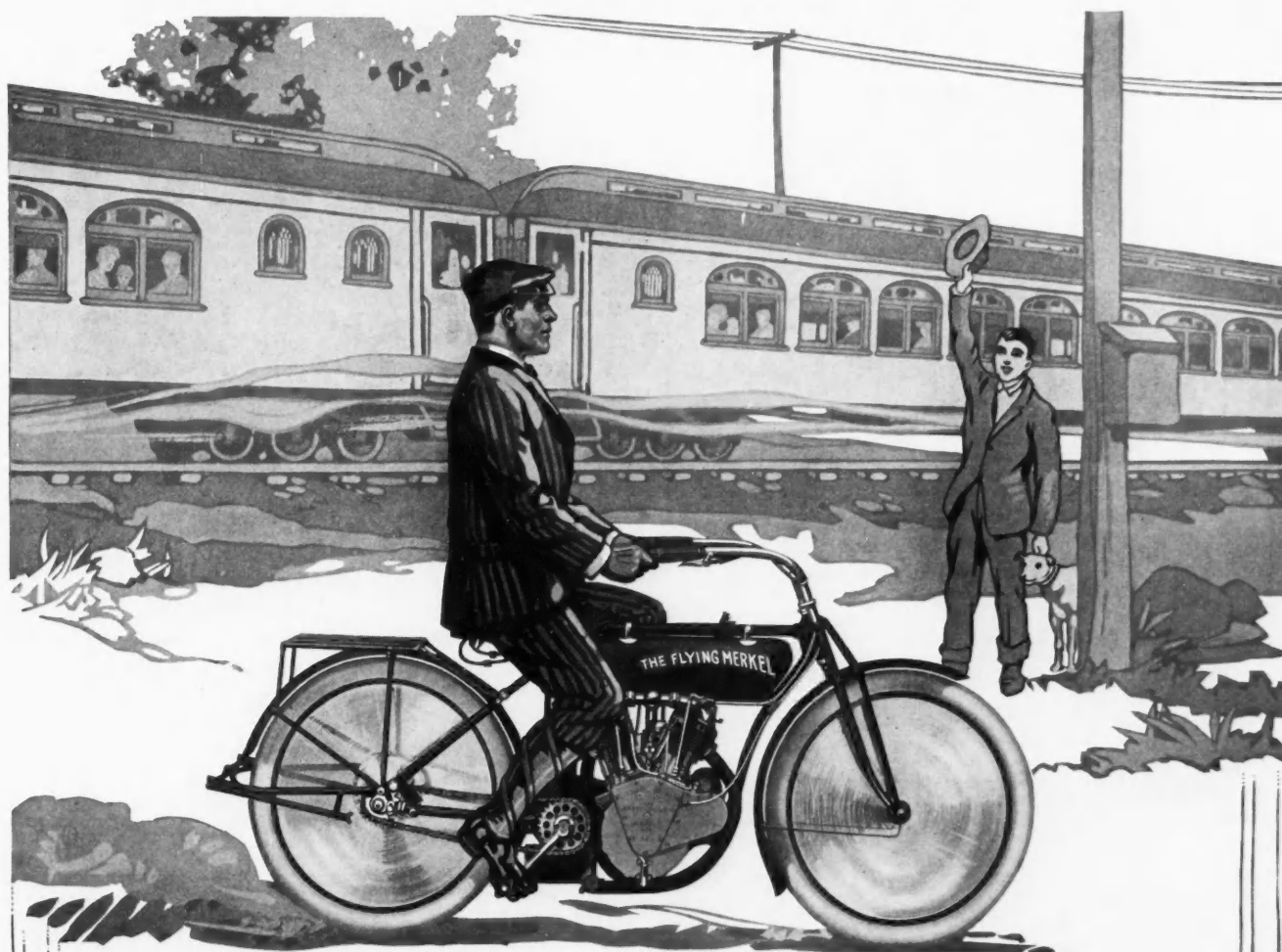

The Pullman of the Open Road

but inadequately expresses the superior and exclusive features embodied in the motorcycle which has created a sensation wherever motorcycles are known.

THE SELF-STARTING—TWO SPEED—SPRING FRAME
FLYING MERKEL
 MOTORCYCLE

for 1913 is the only motorcycle in the world with a Self-Starter and Two-Speed Free Engine Hub—an exclusive feature which at once makes motorcycling more than ever a sport for gentlemen. The original and improved Spring Frame and Spring Fork makes all roads boulevards and the full Hess-Bright ball-bearing motor gives the power plant flexibility not found in any other motorcycle engine. Write for art catalog fully describing the famous prize winner "4-45" and "7-75" "Yellow Jacket" models.

The Miami Cycle & Manufacturing Company
 525 Hanover Street
 MIDDLETOWN, OHIO

When Writing Advertisers Please Mention the American Carpenter and Builder.

KisselKar Trucks and Delivery Wagons exhibited at the New York and Chicago Shows.



A KisselKar Truck used with great success in Escanaba, Mich., for the haulage of building material.

Quicker, cleaner cheaper, better

Motor haulage is a modern method—a quicker, cleaner, cheaper and better way.

Icy pavements and rut-ridden roads have no terrors and hold no risks for a trusty and tireless truck.

KisselKar Trucks offer a service **unlimited in hours, energy and reliability.**

They are always ready to start and to keep going, and they demand no hay on Sundays and holidays.

Buy a mechanically perfect, staunchly built, tried and proved truck from a concern whose responsibility makes effective its guarantees—buy a KisselKar.

KISSELKAR TRUCKS

1500 lb.—1—2—3—4—5—Tons

Rigidly tested steel in all frames—every vital chassis unit Chrome Vanadium treated—heaviest axle forgings—underrated capacities—four speeds—driver's comforts—Kissel long stroke motor—cone leather faced clutch—bodies built to suit.

Inestimable added value acquired in the purchase of a KisselKar Truck is SERVICE. Interest in our product, **after as well as before the sale**, has prompted the establishment of the most completely equipped service stations in America. These stations are in every principal city for the sole purpose of taking mechanical care off the owner's hands and seeing to it that maximum duty and reliability are yielded.

Write for catalog.

Kissel Motor Car Co., 546 Kissel Ave., Hartford, Wis.

Boston New York Chicago Milwaukee
Kansas City Los Angeles Minneapolis
St. Paul Dallas

**KisselKar Service Stations
and Agencies at over 200 leading
points throughout United States**

Old Dobbin Out of It

"Motor haulage service grows in esteem because it constantly reveals unexpected advantages," says Manager Paul A. Rix, of the KisselKar truck. "At its inception it is analyzed too narrowly. How much will be its first cost in comparison with horse equipment? How much more quickly will it cover the same ground? Upon these and other really surface questions the motor is usually accepted or rejected.

"As a matter of fact there is no more uncertain value than Old Dobbin. He is subjected to a vast number of dangerous diseases. He must be well fed, carefully groomed and cautiously driven if the best is to be obtained from him. On an average he is idle fully fifty per cent of the working hours of the day—resting, eating or indisposed. The more work exacted of him the faster he depreciates.

"The reverse is true of the motor. It doesn't get sick, it doesn't need rest, it doesn't eat or depreciate when idle. Used judiciously, it will take on enough duty additional to that performed by its equine predecessor, to pay back to the owner the purchase price with liberal interest added.

"The element of chance is a prime factor for consideration in computing the relative investment merits of the motor and the horse. The one being mechanical, its efficiency is never completely destroyed unless it be completely demolished. The other is animal, subject to all the unforeseen ills of the flesh—a broken leg for instance wipes out the investment. The one is precise and dependable, the other intermittent and uncertain.

"Seldom, if ever, do you hear of a concern which has once adopted motor haulage going back to horses. On the other hand, it is very rarely that you find an intelligent user of trucks who is not an ardent advocate of the new system."

The Kissel Motor Car Company has collected some astonishing records of the service of KisselKar trucks in various cities. An interesting case is the city of St. Paul on account of its hilly nature and the severity of the winters. In St. Paul there are thirty KisselKar trucks in service ranging in capacity from 1500 pounds to three tons, no four or five ton Kissels having been sold in that city. These thirty trucks sent 145 delivery horses to the discard. They travel an aggregate daily mileage of 1,566, making 3537 deliveries. The most significant feature of the case and the most gratifying from the standpoint of the truck man, is the comparative average of initial investment. The trucks, including several specially designed bodies represent a total cost of \$65,600. The horses replaced, including wagons, harness, blankets, etc., represented a layout of \$62,150. This slight difference in first cost, taken in connection with the ability of the trucks to more than double their present mileage if worked a sufficient number of hours, is food for thought.



The Inside—Now the Outside

You have carefully considered the house inside and out, but have you thought of the proper setting to display that house to the best advantage? How will your work show up when it's finished?

Are there to be fences, gates, screened porches, or windows, tree or window guards, or lawn chairs? The builders ought to concern themselves with these details for on such as these depend the ultimate judgment of his work. Suggestions to the owner are usually followed by prompt sales. Write the Buffalo Wire Works Co, Buffalo, New York, and get their information on the above articles. It might place you in a position to make some extra money when the spring and summer come.

When Writing Advertisers Please Mention the American Carpenter and Builder.



You can put Utility Wall Board on at any time—no matter what the weather conditions are.

You don't have to wait for it to dry.

You get rid of all the muss and bother of plastering. You get a better wall—and it doesn't cost as much.

UTILITY WALL BOARD

takes the place of both lath and plaster. It is very tough and stiff. It will not shrink nor warp nor crack. When you put it on it is there to stay as long as the house lasts.

You can decorate it in any way that you would decorate a plaster wall or ceiling.

Made in all widths up to 48 inches and in any length required.

We have a free sample that we want to send to every carpenter or builder. Write for yours.

Reliable dealers in building materials are invited to write for dealer proposition.

THE HEPPE'S COMPANY

4503 Fillmore Street
Chicago, Illinois

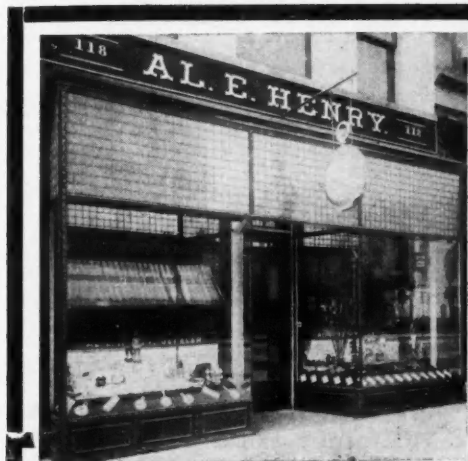

Windows Can't Frost—

A store front is the most important part of any store building. It either attracts or detracts. Mr. Builder establish a reputation for putting in your buildings nothing but the very best.

LOVE BROS. STORE FRONTS

are absolutely guaranteed to be so perfectly ventilated that they simply can't frost. Their simplicity and ease of installation is wonderful.

Adaptable to New or Old Buildings

They will outlast the building itself, at all times presenting a neater appearance than any other store front.

LOVE BROS., Inc.

Aurora, Illinois

When Writing Advertisers Please Mention the American Carpenter and Builder.

Kees Metal Corners

Every carpenter knows what a particular job it is to cut and bevel the ends of the weather boarding to make a perfect mitre corner. No matter how skillfully the work is done the joints are bound to warp or spread open in time.

By using Kees Metal Building Corners—those who have tried them say that a perfect mitre corner is secured with an immense saving of labor and the corner is stronger, more durable and better looking than if the boards are joined



Residence of Mr. David Craig, Albion, Nebr., Cost \$3,500 Finished with Kees Metal Building Corners

in the usual way. A corner like this will never open. Compared with the older style corner board construction, there is a saving in both time and material. (No corner boards are needed).

The corners are made of galvanized iron, shaped to fit the beveled corner formed by the siding, and pierced with nail holes.

They are treated so that they can be painted the same as wood.

A circular showing a number of handsome buildings on which the corners were used, has just been issued by the F. D. Kees Mfg. Co., Beatrice, Neb.

They will be glad to send it to any reader of this paper, together with samples of the corners.



Saving With a Power Hoist

Did you ever get down to brass tacks and figure out how much a power hoist would save you and why? There are a lot of items to consider.

A hoist will save the work of several men as large quantities of material can be placed at one time, saving the labor of men carrying it up ladders or stairs. There's no delay

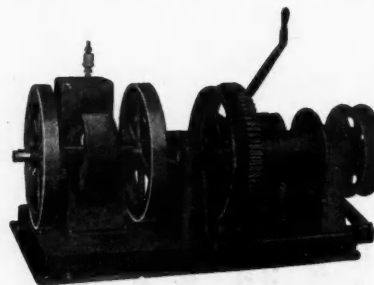

[Gas Engine Power Hoist

either for when the carpenter wants a board or the mason a brick, he doesn't have to wait until some one brings it to him. The hoist keeps a pile at the workman's elbow. Such a machine will pay for itself in a few months. Just give this a thought and look over Catalog No. 21, of the Bates & Edmonds Motor Co., of Lansing, Mich. They carry a complete line of power hoists and on request will tell you all about them.

POSITIVE PROOF THAT KEYSTONE HAIR INSULATOR IS A FUEL SAVER

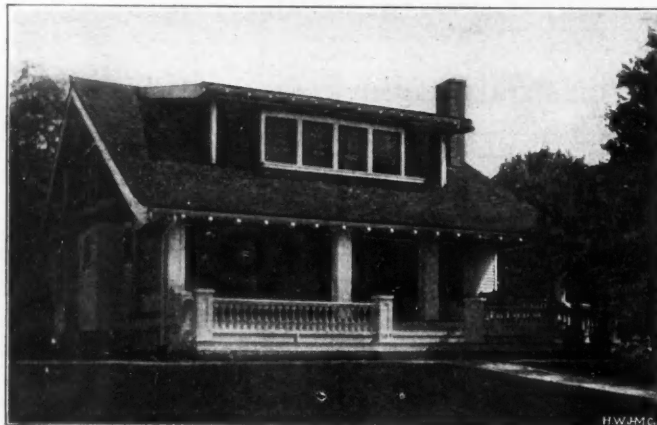

10 Room Bungalow in Cleveland, Ohio, protected from heat and cold with Keystone Hair Insulator

AN ACTUAL TEST

This 10-Room Bungalow was heated during 5 severe winter months at an average monthly cost of \$5.50.

ANOTHER TEST

On the same street a 6-room house not insulated with Keystone averaged \$4.00 per month more for fuel, or \$9.50, during the same period.

Keystone Saved \$20 in 5 Months The Only Practical House Lining

Keystone is made of a thick layer of chemically cleaned cattle hair, Nature's own Insulator, securely stitched between two layers of non-porous building paper. Write nearest Branch for sample and illustrated Catalog.

H. W. JOHNS-MANVILLE CO.

Manufacturers of Asbestos and Magnesia Products **ASBESTOS** Asbestos Roofings, Packings, Electrical Supplies, Etc.

- | | | | | | | | | | |
|------------|------------|-----------|--------------|-------------|---------------|---------------|----------------|---------------|--------------|
| Albany | Boston | Cleveland | Duluth | Kansas City | Milwaukee | New York | Pittsburg | St. Paul | Syracuse |
| Atlanta | Buffalo | Dallas | Houghton | Los Angeles | Minneapolis | Oklahoma City | Portland, Ore. | Salt Lake Cit | Washington |
| Baltimore | Chicago | Detroit | Houston | Louisville | Newark, N. J. | Omaha | Rochester | San Francisco | Wilkes-Barre |
| Birmingham | Cincinnati | Denver | Indianapolis | Memphis | New Orleans | Philadelphia | St. Louis | Seattle | |

For Canada:—THE CANADIAN H. W. JOHNS-MANVILLE CO., LIMITED.
 Toronto, Ont. Montreal, Que. Winnipeg, Man. Vancouver, B. C. 1434

When Writing Advertisers Please Mention the American Carpenter and Builder.

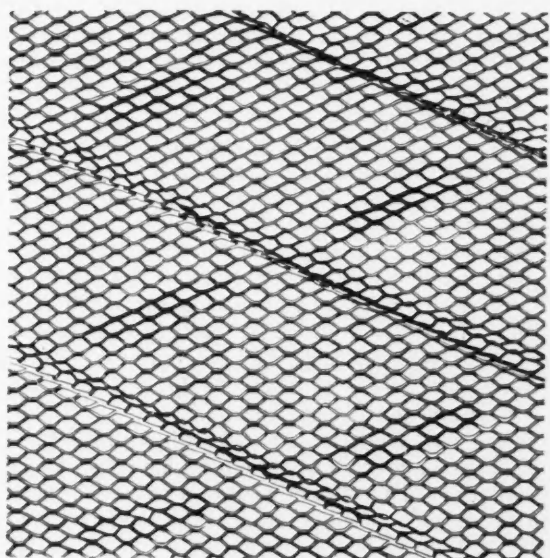

Built Like a Bridge Truss

The "U" Shaped Rib of



EXPANDED METAL LATH

Send for Booklet 937 for Details

Makes the lath extremely rigid and does away with furring strips.

Because the ribs are a part of the mesh, not solid steel with expanded metal between, they become completely imbedded, whether the plaster is applied from one or both sides.

"KNO-FUR" has the same plaster gripping mesh that makes "KNO-BURN" effective. It is acid resisting, coated with highest grade carbon paint and cut from U. S. Standard gauge sheets.

IMPORTANT:—We will ship "KNO-FUR" within 24 hours of receipt of your order. The Best is the Quickest.

We are the largest exclusive manufacturers of Metal Lath in the World.

NORTHWESTERN EXPANDED METAL CO., 903 Old Colony Bldg. CHICAGO



Your Business and Your Profits

in building or repairing depend more on the kind of a roof you give owners than on any other item. A poor roof means trouble from garret to cellar. And it isn't the roofing that gets the blame, but the roofer that sponsored it, who put it on. He can't get any more work from the builder or his friends. Bad news travels faster than good news. The tale of roof disappointments will quickly ripple all over town; undermining the business of the builder involved. The best protection against such calamity is to furnish roofs sure to give permanent satisfaction: roofs economical in first cost and still more economical in the long run—

Genuine Bangor Slate Roofs

They compare favorably with the price of shingles. They offer fire protection. They make even a frame building more fire-proof. Sparks do no harm on slate roofs, but are a frequent fire cause with shingles.

Nowadays people think for themselves. They know shingles are out of date. That's why there are so many patent roofings, which "anybody can lay"—if you believe the makers. But the public knows the snare.

This explains the rapidly growing demand for our slate. Owners are finding it more economical to build, more profitable to sell or rent slate-roofed houses.

It will pay you to point this out to intending builders. They do not always realize the vital importance of the roof. Show them that you are looking out for their interest. Then you will get the contract regardless of competition.

Besides we have special plans and a special department for helping you get more business. Fill out and mail the attached coupon for further information. Write us now before this slips your busy mind. This is too important for you to forget about.

GENUINE BANGOR SLATE COMPANY
Easton, Pennsylvania

You'll miss profits if you don't. This puts you to no expense or obligation.
 Genuinely Bangor Slate Co. Easton, Pa.
 Send particulars about increasing my business and profits to (Sign here)
 Address.....
 Town..... State.....

When Writing Advertisers Please Mention the American Carpenter and Builder.

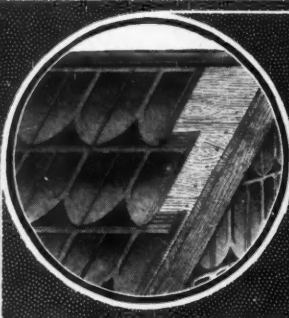

Storm-Proof Roofs

Wood shingles today are not like the wood shingles of years ago—you know that. In fact, it is almost impossible to get good wood shingles today, for wood brings a better price in other forms.

Cortright Metal Shingles

not only make up for the shortage of wood shingles; they are even better than the *best* wood shingles, and here's why:

Cortright Metal Shingles won't rot, split, curl or burn; require less painting and *no* repairs; they are lighter and keep out the hardest driving rain or sifting snow.

They're quicker to lay than wood shingles—"last as long as the building, and never need repairs."

Get our free book "Concerning That Roof" today. A post-card will do.

Cortright Metal Roofing Co.
PHILADELPHIA AND CHICAGO

Clip, Sign and Return This Coupon Now

Cortright Metal Roofing Co Philadelphia.

Gentlemen:—You may send me your Special Contractors' and Builders' Proposition.

Name

Street Address

City State

A. C & B., 3-13.

A New Lufkin Rule

Everyone having use for a rule graduated down to 64ths of an inch knows the difficulty of obtaining accurate measurements in laying out work, knows how impossible it is to get the reading instantly, knows of the eyestrain attendant upon reading such graduations repeatedly; all caused by the fineness of the lines, and the closeness of the lines, one to another, necessary to get 64 lines in an inch. Under the eye the lines have a tendency to "run together." Also because the lines are so close together it is impossible to number each one, and therefore, after arriving at the measurement, it is necessary to refer back to the last figure and count up the 64ths. It is evident that if the same measurement could be arrived at with the same degree of accuracy with a rule graduated down not finer than say 16 lines to the inch, these difficulties would be overcome.

Both of these things are accomplished in the "Allen" Improved Scale—an article just put on the market by the Lufkin Rule Company. The "Allen" Scale is a patented article, and embodies an absolutely new idea in the marking of a machinist's scale.

As any even number of 64ths has an equivalent in 32nds, and possibly in 16ths, one side of this rule is graduated in 32nds and 16ths, and this takes care of all of the even 64ths.

The other side of the rule embodies the new idea. It takes care of all the odd 64ths. The first graduation mark on one edge of this side is 1/64 inch from the end of the rule, and is numbered "1"; the next mark on that edge is 5/64 inch from end of rule, and is numbered 5; the next 9; the next 13, etc., up to the first inch mark, and then repeated in each inch. Here there is a jump each time of 4/64ths, and between the 1/64 inch and 5/64 inch points would come one odd 64th, i.e., the 3/64 inch mark; between 5 and 9, the 7/64 inch mark, etc. All of these odd 64ths appear on the other edge of this side of the rule; that is the first graduation mark there, is 3/64 inch from end of rule and is numbered "3"; the next is 7/64 inch, and numbered "7", etc., in each inch.

Thus the object is accomplished; all the odd 64ths are here given, and yet there are only 16 lines to the inch. This makes it possible to number each graduation mark, and by making each second graduation mark slightly longer than the one before and after it, the figures can be put on in two rows, and this allows room enough to make them large enough to be easily read. The rule is 3/4 inch wide, and is furnished in the two thicknesses commonly known as the tempered and the semi-flexible. It is made in various lengths. The greatest demand no doubt will be for the 6 inch length.

The Lufkin Rule Company manufacture rules and measuring tapes of every description, being the largest manufacturers in this line. Their factories are located at Saginaw, Mich., and Windsor, Canada; branch offices and warehouses at New York City, and London, England.



Edwards Mfg. Co. Increase Holdings

The Edwards Mfg. Co., of Cincinnati, Ohio, have taken over the plant of the Cellular Metal Co., of that city. This deal which includes the real estate, equipment and good will of the old corporation will place Cincinnati in the front ranks of the fire-proofing industries of this country. The consideration under which the sale was made could not be learned.

It is planned to equip the new plant with special machinery which will eventually give employment to 200 men. The company will continue to manufacture the fire-proofing material on which they have built a fine reputation. The officers of the Edwards Mfg. Co. have our best wishes in their new venture.

When Writing Advertisers Please Mention the American Carpenter and Builder.

Granite

TRADE MARK

ROOFING



SIX INCH SOLID LAP

SAFEGUARD

A six-inch lap is better than a three-inch lap. It gives better protection against leaks and permits nailing down on the under sheet only, so that no nail heads appear on the surface. Otherwise this is the same Granite Roofing that we have sold for 29 years for use on great factories. It is immune from damage by coal, smoke or cinders, and it has a sea grit surface which makes painting entirely needless. Behind it is a reputation that has Passed the Quarter Century Mark.

EASTERN GRANITE ROOFING CO.
19 Battery Place, New York

Chicago Pittsburgh

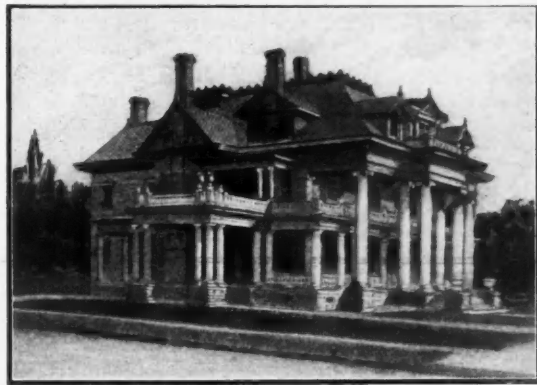

Residence of V. Weiss, Beaumont, Texas, roofed with Asbestos "Century" Shingles in the French Method. H. C. Mauer & Co., Architects, and J. F. Booth, Contractor,—both of Beaumont. Reproduced from an Artist's drawing.

Asbestos "Century" Shingles

"The Roof that Outlives the Building"

IF you do not know the French or diagonal method of laying Asbestos "Century" Shingles, ask your roofer about it. It presents many advantages.

The shingles are fastened independently with copper storm nails, giving the roof great flexibility under expansion and contraction.

This method saves considerable in the number of shingles and labor required.

Write for names of representative roofers who can supply Asbestos "Century" Shingles—and Booklet, "Roofing: a Practical Talk."

Keasbey & Mattison Company, Factors
Dept. B, Ambler, Penna.

Branch Offices in Principal Cities of the United States

This advertisement appears in March Magazines read by the owners and tenants of the better class of buildings. Write to above address for terms and trade prices.

MONTROSS METAL SHINGLES



The man who furnishes the roof that lasts longest is the man who makes most out of the roofing business.

He is not a repairer of roofs, but a builder of new roofs, a replacer of inferior roofs.

Montross Metal Shingles is the lasting roof—the most sightly, the best roof in every way—and they cost less than wood shingles.

They have been in actual service 32 years and look good for as many more. We guarantee our Special painted goods 10 years; Standard, 15 years; Extra, 20 years; Double Extra, 25 years. With ordinary care, the best grades will last a century. Our Galvanized Shingles carry a coating over 60 per cent greater than ordinary Galvanized Iron.

The perfect scientific construction of Montross Metal Shingles fully provides for expansion of the Metal, while the large anti-capillary over-lap and side-lock does away with all "water traps" so destructive to all other metal roofs.

Water drains off all parts of the roof quickly; leaves no moisture to work decay. This insures Montross Shingles giving fully 100 per cent longer service than a roof of faulty construction. All nail-heads are covered; this prevents water filtering through to destroy sheathing.

Let us send our catalog and explain Montross Shingles fully. Live agents wanted for exclusive territory.

Montross Metal Roofing Co., 2nd and Erie Sts., Camden, N. J.

ROOFING SLATE

Sea Green, Purple Vein, Genuine Bangor, All Grades

There will be a big demand in every locality in spring for Slate Roofing. Get in shape to handle the business now. Write today for our delivered prices on all grades of Slate, Slater's Tools and Supplies, and the Lightning Slate Dresser. Full instructions about laying furnished free to new men. We are the Oldest and Largest Roofing Slate Concern in the U. S. operating 3 large quarries at Poughkeepsie, N. Y. and 1 at Bangor, Penna. Orders filled promptly with choice stock. References—any bank in Cleveland. DON'T DELAY—WRITE TODAY—NOW.

THE AULD CONGER CO.
1000 Prospect St. Cleveland, Ohio

Roofs Last Forever

when shingled with Meadow Brook Slate. There is no "wear out" to these shingles. Meadow Brook Slate comes in all sizes and is

Easy to Apply
Neat
Fire-Proof

Put slate shingles on your next building but get the best—Meadow Brook.

Let us forget, write us today for description and price-list. You'll save money.

Meadow Brook Slate Co.
Slatington, Pa.

When Writing Advertisers Please Mention the American Carpenter and Builder.

New H. W. Johns-Manville Co. Plant

The completion of the new plant of the H. W. Johns-Manville Company, at Manville, N. J., marks another important chapter in the history of this enterprising concern.

Beginning with the consolidation of the H. W. Johns Mfg. Company and the Manville Covering Company, in 1901, the H. W. Johns-Manville Company has grown by leaps and bounds until today it ranks as the largest concern in the world engaged in the manufacture of asbestos and magnesia products.

They have branch houses in practically every city of prominence in the United States and Canada, and representatives in almost all foreign countries. Their manufacturing plants

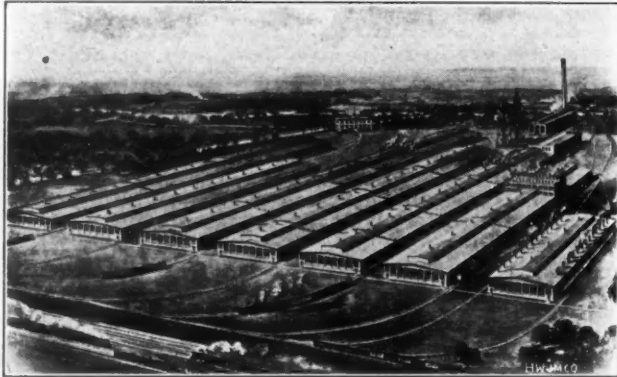

H. W. Johns-Manville Co.'s new plant at Manville, New Jersey, floor space 1,000,000 square feet. Largest Asbestos Plant in the World

are located in Brooklyn, N. Y., Milwaukee, Wis., West Milwaukee, Wis., Hartford, Conn., Nashua, N. H., Lockport, N. Y., Jersey City, N. J., and an asphalt refinery at South

Amboy, N. J. Their asbestos mines are at Danville, Province of Quebec, Canada.

The new Manville plant consists of nine buildings, which, together with their products, are classified as follows: A—Textile and Packing Department. B—Rubber plant; Electrical Specialties and Printing Department. C—Pipe Coverings. D—Paper Mill. E—Magnesia. F—Roofing. G—Mastic and Waterproofing. H—Roofing Coatings. Power Plant and Pump House.

Each building has an average length of 1,000 feet, and is a separate factory in itself capable of being operated as an independent unit without relation to the other buildings in the group. The total combined floor area of all the buildings is about 1,000,000 square feet.

About 3,000 men will be employed at this new plant, making a total of about 7,000 who are now employed by this Company.

Annual Salesmen's Conventions Held

Following a long established custom, the 600 or more salesmen, as well as the Department Managers, of the H. W. Johns-Manville Co., assembled in annual convention on various dates from January 2nd to February 8th at Milwaukee, Boston, New York, Philadelphia, Pittsburgh, Cleveland, Chicago, St. Louis, New Orleans, San Francisco, and Toronto, to learn more about the products which they sell.

One by one about three hundred products of this concern, such as J-M asbestos roofing, shingles, packings, pipe coverings, brake linings, conduit, waterproofing materials, mastic, cold storage insulation, electrical supplies, etc., were taken up and their advantages over competitive products pointed out to the salesmen by specialists in each line.

A week's time was devoted to each of these conventions, with a banquet at the close as a fitting ending.

BETTER THAN THEORY



Our Copper Bearing Open Hearth

ROOFING TIN

is more than theoretically good. Actual service tests have *proved* the superiority of our Copper Bearing Ternes. You should use no other. Shall we send particulars?

Write for Pocket Reference Book containing valuable data and information relative to our Copper Bearing Terne Plates, Apollo Best Bloom Galvanized Sheets, Black Sheets, Formed Roofing and Siding Products, etc.

American Sheet and Tin Plate Company
General Offices: Frick Building, Pittsburgh, Pa.

DISTRICT SALES OFFICES:

Chicago Cincinnati Denver Detroit New Orleans New York Philadelphia Pittsburgh St. Louis
Export Representatives: UNITED STATES STEEL PRODUCTS COMPANY, New York City
Pacific Coast Representatives: UNITED STATES STEEL PRODUCTS COMPANY, San Francisco, Los Angeles, Portland, Seattle

When Writing Advertisers Please Mention the American Carpenter and Builder.



DULLKOTE PAINT Makes Wall-board Washable

A "DULLKOTED" surface can be washed like tile. JOHNSTON'S DULLKOTE is applied to the wall-board with a brush, in the ordinary manner, and can be readily cleaned with a sponge and water.

It dries hard—leaves no brush marks or laps—wears like iron—and is *very* economical. For use wherever wall-board is used, in residences, schools, stores and public buildings.

The wide variety of shades allows of handsome decorative treatment. Write for our free color chart, and several excellent suggestions for interior decoration.

The R.F. JOHNSTON PAINT CO.
Pearl and Main Streets, Cincinnati, Ohio

Do You Want Results?

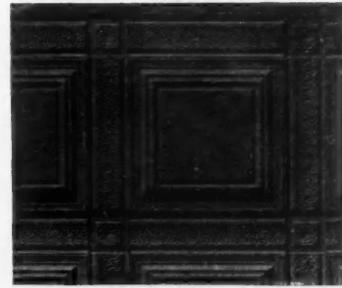

Three things are *responsible* for the results produced by Brooklyn Metal Ceilings.

The *first* is DURABILITY. The quality of *our* metal gives a product that defies the ravages of Time.

The *second* is DESIGN. Our extensive line of patterns contains plain and embossed surfaces of surpassingly rich effect.

The *third* is PRICE. Our methods of factory efficiency give these ceilings and side walls *to you* at a price enabling you to beat competition in your territory.

Write for further information.

Brooklyn Metal Ceiling Company
285 Greene Ave. Brooklyn, N. Y.

You Can Have a Big Year If You Will Let Us Help

The New **ART KRAFT** Catalog

Contains everything worth while in *Metal Ceilings*. The kind that boosts your reputation. As for price—well, the price will get you.

Write to-day for a copy—Now.

CANTON METAL CEILING CO., 1947 Harrison Avenue, Canton, Ohio



OAK FLOORING

Increases the Renting and Selling Values and Attracts a Better Class of Tenants

Builders and owners will find it a clinching argument to say "It's floored with OAK FLOORING." It is the biggest single feature to look for in any house or apartment building. It imparts an air of refinement and elegance. It is the modern flooring.

OAK FLOORING $\frac{3}{4}$ inch thickness by 1 $\frac{1}{2}$ inch or 2 inch faces can be laid over old floors in old homes or over cheap sub-floors at a very low cost. It is cheaper than carpets or pine flooring. When laid it has all the appearance of heavy flooring.

There is a solid satisfaction and lasting pleasure in the substantial and dignified appearance of OAK FLOORING.

Contractors and carpenters find it very profitable to lay $\frac{3}{4}$ inch stock over old floors in old homes during dull periods. A little canvassing is all that is necessary to secure jobs. A carpenter or handy man can lay OAK FLOORING successfully.

For durability, OAK is the best. OAK FLOORING laid thirty years ago, after very hard use, is still in good condition.

Write for Booklet

THE OAK FLOORING BUREAU, 890 Hammond Bldg., DETROIT, MICH.

When Writing Advertisers Please Mention the American Carpenter and Builder.

GILBERT & BENNETT
PEARL
WIRE CLOTH



Here is the Modern Screen for Progressive Builders---

The high metallic finish of Gilbert & Bennett PEARL Wire Cloth makes it *easily* the hand-somest screen material on the market today.

It is of high tensile strength and practically *rust-proof*, consequently almost *wear-proof*.

Now, don't confuse Gilbert & Bennett PEARL Wire Cloth with *galvanized* kinds. They are *not* the same—or anywhere near it. You'll readily recognize the difference by comparing *wear*.

GILBERT & BENNETT
PEARL
WIRE CLOTH

For Screening Doors, Windows and Porches—

Gilbert & Bennett PEARL Wire Cloth has *proven* its worth. It is no experiment. Many years of constant use all over America bear out our statements about it.

Two weights are to be had in "PEARL"—Regular, which is used for doors and windows and Extra Heavy Grade which is especially suited for porches and doors.

All genuine Gilbert & Bennett PEARL Wire Cloth has *two copper wires* in the selvage.

We want you to know about "PEARL."

Ask the best dealer in your town or write our Chicago office for samples and complete information.

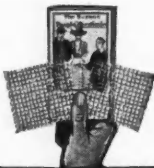

Write for These Samples and Particulars—
Address our Chicago Office.

The Gilbert & Bennett Mfg. Co.

Established 1818

Chicago Georgetown, Conn. New York City Kansas City, Mo.

When Writing Advertisers Please Mention the American Carpenter and Builder.

Johns-Manville Newark Office Moves

The H. W. Johns-Manville Co. announce the removal of their Newark office to 239 Halsey St. Their new office and salesroom is located on the ground floor of a modern building right in the heart of the city's business center. With a floor area of 4000 square feet, ample space is afforded for the display of a varied line of J-M Asbestos Roofings, Packings, and Pipe Coverings, Brake Lining and Auto Accessories, "Noark" Fuses and Protective Devices, Frink Lighting Fixtures, etc.

Open Salt Lake City Office

The demand in Salt Lake City, Utah, and vicinity, for J-M asbestos roofing, shingles, pipe coverings, stucco and other building materials; packings, cold storage insulation, waterproofing materials, conduit, plumbing specialties, lighting fixtures, electrical supplies, and other well-known products manufactured by the H. W. Johns-Manville Co., has increased to such an appreciable extent, that this company has found it expedient to open a branch office in the Dooly Block, in that city.

Their many customers in that section of the country will undoubtedly appreciate this as it should materially facilitate the handling of correspondence, orders, etc., and affords another illustration of this company's inflexible policy to utilize every possible means to further the interests of their customers.



Are You Branching Out?

A contractor or builder ought really to have more than one line that will prove a source of income to him. There is said to be such a thing as having "too many fish on the string"; but the saying does not make good in the case of a wide-awake man with a corps of able assistants.

There is no earthly reason why any live builder cannot make additions to his business so that he can take care of a wider field in realm of construction. In many cases this can be done by assuming the agency for various articles entering into home building, and so the profits instead of going to another man are drawn into the builder's own pocket. Is there any argument against a progressive man assuming charge of decorating the interior of a house, installing a water supply or heating plant?

If a man needs a furnace in his home, why can't you talk to him, take his order and install a heating system? The Bovee furnaces are easy to erect and rank high in comparison with other makes. They are solidly constructed and the large combustion chamber insures an even distribution of heat for long distances. It is said to be a great fuel saver and to give perfect results.

Our readers, we believe can buy these furnaces at manufacturers prices and make a big saving. Write the Bovee Furnace Works, Waterloo, Iowa, for their proposition.



Bovee Furnace

BEAVER BOARD

There's Money for you in the
Genuine Beaver Board

BUT in order to get the most out of our continuous national advertising, and broad, co-operative service, you ought to know this Pure-Wood-Fibre, patented product as thoroughly as you do lumber.

It offers all sorts of opportunities to the man who understands it.

Get started right by sending for free pamphlet "The A. B. C. of Beaver Board Construction."



The Beaver Companies

United States: 180 Beaver Road, Buffalo, N. Y.
Canada: 380 Wall St., Beaverdale, Ottawa.
Great Britain: 4 Southampton Row, London, W. C.



Beaver Board Walls and Ceilings in the offices of
White, Wile & Warner, Buffalo.

CREAM-WHITE and BURNT LEATHER

We have now added these
two finishes to our line of

NEPONSET WALL BOARD

For Walls and Ceilings

These with our original rich oak finish, make it possible to create the most varied and attractive interiors with Neponset Wall Board.

WRITE FOR SAMPLE

Address

F. W. BIRD & SON East Walpole, Mass.
23 River Street



EST. 1795.

New York	Columbus, O.
Washington	San Francisco, Cal.
Chicago	Canadian Plant,
Portland, Ore.	Hamilton, Ont.



The Only Wall Board That Can Be Successfully Papered

BECAUSE it is the only wall board that is strong enough and stiff enough to stand the "pull" that wall paper exerts when adhered to another surface.

Compo-Board is also the only wall board that doesn't have to be paneled. You can panel it if you wish, but you can also have walls and ceilings smoother than plaster that lend themselves to artistic decoration by any method.

The hundreds of contractors and builders who use Compo-Board are able to deliver a more satisfactory job in a shorter time and get a higher price.

Write for a sample and interesting booklets on Compo-Board. Learn about its unique construction, its strength, durability—insulating, fire resisting and moisture proof qualities.

Compo-Board is sold in strips four feet wide and one to eighteen feet long, by dealers in most every town.

Northwestern Compo-Board Co.

5777 Lyndale Avenue North :: Minneapolis, Minn.

Let Plastergon Boost Your Spring Profits

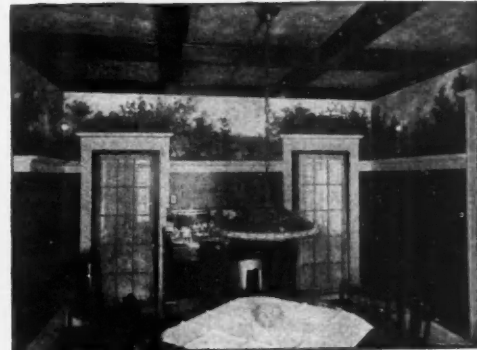

It gives you the Plaster's work—the decorating too. You are not confined to houses—Plastergon is used in Offices, Garages, factories, Stores, Clubs—new and remodeled.

Its many advantages over lath and plaster—its unequaled economy—all intensely interests your customer. Each job advertises you—each month your Plastergon business increases.

Every Panel is Guaranteed

Plastergon is the only guaranteed Wall Board—yet it costs no more than other Wall Boards.

Let's tell you more about Plastergon—how to get customers, etc. This co-operation costs you nothing—but it brings you money. Write for particulars today.

PLASTERGON
TREATED
WOOD FIBRE
WALL-BOARD

Plastergon Wall Board Co.
Dept. A. Tonawanda, N. Y.

The Proper Method of Finishing Woodwork

By **Herbert F. Johnson**

With *S. C. Johnson & Sons*

Every contractor appreciates the importance of well finished woodwork. To be able to speak with authority on this subject will be of value to every architect and contractor. This part of the specifications should not be left to incompetents

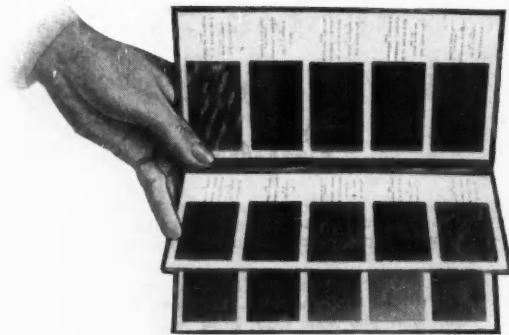

Portfolio of Wood Finishes

or given careless consideration; it is just as essential as the decision on the woods to be used, for no matter how beautiful and costly the woodwork if it is not well finished, it will not be satisfactory to your client.

The inexpensive woods such as pine, cypress, red-gum, birch, etc., are being used more and more for interior woodwork and if well finished these woods give entire satisfaction, as all of these woods have a very beautiful grain and make just as artistic and attractive a finish as the more expensive woods.

I have had over twenty-five years' experience in wood finishing and speak with some authority on this subject. This

article applies to both soft and hard woodwork as the treatment is practically identical.

NATURAL FINISH. Where wood is to be finished in its *natural color*, apply a coat of Natural Paste Wood Filler, first. This will fill the pores and grain of the wood giving a hard, even surface upon which to apply the finish. Never use a liquid filler. This is usually nothing but a cheap grade of varnish which does not fill the pores of the wood at all but remains on the surface and shows every mar and scratch. For the *inexpensive natural finish* of soft wood, apply a coat of Johnson's Under-Lac directly upon the wood. This will give the best one coat finish obtainable. Prepared Wax or Flat Wood Finish may be applied over the Under-Lac if desired.

GOLDEN OAK FINISH. For Golden Oak, Dark Oak, and Antwerp Oak effects a colored Paste Wood Filler should be used. Be sure to let the filler dry thoroughly and the woodwork is then ready for the finish. This matter will be taken up later.

COLORED EFFECTS. If the woodwork is to be finished in color—Mission, Mahogany, Bog Oak, Fumed, Early English, etc., apply a coat of Johnson's Wood Dye directly upon the wood. This dye is manufactured in seventeen standard shades, all of which may be lightened or darkened and two or three shades may be mixed together—in this way you will be able to meet the ideas of all of your clients.

Johnson's Wood Dye is a combination spirit-oil stain. It

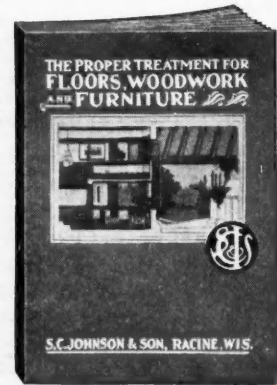

A Worth-While Book



- Bath Tubs
- Water Closets
- Lavatories
- Kitchen Sinks
- Range Boilers
- Heaters
- Laundry Trays
- Water Systems
- Pipe and Fittings
- Steam and Hot Water Boilers
- Radiators
- Brass Goods
- Sanitary Specialties

BOWMAN SUPPLY & MFG. CO., INC.

PLUMBING, GAS, STEAM & WATER SUPPLIES

If Interested Write for Catalog.

PITTSBURG, PENNA.

When Writing Advertisers Please Mention the American Carpenter and Builder.

MAJESTIC

FOUNDATION
COAL CHUTE



Protects the building just where most needed — above the opening.
The heavy steel hopper catches all the coal.



When not in use, the hopper lies in the bottom of the chute body. The door locks automatically either open or closed. Strictly burglar-proof. With 1/4-inch wire glass or steel panel in door.

Write for circular and address of nearest dealer.

MAJESTIC FURNACE CO.
995 to 1001 Sixth Avenue Huntington, Indiana



No. KSB 1/2 inch Price \$0.65
No. KSB 1 inch Price \$0.75
No. KSB 1 1/2 inch Price \$0.90

KEEN KUTTER

Chisels

are sold to you with the absolute guarantee of money back if you are not satisfied. Put them to any test—they will prove true. Famous for their clean cutting quality and ability to hold their edge.

"The Recollection of Quality Remains Long After the Price is Forgotten."

Trade Mark Registered. —E. C. SIMMONS

If not at your dealer's, write us.

SIMMONS HARDWARE CO., Inc.
St. Louis New York Philadelphia
Toledo Minneapolis Sioux City Wichita

YALE INDEPENDENT GAS PLANT MAKES ITS OWN GAS

GASOLINE LIGHTING SYSTEMS FOR EVERY NEED



Modern Illumination

Mr. Contractor: You are interested in modern illumination and so is the householder; we have a proposition that is interesting and profitable. Here is an opportunity for you to make more money and which will be helpful to you in your business. Let us tell you more about it. No obligation. Our literature is free for the asking. Write today.

C. B. YALE MFG. CO., 20 to 30 S. Clinton St., Chicago, Ill.

LET US GIVE YOU THIS TRANSPARENT CELLULOID TRIANGLE

It is 4 inch size, 30°+60° angles. Lowest retail price, 25 cents. Absolutely essential to everyone who draws. We make this offer to introduce our new catalogue showing

SPAULDING'S NEW CARRYING CASES AND COMPLETE OUTFITS

for carpenters, builders, designers, architects, engineers and students—compact, durable and convenient. Spaulding's Carrying Cases are made light and strong. They provide well arranged compartments, including space for drawing board and T square. Handled like a suit case; unique, practical, inexpensive. Outfits include all necessary equipment. If you draw, send us five 2-cents stamps today to pay postage and get the free triangle and the catalogue.

SPAULDING PRINT PAPER CO., 48 Federal Street, Boston

Simonds Hand Saws

Are as near a perfect saw as has yet been made for Carpenters.



NOTE.—For 18c in stamps we will mail to any carpenter a miniature rolled gold plated Hand Saw souvenir watch charm.

Simonds Mfg. Co.

Fitchburg, Mass.

Chicago, Ill. New York City Portland, Ore.
New Orleans, La. San Francisco, Cal. Seattle, Wash.
Montreal, Que. London, Eng.

When Writing Advertisers Please Mention the American Carpenter and Builder.

Here it is Mr. Contractor
—The Machine You've
Been Looking for. It's the
"TRIUMPH"
PLANER, MATCHER
and MOULDER

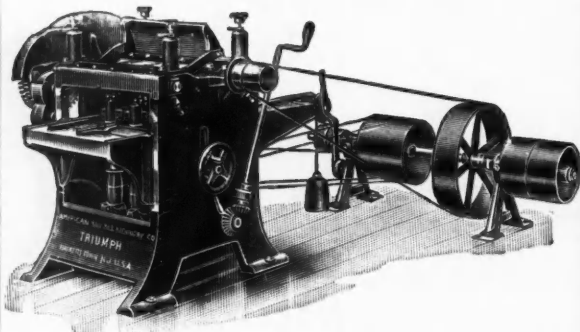

There's no reason now why you shouldn't do, yourself, a large part of the mill work you've been paying a good price for. All you need is a "Triumph."

You can do all your planing and matching. You can make flooring, siding, ceiling, casing, wainscoting, and a large variety of moulding and trim.

You'll make as fine a product as the largest, best-equipped mill—and save money while you're doing it.

Make your machine equipment complete, and further cut your costs, with a "Triumph."

Send for the Circular

**American Saw Mill
Machinery Co.**

82 Main St. 1655 Hudson Terminal
Hackettstown, N. J. New York City

has all the advantages of both a spirit and an oil stain and none of the disadvantages. It is very easy to apply, will not show laps or streaks, penetrates deeply so that the natural color is not disclosed if the wood is marred, and brings out the beauty of the grain without raising it in the slightest. Another advantage of Johnson's Wood Dye is the fact that it dries quickly so that the finish may be applied within a half hour. Any competent painter can use Johnson's Wood Dye with entirely successful results.

FILLED GRAIN COLORED EFFECTS ON HARD-WOOD. On oak, chestnut, and other open grained woods a filler is very desirable. In that case apply a coat of colored filler over the dye; over the brown and mahogany shades of dye use dark filler No. 30; over the green shades of dye use Green Filler No. 50; over the Silver Gray Dye use the German Gray Filler No. 60; etc. Upon birch, pine, cypress, etc., a filler is not necessary for woodwork and the wood is ready to be finished after the dye has been applied.

FINISHING. The finish over the dye or Paste Wood Filler is largely a matter of taste. Some people prefer a high gloss finish, while others consider the dull finish more beautiful and artistic. The ideal finish for woodwork is Johnson's Prepared Wax. This should be applied with a cloth and brought to a polish with a dry cloth or a flat, stiff bristle brush similar to the brushes used for polishing shoes. When the first coat has hardened thoroughly a second coat should be applied and polished in the same manner. The only draw-back to Prepared Wax for woodwork is the fact that there is considerable labor connected with polishing it and of course, labor is the thing that costs. Almost the same effect can be obtained by applying a coat of Johnson's Flat Wood Finish over the Dye or Filler. This is a liquid preparation and is put on with a brush. It dries absolutely flat in three or four hours and no hand rubbing or polishing is necessary. Johnson's Flat Wood Finish gives a very artistic, durable, and satisfactory finish and you will find that nine of your clients out of ten will prefer this finish with a great saving in labor, to a wax or hand rubbed varnish finish. For a high gloss, apply a coat of Johnson's Under-Lac over the Dye or Filler and then one coat of Johnson's Prepared Wax or a coat of varnish, whichever is preferred. Johnson's Under-Lac is superior to shellac or varnish. For a first coater under varnish it is unsurpassed.

I am showing on page 148 a cut of the Johnson's portfolio of wood panels which they are offering free to contractors, architects and builders. This portfolio shows on actual woods the many beautiful effects obtainable with Johnson's Artistic Wood Finishes.

A card from you mentioning this publication will bring you this portfolio free and postpaid. S. C. Johnson & Son will also be glad to furnish you with a copy of their 1913 book, "The Proper Treatment for Floors, Woodwork and Furniture." They have been publishing this book yearly for sometime and practical people look upon it as an authority on the subject of wood finishing.

My space has been limited so that I am unable to go as fully into the subject of finishing woodwork as I would like but shall be glad to furnish additional information on this subject to anyone who will address me care of S. C. Johnson & Son, Wood Finishing Authorities, Racine, Wisconsin.



When Writing Advertisers Please Mention the American Carpenter and Builder.



Stanley's Ornamental Surface Butts No. 165

Save Time and Labor and Please The Owner

The Ornamental leaf screws on the surface of the door, saving half the time of mortising. The slotted ball tip can be unscrewed and the pin reversed so that the butt can be used on either right or left hand doors.

The handsome, dignified, Beveled Edge design harmonizes with the popular designs of hardware. Made in all finishes.

Write for booklet "A" describing this and many other lines of "Stanley" Quality Hardware.



The Stanley Works
New Britain, Conn.

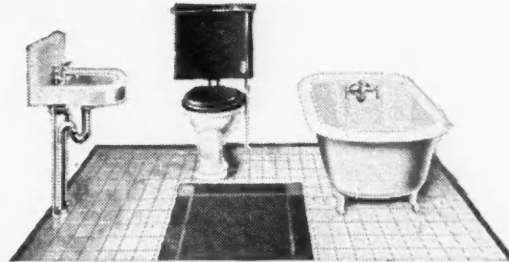

How to Install Your Own Plumbing and Heating Systems

Builders, contractors and home owners, my big new book tells you how to install a modern heating plant or your own water system. New money-saving, time-saving and labor-saving method. Steam or hot water heating plants, complete bath-room systems and all accessories. You can easily install any one of these modern improvements from the complete, simplified plans and instructions furnished to you free. Write today for my valuable book. Post-paid, free to you.

How to Save On All Material



My method for saving on all material is a revelation even to the most experienced contractors and builders. It will open your eyes to the practical Gibbons method of saving money on all improvements. My method means quicker work, better material and more economy for you. Get my free book and see for yourself.

Gibbons New Method Every home even the smallest cottage can now have running water or a modern heating plant. Churches, halls, schools can have these improvements at a low cost. My free book explains all. Write for it today.



Book Free

My new book gives you greater buying power than your local dealer. Thousands of things illustrated and priced. Gasoline engines, hydraulic rams, pumps, pipes, valves, electric lighting plants, acetylene lighting plants, all accessories, everything guaranteed. You certainly ought to have this book. The practical information that it gives you will help you wonderfully. Send your name and you get it post-paid, free. Send today.

M. J. GIBBONS, Dept. 2417, Dayton, O

A SIX-FAMILY HOUSE OF CONCRETE CONSTRUCTION

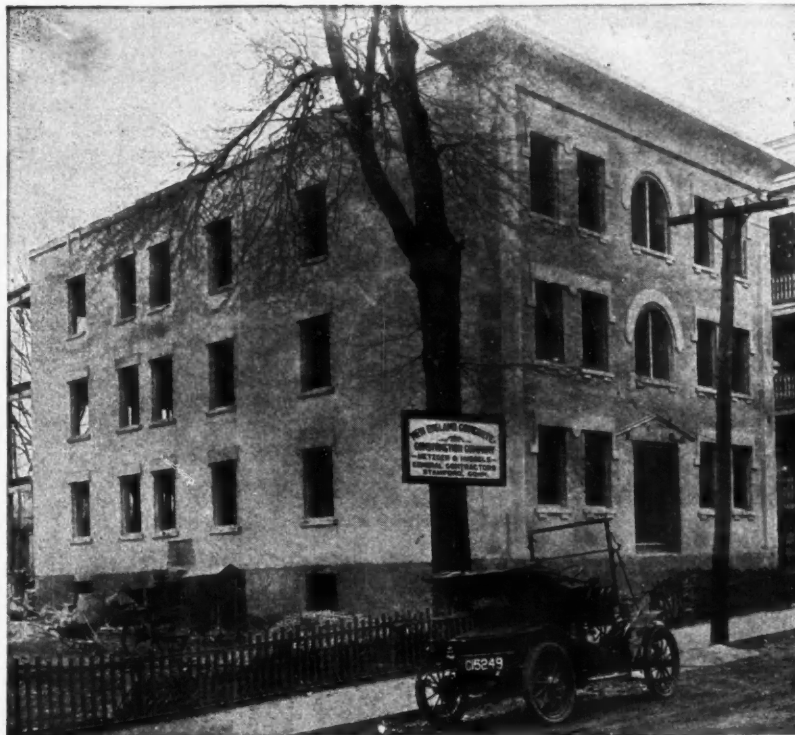

The Concrete Work from Cellar to Roof-Peak was **COMPLETED IN THIRTY DAYS.**

It was necessary on this job to maintain a **THOROUGHLY MIXED, UNIFORM** output.

It was essential that the work be rushed to completion rapidly and efficiently.

The Concrete for This Six-Family House Was Mixed with the

EUREKA MIXER

For speed and uniform output, the Eureka has never been equalled. It means money in your pocket to know more about Eureka mixing. Remember that Eureka Mixers dot the globe and are everywhere cutting costs for their owners. Over 300 Eureka's are used in New York City alone. Write for Catalog, names of users in your locality, and name of nearest distributor for your territory. As a matter of precaution, we suggest that you do not delay should you want Spring delivery.

WHAT THE CONTRACTOR SAYS:

Jan. 8, 1913.

Your Eureka Mixer has worked well and to my entire satisfaction during the entire job.

New England Concrete Construction Co.,
Theodore Metzger, Mgr.

DISTRIBUTING POINTS

W. V. Johnson & Co., General Eastern Agents,
1 Madison Ave., New York City.

CEDAR RAPIDS: Iowa Stone Company.

CHICAGO: F. T. Kinnare, 335 River Street.

CINCINNATI: C. Taylor Handman, Merchants Bldg.

DALLAS: J. Peyton Hunter, 6 Terminal Bldg.

DAYTON: M. D. Larkin Supply Co.

DETROIT: Walter R. Barrie, 1029 Lothrop Ave.

JACKSONVILLE: J. P. Campbell, 118 E. Bay St.

KANSAS CITY: John Deere Plow Co.

PEORIA: Southwestern Port Huron Co., 213 S. Water St.

PITTSBURG: J. M. Bursner, 506 Machesney Bldg.

SALT LAKE CITY: Harris Bros., 310 Atlas Block.

WINNIPEG: Thomas Jackson & Son, 370 Colony St.

EUREKA MACHINE CO., 85 Handy Street, Lansing, Michigan

When Writing Advertisers Please Mention the American Carpenter and Builder.

House Furnishings on Easy Terms

It is surprising nowadays how easy it is for our readers, as well as men in all trades, to furnish their homes comfortably and attractively without a large outlay of cash. There are a number of large, reliable Chicago houses that do business by mail in every State in the Union. The Spiegel, May, Stern Co., of Chicago, is one of these; any one will be certain of receiving fair and square treatment from this concern.

They have a very liberal 30-day trial offer. They make a specialty of furnishing homes and have experts who are ready to advise on how to furnish this room and that room with as little expense as possible. Their prices, as far as we know, are very low; their charge account plan very generous, and free from any of the annoying features that are sometimes connected with so-called "installment" houses, such as collectors, signing of mortgages, etc.



A Safe and Sane Scaffold Bracket

The photograph herewith will show the folding scaffold bracket in use on a building under construction. Every day we hear of some new improvement and think the folding bracket worth a favorable comment.



Reliable Folding Scaffold Brackets in Use. These brackets are made by the Elite Mfg. Co., Ashland, Ohio

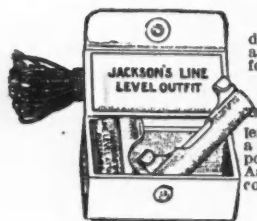

A UNIQUE TIME SAVER.

The Jackson Aluminum Line Level is a mighty small device it brings about a tremendous saving of both time and labor. It takes the place of the old-fashioned sixteen foot straight edge, yet it can be carried in your vest pocket. No contractor, builder, carpenter, mason, bricklayer, architect or plasterer, etc. can afford to be without one. Just stretch your line and hang the level on it—It's positively accurate. The complete outfit is put up in a neat leatherette case and consists of the level with a 40-ft. line also a spring clamp for attaching the level to a steel square or pocket rule, thereby serving as a plumb rule or bench level. Ask your hardware dealer or send \$1.00 for the Level outfit complete post paid. Send for our Catalogue of Tools.

JOS. WOODWELL CO., Sole Agents
201-203 Wood St., Pittsburgh, Pa.

Carpenters know how awkward the old wooden brackets are and what a lot of good lumber is practically wasted in making them. Then too they are not always safe. Time taken to put up a wooden scaffold support is another big item.

The Reliable folding scaffold bracket shown above is strong and durable. It will certainly pay for itself long before it wears out. This support is designed for carpenters, painters, tanners or masons and can be used wherever a scaffold or platform is needed. The bracket can be attached to the studding with nails. Write the Elite Mfg. Co., Ashland, Ohio, for complete description and price of this article.

Right Heating Properly Installed

Whether you are building a home for yourself or for somebody else you want the best and most economical heating system, and a little study of our booklet, "Twice-A-Day," will show you why Campbell's Winter-Chaser Furnace is the one for *wear and service—for health and comfort.* And remember—our heating plans are made by heating engineers, and the work of these experts is at your disposal when you install.

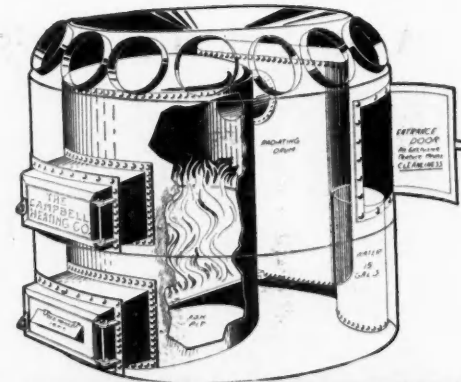

Campbell's "Winter-Chaser"

This furnace with its big jacket gives warm, moist air with a minimum of coal-cost. Has perfect combustion, and a large fire-pot, permitting a checked fire! Has also a fifteen-gallon reservoir which moistens the

air so that it brings "a day in June" to the room it enters. The extra-sized air-chamber provides *more* air—there is no over-heating and the large door gives easy access for cleaning.

Hundreds of Campbell Furnaces 25 Years Old, Are In Use Today

They are *all* steel and *thicker* steel than any other furnace made in the United States. The Campbell Winter-Chaser Furnace makes any house a ready seller.

It is the *cheapest*, because it is the *best*. Write for booklet. And our 1913 plans for selling the Winter-Chaser.

CAMPBELL HEATING CO., 1221 Walnut St., Des Moines, Iowa

When Writing Advertisers Please Mention the American Carpenter and Builder.

HE can't afford to take chances. When he sees the Irwin stamp, he's sure. He knows an

Irwin Bit

is made of one-piece flawless extra high-grade crucible auger-bit steel and tempered by the secret Irwin Process. He knows it will not bend or break where twist and shank unite—the weak spot in common bits.

He knows the Irwin is the only solid-center-stem bit made in all sizes and styles for every purpose—6,500 different sizes and styles to cover every requirement.

He appreciates the fact that the Irwin hand-filed sharp edge will bore true into the hardest wood known, even lignum-vitae.

He has learned that his work with an Irwin will be rapid, true and sure. That his knowledge and workmanship will be backed up to the limit of efficiency when he has Irwins in his kit.

Therefore, he asks his dealer for Irwin Auger Bits. If your dealer hasn't got them, write us direct.

The Irwin Auger Bit Company
Largest in the World
 Station C18 **Wilmington, Ohio**

STAMPED STEEL TILING
 Just the thing for
 Bathrooms, Kitchens, Restaurants,
 Butcher Shops, etc.

AND ITS RIGHT IN YOUR LINE

Real tile frequently becomes loose and falls off. This cannot. The studding or plaster is first sheathed with a narrow, dry boards and the metal put on with small nails.

SIX PATTERNS

Furnished with Baked White Enamel finish—or simply prime painted Metal trim Cap Base, Corners, etc., supplied or you can use wood trim.

NORTHROP, COBURN & DODGE CO.
 29 Cherry Street, New York

Adjustable Torpedo Level and Plumb, No. 601

A strictly high grade tool in workmanship, finish and accuracy. Its shape makes it convenient to slip into vest or any pocket as a lead pencil.

If your hardware dealer cannot supply you, write us and send us his name. *Manufactured by*

THE SOUTHINGTON HARDWARE CO.
 Southington, Conn., U. S. A.

Dimensions—9 in. long, 1 1/4 in. deep, 3/8 in. thick in center, tapering ends, made of rosewood highly polished, tips top and bottom inlaid with brass. Accurately tested bottles well protected.

Sliding Doors

require weather protection. Schouler Patent Weather Strip and Guide is the only practical sliding door weather stripping made. Use it. Schouler Sliding Door Weather Stripping can easily be applied to any type of sliding doors. Made of heavy metal. Wears forever. Catalog and other particulars—FREE. Write NOW Schouler Cement Construction Co., 14 Frelinghousen Avenue, NEWARK, NEW JERSEY

Schouler's Weather Strip and Guide for Sliding Doors

THE LA PLANT HEAVY HOUSE MOVING TRUCKS

When you get a job with an old building on the lot—move it with the La Plant Trucks to another place—instead of wrecking it. There is more profit in it for you.

La Plant Heavy House Moving Trucks are made of steel—on scientific lines—are interchangeable so they can be worked singly, in pairs or in fours.

Write for catalogue O and see how easy it is to wheel a building a mile in a day—and how little the cost is for La Plant outfit compared with the profit to be made in moving houses instead of wrecking them.

LA PLANT TOOL CO. 1100 E. Nevada St. **Marshalltown, Iowa**

When Writing Advertisers Please Mention the American Carpenter and Builder.

More pay for your work

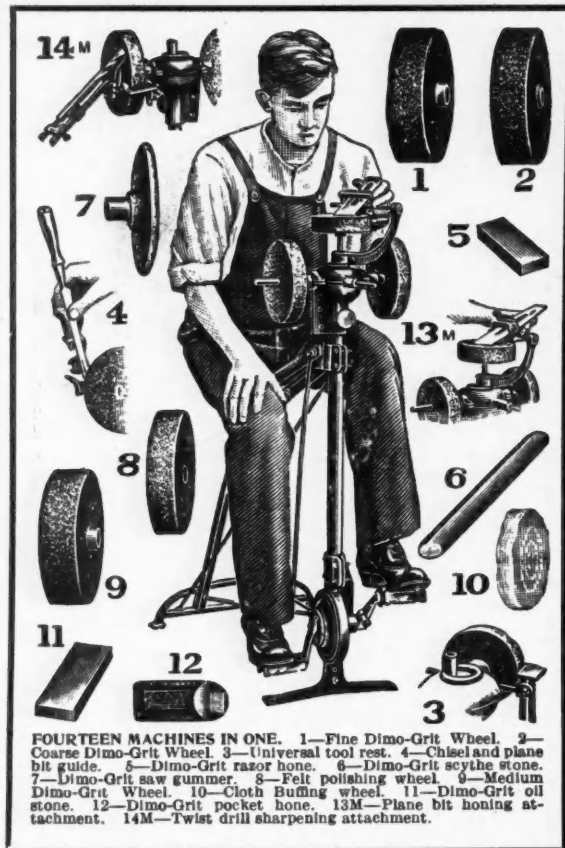

LUTHER SHOP TOOL GRINDER

Sent to You on **FREE TRIAL**

Sharp tools enable you to either reduce your shop costs or get greater profits for your work. The rapid DIMO-GRIT Sharpening Wheels of the Luther Shop Tool Grinder sharpen tools 25 times faster than the grindstone and are many times more efficient than emery. Positively will not draw temper. No water needed for cooling. Special tool rests give you the exact bevel for sharpening all tools. DIMO-GRIT Wheels are especially made for sharpening steel.

The Luther Tool Grinder is built entirely of steel and iron, has enclosed shaft drive like an automobile and dust-proof bearings. No chance to stretch or break.

30 Days Free Trial

Write for 40-page book which gives full particulars about this wonderful labor saving machine. We will send any outfit you may select on 30 days' trial without prepayment.

LUTHER GRINDER MFG. CO.

1805 Michigan St., MILWAUKEE, WIS.

Are You in the Same Boat With Us?

Did you ever have the misfortune to follow anyone through a swinging door and have that blamed thing fly back and land all over your face at the same time? What you said on that occasion wouldn't look well in print would it? We've



Safety—Door Is Checked

had the same experience and said the same things and ever since have been earnest advocates of some method to prevent people from being knocked silly by those rebounding, double-acting doors.

While a swinging door is a great convenience either in the home or a public building (in fact they're indispensable), still mistress or maid or the children ought to be protected



Danger—Double Acting Door without Check

from their malicious onslaughts. The builder who puts a door-check on such doors is really a benefactor of the race.

The Standard Mfg. Co., Shelby, Ohio, make a very efficient door-check. The double-acting spring hinge in the door is controlled by a check in the floor. Each is separate and distinct but co-operate in controlling the door. Standard checking hinges will prevent accidents as shown in the illustrations and any man will readily agree to having them installed on his swinging doors. They ought to prove profitable for our builders. Suppose you write the Standard Mfg. Co. for particulars.

When Writing Advertisers Please Mention the American Carpenter and Builder.

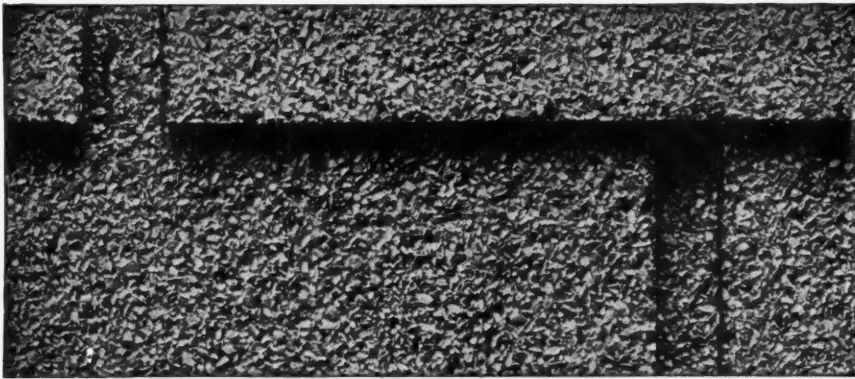

This Cut Shows the surface of Flex-a-tile Shingles—Beautiful, Convenient, Durable.

The most prominent feature of your house is the roof. It is the first thing that is seen—the keynote of the whole architectural scheme. It must afford not only ample protection and durability, but it must be attractive in appearance.

FLEX-A-TILE ASPHALT SHINGLES

are surfaced with chipped slate and granite in rich natural colors of green and red. They are as handsome as tile—as durable as slate, as inexpensive as stained wood shingles and very much easier to lay than any of them. Also—they are practically fire proof.

WRITE TODAY FOR FREE SAMPLE

We want responsible dealers in all parts of the country

The Heppes Company

1010 Forty-fifth Ave.
CHICAGO, ILL.



Is the Roofing FOR YOU

If you are interested in a roofing giving a warm, coppery red tile effect—more durable than shingles or metal, yet less expensive.

If architectural beauty, ease of laying, surety against leaks, extremely fire resisting and absolute permanency appeal to you, look no further for roofing—ZOLIUM is what you want.

ZOLIUM is backed up just as you want it to be. It will serve you well.

Send for sample and booklet A-C-1.

Flintkote Manufacturing Company
88 Pearl St. BOSTON, MASS.

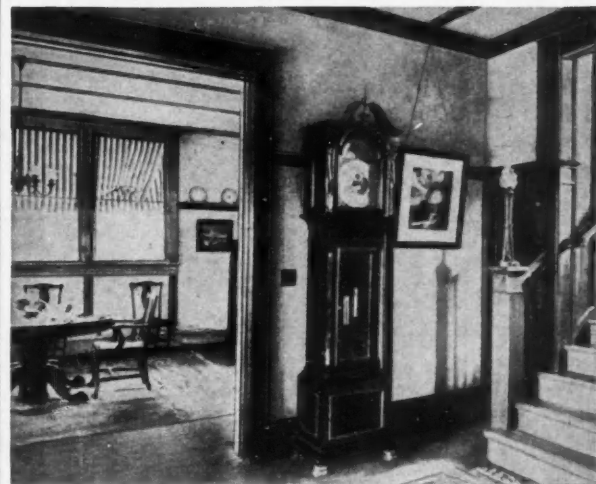

*Your Customer
will be delighted with*

Roberds Ideal Wall Board

It makes such a beautiful interior finish at such a reasonable cost. It can be painted, papered or tinted and lasts forever. It never gets shabby, never cracks, peels, chips or warps and is proof against vermin, heat, cold, fire and moisture.

Roberds Ideal Wall Board comes in sheets all ready to be nailed to the studding. Your cheapest man can apply it without previous experience. No muss, no confusion, no delay and no disappointment.

Our special proposition to carpenters and builders is unusually attractive. Write for it today and we will send you full particulars, samples, prices, catalog and testimonials from other contractors.

The Roberds Mfg. Company
100 Railroad Street :: MARION, INDIANA

When Writing Advertisers Please Mention the American Carpenter and Builder.

Helpful Ideas on Dairy Barn Building FREE!

If you learn more about the newest, best, most economical and most sanitary methods of Dairy Barn Construction — you will make more money. Our free book "Helpful Hints to Dairy Barn Builders" tells about proved principles that it will pay you to know about. It tells facts about plank frames, King system of ventilation; proper width and arrangement; lighting; stable floors;

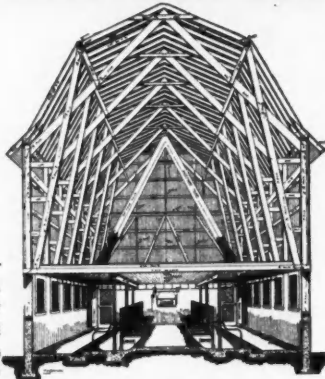

Special Blue Print Offer
We have complete blue prints, specifications, floor plans and lumber bills for several different types and sizes of modern dairy barns. Ask about them. Also ask how to get the free help of our Architectural Department.

site; size; appearance; design; drainage; and sanitary barn equipment with floor plans.

This valuable, interesting book will be mailed to you free if you tell us these facts. "For whom do you expect to build or remodel Dairy Barns? (Give names and addresses). When? For how many cows? Address.

James Mfg. Co.
8575 Cane Street
FT. ATKINSON - WIS.



TWO Rooms in ONE

Utilize every inch of space in building—make 3 rooms equal 5.

Save space for the owner and yet

build an attractive, convenient home for either his use or rental.

PERFECT WALL BEDS have solved the space question. An attractive, richly furnished console or side board conceals bed. Ample ventilation is provided. Entirely sanitary. Space beneath bed easily cleaned—no moving of bed necessary.

Builders investigate PERFECT WALL BEDS. Let us explain them to you in detail—show you how and why your clients like them. Write for full FREE particulars.

Perfect Wall Bed Co.

430-2 S. Wabash Ave.
CHICAGO ILLINOIS



Hardware for Show Cases

P. & F. Corbin, manufacturers of hardware, New Britain, Conn., are calling attention to a new line of hardware for museum cases and other show cases where protection is desired. The line consists of a bolt for single doors. The tube of the lock protrudes through the wood and the strikes are fastened in a casing at each end.

A bolt for double doors is like the one for single doors with the addition of strikes and adjustable bolt heads. The strikes are fastened to one of the leaves, and when the key is turned in the lock, the bolt heads on the other door enter them, fastening the two doors firmly together. This provision makes it unnecessary to have a rail between the two doors to which the doors are locked.

The butt is for use between two doors swung back to back.

The pintle plate is attached to the casing at top and bottom, and each leaf of butt is attached to a door. This also obviates the necessity of a rail or strip to hold the butts, and reduces the obstruction to the vision.

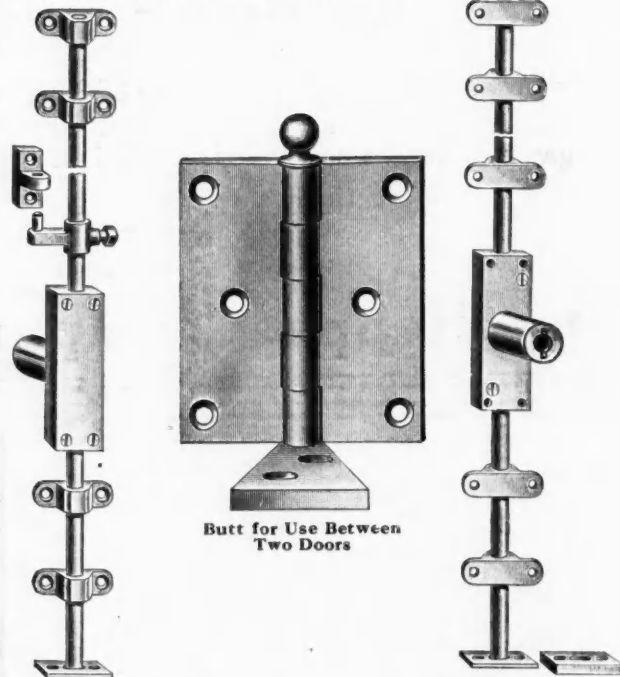

Bolt for Double Doors

Bolt for Single Doors

The cases in Harvard Medical College, said to be the finest institution of the kind in the world, are equipped throughout with these fittings. They are also used in Amherst College, and in a number of other institutions, and the manufacturers are about to make them a part of their regular line. They are equally adapted for horizontal and vertical cases.

Dumbwaiters—Elevators

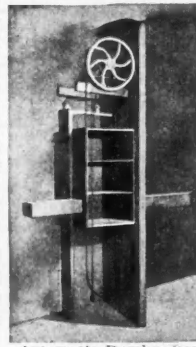

We make a full line of guaranteed machines, absolutely the best. **No leading sheaves to cause friction; no noise; no wear; easy operation.** These elevators are fitted with properly geared iron wheels and the finest material is used throughout.

Install one in the next house or store you build. They save many steps.

Send for catalog or write us your requirements and we'll give you a price.

Chelsea Elevator Co.
330 W. 26th St., New York City

Trade Mark

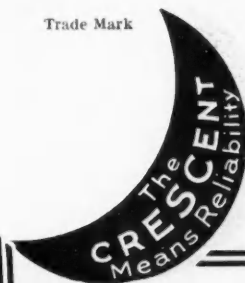

WHY YOU SHOULD SELECT CRESCENT CONCRETE EQUIPMENT

Simply because Crescent equipment is proving in the use of hundreds of contractors that it is practical, reliable and money making.

Don't simply buy your concrete machines upon the say so of any individual.

Investigate the different claims that are made—see for yourself just whether it is the sort of equipment you can best use. We sell Crescent equipment upon the record it has established among contractors and builders—not upon mere general claims.

We know just what Crescent equipment can do, for we know just what it has done. We know how you can make profitable use of it and we're able to show you.

Will you let us?

Crescent Continuous Concrete Mixers—Crescent Vertical Tamping Brick Machines—Crescent Power Brick Machines—Crescent Sewer Pipe and Tile Molds—are in service in every part of the country. They are making good. Can you want better evidence concerning the practicability of Crescent equipment.

Drop us a line NOW for all details. Let us prove to you that we can help you make money with Crescent equipment. We'll send you all information FREE—and it is worth your having.

RABER & LANG MFG. CO.
810 MILL STREET KENDALLVILLE, IND.



No. 440 Cannon Ball Barn Door Hangers

Noiseless, Adjustable, Easy Running
Birdproof—Waterproof

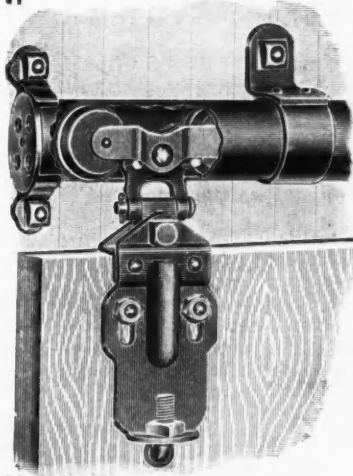

Adjusted in an instant with an ordinary wrench, so that doors can be set nearer or further from building, lowered or raised as desired.

Cannon Ball Barn Doors Hangers are steady, light-running and noiseless.

They never fail to make good.

They are one of our famous "Cannon Ball Battery" door hangers which have won out over all competition.

Write for Catalog and Exclusive Agency Plan
HUNT, HELM, FERRIS & COMPANY
6593 Hunt Street
Harvard Illinois

63

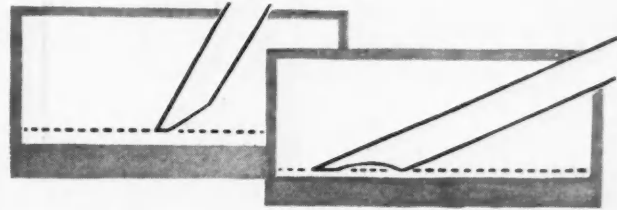

The edge at the right is the only RIGHT EDGE

It's the edge with the concave, hollow-ground bevel that not only cuts the keenest but lasts the longest.

The edge at the left is the wrong kind of edge—convex instead of concave—working slowly and dulling quickly. It's the edge that results from letting the tool slip up and down on the grinder wheel.

The tool can't slip if held in the PIKE BEVEL GUIDE and an accurate, hollow-ground bevel is a certainty. This is an exclusive, patented feature of every



PIKE PEERLESS TOOL GRINDER

Each grinder is equipped with a Crystolon wheel—an electric furnace product with crystals as hard and sharp as the natural diamond and so brittle that they fracture as soon as dull. The surface of a Crystolon wheel never glazes or grows dull and the wheel lasts almost indefinitely. Crystolon wheels are used "dry," yet no other substance that cuts so fast wears down so slowly or cuts so cool.

Every part of a Pike Peerless Grinder—from the pressed steel machine cut spur gears to the machine finished casings—is made so honestly that a Peerless is GUARANTEED FOREVER against all mechanical defects.

Two sizes—Pike Peerless Junior (5 in. wheel), \$5.00. Pike Peerless Senior (6 in. wheel), \$7.00. Foot power \$1.50 extra. Other Grinders from \$3.00 up. Sold by most hardware and tool stores or sent direct. Send for illustrated folder showing full line.

The Pike Manufacturing Co.
27 Main St. Pike, N. H.

FREE—In writing for the Grinder folder, send your dealer's name and 4 cents to cover cost of packing and mailing and we'll include FREE—a Pike India Vest Pocket Stone for pocket knives, awls, etc., also our famous book "HOW TO SHARPEN." You'll be pleased. Write today.



When Writing Advertisers Please Mention the American Carpenter and Builder.



SEBCO

Screw Anchors

Can't Work Loose

For fastening fixtures to walls and floors where ordinary screws will not hold SebcO Screw Anchors are without an equal. When screw is inserted, the shield expands with each turn, thus making it impossible to work loose or pull out.

Send for our catalogue 5R. This illustrates and describes the many uses for our Screw Anchors. At the same time tell us the kind of work you are doing and we will send you free samples. Write us today.

Star Expansion Bolt Co.
 Catalogue Dept. 5R
 147-149 Cedar St. NEW YORK CITY
 120 W. Lake St., CHICAGO

SARGENT

LOCKS

The Sign of Quality

SARGENT & COMPANY
 New Haven, Conn.

New York Boston Philadelphia Chicago

DISSTON Handy Saw Kit

No. 101, Six Blade Set



Contains an assortment of saws suitable for all regular and miscellaneous work. While the illustration only shows the No. 101, or Six Blade Set, the Handy Saw Kit is put up in five different sets, containing three, four, five and six blades.

The blades are made of Disston High Quality Crucible Steel, carefully ground and polished; the handle, of hardwood, carved and polished. The special formation of butt of blade prevents wobbling, and the operation of lever tightener enables an easy and quick attachment, or detachment.

Put up in a durable canvas case, having strong leather bound edges, and containing separate compartments for each blade, with a special pocket for the handle. Convenient, and light to carry.

The combination of Blades in any of these sets provides a Handy Kit for the practical carpenter, householder, farmer, etc. The Plumbers' saw blade is specially tempered for the cutting of wood in which nails may be embedded, lead pipe, and that class of work encountered in the ordinary course of plumbing. These are the finest and most practical Kits on the market.



Established 1840

HENRY DISSTON & SONS
 Incorporated
KEYSTONE SAW, TOOL, STEEL AND FILE WORKS
 PHILADELPHIA, U. S. A.

When Writing Advertisers Please Mention the American Carpenter and Builder.

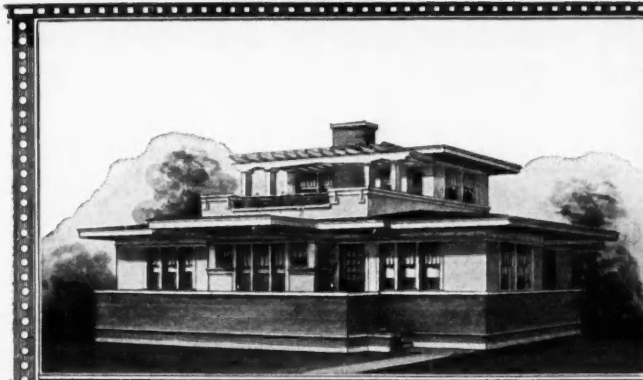

"NEW WAY" HOMES



DOUBLE WARDROBE WITH TWO CARRIERS

**You Can Save
\$100.00 to \$300.00**

in building a new home with my "NEW WAY" Wardrobes instead of the old fashioned closets. A home planned and built with these new space saving, sanitary and convenient Wardrobes, will be more comfortable to live in, and easier to rent or sell, than if built with the old fashioned dusty closets.

Send 50 cents for our "NEW WAY" Home Plan Book, showing the very latest designs ranging from \$1200.00 to \$12000.00 which are planned with these "NEW WAY" Wardrobes.

JOHN THOMAS BATTS
Grand Rapids Michigan

The "NEW WAY" Wardrobe is here to stay. Begin installing them now.

Electric Starting Gasoline Engines

Here's the only farm engine that needs no cranking to start. Touch an electric button and the fly wheels start spinning. This is a most successful labor saving device ever invented. Eliminates nerve trying starting troubles entirely. Write today for full facts about the

**Electric-Starting
WOODPECKER**

—the farm engine that contains over 50 big points of perfection. Note these strong features: Self-priming gasoline mixer, insuring easy cold weather starting; speed regulator, permits adjusting speed while the engine is running; self-contained power plant, protects pipes, wires, ignition, etc. Steel girder sub-base saves the cost of foundation. Develops big surplus over rated horse power.

30 Days Free Trial —NO MONEY DOWN. Write for our proposition on getting an Electric Starting Woodpecker to do your work 30 Days Free. Mail postal today

The Middletown Machine Company
246 First St., Middletown, O.

Gas—
Gasoline—
Kerosene, 1 1/2 to
50 Horse Power.

**30 Days
Free Trial**



**A PROVEN FACT:—KEWANEE
SMOKELESS FIRE BOX BOILERS SAVE
from 14 to 31% of a fuel bill**

You want to know why—of course you do. And we want you to know. Clip the coupon and send it along today and you will receive the **PROOF** by return mail.

KEWANEE

KEWANEE

KEWANEE BOILER COMPANY

Kewanee, Illinois

Steel Power and Heating Boilers, Radiators
and Water Heating Garbage Burners

KEWANEE BOILER CO., Kewanee, Ill.
GENTLEMEN:
Send proof mentioned above to

When Writing Advertisers Please Mention the American Carpenter and Builder.

Get the Building Contracts in your Community



IF YOU CAN BUILD A BETTER HOUSE FOR LESS MONEY, IN LESS TIME AND WITH LESS LABOR THAN YOUR COMPETITOR, you are going to get the building contracts in your neighborhood and give greater satisfaction to your patrons. It requires no argument to prove this. Here are three reasons why you are sure to get the contracts if you buy your lumber from us:

First—You buy your lumber direct from a big manufacturer, **SAVING ALL MIDDLEMEN'S PROFITS.**

Second—You get a higher grade of lumber because every piece we sell you is guaranteed to be up to the standard fixed by the Manufacturers' Association grading specifications. There are no "line boards" in our yards.

Third—You have a big stock to select from—don't have to depend on the limited stock in a small yard; you get exactly what you want in lengths and quality. You save time and labor when you work up high grade stock.

If you need as much as a car-load we will pay your railroad fare to Dubuque and return. You can pick out what you want in our big yards.

We solicit inquiries only from territory which we can reach at a reasonable freight charge from here, viz.: Iowa, Ill., Ind., So. Minn., So. Wis., East half of S. Dak., No. Missouri, E. Nebr.

WE HAVE A SPECIAL PROPOSITION TO CONTRACTORS AND BUILDERS, which you cannot afford to miss. Write us today stating what lumber you require. We will be pleased to give you an estimate.

PETER J. SEIPPEL LUMBER CO., 212 S. Locust St., DUBUQUE, IOWA



No. 84 Solid Wood Chisel



This is a **CHARLES BUCK CHISEL** with a steel handle for severe work. Just the thing for the job where you don't want to use your regular chisel. Ask Dept. A for catalog.

CHARLES BUCK EDGE TOOL CO. MILLBURY, MASS., U. S. A.

CHARLES BUCK TOOLS
The STANDARD Tools of AMERICA

GENUINE BANGOR

Large Facilities, Prompt Deliveries

EAST BANGOR CONSOLIDATED SLATE CO. - - - East Bangor, Pa.

**Roofing Slate
Structural Slate
Blackboards**

HOT OFF THE PRESS!

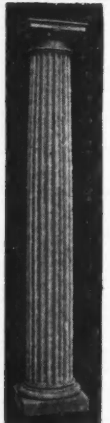

Our trade bulletin No. U-1 Containing valuable information for the Architect, Woodworker and Builder. All the information you need regarding wood columns. Free for the asking.

HARTMANN - SANDERS COMPANY
Sole Manufacturers of
KOLL'S PATENT LOCK JOINT COLUMNS
2155-2187 Elston Avenue, CHICAGO
Eastern Office: 1123 Broadway, New York City
The best columns for porches, pergolas or interior use.



Reason It Out!

Individual Motor Drive with **ROTHMOTORS** will Save Money.



Only the machines that are in actual operation consume power. Over 25 other advantages.

Let us act as your engineers. We will save you money.

Roth Bros. & Co.
1422 W. Adams St., Chicago
New York: 243 Canal St.

1810 THE JAMES SWAN COMPANY 1912

SEYMOUR, CONN.
Manufacturers of

Mechanics' Tools, Augers, Auger Bits, Draw Knives, Chisels, Hollow Augers, Bits, Boring Machines, Gouges, Screw Drivers, etc.

Send for Catalogue



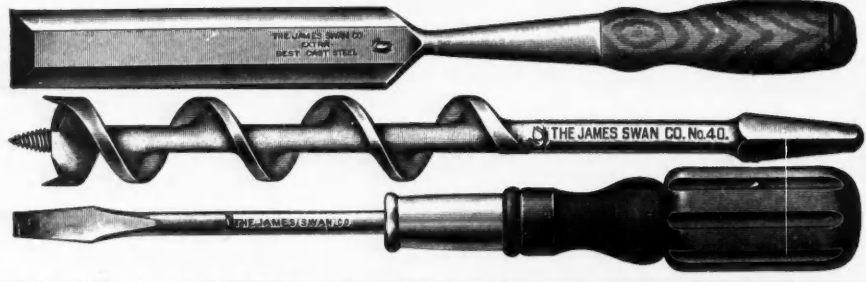

When looking for quality buy goods with the "Swan" trade mark.

When Writing Advertisers Please Mention the American Carpenter and Builder.

WIRE LATHING

The Secret of the durability of the woven wire lathing is owing to the fabric being completely embedded in the mortar, and thus secured from the corrosive action of the atmosphere; and also to the fact that rust will not attack the smooth round wire as it does the thin cut edges of a metal fabric.

"Why not use the proper kind of lath that lasts?"

Before building, write for our Booklet No. 6'A and "Prices."

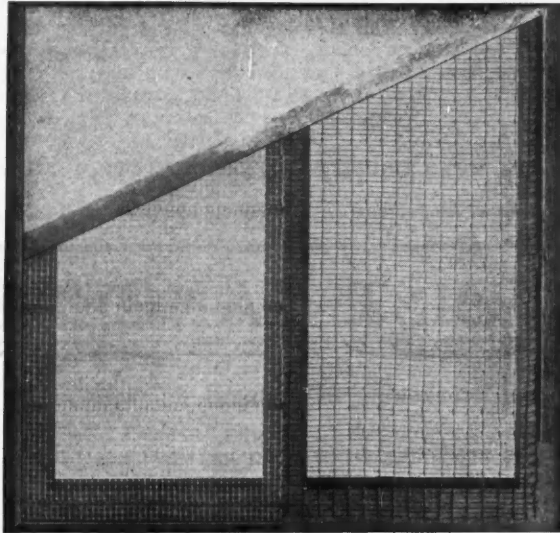

Grimm's Galvanized Corrugated Wire Lathing
"Patent applied for"

Greening's Patent Trussed Steel Wire Lathing

BUFFALO WIRE WORKS CO., BUFFALO, N. Y.

There is Money for You in Our Iron and Steel Work

Any Architect, Contractor, Builder and Carpenter can represent us locally—and make money.

We are specialists in the manufacturing of a varied line of iron and steel ornamental, architectural and structural work, such as iron stairs, fire escapes, window guards, fencing, grates, shutters, lawn seats, etc., etc.

You can find a big demand for our work in your locality—and you'll build up an independent business for yourself. Give just a small portion of your time to this and you'll profit by it.

Let us tell you in detail about our entire proposition. Write for our complete descriptive matter, etc. If you are now figuring on iron or steel work let us quote you before closing with any one.

THE MACK IRON AND WIRE WORKS COMPANY
SANDUSKY OHIO

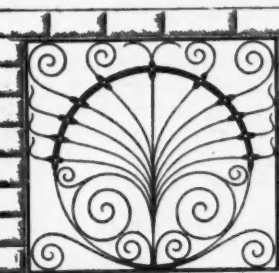

Mr. Builders—If you are lucky enough to read this advertisement, and wise enough to write and tell us what you buy in

IRON, BRASS and BRONZE

we will send you catalog that is attractive enough

to go in any man's library. Do you want it?

DOW WIRE & IRON WORKS

Incorporated
Louisville, Kentucky



On Equal Footing

The trained man has nothing to fear from Capital. He is a part of his employers' success and they acknowledge the fact by placing him in a position of importance at a fine salary. Foremen—Superintendents—Managers—these are men who are holding big jobs at ever increasing wages because of their training. Capital realizes that such men are the backbone of any business and treats them accordingly.

Nowadays, it is only the untrained man who claims that he is underpaid—that he can't make a living wage. A failure because of his lack of knowledge, he is doomed to stick to a little job at small pay for life. If he has ambition, he can easily train himself to get out of the rut. If not, he will plod along year after year as thousands of other men have done, believing his employers are holding him back and bewailing his luck because he never had a chance.

What will you be—trained or untrained? Respected and valued by your employers, or merely a laborer. Training is all you need to become a successful man. Training is all that is necessary to make Capital your friend.

The American School Will Give You the Training You Need

Write today, now, and learn how easy it is to get this training. Your name and address on this coupon will bring our School Bulletin and complete information regarding the course in which you are interested. We will tell you how you can become one of the men "higher up"—a man who is paid for what he knows, not for what he does.

Take this great step toward success now!

American School of Correspondence, Chicago, U. S. A.

Your Opportunity Coupon

Check the Course you want and mail the coupon now

American School of Correspondence, Chicago, U. S. A.
Please send me your Bulletin and advise me how I can qualify for the position marked "X." A. C. & B. 3-13

- | | |
|-------------------------------|-------------------------|
| ... Architect | ... Lawyer |
| ... Building Contractor | ... Bookkeeper |
| ... Architectural Draftsman | ... Stenographer |
| ... Structural Engineer | ... Private Secretary |
| ... Concrete Engineer | ... Accountant |
| ... Civil Engineer | ... Cost Accountant |
| ... Surveyor | ... Cert'd Public Acc't |
| ... Mechanical Engineer | ... Auditor |
| ... Mechanical Draftsman | ... Business Manager |
| ... Steam Engineer | ... Fire Ins. Inspector |
| ... Stationary Engineer | ... Fire Ins. Adjuster |
| ... Gas Engine Engineer | ... Fire Ins. Expert |
| ... Automobile Mechanician | ... Moving Picture Op'r |
| ... Electrical Engineering | ... Sanitary Engineer |
| ... Elec. Light & Power Supt. | ... Reclamation Eng'r |
| ... Electrical Wireman | ... Textile Boss |
| ... Telephone Expert | ... College Preparatory |

Address.....

Name.....

When Writing Advertisers Please Mention the American Carpenter and Builder.

TRADE **SIMPLEX** MARK
Reg. U. S. Pat. Office

THE LIFE OF A ROOF DEPENDS ON THE NAIL



Roofing nails are for paper, not metal, hence a large head is required. The Simplex has a head surface four times that of a so-called large headed nail. Head surface is what holds down roofing. Insist that the roofing comes to you with Simplex Nails. They are time savers as well as having head surface. Made with 1 inch and 1 3/8 inch lengths of stem, and both plain and galvanized. Shipped in cans in prepared roofing—store stock in 100 lb. kegs. Sold by dealers and jobbers.

Made by H. B. SHERMAN MFG. CO., Battle Creek, Michigan



Made in all sizes and styles for use with brick or concrete block walls or with wooden or steel beams.

TRUS-CON JOIST HANGERS

Avoid cutting away and weakening of timbers and walls—save labor, time and money.

Trus-Con Joist Hangers are made from open hearth steel plates, and are proven by actual test to be the strongest on the market. Note the bulb-shaped reinforcement at upper angle.

We also furnish Post Caps, Post Bases, Wall Plates and Base Plates made in rolled steel, malleable iron, or cast iron.

Write for catalog and prices.

TRUSSED CONCRETE STEEL CO. :: 344 Trussed Concrete Bldg. :: Detroit, Mich.

METAL LATH

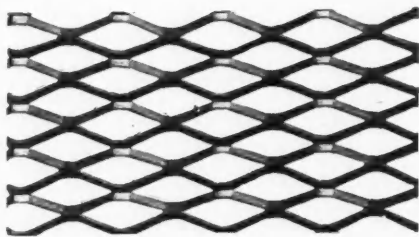

Sykes Expanded Cup Lath

FURNISHED WITH EITHER AN

“Anti-Rust” Coating, Painted Black
or Galvanized

WE ALSO MANUFACTURE

Sykes Trough Sheet Lath

WRITE US TODAY FOR
PRICES AND SAMPLES

The Sykes Metal Lath & Roofing Co.
NILES, OHIO

Be Certain You Get
The Hammer With The

Grip



This is the famous ATHA CLAW nail hammer. It is the hammer that will always draw a headless nail—a cement-coated wire nail—from the toughest oak.

This ATHA CLAW nail hammer grips the shank of a nail—and out she comes.

ATHA hammers are balanced properly. They are easily handled.

All ATHA hammers are carefully forged at uniform forging heats from high-grade bar steel. They are individually and thoroughly tempered. Handles are made from best obtainable all-white, clear, straight grained, second growth hickory. All hammers are finished with brilliant polish.

Look for the Horseshoe Brand

Carpenters and Builders: Get an ATHA CLAW nail hammer from your hardware dealers—if he cannot supply you, send us 65 cents and we will forward you, prepaid, one number one and a half Bell Face Hammer by parcels post.



The Atha Tool Company
NEWARK, N. J.

When Writing Advertisers Please Mention the American Carpenter and Builder.

WE WILL GLADLY Refund Your Money

If you are not more than pleased with our miter box. Send us money order for \$2.00 as first payment and this will give you a chance to examine Box. Fitted with 28x5 or 30x5 saw of the very best make.

\$8.95
cash or
\$10.00
on payments
\$2.00 down
and **\$2.00** per month.

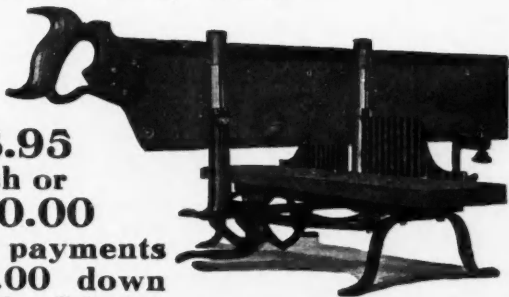

Formerly Sold for \$12.50

The only Miter Box on the market which is so constructed that the operator can with one hand raise saw and at the same time swing swinging bar to any desired angle—this leaves the other hand free to hold stock you are cutting.

We sell direct to carpenters—giving you the benefit of the middle man's profit.

We have other bargains in tools. Send for catalogue.

CROWN TOOL MFG. CO. :: Ottumwa, Iowa



CARPENTER MOUSE CHAIN

48 inches long, fitted at one end with patent sash cord fast, at other end with lead weight.

Price 30 Cents Postpaid
FREE

Our No. 5 Builders' Hardware Catalog and Net Price List. We do not sell to contractors or carpenters in Cook County, Illinois.

REHM HARDWARE COMPANY
1601 Blue Island Avenue
CHICAGO, ILL.



Do Away Sash Weights, Cord, Pulleys, etc.

BY USING
AUTOMATIC SASH HOLDERS

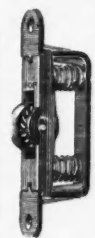

Easily Installed Simple Positive Durable Saves Money Prevents Window Rattling For Old as Well as New Windows Made in Three Sizes for Sash Weighing 35 lbs. and More

If your Hardware dealer does not have them send us \$1.00 for a trial set (enuf to equip two sash or entire window) all charges prepaid, stating weight or size of sash.

ANYHOW send for prices and literature NOW

AUTOMATIC SASH HOLDER MFG. CO.
52A CHURCH STREET, NEW YORK
Canadian Representative Smith Hardware Co., Ltd., Montreal, Que.

When Writing Advertisers Please Mention the American Carpenter and Builder.

An Architect That Figured Right

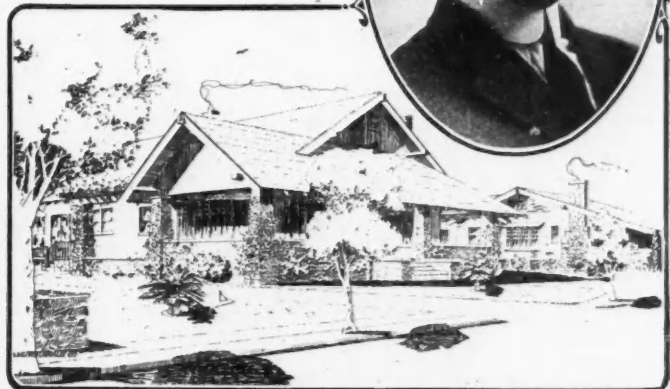

Some men that receive from \$10 to \$15 a week for their services claim that they have no chance of advancement. They figure that they must have reached their limit. Thinking that they have solved their problem, they drop into a rut and stay there.

But such men do not figure correctly. This is clearly shown in the experience of Mr. J. Alfred Larralde, formerly of Hastings, Neb., but now at 1121 South Olive St., Los Angeles, Cal. Six years ago this young man's earning capacity was less than that of the average day laborer. He might have reasoned that he had reached his limit, but he didn't. He figured that the only way to earn more would be to learn more, and accordingly he enrolled for a Course in the International Correspondence Schools. Today as a result of the instruction received from the Schools, Mr. Larralde is a high-class architect specializing in the designing of bungalows, schools, and residences, earning more money in a day than he formerly earned in a week. And all because he figured his problem right. If you are earning only \$10, \$12, or \$15 a week you are only at the threshold of your career. If you want information about the same instruction that Larralde received—if you want to know how your future can be made as bright as his—Mark and Mail the attached Coupon TODAY.

International Correspondence Schools

Box 910, SCRANTON, PA.

Please explain, without further obligation on my part, how I can qualify for a larger salary and advancement to the position, trade, or profession before which I have marked X.

Architect	Estimating Clerk	Automobile Runn'g
Arch'l Draftsman	Civil Engineer	Foreman Machinist
Contract'g & Build.	Surveying	Sh.-Met. Pat. Drafts.
Building Inspector	Mining Engineering	Textile Manufact'g
Structural Eng.	Mechanical Eng.	Bookkeeper
Structural Draftsman	Mechanical Drafts'n	Stenographer
Plum. & Heat. Con.	Stationary Eng.	Advertising Man
Supt. of Plumbing	Electrical Engineer	Window Trimming
Foreman Steam Fit.	Electric Lighting	Commerc'l Illustrat'g
Plumbing Inspector	Electric Railways	Civ. Service Exams.
Heat. & Vent. Eng.	Concrete Const'r'n	Chemist

Name _____

St. and No. _____

City _____

State _____

Present Occupation _____

Perhaps some of my fellow-workers would prefer the
**Oblong Carborundum Combination
Bench Stone**

to the round.—The difference is only in the shape.—Like every other Carborundum Stone they cut quick and clean—give your tools that keen, smooth edge—an edge that stands up. Every Carborundum Stone is uniform throughout—it has no soft spots—won't get slick—and it *will cut*.

You'll find the combination stones mighty handy—one side is coarse grit, for bringing the tool to an edge—the other side fine and smooth—to give the tool a keen finished edge—really two good stones in one.

You can always rely upon Carborundum Stones.—I know, because I use them.—I find them a tool-kit need—a work-bench necessity.

YOUR HARDWARE DEALER HAS THEM

Carborundum Combination Stone, No. 108 (oblong), \$1.25
Carborundum Combination Stone, No. 107 (round), 1.00

**PETE
SAYS—**

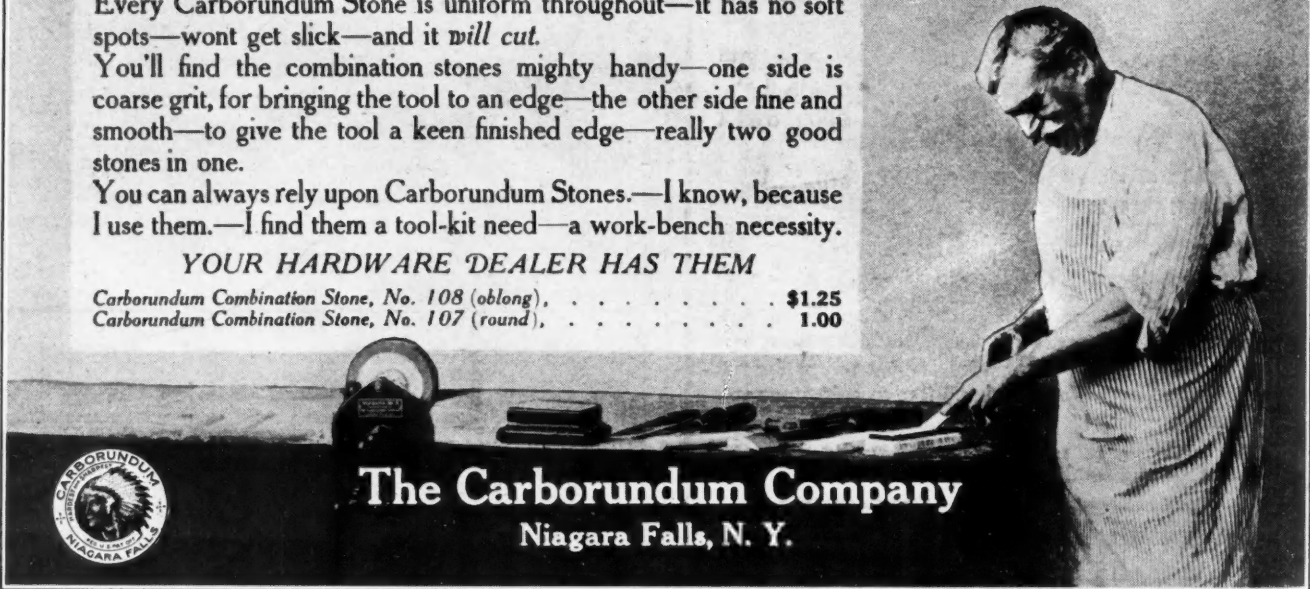

The Carborundum Company
Niagara Falls, N. Y.



The Ives Window Ventilating Lock.

A Safeguard for Ventilating Rooms.
A Lock, quickly applied and operated.
Affording Sure Protection against Intruders.

CHILDREN KEPT IN. BURGLARS KEPT OUT.
—WRITE FOR DESCRIPTIVE CIRCULAR.—

THE H. B. IVES CO., NEW HAVEN, CONN., U. S. A.



PATENTED



A HOT AIR FURNACE

For Less than
\$50 Complete
For 5 and 8 Room Dwellings

An unheard of Price and
a most Remarkable and
Indestructible Furnace

No Pipes No Lost Heat

**AMERICAN BELL AND
FOUNDRY CO.**
NORTHVILLE MICH.

Use KEROSENE Engine Free!

Amazing "DETROIT" Kerosene Engine shipped on 15 days' FREE Trial, proves kerosene cheapest, safest, most powerful fuel. If satisfied, pay lowest price ever given on reliable farm engine; if not, pay nothing. No waste, no evaporation, no explosion from coal oil.

Gasoline Going Up!
Gasoline is 9c to 15c higher than coal oil. Still going up. Two pints of coal oil do work of three pints gasoline.

Amazing "DETROIT"
—only engine running on coal oil successfully; uses alcohol, gasoline and benzine, too. Starts without cranking. Only three moving parts—no cams—no sprockets—no gears—no valves—the utmost in simplicity, power and strength. Mounted on skids. All sizes, 2 to 20 h. p., in stock ready to ship. Engine tested before crating. Comes all ready to run. Pumps, saws, threshes, churns, separates milk, grinds feed, shells corn, runs home electric light plant. Prices (stripped), \$29.50 up. Sent any place on 15 days' Free Trial. Don't buy an engine till you investigate money-saving, power-saving "DETROIT." Thousands in use. Costs only a postal to find out. If you are first in your neighborhood to write, you get Special Extra-Low introductory price. Write!

Detroit Engine Works, 495 Bellevue Ave., Detroit, Mich.



When Writing Advertisers Please Mention the American Carpenter and Builder.

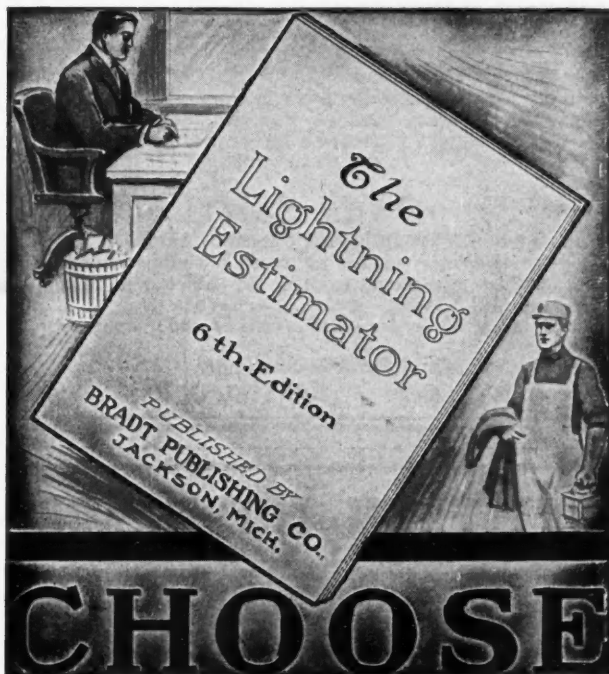

IT'S up to you to be the man at the top instead of the man with the dinner pail.

Don't hesitate to grasp this opportunity to win success, for there's always room at the top for the man who knows how.

The LIGHTNING ESTIMATOR

stops worry, lying awake nights, over or under estimating and guessing—in fact, by showing you how to estimate the cost correctly, it spells the word **Success** for you. Don't do yourself an injustice by passing up the greatest opportunity ever offered to Carpenter, Contractor or Builder.

The New Sixth Edition of the LIGHTNING ESTIMATOR

will teach you: How much time and material involved in each part of your work; how to figure on unfamiliar work; how to estimate quickly and correctly on a large job; how to estimate on time, material and prices in all parts of the country.

This Book is written by a man who has made good in this profession, and is based on hard, solid facts, secured by the knocks of experience, making it an invaluable guide to a one engaged in or those about to enter the building business.

If you are just starting out, here is your chance to get a firm foot hold. If you are an old timer and getting a little behind the times, here's your chance to brighten up and get some new ideas.

This Edition is bound in cloth, profusely illustrated—a feature not found in other books of this kind. The price, \$1.00. Don't delay. Send for it today.

BRADT PUBLISHING CO.

1260 Michigan Avenue

JACKSON, MICH.

*It has the best American record
None other makes so good a roof
or lasts as long*

**MERCHANT'S
OLD METHOD**

*That's the reason
Merchant's Iron Co.
Philadelphia and Eight Branches*

**Galvanized Iron
Cut Nails**



For shingling, slating, boat and wharf building, fencing, sheathing and all exterior work use **Anchor Brand Iron Cut Galvanized Nails** as they will outlast the best of wood under all climatic and weather conditions.

Write for Prices.

E. & G. Brooke Iron Company
BIRDSBORO, PA.



This Pearson's Automatic SHINGLE NAILER WILL PAY FOR ITSELF ON FIRST JOB

Do your nailing fast—faster than ever before—You can use this Pearson's Nailer on any pitch roof. Wear mittens, gloves, etc. This nailer holds about 600 nails—throw nails in by the handful—then start nailing. Nails easily driven through tin or quite heavy sheet iron.

These nailers are made in two sizes—The BLUE Nailer for 3d common No. 14 gauge wire nails. The RED Nailer for 3d galvanized No. 13 gauge 1 1/4 inch wire nails.

Get a Nailer through your dealer or direct from us, prepaid for only \$5.00.

Money refunded if not as represented.

PEARSON MFG. CO. - ROBBINSDALE, MINN.

When Writing Advertisers Please Mention the American Carpenter and Builder.

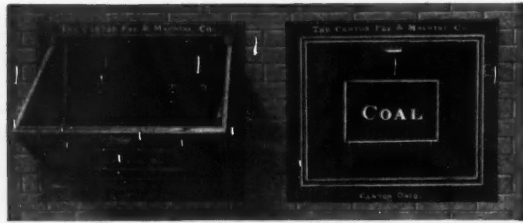

Made in various Sizes

Coal Pile—only by special key, furnished with the Chute. They are necessary for sanitary reasons—for the time and labor they save—for looks and protection they afford.

The Canton Coal Chute

Are made to last and at the same time be practical and ornamental.

Burglar Proof and Self Locking

Locks automatically when closed but can be opened from the outside—when owner wishes to avoid crawling over his soiled and battered Window Frames and Sashes, Littered Walks and Lawns.

We also manufacture Sidewalk Doors (45 sizes), Coal Hole Rings and Covers, and a host of other contractors' and Builders' Accessories.

Get our booklet "B-I" on "The Complete Line for the Contractors and Builders who know."

THE CANTON FOUNDRY AND MACHINE CO.

CANTON, OHIO, U. S. A.

The Bovee Furnaces

AT

Manufacturer's Prices



Will give every one of your patrons most perfect results. They last longer and actually require about one-half the fuel used by other furnaces.

They are made heavy, of the very best material and workmanship. Take your rule and measure the fire pots, the large combustion chamber and the long travel of heat and compare it with all other furnaces and see **WHY** the Bovee

uses less fuel and lasts longer than others.

Get our special prices. We can save you 40% on a heating plant. Any handy man can install them.

Bovee Furnace Works

50 Eighth Street

Waterloo, Iowa

BUY FROM THE MAKER



We have made and sold thousands of steel furnaces in Chicago, and we have sold them everywhere, by mail, direct to contractors, builders and house owners, all over the country, from Maine to China. We don't offer them through dealers, for the **DIRECT DEAL** with the consumer is the most satisfactory to all concerned. It means **BETTER SERVICE**—because of the direct interest of the maker in each contract—and it means **BETTER PRICES**, for the middlemen's profits are cut out.

In buying the Hess Furnace, you needn't have faith. You can buy it now, on trial, and test it before January 1st, 1918. We will deliver it at your station, with all

pipes and registers—freight prepaid.

Set it up and use it. If you're not pleased; not sure you have big value for the price—send it back to us—we paying return charges—and we won't claim one cent from you.

We don't offer you credit, however, for we require the price to be deposited with your local banker when you receive the goods. He holds it till the test is made, subject to the conditions outlined above, and gives it to you or to us, according to the result of the test. You take no risk, and you will save money.

Our furnace is made of steel, **EVERY SEAM WELDED**, and therefore permanently gas, dust, and smoke-tight. Made in six sizes, and burns any fuel. There is no furnace, better, at any price.

Our 48-page booklet on furnace heating is free. Ask for one. It will give you a lot of useful information on heating.

Hess Warming & Ventilating Co.

920 Tacoma Bldg.

Chicago

We make these beautiful white steel medicine cabinets, cheaper than wood.

ARCHITECTS! BUILDERS! CONTRACTORS!



Write at once for the Jahant Specification Hand Book. It contains information of value to you when drawing up plans, erecting, rebuilding and equipping of residences, schools, hotels, churches, apartment houses and business structures.

This book tells what you ought to know about proper heating and ventilation; tells why you ought to specify the Jahant Down-Draft Furnace; explains our co-operative policy of furnishing complete specifications, and blue prints of a made to order Jahant Furnace with complete installation equipment, the kind that you will be proud to include in your plans.

It tells how to estimate on the cost of proper heating equipment; how to reduce your bids and at the same time turn out a better job with a better profit for yourself.

It explains the construction and operation of the Jahant and how it delivers plenty of heat wherever and whenever heat is needed at a saving of one-third to one-half in fuel.

It tells how we back your recommendation of the Jahant Furnace with a legal binding 360 Day Guaranty Bond;—and it contains a lot of other information which you cannot afford to be without. Write for the book today. It's free.

The **JAHANT HEATING CO.**, 85 Mill St. Akron, Ohio

SPECIFY THE JAHANT DOWN DRAFT FURNACE

Mr. Contractor and Builder

Why not equip the home or other building you are erecting with

Davis

Acetylene Lighting?

You can greatly increase your income by selling and installing Davis Acetylene Lighting Systems for new buildings and during dull seasons for buildings already erected. No previous experience required and we help you get started.

Write us for cost of equipping a building and for our terms to salesmen.

Architects desire to recommend the best and we, therefore, invite them to carefully investigate what we have to offer.

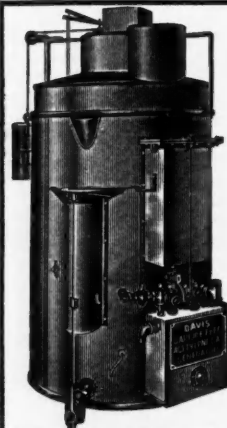

Davis Acetylene Company

90 Crawford St., Elkhart, Ind

When Writing Advertisers Please Mention the American Carpenter and Builder.



DOUBLE CLAW

MARK THE DIFFERENCE!

\$1



START



OUT

Fine Work Little Effort **Great Effort Bad Work**

Get it of your dealer for \$1 if not, send us \$1 and we will pay "Uncle Sam."

Double Claw Hammer Company,
Brooklyn, N. Y.

Gentlemen: Yours of Nov. 22 at hand, also hammer received,
 thanking you very much for your kindness in sending the new pattern hammer which I pronounce one of the best and handiest yet, especially for building staging and when raising, for nailing on braces.

I have shown it to my crew of at least 35 men and they say it is O. K. I may be able to sell some of them.

You can say, using my name, that the Double Claw, as well as the improved Single Claw is O. K., and I would not be without either.

Thanking you again, I remain,
Yours respectfully,
W. W. HAZEN

Perry, Iowa, Dec. 3, 1912.

City and State _____
 Address _____
 Name _____
 cannot supply me with a Hyman's Hammer. For uncased parcels post a Hyman's Gentleman: _____
 Double Claw Hammer Company, Brooklyn, N. Y.
 My dealer _____
 Clip and send in this Coupon _____
 75c at nearest store or send it to us and Hammer will go parcels post.

HOW TO READ PLANS

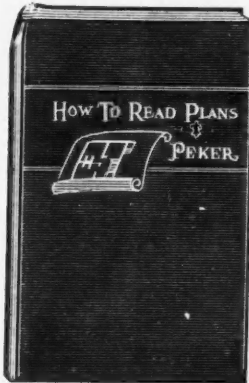

A Valuable New Book
 By
Charles G. Pekar
 88 Pages (5 x 7 Inches)
 43 Drawings in Text
 8 Large Folding Plates
 Handsomely Bound in Cloth

PRICE, 50 CENTS

Sent post-paid on receipt of price.

Your money back if you are not pleased.

MANY building mechanics are handicapped from getting more pay because they are unable to read plans and work from a drawing.

It is for these men that this book was prepared, as it simply explains the meaning of the various lines; plans, views, elevations, sections, scales, blue prints, devices, symbols, etc., to be found on a set of plans.

The book is finely illustrated by 43 illustrations in the text, and 8 large folding plates giving the full plan of a 6-room frame house. This set of plans alone is worth many times the cost of the book; an architect would charge at least \$25 for their equal.

It is one of the most valuable books ever got out for building mechanics, as its information means increasing a man's salary. It is pretty safe to say that to the man who cannot read a drawing now this book will mean at least \$50 more pay during the first year he has it.

INDUSTRIAL BOOK COMPANY

178 Fulton Street,

NEW YORK

WHITMAN'S SULTAN ENGINE

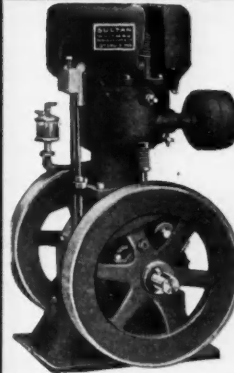

Yes, we are building Gasoline Engines
WHY?

The Steel Queen Gasoline Engine Hay Press Caused it

Hay Baling is Hard Work for Any Engine. Let us tell you all about this little Sultan engine, that will operate a hay press when others fail. Its construction is different than all others and it does its work with perfect ease, so we have decided to build more of them to let you use them on other kinds of machinery besides hay presses. We make the Sultan in seven different sizes, from 1 1/2 horse to 6 1/2 horse power and a better engine for contractors, manufacturers of concrete mixers, implement manufacturers and spraying concerns was never built. Write for special catalogue and see this great little engine before purchasing any.

Manufactured by Whitman Agricultural Co., St. Louis, Mo., U. S. A.

On the Square



every builder should have my little works and be a constant reader of the "Cement World," the leading paper of its kind published.



STEEL SQUARE POCKET BOOK.....\$0.50
 FOLDER (in case with pockets)......25
 DESIGNING (finely illustrated)......50
 CEMENT WORLD.....1.00

All for \$1.75.

\$2.25

DWIGHT L. STODDARD, Author of "Steel Square Pocket Book," 328 W. Raymond St., Indianapolis, Ind.
 Send for other Combination Offers.

When Writing Advertisers Please Mention the American Carpenter and Builder.



No. 24. 24-inch Aluminum Reversible All-around



No. 30. 30-inch Aluminum. Works Either End or Edge

Sand's plumbs and levels are made right in every detail. They are made by men with 25 years' experience in the building line. Men who know just what is necessary in good plumbs and levels.

The Sand's new model aluminum levels are the handiest and most useful levels made. They are strong, light and durable.

Sand's levels are always accurate. Both the new model aluminum and our famous wood levels always give the best of service. There are over 75,000 of our wood levels in daily use.

The aluminum levels are made of the highest quality tested metal.



No. 3024. Plumb and Level, 24-in. Works either end or side up.

The Sand's line is the largest line of levels made. Plain, brass-bound and aluminum. We can make anything to your order.

The Sand's levels are for sale by all good hardware dealers. Get them from your dealer or write us for detailed particulars, catalog, prices, etc.

Insist that the name SAND'S be upon your levels—look out for cheap imitations.



No. 3. Plumb and Level. Made in 72-inch lengths. Plain and brass lined. Works either end up. The only level of that length made. Fine for contractors and carpenters for door and window jamb work.

Use Sand's Plumbs and Levels—Nothing About Them to Get Out of Order



No. 1018. 18-inch.

The wood levels from very old, selected, seasoned White Pine.

In all our levels the spirit glasses are covered by plate glass protecting them from dust, dirt or moisture. The only levels so made. All vials are wired, showing up bubble accurately and readily.

J. SAND & SONS 1023-25 Rivard Street Detroit, Michigan

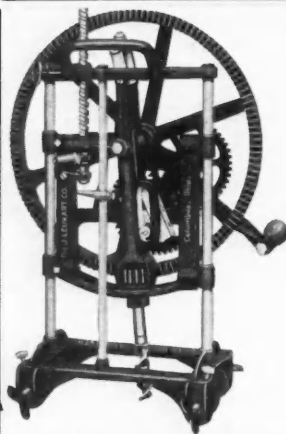

Champion Mortiser

Only machine that will mortise hard, soft or knotty wood, through dowel pins or panel ends with or against the grain of the wood with perfect ease.

Cuts a complete mortise with perfectly straight sides and bottom without the use of brace and bit or any other tool.

Adjustable from perfect round hole to 6-in. slot. Absolutely accurate in its work. Easy to operate. Built to last a lifetime.

Sent on Trial. Write for Descriptive Circular.

THE J. LEUKART CO.

32-40 East Columbus St. Columbus, Ohio

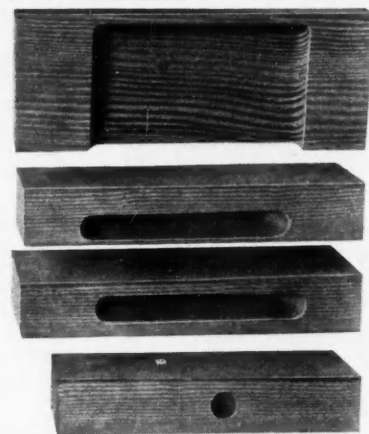

Evergrip Gliding Casters

Won't Scratch Floors!

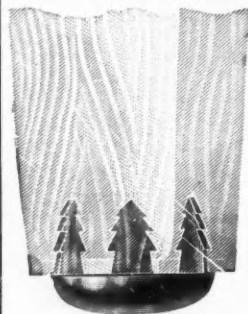

No Rollers. Save Floors, Carpets, Furniture. Noiseless. Furniture moves around without friction. Get the thanks of owners for showing them and show you're up-to-date. Cost 3½ cts. set. Sells 15 to 25 cts. Owners buy 25 to 100 sets. Sample set FREE. Write for Agency plan.

Evergrip Caster Co.
Dept. V, 20 Warren St.
NEW YORK

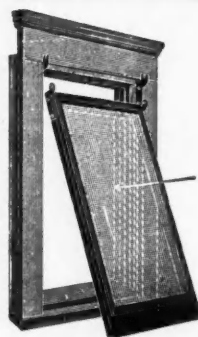

Use these E. Z. Way Hangers in putting up screens, storm sash and basement windows. They are time savers and all owners want them on their buildings.

Kindly note the E. Z. Way Hangers can be applied from the inside of the house, which is an advantage that no other hanger in the market has.

We are also large manufacturers of Screen Mouldings and "Clincher" Felt Weather Strip. Be sure and specify the DENNIS quality if you want the kind that is MADE RIGHT.

Manufactured only by

W. J. Dennis & Co. - 2226 W. Lake St., Chicago
Free Sample to any address for your Hardware dealers' name

When Writing Advertisers Please Mention the American Carpenter and Builder.

The Shelby CHIEF Double-Acting-Door Check and Floor Hinge in Operation

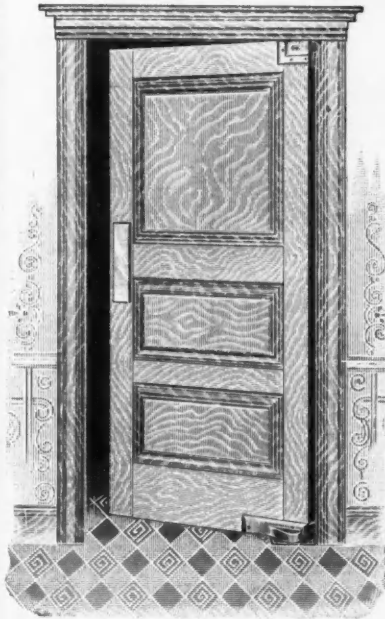

Every double swinging door should be equipped with this new and practical combination. It allows the door to open easily, and close without slamming, and swinging violently.

The cost is much less, but it accomplishes more than any other device for the same purpose.

Easily installed. No cutting in the floor. The hinge sets on the surface of the floor, and the Check on the upper back corner of the door.

Entire satisfaction guaranteed.

Ask your dealer, or ask us about it.

THE SHELBY SPRING HINGE CO.
SHELBY, OHIO

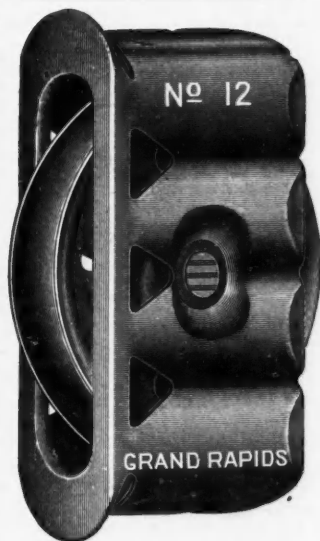

"GRAND RAPIDS" ALL STEEL SASH PULLEYS

**No Nails No Screws
Just Bore 4 Holes**

The time saved by the "Grand Rapids" will actually pay for the pulleys.

You can't afford to use old style pulleys.

Write for free samples and prices.



Grand Rapids Hardware Co.
Manufacturers
188 11th Street, GRAND RAPIDS, MICH.

This fastening is more secure than any number of screws or nails could make it. Saves about 15 per cent. too. **8 C R E W S COST MONEY**

Before You Plan or Build another Residence or Apartment House

"EVERY HANGER A CAR"

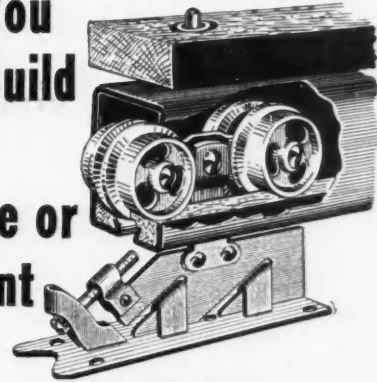

No. 221 R-W
"Advance" Ball-Bearing Trolley House Door Hanger

We want to send you, absolutely free of charge, a sample of our improved Richards-Wilcox House Door Hangers.

We want to place right in your hands one of these satisfaction-giving Hangers that are so popular with leading architects and contractors throughout the country. For we want to show and tell you all about the simple but effective adjustments, in both Hangers and Track, that provide for settling and sagging; the forged steel yokes; the ball-bearing wheels and center hung tracks that insure easy operating doors; the strongly constructed, clincher type, hard maple track that can be quickly and easily removed if required after plastering, without injuring or disturbing the walls, and a dozen and one other desirable features not found in any other hanger. In short, we want to prove to you that Richards-Wilcox Hangers are far superior in every way to the hangers you are now using.

Now then, it's up to you to decide whether or not you want a hanger that stands head and shoulders above the kind you are specifying or installing at the present time. If you do, accept our offer now, today. Don't lay this ad aside and "study about it," for if you do, the chances are ten to one that it will slip your mind, and you'll never think of it again. Send today for sample Hanger.

Richards-Wilcox



MANUFACTURING CO.
AURORA, ILL. U.S.A.



111 Third Street

When Writing Advertisers Please Mention the American Carpenter and Builder.

Fairbanks-Morse Oil Engines

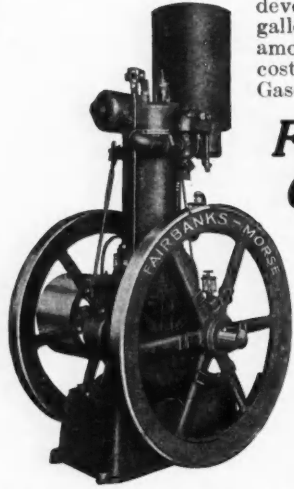

develop the same power on one gallon of Kerosene as on a like amount of Gasoline. With the cost of Kerosene half that of Gasoline the

**Fuel Cost is
Cut in Half**

Fairbanks-Morse Oil Engines are made of durable materials, are easy to operate and thoroughly reliable. They always develop more than rated power. Every engine carries the Fairbanks-Morse guarantee.

2, 3, 4, 6, 9 and 12 H. P. Vertical Engines. 2, 4 and 6 H. P. Horizontal

Engines. Other sizes up to 500 H. P.

Write for Catalog No. 1409F6.

Fairbanks, Morse & Co.

900 S. Wabash Ave., Chicago, Ill.

Hoists, Trench Pumps, Water Systems, Electric Light Plants.

The Ideal Contractors Hoist

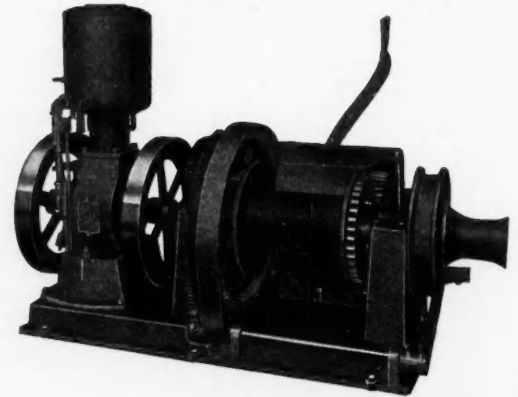

The first cost of the Ideal gasoline contractors hoist is much less than steam, and when equipped with our 5 H. P. Original Air Cooled Engine or our 6 and 9 H. P. Ideal Engine, is as reliable, and very much cheaper to operate. The design is simple, the material and workmanship the best. Let us send you our catalog of hoists, engines, etc.

The Original Gas Engine Co.

R. E. Olds, Pres.

630 Kalamazoo St. E.

LANSING, MICH.

Here is a Vacuum Cleaner That Never Clogs



Most any cleaner will clean your building sometimes, but there is only **one** cleaner that will clean it all the time, carrying out cigar butts, matches and other things that would completely stop the tools, hose and piping of ordinary systems.

THE **TUEC** STATIONARY
Vacuum Cleaner

never clogs because its piping is never less than 2 1/2 inches in diameter and the volume of air passing through it is always ample to carry off anything that can enter the tool. This free and unobstructed air passage through tools, hose and risers reduces to a minimum the friction of operation and enables the TUEC to do the most thorough and efficient work with the least consumption of current.

The simplicity of the TUEC with its enclosed centrifugal fan, direct connected motor and two-point ball bearing, renders it practically proof against break-downs, wear, misadjustment.

TUEC service includes scientific installation and proper location of risers and openings and makes unnecessary the use of long sections of hose.

For old buildings that cannot well be piped and for all buildings in which the present piping is inadequate, we have a special truck machine that can be moved from place to place like a portable, yet it retains all the essential features of the regulation TUEC construction.

The United Electric Co.

30 Hurford Street

::

::

CANTON, OHIO

TUEC Companies in Most Large Cities.

When Writing Advertisers Please Mention the American Carpenter and Builder.

"A Mix A Minute" —

Just the Mixer You Have Been Waiting For

One sixth yard per batch.
Two wheelbarrow loads.
Daily capacity up to 50 yards.

- A Mixer that mixes.
- A Mixer where you see what's going on.
- A Mixer that mixes all kinds of material.
- A Mixer that runs easy and takes little power.
- A Mixer that is easily loaded and unloaded.
- A Mixer that is easily cleaned.
- A Mixer that is strong and durable.
- A Mixer that will save you money.
- A Mixer that you buy at the right price.

Carpenters and Builders this Big and Little batch mixer was built especially for you. Write today for "Biganlitle" particulars and prices that will surprise you.



THE JAEGER MACHINE CO.,
216 West Rich St., Columbus, Ohio

THE EDWARD R. BACON & CO.,
Pacific Coast Representatives San Francisco, Calif.



Making ready to insert the floor beams.

Van Guilder Hollow Wall Concrete Machine— Continuous Air Chamber from Cellar to Roof

Steel Reinforced Throughout

DONT WASTE YOUR MONEY

The labor employed for making building material, such as blocks, brick, tile, etc., we utilize to erect the building. Completely revolutionizing building methods.

Our Walls are stronger

being double and monolithic from footing to roof plate, with a continuous air space everywhere between—a house within a house. The walls are tied together, also steel reinforced horizontally every 9' high.

Our Buildings are Warmer in Winter, Cooler in Summer

Damp proof Frost proof Fire proof Vermin proof No Maintenance Everlasting Cost Less Self Higher Exterior finished up-to-date Italian Stucco

Our Silo Machines

build the best silo walls in the world. Continuous air space. No freezing of ensilage. No vermin. No repairs. Stand forever.

Cold Storage Machine

Makes 3 walls and 2 continuous air chambers at one time. For cold storage, fruit and vegetable storerooms.

See Our Exhibit at the Chicago Cement Fair, Space 175.

VAN GUILDER HOLLOW WALL COMPANY 720 CHAMBER OF COMMERCE BLDG., ROCHESTER, N. Y.

THE PEERLESS CEMENT BRICK MACHINE

was designed at a time when there were no brick machine patents that interfered with the inventors' ideas.

He had a clear field and invented what time has proven the best cement brick machine made.

Since then others have tried to design a machine as good as the Peerless but couldn't do it—the Peerless patents were in the way.

Our catalog will tell you why the Peerless will make more perfect brick at less cost than any other cement brick machine on the market.

Write for illustrated catalog which also shows our Power machine.



Peerless Brick Machine Co.

19 N. 6th St., Minneapolis, Minn.

When Writing Advertisers Please Mention the American Carpenter and Builder.

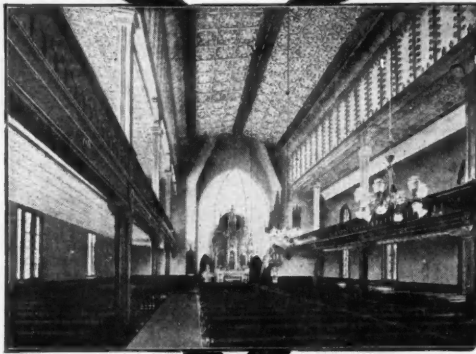

"BERGER'S"
Classik
METAL CEILINGS

**The Ceiling for the
Big Jobs**

The Berger Mfg. Co.
Canton, Ohio.

**For the best service address
nearest branch**

New York Boston Philadelphia
San Francisco St. Louis Minneapolis

We also manufacture Ferro-Lithic and
Multiplex Reinforcing Plates, Metal
Lath, Roofing, Eaves Trough and
Conductor Pipe and Sheet
Metal Building Products
of all kinds.

ASBESTONE

**GUARANTEED
SANITARY AND DURABLE**

**For Floors, Base and Wainscoting
Efficient—Permanent—Supremacy**

"ASBESTONE" is far cheaper than tile, more easily laid and in many other ways superior. Can be laid over any base, new or old, either wood or cement. Any color or combination of colors can be used. Our book on "ASBESTONE" will be sent free.

STEEL-BOND FLOORING

Is a high grade product of great durability. Has most of the qualities of Asbestone, but is not as fine grained nor will it take quite as high a polish. It is a superior and moderate priced flooring. Write us about it.

FRANKLYN R. MULLER CO.

312 North May Street

CHICAGO, ILLINOIS

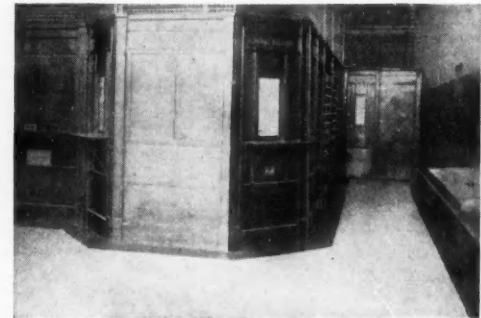

Post Office at Mansfield, Ohio

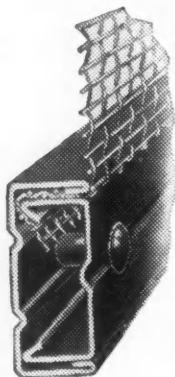

Fly Screens

**Metal Frame
REWIRABLE CIN-MAN-CO.**

See method of securing wire cloth, held by rounded corners, which prevents cutting by vibration.

**Special inducements to
Carpenters and Builders
Booklet Free**

**The Cincinnati Fly Screen Co.
1010-1026 Evans St., Cincinnati, O.**

Send for the Catalogs that Interest You

We manufacture, import and sell, wood, tile and cement mantels; andirons; fenders, spark guards; the Jackson ventilating grate, heating on two floors; Franklin stove for use where there is no chimney; cleanout doors, ash dumps and dampers for fireplaces; iron column plinth bases.

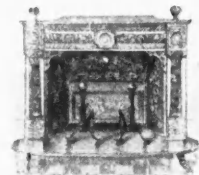

The Majestic coal chute for foundation walls.

Edwin A. Jackson & Bro., Inc.
51 E. Beekman Street New York

When Writing Advertisers Please Mention the American Carpenter and Builder.



Willis Skylights

are Self-Installing, designed and constructed to be installed with the least possible labor and expense. Any handy man can erect them with no tools other than a hammer and screw driver. We guarantee them absolutely water tight without the use of putty.

The ridge and gutter bars are so formed that it is impossible for the skylight to sag, buckle or spread.

Contractors and Builders—We want you to write today for our Catalogue No. 6, showing our full line of Sheet Metal Building Material. This book is very valuable to have before you when figuring and estimating. Send us your plans or specifications for an estimate.

WILLIS MFG. CO. Galesburg, Illinois

Manufacturers of
Wall Tiles—Cornices—Ventilators—Approved Fireproof Windows and Doors
—Crestings, Finials—Gable Ornaments and all kinds of Architectural
Sheet Metal



Two Door Value for One Door's Price

The perfect solution of the screen and storm door problem—the **Standard Combination**—the new door that appeals forcibly to the buyer, the tenant and the owner.

Standard

COMBINATION SCREEN & STORM DOOR

Two perfect doors in one—and at the price of one. Has a removable screen section, two-thirds the full height of the door, which can be removed in a minute, without tools, and replaced with the tight-fitting, wind-and-dust-excluding sash section, beautifully glazed and finished, making a perfect storm door.

Ask for a showing of patterns, and prices on Y. Pine, Cypress, White Spruce, Oak, Ash or Birch—we offer STANDARD Doors in all these woods. Write today.

THE COMBINATION DOOR COMPANY
105 Ruggles Street
FOND DU LAC, WISCONSIN

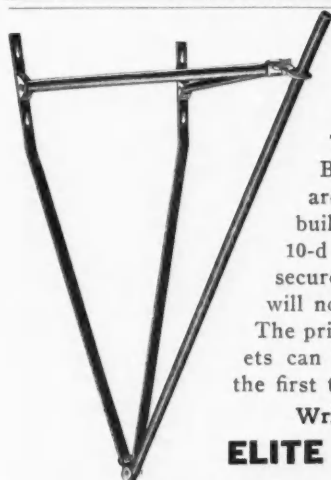

THE RELIABLE FOLDING SCAFFOLD BRACKET

The best and strongest Scaffold Brackets made. Only a few minutes are required to attach them to a building. No boring of holes as four 10-d or 16-d nails will fasten them securely. They are positively rigid and will not vibrate.

The price of a complete set of these Brackets can be saved in time and material on the first two contracts.

Write for circular B and prices.

ELITE MFG. CO., 100 Ohio Street, ASHLAND, WIS.



MADE TO ORDER Fly Screens and Screen Doors

We use the best grades of wire cloth, black enamel, galvanized, pearl and copper bronze, fastened by the Improved Standard Shoulder Strip Method, which makes the wire drum tight and firm, can not sag or pull away.

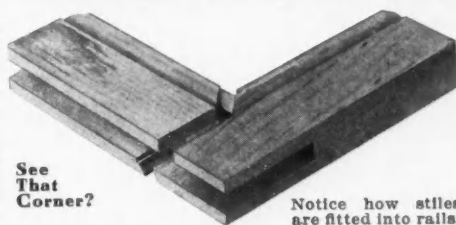

See That Corner?

Notice how stiles are fitted into rails.

Dealers, Carpenters, Contractors and Builders, write for a free copy of our 1913 illustrated catalog

STANDARD SCREEN CO., 1848-50 W. 14th St., Chicago, Ill.

Our screens are all mortised, tenoned, joined with waterproof glue and pinned with steel pins, will last a lifetime.

The Bessler Movable Stairway!

A device combining usefulness, strength and convenience.

- Saves Space! Low Cost!
- Strong and Durable!
- Easy to Operate!
- Operates Automatically!
- Adds Value to House!
- Reduces Fire Risks!
- Secures Good Ventilation!

Write for descriptive circular and price list to

The Bessler Movable Stairway Co.
AKRON, OHIO

We Allow Contractors a Commission.



The Bessler Stairway in Position.

When Writing Advertisers Please Mention the American Carpenter and Builder.

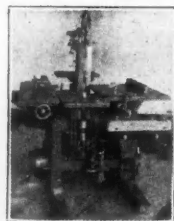
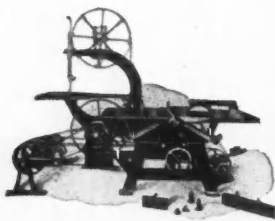

Let Us Quote You On
**Several Styles of
Combination Machines**

Lowest Possible Prices

United Machinery Company
86 Centre St. NEW YORK CITY

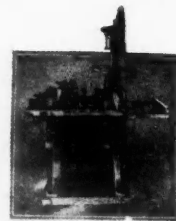
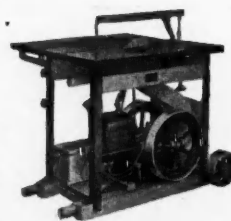

Electric Light from Kerosene!

Sandow Light Plants use kerosene as fuel and furnish electricity for almost nothing. Cheap to buy and cheaper to run. Sold on trial and absolutely guaranteed. Bulletin 300 describes an electric light outfit to suit your needs and your pocketbook. It's free.

DETROIT MOTOR CAR SUPPLY COMPANY, DETROIT, MICH.

"RANGER" BICYCLES

English featherweight steel mud guards, imported Brampton pedals, motor style saddles, bars and grips, and other distinctive features possessed by no other bicycle. No effort or expense has been spared to make the 1913 "Ranger" the **World's Best Bicycle**. Improved factory methods and greatly increased output for 1913 enable us to make a **marvelous new price offer**. Something very special to the first purchasers of 1913 Models in each town. Write us about it today.

WE SHIP ON APPROVAL without a cent in advance, to any person, anywhere in the United States, and **prepay the freight**. We only ask you to examine and try the "Ranger" without a cent of expense to yourself before you think of buying any other bicycle.

10 DAYS FREE TRIAL is allowed on every "Ranger" bicycle. Not a cent cost to you if you do not wish to keep it after riding it for 10 days and putting it to every test. Our "Ranger" bicycles are of such high quality, handsome appearance and low price, that we are willing to ship to you, **prepaid**, let you examine and try one and leave it entirely to you whether you wish to keep it or not.

LOW FACTORY PRICES Our great output, perfected methods and machinery enable us to offer you direct from the factory the best bicycle ever produced at a price that will be a **revelation to you**. Do not buy a Bicycle or a pair of Tires until you receive our large, complete catalog and learn our direct **factory price and remarkable special offer**.

SECOND HAND BICYCLES—a limited number taken in trade by our Chicago, Ill. stores will be closed out at once, at **\$3 to \$8 each**. Descriptive bargain list free.

RIDER AGENTS WANTED in every town and locality to ride and exhibit a sample 1913 "Ranger" bicycle furnished by us. In your spare time you can take many orders for our bicycles, tires and sundries. Write at once for our large catalog and a remarkable **special proposition** we will make you on the first 1913 models going to your town.

TIRES rear wheels with **coaster brake**, inner tubes, lamps, cyclometers, parts, repairs and everything in the bicycle line at **half usual prices**. Do not wait—write today for large catalog containing a great fund of interesting, useful bicycle information. It only costs a postal to get everything. Write it now.

MEAD CYCLE CO., Dept. N-122, **CHICAGO**

Triumph Light

All men and women in any occupation are now interested in light and should write today for particulars and find out all about our **TRIUMPH LIGHTS**

System, Stand and Portable Lamps

before you put in lighting plants or lamps of any kind and avoid regrets. They give 150 to 700 Candle Power Shadowless Light, that can be turned up and down like gas.

They meet all requirements of Home, Store, Church or business lighting, in or out doors at less than half the cost of kerosene or Electricity, simple enough for anyone to install and operate.

Write for A. C. B. catalog, it tells all about them

BRILLIANT GAS LAMP CO., Dept. 20, 182 N. State St., Chicago, Ill.

PHOENIX

INSIDE SLIDING BLINDS

WILKES BARRE, PA.

The Phoenix Sliding Blind Co.
Enclosed find my check for blinds. I am pleased with them and sorry I did not have them put throughout the whole house.
C. W. BURT.

Comfort!
Economy!
Convenience!

The lately improved springs and corrugated steel rods put the "PHOENIX" far in lead of less improved styles. Write for Catalogue "C" and free samples, showing construction.

PHOENIX SLIDING BLIND CO.
BRIDGE & CANAL STS. PHOENIX, N. Y.

Straight-grained cedar that cuts like cheese; smooth, tough leads that make clean-cut, strong marks—that's the way Dixon's Carpenter Pencils are described. Send 16c for generous sample lot 183J.

JOSEPH DIXON CRUCIBLE CO.
JERSEY CITY, N. J.

Buy Through Our Catalog and Save Money—

SEND FOR ONE NOW

We can give you big bargains in high grade sash, doors, frames, blinds, mouldings, inside trim, grilles, colonnades, tiling, roofing and building papers, wall boards, flooring of any kind, screens, steel ceilings, shingles, hardware, etc., etc.

Our catalog lists a complete line of best quality materials at rock bottom prices. We make prompt shipments. Get a copy of our catalog. Write in to-day for one. We can surely save you lots of money on your materials.

The Huber Builders Material Co.
45-49 Vine Street :::: CINCINNATI, OHIO

When Writing Advertisers Please Mention the American Carpenter and Builder.

Saves Ice and Trouble

Every home using ice needs this ice preparing cabinet. Any quality of ice secured instantly and easily. Vastly improves table service. No kitchen up-to-date without it. Shipping all over the country on approval. Not one turned down yet. Two sizes. Low prices. You'll regret leaving it out of your plans. Write for circular and prices.

MILLER MFG. CO.
Plymouth Bldg., Minneapolis, Minn.



An Opening for a Mortise Lock Can be Cut in Two Minutes by using the MILLER DOOR MORTISER

Little labor is required, and a perfectly true job is assured. Makes no difference what thickness the doors are, the device works true on them all. Complete with five cutters, covering locks from 1/2 inch to 1 1/2 inches thick. A real time and labor saver.

Ask for details of our trial offer. Literature on request.

A. W. Miller Mfg. Co.
Riverside, Cal. Cincinnati, O



Hammer Insurance



SPECIAL

¶ Our No. 21 1/2 "Vandor Vanadium" Nail Hammer!—We will send you Parcel Post for your Dealer's name and \$1.
 ¶ This Hammer we insure for life. Made for hard work and lots of it. ¶ You can return it any time if it proves defective and get a new one.
 This hammer is warranted to draw anything from a headless brad to a spike.
 ¶ Drop Forged from the toughest Vanadium Steel. Second growth hand shaved Hickory Handle. Tempered in oil. Easy to work with. Get one to-day. Remember only \$1 and your dealer's name. Mail your order NOW.
Van Doren Manfg. Co., Inc. Chicago Heights, ILL.
(Vanadium Dept.)

Metal Mitre Corners Save You Money and Time and



please your clients, too.
 By using my metal mitre building corners you do away with the time using work of cutting and fitting bevels. They will save you money and labor in finishing each corner.
 My corners take the place of corner boards. They are made of No. 28 gauge galvanized sheet iron. Easy to put on. Last for years. Make a strong neat corner finish. Each piece is painted with a preparation, forming a thin film of gray oxide of zinc, to which paint is guaranteed to stick firmly. I pay the freight. See article page 98, January American Carpenter and Builder.
 Write NOW for circulars, prices and samples.
H. G. ROBBINS, Kewanna, Ind.



The Truth About Credit

We give long credit— Ask no security—
 Ship on 30 days' trial
 Give extra time when wanted

That Means This

You can order from us whatever you want for your home on 30 days' free trial. If you wish to return it, we pay freight both ways.

We sell you on credit, without any security, any red tape or publicity. No interest, no extra price.

We guarantee to save you, and give a bond to save you, from 15 to 50 per cent.

We will let you pay as convenient—a little each month—by saving a few cents daily.

We have no collectors—you remit as you can by mail. If anything happens—sickness or loss of work—we will give you extra time.

A Million Do It

Don't say that such terms are impossible. A million people get them from us now.

And we will, when you write us, give you a Surety Company's legal bond that we do just what we offer.

4,782 Bargains A YEAR TO PAY

Furniture	Baby Cabs	Sewing Machines
Carpets—Rugs	Refrigerators	Kitchen Cabinets
Linoleums	Silverware	Cameras—Guns
Stoves—Ranges	Chinaware	Trunks, etc.

Dollar Book Free

Our Spring Bargain Book pictures 4,782 things for the home, many in actual colors. This mammoth book, with the mailing, costs us \$1 per copy. Write us for it—now, before you forget it. A postal card will do. We will then mail this big book free. (392)

Spiegel, May, Stern & Co.

812 W. 35th Street, Chicago

SLATE WE HAVE WHAT YOU WANT

*In Roofing Slate, Slate Blackboards
 Structural and Plumbers' Slate*

SATISFACTION GUARANTEED IN QUALITY AND PRICE

ASK FOR DELIVERED PRICES

J. K. HOWER, Station, C., Slatington, Pa.

R. J. KICHLINE, Sales Agent

When Writing Advertisers Please Mention the American Carpenter and Builder.

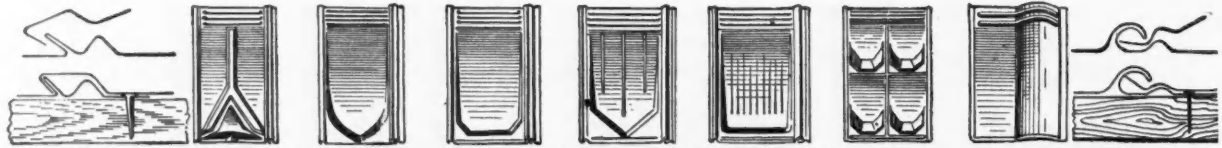

WALTER'S SHINGLES THAT LAST

The Leaders for Twenty-nine Years

Made from I. C. full weight roofing tin, painted or galvanized after stamping. Rust-, storm- and fire-proof. The most complete line of metal shingles and tiles manufactured.

Agents wanted in every community

National Sheet Metal Roofing Co.
JERSEY CITY, N. J.

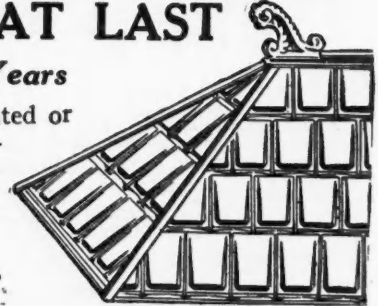
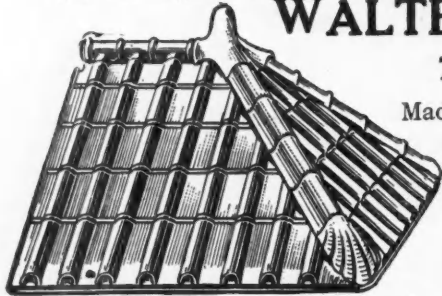

“MORRILL” Steel Forms Are Used

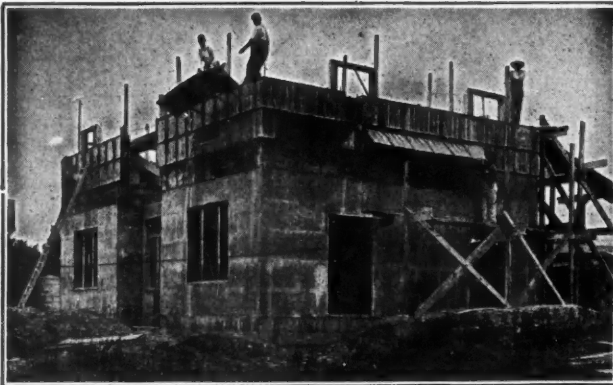

Wherever a durable, fire-proof, poured concrete building is wanted.

Are you a progressive contractor? Are you? Provide yourself with a set of “MORRILL” indestructible, water-tight, easy-working, adjustable forms and out-distance your competitors. You can erect a poured concrete building in less time and at less expense than any other kind.

For Poured Concrete Work

These forms have no equal. There are no bolts, nuts, wires—simple as can be and give a smooth surface. Construction companies use them to make poured concrete houses in one day.

Be a live one. It's easy with the Morrill System. How is it done? Write us today. You'll know tomorrow.

READ & MORRILL, Inc.

179 Jerusalem Street

BROOKLYN, N. Y.

MAPLE FLOORING. Diamond Hard
A SUPERIOR FLOORING. One that can be depended upon at all times to give maximum value at reasonable cost. It is all thoroughly kiln-dried, side and end matched, hollow backed, bored for blind nailing and STEEL POLISHED. For continuous wear and grind “Diamond Hard Maple Flooring” has proven its superiority.

Let Us Tell You More About It

“Than Which There Is None Better”
Menominee, Mich.

J. W. WELLS LUMBER COMPANY

ONE CONTRACTOR SAYS:

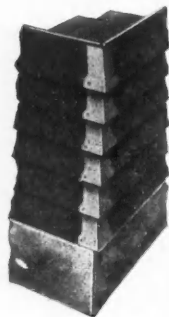

“I like Kees Metal Building Corners very much. They are cheaper and much better than corner strips. Give the building a fine finish. They save lots of time. I will not mitre any more corners so long as I can get them.”

Hundreds of Builders and Owners agree with him.

You want to find out about them. Write for free samples today.

If you've never used our Gossett Hinges for full length window screens, say so and we'll gladly send you a set for trial.

F. D. KEES ^{MFG. CO.} BEATRICE, NEB. Box 552

THE FOLDING DRAW KNIFE

It's the Draw Knife that's the seller
Right up to the Draw Knife law;
It's the workman's prize and treasure,
And the Draw Knife that will draw.



If your hardware dealer does not keep it, we will send it to your address postage paid. : :

A. J. WILKINSON & CO., 180 to 188 Washington St., BOSTON, MASS.

When Writing Advertisers Please Mention the American Carpenter and Builder.

The Only Asphalt Shingle That is Tapered

The Patented Taper Makes it Cling to the Roof.

Winthrop Asphalt Shingles

Will pave your roof with Asphalt half an inch thick, for the same money that you would spend for inefficient, inflammable wood shingles. Winthrop Asphalt Shingles are surfaced with chipped slate in rich, natural colors of green and red. They are very handsome and very durable. Practically fire proof.

Send for free sample.

The Winthrop Asphalt Shingle Company

8 61st Street

ARGO, ILLINOIS



SHEET METAL BUILDING MATERIAL

Roofing, Siding, Gutter Spouting'	Shingles Skylights Cornice Ventilators	Metal Ceilings Metal Lath Store Fronts Everything
--	---	--

"JUSTRIGHT" ROOFING
That Simple Roof That Don't Leak

A catalogue containing the largest variety of Sheet Metal Products in the world will be mailed free by addressing

The Moeschl-Edwards Corrugating Co.,
Covington, Ky.

Can be used as a
**Music Cabinet
Book Case or
China Cabinet**

Measurements:
Length 30 inches
Height 31 inches
Face 11 inches
Glass size 11x22

Chicago Grille Works
828-838 Wells Street
CHICAGO ILLINOIS
Special Prices to the trade.

"Last a Lifetime and Give Satisfaction To the End"

BUTT CHISEL

The celebrated Barton Planes and Edge Tools for carpenters and all other woodworkers are unequalled by any other made for keen, hard, smooth cutting edges. If your hardware dealer does not handle

THE CELEBRATED BARTON TOOLS

Send direct for catalogue and our free story book, True Stories. Be sure to specify "CARPENTER'S CATALOGUE."

**MACK & COMPANY, 20 BROWN'S BACE
ROCHESTER, N. Y.**

TRADE MARK
D. R. BARTON
1892
ROCHESTER, N. Y.

When Writing Advertisers Please Mention the American Carpenter and Builder.

Built-In Refrigerators

Every modern residence should have the convenience of the built-in refrigerator. The owner enjoys it because it saves the kitchen floor from being constantly mused up by the ice man. The contractor or builder is also happy if the refrigerator is the

McCray Refrigerator

Because it is so easy to install and so sure to exceed expectations in its superior ice saving insulation, its handsome finish and stout construction. The McCray patented system of dry, cold air circulation prevents all odors and keeps food always fresh and sweet. Easiest cleaned linings of opal glass, porcelain, enamel or odorless white wood—no zinc.

A full line of stock sizes which also may be provided with an outside icing door if desired. Send for any of the following catalogs:

Built to order for residences.....	No. A.H. 69	For meat markets.....	No. 60
For groceries.....	69	Regular sizes for residences.....	90
For flower shops.....	73	For hotels, clubs, institutions.....	49

McCray Refrigerator Co. 506 Lake Street, KENDALLVILLE, IND.
New York Branch, 231 West 42nd Street
Chicago Branch, 158 N. Wabash Avenue

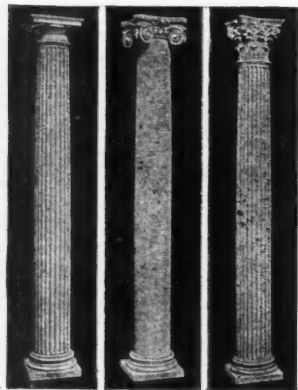
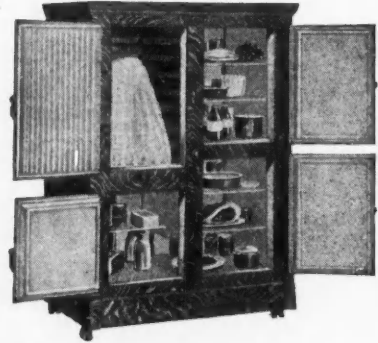

COLONIAL COLUMNS

Hegener's Patent Lock Joint Columns

We make columns from the smallest size up to 40 inches in diameter and 30 feet long. SEND FOR CATALOG



MANUFACTURED BY **RUDOLPH HEGENER CO.,** 9232 TO 9234 HARBOR AVE. CHICAGO

Composition Capitals



Roman Corinthian



Italian Renaissance

Don't Ask the Dealer for Sash Cord. Ask for **"SILVER LAKE"** and see that he gives it to you. It is impossible to



substitute as our name is stamped on every foot of cord. Silver Lake Sash Cord is the Original Solid Braided Cotton Sash Cord, and has been the standard since 1868. No other is just as good.

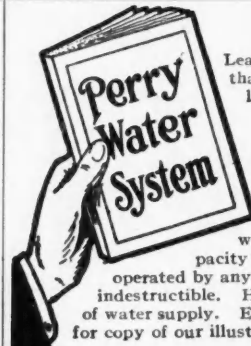

Send for This Book

Learn all about the only system of water supply that eliminates the storage of water. That delivers water fresh from the well. The

Perry Water System

provides all the conveniences of a city water works system. It is designed for large or small capacity—is easy to install in any old or new building—operated by any kind of power—economical and practically indestructible. Has more advantages than any other system of water supply. Every reader of this publication should write for copy of our illustrated catalogue. Address

UNITED PUMP & POWER CO.

495 Old Colony Building, CHICAGO

SEND POSTAL TO DAY

A FREE BOOK

On Concrete Machinery

**BUILDING BLOCKS
BRICK
PORCHES
CHIMNEYS
DRAIN TILE
SEWER PIPE
SILO BLOCKS
AND OTHERS**

It isn't exactly a catalogue because it gives you the cost of making concrete Blocks, Bricks, Porches, and Chimneys. It tells all about the profits in making Drain Tile for farmers. The advantage of drainage, etc.

You ought to have this book if you are interested in concrete. Sixty-four pages of illustrations and interesting reading. Send at once, today, a postal will do.



W. E. DUNN MFG. CO., 4132 Fillmore St., Chicago

Go After the Big Jobs!

If your job is not satisfactory, if your salary is not as big as you'd like it to be, if you want to know more about your trade, if you have no trade, if your future is still undecided—if you are any of the above and are ambitious enough to do a little studying in your spare time, we can lift you out of the low-paid, untrained class, thoroughly teach you a good trade, put you in a big job at a better salary and make you a successful man. That is the business of

Chicago Technical College

Students study plans of buildings actually being constructed. Work approved by leading Chicago architects and builders. *complete outfit free to students.* Low tuition. It costs nothing to mark and mail the coupon. Do it today—NOW! Remember, the home study work is the same as in the college day and evening classes. We give both resident and correspondence courses. State which you want.

CHICAGO TECHNICAL COLLEGE, 654 Athenaeum Bldg., Chicago, Ill. Gentlemen: I have marked with a cross (X) the branch or branches interesting me. Please tell me how I can qualify for a good, well-paying position.

- Architectural Draft'g
- Builders' Course
- Estimating
- Plan Reading
- House Planning
- Bldg. Superintendence
- General Contracting
- Structural Drafting
- Structural Design
- Mechanical Drawing
- Machine Drafting
- Machine Design

Name _____ Address _____

Town _____ State _____

Resident or Home Study Course _____

When Writing Advertisers Please Mention the American Carpenter and Builder.

EASY and SURE Steps to Higher Wages and Larger Contracts



The man who climbs to success is he man who knows how to do things in the best modern way. A bigger share in the

BUILDING OPPORTUNITIES OF TODAY

is surely yours to claim! You can do it without technical training or hard study. To master every detail of your trade or business will be a pleasure instead of a laborious task if you will let us send you for five days' free examination absolutely at our own expense and risk, a set of

RADFORD'S CYCLOPEDIA OF CONSTRUCTION

Carpentry, Building and Architecture

A Practical Uplift to Complete Mastery of Modern Building Methods and Materials

Twelve Massive Vols.—5,000 pages, 3,000 illustrations. Up-to-date, practical, thorough. All in simple English, without higher mathematics. Latest materials and methods. The cream of practical experience of the world's best known builders and contractors. Every detail covered—Carpentry; Framing; Concrete Work; Masonry; Steel Construction; Fire and Waterproofing; Drafting and Design; Heating; Ventilating; Plumbing; Decorating; Contracting; Estimating Cost, etc., etc.

Sent Anywhere on Approval

ORDER ABSOLUTELY AT OUR RISK

No Obligation or Expense to You Unless You Keep the Books
No Follow-Up Agents to Bother You

WHAT OUR FREE TRIAL OFFER INCLUDES:

12 Massive Vols.—Bound in ¾ Morocco leather, with full Persian library covers. A brand new work, costing over \$100,000 to compile and publish, built along new lines especially for the practical builder or contractor. Without magazine, \$1.00 less.

FREE Radford's Portfolio of \$30,000 Prize Building Plans—Over 300 designs of houses, bungalows, outbuildings, apartments, churches, etc. Ranging in cost to suit any purse.

FREE Complete Set of Guaranteed Working Blue-Prints and Specifications for any house design selected from Portfolio—Ordinarily costing \$75 to \$100. We will also include **One Full Year's Subscription to the "American Carpenter and Builder,"** the world's greatest building paper, without extra cost to you.

If you are a Carpenter or Builder, you can do all the ordinary work of the Construction Engineer or Designer without any deep mathematical calculations, thus insuring your title to better recognition, wider responsibilities and higher wages.

If you are a Contractor, your clients will appreciate dealing with a man who is able to give them the latest practical suggestions, and who has back of him the experience and resources of one of the largest architectural firms in the world.

12 MASSIVE VOLUMES

SENT ON APPROVAL FOR FIVE DAYS' FREE EXAMINATION

No Obligation. No Expense. No Risk to You
We Take all the Risk

READ THE COUPON

ON NEXT PAGE

RADFORD ARCHITECTURAL COMPANY, Entire 11th Floor, Medinah Bldg., Chicago, Ill.

SIGN AND MAIL COUPON TO-DAY

When Writing Advertisers Please Mention the American Carpenter and Builder.

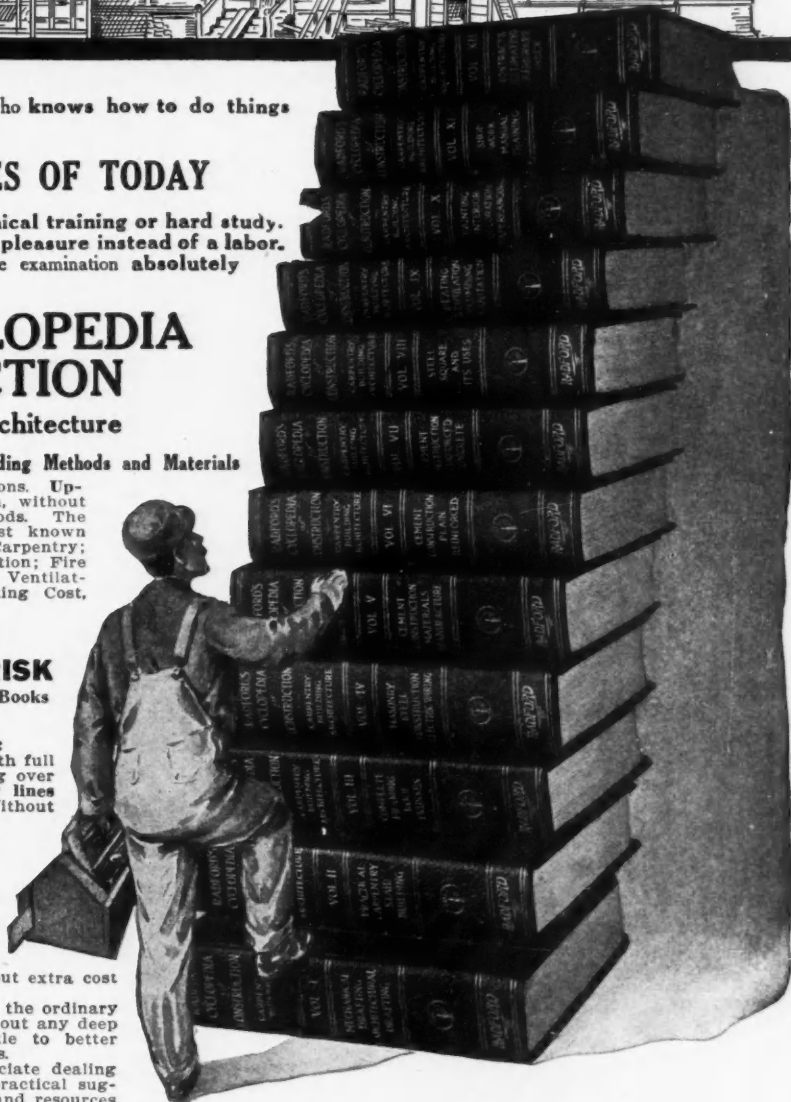



He Waited Too Long

"If I only had this set of books twenty or thirty years ago, they might have changed my whole life. The knowledge in the big CYCLOPEDIA would have enabled me to increase my earning power, to take on big work, paying big money, and possibly have helped me to make a fortune in the building business."

Hundreds of letters like the above have come to us, breathing between the lines the same pathetic story of regret—showing how hard it is for the untrained man to really get ahead in life. **The opportunity is yours NOW**, and the way is easy. **Don't wait too long. Don't wait at all.** Read the terms of our **NO-RISK, Guarantee Offer** over again, and **sign and mail coupon today.** You risk absolutely nothing, and you will reap the benefit ever afterward.

VERY BRIEF LIST OF CONTENTS

To realize their tremendous scope, you must see the books—you can get the books for five days' examination without cost to you.

A.C.B.
3-13.

**Radford
Architectural
Company**

11th Floor Medinah
Building, Chicago

Please send me, express prepaid, your 12-volume Cyclopedic of Construction, for five days' free examination, with privilege of return at your expense. I enclose \$1.00 deposit, which you agree to return if I decide not to keep the books after examination. If I keep the books, I will pay \$2.00 a month until the special price, \$23.80 is paid, otherwise I will notify you within five days after receipt of books.

Your offer also includes Radford's Portfolio of Plans (over 300 designs), and one full year's subscription to the American Carpenter and Builder. You also agree to furnish set of Blue Prints and Specifications, if ordered within 2 months after acceptance of books.

Name.....
Town..... State.....
Street.....

Carpentry.
House Framing
Uses of Steel Square
Rafters Cuts
Strength of Timber
Roof Trusses
Stair Building
Drafting and Design
Working Drawings
How to Read Plans
Blue-Printing
Architectural Forms
Architectural Lettering
Construction Contracts
Forms of Contract
Architect and Owner

Specification Writing
Inspection of Work
Cost Estimating
How to Bid with Safety
Timekeeping, Superintendence
Cement Construction
Origin of Portland Cement
Advantages of Concrete
Common and Hydraulic Lime
Cements (Portland, Natural, etc.)
Proportions for Mixing
Aggregates (Sand Gravel, Crushed Stone, etc.)
Mixing by Hand and Machine
Depositing Concrete
Concrete Troubles
Waterproofing Concrete
Concrete Blocks and Brick
Cement Mortar
Stucco and Plaster
Concreting Machinery and Tools
Concrete Mixers

Block Machines
Number of Blocks Required
Brick and Tile Machines
Forms (Wood, Metal)
Cement Houses
Foundations
Floors and Walls
Roofs and Chimneys
Fireproof Construction
Concrete Sidewalks
Ornamental Use of Concrete
Surface Finishes
Art Tile and Mosaics
Terrazzo Floors
Concrete on the Farm
Fence-Posts and Gate-Posts
Sewer and Drain Pipe
Concrete Silos
Reinforced Concrete
Principles of Design
Reinforcing Materials and Systems
Industrial Buildings
Concrete Piles
Sewer and Tunnel Work
Bridges and Viaducts
Culverts, Reservoirs

Estimating Concrete Work
Standard Specifications
Masonry Construction
Building Stone
Brick and Brickwork
Mortar for Masonry
Bonds and Joints
Steel Construction
Steel Shapes
Use of Handbook Tables
Allowable Stresses
Rivets, Tie-Rods
Columns, Beams and Girders
Floor and Roof Arches
Roof Trusses and Coverings
Mill Building Construction
Steel Bridges
Heating, Ventilation
Furnaces and Pipes
Plumbing
Sewers and Drains
Electric Wiring
Painting
Paperhanging
Furniture Making
Useful Tables, Rules, etc.

PIN A DOLLAR BILL TO THIS COUPON AND MAIL IT AT OUR RISK TODAY

**12 Big Volumes—Free Premiums—No Risk
SENT FOR ONLY \$1.00**

RADFORD ARCHITECTURAL CO.
Entire 11th Floor, Medinah Bldg., CHICAGO, ILL.

When Writing Advertisers Please Mention the American Carpenter and Builder.



\$13.95
per doz. 4 footers
—if you send cash
with order.

THE TAYLOR
STEEL SCAFFOLD BRACKET

Absolutely Safe; two of them will carry a ton, and they last a lifetime. Think of the time you save! One man alone can put them up and take them down easily and quickly.

No Side Swing if you purchase our new fixture at 50c extra per dozen brackets: these keep the brackets absolutely rigid.

Write for Catalog of Builders' Specialties!



THE TAYLOR

About clamps—the sliding jaw on each of ours can be moved in an instant **DIRECTLY AGAINST** the work operated on, so that half a turn of the fine specially threaded screw will apply the power.

Think of the time this saves!

The grip is positive, and special grade of steel in the bar more than doubles the strength of the clamp.

Our No. 10 catalogue shows some very interesting price reductions on four of the most wanted styles. It will pay you to write for it at once.

James L. Taylor Mfg. Co.
Poughkeepsie, N. Y., U. S. A.

CARPENTERS

In these days of close competition need the best possible equipment, and this they can have in

Barnes' Hand and Foot Power Machinery



Our new foot and hand power Circular Saw No. 4, the strongest, most powerful and in every way the best machine of its kind ever made. For ripping, cross cutting, boring and grooving.

SEND FOR OUR NEW CATALOGUE

W. F. & John Barnes Co.
74 RUBY ST. ROCKFORD, ILL.

MR. CONTRACTOR



Do you know that with our **Builders' Hoists and Double Platform material elevators** you can elevate more material at less cost than by any other known method?

Send for No. 21 Catalog and let us show you.

Bates & Edmonds Motor Co.
LANSING, MICHIGAN

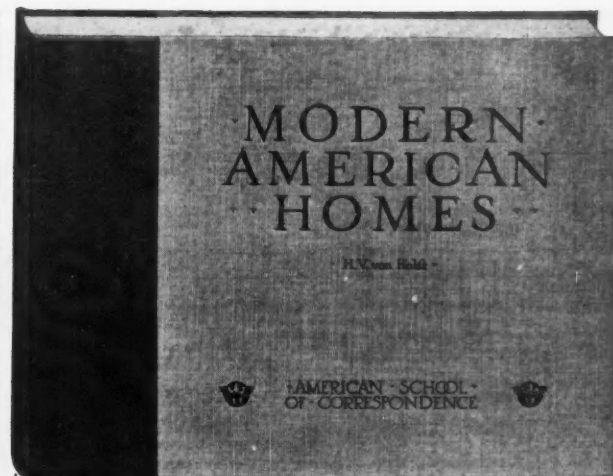

FREE to Carpenters, Contractors and Builders

This big, new Plan Book, **Modern American Homes**, containing hundreds of valuable suggestions, besides 108 plates with complete plans for every style of house, from the medium priced cottage to the most palatial suburban and city residence; also a large variety of apartment buildings, libraries, churches and institutional buildings, tent houses, garages, boat houses—the best in modern architecture by the greatest American Architects. This book of plans is 9 1/2 x 13 in., printed on special paper and substantially bound.

THE CYCLOPEDIA OF Architecture, Carpentry and Building



consists of ten massive volumes; 4,760 pages, 7x10 in.; 4,000 illustrations, full page plates, building plans, diagrams, etc.; hundreds of valuable tables and formulas; carefully cross-indexed for quick, easy reference.

This work covers everything in the building professions, from the first rough sketch of the architect to the acceptance of the finished structure. It includes wood, stone, steel, and reinforced concrete construction; estimating and contracting; a study of the Greek and Roman Orders; interior finishing and decorating; and modern house lighting and sanitation.

Partial Table of Contents—
Mechanical, Freehand, Perspective and Architectural Drawing, Lettering, Pen and Ink Rendering, The Orders, Superintendence, Strength of Materials, Masonry, Reinforced Concrete, Carpentry, Steel Square, Stair-Building, Hardware, Steel Construction, Roof Trusses, Practical Problems, Estimating, Contracts, Specifications, Building Law, Sanitation, Sheet Metal Work, Electric Wiring and Lighting.

We'll Send the Plan Book FREE

With every order for a Cyclopaedia we will include the Plan Book, absolutely free of charge and send you the Cyclopaedia and the Plan Book, express prepaid, for seven days' free examination. You keep the books a full week—examine them thoroughly at your leisure—and if they don't meet with your expectations they may be returned at our expense. Remember—the complete set, Cyclopaedia and Plan Book, are sent free upon receipt of the coupon below and we pay express charges both ways if they are not satisfactory.

Another Free Offer With each set is included a year's Consulting Membership, regular value \$12.00, entitling you to the free advice of a corps of Expert Architects. This will give practical help in handling building problems which are too specific to be taken up in the Cyclopaedia. This service alone is worth more than the first cost of the books.

American School of Correspondence, Chicago, U. S. A.

FREE PLAN BOOK COUPON

American School of Correspondence, Chicago, U. S. A.
Please send Free Plan Book, also Cyclopaedia of Architecture, Carpentry and Building for seven days' examination. I will send \$2.00 within seven days and \$2.00 a month until I have paid \$24.80 for Cyclopaedia (Plan Book included free), or notify you and hold books subject to your order. Title not to pass until fully paid. A.C.&B. 3-18

NAME

ADDRESS

EMPLOYER

When Writing Advertisers Please Mention the American Carpenter and Builder.

"Opportunities"

Have you anything to Sell, Barter or Exchange,
Want Help, Agents, or a Situation? Use our

Classified Department

RATES 5 CENTS A WORD. CASH WITH ORDER

No Display Type Allowed in Classified Advertisements

Patents

O. L. PARKER, PATENT ATTORNEY. Formerly member Examining Corps, U. S. Patent Office. 920 G. St., Washington, D. C. Pamphlet of instructions sent upon request.

PATENTS AND TRADE-MARKS SECURED. Send model or sketch for free search. HARRY PATTON, 355 McGill Bldg., Washington, D. C.

PATENTS THAT PROTECT AND PAY—Books free. Highest references; best results. Send sketch or model for free search. Watson E. Coleman, Patent Lawyer, 622 F St., Washington, D. C.

Instruction

DRAFTSMEN'S, BUILDERS' AND FOREMEN'S COURSES—Day, evenings or by mail. MAACK'S ACADEMY OF ARCHITECTURE, 1742 Chouteau Ave., St. Louis, Mo.

For Sale

FOR SALE—Custom Planing Mill. Farm Lands. W. L. MORSE, Mancos, Colo.

Wanted

WANTED—Reliable Barn Builders and Carpenters to handle a Guaranteed Four Lock Metal Shingle. Liberal Commission. Exclusive Territory. Apply at once, METAL SHINGLE CO., 343 Bellevue Ave., Detroit, Mich.

WANTED—Contractors to work with us, as we design plans for contractors only. Get our free 50-page book, "The Bungalow Book." Plans, specifications and bill of materials, \$5.00 and \$6.00. Commission on every plan, \$2.00. Become our representative. WOOLRIDGE ARCHITECTURAL CO., 308-310 Pierce St., Sioux City, Ia.

Miscellaneous

CEMENT FINISHING TOOLS, eighteen nickel plate, highest grade made, worth \$14.00; closing out price \$3.00. Catalogue. ERNEST BENNINGHOFFEN, Hamilton, Ohio.

SHEET METAL STAMPINGS, Dies, Tools, Experimental and Model Work. Send for catalogue of model supplies. THE PIERCE MODEL WORKS, 3405 Pierce Ave., Chicago, Ill.

FREE—\$1.00 Self-Setting Plane Certificate and Pencil Free. See advertisement on page 20. Self-Setting Planes on trial. GAGE TOOL CO., Vineland, N. J.

ANGLE TRISECTION—Mathematical Achievement—The "Famous Problem" solved. Send \$1.00 and get both methods of trisecting angles, mathematically. Reward of \$20.00 will be paid person successfully asserting methods defective. \$100.00 paid for accurate method of "angle trisection," previously. Angle Trisection, mathematically. Write C. W. TALBOT, Hanford, California.

CHAS. M. THOMAS, Architect at Clinton, Ind., desires manufacturers' catalogues.

MISSION FURNITURE, HOW TO MAKE IT—Our three books contain 98 designs, all different, and give all the necessary instructions for making each piece. Price, 50 cents per vol. or the three books for \$1.50, postpaid. POPULAR MECHANICS, Dept. A. C., 318 W. Washington St., Chicago.

DRAWINGS, Tracings, Blue Prints. DURHAM BROTHERS, draughtsman, 1213 Filbert St., Philadelphia.

ARCHITECT, Assoc. M. A. Soc. C. E.; wishes to expand his present business and to take one experienced country-house-builder for the East and West respectively, to execute his contracts. Partners must sell their business to new corporation and will receive salary and dividends. Well fitted carpenter shops required. Address: SPECIALIST, care of American Carpenter and Builder.

HOISTS & ELEVATORS



Columbia Dumb-Waiters
Pavement or Cellar Hoists
Jumper Disappearing Dumb-Waiters
Chain Blocks, Cranes and Trolleys

Send for Catalog

J. G. SPEIDEL : Reading, Pa.



Parkhill's New Universal Pitch Gauge

marks more Roof-framing in less time than any other tool or method. More pitches. More framing for each pitch. All given by other tools, also both bevels on plancher, fascia, sheathing, and purline; hip backing; octagon and irregular hips and jacks; hopper bevels, etc.

Gauge and Directions are so simple, easy and exact that even unskilled framers can mark all cuts, lengths, etc.—22—for any one pitch—of 100—in 5 minutes. Other tools use over 1000 figures—the Universal has 15 only. Fits any square. Unexcelled as stair and brace gauge. Prepaid for \$1.50. Money back if returned. Agents wanted. JOHN PARKHILL Rochester, Minnesota

THE ZIMMERMAN IRON BASE

is the ONLY BASE having a CENTER BEARING.

It carries the required weight without allowing the corner supports to sink into the floor and prevents the base of column and floor from rotting.

See "SWEET'S" page 876.

S. CHENEY & SON, MANLIUS, N. Y.



Bottom View Showing Center Bearing

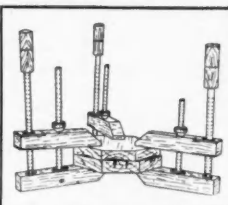

UNIVERSAL CLAMPS

The Illustration shows the superiority of the Ducharme Patent Universal Clamps over the old clamps, as it enables you to set your clamp on the bench while the work being glued is setting. It also has an advantage of using the Clamp in any position where the handles of the old one would not permit you to use, and in this way makes an indispensable device for bench work. For further particulars, please write for Circular C. M. and Price List. Manufactured by

THE DUCHARME MACHINE CO.

3389 Riverside Ave., Medford, Mass.

Axtell Weather Strips

ONLY practical and storm proof device for bottom of doors and swinging windows. In lacquered steel and polished brass. Over a million in daily use.

E. I. CHURCH & CO.,

WEST HANOVER, MASS

THE INTROSTILE

Door Bottom should be in every building specification. It does away with indoor thresholds and seals the cracks absolutely. Write for further particulars.

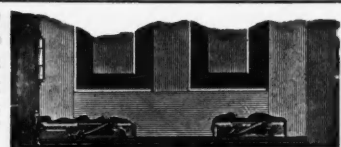

The Introstile & Novelty Co., Marietta, Ohio

When Writing Advertisers Please Mention the American Carpenter and Builder.



Ignores the Elements Defies Wear



Carpenters and Builders, for years you have experienced trouble, dissatisfaction and needless labor in applying Duck for porch Covering.

Then, after laying, the canvas soon buckled, split and rotted, resulting in constant complaints

WE SOLVE YOUR PROBLEM!!

Con-Ser-Tex Canvas Roofing reaches the seat of your trouble. It is of special construction, fibre-treated to prevent mildew and surface coated with non-oil ingredients to keep applied paint from injuring the fibre.

Write us for detailed particulars, prices and instructions as to just how to apply it.

Full information mailed free—and we can show you how and why you can profitably make use of CON-SER-TEX.

William L. Barrell Co., 8 Thomas Street, New York City

Chicago Distributor
GEO. B. CARPENTER & CO.,
Wells and Michigan Streets

Pacific Coast Distributors
WATERHOUSE & PRICE CO.,
San Francisco Los Angeles Portland Seattle

20 Reasons Why You Should Investigate the **SANDOW** Kerosene Stationary ENGINE



It runs on kerosene (coal oil), gasoline, alcohol or distillate without change of equipment—starts without cranking—runs in either direction—throttle governed—hopper cooled—speed controlled while running—no cams—no valves—no gears—no spockets—only three moving parts—portable—light weight—greater power—starts easily at 40 degrees below zero—complete, ready to run—children operate them—5-year ironclad guarantee—15 day money-back trial. Sizes 2 to 20 horsepower. Send a postal today for free catalog, which shows how Sandow will be useful to you. Our special advertising proposition saves you one-half cost of first engine sold in your county. (164)

Detroit Motor Car Supply Co.
196 Canton Ave. - Detroit, Mich.

A SHINGLING HATCHET

WITH POSITIVE GAUGE



CARPENTERS and BUILDERS

Here is a hatchet you can do some fast shingling with—No. 144 (oval head, 169 points.) Gauge is positive—it cannot slip. Clamps on with screw, gauge is readily changed. This hatchet is also made with flat head No. 44, 81 points, milled. Price of either is \$1.75 prepaid. We make a complete line—and the best—of Lathing Hatchets, from 64 to 225 points. Prices \$1.40 to \$1.75. You get your full money value in a Sayre Shingling or Lathing Hatchet. You can be positive of that. Find them at your dealers or sent direct.

L. A. SAYRE & SON
8 OLIVER ST. NEWARK, N. J.

Protect Your Valuable Tools

by using



a "STANDARD TIME" Keyless Chest Lock. Operated by knob in 3 seconds. Can be opened in the dark. Locks automatically as lid is closed.

Absolute Security

One cost only. No keys to lose. Fully guaranteed. Sent prepaid on receipt of Express or postal money order. Price \$2.50 each.

No. 3380 all Brass
Size 4x3 inches

State thickness of wood when ordering.

Miller Lock Co. Frankford, Philadelphia, U. S. A.

Lackawanna Motors

Simple—Few Parts—Built for Hard Use and Economical Operation.

Our Motors are equally successful when installed in Fishing, Freight, Work or Pleasure Boats and Launches. It's the Right Motor at the Right Price. Prompt Delivery. Absolutely Guaranteed. Our 1913 Catalogue tells all about it.

Lackawanna Manufacturing Co.
50 Chester Street Ballston Spa, N. Y.
BEACH & BARNARD, 126 Liberty Street
Agts. for New York and Vicinity.

Direct from the Manufacturer

A Wonderful Paint Offer



If any of your buildings need painting, write at once for our free paint sample offer. We sell the best ready mixed paint in the world at lowest prices ever heard of—55c a gallon for the best Barn Paint, \$1.15 a gallon for the finest House Paint in quantities. We pay the freight charges.

GUARANTEED MIXED PAINT \$1.15 A GALLON

Guaranteed for Ten Years

We furnish full directions how to do any job, and just now we are making a surprisingly liberal offer. Write at once and get this great paint offer, free shade samples, strong testimonials and valuable paint information. Just say "Send me your latest paint offer." Address

Crosby-Frank & Co., 298 Peoria Street, Chicago, Ill.

SHULTZ WINDOW BARS FOR STORE FRONTS

PATENTED

SHULTZ ALL-STEEL BURGLAR PROOF COAL CHUTES

PATENTED

The Newest, Strongest and most Convenient Coal Chute made. Eases and Low-cost. No modern residence complete without it. Looks itself when closed up. Can only be opened from inside. Architects, Contractors and Owners are invited to write for descriptive circular.

C. H. SHULTZ, Manufacturer, St. Joseph, Mo., U. S. A

When Writing Advertisers Please Mention the American Carpenter and Builder.

Take My New Engine —Use It 90 Days FREE!

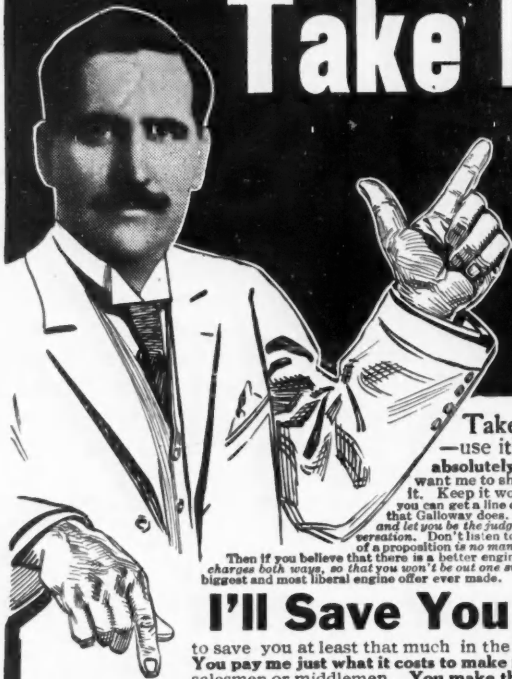

Take one of the wonderful new 1913 Model Galloway Gasoline Engines —use it right on your own farm for one month, two months or three months absolutely free. Write at once for my 1913 catalog—pick out the size and style engine you want me to ship you on this free offer—I'll ship it immediately. Put it to work on your farm the day you get it. Keep it working every day. Watch it carefully. Compare it with any and every engine on the market that you can get a line on no matter what the price. If anybody else is trying to sell you an engine, tell them to make you the same offer that Galloway does. Tell them Galloway is willing to put his engine right side by side on your farm with any other engine in the world and let you be the judge. Tell them you don't want any engine salesman trying to influence your judgment—you're buying engines not conversation. Don't listen to a man who isn't willing to let you judge his engine on its merits. The man who is afraid to meet me on that kind of a proposition is no man for you to do business with. Keep my engine a whole month or even two months or three months if you want to. Then if you believe that there is a better engine than the Galloway anywhere in the world at any price, tell me so and I'll take it back and I'll pay all the freight charges both ways, so that you won't be out one single cent for anything. If you do decide to keep the Galloway, just tell me so and I'll give you the benefit of the biggest and most liberal engine offer ever made.

I'll Save You \$50 to \$300 Sure! I'll make you an actual present of \$50 to \$300. I'll positively guarantee to save you at least that much in the first cost alone. I'll sell you a Galloway direct from my factory where it is made. You pay me just what it costs to make it plus one very small profit—that's all! There are no jobbers, wholesalers, retailers, salesmen or middlemen. You make their profits yourself when you buy a Galloway.

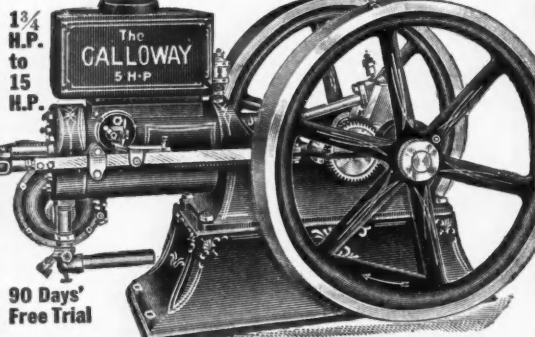

13 1/2 H.P. to 15 H.P.

90 Days' Free Trial

20,000 REASONS

Here are a few expressions from farmers now using Galloway Engines. Twenty thousand others have had exactly the same experiences. These are men just like yourself. Before they bought a Galloway they were in exactly the same position as you are now. You will say exactly the same as they do after you get your Galloway.

Alex. McLachlan, Argyle, Mich. I received my Galloway Engine last week and it is all right. Everybody says it is a dandy engine. Some of my neighbors got bit on other engines by paying \$400 for a 9 h. p. and \$460 for a 10 h. p. I like your engine dandy.

Fred Ruthardt, Mt. Vernon, S. D. I must say the engine is all right. I saved about one hundred dollars in buying from you. I don't want to be without the engine, not at all. I use it for shelling corn and grinding feed.

Frank Peck, Dorchester, Neb. My Galloway Gasoline Engine does lots of work for me. It shells corn, saws wood and grinds feed. I have no trouble with it. It is simple and easy to start. My twelve-year-old boy starts it easily.

(185)

Engines Carried in Stock at Chicago, Kansas City, Council Bluffs, Minneapolis and Winnipeg.

The Only Way Is the Galloway

That's the way to buy an engine, and it's the only way that's absolutely fair to you, and that's the only way that I'll sell an engine, because I won't keep a dollar of any man's money unless he would rather have my engine than the cash. When a man will tell me that—then and not until then do I consider a sale as made. Every single man who does business with me is absolutely protected by my

\$5,000 Challenge—\$25,000 Guarantee

I back every promise, every statement and every claim with \$5,000 in cash. I protect every one of my customers by a \$25,000 guarantee of absolute satisfaction. Understand, I don't say reasonable satisfaction but ABSOLUTE satisfaction—AND YOUR WORD is always good with me.

Special Service Bureau FREE

My force of high salaried Engine Experts are at your command absolutely without charge. They will tell you how to select exactly the engine which is best suited for your particular purposes; how to test and judge an engine; how to use one to best advantage; how to fit up a power house—besides answering fully and completely any question about the care and operation of an engine. This is absolutely free to you whether you buy a Galloway or not.

Important! Get My 1913 Proposition

This year, I've got something better to offer than I ever had before. I've got a plan by which you may get your Galloway Engine either wholly or partly free and, besides, without any soliciting or canvassing, whatever. I can't explain it now, but I tell you all about it in a personal letter when you write me.



Engine Book FREE

Now, don't wait a minute. Get my Engine Book and my special 1913 offer right away. You won't be under any obligations at all—I just want you to fill out the coupon or mail me a postal or letter, that's absolutely all I ask. If you haven't got a pen or pencil handy, go and get one and write me right away.

Wm. Galloway, Pres.

WM. GALLOWAY CO.
1145 Galloway Station, WATERLOO, IA.

Mail This Coupon

to Wm. Galloway, Pres.,
Wm. Galloway Co., 1145 Galloway Sta., Waterloo, Iowa.

I want to get your Engine Book, on your 90 Day Trial Offer and full particulars of your special 1913 proposition all free.

Name

Town

R. F. D. State

Big 144 Page Book of Furniture, Suggies, Harness, implements, etc., goes to you FREE.

INDEX TO ADVERTISEMENTS, MARCH, 1913

	Page		Page		Page
American Bell & Foundry Co.	164	Galloway Co., Wm.	184	Northwestern Compo-Board Co.	147
American Floor Surfacing Machine Co.	6	General Roofing Mfg. Co.	125	Northwestern Expanded Metal Co.	141
American Patent Sales Co.	17	Genuine Bangor Slate Co.	141	Novo Engine Co.	136
American Pulley Co.	17	Gibbons, M. J.	151	Oak Flooring Bureau.	145
American Saw Mill Machinery Co.	150	Gilbert & Bennett Mfg. Co.	146	Original Gas Engine Co.	170
American School of Correspondence.	161-181	Goodell Mfg. Co.	20	Oshkosh Mfg. Co.	3-4
American Sheet & Tin Plate Co.	144	Goodell Pratt Co.	22	Parker, C. L.	182
American Veneer Co.	31	Gordon VanTine Co.	188	Parkhill, John	182
Andrews Heating Co.	124	Grand Rapids Hardware Co.	169	Parks Ball Bearing Machine Co.	8
Arkansas Soft Pine Mfrs. Assn.	117	Grand Rapids Plaster Co.	112	Patton, Harry	182
Art Stone Co.	30	Grimm Mfg. Co.	13	Pearson Mfg. Co.	165
Atha Tool Co.	162	Hall Holmes Mfg. Co.	28	Peck, Stow & Wilcox Co.	108
Atkins & Co., E. C.	2	Hartman Sanders Co.	160	Peck Williamson Co.	126
Auld & Conger Co.	143	Haven Mfg. Co., The	5	Peerless Brick Machine Co.	171
Automatic Sash Holder Mfg. Co.	163	Heald Machine Co.	17	Perfect Wall Bed Co.	156
Barnes Co., W. F. & Jno.	181	Hegener Co., Rudolph.	178	Pettyjohn Co., The	26
Barrell Co., Wm. L.	183	Heppes Co.	139-155	Phoenix Sliding Blind Co.	174
Bates & Edmonds Motor Co.	181	Hess Warming & Ventilating Co.	83-166	Pierce Model Works	182
Batts, John Thomas	159	Hewitt-Lea-Funck Co.	111	Pike Mfg. Co.	157
Beach Mfg. Co.	12	Holland Furnace Co.	127	Plastergon Wallboard Co.	147
Beaver Co., The	147	Hoover Suction Sweeper Co.	12	Popular Mechanics	182
Beckman Co., The L.	19	Howar, J. K.	175	Pratt & Lambert Co.	115
Benninghofen, Ernest A.	182	Huber Builders Material Co.	174	Prentiss Vise Co.	25
Berger Mfg. Co.	172	Hunt, Helm, Ferris & Co.	157	Progressive Mfg. Co.	24
Berry Bros.	185	Hurley Machine Co.	5	Raber & Lang Mfg. Co.	157
Bessler Movable Stairway Co.	173	Huther Bros. Saw Mfg. Co.	20	Radford Architectural Co.	179-180
Bestwall Mfg. Co.	182	Hydraulic Press Brick Co.	34	Read & Morrill, Inc.	176
Bird & Son, F. W.	147	Industrial Book Co.	167	Rehm Hardware Co.	163
Bishop & Co., Geo. H.	24	International Correspondence Schools.	163	Richards Wilcox Mfg. Co.	169
Blystone Machinery Co.	28	Introstile & Novelty Co.	182	Rixson Co., The Oscar C.	20
Bommer Bros.	36	Irwin Auger Bit Co.	153	Roberts Mfg. Co.	155
Bovey Grinder & Furnace Co.	166	Ives Co., The H. B.	164	Robbins, H. G.	175
Bowman Supply & Mfg. Co.	148	Ives Motorcycle Corp.	136	Rodgers & Co., R. M.	14
Boyle Co., John	30	Jackson & Bro. Inc. Edwin A.	172	Rockford Mitre Box Co.	18
Bradt Publishing Co.	165	Jaeger Machine Co.	171	Roth Bros.	160
Brilliant Gas Lamp Co.	174	Jahant Heating Co.	166	Russell Jennings Mfg. Co.	21
Brooke Iron Co., E. & G.	165	James Mfg. Co.	156	Samsom Cordage Works.	7
Brooklyn Metal Ceiling Co.	145	Jennings & Co., C. E.	22	Sand & Sons, J.	168
Buck Bros.	23	Johns Manville Co., H. W.	110-140	Sargent & Co.	158
Buck Edge Tool Co., Charles.	160	Johnson, E. J.	24	Saygen Bros.	14
Buffalo Wire Works Co.	161	Johnson & Sons, S. C.	133	Sayre & Son, L. A.	193
Burlington Watch Co.	120	Johnston Paint Co., The R. F.	145	Schlueter, M. L.	7
Cabot, Samuel	36	Kalamazoo Stove Co.	105	Schouler Cement Construction Co.	153
Caldwell Mfg. Co.	25	Kanneberg Roofing & Ceiling Co.	32	Sears Roebuck Co.	118-119
Campbell Heating Co.	152	Karol, B. B.	33	Sedgwick Machine Works.	14
Canton Art Metal Co.	31	Keasbey & Mattison Co.	143	Seippel Lumber Co., Peter J.	160
Canton Foundry & Machine Co.	166	Kees Mfg. Co., F. D.	176	Seneca Falls Mfg. Co.	8
Canton Metal Ceiling Co., The	145	Keighley Metal Ceiling Co., S.	31	Shelby Spring Hinge Co.	169
Carborundum Co.	116	Keplinger, G. J.	6	Sheldon & Co., E. H.	25
Carey Mfg. Co., The Phillip.	164	Kewanee Boiler Co.	159	Sherman Mfg. Co., H. B.	162
Central Mantel Co.	33	Kissel Motor Car Co.	138	Shultz, C. H.	183
C. H. & E. Mfg. Co.	9	Knickerbocker Co.	29	Sidney Elevator Mfg. Co.	14
Champion Safety Lock Co.	23	Kolesch & Co.	19	Sidney Tool Co.	10-11
Chelsea Elevator Co.	156	Lackawanna Mfg. Co.	183	Silver Lake Co.	178
Cheney & Son, S.	182	Lane Bros. Co.	23	Simmons Hardware Co.	149
Chicago Grille Works.	177	Lansing Co.	28	Simonds Mfg. Co.	149
Chicago Housewrecking Co.	128-129	LaPlant Tool Co.	153	Slatington Slate Co.	17
Chicago Machinery Exchange.	9	Leukart Co. J.	168	Smith & Hemenway Co.	18
Chicago Millwork Supply Co.	134	Lorenzen & Co., Chas. F.	33	Smith Co., The T. L.	28
Chicago Spring Butt Co.	36	Lorenzen Trunk Works, Wm.	22	Southern Cypress Mfrs. Assn.	123
Chicago Technical College.	178	Love Bros. Inc.	139	Southington Hardware Co.	153
Chicago Spring Butt Co.	36	Lufkin Rule Co.	20	Spaulding Print Paper Co.	149
Chief Draftsman.	109	Luther Grinder Mfg. Co.	154	Speidel, J. G.	182
Church & Co., E. I.	182	McCray Refrigerator Co.	178	Spiegel, May Stern Co.	175
Cincinnati Fly Screen Co.	172	McHenry Millhouse Mfg. Co.	187	Standard Scale & Supply Co.	27
Cincinnati Tool Co.	12	Maacks Academy of Architecture.	182	Standard Screen Co.	178
Clow & Sons, Jas. C.	130	Mack & Co.	177	Standard Mfg. Co.	14
Coleman, Watson E.	182	Mack Iron & Wire Works.	161	Stanley Rule & Level Co.	23
Combination Door Co.	173	Majestic Furnace & Foundry Co.	149	Stanley Works, The	151
Corbin, F. & F.	113	Marsh, H. O.	36	Star Expansion Bolt Co.	158
Cortright Metal Roofing Co.	142	Mastic Wall Board Rfg. Mfg. Co.	186	Starrett & Co., L. S.	19
Crescent Brass & Pin Co.	21	Mayhew, H. H.	25	Stern Mfg. Co.	6
Crescent Machine Co.	15	Mead Cycle Co.	184	Stoddard, D. L.	167
Crosby, Frank & Co.	183	Meadow Brook Slate Co.	143	Swan Co., Jas.	160
Crown Tool Mfg. Co.	163	Merchant & Evans Co.	165	Sykes Metal Lath & Rfg. Co.	162
Davis Acetylene Co.	166	Metal Shingle Co.	182	Talbot, C. W.	182
Deco Mfg. Co.	31	Miami Cycle & Mfg. Co.	137	Tannewitz Works, The.	8
Dennis & Co. W. J.	168	Middletown Machine Co.	159	Taylor Mfg. Co., Jas. L.	181
Detroit Engine Works.	164	Miles Mfg. Co., The	26	Thomas, Chas. M.	182
Detroit Motor Car Supply Co.	174-183	Miller Lock Co.	183	Topp & Co., G. A.	22
Detroit Show Case Co.	20	Miller Mfg. Co.	175	Triple A. Machine Co.	7
Didrikson, H. P.	5	Millers Falls Co.	18	Trussed Concrete Steel Co.	162
Disston & Sons Co., Henry.	158	Millwaukee Corrugating Co.	32	United Electric Co.	170
Dixon Crucible Co., Jos.	174	Miotke, Jos.	5	United Machinery Co.	174
Double Claw Hammer Co.	167	Monarch Mfg. Co.	6	United Pump & Power Co.	178
Dow Wire & Iron Works.	161	Montross Metal Shingle Co.	143	Van Doren Mfg. Co.	175
Ducharme Machine Co.	182	Moorman & Otten Co.	33	Van Guilder Hollow Wall Co.	171
Dunn & Co., W. E.	178	Morrill, Chas.	36	Wausau Sand Paper Co.	131
Durham Brothers.	182	Morse, W. L.	182	Weber Mfg. Co.	7
East Bangor Consolidated Slate Co.	160	Muller Co., Franklyn R.	172	Wells Lumber Co., J. W.	176
Eastern Granite Roofing Co.	143	Mullins Co., The W. H.	32	White Co., David	19
Edwards Mfg. Co.	30	Myers & Bros., F. E.	14	White Co., The	16
Eggers Veneer Seating Co., The F.	122	National Mfg. Co.	106-107	Whitman Agricultural Co.	167
Elite Mfg. Co.	173	National Sheet Metal Roofing Co.	176	Wilkinson & Co., A. J.	176
Eureka Machine Co.	151	North Bros. Mfg. Co.	21	Willis Mfg. Co.	173
Evergrip Caster Co.	168	Northern Hemlock & Hardwood Mfrs. Assn.	121	Winthrop Asphalt Shingle Co.	177
Fairbanks, Morse & Co.	170	Northfield Iron Co.	26	Wolff Mfg. Co., L.	114
Fay & Egan Co., J. A.	12	Northrop, Coburn & Dodge Co.	153	Woodwell Co., Jos.	152
Flintkote Mfg. Co.	155			Woolridge Architectural Co.	182
Fouk, Jones & Sons	30			Worcester Mfg. Co.	25
Fox Machine Co.	8			Yale Mfg. Co., C. B.	149
Fox Supply Co.	6				
Frost & Adams Co.	19				
Gage Tool Co.	20-182				

NOTICE TO ADVERTISERS

Forms for the April number of the American Carpenter and Builder will close promptly on March 20. New Copy changes and orders for omissions of advertisements must reach our business office, 178 West Jackson Boulevard, Chicago, not later than the above date. If new copy is not received by the 20th of the month preceding date of publication the publishers reserve the right to repeat last advertisement on all unexpired contracts. AMERICAN CARPENTER & BUILDER CO.

Save Time In Spring Building!

You save a month's time on your Spring Building job by using Bishopric Wall Board for walls and ceilings. Comes ready to use. Goes on dry. Just nail it to bare studding and walls are ready at once for any kind of decoration. Edges meet evenly. No panning needed.

For the modest cottage or the finest house or bungalow, there's nothing better than this wonderful non-warping, fire-resisting Wall Board. Beats plaster—looks better, lasts longer and costs a lot less.



No Skill Needed to Apply It.

Cut Plastering Cost in Half

You cut in half the cost of lath and plaster by using Bishopric Wall Board. Any carpenter can apply it. No annoyance or expense for additional labor—no lathers, no plasterers.

Is ideal for building partitions or remodeling. You can build partitions, apply Bishopric Wall Board, and have room ready for decorators the same day. Is used for turning waste attic or basement space into splendid, usable rooms. No dampness, no dirt.

BISHOPRIC WALL BOARD

Stays Stiff—Can't Warp

This is the only wall board reinforced with lath. Kiln-dried dressed lath are embedded in toughened Asphalt-Mastic (a non-burnable material) and surfaced with heavy sized fibre-board. Is moisture-proof, rat-proof, sound-proof and fire-resisting. Makes a smooth enduring surface that stays stiff.

Users Delighted

The Mastic Wall Board & Roofing Co.,
Cincinnati, Ohio.

Gentlemen:—A few years ago I got some of your wall board and sheathing which has given the best satisfaction, and would like to know present prices on the same kind of goods. Will need about two thousand square feet.

Will you kindly quote prices, and oblige?

(Signed) J. E. BATTEY,

317 Sweetbriar Street, Pittsburgh, Pa.

\$5,000 Anti-Warp Bond

Bishopric Wall Board will not shrink, crack, buckle or pull loose in any climate, winter or summer. This claim is backed by our \$5,000 Anti-Warp Bond. Every purchaser is protected by this bond.

\$2.50 for 100 Square Feet

Comes in sheets 4 ft. square, ready for use. Prices \$2.50 for 100 square feet; \$6.40 per crate of 16 sheets, 256 square feet. Anyone who can drive nails can apply it.

Write for Free Book and Big Sample

Send for Free Book describing and illustrating Bishopric Wall Board and Sheathing, also Free Sample and complete set of Blue Print Plans for Model House. Send 6c in stamps for packing and mailing.

DEALERS: Write for Great Exclusive Agency Proposition!

THE MASTIC WALL BOARD & ROOFING COMPANY

1452 Este Avenue, Cincinnati, Ohio

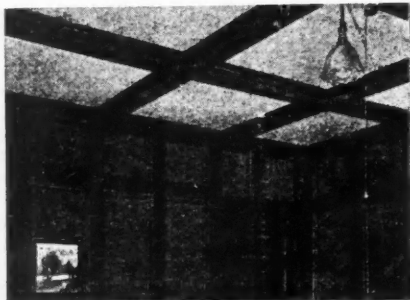

Bishopric Rooms Are Artistic



Free Sample

When Writing Advertisers Please Mention the American Carpenter and Builder.

VERIBEST

the ASPHALT SHINGLE that satisfies

The days of the wooden shingle are past. Twentieth century methods demand a roof covering that must be weather-proof fire-proof, easily laid, lasting and of good appearance. These requirements are met by "Veribest" Asphalt Shingles — and by no other method of covering roofs of residences, churches, schools and other public buildings.



TEN BIG ADVANTAGES

Ask yourself what features are needed for roof coverings, and you'll find every question answered by Veribest Shingles. No further arguments are needed than the following description of Veribest Shingles to convince every carpenter, builder and houseowner of their adaptability to almost any kind of building:

Being composed of Asphalt they are especially fire-resistant.

Their appearance is more attractive than any other method of covering roofs.

Painting is entirely unnecessary.

Their colors will never fade.

The first cost is no more than wooden shingles.

They reduce insurance rates.

They make the house warmer in winter and cooler in summer.

Being practically indestructible, they will outlast the house.

Cannot warp, curl or become dislodged.

Are adaptable to any construction of roof.

Their comparatively low initial cost, and ease of laying, make Veribest Shingles the most economical in initial cost, while their lasting qualities make them far cheaper in ultimate cost of any known. Write for catalog giving full particulars.

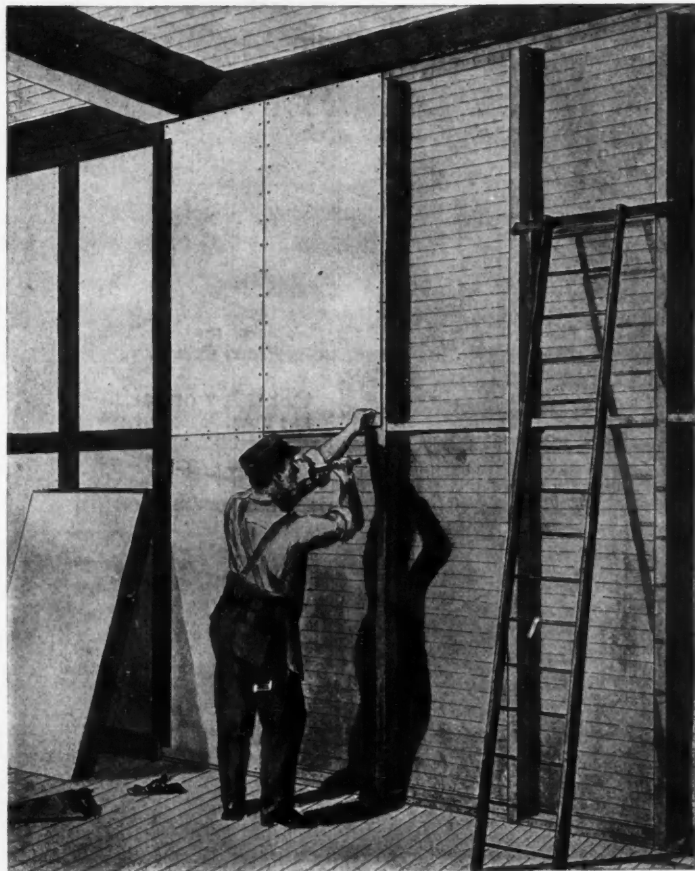

WODWALBOARD

—better than Lath and Plaster, and Easier Applied

Light, strong, fire-retardant and economical from any angle, Wodwalboard is the most practical substitute for lath and plaster ever marketed. Nailed direct over the studding, it is suitable for almost any kind of interior, and gives far better results than the best lath and plaster.

Wodwalboard is cheap to buy, cheap to apply and requires less attention than plaster. It cannot crack, chip or deteriorate with age, can be readily painted or tinted any color, and is ready for decoration directly it is applied. No waste of time or material, and no need of expert labor to apply it.

More adaptable than lath and plaster to practically any form of building. Write for a copy of our catalog.

McHenry-Millhouse Mfg. Co.

South Bend, Ind.

When Writing Advertisers Please Mention the American Carpenter and Builder.

Get This:

Big New Builders' Catalog—Free

5,000 Bargains

Order All Millwork Staples and Specialties Direct from Gordon-Van Tine Co. Save Big Money

Here is a wonderful new Building Material Catalog that fairly bristles with bargains for carpenters and contractors. In it are over 5,000 money-saving offers on staple items in Millwork and specially designed material. No other book ever issued so perfectly meets every requirement of the Builder.

Gives complete data on all high-grade material,

with prices way under the present market. Saves contractors dollars on the smallest job.

And we guarantee quality to be of the highest.

We guarantee prompt shipment, safe delivery and absolute satisfaction.

We refund every dollar and pay freight both ways if buyer is not satisfied.

Prices on Staple Items Now Cut to the Quick

White Pine Doors, 2 ft. 8 in. x 6 ft. 8 in.,
1 $\frac{3}{4}$ —4 panel. Strictly "A" quality, each - **\$1.86**

Yellow Pine Doors, 2 ft. 8 in. x 6 ft. 8 in.,
1 $\frac{3}{4}$ —5 panel. Strictly "A" quality, each - **2.01**

Windows, 4 lts., 1 $\frac{3}{4}$, glazed, 10x20, SS, each **.77**

Windows, 2 lts., 1 $\frac{3}{4}$, glazed, 16x20, SS, each **.70**

Window Screens, 2 lts., 16x24, each **.64**

Yellow Pine Base Moulding, size
1 $\frac{1}{2}$ x2 $\frac{1}{4}$ in., per 100 lineal feet - - - - - **\$0.96**

Lattice, per 100 lineal feet - - - - - **.36**

Yellow Pine Cove Moulding, per
100 lineal feet - - - - - **.33**

Outside Window Frames, complete,
for 10x20, 2 lts., each - - - - - **1.25**

We Carry as Regular Stock What Planing Mills Must Make

Made-to-Order prices always are high! What planing mills must make to order we carry as regular stock.

Hence our prices are a mere fraction of those commonly asked for Doors, Windows, Casements, Sash, Stair and Porch

Material, China Buffets, Mantels, Grilles, Consoles, Colonades, French Windows, Doors, etc., etc.

You can use our immense facilities like a private plant. Get all your "special" material at regular "stock" prices, save money and prevent disastrous delays.

GET THE BIG CATALOG!

Get this wonderful new catalog now. Put our prices, quality and service to the test. More than 100,000 splendid homes have been built from our Millwork and Building Material. *Every item in all these buildings was ordered direct from the Catalog.* This is now saving our customers over a million dollars a year.

Our catalog will help you do business with less money—**increase your bank account.**



Write for Grand **FREE** Millwork Catalog Today
GORDON-VAN TINE CO.

643 Federal St., Davenport, Iowa

3

3

;

-
y
k
r.

