



The
**World's Greatest
Building Paper**

Important Notice

When your subscription expires, renew at once, using the blank enclosed in your final copy. If it expires with this issue your renewal must reach us before July 25 to avoid missing the August number. Use P. O. or Express Money Order if possible, but bills or 2-cent stamps may be sent at our risk.

The
**World's Greatest
Building Paper**

American Carpenter and Builder

Entered as second-class matter July 1, 1905, at the postoffice at Chicago, Ill. under the act of Congress of March 3, 1879.

Published on the first day of each month by

AMERICAN CARPENTER AND BUILDER COMPANY
RADFORD BUILDING, 1827 PRAIRIE AVE., CHICAGO

EDITORIAL DEPARTMENT

WILLIAM A. RADFORD, *Editor-in-Chief*
BERNARD L. JOHNSON, B. S., *Editor*
WILLIAM REUTHER
ADRFRED W. WOODS
ALFRED S. JOHNSON, M. A., PH. D. } *Associate Editors*

BUSINESS DEPARTMENT

WM. A. RADFORD, *President and Treasurer*
H. M. RADFORD, *Secretary*
E. L. HATFIELD, *General Manager*

New York Office: 178 Fulton Street
E. B. WOLFROM, *Eastern Representative*

SUBSCRIPTION RATES

One Year, \$2.00; six months, \$1.00; payable always in advance, Single Copies, 20 cents. Canadian Subscriptions, \$2.50. Foreign Subscriptions, \$3.00.

ADVERTISING RATES

Furnished on application. Advertisements, to insure insertion should reach our Chicago office not later than the 20th of the month preceding date of publication.

PROTECTION FOR OUR READERS

The publishers of the American Carpenter and Builder will not knowingly publish any advertisement of a misleading character nor accept advertising from any individual, firm or company whose business methods are open to question.

We often receive inquiries from readers who desire information about concerns that formerly used the advertising pages of the American Carpenter and Builder, but are no longer doing so. They want to know if these former advertisers are still in business, if they can send them orders with the assurance that they will be filled, and a variety of other questions.

The American Carpenter and Builder will use every legitimate means to safeguard the interests of its readers and to protect them from fraudulent or unreliable concerns. Where the slightest doubt exists our readers should write the publishers for information. It may save them money, time and worry.

In all cases in writing to advertisers say: "I saw your advertisement in the American Carpenter and Builder."

VOL. XV.

JULY, 1913.

No. 4

ON life's race course the good nag Service is after all the one best bet.

When to Turn Down a Job

THEY say that a penny saved is a penny earned. By this token many a good penny is often made by *not* doing some work. What's the use of spending out real money in labor and materials when there is little likelihood of ever getting your pay?

Recently a builder said—and he is a past master in the gentle art of diplomacy, and knows the value of good will and the detrimental effect of neighborhood criticism:

"If a person comes to me and wants work done and I know he is poor pay I just tell him I am so busy that I cannot do anything for him for a long time. And in most cases I don't hear any more from him I don't think it policy to say to him, 'Now, see here, Mr. ———, I would like to do the work for you but you are poor pay, etc.' The result would be that he would get down on me and probably tell things around that would hurt my business to some extent; for there is always some one who will believe such talk."

We Are in Our New Home

BY the time this reaches our readers, we will be in our new home at 1827-33 Prairie Avenue, Chicago. Hereafter please address all communications for the AMERICAN CARPENTER AND BUILDER, also for our sister organizations, the Radford Architectural Co., the CEMENT WORLD and the Dealers' Building Material Record, to this address.

Three months ago, we showed you a picture of this magnificent property. Since then, many workmen have been busy, adapting the building to our special needs for editorial and drafting rooms, book, subscription and business departments, etc. Our one idea in purchasing this property and equipping it as a complete up-to-date publishing and architectural establishment, has been to serve our subscribers and advertisers better and more effectively.

Very soon we hope to have some interesting photographs to show you of the interior of this building, showing the home office of our organization working hard to make good on its program, "of making the next number of the magazine just a little bit better than the last."

Mr. I. Noah Boutet at the Summer Resort—He Builds a Dancing Pavilion



HOME BUILDERS SECTION



A Timely and Reliable Guide to All that is Practical, Satisfactory and Attractive in the Planning, Building Finishing, and Furnishing of the Up-to-Date American Home

A Partnership for Satisfaction



THE best friend the home builder has is the local building contractor. His advice is usually reliable; and, while he may perhaps be sometimes accused of being too much of an optimist, still it is always pretty safe to council "yes" in regard to home building and to act encouraging when home building is being discussed.

A man cannot be blamed for always advising what he knows to be good.

When thinking of building, get acquainted with your local carpenter and builder the first thing you do. Ask his advice. Ask about the best materials to use.

FIND out what plans the builder has or can procure. There is considerable satisfaction and a substantial saving in expense in having one man personally responsible for the entire job from start to finish. Secure the interest and co-operation of your local carpenter and builder at the beginning, even before any plans are drawn and his interest will keep up all the way through.

Builders of course have their failings and so also have home builders (especially bungalow home builders); but the best results are found when these two work in close sympathy from start to finish.

Modern Ventilation

To the Editor: Austin, Nevada.
Permit me to congratulate you on the addition of your "Home Builders' Section."

I am not a carpenter but occasionally do a little building or altering, for myself. Because of its highly technical nature and the consequent difficulty I found in extracting the desired nourishment from its articles—other than advertisements—I had about decided to let my subscription lapse.

I had thought of suggesting to you something in the nature of your present course but decided it would be useless because of your probable belief in the adage "a little knowledge (on the part of the amateur) is a dangerous thing" (for the pocket-book of the professional).

Now, I would like to suggest that, at your earliest convenience, you give us an article embracing a clear statement of the up-to-date theory of ventilation—I presume the principles are the same for hen-houses as for palaces. At school I was taught—and think my case must be typical of a great many—that the proper place for a ventilating outlet is at the highest point of roof or ceiling, while the intake might be anywhere in an outside wall, but preferably at the bottom.

While it was recognized that carbonic acid and other gaseous emanations were heavier than air at a like temperature, their heated condition was supposed to reverse this relationship and cause them to rise to the outlet. It was also, of course, recognized that much heat was thus lost but this loss was regarded as the unavoidable price of pure air.

Apparently modern practice avoids this

loss by a reversal of the old relative positions of inlet and outlet. Where then was the flaw in the old theory?

W. F. COLLINS.

Answer: We are at present at work on this ventilation subject and will have a clear and practical discussion of it in an early issue. Suggestions from the readers will also be gladly received.

EDITOR.

"If I Should Build Again"



If I should build again, sliding doors between the living room and the dining room would be considered a necessity.

The kitchen would be recessed for the ice box and arrangement made for outside icing.

Hardwood floors are more sanitary and easier to clean. I would bear that in mind.

I would not be sparing in the use of building paper. Warmer walls means a house easy to heat and smaller fuel bills.

I would not forget to set my house back far enough so there would be space for a nice lawn and flowers. They add so much to the attractiveness of a house.

The Plan Shop

Practical House Designs "That are Different"



Six-Room Brick Houses for \$3,146.90

An Interesting Home Building Project in a Boston Suburb—Itemized Statements of Actual Costs

ONE of the first questions the home builder asks, and it is a right and proper one, is: "How much will that cost?"

Yet it is seldom that this question can be reliably answered without actually submitting plans and specifications to the building contractors for figuring.

On these dwellings, here illustrated, an exact record of all costs was carefully kept; and, as the designs are in themselves very attractive—just about the size and style that a great many home builders are interested in—this record of actual costs is more than usually valuable.

About two years ago, a number of prominent, public-spirited men and women of greater Boston, formed an association under the name of the Boston Dwelling House Co. Their object was to study the "better housing problem"—to find a suitable piece of land and to start the development of this land by the building of model houses,—some detached houses, some double houses and some six-family group houses.

The piece of land chosen for this experiment is located in the Forest Hills district of the city of Boston, about four minutes by trolley from the Forest Hills terminal of the Boston Elevated. This piece of land contains about thirty acres, is of rolling, somewhat irregular, contour, and is what the real estate men call "well-wooded."

Roadways were laid out, not in checker-board fashion as is usual in such developments, but in sweeping curves, taking advantage of the irregularity of the land. The architects' bird's-eye sketch shows very well the layout of this little home community.

In erecting the houses on these curving roads and paths, a system of grouping was followed that permits every house to have a good exposure and plenty of open space around it.

Kilham & Hopkins were the architects given the commission to design these homes; which were to be built of brick and contain all desirable modern home

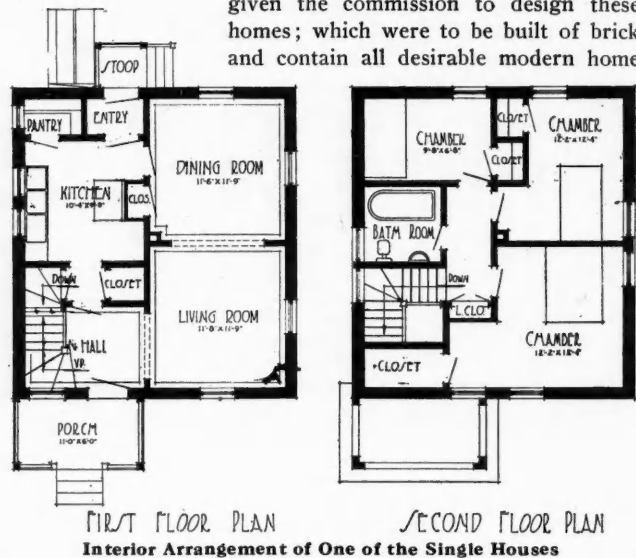

One of the Single Detached Residences at Forest Hills, Boston. Contains Six Rooms and All Modern Conveniences. Cost \$3,666.06

conveniences and improvements. Mr. Robert Anderson Pope was the landscape architect entrusted with the grouping and landscape features. The building contractor who handled the work and to whom we are indebted for very careful and honest record of actual construction costs, was Mr. Arthur W. Joslyn.

These houses as completed, are in every way satisfactory. It is certainly reassuring to find that such substantial, well-planned homes can be built today at such a reasonable figure. A well-constructed, fire-resisting home of six large rooms, completely built and equipped with plumbing, electric lights and basement heating plant, all for \$3,666.06, should make the prospective home builder feel very good.

Of course, when considering this cost, it must be remembered that this Forest Hills project was home building by the wholesale. Under the one contract, 24 homes were constructed at the same

time. Without doubt, this made possible certain economies both in buying the building materials and in handling the work, hardly possible where just a single house is built.

The Single Houses

In this group, as shown in the landscape sketch, there are four single houses all alike in exterior appearance, but differing slightly in interior arrangement. Three of them have six rooms each, the fourth seven rooms. These are thoroughly good houses in every respect. They have concrete foundations with cement basement floor. The exterior walls are faced with a veneer of good quality face brick laid in white lime-mortar; the frame studding is spruce, 16 inches on centers; chimneys are of common brick except the parts that show; fire-places made of the same kind of brick as exterior.



One of the Double Houses at Forest Hills. Each Half Contains Six Large Rooms and Cost Complete \$3,146.90

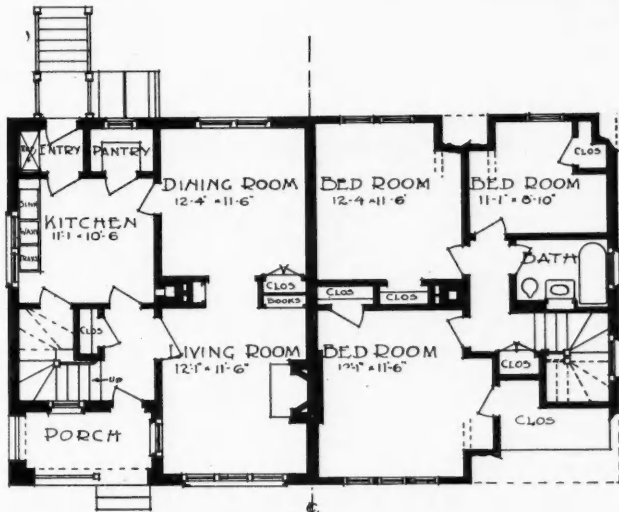

HALF FIRST FLOOR PLAN HALF SECOND FLOOR PLAN
Floor Plan of Two-Family Houses

The following itemized statement of cost shows how completely these houses were finished up ready to be lived in. Even the window shades, wall paper and screens were included. These figures show the costs for all four of the single houses and also for each house.

ACTUAL COST OF FOUR SIX-ROOM BRICK HOUSES

	Total Cost for Four Houses	Cost of Each House
Excavation	\$ 352.95	\$ 88.24
Stone foundation	799.93	199.98
Concrete foundation	55.79	13.95
Drains	315.00	78.75
Grading	44.43	11.11
Common brick	1,287.61	319.65
Face-brick	1,441.84	360.46
Framing	601.35	150.34
Square boarding	143.87	35.97
Matched boarding	276.37	69.09
Studding	374.07	93.51
Setting iron	26.50	6.62
Outside finish	751.40	187.85
Fireplaces	61.01	15.25
Piazza floors	69.78	17.44
Upper floors	351.07	87.84
Concrete floors	94.55	23.67
Whitewashing	11.85	2.96
Coal bins	91.91	22.98
Medicine closets	24.69	6.15
Inside finish	347.55	86.89
Lathing	245.61	61.40
Plastering	614.15	153.54
Roofing	1,368.75	342.19
Electric wiring	224.13	56.03
Ranges and furnaces	458.00	114.50
Stairs	191.66	47.92
Painting	483.33	120.83
Plumbing	1,116.67	279.17
Screens	90.80	22.70
Curtains	32.00	8.00
Hardware	106.33	26.58
Electric fixtures	80.00	20.00
Papering	189.60	47.40
Picture molding	24.70	6.17
Doors	392.37	98.09
Windows	354.11	88.52
Concrete sills, etc.	83.20	20.80
Overhead expense	1,086.87	271.72
Cost per house		3,666.06
Cost per group	14,664.24	



View of One Group of Homes—12 in Number—all completed at Forest Hills, Boston

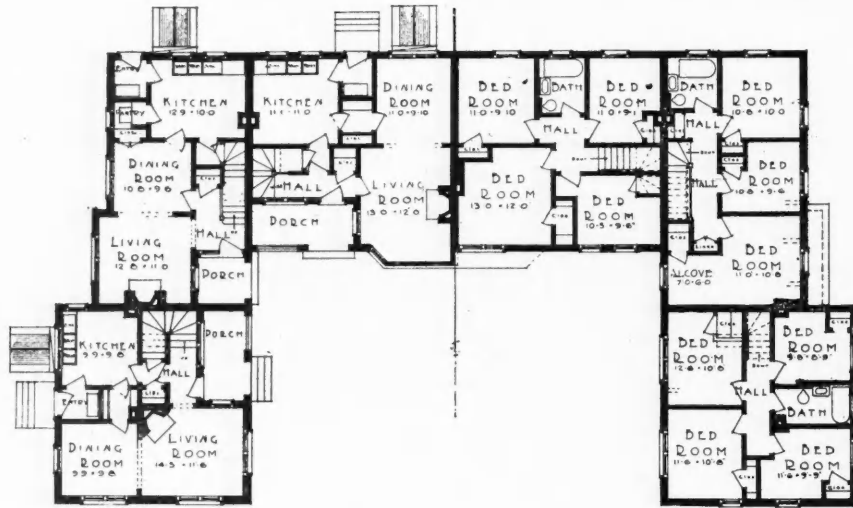

HALF FIRST FLOOR PLAN - HALF SECOND FLOOR PLAN -
Interior Arrangement of 6-Family Group

The Double Houses

The construction of the four double houses was just the same as for the single houses, just described. An effort was made to have them not only substantial and well-built, but also provided with the attractive little finishing touches and features of modern equipment which appeal to both home buyers and renters today. A glance at the floor plan will show how nicely these double houses were laid out.

The inside finish of all the rooms throughout the entire group is North Carolina pine and white wood. The floors are all double, under floors being of square-edge hemlock and finish floors of matched Alabama pine. All of the houses have slate roofs, laid over North Carolina pine roof boards.

The itemized cost of the four double houses is given below, total cost for each item divided by eight is also shown, which gives the cost for each home or unit.

ACTUAL COST OF FOUR DOUBLE HOUSES

	Total Cost for Eight Homes	Cost of Each Home
Excavation	\$ 705.91	\$ 88.24
Concrete foundation	879.81	109.97
Drains	525.00	66.00
Grading	88.86	11.11
Common brick	2,357.55	294.69
Face-brick	1,885.89	235.90
Framing	1,418.44	177.30
Square boarding	303.50	37.95
Matched boarding	357.47	44.68
Studding	796.52	99.56
Setting iron	30.60	3.82
Outside finish	1,284.42	160.53
Fireplaces	66.75	8.34
Piazza floors	90.18	11.27
Upper floors	108.92	88.63
Concrete floors	249.20	31.15
Whitewashing	19.60	2.45
Coal bins	147.84	18.48
Medicine closets	47.52	5.94
Inside finish	1,247.45	155.93
Lathing	488.21	61.03
Plastering	1,228.33	153.54
Roofing	1,409.85	176.23
Electric wiring	454.77	56.85
Ranges and furnaces	916.00	114.50
Stairs	383.34	47.92
Painting	966.67	120.83
Plumbing	2,233.33	279.17
Screens	197.60	24.70
Curtains	72.00	9.00
Hardware	212.66	26.58
Electric fixtures	160.00	20.00
Papering	379.20	47.40
Picture molding	55.48	6.93
Doors	644.98	80.62
Windows	765.04	95.63
Concrete sills, etc.	188.70	23.59
Overhead expense	1,207.64	150.95
Cost per house		3,146.90
Cost per group	25,175.21	

The Six-Family Houses

Surrounded by and facing park-like grounds and enclosing a broad green play-ground, these houses by their compact arrangement give their owners an outlook which, judged by ordinary standards, is out-of-all proportion to the low cost of the individual domiciles. They breath the community spirit without sacrificing the privacy of their occupants. Four of the homes in each of these six-family houses, contain seven rooms and the other two homes six rooms each. Like the single and double houses, they are well-built, are wired for electric lights, piped for gas (the price shown includes a high-grade combination gas and coal range in the kitchen of each dwelling), first-class plumbing and warm air heating plants in each basement with runs of pipe to every room.

The cost of these two six-family houses fully itemized, is given. Each item of cost divided by twelve, gives the cost of each dwelling or unit of these groups.

ACTUAL COST OF TWO SIX-FAMILY BUILDINGS

	Total Cost for Twelve Homes	Cost of Each Home
Excavation	\$ 1,058.87	\$ 88.24
Stone foundation	455.16	37.93
Concrete foundation	1,628.87	135.75
Drains	1,155.00	96.25
Grading	133.30	11.11
Common brick	4,895.20	407.93
Face-brick	4,424.91	368.75
Framing	2,116.90	176.41
Square boarding	501.13	41.76
Matched boarding	602.50	50.21
Studding	1,317.74	109.81
Setting iron	81.14	6.77
Outside finish	1,129.12	94.10
Fireplaces	142.49	11.88
Piazza floors	134.93	11.25
Upper floors	1,057.51	88.13
Concrete floors	356.94	29.75
Whitewashing	24.20	2.02
Coal bins	285.15	23.77
Medicine closets	73.65	6.14
Inside finish	1,373.18	114.43
Lathing	727.21	60.60
Plastering	1,842.50	153.54
Roofing	2,906.25	242.19
Electric wiring	684.40	57.04
Ranges and furnaces	1,374.00	114.50
Stairs	575.00	47.90
Painting	1,450.00	120.83
Plumbing	3,350.00	279.16
Screens	308.40	25.70
Curtains	108.00	9.00

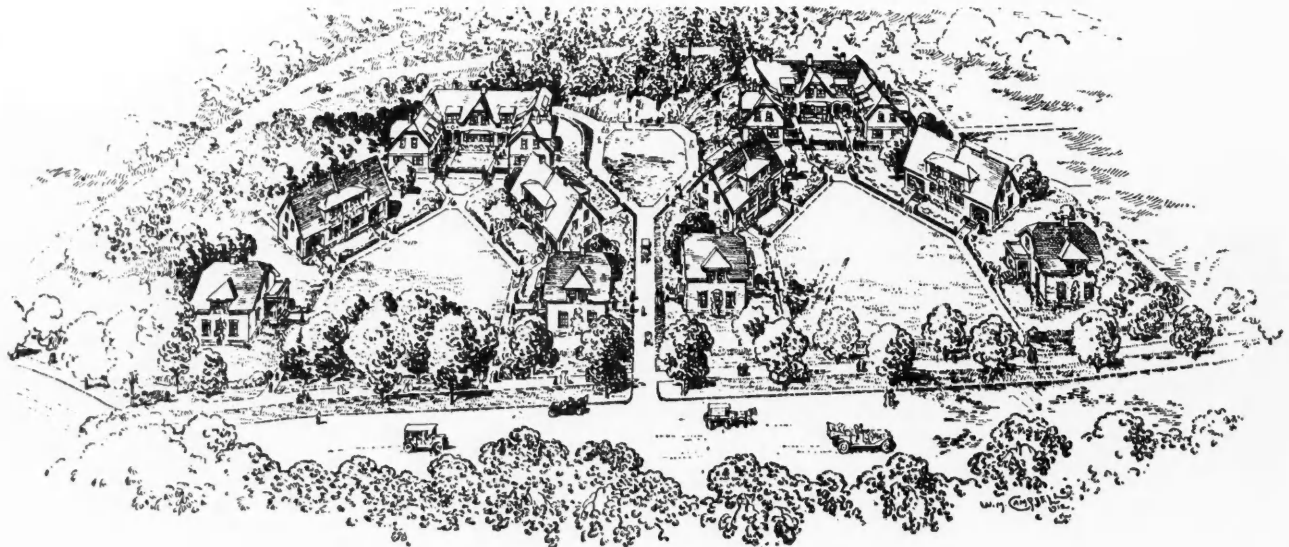

Architects' Bird's-eye Perspective of Home Building Project at Forest Hills, Boston; This Grouping Gives Extraordinary Advantages

COST OF TWO SIX-FAMILY HOUSES

Hardware	317.55	26.46
Electric fixtures.....	240.00	20.00
Papering	632.00	52.67
Picture molding.....	74.40	6.20
Doors	1,113.55	92.79
Windows	1,507.67	125.64
Concrete sills, etc....	249.60	20.80
Overhead expense....	1,328.41	110.70
Cost per house.....		3,478.07
Cost per group.....	41,736.85	

Included in these costs is also the expense of grading, laying out and building the system of brick walks, etc.

All of these costs may be relied on as Contractor Joslyn had an accurate time-keeper on the job all the way through, who kept the time of every workman employed. The four single houses averaged \$3,666.06 each; the cost per unit in the case of the double houses, that is, one-half the cost of the whole house, was \$3,146.90; and the cost per unit of the six-family group was



One of the 6-Family Group Houses—Each Unit or Home Cost \$3,478.74

\$3,478.07, showing that the double houses were most economical per unit, and the six-family type next.

These tabulations of cost are probably the most accurate that have ever

been kept on small houses.

It is through the courtesy of "Brick and Clay Record" that we show these photographs and plans of this Forest Hills home building project.

A \$5,000 Home at Hamilton, Mass.

A MODERATELY priced house used for an all-year-around home, which can be built for five thousand dollars is always a desirable one for a house hunter. The dwelling built by Mr. H. H. Hudson at Hamilton, Massachusetts, is a good example, and its situation as the central feature of attractive grounds shows pleasing landscape treatment as well.

Its gambrel roof produces a quaint picturesque Colonial effect that is most artistic. The house faces the south, allowing for plenty of sunshine; and the windows are so placed as to catch the light from early morning until sunset. A closely clipped lawn extends to the road. The front is partly hidden by

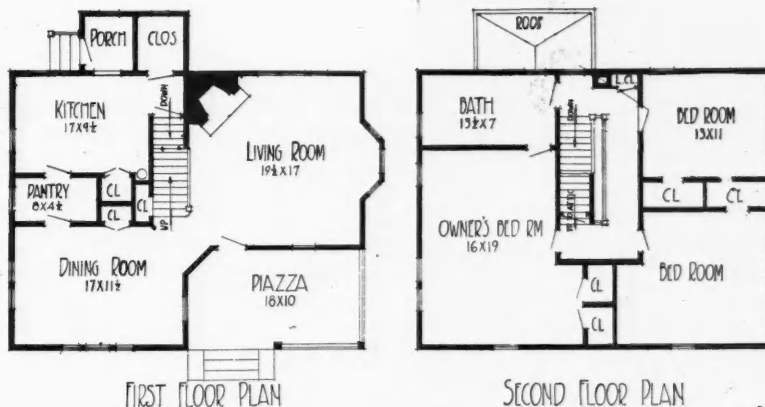

Interior Arrangement of Hamilton Residence



Comfortable and Spacious 6-Room Shingled Residence of Mr. H. H. Hudson, at Hamilton, Mass.

shubbery, while the grove of white birches at the right is a charming addition to the grounds. At the left are more masses of shrubbery and beyond are vegetable gardens and a flower garden.

The exterior of the house is finished in shingles which are left unpainted. The trim, blinds and lattice are of a light green which gives character to the simple lines. Trellises have been arranged over the windows which, later on, will be covered with vines, while window boxes give a bright note.

The features of the exterior are the bay window which is on the east side, the half veranda at the front, and the built-in out of doors sleeping room at the rear. A small porch at the kitchen entrance which has been arranged to accommodate the refrigerator is another convenience.

The use of cobble stones is shown effectively in the English stepping stones which lead to both front and rear entrances, and the posts which are on

either side of the stone steps, topped with concrete.

The entrance door gives into a large living room. This had been designed for two rooms, but for space saving it was decided to throw it into one large room which opens into the dining room, and is so arranged for entertaining purposes, that the two may be thrown into one apartment.

The first floor is finished with hardwood floors, and these are covered with handsome rugs. The living room has windows on three sides, the north, south and west. The scheme color is brown, in different tones, shown in the wall hangings and repeated in the portieres and curtains. The fireplace is finished in bricks, laid in white mortar. The

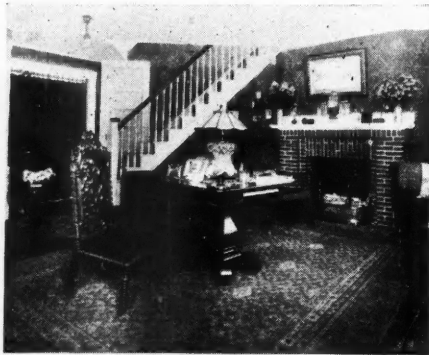

The Stairway in the Hamilton House Goes up out of the Living Room

staircase was planned for the extreme end of the room. Part way up a closet has been devised in the wall space, which is used for coats, hats and overshoes. The woodwork is white, while the furnishings are principally in colonial style, many rare old pieces being used.

The dining room faces the south and



An Idea for Dining Room Windows

east. This room is finished with a high wainscot of imitation black walnut, with a frieze of old gold grass cloth. Separating the two is a plate shelf used for old Colonial pieces. The hangings are of white muslin, which make a pleasing contrast and lighten the otherwise dark interior. Space saving devices are introduced in the way of a small let-in cupboard with glass doors, used for good china, and in the wainscot a cunningly contrived secret closet with ample shelves, which is used for preserves, jellies and whatever else is desired. The passage way between kitchen and dining room has been utilized for a large serving pantry. The kitchen itself is finished in buff tinted plaster, making it sanitary, and has convenient closets for the storage of kitchen utensils.

The second floor contains two large chambers on the front, facing the south, a sewing room with linen closet, and a bath. It opens at the rear onto an enclosed porch, used for sleeping purposes. One of the chambers is finished in tones of old rose, the same color being carried

The Dining Room is Beautifully Paneled to the Plate Rail

out in the hangings. The guests room, which is opposite on the southern part of the house, is finished in Dutch blue.

The attic is reached by an open staircase which leads from the main hall. It contains one large chamber and storage room. The cellar is cemented and allows for a furnace, coal bin, as well as convenient closets for vegetables and fruit.

This same plan may be easily worked out through the use of cobblestones for the first story floor, or it can be finished entirely in cement.

Warding off the Fire Fiend



Recommended Structural Safeguards—2nd Paper

IF, in addition to what was suggested last month, the cellar has a good plaster or plaster board ceiling, it will be a slow and difficult matter for fire or mice in the basement to get into the other stories, not to mention greater ease in keeping the dust down. Plaster on metal lath is more substantial than on wooden lath if the metal lath is firmly fastened to the joists. The underwriters strongly urge its use everywhere instead of wooden lath.

Unless there are unusual openings, from the cellar, such as elevators, chutes, dumb waiters, etc., the only other opening is the stairway, the door to which should be tight fitting and have a door-spring. Chutes and waiters should have trap doors at the bottom, counterbalanced to keep closed. Elevator shafts and all shafts, if not built of brick, should be lined inside with hard plaster preferably on metal lath, or smoothly pointed plaster board, and should have continuous fire-stops behind the finish at frequent intervals all around the shaft. The top of a shaft should have a skylight of ordinary thin glass, and above and below it strong wire netting, the first to prevent firebrands or other things from falling through, and the second to prevent glass from falling. It is not advisable to hold a fire down in a shaft, because it will more likely spread out sideways, therefore thin glass skylights are recommended.

Never sheath a shaft with wood. The whole history of wood sheathing shows

that it transmits fire very rapidly over its surface, particularly when varnished, oiled, or painted, and that it is dangerous where a plaster surface is safe. Wherever wooden sheathing is necessary to the decorative scheme, the space between the studs behind it should be filled flush with plaster.

Above the first floor, there is a front

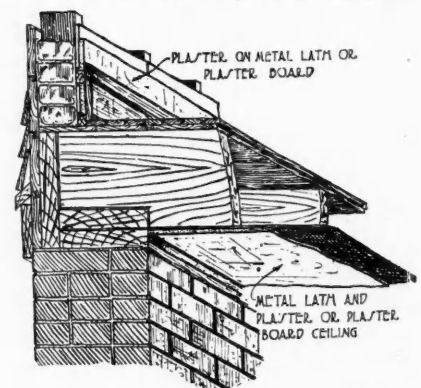

Metal Lathed and Plastered Basement Ceiling Pays for Itself as a Fire Preventor

stairway which, for decorative effect and convenience, is always open. This draught passage cannot well be obviated, but the rear stairway is usually provided with a door at the bottom and often with a door where it communicates with each other floor, and they should always be so arranged, and the doors be provided with springs to close them. It is not practical or necessary in a frame house to provide doors which are incombustible, but where brick or fire-proof construction make their use of greater value, handsome paneled doors of stamped metal can be used, which can be made to closely resemble wooden ones, if desired.

Hot air naturally ascends, therefore flames travel upward. The intent of what has preceded is particularly to show how to greatly retard the upward spread of flames, and if the methods are carefully followed the occupants have time to escape and the fire department time to respond before the fire can spread through the building. Even in a house already built, the stops at the sills and the other treatment of the cellar can be reasonably well applied.

Dwellings are frequently attacked by fire from the outside. Shingle and board roofs are set on fire in every conflagration by large firebrands carried long distances by the wind. Where such danger exists, it is a great safeguard to have only metal or slate roofs, and they greatly aid in withstanding close exposure, even though this may also expose frame walls, especially because the fire department or other aid may not be sufficiently strong to give the needed protection at some crucial time to both the wall and its openings and to the less accessible roof.

What has preceded applies to the ordinary house. Large, expensive houses of brick, with tile floors and roofs, can be built very fire resistive, so far as the structure itself is concerned, without any great departure from regular construction, but the contents and interior trim will burn, and the principle of preventing vertical draftways should be carefully observed. Although brick partitions are not common in ordinary construction, every one materially checks the spread of fire.

Recommended safeguards concerning the construction of chimneys and flues will be presented next month.



A STOREKEEPER who sells bird cages and bird seed got a new clerk from the country. A customer came in shortly afterward and asked for bird seed. "No you don't, smarty!" replied the new clerk. "You can't joke me. Birds grow from eggs, not seed."



A Jewel of Remodeling

HOW any would-be home owner can fail to build artfully or to remodel wonderously with the oodles of inspired advice being passed out now days is a mystery.

Mr. Jiles Urban heeded all he read and the results speak for themselves. The photograph demonstrates what an artistic taste and ingenuity can accomplish in making over the humblest house. This dwelling, as displayed in the picture, was once a mere street car that the company had forgotten about when the car jumped the tracks one day near Glencoe. A simple lake trout fisher family put the car on a wagon one afternoon when the company wasn't looking and took it miles away and set it up on top of a high bluff in a lovely spot overlooking the lake.

Next Mr. Urban discovered it; and he persuaded the fisherman to sell; for he saw at a glance what a beautiful house he could rebuild from the simple street car.

Mr. Urban resolved to preserve in his new house all the advantages as well as the materials of the street car. By

derful rows of windows in Mr. Urban's pretty little dwelling will attest.

Even the wheels of the street car are utilized, three of them being converted into ornamental flower pots on the spacious lawn in front of the house and the fourth one being used by Mr. Urban as a pants presser and lawn roller. And as the visitor approaches the front door his eye is arrested by the motto "Pay as You Enter," one of Mr. Urban's most prized souvenirs of his dwelling prior to its reconstruction.—DICK LITTLE, in "Round About Chicago."



Walt Mason Builds a Shed

I STARTED to build me a shed to hold ice, and the neighbors came over with "helpful advice." They sat on the grass with the trees hanging o'er, and talked of the sheds they had build-



Any Man can do it Better than the One who is

ed of yore. "Such beautiful sheds," said those eloquent jays, "were never beheld in these degenerate days." Whenever I drove a nail into a board, some critic reared up on his hind legs and roared. "Oh, you mustn't do this" and "You mustn't do that," and "Your wall is too high" and "Your roof is too flat." I tried to follow all counsel they gave, as I toiled with my hammer and plane and spoke-shave; I changed and I altered, I fumed and I fussed! I built and rebuilt, I cackled and cursed, and busted my fingers and ruined my thumbs, while those critics sat around me, displaying their gums. And when it was finished it fell with a crash, and nearly reduced me to Hamburger hash. I crawled from the ruins and picked up a rail, and chased all those neighbors through dingle and dale, and cried, as I smote them: "Odds Fish and Cogswound! No more shall I toil with cheap Alecks around. I'll build as I list, since I'm paying the price, and woe to the gaffer who springs 'good advice.'"—The J-M Roofing Salesman.

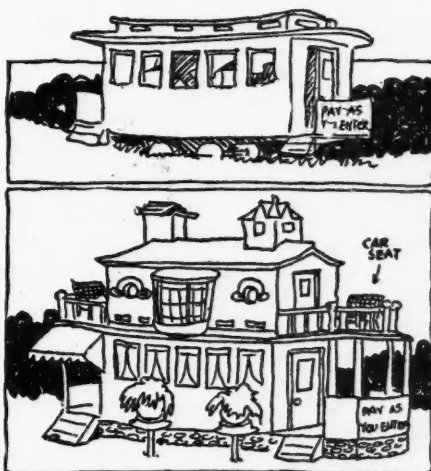

Home, Sweet Home, for Mr. Straphanger (Before and After Taking)

a little judicious planning he succeeded admirably. The rebuilt house has now ten rooms and five bathrooms with a garage in the cellar. Yet the conveniences of the residence when it was occupied by the lake trout fisher family have not been lost sight of, as the won-

Finishing and Furnishing The New Home

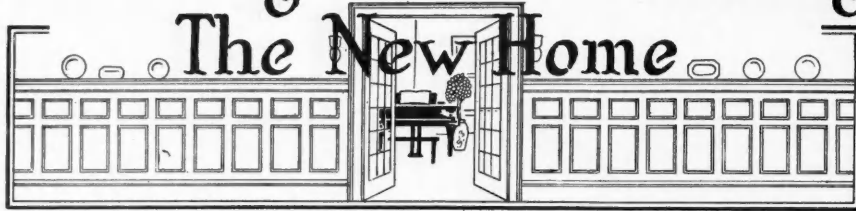

Making the Most of the Living-Room

By Mary H. Northend

Photos by E. J. Hall and the Author

THE living-room, where for the most part the family life centers, is undoubtedly the most important apartment in the entire house, and to its arrangement and furnishing careful attention should be given, lest through over-ornamentation and elaboration of detail, it lose the simple cheery atmosphere that should be its chief characteristic, and without which it lacks the most essential asset to its success.

We of the present generation have come to a realizing sense of the importance of fresh air and perfect ventilation in our homes, and the houses of today are happily being built with a view to obtaining all the air and light possible in each and every apartment. Frequently, however, rooms in which the ventilation and light have been carefully attended to, are robbed of their healthful atmosphere through the nature of the furniture employed, and thus it will be seen that the equipment of a room is quite as important as its con-

struction, and it is this point above all others that the housewife must bear in mind in the arrangement of the living-room.

The living-rooms of yesterday were adorned with heavy curtains, fringed window cornices, crowds of ornaments, chimney boards and other devices for keeping out the air, as well as mantel curtains, picture throws, and several other dust accumulators, and it seems unfortunate that in many homes of the present some of these same undesirable adjuncts are still used, and no doubt will continue to be, until all housekeepers come to a realizing knowledge of their detriment to comfort as well as to health.

Moderns in the arrangement of their homes seem inclined to go from the extreme of unsympathetic stiffness to that of the museum idea, without being able to hit upon the happy medium that lies between these two undesirable ends, and which, when found, effectually solves

the problem of the successful equipment of the living-room.

The living-room of today, to reach the highest state of its development, must be bright and attractive, with decorations of a fairly durable nature, but restful to the eye both in color and design, and with furniture substantial in construction, but easy to keep clean.

To thoroughly appreciate the requirements of the pleasant up-to-date living-room, perhaps it will be well to dwell briefly on the several points that go to make up the finished whole.

Next in importance to ventilation and light is the treatment of the woodwork and walls. To my mind the former is never more attractive than when painted pure white, a treatment that is sure to harmonize well with any wall covering, and one, in addition, that catches and



Very Large Living-Room with Two Sides
all Casement Windows

retains the light far better than a darker finish. Oak-stained woodwork is attractive, as is mahogany, provided the wall hangings are of good contrasting tints, and suited to relieve the dullness which these finishes are apt to impart, and sometimes a combination of two tones in the woodwork can be employed to good advantage as was the case in a fine old living-room I recently visited, where the walls were entirely paneled in wood, stained white, with window and door frames similarly treated, while the doors themselves were of solid mahogany, which imparted a rich finish to a beautiful whole.

The time has passed when wall-paper alone is the solution of wall coverings, and today, in addition, we have burlap, grass cloth, canvas, buckram, leatherole and countless other stuffs to choose from, each presenting strong claims for its consideration. Burlap possesses the advantage of fading far less quickly than paper, and then, too, when it does fade, it can be recolored without removing. Its original tone may be applied in dye or stain, or if a new effect is desired, it can be gained by using a different color. Where a plain wall is desired there is no question of the economy and beauty of burlap, and for this purpose both buckram and canvas can

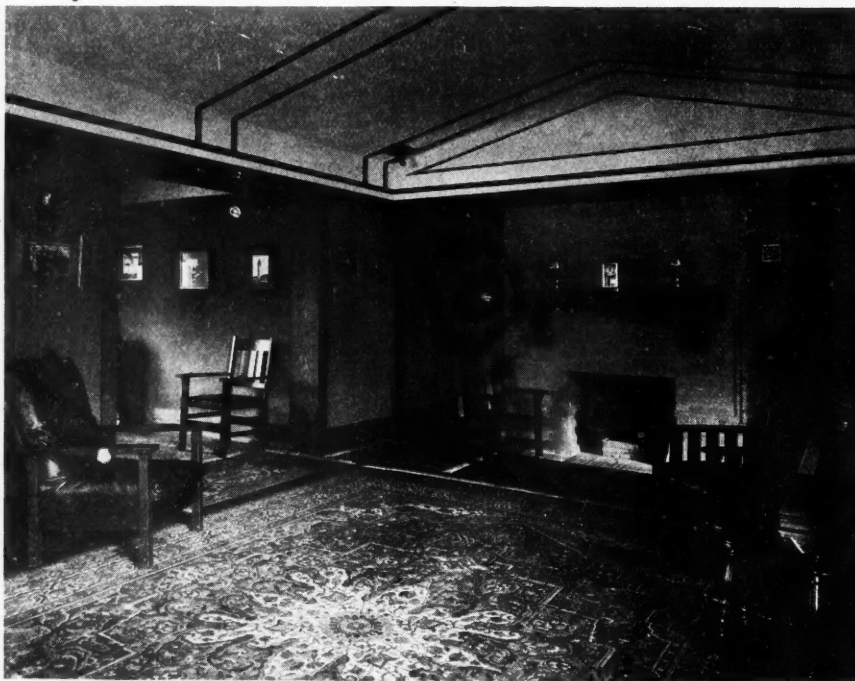

A Living-Room Designed by Frank Lloyd Wright of Chicago, and Typical of the Novelties
being Produced by the Modern School of Architects

also be recommended as they are equally durable and differ but slightly in texture.

Like burlap, grasscloth wears well, and can be recolored in much the same way, and its uneven weave, which produces light and shade and a surface of velvety richness, renders it among the most attractive of the plain surface coverings. It costs more than burlap, but its texture repays for the difference in price.

Of course all these materials are far more expensive than wall papers, and for this reason many housewives stick to the old style wall covering. Two-tone papers do not fade as rapidly as those of plain surface, but the latter in many localities seem to have first call. They come in an almost limitless number of qualities, and thus choice is not difficult. "Ingrain" and "cartridge" are types frequently selected, and crepes and fibers, which present a rougher finish, are also much employed. "Fabric" papers fill a middle ground between plain and two-toned wall coverings, and while not glossy are smooth, and at close range have the appearance of loosely woven cloth. They cost more than the plain papers, but fade far less quickly,

and for this reason the extra expenditure is warranted, and their use is recommended.

Floor coverings, to be effective, are dependent upon the relationship they bear to the general scheme of decoration. Whenever possible, their color tone should be studied in conjunction with the finish of the woodwork and walls, and the relationship of these factors should be thoroughly established before the general furnishings are determined. Likewise, the texture of the covering is quite as important as its coloring, and the finely woven rugs which would be suitable for the drawing-room, should never be used in the living-room, where they would be accorded much rougher usage and thus would soon wear out.

Rugs for the living-room should be of a durable nature, for the wear upon them is sure to be almost constant, and for this reason the Oriental rugs are recommended as are the hand-tufted European weaves in plain colors, with borders in self-tone. The Navajo rugs, too, are admirable, and while they are quite expensive, their wearing qualities

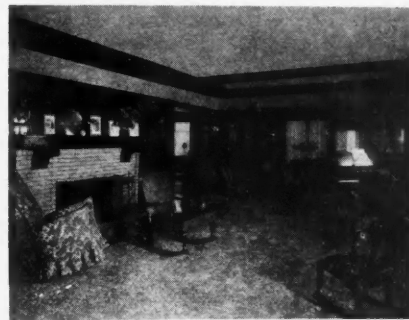

**A Big Fireplace Makes this Living-Room
Cosy and Interesting**

are of the best, and warrant their purchase. Small rugs are frequently effective when used in conjunction with a large central rug, and when of similar texture and coloring are particularly attractive.

The window hangings should be governed principally by the shape and size of the windows themselves. The casement window lends itself readily to decoration, and is most attractive when hung with simple muslin or net curtains, without an under shade of any sort. The sash window, while more difficult to treat, is sure to be artistic if



**The Opening Between Living-Room and Dining Room is a Home Finishing Feature of Infinite Possibilities.
Here is a Recent Idea, Attractive yet Inexpensive**



A Bay Window Fireplace—Formed of Brick and Tile and with an Art Panel Above Flanked by Two Casements

simplicity of line is kept in mind in its arrangement. Looping and draping should be avoided, but a pretty effect is often produced by a valance, provided it is not too deep. In choosing materials, a rule that is well to remember is that plain materials are almost always best, and with figured wall coverings should invariably be used. Figured window hangings should never be employed except with plain walls, and then care should be taken that the design is not too large.

Perhaps the ideal fabric for curtains is silk, which is obtainable in good colors at moderate cost. If the living-room is located on the north side of the house, curtains of yellow silk are good, as the light filtering through them gives the impression of sunshine, provided this color harmonizes with the general scheme of decoration. Green and other cold colors should be used only in sunny rooms.

Whatever the material used, it should be agreeable in color and texture, washable, and as far as possible, sun-proof. It is decidedly better to buy inexpensive goods, which can be easily replaced, than the more costly materials, which, while they last longer, at the best have only a limited life.

Nets of all kinds are especially attractive, and the Arabian net, of a pale string color, is particularly well suited to living-room use. Lace should be used only when it is very good, and real lace or none at all should be the motto of the housewife of good taste.

As to the furnishing of the living-room, there is a quantity of furniture

to select from at the present time, much of it distinctly good, and much of it bad. A point to remember in selecting furniture is not to mix the woods, for a combination of two types in a room is rarely good, and should therefore be avoided.

Wicker furniture, either stained or left in its natural finish, is attractive, and when cushioned to correspond with the wall hangings is particularly good, while the Mission type of furniture has much to recommend it, and is very popular at the present time. Probably the most attractive of all, however, is the furniture of Colonial design. The creations of Chippendale, Hepplewhite and Sher-

aton have come to be regarded as the best the world has yet produced, and while, of course, it is impossible for everyone to possess genuine specimens of these old master wood-carvers' skill, yet their designs are today cleverly copied by furniture-makers throughout the world, and these imitations can be purchased quite reasonably. Windsor chairs, when well made, are desirable, and in mahogany are particularly well suited for the living-room.

Have in your living-room a comfortable couch of some sort, where you can lie down and read or rest, and if there is no library in the house, arrange a bookcase, finished to correspond with the woodwork, along one side of the apartment. If the room boasts a fireplace—and what living-room is complete without one—it is sometimes a good plan to flank it on either side with comfortably cushioned settles, or if it is arranged, as is frequently the case, between two windows, contrive window-seats beneath, and cushion them to correspond with the general color scheme.

Each living-room, of course, requires different treatment, and it is only by careful planning and attention to details that its best points are brought out. There is no fixed rule to be laid down for the embellishment of the living-room, for what would be attractive in one, would probably be ugly in another, and thus the general arrangement of the furniture and the introduction of various essentials to add to the attractiveness of the whole, is best determined by the one to whom the arrangement of the room falls.



Colonial Style Living Room in White Enamel—Wicker Furniture with Colored Cushions to Match the Wall-paper Border

Decorating the Home



Use Soft Colors in Dining Rooms

IN this issue we illustrate a dining room in which a chair rail is the chief decorative feature.

The chair rail extends around the room and is generally about the height of the backs of the chairs. While decorative, it also serves to protect the walls from being marred when chairs are pushed back against them. Sometimes the space between the baseboard and moulding is panelled in wood, like the

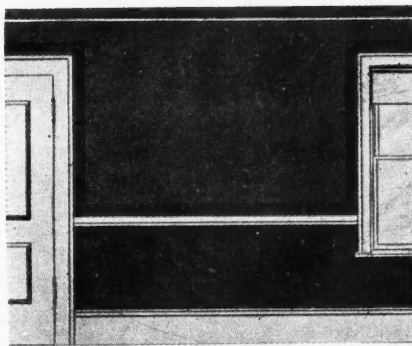

Simple Stencil Border for Dining Room

good old-fashioned wainscoting of our grandmothers' day. We see much of this style in the Colonial homes of the past and it is copied in the new Colonial homes of today.

Where wainscoting or panelling in wood is not used, the wall space must be treated as a part of the decorative scheme. A good plan is to use burlap or decorator's muslin on the wall space, which is easily painted and serves to protect the wall.

Sometimes a wall is divided into three parts, the dado (as the lower space is called), the upper side wall and ceiling. In such cases the deepest shade of the colors chosen should be used in the dado, so as to keep the tone of the wall heavier as it approaches the floor, tying the wall and floor together. A lighter tint of the same color, or some harmonious contrast in a light shade should be used on the upper side wall. The ceiling should be of a light cream, or some other light tint which will harmonize with the rest of the color scheme.

Only in rare instances should a dead or chalky white be used for ceiling or

painted wood work. It is an unnatural color and too cold and hard. The soft white of pure white lead paint is much more pleasing, to say nothing of the fact that it is not so trying on complexions and costumes.

Blues and greens work to good advantage in dining rooms, for here the colors are often stronger than used elsewhere (to aid in the decoration of the whole room).

Old blue and bluish greens are cool tones and should be used only in rooms where there is plenty of sunshine. Old blue is Prussian blue modified by the use of a very little venetian red or black. A bluish green is one in which the blue rather than the yellow predominates. It is the lack of yellow that makes both these tones cool and suitable for sunny rooms.

On the other hand, if the room is on the north side of the house and has very little sunshine, a warm green, or some other color that has a predominance of yellow aids in supplying the sunshine color that the room lacks.

Blue is too cold a color for a north room, but when it is used in combination with brown and warm tan, some of the coolness disappears. Blue for the dado, a creamy tan for the upper side wall and cream for the ceiling make



Design to Produce Panels Below Plate Rail

a beautiful, harmonious scheme. The wood trim could be stained or painted an old ivory which would harmonize with the walls.

A stencil pattern such as illustrated might be stenciled above the chair rail, extended up around the wood-trim, over the window and door casings and down again to the moulding. This makes an artistic and modest decoration.

The colors chosen should be soft and care should be taken not to have strong contrasts. Contrasts emphasize the sten-

cil pattern and tend to make too much of it. The purpose of a stencil is to fit into the whole scheme of decoration without attracting attention to itself.

In a north dining room a yellowish green is very satisfactory color. Most people like it and everything in a room blends into it, for it is one of nature's colors. But when a green is used in a dining room, or in any room for that matter, it should be modified by adding a little black and never be as strong as in nature.

Strong colors make a room seem small and confined, while colors in neutral or quiet tones have the opposite effect.

The lower part of the side wall requires the heaviest shade of green. The upper side wall would necessarily need a much lighter shade of green or a yellowish tan. Use cream for the ceiling.

Frequently the walls of dining rooms have plate as well as chair rails. In such cases, if the space between the plate and chair rail is not paneled off with strips of wood, a stencil pattern may be used directly under the plate rail, and this affords another style of decoration.



Flower Pattern, Showing Special Corner Piece

A band such as shown can be stenciled under the plate rail and the perpendicular lines can be extended to the baseboard, giving the effect of panelling. This can be done in brown, orange and bluish green. The orange should not be too strong and should be worked into the tips of the figure in the disk.

There are many other patterns to choose from in the various stencil books. These are only suggestions that may help in the choice of others.

Success will attend the following of these few rules. Decoration does not mean simply a mass of color and some sort of design; it means color and design assembled together in such a manner as to make a complete, harmonious decorative scheme.—The Dutch Boy Painter.

IN the average house the fireplace is of brick. Formerly a wooden frame and mantel were almost invariable concomitants. Now brick alone is being used extensively, although some architects argue against this practice. There is something about brick which makes a strong appeal in the first place, and then brick seems naturally associated with fire. Even ordinary brick has warmth and cheerful color.

Questions Asked and Answered



Inquiries on all subjects pertaining to Home-planning, building, finishing and furnishing will be answered free in this department

Decorating a Dining Room

My dining room has three windows facing north. The walls up to the plate rail are paneled in burlap with wood battens in an early English finish. The woodwork is also early English. What scheme of decoration shall I follow?

Mrs. C. R. M.
Ithaca, N. Y.

We have seen just such a dining room where the burlap was painted in a stippled gobelin blue. The wall above the plate rail was in a robin's egg blue kalsomine. The ceiling was a light cream. For curtains use a plain white net, with a two inch hem. Over-curtains can be made from a good quality of scrim with a blue flower. All curtains now-a-days hang only to the sill. This color scheme will be restful and cheerful.

L. V. C.

Uses of the Plate Rail

Is the plate rail going out of date? Is it good taste to place anything except dishes on the plate rail?

Waterloo, Ia. Miss P. J. H.

Modern houses all have the plate rail. There is no indication of its decline in favor. Our best people place steins, brass candlesticks, small brass bowls and platters on the plate rail. Many women prefer to stand the large dining room pictures on the rail instead of hanging them on the wall.

L. V. C.

Rag Rugs are in Good Taste

I have a number of small rag rugs or mats. Are these too old-fashioned for use in a modern home?

Joliet, Ill. Miss A. P.

Rag rugs are considered quite "the thing" these days. They are beautiful in a hall where the woodwork is finished in mahogany and white enamel. They are also greatly used in the living room and bed rooms. You are fortunate to have those "old-fashioned" rugs. Many women will envy you.

Taking Ink Out of a Rug

I spilled a bottle of black ink on my living room rug. I tried soaking it with sweet milk but the rug still shows the stain. How can I restore the color?

Ann Arbor, Mich. Mrs. C. R.

You should have wiped up the ink with a damp cloth using buttermilk immediately after. The best thing to do now is to scrub with a fine brush and ivory soap. Then put about three tablespoonfuls of ammonia in a pint of luke warm water and wash the spot clean. When dry the rug will be as bright as ever.

L. V. C.

Bungalow to Fit the Lot

I have a 50-foot lot on which I wish to build a bungalow. How wide should the building be? What material shall I use for construction?

Millersburg, O.

J. H. K.

Your bungalow should be about thirty two feet wide. This will allow plenty of space and light which is necessary for this type of building. Frame, half brick and half shingle, all brick, and stucco are popular in bungalow construction. The choice should depend on the owner's taste and the character of the surrounding houses.

Frost-proof Storehouse

I would like some advice in regard to making a storehouse frost-proof. I have a building 30 feet square and 10 feet high inside, built for storing cabbage; has a six-inch air space, and building is covered with a good roofing paper on roof and sides, sided up with good matched lumber inside and out.

This building is not frost-proof; cabbage will freeze when near zero weather. Will another air space of two inches make it frost-proof or shall I have to make another 8-inch space and fill it out with sawdust? Do you think an air space of two inches more will keep this building from freezing when below zero?

Ransomville, N. Y. C. A. S.

The six-inch air space between walls of matched boards covered with good roofing paper should be sufficient to give you a frost-proof storehouse. It is, of course, essential that no air can get into that six-inch space. That is, it must be absolutely dead air in that space, and no way for air to get in or out. The only reason for the use of sawdust is to be sure that the air is "dead" in the space—that is, to be sure that there is no circulation of air in the six-inch space. If the air space is airtight there is no need of sawdust and, in fact, it is not desirable. Be sure also that there is no chance for the cold air to get into the storehouse underneath the walls. A slight leak of cold air at the floor will cause freezing. All ventilation should be at the top, and that must be kept closed after the first few days the vegetables are in place. The ventilation must be kept up until any "sweating" is over with if you have roots in the house. Then close the ventilators and keep them closed all Winter. Do not open them on warm days. The Rural New Yorker.

The Home Builders' Scrapbook

Ideas Worth Remembering

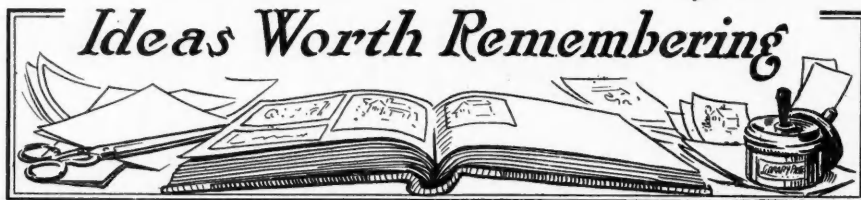

Substantial furniture that will not mar easily should be chosen for the living room. Massive parlor suites are going out of date and single odd pieces are taking their place.

Cover the pantry shelves with white oilcloth. Use brass head tacks. Shelves so covered are easy to keep clean and always look neat.

Window flower boxes are a constant source of beauty and joy to the one who will take a few minutes necessary to make them.

A small glass shelf for the bathroom can be bought in almost any store. It is a sanitary receptacle for odds and ends as brushes, combs, tooth paste, etc.

Monks cloth of all colors is very fashionable for use in making table covers, piano scarfs, cushions and portieres. It is inexpensive.

Tack cheese cloth tightly over the screen frame in the pantry window. The air can enter; dust cannot.

If the bathroom floor has become worn, try covering it with a pretty linoleum.

Soft tones of brown are being extensively used in living room decoration. Stenciling is in high favor.

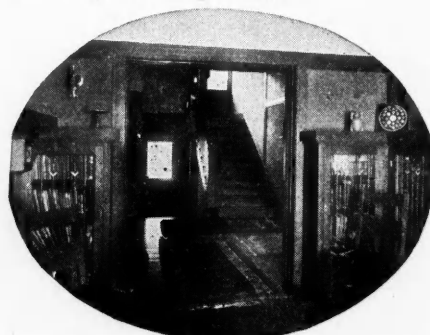

Opening from living room to hall made attractive with built-in corner book cases on each side

New Cicero School

ANOTHER noteworthy example of a fine school building designed by Architect G. W. Ashby of Chicago, is shown.

This building is about to be erected at Cicero, Ill., the contract to be let July 1st. This school will be an excellent addition to a town already known for its splendid school houses. Construction will be of red brick and white stone.

The design, a faithful reproduction of Architect Ashby's ideas, marks the building as a substantial structure, strictly utilitarian. The front elevation is simple yet imposing. A dignified entrance opens into a good-sized vestibule, from the rear of which a wide staircase leads up to the first floor. The stairs to the basement are placed at the ends of the corridors. This basement is arranged for good light and air. It contains the vocational training rooms for pupils of each sex in addition to the toilet rooms and heating plant. The principal's office, a reception room and recitation room together with four class rooms occupy the first floor. On the second floor are five class rooms and a small rest room located at each end of the corridor. All the class rooms are nicely proportioned with adjoining coat rooms and wide corridors. The placing of the many windows gives the best possible lighting.

The utilities provided for the

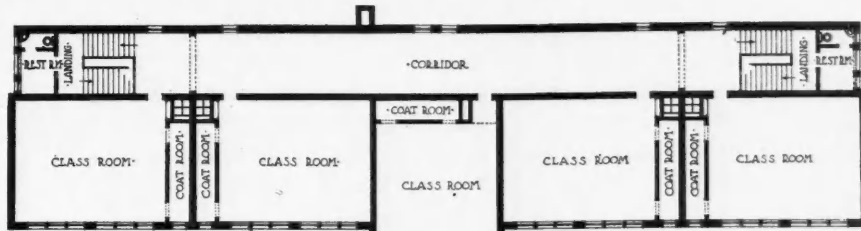

Second Floor Plan

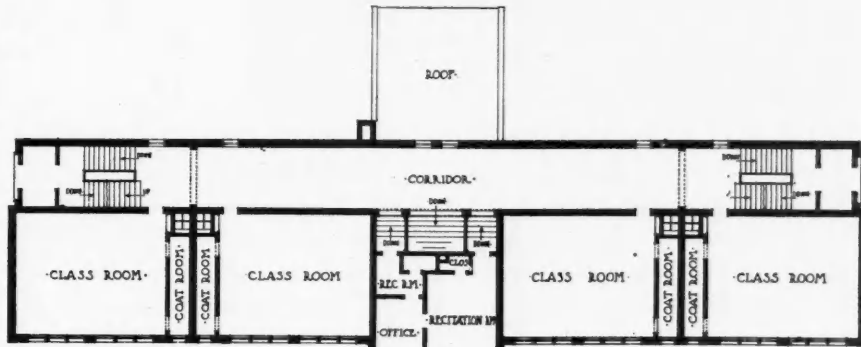

First Floor Plan

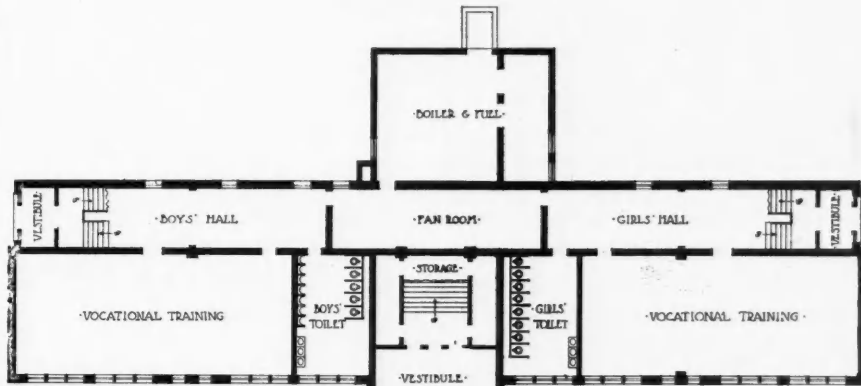

Basement Floor Plan

acomodation of pupils of both sexes are worth noticing. It is a simple and effective arrangement. The corridors are placed to the

rear so at some future time an addition to the building may be made when the attendance out-grows the capacities of this present school.

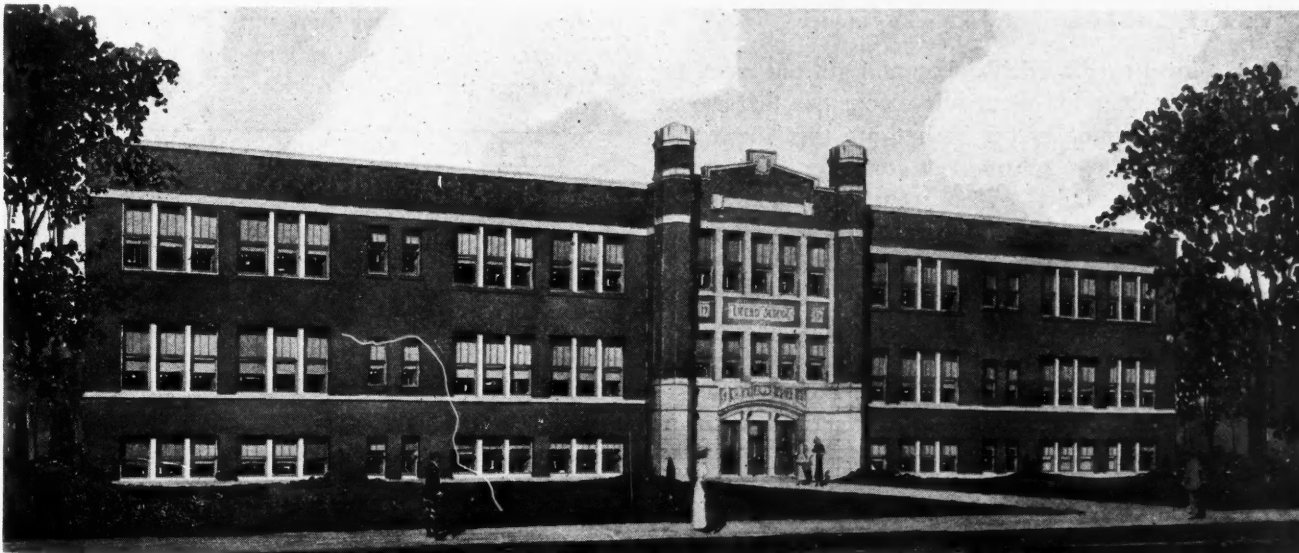

Imposing New School Building for Cicero, Ill., Work on which is to begin soon



Some "Chicken Fixin's"

I TAKE AN INTEREST IN THE POULTRY YARD AND WORK OUT SOME SCHEMES FOR PROFIT MAKERS

By W. D. Graves

Editor AMERICAN CARPENTER AND BUILDER:

I enclose copy intended for the "Making Power Wood Workers Pay" department—to fill while Jimmie is getting married and settled down to business again.

Harriet and the Lord being willing I will start another short series, with a combination machine, next month.

Respectfully Yours,

W. D. GRAVES.

HARRIET always has had the chicken mania to some extent, but has generally held that my presence around the hens was rather detrimental than helpful; a conclusion the justice of which I have never questioned. Lately, however, she and Lorna have been so absorbed in cutting up dress goods and adoring Jimmie that she has expected me to take entire charge of her flock; which is just now in the process of renewal. The clucking I do doesn't sound just like a hen but, fortunately, the women are too absorbed to give it much attention.

Coops—Real Coops; Anybody Can Make them

Harriet has been in the habit of making coops from old boxes and barrels; but I spent very little time in hunting for such truck as that. After the first

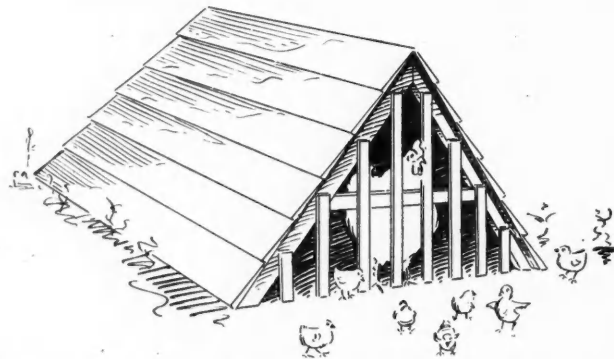

Fig. 1. A Real Coop looks a lot better than the usual Toggled Box or Barrel. A nice little business is to get out the stuff on the Wood Worker and sell it in bundles, one coop to the bundle, which any handy poultry man can set up himself

I went down to Blaysdell's shop and got out stock on Jimmie's machine for about forty coops like that shown in Fig. 1. Jimmie and I both think that there is a chance for profit in getting out stock for such coops, tying it up in bundles of one coop each, and selling it in that form. The cost is slight, it affords another outlet for a lot of scrap; and, as it is K. D., the putting of it together enables the poultry keeper to cherish the "fond delusion" that he is making it himself. The slats for the front and back, or gables, may be of lath or of similar strips ripped from waste stock, while the other materials for one coop are as follows:

- 4 pieces like Fig. 2.
- 2 pieces like Fig. 3.
- 12 pieces six inch bevel siding 30 inches long.

The "talking points" about such a coop are that it costs hardly more than would a reasonable tight box or barrel, it is no more work to assemble it than it would be to fix up the box or barrel; while, unlike the latter, it is good for many season's use. It is water tight, and though light, incapable of being blown over; while its uniform size makes it capable of being piled away snugly when not in use. It is late to do anything with them this season; but Jimmie made me leave him a sample and intends to have a stock of them next spring.

K. D. Yards for Li'l Chix

Getting these coops fixed up gave me a large degree of satisfaction; while Harriet noticed, on one of her hasty trips through the yard, how much neater they appeared than did the aggregation of contraptions she had before. The arrangement was not entirely satisfactory to me, though, because the various families of chix got mixed. Harriet, when she can be induced to take a few minutes off, seems able to straighten them out without much trouble, but they don't seem amenable to my methods of persuasion. In view of the fact that there must be many would-be chicken culturists whose temper is as crisp as mine it seems as though the device by which I overcame

2X2X30" BOTH ENDS CUT AT 45°

FIG. 2

2X2X16" or 18" ENDS CUT 45°

FIG. 3

Shaped Pieces for Coops

this difficulty might also afford some business in Jimmie's line.

I made a number of side frames, of 1 inch by 2 inches, simply nailed together, 4 feet long by 14 inches wide outside. On these I stapled poultry netting of one inch mesh; and on one end nailed a square of heavy paper roofing, as shown in Fig. 4. In each end of each frame were driven two screw eyes in

WOOD WORKERS PAY



such manner that four could be set on edge to enclose a four foot square and be secured at the corners by thrusting pieces of wire down through the screw eyes, making a hinge like joint. This formed a sufficiently large enclosure for one brood of chix and, by placing together the ends covered with roofing, made two sheltered corners. To further shelter these corners, and to guard against interference from other hens, I made for each such pen a cover as shown in Fig. 5. This was simply four strips of 1 inch by 2 inch by 4½ feet, nailed together as shown and covered with poultry netting of coarser mesh; while two opposite corners had triangles of roofing nailed on as shown. Putting these covered corners over the ones sheltered at the sides gave biddy two places of refuge in case of storm while she had ample room to scratch

selling stock as originally designed.

One will, of course, see improvements which may be adopted with advantage, but it is well to sell the old stock down pretty closely before introducing them. It is well to bear in mind, too, that improvements which add to the cost of the product are not very apt to add to the profits, while those which enable one to lessen the selling price will often be accepted as improvements even though you and I might hesitate about so nominating them.

The "make it yourself" bait is being used with considerable success now-a-days and it appears to be a very good one if jiggled just right. There are but few people but like to think themselves of mechanical bent, and while one need not mendaciously add to their delusion, one must be very careful to say nothing which is calculated to dispel it, if delusion it be. It is very trying to a mechanic to see bungled a job which he has carefully designed, but if one is going to make any money he must draw a sharp and distinct line between the mechanical and selling sides of his business. He must also remember that the customer, taking up one of his devices, looks at it from an entirely different viewpoint from his own. Having designed it one's self, one perforce knows the place

(Continued to Page 56)

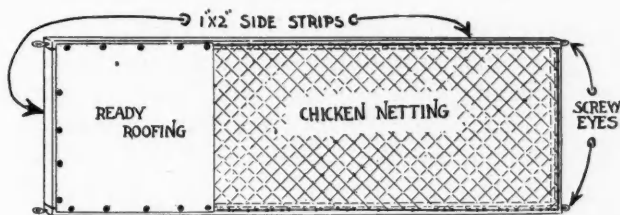

Fig. 4—Light Handy Sides and Ends for Chick Run Yard

in the interim. The whole thing is light and capable of being easily moved to fresh ground, while it may be quickly taken down and stacked away flat when not in use.

The wooden part may be gotten out of scraps, tied in bundles sufficient for one pen, and sold at the price of a dozen eggs, with the same "make it yourself" bait as the other. There must be many unfortunate victims of the chicken craze who would gladly buy them if brought to realize their advantages.

Making a Go of the Selling End

The only difficulty about making a profit on such "chicken fixin's" is to so design them that a lot of people will buy them without insisting on alterations and variations to suit individual notions. Machine work can be done very cheaply if one can make quantities of *one thing*; but as soon as one begins to introduce individual variations the cost begins to run up, often exceeding that of hand work.

If one attempts to make and sell such things he must, of course, have a sample, set up to show; but he should have his stock bundled, and should sell rigidly by the bundle, letting the purchaser introduce, for himself, such variations as he sees fit. Some of these variations will be fearful and wonderful; but one must learn to smile at such—and keep right on

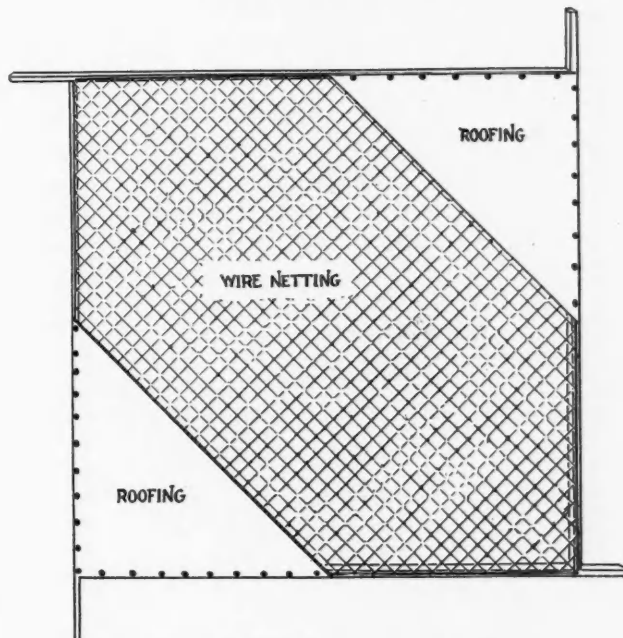

Fig. 5—Roof or Cover for Chicken Run Yards



Noon Hour Talks by the Boss Carpenter

Talk No. 12

THE BOSS TELLS ABOUT THE USE OF CAST IRON COLUMNS AND HOW TO FIGURE SAME FOR CENTRAL LOADS

“AS long as we are talking about columns,” said the Boss, “we might as well consider cast iron columns at this time as at a later time. You fellows will be called upon to figure a cast iron column in some of your work, since this type of column is used very frequently in building construction. In fact, cast iron columns possess many advantages over timber or steel columns and at the same time have disadvantages that you will have to look out for.

“Some of the advantages of these columns are—low cost, ease with which they may be obtained for a given load, adaptability to any given shape or design, and ease of making connections to other parts of the structure. If columns are at least $\frac{3}{4}$ -inch in thickness, they are practically uninjured by rust when not provided with a protective coating. This type of column is said to withstand the effects of fire even better than unprotected steel columns.

“The disadvantages of cast iron columns are lack of uniformity in the metal, the danger arising from internal stresses due to shrinkage, and the difficulty in making tight or riveted connections with other members. Often it is found that the metal in columns is thicker on one side of the column than on the other, or porous sections may exist in some part of the

length. These porous parts are due to ‘honey combing’ of the metal, or the formation of ‘blow-holes’ during the casting of the member. Such imperfections may be discovered by close inspection, or by drilling into the metal.

“Columns with heavy projections or thick parts which join thinner ones are likely to be weakened at these junction points, due to the setting up of internal stresses during the cooling of the cast column. Thin parts cool quicker than heavy sections, and the contraction of the larger part during its cooling will put considerable stress on the thin and already cooled part.

“Cast iron columns may be obtained in many shapes of cross-section and in many styles of finish varying from a plain surface to one of most extravagant ornamentation. Where columns with ornamental caps and bases are used to carry loads, care should be taken to see that the cored or hollow part of the column extends straight through from end to end, and that it does not flare outwards towards the larger ends. Plain moulded caps and bases may be cast solid on the column, but if caps which are largely ornamental, or if heavy projecting bases are desired, they should be cast separately and attached to the straight column by screws.

“The length of cast-iron columns, in inches, should not exceed thirty-six times their outside diameter, or *least* dimension. That is, if a 6-inch diameter column is to be used, it should not be greater than 216 inches, or 18 feet in length.

“The shapes of cross-section in common use are shown in Fig. 22. For interior columns, the hollow cylindrical shape, *a*, meets the requirements better and is more commonly used than any of the other shapes. For exterior columns, as in store fronts, the rectangular hollow shape shown at *c* is commonly used, since it gives a good bearing for the beams which support the walls above. In fire proof construction, the H-shaped section, *e*, is used to a

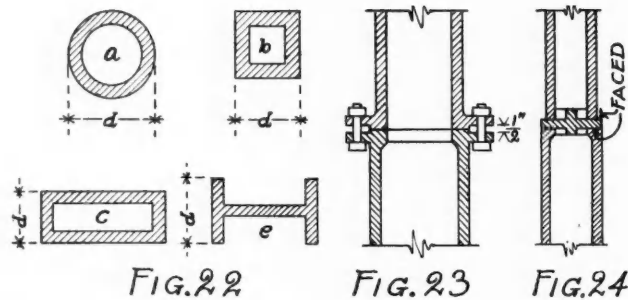

Fig. 22.—Common Shapes of Cross Section for Cast Iron Columns.
Fig. 23.—Columns Joined by Bolting Flanges. Fig. 24.—
Bearing Plate for Columns with Ends Not Bolted

great extent. In such work this shape of column is readily protected at all parts by concrete or masonry so that no open space is left which exposes the metal. The material of the column may be seen at all parts and is easily measured for even thickness.

"In calculating the size of a cast iron column or in finding the load which a column of a given size will carry, we use a modification of our formula No. 8, which was given in Talk No. 11. In this case, the value of C will be from 70,000 to 80,000 pounds per square inch for the ultimate crushing strength of cast iron; K will be 1/6,400. Instead of r^2 , we will use d^2

— for hollow circular cross-sections, and — in the 8 6

case of hollow rectangular cross-sections, where d is always the least outside dimension of the cross-section as shown in Fig. 22. Values of A may be found by doubling the values of the half-areas given in Talk No. 4.

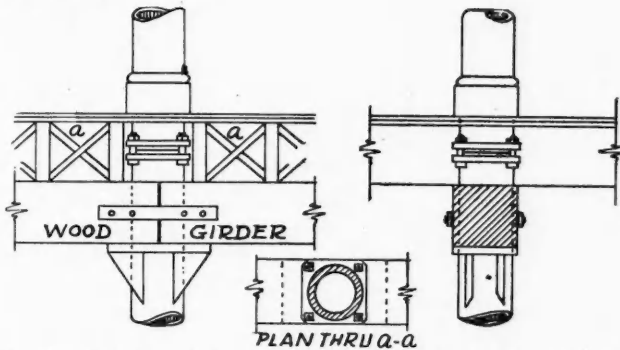

Fig. 25. Cast Iron Columns and Timber Girders, Showing Continuous and Bolted Column

"Suppose that we figure the load which may be carried by the hollow cylindrical, hollow rectangular, and the H-shaped sections of columns using the proper formula with each shape of cross-section. First, we will find what is the allowable central load to be carried by a hollow round cast iron column similar to Fig. 22a, 6 inches outside diameter and 12 feet long, if the metal of the column is 7/8 inch thick, and the ends of the column are turned off flat.

"Changing Formula No. 8 as indicated, we will have for a hollow circular cross-section of cast iron, (Formula No. 8a)

$$C = \frac{W}{A} \left[1 + \left(\frac{1}{6,400} \times \frac{l^2}{d^2} \right) \right] = \frac{W}{A} \left[1 + \left(\frac{1}{800} \times \frac{l^2}{d^2} \right) \right]$$

"Since a factor of safety of at least 8 should be used in figuring cast iron columns, we will assume that the 80,000 iron is of a good quality and use —, or 10,000 lbs. 8

per square inch as the value of C. Filling in Formula No. 8a, we have

$$10,000 = \frac{W}{14.1} \left[1 + \left(\frac{1}{800} \times \frac{(12 \times 12) \times (12 \times 12)}{6 \times 6} \right) \right]$$

141,000 = 1.72 W or W = 82,000 pounds.

"Now let us calculate the central load which might be carried by a cast iron column of hollow rectangular cross-section similar to Fig. 22c. As stated earlier in the talk, we will use Formula No. 8 with changed values for the constant K, C, and r^2 . We will assume that our column is 4 inches by 8 inches outside dimensions; that the metal sides of the column are 3/4-inch thick, and that the length of the column is 12 feet. The ends of the column are supposed to be squared up nicely so that the column rests evenly on its support, and the load bears evenly and centrally on the top of the column. A factor of safety of 8 will be used.

"Changing Formula No. 8, and filling in the proper values, we have

(Formula No. 8b)

$$C = \frac{W}{A} \left[1 + \left(\frac{1}{6,400} \times \frac{l^2}{d^2} \right) \right] = \frac{W}{A} \left[1 + \left(\frac{1}{1,067} \times \frac{l^2}{d^2} \right) \right]$$

$$10,000 = \frac{W}{15.8} \left[1 + \left(\frac{1}{1,067} \times \frac{(12 \times 12) \times (12 \times 12)}{4 \times 4} \right) \right]$$

$$158,000 = 2.2W, \text{ or } W = 72,000 \text{ pounds.}$$

"It is to be noticed that we used the least outside dimension of the column cross-section in solving our problem. This should be done in all cases.

"We will now solve a case like Fig. 22e so as to see the general method of procedure. Suppose that we have an H-shaped column 10 feet long; the metal is 1 inch thick at all parts of the cross-section, while the value of d is 6 inches, and the distance from outside of flange to outside of flange is 8 inches. This column is also to have a factor of safety of 8, and is to bear a central load. Ends are nicely squared.

"The central load for this column would be found by using Formula No. 8a, putting in the value of d as shown in Fig. 22e. The area A , in this case would be found by adding together the area of the two flanges and the area of the web. From the dimension given, $A = 2(6 \times 1) + (8 - 2) \times 1 = 18$ square inches. Filling in Formula No. 8a for this case, we would have

$$10,000 = \frac{W}{18} \left[1 + \left(\frac{1}{800} \times \frac{(10 \times 12) \times (10 \times 12)}{6 \times 6} \right) \right]$$

180,000 = 1.5W, or W = 120,000 pounds."

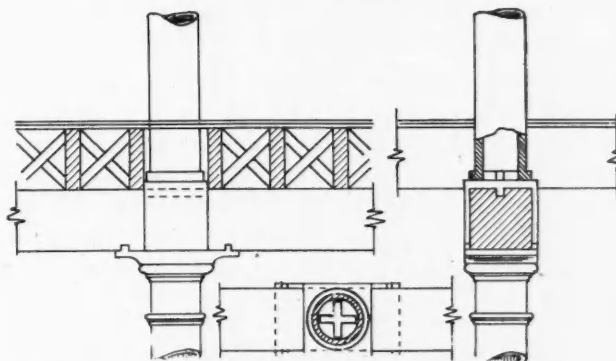

Fig. 26. Detail of Stool and Plate for Timber Girder, Columns Separate

The Boss then copied the following table into the "log book," and explained that it contained values as recommended by Kidder's Architect's Pocket Book. The values given are for the *safe load in pounds per square inch* of cross-section of hollow round and rectangular cast iron columns. These loads are based on a factor of safety of 8.

Safe Loads for Cast Iron Columns					
Length in Inches Divided by Least Value of d.	Round	Rectangular	Length in Inches Divided by Least Value of d.	Round	Rectangular
8	9,259	9,433	23	6,020	6,684
9	9,082	9,293	24	5,814	6,494
10	8,888	9,140	25	5,614	6,305
11	8,688	8,983	26	5,420	6,120
12	8,475	8,811	27	5,233	5,940
13	8,257	8,635	28	5,050	5,764
14	8,032	8,446	29	4,875	5,592
15	7,806	8,257	30	4,706	5,424
16	7,576	8,064	31	4,543	5,260
17	7,347	7,867	32	4,386	5,102
18	7,117	7,670	33	4,235	4,947
19	6,892	7,468	34	4,090	4,797
20	6,666	7,272	35	3,951	4,655
21	6,447	7,076	36	3,817	4,515
22	6,230	6,877			

"To test this table," said the Boss, "we will check back our first problem on the cylindrical column. You

will notice that $\frac{12 \times 12}{6}$ makes $\frac{l}{d} = 24$. In the

table we find that a round column with $\frac{l}{d} = 24$

ought to bear safely 5,814 pounds per square inch of cross-section. The area of our round column was 14.1 square inches. Multiplying 5,814 by 14.1, we get practically 82,000 pounds as we did in our problem.

"This matter might be carried still further by calculating the size of column to carry a given load, but since the mathematics are not as simple as in the preceding cases, we will not have time to discuss the matter this noon."

The Boss then drew Figs. 23, 24, 25, and 26 in the "log book" so as to give the men an idea of methods of joining cast iron columns and method of supporting girders.



Some "Chicken Fixtn's"

(Continued from page 53)

of each piece; instinctively and unconsciously guarding against error and favoring the weak points. The customer approaches from the other side of the shield and, even though he may be a thorough mechanic, is quite apt to make mistakes which seem absurd and needless to us.

When one is selling goods of the "make it yourself" sort he must carefully screen his own candle of mechanical erudition and act as if the other fellow's tallow dip was a million c.p. search light. Also, anything to be sold K. D. must be so made that if put in a bag and shaken it will fall together itself.

Possibilities in Feed Hoppers

As I write there occurs to me another device which

might be made to advantage in many localities. This is a feed hopper for chickens as shown in Fig. 6. There should be supplied with it a flat board cover, not shown, with cleats to drop inside the top and hold it in place. What seems to me the size which would sell best is about eighteen inches long, twelve inches high and eight or ten inches wide on top. The ends should be made of stuff of common board thickness, while the balance would be better of resawed stuff. Many are so situated that the stock for this could be worked from used packing boxes to advantage.

Speaking of packing boxes there is an opening, which has been used in some localities, in the way of

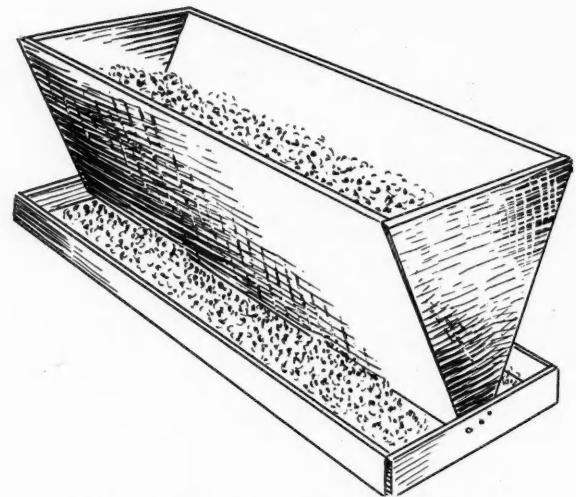

Fig. 6. Feed Box or Hopper for Chicken Yard

working them over into egg cases, which are too common to need description. In addition to the regular thirty dozen size there is, or might be created, a demand for cases of half that size, or smaller. A size to hold twelve dozen would probably be the handiest to make from packing box material, and would need to be twelve inches square inside by eleven inches deep. By systematizing the business, using cheap help to collect the boxes and take them apart, and keeping a sharp eye out for nails, one might work up quite a business in this line wherever packing boxes are to be had cheaply. It would be a good job to work little Jimmie in at, but it will be necessary to provide a saw specially for that purpose, and for him to practice filing on. He will get lots of practice.



Mid-West Cement Show and Convention

The Board of Directors of the Nebraska Cement Users' Association met in Omaha, June 9th, and decided to set the dates for the Eighth Mid-West Cement Show, January 30th to February 4th, 1914. This will give a five days' show, opening on the evening of Friday, January 30th, and closing on Wednesday evening, February 4th.

The dates for the Ninth Annual Convention of the Nebraska Cement Users were set for February 2nd, 3rd and 4th, 1914. President Peter Palmer and Secretary Frank Whipperman anticipate a much larger show than was held last year.

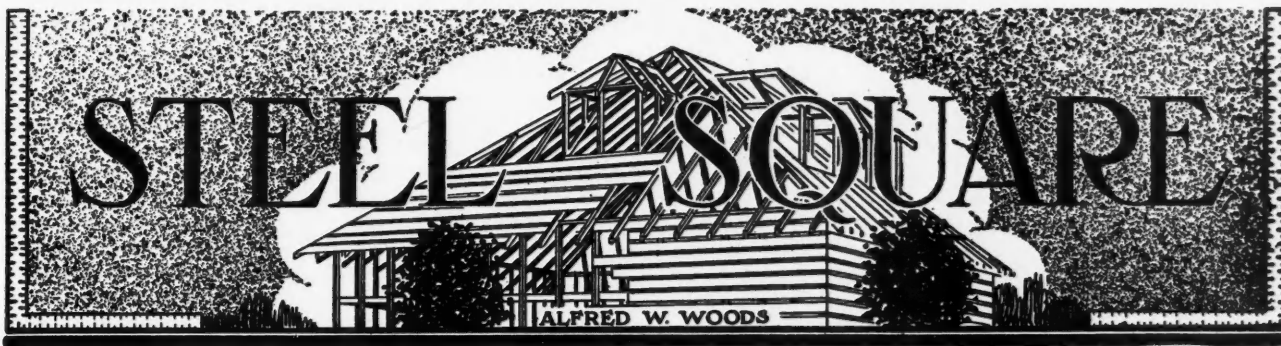

Roof Framing Problem Solved

ILLUSTRATING A GENERAL RULE FOR OBTAINING THE PROPORTIONS TO TAKE ON THE STEEL SQUARE FOR THE LENGTH AND CUTS OF THE RAFTERS FOR ANY ANGLED BUILDING

THERE are many ways of illustrating the parts to take on the steel square for framing the rafters, as every one knows who has at all kept pace with the building journals describing and illustrating by piece-meal, some specific part or cut about the roof. Many of these were given simply because they give a correct result for that particular thing and without knowledge as to the why in the case. Such rules are a detriment because they seemingly satisfy for the case in hand, but back of that, such rules are a barrier, a stumbling block, as it were, instead of one that clears the way of all obstacles and smooths out the kinks for easy going. The rule that is a rule, is the general rule that applies to all conditions, using the same cause and effect; and when once understood, the way is made clear; and when correctly applied, will lead to a safe landing. It is as the compass to the mariner on the high seas. He will have—along with smooth sailing—billows and breakers that may at times seem unsurmountable; but if he has a cool head and understands his compass, he will know where he is and will guide his ship through to a safe landing in a chosen port.

The illustrations we present are not new, as the

older readers can testify, as we have talked about this before—though we may not have presented the subject as clearly as set forth in these illustrations.

Beginning with Fig. 1, is shown the proportion of the rafters for a common hip roof, for a square cornered building with each part named and also represented by reference letters.

Now, everybody knows, or at least should know, that the run and rise of the rafters taken on the steel square will give the seat and plumb cut; but it is the

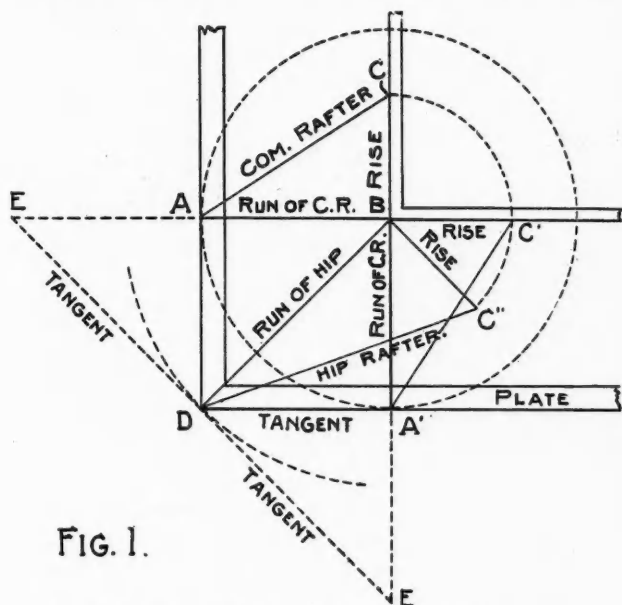

FIG. 1.

Proportion of Rafters for a Common Hip Roof on Square Cornered Building

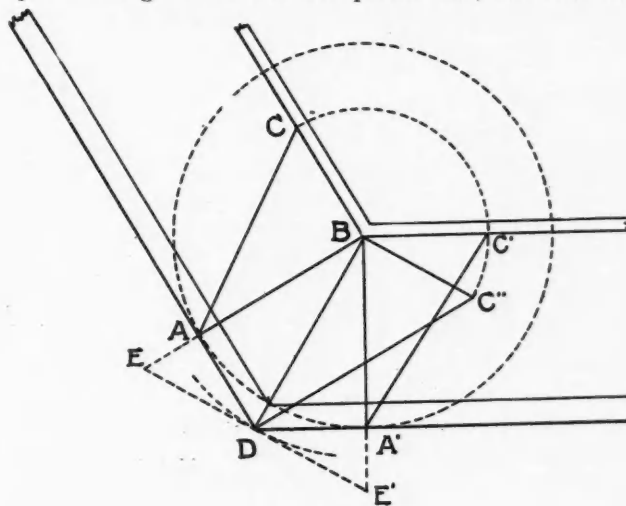

FIG. 2.

Obtuse Corner with Hip Roof

side cut of the hip and jack that bothers most carpenters. Here is the cue. Take the tangent D. A. and the length of the common rafter A. C. and the side of the square on which the latter is taken will give the side cut of the jack rafter. We say side cut, but in reality it is the angle to take across the top of the rafter to obtain the fit of the jack against the hip. The tangent D E' and the length of the hip D C'' will give the side cut of the hip to fit against the ridge piece or the corner of the deck plate, as the case may be.

Now, this is a regular roof, that is, the pitches of the rafters are the same on either side of the hip, and consequently the proportions are the same on either side and the same conditions hold good for any shaped corner so long as the pitches remain regular.

Figure 2 shows that for an obtuse corner, that is,

the angle formed by the plates (reckoned from the inner side), is more than ninety degrees. This particular example represents the octagon; and the reference letters are the same as used in Fig. 1 to represent like parts, but of course it must be remembered

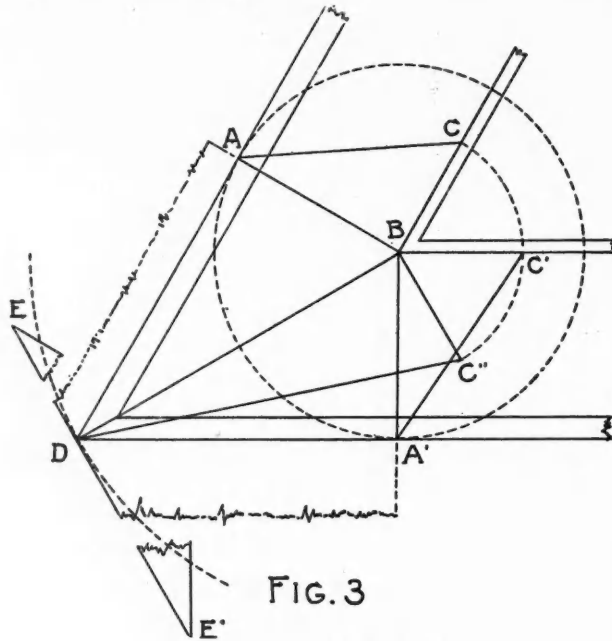

FIG. 3
Acute Corner with Hip Roof

that the angle formed by the plates, being different, the proportions to take on the steel square must necessarily be different. Figure 3 shows that for an acute angle or less than ninety degrees. As in the

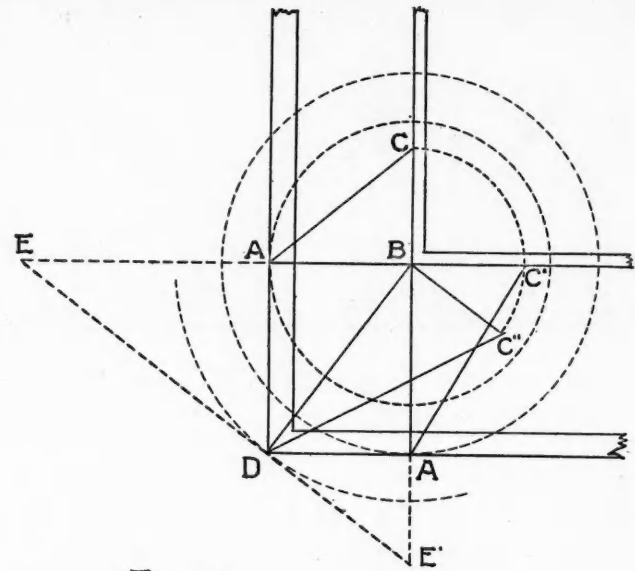

FIG. 4.
Hip Roof with Unequal Pitches

previous examples, like parts are represented by like reference letters.

In Fig. 4, this same rule is applied to the square cornered roof, but with different pitches. Like reference letters are used as in the previous examples, but the proportion of the parts are necessarily changed because the pitches are different and therefore it requires different proportions for the lengths and cuts of the rafters on either side of the hip, but the procedure is the same, more particularly described in the first illustration.

Big Money For A Little of Your Time

CAN you solve the puzzle on the opposite page? Every reader of the AMERICAN CARPENTER AND BUILDER may enter this contest, and we will be disappointed if you don't. You will find it good sport, too—not nearly so hard as it looks.

Beginning with this issue we open a series of interesting and instructive prize contests that we earnestly hope every one of our subscribers will enter. We know that you will derive a lot of pleasure from working out the puzzle, and writing the letter; and if you concentrate your mind upon them, you are almost sure of winning one of the thirteen prizes.

Object of Contest

Month by month we have been telling you how valuable our advertising pages are to you if you use them. Therein you will find represented some 300 of the best manufacturers of their respective lines—all the latest practical ideas in the architectural and building world are announced; and if you will take advantage of these opportunities we know you will value higher than ever the AMERICAN CARPENTER AND BUILDER.

That is the reason of the contest.

We want you to consider the advertising pages just as important as the regular text matter—we want you to read every advertisement of every issue—note what our advertisers have to offer—and buy from them. You are fully protected in every sense—no manufacturer ever has or ever will use the AMERICAN CARPENTER AND BUILDER who is not reliable in every way, and you are sure of satisfactory dealings with

any advertiser that the AMERICAN CARPENTER AND BUILDER introduced you to.

Another thing we want to bring out is the fact that should you ever need anything that you do not find advertised in the AMERICAN CARPENTER AND BUILDER, you have but to call upon us. Any information that is in our power to give you will cost you nothing. We want to be of every possible service to our readers and advertisers, and we know if you read both the advertising and text sections of each issue you cannot help but profit.

Simplicity of Contest

The contest itself is simple. The puzzle will take but a little of your time, and what time it does take we know you will consider well spent. The letter part of it isn't hard—what we want from you is just a plain from-the-heart statement of your ideas on the subject. Your letter doesn't have to be a literary masterpiece to win one of the prizes—just a plain everyday letter that you would write to a friend stands a far better chance than the carefully worded, senseless letter.

On the page opposite you will find fragments taken from 25 advertisers in the present issue—no back numbers are used. Read each and every advertisement through as carefully as you can, and then pick out the advertisements from which these 25 fragments were taken. As you read through the advertisements it would be a good idea to keep in mind the merits of the goods advertised—it will not only make it easier for you to solve this contest, but will help you with the others.

PRIZES and FUN FOR ALL WHO READ OUR ADVERTISING PAGES!



①

Send for Any or All of these Booklets:

KNO-FUR Lath Booklet.
 KNO-BURN Lath Booklet.
 XX Century Lath Booklet.
 Metal Lath for House Construction.
 ECONO Reinforcing Booklet for Architects and Contractors.
 ECONO Reinforcing Booklet for Engineers and Contractors.



③

④



Kriebel System

⑤



SAWSMITHS UNION OF NORTH AMERICA

⑥

Toolsmiths

⑦



⑧

TRUSS LOOP LATH.

⑨

The *Underfeed* saves 1/2 to 3/4

⑩

"A Mix A Minute"

⑪



See that Butt
it means something

⑫

THE BUSINESS END OF A Peerless Screw Driver

⑬



⑭



⑮

ASBESTOS

⑯

"TITELOCK"

⑰



Send for Catalogue

⑱



TRADE MARK

⑲

Now don't you see the point?

⑳



㉑

SPEED & EASE

㉒

5 MILES IN 10 DAYS!

㉓



㉔



⑳

Made in all sizes with Metal or Glass Tops.
 Our FREE CATALOG will help you with your estimating.

JULY AD. PUZZLE PRIZE CONTEST

Above are fragments of 25 advertisements appearing in this issue. Can you identify them? Some are old friends; some you will have to hunt a little to locate. Study our advertising pages this month; read every offer. Then list the 25 ads. these were clipped from. Be sure to give the page numbers. Also write a brief, straightforward letter of 50 words on this subject: "Why I Study and Have Confidence in American Carpenter and Builder Advertising."

13 PRIZES

WE WILL AWARD THESE PRIZES

\$30 IN PRIZES

For the best letter (and correct Puzzle solution) \$10.00 worth of goods selected from our Ad. Pages

For the 2 next best letters (and correct Puzzle solution) \$5.00 worth of goods selected from our Ad. Pages

For the 10 next best letters (and correct Puzzle solution) \$1 worth of goods selected from our Ad. Pages

When sending in your Puzzle Answer and Letter be sure to state the goods you select from our Ad. Pages in case you win a prize goods of any value may be selected, and prizes will apply either in whole or part payment on them.

Address your letters to, Your Friend,

THE ADVERTISING EDITOR,
 American Carpenter and Builder, Chicago

This contest closes Tuesday, July 15th.

Prize winners will be announced in Aug. issue.

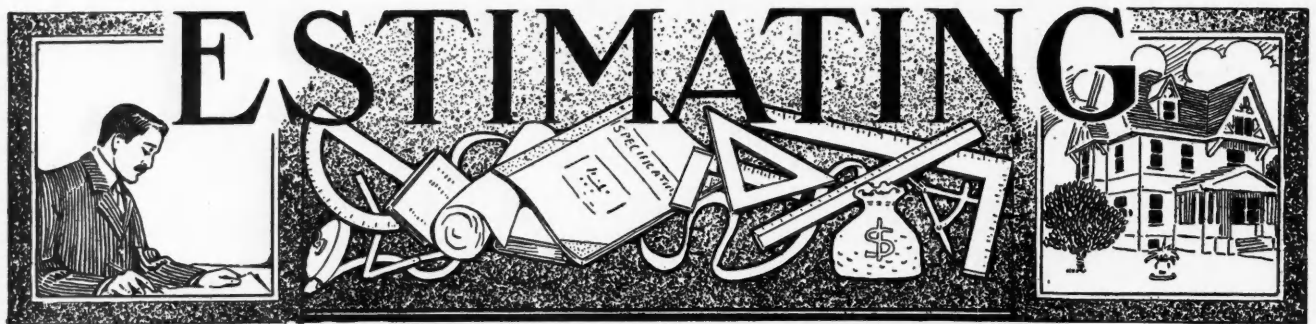

Plea for a Better System of Estimating the Cost of Buildings

By G. Alexander Wright, Architect

THE ever-increasing amount of unproductive time, and usually money, which contractors are called upon to expend in preparing, gratuitously, quantities, as well as prices, often for an owner's benefit, suggests that the time has arrived when all concerned should

take up, and seriously consider, the possibilities of adopting a modern and more sensible system of estimating, such, for example, as has been long in successful operation in older communities. Not a mere copying of such methods, for I advocate the creation of a standardized method of our own—an American system, practical above all things; a system that will be in line with our otherwise progressive building methods; a system that shall be clear and accurate, and that shall stand for square dealing between contractor and owner—in short, a system that shall give every man his due, no more and no less; a progressive system, free from the defects of other systems, such as unnecessary elaboration, and yet one that will reveal to the builder, at a glance, the actual quantity of material and labor in a structure, in any individual trade.

When bidders are invited to submit bids, they are theoretically asked of course to submit competitive prices, but in actual practice their bids are based upon competitive quantities, before the competition in prices commences; which, in my opinion, is as unjust to the contractor as it is ridiculous. A building can only contain a certain amount of material, and no amount of figuring by contractors against each other can make the quantity any more or any less. Where, then, is the sense in a dozen or more general contractors competing against each other in taking quantities? One or more bidders, through being hurried, or being unable to take off the quantities accurately, leaves something out. What happens? Their bids are consequently low, and the owner benefits, at the low bidder's expense, whilst the competent or more careful bidder loses the job, because his quantities are more accurate, or because there may have been room for uncertainty

Building contractors are throwing away thousands of dollars every year in useless estimating—laboriously figuring jobs that the other fellow gets. This plan proposed by Mr. Wright does away with this. It puts the expense of estimating where it belongs—on the owner. It is the system in successful operation abroad. It should be given a trial here.

Editor.

when figuring the plans and specifications.

Not long ago, a general contractor (whom I have known over twenty years) told me that if contractors figured to do competitive work just exactly as plans and specifications called for, a man would not get "one job in fifty."

Now, if this is true, and personally I believe it, there is something very rotten in our methods. In my judgment it lies in our antiquated estimating practices.

Those of us who know something of the unsatisfactory conditions under which bidders are often obliged to figure, time after time without results, have realized that hundreds of thousands of dollars in time and money are taken from contractors' pockets every year, simply because they do not, so far, limit competition between themselves to the matter of prices. They go on competing, and I suggest gambling, with each other as to the quantity of material a building will take, whereas I contend that that is a question of fact, and that competition in the quantities between contractors never can, and never will, in any way, change the fact that a certain fixed quantity of material and labor is necessary to do every job. There can be no legitimate competition in taking off quantities of materials, except that unfortunate competition which bidders make themselves when they take off too much, or, as too often happens, too little.

No Proper Competition in Quantities

The legitimate competition can only come in where one man can handle a job better than another, or one man may have some advantage over another in buying, and so forth. All this kind of competition is legitimate enough, but it must be obvious that no amount of figuring can reduce the real quantity of material which a building will take, and so my contention is that it would be proper and fair to start all bidders figuring upon the same basis, by furnishing each with a schedule, or bill of quantities, showing accurately and clearly the different quantities and kinds of materials which the bidder is invited to figure

upon; and even then there would be plenty of competition left, in placing profitable prices against each item.

Our present method (or rather, want of method) in estimating, and the rapid strides being made in construction, are, as I have said, forcing upon the contractor, more and more every year, an increasing waste of time and money in figuring out quantities. This senseless waste and competition cannot go on for ever. It has already brought men to bankruptcy all over the country, and has often prevented the making of a proper and legitimate profit among those who do succeed in keeping their heads above water.

This is a live question, and it deserves the earnest consideration of all contractors' associations and architectural societies from the Atlantic to the Pacific Coast.

No new or untried principle is involved. It is simply that of a definite quantity of work, for a definite amount of money. In substance the owner says, "I want this quantity of work done. The drawings and specifications show you how this quantity of work is to be assembled or put together: Now, tell me how much money will this cost? I want you to do the quantity of work called for; no more, no less."

At present, the successful bidder often says, in effect, to an owner, "I will erect your building according to plans and specifications," but—mentally—he says, "I do not figure that it will take as much flooring, concrete, plastering or painting as my competitors think it will!" Let me ask, Is this a proper or fair competition between contractors themselves? Is it fair to their own interests? There is only one individual who stands to gain anything under such imperfect methods, the owner, and not always he.

I know of nothing in connection with the work of the contractor that would be more beneficial than the adoption of some equitable recognized system of estimating upon bills of quantities, and these latter would be equally valuable, whether sub-contracts were eventually let or not.

The "Quantity System"

It is not the idea that we accept the methods of any particular country—the author hopes he is too much of an American citizen to suggest that—but where contractors in older communities favor a certain system to the exclusion of the very thing we practice here, than I suggest that we might well stop for a moment and take notice of what is being done. For example, in the year 1909 a conference was held in Great Britain between the National Federation of Building Trade Employers, the Institute of Builders and the London Master Builders' Association, and a resolution was adopted recommending contractors who were members of these powerful organizations to decline to bid in competition against each other, unless bills of quantities were supplied for their use at the owner's expense. A deputation from these contractors' organiza-

tions afterwards attended before the principal body of architects, who promised to further the aims of the contractors as far as was within their power; and today the Quantity System is in full operation, not only in the case of private owners, but in all building work for government and municipal authorities, and upon the principle that it is impossible to obtain accurate bids without accurate quantities.

There must be some good reason for all this, and I suggest that it is worth consideration by any body of men, architects or contractors, who are endeavoring to get and to do better work, and thus elevate the building business to the honorable position which it is entitled to occupy, and to bring about such conditions as will cause owners to hold the competent architect, as well as the contractor, in higher esteem, and not regard him, as is too often the case now, with suspicion.

When Our System Falls Down

Now let us consider, for a moment, a few of the disadvantages of existing methods:

First—The time usually given for figuring is far too short for the accurate taking off of quantities, in addition to the pricing and figuring out of the many items. A bidder usually has contract work in progress, and other matters to be attended to during the daytime; other plans are to be figured by a certain time, and but little can be accomplished in the eight-hour working day, and so advantage must be taken of the night hours, sometimes all night, and even Sundays (as I happen to know), and any other time. Only those who have worked under these conditions and over blue prints at night, hour after hour, taking off items, can appreciate the many difficulties, pitfalls and liability to error through figuring against time, after the real work of the business day is over. But the plans must be returned first thing in the morning, or the bid must be in by a certain hour the next day. Nothing but hurry—hurry—hurry. In not a few cases more information is necessary; something is not quite clear. The plans and specifications do not agree on some point. Which is right? There is no time to find out, the only person who can enlighten you is asleep, perhaps, while the careful estimator is burning the midnight oil, and wrestling with problems which can be avoided and entirely eliminated under a more modern system of estimating.

Again, the careful bidder who honestly tries to get in all the items, and figures to do the work as called for, is frequently beaten by a less competent bidder, who forgets something, or who, maybe, is willing to take a chance anyway, in order to get the job. True, omissions in lists of materials are sometimes unavoidable, under existing methods, which unfortunately aim at speed rather than accuracy.

This article will be continued and this subject further considered in the August issue.

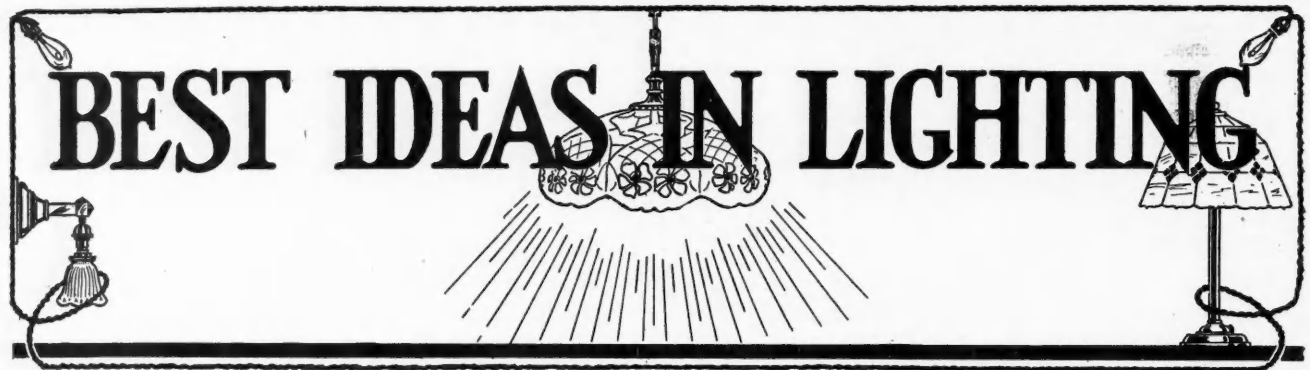

What Every Builder Ought to Know about Electric Lighting and Lighting Fixtures

By Roland T. Hughes

Illustrations by Courtesy of The Chicago Gas Appliance Co. and Beardslee Chandelier Manufacturing Co.

A PARTICULAR annoyance to the average builder of a moderate priced residence, or two-flat building, is the matter of suitable lighting fixtures. While the importance is usually felt, still, the thousand and one designs to select from, only serve to confuse; and as a rule a builder goes through the ordeal of placing his order, as though it were a necessary evil.

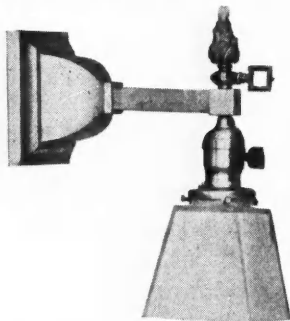

A Neat Side Light Combination Fixture

The suggestions following may prove helpful.

The planning for lighting arrangements should begin when you have your plans drawn up. Architects, as a rule, do not go very deeply into the matter. That is left to the builder (very often for good reasons) to figure out with the electrical contractor. And electrical contractors, from purely mercenary motives, often lead the builder astray.

Number of Circuits Needed

In laying out the wiring plan for city work, where a rigid inspection is made, it is best to provide enough circuits. The style of fixtures now being used call for four and five lights in both the dining room and parlor. Therefore, it is a difficult matter to get by with less than two circuits in each flat, as only twelve lights are allowed on each circuit. Careful consider-

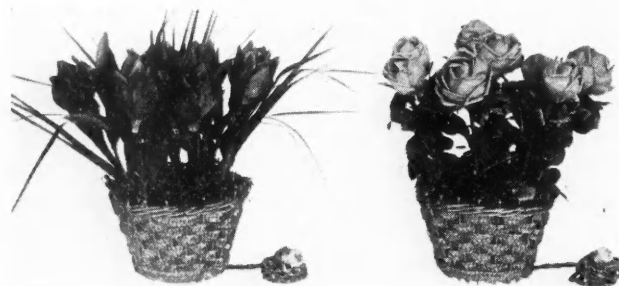

Dining Table Lighting Fixtures—The Heart of Each Flower is a Light Bulb

ation should be given to this. Its importance is too often felt only when the building is nearly completed; and you are forced to select fixtures limited to a certain number of lights.

Switches and the Placing of Outlets

Parlor and dining room fixtures should always be controlled by wall switches. Beam lights are not being used as often as heretofore; the pretty lighting effect not at all equalling the added cost.

In the bath room, it is a very good idea to have the outlet for the fixture placed on the wall beside the medicine case, where the light will be thrown on the face. A bath fixture in the center of the ceiling places the light behind the head, leaving the face somewhat in darkness when facing the mirror. A bracket placed over the medicine case is generally too high for a woman to reach, and very often is placed so low by the electrician that the door of the medicine case hits the lamp.

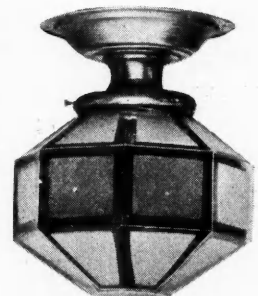

Porch Ceiling Light

An outlet in the pantry is really needed. Either the electrical contractor or the fixture concern will furnish a 4-foot cord, which is cheaper and better than a fixture, inasmuch as it enables one to place the light toward any of the shelves. Outlets in closets are seldom needed, and do not justify the extra expense. A 10 or 15-foot cord with a plug on one end, a socket on the other end, will serve the purpose equally as well the few times a light is really needed, and in addition can be used often for a temporary light on the rear porch, as a basement light, or for any other purpose of getting a light at a required point.

In planning the light for the vestibule in a two-flat building much future trouble can be avoided between tenants by having the outlet containing two circuits, that is, a light for each flat. A vestibule light makes the prettiest appearance on the wall, although

it is a good idea to figure the swing of the outside door. Very often, the door will hit the fixture. If this is the case, the outlet should be placed in the ceiling, *and controlled by a switch*, as the top of the door, 7 feet from the floor, has to pass under the fixture. If a one-light wall bracket for the vestibule is decided on, no switch is needed. For two lights, a switch is needed in both flats. Have your electrician figure the price both ways. If the convenience merits

for your own particular building and requirements, you will find of much assistance.

Selecting the Fixtures

In selecting fixtures, women are a great help. Their ideas are worthy in most cases, as it seems they observe the prevailing designs more closely than men do. A few hints as to the selection of fixtures are possible, still the selection of fixtures is a matter not to be covered in a short article, but depends mainly on the amount allowed for fixtures, the prevailing styles, the suitability of designs to the owner's taste. It is well, however, to bear the following in mind.

Bed room and kitchen fixtures should be equipped with pull sockets. The extra cost per socket is from twenty to twenty-five cents (in the neighborhood of a dollar per flat) and is well worth the difference. Short men and most women have difficulty in reaching the socket key, often having to climb on a chair or bed to turn the light off or on. The 8 inches of chain hanging down from pull sockets is all the difference in the world. If you are thinking of putting a switch in the kitchen, don't do it. A pull socket serves the same purpose at a twentieth the cost. With the parlor and dining room equipped with switches, pull sockets in the kitchen, and bedrooms, bath and hall outlets on the wall,—all fixtures are easily accessible.

Finishes and Styles of Fixtures

Regarding finishes: The regular finish nowadays is Brush Brass. Very fine effects, however, are gotten by using an Antique Brass finish, a brush brass shaded with black in irregular stripes. Polished brass is very seldom used now. Hardware, switch plates, and other metal trimmings are generally matched up with the fixtures. Most hardware stores have samples of all finishes on display. From these you can get an idea of what you want. Fixture houses will duplicate any finish if furnished with a sample of the hardware.

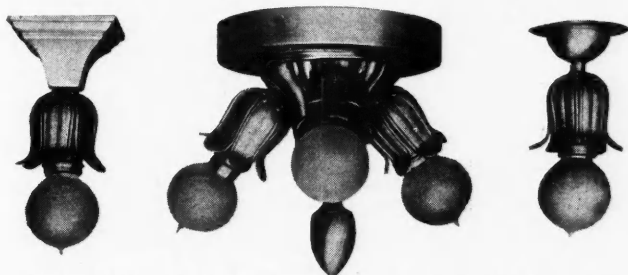

Ceiling Lights, both for Beam Intersections and for Central Cluster

the difference, by all means have separate lights for each flat.

As to Combination Fixtures

Country buildings, as a rule, are lighted exclusively by electricity. In the larger cities, outlets are for both gas and electricity. Even when gas is easily obtainable, it is cheaper and better to eliminate it from all rooms, with the possible exception of the dining room and the kitchen, and sometimes, the bath room. For cases of emergency, gas light for the dining room can take care of the dining room and the parlor. In the kitchen, gas is a convenience to have, as a single gas burner and mantle give a much better light than the electric.

These points above mentioned will help considerably when figuring the cost of gas piping and electric wiring. Even if you do not make use of the suggestions, it is a good idea to mention them to the electrical contractor when figuring. His suggestions



Latest Ideas in Pendant Fixtures for Living and Dining Rooms

Oxidized Copper is used only in kitchens, now. This darker finish, or a dull-black finish, is to be preferred on account of better wearing qualities, and the tendency not to show fly specks or discolorments due to the smoke and grease of the cook-stove. In bath rooms, a Nickel finish is suggested to harmonize with the other bath room trimmings in Nickel. The ob-

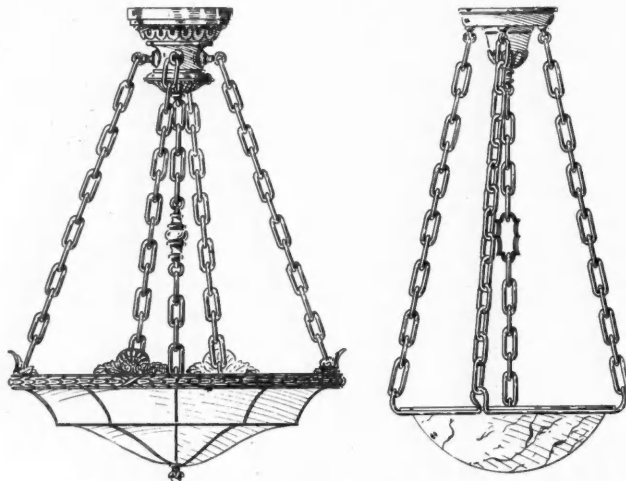

TWO INDIRECT LIGHTING FIXTURES

On the Left—An attractive Classic pattern, showing the graceful bent-glass panel effect. Panels are made of Alabaster glass, which has the appearance of white marble. When lighted a soft glow is diffused over the entire surface of the panels. Diameter of bowl, 22 inches.

On the Right—The rich simplicity of this fixture commands attention. The bowl is genuine marble of bluish-gray color, tinted with brown and amber. Produces a soft light of a rare tone that cannot be produced through glass.

jection to Nickel, however, is that the steam from hot water dulls it quickly. Still, if the nickel plating is heavy, and the surface is unlacquered, the fixture can be polished the same as a faucet, or a piece of nickelled pipe. Lately, up-to-date builders are putting in a fixture finished in white enamel, for the bath room. It makes a very sanitary appearance.

Kitchen Fixtures

In the kitchen, a one-light fixture suffices in most cases. It is advisable that the electric light should hang straight down, instead of the regulation angle-pendant sold by most fixture concerns, as it is more adaptable for the Tungsten lamp, which attains greatest longevity when burning straight down. The tendency has been growing among builders lately to install a two-light fixture in the kitchen. With the general use of electricity for electric irons, toasters, heaters, and other appliances for the household, it is quite a convenience to have a two-light fixture; one socket furnishes the light; the other is to attach the plug of the appliance used. The two-light fixture for the kitchen is an item to consider seriously when making your selection.

The vestibule and landing fixtures are usually something ordinary, with perhaps some special glassware. As a rule, glassware on landing brackets matches with the parlor or dining room glassware; while a glassware of colored or fancy design is generally used in the vestibule to give a soft light, as well as a pretty appearance from the street.

New Ideas in Parlor and Dining Room Fixtures

This brings us, finally, to the designs for the parlor and dining room. No definite suggestions can be given, as the styles and ideas change so often. What one builder likes, another would not take for a gift; and so it goes. Just now, the prevailing designs are in shower effects for both the dining room and parlor. Domes once used almost exclusively in dining rooms are fast declining in favor, and selections of fixtures with a dome for the dining room are rare indeed these days. An art glass shade of rich design is a thing of beauty, and will always be in demand; and the soft, subdued light of the dome is hard to replace in the shower effects.

There is still a later idea than the regular shower effects, and that is the Indirect Lighting idea. Whether this will supersede other forms of residential lighting is a question, but a strong argument against it is the amount of electric current used to obtain the results. Light from a bowl-shaped fixture is thrown directly to the ceiling, and reflected downward, the effect being most restful, soft and rich. All glare is eliminated. However, dust settling in the bowl and on the lamps greatly lowers the efficiency, and spoils the lighting effect.

A means of obviating this is the use of art glass, or a specially manufactured glass for the purpose, affording what is called Semi-Indirect Lighting. Part of the light is thrown to the ceiling diffusing down, the rest filtering through the heavy glass. In all probability, this form of lighting for the parlor and the dining room, and even for bed rooms, will take the place of regular shower effects in due time.

When planning your lighting, or selecting fixture designs, these few suggestions will aid materially in the installation of an up-to-date and convenient arrangement. Some of the points you may have heard before, but in trying to cover nearly all of them, the writer has willfully included those troubles of builders which have come forcibly to his attention.



Rapid Method of Coloring Drawings

Every draftsman has occasion at one time or another to color a drawing or a whiteprint. The use of colored inks is unsatisfactory; cross-hatching in colors obscures the details and is slow, while water colors have the disadvantage of slowness besides being difficult to apply evenly. A quick and satisfactory method of coloring involves the use of ordinary wax crayons and gasoline. Crayon of the color desired is applied and then rubbed with a piece of cloth, wet with gasoline, until the color is even, and extended to the limits desired. If it overruns the lines, it can be erased with a pencil eraser. Some colors, particularly the yellows, purples, greens and light blues, produce much better results than others. It is probable that the gasoline dissolves the wax from the crayon, leaving the pigment as an impalpable powder, which, when rubbed over the paper, colors it uniformly. The method is applicable with equal success to egg-shell and smooth drawing papers and to whiteprints on both paper and cloth.—Says the Engineering and Mining Journal.

More Shop Kinks

HELPFUL IDEAS AND SUGGESTIONS FOR CARPENTERS, CABINET MAKERS AND MACHINE WOODWORKERS

By Wm. C. Jasbury

WIND OF THE STAIRS: Nearly every one has had a few flash light thoughts of the inconvenience of going up or coming down a flight of stairs that had winders. Now as to the winders, they may be faultlessly constructed, in fact I might say as to workmanship they may be Exhibit A; but there is a "something"—the number of falls that could be layed to winders, would be large enough to make a good sized election bonfire. Some stairs are so winding that when the walker-up gets to the top, he is so twisted that he would remind you of a board in the wind. By the way, that word *wind* I am using so profusely is wind, such as wind the clock, wind up the yarn, etc., not wind, such as poor Omaha recently had an overdose, but just wind. So be it, winders are not to be suggested for a healthy flight of stairs, not that their direction is apt to confuse the goer-up and make him

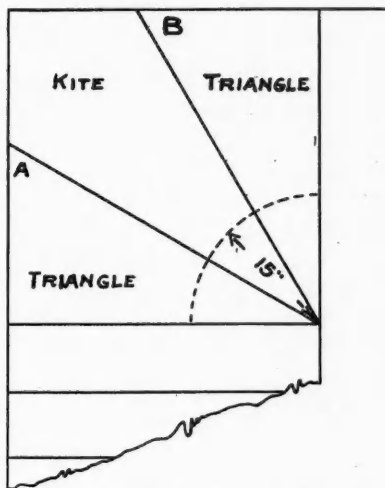

Layout of Stair Having Winders

think he is going back where he started from, but for commodious walking, they are to be eschewed. As the ordinary house designer utilizes nearly all the area for his layouts for broom closets, dumb waiters, clothes chutes and many other up-to-date appurtenances and what room he has left he uses for the stairs, the poor half-breed rear or service stairs have their cup of inconvenience filled to slopping over. Usually the run or horizontal stretch of the stairs is too short to permit all flyers, hence the aforesaid winder's crop up. Usually stairs of this character are from 2 ft. 6 in. to 3 ft. 6 in. wide and the area at the turn that should be given to a platform is allotted to the winders and if there are too many winders in the square or turn of the stairs the treads will be too narrow on the walking line, which is usually about 15 inches from the radius point. The number that seems to be the best fitted for the case is three winders known as two triangle winders and one kite winder as shown. To get this, divide the quadrant into three equal parts, then draw the riser face lines through these points from the apex or radius point regardless of what or where they come out at the wall end. As the walking is done 15 inches from the points, this is the spot to be made normal to the width of the flyers. If this is always done, which I think is perfectly correct, the angle at A and B will always be the cut of 7 and 12 on the steel square.

SOMETHING OF A MALLET. I saw an idea for a wood-workers mallet recently by a sash maker, who was using it to drive sash together. A hammer dents the stiles and rails too much and for that reason, a mallet is what these fellows always use.

Here is the one I saw and how it was made. He took a 3-inch pipe coupling and drilled a 1-inch hole

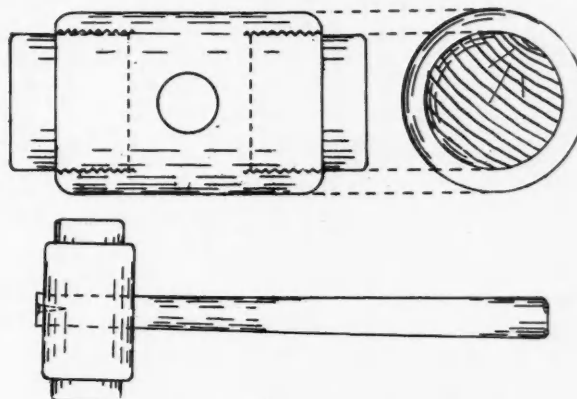

Wood Faced Mallet Made from Pipe Coupling

through it and drove a wagon spoke in the hole for a handle, and for the hammer end part he had the turner make him hickory plugs with a little taper. These he screwed in the ends of the coupling and the thing was done. It makes a good mallet of sufficient weight for ordinary purposes; besides the ends as they become battered can be taken out and new ones put in.

NAIL BOXES. I have turned nail boxes for the bench hands, each one of whom seemed to have an idea of his own as to what was the proper shape, but here are a couple of patterns. The first one is turned out of an inch board and with a turned cover to fit over it like a pill box when not in use, or slipped over

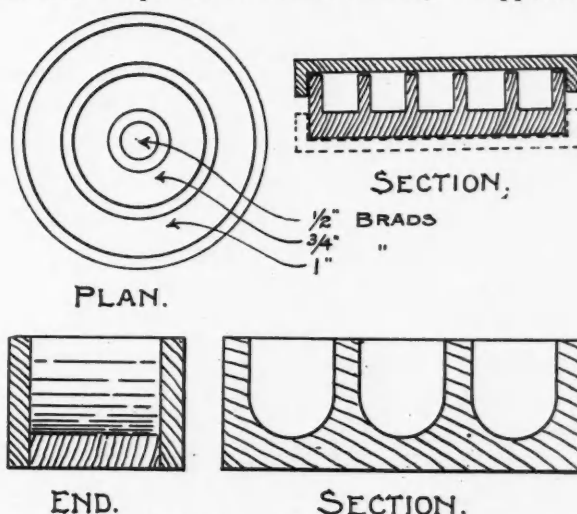

Two Styles of Handy Nail Boxes

the bottom when in use. The second one is made by cutting half circle out of a block, say, 3 by 3 by 12 inches long on a band saw—then nail 1/4-inch pieces on the sides of the block. The circle bottoms thus formed makes it convenient for the fingers in picking up the brads.



Steam Heating—the Three Systems

ONE PIPE SYSTEM—TWO PIPE SYSTEM—OVERHEAD SYSTEM—HOW TO FIGURE PIPE AND BOILER SIZES

By Cecil F. Herington

WHEN the Old Builder got to talking about pipe sizes for steam heating he got prepared for trouble because anyone can start something about this much disputed point. He was not inclined to dodge the issue on this account, but did a little quiet explaining beforehand.

"I really hesitate to tackle the subject of piping," commenced the Old Builder, "because it is a case where doctors disagree and I shall have to limit the subject especially on pipe sizes largely to my own personal experience.

"But before I say anything on pipe sizes I must first divide steam piping into three classes according to the way the piping is run. First is what is known as the 'one pipe system' (which is the most common of all for small residence work; second, the 'two pipe system' (which is now rapidly going out of use for any but the largest of heating jobs), and third, 'the overhead system,' which is sometimes used for apartment houses and in a few other special cases.

"IN THE OVERHEAD SYSTEM all the steam is carried directly up to the attic where horizontal branches are run to the steam drops, which are located so as to supply the various radiators, and the bottom of the drops is connected into a pipe running back to

the boiler below the water line. The advantage of this scheme of piping consists of the fact that the water which is formed by the steam condensing on the inside of the radiators or drops all flows down toward the bottom of the drop and *in the same direction* as the flow of the steam. This prevents to a great extent the danger of 'water-hammer' or 'steam knocking' which is always likely to be present when the flow of condensation water and the flow of steam are in *opposite* directions.

"WITH A TWO PIPE SYSTEM the steam main is run around in the basement and gradually reduces

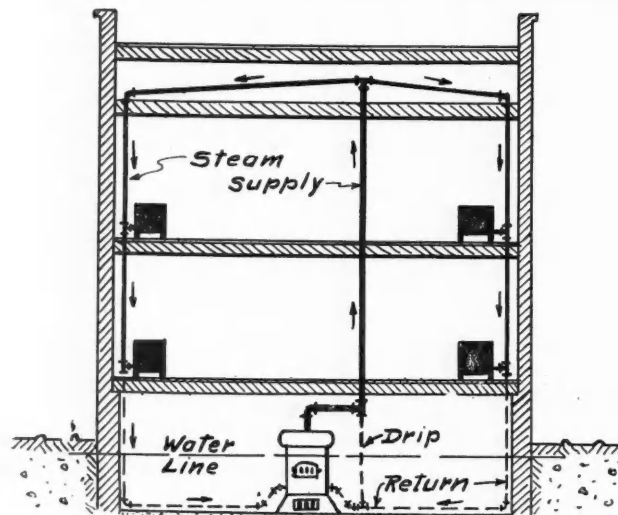

Overhead System Piping Diagram

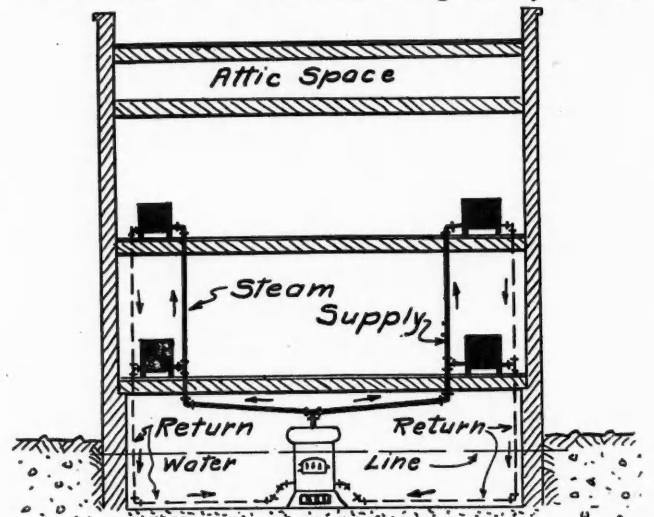

Diagram of Two-Pipe System

in size as the various branches are taken off to supply the radiators. Parallel to this line and increasing in size as the other decreases, is run a smaller return line, into which all the return pipes from the radiators are emptied and which is connected to the boiler. In this system each radiator has two pipes, each with a valve, one entering at one side and allowing the steam to flow in, and the other leaving at the opposite side and allowing the condensation to flow out. This secures the advantage of keeping the condensation water from being opposed to the flow of steam, but is more costly than the overhead system.

"THE ONE PIPE SYSTEM does NOT keep the

flow of condensation from being opposed to that of the steam; but it is the cheapest to install of all systems of steam piping and can be so designed as to produce practically as good results (especially in small jobs such as residences, etc.). In order to give perfect satisfaction it is necessary to install a one pipe system in the following manner:

"Rise up with the main steam pipe from the top of the boiler as high as possible, and then run the main steam (pitching *down* away from the boiler) all around the cellar so as to supply all radiator connections; then connect a drip pipe or bleeder on to the end of the

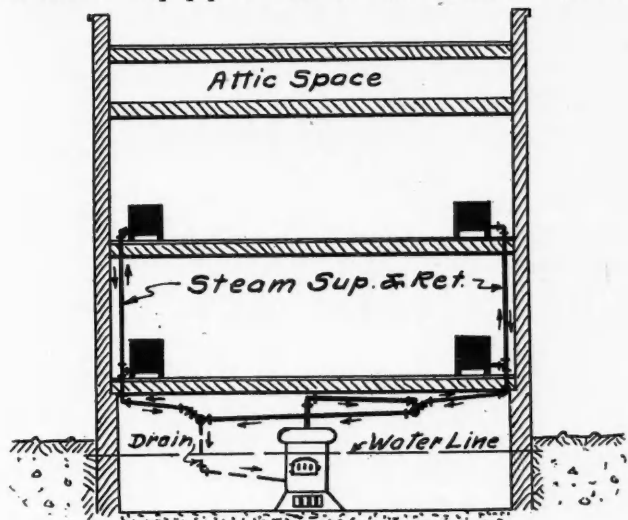

Diagram of One Pipe System

steam main; run this directly down until below the waterline of the boiler and then back to the boiler connecting to the return inlet. Put no pockets in any line, and take the branches to the radiators from the top (or at a 45 degree angle to the side) of the steam main; these branches should pitch *up* from the main to the bottom of the radiator riser pipe.

"In this system particular care must be taken to pitch the pipes so that all radiators and pipes will drain toward the bleeder at the end of the steam main in the basement; and all the pipes must be made large enough to accommodate not only the steam, but also the water of condensation. There is little trouble ever experienced in this system from getting a pipe a trifle larger than absolutely necessary, but when a pipe is made too small the water running back crashes into the steam coming up, making a commotion which not only is annoying on account of the noise, but is liable to waterlog the radiators by holding the water in them so that they get cold and become useless.

Figuring Steampipe Sizes

"Now," continued the Old Builder, "having beat about the bush as much as possible I am going to give you a few rules for determining pipe sizes and then run for cover. You see, there are more rules (each one producing a different result) than you can shake a stick at; but one that is easy to remember and which gives pretty accurate results is:

That the size of the main for a one pipe system is 1/9 of the square root of radiation expressed in square feet and 1/10 in two pipe jobs, considering all uncovered mains as radiating surface.

"Risers are made slightly smaller than this, as the condensation drops down them more rapidly and consequently occupies less space in the pipe; the sizes generally running about as follows:

PIPE SIZES FOR ONE PIPE SYSTEM

- 1 in. Riser up to 34 sq. ft.
- 1 1/4 in. Riser up to 60 sq. ft.
- 1 1/2 in. Riser up to 80 sq. ft.
- 2 in. Riser up to 130 sq. ft.
- 2 1/2 in. Riser up to 190 sq. ft.
- 2 in. Riser up to 290 sq. ft.
- 3 1/2 in. Riser up to 390 sq. ft.

PIPE SIZES FOR TWO PIPE SYSTEM

- 3/4 in. Steam and 3/4 in. Return up to 30 sq. ft.
- 1 in. Steam and 3/4 in. Return up to 48 sq. ft.
- 1 1/4 in. Steam and 1 in. Return up to 96 sq. ft.
- 1 1/2 in. Steam and 1 1/4 in. Return up to 150 sq. ft.

"Radiators and their valves, on the contrary, are generally made larger, these being determined by their manufacturers; one large company uses the following:

RADIATOR VALVE SUPPLY SIZES

- For one pipe work—*
- Up to 25 sq. ft. of surface.....1 in.
 - 25 to 60 sq. ft. of surface.....1 1/4 in.
 - 61 to 100 sq. ft. of surface.....1 1/2 in.
 - 100 or over sq. ft. of surface.....2 in.

- For two pipe work—*
- Up to 48 sq. ft. of surface 1 in. supply and 3/4 in. return.
 - 49 to 96 sq. ft. of surface 1 1/4 in. supply and 1 in. return.
 - 97 and over sq. ft. of surface 1 1/2 in. supply and 1 1/4 in. return.

"The relation between the supply and return mains is determined largely by experience and may safely be made as follows:

CORRESPONDING RETURN-PIPE SIZES

- 1 1/2 in. supply requires a 1 in. return
- 2 in. supply requires a 1 1/4 in. return
- 2 1/2 in. supply requires a 1 1/4 in. return
- 3 in. supply requires a 1 1/2 in. return
- 3 1/2 in. supply requires a 1 1/2 in. return
- 4 in. supply requires a 2 in. return
- 5 in. supply requires a 2 1/2 in. return
- 6 in. supply requires a 3 in. return
- 8 in. supply requires a 3 1/2 in. return

"Then to find the size of the steam main in the basement it is necessary to add up all the radiator surface and to allow about 4 sq. ft. additional for every uncovered second floor riser. This gives:

Sewing Room	16
Front Bed Room	40
Bath	16
Rear Bed Room	48
Alcove	24
Side Bed Room	20
Hall	40
Vestibule	14
Parlor	48
Dining Room	48
Kitchen	40
3 Risers	12
Total	366

366

"The square root of 366 is 19 plus and $\frac{19}{9}$ equals 2.1 or 2 1/2-inch pipe.

"Therefore, we start off from the boiler with 2 1/2-in. pipe and the first branch is the one supplying the kitchen radiator. The kitchen radiator is 40 sq. ft.

and the square root of 40 is 6 plus which, divided by 9, equals about $\frac{3}{4}$ in. It is not advisable in one pipe work, however, to make any horizontal main less than $1\frac{1}{4}$ in. in size so that is what the kitchen branch should be made. In a like manner all the branches are supplied and the size determined until the last branch is reached. Here a $1\frac{1}{2}$ -in. pipe is dropped down, serving to carry the return condensation back to the boiler, the size of this for a $2\frac{1}{2}$ -in. supply pipe being (as given in the table) $1\frac{1}{2}$ in. The steam main, however, carries comparatively so little steam and so much condensation near the end that it is perfectly safe to reduce its size to 2 in., as indicated on the drawing.

How Large a Boiler?

"When it comes to picking out a steam boiler it is necessary to make allowances for the manufacturer's optimism and get a boiler which is apparently anywhere from 25 to 50 per cent larger than is needed. This is to permit running the fire without excessive forcing in the extreme weather; and in this case would be 366 sq. ft. plus 50 per cent or 549 sq. ft., which would require a rating of 550 to 575 sq. ft. All steam boilers are rated in the number of sq. ft. of radiation which they will supply, and the size may be checked by the grate area somewhat the same as the furnace size. All good steam boilers give about 8,000 heat units for every pound of coal, and burning 5 lbs. per sq. ft. of grate gives $5 \times 8,000$ or 40,000 heat units per sq. ft. As the total heat loss on the house was 88,600 plus 10 per cent; and this divided by 40,000 will give the required grate area or 2.4 sq. ft. for the boiler.

"The total radiation at 275 heat units per sq. ft. should be about equal the total loss plus 10 per cent leakage; 366×275 equals 100,650, and 88,600 plus 10 per cent equals 97,460, a small variation."

HEATING QUESTIONS ASKED AND ANSWERED

Builder Herrington Has Had Wide Experience with All Types of Heating. He Will Gladly Answer All Questions. Tell Us YOUR Heating Troubles.—Editor.

School House Heating

To the Editor: Mabel, Minn.

Will you kindly advise me what system of heating you would recommend in a high school building 82 by 87 feet, two stories and basement—fifteen rooms in all?

Some of our local dealers recommend a low pressure steam, others a high pressure steam. Would you briefly state the advantages of each system.

Thanking you in advance for this information, I am

Yours very truly,

D. A. HAINES,
Architectural Designing and Drafting.

Answer: In reply to Mr. Haines' inquiry it should first be remembered that the modern practice in school work does not consider heating as of greater importance than ventilation, so that it may be assumed that Mr. Haines should have

asked about the best method of ventilating his high school, and, incidentally, how to warm the ventilating air so as to prevent the large amount of incoming fresh air from cooling off the building. It is generally admitted (and, in fact, is required by law in Massachusetts) that school buildings should be supplied with 30 cubic feet of fresh air per minute per occupant. The only way that this can be accomplished positively is by use of a fan to force the air in and some sort of a ventilating outlet to allow the air to escape after being vitiated. It is usually customary, and the best results have been obtained, in ventilating rooms of reasonable size and oblong shape to allow the air to enter the room from the inner wall near the ceiling and to place the exhaust outlet near the floor and practically below the inlet register, the exhaust being made usually between $\frac{2}{3}$ and $\frac{3}{4}$ of the capacity of the inlet.

From the correspondent's letter it would seem that the main point of dispute rests upon the fact of whether a high pressure steam system or a low pressure steam system should be used for the purpose of warming the air. Under no consideration would I recommend a high pressure steam system especially in a school on account of the danger to the pupils, the extreme difficulty of keeping the radiator valves packed tightly around the stems and the extra expense of obtaining a licensed engineer for the operation of such a system which would certainly be most inadvisable.

If it is absolutely necessary to generate high pressure steam on the premises for pumps or other apparatus the exhaust should be used for heating and supplemented by a live steam make-up connection through a reducing valve so as to maintain a constant pressure in the heating system of about 5 lbs. Condensation in this case is returned to the boiler either through a trap or a condensation return pump.

The Most Economic System

The most economic system to operate (considering the benefits received) consists of a sufficient amount of direct radiation to maintain a constant temperature in all portions of the building of 70 degrees Fahr. during extreme weather and a purely ventilating system supplying tempered air also at 70 degrees Fahr. to the maximum quantity of 30 cubic feet per minute per pupil with exhaust ducts running to the roof and of a capacity of about 20 cubic feet per minute per pupil. The advantage of this arrangement consists of the ability to heat up the building without the use of the fan and to maintain this temperature until the arrival of the pupils which necessitates the use of the fan for ventilating purposes only, the fan being kept operating during the time of the school session and being immediately shut down again on the dismissal of the pupils. Another advantage in this arrangement is that any temporary breakdown to the fan system will not cause the temperature of the building to drop or make the dismissal of school imperative, the only result in such a contingency being a short period of poor ventilation and lack of fresh air while repairs are being made. This method is recommended but is of course more costly to install than simply a fan system where the incoming air is heated sufficiently, about 70 degrees, to heat the building itself without the use of any other means.

Most economical of all to install and operate is the scheme of using indirect radiators located along the outside walls and connected to the outer air by apertures in the wall behind the radiators or by ducts. This system is unreliable, however, on account of being affected by the wind and will cause the school children to suffer great inconvenience in dusty periods by allowing large amount of dirt to enter the room through the openings.

CECIL F. HERRINGTON.

✱
WHEN you want some important business attended to in a hurry, entrust it to a busy man. He will not have time to neglect it.

MOTOR-CARS *and* CYCLES for BUSY BUILDERS

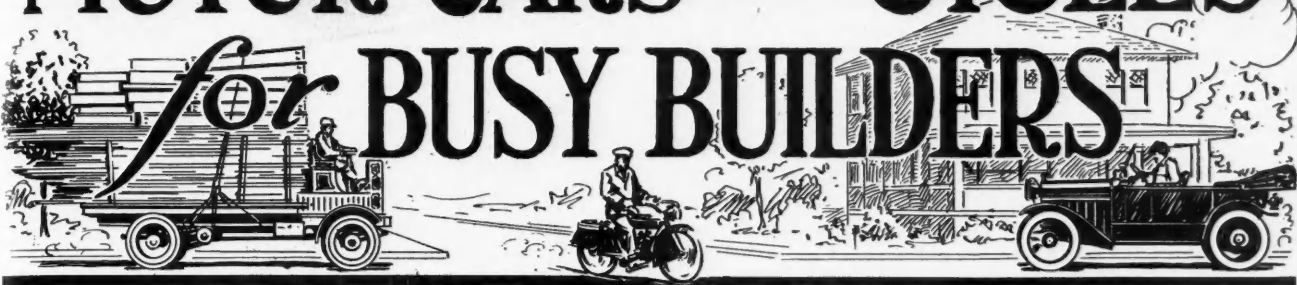

The Building Contractor and Quick Deliveries

CONTRACTORS are using motor trucks to such an extent that they are no longer considered experiments in the building business. They are acknowledged as untiring and constant workers.

If a builder orders in his material by the car load or has to supply a number of jobs with material quickly, he will find teaming not only slow but inordinately expensive. The feed and care of horses is something to give him pause. The motor truck is speedier and can care for a lot of work easily. The cost of a few gallons of gasoline is as nothing compared to the expense of hiring one or more teams by the day. And then too a truck can carry a larger load, keeping the workmen well supplied and saving numerous trips. Quick delivery means that the workmen will have no

ing motor trucks in use by the builders and kindred trades. If the conditions under which you conduct your business could be improved, by all means consider buying a motor truck, but be sure to get a good standard make. Investigate well before you buy. Trucks are not an innovation; they have come to stay and the keen business man will start now to make a clean getaway with the lion's share of the profits by



A 4-Ton Motor Truck, Made By the Sternberg Mfg. Co., West Allis, Wis., is Used By J. H. Werbelovsky, Brooklyn, N. Y.

chance to idle as they usually do when waiting for a team to bring up more material.

The motor truck enlarges the scope of the contractor's or builder's business. He can accept jobs at any distance knowing that there will be no difficulty in hauling his mixers, hoists and other machinery. A motor truck really has no idle moments. Many contractors keep them working continuously by using them to haul away excavated material or the usual litter attendant upon building—leaving the completed job in ship-shape style.

The illustrations given here show some of the lead-



Showing a Pierce Arrow 5-Ton Truck in Use By a Prominent Building Company

adopting the most approved methods of conducting his business.

A motor truck on three gallons of gasoline, costing at the very most twenty cents a gallon, will run twenty miles. For the same distance a team would easily cost \$2.50. The saving is apparent.



One Company Finds the Avery 2-Ton Truck, with a 52 x 168" Body, Very Convenient



Table and Desk for Builder's Office

HOW TO MAKE A LARGE OFFICE TABLE AND FLAT TOP DESK

By Ira S. Griffith

THERE is offered this month two more pieces of furniture suitable for the office of the carpenter or mill man. The first is a table suitable for the placing of plans when figuring, or for any other of the many purposes for which an office table may be used. The second piece is an office desk suitable for foreman or office clerk. Both pieces were designed and built in quantity by boys of the Bradley vocational school.

Both pieces look very well indeed when made of Georgia pine and stained with any one of the very attractive colors now on the market. Oak might be

used, of course, but Georgia pine is usually in stock in most carpenter shops while oak is not always.

STOCK BILL FOR OFFICE TABLE

Top, 1 piece, $1\frac{1}{2}$ by $38\frac{1}{2}$ by 85 inches, S-2-S.
 Top end rails, 2 pieces, $1\frac{1}{2}$ by $3\frac{1}{4}$ by 38 inches, S-2-S.
 Bottom end rails, 2 pieces, $1\frac{1}{2}$ by $4\frac{1}{4}$ by $32\frac{1}{2}$ inches, S-2-S.
 Cleats, 2 pieces, $1\frac{1}{2}$ by $2\frac{1}{2}$ by 32 inches, S-2-S.
 Stretcher, 1 piece, $1\frac{1}{2}$ by $7\frac{1}{4}$ by 70 inches, S-2-S.
 Slats, 2 pieces, $\frac{3}{4}$ by $9\frac{1}{4}$ by 26 inches, S-2-S.
 Slats, 4 pieces, $\frac{3}{4}$ by $5\frac{3}{4}$ by 26 inches, S-2-S.

After the top has been glued up the other parts may be worked to width and length and the mill marks

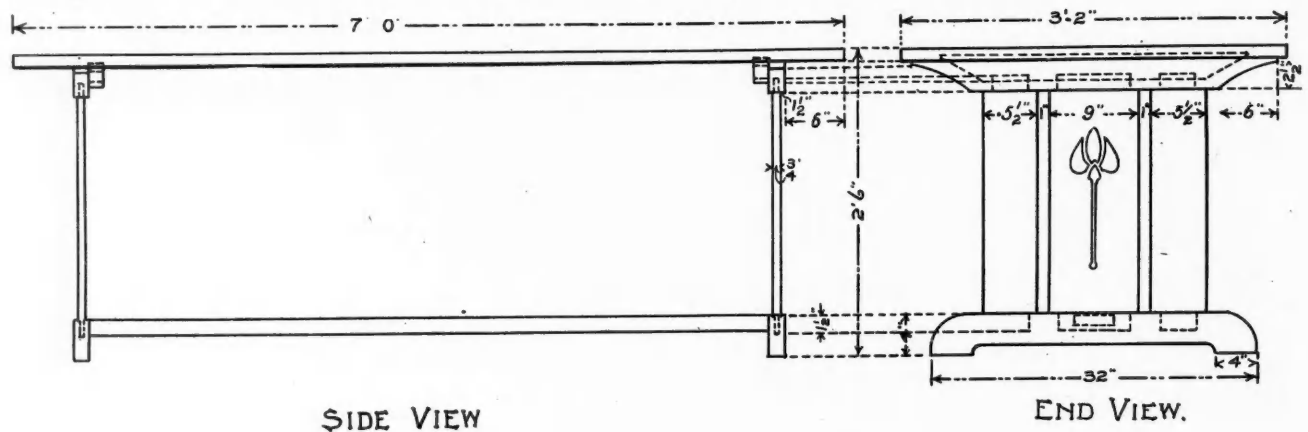

SIDE VIEW

END VIEW.

ARCHITECT'S OR BUILDER'S TABLE.

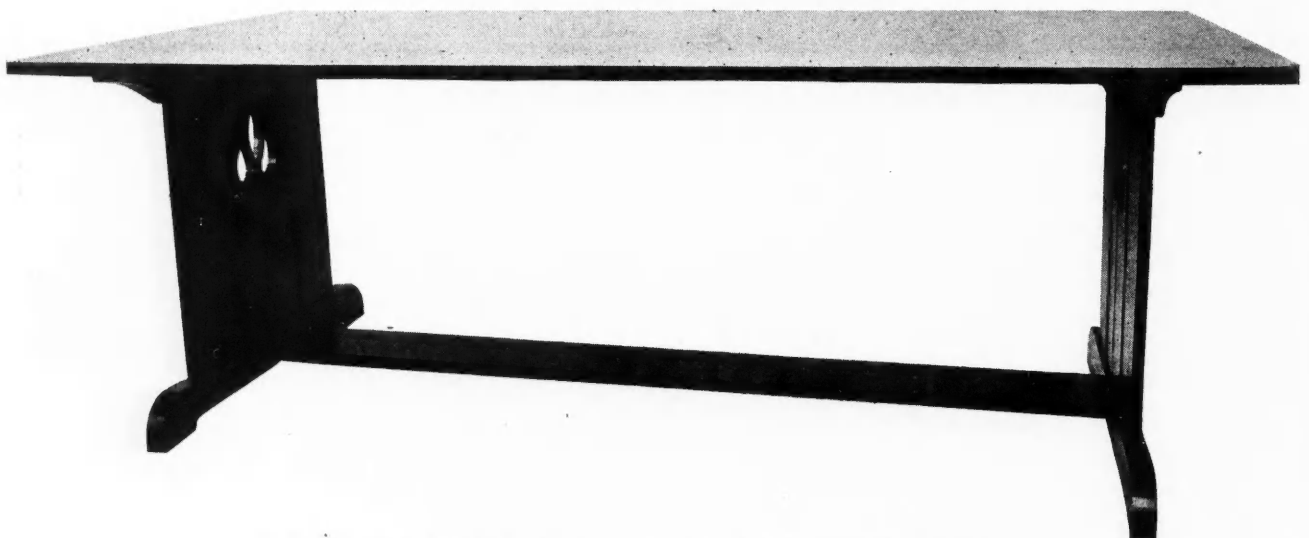

Photograph of Finished Table—Just the Thing for Spreading Out Blue Prints



The Office Desk Completed

removed. Lay off the pieces for the two ends of the table and shape them as indicated in the drawing then, after cutting the tenons and mortises, glue and clamp the parts together.

While the glue is hardening upon these ends the top may be worked to width and length and the surfaces smoothed. Also, the stretcher and the cleats may be cut to shape and the tenons laid out and worked on the stretcher and the holes bored in the cleats.

The decorative design in the middle slat of the end is to be pierced.

Thoroughly sandpaper all the parts after they have been put in place and then apply a stain of a color desired. If a natural finish is desired, apply a coat of thin shellac. Shellac holds out the light color and does not discolor the wood as does a first coat of varnish. Sand the shellac lightly with number 00 paper then apply several coats of a good rubbing varnish. Rub the first coats with curled hair or hair cloth and the last with powdered pumice stone and raw linseed oil or crude oil.

How to Make an Office Desk

The desk shown is not as elaborate as some office desks but is designed more especially for the clerk or foreman whose habits of thinking are more in accord with a well ordered flat top desk than with those of the many pigeon holed roll top desk. There is a psychology concerned with the roll top desk that is not all together in its favor.

The ease with which a document may be stored in a roll top desk is lacking in the flat top desk.

The following stock will be needed:

STOCK BILL FOR A FLAT TOP DESK

- Top, 1 1/8 by 30 1/2 by 42 1/2 inches, S-2-S.
- Posts, 6 pieces 2 by 2 by 30 inches, S-4-S.
- Rails, 5 pieces, 3/4 by 3 3/4 by 26 inches, S-2-S.
- Rails, front and back, 2 pieces, 3/4 by 3 3/4 by 22 inches, S-2-S.
- Rails, front and back, 3 pieces, 3/4 by 3 3/4 by 16 inches, S-2-S.
- Stiles, ends, 4 pieces, 3/4 by 3 3/4 by 17 inches, S-2-S.
- Stiles, back, 2 pieces, 3/4 by 3 1/2 by 17 inches, S-2-S.
- Panels, 2 pieces, 3/4 by 18 by 16 inches, S-2-S.
- Panel, back, 1 piece, 1/4 by 7 1/2 by 16 inches, S-2-S.
- Drawer guides, 6 pieces, 5/8 by 1 1/4 by 25 inches, S-2-S.
- Drawer slides, 6 pieces, 1 by 1 3/4 by 25 inches, S-2-S.
- Drawer slides, 6 pieces, 1 by 1 3/4 by 16 inches, S-2-S.
- Drawer fronts, 3 pieces, 3/4 by 5 1/4 by 14 1/2 inches, S-2-S.
- Drawer sides, 6 pieces, 3/8 by 5 1/4 by 26 inches, S-2-S.
- Drawer backs, 3 pieces, 3/8 by 5 by 14 inches, S-2-S.
- Drawer bottoms, 3 pieces, 3/8 by 26 by 14 inches, S-2-S.
- Drawer pulls, 3 pieces, 1 by 1 3/4 by 6 1/2 inches, S-2-S.

Square up the posts in the usual manner and then lay out the mortises that are to go therein. Next, square up the rails and stiles and groove their edges for the paneling and lay out and cut the tenons needed. Next, this paneling may be assembled and the glue allowed to harden upon it while the drawer supports are being framed.

After the frame has been assembled, the drawers may be constructed and fitted.

The desk may be finished as described for the table.

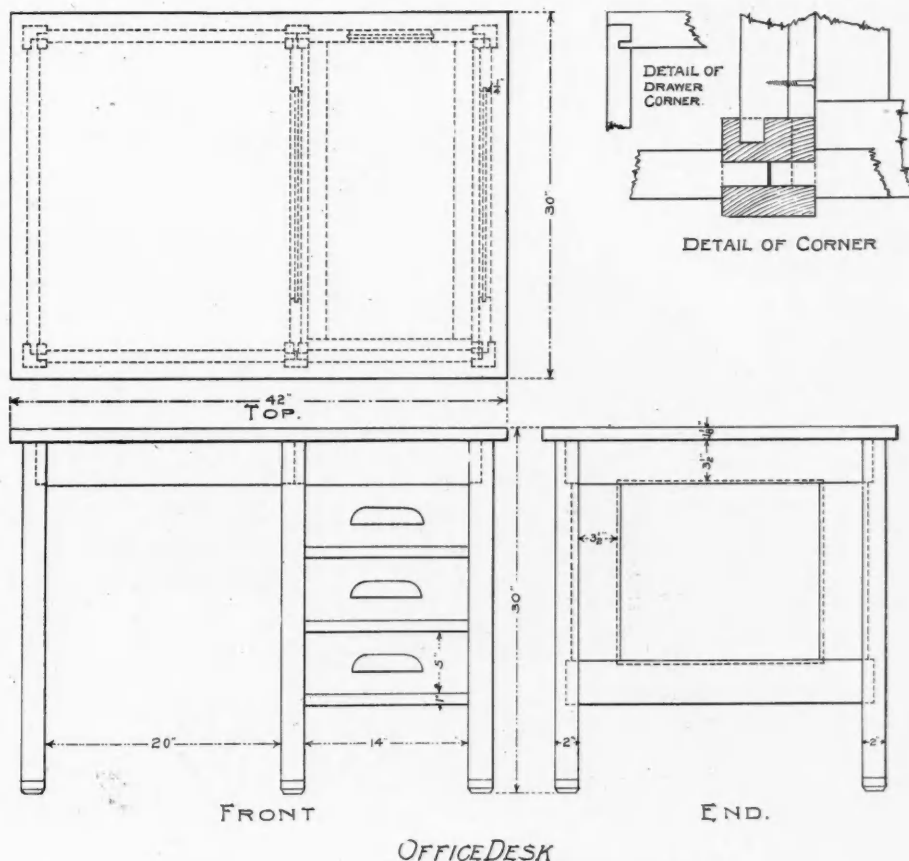



In this issue will be found several of the Honorable Mention Designs from Our Big Prize Competition. They show the uniform high quality of the work the American Carpenter and Builder readers are doing.

Homelike Seven-Room Dwelling

Well Designed Story-and-a-half Cottage at Mt. Sterling, Ky.

Planned and Built by P. O. Andrews, Architect and Superintendent, Mt. Sterling, Ky.

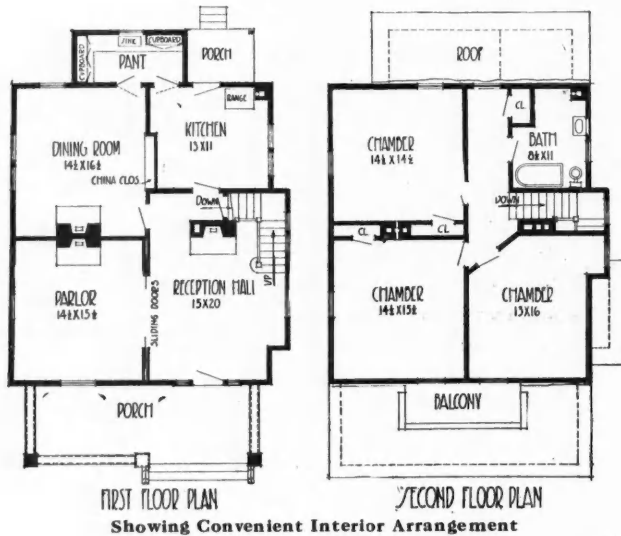

FIRST FLOOR PLAN
SECOND FLOOR PLAN
Showing Convenient Interior Arrangement

Editor AMERICAN CARPENTER AND BUILDER:

THE accompanying plans and photo show a house designed and built by a day laborer, but a charter member of the AMERICAN CARPENTER AND BUILDER.

This house was built for Strother & Sutton of Mt. Sterling, Ky., as a speculation and was sold before the floors were laid.

The floors have concrete below grade rough faced pale yellow brick above, laid in cement mortar with a $\frac{3}{4}$ -inch joint, and rubbed.

Two-ply tar paper was placed directly on studs below belt course, then covered with $\frac{7}{8}$ by 8-inch siding laid rough side out and stained a dark red stain,



Very Neat 7-Room Story and a Half Dwelling. Planned and Built by Architect P. O. Andrews, Mt. Sterling, Ky.

brushed on before being put up, the second coat being given after being put on walls.

Walls above belt course were storm sheathed, papered with building paper and shingled with red cedar shingles put on with galvanized nails. Roof was sheathed open and covered with cedar shingles laid 4½ inches to the weather and nailed with galvanized nails.

All shingles were dipped in a creosote stain before being laid and given a brush coat after being put on—walls a dark green, roof a shade lighter.

Front porch floor, steps and walk are concrete with a 1-inch cement mortar finish.

Porch roof is supported on a concrete truss with a span of 23 feet 8 inches between supports.

The three front rooms on first floor are finished in plain red oak, stained with Weathered Oak stain, given a coat of white shellac, and then waxed.

Floors are of plain red oak filled a dark filler, shellaced and waxed.

Floors in pantry, kitchen and on second floor are B & better yellow pine stained shellaced and waxed.

Walls were plastered with U. S. G. Co. Ivory wall plaster and given a sand finish.

Bath room has Keenes cement wainscot 4 feet high marked off in imitation tile.

All windows except two small windows on stair landing and rear of second floor are the usual double hung type. The four above mentioned are casement fitted with adjusters.

Long may the AMERICAN CARPENTER AND BUILDER continue to be the monthly prize that it has been in the past.

P. O. ANDREWS.
Architect and Superintendent,
Mt. Sterling, Ky.

Storage of Hog Feed

Editor AMERICAN CARPENTER AND BUILDER:

I am sending two pictures and sketches of a small grain bin I built this summer. The bin is intended to



A Great Convenience for Storing Spoiled Grain or Other Hog Feed—Four Bins in One

take care of all odds and ends around the farm such as spoiled, weedy or mixed grain, in fact anything that will do for hog food and yet not good enough to bin with the good grains.

Bin is ten feet square by five feet from floor to top of plate, with four bins of equal size. The partitions run from floor to roof. The granery is filled from the top which is shown by the pictures and diagram. The hopper bottom is divided into four holes, one leading to each bin. Three small lids cover the three bins

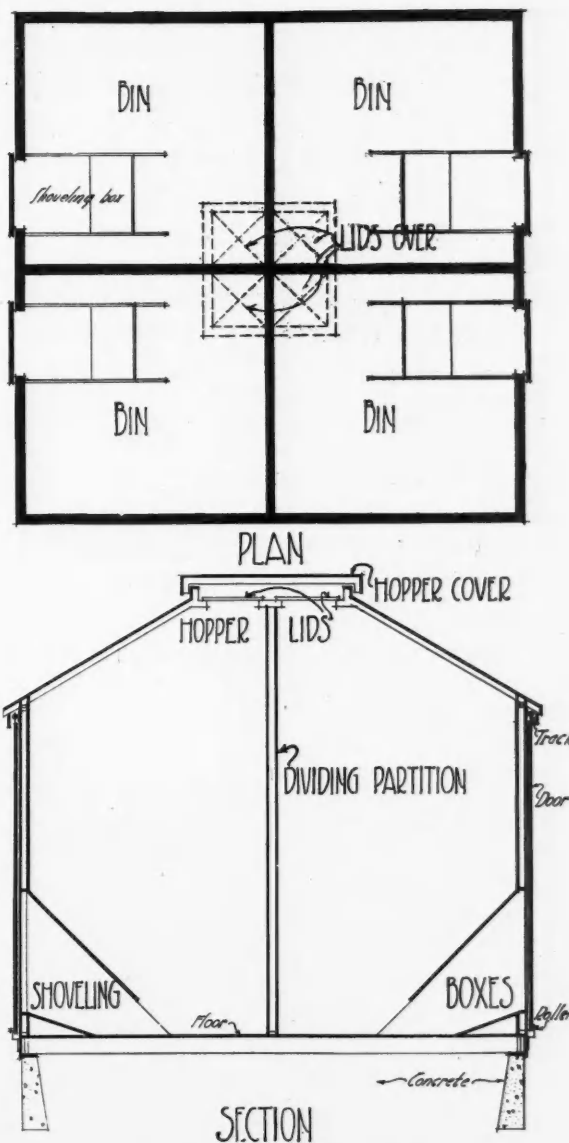

Plans of Hog Feed Storage House

leaving the fourth open to receive grain.

The lumber bill together with hardware, was sold by a local dealer for \$80.

HARDWARE AND LUMBER BILL

- 7 bags of Portland cement.
- 140 feet 2 by 6 yellow pine sills and joist.
- 140 feet 4-inch yellow pine flooring.
- 300 2 by 4 yellow pine general frame, etc.
- 10 2 by 8 yellow pine deck frame.
- 450 feet 8-inch shiplap line sheeting partitions, shoveling boxes, inside doors, etc.
- 220 feet 6-inch bevel cedar siding.



HONORABLE MENTION DESIGNS

70 feet 1 by 4 and 1 by 8 cheap white pine finish doors, casing, corner boards, etc.

70 feet 8-inch chip white pine, cheap grade.
150 feet 3-ply prepared roofing with cement and nails.
2 sheets of 20 gauge galvanized iron 28 by 96.
14 feet of Myers track and 4 sets tandom door hangers.
4 stay rollers for bottom of doors.
1½ dozen screw hooks and eyes.
50 lbs. of 16 penny nails.
100 lbs. of 8 penny nails.
25 lbs. of cement coat 8 box nails siding, casing, etc.

20 lbs. of 6 cement coat nails for doors.

4 sets hinges 6 inches rough iron, inside doors.

1 square foot heavy galvanized screen for openings in foundation.

I completed foundation building and painting in ten days at \$3.00 per day. Making the outfit cost \$115.00 outside of paint. The paint was some left over and the sand he got for the hauling.

LEVI LANDKAMER,
Alexandria, Neb.

How I Saved \$200. on a Heating Job

NEW PUBLIC LIBRARY AT BEAVERTON, ONT.

Designed by W. E. Binning, Listowel, Ontario

Built by Jas Snelgrove, Beaverton, Ont.

Editor AMERICAN CARPENTER AND BUILDER:

HAVING the contract of the Public Library in Beaverton, the floor plans of which I enclose under separate cover, in which there was a low pressure gravity return steam heating system and also a soil pipe for a lavatory, I undertook the installation of the same for the following reason. We have no plumbers living in our town, so I asked for esti-

and threaded them in the lathe, which did away with a lot of hard work and with a helper. I set up the boiler and put up the piping and radiators, having only to cut and thread about 10 or 12 short pieces at the building to make connections. I wired some small chicken netting around the boiler and plastered same with asbestos about 2 inches thick. The basement ceiling is about 11 feet high. I therefore ran a 4

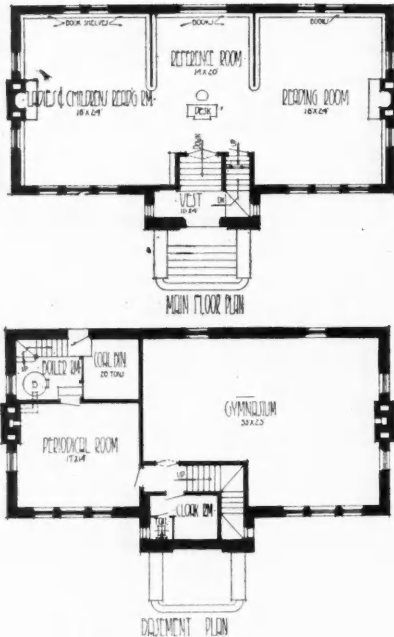

Public Library, Beaverton, Ont., Built by Jas. Snelgrove

inch upright pipe from the boiler and reduced to 2½ inches for my main around the building, branching out to radiators with 1¼ inches and 1½ inches with 2 inch return for first floor radiators, and a 1½ inch return for basement radiators. I have now had the system running a week and it is working first-class and satisfactory in every way. We set up the soil pipe, run and calked the joints. We did the job in 182 hours and paying myself and helper 50 cents an hour, the labor cost \$92.00 or \$630.00 complete, on which I saved \$200.00 on the estimator.

I might say here I wrote you in December asking a question on piping which you answered by letter and also in the January AMERICAN CARPENTER AND BUILDER, for which accept my thanks.

JAMES SNELGROVE,
Contractor and Builder, Beaverton, Ont.

mates from the nearest plumbers, about 25 miles away. In their estimates they asked over \$800.00, which I considered was too high; and therefore started the job myself.

I purchased a cast iron sectional steam boiler of 1350 square feet capacity, nine radiators of 501 square feet radiation for the first floor and vestibule, with seven wall radiators of 262 square feet radiation for the basement. Also paper and feltings which cost me, freight included, \$524.00, and also about 40 feet of 4-inch soil oakum, and lead-pipe, which cost me \$20.00.

I went carefully over the building and measured up the number and lengths of different pieces of piping and took my piping to a machine shop and cut

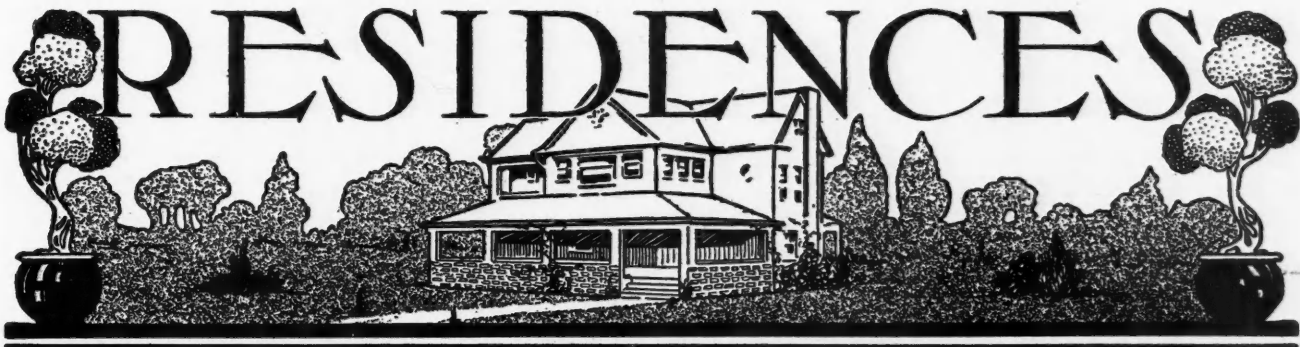

Plans for Modern Home for \$3000

ARCHITECT'S PERSPECTIVE AND COMPLETE SET OF WORKING DRAWINGS OF VERY WELL DESIGNED
6-ROOM DWELLING

THE plans given in the following pages are for one of the neatest houses it is possible to build for \$3,000. The outside up to the second story window sills is boarded with wide, rough boards finished in brown with a creosote stain. Above the boarding is a stucco finish in cream color with paneling of the brown wood strips.

The unusual features of this house place it far above the average. The steps, placed to one end of the porch, give it size to make it roomy and comfortable. Entering the house through a small vestibule, we come to a hall provided with a closet and a built-in seat. The stairs at the rear of the hall are partially screened with a spindle grille, the rear wall being plastered to a height of about five feet and the spindles extending to a line level with the top of the cased opening.

A cased opening between, makes the hall really part of the living room. In this living room we find the built-in book case and fireplace. The dining room reached through another cased opening is large and cheerful. The buffet is built into the bay window. The kitchen has a porch entry, sink, pantry and stairway to the basement. This room is well laid out.

Upstairs we have three excellent chambers with good light and closet space. Besides, the upper hall provides space enough for a pleasant little sewing room or lounging room. The fact that the basement laundry, kitchen and bath are placed directly over one another will save expense in plumbing. The conveniences of this house will recommend it to all. No modern idea has been overlooked in making this one of the most livable houses we have shown.

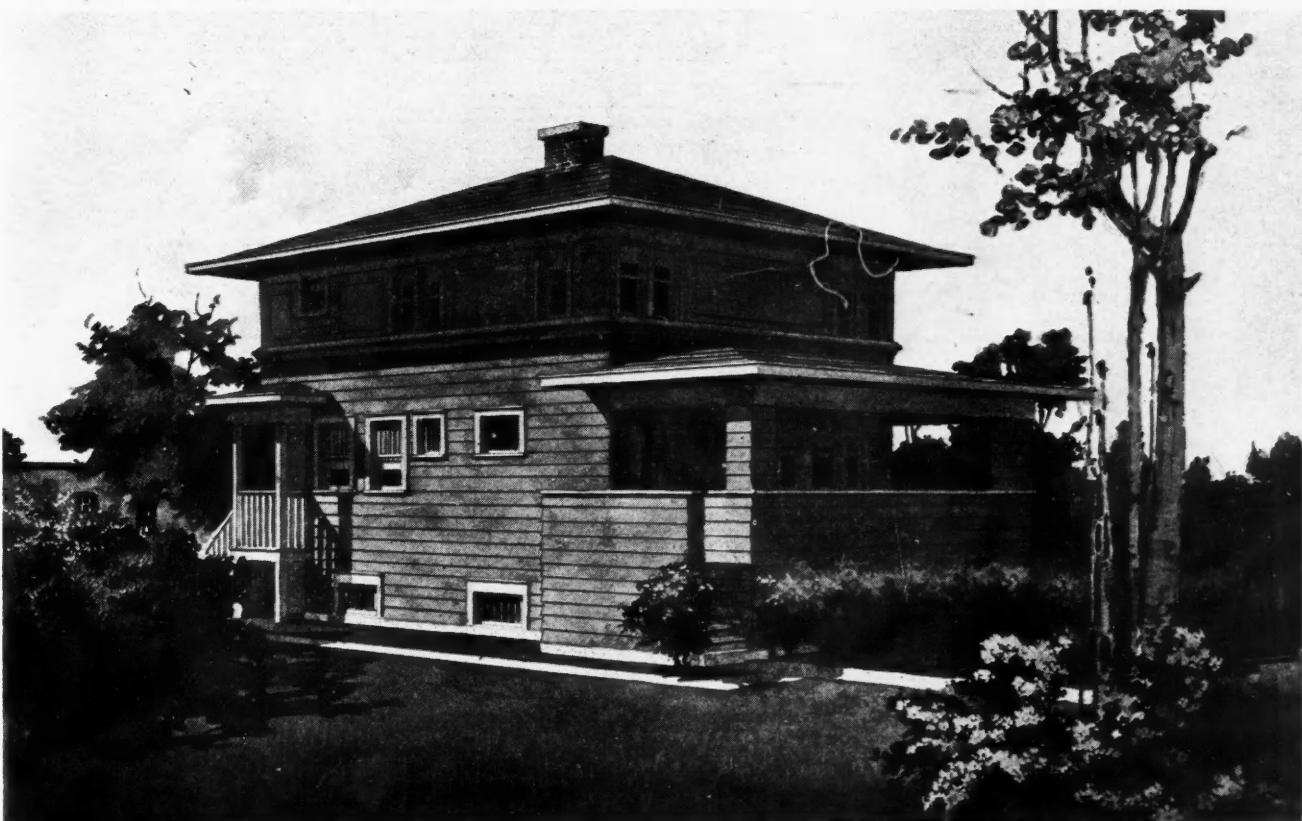

Modern Style Small Residence—Sided With Wide Rough Boards to Second Story Sills With Stucco Above
COMPLETE WORKING DRAWINGS FOR THIS HOUSE ARE PRESENTED ON THE SEVEN PAGES FOLLOWING

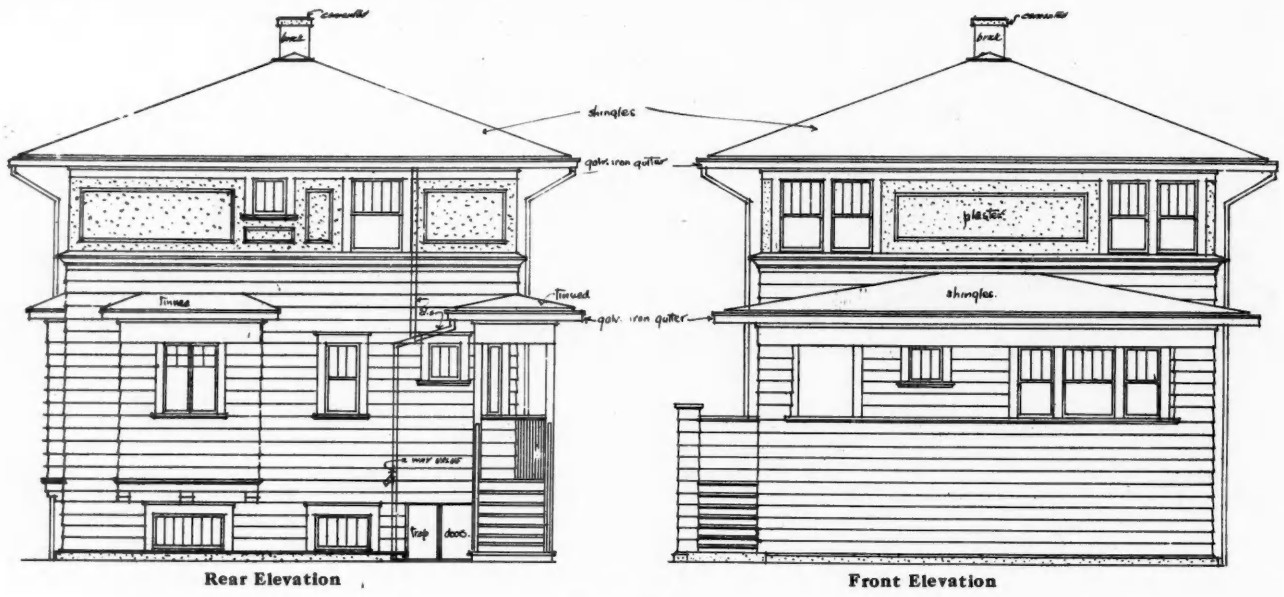

Rear Elevation

Front Elevation

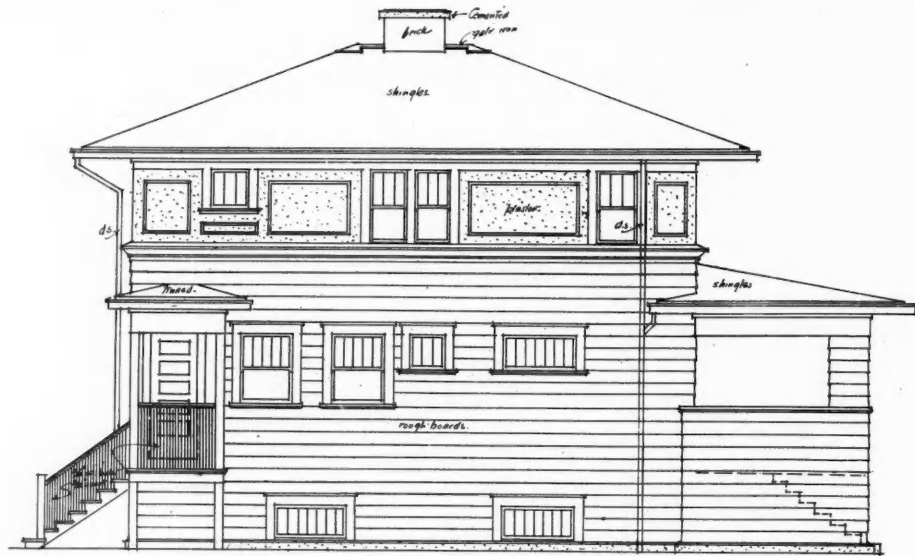

Left Side Elevation

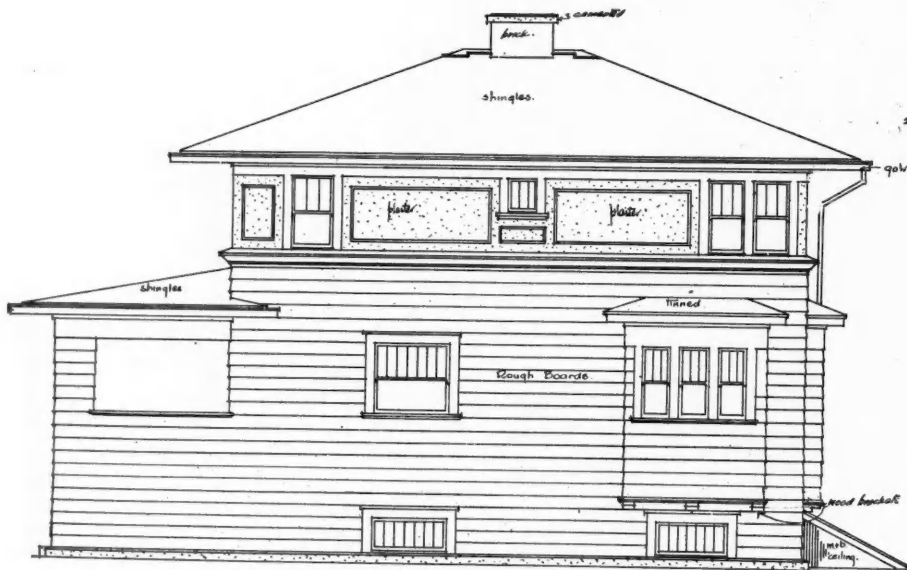

Side Elevation

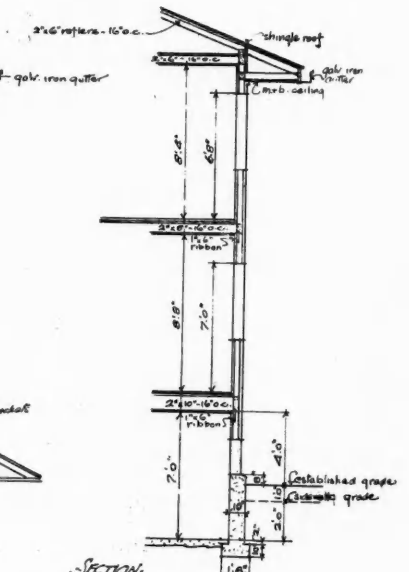

SECTION

ELEVATIONS OF HOUSE SHOWN ON PAGE 75

Plans for Modern Home for \$3,000

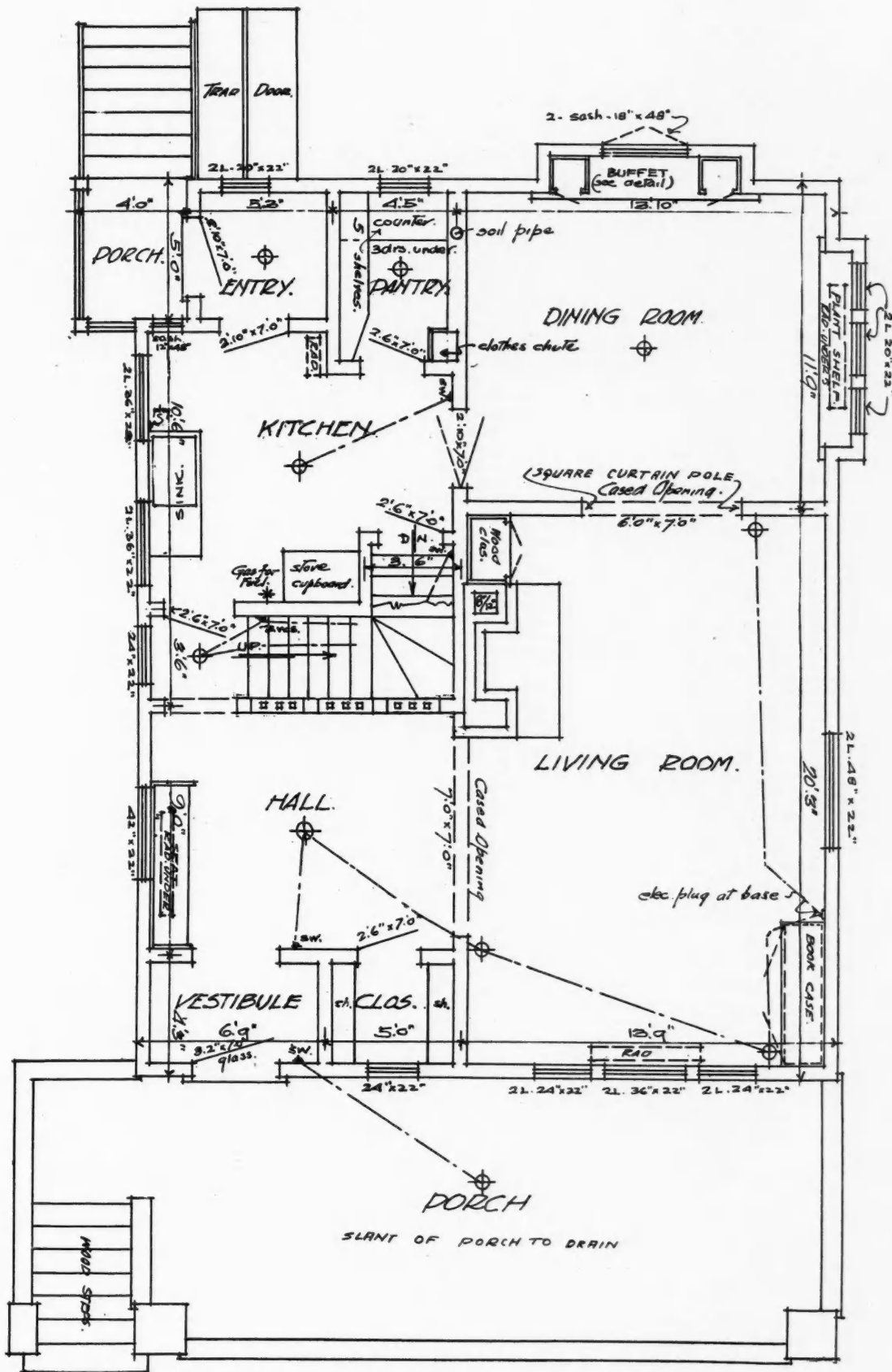

FIRST FLOOR PLAN
(House Shown on Page 75)

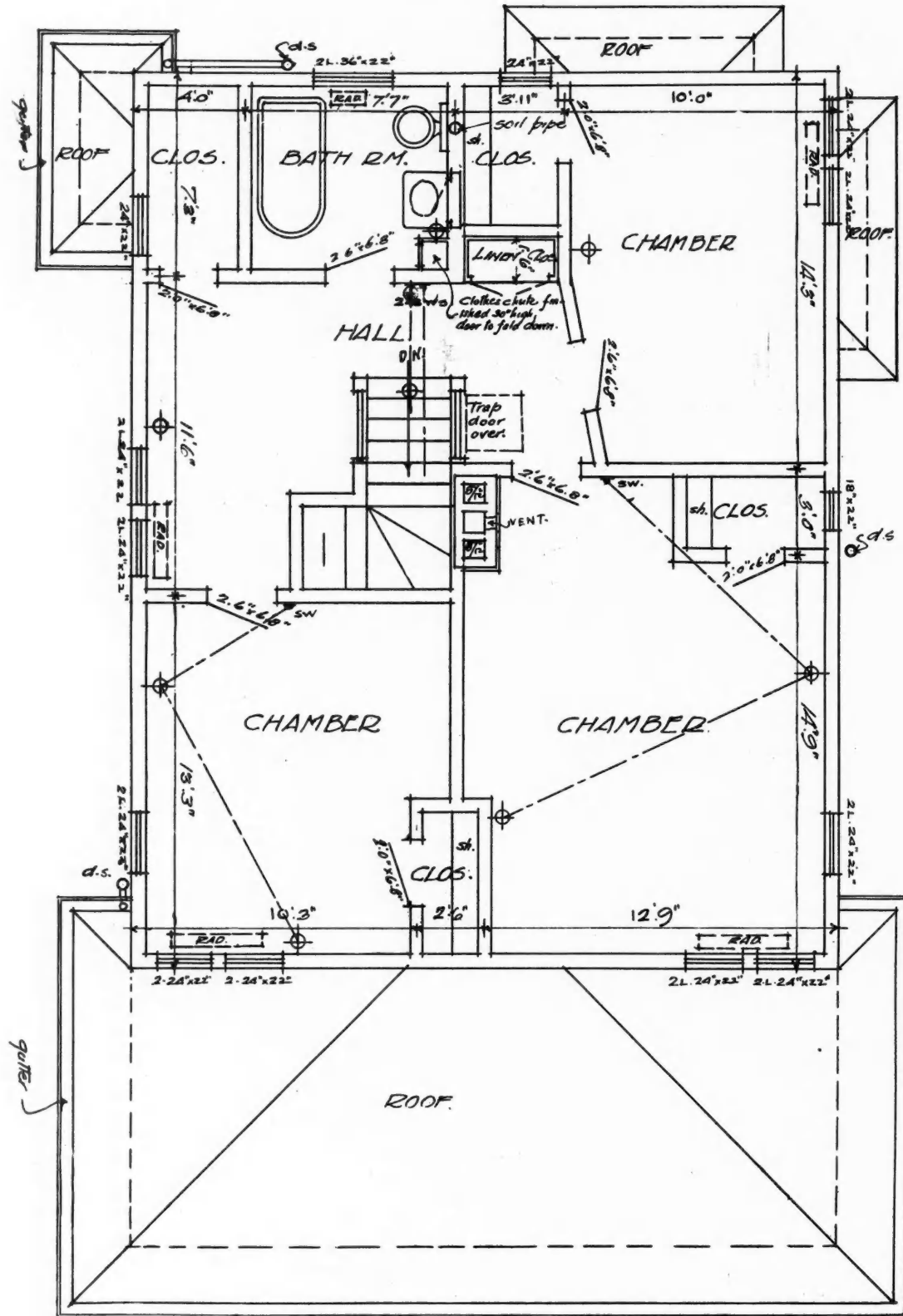

SECOND FLOOR PLAN

(House Shown on Page 75)

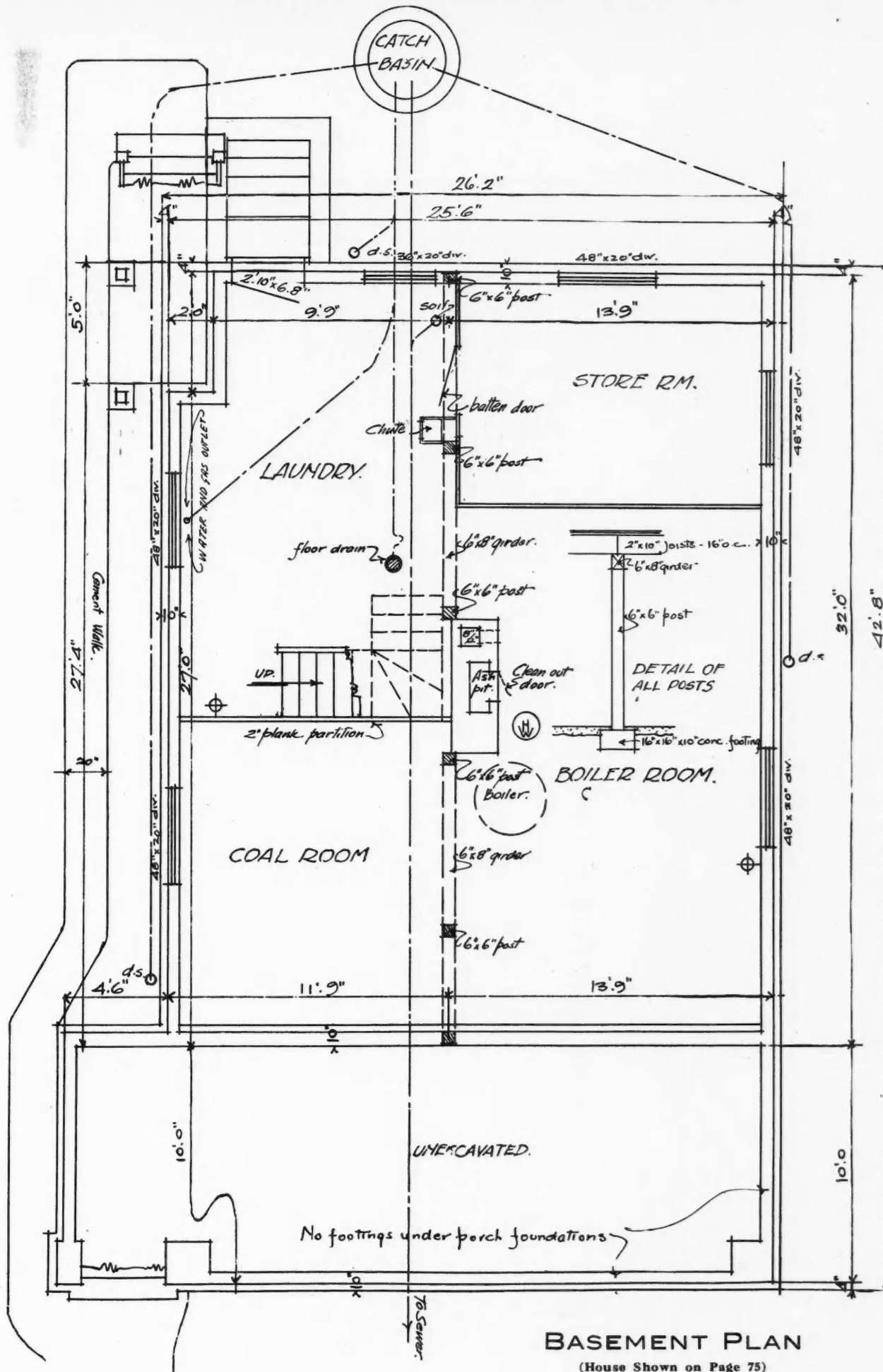

BASEMENT PLAN

(House Shown on Page 75)

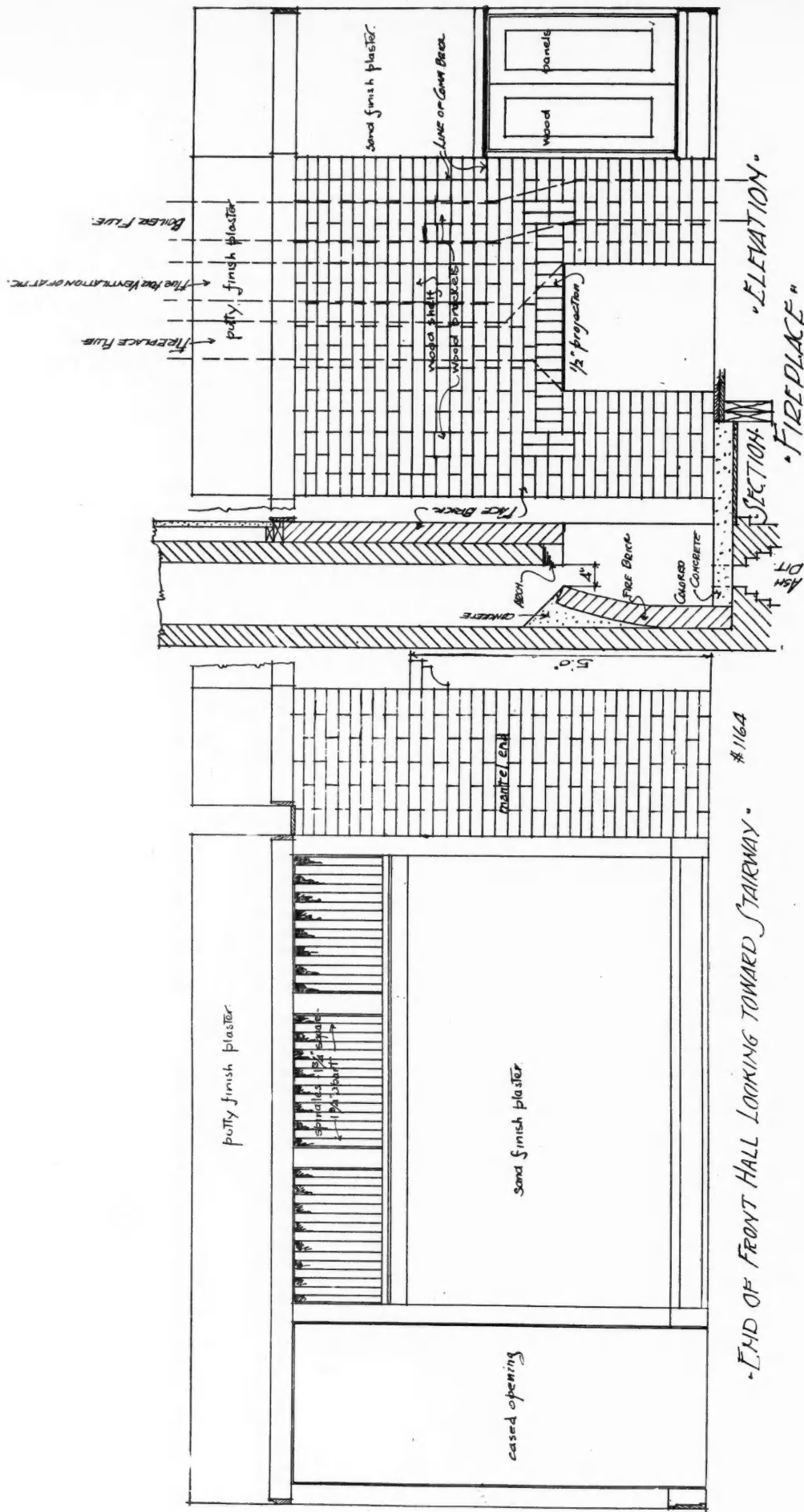

END OF FRONT HALL LOOKING TOWARD STAIRWAY. #1164

DETAILS OF STAIR WAY GRILLE AND OF FIREPLACE

(House Shown on Page 75

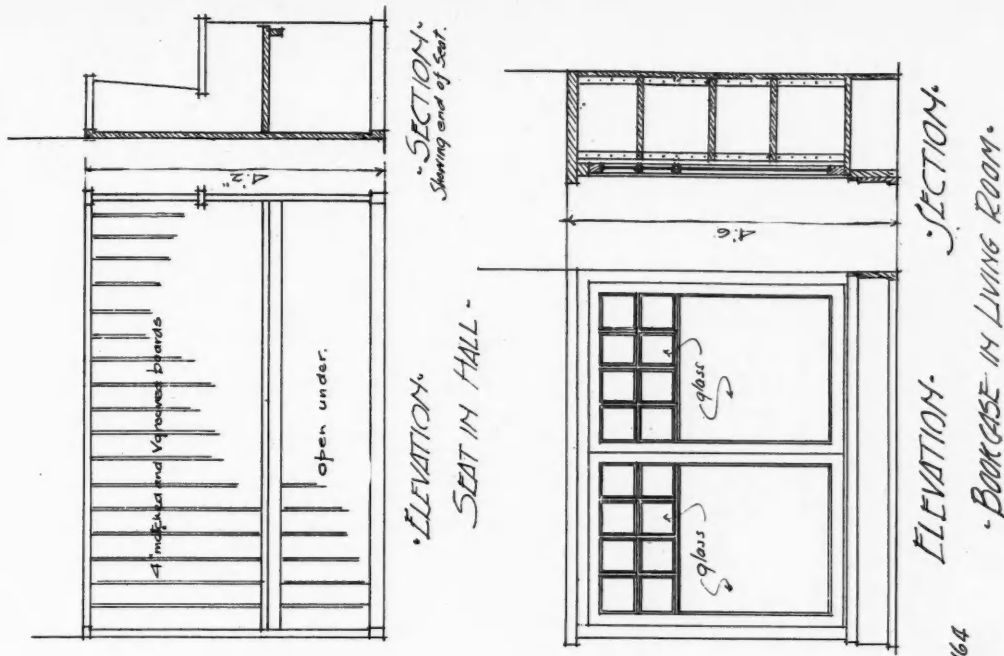

DETAILS OF BAY WINDOW SIDE BOARD, OF BOOK CASE, AND OF SEAT

(House Shown on Page 75)

#1164

BOOKCASE IN LIVING ROOM.

Plans for Modern Home for \$3000.

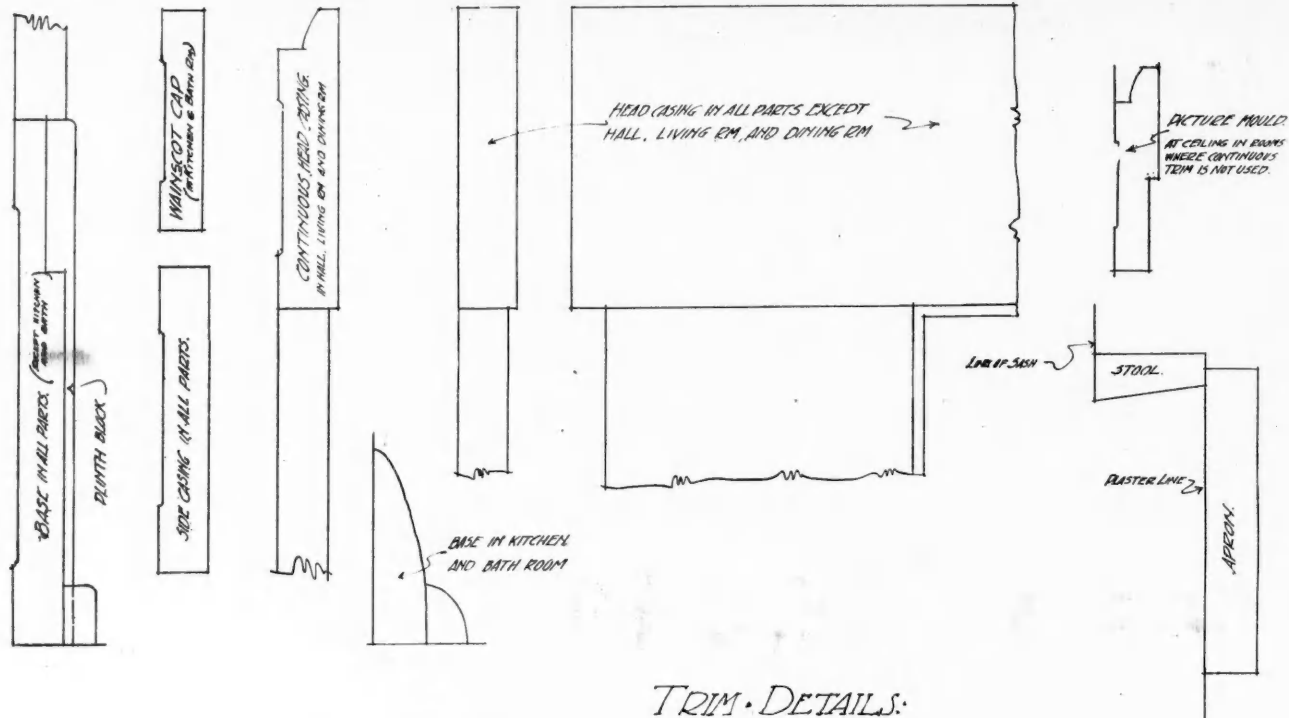

TRIM DETAILS:

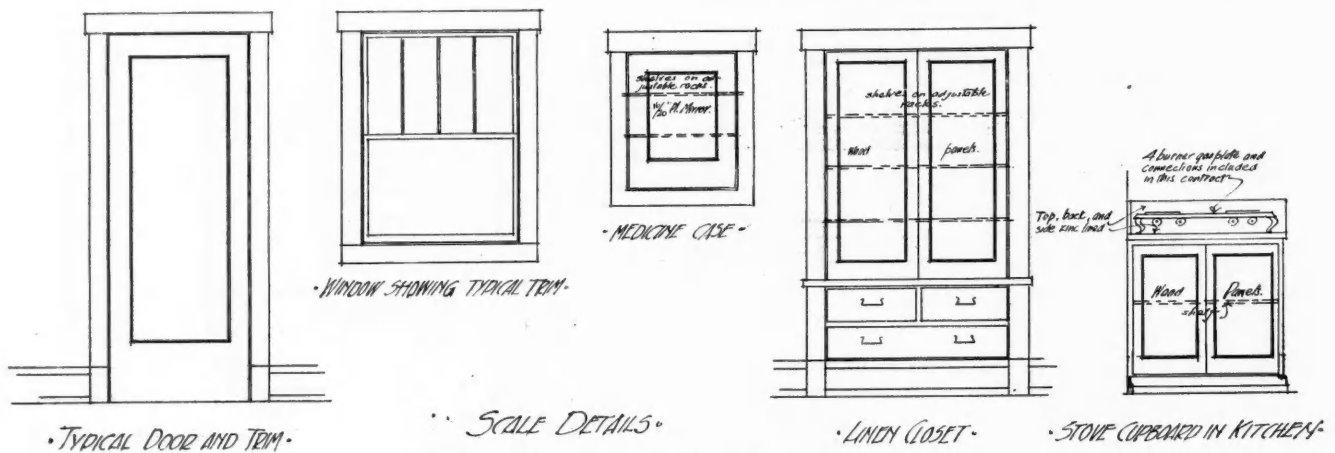

Details of Interior Trim in House Shown on Page 75

Harry Says—

FIND OUT THE REASON. Our errors may be a source of instruction, costly at times but they only help round out our education of which they are a part. Even at that, a mis-cut rafter will not make the next pattern fit if we don't find out the "why" of the first mis-cut.

IT'S THE WORK THAT COUNTS. The man who is onto his job can always find a good demand for his services, but this doesn't apply to the fellow who tries to ring in bogus knowledge and expect to get by on it. And there isn't another business with which we are acquainted that will show a man up as quick as this one. I had to release a man who had more and better tools than I have and who had a letter of recommendation as long as the revised tariff, but he could not shingle for Sheol, nor could he lay flooring enough in a day to cover the Populist platform. Taking the tools and getting on the job tells the story.

CARPENTERS AS MACHINE MEN. One combination of causes is the reason there are not more carpenter shops using machines to save hand work, and that is the carpenter is usually not machinist enough to take care of a machine and not skilled enough to operate one profitably. But when there is such a happy combination in a carpenter, the new combined woodworking machines are a wonder at saving cost.

CHIMNEY FOOTING. A flue set in a frame house should have an extra support under the sill or joists, reaching to a good footing on the ground. It is quite common to see a floor settled around that part of the room directly beneath a flue. This is very easy to avoid by bracing from the ground, where the brick is not run from the ground up.

TO PREVENT SOOT STAINS. Part of my work is looking after the papering and repairing of the tenant houses, and the women want so many things done that I sometimes feel like going around town through the woods to dodge them. Many of the calls for new paper is the result of the flues "sweating" and running a streak of black water down the wall. It is not nice to look at and I have hit on a plan to stop that trouble. In the new houses I have the pipe opening set one course of brick higher than the bottom of the flue, and run a piece of inch pipe up from the bottom of the floor and between the studding, leaving the upper end open and drain the sweat down under the house. It costs very little, is no trouble to put in and saves the wall paper around the flue. It will also prevent the flue from smelling so strong in damp weather, as it assists in keeping a circulation of air which carries off the odor of soot.

H. C. HANER.

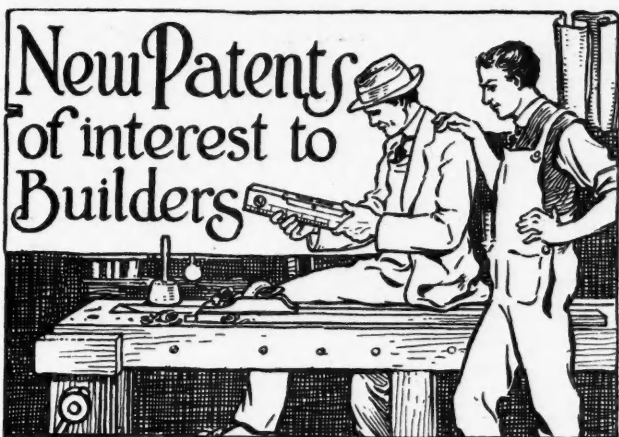

Conducted by **Watson & Boyden**
 Patent Attorneys, Washington, D. C.

A Handy Saw Oiler

Patent 1,052,175. Patented Feb. 4, 1913, by Oscar M. Reis, Toledo, O.

The object of this invention is to provide a saw oiler having a reservoir forming a part of the handle of the saw

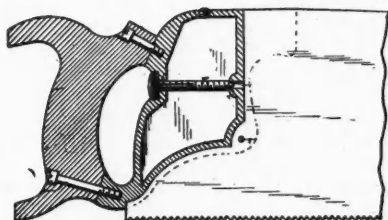

Oil is Contained in Handle of Saw

and which is provided with an improved construction and arrangement of feed valve whereby the oil may be supplied to the saw as needed or desired.



A Carpenter's Laying out Tool

Patent 1,024,863. Patented Apr. 30, 1912, by Gurney Myers, Lansdale, Pa.

This is a device for use with the steel square with the object of laying out structural timbers and for ascertaining their length. It can also be used for stair work. Where the length of a roof rafter is to be gauged, the slide head is

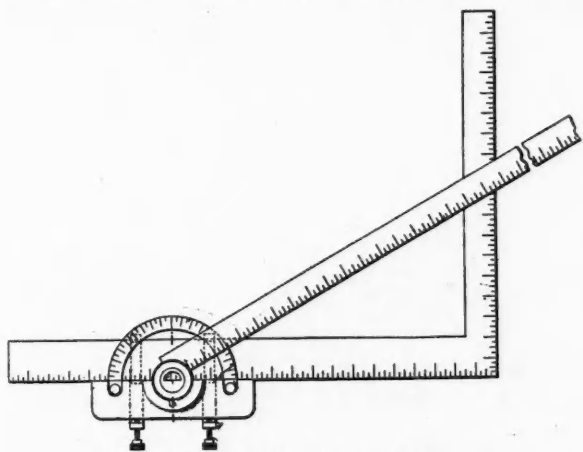

This Tool Simplifies the Steel Square

brought into a certain position on the square and the blade in conjunction with the other side of the square will give the length. The blade and semi-circular scale are used together when the shape of the building structure is given in degrees.

A New Plane

Patent 1,026,636. Patented May 14, 1912, by Christian Bodmer, New Britain, Conn.

This plane is devised for use in squaring up or truing up the edges of boards. It is complete in itself. The bulged palm rest is so made that any pressure applied will cause the guide to bear down on the surface of the board and bring the plane iron right up to the edge. This correct position assumed naturally, insures a true edge.

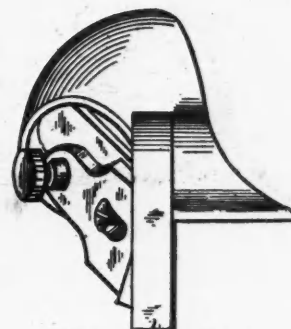

Hand Jointer Plane



Adjustable Stair Gauge

Patent 1,015,773. Patented Jan. 30, 1912, by Henry N. Auger, Worcester, Mass.

This invention is for marking stair stringers, getting the mitre for roof rafters and similar work. An adjustable

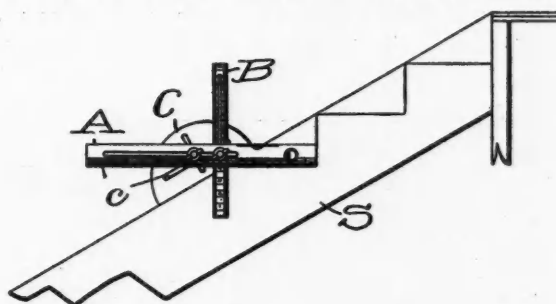

A Time Saver at Laying out Stairs

block to slide along the stringer keeps the level in a horizontal position. The sliding scale can be regulated to any desired position in conjunction with the level. The device is shown in use marking stair stringers.



Plaster Board Partition Stud

Patent 1,033,545. Patented July 23, 1912, by William S. Connell, of New York, N. Y., Assignor to Keystone Fire-proofing Company, a Corporation of Delaware.

This invention consists of a plaster board partition strip employed in making partitions of plaster boards or similar slabs.

It consists of a stud in which detachable keys are employed to secure the plaster boards in the studs.

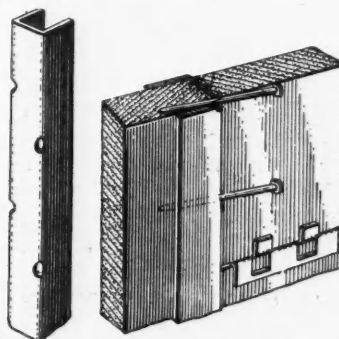

Pressed Metal Stud for Plaster Board Partitions

The invention is satisfactorily illustrated in the accompanying drawing, but the important instrumentalities thereof may be varied, and so it is to be understood that the invention is not limited to the specific arrangement and organization shown and described.



Our Readers are Requested and Urged to Make Free Use of These Columns for the Discussion of all Questions of Interest to Carpenters and Builders

Way Off!

To the Editor: Eagleville, O.

I would like to put in a guess on the frame illustrated on page 92, April issue. I base my theory on the timbers on top of the tower, as 8 by 10 inches; which would make a scale of 3/64 inch to 1; which would make the tower 35 feet high.

✦ EMMET MOSES.

Model of St. Paul's, London

To the Editor: Springvale, Maine.

Here is a photo of the miniature of St. Paul's cathedral, London, England, which I made during my spare time last

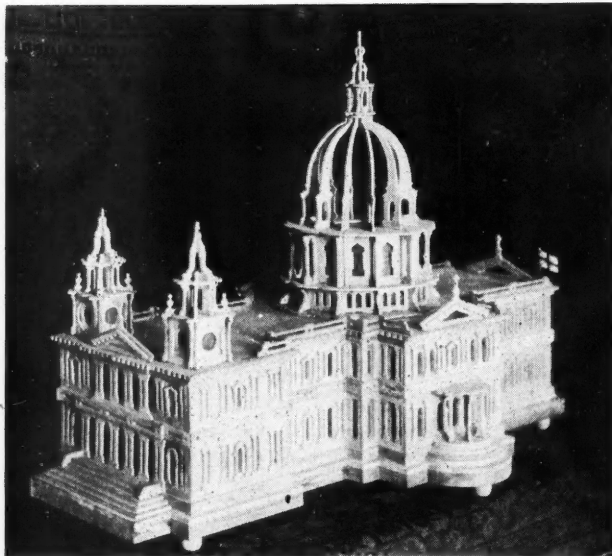

Model of St. Paul's Cathedral, London, 32x23x28 Inches High

winter, it is made of white wood and the dimensions are as follows: Length 32 inches, width 23 inches, height from base to roof 8 inches, height of dome from roof 20 inches, total height 28 inches. There are three layers of wood in the walls, 1/4-inch, 3/16-inch, 1/8-inch. There are 140 windows and it took about 60 square feet of wood. I fastened it together with 3/8-inch screws which amounted to 240 and about 1 pound of 1/2-inch brads and 1 pint of glue.

I am a subscriber of the AMERICAN CARPENTER AND BUILDER and I think it is the best building paper I have seen.

ARTHUR BALDWIN, Carpenter.

Cost of Stucco Work

To the Editor: Kalamazoo, Mich.

Kindly quote me actual cost per square yard of exterior stucco plaster, rough cast, including metal lath and furring.

D. E. A. CAMERON.

Answer: The actual cost of this material will depend upon a great many conditions which cannot be guessed at in giving an estimate. For instance, the cost of material

varies in different localities and also the cost of labor together with the capabilities of the men performing the work. The location of the work in the building; whether wall is paneled or in large surfaces; amount of scaffolding required; and the method of finish around the door and window trim all enter in to the final cost of the work.

We would judge that an average price for three coat work would be about \$1.50 per square yard where expanded metal lath is used. This cost may be as high as \$1.75 per square yard and has been known to be as low as 80 cents per square yard. The price includes putting on metal lath and all materials, but does not include cost of scaffolding.

EDITOR.

Home Made Tool Grinder

To the Editor: Lafargeville, N. Y.

Here is a simple device that even a boy can make; and yet it is very useful. It is made from an old bicycle. The only articles which were purchased were an emery wheel, a piece of pipe and a bolt. The grinding wheel should be six or eight inches in diameter about one inch thick, and should have a three-fourths-inch hole in it. The pipe should be one-half inch inside and just a little over three-fourths inch outside. Remove the front fork, take the wheel out and put the front fork in where the seat post was. Build up a little frame work as shown in the photo for keeping the seat in position. The tire should be removed from the wheel. A piece of clothes line will answer for your belt. To fasten the wheels, file the pipe on two sides and file the holes in the wheels to fit.

MRS. JOHN UPTON.



A Serviceable Grinder Made of An Old Bicycle

This System Works Well

To the Editor: Ashland, Oregon.
 In reply to Mr. Kahler, in your May issue, I am sending one of my time cards on an old job, and a copy of the account slip taken from the cards.
 I issue a card to each man every morning, and he keeps the time and material for each job that he works on that

E. C. PAYNE
CARPENTER AND BUILDER
 Time Card

Date.....Apr 27, 1909.....

No. of Order	Kind of Work Done	Material	Hours
7014	Make window sash.....	1 P 1 1/2 x 10-14.....	7
6096	Make Cupboard.....	1 P 1 x 20-8.....	2
		1 P 1 x 8-8.....	

Name.....W. G. Tucker..... Total Hours....9....

day, the number of the job being taken from the order book, which gives the name of the customer, number of the job, and description of the work to be done.

I have a loose leaf book to hold the account slips, and post from the cards, and always bill from the book, and have a filing box—home made—to take care of them when paid (and note on the slip the promise of the slow customer) and retain the slips.

E. C. PAYNE
CARPENTER AND BUILDER
 Account Slip

No. of Order6096..... Mr. E. E. Hicks.....

Cupboard

Date	MATERIAL	No. Feet	Hrs.	Amt.
4-27-09	1 p 1 x 20-8			40
	1 p 1 x 8-8			27
	W. G. T.		2	
	R. R.		1/2	
28	2-1 x 12-16 Pine	32		92
	1-1 x 18-14 Fir	21		84
	1-1 x 8-14 Pine	10		60
	W. G. T.		9	
	1-5/8 x 10-14			72
	R. R.		7 1/2	
29	1 p 1/2 x 8-14			60
	1 p 1/2 x 10-6			30
	1 p 1/2 x 12-4			24
	1 p 1 x 20-6			30
	1 p Brick Tuld 10 p			25
	1 p 1/2 O 12 p			12
	24 l ft. 1 x 2			10
	W. G. T.		10	
	R. R.		8	
		37	14 80	
			21 46	
5-2	By Cash	21 46		

This method has given me satisfaction for some years, the only trouble being that the men must be watched to see that they get the material down. I usually attend to that part on my own card.

I keep the men's time in the back of the same book on time book leaves that I have punched to fit it.
 E. C. PAYNE.

✪
Satisfactory Time Sheet

To the Editor: Missoula, Mont., May 14, 1913.
 In reply to Mr. N. N. Kahler I am sending copy of my time sheet which I have been using for the past fifteen years.

NEWTON'S TIME SHEET

191..... Work done by.....

Month	Day	Name of Owner	Time		Lumber and Mouldings						Hardware	Dollars	Cents		
			D.	H.	No. 1	No. 2	No. 3	Com.	Md.	Nails				Dray	

Each employe responsible for property destroyed by him.
 I find them very satisfactory. I have file case where I keep each man, year, month, day and job for ready reference at any time.
 E. S. NEWTON, Contractor and Builder.

✪
Sizes of Rough Openings

To the Editor: Oakland, Calif.
 I see in this month's issue there is a request for a series of articles on "plan reading and estimating," and I am sure that such a thing would be greatly appreciated by hundreds of readers.
 It would also be of great advantage to many, if some articles on framing would be included, with diagrams showing size of rough openings for doors and windows. It is a matter which is not thoroughly understood by many and if sizes on plans were taken and explained as regards the rough openings it would be of great assistance.
 NEIL McCALLUM.

Another Woodworking Shop

To the Editor:

Lane, Kansas.

I am herewith sending exterior and partial interior view of my woodworking shop. The outside picture shows the front 50 feet, and the east end of an alley 41 feet; it is mostly brick veneer.

Main room is 26 by 50 feet, but is 41 feet wide for 20 feet of its length.

I notice Mr. Godfrey has a sanding and boring machine that he thinks is hard to beat. We have one built somewhat on the same order, but different. His drum is 24 inches



Woodworking Shop of J. P. Wells, Carpenter and Builder.
Lane, Kans.

in diameter. That makes the throat too wide for short stuff. His boring attachment seems very weak—with only a common brace straightened out for a shaft. But he sure gets there with the holes.

Our sand drum is 12 inches in diameter, built on a steel shaft of $1\frac{3}{8}$ -inch diameter, with a $\frac{1}{2}$ -inch hole in the end for boring. We can insert common brace chucks or mill bits, or the Grand Rapids quadruple bit that bores four holes at once; which Mr. Godfrey's machine certainly would not handle in hard wood, and if he doesn't use the four hole bit he is missing something, if he makes as many window frames as we do. Think of the holes he would bore with it a hole every half second! We timed ourselves the other day, did not try to beat Mr. Godfrey's time, but we worked all by ourselves and we averaged 25 holes in two minutes—small holes through $1\frac{1}{4}$ and $1\frac{3}{4}$ inch deep in Y. P. Success to the AMERICAN CARPENTER AND BUILDER.

J. P. WELLS.

Brother Jasbury in Pessimistic Mood

To the Editor:

Asbury Park, N. J.

It seems to me, when I hear a bunch of mechanics conversing at a building during noon hour, there ought to be some compulsory law making men cease talking idle and on topics that are not only empty, but degrading. While I never had any great grammatical training, I can't help but notice the amount of illiteracy in the average mechanic's conversation on a building. One's surroundings have much to do with it—by associating with nigger and Dago hod-carriers, teamsters, etc.—but I am inclined to believe the time will come when the growing boy will either learn in school, while at home, or learning the trade, that if he is not posted on a topic, to keep his mouth shut and let some one who does know, do the talking. It only goes to prove the old saying, "A man's greatest ignorance is not knowing his own ignorance."

Why I write such and what I am getting at, is this: I was recently sent out on a job (new house) to make some stair and other measurements. Being away from home, I naturally took advantage of the one-half hour noon to do my work, as I had no one to look out for or not be in anyone's way; but the talk of the gang turned to book-read mechanics and trade paper men, and the way those fellows raved of that, made me disgusted with the entire outfit. As I said before, "A man's greatest ignorance is not knowing his own ignorance." Such men never read a trade magazine; they would rather get a drink. They never get beyond the stage of "ordinary."

I believe it was Gen. Grant who said: "In order to be successful, make it a point once within the 24 hours, to converse with some one who knows more than yourself." I can do that by picking up and opening the AMERICAN CARPENTER AND BUILDER.

I recently had an order to build a mahogany side board. I made a small detail and one of the men in the shop did the work. It looked A No. 1 when finished. A teamster and a shop apprentice were sent to deliver it, some four miles away. While taking it out of the wagon, they (of course) did not take out the drawers first, tipped it over, the drawers

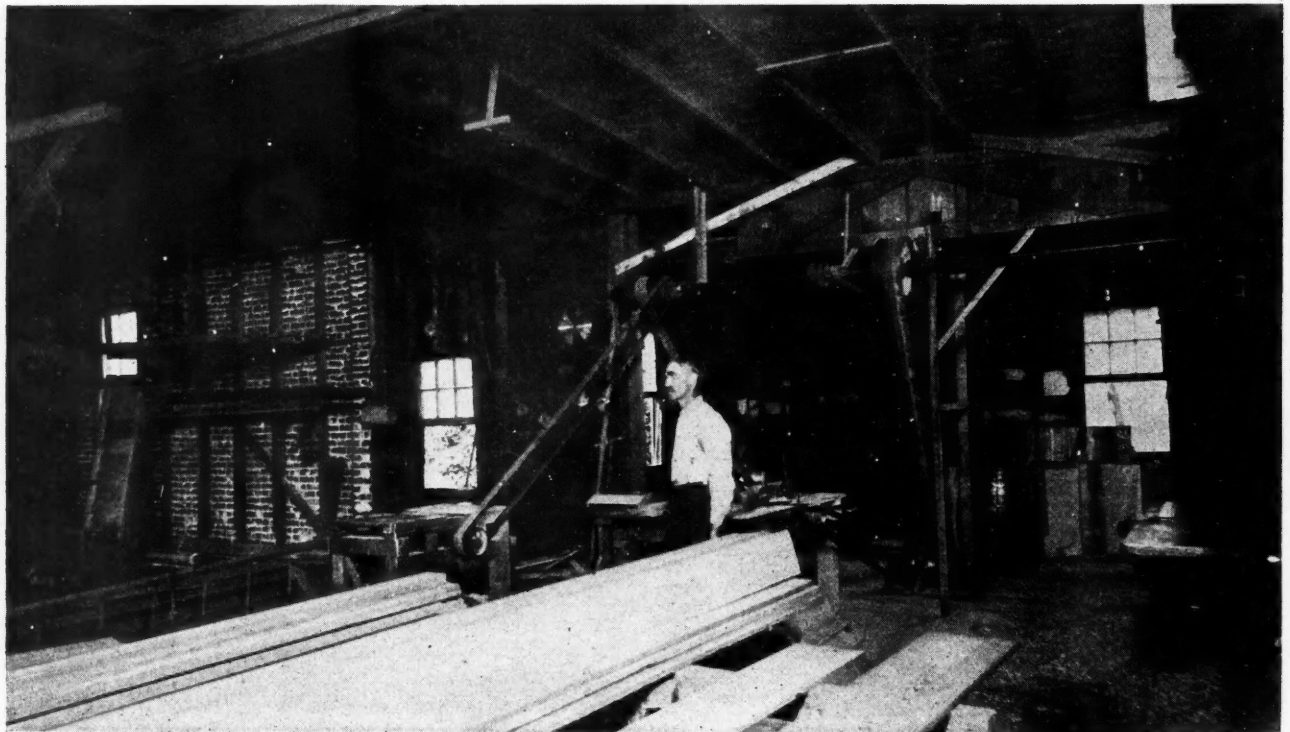

Mr. Wells and His Power Woodworking Shop—where he makes it Pay

fell out on the ground, breaking all three of them. This rattled them so, they let the sideboard proper fall and broke off a carved claw foot. When they got back to the shop, the Boss opened fire; he was dishing out the savage stuff, until a more cool member of the firm said: "You can't expect too much skill and brains out of a driver. If he had either one, he wouldn't be a teamster." That's philosophy, and as I was saying, this same fellow will monopolize the entire conversation. He will make more noise with his Timken roller-bearing tongue than the fog whistle on the "Imperator." It all sums up to this: If a man will read more and talk less idle stuff, he will develop a brain that has heretofore been dormant.

As I was saying, I shall try now to give a touch on the woodworking business, as I now have that other stuff out of my system.

I knew of a stiff argument that took place between a shop foreman and a superintendent, as to whether a piece of material was red oak or white oak. The foreman sent a sample to the Forestry Department, Washington. They wrote him back a nice letter explaining it and he is going to show the letter to the superintendent as the foreman was right, so in his case, "he would rather be right than Super."

I saw an article in the "New York World" today, stating a man found hidden in the crotch of a tree, much silverware and jewelry. That goes to prove there is money in the lumber business.

I was asked recently by a shop comedian, if I could hear the bark of dogwood? Ans. No, but while fishing, I caught some (sea bass) wood.

I shall get down to real articles soon as the moon changes.
WM. C. JASBURY.

Barn with Tapering Posts

To the Editor: Elkland, Mo.
Here is a photo of a heavy frame barn which we are just completing. The posts in this frame are 6 by 6-inch for the main posts, with 4 by 4-inch posts set between. The purlin posts are tapering 6 by 6 inches at the lower end and 5 by 4 inches at the top. They are 16 feet long, and are cut to fit on top of 6 by 6 posts in the center of barn.

Will you kindly ask the brothers to give a rule that will give the number of feet board measure in a stick in the

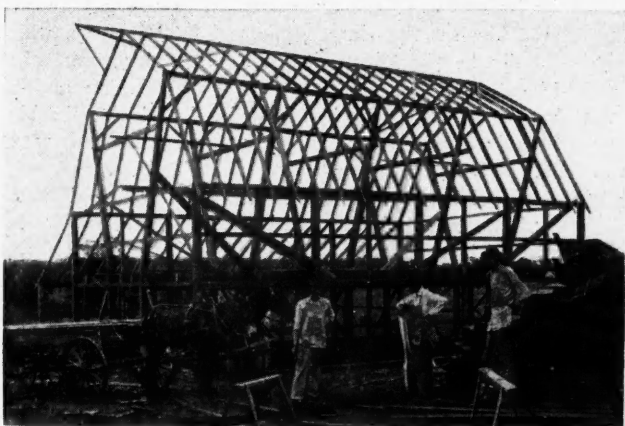

Purline Posts are Tapering

form of one of these purlins 6 by 6 at one end 4 by 5 at the other and 16 feet long. We have figured the bill and the man who did the sawing was not satisfied with our count on these posts.
COFER BROS. AND WEBB,
General Builders.
Per FRANK M. COFER.

Converting Old Building into Work Shop

To the Editor: Alamogordo, N. Mex.
I am taking the liberty of contributing a few lines to your valuable paper, which I consider the most valuable paper of its kind published. As I am one of the old readers of this paper, I want to say a few words about shops. I followed the carpenter trade for a good many years and recently I started a shop for myself. I rented an old restaurant build-

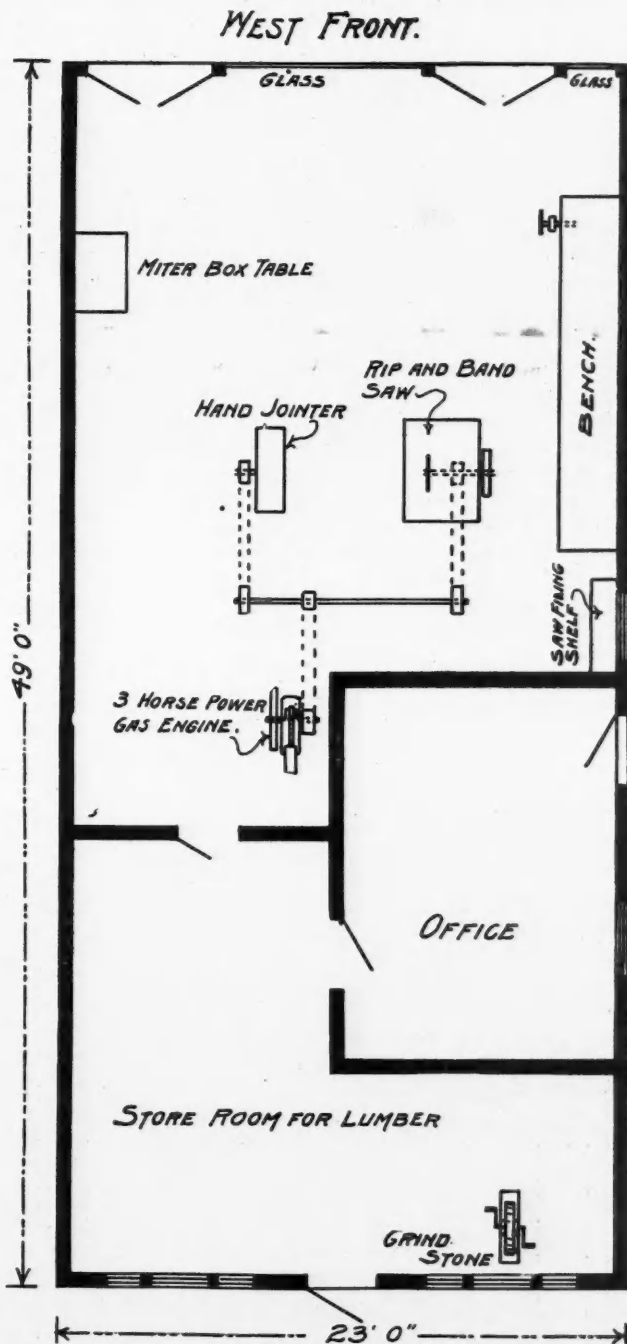

Layout of Mr. White's Woodworking Shop, which was Formerly an Old Restaurant

ing which fronted to the West, and as it had a glass front, it furnished plenty of light.

I am sending you a sketch of the arrangement showing the location of the machinery. I have a small three-horsepower engine belted to a line shaft set 16 inches above the floor. I have a rip cut-off saw and a band saw made by the Parks Co., of Cincinnati, Ohio. The hand joiner I made myself. I got the head from a milling company. My engine was made by the Chicago Gasoline Engine Co.

I have a good room in front and can work stuff 18 feet long. The office was formerly the private dining room. I would like to hear from the boys about the make of their wood-working machines and as to their points of excellence so that we can see who makes the best.

CHARLES R. WHITE,
Contractor and Builder.



To Develop the Hip

To the Editor: Clayton, N. C.
I am sending herewith a sketch of a plan of a church tower with square base and circle roof. Would be glad if you would tell me how to shape the hip rafter to correspond with that of the common rafter. I hope you will find space in your valuable paper for this question and answer for same.

JOHN A. YOUNG.

Answer: We have answered this question before, but as it is one of the things that quite frequently come up in carpentry work, and as it will be new to some, we will answer it briefly by first giving it a comparison illustration. This is one of the easiest to illustrate of all the shapes that may be given a roof, though the treatment we propose to give is applicable to all.

Now, this being a half round roof, just suppose it is a half round piece of mould; and if we cut it square across, the curve on the end of the mould would show just the same as a pair of common rafters. Now, if we cut the mould on an angle of 45 degrees, by looking at it (the cut) at right angles, the curve thus formed would show just the same as

a pair of the hips; the flat side representing the base or diagonal line across from corner to corner; and as the diagonal of a square is 5/12 greater than its width, we have the proportion of the stretch-out of the hips' run to that of the common rafter.

We might illustrate this more clearly by taking a piece of quarter round and place it in a miter box; and by making a square cut the outlines of the end of the mould would represent the run, rise, and curve of the common rafter. Now, without moving the mould in the box, swing the saw around to 45 degrees and make another cut and the piece severed would show a little block, the base of which is a right angle triangle, representing the plans, one side (the square cut side) representing the run of the common rafter; the thin edge side, the tangent or half the width of the tower and the third side representing the run of the hip, while the outlines on the end of the block (45 degree cut) would represent the run rise and curve of the corresponding hip.

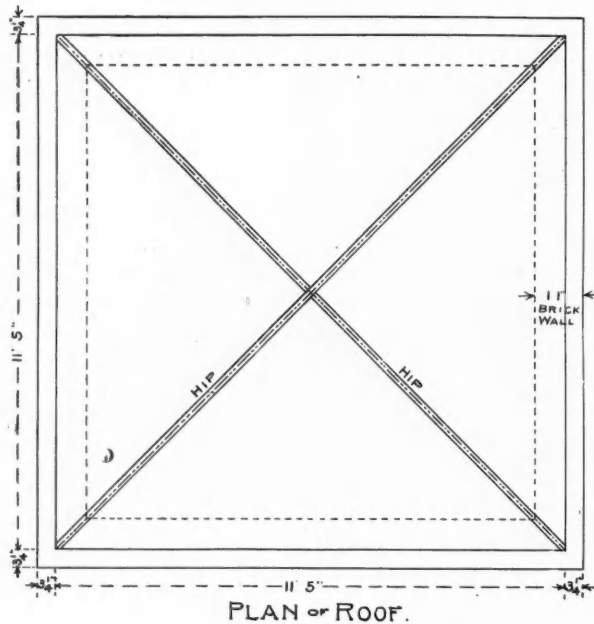
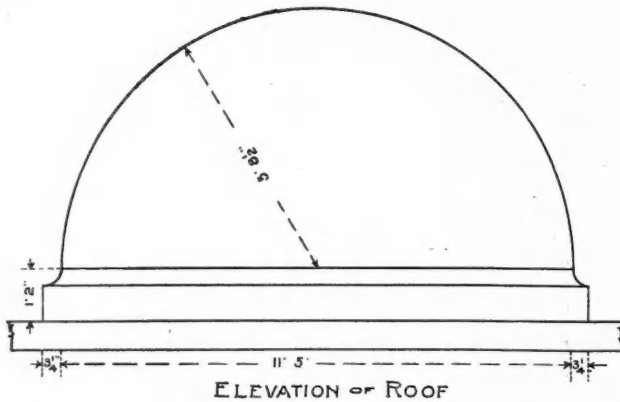

Church Tower with Square Base and Circle Roof

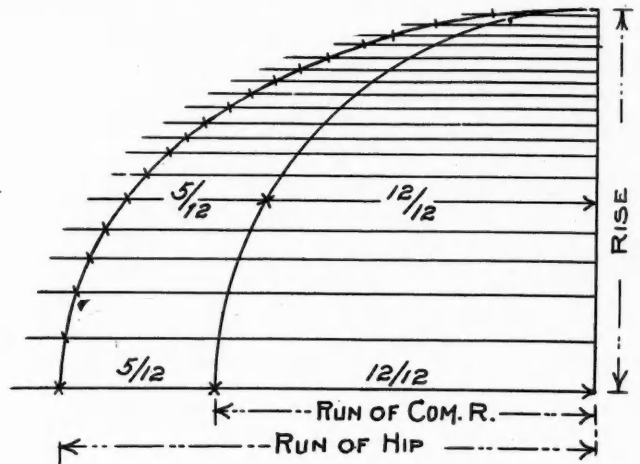

FIG. 2.

Laying Off Curved Hip Rafters

In this little block we have all of the proportions entering into the problem. Cut eight such pieces and place them with the wedge points together and we would have a miniature roof. This is simple enough; but the question arises, how are we going to transfer these proportions to the full size working drawings? There are a number of ways of doing this; the simplest way for an example of this kind would be by means of the trammel. After getting the outline of the hip, set the trammel for the backing line, which would simply be the shortening of the measurement taken for the run of the hip, one-half of its thickness, and go over the pattern again and it will be found that backing line gradually draws nearer to the outer edge of the rafter and finally dies out at the rise line.

The trammel applies to half circle roofs only and in the absence of the trammel, the corresponding curve of the hip may be found by diagram as shown in Fig. 2, by first laying off the curve of the common rafter full size and then lay off a number of parallel lines as shown; the more lines the more accurate will be the result. Now measure these lines accurately from the rise line to the curve, then set off 5/12 of the amount thus found, on the same line beyond the curve and check. That is for each foot in length set off five inches, and for each inch in the fraction of a foot set off 5/12 of an inch.

After all of the lines have been thus measured, run an off-hand curve through the checks and the proper curve is developed, depending of course on how accurately the work is done.

Now for the backing line on the side of the hip, set back

from the curve on each of the lines one-half of the hip's thickness and check and run an offhand curve through these points and the proper gauge line will be developed.

In the case of an octagon hip, the gain is only 1/12 and the amount to set back for the backing line is 5/12 of one-half of the hip thickness and proceed as before.

A. W. WOODS.



How to do it on the Square

To the Editor:

Westfield, Pa.

Please tell me how to determine by the steel square, the length of a hip rafter for a porch with a rise of two feet and a run one way of 8 feet, and 6 feet the other way. I can get this easily by draft, but cannot figure it by the square.

J. K. W.

Answer: Why yes! 6 and 2 give the seat and plumb cuts

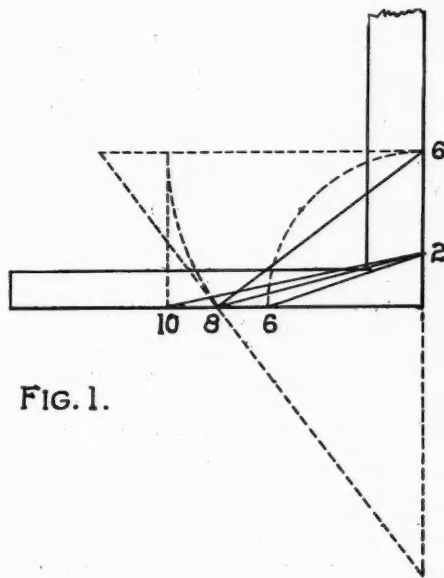

FIG. 1.

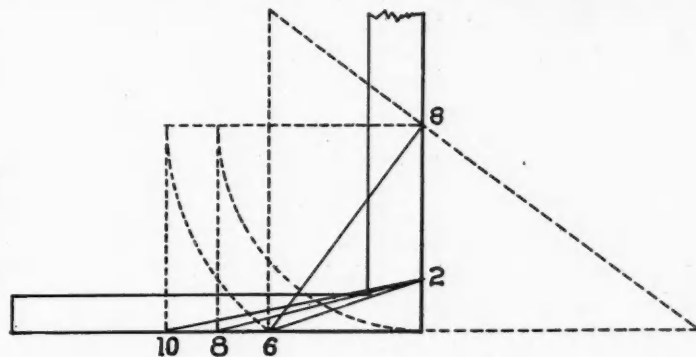

FIG. 2.

Method of Getting Length and Cuts for Porch Hips

of the common rafter for the narrow side and 8 and 2 the same thing for the wide side and the lengths of their diagonals give their respective lengths as per one inch scale to the foot. The run of these rafters represents two sides of the plan. See? (Referring to Fig. 1). Take the run of the short rafter on the blade and draw the line from 6 to 8; this will represent the run of the hip and you will have the plan complete; each side representing a run. Now take hold of the diagonal line at 8 and raise it up until it is level with the upper end and plumb down to the tongue and you will find it strikes at 10; and a line from this point to 2 will represent the length of the hip.

Now, for the cuts. Take the short run of the common and the length of the long common rafter; and the side of the square on which the latter is taken, will give the side cut of the jack for the long side and visa versa for the short side. Now draw a line passing at 8 on the tongue and at right angles to the line from 6 to 8 intersecting the lines forming a right angle, as shown. From 8 either way is called the tangents. The long tangent and the length of the hip will give the side cut of the hip for the short side. The side of the square on which the length of hip is taken, will give the cut; visa versa for the long side.

Referring to Fig. 2 we have identically the same results but illustrated differently. Compare these illustrations and study them and then read our Steel Square Department article for this month, the fourth illustration of which applies directly to problems of this kind.

A. W. WOODS.

Remodeling with Ceiling Beams

To the Editor:

Charter Oak, Iowa.

I want a little information on beamed ceiling; how to construct them in a certain room which I describe below. I am to remodel our school house and the Professor wants me to put in a beamed ceiling in the Assembly Room; which is in size 24 by 36 ft. and 11 ft. 6 in. height of ceiling. His idea is to put one beam through the center lengthwise and two crosswise, and a half beam around the room next to wall—making the room in six panels. The ceiling is to be covered with wall board and also the sides of walls. Now how heavy a beam would you think would be suitable for a room of that size?

LOUIS SPROCK.

Answer: You will need to use a false beam about 10 inches wide and 7 inches deep. Of course it is understood that these beams are not for strength or to carry loads of any

kind, but are simply intended as a means of ornamentation to the ceiling.

We believe that a good way to place these false beams is to nail a strip of wood along the ceiling where the beam is to go and then nail the side boards of the beam to this strip. This gives a firm type of construction if nailed securely. The bottom board of the beam may be either nailed on to the two side boards or fitted nicely into grooves on the inside surfaces of these boards. This will depend upon the amount of nicety you wish to use in your work. A strip of moulding should be used to cover the joint where the beams touch the ceiling.

EDITOR.



Barn with Horse Shoe Roof

To the Editor:

Watkins, Minn.

I am sending you a photo of a barn I and my partner built last summer. It is 36 by 76 feet, with 14 foot posts. The

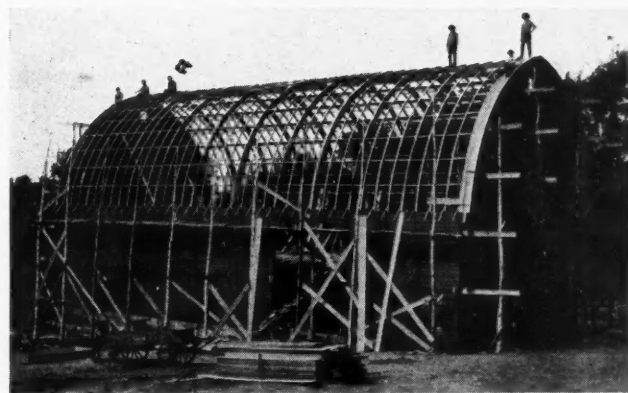

Barn 36x76' with Horse Shoe Roof

striking thing about this is the horse shoe roof. There is room in this barn for 36 head of cattle and 6 horses.

JNO. P. LORGE.

Grades and Foundations

To the Editor:

Centralia, Ill.

When walking along the streets of a city of any size it is surprising to the keen observer, the number of houses that have been built, apparently without any regard whatever to grade. This applies especially to the cheaper buildings, those built without a regular architect's plans and specifications, which, if properly drawn up, will show, and also specify, the amount of grade above a certain joint, generally the sidewalk. It is astonishing how many of even the old heads at the business, employ the "rule of thumb" method of establishing the grade line.

I have had many occasions to notice the brick mason—when running in the footings, after he got about a foot above the ground, stand off a ways, take a look and observe, "well, I think that ought to be high enough," and that settled it as high enough. The result generally was that after the yard was graded it was discovered that there still was a slope from walk to the building and to get anything like a grade would require the covering or filling up over the first course of blocks. Which certainly is a disappointment to the owner.

Now there is really no good excuse for such way of doing work and is only the result of one of two things, either absolute indifference and carelessness, or an effort to save as much material as possible.

Grade lines should always be run with a level of some kind as sloping ground is the most deceiving thing to the natural eye, and while an architect's level or transit is the most accurate instrument for the purpose yet there are other methods to achieve fair results. With the straight edge is one way, though perhaps the poorest there is; because it is a notable fact that you can't level around a ten foot square, and come out at the same place.

Perhaps a somewhat crude looking, yet a fairly accurate way is shown in Figs. 1 and 2. It certainly is very simple and inexpensive, and if accurately made is just as reliable as any. It can be put up directly at the walk, or farther back, close to the building. The advantage of short range lies in the fact that variations don't become quite so pronounced.

Sometimes we find the issue overdone, houses standing maybe only fifteen or twenty feet back from the walk, have maybe 12 inches or 15 inches grade, and gradually slope to a

the result being musty smelling rooms, besides rotting joists and other timber.

Then besides very often the mistake is made of excavating under the building in an effort to get ground to fill up around the house, entirely ignoring the fact that during rainy seasons these excavations will fill with water and the easiest chance for escape is up through the building by evaporation and the ground is nearly always damp and moldy.

As to just how high up it is necessary to go for proper ventilation may be a question often for debate, but it should be any way enough so as to allow for proper circulation of fresh air and enough openings, or ventilators should be provided on all sides of the building so as to afford a draught as the air must be stirred up and move or there is no ventilation.

A basement, if it can be drained or kept dry, is perhaps the best way to preserve the health and the building. Whenever we go higher above ground than is necessary for proper ventilation it becomes merely a matter of taste, and appearance. For a real low, one story building, or cottage, the foundation above the grade should be not more than 2 feet, or 3 rows of building blocks, as a higher foundation will become too prominent against the upper structure, and make it appear lower than it really is.

Concrete is, without a doubt, taking the place of all other material for foundations for the average buildings, and while a great deal has already been said and written on the subject that is wise and otherwise, there is always something can be added that gets away from the highbrows and that remains for the fellow on the job to figure out as best he can. While for concrete walls it requires the building of forms from lumber, still such walls are the cheapest when the entire cost is figured. Another advantage is that walls can be made any desired thickness and are not governed by the size of the material employed. One fact must not be lost sight of in regard to concrete forms, namely, that all the lumber can be used over again with but very little loss if judiciously handled.

We often see carpenters when building forms for basement walls, say, for 4 feet high or even 6 feet 6 inches, use 10-foot or 12-foot studding full length, letting the ends stick up thinking they are saving material by so doing. Let us figure a minute and see where we are at. If we use a plate

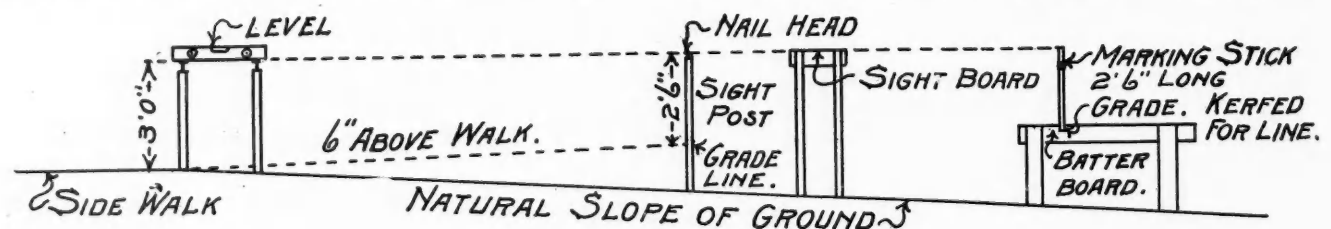

FIG. 1.

Fairly Accurate Method of Sighting Levels

level with the walk, this invariably reminds one of a great big hat, with the brim hanging down all around, walks sloping that much become very dangerous during ice time. Yards with that much grade should be terraced, that is jump up all at once at the lot line as much as is needed to give the balance just enough slope to drain the water nicely. In such a case it becomes necessary to have one or several steps up from the side walk to that of the yard.

Another thing that very often makes otherwise fairly representative houses appear low, is the foundation above the grade. Years ago it was the custom to stay close to the ground, but people have begun to realize the fact that it is very unhealthy as it does not allow for proper ventilation,

at the top as well as the bottom, it becomes necessary to cut the studding the proper length for the exact height of the wall, but then the pieces are not lost, but can invariably be used on the building to good advantage; then a long studding will cut two or three lengths, as the case may be.

The advantages of building the forms in a regular partition style are numerous. In the first place, the plate will add considerable stiffness not requiring to set the uprights so close, besides it doesn't require nearly so strong bracing as the braces can be set a little ways down from the top edge, thereby giving strength, where it is most needed. This also relieves the bottom plate of considerable of the pressure it will otherwise be subjected to if the braces are set above

the top, besides the walls will not bulge out between the braces as I have seen them do to the amount of an inch or more. This not only makes an unsightly job but requires considerably more material to fill up.

When a top plate is used a whole side can be put up in one section nailing it together, boards and all, while laying flat on the ground commencing at the top edge, with a straight board and go down, if the boards lack a little of reaching to the bottom so much the better as that will give additional footings, care must be taken to square the corners to the top or it will not be set plumb when wall is raised. The nails can be driven with solid licks, instead of pecking in a 6-inch space, and maybe you hit it and maybe you don't.

The top can easily be leveled when constructing the forms in this manner, all that is necessary is to get the corners the proper height and wedge the center to it. The bottom plate should be well anchored or there are chances for its giving away; 1 by 4-inch, or on high and heavy walls, 1 by 6-inch driven flat ways and well down, is pretty substantial,

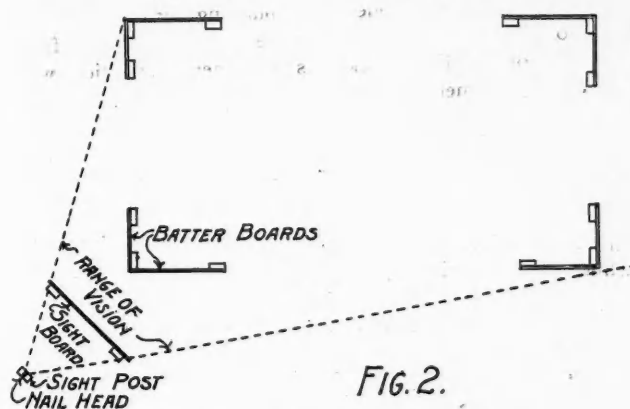

Laying Out and Leveling a Foundation

or on extra long walls it is a good idea to brace from one plate to the other with 2 by 6-inch or 2 by 8-inch, but in that event, a foot or more of concrete must be filled in all around before filling one side too high, or the other side can't resist the pressure.

Very often when the forms are removed we find a cavity or hole under the window frames. This can be avoided by filling in under the frame from one side only instead of from both. Poke the stuff in from one side until it stands level full on the other side, and you can rest assured that there is no hole under the frame.

After the forms are filled, especially with a wet mixture, it will settle considerable until all the water is either absorbed or drained out, a good plan, especially where the sills are laid right on the concrete, to take a mixture of 2 sand and 1 cement, before the other is set hard, and filling up to the level, and strike the top smooth with a trowel or some other tool. If the finishing is done with the coarse stuff it is harder to get a smooth bed.

Some people foster the idea that concrete walls are water proof, but that is a mistake; in fact, it's a proposition to make them so by special treatment. I know of a government building situated on, what was at one time, a water lead. The basement has an 18-inch concrete bottom in it with a special damp course treatment imbedded in it and still it takes water. While it may not appear that way just the same its more difficult to keep ground water out than it is to keep water in a cistern or tank.

Crushed limestone is perhaps the best there is for making concrete and with a little sand added and a proper amount of tamping will show up the finest lines from the molds or forms.

Some times people use what is called "chat," it looks somewhat like limestone but is ground fine, its a refuse from the

lead and ore mines. It makes a fairly good wall but not a smooth finish, the walls look rough and porous. It absorbs water like a sponge. It is difficult, while tamping it into the forms, to bring water to the top although the mixture appeared really wet while on the mixing board.

✦ AUG. C. SCHNAKE.

He Asks Two Questions

To the Editor:—

I have two questions to ask and would like to hear from you and others who have had experience along this line.

First,—I recently got out a built-in buffet. The man who claims to be an expert, hung the doors, by letting the hinges in on the door stile only. It occurred to me, the hinge should have been let in on the door and also on the jamb, and especially so on a fine piece of work.

Second,—I would like to see the wall strings on the enclosed sketch of stairway, showing the method and how to give a graceful shape over the winders and with the wing on the flyers.

J. H. E.

Answer.—Your idea of hanging the doors is undoubtedly the correct way.

As to the second question, that was fully answered on page 94 in the November, 1912, number. It is true that the form is different, but what is said and shown there, applies equally as well to the question in hand.

Editor.

✦

An Improving Gang

To the Editor:

Sherman, Miss.

I am sending photo of house that I am overhauling at this place, for D. P. Yates. I do not consider this house thoroughly up to date, but considering what I began on, do think it a great reformation.

We have neither city water nor light plant. Hence we are installing Pneumatic water system, I am also installing electric light plant to supply 40 lights; the system is taken care of through storage batteries.

In the picture I am standing to the left with square, next is my brother with paint brush in hand. Thus showing his trade and I must say he is a cracker-jack. Small man leaning against work bench is C. I. Wade and is my carpenter foreman.

I have every issue of the AMERICAN CARPENTER AND BUILDER except one, though I am not a charter subscriber, but secured them through other parties. It is my Bureau of Information.

R. P. FINLEY.



R. P. Finley and Crew Remodeling a Southern Cottage

Prize Winner in Parade

To the Editor:

El Paso, Tex.

Enclosed find check for \$2.00 for one years subscription of AMERICAN CARPENTER AND BUILDER. I enclose also a picture of 200 Brothers of local union of the United Brotherhood of Carpenters and Joiners of America in a labor parade, who

who perished in the flames of hte original structure. It was presented to the newspaper owner by his admirers. The resemblance to the former building is perfect, and the stones are the fire blackened granite blocks from the dynamited edifice. It is about twelve feet in height and contains ferns and rare plants, which grow in the arches. The foundation

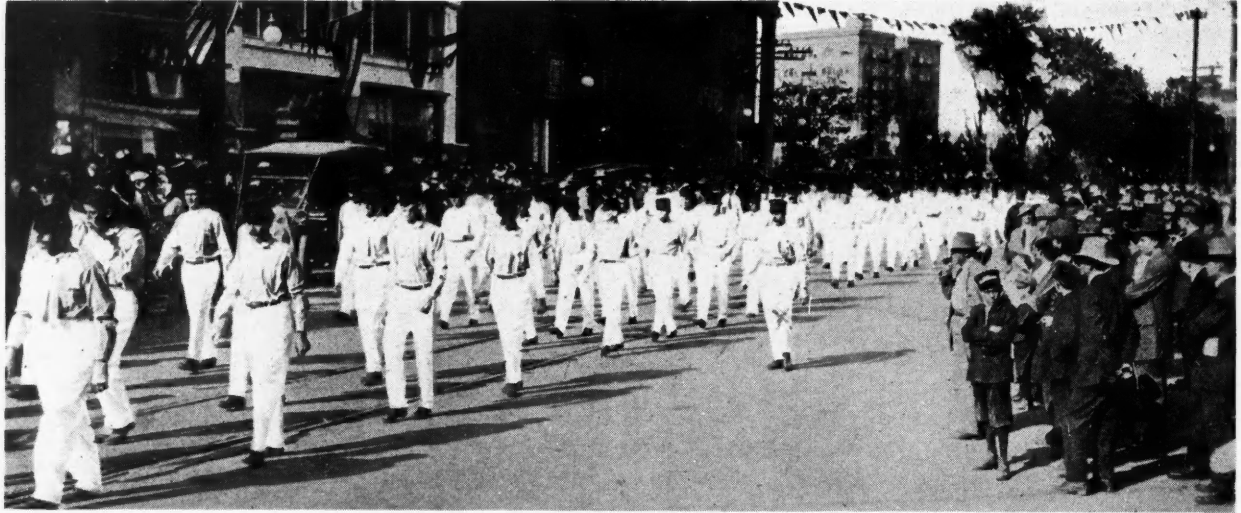

Marching Club of El Paso Carpenters which Won a Prize

won first prize of \$20.00 for making the best showing both in number and in observing best marching order. It's your humble servant with the cross on the knee.

We have a strong union here a membership of about 400 our scale is 62½ cents and hour, El Paso is a thriving city of about 50,000 population, and is growing very fast. With best wishes for the AMERICAN CARPENTER AND BUILDER.

S. M. HYTEN.



Strange Memorial Bulding

To the Editor:

Los Angeles, Cal.

A grim reminder of a tragedy that cost twenty lives and stirred the whole civilized world is the miniature reproduction of the dynamited Times building, which has just been erected upon the grounds of Gen. Harrison Gray Otis, in Los Angeles. As a memorial to his friends and employees



Miniature Castle Built in Shape of Wrecked Times Building, Los Angeles, Cal., of Stones from the Ruined Structure. It Stands as a Memorial in the Garden of General H. G. Otis, Owner of the Times.

and frame of this odd memorial structure are of concrete, while the surface is of granite blocks. C. L. EDHOLM.

Mortised Frame Barn

To the Editor:

Konts, Ind.

Enclosed find picture of frame barn erected by me on the

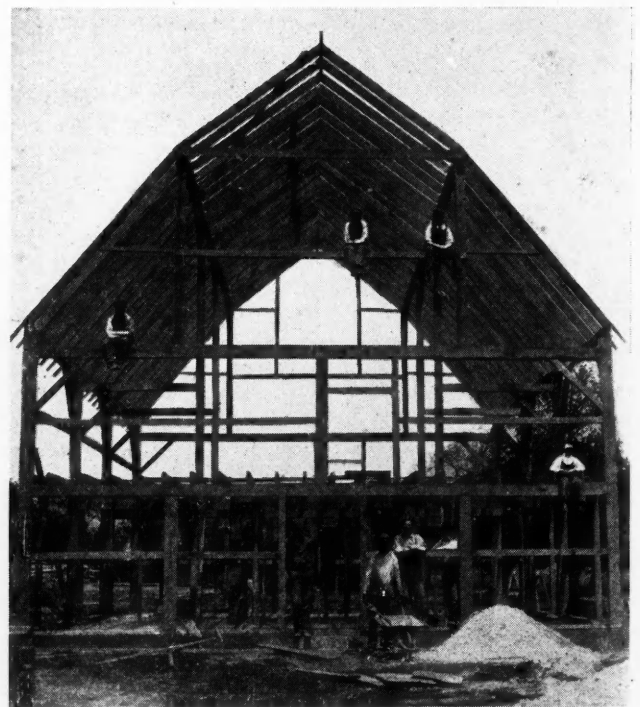

Strongly Framed Barn at Konts, Indiana

farm of Henry Folsom, near Konts, Ind. The size of the barn is 32 by 42 feet with 16-inch posts. It is a mortised frame of Indiana pine posts 6 by 8 inches, beams 6 by 8 inches, plates 6 by 6 inches. There is a concrete foundation and concrete floor throughout. I am a charter member of the AMERICAN CARPENTER AND BUILDER and find a great deal of helpful information in its columns, also in the photos of frame buildings contained therein. T. L. ARNOLD.

Up the Ladder to Success

To the Editor: Wakarusa, Indiana.
 Enclosed please find money order for two dollars for the AMERICAN CARPENTER AND BUILDER, for I would hate to miss one copy of the magazine.

I also enclose a picture of a full mortise frame barn 40 by 70 feet. I have been seeing quite a few pictures in the magazine, but most of them were either of Ohio or Illinois,

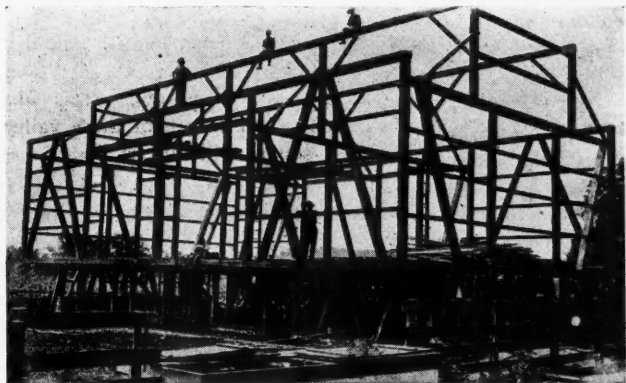

The Way Mr. Nusbaum Frames Them

so I thought I would have to give them a few of northern Indiana.

I also wish to say a few words in regard to "Radfords Cyclopedia of Construction." I have a set of books and would not sell them for five times their cost if I could not get any more like them, for I certainly think they are the greatest books of the kind that ever were put on the market.

I am sure that those who do not yet have the books, will never regret the money invested if they buy now, that is, if they care about keeping on climbing up the ladder to Success. OLIVER C. NUSBAUM, Contractor and Builder.



Stair Work

To the Editor: DeWitt, Mich.
 As I am a charter member of your grand paper from which I have received many valuable hints, I think I may be pardoned if I add my little "spiel" to the rest of the wood butchers in our congregation.

In reply to Mr. W. D. Fisher in regard to putting in stairs, I will give my method. I never saw a way I thought any better.

I first place my risers and nail permanent. Then cut my washboard (or string) as near as may be to the run of the stair. Put in position, and if it does not fit, well, take a scribe and scribe the risers. Re-saw on the riser. If done carefully you will get a very good fit. After string is cut to proper angle at top and bottom, nail in. Then wedge behind riser to remedy any bad joint. Now fit one end of tread to that string, number them and lay one side. Fit string for other side as before. Now you have a good joint on your risers and one end of treads. Now cut the other end of treads, and no matter how tight you put them in, you cannot open a joint. The same method will work on the wall side of an open stair. A. B. MOSES.



Doing a Day's Work

To the Editor: Philadelphia, Pa.
 If you will kindly allow me a small space in the AMERICAN CARPENTER AND BUILDER, I wish to commend Brother Bryant of Paducah, Texas on a small article of the group he had in the January number. This one article means mountains to the journeyman carpenters of this country; and it should make them wake up and they would not wonder why they were always laid off when work becomes slack

As a rule, this kind of men get suspended first just because they don't take enough interest in their work to try and improve their ability to handle any kind of carpenter work. It appears to me, too many are just satisfied in working eight hours and drawing their pay. I notice the good, all-around mechanic who stays on the pay roll is the one who tries to work for his boss' interest. He will have more faith in you and give you all the chance for advancement, which I am sure any of us would appreciate who cares to improve himself or his pay envelope, which will no doubt result, by trying to please your boss and doing a good day's work. I agree with Brother Bryant on making it compulsory for a carpenter to pass an examination to find out if he is a carpenter or a butcher. Most of the journeyman carpenters could improve themselves if they would only spend a little of their spare time in study.

I am very much interested in roof framing and I use a steel square, copper finished with white letters, and find it a nice tool to work with. I am anxious to hear from some Brother in reference to a better mechanical education for the journeyman carpenter in general, as I don't think there is any excuse for any of us to lack in education or knowledge of our respective trades these days with so many free institutions and night schools, where anyone can go who has a desire to do so. C. W. BAKER.



A Successful Barn

To the Editor: Emporia, Kansas.
 In reading your book I get much information from others' experiences and I would like to help them all I can. It may be that some worthy Brother will be benefited from this, if you will be so kind as to place it in your magazine.

This is one of several barns I have built in the last three years and I will say, they are a success. Note the self supporting roof without the abundance of material. In this picture it is impossible to see the supporting braces from the floor to the plate line, but it will be readily noticed that there are no posts in the hay mow space that will be found in the purlin roof. I think it is much better. This frame work is 2 by 6 throughout and I use lots of bolts in my brace work. I truss over all doors and also in the gables.

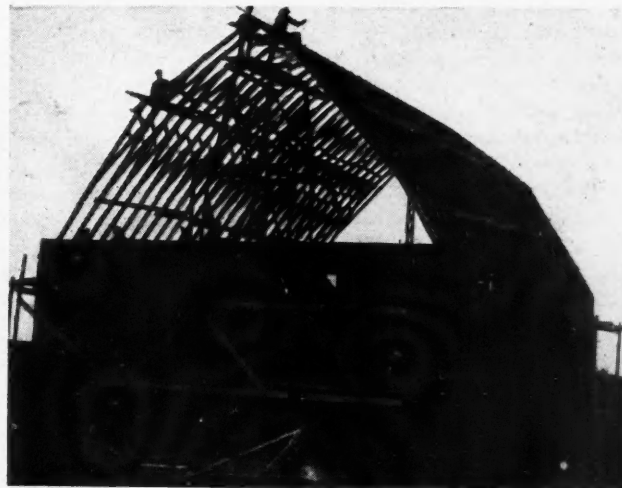

One of Several Barns Built by T. J. Cox

The gable truss or brace can be seen through the right hand corner as you look at the pictures. It is 2 by 2 by 6 set 2 feet apart edge wise, extending from the floor to the roof and then across bridged with 1 by 6. I put two such braces in each gable, one on each side of hay door.

For my eave projection I use 2 by 4 lookouts spiked on the rafter foot and bend the shingles, making a little concave which I think improves the appearance of my job.

T. J. Cox.

Shavings

To the Editor:

San Rafael, Cal.

Brother Jasbury has been giving us some dandy "Shop Kinks" from time to time but they are mostly for the mill. So I am going to give a few for the common carpenter, though some of them will be applicable almost any place.

First place, why do so many carpenters persist in tying a bowline or a slip noose or a rolling hitch or some such long winded affair in fastening cords to window weights? Two, and sometimes three, timber hitches can be put in while one bowline is being tied. Not only in the putting in but in case they have to be taken out (for shortening or lengthening or changing weights), there is a lot of time saved. And nobody can find any fault with the timber hitch; for it loosens easier than any other knot, it is absolutely secure, it never slips. Try it, you fellows that want to make your time tell.

BUNCH OF SHINGLES FOR SAW CLAMP. I was working for a man by the name of Fowler once and he found a nail in his saw's pathway. Twelve blocks from the shop and not a saw clamp on the job. He did something that I never saw before. Took a bunch of shingles, stood it on end, shoved his saw down between the rows—and went to filing.

A CUPBOARD DOOR TRICK. I have seen this done to save time, though I do not advise its general use. Strikes me as a little stingy. On lower doors of china closet, doors under a sink, pantry cupboard doors, etc., the butts were mortised double depth into the door edge and not mortised at all into the jamb. You would not know it when they are closed and unless quite light they are not very conspicuous when open.

BLOCK FOR PLANE GAUGE. A little square block about 1 by 1 by 3, held firmly against the under side of the jointer and pressed close to the board will do almost as well as a plane gauge—and it doesn't cost any dollar and a quarter either.

FOR EQUAL SPACING. Here is a trick that is in a number of the books on carpentry and yet is used *very* seldom. I don't see why either, because it is so handy and saves so much "figuring." Suppose you have a board 11 inches wide and want to rip it into 7 strips of equal width. Instead of dividing 11 by 7 (and probably making a mistake or guessing at the fraction), just lay your square across the board "on a bias" with 1 at the near edge and figure 14 at the further edge. Then made a dot at 2, 4, 6, 8, 10, and 12. Draw your gauge lines through these dots and you have it without figuring at all. It would work just the same if the board were 13 in. wide or only 9. If you wanted three strips, lay the square so 1 and 12 would be at the edges and mark at 4 and 8. And so on. Isn't it worth remembering?

FAST BUNGALOW CORNICE WORK. Out here, in the home of the Bungalow, we have our own method of putting on the cornice. We run the walls up, put on the frieze, and then cut the rafters one inch longer (on the *level*) and let them come down over the *outside* of the frieze. See?

USES OF ADHESIVE TAPE. Keep a bunch of tape in your box and use it for most everything. It is fine to tie up a cracked finger. It will temporarily mend all kinds of broken handles. A few wraps around a hammer or hand-axe handle will keep it from slipping. It makes good ferules for awl, chisel, gouge, file handles, etc. It will save a lot of jar to your hand when you are setting nails in rustic if you will wrap your nail set with it. Besides, it keeps the set from slipping. When you are doing a lot of measuring with tape, all the same length (ceiling joist 32 feet, for instance), just put one wrap of tape around the tape line at 31 ft. 10 in. You can find your 32 ft. mark a lot quicker each time. Does your figuring pencil keep dropping out of your vest

pocket? Couple of wraps of tape will make it "stay put." And it only costs five and ten cents a roll.

H. J. BLACKLIDGE.



An Uneven Pitch Roof

To the Editor:

Pittston, Pa.

Suppose I am building a two-story house and the roof plan is like the plan enclosed. I want to give the sixteen-foot side a rise of eight inches to the foot which makes the ridge sixty-four inches or 5 feet and four inches high. I want to have both ridges even at the top. To do this, I must give the fourteen foot, nine and one-seventh inches rise. Now what I want to know is what would be the length of these valleys and what figures on the steel square will give the cuts? By using a 2 by 5 rafter, the foot cut in the plate of the valley rafter extends back one inch from the inside corner of the plate. Does it make the valley rafter that much longer on the run and that much shorter on the projection?

If I use a ten-inch frieze board, what projection should I give the common rafter and also the valley rafter to make the cornice come even all around?

HENRY GRADY.

Answer: In cases of this kind, the valley should run to the intersection of the cornice line. That is, the projection of the cornice should be laid off same width for both pitches;

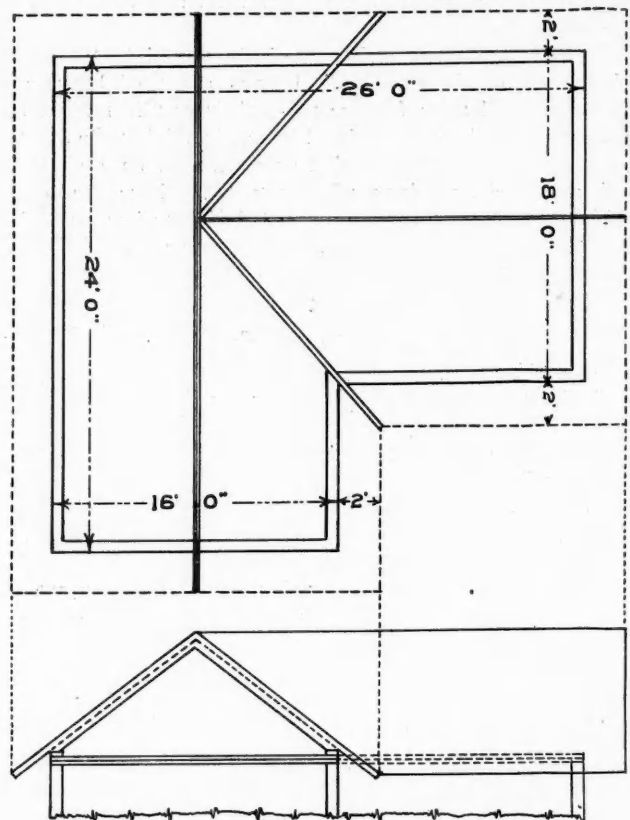

Framing an uneven Pitch Roof

and where the cornice line intersects at the angle, is where the tail end of the valley should run regardless of where it passes over the plate, for in uneven pitches it cannot rest or pass directly over the plate at the angle. The difference in the pitches as submitted in Mr. Grady's problem is so little from the regular that the variation of the passing of the hip in the plan is hardly noticeable. The common rafter can be cut in the usual way but it will require building up of the plate on the steeper side; or the variation can be made in the depth of the seat cut. The difference is equal to the difference in the rise of the two pitches for a run equal to the width of the cornice.

Where the difference in the pitches is very pronounced, the

plancier cannot be finished or put on with the pitch of the rafters because the roof on one side of the angle being steeper than the other, the bed mould cannot miter as the width of the frieze will necessarily be of different heights. Therefore, about all that can be done in cases of this kind is to put on a level plancier and run the cornice across the gable or return the same at the corners. ❖ A. W. Woods.

An Illinois Residence

To the Editor: Minonk, Ill.
I am sending you a photo of house and garage that I put up a year ago for R. G. Clegg of Minonk. The floor plans were destroyed; but the picture will give an idea of what we chips produce.
There are a lot of features out of the ordinary in it. We made all brick there on the ground. The corners are plain cement, the rest crystal spar. The general opinion is that this is the most attractive bit of work in the county.



Very Pretty Place Planned and Built by Fred Tucker, Minonk, Ill.

The south gable is a summer sleeping room. The pantry has a 72-inch McCray refrigerator arranged for outside icing. The trim is quartered white oak.
The house has full basement with cement floor and partition walls of concrete outside concrete to grade, with face brick and backing brick made on job.
The second floor has two large rooms, one in each gable. The bath room is in gable by stairs with sleeping room in south gable. Interior trim on second floor is red oak.

FRED TUCKER,
Contractor and Builder.

Needs of the Building Business

To the Editor: Perryville, R. I.
Before entering fully upon some points that I wish to mention, I want to say one of the great needs of our Contractors is to have the AMERICAN CARPENTER AND BUILDER. Not only are many problems solved clearly therein, but the list of advertisements should be in the reach of the office desk of any progressive Builder.
Were you to ask me what is my greatest need, I would tell you very unhesitatingly "More good men." While we know there are some good mechanics, we realize a large percentage are not. We want men with other interests than the arrival of Saturday afternoon.

A lot of men seem to think if they can get these boards nailed on or these shingles tacked on in a way to get their pay envelope, who cares! Some little regard for the owner is also nice to use. Having him raise a dark cloud of profanity at his house leaks or warps apart for lack of nails etc., is entirely unnecessary.

But we have many men all over the country who are doing such work. It is an age when a certain grade of men think themselves smart to draw good money for their inefficiency.

Give us men who will say "I'm going to turn out a good day's work whether anybody else does or not; and I should do this as nearly perfect as I know how; and I don't intend for my work to be second in quality."

Men like this of honesty are not playing the part of the Braggadocio or making self conceit over prominent, but quietly his workmanship is paving the way to promotion, and some day will be paid for his faithfully earned understanding. His recompense is not only in dollars, but also in the satisfaction that he is a master of his trade.

We are told that we should not carry too much business home. I admit the brain should have sufficient rest to perform its duties properly, but I do admire the man who remembers where he left off and thinks of what to do when he shall arrive on the morrow.

Now another beautiful thing is the noon hour business. What do your men talk about at noontime? If they all talk Base Ball, Flying Machines, Moving Pictures, etc., you have lost a percentage of interest that really belongs to you. The writer has had long experience and if the men are interested in your welfare you'll get near the 100 per cent mark out of them.

Brother Contractor or Foreman whichever you are. Keep your men interested in the job. If you don't go home to dinner get right at some problem in the construction work. Hold out the best methods. When you fail to get one of your men interested begin to tell yourself right there that you are not doing all you ought as a Master Builder or else your man is not just the employe to hire for your best interest and good. At best he don't meet your need.

I have found late years a good many men who said they would like to learn some branch of building business; but I find mighty few willing to put in hours of careful study to make themselves a success. W. R. CARD.

A Nebraska Bungalow

To the Editor: North Platte, Neb.

I have just finished my bungalow here and am sending you a picture of it. It is modern throughout, having hot air heating plant and all modern plumbing; has coil in furnace and is connected with laundry heater for summer use. So it is not even connected with kitchen range.

The building is 24 by 38 feet on ground and has 8-foot front porch under same roof. It has basement 20 by 24, kitchen, bath, den, bed room, living room, dining room, closet, and pantry; also back porch. Has 12-inch post with metal lath 30 inches high; on this is stucco—rough cast finish. Interior is finished in yellow pine; stained, shellaced, and varnished—excepting bath room and kitchen, which is enameled four coat work. All plastering is 3 coat work, sand finish and frescoed throughout.

I have two houses started and two more ready to start. Building is exceptionally good here. I will close by wishing the greatest building paper success.

J. E. PILE,
General Contractor.



Bungalow of good lines Planned and Built by J. E. Pile. No. Platte, Nebr.

What Natural Gas Can Do

To the Editor:

Cincinnati, O.

The destructiveness of natural gas in explosion is here pictured in the wrecking of a home in Cincinnati from a gas explosion in the cellar.

The explosion followed a small fire being discovered in the home. The family escaped from the building during the fire excitement, but at the same time the firemen went in. No sooner had they entered the house and started down into the cellar with their lanterns, when a terrific explosion occurred which lifted the building from its foundation, blew



A Lantern Touched Off the Gas—and the Gas Did the Rest

out the sides and front and then it settled back as best it could in a half collapsed condition. Four firemen were buried in the ruins. They were dug out unconscious, but not fatally injured.

Firemen state that they believe there must have been a leak in the gas pipes in the cellar and the explosion was the result of a pocket of gas becoming ignited from their lanterns. Eight persons lived in the house and had the explosion happened independently of the fire, the firemen are sure that several deaths would have occurred. A fence on the south side of the destroyed building was leveled by the force of the explosion. Windows were broken in houses on either side and the force of the explosion could be felt one square away.

J. R. SCHMIDT.



How to Put on a Piano Finish

To the Editor:

Price, Utah.

Now I would like to tell some of the Brothers how to obtain a piano finish on furniture.

I worked two years in a piano factory and while there I took the opportunity to find out how they obtained such a beautiful finish on their pianos.

The best material, I believe, to use for such work is oak, mahogany, walnut or birch. White wood can be made a

nice mahogany if stain is applied in the right manner.

In my experience, gum wood, also rose wood, has a tendency to check, so that poor results are obtained.

The material to be used must be perfectly smooth and even; all marks and scratches removed, as they show and spoil the effects of your finish, as it shows clearly through the varnish.

Take a stain the required color you prefer; make a few samples till you have the color you desire. Of course, there are a good many stains to choose from; let the stain dry for some time, then apply a paste filler, if the material you are using be oak, taking care to fill all the pores and leave to dry. Apply a thin coat of shellac and let it stand; the longer the better, as the shellac becomes hardened and is easily sandpapered smooth, which gives you a surface to apply the varnish.

There are many different kinds of varnishes that are too hard to rub. Apply five or six coats of varnish, allowing it to dry thoroughly between coats, also between coats rub with a little sand paper; I have used, at times, a hair cloth, which can be obtained from old furniture coverings.

After the fifth or sixth coat have been applied let it remain for eight or ten days at least in a warm and dry place.

Rub with a coarse pumice; to obtain the best results use a block with a felt pad attached and rub evenly till it becomes dull and flat and perfectly smooth, taking care to use lots of water with pad and pumice. Use a sponge and chamois skin and wipe thoroughly dry; leave it to dry over night. Apply another coat of varnish, which is called the flow coat, taking care to spread it evenly; if not you will have window curtains, as the boys used to say. Let it dry for two or three days or longer.

Use fine pumice the same as you would the coarse pumice; then take rottenstone and apply to chamois skin with a little water and rub the same as you would with the pumice stone. Then use a furniture polish with cheese cloth, taking care not to burn the varnish.

THEO. B. HANSEN.



Cause of Leaky Bays

To the Editor:

Morning Sun, Iowa.

I saw in last July number a statement in regard to the cause of bay windows leaking. The article said it was caused by the water beating into the joint between siding and casing; but I find more often that the leak is down through the bottom of the frame among the parting bead; so I use a 2 by 8 sill and let it extend clear under the frame and from stud to stud, thus stopping all leaks from that source. Never have had a leak when I used this method.

I don't want to do without the AMERICAN CARPENTER AND BUILDER. I have been in this business for 38 years and have never found anything of more help.

J. G. BERGEN.



We Never Saw It Done

To the Editor:

Milroy, Minn.

Which is the best way to build a house? Board it up inside and outside? Or just board it up on the outside, and use back plastering on the inside and lath on the 2 by 4 studs?

In back plastering I use 1 by 2 strips next to the sheathing and lath and plaster on that.

I can't see that sheathing upon the inside would make it any better.

P. H. LEBAK.

Answer: We quite agree with you that sheathing on the inside of the studs would not add enough to the warmth of the house to pay for the extra material and labor. We don't know that we ever have seen or heard of a job handled in this way. It certainly is not common practice. If you back plaster in the way you say, you will certainly have a good warm house.

How do other builders handle this question? EDITOR.

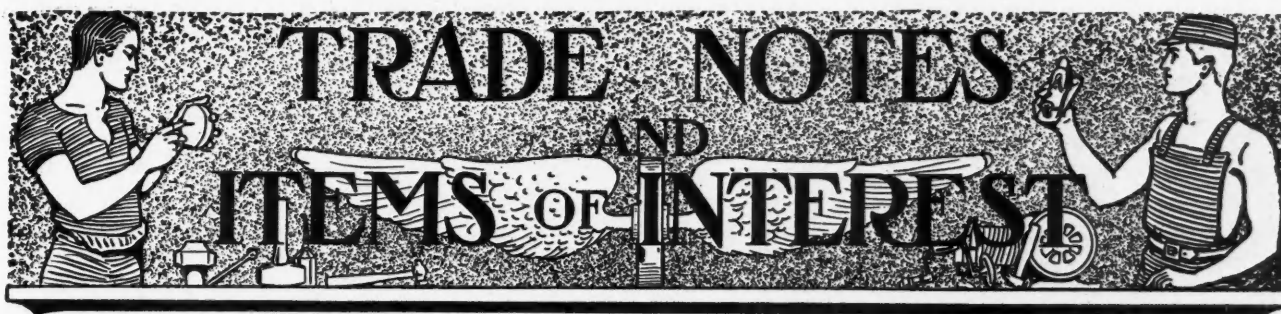

Through this department the editors aim to keep builders, contractors, carpenters and architects in touch with what their friends, the manufacturers, are doing for them in new or improved tools and machinery, methods and materials—pertaining to building. Items for these columns must have real news value; they are offered here as interesting information for our readers; they are not advertising. No matter will be printed here simply because some advertiser wishes it. Likewise, no matter will be excluded simply because the article described is not advertised in this magazine. Suggestions for the betterment of this department are requested of our readers.

New York Contractor Made President of American Hardware Corporation

At a meeting of the Board of Directors of the American Hardware Corporation on June 3rd, Mr. Henry C. M. Thomson was elected president in place of Colonel Charles M. Jarvis, resigned.

The American Hardware Corporation comprising the constituent companies—Russell & Erwin Co., P. & F. Corbin Co., the Corbin Screw Corporation and the Corbin Cabinet Lock Co.—will find Mr. Thomson an able director of its affairs. This gentleman after his graduation from Yale in 1883 immediately identified himself with the hardware business, later forming a long connection with the P. & F. Corbin Co. For twelve years he managed this company's Chicago branch. In March, 1901, Mr. Thomson affiliated with Hoggson Bros., New York City, designers, builders and decorators of homes.

Supported by the admiration and respect that his good qualities have won him, Mr. Thomson will doubtless continue to meet with unusual success in the hardware field.



Architect Opens Office

Announcement is made that Alan Chester, architect, has opened offices in the Bank of Mobile Building, Mobile, Ala. He may be reckoned on as being very proficient in all branches of his work.

Mr. Chester will be glad to have manufacturers send him catalogs, circulars, specification matter and samples of their products which enter into present-day construction. It is pleasing to know that Mr. Chester finds the AMERICAN CARPENTER AND BUILDER a great help in his business.



Metallic Tapes with Instantaneous Readings

For the benefit of those not entirely familiar with the meaning of the name "Metallic" as it is used in connection with measuring tapes, it should be said that this is the name applied to that class of woven tapes, having in addition to the linen threads, Metallic strands interwoven, and it does not mean that the tape is made of steel or metal of any kind, as might be inferred. "Metallic" is the name applied to this class of tapes in general, and is not the name of any particular manufacturer's brand. Tapes of this kind have been on the market for years, and they are generally conceded to be the best grade of woven tapes.

There has just been placed on the market by The Lufkin Rule Company (factories at Saginaw, Mich.) "Metallic" Tapes with Instantaneous Readings. Instantaneous Readings is a method of numbering the graduations of measuring tapes, and described briefly, it means that in small figures, alongside each inch mark, the number of the last preceding foot mark is repeated. This renders it unnecessary to refer back to the last foot mark when taking a reading, avoiding this chance for error, and saving time.

Instantaneous Readings is a Lufkin idea, applied at first only to their steel tapes, and in this connection it is very generally known. It has for several years past appeared on all steel tapes of their manufacture.

The idea is now for the first time applied to Metallic Tapes, and this improvement will, without any doubt, find the hearty welcome the same idea as applied to steel tapes has, since it was first announced.

All Lufkin "Metallic" Tapes are now being supplied with this new marking.



Hess Medicine Cabinets Lower

The Hess Warming & Ventilating Co., 1220 Tacoma Bldg., Chicago, announce a revised price list for its steel medicine cabinets, effective June 1st, and the new price list has been mailed to all of their customers who have purchased cabinets within two years.

The company report that for eighteen months past the orders it has received for cabinets have been in excess of the supply, and that at one time orders were necessarily delayed three months. Some improvements have been made and the quality and the demand for the cabinets are better than ever.



Wood Working Machines

In a catalog recently published, the Crescent Machine Co., 224 Main St., Leetonia, Ohio, have aimed to present such information as a careful buyer usually wants. The descriptive matter and the illustrations are exceptionally fine. The book gives plenty of information in regard to wood working machinery that cannot be otherwise than beneficial for the interested man.

Crescent machines are famous as being models of whatever is best in their line. They are kept right up to date with the latest improvement that modern invention suggests. Thoroughly made from the best materials, they are machines in which a buyer can have every confidence. The builder who takes time to send for this little catalog of 128 pages will be well repaid. The book is sent free.



A Practical Power Floor Surfacer

Every reader of the AMERICAN CARPENTER AND BUILDER who is interested in a well-finished floor, whether in skating rinks, amusement halls, bowling alleys, gymnasiums, club rooms, dancing halls, pavilions, hospitals, banks, libraries, or residences, should write for data regarding the Peerless Floor Surfacing Machine, manufactured by the Peerless Floor Surfacing Machine Co. of Oshkosh, Wis.

This machine works on an entirely different principle from other machines now on the market. This company guarantee that their machine will level, plane, polish, sandpaper and wax or oil a floor that is in either bad or good condition, and make of it the smoothest surface. A representative of the AMERICAN CARPENTER AND BUILDER has seen for himself the



Flooring Finished the "Peerless" Way

work done by this machine and cannot commend it too highly. The Peerless Floor Surfacer, operated by one man and a boy to help, will do the work of 100 expert floor or bowling alley finishers and do it quicker and produce better results.

The earning capacity of this machine is large and will make a very profitable investment for any man who has floors to finish.

The Peerless Floor Surfacer is an electric machine connected with a vacuum cleaner. This vacuum cleaner attachment takes up every bit of dust and dirt. The machine is so arranged that the operator can run right close to the baseboard. Its construction is such that it cannot possibly rip or tear a floor. It is vastly more than a sandpaper machine, inasmuch as it has cutting knives that will take off the varnish of an old floor and level it. This machine has been used for several years and has invariably proved its worth and ability to do the finest kind of work in the shortest possible time.

Readers of the AMERICAN CARPENTER AND BUILDER who are interested should write to the Peerless Floor Surfacing Machine Co., of Oshkosh, and ask them for their proofs of these statements. These will be sent to you and also a very attractive book showing the operation of the machine and the reasons why you should buy it.

In regard to the work done by this machine, this company received the following letter from the Trustees of the Elks Temple of Jackson, Mich.: "The work of smoothing and polishing the floor of our Temple at Jackson, Mich., with your Peerless Floor Polisher was highly satisfactory and your machine did even more than you claimed for it. Our floor is now as smooth as glass and we now have a dancing floor that is second to none in the country at a cost of one-quarter the amount of any former estimate. We are delighted with the work of your machine and take pleasure in recommending it to others."

If there is no electric power in your town, this machine can be purchased with portable electric outfit at a very reasonable cost.



"Peerless" Floor Surfacer at Work

Get Our Quotations On Building Materials

Gordon-Van Tine Co.'s Latest Catalog
Offers Train-Loads of Building Material

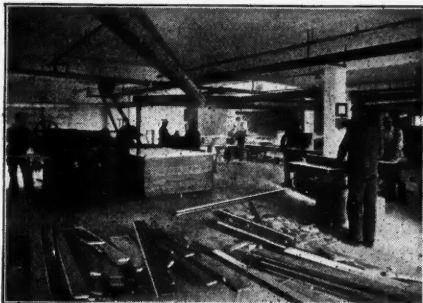

A CORNER IN OUR WOODWORKING SHOP

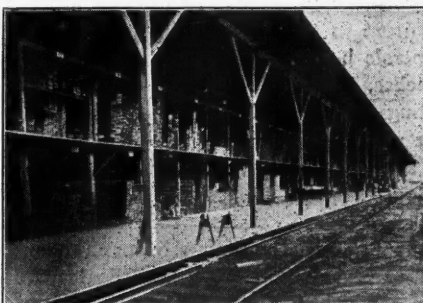

FINISHING LUMBER, SHED NO. 1

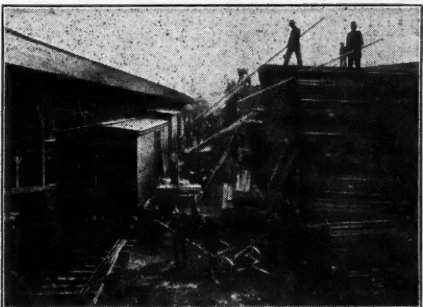

LOADING LUMBER ON TRACK NO. 3



SHIPPING PLATFORM NO. 3

S-e-n-s-a-t-i-o-n-a-l-l-y Low Prices!

The quotations on building material in our new catalog are so far below local prices that every builder who consults his pocket-book should certainly write for it *at once*. The quotations now in effect apply to everything required to put up any building from a modest cottage or bungalow to a palatial residence.

We have furnished all the material for more high-grade homes than any other single concern in America.

Unexcelled Service

The facilities of our millwork plant and warehouses, together with our splendid organization, enable us to give building contractors and carpenters a service that cannot be duplicated elsewhere.

Our stocks cover every possible requirement and offer an almost unlimited variety of exclusive designs. Our arrangements for rapid and accurate handling of orders are absolutely perfect.

The result is that our thousands of regular customers in the building trade have learned that we ship exactly *what* they order, and that *the goods are there on time*.

Some of Our Specialties

We make a specialty of fine designs in *Oak Front Doors*, many with art glass set in copper. Some of these doors, which we sell for \$7.75 to \$12.50, would cost the contractor as high as \$25.00 if made to special order at a local mill.

We offer many beautiful styles of Oak Interior Finish and Trim, with extremely artistic doors and windows to correspond.

Our architects and designers have given us a wealth of exclusive styles in Stair Material, Porch Work, Mantels, Grilles, Built-in Buffets, Beam Ceiling, French Windows, etc., all of which we *carry in stock*, for immediate delivery, and sell at a fraction of the prices demanded for similar goods by local planing mills.

Attractive Quotations on Staple Items

The new catalog quotes rock-bottom prices on all staple items in the building material line, from Corner Blocks to Lumber.

Our latest Lumber Quotations are sensational—*ask for them*.

Quality, Safe Delivery and Satisfaction Guaranteed

Write today for Catalog and Special Bulletins.

GORDON-VAN TINE CO., 657 Federal Street, Davenport, Iowa

You will get SPECIAL ATTENTION if you tell Advertisers you read American Carpenter and Builder

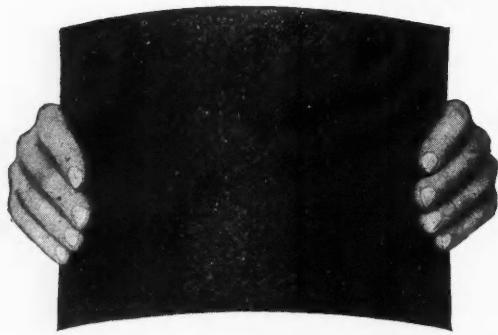

Unusual, Beautiful, Architectural Effects are Possible with Reynolds Flexible Shingles

WITH usual roofing materials it is impossible to produce such a unique, attractive roof as that illustrated below. But with Reynolds *Flexible* Asphalt shingles roll edges, thatch effects and rounded corners are easily made. Such a roof adds real distinction to a well-designed, well-built home, whether modest or most pretentious.

The fact that Reynolds Asphalt Shingles may be bent to any required form does *not* imply that they are flimsy or soon destroyed.

On the contrary, *they last longer than wood shingles*. They cannot warp, split, crack, curl, drop or blow off. For ten years sun, snow, rain, hail have failed to impair their usefulness or beauty. This severe test has been conducted right here in Grand Rapids, where climatic changes are most severe.

Furthermore, Reynolds Asphalt Shingles are a real protection against fire. Flying sparks cannot set them ablaze. *They save part of your insurance cost.*

Reynolds Asphalt Shingles

Guaranteed for 10 years—will last many years longer

Rough surfaced weather defiers made of crushed slate or granite, securely embedded in pure asphalt. Natural colors of garnet, red, or gray-green which *never fade and never need painting*. We are the original makers of flexible asphalt slate shingles and tested them for ten years before putting them on the market. They are uniform in size—8 inches by 12 $\frac{1}{2}$ inches—and are laid 4 inches to the weather. Write for the name of our nearest distributor.

Let us send you a booklet showing photographs of modern houses

roofed with Reynolds Asphalt Shingles—signed opinions of the owners are included. Also opinions of leading architects and builders. Write for a copy TO-DAY.

H. M. Reynolds Asphalt Shingle Co.

151 Grant St., West, Grand Rapids, Mich.

Established 1868

Members National Builders' Supply Association

Residence of M. C. Huggett,
Secretary Chamber of Commerce,
Grand Rapids, Mich.
Roofed with Reynolds' Asphalt
Shingles.

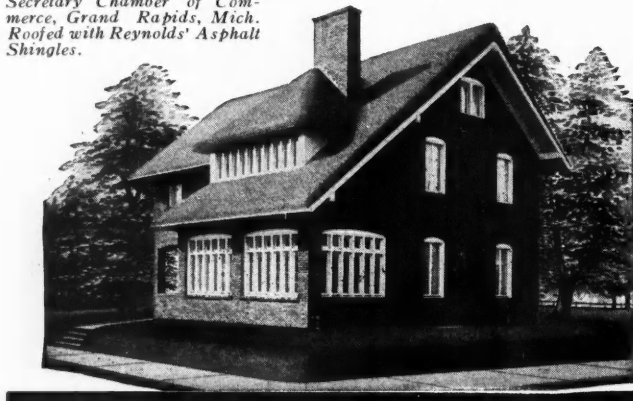

You will get SPECIAL ATTENTION if you tell Advertisers you read American Carpenter and Builder.

The "Hang" of the Fox

One of the advantages of the Fox Floor Scraper, manufactured by the Fox Supply Co. at Brooklyn, Wis., is in the peculiar "hang" or the light and easy pull, due to the patented principle upon which it is built. Most carpenters in using it the first time feel it is too light. This is because of the automatic trip which throws all the weight on the wheels as soon as the blade leaves the floor. While in action fully 95 per cent of the weight is right on the blade edge. This gives the necessary pressure to rapid efficient work. It has an adjustable sliding handle to suit the height of the operator. These are a few of the reasons why a man doesn't find the Fox Scraper hard to handle on long jobs. The Fox people are pushing their scraper and meeting with excellent success.

The Reversible Ideal Hoist

This simple hoist is one that will find the ready approval of every man in the building field. It is suitable for either big or small jobs, the only essential difference being the engine power.

A hoist, as you all know, is one of the most profitable investments a builder can make. It is a positive labor and money saver on every building over one story high. In the Reversible Ideal Hoist the friction clutches are made of three parts—the outside clutch case, the internal expanding ring and the dog or lever for expanding. There are two clutches on the countershaft, the one cast with a gear pinion driving the drum in one direction and the other cast with a sprocket wheel driving the drum in the opposite direction. A single operating lever controls both clutches. The diameter of the hoist drum is 9 inches, length 16 inches between the heads, suitable for operating with a steel cable up to $\frac{1}{2}$ inch or a manila rope of one inch diameter. All bearings are babitted and adjustable. A special ratchet brake is provided for locking the drum to hold the load.

Reversible Ideal Hoists are strongly recommended. We have given only the briefest description of them here, but there are many other good points which can be learned by reading the circulars which are sent free by the Universal Hoist & Manufacturing Co., 193 State St., Cedar Rapids, Iowa. These people have an interesting free trial offer for carpenters and builders.

New Parks Machine

Catalog No. 7 of the Parks Ball Bearing Machine Co., Cincinnati, Ohio, came out early in the spring and in the short time that has elapsed since that time they have gotten out a new combination for which they expect a great future. Convenience of operation has always been the hobby of Mr. Parks since he came to Cincinnati from the backwoods of Kentucky twenty-five years ago. He offered some of his ideas to the large wood working machinery concerns of Cincinnati and they laughed at his inventions. Since that time he has worked hard on the labor-saving combinations for small shop and portable use and he is justly pleased when he reads the ads of the many concerns now manufacturing the combinations he had such a hard time trying to dispose of many years ago.

The new combination adds a jig saw and sand disk on a separate shaft that is operated independently of the other parts of the machine. The engine has been placed where it is convenient to get at and easy to start with a friction clutch to start and stop the circular saw and jointer. The plates of the jointer attachment are 6 inches wide, open hearth steel ground to a true finished surface. The rear plate is 2 $\frac{1}{2}$ feet long and front one 2 feet long. Both plates are furnished with hand wheel screws for raising and lowering to adjust for depth of cut.

Signing our Coupon made \$125 Extra Profit for Nels D. Peterson

This is a true story. We hear of others very similar, from our carpenter friends every day. Nels D. Peterson, a carpenter at Ovid, Idaho, saw our advertising, sent in our coupon, liked our proposition, sent us bill of materials to figure on and ordered a car-load of lumber. We not only saved him \$125.00, but gave him a quality of material which to use his own words "is the best lumber that ever struck Ovid." Mr. Peterson not only added a big extra lump of clean profit to his bank account, but secured such beautiful lumber that every prospective builder in town is coming to him with their work. All sorts of business in sight for him.



Kindly send me following with list of prices delivered my station.

- Catalog of Lumber and Millwork.
- Special Silo Folder.

Name _____

Address _____

Business _____

Hewitt-Lea-Funck Co.

408 Crary Bldg.,
Seattle,
Wash.

Better lumber at 40% to 60% saving means hundreds of dollars extra profit for you

Lumber is one of the biggest items on your bids. Reduce this item 40% to 60%, reserve a bigger profit for yourself and you still can *underbid competition*. At the same time the better quality of the lumber will make a big hit with your customers. Nowhere else in the whole country is there a lumber buying opportunity equal to this.

We own forests and mills—Sell you direct at one profit

Buy your lumber and millwork of us and you buy direct not only from the maker, but from the *lumber producer* as well. We own billions of feet of choice timber in the famous Puget Sound region. From the felling of the trees to the shipping of the finished material, there is just one continuous operation, and just one overhead expense. One profit above this low producing cost is all you pay. When you buy lumber of a dealer locally, you pay five profits. Wholesaler, jobber, commission man, salesman and dealer all come in for a fat profit. That's why your local dealer's prices are so high.

Big Money in Seattle Silos

Never in history have farmers shown so much interest in silos as this year. Thousands are to be erected. Many will be put up in the country surrounding your town.

Get the contract for some of these silos. We furnish complete the best silo in America. One piece fir staves. Beautiful long-lasting stock, no sap or knots. Swinging doors of a new improved kind. Door bars form ladder from which hoops are tightened. Get our prices on silos and get some of this business.

Mail the coupon
today.

Prompt service anywhere in the United States

Six Western mills

We own thousands of acres of choicest Western timber—own logging camps and railways. Six mills convert the timber into lumber and millwork of highest quality

Two Eastern mills

We also control two large mills convenient as Eastern shipping points. From St. Louis we ship cypress, yellow pine, oak, finish, doors, sash, columns, etc. Our Southern mill near Shreveport, La., in the heart of the celebrated Rose Mary Belt, has unequalled facilities for shipping you soft, short leaf yellow pine.

Quick deliveries

West—From Seattle, seven great transcontinental railroads rush our shipments

forward. Reach points West of the Mississippi within two weeks.

East—St. Louis has 26 railroads, Shreveport 8, effecting prompt deliveries to Eastern points as well as Oklahoma and Texas.

Quality and satisfaction guaranteed

We back every shipment of materials with the guarantee that it will grade better than trust or combine standards.

One estimate will convince you

Send us your complete list or schedules of materials for work on which you are now figuring for our prices. We'll enable you to underbid competition, get more business, make more profit. Send lists or schedule today. Send the coupon, too.

HEWITT-LEA-FUNCK COMPANY

408 Crary Bldg., Seattle, Wash.

You will get SPECIAL ATTENTION if you tell Advertisers you read American Carpenter and Builder.

R.L.

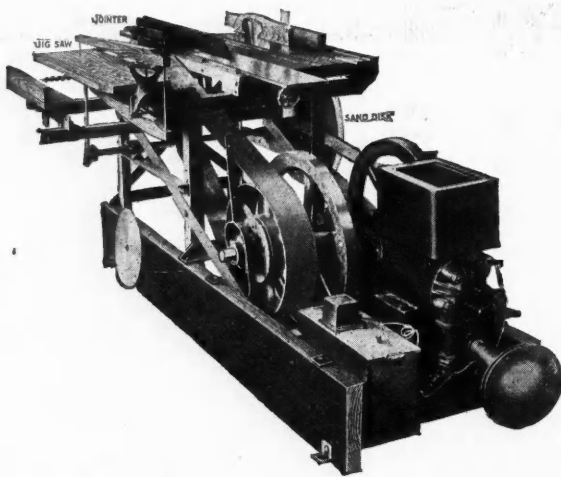

New Style Parks Combination Woodworker

The tilting guide is light, strong and accurate and easily adjusted from 0 to 18 inches, tilts to 45 degrees and is securely locked with hand wheel. It slides over the jointer and can be used for circular saw, and can be quickly taken off by loosening one hand wheel on the under side. The boring attachment consists of an adjustable sliding table to hold the material being bored and the chuck is attached to the end of the saw mandrel. Provision is made to regulate the depth to bore; and table can be lowered to take in 2 1/4 inches below center of bit. The jig saw can be removed by loosening three bolts.

The saw table is made of heavy angle steel and is bolted to two 2 by 10 bases (and is one of the patented features of the Parks machine). The table top is made of channel steel,

ground to a uniformly level and true surface. Height 2 feet 9 1/2 inches, width 22 inches, overhanging base 6 1/4 inches, length 3 feet. The angle steel on each side of table makes a substantial support to bolt wood extensions to for working long stuff. The table is hinged in the rear to raise and lower, adjusting depth of cut, and has an opening for 14-inch saw which will cut 5 inches deep. The rip guide has a convenient adjustment to cut any width up to 22 inches, and is securely held in line with saw by two hand wheels in front of table. The cross-cut guide is mounted on finished steel bar which slides in groove milled true in solid metal, making a perfect fit to do accurate work. It has an angle adjustment of 45 degrees, and is provided with an adjustable stop for cutting to length, and when working long timbers a brace can be connected below material, making a strong, substantial and accurate guide.

Will Ship from Factory

The Smith & Hemenway Co., 150-152 Chambers Street, New York City, inform us that instead of carrying stock in two places they have arranged to carry at their factory, Irvington Manufacturing Company, 130 Colt Street, Irvington, N. J., a complete stock after July 10th and all shipments will be made from the Irvington Manufacturing Company after that date.

This enterprise is a movement in the right direction, as it means facilitating shipment to customers and making more prompt delivery. Also, they have largely increased the facilities of the factory and stock room to take care of additional stock and of their increasing business.

It might be well to mention the fact that they are manufacturers of what is said to be the largest line of hand tools made in the United States, and are owners of the famous trade-mark, the Genuine "RED DEVIL."

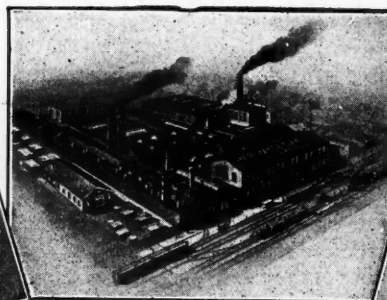
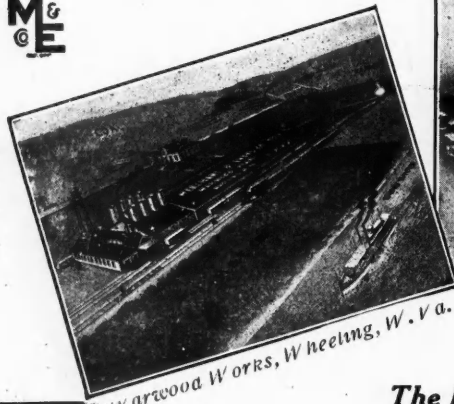

Philadelphia Plant

ESTABLISHED 1864



Chicago Plant

The Premier Metal House in America

Three Plants and Eight Warehouses

This is self-evident proof of the demand for Merchant & Evans Company's products

SPECIALTIES
"Star" Ventilators, Metal Shingles and Tiles.

SMELTING
Printing and Type Metals, Babbitt, Solders, All Soft Alloys and Pig Metals.

TIN PLATE
Bright, Roofing and Fire Door. "Florence" (Bright), "Merchant's Old Method," "Copmet" and all other grades of Roofing.

BRASS AND COPPER
Sheets, Rods, Wire and Tubes, all forms.

MECHANICAL
"Hele-Shaw" Clutches, "M & E" Grease Cups, "Star" Tire Cases, Alignment Joints.

FIRE PREVENTION AND ENGINEERING
Engineering Advice, Evans' Automatic Sprinklers and Stand Pipe Systems.

GENERAL
Sheet and Galvanized Steel and Iron. Everything in Metals.

IMPORTS
We import all these lines not made in the United States or purchasable abroad to advantage.

MERCHANT & EVANS COMPANY



PHILADELPHIA
CLEVELAND

NEW YORK
CHICAGO

BROOKLYN
KANSAS CITY

BALTIMORE
WHEELING



Works: PHILADELPHIA, WHEELING AND CHICAGO

You will get SPECIAL ATTENTION if you tell Advertisers you read American Carpenter and Builder.

P. F. S. M. CO.

Earns \$10 Net Per Day

THE PEERLESS FLOOR SURFACER is a floor-finisher that really finishes a floor much better than could possibly be done by hand. With it one man can do the work of twenty men—do it better and earn big money.

One job will bring you most of the other work in your town. The **PEERLESS FLOOR SURFACER** places you beyond successful competition.



IT WILL NOT RIP OR TEAR THE FLOOR

The principle on which the **PEERLESS FLOOR SURFACER** works is entirely different from that of any other machine. You can surface right close to the baseboard just as easily as you can surface the middle of the floor.

The **PEERLESS** will surface **ANY** floor perfectly. It will remove paint and varnish instantly. The finished floor will be as smooth as glass. If the floor is uneven, the **PEERLESS** will even it. It can't leave a wavy floor.

WE CAN PROVE OUR STATEMENTS

These are strong facts but we can prove them to your absolute satisfaction. If we can't, we don't want your money. There isn't a statement we make that the **PEERLESS FLOOR SURFACER** won't bear out.

We can supply immediately, **PEERLESS MACHINES** for 110 volt direct current, or a machine to meet the requirements of your power plant. If you have no electric current, we will supply you with a portable outfit that will allow you to work anywhere.

Write Us, or Mail the Coupon and Get Complete Particulars

PEERLESS FLOOR SURFACING MACHINE CO.
OSHKOSH, WISCONSIN

PEERLESS FLOOR SURFACING MACHINE CO.,
Oshkosh, Wisconsin.

Gentlemen:—
Please send me full descriptive data regarding your Floor Surfacing Machine. This in no way obligates me.

SEND THIS COUPON TODAY, OR WRITE

Name.....

Street.....

City.....

State.....

You will get **SPECIAL ATTENTION** if you tell Advertisers you read American Carpenter and Builder.

Note the Overlap of CORTRIGHT Metal Shingles



DRIVING rain or fine, sifting snow simply cannot force its way past those three corrugations on the overlap that serve as storm-barriers on

CORTRIGHT Metal Shingles

"The Permanent Roofing"

These shingles make up for the scarcity of good wood shingles, and permit a lighter roof structure than stone slate.

They are fire-proof, "last as long as the building and never need repairs." Get a line on what we are doing for other contractors and builders by sending us your name and address on business letterhead.

If you prefer, simply sign and return attached coupon.

Cortright Metal Roofing Co.
Philadelphia Chicago

Clip, Fill in
and Return

Cortright Metal Roofing Co.

Gentlemen: Please send me more complete information.

Name.....

Address..... A.C.B.-7-13

The Richmond Screw Anchor

The carpenter will often come across various jobs where it is necessary to remove screws and replace them several times. Anyone who has done this, knows that eventually the wood refuses to hold or grip the screw and the screw must be set in some new place. Some good examples of this may be seen in fastening storm sash, revolving doors, screens, portable houses, collapsible crates, wood packing cases of all kinds—in fact, anywhere it is necessary to use the same screw hole time and time again. Great difficulty has also been experienced in cases where the opera chairs in an auditorium have to be removed to allow space for dancing or exhibitions. With the Richmond Screw Anchor now on the market these annoyances can be made a thing of the past.



Fig. 1. Richmond Solid Metal Screw Anchor, used by woodworkers in portable houses, collapsible crates, wagon bodies, etc.

Fig. 1 shows the Richmond Solid Metal Screw Anchor fitted to an ordinary screw. This type of anchor is very much used by carpenters and builders. The metal anchor is screwed into the hole the same as an ordinary screw. It is threaded on the inside and outside. The outside thread grips the wood firmly. The inside thread of the anchor corresponds to the screw thread. You will readily understand that the screw may be removed and replaced any number of times because this little metal case never weakens as wood



Fig. 2. Double Coil Type. Richmond Screw Anchor for wood screws and lag screws. This size in plaster-of-Paris holds 1300 pounds, stronger in cement

does. Fig. 2 shows the double coil type especially used in plaster, brick and mortar work. This style gives a greater gripping surface. The screw and coil are inserted together and then the plaster or mortar is filled in around. In the case of brick, the screw and coil are either set in the joints or a hole drilled in the brick. Mortar or plaster of paris is then plugged into the hole and the screw and anchor inserted. When the screw is removed, the hole remains lined with a steel thread that resists a mighty strong pull. It is claimed that such a screw in plaster of paris will hold 1,300 pounds.

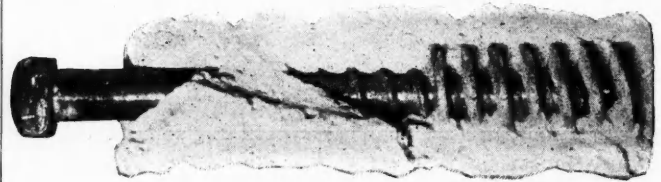

Fig. 3. Flat Coil Type. Under actual test this size Richmond Screw Anchor in cement holds 2500 pounds

Fig. 3—the flat coil style, works on the same principle. It is shown here embedded in concrete for which work it is especially adapted. A glance at the illustration gives an assurance of its strength.

We are glad to say that free samples, circulars and prices will be sent by the Richmond Screw Anchor Co., 10 Church St., New York City, N. Y. Write for them.



Metal Lath and Fireproof Construction

Last year almost four hundred million were lost in fires of various kinds. This is an appalling state of affairs because it shows that the lives of many citizens are in danger from the ravages of the flames.

You will get SPECIAL ATTENTION if you tell Advertisers you read American Carpenter and Builder.

**PICK
of the
PINES**

ARKANSAS SOFT PINE

**PICK
of the
PINES**

**A
R
K
A
N
S
A
S
S
O
F
T
P
I
N
E**

Every foot of it *is usable and of enduring value* to the builder and the building.

To the builder or contractor because the cost of working is low, to the owner because the finished structure contains the elements of enduring worth.

Common Grades of Arkansas Soft Pine unsurpassed for framing and sheathing, are sound knotted. The buyer gets some knots in these grades but is not furnished with a collection of knot holes.

This stock does not split when nailed, does not shrink after being used. It does not gum saws, planes, and other tools.

Arkansas Soft Pine retains paint, stain, filler and other preservers and beautifiers because the wood cells are not filled with pitch.

For interior and exterior trim it has no worthy competitors among the soft woods and few superiors even among the most valuable hard woods.

Its brilliant and wonderful variety of figure has established it firmly in the regard of all who admire a satisfying and harmonious interior.

It will live up to the highest characterization you give it and is worthy of your confidence and your use.

Ask for a copy of the Trim Book.

- Gates Lumber Company Wilmar, Arkansas
- Southern Lumber Company Warren, Arkansas
- Stout Lumber Company Thornton, Arkansas
- Wisconsin and Arkansas Lumber Co. ... Malvern, Arkansas
- Arkansas Lumber Company Warren, Arkansas
- Cotton Belt Lumber Company Beardon, Arkansas
- Crossett Lumber Company Crossett, Arkansas
- Eagle Lumber Company Eagle Mills, Arkansas
- Edgar Lumber Company Wesson, Arkansas
- Fordyce Lumber Company Fordyce, Arkansas
- Freeman-Smith Lumber Company Millville, Arkansas

**A
R
K
A
N
S
A
S
S
O
F
T
P
I
N
E**

**PICK
of the
PINES**

ARKANSAS SOFT PINE

**PICK
of the
PINES**

You will get **SPECIAL ATTENTION** if you tell Advertisers you read American Carpenter and Builder.

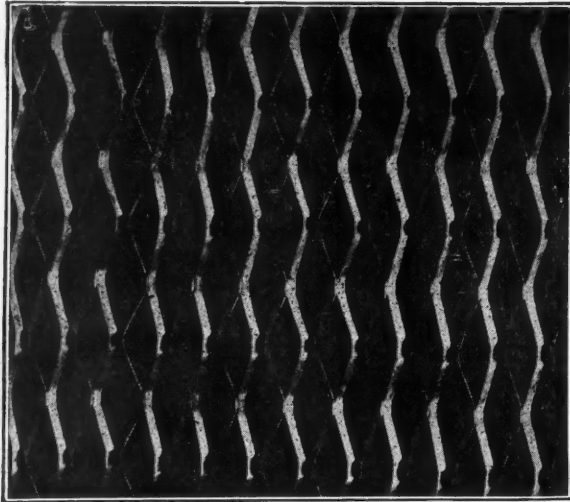

"Brooklyn" Metal Lath

The public consciousness of relief from fire has greatly influenced great classes of builders, architects, contractors, and those primarily interested in the building trades. Hence it is not surprising to note the growing interest in fireproof construction. No longer is this factor treated as a luxury or as a needless expense.

In the evolution of fire preventative methods it is quite natural that a substitute has been found for wooden lath. It is a matter of common knowledge that not only does wooden lath burn, but it also acts as a communicator of flame.

There are many types of mettalllic lath, but an expanded cup-lath manufactured by the Brooklyn Metal Ceiling Company, called "Brooklyn" Metal Lath has achieved the dis-

inction of being termed a universal lath for all purposes. This particular type is suitable for all kinds of buildings, halls, stores, warehouses, and residences. The Board of Education, New York City, has approved and adopted this lath. The U. S. government are increasingly large users of this product.

There are a number of striking points of interest about this universal type of metal lath. In the first place the mortar does not hang on a sharp cutting edge, thus cutting the clinchers in either side wall or ceiling, but rests on a beveled edge in each case, thus permitting the mortar and the lath to get a perfect grip on each other. The small mesh of the lath catches and holds the plaster, preventing it from going all the way through or falling off, and so wasting a considerable amount of mortar. This product is so rigid that it can be set to studs far apart without fear of sagging or buckling.

In the process of manufacture, Brooklyn Lath is not stretched; the proof of it is the integrity of the coat of spelter, despite the cutting of the galvanized sheets. This point is well worth considering

Further information about this and other types of metallic lath may be secured by writing the Lath Department of the Brooklyn Metal Ceiling Company, 285 Green Avenue, Brooklyn, N. Y.

Typewriter Offered on Easy Terms

We wish to call the attention of our readers to the advertisement in this issue of the Smith Premier Typewriter. This will give the opportunity to parties who are anxious to get a typewriter at a low price of the best make on terms that guarantee satisfaction.

It even gives an opportunity to test it and satisfy yourself, because it is a square deal offered at a price that will make it reasonable to anyone requiring the use of a typewriter. If not satisfactory on receipt you may return it.

J-M Asbestocel Pipe Covering

is the most efficient covering for medium and low pressure steam and hot water systems because it confines the largest amount of "dead air"—the greatest known insulator. J-M Asbestocel Pipe covering is built on the arch principle. The air cells, formed of Asbestos in this type of covering, are really sealed rings of dead air encircling the pipe, whereas, in ordinary longitudinal air-cell coverings, they are cylinders or tubes running from end to end allowing free circulation of air and resulting in radiation of heat.

Due to its arch construction J-M Asbestocel is stronger than other low pressure coverings—will not break or crush down under weight, and successfully withstands vibration and hard usage. Can be removed and replaced indefinitely.

Being made of Asbestos it is absolutely fireproof. Prevents sweating and rusting of pipes.

Our nearest Branch will furnish engineering test data, Sample and Booklet

H. W. JOHNS-MANVILLE CO.

MANUFACTURERS OF ASBESTOS AND MAGNESIA PRODUCTS

ASBESTOS

ASBESTOS ROOFINGS, PACKINGS, ELECTRICAL SUPPLIES, ETC.

Albany	Chicago	Detroit	Louisville	New York	San Francisco
Baltimore	Cincinnati	Indianapolis	Milwaukee	Omaha	Seattle
Boston	Cleveland	Kansas City	Minneapolis	Philadelphia	St. Louis
Buffalo	Dallas	Los Angeles	New Orleans	Pittsburgh	Syracuse

THE CANADIAN H. W. JOHNS-MANVILLE CO., LIMITED 1624

Toronto

Montreal

Winnipeg

Vancouver.

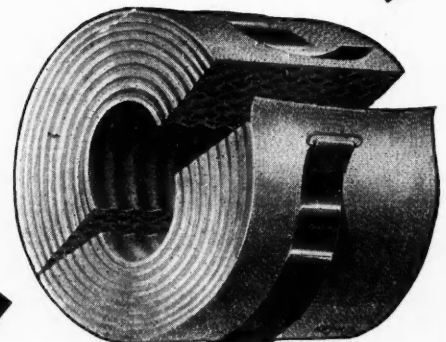

You will get SPECIAL ATTENTION if you tell Advertisers you read American Carpenter and Builder.



HERE'S ONE ON US!



We said } "He Who Builds of Cypress **BUILDS BUT ONCE**," and we said it in perfect sincerity—we believed it sure-enough. (And it is true at that.) Lately, however, the following

REMARKABLE FACT

has come to light, which "puts it on us."

So **NOW WE SAY**, "He Who Uses Cypress May Use It **TWICE**" and Here's the **PROOF**—Read It:

"About 1820 it was deemed advisable for the Ursuline nuns to secure another and larger property, at that time some three miles south of New Orleans on the river bank. Work was here begun upon the construction of a new and larger convent, which was completed and occupied in 1824. This latter building was **USED AS A CONVENT FOR EIGHTY-EIGHT YEARS**, or until 1912, when the City of New Orleans found it necessary to purchase the property in order to run a new line of levee where the buildings stood. During the past two or three months the work of demolishing the old structure has been in progress and **THE REMARKABLE STATE OF PRESERVATION OF ALL OF THE CYPRESS WOODWORK HAS CAUSED MUCH COMMENT. THE CONTRACTORS FOUND THEY HAD AN ASSET IN THE OLD MATERIAL AND ALL OF IT HAS ACTUALLY BEEN SOLD FOR NEW CONSTRUCTION WORK.**

At about the time this work of demolishing began Woodward, Wight & Co., Limited, dealers in heavy hardware and mill supplies, found it necessary to construct two warehouses and they purchased, at twelve dollars a thousand feet, timbers and other material which had thus been in use for eighty-eight years. These ware-houses necessarily had to be of very heavy and strong construction, one of them containing racks or foundations upon which are piled boiler tubes, iron pipes, etc. **THE CYPRESS, DESPITE ITS AGE, HAS NOT THE LEAST SIGN OF DECAY, AND IS EASILY HOLDING THE TREMENDOUS LOADS.**"

**ISN'T THAT A PRETTY GOOD KIND OF LUMBER TO BUY?
"HE WHO BUILDS OF CYPRESS
'The Wood Eternal'
CAN USE IT TWICE."**

"Cypress is the making of a Carpenter's Reputation." **USE IT. TALK IT. RECOMMEND IT. TELL 'EM "YES."**

Let our "BUILDERS' DEPARTMENT" help YOU. Our entire resources are at your service with Reliable Counsel.

SOUTHERN CYPRESS MANUFACTURERS' ASSOCIATION
1216 HIBERNIA BANK BUILDING, NEW ORLEANS, LA.

INSIST ON CYPRESS AT YOUR LOCAL DEALER'S. IF HE HASN'T IT, LET US KNOW IMMEDIATELY.

You will get **SPECIAL ATTENTION** if you tell Advertisers you read American Carpenter and Builder.



AT CHALLENGE PRICES

Our big Southern Mill in Louisiana and our Assembling Yards in Illinois are especially well stocked with highest quality lumber, lath, shingles, etc., of all kinds. Millions of feet are ready for shipment.

Our customers advise our wholesale prices save them about \$100.00 on the average carload.

In order to get the benefit of the lowest carload rate of freight, it is necessary to order 30,000 lbs. or more of lumber, which can be made up of 10,000 ft. lumber, 14,000 shingles and 10,000 lath. An ordinary house or barn will require this amount.

But we now ship lumber in any quantity, from a bundle to a trainload at the prices quoted on these two pages which are guaranteed to July 31, 1913. Send us a small trial order and see for yourself how good our lumber is. Mark your order "Lumber Department 56-A."

CROWN MOLDING. Cypress.
Will Be Shipped in Assorted Lengths.

Size, Inches	Price, per 100 Lineal Feet	Wt., per 100 Lineal Feet
13-16x2 3/4	\$1.10	49 pounds
13-16x3 1/4	1.35	45 pounds
13-16x3 3/4	1.55	52 pounds
13-16x4 1/4	1.74	60 pounds
13-16x4 3/4	1.95	68 pounds

BED MOLDING. Cypress.
Will Be Shipped in Assorted Lengths.

Size, Inches	Price, per 100 Lineal Feet	Wt., per 100 Lineal Feet
13-16x2	\$0.83	28 pounds
13-16x2 1/4	94	31 pounds
13-16x2 3/4	1.10	38 pounds

DRIP CAP MOLDING. Cypress.
Will Be Shipped in Assorted Lengths.

Size, Inches	Price, per 100 Lineal Feet	Wt., per 100 Lineal Feet
1 1/2 x 1 1/2	\$1.17	28 pounds
1 1/2 x 2	1.46	34 pounds
1 1/2 x 2 1/2	1.76	42 pounds
1 1/2 x 3	2.09	52 pounds

COVE MOLDING. Cypress.
Will Be Shipped in Assorted Lengths.

Size, Inches	Price, per 100 Lineal Feet	Wt., per 100 Lineal Feet
3/4 x 3/4	\$0.37	13 pounds
13-16x1 1/2	.45	16 pounds

NOSING. Cypress.
Will Be Shipped in Assorted Lengths.

Size, Inches	Price, per 100 Lineal Feet	Wt., per 100 Lineal Feet
1 1/2 x 2	\$1.45	34 pounds

BRICK MOLDING. Cypress.
Will Be Shipped in Assorted Lengths.

Size, Inches	Price, per 100 Lineal Feet	Wt., per 100 Lineal Feet
1 1/2 x 1 1/2	\$1.17	30 pounds
1 1/2 x 2	2.40	55 pounds

SCREEN MOLDING. Cypress.
Shipped in Assorted Lengths.

Size, Inches	Price, per 100 Lineal Feet	Wt., per 100 Lineal Feet
3/4 x 3/4	\$0.37	13 pounds
7-16x3/4	.39	14 pounds

DOOR AND WINDOW STOP. O. G. Cypress.
Shipped in Assorted Lengths.

Size, Inches	Price, per 100 Lineal Feet	Wt., per 100 Lineal Feet
3/4 x 1 1/4	\$0.37	8 pounds
3/4 x 1 1/2	.41	9 pounds
3/4 x 1 3/4	.59	13 pounds
3/4 x 2	.66	15 pounds

LATTICE. Cypress. Shipped in Assorted Lengths.

Size, Inches	Price, per 100 Lineal Feet	Wt., per 100 Lineal Feet
5-16x1 1/4	\$0.31	8 pounds
5-16x1 1/2	.37	9 pounds
5-16x1 3/4	.50	12 pounds

PARTING STOP. Cypress.
Shipped in Assorted Lengths.

Size, Inches	Price, per 100 Lineal Feet	Wt., per 100 Lineal Feet
1/2 x 13-16	\$0.37	8 pounds

BLIND STOP. Cypress.
Shipped in Assorted Lengths.

Size, Inches	Price, per 100 Lineal Feet	Wt., per 100 Lineal Feet
13-16x1 1/4	\$0.55	21 pounds

QUARTER ROUND. Shipped in Assorted Lengths.

Size, Inches	Cypress Price, per 100 Lineal Feet	Size, Inches	Yellow Pine Price, per 100 Lineal Feet
5/8 x 5/8	36c	3/4 x 3/4	26c
3/4 x 3/4	37c		
7/8 x 7/8	38c		

FLOORING. Yellow Pine. FLAT GRAIN.

Thickness, Inch	Width of Face	Grade	Weight, per 100 Square Feet	Price, per 100 Square Feet, Surface Measure
13-16	2 1/2 inch	Clear	200 lbs.	\$3.10
13-16	2 1/2 inch	No. 1	200 lbs.	2.85
13-16	2 1/2 inch	No. 2	200 lbs.	2.15
13-16	3 1/4 inch	Clear	210 lbs.	2.90
13-16	3 1/4 inch	No. 1	210 lbs.	2.65
13-16	3 1/4 inch	No. 2	210 lbs.	1.93
13-16	5 1/4 inch	Clear	220 lbs.	2.90
13-16	5 1/4 inch	No. 1	220 lbs.	2.65
13-16	5 1/4 inch	No. 2	220 lbs.	2.15

ORDER ENOUGH EXTRA TO ALLOW FOR TONGUE AND GROOVE.
Above prices are for assorted lengths. Specified lengths, 20 cents per 100 square feet, extra.

FLOORING. Yellow Pine. EDGE GRAIN.

Thickness, Inch	Width of Face	Grade	Weight, per 100 Square Feet	Price, per 100 Square Feet, Surface Measure
13-16	3 1/4 inch	Clear	200 lbs.	\$4.10
13-16	3 1/4 inch	"C"	200 lbs.	3.32

ORDER ENOUGH EXTRA TO ALLOW FOR TONGUE AND GROOVE.
Above prices are for assorted lengths. Specified lengths, 20 cents per 100 square feet, extra.

FLOORING. Made Especially for Porch FIR, EDGE GRAIN.

Finished Thickness, Inches	Width Face, Inches	Grade	Wood	Weight, per 100 Feet, Board Measure	Price, per 100 Feet, Board Measure
7/8	3 1/4	Clear	Fir	200 lbs.	\$4.70
1 1/4	3 1/4	Clear	Fir	220 lbs.	5.20

IN ORDERING ABOVE FLOORING ALLOW EXTRA FOR TONGUE AND GROOVE.
If 1 1/2-inch is ordered add 25 per cent to surface measure for quantity board measure.

CEILING. Yellow Pine.

Size, Inches	Clear Grade, Price, per 100 Square Feet	No. 1 Grade, Price, per 100 Square Feet	No. 2 Grade, Price, per 100 Square Feet	Weight, per 100 Square Feet
1 1/2 x 3 1/4	\$2.32	\$2.15	\$1.50	110 lbs.
3/4 x 3 1/4	2.65	2.32	1.60	140 lbs.

Order extra to allow for tongue and groove.

YELLOW PINE PARTITION.

Size, Inches	Clear Grade, Price, per 100 Square Feet	No. 1 Grade, Price, per 100 Square Feet	No. 2 Grade, Price, per 100 Square Feet	Weight, per 100 Square Feet
3/4 x 3 1/4	\$3.02	\$2.71	\$2.00	180 lbs.

Order extra to allow for tongue and groove.

FINISHING LUMBER. Surfaced Both Sides.

Size, Inches	Yellow Pine, Clear Grade, Price, per 100 Lineal Feet	Yellow Pine, Select Grade, Price, per 100 Lineal Feet	Cypress, Clear Grade, Price, per 100 Lineal Feet	Cypress, Select Grade, Price, per 100 Lineal Feet	Weight, per 100 Lineal Feet
1 x 3	\$0.90	\$0.76	\$1.18	\$0.90	65 lbs.
1 x 4	1.13	.95	1.49	1.06	85 lbs.
1 x 5	1.51	1.26	1.93	1.44	109 lbs.
1 x 6	1.66	1.40	2.30	1.72	125 lbs.
1 x 8	2.23	1.88	3.01	2.23	165 lbs.
1 x 10	3.02	2.53	3.87	2.39	210 lbs.
1 x 12	3.58	3.00	5.07	4.01	250 lbs.
1 1/4 x 4	1.55	1.33	1.93	1.41	114 lbs.
1 1/4 x 6	3.36	2.92	4.03	3.05	167 lbs.
1 1/4 x 8	3.17	2.72	3.87	2.80	160 lbs.
1 1/4 x 10	4.22	3.59	5.14	3.90	280 lbs.
1 1/4 x 12	5.00	4.26	6.69	5.37	335 lbs.
1 1/2 x 4	1.88	1.61	2.40	1.76	136 lbs.
1 1/2 x 6	2.80	2.39	3.72	2.84	200 lbs.
1 1/2 x 8	3.74	3.20	4.86	3.70	265 lbs.
1 1/2 x 10	5.01	4.27	6.24	5.06	356 lbs.
1 1/2 x 12	5.98	5.09	8.20	6.57	400 lbs.
2 x 4	2.58	2.16	3.40	2.55	175 lbs.
2 x 6	4.00	3.50	5.20	4.03	270 lbs.
2 x 8	5.00	4.28	6.87	5.31	365 lbs.
2 x 10	6.66	5.65	8.76	6.80	460 lbs.
2 x 12	7.90	6.70	11.33	9.22	550 lbs.

YELLOW PINE DROP SIDING.

Size, Inches	Clear Grade, Price, per 100 Square Feet	No. 1 Grade, Price, per 100 Square Feet	No. 2 Grade, Price, per 100 Square Feet	Weight, per 100 Square Feet
3/4 x 5 1/4	\$2.88	\$2.65	\$2.10	175 lbs.

BEVEL SIDING.

Size, Inches	Kind of Wood	Grade	Price, per 100 Square Feet	Weight, per 100 Square Feet
1 1/2 x 3 1/2	Cypress	Clear	\$2.35	100 lbs.
1 1/2 x 5 1/2	Cypress	Clear	2.45	100 lbs.
1 1/2 x 3 1/2	Cypress	C	2.00	100 lbs.
1 1/2 x 5 1/2	Cypress	C	2.10	100 lbs.
1 1/2 x 3 1/2	Yellow Pine	Clear	1.95	100 lbs.
1 1/2 x 5 1/2	Yellow Pine	Clear	2.05	100 lbs.
1 1/2 x 3 1/2	White Pine	C Select	2.40	80 lbs.
1 1/2 x 5 1/2	White Pine	C Select	2.50	80 lbs.

FIR STEPPING FOR PORCH STEPS.
Surfaced both sides. Nosed and all ready.

Thickness, Inches	Width, Inches	Price, per 100 Lineal Feet	Weight, per 100 Lineal Feet
1 1/4	10	\$6.35	280 lbs.
1 1/4	12	7.90	320 lbs.

WINDOW FRAME STOCK.
Made for 1 1/2-inch windows unless otherwise ordered.

Size, Inches	Clear Grade, Price, per 100 Lineal Feet	No. 1 Grade, Price, per 100 Lineal Feet	Weight, per 100 Lineal Feet
13-16x4 3/4	\$1.95	\$1.60	90 lbs.

INSIDE DOOR FRAME STOCK.
Furnished in assorted lengths, 10 to 20 feet.

Grade	Price, per 100 Lineal Feet	Weight, per 100 Lineal Feet
Clear	\$2.05	110 lbs.
No. 1	1.65	100 lbs.

ORDER LUMBER IN ANY QUANTITY FROM SEARS, ROEBUCK & COMPANY, CHICAGO, ILLINOIS

LUMBER AND SHINGLES



Lumber Sold in Any Quantity

CONCERNING QUALITY. It is a well known fact among contracting concerns and architects that cypress lumber for shingle work, finishing lumber and bevel siding, and yellow pine for dimension, joists, timbers, flooring, ceiling, partition, etc., are very superior in strength and lasting qualities to other kinds of woods, such as hemlock, tamarack, jack pine, etc. In most cases our yellow pine prices are lower than the prices offered by local concerns for cheaper woods, but frequently in some states and localities where hemlock, tamarack, etc., grow a slightly lower price is quoted on these woods than on yellow pine. In all instances, however, yellow pine and cypress will be the cheapest and most satisfactory woods in the end, for they last much longer and make a more permanent building.

CONCERNING SIZES. The sizes specified on this and the inside page for dimension lumber, timbers, boards, shiplap, shingles and matched, etc., are the even inch measurements into which lumber is always cut, green and rough. After allowing for the shrinkage of drying and for surfacing, this stock will still have a little scant in thickness and width. Our lumber is all selected and manufactured in standard or regular Association yellow pine sizes.

In ordering flooring, siding, ceiling, partition, shiplap, dressed and matched, be sure to order enough extra to allow for the tongue and groove. For instance, it takes 4-inch lumber to make flooring with 3 1/4-inch face. The difference is taken up in the tongue and groove. Example: A room 10x10 feet requires 100 square feet plus 25 per cent, or 125 feet, the board measure quantity necessary to cover this room.

CONCERNING GRADES. All our clear finishing lumber,

flooring, ceiling, siding, etc., both in cypress and yellow pine, is made from thoroughly kiln dried stock, very carefully machined. This is the highest grade furnished, is commonly known as Clear grade and is intended for the very best class of work.

Our Select grade finishing lumber is the next grade below the clear and will contain some defects which can be covered with paint. This is the grade usually used for outside finishing lumber.

No. 1 grade dimension and timbers are all sound, straight stock, and our No. 1 boards, flooring, siding, ceiling, etc., are equal to the No. 1 grades usually furnished and are better than as sold in many local territories. No. 1 grade is the highest grade in which timbers, dimension, sheathing shiplap and dressed and matched are manufactured, and this stock is recommended for the best class of work.

Our No. 2 grade boards, sheathing and shiplap are good serviceable stock, and are the grade in which this material is usually ordered in moderate and high priced buildings. Our No. 2 dimension, flooring, ceiling, etc., are equal to the No. 2 grades usually furnished, but should be ordered only for low priced construction.

Our No. 3 grade is the lowest grade we handle, but in many localities No. 3 boards, sheathing and shiplap are used almost entirely. This lumber will be used with some waste, and may be satisfactory for low priced buildings. Mark your order "Lumber Dept., 56-A."

ALL PRICES
On These Two Pages Are Guaranteed
Only To July 31

DIMENSION. Yellow Pine.		Surfaced Four Sides.	
Size, In.	Weight, per 100 Lineal Feet	Size, In.	Weight, per 100 Lineal Feet
4x4	47	4x4	47
4x4	56	4x4	56
4x4	65	4x4	65
4x4	75	4x4	75
4x4	84	4x4	84
4x4	93	4x4	93
4x4	103	4x4	103
4x4	112	4x4	112
4x4	122	4x4	122
4x4	133	4x4	133
4x4	140	4x4	140
4x4	152	4x4	152
4x6	70	4x6	70
4x6	84	4x6	84
4x6	98	4x6	98
4x6	112	4x6	112
4x6	126	4x6	126
4x6	140	4x6	140
4x6	154	4x6	154
4x6	168	4x6	168
4x6	182	4x6	182
4x6	196	4x6	196
4x6	210	4x6	210
4x6	224	4x6	224
4x6	238	4x6	238
4x6	252	4x6	252
4x6	266	4x6	266
4x6	280	4x6	280
4x6	294	4x6	294
4x6	308	4x6	308
4x6	322	4x6	322
4x6	336	4x6	336
4x6	350	4x6	350
4x6	364	4x6	364
4x6	378	4x6	378
4x6	392	4x6	392
4x6	406	4x6	406
4x6	420	4x6	420
4x6	434	4x6	434
4x6	448	4x6	448
4x6	462	4x6	462
4x6	476	4x6	476
4x6	490	4x6	490
4x6	504	4x6	504
4x6	518	4x6	518
4x6	532	4x6	532
4x6	546	4x6	546
4x6	560	4x6	560
4x6	574	4x6	574
4x6	588	4x6	588
4x6	602	4x6	602
4x6	616	4x6	616
4x6	630	4x6	630
4x6	644	4x6	644
4x6	658	4x6	658
4x6	672	4x6	672
4x6	686	4x6	686
4x6	700	4x6	700
4x6	714	4x6	714
4x6	728	4x6	728
4x6	742	4x6	742
4x6	756	4x6	756
4x6	770	4x6	770
4x6	784	4x6	784
4x6	798	4x6	798
4x6	812	4x6	812
4x6	826	4x6	826
4x6	840	4x6	840
4x6	854	4x6	854
4x6	868	4x6	868
4x6	882	4x6	882
4x6	896	4x6	896
4x6	910	4x6	910
4x6	924	4x6	924
4x6	938	4x6	938
4x6	952	4x6	952
4x6	966	4x6	966
4x6	980	4x6	980
4x6	994	4x6	994
4x6	1008	4x6	1008
4x6	1022	4x6	1022
4x6	1036	4x6	1036
4x6	1050	4x6	1050
4x6	1064	4x6	1064
4x6	1078	4x6	1078
4x6	1092	4x6	1092
4x6	1106	4x6	1106
4x6	1120	4x6	1120
4x6	1134	4x6	1134
4x6	1148	4x6	1148
4x6	1162	4x6	1162
4x6	1176	4x6	1176
4x6	1190	4x6	1190
4x6	1204	4x6	1204
4x6	1218	4x6	1218
4x6	1232	4x6	1232
4x6	1246	4x6	1246
4x6	1260	4x6	1260
4x6	1274	4x6	1274
4x6	1288	4x6	1288
4x6	1302	4x6	1302
4x6	1316	4x6	1316
4x6	1330	4x6	1330
4x6	1344	4x6	1344
4x6	1358	4x6	1358
4x6	1372	4x6	1372
4x6	1386	4x6	1386
4x6	1400	4x6	1400
4x6	1414	4x6	1414
4x6	1428	4x6	1428
4x6	1442	4x6	1442
4x6	1456	4x6	1456
4x6	1470	4x6	1470
4x6	1484	4x6	1484
4x6	1498	4x6	1498
4x6	1512	4x6	1512
4x6	1526	4x6	1526
4x6	1540	4x6	1540
4x6	1554	4x6	1554
4x6	1568	4x6	1568
4x6	1582	4x6	1582
4x6	1596	4x6	1596
4x6	1610	4x6	1610
4x6	1624	4x6	1624
4x6	1638	4x6	1638
4x6	1652	4x6	1652
4x6	1666	4x6	1666
4x6	1680	4x6	1680
4x6	1694	4x6	1694
4x6	1708	4x6	1708
4x6	1722	4x6	1722
4x6	1736	4x6	1736
4x6	1750	4x6	1750
4x6	1764	4x6	1764
4x6	1778	4x6	1778
4x6	1792	4x6	1792
4x6	1806	4x6	1806
4x6	1820	4x6	1820
4x6	1834	4x6	1834
4x6	1848	4x6	1848
4x6	1862	4x6	1862
4x6	1876	4x6	1876
4x6	1890	4x6	1890
4x6	1904	4x6	1904
4x6	1918	4x6	1918
4x6	1932	4x6	1932
4x6	1946	4x6	1946
4x6	1960	4x6	1960
4x6	1974	4x6	1974
4x6	1988	4x6	1988
4x6	2002	4x6	2002
4x6	2016	4x6	2016
4x6	2030	4x6	2030
4x6	2044	4x6	2044
4x6	2058	4x6	2058
4x6	2072	4x6	2072
4x6	2086	4x6	2086
4x6	2100	4x6	2100
4x6	2114	4x6	2114
4x6	2128	4x6	2128
4x6	2142	4x6	2142
4x6	2156	4x6	2156
4x6	2170	4x6	2170
4x6	2184	4x6	2184
4x6	2198	4x6	2198
4x6	2212	4x6	2212
4x6	2226	4x6	2226
4x6	2240	4x6	2240
4x6	2254	4x6	2254
4x6	2268	4x6	2268
4x6	2282	4x6	2282
4x6	2296	4x6	2296
4x6	2310	4x6	2310
4x6	2324	4x6	2324
4x6	2338	4x6	2338
4x6	2352	4x6	2352
4x6	2366	4x6	2366
4x6	2380	4x6	2380
4x6	2394	4x6	2394
4x6	2408	4x6	2408
4x6	2422	4x6	2422
4x6	2436	4x6	2436
4x6	2450	4x6	2450
4x6	2464	4x6	2464
4x6	2478	4x6	2478
4x6	2492	4x6	2492
4x6	2506	4x6	2506
4x6	2520	4x6	2520
4x6	2534	4x6	2534
4x6	2548	4x6	2548
4x6	2562	4x6	2562
4x6	2576	4x6	2576
4x6	2590	4x6	2590
4x6	2604	4x6	2604
4x6	2618	4x6	2618
4x6	2632	4x6	2632
4x6	2646	4x6	2646
4x6	2660	4x6	2660
4x6	2674	4x6	2674
4x6	2688	4x6	2688
4x6	2702	4x6	2702
4x6	2716	4x6	2716
4x6	2730	4x6	2730
4x6	2744	4x6	2744
4x6	2758	4x6	2758
4x6	2772	4x6	2772
4x6	2786	4x6	2786
4x6	2800	4x6	2800
4x6	2814	4x6	2814
4x6	2828	4x6	2828
4x6	2842	4x6	2842
4x6	2856	4x6	2856
4x6	2870	4x6	2870
4x6	2884	4x6	2884
4x6	2898	4x6	2898
4x6	2912	4x6	2912
4x6	2926	4x6	2926
4x6	2940	4x6	2940
4x6	2954	4x6	2954
4x6	2968	4x6	2968
4x6	2982	4x6	2982
4x6	2996	4x6	2996
4x6	3010	4x6	3010
4x6	3024	4x6	3024
4x6	3038	4x6	3038
4x6	3052	4x6	3052
4x6	3066	4x6	3066
4x6	3080	4x6	3080
4x6	3094	4x6	3094
4x6	3108	4x6	3108
4x6	3122	4x6	3122
4x6	3136	4x6	3136
4x6	3150	4x6	3150
4x6	3164	4x6	3164
4x6	3178	4x6	3178
4x6	3192	4x6	3192
4x6	3206	4x6	3206
4x6	3220	4x6	3220
4x6	3234	4x6	3234
4x6	3248	4x6	3248
4x6	3262	4x6	3262
4x6	3276	4x6	3276
4x6	3290	4x6	3290
4x6	3304	4x6	3304
4x6	3318	4x6	3318
4x6	3332	4x6	3332
4x6	3346	4x6	3346
4x6	3360	4x6	3360
4x6	3374	4x6	3374
4x6	3388	4x6	3388
4x6	3402	4x6	3402
4x6</			



A Close View of a Good Roof

You builders and carpenters know that the future of your building operations depends directly upon the genuine worth of your present work. And the roof is a prominent feature of every structure you erect.

FLEX-A-TILE Asphalt Shingles

embody every essential for good roofing. They are made of fibrous asphalt into the surface of which carefully graded chipped slate or granite is rolled under such tremendous pressure that it becomes an integral part of the whole shingle. The rich natural color of the slate or granite gives the shingle a handsome, artistic appearance.

FLEX-A-TILE Shingles will lay flat and stay waterproof. They cannot rot or rust. The color is permanent and handsome. Uniformity in size makes it possible to lay more in a day. In price they compete with stained wood shingles.

You should **WRITE** for your **SAMPLE** today
and for **FLEX-A-TILE** Book

THE HEPPE'S CO.

Also manufacturers of **Asphalt Paint, Asphalt Roofing in any Finish and Utility Wall Board**

1010 FILLMORE ST.

CHICAGO, ILL.

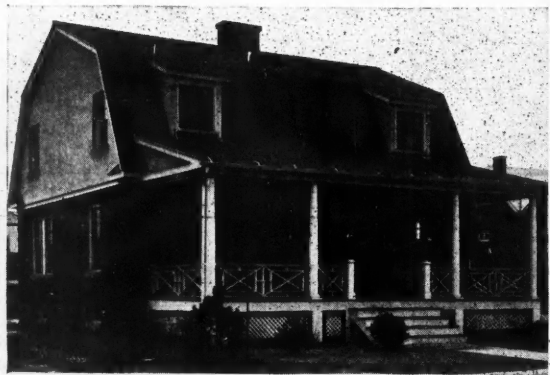

How to Continue the Running of a Line Around an Obstacle

NOTE: Previous installments of these instructive papers on the use of the Transit and Level appears on page 110 April and page 96 June.

If in running a line, an obstacle is encountered, such as a house or barn, which cannot be crossed but can be avoided by going to the right or left, it is easy to continue the original line on the far side of the obstacle in the following manner: Referring to the illustration and assuming that the line is taking the general direction AC and has reached the point A , run a line from A to some point B , making the acute angle at A 60° . Then set the instrument at B and make another acute angle of 60° in the direction of C . By making the distance BC equal the distance AB , C will be directly in the original lines, and the distance AC will equal the dis-

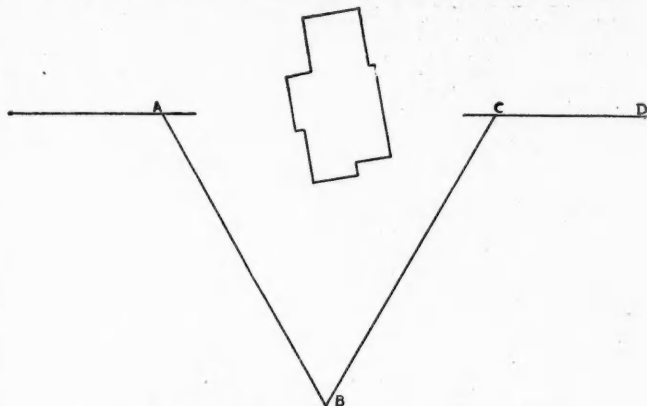

Method of Running Line Around House or Barn

tance AB , which has already been measured. By making the acute angle at C again 60° , the line CB will be in the original direction.

The use of an inexpensive transit, such as the Starrett, makes it easy to do anything like the above. The legs of the instrument must be firmly set into the ground so that the adjustment may not be disturbed. The transit should then be made as nearly level as possible by adjusting the lower parts of the extension legs. It should then be brought to a perfect level by the use of the leveling screws between the plate and the tripod head. This is done by bringing the level over one of the leveling screws and turning one screw in and another out until the bubble appears in the center of the level glass. Then turn the sight tube or telescope through an angle of about 90° , and again adjust the bubble to the center of the glass by means of two leveling screws. This operation should be continued until the bubble stands in the center of the glass, no matter what direction the level may be turned.

Paint Tests

A series of tests on the durability of paints was recently completed by the American Society for Testing Materials. The Pennsylvania Railroad Co.'s bridge at Havre de Grace, Md., was chosen as the scene of the test. Thirty feet of longitudinal space was allotted to each of the nineteen paint manufacturers represented. Frequent observations were made and the condition of the paint and steel were duly chronicled. The conditions of the tests were severe. Observations were made by engineers, chemists and other interested parties. At the end of six years a final observation was made and the standing of the various paint manufacturers determined.

This contest was a most interesting one. The conditions of the competition, the result of the various observations and the final deductions are neatly set forth in a booklet issued by the Lowe Bros. Co., 457 East Third St., Dayton, Ohio. Carpenters, architects and other interested persons may obtain a free copy by writing the Lowe Bros. Co.

You will get **SPECIAL ATTENTION** if you tell Advertisers you read **American Carpenter and Builder**.



Free

Helps To Better Business

For Contractor—Builder—Wood Finisher

THIS Dollar Portfolio of Wood Panels and Instruction Book are two fine examples of the Johnson Service—we offer them free and postpaid—send the coupon today.

The Portfolio shows the beautiful effects obtainable with Johnson's Artistic Wood Finishes on oak, pine, cypress, birch, gum, etc. With it you can show your clients just how their work will look when finished the Johnson way.

The book gives full instructions for finishing all wood—soft or hard; covering capacities, prices, etc.

Johnson's Wood Dye

penetrates deeply, coloring the wood permanently—it dries quickly without a lap or streak. Made in seventeen popular shades, all of which can easily be lightened or darkened.

Johnson's Prepared Wax

imparts a velvety, protecting finish which will not chip, mar or scratch.

Fill out the coupon and mail to us TODAY. The Portfolio and Book will be sent promptly—free and postpaid—you are placed under no obligation whatever.

S. C. Johnson & Son Racine, Wisconsin
"The Wood Finishing Authorities"

S. C. Johnson & Son, Racine, Wis. Value \$1.25 FREE

Please send me Free your \$1.00 Portfolio of Wood Panels with specifications and instructions and your 25¢ 1913 Book BOTH FREE

Name _____

Address _____

City _____

State _____

Mr. Daniel A. Name to _____

His Address _____

ACB7

You will get SPECIAL ATTENTION if you tell Advertisers you read American Carpenter and Builder.

The New Metal Shingle

A very neatly embossed metal shingle is one of the late products of the Edwards Mfg. Co., Eggleston Ave., Cincinnati, Ohio. These people are called "The Sheet Metal Folks" be-

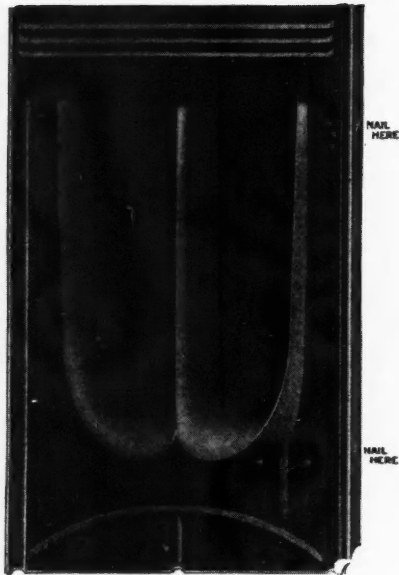

Edwards "Ohio" Design Metal Shingle

cause they are large manufacturers of sheet metal products which include metal ceilings, metal shingles, steel roofing and siding

This new shingle is one for which we predict great popularity. The design is novel and the pattern comes in one size, viz., 14x20 inches. This shingle has the patent interlock-

ing device which makes the roof leak-proof and protects the nail heads. The finest sheet metal plate is used in the manufacture and the shingles are galvanized or painted as desired.

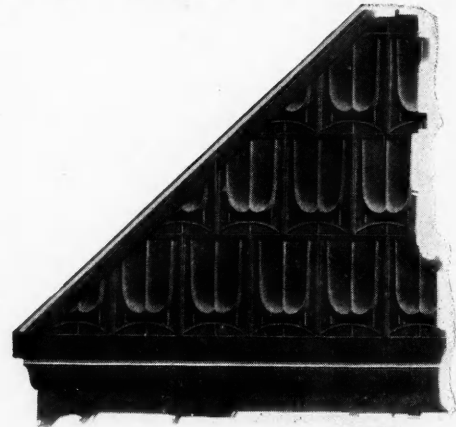

An Edwards "Ohio" Roof

Full particulars regarding these metal shingles which make a durable, economical and handsome roof can be had from the manufacturers. Their other catalogs are also interesting. Ask for them and you'll get them.



New Theatre Model of Architectural Beauty

The new Victoria Theatre, a photo-play house with a capacity of 1,000 recently opened in Shamokin, Pa., has attracted country-wide attention in architectural and theatrical circles.

Men who have had years of experience in theatre construction have travelled many miles to admire the New Vic-

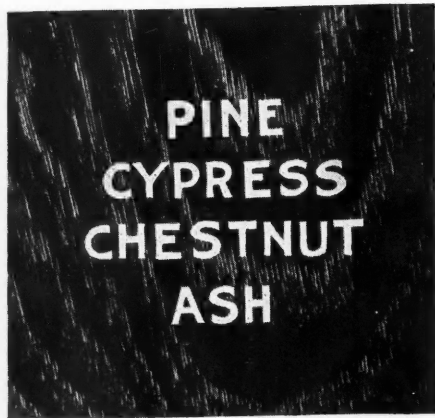

There is Beauty in Every Wood

when properly finished. The commonplace varieties now so generally used can be made to stand out in quiet elegance; to favorably compare with the more expensive woods which the moderate priced home cannot afford.

Such artistic and economical results are only possible with

Bridgeport Standard Wood Finishes

The architect, builder or contractor who specializes on the final finish of his work, uses, or insists on the use, of these finishes. They are dependable for every class of work from the unpretentious Summer cottage to the most palatial residence. Wherever homes are built; wherever woodwork has to be finished, you need

Bridgeport Standard Wood Finishes



Beautiful Portfolio FREE

"Modern Wood Finishing" contains elaborate reproductions of 48 different woods finished in natural colors and 24 pages of valuable decorative suggestions. This valuable and interesting book will be sent you free. Write for it.

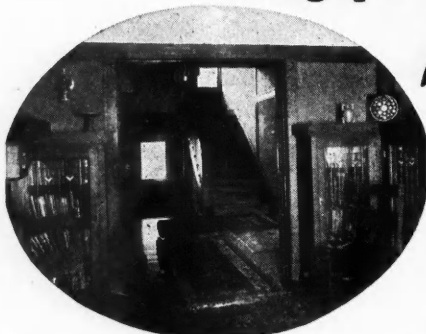

THE BRIDGEPORT WOOD FINISHING CO.

68 West Lake Street, CHICAGO

New York

New Milford, Conn.

Boston

You will get SPECIAL ATTENTION if you tell Advertisers you read American Carpenter and Builder.

"That's the Best Fireproof Wall I Ever Saw."

This is the opinion of every builder who has ever used National Plaster Board.

In addition to forming **Fireproof Walls**, this "Best of all plaster boards" produces a fine, even surface that requires only a very thin coat of plaster. Calcimine or any other decoration may be applied directly to the Plaster Board if desired. National Plaster Board keeps out dampness and cold and never buckles, warps or cracks under any condition. It saves one-half the time usually required to plaster a house.

National PLASTER BOARD

is made in sheets 32x36 inches, $\frac{1}{4}$ of an inch thick. Plaster and wood fibre form the center while each side is covered by a heavy thick paper to which hard wall-plaster will stick firmly. National Plaster Board is often used as sheathing under siding. It deadens sound, forms perfect walls and ceilings and is far better than wood or metal lath because it neither rusts nor stains the plaster.

The sample of National Plaster Board which we mail free of charge will convince you that all this is true.

If your dealer cannot supply you, write for free sample and folder at once.

The National Plaster Board Co., Cleveland, Ohio



PLASTERCON WALL-BOARD
TREATED WOOD FIBRE

Plastergon Is Not "Just as Good" as Lath and Plaster—It's Better

THE constantly increasing sales of Plastergon demonstrate that no progressive builder can afford to ignore it, as a prominent factor in his line of business.

Plastergon makes a more durable, more economical and more ornamental wall than lath and plaster—therefore it will supersede all other wall building materials.

By specifying Plastergon in your contracts, you eliminate the dirt and delays and get the profit of the plasterer and

Every Panel is Guaranteed

We have special business-getting aids for the builder, who specifies Plastergon. We want you to write for them—TODAY.

PLASTERGON WALL BOARD COMPANY
Department A Tonawanda, N. Y.

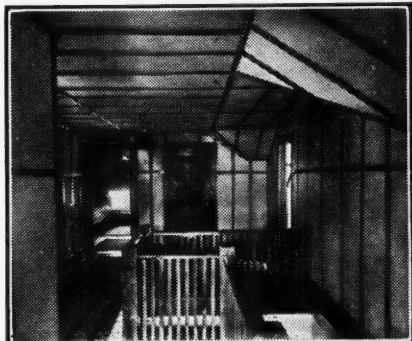

Room in the home of Mr. A. P. Shattuck, Buffalo, Beaver Board Walls and Ceilings throughout.

BEAVER BOARD



THIS spring four solid train-loads of Beaver Board crossed the continent from East to West. That represented merely a part of one month's business, which has steadily increased ever since.

No other building material ever showed such rapid progress in popular favor.

The use of Beaver Board for walls and ceilings, and the opportunity it offers you for a profitable business should not be overlooked.

Write today for "The ABC of Beaver Board Construction," sent free.

The Beaver Companies

United States: 184 Beaver Road, Buffalo, N. Y.
Canada: 384 Wall Street, Beaverdale, Ottawa
Great Britain: 4 Southampton Row, London, W. C.

You will get SPECIAL ATTENTION if you tell Advertisers you read American Carpenter and Builder.

A Simple Test for a Builder to Try

See how many building specialties are advertised in Good Housekeeping Magazine (you can get a copy at any newsstand). Acquaint yourself with the names of the products, and learn from the news-dealer some of the women who take the magazine regularly—or inquire among women which of them take it. Then ask them what they think of the magazine and whether they are interested in any of the construction products advertised in its pages.

You will learn something before you get through! You will find they swear by Good Housekeeping, in the first place, and you will discover they take a lively interest in the beautiful and handy construction specialties it advertises.

Tell them you can easily procure these products, and that you will gladly build them into homes for them or their neighbors. Start a little talk of this kind going the rounds. It will bear fruit where least expected. Many a contractor has "stirred up" orders this way.

Products That Please

Following are some of the construction materials advertised in Good Housekeeping Magazine. Every one of them is absolutely guaranteed by it. The firms behind the products are thoroughly reputable and may be dealt with unhesitatingly.

Monarch Metal Weather Strip	Morgan Doors
Utility Wall Board	Corbin Builders' Hardware
Trus-Con Aseptico	Valspar
Lowe Bros. Mellotone Wall Finish	Vudor Porch Shades
High Standard Liquid Paint and Oil Stains	Sherwin-Williams Paints and Varnishes
Congoleum Rug Border	Standard Sanitary Plumbing Fixtures
Beaver Board	Glidden's Green Label Varnishes, White Enamels, Endurance Wood Stains, Waterproof Flat Wall Finishes and Cement Coatings
Sanitas Wall Covering	Pratt & Lambert "61" Floor Varnish & Vitralite White Enamel
Western Electric Inter-Phones	Southern Cypress Pearl Wire Cloth
Siwelcio Noiseless Closet	McCray Built-in Refrigerators
Alabastine Wall Tints and Alabasco Flat Wall Paint	Aerolux Bo Whip Porch Shades
Macbeth-Evans Glass Shades & Globes	Sturtevant Ready to Run Ventilating Set
Elastica Floor Finish	Benjamin Plug Current Tap
Klearstone Stains, Etc.	Johnson's Wood Dye
Wild's Parquet Inlaid Linoleum	
Brenlin Window Shades	
Pompeilian Bronze Screen Cloth	
Cyclone Fences & Gates	
Cabot's Creosote Stains	
Tapestry Brick	

Give the Public What It Wants It Wants Advertised Goods

The magazine publishes GOOD STOREKEEPING, a quarterly devoted to this question of cashing in on the wide demand for advertised products. A copy of it, and a copy of Good Housekeeping Magazine, will be sent free on request to any contractor or builder. Address Dealers Service Department, Good Housekeeping Magazine, 115 D. West 40th Street, New York City.

Dealers' Service Dept.

Good Housekeeping Magazine

115 A. West 40th St., New York City

toria in order to secure advanced ideas on theatre construction. Many declare that it excels any theatre of its kind in the United States in architectural beauty, convenience of arrangement, and fireproof features.

The building is of steel and brick construction 160 feet deep, 40 feet wide, and 65 feet high, with an elaborate front of ornamental terra cotta. An artistic arch, 30 feet in height, graces the main entrance.

The interior decorations are unusually rich in character, consisting of beautifully carved columns and artistic plastic effects on the walls and ceiling. The lighting system consists of inverted domes which diffuse a soft illumination over the entire interior, permitting the films to be shown as "daylight" pictures.

Up-to-date lighting and heating systems, lavatories and drinking fountains, and a luxurious waiting room for lady patrons, are other features of this model moving picture theatre.

Equal attention has been bestowed on the mechanical equip-

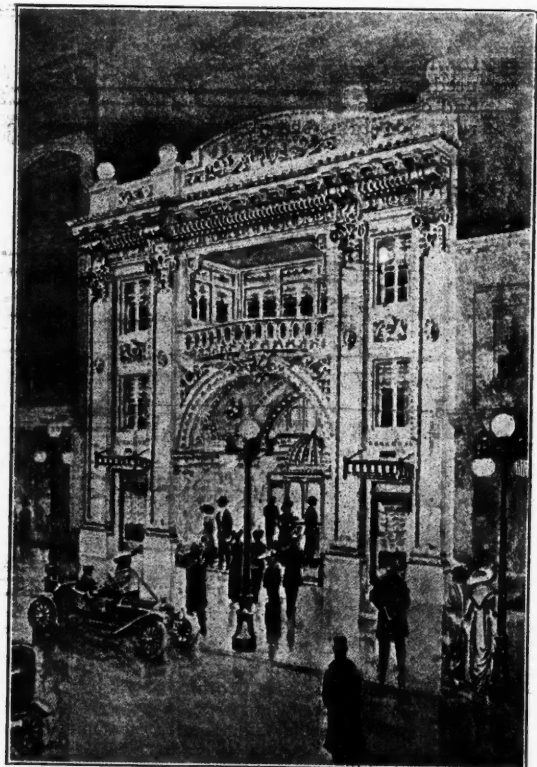

Facade of New Victoria Theatre at Shamokin, Pa.

ment of this building. The entire steam plant, including boiler, motor generator and 5,000 feet of pipe are insulated with J-M Sectional Covering. Among engineers and architects this covering is famous as an insulator against the escape of heat, and is therefore instrumental in cutting down fuel consumption. In a plant of average size its use often means an annual saving of hundreds of dollars.

As an extra precaution against fire the Victoria Theatre is equipped with a J-M Transite Asbestos Wood Booth for the motion picture machine. It has the same physical characteristics as wood, except that it is harder, takes a higher polish and is absolutely fireproof. The makers claim that film fires positively can not spread when this type of booth is installed, and its use always imparts a sense of security to the audience. Owing to the great fire hazard in moving picture houses many states and cities have enacted laws making the use of Asbestos Booths compulsory. J-M Asbestos Booths and J-M Asbestos Theatre Curtains are widely used throughout the country.

You will get SPECIAL ATTENTION if you tell Advertisers you read American Carpenter and Builder.

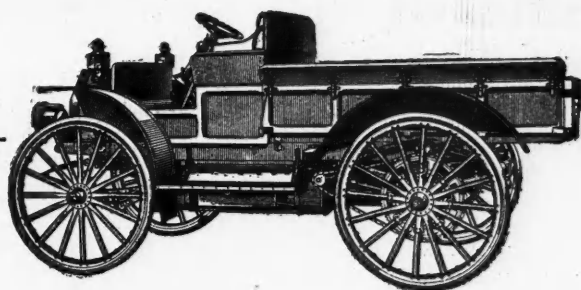

Take a Second Look at This Truck

THE International Motor Truck meets the need of carpenters, contractors and builders everywhere. It reduces the expense of delivering supplies. It shortens the time required for making trips with tools or equipment. It increases by one hundred to two hundred per cent the amount of light hauling that can be done in a given time. It easily takes the place of two single wagons, and of three or four where the average haul is a mile or more.

The International Motor Truck

is powerful and has road clearance enough to travel anywhere that horses can go. It is ready to work twenty-four hours a day if necessary, and will do as much work in the last hour as in the first. If worn, or injured by accident, it is easily repaired and made as good as new.

An International Motor Truck may be the means of largely increasing your present business. At any rate it costs you nothing to find out what it will do for you. A post card brings catalogue and full particulars. Write to us.

INTERNATIONAL HARVESTER COMPANY OF AMERICA
70 Harvester Building (Incorporated) CHICAGO

Smoke is Unburned Carbon

And Carbon is "the stuff that burns and makes heat."

So, every time you see smoke sailing grimly from the top of a stack think about poor "Mr.-Man-to-man-who-pays-the-bills". He is spending money to help turn his city black.

KEWANEE Smokeless Firebox Boilers

Get the maximum of heat from the coal.

They take from the coal—and turn it into heat—20% more of the heat giving carbon than ordinary boilers. Tests made prove this.

Let us send copies of tests made. We will do so gladly if you will tell us you are interested.

KEWANEE BOILER COMPANY

Steel Power and Heating Boilers
Radiators, Tanks & Garbage Burners

Kewanee, Ills.

Branches: Chicago, St. Louis, Kansas City, New York, Salt Lake City

You will get SPECIAL ATTENTION if you tell Advertisers you read American Carpenter and Builder.

A Book on Color Combinations

Samuel Cabot, Inc., compounders of the famous Cabot Stains have lately been sending out something of a novelty in order to illustrate color effects in stains.

A little booklet contains several pages on which are reproduced by a fine process, accurate illustrations of a house finished with Cabot Stains. Each page is divided into three parts—the roof, the second story and the first story. By manipulating the divided leaves, sixty-four color combinations can be made. For instance, one arrangement gives a roof stained a medium moss green, a second story of bungalow brown and a first story of light bronze green. This book is instructive and harmonizes colors in such variety that it will prove very helpful.

You can get this book by asking Samuel Cabot, Inc., Boston, Mass., for it. A word of advice—keep it out of the children's way. It's so amusing that mother will never be able to get them to bed.



Barns Demand Ventilation

Something that is sure to interest our barn builders is the line of combination cupolas and ventilators manufactured by the Thomas & Armstrong Co.

The old wooden cupola has proved a myth as far as ventilation is concerned. Before the foul air had a chance to escape, the outside winds being stronger, threw it back into the barn. On still days, the cupola didn't "draw." In addition to this, the snow and rain drifted in and rotted the joists and roof.

The problem of perfect ventilation is in keeping all the air of the building in constant motion. A continuous exhaust of foul air and an intake of fresh air must go on. By the

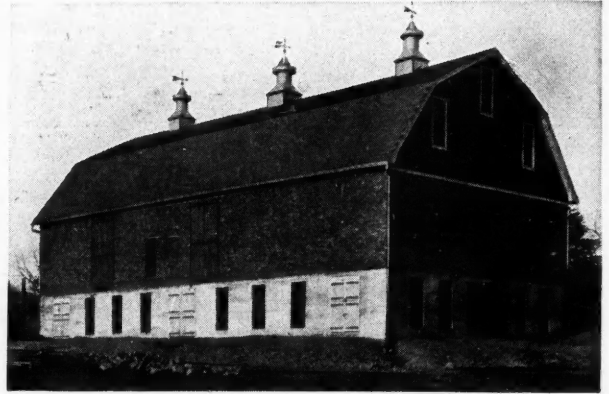

Large Barn Well Ventilated with Buckeye Cupola-Ventilators

Buckeye Cupola-Ventilator, the foul air is drawn from all points near the floor. The significant thing is that ventilation takes place from the floor UP, not from the roof DOWN. It is the down draft that chills stock and causes so much sickness.

Buckeye Cupola-Ventilators, a sample of which is shown, are made of the best galvanized iron to be had. They are specially reinforced with a galvanized iron frame and bolts. No wood is used, so these ventilators are strong and permanent. Their scientific construction prevents snow and rain from entering and gives the greatest ventilating capacity. Being extremely ornamental, they make a beautiful addition to any barn putting a finishing touch to the building. A very fine weather vane is furnished with each ventilator and the manufacturers put the farm name or owner's name on the base of the cupola in raised letters.

A neatly illustrated catalog may be obtained free by writing the Thomas & Armstrong Co., Cupola Dept., London, Ohio.

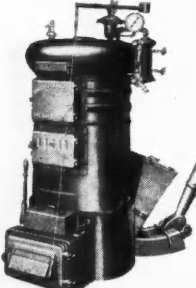

UNDERFEED

Cuts Your Coal Bill

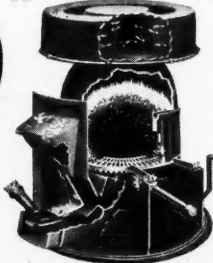

CARPENTERS $\frac{1}{2}$ to $\frac{2}{3}$ BUILDERS

IT will pay you to look into the UNDERFEED—the heater that ADDS to the RENTING or SELLING value of any house. You can easily figure out why. Here's the argument made in the July magazines read by millions of people. You can't expect your coal dealer to cut *his* prices \$2 or \$3 a ton, but the *Underfeed* will do it. *Don't* buy costly anthracite or lump soft coal. Install an *Underfeed*. Then in ordering next winter's coal supply, remember the *same amount* of *cheaper* grades, which cost \$2 or \$3 less per ton, will yield as much *clean, even* heat as *highest* priced grades. The *Underfeed* saves $\frac{1}{2}$ to $\frac{2}{3}$ of coal bills. *Investigate.*

Write for FREE Book. Send us rough sketch or blue print of floor and basement and we will send you FREE Heating Plans and estimate of cost.

An *Underfeed* is a splendid investment, because it *soon pays for itself*.

Let us send you names and cheerful testimony of *thousands* who **KNOW** Underfeed worth.

Sensible Coal Burning Way!—In the *Underfeed* coal is pumped up into the fire pot from *underneath* the fire and like a candle burns from the top *down*, which insures *perfect* combustion and thus *even* heat.

THE PECK Williamson Underfeed FURNACES BOILERS

Heat from Waste!—Smoke and gases (40 to 50 % of the heat units in coal) *wasted* up Topfeed chimneys, must pass up through the flames, are entirely consumed and make *more* heat. Here's where *another* saving comes in.

Always Clean!—The fire, always on top, is in close contact with clean, heat responsive metal. Therefore no soot-covered, hard-to-clean, heat retarding surfaces. No clinkers. Few ashes. Requires less attention than other heaters.

Send today for free Warm Air Furnace Book or Steam and Hot Water Book.

THE PECK WILLIAMSON CO., 436 W. Fifth St., CINCINNATI, OHIO

You will get SPECIAL ATTENTION if you tell Advertisers you read American Carpenter and Builder.



THIS IS INTERESTING

We make *steel furnaces*,—good ones,—and we sell them direct to contractors and consumers, at factory prices. This is a little hard on the local dealers, and we are sorry for that, but it is such an advantage to the purchaser in saving money, and it is such an advantage to us to know what is expected of our furnace and how it is going to be placed, that we prefer to sell in this way.

We had occasion to write to a party in Montana, not long ago, about our furnace, not knowing that he was interested in the sale of other furnaces, and his reply contains this statement:

“We are agents for the — — Furnace Co., and find that it is to our advantage to handle that furnace, as you people sell direct to the people. We do not advise anybody who is inquiring about furnaces to get the Hess, as one sale of a — — furnace would give us as much as five sales of a Hess.”

Now don't you see the point?

The dealer who sells the furnace must have a profit, and the consumer who buys the furnace must pay that profit. The Hess furnace, sold direct to the people, is sold at a price which the dealer cannot match. Therefore, he must handle some other kind which affords him **five times** greater profit, and this profit does not add to the value of the furnace, but it comes straight out of the consumer's pocket.

We can tell you a lot more about the advantage of buying a furnace direct from the factory, and we will do so, if you will send us your name on a postal-card, and tell us something about your requirements in this line.

HESS WARMING & VENTILATING CO., 1220 TACOMA BUILDING, CHICAGO

Money Talks!

*And this space costs money,
so here is OUR STORY*

We will furnish our customers complete equipment including furnace, pipes, registers, etc., at the following prices for ordinary sized houses:

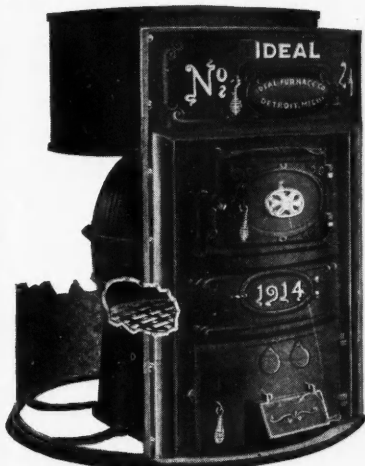

- 5 Room House, **\$60**
- 6 Room House, **\$70**
- 7 Room House, **\$80**
- 8 Room House, **\$90**

No good business man will pay more.

All that you need to know is that it will be an **“IDEAL”** Heater.

Guaranteed for 10 years and will last a lifetime. Our enormous output enables us to make this offer. 30,000

Ideal Furnaces in use. Actual output 9,000 annually.

**WE SPEND OUR MONEY IN MAKING GOOD FURNACES,
NOT IN LARGE ADVERTISING SPACE**

Special Proposition for Contractors.

Catalogs and Details for the Asking

IDEAL FURNACE CO., DETROIT, MICH.

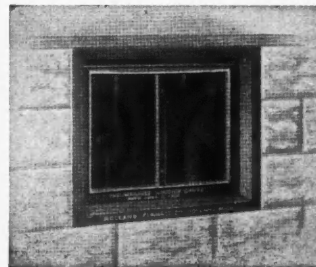

The Window Chute

A Real Window—A Perfect Coal Chute

Useful 364 days in the year for light and one day for the coal man.

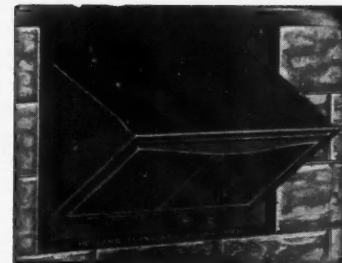

A Burglar-Proof, Air-Tight Window which conforms with architectural lines. Looks best and is best. Write for booklet giving full description.

Holland Furnace Co

Dept. “A. C.” :: Holland, Mich.

—“Holland Furnaces Make Warm Friends”—

You will get **SPECIAL ATTENTION** if you tell Advertisers you read *American Carpenter and Builder*.

Vapor-Vacuum Heating
Kriebel System

How We Help You With the Heating

Every carpenter and builder must know *something* about heating systems; the *more* he knows, the more valuable man he is, both to himself and his clients. Do YOU know why

Vapor-Vacuum Heating (Trade Mark Registered) Kriebel System

is making such a tremendous hit? We'll tell you. By enabling you to reduce pressure at the boiler, and through a combination of vapor and vacuum, this system burns 25 per cent less coal—*guaranteed*.

People, weary of coal-saving claims, were skeptical at first, but investigation proved that VAPOR-VACUUM HEATING (Kriebel System) not only saved 25% in coal, but gave them other advantages offered by no other system.

How does this concern you, you ask? YOU profit from the complete satisfaction given the client.

Write Today and Get All the Details

We'll tell you how our Engineering Department, without charge, gets you up complete heating plans to show your prospect—actual, blue-printed working drawings, showing proper installation.

We'll send you, too, a little book describing the system in Abe Lincoln English—a book your customers can understand and appreciate.

Write now—you'll want to know sometime quick. No obligation. Use the coupon, a postcard—anything.

Vapor-Vacuum Heating Co.
895 Drexel Bldg.
PHILADELPHIA

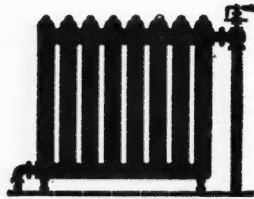

CLIP, SIGN AND MAIL THIS COUPON—IT WILL PAY

Gentlemen: Without obligating me one bit, send me full information by return mail.

Name

St. Address

City State

(A.C.B. 7-13.)

You will get SPECIAL ATTENTION if you tell Advertisers you read American Carpenter and Builder.

Special "Bang Proof" Truck

For hauling nitro-glycerine in Oklahoma, where they "shoot" the oil wells about the same as a subway contractor blasts his way through a wall of rock, a White truck with a special body has been built for the Eastern Torpedo Company at Bartlesville.

Powerful explosives are not often carried on motor trucks and their use by the Oklahoma firm in delivering nitro-glycerine on the bad roads of the Mid-continent oil fields, is fraught with interesting possibilities, particularly in view of the fact that the customary outfit of light spring wagon, mule and driver periodically go aviating in atoms and are never seen again.

To guard against these disasters a rather novel body has been designed for the pneumatic-tired truck. Across the frame there are placed several cross sills of pine. These sills are spanned with a layer of asbestos to prevent heat from reaching the load. Above the asbestos there is a solid pine floor covered with a thick rubber mat to reduce jolts. Over the mat there is a copper pan covering the entire loading space and having high sides to guard against the fluid reaching the chassis in case of a leak in one of the cans. Dividing the entire loading space are thirty cells, each 7 by 7 by 17 inches, into which cans of nitro-glycerine are placed.

The cells have a wood cover to prevent anything being dropped upon them. When a can has been lowered by reel into the pipes of the oil wells, a rock is dropped down the pipe and the ensuing explosion breaks up the subsurface rock and earth, quickening the flow of oil. The truck is now in service, piloted by a driver who is cheerfully indifferent. Forty pounds impact will ignite a charge.



Indispensable Building Equipment

Machinery for the builder, to be classed as a profitable investment must be durable and capable of performing the duties required of it. Any machine or piece of equipment which can be put to a variety of uses must also come under the head of a justified investment. For example, a hoist is a convenient piece of mechanism that can be used to raise all kinds of material to any required height. Bricks, mortar, lumber, sash, shingles—everything necessary in building can be hauled up in less time and at less expense than if men

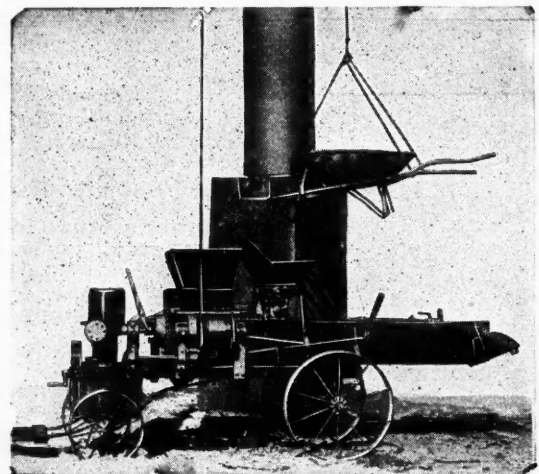

"Baby Grand" Concrete Mixer with Single Drum Hoist

were hired to carry them up. When you can get a concrete mixer with hoist attached then you have efficiency and a profitable investment in the best sense of the words.

Realizing this, the Hall-Holmes Mfg. Co. have added to their "Baby Grand" mixer, a special hoist of the single drum type which is adequate for all ordinary construction work

Jahant Furnaces Always Satisfy

This picture shows the reason why Jahant Furnaces heat Comfortably, Healthily, Airily, Evenly, Easily, Economically, Scientifically. The Down-Draft does it. This phantom picture shows both outside and inside construction of the center sections, and the radiator at top. The white lines show the course of the down draft that makes your coal go farther. The air enters the box where the lower right arrow indicates, goes up thru the right and left Ells, then falls and forms the down draft as shown.

The radiation system means economy of heat. Smoke actually touches 30 square feet of radiating surface before passing out. This saves at least half of the ordinary wasted heat carried off in smoke.

Send the coupon for the full size picture, and see the details of this system that means money in your pocket.

THIS X-RAY PICTURE OF THE JAHANT FURNACE

gives you but a small idea of the good points in its construction. We have a highly finished picture of it, 19 inches high, showing all the features in clear detail. At your request we shall be glad to send it to you.

This 19-inch picture is the central figure in an interesting exposition of furnace facts called **"SOLID REASONS."**

When you read it you will agree that the

Jahants Breed More Contracts For You



JAHANT DOWN-DRAFT FURNACE

365 Day Guarantee

deserves its high reputation among house owners and contractors alike.

The more particular you are about the furnace you install, the better you will like the Jahant. It is made for particular people. And so we are anxious to send "Solid Reasons" to every particular person who is interested in furnaces. The coupon below will bring it.

OUR PROPOSITION TO CONTRACTORS

Ask us for the details. It's the practical show down—real information and real facts that will mean business for you. This coupon will bring it. Use it now, while it's on your mind. Your scissors or knife will cut it out, or just tear off the corner of the page. Fill in and send to

JAHANT, Akron:
Send me that 19 in. Picture and "Solid Reasons" circular today.

Signed

.....

.....

THE JAHANT HEATING COMPANY
AKRON, OHIO

THE Furnace That Made Rotary Air Famous



The Campbells have come! They have been on the job for 30 years with the best furnace ever put on the market. The Winter-Chaser is the last and best as it was the first expression of the Rotary Air Movement. Get our selling plans for 1913 on the original

Campbell's Winter-Chaser Furnace

Our Guarantee behind you means that you can guarantee to your client a heat to 70 deg. in any connected room in his house in any weather. Our experts are at the service of your clients with guaranteed plans.

The 15-gallon reservoir keeps the heat like a June day, and The Campbell is the only jacket furnace made with a large air-chamber and an entrance door.

All these points with greatest economy and ease of operation mean much to your clients. Write and find out exactly what it means to you. We will send our 1913 Selling Plans, also our booklet with full information, etc.

Address

Campbell Heating Company
1221 Walnut St. Des Moines, Iowa

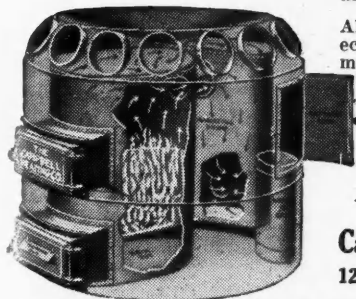

FORBES FURNACE

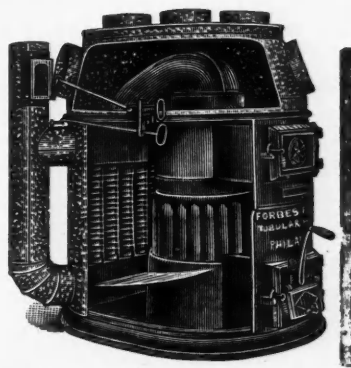

For anyone to install a Forbes Furnace is to have one satisfied customer. This furnace is guaranteed and will give more heat with less coal than any other furnace made, owing to its superior construction. The manifold at the rear with its enormous radiating surface utilizes all the heat which usually goes out the chimney. The cold air enters the rear of the furnace and is partially warmed before it comes in contact with the fire pot where all the heating is accomplished in the majority of furnaces.

It is a great pleasure for us to explain the principle of this furnace to all interested parties. Please write us. Dept. "X."

Tubular Heating & Ventilating Company
228-232 Quarry Street Philadelphia, Pa.

You will get SPECIAL ATTENTION if you tell Advertisers you read American Carpenter and Builder.

where it is necessary to deliver material at considerable heights.

This hoist, as shown in the illustration, is direct-connected to the frame of the mixer. It is strong and rigid. Power is derived from the main countershaft of the machine by means of a sprocket and steel pintle chain. The hoist is so attached to the mixer that it can be run whether the mixer itself is operating or not.

The hoist is equipped with a drum of sufficient size to carry at least 200 ft. of $\frac{3}{8}$ -in. wire cable. This drum is operated by friction clutch and brake-band, so that the hoist can be started and stopped by means of the friction clutch without any sudden jar to the machine. The hoist can be thrown out at any point and the friction applied, so that the load can be stopped and held at any point desired.

This enables the builder to draw up a wheelbarrow full of mortar, hold it at any desired point and dump it. The wheelbarrow will then return to the ground by force of gravity as soon as the friction is released.

The hoist will elevate, at the rate of 100 ft. per minute, about 400 lbs. or an ordinary wheelbarrow full of concrete. The larger concrete mixers made by the same Company—the "Grand" and the "Hartwick"—are also equipped with this hoist, as well as the mortar mixer. Many contractors desire this arrangement in connection with mortar mixers, for elevating mortar and timber. In equipping the concrete and mortar mixers with this hoist, the contractor is given two complete equipments in one at a very small additional cost—in fact, it is claimed, for less than he could purchase even a hand-hoist as a separate equipment for this work.

The Hall-Holmes Mfg. Co., 431 Oak Street, Jackson, Michigan, will be glad to consult with any builder as to the machines especially suited to his needs. These people are competent to offer some mighty good advice and their ideas and catalogs are always gladly given to those who ask for them.

The New Oshkosh "Eveready" Saw Rig

The manufacturers of the Oshkosh "Eveready" Saw Rig say that the newer model is making a decided "hit" with users because of its sturdy, reliable power plant; that the new gasoline engine is a marvel of efficiency under ordinary requirements and has abundant reserve power for any emergency that may arise.

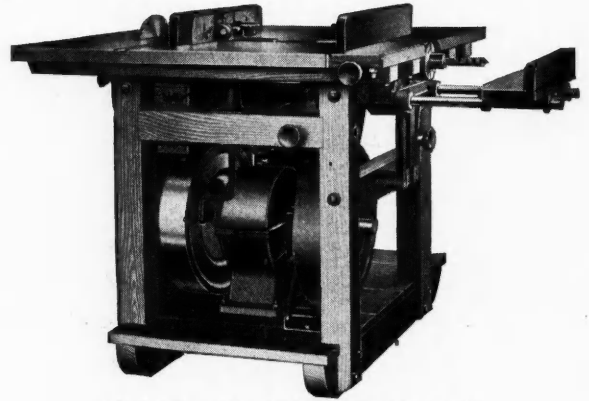

The New Oshkosh "Eveready" Saw Rig

The trouble with many saw rigs seems to have been a lamentable lack of reserve power. For the regular run of light sawing they answered fairly well, but for quick ripping of long, heavy pieces, jointing, etc., where time was at a premium, they frequently fell far short. The power plant was often the cause of the trouble.

This is said to have been completely overcome in the Oshkosh "Eveready" Saw Rig. The new gasoline engine is of their own special design. It is of 4-cycle type with $4\frac{1}{2}$ -inch bore and 6-inch stroke, and is guaranteed to develop over 4 actual brake horsepower.

COLONIAL Fireplaces

Will Save You

Time

and

Money

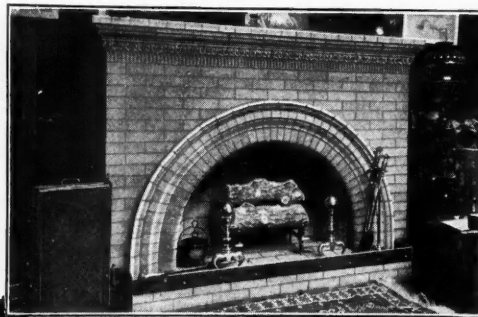

Your Best "Booster"

COLONIAL

Head, Throat
and
Damper

Makes the Job a

Success

is the work you do. Every successful job is a lasting advertisement of your ability.

Colonial Fireplaces are shipped to you ready to set up with full details for installation. They are equipped with the Colonial Head, Throat and Damper, a device that insures correct construction at the fireplace throat and regulates the draft to weather conditions.

Colonial Fireplaces are built in a great variety of styles and at a range of prices that will suit any job you have.

Write for "The Home and The Fireplace" our booklet of full information and let us quote you prices.

Colonial Fireplace Company

4636 West 12th Street
CHICAGO, ILL.

You will get SPECIAL ATTENTION if you tell Advertisers you read American Carpenter and Builder.

Everything Your Customers Expect of a Good Heating Equipment You Will Find In

XXth Century Heaters and Boilers

And in addition many features they do *not* expect but which are vitally necessary for an efficiently and economically heated home.

INDESTRUCTIBLE FIRE POT—Built under our own exclusive patent. It gives a free circulation of air at all times and preserves the firepot.

BURNS ANY KIND OF FUEL—Soft coal or slack is burned just as effectively as anthracite or coke by this special firepot.

BURNS ALL THE FUEL—There's no waste with a XXth Century Heater—the fuel is burned from the side toward the center—thus insuring perfect and complete combustion.

Besides this XXth Century Heaters are constructed so as not to throw off any smoke or soot. They consume their own gases. They have an improved drop front gate—indestructible feed section—self cleaning radiator—automatic damper and an extra large ash pit and ash door which makes removing of ashes extremely easy. Even the grate and rests can be removed through it.

Give your customers what they want and need. Show them that *your* interest in their home does not cease until the question of heating has been properly disposed of. For economy and good solid heating comfort you can depend upon a XXth Century Furnace or Boiler every time.

Send for our catalog 40—it contains the same information that has induced over 40,000 homes to install a XXth Century Equipment. At the same time, send on a plan or sketch of the home, mentioning the

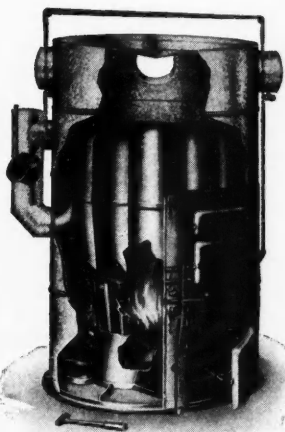

number of rooms to be heated and we'll put our Engineering department on the job to advise you.

The XXth Century Heating & Ventilating Company

Akron, Ohio

The Bovee Furnaces

AT

Manufacturer's Prices



Will give every one of your patrons most perfect results. They last longer and actually require about one-half the fuel used by other furnaces.

They are made heavy, of the very best material and workmanship. Take your rule and measure the fire pots, the large combustion chamber and the long travel of heat and compare it with all other furnaces and see **WHY** the Bovee

uses less fuel and lasts longer than others.

Get our special prices. We can save you 40% on a heating plant. Any handy man can install them.

Bovee Furnace Works

50 Eighth Street

Waterloo, Iowa

You and Your Customer Make Money

THE KALAMAZOO Furnace—sold direct—is far cheaper for the builder, yet it will allow you a *liberal* profit. That's because you and your customer have no jobbers' and middlemen's profits to pay. Besides, the

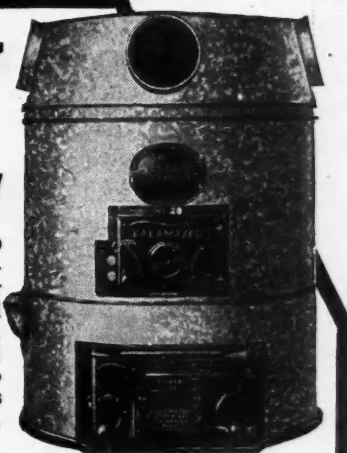

Kalamazoo Furnace

is easy to install. Our furnace experts will back you—give you *blue prints* that show where every piece goes. You can't make mistakes. You can do the work easy. Results are guaranteed. For your next job specify a Kalamazoo. Then you are *sure* of giving your customer lasting satisfaction and making the best deal for yourself at the same time.

Blue Prints FREE

Write For Free Book Ask For Catalog No. 947. We'll tell you how to describe the building you want to heat. Then we'll prepare plans for a complete, practical heating system. Every owner will boost and bring you dozens of other jobs. Don't wait! Mail a letter or postal, for complete information NOW.
KALAMAZOO STOVE COMPANY, KALAMAZOO, MICH.

"A Kalamazoo Direct to You"

Trade Mark Registered

And Gas Stoves Too

You will get **SPECIAL ATTENTION** if you tell Advertisers you read American Carpenter and Builder.

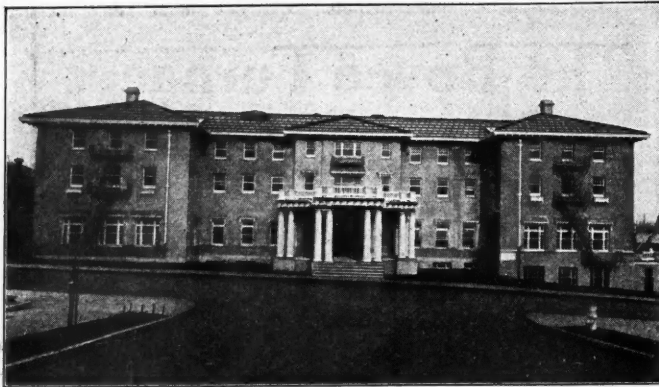

Multnomah Athletic Club, Portland, Ore., Roofed with J-M Transite Asbestos Shingles

12 Reasons Why You Should Specify

J-M Transite Asbestos Shingles

1. They weigh 1/3 less than slate.
2. Are much easier to handle.
3. Transportation charges are less.
4. Roof construction can be lighter.
5. Are tough and resilient—not brittle.
6. Absolutely fireproof.
7. Never require repairs or painting to preserve them.
8. Won't split, crack or chip.
9. Won't curl or exfoliate.
10. Won't rot or deteriorate.
11. Keep a building cool in summer and warm in winter.
12. Outlast the building they cover.

J-M Transite Asbestos Shingles are made of a composition of tough, long-fibre Asbestos and Portland Cement moulded into one solid, homogeneous mass under tremendous hydraulic pressure.

J-M Shingles are furnished $\frac{1}{8}$ " thick with smooth edges and $\frac{1}{4}$ " thick with rough or irregular edges in sizes and shapes to meet all requirements, and in colors of natural gray, Indian red, green and slate.

Write our nearest Branch for Samples, Booklet and our dealer proposition to Carpenters and Builders.

H. W. JOHNS-MANVILLE CO.

Manufacturers of Asbestos and Magnesia Products

ASBESTOS

Asbestos Roofings, Packings, Electrical Supplies, Etc.

Albany
Baltimore
Boston
Buffalo
Chicago

Cincinnati
Cleveland
Dallas
Detroit
Indianapolis

Kansas City
Los Angeles
Louisville
Milwaukee
Minneapolis

New Orleans
New York
Omaha
Philadelphia
Pittsburgh

San Francisco
Seattle
St. Louis
Syracuse

For Canada:—THE CANADIAN H. W. JOHNS-MANVILLE CO., LIMITED
Toronto Montreal Winnipeg Vancouver 1714

You will get SPECIAL ATTENTION if you tell Advertisers you read American Carpenter and Builder.

Aside from its unusual reserve power, this engine starts easily and its operations are steady and uninterrupted. It is simple in construction and all important parts are covered with a dust-proof housing. This keeps them in smooth, harmonious running order always, and prevents all chance of a "hitch" from the time it starts in the morning till the power is cut off at night.

And this reliability is lasting. For the men who perfected the "Eveready's" engine knew what hard work would be expected of it and made it to meet the issue. The bearings are constructed extra large and of the best known bearing metal. The engine itself is cast—not from brittle gray iron—but from tough, semi-steel. It is perfectly balanced, equipped with approved "splash" oiling system, water-cooled, and runs with the precision of a high-grade automobile engine.

The frame of the Oshkosh is constructed, not only of best rock maple, air and kiln seasoned—but with the mortises generous in size, accurately cut, and the connections firmly secured with steel bolts that allow for temperature changes. The result is a frame that will always be rigid. The table is also of high grade maple, but composed of narrow strips jointed and glued under tremendous pressure. Such a table combines permanent trueness with the least possible amount of weight.

With this rig, the hustling carpenter can do almost anything that he will ever desire from a planing mill; for the price of the rig includes the following: Cross-Cut Saw, Rip-Saw, Jointer Head, Dado Head, Sander, Emery Wheel, Jig Saw, Boring Bits, and, of course, ripping guide and cross-cut gauge and miter device. Two or three of his men can skid

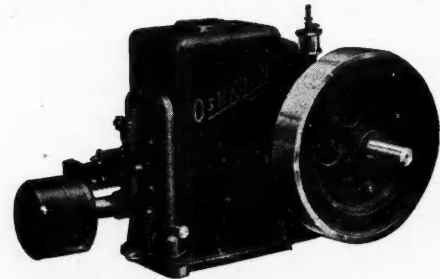

The Compact, Easy-Starting 4 H. P. Gasoline Engine that Drives the New Oshkosh "Eveready" Saw Rig

the rig into a wagon and take it right onto the job, where, with all the above attachments, he is practically independent of the mill, except possibly for moulding, carved work, etc. If he has a shop within his building district, he can keep the "Eveready" rig in it and supply all his jobs with sawed and milled material at an unbelievable saving.

There seems to be no end to the work the "Eveready" rig will do. One carpenter in a large city is said to make, with profit, even his own china closets and book cases. As to its economical side, the "Eveready," the manufacturers maintain, will save from five to six dollars a thousand on mill work in the price of the lumber alone; as it enables the owner to buy the lower grades of lumber, clear it of shakes, checks, knots, etc., and trim the balance to a sufficient amount of usable sizes to actually effect this saving.

The makers of the "Eveready" saw rig say that there is hardly a day during the winter season when it can not be used, as there are always a large number of standard pieces to get out for use when the building season opens; such, for instance, as the braces, short blocks, wedges, keys, etc., necessary for false work, short pieces of ceiling called for by some future contract, and many other things of similar nature.

An interesting circular, describing the "Eveready" and all its attachments, also prices and terms, can be had by writing to the Oshkosh Mfg. Co., 316 South Main St., Oshkosh, Wisconsin; or to the Oshkosh Mfg. Co., 1452 Monadnock Bldg., Chicago.

Notice!
MASON CONTRACTORS
Only

If you will Mail us your Name
 and Address

We will send to you

Absolutely
FREE

A very necessary tool used daily in your work.

This tool while constantly in service is not sold generally by supply or hardware dealers—strange as it may seem.

You Will Appreciate It

MERWIN M'F'G. CO.
 Erie, Pa.

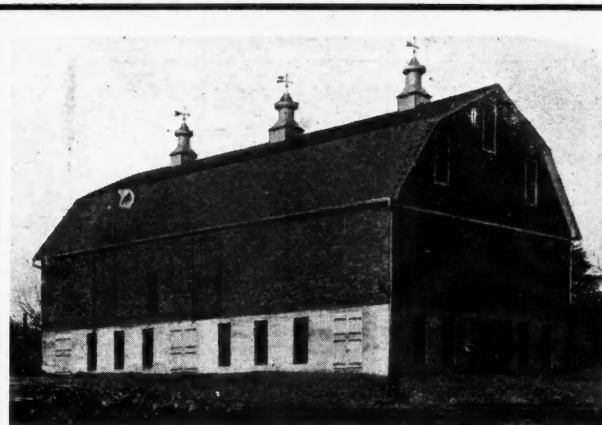

Scientific Barn Ventilation
BUCKEYE CUPOLA-VENTILATORS
 (ALL METAL)

are used on all up-to-date barns in place of the old style wooden cupolas

Built Entirely of Heavy Galvanized Iron from Base to Weather Vane

Supplied With Beautiful Weather Vane
 Carpenters and Contractors wanted to act as agents everywhere. Write for our special proposition and booklet

"The Ventilation of Modern Farm Buildings"

The Thomas & Armstrong Company
 LONDON, OHIO

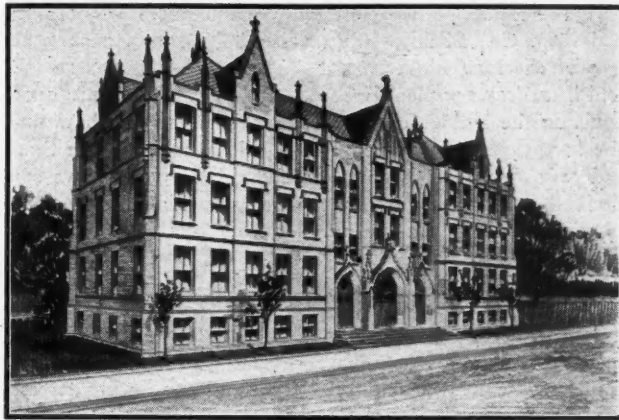

St. Martin's School, Chicago, Ill., roofed with Asbestos "Century" Shingles by Paul J. Krez & Co., Contractor, and Herman Gaul, Architect, both of Chicago. Reproduced from an Artist's drawing.

Asbestos
"Century"
Shingles

"The Roof that Outlives the Building"

WHEN you talk roofing to your architect, roofer or building contractor, Asbestos "Century" Shingles will come up for discussion, of course.

Now, there is just one thing to remember: Asbestos "Century" Shingles are made by the one perfected process for combining asbestos and cement into a shingle of uniform reinforced texture—and by the people who control that process and know how to operate it.

And we are careful to see that they are handled by the roofing people in your section who know how to lay a good roof as it ought to be laid.

Write for names of representative roofers who can supply Asbestos "Century" Shingles, and Booklet, "Roofing: a Practical Talk."

Keasbey & Mattison Co.
 Factors
 Dept. B, Ambler, Penna:

Branch Offices in the Principal Cities of the United States

This advertisement appears in July Magazines read by the owners and tenants of the better class of buildings. Write to above address for terms and trade prices.

You will get SPECIAL ATTENTION if you tell Advertisers you read American Carpenter and Builder.

Spring Hinges and Hardware

A new catalog is being offered to our readers by the Standard Mfg. Co., Shelby, Ohio. This book shows a very neat line of checking hinges, pivot checks, push plates, sash locks and lifts, drawer pulls, cupboard turns, etc. Prices are quoted enabling the builder to figure out to a penny just how much the hardware for that new house will cost him. The Standard Mfg. Co.'s line is complete and reliable and shows some decided improvements over the ordinary kind. The catalog is sent free for the asking.



Glazing without Putty

The trials and tribulations of architects and builders with the old style putty window are known of all men and interests connected with the building trades. The most defective part of modern construction has been the windows. As someone has said, "the national debt could be paid out of the loss and damage caused in the past by the use of putty glazing."

There have been many substitutes devised to replace putty but none of them seem to have met with very great success until the Racine Puttyless Window was invented. Many of them were impractical, some of them were too expensive, but the Racine Puttyless Window offers a practical, durable and economical substitute for putty. It has solved the problem.

Architects, builders and dealers were at first sceptical as to the practicability of this window. We ourselves thought it was only another visionary dream but so persistent were the claims of the Racine Puttyless Window Company of Racine, Wis., of the merits of their invention that we began an investigation.

We found that many reputable and high grade sash and

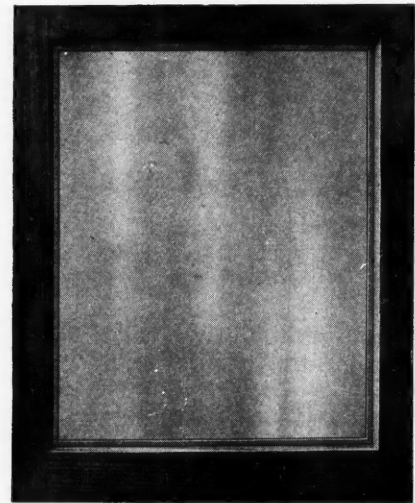

Sash Glazed Without Putty—Note Neat, Strong Appearance

door manufacturers had contracted to make the window and are placing it on the market after making a thorough and exhaustive investigation. When such firms as the Gould Manufacturing Co. of Oshkosh, Wis., Disbrow Sash & Door Co. of Cedar Rapids, Iowa, Central Door & Lumber Co. of Portland, Ore., and the Huttig Mfg. Co. of Muscatine, Iowa, engage in the manufacture of an article it certainly must have merit.

So, to satisfy ourselves, we sent a representative of the AMERICAN CARPENTER AND BUILDER to the factory of the Racine Puttyless Window Co. at Racine, Wis. He was received courteously by the gentlemen in charge of the industry, taken into the factory and told to ask any questions

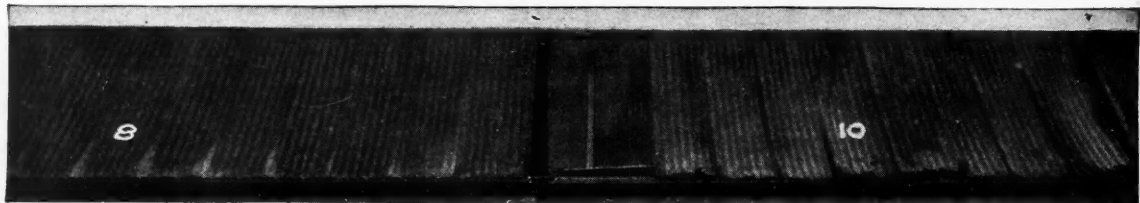

Copper Bearing Steel

One of the so-called "pure irons"

Actual WEATHER Tests of Copper Bearing Steel

Continue to add to the evidence of *durability*. Uncoated sheets in *actual service* under identical conditions is the proof. If you have not read "COPPER IN STEEL—the Influence on Corrosion" send for a copy. It gives the whole story in pamphlet form, with tables and analyses. *Absolute PROOF of service.*

We Use Copper Bearing Open Hearth Exclusively for Roofing Tin

Demand plates that bear the stamp "C. B. OPEN HEARTH" in addition to the brand and weight of coating. You should use no other. Write for full information on our Tin and Terne Plates, Apollo Best Bloom Galvanized Sheets, Black Sheets of every description, Formed Metal Roofing and Siding Products, Etc.

American Sheet and Tin Plate Company
General Offices: Frick Building, Pittsburgh, Pa.

DISTRICT SALES OFFICES:

Chicago Cincinnati Denver Detroit New Orleans New York Philadelphia Pittsburgh St. Louis
Export Representatives: UNITED STATES STEEL PRODUCTS COMPANY, New York City
Pacific Coast Representatives: UNITED STATES STEEL PRODUCTS COMPANY, San Francisco, Los Angeles, Portland, Seattle

You will get SPECIAL ATTENTION if you tell Advertisers you read American Carpenter and Builder.

MONTROSS METAL SHINGLES



Fire-Lightning-and Storm Proof

THE QUALITY OF ROOF

you Furnish a Customer is as Important to YOU as to HIM

He may cease to be the owner, but you will *always* be the builder. Therefore, if you value your reputation as a builder; if you want to have standing advertisements of you and your work, investigate **Montross Metal Shingles**.

No other roof compares with it in price, durability and small maintenance cost. We have prepared a new booklet setting forth in a clear, common sense way the qualities of this roofing—why Montross Shingles have been in service 34 years and look as good as the day they were laid.

You owe it to yourself to write for this booklet NOW—while you think of it.

Montross Metal Roofing Co., 2nd and Erie Sts., Camden, N. J.

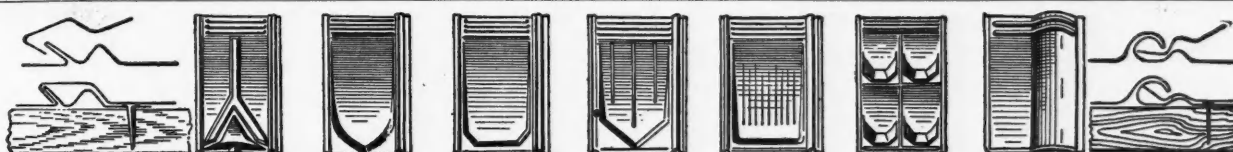

WALTER'S SHINGLES THAT LAST

The Leaders for Twenty-nine Years

Made from I. C. full weight roofing tin, painted or galvanized after stamping. Rust-, storm- and fire-proof. The most complete line of metal shingles and tiles manufactured.

Agents wanted in every community

National Sheet Metal Roofing Co.
JERSEY CITY, N. J.

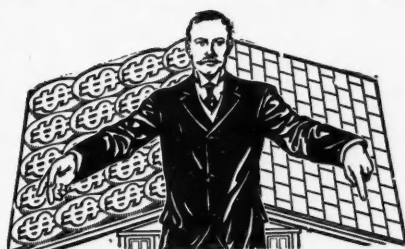
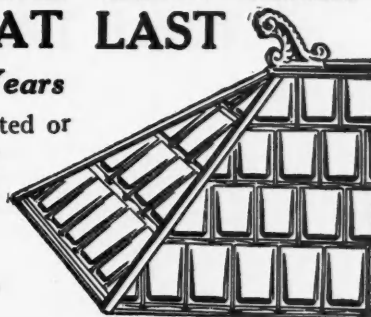
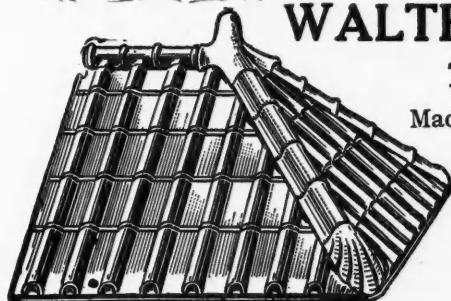

"The man who makes the most money in the long run, is the man who gives his patrons the best run for their money."

Which, applied to roofing, means that you will find it very profitable, in more ways than one, to cover the houses you build or re-roof with

Genuine Bangor Roofing Slate

It means more profit to you than flimsy roofings: also more friends. It will outlive the building, without paint or repairs.

In other words, it will make every owner tell his friends that the roofing you put on for him is giving lasting satisfaction.

And you know a pleased customer is the best advertisement; the best assurance of permanent business and permanent profits.

To help you secure more customers we have established a special Trade Help Department. Let us tell you more about it. It has helped other builders get the cream of the local trade. It will help you.

So that you will not forget it, please fill out, tear off and mail the attached coupon today.

Genuine Bangor Slate Co.
Drake Building Easton, Pa.

COUPON. Fill Out, Sign, Send TODAY.
Name.....
Address.....

Genuine Bangor Slate Company, Easton, Pa.
Gentlemen: Without obligation, please tell me how you can help me secure more profits.

You will get SPECIAL ATTENTION if you tell Advertisers you read American Carpenter and Builder.

Typewriter Sensation

2 Dollars A Month



Buys a Genuine Standard No. 2 SMITH-PREMIER Typewriter

and at \$71.20 less than the manufacturer's price

Never before has anything like this been attempted. Dealers get \$3.00 a month rent for this make of machine, not nearly as perfect as the one we will send you, and you pay only TWO DOLLARS A MONTH AND OWN IT.

Send the Coupon and We Will Ship You This Smith-Premier Typewriter

When the typewriter arrives, deposit with the express agent \$8.80 and take the typewriter three days and try it. If you find it to be the best typewriter you ever saw, satisfactory in every respect, keep it and send us \$2.00 each month, until our special price of \$28.80 is paid. If you don't want to keep it, return it to the express agent, and he will give you back your \$8.80, and return the typewriter to us. We will pay the return express charges.

You won't want to send this machine back after you have seen it and tried it. You can't imagine the perfection of these machines till you see one, and the price is \$71.20 less than the catalogue price, and it is guaranteed just as if you paid \$100.00.

Perfect machines only, complete outfit, nothing extra to buy, no strings of any kind to this offer. Just think of buying such a typewriter for \$8.80 down and \$2.00 a month. Cash price \$26.90. Thousands of people have paid \$100.00 cash for Smith-Premiers. It's standard, by many considered the best typewriter ever built. A key for each character, so each character is always the same, a type brush for cleaning the type built into the machine; the tilting carriage; comes to you with tools, rubber cover, everything ready. It runs beautifully. It's wonderfully simple and strong. It will last a lifetime. I sold a similar supply of these beautiful machines about a year ago to everybody's satisfaction.

Only 200 orders will be filled on this offer. Act today to be sure

This coupon states the terms. Fill it out, send it now, today. You can't lose, and it's the greatest economical typewriter opportunity you will ever have.

COUPON

HARRY A. SMITH
No. 180 North Dearborn Street, CHICAGO, ILL.

Ship me a No. 2 Smith-Premier f.o.b. Chicago, as described in this advertisement. I will pay you the \$20.00 balance of the SPECIAL \$28.80 purchase price, at the rate of \$2.00 per month. The title to remain in you until fully paid for. It is understood that I have three days in which to examine and try the type writer. If I choose not to keep it I will carefully repack it and return it to the express agent. It is understood that you give the standard guarantee for one year.

Name.....

Address.....

Shipping Point..... **E**

he wished, examine any feature of the manufacture and to offer any criticism. He found windows of all shapes, sizes and description, from plate glass down, in process of manufacture, and completed. He returned enthusiastic in his praise of the window.

The process of manufacture is simplicity itself. Any ordinary workman can do the glazing after a few hours' practice. It costs no more to stick the sash, and the cost of the lead inlay and the glazing is only a few cents more than for putty. The finished product presents a fine appearance and gives a permanent and durable glazing.



Putty Peels away in a Year or so—A Dilapidated Sight

The Racine Puttyless Window has many advantages over the old putty window. It can be manufactured and shipped the same day without damage to the glazing. An advantage that will certainly appeal to all manufacturers and dealers. The glass is bedded in white lead and oil and the lead inlay gives a positive and even pressure around all the glass. There are no points to make high spots and crack the glass. The sash is beveled from the lead inlay outward and no water can lodge and rot the wood. The lead acts as a cushion and absorbs the shock in case of rough handling. In shipping, alone, the saving to manufacturer and dealer is large. There is no repairing by the contractor after windows are hung in the building. When once placed the owner will not have to touch his windows for years to come.

It is our opinion that the Racine Puttyless Window is a thoroughly practical article and that it will replace putty in all high grade construction and probably wholly in the near future. The building trade is to be congratulated that at last a practical and economical substitute for putty is obtainable. Full particulars can be had from the Racine Puttyless Window Co., Racine, Wisconsin.

The Merchant & Evans Company's Plant Extensions

The Merchant & Evans Company of Philadelphia, with branches and warehouses in the principal cities, has completed and now have in full operation a new tin plate works at Wheeling, W. Va., and a large, practically rebuilt works at Philadelphia.

The company, formerly Merchant & Company, incorporated, was established in 1864. The business of the company has been on a constant increase, and, under the aggressive management of its president, Mr. Powell Evans, the large West Virginia plant and the complete renovation and rebuilding of the Philadelphia plant were determined upon and carried through during the last year. The company found these changes necessary on account of the fact that the steady

You will get SPECIAL ATTENTION if you tell Advertisers you read American Carpenter and Builder.



STAMPED STEEL TILING

Just the thing for
Bathrooms, Kitchens, Restaurants,
Butcher Shops, etc.

AND ITS RIGHT IN YOUR LINE

Real tile frequently becomes loose and falls off. This cannot. The studding or plaster is first sheathed with narrow, dry boards and the metal put on with small nails

SIX PATTERNS

Furnished with Baked White Enamel finish—or simply prime painted Metal trim Cap Base, Corners, etc., supplied or you can use wood trim.

NORTHROP, COBURN & DODGE CO.
29 Cherry Street, New York

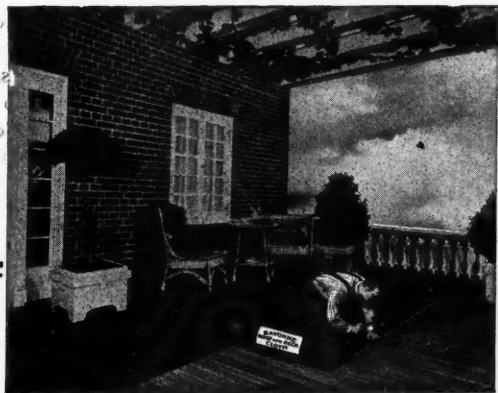

**Architects Recognize
Bayonne Roof and Deck Cloth
as Standard**

"50 years experience back of Boyle's Products" carries weight with the architect and builder who aim to specify and use the "best" building materials.

**BAYONNE
ROOF AND DECK
CLOTH**

This strong waterproof, wearproof canvas roofing answers every requirement in a porch and deck covering. It is so treated that the tensile strength and wearing qualities will double the life of a porch roof. Easy to lay and requires but one coat of paint. It will pay you to investigate. Write for sample card and Booklet N.

JOHN BOYLE & CO., Inc.
112-114 Duane St. NEW YORK CITY
70-72 Reade St.

WARNING!

Please take notice, that on account of certain Manufacturers, Jobbers and Dealers offering an imitation and inferior Metal Lath, representing it to be "BOSTWICK STEEL LATH", we are compelled to issue this notice that the Bostwick Fireproof Steel Lath is manufactured ONLY by us and by no other concern.

We are now attaching to every bundle of our own make, a tin tag, bearing our name.

Below is a fac-simile of the tag

also
of **TRUSS-LOOP** LATH.

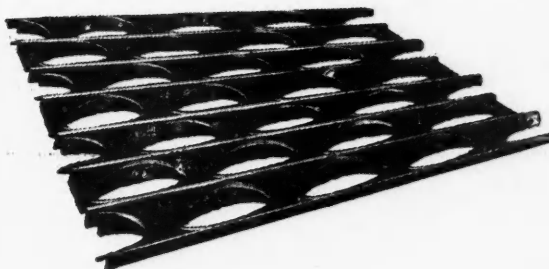
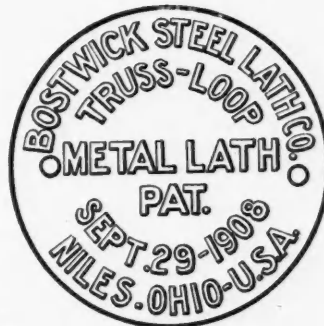

While we appreciate that to imitate our lath is a compliment and most flattering, **WE DO OBJECT** to have others reap benefits from our labors and our good name with the Trade. Some have gone so far as to almost imitate our name. In a spirit of fairness and a "Square Deal", we trust you will place your mark of disapproval upon these questionable methods by making sure that the goods are genuine and sending orders for Bostwick Fireproof Steel Lath "Truss-Loop" to

THE BOSTWICK STEEL LATH CO.
NILES, OHIO

You will get SPECIAL ATTENTION if you tell Advertisers you read American Carpenter and Builder.

growth of their business through the past few years had completely passed the capacity of the Philadelphia and Chicago plants.

The Wheeling works of the company are devoted almost entirely to the manufacture of tin and terne plates, and are absolutely modern in every particular. The Merchant & Evans Company located the plant in Wheeling, as they found it advantageous because of their large business throughout

for so long with fire retarding building materials, and the fact that Mr. Evans himself is a well-known fire-prevention student and expert, who has taken an active part in a public way in the prevention of fire waste, and is the head of the Philadelphia Fire Commission, whose work is attracting widespread attention, has resulted in this company drifting into an extensive department devoted to fire prevention engineering, and the manufacture and erection of automatic sprinkler sys-

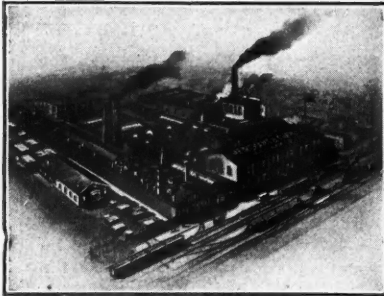

Philadelphia Plant

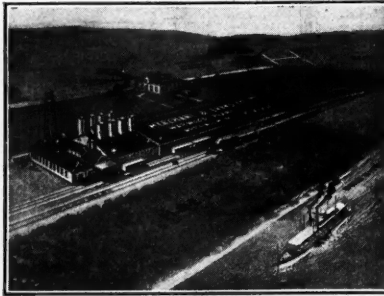

Warwood Plant, Wheeling, W. Va.

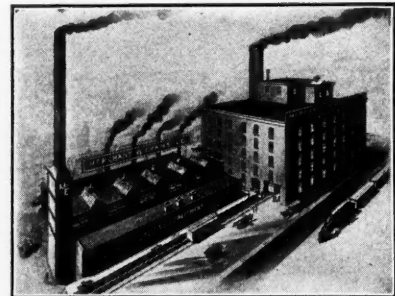

Chicago Plant

the country to put their tin plate mills in the Pittsburgh district.

Coincident with the great growth in volume and territory of this company's business, they have increased the scope of their business. For many years the company was known purely and simply as a metal house, but they have built up and have large and well organized departments devoted to the manufacture of their well-known "Star" ventilators, metal tiles and shingles, newspaper type metals and an especially large department for the production of automobile parts and accessories, including clutches, alignment joints, pressed steel tire cases, etc.

The fact that the business of the company has been allied

tems and standpipe systems. It is interesting to know the very large field covered by this concern in relation to the business of the architect, builder and engineer.

One of the most interesting features of this company's growth and recent expansion is the placing of their West Virginia plant in very close proximity to coal mines and the acquisition of large coal deposits to cover the company's future needs for fuel, making these works practically independent so far as future fuel needs are concerned. The above cut of their Wheeling works shows the modern plant, and its proximity to these coal mines, and also its admirable transportation facilities, both by the Ohio River and by the railroads running into its plant.

KISSELKAR TRUCKS

are built for your business

Saying that KisselKar Trucks are "built for your business" does not merely mean that there is a size to suit your requirements. *There is that and more.* There is back of KisselKar engineering an understanding of the special necessities in *your* line and no truck will go to you that is not scientifically designed to meet them.

Each and every truck order is considered separately—specially studied from the standpoints of burden to be carried, nature of loads, character of roads to be traveled and all other angles of *your* problem. You get a superior vehicle—as good as we can build—which means as good as anybody can build.

1500 lb., 1, 1½, 2, 3, 4, and 5-Ton Capacity

KisselKar Service Buildings, maintained at principal points throughout the United States, are supplied with facilities and trained men to give an unusual service to the owners of KisselKar Trucks.

SEND FOR FURTHER INFORMATION

Kissel Motor Car Co.

546 KISSEL AVENUE : HARTFORD, WIS.

New York, Chicago, Boston, Minneapolis, Milwaukee, Kansas City, St. Paul, Los Angeles, Dallas and 200 other leading centers.

This KisselKar Truck is doing great work for Schaefer Bros., cement dealers of Rochester, N. Y. It is a 5-ton model and wonder for heavy service. Most builders find the smaller Kissel models adequate for their needs.



When you buy a truck ask yourself these questions—

Are the makers of the truck responsible?
Do they maintain service stations?
Will they make repairs without delay?
Have they on hand a complete stock of parts to insure quick replacements?
Is service to owners with them a specialty rather than an incident?

If it's a KisselKar, an emphatic YES is the answer.

You will get SPECIAL ATTENTION if you tell Advertisers you read American Carpenter and Builder.

STANLEY'S

Wrought Steel Screen Door Hardware

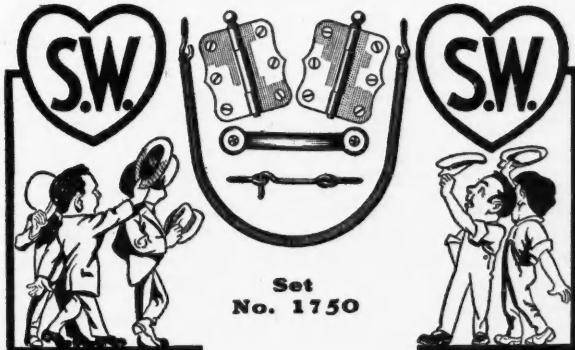

Each Set Complete with Screws Ready to go on the Screen Door

Owners and Builders alike are pleased with the high quality of the hardware and the convenient way it is packed ready for use.

Butts, pull, spring, hook and eye and screws, all of the highest quality of material and workmanship

They can be furnished in Japan, Antique Copper, Brass or "Stanley" Sherardized rust-proof finish, the proper finish for outside doors.

Write us for Circular "A". It tells the story.

THE STANLEY WORKS

New York New Britain, Conn., Chicago



All Kinds. All Styles. All Sizes. All Prices.

And they're all easy cutting.

This quality in a saw depends on the steel that's in it and the way it's ground. Simonds steel is not equaled for toughness and temper holding.

You can make the teeth sharp as a needle and they will stay that way for a long time. Blades ground thinner on the back than at the tooth edge. You saw faster and easier.

Send for a free copy of "Simonds Carpenter Guide"

Simonds Manufacturing Company

Fitchburg, Mass.
New York City
Portland, Ore.
Vancouver, B. C.

Chicago Ill.
New Orleans, La.
San Francisco, Cal.
Lockport, N. Y.

Montreal, Que.
Seattle, Wash.
London, Eng.
St. John, N. B.



On Our

Saved \$360

Material

Bill of \$969 Complete

I furnished all the material complete, for this 8 room house for A. L. Clark, at Rochelle, Ill. Lumber, Lath, Shingles, Doors, Windows, Trim, Millwork, Guttering, Sash Weights, all Hardware, Nails, Paint and Varnish, (two coats inside and outside), everything complete, except masonry, for \$969. Dealer's price was \$1,329, an exact saving of \$360.



H. B. Mungler, Pres. 30 Yrs. Experience.

My two books, plan book (of 50 house plans) and building material catalog (of 8,000 illustrated bargains) mailed absolutely free and without obligation.

The books cost you nothing and show the way to big savings. In building and repair work they are a most valuable price guide.

GOING TO BUILD?

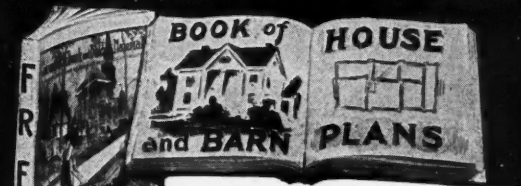

These Two Books Will Reduce Your Building Expense. NOW — Mail Coupon.

Doors of All Kinds

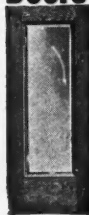

At Wholesale Prices
Glass Doors \$1.77 Up
Lock Sets 21c Up

Wearwell Paint



Perfect guaranteed house Paint, only \$1.20 per gal. in 5 gal. kits. We have all kinds of good paint at wholesale prices.

Economy Rubber Roofing

2-Ply 45 pounds guaranteed 7 years, \$1.35
3-Ply 55 pounds guaranteed 10 years, \$1.60



Clear Lattice 30c Per 100 Feet

Chicago Millwork Supply Co. 1422 W. 37th St. Chicago

Chicago Millwork Supply Company, 1422 West 37th Street, Chicago, Ill.

Gentlemen: Please send your FREE Books, listed below to

Name

Address State

Catalog No. 43, Building Materials. Book No. 53, House and Barn Plans.

You will get SPECIAL ATTENTION if you tell Advertisers you read American Carpenter and Builder.

Clow Cast Iron Specialties



A-2187
Ex. Hy. Cesspool, Long Outlet

Size of top.....In.	12x12	16x16	18x18
Depth.....In.	10	10	10
Size of outlet...In.	3	4	6
Length of outlet..In.	10	10	10
Painted, net Each	3.09	3.68	7.15



A-2185
Extra Heavy Cesspool

Size of top.....Inches	16x16
Depth.....Inches	10
Size of outlet.....Inches	4
Painted, net.....Each	2.00

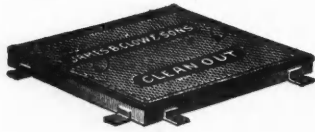

A-1700
Cleanout Cover and Frame

Size.....Inches	27x27
Size of frame, outside...Inches	27 1/4 x 27 1/4
Height of frame.....Inches	4
Price, Standard, net.....Each	\$ 9.00
Price, Extra Heavy, net.Each	18.00

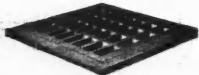

A-2015
Grating with Loose Frame

Size, inches	8x8	10x10	13 1/4 x 13 1/4	18x18
Grate only net.	.60	.98	1.43	1.80
Grate and frame, net	.83	1.28	1.88	2.25

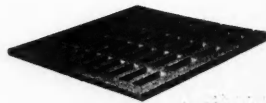

A-2020
Grating
Size, inches..... 9x9 13 1/4 x 13 1/4
Price, each, net... .75 \$1.13

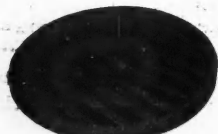

A-1945
Cast-Iron Grating
Concave, diam. 19 in., net, each \$3.38
Convex, diam. 22 1/4 in., net, each 3.75



A-1950
Cast-Iron Grating
Each
Diameter.....Inch net
Diameter.....14 \$1.58
Diameter.....16 2.06
Diameter.....18 2.25
Diameter.....20 2.48
Diameter.....21 1/2 2.81
Diameter.....23 3.19
Diameter.....25 3.56
Diameter.....30 3.94



A-1955
Cast Iron Bar Strainer
Diameter . 4 5 6 7 8 9 10
Net, each. .07 .09 .11 .15 .23 .28 .37



A-1710.
Cleanout Cover and Frame
Opening, diam., in. 18 24 34
Top, Outside, diam., in. 22 28 38
Price, net, ea \$4.13 \$6.00 \$9.00

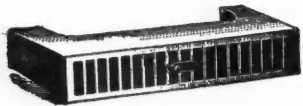

A-2200
Air Brick with Sliding Ventilator
Size.....Inches 8 1/2 x 5 17 x 2 1/2 17 x 5
Price, net...Each 2.50 2.50 5.17



A-1720.
Cleanout Cover and Frame
Opening, diameter, inches... 18
Top, outside diam., inches... 22
Base, outside diam., inches... 28
Price, net, each.....\$4.88

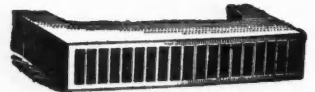

A-2201.
Air Brick
Size.....Inches 8 1/2 x 5 17 x 2 1/2 17 x 5
Price, net...Each 2.20 2.20 4.40

Hollow Wall Construction Greatly Favored

We show here a double house of hollow wall construction with stucco finish, recently built on the old Faulkner estate in Brooklyn, N. Y. The interesting point in this is that it is only one of fifty similar houses to be erected on the same estate. This house is 40 by 44 1/2 feet, the walls being 10 1/2 inches thick. This thickness allows 4 inches each for the inside and outside walls with an air space of 2 1/2 inches. The design by architect C. R. Van Dusen, Hollis, L. I., was carried out by the Hollow Wall Construction Co., New York City. The Van Guilder System was used.

A significant thing in relation to the Van Guilder System of hollow wall construction was recently emphasized by the Board of Building Superintendents of New York City. Each borough has its Building Superintendent who always specifies the thickness of the walls for each building, according to his ideas. Construction is closely watched and inspected. The houses built by the Van Guilder System have come in for their share of attention. When the Board of Building Superintendents met on Mar. 25th, they endorsed the Van Guilder



Double House at 1631 E. 12th St., Brooklyn, N. Y., Built by Hollow Wall Construction Co., 280 Broadway, New York, Using the Van Guilder System

er plan of making the walls 10 1/2 inches thick, that is, with two 4-inch walls separated by a 2-inch in space, the same as in the house shown above. The system was fully approved for use throughout the entire city of New York. This means that Van Guilder Hollow Wall Houses may be built as heretofore.

This favorable decision is indeed a great victory for this method of construction. The stamp of approval placed on the system by such high authorities as the Building Superintendents of our largest city indicates that Van Guilder houses will be universally accepted as high standards.

Not alone in New York but way up in Maine, extensive building is going on. At the Farm for Truant and Delinquent Boys, Hinckley, Maine, twenty-one buildings are proposed by Dr. E. M. Santee, Director of Agriculture. The proposal includes dairy barn, piggery, green house, dairy, cannery, root cellar and 15 poultry houses. The Van Guilder System will be used entirely.

The Van Guilder System, making such rapid strides into public favor, certainly must have merit to back it up. Years of development indicate that this mode of construction will be extensively followed. We sincerely hope our readers will investigate its good points. Catalogs and circular matter will be gladly furnished by the Van Guilder Hollow Wall Co., 720 Chamber of Commerce, Rochester, N. Y.

Send For Catalogue 39

James B. Clow & Sons

CHICAGO, ILL.

You will get SPECIAL ATTENTION if you tell Advertisers you read American Carpenter and Builder.

HE can't afford to take chances. When he sees the Irwin stamp, he's sure. He knows an

Irwin Bit

is made of one-piece flawless extra high-grade crucible auger-bit steel and tempered by the secret Irwin Process. He knows it will not bend or break where twist and shank unite—the weak spot in common bits.

He knows the Irwin is the only solid-center-stem bit made in all sizes and styles, for every purpose—6,500 different sizes and styles to cover every requirement.

He appreciates the fact that the Irwin hand-filed, sharp edge will bore true into the hardest wood known, even lignum-vitae. He has learned that his work with an Irwin will be rapid, true and sure. That his knowledge and workmanship will be backed up to the limit of efficiency when he has Irwins in his kit.

Therefore, he asks his dealer for Irwin Auger Bits. If your dealer hasn't got them, write us direct.

The Irwin Auger Bit Company

Station G-18 *Largest in the World* Wilmington, Ohio

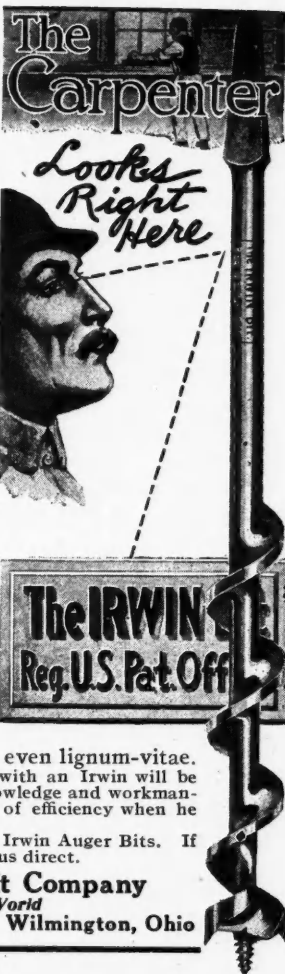

No. KRB—Size 8 in.

Durable Files

Keen Kutter files will easily outlast the ordinary kinds and give better results. They are uniform in temper, teeth are of even depth and cut at proper angle. For quickest and easiest work buy the files bearing the famous trade mark

KEEN KUTTER

and you are guaranteed satisfaction or money refunded.

"The Recollection of Quality Remains Long After the Price is Forgotten."
Trade Mark Registered. —E. C. SIMMONS.

If not at your dealer's, write us.

SIMMONS HARDWARE CO., Inc.

St. Louis New York Philadelphia
Toledo Minneapolis Sioux City Wichita

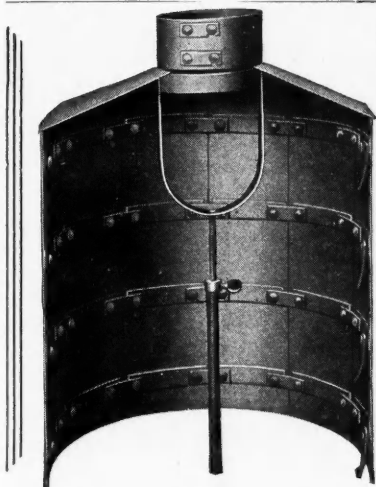

You Can Make 300% Profit MAKING CONCRETE CISTERNS WITH LAUGHLIN COLLAPSIBLE AND ADJUSTABLE FORMS

These forms can be erected by anyone without experience. They are simple in construction, strong and durable and can be adjusted to any size.

*No Tools Required. No Waste of Material.
They Last a Lifetime.*

They are great money makers for the up-to-date builder.

LAUGHLIN MFG. CO. - Dept. F - DAYTON, OHIO

Sliding Doors

For weather protection. Schouler Patent Metal Strip and Guide is the only practical door weather stripping made. Schouler Sliding Door Weather Stripping can easily be applied to any type of sliding doors, of heavy metal. Wears for years. Catalog and other particulars—FREE. Write NOW to Schouler Construction Co., 111 Frelinghuysen Avenue, Newark, N. J.

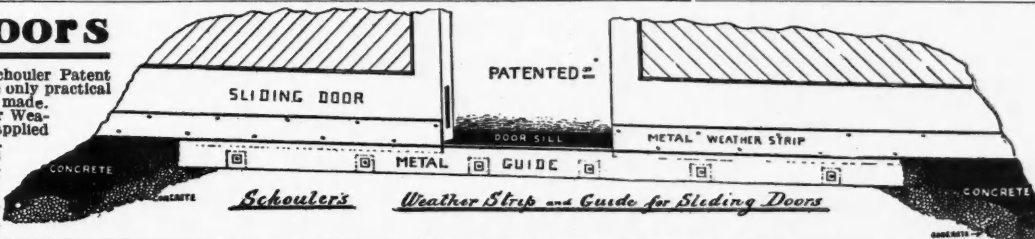

SAMSON SPOT SASH CORD

Reg. U. S. Pat. Off.

Samson Cordage Works

Boston, Mass.

Made of extra quality stock, carefully inspected, and guaranteed free from the imperfections of braid and finish which destroy common cords so quickly. The spots on the Cord, in any color, are our trade mark. Don't be misled by imitations. Samples and full information gladly sent.

A Warranted Success

That the excellent features of the "Big-an-Little" mixer are recognized is evidenced by an order from a European contractor for four of these machines.

Since their start in business years ago, the Jaeger Machine Company have shown a remarkable interest in the development of their mixers. Realizing that the only way to court favor with the carpenters and contractors is to show exceptional merit in their machines, these people have studied how to make the best mixers from the standpoints of durability and efficiency. Their excellent understanding of the builder's needs places them in a position to keep abreast of the times in every little detail. The fact that they have succeeded is borne out by their constantly increasing sales.

Year by year, this company has gone on making an improvement here and there, adding a new feature now and again until the "Big-an-Little" is said to stand in a class by itself. Many of our readers have told us of its good points and we have been glad to hear how popular the mixer was because such determined effort by the Jaeger Machine Company to produce a first-class machine is worthy of success. We're glad too because our people do and will want the mixer that will be a help, not a hindrance.

The "Big-an-Little" mixer equipped with the hoist is certainly an aid to faster and better building—the kind of building that we advocate—the kind that our people want to do. The concrete mixer has come to stay. It is part and parcel of the builder's equipment—indispensable in fact. The hoist! What possibilities there are in a simple hoist! How easy it is to handle with its aid, work that heretofore has required the time of two or three men.

The Jaeger Machine Company, 218 West Rich St., Columbus, Ohio, really deserve the time it will take for you to look over their catalogs. They are sent free.

Potter Bros. New Star Scribes

Potter Bros. Co., 612 W. 110th St., New York, have recently brought out a new line of scribes, which are known and sold as the "Star" 3½-inch scribes. These tools are made with either sharp or broad point and have the Potter exclusive adjustment slot, which allows use of ¾ inch of pencil before readjustment becomes necessary. One of these new scribes is illustrated herewith. They are sold at a comparatively low price and can be furnished with a steel point, which is easily inserted in place of the pencil, if desired. Ask your hardware dealer to show the Star scribes.



Star Scriber with Sharp Point

Potter Bros. Co. also make the well-known line of Peerless scribes and the Peerless bit gauge, for which they have had an unusually large sale. Their line includes at least ten leading specialties particularly designed for carpenters and woodworkers.



D. C. Builders Elect Officers

At the Annual Meeting of the Builders' & Manufacturers' Exchange of the District of Columbia, June 2nd, 1913, the following officers for the year were elected: Chas. A. Langley, president; W. T. Galliher, first vice-president; Thos. W. Smith, second vice-president; E. R. S. Embrey, third vice-president; Frank L. Wagner, treasurer; Chas. E. Welsh, secretary.

On April 15th the Exchange moved to this location from 1317 H Street, N. W., occupying the entire building. The first floor is devoted to Exchange offices, exhibits and desk spaces which are rented to those engaged in various branches of the Building Trades.

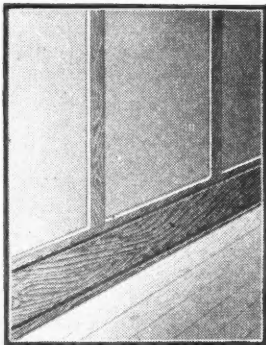

CEIL-BOARD

Ceil-Board

WHICH?

Plaster—with a long wait for drying—cracks, chips and crumbling—inability to decorate for weeks after being put on—moisture absorption and keeping the house damp and unhealthy for a long period, or—

CAREY CEIL-BOARD

lasting as long as the building—no wait for drying—no cracking or falling off—easily put on; all you need is a saw, hammer and nails—cold proof, vermin proof and fire-resisting—takes wall paper, paint and stain beautifully—and costs less than plaster?

Send post card today for sample of Ceil-Board and a descriptive booklet.

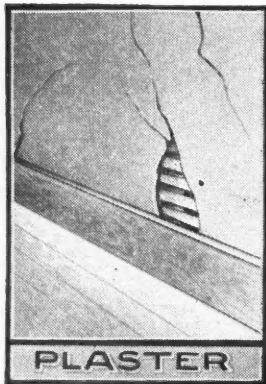

PLASTER

Plaster

versus



THE PHILIP CAREY COMPANY

General Offices and Factory: 58 Wayne Ave., Lockland, Cincinnati, O.

- | | | | | | |
|----------------|-------------|---------------|----------------|----------------|-------------|
| Allentown, Pa. | Chicago. | Jacksonville. | Montreal. | Pittsburgh. | St. Louis. |
| Atlanta. | Cincinnati. | Kansas City. | Nashville. | Portland. | Syracuse. |
| Baltimore. | Cleveland. | Knoxville. | New Orleans. | Rochester. | Toledo. |
| Birmingham. | Dallas. | Little Rock. | New York. | San Francisco. | Toronto. |
| Boston. | Denver. | Los Angeles. | Oklahoma City. | Scranton. | Wheeling. |
| Buffalo. | Detroit. | Memphis. | Omaha. | Seattle. | Winnipeg. |
| Charlotte. | Harrisburg. | Minneapolis. | Philadelphia. | Spokane. | Washington. |
| Chattanooga. | Havana. | | | | |

You will get SPECIAL ATTENTION if you tell Advertisers you read American Carpenter and Builder.

A-A-A-Asphalt
Cement.
B-B-B-B-Fiber
Board.

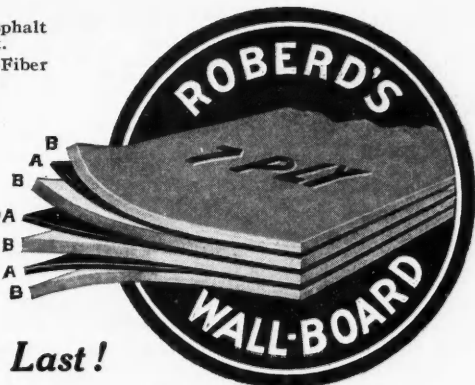

At Last!

Seven-Ply Wall Board

At last you can have a perfect wall board, stiffer, harder, tougher, more easily handled, more quickly applied and more satisfactory when on the walls. We have solved the problem. We are now making

Roberds Ideal Wall Board

with four layers of fiber board and three layers of asphalt adhesive compound. Our discoveries, our special machinery, our secret methods of manufacture and our original asphalt cement make possible the production of this IDEAL WALL BOARD.

Dealers everywhere are enthusiastic about it. Contractors prefer it to all other brands. Home owners delighted with the fine finish and the perfect butting of edges which enables them to paper direct to the wall board.

We have doubled the capacity of our plant to take care of the increasing demand for Roberds Ideal. No advance in prices. Special inducements to the trade. Write today for our dealers' proposition.

The Roberds Manufacturing Co.

100 Railroad Street

Marion, Indiana

Metal Building Corners

A Great Improvement Over Corner Boards

TIME SAVING - MONEY SAVING
MORE DURABLE - BETTER APPEARANCE

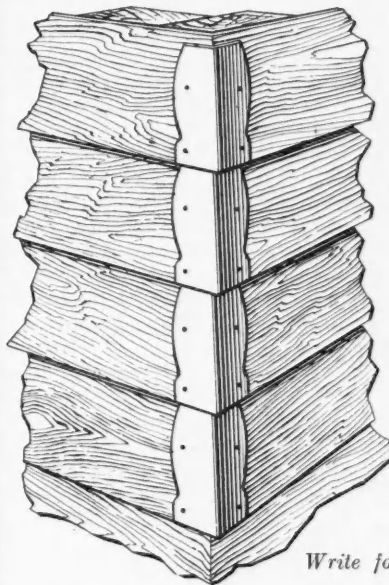

Carpenters!

By using the
**Merwin Metal
Building Corners**

You save much time, consequently money, as no beveling or mitring is required.

There are no joints to warp or open and even the ends of the clapboards need no squaring.

Merwin Metal Corners

are the latest up to the minute accessory. Made of galvanized iron.

Write for Prices and Free Samples

MERWIN MANUFACTURING CO.
ERIE, PA.



*Green, Plain Red and
Red Hexagonal*

NEPONSET

PROSLATE ROOFING

For residences, bungalows, club houses and all buildings requiring an artistic roofing. Just the thing for flat porch roofs.

BIRD & SON
(F. W. Bird & Son)

27 RIVER ST., EAST WALPOLE, MASS.

New York Chicago Washington
Portland, Ore. San Francisco
Canadian Plant, Hamilton, Ont.



The Only Wall Board That Can Be Successfully Papered

BECAUSE it is the only wall board that is strong enough and stiff enough to stand the "pull" that wall paper exerts when adhered to another surface.

Compo-Board is also the only wall board that doesn't have to be paneled. You can panel it if you wish, but you can also have walls and ceilings smoother than plaster that lend themselves to artistic decoration by any method.

The hundreds of contractors and builders who use Compo-Board are able to deliver a more satisfactory job in a shorter time and get a higher price.

Write for a sample and interesting booklets on Compo-Board. Learn about its unique construction, its strength, durability—insulating, fire resisting and moisture proof qualities.

Compo-Board is sold in strips four feet wide and one to eighteen feet long, by dealers in most every town.

Northwestern Compo-Board Co.

5777 Lyndale Avenue North :: Minneapolis, Minn.

You will get SPECIAL ATTENTION if you tell Advertisers you read American Carpenter and Builder.

A Free Book of Money Saving Ideas For Dairy Barn Builders



You will be interested in reading "Helpful Hints to Dairy Barn Builders." It tells many of the things learned by W. D. James—America's foremost dairy barn designer. It will help you make more money.

It tells about the new plank frame construction, the famous King system of ventilation, perfect lighting, proper width and arrangement. It tells about

stable floors, site, size, appearance, design, drainage and equipment. And it shows four floor plans of barns that have attracted widespread attention.

You can obtain a copy of this valuable, helpful book FREE. Merely answer these few questions and the book will come by return mail. For whom do you expect to build or remodel dairy barns? (Give name and addresses.) When? For how many cows? Address

James Manufacturing Company
8675 Cane St., FT. ATKINSON, WIS.

Special Offer Of Blue Prints

Mr. James wants to make you a special offer of complete working blue prints of modern dairy barns of different sizes and types. Also ask how to secure free help from our agricultural department. Write today.



Making Cistern Work Pay

As long as there are houses beyond the reach of city water-works as long will cisterns be in demand. The storage of water is a necessity for the small town or farm house and people have found that the cistern is a pretty useful thing.

Now what is the most economical cistern from the stand-points of first cost, durability and cleanliness? Not wooden cisterns for wood collects moss, rots and dirties the water imparting to it a foul odor. Not brick, for brick and mortar crumble under the action of water and the brick dust will give the water that peculiar dirty red color. Brick cisterns frequently cave in. There still remains the cement or concrete cistern and this always proves the cleanest, most lasting and inexpensive piece of work.

To build such a cistern forms are necessary, but most builders do not know just what these forms are like or where they can be procured. Consequently it is a pleasure to point to the Laughlin Cistern Forms that make concrete cistern building as simple as can be. Such forms must necessarily be strong to withstand the rough usage of inexperienced help beside the usual wear and tear. The builder wants forms that will meet all requirements where the holes are dug unevenly and to offset the disadvantages of wet soil and caveins.

The Laughlin forms shown in the illustration are made from non-rusting cold rolled steel. There is no woodwork to swell and crack the concrete. Neither is there any waste

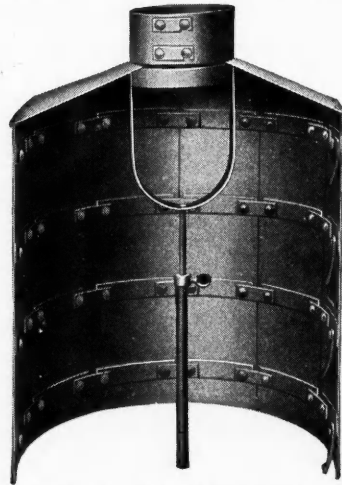

The Laughlin Cistern Form

material as is always the case when wood forms are used. The Laughlin forms are adjustable to any size to give a cistern capacity of from 25 to 100 barrels, as the hole may be dug. With two forms the capacity can be increased to 500 barrels. The arches are collapsible and will not dip. In setting up the forms a hammer is the only tool required. They are just as easy to take down as they are to set up.

Any builder with limited capital will find these forms sure money-makers. He can build three cisterns a week with the one form and no high-priced or experienced help is necessary. Laughlin forms provide a simple and practical method of making cisterns for anyone who knows how to handle concrete.

Our builders should write the Laughlin Mfg. Co., Dept. F., Dayton, Ohio, for further information.

Single 5 H.P. **MONARCH** Twin 10 H.P. \$225 \$275

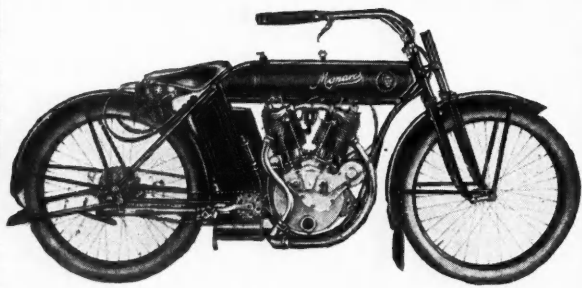

Power - Speed - Durability - Class

The last word in Motorcycle construction. The 10 h. p. twin is indeed the ideal mount. Power enough to go anywhere and more speed than you will care to use, and yet so flexible that it will start on a walk and operate with ease in the busiest traffic.

The single in either V belt or chain is the only machine for the man that wants plenty of power but does not care for a twin.

We would like to post you further; so please address Sales Dept.

IVES MOTORCYCLE CORPORATION
OWEGO TIoga CO. NEW YORK

SASH MOUSE

USE the "HAN-COT" Sash Mouse for placing sash cord in window frames.

59 inches long, consisting of fastener, chain and weight. No tying or untying necessary—takes but an instant to insert the cord in the fastener.

SEND for one NOW—you'll need it on your next job. Price 30 cents prepaid, or at your dealers.

HANDLEY & COTTERMAN
Atlas Bld., 164 N. Wabash Ave., CHICAGO



You will get SPECIAL ATTENTION if you tell Advertisers you read American Carpenter and Builder.

Fasten Your Fixtures

Mantels, Pipes, Switch Boxes, etc., to the wall, whether it be concrete, tile or plaster, with **Richmond Screw Anchors**

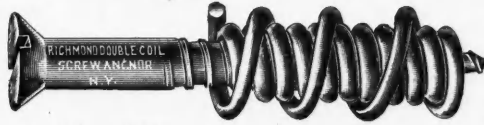

A No. 16 wood screw, with Richmond Screw Anchor, will hold fast anything up to 1300

pounds in weight.

For 50c we will send you Richmond Anchors for any kind of wood screw or work you desire, by parcel post, to prove the qualities of our anchors. SEND NOW!

Our Circular is free and interesting

RICHMOND SCREW ANCHOR CO.
10 Church Street NEW YORK CITY

Weather Vanes

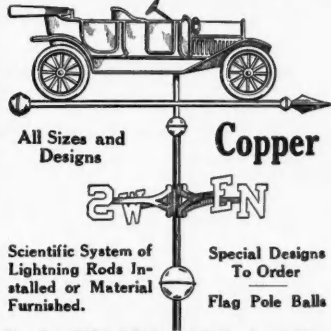

All Sizes and Designs

Copper

2W EN

Scientific System of Lightning Rods Installed or Material Furnished.

Special Designs To Order

Flag Pole Balls

Send for Our New Catalog

Every builder should have a copy of this catalog. It is the first complete catalog on this subject ever issued. Shows all vanes in gold. Write for your copy today.

We Protect the Builder

E. G. WASHBURNE & CO. 210 Fulton Street, New York

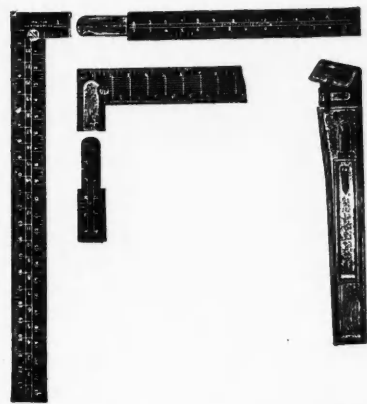

This is the Standard Take Down Square.

It makes good with the user.

Send and know more about it.

Southington Hardware Co.
Southington, Conn.

Reinhardt Profile Gauge

A NEW TOOL

For outlining all irregular Curves or Shapes. Invaluable for Builders, Carpenters, Woodworkers and Patternmakers.

FOR EVERYBODY WHO MEASURES ANYTHING!

Style A—2" 30c., 3" 45c., 4" 60c., 5" 75c., 6" 90c.

Style B—Heavier side plates rods 1 1/2", 8", \$1.60; 10", \$2.00; 12", \$2.40; 14", \$2.80.

Send 15c. for sample. It will show just what the gauge will do.

Satisfaction Guaranteed or Money Refunded

WARREN PROFILE CO., 103 Chambers St., N. Y.



Eureka

Mixer for Building Contractors

50 to 80 yards per day
Furnished in all sizes
from 5 to 35 yards per hour



Over 300 Eureka's used in New York City

These Striking Eureka Advantages Compel Attention

It will save one-half in labor over hand mixing.

A thorough uniform mix is guaranteed and full rated capacity.

The average life is six to eight years.

It can be operated by three men or will accommodate a dozen.

Costs about 50 cents a day for gasoline. Built extra strong and can be depended upon for hard, continuous service.

Easy to move and operate.

Material shoveled direct into bins—no wheeling.

Only necessary to keep bins supplied with material—measured automatically.

One lever stops and starts mixer—another the feeders.

Equipped with a strictly high-grade engine Bosch magneto if desired.

Eureka mixers are in use everywhere and always satisfactory.

On this satisfaction to the user Eureka prestige has been built.

Ask for catalog No. 30 and names of Eureka users in your territory.

EUREKA MACHINE CO.
85 Handy Street LANSING, MICHIGAN

W. V. JOHNSON & CO., General Eastern Agents
1 Madison Avenue, New York City

Atlanta	Dayton	Kansas City
Cedar Rapids	Detroit	Peoria
Chicago	St. Wayne	Pittsburgh
Cincinnati	Houston	Salt Lake City
Dallas	Indianapolis	Winnipeg

You will get SPECIAL ATTENTION if you tell Advertisers you read American Carpenter and Builder.



Builders and Carpenters

Who realize that absolute *customer-satisfaction* is not only necessary for success but also the most profitable to them, are fast coming to appreciate

UTILITY Wall Board

For **UTILITY WALL BOARD** is a wonderfully tough and durable fibre board impervious to moisture. It is air-tight and non-porous, and keeps the house dry, sanitary and healthful. Then, too, it makes a smoother wall than lath and plaster.

UTILITY WALL BOARD is nailed directly to the studding. It comes in sheets of convenient lengths and widths. It is easy to handle and apply. And you can put on **UTILITY WALL BOARD** at any time without regard to the weather.

You should write **TODAY** for the **SAMPLE** we will gladly send you. And for the **Book of Interiors**.

THE HEPPE'S CO.

*Also manufacturers of Flex-A-Tile
Asphalt Shingles, Asphalt Paint
and Asphalt Roofing in any Finish*

4503 Fillmore Street

Chicago, Illinois

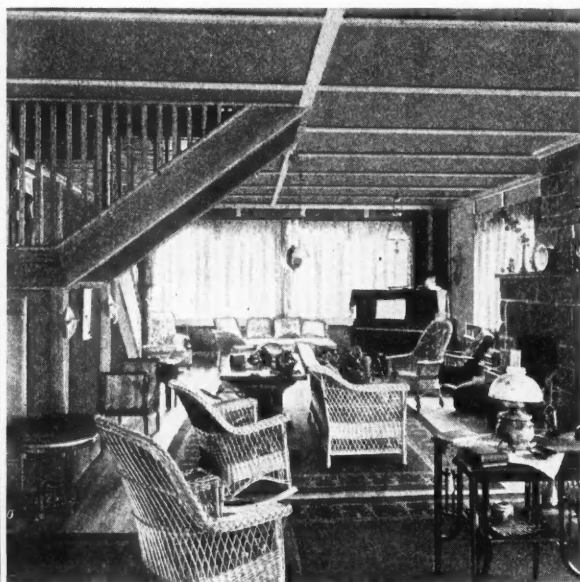

You will get **SPECIAL ATTENTION** if you tell Advertisers you read **American Carpenter and Builder**.

A Contractor's Hand Portable Woodworker

Since the contractor and builder came to realize the importance and necessity of using machinery in his building operations, there has been noted a rapidly growing and ever present demand for a small, compact and reliable combination woodworking machine that can be easily and readily moved by one or two men through any door—a hand portable machine to take on the job or use in the shop and to carry its own power or be so constructed that it can be used in connection with any available power in the building.

It will not be surprising to our readers to learn that the progressive specialists in this line, The Sidney Tool Co., Sidney, Ohio, have met this demand,—as they meet all demands of the modern woodworker,—and have brought out the "Famous" Contractor's Hand Portable Woodworker, illustrated elsewhere in this issue of the **AMERICAN CARPENTER AND BUILDER**.

It is claimed for this machine that, being made entirely of iron and steel, it is more compact and not so bulky and cumbersome as the wood frame machines, will do more and better work, takes less power, and has the advantage of being readily movable from place to place, through any door, one man only being required to move it. Practically every operation in wood done by carpenters, contractors and builders can be done on this new "Famous" machine and it is well worth investigation by our readers.



The "Dimo-Grit" Book

In a new catalog just prepared by the Luther Grinder Mfg. Co., 657 Michigan Ave., Milwaukee, Wis., our builders will find many helpful hints in their selection of tool grinders.

Looking through this fine book, we are greatly impressed with the number and variety of grinding devices shown. There is one for every use the carpenter could think of. All the grinders are nicely illustrated and described, making this book a reliable reference for any time.

"Dimo-Grit," the trade name for a combination of natural

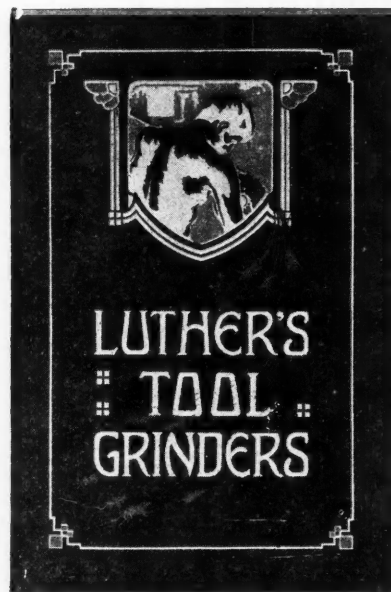

New Catalog Sent Free.

abrasives made up into a high-grade sharpening substance, is not restricted in its use. The manufacturers have prepared several grades of the substance and each grade has after long experiments been found especially good for use in sharpening certain tools. Thus the carpenter is consulting these people as to what stone to use for certain tools is assured of advice that cannot help be beneficial. Such advice coming from such authorities will enable the carpenter to use his tools to better advantage and the tools will last longer.



LIVING ROOM

showing Oscillating Portal Wall Bed with a combination writing desk, book case and dressing mirror on the front of the bed. A buffet, book case or furniture of any kind, may be used. By utilizing the front of the bed for a piece of furniture, you save the wall space that this furniture would otherwise require, and perfectly conceal the fact that there is a wall bed in the room. All of the drawer and locker space of the furniture is available.

Wall Beds

We are the Pioneers of the wall bed industry. We particularly recommend our latest achievement, the Oscillating Portal Wall Bed, which is an absolutely sanitary bed. We also make the old style recessed Upright Wall Bed, which has the wooden frame work under it. To introduce our wall beds more extensively in the eastern and middle States, we will sell at cost, and prepay the freight charges to any part of the United States, where we are not represented, for a limited time only. Write for literature and particulars today.



BED ROOM

with an Oscillating Portal Wall Bed, showing entrance to the closet while the bed is down. No additional door is necessary to permit free access to the closet. The bed is all metal, is full size, standard height. It has no frame work underneath to collect dust or VERMIN. When the bed is not desired, the bed room is immediately transformed into a perfect living or dining room.

Marshall & Stearns Company

San Francisco, Cal.

Durability, Strength and Beauty,

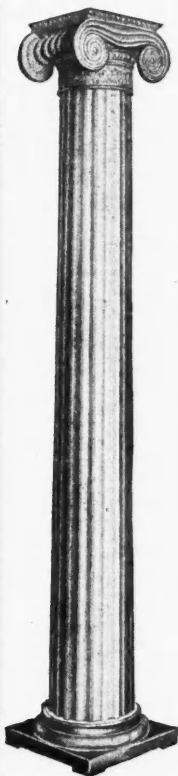

Design No. 214

the three essential requisites for an ideal column are embodied in

Union Metal Columns

(PATENTED)

They are made of combination high-grade steel and cast iron, and are therefore free from such serious defects as splitting, opening up of glued joints, warping, rotting, etc., etc.

UNION METAL COLUMNS are made of the same high-grade materials, and by the same processes, dies and machines, that we use in the production of our popular lines of ornamental lamp posts which are in universal use on the streets of the leading cities and towns throughout the U. S. and Canada. This is the evidence of their real substantial nature as compared with a column made of wood.

How long would a lamp post made of glued-up scrap lumber last, if placed upon the public streets of a city?

UNION METAL COLUMNS are made in all sizes, from the smallest to the largest. Prices are very reasonable.

Send for our new art catalog, mailed free of cost to you on application.

The Union Metal Manufacturing Co.
SOLE MANUFACTURERS
1400 Maple Avenue - CANTON, OHIO

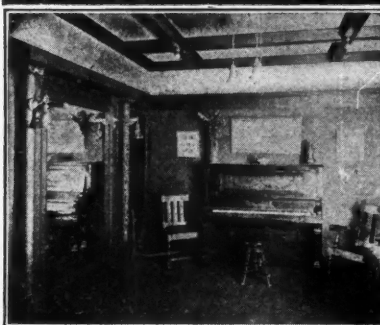

TWO Rooms in ONE

Utilize every inch of space in building—make 3 rooms equal 5.

Save space for the owner and yet

build an attractive, convenient home for either his use or rental.

PERFECT WALL BEDS have solved the space question. An attractive, richly furnished console or side board conceals bed. Ample ventilation is provided. Entirely sanitary. Space beneath bed easily cleaned—no moving of bed necessary.

Builders investigate PERFECT WALL BEDS. Let us explain them to you in detail—show you how and why your clients like them. Write for full FREE particulars.

Perfect Wall Bed Co.

430-2 S. Wabash Ave.
CHICAGO ILLINOIS

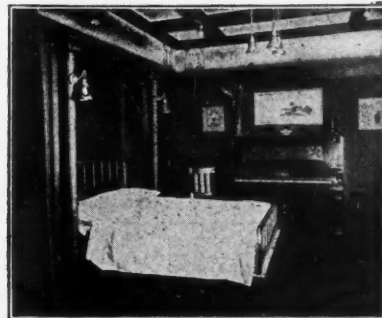

You will get SPECIAL ATTENTION if you tell Advertisers you read American Carpenter and Builder.

Ideal Furnaces

A big feature in the construction of the Ideal Furnace, which is manufactured by the Ideal Furnace Company of Detroit, Michigan, is the unusually large amount of air



A Popular Furnace

space provided around the radiator. This, in effect, produces a continual volume of heated fresh air, rather than a small draft of super-heated air.

Ideal Furnaces are widely known and widely used. They are built upon a thoroughly practical heating principle and

in an entirely scientific and substantial manner. The Ideal Company give an absolute guarantee with every furnace their plant makes.

The fire-pot—"the heart of any and every furnace"—in the Ideal is of two section construction. This type of making avoids cracking from unequal expansion.

A triangular anti-clinker grate, which revolves when cleaned is used. This grate is practically indestructible as it presents a different side to fire each time it is turned.

Other points of particular interest in Ideal construction include deep cut joints between sections, which are packed with asbestos, preventing the escape of gases and smoke, and dust flue connecting the ash pit with the doors and carrying away all dust.

This company are also builders of an Ideal Type No. 20 furnace, which is of standard pattern and construction. It is a powerful heater, economical to maintain and has given universal satisfaction.

Catalogs covering in detail their entire furnace line are issued by the Ideal Company and can be obtained for the asking. Detroit, Michigan, is their address.

New Brush Booklet

"Lest you forget," sit down and write to the Joseph Dixon Crucible Company, Jersey City, N. J., for a copy of their attractive new booklet, "Dixon Graphite Brushes." Dixon's Brushes for dynamos and motors have long had an enviable reputation for perfect commutation.

In addition to complete rules for using the brushes under various conditions of service there are also included valuable suggestions for using Dixon's Lubricating Rods for manufacturing arc light plungers, oilless bearings, dashpots, and for other applications where oil or grease lubrication cannot be conveniently employed.

KNO-FUR METAL LATH

ELIMINATES THE NEED OF SHEATHING, BUILDING PAPER AND FURRING

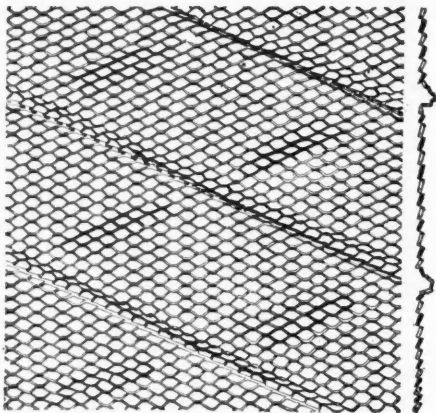

KNO-FUR is cut from U. S. Standard gauge sheet, size 22 x 96 inches.

Contractors, Carpenters, Builders!

Get acquainted with this New Metal Lath for Exterior Work.
Send for our new Booklet 37

It's the plaster-gripping and self-furring features of

KNO-FUR Metal Lath

that makes it the most desirable form of metal lath on the market for exterior use.

The parallel ribs of KNO-FUR are a part of the mesh not solid steel with expanded metal between. The plaster "clings" to the web-like mesh of these ribs—thus forming reinforced concrete beams which greatly increase the strength of the completed work. KNO-FUR eliminates the use of building paper, sheathing and furring.

It is acid proof and rust resisting, being made of a special metal.

NOTICE:—We ship KNO-FUR within 24 hours of receipt of your order.

Send for Any or All of these Booklets:

KNO-BURN Lath Booklet.
XX Century Lath Booklet.
Metal Lath for House Construction.
ECONO Reinforcing Booklet for Architects and Contractors.
ECONO Reinforcing Booklet for Engineers and Contractors.

Northwestern Expanded Metal Co., 903 Old Colony Building., Chicago, Ill.

Also manufacturers of ECONO, KNO-BURN and XX Century Metal Lath

You will get SPECIAL ATTENTION if you tell Advertisers you read American Carpenter and Builder.

LONG LIFE ROOFING AND SIDING



Ask Your Jobber

The Stark Rolling Mill Co.

Canton, Ohio

Also Manufacturers of Black and Galvanized Sheets and Formed Products.



OAK FLOORING

"AMERICA'S BEST FLOORING"

Builders and owners will find it a clinching argument to say "It's floored with OAK FLOORING." It is the biggest single feature to look for in any house or apartment building. It imparts an air of refinement and elegance. It is the modern flooring.

OAK FLOORING $\frac{3}{4}$ inch thickness by $1\frac{1}{2}$ inch or 2 inch faces can be laid over old floors in old homes or over cheap sub-floors at a very low cost. It is cheaper than carpets or pine flooring. When laid it has all the appearance of heavy flooring.

There is a solid satisfaction and lasting pleasure in the substantial and dignified appearance of OAK FLOORING.

Contractors and carpenters find it very profitable to lay $\frac{3}{4}$ inch stock over old floors in old homes during dull periods. A little canvassing is all that is necessary to secure jobs. A carpenter or handy man can lay OAK FLOORING successfully.

For durability, OAK is the best. OAK FLOORING laid thirty years ago, after very hard use, is still in good condition.

Write for Booklet

THE OAK FLOORING BUREAU, 890 Hammond Bldg., DETROIT, MICH.



J. W. WELLS LUMBER COMPANY

**"Than Which There Is None Better"
Menominee, Mich.**

You will get SPECIAL ATTENTION if you tell Advertisers you read American Carpenter and Builder.

A Whack at High Building Costs

With the prices of material soaring to the blue sky, it's no wonder that people often hesitate to have more work done. The man for whom the carpenter works is really the one who has to stand the biggest expense, and naturally he figures pretty carefully before he decides to let out the job.

Yet if our carpenters would realize it, by taking advantage of the opportunities modern building material affords, they could quote so low a price for building that it would stagger their customers. The carpenter would get more work and his profit would be just as much. The reduction in the cost of building would be met by the reduced cost of the material.

For instance a neighbor of ours paid \$170 to have a garage built on the back of his lot. We say garage, but when the thing was up it really looked like a slant roof hen house. Now mind you, the carpenter knew his business, only to put up the building at that price he couldn't do anything fancy. The high price of material made that garage the sick-looking affair it was.

This man's neighbor was also anxious to have a garage but when he heard the price, he nearly keeled over. Being determined to get the best at the lowest cost, he resolved to buck against the local lumber yard. He scouted around until he came across National Plaster Board. The carpenter erected the frame and then nailed this Plaster Board direct to the studding. Filling the cracks between sheets and two coats of paint were all that was necessary to finish the garage. The cost? Nearly \$100 less than his neighbor paid.

This is only one of many instances where we know wide awake men have saved a great deal of money by simply taking time to investigate what modern building material has to offer.

National Plaster Board is composed of plaster and wood fibre laid between two thick sheets of heavy paper. Plaster forms a perfect bond with the board. It makes a truly fire-

proof wall, does away with cracked plaster and ordinary lath stains. It is a material saver because it requires only a thin coat of plaster. Where desired, decoration such as wall paper, paint or kalsomine can be applied directly over the plaster board. It neither splits, warps, shrinks or decays. No weather condition affects it.

This material is coming into great prominence because its use is not restricted to any one thing. It is used for sheathing under siding, as siding for garages, hen houses and other out buildings, partitions, for finishing attics, etc. There are dozens of places where National Plaster Board can be used at small expense and will give the best results. The size of the sheets is 32 by 36 inches and the thickness varies from 5/16 to 3/8 of an inch.

Take a couple of minutes' time and write the National Plaster Board Co., Cleveland, Ohio, for a sample and their descriptive matter.

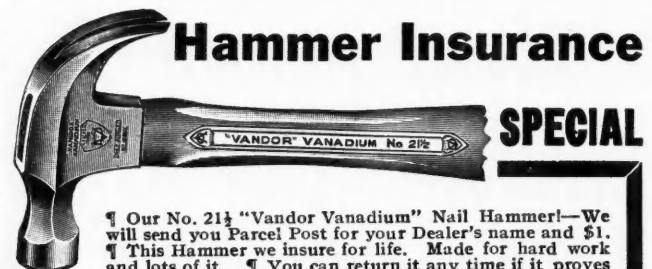

Hammer Insurance

SPECIAL

¶ Our No. 21 1/2 "Vandor Vanadium" Nail Hammer!—We will send you Parcel Post for your Dealer's name and \$1. ¶ This Hammer we insure for life. Made for hard work and lots of it. ¶ You can return it any time if it proves defective and get a new one.

This hammer is warranted to draw anything from a headless brad to a spike. ¶ Drop Forged from the toughest Vanadium Steel. Second growth hand shaved Hickory Handle. Tempered in oil. Easy to work with. Get one to-day. Remember only \$1 and your dealer's name. Mail your order NOW.

Van Doren Manfg. Co., Inc. Chicago Heights, ILL.
(Vanadium Dept.)

Mix Mortar in 3 1/2 Minutes

A machine can mix mortar more thoroughly than a hoe can. Thorough mixing saves material and insures mortar or plaster that will not be weak in spots. A mortar mixer will save time and the wages of SIX laborers.

THE HARDING MORTAR MIXER

will keep 20 plasterers busy when it runs at full capacity. It mixes White Coat, Wood Fibre, Sand Finish Lime Mortar and Keene Cement cheaply and thoroughly. No one can find fault with the work it does.

YOU NEED IT

right now in your busy season. Try it out on a couple of jobs. We send the Harding Mortar Mixer on Free Trial. Just say the word and the machine comes to you. You don't have to buy it if you are convinced it is not a money-maker.

Regular Price \$110. Mounted on Trucks with 2-HP. Engine, \$175. Special Price on the first machine sold in each town \$85.

Be the first one in your town to take advantage of this offer. Get ahead of the other fellow by writing us today for full particulars about the HARDING and our FREE OFFER.

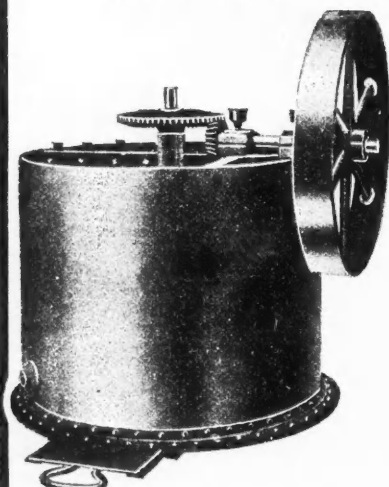

30 inches across, 24 inches deep. Made of iron and steel, weight 340 pounds. Nothing to wear out or give trouble. Guaranteed one year against defects in material or workmanship.

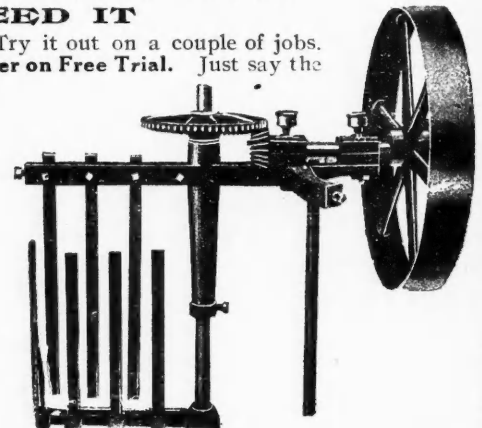

As you see, the mixing apparatus is simple. There is nothing complicated and no chance to let the mortar clog up; so there is no bother in keeping the machine clean and no chance for it to set up before the following batch.

UNIVERSITY SALES COMPANY
Iowa City, Iowa

You will get SPECIAL ATTENTION if you tell Advertisers you read American Carpenter and Builder.

SHORT TALKS WITH OUR SUBSCRIBERS



This Number Should Be Good

IT was prepared in our new home, 1827 Prairie Avenue, Chicago. Hereafter address all communications for the AMERICAN CARPENTER AND BUILDER, or CEMENT WORLD, or the Radford Architectural Company, to this address.

When you are in Chicago, we want you to come and see us. There is nothing we enjoy more than a good heart to heart talk with our subscribers who occasionally run in to see us. It does us lots of good. And to repay you, we guarantee to show you the finest publication offices in Chicago, possibly in America.

Everyone familiar with the great central metropolis, knows of Prairie Avenue, the old historic street of fashion and of wealth. Anyone can direct you to it and you will find our new home, the Radford Building, very easy to reach.

Situated here, right on the shore of Lake Michigan, slightly removed from the noise and confusion and dirt of the congested Loop district, we are able now and henceforth to use all our energies putting out good, helpful material for our readers and real service for our advertisers and other customers, without wasting any on the mere struggle for life—which every city worker is familiar with.

Come and see us in our new home the first time you are in this vicinity.

The Ad Puzzle Contest

ONE of our subscribers wrote us last month that he had never paid any particular attention to our advertising pages until the puzzle contest in the July number got him started. Then he saw how much he had been missing by not keeping posted all the time on what the advertisers are offering Our Folks.

Probably a good many more have felt the same way. We remember well when we used to look on the advertising sections of the magazines as rather an imposition, as just so much stuffing that had to be tolerated and lugged around for the sake of reading the stories. Then we discovered that, even in the story magazine, the advertisements are usually just as full of interest as the fiction features.

If this is true of the story magazines, how much more true is it of a practical business journal such as the AMERICAN CARPENTER AND BUILDER, where every advertisement has to do

Contents for August, 1913

	Page
Adventures in Heating.....	67
Advertising Puzzle Makes Big Hit.....	52
Anchor for Building Construction.....	95
Architecture in the "Paris of So. America".....	54
Artistic Residence.....	90
Attractive 5-Room Bungalow.....	49
Bark-Covered Mail Box.....	43
Better than Back Plastering.....	90
Block-and-Holes Puzzle.....	92
Carpenter Kinks.....	86
Collection of Rare Woods.....	90
Correspondence.....	85
Cozy Five-Room Bungalow.....	63
English Cottage Design.....	47
Estimating.....	76
Forest Notes.....	75
Found His Niche by Accepting Minor Job.....	51
Frame Wall Construction.....	89
Gambrel Roof Proposition.....	86
Grindstone Tool Holder.....	85
Half Third Rule.....	86
Hallway in American Homes.....	39
Harry Says.....	66
His Specialty is Round Barns.....	88
Home Builders' Scrapbook.....	43
Home Builders' Section.....	39
Home Workshop.....	74
Hot Shot from Blackledge.....	85
Hot Water Heating.....	67
House Numbers.....	43
How They Build in Argentina.....	54
How to Make a Hit and Drive Nails.....	75
How to Make a Taboret.....	74
How to Plan the House.....	39
"Human Interest" for Builders.....	88
Human Side O' Life.....	43
Ideas Worth Remembering.....	43
Inaccessible Point of Radius.....	94
Jasbury Jasburies.....	94
Jimmie's Combination Machine.....	70
Kitchen Window Awning.....	43
Little Stories of Success.....	51
Machine for Surfacing Wood Floors.....	95
Making Chimneys and Flues Safe.....	45
Making Power Woodworkers Pay.....	70
More Prizes and Fun for all who read our Advertising Pages!.....	53
More Shop Kinks.....	62
New Patents of Interest to Builders.....	96
Newel Post in 30 Seconds.....	95
Noon Hour Talks by the Boss Carpenter.....	59
Novel and Artistic Inlaid Table.....	86
Oil Mixed Concrete.....	92
Plan Shop.....	46
Plans for Modern 6-Room Bungalow.....	78
Plan for a Better System of Estimating the Cost of Building.....	76
Portable Scaffold.....	95
Practical House Designs "That are Different".....	46
Prize Winning Structures Planned and Built by Our Readers.....	63
Protection Against Lightning.....	91
Provide Definite Specifications.....	51
Public Buildings.....	73
Residences.....	78
Roof Framing Problems Solved.....	65
Rule for Figuring Volumes.....	93
Size of Tapering Posts.....	93
Slow Setting Plaster of Paris Hand.....	43
Splinters.....	72
Steel Square.....	65
Supporting a Flat Roof.....	93
Three Interesting Successful Homes.....	46
Throwing a Brick Stack.....	91
Two Gothic Roof Barns.....	64
Versatile Carpenter and Builder.....	37
Wall Construction.....	90
Wants Boat Building Pointers.....	86
Wants Building Contract.....	94
Warding off the Fire Fiend.....	45
What a Young Carpenter Should Know.....	61
Will Some One Come to the Rescue!.....	93
Yours for Safer Building.....	59

with the daily work and interests of every subscriber!

Some of these ads show builders cheaper and better materials that can now be had. Some show them new and improved tools and machinery—helps for doing their work. The advertising pages of the AMERICAN CARPENTER AND BUILDER form a monthly review of the month's advancement in the building industry. Get in the habit of studying all of these announcements every month. Also get busy at once on this month's ad. puzzle contest. You will find it good fun and you may win a nice prize. Thirteen prizes will be awarded.

"My Hobby: Honest Work"

THERE were hundreds of pleasing little sidelights brought out by the July competition, through the letters sent in with the puzzle. One thing we were watching was in line with last month's talk,—the business letterheads our builders are using. Many of them were neat and dignified, calculated to inspire confidence at once. One of these, bore this legend as part of the letterhead:—"My Hobby: Honest Work."

Honest work—that is the thing to get a reputation for! A carpenter and builder may not be as fast a workman as some, nor have the highest skill even; but if his customers can feel sure that he is giving them the best that he has, absolutely honest work at honest prices, he will never be out of a job; his business will grow.

WE hear from several of our subscribers that they are interesting some desirable new business by "planting" our magazine with its Home Builders' Section, out around among those who are thinking, or ought to be thinking, of remodeling or building new homes. They find that the illustrations and articles help prospective home builders to make up their minds what they want; and so brings them new business.

Send Us Photos of Your Work

WE want to see the kind of work you are all doing this year; and we want to illustrate the best examples of your work in the AMERICAN CARPENTER AND BUILDER. So don't fail to have some photos taken of that nice residence you are just finishing. Have both an inside and an outside view taken and send them to us so that we can help boost your work.

Cordially yours,
Editor AMERICAN CARPENTER AND BUILDER.

CHICAGO SPRING BUTTS

REPUTATION

Do you specify a spring hinge with distinctive features which will appeal to your client and assure satisfaction to all concerned?

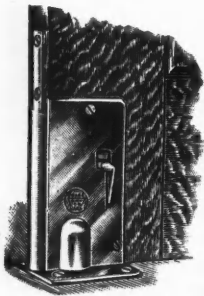

Chicago "Relax" Spring Hinges

are in great demand. They are substantial in construction and readily applied. The EXCLUSIVE FEATURE of spring action release, allowing the door to be placed at any desired position and automatically re-engaging when the door is closed, is of recognized merit and utility.

Send for Catalogue C 29. It fully illustrates and describes the most complete line of Spring Hinges manufactured.

Chicago Spring Butt Company,

CHICAGO



NEW YORK

Yes! the World does Move!

Facts are Stubborn Things

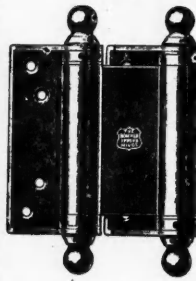

Don't Buy
SPRING HINGES
OF
OBSOLETE
CONSTRUCTION

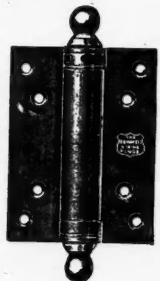

ONLY

Bommer

DOUBLE ACTING

Spring Butt Hinges

Carry the load on the true bearings

and look alike at both sides of the opening when both doors of a pair of doors are opened in or out. The carpenter can scribe for both doors of a pair from the same side, and avoid guesswork, as he can see what he is doing while fitting the doors.

YOUR HARDWARE MERCHANT CAN SUPPLY THEM

Bommer Bros., Manufacturers Brooklyn, N. Y.

Even a Sharp Saw Won't Cut—

unless properly set. The MORRILL Saw Set takes out the wrong set and puts in the right set in one operation. Simple and accurate. Experienced carpenters use no other.

Look for the trade mark APEX.
Send for FREE Booklet "Saw Points"

Chas. Morrill, 94 Lafayette Street
NEW YORK

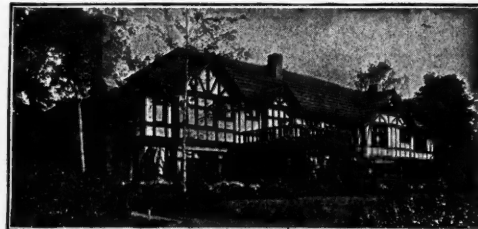
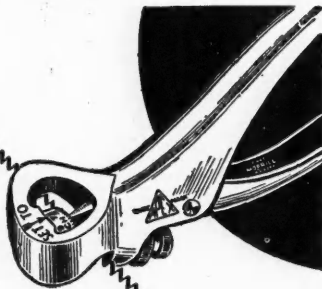

Make Your Buildings Frost-Proof
BY LINING THEM WITH
Cabot's Sheathing "Quilt"

Lined with Cabot's Sheathing "Quilt"
Shepley, Raian & Coolidge, Arch'ts Chicago.

"Quilt" is not like common building papers. It is a matted lining full of dead air spaces and keeps out the cold in the same way that a bird's feathers do. It is forty times warmer (or cooler in summer) than the common cheap papers. It costs about 1 cent a foot and will pay for itself over and over again in saving fuel, and in protecting stock, poultry or stored fruit, and you and your family from discomfort and doctor's bills. Send for free samples and name of nearest agent.

SAMUEL CABOT, Inc., Boston, Mass.
350 Dearborn Ave., Chicago 1133 Broadway, New York
Also Cabot's Creosote Shingle Stains. Waterproof Cement and Brick Stains. Conservo Wood Preservative.

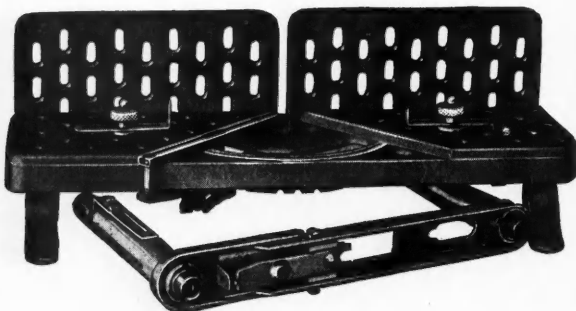

Showing lever detached.

Marsh Ayer ^{Pressed Steel} Miter Box

The lever is detached by a slight turn of two screws, permitting the box to be packed in a small space.

Our circular gives complete description.

H. C. MARSH CO.

606 Race Street

ROCKFORD, ILL.

You will get SPECIAL ATTENTION if you tell Advertisers you read American Carpenter and Builder.