

APRIL 1914 /



# AMERICAN CARPENTER AND BUILDER



615-  
406  
19

THE WORLD'S GREATEST BUILDING PAPER



NINTH  
ANNIVERSARY NUMBER

Price 20 Cents



## The Reflection of a Good Saw is Lasting

Are you really proud of your own Saw? Do you feel—down in your heart—a warm place for this most important tool? Is your Saw standing up to its work and making life pleasanter and easier for you?

### If Not—It Should

ATKINS SILVER STEEL SAWS are the kind of Saws that seem—somehow—to earn their way into the hearts of those who use them.

It's because they are dependable—because they can be relied upon to make good. If you do not feel that your Saw is really a better Saw than the other fellows—then you ought to try an ATKINS—and be happy.

SILVER STEEL is as fine and as highly tempered as a razor blade. It's hard and tough—but not brittle. It won't go back on you—when you need it. Then these blades are ground on a taper and will run—even in wet lumber—free and easy with but very little set. They are distinctive and different and finer than any other Saws.

### How To Get Them

Tell your dealer to show you a genuine ATKINS SILVER STEEL SAW and look for our name on the blade. He has it or will get it for you if you ask. If he won't, then write to us—we'll tell you how to get quick service.

### A Free Carpenter's Apron

Send us ten cents, to pay postage, and we will forward, free of charge, a fine strong carpenter's apron with a monthly time book and lots of useful information in regard to the purchase and care of Saws. Perhaps there will be something else in the pocket which you would like to have.

**E. C. ATKINS & CO., Inc.**      :-:      **Indianapolis, Indiana**

**THE SILVER STEEL SAW PEOPLE**

You will get SPECIAL ATTENTION if you tell Advertisers you read American Carpenter and Builder.

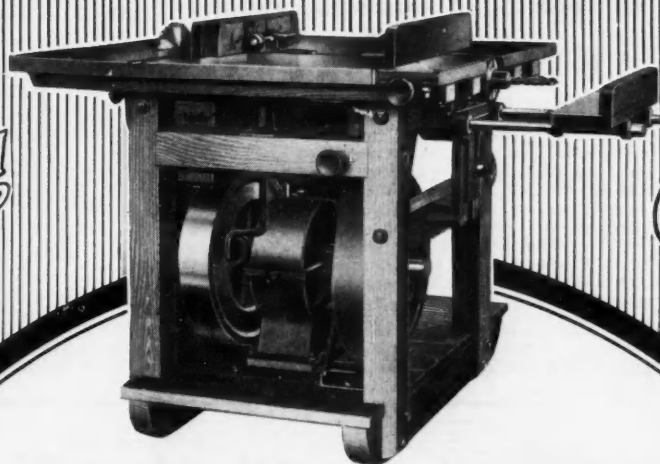

## Eveready Saw Rig

**"Supreme in Its Field"**

The stamp "OSHKOSH" on Contractor's Machinery stands for Supremacy—the result of more than 50 years of manufacturing experience. The OSHKOSH EVEREADY PORTABLE SAW RIG is the one and only machine that delivers perfect service and 100% satisfaction with never a "kick" or a "come-back." It is the Saw Rig that every Contractor *must* have if the *best* is none too good. The "EVEREADY" is a glutton for work. It takes the place of six men. Not only *saws*, but also joints, sands, jig saws, dados, bores, miters and grinds tools. *Complete set of attachments free.* Write for full facts and positive proof today. *"Make us show you."*

## The Oshkosh Mixer

**"Built as a Mixer Should Be Built"**

The OSHKOSH MIXER is in a class by itself. Simplest, fewest parts, strongest, most durable, most economical of operating power. The mixing projections on the OSHKOSH are so arranged in the drum as to cause a *quadruple* or *four-way mix*, which means turning, pouring, kneading and flowing of the batch while it is being mixed. This absolutely insures a perfect mix and we can guarantee that there is none better. Why hesitate—why *experiment* with others—when you can buy a mixer which will give the constant service that you would expect. *Investigate the OSHKOSH MIXER; write for full particulars, now!*

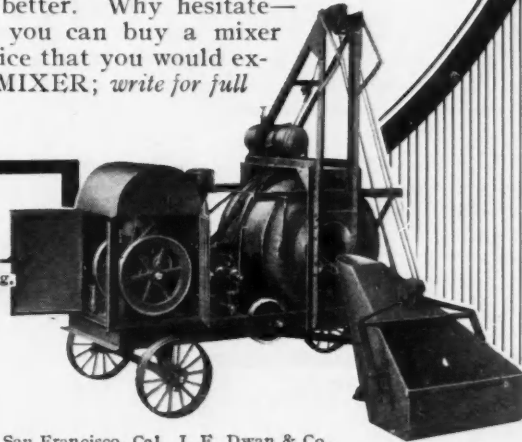

**BRANCH DEALERS IN SAW RIGS AND MIXERS:**

CHICAGO, 1452 Monadnock Block.  
 ATLANTA, GA., Southern Sales Office, 604 Walton Bldg.  
 Cincinnati, Ohio, S. O. Holder Supply Co., 1128 Gilbert Avenue.  
 Denver, Colo., Geo. W. Summers & Co., 355 Railway Exchange.  
 Evansville, Ind., Indiana Builders Supply Co., Furniture Exch. Bldg.  
 Kansas City, Mo., King Supply Co., 1201 Scarritt Building.  
 Birmingham, Ala., Chadwick & Co., 510 Empire Bldg.  
 Los Angeles, Cal., J. E. Dwan & Co., 1835 South Main Street.  
 San Diego, Cal., J. E. Dwan & Co., 250 Fifth Street.  
 Phoenix, Ariz., J. E. Dwan & Co., Creighton Bldg.  
 St. Paul, Minn., Daily-Fraser Hdwe. Co., 417 Cedar Street.  
 Milwaukee, Wis., W. A. Lewis Company, 503 Merrill Building.  
 New Orleans, La., Henry J. Malochee, 802 Perrin Building.  
 Pittsburgh, Pa., F. W. Patterson's Sons, 326 Diamond Street.  
 Portland, Ore., G. A. Saunders, Builders' Exchange, Second and Adler.  
 Richmond, Va., I. Bluford & Co., 1438 East Cary Street.  
 Salt Lake City, Utah, F. C. Richmond Mch. Co., 117-119 West Second South Street.

San Francisco, Cal., J. E. Dwan & Co., 445-447 Turk Street.

Seattle, Wash., Harold G. Stern & Co., 524 First Avenue South.

St. Louis, Mo., C. O. Fisher & Co., 512 Liggett Building.

**SAW RIGS EXCLUSIVELY:** PHILADELPHIA, Dodge & Dodge, 118 Maplewood St. Omaha, Neb., Sunderland Mch. & Supply Co.

**LIVE AGENTS WANTED IN OPEN TERRITORY.**

**OSHKOSH MANUFACTURING CO., 316 S. Main St., Oshkosh, Wis., U. S. A.**

You will get SPECIAL ATTENTION if you tell Advertisers you read American Carpenter and Builder.

FOR SURFACING AND POLISHING HARDWOOD FLOORS  
**The American Floor Surfacing Machine**

**IS NO EXPERIMENT.** Its work since 1903 has established a standard for finely surfaced and polished floors. It is the only machine whose work is specified by leading architects and used in the best government buildings and will surface and polish any kind of a floor from common pine to finest parquetry.

**IT IS THE ORIGINAL** and only two-roll, self-propelled, dust-collecting machine, that surfaces close to the wall and can be used in small rooms. Anyone can operate it.

**ITS WORK IS RAPID, regular, smooth and even** because the power that drives the rolls also propels the machine at the same ratio of speed. It has surfaced and polished millions of square feet of the best floors in America and Europe.

**GET A MACHINE** that does first-class work and in paying quantities, that is fully guaranteed and sold on its merits. Don't be fooled with an imitation.

*We sell direct to the users. Write for our free book "Surfacing Floors as a Business"*

**Use Our Champion Double Disc Machine for Cement, Terrazzo and Marble Floors.**

Manufactured by **The American Floor Surfacing Machine Co., Toledo, O.**



**\$25.85**



THE ADJUSTABLE TOOL

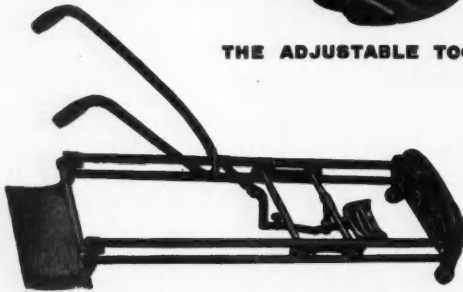

The Haven Planing Floor Scraper

THE  
**Haven Planing Floor Scraper**  
 Becomes the **STANDARD TOOL ON THE JOB**

wherever it is used. Builders have awakened to the fact that it solves the problem for good. Our machine differs entirely from all others. The secret of our splendid success rests on the following points:—

- (1) The scraping tool is a true plane, the world's standard leveler.
- (2) A light running carriage.
- (3) A smooth trackway for carriage.
- (4) A shearing cut on the instant.
- (5) Machine remains stationary while scraping enclosed area.
- (6) Angle of blade and thickness of shaving regulated with ease.
- (7) All woods are alike easy.
- (8) No man-killing truck to pull or push; you rest on the return stroke.
- (9) Planes and scrapes simultaneously.
- (10) No chattering, waving or gouging.
- (11) The planing head does better work than the usual hand work, and from four to six times as much.

If you have tried other machines and been disappointed, then TRY OURS AND BE CONVINCED THAT WE HAVE THE GOODS. A TRIAL COSTS YOU NOTHING. DON'T BUY AN INFERIOR MACHINE WHEN YOU CAN GET THE BEST ON EARTH FOR \$25.85. Send for booklet and complete information concerning our guaranteed machine and free trial offer.

THE HAVEN MFG. CO.

--:

RACINE, WIS.

## Final Price Reduction

This is your last chance to make a big price saving. Buy your

### TRIPLE "A" FLOORSMOOTHER (SPRING DRIVEN)

now. The popularity of our big "Reduced Price Offer" advertised in the "A. C. & B." last month has induced us to keep this offer open during April. This is your opportunity. The offer

ends May 1st. Only one machine at the reduced price sold in each town. Send the coupon before the other fellow beats you to it.

### You Can Make Money

Every day users of the TRIPLE "A" tell us how much they are earning with this machine. The TRIPLE "A" is sold under a binding guarantee. If it doesn't make good on your jobs, you can have your money back. TWENTY DOLLARS a day clear money is the average earning. You can make this money with a TRIPLE "A."

#### FREE COUPON REDUCED PRICE OFFER

TRIPLE "A" MACHINE CO.,  
 Room 315, 300 W. Grand Ave., Chicago.  
 Please send, *without cost to me*, full description and price of the Triple "A." I am not obliged to have the benefit of the reduced price. I am not obliged to pay you any money or buy your machine unless of my own free will.

Name .....

Street .....

Town and State .....

#### Let Us Tell You How

Send in the FREE COUPON. Our circulars give a complete description of the Triple "A." They give facts about floor finishing and the money there is in it for you. Get your name on our "Special Offer List." It doesn't obligate you to buy. It just makes sure that you'll get the reduced price if you want to buy the Triple "A" after you have investigated it. SEND THE COUPON.

TRIPLE "A" MACHINE COMPANY  
 Room 315-300 W. Grand Ave.  
 CHICAGO, ILL.



You will get SPECIAL ATTENTION if you tell Advertisers you read American Carpenter and Builder.

**IMPERVITE** is Guaranteed to Waterproof Walls: Cellars & Pits.

A facing of IMPERVITE MORTAR on the inside will resist water on the outside.

ASK FOR BOOK No. 62

**The Standard Paint Co.** NEW YORK CHICAGO

**Scrape Your Floors with a LITTLE GIANT SCRAPER**

At Our Expense

Its low cost and efficiency make it a very desirable part of each builder's equipment.

Try It Before Buying

Prove to yourself that it is the best floor-scraper on the market.

Send Today for Our Special Offer

**HURLEY MACHINE CO.**

1008 Flat Iron Bldg., New York, N. Y.

**Specify and Install THOR WASHING MACHINES**

They are a necessary requirement to every home. Do away with Laundry troubles. Your clients will appreciate them. So will your wife.

Built to Meet Requirements

Electric Washers from \$30.00 up.

Sold on Liberal Free Trial Easy Payments

**HURLEY MACHINE CO.**

37 So. Clinton St., CHICAGO, ILL.

**I Am An Expert On Floor Scrapers**

The work of thousands of Carpenters in America has been made easier through my efforts.

I am proud of the Fox Scraper. If you could see the number of letters I receive every week from satisfied users of my machines, telling me how pleased they are with them—you wouldn't blame me for feeling proud of my work.

Fox Scrapers are made in five different styles at

**\$12.50, \$15.00, \$18.00, \$25.00 and \$35.00**

Let me show you how to make your floor work easier and better. Write me today. It will pay you.

**FRANK CAMPION, Manager**

**FOX SUPPLY CO.** Brooklyn, Wis.

**AUTOMATIC**  
Ball Bearing Electric FLOOR SURFACING MACHINE

Quickly dresses new floors to stand inspection against the light, or rapidly refinishes old floors. Self propelling; has automatic brake for easy, continuous and uniform work. Surfaces to base board with Edge Roller quickly adjusted to either side

doing away altogether with hand scraping.

**Our Price Will Interest You**

If you are interested in the best floor finishing, we want to show you what others are doing with our machine. Send for the names of well-known users. You should have our booklet too. Above all, get particulars about our **Free Trial Offer**. Made in 3 sizes for small rooms and large areas.

**WAYVELL CHAPPELL & CO.** Dept. 4847 E. Ravenswood Ave. CHICAGO, ILLINOIS

**\$50.00 IN GOLD** and the machine Free if the Boss leaves a square cut in the Floor where you start; that's our Offer and we prove it. The Boss cuts more level than any other Scraper. The Gage on Front of the Knife, Wheels at the rear, makes a Plane out of it. The Knife does not follow the Grain of the Wood and leaves a level Floor. The Knife can be set to any shearing cut. The Screws over the Gage regulates the thickness of shavings.

**Write for Prices.**

**G. J. Keppinger**  
Main Office: DWIGHT, ILL.

Factories: Dwight, Ill., and London, Canada.

You will get SPECIAL ATTENTION if you tell Advertisers you read American Carpenter and Builder.

**Price CUT to \$22.50**  
**During April**

Not because of the tariff—but because  
the big demand for the

**Adjustable Floor Finisher**

Has reduced the cost of making and selling to a point where I can now let you have it for less money.

Of course, you can buy an iron casting and a steel blade for even less, but do you expect it to do as much work so well or so cheaply as a high class machine like the genuine ADJUSTABLE?

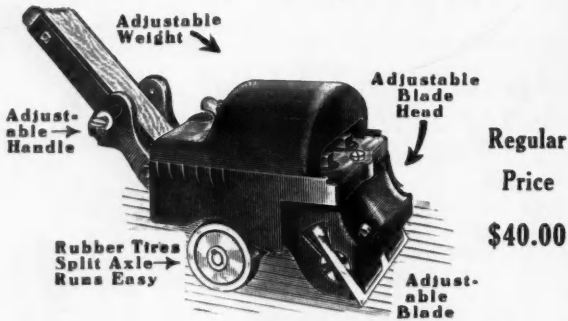

Regular  
Price  
**\$40.00**

**The Adjustable Floor Finisher**

Is the simplest scientific combination of skill, experience, materials and patented features of adjustment whereby every working condition in finishing wood floors of all kinds is successfully met and you are enabled to do the most good work at the lowest outlay for time and labor.

It gives you the **most service** at the **lowest cost**. Anything less is expensive, no matter what the price.

**Sander  
Attachment  
Regular Price,  
\$5.00**

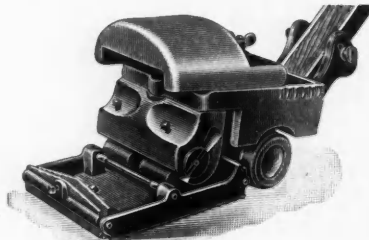

**GUARANTEE:** If at any time, for any reason thru fault of the machine, you are not perfectly satisfied with the ADJUSTABLE you can have your money back if you want it.

**Mail me this \$22.50 Coupon NOW**

**H. P. DIDRIKSEN, Anderson, Indiana**

Without any obligation on my part, please tell me all about the ADJUSTABLE. By this coupon you agree to let me have the complete outfit including the Scraper and Sander with all the accessories for \$22.50 CASH, subject to the above guarantee if I buy during April.

Name.....

Town.....State.....

**C. E. JENNINGS & CO'S**

71-73 MURRAY ST., N. Y., U. S. A.



**COMBINATION SET OF SAWS No. 131**

This set of saws is just what you need. Takes up very little room in the kit and is less expensive than if you bought all the saws separately.

Each blade is fully backed by our guarantee both as to quality and workmanship. The saws are hand-forged from extra refined spring steel, hand filed and set. Warranted to hold edge and set for longest possible time and to run smoothly and easily.

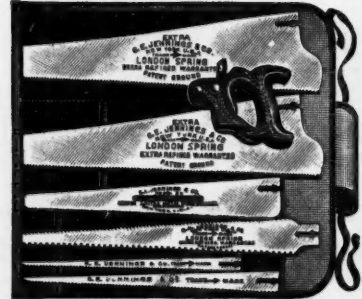

An adjustable lever in the handle operates the screw that holds the blade. Blades may be removed from the handle instantly and another blade substituted. Blade is held firmly and evenly.

Combination Set No. 131 consists of:

- 1—Garland Adjustable Handle
- 1—18-inch Hand or Panel Saw
- 1—18-inch Rip Saw
- 1—16-inch Double Edge Pruning Saw
- 1—15-inch Hack Saw
- 1—14-inch Compass Saw
- 1—12-inch Keyhole Saw

A Waterproof Canvas Case for this set with seven pockets—one for each blade and one for the handle, will be furnished at a slight extra cost.

Ask your hardware dealer to show you Set No. 131. It is so handy and the price so reasonable that you'll like it. Write us for descriptive Circular.

**PHOENIX  
INSIDE  
SLIDING  
BLINDS**

WILKES BARRE, PA.

The Phoenix Sliding Blind Co.

Enclosed find my check for blinds. I am pleased with them and sorry I did not have them put throughout the whole house.  
C. W. BURT.

**Comfort!  
Economy!**

The lately improved springs and corrugated steel rods put the "PHOENIX" far in lead of less improved styles. Write for Catalogue "C" and free samples, showing construction.

**Convenience!** PHOENIX SLIDING BLIND CO.

BRIDGE & CANAL STS.

PHOENIX, N. Y.

WOOD



**FREE TRIAL  
5,000 in use**

**RAPID, FLEXIBLE, SELF-  
PROPELLING WHEN  
RAISING HANDLE**

Send for our new  
list and free trial  
proposition.

**M. L. Schlueter**  
107 N. Canal St.  
Chicago, Ill.

Made in three sizes:  
8 x 18, 8 x 15 and 8 x 12 in. Flexible Roller.  
Edge Roller easily adjusted to either side.

You will get **SPECIAL ATTENTION** if you tell Advertisers you read American Carpenter and Builder.

# Carpenters and Contractors

Try  
This Floor  
Scraper at  
Our Risk

We are willing to place the Weber double-acting floor scraper against any floor-scraping device you know of and let you be the judge. Read this letter:

"Enclosed find check for floor scraper bought of you. I gave the machine a trial and found it absolutely O. K. It does all you claim for it. Thanking you for a square deal, I am  
Yours respectfully, E. TURNER, Paintsville, Ky."

## Free Trial

We will send you a Weber Floor Scraper on 5 Days' Trial. If not satisfactory, return it at my expense. If you keep it, pay 10% at the end of 5 days, balance small monthly payments.



## The WEBER DOUBLE ACTING Floor Scraper

is a ready seller. Sold everywhere on easy payment; you pay me as it pays you. Write today for catalog of Weber's Labor-saving Tools—a letter will bring our proposition that will give prices and many dollars' worth of information. Write us today.

WEBER MANUFACTURING COMPANY  
670 71st Ave. John F. Weber, Pres. West Allis, Wis.

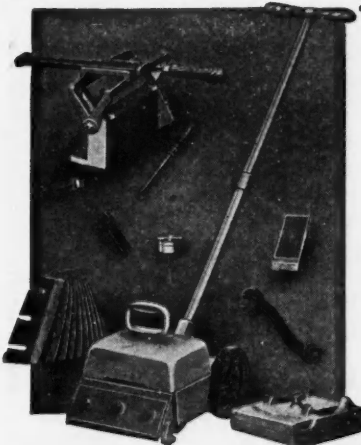

## TRY THIS OUTFIT AT MY EXPENSE—

For years I have been shipping to responsible Carpenters and Contractors on Free Trial the

## ACME FLOOR-SCRAPING OUTFIT

Thousands have accepted my offer, greatly to their profit. If you haven't investigated into the merits of my machines, then do so at once—it will cost you nothing.

Send for catalog and full particulars of my Free Trial Offer, Now

JOSEPH MIOTKE, 247 Lake St., MILWAUKEE, WIS.



Square Over  
the Head

### SIMPLEX NAILS DRIVE STRAIGHT

The Shank extends THROUGH the Head. The hammer blow does not glance, as the blow falls directly on the head of the nail shank—not on the curved dome.

Trade **SIMPLEX** Mark  
Reg. U. S. Pat. Office  
**ROOFING NAILS**

Have four times the head area of so-called large headed wire nails: hence four times the holding power. **ONE PIECE**—not two piece. Head cannot loosen. Made in two sizes—1 inch and 1½ inch. Insist that your prepared roofing be furnished with **SIMPLEX NAILS**. Free sample on request.

**H. B. SHERMAN MFG. CO.**  
BATTLE CREEK MICHIGAN

## STANDARD CLAMP



A Steel Screw and a  
Wide, Strong Frame are

the two features which give the Hargrave Standard Clamps the utmost resistance to wear and failure.

These Clamps are just as carefully made as all of the Hargrave Tools.

Catalogue?

Dept. H  
**THE CINCINNATI TOOL CO.**  
Norwood, Cincinnati, Ohio

You will get SPECIAL ATTENTION if you tell Advertisers you read American Carpenter and Builder.

# A Good Elevator

Is a Good Investment  
Saves Time and Labor

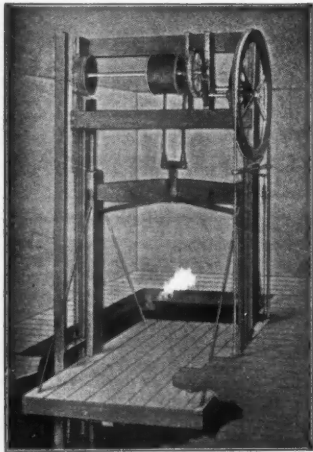

Our product includes *Dumb-Waiters, Carriage, Auto and Store Elevators* — Hand and Power.

These machines are serviceable and will pay for themselves in a very short time. Being practically self-contained, they can be erected by any carpenter or "handy man" in a few hours' time. Plans for erecting furnished with each elevator.

**The Reasonable Cost Will Interest You**

Write to us today stating your requirements, giving style of machine wanted, size of platform and number of feet travel and we will name you a money-saving price on equipment made to serve you well.

**SIDNEY ELEVATOR MFG. WORKS, SIDNEY, OHIO**

TRADE **Sedgwick** MARK  
**ELEVATORS AND DUMB WAITERS**

—HAND POWER—

*Standard of Quality the World Over*

**SEDGWICK MACHINE WORKS**

82 Carroll St.,  
Poughkeepsie, N. Y.

New York Office,  
132 Liberty St.



**THE COLUMBIA**

DUMB WAITERS ELEVATORS  
CELLAR HOISTS  
JUMPER DISAPPEARING DUMB WAITERS  
CHAIN HOISTS, CRANES and TROLLEYS  
SEND FOR CATALOGUE.

**J. G. SPIEDEL, Reading, Pa.**

**NO**

FALLING WINDOWS  
SMASHING GLASS  
POCKET FRAMES  
SASH WEIGHTS  
RATTLING  
BINDING  
CORDS with

**AUTOMATIC  
SASH HOLDERS**



**SPECIFY  
USE  
DEMAND**

**Automatic Sash Holders**

and save labor, lumber and money. Send for trial set (\$1 prepaid) stating approximate weight of sash, or our circular. Automatic Sash Holder Mfg. Co. Church St., New York.

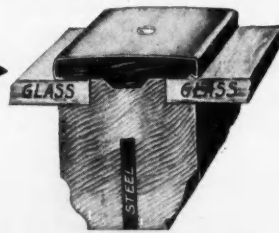

## The Petz Reinforced Store Front Bar

This is the steel reinforced bar that holds plate glass windows safely in the teeth of gales.

You can see that the glass is held in a cushion of red cypress—the eternal wood—over which is drawn a coat of heavy gauge metal.

The use of PETZ metal store front construction is a great help in making a fine, up-to-date store front.



Send for our booklet on metal store front construction.

**Detroit Show Case Co.**

491 W. Fort St. :: DETROIT, MICH.

We make a specialty of furnishing  
**HAND POWER ELEVATORS**  
AND  
**DUMB WAITERS**

*Complete F. O. B. Cars Cincinnati, Ohio*

**F**ULL blue prints and instructions are furnished with each machine. The gearing is all set up complete and run before it is shipped to you, from our factory. This insures a good perfect running gearing and ready to set up when you receive it.

WRITE US FOR CATALOG AND PRICES

*Electric Elevators* for Passenger and Freight Service

**THE WARNER ELEVATOR MFG. COMPANY**  
Cincinnati, Ohio

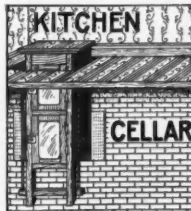

**CARPENTERS WANTED AS AGENTS**  
*During Fall and Winter Months. Big Money! Ready Seller.*

**SANITARY AUTOMATIC DUMBWAITER**  
saves carrying food to and from the cellar. Perfectly ventilated; screened openings; finished inside with durable white enamel. Keeps food perfectly. Top lies flush with kitchen floor. You can walk over it. Operates with push button or lever. Also furnished as a Refrigerated Dumb Waiter. Write for Particulars and Price.  
**YORK AUTOMATIC DUMBWAITER WORKS**  
639 W. Market St. YORK, PA.

**CHELSEA**  
EXEMPLAR OF QUALITY

Send for our Elevator and Dumbwaiter catalog  
**CHELSEA ELEVATOR CO. 330 W. 26th St., N. Y.**

You will get SPECIAL ATTENTION if you tell Advertisers you read American Carpenter and Builder.



THE  
**“Boss” Mixer**

(5 Cubic Feet Batch)

Costs Only \$198.<sup>00</sup>  
 And Will Save  
 You That Much  
**EVERY 10 DAYS**

The principle employed in the mechanism of the “Boss” is the principle used and endorsed by the American Society of Engineers. No other moderate priced mixer has it.

We can show, in black and white, how the “Boss” will save its cost in ten days—besides giving better mixed concrete right along. It’s more than a mixer—it’s a re-mixer, cutting the mass and re-mixing it forty times a minute.

The operation is simple and convenient. No platforms, planks or horses to bother with. Hopper is only 12 inches high, so that contents of wheelbarrow can be discharged directly into it.

It is sturdily constructed, yet has no dead weight. Steel and iron throughout. Chain drive, double-grip clutch, and arranged to permit easy cleaning.

**10 Days’ Free Trial**

The price of the “Boss” is \$198.00. This includes a 3-H. P. Mandt Gasoline Engine and low-charging barrow hopper, the whole outfit mounted on trucks with big steel wheels.

For an extra \$90.00 we include Side Loader and Hoisting Engine which increases its capacity 25% and will save \$5.00 per day.

An iron-clad guarantee goes with every “Boss” mixer. And—we give ten days’ free trial, which does not obligate you to spend a cent until you have convinced yourself that you want a “Boss”—and no other mixer. Ask for details today. Easy payments arranged if desired.

**Steel King 1/3rd Mixer**

If you want a larger mixer — sold at a low price never —our STEEL KING will meet your requirements— built of steel, light in weight smaller capacity.

**The American Cement Machine Co.**

1006 Johnson St., Keokuk, Iowa

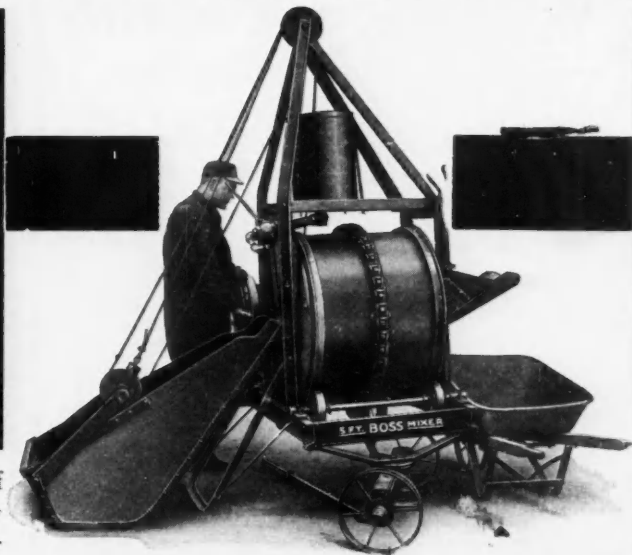

\$288.00 on Trucks with Power Loader 3-H. P. Engine.

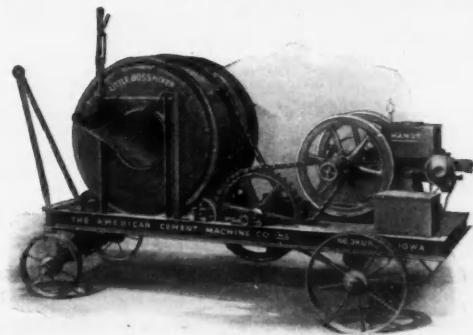

\$198.00 on Trucks with low Wheelbarrow Hopper 3-H. P. Engine.

Shows a complete Machine ready to load. Note Safety Jack and compactness.



**Turn Your Mixer into a Hoisting Engine—**

with a capacity for lifting 500 lbs. 80 ft. per minute, by simply attaching this drum to the “BOSS.” Another money-saving feature—look it up.

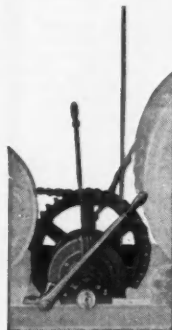

You will get SPECIAL ATTENTION if you tell Advertisers you read American Carpenter and Builder.



### 90 Cubic Yards Per Day

Saves 60 to 90 cents on every yard. Pays for itself several times each season. Gives you the edge on your competitors. So light that two men can carry it. Big savings in freight and handling. Can always be set to discharge direct into forms. Saves all wheeling from machine. This alone saves one-third the labor necessary to operate other mixers.

Not a Man-Killer  
Has an enormous capacity  
**SIMPLE—COMPACT—HANDY—SUBSTANTIAL**  
New Principle—Quick Charging—Quick Action—Quick Discharge

Its mixing blades have a criss-cross, kneading, plowing, hoeing motion which press and fold the entire batch over upon itself many times every second. Insures a quick and thorough mix. You will be proud to say you have a Northfield Hand Batch Mixer, once you see its work.

The SLUSH mixer mixes 4 cu. ft. of finished concrete per batch. A batch per minute or 90 cu. yds. per day is easily possible under favorable conditions. 30 to 60 cu. yds. per day is a fair average on ordinary abutment, floor, wall or bridge work. Over 10 cu. yds. per hour have been averaged. When operated by power—one man alone can mix mortar fast enough for a crew of 20 brick layers.

The DRY or WET mixer is good for any kind of mixing—either Dry, Wet or Slush. Is extra fine for brick or block plants, core sand, plaster, brick mortar, chemicals, etc. Capacity—2 to 3 cu. ft. per batch—or 15 to 45 cu. yds. per day. Is just like the SLUSH mixer except a slight change in the drum heads and agitator. Is the best for an all-purpose mixer. The SLUSH mixer is best for big jobs and rapid contract work where slush mixtures are used.

Two men turn either machine easily and do not work as hard as the shovelers. A pump engine will run them. It is not necessary to have a big expensive power mixer to economically mix concrete. No job is too big or too small for the Northfield. No better mixer can be had, even at ten times its price.

Write direct to factory for catalogue, prices and terms.

**NORTHFIELD IRON COMPANY**  
402 Water Street - Northfield, Minn., U. S. A.

### Supplies the Demand for a Small Perfect Mixer



Capacity  
3 Cubic Feet  
Per Batch

Weight  
800 Lbs.

On Trucks  
1000 Lbs.

On Trucks  
with  
Engine  
1400 Lbs.

McCracken Batch Mixer

### The McCracken Portable Batch Mixer

Is designed and built to meet the demand for a strong, simple, durable and practical mixer, that is large enough for all ordinary contract work, yet light enough to be profitable on the small job as well as on the large. Mounted on good steel trucks, EXTRA LARGE DRUM OF THE PROPER SHAPE, equipped with our own high-grade 2-HP. SIOUX engine, enclosed in a good steel housing (not a cheap box), also has friction clutch, so that drum can be started and stopped without stopping the engine. Capacity, twenty-five to thirty-five yards per day. Cost for power, twenty-five cents per day. The largest, best and most complete mixer on the market for the money. Write today for prices.

Write for Further Particulars

**Sioux City Engine & Machinery Company**  
9th and Division Sts SIOUX CITY, IOWA

## GET THESE BOOKS

# FREE!!!

A post-card, or this ad cut out, with your name and address, designating what books you want is all that is necessary. These books will interest you, and also place you in touch with equipment that you can buy for LESS MONEY than any other. Our

**DIRECT FROM FACTORY PRICES**

ON  
**World-Renowned "CRESCENT" Machines**

will make you ask yourself why you never got in touch with us before.

Find out how the other fellows make money. You're never too old to learn!

Mark the Books You Want

- Book 10, "Crescent" Continuous Concrete Mixers
- Book 11, "Crescent" Sewer Pipe and Tile Molds
- Book 12, "Bull-dog" Hand Batch Mixers
- Book 14, "Crescent" Vertical Tamping Brick Machines (Foot-power)
- Book 16, "Bull-dog" Power Batch Mixers
- Book 17, "Crescent" Power Brick Machines
- Book 18, "Little Wonder" Hand Brick Molds

GET OUR QUOTATION ON ANYTHING YOU NEED  
**RABER & LANG MFG CO.**  
Kendallville, Ind. 810 Mill Street

### Buy The SIMPLEX 1914 Model MIXER

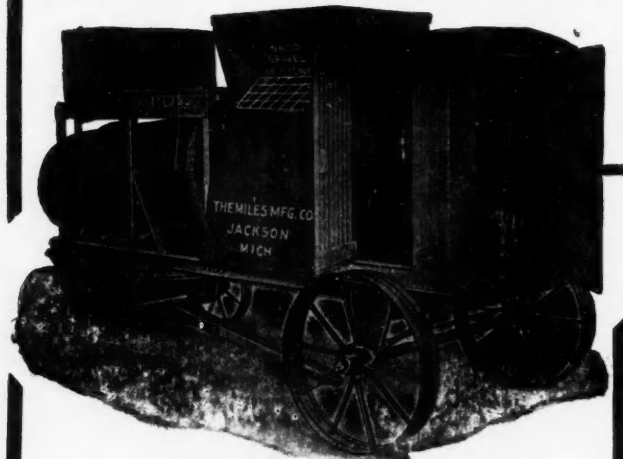

Combining the good features of both batch and continuous mixers in the one machine.

The best feature of the Batch Mixers is the rolling of the materials. The greatest advantage of the Continuous Mixer is the automatic measuring and feeding of the materials.

Only one machine combines these two features—the SIMPLEX. It's the happy medium between the two types of mixers, giving the points of advantage claimed by each, and eliminating the faults of both.

Write for New Complete Catalog.

**The Miles Mfg. Co.**  
309 E. Franklin St. JACKSON, MICH.

You will get SPECIAL ATTENTION if you tell Advertisers you read American Carpenter and Builder.

**"WONDER"  
MONEY-MAKERS**

## Join the Wise Ones

—the hundreds of Contractors and Builders who are now ordering WONDER equipment. These men know a thing or two, and sometimes three. They say preparedness is half the battle—that the known value and proved efficiency of the LITTLE WONDER "FIVE" Concrete Mixer is a *sure* investment—that WONDER standardization and nearly a hundred service stations are guarantees against loss of time and money—that our "MAN TO MAN" TEN DAYS' FREE TRIAL proposition cuts out guesswork—that the enthusiastic endorsement by thousands who have taken this safe and sane course is proof of more than mere satisfaction.

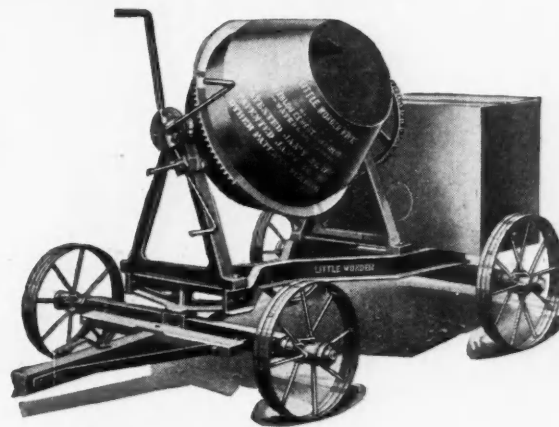

The WONDER "FIVE" is simple and strong. It saves 50 cents per cubic yard over hand work and does it better. Mixes 35 to 50 cubic yards per day. Builds foundations, sidewalks, cisterns—anything in concrete. Mixes mortar, also. Use any crew you chance to have.

## WONDER MIXERS WONDER SAW RIGS

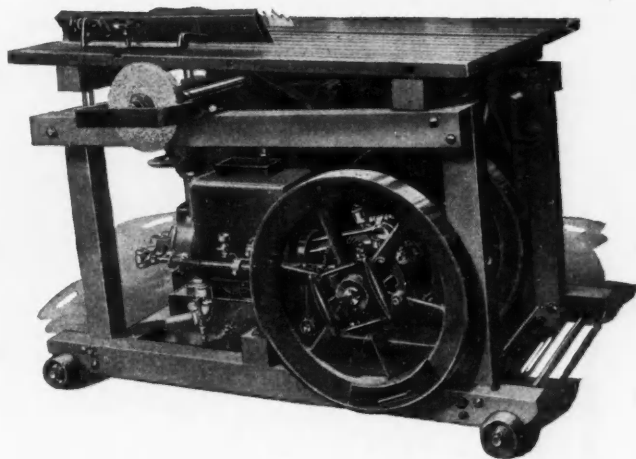

With the WONDER PORTABLE SAW RIG you practically put your shop on the job—saw your own lumber—rid yourself of mill-order delays and put the profits in your pocket. Frame, table, skids, etc., built of best rock maple. Standards of clear maple 3½ in. square, firmly bolted together. Table 60x42 in. and 1½ in. thick. Gasoline engine 5 HP, absolutely reliable. Outfit includes two 14 in. and one 16 in. Disston rip saw; one 16 in. Disston crosscut saw; also 10 in. emery wheel, gauges, wrenches, etc.

*Keep on the safe side of certainty by accepting our "MAN TO MAN" proposition for a WONDER Mixer and don't buy a Saw Rig until you investigate the "WONDER."*

### WATERLOO CEMENT MACH'Y CORP'N

103 Vinton Street, Waterloo, Iowa

You will get SPECIAL ATTENTION if you tell Advertisers you read American Carpenter and Builder.

## Upkeep Costs

On Equipment Kills the Profits from Many a Job.

*A bunch of Contractors around our exhibit at the Chicago Cement Show were arguing about upkeep costs on mixers. They all agreed, however, that there would be mighty little upkeep cost on the CLOVER LEAF.*



"Clover Leaf Mixer with Folding Loading Platform."

You'd say the same if you saw our mixer. If there's a *Clover Leaf Mixer* in your locality, go and see it. It will open your eyes to what a *good* mixer really is.

### THE CLOVER LEAF MIXER

has no paddle or deflector arrangement. The peculiar shape of the drum does the mixing; does it in a way you'll understand and approve. That drum is no "tin soldier" affair, either. There's a sturdy, confidence-inspiring simplicity about the *Clover Leaf* that you'll take to at once. And the *Clover Leaf* will take to your jobs like "a duck to water."

#### *Clover Leaf Contractors' Hoist*

combines the good points to which Contractors are not indifferent. There's the main drum for single line lifting; sheave for double platform elevating; winch head for general utility; ratchet for holding load; forward and reverse operating lever. And above all is *Clover Leaf QUALITY*.

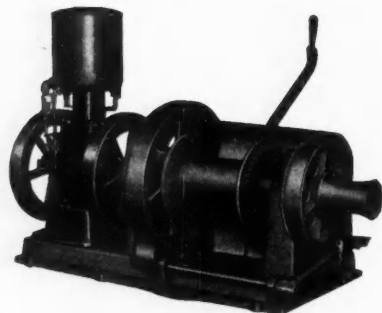

Our Hoist and Mixer Catalogs will explain the things we cannot say here. Both books will be sent free immediately you send us your name and address.

**CLOVER LEAF MACHINE CO.**  
Sample Street Office South Bend, Ind.

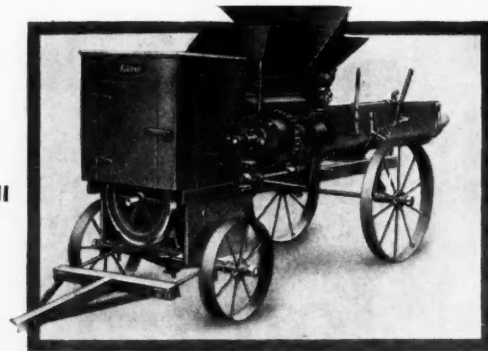

### The BABY GRAND CONTINUOUS MIXER

combines all the good features of *mixer* and *hoist* at the price of *one* machine.

The *BABY GRAND* is a logical investment for the Carpenter and Contractor because both mixer and hoist are greatly used in modern construction. You can afford the *Baby Grand*. It is portable; capacity, 4 to 5 cu. yds. an hour. 2½ H. P. Gasoline Engine furnished with the machine.

**The HOIST** is mounted on the frame (see illustration). Operates with or independent of the mixer. Simple friction clutch for starting and hand brake for holding load. Capacity of hoist, 400 pounds. Lifts load 100 ft. per minute.

Our latest CATALOG gives a complete description. Send for it. We also make the *HARTWICK TWO TROUGH MIXERS* for heavy construction work.

**HALL-HOLMES MFG. COMPANY**  
436 Oak Street Jackson, Mich.

### Why Pay More?

\$100 buys a regular Builders' Mixer that's reliable for all block, brick, foundation or sidewalk work.

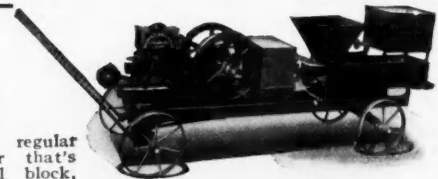

#### SIMPLEX JUNIOR MIXER

is the best ever sold at the price. Perfect in every way. Economical and mixes thoroughly. Low-charging—Labor-saving. Top of hopper is only 2 feet from ground when mixer is on skids. Easily hauled around.

On Trucks With Engine, \$100. On Trucks Without Engine, \$55.  
On Skids Without Engine, \$35.

*The SIMPLEX Is Sold At Your Price. Guaranteed.*  
**FREE TRIAL OFFER. Write Us Today.**

**WESTERN MFG. CO., Oskaloosa, Iowa**

### THE WINNER MIXER



Will make money for you even if you don't have work enough to keep it running all the time. The cost is very small, and one gallon gasoline will run it a day.

Mixes 4 and 5 cubic feet per batch  
Daily capacity, 30 to 40 cubic yards

Ask for our **FREE Catalog**

**THE CEMENT TILE MACHINERY CO.**  
133 Rath Street Waterloo, Iowa

You will get **SPECIAL ATTENTION** if you tell Advertisers you read *American Carpenter and Builder*.

# THE ENGINE IS THE HEART OF A MIXER

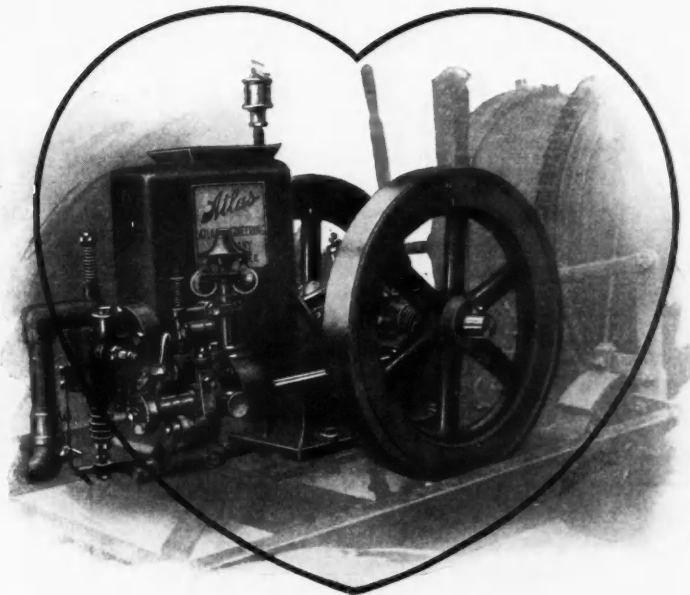

**T**HE engine used on the **Atlas** Mixer was selected after most careful consideration. We realize that the engine is the **heart** of a mixer and only the best engine we could buy was adapted to link with the many fine features of the **Atlas** Mixer.

Several thousand of these engines have been used for years on mixers selling at two to five times the price of the **Atlas**.

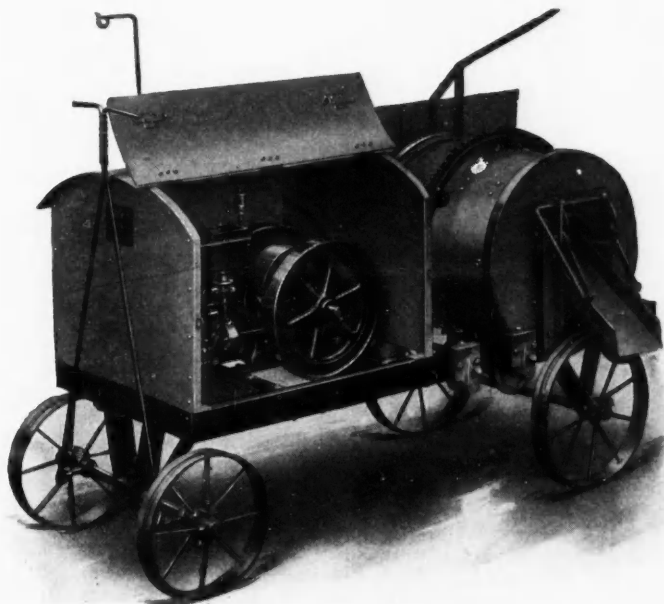

**T**HE use of this engine on the **Atlas** Mixer is conclusive evidence that we are giving the greatest possible value in mixer construction—and bears out our statement that the **Atlas** Mixer is a low-priced, substantially built machine of large capacity.

*Send for Circular "B." It covers the ATLAS in detail. A postal will bring it.*

**PLACE YOUR ORDER NOW AND HAVE AN ATLAS THIS YEAR.**

*Atlas Agencies Everywhere.*

Price, \$275, complete with power equipment.  
F. O. B. Milwaukee, Wis.

## Atlas Engineering Co.

783 Thirtieth Street

MILWAUKEE, WISCONSIN

You will get **SPECIAL ATTENTION** if you tell Advertisers you read **American Carpenter and Builder**.

**This Machine  
Built in  
3 Sizes**

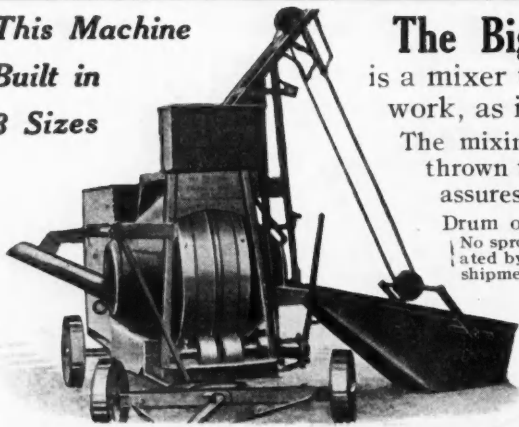

**The Big Sioux Concrete and Mortar Mixer**  
is a mixer that is built for service and to suit any class of work, as it mixes dry as well as wet.

The mixing drum and paddles are shaped so the mixtures are thrown three ways and emptied from the center of drum, which assures an even mix at all times.

Drum operates with friction drive on roller bearings. No gears to rip—No sprockets to wear out. All levers for filling, emptying and water supply are operated by one man. Built of steel and cast iron throughout. Satisfaction and prompt shipment guaranteed. Write for circulars and prices and tell us your requirements.

**The Iowa Foundry Company**

West 2nd and Cook Sts., - SIOUX CITY, IOWA

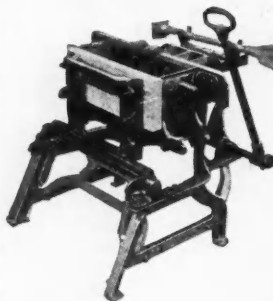

**Miller's  
"Block King"**

Makes the **BEST BLOCK** in the Shortest Time at the Lowest Cost

Unlimited range sizes and shapes. Shipped on trial anywhere. **DON'T** order until you get our catalogue. The low price will surprise you. Also Tile,

Brick, Chimney, Moulds, Automatic Tampers, and Mixers.

**J. C. MILLER CO.,** Box A Jackson, Mich.

## INVESTIGATE THE BOLTE

Thousands in use on all classes of Concrete Work throughout the U. S. and Foreign Countries.

**Positively a Labor-Saver**

over hand or batch mixing, reducing mixing cost 50% over either method.

Sent subject to **Trial. Satisfaction Guaranteed or no Sale.**

**Price Low and terms Right.**

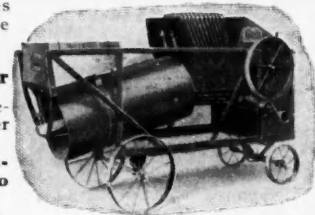

**Write for Particulars.**

Address **The Bolte Mfg. Co.**

**KEARNEY, NEBR.**  
West 21st Street

**OR CINCINNATI, OHIO**  
420 E. 2nd Street

**Big Profit  
Producers  
for Building  
Contractors**

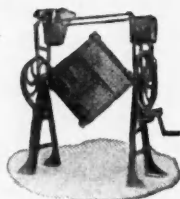

Concrete work is a profitable part of a builder's business—and pays the biggest profits when hand mixing is eliminated and the work done by a good mixer. **LANSING Mixers** give perfect results.

**Prices from \$24**

Our Hand Mixers, costing from \$24 to \$75 are ideal for small work. For larger work a Lansing Power Mixer soon saves its cost in time and labor. Built in seven sizes costing from \$200 up. Can be equipped with side loaders, automatic water tanks and other conveniences. Mix a batch a minute—every batch uniform. Built like a locomotive—for long wear and hard service.

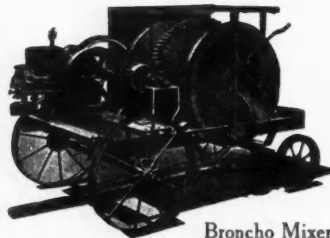

Broncho Mixer

**Get More  
Information—**

by writing for complete catalog and prices of our complete line of Concrete Machinery, and don't forget to ask address of nearest stock.

**LANSING CO.,** 746 Cedar St., Lansing, Mich.

*Home of the Famous "Broncho Mixers"*  
Agents Everywhere



**Built for Work**

The Blystone Concrete and Mortar Mixer was designed by a practical concrete man to meet his own needs. He solved your problems when he solved his own.

It was not originally made to sell, but was wanted to do this man's work. It did his work so well it forced itself onto the market.

The Blystone will mix fibre through hardwall plaster perfectly. Whether the material is wet or dry does not matter.

The material is always in view while being mixed. The open drum is easy to clean.

Mounted on skids with pulleys for belting to power, the Blystone makes a mixer that positively cannot be equalled for the block or tile plant.

You will be interested in a complete description of this unusual mixer. Write while you have it in mind.

**THE BLYSTONE MACHINERY CO.**

19 Carpenter St. : CAMBRIDGE SPRINGS, PA.

You will get **SPECIAL ATTENTION** if you tell Advertisers you read American Carpenter and Builder.

# Here is the mixer you want

- a low priced mixer which has the advantages of "THE STANDARD" Low Charging Mixers.
- one which is sturdy yet simple, compact and light in construction.
- one which can be used for mixing either concrete, cement, mortar or plaster.
- one which can be used on any class of work, foundations, sidewalks, curb and gutter, small viaducts and bridges, silos, block plants, repairing, etc.
- last but not least—a mixer that has long been wanted by the small contractor and builder who do not have enough work to pay for larger mixers.
- this is the mixer for you; will pay for itself in a few weeks in a saving of labor over hand mixing.

**"S.S.S."**  
**Low**

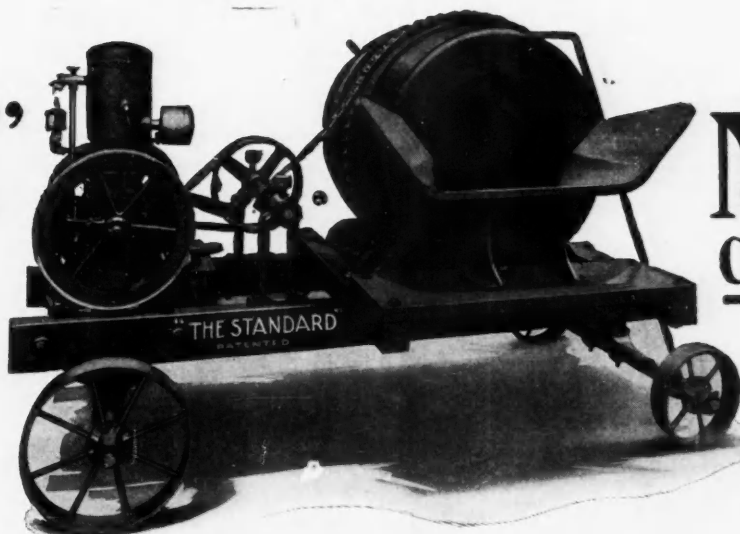

**Mixer**  
**Charging**

"S. S. S." Low Charging Mixers are built with a batch capacity of 3½ ft. Complete on trucks with gasoline engine, it weighs only 1200 lbs. This mixer can be moved anywhere on the job by one man, taken through an ordinary door, or up on material elevator.

"S. S. S." mixers fill the demand of hundreds of contractors who want a small, low-priced mixer with the Low Charging and other features of "THE STANDARD" regular mixers. "S. S. S." Low Charging Mixers are of the batch type—open drum construction, embodying all the time and labor-saving features of "THE STANDARD" regular mixers.

"S. S. S." Low Charging Mixers prices range from less than \$100.00 up, depending on style and equipment. Write for Special Low Price and Circular No. 44-S

## THE STANDARD SCALE & SUPPLY CO.

MANUFACTURERS

CHICAGO  
1345-47 Wabash Ave.

PITTSBURGH  
243-45 Water St.

PHILADELPHIA  
35 South Fourth St.

NEW YORK  
136 W. Broadway

You will get SPECIAL ATTENTION if you tell Advertisers you read American Carpenter and Builder.

# PERFECT CONCRETE

Of even texture without weak or lean spots is produced by the Low Down Continuous Concrete Mixer equipped with the new *Automatic Feeding and Proportioning Device*. In proportioning concrete by hand, it is the easiest thing in the world to get in a little too much or too little sand or stone, and the result is an imperfect batch that escapes notice until the job is finished. This is entirely overcome and the uncertainty of the human mind is eliminated by using the Low Down Concrete Mixer equipped with an automatic mechanical feeding device.

## An INVESTMENT That Pays Large Dividends

Because the machine is constructed of malleable iron and steel which guarantees long life and exceptional wearing qualities.

Because the low down hoppers reduce the labor cost of finished concrete.

Because the mechanical feeding device gives absolutely accurate proportions of materials.



**ELITE MANUFACTURING CO.**

**Ashland, Ohio**

*“I Have Used a No. 9 Coltrin Mixer  
Over Four Years”*

**S. B. LEACH**  
CONCRETE CONSTRUCTION

Lemoyne, Pa., Jan. 29, 1914.

The Knickerbocker Company,  
Jackson, Michigan.

Gentlemen:—I have used a Coltrin No. 9 Mixer over four years. It has worked perfectly satisfactory in every way, and I consider it the best machine on the market for sidewalk and other construction where a portable machine is required. My repair bill in four years has been about \$15.00. This machine has been almost constantly in use during the working season. This winter we overhauled it and now it runs like a new one.

Yours respectfully, (Signed) S. B. LEACH.

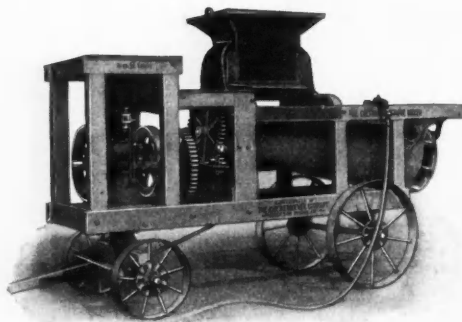

No. 9 Coltrin Mixer. Weight 1900 Pounds

**The Coltrin Continuous Batch Mixers**

*Shipped anywhere on trial. Write for Catalog.*

**THE KNICKERBOCKER CO. :: JACKSON, MICH.**

You will get SPECIAL ATTENTION if you tell Advertisers you read American Carpenter and Builder.





# SPEEDING UP THE JOB

Sooner or later, every contractor asks himself the question: "How can I speed up my job?" For some reason or other you have to rush the work. Will your concrete mixing plant stand the extra strain, or will it fall down on the job? You realize as no one else can, how much money you lose every time your mixer is shut down for repairs during the ordinary work. How much greater will be your loss, therefore, when it came to the "hurry up" work. What you want, is a mixer that is compact and has few wearing parts—One that operates easily—One that is built right, of good material and excellent workmanship—A mixer that will be "ON THE JOB" every moment. Such a mixer is the all-steel

## No. 5 Smith-Chicago Special

It's a batch mixer of an approved type, with a 3½ cubic foot wet capacity. Back of it is the guarantee of the biggest concrete mixer manufacturer in the U. S. It is not a new machine. Ten years have been spent in perfecting it—in bringing it to a point where the contracting trade recognize it as a mixer they can bank on at all stages of the game.

Can you add to its modern, up-to-date features? Check over its advantages: All-steel construction; heavy Z-bar frame; "ground level" loading skip; central drive ring and roller tracks; easily operated "external" discharge spout; large, patented scoop blades which give a perfect mix and fast discharge. Before risking your money on other equipment, post yourself about this machine which has demonstrated its fitness on all classes of work. Send for No. 5 Smith-Chicago Folder No. 39-V.

Send for No. 5  
Smith-Chicago  
Mixer Folder  
No. 39-V  
Including  
Special Proposal

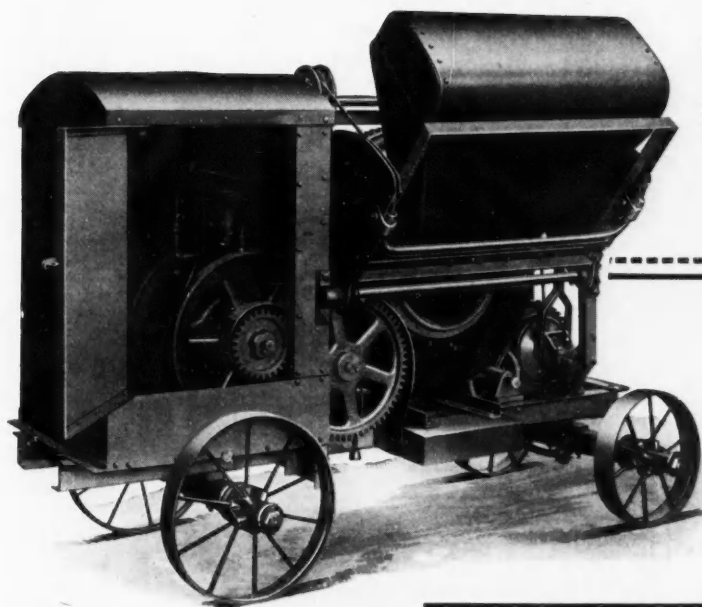

## The T. L. SMITH CO.

3123 Hadley St. - MILWAUKEE, WIS.

1306 Old Colony Bldg.

CHICAGO

### MAILING COUPON

I am interested in a Concrete Mixer that will mix from 40 to 50 yards daily. Without any obligation on my part, send me NO. 5 SMITH-CHICAGO SPECIAL FOLDER NO. 39-V and SPECIAL PROPOSAL.

Name .....

Address .....

You will get SPECIAL ATTENTION if you tell Advertisers you read American Carpenter and Builder

# Double Speed CEMENT MACHINERY for Builders and Lumber Dealers



The Sixteen Moulds are Filled in a Few Moments

Learn more about the **DOUBLE SPEED MACHINES**. Here are machines that make *twice as many bricks and blocks* as any other machine. They are not more expensive than others, yet they do *double the work*. Cuts your operating cost in two. You get double the product in one

day with *no extra work* — *no extra expense*. 16 Bricks or 2 Blocks in *one operation*.

**"DOUBLE SPEED" BRICK and BLOCK MACHINES** have swept the machinery market off its feet. They are winners everywhere. They are a **positive money-making**



One Throw of the Lever Delivers Eight Brick on each side of the machine

equipment for the **Builder or Lumber Dealer**. They make a standard product of the greatest variety—product that finds ready sale.

The **"DOUBLE SPEED" AUTOMATIC TAMPER** made a good record at the



16 perfect clean cut brick in one operation. Time—one minute, 1/2

Chicago Cement Show. It will pay you to consider it before all others.

Let us send you complete descriptions and prices. **"Double Speed" Machines** end all doubt as to the best machines to buy. Send us your name and address.

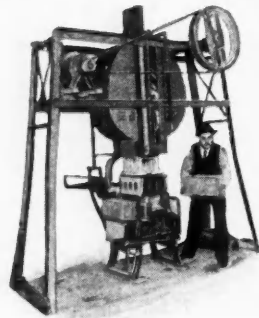

Automatic Power Tamper works directly above brick or block machine. Speedy, safe, reliable

**NORTHWESTERN DISTRIBUTING CO.**  
Sioux City, Iowa

# The Perfect Cement Block Machine

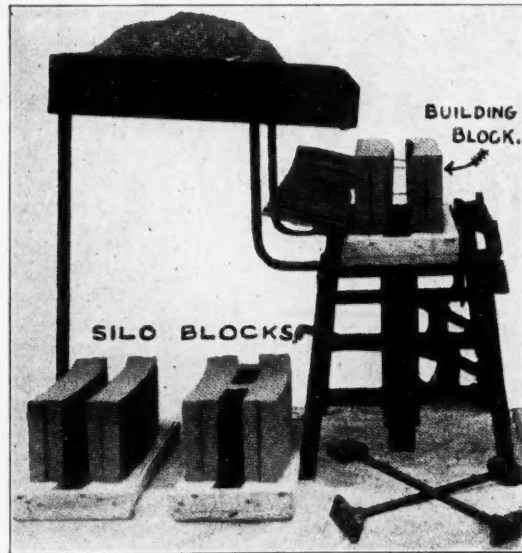

Makes hollow wall building blocks and silo blocks. Complete outfit for work on any kind of building. Simple and inexpensive. No experience necessary to run the Perfect. Blocks 8 in. high, 9 in. thick and 24 in. long, tongued and grooved. Four galvanized iron ties make blocks strong.

Write for More Particulars. The **PERFECT** Pays **J. J. COYNE, Manufacturer :: Fond du Lac, Wis.**

# Think of It!

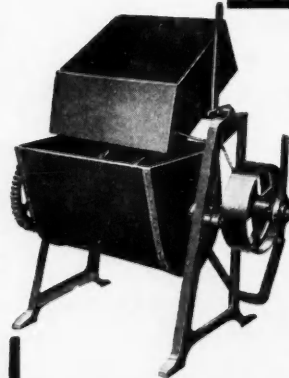

This **HELPER** mixer that will mix mortar and concrete, only **\$35.00**

It will mix two cubic feet at a time. The measuring box enables you to get another batch ready while one batch is being mixed. Requires 1 1/2 h.p. engine to run it. Daily capacity 15 to 20 cubic yards.

Send us your order now, or ask for **FREE** catalog giving more information.

**THE CEMENT TILE MACHINERY CO., 132 Rath St., Waterloo, Iowa**

# THE BEST CEMENT BLOCK IN THE WORLD

Continuous open air space; reinforced all around; staggered bearings. Makes strongest buildings and silos at least cost.

Block Machines, Automatic Tamper, and Continuous Mixers made by the

**BRAGSTAD CONCRETE MACHY. CO. - CANTON, S. D.**

Write for Catalog and Prices

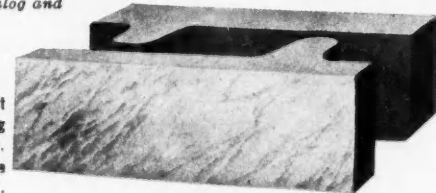

See our Exhibit Space 4 Building Material Exhibit. Insurance Exchange Bldg. Chicago, Ill.

You will get **SPECIAL ATTENTION** if you tell Advertisers you read **American Carpenter and Builder**



# DON'T BUY THREE Block Machines

When You Can Get ONE to Do the WORK of  
THREE—and

## Invest Only \$40.00

Your block making facilities are **not complete** until you have equipment for making **three types of blocks**—the face down, side face and two-piece wall blocks.

But this does not mean installing three machines—not if you buy a **DUNN Combination Block Machine**.

For the **DUNN** makes either type desired **better** than machines that make only one style.

The equipment furnished with every 16-inch machine enables the manufacture of all blocks used in ordinary building construction. It makes blocks 8x16, 10x16 and 12x16, hollow, solid or two-piece wall, in thicknesses of two, three and four inches, two at a time. And it makes these blocks in **Face Down** rock face, bevel panel and smooth design, besides corners, **Side Face** half blocks, etc. **2-Piece Wall**

### Makes 150 Perfect Blocks Per Day

Any unskilled man can easily make from 125 to 150 blocks per day. And every block is **salable** because the **DUNN** Machine effectually prevents any possibility of its cracking or breaking. This is the result of the **DUNN** System of off-bearing, whereby each block is **protected by the mold**. Another feature of this is that a **wet mixture** can be used and **less tamping** is required.

In a word, the **DUNN** Machine offers: Simplicity and safety in operation, absolutely perfect blocks, economy in time and material and **small investment**.

### Sold on 15 Days' Trial

The price of the **DUNN** Combination Block Machine, complete with regular equipment for making the three styles of blocks, is **\$40.00**. And we offer to ship it to any address in the country for fifteen days' free trial, before we accept payment.

Write for complete information and terms—in Catalog No. 30.

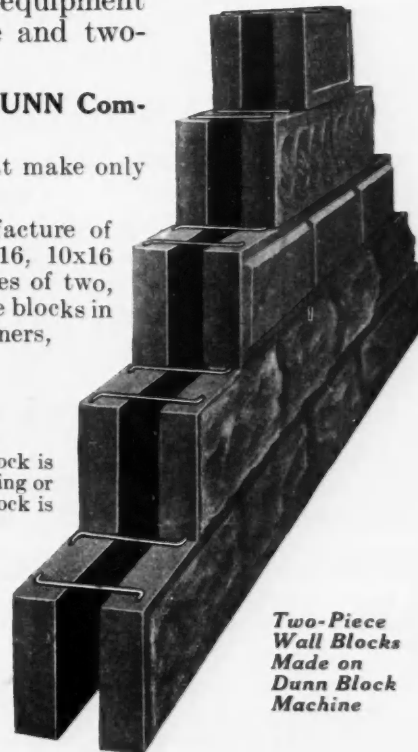

Two-Piece  
Wall Blocks  
Made on  
Dunn Block  
Machine

## Concrete Porches—A Big, Profitable Business for Building Contractors

There's a big and growing demand for concrete porches. And it's business that building contractors can easily obtain and profitably turn out. The long lasting and ornamental qualities of concrete porches appeal to every owner of a house built of concrete, brick or wood, whether it's old or new. And the fact of their **costing no more than wood porches** is a clinching argument.



With an outfit of **DUNN** **Molds** you can make concrete porches complete and at a profit that will open your eyes. Get one job, and the rest will come easy.

We furnish molds to make posts, piers, lattices, cornices, vases, caps and bases, rails, steps, etc., also for making chimneys, silos, etc. Prices and full information in Catalog No. 50, which also describes power Mixers from \$55.00 up.



**W. E. DUNN MFG. CO.**  
4132 Fillmore Street, Chicago



You will get **SPECIAL ATTENTION** if you tell Advertisers you read American Carpenter and Builder.

# SIMPLICITY AND MECHANICAL PERFECTION

are two of the many desirable features found in Ideal Concrete Machines

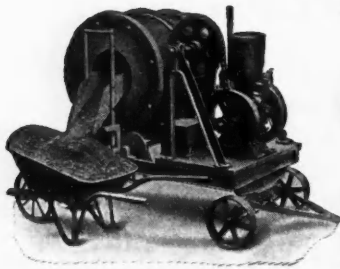

## Contractors and Builders



It is not necessary to explain to the progressive builders, the advantages of concrete in its various forms. However these advantages (and ECONOMY is the chief one) are not to be had if inferior, roughly cast machines are used. Therefore study carefully the characteristics of IDEAL MACHINES.

**Mechanical Perfection.**  
Are Durable and Substantial.

**Speed.**  
Interchangeable Parts and Attachments.

**Portable and Convenient.**  
Produces Greatest Variety of Blocks and Designs.

Sold Under a Positive Guarantee. Write for our Catalogs.

### Makers of High Grade Concrete Machinery

Block Machines  
Brick Machines  
Dimension Stone and Curb Stone Machines

Automatic Power Tampers  
Conveyors and Feeders  
Batch and Continuous Mixers

Ornamental Molds, Sill and Cap, Fence Post, Drain and Sewer Pipe Molds, Tycrete Waterproofing and Colors

## Ideal Concrete Machinery Co.

London, Ont. Canada

1308 Monmouth Avenue, CINCINNATI, OHIO

### BUY THE SIMPLEX BATCH MIXER

1914 Model

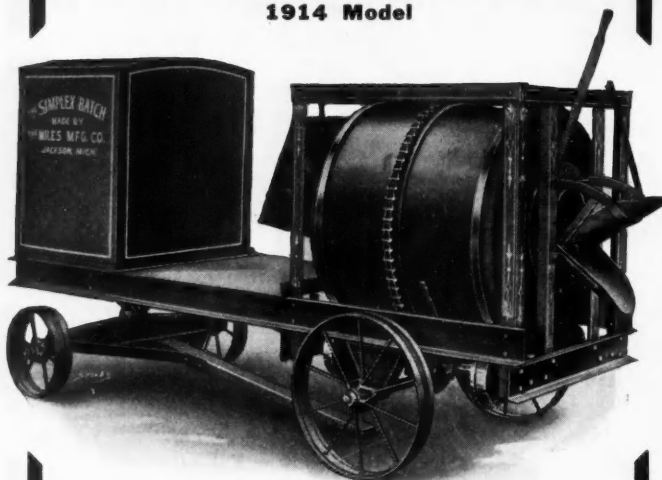

Note the heavy, substantial construction, Low Hopper, Heavy Cast Heads, Drum of No. 8 Steel, Concealed Gears, All-Steel Frame, Rear Discharge, also Side Discharge if desired. And best of all our attractive offer.

Write to-day for catalog.

### THE MILES MFG. CO.

307 E. Franklin Street Jackson, Mich.

## Finishing Tools For Cement Work

We want you to get acquainted with the Arrowsmith Line of Long-Handled Finishing Tools.

One man with Arrowsmith Tools can do the work of six or eight men with short handled tools. Our new Catalog, showing complete and up-to-date line of Contractors' Tools, is ready for you.

Send us a postal or write us today.

ARROWSMITH CONCRETE TOOL CO. ARROWSMITH, ILL.

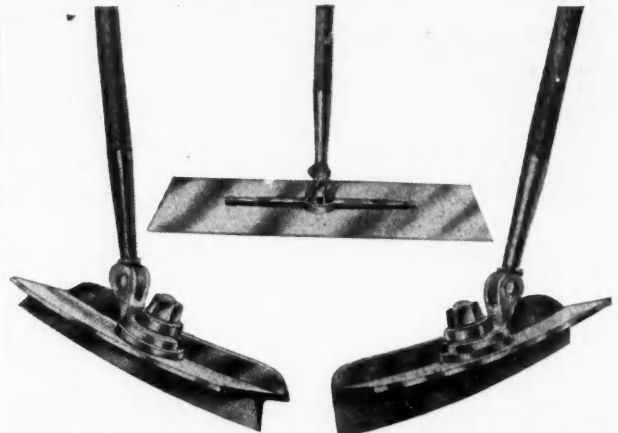

You will get SPECIAL ATTENTION if you tell Advertisers you read American Carpenter and Builder.

## Guaranteed Lightning Protection

Our Pure Copper Cable Lightning Rods and attractive fixtures are easily put on any building by



### Carpenters and Builders—

You know the property owner has confidence in you while working on his building. Get the additional job of protecting his building from lightning. Our rods are in big demand—there's a good profit in selling them. Let us show you the way to more profits on the same job.

Write today for **free** cable samples, agents' prices and catalog.

**Jos. A. C. Barnett & Co.**  
Riverside Iowa



**BUY NOW. SAVE \$15.50**

### Special 30-Day Offer

In order to advertise the **Leader Cement Brick Machine**, we make this special sale price of **\$12.50**. The regular price is \$28.00. You save \$15.50 by placing your order now.



**Sale Price**  
**\$12.50**

The **Leader Cement Brick Machine** is guaranteed. Money back if you're not satisfied. Makes 5 cement brick in one operation. A man can make 1500 to 2000 brick in 10 hours. Built of cold rolled steel. Lasts a lifetime.

This is your chance to get this **GUARANTEED** machine with complete set of face plates and outfit at a very low price. Remember this offer is good for 30 days only. Send your order today. We will cheerfully refund your money if you are not satisfied.

Write us now for **Full Particulars.**

**STARCH BROS. CO., LA CROSSE, WIS.**

# FOX "UNIVERSAL TRIMMER"

TRADE MARK

**A  
Machine  
For  
Every  
Need**

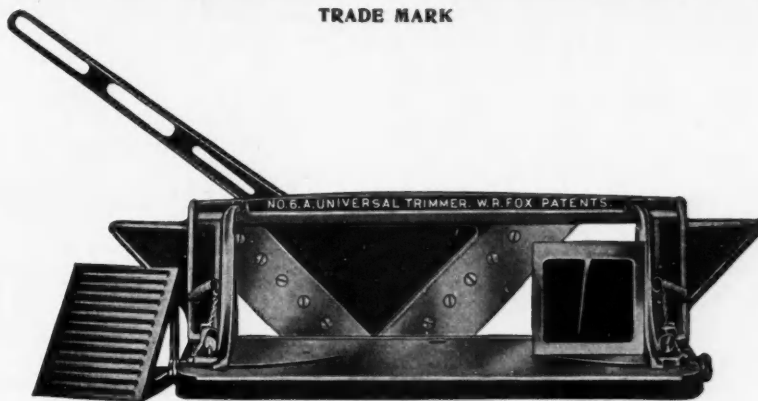

**A  
Need  
For  
Every  
Machine**

GA. FOX "UNIVERSAL TRIMMER"

**You Will Never Know What Perfect Work is Until You Use a Fox "Universal"**

*The fitting of interior finish is greatly improved by using a Fox Universal.*

Write **TODAY** for Our New Catalog

**FOX Machine Co.**  
22 FRONT AVENUE N. E.  
GRAND RAPIDS, - - MICHIGAN

You will get **SPECIAL ATTENTION** if you tell Advertisers you read American Carpenter and Builder.

## How Often is Your Order Held Up at the Mill?

You know from bitter experience what it is to have a hurry job and to have it delayed by failure of the planing mill to get out your order.

When the building season gets in full swing, you're likely to be up against this many a time—and then you have to make explanations and excuses to your customer.

What you want is a

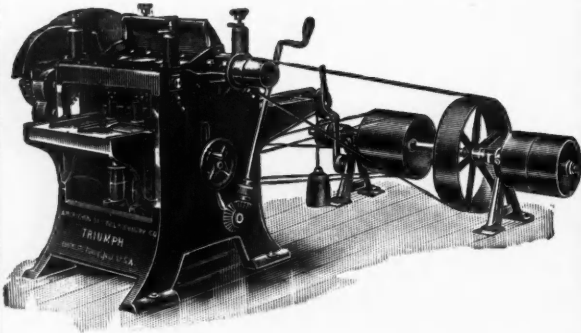

## “TRIUMPH” PLANER, MATCHER AND MOULDER

Right in your own shop—under your own control—working for you alone—making money for you alone.

Then you're independent. You can make your own flooring, ceiling, siding, wainscoting, casing, trim and other machine work—just as good as you can get at the mill. And the profits stay in your pocket.

Send for the “Triumph” Pamphlet

## American Saw Mill Machinery Co.

80 Main Street  
HACKETTSTOWN  
NEW JERSEY

1360 Hudson Terminal  
NEW YORK CITY  
NEW YORK

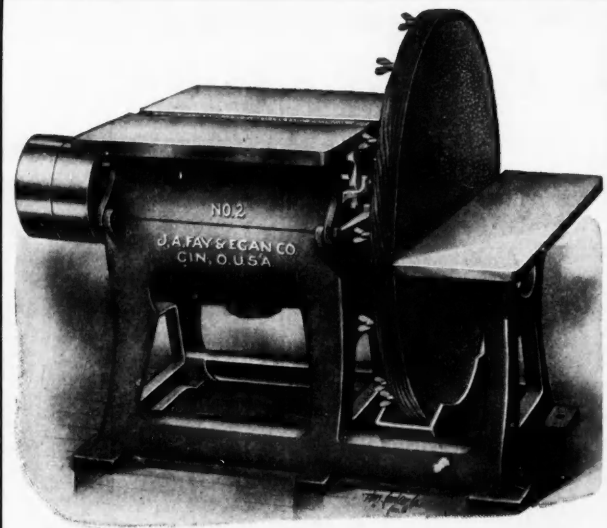

## Sanding with a No. 2 is better and faster than it can be done by hand

A Fay-Egan No. 2 Drum and Disk Sander will sand most anything that turns up in your shop and do it right. Costs little to install, less to operate and will do your sanding at the least cost. You can't well afford to be without one—Ask us more about the No. 2—Now.

J. A. Fay & Egan Co., 545-565 W. Front St., Cincinnati, O.

Four  
Machines  
in One  
\$152.50



## EXTRA GOOD VALUE In Woodworking Machines

Band Saw, Saw Bench, 8" Jointer and Planer, and Hollow Chisel Mortiser—all for \$152.50.

This Type “C” Universal Woodworker is substantial, portable and complete in every way. Base heavy cast iron. Drop rollers. Machine is equipped with all necessary tools and belting. Requires no special skill to operate it. Costs fully two-thirds less than other woodworkers. Saves its cost in millwork on the first three jobs. SOLD ON LIBERAL FREE TRIAL PLAN.

Get our Catalog describing this machine. You can get your money's worth by buying from us. Write before you get too busy.

THE TANNEWITZ WORKS  
815 N. Front Street  
Grand Rapids Mich.

## COMPLETE OUTFIT PRICE \$15.00 HAND AND FOOT-POWER MACHINERY

Our No. 7 Scroll Saw is warranted to be made of good material and workmanship, and to saw pine 3 inches thick at the rate of one foot a minute.

Send for Catalogue.

W.F. & Jno. Barnes Co.

74 Ruby St.

ROCKFORD, ILL.



You will get SPECIAL ATTENTION if you tell Advertisers you read American Carpenter and Builder.

# Do you know why you lost that business?

Some orders that call for close pricing you can take (if you have a "FAMOUS" to do the work) at mighty low prices, and still make good money. You will have capacity for MORE and better work. Things will "look up" quite decidedly for you.

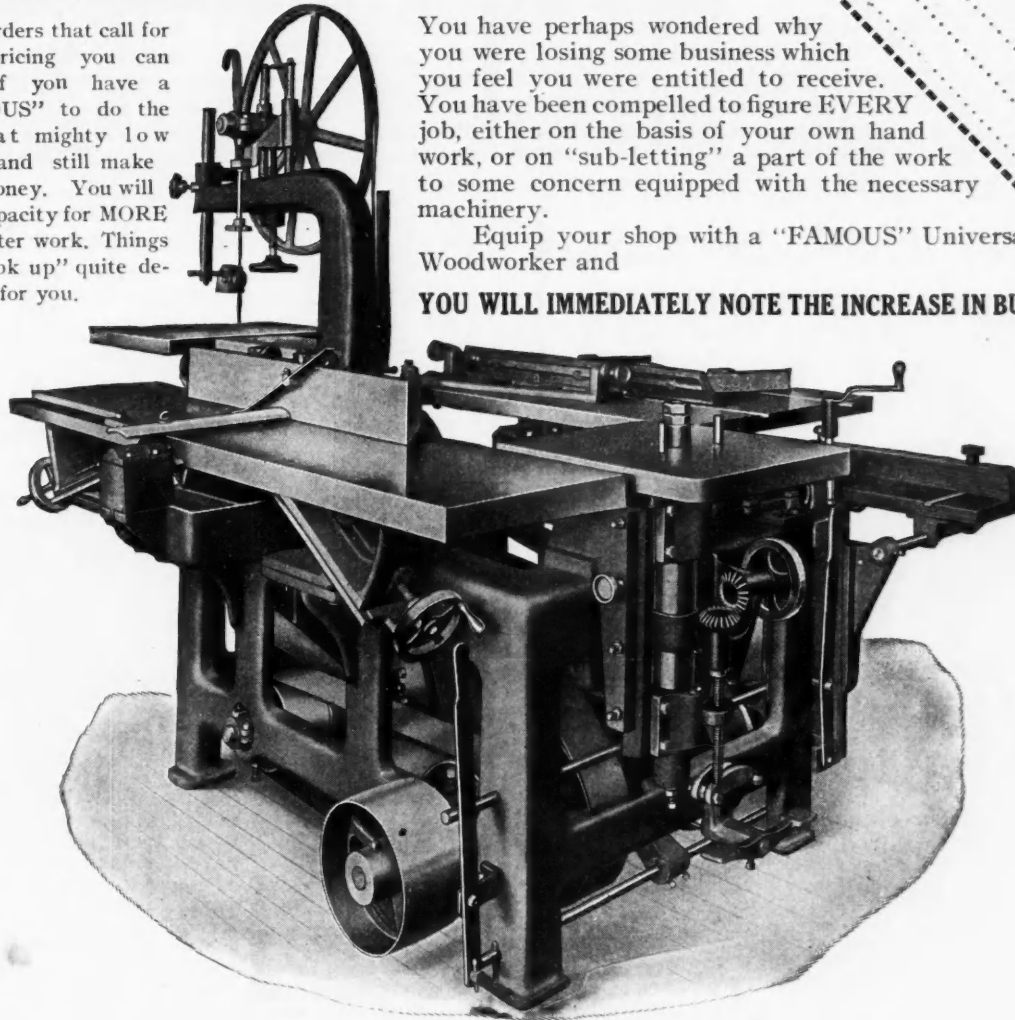

You have perhaps wondered why you were losing some business which you feel you were entitled to receive. You have been compelled to figure EVERY job, either on the basis of your own hand work, or on "sub-letting" a part of the work to some concern equipped with the necessary machinery.

Equip your shop with a "FAMOUS" Universal Woodworker and

**YOU WILL IMMEDIATELY NOTE THE INCREASE IN BUSINESS**

# Increase your business and handle it at a better profit

You can place a Sidney "Famous" Universal Woodworker in a small place on your floor. It will prove the best purchase in the way of a machine to help you get out work quicker and better than you've ever made. You will be able to put every spare moment to good advantage by turning out parts that you now buy from someone else (paying them a good profit, of course!)—you will be able to do the very best work, without overstraining your capacity, when you receive "rush" orders.

We do not know just which one of the "Famous" Woodworkers will prove best for you, but if you will tell us the nature of your work, we can point to just the machine you should have. Do this. Send the coupon for catalog. Look it through. *Then ask questions.* We will not sell you a woodworker until you ARE SATISFIED THAT IT WILL PAY YOU A HANDSOME SUM EVERY YEAR

**SIDNEY TOOL CO.**

**SIDNEY, OHIO**

Sidney Tool Co., Ohio  
Gentlemen—Show me where your "FAMOUS" Woodworkers will HELP ME INCREASE MY BUSINESS and I am interested.  
Send Catalog No. 12.  
Signed.....  
Business.....  
Address.....

You will get SPECIAL ATTENTION if you tell Advertisers you read American Carpenter and Builder.

## WHITE'S IMPROVED LEVEL

**SHIPPED ON APPROVAL**



Our No. 2011 improved level, illustrated herewith, is especially designed for work where a general purpose level is required. Telescope is 12 inches long with magnifying power 25 diameters, and is capable of detecting an error of 1-16 inch in 300 feet. We ship this level out on approval, express prepaid, in order that you may try it out on your own work before deciding to keep it. Ask today for your circular and special net price sheet. Ask today!

**DAVID WHITE COMPANY**  
No. 2011 419 E. Water St. Dept. C Milwaukee, Wis.

## CONTRACTOR CLEARS \$450 IN 10 DAYS

*M. H. Ireland, Anamosa, Ia. —Contractor—*  
cleared above by using **LITTLE WONDERS**—What one man can do with Little Wonders you can do—Get next to this **LITTLE WONDER TRUCK**—It will triple your profits.



**Here's the Little Wonder!**

**10 ROOM HOUSE 5 MILES 10 DAYS MOVED**

Let us furnish your complete House Moving Equipment—everything from Little Wonder Trucks to rollers, jacks, etc. Get our catalog "B" right away. Don't delay. Just a post card brings it in a hurry.

**HOUSE MOVERS SUPPLY COMPANY** 620 Eastlark Court Cedar Rapids, Iowa

## Queen Architects' Level



**For Architects and Builders**

A precision Level with high grade telescope, 12 inches long with sensitive bubble. Capable of doing the most accurate work. Moderate price. Send for catalogue.

**QUEEN-GRAY COMPANY, 616-618 Chestnut St., Philadelphia, Pa.**



## Vest Pocket Manual

of adjustments and instructions in the use of the Level.

A copy FREE for you! Write today for it! Also Illustrated Catalogue.

## Warren-Knight Co.

*Makers of*

### "STERLING" Transits and Levels

136 N. 12th St. - - PHILADELPHIA

Successors to Izard-Warren Co.

## HARDWOOD FLOORING

Builders and owners will find it a clinching argument to say, "It's floored with OAK FLOORING." It is the biggest single feature to look for in any house or apartment building. It imparts an air of refinement and elegance. It is the modern flooring.

Our Finish Flooring is the very highest quality on the market. No better flooring can be had at any price. Improve the rental or selling value of your property 100% by using hardwood flooring.

Polished, Tongued and Grooved, Matched Ends and Bored for Blind Nailing.

OAK FLOORING		Price per 1000 feet
3/4 x 1 1/2 in. face, Select Oak		\$33.00
3/4 x 1 1/2 in. face, Clear Plain Sawed Oak		44.00
3/4 x 1 1/2 in. face, Clear 1/4 Sawed White Oak		60.00
3/4 x 1 1/2 in. face, Clear 1/4 Sawed Red Oak		58.00
13-16 x 2 1/4 in. face, Select Oak		49.00
13-16 x 2 1/4 in. face, Clear Plain Sawed Oak		59.00
MAPLE FLOORING		Price per 1000 feet
3/4 x 1 1/2 in. face, Select Maple		\$31.00
3/4 x 1 1/2 in. face, Clear Maple		37.00
13-16 x 2 1/4 in. face, Select Maple		42.00
13-16 x 2 1/4 in. face, Clear Maple		48.00

Prices F. O. B. Cars Chicago, Ill.

**CHICAGO & RIVERDALE LUMBER COMPANY**  
CHICAGO, ILLINOIS

1000 feet 3/4 in. hardwood flooring can be shipped 400 miles for \$2.00.  
1000 ft. 13-16 in. hardwood flooring can be shipped 400 miles for \$4.40.

## Why Carry A Heavy Transit?



Architects, Contractors, and Builders, this is the serviceable instrument for you. A portable transit that is of special light design. It is easily carried and handled. Is thoroughly accurate and especially adapted for fast work. Built upon practical substantial lines. We manufacture a complete line of surveying instruments in various sizes and at a wide range of prices.

All instruments guaranteed by us. Our circular No. 27 will explain our instruments to you in detail. It will go with you to get it before deciding upon any surveying instruments.

**KOLESCH & COMPANY, 138 Fulton Street, NEW YORK**  
Surveying Instrument Makers. Established 1885.



## No. 8 "UNION" COMBI-NATION SAW

**\$30<sup>00</sup> / 100**

A well-built, light power machine, at a low cost, and has a wide range for work will rip stuff up to 3 1/2 inches thick, also cutoff, mitre, and with attachments, bore, edge-mould, groove, dado, etc.

The No. 8 Union Saw may be easily connected to electric motor or gasoline engine and complete outfit mounted on skids to move from one job to another.

**SEND FOR CATALOG A**

describing our line of Foot and Light Power Wood-working Machinery.

**THE SENECA FALLS MFG. CO., 218 Water St., Seneca Falls, N. Y., U. S. A.**

275

You will get SPECIAL ATTENTION if you tell Advertisers you read American Carpenter and Builder.



# CATCH THE DOLLARS Before They Get Away



**BUILDER**



**MILL MAN**

How are you fixed to handle this season's work? Find out now. Don't wait until the rush is on and then wish you were better prepared. There's a big profit in millwork. Are you going to keep that profit in your own shop or let somebody else walk off with it?

Every time you buy millwork you hand over the good dollars you've made on a job. Don't wait. Get a Crescent Universal Woodworker now. After you've used it one season you'll wonder how you ever got along without it. You will handle more contracts and make more money if you have a

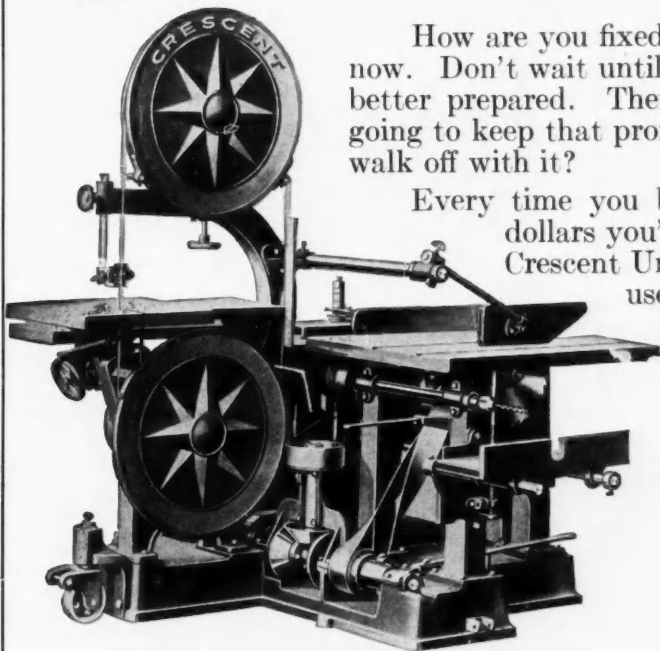

## CRESCENT UNIVERSAL WOODWORKER

With the Crescent each machine is entirely independent of the others—each can be started and run and stopped at will. It is compact. It is convenient. It is well-built throughout—and is always ready for work. The Crescent is particularly suitable for the kind of work **you** have to do. It operates easily. Any average mechanic can handle it satisfactorily. We equip the machine with either 26" or 32" band saw, an 8", 12", or 16" jointer. We can also furnish the machine without the band saw.

Four men can work on the Crescent without interference. There are five separate units that enable you to do

**Re-sawing  
Panel Raising  
Disc Grinding  
Dadoing  
Sanding**

**Cutting Off  
Knife Grinding  
Rabbeting  
Jointing**

**Tenoning  
Mortising  
Boring  
Band Sawing**

**Moulding  
Pole Rounding  
Grooving  
Ripping**

Every part of the Crescent is guaranteed against defective workmanship. If any part breaks, we will replace it free of charge. A reliable machine at a price that won't break you.

Sit right down and send us your name and address. Let us send you the Crescent Catalog. Then it's up to you to decide whether or not you can afford to be without this handy profit-maker.

### THE CRESCENT MACHINE CO.

224 MAIN ST.

LEETONIA, OHIO

You will get SPECIAL ATTENTION if you tell Advertisers you read American Carpenter and Builder.

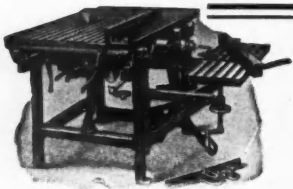

## KEEP THE PROFITS AT HOME

The machine is portable, requires little space in the shop, and is equipped with electric motor or gasoline engine. Furnished with wood or iron frame.

by making a clear saving in fine sawing or in cutting up your dimension stuff. Here's the machine that does the work of from 12 to 30 men.

*Saves big money on every job.*

### The BEACH Double Arbor and Cut-Off MACHINE

can be used in the shop or right out on the job. Each machine includes countershaft complete, rip saw, cut-off saw, arbor wrench, ripping gauge, cut-off gauge, mitre gauge. Can be furnished with Rolling Table for Cut-off and Mitre work. This is the greatest machine made for framing jobs. Satisfaction guaranteed or money back.

WRITE FOR CATALOG

**BEACH MANUFACTURING CO.**  
MONTROSE, PENNSYLVANIA

The Rolling Table works easily with 1000 lbs. weight on it. Locks instantly for ripping or beveling. Allows work on 18-foot lumber.

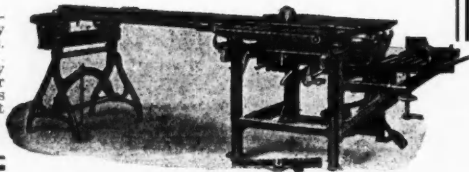

### Parks Portable Shingle or Combination WOODWORKING OUTFITS

are the most practical—the most efficient—the most economical woodworking equipment you can buy

This machine is a combination of circular rip and cross cut saw 6 or 12-inch jointer with tilting guide, boring attachment, jig saw with tilting table sand disk, and gasoline engine, guaranteed to do the work.

Angle steel frame is the strongest structural material known. Machines are made in large quantities which allows us to sell at lowest price and make prompt shipment. WRITE FOR CATALOG

**PARK'S**  
Ball-Bearing Machine Co.  
Fergus Street and C. H. & D. Ry., CINCINNATI, OHIO

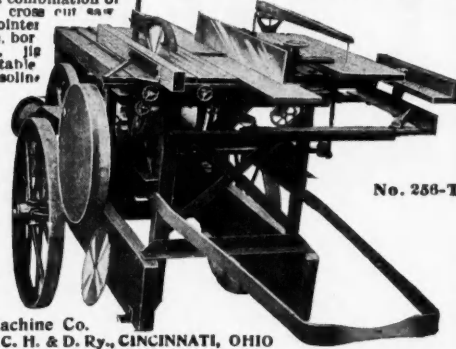

No. 256-T

### BLAKE QUICK ACTING VISE

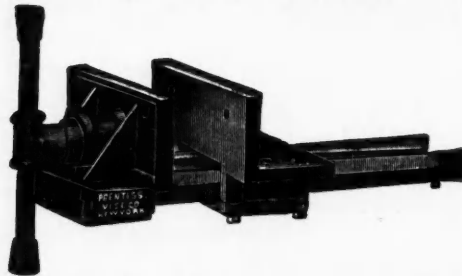

For Cabinet Makers and Wood Workers. Simplest—Strongest—Cheapest—Best  
Send for Catalogue of all kinds of Vises  
**PRENTISS VISE COMPANY, MAKERS**  
106-110 La Fayette St., New York, U. S. A.



# "A Bit of Utility"

Guided by its circular rim—instead of its centre—the Forstner Labor-Saving Auger Bit will bore any arc of a circle, and can be guided in any direction.

Doesn't matter how hard the wood is, no consequence whether it is full of knots, or the grain awkward to negotiate. The Forstner Bit works with equal smoothness under any condition and leaves a true polished surface on every job.

## Unequaled for Delicate Work

Supercedes chisels, gauges, scroll-saws, or lath tools combined, for all kinds of delicate work. Cabinet and pattern makers and carpenters are enthusiastic because they do more work than other bits and cost no more.

We can offer something special in the matter of price on sets packed in a sensible box. Send today for particulars and catalog.

**The Progressive Mfg. Co.**  
Torrington, Conn.

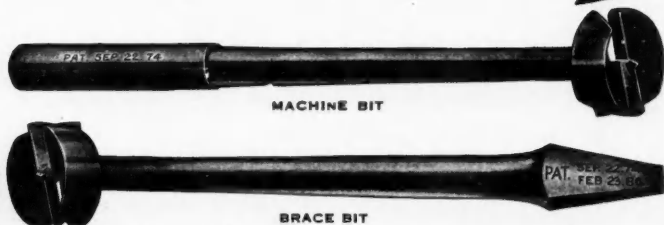

# ROOF SLATES

## STRUCTURAL SLATE BLACKBOARDS

You will get SPECIAL ATTENTION if you tell Advertisers you read American Carpenter and Builder.

**E. J. JOHNSON**  
38 Park Row New York

**Quarry Operator**  
BLACK, GREEN, PURPLE, RED

Booklet, Samples and Prices on Application

# WRITE US

FOR OUR NEW  
1914 CATALOG



AS PIONEERS in the manufacture of PORTABLE SAW RIGS, we are entitled to claim that we manufacture the BEST Portable Saw Rigs on the market today; in fact, we make them complete in five different sizes to meet every requirement of the trade.

We also manufacture hoists, pumps, elevators, mortar mixers, concrete chutes, air compressors, gasoline engines, etc.

*Write Us for our new 1914 attractive Catalog*

**C. H. & E. MANUFACTURING CO., Inc.**  
322 Mineral Street MILWAUKEE, WISC.

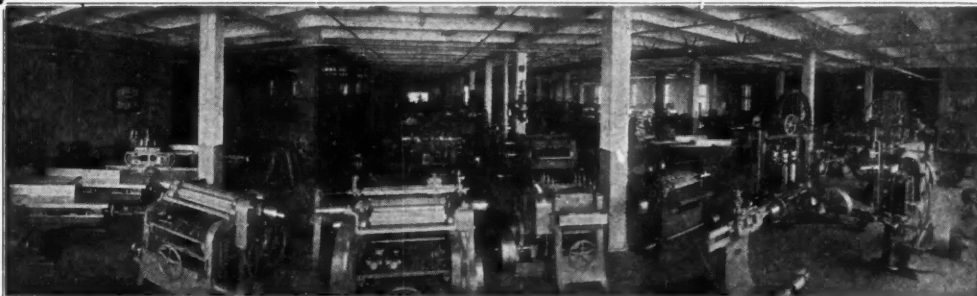

Section of Main Floor Exhibit and Salesrooms

Everything in wood working machinery and supplies for Contractors, Carpenters, Builders, Interior Finish, Sash and Door, Planing Mills, Furniture, etc.

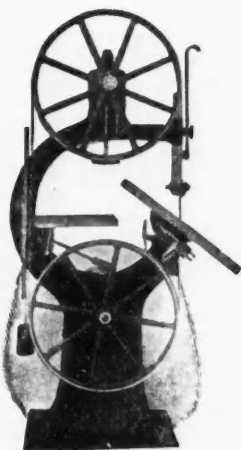

Chicago Band Saw  
27-32-36 inch wheels

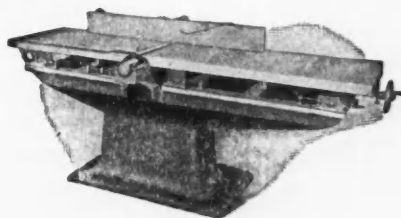

Chicago Jointers  
8-12-16 inch

*Write us Your Wants  
and Get Our Special Price*

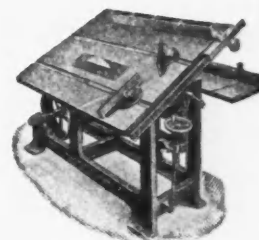

Chicago No. 9 Combination  
Saw

**Chicago Machinery Exchange**  
1215-1223 Washington Blvd. :: CHICAGO

You will get SPECIAL ATTENTION if you tell Advertisers you read American Carpenter and Builder.

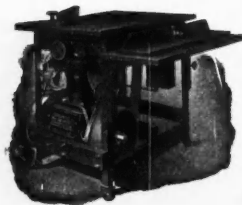
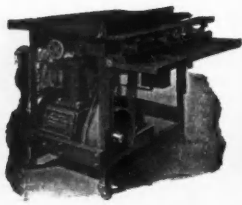

**Standard Portable  
Combination  
Woodworker**

9 Machines in 1  
6 H. P. ENGINE

SEND FOR CATALOG G  
ATLANTIC ENGINE CO.  
Meadville - Penna.

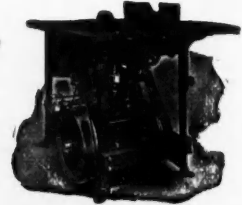
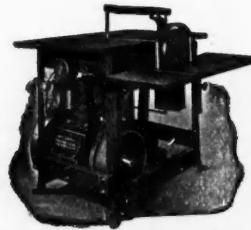

**GENUINE BANGOR**

Roofing Slate  
Structural Slate  
Blackboards

Large Facilities, Prompt Deliveries  
EAST BANGOR CONSOLIDATED SLATE CO.

East Bangor, Pa.

**"OHIO EXTRA" AUGER BITS**

are High Grade Single Twist Bits, carefully made from specially selected auger bit steel. They are the Most Rapid Cutting and Perfect Clearing Bits on the market today and are fully warranted.



**"OHIO" CHISELS, PLANES, ETC.**

All "Ohio" Tools are made with the same painstaking care that has built up our present reputation for making only high grade tools. We use in our Edge Tools high grade steel, treated and tempered by the most improved process, which insures Uniformity and Correctness of Temper, and a Keen, Tough and Lasting Cutting Edge. If you appreciate Good Tools it will pay you to insist on having "Ohio" Tools from your Dealer.



Write for our special Carpenters' Catalogue of High Grade Tools and Benches

OHIO TOOL CO. (Dept. 15) Charleston, W. Va.



**Five Tools In One**

Why pack up and carry five tools when one will do as well? The

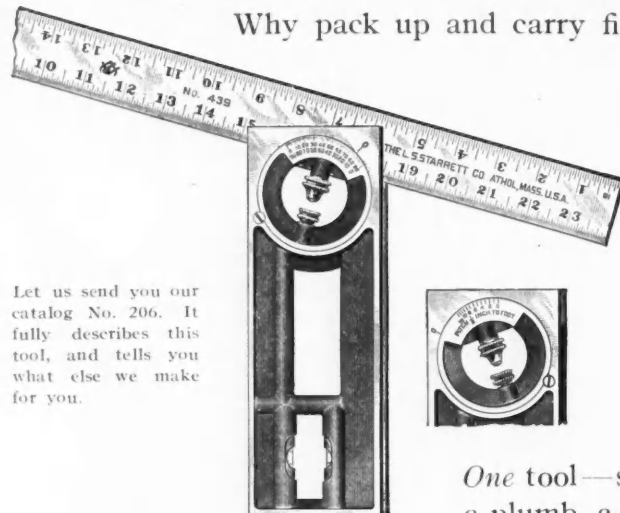

**Starrett**  
Patent  
**Builders' Combination Tool**

Let us send you our catalog No. 206. It fully describes this tool, and tells you what else we make for you.

One tool—serves as an improved try square, a level, a plumb, a depth gage and a bevel.

Although you don't haggle over the cost when purchasing really good tools, yet here's a chance to save the price of the individual tools. Like all products bearing the name "Starrett," the accuracy and finish and convenience of this Builders' Combination Tool are not excelled.

**The L. S. Starrett Co., Athol, Mass.**

New York  
150 Chambers St.

London  
36 and 37 Upper Thames St., E. C.

Chicago  
17 No. Jefferson St.  
42-19

You will get SPECIAL ATTENTION if you tell Advertisers you read American Carpenter and Builder.

You can buy a barrel of rules, but you cannot measure the inside of a barrel unless you use  
**MASTER SLIDE RULE**

The handiest rule a carpenter can have. Newly invented and improved with inter-locking device on every slide. Takes inside measurements of doors, windows, cabinets, cupboards, boilers, furnaces, etc. Useful; practical; strong. Interlocking, rust-proof, fool-proof.

The MASTER SLIDE RULE is far above the ordinary rule. Price is so low that you should use no other. Made of select boxwood and trimmed with solid brass. All lengths, from 2 feet to 8 feet. Rigid when extended. One side gives inside measurements; other side is for outside measurements. Slides pull out automatically when key spring is pressed. Closes easily.

Get the MASTER SLIDE RULE from your hardware dealer, or send us 15 cents per lineal foot and we'll send you any length desired. Write for complete illustrated circulars.

**DAHL MFG. CO., 51-G East 42nd Street, NEW YORK CITY**

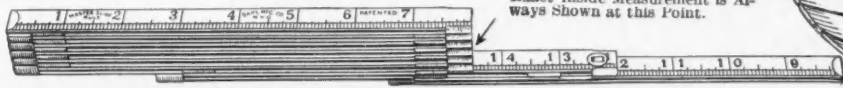

Exact Inside Measurement is Always Shown at this Point.



**Cuts Mortises  
In Three Minutes**

This machine mortises as well, and often better than high priced machines. Can be used for any door lock, sash, screen frame, cabinet work, etc. Adjustable from perfect round hole to 6-1/4 in. slot.

**CHAMPION MORTISER**

is equipped with ball bearings, large gears and automatic stop. Easy working. Cuts perfectly. Mortises in hard or soft wood, through knots, with or against the grain. No other tool required.

You may try the CHAMPION free. Write for particulars about this offer and our circular—"FACTS."

**Colgan Machinery & Supply Co.**  
616 New Hayden Bldg.

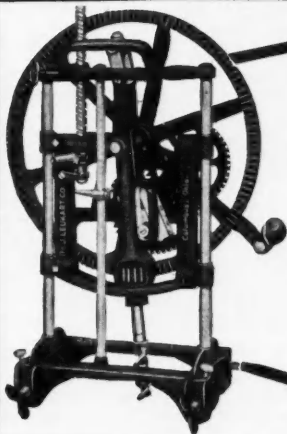

COLUMBUS

OHIO

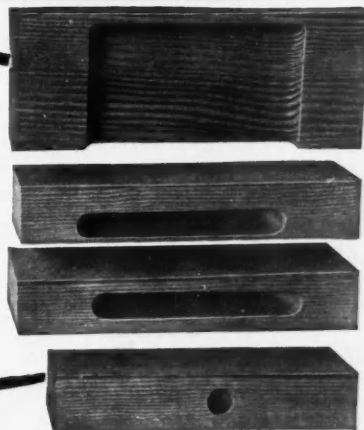

**Hammer Insurance**



**SPECIAL**

Our "VANDOR VANADIUM" Nail Hammers in two sizes. No. 22, 13 oz. Finishing; No. 21 1/2, 16 oz. Standard. We will send either size Parcel Post for your Dealer's name and \$1. This Hammer we insure for life. Made for hard work and lots of it. You can return it any time

if it proves defective and get a new one.

This hammer is warranted to draw anything from a headless brad to a spike.

Drop Forged from the toughest Vanadium Steel. Second growth hand shaved Hickory Handle. Tempered in oil. Easy to work with. Get one to-day. Remember only \$1 and your dealer's name for either size, 13 oz. or 16 oz. Mail your order NOW.

**Van Doren Manfg. Co., Inc. Chicago Heights, ILL.**  
(Vanadium Dept.)

1853



BROS.

1914

Fine Beveled Edge  
Shank and Socket

**Chisels**



**Tang and Socket  
Butt Chisels**

Plain and Beveled Edges

Send for illustrated Catalog

**Buck Bros., Millbury, Mass.**

**THE MYERS GIANT  
ADJUSTABLE TANDEM  
DOOR HANGER**

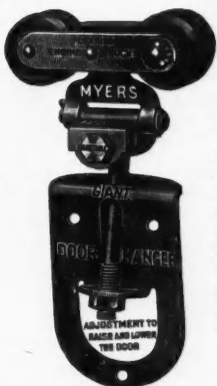

for TUBULAR GIRDER TRACK is adjustable to and from the building, and up or down as necessary. Has flexible engine track with steel rollers revolving on steel roller bearings. The adjustable features prevent trouble from weather conditions or sagging of building. Storms, sleet or ice do not affect it, owing to complete protection afforded by the tubular track. Track and Hanger are constructed to carry and operate heavy doors easily.

This and other styles of Tubular and "Stayon" Door Hangers are shown in our Door Hanger Booklet. Copy mailed on request.

**F. E. MYERS & BRO.**  
ASHLAND, OHIO

"Last a Lifetime and Give Satisfaction  
To the End"

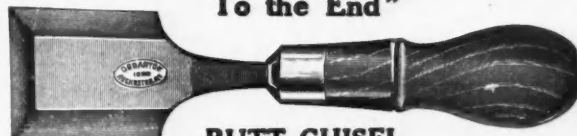

**BUTT CHISEL**

The celebrated Barton Planes and Edge Tools for carpenters and all other woodworkers are unequalled by any other made for keen, hard, smooth cutting edges. If your hardware dealer does not handle

TRADE MARK



**THE CELEBRATED BARTON TOOLS**

Send direct for catalogue and our free story book, True Stories. Be sure to specify "CARPENTER'S CATALOGUE."

**MACK & COMPANY, 20 BROWN'S BACH  
ROCHESTER, N. Y.**

You will get SPECIAL ATTENTION if you tell Advertisers you read American Carpenter and Builder.

# GRINDERS

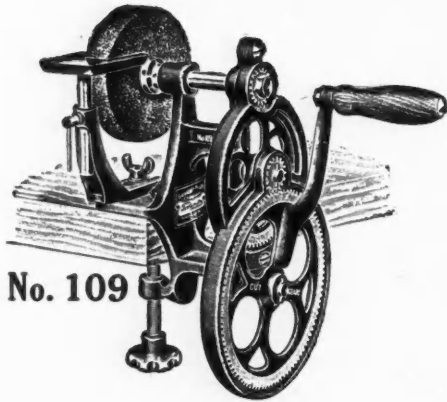

No. 109

*Goodell-Pratt's*

## Bench Grinders

It has been some time since the Bench Grinder supplanted the clumsy old grindstone. For a long time there were no really good Bench Grinders made. Finally we brought out one little machine. The gears were all turned and cut, the bearings reamed, it was nicely finished in red enamel and black japan, carefully assembled, and furnished with the best wheel which we could obtain.

Some people said it was too high priced to sell, but we said that good carpenters would buy good grinders. They did. We are now making eight styles. One of them will suit you.

*Complete Catalog Free*

**Goodell-Pratt Company**

*Toolsmiths*

GREENFIELD, MASS., U. S. A.

## SEBCO EXPANSION BOLTS

**For Brick  
and Stone**

or any material in which a hole can be made use Sebc Expansion Bolts. There is no better means of fastening any kind of support, bracket or fixture to walls, floors or ceilings.



**Quick and  
Efficient**

They mean a great saving of time, labor and money. Sebc Expansion Bolts are now being specified almost universally by architects and builders who have learned their wonderful merits.

*Samples and Catalog on Request*

**STAR EXPANSION BOLT CO.**

147-149 Cedar Street : : New York City  
120 West Lake Street : : Chicago

## Are You Ready for the Spring Rush

Your tools should all be in the best of shape, ready to meet the rush of work that comes as soon as the frost is out of the ground. If your bits are not in good shape, or if some sizes are missing, you can't do better than to stock up with

## Russell Jennings Auger Bits

They are the only bits made of genuine crucible steel. They outlast any other bit. They bore fast, clean, and true. Made with ordinary shank for ordinary brace chucks, or with the new Precision turned shank which never pulls out or wobbles in the Precision brace chuck. And don't forget the new Russell Jennings braces, expansive bits, etc. Any hardware dealer will show you the full line.

**Russell Jennings Mfg. Co.**  
Chester, Conn. 21-108

You will get SPECIAL ATTENTION if you tell Advertisers you read American Carpenter and Builder.

# Stanley Tools



## BAILEY IRON PLANES

“Bailey” Iron Planes have been in use for nearly fifty years, and are the recognized standard for Planes of this type.

While retaining all the original features, many valuable improvements in construction have been added from time to time. Only the finest materials and the best workmanship are used in their manufacture.

Always insist that your order be filled with Planes made by THE STANLEY RULE & LEVEL CO., which carry with them a GUARANTEE backed by a Company that has been manufacturing Carpenters' and Mechanics' tools for over half a century.



**STANLEY RULE & LEVEL CO.**  
NEW BRITAIN, CONN. U.S.A.



You will get SPECIAL ATTENTION if you tell Advertisers you read American Carpenter and Builder.

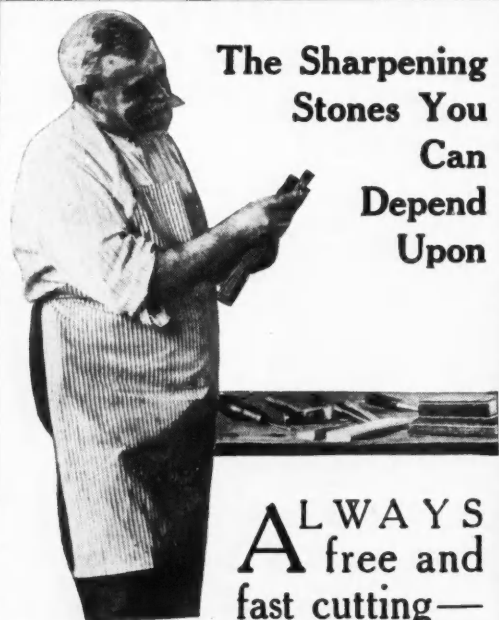

The Sharpening  
Stones You  
Can  
Depend  
Upon

**A** ALWAYS  
free and  
fast cutting—  
uniform in their texture,  
holding their shape, and  
showing almost as long a  
life as your tools.

**CARBORUNDUM  
Sharpening Stones**

Have earned a place in the  
tool kits and on the work  
benches of users of edge  
tools everywhere.

There is nothing harder,  
sharper, or faster cutting  
than Carborundum.

*There is a Carborundum Stone for  
Every Sharpening Job.*

FROM YOUR HARDWARE DEALER OR DIRECT

**The Carborundum  
Company**

Niagara Falls,  
N. Y.

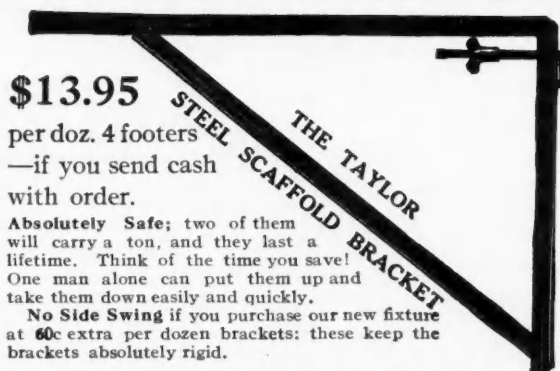

**\$13.95**

per doz. 4 footers  
—if you send cash  
with order.

**Absolutely Safe;** two of them  
will carry a ton, and they last a  
lifetime. Think of the time you save!  
One man alone can put them up and  
take them down easily and quickly.

**No Side Swing** if you purchase our new fixture  
at 60c extra per dozen brackets: these keep the  
brackets absolutely rigid.

*Write for Catalog of Builders' Specialties!*



About clamps—the sliding jaw on each of ours can be  
moved in an instant **DIRECTLY AGAINST** the work operated  
on, so that half a turn of the fine specially threaded screw  
will apply the power.

Think of the time this saves!

The grip is positive, and special grade of steel in the bar  
more than doubles the strength of the clamp.

Our No. 10 catalogue shows some very interesting price  
reductions on four of the most wanted styles. It will pay  
you to write for it at once.

**James L. Taylor Mfg. Co.**  
Poughkeepsie, N. Y., U. S. A.

**MONITOR  
SASH LOCKS**



(PATENTED)

**NEVER BREAK**

**BECAUSE THEY ARE MADE OF VERY HEAVY GAUGE  
METAL AND PERFECTLY CONSTRUCTED.**

If the upper plate drops, the Monitor "Never Break"  
Sash Lock will pick it up from a lower point than any  
other, adjust the sashes perfectly, prevent all vibration  
and lock securely, so it cannot be opened from the outside.

MADE IN TWO SIZES AND ALL FURNISHED BY

**The Champion Safety Lock Co.**  
Geneva, Ohio





## It's Always the MAN Behind

Poets and historians have sung to us for years of "the man behind the gun". He, of all others, is the popular hero.

In times of peace, when the brilliancy and pomp of war are forgotten, the wise folks sometimes acknowledge that much is due to the man behind the plow. Largely through his industry and thrift the man behind the gun is made possible.

But forgotten in both song and story is *the man behind the saw*. Though upon his skill and knowledge the modern world has been built, he goes on his way unnoticed.

Standing behind his saw, day in and day out, for many long and weary hours, he helps to build the ships that carry the great guns—he constructs the frames that hold the plow—he rears the home that protects the plowman—he devises and produces almost everything that makes life worth the living.

Patient, simple, unrewarded though his life may be, we have always recognized his supremacy in the world of industry. We have devoted more than threescore years to making

## DISSTON SAWS

so as to place in his hands an implement that would enable him to develop his skill to the utmost. We have given him the best that could be made and left the rest to him; for it matters not how true the gun—however sharp and shapely the plow—or skillfully designed the saw—it's always the *man* behind upon whom rests the burden of its efficiency.

**HENRY DISSTON & SONS, Inc.**

KEYSTONE SAW, TOOL, STEEL AND FILE WORKS

PHILADELPHIA, PA., U. S. A

You will get SPECIAL ATTENTION if you tell Advertisers you read American Carpenter and Builder.

**PLUMBER'S  
NEST  
OF SAWS  
No. 83**

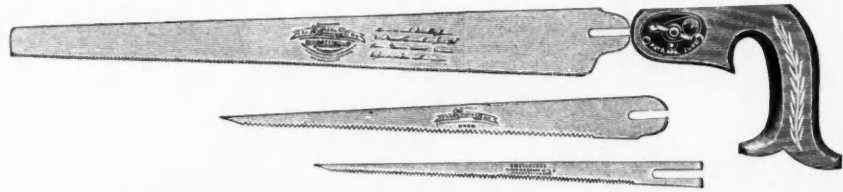

# SIMONDS SAWS

*That cut wood or nails—*

Every Carpenter should have this to cut right through obstinate nails that would injure a regular Hand Saw. Each nest consists of an 18-inch Nail Cutting Blade, a 12-inch Compass Blade, and a 10-inch Keyhole Blade, with a patent adjustable Handle. Price \$1.50 per set.

## SIMONDS MANUFACTURING COMPANY

17th Street and Western Ave.  
CHICAGO, ILL.

FITCHBURG, MASS.

St. Remi St. and Acorn Ave.  
MONTREAL, QUE.

NEW YORK CITY  
PORTLAND, ORE.  
SPOKANE, WASH.

NEW ORLEANS, LA.  
SAN FRANCISCO, CAL.  
VANCOUVER, B. C.

MEMPHIS, TENN.  
SEATTLE, WASH.  
ST. JOHN, N. B.

LOCKPORT, N. Y.

LONDON, ENGLAND

## SARGENT

**O**UR new Rafter Square, No. 500R, is the most complete Square ever made for the carpenter.

It contains accurate measurements for all kinds of rafters, common, hip, valley, jack and cripple—in the most convenient form.

These measurements are all given on the Square; they are complete, correct and final. They save the trouble of multiplying and dividing and then obtaining a result about which there is some doubt.

Simple and easy to use. A great time saver.

For full description and directions for using send for the Sargent Square booklet, free on request.



**SARGENT & COMPANY**

Makers of Squares, Planes and Mechanics' Tools  
1149 Leonard St. New York

Other Sargent Quality Tools are described in the Sargent Tool Book, a handbook for mechanics, sent on application.

You will get **SPECIAL ATTENTION** if you tell Advertisers you read **American Carpenter and Builder**.

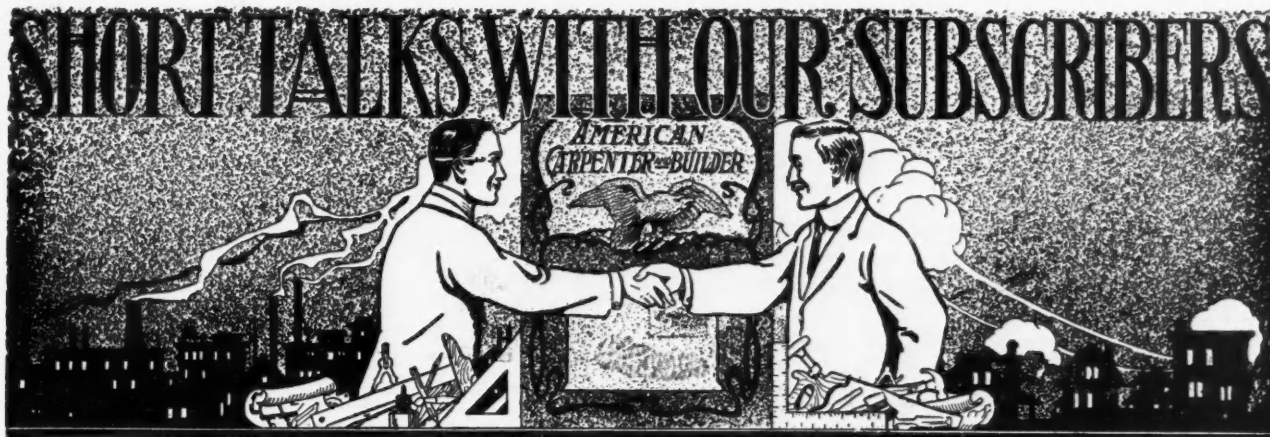

**Ninth Anniversary Sets Big Circulation Record**

OUR readers will be interested to know that they now number more than *Forty-two Thousand*. Also that over 14,000 thriving cities and towns distributed over every state in the Union and province of Canada now has one or more energetic, responsible builders who subscribe to the AMERICAN CARPENTER AND BUILDER!

This is by far the biggest circulation and the widest distribution ever attained by any building paper.

On the occasion of this Ninth Anniversary, we want to

thank you—our subscribers—for the friendly interest and loyalty you have had in the past for *your* building magazine. You have helped in many ways and your help has been truly appreciated.

Here is a way we wish you would help *this* year,—if you enjoy the magazine, tell other first-class builders in your locality about it and get them to subscribe also. We want to be able to announce a circulation of 50,000 best builders by our next birthday, and with your help we can do it.

Yours for growth,

Editor AMERICAN CARPENTER AND BUILDER.

**Sworn Statement of Circulation of American Carpenter and Builder, March 10, 1914**

CENTRAL STATES		EASTERN STATES	
Illinois	3,515	New York	3,438
Ohio	2,777	Pennsylvania	2,420
Iowa	2,470	Massachusetts	1,124
Michigan	1,748	New Jersey	815
Wisconsin	1,416	Connecticut	409
Indiana	1,571	Maine	397
Minnesota	1,344	West Virginia	378
Missouri	1,381	New Hampshire	268
Kansas	1,019	Vermont	157
Nebraska	1,016	Delaware	60
South Dakota	448	Rhode Island	113
North Dakota	427	District of Columbia	34
<b>19,132</b>		<b>9,608</b>	

WESTERN STATES		SOUTHERN STATES	
California	1,178	Texas	1,097
Washington	574	Florida	245
Oregon	489	Kentucky	282
Colorado	288	Arkansas	205
Montana	431	Oklahoma	343
Idaho	251	Virginia	259
Utah	194	Maryland	185
Arizona	88	Tennessee	153
Wyoming	103	North Carolina	141
New Mexico	62	Louisiana	86
Nevada	54	Alabama	127
<b>3,712</b>		South Carolina	77
		Mississippi	89
		Georgia	91
		<b>3,360</b>	

SUMMARY	
Paid-in-Advance Subscribers, United States	35,832
Paid-in-Advance Subscribers, Canada	1,887
Paid-in-Advance Subscribers, Foreign	123
<b>Total Paid-in-Advance Subscribers</b>	<b>37,842</b>
Sales to Western News Co.	3,925
Advertisers, Exchange and Gratis	663
<b>Total Circulation (Affidavit Herewith)</b>	<b>42,430</b>

**AFFIDAVIT OF CIRCULATION**

STATE OF ILLINOIS }  
 COUNTY OF COOK } ss.

Edmund L. Hatfield, being duly sworn, deposes and says that he is the General Manager of the American Carpenter and Builder, located at Chicago, State of Illinois; that he has personally examined and verified the circulation records of the American Carpenter and Builder, and knows that on March 10, 1914, the actual circulation of said American Carpenter and Builder was 42,430 copies, as follows:

Paid-in-Advance Subscribers	37,842
Sales to Western News Co.	3,925
Gratis, Exchange and Advertisers	663
<b>Total Circulation, March 10, 1914</b>	<b>42,430</b>

(Signed) E. L. HATFIELD,  
 General Manager American Carpenter and Builder.

Subscribed and sworn to before me, this tenth day of March, 1914.  
 (Seal) JEANNETTE A. NICHOL, Notary Public.  
 My commission expires July 6, 1915.

**Contents for April, 1914**

	Page		Page		Page
Adventures in Heating	70	Getting Full Value Out of the Coal Bin	70	Neat Six-Room Story-and-a-Half Cottage	49
Announcement of Prizes	82	Going After the Mill Man	104	Nine Weeks Instead of Four	90
Annual Depreciation on Buildings	37	Good System of Time Tickets	77	Ninety-Foot Round Barn	68
April Ad Puzzle Prize Contest	83	Great Salt Lake Preserves Timber	61	Ninth Anniversary Celebrated by Solving	
Big Expense Not Required for Attractive Dwellings	48	Guaranteed Building Plans	48	Nine-Sided Roof Framing	56
Boss Carpenter Question Box	66	Handy Door Holder	89	Noon-Hour Talks by the Boss Carpenter	64
Building Boom Strikes Main Street	74	Heavy Timber Barn Work	93	Octagon Cement Block Barn	96
Built Coal Tipple	87	Home Building by the Wholesale	38	Old Building Quarrel	72
Bulmore's Tool Chest	100	Home-Made Cooling Vat	79	One More to Cross	94
Change of Size in Concrete Forms	37	Home Work Shop	78	Photo of Large Modern Living Room	46
Clever Little Cottage	53	How to Build a Plank Frame Barn	58	Preventing Serious Accident on Swinging Scaffolds	62
Convenient Tool Chest	90	How to Cut the Bed Mould	88	Raising a Heavy Roof	84
Correspondence	84	How to Make Combination Writing Desk and Bookcase	78	Safety First	62
Cumiskey Thresholds	93	How to Make a Strong Door	102	Scotch Threshold	94
Details of One-Story Store Buildings	75	How to Raise the Roof	85	Setting Door Jambs and Fitting Doors	102
Details of Two-Story Store Buildings	76	Jasburings About Furniture, Etc.	86	Seven-Room Gambrel Roof Residence	51
Details of Three-Story Store Buildings	76	Karpenter Kinks	86	Seven-Room "Western" Bungalow	39
Do Metal-Covered Buildings Attract Lightning?	90	Keeps Beeswax in Hammer Handle	87	Six-Room Frame and Stucco Residence	52
Double-Duct System of Ventilating	67	Large Iowa Corn Crib	106	Steel Square	56
Editorial	37	Left-Handed Man Wants Advice	90	Stylish Frame Dwelling	54
Fire-Proof School House Under Way	87	Little Stories of Success	55	Ten-Room English Style Mansion	45
First Pump Mill to Use Saw-Mill Waste	88	Method of Setting Jambs	94	Terra-Cotta Talks	74
Five-Room Mission Type Bungalow	42	Model High School Building	81	Three-Room Bungalow	44
Forest Products Exposition	80	Modern Colonial Residence Design	43	Trade Notes and Items of Interest	108
Gambrel Roof Design	93	More Shop Kinks	73	Unique Seven-Room Bungalow	50
		Moved 175-Ton Bridge	99	Yours for Safer Building	64

# CHICAGO SPRING BUTTS

## REPUTATION

Do you specify a spring hinge with distinctive features which will appeal to your client and assure satisfaction to all concerned?

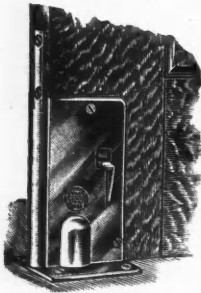

### Chicago "Relax" Spring Hinges

are in great demand. They are substantial in construction and readily applied. The EXCLUSIVE FEATURE of spring action release, allowing the door to be placed at any desired position and automatically re-engaging when the door is closed, is of recognized merit and utility.

Send for Catalogue C 29. It fully illustrates and describes the most complete line of Spring Hinges manufactured.

**Chicago Spring Butt Company**

CHICAGO



NEW YORK

## Yes! the World does Move!

Facts are Stubborn Things

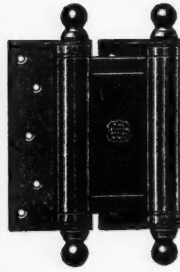

**Don't Buy**  
SPRING HINGES  
OF  
OBSOLETE  
CONSTRUCTION

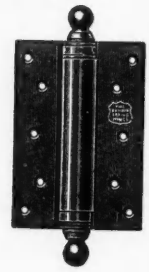

ONLY

# Bommer

DOUBLE ACTING

## Spring Butt Hinges

Carry the load on the true bearings

and look alike at both sides of the opening when both doors of a pair of doors are opened in or out. The carpenter can scribe for both doors of a pair from the same side, and avoid guesswork, as he can see what he is doing while fitting the doors.

YOUR HARDWARE MERCHANT CAN SUPPLY THEM

**Bommer Bros., Manufacturers Brooklyn, N.Y.**

## Cabot's Sheathing and Deadening Quilt

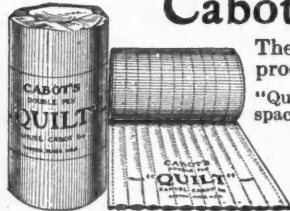

The Cold-proof, Heat-proof, Sound-proof and Fire-retarding Lining

"Quilt" is a matting filled with dead air spaces, and one layer is as warm as twenty-eight layers of common building paper. A house lined with it will always be warm and save coal. Floors and partitions lined with it will stop the passage of sound. Roofs lined with it will keep cool

in summer and prevent heat from escaping in winter. It will save coal enough to pay for itself every two winters as long as the house stands.

Send for a sample and catalog.

**SAMUEL CABOT, Inc., Manufacturing Chemists, Boston**  
24 W. Kinzie St., Chicago - 1133 Broadway, N. Y.

Cabot's Creosote Shingle Stains; Stucco and Brick Stains, Conservo Wood Preservative.

## No Guess Work with a MORRILL SAW SET

Simple and accurate. The only Saw Set a carpenter should use. Takes out the wrong set and puts in the right set at one operation.

The eccentrically beveled anvil is so indexed that you can see what you are doing. Gauge screw and locknut keeps work uniform.

FREE "Saw Points" a valuable Booklet.

**Chas. Morrill, 94 Lafayette Street NEW YORK**

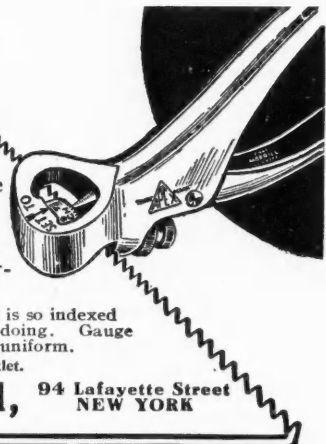

## METALLIC BATTEN STRIPS

PRACTICAL—EVERLASTING—ECONOMICAL

These Batten Strips of Galvanized Metal will never warp, split, or draw away from the boards. Offer no obstruction to sliding doors. Allow for expansion and contraction of the siding. Made in 8-foot and 10-foot length with interlocking joint. Easily cut; no waste. Nailed directly to siding with small nails.



End view showing joint closed. A perfect fitting Batten at all times, in all weathers. Beautifies any building.

End view showing joint open. Provides for expansion or contraction of the siding so nails will not work loose.

Metallic Batten Strips make strong, neat joints. They make the building wind-proof, weather-proof and rat-proof. Also valuable for lining grain bins or wagon boxes.

Write for Free Sample and see for Yourself

**METALLIC BATTEN COMPANY**

**Owensville, Indiana**

You will get SPECIAL ATTENTION if you tell Advertisers you read American Carpenter and Builder.

Tech. 3182 1/2



*The*  
**World's Greatest  
Building Paper**

**Important Notice**  
When your subscription expires, renew at once, using the blank enclosed in your final copy. If it expires with this issue your renewal must reach us before April 25, to avoid missing the May number. Use P. O. or Express Money Order if possible, but bills or 2-cent stamps may be sent at our risk.

*The*  
**World's Greatest  
Building Paper**

**American Carpenter and Builder**  
Entered as second-class matter July 1, 1905, at the postoffice at Chicago, Ill., under the act of Congress of March 3, 1879.  
*Published on the first day of each month by*  
**AMERICAN CARPENTER AND BUILDER COMPANY**  
RADFORD BUILDING, 1827 PRAIRIE AVE., CHICAGO

**SUBSCRIPTION RATES**  
One year, \$2.00; six months, \$1.00; payable always in advance. Single Copies, 20 cents. Canadian Subscriptions, \$2.50. Foreign Subscriptions, \$3.00.

**ADVERTISING RATES**  
Furnished on application. Advertisements, to insure insertion should reach our Chicago office not later than the 20th of the month preceding date of publication.

**EDITORIAL DEPARTMENT**  
WILLIAM A. RADFORD, *Editor-in-Chief*  
BERNARD L. JOHNSON, B. S., *Editor*  
WILLIAM REUTHER  
ADRFED W. WOODS  
ALFRED S. JOHNSON, M. A., PH. D.  
CHARLES E. PAUL, S. B. *Associate Editors*

**BUSINESS DEPARTMENT**  
WM. A. RADFORD, *President and Treasurer*  
H. M. RADFORD, *Secretary*  
E. L. HATFIELD, *General Manager*

**New York Office: 178 Fulton Street**  
E. B. WOLFROM, *Eastern Representative*

**PROTECTION FOR OUR READERS**  
The publishers of the American Carpenter and Builder will not knowingly publish any advertisement of a misleading character nor accept advertising from any individual, firm or company whose business methods are open to question.  
We often receive inquiries from readers who desire information about concerns that formerly used the advertising pages of the American Carpenter and Builder, but are no longer doing so. They want to know if these former advertisers are still in business, if they can send them orders with the assurance that they will be filled, and a variety of other questions.  
The American Carpenter and Builder will use every legitimate means to safeguard the interests of its readers and to protect them from fraudulent or unreliable concerns. Where the slightest doubt exists our readers should write the publishers for information. It may save them money, time and worry.  
In all cases in writing to advertisers say: "I saw your advertisement in the American Carpenter and Builder."

VOL. XVII. APRIL, 1914. No. 1

**I**T'S better to have bid and lost, than to build a house at less than cost.

**Annual Depreciation on Buildings**  
**I**N connection with the Federal Income Tax Schedules, the question has been raised as to what depreciation should be placed upon buildings, and a Joint Committee of The Chicago Real Estate Board and Building Managers' Association, after considering this subject, suggests the following percentages for this purpose:

- FIRE-PROOF STEEL BUILDINGS AND REINFORCED CONCRETE BUILDINGS:**  
Depreciation One (1%) Per Cent. on buildings five years old or less; two (2%) Per Cent. on buildings more than five years old.
- MILL CONSTRUCTED BUILDINGS AND FIRE-PROOF APARTMENT BUILDINGS:**  
Depreciation Two (2%) Per Cent. on buildings five years old or less; Three (3%) Per Cent. on buildings more than five years old.
- BRICK AND LATH BUILDINGS, INCLUDING ORDINARY FLAT BUILDINGS:**  
Depreciation Three (3%) Per Cent. to Four (4%) Per Cent.
- OLD FRAME AND NEARLY OBSOLETE BUILDINGS:**

Depreciation Five (5%) Per Cent. and upward.  
**NOTE:** Where the value of the power plant and machinery, including elevators, can be separated from the total value of the building, compute depreciation at Ten (10%) Per Cent. on it; the remainder being figured at the percentages heretofore named.

**Change of Size in Concrete Forms**  
**T**HE question of change of size of columns in the successive stories of a building is one of cost. The expense of changing the forms is usually greater than the cost of the concrete saved on small columns where the reduction is less than 3 inches, and on large columns where the reduction is less than 2 inches.  
It is often not economical to change the size every story. Frequently when the column would otherwise be reduced, it is desirable to use the size of lowest story columns in order to avoid the expense of splicing at the sides and bottoms of forms for beams and girders. Sometimes when the upper floor has a lighter load to carry than the lower, it would be possible to reduce the size of beams. Economy in form work dictates that the depths may be reduced but not the widths, because this would require splicing out all the floor panels and joists, which is more expensive than the saving in concrete in the beams.

# HOME BUILDING BY THE WHOLESALE

## How They Do It Out in Los Angeles

Photos and Plans by Courtesy of the Commonwealth Home Builders.

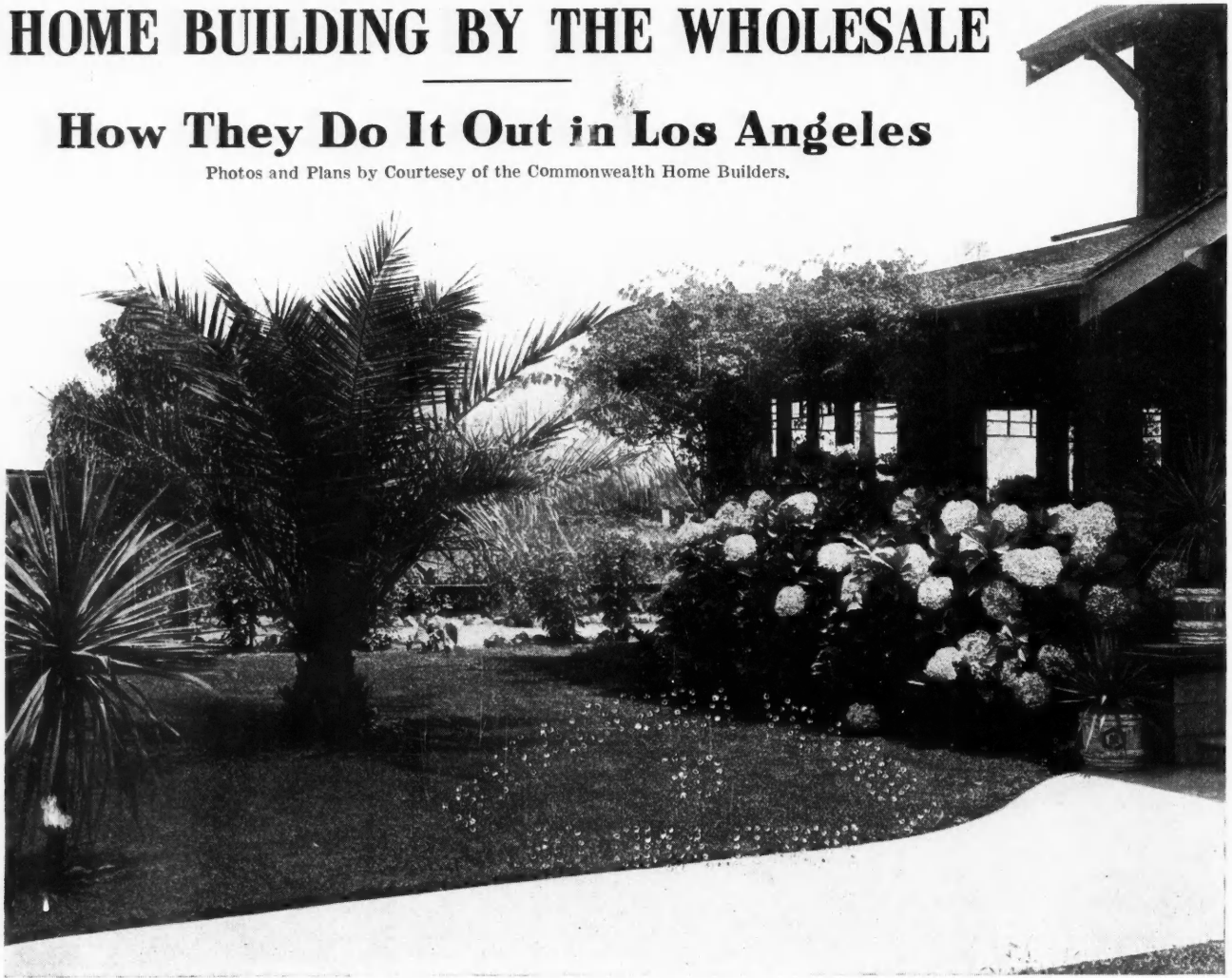

Where Nature Does Her Share The Grounds are the Choicest Part of Any Home. Here in the Semi-Tropics, Shrubs and Trees are Extra Interesting.

“WE made a bad bull on that roof—got it way too low and the rafters too long so that they stuck 'way out over the plates. So we called her a 'bungalow' and tried to look as though we meant to do that way from the first.”

This happened some years ago (along about the first of April) out in Sunny California and—we have it on excellent authority—was the origin of the *bungalow* in this country.

And since then—oh, Bungalow, what sins have been committed in thy name!

Just the same, we have to hand it to the real bungalow designers for having stirred up small and medium size home designing in this country. More new and worth-while ideas have been worked into our modern American residences, directly traceable to this source, than to any other. So that now we have in this country the most interesting, complete, and convenient home domiciles in all the world.

When it comes to home building, too, we have to go out there where they hammered together the first bungalow to

find the process of home building and home buying systematized and wholesaled and brought within the reach of everyone.

Los Angeles, Calif. (it really makes no difference whether you pronounce



You Know When You Have Reached a Modern Home Subdivision by the Classy Street Markers.

that *g* hard or soft), has for a number of years topped the list of cities for number of building permits issued. And while the big majority of Chicago's building permits, for instance, are for flat buildings and apartment houses, only 18% of the Windy City folks living in detached residences, practically all of the building permits out in Los Angeles are for single residences, mostly bungalows.

With the city growing in population so rapidly and the broad, rolling prairies on practically all sides extending back into the foothills and offering not the slightest obstacle to real estate development, it is but natural that home building and real estate concerns should have sprung up in droves.

Los Angeles is the home of that *wonderful* climate, and the paradise of the real estate man. The one has rather thrived by help of the other. No doubt the obligation and service have been mutual and just about evenly balanced!

Certainly the fame of the climate has been spread far and wide, and you may have one guess at who the loudest press

agents have been. So, too, the real estate men have prospered because of the really pleasant Southern California climate. And so the mutual debt has been paid.

Naturally, home building conditions being in such a shape, some wonderfully efficient development, building, and financing concerns have sprung into being in Los Angeles. One of the largest and most successful of these is the company known as the Commonwealth Home Builders. Thousands of families in and around Los Angeles have acquired homes through them. Hundreds of carpenters and other building tradesmen are kept constantly busy on their jobs. And hundreds of small investors have put their savings to work with them, and so have had a larger share in the prosperity that has come along with the rapid development of the city.

The Commonwealth people design all their own plans and they design them well, too. The bungalow is quite a specialty with them.

Also they are past masters at laying



First Floor Plan.

out a residence subdivision so that it will be attractive and find a ready sale.

And when the Commonwealth get around to pull off a "grand opening" of a new subdivision, you can bet there is something doing,—right from the word go! Just to give an idea of what such a "grand opening" is like, we quote the following from a Los Angeles paper that



This Street Marker takes the Form of a Classic Pergola—Adding a Touch of Interest to the Landscape.

came out just after this company opened a new residence tract, "Gotham Park."

**Several Hundred Dollars in Money Orders Dropped From Flying Machine**

"Five thousand people attended the opening of Gotham Park, the latest tract of Commonwealth Home Builders, Feb. 16th. It proved one of the most successful openings of the year. The opening sales amounted to \$42,500.

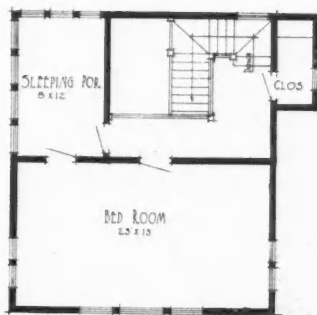

Second Floor Plan.

"The large crowd greeted Aviator Grover E. Bell upon his arrival in his cross-country flight at 11 o'clock. He made a very successful landing. In the afternoon he made exhibition flights, during which he dropped several hundred dollars in money orders from his machine. The machine was first used by Glenn L. Martin in a number of history-making flights, and is the only machine ever flown below sea level. It won a number of victories on the Eastern circuit, and was then driven by Blanche Stuart-Scott in thrilling exhibitions at Los Angeles, 'Frisco, Boston and other noted places.

"There was a band concert beginning at 12 o'clock.

"Gotham Park is located on the main thoroughfare to San Pedro harbor. It is surrounded on three sides by Harbor Boulevard, San Pedro Street and Manchester Avenue.

"The tract consists of a fine piece of level land, comprising forty acres. The improvements are completed. Five houses have already been built

"The improvements consist of artistic cement columns at the street intersections on Harbor Boulevard (Main Street) and on Gotham Way and Manchester Avenue, broad, oiled streets, cement curbing, cement walks, palms, ornamental shade trees, a park through the tract from north to south, a clubhouse with wide veranda on three sides, assembly room, committee rooms, and a children's playground. Thirty houses will be erected at once.

"The paving of Harbor Boulevard (Main Street) will start at once, the contract having been let to Oswald Bros. This will connect the finished Harbor Boulevard at Manchester and complete one of the finest drives in the city extending to the harbor. The Los Angeles railways have secured a franchise for the extension of the Main Street line to Manchester."

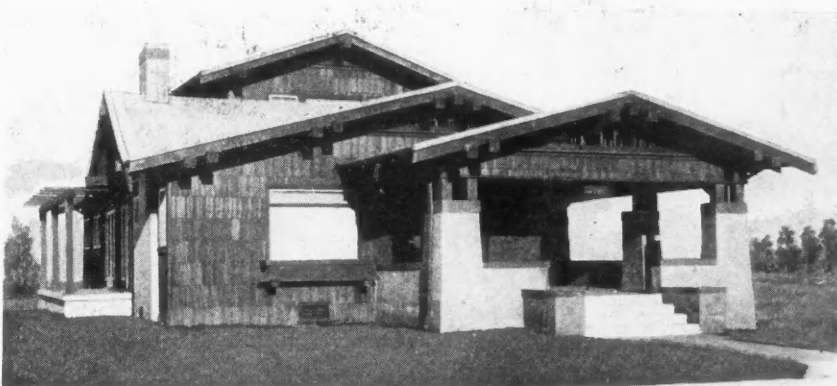

Seven-Room Bungalow just as "WESTERN" as They Make 'em; Sided with Redwood Shakes; Said to have cost \$3900.

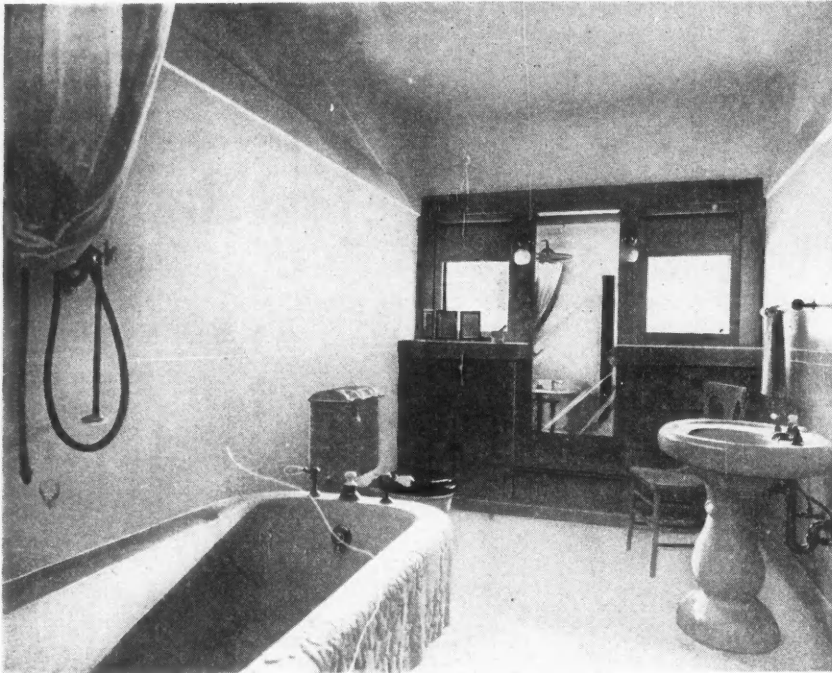

The California Folks are Quite Civilized and ask the Best That's Going in Sanitary Elegance

Real estaters and occasionally a building contractor or two in other parts of this nation have been known to *fly high*; also they have been known to *drop a*

money order or its equivalent; but to drop money orders out of a flying machine for a bunch of prospective home buying or building customers to squab-

ble over!—no; Los Angeles may have her corner on that!

But home builders everywhere can learn many a good lesson from the methods and plans of their Los Angeles brothers.

Notice that even though they are building homes in wholesale lots—an entire street at a time—they are still able to vary the design of every house. You don't see any repeats, no monotonous copying of the same house over and over again until everyone gets sick and tired of it and its selling or renting cost slumps 'way down because no one is very keen to live in it.

The Los Angeles real estate builders and especially the Commonwealth are very particular about their designs. They spend a lot of time and thought on them, to have each one attractive, novel, and convenient. To walk down one of these streets of bungalows is as good as going to a circus, the little homes are that interesting.

Being artistically designed and planned inside for real human needs, these bungalow homes find a ready sale.

And here again the homebuilding company comes to the rescue of the man of moderate means and helps him to get

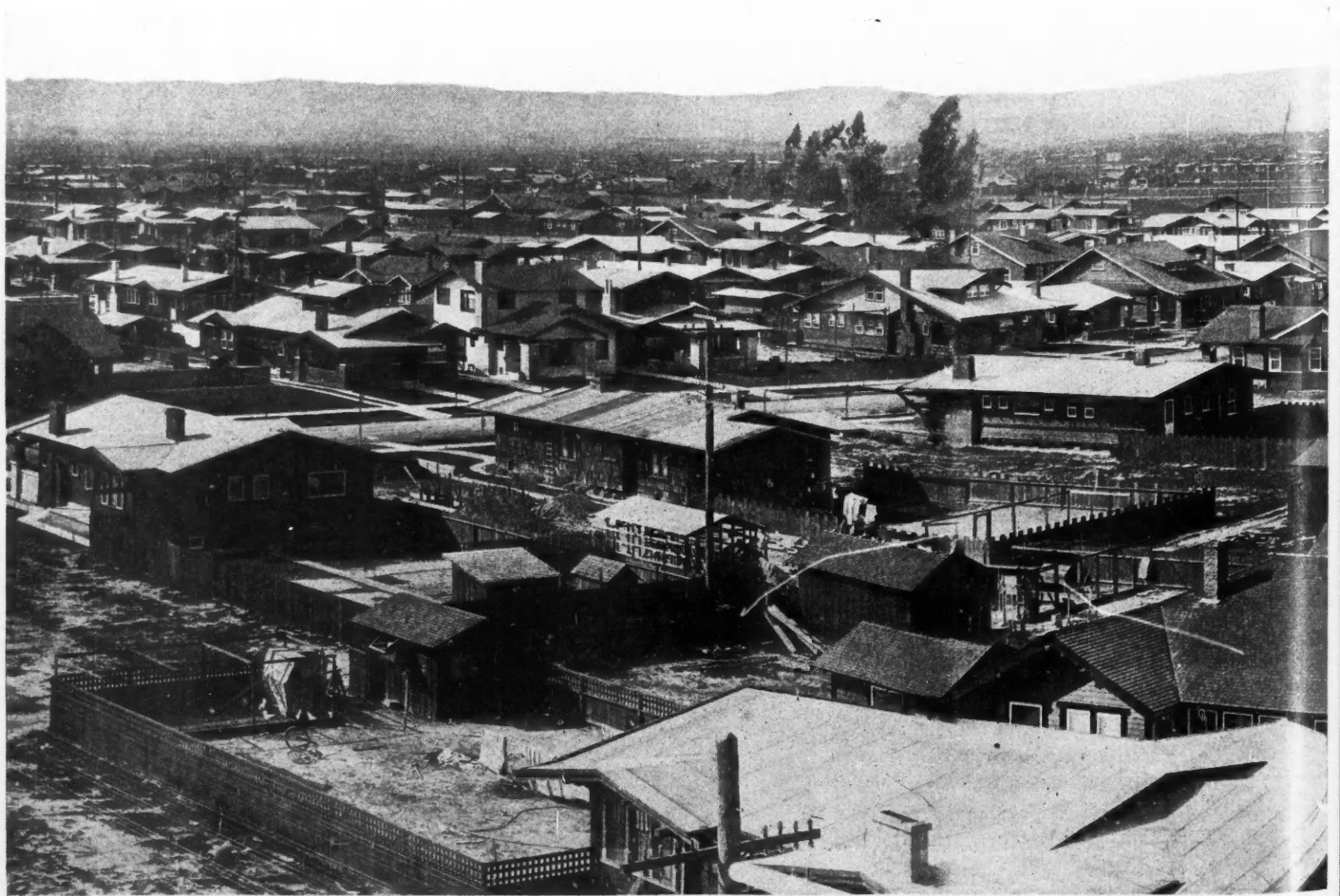

**DARTMOUTH SQUARE, IN SOUTHWESTERN LOS ANGELES—FROM A**  
This wonderful Panoramic Photograph gives an Idea of how the Commonwealth Home Builders and other Big Los Angeles Real Estate and Building was all a barren field. These Little Homes are for the



out of the rent-paying class and own his own home. In the first place, by building on a big scale, a number of houses at once, many economies can be practiced and these tend to hold the final cost pretty well down. Then the company offers easy terms of payment so that the purchaser carries the load from month to month, paying it off like rent.

This should be said in fairness to California bungalow building costs: The prices we so often see quoted in the popular magazines and elsewhere and are inclined to criticise, are doubtless O. K. for construction in semi-tropical Southern California. But built in a colder climate, equipped with full basement, efficient heating plant, regulation walls, etc., the cost would run considerably higher.

Published estimates of cost are poor things to follow anyway. The only safe way to do it to put the job up to whoever will have it to do and find out what *he* can do it for.

The designs here have been selected from a large collection originated by the Commonwealth Home Builders and used by them in their subdivisions. These are very attractive homes. They are



**It Doesn't Matter much about the Design out in California—the vines will soon cover it over anyway.**

appropriate for any climate. Home-builders should get many really good ideas from them.

The first bungalow (on page 39) is a very western type.

This pretty bungalow is simplicity itself in the straight-forwardness of its design. The plan is conceded to be one of the best arranged in use by the company.



### **FROM A BARREN FIELD TO A MODERN SUBDIVISION IN EIGHT MONTHS!**

**Companies Carry out Bungalow Building Projects on an Enormous Scale. In August, 1912, Eight Months before this photo was taken, this tract most part being purchased by monthly payments.**



A Mission Type Bungalow of Five Rooms, Walled with Gravel-Coated Stucco; Cost Said to have been \$3300.

The exterior woodwork is the natural redwood color treated with oil, and the roof light gray composition.

The living and dining-room although finished in hard pine, could not be distinguished from oak by the layman. Note the size of the rooms on the second story.

Cost as shown, \$3900.

The next design (on page 42) is a California mission type. This is considered by critics to be one of the best designed bungalows of the mission type in Southern California.

The gable ends are remarkably well done but difficult to see in the picture

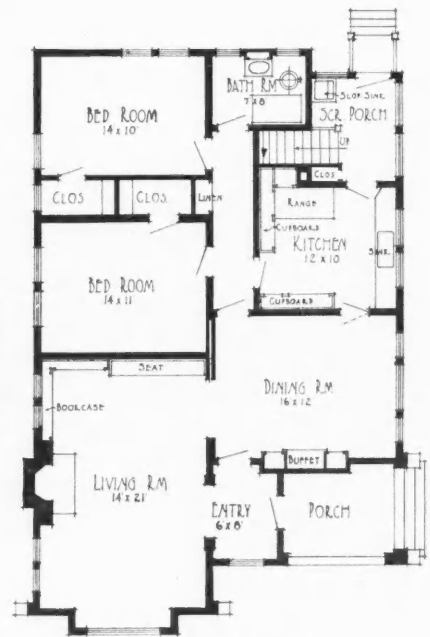

Arrangement of Main Floor.

on account of the vines. The projecting roofs are covered with Spanish tile.

The walls are of stucco gravel floated. It has five rooms.



View of Book Case Corner in Big Living Room of Little Mission Bungalow.

The next design (on this page) is modern colonial—a clean-cut, modern colonial design of striking color treatment. It has a light green roof and darker second story walls of shakes contrasting against the rough white stucco below.

The semi-circular front porch, with its fluted Grecian Doric columns and modified railings above, lends an elegance seldom found so interestingly handled.

The pattern awnings are some advantage in the design. This is just the house to be set off by a beautiful lawn. The plan is hard to beat—compact, con-

venient and attractive. The kitchen is compact and convenient and the bedroom is large with plenty of closet room.

Cost as built, \$1150.

### Splendid English Design Home

A more sumptuous residence is illustrated on page 45. It is an excellent piece of English design—typical of the present day manor. The red tile roof is a fine touch of color. The house requires about a 75-foot lot, or is exceptionally well adapted to a corner lot. The view from the front door to the rear garden is unobstructed and the

The dining-room side walls are panel-stripped about 5' 6" and have a wood cove in the ceiling. The solarium can be used as a breakfast or tea porch when desired. The kitchen is commodious and well equipped. Note the fireplace on the second story and the two large dressing rooms, besides the packers (wardrobes).

Cost approximately \$8000 to \$10,000 to finish.

After noting these great home building activities out in the sunny southwest we all feel drawn by the bungalow idea—



Modern Colonial Design Home of Ten Rooms—Cool and Restful and Appropriate Anywhere; Cost \$5700.

venient and attractive. The kitchen is well arranged and the buffet is exceptionally pretty. A ten-room house.

Cost as shown and finishing in part hardwood, \$5700. Could be reduced to \$5000.

In the cosy little bungalow shown on page 44 there is not an inch wasted. This is just the kind of a little bungalow to commence housekeeping in. It is also an excellent renting proposition. The exterior is exceptionally pretty, covered with shingles stained a light moss green. The trim and timbering is rough and stained a darker green.

The front door is oak with art glass in the top. The living and dining-room is one. The table folds and is put away in one of the cupboards, so when not in use as a dining-room, it makes a large living-room.

At the opposite end to the door is a folding bed which looks like a bookcase



First Floor Plan.

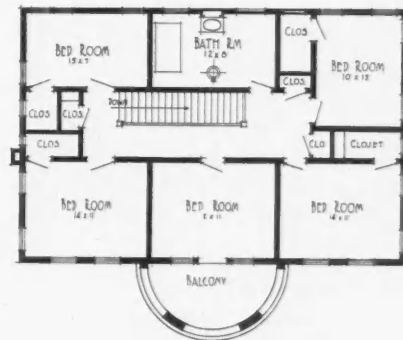

Second Floor Plan.

stairs look very fine in a Gothic English design.

The living-room ceiling is heavily beamed. In the rear end of the room is the fireplace nook or alcove with its long seat. French doors open onto the side porch.

stung by the bungalowbug (so to speak). Those who never before have thought much about home building—seemingly fully content to remain always a renter—suddenly come to life and think they'll "build a bungalow."

And so the activities of our California



Not an Inch Wasted in this 3-Room Nest—It has the Real Bungalow Flavor, too; does it not? Cost \$1150.

brethren have benefited building all over the nation. Their style of dwellings has caught the imagination of all, and has set them to planning.

Wherever land values are low enough that one can afford a big lot the bungalow is the thing. For most cities it can hardly be recommended. It is too extravagant. But where a large building site can be afforded, especially if the site is high, there is nothing more artistic and desirable than a good bungalow design.

Running up and down stairs is the bane of many housewives' existence. They imagine that half the work would be eliminated, just as in a city apartment, if there were no stairs to climb.

However, there are dangers. Unless the bungalow is properly planned the home privacy will be lost. Where all of the rooms are on one floor it is impor-

tant that the sleeping rooms should be somewhat separated from the rest. The bathroom, and kitchen also, should not be too conspicuous.

Another good thing that we can place, in part, to the credit of the California bungalow builders, is the vogue for *open-air* homes—dwellings with screened porches and sleeping porches and an extra supply of windows.

A noticeable feature of bungalows and of all other modern residences is the large number of windows. We are just coming to appreciate the beauty and healthfulness of fresh air and sunshine. Above all else homes must be light and cheery.

The casement windows are considered more artistic than the ordinary double hung windows. They are usually composed of a small number of small lights of glass, either leaded or divided up with wood muntins. The window curtains have to be sash curtains. Both shade rollers and drapery set are attached to

the casement itself.

Occasionally inward opening casements are hung which are not storm tight. If properly made they have a projecting shoe mould fastened to the bottom with sticks out far enough to cover the joint and effectually keeps out the wind or snow.

It is not everywhere that home building can be done by the wholesale as has been the case in and around Los An-

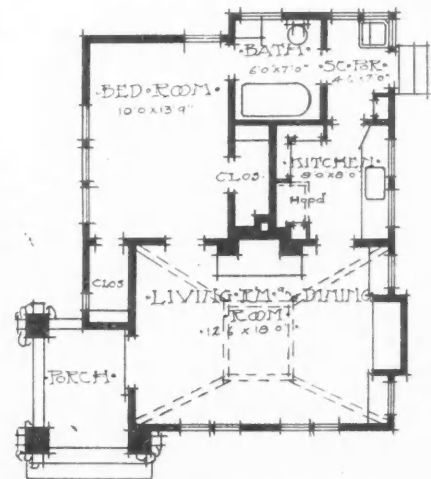

Floor Plan of 3-Room Bungalow.

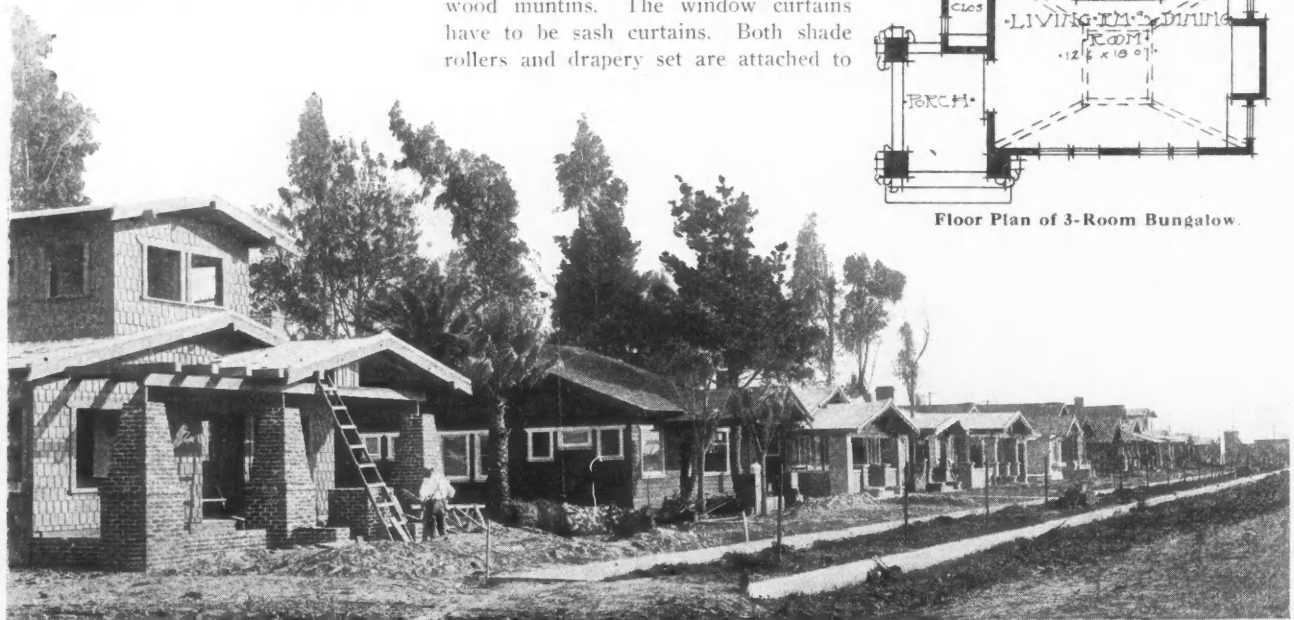

A Typical Building Scene in Dartmouth Square During the Big Building Spree—Weston Street Looking South from 41st Place.



A Real California Bungalow Caught in its Shirt Sleeves.

geles. The Commonwealth Home Builders and the other up-and-doing building concerns out there have made it about the easiest thing a man on salary can do to buy a little home.

The same spirit and much the same methods—in a smaller way—can be used to advantage by contractors and real

estate men elsewhere.

Encourage home buying. Make it easy. There is a great deal of satisfaction in living in ones own home, and it doesn't have to be all paid for either, in order to be enjoyed.

If one has enough laid by to secure a suitable building lot, it should be easy

to borrow enough to put up the building. Both building and lot are, of course, given as security. Then by making monthly payments of just about what one would naturally pay out for rent, the house holder finds that after six or eight years he has a valuable piece of property to his credit, and not merely a big bundle of rent receipts.

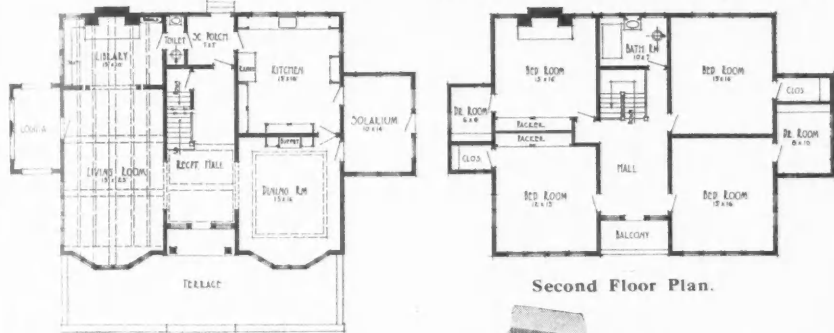

First Floor Plan.

Second Floor Plan.



Grey Stucco Mansion with Red Tile Roof, Designed in the English Style; Contains Ten Rooms; Cost Said to have been \$10,000.



Beautiful large living room, handled in the most modern style; everything comfortable and usable. The ceiling beams produce a warm and cozy effect even in a room of such huge dimensions. A modern living room has to be a big one, even if it takes up all the room in the house. Note the high casement windows at the end of this room with book cases and seat built-in underneath. Full length French windows open to a screened porch. Side walls are tinted gold and brown and ornamental border is carried in stencil work.

# Decorative Value of Tile Flooring

By A. B. LeBoutillier in the Contract Record

**T**ILE floors have a practical value; they also have great decorative value, and it is with the latter that we are at present concerned. Owing to the peculiar limitations of the material and the methods of manufacture, tiles are necessarily small units. To cover a large surface with these units, obviously requires joints. Therefore, the joints, as well as the tiles, should be given importance in the design. From a designer's point of view, the limitations of a material are its greatest asset, each material requiring its own peculiar treatment.

Not many years ago, all the tiles that were available for floors were of the machine-made variety, so perfect in workmanship that they could be laid in a floor with joints of a hair's breadth.

Conditions have since changed, and we have come to realize the value of the joints. It is seldom necessary to lay a floor of plain tiles with joints less than one-quarter of an inch in width. Whether these joints are left the natural color of cement, or are colored, they will always count in the design, and the slight unevenness of the tiles themselves will give a texture that is not as hard and uninteresting as the floors of mechanical perfection.

The character of the building and the location of furniture and rugs affect the design of the floor. If the floor is an important room of a monumental building and is free from large pieces of furniture, it may well be treated so as to be in accord with the architectural treatment of the walls, but if there is to be much furniture and many rugs on the floor it is better treated as a whole. This is a point that is often lost sight of in railway waiting rooms and restaurants.

Church floors afford as great an opportunity for tile work as the windows do for stained glass. Much could be said on this subject alone, but it is sufficient here to make the following observation: The nave aisles should be simple, the choir somewhat more elaborate, and the sanctuary very rich in pattern, symbols and color. In short, the elaboration increases as the altar is approached.

It is not necessary to use large tiles in a large room to get scale, as the tiles can be arranged so that the unit is composed of several small tiles, and the scale of the pattern increased or reduced at will.

It is not essential that all the tiles

laid in a floor come from one factory. Herein has the tile setter great advantage, especially in colored tiles. In the matter of shapes and designs, clay is so easily moulded that there is almost no limit to the variety that the smallest factory can produce. It is in the matter of glazes and quality that manufacturers differ.

it is assumed, have been overcome by the manufacturer.

The ideal method of designing a floor is to arrange a general scheme and then lay out the details on the job, changing and rearranging as occasion arises. This of course, requires an artist as a workman—and there are such—or constant supervision. This is not always possible, but when it is done, the result is spontaneous, and free from

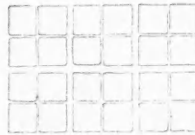

By groups of four squares as a unit separated by wider joints, the scale is increased



A diagonal pattern of square tiles is emphasized by a border

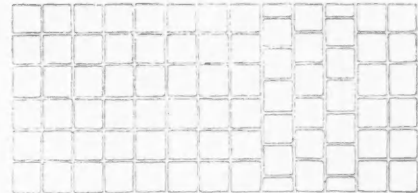

By a few rows of broken joints, an effect of border is produced in a field of square tiles.

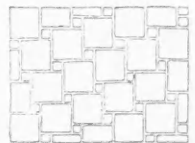

When the small squares are less than one-quarter of the area of the large squares, the pattern runs off at the side



When the small squares are one quarter of the area of the large squares, the pattern has more repose

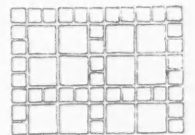

Another way to increase the scale with small tiles.

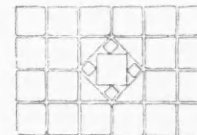

A decorative pattern that can be made on the job

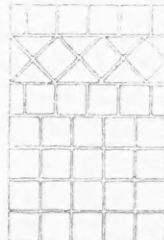

By breaking joints in one course, the border is made wide

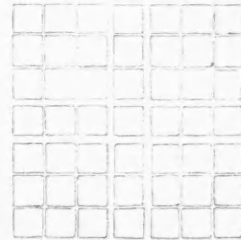

An arrangement adapted to large rooms

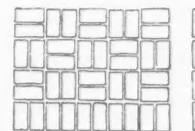

When double squares are laid "basket pattern," the necessary allowance for joints adds interest

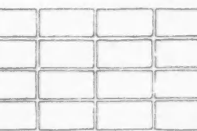

A good pattern for corridors.

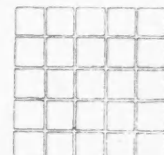

The simplest floor of square tiles is interesting if the joints are in scale.

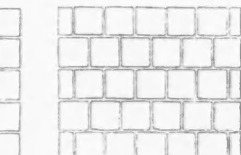

When square tiles are laid with broken joints, long lines in one direction are the result.

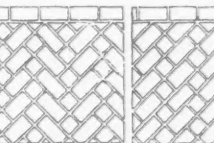

Varieties of "herringbone"

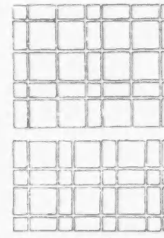

Two combinations suggesting plaids.

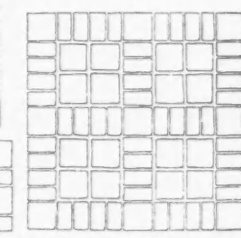

A simple device for a panel or a floor for a large room.

There are many patterns that have been common property ever since the beginning of tile making, and are to be found, with slight variations, in many tile manufacturers' lists. New designs can be readily produced and old ones revived; the process is simply a model in clay or wax, from which a plaster mould is made, then the clay pressed in by hand, removed from the mould, dried and baked; a simple process, to which tiles owe much of their charm. The difficulties are in composition of the clay and glazes; these, of course,

the mechanical look that might come from a hard and fast plan laid on the drawing board.

By the use of color in pattern, and pattern in individual tiles, there is almost no limit to the richness and elaboration possible for tile floors, but on the other hand, it is also possible to make an interesting floor of plain tiles in one color by taking advantage of the joints.

The diagrams will serve as reminders that the joints are of equal importance with the tiles.

Full length French windows open to a screened porch. Side walls are finished with...

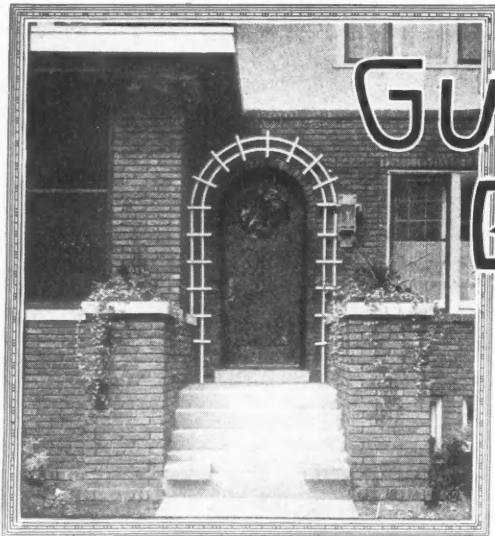

# GUARANTEED BUILDING PLANS

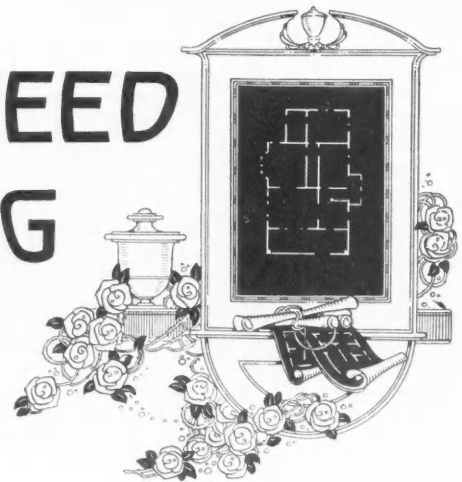

## Big Expense Not Required for Attractive Dwellings

**T**HIS is the day of small families and of small houses. In building we are coming around to little homes as the solution of the servant problem and also as a body

blow at the high cost of living. Few people these days want to pay out what it costs to keep a big mansion going—heat and lights and a whole tribe of servants. And home builders

have found that it isn't necessary.

Architects have been awake to the spirit of the times. They have concentrated on small house designing. They have arrived at very nearly perfection as far as all the comforts and conveniences are concerned.

The American people are coming to think more of real comfort than of making a brave show. There is plenty of comfort in the small, inexpensive homes that are being built today, but no room for pretense.

When such comfortable, convenient little places are the style, they are within the reach of all.

The six designs presented on these pages are representative of some of the best modern work. They are recent designs, planned for clients who demanded that every square foot of space be utilized; who required modern conveniences and comforts. At the same time economy, the holding down of the cost, was the main thing.

These perspective drawings show exactly how these little homes appear when they are complete. The dimensioned floor plan diagrams show just how the rooms are arranged. It is very gratifying to be able to see just how your house will look when it is finished. The ordinary working drawings are deceptive things, frequently offering something that looks good in the plans and turns out disappointingly. In having plans drawn by a local architect, home builders should always insist on having a rendered perspective drawing executed, drawn to exact scale.

These perspective views have been prepared so that our readers may know in advance just how any one of these little homes which may meet the requirements would look after it is built.

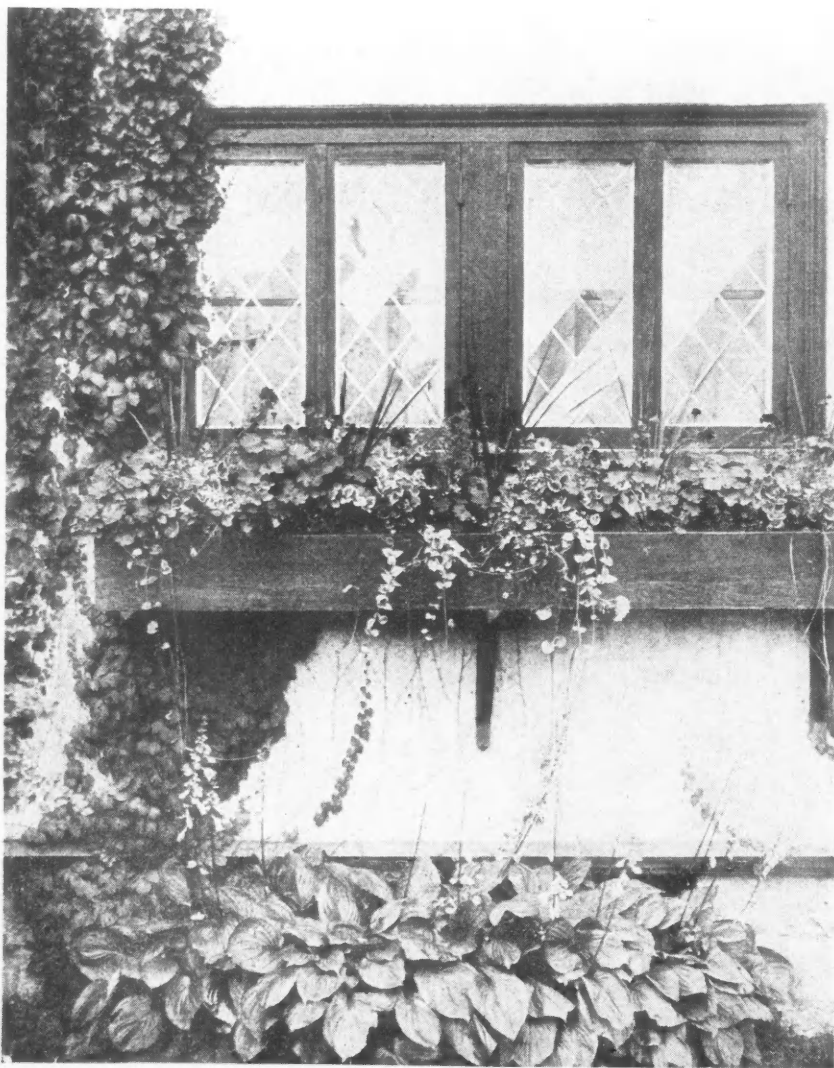

Window Box contains Yucca, Periwinkle, Marigolds, Petunias, and Geraniums.



**Neat Six-Room Story-and-a-half Cottage**

A pleasant little dwelling that will go nicely on a narrow lot is illustrated. It is just about as simple and free from complicated features, that run up the cost, as any house could well be. Its rooms are all pleasant and convenient and there is no waste space.

A house of this kind is inexpensive to build and can be rented or sold at a reasonable price and still give a margin of profit to the owner or builder. As the width is only 22 feet, it will go on a narrow lot very nicely. A narrow lot usually means houses crowded in rather close together; and so in this design the principle lighting is from the front and rear.

The outside appearance of this little dwelling is very attractive; a frame house, with wide clapboard siding, resting on a cement foundation. The shingle roof has a slight curve just at the eaves. Wide fascia boards, sawed out with a flare at the bottom give the front gable end an ornamental appearance.

The front porch is generous in size and has neat porch rail and three turned columns. Entrance is into a square re-

ception and stair hall; from this one can pass into the parlor, through a cased opening to the right, or directly back into the kitchen. The dining room is just back of the parlor.

A special feature in this design is the laundry chute opening from a little closet across the hall from the bathroom on the second floor, also with an opening out of the kitchen on the first floor and leading down to the basement laundry.



First Floor Plan.

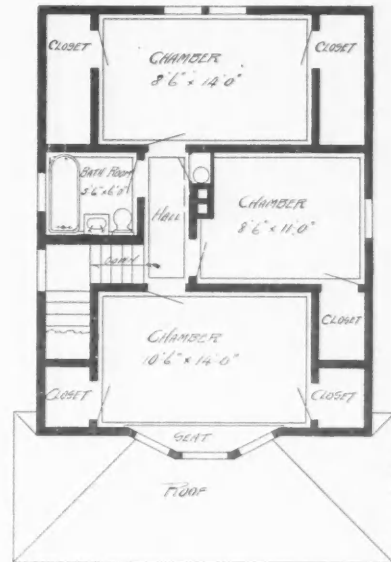

Second Floor Plan.

Arrangement of six-room house. Size, 22 by 28 feet.



Six-room, story-and-a-half, frame dwelling. Size, 22 by 28 feet. A cozy, substantial home. We can furnish complete set of blue-printed working plans and typewritten specifications for only \$6.00 per set. Blue-prints consist of basement plan; roof plan; first and second floor plans; front, rear, two side elevations; wall sections and all necessary interior details. Specifications consist of twenty-two pages of typewritten matter. When ordering, ask for Design No. 6560.

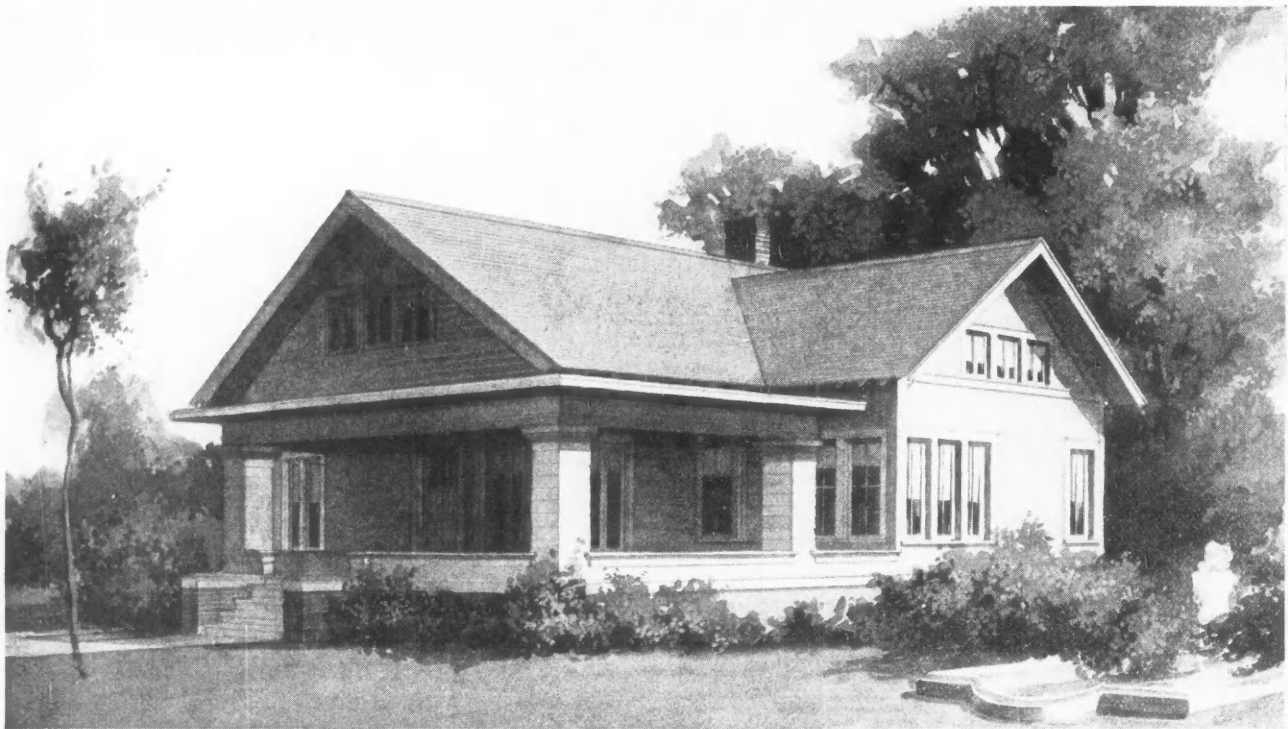

Beautiful seven-room bungalow with wide board siding. Size, 41 feet 6 inches by 41 feet 6 inches. We can furnish complete set of blue-printed working plans and typewritten specifications for only \$9.00 per set. Blue-prints consist of basement plan; roof plan; first and second floor plans; front, rear, two side elevations; wall sections and all necessary interior details. Specifications consist of twenty-two pages of typewritten matter. When ordering, ask for Design No. 6557.

### Unique Seven-Room Bungalow

For those who wish something out of the ordinary, this beautiful frame bungalow is offered. All the features demanded by up-to-date home builders are included—extra roomy porch; enormous living room; all glass room (in the winter time) for a sun parlor and made so that all the windows are fitted with screens for the summer time, when this room becomes an outdoor sleeping porch; also the broad sweep of the house is typical of modern bungalow design.

All of the principal rooms, including one large bedroom, are on the main floor, and the design has this advantage over

so many bungalows, that the second floor space is also utilized. Two good bedrooms are worked in, one in each gable end. The low space out towards the eaves, all the way around, is utilized for closet and storage space. A small room on the second floor is designated as a sewing room. However, as it is 10 by 8 feet in dimension, it would easily do as a servant's bedroom, child's room, etc.

This is the type of house that blends so charmingly with the landscape. It becomes a real part of the building site and is so easily made homelike and attractive by planting a few flowers and

vines and setting out a little shrubbery.

One should not select a design of this kind unless from 60 to 75 feet frontage can be had for the building site; but with a good-size lot and the bungalow set well back from the street on gently rising ground, well sodded, green and smooth, this makes a home worth while, a credit to any community and a proper object of pride for any home builder.

The construction of this bungalow is standard balloon frame, timber work, resting on a brick foundation. The siding is wide boards, laid 8 inches to the weather. These boards are not planed smooth, but are left unfinished and are stained the desired color. This gives a soft, warm effect that is very much liked. It is customary to stain a bungalow some dark shade, such as tobacco brown, maroon, olive green, etc., and handle the door and window casings and cornice in a lighter color. A vigorous or even daring color scheme and decorative treatment are suitable for a bungalow of this kind.

Notice the floor plan diagrams and you will see the interesting way in which the rooms in this residence are grouped. The parlor or living room is divided a little back of the middle by an ornamental colonade which works in with the heavy ceiling beams. This part of the house is plenty large enough for anything that will ever be required of it. The rooms are 16 feet wide and have a combined length of 26 feet 6 inches.

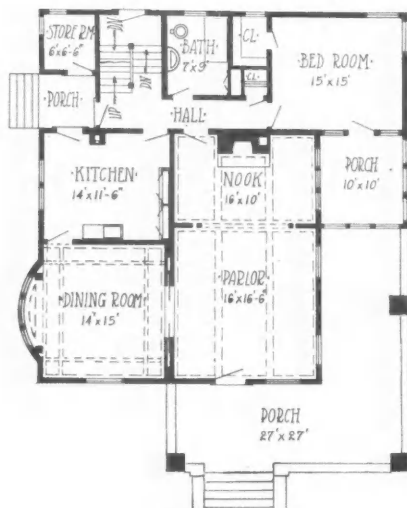

First Floor Plan.

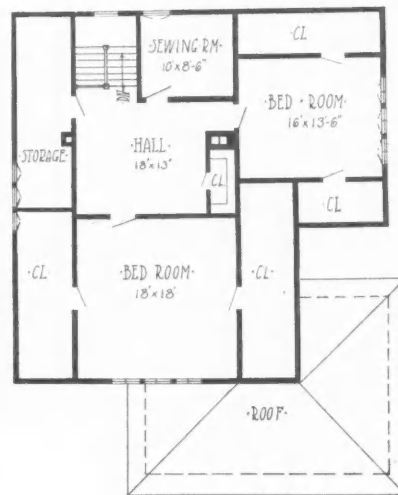

Second Floor Plan.

Arrangement of beautiful bungalow. Size, 41 feet 6 inches by 41 feet 6 inches.

**A Seven-Room Gambrel Roof Residence**

A well designed little home structure that gives a big value for its cost is the seven-room gambrel roof frame dwelling illustrated. A paneling effect has been worked out for the sides of this house that gives it a rather unusual appearance. Little touches of this kind can, of course, be used or omitted, just as the builder prefers. When handled neatly, they often add considerable to the attractiveness of a building. In this instance, the paneling harmonizes very well with the style of porch column used.

The gambrel roof continues a popular style for medium-sized homes. It makes a good appearance when the two slopes to the roof are properly proportioned, and while allowing full use of the upstairs, does away with the expense of the third-story attic.

This house is 29 feet wide by 32 feet deep. A 10-foot porch extends clear across the front; and inside, the large living room, 14 by 28 feet, occupies the entire front of the house. Note the way the vestibule is worked in, half of it coming out of the porch space and half out of the living room. This vestibule will add 50 per cent to the warmth

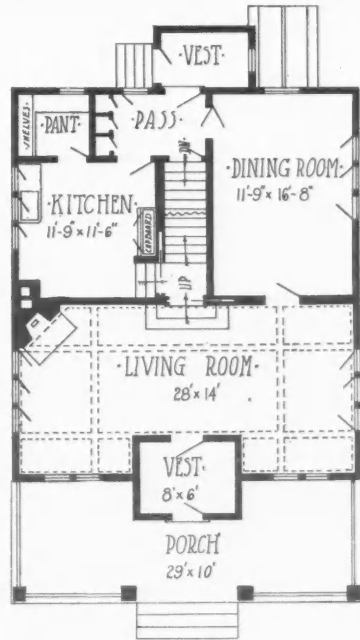

First Floor Plan.

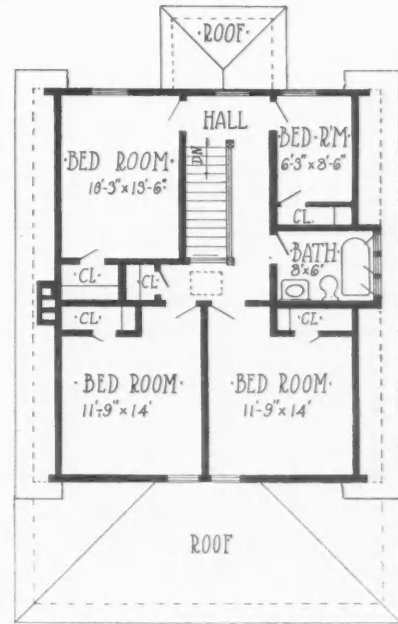

Second Floor Plan.

Arrangement of seven-room gambrel house. Size, 29 by 32 feet.

and comfort of this living room in the winter time.

Directly across from the vestibule entrance door are the stairs to the second floor. The two bottom steps are out into the room and the third step is a

platform landing. A single sliding door closes this stairway opening when desired. Steps lead up to this landing out of the kitchen also, and this doorway is closed with a single sliding door. One seldom sees a better arrangement.



Substantial gambrel roof seven-room residence. Size, 29 by 32 feet. We can furnish complete set of blue-printed working plans and typewritten specifications for only \$8.00 per set. Blue-prints consist of basement plan; roof plan; first and second floor plans; front, rear, two side elevations; wall sections and all necessary interior details. Specifications consist of twenty-two pages of typewritten matter. When ordering, ask for Design No. 6559.

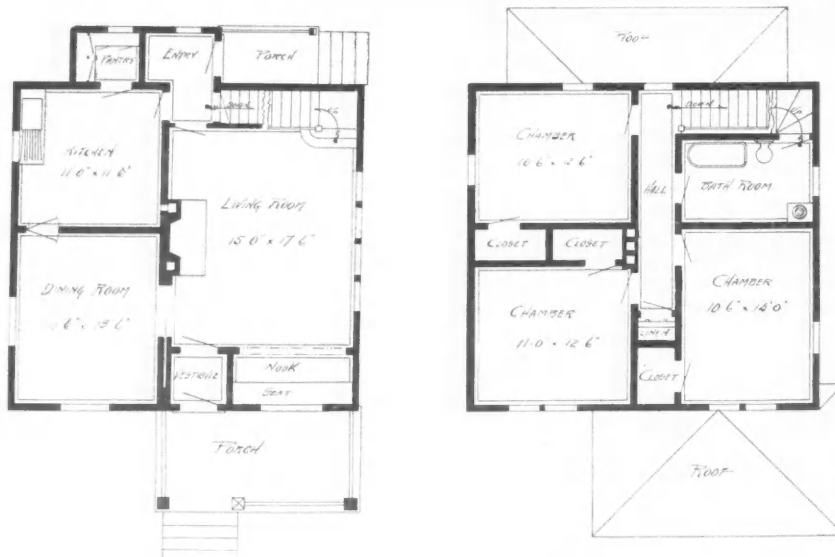

First Floor Plan. Second Floor Plan.  
Arrangement of six-room residence. Size, 28 by 26 feet.

### Six-Room Frame and Stucco Residence

A modern residence design, a full two-story-and-attic house, is offered. It contains many features that up-to-date home

builders will most heartily approve of.

Plain and dignified in outward appearance, there is nothing about this house to show signs of age and dilapidation. Its attractiveness of appearance does not

depend on ornaments stuck on here and there, soon to get broken or to fall off, but comes rather from the proportioning and planning of the building itself. The placing of the windows, for instance, gives a pleasing appearance that will never change. The group of four window casements that light the big living room are beautiful from without and make the pleasantest kind of a room within. The porch is properly placed and seems to exactly "go" with the rest of the building.

This building makes use of ordinary frame construction; the siding is bevel boards up to the second-story window sills, and above that cement plaster on metal lath. This is a combination that has been often used and always looks well.

Turning to the floor plan, we see that the rooms in this house are very nicely laid out. The living room is 15 by 17 feet 6 inches, in its principal part, besides alcove with cozy built-in seat by the broad front window. At the far end of this room the stairway goes up to the second floor. A very interesting, ornamental detail this stair can be made.



Modern frame and stucco residence containing seven large rooms. Size, 28 by 26 feet. We can furnish complete set of blue-printed working plans and typewritten specifications for only \$8.00 per set. Blue-prints consist of basement plan; roof plan; first and second floor plans; front, rear, two side elevations; wall sections and all necessary interior details. Specifications consist of twenty-two pages of typewritten matter. When ordering, ask for Design No. 6561.



Cozy little cement bungalow containing five rooms. Size, 26 by 44 feet. We can furnish complete set of blue-printed working plans and typewritten specifications for only \$6.00 per set. Blue-prints consist of basement plan; roof plan; first and second floor plans; front, rear, two side elevations; wall sections and all necessary interior details. Specifications consist of twenty-two pages of typewritten matter. When ordering, ask for Design No. 6558.

**A Clever Little Cottage**

It is only in recent years that we have learned to plan cottages that are really interesting and livable. It took quite a while to get people out of the notion that some of the old-fashioned customs, always counted as essentials, are not really necessary at all.

No doubt the western bungalow designs have done as much to revolutionize things as any other influence. Certain it is that today when a man with a small family wants to build a cottage, he is not afraid to cut free from the old traditions, and use the small space he has at his disposal for those things he really needs and uses in his home.

In this design there are five rooms on the main floor besides the two screened porches and bathroom. On the second floor there is a big sleeping porch with one side all open, just an ideal place for fresh-air sleeping.

The greater part of the main floor is given over to the living-room-dining-room combination. This is handled almost as one room. The partition between the two doesn't amount to much. The object here is to get plenty of sunlight and fresh air and to handle these rooms big enough so that one does not feel cramped in them, as in the ordinary small house.

Entrance is through a screened porch, which opens both into the living room and through double French windows into the front bedroom. By having the bed on large, rubber-tired rollers, it can be easily rolled out onto this screened porch, where even the hottest summer night can be thoroughly enjoyed.

The bathroom and stairway to the second-story sleeping porch are on a

small inside hall. The smaller bedroom, which can be nicely used as a maid's room, opens also from this hall, and through the cellar way, directly into the kitchen. While this may be considered an unconventional arrangement, it works out very handily.

On the second floor, in addition to the sleeping porch, is a large amount of well lighted attic space.

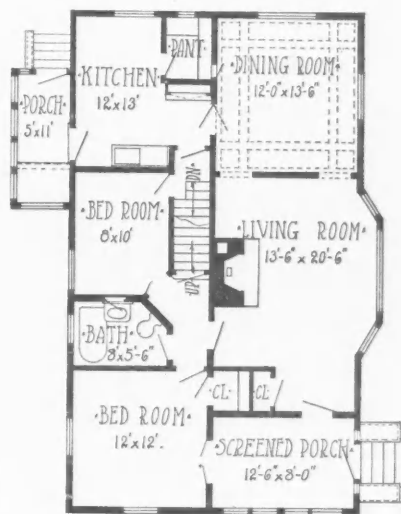

First Floor Plan.

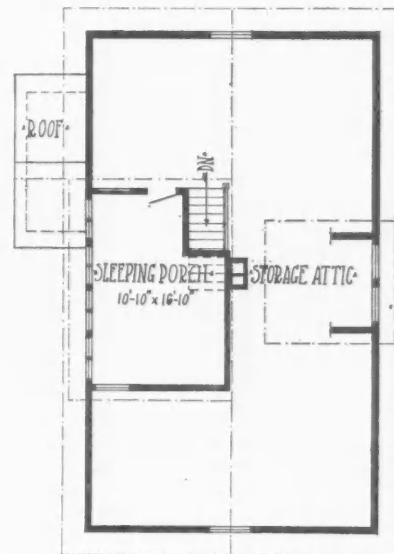

Second Floor Plan.

Arrangement of cozy cottage. Size, 26 by 44 feet.



Six-room frame dwelling of distinctive design. Size, 28 by 28 feet. We can furnish complete set of blue-printed working plans and typewritten specifications for only \$7.00 per set. Blue-prints consist of basement plan; roof plan; first and second floor plans; front, rear, two side elevations; wall sections and all necessary interior details. Specifications consists of twenty-two pages of typewritten matter. When ordering, ask for Design No. 6562.

### A Stylish Frame Dwelling

A home-like little place of more than usual style, containing six rooms, very conveniently arranged, is illustrated. There is no reason why a small or medium-sized residence shouldn't have

some distinctive architectural features without adding very much to the cost. Some ornamental effects can be easily produced, if they are planned for in advance, that give a house an individual, distinctive appearance.

In some towns we see all the houses

built just about alike. There is no variety in design and one can hardly tell when he has reached his own door step. This hurts the selling or renting value of a property. It's worth something to have a stylish, well-designed home; and when the time comes to rent or sell, anyone is glad to pay a little extra for such a dwelling.

In this design offered, there are some novel and striking effects worked in around the front gable and in connection with the porch. It is a story-and-a-half cottage, with three very nice rooms on the first floor and three large bedrooms, four clothes closets, linen press and bathroom on the second floor. Referring to the floor diagrams you will see how nicely this plan works out to make a convenient roomy house, yet one that is really not very large; 28 by 28 feet are the dimensions of the building proper, not including the porches.

Think of the comfort there would be in summer time on this big three-sided porch! Some part of this would be shady all the time. Then notice the conservatory; an ideal place to grow plants; it opens from the parlor and makes a bright interesting spot that the entire household will enjoy.



First Floor Plan.

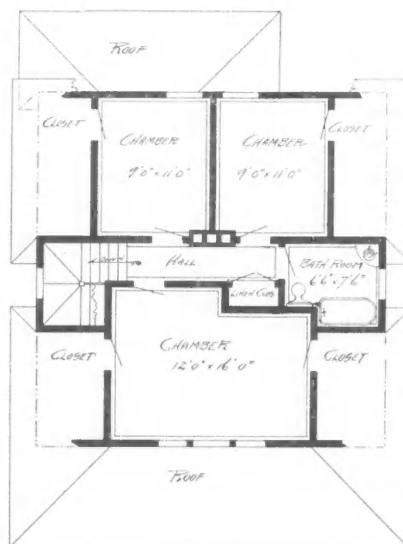

Second Floor Plan.

Arrangement of stylish dwelling. Size, 28 by 28 feet.



### What Do YOU Think?

By H. J. Blacklidge

A MAN came to a small country town one day and began looking for work. Let us call him A. Carpenter. There was but little work going on. He hunted for three days. Finally he heard of a woman who wanted a screen porch and bathroom. He went to see her. She told him just what she wanted and, being ready with figures, he soon had a fairly accurate bill of material made out. He offered to go to the lumber yard and find out what it would cost.

In half an hour he returned and told her the material would cost \$87.45. Then she wanted to know the cost of work. From her conversation he had already gathered that others had figured on it and wanted more than she was willing to pay. But she was too shrewd to let fall any hint as to the amounts of their estimates.

Now, A. Carpenter was no "mutt," neither was he a contractor. He had never figured a carpentry contract in his life—in fact, he had followed entirely different lines. But when a lad he had worked with an uncle, a contractor, for two or three seasons, thus gaining some of the rudiments of the trade at first hand. But he could not say off-hand whether that job would take four days or ten days. Mrs. Lady wanted to know *at once*. Therefore, he put on his gloves and oil and proceeded to TALK. Told her it was always best to do such jobs by the day—that she would probably want some changes before he was through—that he always worked just as hard or harder by day than by contract—and so on (you know all that line!). He convinced her that day work was the best for her (which probably *was* the best for all concerned in this instance).

Now, there were no unions there, never had been and are not to this day, but the three regular carpenters had held staunchly to their \$4.00 a day for nine hours' work for years. (A year later, by the way, they cut it to eight hours.) A. Carpenter went to work for Mrs. Lady at \$3.00!

From that job he went to another repair job, and another and another, working nearly all the time, and always at from a dollar to a dollar and a half lower

than the others charged. Admitted that he was not as good a man as they were. He never laid claim to the title of Mechanic. He never undertook any "A number one, first-class jobs" (because *they* were not offered to him, I suppose). I do not think he ever did any real good jobs—not fancy work, but just ordinarily good. All the dinky repair jobs were his. All the "just-fix-it-up-any-way" work. All the "I-don't-expect-to-be-here-long, fix-it-up-cheap" jobs. He would do almost *anything* in almost any way.

Now, is it fair? Was he justified in doing second-class work at a lower scale than the *carpenter*? He was kept busy almost constantly, while the carpenters were idle a large portion of the time. I do not believe any carpenter would employ such a man. Yet people will say, "Well, old Sikes can do this just as well as the carpenter can. Of course, it won't look quite so nice, but then he won't charge much. I guess we will just let him do it." Is it right? Do I look at it wrong? Perhaps others have had experience with such as A. Carpenter. If so, let us hear what you think about it.



He would do almost Anything in almost Any Way—and at any old Price.

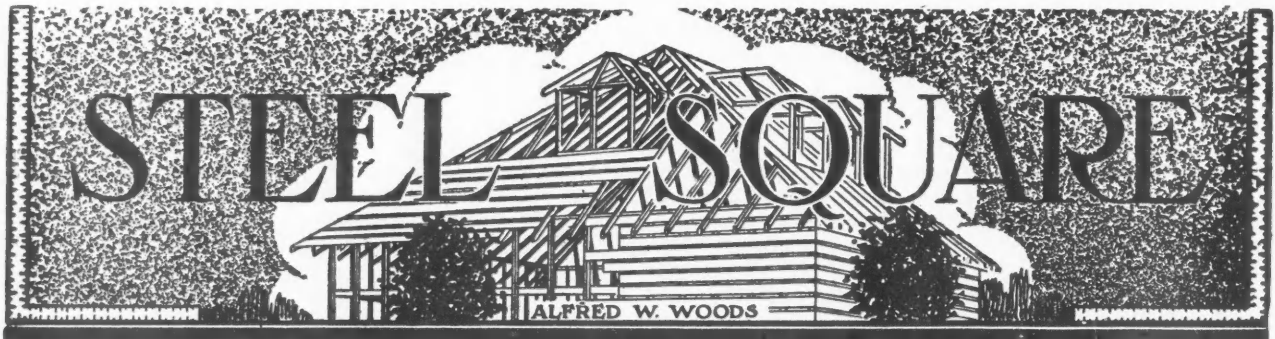

## Ninth Anniversary Celebrated by Solving Nine-Sided Building Roof Framing

THE STEEL SQUARE AND ITS USES FOR THIS WORK

By A. W. Woods

**A** GAIN the Editor has given a reminder that another Anniversary is on tap and that it is up to us to make good and give a square deal to the more than 42,000 subscribers of the AMERICAN CARPENTER AND BUILDER. Nine years have come and gone their way, never to return, and all we have left in them is the hope that we have done some good in helping those that delve with saw, hatchet and square, to a higher plane in the realm of the higher pay for services rendered.

It seems but yesterday since we sat in the office down on Fifth Avenue and saw the Charter Member certificates rolling into the office by the hundreds—more than twenty-seven hundred in one day—and as we look back over those nine years, we wonder how many in the great AMERICAN CARPENTER AND BUILDER family can show an unbroken link in the chain of years since April, 1905. How we would like to say—"Hands Up!" We fancy we see them from California to Maine and from Texas to Montana, and so far beyond that you could not distinguish the line between United States and our Canadian brothers. And that is not all—we see them sticking up far beyond the briny deep, in all directions, clamoring—"Me too!"

It is a grand sight and may it ever be thus. We feel so good over it that we are going to give every reader a nine-cut diamond, whether they can boast of a nine-year lineage in the great AMERICAN CARPENTER AND BUILDER family, or not.

Here it is. It's yours—nobody can take it away from you, because the possession of it is nine points in law, and we present it on the square. See the nine

settings, set on the corners of the nine-sided frame. What can you do with it? By skillful manipulation you can do wonders. It possesses in its make-up the angle to cut the nonagon miter, which is the starting point from which all of the cuts and bevels for a roof of any pitch for a nine-sided building are reckoned, and may be solved by the aid of the steel square.

In Fig. 2 is shown the angle to take on the square and what degrees determine it for the nonagon miter, 12 and  $4\frac{3}{8}$ . The arm of the square on which the latter is taken, will give the miter and also represent the length of the sides per foot of the inscribed diameter; but in calculating for the sides of large diameters, the problem may be simplified by using 4.37, which is the decimal equivalent.

Passing to the third illustration, is shown the complete layout for all of the cuts contained in a nine-sided building, with a 9-inch rise to the foot.

NOTE.—The cuts are given on the arm of the square to

which they belong, as 12 and  $4\frac{3}{8}$  will give the nonagon miter; the blade giving the angle for the cut.

The triangle thus formed on the steel square by the line from 12 to  $4\frac{3}{8}$  forms the plan from which to develop all of the cuts contained in the nonagon roof, regardless of any pitch the roof may have. Starting from the plan, all of the angles are clearly shown in the development of same in connection with the steel square.

In conclusion, we have a letter from the Kavanaugh News Store, of Minneapolis, Minn., which reads as follows:

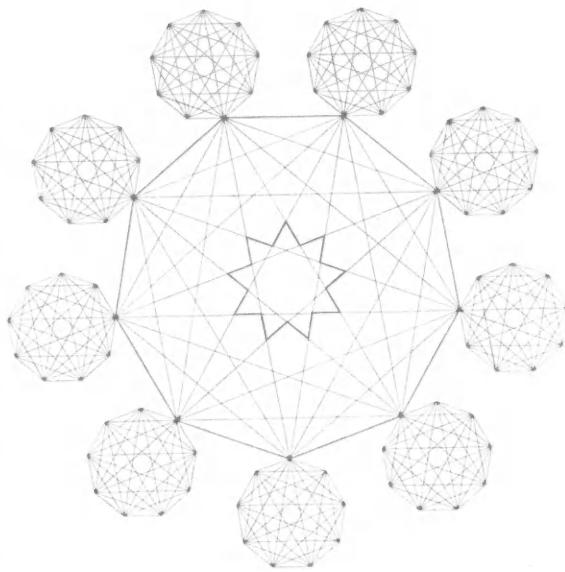

Fig. 1

A little nine-pointed present from Daddy Woods.



"We have a reader that would be very thankful if you would give an illustration in the AMERICAN CARPENTER AND BUILDER, for a polygon hopper. Say, a five-sided one, with a flare of, say, 9 inches to the

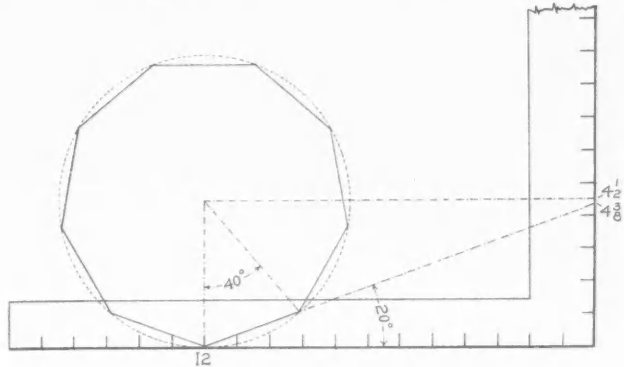

FIG. 2  
Diagram Showing Cuts for Nine-Sided Framing.

foot, and how to obtain the cuts for same on the steel square.

We have it right here in this; that is, the formula. The pentagon miter is at 1 and  $8 \frac{17}{24}$  and the cuts may be developed from this just the same as for the cut of the sheathing in the nine-sided roof to fit over the hip, which, when correctly done, forms a perfect hopper cut. Thus, in the nine-sided hopper, with a 9-inch flare, it is  $4 \frac{3}{8}$  on the tongue and 15 on the blade, and the tongue will give the cut across the face of the board, while the edge cut will be at 12 on the tongue and  $11 \frac{1}{2}$  on the blade, the latter giving the cut. In the case of the pentagon hopper cut, it will be found to be  $8 \frac{17}{24}$  and 15 and 12 and  $2 \frac{5}{8}$ , respectively.

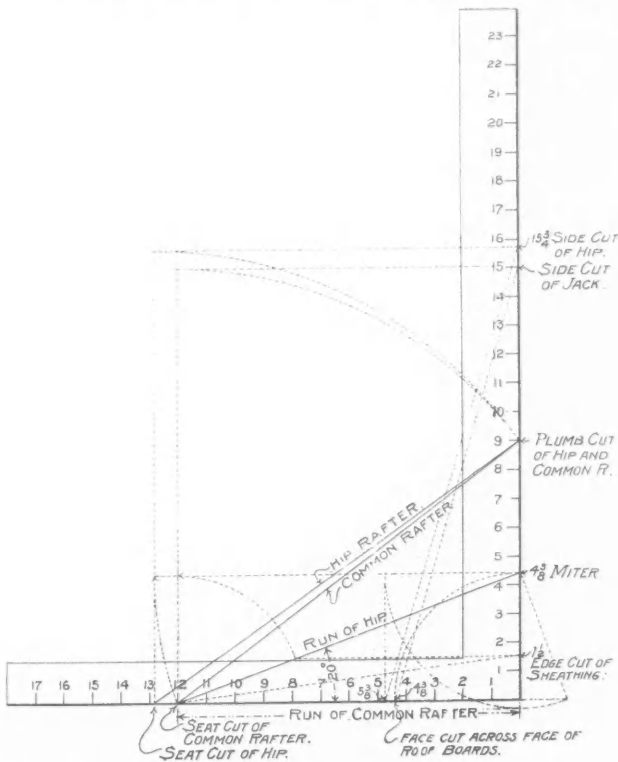

FIG. 3.  
Complete Lay-Out for All Cuts Contained in a Nine-Sided Building with a Nine Inch Rise to the Foot.

Proper Spacing of Roof Boards

To the Editor:

Mazon, Ill.

Here is something that may be new or interesting to some of the readers of the AMERICAN CARPENTER AND BUILDER in regard to putting on roof sheathing and shingles.

In order to have each and every course of shingles nailed as near the desired point as possible, it is necessary to space the roof sheathing on the rafters. This, if done correctly, allows the shingles to be nailed in the same relative position on each course, and the nails always strike the sheathing boards.

To start the spacing right, I draw a sketch of the cornice to scale, as shown in the accompanying sketch. This gives the correct position from which to start the spacing. Then I space all the rafters for the bottom edge of each course of 6-inch sheathing twice the space that I intend to lay the shingles. (If narrow sheathing is used, it must be spaced the

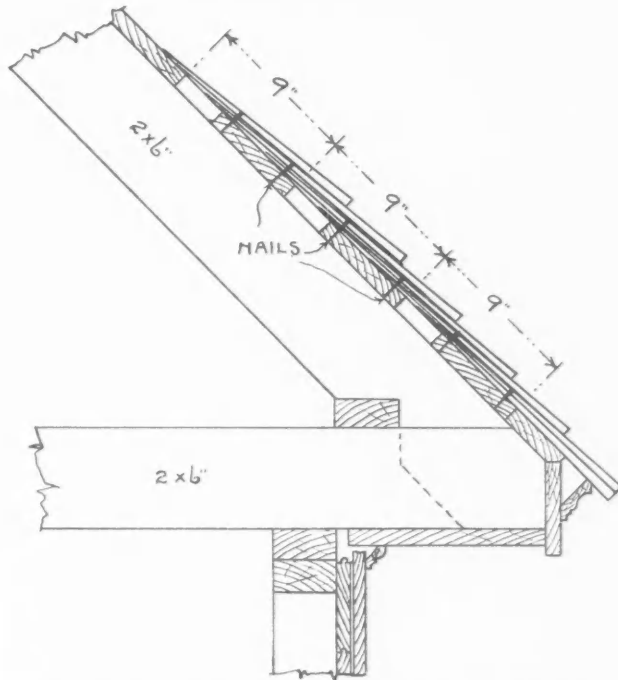

Section Through Cornice Showing Spacing of Roof Boards.

same as the shingles, as only one course of the nails will hit it.) I usually space as many rafters at one time as will lie on the trestles conveniently by using two patterns, one on each side and mark across by a straightedge. I cut all the sheathing boards to the desired length to break joints, etc., "on the ground," then it is a snap to nail it on to the space marks.

This method insures a good surface on which to nail the shingles and takes exactly the right amount of sheathing and shingles, no more, no less. It is quicker and easier done and is neater and better than guesswork. It generally saves one course of sheathing and shingles on each side of a large roof, as guesswork generally gets them closer together than is needed.

Reference to the drawing will show that each nail is equal distance from the butt of the shingle, also that they hit the sheathing every time. This is the shortest cut I have in stock at present for this kind of work. If some reader has a shorter or better method, I would be glad to read it in the AMERICAN CARPENTER AND BUILDER.

O. McKNIGHT,  
Contractor and Builder.

## How to Build a Plank Frame Barn\*

SIMPLE AND COMPLETE DIRECTIONS FOR HANDLING THIS MODERN STYLE BARN CONSTRUCTION

OF late years, the plank frame barn has become very popular in many sections of the country.

There is good reason for this popularity, because this type of barn saves in cost of lumber, provides more storage room for hay, and is much more easily built than the old-time heavy timber frame.

The building of the plank frame barn requires no timber thicker than 2 inches. Girders, trusses, purlins and tie plates are built up of two or more planks, 4 to 12 inches wide, if the barn is not wider than 40

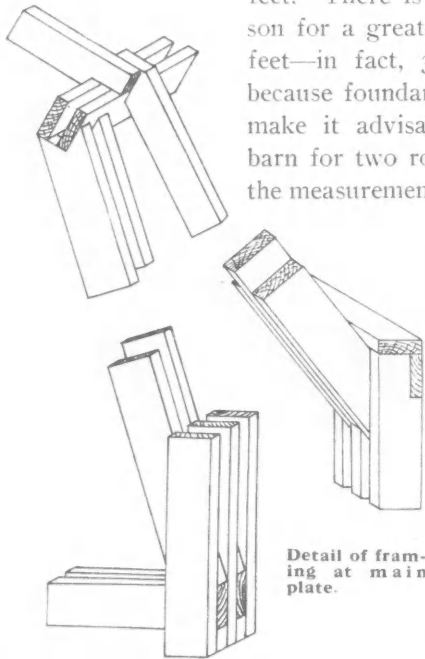

Details of joints at sill and at purlin plate.

feet. There is seldom any reason for a greater width than 40 feet—in fact, 36 feet is usual, because fundamental conditions make it advisable to build the barn for two rows of cows, and the measurements for alleys, gutters, stalls and mangers require only that space.

The scarcity of heavy timbers and their consequent high cost, together with the scarcity of labor, make it well worth while for the prospective builder to study carefully this method of barn construction.

With the old-style heavy timber framing, the cutting of the mortise and tenon joints required a great deal of skill and labor. And since a truss, like a chain, can be no stronger than its weakest point, many of the heavy timber frames are not as strong as they may appear—the joints being only as strong as the thickness of the timber in the tenon.

Girders built up of planks retain the full strength of the entire timber, and are just as satisfactory in every way as the solid timber girders of the same area.

The use of modern hay carrying and grain elevating machinery calls for barns with open centers. In the plank frame barn there are no cross beams nor heavy supporting timbers to interfere with such machinery.

This style of framing leaves the hayloft entirely open, with no obstructions to interfere with and delay the work, so that one man can do as much work in

mowing away hay as three with the old-style frames. It not only required less work to put hay into the barn, but it requires less labor to take it out. The open loft also provides more storage space.

The building of the plank frame barn is comparatively simple. If you could see such a barn in the process of construction, you would realize that it is so easy to build that carpenters of special previous experience are hardly required.

No scaffolding of any kind is needed, and if the right method of raising the trusses is followed, no difficulty will be experienced.

It might be of interest to many, to note the various steps in the building of such a barn.

First, of course, is the excavation for the foundations; good practice requires that this extend below the frost line.

Sometimes the first story is built of concrete or stone. Where this is done, the ventilating intake flues may be of galvanized pipe, set in place and the concrete poured, or the stone laid, around them. Such intakes are shown in the third photo illustration.

Many object to the concrete wall, however, on the ground that it transmits too much moisture. It is also somewhat more difficult and more expensive to set window frames and intake flues in stone than in the frame construction.

The practice preferred by many is to build the foundation of stone or concrete to the window bases, completing the first story with a frame wall—2 by 8s or 2 by 10s forming the studding up to the ceiling. With such a wall it is easy to set in the window frames; and the space between the studding gives room for the proper installation of intake flues, tapping the outside for the register face and the inside for the complete register.

After the foundation is in and the frame for the first story wall completed, the supporting columns are

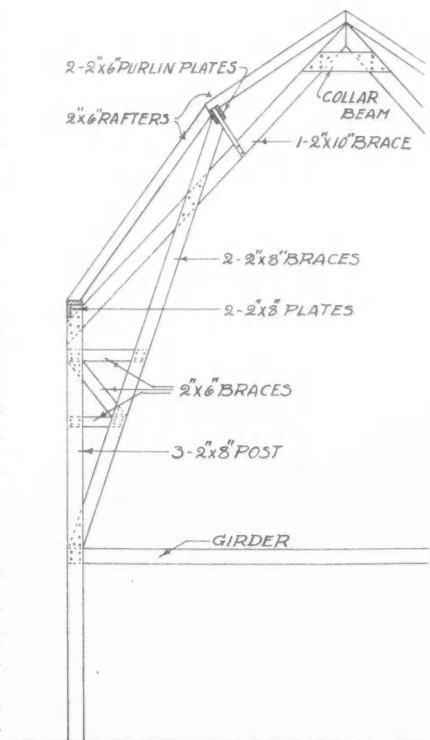

Detail of inside bent in self-supporting plank frame construction.

\*Photographs and text reproduced by permission from the "James Barn Magazine," Copyright, 1914, by James Mfg. Co., Fort Atkinson, Wis.

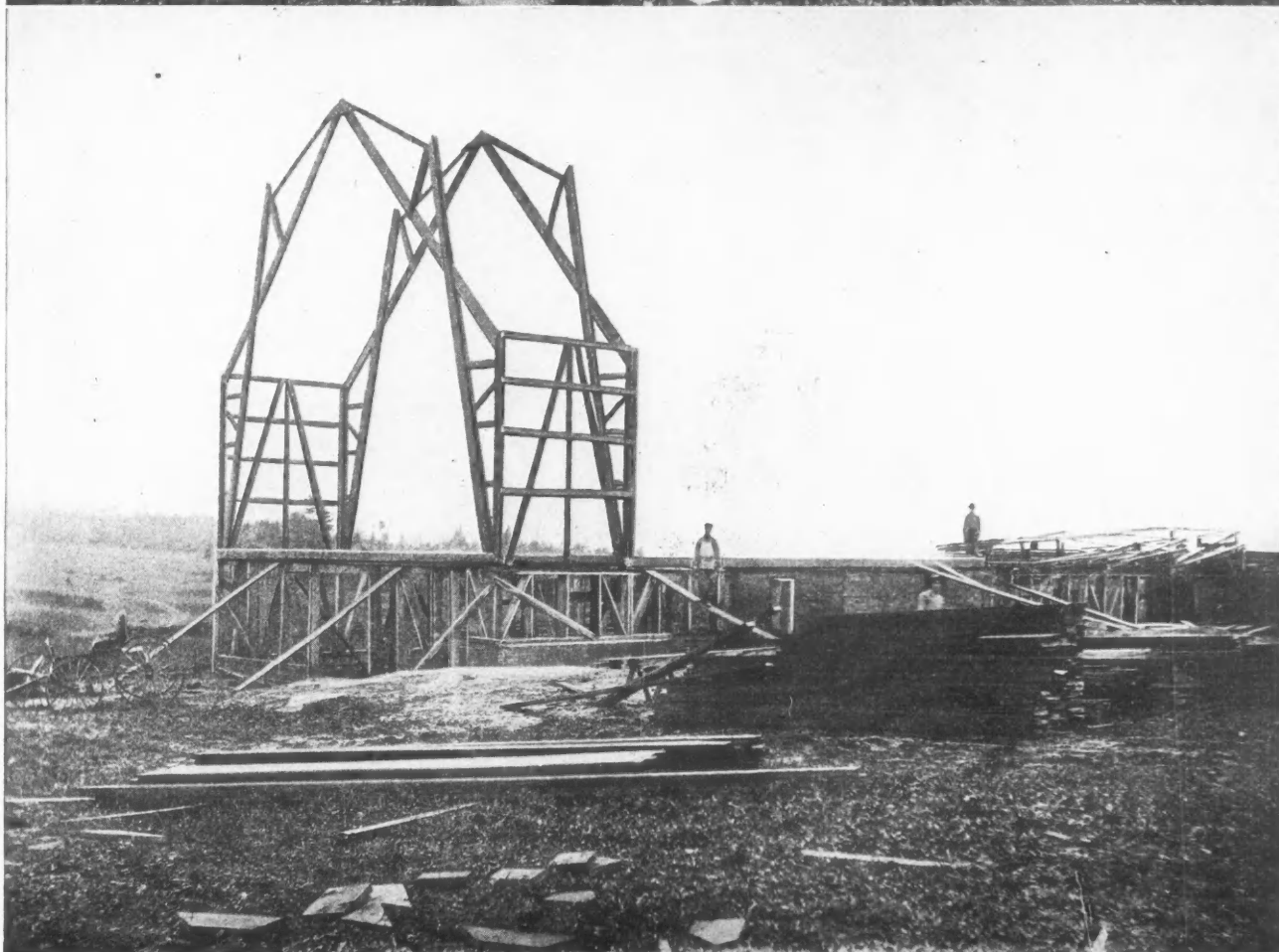
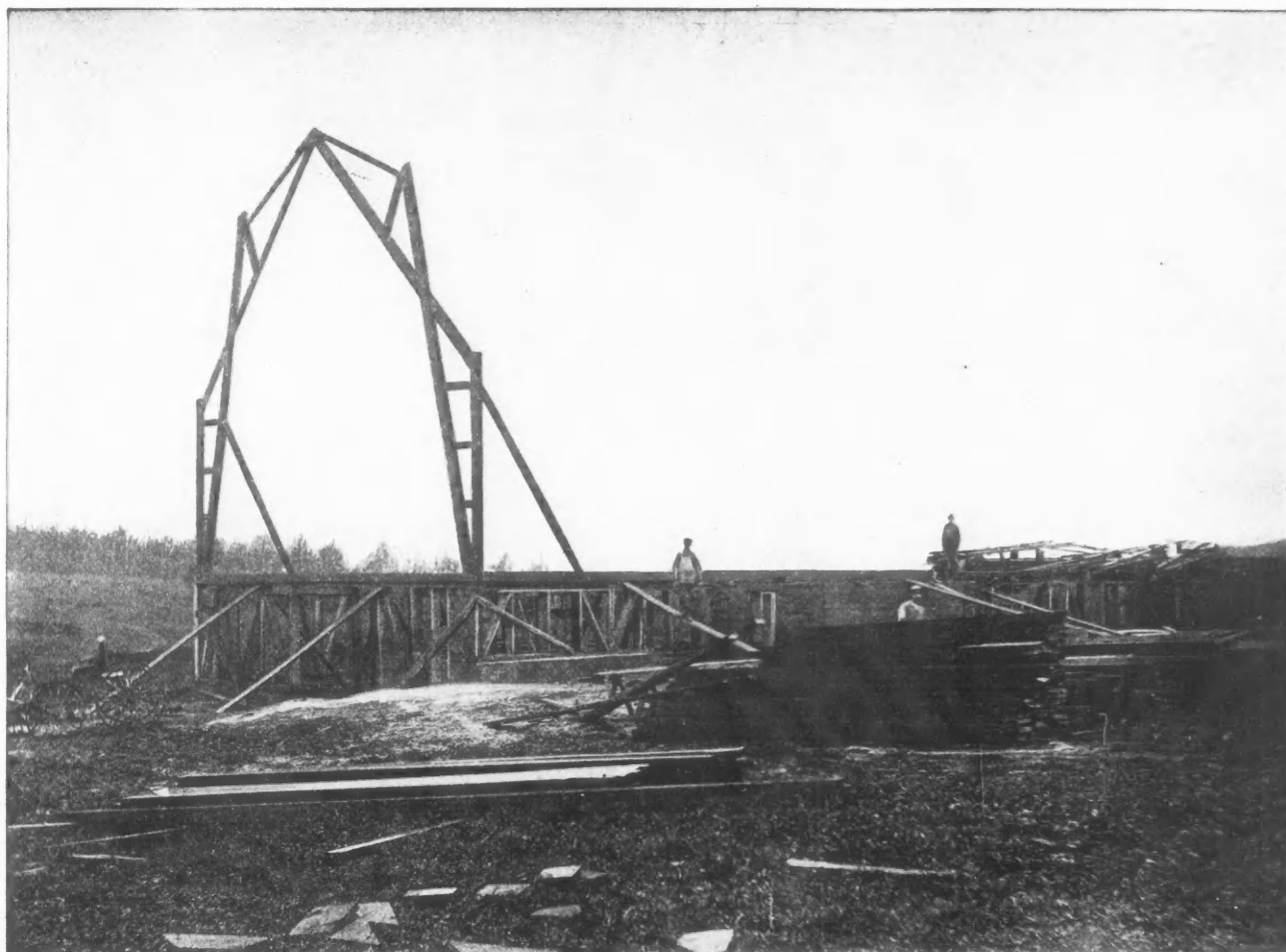

Two photographic views of plank frame barn in its early stages. In upper view first truss has just been raised and braced in position.

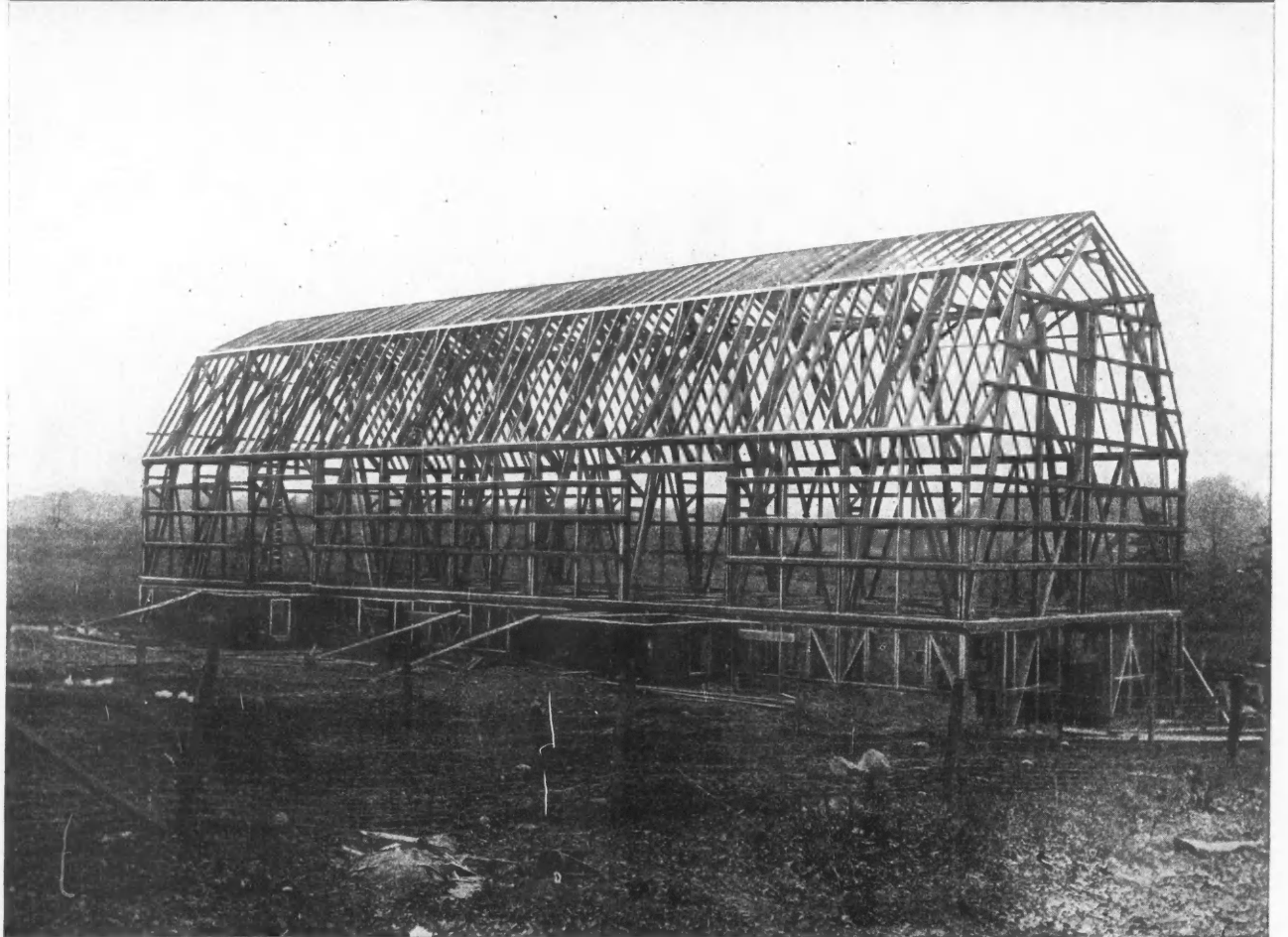
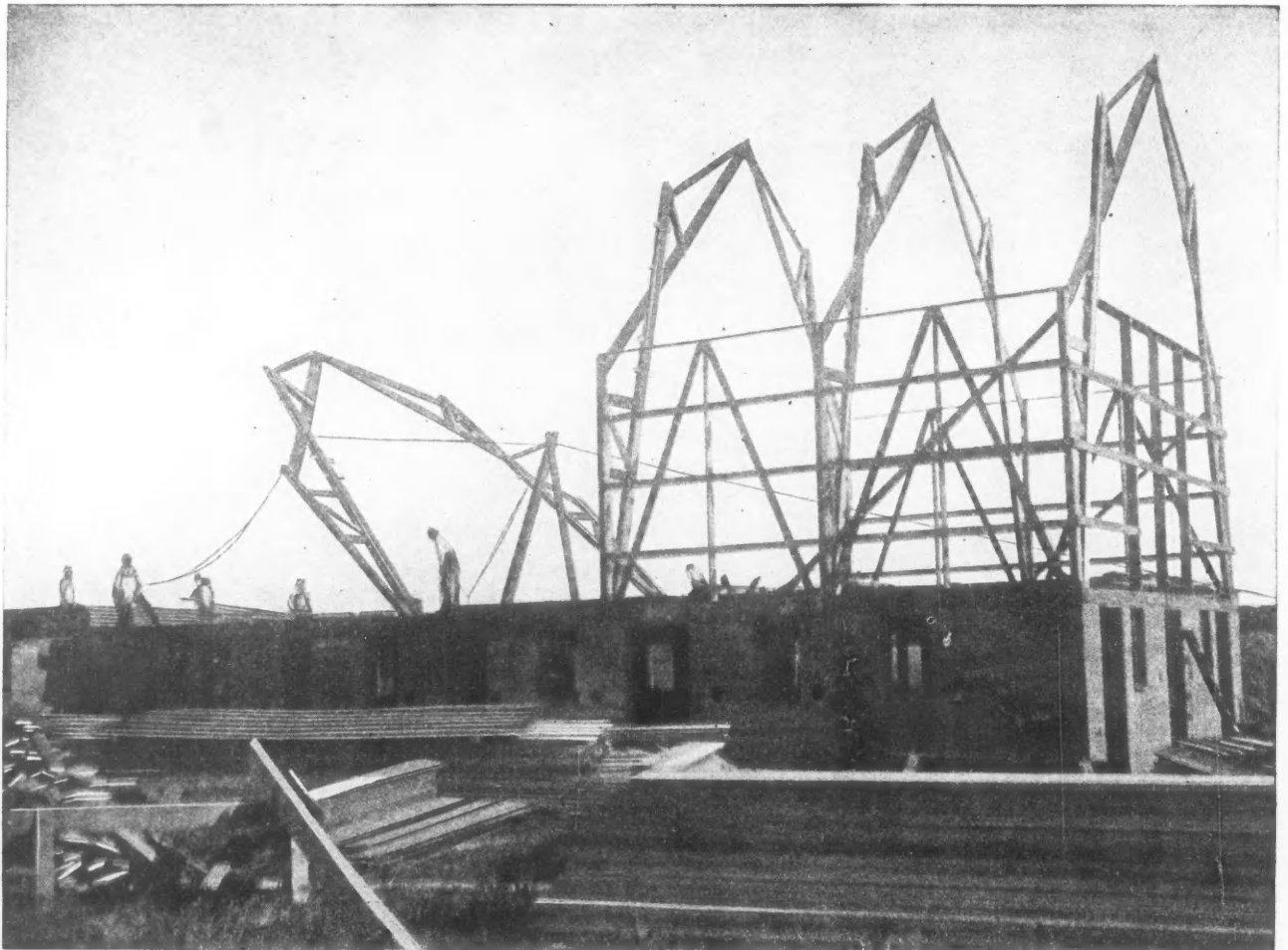

Two photographic views of large plank frame barn. Upper view shows clearly method of raising each truss with gin pole.

next put in place, the proper footings for same having been provided. It is important that these footings be of ample size; if they are not, the building may settle, cracking the concrete floor and doing other damage.

Metal columns being used, the bottom of the column should be 2 to 6 inches below the finished floor line, depending on the method of finishing the floor.

When the columns are in place the girders may be laid.

As suggested before, there are two kinds of girders—one of solid timber, the other continuous built up from 2-inch planks.

The latter are usually preferable, being stronger, because any defects in the lumber are apt to be better distributed. Care must be used, however, to so stagger the joints that the girder has uniform strength; the spacing of the joints depending on the distance between supporting posts and on certain other conditions.

The foundation, the frame of the first-story wall, supporting columns and girders all being in place, the floor joists are next put in. Then a temporary floor of loose boards is laid on the joists, so that the workmen can move about freely while raising the trusses into place.

These joists may be used previously for the concrete forms, in the building of the foundations, thus saving the cost of special lumber for that purpose. This will not in any way injure them for their final use as joists.

The plans will show exactly how to cut and put together the first truss. When this first truss is completed, it may be laid on the floor, and all other trusses may then be built exactly like it, one on top of the other, thus insuring accuracy in all the joints and measurements.

### How Barn is Raised

When all the trusses have been finished, the first truss is placed in position at one end of the barn.

This is usually done by placing the truss on the floor, with the feet of the truss at the places where they are to rest when the truss is raised; with the top toward the center of the barn.

Blocks are then spiked to the joists at the proper points, to keep the feet of the truss in place while being raised—the feet of the truss resting against these blocks and pivoting on them.

A gin pole (one of which is shown in the third photo illustration) is erected at the end of the barn in the center, leaning at an angle of about 45 degrees towards the center of the barn; a block and tackle is rigged, the rope passing over the gin pole, and attached to the upper parts of the truss.

A horse or team is hitched to the block and tackle, and the truss quickly raised to position; it is then braced temporarily, as shown in the first photo illustration.

A gang of men can do the same work, but the horse or team is cheaper. A few men with guy ropes are needed, however, to steady the truss until it is upright and braced in place.

The second truss is then raised in like manner, and as soon as it is up the girts are added, as shown in the second picture.

Then one after the other the trusses are put in place, the girts being spiked on as you go along. The end girts can be added at any time convenient.

To put on the plates no scaffolding is needed, since it is easy to climb up on the truss itself.

The next step is to put the purlins in place, raising them to position with block and tackle.

It will be found easier to nail on the siding before the rafters and cornice are on, as there will then be nothing to interfere with nailing on the boards under the cornice.

How much simpler this is than the old-time barn raising when the heavy timbers were in common use. No longer is there any need for getting thirty or forty men for the raising of a medium size barn; today, half a dozen men will put up a plank frame in less time than thirty or forty could raise the heavy timber frame in the old days.



### Great Salt Lake Preserves Timbers

IN replacing a railroad trestle recently burned along the north shore of Great Salt Lake, engineers have just found that the piles are still perfectly sound after forty-three years of service. Looking for the cause, since these were only of local pine and fir, they found the timbers were impregnated throughout with salt from the lake.

At another point on the lake, 18-inch piles, set twenty-nine years, are similarly preserved with salt, which has penetrated to their very center. Timbers in Southern Pacific trestles across Salt Lake, placed in 1902, appear to be as good as on the day when the piles were driven. They have been preserved well above water line by the salt dashed on to them by the waves, a fact apparently anticipated by the engineers who built the trestles.

The first transcontinental telegraph lines, built before the railroad, extended west from Salt Lake City through the prosperous mining camps of Eureka, Austin, and Virginia City. When the railroad was built, the telegraph line was transferred to follow its right of way and the old poles sawed off at the ground. An engineer who recently examined the butts left in the ground in the salt desert near Fish Springs found that, although fifty years had passed since the poles were cut off, the old butts were perfectly sound.

Telephone and electric companies in the Salt Lake valley have used the local salt for preserving poles. When set up, about 75 pounds of salt is placed around the pole on the ground. This method cannot be used, however, when the pole is on or near a lawn, or in any place where vegetation is desired.

It is pointed out that the reason why the waters of Salt Lake act as a strong preservative, as distinguished from ocean waters, is because the lake water is so much saltier, being practically a saturate solution. Preservation with salt is of no use in ocean piling against the attack of teredos and other marine borers.

Experts in the forest service who have been investigating the preservative treatment of timber offer the suggestion that ties and poles which have been immersed for some time in the waters of the lake ought to be impervious to decay if the salt is not leached out by the action of elements. It has been suggested that this can be guarded against, for example, by painting the butt of the pole with a coat of creosote, which will keep out the moisture and keep in the salt.

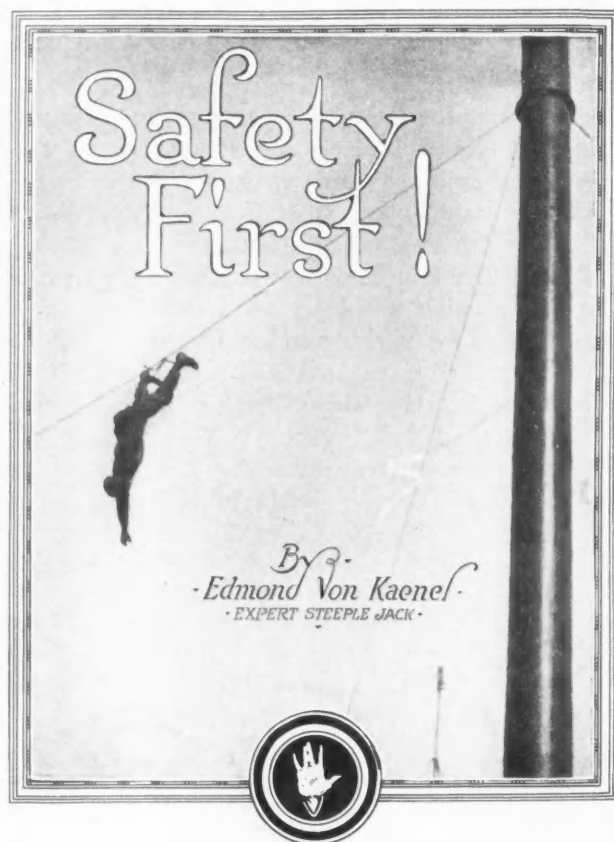

## Preventing Serious Accidents on Swinging Scaffolds

A NEW SAFETY DEVICE FOR PAINTERS AND OTHER ROPE WORKERS.

**H**AVE you ever stopped to consider the number of skilled and unskilled men who are every day earning their money by suspending from a rope—either from a painter's swinging scaffold or a boatswain's chair? Painters, sign makers, cornice workers, and many other men engaged in building work have to work on scaffolds hung from above by ropes, and raised and lowered by block and tackle.

In spite of the always present element of danger, the swinging scaffold is the only economical way to handle these jobs.

The rope scaffold is safe enough too, if one uses ordinary care. Ropes can be depended on not to break, and cornice hooks or other fastenings above are usually trustworthy, and the scaffold itself, especially when provided with an outside rail, is just as safe as any other scaffold.

The one danger point has always been the control line. Frequently the man or men on the scaffold have to pull themselves up and down as their work progresses. Even with block and tackle it is a heavy lift, especially when the scaffold is loaded with paint buckets or other building gear. The men have to untie, then hoist, and then tie up again; *and right there the accident happens.* A sudden weakness, a cramp in the arm, a little fumble or mistake in grasping the rope—any one of these is enough to send scaffold and

man hurtling down to serious injury or even death.

I know this only too well, as I worked with ropes and on rope scaffolds all my life. I have gone down myself, and have heard my mates cry out and have seen them crash down, all because of trouble in tying up. Some mischance or sudden weakness causes the man on the scaffold to let loose of his control line, and he doesn't have to wait half a second for the trouble to begin.

I have worked out a safety device that does entirely away with this old danger. It is very simple, and costs practically nothing. I am glad to give all building tradesmen who use rope hoists for doing any part of their work the benefit of this life-saving discovery of mine. Make it a part of your rigging on your boatswain's chair, and on every hoisting line on your swing scaffold. It will save serious accidents, and sudden death, itself.

### Safety Device Described

In the first photograph you can plainly see a short piece of rope (2 or 3 feet long), spliced to the eye of the block. If you cannot splice it, tie it with a bow line or any other good holding knot. In this picture I am sitting in my boatswain's chair with the control line "tied up" by means of the Blackwall knot, put around under the pulley hook in the regulation way.

Now, as all rope workers know, this is a secure fastening, but to raise or lower the scaffold or chair, the workman has to grasp the control line, throw his weight on it, and unhitch the Blackwall. From then on, until he is in the new position and the new tying-up operation has been properly done, his safety is entirely dependent on his own strength of arm. If he loses his hold, even for an instant, he is a goner.

My little 3 feet of rope is the safety appliance that stands between this man and sudden death. One end is spliced or knotted to the eye of the block, as already explained. The other end is tied with two half-hitches around the control rope. Leave one foot of slack between the block and where the half-hitches are tied. Try this and you will see how it works. The half-



Fig. 1. Author seated in boatswain's chair, points at safety rope spliced to eye of block.



Fig. 2. Safety rope is tied around control line with two half-hitches.



Fig. 3. How the two half-hitches are tied. Be sure to get this just right.



Fig. 4. Half-hitches tighten down and safety rope takes the weight.

hitches do not interfere with the action of the control rope; when hoisting, it slips through very easily, but if there comes a sudden jerk on the control rope from the other side, the half-hitches tighten right down and hold rope and scaffold fast.

The second photograph shows the double half-hitch knot around the control line. The third photograph shows better what this double half-hitch is and how to tie it. I have made this just as clear as I know how, because, I want every working man to use this and get it just right.

The fourth photograph is a better view of this rigging—showing all the knots, and especially the two half-hitches in the safety line, which is just beginning to tighten down and take the weight. In the fifth photograph the knot is pulled tight, and the safety line is bearing all the weight. I am now ready to "tie up" as rope workers call it, in other words, ready to tie the Blackwall knot, and this view shows just how this is done. This is the simplest kind of knot imaginable, just a twist under and into the pulley hook, which tightens against itself and holds fast.

After the Blackwall knot is tied the man must push down the two half-hitches, until the load is on the Blackwall knot.

When the time comes to release, pull down on the control line, release the Blackwall knot. (The half-hitches are on guard all the time.) If the operator wants to go up he holds one hand below the hitches, and the man below will pull him up, the hitches sliding along easily. When at the place to stop he tightens the hitches and is ready to tie up again.

For going down, put one hand on top of the two hitches and pull or push downward. One can get any speed he desires.

Anyone can use this device and will soon find out

the true value of it. It makes it easy to tie up even a heavy scaffolding—a thing it is otherwise hard to do when a man is tired from hoisting himself and the scaffold load.

A great many builders are going to the trouble of building wooden scaffolds, when the swinging rope scaffolds would be much better. For the past eleven years I have been doing work on church steeples, towers, smoke stacks, water tanks, flag poles and cornices of big buildings, not with wooden scaffolds, but with the help of rope. Ordinary contractors have been my competitors, but I do not fear any competition, because I know the others will figure scaffolding.

On one smoke stack job, I recall, they were all about \$900 high from my figures, as they had figured a full month's work on scaffolding, for work that I did in six hours.



Fig. 5. Safety rope supporting all the weight; the workman easily forms a Blackwall knot and "ties up".



## NOON-HOUR TALKS BY THE BOSS CARPENTER

### Talk No. 21—Roof Construction

THE BOSS TELLS ABOUT DIFFERENT KINDS OF ROOF LOADS AND SHOWS HOW TO FIGURE SIZE OF RAFTERS AND PURLINS

"I HAVE shown you fellows," said the Boss, "how to figure about everything up to the roof. Now is a good time to begin to consider the designing of roof members, and to gradually work into the designing of roof trusses. You have probably noticed that roofs are supported by rafters, rafters and purlins, or by a combination of rafters, purlins, and trusses. Roofs may be flat, pitched, or of the gambrel type, each requiring some little difference in figuring. Even with this difference in the method of calculation, there are certain fundamental principles which apply in all cases and which we should know.

"The ordinary loads which a roof has to support are classed as the *dead* load, *snow* load, and *wind* load. If the roof is flat, or nearly so, and may be called upon to serve as a floor at any time, the effect of this so-called *live* load which may occasionally come upon the roof should be taken account of in calculations.

"The *dead* load consists of the weight of the roof itself, and takes into account all the framing of the roof and the roof covering. Table 1 gives the weights of lumber per 1,000 feet board measure, while Table 2 will supply the weights of ordinary roof coverings per square foot. An instance of the use of these tables will be shown a little later in the talk.

TABLE 1

Approximate Weights of Dry Lumber Per 1,000 Feet, Board Measure

Hemlock	2,500 Pounds
Oak	4,800 "
Pine, Norway	3,000 "
Pine, white	2,500 "
Pine, yellow	4,000 "
Spruce	2,500 "

"The *snow* load consists of the weight of the snow, or snow and ice, which is likely to come upon the roof during the cold weather period. This quantity will vary in different sections of the country and with the style of roof, but should be taken large enough to cover the worst condition which may occur. Table 3 will serve as a guide for ordinary cases, and is taken from Kidder's Architects' and Builders' Pocket-Book.

"The *wind* load consists of the load effect due to the wind blowing against the roof, and varies with

TABLE 2

Weights of Roofing and Ceiling Materials

Material	Weight in Pounds Per Square Foot
Asphalt on felt, without sheathing	2
Ceiling, ordinary lath and plaster	6 to 8
Ceiling, stamped steel	2 1/2
Ceiling, wood, 3/4-inch	2 1/2
Composition, 3-ply	1
Concrete, per 1-inch thickness of slab	13
Copper, sheet	1 to 1 1/2
Felt, roofing, 2 layers	1/2
Gravel and felt, without sheathing	8 to 10
Iron, corrugated, No. 18	2 1/2
Iron, corrugated, No. 20	2
Iron, corrugated, No. 24	1 1/4
Iron, flat, galvanized	1 to 3 1/2
Lead, sheet	4 to 8
Sheathing, hemlock, 1-inch thick	3
Sheathing, spruce, 1-inch thick	3
Sheathing, yellow pine, 1-inch thick	4
Sheathing, white pine, 1-inch thick	3
Shingles, wood, cedar	1 1/2
Shingles, wood, cypress	2 1/2
Shingles, metal, tin, painted	1
Shingles, metal, copper	1 1/2
Skylight, glass, 3/16 to 1/2-inch, with frames	4 to 10
Slate, 3/16 to 1/4-inch	7 to 9
Slate, diminishing courses	12
Steel, standing seam	1
Tar and gravel, 4-ply	5 1/2
Tar and gravel, 5-ply	6
Tiles, corrugated	8 to 10
Tiles, flat	15 to 20
Tiles, Ludowici	8
Tiles, on concrete slabs	30 to 35
Tiles, pan	10
Tin, on felt	1
Tin, without sheathing	1/2 to 1
Zinc, sheet	1 to 2

TABLE 3

Allowance for Snow in Pounds Per Square Foot of Roof Surface

Location	Pitch of Roof				
	1/2	2/3	1	3/4	1/2 or less
Southern States and Pacific Slope	* †	* †	* †		
Central States	0-0	0-5	0-5	5	5
Rocky Mountain States	0-5	7-10	15-20	22	30
New England States	0-10	10-15	20-25	27	35
Northwestern States	0-10	10-15	20-35	35	40
	0-12	12-18	25-30	37	45

Columns headed by an asterisk (\*) are for slate, tile, or metal; those headed by a dagger (†) are for shingle roof.



the slope of the roof. Often the snow load and wind load are used as a combination quantity and stated in pounds per square foot of roof surface as in the case of the dead load. A general statement of this combination loading may be taken as 30 pounds per square foot of roof surface in all parts of the United States for roofs of  $\frac{1}{2}$  pitch and over; 25 pounds per square foot for roofs between  $\frac{1}{2}$  and  $\frac{1}{4}$  pitch; while for roofs of less than  $\frac{1}{4}$  pitch, 20 pounds per square foot may be used in the Southern Pacific and Coast States, 30

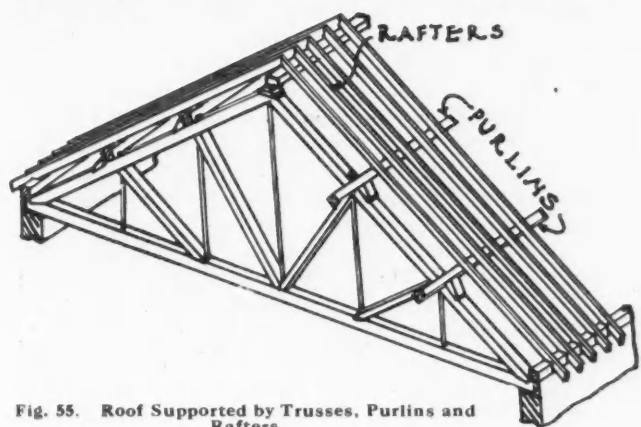

Fig. 55. Roof Supported by Trusses, Purlins and Rafters.

pounds per square foot for the Central States, and 40 pounds per square foot for other locations.

"In finding the load carried by a single rafter, as in Fig. 55, we assume that this rafter carries a section of roof equal to one-half the spacing of the rafters on each side of this rafter, as shown between lines A A in Fig. 56, multiplied by the length of the rafter. Fig. 56 shows the general distribution of loading for rafters and for purlins in a purlin and rafter roof. If the spacing of rafters in a roof is 24 inches on centers, each rafter would bear a section of roof 2 feet wide and the length of the rafter long. For example, each rafter in a roof made up of 2 by 8-inch rafters, 16 feet long, spaced 24-inch centers, covered with 1-inch yellow pine sheathing and cedar shingles would support a roof area of  $2 \times 16$ , or 32 square feet. The dead load would be found as follows:

"One piece 2 by 8-inch yellow pine, 16 feet long =  $21\frac{1}{3}$  board feet.

"Thirty-two square feet of 1-inch yellow pine sheathing = 32 board feet.

"Total, 54 board feet, approximately.

"From Table 1, at 4 pounds per board foot, 54 board feet yellow pine = 216 pounds.

"From Table 2, 32 square feet of cedar shingles = 48 pounds. This would make the total dead load carried by one rafter equal to 264 pounds. If snow load, or snow and wind load is also to be considered, the amount per square foot should be multiplied by the 32 square feet of area supported by one rafter and added to the 264 pounds due to the weight of the timber.

"In a similar manner, a purlin is assumed to carry the load brought upon it by the rafters in each half span on each side of the purlin. If the spans on each

side of the purlin are equal, the load on a purlin is equal to that carried by a section of roof of an area equal to that between trusses and from one purlin to the next, as shown between lines B B in Fig. 56. At the ends of trusses, the purlins carry a load equal to one-half of that on the end panel of roof.

"To figure the size of a rafter when the span and pitch of roof, together with type of roof is known, we would first have to assume a distance between centers of rafters. This may be 12 inches for heavy loads, 16 inches, 20 inches, or 24 inches for light loads. Then knowing the roof covering, a weight per square foot may be obtained from Table 2. This weight multiplied by the area supported by one rafter will give the uniformly distributed load carried by one rafter. For example, a rafter 12 feet long and spaced 16 inches from its neighbor would support 16 square feet of roof ( $12 \times 1\frac{1}{3}$ ). If this roof consists of 1-inch yellow pine sheathing covered with cedar shingles, Table 2 gives a weight per square foot of  $(4 + 1\frac{1}{2})$  or  $5\frac{1}{2}$  pounds. To this must be added an allowance to make up for the weight of the rafter itself. As an estimate, we might consider that  $2\frac{1}{2}$  pounds per square foot of roof surface will roughly take care of the rafter. After the size of the rafter has been obtained, the calculations may be checked over again with the true weight included.

"If this roof is  $\frac{1}{2}$  pitch, a load of 30 pounds per square foot may be added as the effect of wind and snow combined. This would make the total uniformly distributed load per rafter per square foot of roof equal

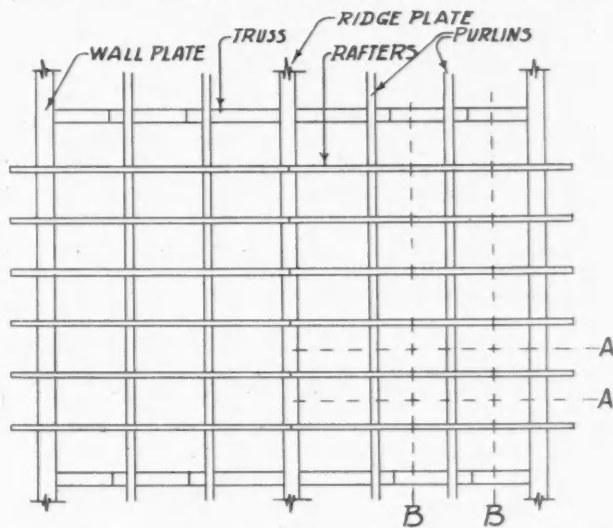

Fig. 56. Plan of Roof Showing Load Areas Carried by Rafters and Purlins.

to about 38 or 40 pounds. Or the uniformly distributed load per rafter would equal about  $16 \times 40$  or 640 pounds.

"We would now apply Formula No. 1, Talk No. 1 ( $\frac{pl}{e} = M$ ), filling in the formula as explained in Talk No. 1, using  $p = 1,000$  pounds per square inch, as given in the table in Talk No. 5;  $M$  as  $\frac{1}{8} Wl$ , as given in Talk No. 1, with the exception that  $l$  may be used

as the horizontal distance between the two ends of the rafter, and not the true length;  $l$  as  $1/12 bh^3$  and  $e$  as  $h$

— The value of  $b$  may be taken as 2 inches.

The horizontal length to be used may be found for any pitch of roof, by knowing that the pitch of the roof is expressed as the height of center or ridge above plate divided by the span between plates. That is, a  $1/2$  pitch would mean that the rise is equal to  $1/2$  the span. Then, if the length of the rafter from plate to ridge is 12 feet, the horizontal length would be found from the formula:

$(\text{rise} \times \text{rise}) + (\frac{1}{2}\text{span} \times \frac{1}{2}\text{span}) = \text{length} \times \text{length}$ .  
All of these quantities are in feet. For the case above this would mean that 2 times the  $(\frac{1}{2}\text{span} \times \frac{1}{2}\text{span}) = 144$ , or the  $(\frac{1}{2}\text{span} \times \frac{1}{2}\text{span}) = 72$ . It is readily seen by trial that  $(8\frac{1}{2} \times 8\frac{1}{2})$  is nearly equal to 72, therefore the  $1/2$  span must be about  $8\frac{1}{2}$  feet. Use this value for  $l$  in Formula No. 1.

"Filling in Formula No. 1, we have

$$\frac{1,000 \times 1/12 \times 2 \times h \times h \times h}{\frac{h}{2}} = \frac{1}{8} \times 640 \times (8\frac{1}{2} \times 12).$$

Solving,  $h^2 = 25$  (nearly), or, since  $h \times h = 25$ ,  $h$  would equal about 5 inches. The nearest commercial size to this would be a 2 by 6-inch timber.

"Other kinds of timber, other pitches of roof, and other spacing of rafters would be treated in a similar manner. The table of bending strengths of timber given in Talk No. 5 will be of service in this connection.

"The rafter figured above is considered to be supported at plate and ridge only, and is for a roof with rafters of equal length on each side of the ridge.

"Purlins would be figured in a similar manner, taking  $W$  as the entire load brought upon one purlin by the method referred to above, and taking  $l$  as the actual length of purlin, in inches. The value of  $b$  would be greater than 2 inches in a case of this kind, and could be assumed by the calculator."

### Boss Carpenter Question Box

State your problems briefly yet clearly and the Boss will gladly answer them here.  
Yours for Safer Building.—Editor.

#### Use of Hand Books

To the Editor:

Brier Hill, Pa.

Referring to "Talk No. 20 by the Boss" in March issue, 1914, I desire to submit the following, which I hope will be accepted in the spirit it is made, and which is for the benefit of the Apprentice who probably knows nothing of the Moment of Inertia—Section Modulus or the meaning of either.

The Boss understands perfectly the subject he is handling, and no doubt is thoroughly appreciated by the more advanced, but the craftsman whose early education has been much neglected, and probably limited to the three R's, will likely derive some benefit from the following also, which is the Boss'

subject, that is, "What size of steel I-beam 32 ft. in length between supports, will be required to safely support a brick wall 32 feet by 9 feet by 1 foot thick?" Now, a wall 32 feet long, 1 foot thick and 9 feet high, contains 32 times 1 times 9 equals 288 cubic feet, and the Boss says one cubic foot of brick weighs 125 pounds, then follows 288 times 125 equals 36,000 pounds weight of wall to support.

From the above we will proceed to find the approximate size of the I-beam and will use a fibre stress of 16,000 pounds per square inch. Now 36,000 times 32 equals 1,152,000; please turn to page 98, Carnegie Steel Co. Handbook, column 12, "Coefficient of strength for fibre stress of 16,000 pounds per square inch." Following down this column we find No. 1,091,900, being the nearest number to correspond with 1,152,000. This stands opposite to an 18-inch I-beam at 70 pounds per foot. Now, as I stated before, this gives us an approximate size of beam and a corresponding weight of beam, which we can assume as the proper weight with every degree of safety. Now, as the beam must support its own weight along with the weight of the wall, we will proceed once more with the same simple process, which will give us the desired information. 70 pounds times 32 equals 2,240 pounds, equals weight of I-beam. 2,240 plus 36,000 equals 38,240, equals total weight of wall and beam. Then 38,240 times 32 equals 1,223,680. Now again look at column 12, same page, same book, exactly same as before, you will find this No. 1,223,680 comes nearest to No. 1,247,600; follow this line across the page and you will find stated there a 20-inch I-beam at 65 pounds weight per foot.

The above eliminates any intricate formula and I trust will be of some value to my fellow craftsmen.

R. F. McKAY.

Answer: We are interested in the letter from Mr. McKay and agree with him that it is advisable for all of the "calculating squad" to provide themselves with the handbook of either the Carnegie Steel Co., Pittsburgh, Pa., or the Cambria Steel Company, Johnstown, Pa. These books may be obtained direct from the company at a small price.

The object in presenting the matter as given in Talk No. 20 by the Boss Carpenter was to show the method used in calculations of this kind without depending upon the other fellows figures. In fact, the Talks are intended as an educational feature in addition to a means of obtaining an answer.

We believe that Mr. McKay is mistaken in regard to "Moment of Inertia" and "Section Modulus," as these quantities have been fully explained in these Talks.

The Boss has hoped that the Talks were given in a plain manner, which would be understood by the average workman. Engineering terms were avoided where possible, and explained as clearly as space would permit where it was necessary to use such terms. He has realized that it is difficult to make clear those points which really demand a previous knowledge of higher mathematics and mechanics, but believes that the "boys" have been able to follow the mathematics which have been given.

We appreciate the criticism given by Mr. McKay, but believe that he overlooked the true object of the articles.—EDITOR.



#### Long and Short Span Beams

Where a floor is built around machinery foundations, frequently a long span and a short span beam come close together. Unless provision is made for a joint between them, there is certain to be an unsightly crack, due to the difference of deflection of the two under the same load. —

Contrary to popular belief, forest fires seldom travel more than 2 or 3 miles an hour. Even in extreme cases it is questionable whether they burn at a rate of more than 6 to 10 miles an hour.

# Double Duct System of Ventilating

EFFICIENT METHOD OF WARMING AND VENTILATING BY WHICH AMOUNT OF HEAT TO EACH APARTMENT CAN BE REGULATED

By Harold L. Alt, M. E.

ANOTHER method by which ventilating air is conveyed from the heater to the various points of distribution is by what is known as the "double duct" system. This scheme is generally carried out somewhat in the manner shown in Fig. 1, and consists of blowing the air partly through the heater and partly through the bypass below into two separate ducts, the upper one carrying the hot air and the lower one the cold air.

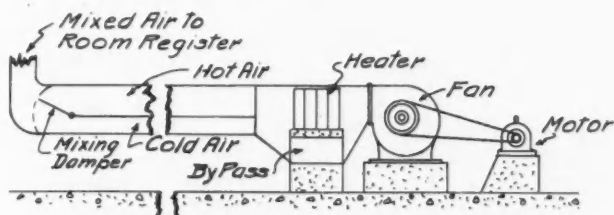

ELEVATION OF DOUBLE DUCT SYSTEM

Fig. 1. Flap-Damper regulates proportion of hot and cold air.

This arrangement is continued until the bottom of the vertical flues going up to each room is reached. Here the upper duct with the hot air is connected into the vertical riser, as is also the lower duct, and the quantity of each kind of air entering the flues is regulated by some sort of a mixing damper which may be of the type shown in Fig. 1, or of another style as shown in Fig. 2. Raising or lowering this damper from the room above will result in graduating the air temperature from the hottest down to the lowest temperature point, which is at least low enough to take care of the variation caused by the position of the different rooms supplied.

It is usually customary to make the hot air duct capable of supplying the required quantity of air needed for ventilation independent of the cold air duct, it being assumed that under normal condition it will not be necessary to reduce the temperature of the air. The cold air duct is usually made from one-half to two-thirds the area of the hot air duct so that a maximum of cold air supply of 50 to 66 $\frac{2}{3}$  per cent can be obtained.

Fig. 2 is a typical detail of the flues running up to the rooms from the end of the double duct. In this case the damper is slid up and down by a chain pull operated from the room so that any desired temperature within the limits of the system can be obtained.

Ventilation in this manner is much more successful and satisfactory if thermostatic control is used to operate the mixing dampers, a thermostat being placed in each room and a small air motor attached to the sliding damper which can be counterweighted so as to move with a very small expenditure of power. These thermostats can then be set so as to admit all hot air when the room is at 65 degrees or below and

to gradually cut the hot air down and to substitute cold air as the temperature rises above this.

If we assume that the hot air is heated to 70 degrees and that the cold air is at say 40, then a mixture of equal quantities of hot and cold air will produce an air supply to the room of 55 degrees which is a good deal lower than any properly designed heating system should ever demand.

Thermostatic control is also installed on the heater coils, the same as previously described for the trunk line system, excepting that the thermostat in this case is not located in the room, but instead, is placed in the hot air duct turning on the coils so as to produce a constant hot air temperature somewhat above 70 degrees. It is not necessary or possible to use a bypass mixing damper so as to obtain the finer graduations of temperature of the hot air as was used in the trunk line system, owing to the fact that this graduation is later secured by the mixing damper located in the base of each flue.

These systems cost considerably more to install than the trunk line systems, owing to the fact that the cold air duct must be run, although the full area required by a trunk line system of equal capacity is carried in the hot air pipe. On the other hand, the occupant of every room is enabled to have the air at the temperature desired. For instance, a gymnasium could be supplied with a much cooler air than a study room, although on the same system. The total air handled with a system of this kind for the same amount of ventilation is no greater than the trunk

line system; and the operating cost is about the same. Therefore, the only difference, as far as expense goes, is the interest on the extra investment required for the cold-air pipe.

One disadvantage, however, under which this system labors in practical installation is the fact that it necessitates slightly more head room than the trunk line system. In a great many cases it is possible to flatten out the ducts so as to overcome this difficulty, yet in so doing, ducts of an uneconomical shape and offering greater friction to the air are produced. More air can be carried through a trunk line system than the double ducts.

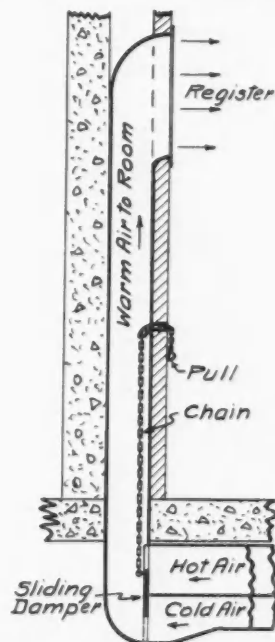

DETAIL OF FLUES TO ROOMS

Fig. 2. Sliding damper controls temperature of emerging air.

## 90-Foot Round Barn

PHOTOGRAPHS AND FLOOR PLANS SHOWING HOW THIS INTERESTING FARM BUILDING WAS CONSTRUCTED AND HOW IT IS ARRANGED ON THE INSIDE

Designed and Built by B. J. Diers, Carpenter and Builder, Granville, Ia.

**F**EW people realize the immense amount of floor space contained in a round barn. Figure for this 90-foot barn, for instance. We know that the area of the main floor is  $\pi R^2$  or 3.1416 times the radius (45) squared, which gives you 6,368 square feet of area.

This 90-foot diameter round barn, then, is the equivalent of a 36 by 177-foot barn. Now, a barn 177 feet long is *some* barn for length. There is a good, long carry for feed in tending to 50 per cent of the cattle. Even placing the silo in the

of the silo would also be of great convenience and the cost would be only a trifle more.

This barn is one I built last summer for Mr. Roy Fry.

It is 90 feet in diameter and 60 feet high to the cupola. The silo in the center is 20 feet in

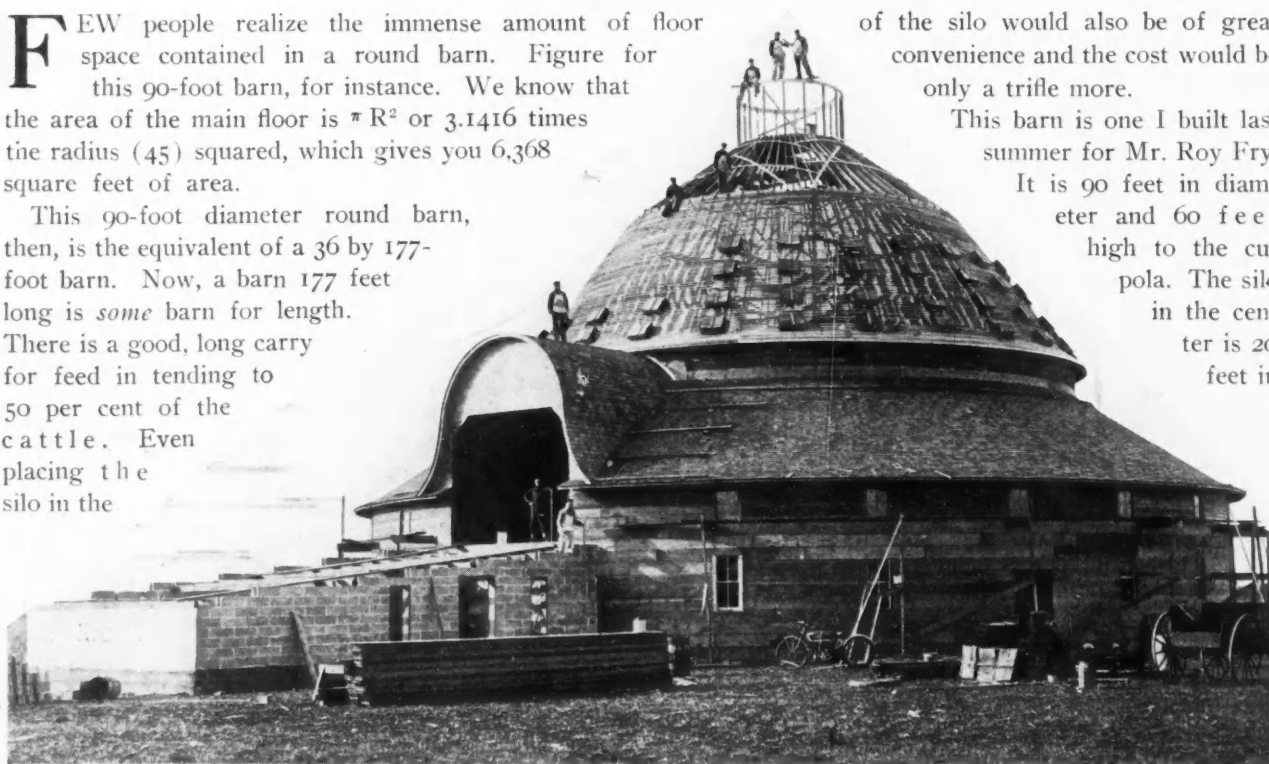

Round barn in course of construction. Horse stable is concrete block section under bridge to haymow floor; roof is sheathed with 1 by 2 in. strips.

middle of one side, the feed has to be carried 88 feet to the cattle at the extreme ends.

Now, with the round barn the silo is located in the center and all the cows are arranged around it. There is a carry of 17 feet to the feed alley and the circuit to the far points is 84 feet. However, in a barn of this kind, most farmers would open up a second door into the feed alley and so cut down the extreme carrying distance to 42 feet.

Two sets of doors on opposite sides

diameter by 48 feet high. The roof is self-supporting, with no ties or braces to interfere with lap siding.

On account of the curve in the roof, we sheathed it with 1 by 2-inch strips. The design of this roof is rather unusual, and you can believe the barn is receiving a lot of favorable comments

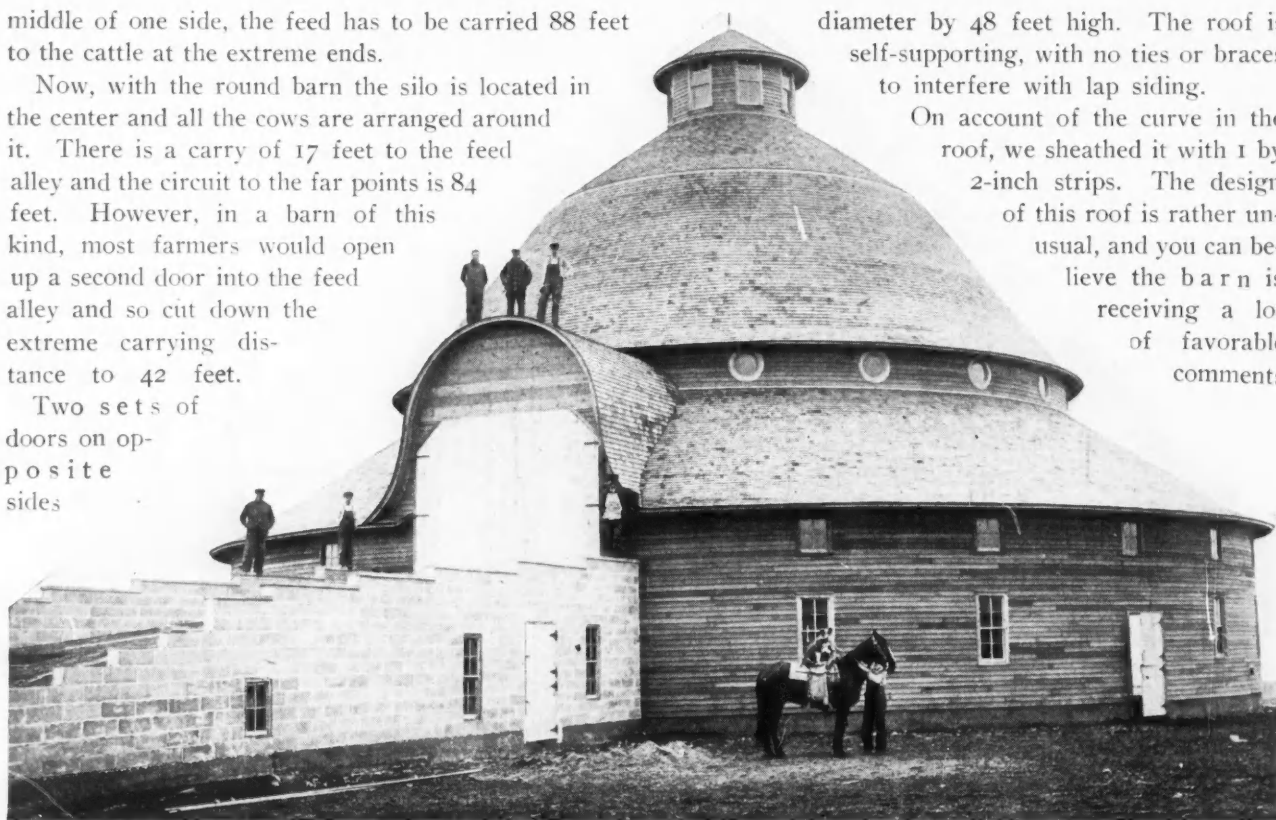

90-Foot Round barn designed and built by B. J. Diers, Carpenter and Builder, Granville, Iowa. Contains 6368 sq. ft. on main floor, and stables 104 cattle in double row of stanchions.

from every one who has seen it. The cupola is 12 feet in diameter and 6 feet high.

Refer to the floor plans and you will see how this barn is arranged inside. There is room on the ground floor for 104 cattle, all in stanchions. These are arranged in a double circle, the cows in the outer row facing in, and those in the inner row facing out. Both rows are served from the one feed alley. The intention is to put in an overhead litter carrier on a track, making a circle of the barn around the outside and also back of the cattle in the inner ring. Farmers find these overhead carriers the greatest labor savers. Considering the service farmers get out of them, the carrier systems are quite inexpensive. The car-

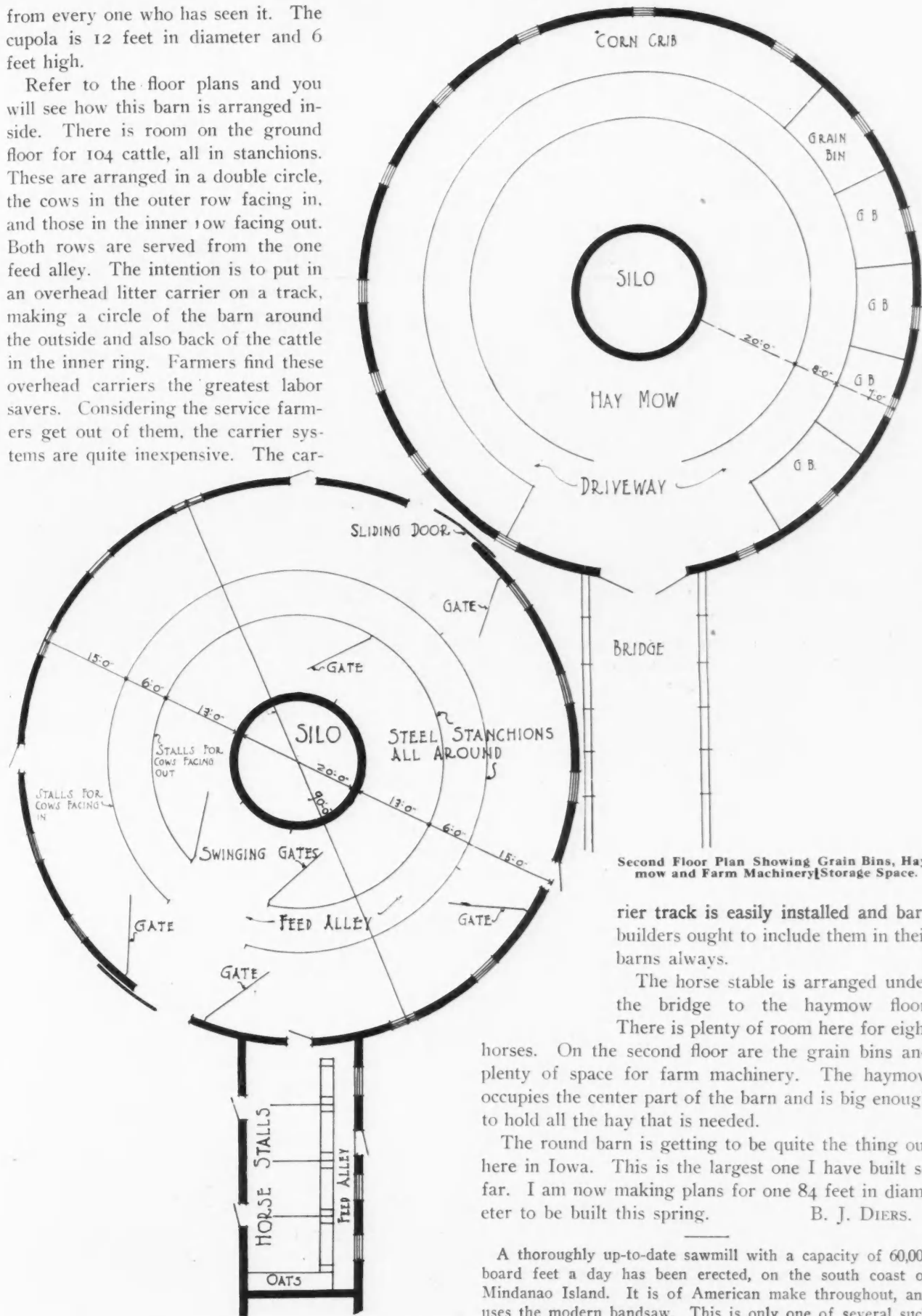

Second Floor Plan Showing Grain Bins, Haymow and Farm Machinery Storage Space.

rier track is easily installed and barn builders ought to include them in their barns always.

The horse stable is arranged under the bridge to the haymow floor.

There is plenty of room here for eight horses. On the second floor are the grain bins and plenty of space for farm machinery. The haymow occupies the center part of the barn and is big enough to hold all the hay that is needed.

The round barn is getting to be quite the thing out here in Iowa. This is the largest one I have built so far. I am now making plans for one 84 feet in diameter to be built this spring.

B. J. DIERS.

A thoroughly up-to-date sawmill with a capacity of 60,000 board feet a day has been erected, on the south coast of Mindanao Island. It is of American make throughout, and uses the modern bandsaw. This is only one of several such mills in the Philippines.

Ground Floor Plan Showing Cow and Horse Stables.



**Builders Experiences in Handling Warm Air Furnace Work and Installing Steam and Hot Water Systems**

## Getting Full Value Out of the Coal Bin

SOME SPECIAL TYPES OF HEATERS AND BOILERS FOR WHICH EXTRA EFFICIENCY IS CLAIMED

By Cecil F. Herington

"IT'S getting on toward spring now, boys," remarked the Old Builder, resuming his talks on heating, "and we can soon count up what our coal bill has been for the past winter. I guess the high cost of living is just as important to us as to anyone and since it has become the proper stunt to inquire into the cost of living from every possible point of view, let us spend a few minutes looking at our coal bills and doing a little figuring.

"The main cost to operate any heating system is of course, the fuel. And the coal which ordinarily is the

best suited for house heating is the nut or range size, although egg is sometimes used in the larger furnaces. Now, these sizes command the highest prices of any paid for coal, so that to effect a noticeable

economy in the fuel bill we must use the cheaper grades; on the other hand these cheaper grades are at the same time of much smaller size. Next to the nut coal in size and prices comes what is known as 'pea' coal, which usually costs about 75 per cent to 80 per cent of the price the larger sizes sell for. Still smaller and more reasonable in cost, comes the buckwheat and rice sizes, which usually cost in the neighborhood of 50 per cent of the price paid for the ordinary sizes.

"Pea coal can be burned on most of the common grates intended for larger sizes and, in fact, is so burned by many people when their draught is sufficient. It must be realized, however, that the finer a coal gets the more closely it packs and the harder it is to get a

proper amount of air through the fire in order to burn the coal completely, effectively and economically.

"And now," said the Old Builder, "I can hear someone in the back of the room saying that the cheaper and finer grades of coal do not give an equal amount of heat. In this they are mistaken; since the finer coal are only the screenings obtained when the larger sizes are crushed, it follows that pound for pound, the number of heat units is the same in both, and therefore if properly burned the finer coal will yield the same amount of heat. In fact many of the larger power houses use these smaller sizes exclusively for the sake of economy, even installing forced draught in order to burn this kind of coal. There is a heat loss, however, which is slightly increased with the use of fine coal; this is the chimney loss. With the larger coal the flow of air through the fire is easier, and therefore the fire will burn with the chimney draught closed a great portion of the time. With the finer coal the chimney draught is found necessary to be kept open a large portion of the time in order to draw the air through the fire and consequently a larger portion of heat is lost this way. This loss will hardly ever exceed 10 per cent and you will see that I have taken this into account later on.

"Of course it is out of the question for a small residence to install a blower system, on account of the expense, but other means have been developed which permit the use of the cheap

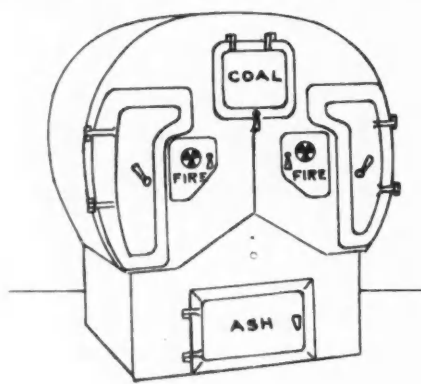

Fig. 1. Water Heater With Hopper Coal Feed Grate.

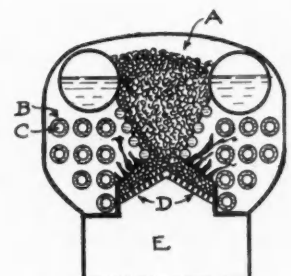
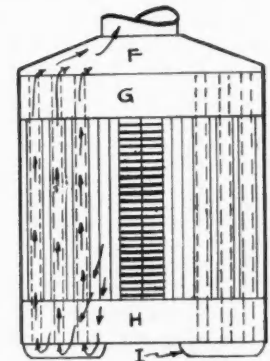

Fig. 2. Horizontal and Cross Sections Through Fire Box and Hopper.

grades of coal of which several types seem to have met the approval of the general public.

"The first of these," continued the Old Builder, "is shown in Fig. 1, and is built on the principle of the parlor stove, with a magazine into which a large supply of fuel is placed. This magazine, which is indicated by 'A' in Fig. 2, is surrounded by a water jacket formed by the steam chamber and water tubes and allows the coal to fall on to inclined grates, keeping the fire of an even thickness and not allowing enough coal to fall over the grate to smother the fire by choking up the draught through it.

"This heater is built in the hot water and steam types, the heater having two drums, (G) and (H), one placed in the front and the other in the rear. These are connected by double tubes, (B) and (C), the outer and larger tubes connecting the inner faces of the drums and the inner or smaller tubes extending through the center of the larger tubes, connecting the outer faces of the drums as shown in the plan view. These tubes and drums are covered with an iron casing to keep the hot gases in contact with the tubes.

"The fire is supported on the inclined grates (D) and may be built on one side only if desired in mild weather. This boiler is one of the quickest steamers known, owing to the large quantity of the water being held as a thin film in the tubes with the fire outside and the hot gases of combustion passing through the inner tube on their way to the stack. After burning to ashes, the residue is shaken through the grates into the ash pit (E) as in the ordinary boiler.

"This type of boiler will burn buckwheat coal successfully, although closer attention to the fire is required than when larger coal is used. This is a fault of the fuel, however, rather than a weakness of the boiler. Its first cost is higher than that of the common boiler, yet a small computation will prove it a great money saver where the additional attendance is not important.

"Suppose one of these boilers is put in a house using say 15 tons of coal per annum. If ordinary

stove or nut coal costs about \$6.00 per ton, the yearly fuel bill will be \$90.00. With a boiler using buckwheat coal at \$3.75 per ton and even allowing 10 per cent more coal on account of the chimney draught being open longer to burn the coal, we have an annual cost of only 15 times 1.10 times \$3.75 or \$61.88.

"This means an annual saving of at least \$28.00 and if your mortgage money costs 6 per cent, \$28.00 divided by 6 per cent equals \$467.00 allowable increase in cost of boiler. Since the increased boiler cost will probably not be over \$100.00, the boiler will actually pay the interest on its own additional cost and on \$366.00 of your mortgage besides.

"Another type of heater which is even more radical than the one just described, is shown in Fig. 3. This heater is of the underfeed type and is built in hot water, steam and furnace constructions.

"The idea worked out in this type is most easily conveyed by the well known illustration of a burning candle. An inverted candle with the flame on the bot-

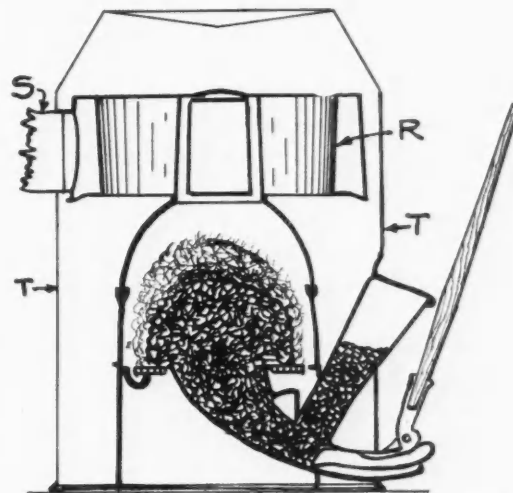

Fig. 4. Warm Air Furnace Arranged to Feed From Below.

tom and the tallow or wax fuel on the top, smokes, smudges, burns improperly and gives so many unpleasant results that no one would ever stop to even consider trying to use a candle in this position. Yet the combustion of an ordinary boiler and furnace represents just this condition of affairs. By righting the candle and putting the flame on top and the fuel below, we get a continuous and even combustion with none of the previous objections as long as the fuel is supplied from the bottom. This idea applied to a coal fire means that the coal must be fed from below and the ashes fall from the fire so as to leave incandescent coal exposed, as much as possible, at all times.

"How this is accomplished is indicated in Fig. 3. The coal is here placed in the hopper (J) and forced into the center of the fire pot at (M) by the plunger (L) at the bottom of the hopper, this plunger being operated by a long lever arm (K). The coal is forced up in the center of the fire pot and overflows out onto

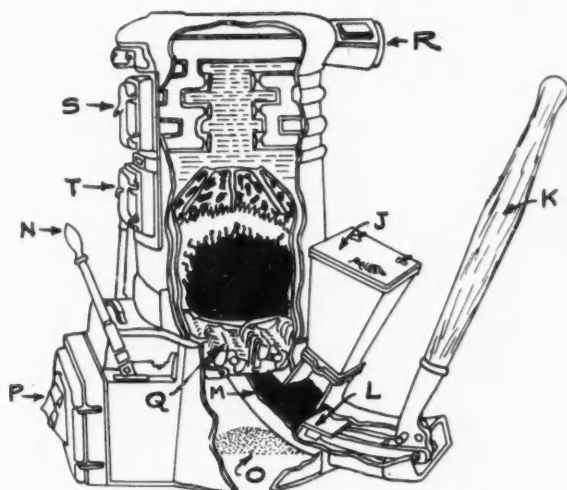

Fig. 3. Water Heater of the Underfeed Type.

## Adventures In Heating

the surrounding circular grate (Q), the ashes falling through the grate bars into the ash pit (O) and the entire top of the mass being incandescent during and after the stoking period—a time when most fires are temporarily dead and valueless as far as heating effect is concerned, caused by the large amount of fresh coal thrown over the bright coal.

“Owing to the long lever arm (K), the force necessary to feed the fire in this manner is very small and the filling up of the hopper is much easier than coaling up the high magazine in the first type described.

“It will be appreciated that this arrangement gives a fire that is never banked and there are no waits ‘for the fire to burn through.’ The only attention required is once or twice a day to force fresh fuel in and to shake the ashes through the grates by means of the shaker arm (N). The ashes are removed through the ash pit door (P), just as in the ordinary boiler, and observation of the fire can be made through the door (T). The top door (S) is for cleaning out the flue spaces in the top, so as to keep the apparatus at its highest efficiency.

“This type of heater is constructed for furnace use as indicated in Fig. 4, the coal being placed in the hopper in the same manner as previously described and the fire pot having a cast-iron radiator (R) set on the top, through which the hot gases pass on the way to the smoke pipe connection (S). The whole apparatus is encased in the furnace casing (T), which keeps the air in contact with the fire pot and radiator, so as to heat it rapidly. The hot-air pipes are taken from the top of this furnace in exactly the same manner as the ordinary furnace, and its operation is exactly the same, the only exception being the increased efficiency due to the fire always being bright and its ability to consume satisfactorily the cheaper grades of fine coal that it is not possible to burn on the ordinary grates.

Another type of economical boiler suitable for larger installations such as schools, or apartment houses, is shown in Fig. 5. This is what is known as the “fire-box down-draft” type and endeavors to secure complete combustion by means of two grates one above the other.

Most of us know that the discharge of black smoke from a chimney indicates poor combustion and a corresponding loss of heat in the fire by not entirely consuming the gases. This, of course, means bigger coal bills and increased expense.

In the fire-box boiler the fire is built on the upper grate (G-1), which is made up with large open spaces. As soon as the coal commences to burn and break

into small pieces it falls through and is caught on the finer grate (G-2), where it forms an incandescent bed. All the gases formed by the fresh coal on grate (G-1), are carried down and forced to pass through the incandescent bed of coal on grate (G-2), thus con-

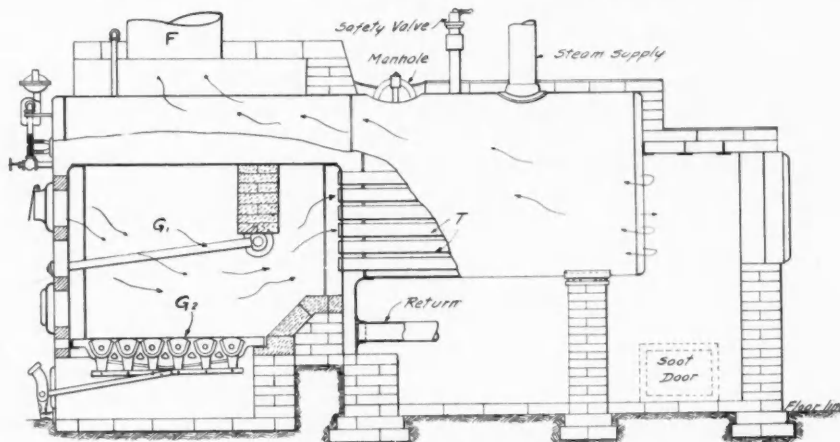

Fig. 5. Course of Draft and Heated Gases in smokeless Firebox Steam Boiler.

suming them. From this point they are carried through the tubes (T) and around the end, back along the drum of the flue (F) from which they enter the chimney.

The draught being drawn from the upper grate down onto the lower is the reverse of the ordinary air flow, thus giving the furnace the name of “down-draft.”



### The Old Building Quarrel

The old quarrel between friends and foes of the festive skyscraper goes merrily on, and is centered just now in Minneapolis. The same old arguments are cited in the same old way, and the amount of unprejudiced, common-sense reasoning done on the subject is negligible.

It is reported from New York that recent skyscrapers have not paid, that the great record breaker is still empty in all its upper floors, and that tenants in other top-lofty structures are seeking rooms nearer the ground. If this be true, the quarrel referred to is likely to become somewhat less bitter, but like other disputes, it will last until “settled right.”

The proposition of Ernest Flagg, architect of the Singer tower, seems to come nearer a rational solution of the problem than any other yet offered. Flagg would fix a height to which all buildings might go. The man who wished to build higher could do so—on 25 per cent of the area of his lot. He might buy of his neighbors their rights in this upper air, but in no case could more than one-quarter of a block be covered by structures of more than the standard height.

The effect of such a building ordinance would be to build up a city of towers. The possible beauties of such construction need no exposition, while it would insure a larger proportion of rooms with light and air than any level system could do.



## More Shop Kinks

HELPFUL IDEAS AND SUGGESTIONS FOR CARPETERS, CABINET MAKERS AND MACHINE WOODWORKERS

By Wm. C. Jasbury

**SPEAKING ABOUT STAIRS AND HAND RAILS**, nowadays it is a very rare thing to see a flight of stairs put up of the old fashioned toad-back rail, walnut, neck balusters, newel, caps, and cap. This style has passed away, never to return, during our administration. And honestly it would take a carload of Sherlock Holmeses and a microscope as large as the Lick lens to find any beauty and style in them; so they are on the go and go they may. There seems to be a style with the architects of today that resemble the newel cap situation, as in the illustration. The improvement is a good one, as it shows more artistic taste and gives a chance to show different kinds of wood and does away with walnut, a wood to some people, only fit to make casket handles, and gun stocks (both pertaining to death).

But to speak about the round cap where the rail miter into it, same as A and B, the cap is turned on the lathe, but not to the same contour as the rail. If it is made exactly the same contour, it will fit with overwood, on the part of the rail; the cap must be

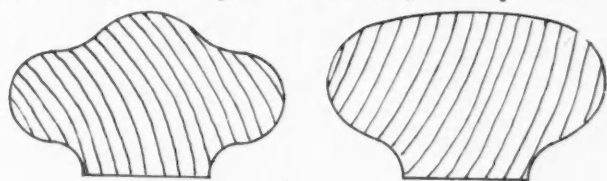

TOAD BACK RAILS.

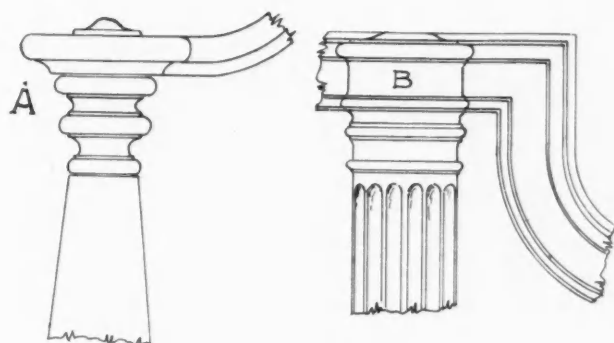
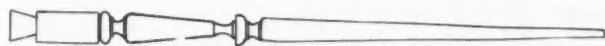

OLD STYLE

ELEVATION



PLAN.

Details of Hand Railing Described by Mr. Jasbury.

turned the same shape as the section of the miter. This insures a neat fit. The degrees of this miter depends on the shape and style of the rail to some extent. In a case where the cap is square in plan, the cap and the rail will be the same contour, but not so with a round cap. Some cases where the rail runs into the cap twice, the miter has to be short; and some cases the joint will have to be coped and mitered owing largely to the shape of the rail, as some of the young draughtsmen of to-day are making rail shapes that would frighten a hearse.

This style of stair rail is much used in birch rail and newel caps, poplar newels and balusters, the poplar painted and the birch stained mahogany, as some call birch Wisconsin Mahogany. This treatment goes very well if they carry it out by painting the risers white and treads birch mahogany, with white strings. This makes a neat design and goes far in furnishing the house, as it is a decorative and commodious feature both.

**A VISIT TO OLD IRELAND.** I visited the famous lakes of Killarny in Ireland, in 1894. I saw men engaged in chopping down trees, hauling them to the road side and ricking them up in neat piles. I was told that the logs were shipped to London and made into furniture for which a big price was asked. It caused a chill of skepticism to run down my back when told of a certain piece of furniture or wood that came "from the spreading chestnut tree (or some other esteemed tree) grown on so-and-so's estate." According to the amount of material, some of these famous trees must have been as large as a Jersey Automobile mortgage.

**SOME DOORS.** I saw a pair of doors in an ancient castle (Mount Argyle) on the Island of Jersey in the English Channel. The doors of which I speak were eight inches thick, twelve feet wide and sixteen feet high. The material, as near as I could make out, was of oak. The construction was a good piece of carpentry and when I saw them they had not been opened for many years, as the hinges had let them settle down into the ground and good sized trees had grown up against them. Such sights to a twentieth century woodworker would make him sweat to think what a job it must have been to do the work without the aid of present day machinery.

**BLOWING BIG BUBBLES.** Bubbles will last for hours, and may be blown to exceed 2 ft. in diameter with the following solution: 1 part oleate of soda, 50 parts distilled or rain water (parts by weight). Mix thoroughly, and leave one day to clear, using only the clear solution. The tenacity of the film is much increased by adding pure glycerine, not exceeding 2 parts glycerine to 3 parts clear solution.



## Building Boom Strikes Main Street

A LITTLE MODERN TERRA COTTA STORE BUILDING IS PUT UP AND STARTS THE REJUVENATION OF THE ENTIRE BUSINESS STREET

**A** BIG building boom and a boost to business all along the street developed rather unexpectedly last season out at Ottumwa.

It all came about because of a little one-story business building.

Curious how a new white store-front shows up the dinginess of its older neighbors! This one surely did. And it was a case of "get out and get under" for all the other store keepers all along Main Street.

Like a good many towns, the business street was old—the store buildings old fashioned—dreary, poorly lighted. While business was fairly good, judged by the old standard, the merchants generally felt that they ought to be doing a lot better. The old fashioned store-fronts did not give much chance to any window display that amounted to anything and no one seemed to take much pains to make his store attractive or easy to trade in.

Then all at once a new store building went up, a

to-date, business-compelling way!

Now the real point of this story comes in concerning the neighboring store keepers. The new store made theirs look overassessed at thirty cents,—dingy, dirty and old fashioned. They had to do something quick; and one of the liveliest repainting, remodeling, and rebuilding booms of the year developed up and down that main street. A good many wanted the white terra cotta work and it was surprising how easily the builders were able to remodel the old fronts by using the plate glass and terra cotta, and in some instances glass, face brick, and terra cotta.

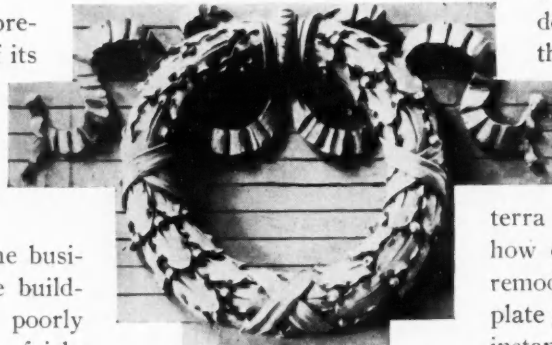

Wreath ornament for pediments or spandrel treatments.

The power of example is a great thing and the builder who started the ball rolling out there by putting through the first really modern store building job, although it was a small one, cashed in on a big line of similar business for himself. Moreover, the whole business atmosphere of the town has brightened.

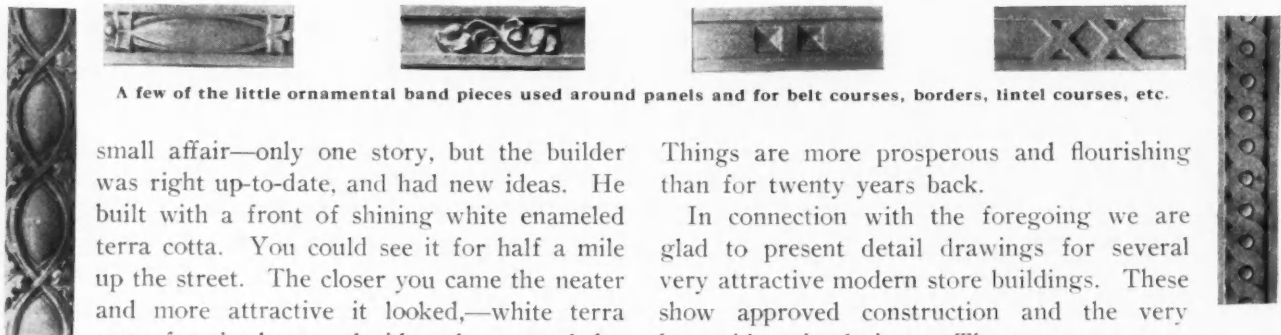

A few of the little ornamental band pieces used around panels and for belt courses, borders, lintel courses, etc.

small affair—only one story, but the builder was right up-to-date, and had new ideas. He built with a front of shining white enameled terra cotta. You could see it for half a mile up the street. The closer you came the neater and more attractive it looked,—white terra cotta for the base and side columns and for lintel and cornice,—a white terra cotta frame around a huge expanse of plate glass! For this was a *modern* store front.

And when the store keeper got his window display arranged inside, the crowd that gathered nearly blocked the street.

No need to mention that the new store was a big success from the first, nor that the owner was pleased with his contractor who had handled the job in such an up-

Things are more prosperous and flourishing than for twenty years back.

In connection with the foregoing we are glad to present detail drawings for several very attractive modern store buildings. These show approved construction and the very latest ideas in designs. The terra cotta pieces called for are all stock patterns,—inexpensive and requiring no delay, as they are carried in stock for immediate delivery.

Notice particularly the great variety of ornamental effects easily secured by combining the different stock pieces in various ways. Five different designs for one-story store buildings are detailed, also an up-to-date two-story building and two schemes for a three-story business building.



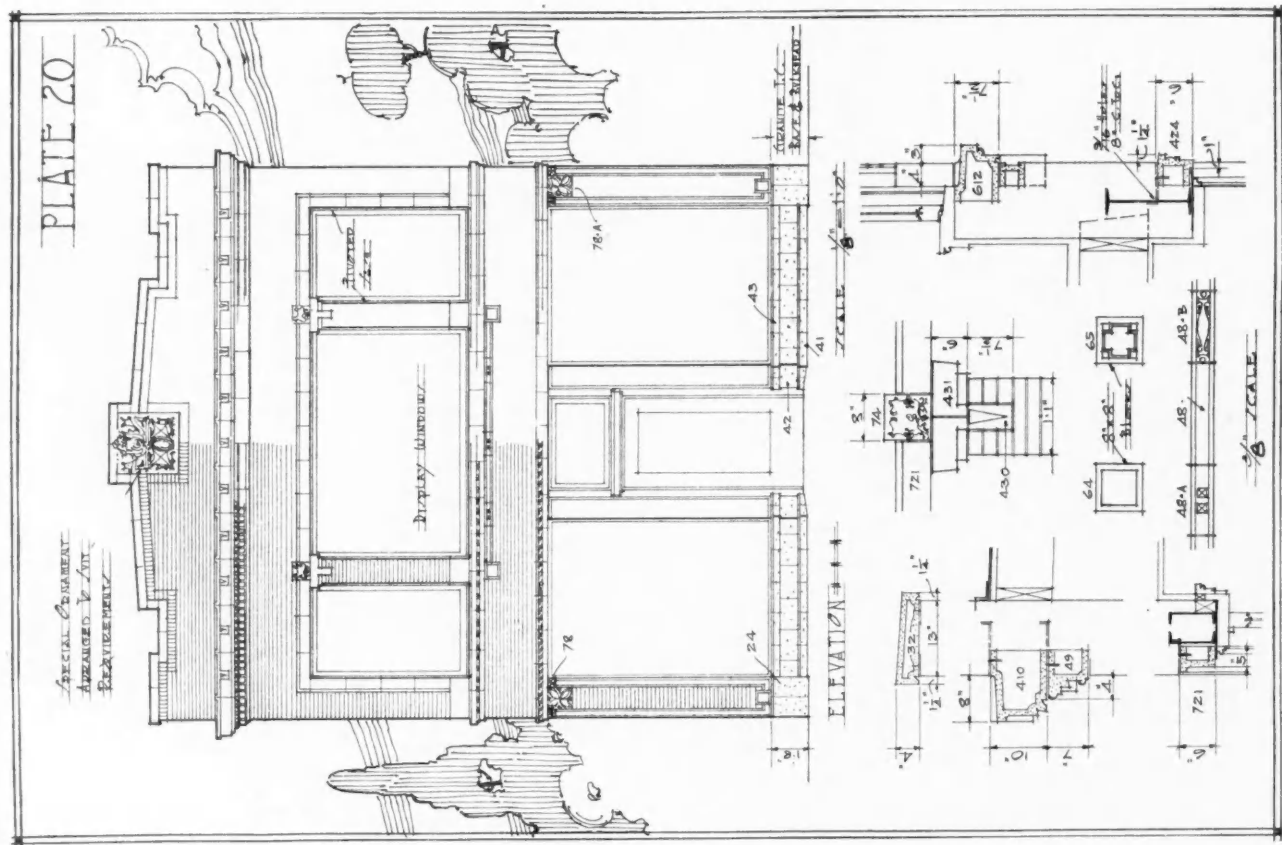

Front elevation and details of modern two-story store building of face-brick with white enamel stock Terra Cotta trimmings.

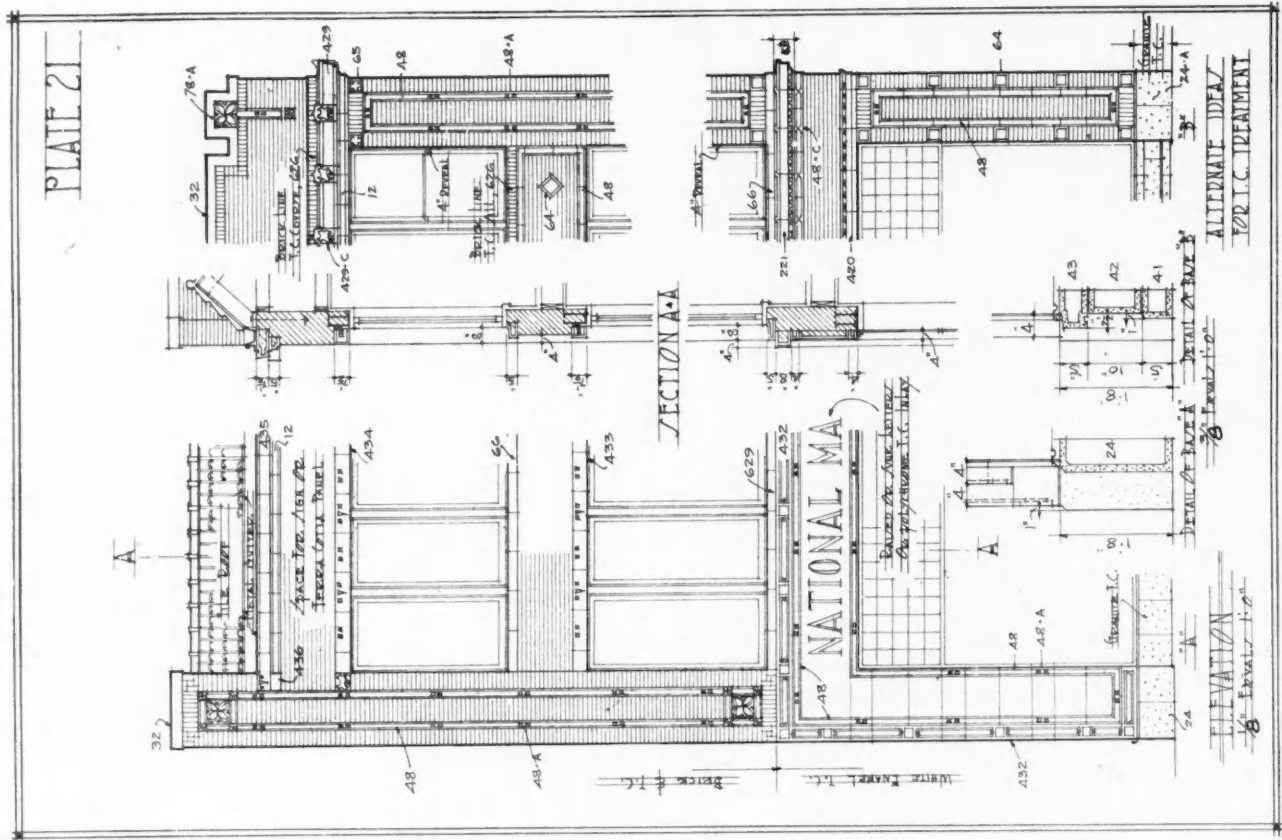

Front elevation and details of two designs for three-story business buildings, showing effective use of stock Terra Cotta pieces.

Details by courtesy of Midland Terra Cotta Co.





## How to Make a Combination Writing Desk and Book Case

By F. A. Shilling

**G**ET the material cut to size in the mill and remove all mill marks. First, take the two sides and taper off one edge, as shown on plan, and cut grooves on the inside to receive shelves. Also dado the back of them to receive the ceiling, or whatever material is bought for the back. Ceiling is preferred, as it makes a better looking back. Bottom should be sawed out next, or this can be done in the mill before material is taken home.

The shelves and middle and bottom rails should next be fixed up. These should be 30½ inches long to within one inch of the front, so the groove will not show on the sides. They should be made of 12-inch material and the back dressed down so it will fit closely to the back. The top of lower shelf should be gained out to receive the back of desk, as it is not necessary for back to extend to the bottom of desk. Middle rail should be blind doweled to middle shelf and the desk is then ready to put in the clamps. Put glue in the grooves and as the material is all one inch stuff, it will probably be better to secure it with barbed nails, putting the nail holes after the desk has been stained.

The top strip should now be gained out to receive the back; also gained out on ends to fit in between the two ends. Put it in place and cut the ceiling to size.

### BILL OF MATERIAL FOR DESK AND BOOK CASE.

- Shelves, 2 pieces, 7/8 by 12 by 46½ inches, S-4-S.
- Shelves, 3 pieces, 7/8 by 12 by 30½ inches, S-4-S.
- Movable shelf, 1 piece, 7/8 by 10 by 30 inches, S-4-S.
- Top strip, 1 piece, 7/8 by 1½ by 30½ inches, S-4-S.
- Middle rail, 1 piece, 7/8 by 3 by 30 inches, S-4-S.
- Bottom rail, 1 piece, 7/8 by 5 by 30 inches, S-4-S.
- Ratchets, 4 pieces, ½ by 1¼ by 23¼ inches, S-4-S.
- Shelf supports, 2 pieces, ½ by 1¼ by 8 inches, S-4-S.
- Castor blocks, 4 pieces, 2 by 2 by 3¼ inches, S-4-S.
- Ceiling and back, 10 pieces, 3/8 by 4 by 41 inches, S-4-S.
- Desk front, 2 pieces, 7/8 by 2 by 12¼ inches, S-4-S.
- Desk front, 7/8 by 2 by 29 inches, S-4-S.
- Desk front, 1 piece, ½ by 8½ by 26½ inches, S-4-S.
- Doors, 4 pieces, 7/8 by 2 by 22 inches, S-4-S.
- Doors, 2 pieces, 7/8 by 2 by 13½ inches, S-4-S.
- Doors, 2 pieces, 7/8 by 2 by 13 inches, S-4-S.
- Bead, 13 feet ¼-inch.
- AA glass, 2 pieces, 11½ by 18 inches.
- Pigeon holes, 2 pieces, 3/8 by 7 by 30 inches, S-4-S.
- Pigeon holes, 2 pieces, 3/8 by 7 by 11 inches, S-4-S.
- Pigeon holes, 4 pieces, 3/8 by 7 by 5 inches, S-4-S.

Lay out the center of desk and put the back in place, working both ways from the center so the material will trim up the same on both ends. Ratchets and brackets should next be made for the movable shelf, and put in, and movable shelf fitted.

Next, make pigeon holes out of thin material. After they have been put in place, secure them with small nails or brads from the back and make the desk front. This should be flush on the inside to form a good writing surface. Then make the two lower doors, rabbeting them out ½ inch to make a closed joint. The glass can be procured at any glass or furniture store and should be put in with the bead on the inside. In making the doors, make them a little larger than the opening, so they can be fitted nicely. Put in the four castor blocks in the bottom and fasten them with long screws and glue. Desk is now ready to be finished. See that all glue and other marks are removed before staining.

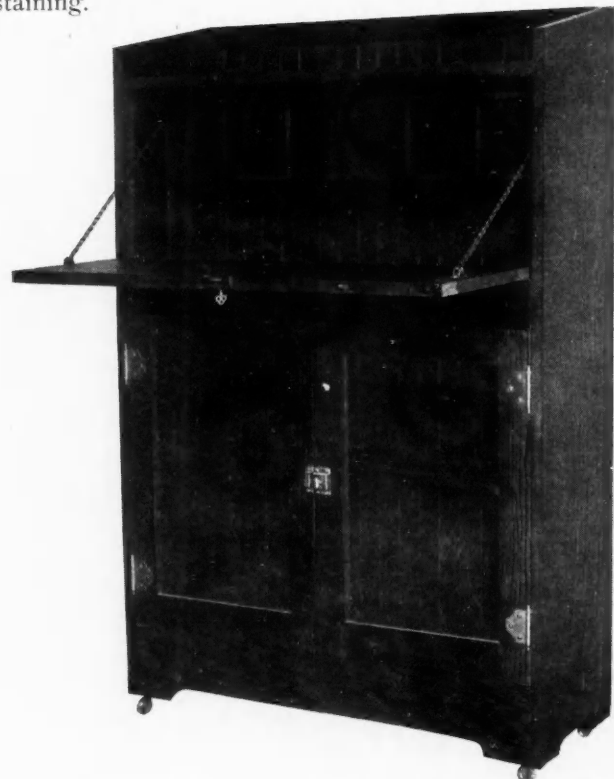

Nicely Constructed Oak Book Case and Writing Desk as it Appears When Completed.

**How to Finish**

As this is a plain Mission style desk, a plain, dull finish will look better than a rubbed finish. Stain the desk to suit, making the stain a little lighter for the inside. After it has been stained, putty all the nail

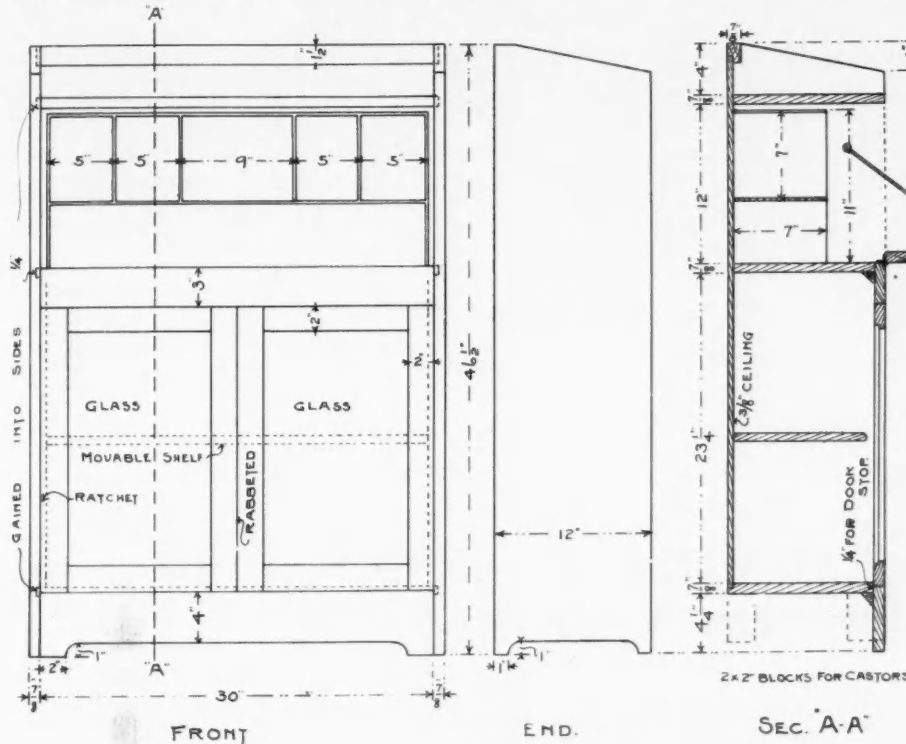

shipping cans spaced six inches apart.

In a corner of the milk house dig the pit for the vat 5 feet wide, 8 feet long and 22 inches deep. If the water is to be fed and removed by iron pipes, these should be laid at once with their ends provided with screw or sleeve couplings 5 inches above the earth bottom of the pit.

Build a box form without top or bottom 4 feet

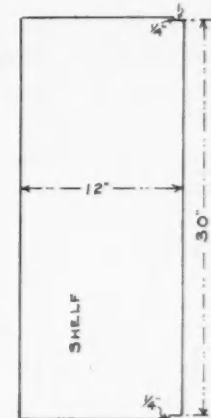

**DETAIL OF LADIES WRITING DESK.**

holes with colored putty and give it two coats of wax, rubbing between coats.

If the desk is made of oak and it is desired to have a fumed finish, put it in an air-tight receptacle and see that the doors and front are open to allow the fumes to circulate. Place a saucer of ammonia in the receptacle and seal up all joints. If it is desired to watch the process, a hole may be cut in the box and a piece of glass inserted. When it has colored to the desired shade, remove the desk and putty the nail noles with putty colored to match, and give the desk two coats of good wax and rub well. This process, although a little difficult, will give better results and will not raise the grain of the wood.



**Home-Made Cooling Vat**

**INEXPENSIVE ICELESS REFRIGERATOR FOR COUNTRY USE**

Many country homes which cannot have ice must depend on other means for keeping milk, butter and farm products cool. Nothing is better and cleaner than a concrete vat sunk in the ground in the milk house and fed by a spring or with water from the well on its way to the stock watering tanks. The size of the vat is dependent on the needs. For a farm with a small dairy, sufficient space is to be had in a tank 4 feet 2 inches by 7 feet 2 inches in the clear, by 23 inches deep and with 5-inch walls and bottom. This vat will hold eight regulation

2 inches wide by 7 feet 2 inches long, outside measurements, and 23 inches deep. Mix the concrete mushy wet of 1 bag of Portland cement, 2 cubic feet of sand and 4 cubic feet of screened gravel or crushed rock, or 1 part cement to 4 parts pit gravel. Place a cork in the ends of the pipes and lay the 5-inch bottom with a strip of woven wire fencing in the concrete within 2 inches of the top. Quickly finish the bottom smooth with a wooden float and a steel trowel and at once set the box form in the pit so as to leave a space of 5 inches on all sides. Fill this space with concrete. Around the corners of the tank, near the top and bottom, imbed an old iron rod. Bring

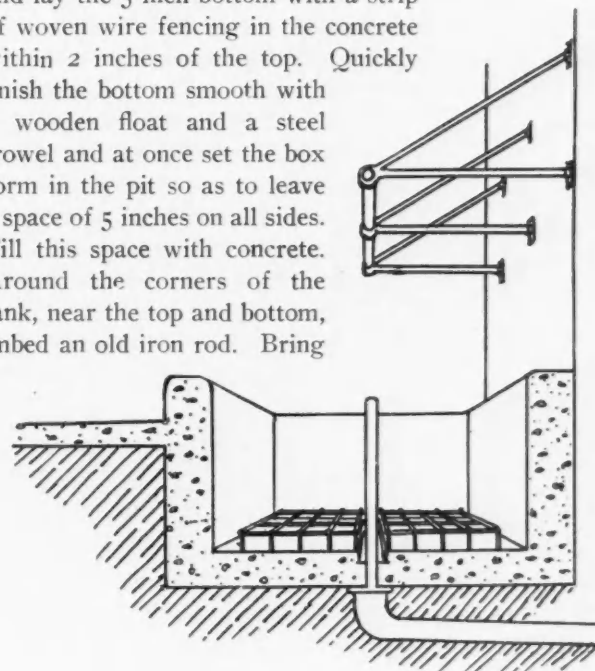

Details of Concrete Milk Cooling Vat.

the outside walls to full height above floor level by using a width of board along the side and end. Round the edges and finish the top of the walls with a trowel.

When the tank is two days old, carefully remove the forms. Rub down the walls with a soft brick and paint them with a creamy mixture of cement and water. Five days later the vat may be used. In the coupling of the outlet pipe, place a section of over-flow pipe 19 inches long, which will draw off the warm water at the top of the tank. The over-flow pipe should be at least  $\frac{1}{2}$ -inch greater in diameter than the inlet pipe so as to remove all danger of flooding the milk and the dairy house. Make a grating of 1-inch slats or gas pipe to place on the bottom of the vat to provide a circulation of cool water under the milk cans. As an aid in lifting the cans, fix a hand-rail at a convenient height above the tank.

### Forest Notes

The forest products laboratory at Madison, Wis., has made 4,000 tests on the strength of American woods.

The gathering and selling of acorns is a new industry, in Arkansas, to supply Eastern nursery firms with material for forest planting.

Thirty different wood preservatives are in commercial use in the United States; many of them utilize creosote of one sort or another; others require chemical salts.

Last year the forest service distributed 116,000 basket willow cuttings: 15,000 to forest schools, 20,000 to agricultural experiment stations, and 81,000 to individuals.

More than 800,000 horsepower has been developed from streams on national forests under government regulation. This represents the output under conditions of lowest stream-flow.

Florida buttonwood, a tree confined largely to the keys along the south coast, is very highly prized for use in cooking on ship's galleys. It burns slowly with an even heat and makes but little smoke or ash.

## The Forest Products Exposition to be Held in the Coliseum, Chicago, April 30 to May 9, 1914

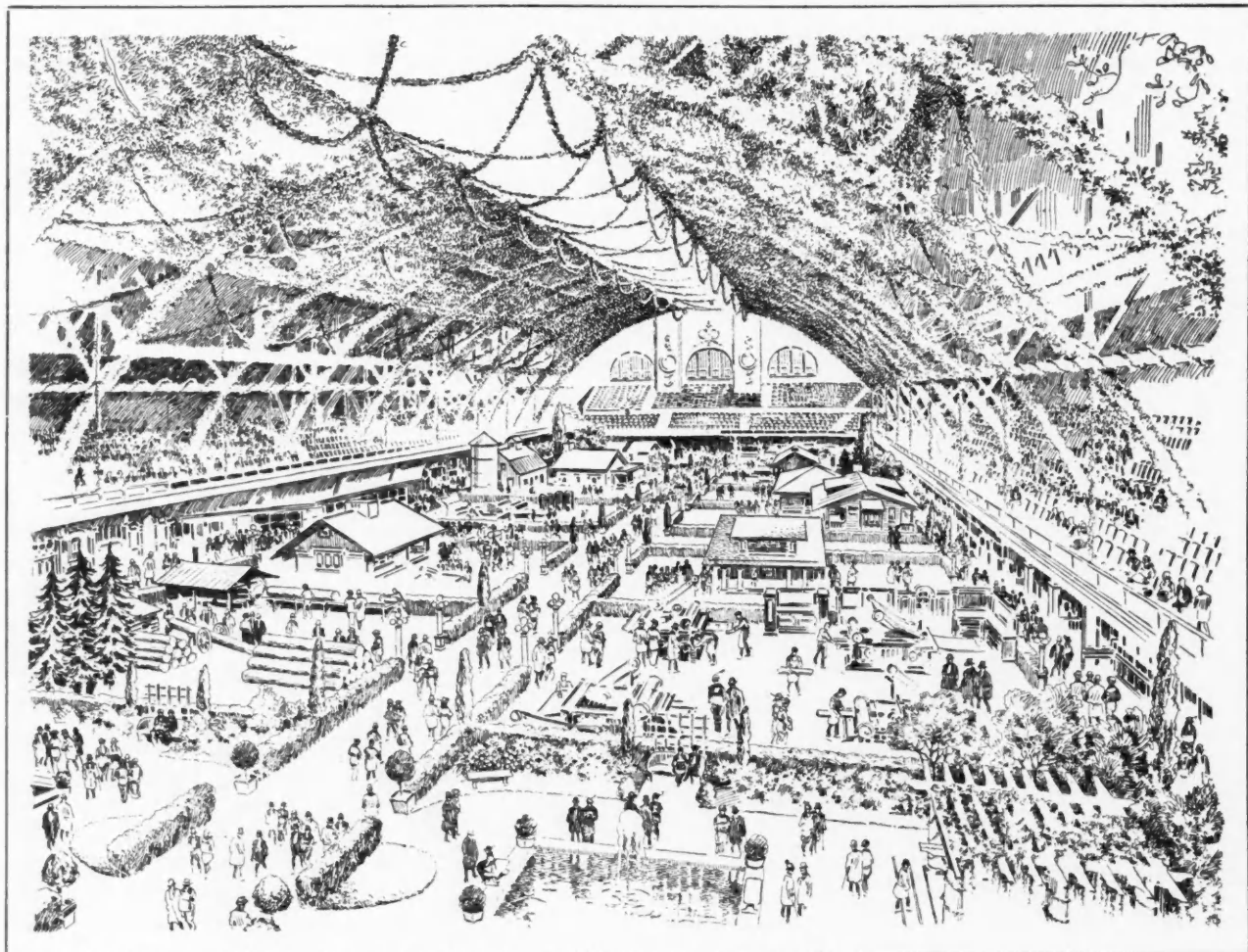

INTERIOR SKETCH VIEW OF THE COLISEUM. THE VARIOUS LUMBER ASSOCIATION EXHIBITS WILL OCCUPY THE CENTER OF THE BUILDING.

The Individual Exhibitors, Displaying Allied Lumber Lines, Machinery, Etc., Will Be Located in the Spaces Surrounding the Large Exhibits, and in the Gallery.



• **Model High School Building**

We present prospective view and floor plans of a modern public school building, which provides ideal accommodations for the several special departments of high school work—including gymnasium, domestic science rooms, manual training department, physical and chemical laboratories, commercial department, etc. The special needs of each one of these lines of work have been considered in preparing this design. Those interested in public school buildings will find many points of interest in this design.

The exterior is handled in a neat, conservative way, in line with present custom. The walls are yellow face brick, trimmed with Bedford limestone. An ornamental effect is gained by laying certain of the brick courses recessed. The roof is slate.

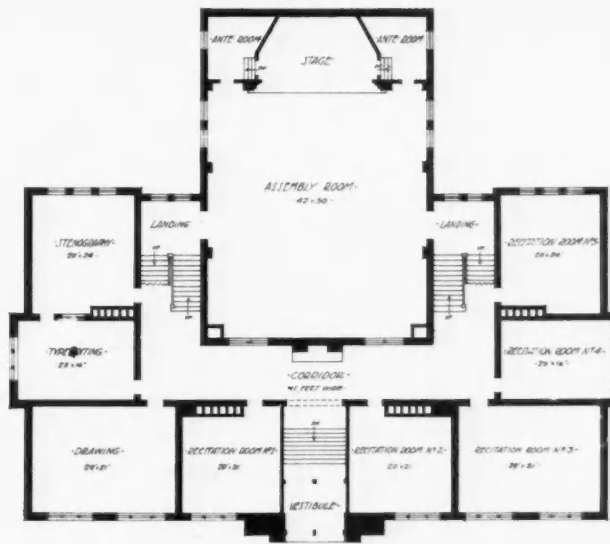

Plan of Main Floor.

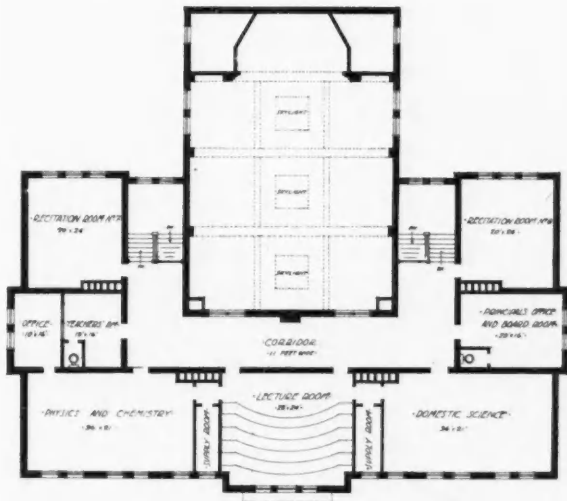

Plan of Second Floor.

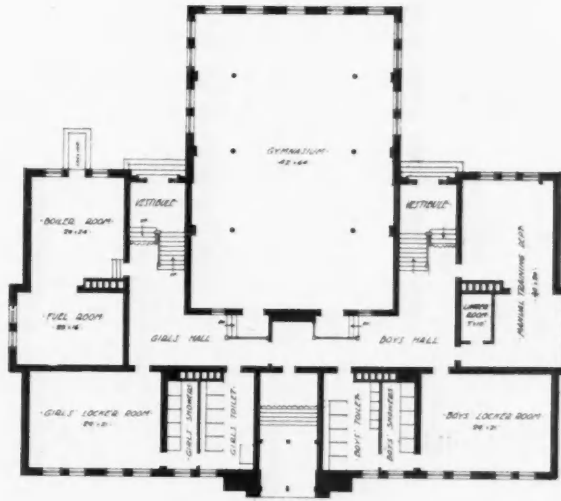

Basement Floor Plan.

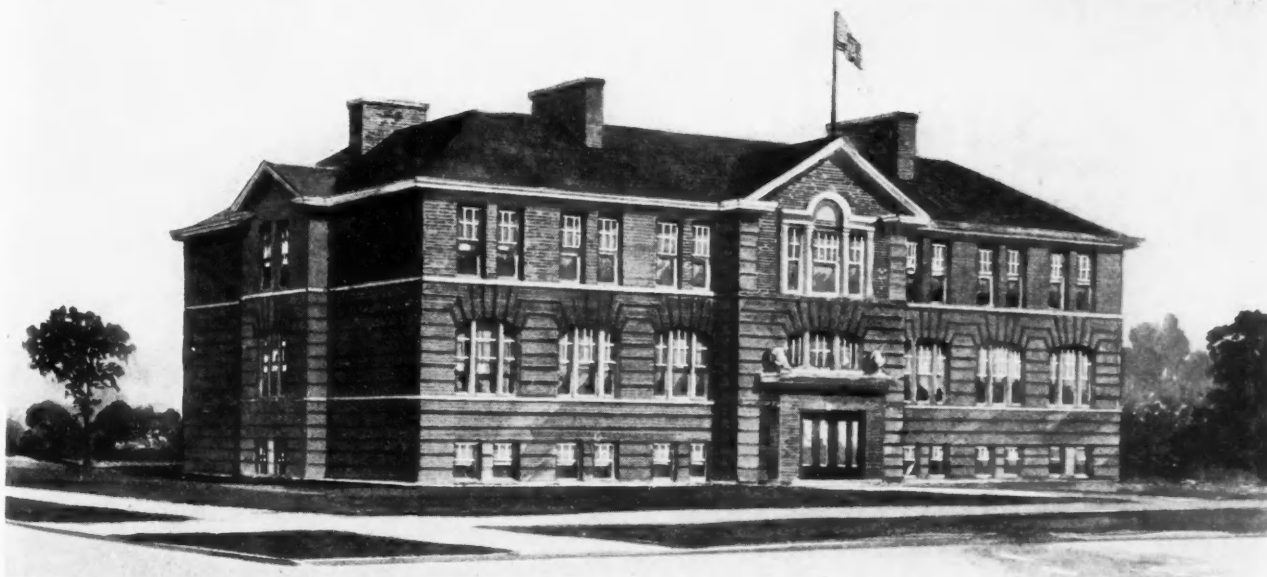

Modern High School Building. Designed by G. W. Ashby, Architect, Chicago, to Take Care of All Present Day High School Requirements.

## Our Folks Big Boosters for Business Stationery and Typewriters

FEBRUARY AD. PUZZLE PRIZE CONTEST PROVES MOST POPULAR AND BRINGS OUT MANY INTERESTING POINTS.

**T**HE typewriter people may look for a big run of business, and a good many printing shops will be working overtime on business stationery, if our readers follow out their own advice as stated in their Puzzle Prize Contest letters!

This turned out the most popular contest so far; everyone seemed to take an interest. We have the finest collection you ever saw of business letter-heads pertaining to the contracting and building business; also some endorsements of typewriter use as a business getter and

money maker for carpenters and builders that would convince the most skeptical doubting-thomas. The strange part of it all is, too, that many of the most enthusiastic of all these letters came in written in **long-hand** on **plain** paper! We take it, however, that these brothers have, in the process of this puzzle work, converted themselves; and have probably already had a session with their local printer about business letter-heads and have written away for typewriter catalogs in order to investigate those advertised in our pages.

### Prize Winners in the February Ad. Puzzle Contest are the Following:

*First prize*, \$10.00 worth of goods selected from our ad pages:

R. J. K. MURRAY, Contractor and Builder, St. Paul, Minn.

*Two second prizes*, each consisting of \$5.00 worth of goods selected from our ad pages:

L. M. SMITH, Mgr. Engineering-Construction Co., General Contractors, Scranton, Pa.

C. V. CHANCE, Mgr. Hawkeye Lumber Co., Mystic, Iowa.

*Ten third prizes*, each consisting of \$1.00 worth of goods selected from our ad pages:

W. A. ODELL, Proprietor W. A. Odell Metal Weather Strip & Screen Co., South Bend, Ind.

HARRY PENCE, with James L. Pence & Co., House Raisers, Movers and Shorers, Cincinnati, Ohio.

HENRY N. EDDY, Manual Training Department City Schools, Detroit, Mich.

HENRY E. BONITZ, Architect, Wilmington, N. C.

FRED CORBETT, Builder and Contractor, London, Ont., Can.

GEO. D. SMITH, General Contractor, New Albany, Ind.

R. B. RICHARDSON, Contractor and Builder, Hammond, Ind.

C. V. MARTIN, Superintendent, J. A. Nixon & Co., General Contractors and Builders, Titusville, Pa.

LOUIS C. BENNETT, Contractor and Builder, Hensonville, N. Y.

T. T. REWERTS, Contractor and Builder, Thomasboro, Ill.

### This Month "Use of Lumber and Lumber Advertising"

**O**N the next page we have a very interesting puzzle contest that will be a lot of fun for builders who have caught the ad. reading habit. (Most wide awake builders today are close students of advertising; they do it to keep posted.) In this puzzle we have combined clippings from 23 ads. appearing in this issue of the AMERICAN CARPENTER AND BUILDER. Study through all of our advertising pages and see the many interesting bargains, the new tools, the improved building and finishing materials, the labor saving equipment that is offered. Investigate all that is new to you. Our advertisers are all responsible, trustworthy concerns and they are anxious to send our readers their catalogs and booklets, to answer questions and quote prices, in fact to serve our readers in every possible way. Write to our advertisers and get acquainted with them. After you have looked through all of the ad. pages this month, you will find it no trick at all to identify the 23 clippings in the puzzle. Note down the names and addresses and the page where each ad. appears.

This done, the next thing is the prize contest letter; and the subject this month is one we are very much interested in. Our readers can give us some very helpful information and we feel sure that practically everyone of Our Folks will be glad to take the time to do so. We want some reliable information from out on the "firing line" about Lumber Advertising and what it is accomplishing.

Many of you have no doubt noticed the publicity work put out in behalf of various kinds of lumber for

interior finish and for general building use. Birch, Arkansas Soft Pine, Southern Cypress, Hemlock, Douglas Fir, Red Gum, Southern Yellow Pine, Northern White Pine, Red Wood, Oak Flooring, Maple Flooring, Red Cedar Shingles—all of these have used more or less advertising space in the general magazines, farm papers, picture periodicals, architectural papers, building magazines, etc. We wish our readers would write and tell us frankly what effect, if any, this publicity work or any part of it has had on their own choice of building materials or, as far as they could observe, the choice of building materials by home builders and others in the community.

In order to simplify this subject, we have outlined it in four questions, as follows, and ask you to answer each of the questions:

**First.** Have you been influenced by any of the lumber ads. to the extent of investigating and using the advertised wood instead of some other? If so, give particulars.

**Second.** Do your customers, the building owners, request you to use any of the advertised woods?—and if so, what advertising or source of information was it that influenced them?

**Third.** In your experience, what is the most direct and effective way to increase the use of a building material (such as Douglas Fir, for instance); is it by advertising to the general public through the newspapers and magazines, or to the contractors and builders who, in turn, recommend to their customers the proper materials to use?

**Fourth.** Do you believe that advertising direct to you through your own building magazine setting forth the merits of any building proposition has a greater influence with you, than the same advertising appearing in the popular magazines and women's papers?

# MORE FUN AND PRIZES FOR ALL WHO READ OUR ADVERTISING PAGES

① 

② At this price the TUEC becomes as necessary to the equipment of any

⑤ **Kar Service**

⑧ *right in TWO in the MIDDLE.*

⑩ **"TAMCO METAL"**

⑪ 

③ 

④ **Classik METAL CEILINGS**

⑥ MY BUSINESS and I am interested.

⑨ **The Crusade Against the House Fly**

⑦ 

⑫ 

## APRIL Ad. Puzzle Prize Contest

Here are fragments of 23 advertisements appearing in this issue. Can you identify them? Some are old friends; some you will have to hunt a little to locate. Study our advertising pages this month; read every offer. Then list the 23 ads. these were clipped from. Be sure to give the names and addresses and page numbers. Also write a brief, straightforward letter answering these questions. (See opposite page for further explanation of what is wanted.)

1. Have you been influenced by any of the lumber ads, to the extent of investigating and using the advertised wood instead of some other? If so, give particulars.
2. Do your customers, the building owners, request you to use any of the advertised woods? And if so what advertising or source of information was it that influenced them?
3. In your experience, what is the most direct and effective way to increase the use of a building material (such as Douglas Fur, for instance); is it by advertising to the general public through the newspapers and magazines, or to the contractors and builders who, in turn, recommend to their customers the proper materials to use?
4. Do you believe that advertising direct to you through your own building magazine, setting forth the merits of any building proposition, has a greater influence with you, than the same advertising appearing in the popular magazines and woman's papers?

**We Will Award These Prizes**  
**13 Prizes—\$30.00 in Prizes**

For the best letter (and correct Puzzle solution) \$10.00 worth of goods selected from our Ad. pages. For the two next best letters (and correct Puzzle solution) \$5.00 worth of goods selected from our Ad. pages. For the 10 next best letters (and correct Puzzle solution) \$1.00 worth of goods selected from our Ad. pages.

When sending in your Puzzle answer and letter, be sure to state the goods you select from our Ad. pages, in case you win a prize; goods of ANY value may be selected, and prizes will apply either in whole or part payment of them.

**This Contest Closes Friday, May 15th, 1914**  
 Prize winners will be announced in June issue

Address your letters to your friend, THE ADVERTISING EDITOR,  
 "American Carpenter and Builder"  
 CHICAGO

⑬ 

⑭ **"Door Beautiful."** Mailed to your address on request, *partly and you can save from \$100 to \$300 in building a home.*

⑱ 

⑲   
**PROFITS**  
**Ideal Power**  
**The Hole Patched.**

⑳ **VITT Co**

㉑ **Buy by Mail**

㉒ **Drop us a card, stating that you are a contractor,**

⑮ **FREE—No. 5.**  
 Hardware Catalog

⑰ 

㉓ **After ten days' trial, if the *SAVING DEVICE* is not what we claim, we will return the money-**

# CORRESPONDENCE



## Questions Answered and Ideas Exchanged.

**Our Readers are Requested and Urged to Make Free Use of These Columns for the Discussion of all Questions of Interest to Carpenters and Builders**

### Raising a Heavy Roof

To the Editor:

Rochester, N. Y.

I find in your question department a letter from Mr. T. H. Brunnen, contractor, Karnos P. O., Manitoba, asking the best way to proceed in raising a cottage roof. I had considerable experience in various lines of carpenter work before I reformed and began to devote my entire attention to concrete and I remember distinctly a job of this kind that I put through a few years ago.

The building in question was an old-fashioned residence, about 30 by 38 feet, with a roof framed of heavy timbers and of probably double the weight of the usual roof as now built. The owner wished to raise this about 5 or 6 feet and we tackled the job in mid-winter. I am inclosing a sketch showing the method used.

First, the floors were shored up at four points, over which the cribs were built for raising. Two long timbers, 4 by 6, were obtained and fastened up under the rafters in such a position as to have, to a certain extent at least, the weight of the roof balanced over the sticks. Two 6 by 6 timbers were then placed crosswise and blocking built up underneath. Additional collar beams were spiked on temporarily low down to the rafters, to prevent any possibility of spreading. The

roof was raised in this way without any difficulty and seemed perfectly secure, even though we had a very high wind during part of the time.

I might add that it is a good precaution as the cribs become rather high, to insert 2 by 4's as a part of the blocking extending to one crib from another. This binds the four cribs into a perfectly substantial base.

Unless some subscriber sends in a better solution of the problem, this may be what your inquirer wants, but will, of course, have to use good judgment in proportioning his materials to the weight of the roof to be raised, but with plenty of blocking at hand, the job would present no difficulty.

VAN GUILDER HOLLOW WALL COMPANY,

By C. D. Gilbert, Secretary.



### To Raise Cottage Roof

To the Editor:

Hayesville, Ohio.

I take notice that T. H. Brunnen wants to know how to raise a cottage roof. Make four troughs 8 feet long, using a 2 by 4 and a 2 by 6, and put one on each corner and spike on outside of building as guides. Cut eight braces of 6 feet run and eight braces of 2 feet run; cut these out of 1 by 6

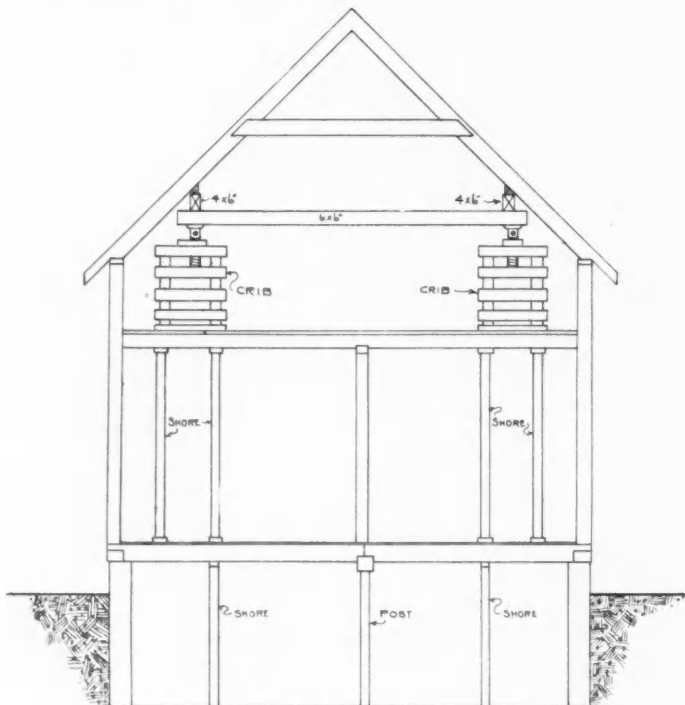

SECTION

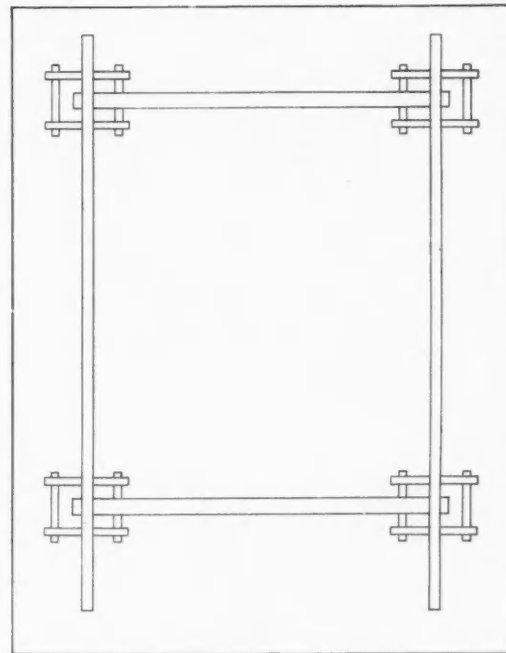

PLAN.

**A method of shoring and raising a heavy roof by means of cribbing.**

and nail to plates and ties to keep the troughs in place. This puts four braces to each corner. Cut corner studding off before putting on trough, judging from the height that it is to be raised. You can work from inside. Bore 1/2-inch hole in corner studding 2 inches down and get two 1/2-inch bolts to reach studding and trough to hold roof while changing jacks. As you raise to the height of jacks, bore a hole, insert bolt, draw bolts tight and it will hold roof while making change. Put all of upper ceiling joists in before you start to raise and fasten as many to rafters, as possible, as this will keep roof from spreading. Leave plate fast to the rafters and cut studding off 4 or 5 inches from plate and this will give place to spike cripples to.

I have raised two roofs this way, and have had no trouble. One 24 by 32 and one 18 by 26. A. E. RUSH.



**How to Raise the Roof**

To the Editor: Armour, N. Dak.  
 In reply to the inquiry of Mr. Brunnen, of Karnas P. O., Monitoba, in regard to raising the roof of a house, he can do it without removing the shingles or cornice (unless to replace with different style) by first removing the siding below frieze, then staying roof at plate by nailing girts from one plate to the other. Use 6 by 6-inch timbers on a common building for jack rests. Place jacks every 2 to 6 feet apart under plate. Cut your studding and start your jacks together and keep them so, and when run up their length, block up crib style under plate. Also crib up for new jack stands. Continue operation until roof is the desired height. Cut studs to fit in, plumb up and level your roof; nail in your studding; brace the roof by side stages from inside; remove the jacks and the job is completed.

I also enclose card photo of a job I did last year in this part of the country. We get lots of experience in this line and so far I have not had the least damage.

J. T. REED, Carpenter and Builder.

**Work Faster, Swear Less, Shingle More**

To the Editor: Pawnee City, Neb.  
 Every month I read something helpful sent in by the readers of the "A. C. & B.," and am glad to see it, because it is from one another that we learn.

Now, I wonder how many still cling to the old way of casing up doors and windows—that is, nail on the casings and then fit the head casings to them. We always put on stool



Pair of Wrought Iron Tongs for Holding Shingles.

and apron first, then put on the head casing and then put on the sides by squaring the stool end and set it up in place, using a gauge same as for siding. It saves much time and gives a better joint.

I have something else to offer and then I am through. It is a device for holding shingles on the roof. Every one knows how annoying it is to shingle when the wind is blowing the shingles all over the place. I have solved that problem by inventing a device which not only holds a whole bunch of shingles, but down to the last one, as it closes up by its own weight as the shingles are used. JOHN P. KNOWLES.



Builder J. T. Reed and his gang at work raising the roof near Armour, N. Dak.

**Karpenter Kinks**

To the Editor: Highland, Mich.  
Here are a few more of my "Karpenter Kinks," which may help some one along in their work.

Fig. 1 shows how I cut the string for a form for making

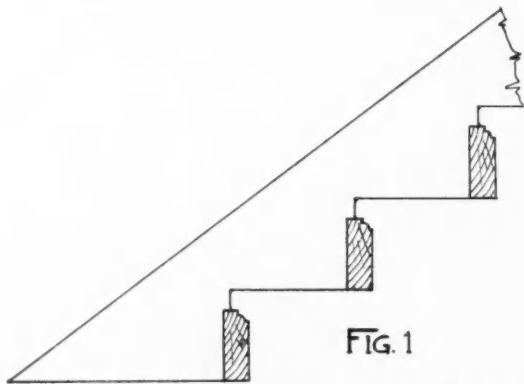

Mouldings Applied to Riser Boards in Forms Make Nosings on Concrete Steps.

cement steps or stairs. Cutting the string, as illustrated, allows the workmen to finish the tread clear out to the end, after which the next riser can be put in place and the whole flight finished in short order. These risers show a reverse cove below the tread to form a nosing.

Fig 2 shows the way I usually build a wood box. I always make them double thickness with paper between and weather-proof lid outside. They will let in a great deal of cold if not properly built.

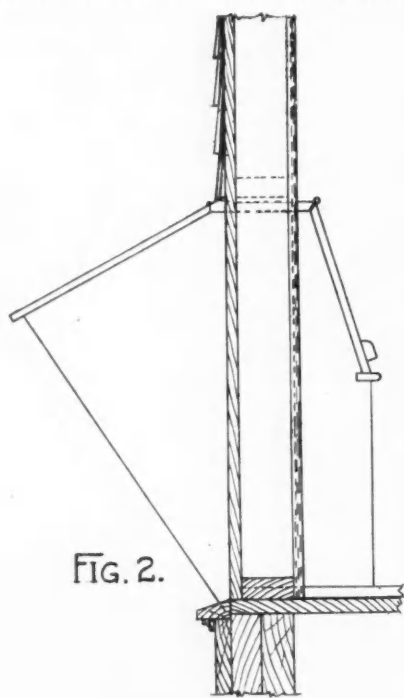

FIG. 2.

Fig. 2. Shows Handy Wood Box Arrangement; Box is Built Into Outside Kitchen Wall.

This one will hold quite a little wood, which is convenient to get from the inside, even to the last stick.

The way to get the length and cut for bridging, is shown in Fig. 3. The width of joist on the tongue and space between joist on blade, as shown,  $7\frac{3}{4}$  on the top edge of piece and  $14\frac{1}{4}$  on bottom.

ALBERT GONNE.

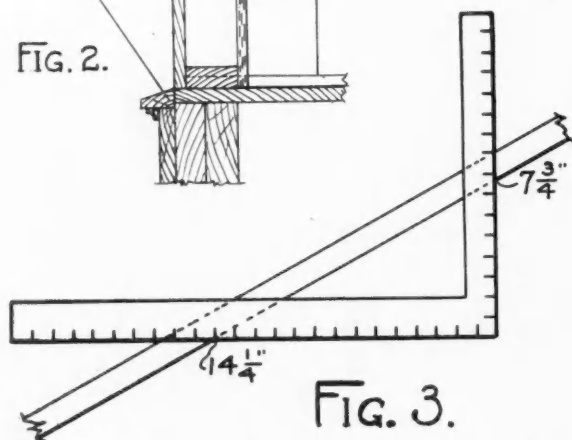

FIG. 3.

Fig. 3. Method of Getting Length and Cut for Bridging with the Steel Square.

**A Plumb Rule for Setting Grounds**

To the Editor: Steubenville, Ohio.

Recently when I was working as a journeyman carpenter, I found a number of contractors that never set grounds around the openings on cheap jobs, for the system they used was too expensive. I find with my rule, one man can set at least six openings with grounds to one the old way some contractors use. I will now describe the plumb rule used for setting grounds for the plasterer to work to.

Take two pieces of dry white pine,  $1\frac{1}{8}$  by 4 inches, which will be used for the gauge and straight edge, then take two cleats,  $\frac{7}{8}$  by 6 by about 14 inches long, strike a center line across each one for plumb line and then spacing two straight edges  $\frac{1}{8}$  inch less than the finished door jamb will be, fasten the two cleats with screws about 10 inches from each end. Now take two pieces  $\frac{1}{2}$  by  $2\frac{1}{2}$  by 4 inches and nail to cleat back of center line. This will keep the cross-cleats away from

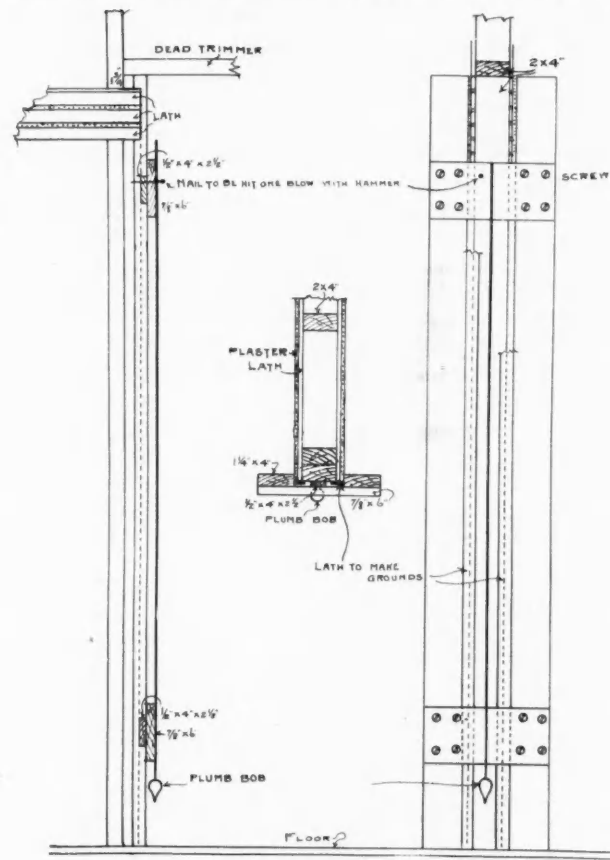

John Thoma's Plumb Rule and How It Is Used.

studding so plastering lath used for grounds can pass between cross-cleats and studding. Drive an 8d. nail about  $\frac{1}{2}$  inch one side of plumb line, divide space at top of rule and studding; hit upper nail one blow with hammer and then move lower part of rule until plumb line from plumb bob is in line with center line of lower cleat. Then hit nail in lower cross-cleat and you are ready for the grounds to be nailed. The ground strip can be plaster lath or pieces of lath, which will do if joined on edge.

JOHN T. THOMA.



**Jasburyings About Furniture, etc.**

To the Editor: Lat.  $40^{\circ} 13'$  Long.  $74^{\circ} W$ .

As the reading element of the building business is always on the alert for thoughts of contemporary colleagues, I shall try my hand again.

One familiar with the carpentry or wood-working business, now and then hears of Chippendale and other furniture

of the class A type. A chair, buffet, or table of the Chippendale period causes some stir of activity. Of course, the design is the main issue in this particular style, but I desire to call your attention to the fact that the hand-made or old European furniture was and is made by cabinet makers who thoroughly understood and have mastered the art of shrinkage construction, *i.e.*, building furniture that will stand up under the usage of generations.

Take the furniture of today, made by the carload in the upper middle west of our thriving country, the machine plays such a part in the make-up that some of the nature is omitted from a design well meant. The idea nowadays is to hurry up the job and get the money back. We rarely see a piece of durable modern furniture nowadays. The manner and method of construction has been brought to such a degree of rush, it's a wonder that some of it don't come apart before it is loaded on the cars. Take, for instance, the mahogany piece of furniture of today. It is veneered of paper thickness, and out-of-the-way parts are made of birch. While some of the alleged antiques are veneered, there is a difference in the general appearance.

Then there is the heating of houses nowadays that is destructive to furniture. There seems to be some dampness connected with the steam and hot water heat that pesters the glue until it lets go, and there you are for a repair job. The heat of the old time was nature's first experiment (wood fire, sunshine, etc.), that kept the old, hand-made furniture in good humor and on good terms with its owner, and stood up and made good.

Speaking about antique furniture, nearly every attic and cellar on earth has an old walnut or mahogany sofa with shiny horse-hair seat covering, stored away or cast off. Now that antique furniture has become so universally popular, I am inclined to believe there will soon be a general rummage convention take place. Some of the Paris furniture (Apaches) manufacturers bore holes in modern furniture that look like worm holes, and then sell these for real antiques to the Americans. I was in France in 1893 and happened to be "in" on this European-American trick.

The style of furniture of today seems to be Mission. This style is very good for a home where the man of the house is in the habit of coming home slopped up, not only because when he tangos or maxixes against it in the dark he won't break it, but when he throws Mr. John Barleycorn into high gear and proceeds to clean house, the furniture will stand the storm. Again, it is often stained green, and that's Irish ("God bless 'em"). If the manual training boys of today keep up the present rate of making Mission furniture, by the time Roosevelt gets back from South America there will be so much furniture of this species in the United States we will have to walk sidewise to get to church.

Speaking about manual training, it is hard for a weather-

beaten wood-worker to get used to seeing or hearing of a woman teaching boys how to make furniture. If it were the welding of box plait, or brazing on a couple of Lushels of old lace, or riveting on a quart or two of passementerie, that, of course, would trickle through the usual channels of humanity. But a person in a hobble skirt with a voice three notes above the scale, telling freckle-faced young Americans how to make a miter, how to use a smoothing plane, how to dovetail a corner, etc., etc., that sounds like a fellow with side whiskers looks—odd. The principal articles made by manual training boys, are chairs and stools. They mean to supply the sitting-down element with berths. At any rate we will not be obliged to stand, that's something.

After doing a day's work in a planing mill, I feel a bit tired, so will say good-night. WM. C. JASBURY.



### Built Coal Tippie

To the Editor: Carbon Hill, O.  
Here is a photo of a coal tippie that I recently built for the Central Hocking Coal Co., at Sand Run, Ohio.  
W. A. DONALDSON.



### Keeps Beeswax in Hammer Handle

To the Editor: Berlin, Pa.  
Here is a little kink for nailing hardwood. Bore a 1/2-inch hole one inch deep in the end of your hammer handle and melt it full of beeswax. Stick your points of nails in this, then try them on hard wood and see how "easy." This is clean and is always with your hammer (or at least with the handle).

I have tried different oils, greases, etc., but with at best poor results. Oils will always show the mark more or less, especially where you finish natural. The beeswax makes no stain. The cobbler or shoemaker always has his wax kit beside him to insert his awl.  
J. C. WERNER.



### Fire-Proof Schoolhouse Under Way

To the Editor: Cleveland, O.  
Here is a photograph that shows the beginning of our work on a new fire-proof public school building at West Mentor, Ohio. There will be a half million brick in this building. We got the foundation in last fall and now have the building up ready for plastering. The outside walls are faced with art brick, backed up with hollow brick making a 17-inch wall for the basement and 13-inch wall from there up.



Work Begins on New Fire-Proof Public School Building, at West Mentor, Ohio. The Mettler-Gloyd Co., Contractors.

The building is absolutely fire-proof. The floors are reinforced concrete, using the Kahn system of reinforcement.

C. G. McCLEARNAND, Supt.,  
With The Mettler-Gloyd Company.



### First Pulp Mill to Use Saw Mill Waste

To the Editor:

Marshfield, Ore.

In the January number you have a little item about sawmill waste of Douglas fir being used to make paper pulp at Marshfield, Ore.

Being a charter member of your valuable paper, and foreman of the carpenter work on this mill, I will enclose you a picture of it.

The mill is built of reinforced concrete. The picture shows warehouse and chemical storage rooms of frame in fore-

at the sides and turning up the gable at the ends.  
W. P. ARNOLD.

*Answer*—Cut both pieces on the regular 45-degree miter and set the level mould to an angle to member with that running up the gable, and nail. Of course, the level mould will not have a solid backing, as it will only touch at its outer edges. This applies to any pitch the roof may have.

If it is desired that the level mould should sit vertical, then the mould running up the gable will not member with it, and we presume this is where Mr. Arnold's trouble lies. Years ago, and not so very many of them, either, when the carpenter was the whole thing on the job, that is, before the modern planing mill usurped all of that part now generally known as mill work, he got out his own moulds by hand and he did it on the job. He carried with him a



Huge Reinforced Concrete Paper Mill at Marshfield, Ore., the First Paper Mill in the U. S. to Utilize Saw Mill Waste for Paper Pulp Making.

ground, with saw mill at right. It may be of interest to many to know that the roofs of all the main buildings of the pulp mill are of reinforced concrete, the largest being the roof of the drying room, which is 65 feet wide and 200 feet long, the outside walls being the only support. The arch is  $6\frac{3}{4}$  inches thick at wall line and 4 inches thick at center, having a rise of 5 feet.

These roofs were built one year ago, and are in perfect condition, showing no cracks or defects. This mill was put up by the C. A. Smith Lumber & Manufacturing Company, buildings being designed by Messrs. Hjalte and Rolph Nerdrum, respectively manager and superintendent of the plant. Thomas Englehart, of Los Angeles, Cal., was constructing engineer.

This is the first plant in the United States to make paper pulp of saw mill waste.

A. B. WOODWORTH.



### How to Cut the Bed Mould

To the Editor:

Louisville, Tex.

I would like to ask a question that has bothered me a great deal, and if you will answer it for me I will appreciate it very much. Here it is.

I want a rule for making the cut on a bed mould for a rake cornice, the mould coming under the plancier

chest full of planes and bits that are not found in the tool chest of today. A problem of this kind did not worry him; he got out his regular mould to run on the level with its back vertical with the frieze, and then he got out another mould set to any desired pitch to member with it, and we will further add, he fit it to a finish. In fact, he would not do it any other way; but nowadays, in the hurry and bustle, this is not done any more, except in following out the classic orders, perfected thousands of years ago by the Greek and Roman builders. It looked good then, and it looks just as good now. We will venture further to say none has been able to set up any better standard of proportion than did these old time builders.

Now, as to the way of laying out the mouldings to intersect, it is arrived at by laying out a full size diagram of both mouldings, and there are several ways of arriving at the corresponding shape of the gable mould to coincide with that of the level mould. Probably as good a way as any is as per the accompanying diagram, which we trust is self explanatory.

First lay off a section of the level mould in its true position; then lay off the desired pitch line, and parallel with this lay off the lines 1, 2, 3, 4 from the level mould as



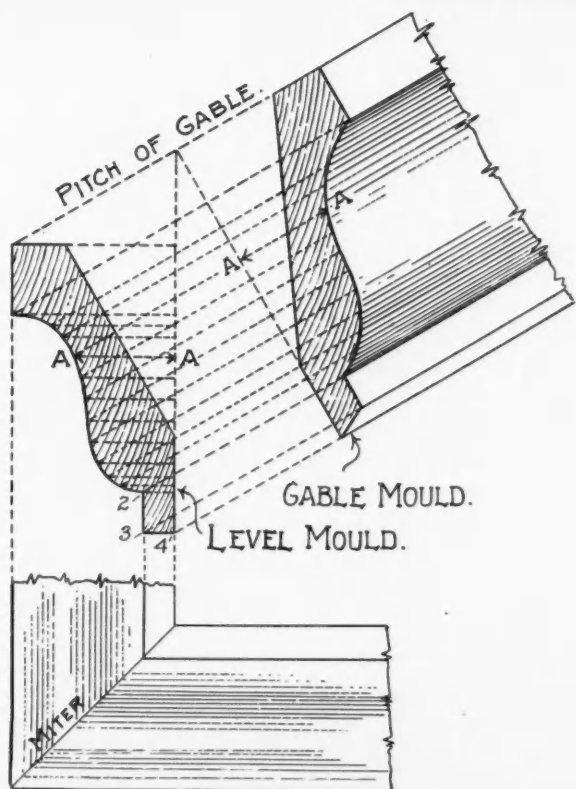

PLAN

Determining miter joint line between level mould and gable mould.

shown. Now, since the projection of the moulds are the same, it is an easy matter to get at the intersecting points by laying off parallel lines from the back or vertical line of the level mould, to its face, as shown, and from the intersecting of these at face, lay off parallel lines with the pitch, the corresponding curve of the gable mould is found by setting off a like distance from its back, as AA in the level mould must be a like distance as A'A' in the gable mould. After all the lines have been transferred and checked, run off-hand curve through the measurement checks and the working line will be established.

It will be seen that any number of lines may be used for this purpose; in face, the more accurate the corresponding curve may be arrived at, as the measurement checks, being closer together, the corresponding curves are more accurately delineated.

The miter for the level mould is at an angle of 45 degrees, but the gable mould must have a sharper angle or, in other words, it is the same as the side cut of the jack.

A. W. Woods.



### A Handy Door Holder

To the Editor:

Buffalo, N. Y.

Here is a little trick for holding doors while planing for fitting, which may or may not have been published before.

Cut two pieces of white pine square on end 6 inches or over by 1 1/8 inch, 6 inches or more long and nail them on edge to a piece about 3 feet long by 3/8 or 1/2 inch thick by any width, exactly the width of the doors apart; then nail two pieces at right angles to the 3/8 or 1/2-inch piece. Tack these to the floor with short nails (just enough to keep it from moving when you start planing and you are ready for work).

When the door is slipped into the space left for it, the weight of itself holds it upright. This has the advantage of being handy for planing either way, according to the grain of the wood, without moving the door, and it can be placed

in any part of the room where there is most room. Hinges can also be fitted on door while in this position.

The apparatus can be moved from room to room or wherever you want it.

D. FULTON.

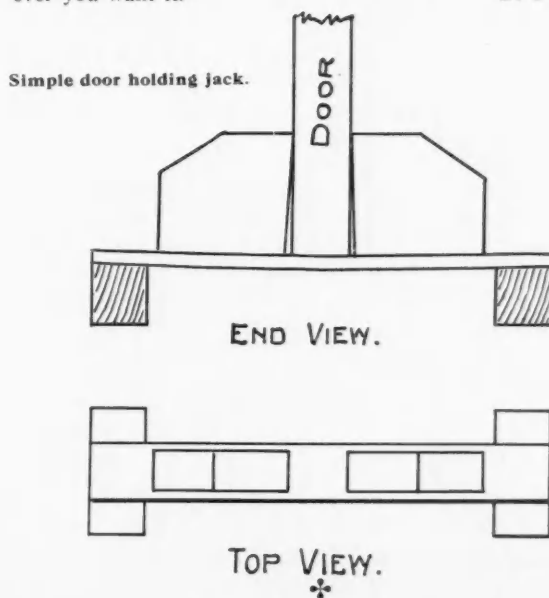

### Worcester Boys' Trade School

To the Editor:

Worcester, Mass.

In February, 1909, seventy-five students enrolled in the Worcester Boys' Trade School. Fifty have graduated. Now there are over three hundred students in the various subjects—cabinet making, carpentry, machine work, tool making, printing, draughting, and architectural drawing.

The students in the wood working departments have made all the wooden stairs for the new building, of which I send you a view.

They make all the repairs on the old building, make the chairs for the class rooms, and the desks for the instructors.

They are now making the large gymnasium in the basement,

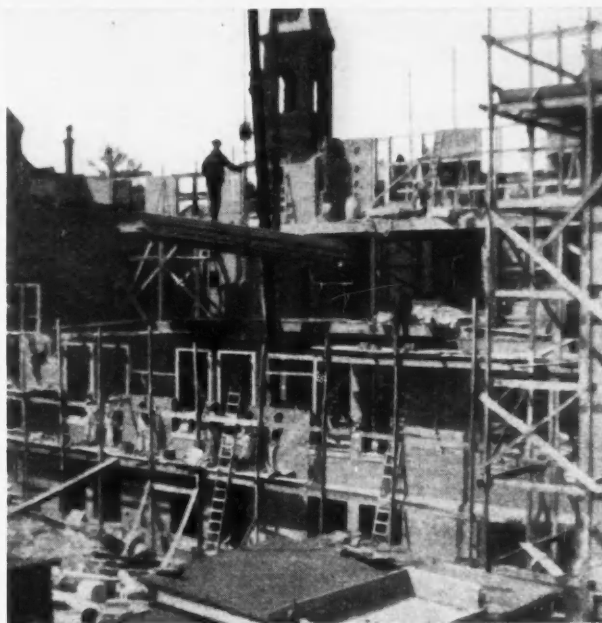

Going up—new Worcester Boys' trade school under construction.

also the seats for the large assembly hall in the new building.

The cabinet making department is finishing the first floor with quartered oak paneling, which is a handsome sight when finished in the natural colors.

R. B. M.

**Shallow Grounding for Lightning Rods**

To the Editor:

Gravity, Pa.

A word or two more about lightning. First, I want to thank Mr. Jones and Mr. Cofer for answering my questions so carefully, but my buildings, and a house I erected for a neighbor, set on solid rock; there is not over 3 feet of earth in the deepest place. The cellar bottoms are all rock. How can we protect our buildings if the rods must go down 10 feet, as Mr. Cofer says?

Mr. Cofer refers to the phone. Some years ago a line was run a few miles west of here (we use the bridge system ground connection); one man grounded his wire in his well, another in the spring, to have the phone work well. Three or four years ago a line was run through here and the man just drove an iron pin into the ground, made his connection and went on. The boys for awhile used to pour water around the pin to keep the ground wet, but for a long time no one has thought of the pin, and it works just the same. We can talk to Scranton and Carbondale, over forty miles of wire, just as well as to a neighbor one-half mile away. May it not be so with the lightning rod?

EUGENE QUINTON.



**Do Metal-Covered Buildings Attract Lightning?**

To the Editor:

Excello, O.

I have been interested in the building line for several years, both in wood and steel structures. At present there is one topic on which I would like to get all the information that you can possibly furnish me without inconvenience to yourself. That is, the lightning resisting qualities of metal covering on buildings, both roof and side.

Kindly put this question to the readers of the AMERICAN CARPENTER AND BUILDER:

Have you ever known a building covered with metal roofing to be damaged by lightning?

J. H. CLASS.



**Convenient Tool Chest**

To the Editor:

Chebrague, Maine.

I am a comparatively new but very much interested subscriber to your magazine, and when I think of the good

things I must have missed, I moan the fact that I did not subscribe earlier.

Enclosed you will find a sketch of a tool chest I made a short time ago. The body is of 5/8-inch cypress, with 1/2-inch maple trimmings. The principal feature is a hinged rack for planes at the back of the chest, that can be lifted up and the planes removed without disturbing a lot of other articles, see Fig. 1.

In front there are three tills or sprays for chisel, bits, screw drivers, level, etc. In the cover is a rack for saws and room for the steel square, while in the bottom there is ample space for the tools that are not used every day.

Fig. 1 shows the position of the planes in the rack, also the rack in place and partly open to remove the planes.

Fig. 2 shows a cross-section taken at (A). I think the sketch explains the rest for itself.

ROBERT A. HAMILTON.



**Left Handed Man Wants Advice**

To the Editor:

Grand Rapids, Mich.

I would like to ask a question for the subscribers to answer. I am rather unfortunate in one way (some men with whom I have worked think it fortunate). I am left-handed and always stand in a left-handed position at a bench. It is very awkward for me to use an ordinary rabbet-plane. I would like to hear from subscribers who are in the same predicament, or have had experience with a rabbet-plane that has a fence to go on right side that can be used by a left-hand man; one in the Stanley line if possible.

I would also like someone to contribute details of framing and finish for store fronts, particularly below the plate glass, and for the bench.

"AWKWARD."



**Nine Weeks Instead of Four**

To the Editor:

Hickman, Neb.

There is a mistake in my letter of February, page 90, about the large residence I planned and built. My letter states that the house was built complete in four weeks. This is a mistake, as it took just nine weeks to complete the house. Please make this change before my brother carpenters begin to dissect me.

J. E. OFFER.

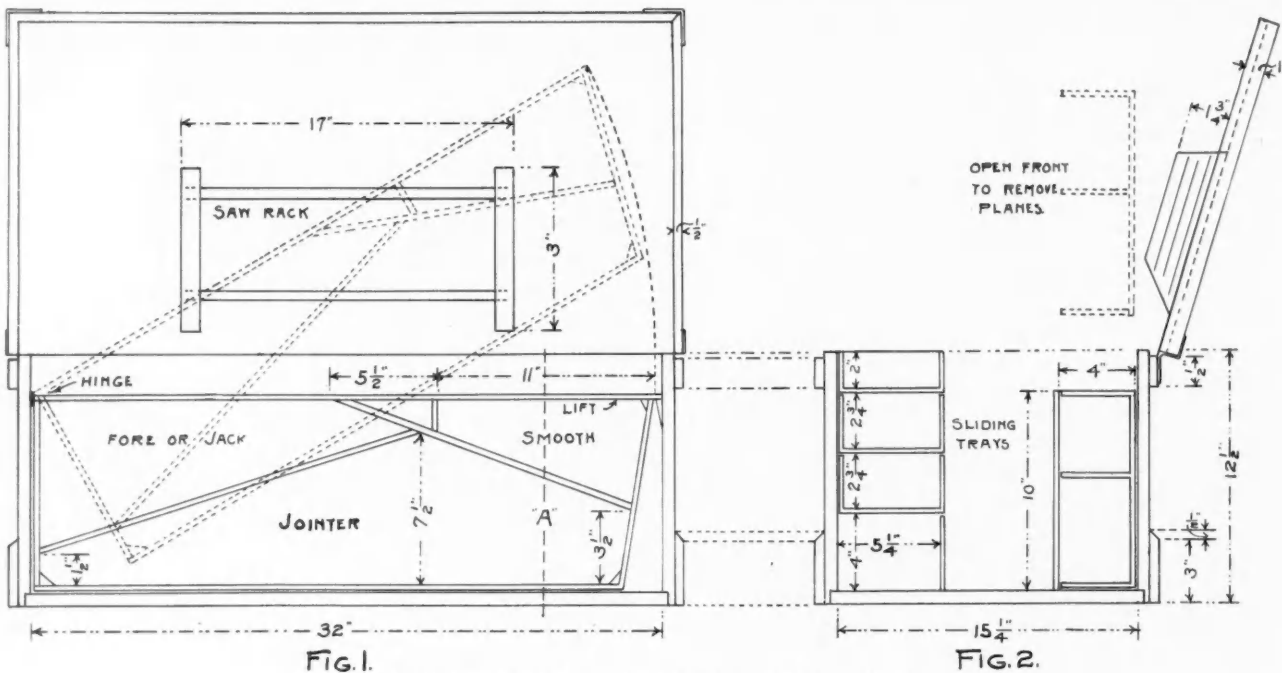

Working Drawings of Ingeniously Arranged Tool Chest.

**Good Home Building in Nebraska**

To the Editor: Howells, Neb.  
 Here is a picture of a house I built last summer. It is 30 by 44 feet, has ten rooms with plastered attic, and a good-sized basement, tiled porch floor, and all modern improvements. The entire inside finish is in oak with slab doors, and the bath room is one of the best equipped and most sanitary in this country. The house has O. G. lap siding,

edges. You may have devices better than this. It can be placed on the floor, anywhere convenient to work, and will not slide or slip. It is adjustable to any thickness of door, from ¾ inch to 2½ inches, and is light and strong. When the door is raised out of the vise-like jaws it releases automatically. Place the door in jaws on its edge, then turn thumb screw just tight enough so that it will stand on edge firm, then it is ready for the plane. It surely helps in fitting and placing hinges on doors.  
 D. F. OVERHOLT.

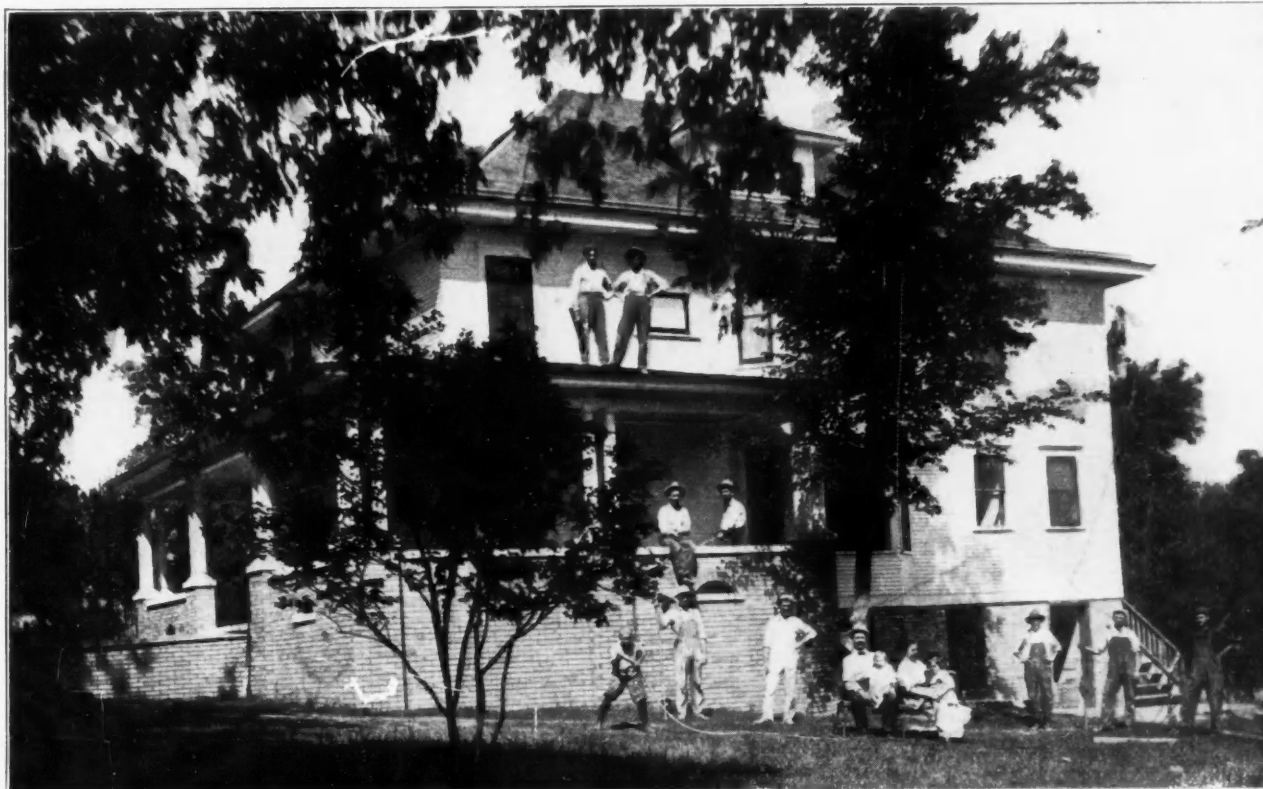

\$10,000 Brick and Frame Residence of Mr. Adolph Folda, Howells, Neb., Built by Contractor James Chadek.

mitered on corners. The cost of it is \$10,000 complete; \$1,125 for the carpenter work only.

I am sitting on the porch railing from the inside, and the owner, Mr. Adolph Folda, a successful banker in Howells, and his family, are sitting on the lawn bench.

I find the "A. C. & B." a great help to me, and I would not be without it. I wish the brother carpenters would send in more photos of different buildings, and letters explaining the same.

JAMES CHADEK,  
 Contractor and Builder.



**Handy Door Vise**

To the Editor: Seville, Ohio.  
 I herewith send you an illustration of a simple device for holding doors, while fitting. It is also useful in putting on hinges, as you can see. It holds the door secure to plane the

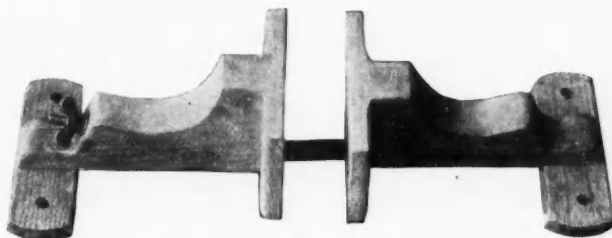

Workmanlike Door Holding Vise.

**To Stop The Leak**

To the Editor: Allison, Iowa.  
 I wish to say to Bro. J. P. Wells, that I think Bro. Charles B. Jarvis' method of putting in thresholds is far better than the one he submitted in the February number, as Mr. Jarvis' conducts the water away before it gets inside, whereas Mr. Well's lets the water get inside and then has to conduct it out. Consequently, if his conductor gets plugged up, I am afraid there would be a wet floor.

Here is the way I always make a drip over windows and doors and have never had one leak yet, and I use no tin over the heads, either. See sketch.

R. BURBRIDGE,  
 Carp. and Bldr.

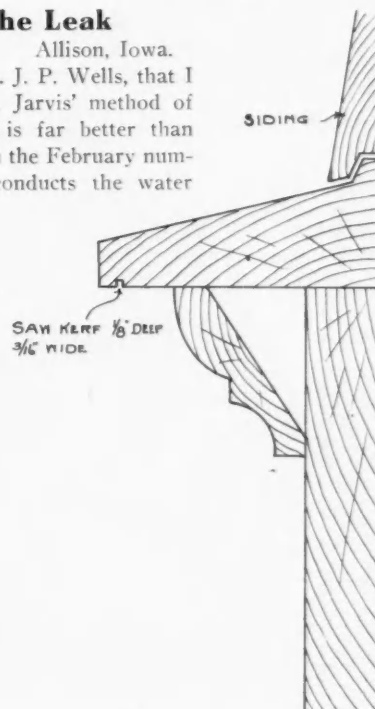

Leakless Drip Board Over Door or Window.

**Well Handled Church Job**

To the Editor:

North Middletown, Ky.

Being a charter member of the AMERICAN CARPENTER AND BUILDER and having been a subscriber without interruption since the first issue, I think I should have the privilege of showing you the class of work I am doing.

I am enclosing a picture of the new Christian Church here which I have just completed a few months back. The plan for this building was drawn by myself, and was preferred by the Building Committee over the designs of architects from Cincinnati, Lexington, and other surrounding towns. I likewise secured the contract for building.

stone brick. The main roof, including dome, is covered with galvanized "Cortright" metal slates.

The building contains, in the basement, eight Sunday School rooms, Sunday School auditorium, kitchen, toilet rooms, furnace room, and engine room. Above we have auditorium and balcony capable of seating about 700 persons, baptistry, choir loft, and large pipe organ. Also on the same floor, we have ladies' parlor and officers' room.

Above the auditorium is the large double dome supported on four elliptic arches, which rest on four large pillars reaching to the basement.

In the engine room is an 8-horsepower gasoline engine,

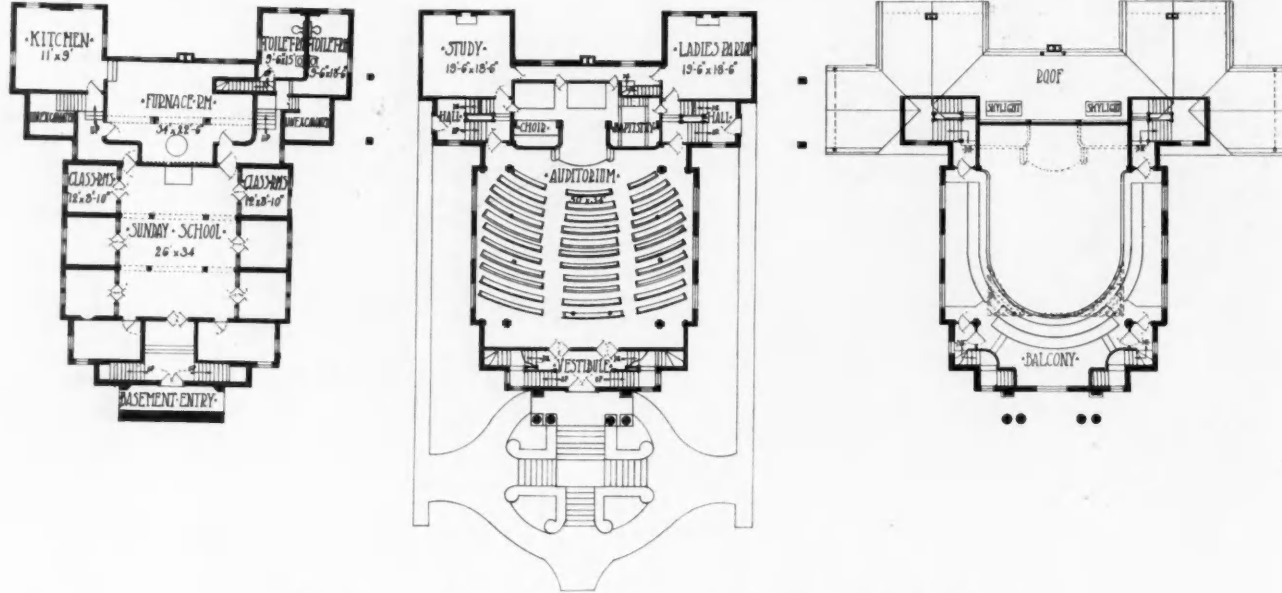

Basement, main floor and balcony plans of nicely arranged church building.

The structure covers a space of 100 by 97 feet and was completed at a cost of about \$25,000. The basement is constructed of concrete faced with sawed freestone, laid in 7-inch courses. The steps are also of concrete. The walls are 6-inch studs boxed and faced with 4-inch white sand-

which drives a 110-120 volt generator. This furnishes current for the electric lights and the organ motor. The furnace room contains the large hot-air furnace, which heats the entire building.

WILLIAM K. HAGAN,  
Architect, Contractor and Builder.

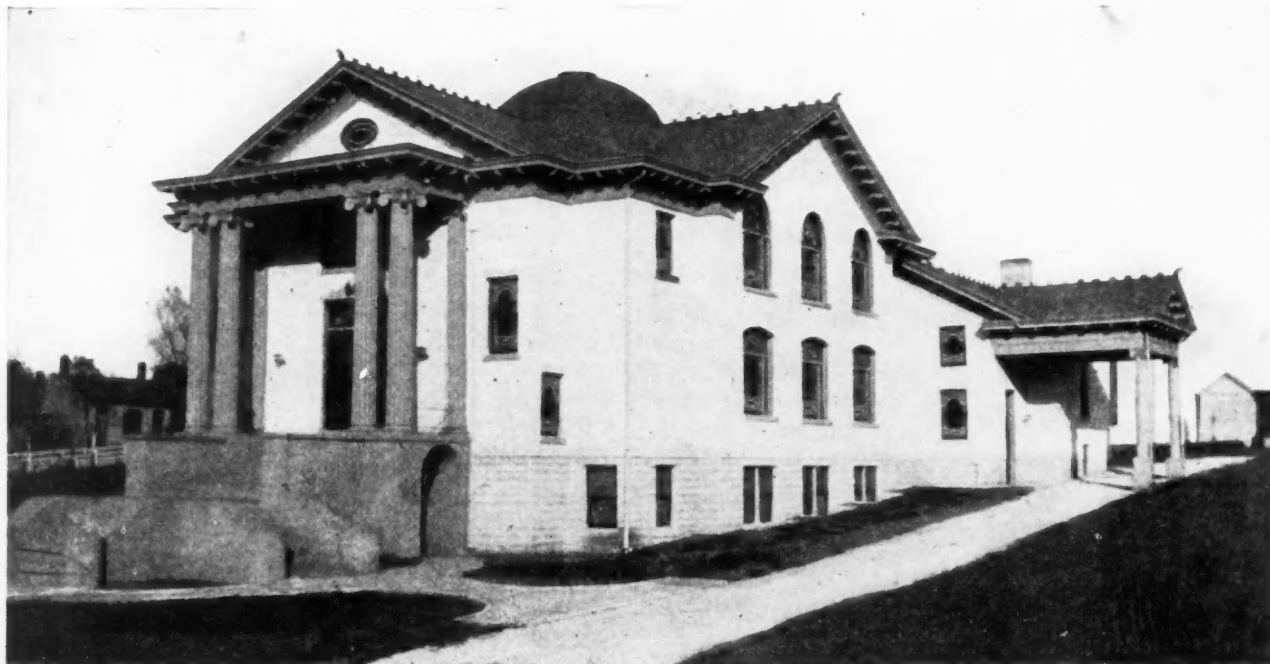

New Christian Church at North Middletown, Ky., designed and built by Wm. K. Hagan. A notable instance of a local man winning out over Foreign talent.

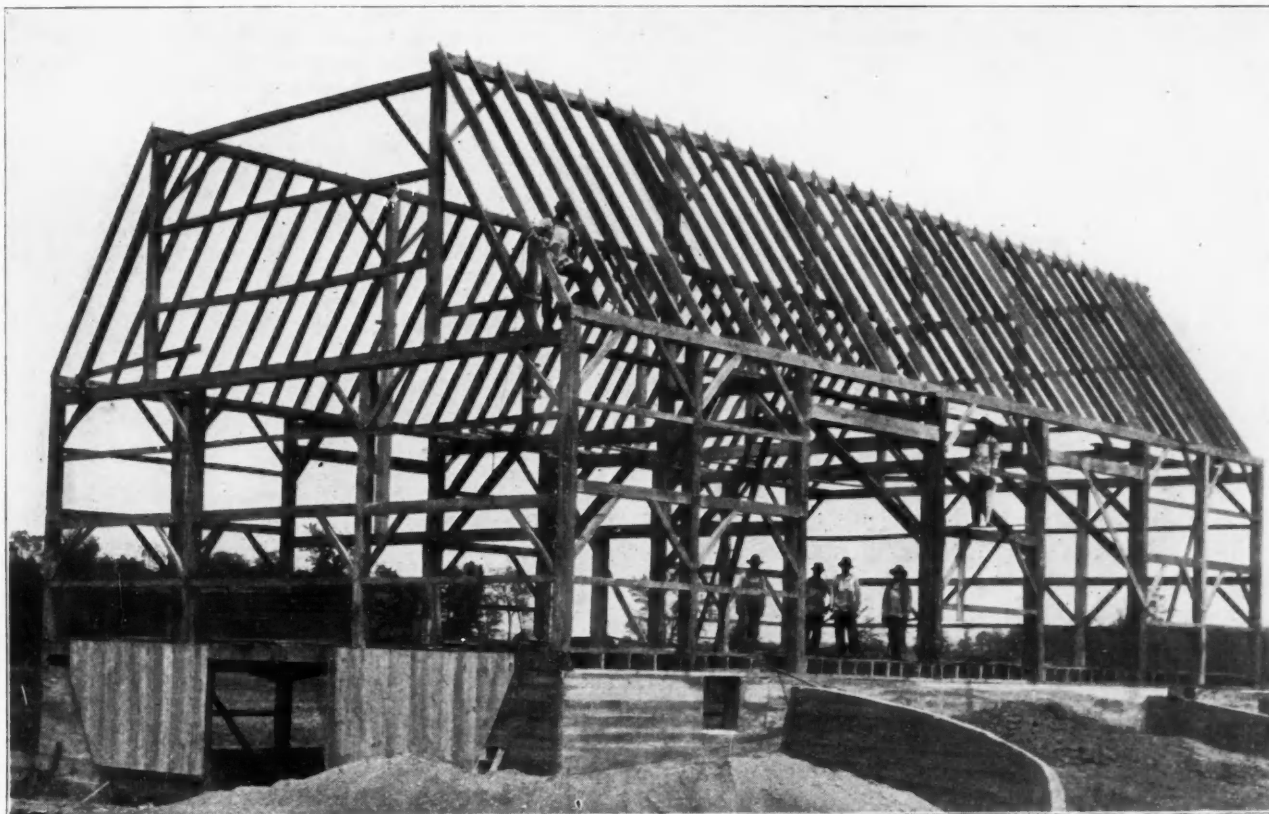

August Ambor and Men on Large, Heavy Timber Barn at Botkins, Ohio.

**Heavy Timber Barn Work**

To the Editor: Jackson Center, Ohio.  
 Here I am with my gang on my first job for the season of 1913. This barn is 42 by 72 feet, with 8½-foot basement, and has 16-foot posts above. Posts are 8 by 8 inches, self-supporting girders 9 by 10 inches. Talk about rafters! Here I had them 2 by 7 by 17 feet long. This is the lower set. The top set are same size, 12½ feet long. I built this barn for J. J. Metz, Botkins, Ohio, dealer in Percheron stallions and mares.

My work is mostly barn work and all of heavy timber.  
 AUGUST AMBOR.

✦  
**Cumiskey Thresholds**

To the Editor: New York City, N. Y.  
 I have noticed in the last three issues of the AMERICAN CARPENTER AND BUILDER, different designs of thresholds to keep out water, which beats against a door. No doubt, Jack Leg has his doors already hung, and in that case believe the

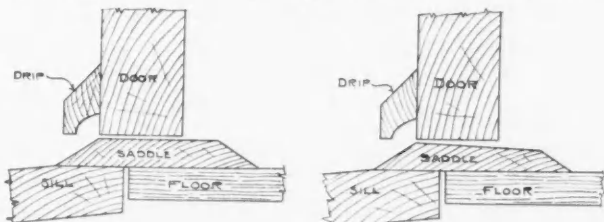

FIG. 1

FIG. 2

most simple method of overcoming his difficulty, would be to nail or screw a drip moulding to the outside of door, as shown in the sketch shown herewith. This would shed the water away from the door and clear of the saddle, but if a condition exists as shown in Fig. 2, a slight bevel on top of the saddle, as shown, will make it almost impossible for water to enter.  
 JAMES H. CUMISKEY.

**A Gambrel Roof Design**

To the Editor: Appleton, Wis.  
 I would like a sketch showing a gambrel roof with a span of 22 feet. I also want to get a room in the gambrel 8 feet 6 inches in the clear. What will be the length of my rafters?  
 W. H. H.

Answer: The accompanying sketch shows a gambrel of 60

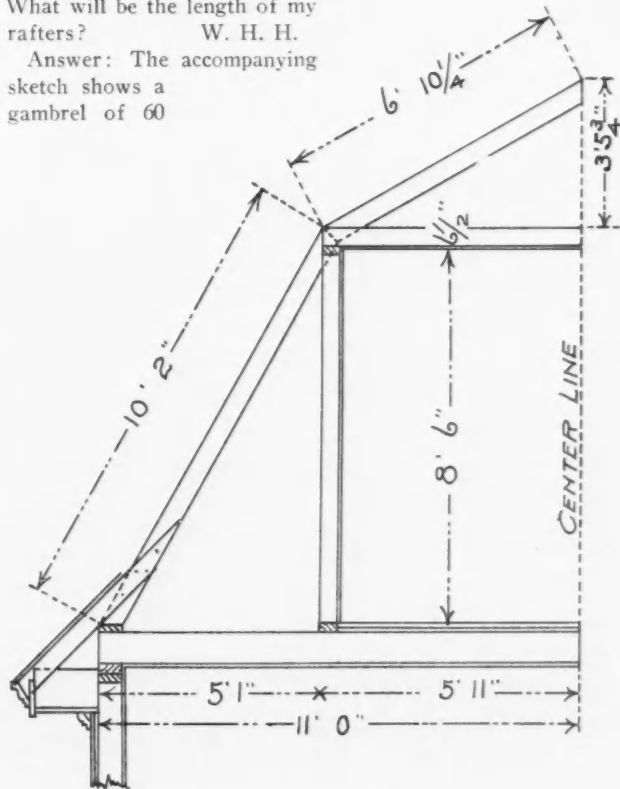

Proportions and Approved Construction of Gambrel Roof Building.

and 30-degree pitch with their respective run and rise. The rafters can have a miter cut at the knuckle, or cut against the room plate as desired.

EDITOR.



**Rubber Weatherstrip for Threshold**

To the Editor: White Haven, Tenn.  
I see in the February issue of the A. C. & B. a form of threshold by J. P. Wells. I have an outside door that gave me a good deal of trouble by letting water in. I cut a groove  $\frac{1}{4}$  inch wide and  $\frac{3}{8}$  inch deep, pressed a solid piece of rubber  $\frac{1}{4}$  inch by  $\frac{1}{2}$  inch into groove, letting rubber come just flush with outside of door, and it fits up close to the door, making it impossible for the wind to drive the rain under; and my wife don't have to clean out the groove, as the brother has to do his.

I hope this will not mislead some good brother. Try it some time.

A. A. GILLESPIE,  
Carpenter and Builder.



**The Scotch Threshold**

To the Editor: Yorkville, Ill.  
In the February number, Mr. J. P. Wells says that the two answers to Jack Leg's inquiry for a threshold do not amount to much. In my estimation, his amounts to but little more, except as a dirt catcher and a nuisance to be cleaned out.

I enclose a sketch of the threshold I make and which I have found in my twenty-one years of experience will turn water in most any storm. The greatest trouble with water driving in over the threshold is because of too loose a fit

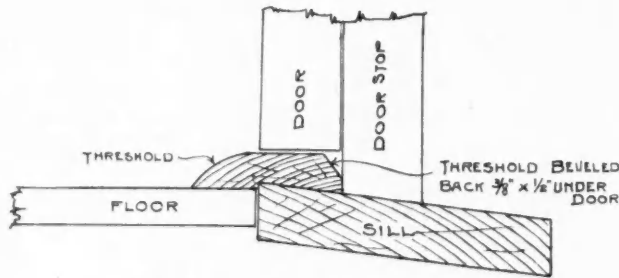

Carefully made threshold of Scotch origin.

of door to threshold. I learned to make this threshold and to fit the door close from a Scotchman—contractor and builder—and who used this style of threshold in all his fifty years at the trade. I find that this style of threshold, with the door fit to less than  $\frac{1}{16}$  inch and given a priming coat of paint on bottom edge of door before the same gets wet and swells, will turn water.

C. A. SHAW.



**Still Another Threshold**

To the Editor: Darby, Mont.  
Enclose a sketch which is used in Southwest Louisiana, where the wind drives the fine rain almost through anything; but this is very successful. The  $\frac{1}{4}$ -inch projection of the door over the steep  $\frac{3}{8}$ -inch bevel on a  $\frac{5}{8}$ -inch thick threshold, lets the water away without any chance to run or blow in.

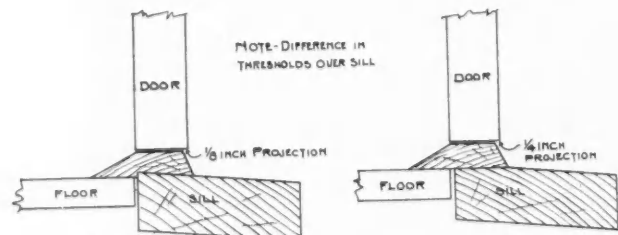

Cross sections of two weather-tight thresholds.

The two drawings in the January and February numbers do not seem very practical; one on account of the tin and long level or slope on the outside of threshold, the other on account of the trough on the inside to catch the dirt.

WILL E. BLACK,  
Carpenter and Builder.



**One More To Cross**

To the Editor: Marquette, Mich.  
I do not agree with Brother Wells in regard to his non-lead threshold. I do not approve of the groove on the inside of door and the holes on the outside as they would soon

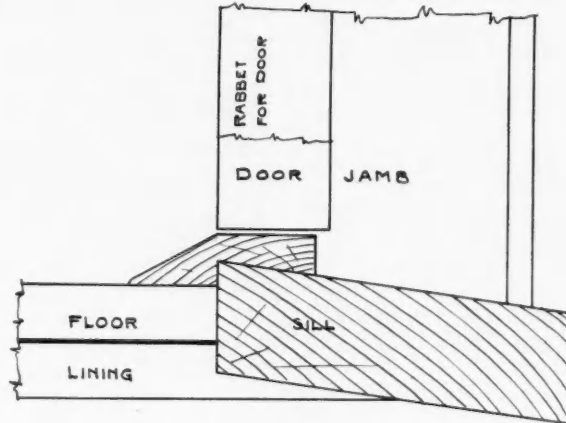

A satisfactory threshold detail.

fill up with dirt. This is not good taste and I think he will agree with me after he gives it a short trial. I always keep the threshold  $\frac{1}{4}$  inch back from the outside face of the door, as shown in sectional drawing.

W. A. JOHNSTON.



**Method of Setting Jamb**

To the Editor: Topeka, Kan.  
I was much interested in Mr. Hicks' article in the February issue on a quick way to set door jambs. I think his way is a good one; but mine is, for me, a better one, and when I say mine I do not mean that it is wholly original with me, for I have a way of appropriating any new idea whenever I find a helpful one.

When knocking the jambs together, I take a pole, say 6 feet long, and measure its exact length below the head jamb, marking it on each jamb with a sharp knife. Then I take a straight edge, and after marking on it the exact width of the opening at the top, I nail it across the bottom, taking pains to have the top of it exactly even with the marks on the jambs and also to have the marks showing the width just right.

Next, I set the jamb in place on the stud that is most nearly plumb, and instead of climbing up to level the head jamb I put the level on the straightedge, and when that is level, of course the head jamb will be level. When one side is higher than the other, I scribe both sides with my rule and both are quickly cut off. I can do it in less time than I can get the exact difference at the top. It is not necessary to make a mark to know how to set the jamb back rightly, for the straightedge is always facing me.

When top and bottom are plumb, I apply a long straight-edge and bring the middle of the jambs just even with it by using shingles.

By this method I have done a little better than three jambs an hour.

Another good way I have used, is to put a block on the floor at each jamb and rest the level on them. If the floor

(Continued on page 96)

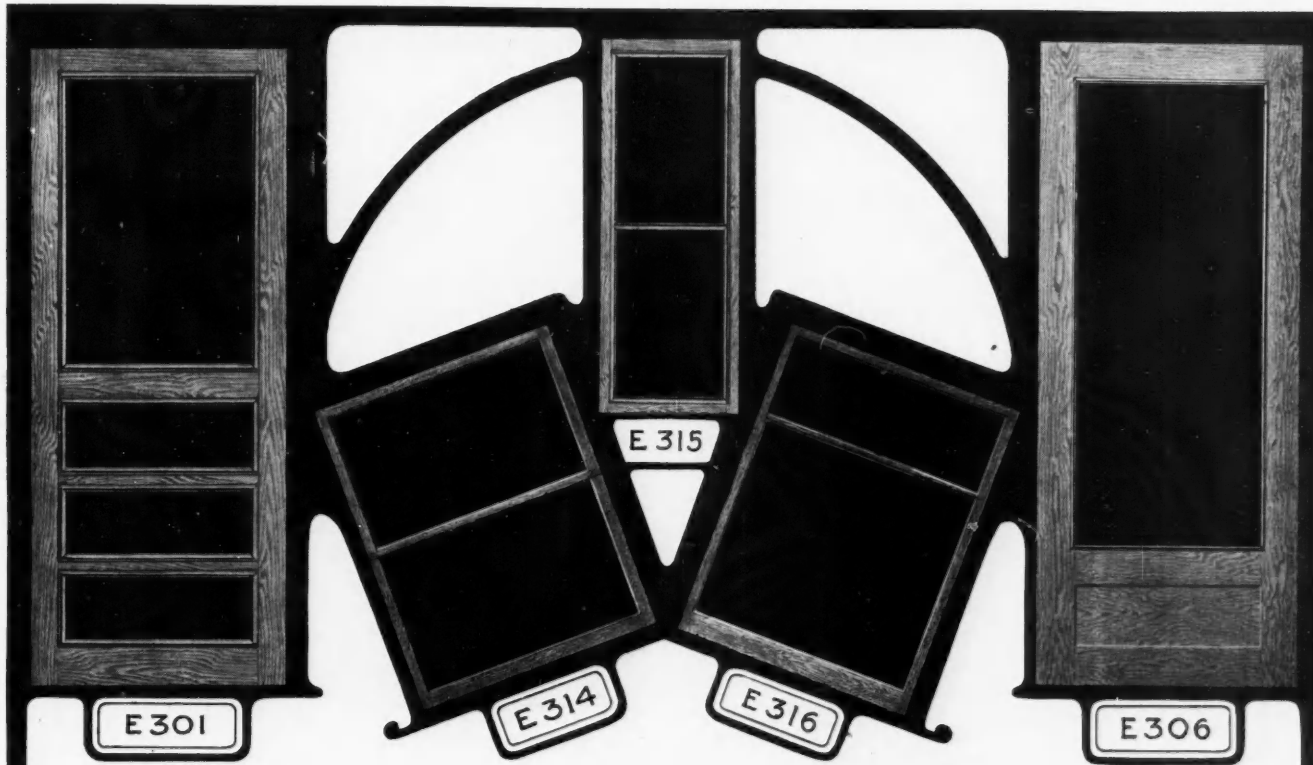

## Quick Shipment on Your Spring Screen Order

We make our screens of the very best grade of **Western White Pine** especially kiln dried.

We use three kinds of wire: Black Wire, Standard Twelve Mesh to the inch, Galvanized Wire, and Copper Bronze Screen Cloth, which last is absolutely the **highest grade screen wire cloth** ever manufactured.

We make the lowest prices in America on these quality screens. For we manufacture them in our own modern plant. We load them on the cars which are tracked into the factory. And we get the screens to you safely by fast freight. **Satisfaction and safe delivery guaranteed.**

## SCREEN PRICES!! SAVE HALF!!

**No. E 301**  
**Screen Doors**  
Planted Green, 1 1/2 inch thick  
Black Wire Cloth

	Price Each
2-6x6-6.....	\$0.90
2-8x6-8.....	.94

**No. E 306**  
**Screen Door**  
Made of best Western White Pine. Filled one coat, varnished one coat. Furnished in Bronze, Galvanized or Black Wire cloth. 1 1/2 in. thick. Side rails 5 1/2 in. wide.

ft. in. ft. in.	Black Wire	Galv. Wire	Bronze Wire
2- 8x6- 8	\$2.00	\$2.30	\$2.65
2-10x6-10	2.12	2.42	2.77
2- 8x7- 0	2.13	2.43	2.78
3- 0x7- 0	2.20	2.50	2.85

**No. E 314**  
**Screen Windows**

Glass Size	Size of Opening ft. in. ft. in.	Price w'h Black Wire	Price w'h Galvan'd Wire	Price w'h Copper Bronze
12x20	1 4 1/2 x 3 11 1/4	\$0.53	\$0.60	\$0.77
12x24	1 4 1/2 x 4 7 1/4	.59	.63	.83
12x28	1 4 1/2 x 5 3 1/4	.65	.71	.89
12x30	1 4 1/2 x 5 7 1/4	.66	.72	.93
14x20	1 6 1/2 x 3 11 1/4	.59	.65	.80
14x24	1 6 1/2 x 4 7 1/4	.62	.68	.86
14x28	1 6 1/2 x 5 3 1/4	.68	.74	.95
16x20	1 8 1/2 x 3 11 1/4	.62	.68	.86
16x22	1 8 1/2 x 4 3 1/4	.63	.69	.87
16x24	1 8 1/2 x 4 7 1/4	.64	.71	.92
16x26	1 8 1/2 x 4 11 1/4	.65	.72	.93
16x28	1 8 1/2 x 5 3 1/4	.69	.77	1.01
16x30	1 8 1/2 x 5 7 1/4	.71	.80	1.04
18x20	1 10 1/2 x 3 11 1/4	.63	.69	.87
18x24	1 10 1/2 x 4 7 1/4	.65	.72	.93
18x26	1 10 1/2 x 4 11 1/4	.68	.75	.99
18x28	1 10 1/2 x 5 3 1/4	.71	.80	1.04
18x30	1 10 1/2 x 5 7 1/4	.74	.84	1.11
20x20	2 0 1/2 x 3 11 1/4	.66	.72	.93
20x22	2 0 1/2 x 4 3 1/4	.67	.73	.97
and so on to 44x34				

**No. E 315—Screen Windows to Fit 4 and 8 Light Windows**

Glass Size	Size of Opening ft. in. ft. in.	Price Black Wire	Price Galvd. Wire	Price Copper Bronze
10x16	2 1x3 3 1/4	\$0.66	\$0.72	\$0.90
10x18	2 1x3 7 1/4	.68	.75	.93
10x20	2 1x3 11 1/4	.69	.75	.96
10x22	2 1x4 3 1/4	.71	.78	1.02
10x24	2 1x4 7 1/4	.74	.83	1.07
10x26	2 1x4 11 1/4	.77	.84	1.11
10x28	2 1x5 3 1/4	.81	.90	1.17
10x30	2 1x5 7 1/4	.84	.95	1.25
12x16	2 5x3 3 1/4	.71	.77	.98
12x18	2 5x3 7 1/4	.71	.78	.99

**No. E 316—Screen Window**

Bottom Glass	Top Glass	No. L'ts	Size of O'p'ng ft. in. ft. in.	Price with Black wire	Price with Galvan-ized wire	Price with Copper Bronze
40x40	40x14	2	3 8x5 1 1/4	\$1.47	\$1.65	\$2.16
40x40	40x16	2	3 8x5 3 1/4	1.48	1.66	2.20
40x44	40x16	2	3 8x5 7 1/4	1.55	1.75	2.32
44x40	44x16	2	4 0x5 3 1/4	1.67	1.89	2.49
44x44	44x16	2	4 0x5 7 1/4	1.74	1.97	2.50
44x46	44x18	2	4 0x5 11 1/4	1.83	2.07	2.73
44x50	44x18	2	4 0x6 3 1/4	1.97	2.22	2.91

### Write for Grand Catalog—5,000 Bargains Ready to Ship

The secret of our wonderful service for contractors is **5,000 items ready** in our warehouses. They go out in 24 hours after the order reaches us. The qualities are guaranteed far above the standards of any of the associations. We have hundreds of articles usually bought only on special order. **We keep them in stock, supply them quickly, and cut cost of building in half. WRITE FOR IT.**

# GORDON-VAN TINE CO.

692 FEDERAL ST. DAVENPORT, IOWA

is not level, the amount of variation can easily be found and one jamb cut off to that measure, thus insuring a level head jamb, and it is done without having to set the jamb in until it is ready to be nailed, care being taken, of course, to set the long jamb on the lower side of the floor and to see that the openings at the top and bottom are exactly the same width.

I indorse very strongly what Mr. Hicks says about the importance of setting good studs perfectly plumb in the first place.

H. N. POND.

### What Caused the Cracks?

To the Editor:

Wayland, Iowa.

I have a few questions I wish to ask through the correspondence department of your paper.

About three or four years ago our school house burned down, leaving a good foundation as high up as the grade line, and the 4-foot wall above grade was rebuilt with cement blocks up to the first floor joist. The outside was built up with home-made cement bricks, by the same men that made the blocks; and the walls were backed up with old clay brick from the structure that burned down. Now we notice that there is a check or crack in the brickwork outside, from the lower window to the basement window, and also the same between the second story to the first story window. This is in every window on the outside, and there is something like twenty-eight windows in each story.

On the inside of the rooms there are only five or six cracks that show. Now why does the building crack on the outside and not on the inside? Is it on account of the cement brick, and clay brick being used on the inside? There is no check or crack to be seen in the old stone foundation that remained.

Please publish this and let us have some answers to the above questions.

C. K. SCHRANTZ,

Carpenter and Builder.

### Octagon Cement Block Barn

To the Editor:

Six Lakes, Mich.

Enclosed please find \$2.00 for another year's subscription to the A. C. & B., which I find a great help to me. Also a photograph of an octagon hollow cement block barn which I



Concrete Block Barn of Unusual Design, Octagon with Gambrel Roof.

roofed for F. W. Johnson, Edmore, Mich. He laid the blocks himself. It is the only one of the kind and shape in this section of the country. If it would not be asking too much room, I would like to see you illustrate more of the brothers' forms of barn construction.

PERCY L. LOVE,

Carpenter and Contractor.



EASY TO LAY



PERFECT PORCH COVERING



MAKES RAIN NOISELESS

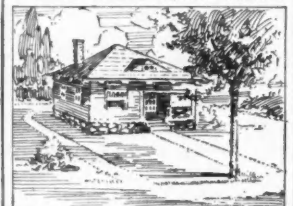

NEAT AND ARTISTIC APPEARANCE



# WHY CON-SER-TEX IS USED

## CON-SER-TEX SOLVES ALL ROOFING PROBLEMS

**WHAT IS CON-SER-TEX?** It is a canvas roofing, chemically treated to preserve the fibre from mildew and the detrimental action of the oil in paint.

**WHAT ARE ITS USES?** It is used for porch and house roofs, piazza floors, sleeping balconies, bathroom walls and floors, kitchen floors and all other places where a serviceable fabric is required.

**DOES IT DO THE WORK?** It never rots or stretches. It hugs the porch or roof surface tightly. Neat and artistic appearance. It deadens sound, is waterproof and weather-proof. Defies treading, coal gas, or any other wearing influence.

**DOES IT COST MUCH?** Con-ser-tex is very inexpensive. Cheaper than most other roofing materials. It is easy to put on—thus saving time and eliminating trouble for the carpenter.

**ANYTHING ELSE?** Yes! We will send you a sample of this wonderful fabric. A moment's investigation will show you its superiority over cotton duck and other roofing fabrics. We will also send you descriptive folder and price list.

**WM. L. BARRELL COMPANY**  
8 Thomas Street, New York

Chicago Distributor:  
Geo. B. Carpenter & Co.  
Wells and Michigan Sts.

California Distributor:  
Waterhouse & Price & Co.  
San Francisco—Los Angeles

CON-SER-TEX  
CANVAS  
ROOFING

You will get SPECIAL ATTENTION if you tell Advertisers you read American Carpenter and Builder.



# Hewitt-Lea-Funck Lumber Saved Montana Contractor \$700 on this house



Here is a specific example of the work we are doing for contractors. Andrew Espey, a prominent contractor of Ismay, Montana, asked us to help him design this house. He submitted in the rough the plan which he wished worked out. He liked the plan, and had us figure on the job. The rest of the story is told in Mr. Espey's letter of January 5th.

**Read what we did for Mr. Espey—  
we'll do just as well for you**

ISMAY, MONT., JAN. 5, 1914.

Hewitt-Lea-Funck Company, Seattle, Wash.

Gentlemen:—We unloaded the lumber out of the car. As far as this lumber is concerned, we couldn't buy such lumber in this town, and as for the saving, we saved about \$700.

Yours respectfully, ANDREW ESPEY.

*Read his letter*

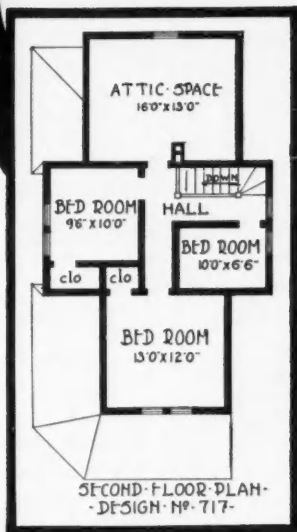
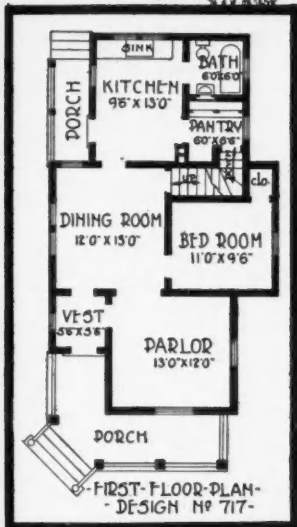

## Double your profits

**Good plans at small cost** Study this plan carefully—it shows what we can do for you. You or any other carpenter can tell that this house is laid out without a square inch of waste space. The man who builds this house gets full value for every cent he spends. There are a hundred good plans in our Plan Book—houses costing \$750 to \$3500. You're sure to find in the book one or more that will just suit a customer of yours. Our architects will draw special plans at the small charge of \$1.50 per room. Six room house will cost you but \$9.00. This includes complete blueprints, specifications, and guaranteed quotation covering cost of all material. Charges made for special plans are refunded when materials are ordered. Ask for copyrighted plan sheet, it will help you. It's free.

**Save up to 60% on your lumber** Mr. Espey's lumber order, delivered Ismay, amounted to \$976.60. The best local bid was \$700 higher.

This shows the kind of a saving you can make. *We sell you direct* from our mill, which is supplied with timber from tracts under our control.

*You save the middlemen's profits* and get lumber guaranteed to grade better than standard. You get prompt delivery, too. We get shipments out inside of 48 hours. Time for delivery averages under two weeks to points West of the Mississippi.

### Mail coupon today for Plan Book and Price List

You've been intending for some time to look into Hewitt-Lea-Funck's proposition—you've wondered how much money you could save by ordering lumber from us, you've wondered how the quality of the lumber they ship would compare with the lumber you're getting. *Look into this proposition now*—get the extra profit that buying of us means, on your spring and summer jobs of 1914. Right now, this minute, take your pen or pencil, fill out the coupon below and send it along to us with ten cents to cover cost of mailing the Plan Book. At the same time, send along the jobs you're figuring on, for GUARANTEED ESTIMATE.

**HEWITT-LEA-FUNCK COMPANY,** 408 Crary Building  
Seattle, Wash.

**Hewitt-Lea-Funck Co.,**

408 Crary Bldg., Seattle, Wash.

(Be sure to write plainly)

Please send me at once:

- New Book of Plans (ten cents enclosed).
- Catalog and General Price List of Lumber and Millwork. Free.
- Special Silo Proposition. Free.
- Copyrighted Plan Sheet. Free.

Name \_\_\_\_\_

Town \_\_\_\_\_

R. F. D. or Street No. \_\_\_\_\_ State \_\_\_\_\_

### Can you sell

**a better silo at a saving up to 60%**

Of course you can! Why not do it then? There's big money in silos, and orders are easy to get with the Seattle Silo. Made of famous one-piece Puget Sound fir, and equipped with patented swinging doors—the finest of their kind. Write for our special silo proposition to you.

You will get **SPECIAL ATTENTION** if you tell Advertisers you read American Carpenter and Builder.



## MORGAN DOORS

are the doors the contractor and builder requires for his own handsome bungalow. His home must bear out his experience and house wisdom with the supreme excellence in *doors* as well as in all other house features.

Every genuine Morgan Door carries the name "Morgan" on the top rail as a guarantee of detail perfection. The highest door standards of design, stability, and economy are shown in Morgan stock styles and sizes. They simplify selection, estimating, delivery and service. They are appreciatively pictured and described in our *free* book, "The Door Beautiful." Mailed to your address on request.

Architects see Sweet's Index, Pages 1004 and 1005.

**MORGAN SASH & DOOR COMPANY, Dept. C-28, Chicago, U. S. A.**

**FACTORY:**  
Morgan Company, Oshkosh, Wis.

**DISTRIBUTED:**  
Morgan Millwork Co., Baltimore, Md.

**NEW YORK OFFICE:**  
6 East 39th St., New York City

You will get **SPECIAL ATTENTION** if you tell Advertisers you read American Carpenter and Builder.

**Moved 175-Ton Steel Bridge**

To the Editor: Sparks, Kan.  
 I am sending you a photo of a bridge I built in this place last winter. And, on account of the drainage people changing the river, we had to move the bridge about 1,000 feet after we had it finished. You can see what kind of a job it was. We jacked it up onto four sets of railroad trucks and moved it along on double tracks; stopped at place ready to take the trucks out, and let it down. The picture shows one end just as we shoved the trucks out. The master carpenter, F. E. Kulp, stands on the left side of the men, and the fourth man from him is the pile-driver foreman, and the seventh man from the end is steel-bridge foreman, T. Hutson.



**Large Steel Railroad Bridge Successfully Moved About 1,000 Feet on Railroad Trucks.**

This span is 176 feet long and 30 feet high. It weighed about 175 tons. I used one 50-ton jack and one 25-ton jack on each corner.

I am sending this card as some of the brother carpenters might like to see what some of the brothers are doing to pass the winter months. T. HUTSON.



**To Find the Length of Side**

To the Editor: Darden, Tenn.  
 I am a reader of your paper and think it the finest of its kind on building I have ever seen. I would not do without it for double its price.  
 Since you are willing to answer questions, I have one to ask. How can I find the length of the sides of polygons? I know how to get the miters after I get the sides, but can you give me a rule that will solve all of them?

E. T. MAXWELL,  
 Contractor and Builder.

Answer: To know the miter and what determines it is the key to the whole situation. We have gone over this a great many times in the past and cannot give space this time to go into the whyfores of the case.

Briefly, here are the figures to use on the steel square for the miters, as follows:

Triangle, 12 and 20 19/24; square, 12 and 12; pentagon, 12 and 8 17/24; hexagon, 12 and 6 11/12; heptagon, 12 and 5 19/24; octagon 12 and 4 23/24; nonagon, 12 and 4 3/8; decagon, 12 and 3 11/12; undecagon, 12 and 3 1/2; dodecagon, 12 and 3 5/24. We trust we have gone far enough to suit most any one. The latter figures in each case will represent the side of steel square on which to make the cut. These figures also represent the length of the side of the polygon to each foot of its inscribed diameter.

Read our regular offering this month, under the head of "The Steel Square," and pick up the relative parts in this and that in the framing of the roof and it will be seen that the miter furnishes the foundation upon which to build the whole fabric contained in the roof. A. W. WOODS.



*Finished with Bridgeport Standard Wood Finishing Products.*



possess certain qualities peculiar to themselves which enable them to bring out the grain and figure of even the most inexpensive woods, such as pine and cypress, in a manner almost past belief; while on the more expensive woods, such as mahogany, walnut and chestnut, they give a charm and richness which must actually be seen to be appreciated.

Leading architects, decorators, painters and contractors unhesitatingly rate Bridgeport Standard Wood Finishing Materials as the most practical, durable and economical.

*Our finely-illustrated book, "Modern Wood Finishing," is an interesting treatise on the finishing of woodwork. Simply write your name and address on the margin of this ad. and mail it to us.*

SOLE MANUFACTURERS  
**THE BRIDGEPORT CO.**  
 WOOD FINISHING  
 NEW MILFORD, CONN., U.S.A.

EXX 105.  
 NEW YORK CHICAGO BOSTON

**You will get SPECIAL ATTENTION if you tell Advertisers you read American Carpenter and Builder.**

### A Stair Building "Secret"

To the Editor:

Chicago, Ill.

The man I coaxed this from is an experienced stair builder, who seriously stated that this method is a "Stair Builder's secret." I sincerely hope my betrayal does not put me in

bad with that worthy faculty; here it is: With stringer straight and pressed close to wall, mark along edge of all nosings. Cut treads back flush with face of riser so that stringer will slip in, and fasten temporarily as close to stairs as possible.

Cut two sticks, one to exact tread length (from face to face of riser) and one to exact height of riser. Using tread length, mark along the front of each riser. Move up stringer one thread so that these lines are plumb over the face of riser they are to fit against. Using riser length, mark along top of each tread. Cut and nail in place.

FRED BRIGGS.

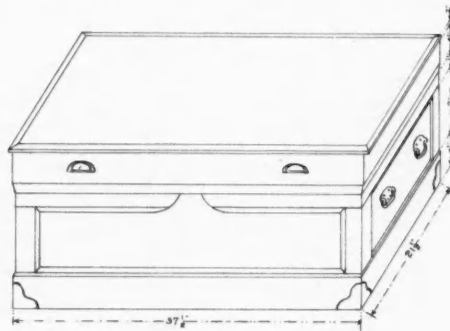

FIG. 1

General view, plan view and detail of convenient tool chest.

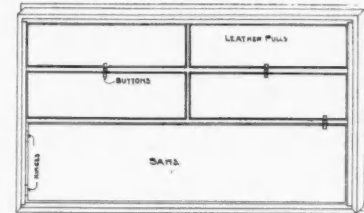

FIG. 2



FIG. 3

Fig. 3. The cover is hinged on the end, thus allowing access to all parts; more like a cabinet than a tool box. The drawers are held in place by buttons and provided with leather pulls. I used three hinges to fasten cover to chest, two on the apartment for saws and two handles on each end of chest,

### Bulemore's Tool Chest

To the Editor:

Medina, N. Y.

Enclosed you will find a sketch of a tool chest which I designed and built for my own use. It measures 18 by 34 inches, with a depth of 13 inches for the chest and 4½ inches for the cover.

It is constructed of red wood, filled, shellaced and varnished. It has four drawers for chisels, bits, chalk, small packages of nails, screws—in fact, anything of that nature.

The best of all is the receptacle for saws, as shown in

which makes it more convenient for carrying.

I hope this will be worthy of a place in your paper and prove of interest to brother carpenters.

FRED BULEMORE.

### Prefers Slow Acting Spirit Glass

To the Editor:

Morrisburg, Ont.

I take exception to one point in I. P. Hicks' article on how to set door frames quickly. On the whole, it is good, but there is one very weak point.

He says to select a quick-acting level. That is wrong. I

## Your Client's Houses Can Be Heated at a Saving of 20 to 30%

Engineering tests prove that, at \$4.00 a ton, it costs \$154.00 a year for coal to deliver steam through 500 sq. ft. of pipe covered with ordinary air-cell covering; whereas the same heating effect can be produced for \$113.50 (a saving of nearly 26%) where the pipes are insulated with J-M Asbestocel Pipe Covering.

This is universally acknowledged to be the most efficient covering for medium or low pressure steam and hot water heating systems because it confines the largest amount of "dead air." And "dead air" is the greatest known insulator.

## J-M Asbestocel Pipe Covering

is made of corrugated asbestos felt built up on the arch principle—see illustration. The air cells run around the pipe, forming a series of *sealed rings* of "dead air." In ordinary air-cell coverings the air cells run *lengthwise*, allowing free circulation of air and consequent radiation of heat.

This arch construction also makes J-M Asbestocel stronger than other coverings. It will not break or crush down under weight and successfully withstands vibration and hard usage. Can be removed and replaced without injury.

Write Our Nearest Branch for Sample and Booklet

## H. W. JOHNS-MANVILLE CO.

Manufacturers of Asbestos Shingles; Roofings; Stucco; Pipe Coverings; Cold Storage Insulation; Waterproofing; Sanitary Specialties; Acoustical Correction; Cork Tiling; Fireproof Doors, Etc.

Albany	Boston	Chicago	Cleveland	Detroit	Louisville	New York	San Francisco
Baltimore	Buffalo	Cincinnati	Dallas	Indianapolis	Milwaukee	Omaha	Seattle
				Kansas City	Minneapolis	Philadelphia	St. Louis
				Los Angeles	New Orleans	Pittsburgh	Syracuse

THE CANADIAN H. W. JOHNS-MANVILLE CO., LIMITED  
Toronto Montreal Winnipeg Vancouver 1915

You will get SPECIAL ATTENTION if you tell Advertisers you read American Carpenter and Builder.

## Bringing Down 100,000 Tons of ALPHA Cement Rock

This picture was taken at the Martin's Creek (Pa.) ALPHA plant at the time of firing 10½ tons of dynamite loaded in thirteen 6-inch holes bored 170 feet deep, down the entire face of the quarry. One hundred thousand tons of the finest cement rock were dislodged by this blast.

This rock has just the proportions for a perfect Portland Cement.

In every ALPHA plant there is the same rigid testing of every boring and the same careful mixing of the rock. Inspections of the product are made hourly, day and night, no matter whether the purchaser is to make his own private test or not.

ALPHA chemists and chemical engineers are real bosses.

In composition, thorough burning, fine grinding, and correct aging, ALPHA Portland Cement represents the high-water mark of quality. Every bag of ALPHA is warranted to more than meet the standard specifications.

Six great plants on six trunk-line railroads—one plant with private docks directly on the Hudson, a daily capacity of 25,000 barrels and storage for 2,000,000 barrels, enable us to render "ALPHA Service" that is on a par with the high quality of ALPHA Portland Cement.

*Send for ALPHA Book No. 10*

### ALPHA PORTLAND CEMENT CO.

General Offices: Easton, Pa.

Sales Offices: New York    Chicago    Philadelphia    Pittsburgh    Boston  
Buffalo    Baltimore    Savannah

### Specify ALPHA and be Sure



You will get SPECIAL ATTENTION if you tell Advertisers you read American Carpenter and Builder.



PLAIN AND NEAT  
IT IS TRIMMED WITH  
MIDLAND STOCK TERRA COTTA

STOCK TERRA COTTA  
WITH  
REAL ARCHITECTURAL  
BEAUTY

NOT DESIGNED BY THE  
ANCIENT GREEKS AND ROMANS BUT  
NEW, UP-TO-DATE, PRACTICAL  
WE HAVE IT  
WRITE FOR OUR PORTFOLIO AND SEE

**MIDLAND  
TERRA COTTA  
COMPANY**

1120 CHAMBER OF COMMERCE  
CHICAGO

You will get SPECIAL ATTENTION if you tell Advertisers you read American Carpenter and Builder.

wish to tell my friend that its quick action shows its imperfection. The glass is warped in cooling when made, and the belly side has been put up in the level, which caused it to take the center quicker.

The last time I wanted a glass for level I visited four towns and examined over one hundred glasses before I got one that was perfectly straight. I repeat that a quick-acting level is caused by its imperfection.

B. S. WICKWARE,  
Builder.



### How To Make a Strong Door

To the Editor:

Red Lake Falls, Minn.

Here is a barn door hung with hinges and shows the way I usually construct the frame of the door. The main thing I wish to bring out is the extension of the brace to the outer edge of the door and by placing the 6-inch flooring up and down, the brace will help the cross-piece at the top and bottom in holding the flooring straight. I also use 1 by 8-inch stuff on each side of the door. This makes the frame more attractive and much stronger. Besides, it furnishes an excellent place to set the hinges and lock. A good double coat of paint should be applied to both sides of the door, so that

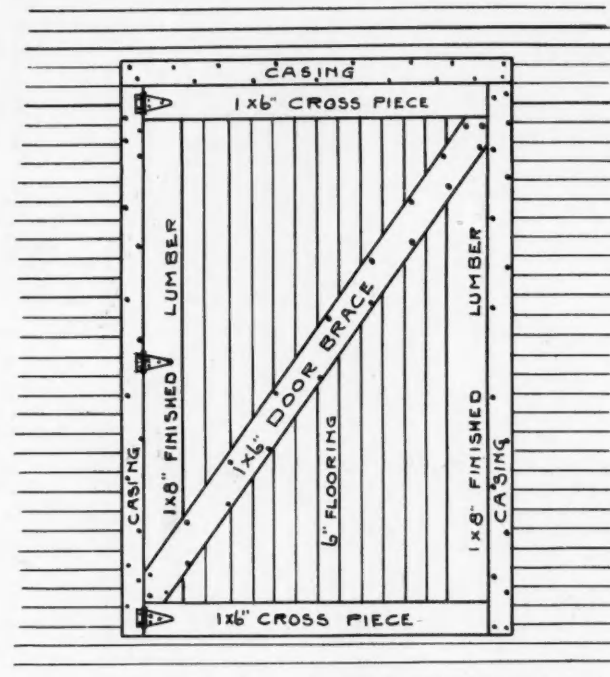

This door warranted not to break or sag.

the dampness from either side cannot enter the wood and cause same to swell. If not painted on the inside, the dampness will settle on the door and the sun draws the door on the outside, thereby causing same to warp more or less.



F. E. MILLER.

### Setting Door Jambs and Fitting Doors

To the Editor:

White Lake, S. D.

I have read the AMERICAN CARPENTER AND BUILDER for some time and have never before offered any information. Here is my method for setting door jambs and fitting doors, which may interest some brother carpenter.

I true up the jambs on bench, allowing an inch for hinge on the side I want the door to swing from. As we have been using half surface butts, I use a butt mortiser attached to common chisel, making a much faster and a better job than can be done with just a chisel. I tack a straightedge across the jamb 12 inches from the bottom, to see if the jamb



**Y**OUR clients will thank you for specifying Kellastone Imperishable Stucco as an exterior covering for their buildings. They'll thank you, not only because of its remarkable beauty and attractive appearance, but because of its lasting, weatherproof qualities. Long after other stuccos have cracked and peeled and crumbled to ruin, your Kellastoned building will remain in all the beauty and attractiveness of the day it was finished—a monument to your judgment and abilities as an architect or builder.

# KELLASTONE

## IMPERISHABLE STUCCO

contains no Portland cement or lime. It possesses such remarkable tensile strength and adhesive qualities that it will successfully cling to stone, brick or wood.

Kellastone hardens like stone and yet possesses an elasticity that enables it to "give" with the settling of the building to a far greater extent than ordinary stuccos, without cracking, chipping or peeling off.

It is a non-conductor of heat, cold and dampness. It is fireproof and commands a very low rate of insurance. It never requires painting and retains its beauty indefinitely, thus eliminating a definite, annual up-keep expense. Your clients will appreciate these qualities.

Many beautiful and artistic finishes, such as "Splatter Dash," Stipple, Sponge, Pebble-Marble and Crown Point Spar-Dash, can be produced with Kellastone. It can be applied rough cast or smooth finish to new or old buildings. The added beauty and attractiveness it imparts to any building always has a cash value to the owner in increased rentals and selling price.

As an interior finish, Kellastone has no equal. It eliminates those unsightly cracks that are always bound to appear in

plastered rooms when the building settles. It can be tinted, stenciled, painted or papered without injury to colors or fabric. For the wainscoting, and, in fact, the entire surface of kitchen and bath room, Kellastone has no equal. It will resist steam and dampness without the least damage.

### KELLASTONE COMPOSITION FLOORING

forms a sanitary, serviceable and beautiful floor for Hospitals, Schools, Banks, Hotels, Restaurants, Institutions, Office Buildings, and for bath rooms, kitchens, etc., in private homes. It is waterproof, fireproof and abrasion proof.

The fact that many of the most representative Lumber and Building Material Dealers in every part of the country are contracting for the exclusive sale of Kellastone in their respective cities is, in itself, ample proof of its quality and popularity.

You, as an architect or contractor, owe it to yourself and your clients to become thoroughly acquainted with Kellastone. We have a new catalog that graphically describes its beauties and merits. May we send you a copy?

**THE NATIONAL KELLASTONE CO. Dept. 4, 19 South La Salle St., CHICAGO, ILL.**

You will get **SPECIAL ATTENTION** if you tell Advertisers you read American Carpenter and Builder.

needs to be cut so that it will square up. This is better than trying to level with head of jamb. On this straightedge I leave an extension of 4 inches on each side of jamb, so when I get the jamb where I want it I can tack it to the studding and it will stay until I can true it up and nail jamb in place. I always fit my door to jambs before I case them, as I think it is much easier and faster than trying to fit doors after the casing is up.

If some other brother has a better way, I would like to hear from him through the AMERICAN CARPENTER AND BUILDER.

L. W. WOODWORTH,  
Contractor and Builder.

**Going After the Mill Man**

To the Editor: Knob Noster, Mo.

It seems the proper thing for nearly every one, at some time or other, to take a shot at the mill man. Now, there is one of his faults that has caused me considerable annoyance at different times. As far as I know, his attention has never been called to it, through the building journals. It is this:

Almost invariably when I have used window frames from the mill, I have had trouble in setting the sash, because they fail to leave any clearance. Now, every one knows, or ought to, that if a sash is 1 3/8 inch thick, it will not work unless the sash-way is a little more than 1 3/8 inch. It frequently happens that a little allowance is made here, but it ought to be equally plain that if a sash is 2 feet 4 1/8 inches wide the frame should be a little wider. But whoever heard of a mill putting out a frame any wider than the net width of the sash? (They often make them narrower.) I have often had to cut the sides of the sash until it became necessary to recut the grooves. Why will the mill man persist in making frames this way, when it is just as easy to allow a

little play and save the carpenter a great deal of unnecessary work? When I make my own frames, it is only about half as much work to fit the sash.

Here are two sketches showing the right way and the wrong way of making the check rail of an ordinary window. Fig. 1 shows the right way, and Fig. 2 the way it is usually done. Any mechanic will see at a glance the advantage of Fig. 1, as one saw cut lets the plug fall out so that it will fit the parting stop without any ripping or chiseling.

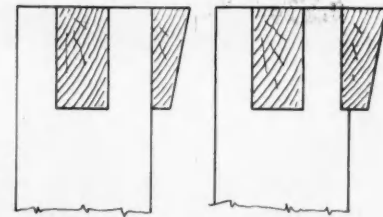

FIG. 1 FIG. 2  
Sections through window check rail.

SAMUEL W. WENGER.

**To Scribe the Stringer to Stair**

To the Editor: Brazoria, Texas.

Mr. Pagan has made me feel like breaking into the family. He wants to know how to scribe and fit a string board over treads and risers in place. Well, Alex, I will say, first, that an expert stairman would hardly plead guilty, but if such a case should turn up in the way of repair work, I would tackle the job in the manner given below:

Since a method of cutting around the nosing of treads would, under the circumstances, require too many lines, which would make my explanation look like a geometrical puzzle, I will give the next best method. Saw out the nosing of all treads so as to form a correct corner in line with tread and riser, as shown in Fig. 2.

Fig. 1 gives an idea of how stringer should slip in between wall and projecting nosing of tread.

# Going to Build Remodel or Repair?



**Building Material Catalog**



**House and Barn Plans**

**These Two Great Books Will Reduce Your Building Expenses**

Everything you need in lumber, millwork, hardware, roofing, paint, etc., is quoted in the Building Material Catalog at factory prices. Why pay high prices when you can buy direct from us, save money, get prompt deliveries and highest quality material?

Our Plan Book shows views of some of the most attractive houses, bungalows, summer houses, barns and garages ever built for the money. It also shows how you can obtain floor and elevation plans free.

Thousands have bought of us and saved money. Why not you? Get the books and see what this means to you. I will quote prices on all material needed, freight paid to your city. Everything guaranteed

Get our Prices on  
**PAINTS, SCREENS**  
and other reasonable goods  
We can save you money

to be brand new—no wreckage. Everything guaranteed to satisfy you or your money back. I will give you new ideas on floor plans, finish, panel and glass doors, windows, exterior and interior trim, paint color schemes, etc.

Building Material Catalog is **FREE**. If Plan Book is also wanted, send 10c to cover cost of postage and mailing. Write today.

H. B. MUNGER,  
President



**CHICAGO MILLWORK SUPPLY CO.**  
AMERICA'S GREATEST SASH AND DOOR HOUSE

1422 West 37th St., CHICAGO, ILL.

You will get SPECIAL ATTENTION if you tell Advertisers you read American Carpenter and Builder.



# SEND TODAY FOR SPECIAL ALADDIN BUILDER'S PLAN

## One Aladdin Carpenter in Each City

The great Aladdin Carpenter's Plan is going to many cities near you. Only one carpenter selected for each city. You should hurry the coupon to us and be sure of getting a direct benefit from the Aladdin Advertising Campaign that covers practically every country in the world. **There is absolutely no cost to you**—merely send in the coupon. This protects you—gives you the first chance to become the Aladdin Contractor for your city and doesn't hinder your regular line of business.



## Many Towns "Closed Up"

Aladdin Carpenters have been appointed in a great many cities. Applications are coming in every day. When your coupon is received, and we accept you, the territory or the town is marked "Closed Up." Why not "Close Up" your city today by sending in the coupon with your name signed to it? Don't wait until it is too late—the other fellows may be writing to us now.



## Increase Your Business 50%

You can get all the Aladdin business in your town without cost, without advertising, if we accept your application. Aladdin Read-Cut Houses will come to your city this year; do you want to build them, increase your business, building new houses without interfering with your regular work?

## Biggest Aladdin Year

Year 1914 will be the greatest in our history. The Aladdin advertising campaign has been greatly enlarged. Orders are pouring in daily. Extra equipment has been added to our mills in order to meet the large amount of work. We want you to help us handle this great increase in business.



## Better Lumber in Aladdin Houses

One dollar for every knot any customer can find in our Red Cedar Siding, shipped from Bay City, is the Aladdin guarantee. Better lumber is furnished for every Aladdin Read-Cut house than found elsewhere. Clear Siding, Clear Flooring, Clear Interior Finish, Clear Shingles are furnished for every Aladdin Dwelling House. Home builders demand better lumber and want Aladdin Houses. No other concern offers the lumber guarantee that is given to Aladdin customers. That is why more Aladdin Houses will be sold this year, than all others combined.

## 5-Room House \$298

To show you the low cost of Aladdin Read-Cut Houses, we have here pict-

ured a five-room Aladdin Read-Cut House, complete for \$298. Price includes everything necessary to build. All lumber cut to fit, windows glazed, lath and plaster or plaster board, hardware, nails, locks, paints, and varnishes for two coats, inside and outside—in fact, everything needed to build.

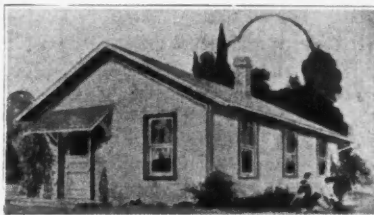

Send Today

## Orders Coming in for Spring Building

Orders are coming in every day; many are now in our hands. This means work for carpenters. Brand new houses from 5 rooms to 12 rooms, every piece of material in every house measuring up to the Aladdin quality standard.

Cut out the coupon, sign your name and get full particulars today. This Aladdin offer to carpenters closes as soon as an Aladdin carpenter is appointed in your town. Send the coupon today.



**North American Construction Co.**  
990 Aladdin Avenue Bay City, Michigan

North American Construction Co.  
990 Aladdin Avenue, Bay City, Mich.

Send me your Special Carpenter's Plan with full information as well as your Catalog No. 99X of houses and floor plans.

Name .....

Street .....

City .....

State .....

You will get SPECIAL ATTENTION if you tell Advertisers you read American Carpenter and Builder.

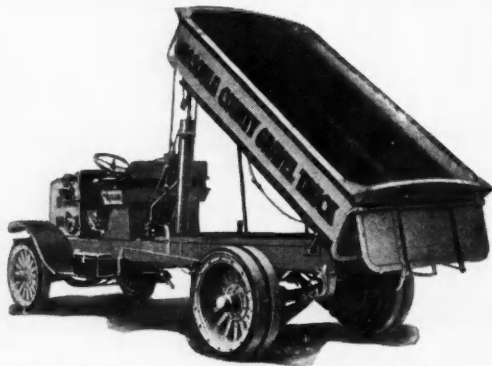

This truck is operated by the County of Missoula, Montana, in hauling material for road construction.

## KesselKar Truck with hydraulic dump body

The patent hydraulic KesselKar dump body shown is used with remarkable success in meeting the transportation requirements of contractors and builders, who measure time in dollars and cents.

It is one of the many KesselKar Truck models that are making money for men in your business.

KesselKar Trucks are good trucks, strong, simple, economical in fuel and tires and responsive to every demand. In more than two hundred lines of business they are being used with the utmost satisfaction to owners.

They are built by a corporation that is here to stay; one which will stand the most rigid inquiry as to its integrity and resources.

### KesselKar Service

KesselKar Service is a definite, specific service **written into the sale**. There is no chance for misunderstanding—the guarantee covers everything plainly.

There are six capacity sizes in KesselKar Trucks—1500 lbs., 1, 1½, 2½, 3½ and 6 tons. Bodies to suit requirements.

**SEND FOR ILLUSTRATED PORTFOLIO**

### KISSEL MOTOR CAR CO.

546 Kessel Avenue HARTFORD, WISCONSIN

Boston, New York, Chicago, Kansas City, Milwaukee, Minneapolis, St. Paul, San Francisco, Oakland, Los Angeles, Dallas and 300 other American and Canadian points.

# KISSELKAR TRUCKS

Now, set the board that you wish to scribe and let it rest on as many corners as a straight edge will rest and temporarily fasten same while the scribing act is being done. Next plumb up carefully all corners or points B and line B B (see Fig. 2) on board. Next find greatest rise and scribe line A parallel with tread intersecting plumb line B B. This will give correct cut to fit tread.

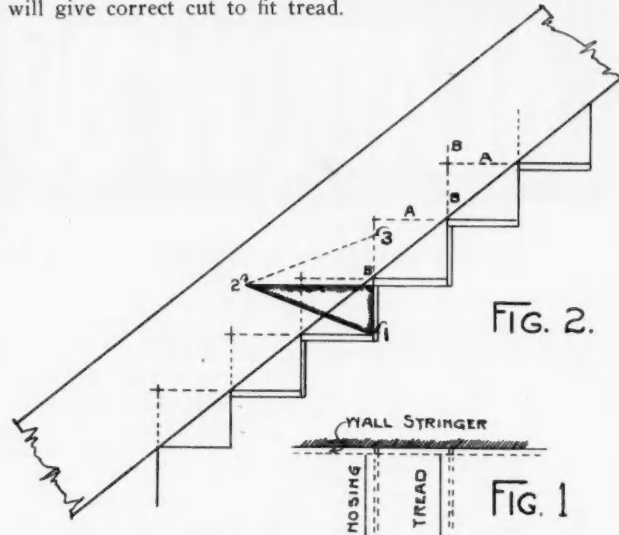

Expeditious method for laying out stair stringers.

Now use a pitch-board, 1, 2, 3, as shown in Fig. 2, holding the same firm against riser and scribe line 1-2 on the stringer. After all of the risers and treads have been scribed, we are ready to place the stringer on the trestles and by using a steel square, we place the blade exactly on line 1-2 and slide along until the tongue of the square intersects line A and B B. This will give correct cut to fit riser, provided the pitch-board used is perfectly square angled.

Now, since I have myself going, and at the possible risk of bringing down the house, I am going to draw attention to another method of stair building extensively used. This consists of nailing riser to rough horses, cut out run and rise on stringer, nail into place, wedge risers to conform to cuts and fit treads with butt joint to stringer—and there you are. You will perhaps be miles away by the time results appear.

F. W. STORCK.



### Large Iowa Corn Crib

To the Editor:

Meservey, Ia.

This picture shows the size and style of corn crib and granary built in this neck of the woods. The size is 32 by 29 feet with a 13-foot driveway.

H. E. SNEDEKER.



Double corn crib, 32 by 29 ft., with central driveway 13 ft. wide.

You will get SPECIAL ATTENTION if you tell Advertisers you read American Carpenter and Builder.



**\$1,650**

Chassis with  
Driver's Cab.  
Body Extra.

Your choice of wheel  
base—130 inches  
or 146 inches.

**REO MOTOR  
TRUCK CO.**

LANSING, MICHIGAN

Builders and contractors have found Reo Motor Trucks not only save money in the hauling of all kinds of materials, but earn dividends by cutting out costly delays in the transportation of lumber, brick, tile, cement, etc.

With a Reo Truck "on the job," your men are never kept waiting for necessary materials. It furnishes a safe, sure and economical means of supply to every job on which you are working.

In any line of industry where speed and low cost of hauling count, Reo Motor Trucks have won the enthusiastic endorsement of business men. If you want to cut costs in delivering your goods, "you can do it with a Reo."

Here are a few of the features that have given the Reo its position of leadership in the two-ton field:

Sectional radiator, of 24 separate, interchangeable units; motor, clutch and transmission cushioned on a sub-frame, away from jars and road shocks; left side drive

and center control; big armored front frame; demountable driver's cab; gas lights and Prest-O-lite tank, and every other constructive refinement suggested by the best engineering practice.

While the price of 54 competing trucks averages \$2,701, the REO Two-Ton Truck sells for \$1,650, chassis only, with driver's cab; body extra. You can have any style body to suit your individual requirements.

Reo dealers everywhere, ready to give Reo service.

Send for the REO Truck catalog, and let us give you some expert advice on the subject of hauling.

You will get SPECIAL ATTENTION if you tell Advertisers you read American Carpenter and Builder.

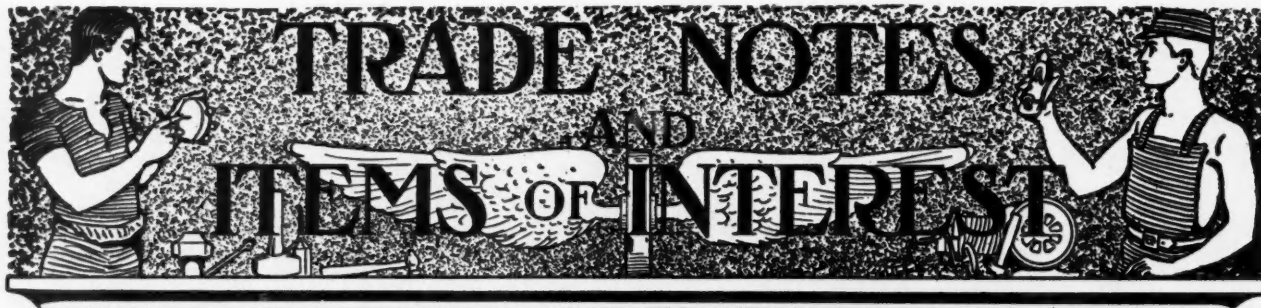

Through this department the editors aim to keep builders, contractors, carpenters and architects in touch with what their friends, the manufacturers, are doing for them in new or improved tools and machinery, methods and materials—pertaining to building. Items for these columns must have real news value; they are offered here as interesting information for our readers; they are not advertising. No matter will be printed here simply because some advertiser wishes it. Likewise, no matter will be excluded simply because the article described is not advertised in this magazine. Suggestions for the betterment of this department are requested of our readers.

### Ideal Co. Offer Improved Mixer

Users of concrete mixers, both contractors and cement products plant operators, will be interested in the new type "B" batch mixer just brought out by the Ideal Concrete Machinery Company, 1308 Monmouth Ave., Cincinnati, Ohio.

The improvement on this mixer is that they equip it with scraper blades in addition to the shovel-shaped paddles. These blades keep the machine clean; and setting the shovel-shaped blades away from the drum about 1 inch does away with any chance of large aggregate or stone getting wedged between the shovel-shaped paddles and the drum. This arrangement also requires less power.

This type "B" machine is preferred because it is open drum, easily cleaned, and the shovel-shaped paddles thoroughly mix the materials.

It is furnished in four styles—either with gasoline engine mounted on same base, or alone without engine, and either

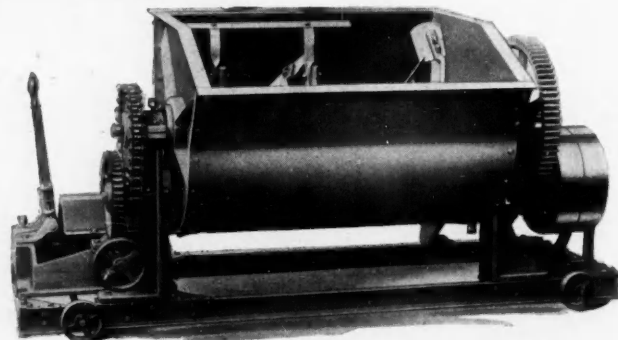

New Ideal Type "B" Batch Mixer with Power Dump.

with power dumper or with hand dumper. This mixer has tested out O. K. for both wet or dry concrete mixing, for mortar mixing and for stucco or hard wall plaster mixing.



## A PAINT LESSON

TO a paste made of white lead and water, add linseed oil and stir.

Watch the oil drive out the water. Presto! an oil paste instead of water paste.

It's the remarkable affinity between Dutch Boy White Lead and Dutch Boy Linseed Oil.



White lead and water, with layer of linseed oil.



Mixture of white lead, linseed oil and water.



Water poured off, leaving white lead and linseed oil.

What chance has rain or snow to dissolve paint made of materials whose very nature is to hold fast together?

Do you want to know more about durable Dutch Boy White Lead Paint? Get a copy of our folder telling how to estimate the quantity of material needed and giving 39 color combinations for interior and exterior work. Sent together with specifications for painting wood, brick, cement plaster and metal, for a two-cent stamp. Ask our nearest branch for Folders B.

*Dutch Boy White Lead—white in the keg—any color you want to make it on the house.*

### NATIONAL LEAD COMPANY

New York  
Cincinnati

Boston  
Cleveland  
(John T. Lewis & Bros. Co., Philadelphia)  
(National Lead & Oil Co., Pittsburgh)

Buffalo  
St. Louis  
Chicago  
San Francisco

You will get SPECIAL ATTENTION if you tell Advertisers you read American Carpenter and Builder.

# I WANT BUILDERS and CONTRACTORS



to Send for My **FREE 1914 Catalog**

*“A New Way to Buy by Mail”*

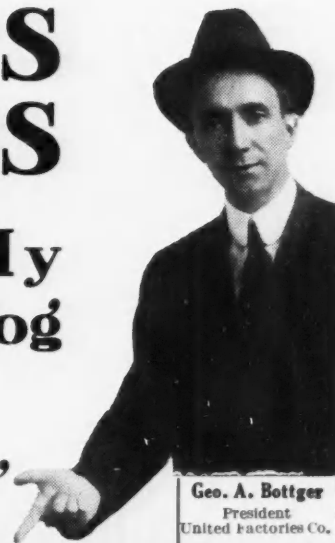

Geo. A. Bottger  
President  
United Factories Co.

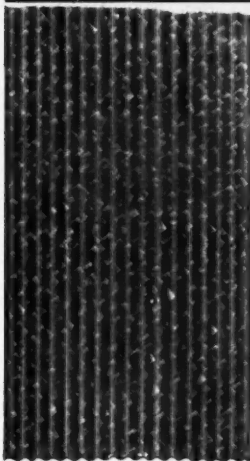

Write for Prices on Metal Roofing

Flexible Shingles in Rolls

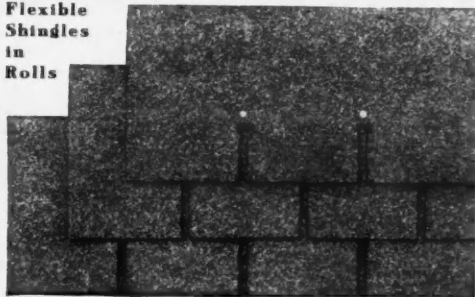

GRAINED WALL BOARD

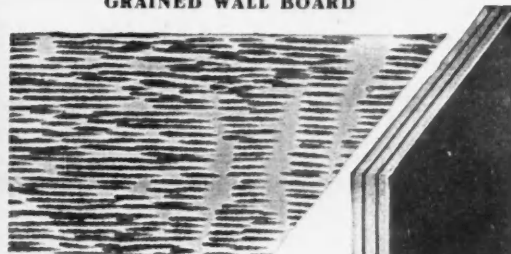

## See the Goods Before You Pay Try them 30 days Before You Pay

I want you to get my prices on Corrugated Roofing and Metal Roofing, Flexible Shingles, Grained Wall Board, Ready Roofing, Metal Tile, Plain Wall Board, Paints, Gasoline Engines, and many other items of interest to contractors and builders.

If you want to save money, let me figure on your estimates and quote you prices. I will positively ship the goods ordered, same as samples furnished.

### No C. O. D. - No Deposit - No Papers to Sign

Any responsible builder or contractor can get all the materials he needs direct from our factories on the above terms. See the goods, test them—if not satisfactory and as represented, return at our expense.

### Write for the FREE Catalog

You will not only be interested in our building materials, roofing and paints, but also in our other lines—all fully guaranteed—all sold on the most liberal and fair terms ever offered. All we ask is an opportunity to show you that we can save you money. Write us NOW, while the matter is fresh in your mind.

GEO. A. BOTTGER, President

**The United Factories Company**  
The United Factories Bldg., CLEVELAND, OHIO



Challenge Ready Roofing, Per Roll 90c.

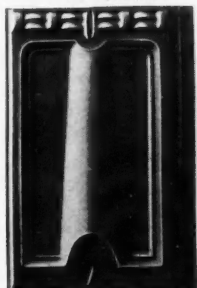

Metal Tiles

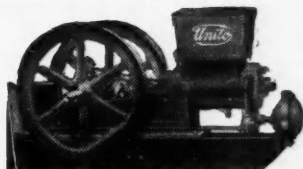

Unito Air-Cooled Gas Engine, Guaranteed for Five Years, 1½ horse power... \$24.75  
Unito Water-Cooled Gas Engine, 1½ horse power... \$27.75  
Other sizes in proportion. Write for full description.



Paint Color Cards FREE

Get Our Estimates

You will get SPECIAL ATTENTION if you tell Advertisers you read American Carpenter and Builder.

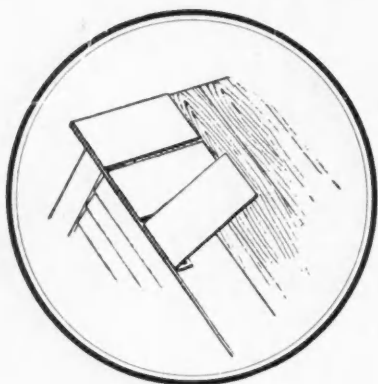

## Nailed at the Bottom

The illustration shows one way to start the laying of Rex-tile Shingles on a roof.

A piece of Rex Valley and Ridge Strip should first be laid full width along the eaves. If there is no gutter, the strip should be lapped over the edge of the roof and nailed in the same manner that prepared roofing is nailed. Rex-tile Shingles can also be started by laying the first course double, as with wood shingles.

Lay the first row of shingles so that the lower edge of the bend will come flush with the eaves or gutters. Shingles should be laid  $\frac{1}{2}$  inch apart.

Into each tab on the lower side, drive two nails,  $\frac{3}{4}$  inch above the bend and 2 inches from each end.

Then turn the long part of the shingles back, covering the nails.

Thus the Rex-tile Shingles are nailed fast at the bottom; cannot flap, curl or warp, and the folded butt end gives an artistic texture which adds greatly to the handsome appearance of the roof.

**Rex-tile**  
TRADE-MARK  
"THE SCIENTIFIC SHINGLE"

is the easiest house roofing to handle and lay in satisfactory manner. Rex-tile Shingles are clean and light and when the job is done you have a roof to be proud of.

Handsome than wooden shingles, slate or tile, economical and long-wearing.

Won't you write today for samples of Rex-tile Shingles and full directions for laying? Let us tell you also about the advertising campaign by which these shingles are being made known to house builders and owners throughout the country.

### FLINTKOTE MANUFACTURING CO.

90 Pearl St., BOSTON, MASS.

659 Peoples Gas Building, CHICAGO

*Manufacturers of the famous Rex Flintkote  
Roofing, for factories, warehouses,  
farm buildings, etc.*

The construction is all of steel and cast iron; nothing about it to buck or get out of order. The capacity is  $\frac{1}{4}$  yard to the batch and a batch mixed and dumped every minute. The power required is 4 h.p. for the hand dump and 5 h.p. where power dumper is furnished.

Write the Ideal Company about this mixer, and also ask them about their Service Department, which they maintain to help users of concreting machinery and those considering getting into the block or brick making business. As they have had years of experience their suggestions are valuable. They are offered to our readers free.



### Astonishing Growth of Automobile Business

The output of the automobile factories in America in 1913 reached a value of \$500,000,000 and gave direct employment to 100,000 men, according to semi-officials' statistics. Which leads President George A. Kissel, of the Kissel Motor Car Company, to the following observation: "The greatest gain in number of cars manufactured in any one year over the previous year was in 1913, when 125,000 more automobiles were built than in 1912. When we consider that only 25,000 cars were marketed in 1905 and nearly 500,000 cars in 1913, the magical growth of the industry must impress itself as incomparable in the whole commercial history of the world. It appears certain that the high-water mark of production has not yet been reached."



### Improved Sharpening Machine

The "Best Maide" Grinder No. 51 is equipped with a double grit-grinding wheel and swiveling device, by which the machine can be swiveled to any position. When the grinder is in upright position, there is a broad, fine face, which is excellent for very fine grinding. When the machine is turned in the horizontal position, the medium part of the wheel is exposed, which is an excellent place on which to do general grinding.

The double grit wheel and swiveling device practically give two wheels in one. It is also a great convenience to have a machine which can be swiveled to any position, and on which you can grind awkward tools, which you cannot grind on a regular grinder.

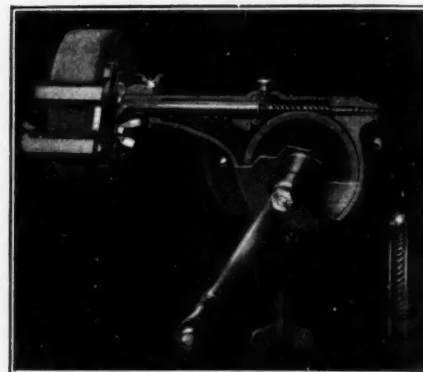

Luther's "Best Maide" Grinder.

Every part of this machine is automatically oiled. This insures a smooth, easy motion and an extra long life. Note also the question of the ball bearings in this machine. They are placed so that they take up all end-thrust with a minimum amount of friction. The driving gear of this machine is also something new, for it is concave. This makes it impossible for the gear to become off-centered, burred or to creep. It is easily seen that this would give a machine a very smooth and even motion.

Anyone interested in efficient, moderate priced machines, would profit by investigating this one. Address the Luther Grinder Mfg. Co., 870 Point Street, Milwaukee, Wis.

You will get SPECIAL ATTENTION if you tell Advertisers you read American Carpenter and Builder.



*Satisfactory  
for*  
**COTTAGE or  
MANSION**

# VULCANITE ORNAMENTAL ROOFINGS

The best builders are those who serve their clients best. If you would build **bigger business** for yourself, if you would give your clients the **best roofing service**, use **Vulcanite Ornamental Roofings**.

Vulcanite Ornamental Roofings have always been sold at a price consistent with their quality. They are the only roofings that have remained the same in price and quality for years.

Our "selling plan" is open and above-board. Your dealer makes only a fair profit—no more. He can buy roofings of inferior grades and sell them to you at an enormous profit. But he can't do that with Vulcanite Roofings. The name is your protection—your assurance of a genuine, honestly made, long-wearing roof.

## VULCANITE ORNAMENTAL ROOFINGS

Made in several artistic designs, giving diamond-shaped, tile, slate or "V" edged effects. Made in strips for easy laying.

Ornamental Style "D"—square corner effect shown above—comes in rolls 10 and 12¾ inches wide. Made in two shades of red and green. These colors are the tints of the everlasting rock and give the greatest ornamental effect, combined with durability.

One house roofed with Vulcanite Ornamental Roofings is a proof of your ability to produce artistic and durable roofs at a low cost. Our catalogues tell all about Vulcanite Roofings and how to lay them. Write for catalogue and samples. They will give you a new idea as to what "best roof" means.

## VULCANITE ORNAMENTILE SHINGLES

Each shingle is 12¾ inches long and 8 inches wide, laid 4 inches to the weather. Uniform in size; laid quickly. Five colors—Garnet, Emerald, Red, Green and Gray—natural tints of rock and slate.

These shingles when laid make a triple thickness—leak-proof, fire-proof, non-warping and non-curling. The satisfaction assured by using these guaranteed shingles recommend them to builders who demand the best.



Vulcanite Reversible Shingle

### Our New Reversible Shingle

Possess all the merits with the same finishes of the Ornamentile shingle, but being made with one round end and with one square end can be laid either way or in a combination giving a very rich, beautiful and ornamental appearance. This is one of our leading styles. Size, 8 by 12¾". Quality guaranteed.

## PATENT VULCANITE ROOFING CO. 49th and Oakley CHICAGO, ILL.

258 Broadway, New York, N. Y.  
114 East Pearl St., Cincinnati, O.

2014 Avenue A, Birmingham, Ala.  
12th St., and Crystal Ave., Kansas City, Mo.

Our new Vulcantile Roofings are unquestionably the roofings of the future. They will double the business of every active builder who applies them. We want to send you particulars.



You will get **SPECIAL ATTENTION** if you tell Advertisers you read American Carpenter and Builder.

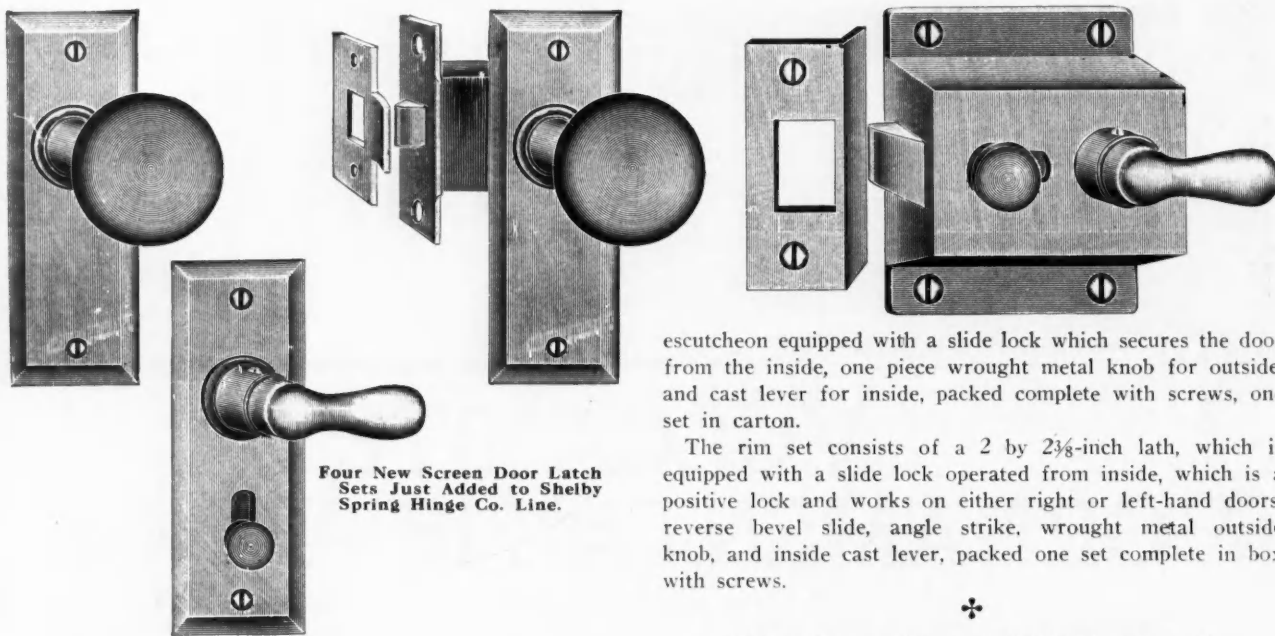

Four New Screen Door Latch Sets Just Added to Shelby Spring Hinge Co. Line.

### Wrought Metal Screen Door Latch Sets

The Shelby Spring Hinge Company, Shelby, Ohio, who for many years have manufactured the well-known Shelby Chief Floor Hinge and an extensive line of builders' hardware, recently added to their line the Shelby Screen Door Latch Sets, both mortise and rim. These sets are made of wrought metal and are nicely finished to match other builders' hardware.

The mortise set consists of  $1\frac{3}{8}$  by 2-inch lath with steel latch bolt, one pair  $1\frac{1}{2}$  by  $4\frac{1}{2}$ -inch escutcheons, the inside

escutcheon equipped with a slide lock which secures the door from the inside, one piece wrought metal knob for outside, and cast lever for inside, packed complete with screws, one set in carton.

The rim set consists of a 2 by  $2\frac{3}{8}$ -inch lath, which is equipped with a slide lock operated from inside, which is a positive lock and works on either right or left-hand doors, reverse bevel slide, angle strike, wrought metal outside knob, and inside cast lever, packed one set complete in box with screws.



### "Outdoor Sleeping Made Easy"

A very interesting little booklet bearing the above title has come to hand. We are very glad to say a good word for such a healthful exercise as outdoor sleeping, especially since the services of the carpenter and builder are usually required to arrange a suitable outdoor sleeping place.

This booklet shows how everyone can have an outdoor bedroom at very little cost. It will solve the problem for thousands who would enjoy an outdoor bedroom, but have no room for one or can't afford to build on a big porch for this

## No Sewer No Water

☞ Every carpenter and builder should investigate.

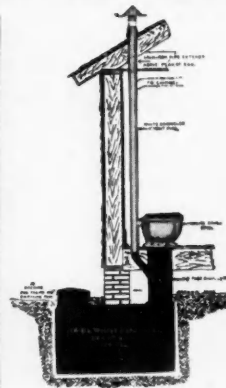

## Odorless Sanitary

☞ Here is the answer to a problem often put up to you.

☞ How are you handling the matter of sewage disposal where you have neither water nor sewer to help you? The **Kaustine Sanitary Closet** is fine enough for the finest building, and cheap enough for the plainest building. If you are remodeling, it can be installed without great expense, inside or outside; no plumbing necessary. We are selling these outfits to live carpenters and builders in every State and have enthusiastic testimonials. Boards of Health approve our system. It is the greatest invention ever promulgated for rural districts or situations where neither water nor sewer is available.

☞ We have a "Get Acquainted" proposition ready to mail to YOU. Ask for it today—this means money in your pocket and credit to your reputation as a shrewd and "posted" builder.

**The KAUSTINE CO., Inc.,** Dept. B, **Buffalo, N. Y.**

You will get SPECIAL ATTENTION if you tell Advertisers you read American Carpenter and Builder



# An Object Lesson American Lumberman

WE reproduce here the front page of the *American Lumberman* of Feb. 7, 1914.

The *Lumberman* is unquestionably an authority on this subject. It is unquestionably in close touch with yards in all parts of the country, and as their plan is marked "Ideal," it is safe to assume that it represents the best judgment and desire of the average retail yard man, plus the expert knowledge of the *American Lumberman*.

We have no desire to criticise them, in fact, we fully agree that it *does* represent actual conditions in the average yard today.

But we call your attention to the fact that less than 13 1/4% of the space (244 sq. ft. out of 14,375 sq. ft.) is set aside for sash, doors and moulding; a very important stock from the contractor's standpoint.

As a matter of comparison, WE use for the same stock upwards of 30,000 sq. ft. of floor space, and if the height were taken into consideration, the contrast would be still greater.

We do not make this comparison to boast. Customers are not interested so much in figures as they are in results, but we do it to point out that the facilities allowed for this branch of the business in the average yard (Ideal yard) are ridiculously inadequate in view of the importance of the line to the builder, and in view of the new styles and designs that have come and are coming into the market.

The doors, finish and sash are what show in a house. They are the items that are largely instrumental in creating a desire for the house on the part of the prospective owner or tenant.

More than any other items, they fix the renting and selling value of the house and should, therefore, receive from the contractor and owner the most careful and serious consideration.

We have no quarrel with the Retail Dealer, he has his legitimate place and function, the 98 1/4% of his yard shows that; but we believe that the millwork proposition has grown faster than he has, faster and larger than he *can* grow, and we believe that the contractor who expects to grow, who expects to make money, must do as every other successful merchant does—study his goods, get the best value for his money that the market affords, goods that will make money for his client and advertise him.

So far as the average Retail Lumber Yard is concerned, the above demonstrates that they do not and cannot afford him the opportunity to do this, because the space at their disposal is insufficient to carry a proper line of even samples in doors alone, to say nothing of other lines.

It follows then, that the progressive, up-to-date, money-making contractor must, of necessity, seek his millwork from other sources, if he is to hold his place in business or improve it.

In seeking a new source of supply, he is obliged to be governed largely by printed statements—advertisements—because it is practically impossible to make personal investigations.

Advertisements are sometimes misleading, not necessarily untruthful, but in leading one to infer what they do not really say or in telling only part of the facts.

We never intentionally do this. If we wanted to we would not dare to, because each of our price lists carries the "Trip to Cleveland" offer:

NORTHWESTERN LUMBERMAN  
ESTABLISHED 1873.

CONSOLIDATED  
JAN. 1, 1899

THE LUMBERMAN  
ESTABLISHED 1880

PUBLISHED WEEKLY  
WHOLE NUMBER 2207

CHICAGO, FEBRUARY 7, 1914.

SINGLE COPY 15 CENTS  
FOUR DOLLARS A YEAR

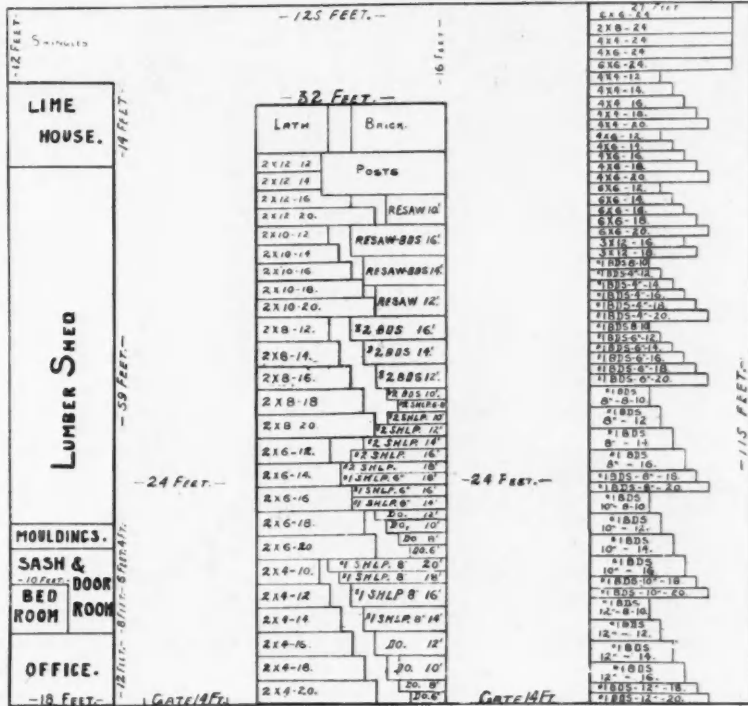

Suggested Ideal Plan for Retail Yard, adapted to a site of limited size in the ordinary village or small city. Convenience of arrangement and close utilization of space characterize it.

## A Trip to Cleveland

IF you have not yet visited us and will come to Cleveland and look over stocks at our Mill and our Warehouse, and will place with us an order amounting to \$100.00 net or more, based on our published prices, we will pay your Railroad Fare. (Limited to territory east of Illinois and north of Kentucky).

Our object is to convince the contractor that we have the stocks, the quality, the Mill facilities, the facilities for Beveling, Silvering, Art Glass work—and the men and the methods to do his business, and do it right; and we ask you to remember when reading our advertisements in the future that every statement can be substantiated by you practically without expense.

It's our only business—Millwork, Glass, Paints and kindred lines—not

one of a hundred departments, not a side show to a large lumber trade, not a new and untried venture, but the growth of several years' effort and experience.

We feel we are qualified to save the average contractor money: to give him goods that are worth more than they cost him; to give them to him when he needs them; to handle his business promptly, economically and efficiently, and we are willing to risk our money to convince him.

Send for our Catalogs { Net Sash and Door... Catalog B  
Net Paint Price List... Catalog C  
Special Mantel... Catalog D  
Art Glass... Catalog E

# The Cleveland Window Glass and Door Co.



DOORS, SASH, FRAMES, FINISH, PORCH and STAIR STUFF, MILLWORK  
PLATE, WINDOW and ART GLASS, MIRRORS and PAINTS

213 Champlain Street

CLEVELAND, OHIO



You will get SPECIAL ATTENTION if you tell Advertisers you read American Carpenter and Builder.

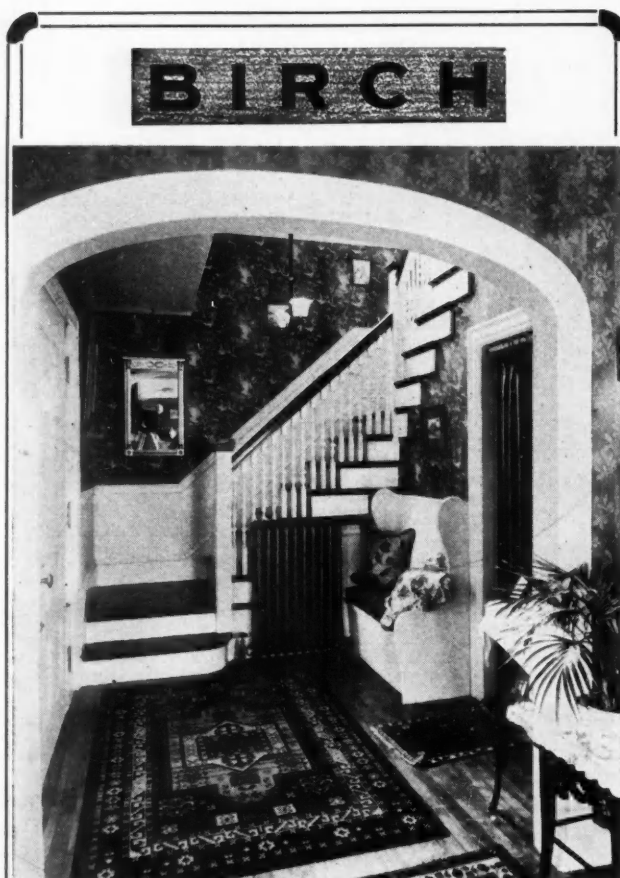

An Inviting Hall and Stairway showing Birch finished in Mahogany and White Enamel.

**BIRCH** is a hard, close-grained, wear-resisting wood of unusual beauty which stays where it is put and takes every kind of finish easily and permanently. This is what makes

### BIRCH THE DEPENDABLE WOOD

for interior work. Moreover, it is so reasonable in price that to specify **Birch** is true economy.

#### A Bungalow builder writes:

"Some time ago you mailed me a set of samples of Birch in different stains, which came in very handy in selecting the different colors, and if not asking too much, I would be pleased to receive a couple of more sets—one for each of my offices. At this writing, I have six bungalows in course of construction and have specified Birch trim in each of them—living room, halls, bed-rooms, closets and bathroom. Colors in living rooms and halls are either mahogany or mission brown—in other rooms, white enamel."

### Ask Today for Our Birch Panels and Birch Book "C"

They will show you just what **Birch** looks like and how to use it.

They are business getters. We pay the postage.

### The Northern Hemlock and Hardwood Manufacturers' Association

Dept. "C"

Wausau, Wisconsin

purpose. It illustrates and describes the Mitchell Outdoor Sleeping Porchet, a most ingenious construction; a safe and durable arrangement; moderate in price that can be attached to any building.

Carpenters and builders should know all about this, as it is the newest thing on the market. A good many of our readers will probably want to have one or more of these Porchets for their own homes. Address the American Porch Construction Co., Dept. 18, South Bend, Ind., for a copy of this very interesting booklet which they will send free on request.



### A New Way to Buy Shingles, Roofing, Wallboard and Paint

The United Factories Company, of Cleveland, Ohio, are offering all kinds of metal and ready roofing, flexible shingles, wallboard, metal tile, paints, gasoline engines, and many other items of interest to builders on the "See-Before-You-Pay" plan—no money down.

They also allow thirty days' trial to prove the high quality of their merchandise, which is shipped direct from factory to purchaser. The aim of the United Factories is to do away



Send for this big catalog of Building Materials.

with the high cost of selling expense, and to save the buyer money.

They are the direct-from-factory selling force for thirty-three big factories, and the products of these factories are illustrated and described in a single book, which will interest any builder or buyer.

Mr. Geo. A. Bottger, president of the company, is confident that this new way to buy will be of especial interest to builders, who can see and examine any purchase—even try it thirty days before paying a penny.

A copy of their new catalog will be sent free to any one interested by addressing Mr. Bottger, the United Factories Building, Cleveland, Ohio.



### Good for Many Years

"Out in Santa Ana, Cal., there is in daily use a sturdy but rather obsolete looking automobile whose record offers an interesting contribution to the ever-present discussion as to what becomes of the old cars," says R. D. Jones of the KisselKar.

"This old car, which was built before fore-doors were heard of, helped to make racing-history. It is a KisselKar '6-60' built in 1909. In 1910 it won the annual road race between Los Angeles and Phoenix in time that has never before or since been beaten. It covered the 418 miles across the desert between those two cities in 15 hours and 44 minutes, 3 hours less than the speediest railroad train.

"Before entering the Los Angeles-Phoenix race this KisselKar had been driven 9,000 miles. After the race it was bought by C. E. Hunter, of the Pacific KisselKar Branch, and he drove it 12,000 miles. Mr. Hunter sold it to Charles Wilson, of No. 116 W. First St., Santa Ana, and Mr. Wilson has added

You will get SPECIAL ATTENTION if you tell Advertisers you read American Carpenter and Builder.

# Written to Us— Addressed to You

Pitcairn, Pa., Feb. 16.

Arkansas Soft Pine Bureau, Chicago, Ill.

Gentlemen: I am now working on specifications for my new residence. I have studied and compared long and carefully and I have concluded to specify Arkansas Soft Pine for the WHOLE OPERATION, exterior and framework and interior and floors. # # # # Please explain where best to use the plain and the slashed figures, and oblige.

BUILDER.

That home, when completed will stand

## A Monument to Intelligence

This builder decided to use Arkansas Soft Pine by process of elimination. He compared values of other materials with wood.

He compared costs and values of other woods with those of Arkansas Soft Pine and *Determined to use our wood "for the Whole Operation,"* because it offered him maximum returns on his investment.

Regarding the use of plain or rift sawed stock and flat or slashed sawed the following recommendations are given:

*Use Rift Sawed Arkansas Soft Pine for:* Floors—we recommend the 2½-in. face stock, stair treads, outside step treads, stiles for doors. Set balusters with the rift edges facing, the the figured sides exposed. Use B and better edge grain flooring for all porches.

*Use Slash Sawed Arkansas Soft Pine for:* All other purposes, except where wood is subjected to heavy traffic or wear.

*Send for Literature*

**Arkansas Soft Pine Bureau**  
308 South Canal Street CHICAGO, ILLINOIS

15,000 miles to its record of service. Today, with a total mileage of more than 46,000 to its credit, including the course of the most grilling of all American racing events, Mr. Wilson is not ready to part with it. He declares his belief that it is good for years to come and is about to have a more modern tonneau built for it."

### ✦ The "Mixer that Mixes"

The Western Mfg. Co., Oskaloosa, Iowa, have brought out a simple, durable concrete mixer that will handle fifteen cubic yards of material a day. It is built strongly enough to withstand hard usage and simple enough not to get out of order. This is a small, continuous mixer built especially for block, sidewalks and foundation work.

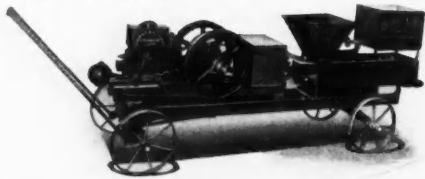

Small Mixer Offered by the Western Mfg. Co.

The illustration shows the general design of this machine. It is such a small view, however, the fine details are lost and so those who are interested are requested to write the manufacturers for their large illustrated circular giving complete specifications.

This mixer is highly recommended by those who have used it because it is easily kept close to the material and near the point where concrete is used. It takes up little room and can be used in cramped places where ordinary mixers cannot work. It is claimed that these machines have time and again paid for themselves in less than thirty days when used in place of hand mixing.

### Be the "Aladdin" Man

Most carpenters and builders have heard of the Aladdin houses. They have been so well advertised in the Saturday Evening Post and the popular magazines, that "Aladdin" has come to be almost a household word. These houses are built like any other well built frame house. The unique thing about them is that all the lumber is cut-to-fit in Aladdin mills and so waste lumber is done away with.

The North American Construction Co., who design the Aladdin houses, and prepare the lumber in their mills, want to arrange with one good carpenter in every community to build these Aladdin houses for home owners who have become interested through the Aladdin advertising. It looks like a good opportunity for good carpenters to cash in on the big Aladdin advertising campaign. There will be only one of our readers in each locality selected for this work. We suggest you write today to the North American Construction Co., 999 Aladdin Avenue, Bay City, Mich., and ask for their special carpenter's plan, with full information, together with their free catalog No. 99X of house and floor plans.



### Hardwood Flooring

Builders should investigate and become acquainted with the very reasonable prices at which hardwood flooring is now being sold. No modern residence or apartment building should be floored with pine flooring, as it is an eye-sore and reduces the rental and selling value of any property. No better talking point can be found about any building than to say, "It has hardwood floors."

The cost of a good hardwood floor is not determined by the price of the material, as the expense of laying it must also be considered. Flooring poorly manufactured and carelessly graded is expensive to lay. A difference of a few

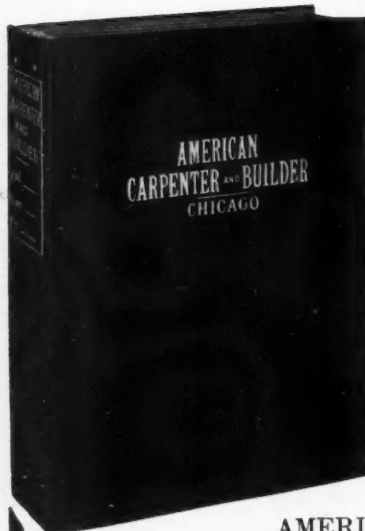

## Have Your Own Reference Library At a Trifling Cost:

Here's a good way to keep your magazines. What's the use of cutting them up? It's just as easy to save the complete magazine and have the use of ALL the good information it contains.

We have had 10,000 Binders made up for our readers. We don't want to make any money on these, so we're selling them at actual cost. We do want you to save every number of the AMERICAN CARPENTER AND BUILDER, because we know that you'll always find it a handy and valuable reference.

These "TORSION" STEEL WIRE BINDERS are made of maroon art canvas and lettered in gold. On the back of each one is a three-color label with spaces for dates and volume number. Each binder holds six numbers (1 volume) of the

AMERICAN CARPENTER AND BUILDER. They keep your magazines neatly and save them from being torn, soiled or kicked around the house. When bound neatly in one of these Binders, the magazines are never in the way and look fine in any bookcase or on any bookshelf.

Send for Binders today and see how nice they are. We are sure when you have one you'll be so pleased that you'll want to bind all your magazines

AMERICAN CARPENTER AND BUILDER  
1827 Prairie Ave., Chicago, Ill.

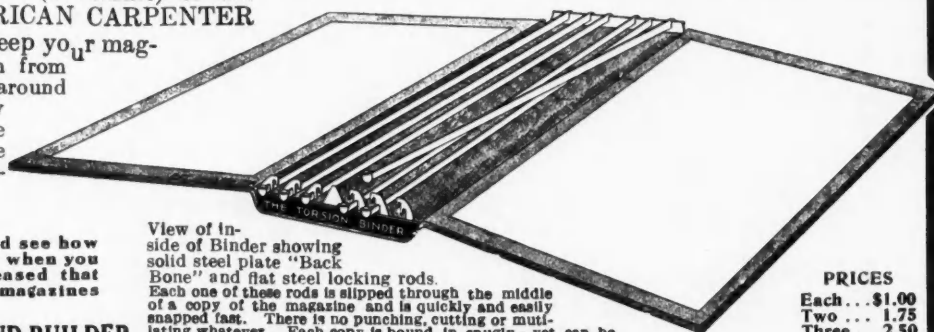

View of inside of Binder showing solid steel plate "Back Bone" and flat steel locking rods. Each one of these rods is slipped through the middle of a copy of the magazine and is quickly and easily snapped fast. There is no punching, cutting or mutilating whatever. Each copy is bound in snugly—yet can be opened absolute y flat. Keeps your magazines clean and fresh—and right where you want them for ready reference.

PRICES  
Each... \$1.00  
Two... 1.75  
Three... 2.50  
Four... 3.25  
Five... 4.00

You will get SPECIAL ATTENTION if you tell Advertisers you read American Carpenter and Builder.



\$823.00



\$1,332.00



\$543.00



\$1,057.00



\$975.00



\$650.00



\$1,569.00



\$757.00



\$1,058.00

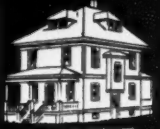

\$1,209.00



\$1,243.00



\$1,283.00



\$978.00



\$779.00



\$992.00



\$693.00

# \$825<sup>00</sup> FOR THE MATERIAL

(Except Cement, Brick and Plaster)

## TO BUILD THIS SIX-ROOM BUNGALOW



**Contractors — Build This Bungalow and Make \$849.00**

\$825.00	Material
826.00	Labor, Cement, Brick and Plaster
\$1,651.00	
\$2,500.00	Selling Price
1,651.00	Material and Labor
\$849.00	Your Profit

### \$1<sup>00</sup> Buys Complete Plans, Specifications and Bill of Materials for House No. 1308

For \$825.00 we will furnish all the material to build this Six-Room Bungalow, consisting of all Lumber, Mill Work, Flooring, Ceiling, Finishing Lumber, Building Paper, Pipe, Gutter, Sash Weights, Mantel, Hardware, Painting Material, Lath and Shingles. NO EXTRAS, as we guarantee enough material at the above price to build this house according to our plans.

By allowing a fair price for labor, cement, brick and plaster, which we do not furnish, this house can be built for about \$1,651.00, including all material and labor.

Rooms on the main floor are 10 feet from floor to ceiling. A large reception hall opens through a cased opening into an exceptionally large living room measuring 13 feet 6 inches by 27 feet and intended to be used as a combination living room and dining room. Note the beautiful Craftsman front door glazed with eight square lights of glass to match window glass. All the windows are Colonial style. Interior doors are five-panel solid yellow pine. Floors and trim throughout are clear yellow pine. The bathroom is located between the two bedrooms.

This house has an excavated cellar 12x24 feet, 7 feet high from floor to joists.

Built on a concrete foundation. Frame construction. Sided with narrow bevel cypress siding and has a cedar shingle roof.

Paint for two coats outside; your choice of color. Varnish and wood filler for two coats of interior finish.

**Can be built on a lot 48 feet wide.**

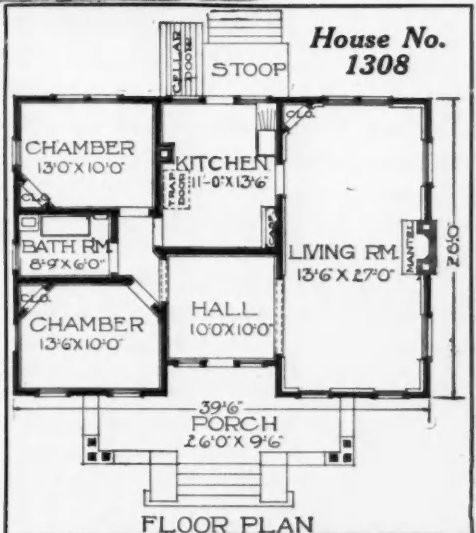

When ordering the plans at the special price of \$1.00, please be sure to mention House No. 1308. Remember, you can get our 1914 Book of Modern Homes containing over 100 designs of houses, also our latest Building Material and Mill Work Catalog and our new Wholesale Lumber Price List FREE. Simply ask for "Building Books No. 5624A" and mention the American Carpenter and Builder. The books will be mailed to you entirely free and post-paid. Write now—a postal will do.

**Sears, Roebuck and Co.**  
Chicago, Illinois

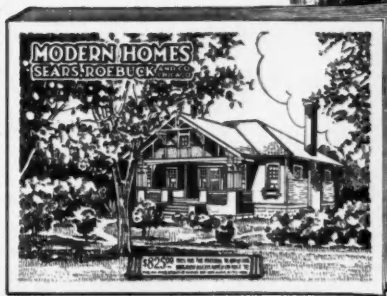

Read How to Get These Two Books Free



\$2,290.00



\$1,575.00



\$825.00



\$887.00



\$711.00



\$832.00



\$1,026.00



\$853.00



\$966.00



\$1,009.00



\$672.00



\$1,271.00



\$1,183.00



\$1,759.00

You will get SPECIAL ATTENTION if you tell Advertisers you read American Carpenter and Builder.

## Saving at the Spiggot

A good many men have deluded themselves with the idea that when a scoopful of "inerts" is thrown into a pot of paint something is saved on the cost of a job of painting. The only tangible result is to make a dissatisfied customer—and a new customer is not born every minute.

You do get a bigger pot of paint, it is true; but when the paint is spread any painter is going to put it on thick enough to hide the surface, no matter how much it takes.

The "inerts" commonly used for adulterating white lead and "extending" paints, are notably transparent and deficient in hiding qualities. Whatever covering power the paint has, it owes to the pure white lead it contains. Enough white lead must go on the wood to cover it and it is cheaper to do it in one gallon of paint than in two.

The practical way to cut the cost of painting is to buy a white lead with maximum covering power, rather than to add transparent pigments which will make a heavier paint film necessary. The distinguishing characteristics of **Carter White Lead** are whiteness, fineness, opacity and covering power. There is a marked difference in the covering power of white lead made by the Carter process and that made by other methods. On measured surfaces it has been demonstrated repeatedly that a given quantity of Carter would cover 25 per cent more surface and cover it better than any other white lead made. A Memphis builder wrote us recently that for white trim he was getting satisfactory results with two coats of Carter, where three coats of paint had been required before.

A paint may be cheap by the gallon, but very dear by the square yard. Carter White Lead will be found economical by the square yard, both as to cost of materials and labor, for it has excellent working qualities and brushes out easily into a thin film that covers perfectly. For priming, finishing or intermediate coats, Carter White Lead is the most economical by the job.

There is a dealer near you who handles Carter. If you don't know his name, write us.

### Carter White Lead Co.

West Pullman, Sta. A Chicago, Ill.  
Factories: Chicago—Omaha

dollars in the purchase price may be offset many-fold by the additional cost of laying. "Riverdale" flooring is said to be so accurately manufactured and uniformly graded that the cost of laying it is reduced to the minimum.

See low net prices on hardwood flooring quoted by the Chicago & Riverdale Lumber Company in another part of this magazine.



### Interesting Gas Engine Catalog

Contractors are getting to be great users of gasoline engines. They will, therefore, certainly be very much interested in the large illustrated catalog of the Witte Iron Works Co. of Kansas City, Mo., which is now being distributed.

It is a most unusual catalog; in fact, it illustrates and explains very fully just how Witte engines are built and how they are sold direct from factory to user, and how they are used. A very interesting story this makes. When a man is in the market for an engine he wants to know all about the engine, also something about the reliability and the business policies of the concern he will deal with in buying his engine. This new catalog of the Witte Iron Works Co. is calculated to answer every question the prospective purchaser or user of gasoline power would want to ask. It is a most attractive book, printed on fine paper, richly illustrated, and printed throughout in two colors. The arrangement is very satisfactory, making it easy to look up any desired point.

We suggest that all of our readers who are interested in kerosene, gasolene, distilate, or gas engines should write at once to Ed. H. Witte, of the Witte Iron Works Co., 1779 Oakland Ave., Kansas City, Mo. He will gladly send this fine engine book, postage prepaid.



### Get a Typewriter and Get More Business

The surest and quickest way of scaring up new business is with a typewriter. It is an indispensable tool for the alert and progressive carpenter and builder. He can single out prospective customers—bombard them with his reason-why arguments, and get them in such a state of mind that to let anyone but him handle their work would be suicidal.

The modern builder uses a typewriter for making out his bills, specifications, contracting estimates, etc., and to carry on his correspondence with the people he does business with. It prevents disputes, also delays. With instructions down in plain, legible type, they cannot help but being carried out. Not so when they are verbal or handwritten. Very few people have a good enough memory to remember everything—and many a mistake has happened because of a forgotten item or a sentence which could not be deciphered.

The correspondence of the architectural world teems with technicalities. Instructions must be carried out to the letter, otherwise there is confusion—oftentimes damages. The "Safety First" way to carry on all business correspondence is with a typewriter.

The big concerns use typewriters—that's why they are big. But not everybody can afford \$100 for a machine. So they waited until a reasonable priced machine came along. It did. It was the Bennett—but it is claimed to give you every improvement and do the work of a \$100 machine.

The Bennett Typewriter which has been advertised in the last three issues of the *AMERICAN CARPENTER AND BUILDER*, certainly should appeal to our readers. Don't think you cannot operate a typewriter—you can. And what's more you can do it in a very few minutes. We know you won't hesitate over the price, especially when it will very quickly pay for itself.

Write the Geo. G. Bennett Co., 3304 Cedar St., Harrisburg, Pa., and tell them we suggested that you get the new Bennett catalog.

You will get **SPECIAL ATTENTION** if you tell Advertisers you read *American Carpenter and Builder*.



On all woodwork where a filled grain effect is desired use Johnson's Paste Wood Filler

Floors finished with Johnson's Paste Wood Filler are sure to give satisfaction

**1  
lb. of  
Johnson's  
Paste Wood  
Filler—FREE**

Johnson's Paste Wood Filler is unquestionably the best on the market. All classes of trade, including furniture manufacturers, prefer it.

It will not harden in the cans, and may be wiped with equal ease in ten minutes or two hours after being applied. It does not settle after thinning.

Johnson's Paste Wood Filler is made in several shades—*Natural, Dark Oak, Golden Oak, Antwerp*, etc. The Natural is slightly tinted with Ochre so it will not show white in the grain of oak, maple and other woods.

Mail the coupon and secure free and postpaid a pound of Johnson's Paste Wood Filler for trial. We will also send you a free copy of our 25c book "The Proper Treatment for Floors, Woodwork and Furniture," which gives detailed information on finishing wood—soft or hard—old or new.

**Johnson's Prepared Wax**

is a complete finish and polish for all wood—floors, woodwork and furniture. Apply with a cloth and in five or ten minutes polish with a dry cloth. Gives perfect results over any finish—varnish, shellac or oil. For polishing **auto-mobile bodies** and bar tops it has no equal.

Johnson's Flat Wood Finish enables you to get hand rubbed effects with little labor and extra profit

**Johnson's Flat Wood Finish**

gives that artistic, hand-rubbed effect at one-third the expense. Does not require rubbing or polishing. Remember—for any work on any wood, Johnson's Finishes are best.

Please send me free and postpaid a pound sample of Johnson's Paste Wood Filler. I agree to try it and report results to you.

I buy paints from .....

Name .....

Address .....

City .....

State .....

To

**S. C. Johnson & Son**

"The Wood Finishing Authorities"

Racine, Wis.

A. C. B. 4

Johnson's Prepared Wax is a lasting artistic finish for floors - new or old - soft or hard



You will get SPECIAL ATTENTION if you tell Advertisers you read American Carpenter and Builder.

### Fire Escapes for Uncle Sam

The Dow Wire and Iron Works have just secured a contract from the United States Government to equip the Indian Schools at Anadarko, Okla., and Lawrence, Kans., with their fire escapes.



### New Beaver Board Offices Opened

The Beaver Board Companies have recently enlarged their Administration Building. The Beaver Board industry has taken such rapid strides during the seven years of its devel-



Interior of Beaver Board Administration Building.

opment that, in addition to plants and offices at Beaver Falls, N. Y.; Roanoke Rapids, N. C.; Thorold, Ont., Can., it has become advisable to triple the floor space and all accommodations at Buffalo, N. Y.

The office interior is of the English style of architecture with heavy beamed ceilings and mezzanine floor around the

entire office. There is an ideal indirect lighting system, a sprinkler system which takes in all the buildings of the plant, and further features which go to make up a thoroughly equipped and up-to-date office and factory.

The interior is entirely finished with Beaver Board, each office receiving certain distinct panel treatments and decorations. The large central office runs through the entire building and shows off with very good effect just how well adapted Beaver Board is for use in large buildings of this sort.



### A Coal Chute for Every Modern Home

One of the details of modern residence construction that goes to make a complete and perfect job, is a coal chute; a cast iron window-frame and hopper which is built into the foundation wall near the coal bin and is used for putting in coal and other fuel. A coal chute protects a property and while costing very little more is a big improvement over the ordinary basement window as a coal hole.

Everybody knows the blackened and battered appearance of the cellar window and window-frame that is used for putting in coal. Very often the glass is broken and other damages done. Burglars often find the coal bin window left unlocked and gain easy entrance through it.

All of these annoyances and dangers are done away with where a cast iron coal chute is built into the new house.

The Holland Furnace Company of Holland, Mich., have made quite a feature of their "Window Chute" which in a very ingenious way provides the cast iron coal chute with a glazed window, so that it lights the coal bin and cellar as well as serving as a fuel chute. Thousands of these are in use; and both builders and home owners are enthusiastic about them. The Holland Furnace Company are now distributing the new booklet "C," telling all about this window chute. If you are interested write for a copy.

## You Don't Have to Buy High Priced Coal!

Even in buildings in cities where a rigid smoke ordinance is enforced, a Kewanee Smokeless Firebox Boiler will allow the use of the cheapest soft coal because it will burn it *smokelessly*.

Smoke is good fuel which has been only partially burned. So, whether a city has a smoke ordinance or not, it means fuel money saved to eliminate smoke.

## KEWANEE Smokeless Firebox Boilers

will make no smoke even when burning the cheapest of soft coals. That fact is conclusively proven in the many installations in cities where smoke ordinances are rigidly enforced.

Furthermore, it has been proven that Kewanee Smokeless Firebox Boilers are as high as 75 per cent efficient when burning soft coal. By that we mean they will utilize, for steam making, 75 per cent of the heat in coal; while 60 per cent is a high average for straight draft boilers.

That is another saving a Kewanee Smokeless Firebox Boiler will make.

Steel Power and Heating  
Boilers, Radiators, Tanks  
and Garbage Burners.

**KEWANEE BOILER COMPANY**  
Kewanee, Illinois

Branches: Chicago, New  
York, St. Louis, Kansas  
City, Salt Lake City.

You will get SPECIAL ATTENTION if you tell Advertisers you read American Carpenter and Builder.



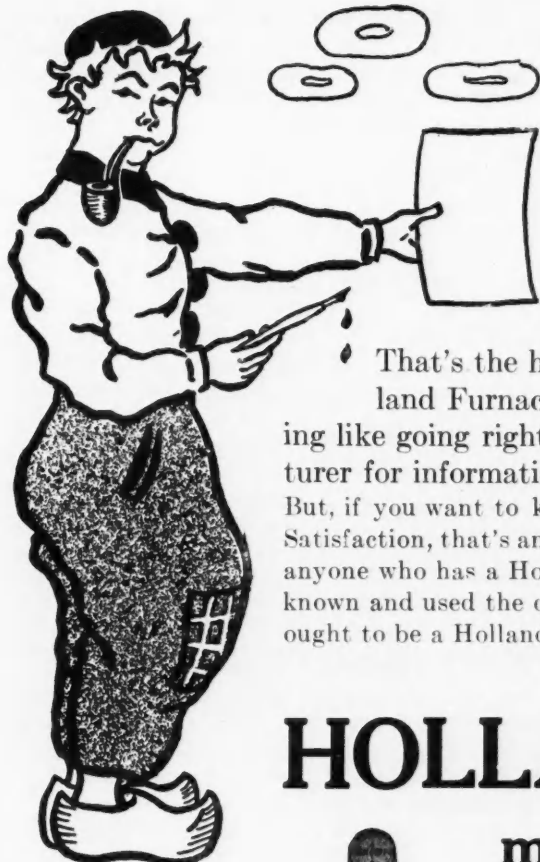

Hans says—

“Write a Letter to  
Holland”

That's the home of the Holland Furnace. There's nothing like going right to the manufacturer for information about a thing. But, if you want to know about Holland Satisfaction, that's another matter. Ask anyone who has a Holland Furnace. It's known and used the country over. There ought to be a Holland in your town.

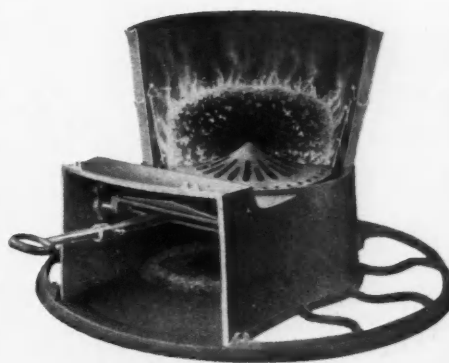

The Air-Admitting Firepot.

# HOLLAND FURNACES

## make warm friends



because Holland service is a *day* and *night* service. Heats all the time. Look at that air-admitting firepot. Can there be any doubt about its efficiency? That cone leads the draft right up into the coal. The Holland burns *every bit* of fuel. Does it cut down heating expense? Of course it does. If the Holland didn't cut fuel bills in half, it wouldn't be the popular furnace it is.

There's a secret to Holland success. It's the secret of good materials, right designing and honest construction. The same things that make you a *good* builder—a *popular* buider.

We've printed a book that tells our story. It's the Holland Catalog. Send for it and we'll send you information that you, as a Contractor or Builder, will be glad to have.

## Get Our Expert Advice

With our Holland Service, any contracting builder can easily install a Holland Furnace. Send us the floor plans of any building you are putting up. Indicate the rooms you want heated. Then our Heating Engineers will submit to you detailed plans and specifications, prices, etc., covering the entire heating equipment. *We make no charge for this service.*

I wish you'd "Write a Letter to Holland" today. Ask for "Special Proposition to Contractors and Builders."  
—Hans.

# Holland Furnace Company, Holland, Michigan

You will get SPECIAL ATTENTION if you tell Advertisers you read American Carpenter and Builder.

# Money Talks!

*And this space costs money,  
so here is OUR STORY*

Where we have no agents started, we will furnish you complete equipment including furnaces, pipes, registers, etc., at the following prices for ordinary sized houses.



5 Room House,	\$60
6 Room House,	\$70
7 Room House,	\$80
8 Room House,	\$90

No good business man will pay more.

All you need to know is that it will be an "IDEAL" Heater.

Guaranteed for 10 years and will last a lifetime. Our enormous output enables us to make this offer. 35,000 Ideal Furnaces in use.

**WE SPEND OUR MONEY IN MAKING GOOD FURNACES,  
NOT IN LARGE ADVERTISING SPACE**

Special Proposition for Contractors.

*Catalogs and Details for the Asking*  
**IDEAL FURNACE CO., DETROIT, MICH.**

## Build Bigger Business This Year

Take over the heating contracts for all your buildings. Put the profits in your own pocket. We'll give you complete instruction free of charge. It will enable you to give your customer the very best possible heating plant.



### Schill Furnaces

Are high grade in every way, large ash pit and door. Duplex grate. Grate can be removed without disturbing the fire. Heats intensely without forcing. Large water tank. Easily set up; no bolts in casing. Door frames hold casings in place.

### Increase Your Profits

It will pay you to install the heating in your buildings. Write for our special Builders' Co-operation Plan and our big profitable offer to Contractors and Builders in unoccupied territory.

**The Schill Brothers Company**

Crestline, Ohio

## Buck Bros. Edge Tools

There is a good deal of satisfaction in looking over a catalog of high-grade edge tools. To anyone who is a lover of tools—and what man making a daily living by the use of wood-working tools doesn't come to feel a real affection for them?—such a book is more interesting than any story book.

Buck Bros., of Milbury, Mass., have just issued their Price List and Reference Book No. 12. It is a book of 126 pages, finely illustrated and printed, a worthy representative of these old, reliable tool manufacturers.

Buck Bros. established their manufacturing business in 1853, sixty-one years ago. It has been their constant aim and effort to produce the best tools manufactured. As pointed out in the preface to this present book, there is no secret about the reasons for their success in producing good tools. They make it their rule to buy the best material to be found in the market, employ the most skilled workmen and given constant personal supervision to the business, which they thoroughly understand. These are sound manufacturing principles. They can't do anything else but produce satisfaction and success.

No doubt many of our readers would like to have a copy of this edge tool reference book. If you write Buck Bros., Milbury, Mass., they will mail you a copy postpaid.



## New "Yankee" Bench Drill

North Bros. Mfg. Co. are now putting on the market two new "Yankee" Bench Drills—their number 1003 for drills up to one-fourth inch diameter, and their number 1005 for drills up to one-half inch diameter. This illustration shows one of these tools clamped to the work bench.

The distinguishing feature of this Drill is its strength, convenience and rapidity of operation. By means of automatic and friction feeds (of same design as used in "Yankee" Chain Drills) the operator has the free use of one hand to hold work.

At top of feed screw is a ratchet which feeds when lever is horizontal. On the inside is a friction feed which operates when lever is vertical. The friction feed is adjusted to work quickly in moving drill to and from work. The automatic ratchet feed is positive, fixed and without adjustment, so that drills from No. 54 up will not be broken in use, as is often the case in feeding by hand. A bracket at top frame, with right and left arms, disengages the ratchet feed at extreme up or down movements of spindle, so that parts cannot be jammed.

The column is cylindrical, giving strength and rigidity as well as being graceful in appearance. At lower end of column is slide to carry an adjustable bracket for table. This table can be adjusted vertically by hand wheel and screw, independently of bracket. These adjustments of bracket and table admit work of unusual depth for bench drills. The bracket and table are quickly removable for any very high work that can be supported on floor or otherwise.

For use with the "Yankee" Bench Drills, a new vise is also offered. This vise as illustrated is designed for use on "Yankee" Bench Drills, or separately attached to bench. The base of vise is 6 in. long and 2 3/8 in. wide. Extreme height 2 in. The opening of jaws, without swivel jaw, is 3 in. This vise weighs 3 3/4 pounds.

Address North Bros. Manufacturing Co., Dept. A, for further particulars.



No. 1003 Bench Drill.



No. 990 "Yankee" Vise.

You will get SPECIAL ATTENTION if you tell Advertisers you read American Carpenter and Builder.

# Did the U. S. Government Make a Mistake?

When the U. S. Government *specified* Williamson Underfeed furnaces for Dam Keepers' houses along the Ohio River, did it err? The Government put the Underfeed through the hardest possible tests and *proved* that such statements as, "Coal bill \$16.22 for 7 rooms;" "\$5.40 to heat 4 rooms;" "Reduced coal bills from \$109 to \$53;" "Underfeed reduces coal bill 60%;" "A great fuel saver;" "Have cut coal bill \$70 each winter for 9 years;" "Saved \$122 a season;" "I have divided my coal bill by five;" "Even temperature with no smoke or dirt," *were absolutely true.* What's best for Uncle Sam is best for you.

## 25,000 Underfeed Users

For over twelve years Underfeed furnaces and boilers have been cutting coal bills  $\frac{1}{2}$  to  $\frac{2}{3}$ , thereby saving millions of dollars for coal buyers. Why not save *your* share? The economy and efficiency of Underfeed heating has startled the world. Cheap

slack soft coal or pea and buckwheat hard coal yield in the Underfeed *more* heat, *cleaner* heat and *even* heat than the most expensive coal burned in other heaters. And 25,000 Underfeed users have *proved* it.

**WILLIAMSON  
UNDERFEED  
Furnaces and Boilers**

**Cut Coal Bills  $\frac{1}{2}$  to  $\frac{2}{3}$**

With the Underfeed, coal is fed from below. All the fire is on top. Smoke and gases are burned up, making more heat with **no** smoke, soot, clinkers, smell and dirt and but few ashes. No other furnace or boiler does this. The Underfeed principle is the greatest improvement ever made on **any** heating system. Soon pays for itself in any home, store, church, hall and other buildings. Adds to renting and selling value of any building. Adapted to warm air, steam and hot water.

## 50% Saving in Coal Bills Guaranteed

With every Underfeed furnace or boiler, when properly installed and operated, we guarantee a saving of at least 50% in your coal bills. This guarantee is backed by a \$750,000 corporation. You take no chances. The burden of proof is on the Underfeed. It has made good for thousands—it will make good for you. Let us send you the names and addresses of over 2,000 Underfeed users—some right in your neighborhood—who **know** that an Underfeed in the basement means

### Clean, Even, Economical Heat

in the home. If you are going to build; if your furnace or boiler is unsatisfactory; if you use stoves or grates; if you want to reduce your high heating costs, then send in the coupon. We'll send you a big budget of money-saving heating facts that will surprise you. Stop making rich coal barons richer by sending the coupon today—NOW.

The  
**Peck - WILLIAMSON CO.**

53 Fifth Street, Cincinnati, Ohio

You will get **SPECIAL ATTENTION** if you tell Advertisers you read American Carpenter and Builder.

**Mail This Coupon and Learn How  
to Cut YOUR Coal Bills  $\frac{1}{2}$  to  $\frac{2}{3}$ !**

**The Peck-WILLIAMSON COMPANY,  
53 Fifth Street, Cincinnati, Ohio**

I would like to know *how* to cut my coal bills from  $\frac{1}{2}$  to  $\frac{2}{3}$  with an Underfeed.

Warm Air \_\_\_\_\_ Steam or Hot Water \_\_\_\_\_  
(Mark an X after System interested in.)

NAME \_\_\_\_\_

ADDRESS \_\_\_\_\_

My Dealer's Name is \_\_\_\_\_

### Stone Roof for Modern Machine Works

The new South Works of the J. I. Case Threshing Machine Works at Racine, Wis., is without doubt one of the most up-to-date plants of its kind in the country.

A notable feature of this plant is the roofing, which is made of asbestos and Trinidad Lake asphalt, two of the most enduring mineral substances in existence. Asbestos is an indestructible, fibrous rock, the same substance which is used in the manufacture of fireproof theatre curtains. For roofing purposes it is made into a felt, layers of which are cemented together with Trinidad Lake asphalt, a great waterproofing substance. The combination of these two materials produces a roofing that is a sheet of pliable stone.

Because of its all-mineral composition, this roofing cannot rot, rust nor deteriorate, hence requires no painting or any other form of coating. It is also said that this roofing is proof against the action of chemical fumes, and that sparks and burning brands have no effect on it. Hundreds of cases are on record in which it has for years withstood a continuous shower of sparks from stacks and cupolas.

The manufacturers of this roofing, which is known as J-M asbestos roofing, claim that their product is the cheapest on the market, on the cost-per-year-basis, on account of its comparatively low cost and the fact that it never needs coating.

An interesting booklet describing this roofing in detail will gladly be sent to anyone who writes the H. W. Johns-Manville Company, New York.



### Hudson Asphalt Shingles

For some years there has been a growing demand for a better article than the wood shingles now on the market. To meet this demand the Asphalt Ready Roofing Company, 9 Church St., New York, is now manufacturing "Hudson" asphalt shingles.

The basic material used for Hudson asphalt shingles is carefully selected long-fibre felt. This felt is saturated with asphalt compound, which makes them not only water-proof, but very strong. This saturated part is then coated with asphalt, into which is rolled crushed slate or feldspar. This produces not only a rich artistic appearance, but gives them also that resisting quality which defies time and the elements.



Shingles nailed on in the ordinary way.

The machines on which these shingles are made have been specially constructed by competent engineers, and are the best obtainable. Only the best materials are put in Hudson asphalt shingles. Each shingle is 8 by 12 $\frac{3}{4}$  in. and when laid is 4 in. to the weather, thus producing a roof of practically three thicknesses.

Being light in weight, they do not require heavy timbers, which materially reduces the cost of building. Before beginning to lay Hudson asphalt shingles, a galvanized iron drip edge or a narrow wooden strip should be attached to the eaves to support the ends of the shingles. At the bottom a double row of shingles should be laid. The centers of the next row should be over the ends of the shingles on the bottom row. The shingles should be cut in half to fit the end of the roof on every other layer. In laying the shingles they should be placed about one-half inch apart. Hudson asphalt shingles are furnished in red and green. The manufac-

## Prepared

Is the contractor who has his "Big-an-Little" Mixer ready for the first job in the Spring.

When You Need a Mixer Bad, You Want It Good

and that is "Big-an-Little" Fills the Bill where the

### BECAUSE

It is built of the best iron and steel—by the best mechanics.

It mixes all kinds of concrete, mortar, etc.

It requires very little operating expense and attention.

It costs next to nothing for up-keep.

It is always ready to do business every day.

It is priced to you on a cash basis and sold at a low figure.

It can be furnished with or without power, or with a Hoist, or Loader and the engine can be used for other purposes. A mixer and outfit built for YOUR particular purpose.



Get our catalog and information and your "Big-an-Little" will come later. Increased profits—More contracts—Better quality work, all go Hand in Hand with the "Big-an-Little."

**The Jaeger Machine Co.,** 318 W. Rich St., COLUMBUS, OHIO

You will get SPECIAL ATTENTION if you tell Advertisers you read American Carpenter and Builder.



"Say Joe - I am going to buy a new mixer and pump. How about the Power Question?"



Stop This Leak

"Well Boss - Just as I have said before, that the Blankety engine, we have now is Junk, when compared to IDEAL POWER. We have had to use hand power on the pump, and mix by hand several times this week, just because that blooming engine stopped. I figure we have lost about \$85.00 thru engine trouble, in the past 2 weeks!"



This advertisement is worthy of your consideration — not because of the story it has told or the story it will tell — but because it now tells your story.

How about reading it over and see how many times the same thing has been brought to you. For every purpose—

**"Ideal"**

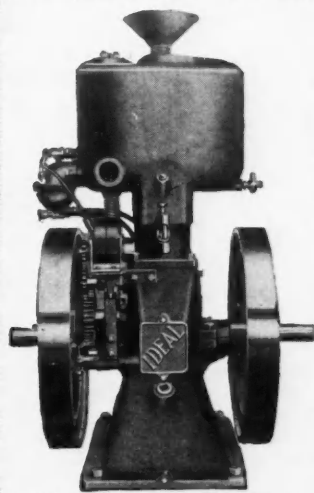

TYPE M

Take it this way— how much is lost in engine breakdown— engine stoppage— engine repair— engine trouble— Now, how much would you save with "Constant Service" Power.

Think it over.

**Engines**

Are you looking for "Always on the Job" Equipment  
If so, Investigate "IDEAL" Hoists and Pumps

**WHEN BUYING EQUIPMENT—BUY "IDEAL" POWER  
ORIGINAL GAS ENGINE CO.**

R. E. Olds, Chairman

Write for Catalog No. 314

630 Kalamazoo St. E.

Lansing, Michigan



"Say boss - I wanted to tell you that when you got IDEAL POWER you sure did right. Why we start that engine and she never stops till every thing is done. It costs less in gasoline and I don't have to pay a man extra to operate it, any of the boys can do that. SIMPLE—that's the whole thing. Nothing complicated, all parts compact and sturdy, and talk about power— She beats anything I ever saw. Bet I saved some coin this week!"

"Well Joe - I'm glad you're pleased. It certainly takes a load off my mind, to know that every thing is pulling along nicely. Guess I'll buy new IDEAL engines for the old rigs. - It'll pay!"



The Hole Patched

You will get SPECIAL ATTENTION if you tell Advertisers you read American Carpenter and Builder.



# UNIQUE

*It is necessary to see a  
room finished with*

**NEPONSET**  
WALL BOARD

in order to appreciate the beauty of this material. When you have once seen a room of this sort, you will see that this Wall Board, with its three finishes, is more than an inexpensive substitute for laths and plaster.

When you finish a room with NEPONSET Wall Board you create something that will advertise you 365 days in the year.

*Write for samples of all finishes  
and name of dealer.*

## BIRD & SON

EAST WALPOLE, MASSACHUSETTS  
23 RIVER STREET



New York Chicago Washington  
Portland, Ore. San Francisco  
Canadian Plant, Hamilton, Ont.

turers will be glad to send samples and prices on request.

The Asphalt Ready Roofing Company have been in business for many years and are also large manufacturers of prepared roofings in rolls, sold under the following brands: Protection brand roofing, which is known as the roofing without an exposed nail head, with 6-inch lap; Arrow brand roofing, similar to Protection brand, but having a 3-inch lap; Rockland roofing, surfaced with gray limestone or red and green slate; and Hudson brand asphalt felts, largely used underneath slate and tile roofs and for sheathing buildings. Readers of the AMERICAN CARPENTER AND BUILDER who are in the market for any kind of roofing should write the Asphalt Ready Roofing Company, 9 Church St., New York, for prices.



### Can Furnish Iron Columns and Light Structural Iron Work

The Canton Foundry & Machine Co., Canton, Ohio, have developed remarkable facilities for handling all kinds of cast iron work used by builders. The Canton coal chute and sidewalk doors have gained quite a reputation for good service and satisfaction. AMERICAN CARPENTER AND BUILDER readers who have used any of these goods will be glad to know that the company is now in a position to submit prices to builders on anything in light structural iron work, cast iron columns, etc.

The large illustrated catalog (B-1) which these people issue, is full of valuable data for our readers, about builders' iron work. Some of these items are only required once or

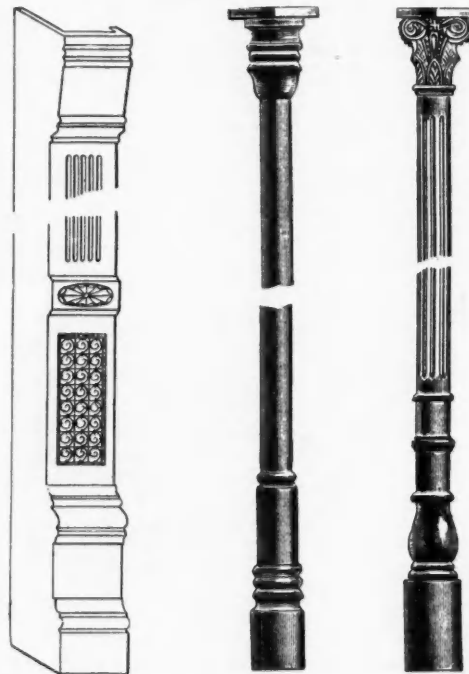

Cast Iron Columns of all Patterns Carried for Prompt Shipment.

twice in a whole season, but when they are wanted, the contractor and builder should be able to know at once, just where he stands, and how he can obtain such goods to the best advantage. We suggest that Our Folks write at once to the Canton Foundry & Machine Company, Canton, Ohio, and look into the lines they offer. The book itself is a liberal education and is mighty handy for reference.

The illustration shows a few of their columns. They have one of the largest collections of patterns in the country. Also maintain their own pattern shop and can furnish any design or shape. All their columns are machined to length. Send in your plans and get net prices on the iron work required.

You will get SPECIAL ATTENTION if you tell Advertisers you read American Carpenter and Builder.

# Why do the *Packard* experts choose UTILITY Wall Board?

**B**ELOW we reproduce an order recently received from the Packard Motor Car Company for 74,350 square feet of UTILITY Wall Board. This is a mighty important bit of evidence for the quality of UTILITY. For, in their mammoth Detroit factories, the Packard experts buy supplies by rule of science — choosing only the best because their standard of quality demands the best.

This Packard order is only one of hundreds we are constantly receiving from firms of similar excellence who buy by test and analysis.



**Packard**  
MOTOR CAR COMPANY  
DETROIT, MICHIGAN

Purchase Order No. **R 13376**  
 Requisition No. **R-15930**  
 For **2-20-14**  
 B.C.  
 Charge **K-1975**  
 Date **2-25-14.**

To **Heppes Company,**  
 45th & Fillmore Sts.,  
 Chicago, Ill.

Please furnish us material specified below: **Freight-Wabash Ry.**

Quantity	Sq. Ft.	Dimensions	Description
14900	32"	wide x 10'-0"	long Utility Board
41700	32"	x 12'-0"	
800	48"	x 8'-0"	
2200	48"	x 10'-0"	
8750	48"	x 12'-0"	
6000	48"	x 14'-0"	

*CMH*

**RUSH RUSH**

Please acknowledge receipt of this order and issue when delivery will be made. Material will be received subject to our inspection and if not in accordance with our specifications, or otherwise defective, will be returned at your expense. We reserve the right to return goods in excess of quantities ordered, unless other arrangements have been made.  
 Invoice or packing slip bearing this order number and bill of lading should be mailed on day of shipment. Use special invoice forms furnished by us.  
 Each package must bear order number and be marked for Construction Department. Failure to thus mark packages will result in charge of \$1.00 to cover cost of transfer.  
 We allow no package or cartage charges.

Yours truly,  
  
**PACKARD MOTOR CAR COMPANY,**  
 Purchasing Manager.

Construction Department  
**R 13376**

## To Be Used in Their Dry Rooms

The Packard people intend to line walls of their dry rooms with this order of UTILITY. They wanted a wall that would stand up and give lasting satisfaction regardless of the enormous heat; a moisture-proof, weather-proof wall surfacing that would not check or fall off on the fresh varnish — and so they chose UTILITY.

## UTILITY Will Withstand Severest Service

It's the "stuff" we put into UTILITY that makes it so good a wall board. The high-quality fibre board that is cemented together with a high-melt-point asphalt under enormous pressure. It's the quality of the materials we use and the way we apply them — backed by our years of satisfaction to customers large and small.

### The Big "Rush" Season Is Now Beginning

UTILITY is a year 'round seller but the demand will be bigger than ever, starting now. Are you prepared? If not, get ready, by all means. Grab off the "cream" of the repair and remodeling business — be a UTILITY Wall Board man this year.

# UTILITY

## the only Five-Ply wall board

We now use five layers because it gives that much more strength and stiffness than the usual two or three layers. These are durably cemented together with four layers of high-quality asphalt. So that we get a non-porous, moisture-proof wall board impervious to heat or cold. It costs more for us to make UTILITY this way — but the cost to you is no higher. We know that you will like UTILITY. Let us send you a specimen and our booklet. Just drop a post card. No obligation at all.

# THE HEPPE'S CO.

Manufacturers also of Flex-a-Tile Asphalt Shingles, Asphalt Paint and Asphalt Roofing in Any Finish  
 4503 Fillmore Street CHICAGO, ILLINOIS

You will get SPECIAL ATTENTION if you tell Advertisers you read American Carpenter and Builder.

### Sand's "E Z Set" Spirit Glass

J. Sand & Sons of 1027 Rivard Street, Detroit, Mich., whose carpenters' levels are well known to our readers, are now offering the level and plumb device illustrated. This is a high-grade, carefully made spirit glass and mounting. With this the carpenter can make his own level and have a good tool at a very low price. They call it "E Z Set" Level because it is so easily adjusted onto a steel square or try square, or onto a straight edge.

The instrument is made of aluminum, light and strong and will never rust. The spirit glass is protected from dust, dirt and weather by heavy plate glass. The spirit tube is securely fastened in position.

One way that builders are making good use of this "E Z Set" Level is for making 6-foot levels and straight edges.

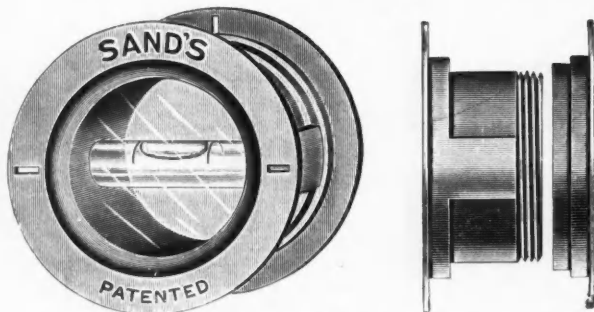

Face and Edge Views of "E Z Set" Level Instrument.

All that is needed is a good straight board from  $\frac{7}{8}$  to  $1\frac{1}{4}$  inches thick, anything suitable for a level or straight edge; bore a hole of the proper size through the board and insert the "E Z Set" Level; a single screw holds the two

faces of the level together; unscrew this and put in the two parts, one from each side; the screw holds all firm and secure.

The price of this little instrument is extremely reasonable. Write the company at once for full particulars.



### Big Sioux Concrete and Mortar Mixers

Every reader of the AMERICAN CARPENTER AND BUILDER who intends investigating in Cement Machinery for the coming season should investigate the equipment manufactured by the Iowa Foundry Co., of Sioux City, Iowa.

Their manufacturing facilities are such that they can build high class, durable, and substantial machinery and sell it to contractors at a low price.

The Big Sioux Mixer has been on the market for over two years; and many have been sold to contractors. It is a machine especially adapted to the various uses a contractor's mixer must be put to; it has given entire satisfaction on heavy street paving jobs as well as on sidewalk, foundation and other small work.

The Big Sioux mixer can be bought in three sizes, varying in capacity from 50 to 175 cubic yards per day.

The Iowa Foundry Co. also manufacture block machines, tampers, and coal chutes. It will pay you to write for their catalogs and circulars.



### Webster's Cement

The W. F. Webster Cement Co., Cambridge, Mass., are manufacturing Webster's Elastic Cement, a product that is especially designed for the use of carpenters, builders and contractors. It is highly satisfactory for bedding slate, for all kinds of pointing work, and for setting glass, instead of putty. Write this concern for prices. They are well known and have been established for over 60 years.

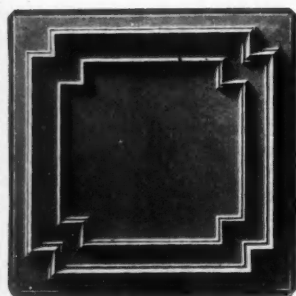

**THINK!**  
**WHAT IT MEANS**  
TO ERECT A  
**METAL CEILING**  
THAT HAS A

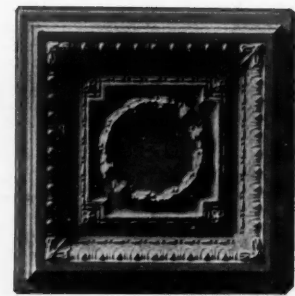

**"GIVE and TAKE" on Every Panel**

**Hours of Worry and Valuable Time Saved**  
**Customers Satisfied**                      **Reputation Boosted**

**No Joints  
can Show  
Dust Proof**



**50% Saved  
Absolutely  
in the Erection**

**Schoedinger's Universal Lock Joint Construction**  
Helps YOU to PUT UP Your CEILINGS. Try It. No Cross Furring.  
No Cross Nailing. No Nails That SHOW. That SPECIAL  
PROPOSITION is Waiting for You. WRITE TODAY

**F. O. SCHOEDINGER, Manufacturer**  
**COLUMBUS, OHIO, U. S. A.**

You will get SPECIAL ATTENTION if you tell Advertisers you read American Carpenter and Builder.



# CADILLAC HARDWOOD FLOORING

## Maple - Beech - Birch

MADE THE CADILLAC WAY

### Cummer-Diggins Company

MANUFACTURERS

"CUMMER"  
BRAND

MAPLE  
and  
BEECH  
FLOORING

Let us tell you how to get less  
than car loads at car  
load prices.

CUMMER-DIGGINS CO.  
CADILLAC, MICH.

### MAPLE

Our superior character of timber growth, and the thorough and systematic application of the superior manufacturing and grading methods produce the famous *Cadillac* Quality. The *Cadillac* district supplies the very best MAPLE in the world.

*Cadillac* Hard Maple is unquestionably of the highest grade. Climatic and soil conditions all tend to make its quality Supreme, and in buying flooring be sure it is *Cadillac* Maple. This wood—sometimes called Rock Maple—is without a peer as a flooring material. It represents the highest achievement in modern floor-making.

The fundamental requisite for a hardwood floor is durability, combined with the quality of beauty; consequently, for use in schools, churches, factory or mercantile buildings, there is no better flooring than *Cadillac* Hard Maple.

### "ELECTRIC"

#### HARDWOOD FLOORING

The Standard of Comparison

The finer possibilities of Michigan Hardwoods for modern floors are becoming better understood and appreciated by the consuming public.

For many years we have devoted our best energies to converting Michigan's superb woods—Maple, Beech and Birch—into the famous "Electric" flooring.

We manufacture the flooring in two thicknesses—standard, 13/16", and thin, or 3/8". Write us today and let us show you whereby you can save money by using the 3/8" Flooring.

We have just issued a folder giving a graphic demonstration by representative users of our flooring, showing the splendid appreciation of our endeavors. We should like to send you a copy.

COBBS & MITCHELL, Inc.  
Sales Dept.  
CADILLAC, MICHIGAN

### BEECH

*Cadillac* Beech is a close-grained, hard, strong and tough wood, and its durability is unquestioned. Beech is a close second to Maple in lasting quality and is particularly desirable for appearance.

The grain of Beech slightly resembles Oak. It is an excellent substitute for Oak and will wear longer and is cheaper. It has a natural warm tone and may be stained to produce many artistic effects.

Beech made the *Cadillac* way, is what you should use and specify.

### "ROCKHARD" FLOORING

The builder who uses "ROCKHARD" Maple flooring makes no mistake.

"ROCKHARD" is appropriately named. By combining *Cadillac* Quality, good lumber, superior millwork, years of experience and the most careful and systematic attention to all details in manufacture, we have produced a flooring that is "ROCKHARD" and one that will give the utmost service.

We manufacture "ROCKHARD" Beech and Birch Flooring. It is milled and graded in the same manner as our "ROCKHARD" Maple Flooring.

Our book on "Modern Hardwood Floors," which retails at twenty-five cents, will be sent free to readers of this paper. It contains many things you should know. WRITE TODAY.

MITCHELL BROS. CO. Sales Dept.  
CADILLAC, MICHIGAN

### SPECIAL

Our 3/8" Maple, Beech and Birch Flooring, only slightly thicker than a carpet, can be easily and quickly laid upon the old floor without inconvenience or large expense, and is equally suited for new buildings if laid on a smooth sub-floor. Being matched on sides and ends, the nails are concealed and cannot work out to the surface.

Made in different grades and selected colors to meet the varied requirements of the home-builder.

We sell only through your Dealer  
Send us his name if he does not know *Cadillac* Quality  
CADILLAC The Home of Quality

You will get SPECIAL ATTENTION if you tell Advertisers you read American Carpenter and Builder.

**WHY BUY MOSSBACK TIE  
WHEN YOU CAN BUY "BOSTWICK" Y  
BOSTWICK  
THREE-STRESS**

PAT. AP'D  
FOR  
TIE

**SAME NUMBER  
OF  
BRICKS TIED BY  
HALF THE QUANTITY  
OF TIES IF YOU USE  
"BOSTWICK" Y'S**

Stress or strain led 3 ways!  
"Bostwick Y's" catch hold  
coming or going!

**"BOSTWICK" Y's  
are  
Heavy, galvanized, with deep  
corrugations at various angles**

**EVERY BRICK  
TIED WITH USUAL  
NUMBER OF TIES  
IF "BOSTWICK"  
Y IS USED!**

Change of position in wet  
mortar will not reduce the  
holding power!

SIZES  
Regular walls, 7" long, 1" wide,  
2 3/4" spread. Veneer walls, 6" long,  
1" wide, 2 3/4" spread. For binding  
concrete walls, 10" long, 1" wide,  
2 3/4" spread. Regular ties packed  
1000 to box. Weight 65 lbs.

**THE BOSTWICK STEEL LATH CO.  
NILES, OHIO**

**A Stairway that Really Disappears**

A device that architects call "a long-felt want" is found in the Bessler movable stairway. Many plans have been tried to displace the stationary stairways in places where the room taken up by this type could be used to great advantage otherwise, but no one seemed to be successful in solving this problem until Mr. Frank Bessler, after many years of study, finally developed what he calls the Bessler movable stairway.

The advantages claimed for this stairway by the Bessler Movable Stairway Company are: Economy in space saved, convenient accessibility to the upper floor; beauty of appearance, nothing but a panel finished to match the woodwork in the room being visible; a perfect means of ventilating little-used rooms, such as attics and lofts; quick egress in time of fire and at the same time speedy accessibility for firemen in reaching these rooms.

The entire device is fully counterbalanced and is operated by one powerful spring, which once adjusted, never needs to be changed. To bring the stairway down, a light pull on a chain, provided for this purpose, is all that is necessary; a touch of the hand will slide the stairs down the panel, and it is ready for use. When no longer needed, the stairs are easily slid back up on the panel, and the stairway swung up into the ceiling, without the slightest slam. It cannot come down until wanted.

Architects and builders all over the country are really enthusiastic over this stairway and predict a great future for it. It seems to be especially popular in the modern bungalow, but is by no means restricted to this type of building. The stairway can be found in the most expensive homes and office buildings, as well as in the more moderate priced ones. Address the Bessler Movable Starway Company, Akron, Ohio, for further information.

**SHAPLEIGH HARDWARE CO.**  
ESTABLISHED 1843  
**ST. LOUIS**

**SHAPLEIGH HARDWARE CO.**  
TRADE MARK  
**DE**  
DIAMOND EDGE

*"DIAMOND EDGE IS A QUALITY PLEDGE"*

You will get SPECIAL ATTENTION if you tell Advertisers you read American Carpenter and Builder.

# \$1500.00 Made In One Month by this Man

—that's what Mr. Eakins made—paid his last \$10.00 for rent of a store window—at the end of 30 days had \$1500.00 in the bank—Today he is independent—a Crispette Machine and Crispettes did it—Perrine, Calif., took in \$380.00 in one day. Every nickel brought him almost 4 cents profit—What are you going to make of the future—just barely earn a living—keep wishing for something to turn up?—DON'T DO IT.

**LISTEN**—take that money you have saved up against the day of opportunity—invest it in a Long Popcorn Crispette Machine and make fortune smile on you—build up a big paying business.

Think of the fortunes made in 5-cent pieces—street cars—moving picture shows—5 and 10-cent stores—Everybody will spend a nickel—Everybody likes Crispettes—children—parents—old folks—You don't need any experience. You can start anywhere—in a store window—a small store-room where the rent is cheap, or the kitchen of your home.

The Crispette Machine and Long's secret formula to the man of limited means is safe and strong—a sure way to independence and fortune—make money right from the start.



## Almost 400% Profit

Every 20 cents spent returns you \$1.00 cash—NOT THEORY—not guess work—not imagination, but the actual, bona fide, proven record of profits of Crispette producers from Coney Island to Oregon—from Canada to Argentine Republic.

**STOP!** You have followed the rut too long. You have accepted only what others care to give. Get on the other side. TAKE ONLY WHAT YOU WANT! F. O. Thompson, Oregon, took in \$575.00 in 27 days. E. H. H., Penn., sold over 12,000 rolls in two weeks, etc. Just a sample of the letters received from "Crispette" merchants from all parts of the country. Our greatest money barons began with a far less advantage than I offer you today. Write NOW—for my handsome illustrated, 48-page, free booklet, "How To Make Money In The Crispette Business." Or

### Come and See Me at My Expense

It isn't necessary to write and tell me you are coming. Just drop in any time. I will pay your traveling expenses within 300 miles if you buy a machine. I will give you all the references you may desire—responsible merchants, bankers, citizens—write to them if you will, then go over the "CRISPETTE" business with me. Get the full information—the startling good news!

I Want to Start You in the Same Business that Made Me Wealthy—  
**W. Z. Long**



**W. Z. LONG COMPANY**

884 High Street Springfield, Ohio



\$100 A DAY MADE BY THIS MACHINE

Fill in The Coupon Below

THE EIGHTH GREAT WONDER OF THE WORLD

## Follow Carefully the Amazing Facts

Answer to Yourself These Pertinent Questions

What salary do you EARN! What salary do you GET! Stop a minute and consider. You know that what you receive from your employer represents but a small portion of what you really earn. Get on the other side! If your earning power amounts to thousands every year—then EARN IT—AND KEEP IT YOURSELF.

NO GREATER, BETTER OPPORTUNITY can be put up to you offering such CERTAINTY OF SUCCESS—producing the enormous—honest—legitimate profits—requiring such small investment—so light running expenses. Any man of ordinary intelligence—ambitious—progressive—energetic—who wants to get ahead in the world—should make a "Crispette" Machine pay for itself in a few weeks.

The world today hungers for the "different," and it pays millions of dollars every year to satisfy this desire. Why not be the one to satisfy this demand in your locality—and reap your share of the golden harvest now ripe and ready for you!

Fill in the coupon—send for free book, "Dollars and Sense In The Crispette Business." It tells the whole story—how and where to start, how to succeed, gives experiences of others, etc. It's worth reading, even if you don't start. If you are looking for a good thing and easy money, send today for this book.

W. Z. LONG CO.,  
(884) Springfield, Ohio.

Without any obligation at all, please send me, free, your book, "Dollars and Sense In The Crispette Business."

Name .....

Address .....

You will get SPECIAL ATTENTION if you tell Advertisers you read American Carpenter and Builder.

**Artistic Metal Ceilings**

"Fine ornamental ceiling you're putting up there, my boy," the Old Builder remarked as he sat down in the store window. "I notice all of these new store buildings seem to have 'em."

"Yes, they're what the people want these days. Look clean and neat, and they're safe—give lots of fire protection. We're putting in metal ceilings in all of this block of stores and three of them are to have metal side walls, too."

"You're right; these are pretty nifty sheets, too. The design is O. K., and they're deep stamped. We're having no trouble putting them up either, as they all run uniform. It was a snap



Artistic Metal Ceiling Offered by Foster Sheet Metal Works.

ordering them, too. We looked over the big catalog of the Foster Sheet Metal Works and found just the design wanted. We could figure exactly how much the goods would cost and sent in our order. You can see yourself the fine shape they shipped the goods to us.

"The Foster Sheet Metal? Oh, they're located at Springfield, Ill., 530 N. 10th Street. They're good, reliable people. Make all kinds of sheet metal building material. If any of your friends would like one of their big catalogs just have them write for one." ❖

**How Much Do You Know About Estimating Paint?**

It's sad but true that many contractors who are their own architects, and handle a job from beginning to end, give too little thought to that finishing touch, which sets off and preserves the results of their handiwork—the painting and varnishing.

A prominent paint manufacturer has been pointing out in his advertising in this paper that the appearance three years hence of the jobs you turn out this year, will depend largely on the paint and that it behooves you to choose with care the paint that you specify.

Of course, paint is a most complex subject and even men who specialize in this work often admit they don't begin to know it all. But there are a good many definite rules that can be adopted and there is a great deal of information that every contractor ought to know about paint.

The subject of paint estimating, from the standpoint of the architect and contractor, is summed up briefly and most helpfully in a book published by the Lowe Brothers Company, Dayton, Ohio, under the title, "High Standard" Paint Specifications. Any reader can get this really worth-while book by mailing a request to this company at 457 E. Third St., Dayton, Ohio.

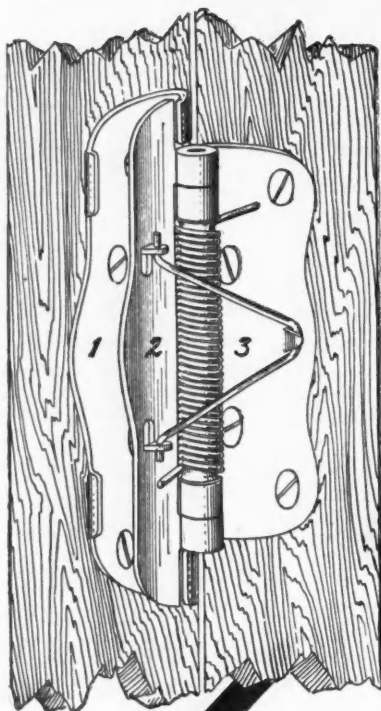

**E-Z-ON SCREEN STORM-DOOR HINGES**

**Be Our Agent in Your Town**

The E-Z-ON is a detachable and reversible hinge for screen and storm doors. Extremely simple of construction and BUILT TO LAST. Anyone can replace a storm door with a screen door if equipped with E-Z-ON hinges in thirty seconds.

The construction of the E-Z-ON eliminates 500 per cent of the wear on spring by the use of a 1/4-inch bushing between spring and pin. Keeps your door and casing in normal condition and has 100 per cent greater resisting force by use of a long jam plate. The weight of the door is carried on the lugs and there is no moving part or friction. This construction

**Absolutely Prevents Door From Sagging**

The E-Z-ON is handsome. It will add style to the door of a cottage or a mansion. Its construction is such that it will outlast others five to one. Leading architects and contractors endorse and specify



**We Want Live Agents in Every Town Where We Are Not Already Represented**

E-Z-ON hinges are selling very rapidly and the agency in your territory will soon be taken up. We are not selling patent rights or territory. We are makers of and sellers of E-Z-ON hinges.

**Do You Want to Represent Us**

We will send you, on receipt of fifty cents, one pair of E-Z-ON hinges for inspection and trial. Money refunded if not satisfactory. Clip coupon today, and get our agency before someone else does.

**RACINE DETACHABLE HINGE CO.**  
RACINE, WISCONSIN

Gentlemen:

Enclosed please find 50 cents for which please send me one pair of E-Z-ON hinges. Money to be refunded if not satisfactory. Also your special agent's proposition.

Name .....

Street .....

Town ..... State.....

**You will get SPECIAL ATTENTION if you tell Advertisers you read American Carpenter and Builder.**

# GET YOUR MONEY'S WORTH

**Large Stock of Builders Supplies Always On Hand**  
**Prompt Shipment Factory Prices**



**H-9, Red Oak Door,**  
**1 1/2 in. Thick.**  
**\$4.75 Glazed.**  
 Glazed with clear D. S. Glass. Without glass, open, \$4.23 This front door is made of fine selected hardwood. We sell it at the lowest possible price. A complete line offers you a nice selection.



**"One Pan" Panelled Door,**  
**\$2.39**  
 Size 2'8"x6'8"x1 1/4" thick. Beautifully paneled and finished. All sizes up to 3'x7' carried in stock at slightly higher prices. Made of selected old growth Yellow Fir. Edge grain stiles and rails, three ply rotary cut, veneered flat panels. Others at equally low prices.



**DOOR SETS**  
 Choice assortment of ornamental and plain designs in various finishes. You will find one or more designs suitable for any style of building. Each set consists of escutcheons, metal knobs, mortise locks, case, Reversible Bolts and Keys. Prices to suit all buyers.

This is your opportunity to get whatever you need for your buildings at cost. No delays; no disappointments. We can supply you with material of all kinds at lower prices than you've ever paid. Every item listed here is exactly what it is represented to be—high-grade stuff that you won't be ashamed to put into your buildings. The price is low—very low—but there's nothing cheap or shoddy about the goods.

**EVERY ITEM LISTED HERE**

speaks for itself. These are only a few of the thousand items for builders listed in our Big Catalog. Quality for quality. We can save you more money on your inside trim, colonnades, roofing, mantels, sash, frames, doors, windows, etc., than any other concern in the country.

**USE THE FREE COUPON**

Don't wait. Send it now. Cost you nothing. We guarantee absolute satisfaction with our goods. Get our big, free books on **Mantels** and **Millwork**, Builders' Hardware, etc. Send your name and address today. Get our prices on guaranteed goods before you place your order elsewhere for this season's material.

**THE HUBER BUILDERS' MATERIAL CO.**

45-49 Vine Street  
**CINCINNATI :: OHIO**



**MANTELS**  
 Get our Mantel Catalog. It will help you appreciate the beauty of the styles we carry. Each one is strictly up-to-date. Fitted for gas or other fuel or without grate, as wanted. Great variety of finishes from which you can make a choice for that new house. Get our handsome Mantel Book, Free. See Coupon.



**WINDOWS**  
**70c and Up.**  
 We carry in stock for immediate shipment an unusually wide range of styles at various prices. It is impossible to list them all here. There are windows of every kind for every purpose. Special Styles can be made to order, very quickly. Tell us your requirements. Prompt attention assured.



**STAIR WORK**  
 Turned and square Porch Newels. 31c to 72c each.  
 Spindles 1 1/4 to 2c each.  
 A very nice selection of newels, balusters and spindles for porch or stair work at very little more than the cost of the wood. Exceptionally clear stock, free from imperfections. Custom stair work is also a leader with us.



**CAP MOLD**  
 R-6, 1 1/4" and 1 1/2". Price \$2.20 per 100 ft.  
 Other styles as low as \$1.00. All kinds of moulding in stock. Head moulds, Base moulds, Base Cleat, Cove Mould, Picture Mould, Window Beads, etc.

COLUMN No. 7133 Shows Column No. 71 with Scamozzi Composition Capital No. 33. 6" to 12" diameter. Price \$2.84 to \$7.91

COLUMN No. 9033 Shows Column No. 90 with Scamozzi Composition Capital No. 33. 6" to 12" diameter. Price \$2.09 to \$6.41



**PLATE RAIL**  
 We have special low prices on Yellow Pine Plate Rail. Carefully finished, from good, clear material. Takes stain or varnish beautifully, and makes a very effective finish. We feature plate rail, beamed ceilings, custom stairs, corner beads and all interior trim. See Catalog for Prices.



**ROLL ROOFING**  
 made of best quality felt. Used on flat or steep roofs. Easy to lay. Water-proof, fire-proof and not affected by temperature, steam, etc. One roll covers 100 square feet.  
 2 Ply per roll \$.65  
 3 Ply per roll .85



**CYPRESS SHINGLES**  
 Style S, \$4.10 per M.  
 Styles R, P, C, and O, \$5.10 per M.  
 These shingles are guaranteed to give unusual value in wearing quality. We also carry extra clear Red Cedar Shingles at \$4.55. Lath, common boards, weather boarding, etc., can also be furnished at extra low prices.

**WALL BOARD**  
 A large stock of the best known wall boards enables us to sell at manufacturers' cost. The best of the standard brands at prices which will make it profitable to buy your wall board from us.

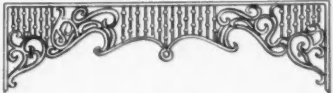

**GRILLES**  
 Style H-69 is illustrated, 18 inches deep at ends. A very neat design, fitted with curtain rods, complete, 86c. per lineal foot. Many other styles illustrated in our catalog. COMPLETE COLONNADES of exclusive design, in Yellow Pine, Oak, Birch, Cypress, etc., at prices from \$12.50 to \$44.00.



**BUILDERS' HARDWARE**  
 At prices much less than you'll pay at your hardware store. We can furnish you with complete hardware for any of your buildings. Our hardware men will pay close attention to your requests. Send us your lists. We guarantee quality and satisfaction.

**FREE! BOOK COUPON**

The Huber Builders' Material Co.,  
 45-49 Vine St., Cincinnati, O.

Please send, WITHOUT COST TO ME, your two big books on Millwork and Builders' Materials and Mantels. Also explain your GUARANTEE on all goods you sell.

Name .....

Street .....

Town and State.....

Are you a contractor!.....

You will get SPECIAL ATTENTION if you tell Advertisers you read American Carpenter and Builder.

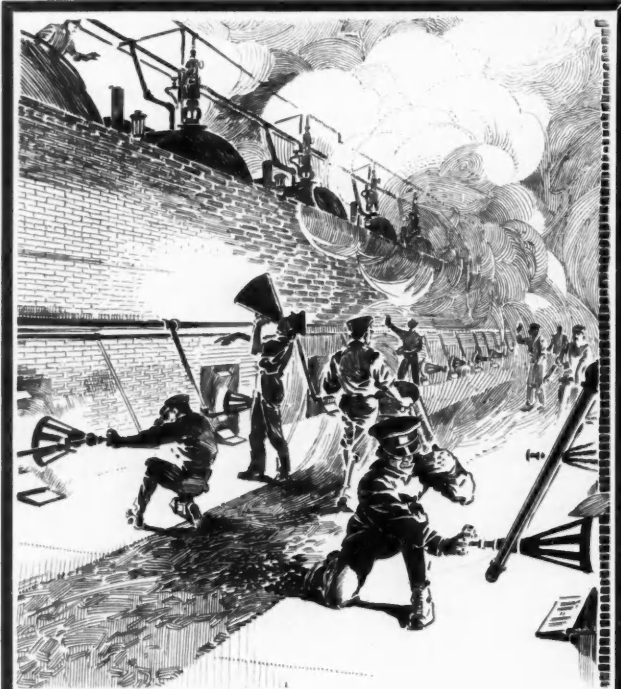

## Asphalt shingles never were made so strong and stiff as these

First, we procure pure wool and compress it into long, strong-fibred felt. Then, this is thoroughly saturated with **TWICE ITS WEIGHT** of asphalt. Over this weather- and moisture-proof sheet we apply a coating of gilsonite—a tough, rubbery, very high melt point asphalt from which all the oils have been removed. And into this, while still hot, we compress, under tons of pressure, the slate or gravel surfacings, whose beautiful, lasting, natural colorings, of red, greenish-gray garnet, emerald and brown, age only makes more brilliant.

## Flex-a-Tile GIANT Asphalt Shingles

More wool and purer wool than other makers use. Asphalt of better grade and **HIGHER MELT POINT**, because we alone employ a direct heat **BENEATH** our saturation kettles. Oils in roofings dry out and evaporate under a hot sun, so we eliminate them entirely. Even in saturating the wool, instead of using oil, we make the asphalt a thorough saturant by melting it at a tremendously high degree of heat.

Of course, it costs us more to insure this extra rigidity, this extra weight and strength. But still we keep the price to you as low as you must pay for inferior brands.

Just write now and say, "Send me specimen Giant Flex-a-Tile." You assume no obligation. Get all the facts. Write today.

### THE HEPPESS CO.

Manufacturers also of Asphalt Paint, Asphalt Roofing  
in Any Finish, and Utility Wall Board

1010 South Kilbourne Avenue, CHICAGO, ILLINOIS

## Buys Nine White Dump Trucks

**WELL KNOWN PAVING CONTRACTORS INSTALL BIG  
FLEET OF MACHINES WITH POWER HOIST**

The Brooklyn Alcatraz Asphalt Company, one of the largest street and road contracting concerns in America, has purchased from the White company nine five-ton, power dump trucks for hauling and dumping street-paving material. Although motor trucks have been widely used in the transportation of street and road-making material, the Brooklyn concern has the distinction of owning the largest fleet of power dump trucks in this line of work.

Other companies who operate fleets of White dump trucks are Warren Brothers Company of Boston; the Pacific Mills of Lawrence, Mass.; Cleveland Builders' Supply Company of Cleveland, O.; New England Crushed Stone and Contracting Company, Roxbury, Mass., and T. W. Thwaites and Ralph Blass of San Francisco.



## L. S. Starrett Co. Joins Leaders' Association

Mechanics in all trades will be interested to learn that the L. S. Starrett Company, of Athol, Mass., have accepted the invitation of the "Rice Leaders of the World Association" to join their organization.

This organization has adopted high standards which all members must meet. Their principles are honor, quality, strength, and service, and an emblem has been adopted which signifies these principles.



## Measuring Materials for Uniform Concrete

By W. Alling

Of the Eureka Machine Co.

The next time you are at a job where the aggregates are measured in wheelbarrow loads, look at the marked difference in loading—look at the different types of men represented—and then ask yourself how uniform concrete can be when it is thus subject to the "man factor." It's the batch-mixer method of making concrete. Compare it with the way in which the aggregates are automatically proportioned in the Eureka self-measuring mixer, "Where Guesswork Ends."

You've heard about the "Melting Pot" of humanity. You'll surely find its characters in your concrete gang and you will find their characteristics as widely at variance as their nationalities.

Need it be any surprise, then, when you stop to think of it, that the wheelbarrows should show such a marked difference in loading?

Each barrow represents the individual's conception of a load, or perhaps his mental or physical attitude at the moment.

And that's the way the aggregates are measured in batch mixing!

Do you wonder that concrete often varies greatly in strength and uniformity?

Just by way of illustration: A prominent contractor recently stopped ten of his wheelbarrow men and had each man's load measured.

He found that the loads ranged from  $3\frac{1}{4}$  cubic feet to 5 cubic feet, although theoretically each load should have been 4 cubic feet.

He also found that occasionally an entire barrow load was left out of the batch, and an extra one added.

The moral of the above is clearly apparent. The "hand-writing on the wall" is plainly visible. It sets forth the need of certainty in concrete construction. It shows the vital necessity of absolutely unvarying proportioning of the aggregates in making of concrete. It points to the "Eureka" self-measuring mixer, "Where Guesswork Ends."

But this is not all. There is a whole lot more to the

You will get **SPECIAL ATTENTION** if you tell Advertisers you read **American Carpenter and Builder**.

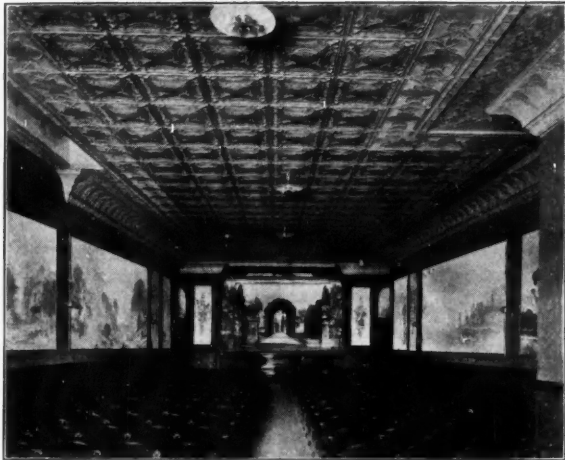

## Klauer's Steel Ceilings

Are the kind you want for the work you now have coming up.

Unexcelled as to designing and mechanical perfection, they are most economical as well as most desirable.

Get our complete catalog and let us figure on your requirements.

**Klauer Manufacturing Co.**

Dubuque, Iowa

## We Don't Travel Salesmen

Our's is an Agency proposition. By keeping selling expenses low, we can increase the quality of our

**Metal Ceiling and Shingles** and offer you better prices.



**SOME TERRITORY STILL OPEN—**

**But!**

Don't wait until tomorrow, or your friend across the way may close it up.

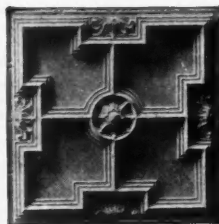

*Catalogs and Special Propositions on Request*

**THE CANTON METAL CEILING CO.**

1947 Harrison Avenue  
CANTON, OHIO

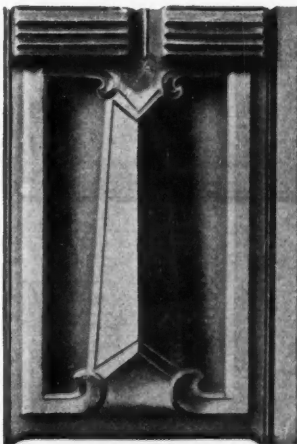

## "TAMCO METAL" TILE OR SHINGLES

Durable and Attractive for Residences, Barns, etc. Send for "Tile" Catalogue.

**Metal Ceiling and Side Walls**

Artistic and Classy

Free Suggestive Drawings. Send Measurements. Ask for Illustrated Catalogue "B".

**THE TIFFIN ART METAL CO.**  
TIFFIN, OHIO, U. S. A.

Manufacturers Metal Roofings, Gutters, etc.

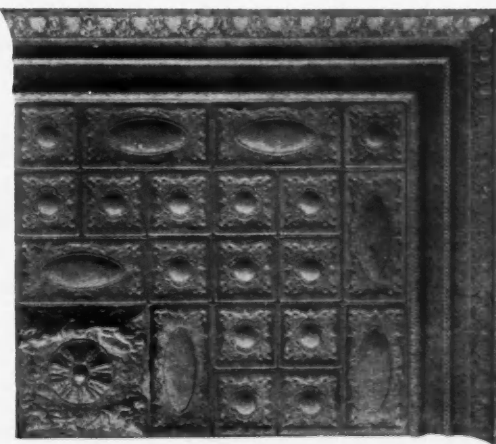

## THE BEST LUMBER FOR THE OWNER OR THE INVESTOR TO PAY FOR IS THE BEST LUMBER FOR THE CARPENTER AND BUILDER TO USE.

Don't Forget That Good Reputations are Built on Good Recommendations. USE AND RECOMMEND

# CYPRESS

(OF COURSE)

BECAUSE IT'S "THE WOOD ETERNAL"

& LASTS & LASTS & LASTS & LASTS & LASTS & LASTS

Write SOUTHERN CYPRESS MANUFACTURERS' ASSOCIATION  
1216 Hibernia Bank Bldg., New Orleans, La.

For VOL. 1, Cypress Pocket Library. (Full Reprint of U. S. Gov. Rept.)

## METAL CEILING

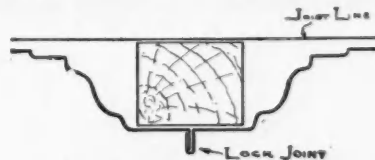

**See that Joint?**

The Acme of perfect construction. Don't nail or slip the joints. Lock them. Full information in catalogue E.

**S. KEIGHLEY METAL CEILING & MFG. CO.**  
PITTSBURGH, PA.

You will get SPECIAL ATTENTION if you tell Advertisers you read American Carpenter and Builder.

"Eureka" story to claim your consideration. Here are just a few of its advantages:

Capacity for capacity, it weighs half as much, costs half as much to buy it, costs a third as much to run and costs a fifth as much to move it. It saves you \$10 to \$20 a day in wheelbarrow-gang salaries, as it can be pushed right up to the work and the concrete chuted. It produces uniform concrete in a continuous stream just where it is needed.

Don't put off investigating this mixer. Every day's delay means just that much lost opportunity to save money in concrete construction.

Ask for new catalog. Address the Eureka Machine Company 12 Case St., Lansing, Mich.



### Painters and the Fire Hazzard

By M. G. Bennett

General Manager Samuel Cabot, Inc.

It is rumored that there is under way a campaign to prevent the use of woodwork in buildings—a campaign to have laws and ordinances passed all over the country to prevent the use of woodwork. These campaigns have been started with a great sound of disinterested desire to prevent conflagration, and in order to make the first step easier the attack has been centered upon shingles.

This campaign has succeeded in many places where ordinances have been passed prohibiting the use of shingles on roofs, only to be repealed again after the public became aware of what had happened and it had been made plain to them that the attacks upon shingles had been tremendously exaggerated.

Further steps have been taken in many places, and in New York it has been proposed to absolutely abolish woodwork in buildings over 150 feet high.

The painter has a responsibility in this, for it is more than

ever up to him to handle his work so that there can be no criticism from the fire-prevention standpoint.

Probably the most flagrant contribution that the painter ever makes to the fire risk is the reckless use of kerosene, benzine and similar dangerous inflammable thinners and cheapeners for paint products. It is not stating the case too strongly to say that the presence of benzine in the ordinary shingle stain as made by painters, and paint dealers as well, has done more than any other one thing to strengthen the original arguments against wooden shingles. A chemical analysis of more than twenty-five shingle stains made by painters, paint dealers and paint manufacturers has shown that they all contain from 50 per cent to 70 per cent of kerosene or benzine, or some other dangerously inflammable petroleum distillate. A little creosote is usually added to furnish a smell, but not enough to serve any other useful purpose. Such shingle stains are not only dangerous to have around a building, but when the shingles are saturated with them a match will set fire to the whole house, and an owner who will permit his house to be done with such stains (if he knows it) is a bigger fool than his cook who kindles the kitchen fire with kerosene. There are numerous cases on record where such stains have caused fires, and now that the cities and towns are drawing up their ordinances, many of them are taking cognizance of the character of shingle stains. In Milwaukee, for example, shingle stains were examined, and Cabot's was the only one that was found free from inflammable ingredients and with a flash point so high that it was considered safe to use.

This is but one item, and painters and paint dealers should consider in what way they can reduce the fire risk in all of their operations, because if the campaign of the "fireproof" substitute is successful, it will not only make our dwelling houses much less attractive, but will tremendously reduce the use of paint, varnish and similar materials.

## Send for Pad of Colors on Wood

OUR treatment with creosote gives protection to shingles just as railroad ties are preserved against worms, dry-rot and decay. You should no more think of leaving shingles unstained than you would think of leaving house and woodwork unpainted.

Our different color shades of green, gray, red and brown permit the most artistic color combinations on roof and side walls.

## "CREO-DIPT" STAINED SHINGLES

14 Different Grades; 16, 18, 24 Inch. 30 Different Color Shades.

Every "CREO-DIPT" Shingle is treated by our exclusive process. The coloring and preserving is sure and thorough. There is no need of brush-coating or painting the shingles; save the waste of time—muss of staining on the job. They come in bundles—ready to lay.

Only high quality Red Cedar Shingles are used. No sleazy or wedge-shaped shingles. You buy no waste. Last twice as long as brush-coated or natural wood. Cost less than stained-on-the-job shingles.

Write today for pad of colors on wood.

State requirements and we will quote prices. Dealers should write for discounts.

**STANDARD STAINED SHINGLE CO.**

1028 Oliver Street

No Tonawanda, N. Y.



Residence of R. J. Mebane, Greensboro, N. C. Architect, E. Raymond Ellis, Hartford, Conn. One color tone on side walls, darker shade on roof.

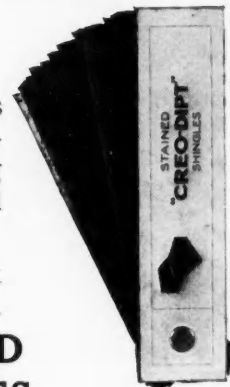

You will get SPECIAL ATTENTION if you tell Advertisers you read American Carpenter and Builder.





Bungalow of Albert E. Small, Amherst, N. Y. Sheathed Asbestos Building Lumber, and roofed with Asbestos "Century" Shingles by Robert Demest, Contractor, Williamsville, N. Y.

## Asbestos Building Lumber

IT is one of the long standing difficulties of the Architect and Builder that clients insist on cutting their building costs to the lowest possible figure. Yet there are hopeful signs of a healthier point of view.

We note in our correspondence, for instance, that more people are waking up to the fact that *building for permanency* is building for economy.

There never was a time when the permanency of Asbestos Building Lumber and Asbestos "Century" Shingles were of more importance to the Architect and Contractor than they are today—nor a building material of greater possibilities.

Write us for terms and trade prices. We will also send you our Booklet, "Roofing—A Practical Talk".

**Keasbey & Mattison Co., Factors, Dept. B., Ambler, Penna.**

*Branch Offices in Principal Cities of the United States*

## REYNOLDS ASPHALT SHINGLES

*Guaranteed for 10 Years*

will last many years longer—Natural colors of garnet, red, gray and green, which never fade.

We are the ORIGINAL MAKERS of Flexible Asphalt Slate Shingles and tested our product for ten years before putting it on the market. Let us send you a booklet.

**H. M. Reynolds Asphalt Shingle Co.**

Established 1868

West Grant St. GRAND RAPIDS, MICH.



## Spanish Tile



The MOESCHL-EDWARDS CORRUGATING CO.



Catalogue "S" showing a complete line of Ornamental Roofings mailed free to Architects, Contractors and Carpenters . . .

Write for Prices on

Coiling	Marquise
Columns	Roofing
Cornice	Shingles
Cresting	Siding
Culverts	Skylights
Finials	Spouting
Garages	Tanks
Gutter	Ventilators

Address The Moeschl-Edwards Corrugating Co.

Covington, Kentucky

You will get SPECIAL ATTENTION if you tell Advertisers you read American Carpenter and Build

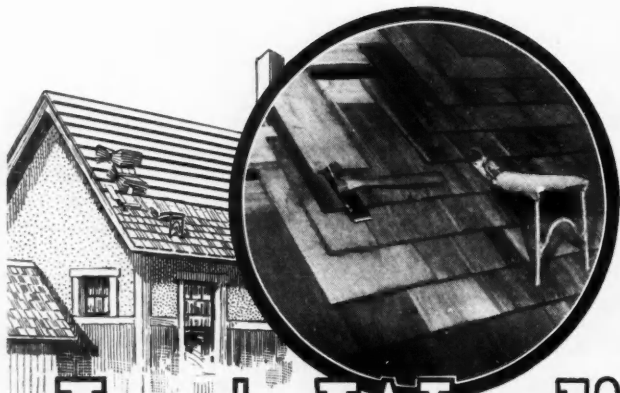

## Just a Word!

You can lay 5,000 shingles a day if you have a  
**TITGRIP SHINGLER'S CHAIR**

**F**INE for painting jobs, too. It makes the day's work easier. Does away with all chalk lines, straight edges, footholds and scaffolds. No need to drive nails in the roof. The "Titgrip" can be easily changed from place to place and can't slip. Grips like a vice. Weighs less than 3 pounds.

Try the Titgrip Shingler's Chair once and you'll never be content to go back to the old way of sprawling all over the roof and ache in every bone after the day's work.

### AGENTS WANTED

Write for Price and Full Description

**C. & E. Mfg. CO.** 107 N. Center St.  
Marshalltown, Iowa



## G. F. T. ROOFING SLATE

Perhaps you like other Builders have decided that ordinary roofings do not give full value for the money.

The Builders who have looked over the field carefully are now using **Slate** on the small buildings as well as on the large ones. They always come back to Slate when they want a **real roof**.

We can show you that **Genuine Franklin Tunnel Slate** is cheaper than **shingles** or **prepared roofings**. The **lasting qualities** of G. F. T. Roofing Slate recommend its use. It is fire-proof, leak-proof and needs no repairs.

To get the utmost value for your money, specify and use G. F. T. Roofing Slate. It's easy to get. Our Book of Specifications, our Samples, our Prices will inform you about Slate as a Roof. Ask us to send these.

### SLATINGTON SLATE COMPANY

Established 1852

SLATINGTON, PA.

Sole Manufacturers of G. F. T. Roofing Slate

### Making Money with "Wonder" Saw Rig

In the contracting business time saved is money made. If a builder can saw up as much form lumber in a single day on a small power machine as he would do by hand in five days, he is just four days wages to the good. Count out the cost of gasoline, interest on investment, and depreciation, and there is still more than three days left for pure profit. Then, too, there is the quick work, the big output, to be considered. At rush times it is often worth more than the first investment in the power saw rig simply to be able to slam the work through on time—ahead of the gang.

Concrete form work—making the cuts on rafters, studs and joists—cutting off siding—working braces and bridging, no contractor can afford to do these, and many other jobs of sawing, by hand, now that such efficient portable saw rigs



"Wonder" Saw Rig Working up Form Lumber.

can be had cheaply, which do such work so much cheaper and in many instances better.

The photograph we illustrate here shows the "Wonder" portable saw rig earning its keep for a prominent Iowa contractor. This machine is sold by the Waterloo Cement Machinery Corporation, 103 Vinton St., Waterloo, Iowa. It is making good for contractors and builders all over the country. Especially for concrete form work it is in great demand. The concrete mixers of the Waterloo Corporation are well known to AMERICAN CARPENTER AND BUILDER readers. Contractors who have equipped themselves with these mixers have felt the need of a first class reliable saw rig as well, and this has caused the Waterloo Cement Machinery Corporation to bring out this "Wonder" portable saw rig.

Right now, before you get so busy you will have no time, write these people and investigate their saw rig and concrete mixers.

### Indianapolis and Louisville Offices Move

The necessity for larger space and better facilities to handle their increased business compelled the Indianapolis, Ind., and Louisville, Ky., branches of the H. W. Johns-Manville Company to seek larger quarters. The new address of the Indianapolis branch is 408-410 North Capitol Avenue; that of the Louisville branch, 659-661 S. Fourth Avenue. Both of these branches will include ample warehouse accommodations, in addition to show rooms for the display and sale of this firm's varied line of asbestos roofing, pipe coverings, insulating materials, lighting fixtures, automobile accessories, etc. In connection with the last-named line, unusual pains have been taken in the equipment of service departments for the benefit of the customers who desire speedy adjustments, repairs or replacements.

You will get SPECIAL ATTENTION if you tell Advertisers you read American Carpenter and Builder.

**The Virtues of Other Roofing Materials Are  
Combined in a Metal Roof—**

if metal of the proper quality is used. Careful research and long service tests at the seashore, in the coke regions and country districts, have proved the superiority of

**COPPER STEEL  
For Sheets and Roofing Tin**

Demand this material in your roofing products, thereby insuring maximum service and satisfaction. Copper Bearing Sheets, both Black and Galvanized, are designated "C. B. Keystone Grade" added to the regular brand. Copper Bearing Roofing Tin is stamped "C. B. Open Hearth" in addition to brand and weight of coating. You should use no other. Send for illustrated booklet showing results of actual service tests.

**American Sheet and Tin Plate Company**  
General Offices: Frick Building, Pittsburgh, Pa.

DISTRICT SALES OFFICES:  
Chicago Cincinnati Denver Detroit New Orleans New York Philadelphia Pittsburgh St. Louis  
Export Representatives: UNITED STATES STEEL PRODUCTS COMPANY, New York City.  
Pacific Coast Representatives: UNITED STATES STEEL PRODUCTS COMPANY, San Francisco, Los Angeles, Portland, Seattle

**For Town or Country Houses**

—USE—  
**HUDSON**

**ASPHALT SHINGLES**

Rich and beautiful for roofing or siding.  
Provide fire protection at the least cost.

They are surfaced with Red and Green Crushed Slate. Fast colors. Require no painting or staining. Rot-proof. Easy to lay.

Send for Samples  
**ASPHALT READY ROOFING CO.**  
9 Church Street : : New York, N. Y.



**BUCKEYE METAL SHINGLES**

Are the latest development in Metal Roofing. Patented Buckeye Raised Side Locking Joints, shown in detail to the right, formed entirely above the surface of the shingles, prevent rusting and leaking.

**Practical—Lasting and Ornamental**

Well made of heavy gauge metal. Absolutely proof against water, fire and weather. Come in three beautifully embossed patterns, one of which is shown to the left. Reasonable in price. Write for our catalog and special proposition to carpenters and builders today.

The Thomas & Armstrong Co., Dep't A, London, Ohio

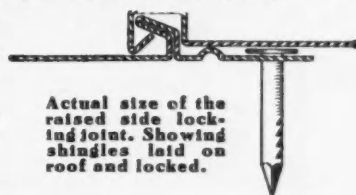
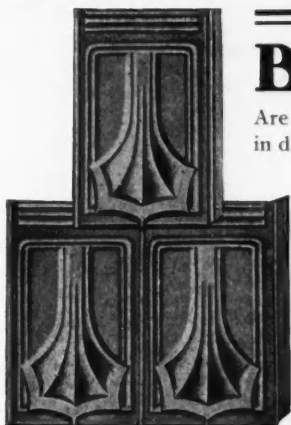

Actual size of the raised side locking joint. Showing shingles laid on roof and locked.

You will get SPECIAL ATTENTION if you tell Advertisers you read American Carpenter and Builder.

### Help for Figuring Sheet Metal

There is more or less sheet metal work required on every building job, yet builders are often at a loss to know how to figure this work, and where they can obtain a selection of first-class goods at reasonable prices. Very often the stock of the local sheet metal man doesn't amount to much and carpenters and builders are up against it whenever they need anything a little out of the common run.



We have just received a handy size, complete catalog and net price list that will be a great assistance to our readers in figuring all kinds of sheet metal work. It is issued by the Badger Steel Roofing & Corrugating Company, La Crosse, Wis. They offer very

attractive prices on cornices, skylights, finials, ventilators, sheet metal roofing and siding, galvanized screw joint, well casing, metal shingles, eaves trough, conductor pipe, galvanized tanks, galvanized culverts, metal ceilings, hip shingles, and metal windows; also tin plate, black and galvanized sheets.

These people will gladly send this illustrated catalog to all of Our Folks who will write them for it.



### "Titgrip" Shingler's Chair

A new patented device is offered which makes the shingler's working day easier and worth more. With it one man can lay 5,000 shingles a day. Its position can be changed easily and instantly without tools.

This is called the "Titgrip" shingler's chair. With it no

nails are driven in roof. Positive grip—can't slip. Weighs less than 3 pounds.

This chair does away with all chalk lines, straight edges, foot holds and scaffolds. It is made of highest grade materials. The manufacturers say that if you try this chair once you'll never go back to the old dangerous scaffold methods.

Address C. & E. Manufacturing Company, 107 N. Center Street, Marshalltown, Iowa, for full particulars.



### Hammer with Hollow Steel Handle

A hammer that will last as long as the head lasts is offered by the Hawthorne Sales Corporation, 220 West 42nd St., New York City. This hammer is fitted with Eastman's Patent Hollow Steel Handle—a handle that weighs no more than wood, but is claimed to be much stronger. It is impossible to break or loosen this handle, as it is keyed from the outer end with a wooden plug, driven through the eye inside the handle.

The handle is enameled smooth and will not blister the



hands. The construction of the handle acts as a shock absorber, and prevents jarring of the hand.

In addition to this improved hollow steel handle, this hammer also has the "Hynaler" claw head. This is of particular interest to carpenters; an indentation under the claw allows for the insertion of the head of a nail, so that the nail can be started easily in a high place.

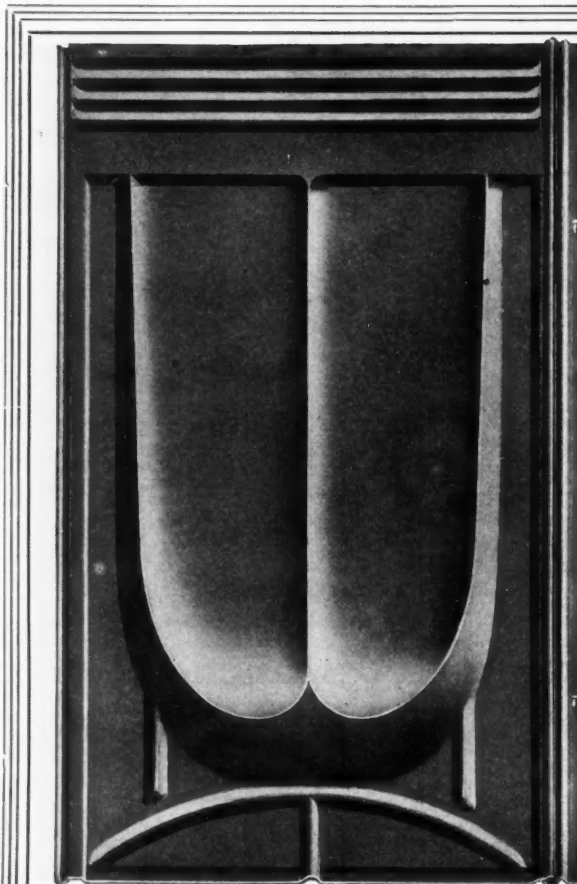

## EDWARDS "OHIO" METAL SHINGLE

The very latest addition to the big Edwards Metal Shingle Family has just arrived.

The "baby" is named after our own great state. Note the handsome, novel design and clean cut embossing. This pattern is made in one size only, 14 x 20 inches.

Manufactured from the best quality Worcester Grade Terne Plate, painted or "Tightcote" galvanized.

The "Ohio" has the patent interlocking device and every other good feature that has made Edwards Shingles famous.

*Samples and Price on Application*

### The Edwards Mfg. Co.

*"The Sheet Metal Folks"*

401-417 Eggleston Avenue, Cincinnati, Ohio

Largest Manufacturers of Metal Ceilings, Metal Shingles, Steel Roofing and Siding in the World.

New York Office: 81-83 Fulton St. Branch Office and Warehouse: 1625-1627 Pacific Ave., Dallas Texas.

You will get SPECIAL ATTENTION if you tell Advertisers you read American Carpenter and Builder.

THE ONLY ROOF THAT STAYS  
 THE ONLY ROOF THAT PAYS

RED  
 GREEN  
 PURPLE  
 BLACK

# SHELDON'S SLATES

Cost no more than wood shingles. Outlast the building. No disadvantages. Used on new and old structures. Easy to lay; quick to obtain.  
 Post a Postal and Get Posted NOW  
**F. C. SHELDON SLATE COMPANY, Granville, N. Y.**



## METAL SHINGLES

### FIREPROOF WINDOWS VENTILATORS

*A Complete Line of Architectural Sheet Metal Goods always in stock ready to ship on Short Notice.*

### Lowest Market Prices

Fireproof construction demands the use of more sheet metal goods this season than ever before.

Do you know where you can buy to the best advantage? Where you can get just what you want on shortest notice? You can't afford to hold up work on a job right in your busiest time.

Let us fill your orders. You'll be satisfied. Our business is big and successful and our prices low because we've always pleased the Carpenters and Builders.

Write today for Catalogs. Let us show you what we can do by quoting prices on whatever sheet metal goods you need on the next job.

**FOSTER SHEET METAL WORKS**  
 530 N. 10th St. Springfield, Ill.

This is One of Our 303 Styles and Sizes



**Armleder**  
 Style No. 655  
**\$64.13**

Body 6 ft. 9 in. long, 39 in. wide, 10 in. deep, 1 1/2 in. axle gear, capacity 900 lbs. A high-grade wagon made to wear. Prompt shipment. Convenient terms.  
 Get our free catalog.

**Address, ARMLEDER, Cincinnati, Ohio**  
 World's Largest Builder of High-Grade Wagons.

## Cortright Metal Shingles Are Fireproof

**E**VERY three minutes an American house catches fire—a large proportion from sparks falling on the roof. After the great fire in Chelsea, Mass., its fire-chief recommended that wood shingles be barred from Chelsea as *unsafe roofing*. This is now a law in many communities.

Cortright Metal Shingles are the logical solution of the fire problem because they *can't catch fire*, or crack, rot, curl or blow away. They meet every building and insurance requirements. A Cortright roof means customer's satisfaction, good will and future business. Cortright Metal Shingles have been in successful use for almost thirty years. They are easily and quickly laid right over old wood shingles if desired.

Our special Contractor and Builder's proposition means money in your pocket. Write for it today.

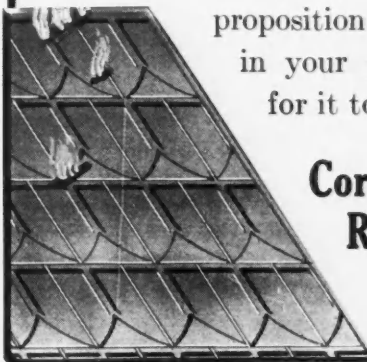

**Cortright Metal Roofing Co.**

Philadelphia and Chicago

**Cortright Metal Roofing Company,**  
 Philadelphia, Pa.

GENTLEMEN—Send me your Special Contractors and Builders proposition.

Name.....

Address.....

City.....State.....

You will get SPECIAL ATTENTION if you tell Advertisers you read American Carpenter and Builder.

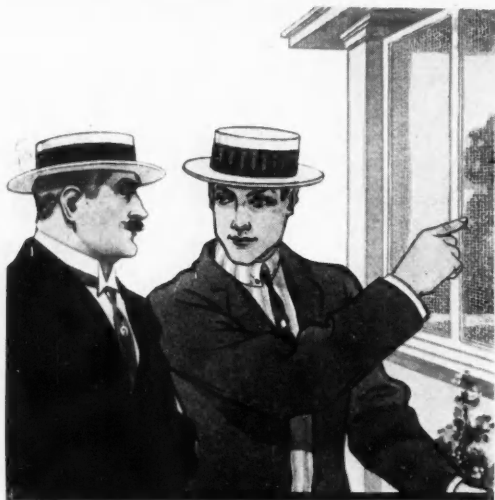

**Stop Buying New Screens**  
**Every Season or So—**  
**“PEARL” Gives Permanent Protection**

Just as long as you continue to use *painted* screens, you're going to have *trouble and expense*. Paint cracks off—*rust* sets in—*holes* result and new screens are necessary.

It's decidedly different when you use Gilbert & Bennett PEARL Wire Cloth—PEARL outwears by far any painted screen you've ever used. Its remarkable wear qualities are derived from a permanent metallic coating which is practically a part of the wire itself.

This same rust-proof metallic coating makes “PEARL” as *handsome* as painted screen is *ugly*. To justly judge PEARL you must have samples to compare with the screen you *have* been using. The smooth meshes of PEARL make it easy to keep clean and after a little exposure to the weather it turns to an ‘invisible’ gray which offers practically no obstruction to the vision.

This year—investigate PEARL before you buy—your only regret will be that you didn't learn of it sooner.



**For Screening Porches, Windows  
and Doors**

We make in addition to our Regular Grade of “PEARL” an Extra Heavy, Extra Strong Grade for door, window and porch use.

“PEARL” is made *only* by the Gilbert & Bennett Mfg. Co. Do not accept “galvanized” or any other material as a substitute. Insist upon seeing two Copper Wires in the selvage and a Round Tag bearing our name on each roll and you'll be *certain* of getting the *genuine* article.

The best hardware dealer in your city sells Gilbert & Bennett PEARL Wire Cloth and will gladly supply you.

Or—write our nearest office and we will send samples, literature and the dealer's name.

**THE GILBERT & BENNETT MFG. CO.**  
(Established 1818)

Dept. A-133 277 Broadway,  
New York  
Georgetown, Conn.

Dept. A-133 38 So. Dearborn St.,  
Chicago  
Kansas City, Mo.



**SAMPLES  
FREE**

Write our nearest  
office

**New Millers Falls Co. Catalog**

A new catalog has just been received from the Millers Falls Co., 28 Warren St., New York City. It is a book of 174 pages. It features a number of entirely new tools in addition to the already intensive line made by the well known tool people. Among these new tools are several models each, of ratchet braces, sill borers, hand drills, breast drills, boring machines, hack saw frames, etc.

The carpenter and builder who takes pride in keeping up with the new and important things will be pleased with this catalog. All of the illustrations are very clear and each tool is adequately described.

Millers Falls Co., will send a copy of this new catalog free to any of our readers who would like to have one.



**Scientific Barn Ventilation**

We have received from the Queen Cupola Mfg. Co., Cresco, Iowa, a copy of their new catalog, “Queen Cupola,” and feeling that credit should be given where credit is due, we must say that we have seldom seen a catalog on barn ventilation that seemed to cover the subject as satisfactorily and attractively. The photographs are excellent, both the detail views of the Queen cupolas and the barn pictures illustrating actual installations of Queen cupolas. There is a little two-color running head and the foot piece on each page, which add a lot to the attractiveness.

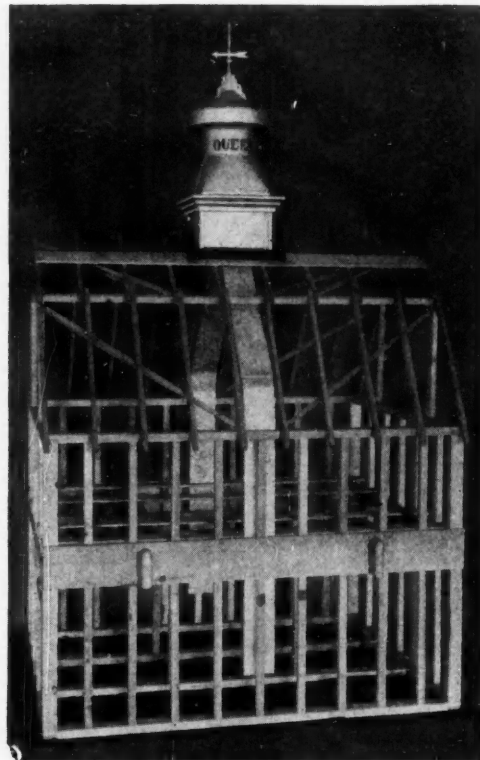

**Model Showing How Barns Should Be Ventilated.**

On one page the accompanying model barn ventilating arrangement is illustrated. This model shows the principle of ventilating plan in basement barn, showing galvanized pipe, 6 by 20, starting about twenty inches from the basement floor to the rafters and between the rafters into the base of the cupola. Also showing the fresh air intake pipe, which is carried to the center of the barn. When building stone basement, the fresh air intakes can be built in the wall. The Queen Cupola Mfg. Co., Cresco, Iowa, wish to send a copy of this catalog to every one of our readers who is interested. They also say to send sketch of your basement barn and they will let you know their way of ventilation.

**You will get SPECIAL ATTENTION if you tell Advertisers you read American Carpenter and Builder.**



### It Pays to Equip Your Buildings with the TUEC Stationary Cleaner

The TUEC adds to the selling value of a building twice as much as it adds to the cost; it increases the rentals out of all proportion to the increased investment involved. It finds quick buyers and ready tenants. And it **keeps** the building **new**

Leading contractors and builders have proven this. Many of them now place their orders for TUECS in quantity. Three out of every five stationary cleaners in use today are TUECS. The proportion will be still greater after the present season, because we are now selling the

**TUEC Stationary Cleaner - 170**  
Complete with Hose and Tools, for only  
**\$160 F. O. B. Canton, Ohio**

At this price the TUEC becomes as necessary to the equipment of any modern building as a stationary heating plant, stationary plumbing and stationary lighting.

Write today for the TUEC Book. Special inducements to contractors and builders. Prompt shipments. Guaranteed satisfaction.

**UNITED ELECTRIC COMPANY**  
30 Hurford St., Canton, Ohio

The TUEC is made in 15 sizes. The TUEC Book tells where thousands of them have been installed in homes, apartments, theaters, hospitals, schools, office buildings and public institutions. Also gives letters from enthusiastic owners.

Sixty TUEC offices in United States. Also offices in Canada, Hawaiian Islands and Australia.

## \$90 WEEKLY -- Gold Cash

I want a hustling carpenter in every town to act as my special Sales Representative, advertising, selling and appointing agents for the R-B COMBINATION VACUUM SWEEPER. Different in construction. Just what the housewife has been waiting for. Three bellows, rubber tired wheels, friction rollers, adjustable brush. Lightens work, kills worry, conquers dirt. Makes carpet look like new. No need to take off floor; no need to beat on line. Saves carpet wear and tear; saves tired, aching backs and arms. No labor, no effort, no drudgery. Push back and forth across floor like old style carpet sweeper. 20 million homes are just waiting for this absolutely new, money-back-guaranteed invention.

### Combination Vacuum Cleaner and Sweeper.



Look! Tremendous Profits—100 Per Cent!

A Monster Money Maker. Gainer, W. Va., made \$12 first hour. Kirch, Pa., "Rush 12, Can sell 20 a day". Sensational sales.

Think what a blessing to every home. Think of the big, tremendous, never-ending volume of business you should get. 2 sales daily means \$54 a week—clean profit.

Spend 1c—That's all. Just spend a penny for a postcard. Write me. Tell me you want the job. Don't let anything keep you from these big profits. Write me now.

C. A. BUTLER, Sales Mgr., 192 Factories Bldg., TOLEDO, O.

# The Screw Adjustment In the Wheeler Screen Makes it Self-Fitting

THREE TROUBLES INHERE in every non-adjusting screen, viz.: (1) Errors of the opening (no man can make two openings of the same size); (2) weakness of the wooden slide-tracks used by all sliding screens except the "Wheeler"; (3) swelling and shrinking of all window frames in wet and dry weather.

WE END THEM ALL. No matter what the error of the carpenter, no matter how imperfect the window frames, no matter what the weather, merely push out the Adjustable Strip in the side, by the infinite gradation of the Thumb-Screw—more at the top—less at the bottom—which-ever is needed—until the Screen just fits.

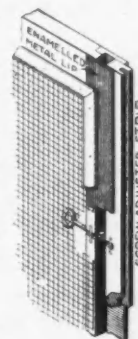

Corner showing Screw Adjustment.

With these inherent troubles ended, conveniences of all kinds at once follow, and the "Wheeler" out-points all others on any and all features. To the Contractor they afford two profits—the usual margin, and another in the saving over cost of fitting and painting the edges of all others. They fit without touch of tool at one-tenth the cost of other installations.

You can make more money SELLING screens to your customers than by making the screens. Keep your men busy at other work. Send us your Screen orders and have this much clear profit. Don't lose money and the time of your high-priced workmen.

You will make FIVE DOLLARS to our one, because we allow you the big-single profit on each individual house-order, since that is the only way for us to get hold of the little-many profits on the hundred house-orders from the tens of towns.

PROMPT SHIPMENTS: Special and automatic machines, on an acre-and-one-half of floor spare, reduce time of filling orders to days where others require weeks; speed is limited only by the time required for drying the finish specified. Three days after receipt of order is our average on White-Pine-Painted Goods.

If we have no Agency in your town, apply at once.

## Wheeler Screen Co.

### Geneva, Illinois

You will get SPECIAL ATTENTION if you tell Advertisers you read American Carpenter and Builder.

### Made \$115 Profit

When a contractor, who is using some of the new labor saving materials, figures a job in competition with others who are still wedded to old style methods, he very often has a chance to reap an extra profit for himself, and at the same time save his customer a tidy sum.

A good instance of this, which occurred last summer at Tonawanda, New York, has recently come to light. A party wanted to put up a moving picture theatre—he wanted an attractive job—something new and striking, as his competitor,

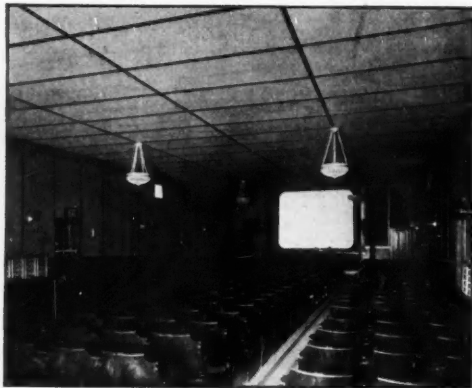

Interior of Tonawanda Theatre Finished in Plastergon Wall Board.

the only theatre then in town, was a beautiful \$9000 play house. However, he did not want to go beyond \$3500.

A local contractor, Joe Eisenhauer, had come to be an enthusiastic user of Plastergon wall board. Starting out as a good deal of a skeptic about this material, which he had seen advertised in the building publications, he finally gave it a test and was at once converted. So when contractor Eisen-

hauer heard of this theatre job, he at once got busy and put in a bid that landed the contract. The little photograph shows what a beautiful and artistic job he made of it.

Now about the profits. As a contractor and builder, Eisenhauer was able to get a special discount on the wall board of approximately \$3.50 per thousand square feet; so on this item he netted \$45.00. He saved four or five weeks which would have been required for ordinary lathing and plastering. A week after starting to nail the plastergon to the studding, one of the men started the interior decorating right over the wall board, using stencils. On the saving of his men's time he made \$70.00 more, which together with the profit on the board, made \$115.00 extra profit on this one job.

In relating this incident, Mr. Eisenhauer said, "Mr. Dietrich, the owner, is delighted with the beautiful Plastergon panel arrangement and harmonious stenciling. Really, I am proud of the job myself. It's seen by thousands of people, and only a few nights ago, Mr. Dietrich told me two or three people had asked him who had done the work."

Plastergon wall board is made and sold by the Plastergon Wall Board Company, Tonawanda, New York. Write them, addressing Dept. A for special proposition to readers of the AMERICAN CARPENTER AND BUILDER.



### Specialists in Sheet Metal Work

B. F. Lichty & Sons Company of Waterloo, Iowa, are gaining a national reputation for special sheet metal work such as cupolas, ventilators, sky lights, metal cornices, etc. Their manufacturing facilities are exceptional, and they have made a point of taking extra care in handling all kinds of sheet metal work.

From their price list it appears that they do their work in the most economical way, and so contractors and builders can do well in dealing with them.

## Heat, Cold and Sound Cannot Penetrate This Layer of Hair

The thick layer of hair in Keystone Hair Insulator—sealed between two strong, non-porous layers of insulating paper—contains millions of minute "dead air" cells, and dead air is universally acknowledged to be the most efficient insulator against heat, cold and sound.

That is why one layer of Keystone has greater insulating value than many layers of sheathing paper. By actual tests, fuel bills have been reduced from 25 to 35% by the use of

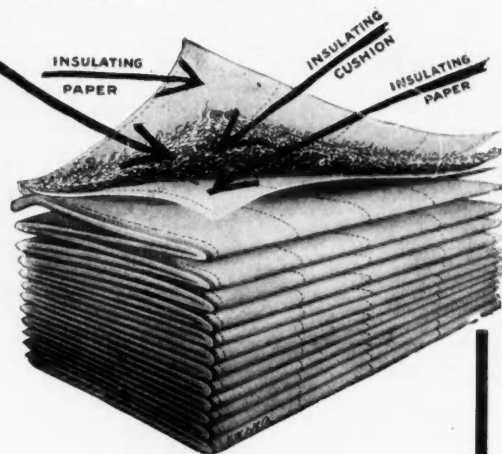

# Keystone Hair Insulator

The hair in Keystone is thoroughly cleansed and sterilized, therefore inodorous and vermin-proof. It will not settle or pack down. Is an effective fire retardant, as it will not carry flame. Will last as long

as a building. Keystone Hair Insulator keeps a house cool in summer, warm in winter and quiet all the time.

Other advantages are fully described in our catalog.

Write nearest Branch for catalog and sample

## H. W. JOHNS-MANVILLE CO.

Albany  
Baltimore  
Boston  
Buffalo  
Chicago

Cincinnati  
Cleveland  
Dallas  
Detroit  
Galveston

Houston  
Indianapolis  
Kansas City  
Los Angeles

Louisville  
Milwaukee  
Minneapolis  
New Orleans

New York  
Omaha  
Philadelphia  
Pittsburgh

San Francisco  
Seattle  
St. Louis  
Syracuse

THE CANADIAN H. W. JOHNS-MANVILLE CO., LIMITED, Toronto, Montreal, Winnipeg, Vancouver

1743

You will get SPECIAL ATTENTION if you tell Advertisers you read American Carpenter and Builder.





**Speaking of Roofs—**

Have you noticed the looks of the average roof after a year's service? Faded, warped, split—just about as bad as a roof can look. Doesn't improve the looks of the building, does it?

Then there's Slate—*West Bangor Slate*. Fifty years of service won't make it look worn and untidy. There's the same uniform color—more mellow and rich with age—architecturally beautiful always.

Don't get a wrong impression about the cost of *West Bangor Slate*. You can't really appreciate the advantages of *West Bangor Slate* until you investigate. Reasonable in *Price*; permanent in *Wearing Quality*; weather-proof; fireproof. You couldn't ask for more in any roof.

Our Samples and Prices will do a lot toward clearing up any of your doubts. You may have these FREE. A line today will bring them. Write.

BANGOR SLATE MINING CO., Trust Bldg., Bangor, Pa.

**Once a Skeptic, this Contractor Now Boosts Plastergon**

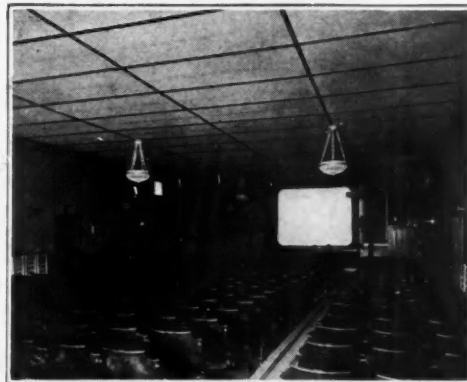

Interior of Moving Picture Theatre at Tonawanda, N. Y., "Plastergoned" by Contractor Eisenhauer.

Mr. Eisenhauer had always used lath and plaster—but last July a customer insisted on Plastergon. The minute the bungalow was finished, Mr. Eisenhauer's skepticism vanished—the job's beauty, its individuality and his profit turned him forever against lath and plaster.

**PLASTERGON**  
WALL-BOARD

In December he secured a contract for a moving picture theatre—see illustration above. His profit on Plastergon and its installation was \$115—and the owner is delighted—both are Plastergon enthusiasts.

Investigate Plastergon—we'll tell you how to duplicate Mr. Eisenhauer's success—how to have a bigger Spring business than ever. Drop us a postal—now, today.

Plastergon Wall Board Co., Dept. A, Tonawanda, N. Y.



Mr. A. P. Shattuck of Buffalo has had fine results from the use of BEAVER BOARD—write him

**Learn How to Use BEAVER BOARD**

There are thousands of people who ask about BEAVER BOARD and its uses. If you can answer their questions and give them a really first-class BEAVER BOARD job, you'll find it profitable.

Good designing and good workmanship are essential to success with BEAVER BOARD. Instructions must be carefully followed.

Our Carpenters' and Decorators' Co-operative Department will keep you posted on every phase of BEAVER BOARD construction.

Your name on our mailing list will entitle you to all the literature of this department. Write a card today.



TRADE MARK

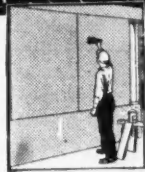

Beaver Board is painted, never covered with wall-paper.

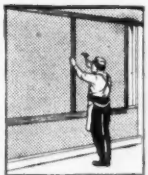

Decorative strips are nailed over edges after painting.

**The Beaver Board Companies**

United States: 331 Beaver Road, Buffalo, N. Y.  
Canada: 531 Wall Street, Beaverdale, Ottawa  
Great Britain: 4 Southampton Row, London, W. C.

**BEAVER BOARD**  
Walls & Ceilings

You will get SPECIAL ATTENTION if you tell Advertisers you read American Carpenter and Builder.

**Steady Progress**



Comes to the man who builds up a reputation in his own town for reliability, and who is not afraid to charge a good price for substantial constructive work—the price that allows him to use good labor and good material.

That this is a sound business principle is proven by the fact that in most towns the most prosperous carpenters, contractors and builders, use

**Genuine Bangor Roofing Slate**

Slate is a general name just as lumber. Our slate represents in Slatedom what the best white oak means in the lumber world.

Every year house owners are awakening more and more to the importance of a substantial roof—and are glad to pay for it.

With our assistance—and we maintain a special department for it—you can easily convince any Doubting Thomas that it will be to his interest to let you cover his house with Genuine Bangor Slate.

If you want to see how profitable this method of business building is for you, send the attached coupon—now before this slips your busy mind.

**Genuine Bangor Slate Company**

Easton, Pa.

April, 1914.

Please send particulars about your ability to help me make more money.

Name . . . . .

Address . . . . .

It will pay you to fill this out, detach, and mail today.

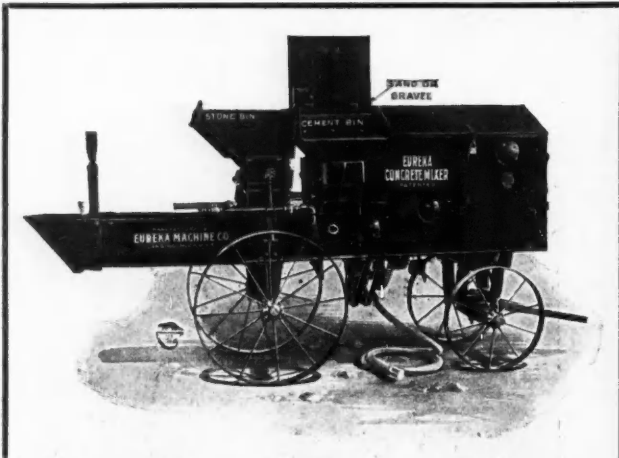

## A Yard Every Twelve Minutes

### A Money Maker

Pays for itself many times over in a year's time, in actual practice.

### Costs Little to Buy

The trifling sum of 80 cents a day pays for it in a year—and after that everything is velvet.

### Quantity Fixed the Price

A large output makes its low price possible. Manufacturing in small quantities would easily add a third more to the price asked.

### Only 4 Cents an Hour to Run It

The time is past when you have to buy and operate big, unwieldy, slow-moving, expensive mixing machinery on any sized job—big or little. The cost to run is next to nothing.

### Built of Steel

No matter how it is used, it's bound to last. It's steel and correctly distributed. Nothing like steel for long life and strength—costs more but will defy accidents and abuse.

### Self Measuring

No filling barrows—no wheeling. Shovel from the pile into the mixer. This cheap method will surprise you.

### Move the Mixer, Not the Material

Easy to move—two or three men can do it. Always handy to the materials.

### Power to Spare

A high grade, guaranteed, 2½ H. P. "NEW-WAY" gasoline engine furnishes surplus power.

Ask for Catalog No. 36, and Names of Eureka Users in Your Territory

## EUREKA MACHINE CO.

12 Case Street

LANSING, MICHIGAN

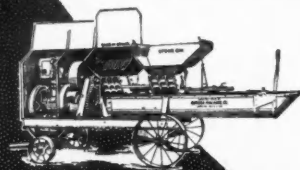

W. V. JOHNSON & CO.

General Eastern Agents

1 Madison Avenue  
New York  
City

Stocks in  
Principal  
Cities

NO WHEELING  
NO WAITING  
NO GUESSING

## Chicago Mixers Now Part of Smith Line

Users of concrete mixers will be interested to know that the Chicago Mixer which was formerly sold by the Chicago Concrete Machinery Company is now a part of the regular Smith line, sold by the T. L. Smith Company, 1138 32nd St., Milwaukee, Wis. They will hereafter be known as the Smith-Chicago Mixers.



### "Prize Plan Book"

We wonder if our readers, the contractors, carpenters, and builders take as much pleasure in studying plan books as the editor always finds in them. We have quite a collection of plan books and wouldn't want to part with any of them. Each is prepared along some different line and contains ideas and unique information of its own.

The latest addition to our plan book library is the "Prize Plan Book," just issued by the Hewitt-Lea-Funck Company, 408 Crary Building, Seattle, Wash. This is a large book, 9 by 12 inches, containing 100 pages; its purpose, as made clear in the first few pages, is "How to Build a House Without Extras." This of itself will at once hold the attention of thrifty builders. A book that will show how to do away with that aggravating problem of shortages and extras is certainly worth while.

As most of our readers know, the Hewitt-Lea-Funck Company are very large manufacturers of lumber and millwork, with immense forest holdings in the Northwest. Their specialties are Douglas Fir and Red Cedar. Anyone, who has not yet tried these woods, has a treat in store for himself. Produced in immense quantities with modern mills right where the timber grows, it is said that this company can compete with local lumber and millwork products throughout all the Mississippi Valley and the Northwest; even considering the freight rates, they are right in line for business. Of course, the Hewitt-Lea-Funck policy of dealing direct with carpenters, contractors and home builders helps to hold down the selling costs.

In this "Prize Plan Book" you will find a large number of interesting houses illustrated. For the most part, photographs of houses actually built are shown in this book. Floor plans giving the size and arrangement of all rooms are illustrated in connection with each design and there is also an itemized statement of cost, showing exactly what the material for any house can be furnished for. This will be a big help in estimating.

Very good taste has been exercised in the selection of house designs presented. There are a good many of Western bungalows, also a choice of the best of the older popular designs. Two-story houses and those planned to go on a narrow lot find a place in this collection. All the way through, the book is full of good ideas; many interior views are included and the descriptive text on each design is very complete and well handled.

Most people like to have all information about any proposition right together in one place where it can all be gotten at easily and studied out any time one is interested—without having to send away for more information and without the bother of referring back and forth. The man of the Hewitt-Lea-Funck Company deserve a good deal of credit along this line for the careful work they have evidently put in on this new plan book. Every point seems to have been considered and taken care of.

They are now mailing out copies of the new "Prize Plan Book" to all who want one. As it is such a big book, they ask that 10 cents be sent to cover cost of mailing. If you want a copy, drop a letter to Hewitt-Lea-Funck Company, 408 Crary Building, Seattle, Wash.

You will get SPECIAL ATTENTION if you tell Advertisers you read American Carpenter and Builder.

# THE NEW HOBBS BLOCK MACHINE

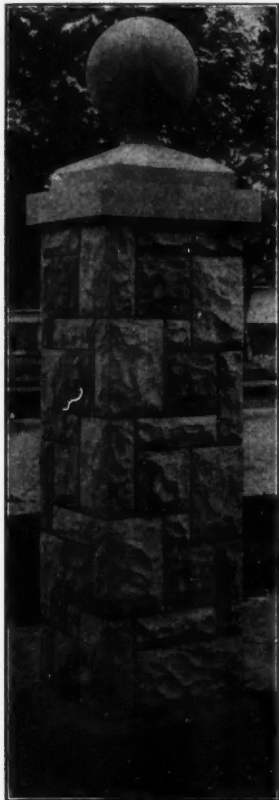

This is the Hobbs, Jr. It is the greatest value and by far the finest block machine in the market for 16" block and fractions. It is low in price, but built as accurate as an engine and makes a block positively true to size. We guarantee it to be absolutely the fastest, the quickest changed and the best built 16" machine in the market. Shipped on trial subject to this guaranty. Ship it back if it don't make good.

There is nothing easier to make than a poor block machine, but nothing to prevent claims that it is the best; the Hobbs was scientifically designed by a mechanical engineer; the castings made in our own foundry and then finished by skilled labor to a standard. Our cost and price to you is low, however, because our shop is equipped with special machinery, jigs and gauges and we do a big business. This explains both our success and why the Hobbs actually *is best*.

Don't order until you get the Hobbs catalogue. Send *today*.

**THE HOBBS CONCRETE MACHINERY CO.**

724 Peter Smith Bldg., DETROIT, MICH.

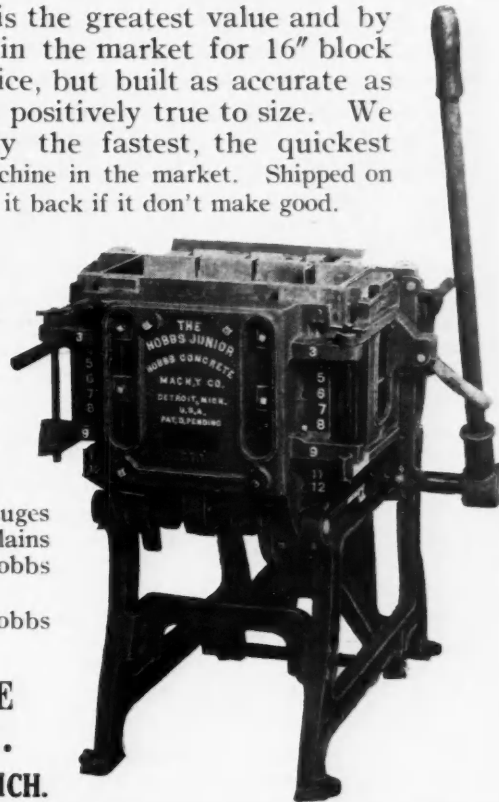

## No Risk with This Mixer

Positively guaranteed to do the best work on your jobs. If it fails to make good for any reason, you get your money back.

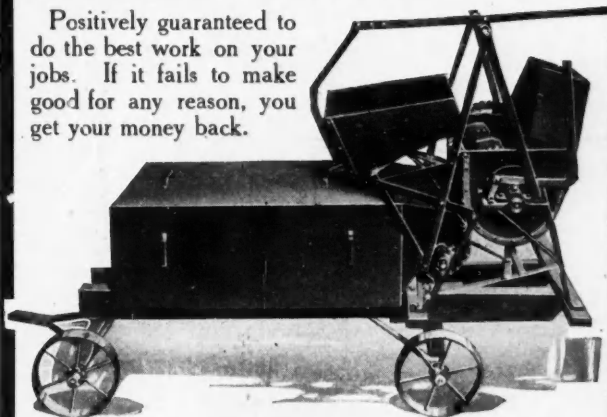

### BULL FROG MIXER

On skids with pulleys. A strong, well-built machine that will give honest value for every dollar you pay for it. Remember it's guaranteed . . . . . **\$60.00**

The Bull Frog Mixer on trucks with 1-3/4 H.P. Water Cooled Engine. Friction clutch drive. Automobile hood over engine and gearing. Complete and ready for the work . . . . . **\$150.00**

Send your check for the mixer you want. Machine shipped promptly. If you're not satisfied, tell us. You won't be out one cent.

**FARMERS SUPPLY CO. - - Janesville, Iowa**



Let me send you a **WITTE Engine** to earn its own cost while you pay for it

Take Full 60 Days' Free Trial to Prove It's Worth Having

### Five-Year Guaranty

I unqualifiedly guarantee every WITTE engine for five years against defects, and consequent faulty operation. I carry the risk, as I have done for my thousands of customers during 27 years. Ed. H. Witte.

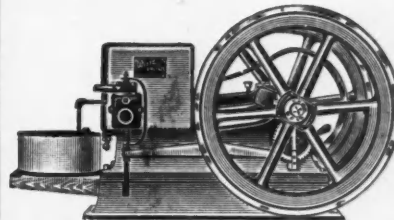

## WITTE Engines

Kerosene, Gasoline, Distillate, Gas

Sizes, 1 1/2, 2, 4, 6, 8, 11, 12, 15, 20, 25, 30 and 40 H. P. Stationary Portable and Sawing Styles. Used and recommended by shop, mill, and factory men all over the earth. All my life I have been a shop man, making my own engines. I sell only what I make. That is why, for 27 years, WITTE engines have always made good and stay good.

**Look at These Prices!** 4 H. P., \$ 75.50  
6 H. P., 99.36  
8 H. P., 139.65  
11 H. P., 208.90

Other sizes proportionately low. WRITE FOR MY FREE BOOK, and all about my New Liberal Offer BEFORE you arrange to try any engine. I save you money, besides giving you the easiest chance to get the best engine service. Write me to show you.

**ED. H. WITTE, Witte Iron Works Co.**  
1779 Oakland Ave., Kansas City, Mo.

You will get SPECIAL ATTENTION if you tell Advertisers you read American Carpenter and Builder.

### An Answer to the Millwork Question

Not so very long ago, people bought millwork—windows, doors and finish, just as they bought bill stuff—so much studding, so many openings of doors or sash, so many hundred feet of moulding, so many thousand shingles. They would get figures and tell the low man to send the stuff out.

Think of it! The doors and trim that they would live with and see every day of their lives, selected with as little care, almost, as the cellar joists. Perhaps the front door received some attention, usually confined to the size and shape of the glass.

Those were the good old days for the western factories, turning out thousands of doors, all white pine and all just alike, and for the retail dealer who bought carloads of them—all the same, except as to size. They were good doors, too—for the factory and dealer, easy to make, easy to handle, easy to stock, easy to sell.

For the owner—well, they filled the openings and stood well, but that is all. They had no beauty of grain or design, or individuality, no adaptability for different finishes, no artistic value whatever.

We hear a great deal about environment, usually meaning good associates, good books, good pictures, etc.

What about the influence of a beautiful and artistic home? A home one is proud to show his friends, comfortable and serviceable, but also attractive, and individual, each room presenting the possibility of its appropriate color scheme and yet preserving through the house a unity of design and treatment.

People are buying millwork nowadays, not on the bases of filling a given opening or covering a wall space, but to make their houses attractive and homelike, reflecting the taste of the owners or occupants and adding to their value for renting, selling or living.

And it is due to the utter failure of the average retail dealer to recognize and adapt himself to this change that the millwork business is leaving him. Perhaps, in justice to him, we should add that it is almost impossible for the average dealer to so adapt himself, and his stock facilities; and you will understand this better by referring to the announcement of the Cleveland Window Glass & Door Company, in another part of this issue.

The carpenter contractor must recognize this tendency, must know of and use, or help the owner to use millwork that will not only answer the purpose of utility, but make his home better to live in, better to rent or better to sell, or he will also miss his opportunity and his success.

One material house that has consistently worked along this line is the Cleveland Window Glass & Door Company, of Cleveland. They have always worked on the theory that the contractor is more interested in what the goods are worth to him or to the owner after they are in the house than in what they cost him.

They have been quick to investigate and to adopt, if meritorious, anything new in their line that might cheapen the cost or add to the value of their goods, and have added department after department in order to accomplish this and to give better service.

But they have never lost sight of the fact that contracting is closely competitive, and that it is essential that their goods, while kept strictly up-to-date in style, assortment and quality, shall be sold on close margins, if their business is to grow; also that if they are to replace the local dealer, they must be prepared to give as good or better service.

To do this, it was necessary to adopt every possible advantage for the prompt and economical manufacture, handling and delivery of their goods.

In order to convince the trade of their exceptional facilities



## ANCHOR

### Automatic Tampers and Block Machines

For Making Continuous Air  
Space Building Blocks

#### Anchor Tamper Facts—

Solid Steel Construction. All working parts housed. Operates with 1½ h. p. Capacity unlimited. Requires no extra time to tamp. Average daily output 600 to 1000 blocks or 8,000 to 12,000 bricks. Requires no room except space directly over mold box. Each tamp rod strikes seventy 700-pound blows per minute.

**WE GUARANTEE** the Anchor Tamper to do everything we claim. We will furnish free of charge any or all parts that break or wear out for three years from date of purchase except for carelessness or accident.

#### Anchor Block Machine Facts—

Makes continuous air space blocks, frost and proof. No furring strips or lath needed. Blocks always perfect. Standard machines make blocks 24 in. long and from 8 in. to 12 in. wide. Junior machines make blocks 16 in. long and 8 in. to 12 in. wide. Complete equipment for fractional and corner blocks for each separate width. Large variety for face plates. Either machine will make any desired block for any building.

Let us prove these facts.



**Anchor Automatic Tamper in operation over the Anchor Block Machine.**

**Anchor Concrete Stone Co.**  
Rock Rapids, Iowa

**Anchor Automatic Tamper in operation over the Hobbs or U. S. Standard Face Down Block Machine.**

You will get SPECIAL ATTENTION if you tell Advertisers you read American Carpenter and Builder.

## Look for the Word "IRWIN"

### The IRWIN Bit

*is imitated as regards pattern, but Irwin Quality cannot be imitated. Look for the trademark (illustrated below) stamped on the shank of every genuine Irwin Bit.*

**The IRWIN Bit**  
Reg. U.S. Pat. Office

WHEN you ask the hardware man for a genuine Irwin Bit, look at the shank of the bit he offers you—see if our trademark (illustrated at left) is stamped there. If so—you're safe. Don't be misled by "pattern" but insist on getting your money's worth by buying a genuine Irwin. For years past we have had the reputation of being the leading Bit Makers; "Irwin" and "Quality" are inseparable. The hardest woods or toughest knots have no terrors for the Irwin Bit-user. Breakage is a thing practically unknown with genuine Irwin Bits, for they are drop-forged from tip to shank, out of one solid piece of steel. You have a right to have the best going and we'll do our part to see that you **do** get it. So if your dealer cannot supply you write us at once.

**THE IRWIN AUGER BIT COMPANY**  
WILMINGTON, OHIO

## SAFETY FIRST

TO PLAY safe in your building contracts is necessary to always assure yourself of satisfied patrons. THEN WHY NOT USE THOSE materials that are past the experimental stage, THAT HAVE BEEN PROVEN BEST BY TEST?

## DRIWAL

Coating for cement, concrete, stone, brick, and stucco is

### A Damp-Proofing Coating

It penetrates into and fills the pores, not lying upon the surface nor obscuring the texture of the surface.

*Our booklet No. 5A gives complete information. Send for it.*

**THE BILLINGS-CHAPIN CO.**

1163 E. 40th Street

Boston

CLEVELAND

New York



## Talk Ventilation

and increase your profits. Your client knows that his buildings ought to be ventilated. He has just overlooked it. Don't you overlook it. And when you need ventilators, don't overlook

## Royal Ventilators

—the best you can buy at any price. But, we've made a price that will induce you to buy. Not too high; not too low. Real low prices mean a skimping in quality, material or workmanship.

So you'll say our prices are "just right." You can get any size, any style of ventilator for any kind of building from us. **Royal Ventilators** are positively guaranteed. They ventilate from the ground up.

Our Ventilator Book describes and shows the latest approved methods of ventilation. Mailed free on request. Write us now.

**Royal Ventilator Co.**

417 Locust Street  
Philadelphia, Pa.



You will get SPECIAL ATTENTION if you tell Advertisers you read American Carpenter and Builder.



### How Many Times Have You Ever Said "Hello"

How many times a day do you suppose that little salutation is called over the telephone?

By the way, are you old enough to remember the sensation of amazement that greeted the first telephone?

That first wire stretched from Boston to Somerville and—Wonder of Wonders!—people were talking to each other over a distance of three miles.

That was nearly forty years ago.

20 for 15c

So long ago it seems like ancient history, doesn't it? But just think! At the time that first telephone was causing so much excitement, Richmond Straight Cuts already had an established reputation as the *Perfecto* of cigarettes.

Time erases many incidents from the memory—but quality is lasting. Quality makes an impression that years cannot wipe out. Time cannot diminish the popularity of Richmond Straight Cuts—they are still the best of all Virginia Cigarettes.

*Leggett & Myers Tobacco Co.*



You will get SPECIAL ATTENTION if you tell Advertisers you read American Carpenter and Builder

they offer to pay the railroad fare of prospective customers in their territory who will come to Cleveland and go over their plant and place with them an order for at least \$100, based on their published prices.

They reason—for the customer—that the \$100 order less the railroad fare makes a perfectly safe transaction as he sees the goods, and the prices are fixed beforehand. Without this provision the company might be often imposed upon.

For themselves—there is usually no profit in the order, but the proof to the customer that their claims are based upon exact facts—that their stocks are large and clean and their assortments modern and complete—that their methods and facilities get results and that their quality is right—usually secures what they are after—the confidence and future of the customer.

They believe that the millwork business has become a distinct and highly specialized trade; that competitive conditions do not warrant several profits between the manufacturer and the contractor; that the contractor knows best the needs for his building and is the one best fitted to order the goods intelligently; that every additional handling of the goods or order adds nothing to the value but rather tends to increase the cost and the liability of error and delay; and that their equipment and methods are peculiarly adapted to carry out these ideas in a practical manner.

This company have also decided, through the columns of the AMERICAN CARPENTER AND BUILDER, to bring their advantages to the attention of a larger number of contractors. Their advertisement in this number will be followed by others, in which they will endeavor to explain their goods and methods in more detail, and to tell why they feel justified in inviting the investigation and support of progressive and wide-awake contractors in territory accessible from Cleveland.



### Yawman Sash Lift Ventilator

This illustration shows an improved type of window ventilator now being marketed by the Pullman Automatic Ventilator Mfg. Co., of York, Pa. It is known as the Yawman Sash Lift Ventilator. It is a sash lift and ventilator combined. The valves can be opened or closed at will to control the air

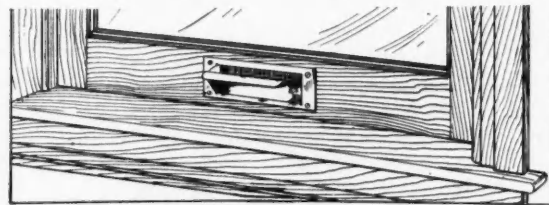

Yawman Sash Lift Ventilator, Viewed from Inside.

current. This ventilator is very easy to install—simply cut a mortise of the proper size in sash rail and attach inner and outer plates. This ventilator gives a constant supply of fresh air without a draft. It is finding great favor for offices and private residences. The cost is moderate.



### Some Confusion in Names

We have been advised by the Stanley Works, New Britain, Conn., that our subscribers in writing to them frequently confuse them with the Stanley Rule and Level Co. While these two concerns are both located in New Britain, there is no connection between the two, and they manufacture entirely different lines. The Stanley Works are the well known manufacturers of hinges and other builders' hardware, while the Stanley Rule and Level Co. make the well known Stanley tools.

In addressing either of these companies our subscribers should take particular care to get the names right.

**EVANS RING JOINT-PATENTED NEVER OPENS**

**CARNAHAN MFG. CO.**  
212 MILL ST. - LOOGOOTEE, IND.  
**HIGH GRADE MILLWORK**

**WE SAVE YOU TIME AND MONEY**

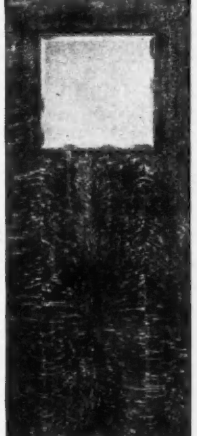

**INDIANA OAK OR ANY VARIETY OF WOOD**

ALL KINDS of DOORS

FLOORING

WRITE FOR PRICES

ESTIMATES FROM LISTS OR PLANS

SANITARY DOORS, FINISH, STAIRS

QUICK ACTION

LARGE OUTPUT

GUARAN-TEED PRODUCT

EVANS PROCESS (Pat'd in U. S. and Canada)

TIP

STILE

LOCK

BLOCK

RIB

AIR

SPACE

RIB

AIR

SPACE

RIB

WE ARE SPECIALISTS  
Send for Catalog No. 111, Sanitary Doors; and Catalog No. 110, Standard Doors and Millwork.

**CATALOG-GET INTO THE RING TELLS ABOUT RING JOINTS**

# NOVO

REG. U.S. PAT. OFF.

## ENGINES AND OUTFITS

### You Cannot Overload This Pump

because it is protected by a shearing pin between engine and driving pinion; one of the many points in construction that assures long service. Valves and piston rod are of brass and valves can be gotten at by removing individual caps without disturbing other parts.

This Novo Suction and Force Pump Outfit is just the thing for domestic, small city or general factory water supply or for supplying boilers located at a distance from a water supply. Made in 16 sizes with capacities of from 300 to 10,000 gals. per hour. Mounted on channel steel base and direct-connected to Novo Engines of from 1 to 10 h. p., making the outfit compact, light and easily handled.

Send for the Novo Book  
"Reliable Power"

You'll find the section on pumps and their use a valuable guide in selecting the pump you need. This catalog gives full details of the big line of Novo Hoists and Pumping Outfits and "The Engine for Every Purpose."

NOVO ENGINE CO.

Clarence E. Bement,  
Sec'y and Mgr.

443 Willow St.,  
Lansing, Michigan.

Novo Pump  
Fig. 1412  
Supplying  
Railroad  
Tank.

**NO TANK  
NO FAN  
NO FREEZING  
TROUBLE.**

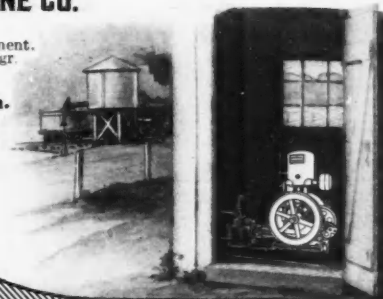

## TOOLS:

WE MAKE A COMPLETE LINE FOR CARPENTERS, MASONS, BRICKLAYERS, PLUMBERS, ENGINEERS AND MANY OTHER TRADES.

O

UR LINE is so complete that we can fill orders for tools of *any kind* from all sections of the country. The leading jobbers throughout the United States carry our line.

Buffum Tools agree with your ideas of quality and price. You can buy cheap tools, but cheap tools are the enemies of good work. To use cheap tools is to put yourself in a class with the junk man. Fair price and best quality have made Buffum Tools the favorites with *every trade*. The Design, the Material, the Finish, the Price—all are *right*. What more could you ask? Oh, yes, a guarantee. Well, we give it on all our tools.

We have built our reputation by selling *good* tools. In making a strong bid for your business, we know we'll hold it. The next time you need a tool or many tools, ask your hardware dealer to show you the Buffum Line. If he doesn't carry them, ask him to do so. Send us his name. You'll get what you want when you want it. No delays.

Scratch Awls	Screw Clamps
Belt Awls	Cabinet Scrapers
Brad Awls	Bench Hooks
Nail Sets	Wood Turners Gauge
Nail Pullers	Wrecking Bars
Saw Sets	Cement Workers' Tools
Saw Swages	Bricklayers' Tools
Saw Filing Vises	Plumbers' Tools
Cabinet Makers' Bevel	Plasterers' Tools, etc.
Carpenter Pincers	







BUFFUM TOOL CO. LOUISIANA, MO.

High grade tools for high grade workmen.

You will get SPECIAL ATTENTION if you tell Advertisers you read American Carpenter and Builder.

**Fire Protection at Doors and Windows**

Fire losses in the United States and Canada during 1913, as given in a report from "Fire Protection," amounted to \$224,723,350.00, as compared to \$225,320,900.00 for 1912, showing a decrease of almost \$600,000.00, which is very gratifying to the manufacturer of fireproofing and fire-retaining equipment and devices.

There is still the necessity of improving construction of buildings by the installation of fire-proof materials, and devising protection of every kind to prevent the spread of fire. In doing this architects and contractors not only assist their clients in protecting their property, but at the same time they are assisting them in reducing their insurance rates. This service on the part of the architect and contractor will be remembered long after the contract is completed.

When shown the result which can be attained by protecting their buildings almost every property owner is interested in safeguarding his property against fire, which may be caused from no negligence whatever on his part. Fire is often transmitted from one building to another through unprotected openings. Protection at this point can be obtained by using Fire Proof Metal Window frames and sash.

In the opinion of prominent architects and builders, the Willis Fire Proof Metal Windows and Tin-Covered Fire Doors and Shutters are of unsurpassed quality and efficiency in this respect, and in addition to these opinions, they are all approved by the Underwriters' Laboratories, Inc., and bear their label.

The Underwriters' Laboratories, Inc., are the highest authority on the fire-resistant qualities of any manufactured product that comes within their scope.

The Willis Manufacturing Company at Galesburg will be glad to assist inquiring architects or contractors in securing

detailed information regarding the protection of window or door openings. In their catalogue "D," which is devoted to this subject, all the different styles are described and illustrated, together with detailed information regarding the sizes of openings, sizes of glass permissible, also other useful information.



**Cast Iron Sockets for Cement Foundations**

An improved appliance for use with concrete foundations which is worth a good deal more than it costs is the Ross post support. These are iron studding sockets manufactured

by G. M. Ross & Co., 1244 Broad St., Grinnell, Ia.

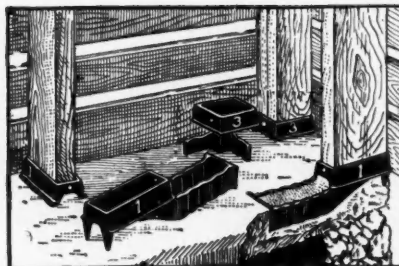

How Ross Sockets are Used.

The illustration here gives an excellent idea of what these sockets are and how they are used on cement floors and cement foundations. Every builder knows how hard it is to

properly seat and fasten wood studs onto a cement foundation wall. These cast iron sockets are built right in when the cement is poured and the lugs hold them firmly in position. There is nothing about them to rot or rust away. The studs set down into these sockets and are perfectly solid without toenailing.

Building contractors who have tried these pronounce them thoroughly satisfactory. Write G. M. Ross & Co. for full particulars and prices.

**Aids to Better Building**

We will supply you with architectural sheet metal goods for your buildings at the lowest cost. We manufacture nothing but the best guaranteed goods and everything we make shows extra good value for the money.

- Ventilators
- Finials
- Ornaments
- Metal Sidings
- Skylights
- Store Fronts
- Cornices
- Metal Ceilings
- Crestings
- Fire Doors
- Metal Roofings
- Gable Ornaments
- Window and Door Caps
- Fireproof Windows, Doors and Shutters
- Sheet Metal Canopies and Marquise

WRITE FOR BIG ILLUSTRATED CATALOG No. 6

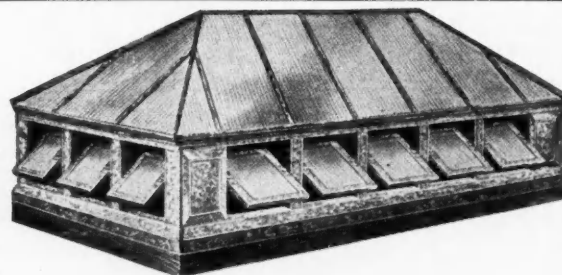

**Hipped Skylight with Pivoted Side Sash**

require no experience to place. Any ordinary workman with a hammer and screw-driver can set them up. The style illustrated combines unusually good lighting and ventilating facilities. Guaranteed water-tight. Side sash operated singly or in batteries and can be held in any position by a mechanical device operated by a cord.

Willis Skylights come in all styles. You can get the kind you want. Strongly built and warranted against sagging, buckling or bending. Bars on large skylights are reinforced.

Catalog No. 6 illustrates complete line. Sent free on request.

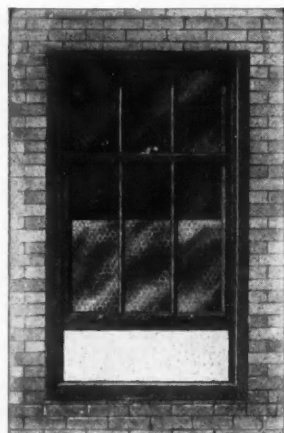

Double Hung Metal Window

**Fireproof Metal Windows**

All our windows and doors are tested and approved by the Underwriters' Laboratories, Inc. Where fireproof construction is to be maintained, you will find that Willis Fireproof Metal Windows, Doors and Shutters fill the bill.

The Fireproof Window illustrated is only one of many styles. Frame is of strong, hollow sheet metal glazed with wire glass. Well made.

Get Our Latest Catalog D.

**WILLIS MANUFACTURING COMPANY**

Manufacturers of Sheet Metal Goods

GALESBURG

ILLINOIS

You will get SPECIAL ATTENTION if you tell Advertisers you read American Carpenter and Builder.



# STANLEY'S

## Wrought Steel Screen Door Hardware



Set  
No. 1750

### Each Set Complete with Screws Ready to go on the Screen Door

Owners and Builders alike are pleased with the high quality of the hardware and the convenient way it is packed ready for use.

Butts, pull, spring, hook and eye and screws, all of the highest quality of material and workmanship

They can be furnished in Japan, Antique Copper, Brass or "Stanley" Sherardized rust-proof finish, the proper finish for outside doors.

The doors are removed in fall by merely slipping out the pins and are as readily re-hung in spring.

Write us for Circular "A". It tells the story.

**THE STANLEY WORKS**  
New York New Britain, Conn. Chicago

## Automatic Screen Door Catch

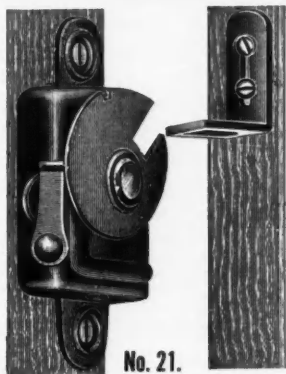

No. 21.

Light trip and strong hold. Only four (4) screws to set.

Furnished with or without night lock.

Every house needs one or two automatic catches, and *here is the best one.* Easy to set and sure to please.

Let us tell you about this, and the other screen hardware you need this spring.

**WATROUS MFG. CO.**  
DES MOINES, IOWA

## A Fine Knife for a Carpenter

For the little jobs that *only* a knife can do; for the quick, clean cut and the blade to plough hard wood or soft, with the grain or against it, you won't find the equal of

### KEEN KUTTER

pocket knives, made from live English cutlery steel and with handles riveted to last. Your pocket couldn't hold better, and all Keen Kutter pocket knives are guaranteed to suit you or the dealer is authorized to hand you back your money.



Pocket Knife  
No. K2613  
2 Blades  
Price  
\$0.85

If not at your dealer's, write us.

**Simmons Hardware Company**

St. Louis New York  
Philadelphia Toledo Minneapolis  
Sioux City Wichita



You will get SPECIAL ATTENTION if you tell Advertisers you read American Carpenter and Builder.

## \$60 A WEEK and Expenses



That's the money you can get this year. I mean it. I want County Sales Managers quick, men or women who believe in the square deal, who will go into partnership with me. No capital or experience needed. My folding Bath Tub has taken the country by storm. Solves the bathing problem. No plumbing, no water works required. Full length bath in any room. Folds in small roll, handy as an umbrella. I tell you it's great! GREAT! Rivals \$100 bath room. Now listen! I want YOU to handle your county. I'll furnish demonstrating tub free. I'm positive—absolutely certain—you can get bigger money in a week with me than you ever made in a month before—I KNOW IT!

### Two Sales A Day—\$300 A Month

That's what you get—every month. Needed in every home, badly wanted, eagerly bought. Modern bathing facilities for all the people. Take the orders right and left. Quick sales, immense profits. Look at these men: Kunkle, Ohio, received \$240 first week; Mathias, Florida, \$120 in two days; Corrigan, New York, \$114 in 60 hours; Newton, California, \$60 in three days. You can do as well. 2 SALES A DAY MEANS \$300 A MONTH. The work is very easy, pleasant, permanent, fascinating. It means a business of your own.



**DEM-ON-STRATING TUB FREE**

I grant credit—Furnish sample—Help you out—Back you up—Don't doubt—Don't hesitate—Don't hold back—You cannot lose. My other men are building homes, bank accounts, so can you. Act then quickly, SEND NO MONEY. Just name on penny post card for free tub offer. Hustle!

**H. S. ROBINSON, President, 201 Vance St., Toledo, Ohio**  
CANADIAN BRANCH, Walkerville, Ont. Can.

## Follow the Specifications

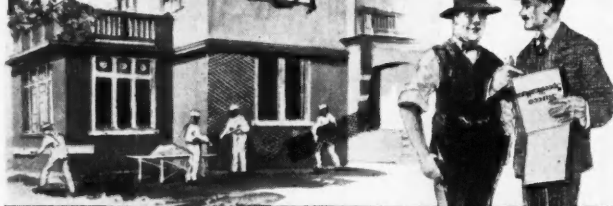

Hand your foreman a copy of "Stucco Specifications" and the success of the stucco work is certain. "Stucco Specifications" explains

### "Standardized" Wall Construction ON



It gives you every detail you need about materials and methods of construction. It is the most helpful book ever compiled for builders and builder-architects and it is correct because it is based on the exact data of the American Concrete Institute (National Association of Cement Users).

You can't go wrong when you use Kno-Burn Expanded Metal Lath because it is the *standard* metal lath. There are numberless jobs that have stood the test of weather and time where the plaster base was "Kno-Burn," and any one of them proves that it is *permanent*. The mesh of "Kno-Burn" is made in the most logical way to grip the plaster tightest and longest. "Kno-Burn" resists fire and rust, comes in sheets that are easy to handle, is easy and economical to plaster.

*Why buy metal laths that claim to be "just as good as Kno-Burn" when you can get the standard delivered promptly at prices that are right?*

Send for booklet No. 36, "Stucco Specifications," this very day. You need it in your business.

### NORTHWESTERN EXPANDED METAL CO.

903 Old Colony Building  
Chicago, U. S. A.



## The "Hobbs, Jr.," Block Machine

Readers of the AMERICAN CARPENTER AND BUILDER will be interested in the new Hobbs Block Machine, called the "Hobbs, Jr." which we illustrate herewith. Like the larger Hobbs, it shows clever designing and thorough workmanship in every line. Like the larger Hobbs, it has an unlimited range of adjustments up to its capacity, and, of course, uses the famous Hobbs composition face plates (instead of iron), which have built up such an enviable reputation for natural, artistic rock faces.

The Hobbs, Jr., has scored a remarkable success from the start, and among 16-inch machines surely stands in the very front rank. First and foremost, it is built to give service under the hardest usage a machine can be subjected to, the frame and mold box alone weighing about 500 pounds. An extraordinary amount of fine machine work is done on everything pertaining to the mold box and cores so that mold comes up absolutely rigid and square in every adjustment. Everything about it is so strong that it cannot possibly be tamped out of true. The adjustments are held by steel studs, which set into holes drilled absolutely to a standard. There are no set screws to slip, and, therefore, no wrench or other tools are required in adjusting the mold for different sizes.



"Hobbs Jr.," Block Machine.

Another exclusive Hobbs feature is the authentic dividing plates which move in and out with the cores, thus making fractional block as quickly as whole block. Perhaps, however, the greatest feature of all is the composition face plates to which the facing does not stick and which produce rock designs so natural that it takes an expert to tell the difference, except on very close examination. Another "brand" new idea is the provision for moving in the end plates to make a 12-inch pier block with rock face on three sides.

The next point that impresses us is the unlimited variety of sizes that can be made; length 2 to 16 inches, advancing 2 inches, at a time depending on the face plate used. To make any thickness from 3 to 12 inches, merely raise or lower face plate and attach ends to suit. A feature that attracts many, and which few machines possess, is the ability to make block 4, 6 and 9 inches high as readily as the standard 8-inch-high block, and this is adjusted for in about three minutes by sliding back plate forward or back and inserting pin.

To avoid misunderstanding, we add here that the above applies strictly to the Hobbs, Jr., as the large machine adjusts up to 24 inches long and 12 inches high.

Cores for any proportion of air space are supplied for any Hobbs machine, and they are changed and operated with an ease that is astonishing. There is nothing cumbersome about the Hobbs, no dread to change over for different work, because it is so easily done and you are always sure that every part will fit.

In speed, the Hobbs is a revelation, due to the automatic dividing plates, the oval cores which make tamping easier, its general simplicity and ease of operation.

If we were to tell you all about how the Hobbs is made and then stop, the reader would think its price must be high. The fact is, with their splendidly equipped factory, automatic machinery and with their own foundry in connection, the Hobbs is offered at a price surprisingly low—in fact, the price per pound is far below the average.

Our readers who are interested in a block machine of the very highest quality and most improved type should not fail to send for a Hobbs catalog. Address Hobbs Concrete Machinery Company, 724 Peter Smith Building, Detroit, Mich.

You will get SPECIAL ATTENTION if you tell Advertisers you read American Carpenter and Builder.

**Your Time Is Worth Money  
WHY WASTE IT?**

The time usually spent in going from job to job is a dead loss. You can get around *more quickly*; you can spend *more time* on each job if you have a *Schickel*.

A Schickel Motorcycle is best for town and country builders. For the town man it saves time, carfare or the expense of keeping a horse and buggy. It enlarges the country man's field of activity. He needn't hesitate to take jobs 20 or 30 miles away. No extra expense for board. He can always eat and sleep at home.

Think it over. The Schickel is a "topnotch" machine as you will learn from our Catalog.

Ask for Catalog and Price List.

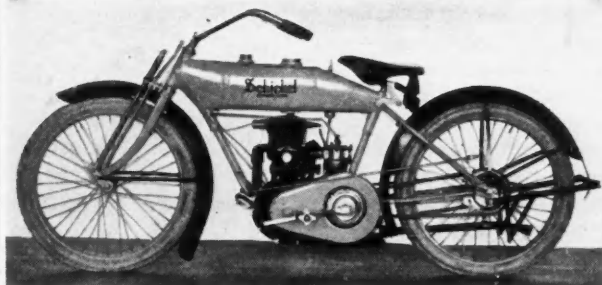

**SCHICKEL MOTOR CO.**  
75 Garden St. STAMFORD, CONN.

**New Typewriter \$18**  
in U. S. A.

Mistakes are costly! Write your bills of material on the **BENNETT** Portable Typewriter—then you know that your order won't be held up because it cannot be read. No chance for mistakes, with everything in clear, easily read type.

**Be business-like—it pays!**

You can write your tender of bids, contracts, contracting estimates, time sheets, bills, and all your correspondence with prospects; to hardware merchants regarding tools, etc., clearly and quickly on this wonderful little typewriter and save a lot of your valuable time. Keep a record of *everything* you write. The Bennett makes legible carbon copies.

**Serviceable—Portable**

The Bennett is a serviceable typewriter that is as easily carried as a book. Weighs but 4½ lbs. Does work of \$100 machine—you save \$82. Low priced because simple. Has only 250 parts, other typewriters have 1700 to 3500. Built in the same factory by same men who make Elliott-Fisher Billing and Adding Machines, selling at \$175 to \$1000. Has standard 84-character keyboard, reversible ribbon, marginal release, etc. Prints lines perfectly straight—writing always in plain sight.

Over 34,000 Bennetts in use

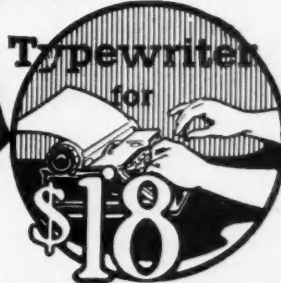

Agents make good money selling Bennetts

**Write for our catalog today**

Let us prove that you can use the Bennett in your everyday work. We will send you this mechanical marvel under a money-back unless satisfied guaranty. Test it thoroughly for ten days—if not all we claim, and more, return it to us.

GEO. G. BENNETT CO., 3304 Cedar Street, Harrisburg, Pa.

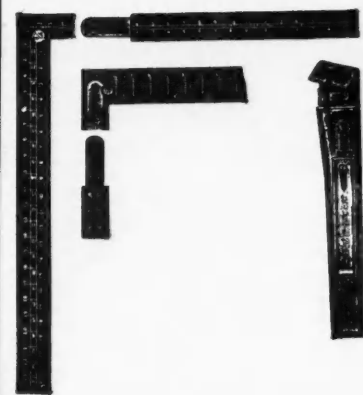

This is the **Standard Take Down Square.**

It makes good with the user. Send and know more about it.

Southington Hardware Co.  
Southington, Conn.

**GET ORDERS**

for the **UNIVERSAL RAT CATCHER**



EVERY farmer, merchant and lumber dealer in your locality will buy one of these Rat Traps. It's a sure and quick way to rid all buildings of the pests. One of these Catchers placed in a livery stable in Scranton, Pa. caught over 100 rats in ONE MONTH. Trap made of galvanized iron; can't get out of order; lasts for years; always clean. 18 inches high, 10 inches diameter. One delivered prepaid upon receipt of \$3. Rats and mice die; no marks left on them.

My proposition requires no time from your work. I can show you how to make money easily. Don't be afraid to ask how. Cost you nothing to find out. I'll guarantee you can sell these Universal Rat Catchers easily.

WRITE TO ME AT ONCE.

H. D. Swarts, Inventor and Manufacturer, Scranton, Pa.

**THE ENTERPRISE Coal and Fuel SHUTE**

will absolutely protect the foundations of your buildings. It saves battered and disfigured walls and broken windows. It is the *cheapest* burglar-proof Fuel Shute on the market at the price for stores, churches, schools, offices and homes. All iron, wonderfully strong.

Price \$7.50. Special Discount to Builders

Write for Special Builders' Discount  
**Enterprise Iron Works** Albert Lea, Minnesota

**LEAVITT Coal Chutes**

are becoming popular with contractors and builders—made of cast iron with the exception of steel apron to protect the wall at the bottom.

**Protect Your Buildings**

Leavitt Coal Chutes protect the side of the building from becoming damaged by careless coal drivers—no dust and dirt to disfigure building or premises—closes tight and locks from inside—absolutely burglar proof.

**Compare Our Prices**

The extremely low price for which we offer these serviceable coal chutes will surprise you. Write us today, get our literature and prices on these coal chutes and other building accessories. We can save you money.

**LEAVITT Manufacturing Co.**  
110 Griggs St., URBANA, ILLINOIS



You will get SPECIAL ATTENTION if you tell Advertisers you read American Carpenter and Builder.



### The Famous "Board of Seven"

If you could place your building problem in the hands of seven highly paid, skilled and experienced men, who would take your trouble off your hands, do the planning and figuring and then send it on to you, you would feel pretty secure, wouldn't you?

Such a body of men is actually at work every day, putting the weight of their combined knowledge and experience into the production of dwelling houses and moderate sized farm buildings, barns, silos, etc.

Until these experts were gathered together, the only buildings commanding such services were great structures of steel and iron, big public buildings and edifices costing hundreds of thousands of dollars.

No one could afford to apply the prohibitive cost of these brains to a five hundred—even a five thousand dollar home. It would be like hiring all the professors of an agricultural college to run an ordinary farm. Their salaries would eat up many times the amount of extra profits they could produce.

The "Board of Seven" of the North American Construction Co. is composed of experts on design, architecture, construction, materials, manufacturing, heating and plumbing. It is

claimed that no detail of the house building problem escapes the keen and searching analysis of these men. All plans must be approved to the complete satisfaction of 1st: the master designer and architect for structural harmony and accuracy; 2nd: the master builder for practicability and strength; 3rd: the manufacturing and factory expert for elimination of waste, standardization of lengths and economy of costs.

The chief business of these men is to *eliminate waste*. One of the greatest and most astounding facts bearing on modern industry was recently announced by the "Board of Seven" as a result of their research work on waste. After a far reaching investigation of timber and wood working interests, they learned that the waste in timber and lumber in the United States amount to *one million dollars a day*.

Think of it! Every working day in the year, one million dollars' worth of the most valuable natural resources of this country is consumed by one item—*waste!*

Really, few of us have ever stopped to think of waste in house building, but it is one of the greatest items in building.

The special investigation of this Board is also backed up by government figures. Can you wonder then that there is a wonderful opportunity for usefulness before these men?

Every Aladdin building—dwelling, bungalow, summer cottage, or garage—passes the rigid scrutiny of this noted body of men, and every fault, item of waste, or artistic point is brought up for consideration.



#### BUILD YOUR HOME "THE NEW WAY"

10 per cent Larger Bedrooms  
50 per cent Larger Wardrobe capacity and you can save from \$100 to \$300 in building a home.  
Send 50c for Plan Book which shows 22 designs—ranging in price from \$1200 to \$12,000.  
**JOHN THOMAS BATTS**  
Grand Rapids, Mich.

#### EXAMINE IT FREE

Send us the name of your local hardware man and say you'd like to examine a Sand's Aluminum Level. We'll send one to the hardware store where you can handle it and try it. If you like it you can buy it. If you don't want to buy, you don't have to. Hand the Level back. Doesn't cost you anything. WRITE TODAY.

## The Carpenter's Choice

always favors a SAND'S LEVEL. That's because the *quality* is there; the *price* is *reasonable* and they can be used for the greatest variety of work. We build *Service* right into our tools.

## SAND'S ALUMINUM LEVEL

will please you. We'll stake our reputation on it. The *lightest* level made. Not heavy and clumsy like other levels. Easily handled. Less danger of dropping and breaking it.

Made of *Aluminum*—that nice, clean, light metal that never rusts. *Sand's Aluminum Level* can't warp, split or crack like the ordinary wood level. Can't "get out of whack."

Spirit glasses covered with heavy plate glass. No dust, dirt or grime can get in to obscure the reading. The plumbs at each end, and the double center level make it *readable in any position and at arm's length*. SAND'S ALUMINUM LEVEL is made in 24-inch and 30-inch sizes for Carpenters and in 42-inch sizes for Masons.

Use it for straight leveling, stair work, roof pitches, sidewalk work, foundation work and all other horizontal and vertical leveling. Sand's Aluminum Level is perfectly reliable. Lasts a lifetime. You can't buy a better one.

EXAMINE THIS LEVEL AT OUR EXPENSE. SEE OUR OFFER ABOVE

**J. SAND & SON, 1027 Rivard St.  
DETROIT, MICH.**

#### OUR CIRCULAR

*gives more complete description of SAND'S ALUMINUM LEVELS. Showing full size pictures. Write us for this circular. It also shows our full line of Mason Levels. We can please you in Quality at a Money-Saving Price.*

You will get SPECIAL ATTENTION if you tell Advertisers you read American Carpenter and Builder.

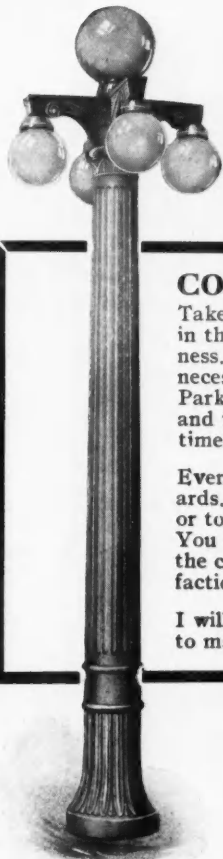

## CONCRETE LIGHTING STANDARDS

### CONTRACTORS

Take the enormous opportunities offered in the Concrete Lighting Standard business. Only a very small investment is necessary. These posts are ideal for Parks, Driveways, Entrances. Cities and towns buy hundreds of them at a time for street lighting purposes.

Everyone is interested in these Standards. They are ornaments to any city or town. Easily sold and at a big profit. You can underbid any competitor, even the cast iron post, and give better satisfaction.

I will sell the Standards or the Molds to manufacture them.

### MY FREE BOOKLET

will tell you how easy it is. Send for it. It will help you double your income. I shall be glad to figure on any special designs of molds or standards that you may submit to me. **I Save You Money.**

**GEO. W. EDGCUMBE**

The Post Man  
BENTON HARBOR MICHIGAN

## Satisfy Your Customers

*Build with* **SEIPPEL'S**  
**Quality Lumber**

**GET MORE CONTRACTS**  
Your interest as a contractor and builder lies in satisfied customers. But your good work is wasted if you build with poor stock.

It takes quality lumber to build a quality house.

Our lumber is all carefully graded up to the manufacturers' grading specifications; and with our enormous stock we fill your order exactly, item for item—no trouble-making substitutions in dimensions or quality.

We carry everything you need, including roofing and mill work—all guaranteed high quality. You get quick service and low freight rates from Dubuque.

If you're in the market for a carload, come to Dubuque and let's talk it over. We'll refund your railroad fare both ways and you select what you want.

**BESIDES, we have a special proposition in which you'll be interested.**

We'll save you money on small orders, and guarantee satisfaction.

Write us at once. Place yourself in position to make more money during this building season.

Orders solicited only from Iowa, Illinois, Southern Wisconsin, Indiana, Northern Missouri, Southern Minnesota, Southeastern South Dakota.

**PETER J. SEIPPEL LUMBER COMPANY**  
212 S. Locust Street DUBUQUE, IOWA

**OUR DUX BAK ROOFING** has no equal in the market for the money. Sells for less and is backed by a longer guarantee than any other standard goods.

Prestige THE REFLECTION OF Quality

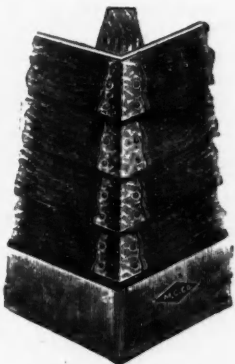

SHOWING OUTSIDE CORNER APPLIED

## "MILCOR"

### METAL BUILDING CORNERS

Metal Corners are being very extensively used and are very popular with the carpenter. They take the place of Corner-boards to finish the corner of the building when weather-board or lap siding is used. Time and expense is saved because it is not necessary to mitre the Weather-board siding. The mitre effect is perfect and the appearance superior to wood Corner-board.

Made from tight coated galvanized steel. Furnished in two sizes. 4 inch and 6 inch inside and outside. Packed 500 corners per box

WRITE FOR SAMPLES AND PRICES

**MILWAUKEE CORRUGATING COMPANY**

BRANCH, KANSAS CITY, MO

MILWAUKEE, WIS.



INSIDE CORNER



OUTSIDE CORNER

## Be the Bungalow Man of your Town

You can build a real Bungalow anywhere at surprising economy of space and cost. My designs have real individuality and are the latest styles. Profitable to build. Easy to sell.

### THE CRAFTSMAN BUNGALOW PLAN BOOK

should be in the hands of every builder. It contains the cream of 1000 designs actually built for \$400 to \$4000, showing exterior and interior photos, floor plans, size of rooms, cost, etc. In fact, all the data you need.

Price \$1.00 Postpaid

Send M. O., stamps or check. Money back if not satisfied.

**JUD YOHO, The Bungalow Craftsman**  
804 Bungalow Bldg., Seattle, Wash.



## You Take No Chances When You Put on Guaranteed Queen Cupolas

They are made right from heavy galvanized steel. Put together by experts. They look right because they are thoroughly finished. They give service and satisfaction. Last a lifetime without painting or repairs.

**Don't Experiment—Get the Cupola That Has a Reputation Back of It**

On the market 15 years. Thousands now in use. That's the kind for you to use.

To prove that the Queen is the best we will ship you one for examination and 30 days' trial.

WRITE FOR CATALOG AND PRICES

Find out what we have and you will not be satisfied with ordinary kind. Address

**QUEEN CUPOLA CO., 405 Peck St., Cresco, Ia.**

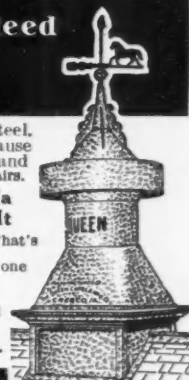

You will get **SPECIAL ATTENTION** if you tell Advertisers you read American Carpenter and Builder.



# Silentflow

A Noiseless Water Closet

**I**N THE TOILET adjoining the sick room one of the distressing noises can be eliminated by installing the "Silentflow."

This closet was not put on the market until it was proven perfect in construction, design and workmanship.

**SPECIFY WOLFF H-7005 FOR RESIDENTIAL USE**

**L. WOLFF MANUFACTURING COMPANY**  
Manufacturers of  
**Everything in the Plumbing Line**  
The only complete line made by any one firm.

General Offices, 601-627 W. Lake St. Showrooms: 111 No. Dearborn St., CHICAGO  
Pottery: Trenton, N. J.

BRANCHES: Denver, Colo.; Omaha, Neb.; Minneapolis, Minn.; Dallas, Tex.; Rochester, N. Y.; St. Louis, Mo.; Washington, D. C.; Cleveland, O.; Cincinnati, O.; Kansas City, Mo.; San Francisco, Cal.



Copyrighted by the L. Wolff Mfg. Co.

## PLUMBING AND HEATING SUPPLIES AT WHOLESALE



When in the market for Plumbing and Heating Supplies and you wish to

**SAVE 20 to 40 Per Cent**

on every article, write for my free illustrated Catalog. The only house that sells first class guaranteed goods at wholesale prices direct. Shipments are promptly made from a very complete stock. Small orders are as carefully handled as large ones.

**B. B. KAROL, 768-772 W. Harrison St., Chicago, Ill.**

## A HOT AIR FURNACE

For Less Than \$50 Complete

For 5 and 8 Room Dwellings

An Unheard of Price and a most Remarkable and Indestructible Furnace

No Pipes No Lost Heat

**AMERICAN BELL AND FOUNDRY CO.**

NORTHVILLE MICH.



## HESS MEDICINE SANITARY LOCKER CABINET

### The Only Modern, Sanitary STEEL Medicine Cabinet



or locker, finished in snow-white, baked everlasting enamel, inside and out. Beautiful beveled mirror door. Nickel plate brass trimmings. Steel or glass shelves.

**Costs Less Than Wood**

Never warps, shrinks nor swells. Dust and vermin proof, easily cleaned. Should be in Every Bath Room. Four styles—four sizes. To recess in wall or to hang outside. Send for illustrated circular.

**HESS, 920L Tacoma Bldg., CHICAGO**  
Makers of Steel Furnaces Free Booklet

## Write at Once for the Jahant Specification Hand Book—It's Free



This book tells you what you ought to know about proper heating and ventilation, and tells why you ought to specify the Jahant Down-Draft Furnace.

It tells how to estimate on the cost of proper heating equipment; how to reduce your bids and at the same time turn out a better job with a better profit for yourself.

It explains the construction and operation of the Jahant and how it delivers plenty of heat wherever and whenever heat is needed at a saving of one-third to one-half in fuel bills.

It tells how we back your recommendation of the Jahant Furnace with a legal binding 360 Day Guaranty Bond;—and it contains a lot of other information which you cannot afford to be without. Write for the book today.

**THE JAHANT HEATING CO. 45 Mill St., Akron, Ohio**  
Furnace Builders for more than 30 years.

**SPECIFY THE JAHANT DOWN DRAFT FURNACE**

You will get SPECIAL ATTENTION if you tell Advertisers you read American Carpenter and Builder.

# BECOME AN EXPERT DRAFTSMAN



**FREE \$20 Outfit**  
**FREE \$20 Library**

This \$20 Draftsman's Outfit as illustrated. Imported German silver drawing instruments in morocco case; 20 x 25-inch drawing board; ebony lined mahogany T-square; transparent triangles; German silver protractor; French curve; triangular boxwood scale; waterproof ink; pencil; erasers; shield; pencil pointer; handmade drawing paper and thumbtacks. Instruments guaranteed accurate—made by largest and most reliable manufacturer. **This handsome, expensive outfit free to you if you enroll now!**

## SALARY GUARANTEE

**THE AMERICAN SCHOOL OF CORRESPONDENCE GUARANTEES** that you will receive an increase of fifty per cent over your present salary within three years from the date of your enrollment; or, failing in this, the School guarantees to refund to you the full amount paid for your course. Back of this guarantee stands the American School—for more than fifteen years the foremost educational institution of its kind in the world. A school that has succeeded because it has been true to its principles of giving its students the instruction for which they enrolled.

## Just Mail the Coupon

Accept this great offer now—today! It never has and never will be equalled. You get the \$20 Drafting Outfit and the \$20 Cyclopedia of Drawing absolutely free of charge. Don't miss this opportunity. Your future success may depend upon whether you fill in and mail the coupon. It will only cost you a stamp to investigate. It may mean success and a big future for you.

**American School**  
of Correspondence, Chicago, U.S.A.

## Learn Mechanical, Structural or Architectural Drafting by Mail

Absolutely the greatest drafting offer ever made. Read it carefully. Then investigate. Sign and mail the coupon at once. Here is your opportunity to get the training you need to hold down a good job and earn big money—\$100.00 to \$250.00 per month paid to expert draftsmen. Our easy, practical method will teach you ARCHITECTURAL DRAFTING, STRUCTURAL DRAFTING or MECHANICAL DRAFTING in a few months. You will receive **expert individual instruction** in the course you select. All drafting instruments and materials supplied absolutely **free of charge**. Also big four-volume Cyclopedia of Drawing sent **free** if you enroll now. Drafting is the foundation of all engineering professions—learn drafting if you are ambitious to be an architect, structural engineer or contractor. Prepare yourself for a real man's work. And remember—this great special offer is made by the greatest non-resident educational institution in the world—a school whose guarantee is backed by sixteen years of successful teaching by correspondence.

# F R E E

This \$20.00 Cyclopedia of Drawing also included absolutely free in this special limited offer. Four big volumes as illustrated below. The only work which thoroughly covers MECHANICAL, STRUCTURAL and ARCHITECTURAL DRAFTING. Worth many times \$20.00 to any drafting student. Not only will you receive the best expert instruction, but you will have these books handy for reference at all times—they will answer all your questions authoritatively and promptly. Just think of it—four big volumes bound in half red morocco, gold stamped, 1,720 pages, 7 x 10 inches, 1,037 illustrations, page plates, diagrams, designs, etc., and the handsome \$20.00 Draftsman's Outfit. **All free** if you enroll now under this special limited offer.

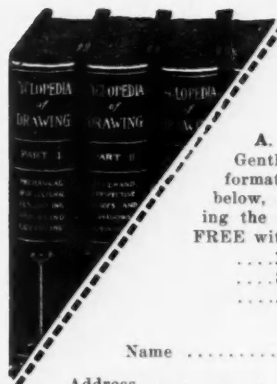

## Free Offer Coupon

A. S. of C.  
Gentlemen:—Please send me full information about the course checked below, also further particulars regarding the drafting outfit and library sent **FREE** with this course.

- .... Mechanical Drafting
- .... Structural Drafting
- .... Architectural Drafting

A.C.&B. 4-14

Name .....

Address .....

You will get **SPECIAL ATTENTION** if you tell Advertisers you read American Carpenter and Builder.

## A Free Book of Money Saving Ideas For Dairy Barn Builders



You will be interested in reading "Helpful Hints to Dairy Barn Builders." It tells many of the things learned by W. D. James—America's foremost dairy barn designer. It will help you make more money.

It tells about the new plank frame construction, the famous King system of ventilation, perfect lighting, proper width and arrangement. It tells about stable floors, site, size, appearance, design, drainage and equipment. And it shows four floor plans of barns that have attracted widespread attention.

You can obtain a copy of this valuable, helpful book FREE. Merely answer these few questions and the book will come by return mail. For whom do you expect to build or remodel dairy barns? (Give name and addresses.) When? For how many cows? Address

**James Manufacturing Company**  
8675 Cane St., FT. ATKINSON, WIS.

### Special Offer Of Blue Prints

Mr. James wants to make you a special offer of complete working blue prints of modern dairy barns of different sizes and types. Also ask how to secure free help from our agricultural department. Write today.



## Send Us Your Plans for Estimates —ORNAMENTAL IRON—

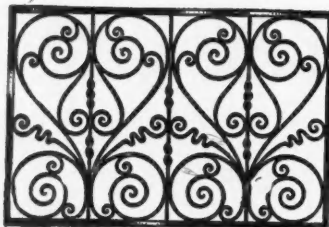

**Iron Stairs  
Railings  
Balconies  
Elevator Enclosures  
Fire Escapes  
Side Walk Doors  
Etc.**

OUR PRICES WILL INTEREST YOU

**THE MACK IRON & WIRE WKS. CO.**  
Sandusky, Ohio

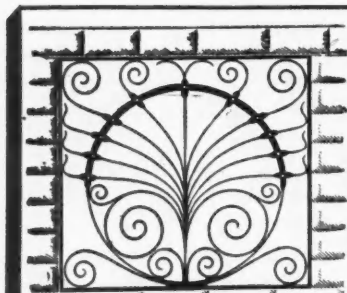

Mr. Builder: — If you are lucky enough to read this advertisement, and wise enough to write and tell us what you buy in

### IRON, BRASS and BRONZE

we will send you catalog that is attractive enough

to go in any man's library. Do you want it?

**DOW WIRE & IRON WORKS**

Incorporated  
Louisville, Kentucky

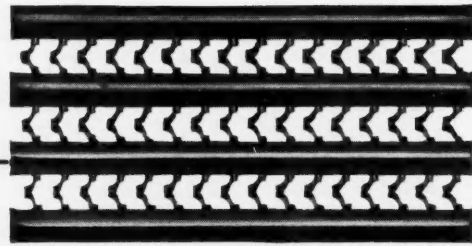

## RIB LATH

**Rigid—Easy to Plaster—Perfect Clinch**

RIB LATH is a superior metal lath with beaded ribs that span between the studs making it exceptionally stiff and rigid, and permitting a wider spacing of studs. RIB LATH provides a perfect clinch for the plaster, which will not streak or crack. Saves time, labor and material in erection. Furnished in three types and nine different weights. RIB LATH on RIB STUDS provide a fireproof hollow partition with open passage for conduits, pipes, etc. Also Detroit Diamond Lath and Steel Corner Beads.

VALUABLE RIB LATH HAND BOOK—Containing details, specifications, tables, illustrations, etc.—FREE to those interested in building.



**Trussed Concrete Steel Company**

644 Trussed Concrete Building

DETROIT

MICHIGAN

Reinforcing, Hy-Rib and Lath, Steel Sash, Etc.

## WIRE LATHING

The Secret of the durability of the woven wire lathing is owing to the fabric being completely embedded in the mortar, and thus secured from the corrosive action of the atmosphere; and also to the fact that rust will not attack the smooth round wire as it does the thin cut edges of a metal fabric.

"Why not use the proper kind of lath that lasts?"

Before building, write for our Booklet No. 6 A and Prices.

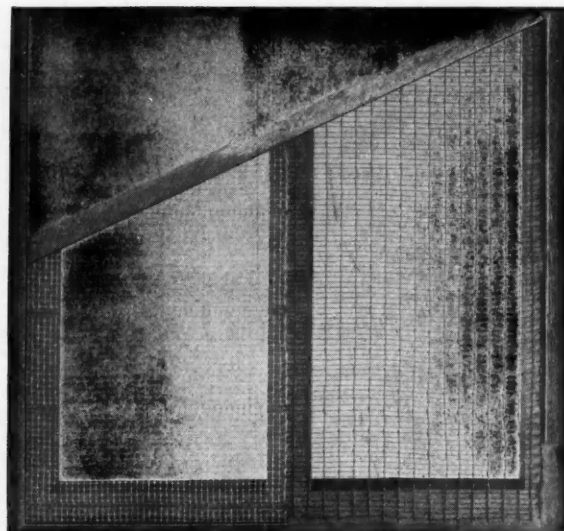

Grimm's Galvanized Corrugated Wire Lathing  
"Patent applied for"

Greening's Patent Trussed Steel Wire Lathing

**BUFFALO WIRE WORKS CO.,**

(Formerly Scheeler's Sons)

BUFFALO,  
N. Y.

You will get SPECIAL ATTENTION if you tell Advertisers you read American Carpenter and Builder.



# \$250<sup>00</sup> MONTH REPAIRING AUTO-MOBILE TIRES

Be first to enter this new big paying business in your town. Open your pockets. Let the dollars pour in. Act quick. Every auto sold means more tires to mend. Automobile business is growing fast—enormous field for tire repairing. Punctures and blowouts are common. Tires need retreading and vulcanizing. Something going wrong all the time. Thousands forced to buy new tires because they can't get old ones fixed. Think of the old bicycle days—repair shops on every corner—all making money—busy day and night. Autos make same proposition over again—only ten times bigger and better. Users of Haywood Tire Repair Plants are making big money. Johnson, Tex., writes: "I made as high as \$18 profit in a day." Another man who bought a plant September, 1911, writes he has cleared over \$3,000.00. That's going some! Operate a plant as side line in connection with auto business—garage or as an independent business. Find neighborhood where there's a bunch of autos—get all the steady business besides transient work. Experience unnecessary. You learn quick. Simply follow directions—practice a few days on a couple of old tires and you'll be ready to coin money. Business comes fast and easy.



## Repair Tires at Home.

Young men! and boys repair father's tires—get money he pays garage man. Get the neighbor's work. Make money to attend college or to start a garage and repair business. Auto owners—repair your own tires—save money—pay for your outfit in short time. We have outfits for home use. Anyhow investigate. Send today for catalogue. See the wonderful possibilities in this marvelous field. Learn of the enormous money-making opportunities in this fascinating new business.

Auto owners—repair your own tires—save money—pay for your outfit in short time. We have outfits for home use. Anyhow investigate. Send today for catalogue. See the wonderful possibilities in this marvelous field. Learn of the enormous money-making opportunities in this fascinating new business.

**HAYWOOD TIRE & EQUIPMENT CO., 696 N. Capitol Ave., Indianapolis, Ind.**

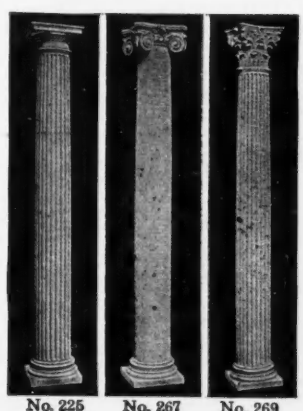

## COLONIAL COLUMNS

Hegener's Patent Lock Joint Columns

We make columns from the smallest size up to 40 inches in diameter and 30 feet long. SEND FOR CATALOG



We are prepared to furnish composition capitals of standard design.

## Composition Capitals



Roman Corinthian



Italian Renaissance

MANUFACTURED BY **RUDOLPH HEGENER CO., 9232 TO 9234 HARBOR AVE. CHICAGO**

## CALDWELL SASH BALANCE



Does away with weights and cords, and VASTLY more durable. Makes sashes work perfectly. Permits greater window space in new work, as box frames are not necessary. May be applied to old windows without altering sashes or frames.

Write for circular to the **Caldwell Mfg. Co. 15 Jones Street, Rochester, N. Y.**

## Start to Succeed NOW

Mail the Coupon



Forget the past. Better times are ahead. Start up out of the old ruts NOW. Mail the coupon. We want to tell you how you can learn Plan Reading, Estimating, Contracting, etc., IN YOUR OWN HOME. We furnish plans of buildings now being built. Never mind the cost—it's small. We want ambitious men now in the building line. Write today.

**\$15.00 Outfit and All Free Blue Print Plans**

**CHICAGO TECHNICAL COLLEGE**

1017 Lake View Building, Chicago, Ill.

CHICAGO TECHNICAL COLLEGE, 1017 Lake View Bldg., Chicago, Ill. Gentlemen: I have marked with a cross (X) the branch or branches interesting me.

- Architectural Draft'g
- Builders' Course
- Estimating
- Plan Reading
- House Planning
- General Contracting
- Bldg. Superintendence
- Structural Drafting
- Structural Design
- Mechanical Drawing
- Machine Drafting
- Machine Design

Name .....

Address .....

Town..... State.....

College or Home-Study Course .....

You will get SPECIAL ATTENTION if you tell Advertisers you read American Carpenter and Builder.



## A WHITE TRUCK

*Is Your Best Advertisement*

**Y**OUR ownership of a White guarantees to your customers the most prompt and efficient delivery system money can buy. A White Truck will cost you a little more to begin with, because it is built a little better, but it will cost so much less to operate and maintain that it is by far the best investment in the end. Always ready to run, good twenty-four hours of the day in all seasons, in a White Truck the dependability of your service to your customers is always assured.

### *What Lumber Companies Say*

"We are satisfied with the White Truck because it has given us good results considering the hills we must climb with it. We have been able to take orders from people living in other towns which we could not do before we had the truck."

Clark Brothers & Company  
Plymouth, Pa.

"We purchased a three-ton White Truck from you on Nov. 13, 1912, which has been in continual service since, and up to this writing have had no expense for repairs connected therewith, and is giving entire satisfaction."

West Lumber and Manufacturing Co.  
Plymouth, Pa.

THE WHITE  COMPANY

Manufacturers of Gasoline Motor Cars, Trucks and Taxicabs

CLEVELAND

!You will get SPECIAL ATTENTION if you tell Advertisers you read American Carpenter and Builder.

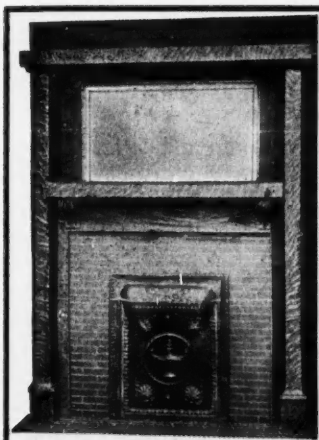

**\$27.00 Our Price to You**

*For Mantel as illustrated with trimmings*

Mantel is made of solid oak with 18x36 bevel mirror at price quoted we include any shade enameled tiling for facing and hearth, with recess grate and plated grate frame and front—Tile Facing 42x39 inches.

ILLUSTRATED CATALOGUE FREE ON APPLICATION

**MOORMANN & OTTEN**

611-613 Main Street

CINCINNATI, OHIO

**MAKE MONEY**

BY SELLING

**FIRE PLACES**

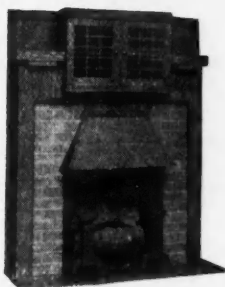

**TILES and MOSAICS**

**for FLOORS and WALLS**

Write for our Large Illustrated Catalogue of Fire Places in Tile, Wood, and Brick Andirons, Gas Logs, Consoles and Colonnades Sent Free on Request.

Write For Discounts to Carpenters and Builders

**CHAS. F. LORENZEN & CO.**

REAPER BLOCK

Cor. Clark & Washington Sts., CHICAGO

**THE BEST COLUMNS**

for Porch, Interior and Pergola use the NICKERSON Patent DOUBLE LOCK JOINT

THEY CANNOT COME APART

We Specialize on Detail-work. "Vignola" is our Standard for proportions when Architect's details are not furnished.



Clinch your Trade by giving them the very best Columns. Ours have the best Construction and correct shape.

All kinds of interior trim to detail.

Write for Catalogue No. 4.

**NICKERSON MFG. CO.**

KNOXVILLE - - - TENNESSEE

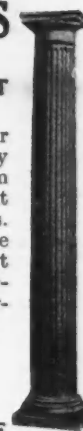

**\$20.00**

in Yellow Pine, Oak or Birch, in the White.

Any size up to 8x8.

Freight paid to your station

**This COLONNADE**

consists of Columns, Pedestals and Beam Brackets. The workmanship and materials are first class in every respect. We offer this colonnade for \$20 for a limited time only. Send your order today, give exact width and height of opening. State what kind of wood. F.O.B. Your Station.

**Chicago Grille Works**

828-838 Wells Street

Chicago, Ill.



**\$22.50 \$27.50**

FOR THESE ELEGANT, MASSIVE, SELECTED OAK OR BIRCH, MAHOGANY FINISHED MANTELS. BEVELED MIRRORS, 18 X 36

Prices include our "Queen" Coal Grate with best quality enameled tile for facing and hearth. Mantels 82 inches high, 5 feet wide. Furnished with round or square columns, as shown in cuts.

*Catalogue Free*—Will send our 100 page catalogue, the finest ever issued, free, to carpenters, builders and those building a home.

**CENTRAL MANTEL CO., 1247 Olive St., St. Louis, Mo.**

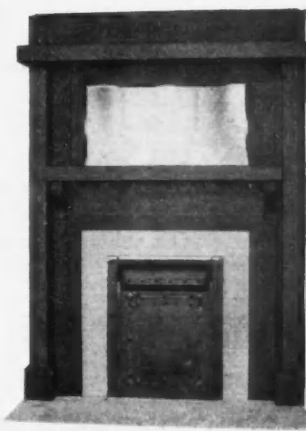

You will get SPECIAL ATTENTION if you tell Advertisers you read American Carpenter and Builder.

**CHOOSE**

**IT'S** up to you to be the man at the top instead of the man with the dinner pail.

Don't hesitate to grasp this opportunity to win success, for there's always room at the top for the man who knows how.

### The LIGHTNING ESTIMATOR

stops worry, lying awake nights, over or under estimating and guessing—in fact, by showing you how to estimate the cost correctly, it spells the word **\$ucce\$\$** for you. Don't do yourself an injustice by passing up the greatest opportunity ever offered to Carpenter, Contractor or Builder.

### The New Seventh Edition of the LIGHTNING ESTIMATOR

will teach you: How much time and material involved in each part of your work; how to figure on unfamiliar work; how to estimate quickly and correctly on a large job; how to estimate on time, material and prices in all parts of the country.

This Book is written by a man who has made good in this profession, and is based on hard, solid facts, secured by the knocks of experience, making it an invaluable guide to any one engaged in or those about to enter the building business.

If you are just starting out here is your chance to get a firm foot hold. If you are an old timer and getting a little behind the times, here's your chance to brighten up and get some new ideas.

This Edition is bound in cloth, profusely illustrated—a feature not found in other books of this kind. The price, \$1.00. Don't delay. Send for it today.

**BRADT PUBLISHING CO.**

1260 Michigan Avenue

JACKSON, MICH.

## Safety First, Mr. Contractor, Always

Consider where you are going to come out on the deal when you buy machinery or power equipment.

**MAKE SURE** that your contracts and profits are protected against loss which is so often caused by an inefficient engine. Freezeups and breakdowns so common on ordinary engines are too expensive to be lightly overlooked.

Guard against accidents and delays by demanding that your power machinery be equipped with the reliable "NEW-WAY" Air Cooled Engine.

Then you will not have to worry about getting the job out on scheduled time.

You can rest assured that your estimated profit will be maintained. The "NEW-WAY" is on the job every minute all day long.

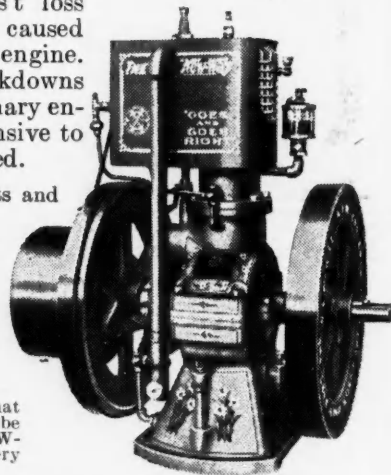

**The "New-Way"** Stands for the utmost in Quality, Efficiency, Durability, Economy.

Write now for Catalog X

**The "New-Way" MOTOR COMPANY**  
LANSING, MICHIGAN, U.S.A.

## A GAS SYSTEM FOR YOUR BUILDINGS

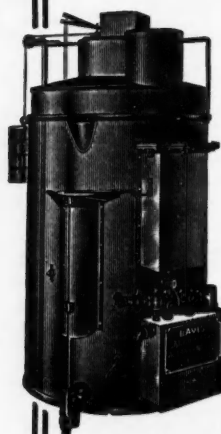

DAVIS GENERATOR

**Big Profits**  
**Easy to Install**  
**Any Carpenter Can Do It**  
**Clean White Light**  
**No Danger from Explosion**

### DAVIS LIGHTING SYSTEM

provides the safest means for lighting homes, stores, churches and offices. The best system known for lighting farm houses. Piping can be run to provide barn lights. No leakage; no explosion. Generator will also supply gas for cooking. The most complete, convenient, sanitary system that can be had.

### WE PAY YOU

to act as our Agent for Davis Acetylene Lighting Systems. We want a reliable man in each town. Write us today and let us tell you how to make money the year around. Good pay; no expense; no risk.

ASK FOR PARTICULARS

**DAVIS ACETYLENE CO.,**  
ELKHART, INDIANA

You will get **SPECIAL ATTENTION** if you tell Advertisers you read American Carpenter and Builder.

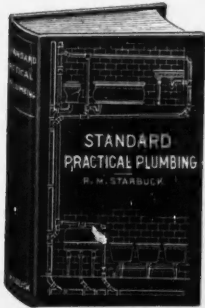

# Standard Practical Plumbing

By R. M. STARBUCK

450 pages, 347 illustrations. Of the three hundred and forty-seven illustrations contained in the book, one hundred of them are full-page illustrations. The illustrations all being drawn expressly for this work, show the most modern and best practice in plumbing construction.

Plumbing in all its branches is treated within the pages of this book, and a large amount of space is devoted to a very complete and practical treatment of the subject of Hot Water Supply and Circulation and Range Boiler Work.

Another valuable feature is the special chapter on Drawing for the Plumber.

### It Contains the Following Illustrated Chapters

- |  |  |
|--|--|
| 1. The Plumber's Tools.                            | 16. Ventilation.   |
| 2. Wiping Solder, Composition and Use.             | 17. Improved Plumbing Connections.   |
| 3. Joint Wiping.                                   | 18. Residence Plumbing.  |
| 4. Lead Work.                                      | 19. Plumbing for Hotels, Schools, Factories, Stables, etc.                             |
| 5. Traps.  | 20. Modern Country Plumbing.   |
| 6. Siphonage of Traps.                             | 21. Filtration of Sewage and Water Supply.   |
| 7. Venting.  | 22. Hot and Cold Supply.   |
| 8. Continuous Venting.                             | 23. Range Boilers; Circulation.  |
| 9. House Sewer and Sewer Connections.              | 24. Circulating Pipes.   |
| 10. House Drain.                                   | 25. Range Boiler Problems.   |
| 11. Soil Piping, Roughing.                         | 26. Hot Water for Large Buildings.   |
| 12. Main Trap and Fresh Air Inlet.                 | 27. Water Lift and its Use.  |
| 13. Floor, Yard, Cellar Drains, Rain Leaders, etc. | 28. Multiple Connections for Hot Water Boilers, Heating of Radiation by Supply System. |
| 14. Fixture Wastes.                                | 29. Theory for the Plumber.  |
| 15. Water Closets.                                 | 30. Drawing for the Plumber.   |

Price, Postpaid . . . . \$3.00

**Radford Architectural Co.**

1827 Prairie Ave. : : : Chicago, Ill.

# SAVE MONEY

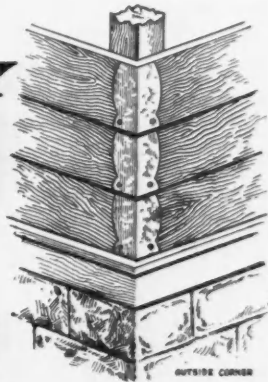

By Using

## MERWIN

### Metal Siding Corners

Less expensive and stronger than either corner boards or mitre corners. Just as handsome on any job.

Easily and quickly applied. Practically invisible when painted.

### MERWIN YOUR CORNERS

A Postal Brings a Sample

**MERWIN MFG. CO.**

ERIE, PA.

AND  
"YANKEE"  
PLUGS

MAKERS  
OF  
"HERRINGBONE"  
WALL TIES

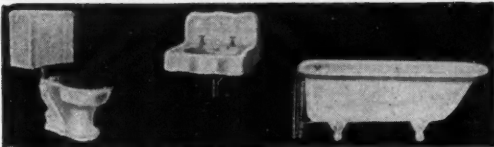

SEND TODAY FOR COMPLETE CATALOGUE "41"  
EVERY ARTICLE GUARANTEED

### EVERYTHING IN GUARANTEED PLUMBING & HEATING SUPPLIES

BUY AT WHOLESALE PRICES Bathroom Outfits, Sinks, Pipe, Fittings, Valves, Faucets, Heating Boilers, Radiators, Water Pressure Systems and Lighting Plants for Country Homes, etc., etc.  
Our \$200,000.00 plant behind our GUARANTEE.

**JOHN HARDIN COMPANY**

30 Years at 4543-53 Cottage Grove Ave., CHICAGO

## Use Webster's Elastic Cement

For Bedding Slate, Pointing Wood, Stone, Brick and Iron for Waterproofing and for Setting Glass.

Write for Prices

**W. F. Webster Cement Co., Cambridge, Mass.**  
Established 1848



## MONITOR Cupola Ventilator

Most sensible made. Galvanized steel construction. Ornamental. Large ventilating capacity in all weathers. Storm-proof; bird-proof. Not drafty. Low-priced; all sizes. Can be attached to roof in 5 minutes. Prompt attention to orders.

Write for Price List

**B. F. LICHTY & SONS CO.**  
Waterloo Iowa



## RIDER AGENTS WANTED

In each town to ride and exhibit sample 1914 model. Write for Special Offer. Finest Guaranteed 1914 Models. . . . . \$10 to \$27 with Coaster-Brakes and Puncture-Proof Tires.

1912 and 1914 MODELS. ALL OF \$7 to \$12 BEST MAKES. . . . . 100 SECOND-HAND WHEELS All makes and models, good as new. Great Factory Clearing Sale. . . . . \$3 to \$8 We Ship on Approval without a cent deposit, pay the freight 10 Days' Free Trial and allow . . .

**TIRES** coaster-brake wheels, lamps and sundries, half usual prices. DO NOT BUY till you get our catalogue and offer. Write now.

MEAD CYCLE CO.

Dept. T-122

CHICAGO



## THE GALE

BARN AND GRANARY VENTILATOR

For all your buildings

INEXPENSIVE, BEAUTIFUL, STRONG Made of heavy galvanized iron. Screened inside. Storm-proof and bird-proof. Perfect ventilation guaranteed. All you have to do is to place ventilator on roof and nail fast.

Write for Illustrated Circular with Complete Prices.

**Galesburg Sheet Metal Works,**  
Galesburg, Illinois

You will get SPECIAL ATTENTION if you tell Advertisers you read American Carpenter and Builder.

# YOU

**Can Now Get  
this large  
"YANKEE"  
with spring in  
the handle to  
drive it back  
quickly for  
the next  
push.**



**A Quick  
and Power-  
ful Tool for  
Carpenters  
and Builders.**

**"YANKEE"  
QUICK  
RETURN  
No. 131**

**Drives most any  
screw, large or  
small, and in  
about one-tenth  
of the time of the  
ordinary screw  
driver.**

**Can be furnished with  
a Drill Point Attach-  
ment, Countersink and  
Screw Holder Bit, same  
as the No. 31.**

**Let us send you the "Yankee" Tool  
Book anyway. A postal brings it.**

*Your dealers sell the "Yankee"*

**North Bros. Mfg. Co.**  
Department A  
PHILADELPHIA, PA.



*A Good  
Motto—  
"Safety First"*



## Wheeler Safety Scaffold Brackets

<p><b>Save Lumber</b></p> <p><b>Save Labor</b></p> <p><b>Save Nails</b></p> <p><b>Save Accidents and Increase Your Profits</b></p>	<p><b>Convenient to handle</b></p> <p><b>No loose parts to get lost</b></p> <p><b>Always ready for use</b></p>
--	--

Made of T steel — Last a lifetime  
Self-locking — Scaffold cannot swing  
They carry 2,000 pounds  
They save enough on two jobs to  
pay for themselves.

WRITE FOR OUR  
**FREE TRIAL OFFER**

**American Steel Scaffold Co.**  
Dept. 7 DETROIT, MICH.

### The Newest Carpenter Tools

(Patents Pending)



Wt. 4 lbs. **All Steel**

No Shift Buckeye Folding Saw Vise  
Jaws 28" long. Folds Up in Space 14 1/4 x 2 x 2".  
Price, prepaid, \$1.60 in U. S.



(Folded)

Weight 2 lbs. (Open)  
Jaws 14" Long,  
All Steel Folding  
Saw Vise



**SMOOTHER.**  
Price, \$2.00

**JACK,**  
Price, \$2.50

**FORE,**  
Price, \$3.00

\$1.50, Prepaid  
Prepaid in U. S.

Foot Power Hammer Saw Set  
Ask Your Dealer, or Order Direct



(Folded)  
Price 90c, prepaid  
in U. S.

Buckeye  
Plane

**BUCKEYE SAW VISE CO.**  
2050 W. 55th St., CLEVELAND, O.

## MONEY FOR YOU

### By Our Plan

### UNIVERSAL CLOTHES DRIER

The kitchen wonder.—Indispensable to every housewife. Can be attached to wall or ceiling. Easily removed. Contains 30 sq. ft. of drying surface. Adjustable to suit convenience of operator. Does away with lines and the cumbersome clotheshorses. No kitchen or laundry complete without a **UNIVERSAL-DRIER**. Neat, durable, irreplaceable. Every demonstration a sale.

Retails for \$1.50. Big commissions to reliable men.

**WE WANT AGENTS**

Write today for our liberal offer that will make money for you during the dull season.

Can be raised to ceiling as shown by dotted lines



**The Universal Clothes Drier Co.**

Factory: **Rutherford, N. J.**      Sales Dept. **Oradway Bldg., Newark, N. J.**

You will get SPECIAL ATTENTION if you tell Advertisers you read American Carpenter and Builder.



Stairway Folded.



Fully Patented

In Position.

Write Now!  
Delays are Dangerous

**The Bessler Movable Stairway Co.**  
AKRON, OHIO Dept. A

Heretofore when it was desired to enter the attic or loft in the ordinary home, a hole was cut into the ceiling and a ladder used, or a permanent stairway was built, necessitating the use of many square feet of valuable floor space.

**The Bessler Movable Stairway** will enable you to enter that attic with the utmost convenience, and at the same time not take up one single square foot of floor space in the floor below. When not in use it is

**Up in the Ceiling—Out of the Way**

When needed a light pull will bring it down ready for instant use, complete with hand-rail as shown. A child can operate it.

**We Want Agents Everywhere**

To live Builders Supply Men and Jobbers, we will offer an attractive proposition.

**Valuable Book for Contractors Who Build Dairy Barns FREE**

**The "HOW" Book**

Here's a book that's bound to save you time and money. Tells how to figure life, strength and quantities needed for all kinds of building materials. Tells how to figure safe loads, bending stresses, crushing strength, timber weights, waste, shrinkage, roof pitches, labor quantities in roofing, carpentry, masonry work, etc.

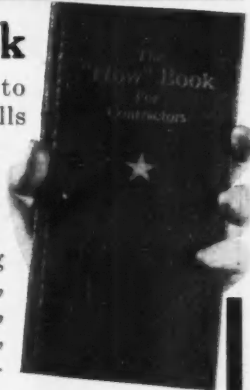

**From Authoritative Sources**

Not only a "How" book but a "ready-reckoner"—compiled from the world's most authoritative sources. Chuck full of time-saving tables, usable formulae and other features favored by progressive contractors and builders

—a wealth of practical, easy-get-at-able facts to refresh the contractor's memory and make the work easier.

Handy pocket size—bound in solid oil leather—126 pages, every page packed with real "meat."

**FREE. Write For It Today!**

YOURS without one penny of expense. Just give us the names of folks in your neighborhood who are going to build new barns

—remodel old ones, or put cement floors in their barns—and you get the "How" Book.

**We have helped contractors increase their profits. We want to help you. This book shows how. It entitles you to the free service of our drafting department—affords you Blue Prints free of all cost.**

Send for this book at once

**HUNT, HELM, FERRIS & CO., 303 Hunt Street HARVARD, ILLINOIS**

**This Coupon Worth AT LEAST 50 Cents**

**"VANADIUM"**

The King of Hand Saws



- 16" \$1.60
- 18" \$1.80
- 20" \$2.00
- 22" \$2.15
- 24" \$2.30
- 26" \$2.50
- 28" \$2.70
- 30" \$2.90

Straight or Skew Back, in Hand, Panel, Carpenter or Rip—any Teeth Desired. Vanadium Steel Saws, made of Vanadium High-Speed Steel, hardened and tempered by a secret process, highly polished blade, extra thin back, and a finished product as a whole that cannot be excelled. Binding guarantee etched on every blade.

**Vanadium Steel Saws "Smile at Nails"**

For every saw ordered with this coupon enclosed deduct 50c from 16" and 18" prices; from all other sizes deduct 75c. This is our great special offer to introduce our saws to carpenters direct.

**Read---Fill In---Mail**

This offer may not be repeated after this month so fill out and mail the coupon today. It will assure you getting, not only the most serviceable saw made, but getting it 50c to 75c cheaper.

DIRECT TO **Pennsylvania Saw Co.**  
FRACKVILLE, PENNA.

Pennsylvania Saw Co., Frackville, Pa.

Gentlemen: I enclose \$..... for your American Carpenter and Builder offer, for which please send me by Parcel Post, prepaid: Length, ..... ins. Teeth, ..... pt. Narrow or Wide Blade, ..... Straight or Skew Back, ..... It is distinctly understood that I can return any or all of these saws if they are not satisfactory after 30 days' trial, and that you will refund the purchase price upon receipt of goods.

Name.....

Address.....

You will get SPECIAL ATTENTION if you tell Advertisers you read American Carpenter and Builder.

# GOODSELL

## You Will Buy This All-Steel Mitre Box

In fact you can't help buying it if it's shown to you, and the more you know about mitre boxes, the quicker you will buy it.

The Goodell is made of Steel—from end to end and all the way through. It is provided with automatic stops for holding the saw, it has an accurate scale in its base, and is fitted with a gauge for making duplicate cuts, etc.

It cannot break and get out of order—it is always ready to do fast, accurate work at no notice.

Send for Circular C and prices—now, in time to have it for your spring building work.

**Goodell Mfg. Co.**  
Greenfield, Mass.

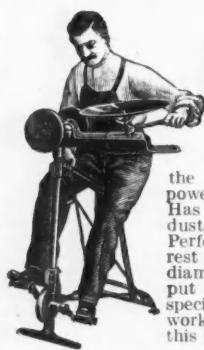
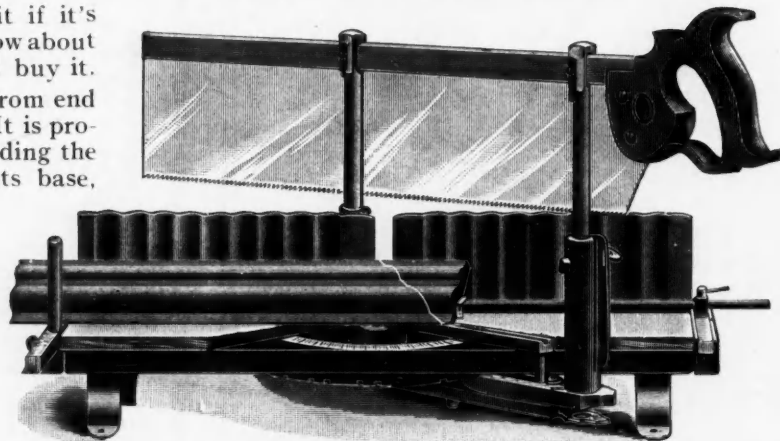

### The shaft driven Luther Hummer Grinder sharpens tools quickly

Write today for free booklet telling all about the lightest running, most accurate foot power tool grinder made—the Luther Hummer. Has steel shafting like automobiles. Enclosed dust-proof bearings and gears. All metal frame. Perfect gravity feed lubrication. Patented tool rest gives proper bevel. DIMO GRIT artificial diamond wheels revolving 4000 times a minute put keen edge on all tools quickly. Thirty special attachments make this Hummer a whole workshop in itself. Get the book and learn why this is the best of all foot power grinders.

**Luther Grinder Mfg. Co.,** 903 Point Street MILWAUKEE, WIS.



No. 2, Single Drum

Before deciding to buy any particular hoist, look over the Eric line, illustrated and described in our catalog.

A postal card will bring this book.

**Eric Clutch & Pulley Co.**  
Erie, Penna.

### ERIE HOISTS

A Complete Line.

We manufacture a complete line of "Reliable Erie" Contractors' Hoists and can please you in price and quality. "Reliable Erie" Hoists give the greatest lifting efficiency and require the least horsepower of any hoist made. They are saving and simple.

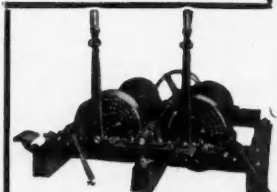

Hoist No. 2, Double Drum

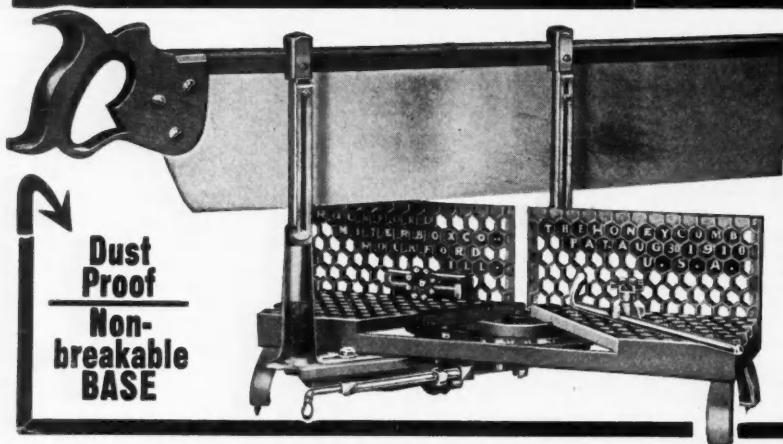

**Dust Proof  
Non-breakable  
BASE**

### AN OFFER TO CARPENTERS AND BUILDERS

We want one of our new improved Honeycomb Mitre Boxes in every community, and will sell one box at wholesale, to Carpenters and Builders where they are not handled by the dealers.

The Honeycomb Mitre Box is the BEST of all good Mitre Boxes, is more easily kept in good condition, and permits faster and more efficient work. It is also furnished with the best Mitre Box Saw in the world.

Our pride is quality and therefore we give honest opportunity for the purchaser to judge for himself. Each Mitre Box is tagged with our guarantee. We refund the money if 10 days' trial does not prove our guarantee.

Write for descriptive circular and prices.

**ROCKFORD MITRE BOX CO.**  
252 Mill St., Rockford, Ill.

It's the only concern that can furnish a Mitre Box Saw that requires no setting.

You will get SPECIAL ATTENTION if you tell Advertisers you read American Carpenter and Builder.



## Accuracy and Serviceability

You will find both exemplified to the maximum degree in all



Beckmann Transits and Levels retain their precise adjustment under hard service. Powerful telescopes. Rugged design and construction. Write for Circular "Y" today.



L. Beckmann Co., 500 Adams St., Toledo, O.

## WHY TAKE A CHANCE

of having a defective wall from using a scrap wall tie in varying thickness as light as tin.

Ask your dealer the weight of a box containing 1000 ties and if the weight is below 50 pounds you are buying an inferior tie and entitled to rebate.

To be safe, specify the

## WHALE BONE WALL TIE



and if your dealer cannot supply same, order direct from us and we will ship the same day as received, at price of \$2.50 per 1000, Pittsburgh, Pa.

ALLEGHENY STEEL BAND COMPANY  
BELL PHONE: 718 Cedar North Side, PITTSBURGH, PA.

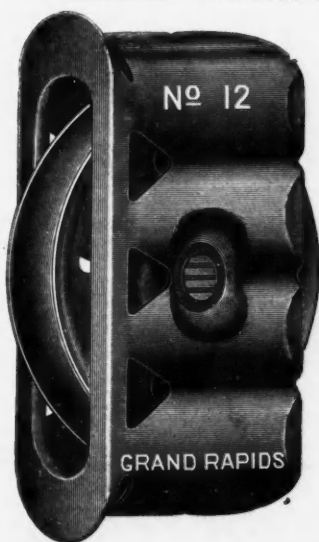

## "GRAND RAPIDS" ALL STEEL SASH PULLEYS

No Nails No Screws  
Just Bore 4 Holes

The time saved by the "Grand Rapids" will actually pay for the pulleys.

You can't afford to use old style pulleys.

Write for free samples and prices.



Grand Rapids Hardware Co.  
Manufacturers  
158 11th Street, GRAND RAPIDS, MICH.

This fastening is more secure than any number of screws or nails could make it. Saves about 15 per cent, too.  
C O R S W S  
COST MONEY

# Typewriter Sensation

## 2 Dollars A Month

Buys a Genuine  
Standard No. 2  
SMITH-PREMIER  
TYPEWRITER



and at \$71.20 less than the manufacturer's price

Never before has anything like this been attempted. Dealers get \$3.00 a month rent for this make of machine, not nearly as perfect as the one we will send you, and you pay only TWO DOLLARS A MONTH AND OWN IT.

### A-GUARANTEED-TYPEWRITER-\$28.80

Perfect machines only, complete outfit, nothing extra to buy, no strings of any kind to this offer. Just think of buying such a typewriter for \$8.80 down and \$2.00 a month. Cash price \$27.40. Thousands of people have paid \$100.00 cash for Smith-Premiers. It's Standard, by many considered the best typewriter ever built. A key for each character, so each character printed is always the same; a brush for cleaning the type built into the machine; the tilting carriage instantly throws all the writing in plain sight. Comes to you with two-color ribbon, complete operating instructions, tools, water-proof cover, practice paper, everything ready. It runs beautifully. Writes as perfect and clean cut a letter as quickly and as easily as any machine bought for \$100.00. It's wonderfully simple; a child can operate it with half an hour's practice, and rapidly attain speed. It's strongly built and will give you years and years of honest service and complete satisfaction.

### Send the Coupon and We Will Ship You This Smith-Premier Typewriter

When the typewriter arrives, deposit with the express agent \$8.80 and take the typewriter three days and try it. If you find it to be the best typewriter you ever saw, satisfactory in every respect, keep it and send us \$2.00 each month, until our special price of \$28.80 is paid. If you don't want to keep it, return it to the express agent, and he will give you back your \$8.80, and return the typewriter to us. We will pay the return express charges.

You won't want to send this machine back after you have seen it and tried it. You can't imagine the perfection of these machines till you see one, and the price is \$71.20 less than the catalogue price, and it is guaranteed just as if you paid \$100.00.

### Only 200 orders will be filled on this offer. Act today to be sure

This coupon states the terms. Fill it out, send it now, today. You can't lose, and it's the greatest economical typewriter opportunity you will ever have.

#### COUPON

HARRY A. SMITH

Robbins Bldg., CHICAGO, ILL.

Ship me a No. 2 Smith-Premier f.o.b. Chicago, as described in this advertisement. I will pay you the \$20.00 balance of the SPECIAL \$28.80 purchase price, at the rate of \$2.00 per month. The title to remain in you until fully paid for. It is understood that I have three days in which to examine and try the typewriter. If I choose not to keep it I will carefully repack it and return it to the express agent. It is understood that you give the standard guarantee for one year.

Name.....

Address.....

Shipping Point.....

A. C. & B.

You will get SPECIAL ATTENTION if you tell Advertisers you read American Carpenter and Builder.



**A FEW SPECIAL ADVANTAGES**

of W. & C. Metal Shingles are here set forth: they are fire, wind, storm, lightning, rust and decay proof; easy to lay; cost no more than ordinary wood shingles; have a thirty-two years' service test that proves their long life; are honestly made from honest material; have been, are now and will be forever the very best metal shingles made. Ask for testimony from the users.



**WALTER'S AND COOPER'S  
METAL SHINGLES**

were the first Metal Shingles ever made: imitations have come and gone, but the good old Walter's and Cooper's still stand at the head; the standard for all comparisons.

Ask for Cat. A. C.



Standard Shingle

**THERE'S MONEY FOR YOU**

in the handling of W. & C. Shingles in your vicinity; there is no end to the money making possibilities right in your own town, right on your own street; we require a live man in your territory and to a live one we will make a selling proposition that is a sure winner. We don't want a half hearted representative, we want a man who'll do a little hustling on his own account. We do not want a passive representative; we can't use him. We're looking for the chap that's out for the cash and we've the cash to send him. Start something.



Excelsior Tile

Ask for Cat. A. C.



**NATIONAL  
SHEET METAL ROOFING CO.**

339-88 Grand Street, Jersey City, N. J.

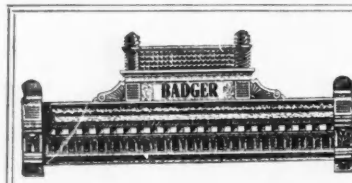

**Badger Quality Always Leads**

Cornices, Skylights, Finials, Ventilators, Metal Ceilings, Slate, Tile, and Tin Roofing, Galvanized and Wood Tanks, Eave Troughs, Conductor Pipe, Wire and Steel Hangers, Sheet Metal Roofing and Siding, Galvanized Screw Joint Well Casing and Culverts, Tin Plate, Galvanized and Black Sheets, Toncan Metal Rust Resisting Sheets.

**Badger Steel Roofing & Corrugating Co.**

213-215 So. 2d Street,  
LA CROSSE, WIS.

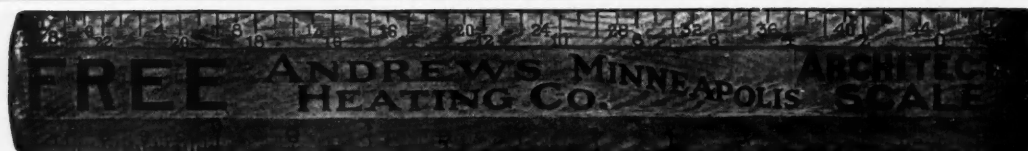

Send us two or more names of persons who are interested in or want to buy Hot Water Heating Plants and we will send you this scale. Back inches are divided into 6, 10, 12, 20, and 40 parts. Also free catalog on request. Mention this paper.

**Andrews Heating Co.,** 1431 Heating Bldg., Minneapolis, Minn.

**MONARCH  
PATENT CORNICE MOULD**

— the handiest tool for making all kinds of plaster cornices and corners. No trouble; no delay; works in one third the time it takes to mould cornices and corners the old way.

Consists of one blade holder, ten assorted blades and one blade scraper. Guaranteed not to rust or warp. Sent on 10 days free trial. If you don't like it you don't have to buy.

Ask for free descriptive circular.

**TIMOTHY F. HORAN**

10 Maple Street Cooperstown, N. Y.

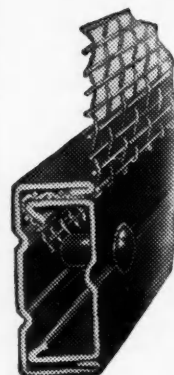

**Fly Screens**

**Metal Frame  
REWIRABLE CIN-MAN-CO.**

See method of securing wire cloth, held by rounded corners, which prevents cutting by vibration.

Special inducements to  
Carpenters and Builders  
Booklet Free

**The Cincinnati Fly Screen Co.**  
1010-1026 Evans St., Cincinnati, O.

You will get SPECIAL ATTENTION if you tell Advertisers you read American Carpenter and Builder.

# Sykes Expanded Cup Lath

Being SELF-FURRING Has No Equal

For ALL STUCCO WORK



The demand is on. For making over old buildings, for new buildings, stucco gives service and beauty. YOU can make a BIG SAVING in construction costs by using SYKES EXPANDED CUP LATH.

No furring strips needed. Both sides alike—cannot be applied wrong. Heavier and costs less than other metal laths. Gives perfect key; saves on plaster; never discolors plaster; never warps. Stucco or plaster, when properly applied on Sykes Expanded Cup Lath, will always be free from crack or blemish. Sheets, 18 x 96 inches, with Anti-Rust (oil), painted Black, or Galvanized Finish. 20 Square Yards to the bundle.

**SYKES TROUGH LATH**—another money-saver. Gives great strength and a positive keying principle that makes it desirable for use in all buildings. For inside plaster work; great for ceilings. Easy to apply; easy to plaster on. Promotes fast, clean, durable work. Sheets 13½, 15½, 18½, 23½ in. wide by 96 in. long.

**SYKES WALL TIES**—extra heavy galvanized metal of full strength and with deep cross corrugations. Grips mortar strongly and does not weaken under strain. Samples and price on request.

**SYKES CORNER BEADS**, in lengths 6 to 10 feet; 10 pieces of uniform length to the bundle. Gives unequalled protection to corners and projections. Cheaper than making a plaster corner. Specially designed to grip the plaster and give great protection.

As a Builder, we know you will be interested in our reliable products. We can save you money and give you a quality that will please you and your clients. Write at once for a complete list of our products, samples and prices.

**SYKES METAL LATH AND ROOFING CO.**  
506 Walnut St. NILES, OHIO

## Straight Talks on Durametal Weatherstrips

¶ You contractors—carpenters and building owners—why not buy weatherstrips direct from the manufacturer and do your own installing?

¶ By our unique plan, we have cut out the usual big selling expenses, which enables you to buy direct from us, make a profit on the strip and good money on the installation besides.

¶ Durametal Weatherstrips have been successfully sold for over 10 years and have stood every possible test. Their durability and simplicity makes them superior to all others.

¶ Made of best heavy zinc, and fully guaranteed. Write for samples and prices now before you turn another page. There's money in this for YOU.

*A few agencies open to responsible, live, local contractors and carpenters.*

**Durametal Weatherstrip Co.**

829 W. Washington Blvd.

CHICAGO, ILL.

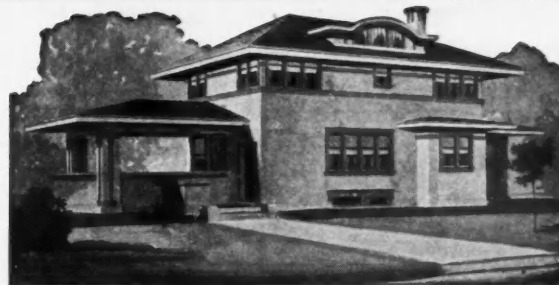

## Cement Houses and How to Build Them

This large book of 176 (8 x 11 inch) pages contains illustrated details of cement construction—standard specifications for cement—concrete blocks—general information concerning waterproofing, coloring, aggregates, mixtures, paving, reinforcing, foundations, walls, steps, chimneys, floors, etc., together with perspective views and floor plans of 87 stucco and concrete block houses.

The illustrations show the houses exactly as they will look when built. All the floor plans are shown, giving the location and dimensions of all rooms, closets, porches, etc.

**This Book Sent Free**

Send in your subscription today and receive one of these books by return mail. Free, postage paid. Regular subscription \$2.00 per year.

**American Carpenter and Builder**

1827 Prairie Ave.

CHICAGO, ILLINOIS

You will get SPECIAL ATTENTION if you tell Advertisers you read American Carpenter and Builder.



## ACCIDENT!!

Can't Happen  
With a

**Canton**  
Sidewalk Door

Because stay rods and chains protect passers-by when door is open. The "Canton" is perfectly flush and level with the sidewalk and presents a checkered surface. No damage suits when you use a "Canton". Complies with all City laws.

"Canton" Sidewalk Doors are firm under the tread. Lie flush with the walk. No protruding hinges to trip passers-by. The best sidewalk door in your town is a "Canton".

You will find many uses for our Sidewalk Doors. Ask for our Catalog. We want you to have it.

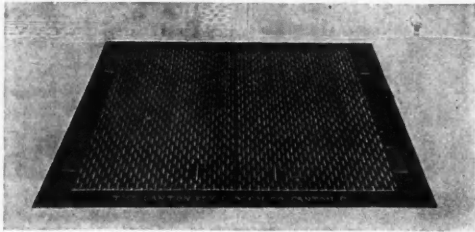

**Canton Foundry & Machine Co.**  
CANTON, OHIO



**Remember the Coal Man**  
when you plan and  
when you build

Windows were made to admit light and air but not to admit coal. One season of battering and banging will ruin the best window that was ever built into a foundation wall. The

## Majestic Coal Chute

absolutely protects the foundation and the woodwork from being injured while the cellar is being filled with the winter fuel. The door opens upward locking against the building protecting the siding. The Hopper swings out and catches all the coal direct from the wagon, barrow or basket. The coal is delivered in the cellar and *nowhere else*.

When not in use the Majestic Coal Chute closes "burglar-proof". But it does not prevent the light from out of doors from getting in. Made of the best of cast metal with a life-time guarantee the Majestic adds much to the value of the house but increases the cost only a trifle.

*Special proposition to contractors and builders on request. Write for it.*

**THE MAJESTIC FOUNDRY AND FURNACE CO.**  
1000 Main Street      Huntington, Indiana

# Every Contractor

should acquaint himself with the special terms we are making on hot-air furnace equipments.

This means that we are offering our furnaces, with pipes, registers, etc., made to measure, for any plan, **direct to contractors**, at a special discount from our regular factory rates.

**We are not offering furnaces to dealers**, and the prices to contractors, therefore, are the best we are making to anyone, and better than they can obtain from local dealers.

Our object in selling direct, is that we may make plans for the equipments we furnish, and thus be sure that pipes, registers, etc., will be planned of the right sizes, and in the right places. If this is not correctly laid out, any furnace will fail, but if we have the planning, we will sell our furnace **on trial** and guarantee the results.

You are invited to send us the plan of any house you are building, and we will return a plan, drawn to a scale, showing every detail of the heating arrangement, with our estimate of cost. We make no charge for this, but it is worth money, for it insures you the services of heating **experts** and the successful and economical heating of your houses.

We have also a **Profit Sharing** arrangement for contractors, aside from the discount we offer on furnaces. Drop us a card, **stating that you are a contractor**, and we will send full particulars.

Our customers are numbered by thousands in every section of the United States. You know some of them.

**HESS WARMING & VENTILATING CO.**  
1220 Tacoma Bldg., CHICAGO

We make, also, white enameled **steel medicine cabinets**, sanitary and classy,—cheaper than wood.

You will get **SPECIAL ATTENTION** if you tell Advertisers you read American Carpenter and Builder.

# The Bovee Furnaces

AT  
**Manufacturer's Prices**



Will give every one of your patrons most perfect results. They last longer and actually require about one-half the fuel used by other furnaces.

They are made heavy, of the very best material and workmanship. Take your rule and measure the fire pots, the large combustion chamber and the long travel of heat and compare it with all other furnaces and see **WHY** the Bovee

uses less fuel and lasts longer than others. Get our special prices. We can save you 40% on a heating plant. Any handy man can install them.

## Bovee Furnace Works

50 Eighth Street Waterloo, Iowa



# If You Build Buy Own

Be up to date and have the world's best  
**The Window Chute**  
for your coal bin.

Thousands in Use  
**The Very Best**



Write for Booklet C.

**Holland Furnace Company**  
Holland, Mich.

World's Largest Direct Installers of Furnaces.

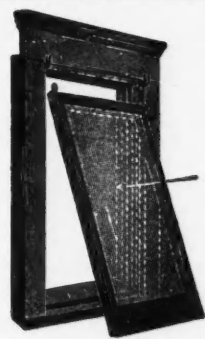

Use these E. Z. Way Hangers in putting up screens, storm sash and basement windows. They are time savers and all owners want them on their buildings. Kindly note the E. Z. Way Hangers can be applied from the inside of the house, which is an advantage that no other hanger in the market has. We are also large manufacturers of Screen Mouldings and "Clincher" Felt Weather Strip. Be sure and specify the DENNIS quality if you want the kind that is **MADE RIGHT.**

Manufactured only by

**W. J. Dennis & Co.** - 2226 W. Lake St., Chicago  
Free Sample to any address for your Hardware dealers' name

**C. G. HUSSEY & CO.**  
Pittsburgh, Penna.

MANUFACTURERS OF **COPPER**

In Sheets, Plates, Rolls

**CORRUGATED COPPER CONDUCTOR PIPE**

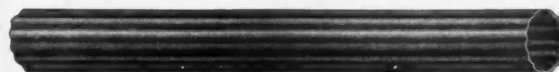

Copper Nails, Copper Rivets, Conductor Pipe, Eaves Trough, Elbows, Shoes, Mitres, Soldering Coppers, Gaskets, Etc.

**The Crusade Against the House Fly**



**E.D. KEES** MFG. CO. BEATRICE, NEB Box 552

Every year more people realize that full-length window screens keep out all the flies **always.** (Half screens do not.)

**Gossett Hinges**

make full screens convenient. They can be removed or swung out instantly to wash the windows. No tools or ladder required. Used also for Storm Sash.

Boost your screen trade by using Gossett Hinges.

Sample set free for trial.



**Holds the Saw TIGHT—Anywhere!**



**THE GUNN SELF-FASTENING FOLDING SAW CLAMP**

Will instantly fasten itself to work bench, tool box, board, joist, or pile of lumber, rail of fence—to any suitable place—and without screws or nails, or any other means of fastening; stands firmer than any other—with their troublesome screws, nails and braces. Made of best malleable iron, 15 inches long; weighs 3 pounds; folds like a jack-knife; can be carried in coat pocket. Guaranteed not to break.

Price, \$1.00 at Most Good Hardware Stores, or Sent Prepaid Anywhere for \$1.25. Money Refunded if Not Satisfactory.

**L. D. GUNN FOLDING SAW CLAMP CO.,** P. O. Box 643, Pittsburgh Pa.

You will get **SPECIAL ATTENTION** if you tell Advertisers you read American Carpenter and Builder.

## Mullins Metal Tile Roofing

has won widespread and lasting favor because of its many superior qualities. Beauty, simplicity, durability—these are its salient characteristics. Absolutely storm-proof and water tight.

When put on according to directions, Mullins Metal Tile Roofing is guaranteed to keep in perfect condition for years. No other roofing can equal it for all-round satisfaction. Many of the finest buildings in this country are equipped with it.

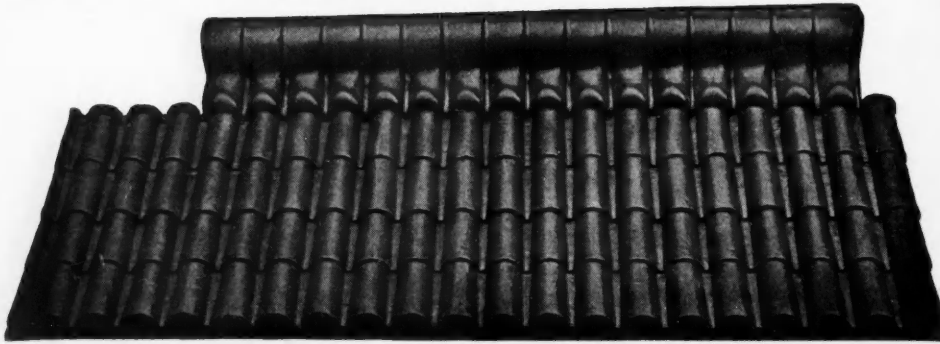

We also make Cornices, Building Fronts, Finials, Tympanum panels, Rosettes, Faces and other architectural ornaments. Many thousands of designs to select from.

Ours is the largest and best equipped factory of its kind in the world. We use

only the finest materials. Every artisan in our employ is a masterhand. Our prices are attractive, our services prompt. Glad to submit quick estimates on special jobs.

Catalogue along any desired line will be sent you by return mail.

### The W. H. Mullins Co.

214 Franklin St.

SALEM, O.



## OAK FLOORING

"AMERICA'S BEST FLOORING"

Builders and owners will find it a clinching argument to say "It's floored with OAK FLOORING." It is the biggest single feature to look for in any house or apartment building. It imparts an air of refinement and elegance. It is the modern flooring.

OAK FLOORING  $\frac{3}{4}$  inch thickness by  $1\frac{1}{2}$  inch or 2 inch faces can be laid over old floors in old homes or over cheap sub-floors at a very low cost. It is cheaper than carpets or pine flooring. When laid it has all the appearance of heavy flooring.

There is a solid satisfaction and lasting pleasure in the substantial and dignified appearance of OAK FLOORING.

Contractors and carpenters find it very profitable to lay  $\frac{3}{4}$  inch stock over old floors in old homes during dull periods. A little canvassing is all that is necessary to secure jobs. A carpenter or handy man can lay OAK FLOORING successfully.

For durability, OAK is the best. OAK FLOORING laid thirty years ago, after very hard use, is still in good condition.

Write for Booklet

THE OAK FLOORING BUREAU, 890 Hammond Bldg., DETROIT, MICH.

Straight-grained cedar that cuts like cheese; smooth, tough leads that make clean-cut, strong marks—that's the way Dixon's Carpenter Pencils are described. Send 16c for generous sample lot 183J.

JOSEPH DIXON CRUCIBLE CO.  
JERSEY CITY, N. J.



**FIRE**—Excitement reigns supreme!

**Panic**—In a twinkling of an eye.

**Exit**—The terror-stricken rush.

**Door**—Though tightly closed—

**Bolt**—Columbia opens with a gentle push.

Full information upon request.

The Columbia  
Iron & Wire Works Co.  
Canton, Ohio

You will get SPECIAL ATTENTION if you tell Advertisers you read American Carpenter and Builder.

**THE VALUE OF A GOOD REPUTATION**

A good reputation is the most valuable asset in the world for a dealer. It is built by handling best quality products at fair prices and distributing both with a generous measure of "The Square Deal."

Make your reputation valuable by handling "Brooklyn" Metal Ceilings—made of highest quality material. Let this be made known to your clients and they will beat a path to your door.

*Write for Our Special Offer*

**BROOKLYN METAL CEILING CO.**  
283 Greene Avenue :-: BROOKLYN, N. Y.

## Look Before You Build

*You Men and Women Who are Going to Build Homes*

and

*You Builders of Skyscrapers, Warehouses and Factories*

## Look Before You Build

A permanent Exhibition of Building Materials and Equipments is now established in Chicago—Open every week day from 8:30 A. M. to 5:30 P. M. You can now do all your looking in one place, under one roof, in the heart of Chicago's business district. No longer need you spend days and weeks traveling from office to office, from factory to factory, from pillar to post. Manufacturers have brought their products to one central point, to display. You can see good things for your house, flat building or office building, all in one place, at a great saving of time and expense.

### List of Material on Exhibit

Art Glass, Brass, Bank Rails, Cinders, Clock Systems, Composition Floors, Concrete Stone, Concrete Mixers, Electrical Appliances, Ejectors, Stationary and Portable Vacuum Cleaners, Electric Washing Machines, Elevator Door Closing Devices, Dumb Waiters, Metal Lath, Face Brick, Tile Fire Proofing, Water Supply Systems, Granite, Graphite Paint, Building Hardware, Heating Systems, Hot Water Heaters, Inspecting Laboratories, Interior Trim, Marble Cleansing Powders, Marble, Weather Strips, Metal Doors, Mosaic Tile Floors, Plumbing Fixtures, Ornamental Iron, Paints and Varnishes, Pumping Machinery, Roofing Material, Wall Board, Rolling Steel Shutters, Rubber Tiling, Fire Hose, Safes and Locks, Sewage Disposal System, Storage Batteries, Vacuum Heating, Wall Beds, Water-Cooling Tanks, Water Proofing.

ADDRESS ALL INQUIRIES

## Building Material Exhibit

*Second Floor Insurance Exchange Building*

**175 W. Jackson Blvd.**  
CHICAGO



WE have issued *Very Interesting Catalogues* containing valuable information for the Architect, Carpenter and Builder regarding wood columns for exterior and interior use. Catalogue "U. 40" for Exterior and Interior Columns. Catalogue "U. 50" for Interior Columned Openings. (Above will be sent FREE on request.) Our Pergola Album, "U. 28," containing Ninety-One (91) various illustrations of Pergolas, Veranda-treatments and Garden Accessories sent to those who want it for 10c stamps

**HARTMANN-SANDERS CO.**  
Exclusive Manufacturers of

**Kolls  
Lock  
Joint**



**Patent  
Stave  
Column**

Suitable for Pergolas, Porches or Interior Use.  
Main Office and Factory  
Elston and Webster Aves., Chicago, Ill.  
Eastern Office: 1123 Broadway, New York City, N. Y.

*This Pearson's Automatic*  
**SHINGLE NAILER**  
WILL PAY FOR ITSELF  
ON FIRST JOB



Do your nailing fast—faster than ever before. You can use this Pearson's Nailer on any pitch roof. Wear mittens, gloves, etc. This "Hand Nailer" is the only Nailer—throw nails in by the handful—then start nailing. Nails easily driven through tin or quite heavy sheet iron.

These nailers are made in two sizes—The BLUE Nailer for 3d common No. 14 gauge wire nails. The RED Nailer for 3d galvanized No. 13 gauge 1 1/4 inch wire nails.

It will come right to your door, quick, by insured parcel post, all prepaid for only \$5.00.

**IT MAKES GOOD.**

**PEARSON MFG. CO. - ROBBINSDALE, MINN.**

You will get SPECIAL ATTENTION if you tell Advertisers you read American Carpenter and Builder.

Established 1837

77 Years' Experience

# Special Offer!



WE realize there are many A1 carpenters who want to get the best chisel they can and who have never used WHITE'S and cannot get them from their dealer. To these carpenters we are going to make a special offer—

*We will send parcel post paid to any point in the U. S. this Set of 6 chisels in a substantial case, leather tip handles—our very best chisels, for \$4.00.*

We will not duplicate any orders—all orders later must come through your dealer. The above offer is made so that every good carpenter can see for himself how much superior our chisels are to the so-called "good" chisels. If we have a dealer in your town, we will ship the set through him; if not, we will ship it to you direct.

*Do not delay. Send Today. We Guarantee Satisfaction.*

*Do you use Adze of any kind? Send for our Adze Booklet.*

**The L. & I. White Company**  
10 Columbia St. Buffalo, N. Y.

## THE IVES PATENT WINDOW STOP ADJUSTER

*Prevents dust, drafts*

*and window rattling*

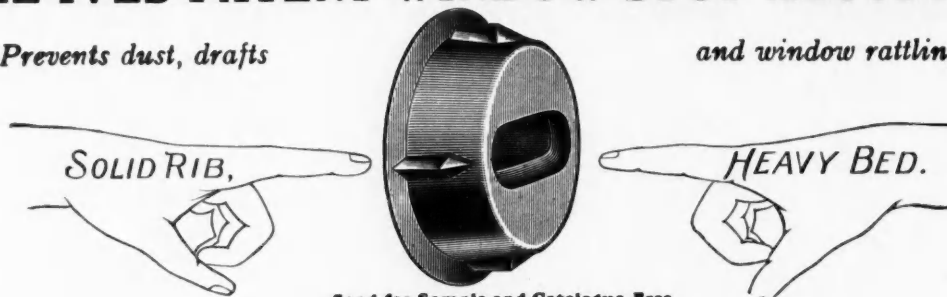

Send for Sample and Catalogue Free

1 piece of metal, will not cup, bend or turn in tightening screw.

**THE H. B. IVES CO., Sole Mfrs. New Haven, Conn., U. S. A.**

### Shultz Corner Posts For Store Fronts

make a strong, handsome and practical joint. They are water-proof and dust-proof and never rot. No putty or filler is used. The glass is bedded on Spanish cork which prevents cracking or crushing. Not expensive.

*Write us for description, prices or estimates.*

All Steel Corner Post Co., St. Joseph, Mo.

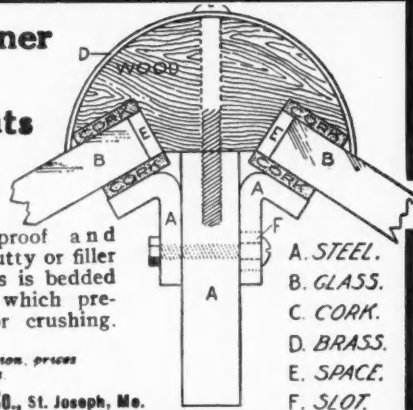

### Introducing the New Sasgen Peerless Steel Derrick

with a full circle swing. Capacity 2,000 lbs. Drum runs in SELF-LUBRICATING BEARINGS. Bottom sills and mast can be folded together.

**PRICE ONLY \$45.00**

equipped complete for hand and power with 125 ft. crucible steel cable, swivel block and fasteners. \$2.00 less for hand power only.

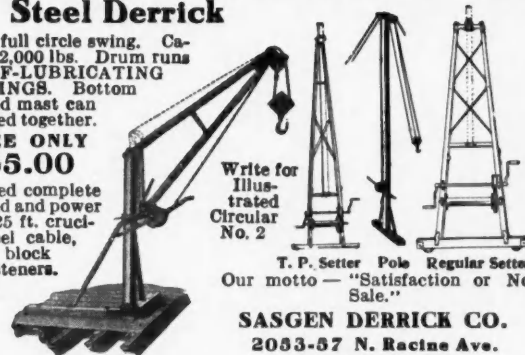

Write for Illustrated Circular No. 2

T. P. Setter Pole Regular Setter  
Our motto — "Satisfaction or No Sale."

**SASGEN DERRICK CO.**  
2053-57 N. Racine Ave.  
CHICAGO, ILL.  
CANADIAN OFFICE, 13 JARVIS STREET, TORONTO, ONT.

You will get SPECIAL ATTENTION if you tell Advertisers you read American Carpenter and Builder.



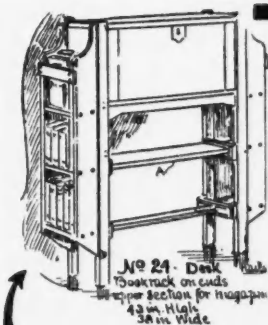

### Easy-To-Make Furniture

As Valuable as a Kit of Tools  
For suggestions to the Carpenter and Mechanic. Easily read scale. 100 up-to-date designs, simple in construction, usable, neat and attractive furniture. Make one piece and save the price. Complete Portfolio sent Prepaid on receipt of \$2.00.

Satisfaction guaranteed.

**Crater & Holt** 43 National Avenue  
Grand Rapids, Mich.

### ONLY SELF-SETTING PLANE

Sent on trial as per circular  
Our \$1.00 certificate if you mention this paper.  
**GAGE TOOL CO.**  
Vineland N. J.



### TEN DAYS' FREE TRIAL

allowed on every bicycle we sell. We **Ship on Approval** and trial to anyone in the U. S. and **prepay the freight.** If you are not satisfied with the bicycle after using it ten days, ship it back and **don't pay a cent.**

**FACTORY PRICES** Don't buy a bicycle or a pair of tires from anyone at any price until you receive our latest **Art Catalog** of high grade bicycles and sundries and learn our **unheard-of prices and marvelous new special offers.** **IT ONLY COSTS** a cent to write a postal and everything will be sent you **FREE** by return mail. You will get much valuable information. **Do Not Wait; write it NOW!**

**TIRES, Coaster-Brake, rear wheels, lamps, parts,** repairs and sundries of all kinds at **half usual prices.**  
**MEAD CYCLE CO. Dept. T-122 CHICAGO**

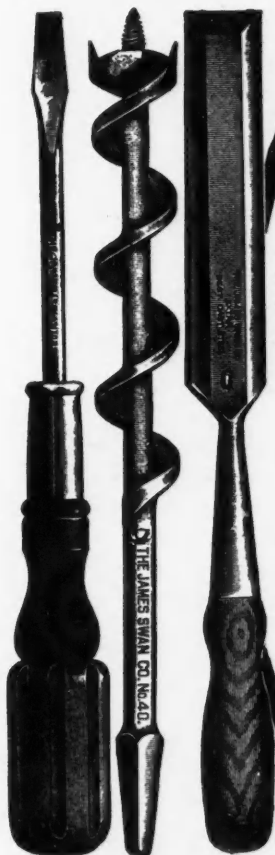

When you want tools of any kind — tools that you can bank on to be just the kind and quality you want them to be, insist on the Swan Trade Mark.



It's a plain guide to all that is best in carpenters' tools and your assurance that you are dealing with an old, reliable firm that makes tools as good and solid as its reputation.

ASK FOR CATALOG  
The **JAMES SWAN CO.**  
Seymour, Conn.

# The Man Who Wouldn't Stay Down



Now Architect



Carpenter

Hard work and low pay are for the man who *thinks* he "hasn't a chance." But the ambitious man trains himself for a better job—and gets it.

Only a few years ago the man whose rise we picture here was working 12 hours a day for 7 days a week. But he made up his mind to train himself for something better. He marked and mailed just such a coupon as you see below. He studied at home. His earnings increased. He was made foreman. And now he is a successful Architect with an income of several thousand dollars a year.

This man had no advantages that you don't have. His education was poor. His spare time was limited. But with the help of the I.C.S. he has "made good." YOU can do the same in your line of work. If you can read and write the I.C.S. can help you.

Mark and mail attached coupon. It won't obligate—and the I.C.S. will show you how you can rise to a high-salaried position through their simple and easy system of home instruction.

## Mark the Coupon NOW

### International Correspondence Schools

Box 910, SCRANTON, PA.

Please explain, without further obligation on my part, how I can qualify for a larger salary and advancement to the position, trade, or profession before which I have marked X.

Architect	Estimating Clerk	Automobile Runn'g
Arch'l Draftsman	Civil Engineer	Foreman Machinist
Contract'g & Build.	Surveying	Sh.-Met. Pat. Drafts.
Building Inspector	Mining Engineering	Textile Manufact'g
Structural Eng.	Mechanical Eng.	Bookkeeper
Structural Draftsman	Mechanical Drafts'n	Stenographer
Plum. & Heat. Con.	Stationary Eng.	Advertising Man
Supt. of Plumbing	Electrical Engineer	Window Trimming
Foreman Steam Fit.	Electric Lighting	Commerc'l Illustrat'g
Plumbing Inspector	Electric Railways	Civ. Service Exams.
Heat. & Vent. Eng.	Concrete Const'r'n	Chemist

Name \_\_\_\_\_  
St. and No. \_\_\_\_\_  
City \_\_\_\_\_ State \_\_\_\_\_  
Present Occupation \_\_\_\_\_

You will get SPECIAL ATTENTION if you tell Advertisers you read American Carpenter and Builder.

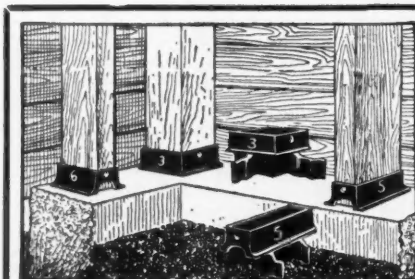

**In Cement Floors  
and Cement Foundations**

**ROSS** *Iron Studding*  
**SOCKETS**

The "100 year" Post Supports

Simply tap Sockets into soft Cement. No sills to rot! No toenailing to rust! You can make easy sales for Corncribs, Barns, Granaries, Hoghouses, Sheds, Garages, etc. Small stock will help you fill orders promptly. Good profits for you. **WE PAY THE FREIGHT.**

Write for Free Booklet **G. M. ROSS & CO., 1444 Broad Str. GRINNELL, IA.**

**Your  
Customers  
Will Use**

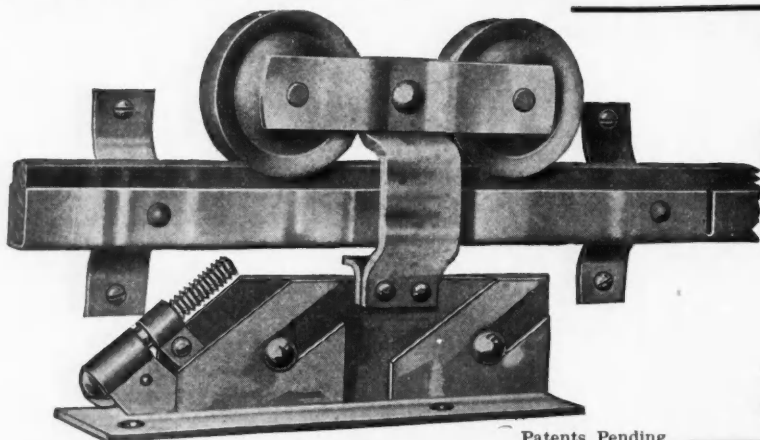
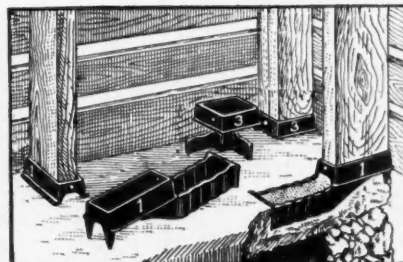

Patents Pending

**IF YOU HAVE NEVER USED  
SHARON No. 2  
PARLOR DOOR HANGERS**

**Don't fail to try a Set**

No Cutting, Grooving or Counter-sinking needed.

Fits any width opening. Simple and always accessible adjustment.

Its smooth, easy, absolutely noiseless running has never failed to please. Money-back guarantee.

Write the

**SHARON HDW. MFG. CO. SHARON, PA.**

**You Can Make Money  
With a  
Millers Falls Boring Machine**

Because it will do better work in less time than any other machine of its class; hence effects a direct saving in wages.

Has every convenience for quick and easy handling. Will bore at any angle from the vertical within an arc of 50 degrees; depth of hole regulated by stop; frame locks at top automatically; speed and power readily adjusted by the cranks.

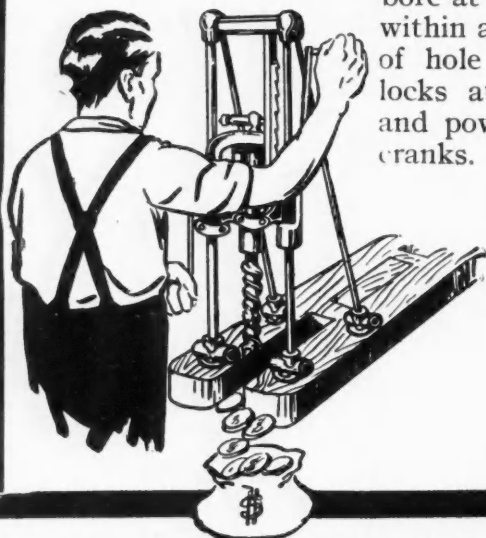

The biggest item of cost in carpenter work is labor, and the device that lessens this is the device it pays to use. That's the reason why it would pay **you** to try our Boring Machine.

**Millers Falls Company**

28 Warren Street

New York

You will get **SPECIAL ATTENTION** if you tell Advertisers you read American Carpenter and Builder.

## Plan the Refrigerator with the House

and give your clients the benefit of the very latest, up-to-date ideas in scientific refrigeration. When designing homes of the better class it will save you time and money to put the entire problem of refrigeration up to us. We guarantee to please you and delight your client.

We co-operate with architects and contractors everywhere in the installation of



## McCray Refrigerators

Our expert draughtsmen are always at your disposal. Simply send us a blue-print of the floor plan and we will gladly prepare plans and estimates to cover all types of work—absolutely without cost.

Investigate the McCray "built-in" Refrigerators. They are models of convenience and economy. The outside door for icing keeps the ice-man and his muddy feet away from the kitchen and saves the housewife lots of work and worry. The various compartments are fitted up with racks for bottled beverages, water cooler, meat racks and hooks. The linings are sanitary and easy to clean. In fact, nothing has been spared to make the McCray Refrigerator the best in the market. When properly installed, the McCray always reflects much credit on the architect and builder.

### ARE YOUR CATALOGS UP-TO-DATE?

Don't fail to get all the latest editions of McCray Refrigerator catalogs. They are full of valuable information that architects, contractors and builders will appreciate.

Write for any of these—FREE:

No. 91—Regular Sizes of Residences  
No. 73—For Florists

No. 50—For Hotels, Clubs and Institutions  
No. 69—For Grocers

No. 60—For Meat Markets  
No. A.H.—Built to Order for Residences

**McCRAY REFRIGERATOR COMPANY, 606 Lake Street, KENDALLVILLE, IND.**

For Branch Salesrooms in All Principal Cities See Your Local Phone Directory.

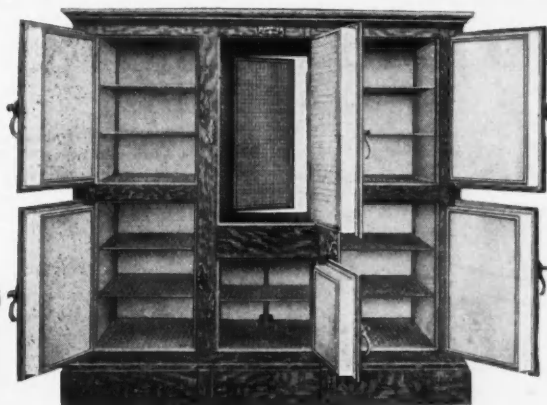

Better Service Better Satisfaction

## HERRICK REFRIGERATORS

**M**AKE the installation of refrigerators as much a part of your building operations as the plumbing or heating.

You are safe in recommending and placing the Herrick in any of your buildings requiring a sanitary, up-to-date refrigerator. Perfect sanitation is assured by the lining and the construction. Economy is certain; doors fit closely and walls are properly insulated. No spoiled food; no wasted ice.

The HERRICK REFRIGERATOR is not by any means the cheapest but by all means the BEST.

Catalog 24 contains fine plans for installing refrigerators and general refrigerator information of genuine value. Send your name and address. The book is free.

HERRICK REFRIGERATOR CO., Waterloo, Iowa

"Built Like a Thermos Bottle"

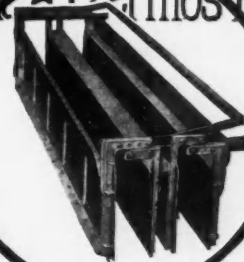

## A Van Guilder Hollow Wall Machine

Can lay a foot of hollow reinforced concrete wall a minute.

Not one foot in one minute, but a foot every minute of the day. This with only one skilled man and common labor.

To do the same work with brick would require six masons and their tenders. The saving in labor is nearly 50 per cent, with a corresponding saving in material.

The Hollow Concrete Wall is the best construction yet devised.

If you see anything in these statements that interests you write for our catalog and 72-page book that will tell what you can do with these machines and how to do it.

The Van Guilder Hollow Wall Co.

720 Chamber of Commerce Bldg.

Rochester, N. Y.

When in New York see our Permanent Exhibit at the Craftsman Home Builders' Exposition. (Space 805) No. 6 East 39th Street.

You will get SPECIAL ATTENTION if you tell Advertisers you read American Carpenter and Builder.

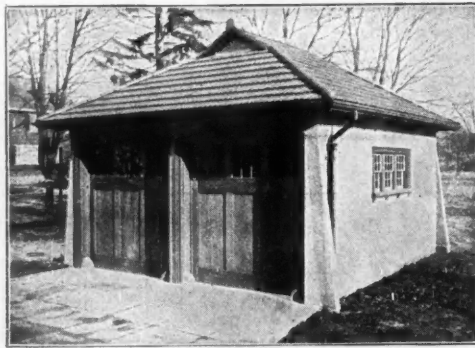

Fig. 1—The Garage

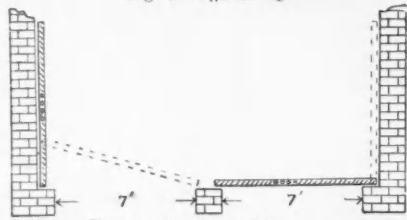

Fig. 2—The Door Plan

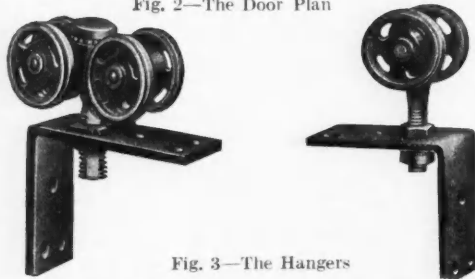

Fig. 3—The Hangers

## A Straight Tip on Zig-Zag Doors

The car-size garage has no room for sliding doors, if the sliding must be done in the usual way. Yet the sliding door is the ideal type for garage service. The case shown in Fig. 1 and 2 is one which presents difficulty, but can be handled satisfactorily by use of

## Richards-Wilcox Right Angle Door Hangers

With these fixtures the doors when opened occupy positions along the side walls. Three runs of track are required, one of which is attached entirely across the inside of the front of building and extends into the wall two inches on each end. Another piece of track is attached to each side wall just above the first track, and resting on top of it with the front end extending into wall two inches.

Write for our special Garage Catalog, which discusses other arrangements of Sliding Garage Doors.

**Richards-Wilcox**  
MANUFACTURING CO.  
AURORA, ILL. U.S.A.

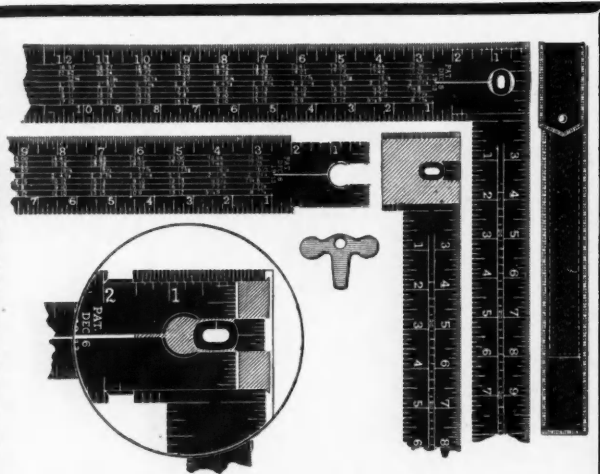

### Nicholls Expansion Fit Take Down Square No. 500-R

Eccentric Cam expands end of body in milled portion of tongue, making an absolutely solid joint, also taking up wear.

Long bearings assure accuracy.

Strength where tongue joins on to body. All other Take Down Squares are cut half into at this point.

These are stamped with our **Rafter Framing Rule**, giving cuts for seventeen different pitches of roof.

Send for our **Little Book** on Rafter Framing. It is **Free**.

**NICHOLLS MFG. CO.**  
OTTUMWA, IOWA

## THE MILLER LOCK MORTISER

### Our Guarantee

The Miller Lock Mortiser will mortise an opening for a  $\frac{1}{2}$ ,  $\frac{3}{8}$  or  $\frac{1}{4}$  inch lock, 5 inches long and  $4\frac{1}{2}$  inches deep in a door in TWO minutes.

The Miller Mortiser will do the work in one half the time that any other device does.

We will replace without cost any broken part due to defective material or workmanship.

After ten days' trial, if the mortiser is not what we claim, we will return the money

We do not misrepresent or exaggerate in our claims.

The Miller Lock Mortiser has been on the market and stood the test longer than any other device of its kind.

The MILLER LOCK MORTISER the Greatest Time and Labor Saver.

**A. W. Miller Mfg. Co.**

Riverside, Calif.  
Cincinnati, Ohio

Write to Nearest Office



You will get SPECIAL ATTENTION if you tell Advertisers you read American Carpenter and Builder.



**HOT WATER**  
 Absolutely Without Labor  
 Supply Unlimited  
 Water Heated on the Run  
 with  
**PERFECT SAFETY**  
 No building is complete with-  
 out hot water the year  
 'round. The  
**Radke "Safety" In-  
 stantaneous Automatic  
 Gas Water Heater**

For  
 Residences  
 Stores  
 Schools  
 Churches  
 Apart-  
 ments  
 Garages  
 Clubs  
 Laundries  
 Halls  
 Armories



**THE "SAFETY" IS ALWAYS SAFE**  
 because it automatically shuts off all gas from the  
 heater in case the pilot light should accidentally go out.  
 Your customer expects you to furnish the best article  
 on the market. **Send for Catalog** and let us tell you  
 wherein this heater excels.

**RADKE MANUFACTURING CO.**  
 173 West Jackson Boulevard  
 CHICAGO, ILL.

**Hot Water Always on Tap—Day and Night**

No running up and down stairs, no bothersome water tanks, no kettles littering up the stove. Simply turn the faucet and in a few seconds the hot water comes pouring out. This is possible wherever there's a

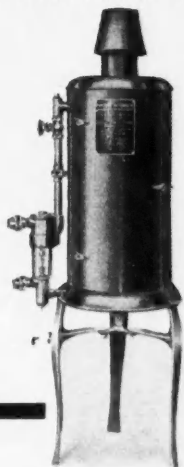

**Parrott Heater**

installed in the basement. It is the only convenient, reliable means of providing an instantaneous hot water supply. No expense unless the hot water is running. **Ten gallons of water heated for one cent.**

The Parrott Heater requires only 20"x 16" floor space. Capacity 2 gallons of hot water every minute. Investigate the Parrott at once. It is sure to satisfy your clients. Price almost as low as that of boiler and heater. Good money made by installing Parrott Heaters. Safe—a child can operate it. We guarantee the Parrott.

Contractors, Carpenters, Builders, write for Free Special Literature, prices, etc.

**Michigan Gas Appliance Co.**  
 Jackson, Michigan

**Carpenters and Builders  
 Let Me Teach You How To Become  
 ARCHITECTS**

You men of the saw, hammer and plane have a mighty good and useful trade. When building is brisk you make good money. But —you don't want to stick to the manual labor end of the building game all your lives—don't you realize that the **big** money is made by the fellows who can do "head" work as well as drive nails? Yes, sir! The man who has a practical knowledge of

**Architectural Drafting**

can, and often does, earn as much in a week for a set of plans as the man who follows the plans and does the **actual work** of building, earns in a month.

The demand for trained architects and architectural draftsmen exceeds the supply and is constantly increasing. Never before have salaries been so high—never before such splendid chances for advancement.

I am now in a position to give the benefit of my many years of experience as an expert Architectural Draftsman and my **personal attention** to a limited number of additional students. As my personal student, you can easily

**LEARN AT HOME**

during your spare moments and without giving up your present work. **Earn as you learn**

I am a graduate of one of the leading Technical schools. I know how architectural drafting should be taught and I have prepared this course so that it covers thoroughly every phase of the business. I teach the course **myself**—give personal instruction to every student—send you **actual work** to do and train you as thoroughly as though you were in the same office with me. So don't confuse my course with the stereotyped and theoretical so-called courses of instructions sent out by some correspondence schools. There is no comparison.

**\$125 to \$200 Per Month**

That's what you can earn right from the start as an expert Architectural Draftsman and Designer—the kind I can train you to be. My graduates **make good**. Many have gone into business for themselves and are earning \$3,000 to \$10,000 a year.

**FREE \$17.50 Set of Drawing Instruments If You Enroll At Once**

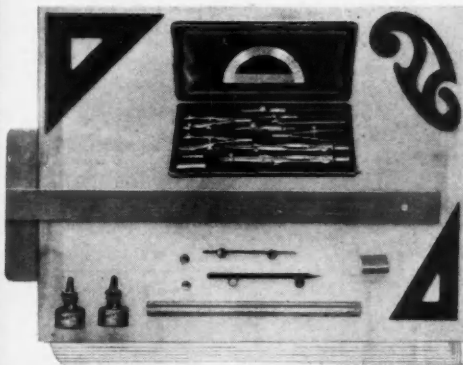

If you enroll in the next thirty days I will give you, absolutely **FREE**, this magnificent set of Drawing Instruments, valued at \$17.50—handy size, leather bound pocket case—the same as I use in my professional work. Will last a lifetime. But you must act at once to get it **FREE**.

**MY GUARANTEE** I guarantee to instruct you until you are placed in a position paying \$75 to \$200 per month. Employment Bureau open and free to students.

**Special Tuition Offer**

For the next 30 days I am offering a \$25 Tuition Credit as a special inducement for prompt enrollment. Mail coupon today. And remember, I guarantee to instruct you until you are placed in a \$75 to \$200 a month position. Let me send you **proof** that my course is the **most thorough and easiest to learn** of any similar course. My book "The Road to Success" and full particulars of my limited offer mailed free. Mail coupon or postal today—Sure!

**FREE Coupon**

Chief Engineer,  
 304 Engineering  
 Bldg., Chicago, Ill.

Chief Engineer,  
 CHICAGO  
 ENGINEERING  
 WORKS,  
 Chicago

Dear Sir:—Without any obligation on my part send me your book, "The Road to Success" and full particulars of your limited offer. Send everything **free** and prepaid.

NAME.....

ADDRESS.....

You will get **SPECIAL ATTENTION** if you tell Advertisers you read American Carpenter and Builder.

# Dealers' Profits

With Berger's Classik Metal Ceilings



## Two New Features

The head is made extra long, in shape of half an oval, reinforcing the ceiling plates at joints, fitting snugly over underlapping bead, making a tight and perfect fitting joint.

The top of Nailing button is counter-sunk, forming a self-centering, self-guiding, never-slip nailing point.

These features permit a considerable saving when erecting.

Our reasonable prices combined with the durable, artistic, attractive

*"BERGER'S  
Classik  
STEEL CEILINGS"*

nets the dealer a very handsome profit.

Architects specify it—contractors prefer it—and the public demands it.

Write today for our large illustrated catalog.

## THE BERGER MFG. CO. CANTON, OHIO

For the best service address nearest branch.

New York	St. Louis
Philadelphia	Minneapolis
Boston	San Francisco

We also Manufacture Ferro-Lithic and Multiplex Reinforcing Plates, Metal Lath, Roofing, Eaves Trough and Conductor Pipe, and Sheet Metal Building Products of all kinds.

Export Department 11th Ave. and 22d St., New York, N. Y.

You will get SPECIAL ATTENTION if you tell Advertisers you read American Carpenter and Builder.

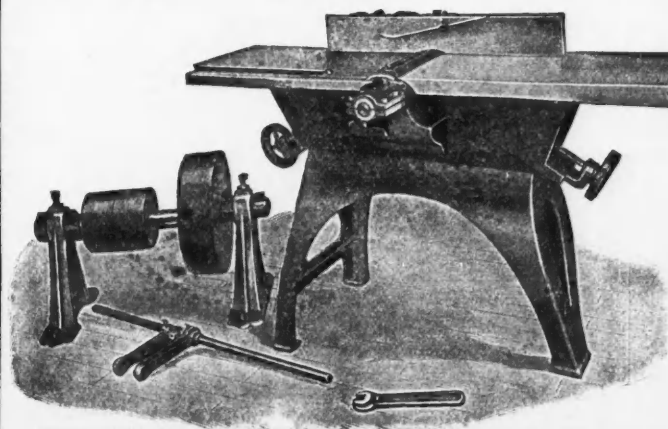

**Save**  
**\$40.00**  
**on a high**  
**grade<sup>12</sup> jointer**

Coupon  
Sidney Tool Co.  
Sidney, Ohio  
Gentlemen—Send me  
complete Circular No. 12 on  
the 150 CYCLONE Hand Jointer  
\$75.00 each.

Signed.....  
Address.....

**The \$75.00 price includes this equipment:**

The machine is furnished with countershaft, adjustable bevel gauge, hold down spring and post, guard, one pair of straight jointer knives with bolts, two extra bolts with wrench. It is ready to set in motion. Ready to save you money. And when we clip a cool \$40.00 right off from the initial purchase price, it becomes a splendid investment. If you have to go to the bank and borrow the money—BUY ONE OF THIS SPECIAL LOT. You will be delighted with the machine, its operation, and what you save both NOW and from month to month as you operate the CYCLONE.

Fill out, sign and send the coupon for IMMEDIATE particulars—you'll have to be prompt if you are one of the 150.

THE Cyclone Hand Jointer or Buzz Planer covers all the practical demands made—and yet is offered at the exceedingly attractive price of \$75.00. You cannot fairly compare this Jointer with any machine sold for less \$115.00—it has the well-known "SIDNEY" quality and workmanship in every fibre of its make-up. It is made for service and lasting satisfaction.

When you read the description and note the specifications you will find yourself wondering HOW we can give so much for the price. Never mind! WE KNOW THAT A MORE GENERAL USE OF THIS MACHINE WILL MEAN A BIG DEMAND. So we are building a special lot of 150 at this time. These will be sold at the heretofore unprecedented price of \$75.00. When these are sold the price may be advanced. It will not be lower.

**SIDNEY TOOL CO., Sidney, Ohio**

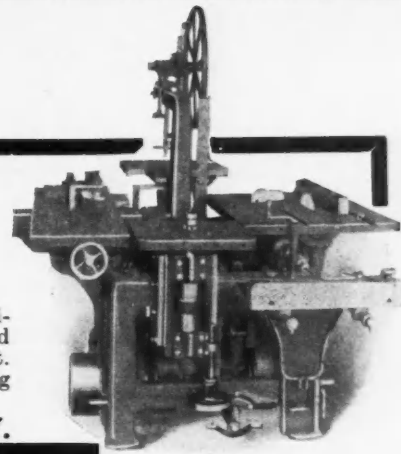
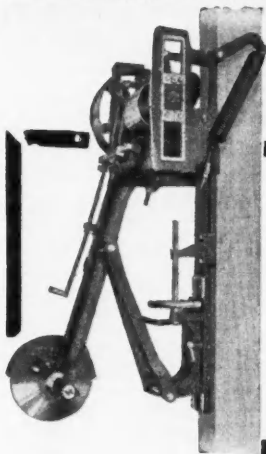

**EXHIBITION**

Complete line of Wood Working Machinery including Universal Combination Woodworkers for Contractors and Builders. Largest stock in New York. New and rebuilt. We are manufacturers of high-grade woodworking machinery. Sixty years in the business. Write us.  
**P. PRYBIL MACH. CO., 512-24 W. 41st St., New York, N. Y.**



**MAPLE FLOORING**

Thoroughly kiln-dried, side and end matched, hollow backed, bored for blind nailing, and STEEL POLISHED. Guaranteed to give best results under hard continuous wear.

Do not be satisfied with ordinary flooring. You can get **DIAMOND HARD MAPLE FLOORING**. You'll receive full value in wearing service and permanent finish.

Write us. We'll Tell You More.

**J. W. WELLS LUMBER CO.**  
Menominee, Michigan

**BERGER'S METAL LATH**



**The Berger Mfg. Co., Canton, Ohio**

Write for Catalog.

New York Boston Minneapolis  
St. Louis San Francisco Philadelphia

You will get **SPECIAL ATTENTION** if you tell Advertisers you read American Carpenter and Builder.

## It Has the Looks of Wood Paneling

but not the high price. Cannot be distinguished from real wood except on very close inspection, because

### CAL-CO-CRAFT

is an exact reproduction of wood on paper. Gives the color, grain and finish of the natural wood. Applied like wall paper and paneled off with simple moulding strips. Splendid for use in halls, dining rooms, churches, clubs, etc. Compared with the effect, the price is absurdly low. Ask for samples in the various finishes.

Dept. C

## The Cott-a-lap Co.

Chicago, Ill  
Walkerville, O., Can. Somerville, N.J.

A-A-A-Asphalt  
Cement.  
B-B-B-Fiber  
Board.

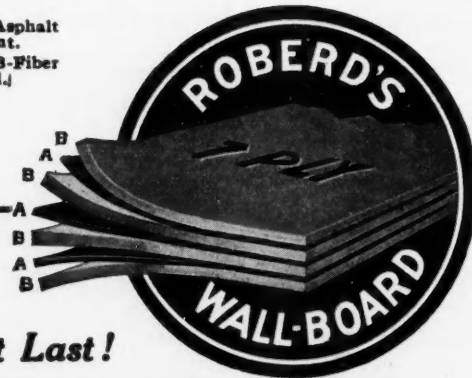

At Last!

## Seven-Ply Wall Board

At last you can have a perfect wall board, stiffer, harder, tougher, more easily handled, more quickly applied and more satisfactory when on the walls. We have solved the problem. We are now making

### Roberds Ideal Wall Board

with four layers of fiber board and three layers of asphalt adhesive compound. Our discoveries, our special machinery, our secret methods of manufacture and our original asphalt cement make possible the production of this IDEAL WALL BOARD.

Dealers everywhere are enthusiastic about it. Contractors prefer it to all other brands. Home owners delighted with the fine finish and the perfect butting of edges which enables them to paper direct to the wall board.

We have doubled the capacity of our plant to take care of the increasing demand for Roberds Ideal. No advance in prices. Special inducements to the trade. Write today for our dealers' proposition.

### The Roberds Manufacturing Co.

100 Railroad Street

Marion, Indiana

The First Put on and the  
Last to Wear Off Is—

## BAYONNE ROOF AND DECK CLOTH

When real durability, waterproofness and economy are the essential qualifications, architects and contractors specify Bayonne for porch floors and roofs in preference to tin, tar and prepared roofings.

Other canvas deck cloths require laying in wet paint—Bayonne does not. Can be laid dry without sizing. One coat of paint after laying is sufficient.

This means a neater and less expensive job.

Bayonne will not peel, buckle or leak. Any one can lay it by following our simple instructions.

Send for Sample Book "N" with  
prices and laying instructions.

## JOHN BOYLE & COMPANY, Inc.

112-114 Duane St., 70-72 Reade St.  
NEW YORK CITY

202-204 Market St.  
ST. LOUIS

Build Your Reputation  
with



Trade Mark Registered, U. S. Patent Office, No. 94746

You can do this by using it as wall lining in buildings you put up.

Compo-Board—the "Wood-Core" wall board—has proved itself by years of use in all climates. Here's a typical letter out of our files:

"We have used Compo-Board for the last ten years, not only for wall covering but for partition panelings, panel wainscoting, door panels, and beam ceiling panels. In every case it has given entire satisfaction.

"About a year or two ago we used it for the wainscoting and gallery fronts in a church. We gave it four coats of paint, then stippled the last coat, which made a very neat and good looking piece of work with the white enameled base and cap moldings. Mr. Cummings, the architect, of Troy, N. Y., was very much pleased with the results. In my own judgment, I think it is the best wall covering on the market today."

P. M. SIMMONS, Johnstown, N. Y.

If you've never used real Compo-Board in building and repairing houses, there's money waiting for you in your business. Find out about this today. Some dealer in your town probably sells Compo-Board. If you don't know him, write for free sample and booklet, and we'll send you his name.

Northwestern Compo-  
Board Company  
5777 Lyndale Ave. No.  
Minneapolis, Minn.

You will get SPECIAL ATTENTION if you tell Advertisers you read American Carpenter and Builder.



# EASY and SURE Steps to Higher Wages and Larger Contracts



The man who climbs to success is the man who knows how to do things in the best modern way. A bigger share in the

## BUILDING OPPORTUNITIES OF TODAY

is surely yours to claim! You can do it without technical training or hard study. To master every detail of your trade or business will be a pleasure instead of a labor. **ious task** if you will let us send you for five days' free examination absolutely at our own expense and risk, a set of

## RADFORD'S CYCLOPEDIA OF CONSTRUCTION

Carpentry, Building and Architecture

A Practical Uplift to Complete Mastery of Modern Building Methods and Materials

Twelve Massive Vols.—5,000 pages, 3,000 illustrations. Up-to-date, practical, thorough. All in simple English, without higher mathematics. Latest materials and methods. The cream of practical experience of the world's best known builders and contractors. Every detail covered—Carpentry; Framing; Concrete Work; Masonry; Steel Construction; Fire and Waterproofing; Drafting and Design; Heating; Ventilating; Plumbing; Decorating; Contracting; Estimating Cost, etc., etc.

Sent Anywhere on Approval

**ORDER ABSOLUTELY AT OUR RISK**

No Obligation or Expense to You Unless You Keep the Books  
No Follow-Up Agents to Bother You

WHAT OUR FREE TRIAL OFFER INCLUDES:

12 Massive Vols.—Bound in ¼ Morocco leather, with full Persian library covers. A brand new work, costing over \$100,000 to compile and publish, built along new lines especially for the practical builder or contractor. Without magazine, \$1.00 less.

**FREE** Radford's Portfolio of \$30,000 Prize Building Plans—Over 300 designs of houses, bungalows, outbuildings, apartments, churches, etc. Ranging in cost to suit any purse.

**FREE** Complete Set of Guaranteed Working Blue-Prints and Specifications for any house design selected from Portfolio—Ordinarily costing \$75 to \$100. We will also include One Full Year's Subscription to the "American Carpenter and Builder," the world's greatest building paper, without extra cost to you.

If you are a Carpenter or Builder, you can do all the ordinary work of the Construction Engineer or Designer without any deep mathematical calculations, thus insuring your title to better recognition, wider responsibilities and higher wages.

If you are a Contractor, your clients will appreciate dealing with a man who is able to give them the latest practical suggestions, and who has back of him the experience and resources of one of the largest architectural firms in the world.

12 MASSIVE VOLUMES

**SENT ON APPROVAL FOR FIVE DAYS' FREE EXAMINATION**

No Obligation. No Expense. No Risk to You  
We Take all the Risk

**READ THE COUPON**

**ON NEXT PAGE**

RADFORD ARCHITECTURAL COMPANY,

1827 Prairie Ave., Chicago, Ill.

**SIGN AND MAIL COUPON TO-DAY**

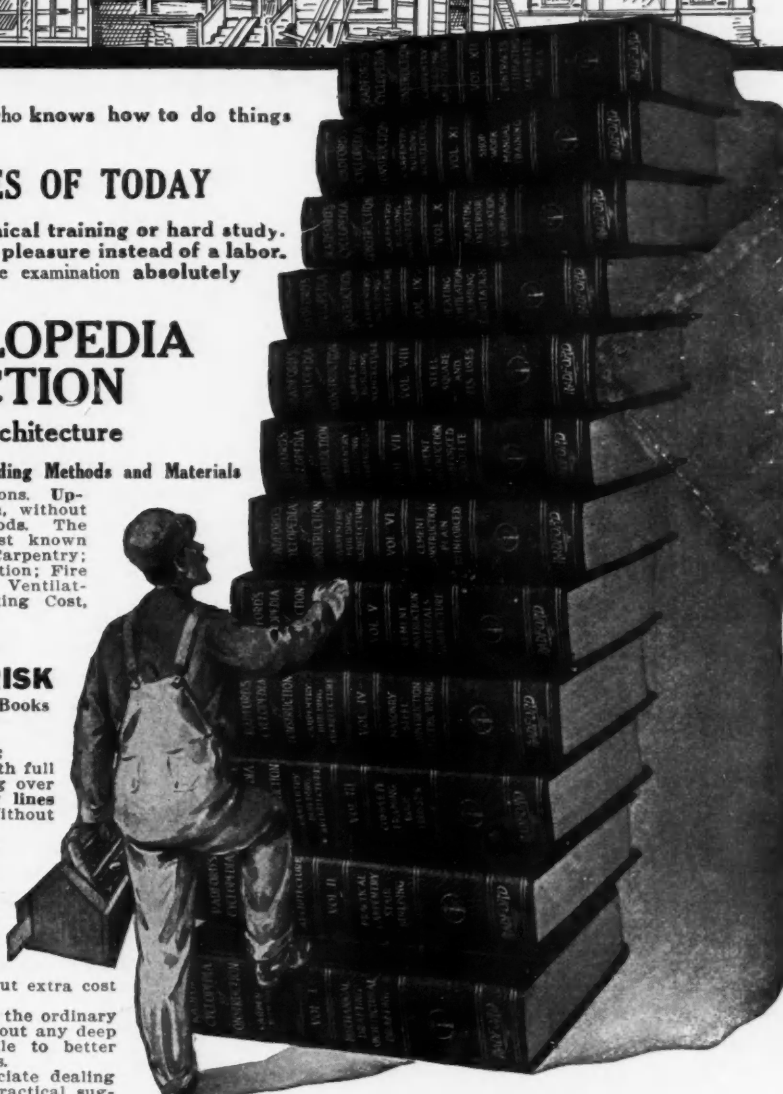

# He Waited Too Long

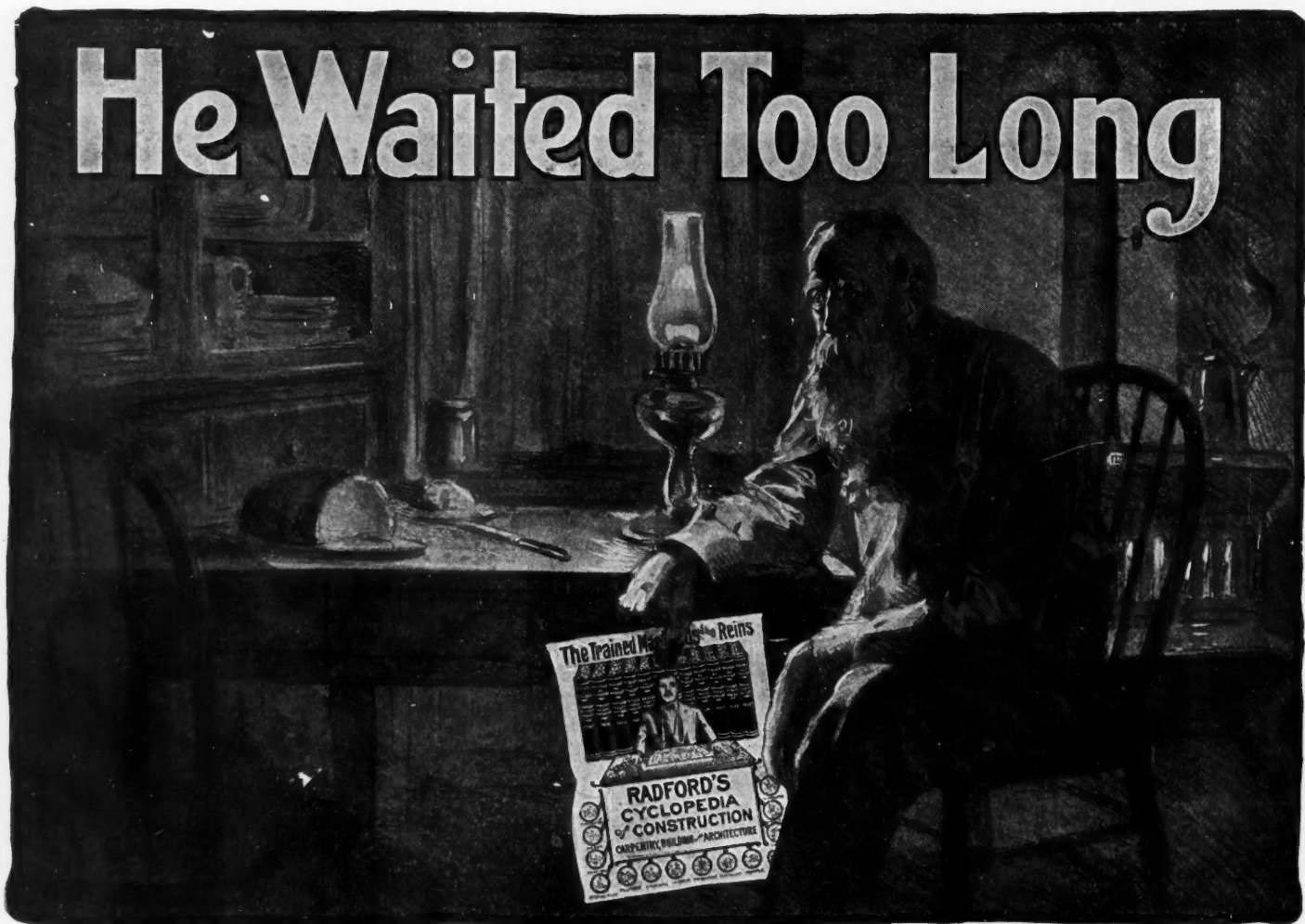

"If I only had this set of books twenty or thirty years ago, they might have changed my whole life. The knowledge in the big CYCLOPEDIA would have enabled me to increase my earning power, to take on big work, paying big money, and possibly have helped me to make a fortune in the building business."

Hundreds of letters like the above have come to us, breathing between the lines the same pathetic story of regret—showing how hard it is for the untrained man to really get ahead in life. **The opportunity is yours NOW**, and the way is easy. **Don't wait too long. Don't wait at all.** Read the terms of our **NO-RISK, Guarantee Offer** over again, and **sign and mail coupon today.** You risk absolutely nothing, and you will reap the benefit ever afterward.

## VERY BRIEF LIST OF CONTENTS

To realize their tremendous scope, you must see the books—you can get the books for five days' examination without cost to you.

A.C.B.  
4-14.

**Radford  
Architectural  
Company**  
1827 Prairie Ave.,  
Chicago

Please send me, express prepaid, your 12-volume Cyclopedias of Construction, for five days' free examination, with privilege of return at your expense. I enclose \$1.00 deposit, which you agree to return if I decide not to keep the books after examination. If I keep the books, I will pay \$2.00 a month until the special price, \$23.80 is paid, otherwise I will notify you within five days after receipt of books.

Your offer also includes Radford's Portfolio of Plans (over 300 designs), and one full year's subscription to the American Carpenter and Builder. You also agree to furnish set of Blue Prints and Specifications, if ordered within 2 months after acceptance of books.

Name.....  
Town..... State.....  
Street.....

**Carpentry.**  
House Framing  
Uses of Steel Square  
Rafter Cuts  
Strength of Timber  
Roof Trusses  
Stair Building  
**Drafting and Design**  
Working Drawings  
How to Read Plans  
Blue-Printing  
Architectural Forms  
Architectural Lettering  
**Construction Contracts**  
Forms of Contract  
Architect and Owner

**Specification Writing**  
Inspection of Work  
**Cost Estimating**  
How to Bid with Safety  
Timekeeping, Superintendence  
**Cement Construction**  
Origin of Portland Cement  
Advantages of Concrete  
Common and Hydraulic Lime  
Cements (Portland, Natural, etc.)  
Proportions for Mixing  
Aggregates (Sand Gravel, Crushed Stone, etc.)  
Mixing by Hand and Machine  
Depositing Concrete  
Concrete Troubles  
**Waterproofing Concrete**  
**Concrete Blocks and Brick**  
Cement Mortar  
Stucco and Plaster  
**Concreting Machinery and Tools**  
Concrete Mixers

Block Machines  
Number of Blocks Required  
Brick and Tile Machines  
Forms (Wood, Metal)  
**Cement Houses**  
Foundations  
Floors and Walls  
Roofs and Chimneys  
Fireproof Construction  
Concrete Sidewalks  
**Ornamental Use of Concrete**  
Surface Finishes  
Art Tile and Mosaics  
Terrazzo Floors  
**Concrete on the Farm**  
Fence-Posts and Gate-Posts  
Sewer and Drain Pipe  
Concrete Silos  
**Reinforced Concrete**  
Principles of Design  
Reinforcing Materials and Systems  
Industrial Buildings  
Concrete Piles  
Sewer and Tunnel Work  
Bridges and Viaducts  
Culverts, Reservoirs

**Estimating Concrete Work**  
Standard Specifications  
**Masonry Construction**  
Building Stone  
**Brick and Brickwork**  
Mortar for Masonry  
Bonds and Joints  
**Steel Construction**  
Steel Shapes  
Use of Hand Book Tables  
Allowable Stresses  
Rivets, Tie-Rods  
Columns, Beams and Girders  
Floor and Roof Arches  
Roof Trusses and Coverings  
Mill Building Construction  
Steel Bridges  
Heating, Ventilation  
Furnaces and Pipes  
**Plumbing**  
Sewers and Drains  
**Electric Wiring**  
**Painting**  
**Paperhanging**  
**Furniture Making**  
Useful Tables, Rules, etc.

**PIN A DOLLAR BILL TO THIS COUPON AND MAIL IT AT OUR RISK TODAY**

**12 Big Volumes—Free Premiums—No Risk  
SENT FOR ONLY \$1.00**

**RADFORD ARCHITECTURAL CO.**  
1827 Prairie Ave., CHICAGO, ILL.

# Read This Letter

Mr. A. S. Johnson, Freeport, N. Y.

DEAR SIR—The work you did for me in waterproofing the cellars under the Lynbrook National Bank and Lynbrook Pharmacy has proven satisfactory in every respect.

The cellars are particularly dry, notwithstanding the fact that the floor is nearly two feet below water level.

Would be pleased to recommend you to anyone interested in the waterproofing problem.

Yours truly,

(Signed) JOSEPH S. SIMONSON.



**WATERPROOFING COMPOUND**

Mr. Johnson uses Ceresit. On the strength of what Ceresit has done, Mr. Johnson has landed many nice contracts for waterproofing leaky cellars. Ceresit has made good in every case. It can make good for **you**, no matter whether against slight moisture or against the heaviest hydrostatic pressures. **Investigate!**

Write for the "Book of Evidence."

**CERESIT WATERPROOFING COMPANY**

910 Westminster Building, Chicago

FACTORIES — Chicago Unna, Germany London Paris Vienna Warsaw

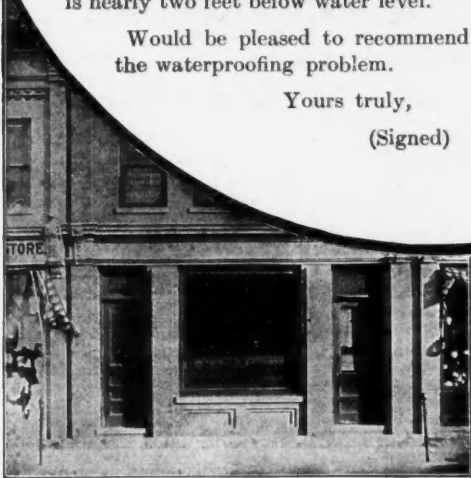

## Articles Every Carpenter Needs

Boxwood Folding Rules

Spring Joint Rules

Steel Rules



Steel Tapes

Woven Tapes

Pocket Tapes

We guarantee to YOU absolute satisfaction CATALOG ON REQUEST

When in need of these say to the hardwareman

**THE LUFKIN RULE CO.**  
New York Saginaw, Mich.

**LUFKIN**

## Lacey (Patented) Silo Doors and Silo Hoops

make silo building easy. You can build better silos for less money by ordering your Doors and Hoops from my factory and buying the rest of the material in your own town. My doors and hoops will save you time and money on all silo work. Your order will receive individual attention. Prompt shipment and Freight Prepaid to any point east of the Mississippi.

Write for my Free Circulars and Silo Book. This book will give you some good pointers on silo construction. Ask for it. Costs you nothing.

Elmer B. Lacey, Endicott, N. Y.

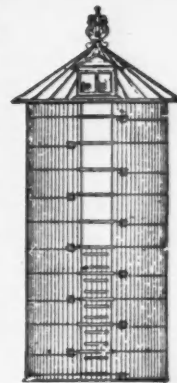

## The World's Most Practical and Economical Device for operating and controlling double swinging doors is the Shelby Chief Surface Floor Hinge and Oil Door Check.

The Hinge rests on the surface of the floor, carries the weight on hardened ball bearings, and closes the door.

The Check sets on top of the door and controls the closing speed.

The fact that the Shelby Chief is so easily installed, and gives such satisfactory results for less money than any other device for the same purpose is the cause of it being used so extensively in dwellings, hotels, hospitals and public buildings.

The Chief allows the door to open easily and close without noise, slam or jar.

No double swinging door should be without a Shelby Chief.

Ask your dealer, or us to tell you more about it.

**The Shelby Spring Hinge Co. :: Shelby, Ohio**

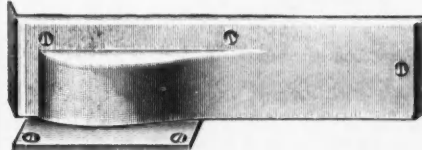
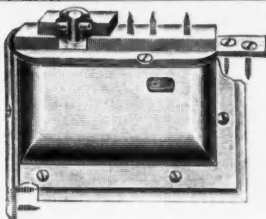

You will get SPECIAL ATTENTION if you tell Advertisers you read American Carpenter and Builder.

**A book of pointers  
for specifying paint**

Painting is a pretty complex subject. Naturally you're often puzzled to know just what paint and varnish to specify for certain results. Here's a little book that tells just the things you want to know. You do the builders you serve and yourself a favor, when you specify

*Lowe Brothers*  
**High Standard  
LIQUID PAINT**

It has the quality that *insures best results*. It is *scientifically* made from selected materials according to formulae that a third of a century's testing and experience have proven weather-worthy. It withstands the elements for years, holds its color, resists sun, rain and frost, and leaves a good surface for repainting.

Write today for this book of specifications, and for "Paint and Painting"—a neat pocket education on the subject. You'll find these books of real help.

**The Lowe Brothers Co.**  
457 E. Third St., Dayton, Ohio  
Boston Jersey City Chicago  
Kansas City Minneapolis

Lowe Brothers, Ltd.  
Toronto, Can.

**PAINT &  
PAINTING**



**Why Waste Time  
with Hand Pumps?**

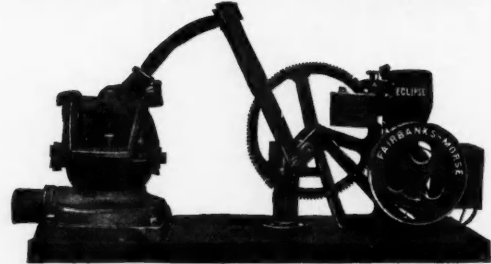

**The Fairbanks-Morse  
Eclipse Engine and Trench Pump**

is **cheaper than hand labor**. On a gallon of fuel per day it will take care of all the pumping needs of a building job, or, on a single pint of gasoline, will pump 3,000 gallons of water against a 20-foot head.

**Starts Easily—Runs Anywhere**

Is a compact geared unit, solidly mounted on a strong base. Built to stand hard knocks—yet is light enough to be moved about easily. Made in two sizes: No. 3, with capacity of 3,000 gallons per hour; and No. 2, about 1,200 gallons per hour; against an 18 or 20-foot head.

Write for description in Catalog 24N1409.

**Fairbanks, Morse & Co.**

900 S. Wabash Ave., CHICAGO 30 Church St., NEW YORK  
158-162 First St., SAN FRANCISCO



**Berger's  
Metal Lumber**

the only fire-proof material to universally take the place of wood timber. Similar to structural steel but lighter. Replaces wood stick for stick.

Write for Catalog.

**THE BERGER MFG. CO.,** Canton, Ohio

For the best service address nearest branch  
New York Boston Minneapolis Philadelphia  
St. Louis San Francisco

**LAUGHS  
AT LOST KEYS**

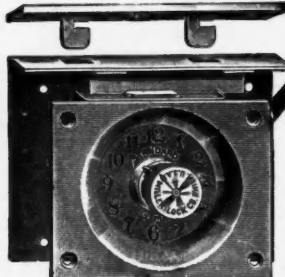

Here's the lock for your tool chest or your shop cabinets. Safe as a bank. No keys to lose. Locks automatically. A few turns of the knob opens it. Made of brass and fits all chests from 7/8" thick and up.

**"Standard Time"  
KEYLESS CHEST LOCK**

No. 3380 Size 4"x3"  
All Brass

will prevent the theft of your tools. You are the only one who can open the lock. Price very reasonable. Can you afford to be without this strong protector for your valuable tools? Of course not.

Write for Keyless Lock Catalog

**Miller Lock Co., Frankford, Philadelphia, U. S. A.**



**34c  
For This Lock Set**

No. 5155 Antique  
Copper Finish

**FREE—No. 5.** Builders Hardware Catalog and net price list to Contractors and Material Men.

We do not sell to contractors or carpenters in Cook County, Ill.

**Rehm Hardware Co.**  
1501 Blue Island Ave.  
CHICAGO, ILL.

No. 5155

**Huthers Bros. Patent Groover or Dado Head**

Will Save Its Cost in Three Days' Time

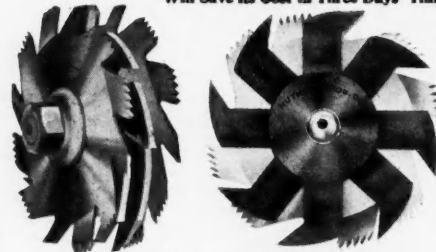

Showing Arrangement of Cutters

Can be used on any Circular Saw Mandrel.

For cutting any width groove from 1/4" to 2" or over. Will cut a perfect groove, either with or across the grain, and leave edges smooth. Will ship to any responsible firm on ten days' approval; if not satisfactory you are at liberty to return at our expense.

We also make a specialty of concave ground smooth cutting circular Miter Saws, for either rip or cross cut; Grooving Saws for all kinds of special work; Lock, Corner Cutters, Concave Saws, etc.

Try our Scraper Blades and you will use no others.  
**HUTHERS BROS. SAW MFG. CO., 1101 University Ave., Rochester, N. Y.**

You will get **SPECIAL ATTENTION** if you tell Advertisers you read American Carpenter and Builder.

# THE FOOS

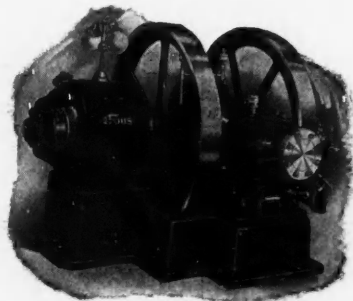

Direct Connected Set for Generating Electric Current

This Factory builds outfits for every service from 1 1/2 to 325 Horse Power. Its electrical units give illumination equal to the best Central Stations and can be installed in any location. If you are in the market for power for any purpose, you will be interested in the big Foos Catalogs, showing engines for lighting, pumping, hoisting, etc., and for general power requirements. We will know what you want if you simply ask for Bulletin No. 47.

**THE FOOS GAS ENGINE CO.**

704 Linden Avenue Springfield, Ohio

INVESTIGATION among leading Architects will prove that

## "AMERICAN"

*Pressed Metal*

### SASH PULLEYS

are popular because they give superior and enduring service, at prices comparing favorably with those of any high grade pulleys.

They are of **pressed** metal, and are less likely to be broken in shipment than are other kinds.



Patented

Face plates to match any hardware. Plain, ball bearing, and roller bearing axles. Combination groove for cord or chain. Non-rusting. Guaranteed.

Send for Catalog

**The American Pulley Company**

Office and Works, Philadelphia, Pa.  
New York Boston Chicago



**EVERLAST HYNALER HAMMER**  
THOUSANDS IN USE

With EASTMAN PATENT Hollow Steel Handle. Handle lasts as long as the Head.

Manufacturers of High Grade Socket Joint Tools with Hollow Steel Handles Exclusively.

Our "Everlast" Brand represents the Highest Possible Standard of Tool Value.

Order the Everlast Hynaler Hammer from your dealer—or sent direct, prepaid parcel post, for \$1.25.

**HAWTHORNE SALES CORPORATION, Manufacturers**  
220 W. 42nd Street New York, N. Y.



## SAMSON SPOT SASH CORD



Reg. U. S. Pat. Off.

Samson Cordage Works

Boston, Mass.

Made of extra quality stock, carefully inspected, and guaranteed free from the imperfections of braid and finish which destroy common cords so quickly. The spots on the Cord, in any color, are our trade mark. Don't be misled by imitations. Samples and full information gladly sent.

## MADE TO ORDER Fly Screens and Screen Doors

We use the best grades of wire cloth, black enamel, galvanized, pearl and copper bronze, fastened by the improved Standard Shoulder Strip Method, which makes the wire drum tight and firm, can not sag or pull away.

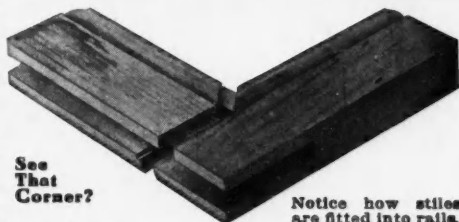

See That Corner?

Notice how stiles are fitted into rails.

Dealers, Carpenters, Contractors and Builders, write for a free copy of our 1913 illustrated catalog

**STANDARD SCREEN CO., 1848-50 W. 14th St., Chicago, Ill.**

Our screens are all mortised, tenoned, joined with waterproof glue and pinned with steel pins, will last a lifetime.

**RED DEVIL BITS**  
SINGLE OR DOUBLE TWIST  
HONED LIKE A RAZOR, NOT SIMPLY GROUND, BUT TRUED ON A LATHE  
Red Devil Bits are made with 10% greater clearance than any other. Will drill with or against the grain, in any kind of wood, and under any conditions.  
If your dealer can't supply, send \$5.25 for set No. 2401 of 32 1/2 quarters in wooden box.  
At any rate, send for Booklet of 3,000 Red Devils.

**SMITH & HEMENWAY CO.**  
156 Chambers St., NEW YORK CITY  
*The Red Devil Bit—Always Makes a Hit*

You will get SPECIAL ATTENTION if you tell Advertisers you read American Carpenter and Builder.

# "Opportunities"

Have you anything to Sell, Barter or Exchange,  
Want Help, Agents, or a Situation? Use our

## Classified Department

RATES 5 CENTS A WORD. CASH WITH ORDER

No Display Type Allowed in Classified Advertisements

### Patents

O. L. PARKER, PATENT ATTORNEY. Formerly member Examining Corps, U. S. Patent Office. 920 G. St., Washington, D. C. Pamphlet of instructions sent upon request.

PATENTS THAT PROTECT AND PAY—Books free. Highest references; best results. Send sketch or model for free search. Watson E. Coleman, Patent Lawyer, 622 F St., Washington, D. C.

### Instruction

DRAFTSMEN'S, BUILDERS' AND FOREMEN'S COURSES—Day, evenings or by mail. MAAOK'S ACADEMY OF ARCHITECTURE, 742 Chouteau Ave., St. Louis, Mo.

### Wanted

WANTED—First class carpenters. Must be sober and hustlers. Steady work. H. A. TAYLOR, Morris, Ill.

AGENTS WANTED for house lighting machines, supplying gas for small country homes as well as large. Simple and economical. Guaranteed. A live proposition. Write for terms. THE ALEXANDER F. MILBURN CO., Baltimore, Md.

### Miscellaneous

CABINET MANTELS direct to builder, \$3.00 to \$40.00. AMERICAN MANTEL TILE & GRATE CO., Hamilton, Ohio.

FREE—\$1.00 Certificate and 4-inch rule. See Ad Page 177. GAGE TOOL CO., Vineland, N. J.

AGENTS—500 per cent profit; free sample. Our new gold and silver sign letters for store fronts and office windows. Easily applied. Big demand everywhere. Write today for liberal offer to agents. METALLIC LETTER CO., 447 N. Clark, Chicago.

### For Sale

"HEAVEN AND HELL"—Swedenborg's 400-page work, 15 cents, postpaid. PASTOR LANDENBERGER, Windsor Place, St. Louis, Mo.

FOR SALE—Barnes' foot and hand or other power woodworker. BROWN, 819 1/2 No. 10th St., St. Louis, Mo.

FOR SALE—Barnes' Bench Lathe, No. 4; also full set Turning Chisels, all new. E. H. NORTON, New Cambria, Mo.

FOR SALE—Peerless 5-ton truck, nearly new, thoroughly overhauled, repainted. ITHACA SAND & SUPPLY CO., Ithaca, N. Y.



### RANGER BICYCLES

Have imported roller chains, sprockets and pedals; New Departure Coaster-Brakes and Hubs; Puncture Proof Tires; highest grade equipment and many advanced features possessed by no other wheels. Guaranteed 5 years.

FACTORY PRICES direct to you are less than others ask for cheap wheels. Other reliable models from \$12 up. A few good second-hand machines, \$3 to \$8.

10 DAYS' FREE TRIAL We ship on approval, freight prepaid, anywhere in U. S., without a cent in advance. DO NOT BUY a bicycle or a pair of tires from anyone at any price until you get our big new catalog and special prices and a marvelous new offer. A postal brings everything. Write it now. TIRES, Coaster-Brake, Rear Wheels, lamps, parts, sundries, half usual prices. Rider Agents everywhere are coinng money selling our bicycles, tires and sundries. Write today.

MEAD CYCLE CO. Dept. T-122 CHICAGO

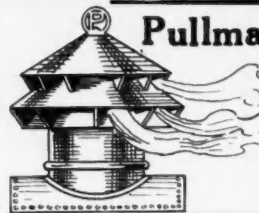

### Pullman Ventilating Cows

are the best exhaust medium on the market. Provide for removing the foul air by using Pullman Cows on the roof. Write for booklet. Ask us to solve your Ventilating problems. The Pullman System means Natural Ventilation.

Pullman Automatic Ventilator  
Mfg. Co., 21 York St., York, Pa.

### MIXER FOR SALE CHEAP

New 8-ft. Northwestern Batch Mixer. Side Loader. Water Tank. Novo Engine.

O. G. MANDT

Keokuk, Ia.

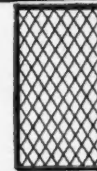

### WINDOW GUARDS ELEVATOR ENCLOSURES

Fences, Gates, Railings,  
and Wire Specialties.

Send specifications for prices, etc. Write today.

KOKOMO FENCE MACHINE COMPANY  
502 North Street Kokomo, Indiana

### For Thirty Years BYERS HOISTING ENGINES

have satisfied their users. Write for Catalogue.

The JOHN F. BYERS MACHINE CO.  
Ravenna, Ohio

Over 1,000,000

Here's What The Axtell  
People Want

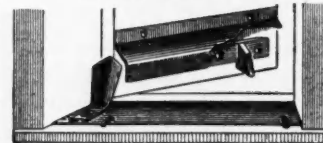

A perfectly tight All-Metal Weather Strip for bottom of doors and swinging windows. Saves sill from wearing and can be put on any door in 5 minutes at 200% profit. Sells at sight wherever shown. Our prices will interest you. Write us.

E. I. Church & Co.  
West Hanover, Massachusetts

In Daily Use



### THE WORLDS GREATEST HAMMERS ALL OTHERS OUT OF DATE.

Smash not thy fingers or Fish Hook the Nails. Do the same work with half the effort. The nail holding feature makes you safe in your Scaffold work.

Get them from your dealer or from us.



DOUBLE CLAW \$1 PARCELS POST

Double Claw  
Hammer Co.  
453 Broadway  
BROOKLYN, N. Y.

You will get SPECIAL ATTENTION if you tell Advertisers you read American Carpenter and Builder.

## SLASHED PRICES ON PRINTED LETTER-HEADS

Size 8 1/2 x 11, Hammermill Bond, white or colors.  
500 for \$1.25; 1000 for \$2.00; 3000 for \$4.75. Cash  
with order. Best work. Lowest prices. Trial proves

PRINTER'S PRICE-WRECKING CO. Dept. 36, 787 Michigan Ave. Detroit



**A UNIQUE TIME SAVER.**  
The Jackson Aluminum Line Level is a mighty small device ut it brings about a tremendous saving of both time and labor. It takes the place of the old-fashioned sixteen foot straight edge, yet it can be carried in your vest pocket. No contractor, builder, carpenter, mason, bricklayer, architect or plasterer, etc. can afford to be without one. Just stretch your line and hang the level on it—it's positively accurate. The complete outfit is put up in a neat matherette case and consists of the level with a 40-ft. line also a spring clamp for attaching the level to a steel square or pocket rule, thereby serving as a plumb rule or bench level. Ask your hardware dealer or send \$1.00 for the Level outfit complete post paid. Send for our Catalogue of Tools.

JOS. WOODWELL CO., Sole Agents  
201-203 Wood St., Pittsburgh, Pa.

## Pioneer Drop Forged Screw Drivers

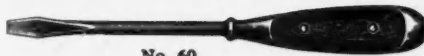

No. 60

One piece. Bead prevents slipping. Most practical, durable, improved driver made.

Show this ad to your hardware dealer, or write us for catalog.

SOUTHINGTON MFG. CO., Southington, Conn.

## Sit at This Table and Earn \$200 a Month Learn to be a Draftsman



We will show you how you can do it. Write us and we will send you full particulars. No enrollment. No first payment. Your own ability is what counts. No \$10 down, \$10 a month game. Just write and find out. Circular C free.

THE T-SQUARE & TRIANGLE CO.  
30-32 CLINTON ST., NEWARK, N. J.

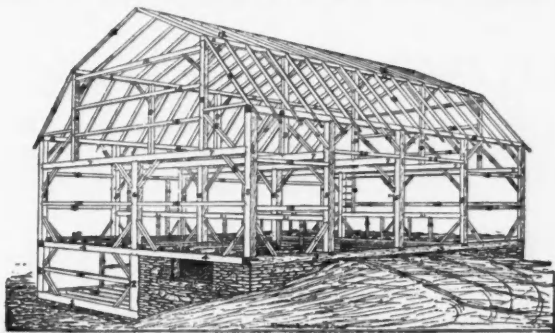

## FRAMING

HOUSE FRAMING, BARN FRAMING  
ROOF FRAMING

By W. A. Radford. 338 (6 x 9 inch) pages, 182 illustrations dealing with house, barn and roof framing, covering the subject in its multitude of forms and designs in a most thorough manner. Nothing is omitted that will help and guide on the construction of houses, barns, roofs, etc., while particular care has been taken to exclude any and every method of framing that has not been given a thorough and convincing test by experienced builders.

Have you received your copy?

No contractor or builder can afford to go without this book. A copy will be sent Free, postage paid, to anyone sending us their renewal or a new subscription. Regular subscription \$2.00 per year.

AMERICAN CARPENTER AND BUILDER

1827 to 1833 Prairie Avenue  
CHICAGO, ILL.

## Big half-a-week's pay

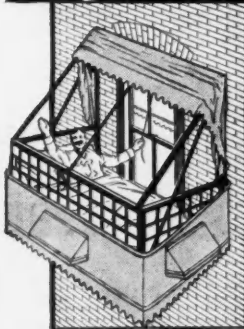

### for half-a-day's work

Millions are eager to sleep outdoors, but only a few have sleeping porches. Here is an improvement on the sleeping porch, that almost everybody can afford. The

### Mitchell Sleeping Porchet

Put up outside any bedroom window. Has quick adjusting storm curtains. Completely equipped for sleeping. Supports a ton. Ornament to home.

Get the exclusive agency

You can put up this Porchet in half a day or less at a big profit. Cost moderate. Sales easy. Write today for prices, our proposition to you, and book, "Outdoor Sleeping Made Easy."

American Porch Construction Works

Dept. 15 South Bend, Ind.

Write for Free Book

## THE ZIMMERMAN IRON BASE

is the ONLY BASE having a CENTER BEARING.

It carries the required weight without allowing the corner supports to sink into the floor and prevents the base of column and floor from rotting.

See "SWEET'S" page 956.

S. CHENEY & SON, MANLIUS, N. Y.

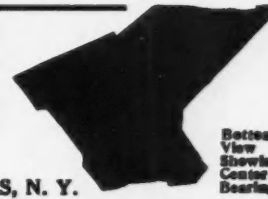

Bottom View Showing Center Bearing

## Triumph Light

EVERYBODY WANTS BETTER LIGHT. HERE IT IS

This new 100 to 700 candle power light turns up and down like gas. One-third cost of electricity, gas or kerosene. For home, church or store. Anyone can operate. Perfection guaranteed or money back. Write for catalog. (A. C. B.) Dept. 20. Agents Wanted. BRILLIANT GAS LAMP COMPANY 1009 S. Wabash Av., Chicago, Illinois



## 8 Grape Vines, 6 Currant Bushes \$1

All best 3 year old stock. If planted now or early spring will fruit next summer. Should ground be frozen we tell you how to protect and keep them dormant ready for early spring planting. Orders accepted now and forwarded at any future time if preferred. Grapes are Worden, Niagara, Iona, Concord, the best early, medium and late varieties. Large cherry currants. Write for list of our \$1 Friend Makers, consisting of all kinds of Fruit Trees, Berries and Roses.

The Landscape Garden Co., Newburgh, N. Y.

## SLATE WE HAVE WHAT YOU WANT

In Roofing Slate. Slate Blackboards  
Structural and Plumbers' Slate

SATISFACTION GUARANTEED IN QUALITY AND PRICE

ASK FOR DELIVERED PRICES

J. K. HOWER, Station, C., Slatington, Pa.

R. J. KICHLINE, Sales Agent

## ROOFING SLATE

OF QUALITY

MINERS

MANUFACTURERS

The AULD & CONGER CO.

DEPT. B.

ESTABLISHED

CLEVELAND, OHIO.

1870

You will get SPECIAL ATTENTION if you tell Advertisers you read American Carpenter and Builder.

1872

1914

**42 YEARS OF FAIR DEALING**  
 WITH  
**CARPENTERS — BUILDERS — CONTRACTORS**

**I**S YOUR assurance that we can serve you to your advantage. We ask nothing more than a trial. When in need of builders' hardware, send us your plans and specifications. Let us bid on your requirements. We can give you better value at a lower price than any other hardware dealer.

**Tools for Every Trade  
 Electrical Supplies  
 Contractors' Supplies  
 Builders' Hardware  
 (80,000 Different Items)**

Our years of experience, our immense buying power, our reputation, have enabled us to place before you the largest assortment of well-known builders' hardware, tools of all kinds, etc., in the country. All the leading manufacturers are represented. Our stock is the pick of the choicest and most reliable.

Your orders will be filled promptly. No delays; no waiting for goods out of stock. You will be entirely satisfied with our selection, for our knowledge of hardware and supplies insures your getting the best. Each piece in every shipment is sorted and labeled from the specifications and packed so the workmen will lose no time in handling.

Let us bid on your next contract. Whether your order is large or small, we appreciate it and give it the individual attention that makes buying from us both pleasant and profitable.

When you are in Chicago, call on us. Let us show you over our big store. Look over our display of "quality" hardware. You will go away with the feeling that we can make good on our promise to give you the best service, the greatest satisfaction, the utmost quality at a moderate price.

**Let us figure on your next bill.**

**UNUSUAL VALUES IN BUILDERS' HARDWARE**

We are discontinuing several lines of Inside Lock Sets, Front Door Bit Keyed Sets, Front and Vestibule Lock Sets, Front Door Cylinder Locks, Vestibule Cylinder Latches and Branford Bronze Butts. These will be closed out at real bargain prices, although every piece is in perfect condition. Write us today for the complete list.

**BERRY WINDOW VENTILATORS**

BERRY VENTILATORS are in demand. We control the sales in the United States. Every reader should know about them and install and specify them in the buildings he erects or designs. Indispensable to homes or offices.

Operate on the right principle. Buglar proof and Indestructible.

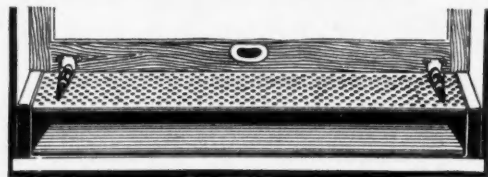

Showing window open with ventilator in use

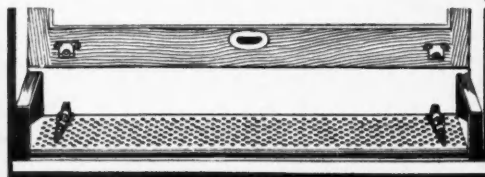

Showing window open with ventilator closed and not in use

Can be adjusted to fit another window. Easily installed and can be furnished in any length.

Send for our SPECIAL OFFER TO BUILDERS. WRITE TODAY.

**Drop In and See Us When You Visit Chicago**



**ORR & LOCKETT**  
 Established 1872 **HARDWARE CO.**  
**14-16 West Randolph St., CHICAGO, ILL.**

You will get SPECIAL ATTENTION if you tell Advertisers you read American Carpenter and Builder.



INDEX TO ADVERTISEMENTS, APRIL, 1914

	Page.		Page.		Page.
Allegheny Steel Band Co.	169	Farmers Supply Co.	147	Northern Hemlock & Hardwood Mfrs. Assn.	114
Alpha Portland Cement Co.	101	Fay & Egan Co., J. A.	22	Northwestern Compo Board Co.	184
American Bell & Foundry Co.	158	Flintkote Mfg. Co.	110	Northwestern Distributing Co.	18
American Cement Machine Co.	9	Foos Gas Engine Co.	189	Northwestern Expanded Metal Co.	154
American Floor Surfacing Machine Co.	4	Foster Sheet Metal Works.	141	Norton, E. H.	190
American Mantel Tile & Grate Co.	190	Fox Machine Co.	21	Novo Engine Co.	151
American Porch Construction Co.	191	Fox Supply Co.	5	Oak Flooring Bureau.	174
American Pulley Co.	189	Gage Tool Co.	177-190	Ohio Tool Co.	28
American Saw Mill Machinery Co.	22	Galesburg Sheet Metal Works.	165	Original Gas Engine Co.	125
American School of Correspondence.	159	Genuine Bangor Slate Co.	145	Orr & Lockett Co.	192
American Sheet & Tin Plate Co.	139	Gilbert & Bennett Mfg. Co.	142	Oshkosh Mfg. Co.	3
American Steel Scaffold Co.	166	Goodell Mfg. Co.	168	Parker, C. L.	190
Anchor Concrete Stone Co.	148	Goodell Pratt Co.	30	Parks Ball Bearing Machine Co.	26
Andrews Heating Co.	170	Gordon VanTine Co.	95	Patent Vulcanite Roofing Co.	111
Arkansas Soft Pine Mfrs. Assn.	115	Grand Rapids Hardware Co.	169	Pearson Mfg. Co.	175
Armleder	141	Gunn Folding Saw Clamp Co., L. D.	173	Peck Williamson Co.	123
Arrowsmith Concrete Tool Co.	20	Hall Holmes Mfg. Co.	12	Pennsylvania Saw Co.	167
Asphalt Ready Roofing Co.	139	Hardin Co., John.	165	Phoenix Sliding Blind Co.	6
Atkins & Co., E. C.	2	Hartmann Sanders Co.	175	Plastergon Wallboard Co.	145
Atlantic Engine Co.	28	Haven Mfg. Co.	4	Prentiss Vise Co.	26
Atlas Engineering Co.	13	Hawthorne Sales Corporation.	189	Printers Price Wrecking Co.	190
Auld & Conger Co.	191	Haywood Tire & Equipment Co.	161	Progressive Mfg. Co.	26
Automatic Sash Holder Mfg. Co.	8	Hegener Co., Rudolph.	161	Prybil, P.	183
Badger Steel Roofing & Corrugating Co.	170	Heppes Co.	127-134	Pullman Automatic Ventilator Mfg. Co.	190
Bangor State Mining Co.	145	Herrick Refrigerator Co.	179	Queen Cupola Co.	157
Barnes Co., W. F. & Jno.	22	Hess Warming & Ventilating Co.	158-172	Queen Gray Co.	24
Barnett, Jos. L.	21	Hewitt-Lea-Funk Co.	97	Raber & Lang Mfg. Co.	10
Barrell Co., Wm. L.	96	Hobbs Concrete Machinery Co.	147	Racine Detachable Hinge Co.	132
Batts, John Thomas.	156	Holland Furnace Co.	121-173	Radford Architectural Co.	165-185-186
Beach Mfg. Co.	26	Horan, Timothy F.	170	Radke Mfg. Co.	181
Beaver Board Co.'s., The.	145	House Movers Supply Co.	24	Rehm Hardware Co.	188
Beckmann Co., The L.	169	Hower, J. K.	191	Reo Motor Truck Co.	107
Bennett Co., Geo. C.	155	Huber Builders Material Co.	133	Reynolds Asphalt Shingle Co., H. M.	137
Berger Mfg. Co.	182, 183, 188	Hunt, Helm, Ferris & Co.	167	Richards Wilcox Mfg. Co.	180
Bessler Movable Stairway Co.	167	Hurley Machine Co.	5	Roberts Mfg. Co.	184
Billings-Chapin Co.	149	Hussey & Co., C. G.	173	Robinson, H. S.	153
Bird & Son.	126	Huther Bros. Saw Mfg. Co.	188	Rockford Mitre Box Co.	168
Blystone Mfg. Co.	14	Ideal Concrete Machinery Co.	20	Ross & Co., G. M.	178
Boite Mfg. Co., The.	14	Ideal Furnace Co.	122	Royal Ventilator Mfg. Co.	149
Bommer Bros.	36	International Correspondence Schools.	177	Russell Jennings Mfg. Co.	30
Bostwick Steel Lath Co.	130	Iowa Foundry Co.	14	Samson Cordage Works.	189
Bovee Furnace Co.	173	Irwin Auger Bit Co.	149	Sand & Sons, J.	156
Boyle Co., John.	184	Ithaca Sand & Gravel Co.	190	Sargent & Co.	34
Bradt Publishing Co.	164	Ives Co., The H. B.	176	Sasgen Derrick Co.	176
Bragstad Concrete Machinery Co.	18	Jaeger Machine Co.	124	Schickel Motor Co.	156
Bridgeport Wood Finishing Co.	99	Jahant Heating Co.	158	Schill Bros. Co.	122
Brilliant Gas Lamp Co.	191	James Mfg. Co.	160	Schlueter, M. L.	6
Brooklyn Metal Ceiling Co.	175	Jennings & Co., C. E.	6	Schoedinger, F. O.	128
Brown, L. W.	190	Johns-Manville Co., H. W.	100-144	Sears Roebuck Co.	117
Buck Bros.	29	Johnson, E. J.	26	Sedgwick Machine Works.	8
Buckeye Saw Vise Co.	166	Johnson & Sons, S. C.	119	Seippel Lumber Co., P. J.	157
Buffalo Wire Works Co.	160	Jud Yoho	157	Seneca Falls Mfg. Co.	24
Buffum Tool Co.	151	Karol, B. B.	158	Shapleigh Hardware Co.	130
Building Material Exhibit.	175	Kaustine Co., Inc.	112	Sharon Hardware Co.	178
Butler, C. A.	143	Keasbey & Mattison Co.	137	Shelby Spring Hinge Co.	187
Byers Machine Co., John F.	190	Kees Mfg. Co., F. D.	173	Sheldon Slate Co., F. C.	141
Cabot, Samuel.	36	Keighley Metal Ceiling Co., S.	135	Sherman Mfg. Co., H. B.	7
Caldwell Mfg. Co.	161	Keplinger, G. J.	5	Shultz All Steel Corner Post Co.	176
Canton Foundry & Machine Co.	172	Kewance Boiler Co.	120	Sidney Elevator Mfg. Co.	8
Canton Metal Ceiling Co.	135	Kissel Motor Car Co.	106	Sidney Tool Co.	23-183
Carborundum Co.	32	Klauer Mfg. Co.	135	Simmons Hardware Co.	153
Carnahan Mfg. Co.	151	Knickerbocker Co., The.	16	Simonds Mfg. Co.	34
Carter White Lead Co.	118	Kokomo Fence Machine Co.	190	Sioux City Engine & Mach'y Co.	10
Cement Tile Machinery Co.	12-18	Kolesch & Co.	24	Slatington Slate Co.	138
Central Mantel Co.	163	Lacey, Elmer B.	187	Smith, Harry A.	169
Ceresit Waterproofing Co.	187	Landenberger, L. G.	190	Smith & Hemenway Co.	189
C. & E. Mfg. Co.	138	Landscape Garden Co.	191	Smith Co., The T. L.	17
C. H. & E. Mfg. Co.	27	Lansing Co.	14	Southern Cypress Mfrs. Assn.	135
Champion Safety Lock Co.	32	Leavitt Mfg. Co.	155	Southington Hardware Co.	155
Chappell Co., Waywell.	5	Lichty & Sons Co., B. F.	165	Southington Mfg. Co.	190
Chelsea Elevator Co.	8	Liggett & Myers Tobacco Co.	150	Spidel, J. G.	8
Cheney & Son, S.	191	Long Co., W. Z.	131	Standard Paint Co., The.	5
Chicago Grille Works	163	Lorenzen & Co., Chas. F.	163	Standard Scale & Supply Co.	15
Chicago Machinery Exchange.	27	Lowe Bros. Co.	188	Standard Screen Co.	189
Chicago Millwork Supply Co.	104	Lufkin Rule Co.	187	Standard Stained Shingle Co.	136
Chicago & Riverdale Lumber Co.	24	Luther Grinder Mfg. Co.	168	Stanley Rule & Level Co.	31
Chicago Spring Butt Co.	36	McCray Refrigerator Co.	179	Stanley Works, The.	153
Chicago Technical College.	161	Maacks Academy of Architecture.	190	Starch Bros. Co.	21
Chief Draftsman	195	Mack & Co.	20	Star Expansion Bolt Co.	30
Chief Engineer	181	Mack Iron & Wire Works.	160	Starrett & Co., L. S.	28
Church & Co., E. I.	190	Majestic Furnace & Foundry Co.	172	Swan Co., Jas.	177
Cincinnati Fly Screen Co.	170	Mandy, O. G.	190	Swarts, H. D.	155
Cincinnati Tool Co.	7	Mastic Wall Board Rfg. Mfg. Co.	194	Sykes Metal Lath & Roofing Co.	171
Cleveland Window Glass & Door Co.	113	Mead Cycle Co.	165-177-190	Tannewitz Works, The.	22
Clover Leaf Machine Co.	12	Merwin Mfg. Co.	165	Taylor, H. A.	190
Cobbs & Mitchell, Inc.	129	Metallic Batten Co.	36	Taylor Mfg. Co., Jas. L.	32
Coleman, Watson E.	190	Metallic Letter Co.	190	Thomas & Armstrong Co.	139
Colgan Machinery & Supply Co.	29	Michigan Gas Appliance Co.	181	Tiffin Art Metal Co.	135
Columbia Iron & Wire Works Co.	174	Midland Terra Cotta Co.	102	Triple A. Machine Co.	4
Cortright Metal Roofing Co.	141	Milburn Co., Alexander.	190	Trussed Concrete Steel Co.	160
Cott-a-lap Co., The.	184	Miles Mfg. Co., The.	10-20	T-Square & Triangle Co.	190
Coyne, J. J.	18	Miller Co., J. C.	14	United Electric Co.	143
Crater & Holt.	177	Miller Lock Co.	188	United Factories Co.	109
Crescent Machine Co.	25	Miller Mfg. Co., A. W.	180	Universal Clothes Drier Co.	166
Cummer Diggins Co.	199	Millers Falls Co.	178	VanDoren Mfg. Co.	29
Dahl Mfg. Co.	29	Milwaukee Corrugating Co.	157	VanGuilder Hollow Wall Co.	179
Davis Acetylene Co.	164	Miotke, Jos.	7	Warner Elevator Mfg. Co.	8
Dennis & Co., W. J.	173	Mitchell Brothers Co.	129	Warren Knight Co.	24
Detroit Show Case Co.	8	Moeschl-Edwards Corrugating Co.	137	Waterloo Cement Machinery Corp.	11
Didrikson, H. P.	6	Moorman & Otten Co.	163	Watrous Mfg. Co.	153
Disston & Sons Co., Henry.	33	Morgan Co., The.	98	Weber Mfg. Co.	7
Dixon Crucible Co., Jos.	174	Morrill, Chas.	36	Webster Cement Co., W. F.	165
Double Claw Hammer Co.	190	Mullins Co., The W. H.	174	Wells Lumber Co., J. W.	183
Dow Wire & Iron Works.	160	Myers & Bros., F. E.	29	Western Mfg. Co.	12
Dunn & Co., W. E.	19	National Keellstone Co.	103	Wheeler Screen Co.	143
Durametal Weatherstrip Co.	171	National Lead Co.	108	White Co., David.	24
East Bangor Consolidated Slate Co.	28	National Lath Co.	108	White Co., The.	162
Edgumbe, Geo. W.	157	National Mfg. Co.	196	White Co., L. & I. J.	176
Edwards Mfg. Co.	140	National Sheet Metal Roofing Co.	170	Willis Mfg. Co.	152
Elite Mfg. Co.	16	New Way Motor Co.	164	Witte Iron Works Co.	147
Enterprise Iron Works.	155	Nicholls Mfg. Co.	180	Wolff Mfg. Co., L.	158
Erie Clutch & Pulley Co.	168	Nickerson Mfg. Co.	163	Woodwell Co., Joseph.	190
Eureka Machine Co.	146	North American Construction Co.	105	York Automatic Dumb Waiter Co.	8
Fairbanks, Morse & Co.	188	North Bros. Mfg. Co.	166		
		Northfield Iron Co.	10		

30 Houses Built at Hanover, Mass.,  
where Bishopric Stucco or Plaster Board was used  
with entire satisfaction.

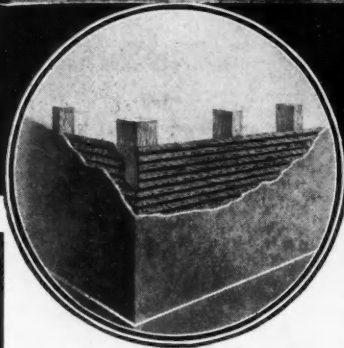
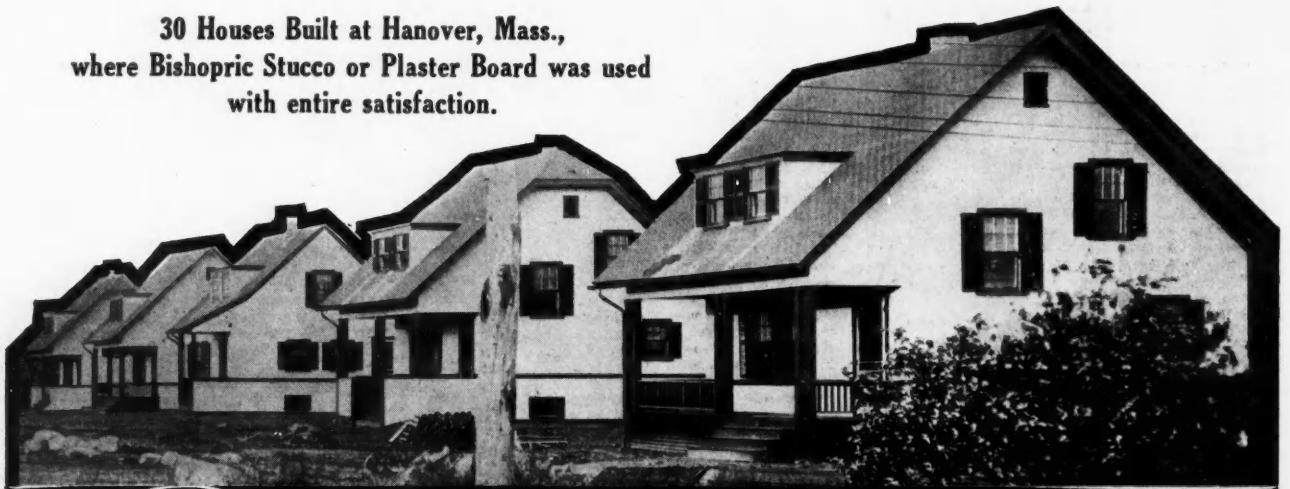

Bishopric Stucco or Plaster Board  
Nailed to Studding and Stucco  
Applied to Stucco Board.

## 25% Saved in Time, Labor Money and Material

**Y**ES, sir! That's just what can be accomplished by using Bishopric Stucco or Plaster Board for both exterior and interior work. Bishopric Stucco or Plaster Board keeps the building damp-proof and is a perfect sound deadener.

For interior work it is applied dry, directly to the studding. No building paper, no wood sheathing necessary. Complete the building 30 days sooner and have permanent construction. Plaster may be applied in one-third less time than with ordinary lath, metal or wood. It makes a permanent construction and a building that is cool in summer and warm in winter, because it is a non-conductor of heat and cold. Don't ceil your cellar with lath and plaster! The constant jarring above will develop cracks and loosen it. Use Bishopric Stucco or Plaster Board with its dovetailed laths that hold plaster like nothing else can.



*"Dampness Can't Penetrate"*

Use Bishopric Stucco or Plaster Board on that new building—both inside and out. Nothing compares with it for backgrounds for stucco, plaster and concrete. Rigid and enduring. Comes in handy sheets.

**Get the Facts** Let us send you full information regarding Bishopric Stucco or Plaster Board. We'll gladly send you our latest book, samples, complete architectural blue print and plans for building a model house—ALL FREE! Write—right now.

### THE MASTIC WALL BOARD AND ROOFING COMPANY

530 Este Avenue, Cincinnati, Ohio

CENTRAL DOOR & LUMBER CO., Portland, Oregon---Licensed Manufacturers and Distributors for Pacific Slope

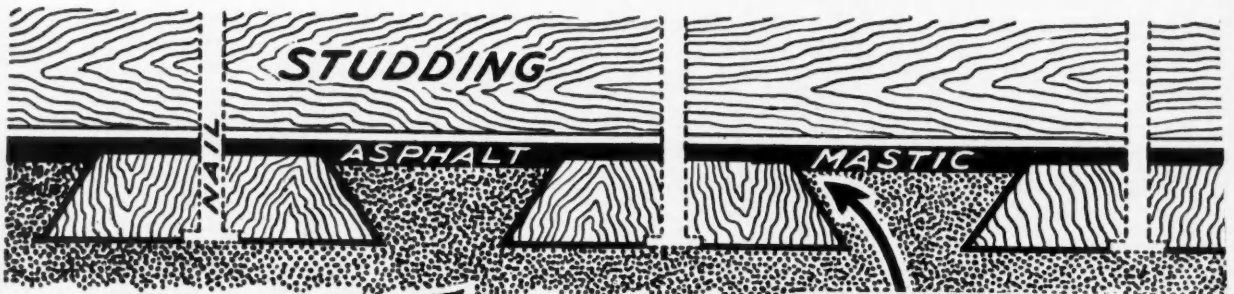

**STUCCO FINISH** ↗

**NOTE THE UNDER-CUT-  
THIS IS THE KEY THAT MAKES STUCCO STICK**

You will get SPECIAL ATTENTION if you tell Advertisers you read American Carpenter and Builder.

# YOUNG MEN WANTED

To **Recome** **Draftsmen and Designers** **At Once**

The constant demand for trained men always exceeds the supply. Positions paying \$75 to \$100 per week are open now. Some weeks over 250 positions paying the highest salaries in all parts of the country stay open. Let me send you one of my regular weekly "Draftsmen Wanted" lists. You can have one of these positions. I'll give you just the training that you need.

## Chief Draftsman Earn \$125 to \$175 Per Month To Start



**Will Train You Personally and Instruct You Properly** on practical Drafting room work **until** you are perfectly competent and **until** you are placed in a permanent paying position at a salary paying **at least \$125 per month.** This is a most exceptional opportunity for a limited number of selected

ambitious men between the ages of 16 and 40, whom I will train personally and give individual instruction. I am making this special offer in order to fill the constant demand for properly trained men in this line. I give **each** of my students my own **personal attention**—and consequently I must limit the number of students. If you desire such an opportunity, get busy **now** and **write to me at once.** Don't wait till tomorrow, do it **today.** **You can earn more** than I charge for my time and personal training.

## Earn Big Money at Once

### I Guarantee

To instruct you **until** competent and placed in a permanent paying position at a regular Draftsman's salary of at least \$125 to \$175 per month and guarantee to furnish you free the complete Draftsman's working outfit at once from the start.

**While You are Learning at Home.** Yes, that's exactly what I mean. As soon as you become my student you can begin earning a handsome income while learning at home. I mean just what I say. This is a special offer I am making. Absolutely no obligations of any kind in

sending the coupon. But you must write at once, as I will take the names in the order I receive them.

### Send the Coupon

Fill out and mail the free coupon at once for my book, "Successful Draftsmanship," also list of open positions and for the free offer to be earning good money at once while learning at home. This offer is positively limited, and in order to benefit thereby you must act **at once.**

**CHIEF DRAFTSMAN** Div. 2664 **CHICAGO**  
ENGINEER'S EQUIPMENT CO. (Inc.)

You **can** make it. I have trained the highest paid draftsmen and know exactly the kind of training those men need who draw the biggest salaries. In my position as Chief Draftsman, I keep in constant touch with the demands of the profession. I will give you just the kind of training you need—in your own home—during your spare time. **Send the Coupon.**

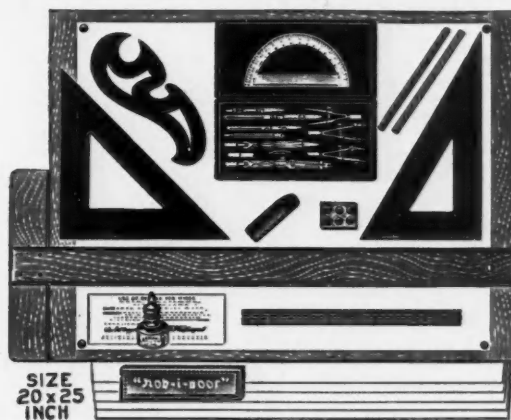

## This \$15.00 Draftsman's Working Outfit Free

These are regular working instruments—the kind I use myself. I give them free to you if you enroll at once. The handsome set of instruments shown here is imported and encased in a plush-lined leather case. One of the most exquisite sets I have ever seen. **Send the FREE COUPON today.**

### FREE BOOK and EARNING while LEARNING OFFER COUPON

Chief Draftsman, Engineer's Equipment Co.,  
Div. 2664, Chicago, Ill.

Without any obligation to me whatsoever, please mail your book, "Successful Draftsmanship" and full particulars of your liberal "Personal Instruction" offer to a few students. It is understood that I am obligated in no way whatever.

Name \_\_\_\_\_

Address \_\_\_\_\_

You will get SPECIAL ATTENTION if you tell Advertisers you read American Carpenter and Builder.

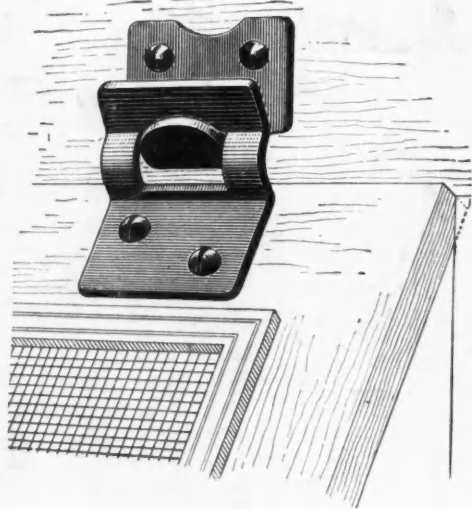
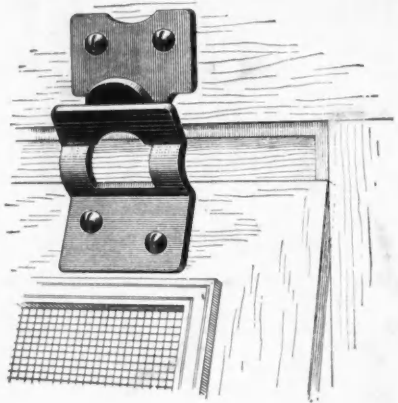

## It's Easy

to hang full length  
screens with

## “National Automatic” SCREEN HANGERS

Simply rest top of screen against blind stops inside of casing and slide screen up. It will hook automatically.

These hangers are easily attached and will hold screen firmly in position and prevent rattling.

Extra bottoms can be secured from your dealer for storm sash.

Ask your dealer for “National” No. 80 Automatic and be sure to get them. They will please both you and your customers.

---

*General catalog mailed on request*

---

### National Mfg. Co.

Sterling, Ill.