

JULY 1914

AMERICAN CARPENTER AND BUILDER

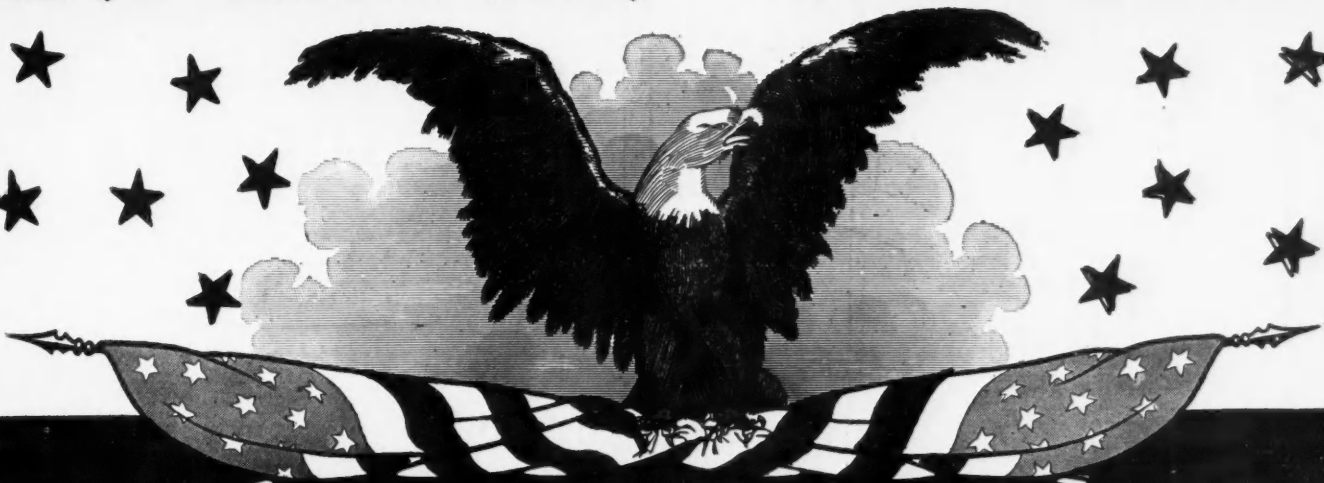

THE WORLD'S GREATEST BUILDING PAPER

BUILDER TYPES

Picturing certain important groups of "Our Readers"

② THE CONTRACTING BUILDER

— IN numbers and importance the most commanding figure in the building world—Keen, conscientious, aggressive—this man turns "air castles" into substantial, enduring structures. No job is too small and no contract too big for this man. Since he builds every day of the year, the amount and variety of building materials he specifies and uses is enormous.



Price 10 Cent

4,000
Blows per
Minute



Do Your Drilling, Chipping, Caulking, or Surfacing with an ELECTRIC HAMMER

or the Manually Operated

Drilhammer



If you have a lot of work to do, the solution of the problem for you is our **Electric Hammer**. If you have but a small amount of work to do at any one time, the **Drilhammer** is the thing to use. In either case you can do the work **ten times as fast**.

Our Drilhammer

does the work in one minute that takes ten times as long by cruder methods. Strikes 1,000 powerful hammer blows per minute. Operater simply turns the crank.

Centrifugal force does the work. Hardened tool steel hammer elements revolving at high speed strike the blows.

Exceedingly simple in construction. Has no springs to weaken or wear out. Makes an immense saving in the cost of drilling concrete, brick, stone, tile, conduit, walls, floors, ceilings, etc.

Made in two sizes and accomodates drills from $\frac{1}{8}$ in. to $1\frac{1}{4}$ in. Can be carried in regular tool kit. Sold at a price that will enable every mechanic to have one. Write for circular 132 and prices.

This ELECTRIC HAMMER

is practically automatic;—i.e. the same pressure that holdst he too' against the work closes the switch in the handle and starts operation. Delivers four thousand blows a minute. Built for various voltages. Requires only one or two amperes on 110-volt circuit. Circular A-13 describes it.

For use on direct current, or can be used on alternating current by using a motor generator set.

Send for the Circulars illustrating and describing these hammers. The price at which they are sold make it desirable that you should own one immediatelp.

ORR & LOCKETT

Established 1872

HARDWARE CO

Main Office, 14-16 W. Randolph St., Chicago

Branch Offices { 401 Broome St., New York
Room 608-79 Milk St., Boston

Our Electric Hammer

is ten times as rapid as the old-fashioned, hit-and-miss method of striking the head of a drill or chisel with an ordinary hammer.

It does not cost a fifth as much for power to operate it as the pneumatic or steam-driven types. It does not involve any complicated generating equipment and transmission lines, such as piping, hose, etc.

It can be installed in half a minute and taken down in less time.

It is portable, self contained, and always ready for the job. Simply attach plug to any convenient electric light socket.



Ceiling
Work
Made
Easy



No
Exertion

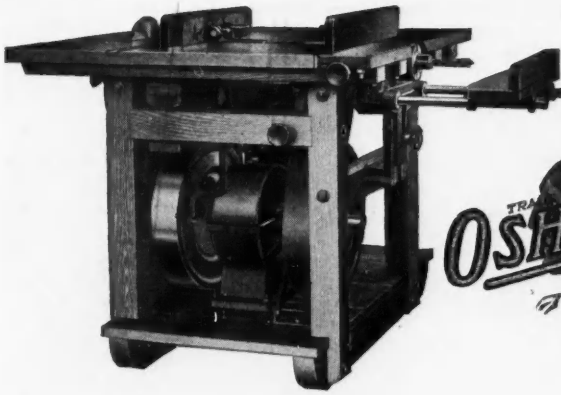

Complete Set of
Attachments
FREE

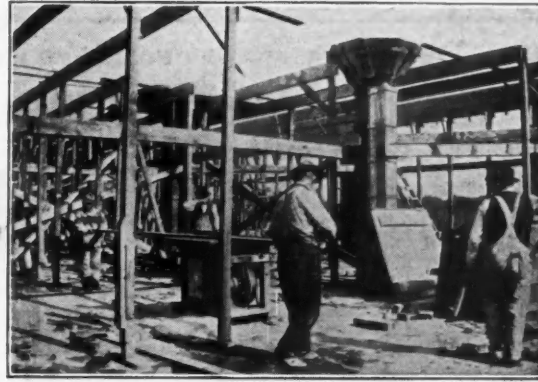

An Eveready Saw Rig Saves the Wages of Six Men

NEW LIST OF AGENCIES

- CHICAGO, ILL.—Oshkosh Mfg. Company, 1440 Monadnock Bldg.
 - ATLANTA, GA.—Oshkosh Mfg. Company, Southern Sales Office, 604 Walton Bldg.
 - CINCINNATI, O.—K. & H. Contractors' Mach'y & Supply Co., 1128 Gilbert Ave.
 - DENVER, COLO.—Geo. W. Summers & Company, 355 Railway Exchange.
 - EVANSVILLE, IND.—Indiana Builders' Supply Co., Furniture Exchange Bldg.
 - MILWAUKEE, WIS.—Badger-Packard Mach'y Co., 74 West Water St.
 - NEW ORLEANS, LA.—Henry J. Malochie, 802 Ferrin Bldg.
 - OMAHA, NEBR.—Sunderland Mach'y. & Supply Company.
 - PORTLAND, ORE.—G. A. Saunders Supply Co., Bldrs. Exchange, 2nd and Alder Sts.
 - RICHMOND, VA.—I. Bluford & Company, 1538 East Cary St.
 - SALT LAKE CITY, UTAH—F. C. Richmond Mach'y. Co., 117 West Second South St.
 - SAN FRANCISCO, CAL.—J. E. Dwan & Co., 445 Turk St.
 - LOS ANGELES, CAL.—J. E. Dwan & Co., 1835 South Main St.
 - SAN DIEGO, CAL.—J. E. Dwan & Co., 250 Fifth St.
 - PHOENIX, ARIZ.—J. E. Dwan & Co., Creighton Bldg.
 - SEATTLE, WASH.—Harold G. Stern & Company, 524 First Ave. South.
 - ST. LOUIS, MO.—C. O. Fischer & Company, 112 International Life Bldg.
 - KANSAS CITY, MO.—King Supply & Equipment Co., 1201 Scarritt Bldg.
 - PITTSBURGH, PA.—Patterson Bros., 421 Wood St.
 - BIRMINGHAM, ALA.—Chadwick & Company, 510 Empire Bldg.
 - ST. PAUL, MINN.—Dally-Fraser Hdwe. Company, 417 Cedar St.
 - CHARLESTON, S. C.—KANAWHA, WEST VA.—O. A. & H. G. Thayer Company.
 - MONTREAL, QUE.—The Canada Mach'y. Agency, 298 St. James St.
 - WINNIPEG, MAN.—John H. Alexander, 604 Builders' Exchange Bldg.
 - VANCOUVER, B. C.—Dominion Dock & Supply Co., 304 Northwest Trust Bldg.
- MIXERS AND PUMPS EXCLUSIVELY.
NEW YORK, N. Y.—John J. Duggan, Room 1652, 50 Church St.

Oshkosh Mixer

It will pay any contractor to get acquainted with the OSHKOSH MIXER. Request brings full information. Write us today for prices and Special Offer.

The Mixer with the Effective 4-Way Mix. Also built for steam or electric power.



Ask for the Bore and Stroke of the Engine

Whether a Portable Saw Rig will *pay* you or not, depends largely on the *Engine*. It requires *power* for a machine to turn out the work of from 4 to 6 men and soon return its *full cost*. Some makers of Saw Rigs *claim* all kind of power for their machines. We state the facts—bore, 4¾ inches—stroke, 6 inches. More than that, we guarantee our Engines will develop over 4 actual brake horse power. Now for some tangible

Proof of What the Eveready Portable Saw Rig Has Done

Note we did not say *will do*. One contractor who formerly bought factory-made window frames, now makes all his own frames with our machine, at 30% less cost and secures even better frames. Another, a building contracting concern, used our machine in building a church and it saved them enough the first season on that *one* contract alone to almost pay for the Saw Rig.

Our Eveready Saw Rig is not a frail, weak machine like some are, but built heavy and strong enough for any service. It is also constructed so that it is easy to *move* from one job to another. Also, so *simple*—anyone can operate it. Besides doing cross-cutting and rip-sawing, it joints, sands, jig saws, grooves, bores, miters, and grinds tools. All attachments complete come with it—*no extras* to buy. Send for our Catalog, which gives complete details and contains a long list of letters from well known users.

Live Agents Wanted in Open Territory

OSHKOSH MFG. COMPANY

316 South Main Street

Oshkosh, Wisconsin

FOR SURFACING AND POLISHING HARDWOOD FLOORS

The American Floor Surfacing Machine

IS NO EXPERIMENT. Its work since 1903 has established a standard for finely surfaced and polished floors. It is the only machine whose work is specified by leading architects and used in the best government buildings and will surface and polish any kind of a floor from common pine to finest parquetry.

IT IS THE ORIGINAL and only two-roll, self-propelled, dust-collecting machine, that surfaces close to the wall and can be used in small rooms. Anyone can operate it.

ITS WORK IS RAPID, regular, smooth and even, because the power that drives the rolls also propels the machine at the same ratio of speed. It has surfaced and polished millions of square feet of the best floors in America and Europe.

GET A MACHINE that does first-class work and in paying quantities, that is fully guaranteed and sold on its merits. Don't be fooled with an imitation.

We sell direct to the users. Write for our free book "Surfacing Floors as a Business."

Use Our Champion Double Disc Machine for Cement, Terrazzo and Marble Floors.

Manufactured by **The American Floor Surfacing Machine Co., Toledo, O.**



\$25.85



THE ADJUSTABLE TOOL



The Haven Planing Floor Scraper

THE Haven Planing Floor Scraper Becomes the STANDARD TOOL ON THE JOB

wherever it is used. Builders have awakened to the fact that it solves the problem for good. Our machine differs entirely from all others. The secret of our splendid success rests on the following points:—

- (1) The scraping tool is a true plane, the world's standard leveler.
- (2) A light running carriage.
- (3) A smooth trackway for carriage.
- (4) A shearing cut on the instant.
- (5) Machine remains stationary while scraping enclosed area.
- (6) Angle of blade and thickness of shaving regulated with ease.
- (7) All woods are alike easy.
- (8) No man-killing truck to pull or push; you rest on the return stroke.
- (9) Planes and scrapes simultaneously.
- (10) No chattering, waving or gouging.
- (11) The planing head does better work than the usual hand work, and from four to six times as much.

If you have tried other machines and been disappointed, then TRY OURS AND BE CONVINCED THAT WE HAVE THE GOODS. A TRIAL COSTS YOU NOTHING.

DON'T BUY AN INFERIOR MACHINE WHEN YOU CAN GET THE BEST ON EARTH FOR \$25.85. Send for booklet and complete information concerning our guaranteed machine and free trial offer.

THE HAVEN MFG. CO.

—:—

RACINE, WIS.

Scrape Your Floors with a LITTLE GIANT SCRAPER

At Our Expense

Its low cost and efficiency make it a very desirable part of each builder's equipment.

Try it Before Buying Prove to yourself that it is the best floor-scraper on the market.



Send Today for Our Special Offer

HURLEY MACHINE CO.

1008 Flat Iron Bldg., New York, N. Y.

Specify and Install THOR WASHING MACHINES

They are a necessary requirement to every home. Do away with Laundry troubles. Your clients will appreciate them. So will your wife.

Built to Meet Requirements Electric Washers from \$30.00 up.

Sold on Liberal Free Trial Easy Payments



HURLEY MACHINE CO.

37 So. Clinton St., CHICAGO, ILL.

THE AUTOMATIC BALL BEARING ELECTRIC FLOOR SURFACING MACHINE

Contractors and builders find, dresses in paying quantities, quarter-sawn oak, etc., the way they want it or rapidly refinishes old floors. Having ballbearings, roller and dust-suction fans spin true and easy; yielding arms give flexible or rigid roller as needed; self-propelling with automatic control (as shown) gauges roller cut for even work and brakes forward pull for large capacity—you simply guide. Surfaces to base baseboard with Edge Roller. No hand scraping

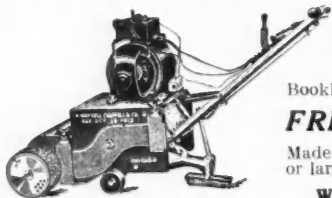

Patented Oct. 15, 1912. Machines sold outright for use anywhere.

Booklet tells all about it and our **FREE TRIAL OFFER.**

Made in several sizes for small rooms or large areas.

WAYVELL CHAPPELL & CO.

Dept. D, 4847 E. Ravenswood Ave. CHICAGO, ILL.

You May Pay a higher Price

but you can't get a better Floor Scraper than the Fox. It's a dandy. Fox Supply Co.

Dept. A
Brooklyn, Wis.



Complete Scraping Outfit

Only \$25



IMPERVITE is Guaranteed to Waterproof Walls: Cellars & Pits.

A facing of **IMPERVITE MORTAR** on the inside will resist water on the outside.

ASK FOR BOOK No. 62 **The Standard Paint Co.** NEW YORK BOSTON CHICAGO

Houses, Flats and Apartments

Buy a Plan Book of Flat Buildings and plan an income in your old age. Our book gives you ideas from two-family flats to twelve families, and our prices are reasonable.

First edition (right off the press) 50c
 Also a book for residences 25c
 Both 65c

H. O. Cook & Company

722 Ashton Building Grand Rapids, Mich.



WOOD

FREE TRIAL
5,000 in use

RAPID, FLEXIBLE, SELF-PROPELLING WHEN RAISING HANDLE

Send for our new list and free trial proposition.

M. L. Schlueter
 107 N. Canal St.
 Chicago, Ill.

Made in three sizes: 8 x 18, 8 x 15 and 8 x 12 in. Flexible Roller. Edge Roller easily adjusted to either side.

MONITOR SASH LOCKS



(PATENTED)

NEVER BREAK

BECAUSE THEY ARE MADE OF VERY HEAVY GAUGE METAL AND PERFECTLY CONSTRUCTED.

If the upper plate drops, the Monitor "Never Break" Sash Lock will pick it up from a lower point than any other, adjust the sashes perfectly, prevent all vibration and lock securely, so it cannot be opened from the outside.

MADE IN TWO SIZES AND ALL FURNISHED BY

The Champion Safety Lock Co.
 Geneva, Ohio

Adjustable Floor Finishers

being sold today than all others combined

There's a reason

Ask me why

H. P. DIDRIKSEN
 Anderson, Indiana

H. P. Didriksen
 Anderson Ind.

Without obligating me in any way, you may send your printed matter, provided you accept this coupon as a partial payment, if I decide to buy for cash.



THIS COUPON IS WORTH \$2.50

Name.....

Town..... State.....

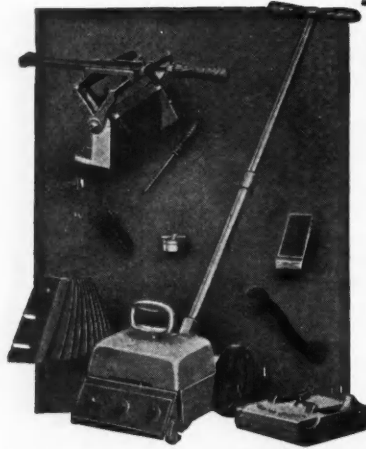

Makes Floor Scraping an Easy Job

The automatic action of the Acme Floor Scraper allows the operator to stand in an easy, upright position while working. No back-breaking positions to get into, and no lifting. Simplest and most effective floor-scraping machine on the market.

Let me prove this by having me send the complete

ACME FLOOR-SCRAPING OUTFIT

to you on a week's free trial basis at my expense.

Catalog and complete detailed information of my Free Trial Offer are yours for the asking.

JOSEPH MIOTKE, 247 Lake St., MILWAUKEE, WIS.

Straight-grained cedar that cuts like cheese; smooth, tough leads that make clean-cut, strong marks—that's the way Dixon's Carpenter Pencils are described. Send 16c for generous sample lot 183J.

JOSEPH DIXON CRUCIBLE CO.

✠✠✠ JERSEY CITY, N. J. ✠✠✠

MONEY FOR YOU

By Our Plan

UNIVERSAL CLOTHES DRIER

The kitchen wonder.—Indispensable to every housewife. Can be attached to wall or ceiling. Easily removed. Contains 30 feet of drying surface. Adjustable to suit convenience of operator. Does away with lines and the cumbersome clotheshorse. No kitchen or laundry complete without a UNIVERSAL-DRIER. Neat, durable, irreplaceable. Every demonstration a sale.

Retails for \$1.50. Big commissions to reliable men.

WE WANT AGENTS

Write today for our liberal offer that will make money for you during the dull season.

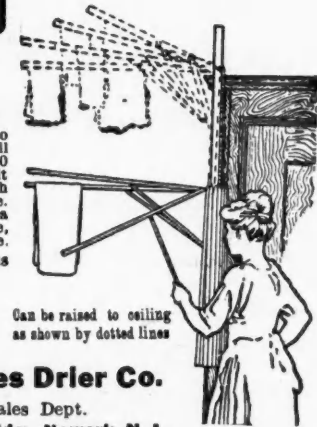

Can be raised to ceiling as shown by dotted lines

The Universal Clothes Drier Co.

Factory: Rutherford, N. J. Sales Dept. Ordway Bldg., Newark, N. J.

\$13.95

per doz. 4 footers
—if you send cash
with order.

Absolutely Safe; two of them will carry a ton, and they last a lifetime. Think of the time you save! One man alone can put them up and take them down easily and quickly.

No Side Swing if you purchase our new fixture at 60c extra per dozen brackets: these keep the brackets absolutely rigid.

Write for Catalog of Builders' Specialties!

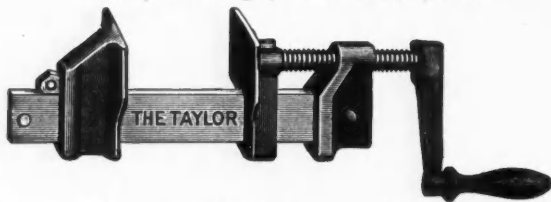

About clamps—the sliding jaw on each of ours can be moved in an instant DIRECTLY AGAINST the work operated on, so that half a turn of the fine specially threaded screw will apply the power.

Think of the time this saves!

The grip is positive, and special grade of steel in the bar more than doubles the strength of the clamp.

Our No. 10 catalogue shows some very interesting price reductions on four of the most wanted styles. It will pay you to write for it at once.

James L. Taylor Mfg. Co.

Poughkeepsie, N. Y., U. S. A.

C. E. JENNINGS & CO'S

71-73 MURRAY ST., N. Y., U. S. A.

TRADE MARK.

COMBINATION SET OF SAWS No. 131

This set of saws is just what you need. Takes up very little room in the kit and is less expensive than if you bought all the saws separately.

Each blade is fully backed by our guarantee both as to quality and workmanship. The saws are hand-forged from extra refined spring steel, hand filed and set. Warranted to hold edge and set for longest possible time and to run smoothly and easily.

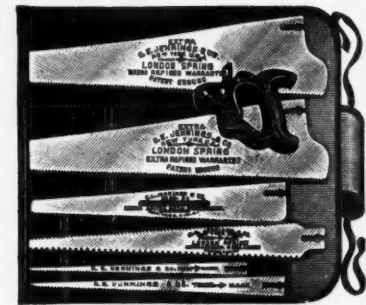

An adjustable lever in the handle operates the screw that holds the blade. Blades may be removed from the handle instantly and another blade substituted. Blade is held firmly and evenly.

Combination Set No. 131 consists of:

- 1—Garland Adjustable Handle
- 1—18-inch Hand or Panel Saw
- 1—12-inch Rip Saw
- 1—16-inch Double Edge Pruning Saw
- 1—15-inch Hack Saw
- 1—14-inch Compass Saw
- 1—12-inch Keyhole Saw

A Waterproof Canvas Case for this set with seven pockets—one for each blade and one for the handle, will be furnished at a slight extra cost.

Ask your hardware dealer to show you Set No. 131. It is so handy and the price so reasonable that you'll like it. Write us for descriptive Circular.

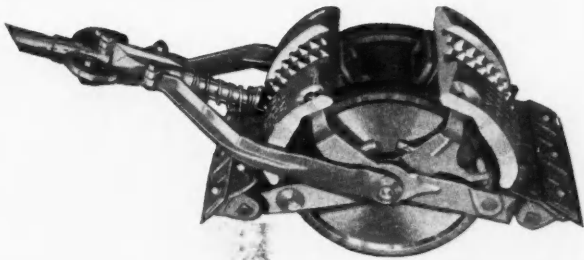

This machine is for you. It is boxed up on my factory floor just waiting for you to mail me your address. Write for it and put it to work.

Take your fingers and count off the things that it will earn this season:--a two week fishing-trip, a new dress for the missus, a set of tires for that auto, a bicycle for Johnnie--depends on how much floor scraping you have to do.

25,000--think of the number of these scrapers that are earning good honest dollars for others. Yours is No. 25,001. Give it a five day trial on any job you have. If you do not wish to keep it --then ship it back to me.

But you won't let it get away from you because it has a lot of little kinks in floor scraping that are all its own--and mighty winning. I'd like to have you here so that I could show you, but as that is not convenient, I'll send it to you and let it show off its own good points.

I expect a letter day after tomorrow. Just tear this ad out, pin to your letter-head, and mail to me. I'll know the rest.

John F. Weber. Pres.,

Weber Mfg. Co.,

670 71st Ave., West Allis, Wis.

The WEBER DOUBLE ACTING Floor Scraper



The Only Floorsmoothing Machine With the Spring Drive

Fully as efficient as a power machine, much less expensive and guaranteed to take *two-thirds* of the work off the operator. Perfectly balanced, smooth running, and adjustable to any floor in any condition.

Adjustable in weight
Adjustable in depth of cut
Adjustable in shear of cut

TRIPLE "A" FLOORSMOOTHER

has a steel spring "engine"—a feature possessed by no other machine. The operator pushes the machine forward. The spring winds and stops the machine at just the right distance. The spring then begins to release, starting the Triple "A" on the return, or cutting stroke. The operator merely guides it.

The only work required is to push the machine forward. It stops, starts back, engages the knife in the floor and finishes the cut. This is why the Spring Drive lessens the operator's work fully *two-thirds*.

Every part of the Triple "A" is worked out with the most careful attention to detail. Simple to use. Nothing to get out of order. A "peach" at a price that makes it a good "buy."

Send for Illustrated Circular and Interesting Data about the Triple "A." It will earn \$20.00 a day easily.

Showing method of burnishing the blades. A free set of tools furnished with each machine



TRIPLE "A" MACHINE CO.
Room 321, 300 W. Grand Ave.
CHICAGO

A Good Elevator

Is a Good Investment
Saves Time and Labor

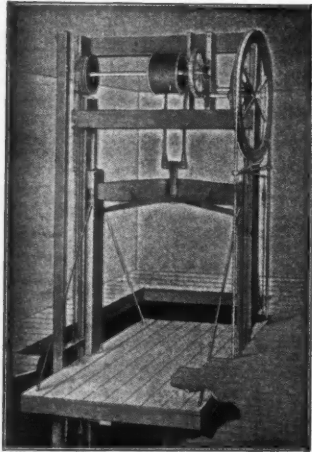

Our product includes **Dumb-Waiters, Carriage, Auto and Store Elevators** — Hand and Power.

These machines are serviceable and will pay for themselves in a very short time. Being practically self-contained, they can be erected by any carpenter or "handyman" in a few hours' time. Plans for erecting furnished with each elevator.

The Reasonable Cost Will Interest You

Write to us today stating your requirements, giving style of machine wanted, size of platform and number of feet travel and we will name you a money-saving price on equipment made to serve you well.

SIDNEY ELEVATOR MFG. WORKS, SIDNEY, OHIO

The Demand For GOOD DUMBWAITERS Is Increasing!

Each job presents special requirements. Some one type of Dumbwaiter will give better results than any other.

The Sedgwick Machine Works have compiled a new catalogue giving full details of many different types. It is sent on request and you should have a copy.

All catalogue sizes and types are carried in stock. Telegraphic orders filled same day they are received.

Blue prints and complete directions for erecting sent with each outfit.

SEDGWICK MACHINE WORKS

132 Liberty Street, New York

STOP THOSE RATTLING WINDOWS

Do away with sash weights, cords, pulleys and pocket frames and save money by using

AUTOMATIC SASH HOLDERS

Proved by Use—Unexcelled for windows without pocket frames. Excellent for new windows.



Send for circular and prices, or \$1.00 for trial set prepaid; state approximate weight of sash.

AUTOMATIC SASH HOLDER MFG. CO. 52 Church St., New York

STORM Dumbwaiters and Hand Elevators

No stock sizes. Built to fit the place. Ask your hardware dealer and write us for catalog. Let us send you our new Catalog with Discounts.

THE STORM MFG. CO.

Herman & Vesey Sts.

NEWARK, N. J.



Excelsior Dumb-Waiters

The only Knock-Down Dumb-Waiter ever offered, shipped complete to a nail, with explicit directions for erecting, for **\$18.50**

Up-to-Date in Every Particular

Hardwood Car, Self Retaining Machine, Adjustable Weight, Guide Ropes, Timbers and Hardware. Ropes joined by coupling. No splicing. Will fit any ordinary opening up to 24" x 30".

Send for Printed Matter

R. M. RODGERS & CO.

74 Emerson Place - - Brooklyn, N. Y.

WARNER ELEVATORS and DUMB-WAITERS

HAND POWER and ELECTRIC

SEND FOR CATALOGUE

The Warner Elevator Mfg. Co.

Cincinnati

New York Indianapolis Birmingham Dayton

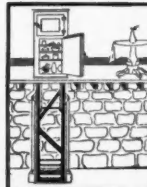

CARPENTERS AND BUILDERS make extra money by installing this practical necessity in new and old homes. It saves 3650 trips to the cellar each year. "WIFE'S JOY" DUMBWAITER—Ball Bearing—Disappearing Operates quickly by a press of the button. Takes up no room. Top lies flush with floor; can be walked on. Practical for any home. Keeps food perfectly. Can be installed complete in 2 hours. WRITE FOR CIRCULARS. Fifteen Days' Free Trial Without Any Deposit. AMERICAN ELEVATOR CO. - - Bloomsburg, Pa.

CHELSEA

EXEMPLAR OF QUALITY

Send for our Elevator and Dumbwaiter catalog

CHELSEA ELEVATOR CO. 330 W. 26th St., N. Y.



CARPENTERS WANTED AS AGENTS During Fall and Winter Months. Big Money! Ready Seller.

SANITARY AUTOMATIC DUMBWAITER

saves carrying food to and from the cellar. Perfectly ventilated; screened openings; finished inside with durable white enamel. Keeps food perfectly. Top lies flush with kitchen floor. You can walk over it. Operates with push button or lever. Also furnished as a Refrigerated Dumb Waiter. Write for Particulars and Prices. YORK AUTOMATIC DUMBWAITER WORKS 639 W. Market St. YORK, PA.



HOISTS & ELEVATORS

Columbia Dumb-Waiters
Pavement or Cellar Hoists
Jumper Disappearing Dumb-Waiters
Chain Blocks, Cranes and Trolleys

Send for Catalog

J. G. SPEIDEL Reading, Pa.



GET THIS MIXER ON YOUR MIND



Because

It is the biggest and best small batch mixer on earth.
 It is built of the best iron and steel—by the best mechanics.
 It mixes all kinds of concrete, mortar, etc.
 It requires very little operating expense, and attention.
 It costs next to nothing for up-keep.
 It is always ready to do business every day.
 It is priced to you on a cash basis and sold at a low figure.
 It is furnished on skids without power, if you have your own engine, or it is mounted on trucks with engine, or mounted complete with Hoist, or mounted complete with Loader, Hoist, Mixer, or engine can be used indefinitely.
 A mixer and outfit built for YOUR particular purpose.
 Get our catalog and information and your "Big-an-Little" will come later—Increased profits—More contracts—Better QUALITY Work, all go Hand in Hand with the "Big-an-Little."

THE JAEGER MACHINE CO.

318 West Rich Street

COLUMBUS, OHIO

STOCK CARRIED BY

The E. B. Kelley Co., 50 Church St. N. Y.
 At Syracuse, Boston, New York and Trenton.
 Lee T. Ward Co.,
 The Bourse,
 Philadelphia, Pa.
 W. M. Pattison Supply Co.,
 Cleveland, Ohio.
 Bournival & Co.,
 Montreal, Canada.

E. R. Bacon Co.,
 San Francisco, Calif.
 At San Francisco and Los Angeles.
 Everett, Bradt Co.,
 At Dallas and Houston, Tex.
 Henry H. Meyer Co.,
 Baltimore, Md.
 S. H. Edlin Co.,
 Indianapolis, Ind.
 Contractors Equipment Co.,
 Des Moines, Iowa.

Sydnor Pump & Well Co.,
 Richmond, Va.
 S. O. Holder Supply Co.,
 Cincinnati, Ohio.
 Ames Agency,
 Salt Lake City, Utah.
 Fred N. Wilson,
 331 W. 35th St., Chicago, Ill.
 Speaks Lime & Cement Co.,
 Superior, Wis.

Don't Consider an Imitation Look for the Patent Mark

Pat. Jan. 24, 1905.
 Pat. Feb. 14, 1905.
 Pat. Jan. 29, 1907.
 Other Patents Pending.



We Can Save You Money In Your Mortar Mixing

Mr. G. Ed. Berry, a Harrisburg, Ill., contractor, writes us that with the Blystone Mixer, "One man has slaked my lime and made mortar for eight and ten masons besides having time to spare for other work. I have saved the cost of at least one man's wages and a gain of ten per cent more mortar per barrel of lime over the old way of mixing."
 Is YOUR mortar or plaster mixing a profit eater. Why not make it a profit producer? Our Blystone Batch Mixer is a mortar and plaster mixer as well as a concrete mixer. It can save you time, labor and material on every mortar or plastering job you do.
 The Blystone Mixer operates very easily. It is filled while in motion and material is discharged while machine is in motion. It mixes material in full view, insuring an absolutely accurate mix. The reverse spiral paddle system of the Blystone mixes rapidly, turning material over forty times in ONE minute. Blystone Mixers are furnished with gasoline engine power equipment, or for belt driving. Mounted on skids or portable hand trucks.

BUILDERS—Get The Facts About The Blystone

Let us send you our catalogs and other matter explaining in detail just how the Blystone can save YOU money. Write us for this information right now—while you have it in mind. Asking us for details puts YOU under NO obligations.

THE BLYSTONE MACHINERY CO.
 19 Carpenter St. : CAMBRIDGE SPRINGS, PA.

A Trial on the Job is the Only Real Test

Words don't prove the worth of a mixer. Work does. You won't be "stung" if you try out a mixer before you buy it.

WINNER CONCRETE MIXERS

are not sold on the "cash with order" plan. We want you to be satisfied that the Winner is the mixer for your jobs before you pay a cent. Then there's no dissatisfaction—no regrets.

Try a Winner Mixer. Costs you nothing for freight whether you like it or not. Send for our catalog, "Money-Making Mixers," and get our idea of fairness to our prospective customers.

CEMENT TILE MACHINERY CO., 135 Rath St., Waterloo, Iowa



Winner Mixer with Side Loader.



90 Cubic Yards Per Day

Saves 60 to 90 cents on every yard. Pays for itself several times each season. Gives you the edge on your competitors. So light that two men can carry it. Big savings in freight and handling. Can always be set to discharge direct into forms. Saves all wheeling from machine. This alone saves one-third the labor necessary to operate other mixers.

Not a Man-Killer Has an enormous capacity

SIMPLE—COMPACT—HANDY—SUBSTANTIAL

New Principle—Quick Charging—Quick Action—Quick Discharge

Its mixing blades have a criss-cross, kneading, plowing, hoeing motion which press and fold the entire batch over upon itself many times every second. Insures a quick and thorough mix. You will be proud to say you have a Northfield Hand Batch Mixer, once you see its work.

The SLUSH mixer mixes 4 cu. ft. of finished concrete per batch. A batch per minute or 90 cu. yds. per day is easily possible under favorable conditions. 30 to 60 cu. yds. per day is a fair average on ordinary abutment, floor, wall or bridge work. Over 10 cu. yds. per hour have been averaged. When operated by power—one man alone can mix mortar fast enough for a crew of 20 brick layers.

The DRY or WET mixer is good for any kind of mixing—either Dry, Wet or Slush. Is extra fine for brick or block plants, core sand, plaster, brick mortar, chemicals, etc. Capacity—2 to 3 cu. ft. per batch—or 15 to 45 cu. yds. per day. Is just like the SLUSH mixer except a slight change in the drum heads and agitator. Is the best for an all-purpose mixer. The SLUSH mixer is best for big jobs and rapid contract work where slush mixtures are used.

Two men turn either machine easily and do not work as hard as the shovelers. A pump engine will run them. It is not necessary to have a big expensive power mixer to economically mix concrete. No job is too big or too small for the Northfield. No better mixer can be had, even at ten times its price.

Write direct to factory for catalogue, prices and terms.

NORTHFIELD IRON COMPANY
402 Water Street - Northfield, Minn., U. S. A.

Supplies the Demand for a Small Perfect Mixer



Capacity 3 to 5 Cubic Feet Per Batch

Weight, 800 Lbs.

On Trucks, 1000 Lbs.

On Trucks with Engine, 1400 Lbs.

McCracken Batch Mixer

The McCracken Portable Batch Mixer

is designed and built to meet the demand for a strong, simple, durable and practical mixer, that is large enough for all ordinary contract work, yet light enough to be profitable on the small job as well as on the large. Mounted on good steel trucks, EXTRA LARGE DRUM OF THE PROPER SHAPE, equipped with our own high-grade 2-HP. SIOUX engine, enclosed in a good steel housing (not a cheap box), also has friction clutch, so that drum can be started and stopped without stopping the engine. Capacity, thirty to forty yards per day. Cost for power, twenty-five cents per day. The largest, best and most complete mixer on the market for the money.

Write for Further Particulars

SIOUX CITY ENGINE & MACHINERY COMPANY 9th and Division Sts. SIOUX CITY, IOWA

THE WINNER MIXER



Will make money for you even if you don't have work enough to keep it running all the time. The cost is very small, and one gallon gasoline will run it a day.

Mixes 4 and 5 cubic feet per batch
Daily capacity, 30 to 40 cubic yards

Ask for our FREE Catalog

THE CEMENT TILE MACHINERY CO.
133 Rath Street Waterloo, Iowa

BOSS Batch Mixer \$198

F. O. B. Factory—Complete with 4½x6 in. Cylinder 3 H. P. Mandt Engine

A sturdy compact mixer. Good for any job. Sold on guarantee to mix as thoroughly fast and economically as any mixer on the market of equal size, regardless of cost.



We can make this price because cheap manufacturing power from Keokuk dam and immense output with low overhead expense keeps down our costs.

Boss mixes and remixes 40 times over—batch a minute. Loads direct from barrow. Self cleaning discharge. Chain drive. Turn under wheels on trucks.

Can be equipped with Builders' Hoist, Engine House, Power Loader and Automatic Water Tank. Write for prices and catalog.

The American Cement Machine Co. (Inc.)
1006 Johnson Street Keokuk, Iowa

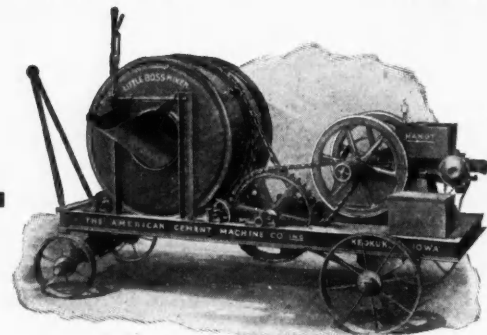

THE BEST CEMENT BLOCK IN THE WORLD

Continuous open air space; reinforced all around; staggered bearings. Makes strongest buildings and silos at least cost.

Block Machines, Automatic Tamers, and Continuous Mixers made by the

BRAGSTAD CONCRETE MACHY. CO. - CANTON, S. D.

Write for Catalog and Prices

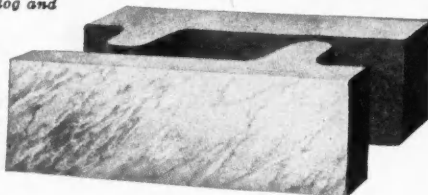

See our Exhibit Space 4 Building Material Exhibit. Insurance Exchange Bldg. Chicago, Ill.

LITTLE WONDER "FIVE"
without Side Loader
Capacity 5 cu. ft. per batch—35 to 50 cu. yds. per day



Between These Two Lies Your Choice if You've Really Investigated Mixers—

and then it's merely a question of capacity—with or without SIDE LOADER, according to your need.

No man who has kept pace with the development of concrete mixing since this machine introduced a new type and inaugurated a new era, can fail to perceive that *the Original of the Type* is still the best buy. Exclusive patented features, improvement following improvement, steady gains in efficiency, with persistent adherence to *QUALITY*, and all without increase in price, have won confidence and sales exceeding anything ever seen in the industry. Nation wide endorsement in letters from thousands of more than satisfied contractors proves all our claims—ask us to show you what they say.

THE LITTLE WONDER "FIVE"

"The Mixer that Makes the Money"

Years of Service

—not months, is the aim and the result of *WONDER* construction. Note the three heavy A-Frame Standards supporting drum and power drive. These give rigidity, long main shaft, wide bearings and room between for pulleys, hoist, etc., also Rotary Pump.

Note I-Beam Steel Section Frame and Axles; staggered steel wheels, wide tires, standard tread. *SIDE LOADER* takes barrows endwise or sidewise.

Drum gives perfect mix, any consistency, including brick mortar; quick discharge, any quantity, and is self-cleaning. Dust-tight grease-cups and perfect lubrication for drum shaft and ball bearings. 2½ H.P. Gas engine, positively reliable, with steel house.

Ten Days' Free Trial

on your own work without any obligation whatever, and a hundred Service Stations throughout the country, cap the climax of *LITTLE WONDER* satisfaction.

TRY the *WONDER* and be *SAFE*

The Most Complete and the Most Efficient Mixing Machine Ever Designed

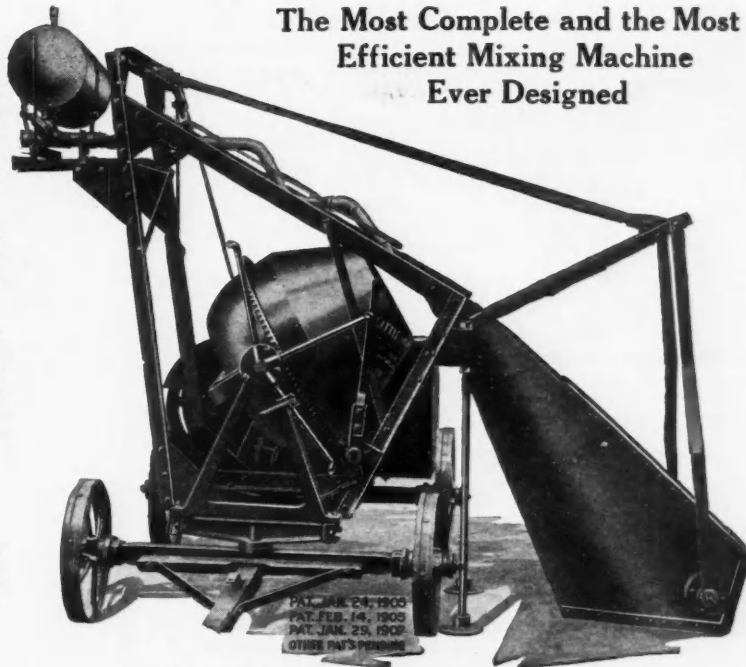

SIDE LOADER with Water-Measuring Tank Doubles Capacity

WATERLOO CEMENT MACHINERY CORPORATION, 103 Vinton Street Waterloo, Iowa

BRANCHES—New York, Philadelphia, Chicago, Kansas City, Montreal. Also 100 Service Stations

"I Don't Think They Can Be Equalled"

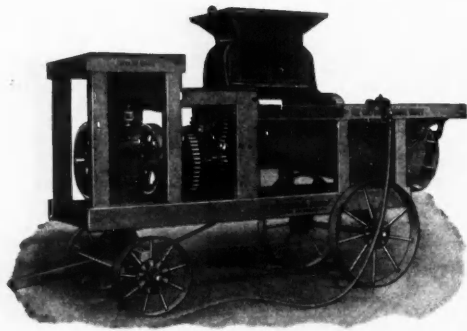

No. 9 Coltrin Mixer.

Clara City, Minn., March 9, 1914.
 THE KNICKERBOCKER CO.,
 JACKSON, MICH.

Gents:—I purchased a No. 9 Coltrin Mixer last spring from your Minneapolis agency. Will say that I don't think they can be equalled. Mixed most every day last summer as high as 225 sacks of cement, 1 to 4, in a day. By attaching an 8-inch pulley, I am pumping water for stock and am also running a small Wonder feed mill, grinding feed for my stock. Works fine, and not an extra needed during time except a change of batteries. All seems as good as new. What machine can duplicate this? I have never seen one.

If you wish to print this, you have my permission. Trusting you may sell me another some time, I am,

Yours very truly,

CHAS. GEIST.

The Coltrin Continuous Batch Mixers

Shipped anywhere on trial. Write for Catalog.

THE KNICKERBOCKER CO. :: JACKSON, MICH.

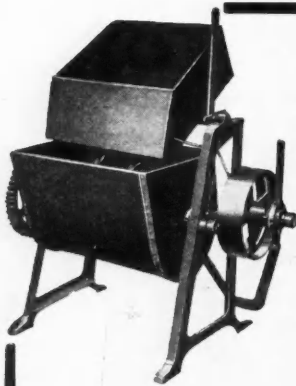

Think of It!

This **HELPER** mixer that will mix mortar and concrete, only **\$35.00**

It will mix two cubic feet at a time. The measuring box enables you to get another batch ready while one batch is being mixed. Requires 1½ h.p. engine to run it. Daily capacity 15 to 20 cubic yards.

Send us your order now, or ask for FREE catalog giving more information.

THE CEMENT TILE MACHINERY CO., 132½ Rath St., Waterloo, Iowa

Introducing the New Sasgen Peerless Steel Derrick

with a full circle swing. Capacity 2,000 lbs. Drum runs in SELF-LUBRICATING BEARINGS. Bottom sills and mast can be folded together.

PRICE ONLY **\$45.00**

equipped complete for hand and power with 125 ft. crucible steel cable, swivel block and fasteners. \$2.00 less for hand power only.



Write for Illustrated Circular No. 2

T. P. Setter Pole Regular Setter
 Our motto — "Satisfaction or No Sale."

SASGEN DERRICK CO.
 2053-57 N. Racine Ave.
 CHICAGO, ILL.

CANADIAN OFFICE, 13 JARVIS STREET, TORONTO, ONT.

Buy The **SIMPLEX** 1914 Model MIXER

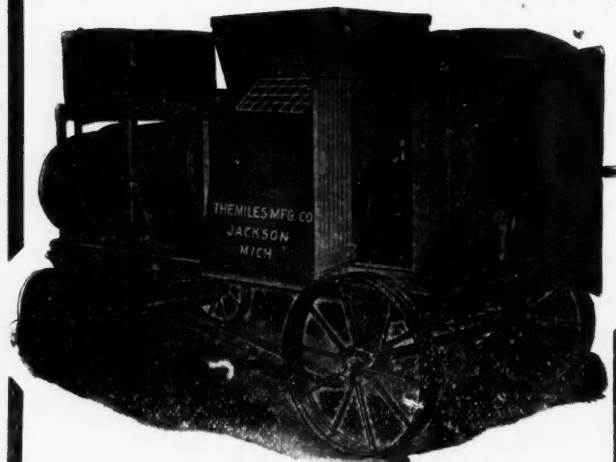

Combining the good features of both batch and continuous mixers in the one machine.

The best feature of the Batch Mixers is the rolling of the materials. The greatest advantage of the Continuous Mixer is the automatic measuring and feeding of the materials.

Only one machine combines these two features—the **SIMPLEX**. It's the happy medium between the two types of mixers, giving the points of advantage claimed by each, and eliminating the faults of both.

Write for New Complete Catalog.

The Miles Mfg. Co.

309 E. Franklin St.

JACKSON, MICH.



SPEEDING UP THE JOB

Sooner or later, every contractor asks himself the question: "How can I speed up my job?" For some reason or other you have to rush the work. Will your concrete mixing plant stand the extra strain, or will it fall down on the job? You realize, as no one else can, how much money you lose every time your mixer is shut down for repairs during the ordinary work. How much greater will be your loss, therefore, when it comes to the "hurry up" work. What you want, is a mixer that is compact and has few wearing parts—One that operates easily—One that is built right, of good material and excellent workmanship—A mixer that will be "ON THE JOB" every moment. Such a mixer is the all-steel

No. 5 Smith-Chicago Special

It's a batch mixer of an approved type, with a $3\frac{1}{2}$ cubic foot wet capacity. Back of it is the guarantee of the biggest concrete mixer manufacturer in the U. S. It is not a new machine. Ten years have been spent in perfecting it—in bringing it to a point where the contracting trade recognize it as a mixer they can bank on at all stages of the game.

Can you add to its modern, up-to-date features? Check over its advantages: All-steel construction; heavy Z-bar frame; "ground level" loading skip; central drive ring and roller tracks; easily operated "external" discharge spout; large, patented scoop blades which give a perfect mix and fast discharge. Before risking your money on other equipment, post yourself about this machine which has demonstrated its fitness on all classes of work. Send for No. 5 Smith-Chicago Folder No. 39-V.

Send for No. 5
Smith-Chicago
Mixer Folder
No. 39-V
Including
Special Proposal

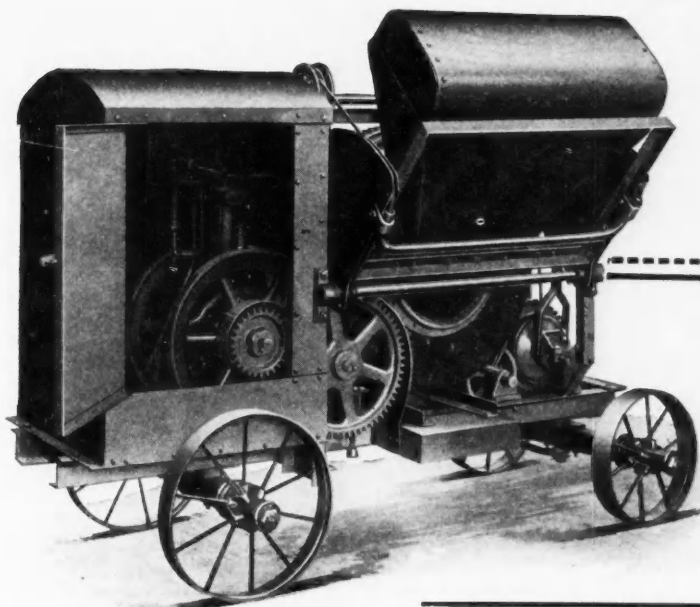

The T. L. SMITH CO.

3123 Hadley St. - MILWAUKEE, WIS.

1306 Old Colony Bldg.

CHICAGO

MAILING COUPON

I am interested in a Concrete Mixer that will mix from 40 to 50 yards daily. Without any obligation on my part, send me NO. 5 SMITH-CHICAGO SPECIAL FOLDER NO. 39-V and SPECIAL PROPOSAL.

Name

Address

—“from the Charge to the Discharge”

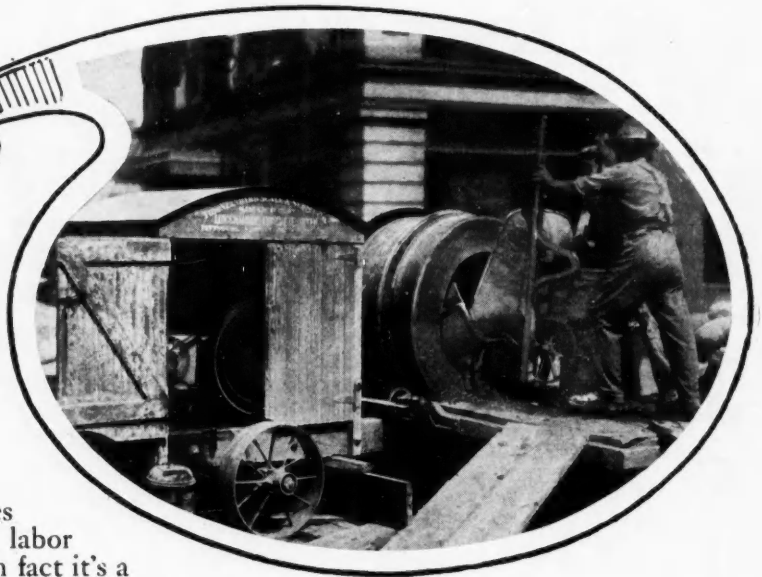

Don't do things by halves—

LOW-CHARGING

—a saver that not only saves on the first cost—but on the labor cost—operating cost—and in fact it's a 1/3 saver from the time you buy until you pay your last man at night.

Study these illustrations—first note the simple, yet sturdy, compact construction. Second, note that manner of charging—up a short incline, into the drum—One Direct Operation Charge from the Barrow. It is this **LOW CHARGING** that effect the 1/3 saving—that pays for the machine and builds your profits. Why not investigate the savings of

“The **STANDARD**” **Low Charging Mixers**

Watch the **LOW CHARGING** in your vicinity. For every class of work—any where and any time you will see that

LOW CHARGING will save you money

WHY NOT GET IN TOUCH WITH

The Standard Scale & Supply Co.

Manufacturers of High Grade Machinery for High Grade Work

CHICAGO PITTSBURGH PHILADELPHIA NEW YORK
1345-47 Wabash Av. 243-245 Water St. 35 South Fourth St. 136 W. Broadway

Why they Save **YOU** 1/3 on every Dollar

State _____
Town _____
Street _____
Name _____

Send Sample Catalog No. 447

TEAR OFF THIS SLIP AND GET CATALOG No. 447

Do you want the most complete Catalog ever issued on contractors equipments?
SEND THIS SLIP



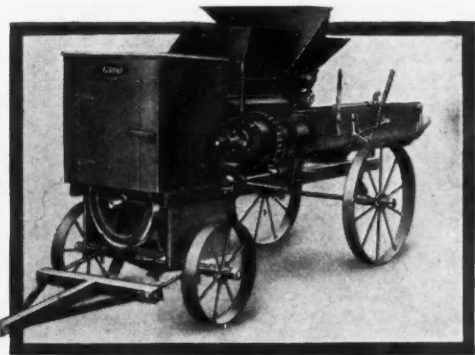

The BABY GRAND CONTINUOUS MIXER

combines all the good features of *mixer* and *hoist* at the price of *one* machine.

The BABY GRAND is a logical investment for the Carpenter and Contractor because both mixer and hoist are greatly used in modern construction. You can afford the Baby Grand. It is portable; capacity, 4 to 5 cu. yds. an hour. 2½ H. P Gasoline Engine furnished with the machine.

The HOIST is mounted on the frame (see illustration). Operates with or independent of the mixer. Simple friction clutch for starting and hand brake for holding load. Capacity of hoist, 400 pounds. Lifts load 100 ft. per minute.

Our latest CATALOG gives a complete description. Send for it. We also make the HARTWICK TWO TROUGH MIXERS for heavy construction work.

HALL-HOLMES MFG. COMPANY
436 Oak Street Jackson, Mich.

ARCHER CONCRETE MIXER

Capacity 4½ cubic feet wet concrete per batch. Just the mixer for economical work on large or Small Jobs.

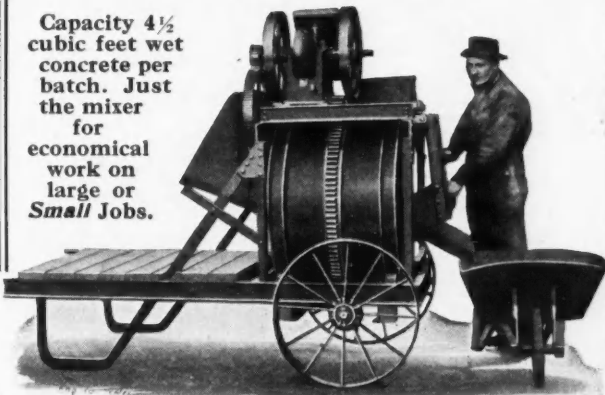

Saves the Work of 5 Men

The Archer Mixer by fast mixing and by discharging the concrete directly into the forms saves the work of five men. No wheeling is necessary. Loading platform is low. Barrow dumps into the charging hopper which is strongly braced so it will not bend or "give" under weight.

The price of the Archer makes it an attractive investment for the Carpenter and Contractor. It is built of first quality iron and steel with blue annealed steel plate drum. 3½ H. P. Gasoline Engine. Platform 5 feet long by 38 inches wide and 21 inches high. Can be used anywhere on the job—in the basement or on the roof. We agree to refund your money if the Archer does not do all we claim. Write for full description and price.

Archer Iron Works
2430 West 34th Place

CHICAGO, ILLINOIS

THE Atlas MIXER



CAPACITY—5-ft. batch, easily fifty cubic yards per day.

Contractors everywhere are enthusiastic in endorsing its wonderful adaptability to any size job and any kind of work.

They tell us that two 5-foot **Low Charging** Atlas Mixers do considerably more work than one 10-foot machine and the cost is no greater.

Atlas Mixers

Portable Durable
Simple Dependable

Sold at a price you can afford to pay

How the Atlas is built

Channel iron frame—heavy boiler plate drum—splendid lubricating system—expanding ring clutch—very low charging hopper and, last but not least, an exceptionally sturdy, powerful engine—the kind used on machines that sell at much higher prices.

Every contractor and every dealer will find the Atlas Mixer Book interesting. Just ask for it.

Atlas Engineering Company

780-90 Thirtieth St. MILWAUKEE, WIS.

Four Points to Consider When You Buy a Mixer

Look for strength in the mixer you buy; look for mixing efficiency—for ease of operation and low price

Dunn Mixers really combine these four features. Heavy steel and iron construction throughout assure more-than-usual reliability. The extra long drum and unique arrangement of mixing paddles mean perfectly mixed concrete. The low charging height make loading and discharging easy. And the low prices—well, just investigate them!



Patent No. 842262 and 782700

This is the Dunn No. 1, with Power Discharge—the Labor Saver.

Prices from \$67.50 to \$224.00

There are Dunn Mixers on skids for \$67.50; these are intended chiefly for stationery use for making cement blocks, brick, tile, etc. There are Dunn Mixers on trucks, complete with gasoline engine, for from \$150, which suit the needs of building contractors exactly.

Investigate Dunn Mixers at once. Investigate the power discharge feature—the quick mixing feature—the liberal guarantee. And don't forget that we give you the privilege of using any Dunn Mixer 15 days before you pay us. Ask for a copy of the mixer catalog today

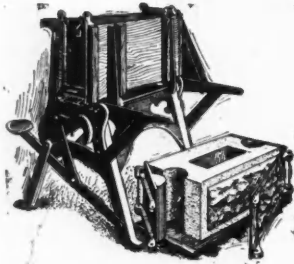

The Block Machine For Builders' Use.

What's the use of buying a block machine that will make only one kind of cement block—when the Dunn Combination Cement Block Machine will make three kinds! You ought to be able to make Face Down, Side Face and Two-Piece Hollow Wall Blocks—Each style is in demand. The Dunn machine gives you such equipment—for one investment.

No possibility of cracked blocks—the Dunn system of off-bearing prevents all fear of breakage. Permits the use of a wet mixture which makes the strongest blocks with little tamping. Price, \$40—on 15 days' trial before you pay us. Write today for block machine catalog, which also tells about Dunn Porch Molds, Sewer Pipe Molds, Drain Tile Machines, etc. Sent free to any address.



W. E. DUNN MFG. CO.
4132 Fillmore Street, Chicago

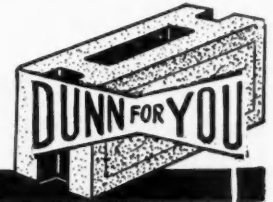

Steel King

10 FOOT SIZE.



The lightest, strongest lowest priced, big capacity mixer ever made. Sold under fairest, squarest guarantee ever written.

These Features Make the Steel King the World's Best

Specially constructed—mixes and remixes batch a minute 40 times over. Dust Proof Wick Oiling System provides thorough lubrication.

Steel construction insures greatest service with least possible wear.

Loading hopper placed just right. Easy to load direct from wheelbarrow. Self-cleaning discharge.

Chain drive—no gears to strip. Steel trucks with turn under wheels. Powerful engine. Capacity just right for 80% of your jobs. Price—so low it will surprise you. Investigate today. Write for literature and complete details.

The American Cement Machine Co., Inc.
1006 Johnson Street Keokuk, Iowa

ROOF FRAMING MADE EASY



By the use of our little book

It's Free

Send today for one of these and learn how to get the lengths and cuts of all rafters for seventeen different pitches of roof. We stamp

this rule on our squares, making it handy and convenient.



We Manufacture the Only Practical Take-Down Square

NICHOLLS MFG. CO.

OTTUMWA, IOWA

Guaranteed Lightning Protection

Our Pure Copper Cable Lightning Rods and attractive fixtures are easily put on any building by



Carpenters and Builders—

You know the property owner has confidence in you while working on his building. Get the additional job of protecting his building from lightning. Our rods are in big demand—there's a good profit in selling them. Let us show you the way to more profits on the same job.

Write today for **free** cable samples, agents' prices and catalog.

Jos. A. C. Barnett & Co.
Riverside Iowa



BUY NOW. SAVE \$15.50

Special 30-Day Offer

In order to advertise the **Leader Cement Brick Machine**, we make this special sale price of **\$12.50**. The regular price is \$28.00. You save \$15.50 by placing your order now.



Sale Price \$12.50

The **Leader Cement Brick Machine** is guaranteed. Money back if you're not satisfied. Makes 5 cement brick in one operation. A man can make 1500 to 2000 brick in 10 hours. Built of cold rolled steel. Lasts a lifetime.

This is your chance to get this **GUARANTEED** machine with complete set of face plates and outfit at a very low price. Remember this offer is good for 30 days only. Send your order today. We will cheerfully refund your money if you are not satisfied.

Write us now for Full Particulars.

STARCH BROS. CO., LA CROSSE, WIS.

FOX "UNIVERSAL TRIMMER"

TRADE MARK

A Machine For Every Need

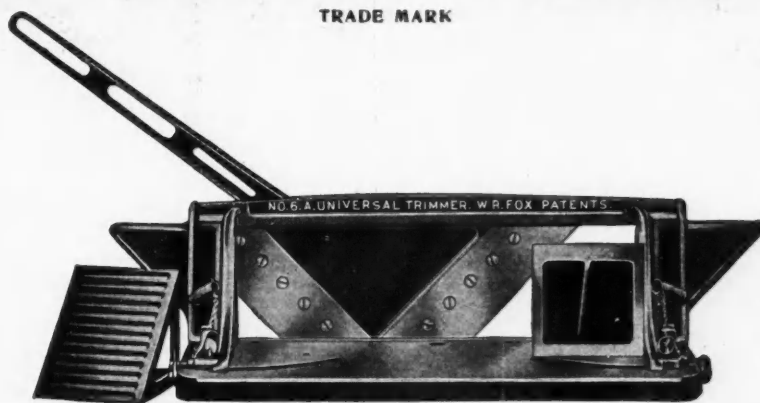

A Need For Every Machine

6A. FOX "UNIVERSAL TRIMMER"

You Will Never Know What Perfect Work is Until You Use a Fox "Universal"

The fitting of interior finish is greatly improved by using a Fox Universal.

Write **TODAY** for Our New Catalog

FOX Machine Co.

22 FRONT AVENUE N. E.
GRAND RAPIDS, MICHIGAN

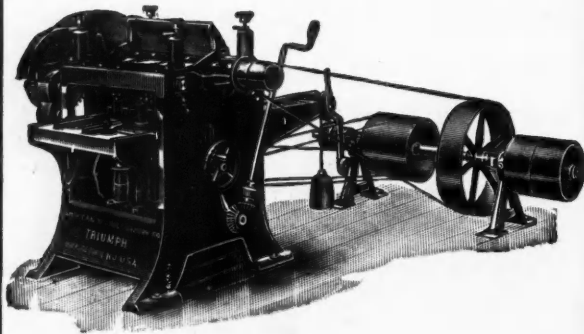

*Save Time
Prevent Delay
Figure Lower
Deliver On Time
Build Your Reputation*

with the

**“TRIUMPH”
PLANER, MATCHER
AND MOULDER**

One of these machines in your own shop gives you a planing mill of your own, that enables you to get your mill work when you want it, at actual cost of production.

This means quick delivery of the finished job, a satisfied customer, and a reputation for rapid, high-class work that builds up business.

Send for the “Triumph” Pamphlet

**American Saw Mill
Machinery Co.**

80 Main Street
HACKETTSTOWN
NEW JERSEY

1360 Hudson Terminal
NEW YORK CITY
NEW YORK

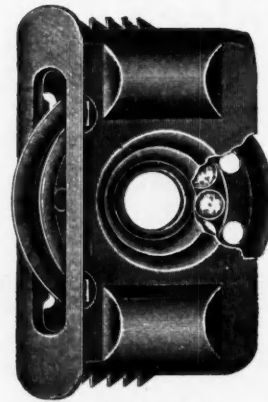

No. 10 Ball Bearing

**“Grand
Rapids”**

**BALL BEARING
ALL STEEL**

Sash Pulleys

Fasten automatically.
No Nails. No Screws.
Just bore four holes.

The automatic saw tooth fastening feature and the simple and easily made mortise will save in labor enough to pay for the pulleys.

The Bearing contains eleven ¼-inch Solid Steel Balls running in lubricant.

NOISELESS. EVERLASTING

Write for FREE Samples

Grand Rapids Hardware Co.
MANUFACTURERS

158 Eleventh St. :: Grand Rapids, Mich.

**Parks Portable Shingle or Combination
WOODWORKING OUTFITS**

This machine is a combination of circular rip and cross cut saw 6 or 12-inch jointer with tilting guide, boring attachment, jig saw with tilting table sand disk, and gasoline engine, guaranteed to do the work.

Angle steel frame is the strongest structural material known. Machines are made in large quantities which allows us to sell at lowest prices and make prompt shipment. WRITE FOR CATALOG

PARK'S
Ball-Bearing Machine Co.
Fergus Street and C. H. & D. Ry., CINCINNATI, OHIO

are the most practical—the most efficient—the most economical woodworking equipment you can buy

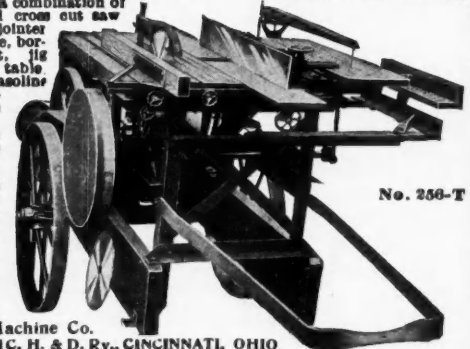

No. 250-T

**COMPLETE OUTFIT \$15.00
HAND AND FOOT-POWER
MACHINERY**

Our No. 7 Scroll Saw is warranted to be made of good material and workmanship, and to saw pine 3 inches thick at the rate of one foot a minute.

Send for Catalogue.

W.F. & Jno. Barnes Co.

74 Ruby St. ROCKFORD, ILL.

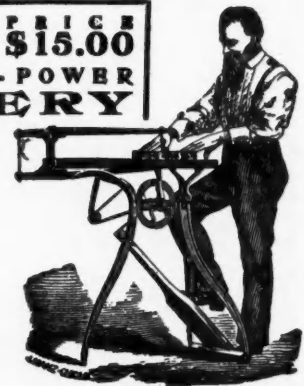

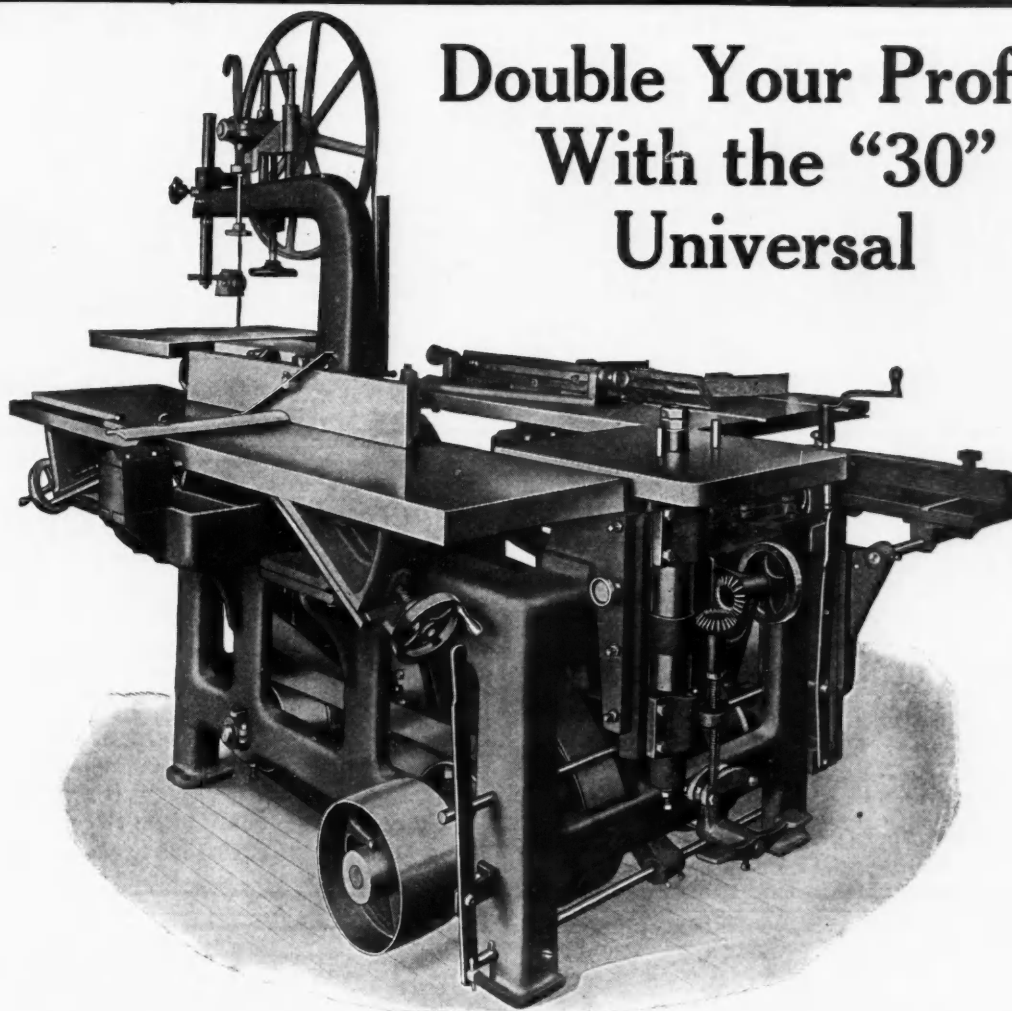

Double Your Profits With the "30" Universal

You helped Smith pay
for his automobile!

Yes, you did! You turned over to Smith and his mill work that you could do yourself with a "Famous" Woodworker. He made a good profit on YOUR work—on OTHER work turned in to him—and NOW he's driving a fine, new car! You helped pay for it. You are helping to pay for OTHER automobiles—and it's time you began to put this extra money into your own pocket.

Are you going to do
it again this year?

A "Famous" Universal Woodworker will enable you to save hand labor—keep the profits that belong to you in your own shop—promise (and DELIVER) more quickly—handle more work at a better profit—stamp you as the progressive man—and add new business by leaps-and-bounds.

There is a special "Famous" for you. Send the coupon and we will tell you something about it. Send it today. Don't help pay for the "other fellow's" car any longer. You want one. A FAMOUS will help get it.

THE SIDNEY TOOL CO., :: Sidney, Ohio
Now!—mail the coupon.

Sidney Tool Co., Sidney, Ohio.
Gentlemen: I want my own car. Prove to me that
you bet, a "Famous" for me—that will do my
work best. Send your catalog No. 12-1
I am interested.
Signed.....
Business.....
Address.....

“OHIO EXTRA” AUGER BITS are High Grade Single Twist Bits, carefully made from specially selected auger bit steel. They are the **Most Rapid Cutting and Perfect Clearing Bits** on the market today and are fully warranted.





“OHIO” CHISELS, PLANES, ETC.

All “Ohio” Tools are made with the same painstaking care that has built up our present reputation for making only high grade tools. We use in our Edge Tools high grade steel, treated and tempered by the most improved process, which insures **Uniformity and Correctness of Temper**, and a **Keen, Tough and Lasting Cutting Edge**. If you appreciate Good Tools it will pay you to insist on having “Ohio” Tools from your Dealer.

Write for our special Carpenters' Catalogue of High Grade Tools and Benches

OHIO TOOL CO. (Dept. 15) Charleston, W. Va.



Articles Every Carpenter Needs

Boxwood Folding Rules
Spring Joint Rules
Steel Rules



Steel Tapes
Woven Tapes
Pocket Tapes

We guarantee to YOU absolute satisfaction
CATALOG ON REQUEST

THE LUFKIN RULE CO.
New York Saginaw, Mich.

When in need of these say to the hardwareman



Fly Screens

Metal Frame
REWIRABLE CIN-MAN-CO.



See method of securing wire cloth, held by rounded corners, which prevents cutting by vibration.

Special inducements to Carpenters and Builders
Booklet Free

The Cincinnati Fly Screen Co.
1010-1026 Evans St., Cincinnati, O.

BLAKE QUICK ACTING VISE



For Cabinet Makers and Wood Workers. Simplest—Strongest—Cheapest—Best

Send for Catalogue of all kinds of Vises

PRENTISS VISE COMPANY, MAKERS
106-110 La Fayette St., New York, U. S. A.

Miller's Lock Mortiser
TWO MINUTES

Will cut an opening in a door for a mortise lock

IMPROVED AND UP-TO-DATE

cuts true, in any kind of wood for any size lock from 1/2" to 1 1/2" thick. Easy to operate; durable in construction. Builders use it everywhere.



Sent subject to trial.

A. W. Miller Mfg. Co.
Riverside, Calif. Cincinnati, Ohio
or Butt Mortiser and Rule Gauge for 75c., Postpaid

GENUINE BANGOR Roofing Slate
Structural Slate
Blackboards

Large Facilities, Prompt Deliveries

EAST BANGOR CONSOLIDATED SLATE CO. East Bangor, Pa.

Standard Portable Combination Woodworker

9 Machines in 1
6 H. P. ENGINE



SEND FOR CATALOG G

ATLANTIC ENGINE CO.
Meadville Penna.

WRITE US

FOR OUR NEW
1914 CATALOG



AS PIONEERS in the manufacture of **PORTABLE SAW RIGS**, we are entitled to claim that we manufacture the **BEST Portable Saw Rigs** on the market today; in fact, we make them complete in five different sizes to meet every requirement of the trade.

We also manufacture hoists, pumps, elevators, mortar mixers, concrete chutes, air compressors, gasoline engines, etc.

Write Us for our new 1914 attractive Catalog

C. H. & E. MANUFACTURING CO., Inc.

322 Mineral Street

MILWAUKEE, WISC.



Section of Main Floor Exhibit and Salesroom

Everything in wood working machinery and supplies for Contractors, Carpenters, Builders, Interior Finish, Sash and Door, Planing Mills, Furniture, etc.

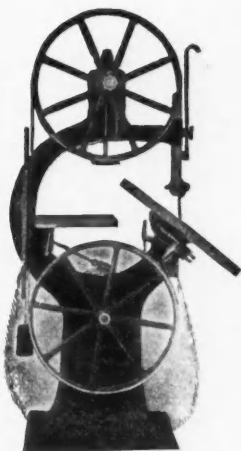

Chicago Band Saws
27-32-36 inch wheels

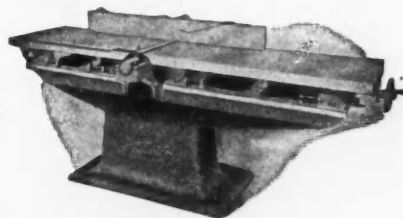

Chicago Jointers
8-12-16 inch



*Write us Your Wants
and Get Our Special Price*

Chicago No. 9 Combination
Saw

Chicago Machinery Exchange

1215-1223 Washington Blvd. :: CHICAGO



EVERLAST

The Handle Never Loosens

HYNALER HAMMER

A very high grade tool that will suit you in grip, hang and hardness of head. Illustration shows nail-holding device for high nailing. Hollow steel handle that will not loosen. Fitted to the head in a way to absorb all the shock of driving.

We manufacture High Grade Socket Joint Tools with Hollow Steel Handles exclusively.

Get the Everlast Hynaler Hammer from your dealer, or send \$1.25 and get one direct by parcel post. Catalog of tools free.

HAWTHORNE SALES CORPORATION, Mfrs.,
228 W. 42nd Street New York, N. Y.



Say SHELBY "CHIEF"

When you ask for a double-acting, ball-bearing, surface floor hinge. "The hinge without woes, as the wise buyer knows." The cheapest floor hinge money can buy, when quality and efficiency is considered.

Shelby Chief should be on the floor plates, accept no other.

THE SHELBY SPRING HINGE CO., SHELBY, O.



Something Every Man With Any Mechanical Ideas Should Have for Himself—And As an Agent

With Compass the New Improvements Now Make
The American Combined Level and Grade Finder
Most Practical, Durable and Convenient Instrument Made

SIDE VIEW



TOP VIEW



At one glance you can get the true slant on any line or grade either in degrees, inches or percentage, or all at the same time, and will at once give the exact distance needed to plumb up to a true level. The additional spirit level glass now placed in middle of instrument with points on dial will give 3 grades for leveling. The longitudinal recess shown in cut is well worth the low price of the instrument. Write AT ONCE for circular and Testimonials. Special Introductory Price given to First Applicants with privilege of taking Agency. ADDRESS

Edward Helb, Mfr., Box 255, Railroad, Penna.

Henderson House and Barn Builder

The best designed machine for framing all material for any building. All material, including bridging braces for a two-story, hip roof residence 16'x32' was prepared in 3 hours and 20 minutes. 4 h.-p. engine gives necessary power to run all the machines at the same time. Hand jointer, rip saw, swing saw, boring machine and work bench 9' long x 32" high, all complete. Handles heavy or light timber.

Write for description and price.

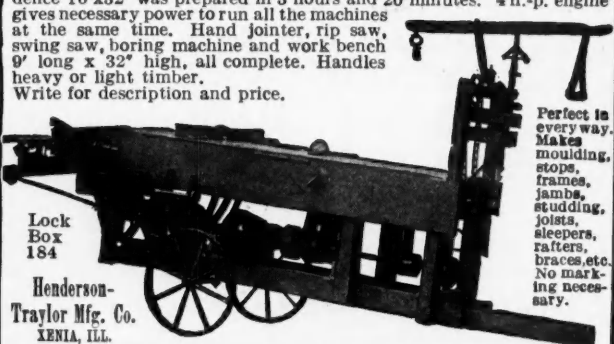

Lock Box 184

Henderson-Traylor Mfg. Co. XENIA, ILL.

Perfect in every way. Makes moulding, stops, frames, jamba, studding, joists, sleepers, rafters, braces, etc. No marking necessary.

STANDARD CLAMP



HARGRAVE

A Steel Screw and a Wide, Strong Frame are

the two features which give the Hargrave Standard Clamps the utmost resistance to wear and failure.

These Clamps are just as carefully made as all of the Hargrave Tools.

Catalogue?

Dept. H

THE CINCINNATI TOOL CO.
Norwood, Cincinnati, Ohio

When you want tools of any kind — tools that you can bank on to be just the kind and quality you want them to be, insist on the Swan Trade Mark.



It's a plain guide to all that is best in carpenters' tools and your assurance that you are dealing with an old, reliable firm that makes tools as good and solid as its reputation.

ASK FOR CATALOG

The JAMES SWAN CO.
Seymour, Conn.







That old hand saw is a mighty useful tool. You couldn't get along without it. But it can't do the work of the "CRESCENT."

You've seen a dozen men sawing away, working their heads off to get their dimension stuff ready for a framing job. Seems foolish, doesn't it, when the Crescent, with one or two men, can do the same work in a few hours? Just put two of your men on the Crescent Universal Woodworker and the rest of the crew can get busy framing. Why, the saving in time and wages on one fair-sized framing job will just about pay for the Crescent. Then there's the other work you can do—the inside trim, the door and window sash, and a dozen other things.

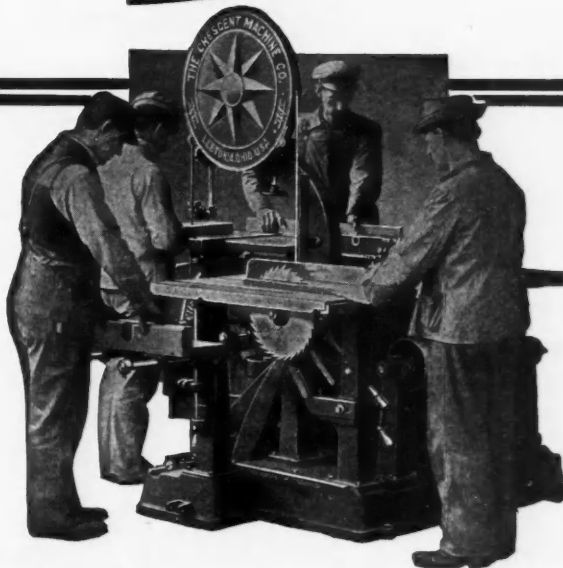

Crescent Universal Woodworker

is practical, compact, convenient. It is especially adapted to your work because it is easily and economically operated. The Crescent provides all the facilities of a fully equipped planing mill at a very low cost. It will cut your mill work bills in two. The construction of the Crescent shows quality

throughout. Today it represents the highest type of woodworker at a low price. It is a purchase for a lifetime.

We equip the Crescent with a 26" or 32" band saw and an 8", 12" or 16" jointer. The machine complete has band saw, jointer, saw table, reversible spindle shaper and borer. Special attachments may be added to make the machine adaptable as a re-saw, hand-feed molder, tenoner, panel-raiser, pole-rounder, disk-grinder, knife-grinder, plain grinder and hollow chisel mortiser. Any part of the machine can be used independently of the others. Four men can work at the same time without interference.

Our New 1914 CATALOG is Ready to Mail

This 143-page book accurately describes the Crescent Universal Woodworker. We manufacture a complete line of wood-working machinery including Variety Woodworkers, Planers, Surfacer, Swing Saws, Jointers, Saw Tables, Vertical Borers, Post Borers and Special Equipment, which are also illustrated and described.

Get This Free Catalog by Writing For It Now.

THE CRESCENT MACHINE CO.
224 Main Street
Leetonia, Ohio

What You Can Do on the CRESCENT

- Re-Sawing
- Cutting Off
- Tenoning
- Moulding
- Panel Raising
- Knife Grinding
- Mortising
- Pole Rounding
- Disc Grinding
- Rabbeting
- Boring
- Grooving
- Dadoing
- Jointing
- Band Sawing
- Ripping
- Sanding

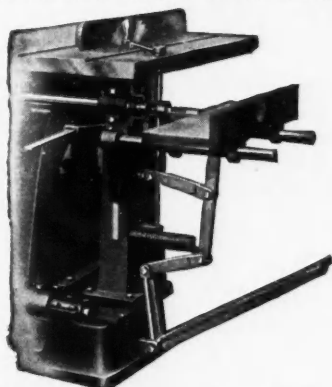

This attachment converts the borer into a hollow chisel mortiser, suitable for cutting mortises up to 5/8 inch square.



ANY ANGLE IN A SECOND

WITH an ordinary Mitre Box, you can cut angles from 45 deg. to 90 deg. only, but with the

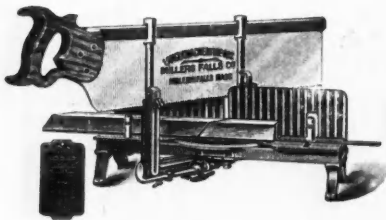

**Langdon
Acme
Mitre Box
Improved**

You can also cut angles on 2½ in. stuff from 15 deg. to 90 deg. This helps on lots of work—extends the scope of the Mitre Box and so gives you more for your money, for the value of a tool is largely measured by what it will do, and the Langdon Acme Improved will do more than any other Mitre Box, hence is worth more.

For hard drilling and lots of it the new

**“MILLERS FALLS”
Hand Drill No. 306**

is unexcelled. It's very strong and rigid; has solid steel frame; cut gears; ball thrust bearings; right or left ratchet; three-jaw STAR chuck, taking round shanks from 0 to ¼ in.



Ask your dealer. Most good dealers handle “Millers Falls” Tools. If yours does not, write us and we'll send you the name of a dealer who does, together with a copy of our *New Catalog*.

Millers Falls Company

Millers Falls,

Massachusetts

CONTRACTOR CLEARS \$450 IN 10 DAYS

M. H. Ireland,
Anamosa, Ia.
—Contractor—
cleared above by
using LITTLE
WONDERS—
What one man
can do with Little
Wonders you can
do—Get next to
this LITTLE
WONDER
TRUCK—It will
triple your profits.



**10 ROOM HOUSE 5 MILES 10 DAYS
MOVED**

Let us furnish your complete House Moving Equipment—everything from Little Wonder Trucks to rollers, jacks, etc. Get our catalog “B” right away. Don't delay. Just a post card brings it in a hurry.

HOUSE MOVERS SUPPLY COMPANY 626 Eastlark Court Cedar Rapids, Iowa

Architects Convertible Level

For builders. An instrument of the highest type of accuracy and efficiency—Combines the ordinary contractors level with a transit. It has all the usual Beckmann nicety of manufacture and accuracy.

Guaranteed in Every Way.

Write for Builders Manual “Y”

THE L. BECKMANN CO.
7500 Adams St., TOLEDO, O.

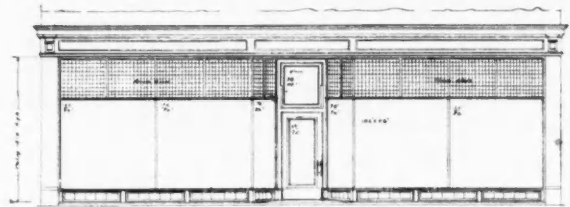

One of Many Petz Patent Store Fronts.

Order Petz Bars on the Rush Store Front Job

Possibly you need only two corner posts—or a transom bar, or 10 feet of sill or sill covering—

But you want it quick—

A store front is waiting—

Then write us a rush order, our material is turned out quickly. Your order isn't one of many—it's a job which has the personal attention of our metal foreman. He's a great fellow for getting the work out and he'll work for you like a brother.

When Detroit people want store fronts in a hurry they telephone us and we get it out on the jump.

No order too small.

If you haven't got a copy of our book on metal store front construction you'd better send for it right away, so you'll always have it right on hand.

And when you get it—use it.

DETROIT SHOW CASE CO.
491 West Fort St. DETROIT, MICH.

WHITE'S IMPROVED LEVEL

SHIPPED ON APPROVAL



Our No. 2011 Improved level, illustrated herewith, is especially designed for work where a general purpose level is required. Telescope is 12 inches long with magnifying power 25 diameters, and is capable of detecting an error of 1-16 inch in 300 feet. We ship this level out on approval, express prepaid, in order that you may try it out on your own work before deciding to keep it. Ask today for your circular X and special net price sheet. Ask today!

DAVID WHITE COMPANY
No. 2011 419 E. Water St. Dept. C Milwaukee, Wis.

Two Instruments for the Price of One

(Pat. Pending)



When in need of an Architect's Level or a Builder's Transit do not fail to investigate our

Transit-Level

It is convertible and will serve as a first class Builder's Transit as well as an Architect's Level. If you should have use for an instrument at all you should buy this accurate, durable and most serviceable instrument which is without question the leader as to general usefulness among all instruments on the market. It has no equal for Efficiency and Economy.

To keep abreast of up-to-date methods send for Catalogs and Circulars and be informed as to the latest and best.

GEIER & BLUHM
672 River Street, Troy, N. Y.

"Sterling" Convertible Level



The wise Builder does not look at price only, but investigates the advantages and practical values before selecting a Level.

If you would know why you should select a "Sterling," write TODAY regarding Free examination privilege.

WARREN-KNIGHT CO.

Makers of

"STERLING" TRANSITS AND LEVELS

136 N. 12th St. PHILADELPHIA, U. S. A.
Successors to Iszard-Warren Co.

LEVEL WORK



Architects Builders Contractors

insure against mistakes in leveling by using our Architects' and Builders' Level. We make a specialty of this instrument. It will give positive, accurate service. Saves its cost in a short time.

We manufacture a complete line of surveying instruments in various sizes and at a wide range of prices.

Our circular No. 27 will explain our instruments to you in detail. It will pay you to get it before deciding upon any surveying instruments.

KOLESCH & CO.
Surveying Instrument Makers. Established 1885.
138 Fulton St. - - - NEW YORK



Rent This Level 10 Months Then It is Yours

Builders --- Contractors --- Architects

This is not the old style Architect's Level. It is the newest model convertible level. There is not a single Builder, Contractor or Architect who has not almost daily need of this instrument. For laying out buildings, locating foundation piers, leveling up foundations, walls and floors, aligning shafting, walls, piers, etc., for getting angles, locating levels anywhere, ditching, laying streets and walks, running straight lines, and a hundred other uses.

Instruction Book Free

Complete illustrated booklet, telling how a builder, contractor or architect can use the convertible level, sent free on request.

WARNING

The Level we offer is the new Aloe Convertible Level. Don't confuse the Convertible Level with the ordinary style Architect's Level. The only work that can be satisfactorily done with the ordinary Architect's Level, is the determining of elevations. But the Convertible Level, besides its use as a level, is a modified transit and broadens the use of the level 100%. You can't afford to buy any but the Aloe Convertible Level.

HALF CENTURY REPUTATION

We have been manufacturers of transits and levels since 1863, and our instruments are the standard of the world.

FREE TRIAL

We allow you to convince yourself by a trial of the instrument before you obligate yourself.

THE RENT BUYS IT

No large cash outlay needed. Just pay the rent for a few months and the instrument is your absolute property.

COUPON

A. S. Aloe Co., 621 Olive St., St. Louis, Mo.

Please send free instruction book on the use of the Convertible Level and complete details of your rental plan. This request in no way obligates me.

Name

Occupation

Street

City..... State.....

Am. C. & B. July 14



“The Handiest Tool In the Whole Tool-Box”

That's what an old carpenter, who had spent nearly all his life at his trade, said when asked what he thought of the

Starrett Combination Square

He said it because he found he could do so much with it. He had used it on all kinds of jobs and under all conditions and found that it was as he said—the handiest tool in the box. He could use it as a rule, or a square, or a level, a depth gage, and a bevel and when serving as any of these it was perfectly accurate. No wonder he was proud of it. If you ever use carpenter's tools, you should look at our line.

Starrett Tools are Sold at all Hardware Stores

Send for Catalog No. 206 and learn what tools we make for you.

The L. S. Starrett Co.
ATHOL, MASS.

NEW YORK

LONDON

CHICAGO

(42-100)

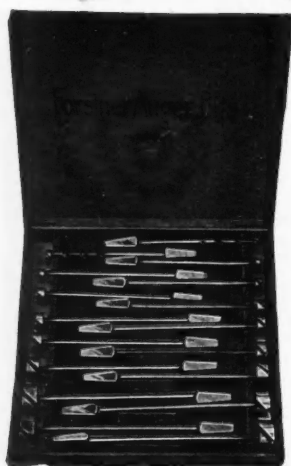
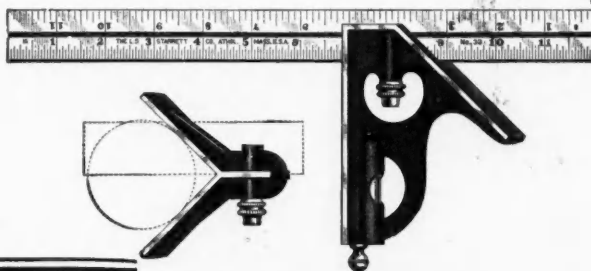

“A Bit of Utility”

Guided by its circular rim—instead of its centre—the Forstner Labor-Saving Auger Bit will bore any arc of a circle, and can be guided in any direction.

Doesn't matter how hard the wood is, no consequence whether it is full of knots, or the grain awkward to negotiate. The Forstner Bit works with equal smoothness under any condition and leaves a true polished surface on every job.

Unequaled for Delicate Work

Supercedes chisels, gauges, scroll-saws, or lath tools combined, for all kinds of delicate work. Cabinet and pattern makers and carpenters are enthusiastic because they do more work than other bits and cost no more.

We can offer something special in the matter of price on sets packed in a sensible box. Send today for particulars and catalog.

The Progressive Mfg. Co.
Torrington, Conn.

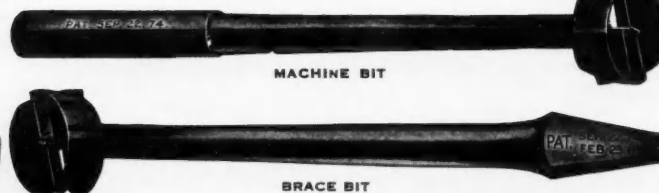

ROOF SLATES

STRUCTURAL SLATE BLACKBOARDS

E. J. JOHNSON
38 Park Row New York

Quarry Operator
BLACK, GREEN, PURPLE, RED

Booklet, Samples and Prices on Application

The Newest Rule — The Best for Taking All Measurements Correctly
MASTER SLIDE RULE The only rule that will accurately measure the inside of door casings, window frames, cupboards, cabinets, furnaces, etc. No guess work. Instantaneous reading. Interlocking device on every slide. Rigid when extended. Made of best boxwood. Trimmed with solid brass. All lengths, 2 to 8 feet. Price, 15c per lineal foot in the U. S. Order from your dealer or send price direct to us and get one by mail.



DAHL MFG. CO., 51-G East 42nd St., NEW YORK CITY

Send for Circular

The "EUREKA" Spiral Screwdriver

Made in Two Sizes. No. 1—14 inches long, opened; 9 inches closed. No. 2—19 inches long, opened; 12 inches closed.

Push on the end and the screw goes in. Can be used as an ordinary screwdriver. The simplest and best made. Durable and powerful. Send for Circulars.



DECATUR COFFIN CO., Decatur, Illinois

If You Like It, Buy It
If You Don't Like It, Send It Back

Those are the only terms attached to our liberal
10-Day, Free Trial Offer

We want to convince you that it will save you time and money, and better the quality of your work if you have a
CHAMPION MORTISER

Perfectly designed and equipped with ball bearings, large gears and automatic stop. Cuts mortises in three minutes. Any size, any shape from a perfect round hole up to 6 1/4-in. slot. Price very reasonable.

TELL US YOU'D LIKE TO TRY THE CHAMPION FOR 10 DAYS FREE OF CHARGE.

Colgan Machinery & Supply Co.
 616 New Hayden Bldg. COLUMBUS, OHIO



Hammer Insurance



SPECIAL

¶ Our "VANDOR VANADIUM" Nail Hammers in two sizes, No. 22, 13 oz. Finishing; No. 21, 16 oz. Standard. We will send either size Parcel Post for your Dealer's name and \$1. ¶ This Hammer we insure for life. Made for hard work and lots of it. ¶ You can return it any time if it proves defective and get a new one.

This hammer is warranted to draw anything from a headless brad to a spike. ¶ Drop Forged from the toughest Vanadium Steel. Second growth hand shaved Hickory Handle. Tempered in oil. Easy to work with. Get one to-day. Remember only \$1 and your dealer's name for either size, 13 oz. or 16 oz. Mail your order NOW.

Van Doren Manfg. Co., Inc. Chicago Heights, ILL.
 (Vanadium Dept.)

1853 **BUCK** 1914 **BROS.**



Fine Beveled Edge Shank and Socket

Chisels

Tang and Socket Butt Chisels

Plain and Beveled Edges

Send for illustrated Catalog

Buck Bros., Millbury, Mass.



THE MYERS GIANT
 ADJUSTABLE TANDEM DOOR HANGER



for TUBULAR GIRDER TRACK is adjustable to and from the building, and up or down as necessary. Has flexible engine truck with steel rollers revolving on steel roller bearings. The adjustable features prevent trouble from weather conditions or sagging of building. Storms, sleet or ice do not affect it, owing to complete protection afforded by the tubular track. Track and Hanger are constructed to carry and operate heavy doors easily.

This and other styles of Tubular and "Stayon" Door Hangers are shown in our Door Hanger Booklet. Copy mailed on request.

F. E. MYERS & BRO.
 ASHLAND, OHIO

"Last a Lifetime and Give Satisfaction To the End"



BUTT CHISEL

TRADE MARK

D. B. BARTON 1852 ROCHESTER, N. Y.

The celebrated Barton Planes and Edge Tools for carpenters and all other woodworkers are unequalled by any other made for keen, hard, smooth cutting edges. If your hardware dealer does not handle

THE CELEBRATED BARTON TOOLS

Send direct for catalogue and our free story book, True Stories. Be sure to specify "CARPENTER'S CATALOGUE."

MACK & COMPANY, 20 BROWN'S RACE ROCHESTER, N. Y.



DO you know that if a level vial is drawn to a true curve the same displacement of the base will produce the same displacement of the bubble no matter at what point the bubble may be. If you haven't forgotten your mathematics, you can easily prove this for yourself.

Well, suppose you put a movable bar over the center of the bubble when in an absolutely level position, that will always indicate the center of the bubble when in an absolutely level position as long as the level remains true. Do you get that?

Then, if your level gets "out," all you have to do is to place the level in an absolutely level position and move the bar to the center of the bubble. Then your level is true once more.

Every Stratton Level has this adjustment. Ask your dealer to show you some, or else write us for a catalog.

1,500 TOOLS
Write for a catalog.

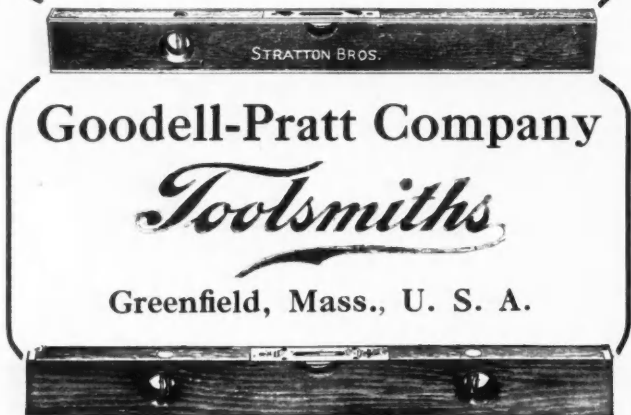

DIAMOND EDGE TOOLS
A RECOGNIZED STANDARD OF QUALITY



A PERFECTLY BALANCED HAMMER
Drop forged in one piece, from crucible Hammer steel of the very best quality. Tempered and hardened to a toughness that enables them to withstand severe usage. Handled with young second-growth polished hickory handles, shaped and driven so as to give perfect *hang* and *balance*. Fastened with a **DIAMOND EDGE** Patent Lock Wedge.

ASK YOUR HARDWARE DEALER—HE CAN SUPPLY YOU—IF NOT, WRITE US—DEPARTMENT "W"

SHAPLEIGH HARDWARE CO.
Established 1843
ST. LOUIS

"DIAMOND EDGE IS A QUALITY PLEDGE"

HOISTS

"RELIABLE ERIE"



All styles single and double drum hoists at prices from \$25 to \$150. Any contractor or builder contemplating the purchase of a hoist will save time and money by getting the "Reliable Erie" Catalog at once.
Our Hoists require less power and have a greater lifting efficiency than other hoists. Made to stand the strain of heavy loads without "give" or breakage.

Let us help you select the hoist you need.
ERIE CLUTCH & PULLEY CO. ERIE, PENNA.

HOISTS

Trade **SIMPLEX** Mark
Reg. U. S. Pat. Office

ROOFING NAILS

FOUR NAILS at PRICE OF ONE
When You Buy Them.
ONE NAIL in place of FOUR
When You Drive Them.

BECAUSE the Simplex has four times the head area of an ordinary roofing nail—hence four times the holding power, as head area is the all-important point in laying prepared roofing or sheathing papers.

Demand Simplex Nails from your hardware dealer. Don't buy prepared roofing unless Simplex Nails are packed in the rolls. **FREE** samples sent on receipt of request accompanied by dealer's name.

H. B. Sherman Mfg. Co. Battle Creek, Mich.



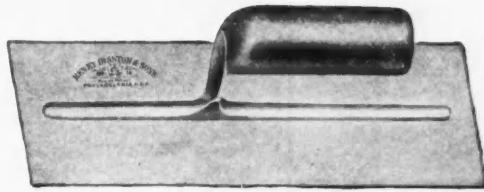

The Disston Standard of Quality Applies to Every One of Their Products

From the beginning, 74 years ago, a high standard was set for Disston Brand Goods. This standard has been raised to keep pace with the advance of the times. So high is this standard that both dealers and mechanics have come to look upon a Disston Saw or Tool as the standard by which to judge all others.

Henry Disston, himself a finished mechanic, insisted upon sending his sons into the shop to learn the business as he did. Realizing the importance of this early training, his sons in turn placed their sons in the shops until they thoroughly understood the manufacturing end of the business.

This means that the sons and grandsons of Henry Disston, who today manage the great business which he established, are all practical men. They know the business from the ground up, which assures a maintenance of the efficiency and high quality of all products manufactured by the Disston Works.



Reg. U. S. Pat. Office

DISSTON BRAND GOODS
QUALITY GUARANTEED

HENRY DISSTON & SONS, Inc.
Keystone Saw, Tool, Steel and File Works
PHILADELPHIA, U. S. A.

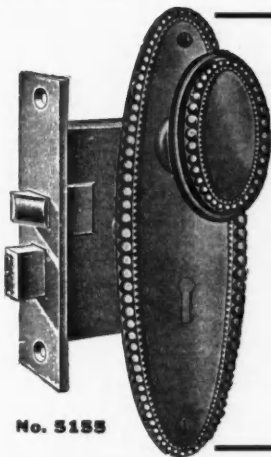

34c For This Lock Set

**No. 5155 Antique
Copper Finish**

FREE—No. 5. Builders Hardware Catalog and net price list to Contractors and Material Men.

We do not sell to contractors or carpenters in Cook County, Ill.

Rehm Hardware Co.
1501 Blue Island Ave.
CHICAGO, ILL.



MAPLE FLOORING

Thoroughly kiln-dried, side and end matched, hollow backed, bored for blind nailing, and STEEL POLISHED. Guaranteed to give best results under hard continuous wear.

Do not be satisfied with ordinary flooring. You can get **DIAMOND HARD MAPLE FLOORING.**

You'll receive full value in wearing service and permanent finish.

Write us. We'll Tell You More.

J. W. WELLS LUMBER CO.
Menominee, Michigan

RELIABLE FOLDING Scaffold Bracket



Strong and safe; requires only a few minutes to attach. No holes to bore. Four 10-d or 16-d nails fasten them securely. Positively rigid; no vibration.

The Low Price of these Brackets can be saved in time and material on the first two jobs.

ELITE MFG. COMPANY
100 Ohio Street ASHLAND, O.

CALDWELL SASH BALANCE

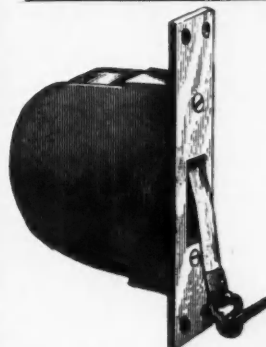

Does away with weights and cords, and **VASTLY** more durable.

Makes sashes work perfectly.

Permits greater window space in new work, as box frames are not necessary.

May be applied to old windows without altering sashes or frames.

Write for circular to the

Caldwell Mfg. Co.
15 Jones Street, Rochester, N. Y.

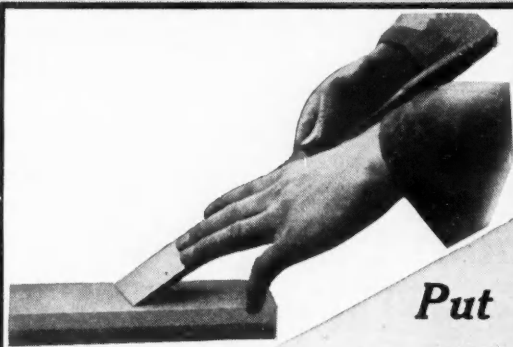

*Put
a
Carborundum
Sharpening Stone
Under Your Edge
Tools*

TWO or three strokes and you know that you have a stone that is different—a stone that really cuts clean and quick.—Carborundum Stones will not fill or glaze if properly used **They will last almost as long as a tool itself**

Use Carborundum Stones in your workshop, in the household—wherever tools are to be kept keen and smooth-edged.

Ask your hardware dealer, or send direct for booklet giving details of the Ten Thousand Dollar Prize Business Idea Contest of the Rice Leaders of the World Association, of which the Carborundum Company is a member.

*One of your business ideas may win
one of the big cash prizes*

**THE
CARBORUNDUM
COMPANY**
NIAGARA FALLS, N. Y.



ABSOLUTE SAFETY

Here's the greatest improvement of recent years in the way of a double-action door spring. Combines all the advantages of the old style, double-action hinge with the all-important Door Check feature. Door swings slowly, stopping at dead center. No "swing bang" motion. Can't fly back unexpectedly.

STANDARD CHECKING

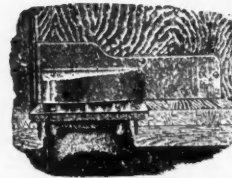

SPRING HINGE

Fills a long-felt want. Children are safe where it is used. Noiseless. Push the door open as hard as you like; it comes back only so fast. Practical for double-acting doors anywhere. Absolutely dependable. Warranted to satisfactorily swing and control inside doors not exceeding 34" in width and 7 feet in height. Wears indefinitely.

Specify and use the Standard. Your name and address on a postal card will bring complete information. Write us now.

Standard Manufacturing Co.
Shelby, Ohio



The Standard Checking Spring Hinge absolutely controls the door at all times.



This Pearson's Automatic **SHINGLE NAILER** WILL PAY FOR ITSELF ON FIRST JOB

Do your nailing fast—faster than ever before. You can use this Pearson's Nailer on any pitch roof. Wear mittens, gloves, etc. This "Hand Nailer" is the only Nailer—throw nails in by the handful—then start nailing. Nails easily driven through tin or quite heavy sheet iron.

These nailers are made in two sizes—The BLUE Nailer for 3d. common No. 14 gauge wire nails. The RED Nailer for 3d. galvanized No. 13 gauge 1 1/4-inch wire nails.

It will come right to your door quick, by insured parcel post, all prepaid for only \$5.00.

IT MAKES GOOD.

PEARSON MFG. CO. - ROBBINSDALE, MINN.



Patented: Nov. 29, 1892
July 19, 1910

A Huther Bros. Dado Head **Fits Any Saw Rig**

Cuts perfect grooves with or across grain. Simple, no-screw adjustment. The choice of experts.

Huther Bros. Saw Mfg. Co.
1101 University Ave. :: Rochester, N. Y.

Bishops Refined "Greyhound" Steel Saw—A Masterpiece

Of the Saw Maker's Art. We are proud of its quality and guarantee it to cut faster and run easier in all kinds of wood, to hold its sharpness and set longer than any other good saws.

It's the Your-Money-Back-If-Not-Satisfied Saw

30 Days' Trial Will Prove Our Guarantee

The "Greyhound" is the result of years of experimenting to originate a purity of steel with fine grain and tough body.



Made in both Straight and Skew Back

Length Each	18	20	22	24	26	28	30	30 inches net
	\$2.35	\$2.50	\$2.65	\$2.80	\$3.00	\$3.30	\$3.65	

Packed One in a Box



GEO. H. BISHOP & COMPANY
LAWRENCEBURG, IND.

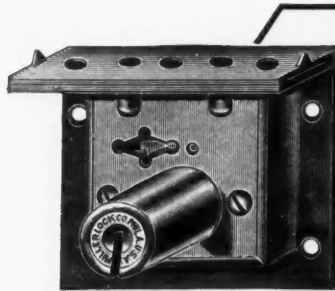

Laughs At Sneak Thieves

Here is the lock for your tool chest or automobile tool box. It is non-pickable; has four

No. CB495. All Brass. Full Size 3 1/2" x 2 1/4" secure levers. Made of solid brass; highly polished. For chests 3/4" thick and up. Price \$1.25 each, postpaid. Don't wait until your tools are stolen but write now. State thickness of wood when ordering.

MILLER LOCK CO.

Frankford, Philadelphia, U. S. A.

For This Month Only



To introduce our line of "Mirror Finish" Cement Tools, we will deliver to your door, transportation charges paid by us.

- No. 1 Mirror Finish Jointer for 50c
- No. 18 Mirror Finish Edger for 50c

Largest Dealers in Bricklayers, Masons, and Plasterers Tools in the United States. Our No. 7 Catalogue is now ready. Send for copy.

Joseph Woodwell Co., 201 Wood St., Pittsburgh, Pa.

GOODELL MITRE BOX

Made Of Steel—Cannot Break

For years this Box has been recognized as being first in quality and improvements, and the new Steel Bottom Plates with Angular Serratures to prevent the work from slipping add still more to its convenience and attractiveness.

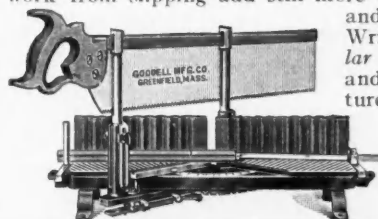

Write for new Circular C describing this and many other features.

Goodell Mfg. Co.
Greenfield, Mass.

KEES SIDING CLIPS

Make permanently tight joints where weather boards join casings or corner strips.

They Save Labor—
Siding need not be fitted exactly.

Make a Better Job—
No chance of pushing casing out of true. The joint is tight and is not affected by subsequent shrinking or swelling of the lumber.

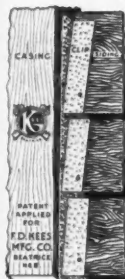

Write for Circular and Free Samples.

F. D. KEES MFG. COMPANY
Box 552, BEATRICE NEB.

(Makers of Kees Metal Building Corners and Gossett Screen Hangers.)

Stanley Tools

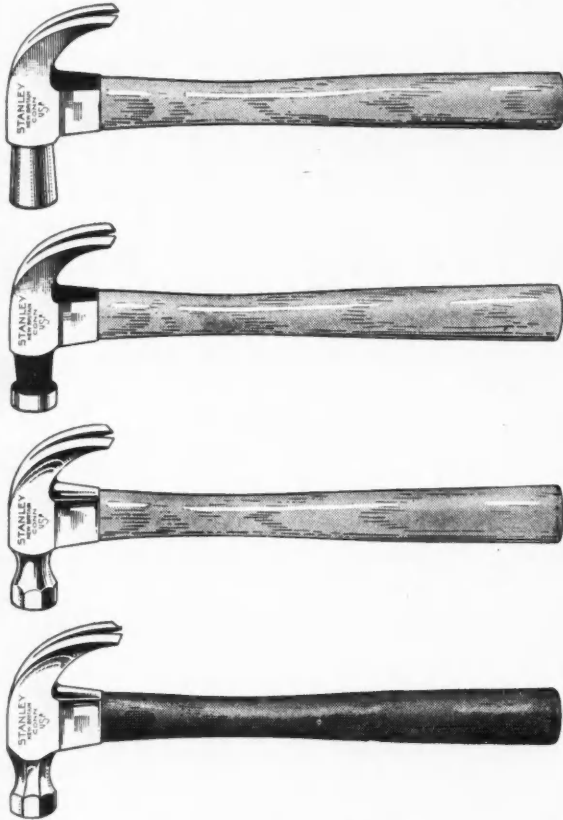

Carpenters' Nail Hammers

A line recently added to the long list of Carpenters' and Mechanics' tools manufactured by us.

The Heads are made of a special steel, carefully forged, hardened and tempered.

The Handles are made of selected, second growth, white hickory.

The Claws are of uniform thickness and so formed that they will grip and hold fast at any point of the shank all sizes and kinds of nails, thus enabling the user to draw them from the toughest kind of wood, even where the head of the nail has been broken off.

The improved method of fastening the heads to the handles makes it practically impossible for the head to fly off.

The above features, together with their specially fine finish, will commend them to all interested in good tools.

A special circular containing a complete description of all numbers and sizes will be mailed upon request.

Address

STANLEY RULE & LEVEL CO.
NEW BRITAIN, CONN. U.S.A.

"Many-a-Use" GAUGE

provides a sure way of measuring openings; cutting thresholds in door frames; setting door jambs; cutting siding in between window frames, etc. It is the only accurate gauge that will enable you to correctly mark and square any work for cutting.

The "Many-a-Use" Gauge can be used on any length pole. You simply set the lower gauge at the required distance from the floor and the upper gauge at the desired height of window or other opening. Thumb screws hold gauges firmly on pole. No chance of slipping. No measuring mistakes.

Price Per Pair \$1.25

If your dealer cannot supply you, send us the price and get a pair of gauges by mail. If you think they are not worth the price, return them and get your money back.

FOX & STANLEY
815 Erie Street
KENOSHA, WISCONSIN



How to Get Lumber at Mill Prices

We ship direct from our Yellow Pine Mills, at Mill Prices to you. We carry in stock over 25 million feet of dry, bright lumber and the capacity of our mills is over 75 million feet annually.

Contractors Home Builders

We can furnish promptly, lumber for building of every character. We can cut and dress timber up to 24 x 30 in. 40 feet long. Can ship quickly form lumber for all kinds of concrete structures. Contractors and home builders write us for delivered prices.

Send No Money

We guarantee the quality of our lumber and ship subject to inspection and approval to all responsible parties.

Home Lumber & Supply Co. 343 S. Dearborn St., Chicago, Ill. Dept. 6085

WHY TAKE A CHANCE

of having a defective wall from using a scrap wall tie in varying thickness as light as tin.

Ask your dealer the weight of a box containing 1000 ties and if the weight is below 50 pounds you are buying an inferior tie and entitled to rebate.

To be safe, specify the

WHALE BONE WALL TIE



and if your dealer cannot supply same, order direct from us and we will ship the same day as received, at price of \$2.50 per 1000, Pittsburgh, Pa.

ALLEGHENY STEEL BAND COMPANY
BELL PHONE: 718 Cedar North Side, PITTSBURGH, PA.

**Quality—
Not Price**



4"-4½", \$2.50



4"-5", \$1.10



4"-5", \$2.00

Are You a First-Class Carpenter?

If you are, you know the value of high-class tools. Our tools cost a little more, sure, but they will wear two or three times as long, and stay sharp longer. Just try one of them and see the difference in the hang and how much easier they are to use. Insist upon WHITE'S— if your dealer hasn't them and won't order for you, drop us a card and we will quote you prices or accept your order direct. **START RIGHT TODAY.**

THE L. & I. J. WHITE CO., 10 Columbia St., BUFFALO, N. Y.



No. 1003

Drills holes up to ½ in.

You use but one hand to operate the

"YANKEE" Bench Drill

With the new automatic features the friction feed brings the drill down quickly to the work, then the ratchet feed operates and prevents breaking of the drill point. This leaves free use of the left hand to hold the work. The quickest and most convenient Bench Drill Made.

Send for the "YANKEE" Tool Book

NORTH BROS. MFG. CO.

Dept. A. PHILADELPHIA, PA.



No. 1005

Two Speeds

Drills holes up to ½ in.

RED DEVIL BONDED TOOLS
ELIMINATE ALL GUESSWORK



RED DEVIL TOOL for EVERY MECHANIC



BOOK of 3000 SENT ON REQUEST. SEND NOW

RED DEVIL BONDED
Chisels, Gauges, Drawing Knives, are covered by a **TWO YEAR Insurance Bond**

If your dealer can't supply, send 50 cents for sample Red Devil Bonded No. 2622, 1-in. Beveled, Socket Firmer, Pocket Chisel.

Red Devils are tools that pay YOU—not simply tools you pay for.

SMITH & HEMENWAY CO. New York

PHOENIX

INSIDE SLIDING BLINDS

WILKES BARRE, PA.

The Phoenix Sliding Blind Co.
Enclosed find my check for blinds. I am pleased with them and sorry I did not have them put throughout the whole house.
C. W. BURT.

Comfort!

Economy!

Convenience!

BRIDGE & CANAL STS.

The lately improved springs and corrugated steel rods put the "PHOENIX" far in lead of less improved styles. Write for Catalogue "C" and free samples, showing construction.

PHOENIX SLIDING BLIND CO.

PHOENIX, N. Y.



Uncle Si Says:

"I read on a blotter the other day that a genius is a man who takes infinite pains. If that's so, then the makers of Simonds Saws are certainly geniuses. To begin with, they're so particular about their steel that they operate their own steel plant, so as to get the best and toughest steel possible. When you get a Simonds Saw you'll find the teeth as sharp as a needle, and they'll do an awful lot of cutting before they need filing. You know the store that sells Simonds Saws."

Why don't you buy one of the best Simonds Saws? If your Dealer doesn't have it, send us \$2.50 and we will send the saw to you, all charges prepaid.



SIMONDS MANUFACTURING COMPANY
FITCHBURG, MASS.

17th St. & Western Ave.
CHICAGO, ILL.

40 Murray St.
NEW YORK CITY

St. Remi St. & Acorn Ave.
MONTREAL, QUE.

SARGENT

OUR new Rafter Square, No. 500R, is the most complete Square ever made for the carpenter.

It contains accurate measurements for all kinds of rafters, common, hip, valley, jack and cripple—in the most convenient form.

These measurements are all given on the Square; they are complete, correct and final. They save the trouble of multiplying and dividing and then obtaining a result about which there is some doubt.

Simple and easy to use. A great time saver.

For full description and directions for using send for the Sargent Square booklet, free on request.



SARGENT & COMPANY

Makers of Squares, Planes and Mechanics' Tools

1149 Leonard St. New York

Other Sargent Quality Tools are described in the Sargent Tool Book, a handbook for mechanics, sent on application.

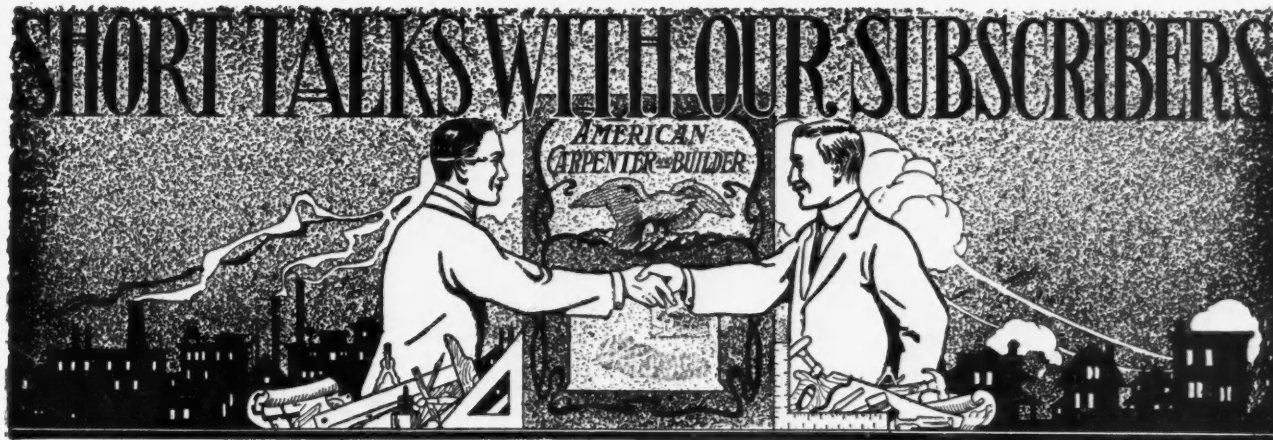

Beware of "Just as Good"

WHEN you go to the hardware store and ask for a certain make of tool, and the storekeeper says, "well—no—but we have something just as good," turn and run; he is trying to pick your pocket.

The best goods are always those that are advertised. Whether it is edge tools, or saws, or any other carpenters' tools, the manufacturer's name and his well advertised guarantee are the purchaser's assurance of quality and satisfaction.

But there is a bigger profit in the unnamed goods; and some hardware dealers are short-sighted enough to try to palm off a package of the unknowns when the customer asks for standard brand goods—he uses the well known explanation that "It's just as good." What he really means is, "These goods cost me less than those you have asked for."

While it is only too true that this substitution evil is much more general than it should be, it is only fair to state that the rank and file of responsible retail merchants do not stoop to such practices. As the standard high grade brands of carpenters' tools become more widely known, through consistent advertising, the storekeepers realize that it is easier to make sales, and that one satisfied customer brings another.

Therefore, although the profit on each sale may not be as much, the retailer finds himself 'way ahead in the long run, by featuring the well known, advertised lines.

Carpenters and builders realize that bargain-counter tools are never a success. The first cost of a tool is really of no importance when spread over from ten to fifty years of satisfactory use. Considering their long time service and the satisfaction that comes from the use of a high grade tool, a far greater difference in price over the unnamed bargain-counter stuff would be justified.

The well known guaranteed lines cost very little more and are worth the difference many times over.

So, beware of the man who offers you something "just as good." Know what you want. Ask for it. And see that you get it.



WE know that this is a busy season, and that you all have plenty to tend to—but, nevertheless, don't overlook the new things that are being advertised in this issue. It will take only a minute's time to write for a catalog that may mean many dollars to you this summer.

Cordially yours,

EDITOR, AMERICAN CARPENTER AND BUILDER.

Contents for July 1914

	Page		Page		Page
Adventures in Heating.....	62	Hanging a Stair Platform.....	78	Quartering Trick	78
Advice to a New Beginner.....	82	Has the "Bungalow" Sized Up.....	83	Recovery for Instantial Performance....	73
Be Always Looking Ahead.....	45	He Ventilates at Meeting Rail.....	85	Satisfaction of Architects.....	73
Box Newel Trick.....	79	Helps to Bigger Business.....	45	Satisfactory Time Check.....	44
\$1,800 Bungalow.....	85	House Designed for Narrow Lot.....	55	Score Two From Haiti.....	84
Concrete Fence Posts.....	81	How to Member the Rail to Column	83	Sense and Nonsense of Government Archi-	37
Correction.....	85	Base.....	83	tecture.....	37
Correspondence.....	82	Improvised Ladder.....	85	Seven-Room New Jersey Dwelling.....	54
Court Decisions Affecting Builders.....	73	Improvised Speed Indicator.....	47	Specimen Plank Frame Construction....	80
Designing Roofs and Estimating Roof	72	Introduce New Ideas and Conveniences..	47	Square, Two-Story House with Attic....	52
Work.....	72	Kitchen Cupboard.....	82	Steel Smoke Stacks and Their Care.....	70
District of Columbia Builders Elect	68	Liability for Dangerous Staging.....	73	Steel Square.....	69
Officers.....	68	Machine Sanding Just Where Needed....	68	Stresses in Roof Trusses.....	64
Dog-Legged Stair.....	79	Normal Training.....	78	Systematize Your Hunt for Prospective	46
Double House of Southern Style.....	59	More Shop Kinks.....	78	Customers.....	46
Editor's Drawer.....	68	Nails Unrusted After Two Hundred and	42	Task and Bonus Work.....	43
Elaborate Private Garage at Watertown,	74	Seventy-Six Years.....	42	Time-Saving Pay-Roll Calculator.....	39
N. Y.....	74	New Abrasives Company Formed.....	68	Trade Notes and Items of Interest....	86
Estimating.....	72	Nine-Room Brick and Clap-Board House	57	Tramps.....	79
Farm Buildings.....	80	Noon-Hour Talks by the Boss Carpenter..	64	Typical Building Conditions.....	46
Flooring from Scraps.....	38	Old George Washington Landmark.....	38	Wants to Build a Boat.....	85
Foreman and His Crew.....	76	Opportunities at Home Better Than in	46	Worm in Cypress.....	78
Freak of the Builder's Art.....	77	Boom Town.....	46	Warm Air System with Exhaust Flues...	62
Fresh-Air Ventilator.....	68	Plan Shop—Practical House Designs....	56	Weight of Castings and Patterns.....	47
From Wage-Earning to Independent Busi-	45	Photo Post Cards Get New Business....	40	Well Planned \$5,000 Residence.....	60
ness.....	45	Popular Bungalow Gives Start.....	59	You Know More Steel Square Than	69
Full-Pitch Roof House.....	53	Possible Suit for Alienation.....	85	You Realize.....	69
Gambrel Roof House Design.....	51	Practical Carpentry.....	76	Yours for Safer Building.....	64
Good Example of Simplicity.....	56	Putting Down Base.....	84		
Good Poultry House.....	83				
Guaranteed Building Plans.....	49				

CHICAGO

SPRING BUTTS

A SUGGESTION

Do you specify a spring hinge with distinctive features which will appeal to your client and assure satisfaction to all concerned?

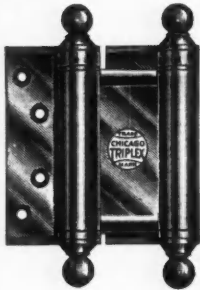

Chicago "Triplex" Spring Butts

offer this advantage to you. The appearance, durability and finish of this article are unsurpassed, and in consideration of prices that are conservative in respect to value, the up-to-date builder cannot afford to risk his reputation with goods that are unsatisfactory.

Send for Catalogue C 29. It illustrates and describes the most complete line of Spring Hinges manufactured.

Chicago Spring Butt Company,

CHICAGO



NEW YORK

Yes! the World does Move!
Facts are Stubborn Things

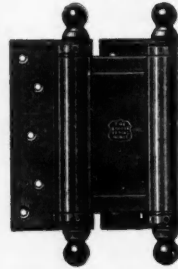

Don't Buy
SPRING HINGES
OF
OBSOLETE
CONSTRUCTION
ONLY

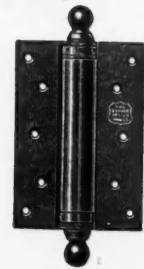

BOMMER

Double Acting Spring Butt Hinges

have the weight-supporting bearings correctly located to liberate the action of the springs, reducing breakage and increasing spring power, preventing unequal wear of the barrels, and giving practically unlimited durability. Bommer double-acting spring hinges open alike at both casings and both doors when both doors are opened.

The carpenter can avoid guesswork and save time when hanging double-acting doors in pairs, as he can scribe and fit both doors of a pair from the same side of the opening.

YOUR HARDWARE MERCHANT CAN SUPPLY THEM
Bommer Bros., Manufacturers Brooklyn, N.Y.

Cabot's Sheathing and Deadening Quilt

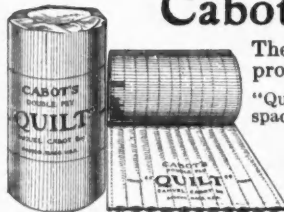

The Cold-proof, Heat-proof, Sound-proof and Fire-retarding Lining

"Quilt" is a matting filled with dead air spaces, and one layer is as warm as twenty-eight layers of common building paper. A house lined with it will always be warm and save coal. Floors and partitions lined with it will stop the passage of sound. Roofs lined with it will keep cool

in summer and prevent heat from escaping in winter. It will save coal enough to pay for itself every two winters as long as the house stands.

Send for a sample and catalog.

SAMUEL CABOT, Inc., Manufacturing Chemists, Boston
24 W. Kinzie St., Chicago - 1133 Broadway, N. Y.

Cabot's Creosote Shingle Stains; Stucco and Brick Stains, Conservo Wood Preservative.

No
Guess Work
with a
MORRILL SAW SET

Simple and accurate. The only Saw Set a carpenter should use. Takes out the wrong set and puts in the right set at one operation.

The eccentrically beveled anvil is so indexed that you can see what you are doing. Gauge screw and locknut keeps work uniform.

FREE "Saw Points" a valuable Booklet.

Chas. Morrill, 94 Lafayette Street
NEW YORK

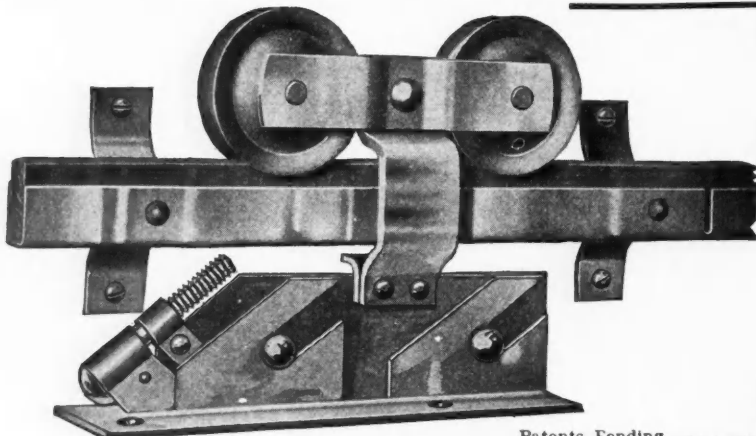
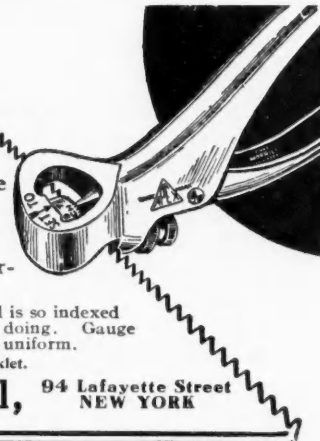

Patents Pending

IF YOU HAVE NEVER USED SHARON No. 2 PARLOR DOOR HANGERS

Don't fail to try a Set

No Cutting, Grooving or Counter-sinking needed.

Fits any width opening. Simple and always accessible adjustment.

Its smooth, easy, absolutely noiseless running has never failed to please. Money-back guarantee.

Write the

SHARON HDW. MFG. CO. SHARON, PA.



The
**World's Greatest
Building Paper**

Important Notice

When your subscription expires, renew at once, using the blank enclosed in your final copy. If it expires with this issue your renewal must reach us before July 25, to avoid missing the August number. Use P. O. or Express Money Order if possible, but bills or 2-cent stamps may be sent at our risk.

The
**World's Greatest
Building Paper**

American Carpenter and Builder

Entered as second-class matter July 1, 1905, at the postoffice at Chicago, Ill., under the act of Congress of March 3, 1879.

Published on the first day of each month by

AMERICAN CARPENTER AND BUILDER COMPANY
RADFORD BUILDING, 1827 PRAIRIE AVE., CHICAGO

EDITORIAL DEPARTMENT

WILLIAM A. RADFORD, *Editor-in-Chief*
BERNARD L. JOHNSON, B. S., *Editor*
WILLIAM REUTHER } *Associate*
ADRFRED W. WOODS } *Editors*
ALFRED S. JOHNSON, M. A., PH. D. }
CHARLES E. PAUL, S. B. }

BUSINESS DEPARTMENT

WM. A. RADFORD, *President and Treasurer*
E. L. HATFIELD, *Vice-President and General Manager*
ROLAND D. RADFORD, *Secretary*
New York Office: 345 Fifth Ave.
E. B. WOLFROTH, *Eastern Representative*

SUBSCRIPTION RATES

One year, \$2.00; six months, \$1.00; payable always in advance, Single Copies, 20 cents. Canadian Subscriptions, \$2.50. Foreign Subscriptions, \$3.00.

ADVERTISING RATES

Furnished on application. Advertisements, to insure insertion should reach our Chicago office not later than the 20th of the month preceding date of publication.

PROTECTION FOR OUR READERS

The publishers of the American Carpenter and Builder will not knowingly publish any advertisement of a misleading character nor accept advertising from any individual, firm or company whose business methods are open to question.

We often receive inquiries from readers who desire information about concerns that formerly used the advertising pages of the American Carpenter and Builder, but are no longer doing so. They want to know if these former advertisers are still in business, if they can send them orders with the assurance that they will be filled, and a variety of other questions.

The American Carpenter and Builder will use every legitimate means to safeguard the interests of its readers and to protect them from fraudulent or unreliable concerns. Where the slightest doubt exists our readers should write the publishers for information. It may save them money, time and worry.

In all cases in writing to advertisers say: "I saw your advertisement in the American Carpenter and Builder."

Sense and Nonsense of Government Architecture

THE commission appointed by the 62nd Congress to frame a standard by which the size and cost of public buildings shall, so far as practicable, be determined, and also to report as to the adaptability in size, accommodations, and cost of buildings hitherto authorized to the communities in which they are to be located has recently brought in its report. Perhaps more interesting, and certainly more illuminating than the official majority report itself, is the minority report brought in by Postmaster General Burleson, who was one of the members of the commission.

He believes that in order to "remedy the conditions against which the law creating the commission was directed" "an entire new public building policy is necessary."

These conditions, briefly summarized, are unintelligent procedure in making appropriations for governmental buildings and congestion in the supervising architect's office, which is, for various reasons, behind in its work from two or three years to eight or ten years, according to various estimates.

Mr. Burleson presents tables, from which we quote five instances as exhibiting gross inconsistencies in the matter of appropriations:

	Area, square feet.	Appropriation.
Wilkesbarre, N. C., postoffice and courthouse	4,500	\$ 58,000
Opelika, Ala., postoffice and courthouse	4,500	105,000
Coeur d'Alene, Idaho, postoffice and courthouse	7,000	86,800
Amarillo, Texas, postoffice and courthouse	7,000	199,999
Corpus Christi, Texas, postoffice and courthouse	10,000	131,000

From other sources we glean the interesting information that the town of Chadron, Neb., with a population of 2,687, according to the census of 1910, is to have a building to cost \$110,000. Willows, Cal., 1,139 population, a \$75,000 building, and Fallon, Nev., rejoicing in 741 inhabitants, will be favored with one costing \$60,000. The latter may be envied by Vernal, Utah, which exceeds Fallon by ninety-five souls, and for which only \$50,000 has been appropriated. East Orange, N. J., with 34,371 inhabitants, will have a building to cost only \$15,000 more than Chadron, although it has twelve times the population. If the appropriation for Chadron is rational, then East Orange has bitter cause of complaint; it should be dowered with a structure to cost not less than \$1,320,000. With forty-six times as many citizens, its building is to cost

only a little over twice as much as that for Fallon.

It must be equally evident to the architect and to the business man that appropriations so widely at variance for structures of the same accommodation are not rational.

It is, of course, entirely possible that there may be mitigating reasons for these disparities. But it is very evident that the appropriations given are not based on service requirements, but are measurable by the ability of congressmen to put them through.

Mr. Burleson, in defining what he believes to be a true public-buildings policy, says:

"The true policy is one under which buildings will be authorized primarily for economic reasons, and constructed primarily for utilitarian purposes. The effect of this policy will be to subserve the material interest of the government and to make possible orderly procedure under a logical programme; at the same time requirements of broad public policy, as well as ideals of architecture, may be satisfied in a reasonable degree."



An Old George Washington Landmark

THE house shown in the accompanying illustration was built by George Washington in 1790—124 years ago. It is located at Glasgow, Barren County, Ky., although when it was built, that section was located in Fairfax County, Va.

Mr. A. L. Harris now owns and occupies the house.

George Washington at the time the house was built owned all that land which now comprises Virginia, Tennessee and Kentucky, it having been granted to him by a grateful American Government in consideration for the services rendered during the Revolutionary War.



Brick House Built by George Washington in 1790, now Standing and in Good Repair at Glasgow, Ky.

George Washington built this house as a residence for his cousin, General Spotteswoode, who was governor of Virginia at that time. General Spotteswoode was, by nature, of a very retiring disposition and later became a recluse. He occupied this house until his death, the exact date of which we were unable to learn, and is now buried at Knob Lick, a small hamlet about five miles from Glasgow, Ky.

The architecture of the house is a wonderful com-

ination of the frontier's man precaution and the city type dwelling. The walls are solid brick, 36 inches thick. The floors are of hardwood, two inches thick, made of chestnut and laid with dowel pins. The original roof was hand-drawn chestnut shingles, one-half inch thick, and fastened with wooden pegs. There is not single nail in the entire building, for nails were not manufactured at the time when the Father of our Country built this house.

The windows are of glass that was brought over from France, for glass was not made in this country at that time. The wear and tear to which a building is subjected in the course of the years is here given full proof, for this glass is worn so thin that many of the panes are no thicker than an ordinary piece of tissue paper. In late years, light rain storms have at times been sufficient to break out some of the panes.

The portion of the roof shown in the accompanying illustration, is still covered with the original hand-drawn chestnut shingles. A small part of the roof was replaced with a tin roof by Mr. Harris a few years ago. Latey, Mr. Harris has covered the kitchen with 800 square feet of J-M Asbestos Roofing.



Flooring from Scraps

IF your machinery equipment has grown big enough to include a sticker, or any four-sided planing machine, it is my opinion that one of the best uses to make of left-overs and scrap lumber is to run into narrow flooring. This is not a mere theoretical opinion, but is based on a study and use of narrow stock of short lengths in floors. I would take as a standard width 1½-inch face, which can be made from strips 2 inches wide, and in any length from 16 inches up, dressed to three-quarters. This gives you a chance to take the scrap from regular inch stock, rip it, cut out the worst knots and work it up to advantage. It should, of course, be thoroughly dry, so it may be ripped as brought in, and then the strips piled to dry, as they will dry out in less time than wide stock. Take pains in establishing a size, and making a pattern for it, and then every time you run some fresh stock, see that it matches exactly. A good idea is to take pattern after some hardwood flooring of that width, and then you can use either hardwood or pine in your work, and often manage to get an excellent floor out of what would likely go to waste. Make it any and all lengths, cutting to meet over joists, for the best kind of a job, but for cheaper work in this narrow stock the joints can come anywhere, provided they are well scattered.

Do not misunderstand the ideas now, and get the impression that it will pay you to go into the flooring business and try making all your own stock. It is both cheaper and better to buy your general run of flooring than it is to try making it, but there is a chance here to use up some left-overs and scrap now and then and turn it to good account as flooring. J. C. TAYLOR.

Time-Saving Pay Roll Calculator

Here is a photo of my pay roll calculator. The way I use it is to move slide till it comes over the price per day. I pay the man, then

move hand till it comes over the number of hours he worked; and then you read off the amount he made, through the hole in the slide. At the extreme left hand are the hours, from one to fifty-four.

The slide is shown over 1.25, which is \$1.25 per day. The figures in this section give the amount of this wage rate for all hours from one to fifty-four.

W. W. BETSWORTH,
Supt. The Blount Construction Co.,
Pensacola, Fla.

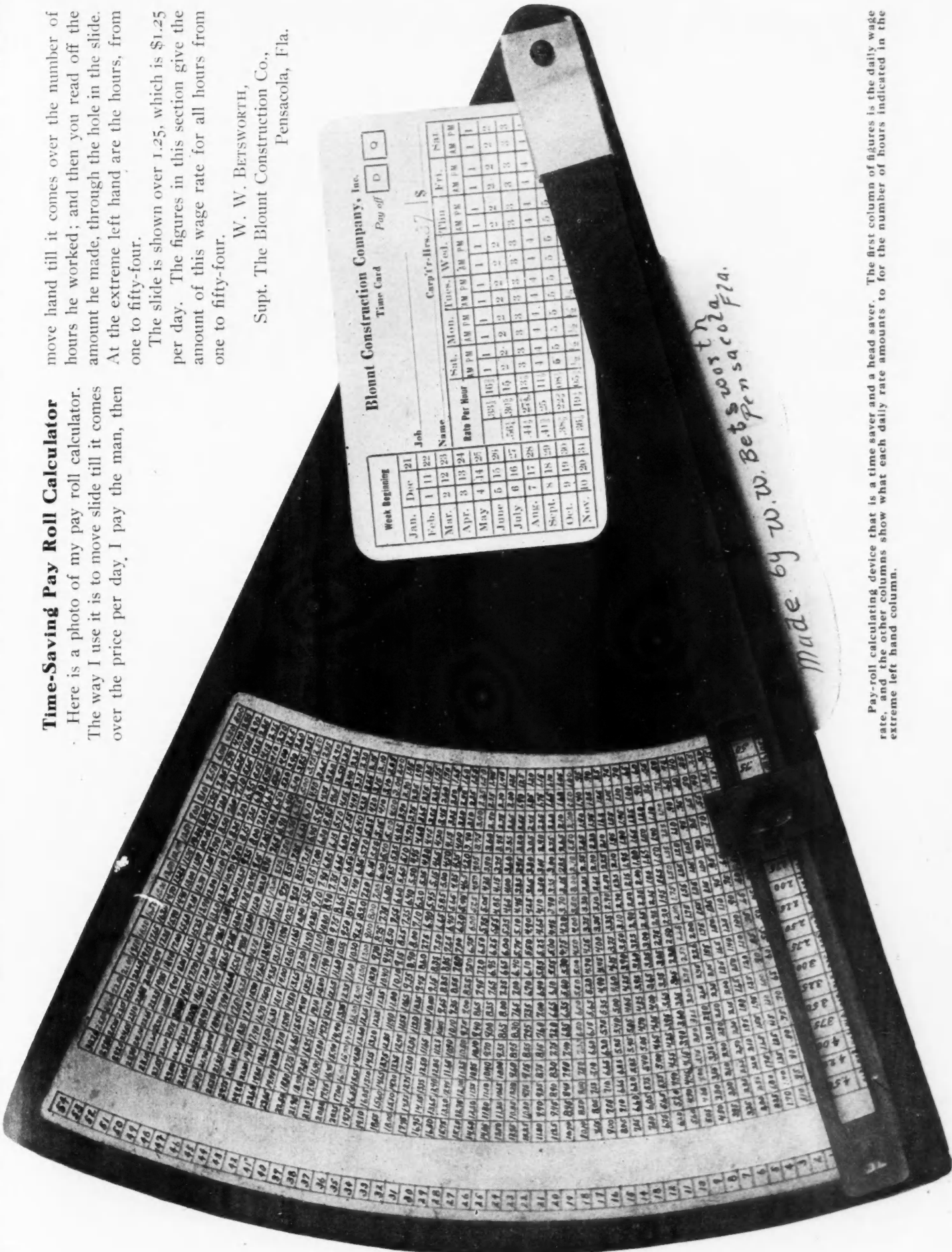

Pay-roll calculating device that is a time saver and a head saver. The first column of figures is the daily wage rate, and the other columns show what each daily rate amounts to for the number of hours indicated in the extreme left hand column.

Photo Post Cards Get New Business

A NOVEL ADVERTISING IDEA THAT CARPENTERS AND BUILDERS CAN USE—DOESN'T COST MUCH, BUT ACCOMPLISHES WONDERS

By J. E. Donaho

Contractor and Builder, Milton, Iowa

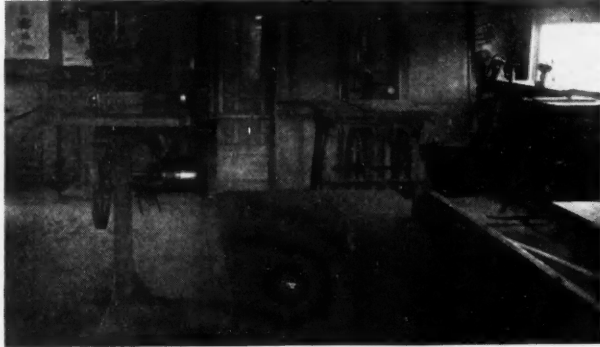

General view of shop interior. Notice that the machines are placed so as not to interfere. The lighting is good and everything is kept picked up neat and clean.

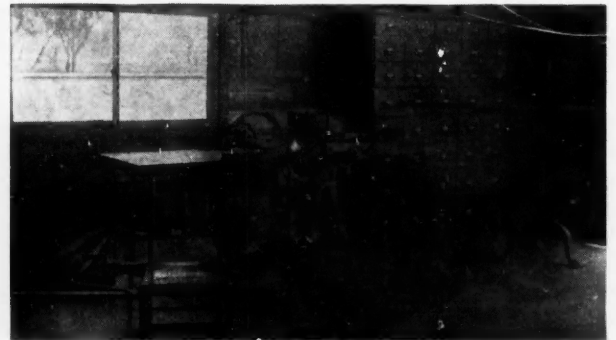

An interesting corner, showing hardware cabinet and two useful hand-power machines. Chair is in clamps, being glued.

DURING the last few years I have made quite a specialty of shop work. I find that if I can keep a pretty good stream of miscellaneous shop jobs coming in, it will keep myself and at least part of my crew, busy during off seasons, when outside work is scarce or impossible because of bad weather.

For advertising my shop and the facilities I have for turning out work, I make use of picture post cards; and they are the best of anything I have ever tried, or heard of.

I have a series of photos of my shop, both outside and inside. I had four or five different views of the interior taken, all different, showing the different ma-

chines and shop appliances. Also, whenever I have a job ready to ship out, if it is in any way interesting or unusual, I take a picture of it.

These post card photos don't cost very much to make, and it only costs a penny to send one out. You will be surprised to find how many different people are interested in such pictures, and you can never tell when they will have some piece of work to be done. I have made a good many friends and acquaintances through sending out pictures, and they keep my shop busy all the time. The work just seems to come in of itself.

Anyone can learn the trick of taking pictures so that with a little practice one can get very good results.



Exterior view of J. E. Donaho's shop at Milton, Iowa. An order of screens stands beside the door, drying. This view used as a photo post card brings in considerable new business.



Contractor Donaho at his shop desk. The book, "Radford's Details of Building Construction," is his best assistant in his shop work. A good supply of catalogs and a complete file of the American Carpenter and Builder are close at hand on his reference book shelves. The cabinet over the desk holds brads, screws, small bolts, and furniture hardware.

Or, if you don't want to bother with taking the pictures yourself, there is always someone who will gladly do it for you at reasonable cost.

Besides taking contracts for the complete construction of buildings of all kinds, I make a specialty in my woodworking shop of making and repairing furniture, and manufacturing screen doors and windows, both in stock sizes and to meet special requirements. With all the bungalows that are being built, I do quite a bit of band sawing for other builders, cutting rafter tails for open cornices. All of these lines are good to fill in; and the best part of it is, they keep the work steady throughout the year.

My shop is back of my residence, so I am able to look after this easily; and the photo post cards go out and work for me all around town and the neighboring country and bring the work to my shop.

I find that if a carpenter and builder has a neat shop, equipped with a few gasoline-power and hand-power woodworking machines, the people have more confidence in him and are more apt to give him the contract on any work they may have.

Of course, after a builder has his shop and his equipment, he must let folks know that he has them, or he might just as well have saved his money. The best way I know of to let people know what you have, is to show them a photograph of it.



Many a factory owner owes a large share of his success to having surrounded himself with good, competent, faithful workmen, and many a workman owes his start in business to the kindness of some employer; so, while we may not be able to say the score is even, we can at least see that each can help the other.



The power corner of shop, showing gasoline engine. This is always interesting to customers. The cabinet back of the engine contains all engine supplies. Note small model screen-door and window back of foot-power grinder. These models help land many orders.



Shop store-room, showing order of screens all ready to ship out. This room contains all odds and ends, so that there is nothing in the way in the shop proper. Even the line shaft is under the floor, out of the way.



Nails Unrusted After Two Hundred and Seventy-Six Years

REMARKABLE DURABILITY OF OLD FASHIONED CUT IRON NAILS DEMONSTRATED

By George M. Huntress

THE oldest brick house in New Hampshire, and in fact it was the first brick house erected in the State, still stands here at Greenland. It is the old Weeks house, erected in 1638, and is, therefore, now two hundred and seventy-six years old. Seven generations of the Weeks family have dwelt under this roof.

There is many a lesson for builders in examining some of these old-time houses. Take nails, for instance. One doesn't have to have been as old a carpenter as I am to remember back to the time when iron-cut nails were in common use. What do the young fellows of today think of nails in use and exposed to dampness for more than 200 years, *without rusting?* We are lucky if nails last for ten years these days. Our popular wire nails rust down to just a little streak of powder in about that time.

Now look at these nails; the longest one I took just the other day from a red oak timber in the cellar of the old Weeks house. It was driven in the year 1638. It is still bright and clean. It was a hand-forged nail and the hammer marks are still plainly seen. Such a record of two hundred and seventy-six years of service in a red oak cellar-beam is quite an argument for better building, and for paying a little bit more

Mr. Huntress is an old-time carpenter, 77 years old. He has worked all his life in the neighborhood of Greenland, N. H., where the oldest brick house is located. We can vouch for the truth of what he says about the present condition of the three old record-setting nails, as the nails themselves were sent to us to be photographed and are now on display in our editorial rooms.—Editor.

and using building materials that will last. The other two nails, while venerable in a way, are mere babes-in-arms compared with this old grandfather nail. I took them from a wooden house built two hundred years ago. The shorter one is a clapboard nail, the other an inside finish nail. Both are clean and bright, absolutely free from rust.

The illustration shows these nails to exact size.

There are several other interesting facts about the old Weeks house that are worth recalling. The walls are 18 inches thick, built of bricks burnt right on the site, at the time of building. Tradition says that this house was built as a sort of garrison with a view of safety from being burned down by the Indians.

The main supporting girders of the first floor are 12 by 14-inch oak beams. Subordinate beams are round red oak timbers, 10 inches in diameter.

The only change that has been made in the outside of the house is in the windows. They were originally made up of small diamond panes, set in lead.

It is said that there is only one house in New England that antedates this Weeks house and that is the ancient Craddock mansion in Medford, Mass., which is stated to have been built seven years earlier. The architectural design of the two houses is identical.

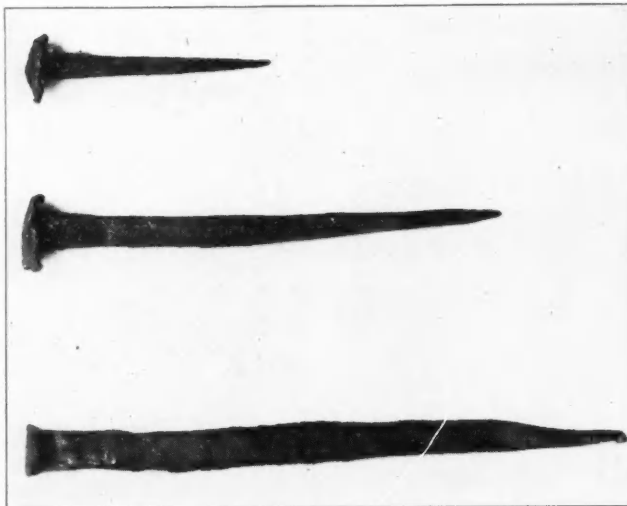

Three old-time, hand-made, cut iron nails; pictured actual size. The longer nail has seen 276 years of service; the other two have been in use 200 years. The short one is a clapboard nail; the middle one, with the large head, an interior finish nail. All are clean and bright, free from rust.



The old Weeks house at Greenland, N. H., the Oldest Brick House in New Hampshire, Built in 1638, and still in excellent state of repair.

Task and Bonus Work Applied to Excavation

HOW A LARGE CONSTRUCTION COMPANY SAVED MONEY BY PAYING THEIR MEN MORE

NO up-to-date manager need be told that a properly conceived and properly applied bonus system will reduce the unit cost of work. Just how much this reduction will be depends largely upon the work being done and the manner in which the bonus is applied.

The diagram on the next page shows how even such prosaic work as excavation—in midwinter—may be made to yield results in economy as well as rapidity of accomplishment. It is a record of work done by the Aberthaw Construction Company, Boston, Mass., in excavating for reinforced concrete factory buildings in New Haven, Conn., for the Acme Wire Company and the Oven Equipment & Manufacturing Company.

Work was started December 29th, with frost in the ground. The building represented by the diagram measures 400 by 62 feet, with basement floor about 10 feet below natural grade. As the material excavated was used in bringing up the grade of depressions about other portions of the lot, the contractors decided to use wheel scrapers. In addition to the earth excavated, quantities of good sand were taken out and placed in storage piles, to be used later in concreting. The

loam and top soil were first removed by the use of plows and frost wedges.

A study of the length of haul and the number of wheel scraper loads per day showed that 120 loads—for a longer haul, 110 loads—made a full day's work. The teamsters in their leisurely way and with apparent disinterest could haul at best only 120 or 130 loads. The application of the bonus to a task easily within limits of accomplishment changed the entire tone of the job from half-hearted endeavor to enthusiastic effort.

A bonus of 50 cents was given each driver who had made 120 loads or more during the day. The bonus was increased to \$1.00 for each man who made 150 loads—a mark which several reached. It was expressly stipulated that the horses should not be mistreated in reaching bonus figures and that loads which were not full would not be credited on the tally board. While these instructions were well followed, it is probable that the horses were worked to their limit.

In applying the chart it will be noted that the scale for unit cost in cents per cubic yard is inverted. This was done for the purpose of making the three curves as nearly parallel as the facts would permit, and the

result is a surprising uniformity in the trend of the curves, location of peaks, etc. As would naturally be expected, the unit cost was lowest when the quantity and consequently the bonus were highest. The gain, however, from a cost of 35c per yard at the time the bonus was first applied to 25c and under for the peak of the curve, was very marked, involving, as it did, a saving of more than \$60 a day for the excavation during the period of highest output.

A Satisfactory Time Check

By **Fred Tucker**
Contractor & Builder, Minonk, Ill.

FOR four years I have been using printed time tickets like the one reproduced below, and I find them quite satisfactory. This sample one is filled out by one of my men who takes care of a lot of small jobs. It is a fair sample of how this time card system works.

You will see that the workman's name is filled in at the top along with the date. There is room to

Fred Tucker
CONTRACTOR AND BUILDER
MINONK, ILLINOIS

Mr. *Chas. Smith*
Time slip for week ending *May 16th 1914*

Paid.....191	Number of Hours Each Day						Total No. of Hours for Each Day	Rate Per Hour	Wages Due
	<i>Jones Job</i>	<i>Ed Walsh</i>	<i>A.R. Fallon</i>	<i>W. Manner</i>	<i>Woodwin Bros</i>	<i>Opera House</i>			
Monday	10						10	35c	
Tuesday	2	8					10	"	
Wednesday			9	1			10	"	
Thursday	6			4			10	"	
Friday	7	2			1		10	"	
Saturday					6	4	10	"	
Totals for Week	25	10	9	5	7	4	60		21 ⁰⁰

Remarks _____

Facsimile of Time Card in use by Contractor Tucker, Minonk, Ill. A New Card is Issued Every Monday Morning to Each Workman. This Card Shows That During the Week, Ending May 16th, Chas. Smith Worked on Six Different Jobs as Indicated.

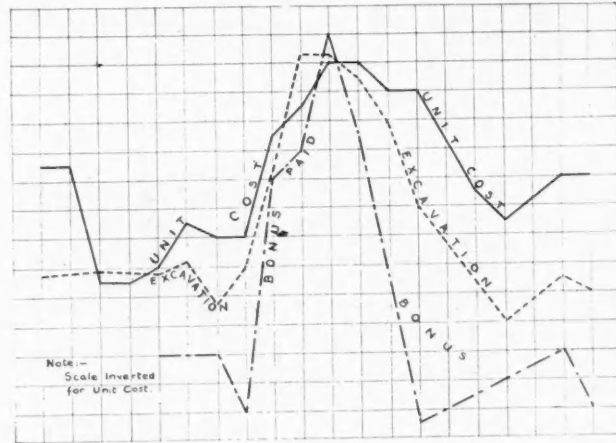

Graphic Plot Showing Relation Between Amount of Bonus Paid Excavators and Amount of Excavation Done. Note Scale for Unit Cost Line is Inverted.

write in the names of seven different jobs; and that generally is enough. If a man is shifted around from one job to another, he fills in the number of hours in the proper square under the name of the job and for whatever day of the week it is. Adding up these columns at the end of the week, shows what charges to make against the several jobs and also the amount of wages due.

If I was having these blanks printed again, I would allow a little more space for writing in the names of the jobs. I would also label this section of the form so that anybody could know without having to be told that the name of the job should be written in there.

I have found this a very handy form of time check, especially suited for a small contractor. I used to have a more elaborate one, but finally "cut out" all the frills and left only what was actually used and needed. Of course, a lot depends on a contractor's method of bookkeeping, paying off, etc.

I keep these time tickets all grouped together by weeks, and I can tell at a moment's notice for four years back where any one of my men was on any given date.

It is cute to see how near you can get your fingers to a saw and not hurt them, but it is a good deal cuter to see how far you can keep them away from it and still keep them occupied to the best advantage. Your fingers will come handy when you are old, but a reputation for cuteness is short-lived and not a bankable asset.

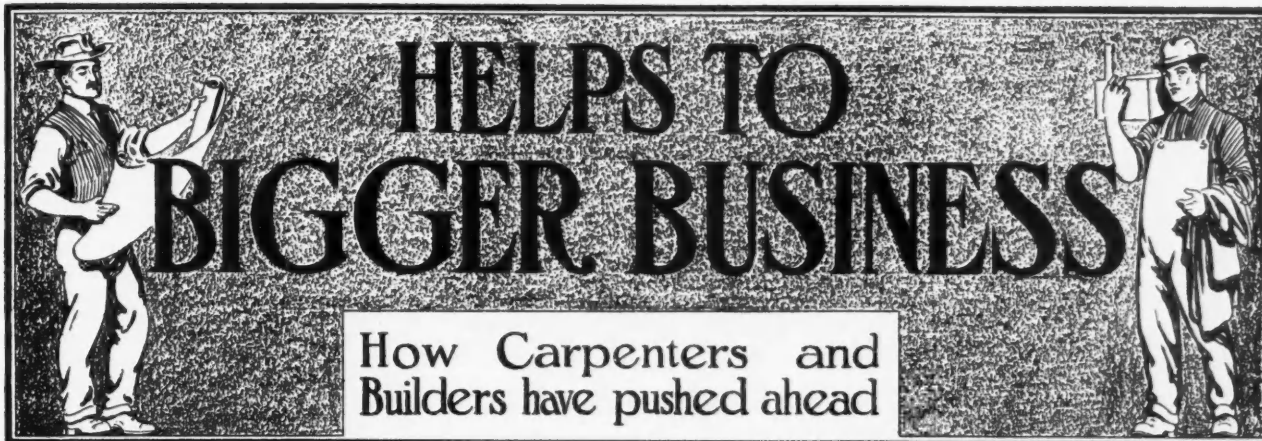

From Wage Earning to Independent Business

HOW CARPENTERS AND BUILDERS CAN WORK UP A PAYING JOBBING BUSINESS IN MOST ANY LOCALITY

By C. Bryant Schaefer

MANY a neat and prosperous town owes its attractiveness to its working carpenters and builders. The skill of the trades has built the homes and many lesser features, and has kept them in repair and up to date. It is an example of good workmanship and its benefits to a community, and of small jobs that deserve more praise.

Something more, however, than skilled labor has been necessary; that is business ability. This latter accomplishment does not consist in an expert application of the practices one may learn in school. It is recognition of the needs that actually exist around one, which differ in every different place; and the offering of one's labor should be governed accordingly. To be right secures the good will of others without further provision. Doing well that work with which one is intrusted secures still better support. Hence it is that any good workman is a candidate for business ranks, and safely so.

The setting up for one's self comes easy to some, others continually try and never seem to catch on. For this there are reasons; correction may lead to success. If we had more business people there would be more places for the unemployed.

Be Always Looking Ahead

Probably some workmen look forward to a time when they will make a grand break, a sudden change and set up in business. Avoid that. Not even much money can make up for lack of preparation. Business strength, like muscle, must be gradually cultivated. Take an interest in those things which would tend to make up your business. No matter if one is not in a position to profit, one is in a position to learn, to get one's hand in, as it is called. Remember what you do; true up the future by referring back.

Other aspirants do not know how to promote themselves. They keep hanging onto situations and old ways of doing. Many a place lost reveals a better

one knocking for recognition. To be fired is a chance to look the world in the face. Those who will not do that are oftenest landed down and out.

It is fortunate employers cannot avoid making changes. Do not desire a steady place unless you make it grow. If it were not for the army of confirmed moral cowards in public office there would be no support for boodlers and grafters. They are like the little dog that was raised in a flat. When taken out of doors his legs gave out, he dropped to the ground and hung on with closed eyes, resisting every effort to make him stir. The fault was in the good people who did not believe in providing a little liberty for mature growth. The person with a berth and a pension lives in a state of permanent legal minority.

One of the complaints is a lack of opportunities, lack of Santa Clauses and opportunities. Some have not been taught that after having enjoyed other makers' opportunities they must make their own opportunities. That is what ails so many men who complain of always being out of work in middle age. They kept no account of their spare time with a view to summing up



Gate Poorly Made and Hung by Owner—Because no Contractor Offered to do it for him.

in after years. It was their best bank in which they never deposited.

Opportunities at Home Better than Boom Town

Other persons make a great rush to booming localities having attractive work under way. They fail to reason that all this business has been growing in plans for some time already and that everything is settled for a long time to come; that no great changes can be made without violating faith with many of those interested. This is business credit, consideration for obvious rights of others. Strangers cannot find openings.

Some move in a cloud of generalities or take an interest in affairs they cannot bring home. Remove all this dust from the eyes, and any bright person can get next to business.

Typical Building Condition

Let us, then, stop off at one of the less prosperous towns and see what the chances are. Lack of repairs, lack of paint, leaning fences, proclaim plenty of opportunities. It does not look inviting, it must be admitted; there may be no demand for workmen, money may not be easy, a run-down reputation argues against success. But right here is where business ability is most needed and the greatest profits can be realized.

Never wait until your good work is demanded. Those who cultivate a habit of waiting, wait forever. A town like this is full of weary waiters. Its very contagion will catch newcomers. Be an antidote.

After learning what people ought to have, strange to say, one has to make them want it. Then show them how they can get it of you, what you have.

Upon getting their ideas up to date and showing them what they are missing, comes the question of money.

Your trade is your capital paid in, as soon as you begin to conduct your own work. When other people get money on the strength of what you can do, you begin to control money.

You can assure the owner of any likely job that the work you give him will not only increase his values

enough to pay you a fair price, but a profit to him also. This starts the money coming.

As I said to begin with, the builders make the prosperous appearing town. And the neglected places have the beginning—perhaps your own native burg. Better stay and make it alive. Consider every detail, prepare every step; it is a safe risk; far more so than seeking for lucky strikes and striving to make popular hits, especially in strange places.

Systematize Your Hunt for Prospective Customers

There is a vast difference stopping at a town on a holiday and stepping off on a common every day when there is nothing doing. Even smart commercial travelers know where they are going, who they will see and all that. To be sure some drift into social gatherings and such doings; but it is a roundabout way. Push your way along your business lines.

At one stopping place we found a gateway like our first sketch. We could not have made the picture without the original in front of us if we had tried. It indicates a scarcity of accommodating carpenters as plainly as words. Some craftsmen are too conceited to use a few old boards the owner may have been saving up. It is in line with his business to accumulate what he can. Some workmen make too big a job over a small need. It is worth more to secure the good will of someone, to have their word for you and their reference.

This gate makes a good picture; would be interesting on some obscure lane, but not on the busy street front. It is a credit to the owner who went out of his way to make it himself. The bent post was already there. On account of it, the hinge at the top swings it constantly open, so that he had to hang on a weight. Another matter he did not anticipate is the placing of the brace, which is bottom side up. The nails will only hang onto it for a short time, until the right man to do the job comes along, for this gate tells of thriftiness. Perhaps you do not believe that, but I saw very smart looking children come out with a gentleman as I passed

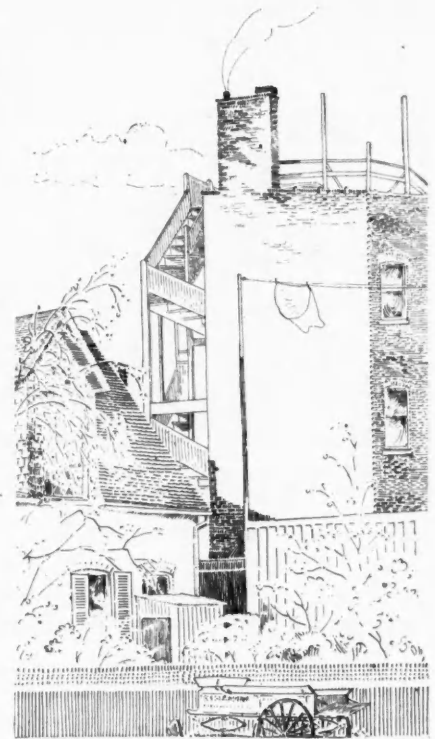

See that Your Work Has a Finished Appearance From Every Point of View.



PRESERVE NATURAL BEAUTIES.

Remodel or Repair Old Houses with Care and Consideration.

on. It is the local carpenter who was shiftless.

Next we have here a picturesque little bit of a cottage, one of the vine-clad kind one likes to read about in poetry. But you know the underpinning is only 12 inches above the ground; that it has become soft with dry rot and that a new sill is badly needed.

Find out who the owner of such a place is, when he will have leisure, and then have a little carpenter talk with him. Propose to do the work with as little disturbance as possible. A few months later, when I came that way, someone had indeed interviewed the job; but they made a clean sweep of everything, trimmed it up until all the poetry was taken out of it, more's the pity. Occupants will postpone improvements a long time before they will intrust their work to careless people.

I know where the owner of a little homestead hauled underpinning himself from a railroad siding a mile away to put beneath his little 20 by 30-foot house. And the beams he had were 12 by 12 inches, 30 feet long, heavy enough to put under a brick warehouse. These sills are there in the back orchard yet, overgrown with grass, while the windows are boarded up and the house leans deserted in the winter storms. He finally induced a contractor to come and build a new house up the road, shame to say.

Introduce New Ideas and Conveniences

There are many inventions on the market for improving old homes artistically. They should not, however, be used to cover up rotting woodwork. Clean out and make a sound body to nail to.

There are many conveniences which might be had



A Comodious Rear Porch Screened would make a Welcome Addition to this House—and to Many Others.

inside, but their introduction has to be explained. Ask to be allowed to look the place over and make suggestions.

One of the mistakes of the past was the overloading of the fronts—sheet-iron balloons on the corners and all that—and shearing everything off on the back.

Sometimes results look ridiculous, as in this other sketch of a flying stairway and solitary clothes pole. Anyone who sees would prefer to house the work up snug.

The kitchen door of this other sketch opens onto a nice and shady garden. It would be easy to convince the occupants that they might and should have a comfortable sitting porch with an adequate roof. Give work a solid appearance by facing the edges, even if only with a plain slat.

Many owners hesitate to introduce improvements because the business is new to them. This unfamiliarity makes them backward, makes it easy to see the difficulties that do not exist in practice.

Some young building hands may also hesitate to push their own business, fearing the operation of an architectural law. The truth of their diffidence is that they are not accustomed to approaching strangers. Brace up! Their enterprise has its own protective laws, which past or future legislation cannot infringe.

Business makes more business, cornering and coercing breed after their own kind—failures and panics.

Try to get over the hump between wage working and business careers. If there is not room at the bottom, it is surely a sign of too much room at the top. And yet the bottom worker may make himself the most free if he simply hustles. Stir and movement dislodge about all the troubles that are imposed upon one.



WEIGHT OF CASTINGS AND PATTERNS.

I have made many wood patterns for castings in my time and oftimes it is desired to know how much a casting will weigh. The answer is for cast iron and white pine pattern, one ounce of wood to 16 ounces of iron (16 to 1). Not grape juice, but cast iron and white pine.

IMPROVISED SPEED INDICATOR. Very recently, I witnessed a good stunt, pulled off by the two extremes of a mill,—the Shop Mill-wright and an office boy. The number of revolutions of the line shaft was desired,—the mill-wright's speed indicator broken, the man held a metal rod up against the edge of a steel split pulley which had a joint that slightly protruded. Every time the joint came around it made a cracking noise. The boy had a white pine board on a bench near by and every time the crack sounded, he made a small quick mark with a lead pencil, with his watch lying on the bench before him. He kept this up for 30 seconds, then counted his marks, doubled it and had the revolutions per minute of said shaft. I will admit it was a new one on Yours truly,

WM. C. JASBURY.

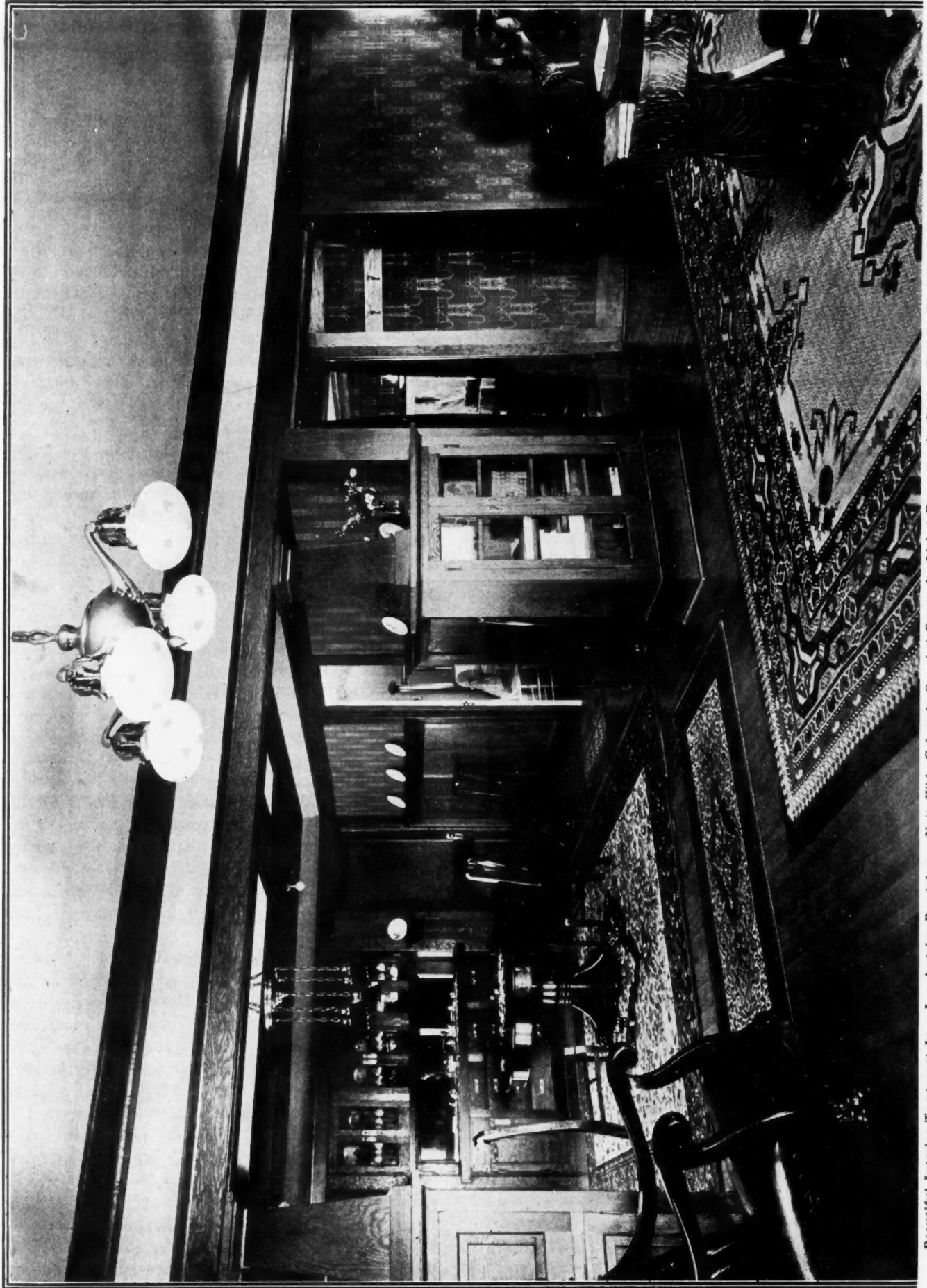

Beautiful Interior Treatment In a Los Angeles Bungalow. Note Wide Colonnade Opening From the Living Room to the Dining Room. This Gives the Popular Spacious Effect, and the Cost Is Moderate.

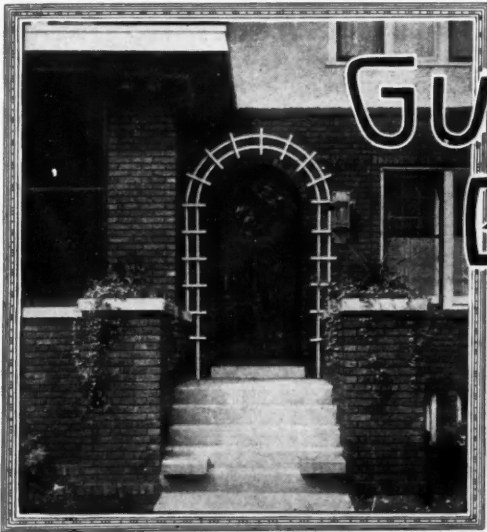

GUARANTEED BUILDING PLANS

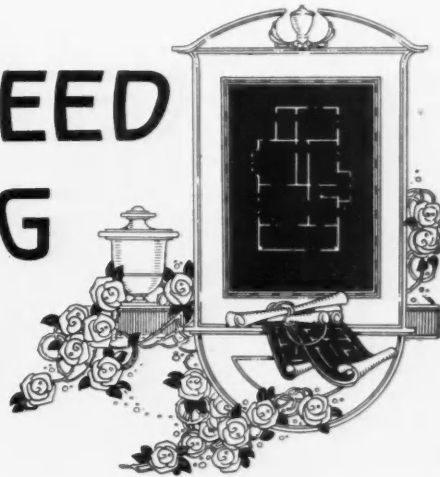

A Five-Room Lake-Side Cottage

To enjoy a summer outing, it is necessary to have a comfortable house to live in. Very few families are aboriginal enough to enjoy themselves any great length of time without most of the household comforts that they have been accustomed to from infancy.

Everybody expects a summer home to look different from a home in the city. One essential to comfort in a summer cottage is plenty of veranda space. When the weather is at all suitable, every member of an outing party likes to spend as much time in the open air as possible, but the glare of the sun is not very pleasant to those accustomed to being in the house most of the time during the balance of the year.

A veranda long enough to provide

space for easy chairs and hanging seats is a great comfort. Each member of the party should be provided with a lounging place on the veranda.

Of course the rooms in the house must be comfortable for stormy days and so arranged and furnished as to be inviting. It is rather a difficult proposition to arrange and furnish rooms in a satisfactory manner, because no one likes to spend much time indoors when off for a summer holiday.

This plan provides a splendid large living room which is a very good compromise between veranda for mild weather and a regular house for cold evenings. There are two bed rooms and a bath room on the second floor and plenty of housekeeping rooms on the first floor.

The construction will be light or sub-

stantial, according to the climate and the length of time the house is likely to be occupied during the summer.

It will also be noticed that the chimney for this house is almost in the exact center. When possible, it is better to build a chimney of this type; it saves heat and it saves expense, and it is worth a great deal more because of the general satisfaction of having it right.



Five-room summer cottage with a long veranda. Size, 27 by 26 feet. We can furnish complete set of blue-printed working plans and typewritten specifications for only \$5.00 per set. Blue-prints consist of basement plan; first and second floor plans; front, rear, two side elevations; wall sections and all necessary interior details. Specifications consist of twenty-two pages of typewritten matter. When ordering, ask for Design No. 6004.

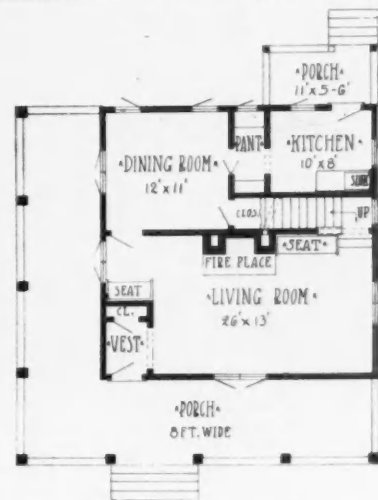
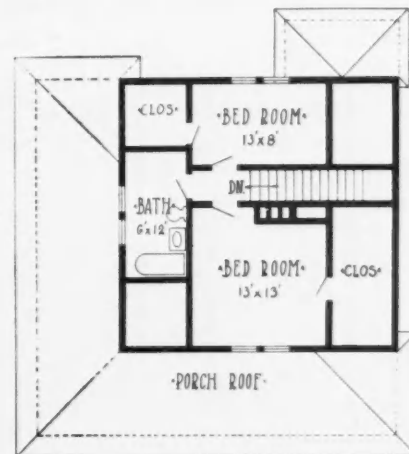

Floor Plans of Summer Cottage.

Six-Room Summer Bungalow

This design shows a light frame, stucco finish, six-room summer bungalow that is very attractive in finish and appearance.

Better summer homes are wanted each year. The old time shacks are not respected any more. Still, comparatively few families care to build expensive houses to use only for two or three months' vacation.

While this plan is strictly a bungalow in design, there is a stairway to the attic, and this attic will be found convenient at times for sleeping cots when the boys come to stay over Sunday. The arrangement of the rooms would prove satisfactory in a more expensive bungalow in town.

A built-in porch after this manner will be appreciated because of the protection it gives against wind and storm. For still rougher weather, the large living room, 15 by 21 feet, offers a very comfortable retreat.

In building a fire place for a summer cottage, the size of the opening must be large enough to take in small logs and stumps. At all summer resorts, more or less drift wood may be gathered and dried out for firewood. A wood fire brightens up a living room better than any other kind of fire. The only fire place furniture necessary are a pair of andirons and a set of fire

irons, consisting of poker, shovel and tongs and a suitable standard to hold them. The open fire is the attraction. The fire place trimmings should be very plain and simple.

No fireplace should be closed with a wooden stop even in summer, for soot in the chimney may take fire or sparks from some other source of heat using

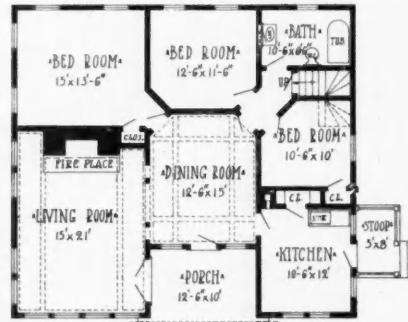

Floor Plan of Summer Bungalow.
Size 40 by 36 feet.

the same flue may fall and set the board on fire.

No wooden finish should ever be applied to the surface of a chimney or any flue for smoke, hot air, or steam, which includes wood lathing. Plaster can be applied to metal lathing in such places. The radiated heat is often quite enough to set any such wooden furring, lathing, or sheathing on fire.

Never leave open an unused pipe hole in a chimney, but provide it with a tight-fitting metal cap, because accumulations of soot in a chimney frequently take fire and burn fiercely. Such a fire, or sparks, may set fire to the house through an opening of this sort.

The summer bungalow requires a wide cornice to give it a summery effect. In this case, the cornice is supported by brackets which are useful as well as attractive.

In a house as compact as this, with so many rooms, the clothes-closet proposition is a difficult one. However, there are three closets parceled among the bedrooms, and there is plenty of attic room for the storage of extra clothing, bedding, etc.

The planting around a bungalow is important. Shrubs and climbing vines add a great deal to the appearance of a well built porch. In fact, no house is complete when the carpenters and painters finish their job. The owner must use a little head work and a good deal of muscle in fixing up the grounds to match the house.

An aristocratic appearance may be given to a poorly designed house by the proper arrangement of vines, flowers and shrubbery. But the best house ever built looks bare and uninviting as long as it stands out alone on a bare lot.

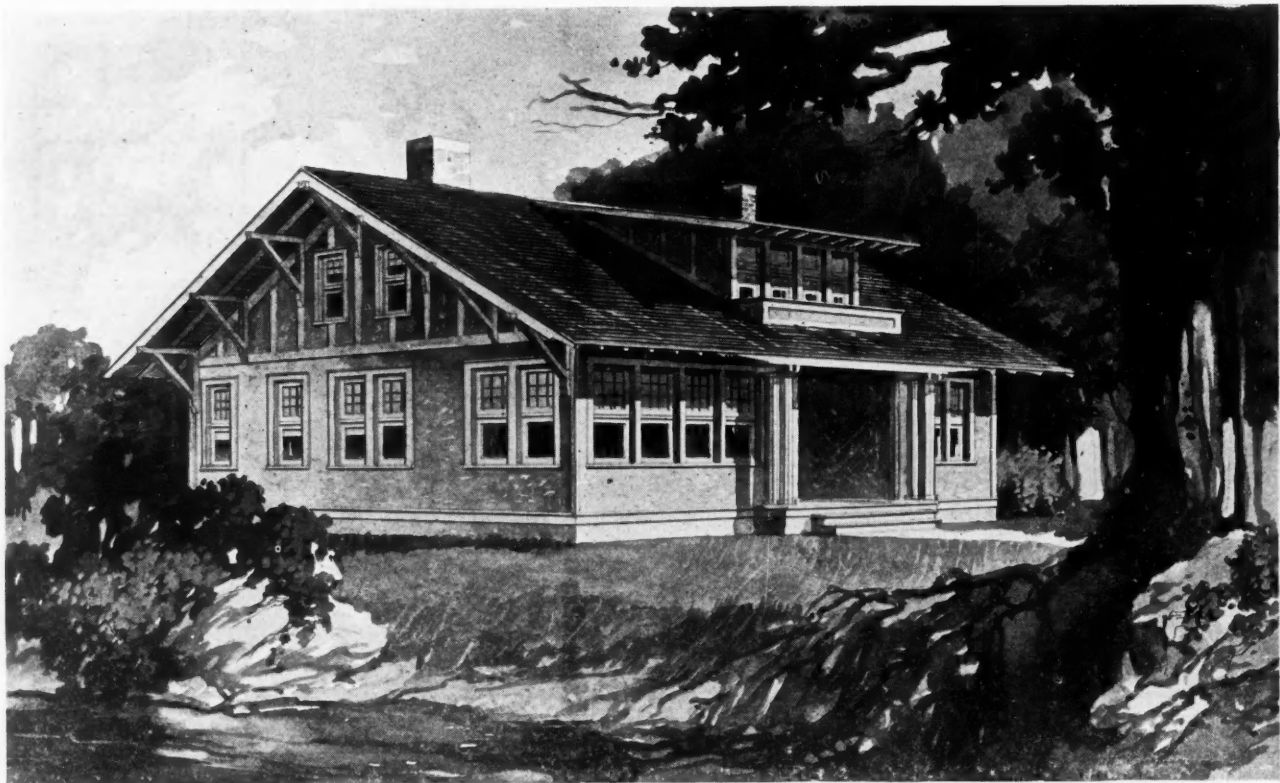

An interesting summer bungalow. It is 40 feet by 36 feet in size, with six rooms and a built-in porch on the first floor. We can furnish complete set of blue-printed working plans and typewritten specifications for only \$5.00 per set. Blue-prints consist of basement plan; roof plan; first and second floor plans; front, rear, two side elevations; wall sections and all necessary interior details. Specifications consist of twenty-two pages of typewritten matter. When ordering, ask for Design No. 6606.



Gambrel or curb roof house design that has been carefully planned to secure the utmost value for the amount of money expended in building. It is 28 by 26 feet in size. We can furnish complete set of blue-printed working plans and typewritten specifications for only \$8.00 per set. Blue-prints consist of basement plan; roof plan; first and second floor plans; front, rear, two side elevations; wall sections and all necessary interior details. Specifications consist of twenty-two pages of typewritten matter. When ordering, ask for Design No. 6586.

Gambrel Roof House Design

A very neat, rather fancy effect is given in this house plan. The first gambrel or curb roofs that became popular with builders were used for barns; but of late years, a great many houses have been constructed on this plan. The reason is that the roof is sensible. Good, sound, common sense usually prevails in the long run, in spite of fashion, or decree of any kind.

In the first place, the roof is roomy without using unnecessary material. A one-story house may be carried up in this way to give sufficient height of ceiling for the bedrooms upstairs without adding a great deal to the expense of the house. Many old-fashioned cottage house plans would cost as much to build as this house and give only half as much room when finished. Economy in roof construction is just as valuable as economy in any other part of the building.

This is a comparatively small house, only 28 feet wide by 25 feet deep, but it contains seven rooms and a large reception hall, and the rooms are comfortable, both in size and proportion.

It will be noticed that no space is wasted in halls or stairway. The hall

upstairs is merely big enough to accommodate the doors to enter the different rooms. The hallway down stairs is simply a coat closet with doorways and an entrance to the cellar.

It takes very careful planning to space the several necessary home conveniences

as economically as this. Every cubic foot enclosed costs just so much money. The waste room in a house costs just the same as room that is valuable.

The side entrance to the cellar and kitchen is a great convenience and it saves tracking dirt into the kitchen.

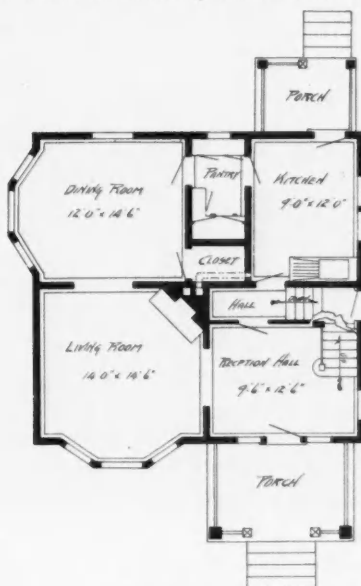

First Floor Plan.

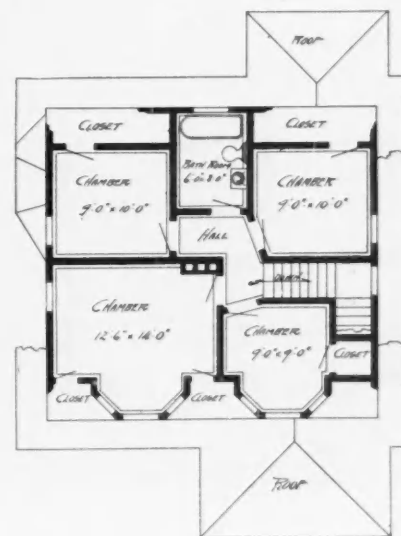

Second Floor Plan.

Arrangement of House, Size 28 by 26 feet.

Square, Two-Story House with Attic

A square built house offers the greatest possible amount of room for the amount of material necessary to enclose it. This design is only 26 feet in width by 24 feet from front to rear, exclusive of porches and the built-on pantry.

The house being almost square, makes up naturally into four rooms upstairs and four rooms downstairs—the one room down stairs being used for an open stairway and reception hall.

The living room is made a little larger.

The appearance of the house is improved by the two porches and the two bay windows and the built-on pantry at the back, together with the dormer windows in the roof. These embellishments relieve what would otherwise be a plain exterior.

The arrangement of windows also is pleasing. The placing of windows is quite a study in house building. Everyone wants to get as far away from the factory type as possible, still windows must be symmetrically arranged. There

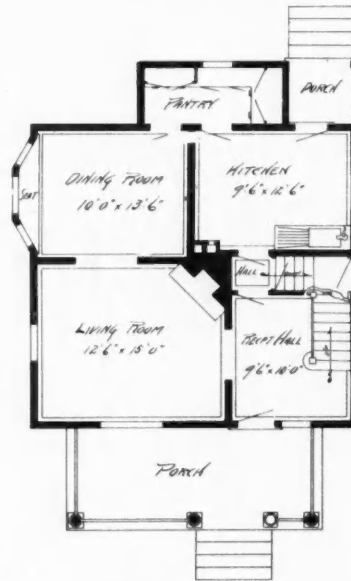

First Floor Plan.

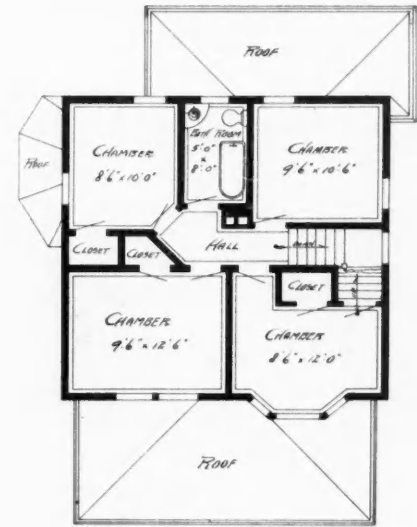

Second Floor Plan.

Arrangement of House, Size 26 by 24 feet.

also is a limit to the height of windows, both top and bottom and sideways because of the proper placing of furniture.

In this plan it will be noticed that

each bedroom has two wall spaces for furniture, free from windows. House-keepers will appreciate this particular advantage.



Square, two-story house with attic. Size, 26 feet wide by 24 feet in length, exclusive of porches and built-on pantry. We can furnish complete set of blue-printed working plans and typewritten specifications for only \$8.00 per set. Blue-prints consist of basement plan; roof plan; first and second floor plans; front, rear, two side elevations; wall sections and all necessary interior details. Specifications consist of twenty-two pages of typewritten matter. When ordering, ask for Design No. 6575.

Full-Pitch Roof House

A neat little house of five rooms is shown in this design.

The peculiar feature about this house is the full-pitch roof, which means that the gable forms an equilateral triangle. It takes more roofing material to build a roof like this, but the rooms upstairs may be lathed and plastered directly on the rafters, if desired, which makes a saving in that way.

Steep roofs last longer, which, of course, is another economy; and a great many people think they look better. At any rate, this roof provides the space necessary for two good bedrooms and a bathroom and plenty of closet space on the second floor.

One dormer gable lights the bathroom and the stairway, while the other furnishes a window to light one of the bedrooms.

On the first floor the arrangement is complete with hall, kitchen, dining room and parlor.

This style of stairway is well liked. It has been built a great many times in different parts of the country and it will continue to be built because it is



First Floor Plan.



Second Floor Plan.

Arrangement of House, Size 24 by 28 feet.

pleasing in appearance, takes up but little room, is well lighted from the two windows and offers an easy tread and riser. Also, the stairway to the

cellar, being underneath and convenient to the kitchen, is well-nigh perfect.

The chimney has an extra flue for the furnace, possibly to be put in later.



Five-room house with full pitch roof. It is 24 feet wide by 28 feet long. We can furnish complete set of blue-printed working plans and typewritten specifications for only \$7.00 per set. Blue-prints consist of basement plan; roof plan; first and second floor plans; front, rear, two side elevations; wall sections and all necessary interior details. Specifications consist of twenty-two pages of typewritten matter. When ordering, ask for Design No. 6572.

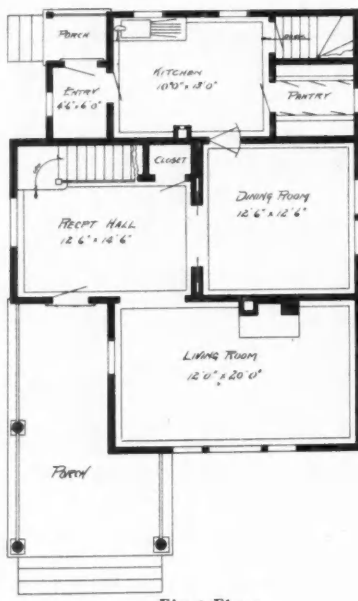

First Floor.

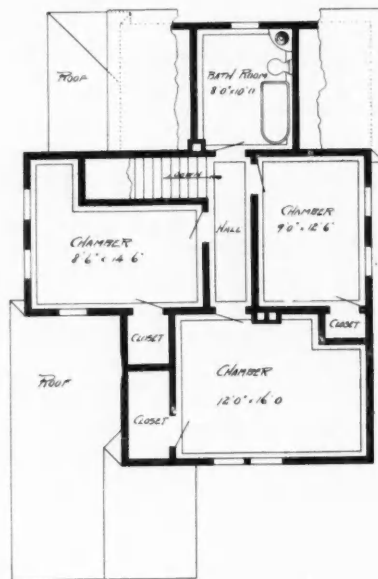

Second Floor.

Seven-Room New Jersey Dwelling

A style of house very often built in the state of New Jersey and other southeastern sections is shown in this design. The plan lends itself easily

to comfortable homelike appointments at a very moderate cost.

As long as this style of house has been built, it still retains its popularity. It seems to provide the room necessary for a family of four or five

with all the comforts that such a home should have.

Every room in the house is light and airy, at the same time it is easily heated by a warm air furnace placed in the center of the cellar.

In building a house like this, it is well to consider the width of the main structure, which is 20 feet. This plan has been spoiled a great many times by narrowing down this part of the house to 16 or 18 feet. Builders often make that mistake. When a house plan has been carefully worked out and duplicated a great many times it is good to either follow the plan as finally adopted or select something entirely different.

This width of 20 feet gives a living room that amounts to something. A living room 12 by 20 affords places for furniture comfortably placed and the room is big enough to entertain a few friends of an evening without feeling unnecessarily crowded.

This manner of building a veranda entrance leaves the front of the house clear of any obstruction so that the wide mullion window may admit both light and sunshine to the living room.



A New Jersey style seven-room house. Size, 29 feet by 36 feet, a story and three-fourths. We can furnish complete set of blue-printed working plans and typewritten specifications for only \$10.00 per set. Blue-prints consist of basement plan; roof plan; first and second floor plans; front, rear, two side elevations; wall sections and all necessary interior details. Specifications consist of twenty-two pages of typewritten matter. When ordering, ask for Design No. 6573.

House Designed for Narrow Lot

A small house of five rooms suitable for an extra narrow lot is shown in this design. It is only 18 feet in width, but the lower part is 40 feet in length, the kitchen being but one story in height.

The one stairway leads to the upper rooms and the steps underneath lead down to the cellar from the dining room. In front there is a very comfortable living room or parlor with a fireplace built so as to leave room for a doorway opening into the dining room and a nook to fit a bookcase in the corner.

A house as high as this needs a good heavy porch across the front to relieve the plain, high front effect. Another essential in this design is to select a nice-appearing front door, and the door must contain glass enough to light the stairway. What would otherwise be a dark hallway is then pleasantly lighted.

One reason for making a house so narrow is to get light on both sides, even when it is placed on a 30-foot lot. Few city lots are narrower than 30 feet, which would leave 12 feet for light. One reason for the one-story kitchen is to give plenty of light in the back bedroom and in the bathroom.

Considerable ingenuity is required to meet all contingencies and to provide a building that is bright and pleasant.

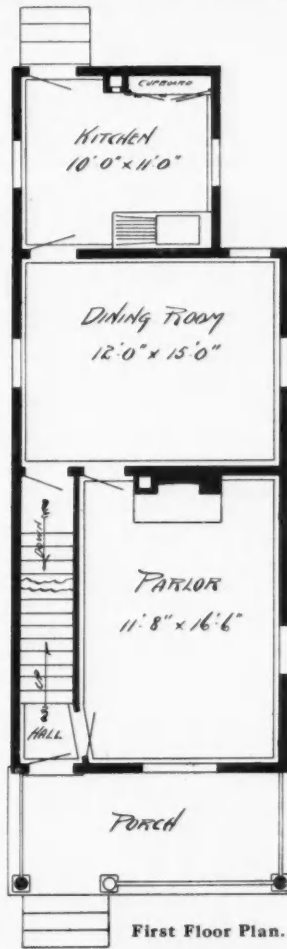

First Floor Plan.

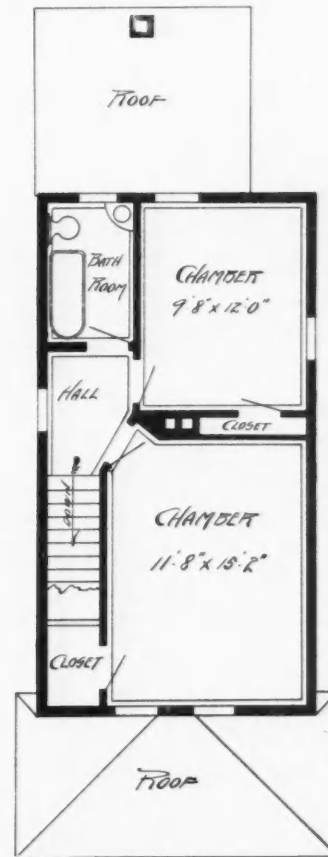

Second Floor Plan.

Arrangement of House, Size 18 by 40 feet.



Two story house designed to fit a narrow city lot. The size is 18 feet by 40 feet on the ground, exclusive of porch. We can furnish complete set of blue-printed working plans and typewritten specifications for only \$5.00 per set. Blue-prints consist of basement plan; roof plan; first and second floor plans; front, rear, two side elevations; wall sections and all necessary interior details. Specifications consist of twenty-two pages of typewritten matter. When ordering, ask for Design No. 6589.

The Plan Shop

Practical House Designs

"That are Different"



A Good Example of Simplicity By Charles Alma Byers

There was a time, not many years ago, when the attractiveness of a home, both in architecture and furnishings, was gauged by the quantity and quality of its bizarre ornamentations, which were largely, if not entirely, superfluous. Today, the keynote of good home-building is simplicity; and our homes of today are unquestionably more attractive and home-like than those of any other period in the history of architecture. And this applies to homes of all kinds, be they large or small, expensive or inexpensive.

The home illustrated here is a good example of this present-day simplicity. The structural lines of the house are extremely plain, and at the same time the style is pleasing and individual. The main part of the building is two stories in height, giving an ample number of rooms to accommodate a fairly large family of moderate means. It is comparatively inexpensive, the cost of construction having been but approximately \$4,500, and yet it is decidedly well constructed, making a dignified and permanent home.

The house occupies a rather narrow lot, but the lots in the neighborhood are of sufficient depth to give room for a large city back yard, which, with proper appreciation, may be converted into a beautiful garden. In this case, the back yard has had considerable attention, and there is an excellent arrangement of trees, shrubs and vines, which gives the house a very attractive setting.

The siding of the house is of cedar shingles, like the roof. The foundation is of concrete, but all other masonry work, including the chimneys

and the small front porch, is of blue brick. The shingled siding is stained a soft brown color, while the trim is painted a deeper tone of the same color. The roof is stained a very light green.

The small front porch is designed very much like the usual second-story loggia, and on each side of the front door there is a tiny window. The entrance leads into an almost square reception hall, back of which is the winding staircase, of simple design, leading to the second floor. To the right of this hall is the large living-

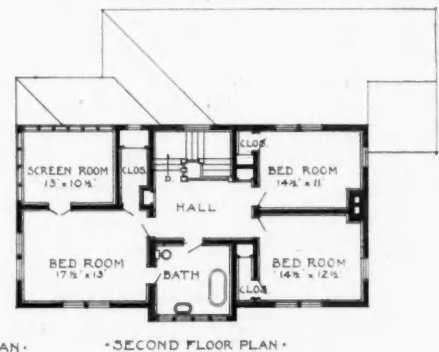
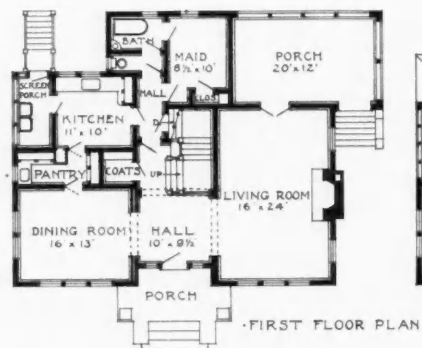

Eight-room Shingled Swiss Chalet Style Dwelling, Built for \$4,500 at Pasadena, Calif.

room, with a broad, open arch connecting the two, and to the left is the dining-room, shut off from the hall by sliding glass doors. This arrangement gives an appearance of spaciousness, and may be utilized to practical advantage when a large number of guests are being entertained.

The flooring in this part of the house is of polished oak, and the

small bath-room in the rear. An excellent feature of the first-floor arrangement is a large porch off from the living-room in the rear, which not only provides a retreat secluded from the street, but commands an excellent view of the back-yard garden.

On the second floor are three bedrooms, a screened sleeping-porch and a large bathroom. A hall forms con-

particularly well arranged for convenience and economy of space. They, however, need not be followed entirely, but will at least serve to suggest effects and ingenious methods for the individual house. The house is located in Pasadena, California, and was designed and built by E. B. Rust, an architect of Los Angeles. While the cost of construction will naturally



Interior view of Shingled Dwelling on Opposite Page. This Hall has a Barrel Ceiling and the Stairs are Handled in a very Interesting Way.

woodwork, which is of clear Oregon pine, is finished to resemble fumed oak in tone. The living-room contains a low, broad fireplace, with a simple mantel of olive-brown tile. The walls of the dining-room are paneled to a height of five feet, around the top of which extends a plate-rail. The walls elsewhere are plastered, and are tinted in different shades of brown and buff.

A small pantry intervenes between the dining-room and kitchen, and off from the kitchen is the customary screen porch. A short hall forms connections between the kitchen, the front hall and the maid's-room and a

nections with all of these rooms, except the sleeping-porch, and each of the enclosed bed-rooms has a large closet. The sleeping-porch may be used either for sleeping purposes or for an open-air rest-room, constituting an admirable asset in either capacity, with its elevated outlook into the garden.

The house has a large basement, with walls of concrete, to which access is made from the small rear hall. A hot-air furnace, located in this basement, furnishes heat to the different rooms.

The floor plans, which are shown, are almost self-explanatory, and are

vary according to the locality, the home should be duplicated almost anywhere at close to the price given above.

Nine-Room Brick and Clap-board House

Lewis Beck, Contractor and Builder of Moweaqua, Ill., designed and built the comfortable house on the next page. It is a two-story residence with a basement under the entire floor space. The first floor and porch columns are red pressed brick. The porch is very large and adds very much to the appearance of the house.

The main cornice has a projection of



Large Brick and Clapboard House Designed and Built by Louis Beck, Moweaua, Ill.



Floor Plans of Brick and Clapboard House Pictured Above.

four feet, which makes it have a very attractive appearance. The first floor throughout is finished in red oak; the second floor in yellow pine stained in oak, and red birch stained mahogany. This house has polished floors throughout and was dressed with a Triple A floor smoother. It has a hot water heating system and is modern in every respect. It has received a great deal of favorable comment. It contains eight rooms and a sleeping room, besides bath, hall and closets.

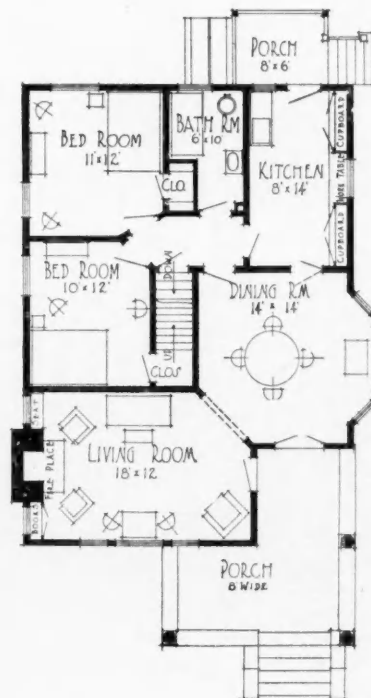

Photograph and Floor Plan of Artistic Five-room Shingled Bungalow, Designed and Built by O. N. Nelson, Rockford, Ill.

Popular Bungalow Gives Start

To the Editor: Rockford, Ill.
 About two years ago I built a bungalow for myself; and it proved to be so popular in layout and design that it has been the means of getting me permanently into the contracting business. I have built *eight* bungalows since then, four of them from this original floor plan. It is a five-room cottage, as illustrated on the opposite page.
 I find them very popular and am figuring a \$4,500 one now for this summer. I enjoy the A. C. & B. ever so much and find it helpful.

O. L. NELSON.

Double House of Southern Style

To the Editor: State College, Pa.
 Here are plans of a double house of southern style. This house was built for Mr. A. J. Mease, instructor at the Pennsylvania State College and Mr. S. K. Hostetter, financial agent for the Pennsylvania State College.
 The structure is of solid brick laid in Flemish bond with red face brick and black hard burned brick for headers.
 It is trimmed throughout in terra cotta, keystones being used in connection with brick lintels over all doors and windows.
 The interior is finished in southern red oak, while the second floor is finished in cypress in its natural color,

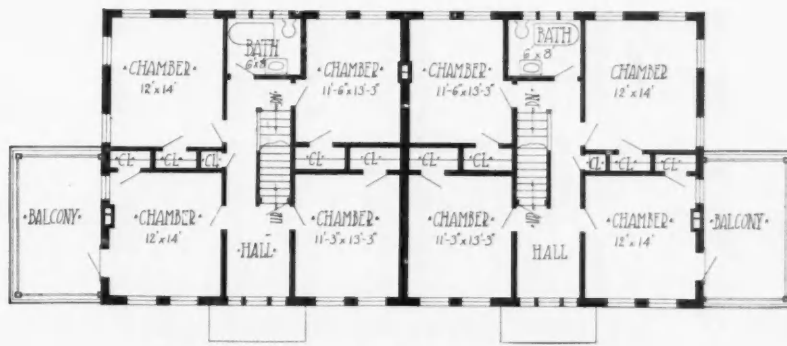

Second Floor Plan of Double Southern Style House.

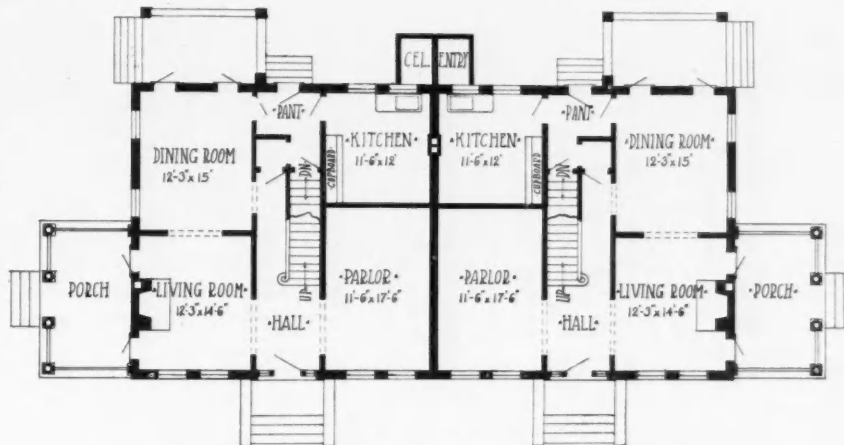

First Floor Plan of Double Southern Style House.

excepting the bath rooms, which are with 7/8-inch oak on first floor and 3/8-inch white enamel. The floors are all of double thickness with 3/8-inch oak on second floor.

P. R. HOMAN.



Double Brick House of Colonial or Southern Style, Designed and Built by P. R. Homan, State College, Pa.

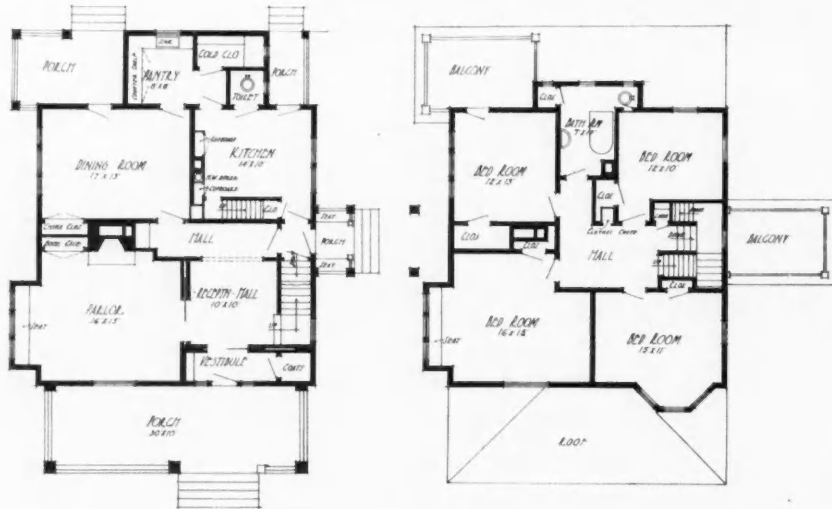

Floor Plans Showing Interior Arrangement of Eight-Room Hip Roof House.

Well Planned \$5,000 Residence

To the Editor: Somerset, Pa.
Here are plans and photographs of what I consider to be the best designed residence for the moderate price of \$5000 that can be built. It is of the square design which furnishes the greatest amount of room for the size and money.

In basement provision is made for heating and laundry equipment also storage space. The basement has water-

tight cement floors and walls. From the vestibule to the reception hall are double sliding glass doors, Balusters along main stairway are thirty inches long and extend from the solid partition to the ceiling, this giving a Colonial effect.

Entering the living room to the left by a single sliding door, one sees a built-in bookcase and mantle over the fire-place. From the reception hall an outlet is had to the right to a side porch and driveway under the balcony, also

to the dining-room which opens to the rear porch giving privacy. This is a very attractive feature, emphasizing the livableness of this house.

The conveniences of the pantry and cold closet do not need comment except that from the pantry lead two speaking tubes, one to the second floor hall and the other to the third floor. The second floor balcony provides ample room for airing beds and bedding. The finish in the kitchen, chamber and bathroom are maple—white enameled. The dining chamber is maple finished in mahogany. The living room is maple with walnut finish. Here there is a bevel plate mirror in the wardrobe door. The hall chamber in curly-maple, the first floor oak. The living room is finished in black, the halls bog-oak, the balance of the oak, golden. The doors through-out the house are select birch in one panel. The bath-room is tiled five feet. There are two rooms on the third floor, wardrobe and toilet, complete. A ten foot porch extends across entire width of house.

A. KENT MILLER.

Don't be prejudiced; glazed Dutch doors (cut horizontally through the middle into two parts) are better than French windows to open out onto a sleeping porch. The half doors permit a nicer regulation of cold air.



Comfortable Eight-Room Hip Roof House, Designed and Built By A. Kent Miller at Somerset, Pa. Cost \$5,000.



A Living Room of Unusual Beauty and Richness. The Ornamental Tile Fireplace and Mantel Fill the Entire End of the Room. There is a Built-in Settle in Each Chimney Corner. A Novelty in Beam Ceiling Treatment are the Heavy Stirrups that Seem to Support the Beams. The Windows are Grouped at the Corners of the Room and Two Art Glass Casements are Over the Mantel.



Warm Air System with Exhaust Flues

EXTRA VENTILATION PROVIDED IN EVERY ROOM OF MEDIUM SIZE HOUSE

By Cecil F. Herington

WHEN the Old Builder continued his discussion of heating problems he called attention to a house he had erected some years ago in which a furnace was put to a much more extended use than ordinarily.

"This house was a very small cozy dwelling," he said, "consisting of a hall, parlor, dining room, kitchen and pantry on the first floor and a front and rear bedroom, a small bedroom, bath and hall on the second floor. The cellar and first and second floor plans are shown.

"The owner of this house was very much interested in ventilation and insisted on supplying fresh air to the house on a basis of 'amount required for ventilation' instead of the 'amount required for heating.' In order to get this down to a proper quantity certain assumptions were made and the amount of air estimated from these assumptions.

"The first thing assumed was that a house of this size would accommodate at the most not more than six occupants who, at 30 cubic feet of fresh air per minute, required 180 cubic feet of fresh air per minute. Since the six occupants might either be in the hall, the dining room or the parlor, it was necessary to supply

this amount of air to each one of these three rooms. In the kitchen it was assumed that not more than two persons would be present for any length of time, making 2 x 30 or 60 cubic feet of fresh air per minute for this room.

"For the bedrooms it was considered that two occupants at 30 cubic feet per minute would be ample, while the bath was figured at one person, or 30 cubic feet per minute. This gives us a list somewhat as follows:

Room.	Cubic Feet per Minute.	Cubic Feet per Hour.
Hall	180	10,800
Parlor	180	10,800
Dining room	180	10,800
Kitchen	60	3,600
Bedroom (front)	60	3,600
Bedroom (rear)	60	3,600
Bedroom (small)	60	3,600
Bath	30	1,800

Maximum demand for air equals (cubic feet per hour).... 48,600

"The actual heat loss from the various rooms figured out as follows:

Room.	Heat Loss, B. T. U.
Hall	8,823
Parlor	8,537
Dining Room	8,720
Kitchen	7,964
Bedroom (front)	8,537
Bedroom (rear)	8,720
Bedroom (small)	3,262
Bath	1,630

56,193

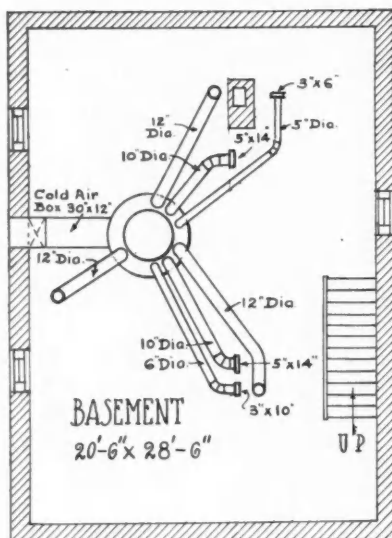

Basement Plan

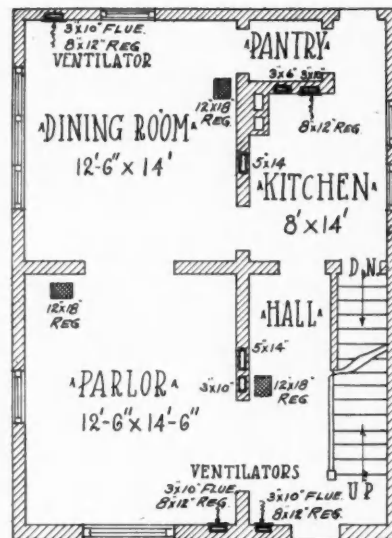

First Floor Plan

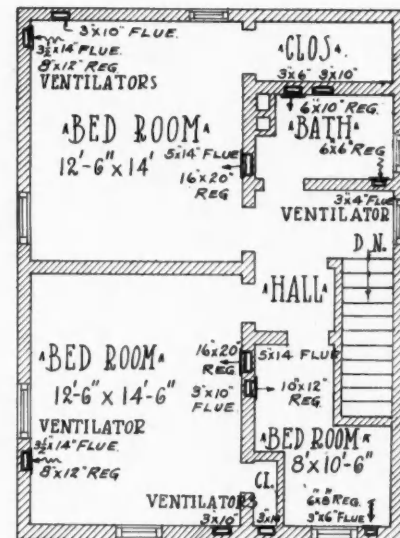

Second Floor Plan

"Deducting the kitchen, which we may assume is heated by a coal stove, we have a total heat loss of:

$$\begin{array}{r} 56,193 \\ 7,964 \\ \hline 48,229 \text{ B. T. U.} \end{array}$$

"We have previously discovered the fact that a cubic foot of furnace air at 120 degrees Fahr. supplies about 1 B. t. u. for heating purposes, so that in no room could our cubic feet of air supplied per hour drop below the B. t. u. loss, but in many the cubic feet per minute, on account of ventilation, exceeded that required for heating alone. This gain is as follows:

Room.	Cubic Feet Required for Heat.	Cubic Feet Required for Ventilation.	Maximum Cubic Feet Required.	Increase % over Air Required for Heating Alone.
Hall	8,823	10,800	10,800	22%
Parlor	8,537	10,800	10,800	26%
Dining Room	8,720	10,800	10,800	24%
Kitchen (Stove)	3,600	(Supplied from Dining Room)		
Bedroom (front)	8,537	3,600	8,537	None
Bedroom (rear)	8,720	3,600	8,720	None
Bedroom (small)	3,262	3,600	3,600	None
Bath	1,630	1,800	1,800	11%

Total air supplied by furnace.....55,057

"We see from this that the largest increase amounts to about 26 per cent in excess of the actual amount of air required by the heat losses. If, however, we supply this 26 per cent excess to *only* the rooms requiring it for ventilation, and if the other rooms are *not* furnished with this excess, then the rooms receiving the excess will soon be overheated, owing to the larger amount of air constantly coming in at the high temperature. This of course, can be remedied by reducing temperature of the air from the furnace, but the minute this is done the rooms *not* receiving the benefits of the additional air will be underheated. To overcome this difficulty we had to add (to the quantity demanded by each room to offset its heat loss) an additional percentage of air equal to the maximum excess percentage furnished to any other room on account of ventilation; this was in our case, 26 per cent. This gives us a table reading as follows:

Room.	Air Required to Heat.	26%	Total.
Hall	8,823	2,294	11,117
Parlor	8,537	2,220	10,858
Dining Room	8,720	2,267	10,987
Kitchen			
Bedroom (front)	8,537	2,220	10,757
Bedroom (rear)	8,720	2,267	10,987
Bedroom (small)	3,262	848	4,110
Bath	1,630	416	2,046
			60,761

"We are now supplying every room with 1.26 cubic feet of air where 1 cubic foot at 120 degrees would accomplish proper heating. We can, therefore, drop the temperature of *all* the entering air to *all* the rooms and not unbalance the heat in any one (with the exception of the kitchen). Since it required approximately one heat unit to raise 1 cubic foot of air from 70 degrees Fahr. to 120 degrees Fahr., or 50 degrees rise, we can drop the entire air temperature from 50 degrees rise to 50 degrees divided by 1.26 or 40 degrees rise. Therefore, our entering air need be only about 110 degrees Fahr. in extreme weather.

"Our furnace size can now be determined with accuracy, it being required to furnish approximately 61,000 cubic feet of air per hour at 110 degrees Fahr.

This in B. t. u. is $\frac{61,000 \times 110}{50}$ equals 134,200 heat units per hour or $\frac{134,200}{8,000}$, which equals 17 pounds of coal per hour in extreme weather.

"With five pounds of coal burned on each square foot of grate this requires a furnace of 17/5, or 3 1/2 square feet of grate area.

"In sizing pipes for this job we found that it was necessary to use 6-inch studs along the center partition in order to get our pipes between studs. With velocities previously used for first and second floor flues we have the following table of pipe sizes:

Room.	Cu. Ft. of Air Per Hr.	Per Min. ity.	Veloc. Sq. Ft.	Area of Flue Sq. In.	Size.
Hall	11,117	185	260	.71	102 12" dia.
Parlor	10,757	179	260	.69	99 12" dia.
Dimension	10,987	183	260	.70	101 12" dia.
Kitchen					
Bedroom (front)	10,757	179	380	.47	68 10" dia. 5x14"
Bedroom (rear)	10,987	183	380	.48	69 10" dia. 5x14"
Bedroom (small)	4,110	68	380	.20	29 6" dia. 3x10"
Bath	2,016	34	380	.10	14 5" dia. 3x 6"

Total of Areas.....482 sq. in.

"For the cold air box we need an area of about 75 per cent of 482 square inches or 361 square inches. This would be a box 12 by 30 inches, or other dimensions giving equal capacity.

"To facilitate the entrance of this large quantity of air an exit consisting of a vent register was placed in each living room, each bedroom and the bath. These vents were figured on a 70-degree inside temperature and zero outside temperature, the ones from the first floor being taken as about 20 feet high and the ones at the second floor as about 10 feet high. The velocities from the first floor were assumed as 250 feet per minute and for the second floor as 150 feet per minute.

"We made the vents capable of removing about 30 per cent of the air supplied, which gave vent pipe sizes as follows:

Room.	Vent Air C. F. M.	Veloc. ity.	Area, Sq. Ft.	Area, Sq. In.	Nominal Size.
Hall	50	250	.2	28	3 x 10"
Parlor	50	250	.2	28	3 x 10"
Dining Room	50	250	.2	28	3 x 10"
Kitchen	50	250	.2	28	3 x 10"
Bedroom (front)	50	150	.33	48	3 1/2 x 14"
Bedroom (rear)	50	150	.33	48	3 1/2 x 14"
Bedroom (small)	20	150	.13	18	3 x 6"
Bath	10	150	.06	8	3 x 4"

Total Vent Area.....1.65
An 18" dia. Ventilator equals 1.7 sq. ft. area.

"These vent flues are all carried up to the attic space and an 18-inch ventilator hood placed on the roof to allow the air free passage. This ventilator has a damper so that it can be shut off when not in use. It will be noticed that a vent is supplied for the kitchen, the idea being that this will help carry off odors and have a tendency to cause an air movement (when the door between is open) from the dining room to the kitchen, thus preventing the cooking odors transferring to the adjacent rooms.

"The vent registers were placed as near to the floor as possible and in the cold corners of the rooms to collect the air after it has cooled and become vitiated. The vent registers were also provided with valves, the same as the furnace registers, to enable these vents to be shut off at night when desired."



Noon Hour Talks By the Boss Carpenter

Talk No. 24—Stresses in Roof Trusses (Continued)

THE BOSS EXPLAINS HOW TO TELL FROM THE STRESS DIAGRAM WHETHER A MEMBER IS IN TENSION OR COMPRESSION, AND SHOWS HOW CEILING LOADS SHOULD BE TREATED

“WHEN we stopped last time,” said the Boss, “I told you that today I would show you how to tell whether the members in the king post truss shown in Fig. 12 are in tension or compression. We have already seen the method of determining the amount of stress in each of the members.

“A standard method for determining the kind of stress in a roof truss uses the scheme of lettering shown in Fig. 12. This method is referred to in general as Bow's Notation. The scheme consists of taking each joint of the truss as a unit and reading the members acting about that joint in a direction corresponding to that in which the hands of a clock turn. Both figures shown in Fig. 12 are required for use in this method.

“We will begin at the left-hand end of the truss and call this the first joint to be considered. At this joint the load ab , the member bh , the member hg , and the supporting force ga all tend to hold the joint in equilibrium and to prevent movement in the truss itself. You will notice that I have read these loads and members in a clockwise direction about the common meeting point of the loads and forces, which we will consider as being the center about which the hands of the

clock turn.

“To follow out this scheme, we will take the member bh as the first member to be considered. Looking at bh on the truss and at the line which corresponds to bh in the stress diagram, we see that the order of the letters in the stress diagram at the right reads downward towards the left when reading this line in the order bh . This would indicate that the stress in the truss member bh acts downward towards the left in that member, or towards the joint which connects this member to other parts of the frame, and about which we are considering the action of the forces at the present time. This would mean that the member of the truss bh is in compression, since the force is attempting to push the member bh down into the joint which we have taken as a center.

“The next member about the joint chosen is the horizontal member, hg . Looking over into the stress diagram at the right, we see that the order of the letters hg reads from the left towards the right-hand side of the stress diagram. This would indicate that the stress in the member hg of the truss, acts over toward the right from the joint which we are considering, or that the member hg is tending to pull away from the joint. This would mean that the member hg is in tension, owing to this pulling action.

“It is a good plan to put a check mark on each one of the truss members just as soon as the kind of stress

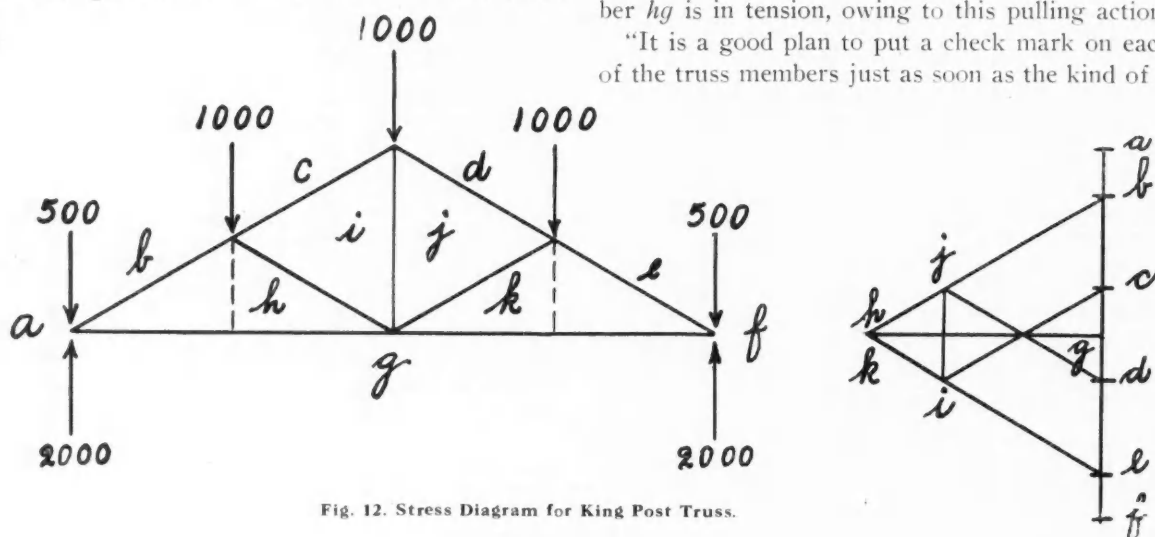

Fig. 12. Stress Diagram for King Post Truss.

in that member has been found. I would suggest that these check marks consist of a + sign placed at the side of members which are in compression and a - sign placed at the side of members which are in tension. This will serve as an indication that the stresses in that member has been found, and also tells us the kind of stress at a glance.

"Passing up to the next joint on the left-hand side of the truss or to the joint where the loads *bc*, the member *ci*, the member *ih*, and the member *hb* meet, we will follow out the same line of procedure for this joint. Taking the common meeting place of these loads and members as a center, we find that the stress in the member *ci* is the first unknown force which we have to deal with. Looking over in the stress diagram at the right we see that the order of the letters *ci* reads downwards towards the left. This would indicate that the stress in the truss member *ci* acts downward towards the left or towards the joint about which we are reading the members. This indicates compression in the truss member *ci*.

"Taking the member *ih* as the next unknown, we see from the stress diagram that the letters *ih*, when taken in their proper order, read upward towards the left. This indicates that the stress in the truss member *ih* acts upwards towards the left or towards the joint which we have taken as a center. This action would indicate compression in *ih*.

"As a check on the scheme which we are following, the stress in the truss member *hb* should be of the same kind as that which was found in the member *bh* when read about the joint at the lower left-hand end of the truss. You can readily see that this must be so, since the same member of a structure could not be in compression at one end of the member and in tension at the other end of the same member, when no joint comes between the two ends. The member which was read in the order *bh* about the lower left-hand end of the truss, is now read *hb* about the next joint in following the general scheme of reading the members right handed about a given joint. Looking over into the stress diagram at the right hand, we see that the order of the letters *hb* reads upward towards the right. This would indicate that the stress in the member of the truss *hb* must act upward towards the right or to-

wards the joint about which we read the letters in the order *hb*. This again would indicate compression, which should be the case, since we saw that this same member, when read as *bh* about the lower joint, was in compression. Now, put in the proper signs for each of the members just investigated.

"We will next proceed to the joint at the peak of the roof and follow out the same general scheme. The forces acting at this point are the loads *cd*, the stress in the member *dj*, stress in the member *ji*, and the stress in the member *ic*. Since we have already found the stress in the member *ci*, and have just seen that the kind of stress in a given member is the same at each end of the member, we will confine our attention to the members *dj* and *ji*. Since the order of the letters about the peak joint reads *dj*, we see from our stress diagram at the right, that *dj* reads upward towards the left. This means that the stress in the truss member in *dj* acts upward towards the left or towards the joint which we are using as a center. This would indicate that the truss member *dj* is in compression. Likewise, *ji* when read in the proper order and compared with the stress diagram, shows that in the stress diagram the letters read downward when read according to the above scheme. This would indicate that the stress in the truss member *ji* acts downward from the joint or that the member tends to pull away from the top joint, thus putting this member into tension.

"Next, we will take the joint on the bottom chord directly below the peak. Since we have already found the kind of stress for *gh*, *hi*, *ij*, all we have to determine is the stress in the member *jk* and *kg*. In the stress diagram it is seen that *jk* reads downward towards the left, thus indicating that the stress in the member *jk* acts downward towards the left or towards the joint on the lower chord. Therefore, *jk* is in compression. Likewise, *kg* is seen from the stress diagram to read over towards the right, thus indicating that the stress in the truss member *kg* acts over towards the right from the joint on the lower chord or away from the joint, thus indicating a tension in that member.

"Another way to determine the stress in the members *jk* and *kg* would be to observe that from symmetry the stress in these members would be the same as that in *hi* and *gh* respectively. This would only

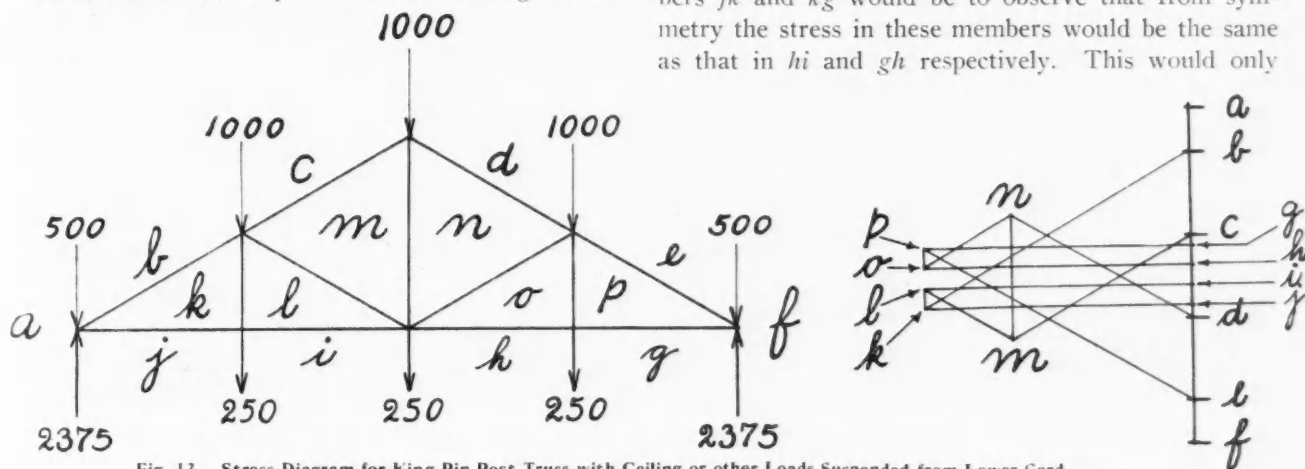

Fig. 13. Stress Diagram for King Pin Post Truss with Ceiling or other Loads Suspended from Lower Cord.

be true where the truss members and loads at the joints were symmetrical about the center line of the truss.

"According to this same argument, it would seem that the stress in the member ek would be the same as that in the member bh . Testing out this quantity by reading ek about the second joint from the right-hand end of the truss, we see that the order of the letters ek in the stress diagram at the right reads upward towards the left or towards the joint under consideration. This checks out our assumption that ek is in compression the same as bh .

"The following table will show what we have found in regard to the kind of stress in the members of the truss in Fig. 12:

Member	Kind of Stress	Sign	Member	Kind of Stress	Sign
bh	Compression	+	ji	Tension	-
hg	Tension	-	jk	Compression	+
ci	Compression	+	kg	Tension	-
ih	Compression	+	ek	Compression	+
dj	Compression	+			

"You may have wondered what the dotted lines were for in Fig. 12. These lines indicate the necessity of tension rods in the locations shown when there is a ceiling load to be carried by this truss.

"Fig. 13 will show the method used in arranging the loads on a king post truss when a ceiling load is also to be carried, and will give a form of stress diagram resulting from the graphical solution of such a roof when carrying both roof loads and ceiling loads. You will notice that the diagram is lettered a little differently since attention was called in our previous talk to the fact that each space in the truss must have a letter so that we may be able to read the lines showing the members of the truss. You will also notice that loads are shown at each of the joints of the lower chord of the truss and that vertical ties are put in in place of the dotted lines shown in Fig. 12. The loads indicated by the arrows along the bottom chord of truss are supposed to show the ceiling loads concentrated at these points, and the values are merely put in as given for the sake of illustration. Reactions, or supporting forces, in this case are each equal to one-half of the total load on the truss.

"The stress diagram at the right is drawn according to the same scheme as described for Fig. 12. We begin by laying off a load line, as in the former case, starting this load line with the half panel load shown at the left-hand end of the truss. The load line will differ a little in this case since the supporting forces at the ends no longer divide the load line into halves as in previous cases. After the load cf has been laid off, then a load of 2,375 pounds should be laid off to scale (Scale: 1 inch equals 2,000 pounds) and spaced off towards a again. No matter where this point comes, the next downward load gh equal to 250 pounds should be laid off down the line according to the scale just given, and followed up by the loads hi and ij , also spaced downward on the load line. The load ja , which is also equal to 2,375 pounds, should then be laid off up the line, and the point of the divid-

ers used in spacing this distance should just reach between the points j and a on the load line. If the supporting force ja does not reach back to *exactly* the point a , something is wrong and the load line should be tested before beginning the work, in order to determine the location of the error.

"After the load line is laid off and checked, the construction of the stress diagram should be started by drawing the lines bk and jk parallel to the corresponding members in the truss. This step is the same as in the previous diagram. It is impossible for us to go to the next joint above on the upper chord, since we will have three unknown forces at this point, while in the previous case there were only two unknown conditions. It must be remembered that two unknown conditions are all that can be handled at one time in this graphical solution.

"An inspection will show that we may proceed with the diagram by taking the next joint to the right on the lower chord of the truss. From the point k , which we have just found in the stress diagram, we will draw kl parallel to the member kl of the truss. Then, from the point i on the load line, draw a line parallel to the member il of the truss. Where these two lines, kl and il , meet, will determine the location of the point l in the stress diagram.

"Now that we have found the magnitude of the stress in the member kl , it will be seen that we may pass to the joint above on the upper chord since cm and ml are the only two unknown members remaining about this joint. A line is now drawn from c on the load line parallel to the member cm , and a line is drawn from l in the stress diagram parallel to member lm of the truss. Where these two lines meet determines the point m .

"Next, go to the joint at the peak of the truss and determine the stress in the members meeting at this point in a manner similar to that just shown. Then proceed to the joint directly beneath on the lower chord and find the stresses in the members about this joint, and proceed in a similar manner with the other joints of the truss.

"A check on the work will be to see that the top part of the stress diagram corresponds in shape to the lower part of the diagram, these two parts being symmetrical about an imaginary horizontal line drawn through the middle of the load line. An examination of the truss and stress diagram according to the notation just shown above, will indicate that the members which are in compression in the previous case are still in compression, and that those which are in tension are still in tension. Applying the rule for finding the kind of stress to the members kl and op , we find that these two members are both in tension.

"Tomorrow noon," said the Boss, "I will show you how to find the values of actual roof loads and ceiling loads such as you will meet in practice. You remember that the loads which we have used in Figs. 12 and 13 have only been chosen for the sake of illustration."

Fire Proof Two-Room School House

A FIRE PROOF school house having two class rooms and two rooms in the basement which may be used for play rooms or for manual training classes is shown in the accompanying design.

All walls and partitions are constructed of concrete or hollow tile. A special hollow tile is used for the fire proof floors. They are especially designed to work in with the monolithic floor slabs to form "T" beams between the tiles. There is a maple floor laid on narrow strips which are imbedded in cinders and concrete to render the floors noiseless and free from dust.

Outside there is a veneering of brick which extends from the foundation to the sills of the school room windows. Above the brick is stucco on tile.

Ventilation is provided by the indirect system which admits air to the basement through suitable flues, and the foul air is drawn off through other ventilating chambers in such a way as to keep up a continuous circulation of air without causing a draft in any part of the room.

The school rooms are the regular size, 25 by 32 feet. Partitions divide the basement into rooms the same size as rooms on the upper floor. The back end of the hallway is used for a cloak room and the same spaces in the basement is utilized for heating plant and coal bin.

For a small school building it is successful from the standpoint of service, convenience and comfort. It is

well lighted with plenty of windows on two sides only of each class room. It has an easy stair leading from the front entrance to the upper hall and there is a double stair to the basement which is just as safe and convenient.

The appearance is all that could be desired. It looks as though it might cost twice as much. The easy lines and graceful proportions give it an artistic appearance, while the materials used add the substantial satisfaction of solidity.



Every ambitious workman hopes to be a boss some day, but there is the task of finding and following the road to attainment that many of us fall down on. Still, we have the hope with us as a continual spur to effort, accompanied by a faith in the future; and, when we sum it all up, these are two great elements in life.

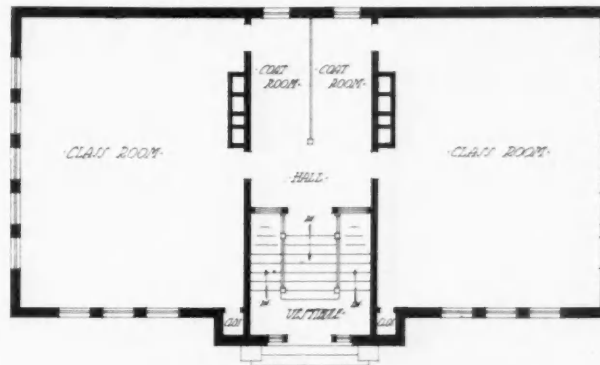

Floor Plan of School.



Very Neat Two-Room Brick and Stucco School House Designed by Architect G. W. Ashby, Chicago.

The Editors Drawer

New things worth while

Machine Sanding Just Where Needed

The increasing and insistent demand for better and more uniform finish on all kinds of interior trim has made it necessary to put in extra work of sanding by hand.

Mills are finding this very expensive, and this condition has caused a machinery manufacturer to build a machine that will save such expense and at the same time provide a means of securing a better finish on all work of this kind.

This machine is known as the Hand-block Belt Sander. The sand belt you see traveling around pulleys does all the sanding. It travels at the rate of about a mile a minute and removes stock from four to ten times as fast as can be done by hand sanding.

The operator applies pressure with the hand-block, bringing the sand belt in contact with the work while the belt is running at a high speed.

The work rests on a rolling table, which can be moved forward or back in order to position it properly while the operator "touches up" just such places as he wants—it may need sanding all over or only in spots.

This machine will handle practically any size of material, and there is almost no shape of work that cannot be gotten at. Contractor shops of all sizes, large or small, are finding this machine to be very profitable.

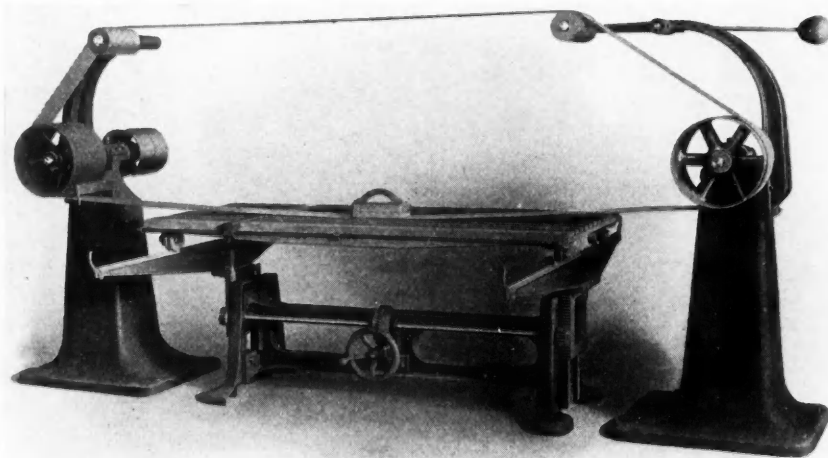

New Labor-Saving Sanding Machine.

Press the Hand Block Against the Inner Face of the Sanding Belt and Surface Any Part of the Work that Needs Special Attention.

A Fresh-Air Ventilator

The illustration shows how a new style window ventilator is used. It is equipped with screen openings and sliding shutters to control the amount of air. One set of openings directs the air upward to the ceiling. This is for use during the winter months. Another set of openings admits the air

directly into the room; this is for use in summer, when fresh air without dust or direct draft is wanted.

This ventilator is neat and attractive, finished in oxidized copper. There are no screws or nails to attach, as it slips in between the window stops. It is adjustable for various widths of windows.

The manufacturers of this ventilator say that the cost of a fresh-air ventilator is about equal to the cost of one call of a physician.

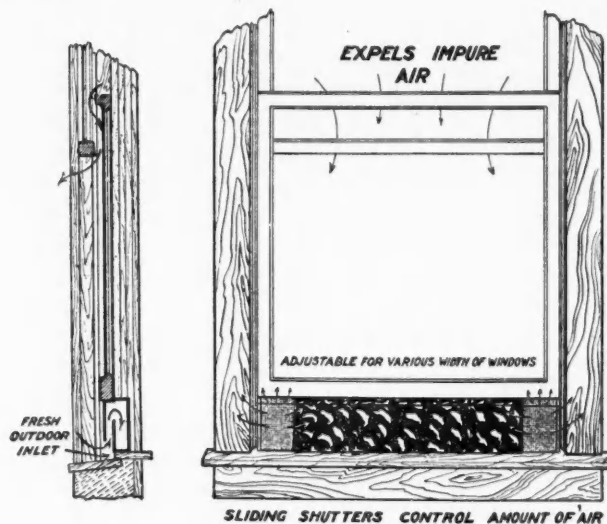

Cross Section and Inside Elevation Views of Fresh-Air Window Ventilator.

New Abrasives Company Formed

The Wausau Abrasives Company has been organized and incorporated for the manufacture of abrasive paper and cloths. This company will manufacture only the best grades of sandpaper, emery cloths and garnet goods.

The new company has purchased the plant, equipment, real estate, trade-marks, etc., of the Wausau Sand-Paper Co., of Wausau, Wis. P. W. Sawyer, formerly general manager of the old company, heads the new company as president and general manager; Charles B. Osen, vice-president, formerly sales manager, and J. K. Sawyer, treasurer, and R. E. Chartier, secretary. This company started operations June 15, 1914.

The AMERICAN CARPENTER AND BUILDER wishes the new company all the success in the world, and knows that with the efficient management that the new company has, its readers will be more than pleased with the product they manufacture.



District of Columbia Builders Elect Officers

Washington, D. C.—At its fourth annual meeting, June 1, the Builders' and Manufacturers' Exchange elected E. R. S. Embrey president by a unanimous vote. Other officers elected without opposition were James L. Parsons, first vice-president; George Plitt, second vice-president; George E. Wyne, third vice-president; James L. Marshall, treasurer; Charles E. Welsh, secretary, and Samuel J. Prescott, C. A. Langley, C. E. Coberth, Fred J. White, Peter R. Pullman, E. C. Graham, W. T. Galliher, Harry D. Watts, Andrew Murray and George E. Walker, board of directors.

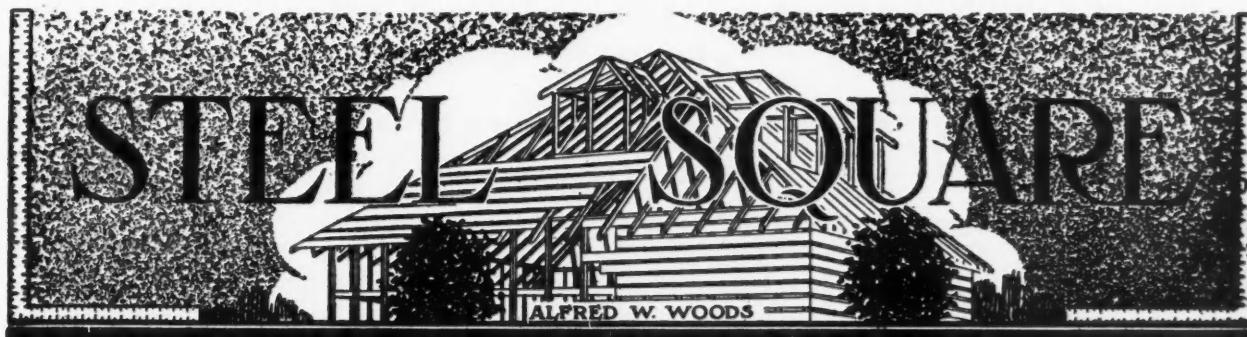

You Know More Steel Square Than You Realize

MANY SOLVE A FRAMING PROBLEM UNAWARES AND WHEN BROUGHT FACE TO FACE WITH IT DO NOT RECOGNIZE IT IN ITS TRUE POSITION

By A. W. Woods

WE are in receipt of several letters of late, asking what are the proportions to use on the steel square to obtain the cuts for a side gable plancier to member with the raking plancier; and as this furnishes a good topic, we are going to take advantage of it for our subject this month, and thereby make one shot at the whole bunch. Therefore, we ask the questioners to sit up and take notice.

We are going to make a broadside shot, as it were, so as to take all in range, as we want to make a clean sweep; and yet we are fully aware that there are some who will think that our aim is not good; that we shoot too high, clear above the heads, as it were. And for this class, we will not stop to argue the question—they can either get out of the road or get shot.

The ammunition we use is "reason." There is a reason for everything, so let us get together and reason it out. Now, let us think before we shoot. Think! Think!! Think!!! with reason. We know some carpenters that are rated as good framers in the ordinary run of work, but when something comes up with a little different appearance from what they are used to, they think they have run up against something hard to crack and they lose themselves and look for a foreign remedy, simply because they did not stop a minute to think and reason it out; for it should be remembered that the general rule runs through all the cuts in and about the roof.

Coming down to the case in hand, what are the cuts on the two planciers so that they will member?

Taking the one running up the gable, it lies in the roof in exactly the same position that the valley jack does, and consequently the cuts must be the same. It is true one is a board and the other is a timber, 2 by 4 or 2 by 6, but that does not make any difference—the only thing is, the cuts are reversed; that is, what was the cut across the back of the jack, commonly called side cut, becomes the cut across the face of the board, and the miter cut across its edge becomes the plumb cut.

Taking the horizontal plancier, it lies in the same position of that of the roof boards to fit into the val-

ley, only it is on the under side of the rafters instead of on top. Consequently the cuts are the same as for the roof boards, provided, of course, that a perfect cut is made.

Now, it should be remembered that the same figures taken on the square to obtain the side cut of the jack will also give the cut across the face of the board, only it is just the reverse on the square. As for the miter cut, if the edge of the board is first beveled, so that the same will stand plumb when in place, it is simply a square cut; but if it is left in the square, then it is simply the hopper cut, and this may be found by taking to scale the length of the common rafter for the gable and its rise and the side of the square on which the latter is taken; these will give the angle for the cut. There are other ways of arriving at this cut, but we will not take any more space at this time to explain them.

Not long ago, we received a letter from an admirer of our efforts to enlighten, telling of the great benefits

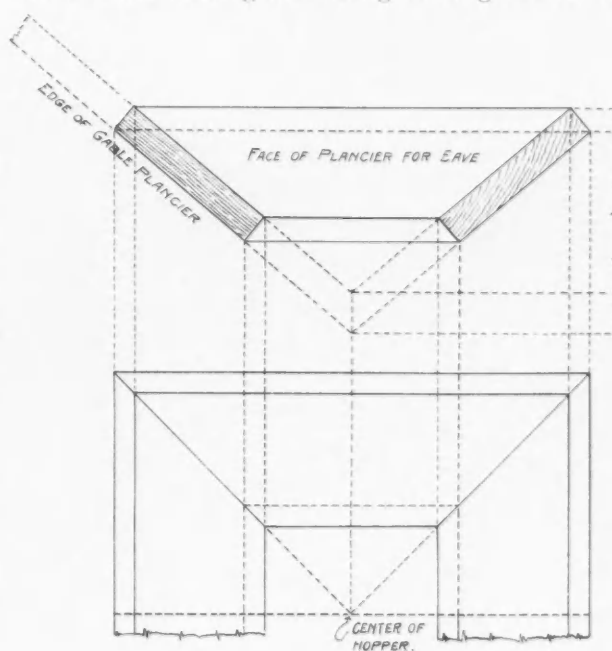

Diagram showing gable and eave plancier cuts in their relation to square corner hoppers.

he had received from reading same, and that he could frame any kind of a roof; which of course caused us to swell up beyond our usual proportions. Then he let us down with something of a thud when he said that he had never yet had occasion to use the hopper cut. Here is a plain case of the man who did not stop to think before he shot. He was using the hopper cut in every hip and valley roof he framed, and yet he was not aware of it. He was doing it by piecemeal; and because it did not show up in a full meal, he thought he was not getting any. Suppose, while he was at it, that he framed enough jacks to completely cover the whole space; that is, by setting them side by side and by spiking them together—he would have a complete roof framed by the jacks alone, and if he were to turn his roof upside down and look at it from the other way, he would have a complete hopper.

Yet he said he had no occasion to use the hopper cut. This simply goes to show that while he could properly frame the rafters, he had failed to grasp the relative cuts contained in the roof.

Here is a case of requiring different figures on the square to member two boards, and yet when put together make a perfect miter. The reason for this is, while both are reckoned from the edge of the board, their position when in place being different causes different figures to be used to obtain the same result.

The illustration is given to show the relation of the joining of the plancier to that of the hopper corner, and which we trust is clear enough without further explanation.



Steel Smoke Stacks and Their Care

By Edmund Von Kaenel, Expert Steeple Jack

THE telephone rang the other day; the call was for E. Von Kaenel, Steeple Jack. A superintendent of a big corporation in Chicago requested the Jack to call and see him regarding the painting of their smoke stacks. This firm had about nine or ten stacks; several of these smoke stacks were burned through and collapsed. The Steeple Jack did as he was instructed by the superintendent. "I want a bid on painting these smoke stacks and wrecking these three that are telescoped, and paint the stack outside," he said.

The Jack seemed to see a point in painting stacks that this man did not see, and said to the superintendent, "Where does a stack get the most wear? and where does a stack start to corrode, inside or outside?" The superintendent said: "Outside, because the atmospheric conditions

have more opportunities to attack the metal."

"But I differ with you," said Jack. "The wear and corrosion forms on the *inside* of the smoke stack much quicker than on the outside. For instance, as you have a steam exhaust on the inside of your stack, this steam and coal gas have a tendency to form sulphuric condition, and this causes scales on the inside. After this scale becomes thick enough, it becomes loose from the stack and moisture gets behind the scale and continually attacks the good metal. Now, if this is pounded off with a hammer and the metal scraped with a steel brush and painted with a graphite paint, it will preserve the life of the stack much more than to paint it outside, which is merely to protect it from atmospheric conditions, and for appearances."

A stack is always dry on the outside, rain or shine, because the heat in an iron stack will do this; and one coat of good paint will protect this for from three to five years. But, the inside should be painted annually. Ninety-nine out of one hundred will paint the stacks outside, thinking the inside doesn't need it.

In the rainy season, some raindrops will get inside the stack, and with the heat, steam is soon formed; and so is the case where no steam exhaust runs through the stack.

Corrosion should be well watched and cleaned off as soon as it appears on the stacks. For a convincing test, open the draft door of your stack and look up inside the stack; then hit the outside of the stack with a hammer and you will find scale varying from 1/16 to 1/4 inch in thickness; test it and see if interior stack painting doesn't pay.

Of course, most steeple Jacks will never recommend it, because it is a very dirty job, but I recommend it every time, because it is really a necessity and the superintendent will give the man who recommends it more credit for his workmanship.

I am making a thorough investigation regarding stacks, and I also find that in guying the stack with cable, many riggers make a failure of guying, and in most cases ruin a steel stack by using a 45-degree pitch for guying. We often see a stack as per sketch, kinked in. This is due to poor judgment; and most engineers fail to see this point until too late.

Riggers are more or less bound to use a 45-degree guying system, because it is most practical on solid cylindrical forms such as poles, masts and heavy pipe. A solid form we know, can readily stand for 45-degree guying, but we also know that

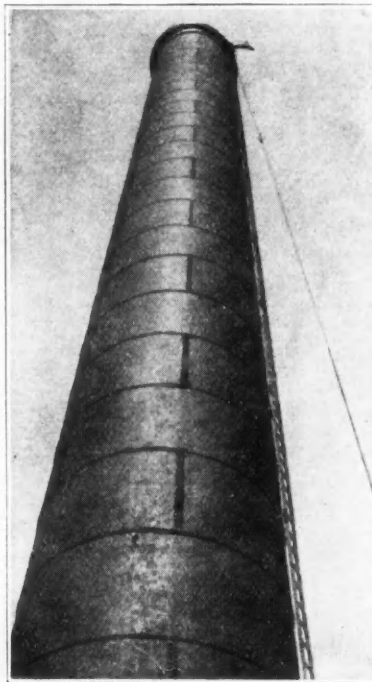

This is not a Dreadnought Gun to Fight the Mexicans with, as you might suppose, but a 12-ft. Steel Stack 200 feet high—Looking up.

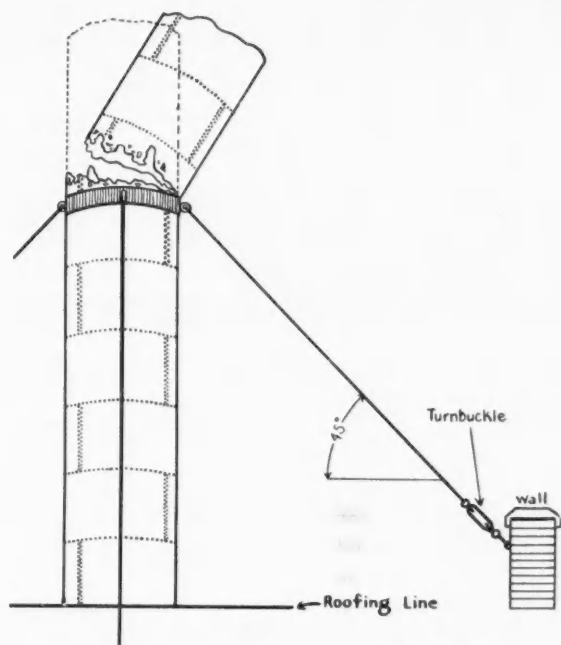

Fig. 1. 45° Guying Causes Steel Stacks to Buckle at the Ring.

a hollow, light-gauge stack metal will not stand for it. For instance, a 45-degree method is employed on a stack 4 feet in diameter, 175 feet high, three-sixteenths gauge metal as mostly the case. In figure No. 1, we see a 45-degree system with turn buckles, to take the slack out of the cable. Turn buckles are always used in either case. Now this stack, in time, is acid eaten and loses 25 per cent of its original power.

We come to this 45 degree, which has a tendency to have an outward pull, as to the way of guying either north, east, south or west. Nevertheless, we have more strain on one wire than another. The outward pull on this guy wire is connected to an iron band as sketched. This cable and band both have

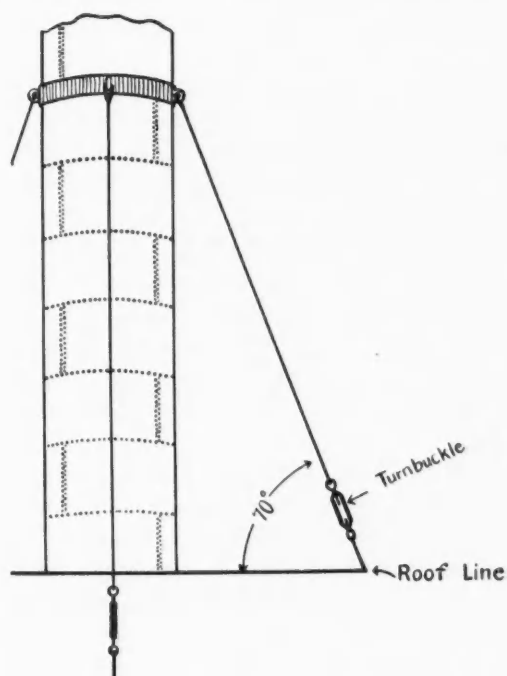

Fig. 2. Proper Method of Guying with Guy Wires Set at 70°.

expansion and contraction; in different periods of the year, the strain multiplies and the strength of the stack decreases at the band point and the result is, that the outward pull resulting from a 45-degree has kinked the stack.

I have a remedy for this: changing the 45-degree to a 70-degree. By doing so, we find that the pull is downward and not outward as in Fig. 1. In Fig. 2, we can see that this pull is downward. Now, we put the cables in the same conditions as in Fig. 1, that is strain due to weather tightening. In fact, gives all that was mentioned in No. 1. We will now see that if the strain becomes too great the guy wire will break, thus we save the stack from kinking in, and this can be replaced much easier, by far, than to put up five or six 5-foot sections of the stack.

We here find a great saving, and it does away with a big risk, both to men and property. Such work,



The Author Coming Down From a 200-Foot Stack, 12 Feet in Diameter.

when these stacks kink in, is very dangerous to the rigger, as experience teaches us. By adopting this system you will profit considerably, and some day you may save the cost of a new boiler and also repairs of the roof it falls on, and possibly the life of your engineer.

"Safety first" is my motto, and a few bits that I am publishing exclusively in the AMERICAN CARPENTER AND BUILDER may probably make you a few points the wiser.

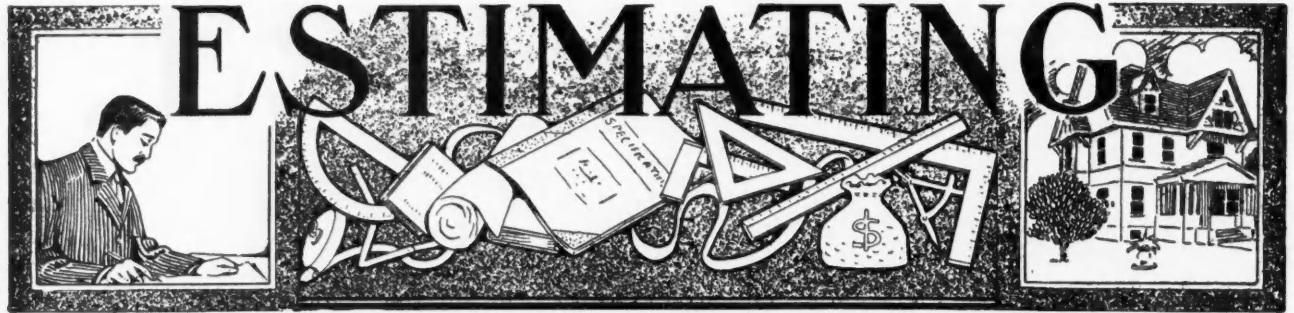

Designing Roofs and Estimating Roof Work

By I. P. Hicks

THE styles of roof, methods and cost of construction, and easy ways of estimating the material and labor for the same is a matter of considerable importance and interest to the carpenter and contractor.

First, we want to talk a little about the styles of roofs. The styles of roof and the proportion of their shapes and size to fit the house have just about as much to do with the appearance of the house as selecting an appropriate hat for a lady.

Figures 1, 2, 3, and 4 represent four styles of roof in general use. These, when used singly or in combination and with variations to meet the different requirements of different buildings, constitute the larger part of the roofing of the average building.

Fig. 1 represents a plain gable roof, which is one of the most common and easily constructed kind of roofs. As to the style of this roof, it is almost always of the plainest type. Yet, to choose a proper pitch for the roof and a proper width of cornice, according to the width and height of building, will have much to do with its general appearance. If it is a building with

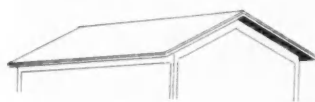

FIG 1 GABLE ROOF



FIG 2 SHED ROOF

12 to 18 ft. studding, 14 to 26 ft. wide, with a plain box cornice, the horizontal projection of the cornice placher should be from 12 to 20 inches, and the pitch of roof from 8 inches to 12 inches rise to the foot, using the wider cornice and steeper pitches of roof on the higher and wider buildings.

We will not attempt to lay down any definite rule for determining all these variations in dimensions, as it is a matter mostly of good judgment with the designer, but it is a sure thing that good proportions in designing the cornices and roof add very much to the general appearance of the completed building, and it is well worth the while for the carpenter and contractor who has more or less of this to do to study up some on the art of designing and proportioning his work so that it will produce the most pleasing results to his patrons.

In our opinion, a plumb cut on the ends of the rafters, so that the fascia stands plumb, always looks best, although it is not always the easiest of construction.

Now, something about estimating the material and labor for this roof. This can quite readily be estimated by the square. Sometimes in making an estimate the length of rafter is not quite exactly known, or the estimator does not want to take the trouble to figure it out just at the moment. It is easy to figure the cost of this work without stopping to figure the length of rafter required. Add the horizontal projection of the cornice to the size of the building, on each side and each end to the size of the building to be roofed, then proceed as follows:

Multiply length of building by the width, and for the different pitches add the following per cents, which will make the amounts of space to be covered for the different pitches.

For a 6x12 pitch add 12%	For a 10x12 pitch add 30%
For a 7x12 pitch add 16%	For a 12x12 pitch add 42%
For an 8x12 pitch add 20%	For a 15x12 pitch add 60%
For a 9x12 pitch add 25%	For an 18x12 pitch add 80%

The above figures will give the exact amount of roof surface, and it is applicable to either gable, shed or hip roofs of any shape or size, or where there are both hips and gables on the same roof of about the same pitch. We do not use it for gambrel roofs because there is too much difference in the pitch of the two roof sections.

Having obtained the number of feet roof surface, divide by 100, which will give the number of squares of roofing. The roof sheathing can be figured from

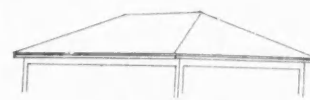

FIG 3 HIP ROOF

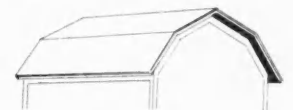

FIG 4 GAMBREL ROOF

the number of feet at the local price for lumber per M.

Where the roof sheathing is put on about two inches apart, as for shingle roofs, it is not necessary to figure any for waste, for the spreading of the boards will fully make up for the waste. If the roof is to be sheathed tight, then add to the above amount 6 per cent to cover the waste in cutting.

The feet board measure per square required for rafters in ordinary roof framing, allowing about 5 per cent for waste in cutting, is about as follows:

Size of timber.	16 inch centers.	20 inch centers.	24 inch centers.
2x4	60 ft. B. M.	50 ft. B. M.	42 ft. B. M.
2x6	90 ft. B. M.	74 ft. B. M.	64 ft. B. M.
2x8	120 ft. B. M.	100 ft. B. M.	84 ft. B. M.

On the framing the labor can be figured at \$8.00 to \$12.00 per 1,000 ft. of timber, figuring the higher rate for roofs that are complicated and require more cutting and framing. By this method the feet of sheathing can be readily found, the number of squares of roof, the feet board measure for the rafters, and then the cost of labor on any part, or the entire roof can be readily determined.

Shingles required per square, laid 4½ inches to the weather. On plain roofs, 900 shingles per square are required. On hip and valley roofs, where there is cutting to do, 1,000 per square will be required.

Our way of figuring the labor for laying shingles on plain roofs is \$1.75 per 1,000 shingles. Hip and valley roof, where there is more or less cutting, and spaces consuming more than ordinary time, \$2.00 to \$2.25 per 1,000.

Other Common Roof Types

Fig. 2 represents a shed roof, which is one of the simplest forms of roofs. It is used principally on additions to the main roof and in the construction of dormer roofs, particularly on roofs of the bungalow type. Shed roofs, as a rule, do not have a very pleasing appearance, yet by taking care to proportion the cornice so that it does not look out of place or botchy in construction, they can be made to look fairly well and sometimes very good for the places where they are used. As a rule, they are cheap in construction as regards material and labor and can be figured on the same basis as the plain gable roof.

Fig. 3 shows the outlines of a plain hip roof. In this form of roof there is, of course, more time consumed in the framing, sheathing and shingling, and it is necessary to figure more for labor. If the roof has numerous hips and valleys, then the framing should be figured at \$10.00 to \$12.00 per M feet, and the shingling at \$2.00 to \$2.25 per M.

Fig. 4 shows an outline of a gambrel roof. There is nothing difficult or expensive about this form of roof and it can be figured on a basis of \$10.00 per M for the framing and sheathing and \$2.00 per M for the shingling.

The gambrel roof has no real pleasing effect, so far as appearances go, but it makes a fairly strong roof, and in a house building it nearly makes a two story house out of a one story building, because the first section of roof is so steep it makes the second floor space nearly all available for use in the rooms. In house building, the first roof section is seldom sloped in more than two feet at the top.

COURT DECISIONS AFFECTING BUILDERS

Mr. John Simpson, a well known legal authority, has been engaged to set forth in plain English certain important points of law that concern Builders. He will also through this department answer legal questions for Our Readers.—Editor.

Liability for Dangerous Staging

The owners of land employed contractors to do carpenter work on certain houses which they were erecting. A carpenter, an employe of the contractors, was injured while shingling the roof of one of the houses by the collapse of a bracket supporting the staging. It appeared that the brackets were furnished by an agent of the owners. The injured employe sued the owners for damages. It was held that the fact that the contract required the contractors to perform and furnish all the carpenter work on the houses, excepting the smoothing of the floors, and that they were also to furnish their own tools ordinarily used, did not preclude the plaintiff from proving that the defendants undertook to provide the staging necessary for the shingling, and a verdict ordered for the defendant was not authorized. *Hall v. Bates*, Massachusetts Supreme Court, 103 N. E. 285.

Recovery for Substantial Performance

If a building contractor with honest intent substantially performs his contract, failure in slight particulars will not prevent him from receiving fair compensation, with due allowance to the owner for any loss or damage suffered by him. In an action to recover the balance due under a building contract, an instruction to the jury that if the plaintiff substantially performed his contract, "he is entitled to recover for such sum as the jury find he is entitled to receive," was held not to be objectionable as permitting the jury to find damages according to their own ideas in disregard of the contract, the jury being fully instructed in the general charge as to the proper amount of damages recoverable. *Smith v. Cunningham Piano Co.*, Pennsylvania Supreme Court, 86 Atl. 1067.

Satisfaction of Architects

A contract for the construction of certain curbing and granolithic work provided that it should be performed to the satisfaction of specified architects, and that final payment should be made when the work should be approved by them. On the completion of the work the architects examined it and decided that it was not satisfactory. In an action on the contract, it was held that their decision was conclusive on the parties, in the absence of fraud or mistake so gross as to necessarily imply bad faith. *J. H. Sullivan Co. v. Wingerath*, C. C. A., 203 Fed. 460.

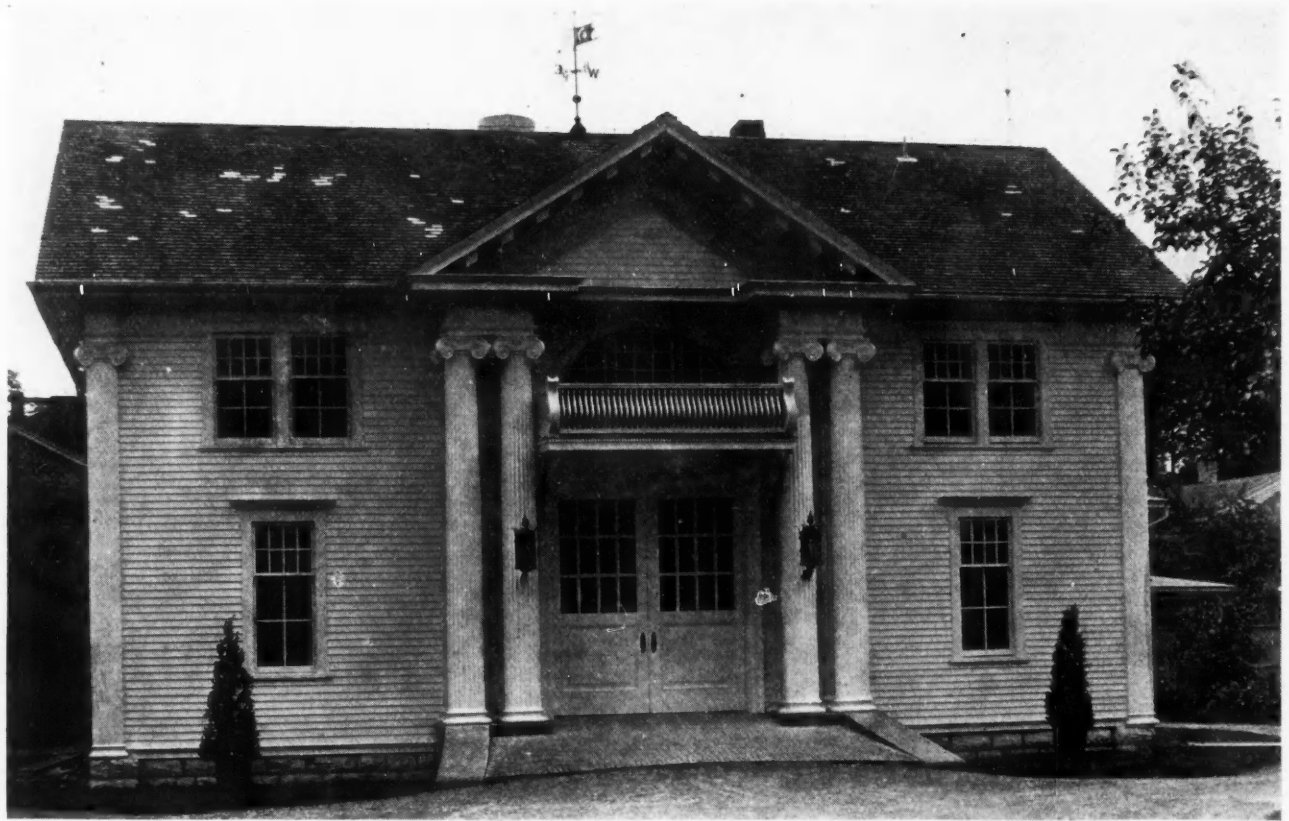

An Elaborate Private Garage at Watertown, N. Y.

By J. M. Kane

THE proper care and housing of private automobiles has come to be an important feature of the business. The owners of private cars are coming to realize that it's to their advantage to have their cars kept on their own premises, where they can at all times keep tab on how the chauffeurs are keeping up the machines and also to have them at their immediate call. When owners send machines out to public garages, they never know how much liberty is taken with them. This is not meant to infer that every public garage is not perfectly honest in this matter, but such is too often the case.

This new, up-to-date garage was formerly built as a stable for the late Governor R. R. Flower of Watertown, N. Y., at his old home in that city. Governor Flower was a fancier of good horses and always kept a number of fine ones. After his death, a few years ago, and up to two years ago, Mrs. Flower kept up the fine stables and horses. Since her death, no horses have been kept there. Last year this fine stable was rebuilt and arranged for Mrs. Emma Flower Taylor, her daughter, for the keeping of her cars, of which she has several. All the stalls and stable fixtures were removed, harness cases, etc. The wooden floors under



Two Views of Interior of Garage Machine Shop in Private Garage at Watertown, N. Y.



the stalls were removed as also the hard brick wash tray and alley floors in stable, to make way for concrete floors throughout.

In the part of the building that was used for the stalls has been fitted up an ideal repair shop with two fine hardwood work benches with the tops built up of 1 1/4-inch by 4-inch beach glued up on edge, so as to form a solid plank 3 1/2 by 10 when finished up. This has 1/2-inch bolts put through to insure a perfect tight job at all times. The front edges of this was rabbeted, set 3/8 by 3 for placing an iron in flush with top and edge for the double purpose of protecting the edge and for pounding the irons on and bending over. A case of drawers was fitted into them for storing tools and supplies. At the back of the benches a trough was made lower than the rest by 2 inches to be used to lay tools in out of the way when working on the benches. This is a great convenience when one has a large piece of work on the bench such as an engine or a wheel or tire. A heavy vice was fitted to each bench capable of handling any piece of work that would be required.

These benches are 2 1/8 feet high by 3 feet wide and 11 feet long, bolted to the wall and solidly on floor. There is a fine engine lathe and a drill press, emery grinder, and buffer; a screw press for forcing on gears and such uses; a shaper is to be installed later. The machines are

driven by a 1 1/2 horse power motor. There is room on this floor for one Packard seven passenger touring car and one National road machine, besides abundant room for scrubbing tanks and floor space for dismantling cars. It has windows of large size on three sides. The walls and ceilings are of No. 1 Georgia pine ceiling varnished, so there is no lack of light. Ample electric lighting is provided also. Two chauffeurs are employed here and each is an expert in care of cars.

The washing of the cars is quickly done on the cement tray with an overhead hose on a swivel connected with hot and cold water through a mixing valve. Double doors are at each end of this tray so that a car comes in directly onto it after a run and then is ready to go out at the other pair of doors.

The former carriage room is now used for the autos. This room occupies the entire front of the garage with entrance through the large doors with the beautiful fluted columns in front. This floor will hold four cars with ease. The balcony was placed in between the columns at the time the alterations were made, to act as a veranda for the use of the chauffeur's family, who live on the upper floors. This is fitted up in fine shape and the entire plant is heated with hot water and lighted by electric lights. The cost of this work, including the shop, was about \$10,000. I had the doing of a part of the work, although the larger part of the changes were done by another party, such as the cement floors, heating and lighting, and part of the painting. I designed and built the balcony, also the work benches in shop and many other pieces of special work.



Side View of Elaborate Private Garage at Watertown, N. Y.



The Foreman and His Crew

By J. Crow Taylor

SUCCESS in carpentering and building consists quite largely in wise management, and one of the important problems in connection with wise management is that of the foreman and the working crew.

There are several angles from which to view this matter to get full light on the subject. One is that which constitutes the ideal of a foreman and what his duties are and should be. The other is that of the number of men that may be employed on the job to secure the greatest degree of efficiency; and yet another angle is that of the kind of men to use for the best results and the best economy.

Another matter that enters here is that of the size of the job and the bearing it may have. There is no such thing as a standard size or typical job, but certain classifications or distinctions can be made. In the present instance we will consider such work as the building of frame cottages and modest homes, say varying in cost from \$1,000 to \$5,000.

Working Foreman on Residence Work

The best working foreman for an undertaking of this kind should be an all around mechanic and should not only lay out the work, but should also be able to do any part of it and to show any man how to do his particular work to the best advantage. In some other lines of industry the main qualifications for a foreman are found in his ability to handle men. The working foreman on a house job must go further than this to be the right kind of a success; he should be a master workman himself and able to judge when men are doing proper work and enough of it, and have the faculty of handling men and getting service as well as seeing that the work is done right.

Opinions differ as to what constitutes the ideal crew for work of this kind. For the original framing and for practically all work until one gets ready for the plasterers, about the best order of efficiency can be obtained with a crew of five or six men and a foreman. Sometimes it may be advisable to use one or two more or one or two less, depending some on local conditions, but a good average crew is five or six men

and a foreman, and to make the conditions really ideal, practically every one of this crew should be a skilled workman.

Here is a point that there is some difference of opinion on. Some contend for half of the crew good workmen, the other half cheaper men, of the class that is called saw and hatchet men. It is practical to use cheaper handy men in this work, too, but in the final analysis it is generally found that the well trained, skilled carpenter will do enough more work than the cheaper handy man to easily make up for the difference in the wages he draws, and the work will be better done and there will be a better order of skill and efficiency all the way through.

Value of Apprentice Boy

There is an old time practice that perhaps we do not have enough of today, of using at least one apprentice with the crew, a youngster learning the trade, who does the odd jobs and roustabout work. This made a good combination and it would be better if we had more of it today. The young man in time will become a better mechanic than some who are passing themselves off as carpenters, and will be able to practically fill the place of one man in the crew right along.

When it comes to the inside work, putting on the finish and hanging doors and windows, and putting up stairways, and all of such work as is done following after the plasterers, a crew of four men is about the right size for modest house work. As to just how to place and handle these to get the best results it is a little difficult to decide, because certain methods of handling are better for one feature of the result and other methods are better in other respects.

One Man Finishes Room Complete

For example, if you place one man in a room with instructions to put in all the finish in that room, you make that man responsible for the room, and when he gets through with it the work is likely to all be done in good shape and nothing overlooked, whereas, if it is simply assigned him to do a certain part of the finishing in all parts of the house, and another man another part, something may be overlooked.

Yet with four men, each man working in a room and doing all the work required in that room, more changes in the work and tools are required and sometimes a bit of confusion between two or more men wanting certain appliances at the same time. Take the matter of miter boxes, for example, and two or three men may want the box at the same time, which makes trouble or makes it necessary to have more of these appliances about the place.

A simpler way, so far as tools and appliances is concerned, is to divide the men so that each will follow up certain parts of the work through every room. This is a good idea in other respects, too, for men are peculiarly gifted in certain kinds of work. For example, there are certain kinds of men who are much better at fitting and hanging doors than others, and where there is a man of this kind in a crew it is well to let him do the door fitting and hanging, and to distribute the work so that each man will be employed at that particular line of work for which he seems best fitted.

equipment such as to get as much of the element of efficiency in the work as possible. This is one way to reduce cost without slighting work, and it is the right road to the best kind of success for the contractor and builder.

A Freak of the Builder's Art

By Felix J. Koch

The most unique large building in America, probably—in point of the manner of its construction—is the Tabernacle of the Mormon Church at Salt Lake City. There is neither nail nor iron used in its construction, except for the curious shingling of the roof—rawhide supplanting all these devices. Every bit of material in the edifice had to be hauled by ox-team from the Missouri River and yet the giant edifice was built in such wise that twenty doors permit of its emptying inside of four minutes.

To the layman, however, the curious aspect of the Tabernacle, like some huge egg, just rising from the ground, constitutes its oddest phase. Erected between

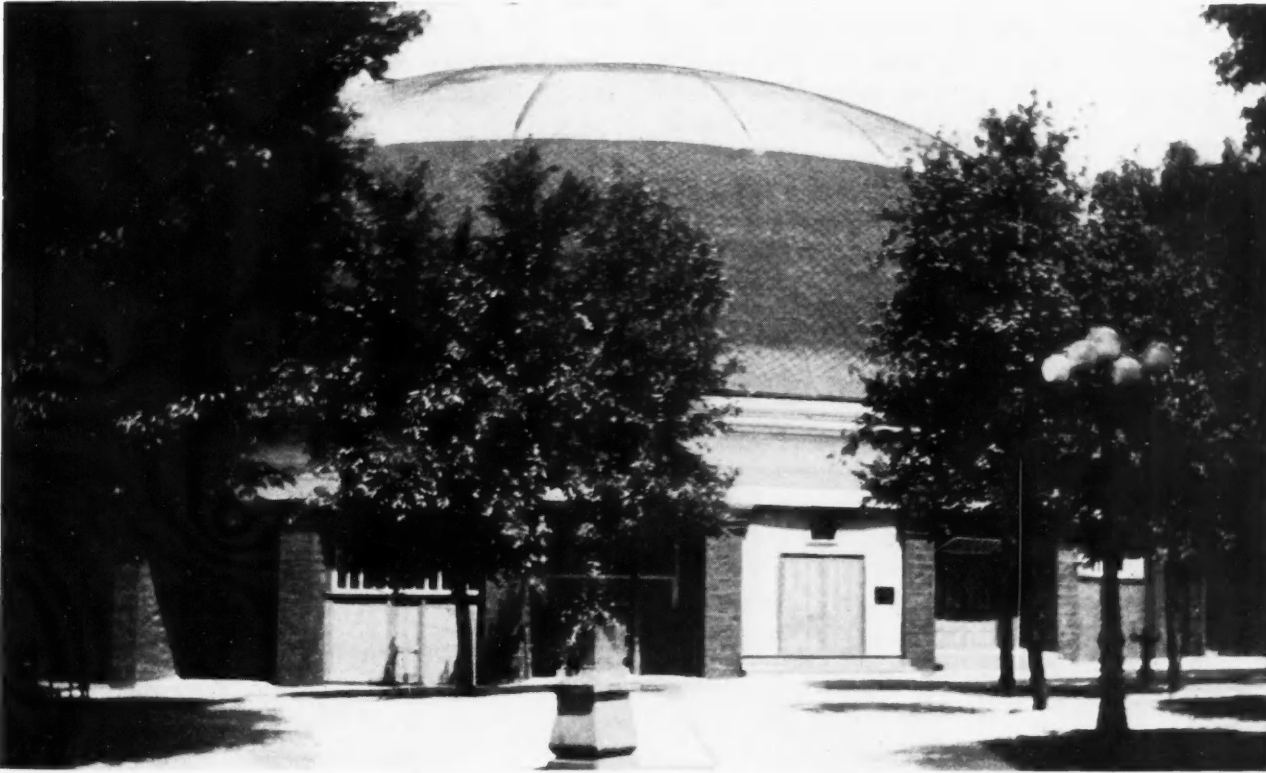

The Mormon Tabernacle at Salt Lake City, Utah. Built 1864-7. This Elliptical Dome, Measuring 250 by 150 Feet and 70 Feet High, is One of the Greatest Unsupported Arches in the World.

To assign work in this way calls for a little closer attention on the foreman's part to see that everything is done in each room and nothing is neglected or overlooked. This, however, is not so difficult for a foreman who is alive and onto his job. It is really part of his duty and, after all, the idea is not so much to simplify the work and make it easy to oversee as it is to handle it in such a manner as to get the greatest order of efficiency and skill and to get a satisfactory job at the lowest practical cost.

This is the great idea all the way through for the foreman and his crew, to make both the size and the

years 1864-7, this huge and extraordinary structure has the shape of an oval or ellipse, 250 feet in length by 150 width, and stands 70 feet in height. The roof which surmounts it and gives it its strange appearance is of wood, topped with iron shingles, so arranged as to cause it to resemble the shell of a turtle or the inverted hull of a ship. This dome is supported by forty-four sand-stone pillars.

The interior of the Tabernacle presents one of the great unsupported arches of the world. There are seats here for over 8,000 people, while standing room for over 12,000 is provided.

MACHINE WOODWORKING

More Shop Kinks

HELPFUL IDEAS AND SUGGESTIONS FOR CARPENTERS, CABINET MAKERS AND MACHINE WORKERS

By Wm. C. Jasbury

A QUARTERING TRICK. I had a quartered oak china closet to build some weeks ago; on each corner was a 4-inch diameter column. The wood in said china closet was selected; but where the columns would show plain oak on two sides and quartered on the other two, I

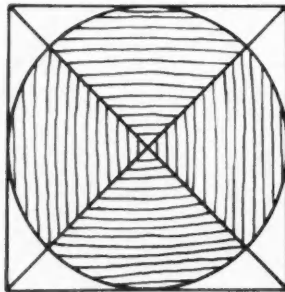

Cutting Quarter-Sawed Oak For Veneering.

was told to glue them up, so that they would show quartered all around, and the way they did it was as per the accompanying illustration. The material was all cut from one plank, giving same color, flake, etc.—the result was pleasing to the designer; and that is something.

KEEPING MOULDING STOCK. Every well regulated mill that carries any amount of stock, usually settles on some period of the year to go over affairs, or take account of stock. I once worked for a concern that used a very novel way of counting mouldings. The man in charge would use a piece of ground glass, place it against the ends of the mouldings in the rack and mark with lead pencil, counting from one up, then if he was interrupted,—which he was, very often, doing a big business,—he could lay down his glass and when he came back and put it up in the rack again, he had the thing O. K. This man used to mark the ends of the mouldings with chalk, 16 ft. red,—14 ft. blue,—12 ft. white, etc., then he could pull out any length wanted on sight. This goes to show that no matter where you go, there are some new things being done.

MANUAL TRAINING. Nearly every well regulated high school of today has its manual training department; and the person teaching the boys the ins and outs of carpenters is a book-learned one, usually a woman. I know of many good carpenters that can no longer climb and are otherwise incapacitated, that would make a good tutor in such a capacity.

HANGING A STAIR PLATFORM. I put up or rather helped to a flight of stairs near Lakewood,

N. J., some time ago. There were two platforms or landings, one of these a hanging platform, i. e., there could be nothing under it for support, as it was over a hall door and nothing to fasten to from above, but fortunately for us, it was in a corner 90 degrees, or square. I first chopped two holes, one in each adjacent wall, and put a 2 by 6 in one, pulled it partly out and shoved it in the other, then nailed or spiked

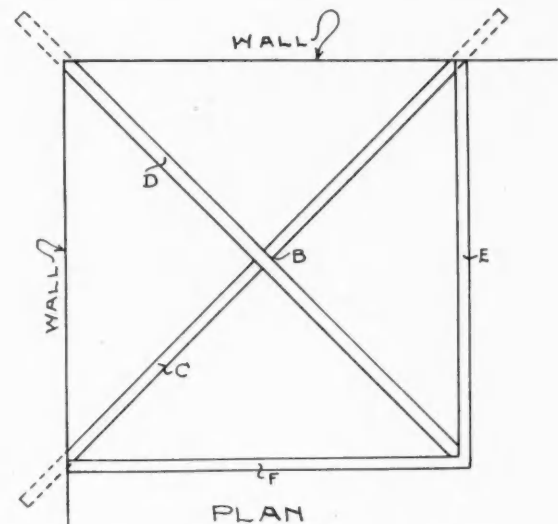

Method of Hanging a Stair Platform.

it, then I cut a notch half way through this piece, midway between the walls, or in the center, then I cut a hole in the corner and shoved another piece of 2 by 6 in there, letting it stick out 45 degrees from the both walls. I cut a notch in this piece to fit the notch in the first piece, B, then the piece, D, was long enough to have a double miter cut on the end, A, so that the pieces, E and F, could be spiked to it, making the corner, A, square. The piece, C, was the one that was doing the most of the carrying of the load, but was so well spiked into the walls and all the others also, it made a cracking good job; then the other work proceeded.

WORM IN CYPRESS. One of the peculiar things one comes in contact with, during a month's work in a planing mill brings to mind a cutter in the shop where I now work. He showed me a piece of

cypress he had cut off and in the end was a worm. A real live one; how this happened I am at a loss to know, as the board was dressed two sides and looked perfect, but how and when the worm got in there was and is to me a mystery.

A BOX NEWEL TRICK. I am about to speak of and try to show some odd things that have come under my observation. Some weeks ago, I saw a stair man making square boxed newels, with a base on them. He did not fasten the base on, as is usually the case; he mitered them around the post, only glueing the miter joints, so that the base (which was

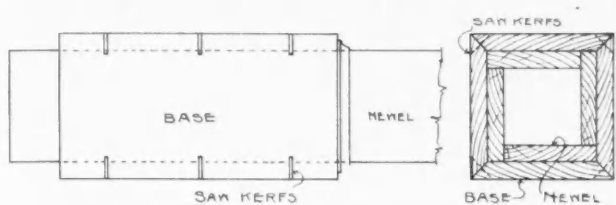

Making a Square Box Newel with Adjustable Base.

no more than a box, without top or bottom) could be slid up or down the post at will, and nailed, when a final place had been decided upon by the erector. This seems to be a unique way of doing this work, but that also helps to prove that no one man's way can be a standard. And again, I would like to say as the miters in the bases were made, he would saw three kerfs in the edge of the miters and put in thin pieces of veneer to strengthen same.

DOG-LEGGED STAIRS. Very often stairs are gotten out in a way that bring two strings in the same vertical plane, or one directly over the other, both against the same wall, called by old stair builders "dog-legged stairs." The angle formed by the two strings inter-

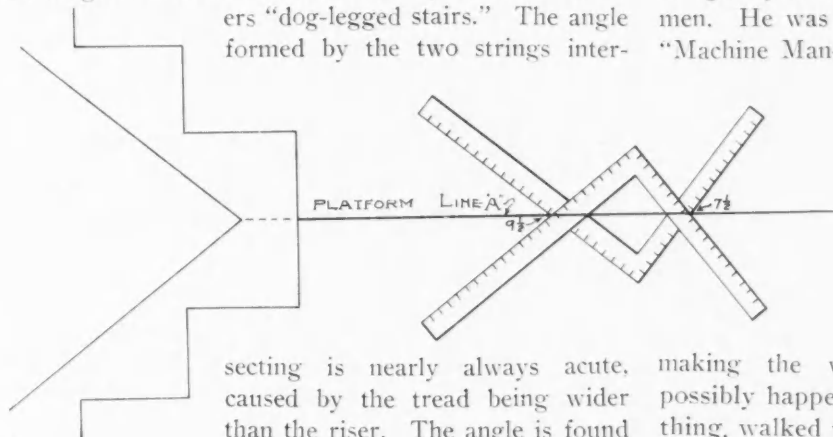

secting is nearly always acute, caused by the tread being wider than the riser. The angle is found by the steel square by drawing a line straight, say 2 feet long. Place steel square on this line with figure, says, $9\frac{1}{2}$ inches tread, $7\frac{1}{2}$ inches riser on the line, draw the 90-degree angle of square, then reverse the process.

SPEAKING ABOUT TRAMPS. I saw a carving hobo, that was "some whittler"; this wandering parasite came to a shop where I was once employed, and got a piece of "good" white pine, $2\frac{3}{8}$ by $2\frac{3}{8}$ by 3 feet. He took an ordinary pocket knife and whittled or carved out a cabin with a three-ball ornament on

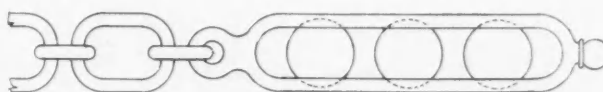

Wood Chain with Balls—a Favorite Whittling Stunt.

the end. The links were perfectly formed and the balls would run the length of the ornament. The ornament had four corner pieces and two ends left uncut, that kept the three loose balls in center from coming out. The stick was square section at first. He cut four rabbets nearly the entire length first move, making it look like the section, as shown, except the end that was to contain the balls, which he left in the original square section. He then laid off the links, digging out the surplus wood, then the end with the ornament was carved out. It was a good stunt. Anyway, Mr. Tramp sold it for 75c—nearly a day's work; not much for a regular full-rigged wood carver, but to a weary knight of the water tank, 75c looms up like the Rockies to a tourist. As a rule, Wandering Willies do not take to wood cutting, but this one, of course, could sit down at it, and *sit down* is a tramp's middle name. I do not know what he did when he got into the part of the country where hickory prevailed.

Now that I am treating on the subject of hoboes, I was at one time employed in a good sized planing mill along a railroad. A tall, middle-aged tramp, about 50 years old, called on the foreman for a job; the plant being busy at the time warranted the taking on of more men. He was asked what his line was, and replied, "Machine Man—this machine," pointing at the band-saw. "Oh, well! most any machine." He was put at band sawing porch brackets. While the foreman stepped out somewhere, this man borrowed rule, lead pencil, chew of tobacco and all the other equipments of a mill man and started at the brackets and when he put a pair of glasses on, he looked fairly human. He was

making the worst mess of the job that could possibly happen; the foreman came in and saw the thing, walked up to Mr. Tramp and said: "Did you ever see one of these machines before?" He said: "Yes, I believe I have seen them, but to tell the truth I never worked in a mill before in my life. I thought I could pull through in order to get a day's pay anyway." The fellow was so honest about the exposure, we made up a collection and gave him the highball wave, as he passed the shop on an outgoing freight train.

That was one case where a man takes a long shot on a good nerve. He was willing to work, but he was in the wrong pew.

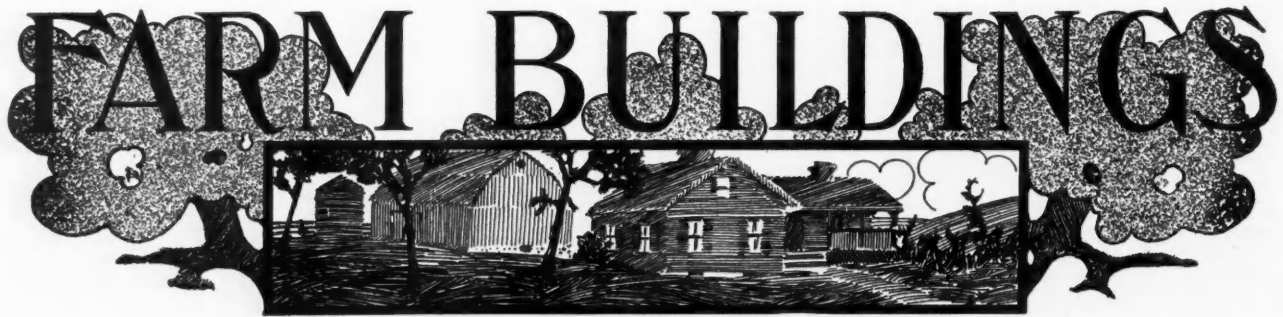

Specimen Plank Frame Construction

THE sketch illustrates the construction of a favorite type of modern dairy barn, which consists of a frame structure, the frame of which is built entirely out of planking not over 2-inch thickness, and built on a concrete foundation, which extends far enough above the floor outside ground level to prevent moisture from coming into contact with the wood sill and frame.

The sill should be well bolted on the top of the concrete foundation and the studding, which are 2 by 6 inches in size

for barns of ordinary dimensions, and spaced 16 or 24 inches on centers, the 24-inch spacing being preferred because any stock length of boards can be nailed thereto without waste. The studding are generally of 14 or 16 foot lengths and have a double 2 by 6-inch plate spiked on top, which ties them together, keeps them in a straight line and forms a sill for the rafters.

The floor joist of the hay mow floor are made of 2 by 8 or 2 by 10-inch joist, as the weight may require, and are spaced the same as the studding, so that the end of each joist may be spiked against the side of the studding and at the same time rest on a 2 by 6 ledger or ribbon which is notched 1 inch into the studding and continues the full length of both side walls with as few joints as possible.

Three lengths of joist are generally required to reach from one side of the barn to the other; the ends of the middle tier of joist are spiked and lapped against the inside ends

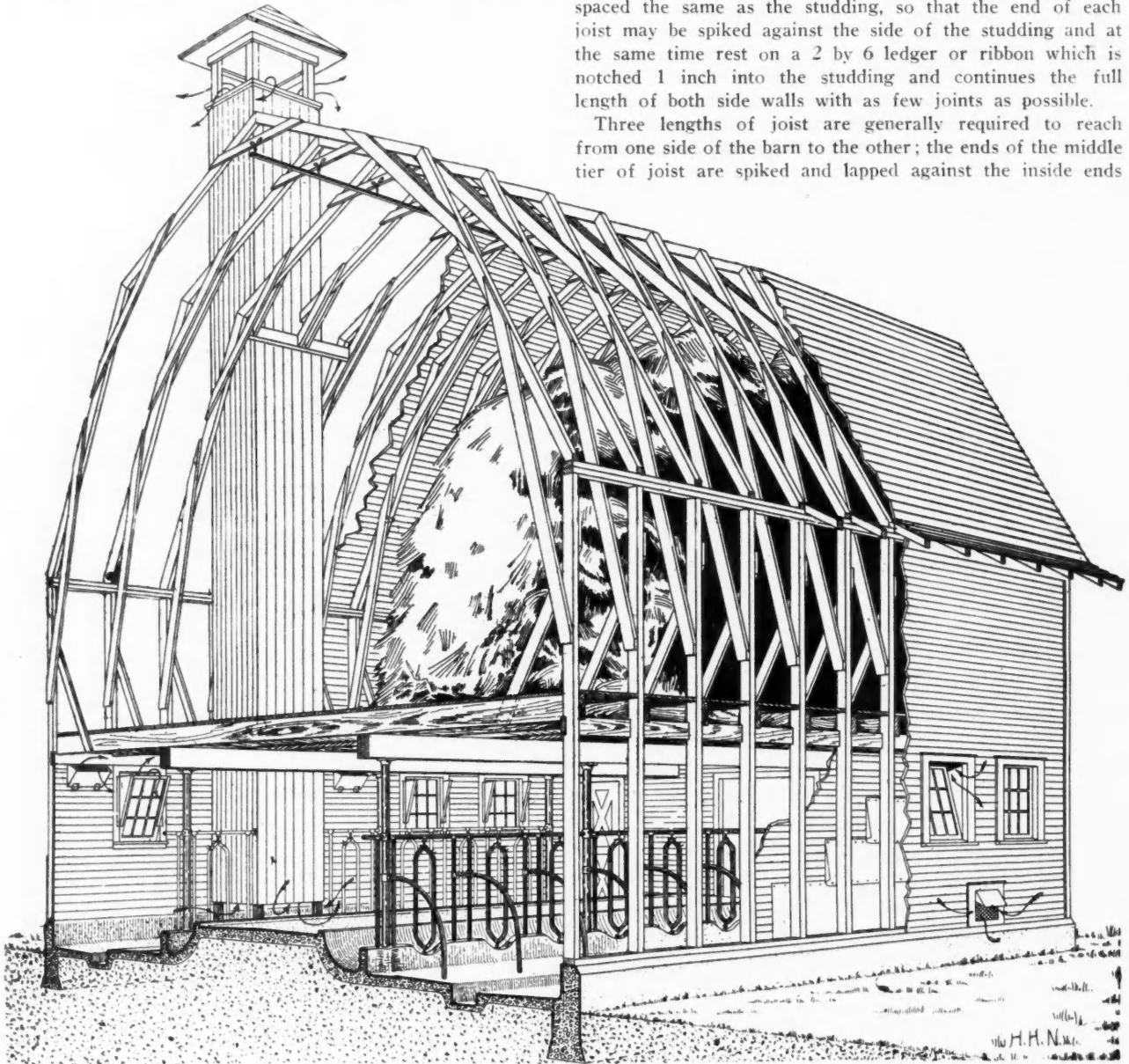

Diagrammatic Perspective Sketch of Modern Dairy Barn, Showing Plank Frame Construction and Ventilating System.

of the two outer tier of joists so that each set of joists are supported under the lapped ends on a set of girders, built up out of three or four thicknesses of 2 by 10 or 2 by 12-inch joist; built up continuously from one end of barn to the other with as few lengths as possible and all end joints broken, so that there will not be more than one end joint at any one place along the length of the barn.

These floor beams are supported by posts or iron columns which are so spaced that they will intersect with the line of stanchions and the partitions between the stalls, and rest on concrete piers built below the concrete floor.

As this article is written more particularly for the inexperienced builder, it is well to mention that as soon as the studding are set in place, they should be well braced against wind, and as soon as the joist are in place more braces should be added. These braces should remain until the siding is in place and the roof has been completed, then they may be taken out.

In framing the roof one set of rafters are carefully laid out on the hay mow floor or other convenient level platform and after the exact length of each piece is computed, these are used as patterns and the required number of pieces cut from this one set of patterns. When all rafters, braces, ties and collar beams have been cut, each set of rafters, braces, ties, etc., are spiked together so as to form a complete arch rib, which will reach from the plate of one side wall to that of the other.

The best method of procedure is to build all these arches laid at, one on top of the other, on the building, the ends of each arch (the heels of lower rafter) resting on the wall plates at the point where it is to be secured after it is raised to a vertical position.

After all of the arches are completed, the end arch is hoisted up to a vertical line perfectly plumbed, well spiked into place, and well braced, a block and rope are hooked to the collar beam (the top horizontal beam to which hay track is fastened) of the arch that is in place, with this the next arch is hoisted, plumbed and nailed in place and this method is continued until all are in place. Each arch is nailed to several sheathing boards that are used as guides and ties to secure the arches as soon as they are raised, and each arch is braced to the studding as soon as set in place. These arches can be raised and set in place by three or four men, while with the old method of heavy purlin and post construction, ten or fifteen may be necessary to help hoist the heavy frame.

This type of roof has the advantage of requiring less material and labor than the heavy timber roof; is just as strong and forms a mow without any obstruction.



Concrete Fence Posts

Where cement is easily obtained and proper aggregates are available, which applies practically to the greater part of the United States, farmers are finding it profitable to substitute concrete posts for posts of wood.

Concrete posts are indestructible, keep in better alignment than wooden posts, and, under normal conditions, cost little more, if as much, as the latter. In some sections of the country they can be made cheaper than a good wooden post. Their fireproof and everlasting qualities make them especially desirable. A simple type of post can be easily made on the farm. A farmer may make his own molds, or he can purchase them from one of the various concerns that manufacture molds on a large scale. Farmers sometimes club together in purchasing factory or metal molds, thus reducing expense to the individual. This is a very good plan, as metal molds do not warp or decay.

The easiest and cheapest wooden mold to make is the straight mold, or one for a post which does not taper. Such

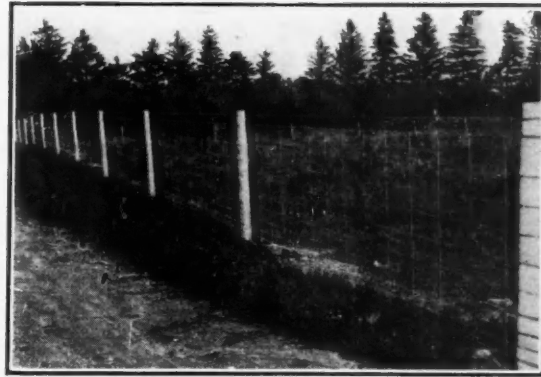

A Line of Concrete Posts with Wire Fencing Attached.

molds are merely long boxes having various devices for making the molding of the post a simple matter. On account of the amount of lumber saved and the ease with which these molds are filled, straight molds are generally made in "sets" or "gangs," by constructing several side by side with a continuous bottom and end pieces.

Posts should be reinforced with a rod or wire in each corner. In most cases round bars 3/16 or 1/4 inch in diameter are used.

After the molds have been oiled or soaped, the concrete should be placed in them at once. If, for any reason, the concrete stands thirty minutes before using, it should be thrown away and a new batch mixed, for cement, if it has once partially set, makes weak, dangerous concrete, even though it is retempered by turning or adding water. After the molds are filled evenly to the depth of three-fourths of an inch or one inch, according to the spacing of the reinforcing rods or wires, the reinforcement should be laid in, properly spaced by means of at least three "fool-proof" wire spacers. The concrete should then be poured in until the molds are filled within three-fourths of an inch or one inch of the top, when the remaining reinforcement is fitted in place in the manner described above and the molds are completely filled. To render the concrete more compact, a crowbar or a pinch bar should be placed under each corner of the mold successively and moved up and down quickly. This vibration makes the concrete more compact by shaking out the air bubbles, but there will be very few of these bubbles if the concrete is thoroughly mixed and of proper consistency.

The following are exceedingly important precautions:

Do not expose the newly made posts to wind, hot sunshine or frost.

Do not remove the mold from the green post until thoroughly hardened, which generally requires two or three days. Even then the post must remain on the bottom board in the shade and not be distributed for at least a week. During the first two days keep the post wet and covered with canvas, burlap or other clean material, and dampen it thereafter each day for about a week.

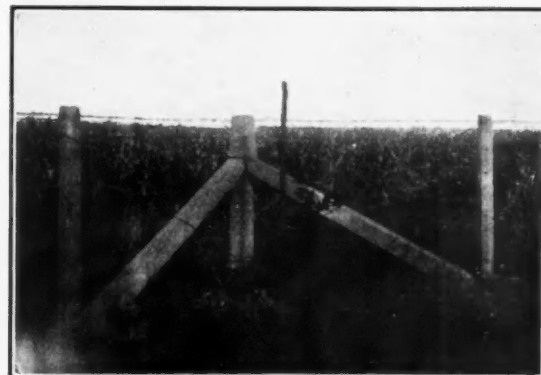

Concrete Field Posts. Braces at Corner Post are also Concrete.

CORRESPONDENCE

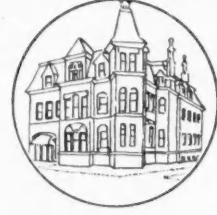

Questions Answered and Ideas Exchanged.

Our Readers Are Requested and Urged to Make Free Use of These Columns for the Discussion of all Questions of Interest to Carpenters and Builders.

A Kitchen Cupboard

To the Editor: Almena, Kans.
 In the May issue of the AMERICAN CARPENTER AND BUILDER Mr. Joe Masters asked for information on kitchen cupboard, or cabinet. I herewith enclose a drawing for one that may help him out.

CHARLES K. ASLING,
 Mgr. Foster Lumber Co.



Advice to a New Beginner

To the Editor: Milton, Iowa.
 I am not a carpenter, though I expect to be. I am working with a carpenter on a house which he is remodelling, raising it from a one-story to a two-story building. The carpenter and the owner have a difference of opinion about the second-story porch floor, where it runs across the front and part of

an octagonal end. The owner insisted that the floor should follow a level line next to the house, while the carpenter insisted that it should show a fall across the bay window part.

I would like to know which is the right way to do the work and what the carpenter should have done about it.

HERBERT ARNEY.

Answer—In answering this question, we presume that you are a young man just starting out on the highway of life, full of vigor and anxious to learn all that is useful in your chosen profession, which is commendable. But you will find such things of which you speak all along the line; somebody will always be ready to jump up and tell you all about it and beat you to it if you give them the least chance. The older carpenters have become used to this and have become calloused and they do not let such things worry them. But there are times when it requires considerable diplomacy. In cases where there is nothing in particular to lose, it may be well not to

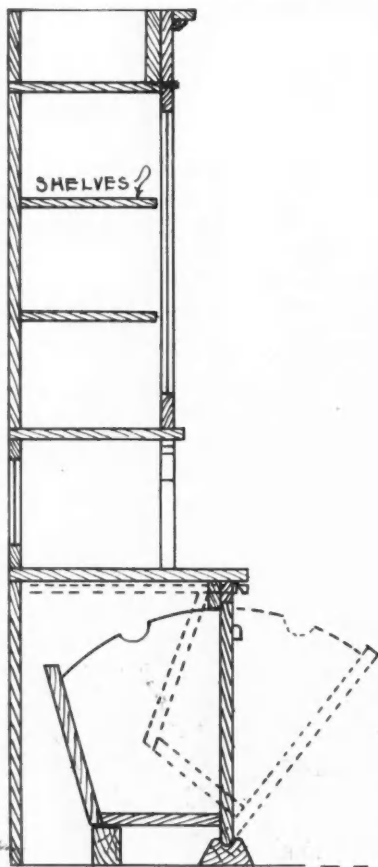

SECTION

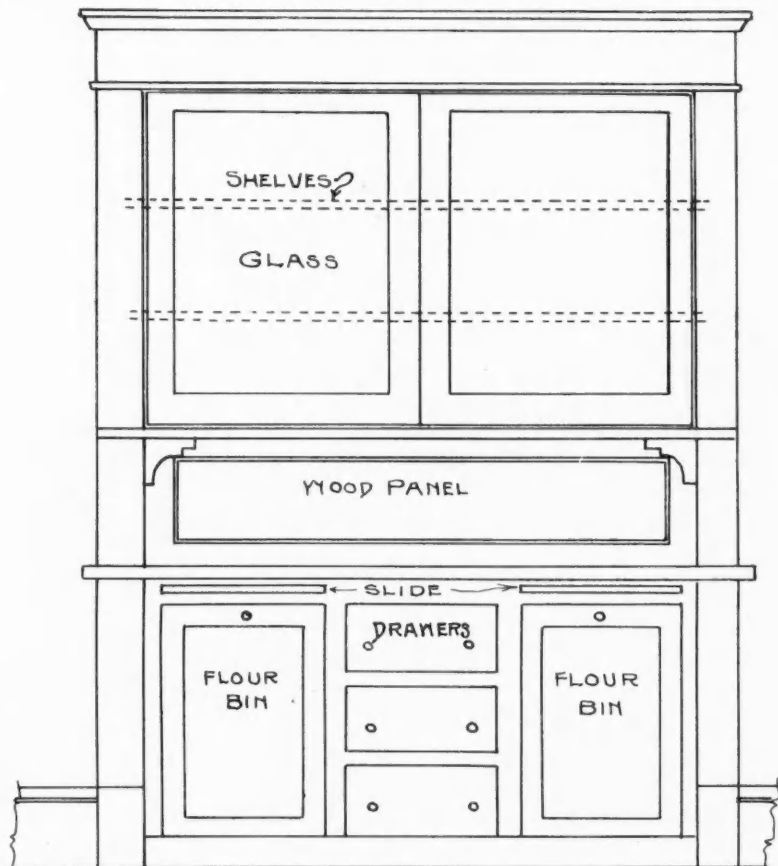

ELEVATION OF KITCHEN CABINET

Details of Handy Kitchen Cabinet Offered by Chas. K. Asling.

contend for your way but if it is something that is liable to revert back against your workmanship as a detriment to your standing in any way when you were in no way to blame, be firm to the last, even if you must go down, but go with colors still flying. The best way is to be sure you are right and then go ahead.

As to the case of which you speak, we have no doubt but that the carpenter was in the right. The proper way is to run the outer edge of the porch level and let the pitch of the floor die against the house, where it will; otherwise with a level line at both sides would result in a warped floor. The common sense way is about the best rule to follow,—because if you try to doctor up a thing after letting it run its natural course, nine times out of ten you will make it worse. In short, advice is cheap; appropriate what you want of it and forget about what is left.

A. W. Woods.



Good Poultry House

To the Editor: Corso, Mo.
After reading the A. C. & B. for some time, I thought it might be that I could write you a few lines that would help to fill up your most valuable paper. I am always glad to get the last number. I suppose I am what you would call a journeyman carpenter, anyway, sometimes I am close to home

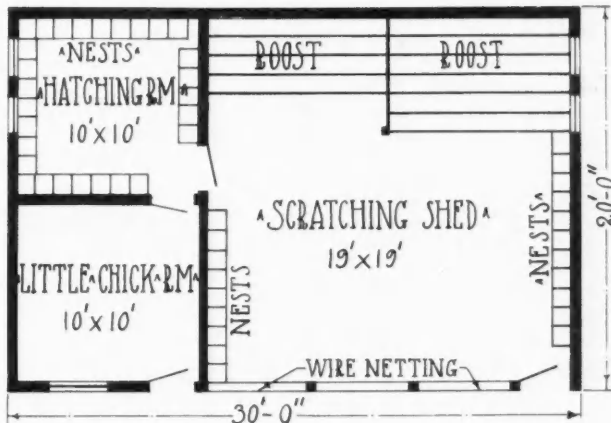

and sometimes I am away some place.

The carpenters in this section are generally pretty busy and can't complain. There is one thing I always try to do, and I would like to impress it on the minds of all young men, just starting out; and that is,—try to do your work right and please your employer so that you can always count on doing his work.

In the year of 1908, I moved from the city to the country. There are several men that have me do their work. Just as sure as I hear of anybody contemplating any kind of building, I never miss it when I tell my partner we will get that job.

Enclosed you will find photographs and outlines of poultry house built on the farm of M. T. Shaw, better known as Meadow Slope Farm. Since I moved to the country I have built, or helped to build, a nine-room residence, two poultry houses, meat house, grocery, woodshed, machine shed 32 by 60, and quite a lot of general repairing, all for the proprietor of Meadow Slope Farm.

I. H. PARK.



Has the "Bungalow" Sized Up

To the Editor: Sterling, Colo.
In answer to query of W. E. B., it is immaterial how he cases his bungalow. As good a way as any, is to go out and get a man that never worked at the carpenter trade and set him to casing it without any instruction, and he will make a bungalow out of it.

I employ a good many men, and when I get a job so botched up that I can't get it straightened out, I just paint it black inside and out and call it a bungalow.

NOEL HOGG,
General Contractor.



How to Member the Rail to Column Base

To the Editor: Mason, Texas.
Will you please tell me how to joint a bottom rail to a base of a column. The bottom rail has nearly the same shape as the moulded base. I have mitered part of rail No. 1 to the half round of base, which did not cause any trouble. Part

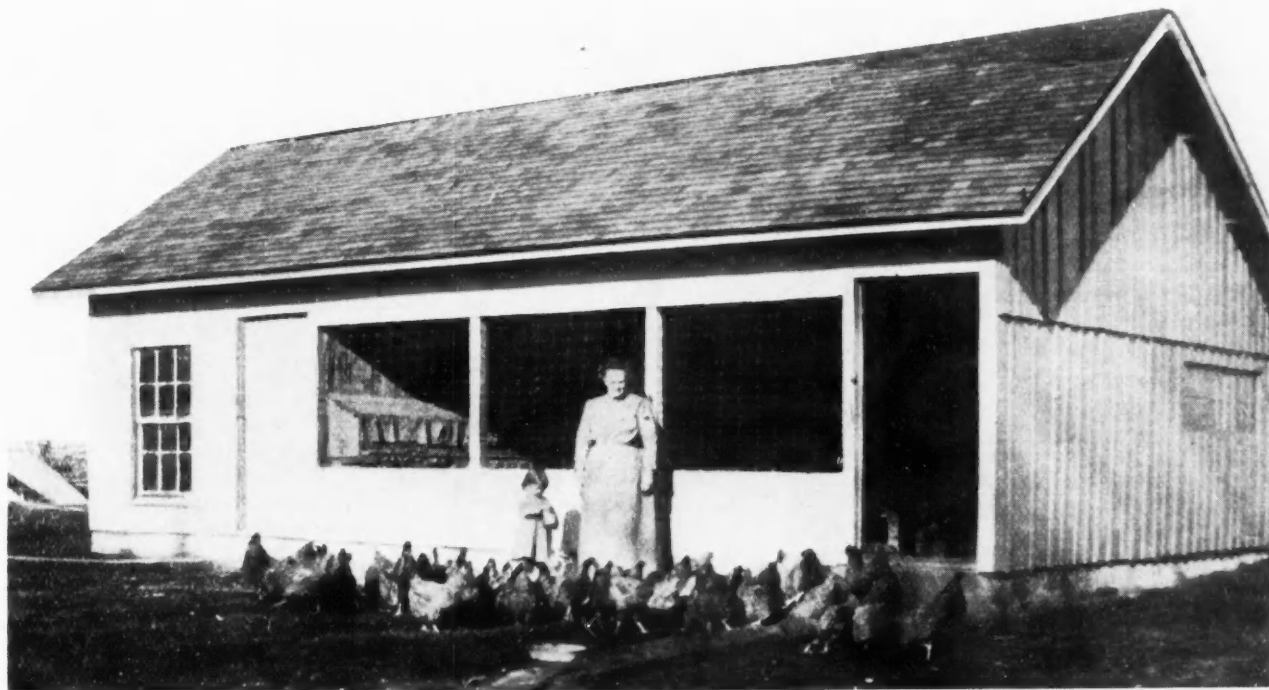

Photograph and Floor Plan of Well Arranged Poultry House at the Meadow Slope Farm, Near Corso, Mo.

No. 2 I have cut square, touching the little half round of base. Where the cove is, I have an open space and this I do not consider as a neat job.

Kindly let me know the best way to make a neat, tight joint where rail and base meet.

R. GROSSE,
Lumber Dealer.

Answer—You have rather a difficult proposition, as we presume you have your columns set up in place and in that case, would suggest that you rip No. 2 in three parts, as shown by the dotted lines, and then cope the ends of the two lower

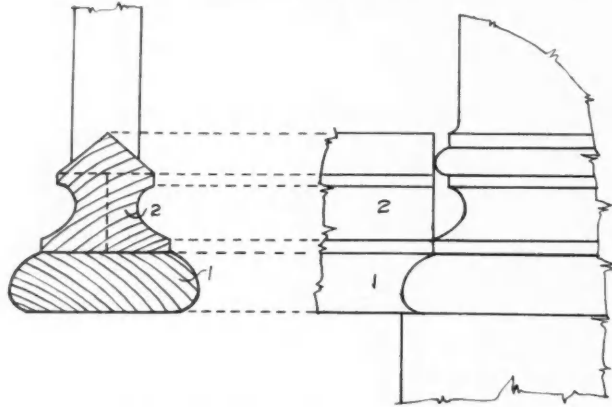

To Member a Porch Rail to Column Base.

pieces to the shape of the base, so that they may be slipped side-ways into their respective place. Then the top piece may be coped to fit over the moulds by springing the center upwards and letting it in from the top, or the mould may be cut out to the shape of the top of the rail and then let in place in the same manner; but this method is liable to split off the moulds where it cuts through same. But the best of all, where the members of the base and rail are of the same shape, is to miter them together; but this would have to be done at the time of setting the base. The rail can then be let into place from the top.

A. W. WOODS.



Score Two From Haiti

To the Editor:

Petit Goave, Haiti.

I am sending you two sketches for a music stand and a door boy. The stand is made out of a piece of 2 by 2

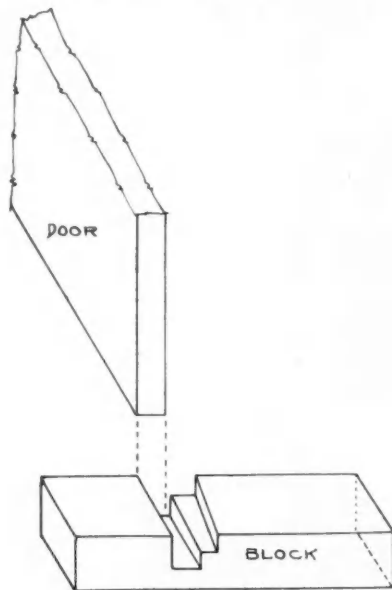

DOOR BOY

A Simple Effective Door Holding Device.

worked to a hexagonal shape, then sawed in two halves, hollowed out and then glued together. The plug is to give more solidity to secure the legs. The round piece that carries book rack is inserted into hexagon and can be adjusted to any desired height by the thumb screw. The rack is made out of light stuff,—center bar 1 3/8 inch thick, two exterior pieces 1/4 inch thick with end pieces 3/4 inch thick. I trust the sketch is plain enough to be readily understood.

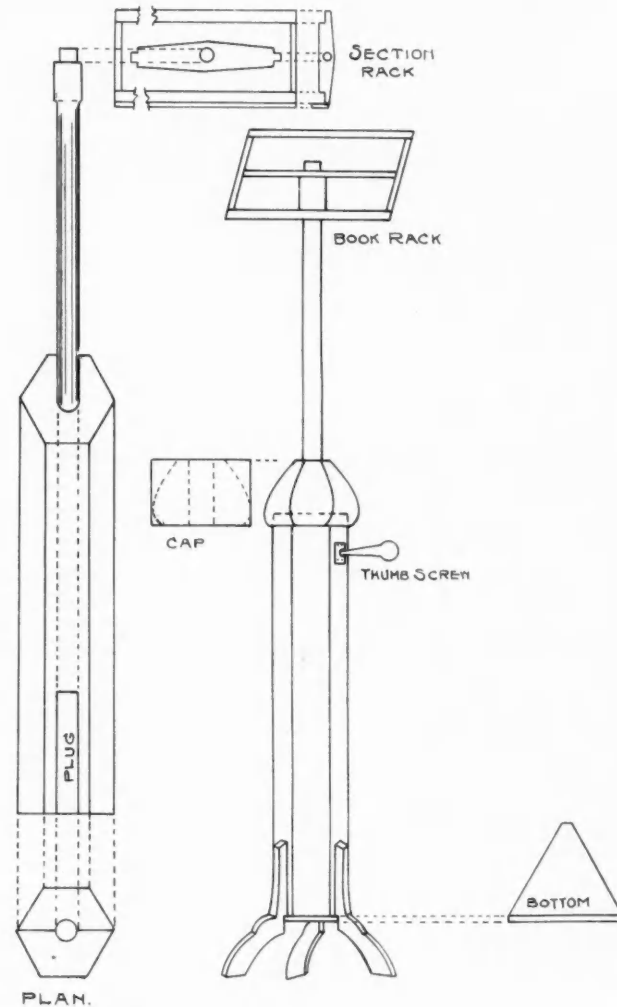

MUSIC STAND.

Working Details of Interesting Music or Reading Stand.

As for the door holder, that is clear enough. Simply a block with a double slot cut into it as shown. By setting the edge of the door in the deep slot and by driving a wedge in the upper slot, will steady the door, so that the same can be fitted and hinged. I think you will find this a very important piece of mechanical utility.

S. A. WILLIAMS.



Putting Down Base

To the Editor:

Petersburg, W. Va.

I know you have not seen my name in the "A. C. & B." heretofore, but I want to say a little in reply to Mr. I. P. Hicks and his article on how to do work fast putting down base. I am inclined to think Mr. Hicks never put down much base himself, as surely he would not be so far behind the times. I had a fellow start this very way for me, not long ago; and when I told him how I do it, he wondered why he had been so blind not to see it long ago; and by the

way, he is a much older mechanic than I am.

Now, to put down base that has a mould already in it, as the base Mr. Hicks shows, I would just cut a 45-degree mitre on the mould part by either placing it in a box, made in a few minutes for the purpose, as by using a mitre square on it; and then use my coping saw. The flat part would, of course, be cut square with the hand saw, same as Mr. Hicks suggests. This is so simple I won't give a drawing of it, for any mechanic will understand how to mitre the moulding.

A. N. CLOWER,
General Contractor.



An Improvised Ladder

To the Editor: Summerville, Ont.

Having occasion to get up and down in a cellar of concrete under construction, with only studding set 6 or 8 feet

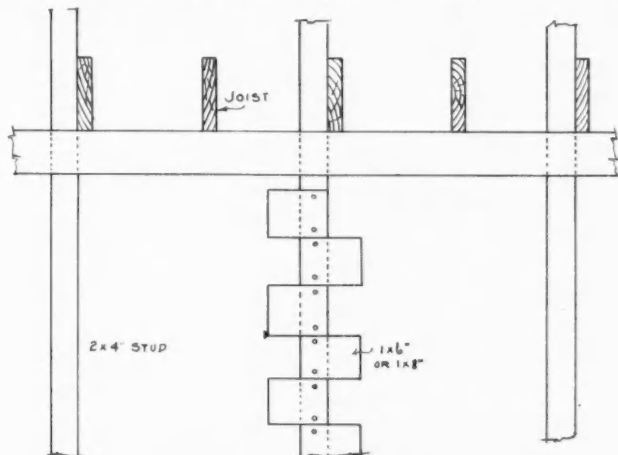

Ladder Made by Nailing 1 by 6 Blocks to Stud.

apart, with ribbon boards to carry joist at the center of span, and having no narrow stuff to form a ladder, by nailing cleats across studs, I picked up some ends and nailed to single stud, as shown, with two nails in each piece and found it made a very convenient ladder. GEO. H. JACKSON.



A Correction

To the Editor: Elgin, Iowa.

In the April, 1914, number there is something perhaps I do not understand—Mr. Woods' article to get the miter for a nine-sided hopper. $4\frac{3}{8}$ is taken for radius and carried into seat line of hip. In another one of his articles in Radford's Cyclopedia on Page 144, Vol. 8, the radius is carried to the pitch line and thence to the blade. Now which is right?

I have been reading Mr. Woods' articles and have learned very much from them, hence my desire for information on the subject.

ALEX PAGAN.

Answer—We stand corrected and we are glad Mr. Pagan has called attention to the article in question. The radius should have stopped at the pitch line instead of the run of the hip, as shown in the April number. We simply thoughtlessly swung in to the wrong line and let it get away without detection and assuming that this was right, caused a second error in reference to the pentagon hopper. We regret the error, but are glad to make correction so far as we can.

A. W. WOODS.



An \$1,800 Bungalow

Bluffton, Ind.

To the Editor:

I have designed and built a six-room bungalow, size 32 by



Neat Little Six-room Bungalow Designed and Built During Spare Time at Bluffton, Ind.

55 feet. It is a little different from anything I have seen in the magazine.

I am foreman in the lumber company's woodworking shop here, and built this house mostly in the mornings before going to work, and evenings after quitting time at the mill. The parlor and sitting room, opening together, extend across the front, 14 by 28 feet. Just back of the sitting room is the dining room, measuring 14 by 15 feet. Back of this is the kitchen, 14 feet square. On the right-hand side are two 12 by 14-foot bedrooms, besides bathroom and closets. This bungalow cost about \$1,800, not counting my own time.

JESSE L. REIFF.



Possible Suit for Alienation

To the Editor: Hershey, Pa.

Enclosed find two dollars for which please renew my subscription for another year.

I am very much interested in the valuable magazine, the AMERICAN CARPENTER AND BUILDER, especially the "Noon-Hour Talks by the Boss Carpenter" and Correspondence Department. I told my wife that this was my final copy, as the subscription had run out; and then she said she was glad because she could never talk to me, as I am always sitting reading. I looked at her and grinned a little and said, "Yes, but I am going to renew it again, for this helps me a whole lot at the trade."

MONROE BOSSLER.



Wants to Build a Boat

Friendswood, Tex.

To the Editor:

I wish someone would send in plans and specifications for building a light skiff. I want one to use with one of the attachable motor propellers. The material available here is cypress, cedar, oak, and natural knees of mulberry and cedar

R. P. KNIGHT.



He Ventilates at Meeting Rail

Am a charter member to your valuable paper, but have never seen my way of ventilating dwellings in print. Here is my way, which may be of interest to brother chips: Meeting rails of lift sash are $\frac{3}{8}$ inch and a $\frac{3}{8}$ -inch parting strip is used, so when window is closed the joint is tight. Now I use $\frac{1}{2}$ -inch parting strip, which leaves a $\frac{1}{16}$ -inch opening; and as the opening is nearly perpendicular, the cold air ascends to ceiling making a perfect circulation without draft, sash locks will close this space nearly half when weather is cold. Here the full opening is none too much.

C. W. YOUNGGREN.

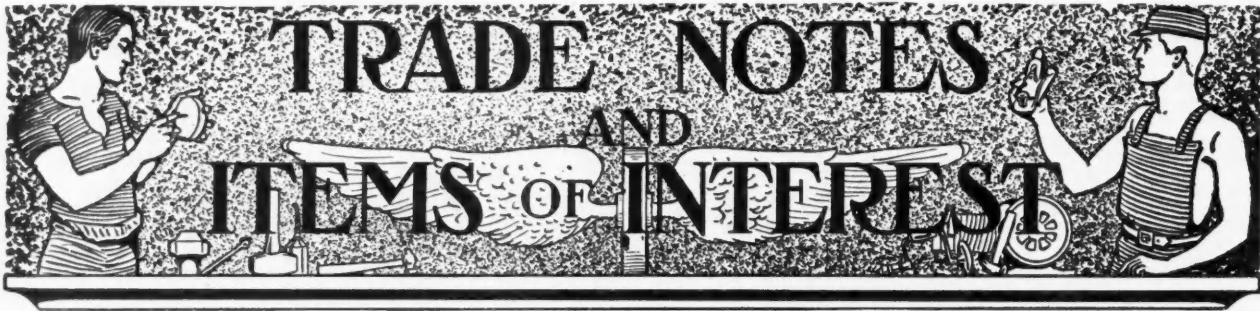

Through this department the editors aim to keep builders, contractors, carpenters and architects in touch with what their friends, the manufacturers, are doing for them in new or improved tools and machinery methods and materials—pertaining to building. Items for these columns must have real news value; they are offered here as interesting information for our readers; they are not advertising. No matter will be printed here simply because some advertiser wishes it. Likewise, no matter will be excluded simply because the article described is not advertised in this magazine. Suggestions for the betterment of this department are requested of our readers.

Essay on Fireproof Construction With Concrete Wins Advertising Prize

J. P. Beck, Publicity Manager of the Universal Portland Cement Company, was awarded the \$1,000.00 first prize for the best constructive and suggestive essay on advertising by the Awards Committee of the Associated Advertising Clubs of America (*now* of the World) at the Toronto convention.



J. P. BECK
Publicity Mgr.
Universal Portland Cement Co.

Mr. Beck's essay covered a hypothetical campaign for fireproof construction with concrete and dealt with the tremendous annual fire loss and annual fire tax, and the relief offered from that loss and taxation by safer and saner construction with concrete.

Mr. Beck's familiarity with the various phases of the cement industry and his careful investigation of fireproof construction formed an excellent basis for his effort. This knowledge, combined with his wide experience with common-sense advertising, led the judges, Professor Paul T. Cherington, of Harvard University; John Renfrew, Los Angeles, Cal., and A. G. Newmeyer, New Orleans, La., to pronounce his essay the best of the thousands submitted.

Mr. Beck has been associated with the University Portland Cement Company, as Publicity Manager, for a number of years. He is widely known in the cement industry as General Manager of the Cement Products Exhibition Company, under whose auspices the annual Cement Shows are held. Mr. Beck was elected Secretary and Treasurer of the first National Conference on Concrete Road Building, which was held at the Auditorium Hotel last February. He has been closely in touch with all the great movements of the cement industry and possibly no man in the country is better qualified than he to write on the subject he chose.



Conklin Reinforced Concrete Silos

The Conklin Construction Company, Hartford, Mich., are making an interesting proposition to carpenters and builders to take up concrete silo work. The Conklin equipment for

building reinforced concrete silos makes it possible for four men to build six feet of silo every day. The machine carries its own scaffolding and is automatically lifted. Not more than 200 feet of lumber is required with this machine to build a large silo. The machine is set up with a 4-inch center mast, carrying adjustable arms for various diameters, adjustable to 10, 12, 14, 16, 18 or 20 feet.

The Conklin system makes use of easily handled steel forms. The walls are reinforced with 4-inch wire mesh and the silos are built with a continuous door. The Conklin Construction Company are not only making an attractive proposition to builders to take up concrete silo work, but are also sending out an expert in each instance to show the best and easiest method of using the Conklin equipment. Write the company at Hartford, Mich., for full particulars.



Concrete Burial Vaults—An Up-to-Date Money-Making Proposition

The ideal business is one that capitalizes the ambition and energy of the individual. Some men have great possibilities if they are assisted by a device or plan that will give their sales ability and business judgment full sway.

This is an age of progress. The customs and practices of yesterday are obsolete today, and to make the best success you must manufacture products that keep you abreast with the times.

The Automatic Sealing Vault has proved a means to larger and better profits for the men who have taken hold of it and pushed it. It is chiefly a manufacturing proposition, requiring only a small, inexpensive plant.

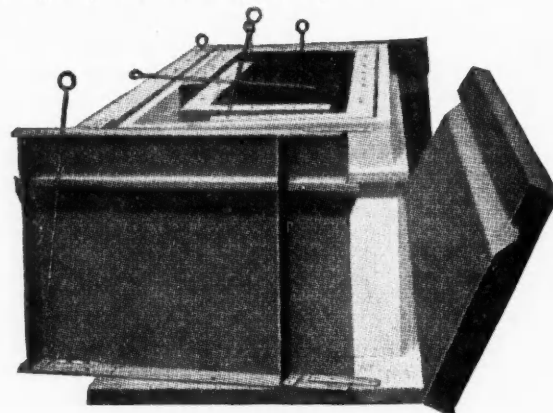

Automatic Sealing Vault and Molds.

Contractors and builders find this concrete burial vault business especially suited to their past experience and business inclinations. The personal experience letters from contractors in all parts of the country who have taken up the automatic sealing burial vault business make very interesting reading, especially to other wide-awake men who are looking

around for similar money-making propositions. This is a business calling for only a small cash outlay, a minimum amount of advertising and very little constructional material. It is said to pay back enormous returns.

The Automatic Sealing Vault Company, Peru, Indiana, desire to correspond with AMERICAN CARPENTER AND BUILDER readers who would like to develop a big paying business. They make their proposition definite, clear and easily understood. There can be no question as to the real merits of their Adjustable Bessemer Steel Molds for making Automatic Sealing Burial Vaults.

The vaults, themselves, possess special advantages that insure the success of anyone making or selling them. Every community furnishes a market for Automatic Sealing Concrete Burial Vaults as you can make and sell them at a price within the reach of all, and still make a good profit. Write the Automatic Sealing Vault Company, Peru, Indiana, today for full particulars and illustrated catalogs.



Dedication of the Disston A. A. Grounds

The official opening of the season and the dedication of the greatly improved grounds of the new Disston Athletic Association took place on Saturday, May 16, at Tacony, a suburb of Philadelphia.

Extensive preparations were made to celebrate the event in a fitting manner, and these plans were carried to successful completion.

Especial interest was felt in this opening, as it was the first public game played on behalf of the new association and marked its real beginning.

The first ball was thrown out by Mr. S. Horace Disston, chairman of the board of governors of the Athletic Association, and the game was called. The opposing teams were the Wissinoming Field Club and the Disston team.

The team which represented Henry Disston & Sons was

selected from the members of fourteen teams representing various departments in the works, which had been playing elimination games during the early part of the season. This meant that the members of the regular team were exceptionally fine players, and as the other team has an extensive reputation for good ball playing, it will be seen that from the start the play was fast and exciting. The Disston team won with a score of 5 to 2.

Opening under such auspicious circumstances, the Disston Athletic Association promises to be a permanent and prosperous organization which will add further glory to the already famous Disston name.



New "Red Devil" Hammer and Snip

A very ingenious, handy hammer and snip has been added to the already large "Red Devil" line by Smith & Hemenway Company, 150-152 Chambers Street, New York, N. Y.

The total length of the tool is 8 inches, with a 3/4-inch cutting blade.

The blades are made very narrow, and will therefore cut readily either round or straight. The tool weighs 10 ounces.

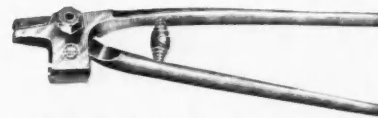

New "Red Devil" Hammer and Snip.

It has an involute spring in the handle, throwing it open. It is made of a high grade steel, hardened and tempered, so that it will cut sheet metal without injury to the tool. It is especially adapted for machinists, mechanics, tanners and automobilists.

Information, prices, etc., will be furnished by the manufacturers.



Kees Siding Clips

A new product is being offered by the F. D. Kees Manufacturing Company, Box 552, Beatrice, Neb. It is referred to as the little brother of the well-known Kees Metal Building Corners. These siding clips are used to make permanently tight and weather-proof joints where beveled lap siding joins the door and window casings or corner strips. As will be seen from the illustration, the clip consists of a piece of galvanized iron about 3/4 inch wide. The main part of the clip covers the end of the siding. A flange fits the lower edge of the siding and another flange fits against the edge of the casing. The upper end of the clip is covered by the board and clip next above it, so that a continuous watershed is produced.

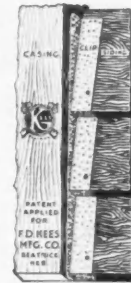

Kees Siding Clips.

It is evident that the Kees Siding Clips will save a great amount of labor, as it is not necessary with them to cut the siding to accurate length, and the ends need not be squared.



A Wonderful Product

Again we are pleased to call the attention of our readers to a wonderful product, "Lignine" wood carvings, manufactured by the Ornamental Products Company, of Detroit, Mich. Their product reproduces hand-carved oak, mahogany



Crack Team Picked From Employees of Henry Disston & Sons, Philadelphia.

and walnut models with full depth of grain, showing even the chisel marks.

The manufacturers have a proposition whereby the initial orders are shipped with the understanding if the buyer is not perfectly satisfied with the carvings, they can be shipped back within ten days at their expense.

A postal card will bring the reader a sample of "Lignine" wood carvings and the Ornamental Products Company's 39-page catalog.



Hand Elevator Booklet Free

While we are watching one end of the building industry, some other end is making improvements, too; and we are surprised, when we get back to look over the whole field again, how far behind the times we really are.

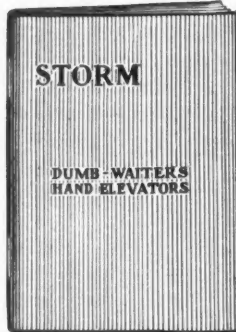

Contractors and builders have perhaps more details to keep in mind and more studying to do, to keep up-to-date in their business, than any other professional or business men. While we concentrate on one branch of the work, another gets the start of us.

We are impressed with this thought in studying over the dumb-waiter and hand elevator book now being issued by the Storm Mfg. Co., Harmon and Vesey Sts., Newark, N. J. If you are interested in this

sort of labor-saving equipment—and every contractor doing building work should be interested in it—write the company for a copy of this booklet. You will find it worth while.



Heitland Hot Water Circulating Fireplace Heater

Everyone enjoys the cheerfulness of an open grate fire; but many worry so much about the heat that goes up the chimney that they feel they cannot afford the luxury. A fireplace hot water heater is now on the market which utilizes all this waste heat, so that now one can heat from three to five rooms

with the same amount of fuel consumed by the old-style fireplace.

The Heitland Grate & Mantel Company, Quincy, Ill., have developed this improved hot water circulation fireplace heater. It has a heavy cast-iron firebox, and across the back and over the top in the smoke arch is a coil of 1-inch charcoal iron pipe. This contains 29 lineal feet of pipe, giving an immense heating surface.

The illustration shows a typical installation. The hot water heating fireplace is in the living room, and dotted lines show hot water piping running to radiators in library and dining room and overhead to second-floor bedrooms.

In many localities this fireplace heating system will become very popular.

All carpenters, builders, and architects should be familiar with this improved fireplace heater, and we suggest that our readers write at once to the Heitland Grate & Mantel Company, Quincy, Ill., for further information.



"Syracuse" Bit Gauge

The illustration herewith shows the "Syracuse" bit gauge, made by the Syracuse Twist Drill Co., Syracuse, N. Y. This gauge has two screws, so that changes from bit to bit and adjustments for depth are easily and quickly made. It is neat, light, strong and very convenient. The smooth, oval



"Syracuse" Bit Gauge.

head of the rod prevents marring the work. Capacity of the gauge is one inch and length of rod is six inches.

The "Syracuse" gauge can be furnished in either black japan or nickel plated. It is sold for a trifle, and if it cannot be obtained at your hardware dealer's, write to the Syracuse Twist Drill Co., Syracuse, N. Y.



Typewriter Opportunity

Would you like to have a good typewriter—a machine, we mean, not a young lady—and yet do not feel like paying one

hundred iron men right out of your pocket all at once for it? Well, here is just the opportunity you are looking for. Harry A. Smith, of Chicago, seems to be a mind reader, and has understood your desire before you expressed it, and has made provision for fulfilling it. To begin with, you don't have to pay out a hundred dollars, now or at any time, for a good machine; no, nor half that amount. He offers you a No. 2 L. C. Smith at a very reasonable price and on easy terms. It is really no more than you would pay if you were renting a machine. This typewriter has all the advantages pertinent to the L. C. Smith No. 2. Everything is guaranteed for the full life of the machine.



Trus-Con Offices Move to Youngstown

On June 1 the general offices of the Trussed Concrete Steel Company were moved from Detroit to



Section of Residence Showing the Heater in Fireplace in Living Room, with Hot Water Radiators in Library, Dining Room and Bed Room.

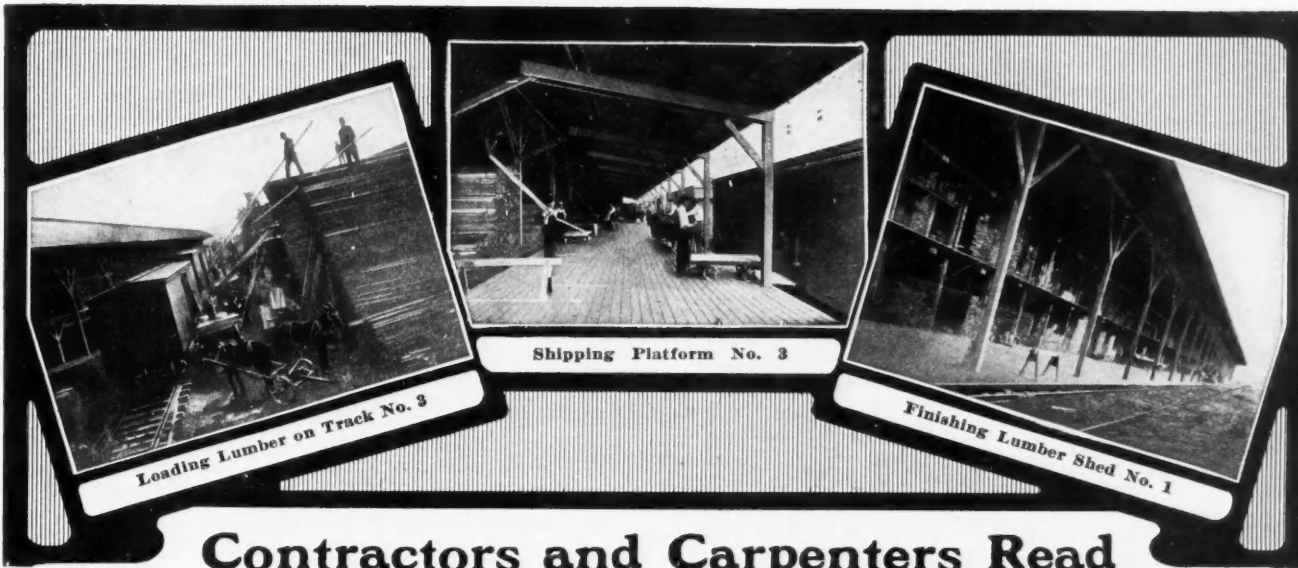

Contractors and Carpenters Read

July Challenge Prices!

Quick Service—Quality Goods!

More Than 10,000 Contractors, Carpenters and Builders Are Our Regular Customers

Lumber—Doors—Windows—Casings

Save \$100 to \$300 per Car on Dressed or Rough Lumber!

Casings

Yellow Pine Pilaster Casings, random length, 8 to 16 ft. 13-16x4 1/4 inches. Per 100 lineal feet **\$1.80**

(Specified lengths 10 per cent extra.)

Craftsman Casings, Black band, size 13-16x1 1/8 inches, Red Oak. Price per 100 lineal feet **\$1.05**

Also most complete line. All quality casings. All bargain prices.

Mouldings

Cove Mouldings, per 100 lineal feet clear 3/4 x 7/8 Yellow Pine **33c**
Also 1 3-16x1 1/8 **41c**
Also White Pine and Oak **40c and 75c**

Also largest selection in all mouldings in all woods, most **artistic designs**, highest quality. All bargain prices.

Write for Free Estimate on Your Lumber Orders

5,000 BARGAINS SHIPPED ANYWHERE

"Quality" Paint—an ideal special Gordon-Van Tine mixed paint for houses. Full measure and full satisfaction guaranteed or new paint free. All colors shown in free catalogue or at our store.

Quarts	\$0.35
Half Gallon	.65
Gallon Cans	1.22
Five-gallon Kits, per gallon	1.17
Also Quality Barn Paints at even lower prices; 75c per gallon and up.	

All Builders' Hardware

Screen Door Latch	.65c to	\$0.85
Screen Door Tension Hinge	.75	
Combination Screen and Storm Sash Hangers, per set	.10	

Windows

2-Light, 26x28, 1 1/2 check, single strength	\$1.24
2-Light, 40x40 and 16, 1 1/2 check, top leaded	3.90

Doors

2-8x6-8 1 1/2 One Panel Fir	\$2.64
2-8x6-8 1 1/2 Five Cross Panel Yellow Pine	2.09

Door Frames

Outside and inside. Plain and moulded cap, plank frames and inside door frames or jambs. Prices **\$1.65** and up for frames.

50c and up for jambs. See free catalogue.

Window Frames

Plain Cap, Moulded Cap and Box Window Frames, Sash Frames and Cellar Sash Frames. Big bargain prices now. All sizes ready to ship quickly. Four light window frames 2 ft. 1 inch x 4 ft. 6 inches, opening (10x12 glass). Per frame, with 13-16-inch outside casing, each **\$1.22**

Porch Materials

Turned Columns, 4x4 length 8 feet **55c**
Washington Fir. Price, each **\$1.40**
All sizes up to 6x6 length 9 feet at **\$1.40**

Colonial Newels, 4 feet long; diameter of shaft at base, 8 inches. Clear **\$1.40**
Cypress, each **\$1.40**

Also all porch materials at big bargains now. See free catalogue.

We Guarantee Safe Delivery to Your Station

Write For Our Grand 5,000 Bargain Catalog NOW!

GORDON-VAN TINE CO.

711 FEDERAL ST. DAVENPORT, IOWA



A corner of our estimating room



View of one of our lumber alleys



Shingles just out the kiln

Double-quick rush service on your estimates and orders

Make doubled profits on your summer jobs. Send us your lumber bills for **quick prices**. We've doubled our estimating department. The very hour we get your bill, we'll start work on it. You'll get a quick price and a low one on **high quality** lumber. It will be a freight-paid price, no extras guaranteed.

Quick shipments

The six big mills under Hewitt-Lea-Funck control have been working top speed for months past. Millions of feet of clean, fresh lumber and big stocks of finest millwork—await your order. We're filling orders in 24 to 48 hours.

Quick delivery

The railroads are on their toes, ready to give us service. We employ an experienced railroad man to crowd shipments through. We're making deliveries as far east as the Mississippi in an average of three weeks.

It's a cinch to sell a Silo like this

Just read the advantages of the

Seattle Silo

- 1—One-piece, old-growth fir staves.
- 2—Quick-detachable doors. Can't stick.
- 3—Door and hoop bars form a ladder.
- 4—Roof fits air-tight on even-cut staves.
- 5—Strongly guyed; guaranteed not to blow down.
- 6—Long tongued and extra-deep grooved staves.
- 7—Silo can be taken down and re-erected.
- 8—Shipped with lumber at carload rate.
- 9—Sold direct to you at manufacturer's price.
- 10—Sold complete, ready to set up; no extras.

Send the coupon for our special Silo representative proposition to contractors and contracting carpenters.

Double profits for you Better lumber for the owner

Distance is no handicap to your dealing with Hewitt-Lea-Funck. Surely it's worth looking ahead two weeks to save \$250.00, as J. A. Schaver of Garrison, N. D., did, or to save \$200.00, as K. Petersen, of Mitchell, S. D., did.

You'll be delighted with the quality of the lumber you get—old-growth yellow fir for structural uses, floors and trims; red cedar, the wood everlasting, for shingles and siding—and the price will mean a doubled profit for you.

Send 10c for Plan Book

Dozens of contractors write us it is the best Plan Book they've ever seen. Over 100 good houses.

Send 4c for Barn Folder

All the latest ideas in barns. Every one planned by a practical farmer. Send for folder today.

Try our rapid fire estimating service on your next bill. See what a low price we can quote

Hewitt-Lea-Funck Co. 408 Crary Bldg. Seattle, Wash.

Don't bother to write a letter
Pin coupon to your letter or billhead

HEWITT-LEA-FUNCK CO.

408 Crary Building, SEATTLE, WASH.

Please send me at once—

(Be sure to write plainly)

- Delivered, freight-paid price on enclosed list (no charge for quotation)
- Delivered, freight-paid price on Seattle Silo.....feet in diameter.....feet high
- Prize Plan Book (10c enclosed) Special Barn Folder (4c enclosed)
- Millwork Catalog and Lumber Price List (free)
- Special Silo Representative Proposition

Name _____

Street No. or R. F. D. _____

Post Office _____ State _____

Business _____

From Forest and Mills Direct to YOU

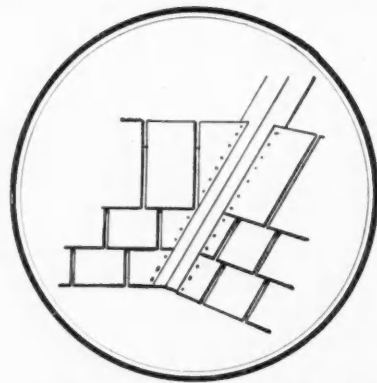

No Metal in Valleys

Rex-Valley and Ridge strip, full width, is used for Rex-Tile shingle roof valleys in the same way that a tin, zinc or copper valley is used.

After the shingles have all been laid, take the cement which comes with every roll of valley strip, and cement along the edge where each shingle laps over.

Then nail the lapping shingles carefully along the edges, driving the nails about 1½ inches apart.

This prevents the rush of water coming down the roof from backing under the edge of the shingles, and eliminates the danger of leaks.

The Use of Rex-Valley and Ridge strip with

Rex-tile
TRADE-MARK

“THE SCIENTIFIC SHINGLE”

makes the perfect roof.

REX-VALLEY and Ridge strip is cheaper and easier to handle than any sort of metal strip for valley, flashings or gutters.

It will not rust or corrode, as does metal; neither does it require the constant painting and repairing that metal must have.

REX-VALLEY and Ridge strip comes in 18, 36 and 54-foot rolls, 24 inches wide.

We can prove to you that it is more economical to lay a REX-TILE roof than a wooden-shingle roof. Write us and learn about it.

We are conducting a national advertising campaign now, to acquaint owners and builders with REX-TILE Shingles. Send for sample shingles and full information.

FLINTKOTE MFG. CO.

90 Pearl St., BOSTON, MASS.

659 Peoples Gas Building, CHICAGO

Manufacturers of the famous REX-FLINTKOTE
Roofing for factories, warehouses, farm
buildings, etc.

McCracken Portable Batch Mixer

A practical mixer for the practical contractor is offered by the Sioux City Engine & Machinery Company, Ninth and Division Streets, Sioux City, Ia. This machine is light enough and strong enough to be practical and fast enough to be profitable. The batch is discharged almost instantly when the drum is tilted, so there is no waiting for the batch to run out.

The manufacturers ask: “Why have a big, heavy, expensive mixer when this mixer will cost you less to buy, less to move around, less to run and less to keep in repair?” It is a question that certainly deserves serious thought. Many contractors and builders whose work runs to just the average, medium-sized jobs have concluded that this McCracken Portable Batch Mixer is just what they need.



McCracken Batch Mixer.

The illustration shows the principle parts of the machine. It is built entirely of steel and iron. The mixer drum revolves on roller bearings, making it easy to operate. The capacity is 3 to 5 cubic feet per batch. It is sold on skids, on trucks, with or without gasoline engine, and with or without free engine clutch. The Sioux City Engine & Machinery Company will send full particulars on request.



Boynton Leaves Universal

Mr. C. W. Boynton, for the past ten years inspecting engineer of the Universal Portland Cement Company, is resigning his position to undertake a new line of work on the Pacific Coast. The Sonoma Magnesite Company is developing its properties in California and Mr. Boynton will take charge of construction and operation.

Mr. Boynton for some time has been a member of eighteen or more prominent chemical, engineering and contracting associations, and during that time has served as chairman or member of a dozen or more committees dealing principally with cement and concrete. His work has always been held in high regard by those associated with him, and particularly by the company by which he has been so long employed. Within the ten years in which he has been actively interested in the cement industry, he has organized and developed the information and inspection bureaus of the Universal Portland Cement Company. These bureaus have now a national reputation. With him go the best wishes of every one with whom he has come in contact in his various endeavors.

Mr. W. M. Kinney, assistant inspecting engineer, who has been in charge of the Universal inspection bureau in Pittsburgh during the past six years, will take up the work which Mr. Boynton leaves.

Every Reader of This Magazine will be Interested in This Neponset Advertisement

IT appeared in the Saturday Evening Post, June 20th, and was read by more than 2,000,000 people.

THESE little NEPONSET Houses are now being sent to all parts of the United States and Canada.

THE house is made of our products, and is a symbol of our business—which is the manufacture of NEPONSET Waterproof Building Products—NEPONSET Shingles, NEPONSET Waterproof Building Paper, NEPONSET Roofings, and NEPONSET Wall Board.

Saturday Evening Post, (June 20th)



When every girl and boy has a Neponset house you will know about Neponset Roofings and Building Products for real houses

THE NEPONSET playhouse is of the old New England Colonial type. It is built with solid wood frame and chimneys. The sides and roof are made of NEPONSET Wall Board. The chimneys are red; the blinds, Colonial green; the roof, slate color, representing NEPONSET Shingles. The windows are translucent fabric. The house is open at the back, so the doll furniture can be easily moved about in all the rooms on both floors. We will deliver this wonderful little house at your home all ready to put together for \$2—in Canada, \$2.50—it is sent in sections for safety in shipping. It will come in perfect condition in a NEPONSET fibre case and will take but a few minutes to put together. Simple directions and all necessary materials accompany each house.

The modern waterproof material for walls, ceilings and partitions is

NEPONSET WALL BOARD

which takes the place of lath and plaster. Its use means a big saving in cost by finishing direct on studding or over old plaster. Unlike any similar material NEPONSET Wall Board comes all decorated in three artistic finishes—quarter oak, burnt leather and cream white. No expense for paint or wall paper. Any one can apply it. A beautiful but inexpensive finish for your summer home, or for any new or old construction. Ideal for partitions, etc.

We have been manufacturing roofings for years and have studied from every angle the problem of making a roof that is permanent, absolutely waterproof, fire-resistant and beautiful. The final answer to this problem is NEPONSET Shingles—the greatest roofing development of the twentieth century. These shingles are single shaped like an ordinary wood shingle—this prevents any tendency to curl. They are made of the same fire-resisting roofing substance as our famous Forest Roofing. When laid on the roof, seven thicknesses of this substance are between the weather and the roof boards. The greatest effect is that of slat—flat, unlike slate, NEPONSET Shingles will not crack and blow off.

NEPONSET SHINGLES

Let us send full information about NEPONSET Products: NEPONSET Shingles, the greatest roofing development of the 20th century. NEPONSET Forest Roofing for barns, houses and commercial buildings. NEPONSET Waterproof Building Paper for roofs, basements, porches and walls. NEPONSET Wall Board (quarter oak, burnt leather and cream white). NEPONSET Floor Covering (made in the factory but is never waterproofed). NEPONSET Waterproof Building Paper (water testable, fire proof).

BIRD & SON (Established 1795), East Walpole, Mass.
 New York Washington Chicago Canadian Mills and Office: Hamilton, Ont.

Makers of

NEPONSET

Roofings and Building Products

NEPONSET Playhouse Complete Please sign or send a letter if you prefer. Cash, check, express or postal order. The house is really a secret.

BIRD & SON, East Walpole, Mass. (Established 1795), Hamilton, Ont. Please return to our NEPONSET Playhouse. All orders shipped free by mail. Return full price. \$2.00 in U.S. and \$2.50 in Canada. If you are outside the U.S. and Canada, please add the cost of shipping and handling. Please enclose this coupon with your order. The house is really a secret.

BIRD & SON, East Walpole, Mass.

Established 1795

New York Chicago Washington San Francisco
 Canadian Office and Plant: Hamilton, Ont.



WHEN WRITING ADVERTISERS PLEASE MENTION THE AMERICAN CARPENTER AND BUILDER

Smith "Hot" Asphalt Mixer

A new 6-page leaflet illustrating and describing the Smith Hot Mixer has just been published by the T. L. Smith Company, Milwaukee, Wis.

The Smith Hot Mixer consists of the standard Smith Mixer on truck, with steam engine and boiler equipped with side-loader, with the following parts added to convert it into a hot mixer: The capacity of the boiler plant is increased and a steam blower added, so as to force the hot air and gas from the firebox through the long asbestos-lined hot pipe which runs from the boiler to the discharge end of the drum. The only other additional feature is the tar tank, which is mounted on the loading skip.

This machine has proven very successful throughout the country, especially for patching purposes. Installations have been made with a great many municipalities, where they have cut their costs in half for the repairing of asphaltic concrete and tar macadam. The particular saving is effected through the fact that the old tar macadam or asphaltic concrete can be torn up from the street, thrown into the machine and remelted, a small amount of new bitumen added, and the resulting mixture relaid on the street.



The Reinhardt Profile Gauge

Every good workman wants the proper tools for his work, and many manufacturers, artisans and mechanics have been quick to use the Reinhardt Profile Gauge or Adjustable Templet, designed for taking profiles or reproducing irregular surfaces. By using the gauge, this result is obtained instantly and accurately. This overcomes the necessity of drawing the object from sight or memory, which more often than not results in uncertainty.

To use the gauge or templet, the rods (which are movable) are simply pressed against the surface to be reproduced.

This gives the exact profile, both concave and convex. To transfer it, simply place the gauge on paper and take the outline with a pencil.

The illustration shows the profile as furnished for particularly large work. The side plates, as shown, are $1\frac{3}{4}$ inches wide and reinforced by extra plates extending the full length and $\frac{3}{4}$ of an inch beyond on one side. The lower plate on one end has two tapped screw holes, the upper one on the other end with two slots, so that any number of gauges can

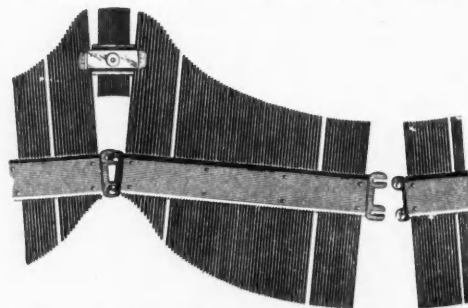

Large Profile Gauge Built up for Cornice Work, etc.

be connected up to form one long straight or curved gauge. The rods are $7\frac{1}{2}$ inches long, 8 to the inch. The small upper gauge, as shown, is fastened in as a filler and is specially constructed for this purpose. This larger gauge is suitable for big cornice work, large circles, ship and boat building, etc., where accurate profiles are desired.

Those whose business requires the taking of profiles should send for folder, which is fully illustrated and contains descriptions and prices of the various kinds. The Warren Profile Company, 103 Chambers Street, New York City, will gladly give any information desired, and they hold themselves in readiness to make special gauges for unusual requirements.

Fireproof, Artistic, Moderate-Priced

J-M TRANSITE ASBESTOS SHINGLES

These shingles satisfy the demand for a moderate-priced artistic roofing that gives absolute fire protection. They are suitable for the most elaborate, high-class building or for the humble cottage.

Because of their thickness and their rough, irregular edges, which relieve the usual monotony of straight lines, they make it possible to secure the most artistic effects.

J-M Transite Asbestos Shingles are made of two fireproof materials—Asbestos and Portland Cement—combined to form an artificial stone that is practically indestructible.

Furnished in $\frac{1}{4}$ and $\frac{1}{8}$ -inch thicknesses, in gray, mottled brown and Indian red; $\frac{1}{4}$ -inch have rough edges.

Write nearest Branch for Shingle Booklet.

H. W. JOHNS-MANVILLE CO.

MANUFACTURERS OF ROOFINGS; STUCCO; PIPE COVERINGS; COLD STORAGE INSULATION; WATERPROOFING;
SANITARY SPECIALTIES; ACCOUSTICAL CORRECTION; CORK TILING; ETC.



Albany
Baltimore
Boston
Buffalo

Toronto

Chicago
Cincinnati
Cleveland
Dallas

Montreal

Detroit
Indianapolis
Kansas City
Los Angeles

Louisville
Milwaukee
Minneapolis
New Orleans

Winnipeg

New York
Omaha
Philadelphia
Pittsburgh

Vancouver

San Francisco
Seattle
St. Louis
Syracuse

2032



Residence of D. T. Dickson, Wayne, Pa., Covered with J-M Transite Asbestos Shingles. Francis Gogert, Wayne, Pa., Architect.



ALPHA

on a bag means something more than 94 pounds of acceptable Portland Cement.

It stands for the finest Portland Cement that the experience of twenty-three years can produce from quarries and mills that are famous in the cement-making world.

In the high quality of raw materials, in exact proportioning, in thorough burning, in fine grinding, in correct ageing, ALPHA is exceptional; it represents

The High Water Mark of Quality

ALPHA on a bag stands for something more—for ALPHA service, which we maintain at the high standard of ALPHA quality.

Six great plants on six great trunk lines give us unusual facilities for cars and speedy shipment. One of our plants is also directly on the Hudson River, with private docks, convenient for coast, canal and export shipments.

Capacity, 25,000 barrels daily.

Storage for 2,000,000 barrels

For twenty-three years we have gone beyond standard requirements as to quality and fully met the requirements of the trade as to service.

Ask for Alpha Book No. 10 giving information of value on cement and concrete work. Sent free.

Alpha Portland Cement Co.

General Offices, Easton, Pa.

SALES OFFICES:

New York
Pittsburgh

Chicago
Buffalo

Boston
Baltimore

Philadelphia
Savannah

Last A Lifetime

CORTRIGHT Metal Shingles cost no more than good wood shingles, yet they last a lifetime, are rain and stormproof, wind-tight, fire-resisting, and add greatly to the appearance of any structure, from the modest dwelling to the most ornate public building.

Wood shingles are short lived. They warp, crack, split, curl-up or blow away; quickly catch fire from sparks and every few years must be replaced at great bother and expense.

CORTRIGHT Metal Shingles

on the other hand have been in successful use for almost thirty years, and many roofs put on twenty and twenty-five years ago are as good as new today.

An ordinary workman can lay Cortright Shingles, even right over the old shingles, if desired.

If you are not already familiar with this modern roofing and with the profits Cortright Metal Shingles are making for contractors and builders handling them, write for full information today.

Cortright Metal Roofing Co.

Philadelphia and Chicago



New Model Boring Machine

The Millers Falls Company, 28 Warren Street, New York, City, are offering a new model boring machine, their No. 145. This machine not only bores vertically, but can be inclined from the vertical to any angle with an ark up to 50 degrees. The bit travel is 12 inches. The entire tool, including base, upright and angle rods, spindle and cranks, is of steel. The cranks are adjustable in length, regulating speed and power. Height of machine, 25½ inches; net weight, 31 pounds.



"The Mixer That Makes the Money"

The above is getting to be the familiar name for the Waterloo Cement Machinery Corporation's "Little Wonder Five" concrete mixer. This little machine has pretty nearly put an end to hand mixing, even on small and medium sized building jobs. Its capacity is 5 cu. feet per batch; 35 to 50 cu. yds. per day. The manufacturers report that these machines are giving good account of themselves in every state in the union.

One building contractor has reported to them that he is making \$17.50 profit every day, by using the Little Wonder Five instead of hand mixing. This is the way he figures it. His crew of eight men, costing him on an average for wages, \$3.00 per day, including finishers, are able to mix and place only 20 cu. yds. per day. This costs \$24.00, or \$1.20 per cubic yard. Now, the same crew, he says, with his Little Wonder Five, easily mix and place 35 cu. yds. per day. His labor cost remains the same, \$24.00, and his gasoline costs him 35 cents for a day's work, making a total of \$24.35, or 70 cents per cubic yard for the day's production.

His concrete mixer thus saves the difference, or 50 cents per cubic yard. This on a daily production of 35 cu. yds. shows a profit of \$17.50 over hand work.



Little Wonder "Five."

More than that, he states that he gets perfect concrete.

Similar reports, coming from building contractors in other localities, give one full confidence in a mixer of this kind.

The Waterloo Cement Machinery Corporation have such confidence in this mixer of their's that they are willing to take all risk and so they are making a ten days' free trial offer. They say they will pay the freight both ways, if a contractor is not satisfied with the mixer in every particular.

At this busy season, when builders have to get onto a job in a hurry and clean it up quickly, the Little Wonder concrete mixer proves itself better than twenty extra men. Look into their offer at once. Write today for full particulars together with illustrated circular giving full specifications. The illustration shows the general style of their mixer, but the large detail photographic views are necessary to appreciate the fine points of the design. Address the Waterloo Cement Machinery Corporation, 103 Vinton St., Waterloo, Iowa.

Something Dependable

*Something you know will hold paint,
Something you know will take stain,
Something that is easy to work,
Something that may be nailed without damage.*

That **Something** will appeal to every contractor, to every carpenter in the land, and that **Something** is

ARKANSAS SOFT PINE

It is within the reach of every builder;
it can be secured in quantities, grades
and sizes required;

It will meet the expectations of the
most exacting;

It will lower the labor cost of building;

It will live up to every representation
made for it.

Get a Copy of "HOW TO BUILD"
Increase Your Lumber Library by Adding Our
Trim Book.
Sent FREE on Request

ARKANSAS SOFT PINE BUREAU

1728 Transportation Bldg.

CHICAGO, ILLINOIS

Safety Screen and Storm Sash Hanger

The Watrous-Acme Manufacturing Company, of Des Moines, Ia., make a leader out of their No. 18 Safety Screen and Storm Sash Hanger.

In the first place, this hanger is equipped with a lug on the lower portion, which is to be driven into the top of the screen frame. Most of the trouble with screen hangers comes from not getting them on right. Any hanger, if set too high or too low, either comes off too easily, or won't come off at all. This lug shows where the hanger should be set so as to work best. Then the hanger is packed with barbed car nails instead of screws. Anyone can drive a nail, but not everyone can set correctly the screws necessary for putting up other hangers. These nails have good holding qualities and give excellent satisfaction. The upper portion has an overhanging guard, which is the safety feature and is fine protection against any sudden accident or bit of carelessness. To remove the screen it is necessary to lift it a little, pressing out and then down. No wind that ever blew could give those motions at once, nor is there one chance in a hundred of a person making them without deliberate intention. These hangers are furnished either in black japanned finish or galvanized. Every set is packed complete with nails and wrapped in a circular which shows you just how to set them.

The Watrous-Acme line includes several other screen hangers, a complete line of butts, hinges, screen door catches, and many other items necessary in good hardware stores, and calculated to please the man outside the counter.



Of Interest to Country Builders

One of the daily problems of builders in all parts of the country is met successfully, so it is claimed, by the Kaustine Private Sewage Disposal System. Introduced and guaranteed after long test by Kaustine Company, Inc., of Buffalo, N. Y., these outfits are now in use by thousands, all the way

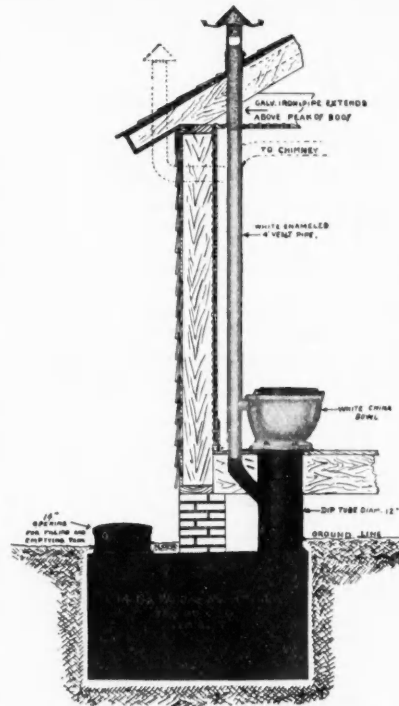

Typical Installation of Kaustine Closet.

from the Great Lakes to the Isle of Pines.

By the action of the powerful chemical solvent, "Kaustine," the sewage germs are destroyed and odors eliminated. Perfect ventilation is also provided. The makers claim superiority over any other system, where easy access cannot be had to city sewer.

It is said that high chemical and bacteriological authority in leading universities east and west support the chemical claims made for this Kaustine System. The system is accepted by the school authorities of New

York, Michigan and other states; many schools have been equipped, scores of factories, pleasure resorts, and thousands of homes east and west.

The outfit is of fine materials and workmanship, bowls being furnished in either vitreous china or white enameled iron. The cost of installation is moderate and so is the cost of operation. There is no danger of freezing.

Perplexing Heating Problems

A Suggestion to the Architectural Fraternity

You will admit that no architect can have at his command too extensive a library for reference when confronted with the ticklish task of designing the most efficient, as well as economical, heating plan for a big building—a palatial home—or, still more difficult, for an old structure of any kind, where installation will be attended by unusual difficulties.

It is *this* fact that adds so greatly to the value—the daily value *to you*—of this 160-page manual on the installation of hot water plants. This handy little volume is a pocket book of heating system facts—a desk book of *value* for daily reference—an exposition of that which is *concrete* in heating system truths. It also includes a technical description of the merits of the

Honeywell System of Hot Water Heating

that will be of professional interest to you.

The economy of the Honeywell System—the fact that it is more responsive to temperature changes than old style systems—the ease with which it is installed in either old or new structures—the fact that it minimizes cutting of floors and weakening of joists—that it keeps *all* rooms at any desired temperature without attention to dampers or drafts—that it prevents water from *boiling in the heater*—and that the radiator valves can be operated with only a quarter turn—have made *this* hot water heating system the most popular among the architects of not only America but Europe.

Upon Your Request We Will Gladly Send You a Complimentary Copy of This Valuable Manual

Honeywell Heating Specialty Company
140 Main Street Wabash, Indiana

The Honeywell Heat Generator—An Absolutely Safe, Dependable Mercury Seal or Pressure Device.

This attaches to the expansion pipe. Through it the expanding water must pass to the tank. In doing so, the water forces a quantity of mercury up in two tubes, twenty-one and one-half inches high, which seal the system from the atmosphere and safely generate a pressure of ten pounds.

This unique Generator causes the water to circulate faster. This results in much more frequent change of water over the heated boiler plates—resulting in a greater absorption of heat units and a greater conservation of the heat of the water itself.

The advantages are obvious.

Thousands have been used to cure old style, unsatisfactory jobs of hot water heating.

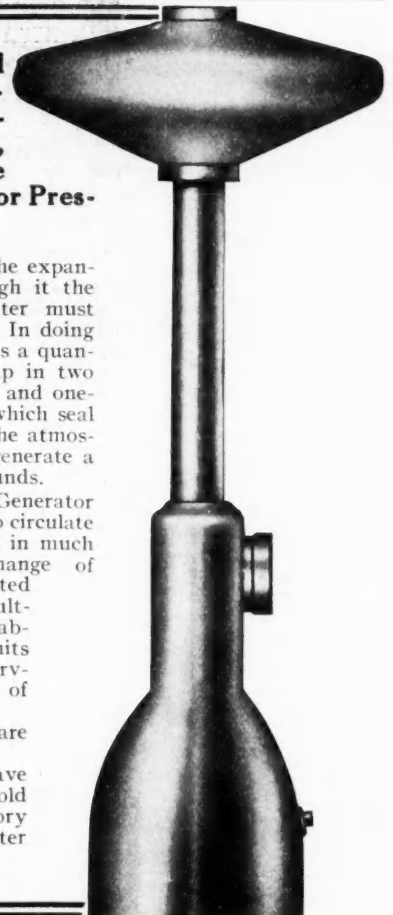

Building Material Exhibit

TO THE ARCHITECT:— TO THE BUILDER:—

The leading manufacturers in every line have spaces at this Building Material and Equipment Exhibit. Their catalogs and booklets are on file, and you can help yourself. Practical builders and estimators are on hand to give you information. The actual materials are on view, including practically everything required to complete a modern building from the foundation to the finial, inside and outside—from the cottage or bungalow to the five-million-dollar skyscraper.

We have spacious Committee Rooms for your use when in Chicago. These are equipped with telephones and you can have meetings here with contractors and others. The entire service of our organization is at your command, without expense to you.

Send us your Plans and Specifications at our expense, we will gladly get bids for you on any lines that you wish.

TO THE BUILDING MATERIAL MEN:—

\$89,150,200 in 1913

This huge sum of money was spent for the erection of buildings in the city of Chicago in the year 1913.

Would you not like to have had the individual attention of each man who paid the bills before the material for his building was finally selected?

Would you not like to have had the opportunity of telling him the advantages of your particular product?

Instead of rushing to the architect or owner at the last moment, when the plans are public property and all your competitors are doing the same thing at the same time, wouldn't you like to have had your product determined upon in the mind of the owner before the plans were even drawn?

Constant, sincere effort toward a logical result has made our reputation.

For information about building materials of all kinds or about exhibit space, write to

Building Material Exhibit (Inc.)

Jackson Blvd., Fifth Ave. and Sherman St., Chicago, Ill.

J. P. FORAKER, President
A. FRIEDMANN, Vice-President

Telephones:—Wabash 2020, 2021, 2022,
2023, 2024, 2025, 2026

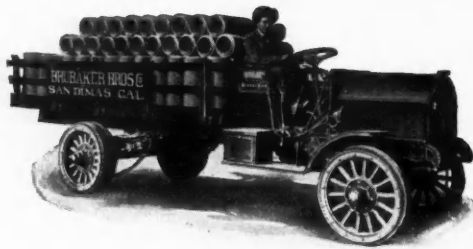

*KisselKar Truck operated by Brubaker Bros.,
San Dimas, California.*

We have a KisselKar Truck that will exactly meet your needs

The business man who has been doubtful about motor trucks meeting the demands of his particular business, should investigate the new series of KisselKar Trucks.

There are six sizes—1500 lbs., 1, 1½, 2½, 3½ and 6 tons. Bodies are built to order, so there is no delivery duty into which a KisselKar Truck will not fit.

You are not asked to readjust your delivery system to the truck—just tell us what you want to haul and we'll furnish a truck that will do the work expeditiously and economically.

Mechanically, no trucks are better than KisselKar Trucks. Compare them, point by point, with others, and then ask present owners for their experiences.

Send for the new truck book with 350 illustrations of KisselKar Trucks in actual use—it's free to you for the asking. Write now, while it is on your mind.

KISSEL MOTOR CAR CO.

546 Kissel Avenue HARTFORD, WISCONSIN

New York, Boston, Minneapolis, St. Paul, Chicago, St. Louis, Philadelphia, Pittsburgh, Kansas City, Los Angeles, San Francisco, Oakland, Dallas and 350 other American and Canadian points.

KISSELKAR TRUCKS

This Furnace Cannot Leak Gas

About the most common complaint about the warm-air furnace is that in time it will leak gas and smoke. This is because the cement in the joints crumbles and works out; and this allows the gas and smoke to get out of the fire box when the furnace is heavily fired. The gases escape into the warm-air pipes and go up into the living rooms. To overcome this,

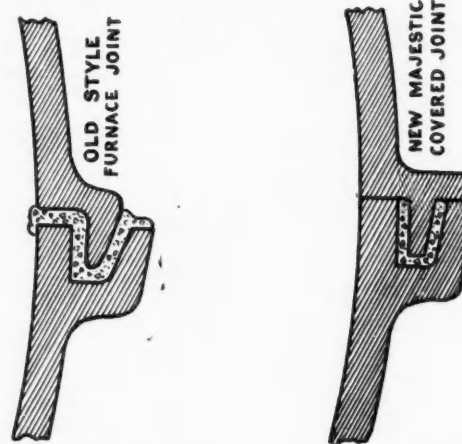

Old Way Joint Not Covered
Allows Cement to Work Out,
by Expansion and
Contraction.

New Majestic Covered Joint Way
Locks Cement Into the Joint.
Cannot Possibly Get Out.

the Majestic Furnace and Foundry Co., Huntington, Ind., have added a noteworthy improvement to their Majestic furnaces—a gas-tight protected joint.

The two little sketches show this new joint and also the common way of joining cast iron furnace sections. Note that in this new joint, the cement is entirely covered; it is an extra deep cup joint and there is an extra ring added so that the cement is entirely enclosed. It is said that all furnace cement will become dry and crumbly in time, but it is evident that in this new joint there is no other way but for the cement to stay in place, positively cutting off the chance of any gas working out.

The round Majestic furnace possesses several other noteworthy features. It has a large, roomy ash pit; a slotted fire bowl which permits the use of slack as well as lump coal, giving perfect combustion,—consequently, a hotter fire and

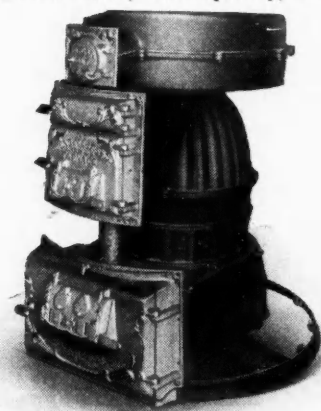

The Majestic Furnace.

little smoke. The feed door measures 13 by 15 inches and is of the double type, the smaller upper portion acting as a baffle-plate. This prevents any smoke issuing from the front door when open for firing.

The combustion chamber is large and roomy; the radiator is of a heavy type in two sections, all cast iron and has a cleanout on the level with the bottom of the radiator. It is



We do not ask you to do our experimenting

During the twenty-one years in which we have been building motor cars, we have *never* asked the public to do our experimenting. Every unit of the Haynes car is designed, checked and thoroughly tested before receiving its final O. K.

The American Simms Dual High Tension Magneto is positively the most simple dual ignition ever devised. It was recommended by the Haynes engineers after careful speed and compression tests *proved beyond doubt* that it was unusually efficient and absolutely dependable.

The Leece-Neville Starting and Lighting Separate Unit System was chosen in 1910 because of its high efficiency, and has been used on the Haynes car *ever since*, although numerous other starting and lighting systems have been tested in our laboratories from time to time. This system is dust-proof and has proven itself 100% efficient in every instance. There is no apparatus, however, on the

HAYNES

America's First Car

that has been subjected to a more severe test than the Vulcan Electric Gear Shift. This device is even a greater improvement than the starting and lighting system, because it not only simplifies the control, but positively prevents stripping of gears.

While the electric gear shift is a great invention, it is not radically new, being just a natural development of the electro-magnet, which has been in use since 1820. The same principle is used by steel companies to lift tons and tons of metal; the electric railways adopted it long ago to shift switches automatically, and the little hammer that strikes the bell in your telephone is actuated by the impulse of a similar magnet.

The Haynes car is *not an experiment*. It represents the height of refinement, convenience and reliability in motor car design. It's the year-ahead car.

The Haynes "Four," 48 dynamometer horsepower, 118-inch wheelbase... \$1785 and \$1985
The Haynes "Six," 65 dynamometer horsepower, 130-inch wheelbase... 2500 and 2700

"THE COMPLETE MOTORIST" by Elwood Haynes, Father of the American Automobile Industry, fully describing the Vulcan Electric Gear Shift, will be mailed upon receipt of ten cents in stamps. Write to

THE HAYNES AUTOMOBILE COMPANY, 14 Main St., Kokomo, Ind.
 Builders of America's First Car

The Haynes car is handled by Direct Factory Branches at 1715 Broadway, New York City, N. Y.; 1702 Michigan Ave., Chicago, Ill., and by dealers in every state in the Union.

Dealers: The Haynes sells readily because of its mechanical features. You may be in open territory—send for catalog and four pages of detailed specifications, giving over 500 items which comprise the Haynes. Write us right now!

THE HAYNES AUTOMOBILE CO., 14 Main St., Kokomo, Ind.
 Enclosed find 10 cents in stamps. Please send me Elwood Haynes' Book, "The Complete Motorist."
 NameAddress
 I expect to buy a car about.....

one of the boasts of the Majestic Furnace and Foundry Company that with their furnace there is no possibility of soot working inside the casing and so getting into the hot-air ducts.

The casing is extra large size, being 47 inches in diameter on a 24-inch furnace. This permits a free circulation of air and better ventilation.

The company have issued the "Majestic Warm-Air Heating Booklet," which contains a great deal of valuable information about selecting and installing warm-air furnaces, besides illustrating and describing in detail the Majestic furnace in its several sizes. Write for this booklet at once, addressing the Majestic Furnace and Foundry Co., 1000 Main St., Huntington, Indiana.



Ellis Kerosene Engines

Many carpenters and builders are finding that they can make bigger profits by installing power woodworking machines, both in the shop and portable to be taken out onto the work. The Ellis engine, as illustrated, has been developed especially for this kind of work. It is said to be a very efficient and economical engine. "More power at half cost" has come to be almost synonymous with Ellis engines; they are designed to use kerosene, but they can be operated successfully with distillate, petrol, alcohol, or gasoline.

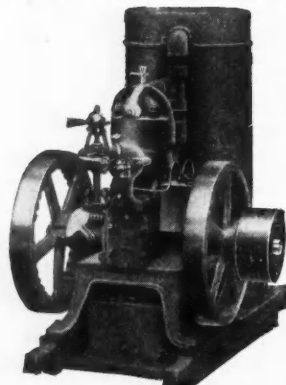

Ellis Engine.

The Ellis is said to be an easily operated engine, with nothing to get out of order. It has only three working parts; an automobile muffler, speed-changing governor, force-

feed oiler, and patented throttle are some of the special features of Ellis engines. A point of special interest to contractors is that this engine runs either way, and is reversible while running.

Write for new catalog, showing 1914 models with special prices, addressing the Ellis Engine Company, 72 Mullett St., Detroit, Mich.



"Diamond Edge" Folding Square

The Shapleigh Hardware Company, of St. Louis, have just notified us of their Diamond Edge Folding Steel Square, which we illustrate herewith.

They state it is absolutely true and accurate as the one-piece square, making it practical.

It is especially adapted for use in the tool chest, as it occupies a 24 by 4-inch space, and will be found a great convenience.

The smooth slide avoids all possibility of wear, such as caused by forcing the tongue in the square.

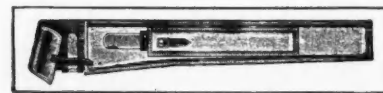

"Diamond Edge" Folding Square in Case.

The solid heel adds increased strength. The tongue cannot drop out or slip, as it is held by a locking screw securely fastened in the square. This screw is easily turned by inserting a coin or flat tool in the slot.

This square is made of gun-metal finished steel, with cuts marked in yellow enamel. Body is 24 by 4 inches. Tongue, 16 by 1½ inches. Face is marked in 16ths, 8ths and 8th square measure. The back is marked in 12ths, 32nds and ¼ths, with a rafter table.

You are the Judge



The Reliability of
CERESIT

The waterproofer for cement

CERESIT
is a thoroughly reliable and permanent waterproofing for cement in any construction

As contained in the five books herein, consists of-

Book 1 Scientific Explanation.
Book 2 Reports and Tests by Authoritative Engineers.
Book 3 Records of Actual Use.
Book 4 Experiences of Users.
Book 5 The "Show Me" Test.

You Should Have a Copy of the 1914 "Book of Evidence"

It contains complete facts, proofs and specifications for



The Dependable Waterproofer for Cement

The waterproofing problem confronts you daily. Ceresit solves the problem. The "Book of Evidence" tells how. Your copy is on the mailing desk waiting for your address.

Ceresit Waterproofing Co.
910 Westminster Bldg. Chicago, Ill

FACTORIES
Chicago Unna, Germany Paris London
Vienna Warsaw

You Can Make More Money
Building Silos
 Than In Any Other Line—Get Our Plans Free!

Carpenters—Builders—Contractors! Farmers all around you are waiting for the man who will build wood silos for them. Now is the time to get busy. Patents on door systems make the prices of ready-made silos prohibitive. We have solved the door problem. The Drico Expansion Silo Door is the simplest, most convenient, most durable door ever devised. Now in operation on silos in all parts of the country.

You build the silo. We furnish you all the plans down to smallest detail FREE! The Drico Expansion Silo Door opens a business for you that is now making thousands of dollars for carpenters, contractors and builders. Write today for information about the

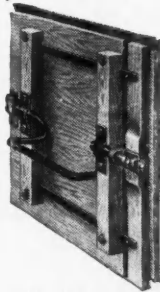

Drico
 Expansion Silo Doors

(Sold through Lumber Dealers)

Just send us the name of your lumber dealer and we will send you a full set of plans for building a silo of any size with flooring and flat bats that you can get at any lumber yard. You do not pay us anything for plans. You do not put yourself under any obligations whatever.

The Drico Expansion Door is wholly independent of the Harder patents—a different door entirely. Instead of building a silo to sell this door we have decided to put the whole business in the hands of local carpenters, contractors, builders and lumbermen.

Our handbook gives complete plans and specifications for 66 different sizes of silos. Any man who can drive a nail can build them. Write for the plans today, and be

the first man in your territory to get the silo business. Be sure to send your lumber dealer's name.

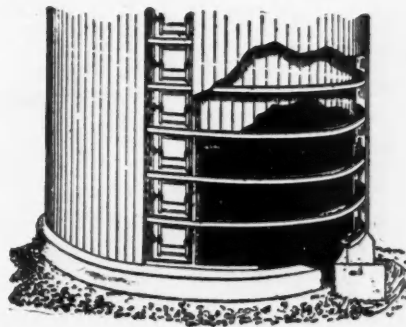

Deal-Rice Lumber Company
 606 Clapp Block Des Moines, Iowa

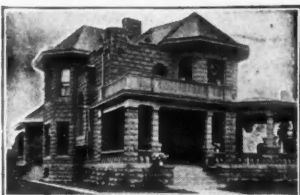

HERCULES CONCRETE BLOCK MACHINES

Are the ONLY machines that meet every requirement of the architect and builder. They are simple in construction, easy to operate and do not require skilled labor. You can install them with small equipment and add to it from time to time, according to your needs. The output from One Hercules exceeds the combined production of from Two to Four machines of other makes. Hercules machines make stronger and more durable blocks because they use a Coarse Wet mixture—other machines do not. For the man who wants to make 16-inch blocks, there is nothing to equal our new Hercules Junior machine with complete equipment, for it is the best block-machine value ever offered. Investigate—send for illustrated catalogue. It's Free.

CENTURY CEMENT MACHINE COMPANY, 220 MILL STREET, ROCHESTER, N. Y., U. S. A.

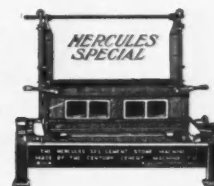

Show your clients how to cut down water bills

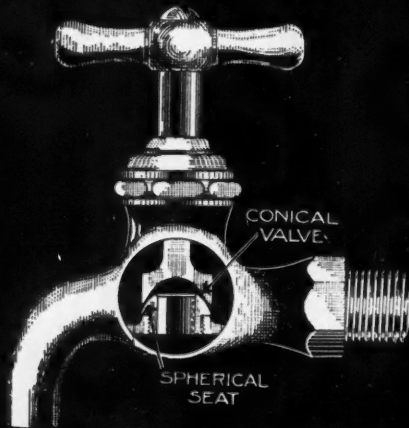

No more leaky faucets, with their annoying drip, drip, drip. No more unsightly stains in fine porcelain wash bowls and tubs. No more bills for re-washing. And no more waste at expensive meter rates.

Faucet troubles and expenses are eliminated for all time when you install the

JM Washerless Faucet

There isn't a client on your books who wouldn't thank you for recommending the J-M Faucet. This is especially true of hotels, apartment houses, institutions, industrial plants, etc., where water is used in large quantities. In such cases the annual *saving* effected by this faucet often amounts to *several hundred dollars!*

The J-M Washerless Faucet is entirely different from all others. A conical metal valve or "jumper" closes on a spherical seating. Perfect contact insured. LEAKAGE IMPOSSIBLE. No WASHER. Nothing to get out of order. Seating is guaranteed for ten years.

Not an experiment. Thousands in use for years. Authorized by Metropolitan Water Board of London and other cities. Endorsed by prominent engineers.

Write our nearest Branch for Booklet

H. W. JOHNS-MANVILLE CO.

Akron	Dallas	Memphis	St. Paul
Albany	Dayton	Milwaukee	Salt Lake City
Atlanta	Denver	Minneapolis	San Francisco
Baltimore	Detroit	Newark, N. J.	Seattle
Birmingham	Duluth	New Orleans	Syracuse
Boston	Galveston	New York	Toledo
Buffalo	Houghton	Omaha	Washington
Charlotte	Houston	Philadelphia	Wilkesbarre
Chicago	Indianapolis	Pittsburgh	Youngstown
Cincinnati	Kansas City	Portland, Ore.	
Cleveland	Los Angeles	Rochester	
Columbus	Louisville	St. Louis	2180

THE CANADIAN H. W. JOHNS-MANVILLE CO., Limited
Toronto, Montreal, Winnipeg, Vancouver

Henderson House and Barn Builder

Many of our readers will recall the interesting article furnished by Chris Henderson, a carpenter and builder of Xenia, Ill., in which he told how he used a power woodworking machine to help him in his business. This article appeared in the January issue of THE AMERICAN CARPENTER AND BUILDER and aroused a great deal of attention.

In fact, Mr. Henderson received so many requests from other builders for a machine like his that he has organized a company to manufacture his power woodworker, and they are now busy filling orders for these machines.



Side View of Henderson Portable Power Shop.

The company is known as the Henderson-Traylor Manufacturing Company, Lock Box 184, Xenia, Ill. They manufacture and sell the Henderson House and Barn Builder. A view of this machine is presented herewith. The machine is especially arranged for framing all the dimension lumber for any building. It can do a wonderful variety of work, including rip-sawing, cross-cut sawing, jointing, and boring. It is equipped with a 4-hp. engine. The work bench is 9 feet long and 32 inches high. The illustration shows the machine mounted on a pair of wheels for moving from place to place.

The Henderson-Traylor Manufacturing Company are issuing an illustrated circular completely describing this machine. We are sure a great many of our readers will want to write for this.

Galloway Quality

Almost anyone can make a gasoline engine, even with mediocre equipment, but it takes brains to make a good gasoline engine.

A good gasoline engine must be simply constructed, and in buying, simplicity should be one of the first requirements. We are not all engineers with technical knowledge, so the simpler the mechanism, the better. "Galloway engines" are simplicity itself; after being once started—a very simple operation—they need no further attention. It took brains to evolve an engine of this type.

The Wm. Galloway Company take an especial pride in the "Galloway engine" and the pride is justifiable, indeed, for the engine is a good engine.

The Galloway engine is more than satisfying 4,000 users in the state of Iowa alone. This is sufficient recommendation alone as to its reliability and dependability.

The Wm. Galloway plant at Waterloo, Ia., is really immense—an institution it may well be called; for, besides the huge factory buildings made entirely of concrete, the administration building, where the offices of the company are located, is a huge, monolithic cement structure, which houses an immense sales and office force.

This building is the result of the great growth of a business that started only a very few years ago. The first Galloway plant was nothing more than one small room, while now it covers acre after acre.

This growth is the natural result of gratified customers plus the indomitable pluck and energy of Wm. Galloway himself.

The Most Important Item In This Advertisement

North American Construction Co.:

Send me your special Carpenters' Plan with full information, as well as your Catalog No. 790 of houses and floor plans.

Name.....

Street.....

Town.....

State.....

WE want carpenters and builders to erect Aladdin Houses—one carpenter in each city—for Aladdin buyers. Would you be willing to do this work?

You may never have another chance—send for the Aladdin Carpenters' and Builders' Plan today. Increase your business, get a better class of business, as well as work with new lumber. Your city may be "closed up"—you may be too late to receive this offer, if you put it off. Send for it today.

Aladdin Read-Cut Dwellings, Bungalows, Garages, Summer Cottages, Barns **\$138 to \$5,000**

Customers want Aladdin Read-Cut Houses—they cost less, are erected quicker, have better lumber (ask about our dollar-a-knot guarantee). Aladdin Dwellings, Bungalows, Garages, Summer Cottages and Barns, \$138 to \$5,000. A complete 5-Room House for \$298. Aladdin Houses save four profits—come direct from the maker, no middlemen. Get the Carpenters' Plan, as well as the Big Catalog, today.

Aladdin Price Includes Everything

All lumber cut to fit, all interior finish, shingles, millwork, lath and plaster or plaster board, all hardware, locks, nails, complete instructions and illustrations for erection. Send today for special Carpenters' Plan and Big Catalog No. 790 of Houses and Bungalows.

NORTH AMERICAN CONSTRUCTION CO., 792 Aladdin Ave., Bay City, Mich.

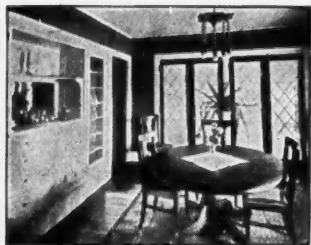

Rain, hail, sleet and snow can't get near a house painted with

Dutch Boy White Lead

and Dutch Boy linseed oil. This paint is waterproof and the wood can't get water-soaked and take the rotting road to ruin. Ask for Folder "A" showing 39 interior and exterior color combinations.

National Lead Company

New York, Boston, Buffalo, Chicago, Cincinnati, Cleveland, St. Louis, San Francisco. (John T. Lewis & Bros. Co., Philadelphia.) (National Lead & Oil Co., Pittsburgh.)



FAULTLESS PIT GENERATOR

The safest known system for lighting with acetylene gas. Generator installed in a pit out in the grounds. Carbide is fed into the water a few lumps at a time. Absolutely no danger of explosion.

CARPENTER AGENTS WANTED!

to take orders for this safest of all Acetylene Lighting Systems. Our Sales Literature makes the sale. You take the order and make the big commission. No money needed; no experience. Before you decide, get our offer and make sure for yourself that it is a good one. Send us your name and we'll explain the whole thing from start to finish.

GEM CITY ACETYLENE GENERATOR CO., Dept. B., Dayton, Ohio



CONTRACTORS

The best equipment produces better work. We have the best equipment. We want the most progressive contractor in each locality to use the

CONKLIN SUPERIOR SYSTEM

Our silo machines produce a perfect wall, round and perpendicular, its simplicity reduces cost of construction fifty per cent. Our special features cannot be duplicated anywhere.

Competition is eliminated the day you purchase the **Conklin Equipment**.

Let us show you the way to larger profits.

CONKLIN CONSTRUCTION CO., 750 West Main St. Hartford, Mich.

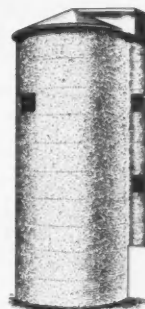

It is not the purpose of this article to go into detail regarding the Galloway engine. Their literature does that far better. Write them today. Their proposition is interesting whether you want to buy a small or a large engine. They manufacture a large variety and can give you just what you are looking for.

Remember in buying an engine that has the name "Galloway" on it, that "Galloway" is a "buy word" for satisfaction.



A Valuable Book on the Concrete Business

What must be considered as one of the most interesting and instructive books on the concrete business, especially from the standpoint of its profit possibilities, is the new catalogue of the W. E. Dunn Manufacturing Company, 4132 Fillmore Street, Chicago, a copy of which has recently reached us. While primarily intended to describe Dunn machinery and molds, its treatment has been extended so that the reader can get a fairly accurate idea of what profits he can expect to make with the various products which the equipment manufacturers.

The book measures nearly 8 by 11 inches and has 72 pages. The first eight pages are devoted to outlining the firm's selling policy of giving 15 days' trial on any machine or mold before purchase is consummated. Several of these pages show some instructive data concerning the wonderful possibilities in manufacturing cement drain tile, and show how cement is supplementing clay for tile in every section of the country. Tables of cost of manufacture and selling prices bear out the statement that this branch of the concrete products business is one that should not be overlooked.

The following 64 pages contain something of value to the progressive cement contractor. The descriptions of the various machines and molds is very thorough, yet not technical,

and the quality of the various illustrations brings out the equipment as it actually is. It is pleasing to note that no attempt has been made to belittle the equipment made by other concerns, although it has been found necessary to make comparisons in certain places in order to give reasons for the distinctive design of Dunn machines. A cursory glance through these pages shows that on page 41 are given the cost of

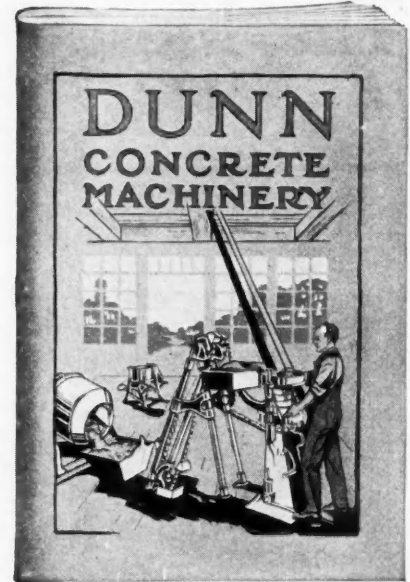

New Catalogue of W. E. Dunn Mfg. Co.

manufacturing concrete fence posts; on page 45, the cost of producing concrete sewer pipe and large tile; on page 53 we get the cost of making concrete blocks; on page 57, the cost of making cement brick. The last pages are given up to describing Dunn ornamental molds, porch molds, etc., together with the cost of manufacture and selling prices.

All told, the book is an excellent example of co-operation between the manufacturer, writer, artist and printer in producing a book that men in the concrete business will appreciate and keep. A copy will be sent to any man interested, upon request.

When You See This Red Stencil

on a bundle of Galvanized Sheets you know that it signifies:

- A strong, pliable, easy working sheet with a perfect coating.
- A sheet that has a proper amalgamation between the coating and the base plate of Copper Bearing Open Hearth Steel.
- A sheet that is unequalled for long life, satisfactory service and efficient protection.

We also manufacture COPPER BEARING OPEN HEARTH ROOFING TIN—the material you should always specify. Reasonable in cost, fireproof, durable—stamped "C. B. Open Hearth" in addition to brand. Write for full information and our interesting booklet, "Copper—Its Effect Upon Steel for Roofing Tin."

American Sheet and Tin Plate Company

General Offices: Frick Building, Pittsburgh, Pa.

DISTRICT SALES OFFICES:

Chicago Cincinnati Denver Detroit New Orleans New York Philadelphia Pittsburgh St. Louis
Export Representatives: UNITED STATES STEEL PRODUCTS COMPANY, New York City.

Pacific Coast Representatives: UNITED STATES STEEL PRODUCTS COMPANY, San Francisco, Los Angeles, Portland, Seattle

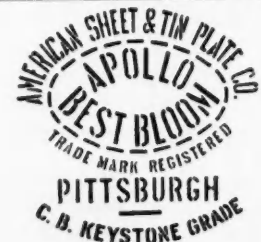

Asbestos "Century" Shingles

The Best-Known Artificial Roofing Slates in the World

WE want you and you want us.

The demand for Asbestos "Century" Shingles is twice what it was four years ago.

You know Asbestos "Century" Shingles, you know all the good and bad points of the "natural" roofing materials.

If you have been in touch with the rise of Asbestos "Century" Shingles you know that they are the only Artificial roofing slates sold on their own merits and not as a more or less efficient substitute for some other roofing.

There are property owners in every town who want to buy the best. There are architects, contractors and builders who want to recommend the best.

The day of the Artificial Roofing Slate is here, and that means the day of Asbestos Century Shingles. These are the only artificial roofing slates made by the PATENTED "CENTURY" PROCESS which makes a roofing material tougher, more lasting than any "natural" roofing or substitute therefore.

Write for terms and trade prices. Also Booklet; "Roofing: a Practical Talk."

KEASBEY & MATTISON CO., Factors
Dept. B., Ambler, Pa.

Branch Offices in Principal Cities of the United States



For Residences, Bungalows, etc.

— USE —
**HUDSON
ASPHALT SHINGLES**

**Fireproof - Sun-fast
Waterproof**

Hudson Asphalt Shingles are surfaced with Red and Green Crushed Slate. They are absolutely fadeless under any weather condition. Require no painting or staining. Give full value in wear and service. Very easy to lay and not expensive.

Send for Samples.

ASPHALT READY ROOFING CO.
9 Church Street New York, N. Y.



Home of J. J. Cleary, Charlotte Blvd., Rochester, N. Y. Architect, H. B. Nurse, Rochester, N. Y. 25,000 CREO-DIPT Red on roof; 17,000 CREO-DIPT Brown on side-walls; Perfection 18" shingles.

Who Is Responsible for Good Colors?

The stain manufacturer cannot guarantee quality of lumber dealers' shingles. The lumber dealer cannot guarantee quality of stain. The stain manufacturer cannot guarantee quality of workmanship on the job.

We are responsible for uniform stains, fast colors and the best quality Washington Red Cedar Shingles. Your safeguard is to buy

**"CREO-DIPT" STAINED
SHINGLES**

14 Grades, 16-, 18-, 24-inch. 25 Different Colors

They come in bundles, ready-to-lay—uniformly stained, ready for the job. We preserve them in Creosote against wet or dry rot or worms. We use only selected Red Cedar Shingles. You pay for no waste in either shingles or stains.

Most pleasing effects obtained by using CREO-DIPT Stained Shingles. They are being specified by architects and used by builders and owners all over the country.

Write us for catalog of CREO-DIPT Houses and Pad of Colors on Wood. CREO-DIPT Shingles last a lifetime.

STANDARD STAINED SHINGLE CO., 1028 Oliver St., N. Tonawanda, N. Y.

"TITGRIP" SHINGLER'S CHAIR

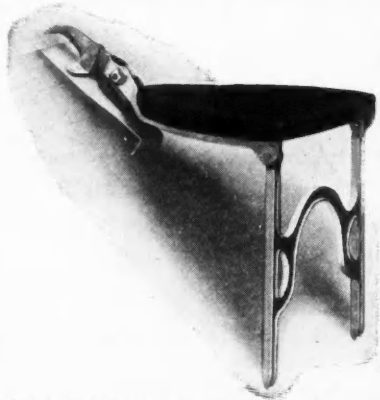

A modern
necessity for
fast, easy
shingling

**YOU can
easily lay
5,000
shingles
a day if
you have
the
"TITGRIP"**

Chair in position on roof. Claw & lips already laid. Quickly released when shifted. **A positive foe to "That tired feeling"**

FINE for painting jobs, too. It makes the day's work easier. Does away with all chalk lines, straight edges, footholds and scaffolds. No need to drive nails in the roof. The "Titgrip" can be easily changed from place to place and can't slip. Grips like a vise. Light and easy to handle.

Try the Titgrip Shingler's Chair once and you'll never be content to go back to the old way of sprawling all over the roof and ache in every bone after the day's work.

AGENTS WANTED

Send \$2.50 today for Sample Chair

C. & E. Mfg. Co. 107 N. Center St.
Marshalltown, Iowa

West Bangor Slate

is your best fire insurance

No building can be insured for its full value. Insurance merely pays back *part* of the owner's loss. It doesn't cover the inconvenience of being burned out and re-building; or the loss of many things more highly thought of than money. Things that can't be replaced.

The greatest percentage of fires is caused by sparks from nearby buildings. A West Bangor Slate Roof renders falling sparks harmless. It is your best protection.

Make the specifications in your next contract read—"West Bangor Slate." Your client will be pleased because you can give him a beautiful, clean, fire-proof, durable roof at a price no greater than the ordinary roof costs. There is a West Bangor Slate for sheds, barns, large or small residences, schools, churches, etc. It costs no more to roof with West Bangor Slate than with shingles or prepared roofing.

Our Free Samples and Price List are real reasons. Write for them.

BANGOR SLATE MINING COMPANY

Trust Bldg.
BANGOR, PENNA.

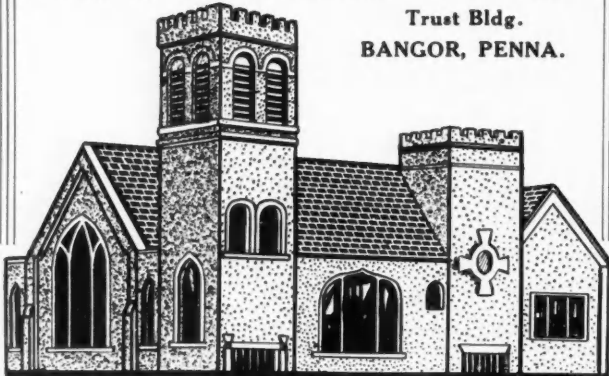

WHEN WRITING ADVERTISERS PLEASE MENTION THE AMERICAN CARPENTER AND BUILDER

The A B C Protractor Square

Practically, the difference between an ordinary workman and a foreman is in the latter's ability to lay out the work. In carpentry, as in stone masonry, a knowledge of geometry and mathematics is usually necessary in order to accomplish some of the commonest forms in construction. While it is always convenient to have an understanding of the sciences, the ingenuity of modern designers has obviated the need of detailed technical training and enabled the mechanic who knows what he wants to do to perform the same operations mechanically as the technical man does with mathematics. An instrument of this character is the A B C Protractor Square, made by the Stamping & Tool Company, La Crosse, Wis.

This instrument, as seen by the cuts herewith, consists of three parts working together, the different pieces being lettered and figured to give the required results. It works on

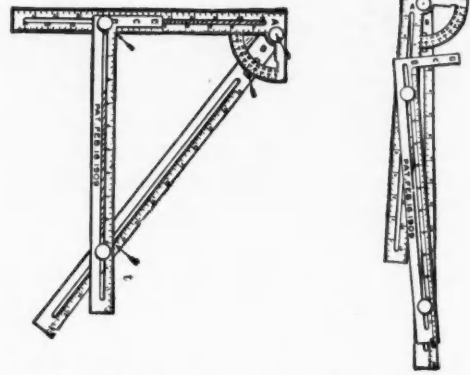

Tool Easily Closes up to Occupy Little Space.

the principle of the right-angled triangle, and is capable of giving any of the cuts required on a building, no matter how intricate, and it will give the length of rafters, etc., as well.

This instrument, so simple that it is called a tool, is meeting with deserved success wherever introduced, and readers of AMERICAN CARPENTER AND BUILDER who are not already acquainted with it should investigate.

We understand that the Stamping & Tool Company, who are placing this tool on the market, guarantee that it will do all they claim. Aside from the very complete directions which come with the tool, they are always willing to explain fully any point not perfectly clear. At this time they are making a special low price on this tool; see their announcement on another page for particulars.



Metal Sockets for Wood Studding

So simple that a boy can use them, so obviously helpful in supplying an urgent need at one of the difficult points in concrete building construction that we wonder why they were not invented long ago, and so ingenious that the attention of builders and contractors is at once attracted to their immense practical utility and value, the iron studding sockets which have been developed by G. M. Ross & Co., 1744 Broad Street, Grinnell, Iowa, are well worthy of careful investigation by everyone who has any building work to do.

Every builder knows how hard it is to connect wood studding, posts, or other upright framing members strongly and securely onto concrete floors or foundations. These "Ross" metal sockets or supports will "do the trick." They are made in all sizes, and adapted to all positions, as at corners, along side or end walls, etc. They are set right in place when the concrete is poured, and the embedded lugs hold them firmly in position. There is nothing about them to rot or disintegrate. The studs, posts, etc., are set right down into

EXTRAORDINARY OFFER!

PLASTERGON
TREATED WOOD FIBRE
WALL-BOARD

There are still a few American Carpenter & Builder readers who have not used Plastergon and to these we make the following proposition

300 SQ. FT. FREE

To every one placing an order of 500 sq. ft. or more at our contractor's price of \$23.00 per M sq. ft. f. o. b. Tonawanda.

Produce A Job Like This!



And Have Your Customers Tell You This!

"I am so well pleased with the Plastergon that I want to put it on the ceiling of our dining room. We will be ready for you in about a week."

Orders will be filled in the order of their receipt in the office. ORDER TODAY—Send check payable to

The Plastergon Wall Board Co., Dept. A, Tonawanda, N. Y.

SNAPPY BARGAINS

in Material you want NOW



Screen Door No. 314, 93c

Right now you need building materials that we can sell you at prices way below what your dealer charges. Figuring in the freight charges, our prices will save you more than enough to make it just "worth while." The quality of the materials we sell is the same as that for which you pay from 25% to 50% elsewhere. You get prompt shipment and a guaranteed saving when you buy from us. Send us your lists when you figure on a new job. With our prices you'll land the contract.



Door Sets \$1.57

Screen Doors (illustrated) 93c and up
Many designs at all prices from 70c to \$3.00
Window Screens (all kinds) 25c to 55c
Front Doors (all designs, various woods) \$1.99 and up
Four Panel Doors (all sizes in various woods) 93c to \$3.81
Two Panel Doors (all sizes in various woods) \$1.67 and up
Check Rail Windows (all styles) 45c to \$3.00
Cellar Sash (all kinds) 31c to 83c
Column No. 9033 (illustrated) \$2.09 to \$6.41
Fancy Glass, per sq. foot 12½c and up
Art Glass (many beautiful designs). Write for prices.

Putty, 12½-lb. or 25-lb. bucket 4c per lb.
Picture Mould, per 100 lineal feet 75c

Stair Rail	Paints	Colonnades
Newels	Varnishes	Medicine Cabinets
Spindles	Stains	Mantels
Tile	Builders Hdwe.	Flooring

Write at once for our two big free catalogs of builders material and mantels. Every article illustrated and priced. Send your name and address today.

The Huber Builders Material Co.
45-49 Vine Street, Cincinnati, Ohio



Red Oak Front Door \$4.23



Grille, 86c per foot

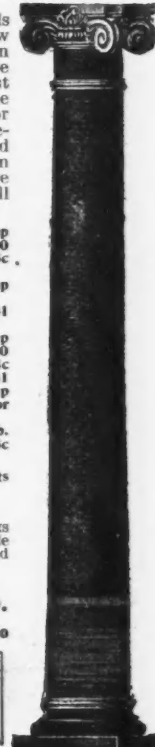

Do Your Buildings Attract Unusual Attention?

Do they cause the passerby to stop and comment on their beauty and attractiveness? They will if covered with Kellastone. Even the most humble bungalow is given a character and individuality not to be secured by other forms of stucco. Its original, beautiful, clean appearance will not be marred by the ravages of time and weather, for

KELLASTONE
IMPERISHABLE STUCCO

contains no Portland cement or lime and is mixed with a compound instead of water, which makes it waterproof and weather-proof. Unlike other stuccos, it requires no after-treatment to retain these qualities. Kellastone is fireproof and more nearly crackproof than any other form of stucco. It is a non-conductor of heat, cold and dampness, and is used as an interior plaster as well as an exterior stucco.

Kellastone Composition Flooring

is the perfect flooring for Public Buildings, Hospitals, Schools, Hotels and Office Buildings, as well as sun parlors, bathrooms, kitchens, etc. in private homes. It is waterproof, fireproof and abrasion-proof.

Send for detailed literature and specifications on Kellastone products.

The National Kellastone Co.
504 Association Bldg., Chicago, Ill.



Will You Take Thirty Seconds To Look Through a Book That Took Us Thirty Years To Write?



A Flat Genuine Bangor Slate Roof Covers This Building

The more substantial work you furnish, the more substantially will it build up your reputation, and the more substantial will be your profit. Instead of offering a "ten year" roof on flat roof buildings, you can now offer a roof that will last as long as the building, by furnishing a

Flat Slate Roof

Before we decided to make this recommendation we had tested out flat slate roofs for thirty years, on all kinds of buildings. Can you ask for better proof that our recommendation is worth listening to? Send today for a handsome 32-page booklet with many illustrations. Simply write your name and address on the attached coupon and mail it today.

July, 1914

Genuine Bangor Slate Co.
Easton, Pa.

Please send Flat Slate Roof booklet.

Genuine Bangor Slate Co.
Easton, Pa.

Signed

Address

City..... State.....

these sockets, and are perfectly solid without any need for the old-fashioned, bothersome toe-nailing that in time rusts away.

It is not only in house-building that we find a field for this valuable device, for today concrete floors and concrete foundations have come into general use in farm structures such as corn-cribs, granaries, barns, hog-houses, poultry houses, coal houses, sheds, garages, etc. Concrete floors, properly built, are dry, so that corn and all kinds of grain keep as well or better than on wooden floors. Concrete floors put rats out of business, and are now saving the farmers millions of dollars every year. And concrete foundations under barns, sheds, and other buildings where a cement floor may not be needed, give excellent satisfaction.

But the "wooden sills and toe-nailing" method of fastening studding to the concrete has been mighty unsatisfactory. Experience has proved that sills soon rot, because they lie flat down and hold moisture. Steel wire nails soon rust off. These "Ross" post supports, however, hold upright posts or studding securely to concrete floors and foundations. There are no sills to rot away, or toe-nailing to rust out. The sockets have been used eight years by progressive farmers and builders, who highly recommend them—one of the best evidences of their great value.

It's a simple matter to set the sockets in place. You simply tap them down into the soft cement. Prongs guide them, so that they will be in line properly as they are driven down to their shoulders, which rest on the surface of the concrete. Openings let the moisture out.

Ross sockets are made for studding dressed one side and one edge, and can be secured in sizes to fit any uprights.

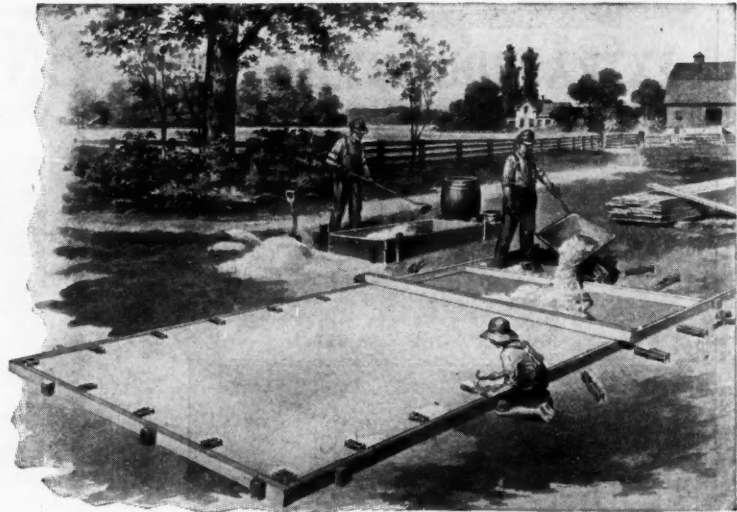

"Ross" Way of Providing Permanent Studding Connections. Boy Taps Sockets Down in Soft Concrete; prongs guide them; shoulders stop them at right place; Openings Let Moisture Out; Nail-Holes Allow Driving of Wrought Nails or Spikes to Hold Studding Down.

Many contractors call these sockets the "100 year" post supports, because the sockets last. Farmers like the "Cement-Iron" construction.

G. M. Ross & Co. publish an extremely interesting little booklet that contractors and builders value very highly. This booklet will tell you more than we can here. It contains directions for estimating quantities of materials needed, placing temporary wood forms for floors or foundations, mixing the concrete, placing the sockets, and setting the uprights. Write for a copy to G. M. Ross & Co., 1744 Broad Street, Grinnell, Iowa.

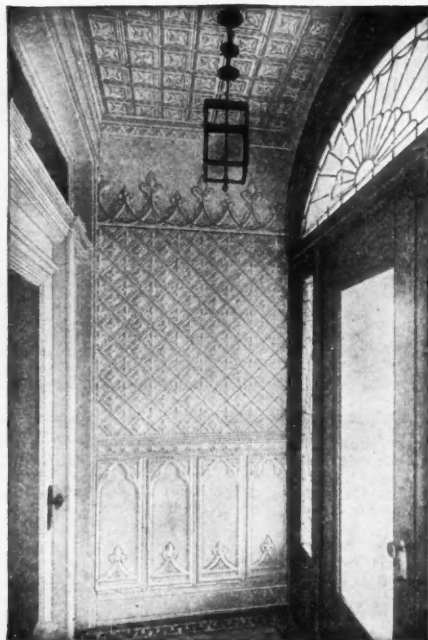

Largest Manufacturers of Metal Ceilings, Metal Shingles, Steel Roofing and Siding in the World.

Here's a Real Business Building Opportunity

Edward's Metal Ceilings and Walls represent big profit possibilities to **one** carpenter or builder in every locality. Hundreds are making big money right now. You can too if you will.

Big Demand—Big Profits

The demand for Edward's Metal Ceilings and Walls isn't coming—it's **here now!** Thousands of home owners and home builders are reading our advertisements in the leading magazines.

EDWARD'S METAL Ceilings and Walls

We **must** have more agents. Territory going fast. Our product is **right**. Our prices are **right**. Don't delay a minute. Write for all the facts N-O-W! Ask for new Ceiling Catalog—**its free**.

The Edwards Mfg. Co.

"The Sheet Metal Folks"

401-417 Eggleston Avenue, Cincinnati, Ohio
New York Office: 81-83 Fulton St. Branch Office and Warehouse:
1625-1627 Pacific Ave., Dallas, Texas.

THE ONLY ROOF THAT STAYS
 THE ONLY ROOF THAT PAYS

RED
 GREEN
 PURPLE
 BLACK

SHELDON'S SLATES

Cost no more than wood shingles. Outlast the building. No disadvantages. Used on new and old structures. Easy to lay; quick to obtain.
 Post a Postal and Get Posted NOW
F. C. SHELDON SLATE COMPANY, Granville, N. Y.



Foster Metal Ceilings

When you need metal ceilings, remember us. Our prices are so reasonable that it is worth while to buy from us. Our metal ceilings are right up to date in design and workmanship. The patterns are deep stamped and clear: the metal of excellent quality and primed ready for painting. Foster Ceilings are easily placed and very neat.

Give us a chance to quote prices on your next job. We can save you money, and that's important to you. Write us.

Foster Sheet Metal Works
 530 North Tenth St. SPRINGFIELD, ILL.



The MOESCHL-EDWARDS CORRUGATING CO.

EVERYTHING IN SHEET METAL BUILDING MATERIAL

Covington, KY KENTUCKY

Write for Prices on

Catalogue "S" showing a complete line of Ornamental Roofings mailed free to Architects, Contractors and Carpenters . . .	Ceiling	Marquise
	Columns	Roofing
	Cornice	Shingles
	Cresting	Siding
	Culverts	Skylights
	Finials	Spouting
	Garages	Tanks
	Gutter	Ventilators

Address The Moeschl-Edwards Corrugating Co.

Covington, Kentucky

REYNOLDS ASPHALT SHINGLES

Guaranteed for 10 Years

will last many years longer—Natural colors of garnet, red, gray and green, which never fade

We are the ORIGINAL MAKERS of Flexible Asphalt Slate Shingles and tested our product for ten years before putting it on the market Let us send you a booklet.

H. M. Reynolds Asphalt Shingle Co.
 Established 1868
 West Grant St. GRAND RAPIDS, MICH.



For Service  For Price

GENUINE FRANKLIN TUNNEL ROOFING SLATE

During its life, you will probably roof a building four or five times. The expense is great. Use G. F. T. Slate and only one roof is necessary. The cost? Practically the same as any good shingle. Cleaner and more artistic, too; also fire-proof.

Send for the **FREE BOOK** that gives real facts about G. F. T. Roofing Slate. Samples and Prices, too.

 SLATINGTON SLATE CO. Slatington, Pa. 



BUCKEYE METAL SHINGLES

Represent the latest, best and most practical of all modern roofing materials. Patented Buckeye Raised Side Locking Joints, formed entirely above the surface, prevent rusting and leaking. Made of heavy gauge metal.

Come in three highly embossed patterns. Write for illustrated Catalog and prices, today.

The Thomas & Armstrong Co.
 Dept. A LONDON, OHIO

OUR AGENCIES ARE ALWAYS BUSY

Diamond Flexible All Metal

WEATHER STRIP

Has built up a permanent, profitable business for contractors and carpenters in all parts of the country. If you have not secured an agency Get busy at once. Some fine territory still open. The thousands of satisfied users testify to the superiority of our strip.

Diamond Flexible Metal Weather Strips

are easier to sell than the old style rigid strip because they are so much better in use—and it doesn't take much argument to convince owners why they're so much better. Carpenters and Builders can develop a big business selling these. \$3,000 to \$5,000 a year is quite possible, because every purchaser of Diamond Strips will be so satisfied that he will gladly boost them to other owners and tenants.

Diamond Weather Strips mean so much more added comfort that no prospective purchaser will begrudge their small price.

Every Door and Window Needs a Diamond

Where Diamond Strips are used the windows don't stick or bind, and the sash can be removed when necessary without displacing the Flexible Weather Strip. Another thing is that all openings are made air tight and wind, dust, moisture and noise hasn't a chance to get in. They have been known to effect an economy of from 20% to 40% in fuel alone, because less heat is required in rooms protected by Diamond Weather Strips.

And it's not only residences that use them. Large public buildings—schools, churches, hospitals, etc., are always in the market for these products. We make all kinds, suitable for all styles of windows and doors.

Being made of zinc and highest grade spring bronze, they never rust, and last for years. Can be put in old buildings as well as new ones.

Description of Cuts

Top cut—The dotted lines show the flexible and adjustable features. Center cut—This section shows how sash and strip can be removed at the same time. Lower cut shows the Diamond Metal Weather Strip in place.

Write today for our Booklet "Diamond Way of Practical Weather Stripping."

It's of Interest to Everyone Who Owns a Building

The Diamond Metal Stamping Co.

626 Kerr Street

Columbus, Ohio

The Metrical Fable of Old Bill Brown

The Ceresit Waterproofing Company, 910 Westminster Building, Chicago, Ill., are getting out some trade literature of more than ordinary pep. We make bold to reproduce below one delightful bit, with pictures. If you like this taste, write the company for more.

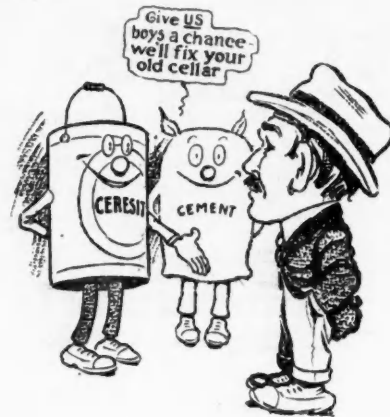

Bill Brown, a contractor, who labored each day, Was heard by his neighbor one morning to say, "Doggone that old cellar, I don't see the reason It gets full of water in each rainy season. I painted the walls and I put in a sump; The water we get nearly chokes up the pump. But it leaks like the mischief and fills up again And today it's as full as it ever has been." His neighbor, it happened, had recently sent For a book that explained waterproofing cement, So he went up to Bill and said, "Cheer up, old top, If you want some ideas I will grow you a crop." "You're the Judge," read the title, and Bill went inside. And pored o'er the book 'til it got through his hide; That cellar of his could be dry as a bone, He could fix it up once, and then leave it alone; The directions were simple and Bill wrote them down, Then 'phoned Smith & Wilson, the dealers in town, To send out cement and some sand, and a bit Of that waterproof paste they call Ceresit. He mixed up some mortar as soon as they came, With Ceresit carefully tempered the same. On the floor of the basement some concrete he placed About three inches thick, and he also made haste To keep the pump going so it could set well, And then left the concrete to dry for a spell. He plastered the walls with the mortar he made And a one-inch top coat on the concrete he laid; He covered all the corners with workmanlike care, And followed instructions he found written there In the book before mentioned, and when he was through He said, "Now we'll see if that book is all true, For if I'm the Judge, I can tell you right here If they're guilty I'll send them across for a year." A day or so later the pump was shut down, And Bill was the happiest man in the town, For the cellar was dry, and as clean as a whistle, And Bill wrote the Ceresit Co. this epistle: "Dear Sirs: There are cellars down here by the score—I've waterproofed one, and I'll waterproof more. The owners will pay a good figure to get A cellar where you can get out of the wet. For you've got the goods, and you just set me down, A Ceresit user for life. William Brown."



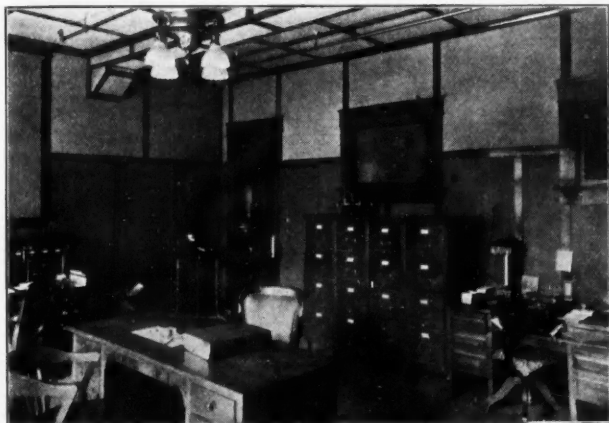

Build For Permanent Profit

When you have a job of interior finishing, whether in an office building, a factory or a private home, don't forget that every dollar you save for your client will be appreciated and that his continued patronage depends on the value you put into the first job. You will please your patron and make a satisfactory profit for yourself when you use

Roberds Ideal Wall Board

Unlike many substitutes for lath and plaster, Roberds Ideal Wall Board is not a make-shift but is a substantial, time-tried and thoroughly practical interior finish that does not shrink or bulge, does not pull off or warp. It goes on in a truly workman-like manner and stays where you put it. Properly applied, it makes the most handsome, durable and permanent form of interior finish. Our proposition to contractors makes this a most profitable line to handle. Write for territory, booklet, samples and prices.

Roberds Manufacturing Company, 100 Railroad St., Marion, Ind.

A Quick Finish for Your Building

Doesn't it often mean a pleased customer, and actual cash in your pocket, to finish a job when promised, or *even sooner?*

You can do this with



Trade Mark Registered, U. S. Patent Office, No. 94745

Just when your man is fuming and fretting over final delays, walls lined with Compo-Board will save 15 to 30 days' time. No waiting for plaster to set and dry. Compo-Board can be papered, painted, or decorated at once. And besides being quicker, you are sure of lifetime satisfaction for your customer. He'll stay pleased.

Compo-Board is the "Wood-Core" wall board. (Look at the corner of this advertisement.) It is stiff and strong, very smooth when properly put on,—and so durable it will practically outlast the house. Being non-porous, it is heat, cold and fire-resisting.

Compo-Board is sold almost everywhere. Write us today and we'll send free sample and booklet and name of dealer in your town.

Northwestern Compo-Board Company

5777 Lyndale Ave. No.
MINNEAPOLIS, MINN.

—and huge condensed milk plants also find 5-ply UTILITY best!

The Chapin-Sacks Co. of Washington, D. C., with condensed milk factories in Michigan, Indiana, New York, Pennsylvania, Illinois and many other parts of the country, use thousands and thousands of square feet of UTILITY—the only 5-ply wall board.

For properly condensing the milk, they require an absolutely air-tight compartment and so they build a room of UTILITY—even to the floor.

The great heat necessary to condense the milk into powder—maintained night and day for two-week periods—has no effect on UTILITY; it is thoroughly heat proof because of the 4 layers of high-melt-point asphalt with which the 5 tough fibre-board layers are joined.

UTILITY

the only 5-ply wall board

In the Chapin-Sacks condensed milk plants, the UTILITY-lined rooms are closed down for cleaning about every two weeks, thus giving this wall-board lining a severe change-of-temperature test. That their orders for UTILITY are constantly increasing is the best and most convincing proof of the satisfactory service it gives.

Samples and Book Free

Test 5-ply UTILITY for yourself; let us send you free specimens and interesting UTILITY book today. Learn why this is the superior wall board for every purpose. Write now—today.

THE HEPPE'S CO.

Manufacturers also of Flex-a-Tile Asphalt Shingles, Asphalt Paint and Asphalt Roofing in any Finish.

4503 Fillmore Street CHICAGO, ILLINOIS

Mayes Levels and Plumbs

For many years, Mayes Brothers, 694 Medbury Avenue, Detroit, Mich., have been making perfect levels and plumb rules. The Mayes Mason Tools have become standard the world over, and the demand for them is constant among the most

Two of these are equipped with the easy-set dial, so that the straight edge can be easily adjusted to any angle work. The other vial case is something of a novelty, as it can be attached to any straight edge without drilling any holes. It is fastened with a thumb-screw.

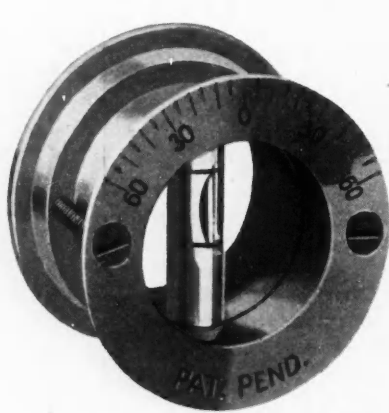

Mayes Single Overall Level Glass and Case.



Mayes Double Overall Level Glasses and Case.

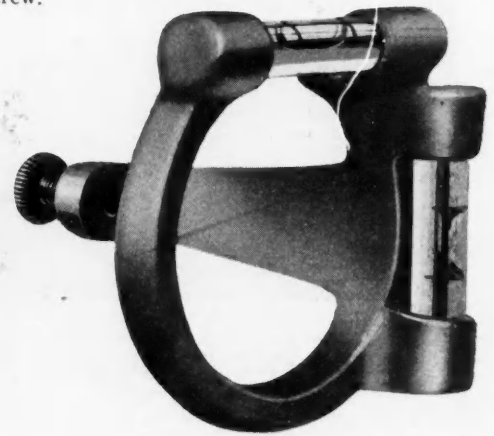

Aluminum Straight Edge Level and Plumb Attached with Thumb Screw.

skillful craftsmen. Their line includes all the regular styles of masons' and carpenters' wood levels, also the reliable Mayes easy-set aluminum levels.

There are a good many workmen who like to construct their own levels, and these will be glad to know where they can obtain thoroughly satisfactory, well-made level glasses. Mayes Brothers make quite a specialty of this kind of trade. They furnish both the simple level glasses and also glasses set in aluminum cases. Three styles of this latter are illustrated. These are the Mayes New Overall Easy-Set Aluminum Cases; they can be used for level or plumb and are reversible.

We suggest that our readers write to Mayes Brothers, Detroit, Mich., for their illustrated catalog, giving full particulars and prices about all of their goods.



It has been discovered that the waste from dogwood shuttle-blocks can profitably be made into handles for steel knives and forks.

The bureau of forestry of the Philippine Islands will send tropical timbers to the U. S. forest service so that their suitability for fine furniture veneers may be ascertained.

The IRWIN Bit

is imitated as regards pattern, but Irwin Quality cannot be imitated. Look for the trademark (illustrated below) stamped on the shank of every genuine Irwin Bit.

The IRWIN Bit
Reg. U.S. Pat. Office

Look for the Word "IRWIN"

WHEN you ask the hardware man for a genuine Irwin Bit, look at the shank of the bit he offers you—see if our trademark (illustrated at left) is stamped there. If so—you're safe. Don't be misled by "pattern" but insist on getting your money's worth by buying a genuine Irwin. For years past we have had the reputation of being the leading Bit Makers; "Irwin" and "Quality" are inseparable. The hardest woods or toughest knots have no terrors for the Irwin Bit-user. Breakage is a thing practically unknown with genuine Irwin Bits, for they are drop-forged from tip to shank, out of one solid piece of steel. You have a right to have the best going and we'll do our part to see that you *do* get it. So if your dealer cannot supply you write us at once.

THE IRWIN AUGER BIT COMPANY
WILMINGTON, OHIO

The Opening Door



Will swing softly on
STANLEY'S
BALL BEARING HINGES
 with Non-Rising Pins

Write for Booklet "Properly Hung Doors"

To Department "A"
THE STANLEY WORKS
 New Britain, Conn.
 New York Chicago

S.W. S.W.

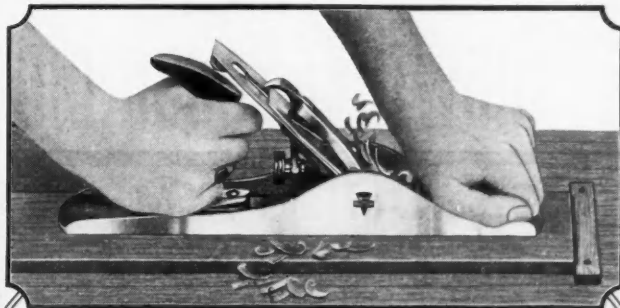

This Plane for Good Work

For fine work, work that's particular, this good Keen Kutter plane will satisfy you or any good carpenter. It has the bang-up stuff in it that has made the name

KEEN KUTTER

another word for quality for forty-six years. Like all Keen Kutter tools, it's sold with the guarantee of good performance or the dealer is authorized to refund the money.

If not at your dealer's, write us.

Simmons Hardware Co.
 St. Louis Toledo New York Minneapolis Wichita Philadelphia Sioux City

Smooth Plane No. K5 Price \$2.25



Wholesale Prices On Concrete Machinery

Convince yourself that Northwestern Machines are the most reliable and **lowest priced** on the market. You can buy Northwestern Machines at **factory prices**, and get just the machine you want—the one most suited to your needs at just the amount you'll consider reasonable.

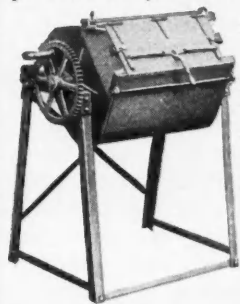

Carpenters Hand Batch Mixer

A convenient, low priced machine for carpenters, brick-layers, masons or farmers requiring moderate quantities of concrete and for whom a power mixer would be too expensive. Capacity 3 cu. feet of loose material. A batch every 1 1/2 minutes. Strong and durable. Made of steel and cast iron. Improved mixing principle insures perfect blending of the materials.

Price, \$23.00

Face Down Block Machine

Capacity 200 to 400 blocks a day. A hand machine well made and of a design to give greatest strength and speed. Requires very little effort and no experience to operate it successfully. Special method of setting face plates, locking mold and withdrawing cores insures perfect, uniform blocks with no breakages. Write for full description and price. Big Free Catalog of Concrete Machinery and Supplies.



Northwestern Steel & Iron Works

625 Spring Street

Eau Claire, Wisconsin

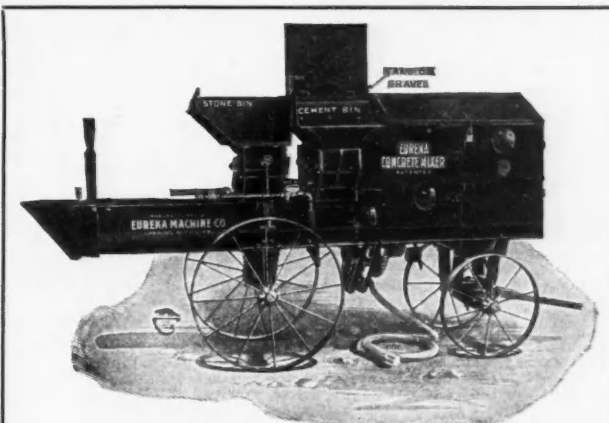

We have some mighty interesting facts for you about the

EUREKA SELF MEASURING MIXER

"WHERE GUESS WORK ENDS"

May we show you these things in a clean cut way—one business man to another—no extravagant claims, no glittering generalities, **JUST PROOFS AND FACTS THAT HAVE AN IMPORTANT BEARING ON YOUR WORK.**

GASOLINE, STEAM OR ELECTRIC POWER

It costs you less than half as much to buy it!
 It costs you less than a third as much to run it!
 It costs you less than a fifth as much to move it!

The Eureka Mixer, capacity for capacity, with any standard batch mixer, weighs less than half as much.

Powerful, Simple, Easy to Operate. Its Cost is Surprisingly Low. Send for the Facts Now.

EUREKA MACHINE CO., 12 Case Street, Lansing, Michigan

Typewriter Sensation

3 Dollars A Month

**Buys a Genuine
Standard Complete
Visible Writing
Model No. 2
L. C. SMITH
TYPEWRITER**



and at less than half the catalogue price

Never before has anything like this been attempted. Dealers get more than this for simply renting this make of machine, not nearly as perfect as the one I will send you, and you pay only Three Dollars a month and own it. **USE AS YOU PAY.**

A-GUARANTEED-TYPEWRITER-\$48.30

Perfect machines only. Complete outfit, nothing extra to buy, no strings of any kind to this offer. Just think of buying such a typewriter for \$9.30 down and \$3.00 a month. Thousands of people have paid \$100.00 cash for L. C. Smith's. It's Standard, by many considered the best typewriter ever built. Has the backspacer, tabulator, two-color ribbon, automatic line spacer, will write on ruled lines, speed dog escapement, insuring equal spacing between letters, even at the greatest speed. Stencil cutting adjustment, adjustable margin stops, margin release key, adjustable paper and platen release, ball bearing carriage, ball bearing basket shift, single shift standard universal keyboard, writing 84 characters, the entire line of writing completely visible, every practical improvement, every modern operating convenience of the latest standard machines; comes to you with instruction book and operating instructions, tools, cover, practice paper, everything ready. It runs beautifully. Writes as perfect and clean-cut a letter as quickly and as easily as any machine bought for \$100.00. It's wonderfully simple; a child can operate it with half an hour's practice and rapidly attain speed. It's strongly built and will give you years and years of honest service and complete satisfaction.

Send No Money—Only Mail Coupon and I Will Ship You This L. C. Smith Typewriter

When the typewriter arrives, deposit with the Express Agent \$9.30 and take the typewriter five days and try it. If you find it to be the best typewriter bargain you ever saw, satisfactory in every respect, keep it and send me \$3.00 each month until the special price of \$48.30 is paid. If you don't want to keep it, return it to the express agent, and he will give you back your \$9.30 and return the machine to me. I will pay the return express charges.

You won't want to send this beautiful typewriter back after you have seen it and tried it. You can't imagine the perfection of this typewriter until you see it. The price is less than half the catalogue price; you use it while you pay for it, and it is guaranteed just as if you paid \$100.

Only 200 Orders Will Be Filled On This Offer. Act Today to Be Sure

The coupon states the terms. Fill it out and send it now, today. You can't lose, and it's the greatest typewriter opportunity you will ever have.

COUPON

HARRY A. SMITH,

Room 702, No. 231 North Fifth Avenue, CHICAGO, ILL.

Ship me a No. 2 L. C. Smith f. o. b. Chicago, as described in this advertisement. I will pay you the \$39.00 balance of the SPECIAL \$48.30 purchase price at the rate of \$3.00 per month. The title to remain in you until fully paid for. It is understood that I have five days in which to examine and try the typewriter. If I choose not to keep it, I will carefully repack it and return it to the express agent. It is understood that you give the standard guarantee for one year.

Name

Address

Shipping Point.....

A. C. & B. 7.

Goodell Steel Mitre Box

When the Goodell Steel Mitre Box was introduced some ten years ago, it marked an improvement in the construction of mitre boxes as radical and important as the earlier substitution in these tools of cast iron for wood. In all the ten years these steel mitre boxes have been in use, the manufacturers, so they report, have not been called on for \$15 worth of repair parts. This certainly speaks well for the strength and durability of the steel mitre boxes.

This mitre box is built like a bridge; it has a regular steel truss frame. This makes a perfectly rigid bed to work on, assuring absolute accuracy and at the same time preventing weakening strains and final breakage.

The Goodell Steel Mitre Box possesses several improved features that make it popular with carpenters and cabinet

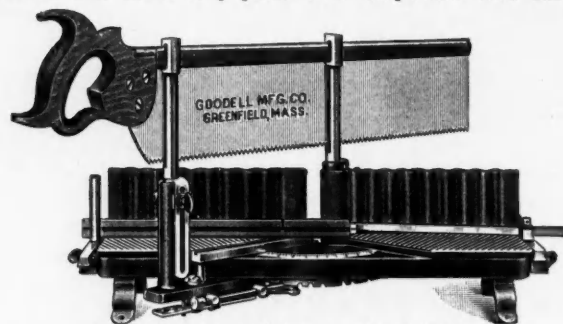

Steel Mitre Box—Solid as a Steel Bridge.

makers. It has automatic detents for holding the saw elevated, which allows the placing of work with both hands. A slight downward pressure instantly releases the saw. A lever carrying the saw may be swung from 45 to 90 degrees either right or left and will lock automatically at all the regular, most used angles. Angles more acute than 45 degrees are obtained by the angle attachment, which is also used as a moulding holder. This, together with the length gauge for cutting duplicate parts of any length up to 20 inches, are easily set up in position and fastened with thumb-screws.

Another very important feature is the serrated steel plates which cover the bed and form the bottom of the box to keep the work from slipping.

All who use or should use a mitre box will be interested to write the Goodell Manufacturing Company, of Greenfield, Mass., for full particulars in regard to this box.



"The Little Boss is Making Good"

The above declaration has come to us from one of our Nebraska subscribers, Mr. L. Landkamer, carpenter and builder, who lives in Alexandria. He sends a photograph of his gang at work laying a new concrete floor in the railroad coal sheds. As you will see, the "Boss" concrete batch mixer is doing the work.

It always gives builders a good deal of confidence in a machine to have it endorsed by a brother builder who has given it a thorough test in actual work. Mr. Landkamer is not the only enthusiastic user of the "Boss" mixer, nor is the popularity of this machine by any means confined to Alexandria, Neb. On a single day this spring the manufacturers received thirty-two orders. Their volume of business has kept right up throughout the spring and summer; in fact, there has been such a demand for their machines that they have been forced to run their factory day and night so as to fill orders promptly and not keep any contractors waiting. When a man orders a concrete mixer at this time of year, right in the busy season, he usually wants it in a hurry, and there is a good deal of satisfaction in dealing with a concern that appreciates the importance of prompt delivery and has the manufacturing facilities to turn out high grade machines on time.

NORTHWESTERN SPECIAL Concrete Mixer

designed for big and little jobs. Has the capacity, construction and efficiency of machines selling at from 2 to 3 times as much. An Ideal investment for any contractor. The price is specially low.

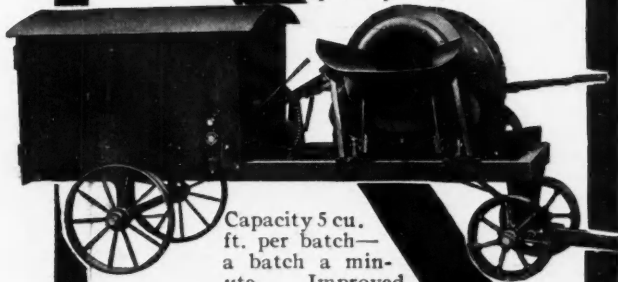

Capacity 5 cu. ft. per batch—a batch a minute. Improved cone type cylindrical drum with low charge and high discharge. Perfect lever control. Mixes in plain sight. Steel braced and riveted truck frame. Sturdy and easily portable. 2½ H. P. Engine.

You will save from \$200 to \$300 by buying a Northwestern Special. Investigate its merits now. Send for complete Catalog of Contractors Concrete Machinery.

Northwestern Steel & Iron Works
625 Spring St., EAU CLAIRE, WIS.

ELLIS ENGINES

Carpenters, Contractors and Builders are making far bigger profits on their jobs by installing a portable, wood-working plant equipped with an Ellis Engine. It is the most economical, most efficient engine they can buy. More power at half the cost is the Ellis way of doing the work. Ellis Engines are

Portable—Easy to Move

from job to job. Another strong point in favor of Ellis Engines, is their low up-keep cost. They develop more power on Kerosene than some engines on Gasoline. They also operate successfully on distillate, petrol, alcohol or gasoline. Ellis Engines

Save 50% on Fuel

Easy to operate—only three working parts. Ellis Engines have patent throttle, giving three engines in one. Force-feed oiler, automobile muffler, speed-changing governor and many other exclusive features. Run either way—reversible while running—this feature of construction is of particular importance to contractors. Buy direct from factory and save money. **We pay freight, 10-year guarantee, 30 days free trial.** Write for new catalog showing 1904 Models with special prices

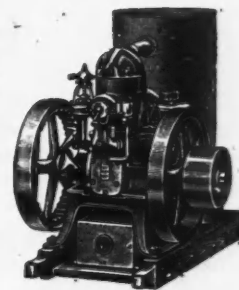

ELLIS ENGINE CO.
72 Mullett St., DETROIT, MICH.

THE RELIABLE MAYES

MASON AND CARPENTER OVERALL ADJUSTABLE AND STATIONARY

ALUMINUM LEVELS AND PLUMB RULES

Carpenter's and mason's Aluminum Line bench or shafting level. No mechanic or mason can afford to be without one. Just stretch your line and hang the level on it. Positively accurate. Weight, 1½ oz.

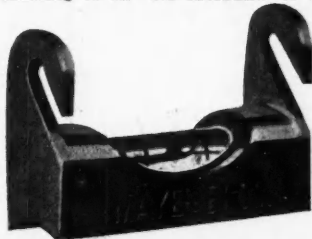

In the event your being unable to obtain the levels from your Hardware Dealer, write for Catalog, and you will be well taken care of.



Made in four sizes—36", 24", 18" and 12" lengths. Finest, lightest and strongest Plumb Rules made. Double constructed. No matter how you pick them up, they are always on the job. Work either edge or end up. Reversible and adjustable to any angle work. We use the best grade of spirit vials that show up bubble readily and accurately.

Made in same lengths stationary. Vials are stationary and fine brass wires are used for marks. The fine brass wires used for marks makes the level stationary and adjustable at the same time. Two heavy glass lenses cover each side of vials, keeping them dust and moisture proof; will not warp or rust, and if used right will last a lifetime. Mechanics who use Mayes' Aluminum Levels say they could not do without them.

MAYES BROS. 692-94 Medbury Ave. Detroit, Mich.

Manufacturers of the Reliable Mayes Mason and Carpenter Aluminum Brass Bound and Plain Levels.



SAND'S ALUMINUM LEVELS

Will Not Warp

Sand's Aluminum Levels are light, strong and durable. They will not warp, split or rust. Nothing to work loose or get out of order. Easy to handle. Need no adjusting. Made in 18", 24" and 30" sizes for Carpenters and 42" length for Masons. We also make a high-grade line of wood levels.

are honestly made of very high-grade aluminum specially prepared for this purpose. The finish is ideal and the greatest strength is placed where most needed. All unnecessary weight is left out. The plumbs are the best that careful experience can make. Each level is fully tested before it is offered for sale. You can count on Sand's Levels being perfect.

Ask Your Hardware Dealer

to show you Sand's Levels. If he does not sell them let us know and we will send you a circular showing full size view of our 24" Aluminum Level and ½ view of the 30". Just like seeing the actual levels.

J. SAND & SON 1027 Rivard St., Detroit, Michigan

Best Level to Use in Dark Places

The plumbs at each end and the double center level make it readable in any position and at arm's length. Pick it up anyway. It is always in position. Vials covered with heavy plate glass which keeps out water, dust and dirt. A Sand's Aluminum Level will last you a life-time.

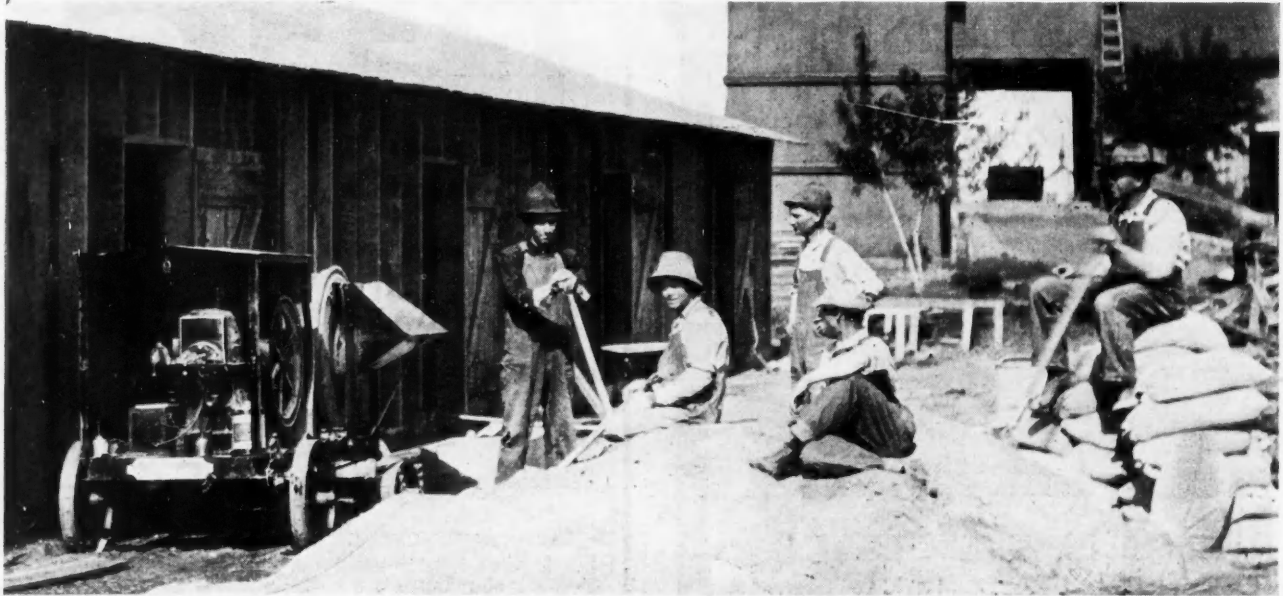

Contractor L. Landkamer and the "Boss" Batch Mixer Putting in Concrete Coal Shed Floor at Alexandria, Neb.

As many of our readers know, the "Boss" concrete batch mixers are manufactured by the American Cement Machine Company, Inc., 1006 Johnson Street, Keokuk, Ia. Their plant is right beside the immense new Mississippi dam, which gives them an unfailing source of cheap manufacturing power. This Keokuk dam project has been one of the great engineering accomplishments of the century. It develops 200,000 electric horsepower.

We are sure that many of our readers would like to look

over the new illustrated catalogs recently issued by the American Cement Machine Company, describing their concrete mixers. The "Boss" is a 5-foot capacity batch mixer and the "Steel King" a 10-foot mixer. Both are made of steel and are equipped with the reliable Mandt gasoline engines. Other types of engines can be furnished instead, if preferred. Electric motor power can also be provided. Write the American Cement Machine Company, 1006 Johnson Street, Keokuk, Ia., for full particulars.



For Contractors Only

The rates we make for furnace heating equipments carry but one profit;—the factory profit, for we do not offer our furnaces to dealers or middlemen. The reason for this policy is that we may plan the "layout" of every job,—then we know the customer will be pleased.

**With Contractors,
We Share Our Factory Profit**

If you are a contractor, and want to know just what this means, send us a sketch of the next house you have to heat, and we will give you an illustration of the advantages a contractor will have if he uses HESS STEEL FURNACES.

Hess Warming & Ventilating Co.
1220 TACOMA BLDG., CHICAGO.

Makers, Also, of White Enameled Steel Medicine Cabinets

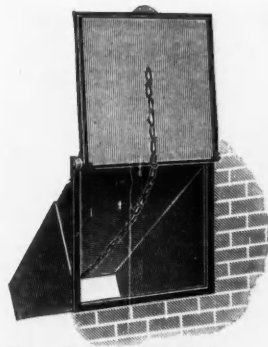

Chute Set in Wall.

"Best"
FUEL CHUTE

A strong Steel and Cast Iron Chute that is easily set in the wall and will last as long as the building. Burglar proof lock. Special device for holding door open when chute is in use. Flange overlaps top of door, preventing rain from running down and rusting the chute.

THREE SIZES

No. 1—18x18" No. 2—18x24"
No. 3 20x26"

Prices Extremely Moderate
Send for Catalog

We also make Chimney Caps, Chimney Tops, Flue Thimbles, Chimney Copping, Clean-out Doors, Door Holders, Cistern and Coal Hole Covers, Cess Pools, Door Pulls, Latches, Sash Hangers, etc.



Chute closed ready for shipment.

Fine Illustrated Catalog Free

Sterling Foundry Company
No. 888 Wallace St., Sterling, Illinois

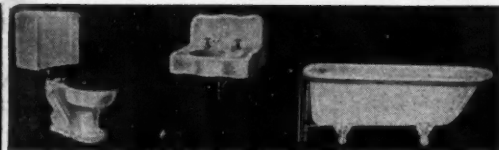

EVERYTHING in Guaranteed Plumbing and Heating Supplies at wholesale. Our \$200,000 establishment behind our Guarantee. Send for complete CATALOG 41.
J. HARDIN CO., 30 years at 4543-53 Cottage Grove Ave., CHICAGO

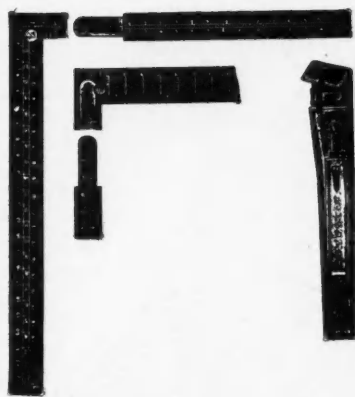

This is the **Standard Take Down Square.**

It makes good with the user.

Send and know more about it.

Southington Hardware Co.
Southington, Conn.

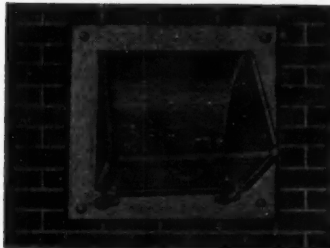

THE ENTERPRISE Coal and Fuel SHUTE

will absolutely protect the foundations of your buildings. It saves battered and disfigured walls and broken windows. It is the *cheapest* burglar-proof Fuel Shute on the market at the price for stores, churches, schools, offices and homes. All iron, wonderfully strong.

Price \$7.50. Special Discount to Builders

Write for Special Builders' Discount
Enterprise Iron Works Albert Lea, Minnesota

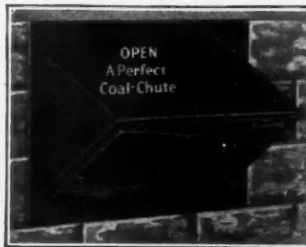

If You Build Buy Own

Be up to date and have the world's best
The Window Chute
for your coal bin.

Thousands in Use
The Very Best



Write for Booklet C.

Holland Furnace Company
Holland, Mich.

World's Largest Direct Installers of Furnaces.

WATERLOO CAST IRON Coal Chutes



Protect the house from careless coal men. They are burglar proof—unlock only from the inside.

Being made of cast iron, are not affected by the weather.

Wire glass in door furnishes light to cellar. When door is open, the glass is protected by heavy steel, which operates automatically.

The watertable at the top of chute protects the inside of foundation from moisture. Doors are extra heavy, with three hinges at top, and are made with a beaded edge which extends over the border opening, making a tight joint. Are made to fit any depth wall.

Send for catalog, which quotes special prices to contractors.

The Waterloo Register Co.

114 Rath Street

Waterloo, Iowa

LEAVITT Coal Chutes

are becoming popular with contractors and builders—made of cast iron with the exception of steel apron to protect the wall at the bottom.

Protect Your Buildings

Leavitt Coal Chutes protect the side of the building from becoming damaged by careless coal drivers—no dust and dirt to disfigure building or premises—closes tight and locks from inside—absolutely burglar proof.

Compare Our Prices

The extremely low price for which we offer these serviceable coal chutes will surprise you. Write us today, get our literature and prices on these coal chutes and other building accessories. We can save you money.

LEAVITT Manufacturing Co.
110 Griggs St., URBANA ILLINOIS



A Bigger Income For You

A New, Uncrowded Field With Big Profits and No Competition

It's the carpenter and builder who foresees the necessity of tomorrow and supplies it—who "gets there." Here's such a necessity—and think of its money-making possibilities, with the sanitary laws now in effect in every state. It's the



Kaustine Sewage Disposal System

Operated by Kaustine—that powerful germ-killing, odor-destroying chemical. Kaustine kills instantly all contagious disease germs—absolutely prevents typhoid or other disease—and

No Water

No Sewer—No Plumbing

Kaustine is so sanitary, so convenient, so economical, that it sells instantly—every rural building is a prospect.

Rural Homes	Churches
Factories	Schools
Hotels	Summer Camps

You can install one in a few hours, and get the plumber's profit, a year-round income—no dull seasons. But

Act Quick

Territory Going Fast

The first Kaustine man in your locality will reap the biggest harvest. You can be that man—and think of his profits—for weeks—for months—for years. But you must get our proposition immediately—write now before you turn over another page.

Kaustine Co., Inc.

Dept. B Ellicott Square Buffalo, N. Y.

Johns-Manville Duluth Office Moves

The Duluth office of the H. W. Johns-Manville Company has moved to larger quarters at 327 West First Street, in order to take care of its increased business. The new office is on the ground floor, with windows for the display of J-M asbestos roofing, pipe coverings, packings, sanitary specialties, auto accessories and other products of this company's well-known and varied lines.



Bowers Ventilator and Cupola

The special feature of a galvanized barn ventilator and cupola manufactured and sold by F. M. Bowers and Sons, Indianapolis, Ind., is that the openings which permit the escape of the foul air are unusually large. Their area is even greater than the cross section area of the ventilator tube. In this ventilator it is claimed that the arrangement of storm bands, cones, etc., diverge the current of foul air as slightly as possible; they are also arranged to prevent the outside wind currents from combating the outflow of the warm, foul air. The wind even assists the ventilating.



Popular Style "Bowers" Ventilator.

The Bowers ventilator and cupola is made of No. 20 and 22 gauge galvanized iron and the base is strongly reinforced with steel angles in the corners and around the top. The weather-vane is gold leafed and may be had with Cow, Horse, Sheep or Hog, as desired. Write F. M. Bowers and Sons, 926 W. Washington St., Indianapolis, Ind., for illustrated price list of these ventilators and their metal specialties.

AGENTS \$45 TO \$80 A WEEK



Thousands of dollars paid to agents already in the field; Will Gunckle, of Ohio, got \$240 worth of orders first week. A. Bernier, of Kansas, made \$30 in four hours. Made 8 calls, took 6 orders. Well, of Missouri, made \$10 in one hour. Hamilton, of Wyoming, made \$60 first two days. We want good agents in every county in the United States, Canada and Mexico.

NEW INVENTION Just out. Nothing like it. **FOLDING BATH TUB.** Gives to every home a complete bath room in any part of the house—without expense. Biggest, quickest, surest money maker of the century for agents. Territory being rapidly assigned. Send your application today. **100% PROFIT** We back you with our capital and experience. We give you complete instructions, assistance and co-operation. No charge for territory. Don't delay. Send your name at once. Write plainly and give name of your county. Complete particulars FREE. Write today.
ROBINSON MFG. CO., 467 Factory Bldg., TOLEDO, O

Birch Panels FREE Birch Book

Panels of Birch in natural, mahogany, white enamel, and other colors; also our beautiful Birch Book "C", sent postpaid. They will get business for you.

The Northern Hemlock and Hardwood Manufacturers Association

Dept. C Wausau, Wisconsin



There's an Immense Profit in the Vault Business

Cement Burial Vaults earn good money for the maker. **Automatic Sealing Vaults** are the best of their kind—neat, indestructible, and absolutely moisture-proof and water-tight.

A set of Adjustable Steel Vault Molds equips you to get this profitable all-the-year-round business. Take it up as a side line and make

\$24.00 Profit on Every Sale

It costs only \$6.00 to make a perfect Automatic Sealing Vault. Each vault sells for \$30.00. The molds make eight standard sizes and eight special sizes. The price of the molds is reasonable and the profits large. There is a demand in every community for **Automatic Sealing Vaults.**

Let us explain how you can make big money at very little expense. You need no experience in this business. If you're out to make money, write us now. We'll help you.

AUTOMATIC SEALING VAULT CO.
36 East River Street PERU, INDIANA



Big Savings For Contractors and Builders—Buy Direct From Us at Wholesale Prices



GET your building material, lumber and millwork at less than wholesale prices! All goods guaranteed to be absolutely as represented, with safe delivery and satisfaction. Send today for our brand new 250-page catalog of Millwork and Building Material. It contains 3,000 superb illustrations and 8,000 bargains for you to save money on. Get our magnificent Book of Modern House Plans also. We ship you lumber, flooring, doors, windows, mouldings, porchwork, building paper, hardware, linework and roofing. Note the few bargains listed below.

H. W. Mungler President.

Porch Post
Clear Fir
4x4, 8 Feet
55c

100 feet of Quarter Round, Dealer's Price, \$1.00—our price, only **30c**

Glazed Windows of all kinds, ready for quick shipment.

2-Light, 68c up
4-Light, 77c up
12-Light, 83c up

1-Light Stall Sash **34c**

4-Light Barn Sash **47c**

Porch Spindles
1/2c

Hardware

8000 PRICE SAVING BARGAINS

Get Our Two Free Books Today

Door and Window Screens

We can supply any kind and style. Rustless galvanized, bronze or black wire—clear pine and oak frames. Window screens for 24 x 28 2-light windows, full size, **79c.** Catalog shows all sizes and prices.

Wearwell Paint

Perfect guaranteed house paint—

\$1.20

per gal. in 5-gal. kit. We have all kinds of paint at wholesale prices.

All kinds of building hardware. You can't beat our goods or our wholesale prices.



Estimates Made Free—We Furnish Everything for Building Your House—We Sell at Wholesale—We Guarantee Everything to be Bright, Brand New Material. We Guarantee Safe Delivery. Don't Plan a Building without Our Aid!

For \$838 We will furnish complete all lumber, millwork, hardware, spouting, paint—everything except masonry and labor to build 7-room house. Plans free. 113.

250-Page Catalog and Book of Plans mailed you FREE. Write today for these books. You need them—whether you build now or not. Both books free. Fill in this coupon right now—mail at once.



CHICAGO MILLWORK SUPPLY CO.
1422 W. 37th Street CHICAGO

CHICAGO MILLWORK SUPPLY CO.
1422 W. 37th Street CHICAGO, ILL.

Gentlemen:—Please send your FREE books listed below, to

Name.....
Address.....

CATALOG No. 45, of Building Material.

PLAN BOOK No. 55, House and Barn Plans.

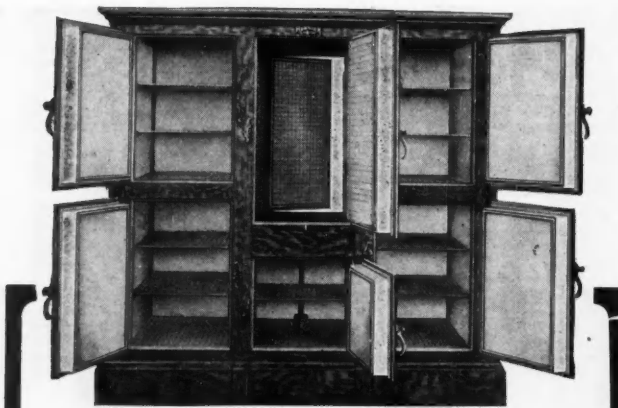

Better Service Better Satisfaction

HERRICK REFRIGERATORS

MAKE the installation of refrigerators as much a part of your building operations as the plumbing or heating.

You are safe in recommending and placing the Herrick in any of your buildings requiring a sanitary, up-to-date refrigerator. Perfect sanitation is assured by the lining and the construction. Economy is certain; doors fit closely and walls are properly insulated. No spoiled food; no wasted ice.

The HERRICK REFRIGERATOR is not by any means the cheapest but by all means the BEST.

Catalog 24 contains fine plans for installing refrigerators and general refrigerator information of genuine value. Send your name and address. The book is free.

HERRICK REFRIGERATOR CO., Waterloo, Iowa

Saving Half the Coal Bill

is the certain result of using a Williamson New Feed Underfeed Furnace or Boiler. For 14 years, and with over 25,000 users, the Underfeed has been the greatest success in heating history. The attention of a 12-year-old boy a few moments daily for firing is all that is required.

**WILLIAMSON
UNDERFEED**
Furnaces and Boilers

Cut Coal Bills $\frac{1}{2}$ to $\frac{2}{3}$

With the Underfeed, coal is fed from below. All the fire is on top. Smoke and gases are burned up, making more heat with no smoke, soot, clinkers, smell and dirt, and but few ashes. No other furnace or boiler does this. Soon pays for itself in any building. Adds to renting and selling value of building. Adapted to warm air, steam and hot water. Don't take the first step toward buying any heating outfit until you have investigated the Williamson New Feed Underfeed.

50% Saving Guaranteed

When properly installed and operated, we guarantee a saving of at least 50% in your coal bills. This guarantee is backed by a \$1,000,000 corporation. You take no chances. If you are going to build, if you want to reduce your high heating cost, then send the coupon below.

The Williamson Heater Company
273 Fifth St., Cincinnati, Ohio
(Formerly Peck-Williamson Co.)

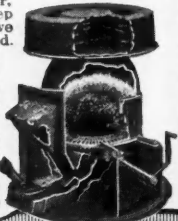

This Coupon Brings the Facts

THE WILLIAMSON HEATER COMPANY
273 Fifth Street, Cincinnati, Ohio

I would like to know how to cut my coal bills from one-half to two-thirds with an Underfeed. Also send me free copy of your book, "From Overfed to Underfeed."

Warm Air.....Steam.....Hot Water..... (Mark X after system interested in.)

Name.....

Address.....

My Business is.....

My Dealer's Name is.....

Bicycles More Popular Than Ever

People are often heard to remark that the bicycle is coming back into popular favor again. But those who are closely associated with the bicycle business are authority for the statement that the bicycle has never gone out—that there are more bicycles in use today than ever.

There are thousands of them in use today that are never noticed. They have become so general in use that they are no longer a novelty. In the cities and larger towns today hundreds of bicycles can be seen on the streets during the morning and evening hours when people are going to and from their work. The bicycle has become a necessary means of transportation for workmen, boys and children.

In the old days when a good bicycle cost a hundred dollars or more, only those with larger incomes could afford them, and they were considered a high priced luxury for children. The average family no longer has to make a sacrifice to provide the boy or girl with a bicycle for doing errands, riding to and from school, and for little pleasure trips into the country and through the parks.

Modern manufacturing methods have brought about better bicycles today for \$25 than ever have been made before at any price.

The boy who works in the summer can easily save enough from his earnings to purchase a bicycle that will last him a number of years and repay him a thousand fold in fun and health. His bicycle will get him out in the fresh, pure air and help him to grow into a robust, healthy, red-blooded man.

Any boy or girl who is interested in bicycles can get a lot of very interesting information from the new 64-page catalog that is being sent out by the Mead Cycle Company of Chicago.

A Husetop That Tops Them All



For artistic appearance and defiance of the elements there is no roofing that can equal

MULLINS METAL TILE ROOFING

It is built-in insurance against fire, rain, wind, acid fumes and lightning. It is guaranteed, when put on according to directions, to remain in perfect condition for years. Expansion and contraction, which are the main faults with most metal tile roofings, have been overcome in MULLINS Metal Tile Roofing.

Architects, Builders, Cornice Makers and Roofers will find our prices the lowest possible consistent with good work and prompt shipments. Special discounts to the Trade.

We are the largest manufacturers in the world of stock and special designs in Sheet Metal Statuary, Cornices, Building Fronts, Capitals, Finials, Tympanum Panels, Enriched Moldings, Rosettes, Garlands and Ornamental Metal Stampings for Cornices.

MULLINS Fireproof Windows reduce insurance rates, as they are approved by the national Board of Underwriters. Estimates on Architects' drawings gladly and promptly submitted. Write for catalog.

THE W. H. MULLINS CO.

214 Franklin Street

Salem, Ohio, U. S. A.

FRESH AIR AND PROTECTION!

The Ives Window Ventilating Lock



A Safeguard for Ventilating Rooms, allowing windows to be left open at the top, the bottom, or both top and bottom, with entire security against intrusion.

Descriptive circular mailed on application.

THE H. B. IVES CO.

SOLE MANUFACTURERS

NEW HAVEN - - CONNECTICUT

You Take No Chances When You Put on Guaranteed Queen Cupolas

They are made right from heavy galvanized steel. Put together by experts. They look right because they are thoroughly finished. They give service and satisfaction. Last a lifetime without painting or repairs.

Don't Experiment—Get the Cupola That Has a Reputation Back of It

On the market 15 years. Thousands now in use. That's the kind for you to use. To prove that the Queen is the best we will ship you one for examination and 30 days' trial.

WRITE FOR CATALOG AND PRICES Find out what we have and you will not be satisfied with ordinary kind. Address

QUEEN CUPOLA CO., 405 Peck St., Cresco, Ia.



Use the ABC Protractor Square

The only sure way of getting correct lengths, bevels and cuts of all rafters and other framing timbers.

The Only Correct Tool for Stair Work

Gives the length, bevel and pitch at the same time. You cannot make mistakes with the ABC Protractor Square. It pays for itself on the first job by preventing errors and speeding up work.

Simple as the steel square but handier to use and quicker in giving correct readings and measurements. Fine for the man who cannot do complicated figuring. Folds up so you can carry it in the tool kit. Complete instructions with each Protractor Square.

Special sample price this month..... each \$1.50 Regular price..... each 3.00

AGENTS WANTED Write for sample at once

STAMPING & TOOL CO. Dept. 7 La Crosse, Wis.

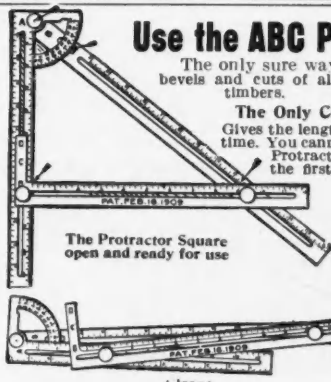

GET ORDERS

for the UNIVERSAL RAT CATCHER

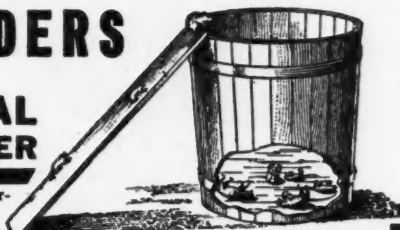

EVERY farmer, merchant and lumber dealer in your locality will buy one of these Rat Traps. It's a sure and quick way to rid all buildings of the pests. One of these Catchers placed in a livery stable in Scranton, Pa. caught over 100 rats in ONE MONTH. Trap made of galvanized iron; can't get out of order; lasts for years; always clean. 15 inches high, 10 inches diameter. One delivered prepaid upon receipt of \$3. Rate and mice die; no marks left on them.

My proposition requires no time from your work. I can show you how to make money easily. Don't be afraid to ask how. Cost you nothing to find out. I'll guarantee you can sell these Universal Rat Catchers easily.

WRITE TO ME AT ONCE.

H. D. Swarts, Inventor and Manufacturer, Scranton, Pa.

Satisfy Your Customers Build with SEIPPEL'S Quality Lumber

GET MORE CONTRACTS
Your interest as a contractor and builder lies in satisfied customers. But your good work is wasted if you build with poor stock.

It takes quality lumber to build a quality house.

Our lumber is all carefully graded up to the manufacturers' grading specifications; and with our enormous stock we fill your order exactly, item for item—no trouble-making substitutions in dimensions or quality.

We carry everything you need, including roofing and mill work—all guaranteed high quality. Remember: We pay all freight charges, no matter how small your order.

If you're in the market for a carload, come to Dubuque and let's talk it over. We'll refund your railroad fare both ways and you select what you want. **BESIDES, we have a special proposition**

OUR DUX BAK ROOFING has no equal in the market for the money. Sells for less and is backed by a longer guarantee than any other standard goods.

in which you'll be interested.

We'll save you money on small orders, and guarantee satisfaction.

Write us at once. Place yourself in position to make more money during this building season. Orders solicited only from Iowa, Illinois, Southern Wisconsin, Indiana, Northern Missouri, Southern Minnesota, Southeastern South Dakota.

PETER J. SEIPPEL LUMBER COMPANY
212 S. Locust Street DUBUQUE, IOWA

Get My Latest Engine Offer

Let a WITTE earn its cost while you pay for it. Take full 60 days' Free Trial to prove its big value.

WITTE Engines

Kerosene, Gasoline, Gas, Distillate

All styles 2 to 22 H. P. Used and recommended by shop, mill, and factory men all over the earth. All my life I have been a shop man, making my own engines. I sell only what I make. That is why, for 27 years, WITTE engines have always made good and stay good.

Five-Year Guaranty
I unqualifiedly guarantee every WITTE engine for five years against defects, and consequent faulty operation. I carry the risk, as I have done for my thousands of customers during 27 years. Ed. H. Witte.

Look at These Prices!

4 H. P.	\$ 69.75
6 H. P.	99.35
8 H. P.	139.65
12 H. P.	219.90

Other sizes proportionately low. WRITE FOR MY FREE BOOK, and all about my New Liberal Offer BEFORE you arrange to try any engine. I save you money, besides giving you the easiest chance to get the best engine service. Write me to show you.

Ed. H. Witte, Witte Iron Works Co.
1779 OAKLAND AVE., KANSAS CITY, MO.

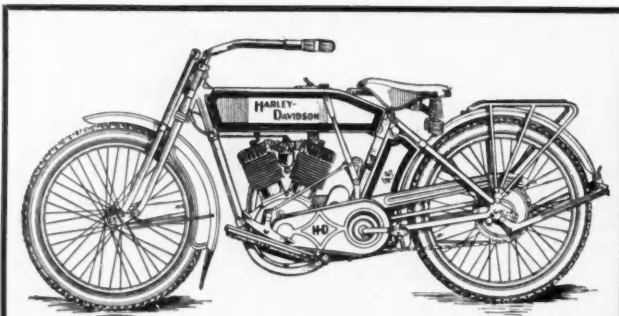

A Prominent Contractor Said

I invested in a Harley-Davidson as I would any other time-saving tool, and am well satisfied with my investment.

The Harley-Davidson not only saves many hours time in going to and from work, running errands, looking up new work, etc., but in addition, when used with a sidecar, it furnishes pleasure for the entire family.

Step-Starter

It is the only motorcycle built with a Step-Starter, a starting device which is simple, efficient and effective and never fails to work.

Double Brake Control

The extra large Harley-Davidson Brake can be operated either by a convenient foot pedal or by back pedaling on either pedal.

These and many other features make the Harley-Davidson the ideal mount for any carpenter or contractor. A demonstration will convince you.

Call on our local dealer or write for illustrated catalog

HARLEY-DAVIDSON MOTOR CO.

Producers of High-Grade Motorcycles for More Than Twelve Years
745 C Street Milwaukee, Wis.

Double Clutch Control

Its double clutch control permits you to operate the clutch either by the customary hand lever or by a convenient foot pedal.

Two-Speed

The Harley-Davidson Two-Speed is the most simple, compact and effective Two-Speed on the market.

Drafting Outfits

Those of our readers who have occasion to make drawings in connection with their business cannot fail to be interested in a catalog of drafting outfits and supplies which has been issued by the T-Square & Triangle Company, 30-32 Clinton Street, Newark, N. J. This concern makes a specialty of complete outfits, with or without drawing tables, for the carpenter, the builder, the architect and the draftsman, and

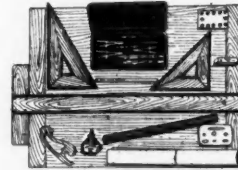

Complete Drafting Outfit.

in the catalog in question the goods are enumerated and special prices are given. The statement is made that should a purchaser fail to be satisfied with the goods selected, the company will permit their return and will refund the money within ten days. The outfit is of

such a nature that it can be used for designing any job of work the builder may be called upon to execute. An outfit consists of a board, a T-square, triangles, a set of instruments, a scale, thumb tacks, pencils, rubber, curves, etc. A copy of the catalog will be sent to any reader of THE AMERICAN CARPENTER AND BUILDER on application to the address given.



New Lufkin Catalog

The Lufkin Rule Company announce the issuing of their new catalog, No. 9, now ready for distribution. Its 110 pages are devoted exclusively to measuring tapes and rules, and it is said to be the most complete catalog of such goods ever sent out. The various items throughout the book are well arranged, and most comprehensively presented. The embossed cover is of strikingly original design, executed in the Lufkin stock label and box colors, tan and maroon. Special attention is invited to the fact that in addition to measuring tapes and steel rules, which lines the company have manufactured for the last twenty-five years, they now have ready for the market a complete line of folding boxwood and flexible spring joint wood rules. Requests for copies of the new catalog will receive prompt attention, and should be addressed either to the Lufkin Rule Company, home office at Saginaw, Mich., or New York office at 106 Lafayette Street.

Campbell Auto Trailers

\$35.00 to \$65.00

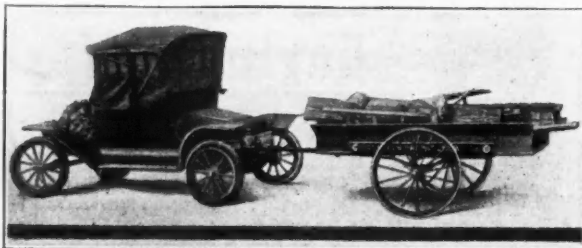

Cut Your Cartage Costs Without Abusing Your Car

Get the Full Value out of your automobile investment. Hundreds of car users are increasing the efficiency of their automobile equipment by the use of trailers.

Short, Quick Hauls are mighty important at times in the busy seasons. The time lost by your workmen in waiting for tools and materials on contract jobs costs you a lot of money. Save that money by hitching a Campbell Trailer to your automobile—and

Get There in a Jiffy with the needed supplies. Don't wait for the return of your delivery wagon, nor spend more money for outside cartage. Use an inexpensive Campbell Trailer on that machine of yours—and do

General Hauling of All Kinds quicker and cheaper than with a horse or motor truck. The Campbell Trailer is built for hard knocks and rapid service. It is strong, compact, safe and durable—and

Mighty Soon Pays for Itself in time saving and convenience. It's a small fraction of the money invested in your car and it increases beyond measure the service you can get out of it.

You Can't Afford to Overlook the money saver that others are profiting by. Better investigate at once.

Photographs and Detailed Specifications are yours for the asking. Write today.

Campbell Manufacturing Co.
210 Dwight Bldg. JACKSON, MICH.

How Big Is Your \$ Dollar?

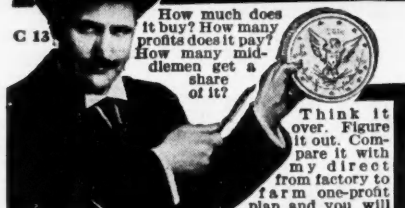

How much does it buy? How many profits does it pay? How many middlemen get a share of it?

Think it over. Figure it out. Compare it with my direct from factory to farm one-profit plan and you will know why your dollar spent with Galloway is larger and brings you more and how I can save the farmers of America over a million dollars every year.

Galloway Makes \$\$\$ Grow
Even if you have no ready cash, you don't want to borrow. You can buy from me on credit at direct from factory to farm prices and get the biggest dollar's worth you ever had.

5 New Selling Plans—Cash or Credit
Here they are. Take your choice. 1—Cash with order. 2—Bank deposit. 3—Part cash, part notes. 4—All notes. 5—Monthly payments. One of these will please you and suit your pocket book.

5 H. P. Engine \$99.50. Write for Catalog
It's the best engine for the money on the market. Sold on 30, 60 or 90 days' trial. Send for catalog and find out all about this great Galloway bargain.

Wm. Galloway, Pres.
Wm. Galloway Co.
945 Galloway Station
Waterloo Iowa

One Builder Orders Fifty Tuecs

In Portland, Oregon, there is a contractor who has discovered a sure way of adding to the sales values and the rentals of his buildings out of all proportion to what he adds to the cost. Recently he ordered fifty Tuecs at one time, to be used in fifty buildings now under course of construction. The

TUEC STATIONARY CLEANER

is priced so reasonably that every home costing \$3,000 or more should be equipped with this service. At only \$160 F. O. B. Canton, Ohio, complete with tools and hose, the Tuec 170 is meeting with a tremendous demand from home owners and builders alike, thousands of whom now regard the Tuec as being quite as essential to a modern home as a furnace or stationary plumbing.

*Write today for the Tuec Book.
Special inducements to Contractors and Builders.
Prompt deliveries.*

The Tuec is made in 15 sizes, providing for the requirements of all buildings.

THE UNITED ELECTRIC COMPANY
30 Hurford Street CANTON, OHIO

FREE

DRAFTSMAN'S WORKING OUTFIT

Complete Draftsman's Working Outfit—just like I use myself, that you couldn't duplicate for less than \$15.00, given to you absolutely FREE as soon as you enroll. Handsome set of imported instruments, T-square, French curve, triangle, etc., all given away absolutely Free to my students. This offer is limited. Write today.

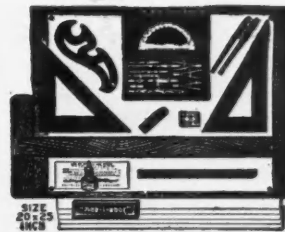

\$125 TO \$175 A MONTH TO START

That's the ordinary salary for a draftsman. Thousands of positions open. Be the man who gets the fat pay envelope. I will teach you drafting in your own home—during your spare time. I will give you practical instruction—the kind that the men must have who make the big money. I am Chief Draftsman of a large and well known company. Let me help you. Write to me today.

WRITE FOR FREE BOOK. Your name and address on a postal is enough. I will send you free and prepaid my big new book "Successful Draftsmanship." No obligation. Find out about your opportunity in the drafting profession. Send me your name and address—today—now.

CHIEF DRAFTSMAN DOBE, Div. 266Y, Engineer's Equip. Co., Inc., Chicago.

BOWER'S BARN VENTILATOR and CUPOLA



The exhaust capacity of the Bowers is far greater than that of any other cupola ventilator. The arrangement of storm bands, cones, etc., gives a direct escape for foul air without drafts. A steady upward "pull" means constant ventilation. Storm-proof and easily set in place on the roof.

The Bowers is made of 20 and 22 gauge Galvanized Steel with steel braced corners and top. The weather vane is gold-leaved. Combines the best in good looks and utility at a very reasonable cost. Our catalog explains why Bowers Ventilator and Cupolas really ventilate. Consult it before you buy. We can save you money on Skylights, Cornices, Finials and all sheet metal goods. Write us.

F. M. Bowers & Sons 927 W. Wash. St. Indianapolis, Ind.

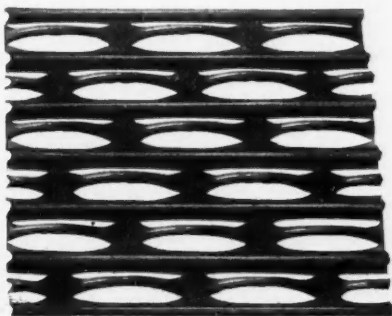

"RIGID AS THE ROCKS"

"Bostwick Truss-Loop" Metal Lath On 20 Inch Centres

Take your pencil and figure your saving in framing. Then write us as to figures on plastering. This proposition is ECONOMY writ large.

The Bostwick Steel Lath Company Niles, Ohio

Berger's Metal Lath

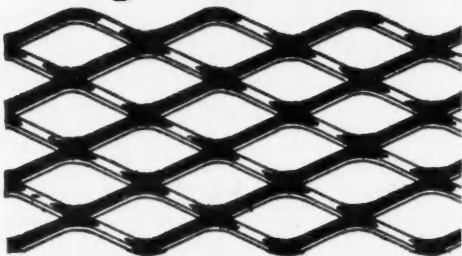

Write for Catalog

The Berger Mfg. Co., Canton, Ohio

For the best service address nearest branch

New York
St. Louis

Boston
San Francisco

Minneapolis
Philadelphia

HIPPED TURRET SKYLIGHT



with swinging sash. Sides 24" high; all windows on each side made to open at the same time. Operating device securely locks them open or closed.

The Skylight is of guaranteed quality. You can use it on any of your buildings with the assurance that it will stand the wear. Watertight. Can be set up in a moment by an inexperienced man.

Write for our Skylight Catalog and Prices

Galesburg Sheet Metal Works

Galesburg, Ill.

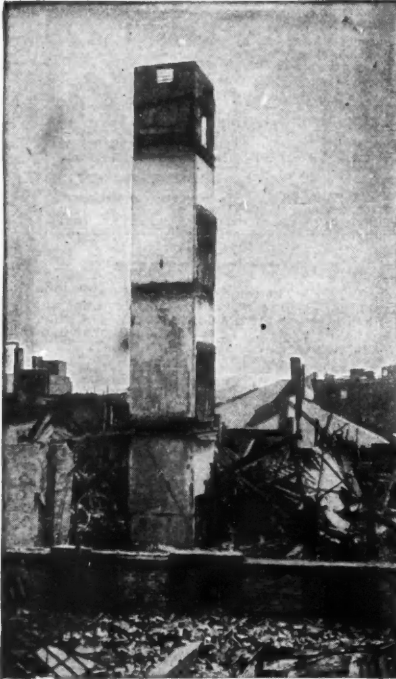

Ruins of Bacon Department Store, Boston, Mass.—Burned January 14th, 1914

Why was this Elevator Shaft Left Standing?

When this big department store burned to the ground, the elevator shaft remained standing among the crumbled ruins like a huge tower. It stood the fierce heat of the flames and later the dragging weight of a thick coating of ice and came through practically undamaged. Why?

— Because it had the fire resisting qualities that only metallic lath construction can give.



has all the fire resisting qualities of any metal lath and in addition is made with a scientifically correct mesh that always clinches the plaster firmly.

“KNO-BURN” is rigid, permanent, economical in plaster consumption and easy to work over. It is built to help the contractor.

Send for Booklet 33 TODAY. It will come in handy for reference.

North Western Expanded Metal Co. 903 Old Colony Bldg. Chicago, U. S. A.

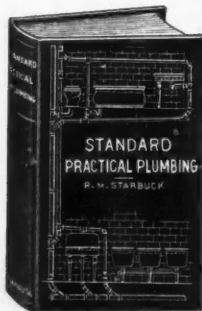

Standard Practical Plumbing

By R. M. STARBUCK

450 pages, 347 illustrations. Of the three hundred and forty-seven illustrations contained in the book, one hundred of them are full-page illustrations. The illustrations all being drawn expressly for this work, show the most

modern and best practice in plumbing construction.

Plumbing in all its branches is treated within the pages of this book, and a large amount of space is devoted to a very complete and practical treatment of the subject of Hot Water Supply and Circulation and Range Boiler Work.

Another valuable feature is the special chapter on Drawing for the Plumber.

It Contains the Following Illustrated Chapters

- | | |
|--|--|
| 1. The Plumber's Tools. | 16. Ventilation. |
| 2. Wiping Solder, Composition and Use. | 17. Improved Plumbing Connections. |
| 3. Joint Wiping. | 18. Residence Plumbing. |
| 4. Lead Work. | 19. Plumbing for Hotels, Schools, Factories, Stables, etc. |
| 5. Traps. | 20. Modern Country Plumbing. |
| 6. Siphonage of Traps. | 21. Filtration of Sewage and Water Supply. |
| 7. Venting. | 22. Hot and Cold Supply. |
| 8. Continuous Venting. | 23. Range Boilers: Circulation. |
| 9. House Sewer and Sewer Connections. | 24. Circulating Pipes. |
| 10. House Drain. | 25. Range Boiler Problems. |
| 11. Soil Piping, Roughing. | 26. Hot Water for Large Buildings. |
| 12. Main Trap and Fresh Air Inlet. | 27. Water Lift and Its Use. |
| 13. Floor, Yard, Cellar Drains, Rain Leaders, etc. | 28. Multiple Connections for Hot Water Boilers; Heating of Radiation by Supply System. |
| 14. Fixture Wastes. | 29. Theory for the Plumber. |
| 15. Water Closets. | 30. Drawing for the Plumber. |

Price, Postpaid \$3.00

Radford Architectural Co.

1827 Prairie Ave. : : : Chicago, Ill.

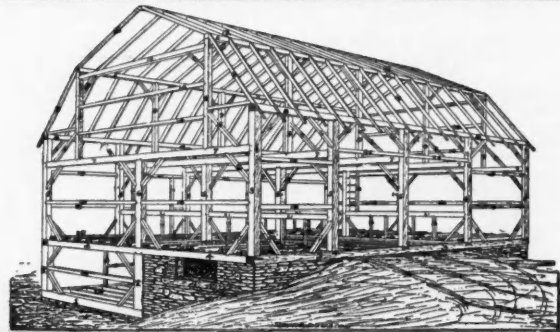

FRAMING

HOUSE FRAMING, BARN FRAMING
ROOF FRAMING

By W. A. Radford. 338 (6x9 inch) pages, 182 illustrations dealing with house, barn and roof framing, covering the subject in its multitude of forms and designs in a most thorough manner. Nothing is omitted that will help and guide on the construction of houses, barns, roofs, etc., while particular care has been taken to exclude any and every method of framing that has not been given a thorough and convincing test by experienced builders.

Have you received your copy?

No contractor or builder can afford to go without this book. A copy will be sent Free, postage paid, to anyone sending us their renewal or a new subscription. Regular subscription \$2.00 per year.

AMERICAN CARPENTER AND BUILDER

1827 to 1833 Prairie Avenue

CHICAGO, ILL.

TRIPPED!!

Can't Happen
WITH A

CANTON Sidewalk Door

There's one point in which Canton Sidewalk Doors excel—the extreme neatness of design. No protruding hinges. Perfectly flush with the surface of the walk. Nothing to stub the toes or trip passers-by. All parts receive even wear, so Canton Sidewalk Doors last longest.

Made of the best Steel and Iron, carefully cast and intelligently put together. They work very smoothly. Checkered surface, stay rods and chain to protect opening, burglar-proof lock are some more reasons why you should always provide the Canton.

Get Catalog B-1—now, while you think of it. A full line of Builder's Iron Work to choose from.



CANTON FOUNDRY & MACHINE CO., Canton, Ohio

Remember the Coal Man when you plan and when you build

Windows were made to admit light and air but not to admit coal. One season of battering and banging will ruin the best window that was ever built into a foundation wall. The

Majestic Coal Chute

absolutely protects the foundation and the woodwork from being injured while the cellar is being filled with the winter fuel. The door opens upward locking against the building protecting the siding. The Hopper swings out and catches all the coal direct from the wagon, barrow or basket. The coal is delivered in the cellar and *nowhere else*.

When not in use the Majestic Coal Chute closes "burglar-proof". But it does not prevent the light from out of doors from getting in. Made of the best of cast metal with a life-time guarantee the Majestic adds much to the value of the house but increases the cost only a trifle.

Special proposition to contractors and builders on request. Write for it.

THE MAJESTIC FOUNDRY AND FURNACE CO.
1000 Main Street Huntington, Indiana

HESS MEDICINE SANITARY LOCKER

The Only Modern, Sanitary STEEL Medicine Cabinet

or locker, finished in snow-white, baked everlasting enamel, inside and out. Beautiful beveled mirror door. Nickel plate brass trimmings. Steel or glass shelves.

Costs Less Than Wood

Never warps, shrinks nor swells. Dust and vermin proof, easily cleaned. Should be in Every Bath Room. Four styles—four sizes. To recess in wall or to hang outside. Send for illustrated circular.

HESS, 920L Tacoma Bldg., CHICAGO
Makers of Steel Furnaces Free Booklet



SAVED BY BUYING A

\$50 Bovee Economy Furnace \$50

At Manufacturers' Prices.

Has large combustion chamber. Saves one-third of the fuel. Has perfect Ventilating System. Most perfect hot air plant sold. Send pencil sketch of floor plan for our manufacturers' price and illustrated catalog. Address

BOVEE FURNACE WORKS
50 8th Street,
WATERLOO - - IOWA



PLUMBING AND HEATING SUPPLIES AT WHOLESALE

When in the market for Plumbing and Heating Supplies and you wish to

SAVE 20 to 40 Per Cent

on every article, write for my free illustrated Catalog. The only house that sells first-class guaranteed goods at wholesale prices direct. Shipments are promptly made from a very complete stock.

Small orders are as carefully handled as large ones.

B. B. KAROL, 768-772 W. Harrison St., Chicago, Ill.



Start to Succeed NOW

Forget the past. Better times are ahead. Start up out of the old ruts NOW. Mail the coupon. We want to tell you how you can learn PLAN Reading, Estimating, Contracting, etc., IN YOUR OWN HOME. We furnish plans of buildings now being built. Never mind the cost—it's small. We want ambitious men now in the building line. Write today.

\$15.00 Outfit and All Free Blue Print Plans

CHICAGO TECHNICAL COLLEGE
1017 Lake View Building, Chicago, Ill.

CHICAGO TECHNICAL COLLEGE, 1017 Lake View Bldg., Chicago, Ill. Gentlemen: I have marked with a cross (X) the branch or branches interesting me.

<input type="checkbox"/> Architectural Draft'g	<input type="checkbox"/> Bldg. Superintendence
<input type="checkbox"/> Builders' Course	<input type="checkbox"/> Structural Drafting
<input type="checkbox"/> Estimating	<input type="checkbox"/> Structural Design
<input type="checkbox"/> Plan Reading	<input type="checkbox"/> Mechanical Drawing
<input type="checkbox"/> House Planning	<input type="checkbox"/> Machine Drafting
<input type="checkbox"/> General Contracting	<input type="checkbox"/> Machine Design

Name.....
Address.....
Town..... State.....
College or Home-Study Course.....



CHOOSE

IT'S up to you to be the man at the top instead of the man with the dinner pail.

Don't hesitate to grasp this opportunity to win success, for there's always room at the top for the man who knows how.

The LIGHTNING ESTIMATOR

stops worry, lying awake nights, over or under estimating and guessing—in fact, by showing you how to estimate the cost correctly, it spells the word **\$ucce\$\$** for you. Don't do yourself an injustice by passing up the greatest opportunity ever offered to Carpenter, Contractor or Builder.

The New Seventh Edition of the LIGHTNING ESTIMATOR

will teach you: How much time and material involved in each part of your work; how to figure on unfamiliar work; how to estimate quickly and correctly on a large job; how to estimate on time, material and prices in all parts of the country.

This Book is written by a man who has made good in this profession, and is based on hard, solid facts, secured by the knocks of experience, making it an invaluable guide to any one engaged in or those about to enter the building business.

If you are just starting out, here is your chance to get a firm foothold. If you are an old timer and getting a little behind the times, here's your chance to brighten up and get some new ideas.

This Edition is bound in cloth, profusely illustrated—a feature not found in other books of this kind. The price, \$1.00. Don't delay. Send for it today.

BRADT PUBLISHING CO.

1260 Michigan Avenue

JACKSON, MICH.



FIRE—Excitement reigns supreme!
Panic—In a twinkling of an eye.
Exit—The terror-stricken rush.
Door—Though tightly closed—
Bolt—Columbia opens with a gentle push.

Full information upon request.

**The Columbia
 Iron & Wire Works Co.**
 Canton, Ohio

C. G. HUSSEY & CO.
 Pittsburgh, Penna.

MANUFACTURERS OF **COPPER**

In Sheets, Plates, Rolls

CORRUGATED COPPER CONDUCTOR PIPE

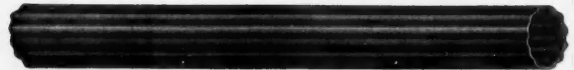

Copper Nails, Copper Rivets, Conductor Pipe, Eaves Trough, Elbows, Shoes, Mitres, Soldering Coppers, Gaskets, Etc.



ARTISTIC HOMES

A book of 280 (8x11 inch) pages showing perspective views and floor plans of 250 artistic modern homes. A large variety of designs are given so as to meet the taste of the majority of home builders. There are artistic houses for people of moderate means and others for the more wealthy, but in every case the design is made with reference to comfort and economy.

Every design shown has been made by the best architects in the world, who have made a study of home architecture and that alone.

GET YOUR COPY FREE

This cloth bound book will be sent **Free**, postage paid, to anyone sending their renewal or a new subscription. Regular subscription \$2.00 per year.

American Carpenter and Builder
 1827 to 1833 Prairie Avenue, Chicago, Ill.

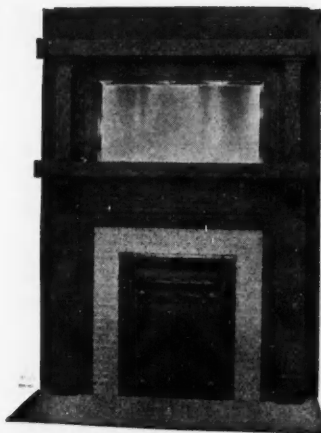

\$22.50 \$25.00

FOR THESE ELEGANT, MASSIVE, SELECTED OAK OR BIRCH, MAHOGANY FINISHED MANTELS. BEVELED MIRRORS, 18 X 36

Prices include our "Queen" Coal Grate with best quality enameled tile for facing and hearth. Mantels 82 inches high, 5 feet wide. Furnished with round or square columns, as shown in cuts.

Catalogue Free—Will send our 100 page catalogue, the finest ever issued, free, to carpenters, builders and those building a home.

HORNET MANTEL CO., 1147 Market St., St. Louis, Mo.

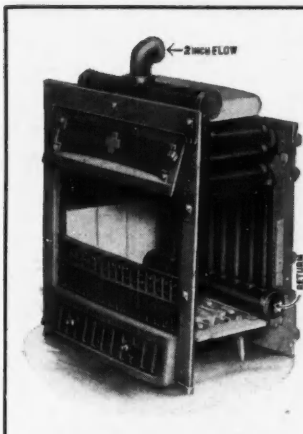
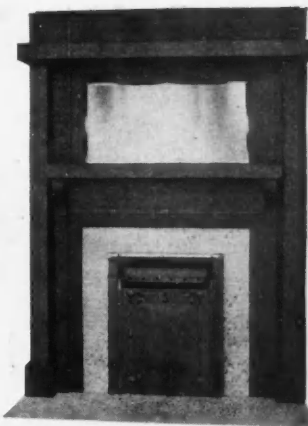

Hot Water Heating From the Fireplace

Illustration shows section of our Heating Coil which if placed in the old style fireplace will easily heat six times the amount of space without additional cost of fuel and affords the same healthful ventilation. Will suit any fireplace or mantel.

Write for descriptive circular.

Heitland Grate & Mantle Co.
No. 126½ N. Fifth St., Quincy, Ill.



MANTELS

Popular Home Favorites in Attractive Designs At Very Low Prices

The mantels illustrated are but two of the 82 beautiful mantels shown in our big Mantel Catalog. Every Carpenter and Builder should have this book. It is free.

Mantel No. 1240. Plain Oak, beautifully finished. Height, 7 feet. Width 5 feet. Pilasters 3½". Mirror 18x36 inches. The finest parlor mantel made for \$16.25.

Mantel No. 1240, Price \$16.25

Mantel No. 1241—Quartered Oak, highly polished. Height 6 ft. 2 inches. Width 5 feet. Columns 5 inches. A fine design; solid and artistic. Price \$23.12.

Huber Mantels are Guaranteed to give complete satisfaction. That's part of our selling policy.

We positively assure all buyers of Huber Mantels of full value, first class material and workmanship, prompt shipment and courteous treatment.

Don't put it off. Get our Big Mantel Catalog right now. Every mantel shown in colors. Illustrations 8"x6". Just send your name and address.

The Huber Builders Material Co.

45-49 Vine Street
CINCINNATI OHIO



Mantel No. 1241, Price \$23.12

THE BEST COLUMNS

for Porch, Interior and Pergola use the NICKERSON Patent DOUBLE LOCK JOINT THEY CANNOT COME APART

We Specialize on Detail-work. "Vignola" is our Standard for proportions when Architect's details are not furnished.



Clinch your Trade by giving them the very best Columns. Ours have the best Construction and correct shape.

All kinds of interior trim to detail.

Write for Catalogue No. 4.

NICKERSON MFG. CO.

KNOXVILLE . . . TENNESSEE

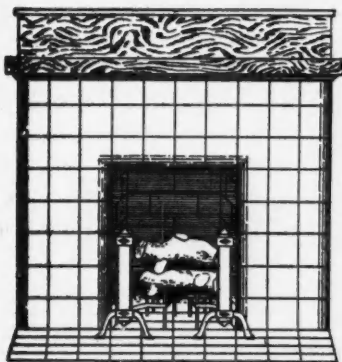

IF You Want the Best Wood or Tile Mantels at the LOWEST PRICES

write for our 50-page illustrated catalogue, mailed free on application.

Special prices to contractors and builders.

MOORMANN & OTTEN, 615-617 Main Street CINCINNATI, OHIO

ASHBY'S
Designs of Schools and Libraries

display a composition of utility, durability and good, pure architecture without any "gingerbread."

No buildings are too large or too small for our personal and prompt attention. We develop your own ideas into a practical set of plans and specifications which can be executed to the smallest details into a building that can be built within your means and to your entire satisfaction.

Ashby's "Designs of Schools and Libraries" will be sent to parties interested in the erection of a school building or library for which plans have not yet been procured.

G. W. ASHBY—ARCHITECT
512 Medinah Building
CHICAGO, ILL.

A Money Saver For Your Shop

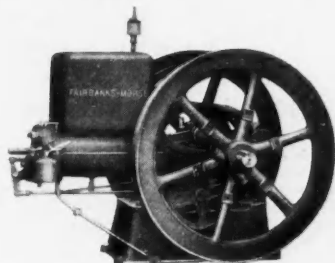

Use *Kerosene* instead of Gasoline as engine fuel. Practically cuts fuel cost in half.

Fairbanks-Morse Oil Engines

develop just as much power on a gallon of kerosene as on a gallon of gasoline. Magneto supplies spark, even at starting. No batteries needed. Throttling governor gives even speed at all loads.

Write for Catalog 2951409.

FAIRBANKS, MORSE & CO.
900 S. Wabash Ave. CHICAGO, ILL.

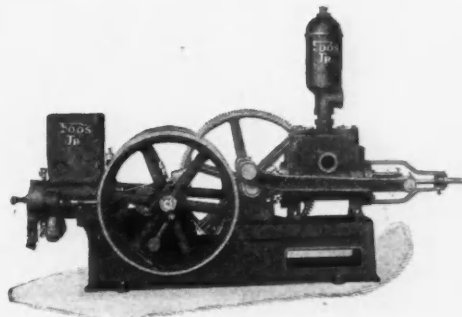

Direct Connected Contractor's Pump
Described in Bulletin 47

ENGINES for construction work, contractors' service and industrial purposes 1½ to 325 H. P. Portable electric plants, pumping rigs and other special outfits for all kinds of work. This factory builds high-grade equipment for any purpose requiring an engine, and carries a stock of contractors' outfits for quick shipment. Its sales engineers co-operate with contractors on municipal work (waterworks or electrical service) and are capable of handling the specifications on any job up to 325 H. P.

THE FOOS GAS ENGINE CO.
704 Monroe St. Springfield, Ohio

This Coupon Worth 75 Cents

"VANADIUM"

The King of Hand Saws



20" \$2.00 22" \$2.15 24" \$2.30 26" \$2.50 28" \$2.70 30" \$2.90

Straight or Skew Back, in Hand, Panel or Rip—any Teeth Desired.

Vanadium Steel Saws, made of Vanadium High-Speed Steel, hardened and tempered by a secret process, highly polished blade, extra thin back, and a finished product as a whole that cannot be excelled. Binding guarantee etched on every blade.

Vanadium Steel Saws Have No Equal

For every saw ordered with this coupon enclosed deduct 75c. This is our special offer to introduce our saws to carpenters direct.

Read---Fill In---Mail

Take advantage of this offer while it is before you. You may never have another chance. Mail the coupon today. It will assure you getting, not only the most serviceable saw made, but getting it 75c cheaper.

DIRECT TO Pennsylvania Saw Co.
FRACKVILLE, PENNA.

COUPON

Pennsylvania Saw Co., Frackville, Pa.

Gentlemen: I enclose \$..... for your American Carpenter and Builder offer, for which please send me by Parcel Post, prepaid: Length, in. Teeth, pt. Narrow or Wide Blade. Straight or Skew Back, It is distinctly understood that I can return any or all of these saws if they are not satisfactory after 30 days' trial, and that you will refund the purchase price upon receipt of goods.

Name.....

Address.....

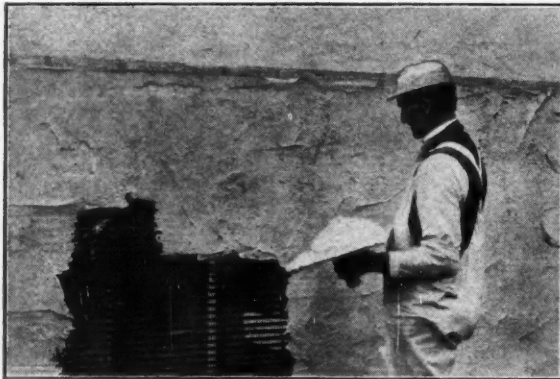

Note Heavy Scratch Coat, Due Entirely to Stiffness of RIB LATH.

Better Stucco and Plaster

are assured by the use of RIB LATH. Plaster cannot streak or crack, as with wood lath. Improved method of manufacture provides a perfect clinch for the plaster. RIB LATH provides a most rigid surface so that plaster can be compacted against it without loosening surrounding plaster.

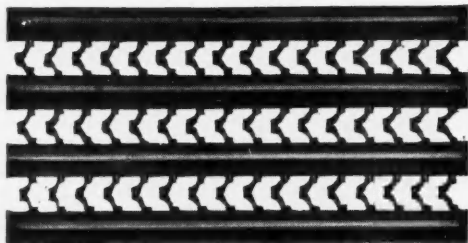

RIB LATH

Saves Labor and Material

The exceptional rigidity of RIB LATH permits wider spacing of studs, and in plastering effects a great saving in labor and material. Two coat work is ample with RIB LATH, where other laths require three. RIB LATH covers about 10% more area than other metal laths because of interlocking ribs along sides of sheets. Self-furring RIB LATH eliminates all furring strips in stucco work.

RIB LATH is furnished in four types and twelve weights. Also Detroit Diamond Lath, Steel Studs for Hollow Partitions and Steel Corner Beads.

VALUABLE RIB LATH HAND BOOK
Containing Details, Specifications, Tables, Illustrations, etc., FREE to those interested in building.



TRUSSING CONCRETE STEEL CO.

Dept. H. 44

YOUNGSTOWN, O.

Reinforcing, Hy-Rib and Lath, Steel Sash, Etc.



Residence of C. A. Mangold. Oak Cliff, Dallas, Tex. Stucco on RIB LATH.



The Parrot says—

“Contractors! Equip your houses with the

PARROTT (Hot Water) HEATER

10 Gallons of water heated for one cent

Put a Parrott Heater in the basement, light the pilot light and all inconvenience is past. Opening any hot water faucet in the house automatically turns on the gas in the heater. The water is heated “on the run”. In a few seconds it is rushing from the faucet.

Supply the Demand

for Hot Water Heaters. The Parrott gives the best service at the lowest price. Clean and convenient. All home owners now want a Parrott Heater. Take up practically no room. Capacity unlimited. Easy to install. Requires no attention. Positively supplies hot water for any purpose at any time.

Your Clients will want a Parrott. Learn more about the Parrott Heater from our literature. Money for you. Write for FREE CATALOG.

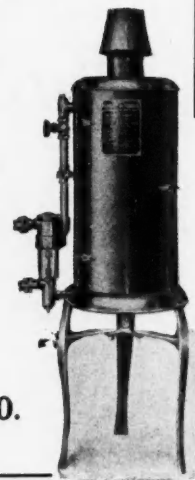

MICHIGAN GAS APPLIANCE CO.
JACKSON, MICHIGAN

Send Us Your Plans for Estimates —ORNAMENTAL IRON—



Iron Stairs
Railings
Balconies
Elevator Enclosures
Fire Escapes
Side Walk Doors
Etc.

OUR PRICES WILL INTEREST YOU

THE MACK IRON & WIRE WKS. CO.
Sandusky, Ohio

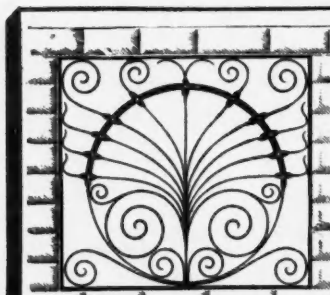

Mr. Builder: — If you are lucky enough to read this advertisement, and wise enough to write and tell us what you buy in

IRON, BRASS and BRONZE

we will send you catalog that is attractive enough to go in any man's library. Do you want it?

DOW WIRE & IRON WORKS

Incorporated
Louisville, Kentucky

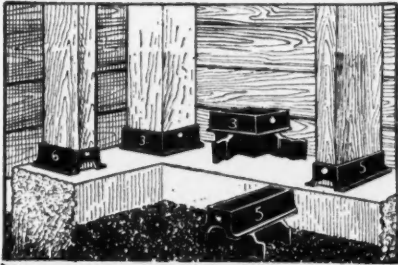

ROSS Iron Studding SOCKETS

The "100-Year" Post Supports for Cement Floors and Cement Foundations

**No Sills to Rot!
No Toenailing to Rust!**

For Corneribs, Granaries, Barns, Hoghouses, Sheds, Garages, etc. Simply tap Sockets into soft cement. Easy and convenient to use. More than save their cost in labor. Ross Sockets last. Good profits for you. We pay the Freight.

Write for Free Booklet **G. M. ROSS & CO.** 1744 Broad Street GRINNELL, IOWA

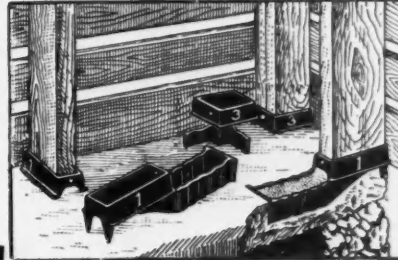

OAK FLOORING

"AMERICA'S BEST FLOORING"

Builders and owners will find it a clinching argument to say "It's floored with OAK FLOORING." It is the biggest single feature to look for in any house or apartment building. It imparts an air of refinement and elegance. It is the modern flooring.

OAK FLOORING 3/4 inch thickness by 1 1/2 inch or 2 inch faces can be laid over old floors in old homes or over cheap sub-floors at a very low cost. It is cheaper than carpets or pine flooring. When laid it has all the appearance of heavy flooring.

There is a solid satisfaction and lasting pleasure in the substantial and dignified appearance of OAK FLOORING.

Contractors and carpenters find it very profitable to lay 3/4 inch stock over old floors in old homes during dull periods. A little canvassing is all that is necessary to secure jobs. A carpenter or handy man can lay OAK FLOORING successfully.

For durability, OAK is the best. OAK FLOORING laid thirty years ago, after very hard use, is still in good condition.

Write for Booklet

THE OAK FLOORING BUREAU, 890 Hammond Bldg., DETROIT, MICH.

METAL CEILING

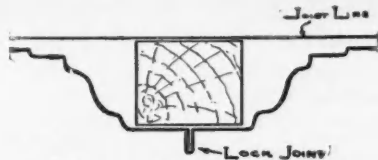

See that Joint?

The Acme of perfect construction. Don't nail or slip the joints. Lock them. Full information in catalogue E.

S. KEIGHLEY METAL CEILING & MFG. CO.
PITTSBURGH, PA.

BULL DOG DIAPHRAGM PUMP

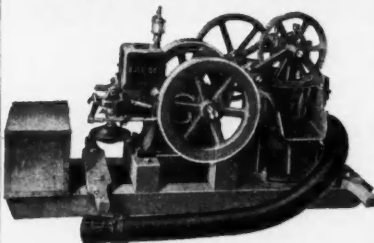

A positive necessity for pumping out excavations of all kinds. This outfit has especially large valve-ways and will handle large quantities of water, sewage, mud, gravel and sand.

Fifteen feet of non-collapse suction hose with nipples and strainers for each pump, furnished at no extra cost.

A portable pump fitted with our well known Bull Dog Gasoline Engine. Safe, speedy, and reliable under any or all conditions.

Catalogue 21 describes our complete line of engine driven pumps. Send us your name and address and let us mail you a copy now.

BATES & EDMONDS MOTOR CO., Lansing, Mich.

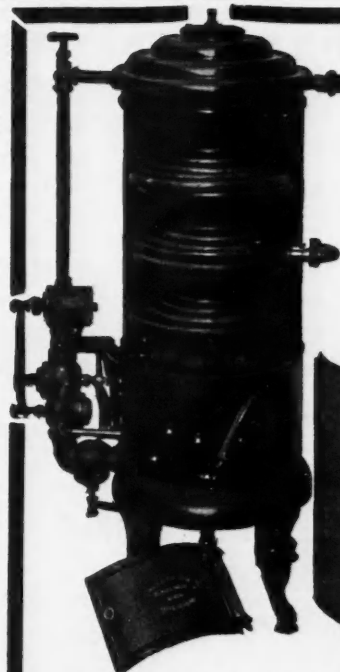

HOT WATER

Absolutely Without Labor
Supply Unlimited
Water Heated on the Run
with

PERFECT SAFETY

No building is complete without hot water the year 'round. The

Radke "Safety" Instantaneous Automatic Gas Water Heater



For Residences
Stores
Schools
Churches
Apartments
Garages
Clubs
Laundries
Halls
Armories

THE "SAFETY" IS ALWAYS SAFE

because it automatically shuts off all gas from the heater in case the pilot light should accidentally go out. Your customer expects you to furnish the best article on the market. Send for Catalog and let us tell you wherein this heater excels.

RADKE MANUFACTURING CO.
173 West Jackson Boulevard
CHICAGO, ILL.



Silentflow

A Noiseless Water Closet

IN THE TOILET adjoining the sick room one of the distressing noises can be eliminated by installing the "Silentflow."

This closet was not put on the market until it was proven perfect in construction, design and workmanship.

SPECIFY WOLFF H-7005 FOR RESIDENTIAL USE

L. WOLFF MANUFACTURING COMPANY
Manufacturers of
Everything in the Plumbing Line
The only complete line made by any one firm.

General Offices, 601-627 W. Lake St. Showrooms: 111 No. Dearborn St., CHICAGO
Pottery: Trenton, N. J.

BRANCHES: Denver, Colo.; Omaha, Neb.; Minneapolis, Minn.; Dallas, Tex.; Rochester, N. Y.;
St. Louis, Mo.; Washington, D. C.; Cleveland, O.; Cincinnati, O.; Kansas City, Mo.;
San Francisco, Cal.



Copyrighted by the L. Wolff Mfg. Co.

"SYRACUSE"---The World's Standard Nail Set



Each point carefully cupped and tested on steel. Clear cut knurling to give firm grip. "Syracuse" Nail Sets have been the standard for 15 years. They are the best that long experience and high grade material can produce.

3 sizes — 2-32", 3-32", 4-32", — Price, 10 cents each

SYRACUSE TWIST DRILL CO. :: SYRACUSE, N. Y.

Ask your hardware dealer for "Syracuse" Nail Sets. If he cannot supply you we will send any number you want for 10 cents each. State size wanted.



SAMSON SPOT SASH CORD

Made of extra quality stock, carefully inspected, and guaranteed free from the imperfections of braid and finish which destroy common cords so quickly. Samples and full information gladly sent.

Samson Cordage Works --: Boston, Mass.



A HOT AIR FURNACE

For Less Than
\$50 Complete

For 5 and 8 Room Dwellings

An Unheard of Price and a most Remarkable and Indestructible Furnace.

No Pipes No Lost Heat

AMERICAN BELL AND FOUNDRY CO.
NORTHVILLE MICH.

BUY YOUR FURNACE

\$10⁰⁰ DOWN — \$10⁰⁰ A MONTH



Our monthly-payment plan of selling direct saves you the dealer's profits and excessive charges for installation. The

Jahant Furnace

with the patented "Down Draft System," is the best for residences, schools, hotels, churches, etc. Saves $\frac{1}{3}$ to $\frac{1}{2}$ in fuel bill. Install the Jahant yourself. We send complete outfit, freight prepaid, with special plans, detailed instructions and all necessary tools for installation. Satisfaction guaranteed or money refunded. Thos. J. Flaherty, Hamilton, N. Y. writes: "Best furnace made. Had no trouble to install it. Had it up and fire started in 12 hours. Write for Free Illustrated book."

This No. 1 Jahant Down Draft Furnace (weight over 1000 lbs.) as it stands \$48.00 each, delivered east of Omaha and north of Ohio River.

THE JAHANT HEATING CO., 45 Main St., Akron, O

SAVES 1/3 TO 1/2 ON FUEL BILLS

A Free Book of Money Saving Ideas For Dairy Barn Builders



You will be interested in reading "Helpful Hints to Dairy Barn Builders." It tells many of the things learned by W. D. James—America's foremost dairy barn designer. It will help you make more money.

It tells about the new plank frame construction, the famous King system of ventilation, perfect lighting, proper width and arrangement. It tells about stable floors, site, size, appearance, design, drainage and equipment. And it shows four floor plans of barns that have attracted widespread attention.

You can obtain a copy of this valuable, helpful book FREE. Merely answer these few questions and the book will come by return mail. For whom do you expect to build or remodel dairy barns? (Give name and addresses.) When? For how many cows? Address

James Manufacturing Company
8675 Cane St., FT. ATKINSON, WIS.

Special Offer Of Blue Prints



Mr. James wants to make you a special offer of complete working blue prints of modern dairy barns of different sizes and types. Also ask how to secure free help from our agricultural department. Write today.

The Man Who Wouldn't Stay Down



Now Architect



Carpenter

Hard work and low pay are for the man who *thinks* he "hasn't a chance." But the ambitious man trains himself for a better job—and gets it.

Only a few years ago the man whose rise we picture here was working 12 hours a day for 7 days a week. But he made up his mind to train himself for something better. He marked and mailed just such a coupon as you see below. He studied at home. His earnings increased. He was made foreman. And now he is a successful Architect with an income of several thousand dollars a year.

This man had no advantages that you don't have. His education was poor. His spare time was limited. But with the help of the I.C.S. he has "made good." YOU can do the same in your line of work. If you can read and write the I.C.S. can help you.

Mark and mail attached coupon. It won't obligate—and the I.C.S. will show you how you can rise to a high-salaried position through their simple and easy system of home instruction.

Mark the Coupon NOW

International Correspondence Schools

Box 910, SCRANTON, PA.

Please explain, without further obligation on my part, how I can qualify for a larger salary and advancement to the position, trade, or profession before which I have marked X.

Architect	Estimating Clerk	Automobile Runn'g
Arch'l Draftsman	Civil Engineer	Foreman Machinist
Contract'g & Build.	Surveying	Sh.-Met. Pat. Drafts.
Building Inspector	Mining Engineering	Textile Manufact'g
Structural Eng.	Mechanical Eng.	Bookkeeper
Structural Draftsman	Mechanical Drafts'n	Stenographer
Plum. & Heat. Con.	Stationary Eng.	Advertising Man
Supt. of Plumbing	Electrical Engineer	Window Trimming
Foreman Steam Fit.	Electric Lighting	Commerc'l Illustrat'g
Plumbing Inspector	Electric Railways	Civ. Service Exams.
Heat. & Vent. Eng.	Concrete Const'r'n	Chemist

Name _____

St. and No. _____

City _____ State _____

Present Occupation _____



WILLIS VENTILATORS

(all Sizes)

Plain or Glass Tops

These ventilators insure greatest efficiency in exhausting foul air and substituting fresh air. Provide a constant circulation without draft. Rain, snow or birds cannot enter. Fitted with dampers to control ventilation. First-class for use on barns, schools, factories, etc. Prices on Copper Ventilators on Application.

Ask for General Catalog No. 6, illustrating our entire line.

WILLIS MFG. CO.

Manufacturers of Skylights, Fire Doors, Metal Windows, and all Architectural Sheet Metal Goods.

GALESBURG

ILLINOIS



THE GALE

BARN AND GRANARY VENTILATOR

For all your buildings

INEXPENSIVE, BEAUTIFUL, STRONG

Made of heavy galvanized iron. Screened inside. Storm-proof and bird-proof. Perfect ventilation guaranteed. All you have to do is to place ventilator on roof and nail fast.

Write for Illustrated Circular with Complete Prices.

Galesburg Sheet Metal Works, Galesburg, Illinois

Grimm's Galvanized Corrugated Wire Lathing

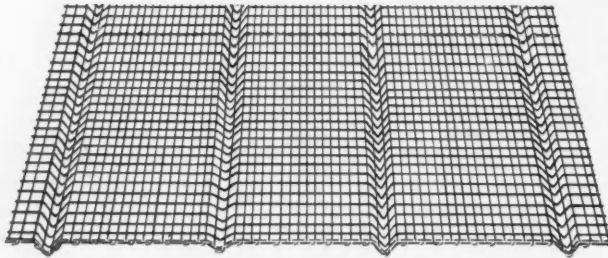

This V-shaped corrugation eliminates furring, keeps plaster clear of wall, thereby securing air space and dry atmosphere. Gives necessary stiffness without added weight, such as is necessary in most forms of stiffened Wire Lathing, in which rods or small angles are woven into the fabric for stiffening purposes.

Plaster keys so firmly that it will not crack or drop off. This lathing is absolutely non-corrosive and will not rust as it is galvanized after woven, which solders each joint and covers the entire surface of the wire with spelter (zinc) and costs 50% less to install than ordinary lathing. It will be to your interest to send for our Booklet on Wire Lathing if you contemplate building. A post card will bring it to you. Send for it now.

BUFFALO WIRE WORKS CO.

Formerly Scheeler's Sons

Suits all in the V. 413 Terrace, Buffalo, N. Y.

In Position

"SAFETY FIRST"

Fold Compactly

Wheeler Safety Scaffold Brackets

Save Lumber—Save Labor—Save Nails—Save Accidents

Pay for themselves on two jobs and last a lifetime. Lock automatically. Men cannot be careless putting them up. Are rigid and firm when in place. Scaffold cannot swing. Write for our **FREE TRIAL OFFER**

AMERICAN STEEL SCAFFOLD CO., Dept. 7, DETROIT, MICH.

We have issued *Very Interesting Catalogues* containing valuable information for the Architect, Carpenter and Builder regarding wood columns for exterior and interior use.

Catalogue "U. 40" for Exterior and Interior Columns.
Catalogue "U. 50" for Interior Columned Openings.
(Above will be sent FREE on request)

HARTMANN - SANDERS CO.
Exclusive Manufacturers of

Kolls Lock Joint **Patent Stave Column**

Suitable for Pergolas, Porches or Interior Use.
Main Office and Factory
Elston and Webster Aves., Chicago, Ill.
Eastern Office: 1123 Broadway, New York City, N. Y.
Pacific Coast Branch, A. J. Koll Planning Mill Co., Los Angeles, Calif.

The Evolution of The Fireproof Building

The cut tells the story of how the owners of the Leavenworth Apartments in Syracuse, N. Y., solved the problem of making their building fireproof throughout at low cost.

Berger's Metal Lumber 7"-4 1/2"-lb. joists were used in the floors and roofs, spaced 16" center to center with 14'-0" spans, giving a 35-lb. per sq. ft. dead load. The joists were placed just as soon as the steel beams and columns were ready for them.

Metal Lumber is adaptable for floors, partitions, sidewalks, etc., saving time and money.

Write for our catalog today.

The Berger Mfg. Co.
Canton, Ohio

For best service address nearest branch.

New York	Chicago	Minneapolis	St. Louis
Boston	Cincinnati	San Francisco	Philadelphia

Also manufacturers of Prong Lock Studs and Furring, Rib-Truss, Ferro-Lithic and Multiplex Reinforcing Plates, Steel Ceilings, Expanded Metal Lath, Sidewalk Forms, Raydiant Sidewalk Lights, etc.



Lasting Construction

In addition to its superior waterproofness, economy and ease of laying, Bayonne is more lasting than tin, tar or other prepared roofings for porch floors and decks.

The quality of the cotton duck and the special preparation and method of treatment give Bayonne a toughness and wearing body that is quite unequalled. Should be laid dry over boards and for roofs requires but one coat of paint—and on decks never more than two. Makes a neat, finished and durable job with the minimum of labor. Endorsed by the best architectural practice.

JOHN BOYLE & COMPANY, Inc.

112-114 Duane Street—70-72 Reade Street, NEW YORK CITY
202-204 Market Street, ST. LOUIS

Write for Sample Book "N" and complete laying instructions and prices.



The success of stucco work or over-coating on remodeled buildings depends on the lath back of the plaster. If the lath reinforces the plaster and contracts or expands the same as cement, success in stucco work is certain.

SYKES

Expanded Cup Lath

is stiffer, stronger, and a better foundation than wood lath. The "cup" feature prevents the plaster from hanging on a sharp edge and does away with the need of furring strips. The keying principle is so perfect that the plaster completely surrounds the strands. The result is a reinforced concrete wall.

There is no waste of material as Sykes Expanded Cup Lath is self-furring and the amount of plaster necessary to make a perfect bond is less than is required by other makes of metal lath.

Expansion and contraction are the same as in cement or concrete. There are no cracked walls where Sykes Expanded Cup Lath is used. It does not buckle or sag.

The United States Government has approved the use of Sykes Expanded Cup Lath on Government Buildings. It will pay you to use it on any of your buildings that are being stuccoed or overcoated.

Made in uniform sheets, 18 by 96 in., with Anti-Rust (Oil) Coating Painted Black or Galvanized. Packed 20 sq. yds. to the bundle. The price is very moderate.

Free samples of Sykes Expanded Cup Lath, Sykes Trough Sheet Lath, Sykes Galvanized Wall Ties. Together with a copy of Sykes Complete Specifications for Stucco on Metal Lath will be sent to any carpenter or builder who asks for them. Ask today and let us explain economy in building.

Sykes Metal Lath & Roofing Co.

506 Walnut Street

NILES, OHIO

Reinhardt Profile Gauge

or Adjustable Templet

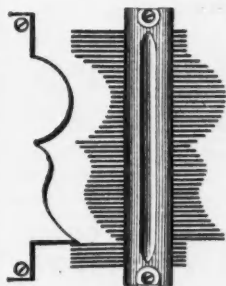

is a special tool that YOU need to take profiles or to reproduce irregular curves and surfaces. Made in various styles and sizes to meet every want.

Send your name and address for illustrated price list.

Little Brother (demonstrator) mailed on receipt of 15c.

Warren Profile Co.

103 Chambers Street, New York

Shultz Corner Posts For Store Fronts

make a strong, handsome and practical joint. They are waterproof and dust-proof and never rot. No putty or filler is used. The glass is bedded on Spanish cork which prevents cracking or crushing. Not expensive.

Write us for description, prices or estimates.

All Steel Corner Post Co., St. Joseph, Mo.

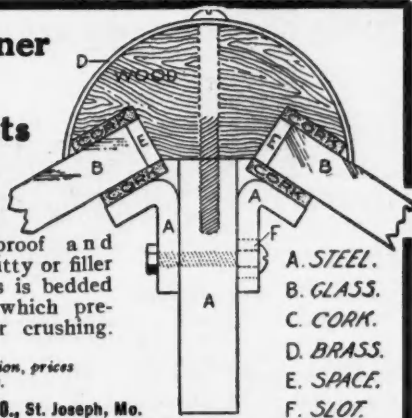

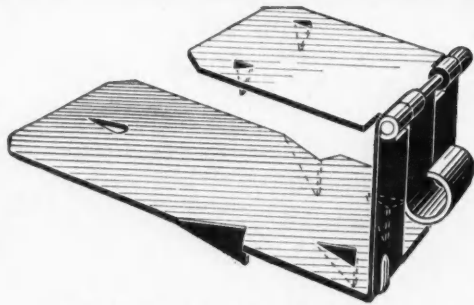

No. 631. R-W Roof Scaffold Bracket

Liability Insurance

Why risk your men and
the profit on the job?

There is always danger on the roof laying shingles, on the scaffolding and on the ladder. Avoid all trouble. Ask for these R-W specialties at your dealer's, or write

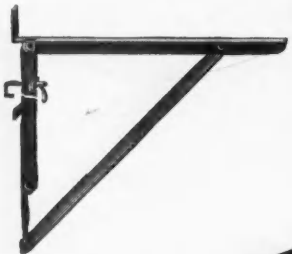

No. 261
R-W Steel
Folding Builders,
Bracket

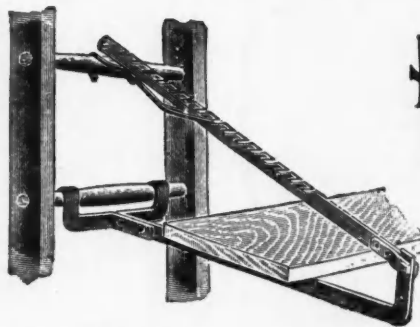

No. 138. R-W Economy Ladder Jack
and Scaffold Support

Richards-Wilcox
MANUFACTURING CO.
AURORA, ILL. U.S.A.

A
Hanger for
Any Door that
Slides

Prestige THE REFLECTION OF Quality

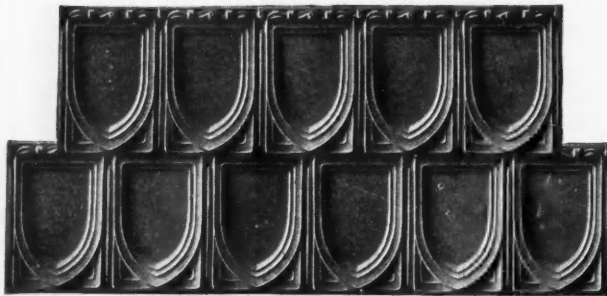

GOTHIC—Style "F"

Write for Samples and Full Information

"METROPOLITAN" METAL SHINGLES

"The Metropolitan" is the same high grade as our regular shingles, but by being made in sheets containing six shingles, the cost is reduced, so they can be used in any sort of building, as they compete with wood shingles besides being much better.

They are made in Galvanized Steel, American Ingot Iron and Copper.

Milwaukee Corrugating Company
Branch—Kansas City, Mo. Milwaukee, Wis.



\$25.00

with your order, will bring this magnificent Book Case Colonnade Complete with Art Glass (no hardware) to your station, all charges prepaid.

This offer is good during the month of JUNE. This is the greatest offer ever made.

Do not fail to take advantage of it.

Pedestals 2 feet wide and 3 feet 6 inches high, 6 inch veneered columns. Workmanship perfect in every detail.

22 years in our present location; this should be sufficient guarantee.

CHICAGO GRILLE WORKS

828-838 Wells Street

CHICAGO, ILL.

MADE TO ORDER Fly Screens and Screen Doors

We use the best grades of wire cloth, black enamel, galvanized, pearl and copper bronze, fastened by the improved Standard Shoulder Strip Method, which makes the wire drum tight and firm, can not sag or pull away.

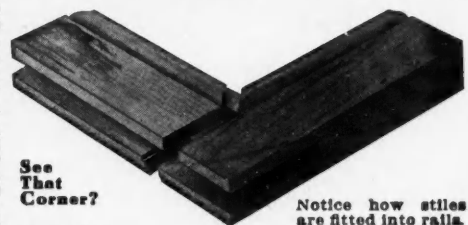

See That Corner?

Notice how stiles are fitted into rails.

Dealers, Carpenters, Contractors and Builders, write for a free copy of our 1913 illustrated catalog

STANDARD SCREEN CO., 1848-50 W. 14th St., Chicago, Ill.

Our screens are all mortised, tenoned, joined with waterproof glue and pinned with steel pins, will last a lifetime.

EASY and SURE Steps to Higher Wages and Larger Contracts

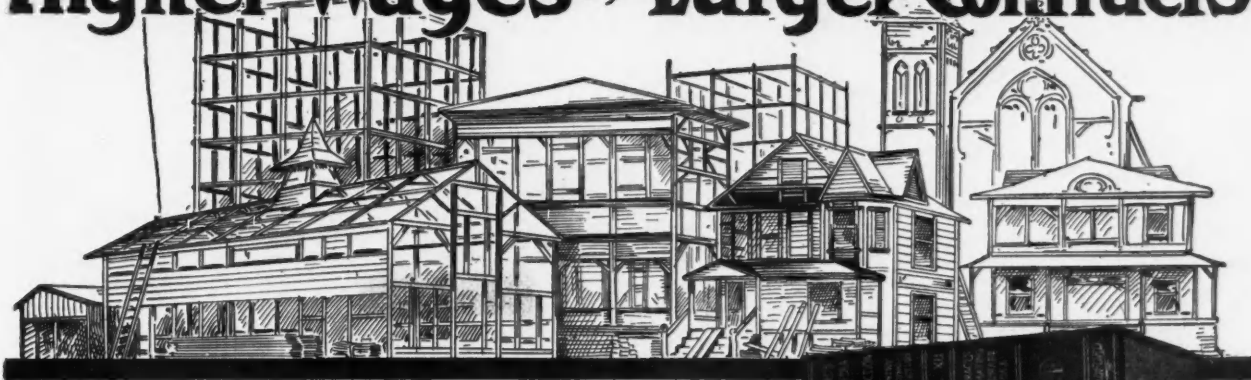

The man who climbs to success is the man who knows how to do things in the best modern way. A bigger share in the

BUILDING OPPORTUNITIES OF TODAY

is surely yours to claim! You can do it without technical training or hard study. To master every detail of your trade or business will be a pleasure instead of a labor. Your task if you will let us send you for five days' free examination absolutely at our own expense and risk, a set of

RADFORD'S CYCLOPEDIA OF CONSTRUCTION

Carpentry, Building and Architecture

A Practical Uplift to Complete Mastery of Modern Building Methods and Materials

Twelve Massive Vols.—5,000 pages, 3,000 illustrations. Up-to-date, practical, thorough. All in simple English, without higher mathematics. Latest materials and methods. The cream of practical experience of the world's best known builders and contractors. Every detail covered—Carpentry; Framing; Concrete Work; Masonry; Steel Construction; Fire and Waterproofing; Drafting and Design; Heating; Ventilating; Plumbing; Decorating; Contracting; Estimating Cost, etc., etc.

Sent Anywhere on Approval

ORDER ABSOLUTELY AT OUR RISK

No Obligation or Expense to You Unless You Keep the Books
No Follow-Up Agents to Bother You

WHAT OUR FREE TRIAL OFFER INCLUDES:

12 Massive Vols.—Bound in $\frac{3}{4}$ Morocco leather, with full Persian library covers. A brand new work, costing over \$100,000 to compile and publish, built along new lines especially for the practical builder or contractor. Without magazine, \$1.00 less.

FREE Radford's Portfolio of \$30,000 Prize Building Plans—Over 300 designs of houses, bungalows, outbuildings, apartments, churches, etc. Ranging in cost to suit any purse.

FREE Complete Set of Guaranteed Working Blue-Prints and Specifications for any house design selected from Portfolio—Ordinarily costing \$75 to \$100. We will also include **One Full Year's Subscription to the "American Carpenter and Builder,"** the world's greatest building paper, without extra cost to you.

If you are a Carpenter or Builder, you can do all the ordinary work of the Construction Engineer or Designer without any deep mathematical calculations, thus insuring your title to better recognition, wider responsibilities and higher wages.

If you are a Contractor, your clients will appreciate dealing with a man who is able to give them the latest practical suggestions, and who has back of him the experience and resources of one of the largest architectural firms in the world.

12 MASSIVE VOLUMES

SENT ON APPROVAL FOR FIVE DAYS' FREE EXAMINATION

No Obligation. No Expense. No Risk to You
We Take all the Risk

READ THE COUPON

ON NEXT PAGE

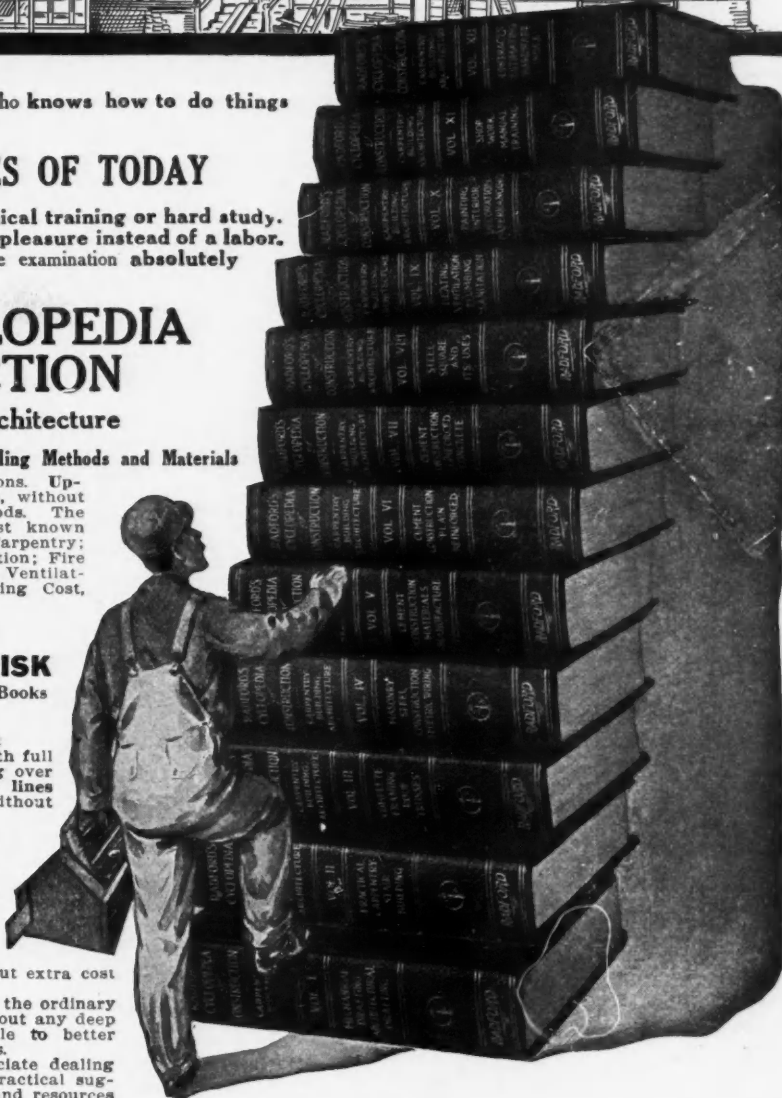

RADFORD ARCHITECTURAL COMPANY,

1827 Prairie Ave., Chicago, Ill.

SIGN AND MAIL COUPON TO-DAY

WHEN WRITING ADVERTISERS PLEASE MENTION THE AMERICAN CARPENTER AND BUILDER

He Waited Too Long



"If I only had this set of books twenty or thirty years ago, they might have changed my whole life. The knowledge in the big CYCLOPEDIA would have enabled me to increase my earning power, to take on big work, paying big money, and possibly have helped me to make a fortune in the building business."

Hundreds of letters like the above have come to us, breathing between the lines the same pathetic story of regret—showing how hard it is for the untrained man to really get ahead in life. **The opportunity is yours NOW**, and the way is easy. **Don't wait too long. Don't wait at all.** Read the terms of our **NO-RISK, Guarantee Offer** over again, and **sign and mail coupon today.** You risk absolutely nothing, and you will reap the benefit ever afterward.

VERY BRIEF LIST OF CONTENTS

To realize their tremendous scope, you must see the books—you can get the books for five days examination without cost to you.

A C.B.
7-14

**Radford
Architectural
Company**
1827 Prairie Ave.,
Chicago

Please send me, express prepaid, your 12-volume Cyclopaedia of Construction, for five days' free examination, with privilege of return at your expense. I enclose \$1.00 deposit, which you agree to return if I decide not to keep the books after examination. If I keep the books, I will pay \$2.00 a month until the special price, \$23.80 is paid, otherwise I will notify you within five days after receipt of books.

Your offer also includes Radford's Portfolio of Plans (over 300 designs), and one full year's subscription to the American Carpenter and Builder. You also agree to furnish set of Blue Prints and Specifications, if ordered within 2 months after acceptance of books.

Name.....

Town..... State.....

Street.....

Carpentry.
House Framing
Uses of Steel Square
Rafter Cuts
Strength of Timber
Roof Trusses
Stair Building
Drafting and Design
Working Drawings
How to Read Plans
Blue-Printing
Architectural Forms
Architectural Lettering
Construction Contracts
Forms of Contract
Architect and Owner

Specification Writing
Inspection of Work
Cost Estimating
How to Bid with Safety
Timekeeping, Superintendence
Cement Construction
Origin of Portland Cement
Advantages of Concrete
Common and Hydraulic Lime
Cements (Portland, Natural, etc.)
Proportions for Mixing
Aggregates (Sand Gravel, Crushed Stone, etc.)
Mixing by Hand and Machine
Depositing Concrete
Concrete Troubles
Waterproofing Concrete
Concrete Blocks and Brick
Cement Mortar
Stucco and Plaster
Concreting Machinery and Tools
Concrete Mixers

Block Machines
Number of Blocks Required
Brick and Tile Machines
Forms (Wood, Metal)
Cement Houses
Foundations
Floors and Walls
Roofs and Chimneys
Fireproof Construction
Concrete Sidewalks
Ornamental Use of Concrete
Surface Finishes
Art Tile and Mosaics
Terrazzo Floors
Concrete on the Farm
Fence-Posts and Gate-Posts
Sewer and Drain Pipe
Concrete Silos
Reinforced Concrete
Principles of Design
Reinforcing Materials and Systems
Industrial Buildings
Concrete Piles
Sewer and Tunnel Work
Bridges and Viaducts
Culverts, Reservoirs

Estimating Concrete Work
Standard Specifications
Masonry Construction
Building Stone
Brick and Brickwork
Mortar for Masonry
Bonds and Joints
Steel Construction
Steel Shapes
Use of Handbook Tables
Allowable Stresses
Rivets, Tie-Rods
Columns, Beams and Girders
Floor and Roof Arches
Roof Trusses and Coverings
Mill Building Construction
Steel Bridges
Heating, Ventilation
Furnaces and Pipes
Plumbing
Sewers and Drains
Electric Wiring
Painting
Paperhanging
Furniture Making
Useful Tables, Rules, etc.

**12 Big Volumes—Free Premiums—No Risk
SENT FOR ONLY \$1.00**

RADFORD ARCHITECTURAL CO.
1827 Prairie Ave., CHICAGO, ILL.

PIN A DOLLAR BILL TO THIS COUPON AND MAIL IT AT OUR RISK TODAY

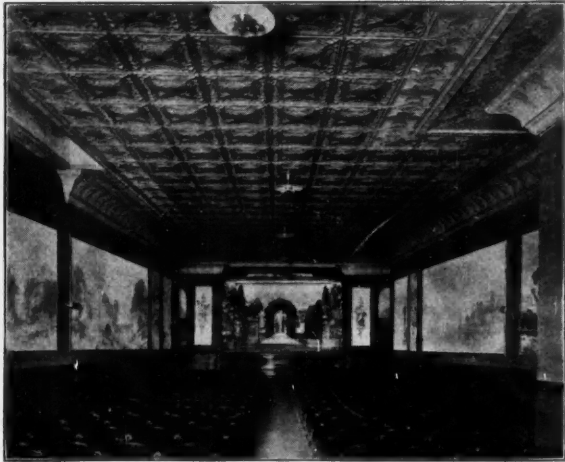

Klauer's Steel Ceilings

Are the kind you want for the work you now have coming up.

Unexcelled as to designing and mechanical perfection, they are most economical as well as most desirable.

Get our complete catalog and let us figure on your requirements.

Klauer Manufacturing Co.

Dubuque, Iowa

Easy Nailing And a Perfect Joint



These features are assured by two new improvements in the construction of

"BERGER'S" Classik STEEL CEILINGS

The nailing is made easy by providing a cup-shaped depression in each button, and the beads are made extra long in shape of half an oval, reinforcing the ceiling plates at joints, and fitting snugly over underlapping bead.

There's big money for you in handling Berger's Classik Steel Ceilings if you get in touch with us right away.

The Berger Mfg. Co., Canton, Ohio

For the best service, address nearest branch.

New York Philadelphia Minneapolis
Boston St. Louis San Francisco

We also manufacture Ferro-Lithic and Multiplied Reinforcing Plates, Metal Lath, Roofing, Eaves Trough and Conductor Pipe, and Sheet Metal Building Products of All Kinds.

Export Department, 11th Ave. & 22d St.,
New York, N. Y.

"American"

Pressed Metal Sash Pulleys

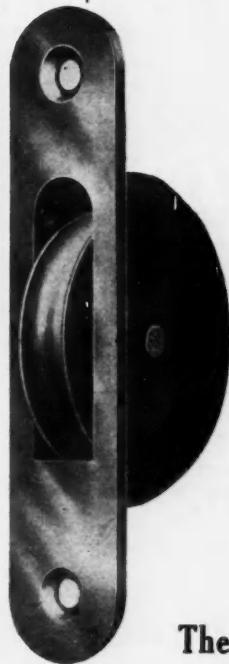

are specified by architects because of their endurance, smoothness of operation, and economy.

Plain, ball bearing, and roller bearing axles. Face plates lacquered, plated, or of solid brass or bronze to match any hardware. Combination groove for cord or chain. Non-rusting and guaranteed.

Write for Catalog

The American Pulley Company

PHILADELPHIA
BOSTON

NEW YORK
CHICAGO

Stocked and Sold by Dealers

Highest in Quality and Design

Lowest in Price



METAL CEILINGS SHINGLES TILE

Our "Safe-Lock" Shingle is a Wonder of Perfection
Write for Sample

The large number of exclusive and beautiful designs enables you to make a quick and appropriate selection for any of your buildings.

Our Metal Ceilings, Metal Shingles and Metal Roofing Tile are of the very best material. You can make no mistake in selecting from our stock. We guarantee satisfaction.



Prices are very low. We employ no travelling salesmen. We cut down expenses and give you the benefit in lowered prices. When you order from us, you get the very best the market offers at prices lower than you will find elsewhere.

Prove this for yourself. Send for catalog and prices now.

THE CANTON METAL CEILING CO.

1947 Harrison Ave.
CANTON, OHIO



"Opportunities"

Have you anything to Sell, Barter or Exchange,
Want Help, Agents, or a Situation? Use our

Classified Department

RATES 5 CENTS A WORD. CASH WITH ORDER

No Display Type Allowed in Classified Advertisements

Patents

U. L. PARKER, PATENT ATTORNEY. Formerly member Examining Corps, U. S. Patent Office, 920 G. St., Washington, D. C. Pamphlet of instructions sent upon request.

PATENTS THAT PROTECT AND PAY—Books free. Highest references; best results. Send sketch or model for free search. **Watson E. Coleman, Patent Lawyer, 622 F St., Washington, D. C.**

Instruction

DRAFTSMEN'S, BUILDERS' AND FOREMEN'S COURSES—Day, evenings or by mail. **MAAOK'S ACADEMY OF ARCHITECTURE, 1742 Chouteau Ave., St. Louis, Mo.**

Wanted

WANTED—Agents to handle our line of Order-Made Window and Door-Screens, for new buildings, as a specialty or a side line. Write **STANDARD SCREEN CO., 1850 Hastings St., Chicago, Ill.**

AGENTS WANTED for house lighting machines, supplying gas for small country homes as well as large. Simple and economical. Guaranteed. A live proposition. Write for terms. **THE ALEXANDER F. MILBURN CO., Baltimore, Md.**

WANTED—Second-hand block machine. Hobbs preferred. **B. E. VANHORN, Munith, Mich.**

WANTED—A carpenter or contractor in every locality to act as silent agent for an article of merit. No canvassing, no experience. This will be of interest and profit. Address Box 425, care of American Carpenter and Builder, 1827 Prairie Ave., Chicago, Ill.

For Sale

FOR SALE—Concrete and mortar mixers of all kinds, batch or continuous, new or second-hand. What is your preference? Warehouses in all principal cities. Also cement block and brick machines, any kind. Real bargains. **CONCRETE MIXER & MACHINERY EXCHANGE, 29 Broadway, New York City.**

Miscellaneous

CABINET MANTELS direct to builder, \$3.00 to \$40.00. **AMERICAN MANTEL TILE & GRATE CO., Hamilton, Ohio.**

FREE—\$1.00 Certificate and 4-inch rule. See Ad Page 143. **GAGE TOOL CO., Vineland, N. J.**

AGENTS—500 per cent profit; free sample. Our new gold and silver sign letters for store fronts and office windows. Easily applied. Big demand everywhere. Write today for liberal offer to agents. **METALLIC LETTER CO., 447 N. Clark, Chicago.**

ATTENTION, WOODWORKERS!—Replace broken plane handles with "Manga-alloy." Lighter than wood; non-breakable. Satisfaction guaranteed. Prepaid, 50 cents. **FULTZFOLK CO., 1304 Hendricks, Anderson, Ind.**

THE UNIVERSAL PITCH GAUGE is the simplest and most complete tool ever devised for roof-framing. With this Gauge a beginner—even a boy—can mark more framing in less time than the best expert can WITHOUT it. Gives 22 lengths, bevels, etc., for 100 pitches. Any pitch in five minutes. Hundreds of irregular hip rafters. Octagon hips and jacks, etc. Two Gauges, making a perfect Stair and Brace Gauge. Prepaid for \$1.00. Money back, if returned. **JOHN PARKHILL, Rochester, Minn.**



Pullman Ventilating Cowls

are the best exhaust medium on the market. Provide for removing the foul air by using Pullman Cowls on the roof. Write for booklet. Ask us to solve your Ventilating problems. The Pullman System means Natural Ventilation.

Pullman Automatic Ventilator Mfg. Co., 21 York St., York, Pa.

NEW WAY TO BUILD—SAVE 16%

You can have the same house or building and still save from 16% to 20%. Hundreds of homes already built by this new method. "The Economics of Home Building" shows how to save money, time and waste; complete in four parts; sent prepaid for \$1.00. Satisfaction guaranteed or money refunded.

BUILDING ECONOMICS, Dept. C. Far Rockaway, N. Y.

THE IDEAL WAY TO BUILD

Use a Van Guilder Hollow Wall Concrete Machine

It builds double monolithic walls tied together and steel reinforced. Continuous air space, dry, warm, sanitary, fire proof, age proof, repair proof. Better than brick, cheaper than wood.

Large illustrated Catalogue and Book "How to Build" free.

VAN GUILDER HOLLOW WALL CO.

720 Chamber of Commerce Building ROCHESTER, N. Y.

Triumph Light

EVERYBODY WANTS BETTER LIGHT. HERE IT IS



This new 100 to 700 candle power light turns up and down like gas. One-third cost of electricity, gas or kerosene. For home, church or store. Anyone can operate. Perfection guaranteed or money back. Write for catalog (A. C. B.) Dept. 20. Agents Wanted. **BRILLIANT GAS LAMP COMPANY, 1009 S. Wabash Av., Chicago, Illinois**

BYERS

HOISTING ENGINES

Specially Designed for Builders

Write for Catalogue No. 20

The John F. Byers Machine Co. Ravenna, O.

"As Near Rust Proof as Metal Can Be Made—"

PEARL
WIRE CLOTH

Insist upon the genuine. Look for the 2 Copper Wires in the Selvage.
THE GILBERT & BENNETT MFG. CO.
Chicago; New York; Georgetown, Conn.; Kansas City

Use Webster's Elastic Cement

For Bedding Slate, Pointing Wood, Stone, Brick and Iron for Waterproofing and for Setting Glass.

Write for Prices

W. F. Webster Cement Co., Cambridge, Mass.
Established 1848

THE ZIMMERMAN IRON BASE

is the ONLY BASE having a CENTER BEARING.

It carries the required weight without allowing the corner supports to sink into the floor and prevents the base of column and floor from rotting.

See "SWEET'S" page 958.

S. CHENEY & SON, MANLIUS, N. Y.



Bottom View Showing Center Bearing



The Eau Claire Chalk Line Reel

Always ready; holds chalk and line together; uses solid chalk, no powder. We furnish no line. Sent to any address prepaid, 75c. We handle Eau Claire chalk. Agents wanted.

THE MILLER-LAUT CO., 916 Monomonia St., Eau Claire, Wis.

8 Grape Vines, 6 Currant Bushes \$1

All best 3 year old stock. If planted now or early spring will fruit next summer. Should ground be frozen we tell you how to protect and keep them dormant ready for early spring planting. Orders accepted now and forwarded at any future time if preferred. Grapes are Worden, Niagara, Iona, Concord, the best early, medium and late varieties. Large cherry currants. Write for list of our \$1 Friend Makers, consisting of all kinds of Fruit Trees, Berries and Roses.

The Landscape Garden Co., Newburgh, N. Y.

ROOFING SLATE

OF QUALITY

MINERS

MANUFACTURERS

The AULD & CONGER Co.

DEPT. B.

ESTABLISHED

CLEVELAND, OHIO.

1870

A SHINGLING HATCHET

WITH POSITIVE GAUGE

CARPENTERS and BUILDERS

Here is a hatchet you can do some fast shingling with—No. 144 (oval head, 169 points.) Gauge is positive—it cannot slip. Clamps on with screw, gauge is readily changed. This hatchet is also made with flat head No. 44, 81 points, milled. Price of either is \$1.75 prepaid.

We make a complete line—and the best—of Lathing Hatchets, from 64 to 225 points. Prices \$1.40 to \$1.75. You get your full money value in a Sayre Shingling or Lathing Hatchet. You can be positive of that. Find them at your dealers or send direct.

L. A. SAYRE & SON

8 Oliver St.

Newark, N. J.



DON'T ORDER

Lignine (Wood) Carvings

UNBREAKABLE—INVESTIGATE

Send postal for free sample and catalog. One cent investment, saves dollars. Let us prove this.

ORNAMENTAL PRODUCTS COMPANY
Fourteenth Avenue, Detroit, Mich.

CYPRESS

(OF COURSE)

BECAUSE IT'S "THE WOOD ETERNAL" & LASTS & LASTS & LASTS & LASTS

ONLY SELF-SETTING PLANE

Sent on trial as per circular

Our \$1.00 certificate if you mention this paper.

GAGE TOOL CO.

Vineland N. J.



SLATE WE HAVE WHAT YOU WANT

In Roofing Slate. Slate Blackboards

Structural and Plumbers' Slate

SATISFACTION GUARANTEED IN QUALITY AND PRICE

ASK FOR DELIVERED PRICES

J. K. HOWER, Station, C., Slatington, Pa.

R. J. KICHLINE, Sales Agent

Delivered to you FREE on Approval and 30 Days Trial

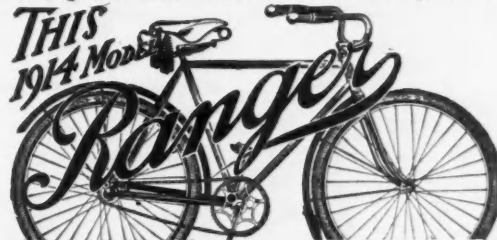

SEND NO MONEY but write today for our big 1914 catalog at prices so low they will astonish you. Also particulars of our great new offer to deliver you a Ranger Bicycle on one month's free trial without a cent expense to you. It's absolutely genuine.

BOYS you can make money taking orders for bicycles, tires, lamps, sundries, etc. from our big handsome catalog. It's free. It contains "commission offers" for re-fitting your old bicycle like new at very low cost. Also much useful bicycle information. Send for it.

LOW FACTORY PRICES direct to you. No one else can offer such values and such terms. You cannot afford to buy a bicycle, tires or sundries without first learning what we can offer you. Write now.

MEAD CYCLE CO., Dept. W-122, CHICAGO, ILL.



Send us two or more names of persons who are interested in or want to buy Hot Water Heating Plants and we will send you this scale. Back inches are divided into 6, 10, 12, 20, and 40 parts. Also free catalog on request. Mention this paper.

Andrews Heating Co., 1431 Heating Bldg. Minneapolis, Minn.

Note these 4 giant reasons for Flex-a-Tile "Giant" Shingles



Asphalt from the Giant Rockies

We use a top-quality asphalt called gilsonite—mined from the depths of the *giant* Rocky Mountains. It cannot melt at a temperature less than 290° Fahrenheit.

This asphalt is entirely free from oil. To saturate it thoroughly with the pure wool felt core of the "GIANT" shingles we use a *great heat in melting* our saturation. No other roofing maker employs this process. Let us show you why it gives *indisputable proof* of the purity of our asphalt.

The Giant Quarries of Vermont Supply the Surfacings



Each Flex-a-Tile "GIANT" shingle has a beautiful, lasting surfacing of emerald or red. These are the natural colors of the slate and stone which we procure from the *giant* quarries of Vermont. It gives a handsomely colored surfacing to a Flex-a-Tile "GIANT" roof that *positively cannot fade, stain or run*; in fact, age only makes these colors more brilliant and attractive. Into both sides of the hot, rubbery, gilsonite-covered sheets, this slate or stone is compressed by *giant* rollers under tons of pressure.

Long, Strong, Giant Strands of Wool

For the base or core of each Flex-a-Tile "GIANT" Shingle, we use only the finest wool felt. For this, we pay the top market-price.



The long, strong, touch, *giant* strands of wool are carefully selected—they must be capable of taking a saturation of *twice their own weight* of high-melting, oil-free asphalt. And then after this saturation, they are again covered with asphalt and surfaced with the stone or slate.

Giant Machines and Giant Experience

The *giant* equipment with which we make these "GIANT" asphalt shingles is the finest that money can buy, the latest and most improved. If you could only see the *giant* machinery and the *giant* scale on which these shingles are made, you would realize what a really remarkable shingle this Flex-a-Tile "GIANT" is. And back of its success are men of trained brains with *giant* experience in roof-making.

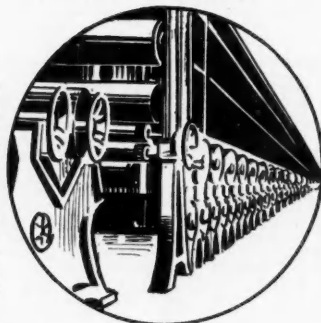

Let Us Send Your Specimen

Don't wait—write to us now for your specimen Flex-a-Tile "GIANT"; get actual proof of this shingle in your own hands. Remember it's 50% thicker, 50% heavier and 100% stronger than any asphalt shingle ever made. Write now and let us send you all the facts. No obligation.

THE HEPPE'S COMPANY

Manufacturers also of Asphalt Paint, Asphalt Roofing
in Any Finish and Utility—the only 5-ply Wall Board

1010 So. Kilbourne Avenue

Chicago, Illinois

INDEX TO ADVERTISEMENTS, JULY, 1914

	Page		Page		Page
Allegheny Steel Band Co.	32	Fox & Stanley	32	Oak Flooring Bureau	133
Aloe Co., A. S.	25	Fox Supply Co.	4	Ohio Tool Co.	20
Alpha Portland Cement Co.	95	Fultzfolk Co.	142	Ornamental Products Co.	143
American Bell & Foundry Co.	134	Gage Tool Co.	142-143	Orr & Lockett Co.	2
American Cement Machine Co.	10-16	Galesburg Sheet Metal Works	125-135	Oshkosh Mfg. Co.	3
American Elevator Co.	8	Galloway Co., Wm.	124	Parker, C. L.	142
American Floor Surfacing Machine Co.	4	Geier & Bluhm	25	Parkhill, John	142
American Mantel Tile & Grate Co.	142	Gem City Acetylene Generator Co.	105	Parks Ball Bearing Machine Co.	18
American Pulley Co.	141	Genuine Bangor Slate Co.	109	Pearson Mfg. Co.	30
American Saw Mill Machinery Co.	18	Gilbert & Bennett Mfg. Co.	142	Pennsylvania Saw Co.	131
American Sheet & Tin Plate Co.	106	Goodell Mfg. Co.	31	Phoenix Sliding Blind Co.	33
American Steel Scaffold Co.	136	Goodell Pratt Co.	28	Plastergon Wallboard Co.	109
Andrews Heating Co.	143	Gordon VanTine Co.	89	Prentiss Vise Co.	20
Archer Iron Works	15	Grand Rapids Hardware Co.	18	Progressive Mfg. Co.	26
Arkansas Soft Pine Mfrs. Assn.	97	Hall Holmes Mfg. Co.	15	Pullman Automatic Ventilator Mfg. Co.	142
Ashby, Geo. W.	130	Hardin Co., John	119	Queen Cupola Co.	123
Asphalt Ready Roofing Co.	107	Harley Davidson Motor Co.	124	Radford Architectural Co.	126-139-140
Atlantic Engine Co.	20	Hartmann Sanders Co.	136	Radke Mfg. Co.	132
Atlas Engineering Co.	15	Haven Mfg. Co.	4	Rehm Hardware Co.	29
Auld & Conger Co.	143	Hawthorne Sales Corp.	22	Reynolds Asphalt Shingle Co., H. M.	111
Automatic Sash Holder Mfg. Co.	8	Haynes Automobile Co.	101	Richards Wilcox Mfg. Co.	138
Automatic Sealing Vault Co.	121	Heitland Grate & Mantel Co.	129	Roberts Mfg. Co.	113
Bangor Slate Mining Co.	108	Helb, Edward	22	Robinson Mfg. Co.	121
Barnes Co., W. F. & Jno.	18	Henderson-Traylor Mfg. Co.	22	Rodgers & Co., R. M.	8
Barnett & Co., Jos. A. C.	17	Heppes Co.	113-144	Ross & Co., G. M.	133
Bates & Edmonds Motor Co.	133	Herrick Refrigerator Co.	122	Samson Cordage Works	134
Beckmann Co., The L.	24	Hess Warming & Ventilating Co.	118-127	San-A-Bestos Products Co.	147
Berger Mfg. Co.	125-136-141	Hewitt-Lea-Funck Co.	91	Sand & Sons, J.	117
Bird & Sons	93	Holland Furnace Co.	119	Sasgen Derrick Co.	12
Bishop & Co., Geo. H.	31	Home Lumber & Supply Co.	32	Sargent & Co.	34
Blystone Mfg. Co.	9	Honeywell Heating & Specialty Co.	98	Sayre & Son, L. A.	143
Bommer Bros.	36	Hornet Mantel Co.	129	Schlueter, M. L.	5
Bostwick Steel Lath Co.	125	House Movers Supply Co.	24	Sedgwick Machine Works	8
Bovee Furnace Works	127	Hower, J. K.	143	Seippel Lumber Co., P. J.	123
Bowers & Sons, F. M.	125	Huber Builders Material Co.	109-129	Shapleigh Hardware Co.	28
Boyle Co., John	137	Hurley Machine Co.	4	Sharon Hardware Mfg. Co.	36
Bradt Publishing Co.	128	Hussey & Co., C. G.	128	Shelby Spring Hinge Co.	22
Bragstad Concrete Machinery Co.	10	Huther Bros. Saw Mfg. Co.	30	Sheldon Slate Co., F. C.	111
Brilliant Gas Lamp Co.	142	International Correspondence Schools	135	Sherman Mfg. Co., H. B.	28
Buck Bros.	27	Irwin Auger Bit Co.	114	Shultz All Steel Corner Post Co.	137
Buffalo Wire Works Co.	136	Ives Co., The H. B.	123	Sidney Elevator Mfg. Co.	8
Building Economics	142	Jaeger Machine Co.	9	Sidney Tool Co.	19
Building Material Exhibit	99	Jahant Heating Co.	134	Simmons Hardware Co.	115
Byers Machine Co., John F.	142	James Mfg. Co.	135	Simonds Mfg. Co.	34
Cabot, Samuel	36	Jennings & Co., C. E.	6	Sioux City Engine & Machinery Co.	10
Caldwell Mfg. Co.	29	Johns Manville Co., H. W.	94-104	Slatington Slate Co.	111
Campbell Mfg. Co.	124	Johnson, E. J.	26	Smith, Harry A.	116
Canton Foundry & Machine Co.	127	Karol, B. B.	127	Smith & Hemenway Co.	33
Canton Metal Ceiling Co.	141	Kaustine Co.	120	Smith Co., The T. L.	13
Carborundum Co.	30	Keasbey & Mattison Co.	107	Southern Cypress Mfrs. Assn.	143
Cement Tile Machinery Co.	9-10-12	Kees Mfg. Co., F. D.	31	Southington Hardware Co.	119
Century Cement Machine Co.	103	Keighley Metal Ceiling Co., S.	133	Speidel, J. G.	8
Ceresit Waterproofing Co.	102	Kissel Motor Co.	100	Stamping & Tool Co.	123
C. & E. Mfg. Co.	108	Klauer Mfg. Co.	141	Standard Mfg. Co.	30
C. H. & E. Mfg. Co.	21	Knickerbocker Co.	12	Standard Paint Co.	5
Champion Safety Lock Co.	5	Kolesch & Co.	25	Standard Scale & Supply Co.	14
Chappell Co., Wayvell.	4	Landescope Garden Co.	143	Standard Screen Co.	138
Chelsea Elevator Co.	8	Leavitt Mfg. Co.	119	Standard Stained Shingle Co.	107
Cheney & Son, S.	143	Lufkin Rule Co.	20	Stanley Rule & Level Co.	32
Chicago Grille Works	138	Maaeks Academy of Architecture	142	Stanley Works, The	115
Chicago Machinery Exchange	21	Mack & Co.	27	Starch Bros. Co.	17
Chicago Millwork Supply Co.	121	Mack Iron & Wire Works Co.	132	Starrett & Co., L. S.	26
Chicago Spring Butt Co.	36	Majestic Furnace & Foundry Co.	127	Sterling Foundry Co.	119
Chicago Technical College	127	Mastic Wall Board Rfg. Mfg. Co.	146	Storm Mfg. Co.	8
Chief Draftsman	125	Mayes Bros.	117	Swan Co., Jas.	22
Cincinnati Fly Screen Co.	20	Mead Cycle Co.	143	Swarts, H. D.	123
Cincinnati Tool Co.	22	Metallic Sign Letter Co.	142	Sykes Metal Lath & Roofing Co.	137
Coleman, Watson E.	142	Michigan Gas Appliance Co.	132	Syracuse Twist Drill Co.	134
Colgan Machinery Co.	27	Midland Terra Cotta Co.	90	Taylor Mfg. Co., Jas. L.	6
Columbia Iron & Wire Works Co.	128	Milburn Co., Alexander	142	Thomas & Armstrong Co.	111
Concrete Mixer & Mach'y Exchange	142	Miles Mfg. Co.	12	Triple A. Machine Co.	7
Conklin Construction Co.	105	Miller-Laut Co., The	143	Trussed Concrete Steel Co.	132
Cook & Co., H. O.	5	Miller Mfg. Co., A. W.	20	United Electric Co.	125
Cortright Metal Roofing Co.	96	Miller Lock Co.	31	Universal Clothes Drier Co.	6
Crescent Machine Co.	23	Millers Falls Co.	24	VanDoren Mfg. Co.	27
Dahl Mfg. Co.	27	Milwaukee Corrugating Co.	138	VanGuilder Hollow Wall Co.	142
Deal-Rice Lumber Co.	103	Miotke, Jos.	6	VanHorn, B. E.	142
Decatur Coffin Co.	27	Moeschl-Edwards Corrugating Co.	111	Warner Elevator Mfg. Co.	8
Detroit Show Case Co.	24	Moorman & Otten Co.	129	Warren Knight Co.	25
Diamond Metal Stamping Co.	112	Morrill, Chas.	36	Warren Profile Co.	137
Didrikson, H. P.	5	Mullins Co., The W. H.	122	Waterloo Cement Machinery Corp.	11
Disston & Sons Co., Henry	29	Myers & Bros., F. E.	27	Waterloo Register Co.	119
Dixon Crucible Co., Jos.	6	National Kellastone Co.	109	Weber Mfg. Co.	143
Dow Wire & Iron Works Co.	132	National Lead Co.	105	Webster Cement Machine Co., W. F.	143
Dunn & Co., W. E.	16	National Mfg. Co.	148	Wells Lumber Co., J. W.	29
East Bangor Consolidated Slate Co.	20	Nicholls Mfg. Co.	16	White Co., David	25
Edwards Mfg. Co.	110	Nickerson Mfg. Co.	129	White Co., L. & I. J.	33
Elite Mfg. Co.	29	North American Construction Co.	105	Williamson Heater Co.	122
Ellis Engine Co.	117	North Bros. Mfg. Co.	33	Willis Mfg. Co.	135
Enterprise Iron Works	119	Northern Hemlock & Hardwood Mfrs. Assn.	121	Witte Iron Works Co.	123
Erie Clutch & Pulley Co.	28	Northfield Iron Co.	10	Wolff Mfg. Co., L.	134
Eureka Machine Co.	115	Northwestern Compo-Board Co.	113	Woodwell Co., Jos.	31
Fairbanks, Morse & Co.	131	Northwestern Expanded Metal Co.	126	York Automatic Dumbwaiter Co.	8
Flintkote Mfg. Co.	92	Northwestern Steel & Iron Co.	115-117		
Foos Gas Engine Co.	131				
Foster Sheet Metal Works	111				
Fox Machine Co.	17				

NOTICE TO ADVERTISERS

Forms for the August number of the American Carpenter and Builder will close promptly on July 20. New Copy, changes and orders for omissions of advertisements must reach our business office, 1827 Prairie Ave., Chicago, not later than the above date. If new copy is not received by the 20th of the month preceding date of publication the publishers reserve the right to repeat last advertisement on all unexpired contracts.

AMERICAN CARPENTER & BUILDER CO.

Built by
John J.
Randall Co.
Real Estate
and Builders,
Freeport,
L. I.,
New York



Bishopric
Stucco
or Plaster
Board
Used on this
Building

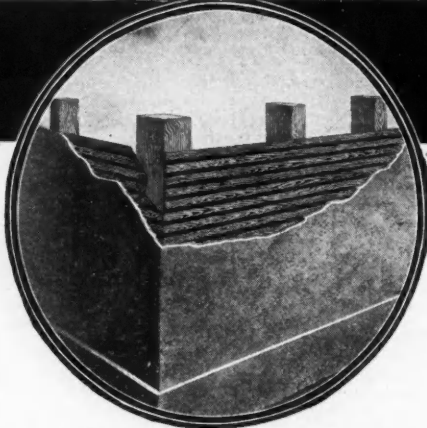

Bishopric Stucco or Plaster Board Nailed to Studding and Stucco Applied to Stucco Board

Durability is the Keynote of All Good Building

John J. Randall Company used Bishopric Stucco or Plaster Board on the house illustrated above to their entire satisfaction. The testimonial below is only one of the hundreds received proving our claims of the superiority of Bishopric Stucco or Plaster Board over all other plaster board.

Read This Letter

TEWS LIME & CEMENT CO. Freeport, N. Y., March 11, 1914.
Mr. Frank Piphorn, 895 Buffum Street, Milwaukee, Wis.
Dear Sir: We have used Bishopric Stucco Board on two houses which we have built during the past fall and winter. We are very well satisfied with the board, and think that it is superior to any metal-lath which can be used. The house which is completed has stood during the winter, and shows no effects whatever from either heat or cold. There are no cracks, nor any signs of dampness.

Yours very truly,
JOHN J. RANDALL COMPANY,
By E. S. Randall, Treasurer.

Mr. Builder: Investigate the merits of Bishopric Stucco or Plaster Board. You cannot help but be convinced of the simplicity, economy and practicability of Bishopric Stucco or Plaster Board. Note carefully the application of Stucco on Bishopric Stucco or Plaster Board in circular illustration. Then study the diagram below and you will begin to really appreciate the great superiority of Bishopric Stucco or Plaster Board.

Bishopric Stucco or Plaster Board makes plaster and cement walls *permanent*—they can't crack, crumble or disintegrate when this time-defying stucco board is used. For five long years we have tested Bishopric Stucco or Plaster Board. *Every test* that a score of building experts know has been



"Dampness Can't Penetrate"

used upon it and it has *always* "stood up"—*always* made good. Its recent introduction and service already rendered have won it hundreds of friends. It will win you, once you investigate and know its many merit points over other backgrounds.

You can recommend and use Bishopric Stucco or Plaster Board without

the slightest hesitation or fear of endangering your reputation. We guarantee Bishopric Stucco or Plaster Board to be as represented.

Don't delay—write today for free samples and free handsome illustrated book, just out, "Durable Homes by the Bishopric System." Contains *latest* information on stucco work. Every builder should have a copy. Get yours *now*.

THE MASTIC WALL BOARD AND ROOFING COMPANY, 530 Este Ave., Cincinnati, Ohio
CENTRAL DOOR AND LUMBER CO., Portland, Ore., Licensed Manufacturers and Distributors for Pacific Slope

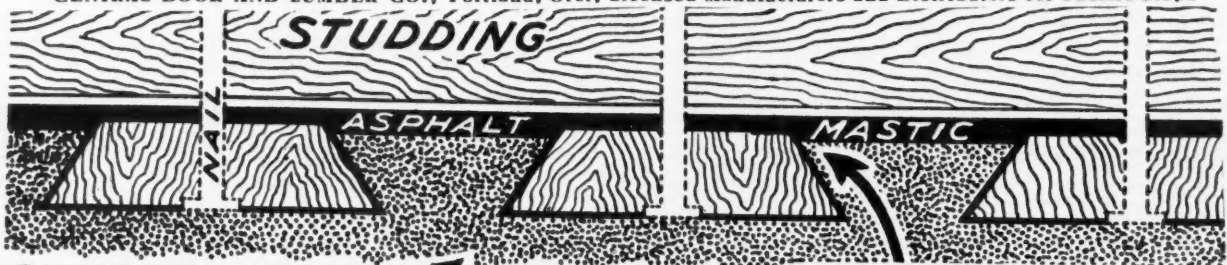

STUCCO FINISH →

NOTE THE UNDER-CUT—THIS IS THE KEY THAT MAKES STUCCO STICK



SAN-A-BESTOS

Flooring and Stucco

Looks and Wears Like Stone
Means Safety First and Always



REDUCES INSURANCE RATES

SAN-A-BESTOS reduces insurance rates simply because it CAN'T burn. It is really *Fireproof* and *Damp-proof*. It is composed entirely of absolutely fireproof materials.

IT WILL NOT CRACK

SAN-A-BESTOS will neither scale, crack nor chip under any conditions. It is the one STUCCO and FLOORING MATERIAL that will meet every demand made upon it.

ADDS BEAUTY

SAN-A-BESTOS is an ideal exterior stucco, as it lends itself to any number of artistic finishes. Its colors are absolutely permanent.

EQUALS TILE OR MARBLE

SAN-A-BESTOS flooring embodies all the good features of tile, terrazzo and marble at a fraction of their cost. Unlike them, San-A-Bestos is resilient, easy and quiet to walk on.

FIRST COST ONLY COST

There is no upkeep cost to SAN-A-BESTOS. It never requires painting. It is easily cleaned. We have a splendid material that is adaptable for buildings of all kinds. Let us send you other information.

CONTRACTORS: HERE IS YOUR OPPORTUNITY TO GET A REAL LIVE MATERIAL FOR YOUR CLIENTS.

Write Us Today

SAN-A-BESTOS PRODUCTS CO.

Waukegan, Illinois



"BIG 4" HANGERS

for

Sliding Doors

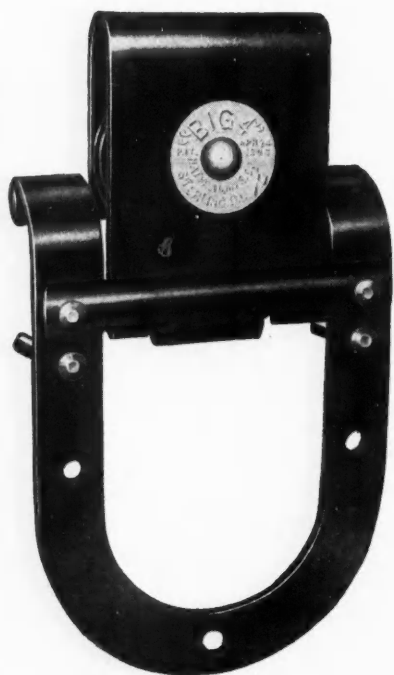

Patented April 24, 1906.
Front View, "Big 4" Hanger

Are easy to attach, and once in position they cannot jump the track and can only be removed at the end of the rail.



View of
"Big 4" Hanger,
showing
flexible feature

When the door hangs straight down, the hanger is rigid and does not swing in the wind. The hinged-joint permits the door to swing out should anything bump against it.

Wheels have roller bearings, and all exposed parts are galvanized to prevent rust. Thousands of them are in use and giving perfect satisfaction.

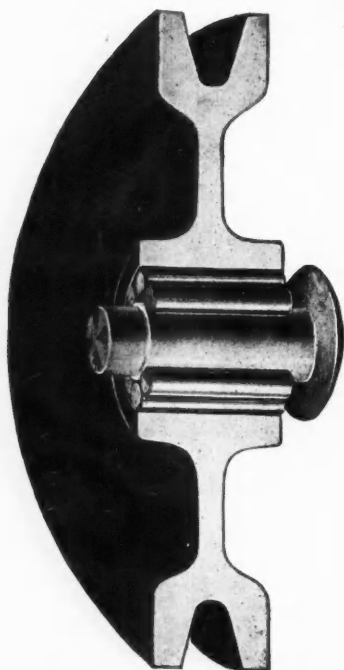

Sectional View of Axle
and Bearings

Braced Rail

Braced Rail is made of $1\frac{1}{4}$ " x $\frac{3}{16}$ " steel with brackets of the same stock. A lug is turned down which rests against the side of the building and acts as a brace, giving at least one-third more strength. The rail is furnished in 4, 6, 8 and 10 foot lengths.



Free Booklet. Write for booklet "Sliding Barn Door Equipment." It has some valuable information every "live" contractor should have. Do it today.

MADE BY

NATIONAL MFG. CO., Sterling, Ill.