

MARCH 1915

AMERICAN CARPENTER AND BUILDER

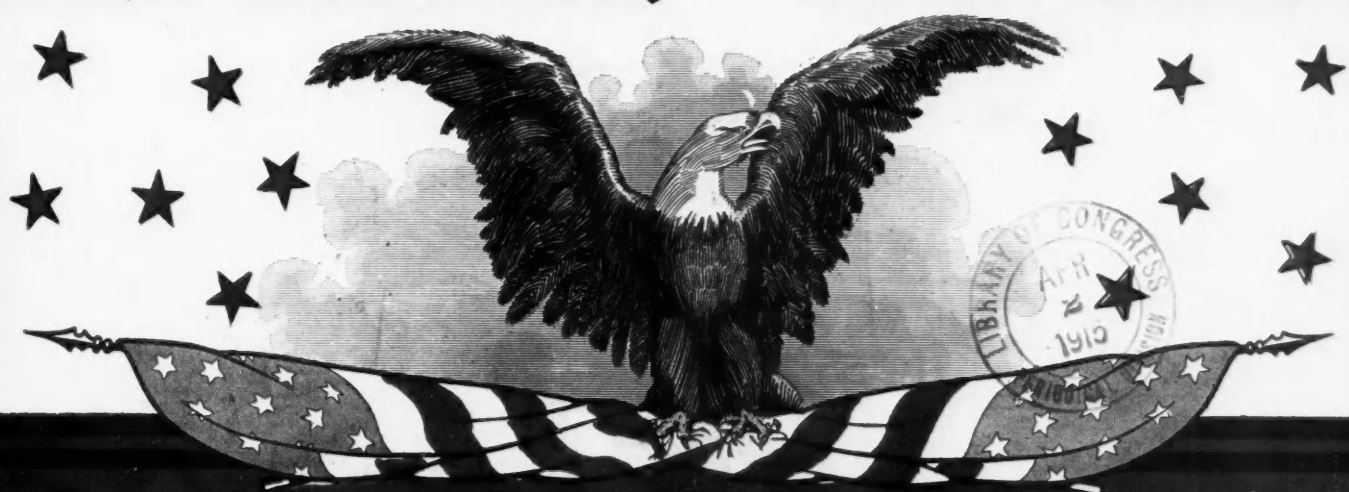

THE WORLD'S GREATEST BUILDING PAPER



Rural
Improvements

Price 40 Cents

The LOWEST PRICED HIGH QUALITY MIXER

All we ask you to do is to read over the specifications given below— they're more eloquent than reams of praise— then write and let us tell you more. Let us give you a price that will open your eyes.

Sold on
Ten
Day
Trial

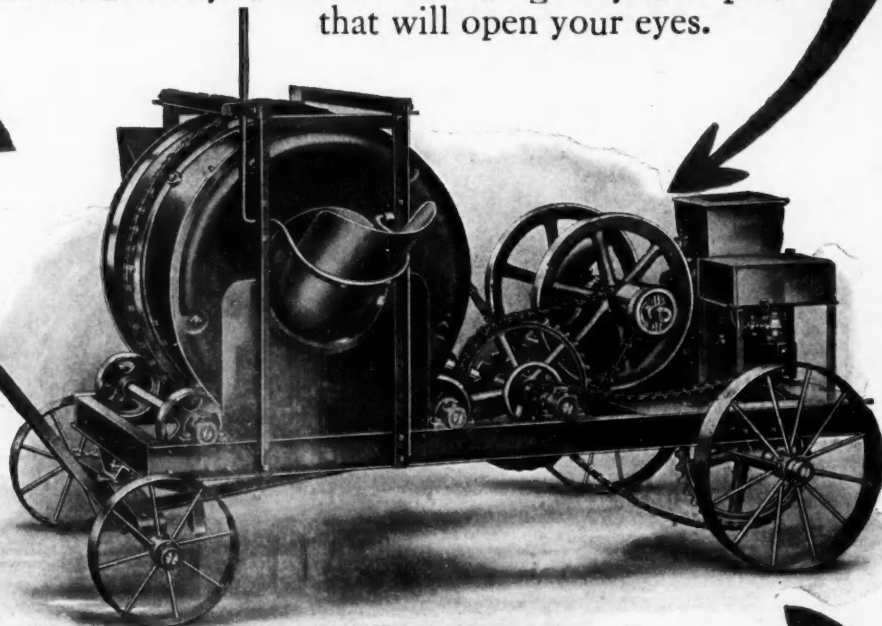

THE NATIONAL

Drum—Capacity, 5 cubic feet unmixed material (34x32 in.), semi-steel cast heads, steel center, steel blades raised off drum.

Power—4-h.p. National Engine, standard equipment. Novo Engine furnished if desired.

Drive—Special chain through National Clutches.

Wheels—Steel, 24x12 in., on 1½-in. steel axles.

Hopper—Standard charging batch and side loader.

Traction—On rear wheels, controlled by jaw and National Clutches.

Steel Construction throughout, etc.

This mixer is sold on a straight 10-day trial. You can't make a mistake. We have just issued a complete folder describing and picturing this mixer in detail. They're free.

You can buy this mixer through your hardware dealer, your supply house, or direct from us.

NATIONAL MIXER COMPANY
200 SIXTH ST., OSHKOSH, WISCONSIN



One Machine Nine Operations

WE'LL be glad to give you the names of those who are using the "Eveready" Saw Rig--the one machine that performs nine duties and does them all well--the machine that lives up to its name--

The Eveready Saw Rig

It Cross-Cuts,
Rip-Saws,
Joints, Sands,
Jig-Saws,
Grooves, Bores,
Mitres and
Grinds Tools

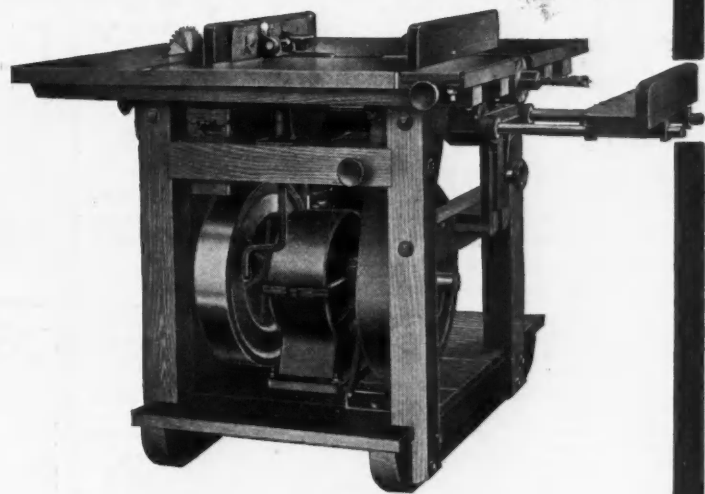

Saves the Wages of Six Men

We would like to submit to you the proof of this statement: "Every day you operate without investigating the merits of the Eveready Saw Rig you are doing your pocket-book an injustice." We would like you to know, among other things, what users of the Eveready think of it--men who have paid out their good hard money for it.

Our Big Free Book will be sent you for your name and address on a postal.



OSHKOSH MFG. CO.

316 1/2 S. Main Street

::

OSHKOSH, WISCONSIN

**Ford's System Adopted
In Packard Mixer Factory
Mixer Prices Smashed**

**THE BIG HIT
AT
CEMENT SHOW**

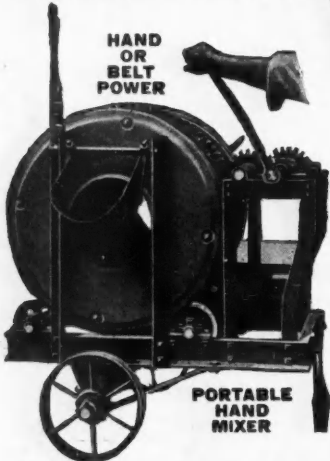

HAND
OR
BELT
POWER

PORTABLE
HAND
MIXER

OWNERS SAY:

S. W. Hill & Son, Minn., say: Mixes fast and thoroughly. Everybody likes the mixer. Batch hopper measures fine, etc.

W. H. Borough, Ohio, says: We investigated all mixers; glad we bought the Packard. 3 H. P. engine a success. Cut mixing cost 30%, etc.

HUNDREDS OF OTHER LET-TERS, NAMES, ADDRESSES, ETC. ON APPLICATION.

**FIVE-FOOT
CAPACITY—
UP TO 65
YARDS DAILY**

**SAME MIXING
ACTION AS
\$2000 PAVER**

Packard SPEED QUALITY
HAND AND POWER MIXER **STURDY** LOW CHARGING
POWER MIXER

**VOLUME
BUSINESS**

OUR EXPERIENCED WORKMEN USING SPECIAL MACHINERY, JIGS AND TEMPLATS, TURN OUT HUNDREDS OF PARTS, FAST BUT ACCURATELY.

MIXER BUYERS! PROFIT BY OUR REDUCED FACTORY COSTS. AT LOWEST PRICES EVER MADE YOU GET A COMPACT STEEL MIXER, WITH A 3 H. P. ENGINE.

COMPARE SIZE ENGINES WITH OTHERS.

\$275 Steel Trucks-3 H.P. Engine-Steel Housing-All Steel Loader.

50 MORE BATCHES A DAY WITH SAME CREW



HINGED
LOADING
PLATFORM
EXTRA

SEMI-STEEL
GEARS

\$185

**BUYS
MIXER**

ON STEEL TRUCKS, 3 H. P. ENGINE, STEEL HOUSING, LOW BARROW HOPPER. READY TO OPERATE.

MEASURING BATCH HOPPER OR HOISTING ATTACHMENT CAN BE PUT ON ABOVE MACHINE AT SMALL EXTRA COST.

FULLY GUARANTEED—SOLD ON TRIAL—CASH OR EASY PAYMENTS.

WRITE FOR OUR SPECIAL PROPOSITION.

STOCKS CARRIED IN ALL PRINCIPAL CITIES.

**CONTRACTORS MACHINERY CO.
105 ELEVENTH ST., KEOKUK, IOWA**

BLYSTONE BATCH MIXER

FOR

Plaster, Mortar, Concrete

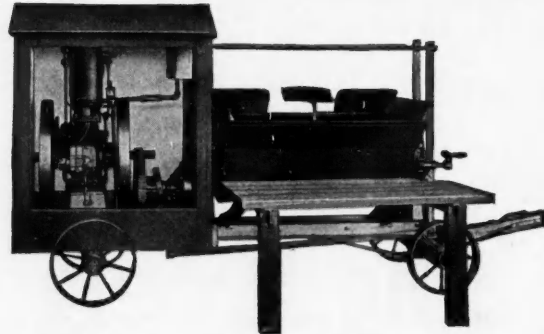

This Machine saved \$25 per day for the contractor who plastered the Detroit Athletic Club's new building.

In addition to mixing hardwall plaster it will also mix perfectly, under all conditions, concrete or brick mortar.

The Blystone will soon pay for itself in any mixing operation. It will be found in hundreds of concrete products plants and contractors' equipments. We'll tell you which of your neighbors has one. There are different sizes and styles, but all have the patented Blystone Reverse Spiral Principle of mixing.

Put your mixing problems up to us. We can solve them for you. Write for catalog today.

Blystone Manufacturing Company
315 Carpenter St., Cambridge, Springs, Pa.

**Why
Pay
More?**

\$100 buys a regular Builders' Mixer that's reliable for all block, brick, foundation or sidewalk work.

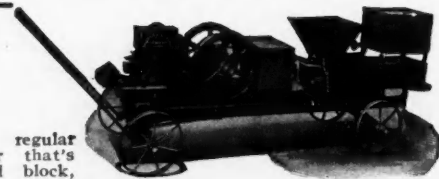

SIMPLEX JUNIOR MIXER

Is the best ever sold at the price. Perfect in every way. Economical and mixes thoroughly. Low-charging—Labor-saving. Top of hopper is only 2 feet from ground when mixer is on skids. Easily hauled around.

On Trucks With Engine, \$100. On Trucks Without Engine, \$55.
On Skids Without Engine, \$35.

The SIMPLEX Is Sold At Your Price. Guaranteed.
FREE TRIAL OFFER. Write Us Today.

WESTERN MFG. CO., Oskaloosa, Iowa
We Manufacture All Types of Mixers, also Culvert Forms.

FROSTPROOFING

The latest and greatest discovery for the contractor and builder. A material that prevents freezing of Concrete, Mortar, Plaster, Whitewash, etc. Tested by experts and prominent contractors and pronounced O. K.

A small amount mixed with the cement or lime keeps it from freezing, prevents rusting of forms or reinforcing, and makes stronger concrete. Can be used in the coldest weather with absolute success.

Get the cold weather prices while the warm weather fellow does the loading. Complete your concrete jobs now instead of allowing them to hang over.

15-lb. sample bags \$1.00 each, f. o. b. factory. 100-lb. sacks carried at all warehouses.

Get posted on this newest and greatest discovery which enables concreting the year around.

LANSING COMPANY,

Lansing, Mich. LE ROY, N. Y.
Warehouses: New York, Boston, Philadelphia, Kansas City, Minneapolis, Chicago, San Francisco.

THIS STURDY ONE BAG SIZE MIXER COSTS NO MORE THAN YOU'VE PAID FOR HALF BAG MIXERS

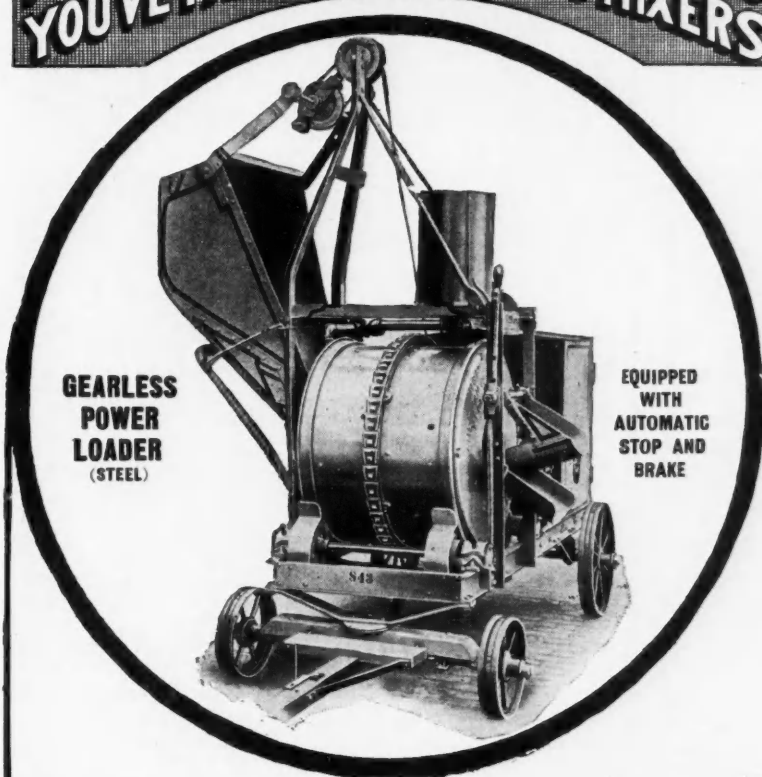

GEARLESS POWER LOADER (STEEL)

EQUIPPED WITH AUTOMATIC STOP AND BRAKE

OIL ONCE A WEEK



SAVES 17% OF POWER

AN EXCLUSIVE IMPROVEMENT ON THE 1915

"Light Weight" BOSS Steel King Mixer

BUILT OF STEEL

Weights One-half Ton Less, yet has 30% More Strength than the Old Cast Iron Mixers

WHY PAY \$200 TO \$350 MORE?

You get in BOSS Mixers for LESS MONEY the same reliable engines (Novo or Ideal) with MORE POWER. Same REMIX MIXING ACTION and general design as other well-known quality mixers of Boss type, plus Steel Construction and HYATT ROLLER BEARINGS.



EXTRA HOIST ATTACHMENT

Can be furnished on this mixer for hoisting concrete, mortar, brick or lumber.

CHEAPEST MANUFACTURING POWER

From 200,000 H. P. Keokuk Dam—plus Modern Factory—Experienced Organization—Labor Saving Machinery—Big Output—have cut cost of building mixers nearly in two. *We pass the gain on to you.*

U. S. Government and hundreds of the largest engineers and contractors use BOSS Mixers. (Some own several of them.)

LOW CHARGING BARROW HOPPER HINGED LOADING PLATFORM

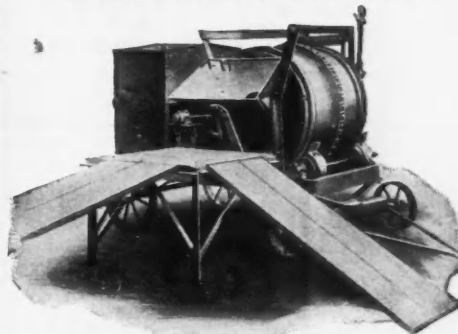

MANDT MORTAR PLASTER MIXERS

Does work of six men. Mixes lime mortar. Patent or hard plaster. Self cleaning.



BUILT IN THREE SIZES

6-Ft. Famous Little Boss	8-Ft. The Mixer that holds a bag (5-3-1)	10-12-Ft. Light Wt. Steamer
--------------------------	--	-----------------------------

GAS - STEAM - ELECTRICITY

This Mixer Backed by the Strongest Guarantee Ever Written

Sold on trial—cash or easy payments. Write for catalog.

AMERICAN CEMENT MACHINE COMPANY, INC.

1006 JOHNSON ST., KEOKUK, IOWA

Stocks carried in all principal cities.

LOW MEASURING BATCH HOPPER HIGH WHEELS FURNISHED





\$75.00 BUYS OUR FOOT POWER MIXER

Capacity up to four feet with one man.

\$100.00 BUYS OUR FOOT POWER MIXER

Capacity up to five feet with two men.

CASH OR TERMS: To save time just send the money. All machines fully guaranteed and are furnished with roller bearings throughout. The operator uses his bicycle muscles eliminating undue strain and distress produced by so-called hand mixers.

Write for prices on full line of power driven concrete mixers.

The Gem City Concrete Mixer Co., DAYTON, OHIO



The GREEN Interchangeable CONCRETE MIXER

Portable Power Equipment with interchangeable parts to fit, which will make any of the following machines, electric, steam or gasoline:

Green Saw Tables	Green Concrete Mixers
Green Mortar Mixers	Green Single or Double Dia- phragm Pumps
Green Centrifugal pumps	Green Rock Crushers
Green Power Hoists	Green Drag Saws
Green Circular Saw Rigs	Green Spray Rigs
Green Bulldozer Pumps	Green Feed Grinders
Green Portable Electric Light- ing Plants	Green Air Compressors

Write for prices on our combination machines. We have the greatest value for the least investment offered by any manufacturer.

THE GREEN CONCRETE MIXER CO.

Eastern Office, Box 127, Dayton, Ohio

Western Office, Box 395, Salt Lake City, Utah

The Knickerbocker 6 ft. Batch Mixer

With Hoisting Drum and Sheave for Silo Work



The Batch Hopper—Holds 6 ft. loose material and is low enough to easily shovel into.

The Hoisting Drum—Will carry 250 feet of cable.

The Power—A 3 H.P. Novo or Ideal Engine.

Transmission—Gear Drive Engine to Countershaft—Chain Drive Countershaft to Drum.

Trunnion Rolls—10 in. Dia.—Have Chilled Wearing Surface and Bronze Bushings.

Let these Points Soak in Before You Decide on Your Next Mixer

Write for Our 1915 Catalog

The Knickerbocker Co., Jackson, Michigan

How's Your Foresight?

When Thousands Talk Like This:—

"I have used several makes of mixers and find the WONDER absolutely the best I have ever seen."

Or:—"What you claim for the WONDER is true and I am recommending it very highly. We now have 40 WONDERS in constant service."

Or:—"The WONDER has proved all you claim and more too. I have seen lots of other machines, but none that equal the WONDER."

Or:—"My WONDER put out more work than a \$1,100 machine. I am very much pleased with it. Either one man or twelve can run it and it will keep all busy."

Or:—"Our two WONDERS cut our cost of mixing 65 per cent and have paid for themselves several times over."

Or:—"I own a WONDER, also three other mixers, and made a bad mistake in not buying all WONDERS."

*Isn't it the part
of Wisdom
to find out the
Reason for
such Universal
Endorsement?*



LITTLE WONDER "FIVE"

"The Mixer that Makes the Money"

Foresight is better than hindsight. The WONDER is the Original of its type. All others of this type are imitations—you don't want them at any price. Investigation of the WONDER now will save you many dollars and much disappointment later.

The WONDER is a perfected machine of strength, durability and economy, and so proved by more contractors than can be shown by any other ever produced. You can also prove it on your own work without obligation of any kind.

You can take it and TRY IT---with or without SIDE LOADER and in either 5 or 10-foot capacity per batch. Find out what WONDER Quality means to you. Don't let any "just as good" deceive you. Find out what WONDER Service means—co-operation beyond anything ever known in Mixer history.

Let us show you the reasons for WONDER Leadership—how your interests are safeguarded and how you can realize the largest dividends on Mixer investment.

TEN DAYS' FREE TRIAL
And Satisfaction or We Pay the Freight

Use Foresight now by sending for our new Catalog. Reserve your judgment until you know the reasons for immense WONDER sales and the magnificent endorsement. Let us show you the nation-wide confidence of contractors in our liberal proposition and how you can profit by their experience, thus eliminating all risk.

Waterloo Cement Mach'y Corp'n, 103 Vinton St., Waterloo, Iowa

Mfrs. Concrete Mixers, Traction Pavers and Contractors' Equipment

NEW YORK PHILADELPHIA INDIANAPOLIS CHICAGO SAN FRANCISCO Also 100 Agencies

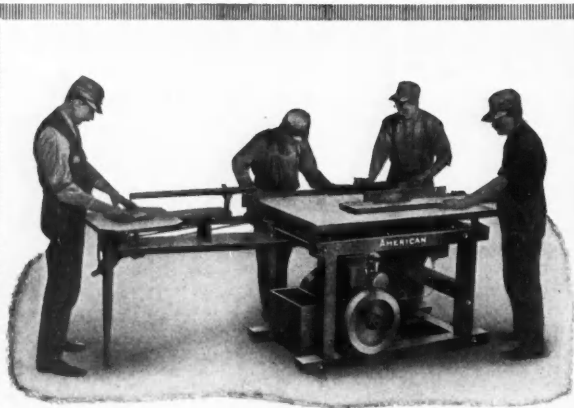

"Your machine is the only one I have ever seen that is built strong enough to stand up under the work it is expected to do."

This is what one contractor said about the

"AMERICAN" CONTRACTORS' PORTABLE VARIETY WOOD-WORKER

And he voiced the opinion of hundreds of users of these machines all over the country, who have found that the "American" is under-rated—in distinction from the many other similar machines which are much over-rated both as to power, capacity and endurance.

The fact is that our long experience as builders of wood-working machinery exclusively enables us to make the "American" Wood-Worker amply strong for the most severe duty, without excessive size and weight.

If you are buying a wood-worker as a permanent and profitable investment, the "American" is the machine you want.

Send for the "American" Pamphlet No. 47.

AMERICAN SAW MILL MACHINERY CO.

80 Main Street
HACKETTSTOWN
NEW JERSEY

1360 Hudson Terminal
NEW YORK CITY
NEW YORK

The ELLIOT WOODWORKER

On the job or in the shop the Elliot Woodworker will save more time and money for you than any other single machine on the market today.

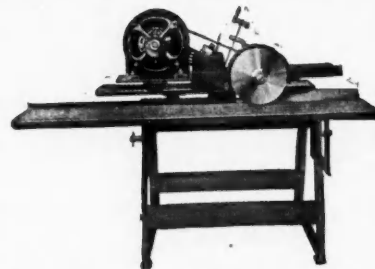

Patented 1910-1914. Other patents pending.

Over 500 are in successful use. Runs on any house lighting current. Cuts 3" thick; it will cut 3" joist, 2x4 fence boards, house out a pair of stair strings 16 ft. long in 35 minutes, and all other dadoing, grooving, etc., required.

Can be swung like a mitre-box to cut any angle and will successfully cross-cut long lumber, as the saw is drawn back and forth like a swing-saw.

The Elliot Woodworker is different from any other machine and will do more work and more different kinds of work than any other.

Write for free illustrated catalogue and liberal terms.

THE ELLIOT WOODWORKER, Ltd.,
2405 Woodward Ave. - - DETROIT, MICH.

Canadian Factory, College and Bathurst Streets,
TORONTO, ONT.

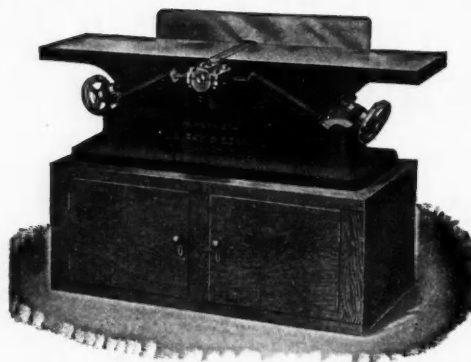

Every Carpenter and Builder Needs Me—

In a small shop I will take care of all planing, jointing, rabbetting, etc.

I am so handy that the hand plane is practically eliminated wherever I am used.

I take up small floor space.

I consume hardly any power in operation.

I can not cut off any fingers as I am fitted with a patented circular safety cutterhead.

I will turn out perfectly smooth work because my safety head is round, runs true and is fitted with thin, air-hardened "Tungsten" steel knives which require sharpening only once a week if jointing attachment is properly used.

I have made money for every wood-shop in which I am used. I am sold at a price within the reach of any carpenter, and quickly pay my own way.

I am the **FAY-EGAN** No. 254 Bench
"Lightning" Hand Planer and Jointer

To find out more about me ask
J. A. FAY & EGAN CO., 545-565 West Front St., Cincinnati, O.,
to send you Bulletin H-7

Every Piece
of Millwork
in that House
was done on



**My Crescent
Universal
Woodworker**



in my own shop. I know what big profits are now. Before buying my Crescent I bought my millwork, just like some of you fellows are doing now. I had to pay fancy prices and often my work was delayed because I couldn't get my stuff on time. But there's a big difference now—I do all my own millwork—everything. My Crescent Universal Woodworker is a compact Planing Mill all in one. I keep my men busy all the year round, too. When we can't work outside, we go to work in the shop making interior trim, sash, etc., for our next jobs and stock. Then, too, I find that it eliminates practically all competition. I can underbid them all, do more work, and bigger work. My only regret is that I didn't get my Crescent Universal Woodworker sooner.

Don't Put it off
—You too will say
“Why didn't I get
it sooner.” Write today for details and particulars concerning this money-making equipment.

The Crescent Machine Co.
224 Main Street
LEETONIA
OHIO

The No. 101 to 112 Crescent
is especially adapted for the Contractor and Builder. Four men can easily work on this machine without interference. There are five units to this machine—a Band Saw, a Jointer, a Shaper, a Saw-Table and a Borer, all mounted on a solid base.

**What You Can Do
On the Crescent**
Ripping
Jointing
Moulding
Boring
Grinding
Pole Rounding
Band Sawing
Grooving
Mortising
Panel Raising
Etc.



A Portable Bench Planer

This machine will take as **heavy** a cut as the largest machines, and you can joint **long** and **heavy** stock on it. It is not flimsy, but as **durable** as the costliest machines. It is **light** and **cheap** because we got down to **fundamentals**. It is fully **guaranteed**, and will be sent on trial anywhere.



WALLACE BENCH PLANER

Either Belt or Motor Driven

- Easily portable, can be carried to the job.
- Stands on bench without fastening.
- Table adjustable to any depth of cut.
- Fence adjustable to any angle.
- Runs from an electric light socket.
- Capacity, any length, and up to 4 inches wide.
- Length of tables over all, 18 inches.
- Weight of machine with motor, 50 pounds.

Our descriptive folders give full information.

J. D. WALLACE

525 W. Van Buren Street - - - CHICAGO

THE HUTCHINSON COMBINATION WOODWORKER

The saw can be set to cut at any angle, and can be raised or lowered 8 inches. This operation makes no difference to the belt, as is the case with other makes of machines. There is no overhanging slide. The table is clear of all obstructions, all work is in full view, and is operated with a 1½ H. P. Motor.

5 Duke St.

Toronto, Ont.

Canada

Write for catalogue

We court competition. Test this machine with other makes before purchasing.

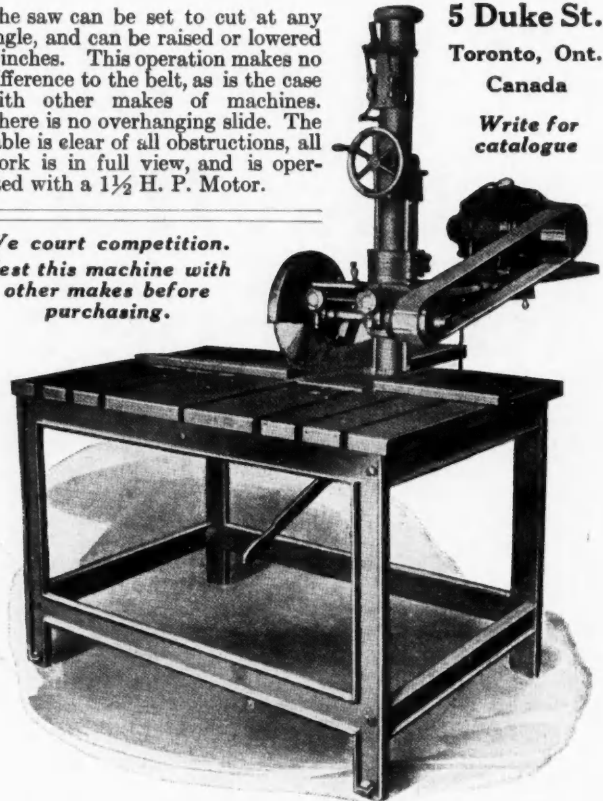



FREE TRIAL

We will send you the **Champion Mortiser** on 10 days *free* trial. If it does not save you time and money and better the quality of your work don't pay for it.

For Mortising any size, any shape from a perfect round hole up to a 6¼ in. slot. The Champion Mortiser is equipped with ball bearings, large gears and automatic stop.

Send for Circular and Free Trial Offer

Colgan Machinery & Supply Co.
616 New Hayden Bldg. COLUMBUS, O.

Parks' Planing Mill to Take Out on the Job



Circular, Rip and Cross-Cut Saw, Swing-Cut-Off Saw, Boring Machine, with 12-inch Jointer, 22-inch Band Saw, Hollow Chisel Mortiser and other valuable attachments can be added.

Send for our New Catalog

Parks' Ball Bearing Machine Co., Fergus St. and C. H. & D. Ry., CINCINNATI, O.

ROOF SLATES

STRUCTURAL SLATE BLACKBOARDS

E. J. JOHNSON

38 Park Row New York

Quarry Operator

BLACK, GREEN, PURPLE, RED

Booklet, Samples and Prices on Application

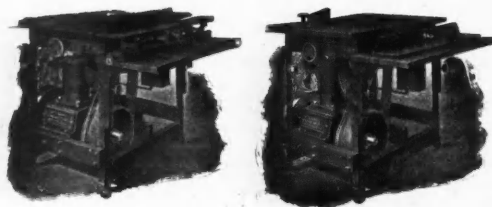

Standard Portable Combination Woodworker

9 Machines in 1
6 H. P. ENGINE

SEND FOR CATALOG G
ATLANTIC ENGINE CO.
Meadville - Penna.

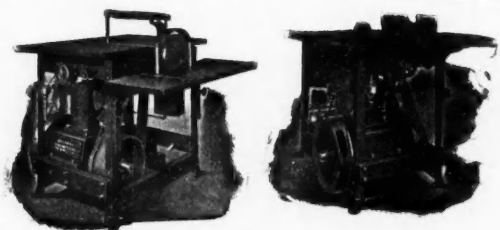

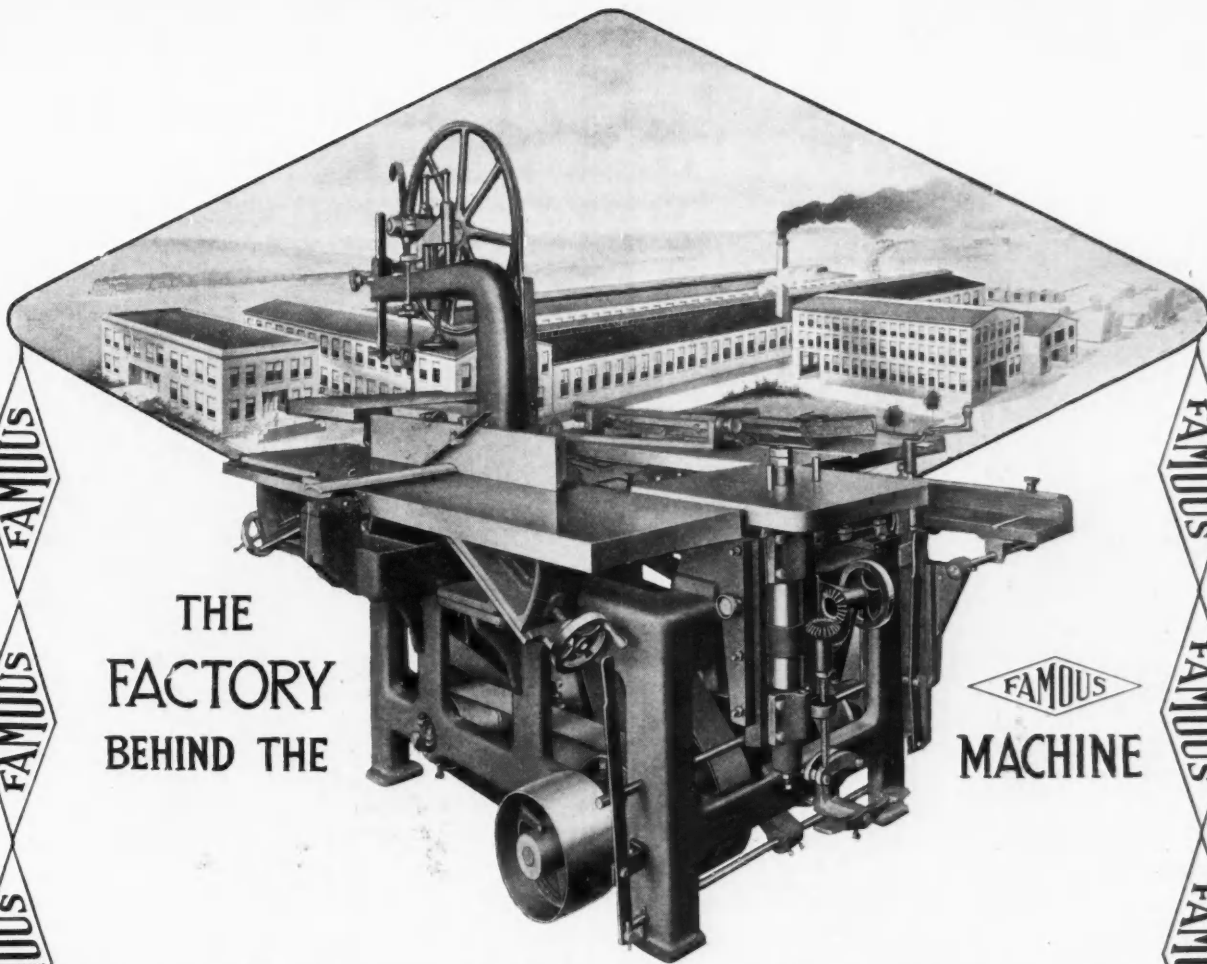

THE
FACTORY
BEHIND THE

FAMOUS
MACHINE

The "Famous" Factory Stands Back of Every "Famous" Machine Shipped

From this factory invisible cords of good-will extend to nearly 4000 satisfied users of "FAMOUS" machines.

Not only is the popular No. 31—illustrated above—backed up, unreservedly, by the "FAMOUS" factory—but every machine from the complete line must prove "TRUE BLUE" or we are here to make it right.

There is much more than a flimsy sheet of paper on which may appear a neatly worded guarantee back of the machine you buy—if you buy a FAMOUS.

The reputation and resources of a giant concern assure you of the utmost satisfaction. And is not this the only tangible worth-while guarantee of quality?

What "FAMOUS" machines are now doing for their owners, speaks well for their goodness. If you are interested in any woodworking machines of any type—mail the coupon for a free copy of the Little Black Book (pocket size) on WOODWORKING MACHINERY Ask for book No. 12.

"FAMOUS" woodworking machines are among the better known products made in the U. S. of America."

SIDNEY TOOL CO., Sidney, Ohio

Sidney Tool Co., Sidney, Ohio.

Gentlemen:—Send your little black book No. 12 on WOODWORKING MACHINERY. I understand this is FREE—no obligation.

Name

Complete Address

.....

THE NEW C. H. & E. No. 6 PORTABLE SAW RIG

This is the Latest Model in a
Combination Portable Outfit

4
Complete
Machines
in 1

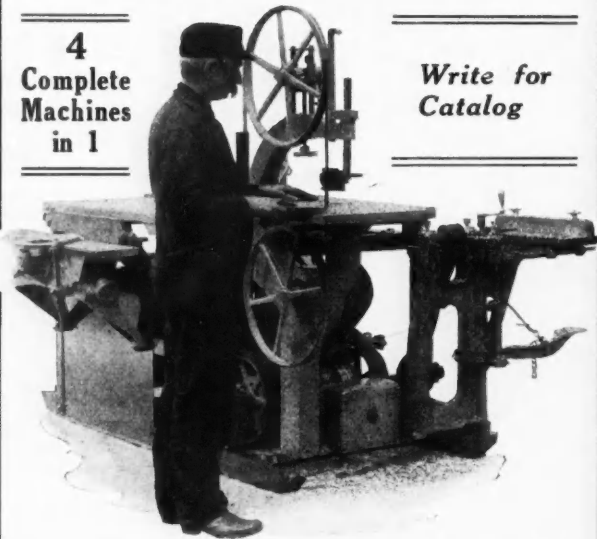

Write for
Catalog

C. H. & E. MANUFACTURING CO., Inc.
322 Mineral Street MILWAUKEE, WIS.

The METCALF DRESSER

will keep your grinding wheels in the best condition. This Dresser is especially efficient for shaping or dressing grinding wheels used for saw gumming. With this device a wheel can be given a fine, close grained face for smooth work or an open face for rapid cutting.

This Dresser can be used for a variety of purposes. It is simple and easy to use. Write for our illustrated folder showing how it is used on all kinds of wheels. Address

The Heald Machine Co.

2 New Bond St.,
Worcester, - Mass.
24 S. Jefferson St.,
Chicago, - Ill.

Note how
Simple

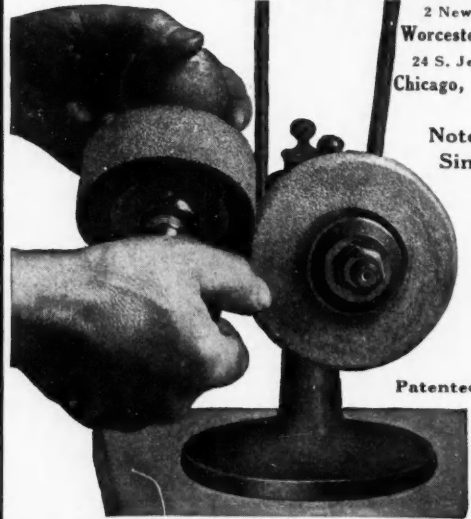

Patented



Combination
Saw Table \$48⁰⁰

F. O. B. Kansas City

We carry a full line of Uni-
versal Woodworkers.

Nelson, Mo., Feb. 25, 1914.
Standard Machine Tool & Supply
Co., Kansas City, Mo.
Gentlemen:—The more I use
my No. 14 Famous Universal Ma-
chine the more I like it. I feel by
the time I get thoroughly ac-
quainted with it I would refuse to
part with it. Yours truly,
R. B. Finley.

Write for our Money-Saving
Catalog and Bargain Prices.

Standard Machine Tool & Supply Co.
1st and Main St. Kansas City, Mo.

CARPENTERS

In these days of close competition need the best
possible equipment, and this they can have in

Barnes' Hand and Foot Power Machinery

Our new foot and hand power Circular
Saw No. 4, the strongest, most powerful
and in every way the best machine of its
kind ever made. For ripping, cross cut-
ting, boring and grooving.

SEND FOR OUR
NEW CATALOGUE

W. F. & John Barnes Co.
74 RUBY ST. ROCKFORD, ILL.

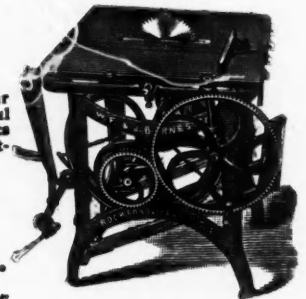

Write
for
catalogue
showing
full line of
Wood
Working
Machinery
for
Carpenters
and
Builders.
Also
Bargains
in second
hand
Machinery.

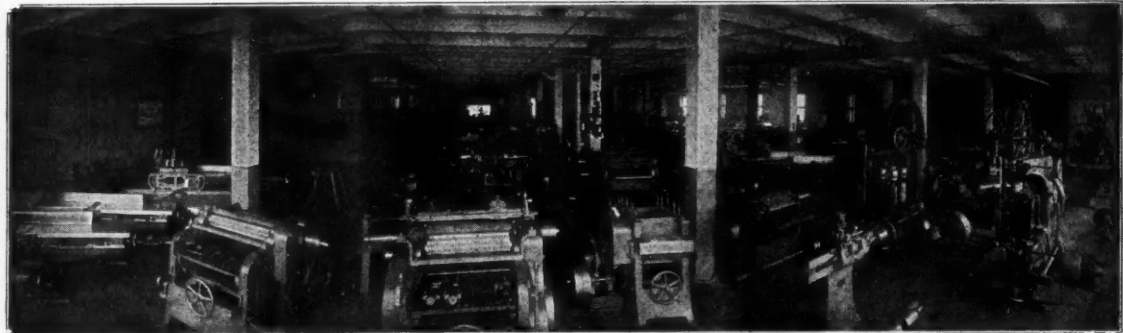

CHICAGO MACHINERY EXCHANGE - 1215-1223 WASHINGTON BOULEVARD
CHICAGO, ILLINOIS

Fox Floor Scrapers

Real Money-Makers on the Job

We have the finest line of floor finishers or scrapers at lowest prices. One of these scrapers will surely fit your needs.

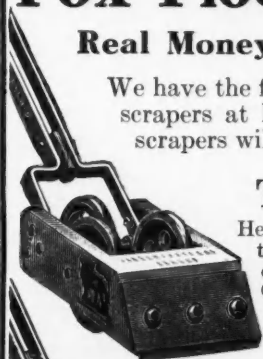

The FOX No. 1

Here is an outfit without equal for the average contractor. With this outfit you can finish any floor. Comes equipped with 8 extra blades, burnisher, hone, wrench, file and rubberpad. **Price complete \$25.**



The Fox No. 1

The FOX No. 3

This machine is similar to the Fox, No. 1 but much heavier. Has adjustable weight. This adjustable feature permits the operator to place this weight where most additional pressure is desired. Comes completely equipped. **Price \$35.**

The FOX No. 4

The Fox No. 3 is just the scraper for the man who does not do much floor finishing. It is much more efficient than scraping by hand.

Price equipped, only \$15.
Write for Catalog showing complete details and samples of work done.

FOX SUPPLY CO.
Dept. A Brooklyn, Wis.



The Fox No. 4

A Money Maker



A Polo, Ill., contractor, H. W. Mades, writes:

"I have been using one of your Floor Scraping Outfits about two years and would not like to get along without it. It surely has been a money maker for me."

You will say the same about the

ACME FLOOR SCRAPING OUTFIT

after you have given it a test. Let me send it to you on a week's free trial. Write for booklet and free trial offer now.

JOS. MIOTKE 247 Lake Street Milwaukee, Wis.

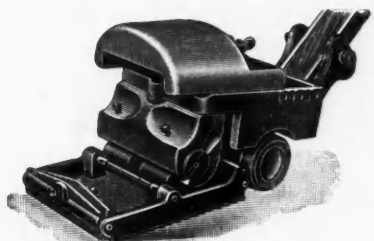

Sander, FREE to Cash Buyers

Why Pay More

Than The Other Fellow?

Is his money better than yours?

When you get the genuine **ADJUSTABLE FLOOR FINISHER** you pay only for the actual cost of manufacture with but one small profit added, for I sell only to the user **Direct**. There are no dealers' profits or commissions for you to pay.

GUARANTEE:—You may use it for **Ten Days FREE**. Put it to the hardest tests you know of—scraping wood floors, hard or soft—old or new.

If it doesn't do your work in a manner entirely satisfactory to **YOU**—quickly, easily, perfectly—if it doesn't prove to be the **biggest time and labor saver—money maker** for the money you ever saw—or if for any reason at any time you are not well satisfied, you may have your money back if you want it.

SCRAPER, complete with six extra blades, burnisher, wrench, etc., on ten days' Free Trial... \$22.00
SANDER ATTACHMENT..... \$2.50

SANDER FREE if cash accompanies order

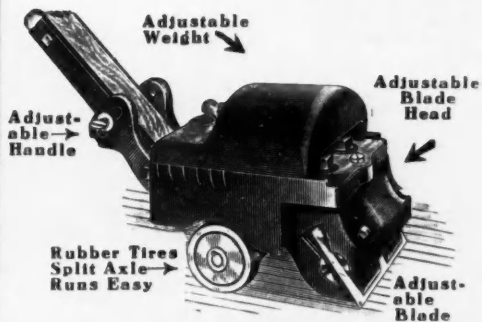

Mail Coupon at Once

H. P. Didriksen
ANDERSON, IND.



THIS COUPON IS WORTH \$2.50

H. P. Didriksen, Anderson, Ind.

Without obligating me in any way, you may send your printed matter, provided you accept this coupon as payment for the Sander, if I decide to buy for cash.

Name.....
Town..... State.....

NORTHERN FLOOR SURFACERS

For Surfacing All Floors

Wood
Terrazzo
Mosaic
Marble
Concrete
Composition
Tile, Etc.

This is the only Surfacers
manufactured that can be
operated by either electric
motor or gasoline engine.

It will pay you to investigate this Floor
Surfacers. Write today for catalogue.

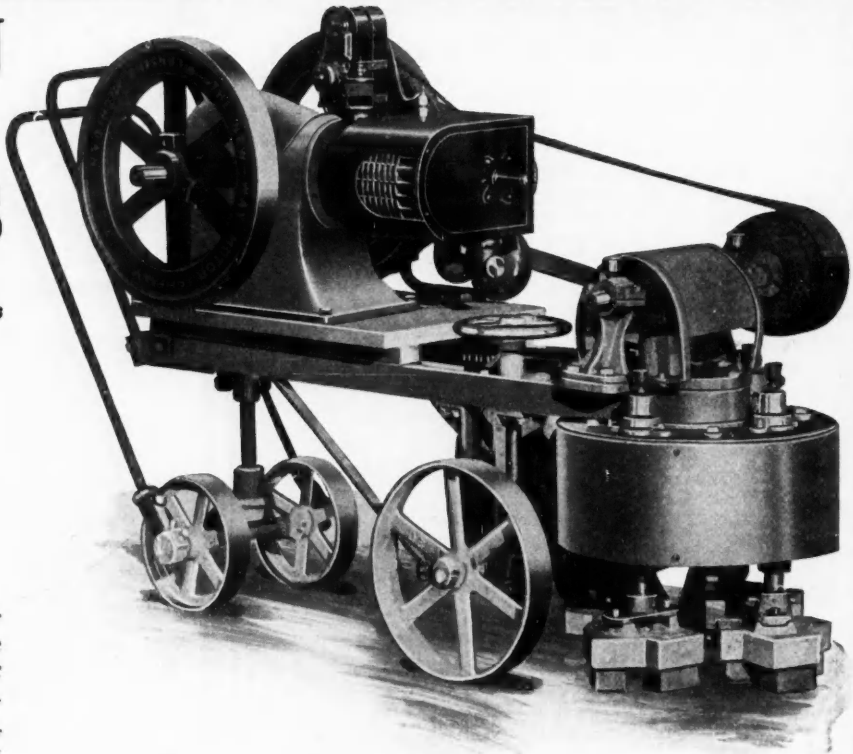

CHICAGO BUILDERS SPECIALTIES CO.
450-470 Old Colony Building CHICAGO

FOX

"UNIVERSAL TRIMMER"

TRADE MARK

A
Machine
For
Every
Need

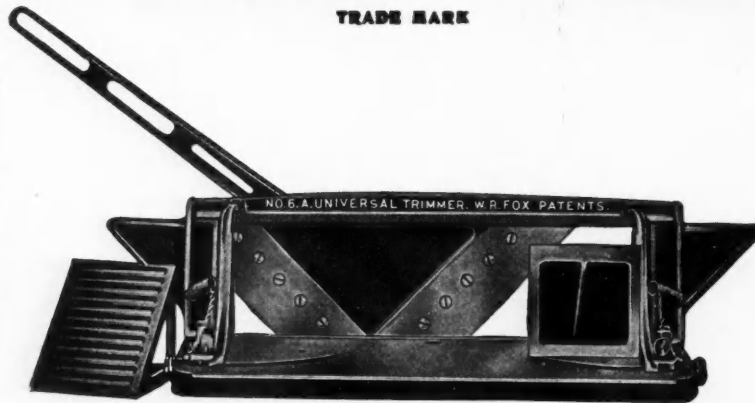

6A. FOX "UNIVERSAL TRIMMER"

A
Need
For
Every
Machine

**You Will Never Know What Perfect Work is Until You
Use a Fox "Universal"**

*The fitting of interior finish is greatly improved
by using a Fox Universal.*

Write TODAY for Our New Catalog

FOX Machine Co.
22 FRONT AVENUE N. E.
GRAND RAPIDS, . . MICHIGAN

INTERLOCKING MASTER SLIDE RULE

Measures Both Inside and Outside Accurately

A Carpenter's practical rule that will take inside and outside measurements correctly. Two Rules in one. Made of select boxwood, trimmed with brass plated steel. Strong. Rigid and convenient. Made in all lengths—two to eight feet. Low priced. Send 15 cents a lineal foot (in U. S. A.) if your dealer cannot supply you, and get one by mail.



Circulars giving full description sent FREE.
DAHL MANUFACTURING CO.

51-G East 42nd St.
NEW YORK CITY

10 Cents

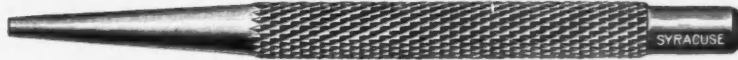

is the price of a "Syracuse" Nail Set—Highest Quality, Longest Service.
Made in 3 sizes—2-32"—3-32"—4-32" points—Price 10 cents each.
If your hardware dealer does not sell "Syracuse" Nail Sets, we will send you one or more at 10c each. Specify size wanted.
SYRACUSE TWIST DRILL CO. SYRACUSE, N. Y.

FREE TRIAL: RAPID—FLEXIBLE—AUTOMATIC ELECTRIC FLOOR SURFACERS

Mosaic, Marble or Composition Floors

Old or New Wood Floors



SEVERAL SIZES

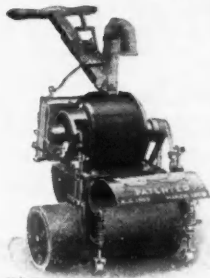

SEVERAL SIZES

Send for our proposition

M. L. SCHLUETER, 225 W. Illinois St., Chicago, Ill.

KNOWN THE WORLD OVER THAT

The WEBER DOUBLE ACTING Floor Scraper

WILL DOUBLE YOUR PROFIT

ON YOUR HARDEST FLOOR JOB

Weber Mfg. Co.
670-71st Ave, West Allis, Wis.

5 Days Free Trial At Our Risk

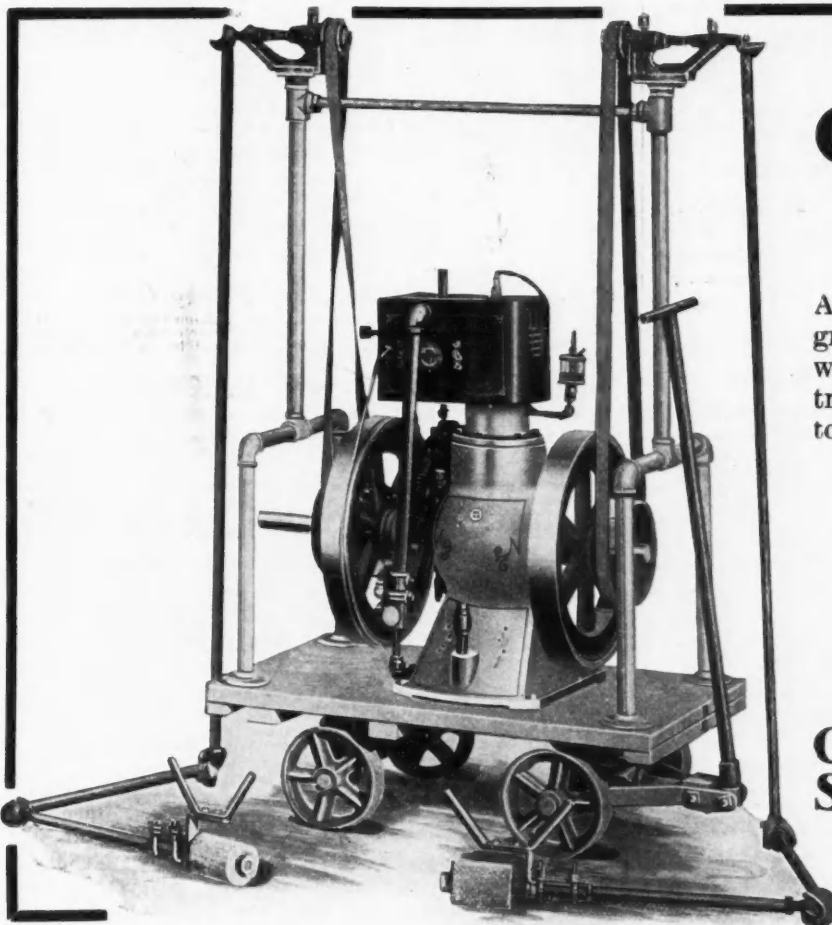

C. B. S. Cove Base Machine

A wonderful machine that is a great labor-saver. This machine will rub any radius cove. Electric or gasoline power. No jar to operate.

Hundreds in use all over the country. If you want to save money investigate this machine.

Sent on two days' free trial. Write for catalogue.

Chicago Builders Specialties Co.
450 Old Colony Building
CHICAGO



**YOU LOST THAT BIG JOB
BECAUSE YOUR BID WAS TOO HIGH**

YOU ALSO LOST THE ADVERTISING WHICH THAT JOB WOULD HAVE GIVEN YOU. IT HURTS, BUT NEXT TIME

REDUCE YOUR BID \$400.00 TO \$700.00

AND DEPEND UPON THIS FLOOR MACHINE TO MAKE GOOD EVERY CENT OF IT. IT RUNS BY ELECTRICITY.

THINK THIS OVER—THEN WRITE US—NOW.

**THE AMERICAN FLOOR SURFACING MACHINE CO.
TOLEDO, OHIO**



The AUTOMATIC BALLBEARING Electric FLOOR SURFACING MACHINE

Patented Oct. 15, 1912. Made in several sizes.

will save you money by rapidly finishing your new or old floors just the way you want them. Is self-propelling—you simply guide.

Write today for Booklet telling all about the machine, our free trial offer, and list of users near you.

WAYVELL CHAPPELL & CO.
Dept. D. 4847E Ravenswood Ave. CHICAGO
Phone Ravenswood 4143.

THE IDEAL

Electric Floor Sander

For surfacing all grades of wood floors, works equally well on new or old floors. Removes paint, varnish, dirt, grime. Will surface 6,000 square feet once over in eight hours. The lowest priced and most efficient floor sander on the market.

The Ideal Floor Sander is simplicity itself and built mechanically correct to withstand years of hard service.

Write for our FREE TRIAL proposition



Ideal Floor Sander Co.
Not Inc.
105-109 N. Canal St. CHICAGO

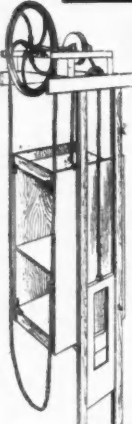

Excelsior Dumb-Waiters

The only Knock-Down Dumb-Waiter ever offered, shipped complete to a nail, with explicit directions for erecting, for **\$18.50**

Up-to-Date in Every Particular

Hardwood Car, Self Retaining Machine, Adjustable Weight, Guide Ropes, Timbers and Hardware. Ropes joined by coupling. No splicing. Will fit any ordinary opening up to 24" x 30".

Send for Printed Matter

R. M. RODGERS & CO.
74 Emerson Place - - Brooklyn, N. Y.

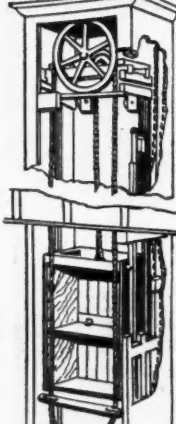

A. B. C. DUMBWAITERS

Called This For Their Simplicity And Perfection

They can be relied on to give permanent satisfaction. The design is right, the workmanship and materials of the best. Our broad experience and reputation stands back of all our Dumbwaiters. Why not handle King Dumbwaiters. They will net you a good profit and make all your customers boosters.

The King "Safety Check"

is part of the equipment of all our Dumbwaiters. It will hold load at any floor. Our catalog describes it. Send us your specifications and let us figure them. Send for catalog now.

WM. F. KING
20 Kingsland Ave. Brooklyn, N. Y.

HOISTS & ELEVATORS

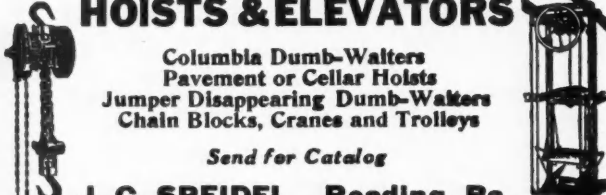

Columbia Dumb-Waiters
Pavement or Cellar Hoists
Jumper Disappearing Dumb-Waiters
Chain Blocks, Cranes and Trolleys

Send for Catalog

J. G. SPEIDEL Reading, Pa.

DUMBWAITERS AND ELEVATORS

CHELSEA
EXEMPLAR OF QUALITY
Made in the U. S. A.

SHIPPED OR ERECTED ANYWHERE

Our Catalog "C" Mailed on Request

We manufacture only one quality and that is the best that can be made. So we guarantee each Dumbwaiter we make.

CHELSEA ELEVATOR CO.
334 W. 36th St. NEW YORK CITY



KITCHEN
CELLAR

CARPENTERS WANTED AS AGENTS
During Fall and Winter Months. Big Money! Ready Seller.

SANITARY AUTOMATIC DUMBWAITER

saves carrying food to and from the cellar. Perfectly ventilated; screened openings; finished inside with durable white enamel. Keeps food perfectly. Top fits flush with kitchen floor. You can walk over it. Operates with push button or lever. Also furnished as a Refrigerated Dumb Waiter. Cost of installation nominal.

Write for new catalog just now
York Automatic Dumbwaiter Works, 639 W. Market St., York, Pa.

ELEVATORS of REAL MERIT

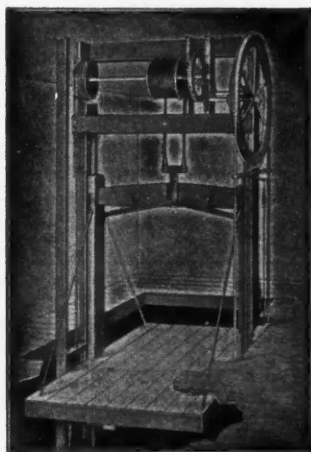

We are offering an attractive line of Dumbwaiters, hand and electric power elevators of exceptional merit.

MR. CONTRACTOR, don't fail to get our proposition for your requirements. Satisfied customers mean more and better business for you.

One truly satisfied customer has just written, unsolicited by us, as follows:

"Am very glad to say that we are well pleased with the elevator. It operates with even greater ease than we had hoped for. My little six-year-old boy can run it up or down unaided."

Yours most truly,
(Name sent on application.)

Our Machines are easily installed from our complete plans and instructions which are sent with each elevator.

The Reasonable Cost Will Interest You

Write to us today stating requirements, giving style of machine wanted, size of platform and number of feet travel and we will name you a money-saving price on equipment made to serve you well.

SIDNEY ELEVATOR MFG. WORKS, Sidney, Ohio

There's Genuine Economy In Buying

SEDGWICK DUMBWAITERS

In the first place, **Sedgwick** prices are as low as those of most outfits that are actually inferior; and they're lower than you'd pay for equal quality elsewhere—if you could get it.

In the second place, the **Sedgwick** price covers the outfit complete in every detail. No extras are needed. All you have to figure on is the labor of installing. And that is small because we give you complete working plans.

In the third place, you can get your money at once on a **Sedgwick** installation, because it gives satisfaction from the start and continues to do so. Your payments are not held up.

Lastly, the satisfaction that a **Sedgwick** Dumbwaiter gives makes it talked about—creates a reputation that comes back to you—makes it easier for you to put in a **Sedgwick** on the next job, with profit to yourself.

A Copy of Catalog "L" is Ready for You.

SEDGWICK MACHINE WORKS

132 Liberty Street,

NEW YORK

2/3 of the Work is done by the Spring on the Triple "A" FLOORSMOOTHER

Earn \$20 a Day this Season



surfacing floors as a specialty. The Spring "Engine" in the Triple "A" enables you to do all of the work that can be done with a heavy power driven machine, while its initial cost and expense of operation is much less. It can be easily operated by any carpenter, as its principle of operation is similar to that of a hand scraper, only on a larger scale. It is so constructed that the scrapers can be easily sharpened in the machine, and in operation can be readily adjusted for light or heavy cutting as may be required.

Start surfacing floors the "TRIPLE 'A' WAY." The floor surfacing of an average residence amounts to about \$30.00 and can be done in a day and a half. Then too, there are many old floors that need resurfacing for which the Triple "A" is especially well adapted, owing to its abundant Weight, Power and Adjustability. Be the first to order a Triple "A" in your town and thus secure the advantage of our Agency Discount. Send in the coupon now.

Triple "A" Machine Co.

Room 337—300 W. Grand Ave.
Chicago Illinois

Triple "A"
Machine Co.
Room 337
300 W. Grand Ave.
Chicago Illinois

Gentlemen:—
Please send me full description of the Triple "A" Floor smoother and your agency proposition.

Name.....

Address.....

CLIP THIS COUPON—SEND IT IN NOW

MODERN TOOLS

Every Carpenter should have

The BUCKEYE No Shift Folding Saw Vise
 being 28 inches long when opened enables you to file a saw the full length without shifting. Folds up in a space 14½x2x2 inches and takes up no more room in a tool chest than a hammer. Made of steel and weighs only 4 pounds. Price **\$1.60**

BUCKEYE All Steel Folding Saw Vise
 Here is a light steel handy saw vise with jaws 14 inches long. With this vise only one shift is required when filing and jointing a saw. The price of this tool is **90c**

The Improved BUCKEYE Plane
 The Cap Plate is now removable, it comes out with and is dropped back in with the bit. It takes but three seconds to do this. It will cut exactly the same thickness of shaving it did before taking it out and it is impossible to set it wrong. These are positively the quickest, simplest and easiest set and adjusted planes on the market. A trial will convince the most skeptical.

Prices of planes are as follows:
 Smooth Plane, each \$2.25
 Jack Plane, each 2.75
 Fore Plane, each 3.25
 Postpaid to any part of U. S.

Buckeye Saw Vise Co.

2050 W. 55 St.,
 Cleveland, Ohio

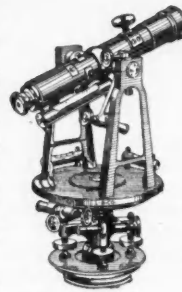

Builder's Transits

For the builder or architect who wants to raise the standard of his work—who takes conspicuous pride in the accuracy of his efforts, this transit is especially designed. It is but one of the complete line of Beckmann quality instruments. Send for our complete free catalog.

The B. L. BECKMANN CO.

7500 Adams Street :-: Toledo, Ohio

LEVEL WORK

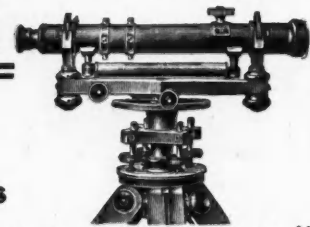

**Architects
 Builders
 Contractors**

insure against mistakes in leveling by using our Architects' and Builders' Level. We make a specialty of this instrument. It will give positive, accurate service. Saves its cost in a short time.

We manufacture a complete line of surveying instruments in various sizes and at a wide range of prices. Our circular No. 27 will explain our instruments to you in detail. It will pay you to get it before deciding upon any surveying instruments.

KOLESCH & CO.
 Surveying Instrument Makers. Established 1855.
 138 Fulton St. - - - NEW YORK

"Sterling" Convertible Level



Designed and Made by
Warren-Knight Co.

This name on a Level or Transit means Accuracy, Simplicity, Durability, Efficiency, Satisfaction!

Write today for Illustrated Folder and Details of Free Trial Offer and Rental Purchase Plan.

All Makes of Instruments Repaired

136 No. 12th St. Philadelphia

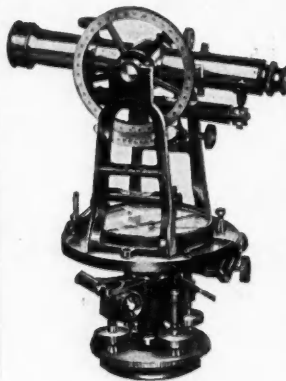

Builders' Transit

Building requirements of today demand the use of an accurate instrument for laying out, squaring and leveling Foundations; plumbing walls and girders, locating stakes etc. The Transit illustrated herewith is especially designed for the Contractor and Builder who wishes to do the above work accurately and quickly. It is of light construction without sacrificing strength and rigidity. All of the necessary surveying connected with building operations can be done with this instrument. We also make a large variety of Levels of the convertible and plain type. Before deciding on any make of instrument be sure to obtain our beautiful illustrated catalogue and special Discount Sheet.

DAVID WHITE CO., Inc.
 419 East Water Street
 MILWAUKEE :: WIS.

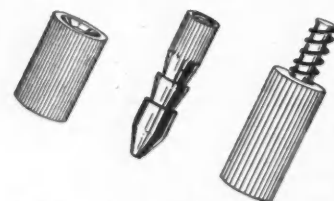

Get a
FREE

Sample of
STINE SCREW HOLES

We want to acquaint all Carpenters and Builders with this new invention, so we will send without obligation a free sample to those sending us their name and address. Make your own demonstration; we know you will be satisfied with the result. We have solved the Screw Hole Problem. Send today.

STINE SCREW HOLES CO., Review Building, Decatur, Illinois

The **G & B**
Convertible Level

is Accurate, Durable and Simple to operate. A high-grade, well made instrument

Sent on Approval

Have the G & B Convertible Level sent on approval—if you have several makes you will decide on ours. Our Guarantee is money back if not satisfied. Send for Circular A, prices and terms. We are reasonable.

GEIER & BLUHM
 672 River Street, Troy, N. Y.



Builder's Transits
 or
 Architect's Level
 The
G & B



BISHOP'S BULLDOG No. 200X

The recent laws enacted in various cities prohibiting the mechanic from carrying saws and other tools projecting from the old style tool box in public conveyances, necessitated the adoption of the suit case box and prompted the invention of the **Bull Dog** design hand saw, which possesses a twenty-six inch cutting capacity and reduced in length to be carried with safety in a twenty-six inch space. It is especially recommended for cutting heavy lumber and particularly for sawing rafters; its symmetrical lines and even balance permits constant use without tiring the wrist. A trial will convince the most critical mechanic of its efficiency.

Made from **high grade alloy steel**, highly polished blade. carved apple handle and four polished brass screws. **Fully Warranted.** Made in both Straight and Skew Backs.



		PRICES					
Inches	18	20	22	24	26	28
Price, each.	\$1.50	\$1.60	\$1.70	\$1.85	\$2.00	\$2.25
Packed one in a box							

GEO. H. BISHOP & CO.
Lawrenceburg, Indiana



Rent This Level 10 Months Then It's Yours

Builders and Contractors

This is not an old style Level. It is the newest 1915 model *convertible level*. There is not a single Builder or Contractor who has not almost daily need of this instrument. For laying out buildings, locating foundation piers, leveling up foundations, walls and floors, aligning shafting, walls, piers, etc., for getting angles, locating levels anywhere, ditching, laying streets and walks, running straight lines, and a hundred other uses.

Instruction Book Free

Complete illustrated booklet, telling how a builder or contractor can use the convertible level, sent free on request.

WARNING

The Level we offer is the new Aloe Convertible Level. Don't confuse the Convertible Level with the ordinary old style Architect's Level. The only work that can be satisfactorily done with the ordinary Architect's Level, is the determining of elevations. But the Convertible Level, besides its use as a level, is a modified transit and broadens the use of the level 100%. You can't afford to buy any but the Aloe Convertible Level.

HALF CENTURY REPUTATION

We have been manufacturers of transits and levels since 1863, and our instruments are the standard of the world.

FREE TRIAL

We allow you to convince yourself by a trial of the instrument before you obligate yourself.

THE RENT BUYS IT

No large cash outlay needed. Just pay the rent for a few months and the instrument is your absolute property.

Send Coupon---No Obligation

Send the attached coupon today and we'll send illustrated booklet and complete details of how you can own the Aloe Convertible Level for 10 months' rent.

A. S. Aloe Co., 621 Olive St., St. Louis, Mo.

COUPON

A. S. Aloe Co., 621 Olive St., St. Louis, Mo. Please send free instruction book on the use of the Convertible Level and complete details of your rental plan. This request in no way obligates me.

Name

Occupation

Street

City..... State.....

Am.C.&B. Mar.15

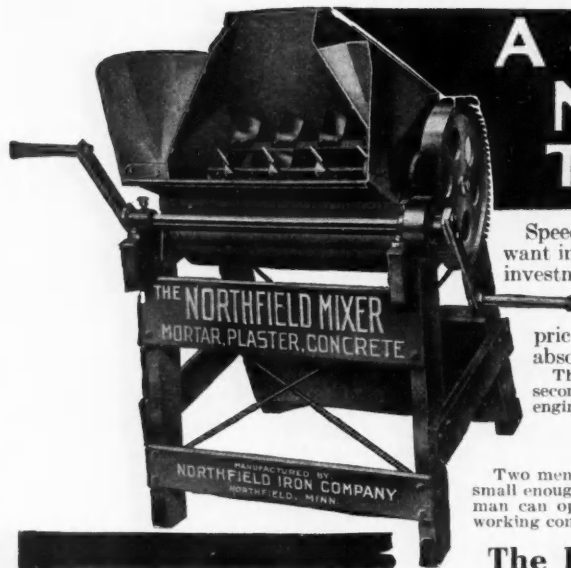

A 4 Ft. Batch-Perfectly Mixed-Every Minute That's Northfield Service

Speed and perfect mixing—that's a combination hard to beat. It's what you want in any mixer, big or little, and it's what makes the Northfield Mixer an investment, instead of an expense.

Listen—You can set all the concrete mixers ever made up in a row and test them, and you won't find one—big or little, high or low-priced—that will turn out a better mix than the Northfield. That's an absolute fact that every Northfield in service is proving every day.

The mixing action is a new one—the batch is stirred, turned, hoed 180 times in 30 seconds. Every batch that comes out is exactly right—this mixer gets the O. K. of all engineers, architects and inspectors.

Light Weight and Light Running

Two men can move the Northfield about and three can load it for transportation easily. It's small enough to be loaded in the same farm wagon with your tool box and your crew. One man can operate it easily, and it will turn out thirty to sixty yards of slush, under ordinary working conditions, every day—three times as much as could be mixed by hand by the same crew.

The Biggest Value for You

You'll never have a job so large or so small that the Northfield Mixer won't save you money and make you money at some phase of the work. It's the handiest, most convenient and most satisfactory hand mixer you can buy—users say so.

The Northfield is substantial, sturdy and extremely durable. You can depend on it in service—it's built right and it works right. It's a batch mixer—some people call it "the continuous batch mixer"—insures you an even, uniform grade of slush at all times.

We'll sell you a Northfield Mixer at a price that makes it the biggest of values—more mixers for the money than was ever offered before. If you want to save money on your jobs—without sacrificing quality of work—write for our catalog today.

THE NORTHFIELD IRON CO.
402 Water Street, NORTHFIELD, MINN.



READ THESE LETTERS

Cannon Falls, Minn. 2-5-14.
Northfield Iron Co., Northfield, Minn.

Gentlemen:—
In August, 1912, when we began erecting our plant, we purchased from you one of your little "Northfield" mixers. After using it for a few days we found that we made no mistake.

While we are not Building Contractors, we put in several hundred yards of concrete into our plant and the little mixer is still on the job ready for work next spring.

We would certainly recommend this machine to any one. Yours very truly,

Commercial Grain and Malting Co.
A. R. Mensing, President

Mr. Earl D. Smith, a general contractor, of Roston, Texas, writes:

"Ship me quick by freight another slushy wet mixer with cranks and power attachment similar to the one I bought from you on 12-15-13. This order will show you what I think of your machines."

ROOF FRAMING MADE EASY



By the use of our little book

It's Free

Send today for one of these and learn how to get the lengths and cuts of all rafters for seventeen different pitches of roof. We stamp on our Squares, making it handy and convenient.



We Manufacture the Only Practical Take-Down Square

We have a number of Atkins & Disston Miter Box Saws, sizes ranging from 28x4 to 30x5, special price, 50c small size; 75c large size; weight 5 lbs. Include enough postage for parcels post charges.

NICHOLLS MFG. CO.
OTTUMWA, IOWA

GET THESE BOOKS

FREE!!!

A post-card, or this ad cut out, with your name and address, designating what books you want is all that is necessary. These books will interest you, and also place you in touch with equipment that you can buy for LESS MONEY than any other. Our

DIRECT FROM FACTORY PRICES

ON World-Renowned "CRESCENT" Machines

will make you ask yourself why you never got in touch with us before.

Find out how the other fellows make money. You're never too old to learn!

Mark the Books You Want

- Book 10, "Crescent" Continuous Concrete Mixers
- Book 11, "Crescent" Sewer Pipe and Tile Molds
- Book 12, "Bull-dog" Hand Batch Mixers
- Book 14, "Crescent" Vertical Tamping Brick Machines (Foot-power)
- Book 16, "Bull-dog" Power Batch Mixers
- Book 17, "Crescent" Power Brick Machines
- Book 18, "Little Wonder" Hand Brick Molds

GET OUR QUOTATION ON ANYTHING YOU NEED

RABER & LANG MFG. CO.
Kendallville, Ind. 810 Mill Street



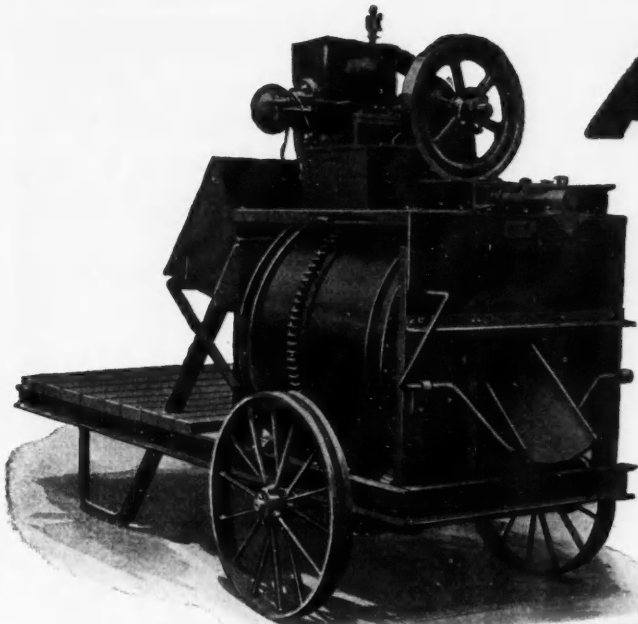

A MIXER

Years ahead of the rest—in Design, Construction and Portability

THE No. 1 ARCHER SPECIAL CONCRETE MIXER

is a mixer different from all the rest. It is a marvel of compactness. Its design enables it to do things other mixers can't do. Every detail has been carefully worked out to the best advantage:—Loading, Discharging, Placing of Engine and its balance. It is all Gear-driven and is the best made and sturdiest machine in all "Mixerdom." Notice carefully its design and where the wheels are placed, then you'll understand why this mixer is easy to haul around and why it fits in places where other mixers can't go.

Loading and Discharging

is easiest and quickest with the Archer. Only on mixers of very large capacities are power loaders an economy. Power loaders mean about five hundred pounds of machinery for you to carry around. To load the Archer simply wheel the barrows onto the loading platform and tip into the hopper. No shoveling necessary. Come around to the discharging end now. Notice it's on the farthest side from loading operations. No chance for interference between loading crew and discharging crew. The best feature of all is the ability of the Archer No. 1 to spout concrete directly into the forms. On account of its narrow width and end discharge it can be wheeled so as to spout directly into the forms. This is especially valuable in sidewalk work. Its perfect balance allows one man to lift the loading platform and shift wherever wanted. This end-discharge, combined with its portability are two big money-saving features that cannot be overlooked.

Archer Mechanics

The Archer has a capacity of $4\frac{1}{2}$ cubic feet wet concrete per batch, and easily averages 50 cubic yds. per day. We also can equip this mixer with a special batch hopper with sliding gate. This will enable you to load a complete batch while the other is mixing. This will increase the capacity to 70 cubic yds. per day. The engine on the Archer is simple and reliable. The engine is mounted on top of the frame out of the way, thus saving space. All engines are carefully tested before leaving the shops and are included in the Archer Guarantee. $1\frac{1}{2}$ to 2 gallons of gasoline will drive the Archer all day. The mixing drum is 32 inches long and 34 inches in diameter, of best blue annealed steel 9-64 in. thick, and cast iron drum heads. Mixing is done by bucket and blade method. This arrangement gives a back and forth motion as well as a pour over mix. You can always depend on the Archer to produce an accurate, thoroughly mixed aggregate. The No. 1 Archer Special Concrete Mixer is all Gear-driven. This is by far the best way; it saves you trouble and repair bills. All Gears carefully housed and protected. The Archer is a machine designed for fast mixing, easy charging, and quick discharging. Let us prove it.

The Archer No. 1 Special Concrete Mixer is fitted for all classes of work and will show a saving in money wherever used. We will send our Catalogue No. 25, giving complete and detailed information. Send us your name.

ARCHER IRON WORKS

2430 West 34th Place
CHICAGO, ILLINOIS

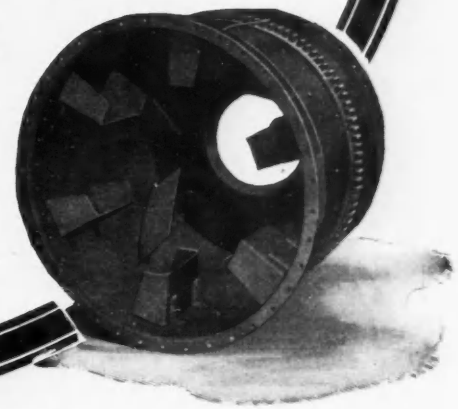

Make Time and Money On Both Charge and Discharge

You couldn't get the materials into the drum of the **Northwestern Mixer** any faster unless you blew them in by blast. They go in by gravity—into the biggest opening of any mixer on the market. You couldn't get the mixture out any faster if you tried—yet its escape is controlled so that the wettest of grouting mixtures will not slop a particle.

And You Get A Mix Every 60 Seconds

You get a perfect mixture every minute—a mixture that has gone through the Shower as well as the Whirlpool motions in a coned cylindrical drum.

Three revolutions of the drum empties it and the operator has perfect control of it every instant.

Northwestern Is Light In Weight

You can haul a **Northwestern** anywhere on the job with three men—not horses—yet that Mixer will handle from 40 to 50 yards of concrete a day with a 2½ h. p. engine. There is a big, illustrated book waiting for you to send for it—a postal card will do.

Put Your Concrete Problems up to our Service Department

Everything For Concrete Work

We make Block Machines, Concrete Brick Machines, Batch Mixers, Sewer Pipe and Drain Pipe Molds, Burial Vault Molds, Cap and Sill Molds, Silo Molds, Molds of all kinds, Tools of all kinds for concrete work—and factory prices are our only figures.

Big Free Book For The Asking

Our book on concrete machinery is the most complete thing of its kind ever published on this subject—contains information that will be invaluable to you, even though you never buy one penny's worth of Northwestern products. A copy is free.

Free Book if You Only Ask for it

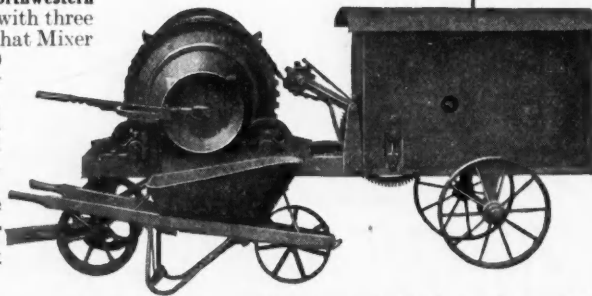

Northwestern Steel & Iron Works 252 Ball St. Eau Claire, Wis.

Ransome's BANTAM

Light as to Weight—Large as to Capacity

2700 lbs.

1 bag batch up to 1-3-6

Low as to Feed
27 inches

Low as to Price
\$275.00 f. o. b. Dunellen, N. J.

The Machine You Have Been Waiting For

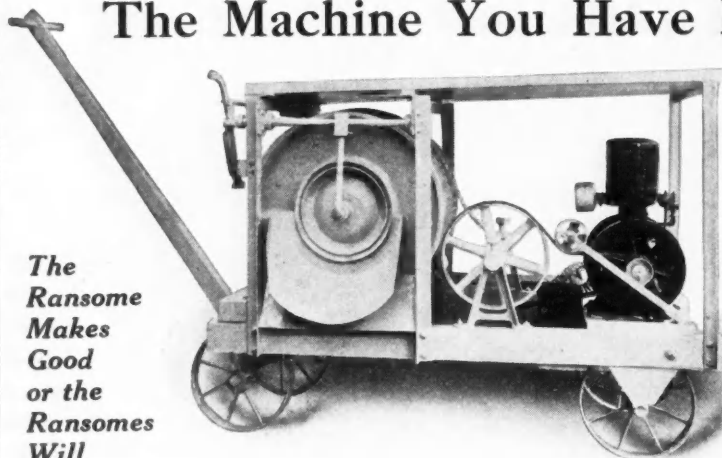

The Ransome Makes Good or the Ransomes Will

Here Is What One of Our Customers Says About One of Our Little Bantams:

Philadelphia, Pa., Dec. 11, 1914.

I am in receipt of your letter dated the 10th, and will say that the Bantam Mixer that you have sold us we have had on three separate jobs, and have mixed over 1000 cu. yds. up to date in it. This machine has given us absolute satisfaction in its workings, and it is the handiest little machine to get around with, we have ever owned as yet.

Should we be in need of another small machine, we do not know where we could place our hands on any as good or better for the money.

Respectfully yours,

(Signed) WM. LINKER CO.

Write Us for More Complete Information

RANSOME CONCRETE MACHINERY COMPANY

:-: Dunellen, N. J.

THE Atlas MIXER

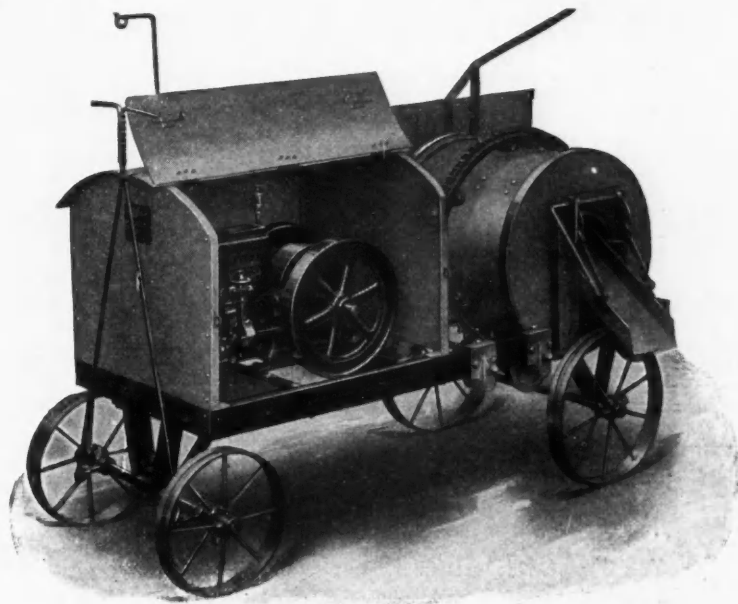

CAPACITY—5 ft. batch, easily fifty cubic yards per day.

“Notice” Our success with the Atlas Mixer,
and the large sales made the past year have
enabled us to reduce factory and selling costs.

We are going to share this extra profit with our customers.

You cannot afford to buy any Mixer until you have
asked us the price of this machine for 1915.

Send for particulars of the “7-ft.” Atlas with pressed steel drum.

The Atlas self-propelled road machine for paving work is a
sensation.

Atlas Engineering Company
783 Thirtieth Street MILWAUKEE, WIS.

WHEN WRITING ADVERTISERS PLEASE MENTION THE AMERICAN CARPENTER AND BUILDER

\$150

A 5 ft. Mixer
with a
2½ H.P.
Engine

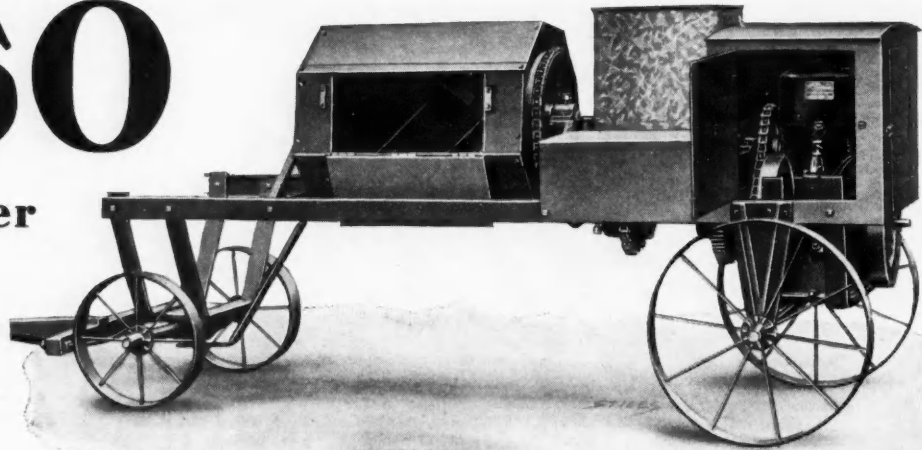

The GRAND BATCH MIXER

Here is the Machine you have long wished for—a high-grade Batch Mixer at a low price. This Machine is especially efficient for the average Contractor doing small work. It is very portable and is easily loaded and discharged. Machine has power dump being equipped with double reverse clutches so that drum can be rotated either way. Loads and discharges from either side. The Grand Mixer is equipped with a 2½ H. P. High Grade, tub top, water-cooled engine. All parts of this Mixer are of highest quality and it will give years of hardest service. If you want an all around Mixer for all kinds of work that is low in cost, investigate the new Grand Batch Mixer.

We also manufacture the famous Grand and Hartwick Continuous Mixers. They are leaders in their line. Write for Catalogue showing the complete Hall-Holmes line of Concrete Mixers.

Hall-Holmes Mfg. Co., 445 Oak St., Jackson, Mich.

Double Drum Batch Mixer

Makes Concrete

BY THE ONLY

Correct Method

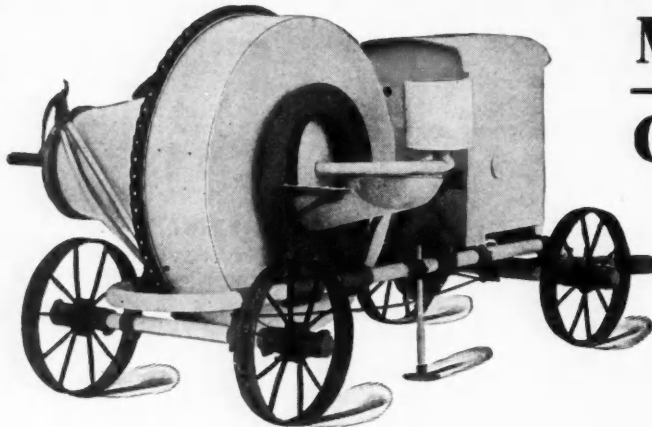

Specifications:

Large substantial wheels, tubular frame and axles. All sheet iron. 12" galvanized, basic open hearth iron. Trunnions, runways semi-steel. All cross-members, clips, etc., are malleable iron.

Drive is by heavy steel chain with case-hardened pins and rollers. Large sprocket is steel.

One Drum Mixing Dry while the
Other Drum is Wetting

Double Mix — Double Capacity

Mixes Sand or Pit Run Gravel
as Wet or as Dry as Desired

The "Double Drum"

Make these features possible. Very low, easy feed. High discharge.

— Very Low Mixing Cost —

Absolutely uniform proportion. Correctly mixed concrete.

Wheel barrow loader which keeps coarse material mixed with fine until discharged.

Enormous capacity for size. Others have taken the lead with this mixer. Why not you? Write for book, "Why the Double Drum," prices and terms.

Basic Patent on Double Drum, others pending.

Olsen Concrete Mixer Co.
301 Olsen Street — ELKHORN, WIS.

“THE STANDARD” LOW CHARGING

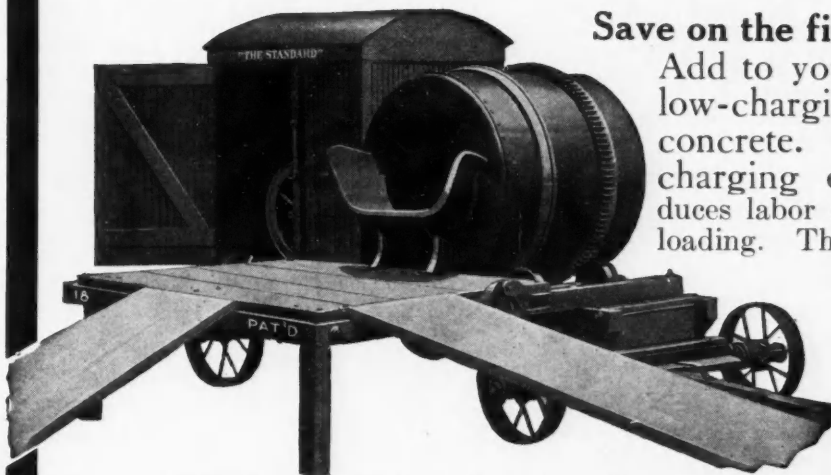

“The Standard” Capacities 4 to 40 cu. ft.

Save on the first cost of your mixer.

Add to your profits by using the low-charging method in mixing concrete. **WHY?** Because low-charging of “The Standard” reduces labor costs. No time wasted in loading. The design of the drum makes this method of charging the most simple because complicated loading devices aren’t required. You can’t save much on materials but you can save by having the right kind of machinery. Low-Charging will do it.

“S S S” LOW CHARGING

= \$145.00 =

Four foot size as illustrated mounted on Truck with Gasoline Engine, Gear Drive, for \$145.00 cash, f. o. b. factory. Charging Chute and Support and Steel House for Engine furnished for \$15.00 extra. The “SSS” Mixer has the same advantages of “The Standard.” You can either charge your materials into drum from wheelbarrows or shovel direct from material piles. When shoveling direct the charging chute is not needed. The advantage of Low-Charging Open Drum will soon save the entire cost of the mixer.

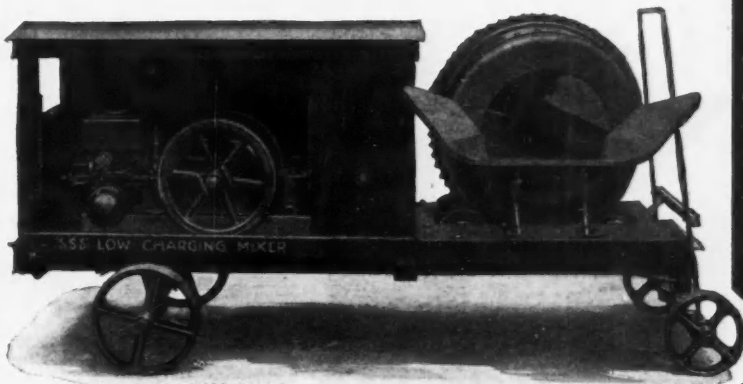

The “S S S” Capacities 4, 6, 8 cu. ft.

Write for Catalog No. 44-3 NOW

The Standard Scale & Supply Co.

MANUFACTURERS

New York
136 W. Broadway

Pittsburgh
243-5 Water St.

Philadelphia
35 South 4th Street

Cleveland
1547 Columbus Road

Chicago
1345-7 So. Wabash Ave.

GREATEST MIXERS ON THE MARKET

In order to have a perfect mix, it is essential that the mixer be designed so that it shovels in place of mixing by gravity. A shovel mixer will do the mixing thoroughly and quickly.

In semi-dry mixtures the mixer should be of such design as to enable you to not only see but feel the mixture so as to avoid its being either too dry or too wet.

To get the best results a mixer should be—easily cleaned, in fact, a self cleaner; easily operated; strongly built; durable; at the same time simple and not complicated.

FRANK'S UNEQUALED MIXERS

Meet all of these requirements. They are low down, so are easily filled. Its shovel operation makes it a self cleaner. **They mix thoroughly and quickly—a batch a minute. A boy can operate it.** They are easily unloaded.

Mixing is always in plain sight. (Note illustrations.) They are simple, strong and efficient. Are time and labor savers.

No tilting—tipping—slop over or spill. Made in two sizes—on skids or on trucks with engine.

They are **guaranteed** mechanically perfect, are unequalled for Sidewalk and Floor work, for Concrete Block or Brick Plants, General Farm Work or for Country Road Work, and yet **they sell for less** than others not so efficient. They are equal to any selling at double the price.

They are built of steel and iron. The drum is round and flat at the bottom. Has no sharp angles or corners for cement to collect in. It has a clutch operation.

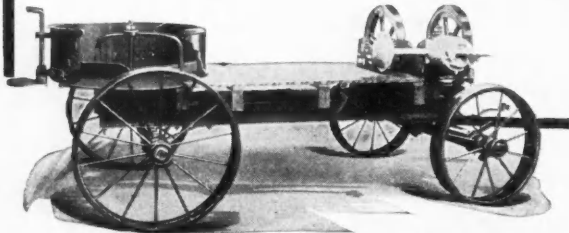

Frank No. 2 on Trucks with cutaway view of drum

If you want a mixer that will help you make more money on every contract—a mixer that is unequalled for all around efficiency—investigate the Frank Mixers.

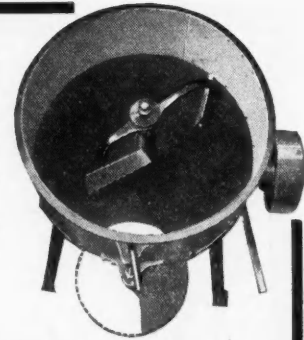

Inside view of drum showing door for unloading



Frank No. 1 on skids

Circular and Prices sent upon request. Write today **FREE**

Frank Manufacturing Company

209 W. Second Street

Des Moines, Iowa

The
"Little Builder"
 —the
 Ball Bearing
 Concrete
 and
 Mortar
 Mixer

PRICE AS SHOWN
\$165



Easy to Shovel Into

There are bigger mixers than this, but none better. Dozens cost more without being worth more. If you want a mixer that will mix concrete and mortar better, quicker and cheaper than hand methods, that will last and does not necessitate a large expenditure, that will handle little or big jobs, that is convenient and efficient, then the **Little Builder** will answer your every requirement.

Built for the roughest, hardest service. Rugged and strong all through. Easy to haul.

And the price! Anyone can afford it. \$165.00 as illustrated; \$265.00 with Power Loader; Hoisting Attachment for building purposes, \$30.00.

Get our complete catalog on concrete machinery and larger mixers.

LANSING COMPANY, 1002 Cedar St., Lansing, Michigan

WAREHOUSES:

New York Boston Philadelphia Kansas City San Francisco Chicago Minneapolis

THE JAEGER Big-an-Little

**A-MIX-
A-MINUTE**



Batch Mixer



**Designed and Built to Show
BIG PROFITS
on the Big Job — on the Little Job
That's the Jaeger "Big-an-Little"**

It's built for the average Contractor who handles all kinds of work. It's an all-around mixer that will show a substantial profit on a little sidewalk job as well as on big construction work. The "Big-an-Little" is exceptionally reasonable in price—so reasonable that you absolutely cannot afford to mix by hand. Neither can you afford to pay much more for a mixer that has not the wide range of work the "Big-an-Little" has. You Carpenters and Builders should use particular care in selecting a mixer, because you are the very Contractors that have these various big jobs and little jobs. You will find the "Big-an-Little" will take care of these jobs most efficiently and increase the margin of profits on them. Not only that it will aid you to under-bid your competitors and increase your business.

We also manufacture the "Jaeger Big" and the "Jaeger Little." They are built along similar lines as the "Big-an-Little." They all turn out "A-MIX-A-MINUTE" and are built "Quality First." Our new Catalogue shows the complete Jaeger line, and will surely interest you. Write for your copy today.

THE JAEGER MACHINE CO.
318 W. Rich Street, COLUMBUS, OHIO

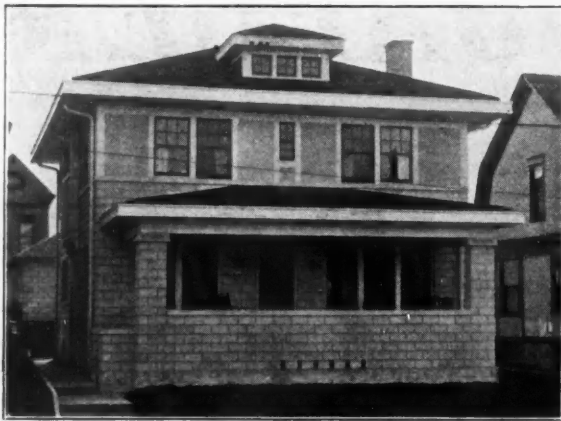

No Greater Opportunity

to develop a profitable business will be presented to you than our invitation to learn about the assistance rendered both by our Service Department and our Engineering Department to purchasers of

Ideal Concrete Machinery

The equipment is simple.

The operations of making a block are few, yet even our **\$125.00** outfit handles a wide range of work in several face designs and enables you to manufacture high class products at low cost.

Ideal Concrete Machinery Co.

1308 Monmouth Avenue - Cincinnati, Ohio
Windsor, Ontario



Get this Bit for your "YANKEE"



Screw Holder Bit for No. 30, 31, 130 and 131

Great for driving or drawing screws in places out of reach, overhead, or in tight corners. Takes the screw quick as a wink, holds it firmly with bit in slot and releases as the screw is driven home. Slip the spring back and use it as a plain bit for all ordinary work — a great attachment. Made for the No. 30, 31, 130 and 131. **Price 35c.** Your dealer can supply you.

 Send for the Yankee Tool Book.
Tells all about the Yankee Line

North Bros. Mfg. Co.
Dept. A Philadelphia, Pa.

Carpenters Who "Know" USE

SEBCO Expansion Bolts

because they absolutely cannot work loose or pull out. Recently a $\frac{1}{2}$ " diameter bolt by $3\frac{1}{2}$ " actually withstood a weight of 8,200 pounds before stripping the threads of the lag screw. Sebco Expansion Bolts are used for fastening fixtures to walls, floors and wherever ordinary screws will not hold. When screw is inserted the shield expands with each turn, making it impossible to pull out. Send for working samples; also catalogue 5R absolutely free.

SOLD BY ALL DEALERS.

Star Expansion Bolt Co.

147-149 Cedar St., New York City
120 West Lake Street
Chicago



15 Days Trial Before You Buy

We Make Them Good Contractors who make For Our Own Good Dunn Cement Drain Tile Can Live on "Easy Street"



We put extra quality into Dunn Mixers, and charge it to "investment." The dividends are represented by Re-orders.

Once a Dunn user always a Dunn user—for the following reasons:

Labor Saving is an important consideration. The Dunn Power Discharge feature is the greatest labor-saving feature ever employed in mixer construction.

Mixing Efficiency—the Dunn 4-blade principle is the most efficient yet evolved.

Mixing Angle should be varied to suit the consistency of the mixture. The drum on Dunn Mixers can be tilted and held at any angle.

Long Drum gives more mixing room. Dunn drums are seven inches longer than ordinarily.

Durability—the Dunn is all steel and iron. Has one-piece hollow yoke, steel trucks, steel wheels, 12 gauge boiler plate drum, reliable engine.

Manufacturing cement drain tile is a good, clean, profitable and legitimate business, free from any semblance of risk or speculation. Requires but a moderate investment for equipment, and opens up a new field for building contractors located in or near farming communities.

Buy a Dunn No. 1

The price is small but the machine is not. In size, operation and price the No. 1 is exactly right. Uses 1, 2 or 3 men, makes all size tile from 3" to 12" in diameter, has a capacity of from 1,500 to 2,000 tile daily. Makes the strongest, densest tile ever marketed, is the easiest machine to operate. Investigate the business and the machine by writing for tile catalog. Price of the Dunn No. 1, **\$165**



Patent No. 842262 and 782700

DUNN

Concrete Mixers

Made in two sizes and several styles. No. 1 has a capacity of 5 cubic ft. to batch; No. 0 has 3½ cu. ft. to batch. Furnished on skids or trucks, with or without engine.

Your business demands a concrete mixer—sooner or later you will buy one. Investigate the Dunn Mixer now by writing for catalog.

Prices of Dunn Mixers from **\$67.50** to **\$224**

Cement Blocks

In Three Styles and Many Sizes

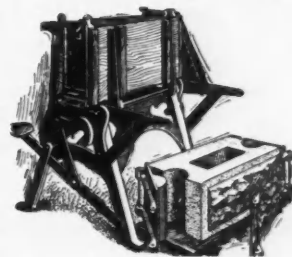

Consider the serviceability of the Dunn Combination Cement Block Machine.

It makes blocks 8x16, 10x16 and 12x16, in rock-face, level panel and smooth designs. Operates as a face-down, side-face and two-piece hollow wall machine. Uses wood pallets—a wet mixture—assures nothing but dense, perfect blocks. Capacity, 150 blocks per day.

Write for Block Machine catalog; price of machine, **\$40**

Concrete for Porches and Ornaments

Use Dunn Molds for producing profitable concrete ornaments—complete porches, vases, columns, lattices, balusters, flower boxes, chimneys, etc. Also, concrete block molds, silo block molds, etc. The molds which make the porch illustrated will also make blocks for other purposes. Price of outfit **\$39**

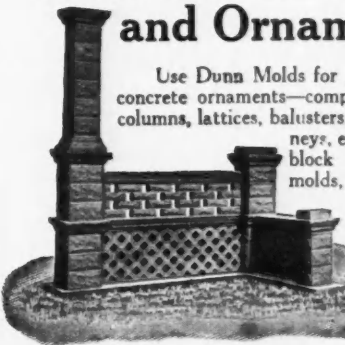

OUR SALES PLAN

Here's the way Dunn Machines and Molds are sold—all of them. You order on 15 days' trial, reserving your buying judgment until you have used the equipment for two weeks. Then you buy or return it, just as you wish. We never force a sale against the user's inclination.



W. E. Dunn Mfg. Co.

4132 Fillmore St., Chicago





Double Your Output With No Extra Expense



Competition is so keen that every business man is constantly looking for methods by which his overhead can be reduced without affecting his profits or product.

Double Speed Machines will do it. You can not only double your output with the same labor cost, but you can increase your profits as well.

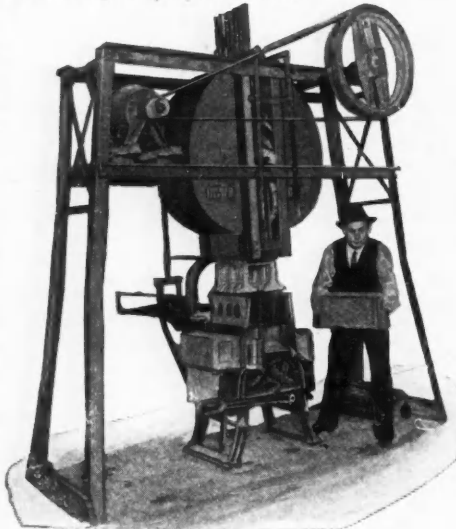

Every *Double Speed Machine* is guaranteed to double the output of any other make of its size. They are easy to operate. No trouble or complicated parts. They will pay for themselves in fifteen days.

DOUBLE SPEED POWER TAMPER

One DOUBLE SPEED power tamper will turn out 1,500 blocks or from 12,000 to 15,000 bricks per day. It only requires a 2 h.p. gasoline engine or electric motor to drive it or can be run from line shaft. This tamper can work over the brick or block machine by simply changing the feet. Has automatic device for removing surplus material after blocks are tamped, which means a perfect face and smooth back on each block

DOUBLE SPEED—Block Machines

will make twice as many blocks or building slabs as any other machine. This machine automatically makes two blocks or two slabs at each side with only one operation of the lever. This is a face-down machine and can produce all kinds of beautiful designs, with granite faces, marble dust, etc. All styles of Blocks and Slabs can be turned out double the speed of any other machine.

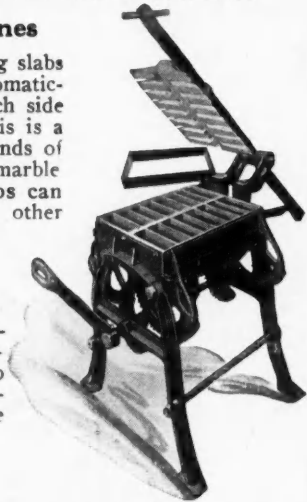

DOUBLE SPEED--- Cement Brick Machines

Make sixteen bricks at one time—think of it—delivering eight bricks at each side of the machine with one operation of the lever. It is also a face-down machine, allowing all kinds of ornamental faces to be produced on it. This machine actually pays for itself in 15 working days.

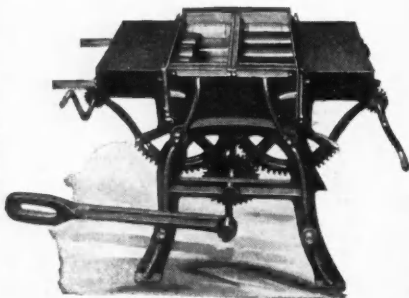

YOU CAN DEFY COMPETITION

With *Double Speed Machines* you can meet a competition, no matter how keen. They cut your costs to a minimum and enable you to sell for less and still make a greater profit.

Don't Delay—Write today for catalog and full particulars. Get the bigger profits. Just let us prove that with *Double Speed Machines* you can make more money.

Northwestern Manufacturing Co., 31 Orcutt Bldg. **Sioux City, Iowa**



GUARANTEED EDGE TOOLS

This Stamp (T. H. WITHERBY WARRANTED) on Edge Tools assures complete satisfaction sure your chisels, gauges or draw knife bears the above stamp. For sale by all dealers. Send for illustrated

booklet showing all styles. It assures longest service too. We stand back of our guarantees. Be

THE WINSTED EDGE TOOL WORKS

WINSTED, CONN.

THE NEW SASGEN PORTABLE 1-TON STIFF LEGGED DERRICK

THE ONLY DERRICK OF ITS KIND
ON THE MARKET

Built Strong and Light of all Crucible Steel Fittings, including Double Drum Geared Winch. Can be used hand or power. Price very low according to length of boom.

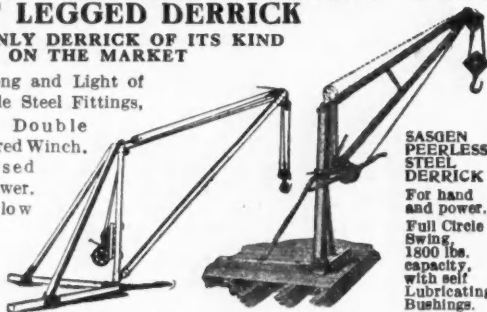

SASGEN PEERLESS STEEL DERRICK For hand and power. Full Circle Swing 1500 lbs. capacity, with self Lubricating Bushings.

SASGEN DERRICK CO.
2053 N. Racine Ave., Chicago.
Canadian Office, 1 Wabash Ave., Toronto

Price only \$45.00 complete ready for use, \$43.00 for hand power only. Write for Circular No. 2. Satisfaction—Prompt Shipment Guaranteed.

CONTRACTORS AND BUILDERS

Why not manufacture your own Brick for one-half the price you are paying for them. This can be done on the Perfect Automatic Adjustable Brick machine. Write for catalogue. It contains a full line of the latest improved Concrete machinery. Retain this coupon it will answer as cash to the amount of \$10.00 on your purchase, on either Brick, Block, or Power Tamper. The Perfect Line consists, of Brick, Block, Machines, Power Tampers, Cistern Well, and Silo Molds. Address



Brick Machine.



Block Machine.

C. S. WERT, Kendallville Ind.

\$246.-

This low price covers the dandy rig shown in Figure 2136. It consists of a Mixerette on steel truck with 2 H.P. gasoline engine, steel house and low-down, gated batch feeding hopper.



Figure 2136

Our "Straight-from-the-Shoulder" Guarantee Covers the Smith Mixerette Absolutely

THE GUARANTEE

We Guarantee the Smith Mixerette to have a capacity of 3 cubic feet of mixed concrete per batch, to comply with the specifications shown in our catalog, and to produce when fed to capacity, not less than 45-60 batches per hour of first-class concrete, to pass any inspection. If it fails to do so, we will take back the machine, refund the purchase price and the freight with 5% interest from date of payment to date of return. Any defects or complaints must be reported promptly to this office.

We Guarantee the Smith Mixerette to be of first-class workmanship and material throughout; and will replace F. O. B. factory any material which, within one year from shipment, proves to have been defective when furnished.

We Guarantee the engine to pull the load. It is also covered by the special guarantee of the maker.

THE MIXERETTE

If you are going to buy a small Mixer, buy one that "stacks up right." Get a machine that will do your work rapidly and economically—one that you can use on the big job as well as the small one.

For fourteen years the **Big Smith Mixer** has demonstrated its economy and superiority on hundreds of famous projects. It has well earned its wonderful reputation. And it is this reputation that is back of the **Smith Mixerette**; that insures your safety under our broad and comprehensive guarantee.

Read the guarantee! Then read it again! **You** have nothing to lose and everything to gain. We are staking our reputation that the **Smith Mixerette** will do your work and do it to your entire satisfaction.

You wouldn't deliberately blindfold your eyes and take your chance picking out a good house and lot. Nor would you buy a Mixer without comparing the various makes. Get our catalog No. 116-C, and make the comparisons yourself.

The T. L. Smith Co.

3123-C Hadley St.
MILWAUKEE - WISCONSIN

1343-C Old Colony Bldg.,
CHICAGO, ILL.

\$315.-

Covers the cost of the outfit shown in Figure 2137. This machine has a gear-driven power charger in place of the batch hopper. Otherwise these machines are identical.

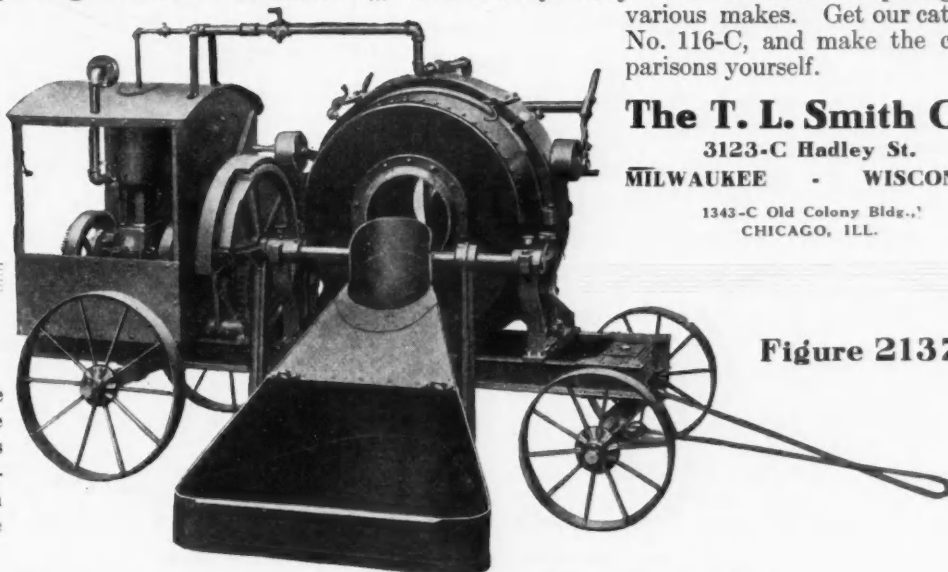

Figure 2137

"THE LITTLE DEVIL"

Always on the Job

Segmental Gear.
Direct Gear Drive.
Hoist with Brake.

Hoisting Drum will
Hold 150 ft. of
1/4-inch Cable.

Can Furnish with 4
Wheels and
Batch Hopper if Desir-
ed.

Write today
for prices
and booklet
showing
the "Little
Devil on the
Job".

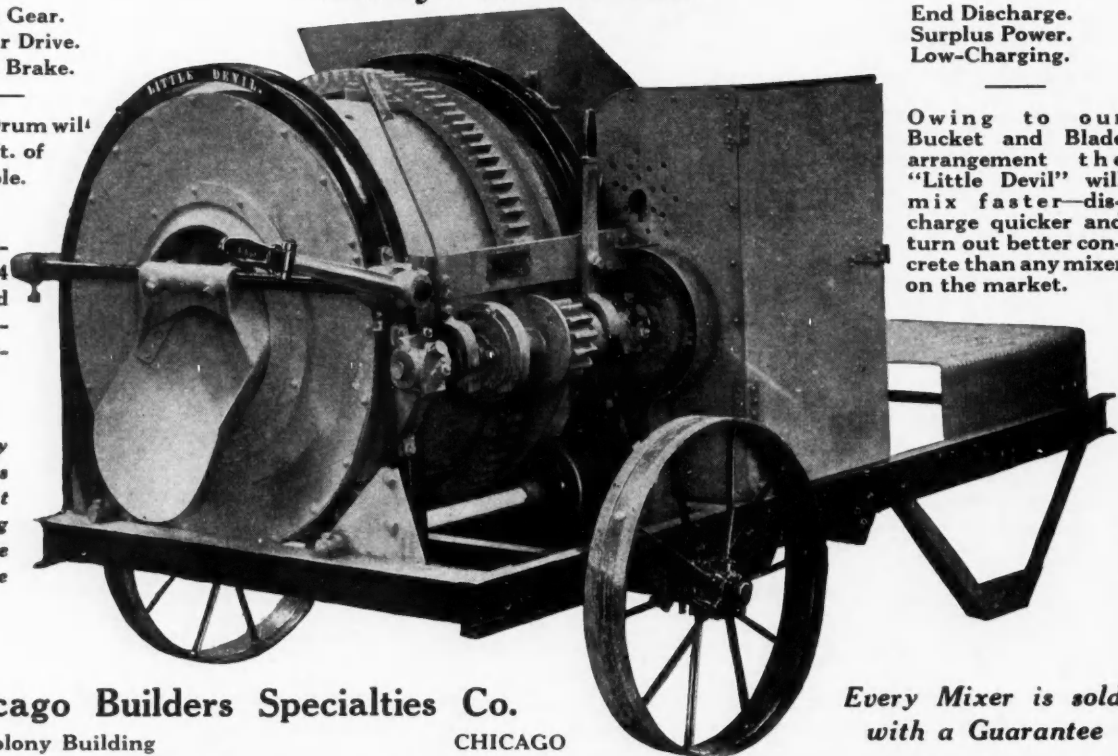

End Discharge.
Surplus Power.
Low-Charging.

Owing to our
Bucket and Blade
arrangement the
"Little Devil" will
mix faster—dis-
charge quicker and
turn out better con-
crete than any mixer
on the market.

Chicago Builders Specialties Co.

450 Old Colony Building

CHICAGO

Every Mixer is sold
with a Guarantee

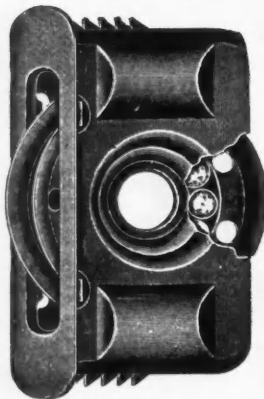

No. 10 Ball Bearing

"Grand Rapids"

BALL BEARING
ALL STEEL

Sash Pulleys

Fasten automatically.
No Nails. No Screws.
Just bore four holes.

The automatic saw tooth fastening feature
and the simple and easily made mortise will
save in labor enough to pay for the pulleys.

The Bearing contains eleven 1/4-inch Solid
Steel Balls running in lubricant.

NOISELESS EVERLASTING

Write for **FREE Samples**

Grand Rapids Hardware Co.
MANUFACTURERS

158 Eleventh St. :: Grand Rapids, Mich.

MONITOR SASH LOCKS

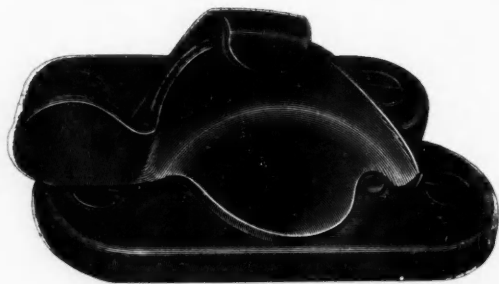

(PATENTED)

NEVER BREAK

**BECAUSE THEY ARE MADE OF VERY HEAVY GAUGE
METAL AND PERFECTLY CONSTRUCTED.**

If the upper plate drops, the Monitor "Never Break" Sash
Lock will pick it up from a lower point than any other,
adjust the sashes perfectly, prevent all vibration and
lock securely, so it cannot be opened from the outside.

MADE IN TWO SIZES AND ALL FURNISHED BY

The Champion Hardware Co.
Geneva, Ohio

Winner Mixer

The "BIG BEN" of *The* CONCRETE WORLD

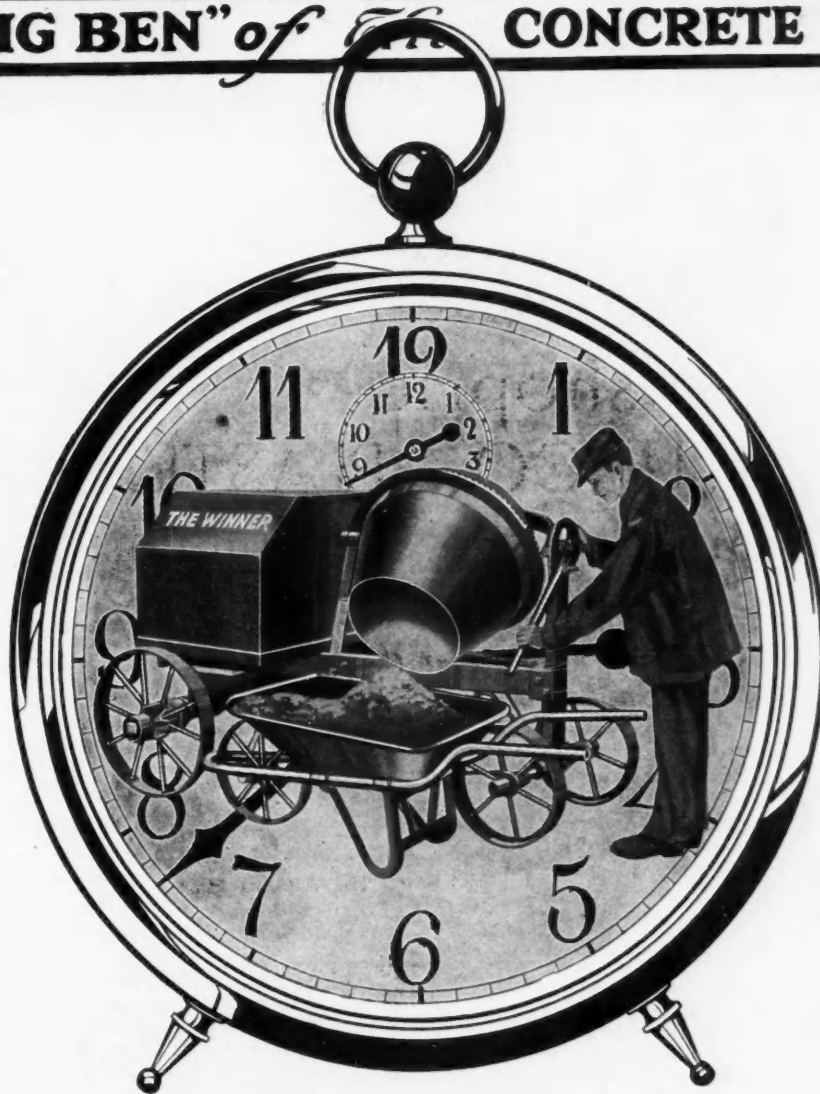

THE WINNER has looked all kinds of jobs square in the *Face*, been *Timed* per hour and per day, worked under thousands of different bosses but when the gong sounds the WINNER is always *on time* and ready to start.

The Winner is **SO GOOD** through and through that every time the clock *ticks* off ten hours—Five Winner Mixers are given new owners.

American contractors everywhere are finding the Winner the *Main-Spring* of their business and wherever you find the Winner in operation—It's the whole *Works*.

The Winner is simple, compact, economical, efficient; perfect in design, principle and workmanship. When you put it on the job it wins with *hands down*.

As a real genuine money-maker and *time saver* the Winner rings the profit bell with the biggest and boldest figures.

Tick Tock—the batch is loaded; *Tick Tock*—the batch is mixed; *Tick Tock*—the batch is dumped; *Tick Tock*—all day long, day after day, month after month, year in and year out, the Winner keeps Time with the clock, saving men's backs and making men profit.

Wind the Winner up in the morning, feed it a gallon of gasoline and a few drops of oil—that's all the pay it asks and with *two hands* it will do the work of *six*.

The Winner is made in four sizes—The Baby Two, The Little Three, The Big Four and The Light Six—Each one a *Jewel*. You can buy them with trucks, without trucks, with engine or without engine, with loader or without loader—any way you prefer.

The Winner is the best *Alarm Clock* for your business that you can buy—it wakes everybody up—lets people know you're on the job—turns the hours into minutes—fills your men with vim and hustle and is always *on time*.

Let us put the Winner on your work for ten days—try it by the clock, and if you don't find it the most prompt, most steady, most faithful and most profitable helper on the job—send it back.

The price?—Just write the Cement Tile Machinery Company of 138 Rath Street, Waterloo, Iowa, and they will tell you the whole story.



THREE FAMILY APARTMENT

Built with Bishopric Stucco or Plaster Board

Ed. F. Freeman
Owner and Builder
Roxbury, Mass.



Bishopric STUCCO or PLASTER BOARD Built on the Wisdom of the Ages~

A modern combination of materials and principles that ages of actual use have proven the most efficient in building construction.

The Dovetailed Lath

Centuries ago the artisan recognized the utility of the dovetailed joint in building construction; and since then every master builder has used the dovetailed joint where a permanent, lasting and efficient joint was desired.

The cement, stucco or plaster dovetails into the Bishopric Stucco or Plaster Board and is held absolutely firm, so that cracking or crumbling is impossible. The covering becomes a part of the board and will last for ages.

The Creosoted Lath

Creosote is a wood preservative. It is customary to creosote wood that is exposed to severe weather conditions—railroad ties for instance. The lath in the Bishopric Stucco Board are creosoted.

The Asphalt Mastic

Covering one side of the card board is the toughened



"Built on the Wisdom of Ages"

Asphalt Mastic in which the lath are imbedded. Asphalt Mastic is moisture-proof, fire-resisting and a wonderful preservative. Asphalt was the important element used by the ancient Egyptians to preserve their mummies.

The Heavy Fibre Board

Paper and paper board is so extensively used in building construction that its advantages need hardly be mentioned. It forms a very important part of the Bishopric Stucco Board, not only for its protection against heat and cold, but also because it is a sound deadener.

Plaster and cement walls cannot crack if Bishopric Stucco or Plaster Board is used.

—because Bishopric Stucco Board is right scientifically. It is built on principles that have been tested and proven the best, not for years, but for *centuries*.

—because Bishopric Stucco Board is right in practice. Years of the severest tests under all conditions prove absolutely that in actual use Bishopric Stucco Board is unequalled.

Better Walls — Less Money

Write at once for **FREE SAMPLES OF BISHOPRIC STUCCO OR PLASTER BOARD** and our illustrated book *"Durable Homes by the Bishopric System"* illustrating buildings of all kinds on which Bishopric Stucco Board has been used. This book also contains letters from Builders, Architects and users of Bishopric Stucco Board and furnishes facts and figures to prove that it cuts the cost 25 per cent.

THE MASTIC WALL BOARD AND ROOFING COMPANY
658 Este Avenue, CINCINNATI, OHIO

Building Principles
that have been
Tested for Ages

Short Talks with Our Subscribers

Farm Building Improvements

BUSINESS indications point to improved conditions. The trend of prices for all farm produce is upward. Farmers all want home improvements and general farm improvements. Most of them already have substantial bank accounts which they are willing to draw on for such purposes as soon as they know what they want. There is a sentiment among farmers that they are entitled to better home conveniences, and they are free to admit that their farms should have better fences and better buildings.

Local carpenters and builders have a great opportunity to increase their own business by taking up the subject of building and building repairs with their farmer customers and acquaintances. It is safe to assume that every farm is short on buildings and fencing. Farmers are busy at home and they are slow to tackle a job that is new to them. At the same time, a few minutes' conversation will prove that every farmer would like to improve his home surroundings and he is perfectly willing if an easy way is pointed out to him. At no time since the Pilgrim Fathers landed on Plymouth Rock have the farmers been in such good financial condition as they are at the present time. This is an opportunity for carpenters and builders to secure a great deal of good new business.

Farm power is a big proposition on all large farms. Hand labor is so expensive that machinery must be employed to do the heavy work. Gasoline and crude oil engines are being built especially for farm use. When a good power plant is installed it suggests many labor-saving conveniences.

The first and the most important is an ample supply of good pure water under pressure and piped to the house and to the different watering troughs for

live stock. This necessarily leads to alterations in the house to provide bathrooms, laundries, kitchen sinks and a sewer system.

It leads to the building of a creamery and the installing of machinery and the carrying of power from the engine to drive the different machines.

It often means a special power house with shafting, belting and rope conveyors to carry power to other buildings. A farm power plant always induces the farmer to keep more live stock.

Live stock demands extra stable accommodations, and this leads to the study of sanitary buildings with concrete floors, stable carriers for feed and for manure, with hay forks, and a power drive for cutting box, feed chopper, fanning mill, etc.

These modern farm power equipments may lead to the building of a substantial new barn. One fine new barn in a neighborhood is the most effective argument to induce the neighbors to do likewise. When the building fever is once started, it spreads all over the county.

There is a substantial reason for all this. It is based on the fact that profitable farming comes only through the keeping of live stock. During seven or eight months of the year live stock must be protected from weather. Every farmer realizes that a cold storm on fattening animals will take off more than a week's feeding can put back. Good farmers house their animals both for sentiment and for profit. Farmers are naturally humane, and they dread to see animals neglected. They take care of animals also because it pays well to do so.

Every farmer is anxious to have better stable accommodations. It often happens that very little argument is necessary to get his contract. It is up to the carpenter and builder to make his first job give satisfaction, and it will sure bring others.

Contents for March, 1915

	Page		Page
Acetylene Lighting for Country Houses	40	Farm Buildings	62
Bed Room—Full Page Photographic Plate	50	Filling Cracks in Timber	88
Between "Heavy Timber" and "Plank"	86	Fine Example of Corn Crib Framing	88
Bringing the Old Farm Home Up-to-Date	38	Fink Truss Design	76
Broom Holder from Old Rubber Boot Heel	89	Fly Fighting for Farmers	37
Brown Print Paper	90	Gable End Cottage House	53
Carpenter Jobbing Shop	89	Gasoline-Gas Lighting Used in Senator Wilson's Home	41
Cement Building Construction	70	Gothic Roof Barn	64
Chemical Closets Best Sanitation for Rural Homes	61	Guaranteed Building Plans	42
Colored Plaster Work	90	Helps to Bigger Business	58
Comparison of Construction Cost	37	House Moving—How to Jack Building Up and Arrange Running Timbers	60
Construction Details of Gothic Roof Barn	65	Huge Square Stock Barn	93
Construction Details of Prize Farm House	44	Instance Where Two Plus Four Does Not Make Six	70
Correspondence	85	Interesting Four-Room Bungalow	47
Cottage House of Four Rooms	46	Interior Details of Prize Farm House	45
Country House with Circle Porch	52	Keen Interest in Bench Planer	85
Dairy and Horse Barn	66	Man from the Lumber Yard	56
Details Explained	88	Metal Lath and Plaster will Protect Any and Every Home	72
Detail Sheet of Gambrel Roof Barn	67	Modern Building Improvements and the Farmer	38
Dining Room—Full Page Photographic Plate	48	Modern Conveniences for the Home	79
Electricity for Farm House and Village Lighting	39	Neat Window Seat for Radiator	87
Elegant Country Home	51	New Gothic Roof Barns in Canada	90
		Noon Hour Talks by the Boss Carpenter	76
		Not Nice for Wedding Present—But Here's An Idea	92
		Only One Guess Needed	87
		Patents New Dividing and Measuring Tool	87
		Pleasant Answer	87
		Plymouth Congregational Church, Lincoln, Nebr.	75
		Possibilities of the Steel Square	83
		Poultry House Plans	85
		Prize Farm House Improved	42
		Public Buildings	55
		Scientific Ventilation for Farm Buildings	68
		Screened Porch with Fly Exits	89
		School Building at North Chicago, Ill.	55
		Seven-Room Story and a Half House	48
		Steel Square	83
		Strong on Remodeling	92
		Stucco Board Proved Stronger than Sheathing	80
		"Sunshine" Winter Hog House Design	63
		That Heavy Timber Detail	85
		Trade Notes and Items of Interest	94
		Vacuum Cleaner's Part in Health and Home Building	79
		Value of Labor-Saving Buildings	62
		Well Built, Convenient Hog House	92
		Window Display Advertising for Builders' Shops	58
		Wood Form for Steps and Ramp	71
		Yours for Safer Building	76

CHICAGO SPRING BUTTS

REPUTATION

Do you specify a spring hinge with distinctive features which will appeal to your client and assure satisfaction to all concerned?



Chicago "Relax" Spring Hinges

are in great demand. They are substantial in construction and readily applied. The EXCLUSIVE FEATURE of spring action release, allowing the door to be placed at any desired position and automatically re-engaging when the door is closed,

is of recognized merit and utility.

Send for Catalogue C 29. It fully illustrates and describes the most complete line of Spring Hinges manufactured.

Chicago Spring Butt Company

CHICAGO



NEW YORK

Yes! the World does Move!
Facts are Stubborn Things

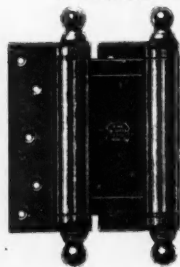

Don't Buy
SPRING HINGES
OF
OBSOLETE
CONSTRUCTION
ONLY

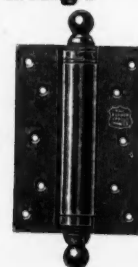

BOMMER

Double Acting Spring Butt Hinges

have the weight-supporting bearings correctly located to liberate the action of the springs, reducing breakage and increasing spring power, preventing unequal wear of the barrels, and giving practically unlimited durability. Bommer double-acting spring hinges open alike at both casings and both doors when both doors are opened.

The carpenter can avoid guesswork and save time when hanging double-acting doors in pairs, as he can scribe and fit both doors of a pair from the same side of the opening.

YOUR HARDWARE MERCHANT CAN SUPPLY THEM
Bommer Bros., Manufacturers Brooklyn, N. Y.

Cabot's Sheathing and Densolint Quilt

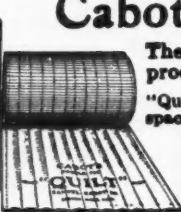

The Cold-proof, Heat-proof, Sound-proof and Fire-retarding Lining

"Quilt" is a matting filled with dead air spaces, and one layer is as warm as twenty-eight layers of common building paper. A house lined with it will always be warm and save coal. Floors and partitions lined with it will stop the passage of sound. Roofs lined with it will keep cool

in summer and prevent heat from escaping in winter. It will save coal enough to pay for itself every two winters as long as the house stands.

Send for a sample and catalog.

SAMUEL CABOT, Inc., Manufacturing Chemists, Boston
24 W. Kinzie St., Chicago - 1133 Broadway, N. Y.

Cabot's Crocote Shingle Stains; Stucco and Brick Stains,
Conserve Wood Preservative.

Worth Much to You

Morrill Saw Set

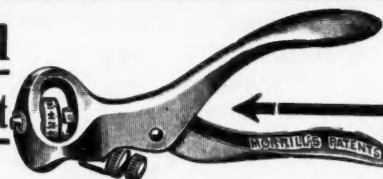

All master carpenters are using this Saw Set. In one operation it takes out the wrong set and puts in the right one. Write for FREE booklet "Saw Points". It tells how to properly joint, set and file hand saws.

CHAS. MORRILL

94 Lafayette Street
NEW YORK

IMPERVITE is Guaranteed to Waterproof Walls, Cellars & Pits.

A facing of IMPERVITE MORTAR on the inside will resist water on the outside.

ASK FOR BOOK NO. 62 **The Standard Paint Co.** NEW YORK BOSTON CHICAGO

Copyright 1915 by American Carpenter and Builder Company



The
**World's Greatest
Building Paper**

Important Notice

When your subscription expires, renew at once, using the blank enclosed in your final copy. If it expires with this issue your renewal must reach us before March 25, to avoid missing the April number. Use P. O. or Express Money Order if possible, but bills or 2-cent stamps may be sent at our risk.

The
**World's Greatest
Building Paper**

American Carpenter and Builder

Entered as second-class matter July 1, 1905, at the postoffice at Chicago, Ill., under the act of Congress of March 3, 1879.

Published on the first day of each month by

AMERICAN CARPENTER AND BUILDER COMPANY
RADFORD BUILDING, 1827 PRAIRIE AVE., CHICAGO
Member Audit Bureau of Circulations

SUBSCRIPTION RATES

One year, \$2.00; six months, \$1.00; payable always in advance. Single Copies, 20 cents. Canadian Subscriptions, \$2.50. Foreign Subscriptions, \$3.00.

ADVERTISING RATES

Furnished on application. Advertisements, to insure insertion should reach our Chicago office not later than the 15th of the month preceding date of publication.

PROTECTION FOR OUR READERS.

The publishers of the American Carpenter and Builder will not knowingly publish any advertisement of a misleading character nor accept advertising from any individual, firm or company whose business methods are open to question.

We often receive inquiries from readers who desire information about concerns that formerly used the advertising pages of the American Carpenter and Builder, but are no longer doing so. They want to know if these former advertisers are still in business, if they can send them orders with the assurance that they will be filled, and a variety of other questions.

The American Carpenter and Builder will use every legitimate means to safeguard the interests of its readers and to protect them from fraudulent or unreliable concerns. Where the slightest doubt exists our readers should write the publishers for information. It may save them money, time and worry.

In all cases in writing to advertisers say: "I saw your advertisement in the American Carpenter and Builder."

EDITORIAL DEPARTMENT

WILLIAM A. RADFORD, *Editor-in-Chief*

BERNARD L. JOHNSON, B. S., *Editor*

WILLIAM REUTHER

ALFRED W. WOODS

ALFRED S. JOHNSON, M. A., Ph. D.

CHARLES E. PAUL, S. B.

*Associate
Editors*

BUSINESS DEPARTMENT

WM. A. RADFORD, *President and Treasurer*

E. L. HATFIELD, *Vice-President and General Manager*

ROLAND D. RADFORD, *Secretary*

New York Office: 345 Fifth Ave.

E. B. WOLFROM, *Eastern Representative*

VOL. XVIII

MARCH, 1915.

No. 6

MIND your own business and in time you'll have a business of your own to mind.



DISHONESTY is never an accident. Good men, like good women, can see temptation when they meet it.



YOU owe so much to yourself you can't afford to owe anybody else. Keep out of debt or keep off the job.



Fly Fighting for Farmers

LIFE in the country may be made much more comfortable by a little work along sanitary lines. House flies are carriers of disease. They wallow in the filthiest places, but immediately travel to the house at meal time. Flies detect the odor of cooking very easily. They crowd into the dining room and kitchen.

See to the screens for all doors and windows.

The great source of flies on farms is manure. The easiest way to fight flies is to keep the manure carted out and the barnyards and stables clean. After stables and barns have been thoroughly cleansed and all the trash swept up and disposed of out in the fields where it belongs, then the spreading of disinfectant early in the spring before the flies hatch will reduce the numbers by the million.

Heretofore farmers have unintentionally provided the very best breeding grounds possible for house flies. Nature has so arranged the compensation that this profitable work of fighting flies on the farm and carting the manure out and applying it to the crops will more than pay for the extra labor, while the health of the family is an extra prize.



Comparison of Construction Costs

AN interesting suggestion was made in the discussion before the Boston Society of Civil Engineers on a paper by Leslie H. Allen of the Abertaw Construction Company, Boston. It is well known that some excavation work is so simple that it will cost less than half what other work of the same sort costs. "A superintendent on a job at Philadelphia may receive a cost comparison and see that a man on a new job in New Hampshire is beating his costs by half. If he is conscientious this may worry him. Why not send out a comparison of costs per unit divided by the estimate per unit, this to be corrected if later knowledge should show it to be low? In this way the superintendents would get their comparative *efficiencies* instead of comparative *costs*, a more equitable comparison."

MODERN BUILDING AND THE

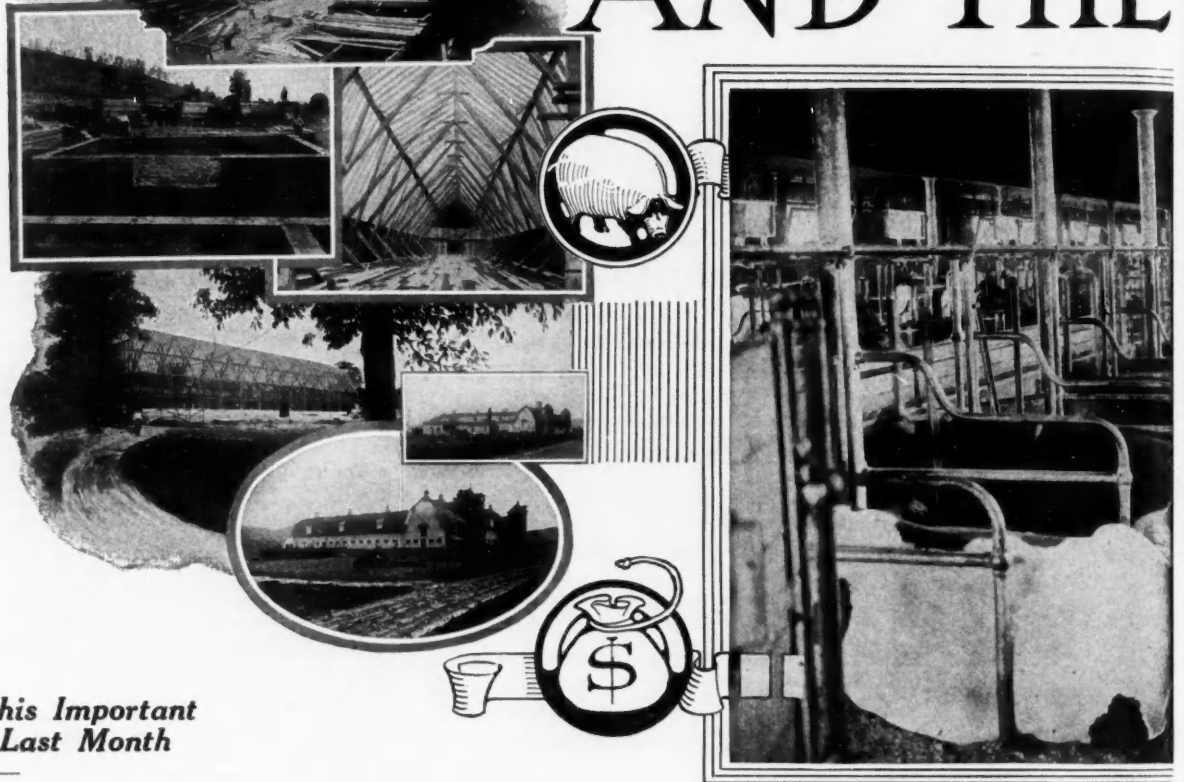

Continuing this Important Series from Last Month We Present—

Bringing the Old Farm Home Up-to-Date

Methods Used on Our Own and Adjoining Farms for Bringing the Best "City Conveniences" to the Country—Remodeling Houses to Make Them More Comfortable and More Attractive

By Herbert Shearer

AS I mentioned in the February number, I profited greatly through the co-operation of the local contractor. In all our building operations, he took the lead by offering plans and suggestions, and he never seemed to tire of making changes or digging up new ideas that savored of improvement.

In the business of farming there came a time when the women folks thought we should have a modern, up-to-date home. They wanted all the improvements found in city homes such as running water, house plumbing, heating and lighting, and interior woodwork. The idea grew until it interested every member of the family, and we have set about discovering improvements that other farmers have made.

Our old house has stood for about fifty years without much alteration. It still makes a comfortable home. The walls are plumb and solid; the rooms are fairly large, cool and comfortable in summer, and we make them warm and comfortable in winter by the liberal use of stoves and fuel. But the walls are dingy with age, the floors are worn thin between the knots, in fact the whole interior needs renewing.

The local contractor is working with me now, the same as before. We are making excursions to visit other farmers and learn the latest and best in every line of house improvements.

Inspection of Neighbor Smith's House Gives Remodeling Ideas

One of our first expeditions took us to the home of Abel Smith, who lives about four miles east. His house is large and neglected, but it is now undergoing extensive repairs and alterations. The contractor has this work in hand and he has started in to make a thorough job that is sure to prove satisfactory.

Mr. Smith lives in a two-story wooden house, square built, and covered with a hip roof. The house is 32 by 38 feet in size and is full two stories in height. There is a good cellar wall under the whole house. It is a good stone wall, rather higher than most old farm cellars.

The cellar has been used principally for storage in the winter time. The present improvements call for a warm air furnace which necessitated the building of a partition across the cellar to divide it into two parts, so that there would still be a cold room for winter storage.

Strengthening Cellar Piers

The weak part about the house was the center piers. These piers were made too small; they had settled until the floors were all uneven. I find that to be a common fault with country houses. Old builders failed to appreciate the great weight and continuous pressure that rests on center piers. In making repairs on Mr. Smith's house the builder could do nothing until he put in good underpinning. The contractor had jacked up the floors to make them level and true and had built a solid concrete cross wall in the cellar and had also put in extra piers with heavy supporting posts.

New Porch Rejuvenates House Front

The front of the house has been greatly improved by building a fine new veranda. There used to be a narrow gallery reaching about two-thirds of the way across the front of the house. It looked like an afterthought, because it failed to match up with the good, solid appearance of the main structure. I was surprised to see a new veranda supported by heavy brick piers joined by a brick wall—all built together in the same

IMPROVEMENTS FARMER

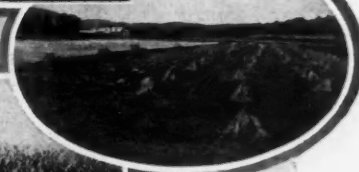
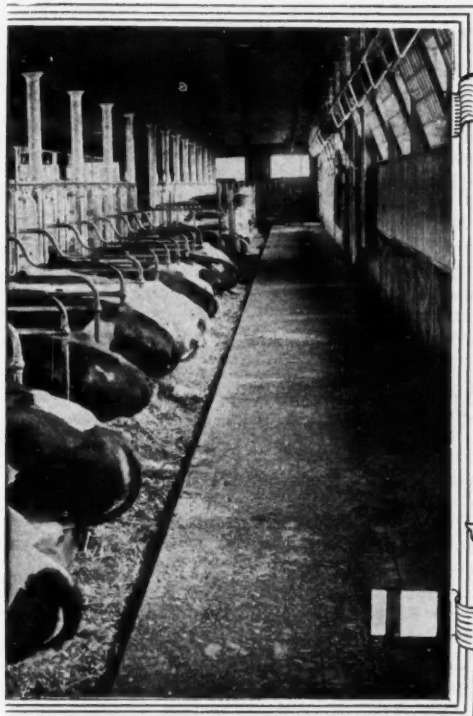

solid style as the big, old-fashioned house chimney.

A wooden house as large as this can stand considerable brick trim without having the appearance of being overdone. The new veranda is 10 feet wide and has a hip roof with an overhanging cornice the same width and pattern as the house.

Wallboard for Old Cracked Walls

In going through Mr. Smith's house we noticed how the old walls had cracked, probably because of the settling. We noticed doors that were damaged almost beyond repair by the cutting off of parts of the tops or bottoms to make them shut easily. We noticed how the plaster had broken down in places and had been patched, so that the walls presented a rough appearance that seemed difficult to remedy. A fellow hates to take the plaster off when the family has no place to move to.

Mr. Smith and the contractor informed me that they decided to use a good deal of factory-made interior woodwork. The old floors are being covered with thin hardwood flooring, and new baseboards, window casings and panel divisions of different kinds are to follow one general decorative design. There will be beam ceilings in several of the rooms.

The plan is, not to disturb the old plaster. To cover the old plaster the contractor is using a good deal of wallboard.

I do not wish to convey the idea that the panel proposition is being overdone. While the use of wallboard seems to call for interiors in panel form because of concealing the joints, I find that manufacturers are now turning out wallboard in such large pieces that the panel idea may be modified in such a way as to eliminate entirely the monotonous repetition.

There are a great many new inventions including new materials that

help wonderfully in making an old house look like new. Commencing with a good foundation and a good solid frame, it is not difficult to modernize rooms in a very satisfactory manner at reasonable cost.

The contractor is taking advantage of the work done by machinery. He has an economical way of using hand labor to fit together the factory-made mouldings, casings and panel divisions to build up splendid designs that are manufactured in factories.

Electricity for Farm House and Village Lighting

AS I stated in a former letter, my mind was made up to use electricity for lighting our farm house and other farm buildings, but I wanted all the information I could get from those using electricity.

The builder told me about an installation on a farm in the next township where he had recently built a small building to house the engine that generated the electricity for use on the farm. The farm is owned by a prominent dairyman.

The stables are long and as the milking is done early in the morning and is done by machinery, a good deal of light and power is wanted. There are about one dozen men working before daylight in the different buildings, so it requires considerable electricity to supply all the different circuits when the stable lights are all turned on at one time.

Electricity on this farm is used in units, some lines extending a distance of 200 or 300 feet from the generator. The whole system is operated on the 32-volt system, as that system costs less to install than some others, and the maintenance is less than when a higher voltage is used. There are fewer parts than any other electric light plant that I have examined; which should be an advantage.

Not Necessary to be an Electrician

Technical knowledge of electricity and its behavior under different circumstances is hardly necessary, because everything is provided by the manufacturers in proportions suitable to the plant. At the same time, it is just as well to know something about generators, batteries and switchboards and the meanings of such names as volt, ampere, battery poles,

voltmeter, ammeter, rheostat, charge and discharge switch, underload circuit breaker, false fuse blocks, etc., because familiarity with these names gives the person confidence in charging the batteries and in the one necessary battery precaution, which is, not to use out all of the electricity the batteries contain.

Those who have electric lighting plants on the farm do not seem to feel the cost of running the plants, because they use the engine for other purposes. Generally manufacturers figure about 1 H.P. extra to run a dynamo to supply from 25 to 50 lights. My experience with farm engines is that for ordinary farm work such as driving the cream separator, working the pump and grinding feed, a two-horse engine is more useful than any other size. Farmers who conduct business in the usual way will need a three-horse engine if they contemplate adding an electric lighting system to the farm equipment.

Fine for the Women Folks

Among the advantages of an electric lighting system is the freedom from care on the part of the women. There are no lamps to clean, or broken chimneys to cut a finger, so that when the system is properly installed the only work the women have to do is to turn the switches to throw the lights on or off as needed.

The expense in starting a farm electric light plant may be a little more than some other installations, but it seems to be more economical in service when figured from a farmer's standpoint, taking into consideration

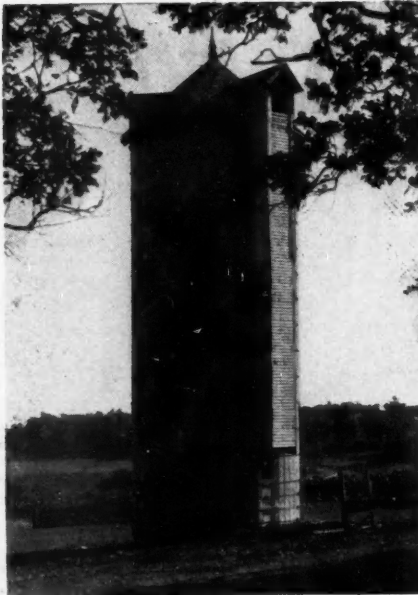

A Cement Stave Silo out in the cow pasture for late Fall Feeding. "Silo pasture" never dries up.

that he is using power that under other management goes to waste. A three-horse engine will do the same amount of work with the same amount of gasoline as a two-horse engine. This statement may not hold good when figured in fractions, but it will in practice. Also when running a pump or cream separator the engine is capable of doing a little extra work so that the storage batteries may be charged with very little extra expense.

Acetylene Lighting for Country Houses

THE next farm we visited was owned by Culver, an old schoolmate who lives eleven or twelve miles away. As we are both busy, we do not see each other very often. But I knew something of his farm house improvements and was anxious to learn particulars.

Culver wanted a lighting system to light the house and the horse barn. He was perfectly willing to use lanterns around the other buildings, but he wanted the house and horse barn furnished with every modern convenience. After investigating the different kinds of lighting systems he finally decided on acetylene. He gave his reasons as follows:



Well Built Little Concrete Pit or Vault for Acetylene Generator.

"I find acetylene light the easiest and most satisfactory to read by of any light except sunlight. I am fifty-four years of age and while I feel like a boy in every other respect I find that I require a little more light for reading than formerly.

"My attention was called to the acetylene light through the report of an experiment conducted at Cornell University, where plants were made to grow by acetylene light.

"Acetylene gas is made by bringing calcium carbide into contact with water. Calcium carbide is composed of coke and lime and is manufactured and sold in air-tight drums weighing 100 pounds each.

Acetylene gas is made automatically in small quantities as required. The machine that manufactures the gas is not much larger than a heating stove. It is called the generator and is ordinarily placed in the basement.

"We use our basement under the house for the storage of fruits and vegetables and I didn't want to take any chances, so I put my generator in a concrete vault, that is built

partly underground, between the house and horse barn.

"Acetylene generators are authorized by insurance companies so it did not affect my insurance in any way. The generator I have, feeds the carbide in very small quantities into the water as required. When the carbide drops into the water in the bottom of the generator it is dissolved and gives up what gas it contains.

"The gas in leaving the lower part of the tank is forced through a chamber containing hair, that looks like plastering hair, which purifies the gas by collecting little particles of carbon and other impurities. The gas also is forced through a washing process and goes up into the gas holder, or gasometer, in a pure state ready for use in the burners. The generator I have, holds a charge of 50 pounds to supply 50 lights, although we never light all the jets at one time."

Mr. Culver then showed me the apparatus and explained how the gas is carried in pipes to the different rooms in the house and across the lane to the horse stable. The burners most in use are fitted with electric lighting attachments which operate by pulling a chain. It seems that the generator requires very little attention and the light is very satisfactory.

Culver's house is about 40 feet square, full two stories in height with heavy stone walls for the cellar and solid brick walls for the two stories above the cellar. Also there is a solid brick partition wall; showing that farmers in the middle of the last century believed in building for the future.

The house has large window openings, wide doorways and is liberal in proportions in every way. Such houses are easily kept in repair. You have to hunt for defects and it is difficult to suggest improvements, except to add lighting systems, plumbing and power for laundry purposes and for other machinery connected with housekeeping on a large farm.

Mr. Culver had paid more attention to the laundry than any other part of the house. It is a large room in the southwest corner of the basement. It contains besides the regular laundry tubs a washing machine that works on the rotary principle, the same as used in our steam laundries.

The power is supplied by a two-horse gas engine mounted on a truck. The same engine is used further down the same lane at the dairy, to run the cream separator every night and morning.

Water for the house and horse barn is pumped by wind-mill power and is stored in a tank in the wind mill tower.

The little gasoline engine pumps water for the other farm stock from a well at the dairy house.

A small bedroom upstairs has been made over into a bathroom, so that with acetylene gas for lighting, and hot air furnace to heat the living rooms, and hot and cold water from the kitchen range, the old farm house contains all the real luxuries necessary.

Gasoline-Gas Lighting Used in Senator Wilson's Home

THE contractor called for me one morning and took me in his automobile to see some house repair work he was doing for Senator Wilson.

The senator lives in an old-fashioned farm house, that has served the family for two generations, but he has been adding what are commonly termed "modern improvements" from time to time, so that he has kept up with the procession a little better than some of the rest of us.

I was very much interested in his front entrance, including the vestibule, reception hall and fine open-work stairway. His front porch is new, but he followed the same structural house designs that belong to the main structure to such an extent that the porch addition fits perfectly into the original style of architecture. I have seen additions to farm houses that were mere architectural blemishes, like a wart on a man's nose, but the senator has avoided all such blunders.

The interior of the senator's house, commencing with the front door, follows one general design of interior woodwork. The front door is plain, heavy and wide, and at the latch or lock side of the door is a plate glass panel, the bottom of which rests on a wooden sill elevated about a foot above the concrete door step. The top of the plate glass panel is even with the top of the door.

The woodwork surrounding the front door and plate glass panel cor-

responds with the front hall and fine open stairway. The general order of the woodwork is plain—almost severely plain, but it is pleasing, because the proportions are right. The senator told me the woodwork was made in a large factory having facilities for turning out special designs. The builder took careful measurements of the front hall and stair opening through the ceiling, and the woodwork was made and shipped in the knockdown, and the local contractor put it together.

I noticed that similar designs were worked into the decorative features of all woodwork throughout the rooms in the front part of the house. The woodwork is made attractive by proportionate harmony of design. It is something like viewing a picture done by a good artist.

The lighting system in the senator's house is different from any other farm lighting plant in our neighborhood. Although it is said to be very much used in other places. It is popularly known as gasoline gas lighting. The gas is manufactured in a small generator by evaporating gasoline into gas and mixing it with air. About 5 per cent of gas and 95 per cent of air.

We are all familiar with the little brass gasoline torch heater that tinners and plumbers use to heat their soldering irons.

There are three systems of using gasoline gas for farm house lighting purposes:

Hollow wire, tube system and single lamp system.

The hollow wire system carries the liquid gasoline through the circuit in a small pipe called a hollow wire. Each lamp on the circuit takes a few drops of gasoline as needed, converts it into gas, mixes the gas with the proper amount of air and produces a fine, brilliant light. Each lamp has its own little generator and is independent of all the other lamps on the line, except that it gets its supply of liquid gasoline from the same hollow wire.

The tube system of gasoline lighting is similar in appearance, but the tubes are larger and look more like regular gas pipes. In the tube system the gas is generated, in a separate generator, and is mixed with air before it enters the distribution tube, so the lamps do not require individual burner generators.

In the separate lamp system, each lamp is separate and independent. Each lamp has a supply of gasoline in the base of the lamp and a gas generator attached to the burner which converts the gasoline into gas, mixes it with air, and feeds it into the burner as required. Farm lanterns are made to work on this principle.

In this way any farmer can make a choice as to which system will suit his purpose the best.

Senator Wilson wanted gasoline gas street lamps on top of his big concrete gate posts and this was one reason why he decided to adopt this system of lighting.

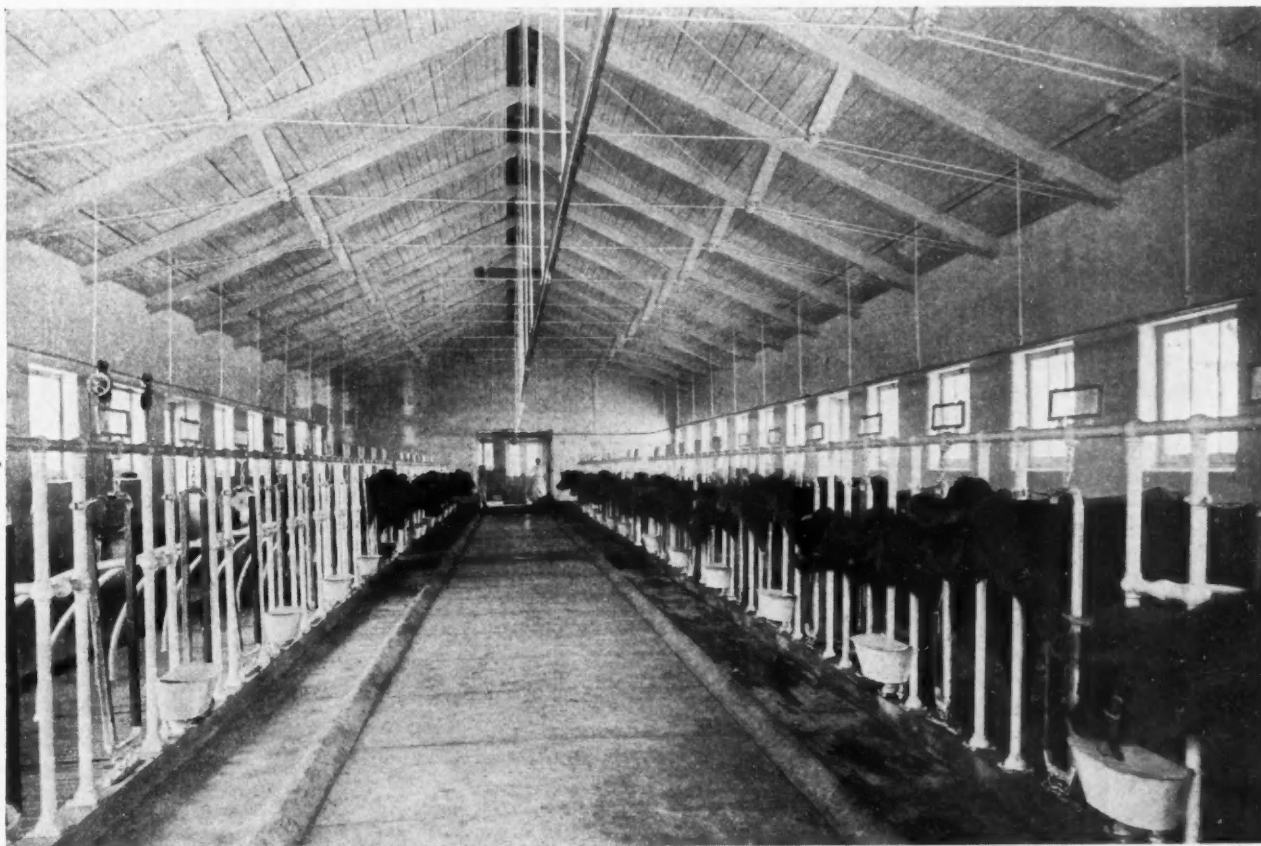

"Bring Me My Supper."—An expectant moment in the sanitary and well equipped cow barn of the Oak Ridge Dairy, Oak Ridge, Va. Notice design of concrete manger and feed alley—no sharp corners.



GUARANTEED BUILDING PLANS

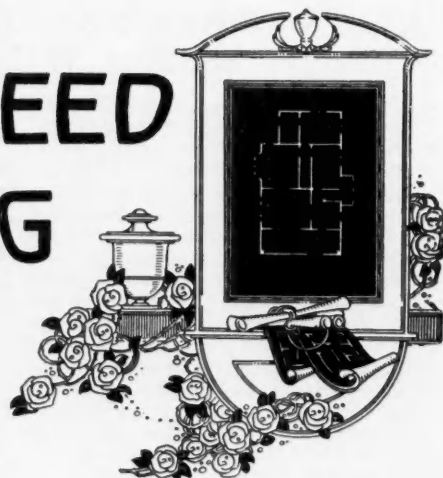

Prize Farm House—Improved Design

Here is an improvement on a first prize winning farm house design. It was adapted from the first prize plan in the competition conducted by the Minnesota State Art Society, a department of the state government of Minnesota.

The idea worked out is along the lines of combining farm business with home comfort. It is impossible to separate a farm house from the business of farming, because the two are inseparable, according to American practice. American farmers live on their farms and every member of the family takes an interest in the farm development and has a share in the actual work of carrying on the different departments connected with farming.

This house combines the farm home with the dairy, laundry, cold storage, and a general workshop in the cellar. The general design is a renaissance from the old English style half-timber. This house is covered with metal lath and cement plaster stucco, applied in a pleasing panel relief.

The interior arrangement is a modernized invention designed to meet the demands of business farming. The large open combination living room and dining room is a social center at ordinary times, but is quickly converted into a great dining room at thrashing time and for social functions, such as church sociables, family gatherings, etc.

To facilitate combin-

ing the different rooms into one, a new door proposition has been introduced—double folding and accordion folding doors. The first are hung on extra strong, or parliament butts; and the latter are suspended from an overhead track which carries a double roller traveler, made to run back and forth in this track as the door opens and closes. The traveler carries the weight of the door, so there is no strain on the hinges.

In the planning, commencing with the cellar, there is in the rear of the house a laundry room, 16 feet 6 inches by 34 feet. This room contains the power washing machine, stationary washtubs, laundry wringer, etc., and house heater.

A creamery room, 10 feet 6 inches by 11 feet occupies the corner of the cellar under the dining room. The reason for this is that there is some noise in the creamery when the machinery is running, and it is less annoying in this loca-

tion, because a dining room is occupied for a shorter time than any other room in the house.

Next to the creamery is the cold storage for dairy products. This room extends out under the front porch, where a chute is provided to take in the ice. Under the living room is storage for vegetables and fruit, with abundant shelf room for canned goods.

All partitions in the cellar are solid concrete construction, reinforced at the corners.

The first floor arrangement is very interesting. All across the front of the house, the windows are about as close together as they can be placed, so that abundant light is admitted to the dining room and big living room.

The fireplace in the end of the living room adds a great deal of comfort and luxury, and it really furnishes one end of the room. The mantel and bookshelves at the sides of the fire place are constructed of factory designs, with mouldings, to bookcases and doors, all to match. This kind of inside woodwork is universally carried in stock.

In the rear of this floor is a side hall with doorways opening into the large pantry, kitchen, men's washroom, upstairs to the men's rooms and down stairs to the cellar. There also is an outside cellar stairway, which is very convenient in stormy weather, and it saves steps.

The men's washroom is fitted with lockers or cupboards to hang their coats and to keep their extra belongings. This washroom and toilet is a great con-

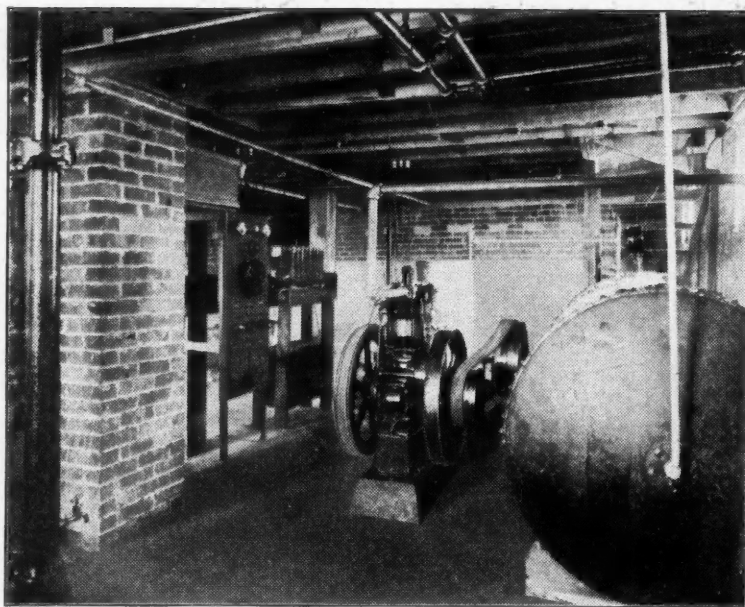

Photo of Basement, Showing How Electric Light Plant and Water System are Installed.



Ten-Room Farm House. Size, 36 feet 6 inches by 26 feet 6 inches. We can furnish complete blue-printed working plans and typewritten specifications for only \$12.00 per set. Blue-prints consist of basement plan; roof plan; first and second floor plans; front, rear, two side elevations; wall sections, and all necessary details. Specifications consist of twenty-two pages of typewritten matter. When ordering ask for Design No. 6627.

venience and is well liked by the men as also by the housewife. It keeps the dirt from washing out of the kitchen.

The stairway in this house is different from most houses from the fact that it is built double, really a combination of front stair and back stair, but each one is kept separate. The reason is to provide a separate stairway for the three bedrooms on the second floor that are intended for use of the men at work on the farm.

Upstairs, besides these three bedrooms are three other bedrooms for the use of the family. A separate stairway leads up from the living room to these family

sleeping rooms. The upstairs is in this way made into two separate apartments, with or without a doorway connecting them, according to the ideas of the farm housekeeper.

In outside appearance, this house looks larger than it really is. The size on the ground is 36 feet 6 inches by 26 feet 6 inches, exclusive of the front porch. Making two story porches of both front and rear porches makes the six bedrooms upstairs and a double stairway possible.

Farmers who make a business of farming extensively need a house that will accommodate business as well as

living quarters. They also want a house that will expand on occasion; for there are times when extra help is necessary, and there are other times when the family may be almost alone. It depends a good deal on the nature of the business.

This house is designed for a dairy farm, where one or two men are needed the year round. In summer time, two or three men are required a few days or a few weeks at a time. In order to get the right kind of help, it is necessary to have comfortable places for them to sleep. The privacy for the family provided in this house will be appreciated.

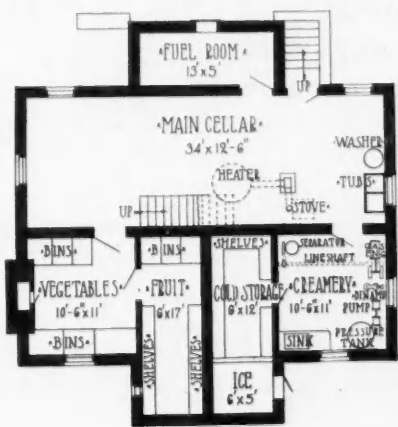

Basement Plan.

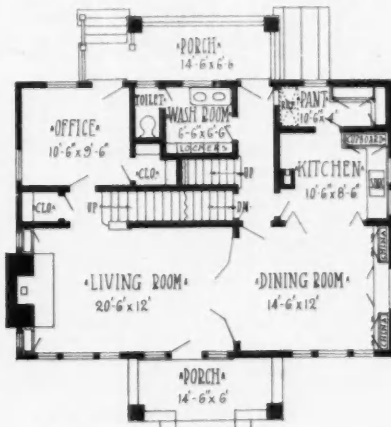

First Floor Plan.

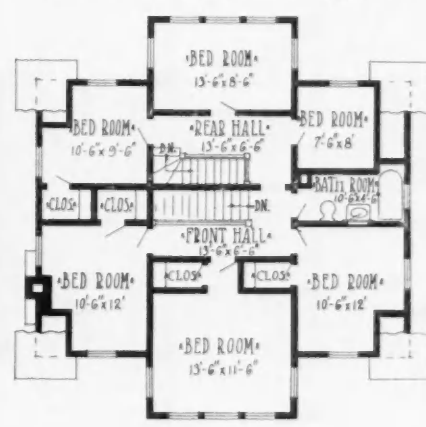

Second Floor Plan.

Arrangement of Prize Farm House. Size, 36 feet 6 inches by 26 feet 6 inches.

For Interior and Construction Details of this House see Next Two Pages.

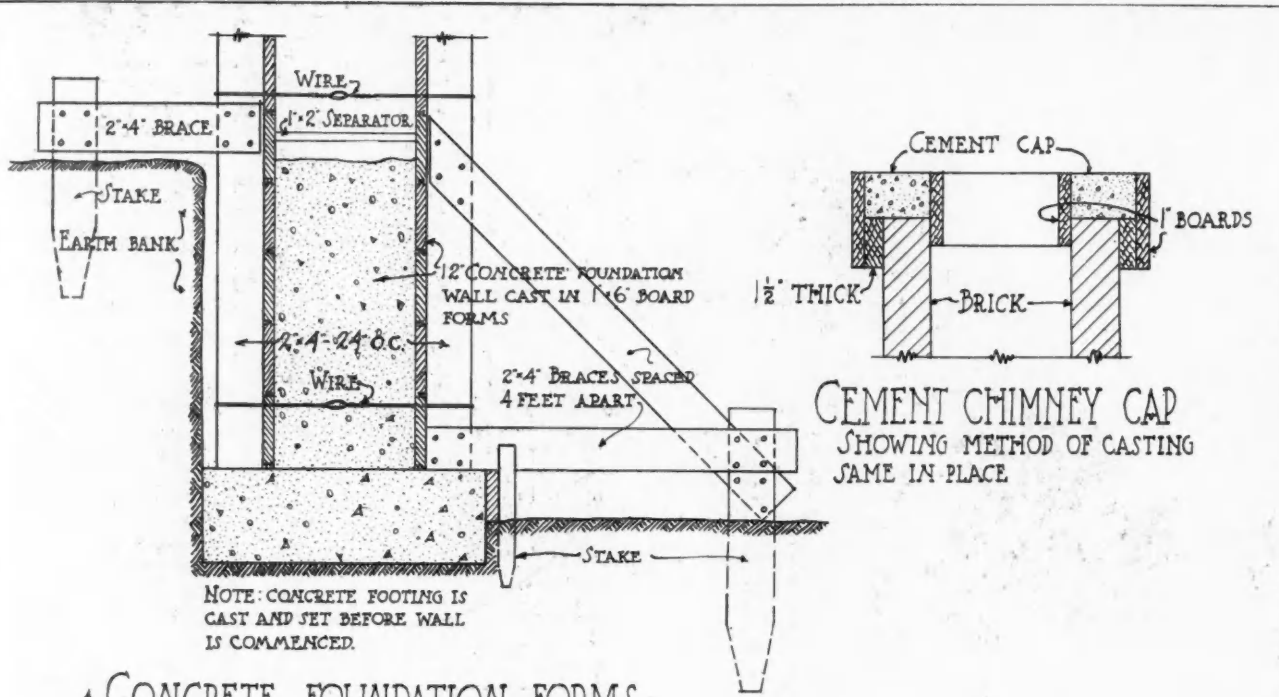

CONCRETE FOUNDATION FORMS
• 3/4" EQUALS 1'-0"

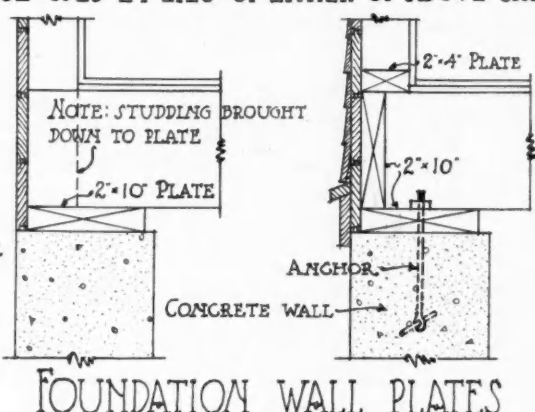
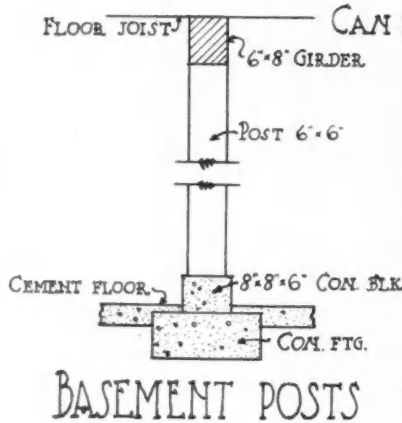
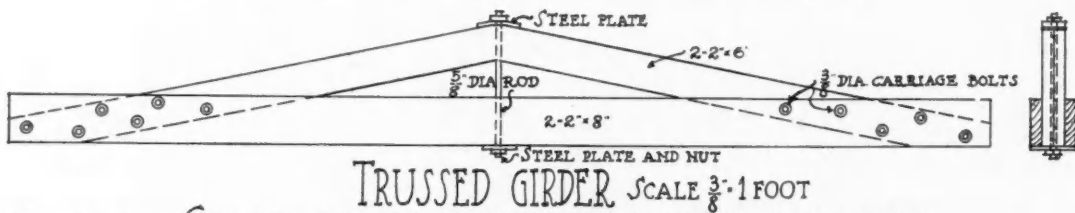
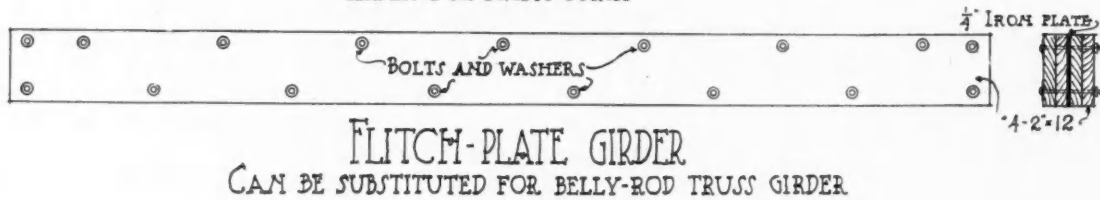
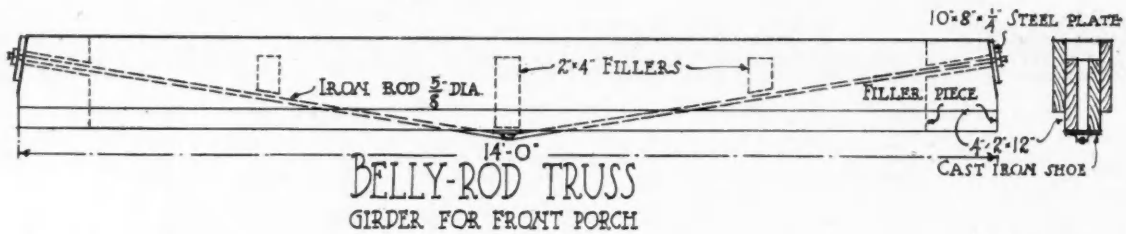

SHEET
of
EXTERIOR
DETAILS
SCALE 3/4" & 3/8" = 1 FOOT

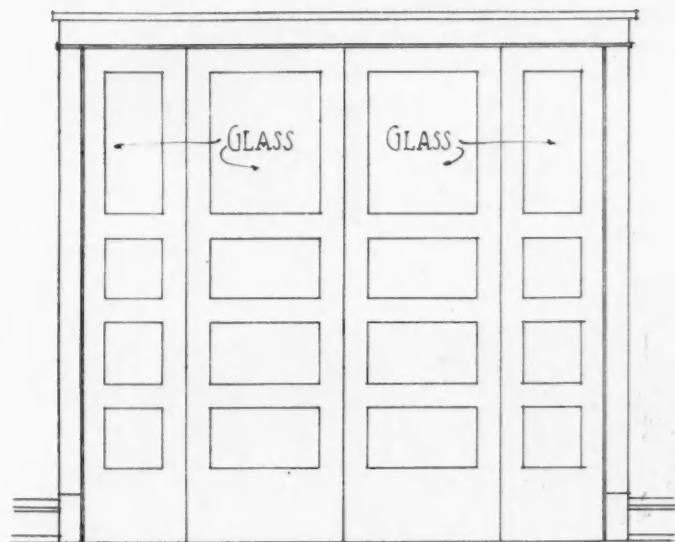

ACCORDION DOORS

• 3/8" = 1'-0" •

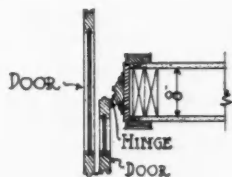

SECTION THRU ACCORDION DOOR JAMB

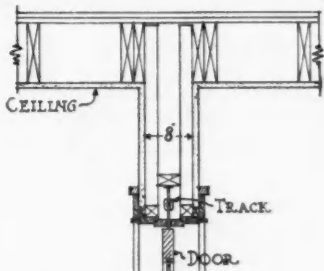

SECTION THRU ACCORDION DOOR HEAD SHOWING OVERHEAD TRACK CONSTRUCTION

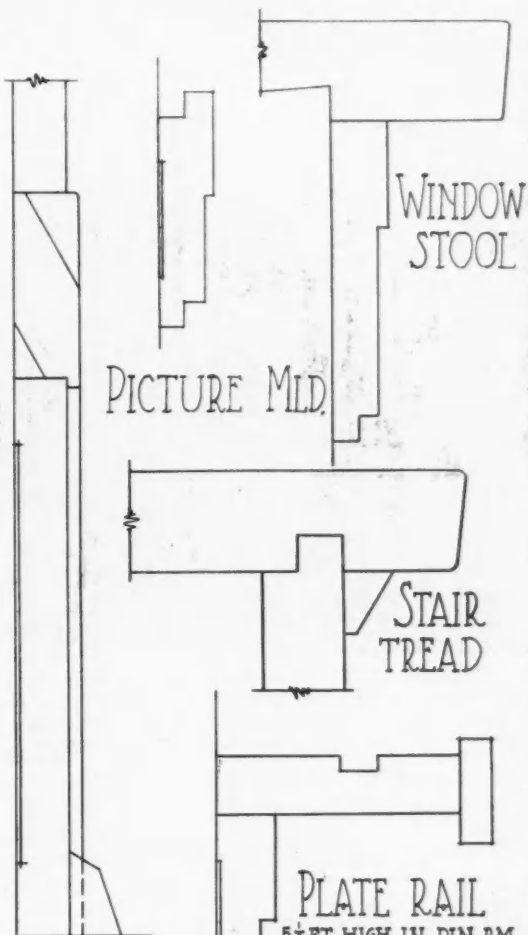

BASE

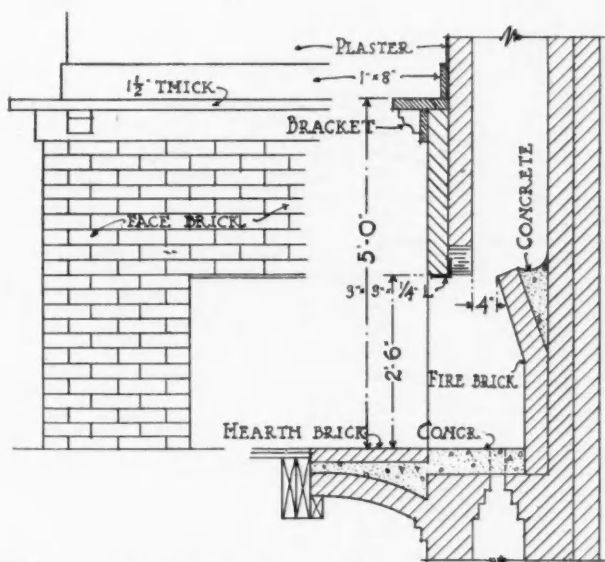

HALF ELEVATION & SECTION OF FIRE PLACE

• SCALE 3/8" = 1'-0" •

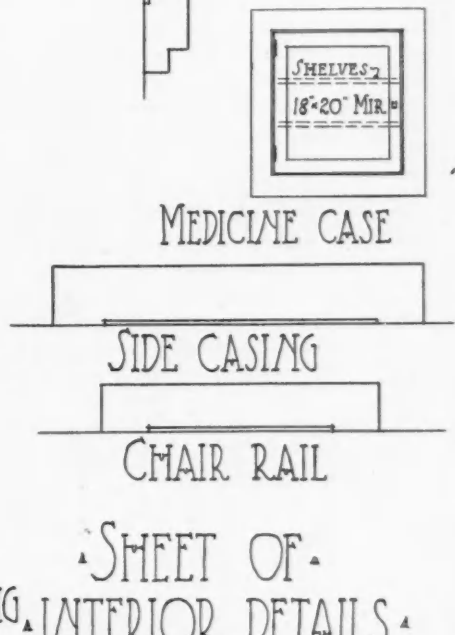
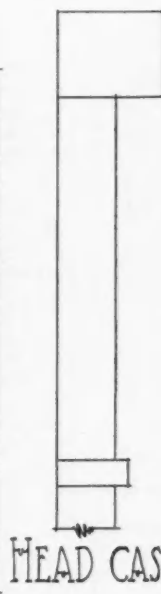

SHEET OF INTERIOR DETAILS
• SCALE 3/8" = 1' 1/2" FULL SIZE •



Substantial Hip-Roof Bungalow of four rooms. Size 32 by 33 feet. We can furnish complete set of blue-printed working plans and typewritten specifications for only \$8.00 per set. Blue-prints consist of basement plan; roof plan; main floor plan; front, rear, two side elevations; wall sections; and all necessary interior details. Specifications consist of twenty-two pages of typewritten matter. When ordering, ask for Design No. 6668.

Spacious Four-Room Bungalow

A neat, comfortable, four-room cottage is shown in this design. It is 32 by 36 feet on the ground exclusive of the front porch. It is covered by a hip roof with a gable end extension to cover the front porch. Building the front porch and protecting it by a gable end roof in this way gives the building a substantial and distinctive appearance. Another good point also is the use of considerable concrete in and about the front porch.

The floor plan shows three living rooms and one bedroom or two living rooms and two bedrooms, according to the requirements of the family. There is a fine front corner room with a fireplace and built-in bookcases made in living room style. On one side of this room is a blank wall intended for the placing of a large davenport big enough to sleep on. Furnished in this way, it is easy to change the room into a bedroom on short notice, because the bath room naturally belongs between the two bedrooms.

The kitchen is very nicely arranged between the dining room and the rear porch. The dining room has an extension window recess, which is eight feet long. There is a buffet provided for this space. The rear porch is fitted with windows and screens, so

that it may be used for a summer dining room, if so desired. Plenty of glass cupboards are provided; and there are three extra big clothes closets—no chance to find fault with this bungalow on that score.

The pantry is 4 feet by 7 feet 6 inches. A case of drawers is built into one end and a refrigerator is placed in the other end opposite a window which opens into the rear porch. The stairway to the cellar goes down from the rear hall.

A cottage house like this is very pleasant in summer, and it is so small and compactly built that it may be easily heated in winter. There are two chimneys, one for the fireplace in the living room and one for the kitchen range. The furnace in the basement may smoke into either chimney.

The manner of building houses of this order follows the simplest lines of architecture. There is a good cellar with considerable height of ceiling for two reasons. It is necessary to have the height to furnish sufficient headroom for a warm air furnace. Also people living in cottage houses like to have the living room floor set well up above the ground. It affords a better view, and a feeling of security; and a great many people think the house is dryer for having considerable room between the floor and the ground. In this respect a great deal depends on the character of the land. Usually where the streets are undermined with a sewer system the ground is dry enough. This bungalow is O.K.

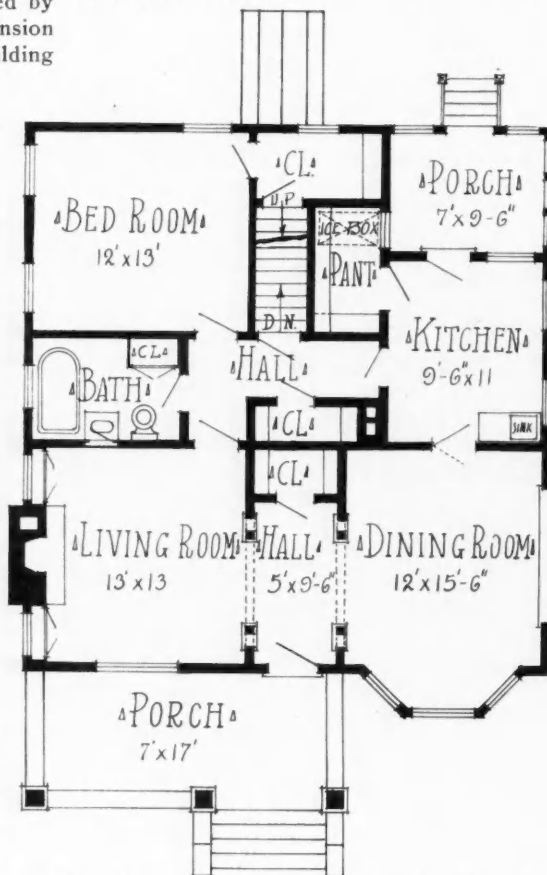

Floor Plan of Bungalow. Size 32 by 33 feet.

Bungalow with Cement Plaster Pillars

A rather odd looking, but very attractive bungalow, is shown in this design. It is 36 feet in width through the rear end; but the front part is only 21 feet wide—which reduces the size to small dimensions. However, it looks quite large because of the front porch and side veranda.

There are situations where unusual designs look especially well provided they are gotten up with regard to symmetrical proportions with artistic blending of shades or colors. In this particular design the large, square porch columns merge very nicely into the general color scheme. The woodwork is painted drab, slightly darker than the stucco columns. The extra wide projection of cornice is absolutely necessary on a bungalow of this design to give it the proper effect.

The floor plan includes a very pleasant living room in front which opens into a fireplace nook. This cozy nook is supposed to be furnished with lounges and lots of pillows in real bungalow fashion. The wide opening between the living room and the nook connects rather than divides the two rooms.

A great convenience is the vestibule with the large coat closet, convenient to the front entrance. There is a wide

opening between the living room and the dining room, and for this reason

the woodwork of the front part of the house is all designed to match.

The dining room has three full length French windows looking out across through the side veranda in the direction of the most interesting view. These are thrown wide open in warm weather, making this big side porch a part of the house.

The bedroom and bathroom are situated in the back part of the house opposite the kitchen. Between the kitchen and bathroom are several closets and cupboards which are appreciated by all housekeepers. The stairway to the cellar is conveniently placed for running back and forth between the kitchen and cellar store room. The rear porch is almost as interesting as the large porch in front. The idea is to build a bungalow that will be interesting and pleasant where the climate provides several months of warm weather. So much porch and veranda space is a great inducement to live outdoors a good deal of the time. Everybody likes a porch parlor in the summer time. It may be fitted with rugs, a swinging seat, and other porch furniture arranged for comfort in the daytime and at night.

A little bungalow of this kind is supposed to be set well up above the surface of the ground so that an outside cellar entrance is easily made.

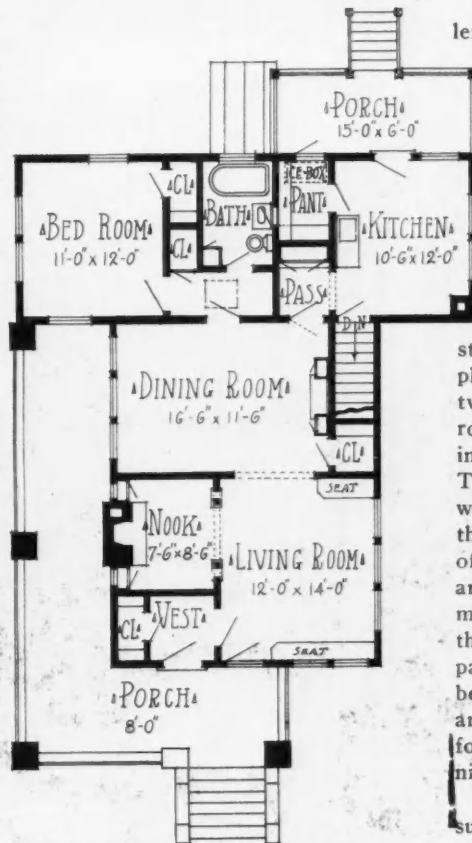

Floor Plan of Bungalow.
Size 36 feet by 39 feet 6 inches.



Bungalow for outdoor living. Size 36 by 39 feet 6 inches. We can furnish complete set of blue-printed working plans and typewritten specifications for only \$7.00 per set. Blue-prints consist of basement plan; roof plan; main floor plan; front, rear, two side elevations; wall sections; and all necessary interior details. Specifications consist of twenty-two pages of typewritten matter. When ordering, ask for Design No. 6671.



A Modern Dining Room of Great Refinement of Line. The Slight Curve of the Ceiling with its Double Encircling Beam Border Strikes the Note of Elegant Good Taste. The Buffet Built Into the Broad Bay Window is Well Handled. The Lighting Fixtures Deserve Special Notice.

Seven Room Story-and-a-Half House

A house with four rooms on the first floor and three rooms close up under the roof, is shown in this design. In size, it is 27 feet 6 inches by 40 feet 6 inches on the ground, and is built with the slant of the roof towards the street.

There is an outside entrance at the back of the cellar, which comes in handy on washdays, also for other work that is done in the cellar, such as attending to the furnace and getting in the coal. Outside cellar ways add very little to the expense of a house, and are greatly appreciated at times.

The first floor plan provides for large living rooms on the sunny side of the house, while the other side is taken up with porches, reception hall, stairway, pantry and a room that may be used either as a bedroom, den or office. It makes a roomy house that is light, airy and comfortable at all seasons of the year.

There is a fine kitchen in the rear of this house 14 by 11 feet 6 inches, which is lighted by three good sized windows. The kitchen is supposed to

be finished in light wood or painted white. White woodwork and white walls and ceilings, together with

white enamel sink and other kitchen furniture look clean and inviting. The white finish seems to go naturally with the large windows and other modern improvements.

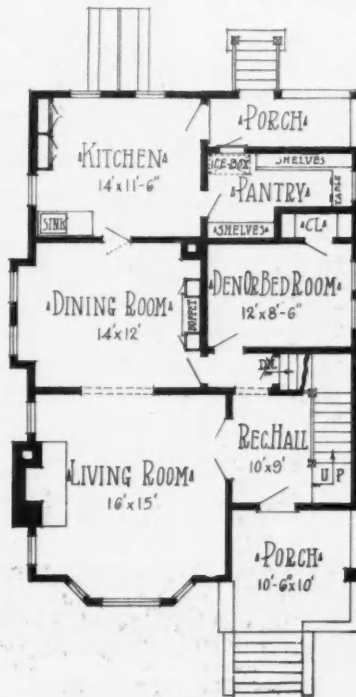

First Floor.

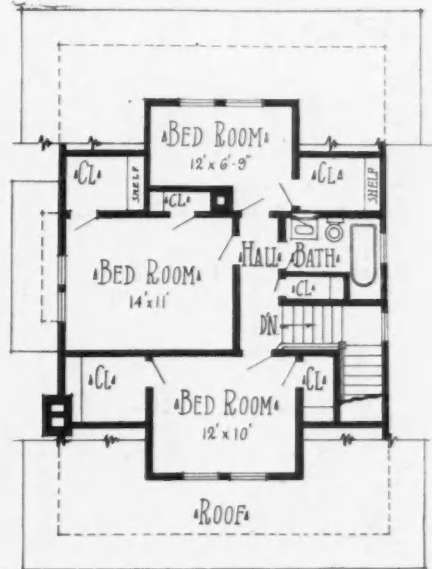

Second Floor.

Arrangement of House, Size 27 feet 6 inches by 40 feet 6 inches.



Seven-room shingled house. Size 27 feet 6 inches by 40 feet 6 inches. We can furnish complete set of blue-printed working plans and typewritten specifications for only \$8.00 per set. Blue-prints consist of basement plan; roof plan; first and second floor plans; front, rear, two side elevations; wall sections; and all necessary interior details. Specifications consist of twenty-two pages of typewritten matter. When ordering, ask for Design No. 6664.

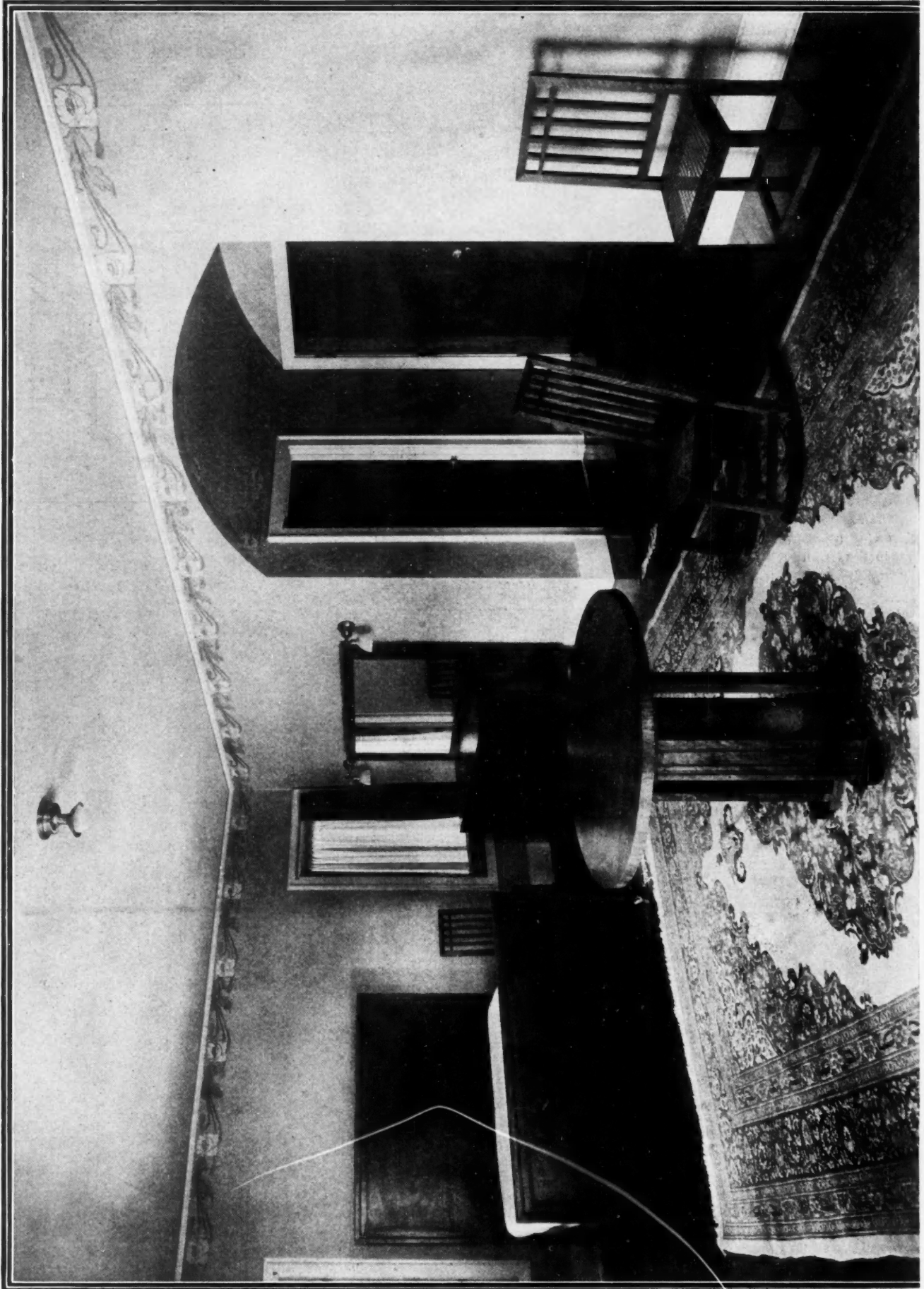

Bed Chamber to Match the Dining Room Illustrated on Page 48. The Curving Ceiling Appears Again, this Time in the Vestibule Alcove. This Alcove Arrangement is to be Commended; It Gives Extra Privacy. It is an Idea Adapted from the Best Hotel Planning.



Large country home 38 by 39 feet in size. We can furnish complete set of blue-printed working plans and typewritten specifications for only \$8.00 per set. Blue prints consist of basement plan; roof plan; first floor plan; front, rear, two side elevations; wall sections, and all necessary interior details. Specifications consist of twenty-two pages of typewritten matter. When ordering, ask for Design No. 6667.

Elegant Modern Country House

An elegant appearing house is represented in this design. It is 38 by 39 feet in size, on the ground, exclusive of the front veranda. The extra fine appearance is due partly to the manner in which the veranda is built. The heavy brick corner piers and the mason work which forms the ends and the sides of the veranda give the house an exclusive and expensive character that is calculated to excite envy and jealousy amongst the neighbors. The proportions of the large corner abutments, the expanse of the truss that reaches clear across the house from one corner to the other, the wide expanse of the roof and the pitch of the roof, together with the wide spreading front dormer—all combine to give the house an air of elegance that is very striking.

The construction is solid throughout. Commencing with the cellar walls, which are built with wide footings, the whole foundation is solid. The center piers in a house of this size are required to support considerable weight and to carry the strain for a good many years. It often happens that the importance of center piers is not thoroughly appreciated by either the builders or the owners of house property. A great many houses are built with

small concrete or stone center piers without footings. These piers are topped with wooden posts as light as 6x6 or 6x8 inches. A six-inch post is insufficient for any house big enough to accommodate an American family.

When it comes to building a house of this size and weight, the center piers

should be placed not more than 12 feet apart, and should have wide footings. To save room above the cellar floor the piers may taper to a size little larger than the permanent posts, but the footings should reach down into the ground where the earth is solid and have sufficient spread to prevent the possibility of settling.

Another reason for the settling of floors in the middle of a house is the indentation of the tops of the posts into the girders. The shrinkage of green girders and floor joists may have a further effect. However, the same joist shrinkage applies to the other ends of the joists, so that figuring the shrinkage of the joists alone, the floors would settle evenly so far as the joists are concerned. But the shrinkage of girders and the indentation of the upper ends of the supporting posts into the bottoms of the girders still remains as a factor and this point too often is forgotten or overlooked during the hurry.

The floor plan calls for three bedrooms and a bathroom, which occupy all of one side of the house. On the sunny side we have parlor, dining room, and kitchen, with the smaller rooms necessary in a house of this size. An interesting beam ceiling decoration is shown in dotted lines on the floor plan.

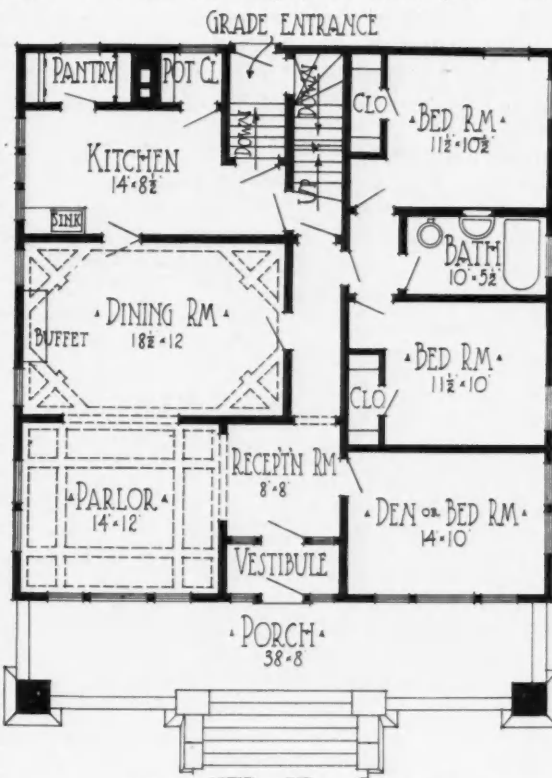

Floor Plan. Size 38 by 39 feet.



A good sized attractive country home. It is 27 feet by 40 feet on the ground and contains eight rooms besides the large reception hall. We can furnish complete set of blue-printed working plans and typewritten specifications for only \$10.00 per set. Blue-prints consist of basement plan; roof plan; first and second floor plans; front, rear, two side elevations; wall sections; and all necessary interior details. Specifications consist of twenty-two pages of typewritten matter. When ordering, ask for Design 6588.

Country House with Circle Porch

A very substantial house, either for the farm or big lot in town is shown in Design 6588. It is 27 feet by 40 feet in size and has an imposing general appearance which requires considerable room to show it off properly.

This house has a very pleasant, sunny disposition, which makes itself manifest in every outward feature. Large houses require considerable sunlight to fit them to get along easily with all the inmates. Gloomy houses always get into a fight sooner or later and have a roof knocked off or the little windows punched out to make room for larger ones.

Four rooms downstairs and four good bed rooms upstairs give the general design of this house in a nut shell.

Going into detail, we find comfort written into each room because the plan gives encouragement to light and cheerfulness in every corner of the house. All living rooms are large, airy, well-lighted and comfortable, while the convenience in the culinary arrangements is especially good.

The grouping of the reception hall, parlor and library are well intended to

facilitate home comfort when the family is alone, or to make the three rooms practically into one when the coming of a few friends makes more room necessary.

A pleasing effect is produced in the

library by building book cases at the sides of the fire place. Books give an air of refinement to any room. They are indispensable in a library.

Built-in book cases look better than movable ones.

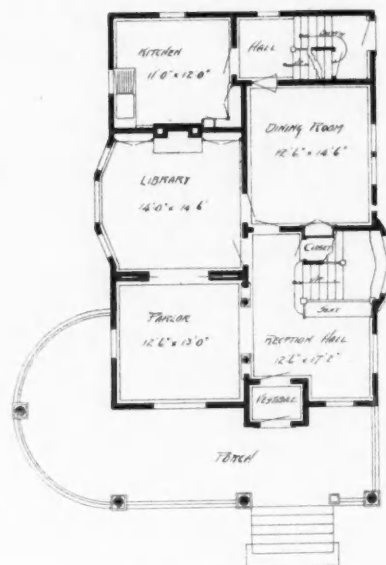

First Floor Plan

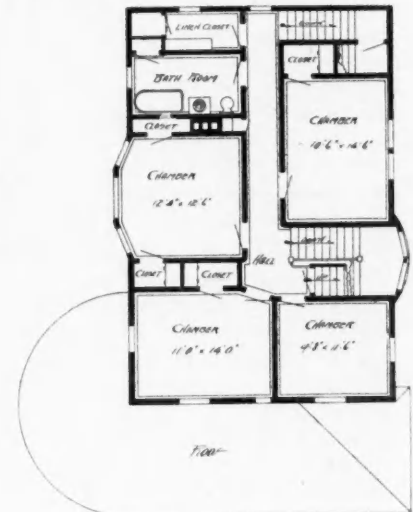

Second Floor Plan

Arrangement of House, size 27 by 40 feet.

Gable End Cottage House

A cottage house containing five rooms is illustrated in design No. 6669. It is well set up from the ground by using 3½ feet of false truss work above the wall. This style of building is very much resorted to in localities where cellar wall material is scarce or expensive.

In some sections where gravel or stone is scarce and freight rates are high, cellar walls are made of hard-burned brick. Brick for this purpose should be laid in cement mortar and plastered on the outside with a thin coating of waterproofed cement plaster. Bricks are porous and will absorb moisture like a sponge. Brick cellar walls that are not properly laid up are not suitable for house use. Dampness in a house cellar often means sickness for the family.

This style of building also is resorted to in certain sections of cities where the contour of the land requires that sewers shall be near the surface of the ground. Again in the warmer sections of the country cellars are not so much needed as basements. People living in a one-story house find more use for a basement than when the house proper contains more room. The basement, if built well and is mostly above ground, may be made to serve many purposes in economical household man-

agement. It is a useful storage place. The plan of the rooms in this house is somewhat on the bungalow order. The

two bedrooms and the bathroom are on the short side of the house, and the three living rooms on the sunny side work to good advantage.

The wing at the back of the main structure makes room for the bedroom, kitchen and rear porch. There is a stairway going down to the cellar from the little back hall that has a convenient entrance from the kitchen. Over this there is a stair leading from the kitchen up to the attic. This is a great convenience.

The rear end of the house is nicely planned to save steps while doing the house work. The kitchen, pantry and rear porch with the cellar stair all "in a nut shell" are intended to save steps. Also there is splendid storage for green groceries and other household supplies in the basement, cellar stair, little back hall, and pantry.

The business end of this little house has received very careful attention. The rear porch being 9 feet 6 inches by 6 feet is large enough for a very comfortable summer work room, and it is often used for that purpose.

There is an outside cellar entrance at the back which is a great convenience in a house built in this way. It makes it possible to turn the basement into a summer kitchen or other work room, according to the necessities of the family.

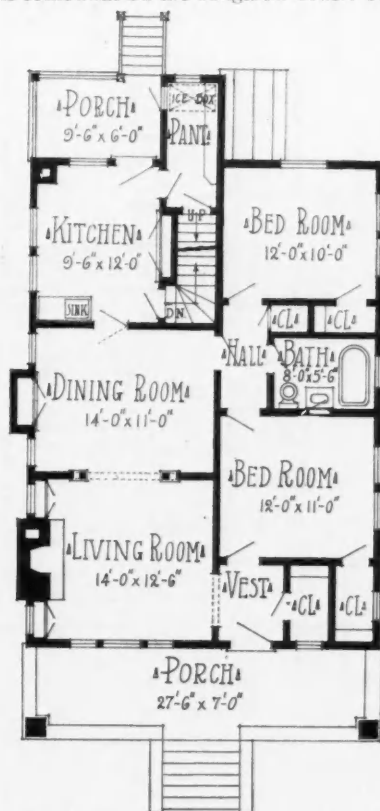

Floor Plan. Size 27 feet 6 inches by 37 feet 6 inches.



Gable End Cottage house of five rooms. Size 27 feet 6 inches by 37 feet 6 inches. We can furnish complete set of blue-printed working plans and typewritten specifications for only \$6.00 per set. Blue-prints consist of basement plan; roof plan; main floor plan; front, rear, two side elevations; wall sections; and all necessary interior details. Specifications consist of twenty-two pages of typewritten matter. When ordering, ask for Design No. 6669.

Shingle Sided Eight-Room Dwelling

A comfortable home on the craftsman order is shown in Design No. 6672. It is 27 feet 6 inches by 42 feet 6 inches in size, exclusive of projections.

It is a solid, well-built house, containing five rooms on the first floor and three rooms and a bathroom on the second floor. The multiple window system on the casement order is used throughout the house, which is rather unusual in house building. Recent improvements in casement window construction, together with inventions for opening and closing the curtains have greatly increased the popularity of casement windows, and accounts for their extended use. Casement windows have long been favorites when considered from the outside. The objection has always been the difficulty of using shades or curtains when the windows were open for ventilation.

The shingle siding and the pergola fashioned dormer and side porch, together with the large rough finished brick chimney, laid up in white mortar—all combine to produce an unusual effect, but one that is on the whole pleasing and satisfactory.

The floor plans are worked out on the

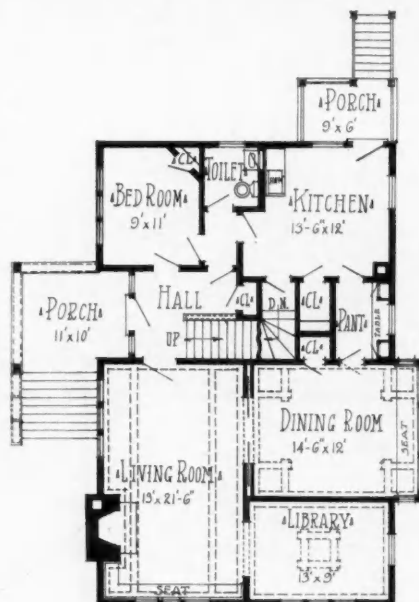

First Floor.

with a fine large fireplace and six windows, which is intended to make a light, airy, comfortable living room, that carries an air of refined luxury.

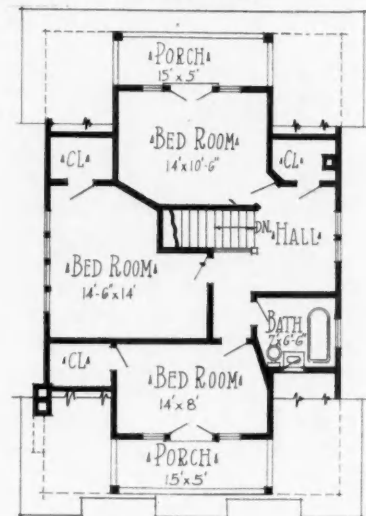

Second Floor.

Arrangement of House, Size 30 feet 6 inches by 42 feet 6 inches.

most approved lines when considered from the standpoint of comfort and health. A house of this character is supposed to be built on a rather wide lot, where it is exposed to the air and sunshine from all sides.

The large living room is 14 by 22 feet,

There are many conveniences both on the first and second floor in the nature of clothes closets, and plumbing for different purposes to make up a very interesting house plan.

Upstairs two of the bedrooms are built with sleeping porches.



Shingle Sided Eight-Room house. Size 30 feet 6 inches by 42 feet 6 inches. We can furnish complete set of blue-printed working plans and typewritten specifications for only \$10.00 per set. Blue-prints consist of basement plan; roof plan; first and second floor plan; front, rear, two side elevations; wall sections; and all necessary interior details. Specifications consist of twenty-two pages of typewritten matter. When ordering, ask for Design No. 6672.

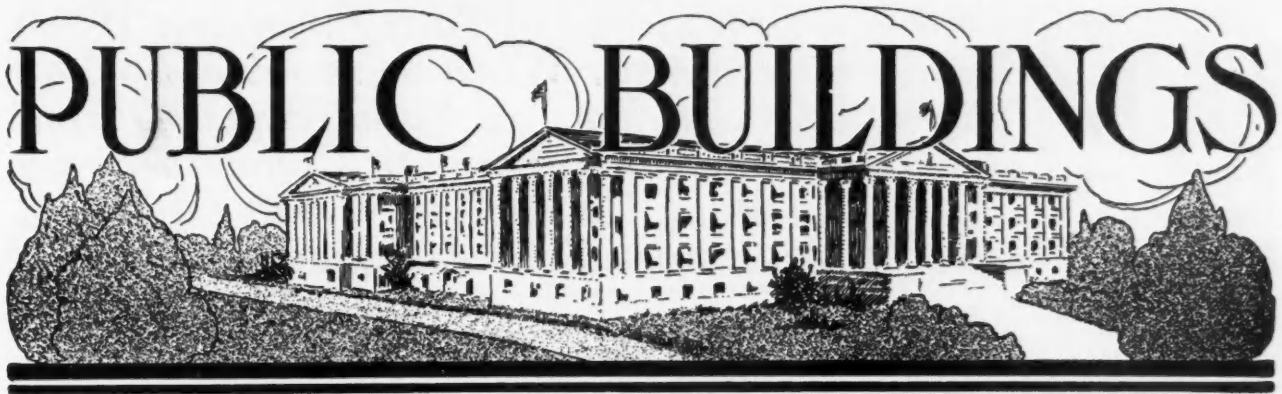

New School Building for North Chicago

PHOTOGRAPH OF NEWLY COMPLETED BUILDING, TOGETHER WITH FLOOR PLANS PRESENTED.

ONE of the most handsome school buildings on the North Shore has just been completed for the town of North Chicago, Ill. G. W. Ashby, of Chicago, is the architect. Mr. Ashby is noted for his school building designs, and this one is typical of his work. Strictly modern, and including all that is best in school building design, North Chicago may be proud of its new building.

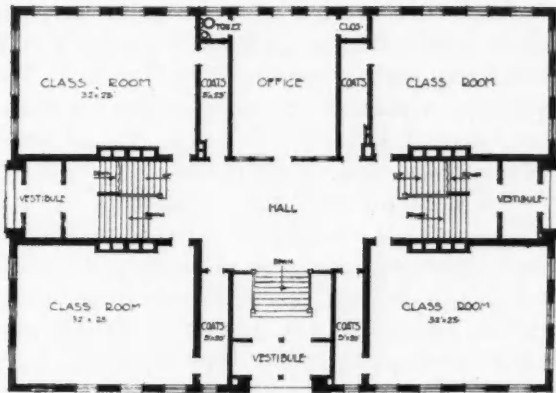

First Floor Plan.

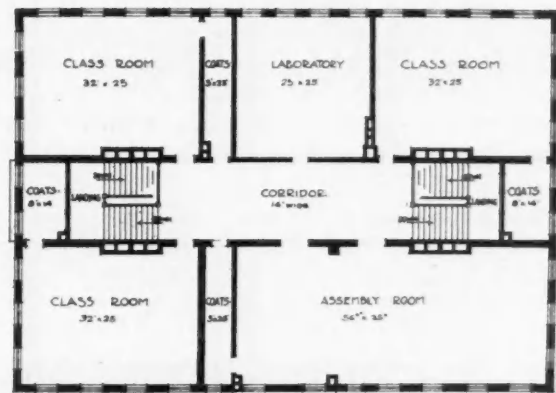

Second Floor Plan.

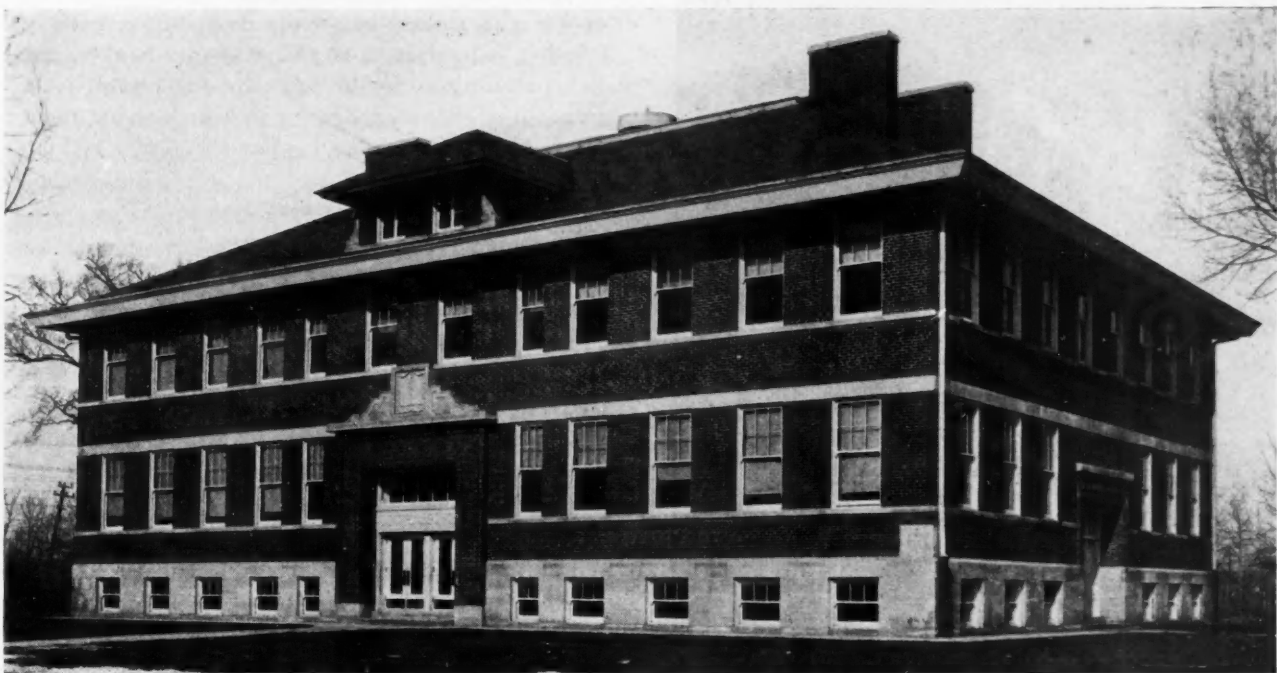

The Handsome New North Chicago School Building.

“As You Must Have Confidence in Your Physician When You Are Sick; in Your Attorney When in Trouble; So You Must Have Unlimited Confidence in Your Banker During That Time of Stress Which is Certain to Come to Every Business. A Safe Banking Connection Wards Off Fear. Freedom From Fear Multiplies Your Efficiency.”

—THE MAN FROM THE LUMBER YARD

EVERYONE will remember the youthful experience after eating too much turkey and mince pie, of being awakened in the small hours of the morning by a grinning horse sitting on his stomach. It was always a comfort to have the protection of mother or a big brother.

Some of us, who have grown so fast that our hair does not cover the top of our heads, have been awakened by the terrifying thought of a low bank balance, and bills to be paid. It is a great comfort to have in the background a friendly banker who has the confidence in you to use your paper.

My wife pays all of her accounts by check; the egg and butter man, the grocer, the dry goods man, etc. A cancelled check recently served as evidence when the hardware dealer presented a statement that had been paid.

I have a carpenter friend that does a great deal of his bookkeeping through his bank book and deposit slips. He has a blank book 3½ inches by 7 inches, and carries a piece of carbon paper on it.



As a Youth 'this Gets You—

When he makes a deposit he makes a carbon copy in this book and enters the names in his book. The entry in this book shows as follows:

Deposited by John Smith.

<i>Dr. Jones</i>	\$3.00	
<i>Mrs. Perkins</i>	2.50	\$5.50
<i>Wm. Simpson</i>		3.90
<i>Sam'l Johnson</i>		7.65

\$17.05

The plain type shows that which appears on the deposit slip. The two top names in italics are people who paid cash, when the \$5.50 was deposited. The two last names paid by check.

My friend deposits every cent of cash he collects and pays every possible bill by check. He never carries over a dollar or so in his pocket.

It never does any good, and often does harm, to display money.

A bank account makes a "man of affairs" out of a laborer. It makes for his self-respect, encourages savings, is a convenience in making remittances; aids in establishing a credit, and is frequently a foundation-stone in building financial independence.

It is worth while having a speaking acquaintance with your banker. He is no better than the baker, or candle stick maker; but he can do you more good.

I find it an education to talk with my banker, and make opportunities to do so. No one knows what moment an emergency may arise that such an acquaintance would be of big value.

To the Business Man

Your banking connection may mean success or failure to you. In no detail of a large business is it any more important to use discretion and good judgment than in making your banking connection. Carelessness or poor judgment along this line has been the cause of hundreds of failures in the business world.

If you will ask any business man of large affairs, who is honest in his statement, he will tell you his banking connections have been one of the big things that made for his success. The financial graveyard is full of many monuments that have been erected over business concerns that have failed, simply because they did not have a banking connection to help them over some emergency. By reason of the fact that banking is based on confidence; and confidence is a creature of

slow growth, it is well for every business man to stop, consider and think, as to whether he is strongly fortified in this essential feature.

In picking out a banking connection it is by no means wise to select the largest financially, or yet the long established institution; it is, however, imperative to select one that is operated on an absolutely safe and sane basis.

You and the Banker

No matter how you keep your word or obligations with any one else,—never fail to make good with your banker. You can't afford to have him consider you a bad actor.

Your sweetheart may take you back if you have been fickle. Your wife may forgive your indiscretions;—but you might as well beat your head against a stone wall, as to expect a return of the confidence of your banker when you have once violated it. Remember that your banker spends most of his active hours within narrow walls. His liver is apt to be torpid. Caution is a religion with him. He leans towards pessimism. From discounting paper he learns to discount everything.

No matter what capital a man may have, a banker fears a quitter. A man who is easily stampeded in either a fire panic or a financial panic, is always dangerous.

Extraordinary talent is not in it with dogged determination. Personified persistence is more than business genius.

The Banker and You

Some people know it all, and do not desire to consult any one. People of that kind generally belong to the "pee-wee" class. Granted that you have had experience. Assume that you have remarkably good judgment; still you profit largely when you draw on the experience of your banker. You want the experience of the apothecary in preparing your prescription. The architect does not get your fee unless you expect to benefit by his knowledge.

In the game of finance, it is only a fair assumption that your banker has made it a study, and can keep you off the rocks until he can float you in the still waters of a safe harbor. You do not get your dues if you do not get this help from your banker.

You are entitled to accommodations. These are determined by your responsibility and the collateral you can give.

Reciprocity

Your banker, especially if he is not of the billion dollar-unapproachable type, is human. This means that if he is normal he is appreciative. There is no way you can impress yourself on him more, or make him under more obligations, than by securing new accounts for him. Even if the man you introduce does carry only a small balance, he is appreciative of your good intent.

Be a Booster. You cannot present to your banker a certificate of either honesty or ability. The fact of



—and as a Grown-up This!

your trustworthiness must be gotten into the mind of the credit man by: (a) keeping a clean record, and (b) impressing him by your personality that you are an "isser." The banker, least of all, has any use for the "has been." He will watch a "going to be" against the time that he arrives in the "isser" class.

It is by no means wise to take up the question of a line of credit with your banker until you can: (1) feel sure you have his confidence, and (2) you have what will be considered proper collateral.

There are so many angles to this question that cannot be covered in a general letter, that I will be pleased to take up any special phase of the matter with any one who cares to write me.

Conclusions on Credit

Credit is like a woman's reputation: it is ruined when under suspicion.

Good business ability and good personal standing are the foundation-stones for good credit.

Character, capability and capacity are characteristics which are essential for credit.

Credit should be covered by quick assets.

Credentials other than such as are written on a man's face, and by his acts, will not receive credit.

Reputation is not character. Both must be good to receive credit.

A clear conscience secured by a clean character is an aid to credit.

St. Peter and your banker estimate your credit from different angles, but both insist on the same identical points. Yours for dependability,

THE MAN FROM THE LUMBER YARD.

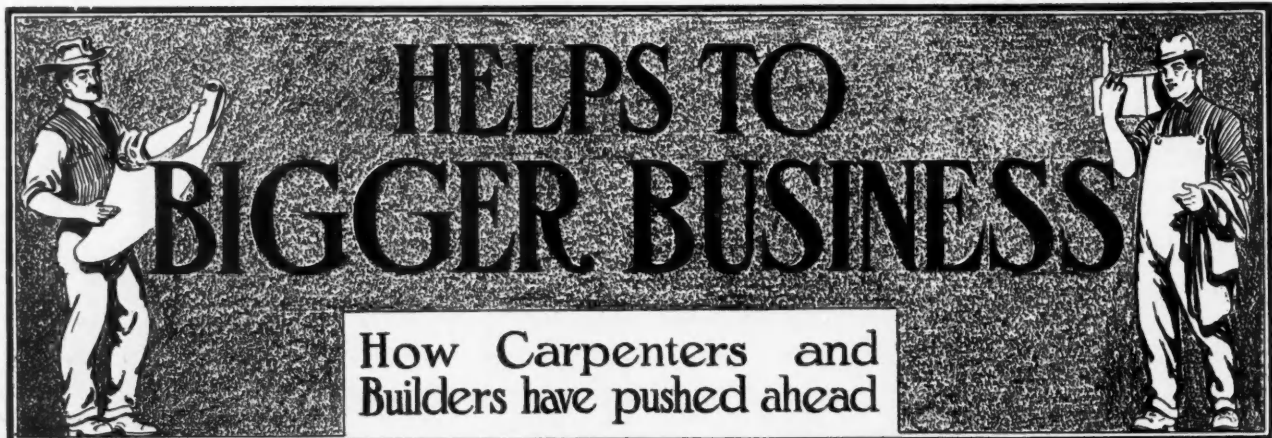

Window Display Advertising for Builders' Shops

A RECORD OF SOME STUNTS THAT HAVE BROUGHT BUSINESS

By H. J. Blacklidge

IN a certain western town of some five thousand inhabitants, there are about one hundred members of the local carpenters' union. Of this number probably thirty do a more or less contracting and building business—that is, they *employ*. The rest all work for wages. Of these builders only one firm makes any pretense of advertising—real, live, up-to-the-minute advertising, I mean. The rest merely run

a small card in the local papers and perhaps half a dozen have signs to be used on the job. Some of them do not even run a card in the newspaper. And as I write this, they are complaining about slack work this winter. Now a measly little one-inch ad, in a one-horse weekly (weakly) is not going to overburden *anyone* with work.

Anybody who reads the current magazines is familiar with such advertisements as "There's a reason," "If it isn't an Eastman, etc.," and so on. In fact we would be lost to pick up our favorite magazines and not see these old friends staring us in the face. Yet how many carpenters and builders ever think of doing a little unique or original advertising themselves? Of course, we cannot make a nation wide sweep of it—*but who wants to?* All a carpenter or builder wants is local advertising. But to make it pay he must do something more than stick a card in a weekly newspaper. Here is what a lumber dealer did.

A Scheme that Collected Old Accounts

Blank & Son had some \$5000 outstanding and decided to spend \$200 in trying to collect it. This amount stood on some hundred and twenty separate accounts. They procured a hundred and twenty-five small boxes. In one they put a \$10 gold piece. In the next five they put \$5 gold pieces. In the next twenty, \$2 bills. In the next fifty, silver dollars. And the rest, fifty cent pieces, making a total of \$149.50. The boxes cost \$3.50 at the druggist's. The balance of the two hundred they used in newspaper display ads. and handbills and dodgers, advertising that a prize of from fifty cents to \$5 would be given to every person who paid his account in full before Jan. 1. The campaign started about Nov. 10.

Luck was indeed in this venture, for the first man to settle up paid a \$24 bill and drew a prize of Five Dollars. He spent most of the following two days telling of his good luck. The plan worked like a charm. Just make people think they are getting something free, and you can pull them every time. But this

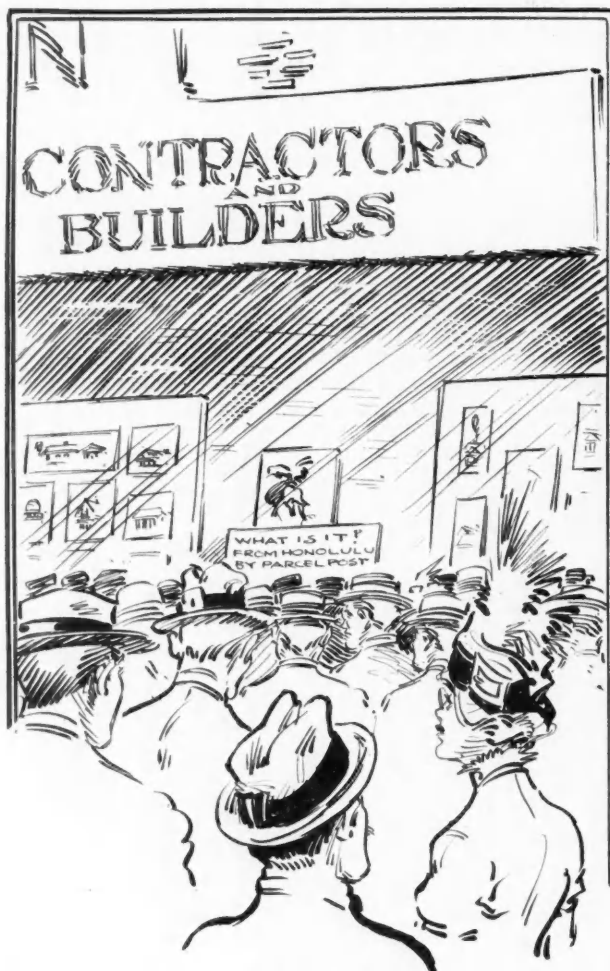

The crowd came to view the curiosity and remained to study the House Designs.

firm collected a little over \$4,000 by the first of January, some of which had become outlawed.

Contractor's Shop Window Display Gets Crowd

The contracting firm referred to above as being the only one that did any regular advertising, put a whole collection of photos, blue prints, plans, samples and models in the front window of their shop. In the center they hung some kind of a curious vegetable or fruit from Honolulu, with the caption, "What is it? From Honolulu by Parcel Post." It was just after the open-

could not design anything herself, and had never seen just what she wanted until she saw the photo in the window.

I know a carpenter who built a playhouse for his little girl. But how many would have thought of making a good strong ad. out of a playhouse for a child. It is only about 6 by 8 feet floor plan, and about 4-foot walls, but it is a perfect model of a little bungalow. Every detail is complete, down to the small hardware, including a door bell. It sets close to the street and attracts attention every day.

"Money in Our Work for Home Builders"

Another had a tiny bungalow built, about 2 by 3 feet, and set in the shop window. From the street it looked perfect in each detail as far as completed. But it was only partially finished, showing in the building of it as many different materials as possible. Silver dollars were placed all through it—stuck into the plaster, klinker brick chimney, cement walks, and concrete foundation; caught in cracks of siding, wall board, etc.; slipped under seven varieties of roofing; laid on sticks of cypress; and over it all hung the sign: "DOLLARS IN OUR BUILDINGS FOR YOU." To one side stood a tall placard:



A Window Trim on Contractors' Fire Insurance.

ing of the parcel post. The shop was on a street leading from the business section to the depot and for three days there was not a crowd but a jamb. And dozens who stopped to look at the curiosity lingered to look at plans or photos.

Just a few examples of the direct results of this display: One lady had a dumb waiter put in; a business man built a sleeping porch; another ordered "Con-ser-tex" for a leaky upstairs porch; one lady ordered a serving table, and another a hall tree. The first lady had always thought dumb waiters were more costly; the business man saw a photo showing just how he could add his sleeping porch without spoiling the appearance of his residence; the lady had always wanted something on the order of a serving table, but

Let Us Build Your Home and Save

- Dollars on the foundation—Mixed by modern machinery.
- Dollars in all foundation lumber—we use only Cypress.
- Dollars on the trim—We make our own.
- Dollars on waste spaces—We finish them with wall board.
- Dollars on the whole transaction—Because we will insure it for one year after date of completion.
- And furthermore, it will be built just as YOU want it—not to suit us or the architect or the carpenter or anyone else except YOU!

A Fire Protection Window Display

The same firm at another time had a little building cleverly made of concrete and sprayed with oil from a pipe concealed inside. The oil was fired and from the street it was a perfect picture of a burning building. A temporary funnel-shaped affair above, with the aid of an electric fan, effectually carried away the smoke, fumes and heat. To one side stood the family (dolls), watching it burn. The head of the family says, "I should worry," and is showing his insurance policy, which is tagged, "Paid by Blank & Blank, Contractors and Builders." Judging by the number of people who went especially to see it, that was the best ad. ever put in a window in that town.

Window displays are one of the very best of advertisers for our business. If your shop is located on a street where there is any traffic at all, by all means have a window display. I have written to

AMERICAN CARPENTER AND BUILDER advertisers and have received samples, patterns, specimens, catalogues, enough to make about three good displays. Again I would say, by all means have a window in the front of your shop—and *make use of it*. A pretty frame, tray, clock, or taborette, made in odd moments, and placed therein with a neat card giving the price, will often, very often, bring orders for several.

Always give the price on any object displayed for sale. How many times have you stood before a window and wished you knew the price of some article displayed? And did you go in, enquire, find it too high for your sack and "beat it"? No, as a rule you "beat it" before making inquiries. A woman can

enquire prices on article after article and no one be surprised if she does not buy. But some way "us men" are not built that way. Have one price for all and always put it where it is plainly visible.

"It pays to advertise." Nobody doubts that. But the point is to get something new, or unique, or extraordinary, that will attract the attention of even the most hasty passerby. CATCH THE ATTENTION—with *anything*. Then have the article to be advertised in the immediate vicinity, so that the least wandering of attention from the central object will be instantly arrested by the REAL OBJECT. Therein lies the secret of successful window advertising for contractors, carpenters, builders.

House Moving—How to Jack Building Up and Arrange Running Timbers

SECOND ARTICLE—SAFE METHODS EXPLAINED BY AN EXPERT—VALUABLE POINTERS FOR ALL BUILDERS

By E. W. La Plant

President La Plant-Choate Mfg. Co.

IN my first article (page 80, Feb. issue), I gave a general idea of the profits to be made in the house-moving business, the equipment required, and a brief sketch showing loading of building to carry it safely.

In this article and in the succeeding ones I propose to go more into detail with regard to various phases of house moving, so as to give the reader a good understanding of the work. The present article will cover the subject of raising a building.

Getting a Building up off its Foundation

Before any building can be moved it must be raised off its foundation by means of jack screws, so that timbers and trucks can be set under it. In raising a building the standard crib jack (Fig. 1) with a pair of collar blocks (Fig. 2) are generally used. The best men in the business today consider this style of jack safer to use than the bell bottom standing jacks, which six years ago were universally used. This is because of the broad foundation secured by widening out the crib of blocks for the crib jacks.

The first step on the job is to knock holes in the foundation at various points around the building in order to admit the crib jacks. If the sills under the house are in bad shape, then use a 2 by 8 or 3 by 12 short piece for a header block. The customary practice in raising a house is to place a jack every 12 feet for a one-story building, and every 8 feet for a two-story building; in order to properly support the load at all points.

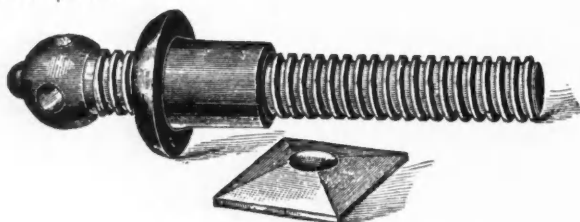

Fig. 1. Standard Crib Jack.

How to Place Jacks

It is very important to have the jacks rest on a good solid base, building the crib wide and solid, of 6 by 6-inch by 3-foot blocks, because the jacks must be set so they are absolutely perpendicular or straight. If not so set they will have a tendency to swing the house the way the jacks lean and there is the possibility of the house being damaged or workmen injured. Don't overlook this point of setting the jacks perfectly straight, because it is very important, saving time and work and avoiding danger.

Underneath a house the jacks should be placed every 10 to 12 feet along the sills and under all partitions. Where a building has a brick mantle or a flue running from cellar floor to roof, it is necessary to cut about half the chimney off at the level of the under side of joists on first floor, then run a heavy timber or cross-sill through the full width of the house, if it is to be moved. If to be only raised, a short sill will do, as shown in Fig. 2 in the article in February. The object is to save the chimney and prevent damage to the building if the building should fall. Where it is intended to move the house, it is necessary to run the timber under the chimney the full width of the house; but if you simply are raising the house, then a timber 10 or 12 feet long will be sufficient.



Fig. 2. Collar Block.

This Method Prevents Cracking Plaster

In order to prevent cracking the walls of the house it is necessary to have the raising done carefully. All the jacks should be of the same size thread. When everything is ready to start raising, the best way is to start at one corner and go from jack to jack all around the building, giving each jack a quarter turn. Repeat this operation until the house is raised to the

desired height; and while one or more men are raising the outside jacks another man should be stationed in the cellar to keep the jacks under the house raised the same amount. If it becomes necessary to stop the work of turning up the jacks, care should be taken to have the men start at the same jack where they left off. If this rule is followed, there will be no danger of racking the walls or cracking the plaster. It takes but a very little while to raise the building in this manner and by following this system the work will be done safely and speedily.

When it is necessary to remove a jack, or reset it in the same or another place, it is best to have a 2 by 12 standing-jack close to the jack you wish to reset, instead of keeping the building up with wedges in order to release the jack. Wedges are hard on the plaster and mean hard work for the men. Using the standing-jack means the safe way, the easy way, and the saving of time and labor.

Arranging Running Timbers

If the building is to be removed to a new location, the next step, after it is raised, is to put in the running timbers, which extend from the two rear corners to a point on the center at the front end, making a V-shape arrangement, as shown in Fig. 2, page 80, February article. These running timbers should be 10 by 10 inches or 12 by 12 inches, 36 to 40 feet long, depending on length of house. Keep the rear end of timbers about 2 feet in from the corner of the building if possible, which will give the mason a good chance to lay the foundation after the building is moved to its new location.

After the running timbers are placed under the building and held at each end by jack screws, slide in the cross sills where needed.

To prevent the outer corners of the front of building from springing, place a 1-inch board at each end of front cross sill, a $\frac{3}{4}$ -inch piece under the next cross sill and taper on down to the end near the rear trucks.

Then lower the house onto the platform of timbers, and you will find the cross sills, not the corner of the house, will spring down at the front end, as we took up the spring of the front cross sills by the 1-inch board pieces. The house therefore rides perfectly even, and can be carried any distance over bad roads without danger of the partitions settling or springing down out of shape. The house rides on an even keel no matter how rough or humpy the right of way may be. It will always ride safely without twist or racking out of shape, because it is riding on three points.



Chemical Closets Best Sanitation for Rural Homes

By Dr. Hyde R. Fussell, Sanitarian

SANITATION, like charity, is a much abused subject. It is frequently applied indiscriminately and indefinitely against all forms of possible contamination, and, like charity, is often prevented by

well-meaning but ill-informed individuals and Health Bodies.

A favorite topic of Sanitarians is the Outhouse. Much is written and said, but little accomplished in removing this thoroughly disgusting equipment of the rural home. The foot and mouth disease is immediately throttled and stamped out. Outhouses and cess-pools are still permitted and encouraged in spite of their known dangerous and disastrous effects upon human life.

Determined action on the part of every owner of an outside privy would remove quickly this real estate depreciator and landscape eyesore. Why wait for government compulsion, as was necessary in the recent foot and mouth epidemic, to make you rid of your outhouse when your own interests, both from a financial and health viewpoint, demand its destruction.

Why has the outhouse to go? The reasons are legion. We will consider only one or two. The outhouse privy as a breeder of constipation has no rival. It is a silent salesman working day and night for all cathartic compounds. Consider the stench of the outhouse in summer, its night horrors in winter, and its general inconvenience in cold and bad weather.

Consider the possibilities of infecting the water supply from seepage from the outhouse. Soil does not prevent disease germs from infecting your drinking water. No matter how well screened and in other ways protected, the outside privy is still a menace to health.

The inside sanitary chemical toilet is direct sanitation. It takes care of the poisons of the body at a convenient and proper time. There is no waiting, no disagreeable odor and there is no inclement weather to encounter. The properly constructed and correctly installed sanitary closet never, at any time, has any odor. The material entering the sanitary inside chemical toilet is thoroughly treated and its disease bearing organisms destroyed.

The two vital principles of the sanitary inside chemical closet are draft or ventilation and chemical action. Without these two attributes, there is no sanitary closet and our good intentions may result only in moving the outside privy inside the home, something to be very much avoided.

A vent or draft pipe must be at least four inches in diameter and all joints should be tight. Fresh air intakes should be provided and a chemical used that will not only in laboratory tests show sufficient strength, but also in tests made under actual sanitary closet conditions. Further, it must be determined beyond question that the chemical used comes actually in contact with the material in the closet or it will not disinfect same and will give uncertain protection.

A little investigation of the types of sanitary closets now in the market will clear up these points. The prices of these toilets are reasonable and they are undoubtedly good health insurance, aside from your interest in the welfare of the country at large.

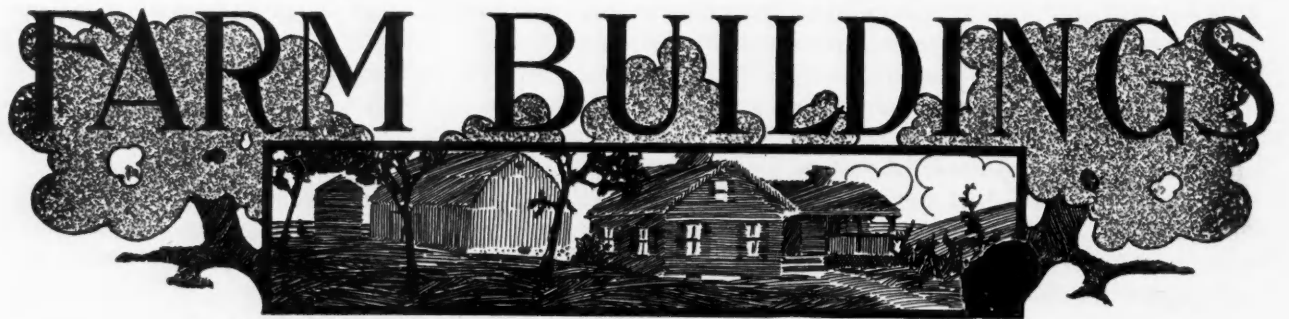

Value of Labor-Saving Buildings

FARM machinery to save labor has been wonderfully improved in the last few years. Farm buildings also are receiving attention from inventors. The best farming conditions are found in the middle temperate latitudes, which means that the most profitable farming is conducted in the sections where there is a good deal of cold winter weather—sections where live stock have to be

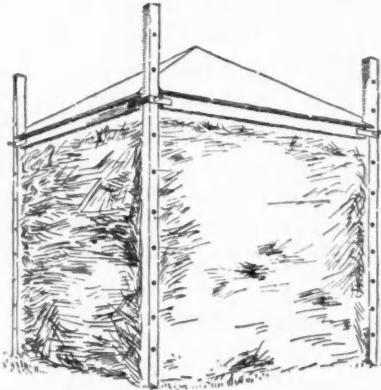

An Adjustable Roughage Stack Cover—Roughage, stacked in the hog lot where it can be easily thrown down for feeding sows in winter, should be protected by a cover. A simple roof adjustable on four corner posts is satisfactory.

cared for in barns and sheds for months at a time.

The proper handling of live stock in considerable numbers at such times requires labor-saving buildings to make labor-saving machinery possible. With up-to-date equipment, it is easy for one man to care for large numbers of beef cattle and to keep them growing every day all winter long. The difference between growing animals and roughly wintered stock is the difference between profit and loss. Unless the animals increase in weight, the feed given them must all be charged up to expense. It finds the easy way into the wrong column.

To make cattle gain during the winter season it is necessary to make them comfortable. Then the proper feeding must be provided for in large quantities and in the proper variety. To make animals comfortable and to feed them properly requires certain facilities to make the work easy and to make it

easy enough to be profitable. Large numbers of cattle scattered around in small, isolated, inconvenient sheds for feeding, so that the different feeding materials must be gathered together by hand and distributed in small lots under difficulties, is conducting the feeding business along lines that can hardly be profitable. With buildings rightly constructed, with feeding devices that insure an equal show for large and small animals, so that the feeding may be quickly done by machinery, puts the problem of feeding cattle in the winter time on a business basis, so that a man can almost figure his costs and profits for each 24 hours.

Labor-saving buildings mark the difference between retail losses and wholesale profits.



Paddock Fences Important Items

In connection with every live stock farm, small and large paddocks in connection with a barnyard are necessary for the proper dividing and handling of the different kinds of stock. Not one farmer in a hundred knows how to build a paddock fence. Local carpenters probably have never given the subject much thought.

Paddock fences should be built of wooden posts and lumber, and when finished, the fence should be 5 feet high and capped with a rain board.

Posts 6 inches in diameter and 8 feet long and set 3 feet in the ground, 6 feet apart are the proper post specifications for a small paddock annex to the barnyard. Larger pasture paddock fences are not so particular. However, every enclosure to hold live stock should be thoroughly well fenced. There are certain times when it seems almost impossible to hold farm animals in the yards, as every live stock farmer knows.

Whether these small paddock fences are made with boards placed horizontally or upright depends on the exposure. A small paddock fence should be high and tight enough to prevent winds from blowing through. A bottom board runs lengthwise and is buried in the earth two or three inches to prevent hogs from digging under and to prevent a cold draft. South fences are built with spaces between the boards. A good plan is to have a tight board fence on the east, north and west with an open board fence on the south. The paddock is supposed to be to the north of the barnyard.

The rain board at the top makes a convenient seat when watching animals to get acquainted with them. Every good breeder of live stock spends hours studying individual animals. The rain board is also some protection to the fence proper and it makes a finish. A paddock fence does not look finished without a rain board laid flatwise or at a slight angle sufficient to turn rain.

The 2 by 6 rail, two feet from the ground, bolted to the inside of the paddock fence posts, is for convenience in roping stock to hold them for inspection or for other purposes. Also it forms a handy step or seat, and it strengthens the fence. It also prevents cattle from crowding against the boarding. Sometimes the boards are broken or the nails pulled by cattle ramming against them.



"Sunshine" Hog House

A winter hog house of a very practical design is shown on the opposite page. It makes use of a series of special "Sunshine" skylight windows set in galvanized metal,—this accomplishing the warming and lighting of every part of the interior. Another interesting feature is the row of "side wall" windows made of galvanized iron both sash and frame.



The Business End of the Huge Dairy Barn on the Woodcrest Farm at Rifton, N. Y.

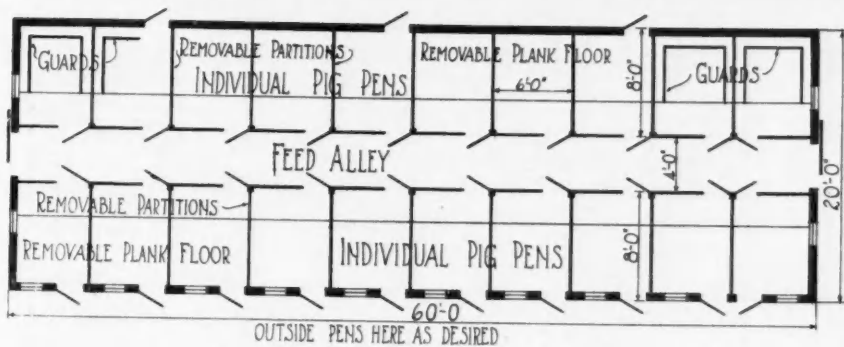

SUNSHINE WINDOW DETAIL



SIDEWALL WINDOW DETAIL



DOOR DETAIL

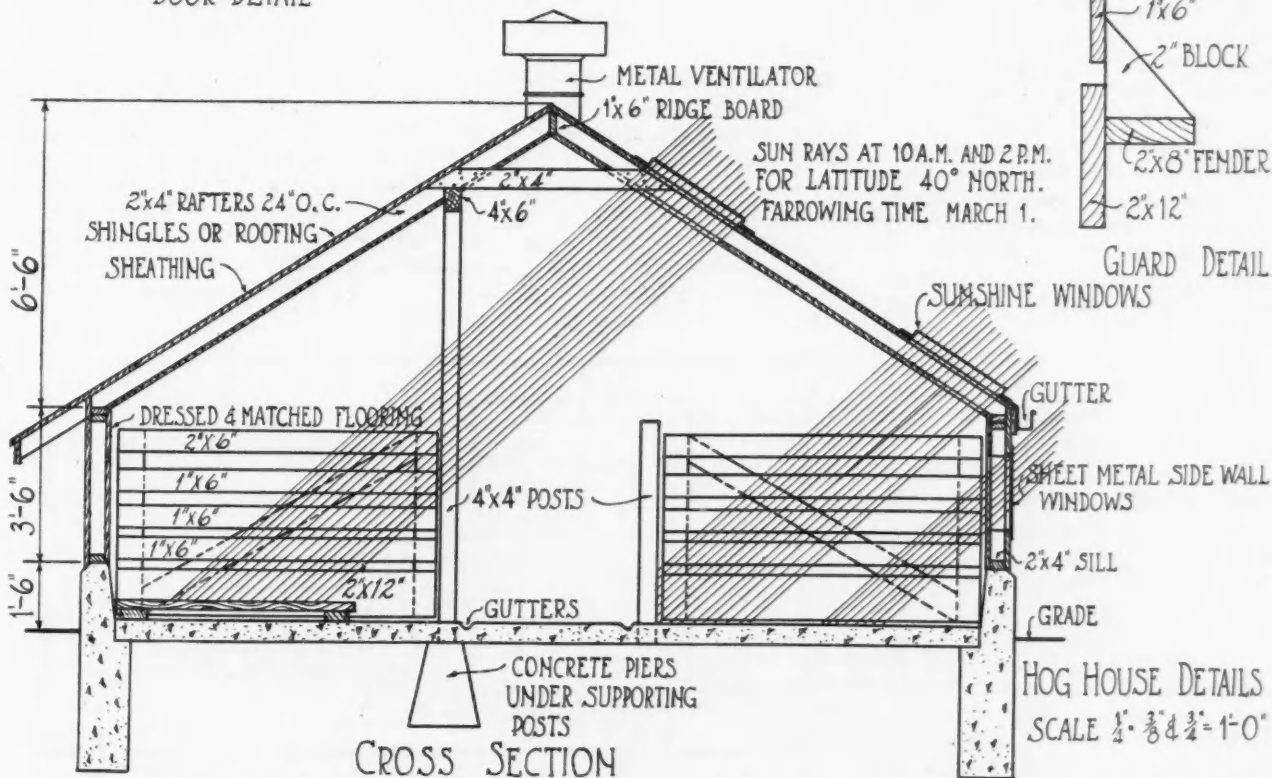

CROSS SECTION

HOG HOUSE DETAILS
SCALE 1/4" = 1'-0"

Perspective View, Floor Plan, and Construction Details of a "Sunshine" Winter Hog House with Special Windows Set in the Roof so as to Light and Warm the Furthest Corners of the Inside. Place this house to face the south. Dimensions of hog house, 60 by 20 ft. Contains twenty 6 by 8-foot pens. We can furnish complete set of blue-printed working plans and typewritten specifications for only \$5.00 per set. When ordering, ask for Design No. A285.

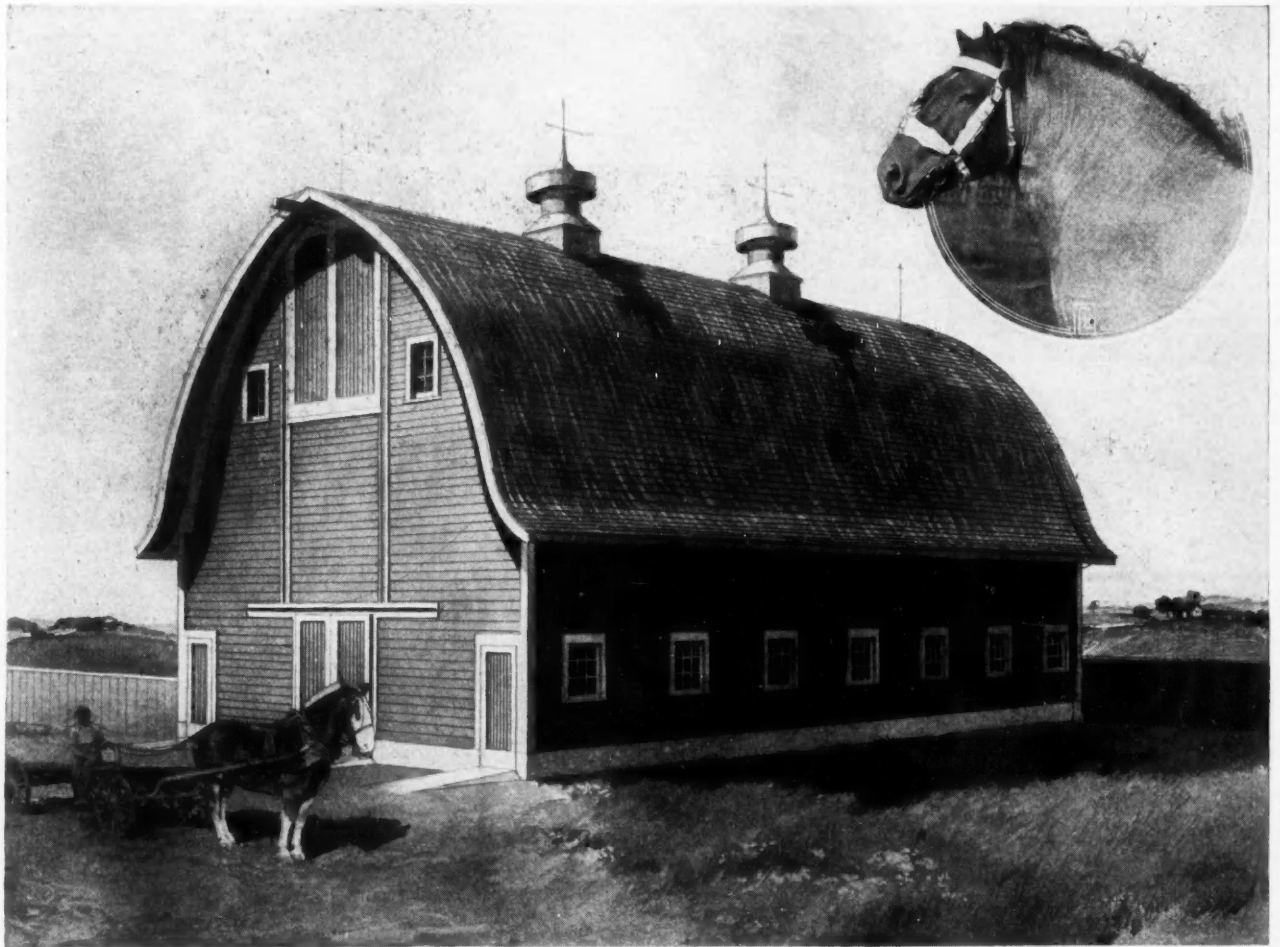

A businesslike Gothic-roof design to stable 16 cows and 14 horses. Overhead litter carrier runs through both stables. Size on ground, 70 by 36 feet. We can furnish complete set of blue-printed working plans and typewritten specifications for only \$10.00 per set. When ordering, ask for Design A282.

Gothic Roof Combination Barn

A Gothic or curved roof barn, 36 by 70 feet is shown in this design. Gothic roofs on barns are becoming popular in many sections of the country, because of their neat appearance and smooth interior. A roof of this shape is strong, because of the built-up arches. The heavy trussed rafters are 6 feet apart on centers. There are two lighter rafters between, which brings the bearings for the roof boards two feet apart.

The detail drawings show the manner in which the rafters are built up, as well as the end bracing and other details of construction.

There is a concrete wall 5 feet 6 inches in height, commencing with the footings four feet below grade and extending 18 inches above grade. The stable floor is placed at grade at the sides of the building in front of the mangers.

The stable standing floor has the usual incline and the gutter is 16 inches wide. The general plan of the cow stable is arranged to face the cows out, leaving a driveway through the center of the stable 8 feet 6 inches in

width between the two gutters. The same driveway extends through the horse stable.

Stabling is provided for 16 cows and 14 horses. The horse stable is partitioned off from the cow stable, so that the two stables are quite separate, except that they are connected by doorways in all three alleys.

The horse stable floor is level and the stall partitions are made of wood. There are wooden columns in the horse stalls and five inch wrought iron col-

umns filled with concrete in the cow stalls.

The cow stable walls are made double and ceiled on the inside with narrow flooring tongued and grooved without heading. The ceiling joists are covered in the same way. The boarding is carefully painted with three coats of white paint made by grinding white lead into linseed oil. This makes a ceiling that may be washed and kept clean, and being white, aids very much in lighting the stable.

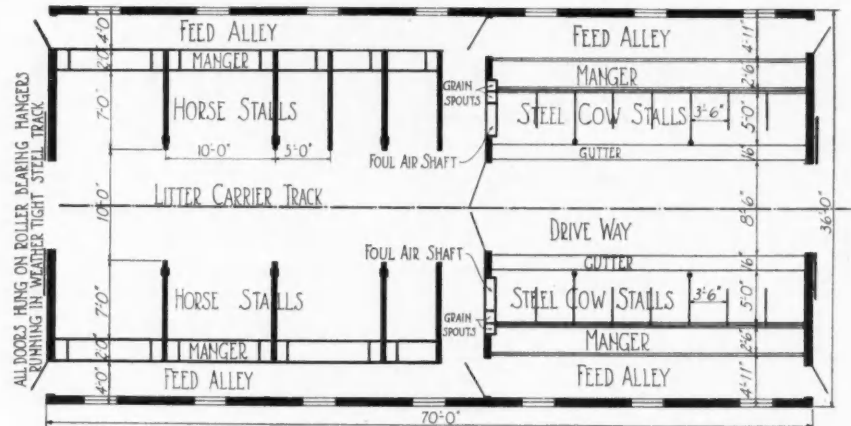

Floor Plan of Gothic Roof Barn. Design A282.

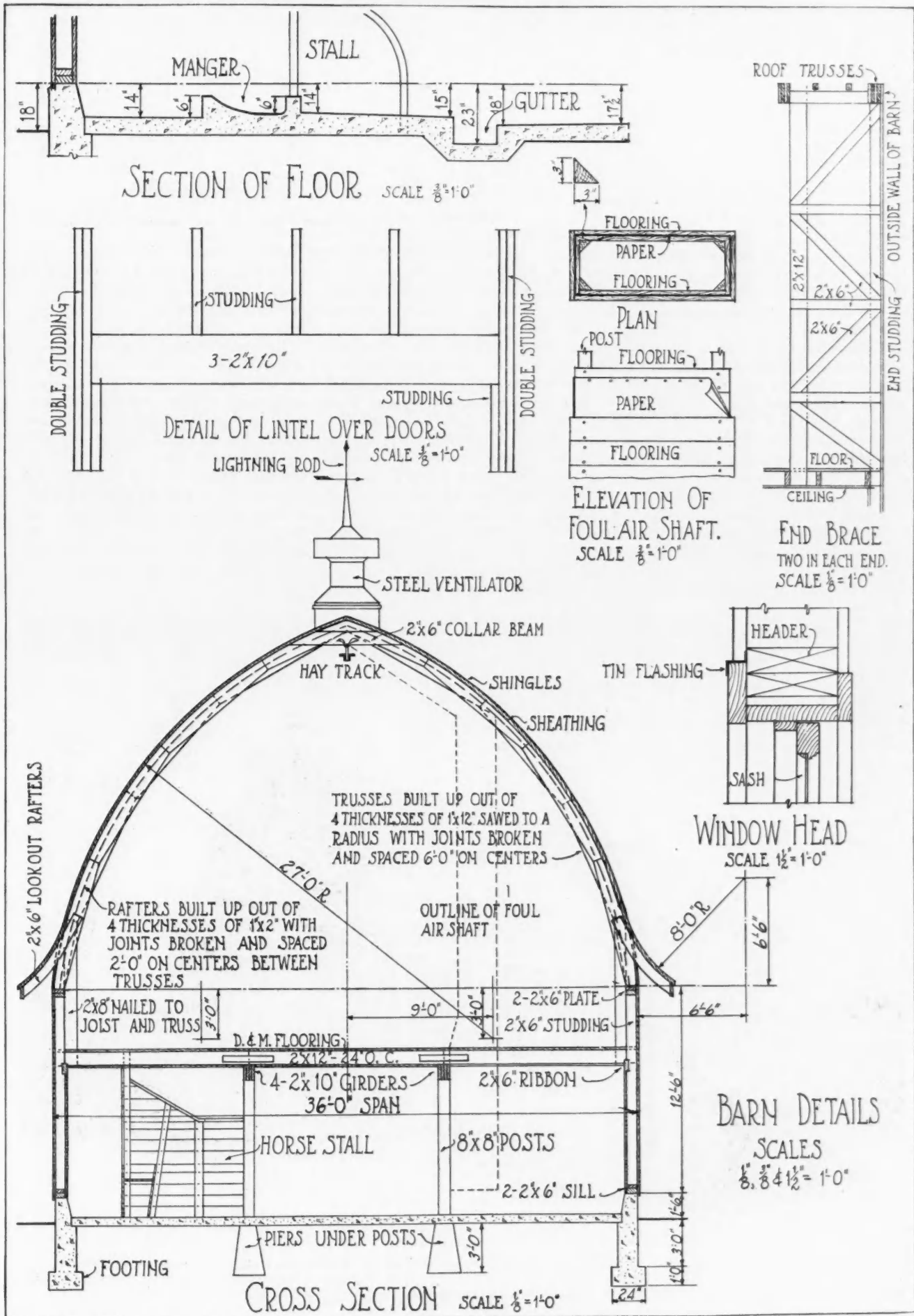

DETAILS OF GOTHIC OR CURVING ROOF BARN (DESIGN A282) SHOWN ON OPPOSITE PAGE.

Combined Dairy and Horse Barn

A dairy and horse barn 36 feet in width by 74 feet in length is shown in the accompanying perspective and floor plan. The plan is built to accommodate twenty-two cows and six horses in the standing stalls. In addition there are three box stalls which may be used for any kind of live stock, because they are partitioned off by themselves with convenient doors to enter from different directions.

Each cow stall has an iron stall partition which takes up little or no room. It is there for the purpose of preventing the cows from turning sideways and crowding their smaller neighbors. Such stall partitions really affect a saving in room and are almost indispensable. At least dairymen who have used iron stall partitions never care to get along without them afterwards.

The construction of this plan is a little different from the ordinary, from the fact that the foundation wall extends up four feet above grade. The wall is of concrete started two and one-half feet below grade with wide footings to ensure against settling or cracking.

The wall and concrete floor are all

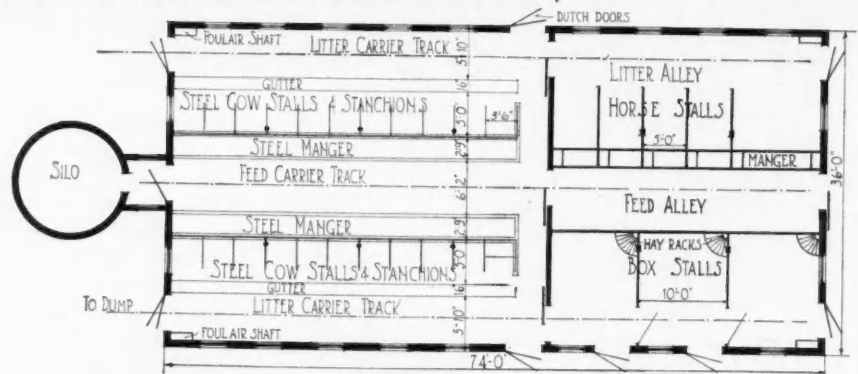

Floor Plan of Gambrel Roof Barn. Design No. A284.

made together almost like one piece. The framework of the building is plank frame construction starting from the top of the wall. Plank frame truss work reaches from the top of the wall to the peak, which makes a very stiff frame.

The ventilating system consists of four foul air shafts, which reach from near the floor to the metal ventilators on the peak. These foul air shafts are protected by the corners of the building next to the stable doors. There are three ventilators on the roof, the two end ventilators are used especially to take care of the foul air from the shafts, and the ventilator at the center is for the hay mow only.

Intake pipes are provided in the walls

in such a way as to take the air in from just above the concrete wall and deliver it into the stable near the ceiling.

The stable is lined as smooth as possible. With a smooth interior and smooth iron stall partitions and stanchions, and a good ventilating system, it is comparatively easy to keep a cow stable clean and sanitary.

Manure carriers are suspended from overhead tracks back of the cows, so that the stable may be cleaned quickly as soon as the cows are turned out for an airing. These manure carriers are labor-savers to such an extent that they soon pay back the cost in the saving of labor alone.



A modern gambrel-roof barn for 22 cows and 6 horses, besides three large box stalls. Cows are stanchioned in two rows, facing in. Size of barn 74 by 36 feet. We can furnish complete set of blue-printed working plans and type-written specifications for only \$8.00 per set. When ordering, ask for Design No. A284.

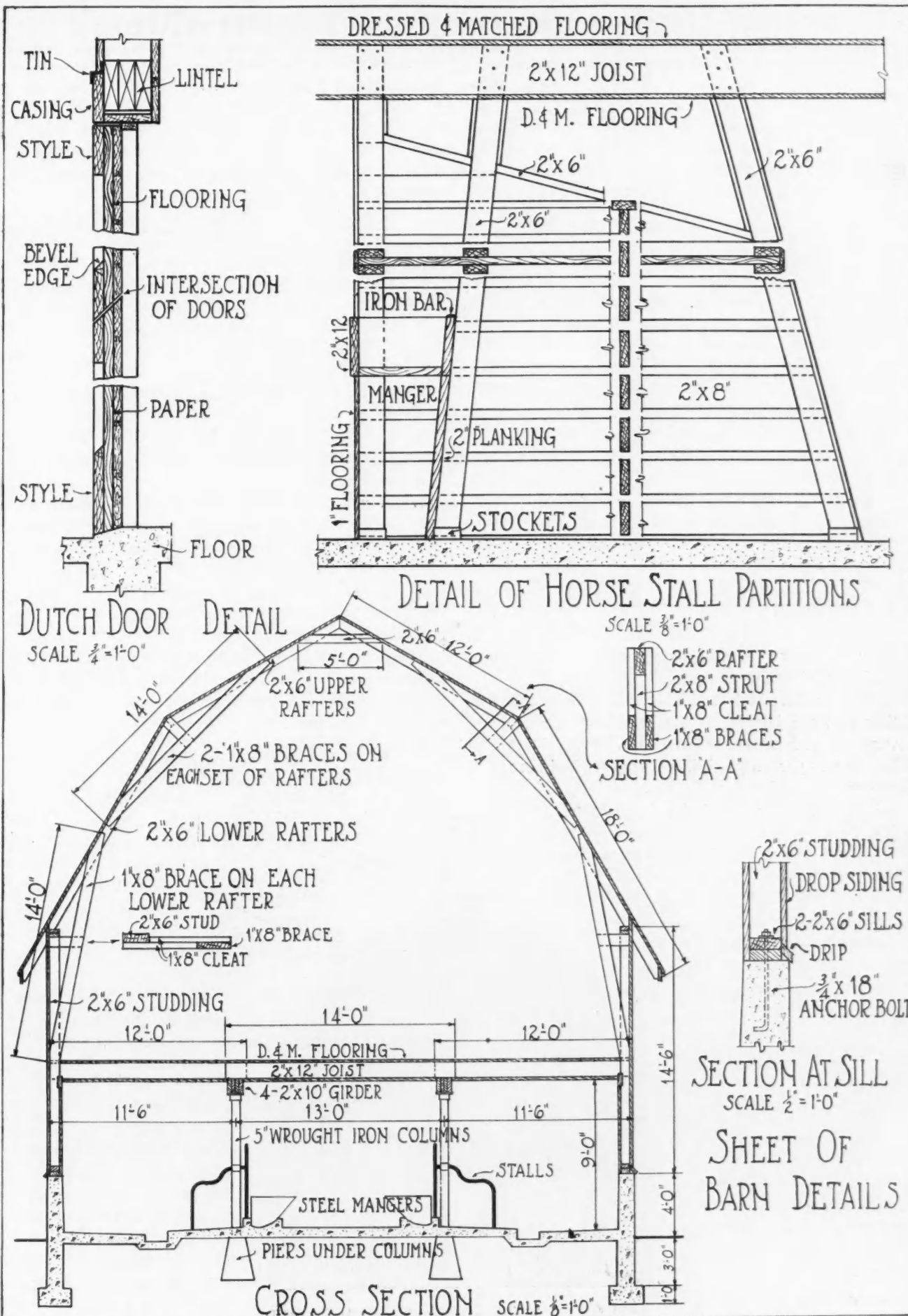

CONSTRUCTION DETAILS OF 36 FOOT SPAN GAMBREL ROOF BARN (DESIGN A284) SHOWN ON OPPOSITE PAGE.

SHEET OF BARN DETAILS

Scientific Ventilation for Farm Buildings

CAUSE OF ROTTING BARN TIMBERS DISCOVERED—FRESH AIR MOST IMPORTANT FOOD FOR LIVE STOCK—APPROVED PRINCIPLES OF VENTILATION PRESENTED

By L. Klima, Barn Ventilating Expert

IT is a cold, frosty January morning and Mr. Jones, one of the biggest dairy breeders in his locality, has just come into the house with a pail in each hand. Setting the pails down, he says to his wife: "There is something wrong with the lumber which I purchased for our barn a few years ago. I notice, this morning, that the sills are rotting out and that the framework which connects to the sills is also rotting out at the lower end. I think I will call up my contractor and see what he knows about this lumber dealer where I purchased the lumber."

He called up the contractor who built the barn; and the next morning this contractor and the dairyman went out to the barn to examine the failing timbers. This they had purchased at the time the barn was built, and was the very best grade of lumber that could be purchased.

It was a barn for horses and cows, the cows being in one end of the building and the horses in the other with a driveway in the center, from which the hay was unloaded into the hay mow. It so happened that one of the sills which was in the dairy barn or the cow stable extended out into the driveway. Upon close examination they found that this sill was rotted in the room where the cattle were housed, but was perfectly sound in the driveway.

This set them both to thinking; they found out further that the boards on the outside of the building were rotted from the inside, while the outside of the boards was perfectly solid, because they had been protected by paint.

The contractor asked the dairyman what he had done to ventilate his building and was advised that nothing had been done excepting to open the hay chute; and of course this did not help the ventilation very much, because it took from the stock room the warm air which is necessary to keep in a building in order to keep up the temperature.

Thousands of Farm Buildings Suffering

Now this condition does not exist in this one barn only, but in thousands of the best barns in the United States. The better the barn is constructed the more necessity for a proper ventilating system.

Perhaps there is no word in the American language

with four syllables, which is more used or more abused than the word "ventilation," for the simple reason that very few have given this word any study to amount to anything.

A room which is perfectly tight can be ventilated by putting an opening 2 inches in diameter in one of the walls and it would be ventilated. You could also open one wall and still the building would be ventilated.

It therefore resolves itself into this fact—that ventilation is divided into three separate and distinct classes, *not enough—too much—and correct.*

For many years experts have devoted a great deal of time and study to the ventilation of school buildings, factories, stores, etc., but very little time and study have been given to the subject of proper ventilation for farm buildings.

When you take into consideration that there are only three things that make gravity ventilation possible, and we must admit that gravity ventilation is the only practical ventilating system for a farm building, you will more readily understand why proper ventilating systems have not been constructed for farm buildings to any greater extent.

The three things that make gravity ventilation possible are the elevation of the flue, the difference in the temperature in and outside of the building, and the velocity of the wind.

Enormous Quantities of Oxygen Needed

Let us take a pound of hay and put it on a table and light a match to it and we find that it requires 56 cubic feet of air or the oxygen contained in 56 cubic feet of air to consume this pound of hay. If you will put an air-tight dome

over this, you will find that as soon as the oxygen in the dome is burned, the flame will be extinguished.

This is caused by the lack of oxygen. Oxygen must be mixed with the gases that come from the hay in order to burn it up. It requires the same amount of oxygen in a cow to assimilate properly one pound of hay as it does to burn it up with a flame. This will give you some idea of the immense amount of oxygen that should be supplied to get the 100 per cent efficiency from the cattle.

To give you a little better idea of the immense

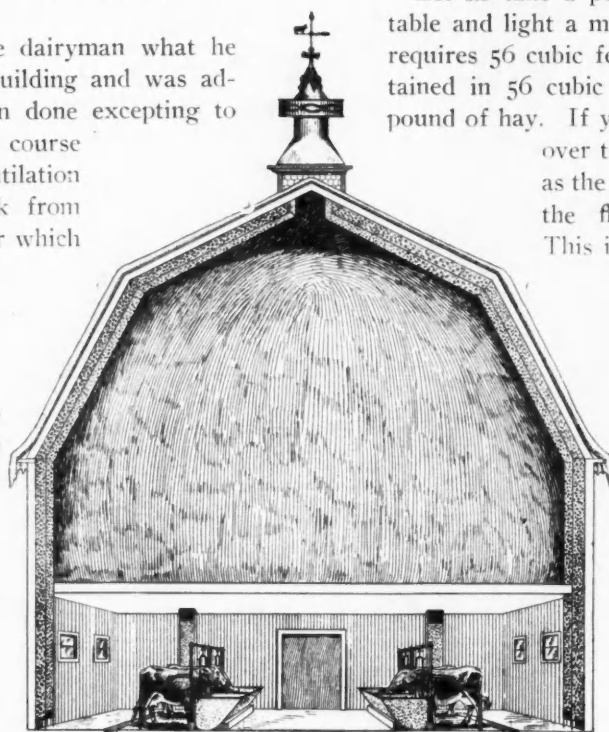

Clean Air and Healthy Cattle in Well Ventilated Barn.

amount of fresh air that it requires for a cow: If it were to be carried to her in pails, you would have to carry seven pails of fresh air every minute to each cow of the herd. You can see by this that it requires a ventilating system of more than ordinary ability to supply this immense amount of fresh air and still retain the temperature of the building.

To further illustrate this point, a cow consumes about 2800 cubic feet of air every twenty-four hours. If a cow was to be placed in a room sufficiently large to supply her with this amount of air, it would require the space of about six or seven of the stalls which she is now allowed; and the air would have to be changed in this room at least twice a day in order to give her the proper air to breathe.

Function of Barn Ventilating System

A ventilating system properly planned for a stock barn will bring in and take out of the building enough fresh air so that it will reduce the carbon-dioxide to about 3 to 5 per cent, absorb this immense amount of moisture that is thrown off by the cattle, draw it out of the building, and at the same time keep up the temperature.

It is a very easy matter to ventilate a building. All that is necessary is to open the doors and windows and you will get plenty of fresh air. But if you do this you have not gained anything by building your barn, and your cattle will have to consume a great deal more feed in order to fight off the cold.

A properly planned gravity ventilating system will remove the cubic contents of a room every 15 to 30 minutes—this depending a great deal upon the humidity of the air, because there is not as large a movement in a ventilating system on a day when the air is charged with 75 degrees of humidity as there is when the air is charged with only 60 degrees of humidity. Oxygen is two-thirds of a cow's ration; and if more people knew the immense value of this oxygen to their stock, more buildings would be properly equipped with ventilating systems.

If a barn is properly constructed so that the wind does not blow into the cracks and around the windows, the colder the atmosphere is on the outside and the warmer it is on the inside, the more air will pass up a flue.

There are three separate units to a gravity ventilating system and these are the *fresh air intakes* which bring in the fresh air from out of doors, the *foul air flues* which take the air out of the building, and the *pump or ventilator* which is on top of the roof.

In order to make a gravity ventilating system work properly, these three units must be perfectly balanced. The fresh air intakes must be in proper relation to the foul air flues—not only in size but in location, so that the air movement in the building will distribute the fresh air to all parts. The pump or ventilator on the roof must be so constructed that it will work all the time, not having to depend on wind—or no wind.

Shrewd Builders Favor Good Ventilation

Some contractors or builders might think that if a building rots out from the moisture which is thrown off by the cattle, they would get the contract for renewing these parts; but if you will take into consideration the fact that if this man did not have to replace part of the old building he would have that much more money to put into new buildings, you will at once see that it would be advisable and preferable to work on new buildings than to be tearing down and patching up old work.

To give you some idea of the immense amount of moisture which is thrown off by the cattle in a barn, it has been proved that the average cow throws off through the pores of her body and through her nostrils in the form of invisible moisture, ten pounds every day. This would mean that in a herd of forty cows approximately *a barrel of water is thrown into the stable every twenty-four hours!* If the building was absolutely water and air tight and still the cattle could get fresh air to breathe it would not take many years before there would be enough moisture thrown off from their nostrils and pores of their bodies to drown them right in their stable!

This carbon-dioxide and moist, heavy laden air will rot out the best lumber material. Years ago, when the cattle lived in the old straw sheds and the wind whistled through them and the snow blew half way into the building there was no necessity for artificial ventilating systems, for the cattle then breathed the pure fresh air and little was known of tuberculosis.

Good barns, which are made to keep the cattle warm, are the cause of many of the diseases that are now found in cattle. The object of building a good tight barn is to keep the cattle warm so that the feed which they consume does not have to go toward fighting off the cold. If they are supplied with fresh air they should show a large increase in the flow of milk where they are properly housed in a warm barn.

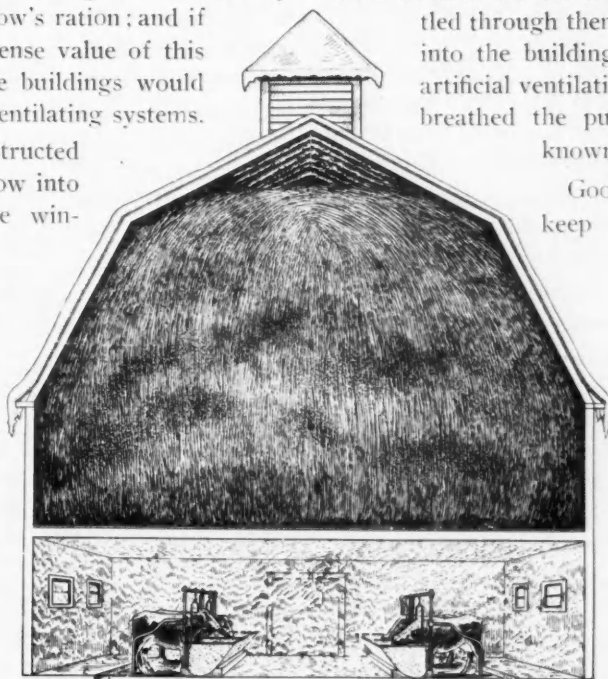

Stale, Heavy Air Filled with Water Vapor—Bad Alike for Building and Live Stock.



EDITOR'S NOTE—Our readers are urged to make full use of this Department. Put your concreting problems up to us; also write us your experiences and accomplishments in the Cement field for publication here.

An Instance Where Two Plus Four Does Not Make Six

THE FIRST PRINCIPLES OF CONCRETE WORK SHOWING WHY SOME ESTIMATES FALL SHORT

By H. Colin Campbell, C. E.

ONE sack of Portland cement, accepted generally as one cubic foot in proportioning concrete by volume, mixed with 2 cubic feet of sand and 4 cubic feet of gravel or broken stone, will produce approximately 4.5 cubic feet of concrete. To make one cubic yard of concrete in proportions of 1:2:4, requires 6 sacks of Portland cement, 12 cubic feet of sand, and 24 cubic feet of gravel or broken stone. That is to say, 42 cubic feet of concreting materials, when properly combined, produce a total volume of only 27 cubic feet.

Why? Because in a properly graded mass of materials the cement fills the voids in the sand, and the sand-cement mortar fills the voids in the gravel or broken stone.

As theoretically perfect grading is a practical impossibility, proportions for concrete mixtures are calculated so as to provide an excess of fine materials of approximately 10% over actual requirements, thus compensating for slight errors in proportioning. Many a contractor, new to the concrete business, has cheated himself through his own ignorance in not realizing that the 2 cubic feet of sand in a properly graded 1:2:4 mixture would be practically lost in the voids of gravel, and hence has underestimated the quantity of aggregates necessary to a certain job, to his own financial loss. On the other hand, many a contractor has cheated the job, although not always knowingly, by using a 1:6 mixture in which the aggregate consisted of bank-run material as taken from the gravel pit, because the quality of the resulting concrete has been far under the engineer's estimate if he calculated it on a definite 1:2:4 concrete.

There are numerous contractors, building superintendents, and foremen, who fail to appreciate the fact that no natural bank-run material will produce a definitely specified concrete mixture. Bank-run gravel almost invariably contains an amount of sand greatly in excess of requirements for concrete of maximum

density and strength. One experiment with a screen will prove the truth of this. As a rule, fine material in bank deposits exceeds the coarse by twice, while for good concrete the requirements are approximately the reverse.

Dirty Materials Make Trouble

Next to the fault of using improperly graded material is that of using dirty material; that is, aggregate containing loam, silt, and organic matter or clay, especially in the form of coating on the particles. Regardless of the amount of cement which may be used, such foreign substances always remain inert in a concrete mass, and will show their presence ultimately in one or more of several ways. If the foreign matter is present in excess, and the concrete containing it has been thoroughly mixed, then the adulteration will be evident by slow hardening and weakness of the concrete, or failure to harden up at all; while if insufficient mixing is given, the presence of foreign material will be indicated by soft spots or pockets in the final mass of hardened concrete.

Bank Run Gravel Rarely Suitable

Unquestionably the most frequent cause of permeable concrete is disregard of the unsuitability of natural bank-run material—its poor grading. The same is true of crusher-run broken stone. Numerous tests have been made to determine the possibility of securing impermeable concrete. New evidence is almost daily being added to the old to confirm the belief that impermeability for all practical requirements can be secured without integral compounds, and depends wholly upon proper grading and proportioning of materials, mixing them with just the right quantity of water to insure that the concrete will settle into place under the influence of slight puddling, rather than tamping, and that where the mass is exposed to wind, sunlight, or other rapid drying influences, proper protection be given to prevent too rapid drying and hence

insure thorough and uniform curing. Not only do these precautions insure impermeability, but they insure maximum strength for any given mixture, providing the cement is of standard quality and the aggregates meet specifications for hardness, cleanness and uniform grading.

Cheap Labor and Skilled Supervision

Superintendents and foremen should realize that by no possibility in the normal run of conditions on any given job, can definitely specified mixtures be obtained throughout the work by substituting natural bank-run materials for the specified volumes of properly graded sand and gravel. Until there is a widespread realization of this indisputable fact, concrete work will in the future, as in the past, frequently meet with just criticism.

The very fact that most of the actual labor of concreting can be performed by unskilled laborers, has caused many to "rush in where angels fear to tread." They forget that the success of concreting depends in great part on the skilled supervision that exercises watchfulness at every step of the work's progress—insures that the precautions and requirements outlined as necessary in the foregoing paragraphs are strictly observed.

Wood Form for Steps and Ramps

Three good Schemes for Step Nosing Forms

HERETOFORE the building of steps and ramp walls at one operation has required complicated forms and the practice has been to build steps and ramp walls separately. The accompanying drawing illustrates a method of form construction, by means of which ramps or side walls and steps may be built in one operation; and the form construction is so simple that construction both of one and two-course types may be done with equal facility.

After having made the proper excavation, set up and securely place the outside ramp form, indicated by the pieces marked "A." Next drive two stakes into the ground at the top of the steps and to them nail the suspension bar "B." Reinforcement, if used, should be placed next. Forms for the inside of the ramps and steps (pieces C) are single units and should finally be hung from the suspension bar and blocked as shown. Next the reinforcement may be secured in proper position. Concrete of quaky consistency, mixed in the proportions 1:2:3, is then placed in the forms and the tops and edges finished before form removal.

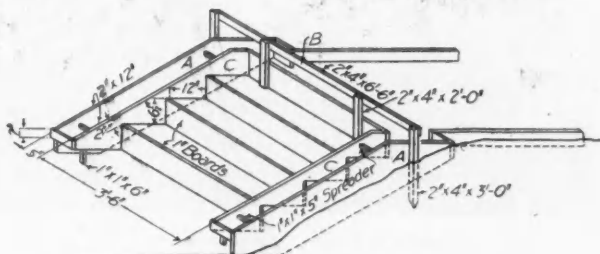

Arrangement of Concrete Step Forms.

In the average clear summer weather, the pieces C can be removed within two or three hours after placing the concrete, following which the inside of ramps and rise is finished. Outside forms, pieces "A," may be left in position as long as desired. Separators, and blocks supporting the inside units (pieces C), should be removed after enough concrete has been placed to afford necessary support to the forms. To remove the inside unit loosen it from the suspension bar and pull it carefully forward by means of rings attached

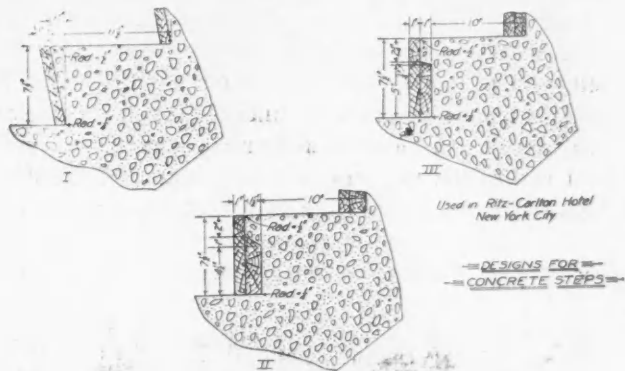

Forms for Concrete Steps to Make Nosing.

to the inside ramp form just in front of the first riser. The outside ramp form is cut from a piece of 2 by 12-inch pipe to the shape shown, the actual dimensions, of course, varying with the required slope. Likewise, the inside ramp form is cut to the shape shown. In cutting for the width of tread, allowance must be made for the 1-inch-thick riser forms. If the pieces C are not to be removed as units, toe-nail the riser forms to the inside ramp forms from the inside. When ready to remove, draw these nails and take up the inside ramp form and riser pieces one by one.

Various attempts have been made to reproduce in concrete steps the rounded edge used on wood treads.

In one of the accompanying illustrations (I) a design is shown which provides for a panel of 1 1/4 inches, extending down the entire face of the 7 1/2-inch rise. To secure this result it is necessary only to bevel slightly the board used as a form for the riser and then set the piece at proper angle. Such a type of step should prove very satisfactory for cellars.

Design II shows a 1 1/2-inch lip extending downward 2 inches from the top of the tread, the profile forming a bevel toward the riser which it joins 1 inch lower. This causes an obtuse angle which adds to the facility with which the steps may be constructed and at the same time affords a pleasing appearance for terrace and porch steps.

Design III differs from the second only in the dimensions of the lip, which shows a lesser obtuse angle upon the lower side and is 1/2 inch thinner. This last design was used in the Ritz-Carlton Hotel, New York City, and presents no serious difficulties in construction, at the same time being especially applicable to interior stairways of residences, office buildings and hotels.

Metal Lath and Plaster Will Protect Any and Every Home

FIRE LOSSES CUT DOWN AS CEMENT PLASTER CONSTRUCTION ON EXPANDED METAL OR WIRE LATH COMES INTO GENERAL USE

By W. Geo. Lane

ARGUMENT is unnecessary to show the need of fire protection on the North American continent; and yet it is well to remind ourselves of the reasons for the expenditure of the time, money and effort that is being made throughout this country to call attention to the annual fire loss. In spite of the fact that much has been done and the attention of the people focused on the subject, it is evident from the figures recently published that much still remains to be done before the American people will realize the vastness of their losses and the ease with which those losses can be prevented.

The report of the national board of fire underwriters shows that the loss by fire in 1913 for the United

an injured person was taken, and every $\frac{3}{4}$ of a mile would mark the spot where had lain the charred remains of a human being.

Much of this fire loss is on family dwellings and tenements. While the writer has not figures of the whole country before him, the statistics of fires and operations of the New York Fire Department in 1913 show that more than two-thirds of their work was caused by fires in such buildings.



The Workmen Like Metal Lath Because It Presents such a Fine Plastering Surface. Photo shows Bostwick's "Truss Loop" Lath.

States and Canada reached the stupendous total of \$235,000,000—\$10,000,000 more than 1912. In addition to this loss \$315,000,000 were paid for insurance, a total of nearly \$600,000,000.

It may be that these figures are too large to be comprehended in their full significance by the individual. To reduce it to an individual amount every man, woman and child in America lost \$2.21 by fire; and the buildings consumed if placed on lots of 65-foot frontage would line both sides of a street extending from New York to Chicago. Passing along this street every thousand feet would mark a ruin from which



A Sykes "Cup Lath" Cottage Built for Goodyear at Akron, O.

Owing to the complex nature of our political system, it is utterly impossible to expect any adequate measure of relief through the formulating of building codes, the increase of municipal building inspection or other corporate action.

The question must be brought to the direct attention of the individual builder, and every reader of the *AMERICAN CARPENTER AND BUILDER* must meet the situation and take his full share of the responsibility. The change from the present method of building in America to the construction used in older countries is out of the question. The reform would be of such a radical nature that it would clash with our present

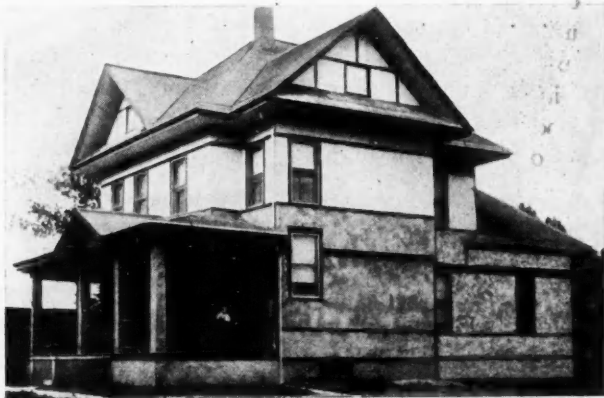

Old Frame Houses are Ideally Remodeled by Overcoating with Cement Plaster on Metal Lath. N. W. Ex. Metal Co.'s "Kno-Burn" Lath was nailed Direct to old clapboards of this house at Virginia, Ill.



Notable Buildings on Farm of James Couzens, Bloomfield Township, Mich. Trussed Concrete Steel Co.'s "Hy-Rib" Used to Reinforce Silos, Fences, Partitions, etc. Albert Kahn, Arch., Ernest Wilby, Associate.

economic conditions to such an extent that it would defeat itself.

A way must be found to secure an effective measure of fire protection without disturbing present conditions unnecessarily. That this way is at the hand of every

Recent investigation made in various parts of the country, and taking into consideration transportation and other conditions, have shown that stucco on metal lath exteriors can be furnished at 2.9% increased price above regular clapboard construction.

This percentage upon a \$3,000 house would amount to \$87, and for this ridiculously small amount the builder could be assured that he would not lose his property through the spread of fire from his neighbors. This would be the only extra as metal, asbestos or other non-combustible roofing can be secured at a cost very little more than that of shingles and can be maintained at a very much lower up-keep expense.

We have become so accustomed to figuring fire loss in dollars and cents that we are apt to overlook the

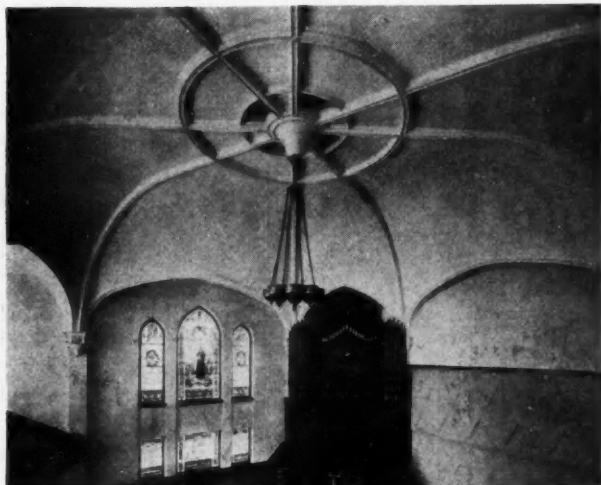

Ceiling of Trinity Reformed Church, Philadelphia. Carl P. Berger, Arch. Lathed with Bostwick "Truss Loop."

American builder has been proven by the Cleveland fire test in 1913 and the test conducted by Prof. McGregor in New York last year. In each of these cases it was conclusively proven that metal lath and plaster construction would stand approximately 1,800 degrees Fahrenheit of fire for two hours, effectively protecting the rest of the building and contents.

The efficiency of this construction having been established, the next thing necessary is to show the prospective builder that the cost of this construction will not interfere with his financial arrangements and will not place beyond his means the protection necessary for himself, and for him to take his share of the responsibility for reducing a national loss that would put any other nation in a bankrupt condition.

Twenty-seven per cent, or more than one-fourth of the fire loss, is due to the communicating of fire from one building to another. Therefore we will first consider exterior fire protection.

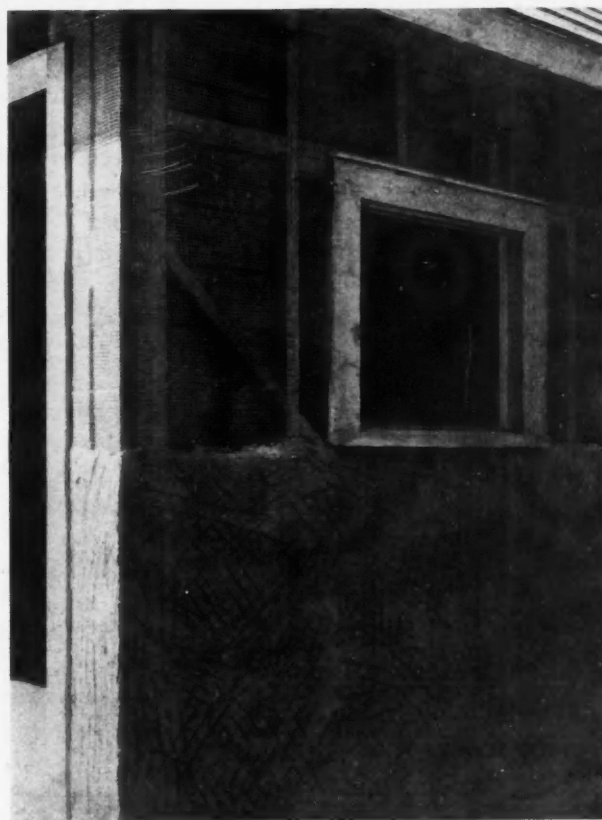

Fire Resisting Garage Sided with Wire Lath and Stucco. Buffalo Wire Works Lath.

many priceless treasures that every home contains and which can never be replaced. There is scarcely a home on this great American continent that does not contain some souvenir of the past, the intrinsic value of

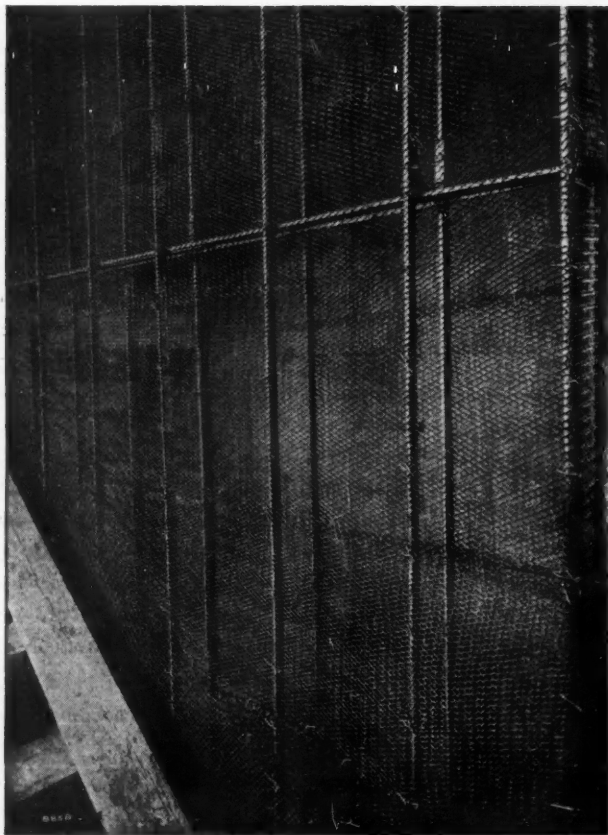

Foundation for Double Wall Fireproof Stairway Inclosure in Larkin Bldg., Philadelphia, Using Northwestern Expanded Metal Co. Goods.

which would be little or nothing, but around which by association are values that are priceless.

We fail to figure the loss of human life and we fail to realize the danger of the weakening of the life that is saved through exposure and similar causes.

It is not beyond the means of any builder to provide himself with protection both for the treasures that his home contains and for the lives of those for whom he has made that home.

Metal lath and plaster construction on side walls, ceilings and partitions has proven its ability to prevent the spread of an interior fire beyond the room of origin. From 20 to 30 cents per square yard is the price that it would be necessary to pay for this protection. This being the average increased price of metal lath and plaster as compared with wood lath and plaster construction. The average number of square yards of interior plaster surface upon a \$3,000 house, to continue a building of this character as our illustration, contains about 700 square yards of plastering surface, at 20c per square yard, the extra cost would be \$140.

It does not need a long explanation to show to any man that his loss on one or two articles of furniture would more than cover this amount.

To take the two extra charges together we have

exterior protection with that of interior fireproofing for a total of \$227. At 6% this amount would be an interest charge of \$13.62, or a fraction over \$1.13 a month, less than the average man's cigar and tobacco money.

Our figure comparison does not rest here, as with metal lath and plaster construction or stucco exteriors the up-keep expense is greatly reduced.

The unsightly discoloration of ceilings, the bane of every housewife, and the reason for the expenditure of many dollars in renewing is said to be entirely absent where metal lath and plaster are used.

To sum up the whole subject, every builder during 1915 has a personal responsibility in so building that he will reduce and not increase the fire loss of the American people. He can do this with metal lath and plaster construction at a cost that is entirely within his means, by methods that are at his hand, and that have been proven efficient in the results secured.

The further fact that the slightly increased first cost comes back to the builder with an added profit in the saving of up-keep expense only accentuates the lack of thought along the lines of safer and saner buildings



"Keyridge" Metal Lath and Stud Combined as Furnished by Edwards Mfg. Co. Used in New Hotel Metropole, Cincinnati.

which is showing such disastrous results, but also lack of appreciation of what the developments of the twentieth century have done to save that which is the most precious in the eyes of any human being, his home and his home people.

**Plymouth Congregational Church,
Lincoln, Neb.**

The contract for the new Plymouth Congregational Church at Lincoln was recently let to the Olson Construction Company of that city, and will cost, when completed, about \$35,000. It will have mat face brick and white stone trimmings. It is 82 by 82 feet square with the main fronts showing practically the same.

The auditorium will have bowl floor and will seat 375 in the pews. On special occasions the lecture room can be thrown open to the main auditorium, which will accommodate nearly as many more. Then there is a gallery running the full width of the building, that will seat about 170 more.

The large pipe organ and the choir are located just

back of the rostrum and several steps higher, so that a good view can be had from all parts of the audience.

There will be a large ceiling dome over the main auditorium in which will be an art glass skylight protected by a storm skylight above. The lecture room will also have an art glass skylight.

The Sunday school is provided for in the basement which is also arranged for social purposes.

There are a number of class rooms on the gallery floor to be used in connection with the Sunday school work.

The pastor's room, library and choir are located on the main floor and all well arranged for their purposes.

The plans and specifications for this building were furnished by A. W. Woods, the Lincoln architect who has made quite a specialty of church work.

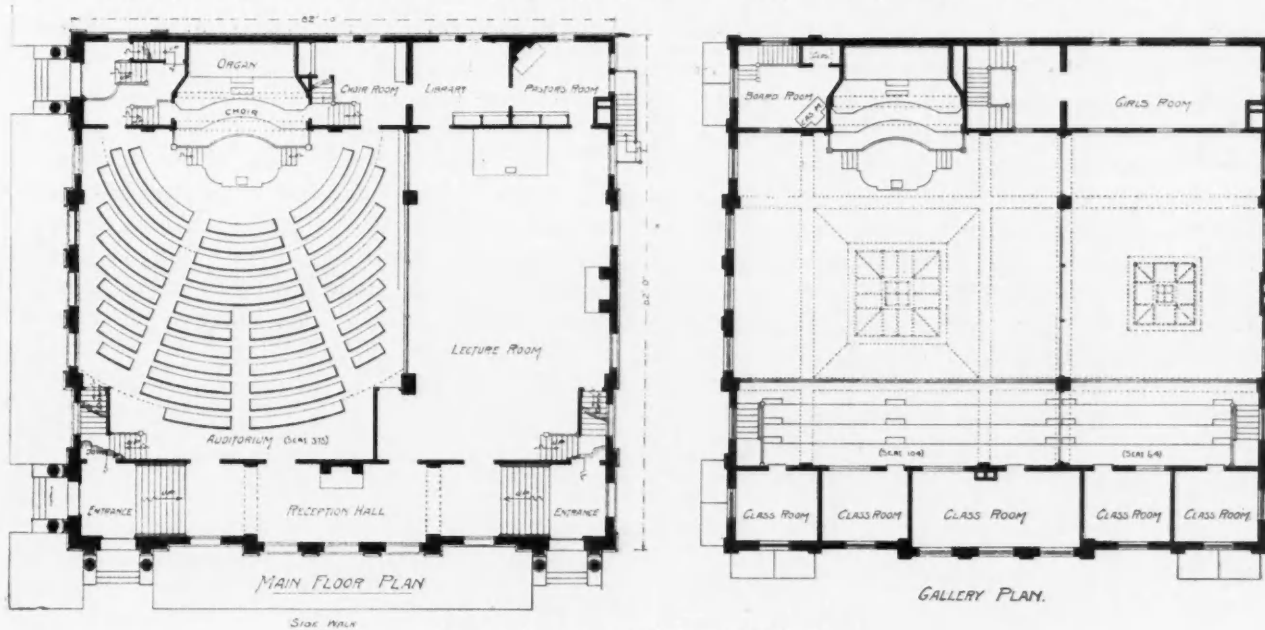

Interior Arrangement of Plymouth Church.

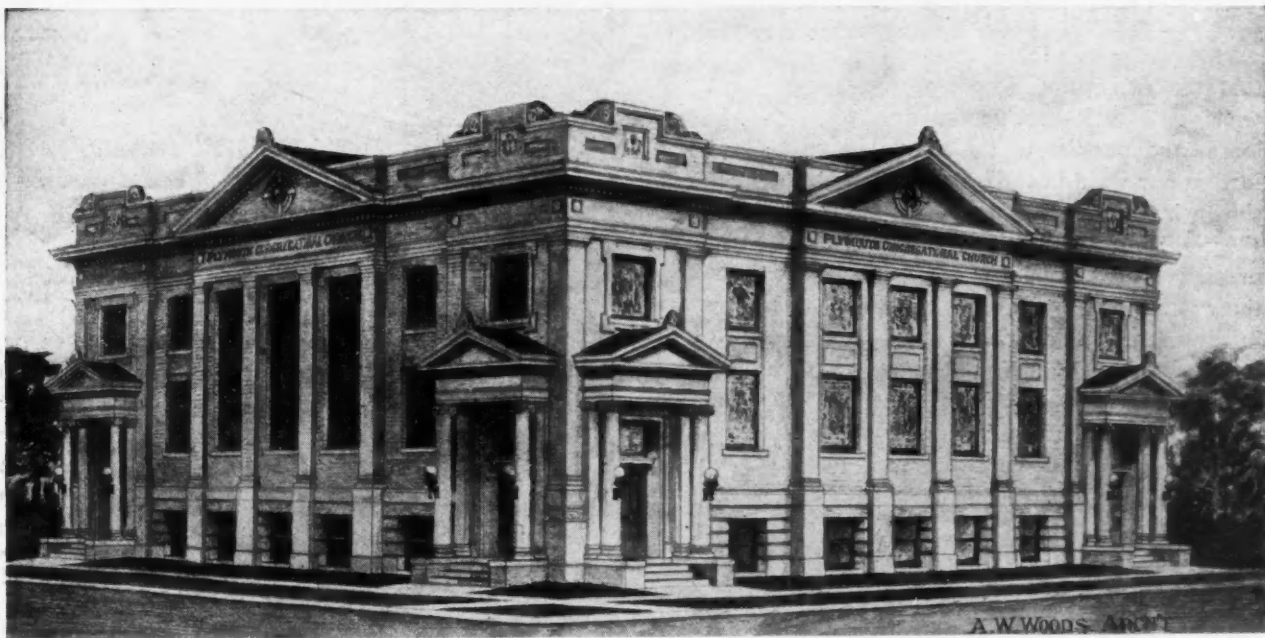

Architect's Perspective of New Plymouth Congregational Church, Lincoln, Nebr., to Cost \$35,000.



Noon Hour Talks by the Boss Carpenter

Talk No. 32—Fink Roof Truss (Steel)

THE BOSS TELLS HOW TO FIND THE STRESSES IN A COMPOUND FINK ROOF TRUSS WITH A ROLLER SUPPORT AT ONE END

"SOME time ago," said the Boss, "I told you fellows that I would show you how to use the graphical method of finding the stresses in the members of roof trusses where there are more than two unknown conditions present at any joint of the truss. Today I am going to show you a very common type of steel truss which is used on roofs of 40 to 80 feet span and which requires the use of what we call an *auxiliary* member in drawing the stress diagrams. This truss, as in the case of the truss shown in Talk No. 29, is made up of steel angles used singly or in pairs and riveted together at the joints. Later I will give a talk on truss details which will show you the method commonly used for joining all of these different members.

"All of the trusses that we have considered in our talks up to this time have had the ends fixed at the walls in such a manner that the supporting forces at the walls were vertical for vertical or dead loads, and parallel to the normal wind load in our wind load diagrams. The truss shown in Fig. 27 has a roller as a support at the right end, while the left end is fixed as in previous cases. The effect of this roller is to make the supporting force at the right end *always* vertical in direction, thus making us find the direction of the left supporting force for all except vertical loadings. This fact will not disturb our dead and snow load diagrams, but will enter into our wind load diagrams and make us draw *two* wind diagrams, one for each side of the roof, where one has been sufficient in our previous problems.

"We will begin by laying out our truss outline to scale as in previous talks. Then letter the outline as shown at the left in Fig. 27. One letter, *k*, will be sufficient to take care of all the members of the bottom

chord of the truss, and we will forget the letter *z* on the left for the present.

"Next, assume that our loads at the joints of the upper chord due to the weight of the truss and roofing material are 500 pounds at each of the end joints of the truss and 1,000 pounds at all other joints of this chord. No ceiling loads are indicated, so there will be no loads at the joints of the lower chord. We have

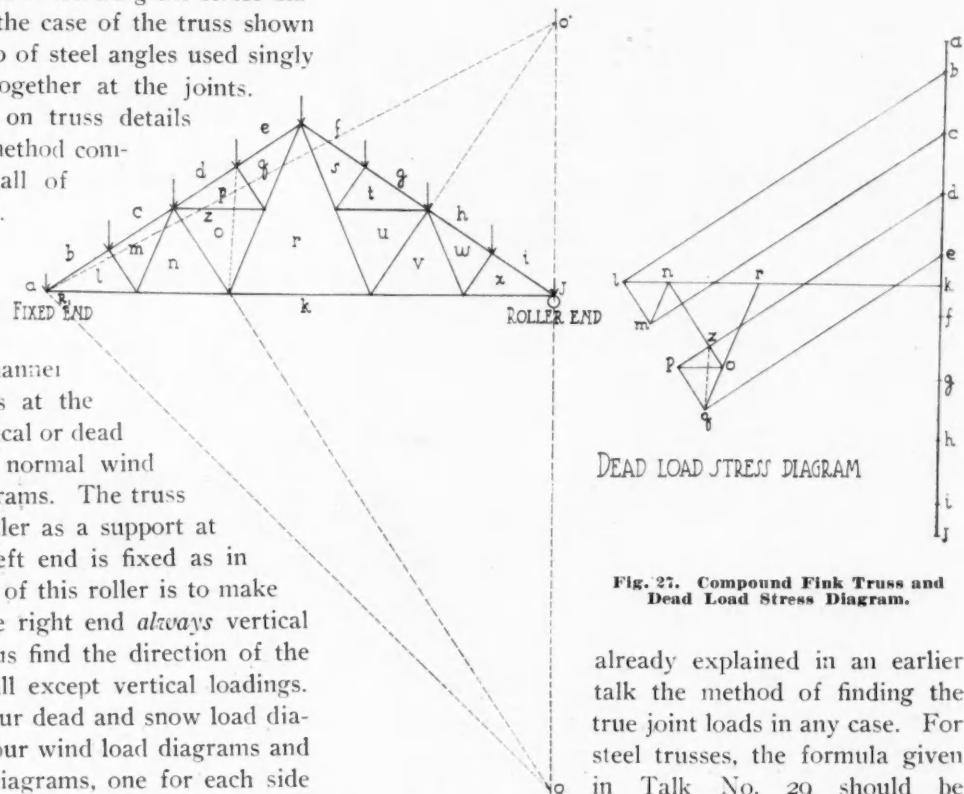

Fig. 27. Compound Fink Truss and Dead Load Stress Diagram.

already explained in an earlier talk the method of finding the true joint loads in any case. For steel trusses, the formula given in Talk No. 29 should be used in finding that part of the joint loads due to the weight of the truss itself. If you have followed these talks each time, you will have no difficulty in this matter.

"Now lay off a vertical load line for the dead load stress diagram as shown at the right in Fig. 27, laying

off the loads *ab, bc, cd, etc.*, to scale, and dividing this line into two equal parts by the point *k*. This makes *jk* and *ka* the supporting forces due to the dead load only.

“Now begin to draw the dead load stress diagram by drawing a line *bl* from *b* on the load line parallel to the direction of the member *bl* of the truss. From *k* on the load line draw a line parallel to the member *kl* of the truss. Where these lines meet locates the point *l* which is common to both lines. As explained before, the length of these lines measured and multiplied by

place of both of them, draw from *d* on the load line a line parallel to *ds* of the truss, and from *n* in the diagram a line parallel to *ns* of the truss. This will locate *s* in the diagram. Then draw *eq* and *sq*, locating the point *q*. Now do away with the dotted auxiliary and the letter *s* in the truss and put back the letters *o* and *p*. Draw *pq* and *dp*; then *no* and *po*. Draw *or, kr, and qr*. This completes one-half of the diagram. For similar joint loads on the other side of the roof, the stresses in corresponding members will be the same.

“A table should be made as in previous cases and

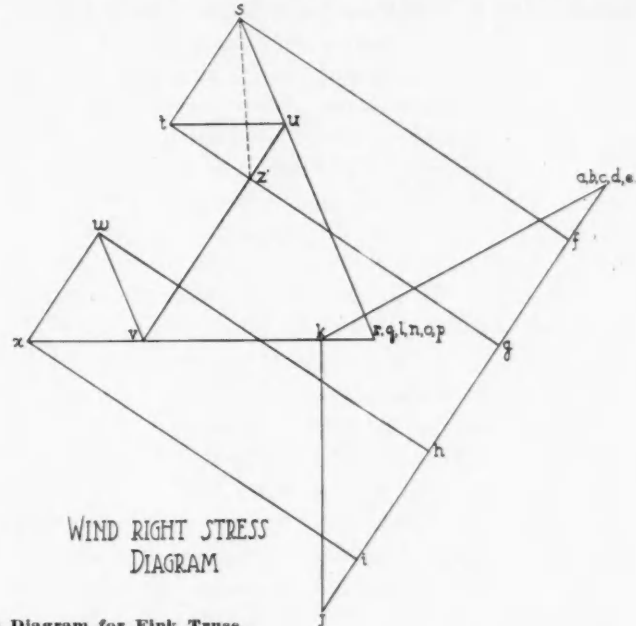
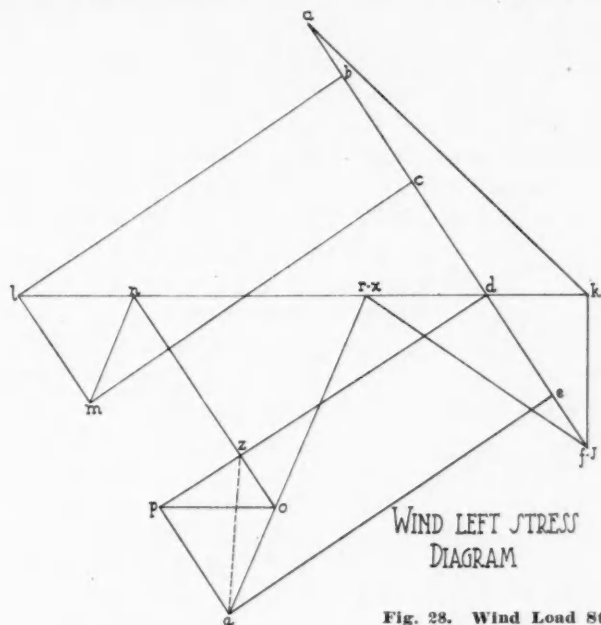

Fig. 28. Wind Load Stress Diagram for Fink Truss.

the scale used in laying off the load line will give you the number of pounds of total stress in each of these members. Then in a similar manner draw *cm* and *lm*. Then *mn* and *nk*.

“You will remember that we have tried in our previous problems to proceed from joint to joint on our trusses, always picking out a joint at which *only two* of the members were not already represented in our stress diagram. We have followed this scheme so far in this case, but now find on examining the next upper or lower chord joint that there are *three* unknown members at each joint. Here is where we make use of the dotted auxiliary line shown on the left of the truss. In other words, we take out the members *op* and *pq* for a while and put in the single dotted member, which we will call *sq*. This will help us out and allow us to go on as you will see if you follow the order of construction indicated. After we find the stresses in some of the unknowns by the use of this auxiliary, then we can take it out of the truss and put back the missing members. You will note that the auxiliary line still preserves the arrangement of members in triangles and does not change the length or condition of *dp, eq, on,* or any of the other members of the truss.

“Remembering that the letters *o* and *p* are not used for the time being and that the letter *s* has taken the

letters of members and amounts of stress in each inserted. Bow’s notation will tell you whether a + or — sign should be used for the stress.

“The regular snow load diagram may be constructed, or the stresses may be found by simple arithmetic from those just found for the dead load. The regular snow load diagram is drawn in the same manner as that just described for the dead load, only using different joint loads as described in previous problems. The arithmetic method consists of the following:

“Multiply the dead load stress just found by the snow load at one joint and divide this answer by the dead load which you used at one joint. Cancellation may help some in shortening this work. For instance, if the dead loads at the joints are 1,000 lbs., and the snow loads 750 lbs., and if a dead load stress of 10,000 lbs. has been found in the member *cm*, then the snow

$$\text{load stress in } cm \text{ would be } \frac{750}{1000} \times 10,000 = 7,500 \text{ lbs.}$$

“This same scheme may be applied to each of the stresses in the dead load column of the table and the values entered in another column headed by the words *Snow Load Stresses*. The signs of these stresses will be the same as for the dead load stresses.

“Owing to the action of the roller, we will have to draw two wind load diagrams for this truss—one for

wind on the left side of the roof and the other for wind on the right side. Fig. 28 shows these two diagrams. The main thing to be noticed in these diagrams is that the point k is no longer on the main load line, and that the main load line is perpendicular to the side of the roof that the wind is blowing against.

"To lay out the load line for either of these diagrams, draw a line perpendicular to that side of the roof and lay off the wind loads at the joints to scale, remembering that a half joint load acts at the ridge and at the ends of the truss. After the main load line is complete, for the *Wind Right* diagram make a dotted construction on the truss outline similar to that shown by the dotted lines meeting at O^1 above the truss in Fig. 27. In other words, draw a line straight up through the center of the roller until it meets a line drawn perpendicular to the right side of the roof from the middle of that side. From the point where these two dotted lines meet, O^1 , draw another dotted line to the fixed end of the truss. The direction of this last line shows the direction of the fixed end supporting force when the wind blows on the right side of the roof, while the roller support is shown in direction by the vertical dotted line.

"When the wind is blowing on the left side of the roof the dotted construction lines below the truss show the direction of these supporting forces. The same general scheme has been carried out, but with a perpendicular from the middle of the left side of the roof.

"To use these direction lines when laying off the supporting forces in the load diagrams, lay off ab , bc , cd , de , and ef in the ordinary way in the wind left diagram. This last point on the load line may be marked f , g , h , i , and j , since there are no wind loads in this diagram between f and j . Next comes jk , the roller supporting force, and then ka , the fixed supporting force. To locate the point k , draw a vertical from f and a line from a parallel to the direction of the dotted reaction line, OR_1 . Where these lines meet will be the point k .

"When the wind blows on the right side of the roof, the main load line should be laid off perpendicular to the right side of the roof, calling the first point at the top of the line a , b , c , d , and e . The first load to be laid off down the line will be the half joint load, ef .

The supporting forces in this case and the location of the point k are found by drawing a vertical line through the point j , and a line from a parallel to the direction of the dotted line, O^1R_1 of the truss.

"The stresses in the members due to the wind loads are found by the same method as used for the dead load stresses. The auxiliary line must be used in these diagrams and the order of the construction followed is the same as that given earlier in this talk. You will find no difficulty with these diagrams if you follow our scheme carefully. Fig. 28 shows the general form of the construction for both of the wind load diagrams.

"The stresses from the two wind load diagrams

should be measured off to scale and entered in the table the same as you have done with the dead and snow load stresses. The table should contain stresses for every member of the truss instead of for one-half of the truss, as in previous problems. Likewise, every member should be examined by Bow's notation to see if there is any difference in the kind of stress due to the wind loads.

"A common way of finding the maximum stresses in any member of a truss of this kind is to add the stress due to the dead load, one-half the stress due to the snow load, and the larger of the two wind load stresses. This sum is considered to be the total stress which is likely to be present in that particular member. This total stress should be used in designing the member.

"Our talk on truss details," said the Boss, "will show some of the points necessary in holding these members together in the truss form shown in Fig. 27."



Pure Water and Plenty of It

By W. T. Hatmaker

Nothing is more necessary to the successful operation of the various departments of the house than pure water and plenty of it. And yet, the question of water supply is apparently of so little importance to many indifferent house owners before the house is built that it is not surprising many mistakes are made in providing a water supply which proves inadequate after the house is completed. And it is unfortunate that such mistakes only become apparent when it is too late to correct them,—at least, not without considerable inconvenience and expense.

At the very beginning of planning, consideration should be given to these all important points: From what source will the water be obtained? Is it pure? Will it prove abundant? Because comfort, health, sanitation and protection from fire depend entirely upon

- (1) A dependable source of water supply.
- (2) A reliable and economical method of distribution.

Assuming that the source of supply is assured, the selection of a suitable pump or water supply system should be given the same careful consideration that is given the heating plant or other home equipment. In fact, even more care should be used because water is absolutely necessary every day of the year, while the heating plant is only used four or five months of the year.

Sanitation. The old-fashioned idea of having the well in close proximity to the house is being relegated to the discard as fast as a growing knowledge of sanitary science can put it there. To locate the well away from the zone of possible contamination and at the same time meet the requirements of house, barn, garage and garden, is causing a decline in the demand for the long popular cheap pump. The growing demand for modern conveniences in suburban districts is creating a demand for a better grade of pumps.

MODERN CONVENIENCES FOR THE HOME

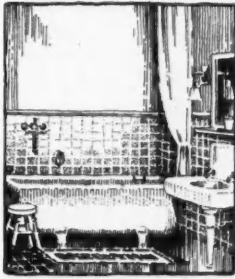

The Vacuum Cleaner's Part in Health and Home Building

By F. W. Eichorn

I HAVE been requested to write an article for the AMERICAN CARPENTER AND BUILDER, dealing with the part played by the vacuum cleaner in modern homes, and a short resume of my investigations and studies along that line.

Only a few years ago, the question was often asked, "Is the automobile here to stay?" The same answer to that question would suffice were the word vacuum cleaner substituted for automobile. The vacuum cleaner is, emphatically, here to stay, and the time is not far distant when to be without an air cleaner in your home will be equivalent to being without a bath tub!

You ask, perhaps: Why do I require a cleaner in my house, which is kept spotlessly clean by my wife or my maid or my twenty servants? I'll ask first a question or two. Would you carry home a filthy roller towel from a public lavatory and ask your wife and children to use it? Would you permit them to use a common drinking cup? Would you take them to a house in which there was some contagious disease? I hear you say with great indignation, "Of course not." Did you but know that by not being blessed with an efficient vacuum cleaner you are exposing your family and yourself to just such unnamable filth, you would be fully as vehement in demanding of the law that it make the installation of such machines compulsory in all homes!

Your Home a Pest House Without Air Cleaner

For it is a fact that has been demonstrated many, many times, and I will tell you just how you can prove it for yourself and to your own satisfaction. Ask your physician to get for you a Petri plate, which he can obtain from some institution of medical research or bacteriological laboratory, and which plate, by the way, is a small glass disc with an hermetically sealed cover. On the surface of the Petri plate is deposited a germ culture medium for the propagation of any microscopical life that may be placed in contact with the coating. Select a spot, preferably in the reception hall near the front door. Remove the cover of the plate, and holding the disc, face downward, just above the carpet, brush the fabric so that the dust raised will fly all about and onto the surface of the plate. Examine

the glass—it will appear just as it did before. Then replace the cover carefully, and lay your culture away in a dark, rather warm (not hot) place for a few days. Upon taking it out at the end of that time, you will probably see some irregular brownish-green and yellowish-gray splotches. Wrap the plate carefully, and ask your physician to send it to a laboratory for analysis. That is all! I can see a large interrogation mark, such as cartoonists are wont to draw, just above your perplexed brow. I'll tell you why. We have laws prohibiting expectoration in public places, which laws, sad to relate, are observed and enforced in a very desultory manner. You, your family, your callers, your servants, your tradesmen, are all compelled to walk upon the streets. You cannot watch and pick each footprint. Need I go further?

To my mind, the above is the one, all important, fundamental, paramount and overwhelming reason why an efficient vacuum cleaner should be installed in every home. Its installation spells sanitation and cleanliness!

There are other strong reasons, too. One is that the labor of cleaning is reduced about 90 per cent, and that instead of playing "ducks and drakes" with the dust and dirt and shooing only a small portion of it out of the house, as is the case where the most painstaking and careful "broom" and "carpet-sweeper" cleaning (?) is attempted, every last particle is gathered—not in the air and on pillows, dishes and in lungs, but into the all devouring maw of a metal cleaning tool, then along a steel ribbed hose and down through iron piping to an hermetically sealed tank in the basement. As Shakespeare said, "If t'were well done when 'tis done, t'were well t'were done quickly!"

Next, think of your office fan, your desk telephone support, adjustable so that you need not tire yourself by leaning over to 'phone a friend and ask him out to dinner! Think of your office boy who saves you a thousand steps each day—the button on your desk by means of which you call your stenographer or bookkeeper, and the hundred and one conveniences you have at your place of business. Then think of the one at home—think of what she does—what conveniences have you provided for her? In my estimation, this phase of the matter is worthy a few good solid thoughts!

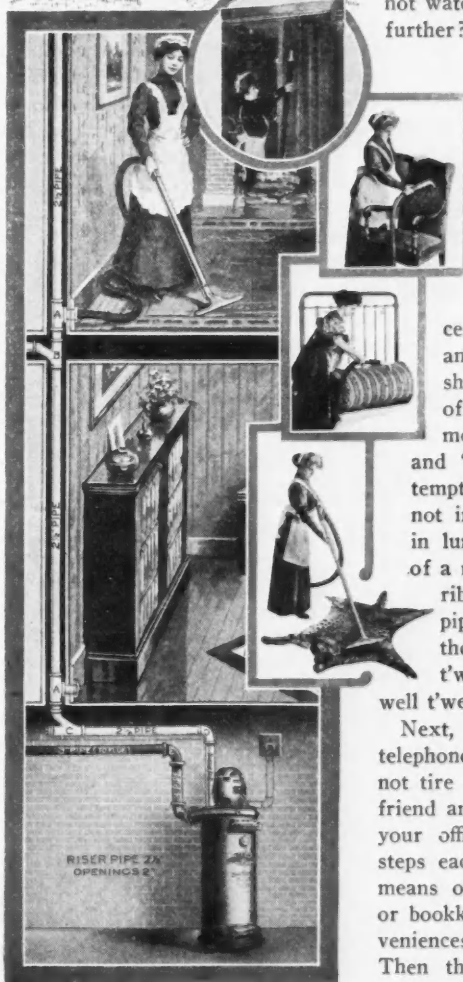

Stationary Cleaner Installed and the Many Ways in Which It Can be Used. The Tucc Company Have to Their Credit Over 7500 Installations of this kind.

Next, let us take the vacuum cleaner from a standpoint of economy—a saver of dollars and dimes. Do I see you looking up interested? Well I can convince you of *that*, too.

After several years of experimentation, the largest store in the United States learned that by systematic and regular cleaning by means of the "air process," the life of their carpets (of which they had thousands of yards, costing exactly \$4 per yard) was increased or lengthened by 50 per cent. The carpet not thus cleaned had an average life of four years, while the carpets from which all the imbedded grit and sharp-edged sand had been regularly removed by vacuum cleaning gave promise of lasting two years longer. The air of our cities, and even in

the country adjacent to the urban centers, carries with it infinitesimally small particles of sand, carbon and metal filings. These particles examined under a strong lens appear to be sharp, jagged chunks of steel, glass and rock. When this sort of collection is matted deeply into the floor covering, and the pressure of one's footstep is applied above it, the soft fibre of the rug or carpet is ground against the saw-edges and the result is easily apparent the next time the "dust pan" or "carpet sweeper" is emptied. Note the fuzzy, woolly dust. Know what it is? It is simply ocular demonstration that your carpets are on the highroad of baldness—that instead of sweeping the dirt and grit from them you are—well, it's about the same as trying to cure a sore throat by amputating a leg!

Stucco Board Proved Stronger Than Sheathing

RESULTS PRESENTED OF INTERESTING ENGINEERING TESTS OF "BISHOPRIC" CONSTRUCTION AS COMPARED WITH ORDINARY LATHED AND SHEATHED WALL

Tests Conducted By H. W. T. Collins

Mechanical Engineer, Norwood, Ohio

WITH the advent of "balloon framing" builders are depending a good deal these days on the sheathing boards to give rigidity and strength to the outside walls of their houses. Seven-eighths inch boards have long been considered standard for sheathing; and, when well nailed, with tight joints, and covered with building paper go to make a good wall.

During the past few years "Bishopric Stucco Board" has come into prominence as a sheathing material—used in place of the boards and building paper. And the question has been raised as to the strength and rigidity of walls so constructed.

When the wind acts on the side of a building, there are stresses set up in those walls at right angles to the surface upon which the wind acts. Those stresses tend to "rack" or cause a movement in the plane of the walls, which movement, although slight, is injurious to the interior or exterior plastering. A series of tests have been performed to determine the resistance offered by the different types of construction, to stresses approximating those caused by wind pressure.

The sections of walls to be tested were five in number.

Because of lack of space, however, we will discuss the first two only. These were constructed in the following manner: The first consisted of a frame 4 feet high by 8 feet long, made by 2 by 4-inch rough studding spiked together with 4-inch (20d) wire spikes, as shown in Fig. 1. Bishopric stucco board was nailed to both sides of this frame with one 1½-inch (4d) nail in each lath in each stud. The laths were laid horizontally.

Test Section No. 2 consisted of a frame of the same size and construction as No. 1, but with common lath on one side and sheathing on the other. The sheathing boards were 1 inch thick, 5½ inches wide and 8 feet long. Each board had two nails 2½ inches long (8d) in each stud. The sheathing was not dressed nor matched, but was closely laid and securely nailed.

Testing Apparatus

The principal apparatus for testing the sections consisted of a screw jack for applying the load, a bell crank lever constructed of timbers, and a Fairbanks platform scale. The arrangement of the apparatus is shown in Fig. 3. It will be seen that the force was applied in a horizontal direction by the jack and transmitted through the bell crank lever to the platform of the scale. The fulcrum of the bell crank lever consisted of a round steel bar, fitting loosely in a hole drilled in the timber.

The bottom sill (B, Fig. 1) of the section to be tested was securely spiked and bolted to the timbers, B, shown in Fig. 3. In the shorter specimens a light brace was used to prevent their being sprung sidewise by the load. The block, C, was adjusted on the scale platform, and the jack so placed that the vertical distance from the center line of the jack to the center of the fulcrum was the same as the distance from the center of the block, C, to the center of the fulcrum. The dimensions are shown in Fig. 3, and were the same for each test.

The dead weight of the bell crank and blocks was measured on the scale and balanced by a tare-poise, F, Fig. 3.

The force applied by the jack was transmitted by the bell crank to the scale platform. The load as measured by the scale was considered equal to the force at the jack.

The jack after being placed in position was tightened sufficiently to hold itself in place. This produced a force about two hundred pounds on the scale. A steel rule was then fastened to the top of the frame and a steel plate in the upright, E, Fig. 3 (which was independent of the section tested), was set up at a definite point on the rule. As the force

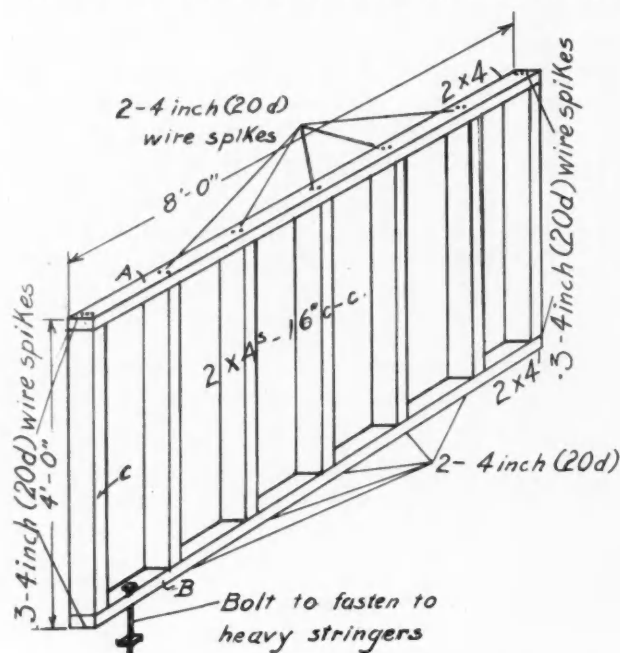

Fig. 1. Frame for Testing Built Like Regular Stud Wall.



Fig. 3. Testing Frame with Stucco Board on Both Sides Withstanding Test Pressure of 2650 Pounds with Deformation of Only $1\frac{1}{16}$ In.

was applied, the rule moved under the steel plate, thus indicating the amount of the deformation in a line parallel to the direction of the application of the force. The deformation measured did not include the slight initial deformation caused by the force required to hold the jack in place.

The load was applied in one hundred or two hundred pound increments, and the deformation was measured at each load.

Interesting Results of Test

The results are shown in the table and curves attached. In these curves the deformation in inches is read along the horizontal scale. The initial deformation produced by the force necessary to hold the jack in place has been obtained graphically and included in the total deformation as plotted. The value of the force acting on the center line of the jack—that is, the load—as measured by the platform scale, is read along the vertical scale. The deformation for any load may thus be determined.

Fig. 3 is a photograph of No. 1 (with stucco board on both sides of the frame) after a load of 2,650 pounds had been

applied. At this load, the rule showed deformation of $1\frac{1}{16}$ inches. On examination it was found that the spikes in the bottom of the first stud (C, Fig. 1) had been pulled out, allowing the stud to rise. This upward movement increased, to some extent, the deformation as measured. The paper backing of the stucco board was also ruptured near the point where the stud had been pulled out.

Fig. 4 is a photograph of No. 2 (with common lath on one side and sheathing on the other) after a load of 1,650 pounds had been applied. The deformation at this point was shown by the rule to be $5\frac{11}{16}$ inches. The stud (C, Fig. 1) was pulled up in a similar manner to that in No. 1, but to a less extent.

Fig. 5 shows the load deformation curves of Test Sections No. 1 and No. 2, plotted to the same scale. It is evident from these curves that No. 1 is more rigid than No. 2.

Fig. 10 shows the load deformation curves of No. 4 and No. 5. It is evident from the curves that No. 5 is more rigid than No. 4.

Fig. 11 shows the load deformation for all test sections,

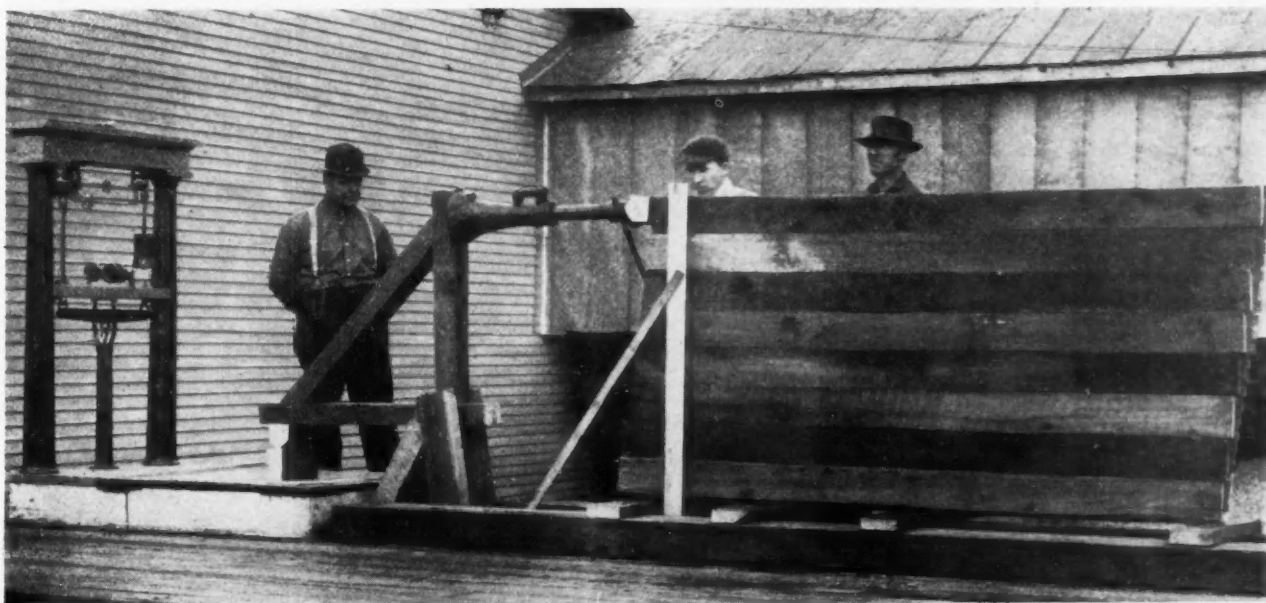
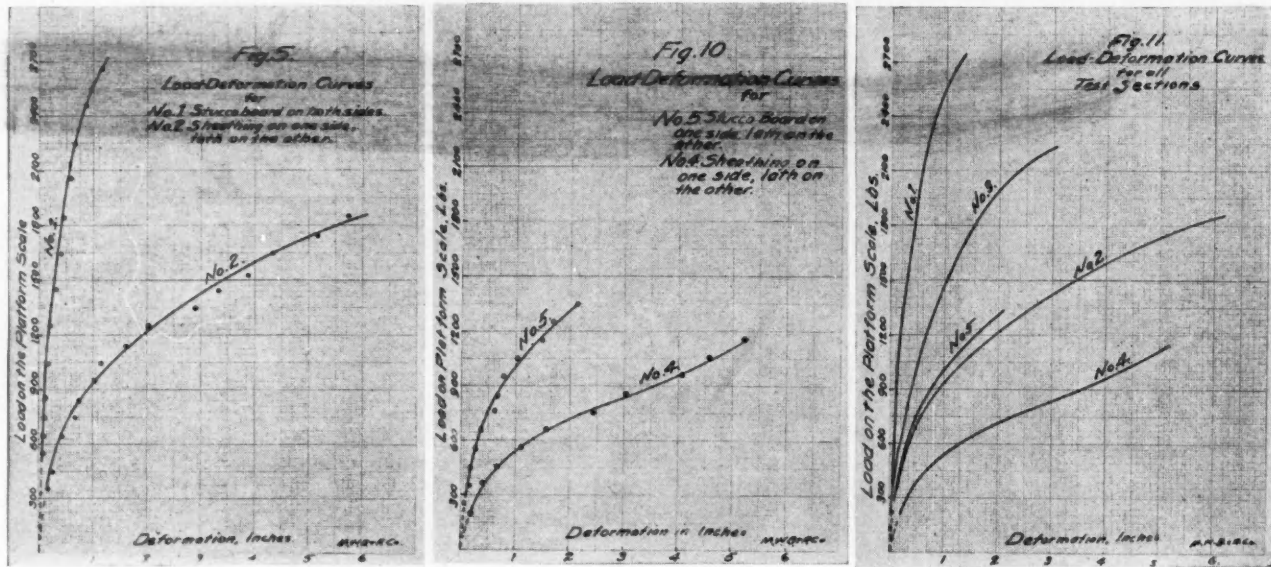

Fig. 4. Testing Frame Same as Fig. 3 Above, Except Covered with Common Lath on One Side and Sheathing on the Other. Under a Load of 1000 Pounds Less Deformation was $4\frac{1}{2}$ Inches More Than in Stucco Board Test, Fig. 3.



Graphic Records of Tests Showing Superior Strength of Stucco Board to Resist Wind Pressure Strains when Used in Place of 3/8-Inch Sheathing.

plotted on the same sheet for easy comparison.

The following table gives, as a summary, the deformation of each section at three loads. The test sections are listed in the order of rigidity. The values for the deformation are determined from curves, and include the deformation caused by the initial load required to hold the jack in place.

Section No.	Size	Construction	Deformation at loads of		
			300	600	900
1	4 by 8	Stucco board on both sides.	0.05"	0.07"	0.10"
3	4 by 4	Stucco board on both sides.	0.05	0.17	0.38
5	4 by 4	Stucco board on one side, lath on the other.	0.08	0.30	0.75
2	4 by 8	Sheathing on one side, lath on the other.	0.10	0.35	0.90
4	4 by 4	Sheathing on one side, lath on the other.	0.35	1.30	3.55



How "Bishopric" Stucco Board Looks on the Wall—All Ready for Cement Plastering. Photo of a Group of Fine Residences Being Put Up by the Passaic Building Co.

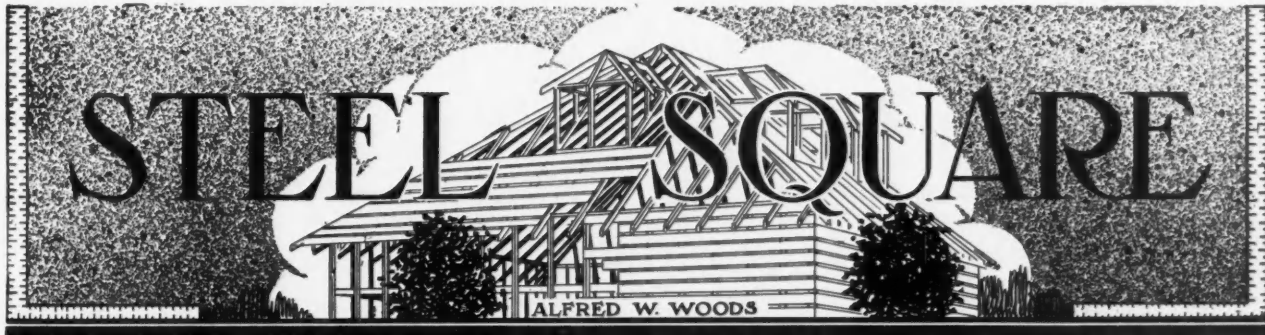

Possibilities of the Steel Square

AN ILLUSTRATIVE ANALYSIS OF THE USE OF THE STEEL SQUARE FOR FRAMING ANY SHAPE ROOF OF REGULAR PITCHES

By A. W. Woods

SUPPOSE we take two steel squares, one we will call A and the other B, and we pivot the heel of B at figure 12 on the tongue of A, so that we may take their blades in our hands and work them as though they were a huge pair of shears. What a funny pair of shears,—and yet, what wonderful calculations can be wrought with them in the way of finding the angles, lengths and cuts for all kinds of frame work, because the proportions found are based on right angled triangles developed from a part of another triangle. The steel square furnishes the right angle corner, and when the two are worked together in the manner shown, the miter for any angle may be determined, as illustrated from No. 1 to 6 inclusive.

Numbers 2, 3, 4 and 5 are for regular polygons and represent obtuse angles,—that is, for an angle of more than 90 degrees. That for No. 1 represents an angle of 90 and that for No. 6 is for an acute angle and is the only one that forms a regular polygon. In this, the angles are so extended that they reach beyond the arms of the squares, but by reversing square A the blade of B will just catch the points on the former, but the lower angle runs far beyond the tongue on the latter, so that it would be necessary to reduce the scale to bring the points in range to use on the squares to

obtain all of the cuts that would enter a roof of this shape.

NOTE.—The angle formed on square A by the use of square B represents the ground plan, or starting point from which to obtain all of the measurements and cuts that enter into the roof, regardless of pitch given same. The figures on square A of No. 1 are 12 and 12. Now suppose that 12 on the tongue of A is pivoted at the heel of B and we take hold of the blade and swing it forward until its tongue rests along the blade of square B; and it will be found that 12 on the blade will rest on one of the lines that helps to form its respective polygon. What is true of this, is true of any of the other polygons by using the figures on the square, as shown for the respective polygon.

So far, we have only laid the foundation work upon which to build the roof, and it will hold good for any pitch we choose to erect upon it regardless of size or pitch given the roof.

Now, then, let us look to the pitch. By the same arrangement of the squares A and B, as shown in No. 7, we find the length and cuts for the common rafter and with the combination of the foregoing respective corners (See No. 1) we have the key to all of the lengths, cuts and bevels that enter into the roof. In

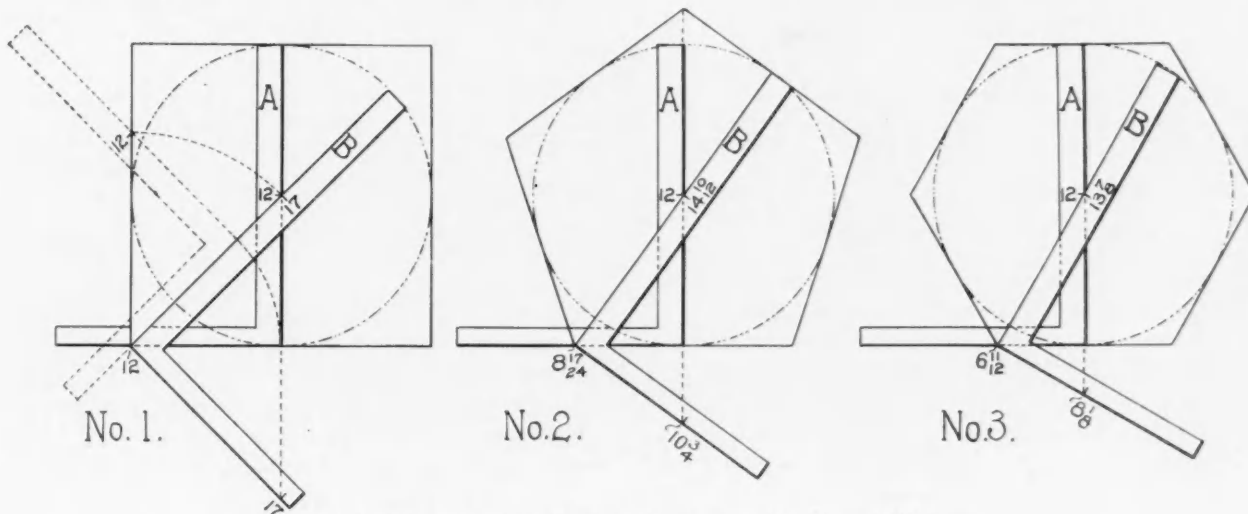

The Steel Square Rules Hold Good for Any Regular Shape Building.

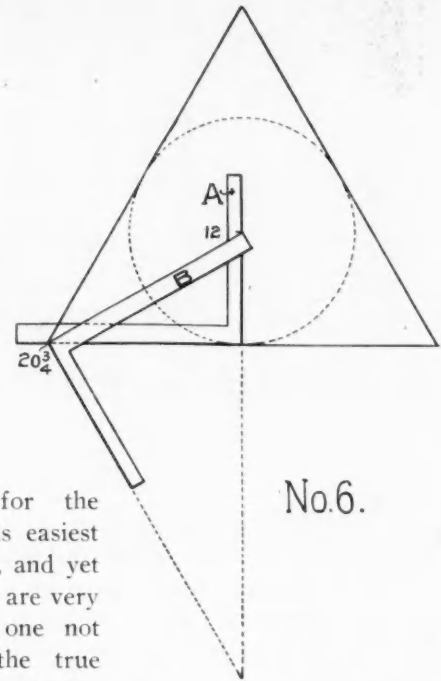
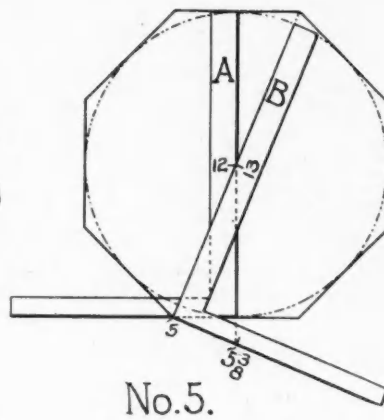
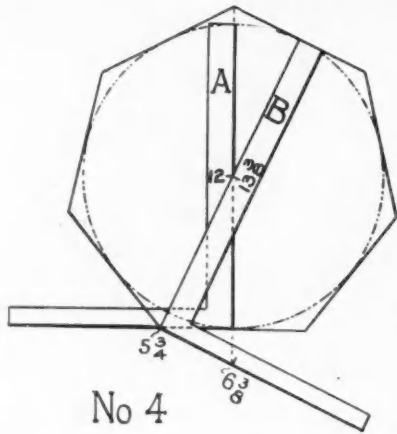

this example we have taken the 9 inch rise ($\frac{3}{8}$ pitch) for illustration purposes and with the heel of B pivoted at 12 on the tongue of A, we are now ready to work our great shears again, but this time for cutting the rafters.

The inch divisions on the blade represent the scale of pitch and the divisions of the inches, each representing a complex pitch, but we will cut that out and only consider the inch divisions—and right here we want to tell how to reckon the pitch quickly on the square. It is so simple, one could not forget it even if he wanted to.

Here it is,—just think what proportion the desired rise is to the length of the blade. Thus, an 8-inch rise is equal to $\frac{1}{3}$ pitch; a 9-inch rise is $\frac{3}{8}$ pitch, and that is what we have chosen for our illustration. No. 7, with combination of No. 1, shows that for the square corner. All of the necessary figures are shown for the lengths, cuts and bevels that enter into the roof, and the transformations are shown.

The roof for the square corner is easiest of all to frame, and yet the parts to use are very misleading to one not grounded in the true principle involved, because its foundation work rests at the equalizing point (45 degrees) between the tangents and co-tangents and therefore we have a duplication of figures that does not occur in any other corners, as will be seen by referring to No. 8.

Here we have the $\frac{3}{8}$ pitch for a pentagon and note we have four sets of figures on the tongue of A instead of two as for the square corner (No. 8 is a combination of No. 2), and yet the parts are determined from identically relative parts of their respective angles.

The foregoing, of course, is for regular polygonal corners of known degrees, but that does not matter, as it is not necessary to know what the angle is in de-

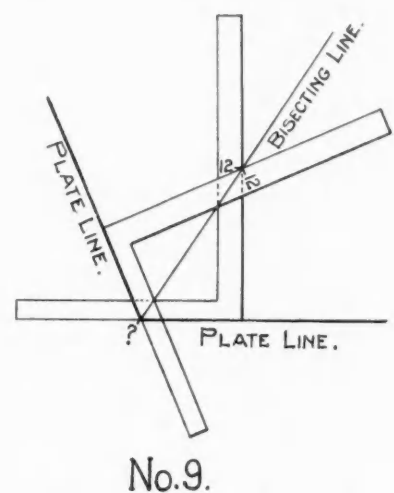
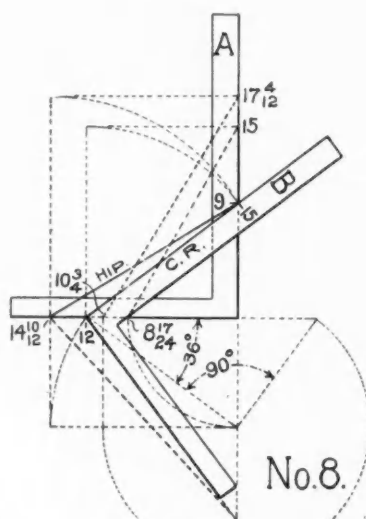
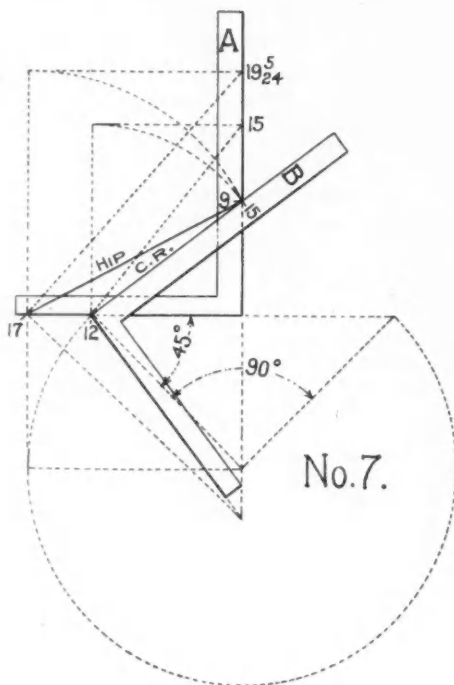

degrees, so long as the form is known. Suppose we have an angle as in No. 9. To find starting points, take two squares, place their tongues on plate line, slide them along until blades cross at 12-inch mark. Intersecting point on tongues will be figures to use on that number and furnishes the basis from which to proceed.

CORRESPONDENCE



Questions Answered and Ideas Exchanged.

Our Readers Are Requested and Urged to Make Free Use of These Columns for the Discussion of All Questions of Interest to Carpenters and Builders.

Keen Interest in Bench Planer

We are glad to pass on to our readers the following letter from John D. Wallace, M. E., 527-529 W. Van Buren Street, Chicago:

EDITOR AMERICAN CARPENTER AND BUILDER:

You may be interested to know that I have uncovered a most lively interest in the Wallace Bench Planer through the advertising in your paper; and while the actual sales made have not been phenomenal, they are satisfactory, and the inquiries promise well for the future.

I enclose herewith a cut showing a rig suggested by one of my buyers for planing long and heavy stock on the Bench Planer.

It is possible that this "kink" may be of interest to a large number of your readers who have larger machines than the Bench Planer, as I have seen it used in several shops where the run of work was long.

It is especially valuable in the case of my Bench Planer, however, as it makes this machine equal to the longest planers, and still leaves it ready for the small work.

J. D. WALLACE.

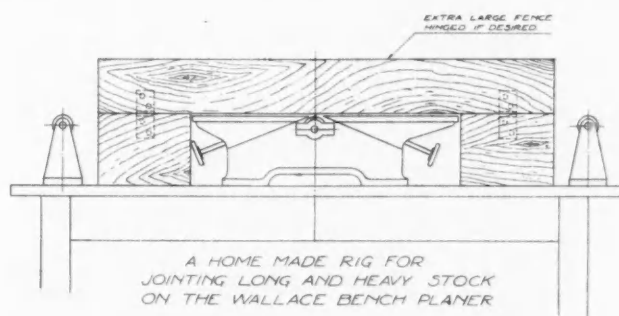
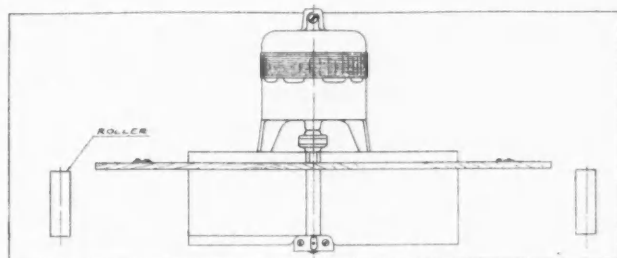

Small Electric Bench Planer with Extension Rollers.

Mr. Wallace will send full particulars concerning his Bench Planer to anyone writing him. It is certainly a worthwhile machine.

EDITOR.

That Heavy Timber Detail

To the Editor:

Bellerie, Ia.

I have just received my February issue of the AMERICAN CARPENTER AND BUILDER and have been reading and studying it. Mr. Shearer's talk on barns and outbuildings is very interesting and I have given some special attention. On the upper right corner of page 43 there is a diagram of the way braces are joined by mortise and tenon. I wish you would explain how these timbers are put together.

ALVIN O. SETZEPHANDT.

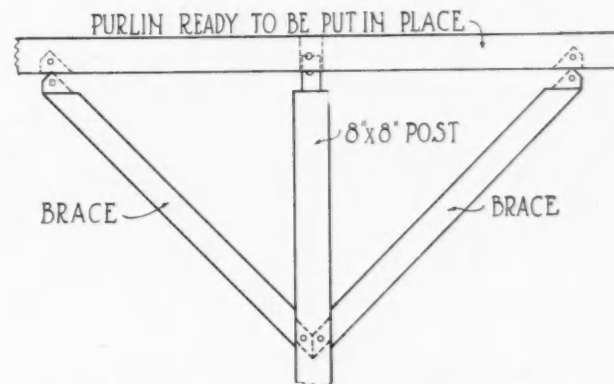

Showing How Mortises and Tenons Go Together.

Answer—Such bracing is common in old timber frame barns. The drawing in question was given in perspective. A cross section would show a tenon on the end of the post projecting through or part way through the girder. In putting the bents together the braces are held in place while the girder slips down over the tenon on the upper end of the post. It is customary to clip the corners of the tenons on the braces, but some carpenters prefer to allow a little extra room in the mortises. The particular point is to have the lower edges of the tenons on the braces to fit accurately when the girder or purlin drops into position.

EDITOR.

Poultry House Plans

To the Editor:

Bay Shore, via Keyport, N. J.

Am enclosing you a plan of one of the best poultry houses that can be built; have just built seven for one of the largest poultry raisers in Monmouth County.

Fig. 1 shows a front view of the house, where the windows and wire openings are placed.

Fig. 2 shows an end view so that the way of putting in the roosts may be seen after the front of the dropping pit has been built; the top under the roosts is covered with 2-inch mesh wire to keep the hens from scratching in the droppings.

Fig. 4 shows a detail of the back of the scratching shed,

where the nests and feed hoppers are placed and the coop for broody hens.

Fig. 3 shows a complete layout of the floor plan, showing the roosts and scratching shed in which the nests and feed hoppers are placed.

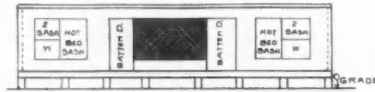

Fig. 1.

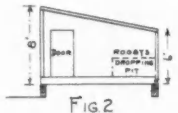

Fig. 2.



Fig. 3.

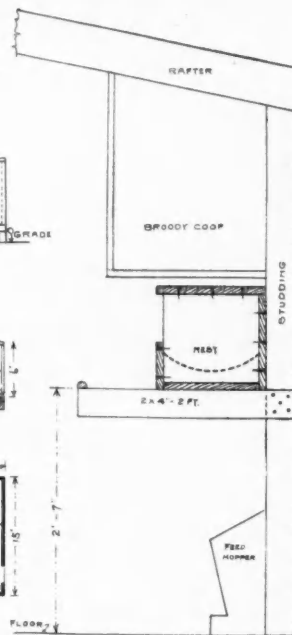

Fig. 4.

Floor Plan and Details of Poultry House.

In Fig. 4 note the way in which the nests are built to make them easy to clean, as the top and sides can be lifted off and the bottom taken out for scrubbing.

BENJ. R. BUSH,
Carpenter and Builder.



Between "Heavy Timber" and "Plank"

To the Editor:

Howard, Ohio.

Enclosed find two photographs of a barn I built last spring. I think you will see that it is different from the plank frame and yet it is not a heavy timber frame. The barn is 36 by 62 feet—24 feet to square. Timber used, beach and sugar maple.

First story posts are 8 by 8 inches; girders, 8 by 12 inches, except end ones which are 8 by 8 inches; ties 2 by 5 inches; braces 4 by 4 inches and 2 by 6 inches; caps on posts 2 by 8 inches—24 inches long.

Second story posts are 6 by 6 inches, two posts in each end, and each side of hay doors are 4 by 6 inches; ties 2 by 4 inches; braces 2 by 6 inches; main plate two 2 by 8's; purlins one 2 by 6 and one 2 by 8; rafters 2 by 4 on 30-inch centers. Ties and braces are joined in on first story, except the braces that run lengthwise of the barn; they are spiked on. We bored holes and used heavy 8-inch spikes.

Second story ties and braces are just lapped on and spiked. (Joists are 2 by 8 inches except the ones where the braces fasten, they are 4 by 8).

Purlin posts set in 7 feet from outside. Tie at top of outside post is 1½ by 10. "Post" braces are 4 by 6 inches, and "Pull" braces 1½ by 8 inches; this makes a very rigid frame. The pull brace laps down on the girders and ties them securely. These four frames on each side of the mow do not interfere with mowing the hay away, but make splendid ventilators up through the hay. There are no ties across mow except in the ends. The hay doors open in, are 8 feet wide, 10 feet high to square. The angle doors above them swing up against rafters and are made of slats for ventilation. We use a swivel carrier and the fall rope comes down the hay chute (which is 4 ft. by 6 ft. with slats around and a ladder inside). There is a swivel sheave near the track

in the middle of the barn, and one over the chute. All that is necessary to change from one end to the other is to throw the trip rope out the other end and pull the carrier over, taking hay in at either end of barn. (The scaffold that we put up the upper rafter from was still up when picture was made).

Roof is not "standard" exactly, but all that see the barn say it is "just right." Bottom section is 7 ft. run and 11 ft. rise; top section is 11 ft. run and 7 ft. rise.

The curve at bottom is 3 ft. long and 5 ft. radius. We used a 28 gauge 1¼-in. corrugated sheet and bent it ourselves.

The picture shows the manner of putting the building together. Concrete piers extend up above bottom of siding 8 or 10 inches to keep posts dry and above the litter. One

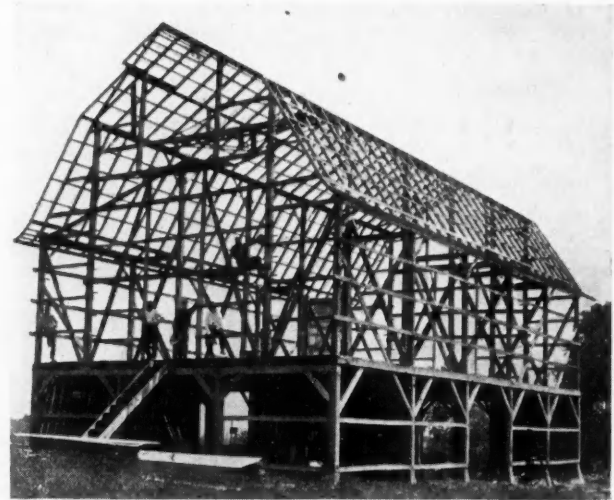

Frame Work of Anderson Barn.

or two skilled men with the regular farm hands can put such work together.

I believe we can use rough lumber to a better advantage in this manner of construction than in either a plank or heavy timber construction.

While I am a charter member of the AMERICAN CARPENTER AND BUILDER this is my first appearance, and if this is of any interest will come again. I don't try to get along without the AMERICAN CARPENTER AND BUILDER.

W. B. ANDERSON,
Carpenter and Millwright.



Anderson Barn Completed.



Only One Guess Needed

Pittsfield, Ill.
To the Editor:
I am mailing you a picture of the old man reading his favorite magazine. I will leave it to you to guess the name of the magazine. Wishing the whole family a prosperous and busy building season.

BEN JOHNSON,
Carpenter and Builder.

ment, the instrument may be moved so that either one of arms is off the segment, and the center slot will still mark a radius.

Then, by means of a scale on one of the right angles, the tool may be used to mark off any angle on a piece of material. Besides these uses, it makes a perfect straight-edge, and try-square.

THEODORE H. SMITH.

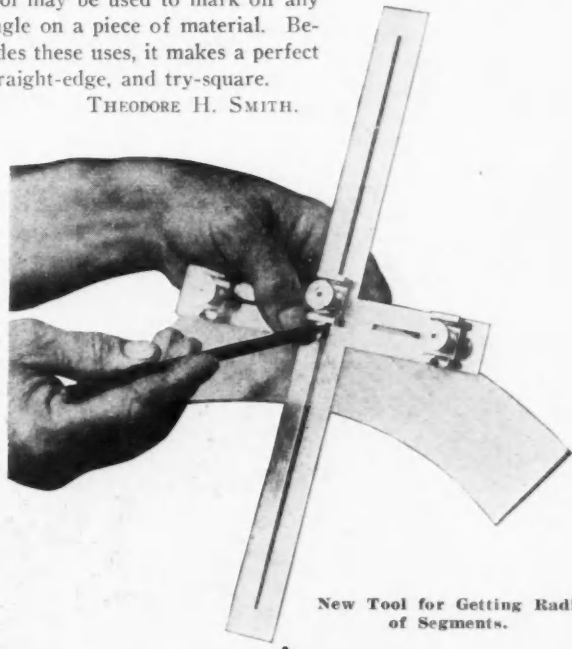

Neat Window Seat for Radiator

To the Editor: Sumner, Iowa.
Will you please give me a sketch for a radiator seat; one with arm and back, and one plain? Size of radiator follows: Length, 7 feet; height, 1 foot 6 inches; width, 1 foot 2 inches. The radiator sets 4 inches away from wall and is 2 inches below window stool line. Is it proper to connect on stool or build it separate?
E. T.

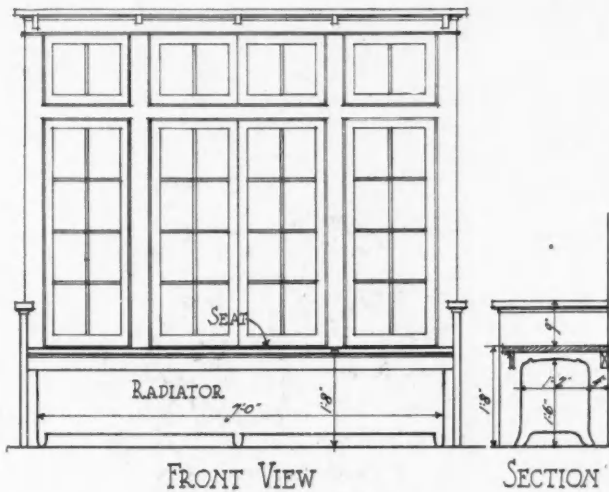

Radiator Window Seat Can be Built Either With or Without Arms.

Answer—We show here detail drawing for an artistic seat of this description. While our plan shows seat with arms, it is a simple matter to cut them at seat level, should that be desired. It will be noticed that height of seat is given as 1 foot 8 inches—the standard measurement for window seats. Our drawing also shows a nice arrangement of four casement windows, topped by transoms.
EDITOR.

Patents New Dividing and Measuring Tool

To the Editor: Fairport, New York.
I have just received my Letters Patent on the measuring and dividing device, of which I send you a photo.
By setting the studs of the short cross-arms at the same place, in their respective slots, and applying them to the outer or inner edge of a circle segment, the slot in long cross-arm will mark a radius of the circle. Then, by setting the stud in that long slot to rest against the same edge of seg-

A Pleasant Answer

To the Editor: Baltimore, Md.
In answer to the inquiry by Mr. V. A. Pleasant, "A Kink to Unravel," in December number, would say that my sketch herewith solves the problem and needs no further explanation. Hope it may prove helpful to him.

JOHN T. CROSSWELL.

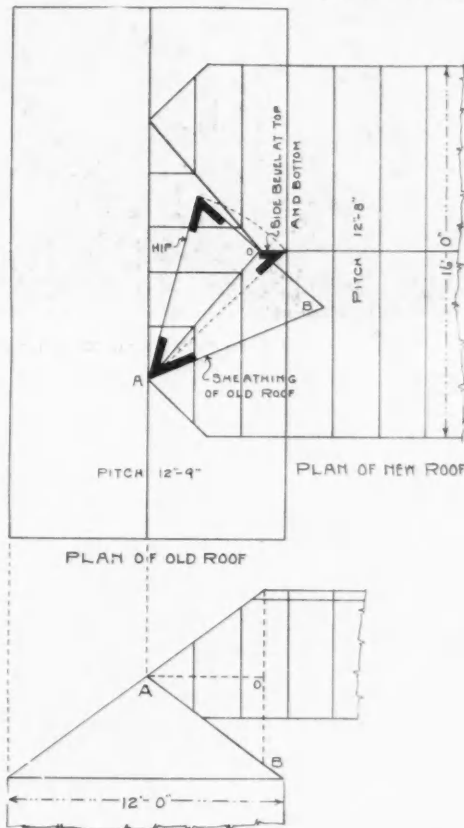

Explaining Mr. Pleasant's Roof Problem.

Fine Example of Corn Crib Framing

To the Editor:

Ellsworth, Iowa.

Here is a photo of frame for a new double corn-crib we have recently built for Mr. Axel Vold. The picture was taken while some of the boys were on the job.

As you see, we believe in heavy, substantial frames. They have to be, to hold up the crops we are having out this way.

This new type of granary and crib is getting mighty popular

Answer: A cement for concealing the flaws in wood may be prepared as follows: Put any quantity of fine saw-dust of the same wood your work is made of into an earthen pan, and pour boiling water on it; stir it well, and let it remain for a week or ten days, occasionally stirring it. Then boil it for some time, and it will be of the consistency of pulp or paste. Put it into a coarse cloth and squeeze all the moisture from it. Keep for use, and when wanted mix a sufficient quantity of thin glue to make a paste. Rub it well

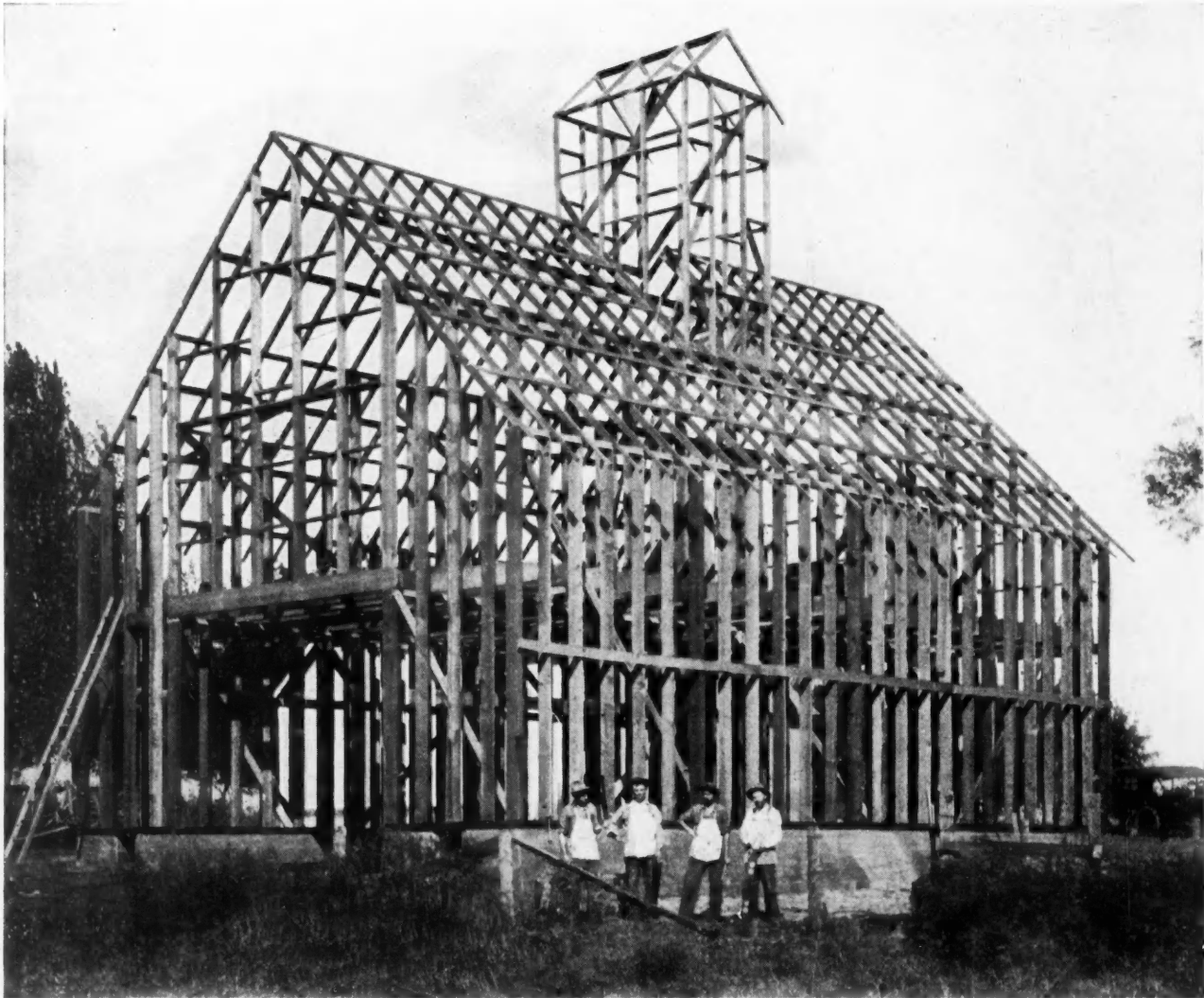

Corn Crib Frame Built by Holt & Lande, Ellsworth, Ia., for Mr. Axel Vold.

here. The driveway and elevator cupola make it easy to handle the grain quickly and with very little waste. Of course, the foundation work is cement, and there is very little trouble from rats.

HOLT AND LANDE.



Filling Cracks in Timber

To the Editor:

Olney Station, Phila.

I am employed by a firm who own a number of wagons. Since I am a carpenter, they frequently call on me to fix them, and they often have large cracks in the woodwork. Sometimes these cracks are $\frac{1}{8}$ -inch in width. I have used saw-dust and glue, but that does not hold as it should. Sometimes it will hold for one or two months and then break out, spoiling the paint and varnish. It is a very expensive proposition to paint a wagon and then have it spoiled in such a short time.

If you can suggest something to prevent this trouble you would help me out very much.

WALTER SUMMERS.

into the cracks or fill up the holes in your work with it. When quite hard and dry, clean the work off, and, if carefully done, you will hardly discern the imperfection.



EDITOR.

Details Explained

To the Editor:

Pinconning, Mich.

I have been studying architectural drafting, and have had some good experience before this, but the part that has always been a problem for me is projections, and I would appreciate the help of your Expert Service Dept. in mastering this subject.

I cannot draw nor understand projections. I enclose a drawing that I have taken off a blue print showing the full details of the cellar frames for the new parochial school being built here, the materials for construction being furnished by my company. (See Fig. 1.)

As I am the manager of the company it usually rests with me to look after the carpentry work, and, as I am unable

to understand such drawings as I sent you, it makes it rather difficult for me to get out this work without the aid of someone who well understands the plans.

In other words, it is very difficult for me to take measurements from the plans as drawn like the enclosed, and if your corps of experts will instruct me on these points I will certainly appreciate it.

Kindly explain also what form of drawing this is, so that I may fully understand further matters.

FRED J. CAMPAU.

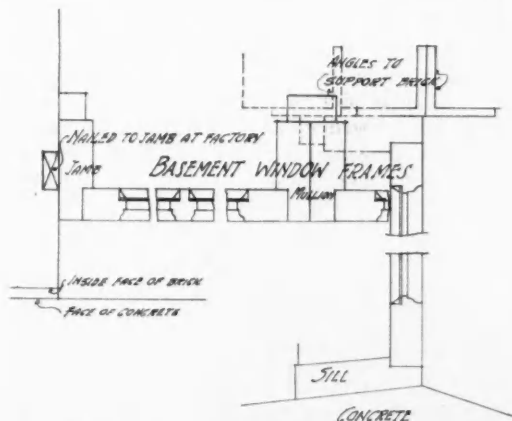

Fig. 1. Vertical and Horizontal Sections through Window.

Answer—We have separated the drawing which you show in Fig. 1, and removed the side view of the window away from the top view. This will possibly make matters a little clearer to you. The lettering which we have put onto Fig. 2 may clear up a few of the blind points which trouble you.

The part of Fig. 2 to the right shows a section cut down through the wall perpendicular to the ground and passing through the lintels and window frame. That part at the left shows a section through the wall parallel to the ground, cutting the frame and sash at a point above the sill. We believe that the details will be clear to you if looked at from this viewpoint.

EDITOR.



Window Refrigerator

To the Editor: Parksburg, W. Va.

Please find enclosed rough sketch of a window refrigerator made of $\frac{7}{8}$ by 12-inch material. For window with glass 24 by 30 inches, make a box 28 by 34½ inches, putting in two shelves of same material; then cover the outside with hardware cloth.

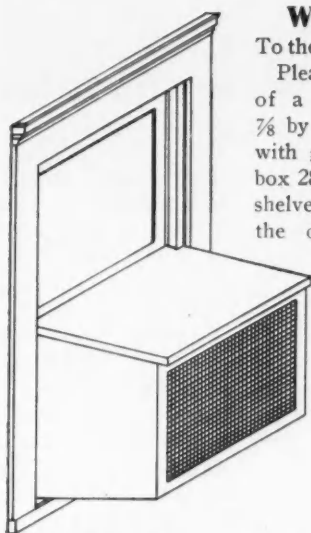

Ventilated Window Food Box.

This slides in between the outside casing, rests on the subsill and comes up under the meeting rails. Use four 1½-inch screws to fasten same to casing and it is a good plan to nail a strip the thickness of the bind stop on the inside of the top, so as to close up the space between the frame and the meeting rail; this enables you to use the bottom sash to close it from the heat.

J. W. ASHLEY,
Building Contractor.



Screened Porch with Fly Exits

To the Editor:

Wilmette, Ill.

While repairing a porch for a farmer in my district, the women of the house complained that since the porch was

screened it seemed to trap the flies. They could get behind the screens; but it was very difficult to get them out.

A short time before I had read that flies could be fooled into walking out by making an opening in the top of the screen, just wide enough to let a fly crawl through. It is done by tilting the screen frame out away from the upper stop about 3/16 of an inch. The flies always walk up a screen hunting for an opening to crawl through, but they are so constructed by nature that they never crawl down to hunt a hole, so that screens opening at the top provide an

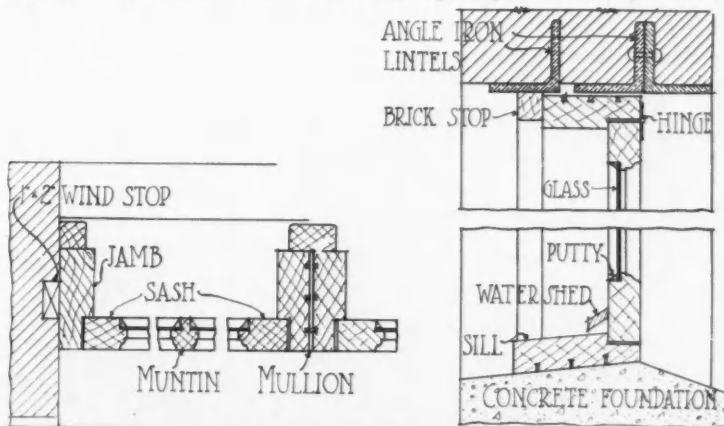

Fig. 2. Details Separated and Labeled for Clearness.

exit, but very few flies find their way in.

A better way is to have a double screen. A narrow screen extending three or four inches from the top is placed inside of the lower screen, so that a space is left about two inches deep where the screens pass each other. It is one of the simple little tricks that help to round out a builder's knowledge.

FRANK HENRY.



Broom Holder from Old Rubber Boot Heel

To the Editor:

Stuttgart, Ark.

The accompanying drawing shows a very handy broom-holder. The two pieces of rubber which I used were each 2½ inches long and 1 inch wide, and were cut from the heel of an old rubber boot. The handle of the broom should be shoved in between the two pieces of rubber from underneath, not from the side; and when removing the broom do not pull, but lift it from the holder. This is a handy little device easily made.

RICHARD SCHEIDERER.

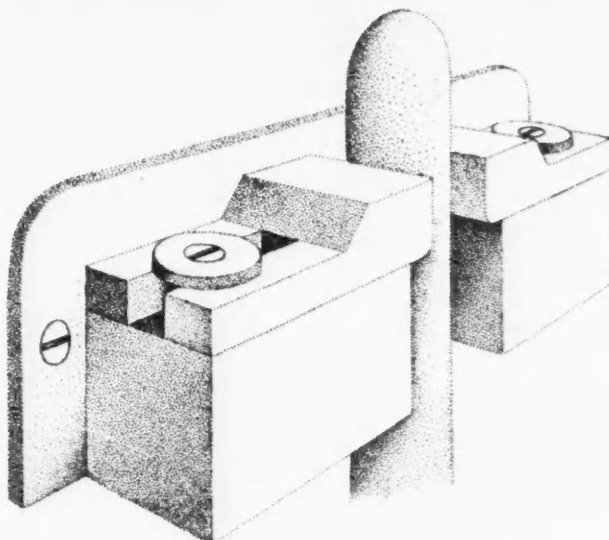

Broom Holder Made of Rubber Boot.

Colored Plaster Work

To the Editor: White Oak, Ohio.
I would like to know if the finishing coat in plaster work can be colored to any shade that is wanted by mixing the coloring material with the plaster of Paris before applying same.
R. L. HALL.

Answer: We are not familiar with this method of finishing and doubt very much if same would be a success, owing to the liability of variation in color on the different parts of the same wall. It is very difficult to mix any coloring matter into mortar and have the entire mixture of the same color at all parts. This would be especially true in material which has to be mixed in small batches. Unless great care was used and very exact measurements used each batch of material would probably be just a little different in color. There is always the danger of mineral colors fading when

Brown Print Paper

To the Editor: Lanark, Ont., Can.
Will you kindly inform me where I may obtain a formula for use in sensitizing brown print paper for architectural work. I would like one which can be developed by one process?
W. M. CONNERS.

Answer: We believe that the following information will be of service to you in connection with a formula for making sensitized brown print paper for architectural work.
Size with arrowroot, 90 gr.; cold water, 5 oz., rubbed into a cream; and add glucose, 20 gr.; hot water, 5 oz. Mix well and boil for 2 minutes. When cool, soak the paper until saturated, and hang up to dry. Sensitizer: Nelson's gelatine, 6 gr.; water, 1 oz. Swell in cold water, melt on water bath, and add in the following order: Tartaric acid, 8 gr.; silver nitrate, 9 gr.; ammonia-citrate of iron, 40 gr. A sub-



42 by 30-Foot Horse Barn Built for Mr. J. Caster by J. & W. S. Addie, Arcola, Sask.

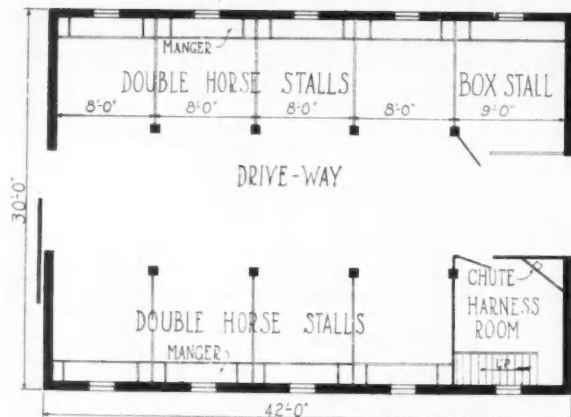

Floor Plan of Horse Barn.

used in mortar, especially if exposed to sunlight or to weather. If colored work is desired it is better to use colored sand or aggregate in plaster or concrete work, or else follow the usual and entirely satisfactory course of tinting the finished wall with cold water paint.
EDITOR.

dued light should be used, and the mixture filtered. Printed in bright light until slightly darker than ordinary printing out paper. Wash for 5 minutes, and immerse in a 2½% solution of hypo until the desired color is obtained. Wash and dry.
EDITOR.



New Gothic Roof Barns in Canada

To the Editor: Arcola, Saskatchewan, Canada.
Enclosed find \$2.00 for my renewal. Am also sending you photos of some of the barns we built last summer around here of the Gothic roof type. Out of nine we built, seven had the Gothic roof. The farmers up here never saw the like before, and think they are just the thing for this country. I am certain that there won't be many more gambrel roofs go on here.

The big barn (shown both in construction and finished) is 52 by 66 feet on the ground. This barn was roofed and sheathed with corrugated iron.

Am giving you detail of truss. These are built up of three pieces 2 by 12 inches, 9 feet long, spaced to bring the joints 3 feet apart. The outside is sawed on a 38-foot radius; 2 by 8-inch purlins steady the frame work and serve as strips for

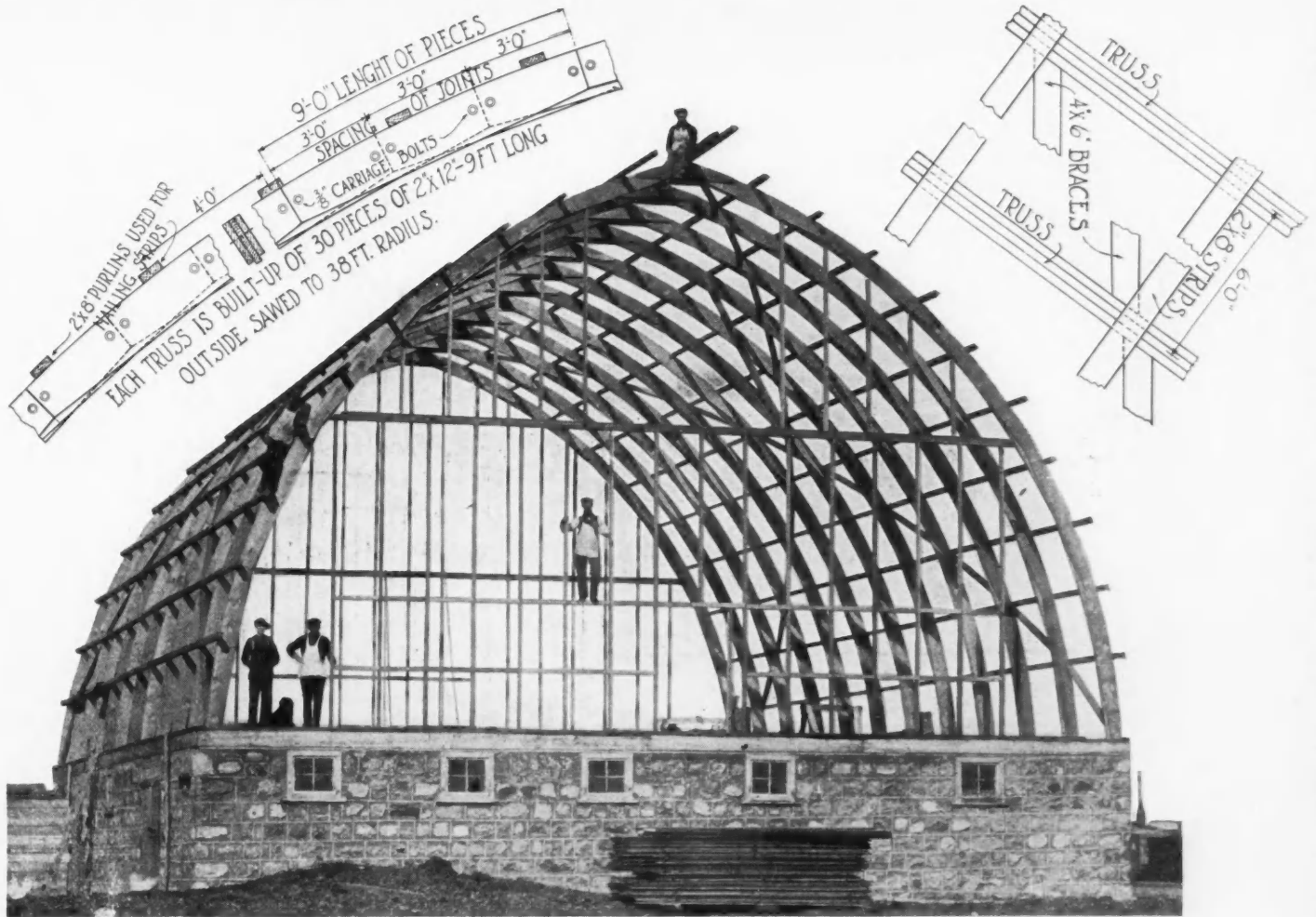

Construction Photo and Dimensioned Drawings Showing How Gothic Roof is Framed.

nailing on the roofing sheets. These are spaced 4 feet apart. Also here is a detail of the diagonal braces that run from ridge to sill over the roof; 4 by 6-inch pieces were used in these braces.

The small barn is 30 by 42 feet. I am sending you floor plan of this.

I like your magazine very much. I always look for the next issue to see if there is anything new in it.

WILLIAM L. ADDIE,
Woodworker, Builder, and Contractor.

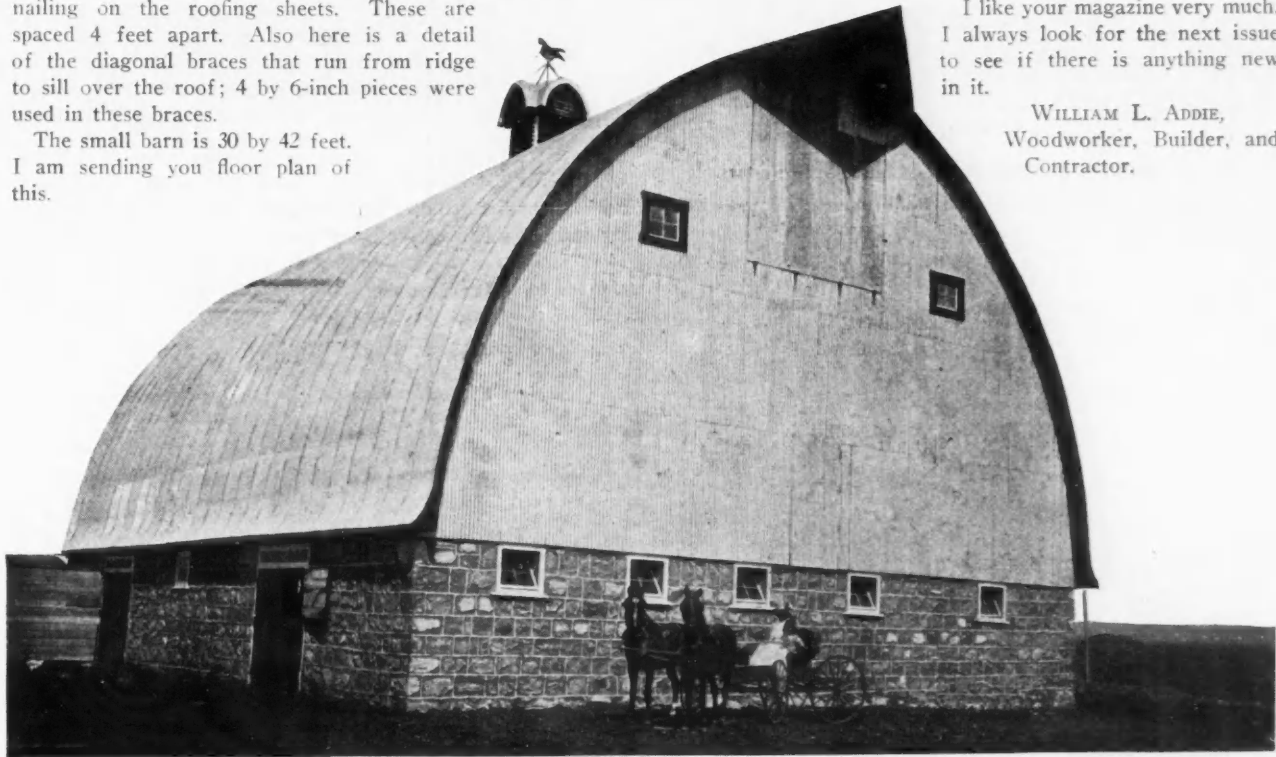

Unique Stone and Iron Barn, 32 by 66 Feet on the Ground, Built Near Arcola, Sask., by Wm. L. Addie.

**Not Nice for Wedding Present—
But Here's An Idea**

To the Editor: Wilkes-Barre, Pa.
I have been a reader of the AMERICAN CARPENTER AND BUILDER for three or four years, and think it is a very valuable paper for the carpenter—especially for the young carpenter. I believe that if more of our young carpenters would read a trade journal and make use of the articles in it, we would have fewer wood butchers working at the trade.
I would like some information as to the proper size of a baby's cradle. I am not married, nor am I thinking of it. I want to give it as a wedding present.
Hoping that some of the married brothers that know all

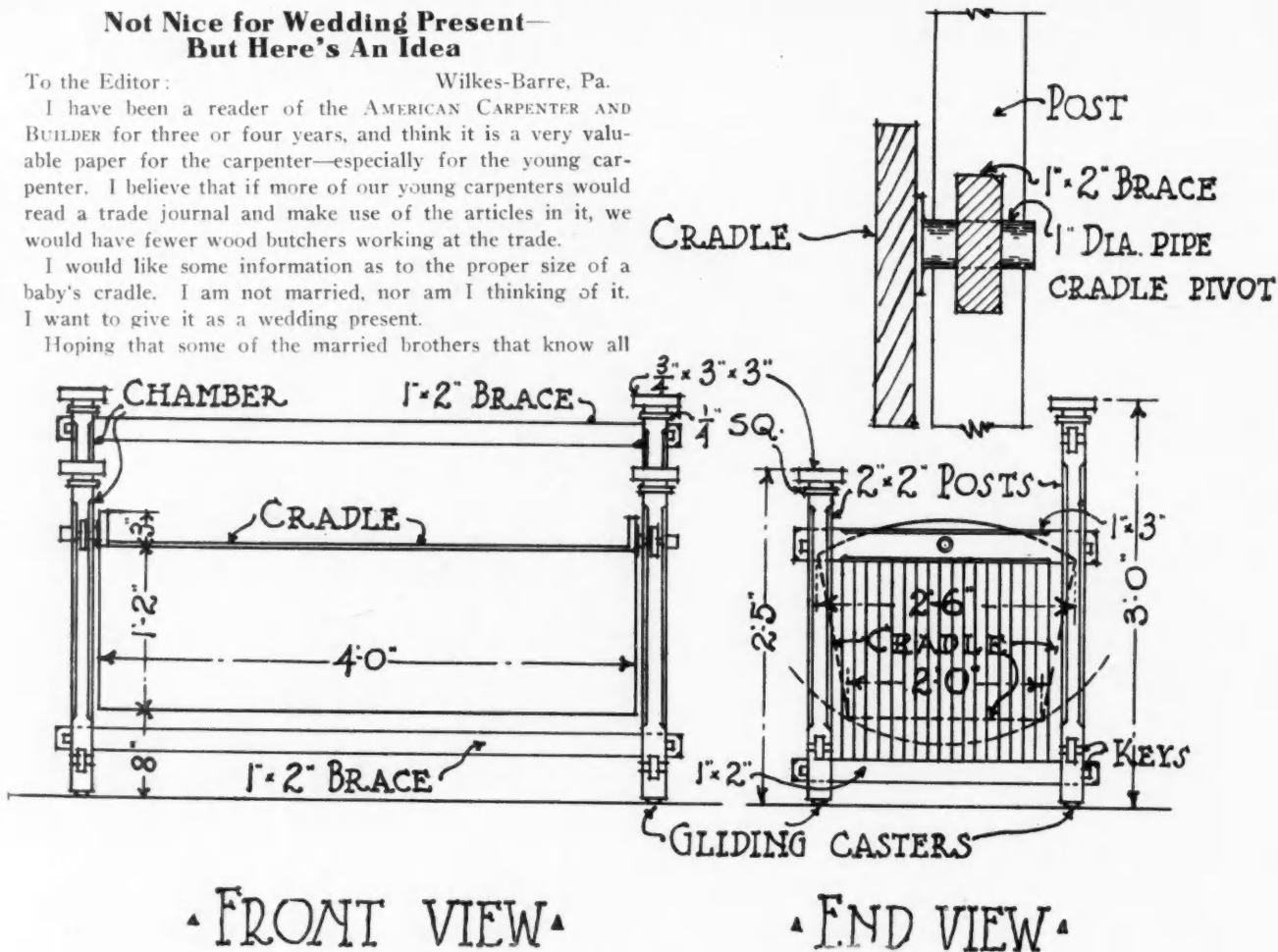

▲ FRONT VIEW ▲

▲ END VIEW ▲

Working Drawings of Craftsman Crib or Baby's Cradle.

about such things might help me in my distress, as to design and proper size, I remain

W. H. R.

(No wonder he wants just his initials to appear!)

Answer—Detail shows a classy cradle. Our two boys slept in a big clothes basket—padded and lined; but for a present, this is better.

EDITOR.



Well Built, Convenient Hog House

To the Editor: Lake Wilson, Minn.

I am enclosing photograph and floor plan of a hog barn which I think is very good.

The window arrangement gives lots of light and makes it easy to ventilate.

I have made a door in front of each pen, so I can close it and keep hogs back from trough when putting in feed.

Would like to hear from some brother carpenters of best way to put in a truss across gable end of a barn.

HAROLD DUNNETT.



Strong on Remodeling

To the Editor: Fostoria, Ohio.

The call for small houses is greater here than any place I've been in for several years. The renting proposition here is a hard one to handle. Most of the available houses are of old designs and hardly any of them modern; and those they try to modernize are so bungled up that no one cares to rent them. I have picked up a couple of properties here that I am going to overhaul in the spring into tasty bungalows. I bought a property that I am remodeling for my own home. Will send you later photo and plans of same before and after working it over. I think I can take any old building and

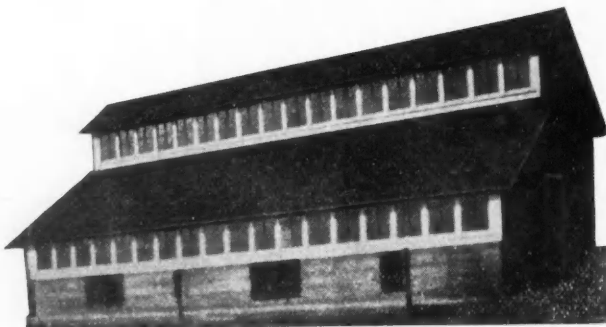

Winter Hog House Built at Lake Wilson, Minn.

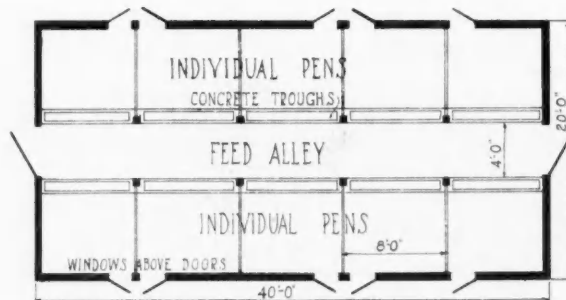

Floor Plan of Hog House Built by Harold Dunnett.

make it look right and arrange it neatly, a little better than the next one, and at the least expense. I have been taking the AMERICAN CARPENTER AND BUILDER for a good many years and would not do without it. Think it the best building paper I ever got a hold of.

Wishing you a prosperous year in 1915,

E. C. MANN.



Huge Square Stock Barn

To the Editor: Geneva, Ill.
 I am enclosing a view of "Peck's Barn," as I think it will be of interest to your readers. It is 140 feet square. The walls are of concrete, 9 inches thick and 12 feet high. It is 40 feet to the top of the first pitch which is about 3/4 pitch, and the top of the ventilator is 80 feet above the ground. This is Mr. Peck's idea of a stock barn.

Enclosed you will also find a sketch of the floor plan. There are two doors on each side, and a 35-foot driveway extends clear around. The center of the barn is fenced off for hay. This hay loft is 70 feet square and 45 feet high. All posts, braces, and beams are built of 2-inch stock, it being claimed that timbers the right length and size could not be procured without too much expense.

The corner posts are composed of four 2 by 10 and five 2 by 6 spiked together. They are 40 feet long. The upper roof is a truss, designed by Mr. Peck. There were something like 160,000 feet or 12 carloads of lumber used in the construction. The roofing used was prepared material with a fine crushed cement surface.

Another notable feature is that there are no wooden window casings or frames. When making the walls a groove was left next to the inside for the windows to sit in.

Mr. Peck expects to house and feed between 1,000 and 1,500 sheep in the barn, although there is room for 2,000. He built it according to his own ideas. Fred Hillquist, our local contractor, was the builder. The carpenters worked a year on this structure.

It might be interesting to know that Mr. Peck invented the corn harvester, for which he still receives royalty.

EDWIN L. BRADLEY.



Interior Photo Showing Framing Underneath the Cupola.

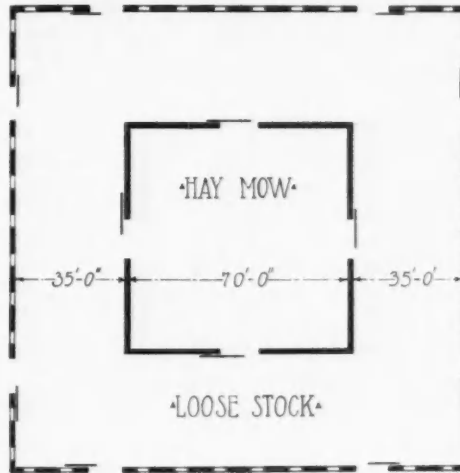

Floor Plan.



Unusual Type of Stock Barn. 140 Feet Square, Built at Geneva, Ill., by Fred Hillquist, the local contractor. His carpenters worked 1 year on this job.

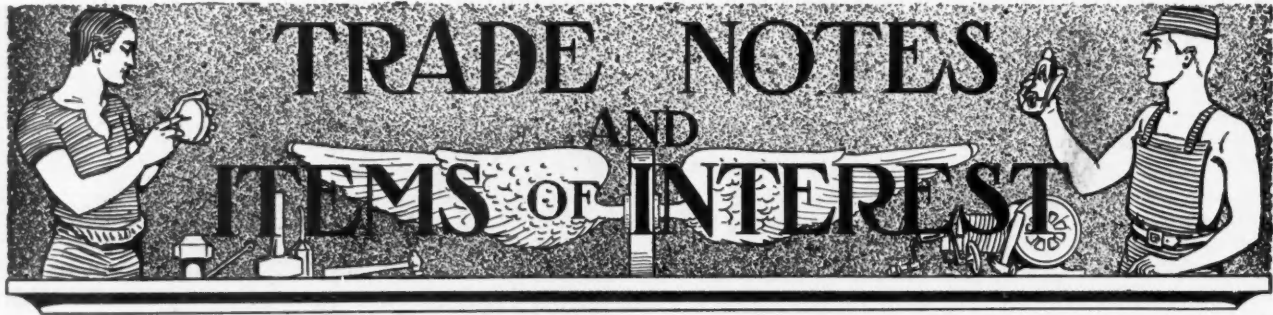

Through this department the Editors aim to keep builders, contractors, carpenters and architects in touch with what their friends, the manufacturers, are doing for them in new or improved tools and machinery, methods and materials—pertaining to building. Items for these columns must have real news value; they are offered here as interesting information for our readers; they are not advertising. No matter will be printed here simply because some advertiser wishes it. Likewise, no matter will be excluded simply because the article described is not advertised in this magazine. Suggestions for the betterment of this department are requested of our readers.

National Plaster Board Thwarts Fire

"Safety First"—the slogan we see and hear in every section of the country is particularly applicable to the building industry. Every builder and building owner is today interested in fire prevention and fire retarding materials.

The two illustrations here show how the work of a hot fire originating in a chemical laboratory is confined to one small room by National Plaster Board walls and ceilings.

In removing the charred plaster and plaster board from the walls of the demolished room the studding was found to be in perfect condition, not even scorched.

Plaster board is composed of plaster, wood fibre and paper. The sheets are 32x36 inches and 5/16 to 3/8 inches thick.

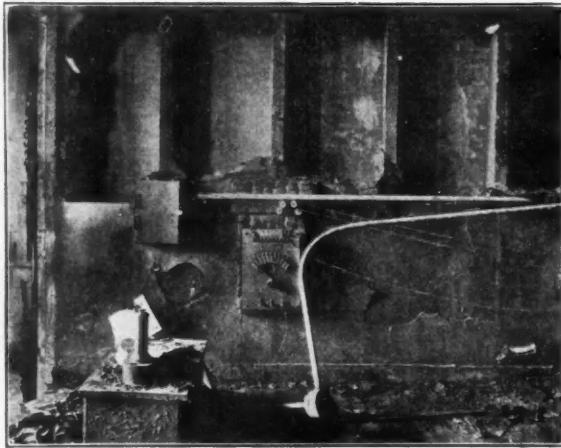

Note Perfect Condition of Studding from Which Charred Plaster and Plaster Board Have Been Removed.

Fire resistance, however, say the manufacturers, is only one of its many advantages as a wall lath or sheathing. Plaster Board makes perfect bond with hard wall plaster. It is light, has great tensile strength and produces strong, firm walls and ceilings. It deadens sound, and is a splendid insulator against heat and cold.

National Plaster Board is sold by building supply houses throughout the country, and is manufactured by the National Plaster Board Company of Cleveland, Ohio.



Write for this Motor Truck Book— It's a Money-Maker for Car- penter and Builder

One of the greatest helps the carpenter or builder can have in his race for success, is a means of easily transporting tools, materials and men from one job to another. Hired service is

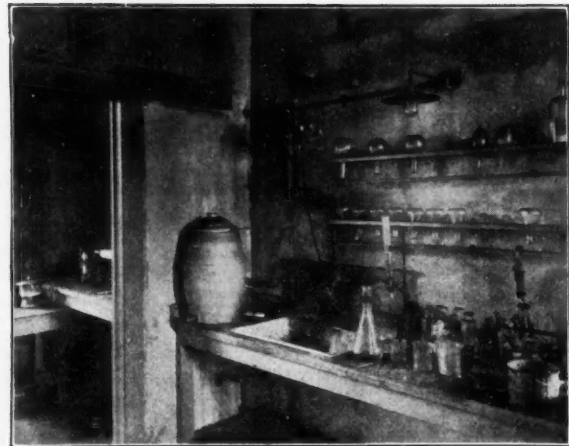

Note Perfect Condition of Reverse Side of Same Partition After Fire.

unreliable. Horses are slow. A motor truck that will stand up under all kinds of work and conditions, that will not continually need repairing, and that can be handled with some speed, will soon save its cost to the man who uses it.

The Dart Motor Truck Company, Waterloo, Iowa, make just such a truck. Their three models, "A," "B," and "C"—with capacities running from 750 to 4,000 pounds—are built for such work as the carpenter and builder would give them. The motors are, respectively, 20 H.P., 25 to 30 H.P., and 40 H.P. Every detail of construction has been thoroughly tested and proven. So well is this followed out that Dart

(Continued on page 98)



A "Dart" Truck Paying Out for Lumber Hauling.



Our Service Bureau Helps 10,000 Contractors Make Money

FREE To You

ALTHOUGH we are today serving an army of nearly 20,000 contractors, carpenters and builders, we realize that we are only touching the surface. There are six times that number who would take advantage of our service if they only knew more about it. For example, do you, yourself, know the Gordon-Van Tine Service? Do you understand our one-price, low-cost, high-quality methods of doing business? Are you familiar with our "Guaranteed Right" plan of prompt estimating? Do you know we employ a staff of high class architects to develop and work out your own ideas? Do you know you can have us do this for you cheaper and better than your local architect? Have you understood that our Service Department is at your Free Disposal to solve for you any knotty or unusual problems that come out of the day's work? Do you know the "Factory Price Plan" which has created our enormous business? Ask yourself these questions. If you do not know the complete answer to every single one of them, write to us and let us answer them for you.

All Our Estimates Are "Guaranteed Right"

WRITE us for a "Guaranteed Right" estimate on your needs. Try it once; you'll repeat it. Quality for quality, our prices are lowest; our stocks give the widest selection of any building material concern on the continent; our service is the quickest (rush orders a specialty) and our guarantee covers everything.

Let Our Service Save You Thousands of Dollars

ONE builder wrote us recently that in 14 months we had saved him \$3,000 on a total of \$10,000 worth of building material. That is a 30% saving. But, mark you, he had his regular profit as well. So this \$3,000 extra profit was virtually an additional bonus over and above regular profits! It is worth your while to save \$3,000 on every \$10,000 of material you buy. You can do it, too. Our Service Bureau will show you how; that's what we have it to do. Write for details.

Make the Coupon Bring You Our BUILDING MATERIAL CATALOG

THIS splendid 156 page profusely illustrated catalog containing over 5,000 bargains in high grade Building Material is a veritable encyclopedia of Building Information for contractors and carpenters and a price-maker for the entire building trade. We will send you a copy **FREE** on request.

If you have never dealt with us a test order is all we ask. Our catalog prices speak for themselves and a test order will convince you the quality and service are back of them. Every item listed is ready for immediate shipment—and hundreds of special fancy pieces of millwork that you

could not get locally in less than two or three weeks can be shipped to you at once. We ship direct to you **anywhere** you live. Satisfaction or Money Back—three strong banks and 100,000 satisfied customers endorse this.

Use the Coupon

GORDON-VAN TINE COMPANY

751 Case Street, Davenport, Iowa



GORDON-VAN TINE CO.,
751 Case St., DAVENPORT, IA.

Gentlemen—Please send the books checked below.

<input type="checkbox"/> Millwork	<input type="checkbox"/> Plan Book
<input type="checkbox"/> Roofing Circular and Samples	<input type="checkbox"/> Lumber

Name.....
Address.....
Occupation.....

In sending for Plan Book, enclose 10 cents for postage and mailing. You will receive the books by return mail.



Build up Your Business on J-M Responsibility.

Back of every J-M Product is over half a century of experience combined with modern manufacturing facilities that make the product the standard of its kind. Added to that are the ample resources and large organization that covers the continent with branches and service stations—one of which is near you to advise you about the use of J-M Products on your jobs. And over all is J-M Responsibility, that not only guarantees materials, but stands back of you when you tell your customers every J-M product must give absolute satisfaction in service. When you use J-M goods on your jobs, your guarantee of satisfaction is based on J-M Responsibility.



First Congregational Church, St. Petersburg, Fla., covered with J-M Transite Asbestos Shingles.

An All-Stone Shingle That Never Wears Out

These shingles are made of two indestructible materials—Asbestos Fibre and Portland Cement. The result is a fire-proof, durable roof that will outlast the building it covers.

J-M Transite Asbestos Shingles

are also highly artistic and can be used with good effect on a costly residence or a public building.

Breakage in application is practically eliminated.

They weigh less than slate, become durable with age, never need coating or painting, and keep a building cooler in summer and warmer in winter. Smooth or rough edges, in colors, shapes and sizes most desirable for various roof construction.

Write our nearest branch for samples of shingles and "J-M Transite Shingles Booklet."

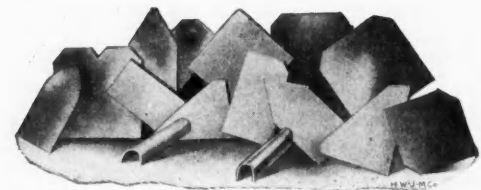

Desirable Shapes for Various Roof Constructions.

H. W. JOHNS-MANVILLE PRODUCTS

J-M Drinking Water System
J-M Transite Asbestos Wood
J-M Asbestos Stucco and Plaster
J-M Asbestos Cloth and Vitribestos Theatre Curtains
J-M Architectural Acoustics
J-M Waterproofing Materials
J-M Mastic Flooring
J-M Asbestos-Sponge Felted Pipe Covering and Sheets
J-M Asbestocel Pipe Covering and Sheets

J-M Zero Pipe Covering
J-M Anti-Sweat Pipe Covering
J-M Sectional Underground Conduit
"Noark" Enclosed Fuse Devices
J-M Corrugated Asbestos Roofing
J-M Regal Roofing
J-M Asbestoside
J-M Asbestos Slater's Felt
J-M Asbestos Roofing and Insulating Felts
Keystone Hair Insulator
J-M Hair Felt

J-M Sound Deadening Felts
Cold Storage Insulation
J-M Weatherite Paper
J-M Mineral Wool
J-M Asbestos Fire- and Damp-proof Flooring Felt
J-M Cork Floor Tiling
J-M Washless Faucet
J-M Sanitor Drinking Fountain
Audiffren-Singrun Refrigerating Machine

WHEN WRITING ADVERTISERS PLEASE MENTION THE AMERICAN CARPENTER AND BUILDER

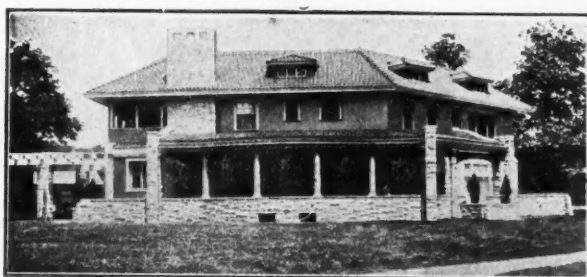

Residence of Arthur Capper, Topeka, Kan. J-M Asbestos Stucco applied to residence and garage. ROOT & SIEMENS, Architects, Kansas City, Mo.

“Your Asbestos Stucco is better than anything I have ever seen,” says Governor Arthur Capper of Kansas.

Where a highly artistic effect is wanted, combined with fire-resistant and insulating qualities and also greatest durability, use

JM Asbestos Stucco

Read This Unsolicited Letter from the Owner.
H. W. JOHNS-MANVILLE CO.,
Kansas City, Mo.

Dear Sirs

I am glad to say that no mistake was made by my architects in specifying J-M Asbestos Stucco for my new residence. To say that I am delighted with it, puts it mildly. Your J-M Asbestos Stucco is better than anything I have ever seen, and it will be a pleasure to me to recommend it to my friends.

Very respectfully,

ARTHUR CAPPER.

Not a sand stucco, but made of Asbestos and Portland Cements.

Makes the house you put it on a landmark for beauty. Dries slowly and sets without tendency to crack. Spreads easily and gets harder as it grows older. Contains no foreign matter to cause discoloration. Furnished mixed with white or with ordinary Portland Cement in white or gray color.

Write Nearest Branch for “J-M Stucco Booklet.”

**A Cushion of Confined
“Dead” Air Insulating Against
Heat, Cold and Sound**

Keystone Hair Insulator

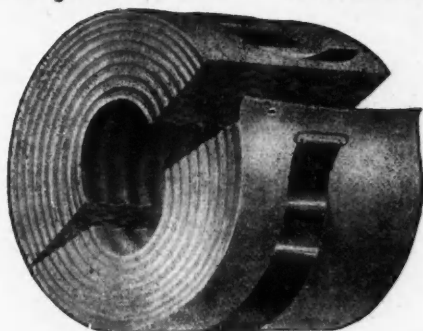

One of the Many J-M Pipe Coverings

Keeps buildings cooler in Summer, warmer in Winter, and more quiet all the year around—a result ordinary building paper cannot give. Pays for itself in fuel saving. Made of chemically cleansed cattle hair, stitched between two sheets of non-porous building paper. Vermin-proof, odorless, will not rot or collect moisture, cannot carry flame, will not pack or settle nor dry out or split.

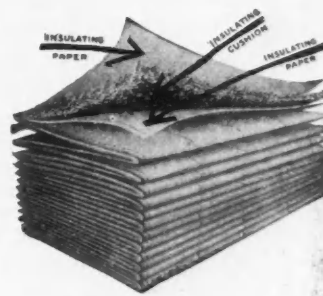

Keystone Hair Insulator

Let JM Service Accept Your Complete Pipe Covering Responsibility

Johns-Manville Pipe Covering service can relieve you of the whole contract. Specifications, planning, furnishing the covering and its installation.

If you are working to a time limit, put it up to our contract department at nearest branch office.

We stand ready to confer with you on any problem that may be perplexing you in your building work.

Let us be your sub-contractor.

Write Our Nearest Branch For “Keystone Hair Insulator Booklet.”

H. W. JOHNS-MANVILLE CO.

Akron
Albany
Atlanta
Baltimore
Birmingham
Boston
Buffalo

Chicago
Cincinnati
Cleveland
Columbus
Dallas
Dayton
Denver

Detroit
Duluth
Galveston
Houghton
Houston
Indianapolis
Kansas City



Memphis
Milwaukee
Minneapolis
Newark
New Orleans
New York
Omaha

Philadelphia
Pittsburgh
Portland
Rochester
St. Louis
St. Paul

Salt Lake City
San Francisco
Seattle
Toledo
Washington
Wilkesbarre
Youngstown

Toronto

THE CANADIAN H. W. JOHNS-MANVILLE CO., LIMITED.
Montreal Winnipeg

Vancouver

WHEN WRITING ADVERTISERS PLEASE MENTION THE AMERICAN CARPENTER AND BUILDER

Fellows! You Ought To Have These Books

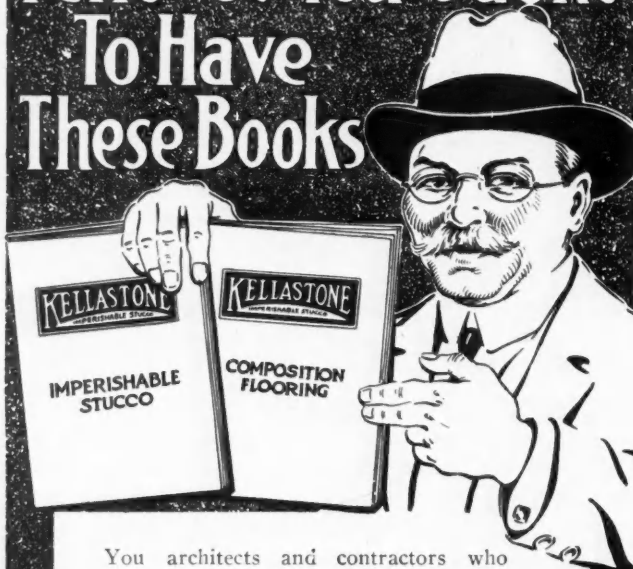

You architects and contractors who want to get away from that monotonous sameness in the appearance of your jobs—you men who want to instill durability, character, dignity and unusual beauty into your building—you ought to have these books. One tells about the remarkably artistic effects secured with

KELLASTONE IMPERISHABLE STUCCO

—how it embodies no Portland cement, lime or gypsum. How it is moisture-proof and fire-proof and withstands far greater settling strains than any other stucco without cracking.

How it is a non-conductor of heat, cold and dampness and how it possesses greater tensile and tension strength than cement stuccos and is not so brittle. It tells how easily Kellastone can be successfully applied over wood lath, metal lath, byrnett sheathing, hollow tile, brick and stone walls, and how perfectly it bonds to door and window casings.

It tells how valuable Kellastone is in remodeling old buildings, how it is used as an interior plaster and the beautiful stucco and plaster effects it produces. And it tells how Kellastone can be applied with the same success in winter or summer. The other book tells about

Kellastone Composition Flooring

and how it is composed of materials in powder and liquid forms which, when mixed and spread, form a tough, seamless mass over the entire floor including cove and base, if desired, thus providing a sanitary, durable floor without seams or joints and easy to keep clean.

It tells how Kellastone Composition Flooring can be laid on bases of concrete, wood or steel. How beautiful border designs and terrazzo effects can be secured and how its lightness, warmth, resilience and quietness make it especially adapted for hospitals, schools, theatres, office buildings, public buildings, private homes, apartments and manufacturing establishments.

Send for These Books Today.

They're brief, interesting and instructive. Your name on a postal brings them. Kellastone is carried by lumber and building supply dealers. If your dealer cannot supply you, write us.

The National Kellastone Co.
504 Association Bldg. Chicago, Ill.

Motor Truck for Builders

(Continued from page 94)

trucks are known, the country over, for their efficiency, durability, and simplicity.

Whether considering the purchase of a truck or not, AMERICAN CARPENTER AND BUILDER readers may, with great benefit, send for the catalog these people are distributing. It is a book full of ideas, and well worth reading by the man who is looking always for something better.



B. F. Affleck, New President of Universal Portland Cement Company

B. F. Affleck has been elected president of the Universal Portland Cement Co., owned by the United States Steel Corporation, to succeed Edward M. Hagar, whose resignation was recently announced. Mr. Affleck entered the service of the Illinois Steel Co. in 1896, and from 1901 to 1903 represented the cement department of the company in the St. Louis territory. When the Universal Portland Cement Co. was incorporated in 1906 to take over the cement business of the Illinois Steel Co., he became general sales agent. From a small plant at South Chicago, producing 30,000 barrels in 1900, the business has grown steadily and the company now has plants at Chicago and Pittsburgh with a plant under construction at Duluth, the combined capacity being about 13,000,000 barrels per annum.

He is vice-president of the Cement Products Exhibition Co., under whose management the Annual Cement Shows have been held in Chicago. He is recognized as the pioneer in promoting the use of concrete as a paving material.



B. F. AFFLECK.

Newly Elected President of the Universal Portland Cement Company, Formerly General Sales Agent. He is also Vice-President of the Cement Products Exhibition Company, under whose auspices the annual Cement Shows are held.

No Paint— No Repairs—Just Wear—Use PEARL for Screens

What's the use of screening with a wire cloth you know will have to be repaired, repainted or renewed in a season or two at most?

Practice *real* economy. Screen with genuine Gilbert & Bennett PEARL Wire Cloth. Rust, *not* wear, ruins screens. PEARL Wire Cloth is as near rust-proof as metal can be made and consequently as near wear-proof as a screen can be.



*For Screening Doors,
Windows and Porches*

Made in Two Weights--Regular and Extra Heavy

Smooth surfaced and with a metallic lustre, PEARL is beautiful as a screen can be. Easy on the eyes and less visible the longer it's used.

Don't be deceived. There can not be a "just the same as PEARL." The manufacture and application of the non-crack, non-chip coating from which it derives its wonderful rust-resisting qualities is a secret process, the exclusive property of this company.

But to be sure of PEARL-Wear you must get genuine PEARL Wire Cloth with two Copper Wires in the Selvage and the Round Tag bearing the Gilbert & Bennett name on each roll.

Write our nearest office for samples of both Regular and Extra Heavy PEARL, full details regarding same, and the name of nearest dealer.

*Conscientious Carpenters, Contractors
and Architects recommend and use
Gilbert & Bennett PEARL Wire Cloth.*

The Gilbert & Bennett Mfg. Co.

(ESTABLISHED 1818)

Dept. R 277 Broadway - New York
Dept. R 38 S. Dearborn St., - Chicago
Georgetown, Conn.
Kansas City, Mo.



Blaine S. Smith New Universal Portland Cement Co. Sales Mgr.

Announcement is made from the office of secretary of the Universal Portland Cement Co., 208 South La Salle Street, Chicago, Ill., that Mr. Blaine S. Smith has been appointed general sales manager, effective Feb. 3rd, succeeding Mr. Benjamin F. Affleck, who has been elected president.



Another Firm Adds Batch Mixer to Its Line

Much interest was shown in the Raber & Lang Manufacturing Company's exhibit at the Cement Show. The cause was their new "Bull Dog" batch mixer.

This is one of the most compact, stoutly built machines we have seen. The trucks are low and unusually wide—making a solid stand for the mixer, and yet being easy to handle. As will be seen from illustration, the machine does not occupy much room, which will be an advantage in many instances.

A four horse-power engine furnishes power—steam, gasoline, or electricity is optional. If desired, a side loader is included in the equipment. The automatic type of water tank is used. Great care is given the grinding of trucks on drum, and tracker wheels have chilled faces—which makes a mighty smooth-running drum. The

tracker wheels are self-oiling, needing attention but once a month.

The "Bull-Dog Junior" is the "Bull-Dog's" little brother. With capacities of from two to five cubic feet, the two models of the Junior are wonderful little machines. They are arranged for hand or power, mounted on frames, skids, or trucks.

Full information on the Crescent and Bull-Dog lines (comprising continuous mixers, sewer pipe and tile molds, brick machines, etc.) may be had by addressing them at Kendallville, Ind.

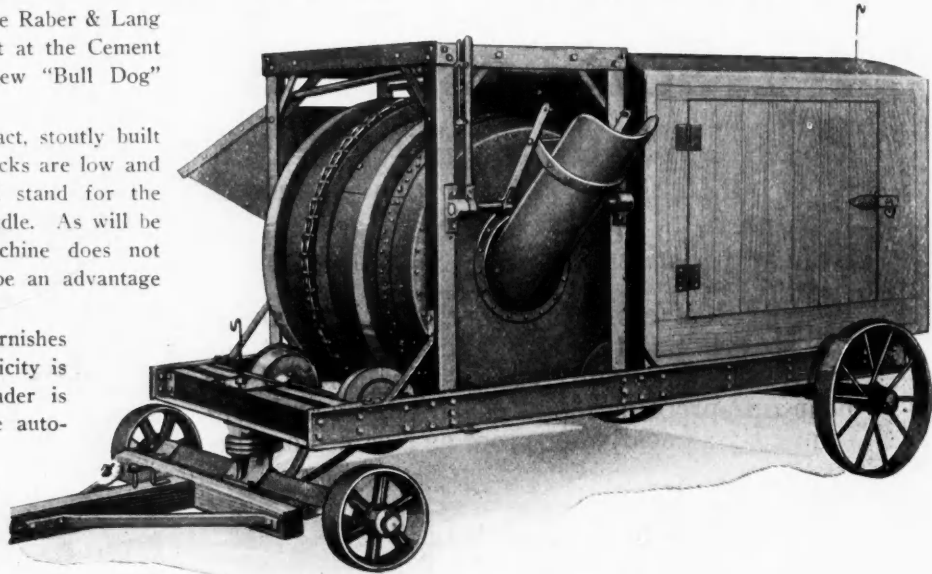

Raber & Lang's "Bull Dog" Batch Mixer.

CARTER
The White
White Lead

White, Whiter, Whitest

There is always one detail or another about a house that calls for white paint; and then it cannot be too white.

When you specify Carter White Lead for any painting you are sure of getting the whitest white lead on the market. The Carter process excludes everything that might discolor it or impair its paint value.

The name "Carter" on a keg of white lead is more than a guarantee of purity; it identifies the highest grade white lead on the market, unsurpassed by any for whiteness, fineness and every quality that makes good paint.

Yet builders of experience know that using Carter does not increase the cost of doing a first-class job. It is economical as well as beautiful and desirable.

The Carter Paint Calculator will tell you what you wish to know about mixing paint. It specifies the quantities of lead, oil, turpentine, drier and color needed for various surfaces and colors. The price is 25c, but it will be sent to any contractor or architect without cost.

CARTER WHITE LEAD COMPANY

West Pullman, Station "A"

CHICAGO, ILL.

WAR causes lumber famine high prices coming Buy Lumber **NOW**

Today lumber is cheaper than it has been for fifty years. Building with railroads and in the cities has been at a standstill. But these low prices *can't last*. Europe will shortly be clamoring for American lumber as she is clamoring now for American wheat. Hundreds of cities and towns need rebuilding.

In England right this minute there is a lumber famine. Norway—the chief source of supply—is cut off. Yet, *right now*, you can buy famous H-L-F quality lumber almost cheap as dirt—wait a month, or a week, and there's no telling how much more you'll have to pay. **Don't wait.**

Line up new jobs while lumber is low

Go to the people who are thinking of building—tell them the lumber situation as it now stands—urge them to order now—tell them that if they wait it may cost them a lot of money. Do them as well as yourself a good turn.

Get a price on jobs without bill of materials

by the use of the H-L-F House Pricer. Use the coupon—ask for a supply.

Simply answer a few questions—give us a clear idea of what you have in mind—we'll send you quick price.

Send material bills quick—for low price

See how amazingly low prices are scaled at present on H-L-F lumber, before the price goes up. Hurry up the bills you now are figuring. Days are precious now. Get your quotations before the price goes up; as it surely will.

\$1000 saved on these jobs using H-L-F lumber

Saved \$10 per M

"You saved me about \$10 per M on my lumber bill—a total saving of \$240.

"J. O. BJORKLUND,
"Henning, Minn."

Saved \$150—quality best ever seen

"I did not expect to get as good lumber as I received. The millwork is by far better than I have seen anywhere before. I saved about \$150 in cash and the better quality is worth considerable.

"H. A. ERDAHL,
"Blue Earth, Minn."

Much pleased with quality—saved \$175 to \$200

"Will say that I am very much pleased with the grade of lumber you sent me. Will also let you know that I've saved from \$175 to \$200 on the lumber.

"J. J. PENNER,
"Woodworth, N. Dak."

Saved \$9 per M—quality satisfies

"The quality is as good if not better, grade for grade, and I believe we saved about \$9 per M. All parties satisfied as to quality.

"W. W. DURAND,
"Powell, Wyo."

Finest lumber ever seen—saved 40%

"A finer lot of material was never unloaded at Driggs before—or as fine by long odds—and we are fully satisfied with your treatment of us. Oh! we like your ways! Especially the quality of your goods and the 40 per cent we are able to save thereon.

"GEO. R. SMITH,
"Driggs, Idaho."

Not a bad stick in the bunch

"The car of lumber has arrived and is unloaded. It is all good, the best I have ever seen. Not a bad stick in the bunch.

"CHAS. F. COLLINS,
"Sorrento, Colo."

Grades, count, satisfaction, absolutely guaranteed

Every timber, every board, every shingle shipped by H-L-F is guaranteed. We also guarantee count—guarantee satisfaction in every way or money refunded. Our estimators are experienced men. They know their business. Shipments are being made like clock work from our mills. Freight is moving briskly. There never was a better time to buy from H-L-F—never a time when you could make such a big saving on lumber of highest quality. Send along your bills of materials—ask on the coupon for the H-L-F House Pricer, H-L-F Barn Builder's Guide, 4 cents—and anything else you wish.

Order your lumber—before the price goes up

Hewitt-Lea-Funck Co., 708 Crary Bldg., Seattle, Wash.

Capital \$1,000,000 Not in any trust or combine

HEWITT-LEA-FUNCK CO.

708 Crary Bldg., SEATTLE, WASH.

Gentlemen—Please send me the following:

- Delivered, freight-paid price on enclosed list of materials (no charge)
- H-L-F House Pricer (free) Plan Sheet (free)
- Information on H-L-F Stud and Wall Board Construction.
- Barn Builder's Guide (send 4c) Millwork Catalogue (free)

Name _____

Street or R. F. D. No. _____

Post Office _____

State _____ Business _____

I will send list about _____



ANSWER EVERY VENTILATING QUESTION

with a



STYLE

No. 125

WILLIS VENTILATOR

There is a ventilation question with every building you put up. Barns, school houses, public buildings and residences, must be ventilated in the very **best way** if they are to be satisfactory. Twenty-three years of work in this line enables us to design ventilators that will ventilate under every condition.

We have a ventilator for every problem you run up against. And no ventilator is made to beat ours for workmanship, material, appearance and price.

Our ventilators are absolutely bird and storm-proof.

The Willis line is complete. Anything in sheet metal, skylights, ceilings, roofings, store fronts, ornaments, etc., at lowest prices, and of Willis ("first") Quality. Shipments promptly made.

Let us send you our big catalog at once.

WILLIS MFG. COMPANY
GALESBURG, ILLINOIS

STYLE

No. 125G

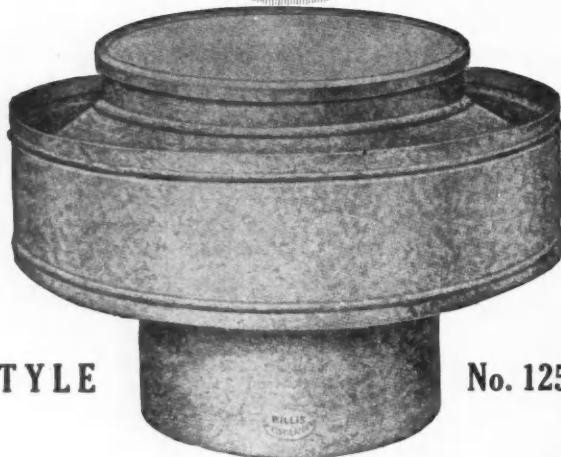

"Drive Your Business During 1915---or You Will Be Driven Out"

So Says Well Known Business Man

There is a lot of truth in this statement. There is also a lot of inspiration. Every contractor and dealer can take it to heart.

Due to the unusual conditions in the world today, it is up to each one of us to get busier than ever to stir up business. Real, profitable business lies around everywhere if we only get a hustle on and go after it. Merely asking a man to "give you business" is not enough these days to get it. You must exert yourself more than merely asking. You must be of service to him first. In other words, you must suggest things to him that will be desirable and profitable for him to do, in order to make him want to give you the business that results.



A Morgan Door.

For instance, suppose you pick out a good looking home which is not equipped with a sleeping porch or a screened-in front porch. Make a little diagram as to how you could equip this home with both of these profitable and comfortable features. Then go to the owner and tell him of your plan. Give him the details of how much it will cost. Make your price reasonable. Really try to get the business by winning him rather than forcing him, and in the majority of cases you will get it. A job like this well done is not only profitable in itself, but it may at any time open the way to bids on new buildings where you will get more profit.

A successful contractor and builder is one who works with proper materials and finishes off the job in a workmanlike manner. This means good advertising.

Morgan doors and millwork are produced with the care and finish that reflect credit on the contractor. The Morgan's factory equipment is the most modern that can be devised, and Morgan's workmen are all wood-working experts who have spent years (and many of them their lifetime) in turning out high-grade doors and millwork.



Improvements Like This Interest the
Prospective Home Builder.

Furthermore, the Morgan Company carry numerous stocks of standard as well as unusual designs and patterns, and shipment can be made on shortest notice.

The contractor will not be blamed by his customer for troublesome delays in building due to non-arrival of doors and millwork ordered from Morgan. Morgan's package car delivery is a wonderful addition to the Morgan service—they have letters from many dealers telling them that the goods arrive there "almost as quick as the mails."



**Recommend
King Aerators**

and The King Sanitary Ventilating System

Save Work and Money—Fore stall Spontaneous Combustion, Lightning and the Other Risks of Poor Ventilation

For safety's sake, your customer will want "Kings." For economy of labor and material, you will want to recommend them. -

Spontaneous Combustion in the haymow, the big cause of many fires in farm barns is unknown in buildings ventilated with the "King." And lightning, which is always attracted by hot, dead air, is forestalled in the "King"-equipped barn, because the air in the barn cools with the outside air.

A carpenter and a helper can put King Aerators on a barn while the rest of the crew is picking up the tools. Recommend the "King" equipment—please your customers—and save the hard, time-eating work of building wooden cupolas.

Write for our Catalog—Mailed Free

You will find in it a number of photographs of barns equipped with King Aerators. It will be a big help in showing your customer their efficiency as a ventilation equipment and their beauty in architecture.

King Ventilating Co.

1120 Cedar St., Owatonna, Minn.

Formerly Galvanized Steel
Cupola Co.



FREE!



TO INTRODUCE MIDLAND STOCK WHITE

Special Offer \$300⁰⁰ As Specified

F. O. B. CHICAGO

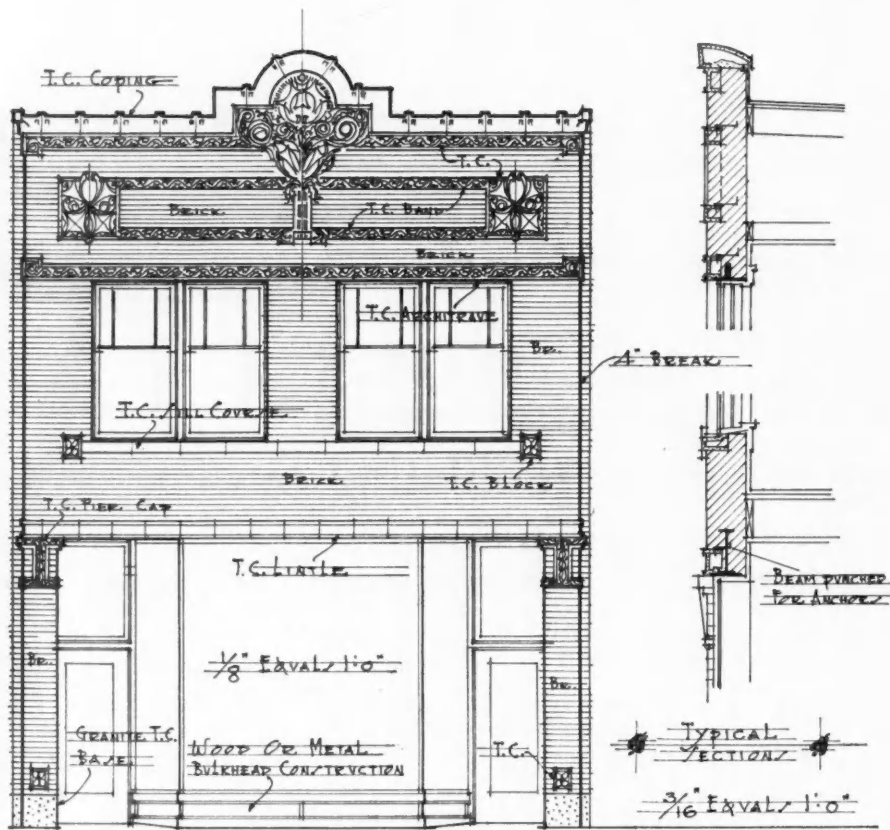

SPECIFICATIONS

OUR OFFER:—includes all material marked "T. C." on elevations.

FINISH AND COLOR—Pier bases are polished granite T.C. Work above is our finest white enamel.

ORNAMENTATION—An exquisite example of Sullivanesque modeling.

DETAILS AND DATA—With each shipment we include setting plans, which show where each piece is to be set in building. Any mason or builder can do the work.

CUTTING AND FITTING—Every piece carefully fitted, allowance made for joint anchors, etc., then numbered to correspond with setting plans.

CRATING AND SHIPPING—We carefully crate and pack each shipment for safe transportation. Work placed on board cars Chicago and routed as directed.

GUARANTEE—We guarantee the material to be of the highest quality in every respect.

THIS OFFER GOOD

MIDLAND TERRA COTTA CO

1120 CHAMBER OF COMMERCE # CHICAGO

IN YOUR LOCALITY ENAMELED TERRA COTTA

Special Offer **\$250⁰⁰** As Specified

F. O. B. CHICAGO

READ CAREFULLY

At this introductory price we intend to book only one order in any town or city. Therefore, "First come, first served."

Without extra charge we fit T.C. to any width of front up to 26 ft.

On the two-story Building the sill course is made to fit any window openings desired.

Midland Terra Cotta requires no Painting or Repairs; soap and water will remove Dirt and Soot. Thus your building will always be attractive and up-to-date.

We carry a large stock of white enameled Terra Cotta—for immediate delivery—suitable for any building. You don't have to wait six weeks or more. You can have it NOW—just when you need it.

Midland Stock Terra Cotta is illustrated in a portfolio of designs—is your name on our mailing list?

Our designing department is at your service—send in your plans for ideas and estimates.

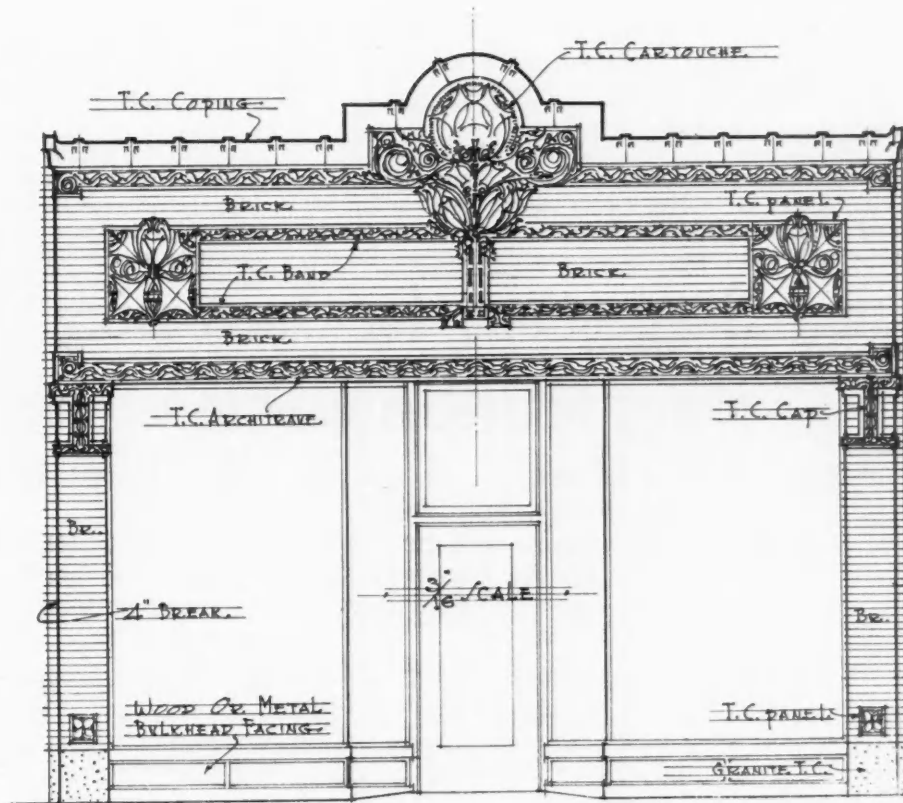

UNTIL MARCH 31ST

MIDLAND TERRA COTTA CO

1120 CHAMBER OF COMMERCE # CHICAGO

Sliding "T" Bevel, with Device to Lock Blade

The classiest looking little tool we have seen for some time in the new sliding "T" bevel gotten out by the Southington Hardware Company, Southington, Conn. More than that, it is altogether different from anything of the kind of which we have heard.

The clamping device is a little lever which sets down flush with the handle. A flip of the finger opens the clamp, allowing the blade to run quite free. When blade is set at

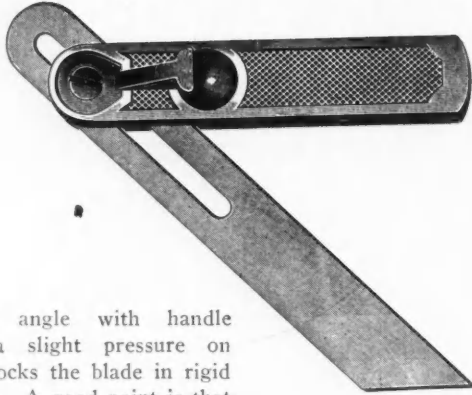

The Blade Locks in Any Position.

desired angle with handle body, a slight pressure on clamp locks the blade in rigid position. A good point is that this pressure may be applied without moving hand from holding blade in position.

As will be seen from illustration, the blade works in slot into which it may be folded to carry. While the blade is 8 inches long, the folded length of the bevel is but 8½ inches. Our illustration hardly does credit to the appearance of this tool. It is one of those tools a man likes to

have with him. The edges, name plate, and blade are finely polished. The sides of handle are sunken and knurled.

The clamp parts are drop forgings, case hardened, so it will last a long time. The screw that holds clamp washer, also acts as adjusting screw.

Complete information and prices may be had by writing the manufacturer.

Annual Exhibit of Evening Work at Pratt Institute

Wednesday evening, March 10, will be observed as "Visitors' Night" in the School of Science and Technology of Pratt Institute, Brooklyn. From eight to nine o'clock all the shops, laboratories and drawing rooms of the school will be open to the public, and all persons interested in industrial education will be given an opportunity not only of viewing the students at work in the various courses, but also of inspecting both the results and methods as well as the equipment and general facilities of the Institute for conducting this kind of industrial training.

The School of Science and Technology provides instruction in industrial electricity, technical chemistry, mechanical drawing and machine design, strength of materials, stationary engineering and power plant machinery, machine work and tool making, carpentry and building, pattern making, sheet metal work, plumbing and trade teaching for the training of skilled workmen who desire to prepare themselves for the teaching of their trades.

Practically all of the thousand students in the evening classes of this school are men who are regularly employed in their several vocations, and who use these courses as a means to prepare themselves for more efficient service, a fact which indicates the practical character of the work offered by this institute.

Some Suggestions for Increasing Your Business by using MORGAN DOORS and Millwork:

- 1—In new buildings of any size or cost—cottages, bungalows, residences, offices, apartments, institutions.
- 2—Many old houses will put in new front MORGAN DOORS if you will suggest to the owners what a great difference it will make in the looks of his property and how much better service he will get out of a MORGAN DOOR.
- 3—Suggest the installing of a MORGAN Mirror Door to a list of families where there are growing daughters.
- 4—Some people in your town would welcome the suggestion of installing a new Morgan sideboard, buffet or medicine chest.
- 5—Many residents of your town will build a new and larger porch or screen in the old one if you go to them with a definite suggestion.
- 6—Every house ought to have a sleeping porch, but most people think they cost too much. You know what it costs—why not tell them?

The contractor who digs up business is the man who will get it this year, and it will be a big year if we all hustle. Provide yourself with the Morgan Millwork Handbook at once and get busy.

Your dealer can supply MORGAN DOORS without delay from our immense stock.

Morgan Sash & Door Company

Department A-23, CHICAGO

FACTORY: Morgan Co., Oshkosh, Wis.
Eastern Warehouse and Display,
Morgan Millwork Co., Baltimore.

DISPLAYS: 6 East 39th Street, New York
309 Palmer Bldg., Detroit
Building Exhibit, Insurance Exchange, Chicago

A Special Message

Addressed to You

If you had assembled all the facts pertaining to all the pines, you would select **Arkansas Soft Pine** for all manner of interior woodwork, and get your "**Pick of the Pines.**" Your conclusion would be the same as that reached by United States Government officials, if you, as they, were absolutely unbiased and guided by the facts your investigation brought to light.

Predicated on the investigations that have been made for you by Uncle Sam, you should employ Arkansas Soft Pine for interior and exterior use for these reasons:

For the Interior

No other wood shows such a variety of pleasing figure. Some of it is splashy and bold; some of it has been delicately engraved by nature, the greatest of all artists.

Its uniform texture insures the even absorption of fillers, stains or dyes, and a proper finish with shellac, varnish or wax. Properly treated, an effect is secured that is unsurpassed by the finished appearance of any other wood.

For the Exterior

Arkansas Soft Pine contains practically no resin or resinous oils. There is a notable absence of pitch streaks. It does not gum the carpenter's tools or power machinery.

Open cells permit of the absorption of sufficient of the oil and pigment to bind paint firmly to the surface to which it is applied. The result is that Arkansas Soft Pine holds paint. It is easy to work and worth working.

These are elemental Arkansas Soft Pine facts with which you should be familiar, because the difference between the cost of this wood and others not so good is so slight that you cannot afford to take a chance.

For Interior Woodwork there is no comparison between the value of Arkansas Soft Pine and other soft woods.

Arkansas Soft Pine Bureau

608 South Dearborn Street

Chicago, Illinois



This Roof is Weather Proof

When you complete the laying of a Rex-tile roof you can give the house-owner a weather and time-proof guarantee.

Rex-tile

TRADE MARK

can't flap, warp or curl—on to stay—water can't leak through. Fastened at the bottom through a patented turn-under fold that gives a double butt-end and protects the nails from moisture and rust.

No painting is necessary. The color is a part of the shingle, and is there to stay.

Builders will appreciate the ease of handling Rex-tile Shingles. Much lighter than slate and tile—not sticky like some prepared roofing.

Rex-tile Shingles are sold at one price. No fear of price-cutting competition if you use them on your roofing jobs, because the turn-under fold for nailing—at bottom—no flapping or warping—nails perfectly covered—is patented and exclusive.

Rex-tile Shingles are being advertised in a country-wide campaign. We'll be glad to send you sample advertisements and shingles with full information, prices, etc.

Flintkote Manufacturing Co.

90 Pearl Street, Boston, Mass.

67 Beaver St., New York

659 Peoples' Gas Bldg., Chicago, Ill.

Also manufacturers of Paradux—a waterproof canvas covering for all surfaces on which walking will be done—such as sleeping porches, piazza roofs, roof gardens, balcony roofs, boat decks, etc. Easier to lay than tin or metal—far more durable—requires no special preparation of the surface to be covered. Can be painted any color desired.

Bargain Building Material Catalog of Interest to Builders

We illustrate three interesting farm buildings taken from a typical page of the United Factories Co. catalog. The

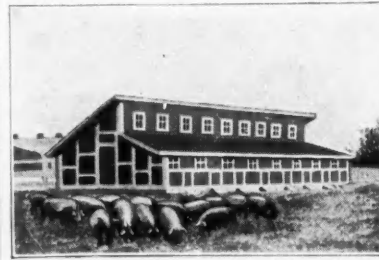

"Unito" Wall Board Hog House.

page was one given over to their Unito water-proof wall board, and the photos illustrate the use of this board in the construction of implement shed, hog house, and poultry house.

It is now largely used for the building of poultry houses and other small buildings

about the farm, for waterproof sheathing or siding as well as for roofing on small buildings. Unito board makes a splendid material for buildings of this kind. It is absolutely waterproof; and although but $\frac{3}{8}$ inch thick, it is equal in warmth to a board 1 inch thick. This is graphically illustrated by the cross-section

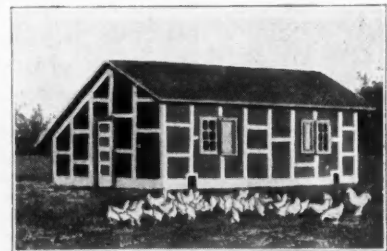

Poultry House of "Unito."

view.

The company suggests a test, which we show. A piece of Unito may be soaked in a pail of water for an indefinite time, and when taken out

will not be found to have absorbed a drop of the water. The waterproofing compound also makes the board proof against rats, mice or insects.

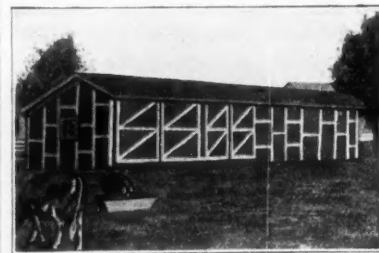

Farm Implement Shed.

Throughout the catalog are items of equal interest to the carpenter or builder. Engines, electric lighting outfits, roofing

of all kinds, paints and varnishes, and fencings are some of the things covered. A great number of interesting illustrations

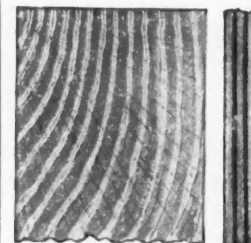

Wall Board Just as Warm as Boards One Inch Thick.

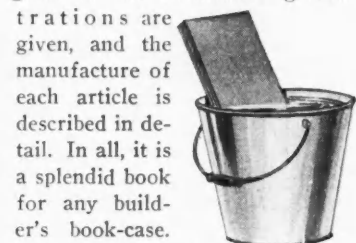

A Waterproofing Test.

A letter addressed to 22-26 Factories Bldg., Cleveland, Ohio, will bring it—also free samples of these materials.



Parks Celebrates 30th Anniversary

The year 1915 is a notable one with the Parks Ball Bearing Machine Company, as it is the thirtieth anniversary of this concern. Thirty years ago when Mr. Parks first came to Cincinnati he could see the demand for cheap and serviceable

Asbestos "Century" Shingles



Residence
San Antonio, Texas



Hotel
Sulphur Springs, Ark.



Bungalow
San Juan, Porto Rico

The Artificial Roofing Slate that Outlives the Building in any Climate in the World

It is one of the peculiarities about American building conditions that any contractor anywhere is likely to be called on at any time to construct anything from a shed to manufacturing plant, or exclusive private residence.

With the use of Asbestos "Century" Shingles increasing 35% every year, the contractor who wishes to hold the leading business of his community finds it more imperative than ever to learn all there is to know about these reinforced concrete shingles—and to be in position to supply them.

It is especially important to remember that the original roofing slates are the Asbestos "Century" Shingles—

That only these Shingles are or can be made by the patented "Century" process, assuring even reinforcement and uniformity of texture—

And that Asbestos "Century" Shingles give a durability, a freedom from repairs, and upkeep charges not found in a like degree in any other roofing material either artificial or natural.

If you are not actively in touch with the Asbestos "Century" Shingle proposition, write us for terms and trade prices.

Keasbey & Mattison Co., Factors

Dept. B.

Ambler, Pa.

Branch Offices in Principal Cities of the United States



Mining Camp
Red Ash, W. Va.



Stable
New Port, R.I.



School
Charleston, Ill.



Industrial Plant
Newark, N. J.

woodworking machines among small shops throughout the country, and his first inventions were for machines to help this class of trade.

He endeavored to interest some of the large woodworking machinery companies in Cincinnati; but they could not see any market for this line of machines and he was, therefore, forced to make them himself. He started in business with practically nothing, and after thirty years of hard work, it is very gratifying to him to see the large number of concerns manufacturing woodworking machinery for the small carpenter shop; also portable outfits which can be taken out on the job.

We show a sketch of his first portable woodworker, showing gasoline engine made by him, mounted on wood base.

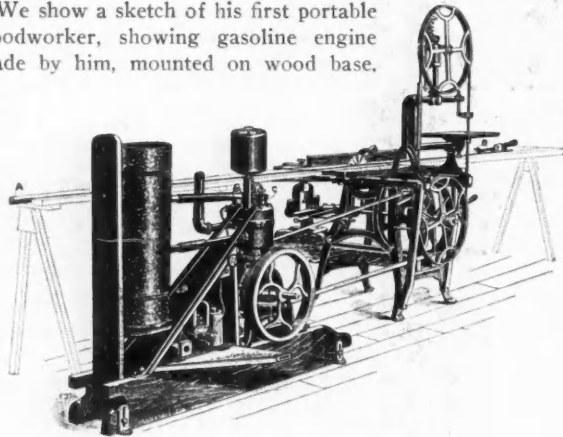

The Original Parks Outfit of 30 Years Ago.

which was the first gasoline engine ever mounted on wood skids. Proving that his ideas are intensely practical, practically every gasoline engine manufacturer is today building part of his line mounted in this way.

The circular saw and band saw combination with boring attachment is another of his pioneer inventions, and Mr. Parks is glad to be able to say that he made the first circular saw—band saw—jointer combination sold in this country.

In the other illustration is shown what might be called the "last word" in a portable outfit. This machine is practically a planing mill on wheels and can be moved from job to job with no loss of time. The swing cut-off saw is always ready for instant use and drops below the table surface when idle. The gasoline engine is mounted in the rear of the machine and is very accessible to get at. With an outfit of this kind contractors can reduce their labor bills in building construction; and a machine of this kind soon pays for itself. Everything about the machine is substantial.

The new catalog of the Parks Ball Bearing Machine Company is about ready to be printed, and it will contain quite a number of new machines which will be of interest to the readers of the AMERICAN CARPENTER AND BUILDER. This catalog will be sent to anyone on request.



Do You Read "The Carter Times"?

The March issue of "The Carter Times" is a special "Interior Decorating Number." The leading article is on "Inexpensive Methods of Finishing Interior Woodwork," by W. M. Reynolds, an interior decorator of long experience. It gives detailed instructions for the most popular finishes for bedrooms, bathroom, living room, dining room and kitchen of a modern cottage or bungalow.

Another article is on "The Use of Oil Colors for Mottling and Blending and Tiffany Glaze," on plastered walls, etc., etc.

"The Carter Times" is issued by the Carter White Lead Co., West Pullman, Station "A," Chicago. It is distributed free of charge to painters and those who superintendent painters.

ELASTICA
TRADE MARK
FLOOR FINISH

**Standardized
PRODUCTS**

ELASTICA
TRADE MARK
FINISH No. 2

Look for These Trade-Marks

A Little Thing to Look For---A Big Thing to Find

They are a guarantee that you have the best brands made by the largest varnish works in the world.

ELASTICA FLOOR FINISH, a varnish made especially for floors, made to meet and resist all the conditions to which floors are subjected.

ELASTICA FINISH No. 2, a strictly high grade varnish for interior work, which will retain its original luster and beauty—the favorite of painting contractors, as its use insures a very satisfactory job.

SATINETTE WHITE ENAMEL, a most pleasing, satisfactory and sanitary finish. Can be recommended because of its beautiful appearance and enduring qualities.

KLEARTONE STAINS, made in every desired color for every known wood. They are demanded by those who insist on unquestioned and permanent beauty of effect through the use of the highest grade materials.

KLEARTONE
TRADE MARK
STAINS

Standard Varnish Works

New York Chicago London
San Francisco Berlin Melbourne

International Varnish Co., Ltd.,
TORONTO

Satinette
TRADE MARK
WHITE ENAMEL

WANTED—The Right Sort of Man

One That Can Make Good on a New Proposition—Can You Recommend Him?

HERE is an opportunity for one man—and only ONE. As soon as another man takes it, you lose it! What we are looking for is not a man out of a job; but a man who wants to get out of a job and start a business. Nor do we want men who have failed in other lines of work; but men who have already succeeded and are after still greater success.

WE WANT the best—not necessarily the biggest young contractor or builder in your neighborhood. \$5,000 to \$10,000 a year earnings must not be beyond his ambitions. But he must be prepared to work, to overcome obstacles and able to judge a new proposition on its own merits. Furthermore, he must be willing to back his own judgment by investing from \$150 to \$5,000 in his equipment.



ON THIS investment he should, after a few months of good preliminary work, earn not less than 10% a month profit, which rate should not only remain steady, but steadily increase. A man out in Michigan—to take a striking example—piled up nearly 2,000% profit in six years. Our proposition is neither a theory nor an experiment, but a tried out and tremendously profitable manufacturing line for a practical man with imagination and enterprise enough to crave something bigger than the rather crowded opportunities to be found in the regular contracting line.

ON THE other hand, the Norwalk proposition is neither a "sure thing" nor a get-rich-quick game. For the man willing to work hard enough and invest money enough to get a fair start, it will give bigger and more certain returns than any other legitimate business we ever heard of. This is all we claim—and this we can prove. If you are interested let us give you more details—you may investigate and check up to your heart's content.

OUR eight years' experience has shown that two kinds of men are most successful with the Norwalk Vault proposition:

- a—The man already doing well, whose business, however, is not developing rapidly enough to suit him or has slow seasons at one time or another.
- b—The man who wants to go into business for himself but has so far seen nothing really worth his while.

STARTED as a side line, it is more than likely some day to prove at least as important as your present business. A man in a little town on the Hudson, working nights and holidays in a cellar, paid up in a single year his original investment of \$450, and in the second year cleared 200% profit. Naturally, however, we would much rather hear from a man with capital enough to make the business a pleasure rather than a struggle. For it is just as easy—and lots more certain—to make as good a rate of profit on \$4,500 as on \$450.

THE NORWALK VAULT business is still in its infancy. Not one man in ten knows now that he can provide for a departed wife or child an absolutely moisture-proof, airtight burial vault as smooth and clean cut as your desk, yet solid as if hewn out of granite. Undertakers everywhere are waking up to the fearful crudeness of the old-fashioned method of burying unprotected in the muddy bottom of a six-foot cistern. As soon as the public begins to realize there is something better—and we are taking advertising steps to see that they do before long—the holders of the Norwalk Vault franchise for any given district will find they have a mighty valuable possession.

FOR THE Norwalk Vault Company is, we believe, going to become one of the big business institutions of the country. We propose to unite several thousand local manufacturers all over the United States—each in his own territory—into a sort of giant partnership. Then we propose making the idea of a

cement burial case as thoroughly understood as the idea of a Pullman sleeping car, and the name "Norwalk Vault" as familiar as the name "Nesbitt Biscuit." The Norwalk Company has already a branch factory of its own in New York City; but the United States is pretty big, and to cover even a small part of it with our own shops would take far too many years. There is, therefore, this opportunity for the right man to take over local manufacturing rights—and get in on the ground floor of what is to become one of the great manufacturing businesses of the country.

NOW suppose you arranged a sort of partnership with all your local undertakers—they to sell, you to manufacture for your locality. Figures from more than a hundred concerns in various parts of the country show the average manufacturing cost per vault to be considerably less than \$10. Nowhere in the country is one of the finished vaults sold to the undertakers for less than \$20, and in most cases they bring \$25 or \$30. All the selling—the direct retailing—is taken entirely off your hands by the undertaker who pays your wholesale price and makes for himself \$20 profit or more, according to his customer.

SUPPOSE you could ever reach the point where you made \$10 every time a funeral took place in your county. Wouldn't worry much about your income, would you? European wars, bad crops, hard times never affect the annual death rate.

AS YOU can see, there is a perfect gold mine of business on all sides—waiting—but this being a new and rather unusual proposition, it takes rather a good man to cash in. If you are the kind of man who has made good already or can make good, this may be your opportunity. No technical experience necessary. The equipment required is not expensive; any respectable shed may be converted into a factory; no high-priced labor—the knack of making the vaults can easily be taught an unskilled laborer; no large sum tied up in machinery or materials—a few dollars at a time will keep the business running. Once established the business is not affected by hard times, no burdensome fixed charges—you can open up and shut down like an umbrella, according to your sales and collections.

THE amount of money required to start with, varies directly with the size of territory occupied. One man, for example, recently bought outright the entire state of Maine; another started at the same time on a royalty in a half-county in Ohio.

YOU may acquire your territory outright or we will share with you on a royalty basis. In either case—compared with the possible returns—the cash investment is ridiculously small.

REMEMBER, the Norwalk Vault is a trade-marked article fully protected by patents. Eight years' test has shown no weakness. More than 12,000 vaults have already been made, sold and used. Half of the good territory of the whole United States is already gone. And remember that every day—with each new round of advertising, with the opening of every new territory—comes a jump in values for those already in.

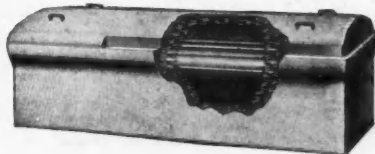

SO IF the proposition appeals to you at all, don't pass it by because it is new; before it is much older someone else may take it. Let us prove it out for you. We will be glad to show you original letters, figures, maps, models, or to take you to the nearest local factory and let you see the vaults themselves. (We are so busy, however, that we would greatly appreciate the favor of your not writing, unless you are in a position to talk real business in case you are thoroughly satisfied on every point.) If you think you might be interested, ask us anything you want to know—our office and sales force are paid to answer your questions—no obligation on your part whatever.

THE NORWALK VAULT COMPANY

40 Seminary Street

Norwalk, Ohio

WHEN WRITING ADVERTISERS PLEASE MENTION THE AMERICAN CARPENTER AND BUILDER

BOSTON

TRUSS LOOP LATH

The Builders Metal Lath—heavy—five (5) pounds per square yard for interior work—eight (8) pounds per square yard for exterior work—easily erected, no stretching and pulling—gives the lowest cost of finished plastered surface of any Metal Lath.

METAL LATH

A Building is not modern without some measure of fireproofing. Metal Lath and plaster is fireproof. Professor McGregor's New York test proves it (write for a copy for your own satisfaction), then build your side walls, ceilings and partitions of Bostwick "Truss-Loop" Metal Lath and plaster to give the greatest strength to get the lowest cost.

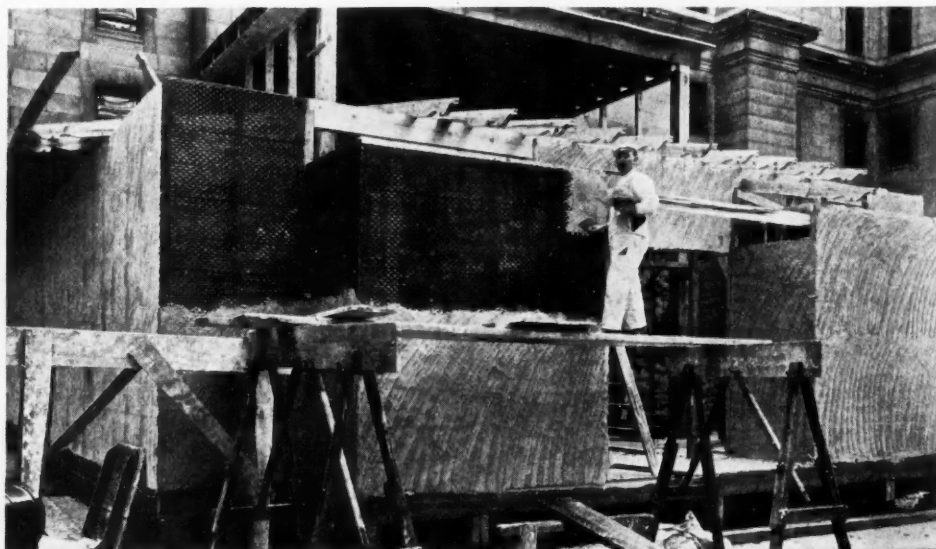

W

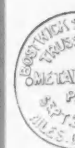

surface
plaster
Note
When l

For s
heavier
you mo
pounds
saver f

To fi
unsight
lines.
(the B
makes
"Bostw

The

PH

BOSTWICK

Why TRUSS LOOP Lath



Not on account of cost or of weight and strength only, the plaster key is the largest, heaviest and strongest furnished by any Metal Lath. There are no come-backs for the plaster loosening and breaking away from the Lath with "Bostwick Truss-Loop" and "What's in a name," the "truss" in "Truss-Loop," not only in the name but in the Lath. Ask any Architect or Engineer for the best principle of construction for weight carrying capacity and he will answer "Truss"; the principle is applied to Metal Lath in "Truss-Loop," insures you a plaster base that will neither buckle nor sag and gives a

surface of such rigidity that the quickest possible time can be made in plastering.

Note these "Trusses," then send for a sample and examine the real thing. When buying the Lath, watch for this tag. Do not buy imitations.

FOR STUCCO WORK

For stucco work you specially need strength and rigidity—your ground is heavier, a movement in your wet mortar coat means surface cracks; they cost you money, time, reputation. Bostwick "Truss-Loop" Special XXX—eight (8) pounds per square yard—will hold your work as it should be held; is your life saver for Stucco, Pebble Dash or Half Timbered work.

BOSTWICK METAL CORNER BEAD

To finish your Metal Lath and plaster work, to protect yourself against unsightly chipped and broken corners, to facilitate the plumbing of your outlines, use Bostwick Metal Corner Bead—the clip fits every angle of the bead (the Bostwick feature) re-enforces to double strength every 12 inches it is used, makes it applicable to any ground. It's one bead for EVERY purpose if it's "Bostwick."

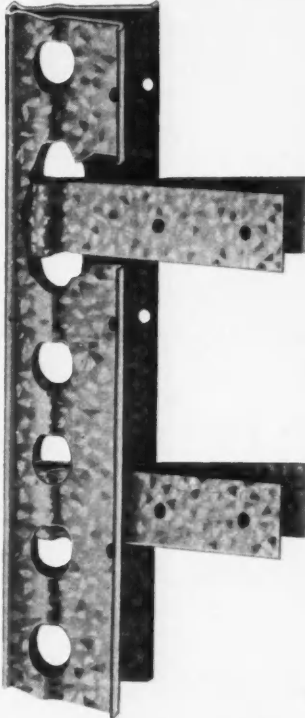

The Bostwick Steel Lath Co.
NILES, OHIO

Philadelphia, Penna., Branch, 135 North 22d Street

GROUND BEAD OR BASE SECTION

The last word in Hygienic, fireproof construction, does away with the unsanitary Base Board—when composition floors are used—prevents your plaster and composition from mixing, insures full depth of ground for each. Inside and outside corners supplied as desired.



THE COUPON ATTACHED IS VALUABLE

THE BOSTWICK STEEL LATH CO., NILES, OHIO
Philadelphia, Penna., Branch, 135 North 22d Street

The Bostwick Steel Lath Co.,
Niles, Ohio.

Gentlemen:—

Please send me FREE OF CHARGE, sample of Bostwick "Truss-Loop" Lath with specifications.

Name.....

Address.....

City.....

State.....

"Double Speed"—A Trademark with a Meaning

Few trademarks more fully describe the product they represent than does this one, as applied to the line of cement brick and cement block machines made by Northwestern Manufacturing Co., 31 Orcutt Bldg., Sioux City, Iowa.



Both brick and block machines are made with a double row of forms, making it possible for an operator to practically double his output. Their power tamper is arranged to work over either brick or block machine, by simple change of feet. It has an automatic device for removing surplus material.

Both machines are of the face-down type, making it possible to turn out all kinds of designs.

Any builder in the market for cement machines would do well to address this manufacturer for information on his line before coming to any decision.



Specially Prepared Burlap Ideal Wall Covering for Public Buildings

We have before us two samples of ready-to-put-on wall burlap. One is a coarse grain cloth for use where the regular burlap effect is desired; the other is fine in weave, for use where an absolutely smooth surface is wanted. These are put out by the Cott-a-lap Company, of Somerville, N. J.

The fabric, in each case, has been sized and given one coat of genuine linseed oil paint. This makes it waterproof, and prepares it for putting on walls.

Any paper-hanger can put it on. After hanging, a coat of color to suit may be applied. For a tile surface, the

finer weave may be given two coats of enamel.

Being waterproof, these burlaps may be washed with soap and water, or an antiseptic.

In buildings where wear is hard on walls, such as schools, hospitals, apartment houses, stores, offices or theatres, this wall covering is ideal. The textile is so strong that the hardest average knocks will never mar the plaster or surface beneath. Cracks in plaster are held from widening, or altogether prevented.

The company will be glad to send samples and prices to any one inquiring.



How to Concrete in Cold Weather

An entirely new discovery has enabled the laying of concrete in cold weather without the usual methods resorted to of covering with straw or canvas, heating water, keeping fires, etc.

This mixture is the invention of an eastern man, and great things are claimed for it. Following is a letter from one user in Boston, Mass.:

Lansing Co.,

Lansing Mich.

Gentlemen:—Replying to yours of the 19th, in relation to Frost-proofing, will state we have used this on a fireproof garage which we built for ourselves late last fall and in freezing weather. We put on a reinforced concrete roof, using the Frostproofing as directed. The following day we trowelled and finished the roof without the concrete freezing.

The temperature did not go below 20 deg. at the time we started to pour the concrete, but we had a very severe snowstorm within a few days after the job was finished and the snow lay on the roof for two or three weeks. When it was cleared we found the roof to be in the same condition as it was before the snowstorm, which was perfectly satisfactory.

W. A. MURTFELDT CO.

The Lansing Company will send to all of our readers complete data, tests, and full information on this material, and we would recommend everyone having concrete work to do to write the Lansing Company, 1002 Cedar St., Lansing, Mich., for full particulars.

A Better Wall-Board at a Lower Price

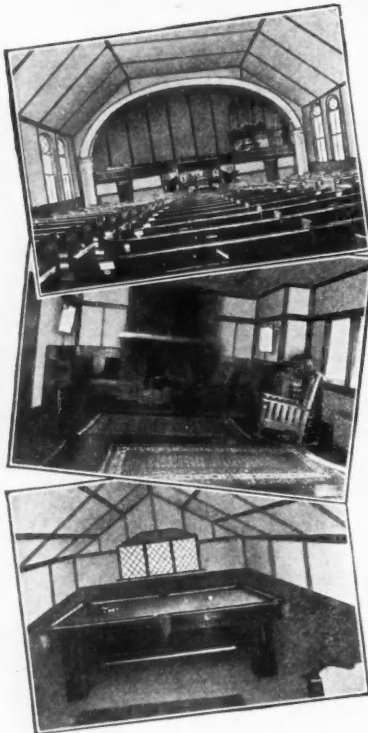

Because—

Huge modern mill facilities assure low production cost. \$3,500,000 investment. 15,000 acres of timber land owned by us and located at our mill doors in Wisconsin. 20,000 H. P. dam owned by us and built as a part of our mill. Daily capacity, 300,000 sq. ft. of wall-board.

CORNELL BOARD

All Pure
Wood
Fibre

The only wall-board made from log to finished product under one roof and one management. We control our quality from start to finish. Cornell Board is sized throughout—produced at a lower cost than possible for any other source of supply.

Distributors everywhere. Write for samples, prices, dealers' names, etc.

Cornell Wood Products Co.

General and Sales Office
Cornell, Wisconsin



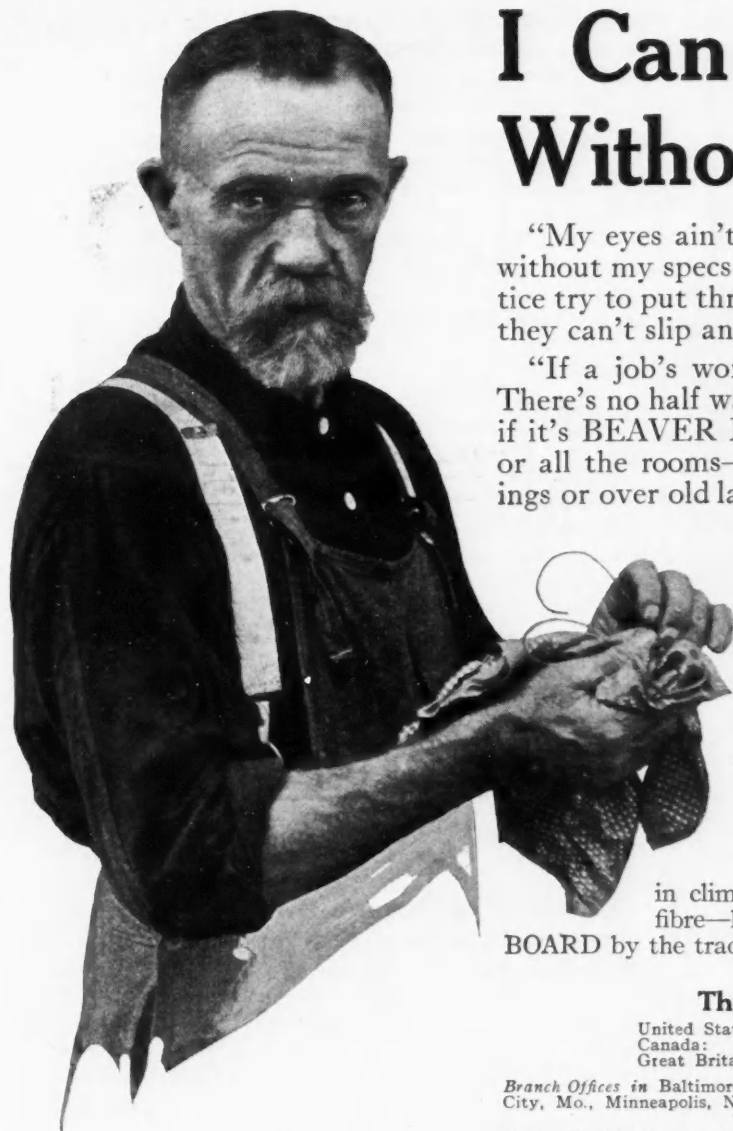

I Can See It Without My Specs

"My eyes ain't any too good but I can see a bad job without my specs. I've seen many a fresh young apprentice try to put through a job slap-dash, any old way. But they can't slip anything over on the old man.

"If a job's worth doing at all, it's worth doing well. There's no half way about it. Don't make any difference if it's BEAVER BOARD walls and ceilings in one room or all the rooms—in big houses or small—in new buildings or over old lath and plaster—the BEAVER BOARD goes up *right* as long as I'm on the job. I took just as much pains with the attic I finished off for a spare room as I would with any fine living room.

"Take my advice and get started right on BEAVER BOARD. The Builders' Service Department gave me all the pointers. They'll do the same for you."

You can't expect other wall-boards to give the same satisfaction to the customer as BEAVER BOARD. It's sized on both sides to prevent absorption of moisture and withstand changes in climate or temperature. It's made of pure-wood-fibre—long, tough, durable. Identify genuine BEAVER BOARD by the trade-mark stamped on back of each panel.

The Beaver Board Companies

United States: 218 Beaver Road, Buffalo, N. Y.
 Canada: 418 Wall Street, Beaverdale, Ottawa.
 Great Britain: 4 Southampton Row, London, W. C.

Branch Offices in Baltimore, Boston, Chicago, Cleveland, Detroit, Indianapolis, Kansas City, Mo., Minneapolis, New York City, Omaha, Philadelphia, San Francisco.

A cordial invitation is extended to builders, contractors and carpenters to visit any of the above offices

BEAVER BOARD
 ceiling in the Elk's Lodge
 Room, Rocky Ford, Col.
 A big job—well done.

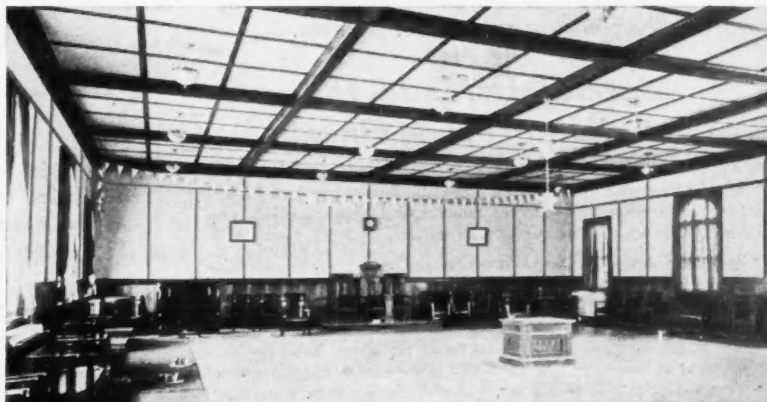

Send for free sample and book of special interest to carpenters.

BEAVER BOARD WALLS & CEILINGS

WHEN WRITING ADVERTISERS PLEASE MENTION THE AMERICAN CARPENTER AND BUILDER

This job showed a \$22 Profit

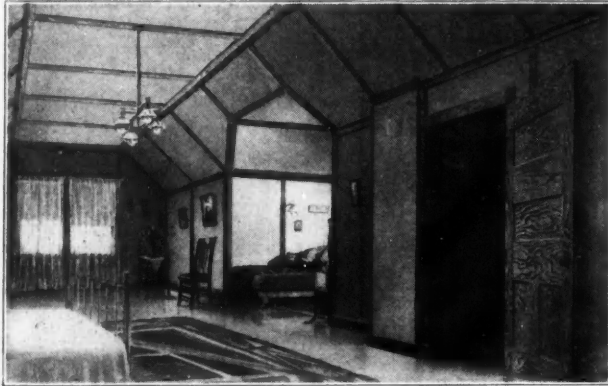

THE CONTRACTOR was able to do the job in stormy weather because he used Utility-Board. You, too, can make similar profits when business is slack or weather unfavorable. Every town has a job like this to be done.

UTILITY-BOARD the preferred wall-board

Utility-Board is a special composition fibre board—built up of layers lastingly welded together with hot asphalt under tons of pressure into stiff, moisture-proof sheets of convenient size.

Utility-Board nails direct to the studding and joists or it can be applied over old plaster or ceiling without removing the plaster or ceiling from the walls.

Special Offer to the Building Trade Only

We have had struck off a number of enlarged reproductions (size 5"x6") of the attic room shown above. While they last we will send them, together with liberal samples of Utility-Board to any carpenter, builder or contractor who writes us.

Every attic should be lined—it makes the top of the house cooler in summer and warmer in winter—shuts out the dust and dirt—puts the attic in shape to be lived in. You probably know of several families in your town who could use an extra room in their attic to advantage. Drop postal today for one of these pictures and use it to show them what can be done with Utility-Board at very small cost. They will want one of these rooms when they see the picture.

THE HEPPEES COMPANY

Mfrs. also of Flex-a-Tile Asphalt
Shingles, Asphalt Paint and Asphalt
Roofing in Any Finish

4503 Fillmore Street,

CHICAGO, ILL.

Builders Find Opportunity in Growing Popularity of Acetylene

The public is gradually coming to recognize acetylene gas as the solution to many lighting problems. In nearly every community are scores of houses where this gas might be used economically. And, without doubt, plants will be installed for these people very soon.

Many carpenters and builders are following up this opening. Their knowledge of building and lighting problems gives weight to their recommendations along such lines.

A handsome commission proposition is offered any builder who cares to follow this up. Address the Gem City Acetylene Generator Co., Dept. G, Dayton, Ohio. These people manufacture the "Faultless" pit generator. A sectional view of one is shown. Anyone interested, however, should communicate with them toward getting more complete information, illustrations and prices.

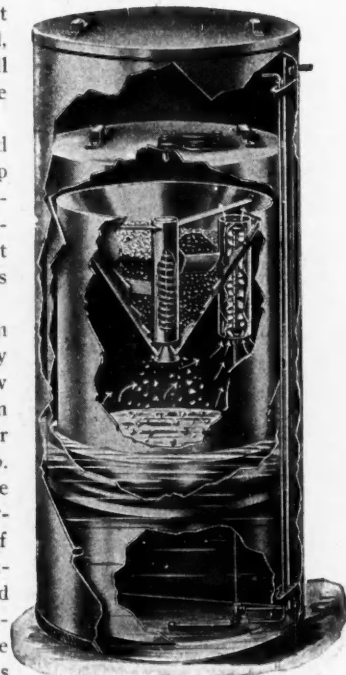

Gem Acetylene Generator.

Valuable Reference Book on Roofing

The Heppes Company has just published a complete reference book of all their different lines of roofing. This book is unique in that it shows the different brands of roll roofing manufactured by the Heppes Company just as they look on the roofs. Particularly timely is their offer to include with the copy of this handsome reference book, samples of their new Flex-a-Tile Giant asphalt shingles. The Flex-a-Tile Giant is not only 50 per cent thicker, 50 per cent stiffer and 100 per cent stronger than their standard asphalt shingle, but it possesses the quality which only the finest and most carefully chosen materials can assure.

Every contractor should have this reference book in his files, together with samples of all the Heppes roofings. As is well known to the trade in general, the Heppes Company have for years specialized in the high grade roofing.

We advise every contractor to send for this new reference book, which in itself is a work of art, in addition to its informative value, and to ask at the same time for the samples which the Heppes Company will willingly send. Their address is 4503 Fillmore St., Chicago.

The Sultan at the Cement Show

One of the features of the 1915 Chicago Cement Show was the fine exhibit of the Sultan power equipment family in the space of the Whitman A. Company of St. Louis, Mo. This line of machinery and woodworking equipment attracted the big attention from visiting contractors.

One of the features was that shown in photo on page 118 and is worthy of special description. The Sultan tilting cross-cut saw is very compact in its construction; the outfit is adapted for cross-cutting of all kinds, especially for cutting stock for boxes, sash, doors, furniture and all general contracting and mill work. It can be belted from above, below or rear. The machine has its own table made with hand

“Every Roof is my Roof”



“That’s a fact. Every NEPONSET Roof in my town is *my* roof. A few people don’t even know the name of the shingles, but they *do* know that *I* laid them. To hear them talk you’d think that *I made* the shingles!

NEPONSET Shingles

PATENTED

have meant a lot of new business for me — business I never would have got, and yet I’m laying just as many wooden shingle roofs as ever!

“These are the only *built-up* shingles I know of — durable, attractive and fire protecting. Easy and economical to lay.”

The same materials are used in **Neponset** Shingles as in the well known **PAROID** Roofing, also used in **Neponset** Proslate, the highest grade colored ready roofing ever made. **Neponset** Wall Board, **Neponset** Waterproof Building Paper and **Neponset** Floor Covering are other well known **Neponset** products

Bird & Son, Department C, East Walpole, Mass.

Please send me a sample of the NEPONSET Shingle. This does not obligate me in any way whatever. Also send copy of your booklet “Repairing and Building.”



Name.....

Address.....

COUPON

COUPON

holes, belt shifter and counter shaft that can be easily regulated to take up the slack in the belt (this in addition to automatic belt tightener), and countershaft with tight and loose pulley, 8-inch diameter by 4-inch face, which should be run at 800 revolutions per minute. The Whitman A. Company have overcome the necessity of putting up a countershaft, as in some cases saws cannot be run at all unless belted from overhead.

The machine shown is well constructed of steel and iron, top planed, provided with offsets to receive extensions of any desired length in case iron extensions are not used, and equipped with conductor pipe from the saw to the fan pipe. The saw is 16 inches in diameter, cuts 18 inches wide, and can be fed to the work either by hand or foot power. After the cut is made the saw returns to the iron guard, making it absolutely safe for the operator.

On structural steel buildings this saw may be used to a great advantage for frame cutting when concrete is poured around the steel beams. Being light in weight and easily portable, it can be moved from floor to floor on any standard gauge material elevator. Aside from steel concrete construction work, this machine is very economical for cross-cutting work on large buildings where thousands of feet of lumber must be cut.

Other forms of equipment supplied by the Whitman A. Company consist of gasoline engines for contractors' work, home electric lighting plants and water supply systems, trench pumping outfits, reversible gasoline engine hoists, electric driven builders' hoists, double gauge material elevators, builders' winches and dump cars and self-dumping and self-righting concrete buckets.

This concern has placed upon the market five sizes of the Sultan concrete bucket, ranging from the smallest size practicable up to the largest size that is used. The six-foot bucket

fills a want long felt by the average small contractor and builder, and can be successfully operated with a small gasoline hoist. These buckets are tight in the seams, well made and thoroughly tested.

We would advise that our readers write to the Whitman A. Company, 7003 South Broadway, St. Louis, Mo., and obtain their latest catalog on contractors' equipment. This catalog contains much valuable information and will prove of interest to any builder or contractor who uses either wood-working or general contracting equipment.

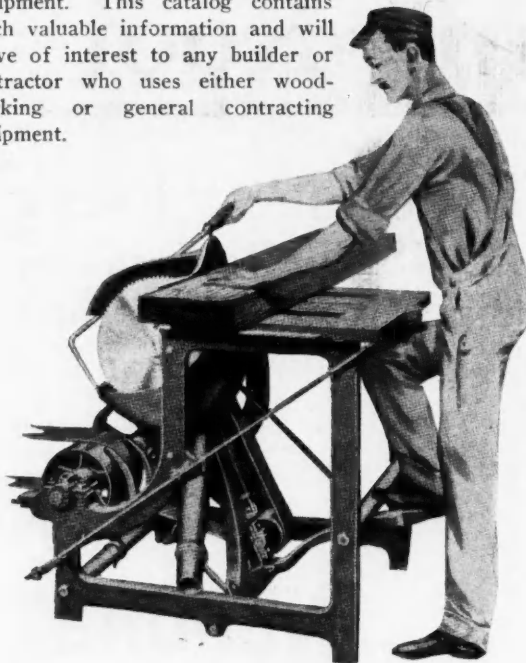

One of the Novelties in the Whitman Line. Write for Catalog.



When Building—

Make your walls fire proof, sound proof, damp proof, warm in winter and cool in summer, with

National Brand Plaster Board

- 1 National Plaster Board**—in sheets 32x36 inches and 5-16 to 3-8 of an inch thick. It is incombustible, deadens sound, insulates heat and cold and is an efficient fire retardent.
- 2 National Plaster Board** is light and has great tensile strength; it makes strong, firm walls and ceilings which are quickly and easily built.
- 3 National Plaster Board** makes a perfect bond with hard wall plaster, which can be applied immediately, saving time, labor and material. It is also an excellent substitute for wood sheathing under siding.

The Ideal Lath

It will not warp, rot or corrode—and the price is reasonable



Write us for a sample of Plaster Board and test it in any way you wish.

The National Plaster Board Company
1408 Rockefeller Bldg.

Cleveland, Ohio

ROBERD'S OAK WALL BOARD

OUR OAK FINISH

is NOT pasted on, nor is it in any way a mechanical or imitation design of oak, but is an exact reproduction of the genuine wood, so perfect that even the most skilled observer cannot detect it. Our Oak Wall Board is produced by an exclusive process which is controlled by us, and is furnished in either 32 or 48 inch widths. This new Oak Finish has a thousand uses. For wainscoting or paneling it is unsurpassed. Will give the most artistic and beautiful results at the minimum cost.

ROBERD'S *Ideal* WALL BOARD

in our regular shades of gray and tan is made of four sheets of macerated wood fibre cemented together with a heavy layer of asphalt cement under hydraulic pressure. It is not only superior to plaster, but is the heaviest, toughest and most durable wall board made, being the only brand which is composed of seven distinct layers, making it 7 ply.

Builders everywhere are now using Ideal Wall Board because it is far superior in every way to the old style plastered walls and ceilings. It is absolutely water-proof, will resist heat and cold, is fire retarding, will not check nor crack, will not mar nor crumble, and can be kalsomined, stenciled, painted or papered.

Read these two letters which show that ROBERD'S IDEAL WALL BOARD is a business getter for any dealer, carpenter or builder:

Kokomo, Ind.
"The IDEAL Wall Board recently purchased from you for the Bittinger Apartment building in this city has given good satisfaction. It saved time and made less dirt and moisture, and above all it is more economical than plaster. Our customers are well pleased."

MOORE & DANNER,
Contractors and Builders.

Ludington, Mich.
"Your IDEAL Wall Board has given us the best satisfaction of any Wall Board that we have bought, sold and used. We take great pleasure in recommending IDEAL Wall Board. It is economy to use it."

PERE MARQUETTE PAINT &
SUPPLY Co.

Write today for free samples and prices of our complete wall board line. Finished in gray, tan, mission oak and quarter sawed oak.

The Roberds Mfg. Co.

100 Railroad Avenue
Marion, Ind.

• MARCH •

Sun	Mon	Tues	Wed	Thurs	Fri	Sat
	1	2	3	4	5	6
7	8	9	10	11	12	13
14	15	16	17	18	19	20
21	22	23	24	25	26	27

Time to the

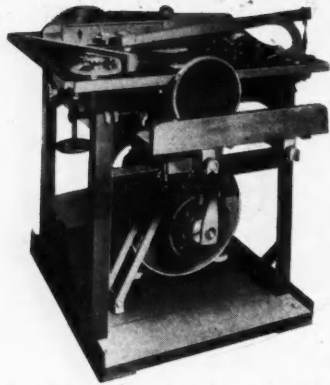

THE SULTAN COMPLETE PORTABLE SAW RIG
For all around efficiency this machine is unsurpassed. Is equipped with five H. P. Sultan Sawing Engine. The Saw has gravity blower to take saw-dust or shavings away from engine at all times.



LIGHT PORTABLE SULTAN WOODWORKER
This machine is easily portable. This Sultan with one man will get out as much work as six with hand saws in two days. Figure out—can you afford it?

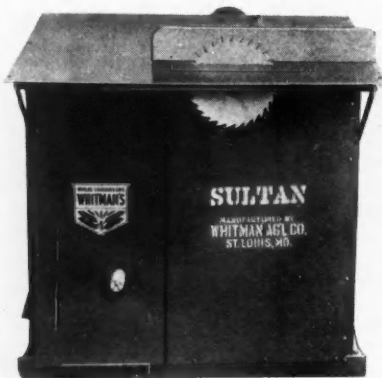

THE SULTAN MIDGET PORTABLE SAW RIG
Here is an all-steel Portable Saw Rig. It is especially made for cross-cutting and rip sawing. It is very reasonable in cost and will pay for itself on a few jobs.

with SULTAN Power and Equipment Make This Year a Record-Breaker

Make it show increased business and larger profits by investing in dependable, money-making Contractors' Equipment. Sultan equipment enables you to underbid your competitors and make big profits, too. It also increases your capacity for work during a season. Every practical man can see the many advantages modern equipment has over old methods. The same practical man will quickly see the superior qualities of Sultan Contractors' Equipment. All Sultan Power Equipment has the Improved Sultan Engine. As you know the engine is the heart of any power equipment so you should give it particular thought. We are pioneers in the gasoline engine field and the Sultan Improved Engine represents highest degree of efficiency in Gas Engine construction and design. It is built for hard and continued service. With the Sultan you will have no costly break-downs or engine trouble. Years of experimenting and experience in making Propelled Machinery have resulted in an improved type of engine that is simple to operate, that is economical in fuel consumption and, above all, an engine that will give continuous service day in and day out. No matter what sort of contracting work you do, we have a machine for your individual needs that will earn you money.

WHITMAN A. COMPANY
7003 South Broadway, St. Louis, Mo.

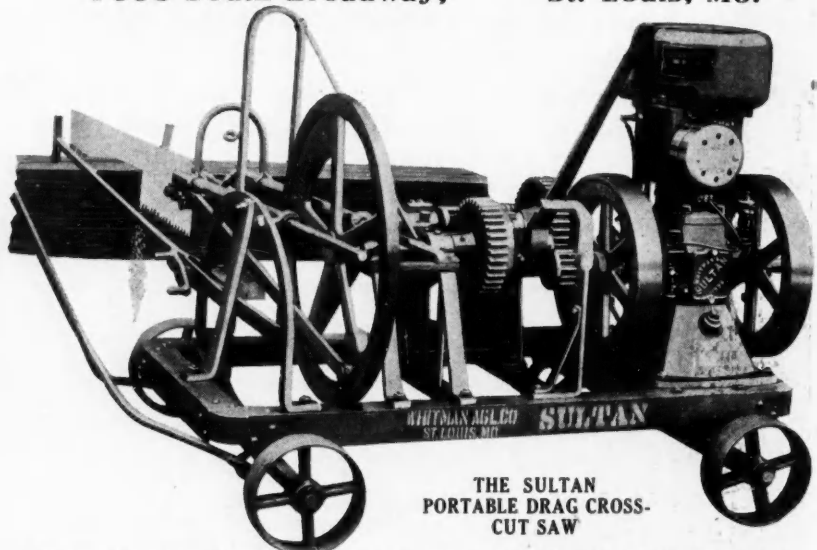

THE SULTAN PORTABLE DRAG CROSS-CUT SAW

This complete Engine-driven Steel Frame Drag Saw will pay for itself. The saving in time and labor is tremendous. It saws three to five times the logs or timbers eight to ten men saw in a day. Saws timbers or logs while they are lying on the ground. This engine-driven saw will be found invaluable on heavy construction work where heavy logs or timbers are used.

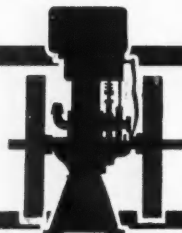

WHITMAN A.

7003 South Broadway

Get on Job

• MARCH •						
Sun	Mon	Tues	Wed	Thurs	Fr.	Sat
7	8	9	10	11	12	13
14	15	16	17	18	19	20
21	22	23	24	25	26	27
28	29	30	31			

SULTAN

Saw Rigs, Hoists, Winches, Swing Saw Tables, Material Elevators Portable Drag Cross Cut Saws Pumps, Self-Dumping Concrete Buckets, Tilting Cross Cut Saws, Etc.

We Make Three Models of

Saw Rigs—The Sultan Complete Portable Saw Rig, The Light Portable Saw Rig and Sultan Midget Portable Saw Rig. All are driven by the Improved Sultan Engine and all are equipped with the well known Disston Saws. Our Catalogue shows complete equipment and parts of each machine. We also make two types of Hoists. The Sultan Direct Friction Hoist and the Sultan Skidded Belt-Driven Hoist. These hoists do the work of a large force of men at a fraction of the cost and time. Sultan Hoists show big profits wherever used. We wish to call special attention to the Sultan Portable Drag Cross-cut Saw. Here is the latest Sultan money-maker for the Contractor. This machine eliminates all slow and tedious hand cross-cutting. It saves time and labor, unnecessary to lift logs off the ground. We can't begin to tell of its merits here. Will saw off a 12 by 12-inch in 39 seconds.



SULTAN WINCHES

are solid and rigid. Being bolted and riveted as to make the whole frame a solid unit. Gearing is lined perfectly and an extra strong steel ratchet pawl engages large gear, enabling operator to securely lock the winch at will.

The Sultan all-steel winch or crab is rigid and powerful and can be used for hoisting, pulling out concrete forms, for loading, etc. These winches are strongly made and built for the hardest kind of service. Made in several sizes to fit various needs.

Sultan Swing Table Sawing Machines are very handy around construction work, where power is obtainable. They saw heavy timbers, beams, joists, etc. This same machine can be converted into a cordwood sawing machine by simply changing the table to the frame end of the saw.

WHITMAN A. COMPANY

7003 South Broadway
ST. LOUIS, MISSOURI

WHITMAN AGENCIES

W. A. LOUER, Old Colony Building, Chicago
GEO. F. SMITH, 81020 Main Street, St. Louis, Mo.
E. R. BACON, San Francisco, Los Angeles, Cal.

MILLS & LIPTON, Chattanooga, Tenn.
ELLIS WOOLMAN, Minneapolis, Minn.
W. W. DUPRE, Keokuk, Iowa
PATTERSON SUPPLY CO., New Orleans, La.

BECKWITH BROS., Pittsburgh, Pa.
GEO. T. WALLACE SALES CO., Detroit, Mich.
FRANK DYKAMA, Grand Rapids, Mich.
WARREN BROS., Louisville, Ky.

MILLS BROS., Toronto, Canada

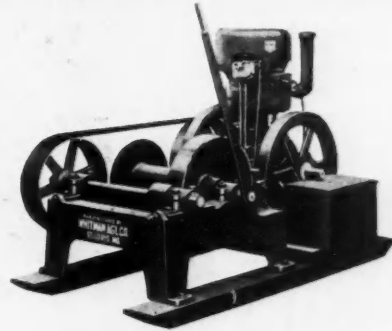

SULTAN SKIDDED BELT-DRIVEN HOIST

This hoist is especially adapted for Contractors and Builders. Make your jobs pay bigger profits by using power hoists. Hoist illustrated above is the Sultan Belt Driven Hoist.

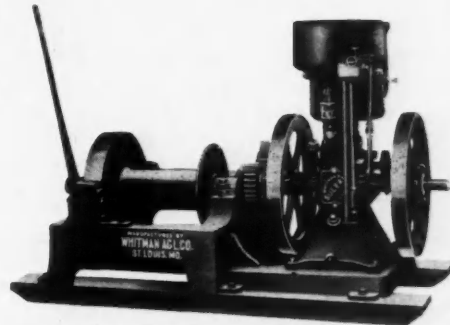

SULTAN DIRECT GEAR-DRIVEN HOIST

Here is a light portable hoist for hoisting brick, mortar or other building materials. It operates a whole day for about 45 cents. The construction is all iron and steel and it will last indefinitely. It is simple to operate and will give constant reliable service.

SULTAN BELT-DRIVEN HOIST WITHOUT ENGINE

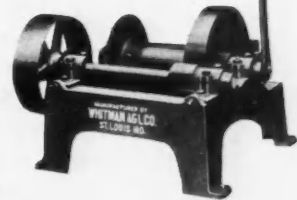

Send for your copy of this book.

SULTAN CONTRACTORS EQUIPMENT

It takes up every machine illustrated here in detail and more too. Everything for the Contractor. It shows all details of the Improved Sultan Engine and shows why it is better for Contractors' Equipment. This handsome book is given to Contractors and Builders absolutely Free. Send for your Copy today.

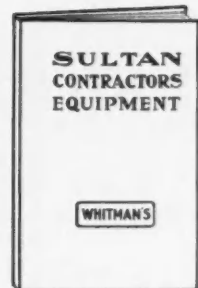

COMPANY

St. Louis, Missouri.

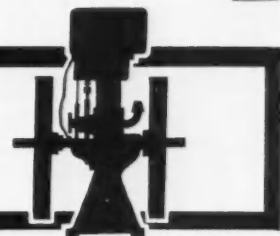

Another Improvement on Buckeye Planes

By means of a little device in the cap plate—an adjusting thumb screw, and a thumb screw to lock the adjusting screw—the Buckeye Saw Vise Company, Cleveland, Ohio, have turned out a plane which requires but a few seconds to set blade. Heretofore the planes turned out by this company have had cap plate stationary in plane. In the new model, cap plate is removable as shown in illustration.

The advantage of this plane is that a slight turn on adjusting screw will control depth of shaving, no time being required to "set" blade. By moving screw to right or left, the edge of blade may be squared with bottom of plane.

To the man who is looking for time-savers, this plane will be very interesting. Every detail of construction is up to the Buckeye standard. Their catalog, which may be had by writing to above address, gives full information regarding this plane, as well as their line of saw vises.



Plane Has Instant Setting Screw.

Importance of Wood Filler

As the present tendency is to finish all the interior trim of our homes in natural finishes, a word in regard to the treatment of the wood will not be out of place.

There are a number of painters who have an idea that shellac makes the best filler. Shellac, as a rule, always

raises the grain of the wood, and in such condition that to make a good job the trim will have to be sandpapered again; and that takes time, also within a short time the color darkens and the beauty of the grain of the wood is lost. Then again, some think any old thing will do for a filler, as they put two and three coats of varnish on every other day, or, in fact, before the under coat is dry.

The mistake here is like a house placed upon a poor foundation, there is always trouble, whereas my experience, writes an authority, is that where you use a liquid or a paste wood filler you should use the best. I have finished work with only one coat of varnish that has stood for five or six years without losing its luster. Whereas, in using a poor filler and two or three coats of varnish, in less than six months time the varnish has shown cracks and lost its luster entirely. I have used filler of different kinds; one that has given me entire satisfaction and saved me money is the Rices Superior light liquid wood filler, as made by the S. E. M. Rice Filler Co., Irvington, N. J., formerly of Newark.

Copper Eaves Troughs Give Lightning Protection

Many people are coming to see that copper eaves troughs and conductor spouts are valuable in more ways than one. In addition to the facts that these copper troughs and spouts practically never wear out—lasting a lifetime without any attention of any kind, not even requiring painting—they are splendid conductors of electricity—and naturally act as protection against lightning. They cost no more to put on than iron, which would make it seem they were about right for the uses mentioned.

C. G. Hussey & Co., of Pittsburgh, Pa., specializes in this material, and will gladly furnish literature and prices on request.

Why White Lead Independence Hall?

It is the birthplace of our Nation. It has stood since 1729 and the people demand its preservation. Here met the Continental Congress which made Washington Commander-in-Chief of the American Army. Here the Declaration of Independence was framed. Those responsible to the American people for the preservation of Independence Hall protect it with Paint made of

Dutch Boy White Lead

and pure linseed oil—the paint that laughs at time and defies the weather.

The preservation of the houses you plan is equally important to you. See that **Dutch Boy White Lead** and **Dutch Boy Linseed Oil** are used, mixed to suit conditions and tinted any color. With low first cost and long wear your client saves at both ends and gets maximum protection.

The paint does not have to be white. Most any color can be had by the addition of tinting matter.

Would you like to see some of the color combinations obtainable? Ask our nearest branch to mail Folders "B"—they include directions for mixing specifications, etc.



NATIONAL LEAD COMPANY

New York	Chicago	Cleveland
Buffalo	Cincinnati	St. Louis
Boston	San Francisco	

John T. Lewis & Bros. Co., Philadelphia
National Lead & Oil Co., Pittsburgh

Listen, Mr. Contractor and Builder! Hog Raisers All Want Sunshine Hog House Windows

They Look to You for Modern Plans

There's a profit coming to you because of that, if you want it.

The average farmer now-a-days knows very well that his hogs need sunshine and that he cannot afford to keep them in damp, unlighted hog houses. He wants windows in that hog house that will give the hogs direct sunshine in the winter months without their being exposed to outdoor temperatures.

Sunshine Hog House Windows are the best made for the purpose and the farmer knows it—that's why he demands them.

You Can Install Sunshine Windows More Quickly and Easily than any Others

They are made of heavy galvanized iron and fit into the roof of the house. All that is necessary to do to put them in place is simply to remove the shingles from a space large enough to admit the window, insert the window and then reshingle over the flashing. They can be put into either old or new hog houses and they'll please your customers—every one of them. There's more profit for you in the actual work if you sell and install Sunshine Windows than you can make on wooden windows. More than that, your customers will be absolutely satisfied—they get rust-proof, rot-proof and leak-proof windows that are good for many times the service wooden windows give. Sell Sunshine Windows—handle the modern product and pocket the profits that are yours for the taking.



Chief Sidewall Sliding Window and Sash Combined— For all Farm Buildings

The happiest, most practical, most economical and most satisfactory window you can install. Suited to any kind of a building where light is wanted. Made of heavy galvanized iron and made so that it can't leak. Rot-proof and rust-proof. Neat, strong and extremely durable. You can install these windows in old buildings or build them into new ones. They can be set to slide open, up, down or sideways, as desired. Window always slides easily in the frame. There's no shrink or swell to our metal frames. Glass is easily replaceable—no putty used. Chief Sidewall Windows satisfy users. They cost about the same, last longer and give more satisfactory service than wooden sash.

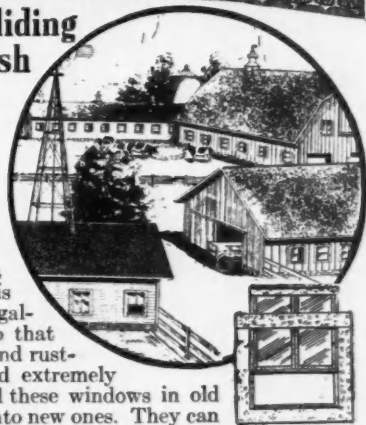

Chief Cupolas Give Stock Pure Air

They are scientifically designed and constructed and they absolutely insure fresh air in buildings where installed. They suck up and out the bad air and odors, leaving the barn full of pure air. They keep stock healthy.

Chief Cupolas are made of heavy galvanized steel—good for a lifetime of service. They won't rust and can't rot, break or wear out. They require no paint and no repairs. They won't leak, and birds can't nest in them.

They cost less than wooden cupolas, look better, ventilate better and last much longer.



Add to Your Profits

There's money in these windows and cupolas for you. The demand for them is large and is growing constantly. They satisfy every user, increase your business and give you a good individual profit—more profit, your time and labor considered, than you can realize from the installation of old-fashioned windows and cupolas.

Write for our literature and prices on Chief Products. We'll make you a mighty interesting proposition and we'll help you make sales and get the cream of the window and cupola business. Write us today.

Shrauger & Johnson

430 Walnut St.

ATLANTIC, IOWA

The Center of the Picture

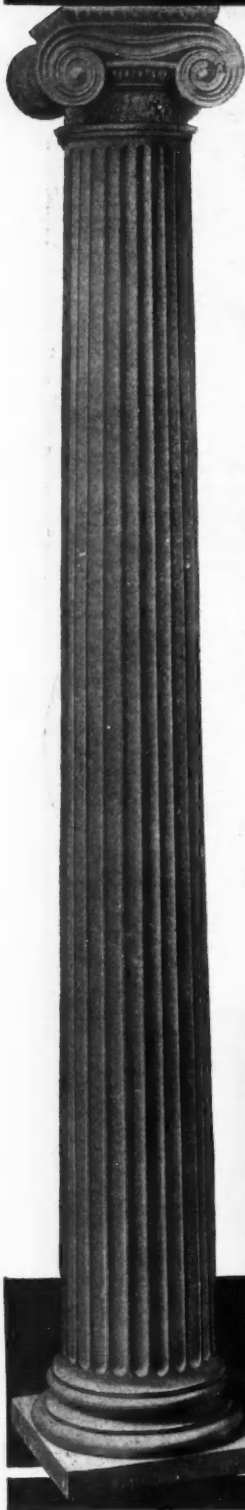

On any building where columns are used they are the first thing to catch the eye and the longest remembered.

How important that they should be of material that will not check, split, rot, warp or open at the joints and thus spoil the looks of the entire job.

UNION METAL COLUMNS

"THE ONES THAT LAST A LIFETIME"

are of open hearth steel specially galvanized—a sufficient guarantee that they will never mar the building with unsightly cracks and crevices which are bound to show up in wood columns.

Union Metal Columns are correct in design—with Entasis and Stopped Flutes—conforming in every particular to the classical orders of architecture.

They are made in all sizes up to 40 inches in diameter and 35 feet high and there are ten artistic designs to choose from.

Write for folder showing installations, construction and various styles.

See Sweet's Catalog for Data

The Union Metal Mfg. Co.
CANTON - - - OHIO

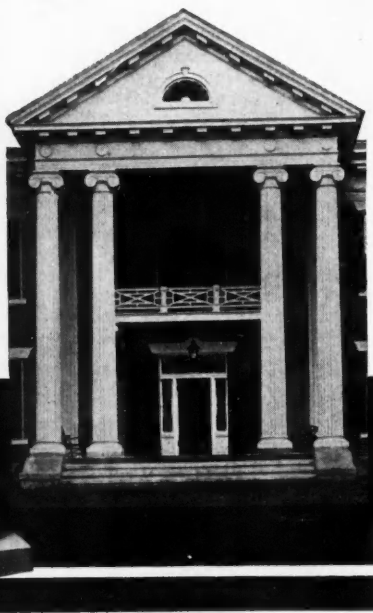

Terra Cotta Offer is extended to March 31st

The offer made by the Midland Terra Cotta Company last month has created quite a sensation in the trade. They offered, as an introduction, to furnish either of two handsome store fronts of their high-grade terra cotta at a price startlingly low. Because of this extremely low price the offer was limited to one order in a community, and that within thirty days.

The results of this offer have been way beyond the wildest dreams of everyone concerned. Clerks, shopmen, inspectors, packers, shippers, bookkeepers—in fact, everybody at their plant—has been kept on the jump to keep up with the orders, and their staff of architectural draftsmen have been busy designing and estimating modifications and changes from the two store fronts offered, where something different was wanted.

Without doubt a good many of our folks have not been able to get action on this proposition in the thirty days allowed—it's a fine and strong "talker" in soliciting store front business—so in order not to disappoint anyone the Midland people are extending the offer to March 31st.

We urge our readers to get in, this time, without fail. Elsewhere in the paper, their announcement gives details of the offer. If information found there is not sufficient, write the Midland Terra Cotta Company, 1120 Chamber of Commerce Building, Chicago.



Protractor Square that makes Calculations for Carpenters

The A B C Protractor Square, manufactured by the Stamping and Tool Company, Department 7, La Crosse, Wis., is one of the most useful tools the carpenter or builder can have in his tool chest. It is as simple to use as the steel square, but is far quicker in giving correct readings and measurements.

It is chiefly valuable in finding lengths, bevels and cuts of rafters and other framing timber. To the man who has no time for making difficult calculations, this tool is a mighty good friend. Complete instructions for using, clearly worded, come with each square. And the price to our subscribers is very reasonable.

In the catalog of this company are listed a number of other things of interest to our readers.

Among them are door fasteners, handles, combination wrenches, foot-scrapers, aluminum house numbers, cement brick machines, etc. Upon request, the company will gladly mail price list, catalog, and any other information desired.

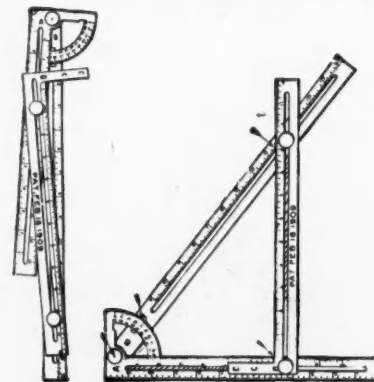

"ABC" Protractor Square in Opened and Closed Positions.

New Enterprise Offers Much to Ambitious Men

The successful man who is yet not satisfied with the amount of his success—the man who is determined to become a really *big success*—will find an announcement of great interest on another page of this issue, by the Norwalk Vault Company, 40 Seminary Street, Norwalk, Ohio.

This company is introducing a project which they are going to make nation-wide, through advertising. It is the manufacture, by a process they control, of cement burial cases or vaults. The idea is sound—nothing hurts a man more

Builders: JAMES Service Will Help You to Get More Barn Jobs

And nothing will do more to open up a **big** barn building business for you than to erect one in a neighborhood with the advice and assistance of JAMES experts. That one job will lead to more, for the dairyman who sees a JAMES-designed barn wants one for himself.

It will pay you to learn more about

the latest, most economical and most sanitary methods of Dairy Barn Construction. It will open the way to new and bigger profits.

Builders in all parts of the country have taken advantage of this service, and many of them have made barn building the most profitable feature of their work.

Helpful Dairy Barn Ideas FREE

See Special Blue Print and Barn Book Offer Below

Our free service tells about proved principles that enable the builder to establish a reputation as the best barn-builder in his community. It tells about the plank frame construction—about ventilation, proper lighting and location, proper size and arrangement, construction of floors, position of posts, drainage, equipment, etc.

All we ask you to do is give us the names of

dairy farmers in your section who expect to build or remodel barns. We'll help create the business for you. **Let's work together.**

We have complete blue prints, specifications, floor plans and lumber bills for many different types and sizes of modern dairy barns. Ask about them now—and how to get the free help of our Architectural Department;

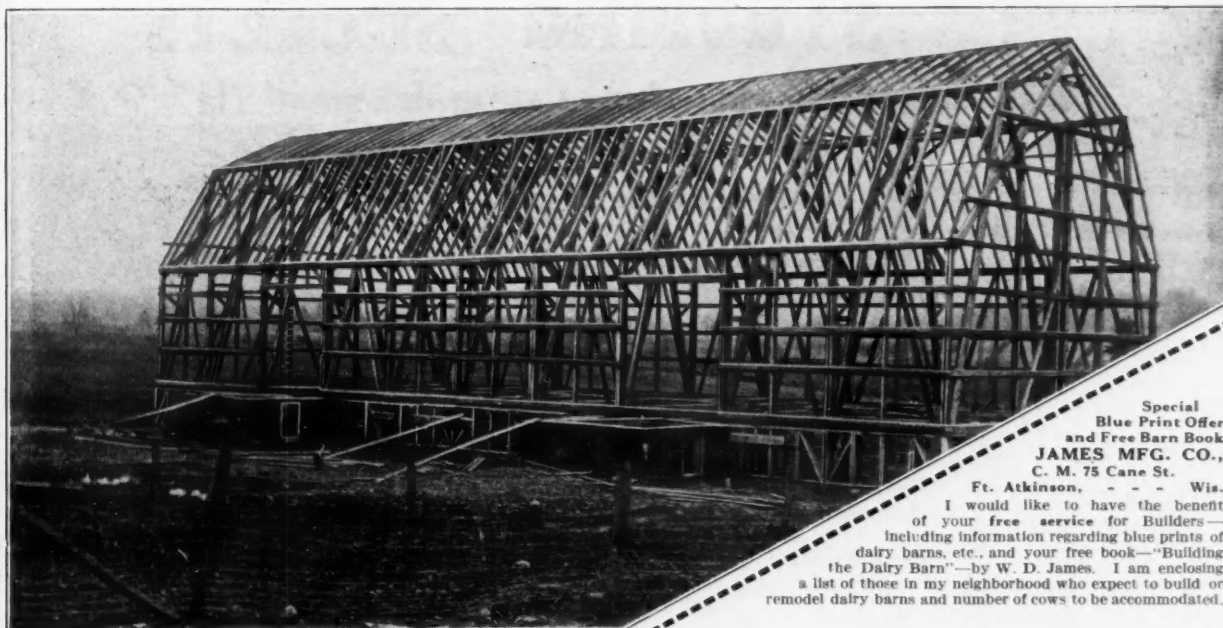

JAMES MFG. CO.,
C. M. 75 Cane St., Ft. Atkinson, Wis.

Special
Blue Print Offer
and Free Barn Book
JAMES MFG. CO.,
C. M. 75 Cane St.

Ft. Atkinson, - - - Wis.

I would like to have the benefit of your free service for Builders— including information regarding blue prints of dairy barns, etc., and your free book—"Building the Dairy Barn"—by W. D. James. I am enclosing a list of those in my neighborhood who expect to build or remodel dairy barns and number of cows to be accommodated.

Name.....

Postoffice.....

R. F. D. State.....

than the thought of burying the body of a loved one without ample protection. Since their start 12,000 Norwalk Vaults have been made and used, without finding a single weak place. There is no doubt but that the Norwalk Vault will come into *universal* use once it is thoroughly put before the public.

Because of that fact, it will be impossible for one concern to enlarge fast enough to supply the demand. The Norwalk people propose, therefore, to divide their manufacturing rights with big-calibre men all over the country. They will do this either outright or on a royalty basis.

The opportunity is there. For the man who is big enough to tackle a new proposition and climb over obstacles; who is willing to back his own judgment with capital enough to purchase equipment, success in big letters is waiting.

Nothing need be taken for granted. The cost of the outfit will vary according to the size of the territory. On this investment, after a few months good preliminary work, a man should be earning ten per cent profit. This rate will not remain that, but will steadily increase, so they promise. One striking example is a man in Michigan who piled up some 2,000 per cent profit in six years. Another man in a little town on the Hudson, working nights and holidays, paid up his \$450 investment in one year, and made 200 per cent profit the next.

A vigorous advertising campaign is about to be started. When the proposition gets well under way it will be impossible to get territory. If you feel that you are the man to handle this proposition in your part of the country—if you are ready to investigate and take action *now*—write The Norwalk Vault Company, 40 Seminary Street, Norwalk, Ohio, at once. They will give you original letters, figures, maps, models, etc., or else take you to the nearest factory and let you see the actual work.

What Will Scaffold Brackets Save You?

The day of the old-time wooden staging and scaffolding is past. Up-to-date contractors who figure the cost know that the Detroit Scaffold Brackets will save them from \$50.00 to \$100.00 on every house they build and at the same time will furnish them with stronger, safer, and more reliable scaffolding.

When you consider that it costs from \$25.00 to \$30.00 for lumber alone in the average wooden scaffolding and that it takes a day or sometimes two days to erect this scaffolding and another half day to tear it down you will see the waste of time and money in being without scaffold brackets. With our brackets the entire scaffolding around a building can be put up in one hour's time, at a cost of from \$20.00 to \$25.00, including the scaffolds and planks, and these brackets can be used over and over again for years and years as they are constructed of steel and cannot possibly wear out. They fold up into a compact bundle and can be easily moved from one job to another.

The Folding Scaffold Bracket Company, 60 W. Lafayette Avenue, Detroit, Mich., were the original scaffold bracket manufacturers of this country, and today their brackets are sold in every town and village in the United States, and, in fact, throughout the world. It would pay contractors to write for full particulars and special trial prices on their scaffold brackets. Now is the time to obtain this information and make arrangements for buying your scaffold brackets when the building season opens up, which will be in a very short time.

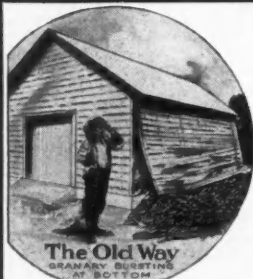
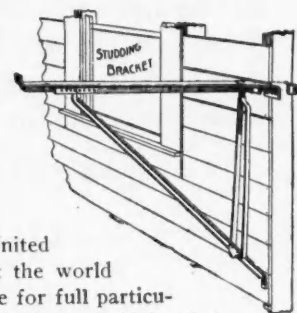

"Toenailing rusted,
Wooden Sills busted"

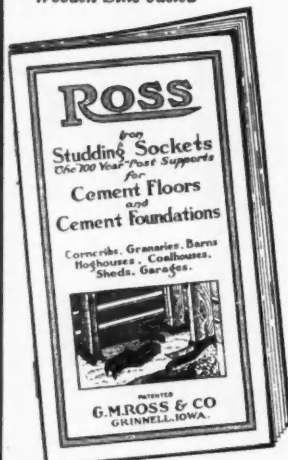

This interesting illustrated Booklet contains directions for building cement floors and foundations, placing Sockets, setting uprights, etc. Your name on a 1c postal will bring it by return mail.

ROSS STUDDING SOCKETS

The "Strong Connecting Link" between

Cement Floors and Foundations and Frame Construction

Contractors and Builders, Write Today!

Ross Sockets are easy and convenient to use. Simply tap them into soft cement. No sills to rot. No toenailing to rust. A perfect unity of iron and cement that will *last*.

Ross Sockets sell at a price so low, every builder should use them. More than save their cost in labor. Ross pays the freight.

Good Profits for You!
Write Today.

G. M. Ross & Co.
344 Broad Street
Grinnell, Iowa

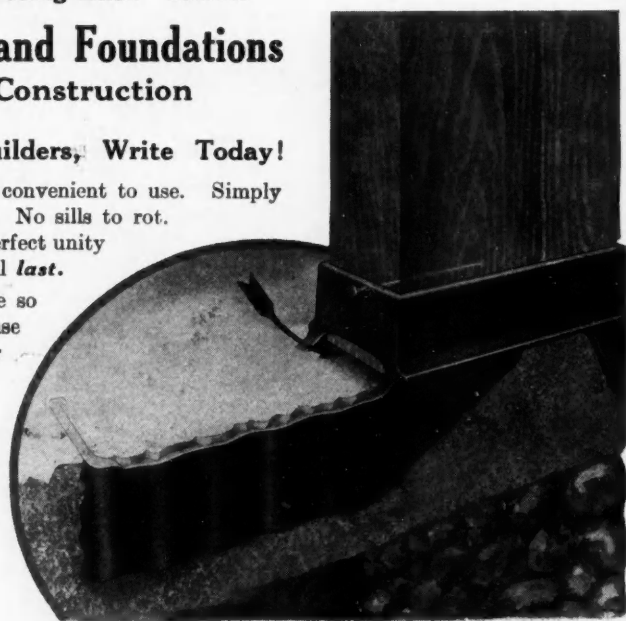

No.1 "Glide" Hanger and Track

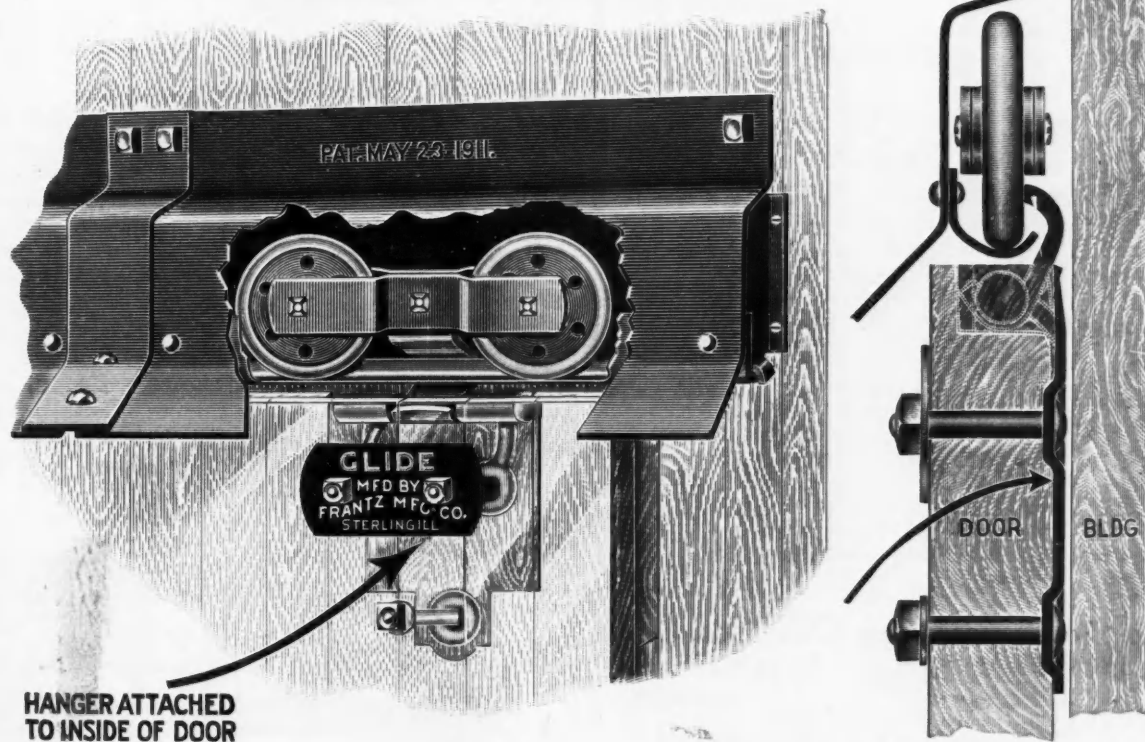

HANGER ATTACHED
TO INSIDE OF DOOR

The Track That Made Sterling Famous

WHEN we brought out this piece of goods four years ago, we were sneered at, laughed at, reviled, lied about, and figuratively speaking, were spat upon, but the fact that the "Glide" has been so extensively imitated, proves conclusively that it is a mighty good thing. If you don't believe it is, ask any carpenter who has ever hung a door with it, or any man who has it in use on his buildings and be quickly convinced that it is all we claim for it, and then some.

Give us your dealer's name and receive a copy of our complete catalogue, which is fully illustrated and shows our complete line of builder's hardware.

Frantz Manufacturing Company
Sterling, Illinois

The WHEELER SCREEN

is truly "Self-Fitting"
by its Screw Adjustment

You will find three troubles in every non-adjusting screen. (1) errors of the opening (no man can make two openings of the same size); (2) weakness of the wooden slide-tracks used by all sliding screens, except the "Wheeler", (3) swelling and shrinking of all window frames in wet and dry weather.

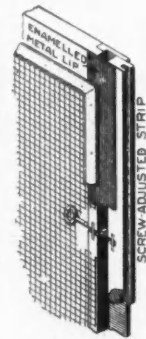

Corner showing Screw Adjustment

We End All Troubles

No matter what trouble comes up, whether it be the error of the carpenter or imperfect window frames, no matter what the weather, merely push out the Adjustable Strip in the side by means of Thumb Screws located at the top and the bottom. These screws enable you to push out this Adjustable Strip—more at the top—less at the bottom—until the Screen *exactly fits*. With these troubles ended, conveniences of all kinds at once follow and the "Wheeler" outpoints all others on any and all features. To the Contractor they afford *two profits*—the usual margin, another in the saving

over cost of fitting and painting the edges of all others. They fit without touch of a tool at one-tenth the cost of other installations.

Big Money Selling Our Screens

You can make more money absolutely, selling the "Wheeler" Adjustable Screens to your customers than by making other screens. Keep your men busy at other work. Let us take care of your Screen orders and you will have this much clear profit. Don't lose money and the time of your high-priced workmen. You actually make \$5.00 to our \$1.00, because we allow you the big-single profit on each individual house-order, since that is the only way for us to get hold of the little-many profits on the 100 house-orders from the tens of towns.

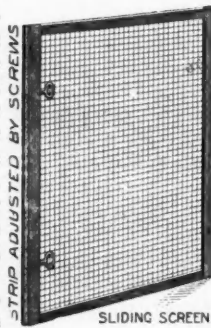

SLIDING SCREEN

PROMPT SHIPMENTS:—Special and automatic machines, on an acre-and-one-half of floor space, reduce time of filling orders to days where others require weeks; speed is limited only by the time required for drying the finish specified. Three days after receipt of order is our average on White-Pine-Painted Goods.

Don't Delay—Screen-Time Is Soon Here

We want a live reputable carpenter and builder in each town to act as our agent. These Wheeler Adjustable Screens are very popular and you will reap the benefits of their popularity in the way of big profits.

Write today for our proposition.

Wheeler Screen Co.
Geneva, Illinois

Free Silo Plans

A splendid opportunity is given builders and carpenters in the offer of the Central Unadilla Silo Company, 633 S. W. Ninth Street, Des Moines, Iowa. They have a plan of silo construction which is extremely simple, and which does away with door trouble and many other problems. By this plan, silos may be put up in about half the time usually required.

They offer to furnish plans to carpenters and builders, without charge. Because of the fine construction, owners are bound to be satisfied.

Elsewhere in this issue will be found a skeleton sketch of this silo. It certainly seems to be an interesting proposition, and one which every carpenter and builder should investigate. The company will furnish complete information on request.



Green Interchangeable Power Equipment

The application of principles in the design of contractors' machinery which gives an owner a wider range of uses without detriment to operation or inconvenience of handling, always finds a welcome reception with the trade.

New literature illustrating an advanced development along this line has been received and may be obtained from The Green Concrete Mixer Co., of Dayton, Ohio, or Salt Lake City, Utah. This company has manufacturing plants in both cities and distributing agencies in important centers.

They offer at low initial investment either a steam, gasoline or electric power unit, on wheels or skids with interchangeable machines that can be attached to the steel frame. No foundations are required as this steel frame forms a substantial base for both power and machinery.

Contractors frequently grow through competition to a con-

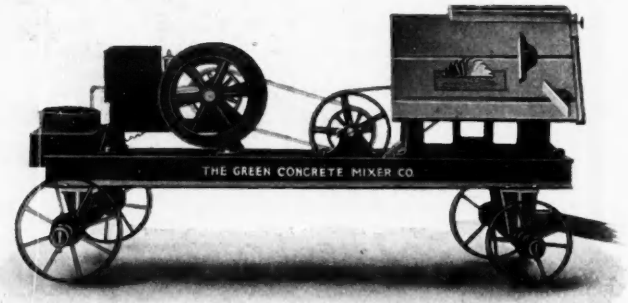

The Green Steel Truck with Saw Table.



The Green Truck Equipped with Centrifugal Pump.

dition of holding much idle machinery between jobs, thus becoming "Equipment Poor," while the small contractor is generally handicapped with insufficient or inefficient machinery. The object of the Green Line is to alleviate this condition.

The advantage in a combination of machines is evident, since at a nominal price mixing drums, pumps, saw rigs or other apparatus may be added, permitting great flexibility without sacrificing efficiency or handling facilities.

“Fighting Bob” said:

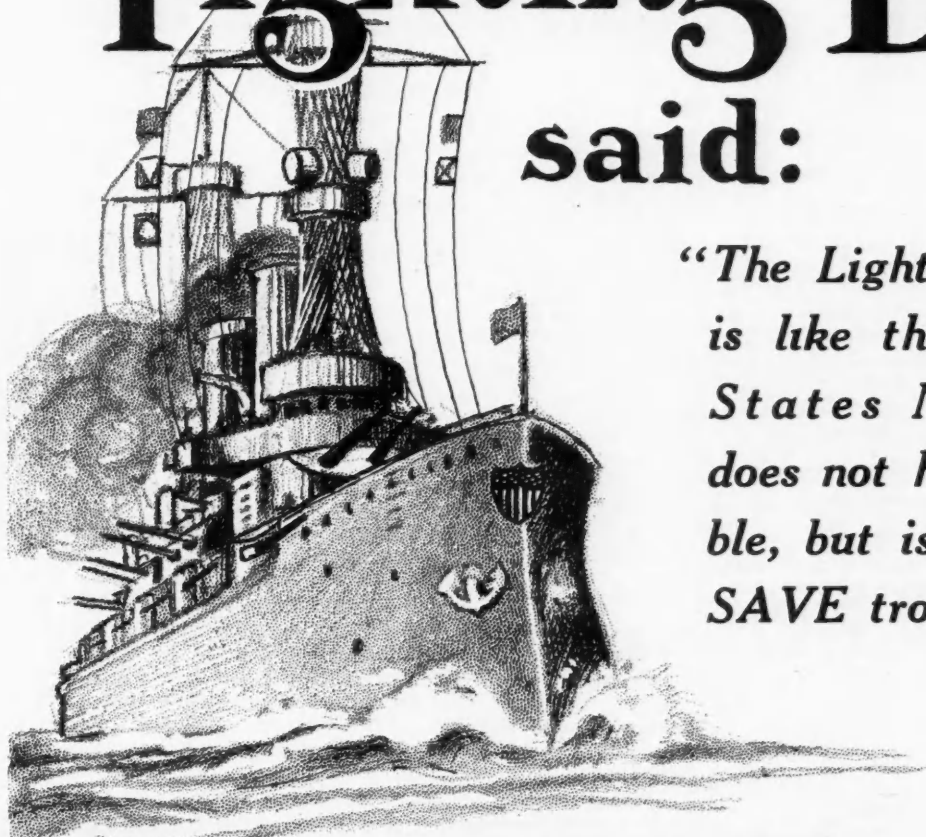

*“The Lightning Rod
is like the United
States Navy—it
does not hunt trou-
ble, but is there to
SAVE trouble.”*

and it does—Most Efficiently

The old saying, “An ounce of prevention is worth a pound of cure,” hits the nail on the head when the ever-present question comes up: Do buildings need Lightning Rods? The answer is YES, according to exhaustive tests conducted by the U. S. Government, private institutions and insurance companies, as shown by their statistics. Vivid testimony—below are shown actual reports showing the Loss by Lightning in only two states for one year.

Rodded Buildings, - - \$142.31

Unrodded Buildings, \$107,164.35

Positive Protection By Scientific Methods

When you are putting up fine barns and houses for your customers, tell them about the Reyburn, Hunter System of Lightning Rods. They realize the danger that threatens their buildings every time a storm comes up. And when you recommend a positive protection against lightning, you will find them only too willing to spend a few extra dollars for the protection of their buildings, their live stock and themselves. The Reyburn-Hunter System, when correctly installed, makes your customers' buildings safe against lightning.

There is nothing extraordinary about this; it is based on scientific fact. The lightning, instead of striking and setting fire to your buildings, follows the line of least resistance, which is through the Conductors and Cables to the Ground.

**!We want the co-operation of a reputable Contractor,
Builder or other suitable representative in each locality.**

We are the largest and oldest manufacturers of practical Lightning Rods and equipment. Lightning Rods are fast coming into their own; and the Reyburn-Hunter System is recognized as the standard. If you wish to take advantage of this money-making business in your locality, write for our proposition. Address Chicago Office.

REYBURN, HUNTER & CO., 412-432 N. Sangamon St., Chicago, Ill.

Wire Guards Stop Snow Slides From Roofs

Not infrequently we read in the paper of some one having been injured by a heavy slide of snow and ice from a roof. And that usually means a suit for damages against the owner of the house. Or, if luckily no one was hurt, perhaps ten to twenty feet of gutter comes down with the snow. In either case the owner of that house has no kindly feeling toward the beautiful snow.

The Clason Metal Works, Providence, R. I., offers a guard against such happenings. They make several styles of snow-

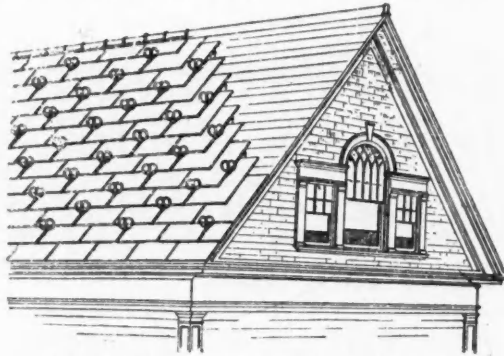

Snow Guards are Cheap Accident Insurance.

guard. The principle is simple—a sharp hook or point for fastening into roof boards, and a loop, or double loop to catch and break up the masses of snow and ice.

While our brother builders of the Far South will have little use for this device, it is something which has a real, practical value in the North. For full information and prices write to the company, at above address.

“Up-To-The-Minute” Quotations

Sounds sensible, doesn't it? It is sensible, too. Many a contractor has suffered loss by figuring from catalogs or prices which are out of date. To secure the best contracts and make the most money, a contractor ought to have an “Up-to-the-minute” estimate.

Barrows & Donnellan Co., 8753 Baltimore Ave., Chicago, have always made that a distinctive part of their service to contractors exclusively. They prefer to serve their customers constantly and always by making estimates from contractors' lists of millwork and lumber. Why bother with catalogs when that company wants to relieve you of the work of figuring? Plans show what is wanted, or owners usually have certain designs in mind. Whatever the designs, Barrows & Donnellan Co. volunteer to estimate millwork and lumber from lists and give the contractor the best show, with an “Up-to-the-minute” delivered price.

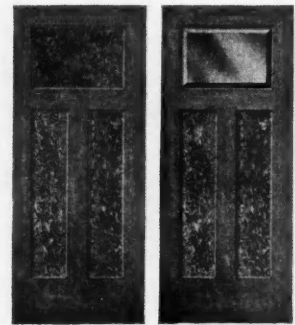

Two Doors Popular in Style and Novel in Wood.

Their gypsum wall board is reported to be a whirlwind seller and a perfect satisfier. So are their low-priced doors, like these, which came from “the tall timber,” some trees 250 feet high and 200 years old. A folder—yours for the asking—describes both doors and gypsum wall board. Write on your letter head or enclose your business card to show them you are a builder.

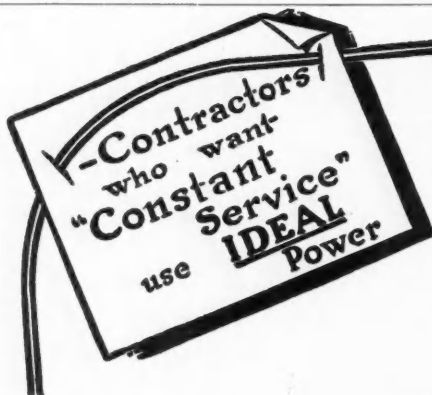

It is a well spent minute that is spent investigating---

Don't accept “face value”—get down into the heart. Find out what makes the wheel go round. That will tell the story and prove an engine's worth. Engines are factors that can make or lose you many dollars.

For years Ideal Power have been exclusively in the profit building game. Now is the opportunity—annex your equipment to

IDEAL TYPE M ENGINES

What is behind Ideal Power? The prestige of the best engine designers in the country. A factory that has always kept abreast of the times. Their own reputation as *real power producers* with a wonderful percentage of economy.

Ideal engines embody the most modern of engine builder's improvements.

Enclosed Crank Case—Self Oiling Boxes—Large Valves—Large Cooling Tank—No Vibration—Frost-Fool-Dirt Proof.

For contracting and engineering work—use Ideal Power Driven equipment.

IDEAL—MUD PUMPS—CENTRIFUGAL—PUMPS
IDEAL—TANK PUMP—FORCE PUMPS
IDEAL—SINGLE HOISTS—REVERSING HOISTS

Now is the time, write for latest book 415

Original Gas Engine Company
R. E. OLDS, Chairman,

630 Kalamazoo St., E
LANSING, MICHIGAN

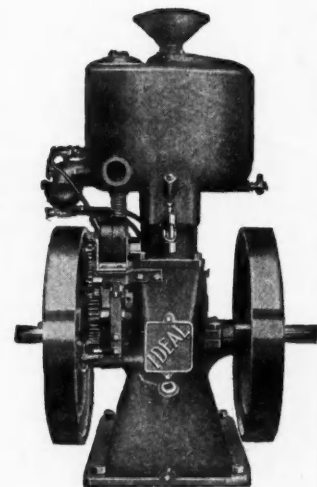

Equipped with National Magneto

—the engine of real service

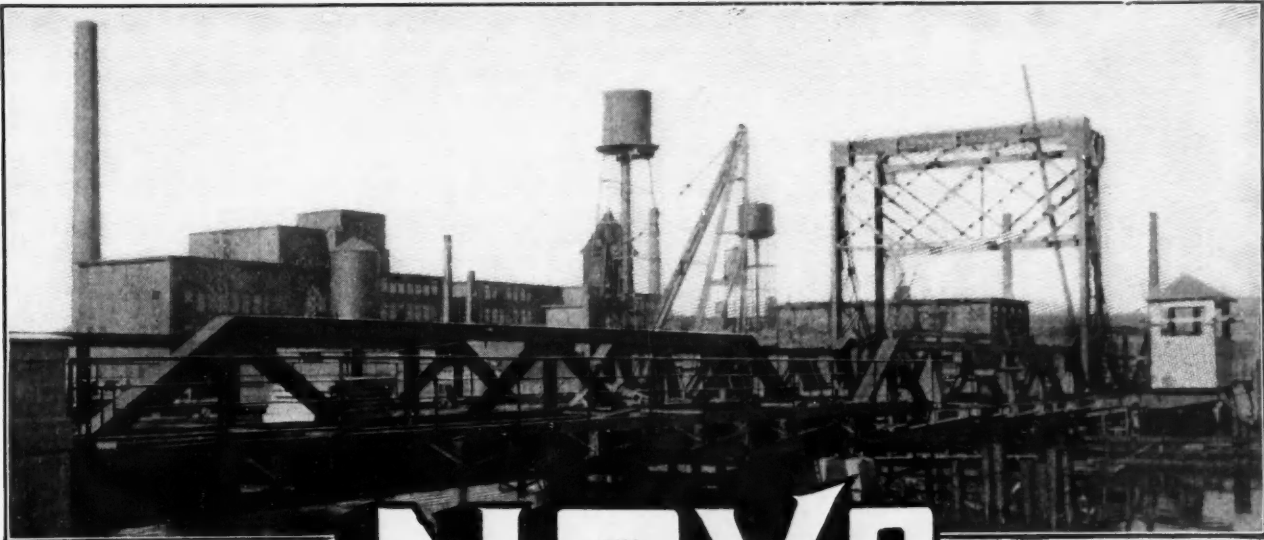

8th Street Bridge, Passaic, N. J., over the Passaic River. A Novo helped in its construction.

NOVO

REG. U.S. PAT. OFF.

ENGINES and OUTFITS

W. G. BROADHURST, PRESIDENT
E. W. STEVENS, MANAGER

F. R. LONG--W. G. BROADHURST CO.
CONSTRUCTING ENGINEERS
FOUNDATIONS
BRIDGES DOCKS DREDGING

TELEPHONE, 120 HACKENSACK

HACKENSACK, N. J., Feb. 11, 1915. 191

"In 1914 we bought a 6 HP. Novo and used it to operate a 4 inch centrifugal pump for unwatering the five cofferdams of the Eighth Street Bridge which we are constructing over the Passaic River in Passaic, N. J. (See photograph).

It is our intention to gradually introduce Novo engines for all power used on our construction operations, such as Derrick Hoists, Pile Drivers, Concrete Mixers, Centrifugal Pumps, etc., as we believe the gasoline engine to be the solution of the power problem for contractors. We know the Novo gasoline engine will stand up to the very roughest treatment to which it is subjected. It is so simple that an ordinary mechanic can operate it. The difficulty and expense of getting water and coal to many of our jobs are very serious items that the Novo does away with."

F. R. Long -- W. G. Broadhurst Co.

W. G. Broadhurst
Pres.

NO FAN
NO FROST
NO FREEZING
TROUBLES

"The Engine for Every Purpose"

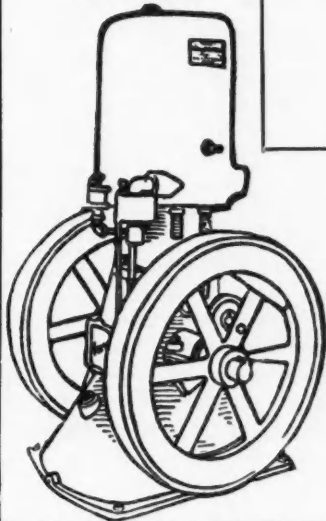

The F. R. Long--W. G. Broadhurst Company, a large New Jersey contracting firm, has found Novo Engines and Outfits the solution of its power problems. Novo will solve your power problems.

Investigate now. Put Novo on your pay roll. Write for a copy of our book, "Reliable Power," which explains the 75 varieties of Novo Engines and Outfits.

NOVO ENGINE CO., 447 Willow St., Lansing, Mich.
CLARENCE E. BEMENT, Secretary and Manager

- Novo Reversible Hoisting Outfits
- Novo Non-Reversible Hoisting Outfits
- Novo Double-Drum Reversible Hoist Outfits
- Novo Suction and Force Pumping Outfits
- Novo Centrifugal Pumping Outfits
- Novo Diaphragm Pumping Outfits
- Novo Saw Rigs
- Novo Air Compressor Outfits



Increase Your Sales and Profits

Add to Prestige and Profits the New-Feed UNDERFEED Way

Building Contractors—make a hit with your clients by installing a **Williamson New-Feed UNDERFEED Furnace or Boiler** in new buildings, or those you're remodeling. Or, if you're in need of a heater for your own use, by all means install an **UNDERFEED**.

It will prove a lasting advertisement for you and the results obtained will enable you to materially increase future sales and profits.

For the **New-Feed UNDERFEED** gives cleaner, better, more uniform heat at half the coal cost of "overfed" heaters.

The saving of at least half in coal bills is guaranteed. Remember that!

Thirty thousand users testify to **UNDERFEED** efficiency, comfort and saving. Less trouble to operate. No clinkers. Every bit of coal burned to a clean white ash. No sifting to do.

WILLIAMSON CUT
NEW-FEED COAL
UNDERFEED BILLS
Furnaces and Boilers $\frac{1}{2}$ to $\frac{2}{3}$

In the **New-Feed UNDERFEED**, coal is fed from below. The clean live coals and fire are always on top in direct contact with most efficient radiating surfaces.

Burns Cheaper Grades of Coal

The **New-Feed UNDERFEED** burns the cheaper grades of coal. Cheap slack soft coal, or pea or buckwheat sizes give same heat as more expensive grades in other heaters. No smoke or gas. These are consumed and transformed into clean usable heat in the **New-Feed UNDERFEED**. Adapted to warm air, steam or hot water.

Free Heating Plans

We help you install the **New-Feed UNDERFEED**. We furnish, free, complete heating plans for any building. There's a wonderful book you'll be glad to read—"From Overfed to **UNDERFEED**." Write for it today. Writing involves no expense or obligation on your part.

For a better, bigger business, and satisfied clients, write NOW. Say whether you are interested in warm air, steam or hot water heating.

THE WILLIAMSON HEATER CO.

(Formerly the Peck-Williamson Co.)

107 Fifth Avenue

CINCINNATI, OHIO

New Concrete Mixer on Market

The Republic Iron Works, of No. 100 Capitol Nat'l Bank Bldg., Lansing, Mich., have given the building world a new mixer—the Republic "Six." It is a machine very carefully designed and built, to include all the features which have been found most valuable in mixer construction, and to eliminate all features which have been found unsatisfactory.

The drum will hold five cubic feet of sloppy concrete, or six cubic feet of loose dry material. It is very strongly riveted, instead of being bolted with rods—which does away with obstructions and pockets.

A special arrangement of the mixing blades, or paddles, inside the drum, insures a quick, thorough mix. Thirty seconds is the time required for a well mixed batch. One minute is estimated as equal to 450 hoe strokes.

The engine furnished is enclosed, of the upright type—frost-proof, dirt-proof, and of the simplest construction possible. Direct gear drive is used—gears being 50 per cent oversize. Engine pinion is of crucible steel, all other gears being of semi-steel.

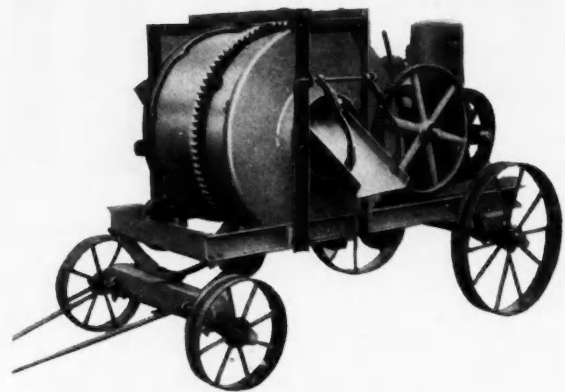

The Republic "Six"—Investigate It.

An exclusive feature of the Republic "Six" is the use of floating bearings in countershaft brackets. By this means the countershaft may adjust itself to unevenness—which eliminates all binding, friction, and loss of power.

Other interesting details of construction, prices, etc., may be secured from the company, in their new catalog.



Contractors Save Time and Expense with King Aerators

It is no longer necessary to build wooden cupolas for farm barns.

This part of the building job which has always been handled at a loss because of the time-eating work which never shows its value in the eyes of the owner and because of its holding back the crew at the last minute, is now being done away with by the simple and easy work of installing King Aerators in connection with the King Sanitary Ventilating System.

It has been found that a good carpenter and helper can put the King Aerator on a barn in about the same time that it takes the rest of the crew to pick up the tools and leave the job. When you stop to think that the wooden cupolas generally cause you the time of a good man for at least two or three days, here is a saving that is very important, especially in the busy season.

Besides this there are many more advantages for the contractor or carpenter in installing the King system of ventilation. It keeps the building dry and in a sanitary condition. While this may eliminate a few small repair jobs here and there later on, it leaves the farmer with more money because of the better condition of his barn and his increase in stock profits. All of which puts him in a more satisfied frame of

I Want Every Carpenter Builder and Contractor To Have **FREE BOOK**

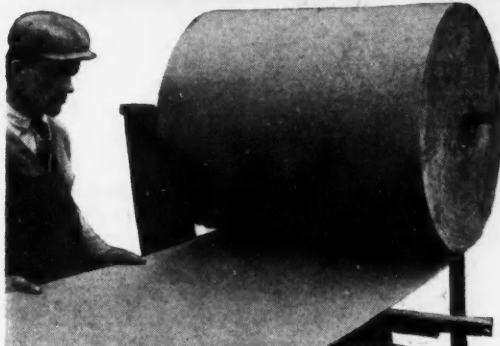

Just Out—Our 1915 Catalog

I want to show you how you can save a lot of money this year on your orders for Paint, Roofing, Wall Board, Metal Ceiling, etc. The United Factories Co. not only offers you highest quality goods for less money than you can obtain them anywhere else in America, but our New Plan of shipping on 30 days' approval gives you an opportunity to **SEE AND TRY THE GOODS 30 DAYS BEFORE YOU PAY.**



Fill Out The Coupon, Send for **FREE Catalog** Today

Geo. A. Bottger, Pres. of The United Factories Co.

Every Foot Inspected **Unito** Every Roll Guaranteed

ROOFING
See These Bargains!
78c a Roll
Buys **Unito Guaranteed Two-in-One ROOFING**

Body made of best wool felt and saturated with pure mineral asphalt. Double surfaced, finished sanded on one side and rubber on the other. Comes in three weights. Greatest piece of roofing ever sold at the price. Send for free sample.

Unito Rubber Roofing
"Farm Journal" subscriber writing to publisher, says of this roofing: "Could not get the same goods here for less than \$2.25 per roll. Made in four weights. Our price per roll, and up **80c**

Unito Double Flint Coat Roofing
Every foot inspected and every roll guaranteed, yet sells at price usually asked by others for mill ends. Made in four weights. Price, direct from Factory only and up **90c**

Unito Diamond Coat Roofing
Guaranteed for 20 years. Heavily surfaced with mica, giving beautiful sheen. Makes handsomest roll roofing for fine buildings. Price, for medium weight per roll only **\$1.65**

Unito Star-Point Roofing
Comes in roll, but when laid gives ornamental shingle effect; especially handsome in the mellow, non-fading Red and Green Granite, or Red and Green Slate. Lowest price ever quoted on ornamental roofing. Per Roll, only **\$2.95**

Unito Asphalt Shingles
Cut separately or in continuous strips, furnished in Red or Green Granite, Red or Green Slate, or Brown Gravel. Price, per Roll, or Square, only **\$4.75**

Write for Free Samples

Moisture-Proof Wallboard

We supply the only Wallboard that is guaranteed to be absolutely **Moisture-proof**. Write for free samples and test to your own satisfaction. Compare with others. Made in Natural Gray or Tan Finish at **\$2.25** and **\$2.35** a Square, or in handsome quartered Oak Grain effect at **\$2.60** per Square.

Special Discount for larger quantities. We also make an Outdoor Wallboard for siding or roofing poultry houses, etc. Guaranteed water-proof. **\$2.95** Price, per Square.

\$27⁷⁵ and up
Sizes 1 1/2 to 15 H.P.

UNITO ENGINES are the most dependable, economical power plants either for shop use or for heavy outside duty. Our prices save you 40 to 60% and you have 30 days' Free trial before you pay. Write for Special Catalog Folder showing complete line in colors and quoting lowest prices.

Paint 95c a gal.

Contractors everywhere are finding out that using **UNITO PAINT** allows them better profits and assures permanent satisfaction to the property owner. We make Barn Paint, best grade, only **65c** a gallon. House Paint, two grades, **Guaranteed Unito Brand** at **\$1.20** per gallon, and **Challenge Brand** per gallon only **95c**



Write for Free Color Samples

Very Low Prices Now on Metal Roofing

Until April 1st, 1915, our prices are extremely low. If you have contracts calling for Metal Roofing, better get in your order at once and save a lot of money. For fine residences and public buildings, try **UNITO METAL TILE**. Samples gladly furnished, Free.

Metal Ceilings

Unito Metal Ceilings are attractive in pattern, durable and lowest in price. Easy to put up and most economical, sanitary and fire-proof material you can use. Send for samples.



Write for FREE Catalogs

or just fill out the coupon at right. Mark the items in which you are interested, and we will gladly send you our latest catalogs and folders, printed in colors. All sent free—postpaid.

The United Factories Co.
22-27 Factories Bldg.
CLEVELAND, OHIO

THE UNITED FACTORIES CO., 22-27 Factories Bldg., Cleveland, O.

GENTLEMEN:—Send me your latest Catalog: Metal Ceiling, Wallboard, Ready Roofing, Metal Roofing, Incubators, Cream separators, Paint, Gasoline Engines, Engines, Fencing, Electric Light Outlets, Stoves and Ranges.

NAME _____ P. O. _____ State _____ R. F. D. or St. No. _____

mind to build new buildings and, which, of course, means more and better business for you.

The King Aerator and King Ventilating System are widely known among the farmers owing to the fact that they have been well advertised for some time.

In the King catalog there are quite a number of photographs of farm barns equipped with the King Aerators and showing them to your prospective customers will be a great help in getting them to specify Kings in their buildings. This catalog can be had from the King Ventilating Co., at Owatonna, Minnesota, on request.



Frank's Concrete Mixers

In order to have a perfect mix, it is essential that the mixer be designed so that it shovels instead of mixing by gravity. A shovel mixer will do the mixing thoroughly and quickly. To get the best results a mixer should be easily cleaned—in fact a self-cleaner—easily operated, strongly built, durable, at the same time simple and not complicated.

Frank's unequalled mixers, as offered by the Frank Manufacturing Company, 209 W. Second Street, Des Moines, Iowa, meet all of these requirements. They are low down, so are easily filled. Its shovel operation makes it a self-cleaner. They mix thoroughly and quickly—a batch a minute. A boy can operate it. They are easily unloaded. These machines are guaranteed mechanically perfect. They are offered for sidewalk and floor work, for concrete block or brick plants, general farm work or for country road work, and yet they sell at a very low price.

If you want a mixer that will help you make more money on every contract—a mixer that is dependable for all-around efficiency—investigate the Frank Mixers. They are made in two sizes.

Edwards Steel Trucks

A new line recently placed on the market by the Edwards Manufacturing Company, 401-407 Eggleston Ave., Cincinnati, Ohio, is the Edwards steel trucks. We believe a good many of our readers will be interested in the accompanying illustration of one of these trucks, known as "Edwards' General Purpose Truck."

These trucks are of practically indestructible construction—a steel truck that is strongest where the old-style wood frame trucks are weakest. The frame is one continuous U-shaped piece of steel. The wheels are set within the body lines, allowing free passage of obstacles. The proportions of this truck are those most preferred for handling heavy loads.



Edwards Mfg. Co. Steel Truck.

Make No Mistake!

*If You Want the BEST You
Must Buy the HOBBS*

It is the one Block Machine that produces a **natural** rock face because of the Hobbs Composition Face Plates—the only Block Machine which makes **real** Broken Ashlar (see picture).

We ship on trial and absolutely guarantee these advantages—also the following:

The wettest block because of the oval cores and drawing device.

The greatest speed due to the simple design, the quick changes and the **automatic dividing plates**.

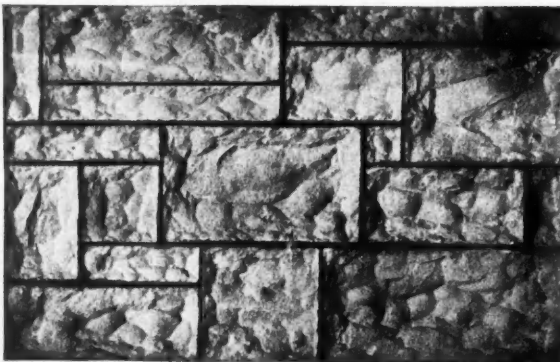

"Greater capacity"
"Wetter mixture"
"Wider range"
"Much finer,
stronger block"

Every
claim
proved
by free
trial



Adjustable to over 2,000 sizes and adjustments simple as A, B, C.

The best made and finished piece of concrete machinery you ever saw.

Make no mistake! Positively no other Block Machine can produce such results or make you money like the Hobbs.

Send today for a Hobbs catalogue and get started and get started right.

Hobbs Concrete Machinery Co.
724 Peter Smith Bldg. :: DETROIT, MICH.

The New Eureka Batch Mixer

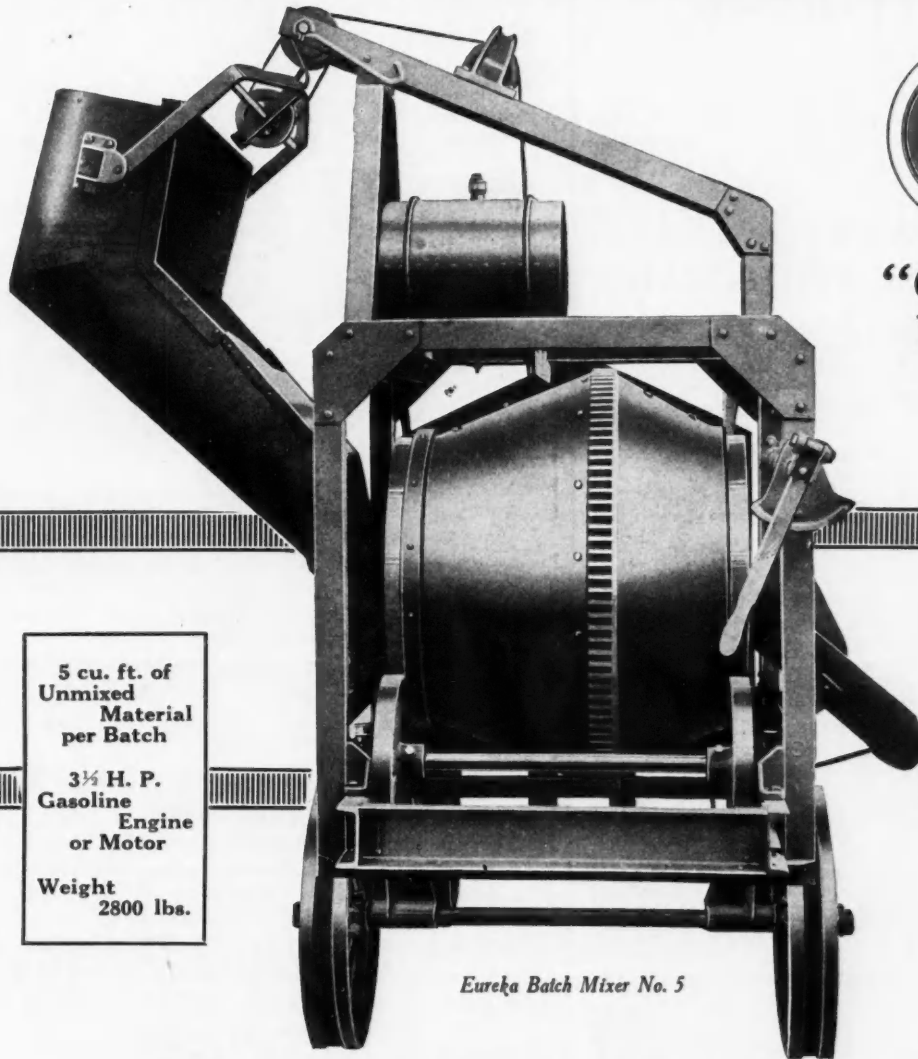

"Quality Wins"

5 cu. ft. of
Unmixed
Material
per Batch

3½ H. P.
Gasoline
Engine
or Motor

Weight
2800 lbs.

Eureka Batch Mixer No. 5

"THE INCOMPARABLE FIVE"

The Eureka has withstood the test of time. Ten years of unparalleled success in building high-grade continuous mixers proves conclusively that we build for strength, reliability and service. It is admitted, we believe, that this company produced in the continuous mixer field, a series of mixers that easily proclaimed them leaders.

Reaching the ultimate—a point beyond which it is not possible to go, we have placed on the market a **Batch Line** of Concrete Mixers of exclusive features and quality. The latest achievement, the **Eureka Batch Mixer** represents a distinct advancement in the development of Concrete Mixers.

This Mixer is correct in design—the material is of the highest quality—and the workmanship measures up to the highest Eureka standards. Our engineers have devoted nearly three years to the building of the **Batch** type. Serious consideration has been given to every reputable mixer—endeavoring to scrutinize with scientific impartiality the virtues and limitations of each and every one alike.

Building and experimenting in turn, we have been carried irresistibly forward in our research to the best in mixer construction. We confidentially assert that the **Eureka Batch Mixer** stands without an equal. Your own judgment will confirm this statement.

Send for Bulletin No. 52

EUREKA MACHINE COMPANY

103 Handy Street

Lansing, Michigan

"Builders of Quality Mixers"

PRODUCE A SILO A DAY \$50 TO \$100 PROFIT IN A SINGLE DAY

This is a wonderful opportunity for the contractor. Make \$50 to \$100 on a single day's output of cement silo staves. Enough for one silo made in a day. You make this money if you simply make and sell the staves, but you can almost double your profit by erecting the silos as well as making the staves. Just look at the field.

640,000 SILOS IN SIX YEARS ERECTED IN THE UNITED STATES

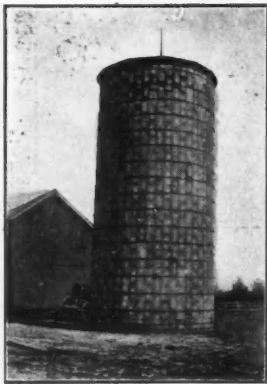

This is according to government reports. The farmer is thoroughly alive to the possibilities of the silo and there are six million farmers in the United States needing silos. Your community and your county needs its share.

The silo has come. It has come to stay. The demand is for a silo that is permanent, durable, substantial and that the tooth of time will not touch, that will not burn nor rot nor shrink nor blow over. The cement stave silo meets these requirements.

Here is the silo which will make you money. Build it in hours instead of days. Consequently handle more jobs and make more money. It is built of pressed cement staves made under terrific pressure. Make them in a plant or right on the job.

THE HELM SILO STAVE PRESS WILL PRODUCE A SILO A DAY

Get this machine and control the silo business of your community or your whole county. Get absolute control with no one else allowed to operate such a machine in your county. Get the exclusive right with this wonderful machine. Have an immensely profitable business firmly within your grasp.

The enormous capacity of this machine and consequent low cost of production will give you absolute control. Do you want to control your county? Think of the profits! Think of the handsome income from only 50 silos a year! As high as \$5,000 a year. Does it interest you? Then send the coupon now, without fail.

**Helm Brick
Machine Co.**
173 Beech St., Cadillac, Mich.

Send, without obligation, full particulars on your Silo System and Press.

Name

Address

**HELM BRICK
MACHINE CO.**

173 Beech St.,

CADILLAC,

MICH.

New Batch Mixer Offered at Low Figure

A mixer that will appeal especially to the average contractor doing small work, is the Grand batch mixer which has just been placed on sale by the Hall-Holmes Manufacturing Company, 445 Oak Street, Jackson, Mich.

Length of the machine is 10 feet, width but a few inches over 4 feet, height 4 feet 10 inches. Loading opening is but 36 inches from the ground, and loading or dumping can be done from either side. Speed of drum is nineteen revolutions per minute; six revolutions giving a thorough mix. Water is supplied through the end of the drum, regulated by a globe valve.

A two and one-half horse-power tub top, water cooled



The "Grand" Batch Mixer Designed on a New Principle.

engine furnishes power. For silo work the mixer may be equipped with hoist. Complete weight is but 1,650 pounds.

All parts are made of highest quality material—the machine is made to give long, hard wear. The remarkably low price should make this mixer a winner. The complete Hall-Holmes line is illustrated and described in a catalog which they are distributing. We would suggest that our readers write for it.



Heppes Co. Offer Valuable Trade Suggestion

On another page the Heppes Company show a picture of a remodeled attic, illustrating how "Utility" board may be used to add an extra room to any home at small cost.

The chief advantage of this suggestion, however, to the trade, lies in the fact that the Heppes Company tell more than how this effect can be obtained with "Utility" board—they also tell how much the profit to the contractor is.

In this particular case the contractor's profit was \$22.00 for about two days' work. This striking example of extra money earned by the contractor is still more advantageous when it is considered that the work was done during stormy weather when ordinarily business is at a low ebb. "Utility" board being impervious to weather, can be laid with equal facility regardless of climatic conditions.

A number of enlarged reproductions of the illustration shown on page 116 have been struck off by the Heppes Company engraving department and will be gladly sent to any contractor who writes for them. These reproductions will prove very helpful to the contractor who wishes to show a prospective user of "Utility" board just how the finished job will look.

This is an example of real co-operation between the manufacturer and the contractor, which deserves more than passing mention. Every contractor should welcome the opportunity to obtain the picture mentioned and also the other valuable trade suggestions which the Heppes Company will give. We advise every reader to communicate with the Heppes Co., 4503 Fillmore St., Chicago, at once before the supply of these pictures is disposed of. There is no charge whatever, nor any obligation.

Aladdin Houses Protect You

**You Can
Make Larger
Profits**

Have you ever *lost money* on a job? Have you *always* pleased your customer on the *quality of material* in the house? Have you ever *lost a contract* because your competitor submitted a better design, a lower price and finished the job in half the time? Aladdin Readi-Cut Houses help you to make a safe bid on the job—the complete cost of each design is listed on each page. Aladdin Houses are guaranteed—all exposed material inside and outside *clear and knotless*. Aladdin Houses save you a third—all material cut-to-fit—you pay for no waste; you can build them in less time. The Aladdin catalog pictures over 100 designs. Get this catalog and have us prove our statements.

Aladdin Houses \$138 to \$5,000

Dwellings, bungalows, summer cottages, garages, barns, farm buildings—the Aladdin catalog enables you to give your customer a picture of the building before it is started.

5-Room House Complete \$298

A complete five-room, year round Aladdin House for \$298. Price includes all material necessary to complete. Aladdin Houses are sold direct—no middlemen's profits.

**You Can
Figure Safer
Estimates**

Aladdin Readi-Cut Houses Save Carpenters a Third

Price Includes Everything

You get material absolutely guaranteed to be sufficient for the completion of your house, as follows: Sills, cut to fit; joists, cut to fit; studding, cut to fit; building paper; sub-floor, cut to fit; rafters, cut to fit; roof sheathing, cut to fit; siding, cut to fit; outside finish, cut to fit; flooring, cut to fit; lath and plaster or plaster board, inside finish, doors, windows, glass, nails of all sizes, locks, hinges, paints, oils, varnishes, stains, with complete drawings, illustrations and instructions for erection—**The Complete House**. The big Aladdin catalog No. 790 tells all the interesting facts.

NORTH AMERICAN CONSTRUCTION CO.

796 Aladdin Ave. BAY CITY, MICH.



**Your Customer
Gets a Better
House**

Are You One of the Live Ones?

Would you add a very profitable line to your business? If you are alert to all the avenues of legitimate profit, write the Diamond Cable Co., Bourbon, Indiana, for prices and terms to agents. Secure the agency for their

**Pure Soft Copper Cable
Lightning Rods**

You can often include them in building contracts, and if you work the line it will prove to be the best paying department of your entire business.

Diamond Cable Co., Bourbon, Ind.

More and Better Silage

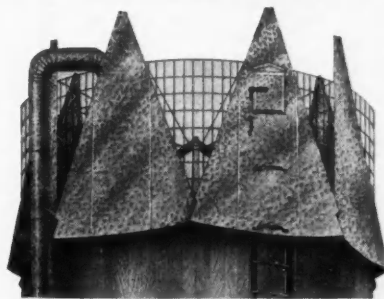

The Champion Opening Silo Roof makes it possible to fill your silo to the roof—increases its capacity from 12 to 15 tons. Protects silage winter and summer—makes better silage—prevents loss. Easy to put on; can't blow off; strong, durable—built of galvanized steel.

**WILL FIT ANY SILO
Easy to Open or Close**

Costs little more than wood—pays for itself the first year in more and better silage and labor saved.

We want good men everywhere to handle the Champion Silo Roof. You can sell it against any other on the market because of its strong points of superiority.

Write for our Offer to Agents.

Champion Mfg. Co. 424 B Avenue Cedar Rapids, Ia.



Before you lay your first roofing job, put on your first porch covering, or re-lay any old roofs this Spring

INVESTIGATE CON-SER-TEX

It costs very little. It is easy to lay, and adheres tightly to the surface, giving the porch, piazza, or sleeping balcony a neat, clean, trim look. It is the ideal covering for the garage roof and outhouses.

CON-SER-TEX is a scientifically treated cotton duck which is waterproof, and will not mildew, absorb moisture, nor shrink.

Write for generous sample today.

William L. Barrell Company

8 Thomas Street

:-: New York

Chicago Distributor:
Geo. B. Carpenter & Co.
Wells and Michigan Sts.

California Distributor:
Waterhouse & Price Co.
San Francisco, Los Angeles

Beach Power Machines for the Shop

One of the biggest advances in the building trades, during the past ten years, has been the adoption of power sawing machinery in the shop. A great deal of valuable time and energy has been saved, which formerly went into heavy sawing.

The line of power woodworking machines put out by the Beach Manufacturing Company, Montrose, Pa., is one of the most complete in the field. Everything for the shop, from a plain rip saw frame to box-makers' six-stop, cut-off frame, combination rip and carriage cut-off saws—with or without tilting tables—is offered. One of the most important improvements in the construction of each saw is the anti-friction, rolling table. This device consists of tracks on frame, corresponding tracks on under side of table, and rollers, engaging them. Friction is practically done away with, as proven by the fact that oil is not needed on any part of the device.

Their double arbor rip and cut-off saw is especially interesting to the man who can use only one machine in his shop. There are two separate arbors (for rip saw and cut-off) carried on a special frame which allows the working arbor to be belted direct to countershaft. The unused arbor is always at rest. A boring attachment, with table, is independent of the saw table. It comes with half-inch hole in arbor, and has horizontal movement of six inches. Either foot or hand lever may be used to operate it.

An exhibit of seven Beach machines will be located in Block 42, The Machinery Building of the Panama Exposition. This will be in charge of Harron, Ricard & McCone, of San Francisco and Los Angeles.

The Beach Manufacturing Company has won a number of medals and highest awards for light sawing machines at the big expositions held in the past fifty years.

New Hoists Being Placed on Market

The Brown Clutch Company, known for their famous "Little Giant" hoists, are placing before the building trade their new "Morgan," single and double drum hoists. These hoists are to fill a demand for large, heavy machines to be used with gasoline engines.

The clutch is operated by throwing in lever which is

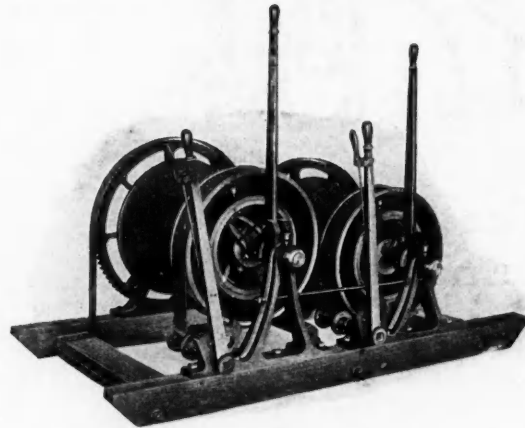

A Great Hoist for Builders, Made by the Brown Clutch Co.

attached to toggle, having powerful left and right hand screw. Control is by means of powerful hand lever band brake, and a ratchet dog brake. As regularly equipped, the hoist is chain and sprocket drive—but belt drive will be furnished, if desired.

Equipment consists of winch head, 10 feet of chain and 36-tooth sprocket, with 6-tooth sprocket for engine shaft. Attractive prices are being made. Write for full particulars.

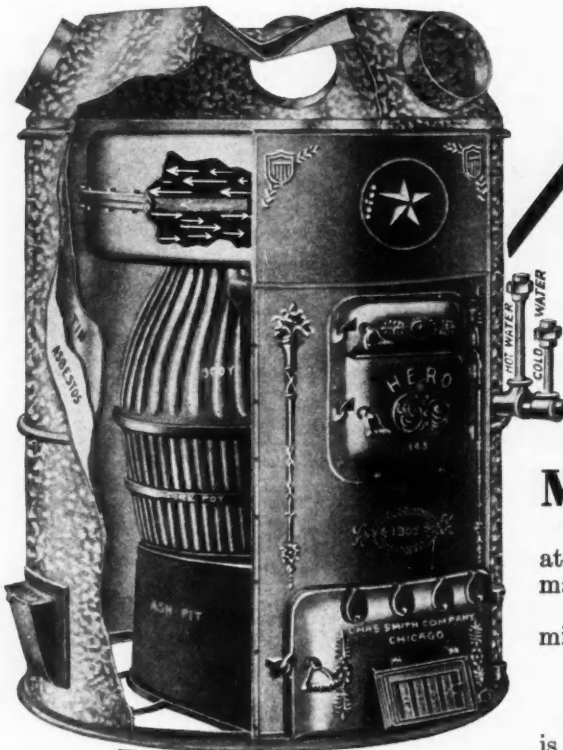

Notice These Points About the **HERO FURNACE**

All Cast Iron, because—Cast Iron is more durable than steel and carries an even heat owing to heavy body.

Direct heating surfaces are corrugated. Corrugation increases heat surfaces and also takes care of expansion and contraction.

Modern in Every Respect

The Hero has large feed doors, large roomy ash-pit, get-at-able in every way. Notice the straight fire pot giving maximum amount of grate area.

Hero furnaces give the maximum amount of heat with the minimum of fuel making them the most economical.

Specify and Install the Hero

Choosing a heating plant is very important. The Hero is high-grade in every detail. Your customers will like

them and you'll profit by installing them. We would like good, reliable contractors and builders to act as our agents. *Write for our special proposition today.*

CHARLES SMITH CO., 57 W. Lake Street, CHICAGO, ILLINOIS

THE REPUBLIC "SIX"

THE SENSATION OF THE YEAR



Ten Days' FREE Trial

We are so sure the mixer will make good that we will send it to you to use, for ten days, on approval. Put it through your regular run of work. If it looks good to you, pay for it. If it doesn't—if you don't think it is as good as we have claimed—you return it at our expense.

That's as square an offer as we know how to make. Let us tell you all about it.

Never before in the history of Concrete Mixers has such value, such features, such improvements been offered as are represented in the Republic "Six." And the cost—that's where the big surprise comes, the cost is a good deal under the majority of mixers on the market which do not possess the money-saving features or high grade construction the Republic "Six" has.

A FEW SPECIFICATIONS

- Frame:** 4-inch channel, hot riveted and bolted. Engine rest on two channels.
- Drum:** Gear driven. Batch type. 30 inches wide by 36 inches in diameter (inside). Heads of semi steel heavily riveted, not bolted, to sheet steel shell. Capacity five to six cubic feet.
- Engine:** Upright type—enclosed. Dirt-proof and Frost-proof. Well balanced, smooth-running—very few wearing parts. Solid drop forged crank shaft and connecting rods. Requires but one and a half or two gallons of gasoline per day.
- Truck:** Equipped with high, wide wheels. Rear wheels 30 inches diameter, front wheels 18 inches diameter; 4-inch tires. Steady foundation—but very portable.
- Equipment:** Either standard hopper, batch hopper, power loader, or hoisting attachment can be furnished.

All material strictly first quality. Space does not permit our giving full details on all the splendid features of the "Six"—many of them used only on our machine.

Write Today—so you won't forget—for our catalog. Let us tell you in just how many different ways a Republic Six will save and make money for you. Read the catalog through and you'll understand why we are willing to make our wonderful ten day trial offer. You can't afford to buy without knowing all about the Republic Six—so let us hear from you right away.

THE REPUBLIC IRON WORKS

100 Capitol National Bank Bldg., Lansing, Mich.
Pittsburgh, Penna.

\$2430.00 IN 90 DAYS

\$27 A DAY

actual clear cash profits is what one man made in just three months with a Helm Press in a little town of 375 inhabitants. He saw a big opportunity in manufacturing pressed cement brick and blocks, was quick to grab it and is realizing big money now. Look round about you. See how concrete is taking the place above all other materials in building construction. Realize what a chance is yours now to get in this big industry on the ground floor. \$20 to \$50 a day profit is easily made with the Helm Press. You will be turning out a product that is as staple as sugar, as much in demand as the clothes on your back.

Ten Billion Brick

are used every year in the United States. Thirty-three and a half million every working day of the year. Consider how enormous the demand, how contractors are crying for more brick. Be the one to supply this demand in your locality. You can start in this business. Be a manufacturer of pressed cement brick and make money from the start. No experience is necessary and very little capital needed.

There are Big Contracts with their Big Profits ready for You

No matter where you are, how little the town or how big the city. Builders are turning to this product because it solves the problem of high cost of building. Concrete must take the place of wood, stone and clay. Here are experiences which you can duplicate in your community:

I landed a \$90,000 government contract with Helm pressed cement brick.

Just landed a contract for 400,000 Helm pressed cement brick.

We are working on a contract for half a million pressed cement brick.

Made a million brick this season on one of your Helm presses. My daily manufacturing profits on pressed cement blocks average \$25.

Working on a contract for a quarter of a million pressed cement brick.

Made 17,000 pressed blocks for one contract in less than a month.

Six weeks behind on Helm pressed cement brick and block orders.

We want you to know more about these manufacturers who are landing the big business and making the big money. We want to show you how they started with but little capital.

FACTORY OWNERS

are the biggest money makers in America and this machine will place you in their ranks. You can start with little capital and even without experience. This is the machine for you because it makes pressed cement brick and blocks under 80,000 pounds pressure. No tamping, and easy work. It makes 1,000 blocks or 10,000 brick daily. No burning required. Ready for the market in a few days' time. Eventually someone will make pressed cement brick and blocks in your community, but now the opportunity is yours. No matter if cement products are now made there—these brick and blocks made by pressure will be demanded. The possibility of failure in this business is almost eliminated. You can enter it with almost a dead certainty of meeting success. Costs you nothing to learn all about it. Fill in the coupon here, mail it today, and receive free, full information of the Helm Press and the money to be made in the cement brick business.

Helm Brick Machine Co., 173 Mitchell St. Cadillac, Mich.

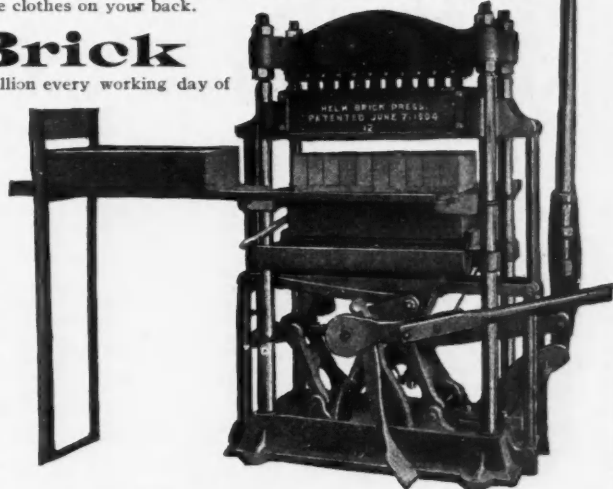

Helm Brick Machine Company,
173 Mitchell St.,
Cadillac, Mich.

Please send FREE the book on concrete and Helm Presses.

Name

Address

Hot Water Heating

SPECIAL for CONTRACTORS



The Andrews Method of building heating systems "to measure" and shipping them complete, ready to screw together, makes them very nice for contractors to handle. And on top of this, Andrews takes all the risk of the plant's success, offering a 360-day money-back guarantee.

Andrews Steel Boilers

Different from all other boilers for residence heating. Made of steel plate like power boilers. Heat up much quicker than cast iron boilers. Burn less fuel, any grade. Last longer. Vertical and Locomotive styles.

Let Us Give You an Estimate on Your Next Job.

Our estimate will include the whole system, figured from the Architect's plans, complete and ready to screw together, or we will sell the boiler alone. Best of material throughout is used in a complete system.

Big Book FREE

This book is more than a catalog. It is a general information book on all equipments for modernizing the home. It also tells you the information we need to make you a complete plant or give a complete estimate.

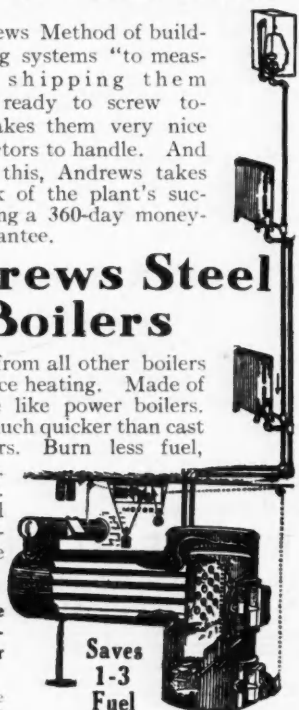

Saves 1-3 Fuel

Sewage Disposal

For Suburban or Other Districts Not Having Municipal Sewer



This system employs nature's own methods and provides a perpetual service in all seasons and all climates. No chemicals are used and practically no attention is required. Sewage disposal is accomplished by bacterial action.

Complete, Ready to Connect Up

Very easy for contractors to handle as the work is very simple and there is absolutely nothing to go wrong. The tank is all self contained and re-

quires no fitting. Write for Sewage Disposal Booklet.

ANDREWS HEATING CO.

1463 Heating Bldg.
MINNEAPOLIS,
MINN.

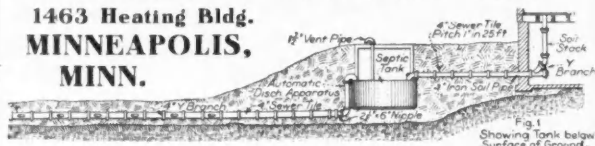

Money Making Mixers

In this day and age, time is money. If you live in a community where labor is hard to get or where the cost of labor is high, and you find that your concrete construction work is costing you more money than you think it should, you will grasp eagerly at the chance to perform a greater amount of work at a smaller cost if such a thing is possible. Here is where the efficiently designed concrete mixer is a very important machine for you to own. With a mixer, the amount of labor required is less, it takes less time to do this labor, and you can do more work at an additional profit than you have previously done.

In another instance, we will assume that you have a competitor, and that he is pushing you hard in the field. If you buy a mixer and he uses the hand method you will be able to give your patrons better work, and you will also be able to take work for less money than he can afford to take it, since you will be able to do the work quicker and at a greater profit.

The illustration below shows the "Winner" concrete mixer made by the Cement Tile Machinery Co., 103 Vinton St., Waterloo, Iowa. This machine is driven by gasoline engine power, and is equipped with a side loader operated by the same power. In the instance shown, the machine has the drum in the dumping position and the side loader is in the loading position.

A noticeable point in connection with this mixer is that the engine is completely housed with a steel housing to keep out dust, dirt and cement from the working parts.

The "Winner" is very light running, and the drum can be swung from one side to the other with very little effort. The drum is so placed that it balances perfectly, and it is not necessary to lift the entire weight of the



Popular Small Mixer for Builders.

drum and material in swinging it from one side to the other. The engine can be started by simply turning on the gasoline, lubricating oil and the battery, and then turning the crank. The mixer can be stopped instantly by turning off the battery. The machine may be loaded while the drum is revolving and may also be dumped without stopping the drum. The drum can be stopped by throwing over a clutch without stopping the engine.

The Cement Tile Machinery Company can furnish you with practically any size of mixer that you feel need of in your work, and will be glad to take up the matter of type of mixer and size of same with you if you will drop them a line. They will also be glad to send you information and catalogs of any kind in connection with their line of machinery if you will ask for it.

Build the Everlasting Way

Good concrete — and that means concrete made with highest quality of Portland Cement — grows harder and stronger every year.

In your building work you cannot afford to take chances with the cement you use. The U. S. Government, in Bulletin 481, states that "many brands of Portland Cement are on the market" and advises users to "select a make *guaranteed* by the local dealer to meet the standard specifications for cement of the United States Government."

ALPHA THE GUARANTEED PORTLAND CEMENT

THE HIGH-WATER MARK OF QUALITY

is warranted to **more than** meet the U. S. Government requirements and all other standard tests. It may be relied upon for **everlasting** concrete work.

ALPHA goes further and is more economical than ordinary Portland Cements, because every ounce is live, active and full of binding power. Every hour, day and night, it is tested by chemists. Don't ask for just "Portland"

Cement; specify **ALPHA** and be sure. Six great plants on six trunk-line railroads; capacity, 25,000 barrels a day.

Send for the ALPHA Book No. 10, giving valuable information about cement and concrete work generally. This illustrated book tells how to do stucco work, how to build concrete barns, silos, ice-houses, and other small concrete buildings, walks, tanks, storage cellars, steps, etc.

ALPHA PORTLAND CEMENT COMPANY GENERAL OFFICES: EASTON, PA.

Sales Offices: New York, Chicago, Philadelphia, Boston, Pittsburgh, Baltimore, Buffalo, Savannah.

Specify ALPHA and be SURE

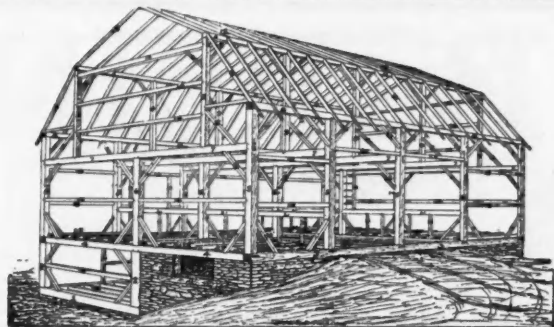

FRAMING

HOUSE FRAMING, BARN FRAMING
ROOF FRAMING

By W. A. Radford. 338 (6x9 inch) pages, 182 illustrations dealing with house, barn and roof framing, covering the subject in its multitude of forms and designs in a most thorough manner. Nothing is omitted that will help and guide on the construction of houses, barns, roofs, etc., while particular care has been taken to exclude any and every method of framing that has not been given a thorough and convincing test by experienced builders.

Have you received your copy?

No contractor or builder can afford to go without this book. A copy will be sent **Free**, postage paid, to anyone sending us their renewal or a new subscription. Regular subscription \$2.00 per year.

AMERICAN CARPENTER AND BUILDER
1827 to 1833 Prairie Avenue
CHICAGO, ILL.

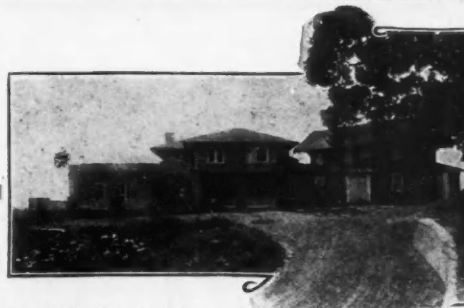

R. S. Shapler, Architect.
Summit, N. J.

All Stucco Houses Should be Finished with CABOT'S Waterproof Cement and Stucco Stains

Cabot's Waterproof Cement and Stucco Stains add fully 100% to the appearance of a building.

These Stains are not paint but a transparent, waterproof, durable coating that penetrates all the pores and shows up all the variations of texture in the surface. This coat keeps out all moisture and acts as a preserver. Stains are easily applied and very inexpensive. One gallon covers from 200 to 250 square feet.

Let us send you **FREE** Color Cards, showing the richness and beauty of these Stains.

SAMUEL CABOT, INC.
Mfg. Chemists

15 Oliver St. Boston, Mass.
AGENTS ALL OVER THE COUNTRY.

Hyatt Roller Bearings used in Boss Mixers

Cement, grit and sand combined with water have been one of the worst enemies of a concrete mixer on account of cutting out bearings and continual reab-bitting,—a problem for both contractors and the manufacturers for years.



Mixer with Hoisting Attachment.

The American Cement Machine Co., after consulting with the chief engineers of two of the very largest traction engine concerns, adopted the bearing they had found would stand the wear and tear,—viz.: Hyatt Roller Bearings. This happened more than a year ago, and exhaustive tests since then have proven that Hyatt Roller Bearings on "Boss"

mixers, which run in oil, encased in special dust and grit proof boxes, save 17% of the power and easily 70% of the oil bill, and have the big advantage of requiring oiling only once a week. The bearing used is known as the Flexible Heavy Duty Type, which absorbs shocks—adding life to the mixer.

This concern has brought out a quality machine—as can be judged by the costly bearings, the "Novo" engine, power, and the all steel construction. Because of their manufacturing power and big factory facilities, they have succeeded in bringing out a full sized machine that they can sell at a price which you formerly paid for a small mixer that required splitting sacks.

The 6 ft. famous "Little Boss" mixer has found hundreds of friends amongst the carpenters, silo and general contractors, who want a combination mixer and hoisting engine for their small jobs. This mixer can also be equipped with batch hopper or the low charging barrow hopper, with hinged loading platform. The extra hoist, which operates independently of the mixer yet is run by the same engine, is shown in

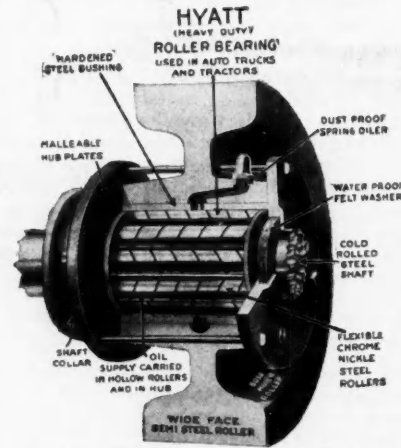

Construction of Hyatt Roller Bearing.

the accompanied photograph at work on a large job.

The American Cement Machine Co., 1006 Johnson St., Keokuk, Ia., has branches in all the large cities of the United States and Canada where it carries stock for prompt shipment. We suggest that every contractor get a copy of the new complete specifications and prices on concrete mixers, and the New Mandt Mortar and Plaster Mixer.

View shows electric motor drive.

BERLIN
Woodworkers also come with Gasoline Engine Drive Either 4 H. P. or 6 H. P.

BERLIN

Portable Woodworking Mills

The Berlin heavy duty portable Saw Rig is a combination of rip saw, cross cut saw, dado saw, grooving machine, jointer, jig saw, boring machine, sander and emery wheel with its own power plant so conveniently arranged that it can be moved from job to job in a light spring wagon at no more expense than a carpenter's tool box. It actually does the work of twenty men with one operator and 20 to 50 cents worth of gasoline.

Designed and Built for Durability plus Portability

The Berlin Saw Rig is easily moved from job to job—but strong and rugged enough to withstand the hardest service building contractors may put it to. Frame and main bearings are cast semi-steel, made in one piece without joints. Frame is then supported by two-inch extra heavy pipe legs on wood skids, which makes a very strong, rigid construction. "Berlin" Gasoline engines are four cycle, horizontal water cooled engines and have built-in magnetos, eliminating battery and ignition troubles. These engines are easily started in cold weather and are accessible by simply raising the wooden table. Machines are equipped with highest grade saws, knives and accessories.

Guaranteed for Two Years

All Berlin Saw Rigs are guaranteed against defective workmanship or material for a period of two years. During this time any broken or defective part will be replaced free of charge. Write for detailed specifications and information. The BERLIN Saw Rig is unsurpassed for combined durability and portability.

SCHAEFER MFG. CO.

BERLIN, WIS.



9 Sizes—\$20 to \$38 Up

There is space between front edge and top to slip wide tracing or drawing to prevent rubbing.

The Frame is solid oak selected and seasoned. The design is right and the construction is right. When bolted together no table can be more solid. Drawer Cabinets are of any size desired. They are ordered extra of standard dimensions.

Complete Drafting Room Equipment

Write for Catalog—State Requirements

American Drafting Furniture Co.,

This table is a favorite with Contractors and Builders who

Have Any Drafting Work

Every Contractor, Builder or Carpenter who draws his own plans or works over drawings should have this combination Drawing Table and Cabinet.

Useful at Home or on the Job

You Can Knock It Down—Take It Anywhere

The Bolts and Rods Make It Stronger Than Glue Joints

The Top is a pine drawing board adjustable from horizontal to vertical and is rigid at any desired angle.



Draftsman's Chest



rawing Tables



Blue Print Outfits

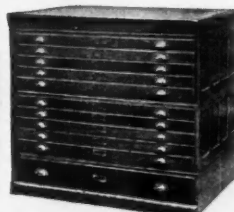

Filing Cabinets (Sect.)

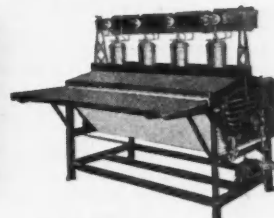

Blue Print Machine

12 Railroad St.
Rochester, N.Y.

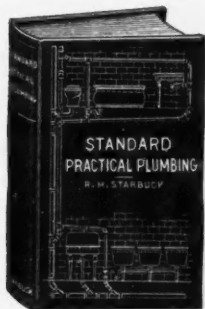

Standard Practical Plumbing

By R. M. STARBUCK

450 pages, 347 illustrations. Of the three hundred and forty-seven illustrations contained in the book, one hundred of them are full-page illustrations. The illustrations all being drawn expressly for this work, show the most

modern and best practice in plumbing construction.

Plumbing in all its branches is treated within the pages of this book, and a large amount of space is devoted to a very complete and practical treatment of the subject of Hot Water Supply and Circulation and Range Boiler Work.

Another valuable feature is the special chapter on Drawing for the Plumber.

It Contains the Following Illustrated Chapters

- | | |
|--|--|
| 1. The Plumber's Tools. | 16. Ventilation. |
| 2. Wiping Solder, Composition and Use. | 17. Improved Plumbing Connections. |
| 3. Joint Wiping. | 18. Residence Plumbing. |
| 4. Lead Work. | 19. Plumbing for Hotels, Schools, Factories, Stables, etc. |
| 5. Traps. | 20. Modern Country Plumbing. |
| 6. Siphonage of Traps. | 21. Filtration of Sewage and Water Supply. |
| 7. Venting. | 22. Hot and Cold Supply. |
| 8. Continuous Venting. | 23. Range Boilers; Circulation. |
| 9. House Sewer and Sewer Connections. | 24. Circulating Pipes. |
| 10. House Drain. | 25. Range Boiler Problems. |
| 11. Soil Piping, Roughing. | 26. Hot Water for Large Buildings. |
| 12. Main Trap and Fresh Air Inlet. | 27. Water Lift and Its Use. |
| 13. Floor, Yard, Cellar Drains, Rain Leaders, etc. | 28. Multiple Connections for Hot Water Boilers; Heating of Radiation by Supply System. |
| 14. Fixture Wastes. | 29. Theory for the Plumber. |
| 15. Water Closets. | 30. Drawing for the Plumber. |

Price, Postpaid \$3.00

Radford Architectural Co.

1827 Prairie Ave. : : : Chicago, Ill.

BUY NOW!

Never were prices on building material as low as ours are now. Buying now for coming season means increased profits to you. Our goods are highest quality—shipments are made day order comes in.

ARE YOU A CONTRACTOR?

We supply mill work, mantels, builders' hardware, roofing, paints, screens, doors, art glass—everything for building. Get our catalogs quick—they mean money to you.

THE HUBER BUILDERS' MATERIAL CO.

45-49 Vine Street,
CINCINNATI, OHIO



GRILLES

Style H-69, illustrated, 18 inches deep at ends. A neat design, with curtain rods, complete, 86c. lineal foot. Other styles illustrated in catalog. COLONNADES of exclusive design—Yellow Pine, Oak, Birch, Cypress, etc., from \$12.50 to \$44.00.



DOOR SETS

Choice assortment of ornamental and plain design. You will find one or more designs for any building. Each set consists of escutcheons, metal knobs, mortise locks, case, Reversible Bolts and Keys.

SCREEN DOOR



WINDOWS

70c. and Up. We carry in stock a wide range of styles at various prices. Impossible to list them here. There are windows for every purpose. Special styles made to order quickly.

No. 314
93c.

Here are a few items from our large millwork catalog.

STAIR WORK.

Turned and square Porch Newels 31c. to 72c. each. Spindles 1 1/2 to 2c. each.

A nice selection of Newels, Balusters and Spindles for Porch or Stair Work, at little more than cost of wood. Clear stock, free from imperfections.

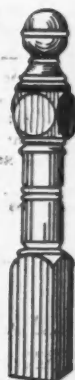

OUR AGENCIES ARE ALWAYS BUSY

Diamond Flexible All Metal Weather Strip

Has built up a permanent, profitable business for Contractors and Carpenters in all parts of the country. If you have not secured an agency get busy at once. Some fine territory still open. The thousands of satisfied users testify to the superiority of our strip.

Diamond Flexible Metal Weather Strips

are easier to sell than the old style rigid strip because they are so much better in use—and it doesn't take much argument to convince owners why they're so much better. Carpenters and Builders can develop a big business selling these. \$3,000 to \$5,000 a year is quite possible, because every purchaser of Diamond Strips will be so satisfied that he will gladly boost them to other owners and tenants.

Diamond Weather Strips mean so much more added comfort that no prospective purchaser will begrudge their small price.

Every Door and Window Needs a Diamond

Where Diamond Strips are used the windows don't stick or bind, and the sash can be removed when necessary without displacing the Flexible Weather Strip. Another thing is that all openings are made air tight and wind, dust moisture and noise haven't a chance to get in. They have been known to effect an economy of from 20% to 40% in fuel alone, because less heat is required in rooms protected by Diamond Weather Strips.

And it's not only residences that use them. Large public buildings—schools, churches, hospitals, etc., are always in the market for these products. We make all kinds, suitable for all styles of windows and doors.

Being made of zinc and highest grade spring bronze, they never rust, and last for years. Can be put in old buildings as well as new ones.

Description of Cuts

Top cut—The dotted lines show the flexible and adjustable features. Center cut—This section shows how sash and strip can be removed at the same time. Lower cut shows the Diamond Metal Weather Strip in place.

Write today for our Booklet Diamond Way of Practical Weather Stripping.

It's of Interest to Everyone Who Owns a Building.

The Diamond Metal Stamping Co.
626 Kerr Street . Columbus, Ohio

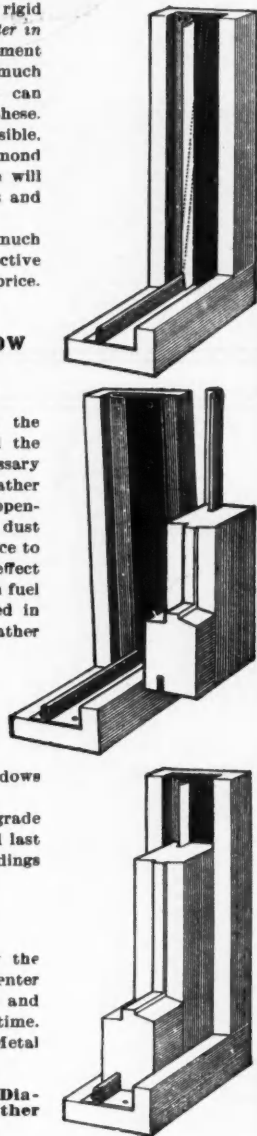

James Equipment—A Good Investment

The old idea that a barn on the farm was merely a place for the storage of feed and the housing of stock or horses has long passed. The up-to-date farmer knows that an economical arrangement of his barn and its fittings, together with all labor-saving devices that he can install, is the true secret of his ability to do work easily and make money. Modern equipment for dairy barns and stock barns has reached a high degree of perfection.

One of the foremost concerns making a specialty of modern barn equipment is the James Manufacturing Company, Fort Atkinson, Wis. We do not know of any better way for the farmer who is in need of equipment or for the builder who will do the work to find out the advantages of the "James Way" than to send to this concern and ask for their book showing how to build and equip a practical up-to-date dairy barn. The photographs and illustrations in this book tell a more important story than we could tell in many pages of description.

Not only is this book of value to the man who is building a new structure, but it is of equal service to the man who is remodeling his old barn and bringing it to an up-to-date condition where work can be done easily and in a sanitary manner. Cattle and other animals require sanitation as much as do people. With the equipment furnished by the James Company, a modern barn may become as sanitary a place as one's own residence. Through the installation of litter carriers and proper trackage, the grounds surrounding a structure of this kind may be kept clean and sanitary. The different types of stalls, pens, mangers, stanchions and carriers furnished by this company are a revelation to a person who has not kept in touch with this line of modern equipment.

Another important feature of the James equipment is the types of ventilators which they offer for keeping the air in the barn fresh and proper for breathing. The pages in their 256-page catalog which are devoted to this phase of barn construction are well worth the attention of any thinking farmer or barn builder. The diagrams given are very clear, and the methods of installation are shown both on the outside and interior of actual structures. The design of the James ventilator is based upon scientific principles, and makes it an important addition to the modern dairy barn.

If you are interested in building some new barn, or if you have seen conditions in some old structure and wish to make it up-to-date in its equipment and in the method in which to handle the stock, write to the James Manufacturing Company, and have the benefit of their special knowledge and long experience. It will be given you free of cost and without obligation on your part. They invite you to write to them, submitting your ideas or telling them your problems. They may be able to make suggestions that will help you in your work and save you money. They have done this for many of your brother builders and farmers and dairy men.

Cement Bag Cleaner with Some New Ideas

A cleaner which will handle several thousand bags per day, turn out each one thoroughly clean, keep automatic count, and ring a bell when fifty have been run through!

The machine is barrel shaped, with box beneath for cement. All working parts are protected from the cement, and are ball bearing—which means something, if you are to use the hand-power model.

One of these cleaners will certainly pay for itself in saving time and trouble. And that doesn't say anything of the cement rescued from the bags.

The Century Cement Machine Co., 60 Browns' Race, Rochester, New York, make the machine, and will be glad to furnish particulars and prices on request.

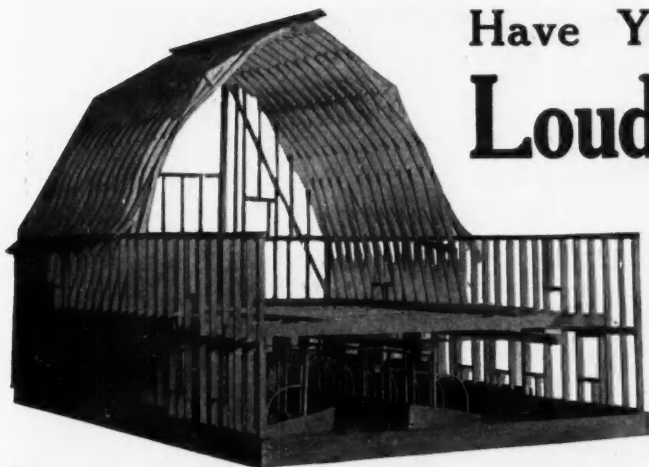

Have You Received Your Copy of Louden Barn Plans?

It is stored with Practical, Money-Saving Information Every Barn Builder Needs

The Service We Offer You

Louden barn plan service will help you build better barns. It will help you build them more economically. It will enable you to approach your client with plans to meet his individual needs. It will enable you to secure more barn contracts.

We make no charge for preliminary plans and suggestions, or for advisory service.

Write today for further information about Louden Barn Plan Service.

Our Book of Barn Plans

LOUDEN BARN PLANS contain the most valuable collection of practical barn plans ever published. Its 194 drawings and photographs illustrate practically every phase of modern barn construction; drainage, concrete work, strength of materials, lighting, ventilation, etc. The published price of LOUDEN BARN PLANS is \$1.00; it's free to you if you build barns.

You need this valuable book—Write for your copy today.

LOUDEN MACHINERY CO., 5603 Fourth St., Fairfield, Iowa

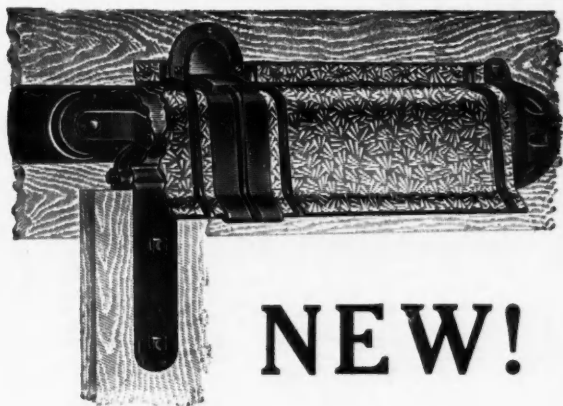

NEW!

You know the old, reliable Cannon Ball Barn Door Hanger—competitors have been trying to equal it for years and haven't hit the mark yet.

Well—if such a thing is possible—we've improved the Cannon Ball—made an addition which gives the user protection plus.

A cover for Cannon Ball track—as illustrated above, is now to be had at nominal cost with new track. It gives the finishing touch of protection—makes the outfit positively weatherproof in every respect—keeps rain and weather away from the hanger and top of the door itself—and adds but little to the cost.

New Track For Cannon Ball Barn Door Hangers Now Furnished With Cover If Desired

Write for detailed information—prices, etc. In addition to the largest line of door hangers, we make the best barn equipment, too. Ask us.

Hunt, Helm, Ferris & Company

304 Hunt St. - - HARVARD, ILL.

HERE IT IS Automatic Screen Door Catch

Just what every housewife is looking for. No more open screen doors—good bye easy access for the flies. Wind can't blow door open. The best and simplest on the market. Automatic catch—with or without night lock. Simple in construction. Door easily opened by any person when night lock is open. Door cannot rebound or rattle.



THE BEST DOOR CATCH ON THE MARKET

Light trip and strong hold. Only four (4) screws to set. Every home needs at least two. Easy to set and **sure to please.** Furnished in Brass or Steel.

Ask your dealer. If he can't supply you send us his name.

Write for information on other screen hardware and time saving hardware specialties. Our Wrought Steel Butts give better satisfaction.

WATROUS-ACME MFG. CO.
DES MOINES, IOWA

Chicago Sales Office, 180 No. Dearborn Street

Valuable Catalog on Lathing Problems

We have just completed a study of The Northwestern Expanded Metal Company's latest catalog. It covers their lathing line thoroughly, giving in addition much information which is of great value to the builder.

Six pages are given over to an interesting list of specifications for metal lath; fifteen pages to a discussion of typical "Construction Details"; and seven pages to a list of lath accessories. The balance of the 51-page booklet is used to describe their excellent line of lathing materials.

The catalog is very handsomely illustrated. The price of a stamp is small, indeed, compared with the value to be had from a study of its pages.

A request for the booklet, number 33, should be mailed the company at 903 Old Colony Building, Chicago.



Composition Face Plates Make Possible Real Broken Ashlar Cement Blocks

By means of a special composition, with which it is possible to make face plates direct from the cut or chipped stone, the Hobbs Cement Block Machine turns out blocks in which all the fine edges and sharp detail of the original cut stone are retained. This process is the property of the Hobbs Concrete Machinery Co., 724 Peter Smith Bldg., Detroit, Mich. The beauty of the blocks turned out in this way places them in a class by themselves.

Their cement block machines are so arranged that some eighteen sizes and shapes of this block may be made with no loss of time. So with the use of even two or three face plates, real broken, or random Ashlar cement blocks are possible. The beauty of this style of masonry is too well

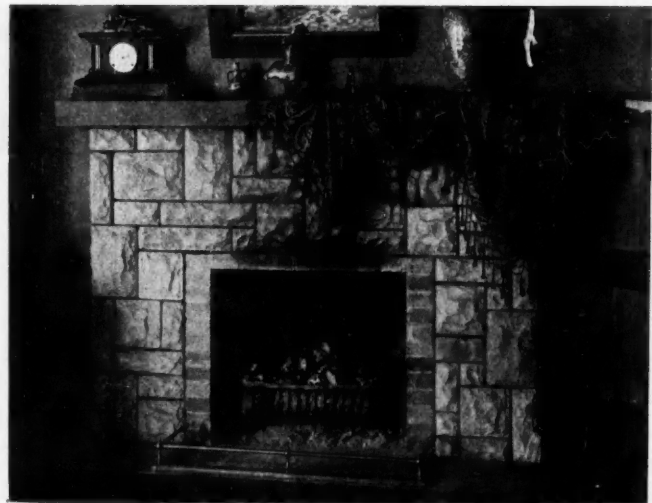

Hobbs Block Fireplace Built by Geo. W. Edgumbe, Benton Harbor, Mich.

known to require explanation here. It is certain, however, that this Hobbs process is gradually changing the entire cement block map.

All of this and much more may be learned by reading their catalog—details of how 2,000 different block sizes may be made on the one machine; how three quarters of the changes may be made with the bare hands in time under five minutes; and full information regarding this wonderful machine—all this is contained in the very interesting catalog they put out on this machine.

The photograph shown is of a beautiful fireplace, built by George W. Edgumbe, Benton Harbor, Michigan, with a Hobbs machine.

The All-One Cabinet Bed

A REAL SPACE SAVER

To the Living and Bed Room what the Kitchen Cabinet is to the Kitchen. Is designed to meet the Great Demand for More Room and at the same time give More Convenience and Comfort.

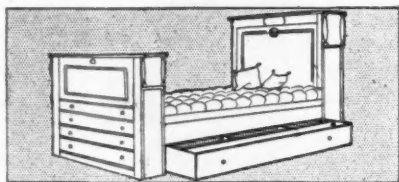

As a Couch. Also note large Divided Drawer

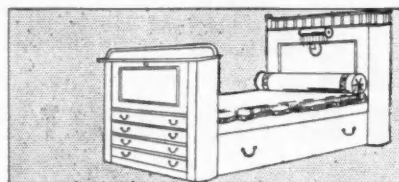

As a Luxurious Bed. Finest Steel Springs

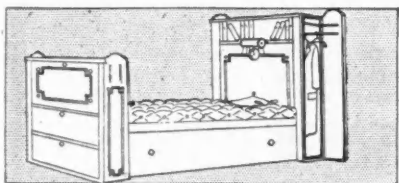

Showing Large Wardrobe—Adjustable Reading Lamp

SOME of the Features of an **ALL-ONE** are Bed, Dresser, Chiffonier, Desk, Wardrobe, Dressing Table and many others.

An **ALL-ONE**, Table and Chair will furnish a Room Complete.

Adds at least 30% to your Floor Plan.

Ideal for Small Apartments, Bungalows and Hotels.

We Want Your Co-Operation and will pay well for it.

We want you to figure them in your Floor Plans, recommend them to your Customers, show them where they can Save Money by Using an **ALL-ONE**.

Explain to them that you can build a Smaller House and get the same amount of Floor Space.

An **ALL-ONE** in an 8x10 room gives you more Floor Space than 10x12 the old way.

Get in touch with us. We'll send **ALL** Details and Catalogue. It's Profitable.

THE CABINET BED CO.

830 Consumers Bldg.

Dept. G.

CHICAGO

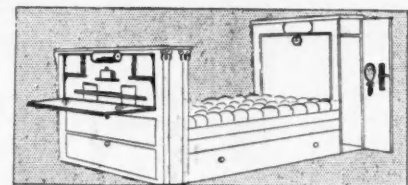

Showing Commodious Desk. Note Desk Light

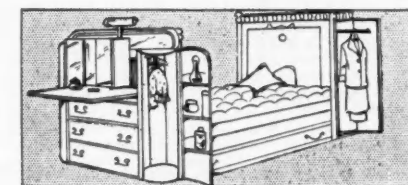

Dressing Table. Triplicate Mirror. Adjustable Light

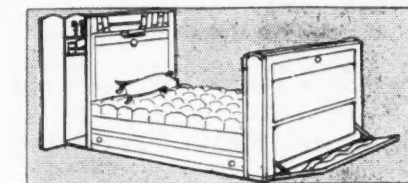

Shoe, Rubber and Slipper Space

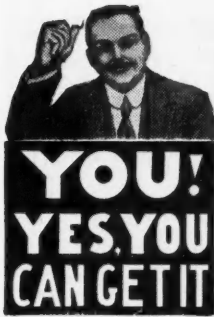

\$300 MONTHLY for YOU

BE MY GENERAL AGENT IN YOUR COUNTY! GET INTO AN HONEST, DIGNIFIED BUSINESS of your OWN!

The man who makes big money doesn't depend upon his own efforts. He organizes other men and makes a profit from their labor, too. I show you how to do just that. Give you valuable exclusive sales territory absolutely free. Put you in a position to manage a large crew of successful agents and make fat commissions on their work as well as yours. With the fastest selling specialty on earth—with the help I can and will give you, and with money rolling in from your own sales and the sales of from six to ten men working under your direction—**YOU SIMPLY CAN'T HELP BUT SUCCEED.**

You are an opportunity seeker. All you want is the chance. I know you will do your part. If anyone will convince you that he can establish you in a paying, honest, dignified business where big money is practically sure, you'll take the job, won't you?

All right, I'll take you up on your own proposition. I'll appoint you as my representative on that very basis. I'll convince you that we've got the best selling specialty in existence. I'll prove to you that when you secure the exclusive representation for your county that you're not entering into a dinky, paltry agency proposition. You're putting yourself in line for an amazingly big paying business of your own with profits of from \$30 per week upward.

Over 70% Are Without Bath Rooms

In country and small towns and cities, the percentage is vastly greater than that. These people have gone without the exhilarating, invigorating health-giving bath simply because until now they could not get it. They have used all sorts of makeshifts, sponge baths, wooden, zinc and metal tubs of various kinds. Heavy, clumsy, unsanitary, in-the-way tubs. Lugging them in and out before and after the bath. Taking up valuable space all the time.

I have invented a practical bath tub that can be used in any room—bedroom—sickroom—kitchen—anywhere—a tub that can be sold at a price within reach of the masses—a tub that is light and yet durable, one that can be folded up and stood up in any corner when you are through with it.—**THE ROBINSON STEELINE PORTABLE BATH TUB.**

I wish I could show you this wonderful tub. Look at the picture. See how it folds up after the bath. Pick it up with one hand and stand it away in a corner just as you would an umbrella. Isn't that the climax of convenience? In use it's as stable as the stationary tub—as luxuriant a submergent bath as any city bathroom affords. Can't tip or splash, equipped with a handy self-emptying device—plenty of room—just the right shape—simple—perfect—absolutely ideal.

We build it of STEELINE, the wonderful new material, and guarantee it for ten years.

YOU MAKE \$5.00 ON EVERY SALE

Think of it. What's the use of wasting your time and effort pushing some specialty that sells for a few cents, when the same time and energy will make you \$5. You get exclusive territory. We protect you. Give you county rights. No cost to you to secure exclusive territory. Then you can appoint sub-agents. If you are a hustler you can make more on this proposition than many a high-class salesman makes on a straight salary. In fact there is no limit to what you can earn. Just one sale a day means \$30 a week. Think of that—two a day means \$60 a week.

NO EXPERIENCE NECESSARY I don't care if you have never had a day's selling experience in your life. I know that you can sell this tub and sell it fast enough and often enough to make big money. I know it because fifty per cent of my best representatives are men and women and even boys and girls who never sold a dollar's worth of any kind of goods in their life before they started to work for us.

This is no fairy-tale. No dream of mine. Every word I write is founded on what has been done by the representatives who are now working for me. I know that they are just ordinary men and women. I know that if they can sell these tubs as they are selling them that YOU can do the same thing—that YOU can make the big money just as they do. I want to tell you all about it—what my men have done and what you can do. Let me send you full descriptive matter about my goods and convincing testimonials from others I have helped to succeed.

Write today—NOW this very minute—either a postal or letter. These exclusive county agencies won't last long. Pick one of these plums while you can—NOW!

H. S. Robinson, Pres., THE ROBINSON CABINET MFG. COMPANY
798 FACTORIES BLDG., TOLEDO, OHIO. For Canadian Territory Write Our Canadian Branch at Walkerville, Ontario, Canada

Send no money. Just name on penny post card for free tub offer. Hustle!

I tell you people are simply falling over each other to buy these tubs. All you have to do is to show them and write out the order. In the country and smaller towns practically every home is a prospect. Even in the city it is surprising how they sell. Right here in Toledo, Mr. N. J. Smith is averaging two sales a day. Used to work in a hardware store at \$65 a month; now he makes that much every week. You can, too. I will send you the records of lots of men who are making big money—just ordinary men and ordinary towns.



DEMONSTRATING TUB FREE

I grant credit—Furnish a sample. Help you out—Back you up—Don't doubt

—Don't hesitate—Don't hold back—You can't lose. My other men are building homes, bank accounts, so can you! Act then quickly.



Linofelted Home of Dr. L. M. Hardin, Flandreau, S. D.

"Linofelt Cut My Coal Bills in Half"

Dr. L. M. Hardin, Flandreau, S. D., writes: "I used Linofelt throughout in building my 8-room bungalow. As a result, my coal bills are cut down to one-half that required to heat a building of equal size ordinarily constructed."

Linofelt is a building quilt made of pure flax fibre 1/4 inch thick between two layers of Kraft paper. It is put on just like building paper. But it takes the place of both back plaster and building paper. Costs no more than back plaster. And is as efficient as 38 thicknesses of building paper.

LINO FELT

"BETWEEN YOU AND THE WEATHER"
(Copyright, 1914, by Union Fibre Co., Winona, Minn.)

Keeps cold out in winter and heat out in summer. Keeps out the chilly drafts that sneak in around door casings, windows and the base of walls. Effects actual saving of 40 per cent of coal bills when applied according to our simple specifications. Vermin-proof, odorless and sanitary.

WRITE FOR BIG FREE BOOKS

that will show you how easily you can build warmer homes, barns, buildings for your customers. Learn about LITH Insulation, too. Get our valuable FREE cloth-bound book, "Insulation for Cold Temperatures."

Union Fibre Co.
118 Union St.
WINONA,
MINN.

The Linofelted Freund Apartment, 21st and Ellis Ave., Chicago.

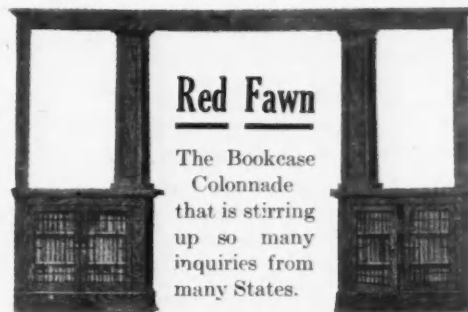

Red Fawn

The Bookcase Colonnade that is stirring up so many inquiries from many States.

The fashionable leader of all built-in furniture. Every Contractor should sell it.

Red Fawn Describer free to Contractors who write for it on their letter head or enclose business card.

Get Our Estimates On LUMBER and MILLWORK for any Jobs You have

You can figure absolutely safe. You can make more. Your customer gets the best building.

BARROWS & DONNELLAN Co.

8753 Baltimore Avenue, - CHICAGO

A good many prosperous Contractors owe their success to dealing with us.

A Very Difficult Proposition—

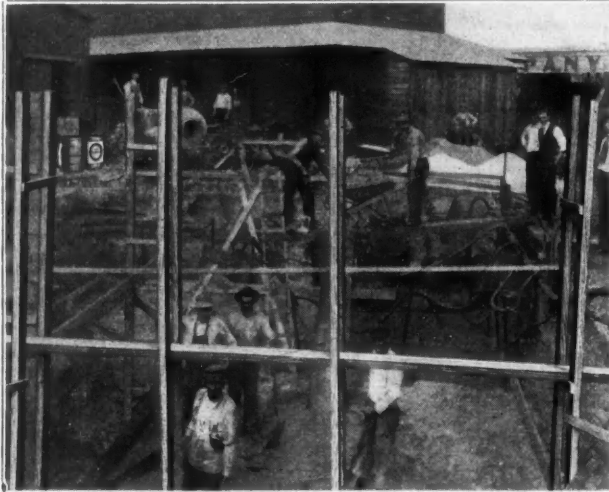

A USER SAYS:—"We used CERESIT Water-proofing Compound in the basement of our new office building. We have about 4½ feet of water pressure in our boiler pit and are about 2½ feet below sewer level. Our basement is as DRY AS A BONE. We can well recommend CERESIT and appreciate the assistance given by your engineers."

You need not hesitate to contract for any water-proofing job, no matter how difficult, if you use CERESIT WATER-PROOFING COMPOUND.

When you buy Ceresit you get not only the best water-proofer but you get the full co-operation of our engineering department and the benefit of our long experience.

With this combination there can be only one possible result—ENTIRE SATISFACTION to your client.

We will appreciate the chance to co-operate with you on your next waterproofing job.



Other CERESIT Products of equal merit are Weather wear Roof Coat, Floor Hardener, Damp-proof Plaster Bond, Damp-proof Coating and Stone Backing.

Ceresit Waterproofing Co.

910 Westminster Building
Chicago

MADE IN U. S. A.

Electric Pumping System for Residences

Two models of a light, automatic electric pump for soft or hard water, are offered the building trade by the Wenzelmann Mfg. Co., Galesburg, Ill.

No. 1 is an upright model; No. 2, horizontal. Either pump may be used with penumatic tank, or attic tank. Outfits are complete. Construction is such as to give longest and most efficient service—special attention having been paid to the elimination of noise. No additional air compressing apparatus is necessary with one of these outfits.

The automatic feature of either pressure tank or overhead tank system is most valuable—requiring no attention whatever.

Illustrative circular matter may be had by addressing the manufacturer.

A Test of Endurance in Concrete Mixing Machinery

"The Standard" low-charging mixer has been strongly guaranteed to the trade as a machine most able to withstand for years any hard usage to which it may be subjected.

Four years ago this May, the mixer, "The Standard," shown in the foreground of the illustration, was purchased by the New York City Dock Department. It can be readily observed in what a good state of preservation it is after almost four years of severe usage. Appearing as it does, "on the job," shows that it is just as capable of doing today what it did four years ago.

This manufacturer has continually maintained that the simplicity of "The Standard" produces its strength and endurance. The low-charging arrangement of the drum of

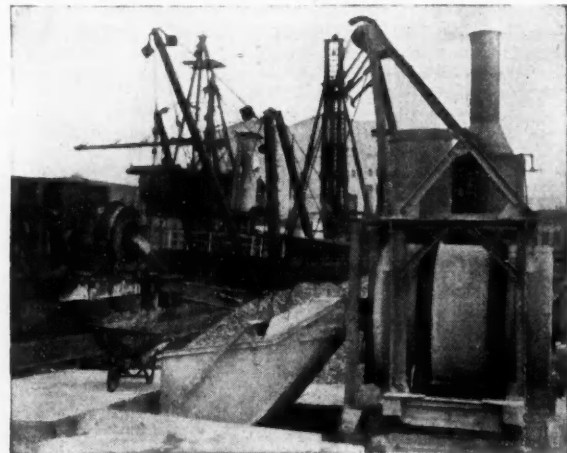

"The Standard" Mixer on N. Y. Dock Work.

"The Standard" saves the wear and tear on this machine and thereby the life of the mixer is greatly prolonged.

"The Standard" mixers are charged at the base of the drum instead of the top. It is proof that such an arrangement saves power, saves time, insures greater production per day and consequently proves a boon to a contractor's profits at the end of a year.

To attain strength, the first thought is bulk and weight. Instead, strength is developed through few parts in "The Standard." This means no complicated devices. The result is light weight.

The Standard Scale & Supply Co., main offices at Pittsburgh, with branches in New York, Philadelphia, Cleveland, Chicago, and many other of the principal cities, are among the oldest concerns engaged in concrete mixer building. Thousands of their machines are in the field of operation. They will be more than pleased to send to anyone interested their descriptive literature covering the twenty-four different types which they manufacture.

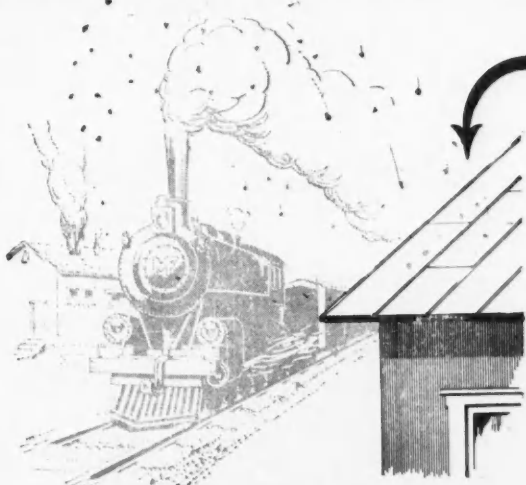

AN MF ROOF IS FIREPROOF

A metal roof is recognized as the best form of fire protection. But an MF Roof adds service to protection.

MF ROOFING TIN

is made from Copper Bearing Open Hearth Steel, guaranteeing the user lasting service and unquestioned satisfaction. Write for booklet "Copper—Its Effect Upon Steel for Roofing Tin."



C.B. OPEN HEARTH
1 C
32 POUNDS COATING

American Sheet and Tin Plate Company
General Offices: Frick Building, Pittsburgh, Pa.

DISTRICT SALES OFFICES: Chicago Cincinnati Denver Detroit New Orleans New York Philadelphia Pittsburgh St. Louis
Export Representatives: UNITED STATES STEEL PRODUCTS COMPANY, New York City
Pacific Coast Representatives: UNITED STATES STEEL PRODUCTS COMPANY, San Francisco, Los Angeles, Portland, Seattle

G. F. T.
Slate

ROOFS
Can't Wear Out

Because they are solid rock clear through. Fifty years of service won't make it look worn or dilapidated. In fact, its looks improve with age. Then, too, it is absolutely fireproof and greatly lessens insurance rates. G. F. T. Roofing Slate is by far the lowest cost roofing in the long run because there are no up-keep costs, the first cost is the only cost.

Our 1915 illustrated 40-page Book on Slate will be ready for distribution March 1st. It contains valuable information for everyone interested in the roofing question. Send for your copy today.

SLATINGTON SLATE CO.
Slatington, Pa. (Est. 1852)

Would you forgive any man in your employ for neglecting the slightest chance to learn something of advantage to you?

The attached coupon brings you some facts that it will pay you to know—pay you well.

But you can only find them out by filling out the attached coupon and mailing it to us today—before this slips your busy mind.

February, 1915

Genuine Bangor Slate Co., Easton, Pa.
Please send information.

Signed

Address

City..... State.....

V. & B. All-Steel Wood Chisels

Vaughan & Bushnell Manufacturing Company have brought out a new all-steel wood chisel to meet the demand for a prying and cutting chisel that can be used for all classes of work. This is a much higher grade chisel than the ordinary all-steel octagon handle chisel. The knurled handle is a dis-

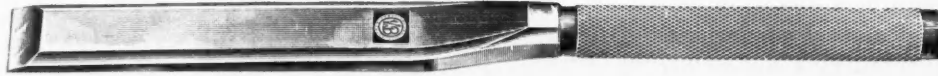

V & B All Steel Chisel for Hard Service.

tinctive feature of the V. & B. product and makes it a most attractive tool.

It is not intended to displace the thinner blade wooden handle chisel for fine cutting, but to save the regular chisel on rough and heavy work, and is, therefore, a very economical tool to have in the kit.

The regular wooden handle chisel will break on account of its flexibility, when prying off interior trim, etc.; but in the V. & B. chisel the blade taper is greater, which, together with the superior quality of the steel, provides the rigidity when under strain of prying or heavy cutting.

You will find these V. & B. chisels on sale at most good hardware stores. Examine them carefully there, or write the makers, Vaughan & Bushnell Manufacturing Company, 2130 Carroll Avenue, Chicago, for catalog.



Beautiful Metal Columns Fast Replacing Wood

Six years ago the Union Metal Manufacturing Company, Canton, Ohio, first placed their metal columns on the market. From that date metal columns have rapidly grown in use. With them there is no splitting, warping, or opening of seams.

And in the six years the artistic construction of Union columns have been improved till the present product leaves nothing to be desired. We give a detail section view of the column, which shows construction.

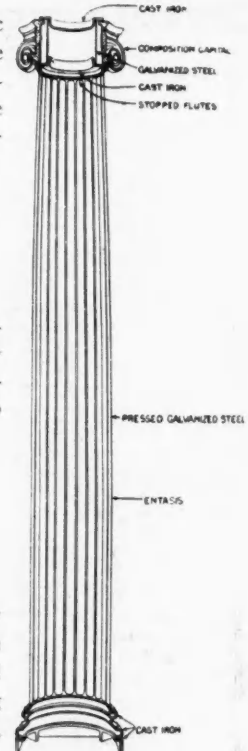

Construction of Union Metal Column.

This company distributes a beautifully illustrated catalog—which may be had for the asking—that will interest every carpenter or builder who reads it.



Splendid Catalog of Splendid Line of Tools

A book which will delight every man who likes a fine tool, is gotten out by the Winsted Edge Tool Works, of Winsted, Conn., covering their well known "T. H. Witherby, Warranted," line of edge tools.

This line of tools is known by woodworkers and carpenters for the exceptional quality of material and workmanship which goes into their making.

Write them for their catalog if you have not already secured a copy.

PATENTED DEC. 29, 1914

TYSCRU

PATENTS PENDING TRADE MARK

THE TIE THAT LEAVES AN ANCHOR

METHODS OF ATTACHING TO WALL FORMS

TYPICAL SECTION OF FLOOR FORMS SUPPORTED FROM ABOVE BY TYSCRU

PLAN OF COLUMN

TYPES OF ANCHORAGE

QUICK — SURE — ECONOMICAL

A REINFORCEMENT — A SPACER — AN ANCHOR

Write for Prices and Discounts to

UNIT-WALL CONSTRUCTION CO., Inc. DEPT. N.

1328 Broadway, New York

Quality The DICKELMAN EXTRA Distinguishing Trade Mark Metal Tile and Shingles

It means an end to ROOFING EXPENSE, ROOFING DANGER and ROOFING TROUBLES.

When you put it on your buildings you are putting on INSURANCE. Every sheet means "MORE PROTECTION."

Fire, Lightning, Storm, Rain and Wind Proof.

Cheaper than wood Shingles or Slate and 100 per cent better.

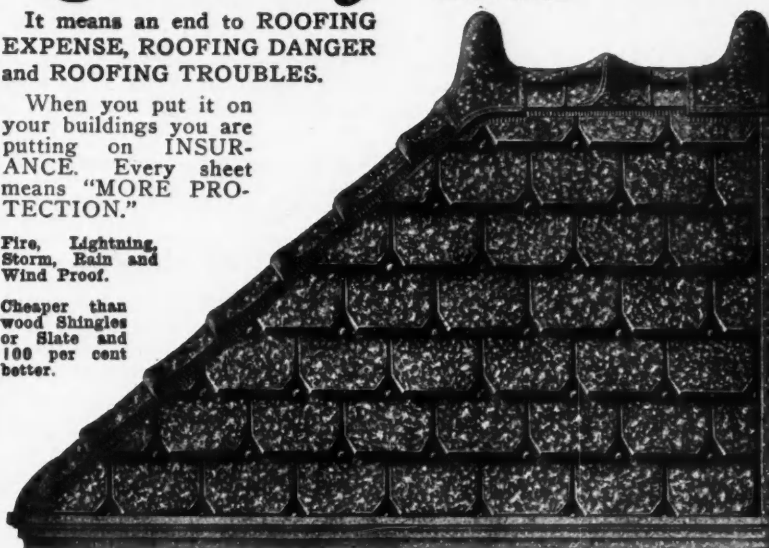

Consist of 99.9% pure, open hearth iron. This combined with perfect galvanizing, enables us to give you a roof that will last! Over a quarter century experience is back of all our products, which include corrugated, V-crimped and roll Roofing besides shingles and other metal specialties.

DEFIES THE DESTRUCTIVENESS OF TIME

Here is an investment that pays unusually large dividends to

Carpenters and Builders

Galvanized Shingles can be laid by a Carpenter or Roofer quicker than any other material. No soldering required, just nails; the lock and flange take care of the rest. Under no condition can any of our DICKELMAN EXTRA Metal Shingles or Tile ever blow off.

No little bills to pay for Soldering and Painting on account of Leaking. Once on, on for a life time.

Reduce the cost of insurance, being both fire and lightning proof. Lightning was never known to strike or injure a building covered with a metal roof.

Can be successfully laid by any workman who will read and follow our printed instructions. No solder is used; only a pair of snips and a hammer are needed.

Write for FREE CATALOG.

Offers many valuable roofing suggestions. Explains "Dickelman Quality" and guarantee.

THE MOST BEAUTIFUL ROOF IN THE WORLD.—Ornamental and Lasting.

Many different designs in painted tin, galvanized or copper. Easy to lay, economical, beautiful.

If you are a builder and contractor, let us know, for we have a profit-sharing arrangement which we make with builders, and it would pay you to ask us about it.

The Dickelman Manufacturing Co., Department "C" Forest, Ohio

SAFETY REYNOLDS SHINGLES



Contractors and Builders will find these shingles more adaptable for roofs above one-quarter pitch than any other shingle of any type. They are flexible, and will work perfectly on roofs as thatched effects, will bend around shapes and always give satisfaction. They never disappoint. They are the original asphalt shingle, and have been on roofs for more than ten years. They are guaranteed for ten years and will last much longer.

WRITE FOR BOOKLET AND SAMPLES OF COLORS

H. M. Reynolds Asphalt Shingle Company
ORIGINATORS OF THE ASPHALT SHINGLE.
Grand Rapids, Michigan

FIRST

THE ROCK OF AGES CLEFT FOR YOU

RED GREEN
SHELDON'S
PURPLE BLACK
SLATE

THE ROOF FOR AGES ALWAYS NEW

ECONOMICAL — ARTISTIC — FIREPROOF
Outlast the building. First cost, only cost. The only roof you can afford to consider for a permanent investment. Artificial substitutes bring endless expense for upkeep. Post a postal and get posted.

F. C. SHELDON SLATE CO., Granville, N. Y.



Make Money Faster and Easier than You Ever Did

before, by handling W. & C. Metal Shingles. We have a special selling proposition to make to one live man in every town in the country, and its acceptance puts the acceptor in a position to make a great deal of money easily

Walter's and Cooper's Metal Shingles

are proof against fire, wind, storm, snow, rain, lightning, rust and decay; will not curl, check, split, rot, crack, blow or drop off, and are long lasting. Cost no more than wood shingles. Ask for catalog and selling plan.

National Sheet Metal Roofing Co., 339-345 Grand Street Jersey City, N. J.

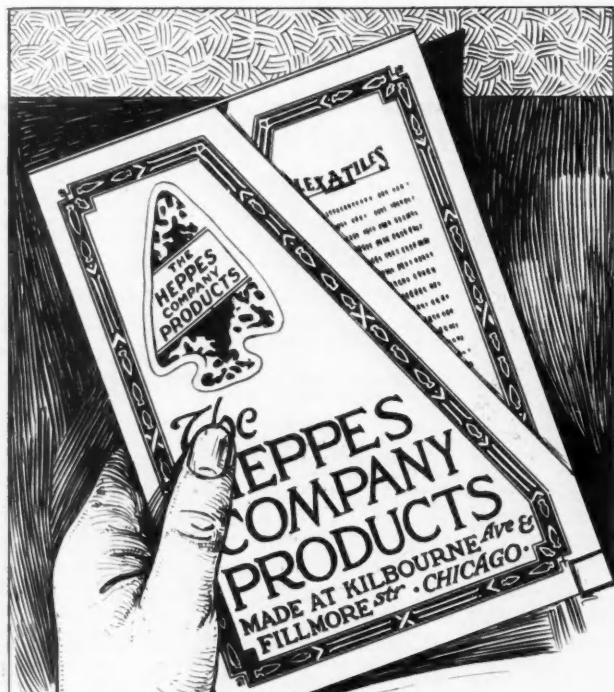

Get This

Reference Book on ROOFING

Just off the presses. Our new handsomely illustrated Roofing Reference Book. Of interest to every contractor, builder and carpenter.

It explains all about our various brands of Roofing and shows the actual colors of our sturdy Asphalt Shingles just as they look on the roofs.

Liberal FREE Samples of the FLEX-A-TILE "GIANT"

a new asphalt shingle accompany the reference book.

Flex-a-Tile "GIANT" Asphalt Shingles are 50% thicker, 50% heavier and 100% stronger than the standard asphalt shingle. This means a 25% saving in labor.

Flex-a-Tiles are also made in standard weights and can now be had in five (5) handsome colors, red, greenish gray, garnet, emerald and brown. See Reference Book for full information.

Flex-a-Tiles make handsome roofs and afford you handsome profits.

Drop postal or write today and we will send book and samples for your files. This reference book is one that every contractor, builder or carpenter can show to his prospective customers.

THE HEPPE'S COMPANY

Manufacturers also of Asphalt Paint,
Asphalt Roll Roofing in any Finish and
Utility-Board, the preferred Wall-Board

1010 South Kilbourne Ave., CHICAGO, ILL.

Carpenters Put Up Lightning Rods

C. H. Townsend & Son, 209 E. Second St., Des Moines, Iowa, makers of lightning protection fixtures, argue that the logical man to install lightning rods is the builder of the building.

They make a fine line of such goods—high in quality, and artistic in finish. To carry out the idea mentioned, they are offering a most liberal proposition to carpenters.

Full instructions make it easy to handle the actual work of installation, and the opportunity is being accepted by a goodly number of builders.

A card to them would bring entire information as to prices, territory, methods, etc.



The Mixer Controls the Job

When you come to consider the fact that, on the job, every other piece of equipment—every operation—is dependent upon the mixer, you are not astonished when you learn that much valuable time is lost by waiting on the mixer.

Yes, indeed, much depends upon the mixer—much, aside from the saving of time—although this is one of the most important considerations.

It is not the matter of immediate profit alone, that is controlled by the mixer. There is a much bigger and more important aspect of the affair than that—the reputation of the contractor.

After the job is done—after all the materials, the time and labor have been put into it—there is no such thing as backing out. If the job is not right there is no such thing as hedging—the work is there to show for itself. If the mixer failed to do its work properly there is no excuse that can be made—*The job is done.*

Time An Important Element But Quality Is More So

It is important that as much time as possible be saved on a job—but it is more important that the product should be of the highest quality—that it will perform the duty for which it was placed there.

If the two elements of "time-saving" and "quality of product" can be combined with certainty then the perfect arrangement can be said to have arrived.

This combination of speed and quality of mix has been obtained by the Oshkosh Mfg. Co., according to their claims, and they have issued a very elaborate book describing and picturing their justly-famous "Four Way Mixer." This book will be sent to any address upon request for it.

The way the Oshkosh people explain their "Four-Way" mixer is like this:

With each revolution of the drum the materials in it go through four distinct operations.

When the material enters the drum it is thrown against the opposite side of the drum. Next, because there is too much material for the buckets to take care of at once, a part of the mix falls to the bottom of the drum again. It is then picked up once more by the buckets and discharged onto the discharge chute. From this position it is thrown against the opposite side of the drum. All this is done in one revolution of the drum.

How many contractors have you heard say: "I can get the stuff to the mixer all right—and I can get it away from it. If I could only get it *through* the mixer faster I'd be all right."

That is the very problem the Oshkosh people claim they have solved—they say that a laden drum can turn only about "so many" times in a minute—the thing is to get the greatest number of motions—real mixing motions into one revolution—to do the most mixing in the shortest possible time.

A glance through this Oshkosh book—a copy of which lies

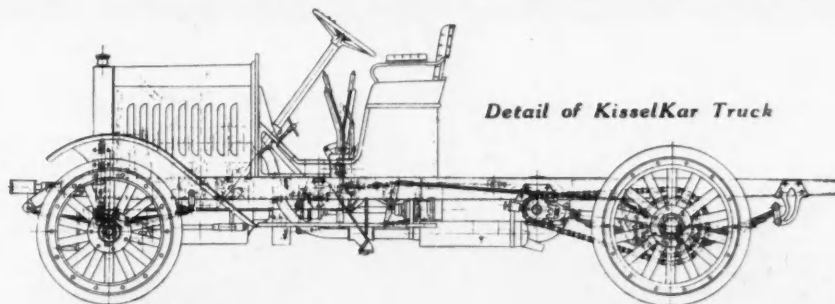

Detail of KisselKar Truck

Let KisselKar Truck Owners Tell You Their Story

If you are going to buy a truck, the place to look for information is among present owners.

Find out what KisselKar Trucks have done for men in your line of business. The Kissel Motor Car Company will be glad to give you the names.

See them or, if at a distance, write them. They will tell you just how sturdy and dependable KisselKar Trucks are and what you can expect them to accomplish.

KisselKar Trucks are used to advantage in 200 lines of business. In many cases they have paid for themselves the first year.

KISSELKAR TRUCKS

There are six sizes of KisselKar Trucks—1500 lbs., 1, 1½, 2½, 3½ and 6 tons carrying capacity. Special bodies can be built for any requirement.

Send for illustrated truck portfolio — tersely in words, graphically in pictures.

KISSEL MOTOR CAR COMPANY
546 Kissel Avenue HARTFORD, WISCONSIN

New York, Chicago, Boston, Philadelphia, St. Louis, Milwaukee, St. Paul, Omaha, Minneapolis, Baltimore, Pittsburgh, Cleveland, San Francisco, Detroit, Los Angeles, Seattle, Buffalo, Rochester, Columbus and 300 other principal points.

Only A Penny

Invested in a Postal will bring you full information and prices about



Blue Valley
Unfading Roofing Slate

World's Fair Premium Slate Blackboards.
Electrical and Structural Slate. Get in touch with us today
BLUE VALLEY SLATE MFG. CO., Ltd.
Box 472 SLATINGTON, PA.



Genuine Bungalows
STILLWELL
CALIFORNIA
HOMES

3 Big Plan Books for \$1, postpaid

Our books show 132 Practical 1 and 2 story Plans adaptable to any climate.

"Representative California Homes"	"West Coast Bungalows"	"Little Bungalows"
50 Ideal Plans, \$1600 to \$6000—Price 50c	51 Plans, \$600 to \$2000—Price 50c	31 Plans, \$300 to \$1700—Price 25c

We sell Books and Blue Prints on a money-back guarantee.

E. W. Stillwell & Co., Architects
4363 Henne Bldg. LOS ANGELES, CALIFORNIA

Best for Your Clients---Best for You

Save the time, muss, expense of staining on the job
Secure not only the best Cedar Shingles, but even color stains—we are responsible for both.



Residence of Dr. A. J. Garver, Worcester, Mass. Architects, L. W. Briggs & Co. 24" "CREO-DIPT" Shingles on Side Walls; special "CREO-DIPT" Shingles on Roof.

"CREO-DIPT" STAINED SHINGLES

17 Grades. 16, 18, 24-inch. 30 Different Colors.
They Come in Bundles Ready to Lay.

Our special process of creosoting and staining preserves them against dry-rot, worms and weather. Colors do not fade or wash out in streaks. We select best cedar shingles, thoroughly dried. The result is more value for roof and side walls than you can get in any other way.

Write today for sample colors on wood and book that shows "CREO-DIPT" houses in all parts of the country.

STANDARD STAINED SHINGLE CO.
1028 Oliver St., NO. TONAWANDA, N. Y.
Shipments prompt. Branch Factory in Chicago for Western Trade.



The Oshkosh Mfg. Co. Mixer Makes Good on the Job.

in front of the writer—is sufficient to convince the most skeptical, or the most critical regarding the manner in which the Oshkosh mixer is produced.

On this page we are showing a picture of the Oshkosh mixer hard at work.

We could write pages about this machine—but there would be little sense in that when the company producing the mixer has issued such a masterpiece of a book.

And, by the way, this book does not picture and describe only the Oshkosh mixer—it lives up to its title, which is "Oshkosh Contractors' Equipment."

We urge every live contractor to send for this book—the man who is alive to his opportunities will find something enlightening on every page—there is no charge for it, and there is no obligation attached to it—and it's a beauty. Address the Oshkosh Mfg. Co., 316 S. Main St., Oshkosh, Wis.

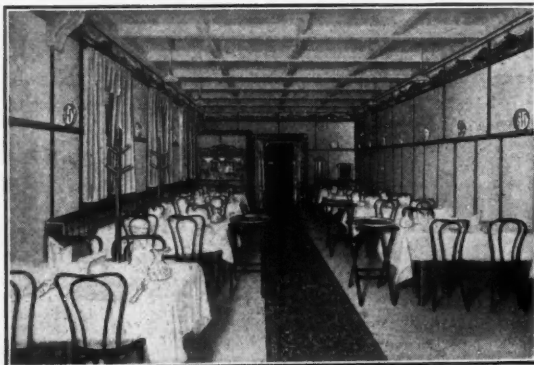

"Emerson Cafe, Attleboro, Mass., finished throughout with Carey Ceil-Board."

Don't let the weather put you out of business

Use **Carey Ceil-Board** for your winter alteration jobs and the cold can't lay you off. **Carey Ceil-Board** can be applied at any season. Nothing to dry. Takes place of lath, plaster and paneling.

Carey Ceil-Board

pleases the owner because it makes no dirt when being applied, keeps out heat and cold, is more sanitary than ordinary wall materials, and can be decorated as desired—paint, paper, tint—or left in the original finish—Gray, Tan, Mission Oak, Golden Oak and Circassian Walnut.

Carey Ceil-Board pleases the builder because it is so inexpensive and easy to apply he can make prices that get the business and still make more money himself.

Every wide-awake carpenter and contractor should know all about **Carey Ceil-Board**. We will tell you if you will send your name and address. Free samples, description, instructions, complete.

Carried in stock by our Branch Houses in most large cities and by best dealers.

THE PHILIP CAREY COMPANY

General Offices: 1001 Wayne Avenue Lockland, O.



Go As Far As You Like

—you'll never find another building material or wall lining like this—none so strong and flat, with so slight a tendency to warp or shrink; none so easily handled, sawing so clean and smooth with so small an amount of litter; none so durable; none with such a stubborn resistance to air, cold, heat, moisture and fire; none so adaptable to so wide a range of uses.



Trademark Reg. No. 94745.

has all these features in its favor, because it is the only material of its kind with a center core of kiln-dried wood slats.

How important it is, then, that you get **COMPO-BOARD**, when you ask for it. You can't be fooled. If you look for the wood core, for it is easily and quickly identified. The border cut of this "ad" gives you a fair idea of how it looks.

You can get just the amount you need for any job, in strips four feet wide and in even feet lengths up to 18 feet long.

Sold by dealers everywhere. Write for interesting book and free sample piece.

Northwestern Compo-Board Company

5777 Lyndale Ave., No.
MINNEAPOLIS, MINN.

Every Carpenter Needs This Tool

Save your valuable time — save expensive delays — and do a far better job than you ever could by the old way — by using the

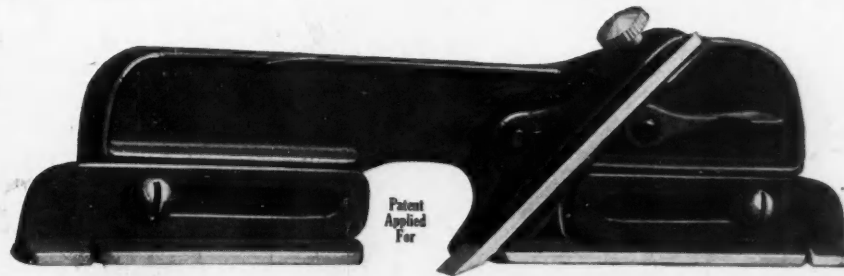

Green Gauge Lock and Butt Router Plane

It reduces the labor one-half in setting locks and butts. Works equally well in hard or soft wood. Can be set by lever to any depth, and will cut out seat for lock or butts to a uniform depth below surface, thus avoiding the uncertainty of setting butts. Has extensions to enable workmen to rout out large butt seats as easily as small ones. Eliminates the necessity of removing butt to put paper under it, or trimming front and back with chisel. Leaves seat as true as face of jamb. Its use means convenience, speed and accuracy.

GET ONE FREE

Believing that "one in use" is worth two salesmen, we will give one free to a carpenter in every community—we know it must be seen to be appreciated. Write us about this free offer. Price of this tool is \$1.25 postpaid. Money back if you want it. Order one today.

I. N. SUTTON & SONS, 215 Poplar Street, Atlantic, Iowa



HUDSON ASPHALT SHINGLES
Durable, Beautiful, Low in Cost. Colors: Red and Green
Write for FREE Samples and Circular A
ASPHALT READY ROOFING CO.
9 Church Street New York, N. Y.

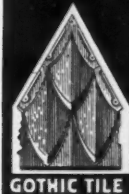

GOTHIC TILE

Indestructible Roofing

Cover your buildings with Montross Metal Shingles and save yourself time, money, worry. Economical in price and easily laid. Our booklet, "The Best Roof Under The Sun" will make you a roofing expert. Free on Request.

AGENTS—MAKE MONEY

On our profit sharing inducement to all reliable live wire dealers. Write for information, how our agents are growing rich handling Montross Metal Shingles. Big demand. This is your chance. Don't overlook it. Testimonial letters and affidavits cheerfully given.

MONTROSS METAL ROOFING CO., 102 Erie St., CAMDEN, N. J.



We can offer something **SPECIAL** in the way of **PRICE**. Write for catalog and particulars.

"A Bit of Utility"

FORSTNER BITS are DIFFERENT from all other wood boring tools. Being guided by the outer rim they may be turned in any direction. The work is left smooth and polished.

Unequaled for Delicate Work

Practical for use as gouges or chisels, suitable for scalloping, fancy scrolls, twists, columns, newells, ribbon mouldings, mortising, etc.

Cabinet and pattern workers are enthusiastic over them. They do more work and cost no more than other bits.

The Progressive Mfg. Co.
Torrington, Conn.

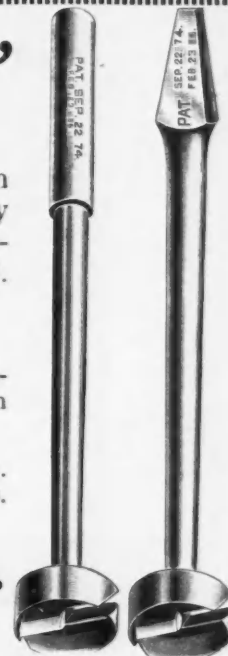



**BAYONNE
ROOF AND DECK
CLOTH**

Requires No "Setting"

Ordinary roof and deck cloths require "setting" in wet paint. Not only is this expensive and troublesome, but it often means a buckled job.

Bayonne is laid right on the dry boards—even the laps do not require painting. It will not crack, peel or stretch, and assures a perfectly smooth, attractive job.

Besides which Bayonne is wear and weather proof. Under foot—under weather exposure, Bayonne stands the test. You can sluice it with a hose without fear of leaking or dampness.

Many architects and contractors have learned to depend on Bayonne. Why shouldn't you know more about it?

John Boyle & Co., Inc.
112-114 Duane Street
70-72 Reade Street
NEW YORK, N.Y.
202-204 Market St.
ST. LOUIS, MO.

Write for Sample Book N giving prices and laying instructions.

Eureka Batch Mixer Ready

Since the first announcement that the Eureka Machine Co., of Lansing, Mich., would soon have a batch mixer ready to market, the eyes of the building world have been toward their plant. Consequently their floor space at the Cement Show, with this new batch mixer in action, was a center of attraction.

Having perfected their continuous mixers, the Eureka people have spent three years in turning out a batch mixer which should be worthy of the trade's confidence. Judging



New Batch Mixer Offered by the Eureka Machine Co.

from the appearance of the machine, and what we know of Eureka quality, they have succeeded.

The capacity of the new machine is 5 cubic feet of unmixed material per batch. The drum is of double cones—each of different taper; the larger of semi-steel joined to a smaller, slightly rounded head by a shell of heavy boiler plate steel. It is of the non-tilting type, and is gear-driven.

A side loader, or batch hopper of same capacity as drum will be furnished with machine—as desired. The water tank is of positive measuring type, with a capacity of 12 gallons. Power is regularly furnished by a 3½-H.P. "New-Way" gasoline engine; but electric motor is optional. The trucks are all steel, three point suspension. The rear wheels are 24-inch diameter; the front ones, 18-inch, with face of 4 inches.

Every builder should be familiar with this machine. If impossible to see the machine itself, a catalog should be secured and studied.

We are informed that the manager of this company desires to contract with reliable sales agents in unoccupied territory. Information concerning this, and the mixer itself, may be had by addressing Eureka Machine Co., 103 Handy Street, Lansing, Mich.



Underfeed Furnace Idea Has Proven Big Success

Nearly everyone is familiar with the Williamson (formerly Peck-Williamson) Heater Company's underfeed furnace. Their "cut-your-coal-bills-in-half" advertising has been prominent in national and trade publications for the past ten or twelve years.

It Has the Looks of Wood Paneling

but not the high price. Cannot be distinguished from real wood except on very close inspection, because

CAL-CO-CRAFT

is an exact reproduction of wood on paper. Gives the color, grain and finish of the natural wood. Applied like wall paper and paneled off with simple moulding strips. Splendid for use in halls, dining rooms, churches, clubs, etc. Compared with the effect, the price is absurdly low. Ask for samples in the various finishes.

Dept. C

The Cott-a-lap Co.

Chicago, Ill
Walkerville, O., Can. Somerville, N.J.

Fiberlic Building Board

Fiberlic products are both theoretically and practically correct, brought together not as a substitute for any other form of interior construction but as a distinct and original method.

Fiberlic construction may be carried on any time of the year. No time lost in drying. Gas fitting, plumbing, electric installation, laying of hardwood floors, building of stairs, fitting of mantles and other wood work may be carried on without interruption.

Fiberlic permits of great economy in alterations and repairs. Write for samples of Fiberlic Building Board and Fiberlic Paint Color Cards.

The Fiberlic Company

CAMDEN, - - NEW JERSEY

Every Other Guaranteed Wall-Board Costs You More Than Plastergon

Which proves that **Plastergon** is in a class by itself, and that it is needless to pay others more than we ask.



WE ARE THE PIONEER MANUFACTURERS of a **TREATED WOOD FIBRE BOARD** and the originators of the **GUARANTEE on Wall-Board**

PLASTERGON

TREATED WOOD FIBRE

WALL-BOARD

"Every Panel Guaranteed."

One by one the other manufacturers are coming around to our method of filling the pores of the wood fibre to make the board moisture-resisting but they are four years behind us in experience and many dollars above us in price.

Have our catalogue and samples with you on every job. They're free.

Plastergon Wall-Board Co., Tonawanda, N. Y. 101 Fillmore Ave.

Save 50% on Your Building Material Bill!

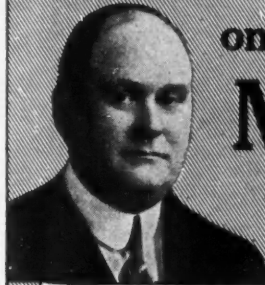

LET me send you our Building Material Catalog showing 8000 price bargains on building material and also our Plan Book showing views and floor plans of 50 modern Houses and Bungalows. They will prove you can build, remodel or repair for much less than you expected. We ship everything everywhere in the way of high grade lumber, flooring, roofing, doors, windows, storm sash, moldings, porch work, screens, hotbeds, building hardware, paints, wall-board, plumbing, heating and water supply outfits, cement machinery and interior woodwork. **Material Complete for Houses from \$398.00 up** All at Wholesale Prices Direct to You. Quality, safe delivery and satisfaction absolutely guaranteed. **Building Material Catalog Is Free.**



CHICAGO MILLWORK SUPPLY CO.
"AMERICA'S GREATEST SASH AND DOOR HOUSE."

H. W. Williams, Pres.

BUFFETS
\$17.00

and up

Built-in Cases for every purpose are shown in our free catalog.



Our Big Free CATALOG shows our full line of Colonnades and Grilles

This Bookcase COLONNADE complete as shown 8 ft. x 8 ft. Yellow Pine

\$22.50

Oak, Birch or Cypress

\$23.50

Beautifully Illustrated PLAN BOOK

Catalog of 8000 Price Bargains

Don't plan to build, remodel or repair until you see these two books.

Mail address on coupon today.

Chicago Millwork Supply Company 1422 W. 37th Street Chicago, Ill.

Please send me your Free Building Material Catalog. (If the Plan Book is wanted, send 1-¢ for mailing.)

Name _____

Address _____

Town _____

State _____ R. F. D. _____

That their idea was right is proven by the success that has been built up during that time. Each year has seen some improvement made on the original furnace. Each year has seen more and better advertising. And each year has seen more Williamson heating systems put in, and more men engaged in putting them in.

Great Help in Laying Asphalt Shingles

On another page in this issue will be found the announcement of J. H. Wiekamp, Mishawaka, Indiana, concerning his new "Lightning Shingler," or shingling gauge.

This device, as will be seen by illustration, consists of a

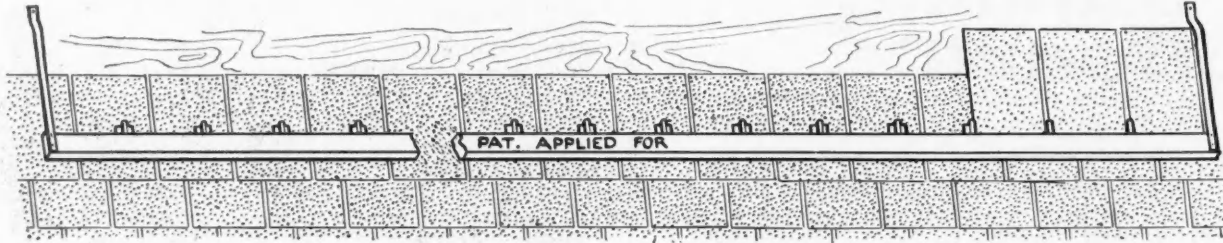

The Wickamp "Lightning Shingler" for Laying Asphalt Shingles Evenly and Rapidly.

This year further improvements have been made—most important is the change by which no stooping is necessary to operate the feed lever. It is simply another satisfaction-giving feature. There is no question but that a man acts wisely in installing the Williamson.

This company offer the service of its engineering department to assist the builder in solving his heating problems. Complete plans, in detail, for installation are furnished free.

Their book, for the contractor and builder, covers the subject in detail. It should be on the reference shelves of every man interested in building. Address the Williamson Heater Co., 147 Fifth Ave., Cincinnati, Ohio, and request copies of their "From Overfed to Underfed," and other literature.

series of little spacers nailed at proper intervals along a straight-edge of the width it is wished to weather the shingles. Straps at each end by which to tack down the straight-edge to roof, complete the shingler.

With this gauge, a boy can lay the shingles in the spaces left between spacers, more rapidly than two men can nail them down. For the second and following rows, the straight-edge is shifted to bring the shingle joints in place desired. In this way a beautifully shingled roof is laid in about half the time usually required. And it is unnecessary to have shingles distributed all over the roof—to be blown away by the wind.

Prices and further particulars may be had by writing to Mr. Wiekamp.

"Mephisto"
Quality Tools

NEVER PUSH a "Mephisto" Bit. This Bit pulls itself into any wood.

"Mephisto" Bits. The Bit with a Razor Edge
The only bit honed like a razor. Made of special "Mephisto" steel, fully warranted. Guaranteed to bore with ease in hardest woods, with or against grain. Non-clogging—Bit will bore all the way through without splintering the wood, leaving a clean, smooth hole.

"Mephisto" Chisels
Made of the same high-grade "Mephisto" steel. Blade is forged from one end of the steel rod which goes through the handle and other end being "upset" to form the head. "Mephisto" Chisels will hold their edges longer than any other chisel made. Made in all styles and sizes. Handles are indestructible.

"Mephisto" Ratchet Brace
A Brace built for hard service. Jaws are so constructed that they will hold and drive from a small size twist drill up to one-half inch round, straight or taper shank drills and bits, also any square taper shank bits up to and including large expansive bits.

All good dealers carry "Mephisto" Quality Tools. If your local dealer doesn't carry them, write to us for catalogue and name of nearest dealer.

W. A. IVES MFG. CO.
Wallingford, Conn.

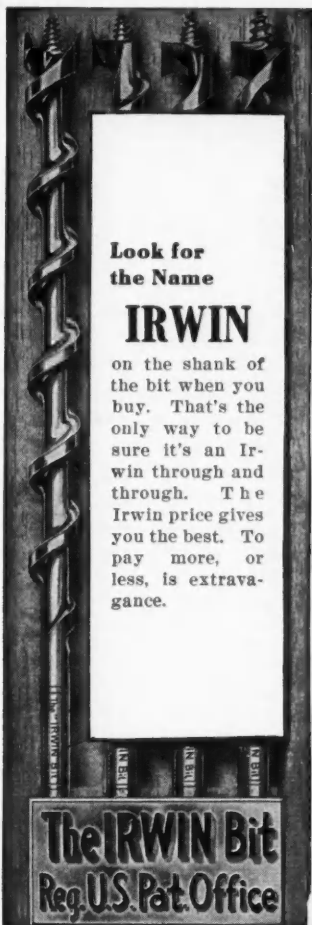

Look for the Name

IRWIN

on the shank of the bit when you buy. That's the only way to be sure it's an Irwin through and through. The Irwin price gives you the best. To pay more, or less, is extravagance.

The IRWIN Bit
Reg. U.S. Pat. Office

THE TRIED TOOL

Whatever bit you buy, you buy it on faith. All you can SEE is the pattern and the finish. You cannot determine the accuracy of its making without delicate instruments. You cannot judge the quality of its steel without laboratory tests. You buy on faith.

Use alone is the mechanic's test of a tool. Every year of the thirty-odd years that the Irwin Bit has been in use has been a year of test. That is the foundation of the users' faith in Irwin Bits.

The Irwin Bit isn't a bit of a certain pattern—although it is the original solid center bit. It is the bit of a standard of quality—quality in material and quality in workmanship. The Irwin twist is not difficult of imitation. But the Irwin heads have baffled reproduction and the Irwin special crucible steel has defied simulation, through all the years that the Irwin Bit has held its place as standard.

The Irwin Auger Bit Company
Wilmington, Ohio

V. & B. ALL-STEEL WOOD CHISEL

PATENTED

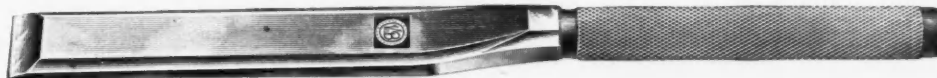

Should be in every Tool Chest.

It's all in the taper.

Saves your Wooden Handle Chisel when doing heavy work.

Will not break or take a set.

For prying they are invincible.

Size	1/2	5/8	3/4	1	1 1/4	1 1/2
Price	.50	.55	.60	.70	.80	.90

Ask your dealer for this Chisel. If he cannot supply you, write us.

Vaughan & Bushnell Mfg. Co.

2130 Carroll Ave. - - - CHICAGO, ILL.



SAND'S ALUMINUM LEVELS

Will Not Warp

Sand's Aluminum Levels are light, strong and durable. They will not warp, split or rust. Nothing to work loose or get out of order. Easy to handle. Need no adjusting. Made in 18", 24" and 30" sizes for Carpenters and 42" length for Masons. We also make a high-grade line of wood levels.

are honestly made of very high-grade aluminum specially prepared for this purpose. The finish is ideal and the greatest strength is placed where most needed. All unnecessary weight is left out. The plumbs are the best that careful experience can make. Each level is fully tested before it is offered for sale. You can count on Sand's Levels being perfect.

Ask Your Hardware Dealer

to show you Sand's Levels. If he does not sell them let us know and we will send you a circular showing full size view of our 24" Aluminum Level and 1/2 view of the 30". Just like seeing the actual levels.

J. SAND & SON 1023 Rivard St., Detroit, Michigan

Best Level to Use in Dark Places

The plumbs at each end and the double center level make it readable in any position and at arm's length. Pick it up anyway. It is always in position. Vials covered with heavy plate glass which keeps out water, dust and dirt. A Sand's Aluminum Level will last you a life-time.

**\$25.00 PAID
FOR ONE DAY'S WORK**

**NEW
MIGHTY
MONEY
MAKER**



**Over
One
Million
in
Use
Millions
to be
Sold**

The Million Dollar Hit!

New, wonderful home invention, just introduced, yet million sales already recorded. Tremendous, rapid sale staggers country. Agents happy—banking enormous profits daily. Mighty opportunity for you to get the mighty dollar. Failure impossible. Experience unnecessary. Money rolls in first hour—\$10.00 to \$30.00 daily. Amazing cash records made. Walters made \$25.00 first day; never sold goods before. Arnold, N. Dak., Carpenter, orders one, then 2 gross; sold 160 in 2 days.

Cleared \$80.00 in Two Days

Hagen, Texas, sold 100 in two days. Webb, Pennsylvania, Contractor, averaged 10 sales per hour. O'Connell, Montana, 25 first day. Mike Bock, Minn., writes: "They are fine sellers; worked one day and sold 30 (profit \$15.00)." Harry Gassmann, Illinois: "Can sell scrapers as fast as I can get them. Overwhelmed with orders. Everybody wants scrapers; 100 already sold." Roy Burningham, Mass.: "Send 10 dozen. One week's work." Hundreds like these. You, too, can have money in abundance.

Grab's Scientific Shoe Cleaner

Sells itself—you take orders—that's all. Every family wants one on their doorstep. Replaces unsightly, unsanitary, crude door mat. Automatically removes mud, dirt, snow from shoe in one operation. Cleans sole, sides, heel. Works like magic—sells like "sixty." Saves drudgery, time, money, shoes—saves carpets, floors. Mechanical wonder. Has 7 new patented features not found in any other scraper—10 steel blades—10 dirt outlets—twin adjustable and removable brushes—compound springs. Rotates for sweeping. Can't clog—practically self-cleaning. Handsomely enamelled. Nothing else like it. Nothing so popular—so easy to sell. Selling price only \$1.00. You make half—100%. Satisfaction guaranteed. Write quick for free catalog—exclusive agency. Better still, send order, naming territory. Investigate anyhow.

Security Mfg. Co. Toledo, O. Dept. 102

Chisels and Braces Added to the "Mephisto" Line

All users of edge tools will rejoice to know that Mephisto bits, "the bits with the razor edge," have recently had an



addition to the family—a complete line of Mephisto chisels and braces. Any workman who

has ever used a Mephisto auger bit will not be slow to invest in one or more of these new Mephisto tools.

Mephisto edge tools are manufactured by the W. A. Ives Mfg. Co., Wallingford, Conn. Their auger bits have been on the market for some time, and during the last two and one-half years especially have been enjoying a very brisk sale. It is a strong endorsement, both for the quality of these tools and also for the energetic business methods of the Ives Company that in so short a time they have developed such a business on the Mephisto line. Today more than 7,000 hardware dealers are selling Mephisto tools.

In practically every locality our readers will be able to examine personally the Mephisto bits, braces and chisels. There is a good deal of satisfaction in being able to investigate, in person, these good things as they come onto the market.

Every tool is protected by a positive guarantee, the W. A. Ives Mfg. Company stating positively that they will replace without charge and no questions asked any broken tool branded "Mephisto." Moreover, they instruct their dealers to give any purchaser his money back if he is not better satisfied with the Mephisto than with any other. This is certainly a broad guarantee, one of the kind no company could afford to make if there were any doubt about the quality of the goods.

The Mephisto bits comprise a complete line of standard bits in all sizes, also electricians', car and ship builders', plumbers', sill borers', screw driver, and special hardwood boring bits. Two styles of expansive bits are also offered—the regular Mephisto pattern and the popular Ives Clark pattern expansive bit.



"Mephisto" Expansive Bit and Screw Driver.

These bits are put up in sets furnished either in canvas roll or in Bartlett box. All of these goods are the very highest quality bit steel, honed to razor edge. The Mephisto is guaranteed to bore without pushing, into the hardest wood, with ease under any condition with or against the grain, and not to clog; will not tear the wood, but will bore all through without splintering, leaving a perfectly smooth hole.

The chisels recently added to the Mephisto line comprise a complete range of sizes of firmer chisels, pocket or cabinet chisels, and butt chisels. They can be purchased singly or in sets, packed in fancy hardwood boxes, or in canvas rolls.

Another new item is the Mephisto ratchet brace, a brace of great power with jaws so constructed that they will hold a small twist drill up to one-half inch round whether straight or taper shank. Four sizes are offered: 8, 10, 12 and 14-inch sweep.

The original and genuine "Mephisto" bit (this name being copyrighted and owned by the W. A. Ives Mfg. Co.) is always stamped "Mephisto" on the round shank of the bit, and on the square shank of the bit that enters the brace it is always painted red. You will also find on this genuine "Mephisto" the name of the manufacturer, The W. A. Ives

A BIG OPPORTUNITY FOR CONTRACTORS & BUILDERS



Our reports from all sections of the Middle West show that building operations will be more active than in many years past. The farmers in your neighborhood need more barns and bigger barns to take care of bigger crops and more livestock.

DuxBak Roofing

We can save you from 50 to 75 per cent and give you the highest grade, longest guaranteed roofing on the market.

- 1-Ply \$1.15 per sq. Guaranteed 5 Years.
- 2-Ply \$1.40 per sq. Guaranteed 10 Years.
- 3-Ply \$1.70 per sq. Guaranteed 15 Years.

PETER J. SEIPPEL LUMBER CO., 212 S. Locust Street, DUBUQUE, IOWA

GET YOUR SHARE OF THE BIG WORK

Tell your friends that you are going to build with the highest grade lumber, along the most modern lines, at the lowest possible cost, and finish the job promptly on time.

YOU DON'T HAVE TO WAIT, or take troublesome substitutes, when you buy lumber from us. We supply you on short notice with everything you need for any kind of building—from sills to roofing—and millwork of every description.

We guarantee every shipment and our direct-to-you factory prices will save you money, not only on car lots but even on small orders.

We Will Pay Your Railroad Fare to Dubuque and Return

We want you to come and pick out the material you need, in our big yards and sheds—see every piece loaded before you pay for it. If you buy a carload or more, we will pay your railroad fare both ways. You will have a pleasant trip and save money, too. Write for our Home Builder's Guide.—It is Free.



Let us send you our big, new, 1915 Home Builder's Guide. It gives illustrations, descriptions and prices. It's a valuable book of reference for builders. Shows you how much money you can save. Write for it today.

HERE'S YOUR CHANCE FOR MORE PROFITS ON THE SAME JOB

As a matter of convenience to your customers—and as a matter of profit to yourself—you should be in a position to equip every building you erect with

THE BARNETT SYSTEM OF GUARANTEED LIGHTNING PROTECTION

You have the owners' confidence and your interest in seeing that his buildings are adequately equipped with proper protection from loss by lightning will make it easy for you to secure this additional work.

Our Rods are in big demand and there is a big profit in selling them. They are made of continuous length, pure copper cable, with attractive fixtures, and are easily installed on any building.

Let us show you the easy way to more profits on the same job.

Write Today for Free Cable Samples, Price List and Catalog.



JOS. L. A. BARNETT & CO., Riverside, Iowa

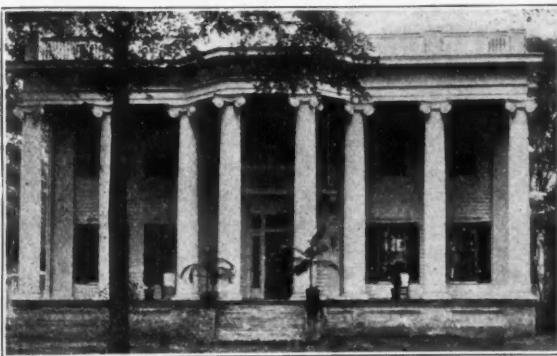

Hegener Patent Lock Joint columns used here.

Colonial Columns

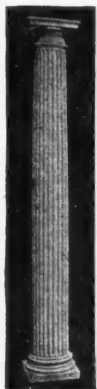

We manufacture all sizes, and guarantee satisfaction. All our columns are made with the "HEGENER PATENT LOCK JOINT." We also furnish composition capitals. Send us your specifications and let us quote you prices.

Send for catalog and price list

RUDOLPH HEGENER CO.
9232 to 9234 Harbor Ave.
CHICAGO

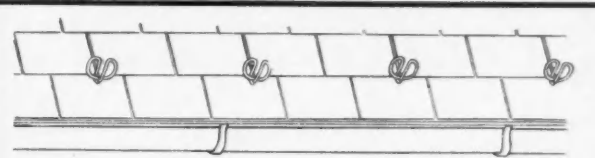

SNOW GUARDS

"CLASON" Guard for New Roofs.

should be on every roof where snow falls

"H-B" Guard for New Roofs.

What They Do

They prevent snow and ice from sliding and dropping on passers-by, thereby saving damage suits. They also protect gutters and eaves from being torn away by heavy snow slides.

"H-B" Two-piece Guard for Roofs Already Laid.

MADE IN THREE STYLES

The "Clason" and "H-B" Guards for new roofs and the "H-B" Two-piece Guard for roofs already laid.

FREE SAMPLES ON REQUEST

We want all Carpenters, Builders and Roofers to write for FREE Samples and Details. Address the

CLASON METAL WORKS
Providence, Rhode Island

Mfg. Co. Be sure and examine carefully that you may get the genuine "Mephisto" bit.

We suggest that our readers call in at the nearest place where good tools are sold and ask to see the Mephisto tools, or write the W. A. Ives Mfg. Co., Wallingford, Conn., for a copy of their illustrated catalog and full particulars concerning these tools.

Attractive "Extra" for Carpenters and Builders

When the housewife first occupies her new home, there is nothing of which she is quite so proud as the beautiful floors. In truth, there is nothing about the house which is really

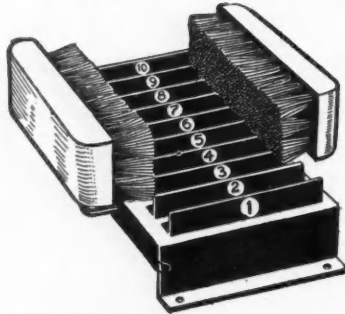

Sells Readily to New House Owners.

more attractive than a finely finished, neatly laid floor. To protect her floors, the lady of house must fight a continuous, mighty battle against dirty, muddy feet.

To help her in this fight the Security Mfg. Co. offer a shoe cleaner which cannot be bettered for its purpose.

The carpenter or builder would have a better opportunity to furnish a new building with these cleaners, than any one else. Older buildings, too, offer a fine chance to pick up extra money, as the commission allowed carpenter agents by this manufacturer is most liberal.

A card to the Security Mfg. Co., Dept. 72, Toledo, Ohio, will bring full particulars, and illustrated circular matter.

New Shingle-Two on at Once

The "Neponset" shingle is unlike the so-called asphalt shingles because each "Neponset" shingle is of a built-up construction, which makes a heavy butt end, three times as thick as the other end. When these shingles are laid they form seven layers on the roof.

The same materials are used in making these shingles as are used in "Neponset" Paroid Roofing, with which builders and owners of farm buildings and railroad or factory men are familiar.

"Paroid" is the roofing which the United States Government has used so extensively—1,600,000 square feet at Panama alone.

In addition to the feature of having unusual durability, the "Neponset" shingle also has the advantage of ease of laying. It can be laid very quickly, and at less cost than wooden shingles. This is due largely to the fact that it is made in pairs, so that you lay two shingles at once. This is also due to the uniformity of the shingles. The carpenter does not have to stop and trim each shingle to fit, as each shingle is just right for the space. For that reason the shingles can be slapped down much quicker than wooden shingles and it requires one-third less nails.

This double form of shingle also decreases the number of joints between shingles. This means a better roof because there are fewer opportunities for leaks to occur.

With all these advantages, the "Neponset" shingle is also architecturally beautiful. It has been specified by architects of high standing and is being used in the best kinds of residences. It is not in any sense of the word a freak shingle when laid on the roof, but closely resembles slate.

The shingles may be painted red or green.

This shingle is manufactured by Bird & Son, of East Walpole, Mass. Write them for sample.

This Window

is keeping out the cold, wintry blasts because it is equipped with

PULLMAN ALL METAL WEATHER STRIP

It is the kind of weather that demonstrates the superiority of PULLMAN ALL METAL Weather Strip.

Good Business Right Now

Winter is here and people realize the necessity of Weather Strips.

Get in touch with us today and we'll make you our Local Agent, giving you Special Discounts. You can realize a handsome profit on it, and the installation, too.

Hurry—Write Now!

Pullman Metal Weather Strip Co.
22 York Place, - - York, Pa.

Straight Talks

on Durametal Weatherstrips

¶ You contractors—carpenters and building owners—why not buy weatherstrips direct from the manufacturer and do your own installing?

¶ By our unique plan, we have cut out the usual big selling expenses, which enables you to buy direct from us, make a profit on the strip and good money on the installation besides.

¶ Durametal Weatherstrips have been successfully sold for over 10 years and have stood every possible test. Their durability and simplicity makes them superior to all others.

¶ Made of best heavy zinc, and fully guaranteed. Write for samples and prices now before you turn another page. There's money in this for YOU.

A few agencies open to responsible, live, local contractors and carpenters.

Durametal Weatherstrip Co.

10 E. Austin Ave.

CHICAGO, ILL.

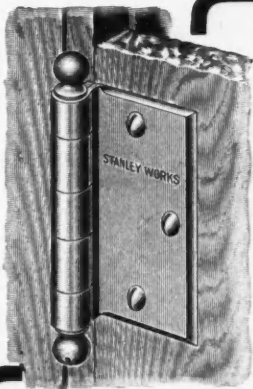

Stanley Ornamental Surface Butts No. 165

*Save Time and Labor
and Please the
Owner*

The Ornamental leaf screws on the surface of the door, saving half the time of mortising. The slotted ball tip can be unscrewed and the pin reversed so that the butt can be used on either right or left hand doors. Packed with **Oval Head Screws** which fit into the countersink and hold the door firmly. Round head screws will not hold the doors securely in place and if not screwed in straight will cause trouble. The screw head is liable to break or the head will meet the butt on an angle so that it is impossible to draw the butt tight to the door. This makes an unsightly appearance.

The handsome, dignified, **Beveled Edge** design harmonizes with the popular designs of hardware. Made in all finishes.

Write for Booklet "A" describing this and many other lines of "Stanley" Quality Hardware.

The Stanley Works
New Britain, Conn.



KEEN KUTTER Chisels

are sold to you with the absolute guarantee of money back if you are not satisfied. Put them to any test—they will prove true. Famous for their clean cutting quality and ability to hold their edge.

*Send for our Home Furniture
Design Booklet No. L976.*

If not at your dealer's, write us.

SIMMONS HARDWARE CO., Inc.
St. Louis New York Philadelphia
Toledo Minneapolis Sioux City Wichita



A MONEY SAVER

The Carpenter looking for real saw value with all the frills removed will find the largest degree of that value in **Simonds No. 8 Hand Saw**. This sells for \$1.75 in 24-inch or 26-inch length, either hand or rip tooth, is furnished any standard number of teeth, has a blade full taper ground for greatest clearance, a plain polished highest grade thoroughly seasoned applewood handle, and five brass screws. The saw is sway back. It is sold by Hardware Dealers or will be sent direct upon receipt of price, when it cannot be obtained from a Hardware Dealer. Every one absolutely guaranteed. If, after trial, you are not entirely satisfied with your purchase the saw can be returned and your money will be refunded.

When you order, ask us to mail you a free copy of our booklet about filing and caring for saws, entitled "Simonds Guide for Carpenters."

SIMONDS MANUFACTURING COMPANY

FITCHBURG, MASS.

::

::

CHICAGO, ILL.



Send
50c
for
Sample

The "HOLD-FAST" Sliding T-Bevel-Iron Handle

An entirely **new Patented** device for holding the blade rigid—which it does do, as the name "**Hold-Fast**" implies.

Made only by

THE SOUTHWINGTON HARDWARE CO.
Southington, Conn.

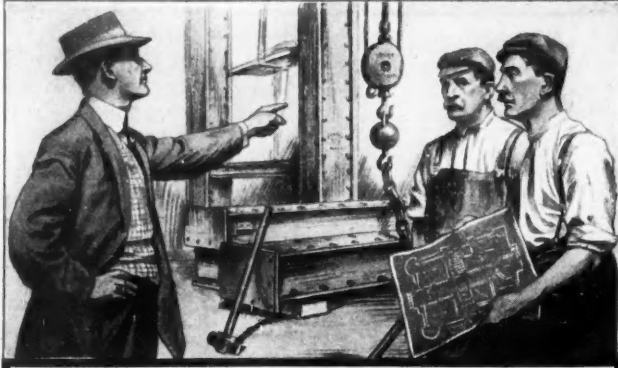

**\$2 a DAY or
\$2 an HOUR
Which?**

Yes, which will it be? You may continue to plod along in the \$2-a-day class, if you're satisfied with that. But if you've got ordinary ability and are not afraid of a little hard work you can qualify yourself to get into the \$2-an-HOUR class.

\$2 a DAY or \$2 an HOUR—the difference is only a matter of *training*. The fellow who hammers away from year to year without trying to learn anything better will always be in the poorly paid class. It's the fellow who learns the business from the bottom to the top who gets into the \$2-an-HOUR class.

If you want to learn how to read drawings, estimate costs, draw plans, or do contracting—if you want to get into the \$2-an-HOUR class as a Builder or Architect—the **International Correspondence Schools** can help you. Right in your *own home* during your *spare time* they can give you the very training you need.

For over 23 years the **I.C.S.** have trained carpenters for good jobs as Draftsmen, Builders, and Architects. *They can do the same for YOU.*

You are ambitious. You want to get ahead. Then don't turn this page until you have marked the coupon and sent it to the **I.C.S.** for full particulars about their system of home instruction.

Mark the Coupon NOW

International Correspondence Schools

Box 910-J, SCRANTON, PA.

Please explain, without further obligation on my part, how I can qualify for a larger salary and advancement in the position, trade, or profession before which I have marked X.

Architect	Foreman Steam Fit.	Automobile Runn'g
Arch'l Draftsman	Plumbing Inspector	Foreman Machinist
Contract'g & Build.	Heat. & Vent. Eng.	Sh.-Met. Pat. Drafts.
Estimating Clerk	Civil Engineer	Text'le Manufact'rng
Building Foreman	Surveying	Bookkeeper
Building Inspector	Mining Engineering	Stenographer
Structural Eng.	Mechanical Eng.	Advertising Man
Structural Draftsman	Mechanical Drafts'n	Window Trimming
Concrete Construct'n	Stationary Eng.	Commer' Illustrat'g
Plum. & Heat. Con.	Electrical Engineer	Civ. Service Exams.
Supt. of Plumbing	Electric Lighting	Chemist

Name _____

St. and No. _____

City _____ State _____

Present Occupation _____

Galesburg Goods Give Great Satisfaction

The illustrations show two articles of the well known Galesburg Sheet Metal Works' line. This company has earned its prominence through the high quality material and good workmanship invariably put into its goods.



One of the Galesburg Skylights.

Their hip-ped turret skylight, shown, is so

arranged that windows may be operated in battery, or separately. The operating device automatically locks them open or closed. The construction is excellent, allowing for largest possible glass area. At the same time strength is not sacrificed.

Great care is given to the construction of the Gale ventilator, also illustrated. It is said to ventilate perfectly even when there is no current of air outside. Special design gives strength and wearing quality. Screening is used to keep out birds. Anyone can put the ventilator on—nothing is required but nailing.

A card to the company's offices at Galesburg, Ill., will bring an illustrated catalog which shows their complete line.



Popular Cupola Ventilator.

Milwaukee Wins Archer Mixer at Cement Show

N. G. Rasmussen, 293 34th Ave., Milwaukee, Wisconsin—with a guess only 14 from being the exact number—won the big "how-many-stones-in-the-hopper" contest, held by the Archer Iron Works at the 1915 Cement Show, just closed at the Chicago Coliseum.

This contest was limited to builders, contractors, or others directly engaged in concrete construction work. The contest itself consisted in guessing the number of stones in a batch hopper-full, at the Archer exhibit. The prize offered was the Archer No. 1, Special Mixer, exhibited.

That everyone wanted to capture that No. 1, Special, was evidenced by the crowds surrounding the Archer space. Some of them tried to figure it out; some calculated it roughly, in their heads; still others turned around three times for luck, put their hats on backward, and gave a wild guess.

The Board of Judges appointed to count the stones consisted of a number of highly reputable trade paper and advertising men. These gentlemen are greatly given to fine raiment; their outfits being especially gorgeous in honor of the Show. The stones with which the hopper was loaded were pieces of crushed limestone aggregate. And crushed limestone aggregate carries with it a beautiful, gray, powdery dust. This dust spread itself, peacefully, all over those nice suits—much to the disapproval of the wearers.

The load of stones was divided, and each man counted his share. Then the totals were added, giving the correct number—13,299. Mr. Rasmussen's guess was 13,313.

Mr. Rasmussen is connected with Chas. Fisher and Son, cement products manufacturers and contractors. There is no doubt but that he will find plenty of use for the mixer, which is a regular stock machine, of true Archer quality.

The contest has proved a decided success, we are informed

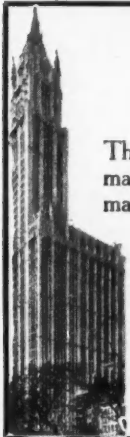

Use Wright Wire Lathing and Build for the Future

The magnificent Woolworth Building was built for generations yet unborn. All materials were selected to stand the test of time. The architects chose from the different makes and varieties of lathing Wright Wire Lathing for this building. They knew that no other make could equal it for rigidity, durability and resistance against fire and time. Let your specifications read Wright Wire Lathing.

The illustration at the right shows Wright Stiffened Lathing with a light coat of plaster to show the key. When the plaster is properly applied, it covers thoroughly both sides, making an impenetrable barrier against fire.

Our Catalog W describes in detail various sizes of lathing for different types of building. Write for a copy today.

WRIGHT WIRE COMPANY,

Worcester, Mass.

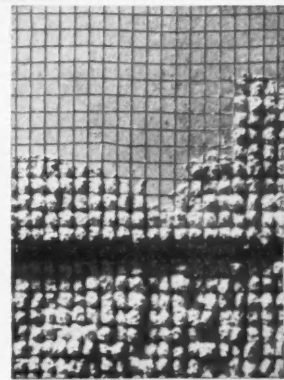

Wright Wire Lathing is made in three finishes, plain, japanned and galvanized.

FRESH AIR AND PROTECTION!



The Ives Window Ventilating Lock

A Safeguard for Ventilating Rooms, allowing windows to be left open at the top, the bottom, or both top and bottom, with entire security against intrusion.

Descriptive circular mailed on application.

THE H. B. IVES CO.

SOLE MANUFACTURERS

NEW HAVEN . . . CONNECTICUT

The "Rustless" Rule

A Revelation in Lightness, Durability, Compactness, Convenience and Low Price!

Here's the rule that every carpenter and builder has waited for. Won't rust, weighs little; fits the vest pocket, yet opens up to 2, 3, 4, 5 and 6 feet; costs less than steel rules, yet is just as durable; has large figures and accurate graduations; has permanent legibility.

The "RUSTLESS" Rule is made of Luminoy—a special alloy of aluminum, with a bright polished surface that will never tarnish. The rule weighs about one ounce to every lineal foot, is not bulky, and folds up into six inch lengths; the joints cannot work loose.

Buy one from your local dealer. If he cannot supply you send us the price of the Rule wanted and same will go forward to you promptly postage prepaid.

Prices—2 ft., 50c; 3 ft., 75c; 4 ft., \$1.00; 5 ft., \$1.25; 6 ft., \$1.50.

Send for printed matter.

Reliable Stamping Co., Inc.
369 Seventh Street
Buffalo, N. Y.

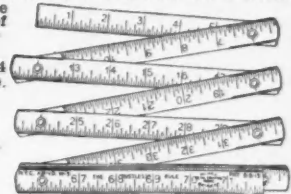

Show This Advertisement to the Home Builder

Boudoir Floors

My Lady America is exquisite. Her daintiness, her discriminating taste and her personality are impressed on all with whom she comes in contact, emphasized by all she does. Her apartment is the lightest, the airiest, the most attractive, the most inviting in the home. Encourage my lady by providing

Suitable Floors on Which to Tread

Because we do not want the least shadow to darken her path we give her Maple, Beech or Birch floors. They have the exquisite appearance and the substantial character that appeal to the one for whose use they have been perfected.

No floor can be beautiful or attractive unless it is durable and durability is an essential quality of Maple, Beech and Birch floors.

This year you will finish many apartments for Lady America. If you wish to make her your lifelong friend, strongly recommend the use of Maple Flooring, finish in natural color, and trim the room to harmonize with the floor. She will do the rest.

"Your Flooring Problem Solved," will help you to solve "Her Flooring Problem." Send for copy.

Maple Flooring Manufacturers' Association

Stock Exchange Building

Chicago, Illinois



Do you realize the possibilities of Parquet Flooring as a money maker?

Do you appreciate the high favor in which it is held by owners, builders and contractors?

Do you know that "Price" is no longer an objection because Federal Parquetry Flooring costs practically the same as good strip flooring?

Do you grasp the many chances offered you for good, profitable jobs of Parquet Flooring or do you lose them because you don't know where to get the Right Parquetry at the Right Price?

Federal Oak Parquetry is of the finest quality of Kentucky White Oak, thoroughly kiln-dried; accurately milled; of uniform color, character and design.

Easy to lay according to directions supplied with each shipment.

Usual sizes in stock or special sizes to order.

Write for Special Circular No. 96

FEDERAL PARQUETRY MFG. CO., Inc.

Offices:
175 5th Ave., New York

Mills:
Lexington, Kentucky

Agents wanted wherever we are not now represented

by the Archer people. They have received a lot of additional publicity for their already well known line, and have made many new friends.

Mr. Rasmussen is to be congratulated on his good fortune, and the Archer Iron Works are to be commended for the satisfactory way in which the entire contest was handled. The gentlemen who acted as judges deserve the thanks of all concerned—and if the job is offered them another time can do one of two things: (1) pass it up, or (2) wear overalls.

Notable Carborundum Exhibit at Big Frisco Fair

Machinery Building at the Panama-Pacific Exposition, which opens at San Francisco on February 20, will undoubtedly house some wonderful exhibits and among them will be the exhibit of The Carborundum Company. In arranging this remarkable exhibit, industrial education was the principal thought as the visitor to the Carborundum exhibit will surely gain a wealth of knowledge regarding many of the varied manufacturing processes in which the abrasive products manufactured by this Company play a most important part, the plan, in brief, being to show in most cases the articles in the crude and in the finished state, together with the Carborundum products with which the work was done.

From manufacturing plants all over the country, from plants in England, India, New Zealand, Australia and South American countries the exhibits have been gathered and the result is a wonderful collection of materials ranging from steel shafts to watch dials, from tooth picks to sections of flooring, from flour mill rolls to needles, beautiful examples of cut and engraved glass, sueded skins, polished and moulded marble onyx, semi-precious stones and pearl work in the

grinding, shaping or finishing of which Carborundum products have been used.

To attractively display the four hundred or more different exhibits, no expense has been spared and from the artistic viewpoint the Carborundum exhibit will surely be noted among the hundreds of exhibits in the Machinery Building.

"Bull Dog" Saw for Tool Carrying Box

A new Bishop saw with cutting capacity of 26 inches, but which may be carried in a 26-inch space, has been introduced to comply with the requirements of many cities that a saw shall not protrude from tool box when carried in public

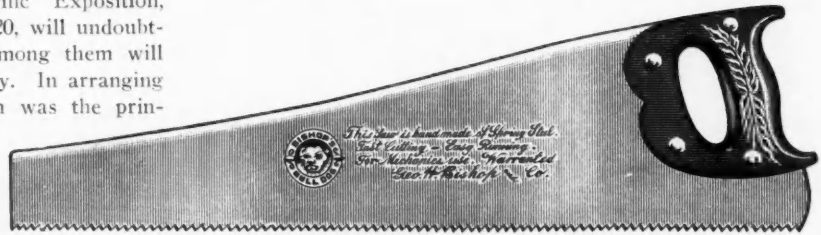

The "Bull Dog" Bishop Saw Handy for Carrying.

conveyance. Great care has been taken in designing this saw, and it is so symmetrical and evenly balanced that continued use does not tire the wrist.

A fine grade of alloy steel has been used, and the handle is of carved apple—in appearance, as in fact, a splendid tool. We are informed that it is made in both straight and skew back.

Full information, prices, etc., may be had from the manufacturers—Geo. H. Bishop & Co., Lawrenceburg, Ind., who are well known through their splendid "Greyhound" line of saws.

BEAT THE CLOCK with a



You, Mr. Contractor; You, Mr. Builder; You, Mr. Lumberman— what is **time** worth to you?

What makes a job a profit or a loss? Just the difference in **time**—that's all. But it's **enough**. Five or ten men drawing 35c to 50c an hour each, loafing because they cannot get to the job quickly or because the material is delayed—that's when **time** has the handicap on you—and you "pay the freight."

You can sit down and look over your 1914 contracts and right there you can **see** your losses on **time** sticking out like organ-stops. How about it?

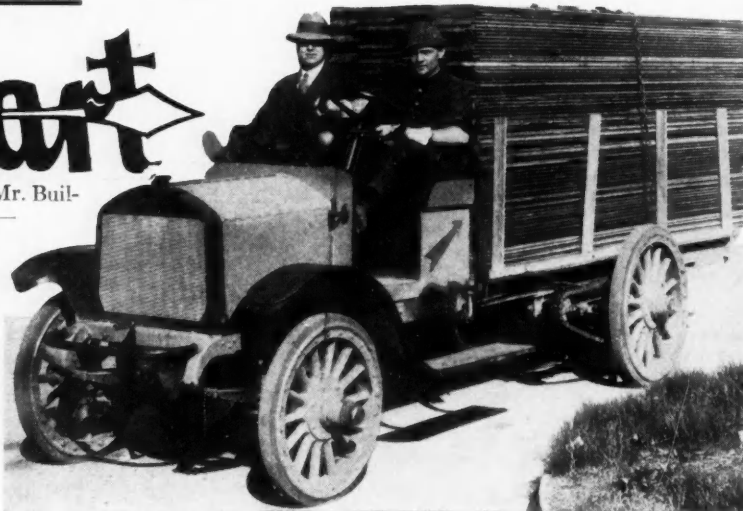

What you need is Dart "time discounter." Take another look at 1914's **time losses**—then you will see that if you had had your "Dart" then what you would have **saved** would have more than paid for it. If it takes a team 45 minutes to make a trip, a loaded "Dart" truck will easily make it in 15 minutes or less; and in moving material remember that a loaded "Dart" will pull more than its own load on trailers behind it.

YOU SAVE TIME WHILE YOU BUY ON TIME—

that's the way we sell "Dart" trucks to the man who wants to pay as he saves. Mail that coupon and we will show you how a "Dart" turns **time lost** into **money found**.

DART MOTOR TRUCK COMPANY

Department C B

WATERLOO, IOWA

COUPON

Interested in your proposition and would like to know more about it.

Name

Address

Town State

AUTOMATIC ELECTRIC OR GASOLENE WATER SUPPLY SYSTEMS FOR FARM, CITY OR SUBURBAN RESIDENCES

Direct Drive Noiseless

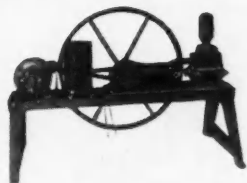

Open Tank or Compression System

"SANI-COPPER" ELECTRIC WASHING MACHINE

Power Washing Machines For Farm Use

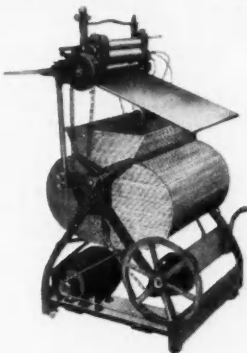

Tub Made of Tinned Copper Complete with Motor

Complete Electric Lighting Systems for isolated residences. Wenzelmann Stationary and Portable Grain Elevators. Best by test for the last fourteen years.

Write for circulars on the line which interests you.

WENZELMANN MFG. CO. Galesburg, Ill.

15 Years On The Market Never A Dissatisfied User

Queen Cupolas have that record. We've been making them for more than fifteen years and they are today giving satisfaction to thousands of farmers. Not a single user dissatisfied.

Queen Cupolas

satisfy because they do what a cupola should do—ventilate your barn. They're strong, handsome, durable and highly efficient. Light in weight and easily put on. Made of high grade galvanized steel. Rain proof. Snow proof. Rust proof. Birds' nest proof. Write for our catalog and 30 days' free trial proposition.

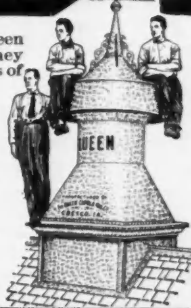

Queen Cupola Mfg. Co., 405 Peck St. Cresco, Iowa

WATERLOO CAST IRON Coal Chutes



Protect the house from careless coal men. They are burglar proof—unlock only from the inside.

Being made of cast iron, are not affected by the weather.

Wire glass in door furnishes light to cellar. When door is open, the glass is protected by heavy steel, which operates automatically.

The watertable at the top of chute protects the inside of foundation from moisture. Doors are extra heavy, with three hinges at top, and are made with a beaded edge which extends over the border opening, making a tight joint. Are made to fit any depth wall.

Send for catalog, which quotes special prices to contractors.

The Waterloo Register Co.

114 Rath Street

Waterloo, Iowa



The rapidly increasing use of cement for garages, barns, corncribs, stables and other buildings has created a big demand for

WAGNER Studding Sockets for Cement Floors

—the easiest-to-use, most durable and best all around way of anchoring studding in cement floors.

Set into the cement while fresh, they are tightly secured and hold with a grip of steel. Protect ends of studding against decay and insure long life to the building.

Made in two sizes—for 2x4 and 2x6 or 2x8 studding; also light weight for partitions.

Your Dealer Can Supply You

We fill orders direct where we have no dealers. Write today for descriptive folder.

Wagner Mfg. Co. Dept. F CEDAR FALLS, IA.

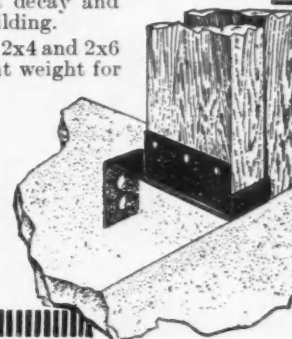

Make Your Own CONCRETE

Requires only a 2 H. P. Engine

Save \$5 to \$10 Per Day

Champion Power Batch Mixer

Is a big money maker on the farm, for laying barn floors and curbs, walks, fence posts, silo blocks, etc.

Will mix more than one-third cubic yard at a batch. Can be used as feed mixer when desired. Strongly built, repair proof, will do steady, hard work for years.

Price Only \$35.00

Guaranteed to satisfy you or money refunded. Special price when mounted on truck with engine attached. We make also a hand mixer of same pattern at lower price.

WRITE US TODAY—ILLUSTRATED LITERATURE FREE



Drum 36 in. Dumps Clean Full Length

Weights Only 100 lbs.

Champion Mfg. Co. 425 B Ave. Cedar Rapids, Ia.



How to Get Lumber at Mill Prices

We ship direct from our Yellow Pine Mills, at Mill Prices to you. We carry in stock over 25,000,000 feet of dry, bright lumber and the capacity of our mills is over 75 million feet annually.

Contractors Home Builders

We can furnish promptly, lumber for building of every character. Special bills cut to order. Low prices quoted on millwork, asphalt roofing and superior wall board. Contractors and home builders write us for delivered prices.

Send No Money

We guarantee the quality of our lumber and ship subject to inspection and approval to all responsible parties.

Home Lumber & Supply Co.

343 S. Dearborn St., Chicago, Ill.

Dept. 6087

One Pound JOHNSON'S Paste Wood Filler Free and Postpaid



FILL out and mail the coupon and receive in return a 1 lb. can of Johnson's Paste Wood Filler. There are no strings tied to this offer—all we ask is that you use the material we send you on a piece of work—a pound is sufficient for filling 40 sq. ft.

Johnson's Paste Wood Filler is made from pure linseed oil, the best Japan Dryer and finely ground Metronite-Quartz from our own mine. It is put up in cans ready for use in the following shades:

- | | |
|-------------------|----------------------|
| Natural No. 10 | Antwerp Oak No. 40 |
| Golden Oak No. 20 | Green Antwerp No. 50 |
| Dark Oak No. 30 | Mahogany No. 70 |

When jobs are to be finished in colored effects you can save the cost of the stain coat by using one of the colored shades of Johnson's Paste Wood Filler. It stains and fills in one operation.

Johnson's Paste Wood Filler does not become hard in cans—will remain usable indefinitely after thinning, and may be wiped with ease in from fifteen minutes to six hours after application. These three advantages over other brands, together with its absolute filling quality, forming a perfect oval pore, make Johnson's Paste Wood Filler popular with the artisan.

Hundreds of barrels of Johnson's Paste Wood Filler are sold every year to fine furniture manufacturers who demand the best materials for finishing the beautiful furniture and pianos they put on the market.

INSTRUCTION BOOK

We will also send you free a copy of our 25c color Instruction Book. This is the work of famous experts. It gives full information on the proper method of finishing all wood. It will prove good, profitable reading for every progressive painter and decorator.

ACB-3
Please send me free and postpaid a 1-lb. can of Johnson's Paste Wood Filler No. also booklet "The Proper Treatment for Floors, Woodwork and Furniture."

Name

Address

City & State

Fill out and mail to
S. C. JOHNSON & SON
"The Wood Finishing Authorities"
RACINE, WIS.

A Pair of Handy Bench Tools

The Stanley Rule and Level Co., New Britain, Conn., turn out a portable bench dog (No. 202) and a bench bracket

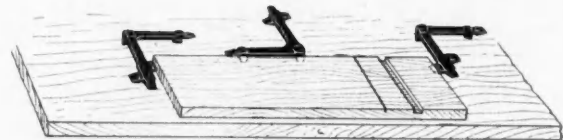
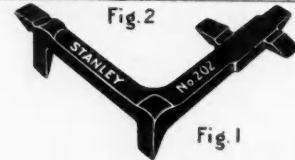
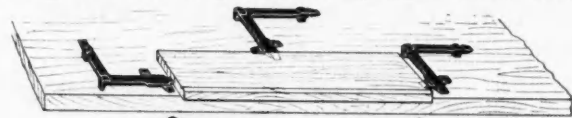

Fig. 3

The Stanley Bench Dog.

(No. 203) which should be valuable to both the man who has a completely fitted bench and the man who hasn't. Sketches of the tools are shown. It will be seen from them just how bracket and dog are used.

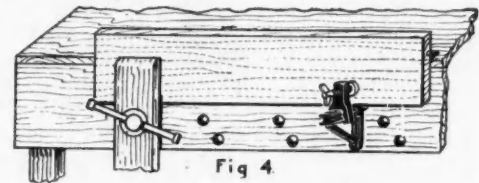

Fig. 4

Bench Bracket in Use.

There are plenty of times when the man who has a permanent dog on his bench could find use for an extra one; or when a bracket could be well used besides a vise. The man who has neither dog nor vise on his bench can hardly do without tools such as these.

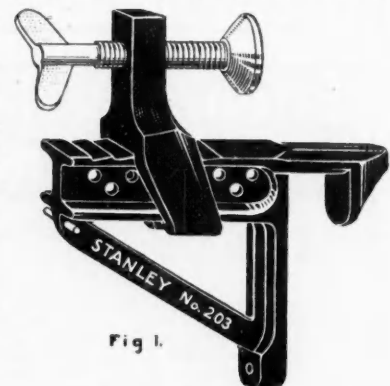

Fig. 1

Detail of Bench Bracket.

Both tools are simple of operation. The dog holds bench and material by means of wedge points; the bracket holds to bench by means of a hooked nose which is put through any one of a series of holes in bench face.



Kissel Kars to the Front

Foreign shipments of motor trucks aggregating in value more than \$700,000 have been made by the Kissel Motor Car Company of Hartford, Wisconsin. Advices received by the company from abroad and from American agents of European governments indicate that even greater business will soon be placed and that KisselKar trucks will be specified in a large portion of it.



Chicago Building Material Exhibit to be Further Enlarged

There is nothing small about the Building Material Exhibit in Chicago. Its size and completeness has proved one of the main factors in its success. A fair idea of the magnitude of the thing can be gained by considering the fact that the 125 exhibits there now cover a floor space of 25,000 square feet.

**We Pay
Freight**

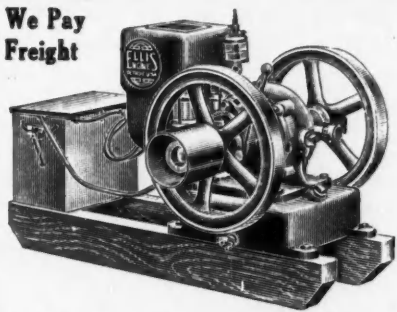

All sizes for all purposes. 1½ to 18 H. P. Vertical and horizontal. Guaranteed 10 years

Don't Pay For Your "Ellis" without getting it

Every carpenter or contractor who does not use a reliable engine is paying for the engine without getting it. He pays for it in lost time, and in labor costs. You can buy an Ellis Engine out of two weeks' wages to one workman; and your Ellis will give you reliable service for many years.

Ellis Engines are America's favorite with carpenters, contractors and builders. Very compact in design; light in weight in proportion to power. Easy to operate; no cranking. Run either way; reversible while running. They work successfully on common cheap lamp oil at a fuel cost of

6 cts. for 10 hours

for each horsepower developed. Just the thing for wood-workers, rip-saws, planers, cement mixers, hoists; in fact for every job where power can be used. Write for free book "Engine Facts" giving valuable information and full details of our 30 Days' Free Trial Offer, with opinions of users from all parts of the world.

Ellis Engine Co., 2863 E. Gd. Boulevard, Detroit, Mich.

THE FOOS

ENGINES FOR PUMPING

Electric lighting, hoisting, carpenter shop, contractor's service — 1½ to 400 H. P. Send for No. 47—the largest gas and oil engine catalogue ever printed.

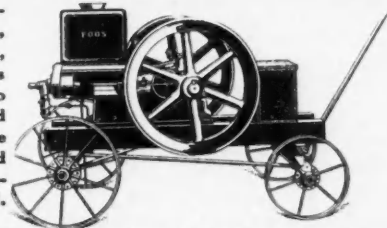

THE FOOS GAS ENGINE CO. SPRINGFIELD, OHIO

HOISTS

An Ebel Hoisting Engine does the work of a large force of men at a fraction of the cost. Built in three sizes—3 to 2 R. H. N. P.

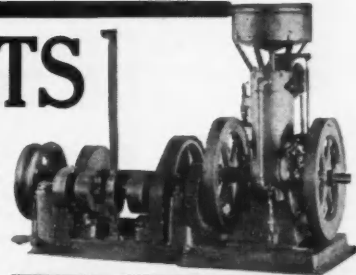

EITHER BELT OR DIRECT GEAR DRIVE

Here is a hoist that will soon pay for itself. In these days of strong competition no contractor can afford to be without one. The Ebel is solidly constructed and will never wear out. Write for catalogue giving complete information and details.

Lansing Motor & Pump Co.

Lansing, Mich.

One of Eleven School Houses in Minnesota recently equipped with UNIT Sash Balances

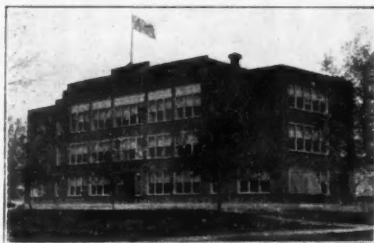

High School, Dassel, Minn., fitted with UNIT Sash Balances throughout

Many of the best buildings now under construction are fitted with

PULLMAN

Unit Sash Balances



instead of the old-fashioned cords and weights. UNIT Balances are noiseless, present a fine appearance and last almost indefinitely. Box frames are dispensed with, permitting the use of narrow mullions and reducing the cost of the woodwork.

Uniform Size Face Plates

Makes the cutting of mortises just as easy as for sash pulleys. UNIT Balances can be installed with less labor than cords and weights, and usually at an actual saving in cost. At the same time PERFECT WORKING WINDOWS ARE ASSURED.

Catalog with blue prints sent upon request.

PULLMAN MFG. CO., 10 Industrial St., Rochester, N. Y.

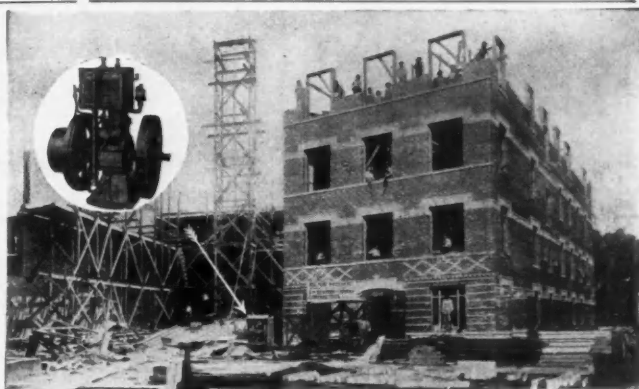

Who Pays When the Engine Stops?

Surely not the Mixer Manufacturer or the people who build the engine.

You know very well that every time your engine coughs a few times and stops that you are the one who foots the bills. The wages of a dozen or more men idling around comes out of your pocket—and all of this time you fuss and fume with your engine. YOU CAN ELIMINATE ALL THIS BY EQUIPPING YOUR POWER PLANT WITH

THE "New-Way" Engine

A durable and economical engine especially adapted to the contractor's requirements.

No breakdowns. No attention. No regrets. No water. No freezing. No pumps. No falling down on contracts because of inefficient power on your machines.

WRITE FOR CATALOG X AT ONCE

**THE "New-Way" MOTOR COMPANY
LANSING, MICHIGAN, U.S.A.**

It is easy to see that the individual exhibits are very comprehensive displays and it is in this that their value to the architect lies. Take the case of brick. There are several of these exhibits on the floor, and every one of them is sufficiently large to show the visitor just how the bricks will appear and how they can be used in actual construction. One brick or a half a dozen bricks won't give a true idea, but a wall or a complete front is as good as a house to show the effect.

Then the size of the exhibits gives the architect an opportunity to test from every angle the material in which he is interested. He could hardly obtain a more complete or satisfactory demonstration at the factory. When he is through, he can get his figures and place his order right there at the Exhibit if he wishes, for practically every manufacturer represented has a top notch man in charge of the display of his products.

It is probable that a fair sized house could be built from the materials shown on this second floor of the Insurance Exchange Building, where the Exhibit is located. Such a house, by the way would be a modern one, too, from foundation to chimney.

Another new room, to be built at one end of the exhibition floor, is planned by President Friedmann. There are already two large assembly rooms for the use of exhibitors, architects and contractors; but the rapidly increasing interest in the Exhibit demands another and larger one. President Friedmann believes he will be warranted in setting aside the new room entirely for the use of out-of-town architects—who take advantage of the invitation to make the Exhibit their headquarters while in Chicago.

New Plane Saves Labor in Cutting Butt or Lock Seats

A progressive builder has brought forward a device which does away with one more of the "nasty" jobs which have confronted carpenters in the past.

This is the Green Gauge Lock and Butt Router Plane, by the use of which setting butts and locks is made easier by twice! Also, it takes away the uncertainty of this operation—finishing absolutely true so that there is no need for truing up afterwards with paper pads.

The blade is adjustable to any depth, so that it may be used for any size butt seat. The tool itself is made of the best materials, and will practically last a lifetime. The



The Green Gauge and Router Plane.

manufacturers, I. N. Sutton & Sons, Atlantic, Iowa, have made a very generous offer to carpenters as a means of introducing this new tool. They are giving one of these planes free to one carpenter in each community. We are not familiar with the conditions of this free offer, but suppose that the man who writes them first gets the free plane. We suggest that you write them immediately, asking for particulars about the Green Gauge Lock and Butt Router Plane and tell them you want to take advantage of their free offer.

The Lightning Shingler

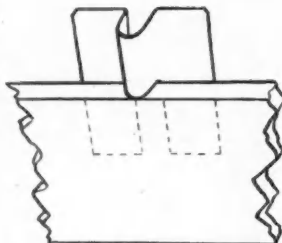
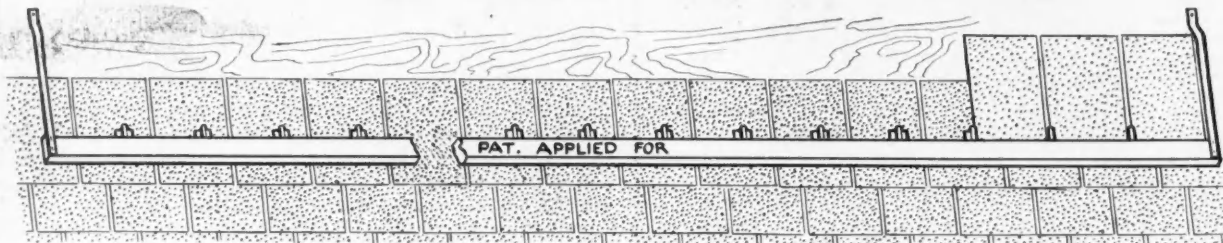

Detail View of Spacer

A piece of specially formed sheet metal—with a raised shoulder to take edge of shingle. They are nailed along straight edge width of asphalt shingle apart.

Doubles Your Speed Guarantees Accuracy Increases Your Profits

This shingle spacer is about the **biggest** little thing ever put out to help the carpenter make money and save time. The spacers are nailed to your straight edge, the width of asphalt shingle apart. Then you can take a carton of shingles and slap them into place faster than two men can nail. For your next row shift the straight edge to bring shingle joints in proper position—and let 'er go. The result will be a beautifully laid roof. The man who doesn't use them has no chance with you.

Price \$7.75 a Set or \$4.00 half set, Postpaid

A set consists of 300 spacers and 3 doz. hanger straps for straight edge. This amount is sufficient to take care of a big job. A half set will handle smaller jobs—but the more economical way would be to get a full set. We give complete directions for use, with shipment. Terms are cash with order. Better snap it right up.

J. H. WIEKAMP

533 Webster Street

MISHAWAKA, IND.

Mr. Carpenter and Builder

Do you wish to substantially increase your yearly income?

Good! Now we can talk business

PERHAPS in your town or county where you are acquainted and now doing business, our metal weather strip is not represented.

WHY NOT TRY to secure the exclusive right of furnishing and installing our metal weather strip in your territory.

YOU buy the strip on the per foot basis and install same at a handsome profit.

Our weather strip is the easiest sold on the market

Because—It is the strongest and gives greatest protection.

The meeting-rail strips are double nailed and tight. Our spring bronze is extra heavy gauge and straight. NO KINKS.

The All Brass Threshold has conquered the door bottom problem.

When writing for our proposition—tell us something about yourself, also territory desired.

Niagara Metal Weather Strip Co.
737 Main Street - BUFFALO, N. Y.

Lorenzen

As Usual in the New **MORRISON**

Chicago's Latest and Greatest Hotel

Wherever tile and mosaic work was used in this famous new hostelry, the Lorenzen line was selected.

The walls and floors of the wonderful first floor grill with the attractive blue and white color scheme; throughout the kitchens; in the bathrooms—Lorenzen tiles and ceramic mosaics were used.

This is only one of many where the Lorenzen line was selected for its distinctiveness and breadth.

Write today for "Tiles and Mosaics," describing our complete line for all sorts of work.

Chas. F. Lorenzen & Co.
103 N. Clark St.
CHICAGO.

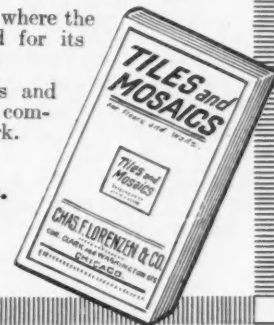

Get This FREE BOOK On House Moving—NOW!

Here is a book that is worth a lot of money to any one who is interested in house moving—or to any carpenter or contractor who isn't making as much money as he'd like to, and is willing to make some extra money just by investing two or three hundred dollars and doing a little head-work. Take notice right here that I tell you frankly at the start off that the plan I want to put up to you requires the expenditure of a little cash, but you hold the stakes at all times and I know by long experience that my plan is a winner—and if you follow the plan I will outline to you, absolutely free, you can

Make \$1,500 to \$3,000 a Year—Extra

You can handle this proposition right along with your regular contracting business or you can make it your entire business, just as circumstances dictate. That part is up to you. What I want to do now is to show you where a mighty profitable business is being neglected and how you can step right in—now—and clean up a lot of money. Others are doing it, and you can do it, too. I know of one contractor who cleared \$450 in just 10 days—some are netting \$100 to \$300 or more on every job they tackle.

Considering the small amount of money you have to invest in equipment, I don't know of any business that will pay such enormous profits as house-moving. Now bear in mind that house moving isn't in the class it used to be. New tools have been invented—new systems have been worked out—

greater efficiency has been attained all along the line. House moving today is a clean, practical, big-money-making business, and if you're willing to invest 2c in a stamp to mail me the coupon below, I will outline a practical, thoroughly-tryed-out plan that will start you on the real road to money making. I cleaned up fifty thousand dollars in the house-moving business in ten years—and I'm willing to give you the benefit of my experience and show you how you can get started. This is a business proposition that you can't afford to neglect.

Just Mail This Coupon

Get full details of the plan I offer to send you free, then judge for yourself, whether or not you can afford to pass up this opportunity to make thousands of dollars—extra—every year. Tear out the coupon—fill it in—send it to me now!

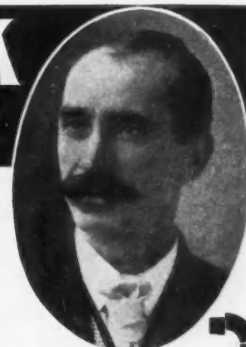

E. W. La Plant

President of La Plant-Choate Mfg. Co., designer of the original La Plant house moving tools and the new all Steel Giant Trucks which have revolutionized house moving.

E. W. La Plant, President,

La Plant-Choate Mfg. Co.,

620 Eastlack Court, Cedar Rapids, Iowa.

Send me your free book on housemoving and complete details of your plan, without obligation to me.

E. W. LA PLANT, President
620 EASTLACK COURT, - - - CEDAR RAPIDS, IOWA

Name

Address

City State.....

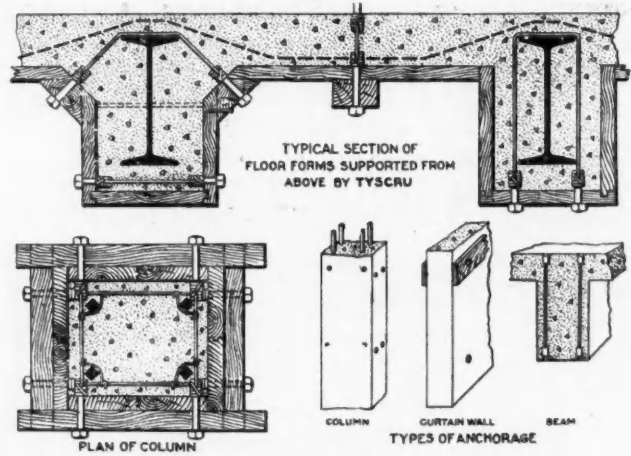
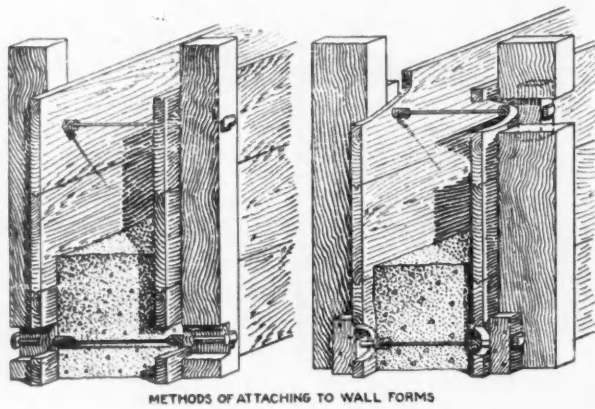

Various Applications of "Tyscru" as Form Tiers, Anchorage, and Reinforcement.

Tying and Anchoring Device

A very useful purpose is met in a most ingenious way by the simple device known as the "Tyscru," manufactured by the Unit-Wall Construction Co., Inc., Dept. N, 1328 Broadway, New York City. Various applications of it, for holding wall, column, and beam forms in place, and afterward providing secure anchorage for fastening or hanging attachments, are illustrated in the diagrams herewith.

Some mechanical appliance serving this purpose is indispensable for all concrete work for which forms are built up. These "Tyscru" act as form clamps; leave no holes for leakage; are quickly and securely fastened; take the place of many sets of twisted wires and bracing; act as wall spacers, giving exact measurements; and provide a real reinforcement, as the coiled ends act as washers, giving solid mechanical bond. They are claimed to be the only bolt anchorage that distributes stresses; and they cannot work loose under vibrating loads.

If forms happen to have been removed too soon, they can be replaced quickly and safely through help of this device.

These are some of the special features of this unique invention. There are others that you can learn about by writing the manufacturers.

PATENTED DEC. 29, 1914



Coils Give Positive Grip for Screw Threads.

**INSPECTED AND TESTED
AFTER EVERY MANUFACTURING PROCESS**

**GERMANTOWN
MASTER BUILDER**

HAMMERS AND HATCHETS

From the initial forging of these famous tools to the final fitting of the handles there is not one process they undergo but is passed upon by expert inspectors. If the slightest defect is found, the tool is unhesitatingly discarded. This attention to detail is, naturally, costly, but it absolutely prevents any but perfect "Master Builders" getting on the market.

And for over 57 years the perfection of these tools has had international reputation among those who recognize and demand the BEST.

Famous Master Builder Hammer, ideal hardness, oval-faced head and a claw that grips. Handle of second growth hickory, natural finish, octagon shape to prevent slipping. Perfect in hang and balance. Made in three sizes, No. 745, 11-oz., No. 746, 16-oz., and No. 747, 20-oz. Each, . . . \$1.00

Famous Master Builder Hatchet. Thin bit, splendid balance, perfect cutting edge. Handle of second growth hickory, octagon-shaped and swell-ended to prevent slipping. Drives nails like a hammer. No. 319, Size 1, and \$1.50 No. 320, Size 2. Each. . .

**Germantown Tool Works
Philadelphia, Pa.**

Branch: 62 East Lake Street, CHICAGO

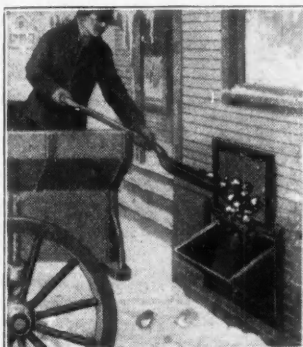

Majestic Coal Chutes

Keep the Building and Lawn Clean

Over 100,000 In Use

The Majestic Coal Chute is made extra durable, and will outlast the building. It has a heavy steel body—cast-iron door frame and boiler plate hopper. When open, the hopper comes out automatically, catching all the coal. When chute is closed it sets flush with the foundation. It has a glass door, giving good light to the basement. It locks from the inside and is absolutely burglar-proof.

Send For New Catalog and Prices

THE MAJESTIC COMPANY 505 Erie Street HUNTINGTON, IND.
 New York, 50 Beekman St Kansas City, 5212 Saïda St. The Galt Stove and Furnace Co., Galt, Ontario, Can.

The "BEST" FUEL CHUTE

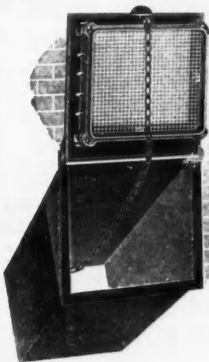

GLASS OR SOLID DOOR
 The "BEST" Fuel Chute is insurance against marring of your building. Is made with either glass or solid door. Both are absolutely burglar-proof. When chute is open, heavy screen protects glass from breakage. In warm weather glass can be removed and it serves as a Ventilator, the "BEST" is neat in design and looks well on any building.

THE BEST LINE

THE "BEST" THIMBLE
 Be up to date and use our ALL CAST IRON Flue Thimble. We make the "BEST" in five sizes for 6 in., 7 in., 8 in., 9 in., and 10 in. pipe.

Write for circulars showing the complete "BEST" line.
 STERLING FOUNDRY CO.,
 8 Ave A, Sterling, Ill.

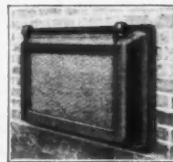

The "Ottomatic" Coal Chute

Patented Sept. 15, 1914

Fire Proof-Burglar Proof-Fool Proof

Best—Indestructible—the One Operation Chute—Locked in Both Positions.

No. 1, 17x24", wt. 100 lbs... \$12.00
 No. 2, 22x33", wt. 150 lbs... 17.00

CAN BE PUT IN OLD OR NEW BUILDING
 Special Discount to Agents

THE MAXIMILIAN CO.
 844 Monadnock Block Chicago, Ill.

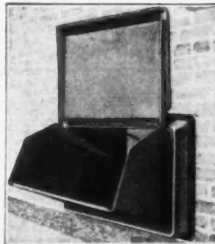

If You Build Buy Own

Be up to date and have the world's best
The Window Chute
 for your coal bin.

Thousands in Use

The Very Best

Write for Booklet C.



Holland Furnace Company
 Holland, Mich.

World's Largest Direct Installers of Furnaces.

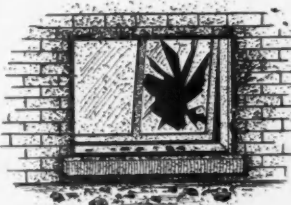

Avoid this

in future buildings
 by installing
CANTON COAL CHUTES

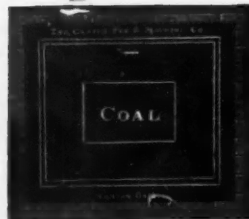

Foundations are going up now—show the owner how he can save endless trouble and inconvenience by installing a Canton Coal Chute. Include them in your specifications for the coming season's jobs. They are absolutely essential to modern buildings.

Canton Coal Chutes are rugged and substantial in construction, neat appearing and easily installed. They are positively burglar proof.

Made in 3 Sizes

Our Catalogue B-I showing our complete line of Builders' Iron Work will be sent free

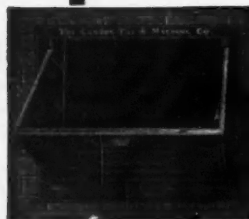

Canton Foundry & Machine Co.
 Canton, Ohio

An Improvement in Sanitation

In localities where a sewer system is lacking it has been the common practice to dig a cesspool at some distance away from a residence to receive all sewage and often the drainage from the building. Cesspools are only temporary, and are very unsanitary. No one putting in a cesspool expects it to last more than a few years at the best. Every one knows that they must be cleaned, and that the cleaning is both expensive and a great nuisance. After a cesspool has once filled up, they will fill up again very soon after cleaning.

It is the unsanitary features of the cesspool that concern the public at the most. Can you imagine a more unwholesome, unsanitary, unhealthful attempt at sewage disposal than a cesspool close to your house and containing quantities of stagnant drainage?

Thanks to the work of the health boards and to general education, the old-fashioned cesspool is being gradually eliminated.

It has been the cause of thousands of deaths and will continue its work of destruction as long as it exists.

The modern septic tank has been found to be of great service where connection to a sewer system was impossible. These tanks are made of a variety of materials and in various forms. One of the most satisfactory forms of septic tank and one which is easily installed in or near a residence is that furnished by the Andrews Heating Company, 1463 Heating Building, Minneapolis, Minn. The Andrews tank is made of sheet steel riveted at all parts so that it is tight and fitted with pipe connections for the entering and discharge lines. A tank of this kind makes it impossible for any of the sewage to reach the soil before coming to the drain tile which forms part of the purification bed.

An advantage in the use of the Andrews steel tank is that it can be installed in ground of any slope merely by the use of properly constructed manholes for inspection of the interior of the tank. A tank of this kind is connected up to a filtering bed, consisting of 4-inch drain tile with open joints and bedded in porous material, such as sand, gravel, crushed rock, etc.

Little attention is needed for the proper working of the tank under all conditions. By using a filtering bed of proper consistency or by carrying the discharge from the tank to a bed of running water there is claimed to be absolutely no danger of contaminating nearby well water, nor is there great danger of contaminating the running water into which the liquid may be discharged. When a filtering bed is used near the surface of the ground, the soil over it is greatly enriched and profuse vegetation results.

If you are interested in the installation of a septic tank, the Andrews Heating Company invite you to allow their engineers to make plans for you and give special suggestions covering individual requirements. This will be done free of cost to you. We would also suggest that you write to the Andrews Heating Company and obtain their pamphlet showing different cases where this septic tank has been made use of and see what other people have to say who have faced problems similar to your own.

SILO AGENTS and OTHERS

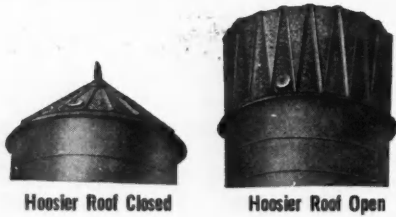

are making good money taking orders for the Hoosier Silo Extension-Roof. It sells on its own merits. Every one familiar with the Hoosier roof agree that it marks a new epoch in silo construction. Every farmer who has a silo wants

a Hoosier Roof. Every farmer who buys a silo, will buy a Hoosier Roof. If you are selling silos and do not have our agent's proposition, WRITE US TO-DAY. All silo salesman who sell the Hoosier roof declare that the roof boosts their silo sales.

Write to our nearest office for Hoosier catalogue and agent's proposition.

SHEET METAL SPECIALTY CO.

GOSHEN, IND. Dept. X KANSAS CITY, MO.

Ask for Agency Proposition on the Victor Barn Ventilators



ENGINE PRICES DOWN ANOTHER NOTCH!

Look at these Prices!
 2 H-P, \$34.95; 4 H-P, \$69.75;
 6 H-P, \$97.75; 8 H-P, \$139.65; 12 H-P, \$219.90.
Other sizes up to 22 H-P, proportionally low.

Direct from Factory to User!
 Why pay two prices for any good engine, or take chances on a poor, or an unknown engine, when the "WITTE" costs so little, and saves you all the risk.

WITTE ENGINES, Kerosene, Gasoline & Gas

Stationary, Portable and Saw-rig Styles.

Liberal 5-Year Guaranty

GET your engine from an engine specialist. All my life I have done nothing but make engines. **The success of my customers and nothing else, makes my success.** I've simply got to sell better engines. I can't lose money on an engine and make back the loss on something else. My factory is the only one, that started in the engine business 27 years ago, which has come through successfully under the same management with which it started. Only WITTE engine-quality has made that possible.



CASH OR EASY TERMS.

It is cheaper and easier to own a "WITTE" engine than to do without one. My New Offer makes it easier to get the work done by machinery than by muscle or brute power. No need now to get along without a "WITTE."

New Book Free My New Book—the finest in the whole engine business—explains all. It tells you how to be sure in your selection, even if you don't pick a "WITTE." Send me your address today, so I can send you this book FREE with my New Offer.

ED. H. WITTE, Main Desk, Witte Iron Works Co.
 1774 Oakland Ave., Kansas City, Mo.

LET ME send you a "WITTE" engine to earn its own cost while you pay for it. It's cheaper than doing without one. I have proved that to thousands who are now WITTE users.
 Ed. H. Witte.

HOW TO JUDGE AN ENGINE
 READ THIS BOOK BEFORE YOU BUY ANY ENGINE IT IS SENT FREE FOR THE ASKING.

SEND US THE NAMES OF PARTIES
 Who are Building New Homes who
 may be interested in an Electric Light
 and Power Plant for same. If we can
 sell them a Plant we will send you
 a check for \$10.00.

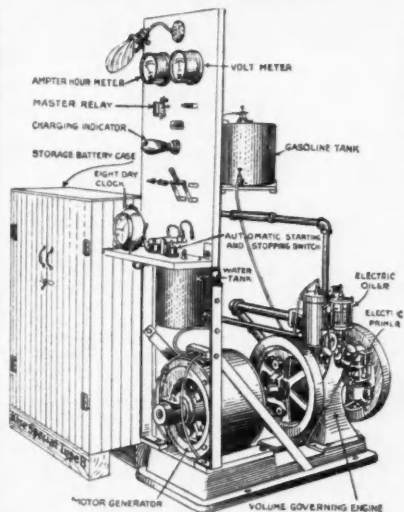

Make the Home modern. Use an Electric Plant. One that will light the home and outbuildings, pump water, run the washing machine, vacuum cleaner, electric irons, fans and all modern electrical appliances. We build plants for small towns, Churches, Country Clubs, Public Buildings, Garages, County Farms and country homes.

Send for Bulletin No. 22.
 "Mr. Contractor, write for our Special Proposition to you."

KISE ELECTRIC CO., Inc.
 Peoria, Ill., U. S. A.

Globe Lawn Fencing

*increases your business
 and profits*

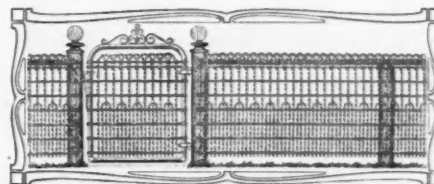

Cheaper than wood—sanitary, artistic and durable—conducive to growth of flowers and vegetables by letting in air and sunshine.

Easily and quickly erected on wood or iron posts.

We make to exact measurements a **ready-to-erect** iron post and top rail construction finished in black enamel or all galvanized.

Send for Catalog, Discounts and Business Pulling Proposition to Contractors and Builders.

GLOBE FENCE CO.
 20-22nd Street (Un-Inc.) North Chicago, Ill.

Peerless STEEL CEILING

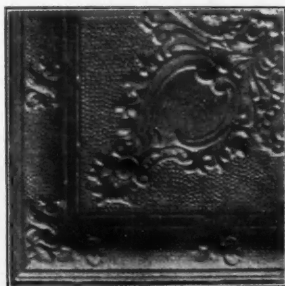

All the newest, most artistic designs—for every class of building. Quarter century in Sheet Metal business means highest quality at lowest prices. Pictured is a popular design. Send for Catalog "C" and net price list.

INDIANAPOLIS CORRUGATING CO.
 Indianapolis, Ind.

METAL CEILING

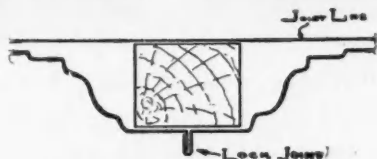

See that Joint?

The Acme of perfect construction. Don't nail or slip the joints. Lock them. Full information in catalogue E.

S. KEIGHLEY METAL CEILING & MFG. CO.
 PITTSBURGH, PA.

A Housetop That Tops Them All



For artistic appearance and defiance of the elements there is no roofing that can equal

MULLINS METAL TILE ROOFING

It is built-in insurance against fire, rain, wind, acid fumes and lightning. It is guaranteed, when put on according to directions, to remain in perfect condition for years. Expansion and contraction, which are the main faults with most metal tile roofings, have been overcome in MULLINS Metal Tile Roofing.

Architects, Builders, Cornice Makers and Roofers will find our prices the lowest possible consistent with good work and prompt shipments. Special discounts to the Trade.

We are the largest manufacturers in the world of stock and special designs in Sheet Metal Statuary, Cornices, Building Fronts, Capitals, Finials, Tympanum Panels, Enriched Moldings, Rosettes, Garlands and Ornamental Metal Stampings for Cornices.

MULLINS Fireproof Windows reduce insurance rates, as they are approved by the national Board of Underwriters. Estimates on Architects' drawings gladly and promptly submitted. Write for catalog.

THE W. H. MULLINS CO.
 214 Franklin Street Salem, Ohio, U. S. A.

BETTER TOOLS You Cannot Buy Than Goldblatt Tools

"WE COULD SELL CHEAPER TOOLS, BUT WE WON'T"
"We Would Sell Better Tools, But they are not Made"

**Goldblatt
Plasterer's Trowel**

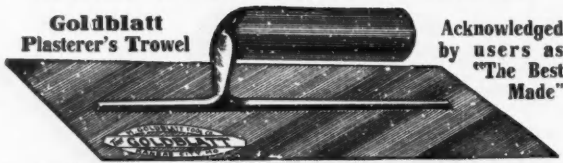

Acknowledged
by users as
"The Best
Made"

No. 1G—Finishing Trowel, made of 22 or 24 gauge **best trowel steel**, highly polished and etched. Mounting extends within one inch of each end of blade and has **ten large rivets**. Has plenty of spring. Lime cannot work between blade and mounting. Three sizes, 4 1/4 x 11 inch, 4 3/4 x 11 1/2 inch, 5 x 12 inch. Low, medium and high mounts. Price \$2.00 charges prepaid. Your dealer or direct.

Goldblatt's Plasterer's Hawks



Made of selected soft wood; 6 inch dovetail; 6 inch handle; weight about 1 1/2 pounds. Sts. handle.....75c
Patent screw handle.....\$1.00

Tool Bags—Valise Shape



Made of heavy canvas, hand sewed to hoop steel frame. Has lock, 2 straps, inside pocket, leather trimmed. 6 sizes \$1.50 to \$2.25. 16 to 24 inches long.



**Goldblatt's
Plasterer's
Brushes**

Made of finest quality Russian bristles. Price \$2.00 and Up.



Goldblatt's Tile Markers
Most practical and best Plasterer's Tile Marker made. Price 40c.

Guaranteed Plumb

Rules \$1.75, \$3, \$4.75



All our Tools are thoroughly tested and are known to be the best. Write for illustrated Catalogue and Handy Book. Tools of all kinds for Plasterers, Bricklayers, Tile Layers, Stone Masons, Cement Workers, Stone Cutters, Terra Cotta Workers and Marble Setters.

H. Goldblatt Tool Co. 212 E. 15th Street, Kansas City, Mo.



ARTISTIC HOMES

A book of 280 (8x11 inch) pages showing perspective views and floor plans of 250 artistic modern homes. A large variety of designs are given so as to meet the taste of the majority of home builders. There are artistic houses for people of moderate means and others for the more wealthy, but in every case the design is made with reference to comfort and economy.

Every design shown has been made by the best architects in the world, who have made a study of home architecture and that alone.

GET YOUR COPY FREE

This cloth bound book will be sent **Free**, postage paid, to anyone sending their renewal or a new subscription. Regular subscription \$2.00 per year.

American Carpenter and Builder
1827 to 1833 Prairie Avenue, Chicago, Ill.

In Position "SAFETY FIRST"
Fold Compactly

Wheeler Safety Scaffold Brackets

Save Lumber—Save Labor—Save Nails—Save Accidents

Pay for themselves on two jobs and last a lifetime. Lock automatically. Men cannot be careless putting them up. Are rigid and firm when in place. Scaffold cannot swing. Write for our **FREE TRIAL OFFER**

AMERICAN STEEL SCAFFOLD CO., Dept. 2, DETROIT, MICH.

The Hammer Carpenters Made Famous

Our "VANDOR VANADIUM" Nail Hammers in four sizes. No. 21 1/4, 16 oz. Standard; No. 22, 18 oz. General Purpose; No. 22 1/2, 16 oz. Finishing; No. 721 1/4, 16 oz. Rippling Style. We will send either size Parcel Post for your Dealer's name and \$1. This Hammer we insure for life. Made for hard work and lots of it. You can return it any time if it proves defective and get a new one.

This Hammer is warranted to draw anything from a headless brad to a spike. Drop Forged from the toughest Vanadium Steel. Second growth hand shaved Hickory Handle. Tempered in oil. Easy to work with. Get one today. Remember only \$1 and your dealer's name for either size, 16 oz., 10 oz., 13 oz., or 16 oz. Rippling. Mail your order NOW.

VAN DOREN MFG. CO., INC. Chicago Heights, Ill.
(Vanadium Dept.)

EVERY CONTRACTOR

who has an engine should have work for a Hoist on buildings of Brick, Concrete or Stone construction.

The Morgan Hoist

is very easily operated and is regularly driven with a chain and sprockets, though it can be used as a belt drive. The Morgan Hoist is guaranteed to lift 3,000 lbs., and operate successfully 2,500 lbs. without any effort on the part of the operator.

We manufacture a complete line of Friction Clutch Pulleys and Friction Hoists.

THE BROWN CLUTCH COMPANY
Box 273
Sandusky, Ohio

Style D 11 Senior Senator, 2 Blades. Price \$1.20.

ARCHITECTS, CONTRACTORS, LUMBER-DEALERS

The Greatest Sales Stimulant Ever Offered

These beautiful high-grade pocket knives with your advertisement on, will surely land those contracts if one is presented along with your estimates and plans. Not like that cigar that goes up in smoke, and cheap novelties that are soon cast aside. This knife will be carried right in the pocket, year after year, retaining your ad., and will be brought to attention many times. Be prepared to get that Spring business. Write for prices on quantities at once. Catalogue upon request. We have the best paying agent's proposition in the United States. Exclusive territory guaranteed. Unexperienced shown how to earn big money. For full particulars, write Dept. E., The United Cutlery Company, Canton, O.

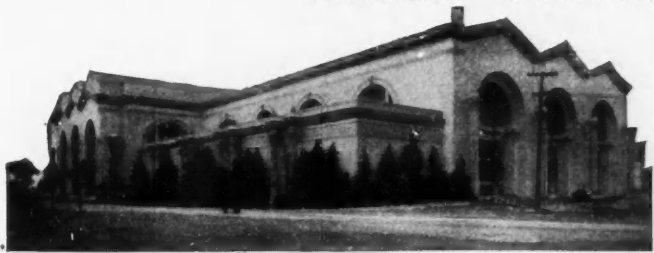

The Palace of Machinery, built to house every type of machinery used for the generation, transmission and application of Power. "KNO-BURN" lath used in its construction.

Kno-Burn at the Panama-Pacific

Wonderful buildings have sprung up on the Exposition grounds at San Francisco. They embody the newest and best in stucco construction. **Kno-Burn Expanded Metal** lath has been used extensively as a plaster base. Do you not think that the metal lath selected for this great work is worthy of your consideration?

Send for "Standard Specifications," a compilation of established methods of experts for the use of metal lath.

North Western Expanded Metal Co., 903 Old Colony Bldg., Chicago, Ill.

Palace of Mines. It might well be called the "Palace of Romance," for it shows the method of exploration for all kinds of metal. "KNO-BURN" was used as the plaster base.



OAK FLOORING

"AMERICA'S BEST FLOORING"

Builders and owners will find it a clinching argument to say "It's floored with OAK FLOORING." It is the biggest single feature to look for in any house or apartment building. It imparts an air of refinement and elegance. It is the modern flooring.

OAK FLOORING 3/4 inch thickness by 1 1/2 inch or 2 inch faces can be laid over old floors in old homes or over cheap sub-floors at a very low cost. It is cheaper than carpet or pine flooring. When laid it has all the appearance of heavy flooring.

There is a solid satisfaction and lasting pleasure in the substantial and dignified appearance of OAK FLOORING.

Contractors and carpenters find it very profitable to lay 3/4 inch stock over old floors in old homes during dull periods. A little canvassing is all that is necessary to secure jobs. A carpenter or handy man can lay OAK FLOORING successfully.

For durability, OAK is the best. OAK FLOORING laid thirty years ago, after very hard use, is still in good condition.

Write for Booklet

THE OAK FLOORING BUREAU, 890 Hammond Bldg., DETROIT, MICH.

RELIABLE FOLDING Scaffold Bracket

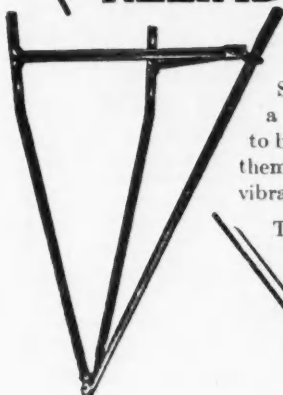

Strong and safe; requires only a few minutes to attach. No holes to bore. Four 10-d or 16-d nails fasten them securely. Positively rigid; no vibration.

The Low Price of these Brackets can be saved in time and material on the first two jobs.

ELITE MFG. COMPANY
100 Ohio Street ASHLAND, O.

BUILD YOUR OWN Grandfather's Clocks WITH OUR HELP

With the blue prints, instructions, finishing material, etc., we furnish, any handy man can build his own Grandfather's Clock. We sell you the works, dial, weights, pendulum, and everything you need at prices so low as to surprise you.

Works complete. \$5.00 each; others with chimes, all prices.

Here's winter work you can turn to good profit. Make duplicates for your friends. Our designs are clear cut, attractive and salable.

Write for our free offer on the drawings, etc.

Clock Company
1655 Ruffner St. Philadelphia, Pa.



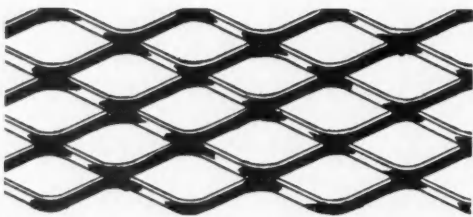

Berger's Expanded Metal Lath
Made from Steel or Toncan Metal (Anti-Corrosive), in all gauges, painted or galvanized.

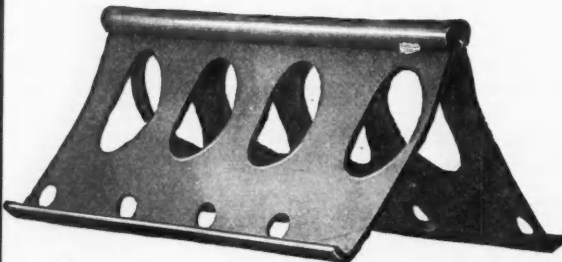

Corner Beads

Berger's complete line will meet requirements of any specifications. Galvanized before or after forming.

Export Department:
11th Ave. and 22nd St.,
New York City, N. Y.

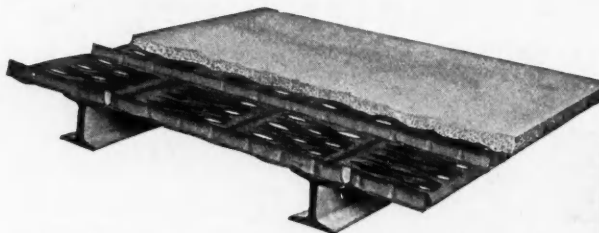

Rib-Truss Reinforcing and Furring Plate
For Concrete Roofs, Side Walls, Ceilings, Partitions, etc. No centering or false work required on ordinary spans. *Send for details and instructions.*

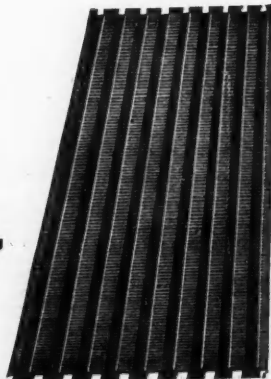

Ferro-Lithic Reinforcing Plate, for concrete roofs, floors, walls, etc.

Write for Information
The Berger Mfg. Co.
CANTON, OHIO

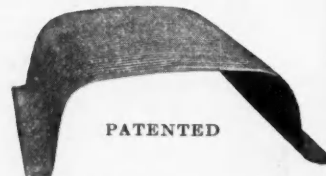

PATENTED

Berger's Corrugated Steel Core

For coring out concrete floors. Adaptable to all classes of construction. Regular lengths 2 and 3 feet.

Send for Designing Data.

For the best Service address nearest branch.
New York Minneapolis Philadelphia
Boston San Francisco St. Louis
Chicago

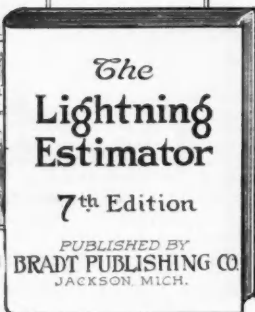

SUCCESS

In the Building Field comes Through Knowledge

The Lightning Estimator

Will give you this Knowledge. Compiled by a successful Builder covering his years of experience. It will protect you against the dangers of under-estimating, will help you solve all Building problems.

The Big, New Seventh Edition is just out. This new, large edition contains a vast lot of new material about Modern Buildings and Building Construction. It will give you many new ideas and keep you up-to-date.

PRICE ONLY \$1.00

Think of It! for this volume of money-making information. It is well bound and has numerous illustrations. Send a dollar bill and put in these long, winter evenings to help you along the road to success.

BRADT PUBLISHING COMPANY
1260 MICHIGAN AVENUE JACKSON, MICH.

Save
3 to
5c a
Sq.
Yd.

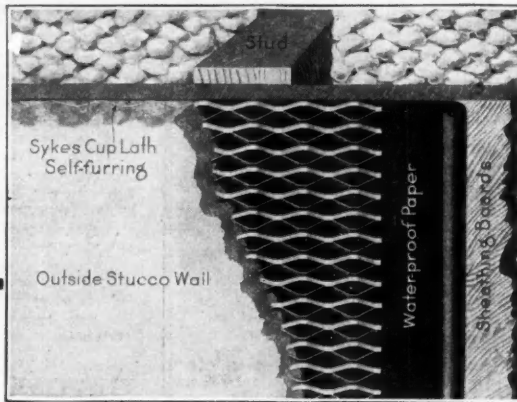

Heavier—Stronger—Better

A Metal Lath that is self-furring, makes quick work, saves time and money on every job. Especially adapted for Interior Plaster Work, Overcoating and Stucco Work. Wide strand, heavy and strong—cannot be applied wrong.



Expanded cup crimped, makes a perfect key for the mortar. Indorsed by architects; approved by U. S. Government for Post Office work.

Write today for free sample and Book of Specifications for Stucco on Metal Lath—it saves money for you.

Sykes Metal Lath & Roofing Company
504 River Road WARREN, OHIO

The Perfect Corner Finish for Lap Siding— Kees Metal Building Corners

Here is what contractors say of them:—

“They saved me more than three times their cost.”

“**Kees Metal Building Corners** are the only thing to make a weather-proof and permanent corner.”

“They are certainly great labor savers and add very materially to the making of a first-class piece of work.”

They give the popular mitre corner effect without the slow, accurate and expensive work of cutting and fitting the mitres. The boards will not warp apart as they do when the corner is made in the usual way.

Formed with clean accurate angles. When applied they present a perfectly smooth surface without projections to catch dust and moisture. After they are painted they can scarcely be noticed.

Made in sizes to fit all widths of lap siding up to 12 inches.



For Outside Corners



For Inside Angles

Kees Siding Clips

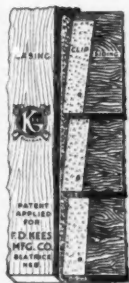

Make **permanently tight and weather-proof joints** where beveled lap siding joins the door- and window-casings or corner strips.

Save Labor. It is not necessary to cut the siding to accurate length. The ends need not be squared. **Make a**

Better Job. There is no danger of pushing the casing out of true, as often happens when the siding is cut a trifle long, and sprung into place. The joint is as tight and true and is not affected by the subsequent shrinking or swelling of the lumber.

A card will bring free samples, delivered prices and pictures of houses finished this way.

F. D. Kees Manufacturing Company
Box 400 BEATRICE, NEBRASKA

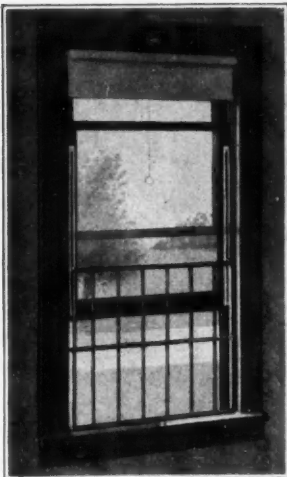

patented Sept. 15, 1914

Make the Open Window Safe

The House or Flat Building equipped with all modern and up-to-date conveniences will sell or rent quickly and bring a good price. You will find this especially true when the House or Apartment has installed in it

FOR HEALTH "SECURITY" WINDOW GUARDS FOR PROTECTION

Just slips on or off the **inside** of window. No locks, bolts, or catches. Instantly removable from inside but **impossible** from outside. Permits leaving windows **WIDE OPEN** or any distance with security. All steel construction handsomely finished. Easy to handle and attach.

WRITE TODAY FOR ILLUSTRATED FOLDER AND OUR LIBERAL AGENCY PROPOSITION
SECURITY WINDOW GUARD CO. 30 E. RANDOLPH ST., CHICAGO

RICE'S SUPERIOR Light Liquid Wood Filler

as manufactured by the

S. E. M. RICE FILLER CO.

OF IRVINGTON

Formerly of Newark, N. J.

is the most **RELIABLE** and **MONEY-SAVING FILLER** made; *never* settles hard in the can and works *freely* under the brush and the work is *filled* ready for the varnish.

Look for the **RED R** on the can.

Boss Carpenters

and Journeymen Carpenters have many a week with no work. Why not attach to Chairs and Furniture Evergrip Gliding Casters? We furnish plenty **Free Demonstrating Sets**.

HERE'S OUR OFFER

Send your business card or letterhead and we will send you 100 sets. Also 25 **FREE Demonstrating Sets**. Sell the 100 sets for 10 cents a set. Your profit \$6.50. Send no money till all are sold. Then order more. With each lot we send 25 **Free Demonstrating Sets** with each 100 sets. If the Boss Carpenter can't spare the time, arrange with your Journeymen and divide profits. Thousands can be sold. The public will appreciate the **Free Demonstrating Sets** and buy 6 to 20 sets. The good will of the people thus secured may result in carpentry work for the boss. Either way you win. We have over 150 Carpenters doing well with this proposition. Now Carpenters go to it!



STRANSKY MFG. CO., Dept. V. 20 Warren Street, NEW YORK

Northrop's Stamped Steel Ceilings



For the residence, the store, the church, school, etc. We have ceilings for all of them—and the best of their kind. Use incombustible material when possible.

Send us measures and diagrams of the rooms to be ceiled, so that we can advise you and estimate.

NORTHROP, COBURN & DODGE CO.
40 Cherry Street New York

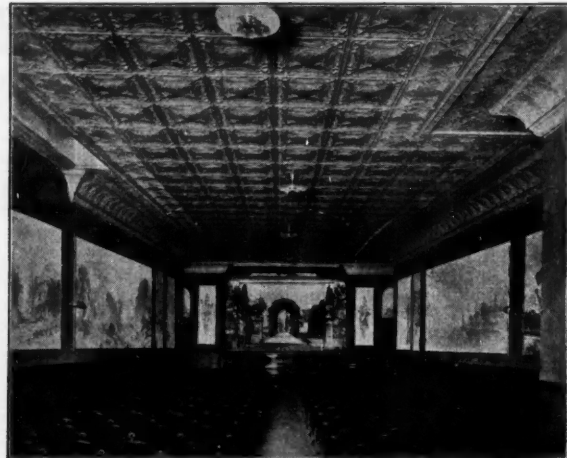

Klauer's Steel Ceilings

Are the kind you want for the work you now have coming up.

Unexcelled as to designing and mechanical perfection, they are most economical as well as most desirable.

Get our complete catalog and let us figure on your requirements.

Klauer Manufacturing Co.
Dubuque, Iowa

1800 Degrees Flaming Heat UNDER

BERGER'S
Classik
STEEL CEILINGS

For 1 hour and 10 minutes, entire duration of official fire test, under auspices of Board of Fire Underwriters and City Fire Department, New York City, at Fire Testing Stations, Columbia University, Greenpoint, N. Y. The Berger's "Classik" Steel Ceiling section remained intact throughout time of test while Lath and Plaster fell 6 minutes after test started.

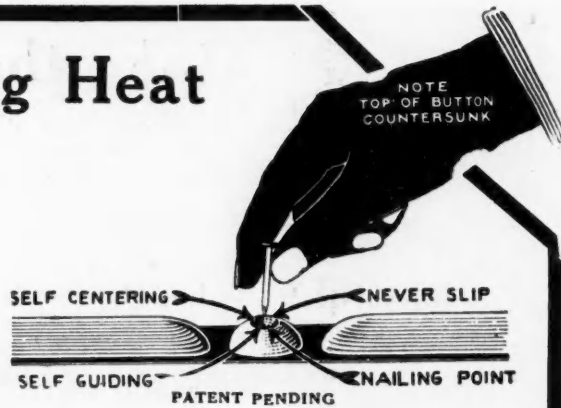

Is Not This Proof

That Berger's "Classik" Steel Ceilings are Fire Retardant? That Berger's "Classik" Steel Ceilings are perfect in construction? They are also sanitary, ornamental, moderate in cost and easy to erect.

Write for Catalog and Prices

THE BERGER MFG. CO., Canton, Ohio

For the best service address nearest branch

New York Philadelphia Boston St. Louis Minneapolis San Francisco Chicago

We also manufacture Ferro-Lithic and Multiplex Reinforcing Plates, Metal Lath, Roofing, Eaves Trough and Conductor Pipe and Sheet Metal Building Products of all kinds.
EXPORT DEPARTMENT: 11th Avenue and 22nd Street, New York, N. Y.

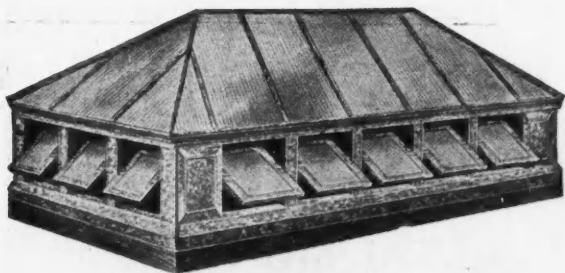

Any Man can Erect the **WILLIS SKYLIGHTS**

A hammer and screw-driver the only tools needed

Simple in construction, our skylights are built to withstand *long wear*. Only the best sheet metal is used. Every Skylight Guaranteed not to sag, buckle or spread; designed for greatest possible glass area. Waterproof frame doesn't require putty. Side sashes may be operated either singly or in batteries by a special device insuring best ventilation. These devices are guaranteed.

The cost is moderate—freight charges are reduced by shipping the skylights knocked-down. Erection cost is low—*any one* can do the work. And satisfaction—yours and the owner's—is guaranteed!

THE WILLIS LINE

includes everything you can need in sheet metal. We supply Ventilators, Fireproof windows and doors, skylights, crestings, store fronts, Metal Roofings, Metal Ceilings, Tower Finials, Cornices, Gable Ornaments, Sheet Metal Canopies, Marquise, etc., and everything true Willis—quality; at our low prices. Our 180-page illustrated catalogue should be in the hands of every carpenter, builder and architect. Let us send it to you.

WILLIS MFG. CO.
Galesburg, Ill.

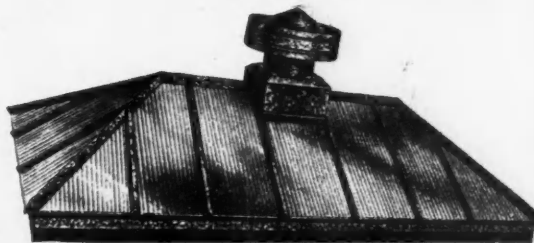

CORNICES

Skylights — Ventilators

METAL FIRE
SHINGLES DOORS

Sheet Metal Building Materials

Our Price Is Right

THE BREESE BROS. CO.

MANUFACTURERS
CINCINNATI, OHIO

Send us your plans and specifications or give us an idea of what you want and we will quote you price

"No Job Too Big Or Too Small"

CATALOG ON REQUEST — TRY US



Monitor Cupolas

Should be on every barn you build. They come all put together. No frame to build under roof. Can be erected in five minutes. Absolutely Bird and Storm proof. We sell direct to contractors where we are not represented by dealers. Write for our special proposition to contractors and our complete catalog of Ventilators, Cupolas, Skylights and Sheet metal Specialties.

B. F. Lichy & Sons Co.
Sta. A, WATERLOO, IOWA

HIPPED TURRET SKYLIGHT



with swinging sash. Sides 24" high; all windows on each side made to open at the same time. Operating device securely locks them open or closed.

The Skylight is of guaranteed quality. You can use it on any of your buildings with the assurance that it will stand the wear. Watertight. Can be set up in a moment by an inexperienced man.

Write for our Skylight Catalog and Prices

Galesburg Sheet Metal Works - Galesburg, Ill.

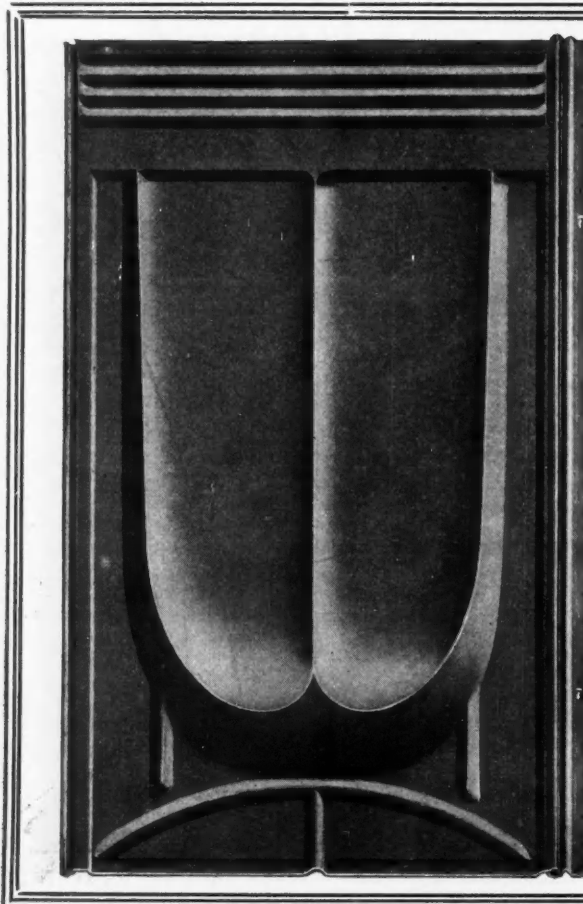

EDWARDS "OHIO" METAL SHINGLE

The very latest addition to the big Edwards Metal Shingle Family has just arrived.

The "baby" is named after our own great state. Note the handsome, novel design and clean cut embossing. This Pattern is made in one size only, 14x20 inches.

Manufactured from the best quality Worcester Grade Terne Plate, painted or "Tightcote" galvanized.

The "Ohio" has the patent interlocking device and every other good feature that has made Edwards Shingles famous.

Samples and Price on Application

The Edwards Mfg. Co.

"The Sheet Metal Folks"

401-417 Eggleston Avenue, Cincinnati, Ohio

Largest Manufacturers of Metal Ceilings, Metal Shingles, Steel Roofing and Siding in the World.

New York Office: 81-83 Fulton St. Branch Office and Warehouse: 1625-1627 Pacific Ave., Dallas Texas.

Mr. Manufacturer:

HAVE YOU A BRANCH OFFICE IN MINNEAPOLIS?

The great northwest is booming; lots of business to be had if you want it. No need to experiment, you can get it and at trifling cost. Clip the coupon below and send it today to

Northwest Building Material Exhibit

J. B. FORAKER, President

Entire 4th Floor, First National—Soo Line Bldg. Minneapolis, Minnesota

Everyone interested in building—contractors, architects, owners, builders of homes, apartment houses, builders for investment—these are the people you will reach here. They want to know all about your product. Why not tell them about it?

CONTRACTOR'S COUPON
Northwest Building Material Exhibit, Minneapolis, Minnesota. I want to know without any obligation how the Northwest Building Material Exhibit can help me.

Name _____
Address _____

MANUFACTURER'S COUPON
Northwest Building Material Exhibit, Minneapolis, Minnesota. Let us know about the possibilities for getting more business in the Northwest.

Name _____
Address _____

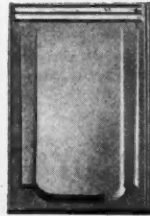

BERGER'S Distinctive Extra Quality Metal Shingles

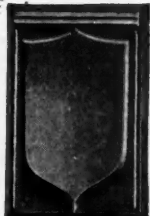

The CHIEFTAIN

The SWANEE

for bungalows, residences, churches, garages, etc. The three point contact side lock is simple yet effective and cannot possibly become unhooked after shingles are nailed in place.

Expansion and contraction are fully provided for, and high ribs are formed at the top of each shingle to prevent leaks—a very important feature.

Size 10 x 14 inches covers 8½ x 12½ inches; one hundred and thirty-six shingles cover one square or one hundred square feet.

Furnished in Galvanized Toncan Metal, Galvanized Open Hearth Steel or Terne Plate of any standard weight of coating.

Write today for Catalog.

The Berger Mfg. Co. Canton, Ohio

New York Boston Philadelphia St. Louis San Francisco Minneapolis

Building Material Index

For Carpenters and Builders

STEEL CEILINGS. Kanneberg steel ceilings are adaptable for stores, churches, residences and all kinds of public buildings. Special proposition to agents. Write for it and our Ceiling Catalog.

METAL SHINGLES. Kanneberg shingles afford a highly artistic steel roof for the home, barn or outbuilding. They are very moderate in cost and assure protection against fire, lightning and all elements. Catalog and prices upon request.

STORE FRONTS. Kanneberg steel store fronts are easily erected, giving a modern, up-to-date appearance to any store. Send us plans for estimates.

SKYLIGHTS AND VENTILATORS. Kanneberg skylights, ventilator and finials give perfect satisfaction where used. We make any size or style wanted. Send for descriptive catalog and prices.

EAVE TROUGH AND CONDUCTOR PIPE. Kanneberg eave trough and conductor pipe afford long life and the maximum for your money.

The Kanneberg Roofing & Ceiling Co.

"Everything in Sheet Metal"

928-930 Robin Ct., S. E. Canton, Ohio

Last A Lifetime

CORTRIGHT Metal Shingles cost no more than good wood shingles, yet they last a lifetime, are rain and stormproof, wind-tight, fire-resisting, and add greatly to the appearance of any structure, from the modest dwelling to the most ornate public building.

Wood shingles are short lived. They warp, crack, split, curl-up or blow away; quickly catch fire from sparks and every few years must be replaced at great bother and expense.

CORTRIGHT Metal Shingles

on the other hand have been in successful use for almost thirty years, and many roofs put on twenty and twenty-five years ago are as good as new today.

An ordinary workman can lay Cortright Shingles, even right over the old shingles, if desired. If you are not already familiar with this modern roofing and with the profits Cortright Metal Shingles are making for contractors and builders handling them, write for full information today.

Cortright Metal Roofing Co.

Philadelphia and Chicago



Spanish Tile



Address The Moeschl-Edwards Corrugating Co.

The MOESCHL-EDWARDS CORRUGATING CO.

EVERYTHING IN SHEET METAL BUILDING MATERIAL

Covington, Kentucky

Catalogue "S" showing a complete line of Ornamental Roofings mailed free to Architects, Contractors and Carpenters.

Write for Prices on

Ceiling Marquise
Columns Roofing
Cornice Shingles
Cresting Siding
Calverts Skylight
Finials Spouting
Garages Tanks
Gutter Ventilator.

Covington, Kentucky

C. G. HUSSEY & CO.

Pittsburgh, Penna.

MANUFACTURERS OF **COPPER**

In Sheets, Plates, Rolls

CORRUGATED COPPER CONDUCTOR PIPE

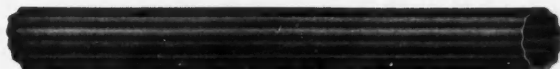

Copper Nails, Copper Rivets, Conductor Pipe, Eaves Trough, Elbows, Shoes, Mitres, Soldering Coppers, Gaskets, Etc.

THE GALE

BARN AND GRANARY VENTILATOR

For all your buildings

INEXPENSIVE, BEAUTIFUL, STRONG

Made of heavy galvanized iron. Screened inside. Storm-proof and bird-proof. Perfect ventilation guaranteed. All you have to do is to place ventilator on roof and nail fast.

Write for Illustrated Circular with Complete Prices.

Galesburg Sheet Metal Works, Galesburg, Illinois



*The result of
22 years' successful
experience in
building motor cars*



America's Greatest "Light Six" \$1485
TRADE MARK REGISTERED

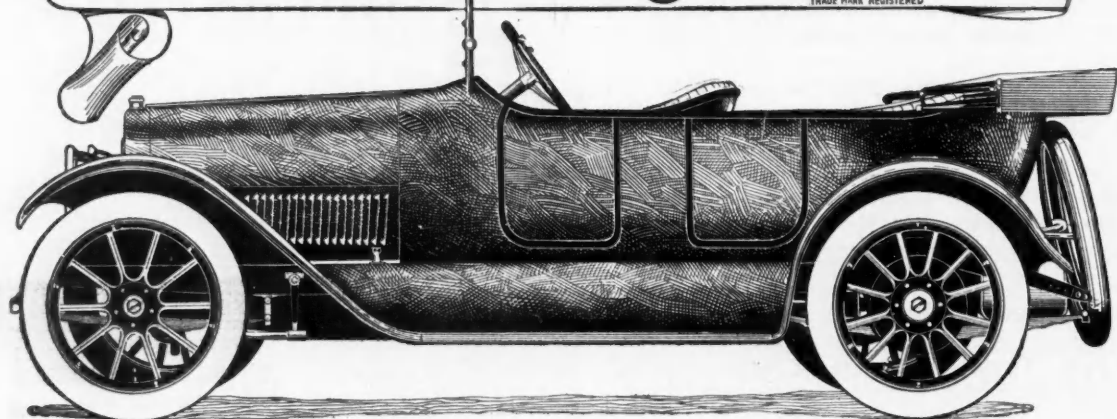

**166 Miles on Low Gear
Without a Stop**

In December a stock Haynes "Light Six" in a test run in the hilly portion of New Jersey, traveling in low gear, covered 166 miles without a motor stop in 11 hours 7 minutes. An average car speed of 15 miles per hour was maintained.

Not a single drop of water was added to the cooling system at any time. The water level in the radiator was only one-quarter of an inch lower at the end of the run than at the start, and the water temperature averaged 120 degrees F.

Running in low gear, with a total reduction at the rear wheels of 11-1/4 to 1, the car traveled 8 miles to the gallon of gasoline and consumed but 7 quarts of oil—proof positive of a perfect cooling, ignition, and lubricating system, and of a perfectly balanced power plant as well.

Two Models---Three Body Styles

Model 30—America's Greatest "Light Six"— 5-passenger touring car, 121-inch wheel- base, weight 2950 lbs.	\$1485
Model 30—The Prettiest Roadster in America	1485
Model 30—The Haynes "All-Weather" Cabriolet	1750
Model 33—The Kokomo "Six"—a "light" 7-passenger touring car, 127-inch wheelbase, weight 3050 lbs.	1550

WRITE NOW TO

THE HAYNES AUTOMOBILE COMPANY, 14 So. Main St., Kokomo, Ind.

Please send me your 1915 catalog with full particulars in regard to America's Greatest "Light Six."

Name Address

I expect to buy a car about

Add From \$1,000 to \$2,500 to Your Profits This Year

We have a proposition that is unusually attractive to contracting builders of the better sort—men who have the confidence of their clients and who are capable of dealing with a big opportunity in a big way. No interruption to your regular business. Every home owner is a prospect for the—

TUEC STATIONARY CLEANER

For Health and Cleanliness

Thousands already in use and every one satisfactory beyond all comparison with cleaning systems of less efficient types. We will co-operate with you in every way and help to get the business in your community. Splendid profits can be earned by you.



If you are looking for an opportunity to increase your net earnings from \$80 to \$250 per month, write us a personal letter at once.

A. J. TICE, General Manager.

THE UNITED ELECTRIC CO.
30 HURFORD STREET CANTON, OHIO

MORE PROFITS IN SILO BUILDING

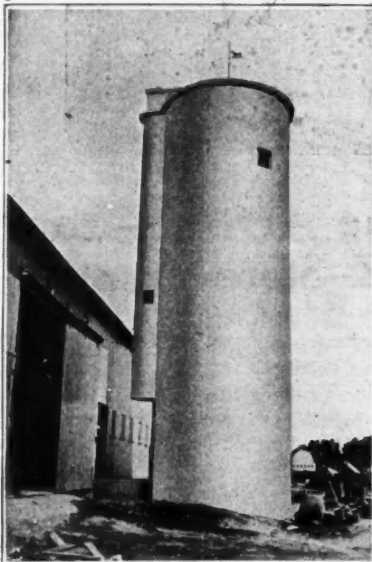

Silo and Water Tank (Holding 5084 Gals.)

Conklin Construction Co.
750 West Main St., HARTFORD, MICH.

Write for 1915 catalog and prices.

We will give you **SPECIAL PRICES**

on **ALL OUR EQUIPMENT** providing the order is received by March 18, 1915.

We Cut Your Expenses

50%

MAKE MORE MONEY

You can make twice as much money building **Unadilla Silos** than on any other, because they are easy to erect and our **free plans** enable you to put up two **Unadillas** in the time it takes to erect any other kind.

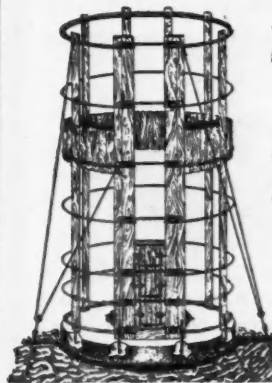

The frame construction of the **Unadilla** makes the most rigid silo. It is

A Building Not a Barrel

Its many conveniences make it easy to sell. The Borden Condensed Milk Co., The U. S. Government experimental stations and many other discriminating institutions and individuals **indorse** by use the **Unadillo Silo**.

Get the bigger profits. The **Unadilla** will open the way. Now is the time to act.

Write today for full particulars and territory.

Central Unadilla Silo Co.,
633 S. W. Ninth St. Des Moines, Iowa



"D & A" All Steel,
6-Mold Outfit

The "D & A" CEMENT FENCE POST MACHINE is a Profitable Investment for You

"D & A" Posts are STANDARD upon prominent railways; made by Concrete Products Plants, and used by Land Owners in all parts of the world. Why not YOU? There's a Profit waiting for you.

Shape of "D & A" All-Steel Molds, combined with the "Shaking System" using WET (not slush) mixture, makes Strongest, Cheapest and Everlasting Posts. SIX OR TEN POSTS MADE AT ONCE.

200 FREE TICKETS TO THE CHICAGO CEMENT SHOW 200

To The FIRST 200 Who Answer This Advertisement.

CONDITIONS:—Must be official or stockholder of Cement Products Plant in city or town of 50,000 or less, (using firms' stationery), or Land Owner with 100 acres or more, requiring fencing; agreeing to visit the "D & A" exhibit spaces 44 and 62, stating day you expect to attend show. RUSH.

Also, all purchasers of "D & A" Molds at this or former shows will receive tickets at our booth, upon request, for another admission. Our 1915 prices are interesting. Outfits \$11.00 and up.

Various sizes, shapes and lengths of LINE, ANCHOR and BRACE MOLDS, also POST REINFORCEMENT of many kinds in stock. Send for Catalogue. See us at the Chicago Cement Show.

D. & A. Post Mold Co., 405-9 3rd. Ave. Three Rivers, Mich., U.S.A.

FOR AN ENDURANCE TEST

The Shelby "CHIEF" Double Acting, Ball Bearing Surface Floor Hinge

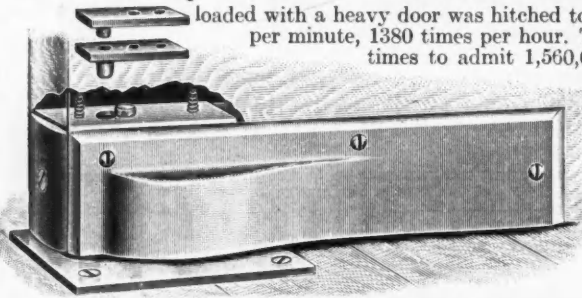

loaded with a heavy door was hitched to a machine. The machine swung it back and forth 23 times per minute, 1380 times per hour. This driving pace was kept up until the door had swung enough times to admit 1,560,000 people—one at a time. When unhitched, it was not a lifeless, grinding, wornout hinge as any one would expect. It was still working quietly and performing the duties of a first-class floor hinge.

1,560 000 times was enough. Enough to show us, and if you could be at our factory 10 minutes, we could prove to you our statement, that the Shelby Chief is the cheapest floor hinge on the market, if quality and efficiency are considered. Don't you think the Shelby "Chief" is the hinge you should insist on using?

The Shelby Spring Hinge Company
SHELBY, OHIO

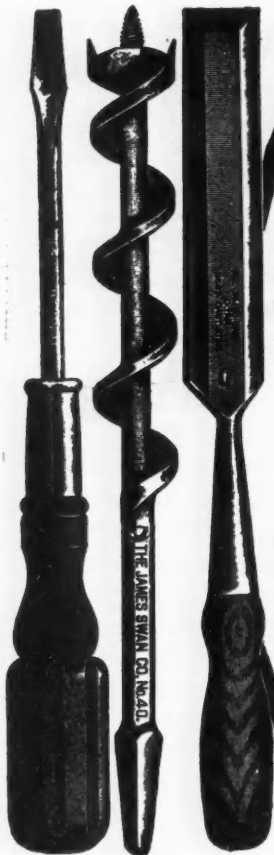

When
you want
tools of any kind
—tools that you
can bank on to be
just the kind and qual-
ity you want them to
be, insist on the Swan
Trade Mark.



It's a plain guide to all that
is best in carpenters' tools
and your assurance that
you are dealing with an
old, reliable firm that
makes tools as good and
solid as its reputation.

ASK FOR CATALOG
The
JAMES SWAN CO.
Seymour,
Conn.

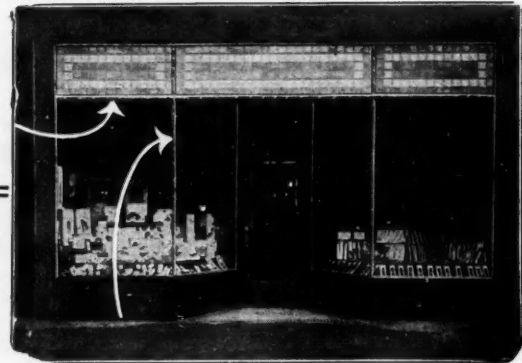

Follow the Arrow --- to the PETZ Store Fronts

There you'll find the store front bars that make a contractor's life less hard.

The Petz fronts don't take a lifetime to install—no, you can save money by your quick installation.

Service is our middle name.

Try us and see—have us figure your plans—if you are in a hurry for the material, just say so—we'll get it out quick.

Don't you need a catalog and blue print?

Detroit Show Case Co.

491 West Fort Street

Detroit, Mich.

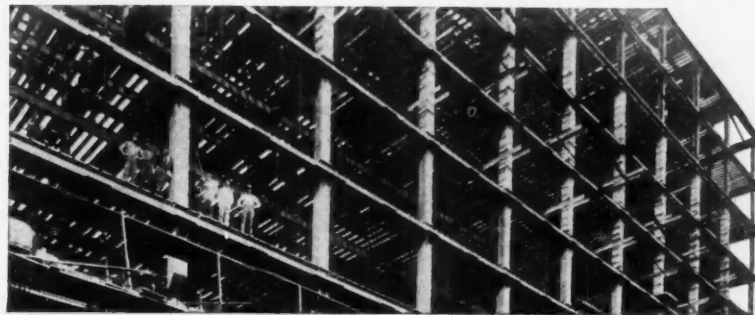

11 Floors of Metal Lumber

The erection of the new eleven-story Renkert Building in Canton, Ohio, marked a new epoch in the history of skyscraper construction, as Berger's pressed steel joists were used throughout for the floor construction and installed in seven weeks.

The total area was 112,000 sq. ft., and the building since completion has been regarded by architects, contractors and engineers as a model for strength and fire-proofing qualities.

Do you know that Berger's Metal Lumber pressed steel members withstand greater loads under high temperature than rolled steel members of greater sizes and weight?

Do you know that Metal Lumber costs considerably less than any other system of fire-proof construction and affords greater fire resistance?

Why not send today for our catalog and look into our Metal Lumber Construction? The facts will interest you.

Berger's
Metal Lumber

The Berger Mfg. Co., Canton, Ohio

For best service address nearest branch.

New York Philadelphia Minneapolis Boston San Francisco St. Louis Chicago Cincinnati

Also manufacturers of Prong Lock Studs and Furring, Rib-Truss, Ferro-Litic and Multiplex Reinforcing Plates, Steel Ceilings, Expanded Metal Lath, Sidewalk Forms, Raydiant Sidewalk Lights. Etc.

Export Department, 11th Ave. and 22d St., New York City

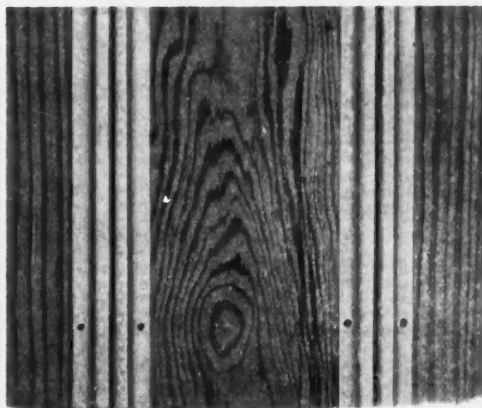

USE METALLIC BATTEN STRIPS

for Vertical Barn Siding and other Buildings where Vertical Siding is Used

Far superior to wooden battens. They'll make your barns wind, rain and snow-proof. You'll notice the difference. Metallic Battens will keep your barns warmer and will last indefinitely. They also make a building much more attractive looking.



End View Showing Batten Closed

Pat. Feb. 18, 1913



End View Showing Batten Open with Seasoning of Timber

Always Tight

Metallic Batten Strips are always tight. They expand and contract with the siding. No Warping, Splitting or Drawing off. Metallic Batten Strips always lay flat and do not interfere with sliding doors. Put Metallic Battens on all your vertical siding buildings—Time will Tell. Also used successfully on Garages, Chicken Houses, Hog Houses, and makes Granary and Corn Crib Floors rat-proof.

Let us send you a FREE sample of this Metallic Batten Strip.

Metallic Batten Co., Owensville, Ind. Canadian Representative, Taylor Mfg. Co., Hamilton, Ont

CALDWELL SASH BALANCE

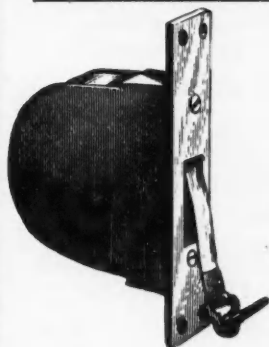

Does away with weights and cords, and VASTLY more durable.

Makes sashes work perfectly.

Permits greater window space in new work, as box frames are not necessary.

May be applied to old windows without altering sashes or frames.

Write for circular to the

Caldwell Mfg. Co.
15 Jones St. Rochester, N. Y.

Get acquainted with the kind of pencils and crayons that make marking and writing a pleasure.

DIXON'S Carpenter PENCILS

Send 16c in stamps for sample lot No. 183-J (as illustrated).

Joseph Dixon Crucible Co.
JERSEY CITY, N. J.



THE
"Alamo" School-Room Heater
 is SAFE for SCHOLARS



Gas Proof
 welded by acetylene,
 has no joints, cannot
 leak gas or smoke.

Sanitary
 The Humidifier, a
 new feature, makes a
 temperature of 65°
 more healthful and
 more comfortable than
 75° would be with-
 out it.

Warms Fresh Air Only
 Air supplied from out-
 side air duct.

Removes All Foul Air
 Separate duct not in-
 terfering with chimney
 draft.

Prevents Danger of Fire
 Ash pits sets 8" above
 the floor.

Cannot Burn Scholars
 All exposed castings set
 back from face of heater.

The "Alamo" Heater is used for Churches and Halls and has special features unlike stoves and furnaces. WE WANT RESPONSIBLE AGENTS.

The "Alamo" Heater Company
 Charles Smith's Specialties.
 72 West Lake Street, Chicago

Send for Catalogue
 and Prices

WE GIVE
CONTRACTORS

better terms than we offer to any other class of buyers of **Hess Furnaces**. Our Heaters are not offered to dealers, but are sold direct to contractors and consumers. We give contractors a special discount, and also a Profit Sharing allowance for information concerning building operations which they can give us without taking time or trouble.

If You Are a Contractor

ask us to let you know more about it. Very many contractors, all over the United States, are installing our Furnaces, and their repeated orders indicate the satisfaction and profit they receive.

HESS WARMING & VENTILATING CO.

1220 Tacoma Bldg., Chicago.

\$50 Saved \$50

BY BUYING A

Bovee Economy Furnace

at Manufacturers' Prices



Has large combustion chamber.
 Saves one-third of the fuel.
 Has perfect Ventilating System.
 Most perfect hot air plant sold.
 Send pencil sketch of floor plan for our manufacturers' price and illustrated catalog. Address

Bovee Furnace Works
 50 8th St., Waterloo, Iowa

HESS MEDICINE SANITARY LOCKER



The Only Modern, Sanitary
STEEL Medicine Cabinet

or locker, finished in snow-white, baked everlasting enamel, inside and out. Beautiful beveled mirror door. Nickel plate brass trimmings. Steel or glass shelves.

Costs Less Than Wood

Never warps, shrinks nor swells. Dust and vermin proof, easily cleaned.
 Should be in Every Bath Room. Four styles—four sizes. To recess in wall or to hang outside. Send for illustrated circular.

HESS, 920L Tacoma Bldg., CHICAGO

The Recessed Steel Medicine Cabinet Makers of Steel Furnaces Free Booklet



A HOT AIR FURNACE

For Less Than
\$50 Complete

For 5 and 8 Room Dwellings

An Unheard of Price and a most Remarkable and Indestructible Furnace.

No Pipes No Lost Heat

AMERICAN BELL AND FOUNDRY CO.

NORTHVILLE MICH.



SHINGLE NAILS

WILL MAKE YOUR SHINGLE ROOFS
PERMANENT

Ordinary nails will not do. You must give satisfaction on all your shingling jobs. Your customers expect it. Your reputation demands it.

Zinc-Clad Shingle Nails will give unusual service; they are guaranteed non-rusting and provide the strongest wear-resisting shingle nail for the price. Sold only in five-pound cartons—bearing our trade mark. At your dealers or direct from us at 8c per pound.

Size	Length	Nails to a lb.
3d	1 1/4 in.	250
3 1/2d	1 3/8 in.	225
4d	1 1/2 in.	200

We also make pure Zinc and pure Copper Shingle Nails

Address Dept. A

W. H. MAZE COMPANY, PERU, ILLS.

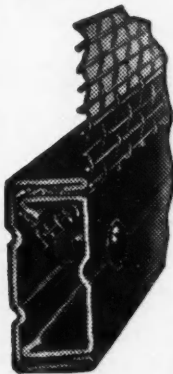

Fly Screens

**Metal Frame
REWIRABLE CIN-MAN-CO.**

See method of securing wire cloth, held by rounded corners, which prevents cutting by vibration.

Special inducements to
Carpenters and Builders
Booklet Free

**The Cincinnati Fly Screen Co.
1010-1026 Evans St., Cincinnati, O.**

MAKES ALL FRAMING CUTS

All Rafters, Bay Window Work
Mitre Work and Stair Work

The A. B. C. Protractor Square

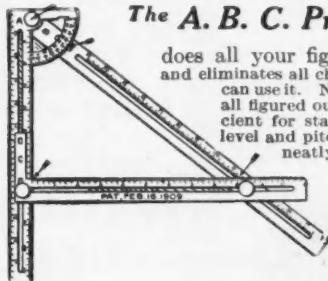

does all your figuring. Saves you time and eliminates all chances of errors. Any man can use it. No mathematics—everything all figured out for you. Especially efficient for stair work as it gives length, level and pitch at the same time. Folds neatly and fits in any tool chest.

We want carpenter agents—show it to your fellow-workmen. Sells itself. Send for circulars and proposition.

**Stamping & Tool Co.
Dept. 7, LaCrosse, Wis.**

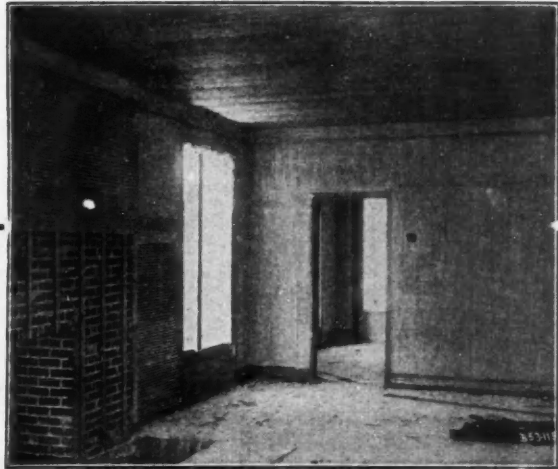

Rib Lath as Used for Partitions, Ceilings and Furring in Detroit Residence

Save Material, Labor, Time and Money by Using the New 3/8-in. Hy-Rib

In stucco and plaster for sidings, partitions, ceilings and furring, the new 3/8-in. Hy-Rib permits wide spacing of supports, saving labor in installation and providing a strong, rigid construction. Its stiffness permits the use of two plaster coats instead of the three required for other laths, thus saving material and money. The clinch is positive, preventing the dropping of plaster.

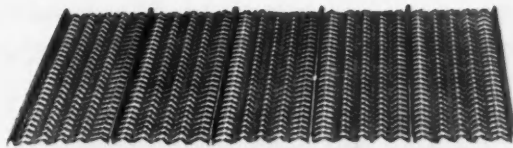

Hy-Rib is manufactured in four depths and various gauges so as to exactly meet your requirements. There are also three distinctive types and weights of Rib Lath as well as Detroit Diamond Lath. So no matter what the nature of your construction, we can fill your needs efficiently and economically.

Write for quotations and catalog



TRUSSED CONCRETE STEEL COMPANY

Department H-44 Youngstown, Ohio



Rib Lath for Stucco Residence of C. A. Mangold, Oak Cliff, Texas.

**Modern Building Practice Demands
HERRICK OUTSIDE ICING
SANITARY REFRIGERATORS**

*When Laying Out Plans, Don't Fail to Include
This Economical Service for Your Home Builders*

Be Progressive! The latest refinement for modern building is this outside icing—Herrick. It eliminates all the disagreeableness of the iceman entering the house and dirtying the kitchen.

The Herrick Outside Icing Refrigerator gives 12 months' service, requiring ice only during the warm period. During the cool months no ice is needed.

HERRICK REFRIGERATORS are built for service. Scientifically constructed so as to assure perfect air circulation, they keep foods clean and fresh. Walls are heavily insulated, assuring minimum cost of operation, and consequently show a substantial saving in ice consumption.

Our Special Builders Service Department is at your disposal. Send us your plans and let us figure on them. It won't cost you a cent and you can talk it over with your customers. We also make Refrigerators for Stores, Hotels, Florists, etc. Write to us for our Large Catalogue 24-A, showing all styles. It's Free.

HERRICK REFRIGERATOR CO. Waterloo, Iowa

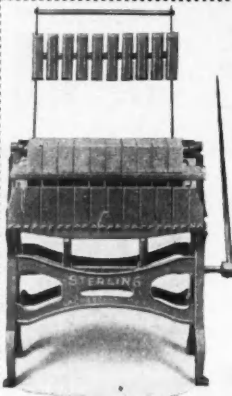
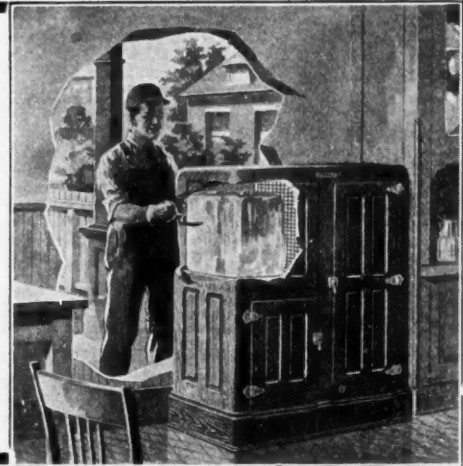

STERLING CUBE BATCH MIXER

All mixers are good, some are better than others. Write for our 1915 Catalog, find out why the Sterling is Best. Built in 3 sizes.

SOLD ON TEN DAYS' FREE TRIAL

Sterling Combination Brick and Block Machine

Simple in operation. Handles Wet Mix.
Produces Waterproof Brick and Block.

SOLD ON TEN DAYS' FREE TRIAL

Get our Prices and Liberal Terms.

Sterling Machinery Co., Box] A, La Crescent, Minn.

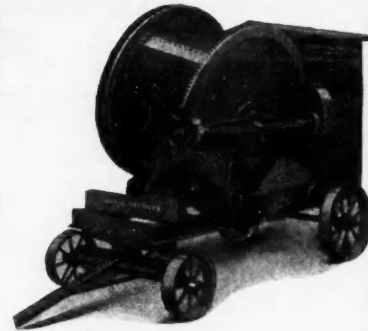

Made to Order Paint

For Builders



It's all right for the owner to smear stale paint on his house, but as a builder, you can't afford it.

Paint made fresh-to-your-order just when needed has the *full life in it* and gives gloss and class that no stale paint can give.

I am a paint maker for builders and painters who know the superior value of Freshly Mixed Paint. I match any color—make your order—and ship on the dot. I guarantee the wear.

Write Today For **FREE PAINT BOOK** With Color Card TELLS WHY PAINT SHOULD BE FRESH

O. L. Chase, The Paint Man, Inc., Department 20, ST. LOUIS, MO.

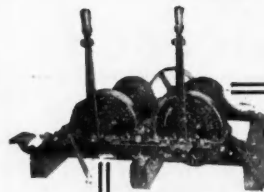

ERIE HOISTS

represent the highest degree of efficiency in Hoisting apparatus. They give the greatest lifting power and require least Horse Power. We manufacture a complete line of Erie "Reliable" Hoists ranging in price from \$25 to \$150.

You can always depend on an Erie for continuous service at least cost. Don't buy a hoist without first seeing the Erie Catalogue. Write for it.

ERIE CLUTCH & PULLEY CO.
Erie, Penna.



The Century Bag Cleaner

If you sell Portland cement, if you are a contractor, if you operate a cement products plant, if you use cement for any purpose, you need a Century Bag Cleaner. It will save you money, labor and time. It automatically cleans and counts the bags. Send for full particulars concerning this profit-making machine.

CENTURY CEMENT MACHINE COMPANY
220 Mill Street Rochester, N. Y., U. S. A.

HERCULES Concrete Block Machines

Are the **ONLY** machines that meet every requirement of the architect and builder.

They are simple in construction, easy to operate and do not require skilled labor. You can install them with small equipment and add to it from time to time, according to your needs. The output from **One Hercules** exceeds the combined production of from **Two to Four** machines of other makes.

Hercules machines make stronger and more durable blocks **because** they use a **Coarse Wet** mixture—other machines do not.

For the man who wants to make 16-inch blocks, there is nothing to equal our new **Hercules Junior** machine with complete equipment, for it is the best block-machine value ever offered.

Investigate—send for illustrated catalogue. It's Free.

CENTURY CEMENT MACHINE COMPANY
Rochester, N. Y., U. S. A.

RAILINGS
OF ALL KINDS

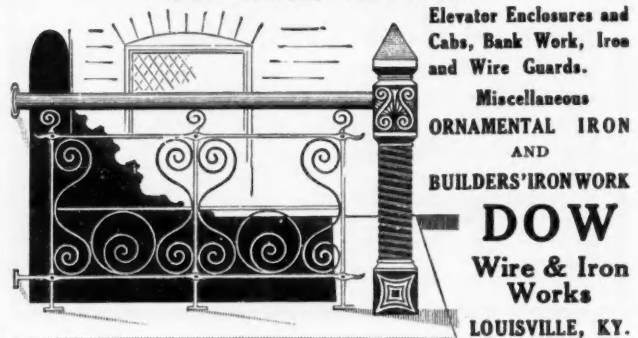

Elevator Enclosures and Cabs, Bank Work, Iron and Wire Guards.

Miscellaneous **ORNAMENTAL IRON** AND **BUILDERS' IRON WORK**

DOW
Wire & Iron Works
LOUISVILLE, KY.

Wolverine Chemical Closet

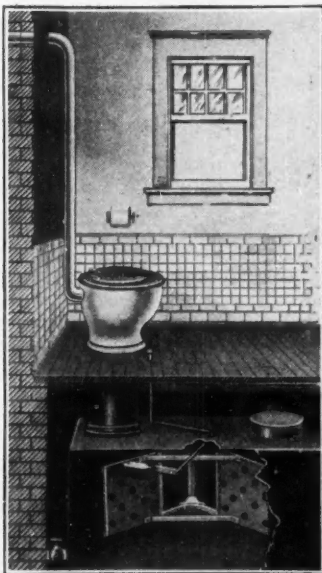

No Water No Sewer
No Expensive Plumbing

Rural Homes, Schools, Churches can now have every convenience of a water closet at half the cost. Our system can be installed in any new or old building in a few hours' time. It is guaranteed absolutely odorless and sanitary. Health Boards approve it. Chemical used is eighteen times stronger than carbolic acid and positively kills all disease germs. Hundreds of them to be sold in your community. Get our agents proposition at once.



Greatest Opportunity Ever Offered

Dall Steel Products Company

730 Main Street

Lansing, Michigan

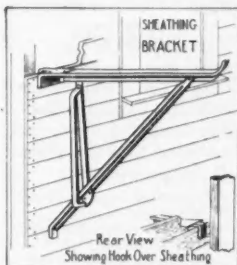

Make no Mistake

When you buy Scaffold Brackets buy the best. We are replacing other brackets almost every day.

Remember that our Sheathing bracket is the only bracket made that does not pull out on the Sheathing board. 80% of the strain is a direct downward pull, which makes it ten times stronger and safer.

Our Studding brackets are made to support a load of over a ton, and both these brackets are put up without the use of nails or screws. They are constructed to carry ten times the weight they are usually called upon to sustain.

We are now making the following special trial prices, providing cash accompanies order:

- No. 1—3 ft. Sheathing Bracket \$15.00 per dozen
- No. 2—4 ft. Sheathing Bracket 18.00 per dozen
- No. 3—4 ft. Studding Bracket 20.00 per dozen

We can make shipment immediately. Money back if not satisfied.

THE FOLDING SCAFFOLD BRACKET CO.

60 W. Lafayette Ave. - - - Detroit, Mich.



THE COLLAR

Pull-Easy Nail Collars

Save five times their cost on any job—small or large.

Get Free Sample No. 12

Try them out now. Save money, time and lumber. They simplify all temporary work.

WAGNER-BEHM CO.
20 E. Jackson Blvd.
CHICAGO



IN PLACE



ON THE NAIL



IN THE CLAW

Carpenters

You Can Save Money On Every Spring Job

Here's something right in your line—a Chemical Closet that you can sell to a home builder cheaper than a wooden privy and make a bigger profit for yourself. Here's something you can sell at odd times or turn over to your son or your foreman to sell.

RO-SAN CHEMICAL CLOSET



An absolutely sanitary, odorless indoor closet that may be placed anywhere in the house. Abolishes the germ-breeding, outdoor vault. A comfort and a convenience where there is no sewer connection. Germs killed by chemical. Easily emptied as the ash pit of a stove.

AGENTS WANTED

We want one live carpenter-contractor in each town to act as our agent. Good profits for little work. **We help you sell them.** Write today for complete details.

ROWE SANITARY MFG. COMPANY
203-C SIXTH STREET
DETROIT :: MICH.

Ask about the Ro-San Washstand. Running Water (Hot or Cold) Without Plumbing.

BUFFALO DIAMOND MESH FABRIC

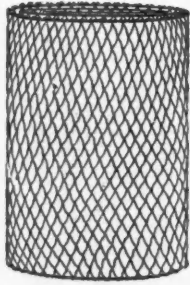

Is used to advantage in openings under Verandas and Porches. Allows free Ventilation and prevents Cats, Dogs and other animals from getting under. It is easy to install and takes less time than wood lattice work. Looks neat and cost no more than wood.

Made on power looms in meshes ranging from 1/2 inch to 3 inches, and widths ranging from 24 inches to 72 inches wide.

Put up in rolls of 100 linear feet with or without 3/16 inch galvanized wire edge.

Also used for tool room enclosures, window guards, etc. Write us for prices—Get our folder No. 52-B.

BUFFALO WIRE WORKS COMPANY
(Formerly Scheeler's Sons)

413 Terrace - - - - - BUFFALO, N. Y.

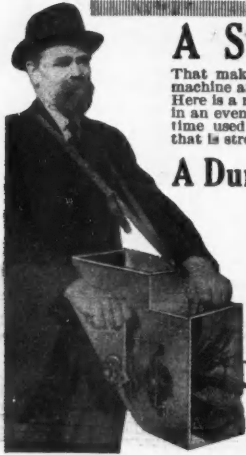

A STUCCO MACHINE

That makes Stucco Work easy and simple. With this machine any man can apply all Stucco Finishes. Here is a machine that will apply Cement Plaster or Stucco in an even, uniform coat. Taking only a fraction of the time used in applying stucco by hand and making a wall that is stronger and far superior to hand work.

A Durable Finish—Low in Cost

With this Automatic Stucco Machine you can apply a coat of durable stucco at the cost of a good painting job, with the advantage of endless durability. Why not get in on the remodeling business? This machine can do the work of twenty men doing stucco work by hand and do it better.

SPECIAL INTRODUCTORY OFFER
For a limited time, to introduce to builders, we will sell this machine at a discount of 33 1/3% from regular price. Write for further particulars and free booklet.

AUTOMATIC STUCCO MACHINE CO.
51 E. 42d ST., NEW YORK CITY, N. Y.

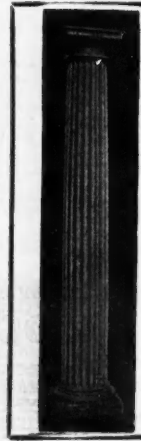

WE have issued *Very Interesting Catalogues* containing valuable information for the Architect, Carpenter and Builder regarding wood columns for exterior and interior use.

Catalogue "U-40" containing useful information about Exterior and Interior Columns.

Pergola Album "U-28" illustrates Pergolas, Garages, Lattice, Fences, Veranda Treatments and Garden Accessories, either one will be sent to those who want it for 10c in stamps.

HARTMANN-SANDERS CO.

Exclusive Manufacturers of

Kolls
Lock
Joint



Patent
Stave
Column

Main Office and Factory:
Elston and Webster Aves., Chicago, Ill.
Eastern Office: 6 East 39th St., New York City, N. Y.

THE BEST COLUMNS

for Porch, Interior and Pergola use the
NICKERSON Patent DOUBLE LOCK JOINT
THEY CANNOT COME APART

We Specialize on Detail-work. "Vignola" is our Standard for proportions when Architect's details are not furnished.

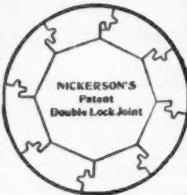

Clinch your Trade by giving them the very best Columns. Ours have the best Construction and correct shape.

All kinds of interior trim to detail.

Write for Catalogue No. 4.

NICKERSON MFG. CO.
KNOXVILLE . . . TENNESSEE

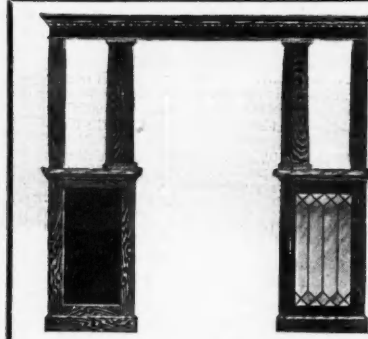

\$25.00

with your order, will bring this magnificent Book Case Colonnade Complete with Art Glass (no hardware) to your station, all charges prepaid.

This offer is good for a limited time only.

This is the greatest offer ever made.

Do not fail to take advantage of it.

Pedestals 2 feet wide and 3 feet 6 inches high, 6 inch veneered columns.

Workmanship perfect in every detail.

22 years in our present location; this should be sufficient guarantee.

CHICAGO GRILLE WORKS
626-636 Wells Street CHICAGO, ILL.

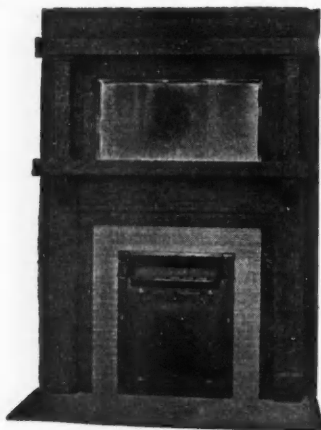

\$22.50 \$25.00

FOR THESE ELEGANT, MASSIVE, SELECTED OAK OR BIRCH, MAHOGANY FINISHED MANTELS. BEVELED MIRRORS, 18 X 36

Prices include our "Queen" Coal Grate with best quality enameled tile for facing and hearth. Mantels 82 inches high, 5 feet wide. Furnished with round or square columns, as shown in cuts.

Catalogue Free—Will send our 100 page catalogue, the finest ever issued, free, to carpenters, builders and those building a home.

HORNET MANTEL CO., 1147 Market St., St. Louis, Mo.

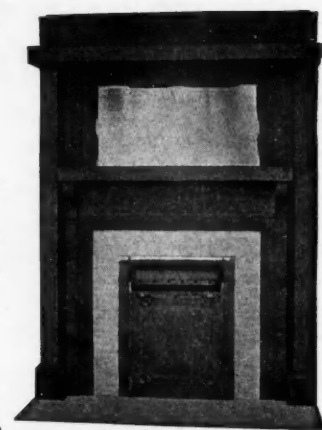

Quickly Adjusted to Any Angle and to Any Depth of Cut



Saw supports may be instantly locked at either a positive or an intermediate angle. Graduated arc and index plate show where to set the saw for any cut. Gauges may be set to stop the saw at any depth desired. Length gauge provides for sawing duplicate lengths with one adjustment. Simple automatic device holds saw guides when raised to highest point and re-

leases instantly. Another feature of importance is the slotted support which is always immediately beneath the saw and holds the work to prevent splintering at the end of the cut.

The time-and-labor-saving merits of this mitre box are recognizable on first inspection and its accuracy is beyond question.

MILLERS FALLS LANGDON ACME MITRE BOX IMPROVED

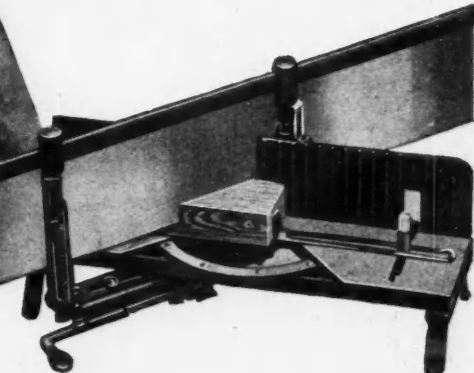

Ask to see it at your dealer's and have him show you also Millers Falls Bit Brace 872, Extension Bit Holder 6 and Hand Drill 1980—new and improved tools with the high quality and reliability that distinguish every tool of Millers Falls make. Send for pocket catalog showing complete line.



MILLERS FALLS CO., Millers Falls, Mass.

STANDARD Fly Screens



Made of Northern White Pine, with mortised corners. The Standard Shoulder Strip Method holds each strand of wire evenly and firmly. Easy to rewire. Standard Fly Screens are the standard of quality.

MAKE IT YOUR BUSINESS

to sell standard fly screens and screen doors; Send us your specification for estimate.

Write for copy of new catalog.

STANDARD SCREEN CO.
1856-58 Hastings Street Chicago

LIGHT YOUR HOUSES With Davis Acetylene Lights

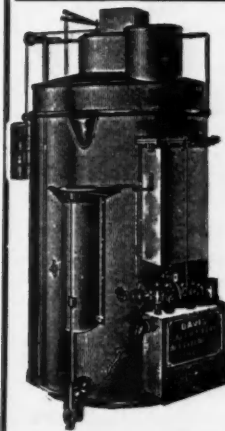

The Davis System provides a perfectly safe and reliable means of lighting any building. No experience is required to install this system in new or old buildings.

The excellent points of Davis Acetylene Lighting systems cannot be fully appreciated until you have read what we have to say about them. They are vastly different from any other Acetylene lighting system because there is positively no danger from leakage or explosion. The light is always strong and steady.

Architects and Builders

will find it profitable to accept our offer to local representatives and salesmen. Write for complete details and description.

Get the Best Light—the Best is the Davis

DAVIS ACETYLENE CO.
90 Crawford St. Elkhart, Ind.

PLUMBING AND HEATING SUPPLIES AT WHOLESALE

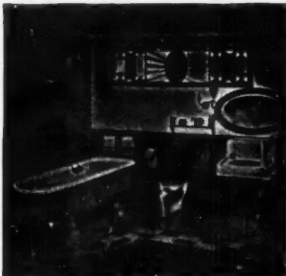

When in the market for Plumbing and Heating Supplies and you wish to

SAVE 20 to 40 Per Cent

on every article, write for my free illustrated Catalog. The only house that sells first-class guaranteed goods at wholesale prices direct. Shipments are promptly made from a very complete stock.

Small orders are as carefully handled as large ones.

B. B. KAROL, 768-772 W. Harrison St., Chicago, Ill.

Start to Succeed NOW

Forget the past. Better times are ahead. Start up out of the old ruts NOW. Mail the coupon. We want to tell you how you can learn Plan Reading, Estimating, Contracting, etc., IN YOUR OWN HOME. We furnish plans of buildings now being built. Never mind the cost—it's small. We want ambitious men now in the building line. Write today.

\$15.00 Outfit and All Free Blue Print Plans

CHICAGO TECHNICAL COLLEGE

1017 Lake View Building, Chicago, Ill.

CHICAGO TECHNICAL COLLEGE, 1017 Lake View Bldg., Chicago, Ill.

Gentlemen: I have marked with a cross (X) the branch or branches interesting me.

- Architectural Drafting
- Builders' Course
- Estimating
- Plan Reading
- House Planning
- General Contracting
- Bldg. Superintendence
- Structural Drafting
- Structural Design
- Mechanical Drawing
- Machine Drafting
- Machine Design



Name

Address

Town..... State.....

College or Home-Study Course

SARGENT
REG. U. S. PAT. OFF.

WROUGHT STEEL BLOCK PLANES

Block Planes that cannot break, convenient for the pocket. Quick and easy adjustments.

If your dealer cannot supply you, we will send you one prepaid, on receipt of the price.

No. 5206—6-inch Nickel Plated Plane, \$1.00
No. 4206—6-inch Polished Plane, - 90 cents



For full description of Sargent Warranted Planes, send for the Sargent Plane Booklet.

SARGENT & COMPANY, Makers of Planes, Squares and Mechanics' Tools
51 Water Street, New Haven, Conn.

WANTED

Good Contractors and Builders to act as our agents in every community for our well advertised



Buckeye Cupola Ventilators

— and —

Buckeye Metal Shingles

Two indispensables that every barn builder will need. These goods lead in simplicity and strength of design, easy application and quick salability.

Write for our free booklet on "The Ventilation of Modern Farm Buildings" and "Buckeye Metal Shingles."

See How It Locks?

This is the Raised Side Locking Joint which make Buckeye Metal Shingles the best roofing material ever produced. Makes a watertight lock that commends itself on sight. Many other points of superiority in Buckeye Metal Roofing Goods that the big catalog will tell you all about.



LAYED

↑

Write for Our Catalogs Today
Ask for our agents' proposition. There is real money in it for the man who is wideawake.

The Thomas & Armstrong Co., Dept. A. LONDON, O.

Carpenters and Builders Can Make Money

acting as our local representative. We will pay you a big commission on every acetylene generator ordered through you. Hundreds of homes in your locality should have private lighting plants. Scores will install acetylene gas plants soon. You can "cash in" on every installation and clean up a substantial income yearly, if you get in touch with us right now. Write for full details and proposition at once.

THE GEM CITY ACETYLENE GENERATOR CO
Dept. G. DAYTON, OHIO

Manufacturers of Faultless Pit Generators.



ACETYLENE GAS THE HOME MADE LIGHT



Our Small Gas Plants

are simple in construction, durable, absolutely safe and furnish the best light for the country home. No experience is necessary to install our plant. WE PAY THE FREIGHT and guarantee safe deliveries.

Agents Wanted Catalogue Free

The Geo. W. Clark Co. Dept. C Jacksonville, Fla.

$$\frac{.25 M}{4} = \$\$ \$$$

Yes—it's a problem in arithmetic, all right. And a big one at that.

It means that we have a method which will save you 25c—one-quarter of a dollar—on each thousand bricks you handle.

The "method" is something new in builders' hoists. It's going to make money for the men who use it—25c on each M!! We are going to **guarantee** that!

Send us the estimate of about how many bricks you will handle this season and we will tell you how much money we can save you.

So about the best thing to do is to write for our catalog. It gives the answer to this problem. **And the best time to write is now.**

We want reliable agents. This hoist is going to go BIG, so get in now.

H. B. Sackett Screen & Chute Company

Main Office and Warehouse
1683 Elston Avenue
CHICAGO

Branch Warehouse
197 Medford Street
CHARLESTOWN, MASS.

Buy The SIMPLEX 1915 Model MIXER

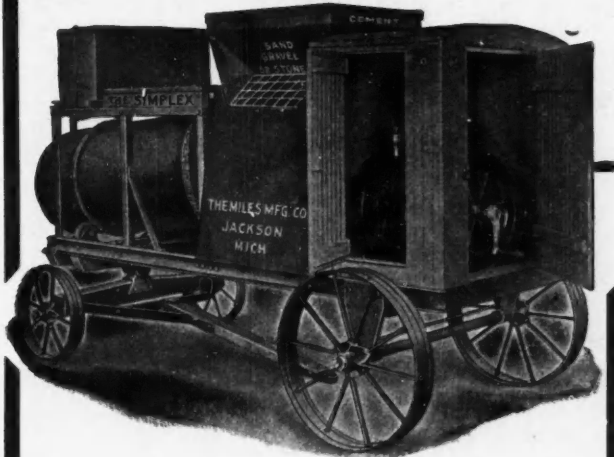

Combining the good features of both batch and continuous mixers in one machine.

The best feature of the Batch Mixers is the rolling of the materials. The greatest advantage of the Continuous Mixer is the automatic measuring and feeding of the materials.

Only one machine combines these two features—the SIMPLEX. It's the happy medium between the two types of mixers, giving the points of advantage claimed by each, and eliminating the faults of both.

Write for New Complete Catalog.

Reliable Agents Wanted.

The Miles Mfg. Co.
309 E. Franklin St. Dept. C JACKSON, MICH.

Typewriter Sensation

2 Dollars a Month
Buys a Genuine Standard No. 2

Smith Premier Typewriter



and at \$71.20 less than the Manufacturer's Price

Never before has anything like this been attempted. Dealers get \$3.00 a month rent for this make of machine, not nearly as perfect as the one we will send you, and you pay only TWO DOLLARS A MONTH AND OWN IT.

A - GUARANTEED - TYPEWRITER - \$28.80

High-grade machines only, complete outfit, nothing extra to buy, no strings of any kind to this offer. Just think of buying such a typewriter for \$8.80 down and \$2.00 a month. Cash price \$27.40. Thousands of people have paid \$100.00 cash for Smith-Premiers. It's standard, by many considered the best typewriter ever built. A key for each character, so each character printed is always the same; a brush for cleaning the type built into the machine; the tilting carriage instantly throws all the writing in plain sight. Comes to you with complete operating instructions, tools, waterproof cover, practice paper, everything ready. It runs beautifully. Writes as perfect and clean cut a letter as quickly and as easily as any machine bought for \$100. It's wonderfully simple, a child can operate it with half an hour's practice and rapidly attain speed. It's strongly built and will give you years and years of honest service and complete satisfaction.

SEND THE COUPON AND WE WILL SHIP YOU THIS SMITH-PREMIER TYPEWRITER

When the typewriter arrives, deposit with the express agent \$8.80 and take the typewriter three days and try it. If you find it to be the best typewriter you ever saw, satisfactory in every respect, keep it and send me \$2.00 each month, until our special price of \$28.80 is paid. If you don't want to keep it, return it to the express agent, and he will give you back your \$8.80, and return the typewriter to us. I will pay the return express charges.

You won't want to send this machine back after you have seen it and tried it. You can't imagine the perfection of these machines till you see one, and the price is \$71.20 less than the catalogue price, and it is guaranteed just as if you paid \$100.00.

The supply at this price is very limited, the price will probably be raised when next advertisement appears, so don't delay. There is no red tape. I employ no solicitors—no collectors—no chattel mortgage. It is simply understood that I retain title to the machine until the full \$28.80 is paid. Without sending any money write me now to ship you this typewriter for free trial.

This coupon states the terms. Fill it out and send it now, today. You can't lose, and it's the greatest economical typewriter opportunity you will ever have.

COUPON

HARRY A. SMITH,
905-231 N. Fifth Ave., CHICAGO, ILL.

Ship me a No. 2 Smith-Premier f. o. b. Chicago as described in this advertisement. I will pay you the \$20.00 balance of the SPECIAL \$28.80 purchase price, at the rate of \$2.00 per month. The title to remain in you until fully paid for. It is understood that I have three days in which to examine and try the typewriter. If I choose not to keep it I will carefully repack it and return it to the express agent. It is understood that you give the standard guarantee for one year.

Name.....
Address.....
Shipping Point.....
Amer. Carp. & Bldr., Feb.

ASHBY'S
Designs of Schools and Libraries
 display a composition of utility, durability and good, pure architecture without any "gingerbread."
 No buildings are too large or too small for our personal and prompt attention. We develop your own ideas into a practical set of plans and specifications which can be executed to the smallest details into a building that can be built within your means and to your entire satisfaction.
 Ashby's "Designs of Schools and Libraries" will be sent to parties interested in the erection of a school building or library for which plans have not yet been procured.
G. W. ASHBY—ARCHITECT
512 Medinah Building
CHICAGO, ILL.

Starrett Expansion Pliers

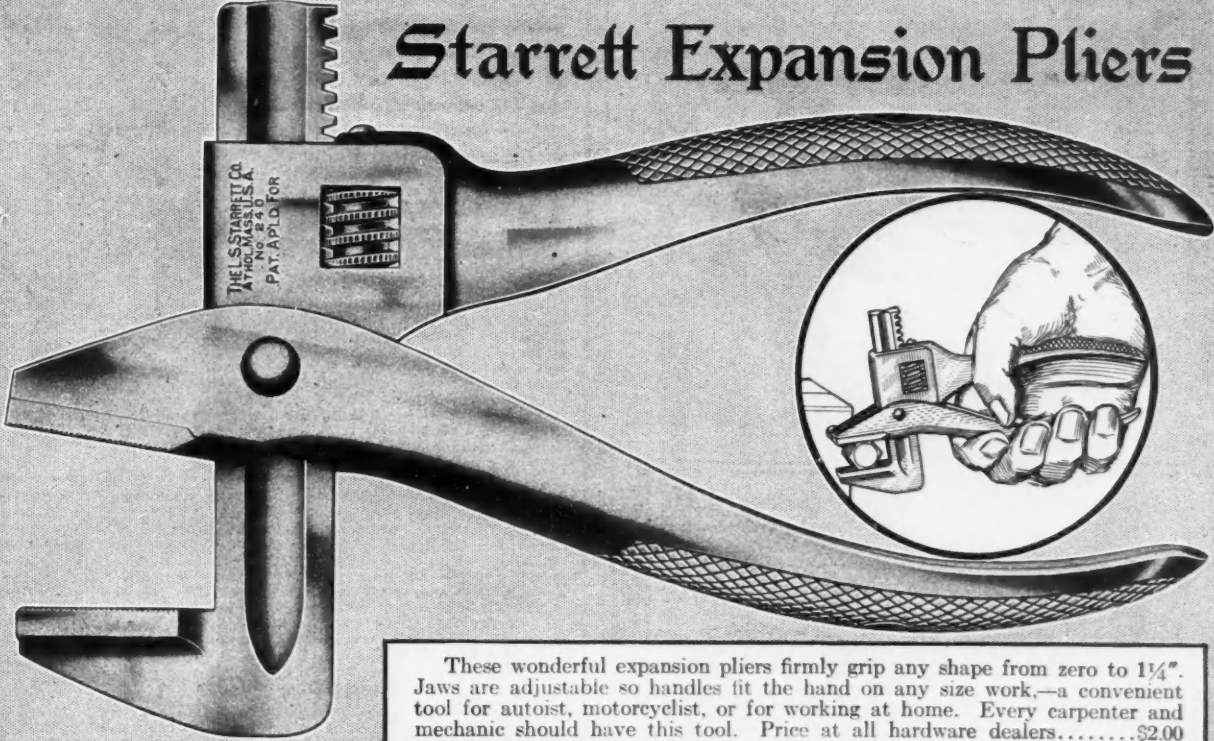

These wonderful expansion pliers firmly grip any shape from zero to 1 1/4". Jaws are adjustable so handles fit the hand on any size work,—a convenient tool for autoist, motorcyclist, or for working at home. Every carpenter and mechanic should have this tool. Price at all hardware dealers.....\$2.00
 Send for free catalog No. 206. 42-423

The L. S. Starrett Co., Athol, Mass.
World's Greatest Toolmakers

REHM'S NEW CATALOG

Is Ready for You



Shall we send a copy to you

We do not sell to Contractors in Cook County, Illinois.

5493—Sash Lock, Antique Copper Finish.
 Per doz. - - - 40c

REHM HARDWARE CO.
 1501 BLUE ISLAND AVE.
 CHICAGO, ILL.

Articles Every Carpenter Needs

**MEASURING TAPES
 SPRING JOINT RULES
 BOXWOOD RULES**



We guarantee to YOU absolute satisfaction.
 CATALOG ON REQUEST

THE LUFKIN RULE CO.
 New York Saginaw, Mich.

When in need of these say to the hardwareman
LUFKIN

"Last a Lifetime and Give Satisfaction To the End"



BUTT CHISEL

TRADE MARK
D. B. BARTON 1888 ROCHESTER, N. Y.

The celebrated Barton Planes and Edge Tools for carpenters and all other woodworkers are unequalled by any other made for keen, hard, smooth cutting edges. If your hardware dealer does not handle

THE CELEBRATED BARTON TOOLS

Send direct for catalogue and our free story book, True Stories. Be sure to specify "CARPENTER'S CATALOGUE."

MACK & COMPANY, 28 BROWN'S RACE
 ROCHESTER, N. Y.

Miller's Lock Mortiser

TWO MINUTES

Will cut an opening in a door for a mortise lock
IMPROVED AND UP-TO-DATE

cuts true, in any kind of wood for any size lock from 1/2" to 1 1/2" thick. Easy to operate; durable in construction. Builders use it everywhere.



Sent subject to trial.

A. W. Miller Mfg. Co.
 Riverside, Calif. - Cincinnati, Ohio
 Our Butt Mortiser and Rule Gauge for 75c., Postpaid

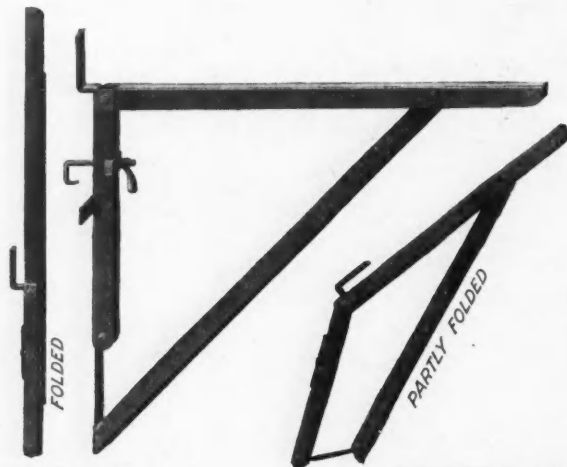

Why not consider builders' brackets from the saving as well as the safety point of view?

Wood brackets are a continual expense for repairing and replacing—are too bulky to move easily.

R-W STEEL FOLDING BUILDERS' BRACKETS

Strong, convenient and durable. Can be folded compactly. Provided with hook and tail screw for fastening bracket to studding, assuring positive safety. Sway brace prevents swinging motion of bracket when in use. Convenient for handling and requires small storage space. The strongest bracket made and the most easily applied. These brackets cost no more than wood brackets and will last a lifetime. Save their cost on any job requiring two dozen or more brackets. Contractors are enthusiastic about them.

Ask Your Dealer

Richards-Wilcox

MANUFACTURING CO. AURORA, ILL. U.S.A.

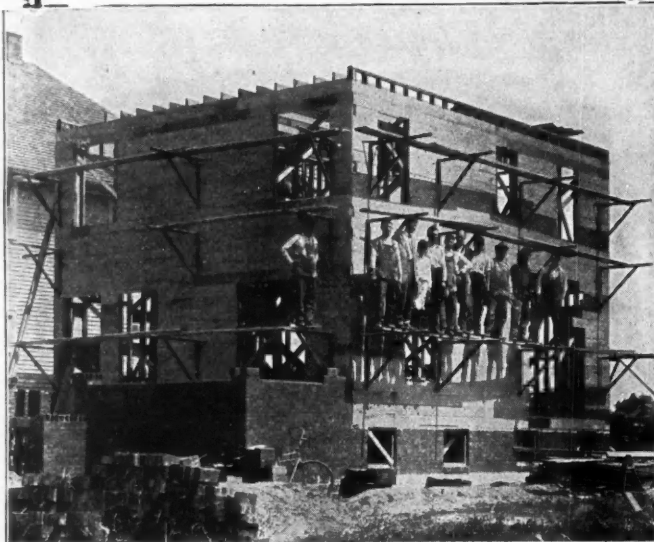

FREE!

To Contractors Who Build Dairy Barns

This Valuable Reference Book

Here's a 126 page pocket size book bound in durable Keratol leather—packed from cover to cover with information that's bound to save you time and money. The "How Book" for Contractors is yours free of all cost if you'll write for it and give us the names of folks in your neighborhood who are going to build new barns—remodel old ones or put in concrete floors.

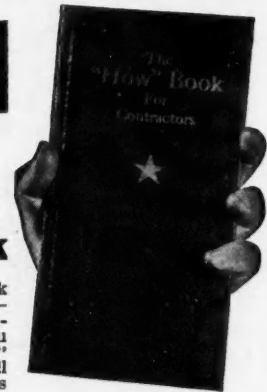

Pocket Size—Encyclopedia Contents

The "How Book" for Contractors tells how to figure life, strength and quantities on all kinds of building materials. Safe loads—bending stresses, crushing strength—timberweights—waste—shrinkage—roof pitches—labor costs in roofing, carpentry and masonry work, etc.—tells how to figure them all. It's a ready reckoner too—compiled from authoritative sources. A wealth of practical, usable, every-day information that you as a contractor can't afford to be without. And it's free to you. Write for it.

Our drafting department is at the service of our contractor friends. We furnish special blue prints for your customers at no cost to you.

Read This—Write Us

Write today—sending us the names of folks in your neighborhood who are going to build new barns—remodel old ones or put in concrete floors and we'll send you a copy of the "How Book for Contractors" bound in keratol leather and details of our Free Blue Print Service.

HUNT, HELM, FERRIS & CO.

304 Hunt St.

HARVARD, ILL.

"STRICKLER"



HAY TOOLS and Sanitary

BARN EQUIPMENT

Steel Stalls, Cow Stanchions, Litter Carriers, Feed Carriers, Watering Bowls. Every modern barn should be equipped with Strickler goods. All Carpenters and Contractors should send for our FREE CATALOG and Builder's Proposition. Write Today.

STRICKLER HAY TOOL CO., Janesville, Wisconsin

15 Saws Sharpened

with an edge of a

Gold ★ Medal File

A Trial Will Convince

Send for Samples at 10c

LIVERIGHT BROTHERS

North Philadelphia

::

::

Pa.



\$13.95
per doz. 4 footers
—if you send cash
with order.

Absolutely Safe; two of them will carry a ton, and they last a lifetime. Think of the time you save! One man alone can put them up and take them down easily and quickly.

No Side Swing if you purchase our new fixtures at 80c extra per dozen brackets: these keep the brackets absolutely rigid.

Write for Catalog of Builders' Specialties!



Save minutes for your workmen and you will save money for yourself. A man's time costs just so much per hour; use clamps that will increase his output.

Moreover, TAYLOR CLAMPS cut down the amount actually expended for tools. In the Brooklyn Navy Yard TAYLOR CLAMPS have lasted more than twice as long as the next best clamps made.

Catalogue No. 11 shows 22 styles. Free on request.

James L. Taylor Mfg. Co.
Poughkeepsie, N. Y., U. S. A.



THE AMERICAN SASH PULLEY
Pressed Metal

903 Park Avenue, New York

—one of New York's newest, finest apartment houses—is merely one of the many representative buildings fitted with American Sash Pulleys (pressed metal). The choice of these pulleys, by the discriminating architects of such structures, is a testimonial of their quality. Lightness, strength, and beauty of finish, are their distinguishing features.

The American Pulley Company
Office and Works—Philadelphia, Pa.
New York Boston Chicago
Good Machinery Dealers Everywhere

For Wide Clamping This Special Perfection Clamp Made in Three Patterns—Lengths to Suit

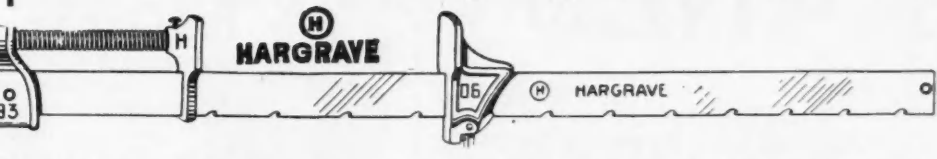

For all kinds of wide clamping, including sash work, doors, furniture, blinds, etc. It has the staying quality of all Hargrave tools, made from best material only. Frame is malleable iron with manganese spring steel bar, which will not buckle or bend. Hardwood handle turns easy, won't break nor come off. Tip of malleable iron with plenty of bearing for screw, and slides easy on bar. On clamps over 5 ft. long extra heavy bar and castings are used. Slide is equipped with hardened forged steel dog, which will not wear out.

Glad to send you our special free catalog telling all about Hargrave Quality tools. Have a copy in your kit for reference. Write Dept. H.

Hargrave Quality Tools Made Only by **The Cincinnati Tool Co., Norwood, Cincinnati, O.** Address Dept. H for Catalog

BLAKE QUICK ACTING VISE

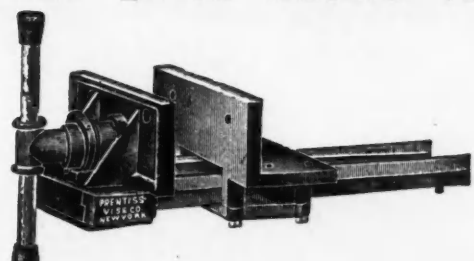

For Cabinet Makers and Wood Workers. Simplest—Strongest—Cheapest—Best.

Send for Catalogue of all kinds of Vises.

PRENTISS VISE COMPANY, MAKERS
106-110 LaFayette St., New York, U. S. A.

"RED DEVIL" Bonded Chisels

Couges, Drawing Knives, are acknowledged for their quality by many satisfied users.

Bonded "Red Devil" Chisels are the best that mechanics can produce. The steel is the highest grade for the purpose. The handles are select second-growth hickory, well-seasoned, and made to fit the tool.

Each Chisel is ground sharp, hand-honed and set. Packed one in a box, protecting the edge; ready for instant use.

With each Tool is packed a "Bond," insuring absolute satisfaction for two years.

This is the ONLY Chisel that carries an insurance policy.

You can obtain "Red Devil" Tools from your dealer. If not, we will send one sample of "Red Devil" Bonded No. 2622-1" Beveled Socket Firmer Chisel with leather tipped handle for 50c.

Send for Booklet of 3,000 "Red Devils" and copy of Bond, anyhow.

SMITH & HEMENWAY CO., Inc.
156 Chambers Street, NEW YORK CITY

Stanley Tools

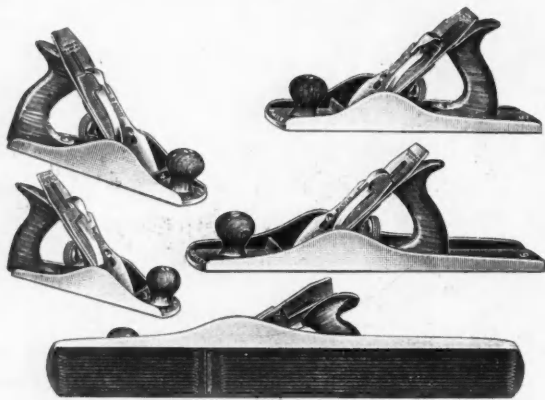

BAILEY IRON PLANES

"Bailey" Iron Planes have been in use for nearly fifty years, and are the recognized standard for Planes of this type.

While retaining all the original features, many valuable improvements in construction have been added from time to time. Only the finest materials and the best workmanship are used in their manufacture.

Always insist that your order be filled with Planes made by THE STANLEY RULE & LEVEL CO., which carry with them a GUARANTEE backed by a Company that has been manufacturing Carpenters' and Mechanics' tools for over half a century.

STANLEY RULE & LEVEL CO.
NEW BRITAIN, CONN. U.S.A.

DIAMOND EDGE TOOLS MAKE YOUR WORK EASY

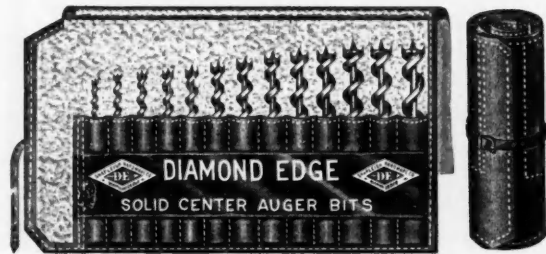

For over 50 years *DIAMOND EDGE* has stood for quality. Made of the highest grade steel known to man by experienced workmen. These facts make them cut easier and hold a sharp cutting edge longer than any tools made.

DIAMOND EDGE AUGER BIT SETS

in canvas rolls, lined with cotton fleece are protected from damage. The ideal package for the tool chest. Forged from crucible steel; tempered in oil and hand ground. Every *DIAMOND EDGE* tool fully guaranteed. Ask your hardware dealer for *DIAMOND EDGE* Tools. He can supply you. If not, write us—DEPARTMENT W.

SHAPLEIGH HARDWARE CO.

Established 1843
SAINT LOUIS
"DIAMOND EDGE IS A QUALITY PLEDGE"



Trade **SIMPLEX** Mark
Reg. U. S. Pat. Office

ROOFING NAILS

FOUR NAILS at PRICE OF ONE
When You Buy Them
ONE NAIL in place of FOUR
When You Drive Them

BECAUSE the Simplex has four times the head area of an ordinary roofing nail—hence four times the holding power, as head area is the all-important point in laying prepared roofing or sheathing papers.

Demand Simplex Nails from your hardware dealer. Don't buy prepared roofing unless Simplex Nails are packed in the rolls. **FREE** samples sent on receipt of request accompanied by dealer's name.

H. B. Sherman Mfg. Co. Battle Creek, Mich.

1853 **BUCK**  **BROS.** 1915

Fine Beveled Edge
Shank and Socket

Chisels



Tang and Socket
Butt Chisels

Plain and Beveled Edges

Send for illustrated Catalog

Buck Bros., Millbury, Mass.

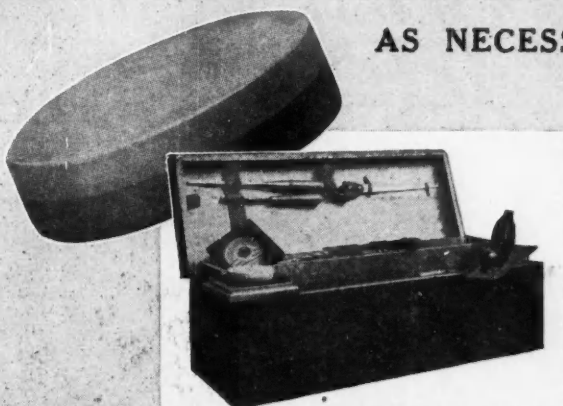

AS NECESSARY AS A SAW OR A HAMMER
IN YOUR TOOL KIT

Carborundum Sharpening Stones

Quick, clean-cutting stones, that bring the edge to the tool with just a few strokes. **AND THEY CUT THE EDGE ON THE TOOL—THEY DON'T MERELY RUB IT ON** Every stone positively uniform in grit and hardness, holds its shape, shows long life. The round Carborundum Combination Bench Stones for general tool sharpening, the beveled edge slips for touching up gouges, carving bits, etc.—the extra hard, extra fine Carborundum stones for that finer edge for your finer tools.

EVERY STONE IS GUARANTEED

ASK YOUR HARDWARE DEALER

THE CARBORUNDUM COMPANY

NIAGARA FALLS, N. Y.



Fits Any Saw Rig



Patented Nov. 29, 1892.
Feb. 19, 1910.

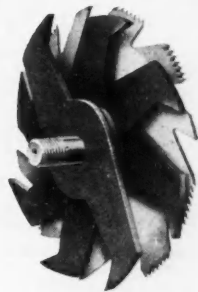

Showing position of cutters on mandrel

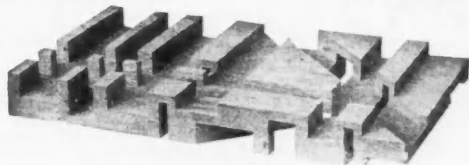

Grooves cut with Huther Dado Head.

Huther Bros. Dado Head will cut perfect grooves, any width, with or across grain. It consists of two outside cutters and enough inside cutters to make the desired cut.

The Head comes to you ready to use and **guaranteed** to do your work satisfactorily.

Ten days free trial at our expense. Our No. 34 Catalog, sent on request, describes full line of tools for the saw rig.

Huther Bros. Saw Mfg. Co.

1101 University Avenue :: :: Rochester, N. Y.

The Finest Product
of the Greatest
Plant —

DISSTON "D-115"



The handsaw which in material, temper, toughness, adjustment and finish is as near perfection as the greatest saw-works in the world can produce after three-quarters of a century's specialized experience.

If you as a mechanic take a pride in your tools, add the "D-115" to your kit.

Write for descriptive circular "D-115"

Henry Disston & Sons, Inc.

Philadelphia, U. S. A.

He Waited Too Long

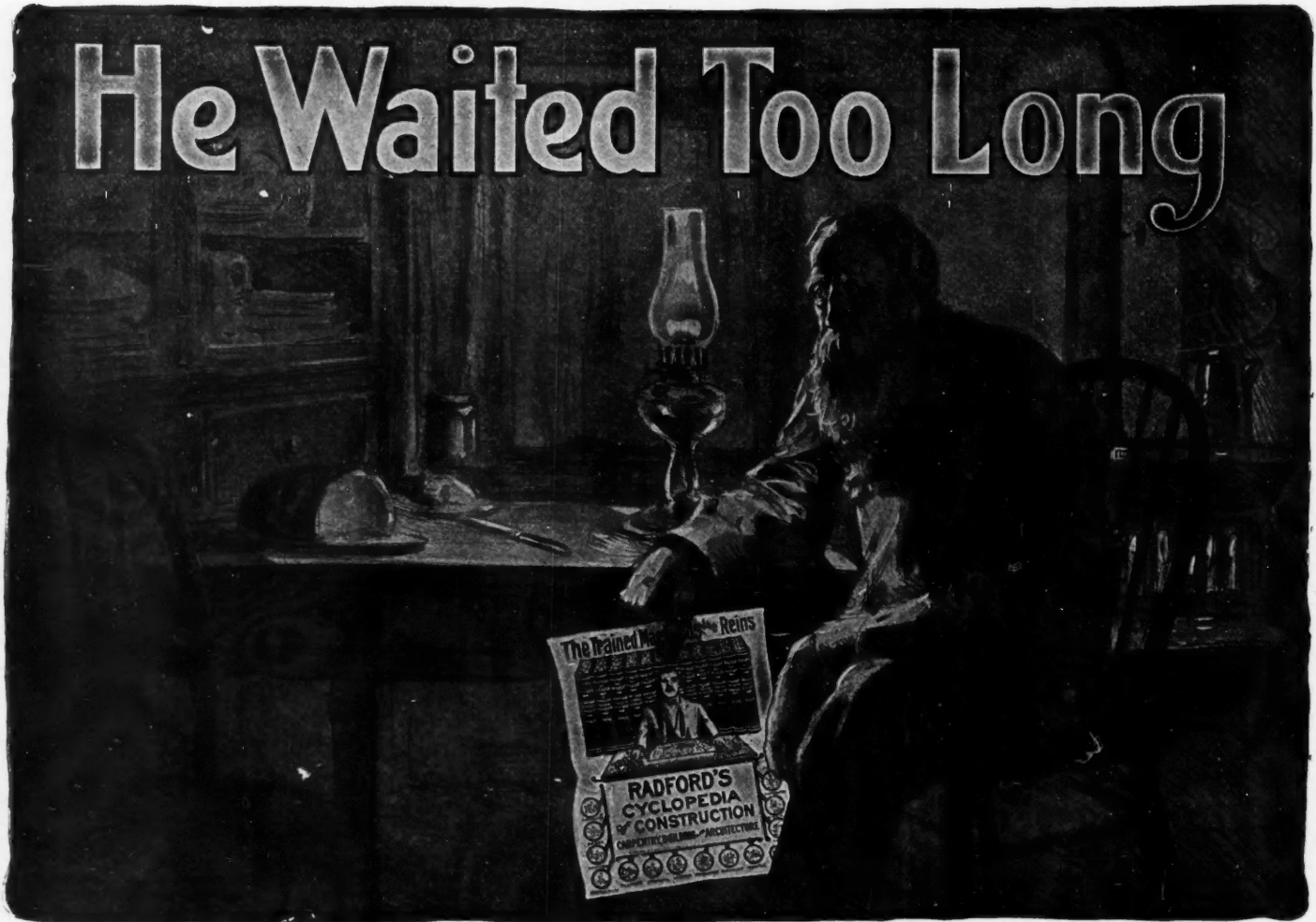

"If I only had this set of books twenty or thirty years ago, they might have changed my whole life. The knowledge in the big CYCLOPEDIA would have enabled me to increase my earning power, to take on big work, paying big money, and possibly have helped me to make a fortune in the building business."

Hundreds of letters like the above have come to us, breathing between the lines the same pathetic story of regret—showing how hard it is for the untrained man to really get ahead in life. **The opportunity is yours NOW**, and the way is easy. **Don't wait too long. Don't wait at all.** Read the terms of our **NO-RISK, Guarantee Offer** over again, and **sign and mail coupon today.** You risk absolutely nothing, and you will reap the benefit ever afterward.

VERY BRIEF LIST OF CONTENTS

To realize their tremendous scope, you must see the books—you can get the books for five days examination without cost to you.

A.C.B.
3-15

**Radford
Architectural
Company**
1827 Prairie Ave.,
Chicago

Please send me, express prepaid, your 12-volume Cyclopedic of Construction, for five days' free examination, with privilege of return at your expense. I enclose \$1.00 deposit, which you agree to return if I decide not to keep the books after examination. If I keep the books, I will pay \$2.00 a month until the special price, \$23.80 is paid, otherwise I will notify you within five days after receipt of books.

Your offer also includes Radford's Portfolio of Plans (over 300 designs), and one full year's subscription to the American Carpenter and Builder. You also agree to furnish set of Blue Prints and Specifications, if ordered within 2 months after acceptance of books.

Name.....
Town..... State.....
Street.....

Carpentry.
House Framing
Uses of Steel Square
Rafter Cuts
Strength of Timber
Roof Trusses
Stair Building
Drafting and Design
Working Drawings
How to Read Plans
Blue-Printing
Architectural Forms
Architectural Lettering
Construction Contracts
Forms of Contract
Architect and Owner

Specification Writing
Inspection of Work
Cost Estimating
How to Bid with Safety
Timekeeping, Superintendence
Cement Construction
Origin of Portland Cement
Advantages of Concrete
Common and Hydraulic Lime
Cements (Portland, Natural, etc.)
Proportions for Mixing Aggregates (Sand Gravel, Crushed Stone, etc.)
Mixing by Hand and Machine
Depositing Concrete
Concrete Troubles
Waterproofing Concrete
Concrete Blocks and Brick
Cement Mortar
Stucco and Plaster
Concreting Machinery and Tools
Concrete Mixers

Block Machines
Number of Blocks Required
Brick and Tile Machines
Forms (Wood, Metal)
Cement Houses
Foundations
Floors and Walls
Roofs and Chimneys
Fireproof Construction
Concrete Sidewalks
Ornamental Use of Concrete
Surface Finishes
Art Tile and Mosaics
Terrazzo Floors
Concrete on the Farm
Fence-Posts and Gate-Posts
Sewer and Drain Pipe
Concrete Silos
Reinforced Concrete
Principles of Design
Reinforcing Materials and Systems
Industrial Buildings
Concrete Piles
Sewer and Tunnel Work
Bridges and Viaducts
Culverts, Reservoirs

Estimating Concrete Work
Standard Specifications
Masonry Construction
Building Stone
Brick and Brickwork
Mortar for Masonry
Bonds and Joints
Steel Construction
Steel Shapes
Use of Handbook Tables
Allowable Stresses
Rivets, Tie-Rods
Columns, Beams and Girders
Floor and Roof Arches
Roof Trusses and Coverings
Mill Building Construction
Steel Bridges
Heating, Ventilation
Furnaces and Pipes
Plumbing
Sewers and Drains
Electric Wiring
Painting
Paperhanging
Furniture Making
Useful Tables, Rules, etc.

**12 Big Volumes—Free Premiums—No Risk
SENT FOR ONLY \$1.00**

RADFORD ARCHITECTURAL CO.
1827 Prairie Ave., CHICAGO, ILL.

PIN A DOLLAR BILL TO THIS COUPON AND MAIL IT AT OUR RISK TODAY

EASY and SURE Steps to Higher Wages and Larger Contracts



The man who climbs to success is the man who knows how to do things in the best modern way. A bigger share in the

BUILDING OPPORTUNITIES OF TODAY

is surely yours to claim! You can do it without technical training or hard study. To master every detail of your trade or business will be a pleasure instead of a laborious task if you will let us send you for five days' free examination absolutely at our own expense and risk, a set of

RADFORD'S CYCLOPEDIA OF CONSTRUCTION

Carpentry, Building and Architecture

A Practical Uplift to Complete Mastery of Modern Building Methods and Materials

Twelve Massive Vols.—5,000 pages, 3,000 illustrations. Up-to-date, practical, thorough. All in simple English, without higher mathematics. Latest materials and methods. The cream of practical experience of the world's best known builders and contractors. Every detail covered—Carpentry; Framing; Concrete Work; Masonry; Steel Construction; Fire and Waterproofing; Drafting and Design; Heating; Ventilating; Plumbing; Decorating; Contracting; Estimating Cost, etc., etc.

Sent Anywhere on Approval

ORDER ABSOLUTELY AT OUR RISK

No Obligation or Expense to You Unless You Keep the Books
No Follow-Up Agents to Bother You

WHAT OUR FREE TRIAL OFFER INCLUDES:

12 Massive Vols.—Bound in ¾ Morocco leather, with full Persian library covers. A brand new work, costing over \$100,000 to compile and publish, built along new lines especially for the practical builder or contractor. Without magazine, \$1.00 less.

FREE Radford's Portfolio of \$30,000 Prize Building Plans—Over 300 designs of houses, bungalows, outbuildings, apartments, churches, etc. Ranging in cost to suit any purse.

FREE Complete Set of Guaranteed Working Blue-Prints and Specifications for any house design selected from Portfolio—Ordinarily costing \$75 to \$100. We will also include One Full Year's Subscription to the "American Carpenter and Builder," the world's greatest building paper, without extra cost to you.

If you are a Carpenter or Builder, you can do all the ordinary work of the Construction Engineer or Designer without any deep mathematical calculations, thus insuring your title to better recognition, wider responsibilities and higher wages.

If you are a Contractor, your clients will appreciate dealing with a man who is able to give them the latest practical suggestions, and who has back of him the experience and resources of one of the largest architectural firms in the world.

12 MASSIVE VOLUMES

SENT ON APPROVAL FOR FIVE DAYS' FREE EXAMINATION

No Obligation. No Expense. No Risk to You
We Take all the Risk

READ THE COUPON

ON NEXT PAGE

RADFORD ARCHITECTURAL COMPANY,

1827 Prairie Ave., Chicago, Ill.

SIGN AND MAIL COUPON TO-DAY

WHEN WRITING ADVERTISERS PLEASE MENTION THE AMERICAN CARPENTER AND BUILDER

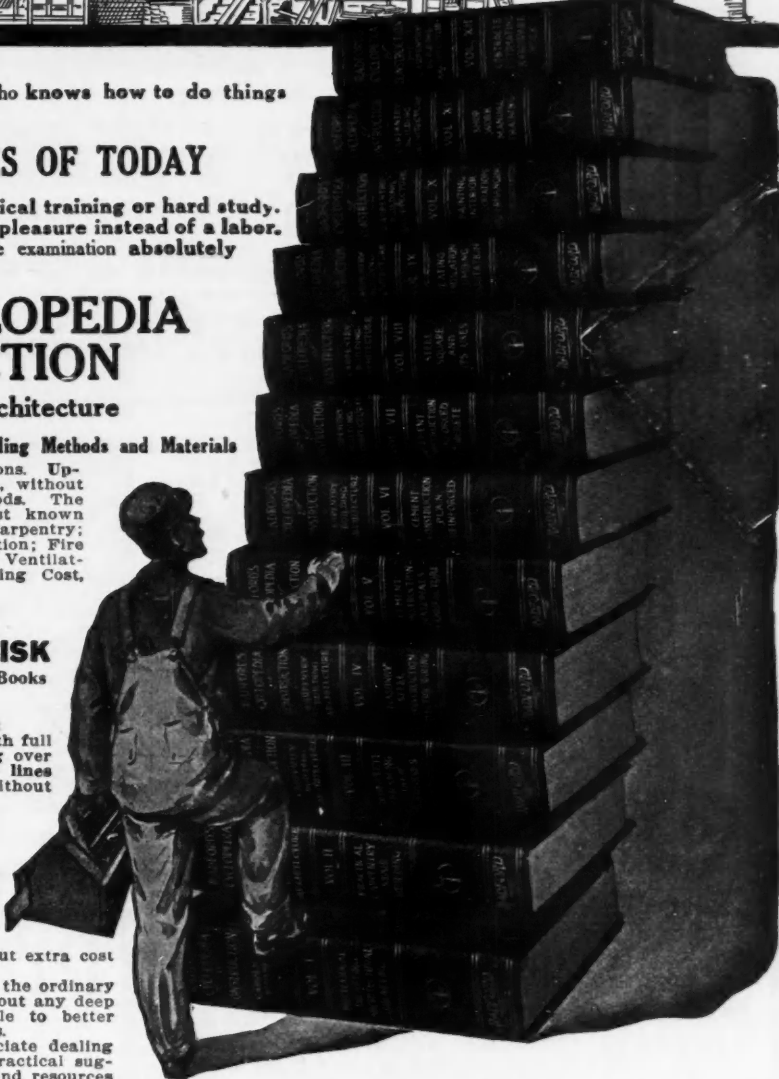



Cheap men buy cheap tools—readers of American Carpenter and Builder are not cheap men, so they buy WHITE tools and get the kind that they can do good work with. It pays them—It will pay you. Just try them and see.

Drop us a card and ask for our Adze folder.

The L. & I. J. White Co., 10 Columbia St., Buffalo, N. Y.

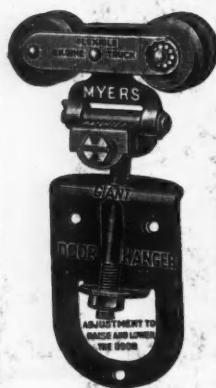

**THE MYERS GIANT
ADJUSTABLE TANDEM
DOOR HANGER**

For TUBULAR GIRDER TRACK is adjustable to and from the building, and up or down as necessary. Has flexible engine track with steel rollers revolving on steel roller bearings. The adjustable features prevent trouble from weather conditions or sagging of building. Storms, sleet or ice do not affect it, owing to complete protection afforded by the tubular track. Track and Hanger are constructed to carry and operate heavy doors easily.

This and other styles of Tubular and "Stayon" Door Hangers are shown in our Door Hanger Booklet. Copy mailed on request.

**F. E. MYERS & BRO.
ASHLAND, OHIO**



**This Pearson's Automatic
SHINGLE NAILER
WILL PAY FOR ITSELF
ON FIRST JOB**

Do your nailing fast—faster than ever before. You can use this Pearson's Nailer on any pitch roof. Wear mittens, gloves, etc. This "Hand Nailer" is the only Nailer—throw nails in by the handful—then start nailing. Nails easily driven through tin or quite heavy sheet iron.

These nailers are made in two sizes—The BLUE Nailer for 3d. common No. 14 gauge wire nails. The RED Nailer for 3d. galvanized No. 13 gauge 1 1/4-inch wire nails.

It will come right to your door, quick, by insured parcel post, all prepaid for only \$5.00.

IT MAKES GOOD.

PEARSON MFG. CO. - ROBBINSDALE, MINN.

**GOODSELL MITRE BOX
Made Of Steel—Cannot Break**

For years this Box has been recognized as being first in quality and improvements, and the new Steel Bottom Plates with Angular Serratures to prevent the work from slipping add still more to its convenience and attractiveness.

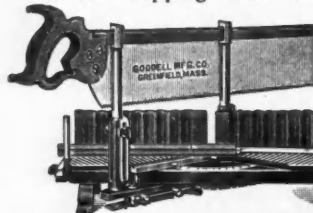

Write for new Circular C describing this and many other features

**Goodsell
Mfg. Co.
Greenfield, Mass.**

**PHOENIX
INSIDE SLIDING
BLINDS**

WILKES BARRE, PA.

The Phoenix Sliding Blind Co. Enclosed find my check for blinds. I am pleased with them and sorry I did not have them put throughout the whole house. C. W. BURT.

**Comfort!
Economy!
Convenience!**

The lately improved springs and corrugated steel rods put the "PHOENIX" far in lead of less improved styles. Write for Catalogue "C" and free samples, showing construction.

**PHOENIX SLIDING BLIND CO.
BRIDGE & CANAL STS. PHOENIX, N. Y.**

\$42²⁵ GUARANTEED
 GRADE "A" PLUMBING & HEATING SUPPLIES.
 COMPLETE AS SHOWN DIRECT TO YOU AT
WHOLESALE PRICES
J. HARDIN CO.
 35 YEARS AT 4543-53 COTTAGE GROVE AVE
 CHICAGO

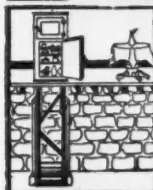

CARPENTERS AND BUILDERS
 Make extra money by installing this practical necessity in new and old homes. It saves 365(1) trips to the cellar each year. "WIFE'S JOY" DUMBWAITER Ball Bearing Disappearing Operates quickly by a press of the button. Takes up no room. Top lies flush with floor. can be walked on. Practical for any home. Keeps food perfectly. Can be installed complete in 2 hours. WRITE FOR CIRCULARS. Fifteen Days' Free Trial Without Any Deposit.
AMERICAN ELEVATOR CO. - Bloomsburg, Pa.

\$4 A MONTH
 BUYS THIS VISIBLE **OLIVER TYPEWRITER**
 Nothing Down—Free Trial. Less than Agents' Prices. Shipped on approval. If you want to keep it, send us \$4 a month. Send for famous FREE typewriter book. Tells how to save \$48.00. Write today. Typewriters Distributing Syndicate 166-28A N. Michigan Blvd., Chicago (270)

PEERLESS BLUE PRINT CO.
DRAWING PAPERS TRACING PAPERS
 All orders for Blue Prints shipped same day as received. Send for our Latest Catalogue.
 341-347 Fifth Avenue NEW YORK

Over 1,000,000 Here's What People Want **The Axtell**
 A perfectly tight All-Metal Weather Strip for bottom of doors and swinging windows. Saves sill from wearing and can be put on any door in 5 minutes at 200% profit. Sells at sight wherever shown. Our prices will interest you. Write us.
E. I. Church & Co.
 West Hanover, Massachusetts

SAMSON SPOT SASH CORD
 Made of extra quality stock, carefully inspected, and guaranteed free from the imperfections of braid and finish which destroy common cords so quickly. Samples and full information gladly sent.
Samson Cordage Works - Boston, Mass.

AT LEAST 75c For Every American Carpenter and Builder Reader :::::

THE KING OF HAND SAWS "VANADIUM"

20"	22"	24"
\$2.00	\$2.15	\$2.30
26"	28"	30"
\$2.50	\$2.70	\$2.90

Straight or Skew Back, in Hand, Panel or Rip—any Teeth Desired. All styles.
 Vanadium Steel Saws made of Vanadium High Speed Steel, hardened and tempered by a secret process. If the Vanadium Steel Saw does not give better service than any other saw you have ever had, return it and your money will be refunded.

VANADIUM STEEL SAWS
 have proven so satisfactory to every user, that once you try them you will always use them.

OUR PROPOSITION
 In order to get at least one Pennsylvania Vanadium Saw into the hands of every American Carpenter and builder tool user we offer a reduction of 75c cash from price shown herewith on every saw ordered on coupon attached—and it will come prepaid, too.

Send in for Your Trial Saw
PENNSYLVANIA SAW CO., Frackville, Pa.
 Manufacturers of Saws, Scrapers, Try Squares, Etc.

Pennsylvania Saw Co., Frackville, Pa.
 Gentlemen:—I enclose \$..... for a trial saw
 Length..... inches. Teeth..... pts.
 Narrow or Wide Blade..... Straight or Skew
 Back..... prepaid I am an American Carpenter and
 Builder reader.
 Name.....
 Address.....
 Name of Dealer.....

WHEN WRITING ADVERTISERS PLEASE MENTION THE AMERICAN CARPENTER AND BUILDER

RUN THIS ENGINE for 30 DAYS FREE
 Detroit Kerosene and Gasoline engine sent YOU for 30 days FREE TRIAL; guaranteed 10 years. Economical horse power, lowest prices; farmer agents wanted everywhere. Engine operates on gasoline, kerosene, alcohol, distillate or naphtha. Saws wood, grinds feed, churns, pumps, separates, makes light any job around the farm. Only 3 moving parts, no cams, gears, sprockets, etc.
 Send for "Common Sense Power Book."
2 1/2 to 18 H.P.
503
 Detroit Engine Works, 455 Bellevue Ave. Detroit, Mich.

OLMSTED'S IMPROVED MITRE BOXES
 Wood and iron, with adjustable saw guides. Suitable for any cross cut or back saw. Insures perfect mitres. Carefully made. Several styles. Prices very reasonable. Write for circular.
Olmsted's Tool Grinder and Sharpener
 No foot power required. Guide rests for tools, etc. Requires no skill for operating—does rapid work. Ask for further particulars.
L. H. OLNSTED'S SON - Hasbrouck Heights, N. J.

STORM Dumbwaiters and Hand Elevators
 No stock sizes. Built to fit the place. Ask your hardware dealer and write us for catalog. Let us send you our new Catalog with Discounts.
THE STORM MFG. CO.
 Herman & Vesey St., NEWARK, N. J.

THE ZIMMERMAN IRON BASE
 is the ONLY BASE having a CENTER BEARING.
 It carries the required weight without allowing the corner supports to sink into the floor and prevents the base of column and door from rotting.
 See "SWEET'S" page 958.
S. CHENEY & SON, MANLIUS, N. Y.

"Opportunities"

Have you anything to Sell, Barter or Exchange,
Want Help, Agents, or a Situation? Use our

Classified Department

RATES 5 CENTS A WORD. CASH WITH ORDER

No Display Type Allowed in Classified Advertisements

Patents

PATENTS SECURED—Booklet on request. HARRY PATTON CO., 255 McGill Building, Washington, D. C.

C. L. PARKER, PATENT ATTORNEY. Formerly member Examining Corps, U. S. Patent Office. 920 G St., Washington, D. C. Pamphlet of instructions sent upon request.

PATENTS THAT PROTECT AND PAY—Books free. Highest references; best results. Send sketch or model for free search. Watson E. Coleman, Patent Lawyer, 622 F St., Washington, D. C.

NO ATTORNEY FEES UNTIL PATENT ALLOWED. Send sketch for free report. Books free. FRANK FULLER, Washington, D. O.

PATENTS SECURED OR FEE RETURNED. Send sketch for free search. Latest and most complete patent book ever published for free distribution. GEORGE P. KIMMEL, attorney, 223 Barrister Building, Washington, D. C.

Instruction

DRAFTSMEN'S, BUILDERS' AND FOREMEN'S COURSES—Day, evenings or by mail. MAACK'S ACADEMY OF ARCHITECTURE, 1742 Chouteau Ave., St. Louis, Mo.

"FROM UNIVERSITY TO HOME." We train you in Bookkeeping, Accountancy, Interstate Commerce Law, Show Card Writing, and Photo-Plays. Easy payments. TURNBULL, 469 State St., Brooklyn, N. Y.

LEARN TO DO YOUR PLUMBING AND HEATING FROM practical work on jobs. Good positions for students who have taken a course at the Litchfield Trade School. Write for particulars LITCHFIELD TRADE SCHOOL, Libertyville, Ill.

Wanted

AGENTS WANTED for house lighting machines, supplying gas for small country homes as well as large. Simple and economical. Guaranteed. A live proposition. Write for terms. THE ALEXANDER F. MILBURN CO., Baltimore, Md.

WANTED—Manager for Sash and Door Factory in Western Canada City, employing about thirty hands; must be mechanic and thorough Estimator; State Experience, References and Salary required. Address Post-Office Box No. 206, Winnipeg, Canada.

WANTED—Agents for Hand Power, Electric Portable and Stationary Vacuum Cleaners, suitable for country homes, city residences, schools, churches and skyscrapers. Can be used for cleaning stock in dairy barns and everywhere dust is to be eliminated. Also heavy service Portable Vacuum and blowing cleaners for stores, factories and hotels. Hustlers can make up to \$20.00 a day Cleaning Carpets in their own towns. Spring Carpet Cleaning business is at hand. Get our bargain prices before buying a vacuum cleaner from any one at any price. Mammoth Vacuum Cleaner Manufacturers. Write for descriptive matter and terms. Liberal Commissions to live agents. Special discounts to plumbers, steam fitters, contractors and builders. THE CLIFTON-PRATT CO., Dept. 15, 1224 W. 8th St., Cincinnati, O.

For Sale

FOR SALE—Carpenter Aprons. The best made. If not right, return and get your money. By mail, 75c, postpaid. O. H. ALBAUGH, 9320 Fuller Ave., S. E. Cleveland, Ohio.

FOR SALE—Cabinet Planer, Power Mortiser, Mattson Turning Machine, Swinging Saw, Drum Sander, Shaper, Rod Machine. W. A. REINEKE, Perry, Ill.

FOR SALE—One 12-in. Hand Planer, one 6-in. one-side Sticker, one 10-horse Gasoline Engine, one Rip and Grooving Table, and one Cut-off Table. First class outfit for carpenter and contractor. FITSCHEN & CO., Washburn, Ill.

FOR SALE—Two second-hand quarter-sawn white oak mantels with aldrine grates and metal front instead of tile. Everything complete and perfect in every way. Write for prices. H. A. TAYLOR, Morris, Ill.

FOR SALE—CABINET MACHINERY, Gang dovetail, No. 3 Way-mouth lathe, saw tables, Rogers moulder, Boulton carver, two head White shaper, several glue kettles. Send for list. LUOAS & SON, Bridgeport, Conn.

Miscellaneous

TWELVE SKELETON KEYS, will unlock almost any door, 50 cents. Just what carpenters and property owners need to replace missing keys. AMERICAN MANTEL, TILE & GRATE CO., Hamilton, Ohio.

BUILDER'S ESTIMATING SHEETS—25, 50c; 10, 25c. Save time, prevent loss. COMMERCIAL PRINTING CO., Wooster, Ohio.

"ABBALENE," the concrete water-proofing. Sample free. ABBALENE CO., 401 Caxton Bldg., St. Louis, Mo.

150 HAMMERMILL BOND LETTERHEADS and 150 Envelopes, printed to order, \$1.00, postpaid. Samples free. ANDREW F. BREMS, Corona, N. Y.

AGENTS—500 per cent profit; free sample. Our new gold and silver sign letters for store fronts and office windows. Easily applied. Big demand everywhere. Write today for liberal offer to agents. METALLIC LETTER CO., 447 N. Clark, Chicago.

WE ARE OFFERING Asphalt Prepared Roofing and Wallboard at less than factory prices. Write for samples and our low delivered prices. Genuine high-grade Asphalt Roofing as low as 90c per roll, containing no short pieces or mill ends. Write to us for our lumber catalogue and price list. HOME LUMBER AND SUPPLY CO., 343 S. Dearborn St., Chicago, Ill.

DELIVERED TO YOU FREE

On Approval and 30 Days' Trial



SEND NO MONEY but write today for our big 1915 catalog of "Ranger" Bicycles, Tires and Sundries at prices so low they will astonish you. Also particulars of our great new offer to deliver you a Ranger Bicycle on one month's free trial without a cent expense to you. It's absolutely genuine.

BOYS you can make money taking orders for bicycles, tires, lamps, sundries, etc., from our big handsome catalog. It's free. It contains "combination offers" for re-fitting your old bicycle like new at very low cost. Also much useful bicycle information. Send for it. LOW FACTORY PRICES direct to you. No one else can offer such values and such terms. You cannot afford to buy a bicycle, tires or sundries without first learning what we can offer you. Write now.

MEAD CYCLE CO., Dept. G-122, Chicago, Ill.

BIG PROFITS

Carpenters & Builders are overlooking big profits when they do not arrange to put up the lightning rod protection on buildings they erect—

Why not get these big profits

We offer you a liberal proposition to become agent of our **guaranteed lightning protection**. Our full instructions make the work easy. Our cables are pure soft copper and extra heavy. Attractive fixtures.

Write for territory, prices and proposition. No capital required.

C. H. TOWNSEND & SON,
Des Moines, Iowa.
209 E. Second St.

CYPRESS

(OF COURSE)

BECAUSE IT'S "THE WOOD ETHERNAL" & LASTS & LASTS & LASTS & LASTS

Royal Ventilators

Royal Ventilators used the world over. They issue a constant supply of fresh air. Low in cost—high in quality.

A postal brings our catalogue.

ROYAL VENTILATOR CO.
417 Locust St., PHILADELPHIA, PA.

THE MILLS GRAVITY LINE CHALKER PAYS FOR ITSELF

on One Shingling Job. No Walking Across Roof. Prepaid to Any Address. \$1.50. Send for Circular.

AGENTS WANTED

B. F. MILLS Decatur, Ill.
1552 N. MORGAN ST.

The "IONA" Ventilator

Provides ideal ventilation for all buildings, factories, barns, theatres, etc. Simple, natural, best ventilation, because we use the straightest and shortest way out. The only ventilator, for which test demonstration is offered and given.

Write for our catalogue.

Iona Ventilator Company
2317 N. Laura St., Philadelphia, Pa.

DON'T ORDER Lignine (Wood) Carvings UNBREAKABLE—INVESTIGATE

Send postal for free sample and catalog. One cent investment, saves dollars. Let us prove this.

ORNAMENTAL PRODUCTS COMPANY
Fourteenth Avenue, Detroit, Mich.

JOHNSTON'S Patent SHELF PIN

1 DOZ 15¢
1 GROSS 85¢

These Pins are used for supporting movable shelves in Book Cases. Cannot fall out or sag down. The best shelf pin made. Easily put in place by any one.

Send for free sample to **J. D. JOHNSTON,** NEWPORT, R. I.

A UNIQUE TIME SAVER.

The Jackson Aluminum Line Level is a mighty small device but it brings about a tremendous saving of both time and labor. It takes the place of the old-fashioned sixteen foot straight edge, yet it can be carried in your vest pocket.

No contractor, builder, carpenter, mason, bricklayer, architect or plasterer, etc. can afford to be without one. Just stretch your line and hang the level on it—It's positively accurate. The complete outfit is put up in a neat leatherette case and consists of the level with a 40-ft. line also a spring clamp for attaching the level to a steel square or pocket rule, thereby serving as a plumb rule or bench level. Ask your hardware dealer or send \$1.00 for the Level outfit complete post paid. Send for our Catalogue of Tools.

JOS. WOODWELL CO., Sole Agents
201-203 Wood St., Pittsburgh, Pa.

20 Reasons Why You Should Investigate the **SANDOW** Kerosene Stationary ENGINE

It runs on kerosene (coal oil), gasoline, distillate and alcohol without change in equipment—starts without cranking—runs in either direction—throttle governed—hopper and tank-cooled—speed controlled while running—no cams—no valves—no gears—no sprockets—only three moving parts—light weight—easily portable—great power—starts easily at forty degrees below zero—complete ready to run—children operate them—low factory prices based on enormous output.

30 Day Money-Back Trial—10 Year Frictional Guarantee

Sizes 1 1/2 to 18 horse power. Send a postal today for free catalog which tells how Sandow will be useful to you. No go-betweens. Pocket agent's and middlemen's commissions by dealing direct with factory.

Detroit Motor Car Supply Co.
198 CANTON AVE. DETROIT, MICH.

Triumph Light!

EVERYBODY WANTS BETTER LIGHT. HERE IT IS

This new 100 to 700 candle power light turns up and down like gas. One-third cost of electricity, gas or kerosene. For home, church or store. Anyone can operate. Perfection guaranteed or money back. Write for catalog. (A. C. B.) Dept. 20. Agents Wanted.

BRILLIANT GAS LAMP COMPANY
1098-S Wabash Av., Chicago, Illinois

Sash Rail Ventilators and Window Ventilators

Regular and Special Types

Architects, Contractors and Builders will do well to consult us regarding these devices. Established 1901.

Pullman Automatic Ventilator Mfg. Co.
21 York Street, :: :: :: York, Pennsylvania

STOP THOSE RATTLING WINDOWS

Do away with sash weights, cords, pulleys and pocket frames and save money by using **AUTOMATIC SASH HOLDERS**

Proved by Use—Unexcelled for windows without pocket frames. Excellent for new windows.

Send for circular and prices, or \$1.00 for trial set prepaid; state approximate weight of sash.

AUTOMATIC SASH HOLDER MFG. CO. 52 Church St., New York

ROOFING SLATE

OF QUALITY

MINERS **MANUFACTURERS**

The AULD & CONGER CO.
DEPT. B.
ESTABLISHED CLEVELAND, OHIO. 1870

SLATE WE HAVE WHAT YOU WANT

In Roofing Slate. Slate Blackboards Structural and Plumbers' Slate

SATISFACTION GUARANTEED IN QUALITY AND PRICE

ASK FOR DELIVERED PRICES

J. K. HOWER, Station, C., Danielsville, Pa.

R. J. KICHLINE, Sales Agent

TROUBLE-SAVERS

Time - Savers

My men will take down and put up your Steel Brackets in less time than it takes to get lumber ready for wooden Scaffolds.

G. L. Miller,
Evansville, Ind.

I find your "Trouble-Saver" Scaffolds indispensable. They save both time and material.

J. H. Wallace,
Cleveland, Ohio.

Your Porch Scaffolds are just as handy as the Weatherboarder and Shingler. Would not be without them, as they soon pay for themselves.

A. F. Bornefeld,
Evansville, Ind.



PORCH BUILDER'S AND PLASTERER'S TRESTLE



Here are Two Trestles of the Same Size; One at the High and the Other at the Low Point

Money - Savers

I figure I can save from \$5.00 to \$10.00 on labor on every house where I use your "TROUBLE-SAVER" Brackets.

G. W. Atkinson,
Columbus, Ohio.

Enclosed find check for \$100.00. I have given your Scaffolds a thorough test and think them the best investment I ever made in the plastering line. My foreman says they will more than pay for themselves on this one job. I will give you an order equipping my entire yard with them, in the Spring.

A. K. Musselman,
Dayton, Ohio.

DON'T REPAIR YOUR OLD SCAFFOLDS

Let us **cut your Repair Bills out entirely.** Let us **cut out your Bills for Waste Lumber—Nails—Labor.** We will put from 75% to 90% of this expense in your pocket—your **Extra Profit.** Above all—we will give you a **Safe Scaffold.**

We will guarantee our "TROUBLE-SAVER" Scaffolds for five years, both as to material and workmanship.

We will lend you a set of these Scaffolds for thirty days, and if you like them you can buy them. We prepay the freight and you are not out a penny or under any obligations to us whatever. If we don't convince you it will pay you to buy them, after trying them, you return them at our expense. **You can't lose—the risk is all ours.** The profit will be yours if you use them.

Write us what kind of Scaffolding you are interested in and we will make you a definite proposition.

THE STEEL SCAFFOLDING COMPANY

EVANSVILLE, INDIANA

INDEX TO ADVERTISEMENTS, MARCH, 1915

	Page		Page		Page
Abbalene Co.	206	Fox Supply Co.	13	Original Gas Engine Co.	130
A. B. C. Dumbwaiter Co.	16	Frank Mfg. Co.	25	Ornamental Products Co.	207
Alamo Heater Co.	188	Frantz Mfg. Co.	127	Oshkosh Mfg. Co.	3
Albaugh, O. H.	206	Fuller, Frank.	206	Parker, C. L.	206
Aloca Co., A. S.	19	Galesburg Sheet Metal Works.	181-183	Parks Ball Bearing Machine Co.	10
Alpha Portland Cement Co.	141	Geier & Blumh.	18	Patton, Harry.	206
American Bell & Foundry Co.	188	Gem City Acetylene Generator Co.	194	Pearson Mfg. Co.	204
American Cement Machine Co.	5	Gem City Mixer Co.	6	Peerless Blue Print Co.	205
American Drafting Furniture Co.	143	Genuine Bangor Slate Co.	149	Pennsylvania Saw Co.	205
American Elevator Co.	205	Germantown Tool Works.	172	Phoenix Sliding Blind Co.	204
American Floor Surfacing Machine Co.	16	Gilbert & Bennett Mfg. Co.	99	Plastergon Wallboard Co.	157
American Mantel Tile & Grate Co.	206	Globe Fence Co.	175	Prentiss Vise Co.	199
American Pulley Co.	199	Goldblatt Tool Co., H.	176	Progressive Mfg. Co.	155
American Saw Mill Machinery Co.	8	Goodell Mfg. Co.	204	Pullman Mfg. Co.	169
American Sheet & Tin Plate Co.	149	Gordon VanTine Co.	95	Pullman Automatic Ventilator Mfg. Co.	207
American Steel Scaffold Co.	176	Grand Rapids Hardware Co.	32	Pullman Metal Weatherstrip Co.	162
Andrews Heating Co.	140	Green Concrete Mixer Co.	6	Queen Cupola Mfg. Co.	167
Archer Iron Works.	21	Hall Holmes Mfg. Co.	24	Raber & Lang Mfg. Co.	20
Arkansas Soft Fine Mfrs. Assn.	107	Hardin Co., John.	205	Radford Architectural Co.	202-203
Asby, Geo. W.	196	Hartmann Sanders Co.	192	Ransome Concrete Machinery Co.	22
Asphalt Ready Roofing Co.	155	Haynes Automobile Co.	184	Rehm Hardware Co.	197
Atlantic Engine Co.	10	Heald Machine Co.	12	Reineke, W. A.	206
Atlas Engineering Co.	23	Hegener Co., Rudolph.	161	Reliable Stamping Co., Inc.	165
Auld & Conger Co.	207	Helm Brick Machine Co.	136-139	Republic Iron Works.	139
Automatic Sash Holder Mfg. Co.	207	Heppes Co.	116-152	Reynburn, Hunter & Co.	129
Automatic Stucco Machine Co.	192	Herrick Refrigerator Co.	190	Reynolds Asphalt Shingle Co., H. M.	151
Barnes Co., W. F. & Jno.	12	Hess Warming & Ventilating Co.	188	Rice Filler Co., S. E. M.	179
Barnett & Co., Jos. L. A.	161	Hewitt-Lea-Funk Co.	134	Richards Wilcox Mfg. Co.	198
Barrell Co., Wm. L.	137	Hobbs Concrete Machinery Co.	134	Roberts Mfg. Co.	119
Barrows & Donnellan Co.	147	Holland Furnace Co.	173	Robinson Cabinet Mfg. Co.	147
Beach Mfg. Co.	143	Home Lumber & Supply Co.	167-206	Rodgers & Co., R. M.	16
Beaver Co., The.	115	Hornet Mantel Co.	192	Ross & Co., G. M.	126
Beckmann Co., The L.	18	Hower, J. K.	207	Rowe Sanitary Mfg. Co.	191
Berger Mfg. Co.	178-180-182-187	Huber Builders Material Co.	143	Royal Ventilator Co.	207
Bird & Son.	117	Hunt, Helm, Ferris & Co.	145-198	Sackett Screen & Chute Co., H. B.	195
Bishop & Co., Geo. H.	19	Hussey & Co., C. G.	183	Samsom Cordage Works.	205
Blue Valley Slate Mfg. Co.	153	Hutchinson Woodworker & Contracting Co.	10	Sand & Sons, J.	159
Blystone Mfg. Co.	4	Huther Bros. Saw Mfg. Co.	201	Sargent & Co.	194
Bommer Bros.	36	Ideal Concrete Machinery Co.	28	Sasgen Defrick Co.	30
Bostwick Steel Lath Co.	112-113	Ideal Floor Sander Co.	16	Schaefer Mfg. Co.	142
Bovee Furnace Works.	188	Indianapolis Corrugating Co.	175	Schlueter, M. L.	15
Boyle Co., John.	156	International Correspondence Schools.	164	Schrauger & Johnson.	123
Bradt Publishing Co.	178	Iona Ventilator Co.	207	Security Mfg. Co.	160
Breese Bros. Co.	181	Irwin Auger Bit Co.	159	Security Window Guard Co.	179
Brems, Andrew F.	206	Ives Co., The H. B.	165	Sedgwick Machine Works.	17
Brilliant Gas Lamp Co.	207	Ives Mfg. Co., W. A.	158	Sempel Lumber Co., F. J.	161
Brown Clutch Co.	176	Jaeger Machine Co.	27	Shapleigh Hardware Co.	200
Buck Bros.	200	James Mfg. Co.	125	Sheet Metal Specialty Co.	174
Buckeye Saw Vise Co.	18	Johnson-Manville Co., H. W.	96-97	Shelby Spring Hinge Co.	186
Buffalo Wire Works Co.	192	Johnson & Sons, S. C.	168	Sheldon Slate Co., F. C.	151
Cabinet Bed Co.	146	Johnson, E. J.	10	Sherman Mfg. Co., H. B.	200
Cabot, Samuel.	36-141	Johnston, J. D.	207	Sidney Elevator Mfg. Co.	17
Caldwell Mfg. Co.	187	Kanneberg Roofing & Ceiling Co.	183	Sidney Tool Co.	11
Canton Foundry & Machine Co.	173	Kearney & Mattison Co.	109	Simmons Hardware Co.	163
Carborundum Co.	201	Keasbey & Mattison Co.	109	Simonds Mfg. Co.	163
Carey Mfg. Co., The Philip.	154	Kees Mfg. Co., F. D.	179	Slatington Slate Co.	149
Carter White Lath Co.	100	Keighley Metal Ceiling Co., S.	175	Smith Co., Chas.	138
Cement Tile Machinery Co.	33	Kimmel, Geo. P.	206	Smith, Harry A.	185
Central Unadilla Silo Co.	185	King Ventilating Co.	103	Smith & Hemenway Co.	31
Century Cement Machine Co.	190	Kise Electric Co.	175	Smith Co., The T. L.	39
Ceresit Waterproofing Co.	148	Kissel Motor Car Co.	153	Southern Cypress Mfrs. Assn.	207
C. H. & E. Mfg. Co.	12	Klauser Mfg. Co.	180	Southington Hardware Co.	163
Champion Hardware Co.	32	Knickerbocker Co., The.	6	Speidel, J. G.	16
Champion Mfg. Co.	137-167	Kolesch & Co.	18	Stamping & Tool Co.	189
Chappell Co., Wayvell.	16	Lansing Co.	4-26	Standard Machine Tool & Supply Co.	12
Chase The Paintman, O. L.	190	Lansing Motor & Pump Co.	28	Standard Paint Co.	36
Chelsea Elevator Co.	16	LaPlan-Choate Mfg. Co.	171	Standard Seale & Supply Co.	25
Cheney & Son, S.	205	Lichty & Sons, E. F.	153	Standard Screen Co.	193
Chicago Builders Specialties Co.	14-15-32	Litchfield Trade School.	206	Standard Stained Shingle Co.	153
Chicago Grille Works.	192	Liveright Bros.	198	Standard Varnish Works.	110
Chicago Machinery Exchange.	12	Lorenzen & Co., Chas. F.	171	Stanley Rule & Level Co.	200
Chicago Millwork Supply Co.	157	Louden Machinery Co.	145	Stanley Works, The.	163
Chicago Spring Butt Co.	36	Lucas & Son, J. L.	206	Star Expansion Bolt Co.	28
Chicago Technical College.	193	Lufkin Rule Co.	197	Starrett & Co., L. S.	197
Chief Draftsman.	211	Maacks Academy of Architecture.	206	Steel Scaffolding Co.	208
Church & Co., E. I.	205	Mack & Co.	197	Sterling Foundry Co.	173
Cincinnati Ply Screen Co.	189	Majestic Co.	173	Sterling Machinery Co.	190
Cincinnati Tool Co.	199	Maple Flooring Mfrs. Assn.	165	Stillwell & Co., E. W.	153
Clark Co., The Geo. W.	194	Mastic Wall Board Roofing Mfg. Co.	34	Stine Screw Holes Co.	18
Clason Metal Works.	161	Maximilian Co., The.	173	Storm Mfg. Co.	205
Clifton-Pratt Co., The.	206	Maze Co., W. H.	189	Stranaky Mfg. Co.	179
Clock Co.	177	Mead Cycle Co.	206	Strider Hay Tool Co.	198
Coleman, Watson E.	206	Metallic Batten Co.	187	Sutton & Sons, I. N.	155
Colegan Machinery & Supply Co.	10	Metallic Sign Letter Co.	206	Swan Co., Jas.	186
Commercial Printing Co.	206	Midland Terra Cotta Co.	104-105	Sykes Metal Lath & Roofing Co.	178
Conklin Construction Co.	185	Milburn Co. Alexander.	206	Syracuse Twist Drill Co.	178
Contractors Machinery Co.	4	Miles Mfg. Co., A. W.	195	Taylor, H. A.	206
Cornell Wood Products Co.	114	Miller Mfg. Co.	197	Taylor Mfg. Co., Jas. L.	199
Cortright Metal Roofing Co.	183	Millers Falls Co.	193	Thomas & Armstrong Co.	194
Cott-a-lap Co., The.	156	Mills, B. F.	207	Townsend & Son, C. H.	207
Crescent Machine Co.	9	Miotke, Jos.	13	Triple A. Machine Co.	17
D. & A. Post Mold Co.	186	Moeschl-Edwards Corrugating Co.	183	Trussed Concrete Steel Co.	139
Dahl Mfg. Co.	15	Montross Metal Roofing Co.	155	Turnbull.	206
Dall Steel Products Co.	191	Morgan Co.	106	Typewriters Distributing Co.	205
Dart Mfg. Co.	166	Morrill, Chas.	36	Union Fibre Co.	147
Davis Acetylene Co.	193	Mullins Co., The W. H.	175	Union Metal Mfg. Co.	124
Detroit Engine Works.	205	Myers & Bros., F. E.	204	United Cutlery Co.	176
Detroit Motor Car Supply Co.	207	National Kellastone Co.	98	United Electric Co.	185
Detroit Show Case Co.	186	National Lead Co.	122	United Factories Co.	133
Diamond Cable Co.	137	National Mfg. Co.	212	Unit Wall Construction Co.	150
Diamond Metal Stamping Co.	144	National Mixer Co.	2	Vandoren Mfg. Co.	176
Dickelman Mfg. Co.	151	National Plasterboard Co.	118	Vaughan & Bushnell Mfg. Co.	159
Didrikson, H. P.	13	National Sheet Metal Roofing Co.	151	Wagner-Behm Co.	191
Disston & Sons Co., Henry.	201	New Way Motor Co.	169	Wagner Mfg. Co.	167
Dixon Crucible Co., Jos.	187	Niagara Metal Weatherstrip Co.	171	Wallace J. D.	10
Dow Wire & Iron Works.	190	Nicholls Mfg. Co.	20	Warren Knight Co.	18
Dunn & Co., W. E.	29	Nickerson Mfg. Co.	192	Waterloo Cement Machinery Corp.	7
Durametal Weatherstrip Co.	162	North American Construction Co.	137	Waterloo Register Co.	167
Edwards Mfg. Co.	182	North Bros. Mfg. Co.	28	Watrous-Acme Mfg. Co.	145
Elite Mfg. Co.	177	Northern Hemlock & Hardwood Mfrs. Assn.	210	Weber Mfg. Co.	15
Elliott Woodworker, Ltd.	8	Northfield Iron Co.	20	Wenzelmann Mfg. Co.	167
Ellis Engine Co.	169	Northrop, Coburn & Dodge Co.	180	Wert, C. S.	30
Erie Clutch & Pulley Co.	190	Northwestern Building Material Ex-hibit.	182	Western Mfg. Co.	4
Eureka Machine Co.	135	Northwestern Compo Board Co.	154	Wheeler Screen Co.	128
Fay & Egan Co., J. A.	8	Northwestern Expanded Metal Co.	177	White Co., David.	18
Federal Parquetry Mfg. Co.	165	Northwestern Mfg. Co.	30	White Co., L. & I. J.	204
Fiberlic Co.	157	Northwestern Steel & Iron Co.	22	Whitman Agricultural Co.	120-121
Flitschen & Co.	206	Norwalk Vault Co.	111	Wiekamp, J. H.	170
Flintkote Mfg. Co.	108	Novo Engine Co.	131	Williamson Heater Co.	132
Folding Scaffold Bracket Co.	191	Oak Flooring Bureau.	177	Willis Mfg. Co.	102-181
Foos Gas Engine Co.	169	Olmstead's Son, L. H.	205	Winsted Edge Tool Works.	30
Fox Machine Co.	14	Olsen Concrete Machinery Co.	24	Witte Iron Works.	174
				Woodwell Co., Jos.	207
				Wright Wire Co.	165
				York Automatic Dumbwaiter Co.	16

The New Birch Book

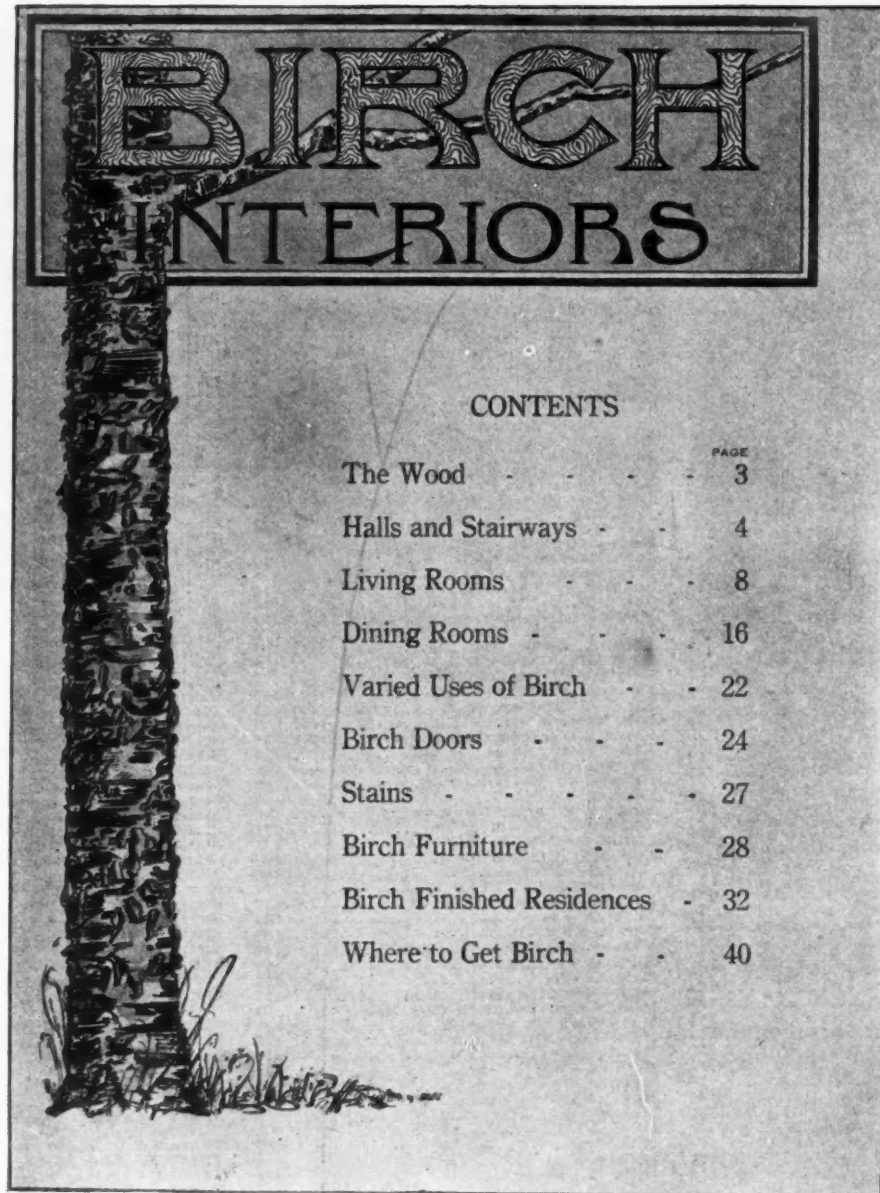

THE new Birch Book, the cover of which is pictured above, is now ready for distribution. It is 9x12 inches in size, well bound in heavy gray paper and contains 40 beautiful pages illustrating modern halls, stairways, living rooms, dining rooms, fire-places, and floor plans; shows styles of interior finish and color schemes that every architect and builder will appreciate.

Write today for Birch Book "C" and a set of Stained Birch Samples. Sent Postpaid.

They will help you get business.

The Northern Hemlock & Hardwood Manufacturers Association

Dept. C

WAUSAU, WISCONSIN

of drawings

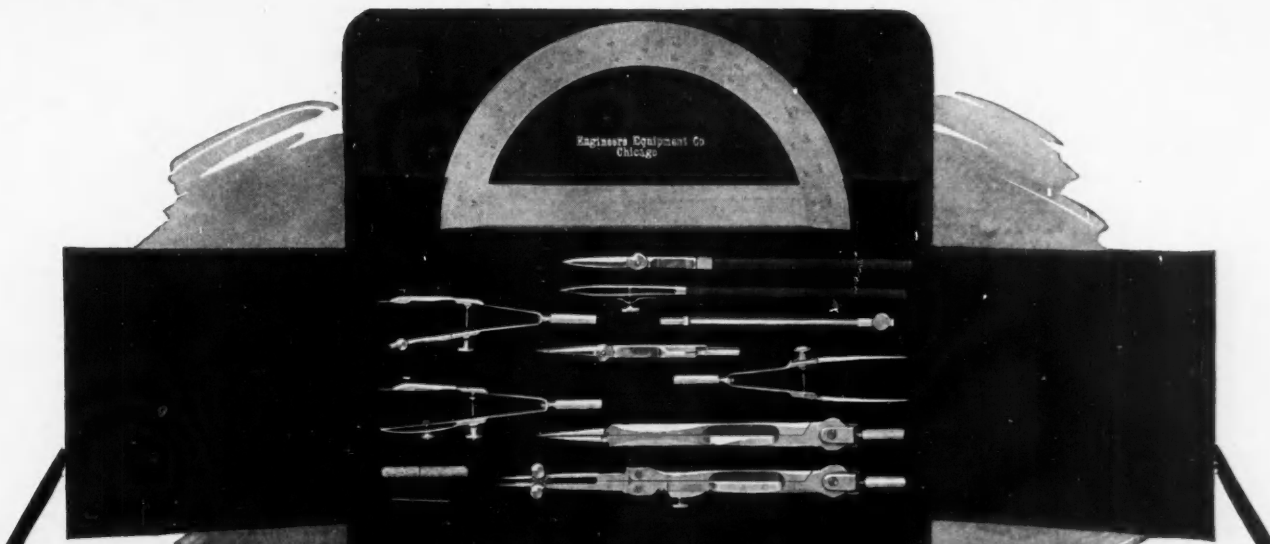

F R E E

\$15.00 Draftsman's Complete Working Outfit

Yes, sir. I will give you a complete draftsman's outfit absolutely free. It does not cost you a penny. Besides these German Silver Draftsman's Instruments shown here I also give you absolutely free a 20x25-inch drawing board, a 24-inch T square, 12-inch rule, supply of drawing paper, 2 triangles and French curve, pencil and eraser, drawing ink and thumb tacks, etc., etc. All free. Send the coupon now.

This is just the kind of an outfit I use myself. Genuine working instruments. You couldn't get this outfit anywhere for less than \$15.00. But you must hurry. I cannot give these outfits away to every one that writes but will consider the names in the order in which they are received. Send the free coupon. Now—tomorrow may be too late.

Be a Draftsman | Make More Money ^{Working} At Home Earn \$125 to \$165 a Month at Once | You Can Earn While Learning

Thousands of positions paying big money are open right along. All over, concerns are constantly wanting trained men. They pay big money. Hundreds of positions open paying from \$75 to \$100 weekly. A prominent chief draftsman will give you just the kind of training that you need, practical training, the kind demanded by firms that pay the biggest salaries. You can learn to become a draftsman in your own home—during your spare time—by mail. I will give you personal instruction until you are in a position drawing \$125 to \$175 a month. Write for full particulars.

I will give you paying work to do as soon as you enroll. Practical drafting work will give you experience and put you in the big money-making class. Start earning money as soon as you are my personal student. You may earn \$5 a day as soon as you enroll. Big opportunity for men who act at once. Send the free coupon for full particulars—now. Do not delay. Write immediately.

I Guarantee
To instruct you until competent and placed in a position at a regular salary paying from \$125.00 to \$175.00 per month and furnish you free \$15.00 Working Outfit at once.

Chief Draftsman Will Instruct You Personally

For 20 years I have been doing the highest paid expert drafting work as Chief Draftsman of a large and well known company. I will train you personally and give you just the kind of practical training that you need to hold one of the biggest paying positions. I know what the big firms demand, and I will give you this kind of training as long as required during your spare time, in your own home. Send the free coupon at once. Do not delay. Write today—now.

Pay as You Wish Don't bother about the money. If you are ambitious and wish to become an expert draftsman, don't worry about money. Write now—we'll fix it up.

Send the Coupon for Big New Free Book

Just put your name and address in the free coupon and send it to me at once. I will send you absolutely free and prepaid the big new book, "Successful Draftsmanship." The book will tell you about the exceptional opportunities you will have after you join the profession. Explains exactly how you can learn to become an expert draftsman in your own home—during your spare time. Do not delay a single instant. Here is your chance. Every minute that you delay means one day longer at the old job—at the small pay. Get out of the rut now. The first step toward success and a big job is to fill out the coupon. No obligations of any kind. Write today.

CHIEF DRAFTSMAN

Div. 1693, Engineer's Equipment Co., Inc., Chicago, Ill.

Free Outfit Coupon

Chief Draftsman

Div. 1693 Engineer's Equipment Co., Inc. Chicago, Ill.

Please send me your book, "Successful Draftsmanship" and also full particulars of your liberal "Personal Instruction" offer to a few students. It is understood that I am obligated in no way whatever.

Name

Address

You will get SPECIAL ATTENTION if you tell Advertisers you read American Carpenter and Builder.

of drawings