

AUGUST 1915

PUBLIC LIBRARY

# AMERICAN CARPENTER AND BUILDER



THE WORLD'S GREATEST BUILDING PAPER

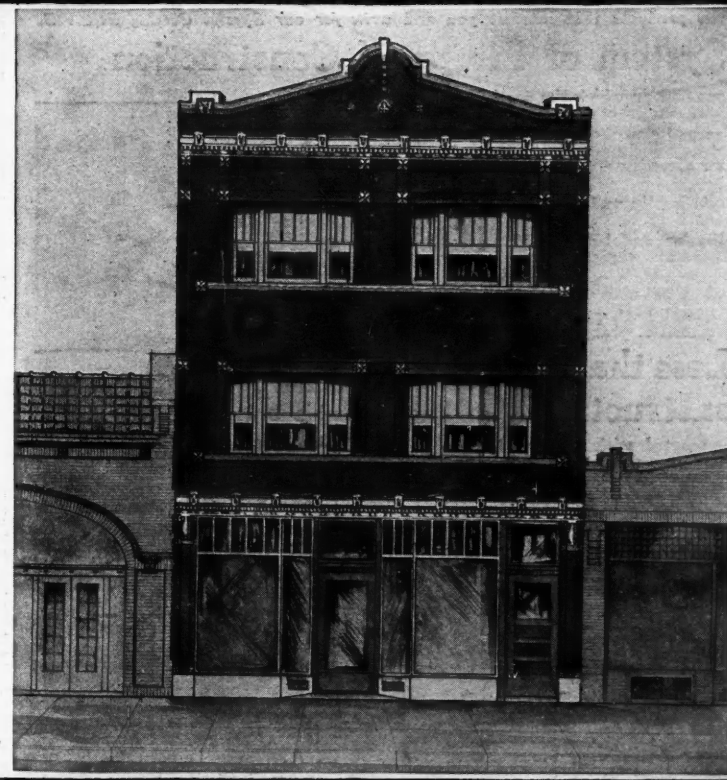

## City Building

REAL city building goes hand in hand with store building improvements. Nothing helps a business street so much as modern, attractive store buildings.

Be public spirited. Boost for the rejuvenation of the business buildings in your town. It will help your community to grow.



Floor Plans of this Up-to-Date Business Building, also Details of Construction and Finish Are Presented on Pages 42-45.

Price 10 Cents

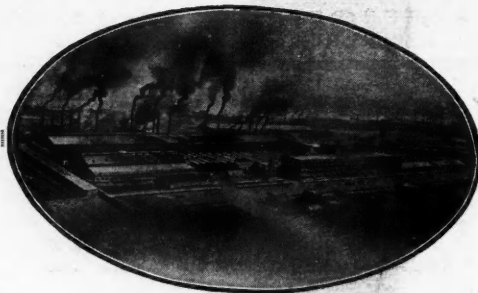

"The Largest Pressed Steel Works in the World"

Canton, Ohio

## Berger's Reinforcing and Metal Building Materials



### Berger's Pressed Steel Core For Coring Out Concrete Floors and Roofs

Reduces cost and lessens dead load. Used where the construction is designed for long spans, light or heavy construction. Made in several depths, sizes and gauges. Our standard size has a base of 20" with flanges adapted for making concrete joists 24" on centers.

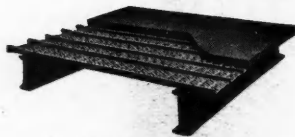

### Berger's Rib-Truss Reinforcing and Furring Plate Especially Adapted for Reinforcing Thin Concrete Slabs for Roofs, Floors, Sidewalls and Partitions

The loops or mesh are expanded vertically and ribs run through the length of the sheet on 6-inch centers which give stiffness to the plate and support it while the soft concrete is being applied. No supports necessary for short spans.



### Berger's Expanded Metal Lath Used on Stucco Walls, Partitions, Ceilings, and All Kinds of Work Where Plaster is Required

The diamond shaped openings are small, and expanded in such a manner as to permit of a perfect clinch of the plaster. A minimum amount of plaster is required for a practical job. Made from Open Hearth Steel or Toncan Metal. Painted or galvanized. Standard sheets are 18" wide by 96" long. Made in gauges No. 27-26-25-24.

### Berger's Multiplex Steel Plate

#### For Heavy Surface Floor Construction

No centering needed. Easily installed. No skilled labor required. Saves concrete and reduces dead load to a minimum. Particularly desirable where under-surface cannot be readily plastered, or in buildings where no plaster ceilings are wanted or required. Made in gauges No. 16 to No. 24, and in lengths up to 10 ft.

### Berger's Ferro-Lithic Reinforcing Plate

#### Used Extensively for Floors, Sidings and Roofs

Requires no supports for short spans while putting in the concrete. Made of a series of dovetailed members running full length, which give stiffness and provide a key for bonding the concrete and plaster. The standard plate is 1/2" in depth made of 24 gauge steel. Even when not plastered on the under side it makes an attractive appearance.

**Berger's Corner Beads** for protecting exposed corners of plastered walls applied directly to metal lath, wood or any other ground and plastered over, leaving only the face of the nose exposed. Made from galvanized steel in several styles to meet any requirement.

See Sweet's Index, Pages 210 and 220-224. Mention the products that interest you and write for our Special Catalog F. A. B.

## Berger's Metal Lumber System of Fireproof Construction

### Typical Supporting Partition Construction

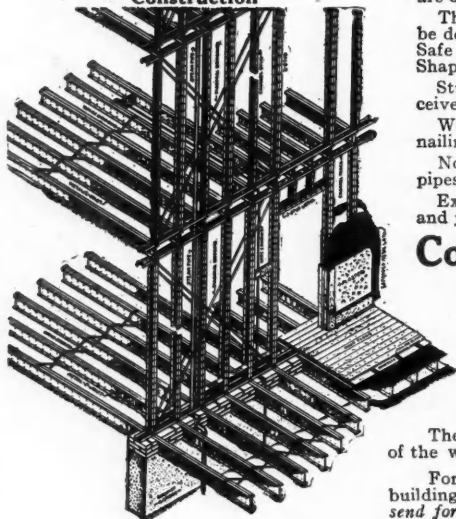

Note the manner in which the partitions are designed and constructed.

The location and size of studs can readily be determined by referring to our Tables of Safe Loads on Metal Lumber Pressed Steel Shapes.

Studs placed directly under I joists to receive floor loads.

Wood blocks inserted between studs for nailing baseboard and chair rails.

Note advantages for concealing plumbing pipes and conduit between studs.

Expanded Metal Lath attached to studs and joists by means of prongs.

### Costs Less than Wood Construction

Constructed with Berger's Metal Lumber, this residence cost less in fireproof construction than the lowest bid of the general contractor based on the use of wood joists and studs for this building.

The house has now been occupied for more than a year and there isn't a crack in any of the walls or ceilings where plaster was applied on Metal Lumber studding and joists.

For full information as to how Berger's Metal Lumber System may be used in any building, regardless of size, purpose or location, see Sweet's Index, Pages 278-285, and send for our Special Catalog L. A. B.

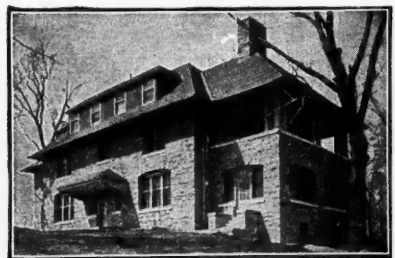

Residence of Prof. G. B. Pegram  
of Columbia University, New York.  
Architect: Wm. B. Clafin, West Redding, Conn.

The residence was built under the  
superintendence and direction of  
F. W. Conner, Construction Specialist

## The Berger Mfg. Co., Canton, Ohio

Our Nearest Branch for Best Service:

Boston

Chicago

Minneapolis

New York

Philadelphia

St. Louis

San Francisco

Export Department: Berger Building, New York City, U. S. A.

WHEN WRITING ADVERTISERS PLEASE MENTION THE AMERICAN CARPENTER AND BUILDER

# “Buying Plans Helps Me Out In Rush Seasons”

PRACTICAL BUILDER TELLS HOW HE MANAGES HOUSE PLANNING END OF HIS BUSINESS

“DO you draw your own plans?” we asked one of our folks who dropped in to renew his subscription the other day,—an enterprising, wide-awake building contractor from down the state.

“Sure thing I do,” he replied, “that is, I do when I have time. Our people down there are wanting good designs, too, and I have to give them what they want.

“I keep two gangs of men busy, one handling the country barn building work, and the other right in town on dwelling houses, with occasionally a store building, garage or school house. I manage to keep busy pretty much all the time, and I have so many things to look after that I am not able to do as much plan drawing as I used to. It is only in the winter season—when it’s apt to be quiet—that I can get much time at my drafting board.

### “Published Designs a Great Help”

“For years I have been keeping a portfolio or scrap book of nice looking houses and bungalows that are well and conveniently planned. Several of the general magazines illustrate good home building ideas; and then out of the AMERICAN CARPENTER AND BUILDER I get eight or ten good designs every month. Besides these, of course, I have your Plan Books; and so you see I am well supplied with dependable helps for the planning of most any sort of a building that may be wanted. This saves a lot of time at the drafting board, as I can follow the general lines for design and arrangement, probably only working in a change here and there that I know will be wanted by the parties for whom I

will build. With a good illustration and set of floor plans as a general guide before me, I can work out my plans in short order, and what is more, be sure that they will look right when built.

### “Often Cheaper to Buy than to Draw”

“Take at this season of the year, though, I can’t afford to take my time to make working drawings—especially not when I can buy from you people complete blue-printed working plans and typewritten specifications at from \$5.00 to \$10.00 per set.

“I figure my time at \$10.00 per day; it is probably worth more, as I have a big gang and important jobs to look after. So you see if I am busy at all, I can’t afford to take from a day to three or four days’ time at the drafting board, working out plans,—not when I have such a big and up-to-date collection of designs in your plan books to choose from, and when the blue prints are so complete and satisfactory, and the price so small.

“You people are certainly doing us small city builders a great service with your definite, usable home building suggestions and plans. We are a good many miles from the nearest professional architect; but our customers want nice looking designs and all the new ideas, just the same.”

We blushing acknowledged the compliment and expressed the hope that our 39,999 other builder subscribers feel the same way about it.

Yours to help,

Editor AMERICAN CARPENTER AND BUILDER.

## Contents for August, 1915

	Page		Page		Page
Anchoring Houses in Overflow Districts..	72	Farm Buildings .....	74	New School for Argo, Illinois.....	61
Applying Moulding to Circle.....	92	Farm Poultry House. Size 20 by 15 Feet	75	Noon-Hour Talks by the Boss Carpenter..	58
Artistic \$4,000 Residence to Cleveland		Federal Buildings to be Standardized....	81	Octagons and Hexagons.....	64
Builder .....	56	Finishing Floors.....	87	On-Fussy Shingling.....	98
Artistic Hip-Roofed Bungalow.....	46	Forms for Concrete Tub and Roller.....	86	Ornamental Concrete Side Line.....	93
Building Small Concrete Culverts.....	85	French Window Details.....	90	Pan-American Road Congress.....	81
Bungalow with Ventilated Attic.....	48	Handsome Seven-Room Dwelling.....	53	Pickups on the Job.....	39
Business Farm House.....	49	Hay Doors for Barn.....	89	Placing Concrete Well Lining.....	97
Calimine on Damp Walls.....	93	He Wants the Why in the Case.....	92	Power Ring for Barn Raising.....	98
Cement Building Construction.....	82	Homecraft Office Desk.....	78	Purlin Brace .....	92
Chicago Strike Over; Carpenters to Get		Home Craftsman .....	78	Quit Your Kidding!.....	98
70 Cents .....	37	Home of Redwood.....	54	Sand Boxes of Concrete.....	83
Combination Store and Apartment Building	42	Hood Rafters .....	87	Says Many Sales Are Lost Because of	
Concrete Block Ice House.....	82	House with Cobblestone Trimmings.....	88	“Price” Secrecy .....	38
Concrete Foundations for Gas Engines..	60	House with Hip Roof Corner Bays.....	47	School Room Lighting in Indiana.....	93
Cornice Corbels on the Level and Up the		How About Architecture by Mail!.....	85	Separate Dairy Stable.....	76
Rake .....	65	Ideas for Sun Parlor Addition.....	85	Steel Square and Its Uses.....	69
Cozy Little Cottage of Five Rooms.....	41	In No Position to Urge Payment.....	71	Store Front Details.....	43
Creosoted Wood Block Floor.....	80	Jasbury Soreheads About Systems, Bosses,		Stripping for Profits.....	71
Curb Roof Farm House.....	50	Etc. ....	93	Success in Gluing.....	92
Details of Dairy Stable.....	77	Keeping the Lumber Pile Away from		Timber Floors .....	58
Details of Interior Trim.....	44, 45	Moisture .....	84	To Find the Length of Jacks.....	90
Difficult Proposition to Sink Well.....	87	Longest Barn in Lancaster County....	86	Trade Notes and Items of Interest.....	100
Does the Radiator Valve Leak on the		Man from the Lumber Yard.....	62	Tricks of the Carpentry Shop.....	64
Floor? .....	81	Manual Training “At Home”.....	65	Two and Three-Family Houses Wanted..	94
Economics of Home Building.....	66	Meeting the Competitor Who Underbids		Valuable Prizes for Personal Experience	
Editor’s Drawer .....	80	You .....	94	Letters About Extra Profits.....	88
Efficient Band Saw Guard.....	81	Michigan Architects Must Now Be Licensed	37	Who Knows? .....	86
Explanation of Specification Provisions—		More About the Falling Line System....	89	Why, Mr. Figurer?.....	90
Carpentry Finish .....	66	New Kitchen Door Has Parcel Boxes....	80	Yours for Safer Building.....	58

# CHICAGO SPRING BUTTS

## A SUGGESTION

Do you specify a spring hinge with distinctive features which will appeal to your client and assure satisfaction to all concerned?

### Chicago "Triplex" Spring Butts

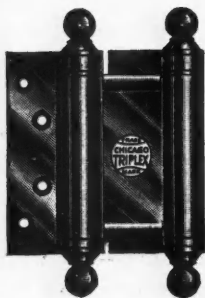

offer this advantage to you. The appearance, durability and finish of this article are unsurpassed, and in consideration of prices that are conservative in respect to value, the up-to-date builder cannot afford to risk his reputation with goods that are unsatisfactory.

Send for Catalogue C 29. It illustrates and describes the most complete line of Spring Hinges manufactured.

**Chicago Spring Butt Company,**

CHICAGO



NEW YORK

## Yes! the World does Move! Facts are Stubborn Things

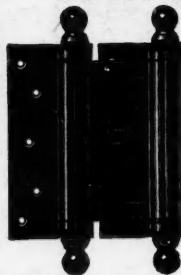

**Don't Buy  
SPRING HINGES  
OF  
OBSOLETE  
CONSTRUCTION  
ONLY**

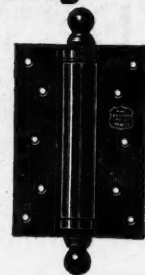

# BOMMER

## Double Acting Spring Butt Hinges

have the weight-supporting bearings correctly located to liberate the action of the springs, reducing breakage and increasing spring power, preventing unequal wear of the barrels, and giving practically unlimited durability. Bommer double-acting spring hinges open alike at both casings and both doors when both doors are opened.

The carpenter can avoid guesswork and save time when hanging double-acting doors in pairs, as he can scribe and fit both doors of a pair from the same side of the opening.

**YOUR HARDWARE MERCHANT CAN SUPPLY THEM  
Bommer Bros., Manufacturers Brooklyn, N.Y.**

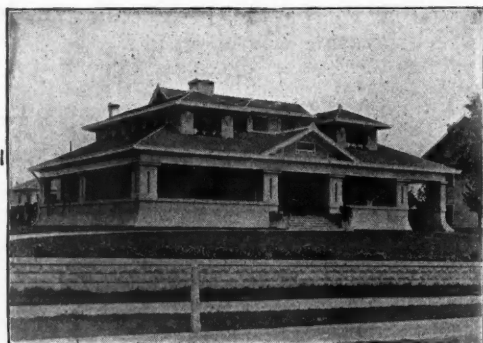

## Cabot's Waterproof Cement and Stucco Stains

produce the most artistic rich-colored surfaces that are permanent and positively waterproof. Give your cement and stucco houses a distinctive appearance, the cost is exceedingly small and the pleasing result is well worth it. Cabot's Waterproof Cement and Stucco Stains are very inexpensive and one gallon will cover from 200 to 250 square feet. These Stains do not give a painty appearance, but show the various colorings and texture of the surface. These Stains come in a variety of pleasing colors.

**FREE Color Samples**  
together with Full Information about Cabot's  
Waterproof Cement and Stucco Stains.  
Send us your name and address.

### Samuel Cabot, Inc., Mfg. Chemists

15 Oliver St. Boston, Mass.  
Agents All Over the Country.

## Worth Much to You

### Morrill Saw Set



All master carpenters are using this Saw Set. In one operation it takes out the wrong set and puts in the right one. Write for FREE booklet "Saw Points". It tells how to properly joint, set and file hand saws.

**CHAS. MORRILL**

94 Lafayette Street  
NEW YORK

## This Cylinder Night Latch for 92c

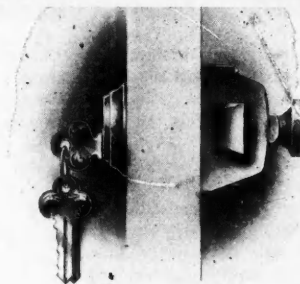

is only one of the many good values described and listed in our large catalog of builders' hardware and supplies.

Get our FREE Catalog today

**Gregg**  
Hardware Co.  
44-46 Cadillac Square

Detroit, Mich.

Prompt shipment and a full line to pick from. We supply Corbin Locks to builders everywhere



Member of the Audit Bureau of Circulations  
Circulation Audited and Verified February, 24, 1915

<i>The</i> <b>World's Greatest Building Paper</b>	<b>Important Notice</b> When your subscription expires, renew at once, using the blank enclosed in your final copy. If it expires with this issue your renewal must reach us before August 25, to avoid missing the September number. Use P. O. or Express Money Order, if possible, but bills or 2-cent stamps may be sent at our risk.	<i>The</i> <b>World's Greatest Building Paper</b>
--	---	--

**American Carpenter and Builder**  
Entered as second-class matter July 1, 1906, at the postoffice at Chicago, Ill., under the act of Congress of March 3, 1879.  
*Published on the first day of each month by*  
**AMERICAN CARPENTER AND BUILDER COMPANY**  
RADFORD BUILDING, 1827 PRAIRIE AVE., CHICAGO  
Member Audit Bureau of Circulations

**SUBSCRIPTION RATES**  
One year, \$3.00; six months, \$1.00; payable always in advance. Single Copies, 20 cents. Canadian Subscriptions, \$2.50. Foreign Subscriptions, \$3.00.

**ADVERTISING RATES**  
Furnished on application. Advertisements, to insure insertion, should reach our Chicago office not later than the 15th of the month preceding date of publication.

**EDITORIAL DEPARTMENT**  
WILLIAM A. RADFORD, *Editor-in-Chief*  
BERNARD L. JOHNSON, B. S., *Editor*  
WILLIAM REUTHER  
ALFRED W. WOODS  
ALFRED S. JOHNSON, M. A., PH. D.  
CHARLES E. PAUL, S. B.

*Associate  
Editors*

**BUSINESS DEPARTMENT**  
WM. A. RADFORD, *President and Treasurer*  
E. L. HATFIELD, *Vice-President and General Manager*  
ROLAND D. RADFORD, *Secretary*

**New York Office: 345 Fifth Ave.**  
E. B. WOLFROM, *Eastern Representative*

**PROTECTION FOR OUR READERS**  
The publishers of the American Carpenter and Builder will not knowingly publish any advertisement of a misleading character nor accept advertising from any individual, firm or company whose business methods are open to question.  
We often receive inquiries from readers who desire information about concerns that formerly used the advertising pages of the American Carpenter and Builder, but are no longer doing so. They want to know if these former advertisers are still in business, if they can send them orders with the assurance that they will be filled, and a variety of other questions.  
The American Carpenter and Builder will use every legitimate means to safeguard the interests of its readers and to protect them from fraudulent or unreliable concerns. Where the slightest doubt exists our readers should write the publishers for information. It may save them money, time and worry.  
In all cases in writing to advertisers say: "I saw your advertisement in the American Carpenter and Builder."

**Michigan Architects Must Now Be Licensed**

MICHIGAN has recently passed an architects' registration law that becomes effective August 24, 1915.

It prescribes for the licensing of all persons that are engaged in the drawing of plans and specifications for buildings for others, which are to be constructed by a person other than the architect. Any builder may draw plans for himself, however, or for any building that is being erected under his own supervision.

A board of five examiners has been appointed by Governor Ferris to examine and register all who desire to use the title of architect or to practice architecture in the State of Michigan. The members of the board are: Prof. Emil Lorch, of the University of Michigan; George D. Mason, Detroit; D. Fred Charlton, Marquette; A. R. Munger, Bay City; and S. Eugene Osgood, Grand Rapids.

Those who have practised architecture prior to February 5, 1915, and can show satisfactory evidence of character, competency and qualifications, can obtain a license by applying to the state board of examiners before Aug. 5, 1915. Architects licensed in another

state will be granted Michigan certificate on application.

Upon becoming registered, the applicant is required to pay a fee of twenty dollars and receives a certificate of registration.

Any violation of the provisions of this act is a misdemeanor punishable by heavy fine or imprisonment.



**Chicago Strike Over; Carpenters to Get 70 Cents**

THE building strike, which had been in progress for three months and had largely paralyzed building in Chicago, is over.

Agreement on all points at issue were reached at 3:30 o'clock the morning of July 10, after the committee representing both sides had been locked in since the middle of the afternoon.

The points finally agreed upon are that the men will receive a flat scale of 70 cents an hour for the next three years, dating from May 31 last to May 31, 1918, and that they will submit to the working conditions as provided in the uniform agreement proposed by the

employers. The settlement is a compromise. The carpenters asked for a sliding scale of 70 cents for the first year, 72½ for the second, and 75 for the third. They have been receiving 65.

One phase of the uniform agreement in which the men acquiesce, is that there shall be no restriction regarding the source of material—whether made in the Chicago district or elsewhere.



### Says Many Sales are Lost Because of "Price" Secrecy

WE commend the following letter to the careful thought of sales managers and advertising men in the building field:

To the Editor: San Francisco, Cal.

In the June issue you ask editorially, "Should the Price be Stated?" Will you allow me the privilege of expressing my opinion as one of a firm of architects, whose present individual province is chiefly to draft specifications, supervise construction, and to see that nobody gets paid twice for the same thing. I answer, yes—emphatically, yes. Give prices in trade ads.

Publicity men, like architects, still have something to learn. Trade advertising is good reading, anyway; but the addition of the price would often increase the selling power of the ad 500 per cent. Explaining "why" trade ads do not generally give prices is no answer. Most of us have heard the reasons alleged. We want the prices. Contractors want prices. Owners (the men who pay) want prices. Everyone is asking, "What is the price?" There should be no mystery about it in these days of commercialism. The period of the Secret Guild is over. Then again, why give a price for an article subject to 40 per cent, 10 per cent, and 2 per cent off, and such like, unless it be to hoodwink the man who eventually pays—the consumer?

Your correspondent, Mr. Wm. H. Welch, is dead right; let the ads give the prices as far as it may be possible to do so. Trade ads are regarded differently from ordinary newspaper ads. They are often good reading and make a direct appeal in such magazines as the AMERICAN CARPENTER AND BUILDER, to the man who needs—who wishes to buy—to specify or to use a certain line; but the seller seems afraid to give his price, openly and frankly. It has to be pulled out of him.

What often happens is this: An architect becomes interested in a trade ad for, we will say, a furnace, made by Mr. Jones of Jonesville, Ill., or N. Y. It appears on the face to have certain advantages over other furnaces, and the architect wonders what the price is. Whether it is more or less than the furnaces he has used before. He writes Mr. Jones for the price delivered at some given point here, or inquires what it would cost, including freight, from Jonesville. Does he get what he asks for? No. Very seldom. In eight or ten days at the earliest, he receives a stereotyped letter containing a lot of unnecessary verbiage concerning the valued inquiry, catalog under separate cover, thanks for past patronage (?) and the usual solicitude as to securing future orders, and promises of careful attention, etc., everything under the sun, nearly, except what is wanted, viz: the price of the furnace at the point designated in the original inquiry. The catalog gives certain printed prices, of course, as to cost f. o. b. Jonesville, but that is all, except the usual printed assurance that Mr. Jones desires at all time to serve his customers to the best of his ability, etc., which probably he does, from his particular viewpoint. Can you wonder, then, that later on, the contractor is directed to use another type of furnace? Mr. Jones loses this order, also his chance for future repeat orders.

It is, of course, not actually furnaces to which I refer, but the illustration applies to a large percentage of the building goods now being advertised. It is unnecessary to refer to the cost of the subsequent "follow-up" letters and maybe "drummers" calls at the office, all of which the "careful" sellers (and they are scattered around all over the country) have to pay.

By all means, Mr. Editor, encourage the giving of the prices in trade ads whenever possible. To the advertiser I would say, when you get an inquiry from a distant point, be prepared, and give the prospective customer a line on the cost of the freight, give the full information desired. Cut out the usual hot air. Visit the Pacific Coast architects occasionally, listen to their kicks, ascertain what they want, and how they want it. Incidentally, come and see the greatest Exposition on earth. Admission price, 50c. No discount!

With best wishes,

Yours truly,

SAN FRANCISCO ARCHITECT.



### Valuable Prizes for Personal Experience Letters About Extra Profits

THERE are many ways in which carpenters and builders pick up considerable money "on the side." There are any number of popular building novelties and pieces of modern equipment for buildings that are being sold by carpenters and builders. Hustlers in the building field secure the agency for such building specialties and find it no trouble at all to work up a nice little business in connection with their regular building work.

We believe that a good many more of our readers might just as well be picking up these extra profits. Of course, conditions are not the same in all localities; but almost everywhere a wide-awake man can find sale for some of the special lines announced in our advertising pages.

#### Popular Department Revived

We want to begin again that interesting department which created such a favorable impression last fall, "EXTRA PROFITS, How Builders Make Money on the Side." We want to hear from all of our readers who have been handling agency propositions in connec-

# Extra Profits

How  
Builders  
make  
Money

"On the side"

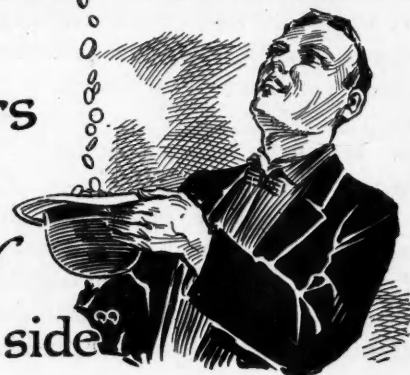

tion with their building work. We want brief, straightforward letters that tell actual facts. Give us your personal testimonials about the way the agency business goes and also what effect it has on your regular building work. All letters must be signed, but names will not be published if you request us not to.

**For the best letter each month we will pay \$10.00 (in goods selected from our advertising pages); also \$1.00 (in advertised goods) for every other letter published.**

Study through our advertising pages and note the variety of interesting offers for carpenters and builders to act as local agents. There seem to be good oppor-

tunities for profits in connection with each of the following:

- |                   |                         |
|-------------------|-------------------------|
| Dumbwaiters       | Metal shingles          |
| Store Fronts      | Weatherstrips           |
| Ventilators       | Wood mantels            |
| Skylights         | Wall board              |
| Silos             | Floor finishing         |
| Furnaces          | Steel roofing           |
| Bath room outfits | Waterproofing           |
| Vacuum Cleaners   | Door and window screens |
| Coal chutes       | Lighting systems        |
| Metal ceilings    | Lightning rods          |

We would like to hear from builders who have had experience in handling any of these. Your advice and encouragement may be worth many dollars to other builders.

Address EXTRA PROFITS Editor, American Carpenter and Builder, Chicago.

## Pick-ups on the Job

NEW IDEAS AND OLD STANDBYS SERVED HOT

By H. J. Blacklidge

**W**HEN my pencil or fountain pen gets into the disagreeable habit of dropping out of its proper pocket I take a rubber band and wrap around it. Then it "stays put."

**W**HEN you are awkward enough to cut your finger, try wrapping a small piece of bicycle tape around it. Beats court plaster "all holler."

**A**LITTLE vaseline on tools when you put them away for several weeks, especially in wet weather, will keep them bright and clean.

**I**SAW a fellow trying to turn out a stubborn screw the other day, and after he had wrestled with it until I was nearly ready to say things, he reached for his hammer. Bearing down hard on the screwdriver with his left hand, he hooked the claw of the hammer over the blade of the screwdriver with the other hand—and—well, the screw started.

**S**PEAKING of skylights, I was always having trouble with the water seeping back upwards under the lap of the glass, until an old glazier gave me this little trick. Place your bottom light of glass. Then put two glazier's points at the upper part on each side where the next light will lie on the two points instead of directly on the glass below. This leaves a space between the two lights of glass that will in no wise affect the temperature inside the house, and at the same time the space is too large for capillary attraction to cause the water to flow upwards.

**D**ID you ever try rubbing a little paraffine along the stiles of squeaky windows? It is worth trying. It would be a most excellent idea to always paraffine all window jambs.

**I** WAS called on to make a large drawing table, and after I had finished it, the architect came around and said it was not done yet. He had me nail a one inch block on the front edge at each end. Then a two by four was smoothed and rounded off and nailed to the blocks (with a pair of slim lag bolts). After puz-

zling over it for some time, I asked him what the idea was. He said sometimes he had big drawings that came down over the front of the board. By slipping them down through the crack between the board and the two by four they did not get creased and marred where the draughtsman leaned over the table.

**I**F you will hold a board up until it is almost parallel with the sun's rays and look across or along it toward the sun you can see every scratch, mark, or imperfection of any kind on the surface of it.

**I**F you want to save some time the next hot day you are working on the roof, just take a canteen of water up aloft with you. If it is real hot you will save nearly an hour with four men in one day. Leastwise, I did over in the hot San Joaquin Valley.

**A**NOTHER time saver; instead of compelling the men to teeter around on the joists or a few pieces of sheeting, place plenty of boards on top the joists—either floor or ceiling. You will find the ease and speed with which they can get around will repay you several times the time required to put up a few extra boards. And right along the same lines put up a good substantial staging. Don't be afraid of bracing it. If there is any one thing around a job that will make a man go slow (both walking and working) it is a rickety scaffolding. By the same token place ten- or twelve-inch rough boards on the stair stringers when they are put up, unless the treads are to be put on at once.

**I**SAW the painter a few days ago painting some porch posts, painting up part way with one color and then a little way with another, etc. I wondered how he got them all so even where the two colors met, so I kept my eye on him. He snapped a line along the five posts at the proper height and then tied a piece of twine around the posts at the chalk mark. Left it there while he painted up to it (in about one-sixth the time it would have required if he had depended on simply a steady hand).

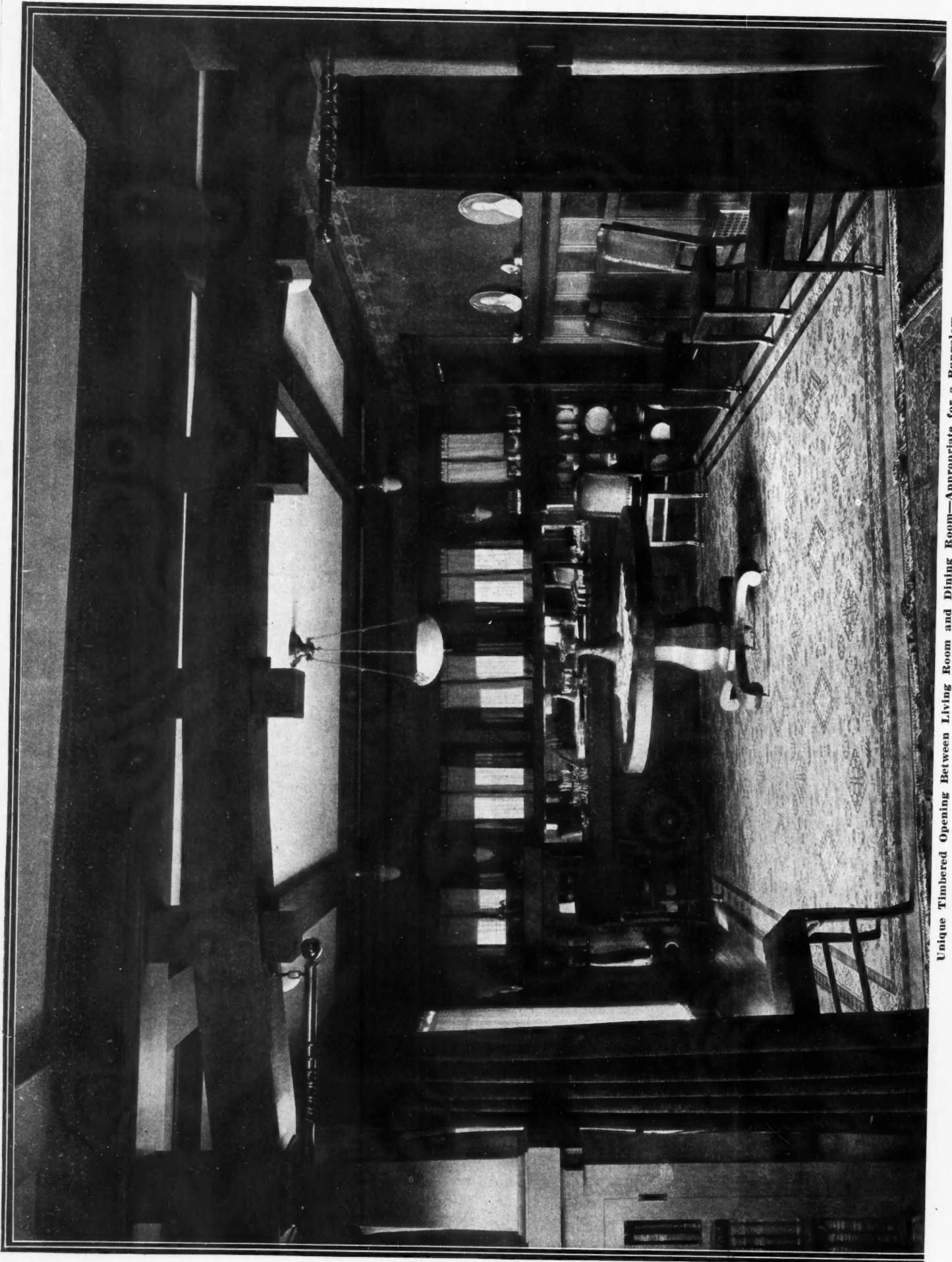

Unique Timbered Opening Between Living Room and Dining Room—Appropriate for a Bungalow.





**Cozy Five-Room Cottage**

This home seems to invite you in to enjoy its pleasant, comfortable rooms. The broad porch with its projecting gable roof is designed in a very artistic manner. The heavy porch pillars and the lattice work in the porch rail are very attractive. Heavy porches of this kind always look better when they are set well above the ground.

In modern houses it is required that no space be wasted. People are turning more and more to the smaller house that is compact and is easy to live in and keep clean. The design shown here is of this sort. Especially is this true of the working end of the house.

The door from the front porch

opens into a reception hall that is connected to the living room by a cased opening. The reception hall is large and roomy and has a good-sized wardrobe in the back. There are doors from this hall into the central hall through the house and also into the front bedroom.

The opposite side of the house from the living room, dining room and kitchen is taken up by two bedrooms and a bathroom connected up by the central hall. There are plenty of closets—one in each of the bedrooms, one in the bathroom and also one in the hall. Additional space for storage is provided in the attic.

A large and well lighted basement is provided in this design. The entrance is from the kitchen.

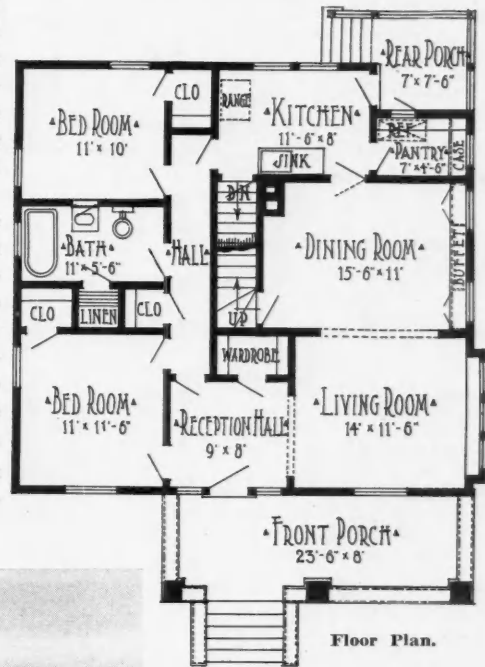

Comfortable, well-arranged cottage of five rooms. Size, 35 by 32 feet 6 inches. We can furnish complete set of blueprinted working plans and typewritten specifications for only \$5.00 per set. Blueprints consist of basement plan; roof plan; main floor plan; front, rear, two side elevations; wall sections; and all necessary interior details. Specifications consist of twenty-two pages of typewritten matter. When ordering, ask for Design No. 6722.

**Modern Store Building**

The design shown here presents an attractive, business pulling structure. On the first floor is a fine, light store room. Back of this and connected with it is a three-room apartment.

On the second and third floors are apartments of five rooms each, most comfortably arranged.

The detail sheets on the following three pages show all exterior and interior details. Two methods are given on the page opposite for constructing the front show windows—both of them standard methods of doing this sort of work. The framing for the three floors and the wall section are also shown in this same sheet. The terra cotta trim shown can be easily secured, as it is stock terra cotta—no waiting even on a job of this size.

On the other sheets, pages 44 and 45, are shown the details of the stairs, mantel, standing trim, etc.

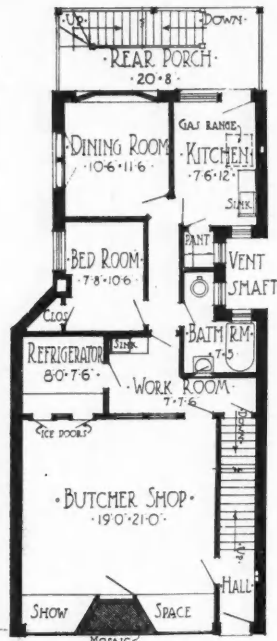

Ground Floor.

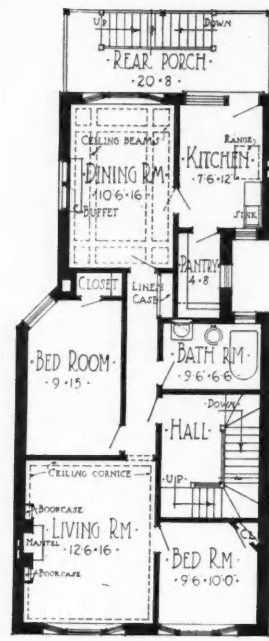

Second Floor.

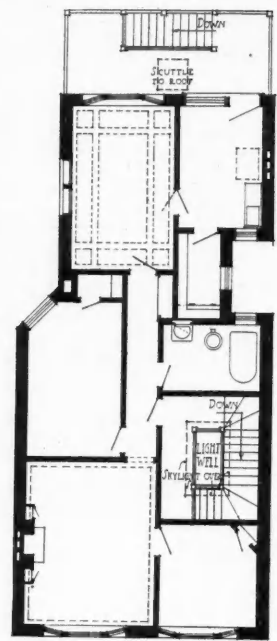

Third Floor.

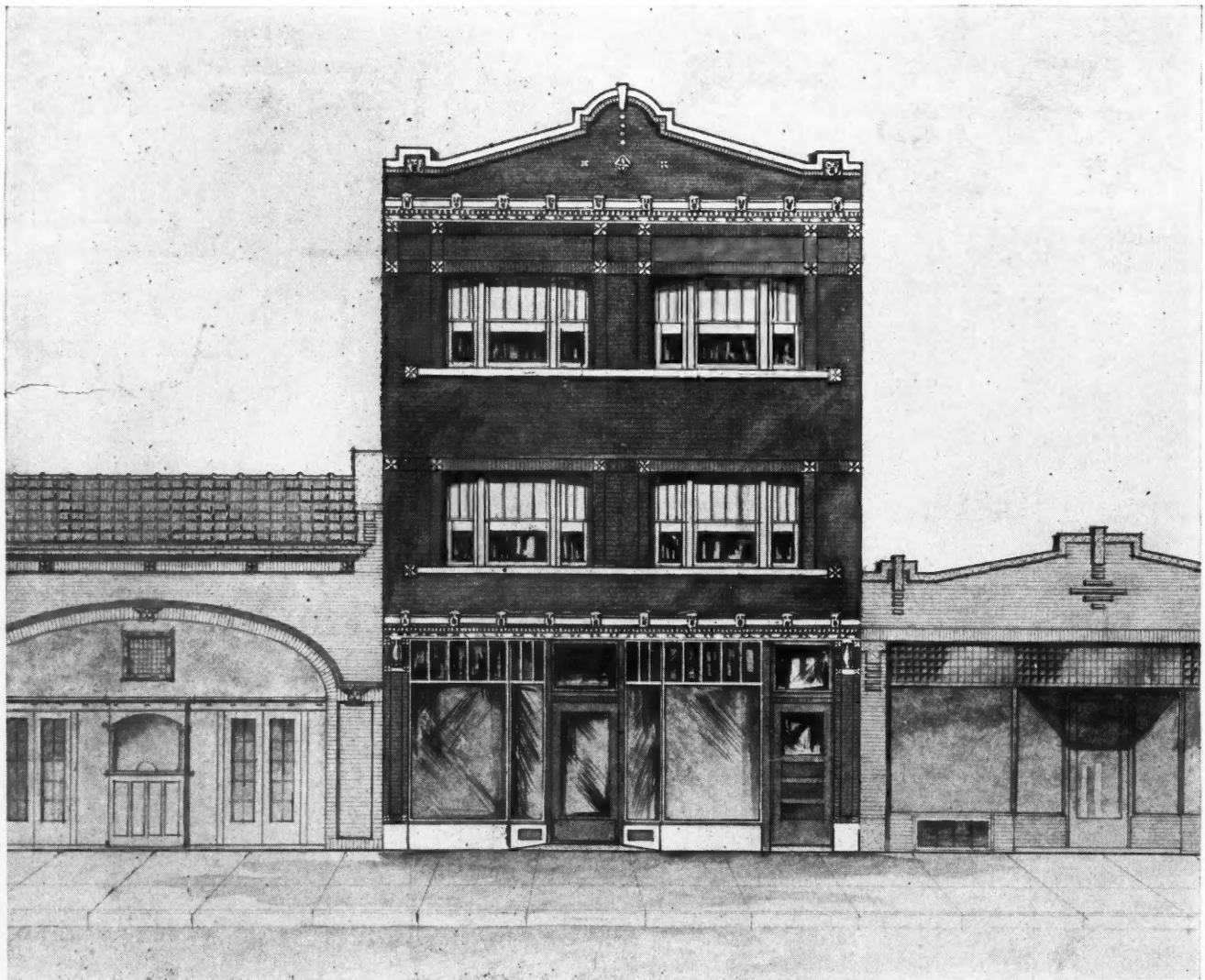

Well designed store and apartment building. Size 25 feet by 52 feet 6 inches. We can furnish complete set of blueprinted working plans and type written specifications for only \$10.00 per set. Blueprints consist of basement plan; roof plan; first, second, and third floor plans; front, rear, two side elevations; wall sections; and all necessary interior details. Specifications consist of twenty-two pages of typewritten matter. When ordering, ask for Design No. 6736.



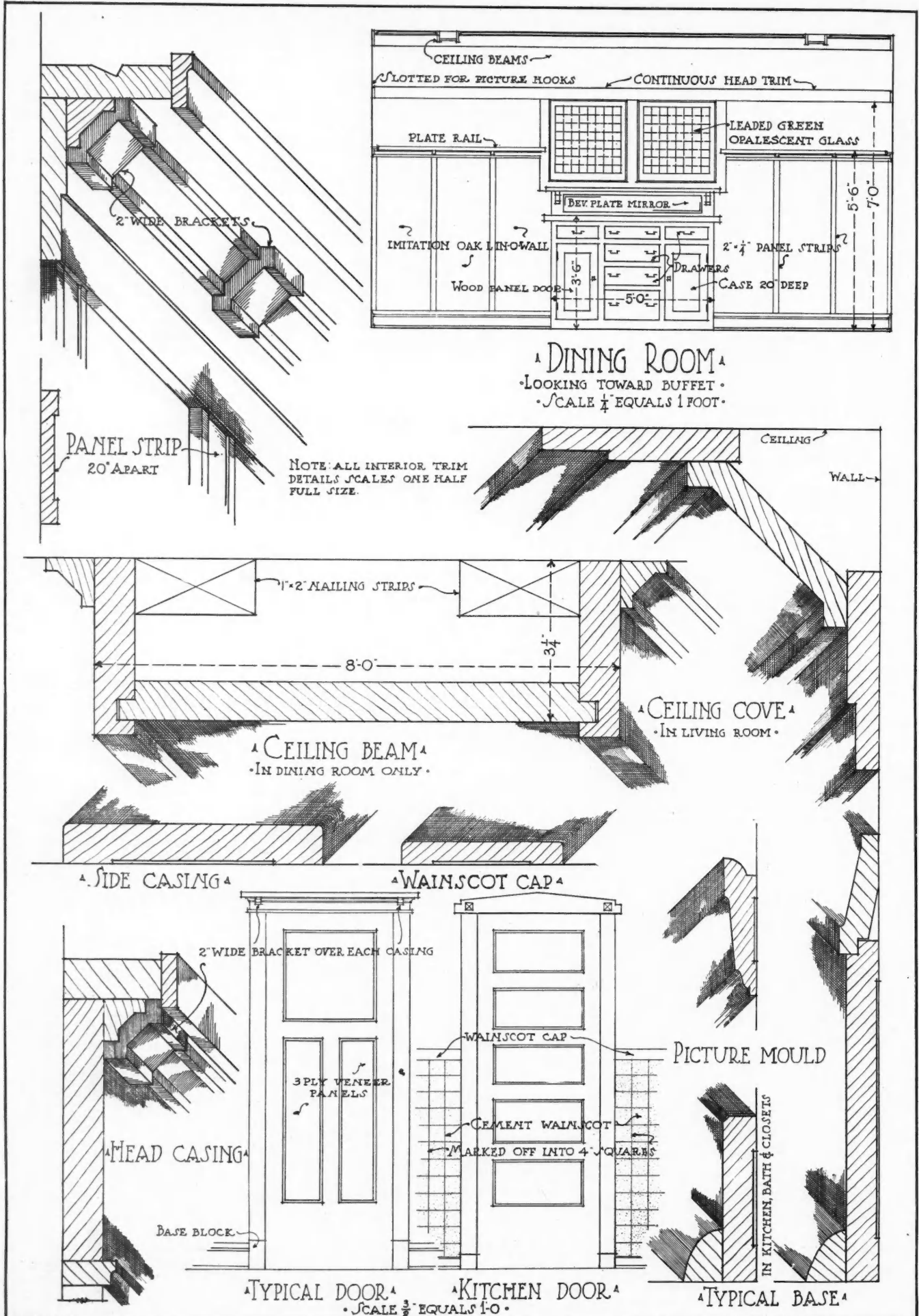

DETAILS OF INTERIOR FINISH IN 2ND AND 3RD FLOOR APARTMENTS (DESIGN 6736) SHOWN ON PAGE 42.

NOTE: ALL PLASTERED WALLS AND CEILING INCLUDING WOODWORK TO BE FINISHED WITH WHITE ENAMEL IN BATH ROOM

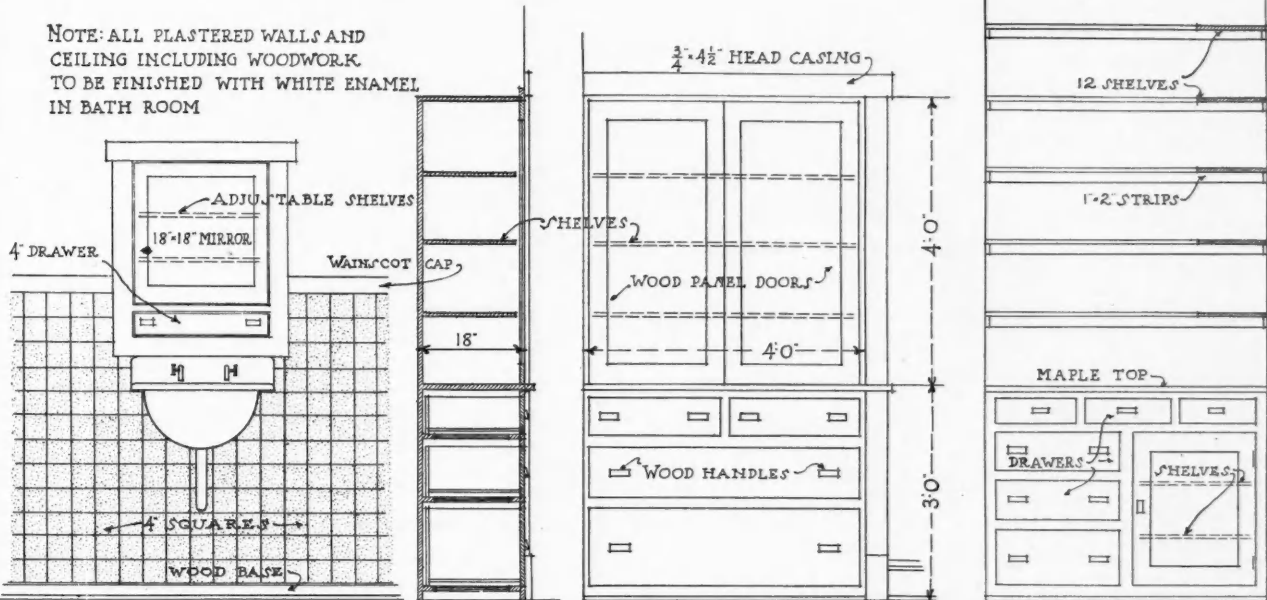

A MEDICINE CASE A

A LINEN CASE DETAILS A

A PANTRY DETAILS A

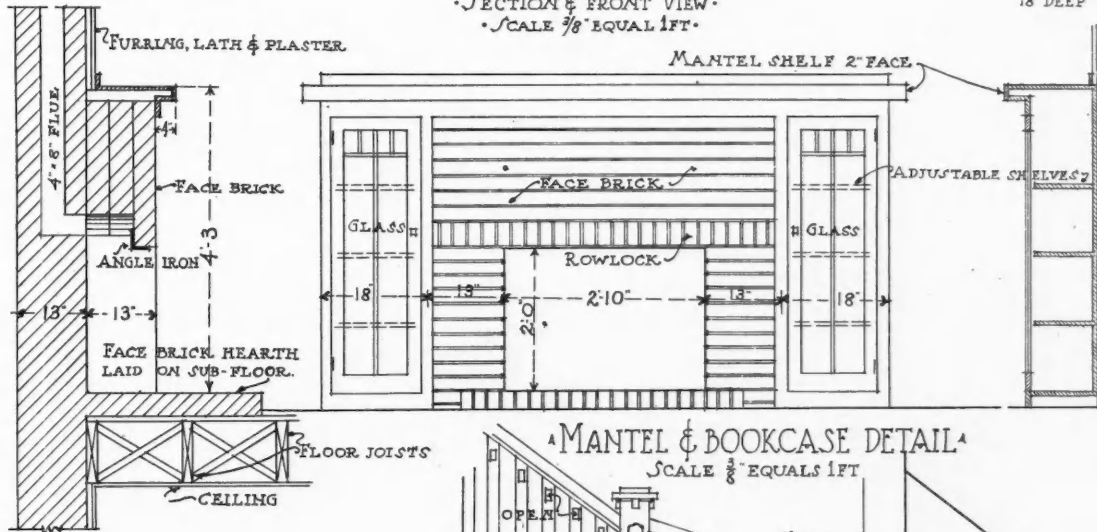

A MANTEL & BOOKCASE DETAIL A

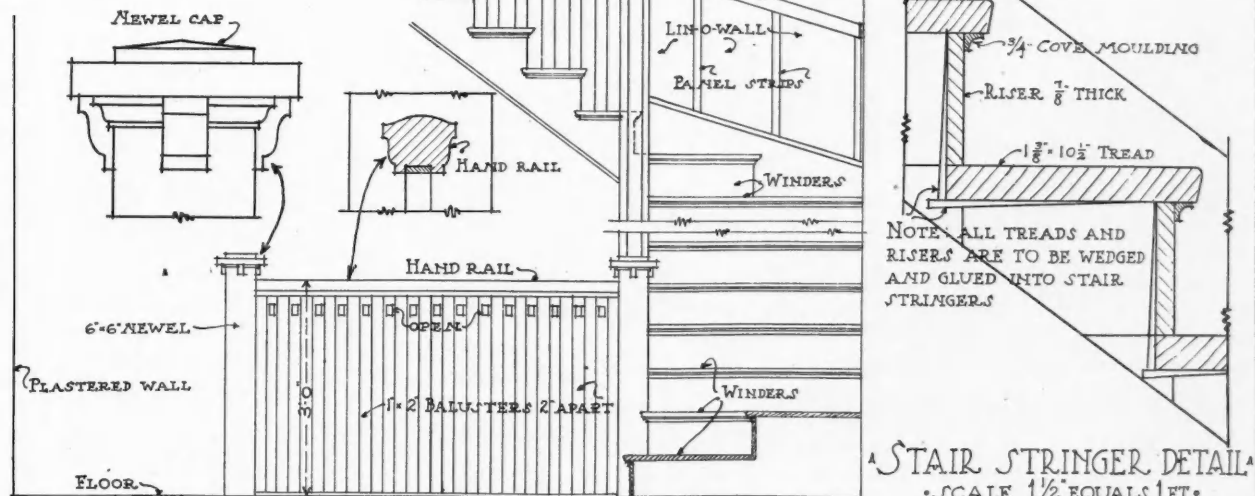

A SECOND FLOOR STAIRWAY DETAILS A

A STAIR STRINGER DETAIL A

DETAILS OF SPECIAL INTERIOR TRIM IN HALL AND IN LIVING QUARTERS (DESIGN 6736) SHOWN ON PAGE 42.

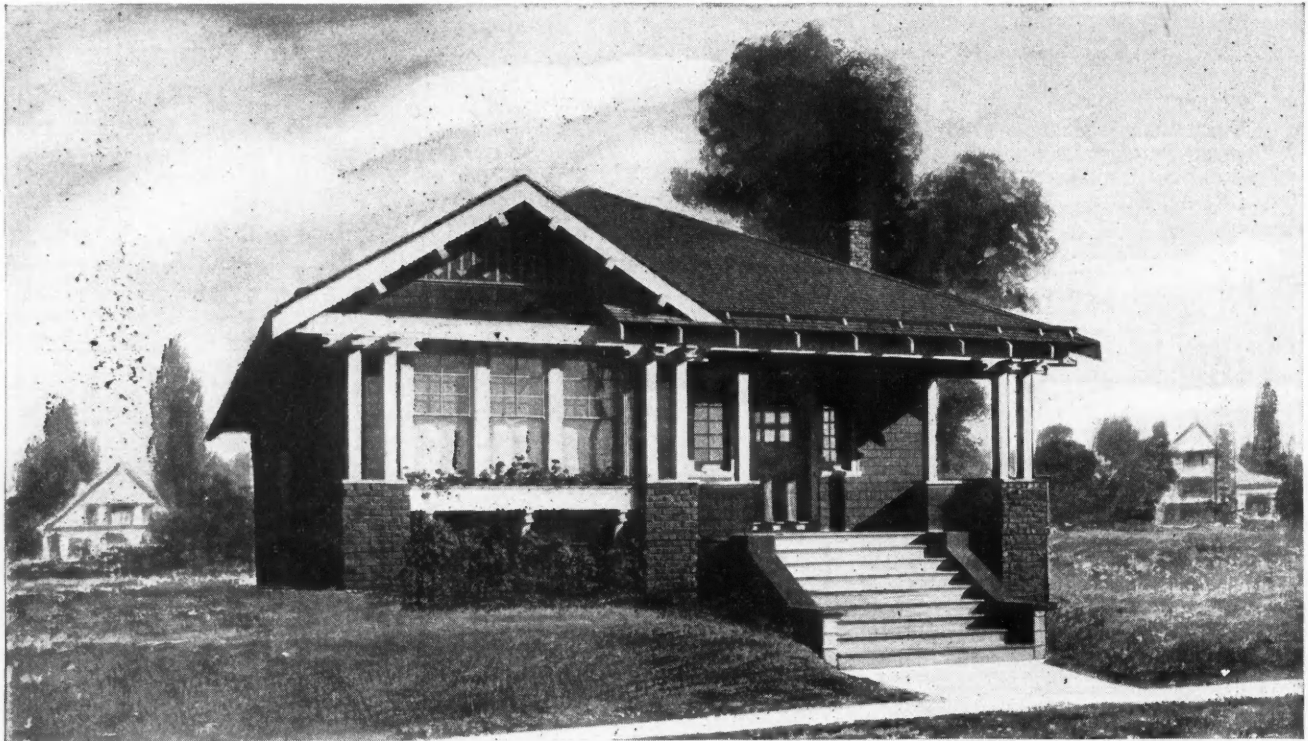

Five room bungalow with sun parlor. Size, 25 by 43 feet. We can furnish complete set of blueprinted working plans and typewritten specifications for only \$6.00 per set. Blueprints consist of basement plan; roof plan; main floor plan; front, rear, two side elevations; wall sections; and all necessary interior details. Specifications consist of twenty-two pages of typewritten matter. When ordering, ask for Design No. 6702.

### Artistic Hip-Roofed Bungalow

A bungalow of five rooms which is particularly well adapted to a narrow lot of fair depth is shown in Design 6702. The bungalow is covered with a hip roof and a projecting gable is built out over the sun porch. The combination of these two types of roofs gives a unique appearance to this design.

The exterior treatment of this bungalow is worthy of comment. The sides are shingled and the many windows are all trimmed in white. There are three rough brick pillars along the front of the house—one on each side of the sun parlor and one at the outside corner of the front porch. On top of these are double white columns, which add a pleasing effect to the general appearance.

In the gable over the sun porch is an ingenious bit of paneling. The neat flower box along the triple window in the front of this porch adds to the appearance of this already handsome window. The front door is finished in rather an unusual way. The lower part is plain with no panels, while the upper part has small square panes of glass with rather wide sticking between.

One side of the house is occupied by the sun porch, living-room, dining-room, and kitchen, and the other by two bedrooms and a bathroom. A small vestibule and the front porch are also on this side of the house.

The sun parlor is a pleasant feature of this well-lighted house. It has the triple window in the front, that has been men-

tioned before, with a window box on the sill and a double window on each side. We can imagine noth-

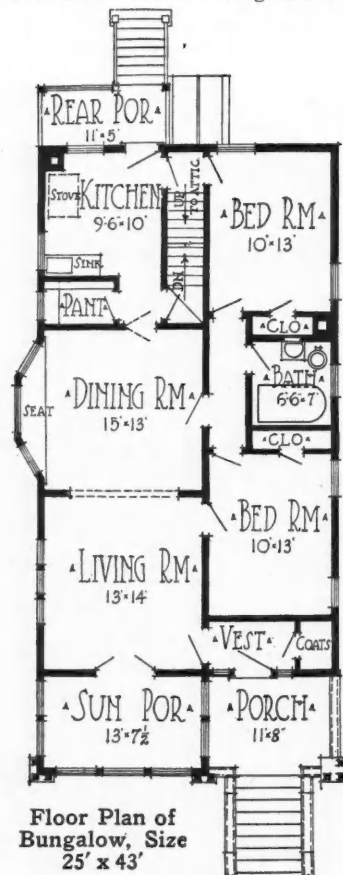

Floor Plan of Bungalow, Size 25' x 43'

ing nicer than to get out on this porch on a bright day with a good book. It is almost impossible to

have a gloomy house, no matter how hard you try, if you have a room like this. It adds much to the general disposition of the entire household.

The front porch opens into a small vestibule, which has a closet on the side. The living-room is reached through a single door from this vestibule. It is a large, comfortable room, and is lighted by three large windows on the side. There is a wide cased opening into the dining-room from this room.

The dining-room in this design can be made into one of the most attractive rooms in the house. The sides up to the plate rail can be finished in panels with wall board or veneer and the room made very pleasant. The curved bay with its wide seat adds a cozy appearance to this room.

The two bedrooms with a bath between are arranged along one side of the house. These are large comfortable rooms, and there is a roomy closet in each one.

There are stairs in the kitchen to both the storeroom in the attic and the basement. There is also an outside basement entrance which is often a great convenience.

There is ample basement room in this design which is a good feature in a house. Many people also insist on an outside entrance to the basement. They say that the time saved and the reduced wear and tear on the kitchen floors make them a necessity.

The back porch extends the full width of the kitchen, which makes it quite large and capable of holding the many things that are often placed on the back porch. Taken altogether, this is a well-arranged, attractive design.

**House With Hip Roof Corner Bays**

This design (No. 6719) presents many original features. The roof treatment is especially worthy of comment. The main roof and the various projecting roofs are all of the hip type. There is one of these roofs over the dormer window built out from the attic and also one over each of the front corner bays. The artistic appearance of this house shows what can be done by making a roof a little different from the ordinary. The sharp peaks surmounting these various small roofs add to the looks of this design. The two bay windows at the front corners of the house with their supporting brackets present something unique and very attractive.

The method of constructing the front bay with the pillars on each side of it is decidedly unusual. The bay is set back a little under the second story

projection and curves out between the two columns. This is shown clearly on the first floor plan.

The first floor contains a living room, a dining room, reception hall, sun parlor, and kitchen. The living room is arranged in an artistic manner. Most

side but this one, just to show how easy it is to be original, has the fireplace forming the wall between itself and the dining room. On each side of the fireplace is a cased opening making the entrances to the dining room. The combination of the curved bay in one end of the room and the fireplace in the other is very attractive.

In the far end of the dining room from the living room is a buffet with an entrance on each side to a sun parlor which is a cheerful feature to have in a house. The sun parlor has a double window on the side and in the back.

There are four bedrooms, a bathroom, and a sleeping porch on the second floor. There is also a little alcove at one of the front corners that can be used as a sewing room. Both the front corner windows have window seats—the projections seem exactly suited to them. These seats and the wide windows with their Queen Ann sash help to make an attractive room. The

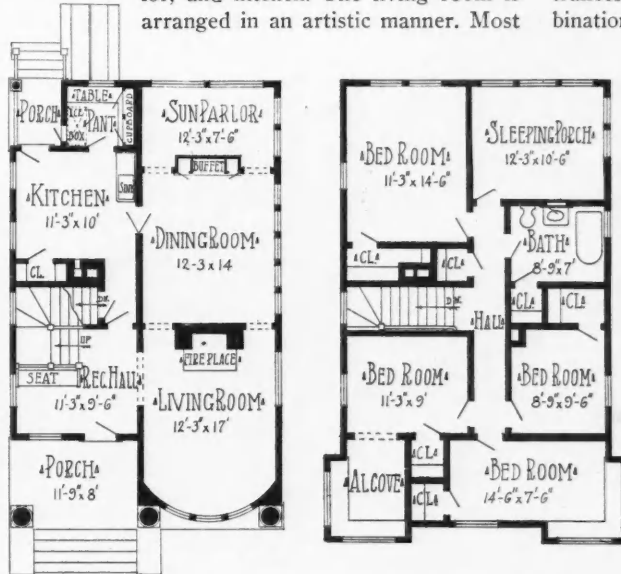

First Floor. Second Floor.  
Arrangement of House, Size 25' x 41'.

living rooms have the fireplace on the outside appearance is very striking also.



Ornamental corner bays make this house unique. Size, 25 by 41 feet. We can furnish complete set of blueprinted working plans and typewritten specifications for only \$8.00 per set. Blueprints consist of basement plan; roof plan; first and second floor plan; front, rear, two side elevations; wall sections, and all necessary interior details. Specifications consist of twenty-two pages of typewritten matter. When ordering, ask for Design No. 6719.

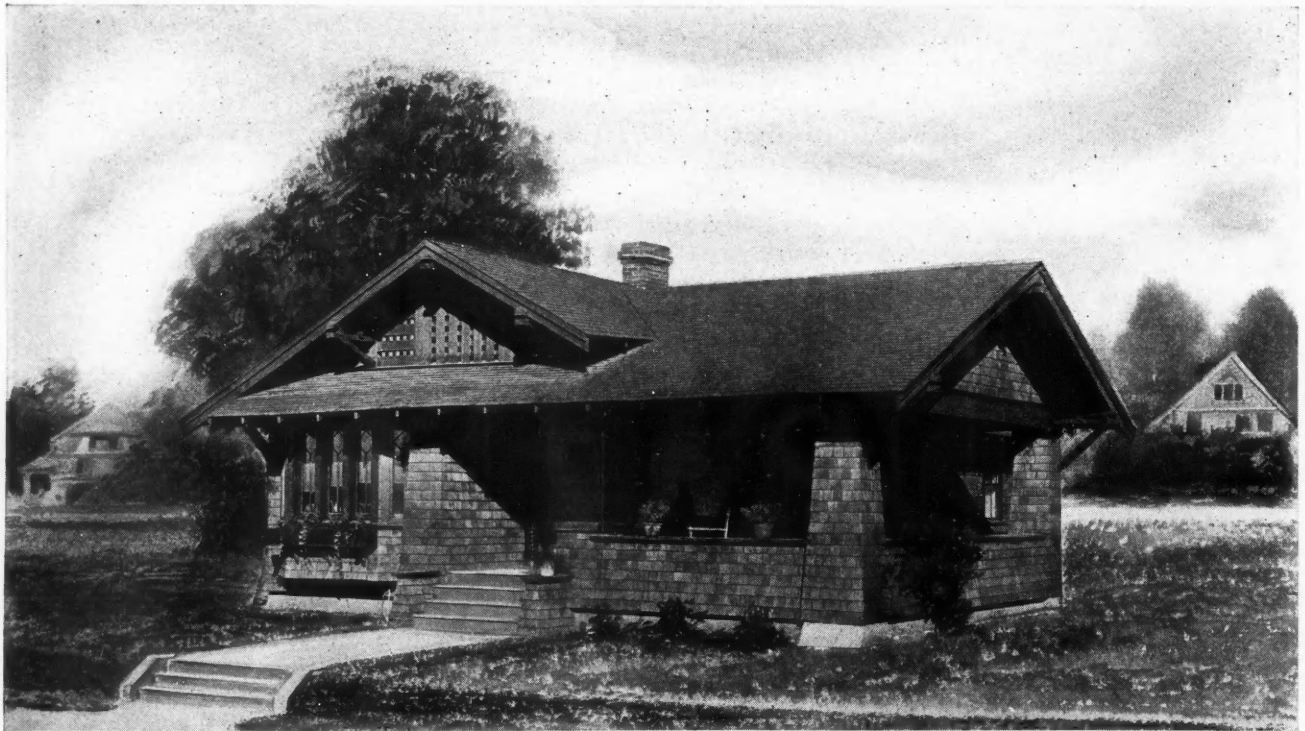

Ventilated attic bungalow of five rooms. Size, 34 x 35 feet. We can furnish complete set of blueprinted working plans and typewritten specifications for only \$5.00 per set. Blueprints consist of basement plan; roof plan; main floor plan; front, rear, two side elevations; wall sections, and all necessary interior details. Specifications consist of twenty-two pages of typewritten matter. When ordering, ask for Design No. 6708.

### Bungalow with Ventilated Attic

A beautiful and distinctive home of the bungalow type is shown here. The beauty and attractiveness of bungalows depends a great deal on the treatment of many small details that will either make a house that will command attention or will relegate it to the commonplace.

The method of handling the gable lattice work in this design shows how attractively this important ventilating arrangement—which should be provided for every one-story house—can be handled. It is a real decoration; and while unusual and artistic, can be made at a small expense. The lattice work in this gable is made of wide strips in one direction and narrow in the other. On the right side of the gable, toward the house, the wide strips are vertical and the narrow ones are horizontal. On the left side the arrangement is reversed. The wide strips run horizontally and the narrow ones vertically.

The front bay window, in the library, is divided into narrow frames, of which there are five; and the panes in these are leaded. The window box adds to the striking appearance of this handsome window.

In small bungalows the porch should be made large, since a bungalow is suggestive of outdoor living and the porch is used a great deal. This bungalow is no exception to this and has a roomy

porch intended for use as well as for ornamental purposes. The overhanging roof; heavy, tapering pillars; and wide windows from the living room all add to the cozy impression this bungalow porch creates.

ing doors that go to the living room. In the back of the hall is an ample closet for wraps of various kinds.

The dining room and library should be finished in the same style, because they will probably be used together a great deal, and also the cased opening between them is so wide that they give the impression of being one big room. Wall board paneling or a wood veneer could be attractively suited to these rooms. The buffet built into the bay window in the dining room is a feature of this room.

The library presents a cozy, home-like appearance. The beautiful bay in the front with the seat is very inviting. It is the sort of an arrangement that welcomes anyone into a room to enjoy its restful, pleasing character. On each side of the seat are built-in bookcases which are much more striking than the ordinary movable kind.

There is a hall in the middle part of the house that opens into the various rooms and adding much to the convenience of this design.

Too little attention is often paid to the arrangement of the working part of a house. People often think that the kitchen is in the back part of the house and not noticed generally and can be arranged in any way that happens to fit. As some one has said, "Too often houses are built with a Queen Ann front and a Mary Ann back." The kitchen should be arranged so as to save steps.

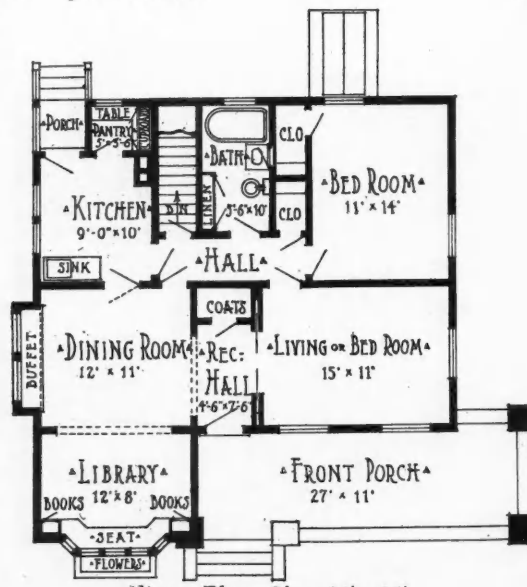

Floor Plan, Size 34' x 35'.

The floor plan calls for a library, a dining room, a living room, a bedroom, and a kitchen. If necessary, the living room can be used as a bedroom and the library and dining room used as living rooms. There is an abundance of closets.

The reception hall opens into the dining room on the left through a cased opening and on the right are double slid-



## Business Farm House

Farmers and physicians combine home and office. Farmers require other business arrangements about the farm home in addition to office or bookkeeping facilities.

Design No. 6673 shows a farm house, reasonable in cost, 44 ft. by 29 ft. 6 in. in size, exclusive of porches, that contains conveniences for house work and dairy work along the lines of modern farm economy. Special attention has been given to the basement. The basement under a farm house is used a great

deal for storage and as a workshop when it is properly built for the purpose.

In this house the foundation wall is made of concrete, made solid up to the sills. The basement walls are fitted with large windows on the workroom side and smaller windows towards the front of the house, where the cellar is used for storage of fruit and vegetables for winter use. There is a crosswall to keep out the heat from the furnace so that a cold temperature may be maintained all winter in the storage department. The

laundry work is done in the furnace room in the rear of the basement. The other side of this large room may be used for the cream separator or other work of a like nature if so desired.

Some farmers prefer a separate dairy house, but a great many like to have the milk taken care of in the basement of the house when such a basement is properly built for the purpose.

This plan calls for a good concrete floor, finished with a hard surface of cement mortar, carefully trowled smooth. The inside surface of the con-



Basement Plan.

First Floor Plan.

Second Floor Plan.

Interior Arrangement of Rooms in Farm House Design No. 6673.



Business farm house economically planned yet offering exceptional advantages. Size, 44 by 29 feet. We can furnish complete set of blueprinted working plans and typewritten specifications for only \$10.00 per set. Blueprints consist of basement plan; roof plan; first and second floor plans; front, rear, two side elevations; wall sections, and all necessary interior details. Specifications consist of twenty-two pages of typewritten matter. When ordering ask for design No. 6673.

crete cellar walls is finished in the same manner. Similar treatment of the ceiling overhead is recommended, but a great deal depends on the use of the basement, whether it is advisable to go to the extra expense of plastering the basement ceiling or not.

Above the concrete wall the house is built of studding in the usual way, covered with boarding, building paper and narrow siding. It is strongly recommended that the building paper be put on carefully and fitted around each door and window frame to make the house frost-proof in winter and heat-proof in summer.

One main roof with two gable ends covers the main part of the building and the front corner porch. This is the main entrance porch and it is built in. The little front porch and the side office porch are built on. This construction is reasonable in cost and it is very satisfactory.

The arrangement of the rooms in this farm house is different from the ordinary. The idea is to provide living rooms for the family as private and ex-

clusive as possible, and to still retain the business features in a large farm house where diversified farming is carried on.

At certain seasons of the year it is necessary to have considerable extra help; generally at such times the extra helpers are provided for on the farm. For this reason there is an extra side porch and a side entrance into the men's washroom, which contains a washstand supplied with hot and cold running water. And there is a cupboard for the use of farm hands where they can hang coats and leave their muddy boots. The farm office is in this corner of the house, and the same side entrance is used in coming and going from the office.

From this side washroom a stairway for the men leads up to the men's sleeping rooms on the second floor. On the second floor in this end of the house are two bedrooms and a bathroom for the exclusive use of the men, entirely shut off from the other part of the house.

The family quarters comprise a splendid large living room, 24 ft. 6 in.

by 13 ft., with a porch entrance that is not supposed to be used a great deal. The built-in porch in the front corner is the regular house entrance.

Special attention has been given to the arrangement of the kitchen, pantry and dining room. The kitchen occupies one corner of the house and is made light by one double and one single window of generous proportions. There is a large kitchen sink with wings, which occupies the whole space between the chimney and outside wall. There may be a sliding door over this sink to pass dishes through into the pantry.

The pantry is large and is fitted with cupboards and shelves, and it has a table in front of the window as a sort of pastry cook's department.

The dining room is 12 ft. by 17 ft., so arranged that when a great deal of extra help is employed the long dining table may be extended through the archway into the living room. Such occasions do not happen often, but at threshing time and on a few other gala days during the year it may become necessary. Farm housekeepers are called upon to devise

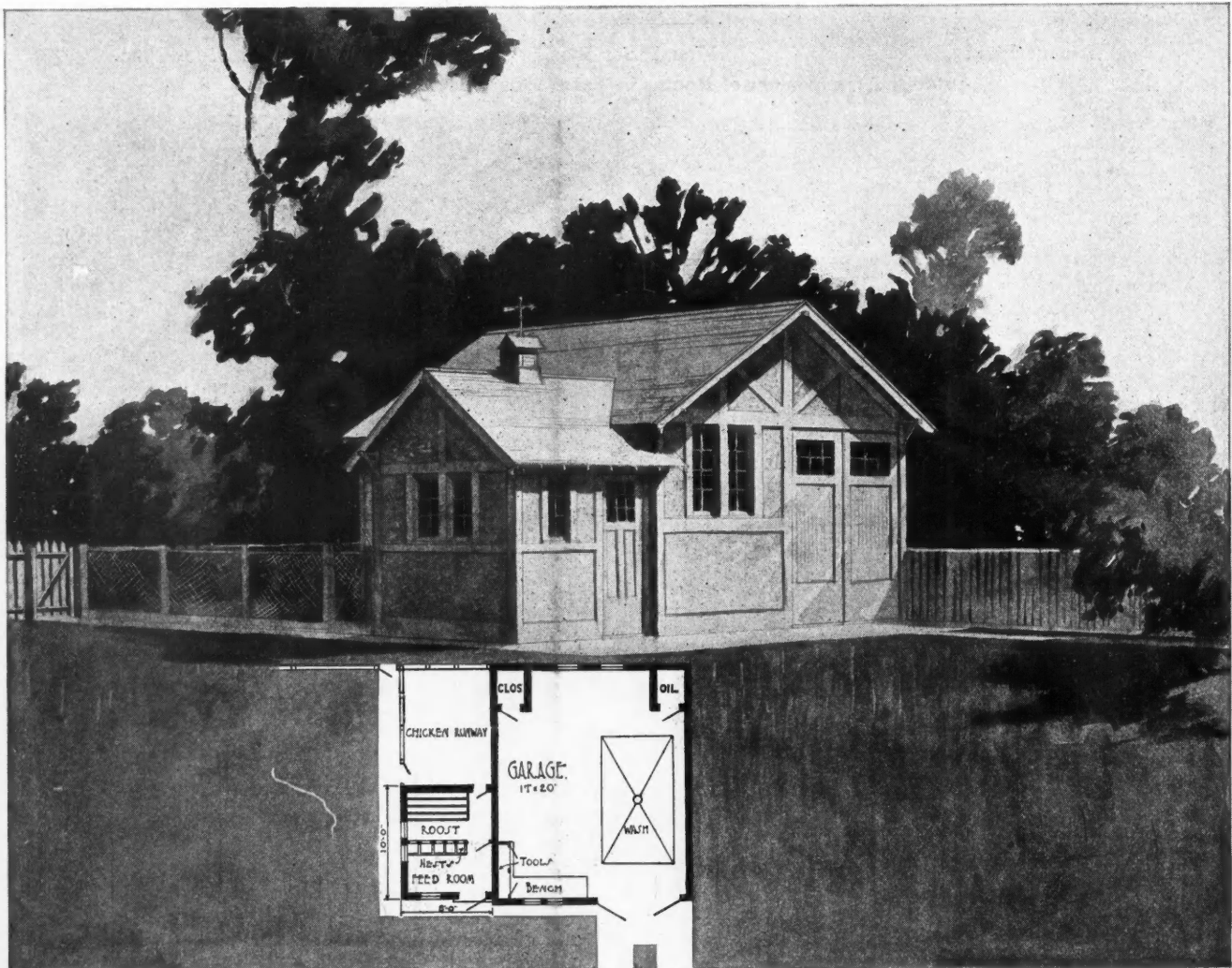

Combined garage, workshop and poultry house of cement plaster construction, good arrangement, and fine appearing exterior design. Size of garage part, 17 by 20 feet, of poultry house addition, 8 by 10 feet. We can furnish complete set of blueprinted working plans and typewritten specifications for only \$6.00 per set. When ordering, ask for Design No. G156.



Curb roof farm house of compact, sensible, yet improved design. We can furnish complete set of blueprinted working plans and typewritten specifications for only \$7.00 per set. Blueprints consist of basement plan; roof plan; first and second floor plans; front, rear, two side elevations; wall sections and all necessary interior details. Specifications consist of twenty-two pages of typewritten matter. When ordering, ask for Design No. 6674

some very ingenious schemes to accommodate all the extra help and visitors on a large farm.

A study of the plans and dimensions of the house will interest farmers who are in need of especial accommodations because of increasing business on the farm.

**Curb Roof Farm House**

A medium sized house 20x38 feet in size, exclusive of the porch, is shown in the illustration on page 51, Design 6674.

The plan of the house provides for a splendid large living room, 19 by 11 feet, with a fine big fireplace. This room is well lighted by three large windows and two small windows. A stairway leads upstairs from the dining room. Under this stairway is the stair leading down to the cellar.

There is a splendid kitchen which occupies the rear corner of the house where it has plenty of light and ventilation from the different windows. The connection between the kitchen and pantry is intended to make these two rooms into a very satisfactory workshop with superior conveniences for doing the housework. There is a bakery work table in front of a large window in the pantry for making pastry that takes this kind of work out of the kitchen.

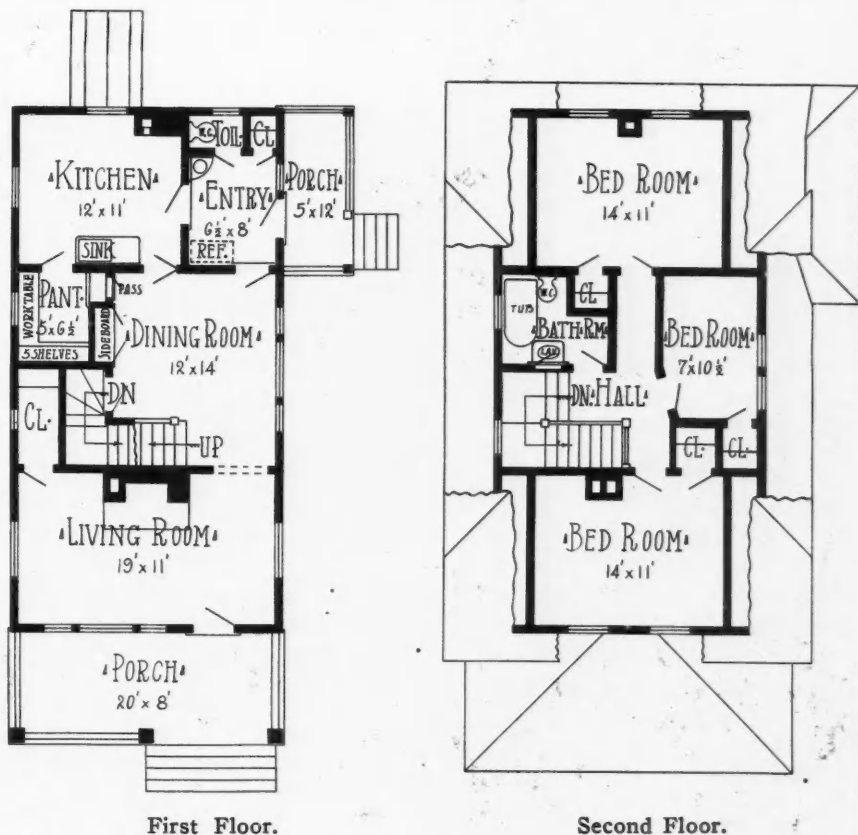

First Floor.

Second Floor.

Arrangement of Farm House Illustrated Above, Size, 20 by 38 ft.



An Example of Rich and Simple Elegance—Photo of Sitting Room, "Home of Redwood," Panama-Pacific International Exposition, Showing Redwood Panels Finished in Velvet Brown.



Hip-roof residence of "square" plan. Size, 27 feet 6 inches by 32 feet. We can furnish complete set of blueprinted working plans and typewritten specifications for only \$8.00 per set. Blue prints consist of basement plan; roof plan; first and second floor plans; front, rear, two side elevations; wall sections, and all necessary interior details. Specifications consist of twenty-two pages of typewritten matter. When ordering, ask for Design No. 6714.

**Handsome Seven-Room Dwelling**

An artistic residence of seven rooms, besides a large reception hall, is shown in this design. It is well designed to utilize all possible floor space, and is at the same time very attractively finished. The railing around the second story corner windows, and the projecting bay on the side between the first and second stories are some of the distinctive features of this house. This bay accommodates the stair landing, and in connection with its window treatment presents a pleasing appearance both from the inside and from the exterior.

The reception hall, which is entered from

the front porch, is of generous proportions and has a cozy seat against the stairs to the second story.

The living room is to the right of the reception hall as you enter. It has a

triple window facing the front of the house and a window on each side of the big brick fireplace. The entrance to this room from the reception hall is through a cased opening, while sliding doors are used between it and the dining room.

The dining room and kitchen form the back part of the house and are well arranged and also very well lighted.

The second floor plan calls for four bedrooms, a bathroom, and a small central hallway. The closets in all the rooms are large and convenient. The stairs to the ground floor and to the store room in the attic are reached through the hall. The part of the attic under the dormer window may be finished off as an attractive little room.

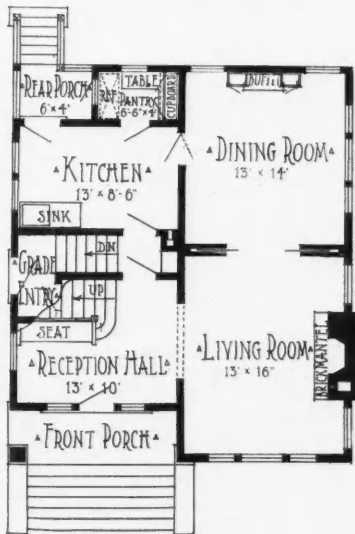

First Floor Plan.

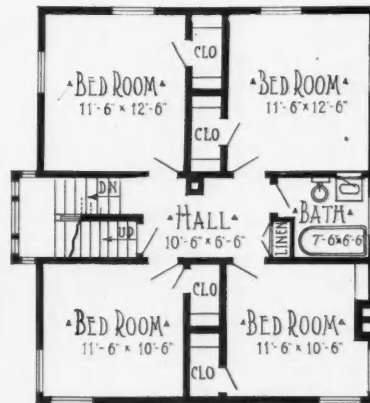

Second Floor Plan.

Arrangement of Rooms in House, size 27' 6" x 32'

## The Home of Redwood

Exhibit Bungalow at San Francisco Fair Shows Beauty of Redwood Finish

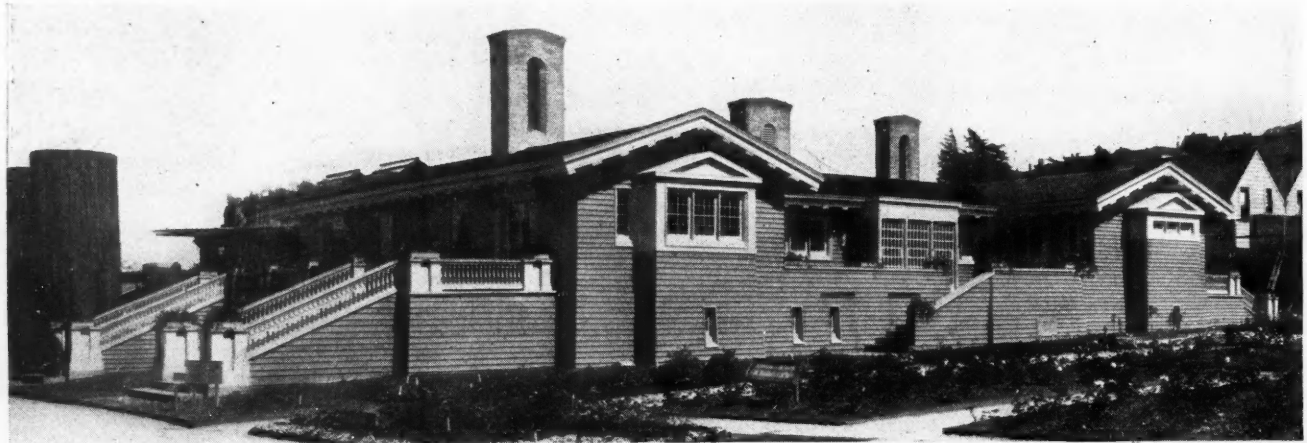

The "Home of Redwood," at the Exposition, Showing Side Porch and Entrance of Service Quarters.

THE purpose of the Home of Redwood at the Panama-Pacific International Exposition is to show just how beautiful redwood is when properly treated, and to bring together under one roof authoritative examples of the many and diversified qualities of this building material. All the lumber used except the floors is redwood.

The redwood, technically called *Sequoia Sempervirens*, is one member of a distinct and unique family of trees, the *Sequoia Gigantea*, or "Bigtree," being the other species. The *Sequoia Sempervirens* is found only along the fog belt of the California coast, extending in a strip from 10 to 35 miles wide from the Oregon line on the North down into Marin County, with a few scattered groves of small commercial importance as far south as Monterey.

The redwood tree grows to a height of 150 to 300 feet, with a diameter from 3 to 15 and even 20 feet at the base. The trees grow very close together and will average from 75,000 to 100,000 board feet to the acre. The record yield per acre is 1,000,000 board feet.

Largely on account of lack of transportation facilities, redwood has been little known outside the Pacific Coast territory, but with the recent completion of direct rail connection this lumber will soon become one of the most important of building woods.

The imperviousness of redwood to decay has long been known, and therefore its use by the home builder for foundations is not only natural but advantageous. Homes in Humboldt and Mendocino Counties were built on redwood foundations as long as fifty years ago, and the original sills are at the present day as sound as when first laid down.

The weather resisting qualities of red-

wood, even when unpainted, are proverbial and make it pre-eminent for exterior use. Barns erected in Humboldt and Mendocino Counties as early as 1855 were sided with unpainted redwood boards and covered with redwood shingles and shakes, none of which today show the slightest deterioration from exposure. The Russian Church erected at Fort Ross, California, in 1811, was built entirely of hewn redwood, and although the building itself was completely wrecked by the earthquake in 1906, the redwood itself is as sound today as when the trees from which it was hewn were felled.

The fire-resisting qualities of redwood are well known, and no forest fire, no

matter how severe, has ever destroyed a redwood forest or killed a sound, mature redwood tree. In the great San Francisco fire of 1906, this characteristic was put to a most severe test, and while it is not claimed that redwood will not burn, it burns more slowly than any other wood, and when saturated with water, hardly at all.

Redwood for interior finish gives the home builder a wide range of possibilities. It has, in the first place, all of the merits of any other, except the hardwoods; in addition to which the entire absence of pitch renders it especially adaptable to paint or enamel. Again, the great beauty and varieties of the grain permit beautiful effects, especially

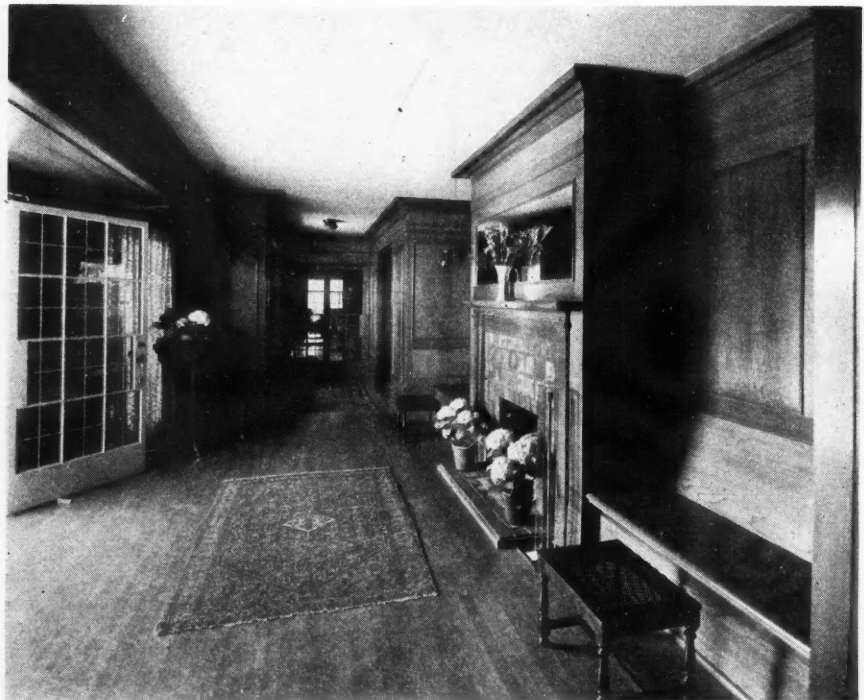

Entrance Hall, Showing Redwood Panels Finished in the Natural.

in the natural finish, or when combined with the use of paint or stain.

The Home of Redwood embodies all these uses of redwood.

Its foundations, underpinning and floor joists are of redwood because they will not rot. Its entire frame is of redwood because it is in every way suitable for this purpose and is fire resisting. The roof is covered with sawn redwood shakes and the sides with a novel combination of sawn redwood shakes and redwood beveled siding, because this material is everlasting and gives great protection in case of fire.

The interior finish, with the exception of the floors, is of redwood because the width of panels and extreme beauty and varieties of grain are characteristic of this wood. The surface finishes are beautiful and vary from the simple white of hygienic utility to tones of exquisite depth and richness.

In fact, this residence shows in finished form the uses of redwood in house construction wherever it is suitable. Attention is called to the fact that the only places in the entire structure where redwood is not used are the floors and steps. Here oak is used for the interior and Douglas fir for the exterior.

**Specifications of the Home of Redwood**

In the limited space available it is not possible to give full specifications governing the material and workmanship represented in this exhibit, but to those who are desirous of duplicating the Home of Redwood, either in whole or in part, full information and complete list



View of Living Room, Showing Fireplace and French Doors Leading Into the Dining Room.

of materials will be furnished upon request.

The foundation, underpinning, floor joists, and frame, are all built of merchantable redwood.

The entire building is sheathed, inside and out, with surfaced one inch No. 2 common redwood, building paper being put next to the sheathing and immediately underneath the exterior and interior finish.

The roof is covered with sawn red-

wood shakes dipped in shingle stain before laying.

The sides are covered with a combination of sawn redwood shakes and a special pattern of clear dry redwood siding.

In general, the proper treatment of redwood surfaces is as follows:

After the wood is thoroughly sanded and cleaned smooth, apply a coat of white shellac; then mix pigment of whatever color desired with white lead or zinc and boiled oil, thinning the mixture with turpentine if necessary, applying with a brush. Immediately thereafter, while wet, wipe with a soft rag, cheesecloth or dry brush, leaving a thin film of color and allowing the redwood grain to show through uniformly.

**Cost of Building**

Many questions have been asked relative to the cost of the Home of Redwood and as to what the building could be duplicated for in various parts of the United States.

This is a question that is very difficult to answer, not only because the cost of the raw material differs greatly in different sections, but also the cost of the labor is much higher in some localities than in others. For example, in San Francisco labor is probably higher than in any other place in the United States, while the cost of redwood lumber would be less; yet it is the labor that really counts.

In a general way it can be said that it costs no more to build a home out of redwood than any other soft wood, and it costs considerably less than some soft woods.



Dining Room, Looking Toward Living Room. Redwood Panels Finished in California Brown.

### Artistic \$4,000 Residence of Cleveland Builder

"Homelike, inviting" are the words that come to mind on entering the new residence of Mr. Chas. K. Turney, at 1130 East 174th St., Cleveland, Ohio.

The front view, shown here, is attractive because of the broad dormer windows above, and the full-width built-in porch. The vestibule is finished in oak, with an attractive tile flooring.

A lot of room is given to the living room, at one end of which is a big fireplace. Separated by a low partition is the paneled approach to the stairway. Dining room and library are handled with beamed ceilings. Fireplaces in each room add greatly to their handsome appearance. Kitchen, pantry, a large porch, a sewing room, and a toilet room just off the kitchen complete the ground floor plan.

The second floor is centered about a little hall. A feature of this residence is the use of a fireplace in each of the sleeping rooms. The bathroom is large and well lighted; and there is a 15 by 13-foot sleeping porch for those who like fresh air.

A dumbwaiter and clothes chute will

help the housewife a great deal in her work. Complete laundry facilities, including a power washer, are found in the basement. Also there is a large vegetable cellar.

While no exact account was kept of the building cost, Mr. Turney informs us that \$4,000 is a very good estimate. Certainly it is a very attractive residence.



First Floor Plan.

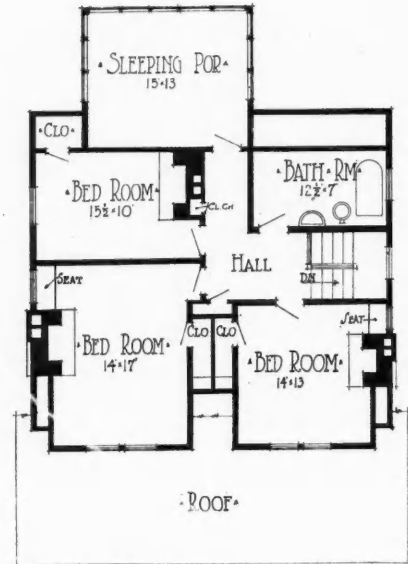

Second Floor Plan.



Dining Room in Turney Residence—Showing China Closet, Paneling, and Fireplace.





Corner of Library in Turney Residence, Showing Nook, Bookcase, and Fireplace.



Front View of \$4,000 Residence of Chas. K. Turney. Note the Dormer Windows that Promise Bright, Cheery Bedrooms.

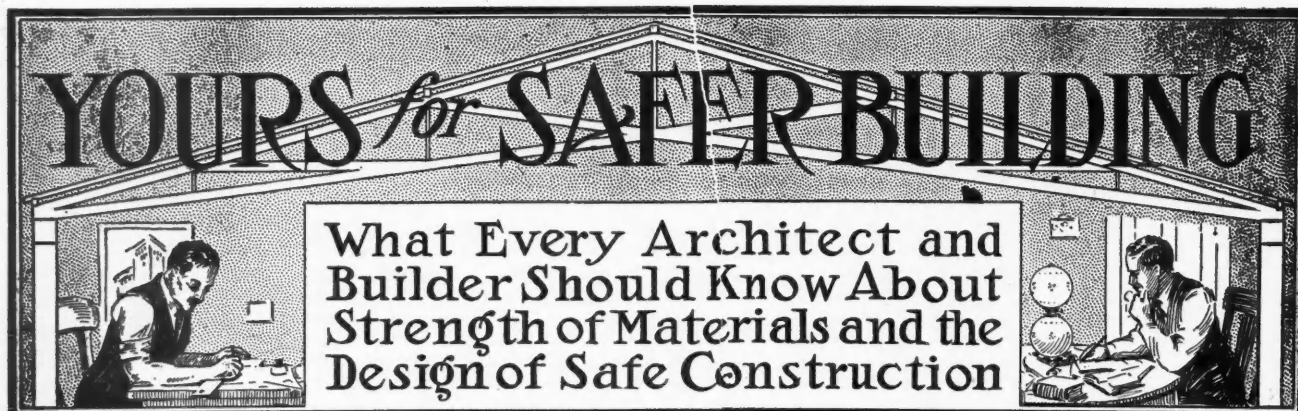

## Noon Hour Talks by the Boss Carpenter

### Talk No. 37. Timber Floors—Construction Series No. 1

THE BOSS BEGINS A SERIES OF PRACTICAL TALKS ON BUILDING CONSTRUCTION, AND GIVES THE PRINCIPLES NEEDED IN CALCULATING TIMBER FLOORS

“ONE of the men,” said the Boss, “came to me today and said that while he understood how to figure the size of a simple beam, he did not know how to apply his knowledge when he was up against the proposition of figuring the floors of an entire building. I imagine that some others of the ‘Calculating Squad’ may be in a similar position, and it may be well for us to take a building similar to that shown in Fig. 54 and figure the more important parts.

“As long as the lower floors are often called upon to support a part of the load from the upper floors, owing to the location of partitions, we will begin with the upper floors first and then go down through the building.

“The load to be carried by the floor beams will consist of the weight of the beams themselves, and the flooring and ceiling which is fastened to them; the weight of any partitions or supports which rest on this floor, together with the load on the partition or support, and the weight of the load which is to be placed on the floor when the building is in use. The first load mentioned will depend upon the kind of timber used, the size of material, and the kind of ceiling supported from the under side of the beams. Since the size of the timbers is what we are after, and therefore is not known at the start, we may have to estimate this part of the load in making our calculations. If it is thought necessary, you can go back over your calculations after you have determined the size of your beams, using the correct weight of the beams. In ordinary cases this is not done, since the error in the weight of the beam is small as compared with the other loads.

“As to the weight of the material used in floor and ceiling, it is well to reduce all weights to a square foot of floor basis, as that is the standard commonly considered. If we consider that a board foot of spruce or hemlock weighs about 3 pounds, and that a board foot of yellow pine weighs 4 pounds, it is easy to find the weight of a piece of material of a given size by

finding the number of board feet in the piece. You will remember that this is done by multiplying together the end dimensions of the piece in inches, then multiplying by the length of the piece in feet, and dividing the result by 12. For instance, a 2-inch by 12-inch yellow pine beam 15 feet long would contain 30 board feet of material and weigh 120 pounds.

“To reduce the weight of the beam to a square foot basis, divide the weight of the beam in pounds by the number of square feet of floor that this particular beam holds up in place. Beams which are spaced 12 inches on centers hold up 1 square foot of floor for each foot of length of beam, while beams spaced 16 inches on centers support  $1\frac{1}{3}$  square feet of floor per foot of length. In the case shown above with beams spaced 16 inches on centers, the load per square foot of floor due to the weight of the 2 by 12-in. beam alone would be 120 divided by  $15 \times 1\frac{1}{3}$ , or 6 pounds.

“The weight of flooring can be taken as about 3 pounds per square foot of floor for each inch of thickness of wood. The weight of a ceiling, if one is attached direct to the under side of the floor beams, may be taken as 10 pounds per square foot for lath and plaster, and 2 pounds per square foot for steel or wood ceiling.

“When a floor carries the weight of a partition which extends across the beams perpendicular to their direction and located at a distance in from the ends of the beams, it is necessary to find the weight of the partition which is carried by one beam and treat this weight as a concentrated load on the beam. This weight may be found by multiplying together the height of the partition in feet, the distance between floor beams (on centers) in feet, and the weight of the partition per square foot of wall surface. A unit of 20 pounds per square foot is often used as the weight of a partition made up of 2-inch by 4-inch or 2-inch by 6-inch studding plastered on both sides.

“If a partition carries load from a floor above, as in the case of an attic, this load should be figured and added to the weight of the partition itself. It is custo-

mary to find the total weight carried by the partition, then divide this by the length of the partition in feet to get the load per linear foot. This result is then multiplied by the spacing of the floor beams in feet to give the concentrated load per beam.

“The load which is likely to come upon a floor after it is in place is variable and is often spoken of as the ‘live load’ to distinguish it from the ‘dead load,’ or that part of the load which is always present in the form of the weight of the building material itself. The live load to be allowed in designing the floors of a

buildings, and the corridors of all public buildings, including hotels, 120 pounds.

“The length of floor beams needed in any particular job should be kept as small as possible since the strength and stiffness of a beam of a given size both depend to a great extent upon the length of the piece. It is advisable to keep all beams down to 24 or 25 feet in length when possible. Where piers or posts are not objected to, a main girder can be used to break up long floor beams into two sets of shorter beams.

“The use of bridging, as shown in Fig. 56, will be

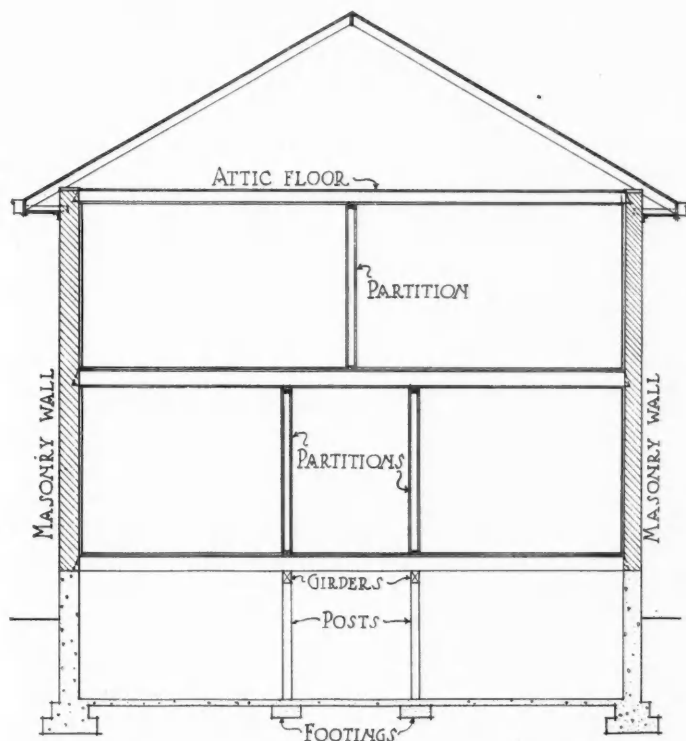

Fig. 54. Section through Building, Showing Floors and Location of Partitions.

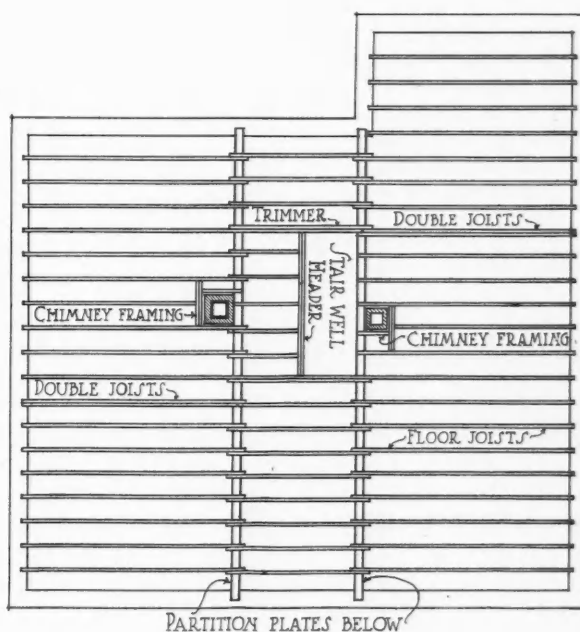

Fig. 55. Plan View of First Floor of Building Shown in Fig. 54.

building varies with the kind of building and the part of the country in which the building is to be built. City building ordinances demand different allowable loads even for the same kind of buildings. One city will insist on 40 pounds per square foot as the allowable load for floors of dwellings, while another city may require 60 pounds per square foot for the same kind of a building. Likewise a different amount of load is required in the case of schools, office buildings, churches, warehouses, etc. These amounts all vary in different localities, and you should find out what is demanded in your locality before making any calculations.

“In the absence of any specified loading, Kidder in his Architects’ and Builders’ Pocket Book recommends the following floor loads in pounds per square foot as giving a good degree of safety: dwellings, 40 pounds; schoolrooms, 50 pounds; upper floors of office buildings, 60 pounds; lower floors of office buildings, banks, churches and theaters, 80 pounds; assembly halls, dancing halls, stores, manufacturing and light storage

of service in stiffening a floor and also aids in strengthening a floor to resist the effect of concentrated loads. The small pieces of wood used are nailed at each end with two ten-penny nails. The pieces may be of 1-inch by 3-inch stock for beams 2-inch by 10-inch and under, but should be 2-inch by 3-inch for greater depths of beam. The bridging should be used in pairs in a straight line along the floor with the lines spaced from 6 to 8 feet apart.

“Where a partition extends in the same direction as the floor beams, the beam directly under the partition should be made large enough to carry the load from the partition. It may be well to strengthen the beams on each side of this carrying member to provide a stronger and stiffer floor.

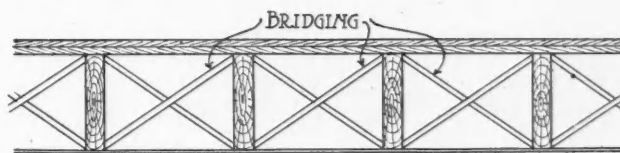

Fig. 56. Arrangement of Bridging in Floor.

"If a building is so wide that it is not advisable to use beams of a length that will reach across the entire span between walls, a larger main girder can be used to support one end of two shorter sets of beams. This main girder is supported at frequent intervals by posts, or brick piers if in a basement. The method of figuring this main girder is similar to the method used for the smaller floor beams. We consider that a girder of this type supports an area of length equal to the length of the main girder between piers or posts, and of a width equal to the distance between the centers of the floor spaces on each side of the girder. This area multiplied by the floor load, dead and live, will give the load carried by the main girder. If partitions or posts bring extra load onto the girder, these loads must be considered in addition to the regular floor loads when determining the size of material needed.

"For example: a building 40 feet wide might have two sets of floor joists 20 feet long. If these joists have one end held up by a main girder which is supported by brick piers 12 feet apart, the area of floor supported by the main girder will be  $20 \times 12$ , or 240 square feet. If the floor load is 60 pounds per square foot, the load carried by the main girder between two supports will be 14,400 pounds. This is treated as a uniformly distributed load.

"One other important point that has to be watched at all times is to see that the deflection in the floor joists or girders is not enough to cause the plaster ceiling to crack. We will investigate this point as we proceed in our problem."

At this time the Boss announced that the noon hour was ended and that the Squad would begin at once on the actual calculations at the next meeting. The Boss invited several of the men who had been with him but a short time to attend the Noon Hour Talks and follow out the calculations with the rest of the regular class.

### Concrete Foundations for Gas Engines

TO obtain the highest efficiency an engine should have a heavy and firm foundation. This will not only reduce wear and tear incident to excessive vibration, but will result in prolonged and better service. Rigidity and durability in the foundation are best obtained through the use of concrete.

The concrete should be mixed in the proportion of 1 part Portland cement, 3 parts clean, well-graded sand, and 5 parts crushed stone or gravel.

*Footings.* For footings over 6 or 8 square feet in plan, stone up to  $2\frac{1}{4}$  inches may be used.

*Construction.* After the exact location of the center line of the foundation has been carefully established, a pit 2 feet to 4 feet deep should be excavated, the

length and width being the exact size of the footing. Deposit the mushy wet concrete to the depth determined on the plan. In order to thoroughly key the engine foundation to the footing, embed 3- or 4-inch stones in the portion of the footing under the engine so that they will protrude from the footing.

*The Forms.* A box form 8 inches larger in length and width than the engine base should be carefully set over the footing. The inside of the forms should be thoroughly oiled to prevent the concrete from adhering. It is essential that the anchor bolts for the engine be carefully spaced and so placed as to take care of any small variations in position. Use a templet for this purpose, and supply for each bolt greased gas-pipes of twice the diameter of the bolts, the pipes to be removed before the engine is set. The purpose of the

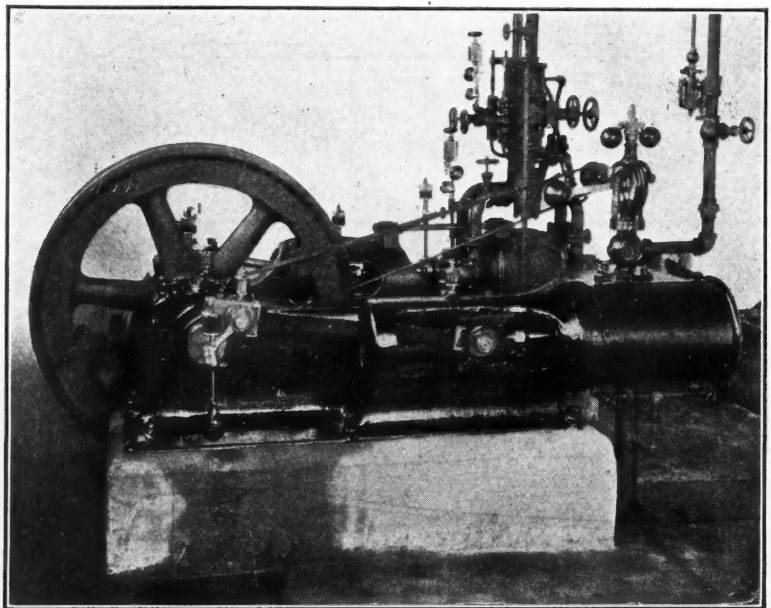

A Durable and Rigid Engine Foundation of Concrete.

pipes is to provide for such slight adjustment of bolts as may be required. The anchor bolts should be embedded in the concrete at least 18 inches, and supplied with cast-iron washers at the lower ends.

After the templet has been accurately set over the forms and the bolts so arranged that the tops are at proper elevation, the concrete is carefully deposited and spaded in the forms. Turn the gas-pipes from time to time, thus preventing them from sticking to the concrete. The concrete along the forms should be carefully spaded to prevent the formation of air-bubbles or pockets.

Damp burlap should be placed over the form after the concrete is placed. This will insure normal setting of the material. After twenty-four hours remove the form. The engine may be set and the bolts adjusted after forty-eight hours. Before the engine is set remove the gas-pipes referred to above, and when the engine is finally placed, fill the space around the bolts with 1 : 1 mortar.

**New School for Argo, Illinois**

**I**N some of the school houses we have shown at various times the plan has been designed so that only part of the building is put up at first and the rest of it to be easily added when needed. Most of these extensible school houses are planned in such a way that the front half of the building can be erected first and the back half when the room is needed.

In the new school at Argo, Ill., however, the entire ground floor has been completed and makes an elegant building just as it is; then later, when more room is needed, the second floor will be added. Four rooms are sufficient now, but when the building is entirely completed according to the original plans there will be eight rooms, which will provide for the natural growth of the community well into the future.

In the basement are two play rooms: One for the boys and one for the girls. The two large toilet rooms are also located on this floor. The boiler room with the fuel room adjoining occupy the back part of the basement opposite the main entrance.

On the main floor are four class rooms, the office and the connecting corridor. The class rooms occupy the four corners and the office is located opposite the main entrance.

The exterior of the building is finished in brick with white enamel terra cotta trim. Each class room is well lighted by nine windows—four on one side and five on another.

This school is one of the well-planned designs of Mr. G. W. Ashby, architect, whose extensive experience enables him to plan school houses that exactly suit the many varying school building requirements.

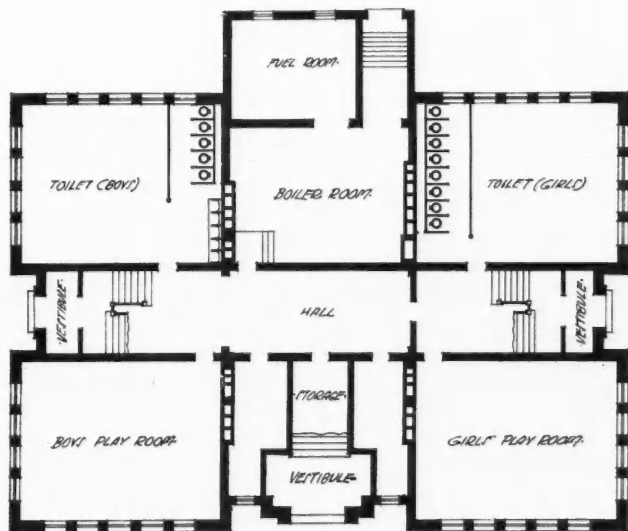

Basement Floor Plan.

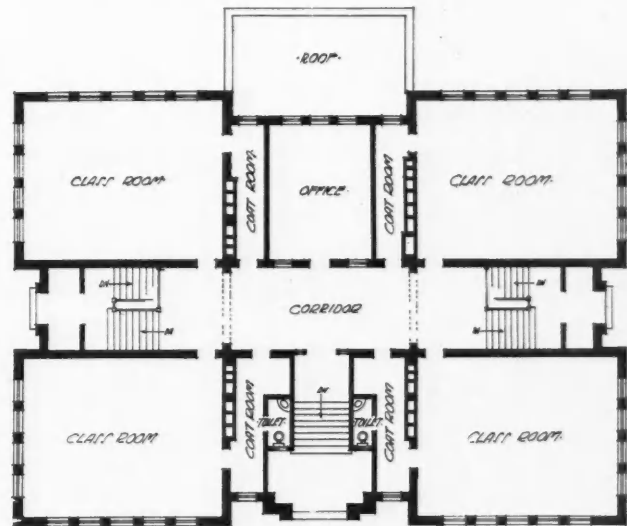

First Floor Plan.

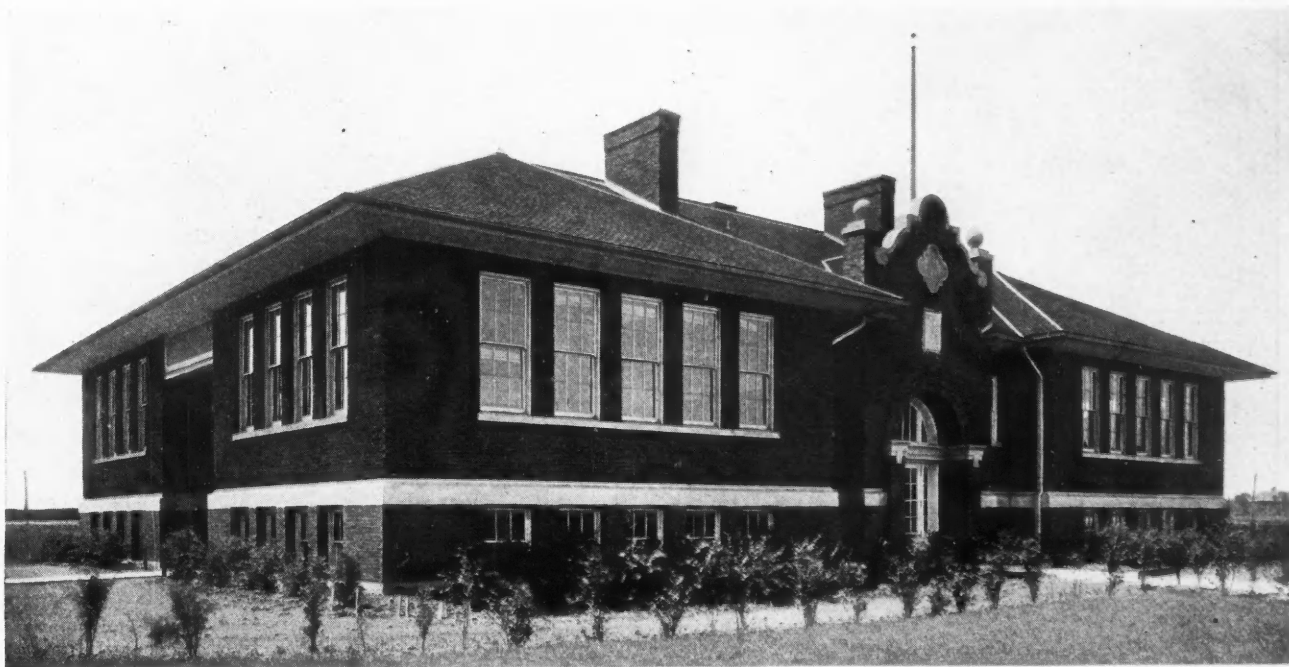

Four-Room School Recently Completed at Argo, Ill., a Growing Community, which will Need in Time to Add a Second Floor to this Building.

## "Don't Blame the 'Grouch,' He May Have Ingrowing Toe Nails, Itching Piles or the Toothache"

### THE MAN FROM THE LUMBER YARD

We believe it is generally best to deal with man's positive qualities in place of the negative; but we do especially commend the consideration of the two negatives discussed in this letter, and also the "saw dust" given.

EDITOR.

**Y**OU find him everywhere, behind the pulpit, the counter, and the bar. He drives golf-balls, and dray-wagons. He handles the saw, the pen and the yardstick. A few may love him, the others may tolerate. He puts to flight good cheer and casts a cloud over the merriest. No one has found the correct answer for, "Why is a 'Grouch?'"

The dietitian says, "poor cookery"; the minister, "an unregenerate heart."

Don't blame the grouch, he may have ingrowing toe nails, itching piles, or the toothache. But why injure your work, your business, your health by a grouch?—no matter what may affect you either above or below your collar. It doesn't get you anywhere.

Old man Simpson always said: "What doesn't help will surely hurt."

With a grouch on, a man knows that he would be money in pocket, if he had never been born.

Some men acquire a grouch. Overeating and wrong

drinking bring on the grouch with many men. Others blame their parents for their grouch. This is unkind and unjust.

It is unkind because it is probably an untruth. It is unjust because you pass judgment on people who cannot defend themselves.

No one loves a grouch or wants him around. Even as a crepe-hanger every one prefers a cheerful man.

Let the grouch present a proposition most thoroughly and it will be so enveloped in gloom that no one will buy.

I have known the "Grouch" germ to be let loose in an office and everyone in the office be bitten before quitting time.

You don't have to encourage the grouch. If a man with a torpid liver or his nerves near the surface is inoculated, it spreads rapidly.

The best remedy for the grouch is a good cathartic, a brisk walk with the chin held well up, and the affirmation from Browning, that:

"God's in His Heaven, all's right with the world."

Don't think "How beastly hot it is"; but, "How good it is for the corn."

Don't mention the nasty storm; but speak of the "fine rain."

Don't say "It can't be done"; but go and do it.

Some people have to fight the grouch; if they can keep pleasant every morning until ten o'clock, the rest of the day will take care of itself.

The dairyman provides pleasant surroundings so his cows will give more and better milk. The farmer places a machine that oils the hog as it scratches its back. This oil keeps the flies off and thereby the hog fattens sooner. All this is done to keep these producers in a pleasant temperament.

When I was holding down my job in the lumberyard, the grouch was not numerous. I don't find him now among the fellows who are driving the nails. He is found most in the bosses' chair. Yes, I know there are aggravating things to fret, but what good does it do you? The human worker needs and profits by a pleasant atmosphere, free from nagging, even more than the four-footed producer.

If this should be read by some one who suspects that he is a grouch, let him stop, think, listen. Let him consider the hurt that is being done himself and his people.

#### The Indecisionist

One of the fruits of the grouch is lack of personal confidence. Lack of confidence makes an indecisionist.



The Grouch is Found Mostly in the Bosses' Chair.

I had a schoolmate that was never able to decide whether he wanted ham or eggs, with the results that sometimes he got neither. Later on, he thought he was in love with two girls and was unable to decide which he loved the more. I got one of them and a banker got the other. My friend is still a bachelor.

I know a man who attributes much of his worldly success to a rule he made for himself. He saw how much time and how many opportunities went wrong, and how much money was wasted by "Indecisionists," as he called them. So he adopted for one of his mottos: "Decide quickly and stick to it." It is unfortunate to decide wrong; but even that is better than to die of indecision. Tighten up your mental machinery, and make it produce decisions when you need 'em.

You'll make some wrong ones, everybody does. But you won't be any shilly-shallying nonentity, at least.

Don't be a hesitator. Be a decider.

I come in contact with all manner of men, not only the butcher, the baker and candlestick maker (who now makes incandescents), but the banker also, the barber and the dry goods dealer.

No one class of men has so many opportunities of being effective doers as the readers of the AMERICAN CARPENTER AND BUILDER. No other set of men has such opportunity for creative work.

Naturally, I am especially interested in my own people. I want to see my particular friends free themselves of all negative qualities that handicap. I want each one to carry the success banner.

Nor do I count that success means money. Some of the worst failures of the age are loaded with dollars. One of the biggest financial successes in the central states had not a tear shed at his death bed in a New York hotel. His body was placed in a wicker basket, taken down on a freight elevator and hauled on an express wagon to his palatial house where his wife lived. If anyone grieved for him it was another woman who lived in an even more splendid house that was built for her by his failure.

As compared to him, the day laborer, who is greeted by a trusting wife and family, is a success beyond compare.

#### The Leader of Your Community

I do not mean the society leader, nor yet the financial leader. You who read this should be the real home leaders. You should be the men who set the pace for home improvements. Many of your neighbors will follow. The banker and realty man will eventually follow, but you get the first come-back from any general move for better conditions.

#### "Sawdust"

The grouch has to make good and never smiles.  
The worst fool there is, is the fool who fools himself.  
Only the pee-wee man will abuse his wife, because he is afraid to abuse a man of his size.

The busiest man there is, is the man that attends



Was Unable to Decide Which He Loved the More.

strictly to his own business; yet he often has time to do for others.

We are willing to trust our own judgment during success, but when we fail we pray to the Lord for help.

A dead dog makes more stink on the boulevard than in the back alley.

The fall of prominence is greater than the fall of the lowly.

The skunk enjoys his own stink, and the foul mouthed enjoy the rottenness of their talk. Both should be avoided.

The "fussy" man, and the dog with fleas never get anywhere.

Keep cheerful, for you will be a long time dead.

The ant and the bee never quarrel. They are too busy.

The misfortunes hardest to bear are those which never occur.

The pessimist is never so happy as when he is unhappy.

If you should stumble, don't worry. A worm is the only thing that can't fall.

Yours for the optimisms of life,

THE MAN FROM THE LUMBER YARD.

✦  
WHEN you get angry it is righteous indignation. When the other fellow gets angry it is an exhibition of beastly temper.

# TRICKS *of the* CARPENTRY SHOP





## Hex.- and Oct-agons

HOW TO TAME AND TRAIN THEM

By Wm. C. Jasbury

**W**HILE laying out some mill work recently, I accidentally discovered an odd thing about the six-sided figure, or hexagon. The same thing might have been known and used before the flood, but that has nothing to do with me. This is Mr. Hexagon.

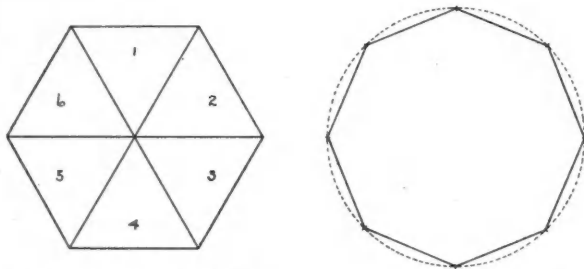

Six Equilateral Triangles Make a Hexagon. Octagon Laid Out in Circle.

1. Six equilateral triangles make a hexagon.
2. 360 degrees divided by 6 angles equals 60 degrees.
3. The hexagon angle on the steel square is 7 and 12; draw on 7.
4. Miter of hexagon angle 7 and 12; draw on 7.
5. Angle of triangle 60 degrees,—7 and 12; draw on 7.
6. Miter of triangle 30 degrees,—7 and 12; draw on 12.
7. Area of hexagon. Area of an equilateral triangle, multiply  $\frac{1}{2}$  the base by the altitude. The answer multiplied by 6 gives area of hexagon. Because 6 triangles equal 1 hexagon.

### And Now for Mr. Octagon

While I am on geometrical figures, I will give you the various ways I have seen octagons laid out.

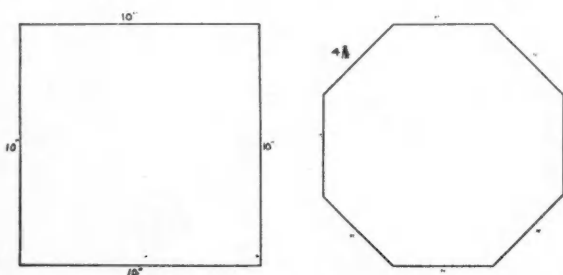

To Octagon a Square Multiply Side by  $4 \frac{2}{12}$  and Divide by 10.

Strike a circle, step off 8 times, with the compasses, then draw lines, as per sketch.

Multiply the square by 5 and divide by 12 gives side.  $5 \times 10 = 50$ ;  $50 \div 12 = 4 \frac{2}{12}$ .

Multiply square by decimal .4142, thus,  $10 \times .4142 = 4.1420$ ; and 4.1420 is the exact size of the side of the octagon, where  $4 \frac{2}{12}$  as above is not absolutely accurate, but near enough for practical purposes.

Take two cardboards or pieces of paper, cut

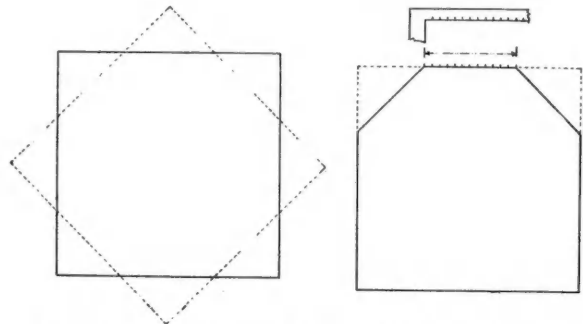

Two Card Board Squares Laid Together Form Octagon.

them 10 inches square, place one on top of the other diagonally and mark with pencil, which gives an octagon.

On the tongue of an ordinary steel square is found dots that are used in laying out octagons. If the stick that is to become octagon is 12 inches square, take 12 on these points on the compasses and placing them on the side of the stick gives the octagon side.

Lay steel square across a stick diagonally so that

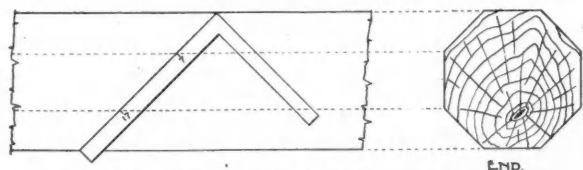

Mark Square Stick on "7" and "17" to Lay Off Cut for Octagon.

the ends of the blade come flush with the edge of dot at 7 and 17; this gives the distance of octagon side. This can be of good service where the stick is of a fractional width, same as  $12\frac{3}{8}$  or  $10 \frac{5}{16}$ ,  $8\frac{3}{8}$ , etc.

Take a square, say 12 and 12, place one point of the compasses in the corner and one point in the center of the square; scribe a line or quarter circle around, touching two sides. Do this four times, then



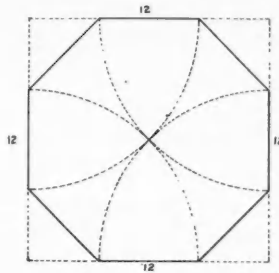

With corners of square as centers and Half Diagonal as Radius cut Sides for Octagon Corners.

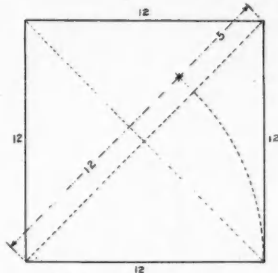

With square corner as center and square side as radius cut diagonal; remainder of diagonal equals octagon side.

connect the points, which forms an octagon.

Take a square 12 and 12 to be made octagon; draw diagonal lines, corner to corner, then take a distance on the diagonal line equal to the length of the side of the square and from this point to the corner is the side of an octagon of aforesaid square. Five is the length of the desired octagon side.

**CORNICE CORBELS ON THE LEVEL AND UP THE RAKE**—To mould corbels running up the rake is a difficult trick, if one is not onto the method below. First, I shall show how to develop the side mouldings for a rake corbel. The moulding C or typical A and B are developed

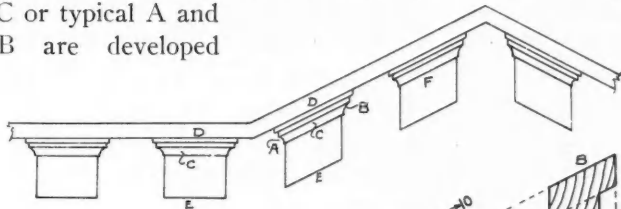

from it for the right and left corbels of the rake. The distance DE is the same on both sets of corbels, level and rake. To develop A and B from C is as per detail sketch.

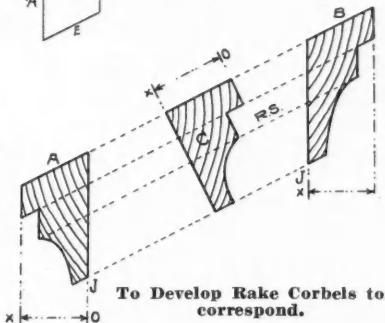

The distance  $x_0$  is the same on both mouldings A and B. All other dimensions are measured out level from corbel edges J-J or plumb; then the curves can be developed free hand or by more lines, as R-S.

The illustration shows a miter box that will cut these miters with very little over wood. If the pitch of the cornice is 6 inches to the foot rise, or 6 and 12 pitch, I cut a board similar to a stair pitch board, tack this on an ordinary miter box, as shown in illus-

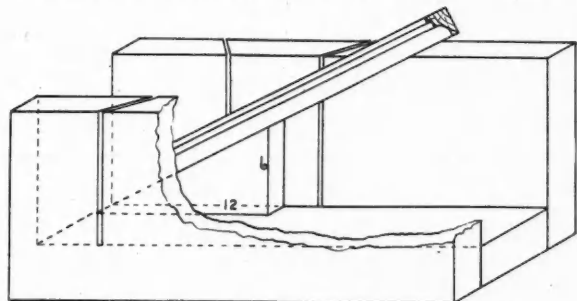

Miter Box and Pitch Board to Cut Rake Moulds.

tration. The typical moulding, C, is mitered with its back against the side of the box, same as ordinarily, except it rests on the block, as shown. Then reverse ends and cut again. This has the front moulding, C, ready to nail on the corbel. Now, for the two side mouldings, or developed ones, remove the block and miter them in the same box in the regular way, as though they were not developed; that is, keep the backs against the side of the miter box and the trick is done. If I have made myself clear on this, you will not have any trouble in mitering three different shaped mouldings, with little or no over-wood.

**A MANUAL TRAINING "AT HOME."** I recently made a visit to the Commencement exercises of the local High School. I never could figure out where the commencement came in unless it is that the students commence to hunt around for something to do for all the fuel the Old Man shoveled into them during the past winter. Anyway, I was shown through the manual training ward. One boy was making a book-rack. He was so full of speed he looked like a box nailing machine with the D. T.'s. Another fellow was building a tabourette. He had so many hammer marks in it, it looked like the flat side of a dog biscuit. Another fellow who seemed very anxious to get through with a small cabinet and explain its works and valves, etc., hit his fingernail with the hammer. One of the visitors asked him if he hit the wrong nail. The last I saw of this fellow was headed off towards the emergency hospital. Another boy was doing some wood turning. The attitude of this husky was formidable enough to fit a German cruiser, and at that he was trying to turn a piece of wood no larger than one of Rockefeller's gifts to charity. One young American was showing the possibilities of a hand-saw. The fellow was so intent on following the line, his chin stuck out so far it looked like the cow-catcher on a Big Four yard engine. So went the merry whirl of youthful workers and crowds of interested and innocent on-lookers.

The working of wood, as I've said before, can become a pleasure and also a task. Take the leather-fisted husky behind a fast fed planer on a day when Mr. Fahrenheit's mercury says  $94^\circ$ . This man would not think woodworking an interesting art, if he said it himself. That's work. But the man of leisure, who, for mere pastime, does pyrography on bass-wood, and other light and fancy things where woodworking comes in; this fellow thinks it one of the greatest amusements on this planet.

I have no fear of the wood supply petering out during my existence, but cement and steel, particularly cement, are coming to the bat. It is getting so now-a-days a tie post is a novelty, in fact, they will only be found in museums in a few decades. So we woodworkers must keep on cutting, and, as Shakespeare says in Julius Ceasar, "We must take the current when it serves or lose our ventures."

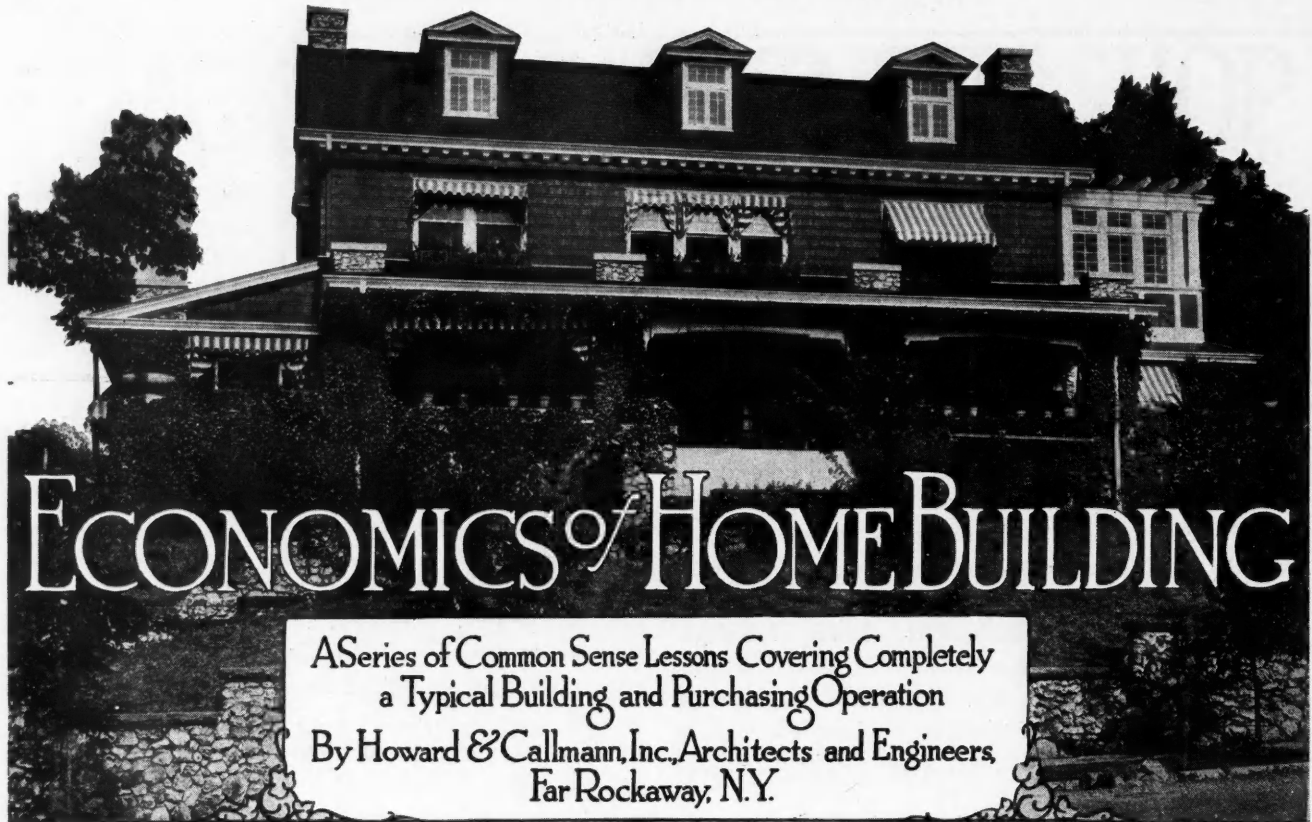

# ECONOMICS OF HOME BUILDING

A Series of Common Sense Lessons Covering Completely  
a Typical Building and Purchasing Operation  
By Howard & Callmann, Inc., Architects and Engineers,  
Far Rockaway, N.Y.

IN TWELVE PARTS—PART IX

## Explanation of Specification Provisions— Carpentry Finish

**C**ONTINUING the study of typical carpentry specifications, we next come to the mill work and carpentry finish.

(198) *Cellar Window Frames.* Supply and set cellar window frames made out of 3" x 4" white pine with half-inch rabbet to receive the hinged sash.

(199) *Box Window Frames.* All the windows shall have white pine box frames, made with 1 1/8" pulley stiles, 2" rabbeted sills, 7/8" x 8" check sill, 1 1/8" x 4 1/2" blind stop and 1/2" x 1" parting strip.

Flash around outside of window frames with two-ply tar paper and make them weatherproof.

*Box frames are constructed to hold weights which balance with the sash and are necessary to make the sash work easily.*

*A "pulley stile" is the face of the box frame against which the sash slides.*

*A "rabbet" is a channel sunk on the edge of the sill.*

*A "check sill" is set over the heavy sill.*

*A "blind stop" is the wood trim which shows on the exterior of the building around all window openings.*

*A "parting strip" is the projecting nib between the two sash.*

(200) *Sash.* All sash throughout shall be of white pine 1 1/2" thick and double hung.

*White pine is universally used for sash as it does not warp.*

**Exterior Millwork—Interior Millwork—Flooring—Doors and Windows—Glass—Stair Case Work—Miscellaneous Finish**

(201) *Glass.* Glaze all window sash throughout. Include for glass in entrance doors to main Hall and French casement doors between rooms.

Glass shall be strictly first quality, and shall be clear and well tacked and puttied.

All rabbets shall be painted one coat before the glass is set.

*"Rabbet" is the jog in which the glass is set. If the rabbet is not painted the putty will fall out.*

All glass shall be "Double thick American" except that in basement, which shall be "Single thick American."

Kitchen door upper panel shall be glazed with 1/4" plate glass.

*Single thick glass is suitable for basement windows or small panes. It is about 1/16 of an inch thick. Double thick glass is suitable for large panes up to 3' x 3'. It is about 1/8 of an inch thick. Plate glass is a fine grade of glass, very clear, suitable for large windows. It is 1/4 of an inch thick.*

(202) *Exterior Woodwork.* Exterior woodwork shall be of clear white pine for cornices, soffits, fascia work and mouldings, and shall be made in accordance with the Architect's full size detail drawings.

*White pine is specified for exterior woodwork—as it is good for the purpose. Cypress is very serviceable and costs less.*

A "cornice" is a project moulding composed of several parts.

All soffits of cornices, gable rake and other projections shall be ceiled up.

A "soffit" is the underside of a projecting cornice.

A "facia" is a board which is to be exposed in the finished work.

"Mouldings" are wood strips shaped to certain forms.

A "gable" is the triangular form of roof.

(203) *Door Frames and Jambs.* Front and rear doors shall have  $1\frac{3}{8}$ " rabbeted jambs of white pine with 2" sill.

All inside door jambs shall be  $1\frac{1}{8}$ " thick with  $\frac{1}{2}$ " rabbet for door.

"Rabbet" is the jog in the door frame which receives the door when closed.

### Inside Trim (Door and Window Casings)

(204) *Back Band Trim.* Trim all door and window openings throughout all floors with a trim made up as follows: First a flat piece of trim  $\frac{7}{8}$ " x  $4\frac{1}{2}$ " with moulded edge, the moulded edge shall be worked as the window stop in the window trim. This flat trim shall be set with a horizontal joint at the head of each door and window. Against the flat trim set a back band  $\frac{7}{8}$ " x  $1\frac{3}{4}$ ", and at joint of the flat trim and back band set a mould  $\frac{3}{4}$ " x  $\frac{7}{8}$ ".

"Trim" is the wood casing set as frame around doors and windows.

"Back band" is part of the trim. It is set against the plaster and the flat part of the trim.

"Window stop" is the strip of wood set against sash to hold the lower sash into place.

Set a  $\frac{1}{2}$ " x  $\frac{1}{2}$ " wall mould at the intersection of the back band and plaster face; it shall be run all around each opening and on top of the base board around each room.

"Wall mould" is a small bead to cover the joint of the wood trim and the plaster.

(205) *Stools and Aprons.* All windows shall have  $\frac{7}{8}$ " stools and  $\frac{7}{8}$ " x 4" moulded aprons.

A "stool" is the inside window ledge. An "apron" is the moulding set against the plaster under the stool.

(206) *Moulded Trim.* All trim shall be moulded in accordance with the Architect's detail drawings.

(207) *Base Boards.* Set a moulded base board around each room  $\frac{7}{8}$ " x 8" high—the wall mould of trim shall be run on top of the base. Set a 6" base board around all closets with bevelled edge.

(208) *Hardwood Trim.* Trim of Living room, Dining room and Hall shall be of straight oak (or other hardwood as may be preferred).

Quarter-sawed oak can be used, but it is more expensive.

(209) *Second Story Trim (Door and Window Casings).* Trim of second story shall be of white pine (or other wood desired).

(210) *Trim of Kitchen, Butler's Pantry, Etc.* Trim of kitchen, butler's pantry and servant's bed-

room shall be of white pine.

White pine is specified for the working department; it makes a good base for paint. Varnished woodwork is not good as it discolors quickly.

### Doors

(211) *Single Doors.* All interior single doors shall have five horizontal panels, blind tenoned and a mould worked on stiles.

"Stile" is the heavy frame of a door.

"Tenon" is a 3" piece of the horizontal door stile, which is sunk into the vertical stiles to hold them together.

"Blind" means that the tenons must not pass clear through the vertical stiles as they would show on the edge of the door.

A "panel" is the part of a door between the horizontal and vertical stiles.

(212) *Front Entrance Door.* Front door shall be 2" thick, with sash as shown on the drawings and made of the same wood as the trim in the Hall.

"Sash" in a door means there is to be a glass panel or panels.

(213) *Side and Rear Doors.* Side and rear doors shall be  $1\frac{3}{4}$ " thick, with sash in the upper panel.

(214) *First Story Doors.* First story doors shall be  $1\frac{3}{4}$ " thick, French casement doors  $1\frac{3}{4}$ " thick, with astragal on both sides.

"Astragal" is a strip of wood set on the edge of one of a pair of doors to cover the meeting joint.

(215) *Second Story Doors.* Second story doors shall be  $1\frac{3}{4}$ " thick, birch veneered. Closet doors shall be  $1\frac{1}{2}$ " thick.

Stock birch veneered doors can be purchased at a lower figure than the ordinary doors can be made by the average mills.

"Veneer" is a thin surface of wood glued to a central wood core; most hardwoods, if used in heavy pieces, warp and are not suitable for doors. It is better to have a door made of white pine and veneered with wood to match the finish of the rooms.

### Staircase

(216) Build Staircase from first to second floor of Straight Oak as follows:

Strings  $1\frac{3}{4}$ " thick, treads  $1\frac{1}{8}$ " thick and  $10\frac{1}{2}$ " wide, risers  $\frac{7}{8}$ " thick and  $7\frac{1}{2}$ " high, with projecting nosing and mould under nosing. Treads and risers shall be housed into strings, wedged and glued together.

(217) *Carriages.* Set a 4" x 6" carriage under the center of the Staircase to stiffen the treads and risers.

"Strings" are the wood supports on the side of a staircase into which the treads and risers are set. If the steps up the staircase are to show on the side it is an open "string," if they are not to show it is a closed "string."

A "riser" is the vertical piece between each tread. A "tread" is where the foot is set. A tread always projects over the riser—the projection is called the "nosing" and a mould is set under it.

"Housing"—a groove cut in the strings to receive the ends of the treads and risers.

(218) *Newels*. Main newel shall be 6" x 6" paneled and moulded with moulded cap. Balance of newels shall be 4" x 4" paneled and moulded as per detail drawings.

*A "newel" is a vertical post which receives the handrail.*

(219) *Handrail and Balusters*. Moulded handrail shall be 3½" x 4½", with ramps to newel posts.

*"Handrail" is the sloping rail for the hand.*

Set two balusters on each step 1¾" x 2⅞" sawed out as per detail drawings.

*The curved part of a handrail where it strikes the newel post is called the "ramp."*

Include for facias and turned rosettes where the handrail ends against the wall.

(220) *Cellar Stairs*. Build cellar stairs with 1¾" strings, ⅞" x 8½" risers, 1¾" x 9½" treads of yellow pine, with round handrail and square newel.

#### Special Interior Finish

(221) *Dining Room Wainscot*. Set in dining room a paneled wainscot, height 5' 6" from finished floor to the top of cap, built two panels high with vertical stiles as near 18" on centers as the breaks in the room will allow. Stiles ⅞" x 3" with a ½" x ½" mould run around each panel.

*"Stile" in this case means the vertical and horizontal pieces into which the panels are set.*

Run an 8" moulded base at the bottom of the wainscot, and a 1¾" x 4" moulded shelf as a cap, with sawed out brackets 1⅞" thick set over each stile.

(222) *Wood Cornice in Entrance Hall* Set a 6" wide and 6" deep wood cornice at intersection of ceiling and side walls in the entrance hall.

(223) *False Ceiling Beams*. In living room and dining room set false ceiling beams as indicated on the plan—size 6" x 8" with a crown mould 2" x 2" set at intersection of the false beam and the plaster of ceiling. Set a half beam around all side walls with a crown mould, and a bed mould set at intersection of the underside of the false half beam with the vertical plaster wall.

*False ceiling beams are set over the finished plaster ceiling, and do not support the floors above.*

*A bed mould is always set at the intersection of a vertical and horizontal plane.*

The wainscot, ceiling beams and cornice shall be of straight oak and according to the detail drawings.

(224) *Flooring*. Lay flooring on all floors of combed grain N. C. pine T. and G., blind nailed, measuring 2½" between the exposed joints when set.

*"Combed" means edge grain, or quarter-sawed.*

All floors shall be scraped before the Painter starts his work.

*Scraping of floors is necessary to bring all the boards even.*

#### Closets

(225) *Bedroom Closets*. All Bedroom closets shall be trimmed with 4" mitered beveled edged trim on the inside and shall have two shelves, one on top of base, and one 5' 6" up from finished floor. Set a pole 2" diameter from wall to wall for clothes hangers, pole shall be set at each end on a moulded wood disk sunk to receive the pole, one disc to have groove to remove pole when desired.

(226) *Store Closets*. Linen, kitchen and laundry closets shall have four shelves full depth of closet.

(227) *Dressers*. Build and set dressers in kitchen and butler's pantry with 1½" top and three drawers under the top. On one side of the dresser continue with drawers to the base, and the balance of the space under dresser top shall be made into closet space with wood panel doors and shelves. Upper part above the dresser top shall have three rows of shelving for china enclosed with hinged glazed doors and supplied with cleats and hooks complete.

Dressers shall be 7' 6" high of width and depth shown on the drawings.

(228) *Drip Boards*. Kitchen and butler's pantry sinks shall have 1⅞" grooved drip boards of ash, size shown on the plan.

*Ash is the best for drip boards; it does not discolor as readily as other woods.*

(229) *Boxing Pipes*. Supply board supports required for plumber's pipes and box in soil or waste pipes where exposed. Front of box shall be secured with screws.

*Screws are used so the front can be easily removed when necessary.*

(230) *Plaster Guards*. Set guards on all exposed plaster corners.

*"Guards" are of wood and set on the outside plaster angles as a protection.*

(231) *Door Stops*. Set rubber tipped stops to all doors.

*These stops are set on the base board to prevent the door handle damaging the plaster.*

(232) *Picture Mould*. There shall be picture moulding ⅞" x 1½" in all rooms and set where the Architect directs.

*The picture mould should be set at the intersection of side wall and ceiling.*

(233) *Clothes Posts*. Include for four turned clothes posts in yard.

(234) *Boxing of Rough Wood*. Box in all rough wood around side entrance and finish with facias around plaster wall.

*This is to cover up any rough edges of plaster or exposed rough timbers.*

#### Cellar Woodwork

(235) *Coal and Wood Bins*. Build coal and wood bins, size of each shall be 8' 0" x 10' 0" made of T. and G. dressed boards 5' 0" high with studs run to ceiling beams at all angles.

*(Continued to Page 70)*

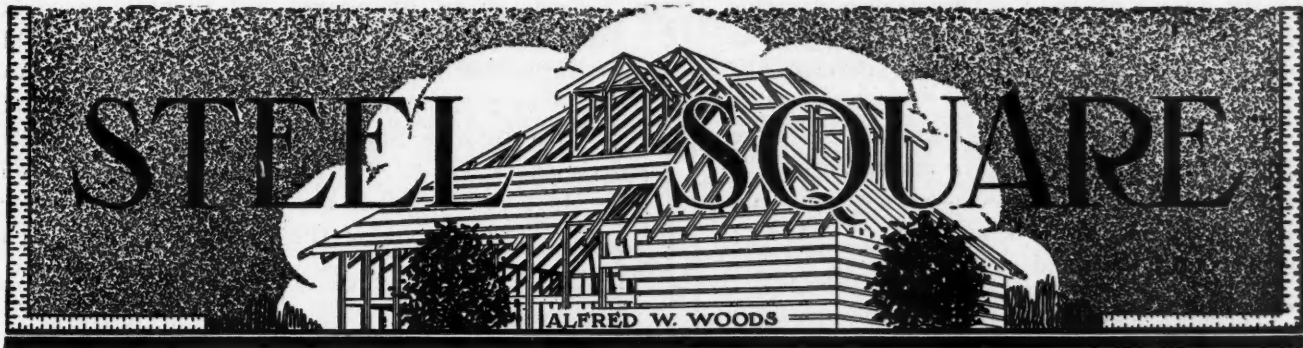

## The Steel Square and Its Uses

DEMONSTRATING THE STEEL SQUARE ON A LARGE SCALE, SHOWING THE SIMPLICITY OF APPLICATION AND HOW THE DIFFERENT PARTS ARE DETERMINED BY THE SQUARE

By A. W. Woods

**S**UPPOSE the steel square be increased twelve times its present size,— that is, instead of having a blade twenty-four inches and with a tongue sixteen or eighteen inches in length, these proportions be suddenly changed to as many feet with the regular inch and fractional divisions. What a huge square this would be. Why, it would take a half dozen men and a good size derrick to handle it!

But, hark! Our ears ring with the Ha, Ha's let loose over the absurdity of such a thing and yet the idea is simplicity in itself, because when the square is placed with the desired run and rise, the proper length and cuts of the rafter is at once solved without any further calculation either in figures or the manipulation of the square.

In Fig. 1 is shown the square in its relative position with a gable or common rafter having a twelve foot run and a fourteen foot rise. Now, the same ratio of proportion must exist at any other place on the square; but the most natural place to take for one of the parts is at 12, because it represents the standard of measurement. This can represent full scale for one foot run

or one-twelfth scale for any run in feet; or if there are fractions of a foot in the run and rise, this can be taken care of by either of two methods.

First, by letting as many inches and twelfth inches represent as many feet and inches respectively. The length of the rafter is then found by scale.

Second, by the full scale for one foot run; it is necessary to place the square as many times as there are feet in the run; and, if there be a fraction of a foot in the run, measure square out from the last plumb line the amount of such fraction; this will give the point for the proper plumb cut for the common rafter. The relative proportion for the hip is to measure off the diagonal length of such fraction.

But let us go back to our big square and show its relative position in connection with a hip roof.

In Fig. 2 is shown such a roof. We have shown it here as though the roof were square simply for illustration purposes, as it brings the rafters to a common center.

A few years ago we published an illustration of this kind and received a letter from one of the readers glowing in praise for the simplicity of the illustration but asked why do you choose a square building for illustrating purposes when, as a matter of fact, they are hardly ever built that way? Here is a case of a man that thought he fully understood the illustration, and yet he failed to see that it applied to an oblong building as well as for one with its four sides of equal length. The framing of the rafters would be the same, and in the case of a building with two of its sides longer than the other two, the difference is made up by filling in between the end framing with common rafters. All the space that is needed to reckon from for the development of the rafters, is that part bounded by the runs of the hip and common rafter and the plate which joins the two. This forms a right angle triangle. This is well illustrated by the use of squares in Fig. 2.

NOTE—Square No. 1 is lying flat on a level surface and Square No. 2 is standing vertically with its heel at 12 on the blade and with its tongue crossing at 12

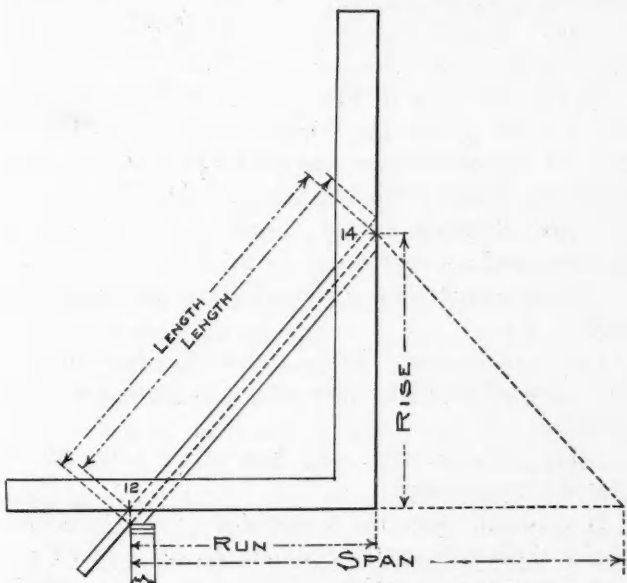

FIG. 1.

Steel Square Applied to Common Rafter of 12 ft. Run and 14 ft. Rise.

on the tongue of No. 1. This angle formed by the two squares furnishes the triangle or plan as above mentioned from which to develop the rafters.

NOTE—The figures shown on square No. 1 are those that give the miter for a square corner. If our subject had been an octagon, we would use the figures that give the octagon miter (12 and 5) and we would proceed in the same manner as here outlined for the square corner.

Square No. 2 is made to represent the base and altitude of another triangle, and by the addition of square No. 3 forms the base and altitude for still another triangle; and still there are others, but we have gone far enough to illustrate the

point in hand,—namely, the run and rise of the hip and common rafter.

Square No. 3 bears the same proportion as No. 3, but rests at right angles to it and gives a better view of the true position that it occupies in the roof. In this, we have shown 14 to be the rise and the dotted lines converging from that point to those on the plan represent the position of the rafters together with their respective runs and rise. Remember, the rise can be anything from nothing up, as high as you choose to go; but the figures on the plan, as shown on Square No. 1, and on the tongue of Nos. 2 and 3, remain the same.

The position of the squares in connection with the dotted lines clearly shows the parts to take for the seat and plumb cuts for the rafters. The jack rafters are not shown here—neither is it necessary, as the jack is but a part of a common rafter and therefore its seat and plumb lines remain the same as for the common rafter; but in connection with the latter it requires the cut to be made at an angle across the back of the rafter to fit against the hip—which is commonly called side cut of the jack.

This is a cut that bothers a good many, though needlessly so. If they would just stop a minute and do a little thinking the problem would naturally solve itself. If there was no pitch, this cut would simply be a 45 degree cut and the figures as shown on Square No. 1 would be the proportions to use; run and tangent which in this case are the same (12 and 12); but when a pitch is given, the length of the rafter must be used instead of the run, and in the case of the illustration would be 12 and  $18\frac{1}{2}$ .

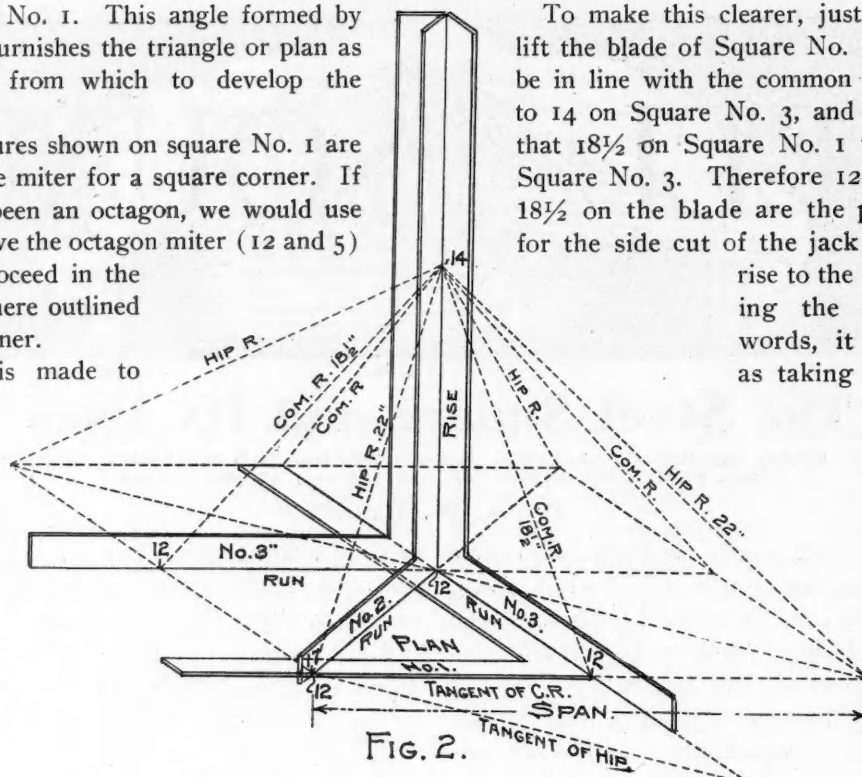

FIG. 2.  
Giant Size Squares Demonstrate Rafter Framing Methods.

To make this clearer, just suppose we could lift the blade of Square No. 1 up until it would be in line with the common rafter, as from 12 to 14 on Square No. 3, and it would be found that  $18\frac{1}{2}$  on Square No. 1 would be at 14 on Square No. 3. Therefore 12 on the tongue and  $18\frac{1}{2}$  on the blade are the proportions to use for the side cut of the jack and for a 14-inch rise to the foot; the blade giving the angle. In other words, it is just the same as taking the distance from

the corner along the plate to the foot of the common rafter and the length of the common rafter. This rule applies to any angle the building may have and therefore is a general rule. The same principle applies to

the side cut of the hip, which we trust is clear enough without further explanation.

### ✦ Carpentry Specifications

(Continued from page 68)

(236) *Trunk Platform.* Build a platform 1' 6" high from cellar floor for trunk storage.

(237) *Storage Closet in Cellar.* Build a storage closet 8' 0" x 8' 0" of  $\frac{7}{8}$ "  $2\frac{1}{2}$ " dressed slats set  $\frac{1}{4}$ " apart and run from floor to ceiling, with slat door and padlock. Set four lines of shelving around three sides of closet.

*Slats are used to ventilate the basement closet. Dressed is planed smooth.*

(238) *Metal Weatherstrips.* Metal weatherstrips are to be set on all windows throughout.

Include the sum of One Hundred (\$100.00) Dollars for this work; the Owner reserves the right to give out this work direct and deduct the One Hundred (\$100.00) Dollars from the contract price.

(239) *Window Easing.* Contractor shall ease all windows and doors at entire completion.

*This is to make the windows and doors fit and work easily.*

(240) *Cleaning.* Scrape stains off glass and have same cleaned and leave everything in perfect working order.

(241) *Fly Screens.* Fly screens are not to be included in this contract.

*It is best to have the manufacturers of fly screens figure separately as the Builders profit is saved and they install them complete. Full length outside screens are recommended as ventilation can be had from the upper and lower part of a window at the same time.*

## Stripping for Profits

NOW IS THE ACCEPTED TIME—DON'T WAIT FOR THE COLD WEATHER

**F**ROM now on the contractor and carpenter does not find business very brisk in his line; and the wise ones have discovered a way to earn good money with a very small investment, by taking an agency for a line of metal weather strips which can be sold and installed by his regular men or by himself. However, in selecting a weather strip to represent, be careful to get one that has all the talking points as well as being practical in use.

Heretofore the weather strip business has been made a mystery of the manufacturer refusing to sell the material to any one but the territorial agent who would install it, making a large profit off the contractor. However, a great many manufacturers have seen the "handwriting on the wall" and have offered to sell the material to any live, responsible contractor or carpenter, together with instructions, etc. Any carpenter of ordinary intelligence can install metal weather strips; and this work really belongs to him as much as the fitting of sash, etc., does.

There are numerous kinds of weather strips on the market, but the most successful ones are made of zinc or copper. In selecting one should always take into consideration the ease with which it can be installed, but most important, be sure and see that the one you select is so made that it can be removed without damage when it is necessary to take out the sash. Another important feature to consider is whether it will allow for shrinkage and swelling of the sash. It is a well known fact that sash have a tendency to warp, and when it does so it generally binds and causes the window to work hard or not raise at all. A weather strip, to be practical, must contain features for easy removing, and be flexible so as to go and come with the swelling and warping of the sash. These features are important because your customers will condemn the strip if it gives them any trouble after it is installed, so be safe and see that you select a strip that provides for these conditions.

### The Selling and Money End

The selling of the strip is a matter of persistent effort as most all manufacturers have a line of selling talk that is not only convincing, but most of them have the finest kind of letters of recommendation from people who have tested them out. The benefits derived from weather stripping are now recognized by all up-to-date architects and builders. The saving in fuel alone is one of the best features. The installation of the strip is simplicity itself, notwithstanding some manufacturers to the contrary. Instructions are generally very clear and the models that manufacturers supply their agents are actual demonstrations of how the strip is applied.

The profits to the agent are without question good.

It is quite possible to clear as high as \$10.00 per day, all depending on your ability as a salesman. The average record for a day's work of installing metal weather strip is 150 feet per day of nine hours. Figuring 50c per hour equals \$4.50, or 3c per lineal foot for labor. The average cost of material runs around 5c per lineal foot, making a total cost of 8c per lineal foot for labor and material. The average window requires about 20 lineal feet of strip, and the average charge to consumer is about 15c per foot installed in the building, making the charge for the average window \$3.00, which leaves a profit after deducting labor and material of \$1.40 per window. An ordinary house has from 10 to 15 windows, say 10. You get \$30.00 for the job. Deduct \$16.00 for labor and material and your profit is \$14.00. The pleasing part of this business is the fact that you do not have to invest a dollar in it until you have actually sold the goods.

### Easy to Get Started

All manufacturers of metal weather strip furnish samples or models, some more elaborate than others. Some of the larger ones have beautiful outfits complete in themselves, which they loan you for soliciting purposes, requiring a deposit on them, which is immediately returned to them when the models are returned to them.

Every carpenter has about all the tools necessary to install strip, with the exception of a special plane and a pair of small snips. These can generally be bought from the manufacturer at cost, while some furnish these free of charge.

The possibilities of this business are great. Because of the money saved in fuel by their use they interest every home owner, and the fact that they can be installed in old buildings as easily as new makes the field unlimited. The successful agent is the one who gets hold of the best line and keeps continually putting it before the people by personal solicitation. It takes perseverance and determination but the results justify the efforts.

We advise all those contemplating taking this business up to write to the different advertisers in our columns and get all the information they want, then select what is, in their judgment, the best one, and try it out.

Many contractors and carpenters handle a line of weather strips in connection with their regular business, and are making a good profit, which helps out greatly during the fall and winter months.



### In No Position to Urge Payment

"Why did you throw up that job I got you as collector for Jones?"

"Why, hang it, I owed money to about all the men he sent me to dun."

# Anchoring Houses in Overflow Districts

DETAILS OF INEXPENSIVE LOG ANCHOR SCHEME—ALSO OF REINFORCED CONCRETE ANCHORING

By B. Youngblood

Director Texas Experiment Station.

**A** CONSIDERABLE loss of houses occurred during the recent floods on the Brazos and Colorado rivers and their tributaries, which might have been avoided had the houses been securely anchored to the earth.

For the convenience of those wishing to secure their houses so that they will withstand the heaviest floods, the writer has had Professor A. Mitchell of the School of Engineering, A. and M. College of Texas, prepare plans for two kinds of foundations or piers, to be used in anchoring houses in the river bottoms. The first design, as shown in Figure 1, calls for three logs, an iron rod, two washers, two nuts, and some tar for painting the iron. It shows the pier to be a log averaging 10 inches in diameter, and the other two logs, or "dead men," 12 inches in diameter; the rod to be 11 feet and 8 inches long and 1 1/4 inches in diameter, assuming that an elevation of six feet is necessary in order to keep the house above the water in times of highest overflow. These materials obviously are of sufficient dimensions for most any building likely to be built in the bottoms.

For the smaller tenant houses, provided they are not built in a location where the current is likely to be very strong in times of overflow, smaller rods and shorter "dead men" might be used with safety. The only reason, however, for reducing the size is the matter of saving a few dollars per building in the cost of iron. The elevation of the house is purely a matter of

judgment on the part of the farmer. He can determine for himself how high each building should be elevated above the ground in order that it may remain out of water when the floods are highest. The marks on trees and buildings made by the recent overflow are a very good basis for an estimate of the proper elevation.

The iron should all be cleaned, and painted with hot tar to prevent rusting. A 2x6 stringer, shown in the figures, on top of the floor joists, is provided to overcome the buoyant force of the water and to hold the house firmly in position on the piers.

### Setting the Log Foundation

In setting the log foundation, dig a trench five feet deep, eight feet long, and wide enough for a man to work in. Through the log bore a hole 1 3/8 inches in diameter, three and one-half feet from the end of the eight-foot log. Put the iron rod through this hole, put on the washer, and screw up the nut on the rod. Drop the log into the trench with the rod standing vertically. At right angles to this trench and across the middle, dig another trench six or eight feet long, to the level of the top of the log first placed. Into this trench drop the other log, close to the rod, as shown in the plan of Figure 1.

On top of the second log set the upright post on the horizontal log, at the point of intersection, hewing the bearing surface slightly to give a smooth footing for the post. Fill up the trenches with the same soil as originally removed, and tamp carefully as filled.

Referring again to Figure 1, please note:

1. That the rod is anchored to the lower log.
2. That the upper log lies across the lower.
3. That it is not necessary to tie the logs together, as the soil will hold them in place.
4. That the post sits on the *upper* log immediately above its intersection with the lower.
5. That the logs must be surfaced at the bearing points.
6. That the rod passes through a solid sill (6x6 or 8x8, depending upon the size of the house), up between the floor joists, which should not be lighter than 2x6, and through a stiff stringer, not lighter than 2x6, which is notched into the floor joists.
7. That the rod is fastened by a nut resting on a washer not smaller than five inches in diameter.

### Strength of Rods

The strength of the various sized rods recommended for use in the log foundations will be found in the following:

1/2-inch rod will hold an upward pull of . . . . . 4,000 pounds  
 3/4-inch rod will hold an upward pull of . . . . . 8,800 pounds  
 1-inch rod will hold an upward pull of . . . . . 15,800 pounds  
 1 1/4-inch rod will hold an upward pull of . . . . . 24,600 pounds  
 1 1/2-inch rod will hold an upward pull of . . . . . 35,400 pounds

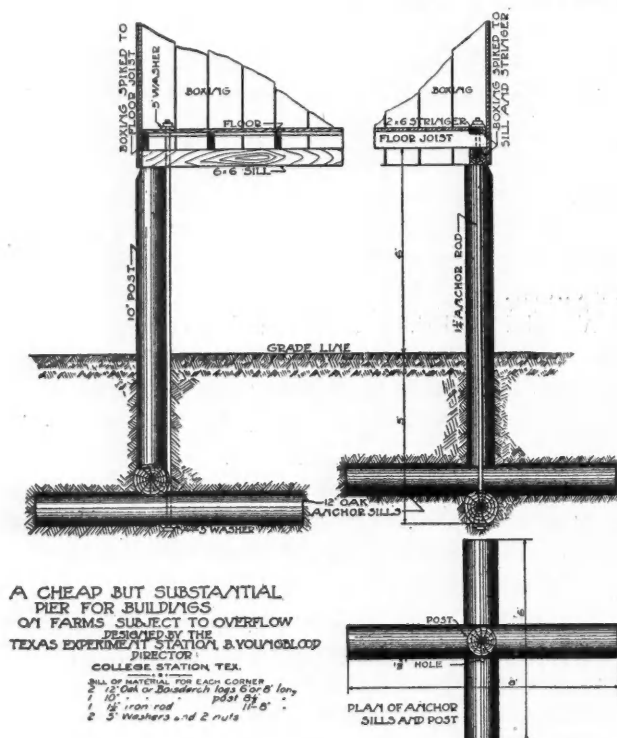

A CHEAP BUT SUBSTANTIAL  
 PIER FOR BUILDINGS  
 ON FARMS SUBJECT TO OVERFLOW  
 DESIGNED BY THE  
 TEXAS EXPERIMENT STATION & YOUNGBLOOD  
 DIRECTOR  
 COLLEGE STATION, TEX.  
 BILL OF MATERIAL FOR EACH CORNER  
 2 10" Oak or Boudierch logs 8 or 6' long  
 1 1 1/4" iron rod post 11' 8"  
 2 Washers and 2 nuts

Fig. 1. Details of Log Anchors for Small Building Corners.



These figures would indicate that even a one-half-inch rod would be sufficiently strong to hold the average river valley tenant house very securely, and, of course, is cheaper than the larger rod.

**Cost of Iron**

I am advised that these rods may be purchased of hardware dealers for three and one-half cents per pound, and the nuts and washers for eight cents per pound.

The following figures will give the weight of the rods of various sizes, per foot, from which one can easily compute the cost of a sufficient number of rods to anchor a given house:

- 1/2-inch rod weighs .67 pounds per foot.
- 3/4-inch rod weighs 1.5 pounds per foot.
- 1-inch rod weighs 2.67 pounds per foot.
- 1 1/4-inch rod weighs 4.17 pounds per foot.
- 1/2-inch nuts weigh 14 nuts to the pound.
- 3/4-inch nuts weigh 4 3/4 nuts to the pound.
- 1-inch nuts weigh 2 1/4 nuts to the pound.
- 1 1/4-inch nuts weigh 1 1/4 nuts to the pound.

Four rods 11 feet and 8 inches long, eight washers, eight nuts, and two 2x6s to go across the ends of the floor joists are all the materials that would have to be bought in order to anchor a rectangular house according to the plans suggested.

For convenience, we will figure that each nut and washer for the rods will cost five cents each, or a total of eighty cents per rod, for washers and nuts.

Using the preceding figures, the cost of hardware for anchoring one house will be as follows:

Using 1/2-inch rod:	Using 3/4-inch rod:
4 rods 11 ft. 8 in. long =	4 rods 11 ft. 8 in. long =
46.66 ft. = 31.26 pounds	46.66 ft. = 70 pounds at
at 3.5c per pound. .... \$1.10	3.5c per pound. .... \$2.45
8 washers at 5c each. .... .40	8 washers at 5c each. .... .40
8 nuts at 5c each. .... .40	8 nuts at 5c each. .... .40
<b>\$1.90</b>	<b>\$3.25</b>

Using 1-inch rod:	Using 1 1/4-inch rod:
4 rods 11 ft. 8 in. long =	4 rods 11 ft. 8 in. long =
46.66 ft. = 125 pounds	46.66 ft. = 194.5 pounds
at 3.5c per pound. .... \$4.35	at 3.5c per pound. .... \$6.81
8 washers at 5c each. .... .40	8 washers at 5c each. .... .40
8 nuts at 5c each. .... .40	8 nuts at 5c each. .... .40
<b>\$5.15</b>	<b>\$7.61</b>

The cost of digging the trenches for the "dead men" and of getting out the logs is not included, but certainly the total expense, everything counted, is insignificant when considered as an assurance that the house will not be washed away.

**Reinforced Concrete Anchors**

Figure 2 shows details for reinforced concrete pier, which is described as follows:

This figure represents two reinforced concrete piers, one for a corner and one intermediate pier. The specifications given are for 1:3:5 concrete. The footings may be reinforced with rods or old railroad rails, as shown in the sketch. The reinforcing should be placed near the upper surface of the footings, since that surface is in tension due to the upward and lateral force of the water in times of flood. The reinforcing rods and anchor rods should be bent at the ends, as shown. The stringer shown on top of floor joists should be stiff, as it is depended upon to hold the floor system down and overcome the buoyant force of the water. It is estimated that a force of ten tons would be required to lift one of these piers out of the ground.

Plantation and farm owners are urged to anchor their houses, not only as a protection to the houses, but also to the lives of the people on the farms. The purpose in elevating the houses is twofold: First, to keep them above the water; and, second, to improve health conditions.

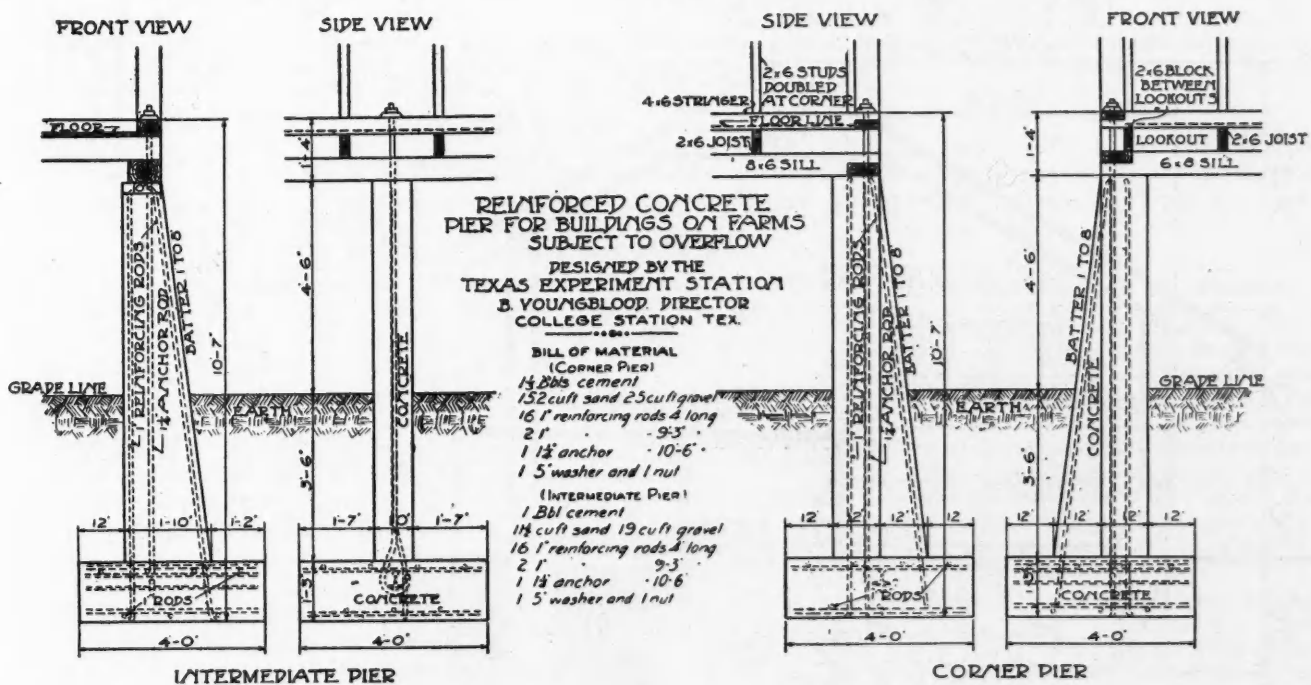
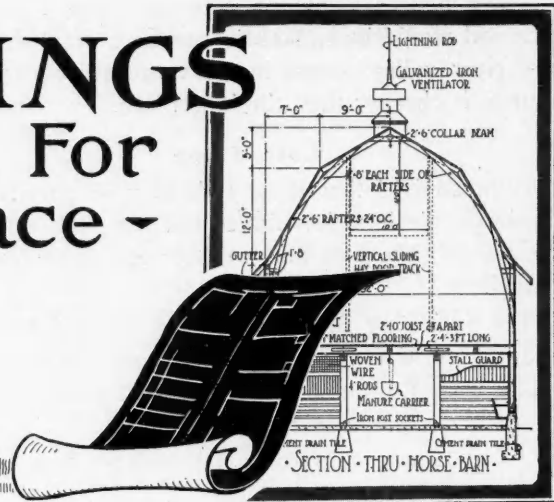
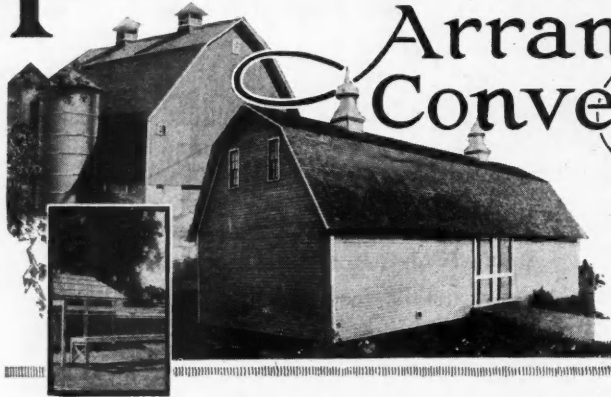

Fig. 2. Details of Reinforced Concrete Anchors to Hold Down Larger Buildings.

# FARM BUILDINGS

## Arranged For Convenience



### Farm Poultry House. Size 20 by 14 feet

A medium sized poultry house suitable for farm use is shown in Design No. A338.

It is 20 by 14 feet in size and is divided into two rooms, one for the general laying hen department and the other as a special room for incubating and brooding purposes.

The construction of this poultry house has been very carefully worked out along permanent lines. Farm

poultry houses too often are carelessly built. Poorly constructed houses become so infested with vermin of different kinds that it seems better to tear them down and build new than to try to renovate them. Modern poultry houses are much better than the old-fashioned sort, and the breeds of poultry have improved to such an extent that better houses are becoming quite common.

This house is built with a good solid concrete foundation that goes below

frost. The floor also is of concrete or lime. Some poultrymen prefer building a floor of lime. Ordinary burned lime is spread over the ground several inches deep and pounded down and made level. Water is then thrown on the lime to cause it to slack. Enough water is used to slack the lime into a pasty mortar, and it is left in this condition until it dries and hardens. This kind of a poultry floor is not so hard as concrete and the chickens will scratch depressions in it in

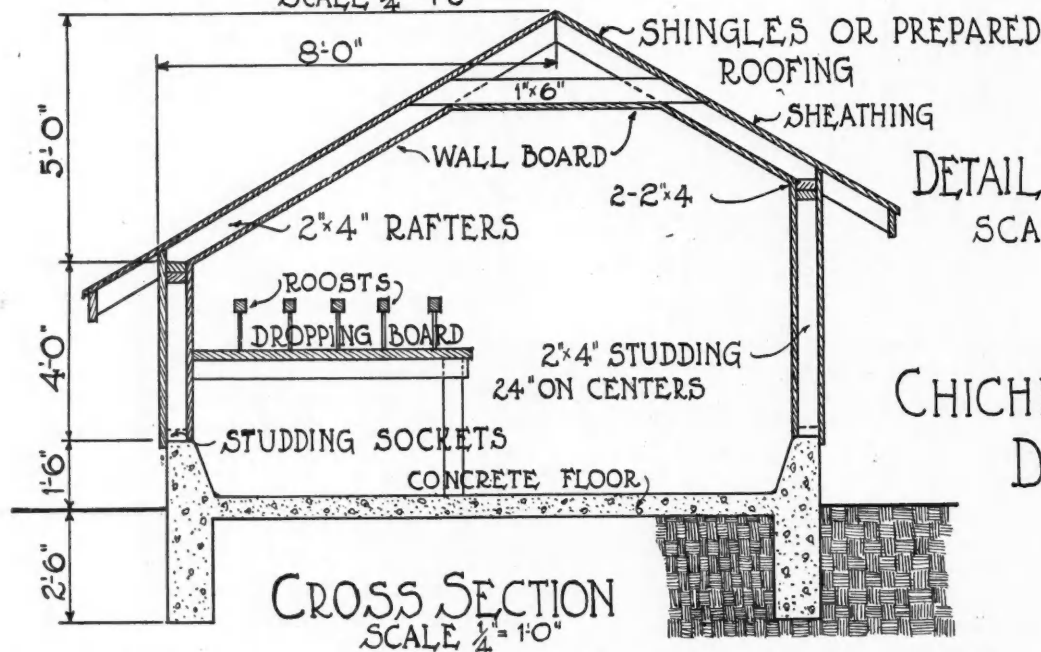
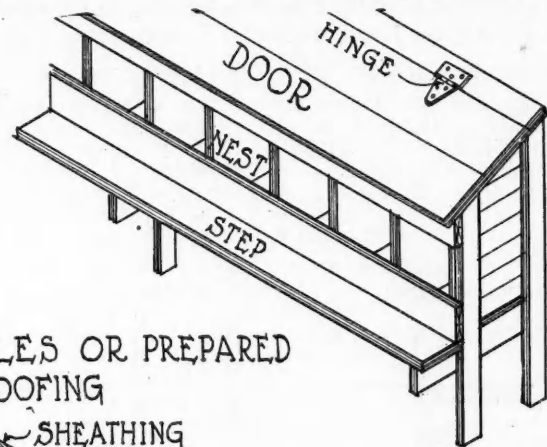
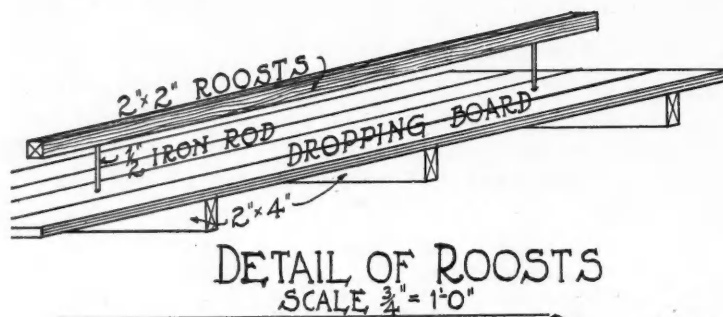

### CHICKEN HOUSE DETAILS

Working Details of Poultry House Construction (Design A338), 20 by 14 Feet in Size, Shown on Opposite Page.

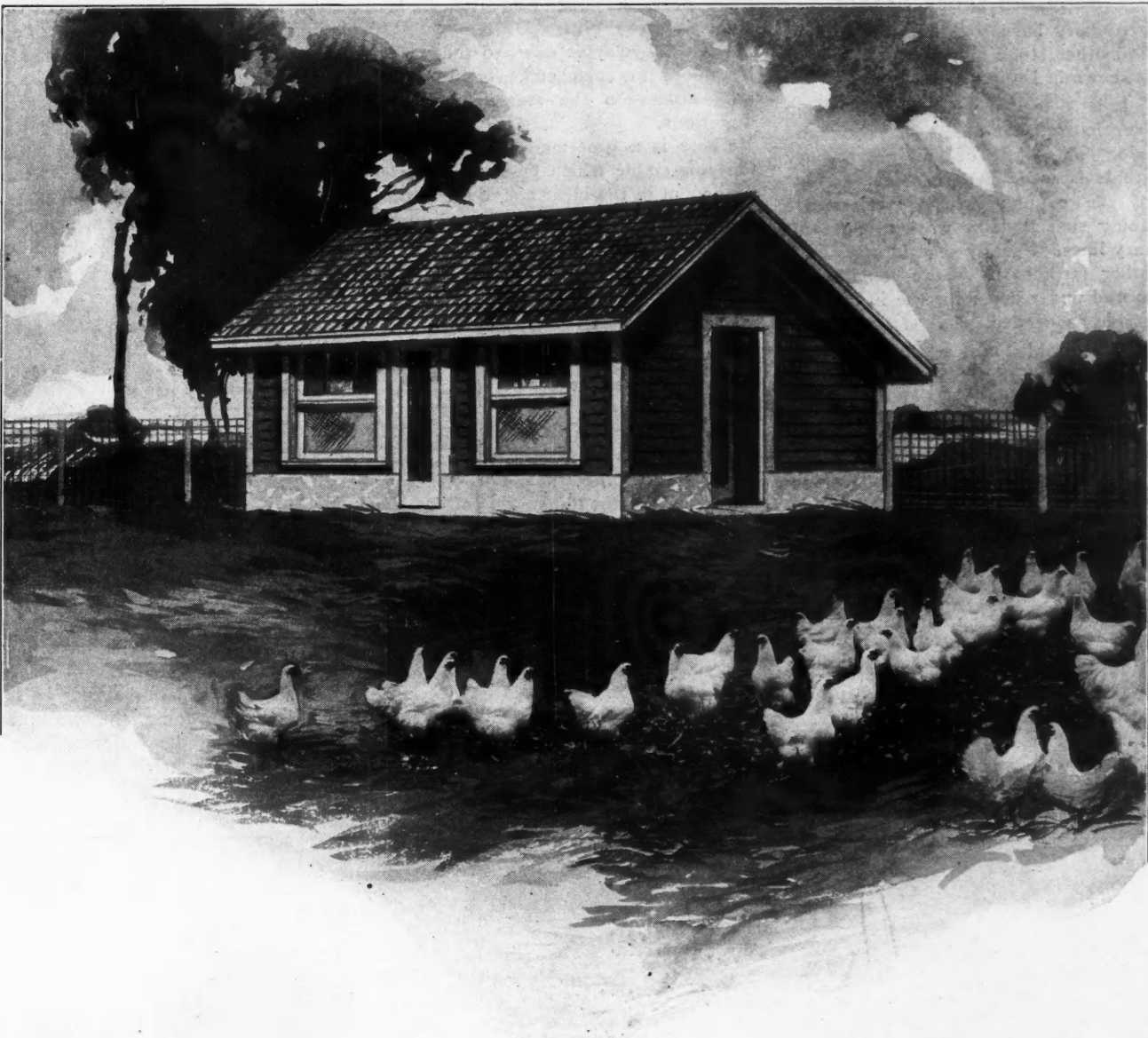

**Farm Poultry House Containing Two Rooms.** Size on the ground 20 by 14 ft. We can furnish complete set of blue-printed working plans and typewritten specifications for only \$3.00 per set. When ordering, ask for Design No. A338.

places in their efforts to uncover the grain that is scattered in the litter.

In digging up the ground, they get considerable lime, which goes to manufacture egg shells. If the original lime is good and the slacking is nicely done, the floor is satisfactory for some time. If soft places develop and the hens dig clear through, it is easy to throw a little fresh lime and water enough to slack and fill the depression.

There are poultrymen who insist that this is the only method known to the poultry fraternity for making a faultless floor. This kind of a floor may be made to cover both of these rooms or only one of them, but there probably is no better way to make poultry floors for the benefit of the hens or young chicks, and it is a floor that will discourage rats and mice

almost as effectually as concrete. This is one great advantage in using concrete or lime in the bottom part of a poultry house.

In building the walls, bolts are embedded in the concrete, which pass through augur holes in the sills. As the sills are put down, the top of the wall is spread with soft cement mor-

tar, so the sills are embedded. The mortar is troweled up against the sills inside and outside carefully to prevent a draught.



### Colony Houses for Poultry

Our colony houses are small affairs. They are built on sill runners eight feet long, floored with good matched stuff to prevent drafts from coming up through cracks in the bottom. The fronts are covered with one-inch poultry mesh. Outside of the poultry netting there are doors to close at night. We hitch a pair of horses to the runners of these portable houses and drag them to new feeding grounds as needed.

There is probably no other way of raising poultry in connection with diversified farming that turns out as satisfactorily as colony houses for spring and summer, with a curtain front house for winter use.—Herbert Shearer.

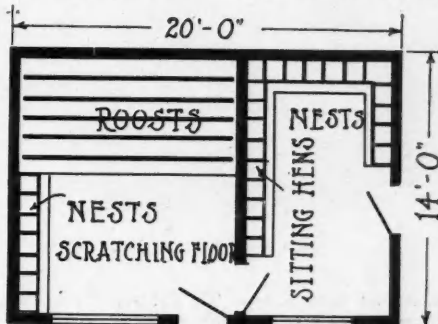

Floor Plan of Farm Poultry House A338.

### Separate Dairy Stable

A dairy barn to hold twenty cows and other stock in the two box stalls is shown in Design A301.

It is 36 feet in width and 54 feet in length, exclusive of the feed room and silo. This style of building a dairy stable is well liked in some sections of the country where farmers are doing special dairy work along sanitary lines. Usually such farmers have other farm barns where roughage is stored under cover for use in the cow stable as needed.

This stable has a solid concrete foundation with walls that extend up two feet above grade. They are waterproofed on the outside to keep moisture away from the foundation.

Inside the foundation walls is a solid concrete floor, which is laid off with mangers at the sides of the center feeding alley, with a cow standing floor, the front portion of which is on a level with the bottom of the mangers. These standing floors slope back to the gutters. The alleys behind the gutters are several inches lower than the standing floors and are wide enough to make room for the manure carriers which run on overhead tracks, so the stable may be cleaned easily and quickly with the

least possible expenditure of hand labor.

Each alleyway is open to the yard by doors in each end, so there is easy access to the stable from all directions.

There is a well made ceiling over the cow stable which gives eight feet headroom in the clear above the floor of the center feed alley. This ceiling is carefully constructed to make it airtight. Ventilation is given at the sides by putting ventilating flues in the walls, which carry the foul air up the slope of the roof to the center monitor windows.

Above the stable is a space that is usually filled at thrashing time with straw for bedding. The straw is let down into the feed room between the stable and the silo, otherwise there is no connection between the stable and the storage room above. Careful dairymen object to having any kind of a storage room in connection with the dairy stable, because of the dust which floats about when the bedding or other roughage is dropped down. But the arrangement of drop-

ping it into the feed room is not objectionable, because the doors are kept shut at such times and the dust is confined to the feed room.

The same chute is used to drop silage from the different silo doors as required. All outside doors are hung with special roller tracks, so they open and shut very easily and fasten with heavy iron fasteners, which may be operated from either the inside or outside.

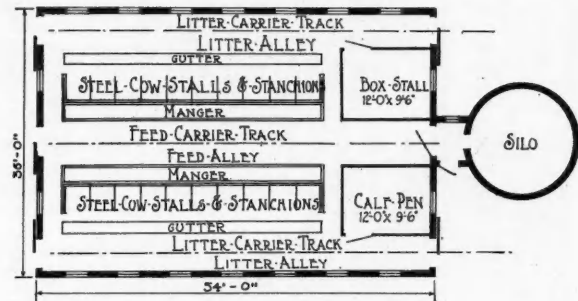

Floor Plan of Dairy Stable A301.

A great many little inventions to the finish of a dairy stable have been put on the market in recent years, which all help as labor savers or for convenience in doing the work, so that dairying is becoming a much more satisfactory business than formerly.

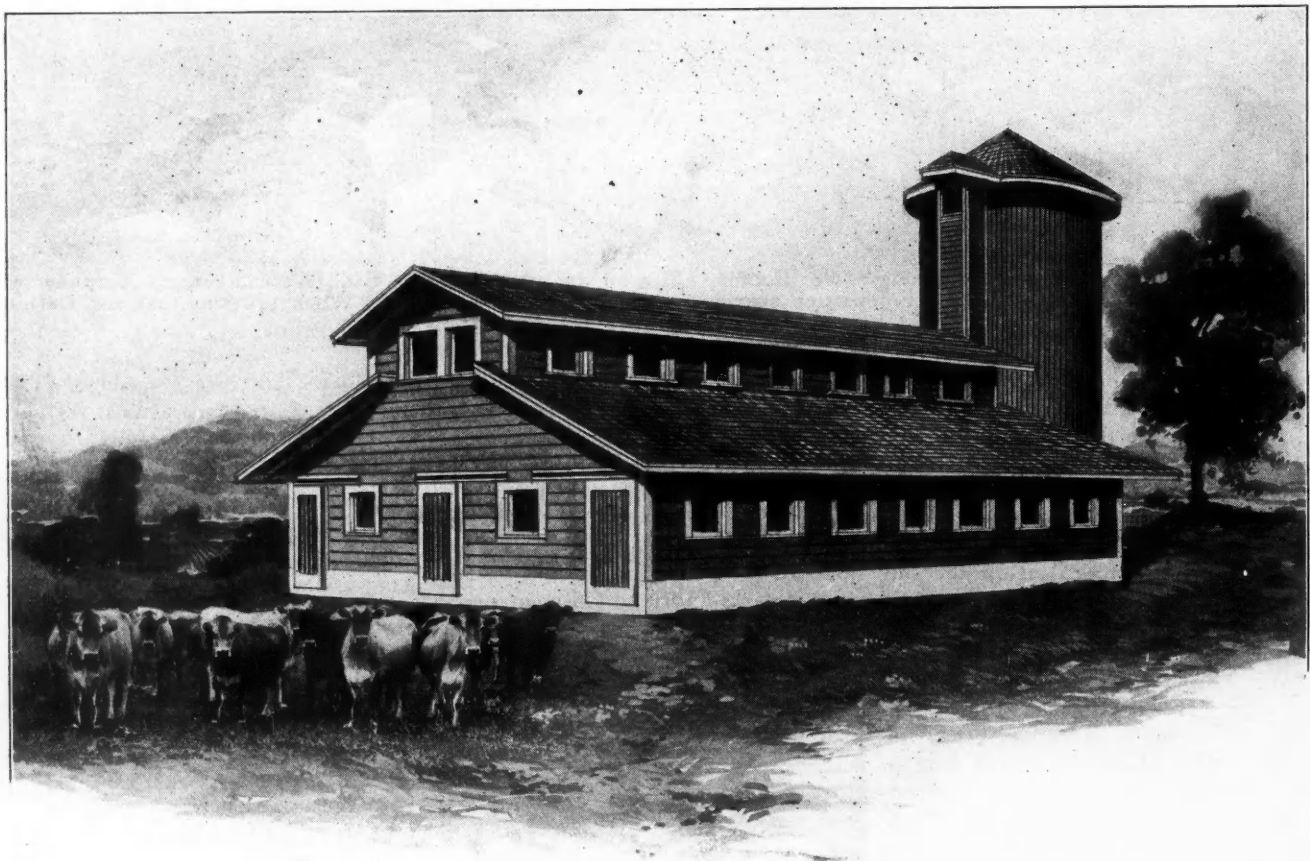

Separate Dairy Stable, 36 feet wide by 54 feet long. To House Twenty Cows. We can furnish complete set of blue-printed working plans and typewritten specifications for only \$7.00 per set. When ordering, ask for Design No. A301.

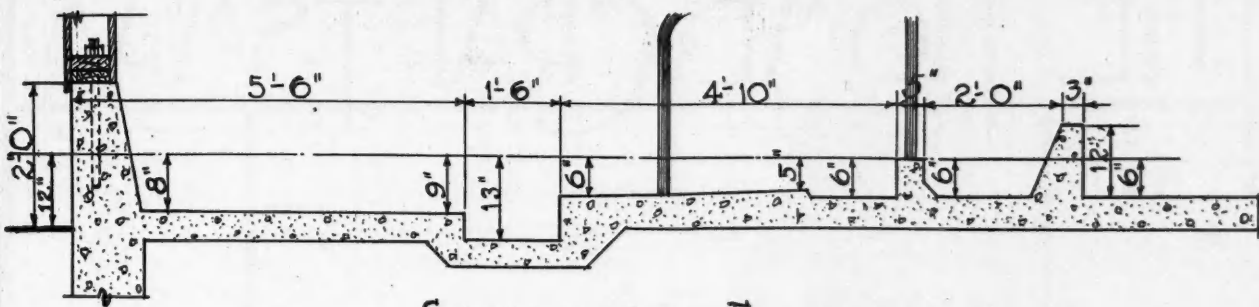

SECTION OF FLOOR  
SCALE  $\frac{3}{8}$ " = 1'-0"

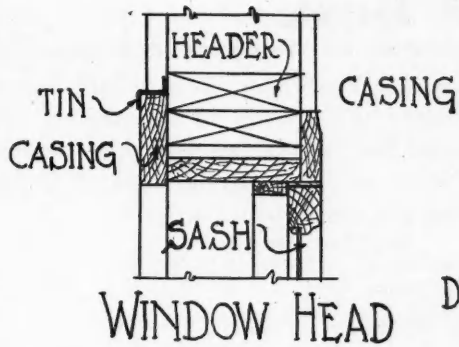

WINDOW HEAD

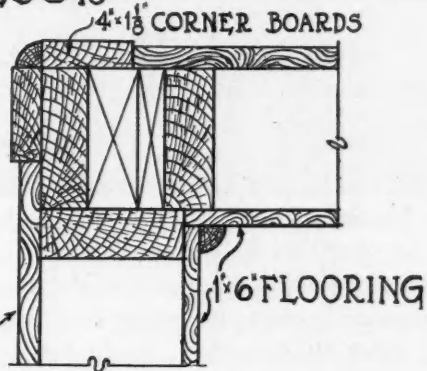

CORNER POST DETAILS

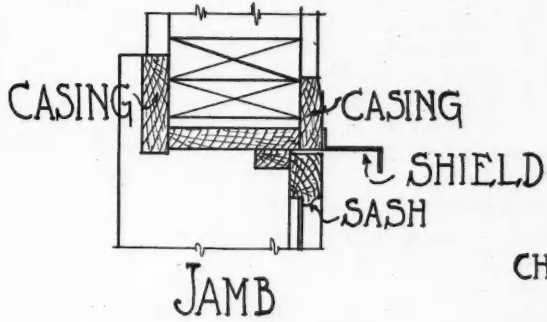

JAMB

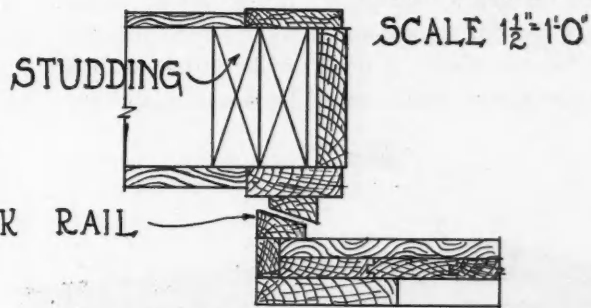

BARN DOOR DETAILS

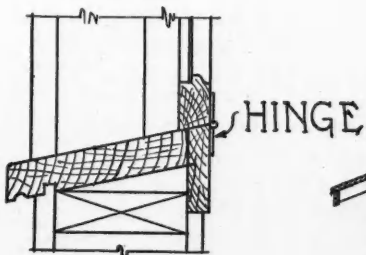

SILL  
SCALE  $\frac{1}{2}$ " = 1'-0"

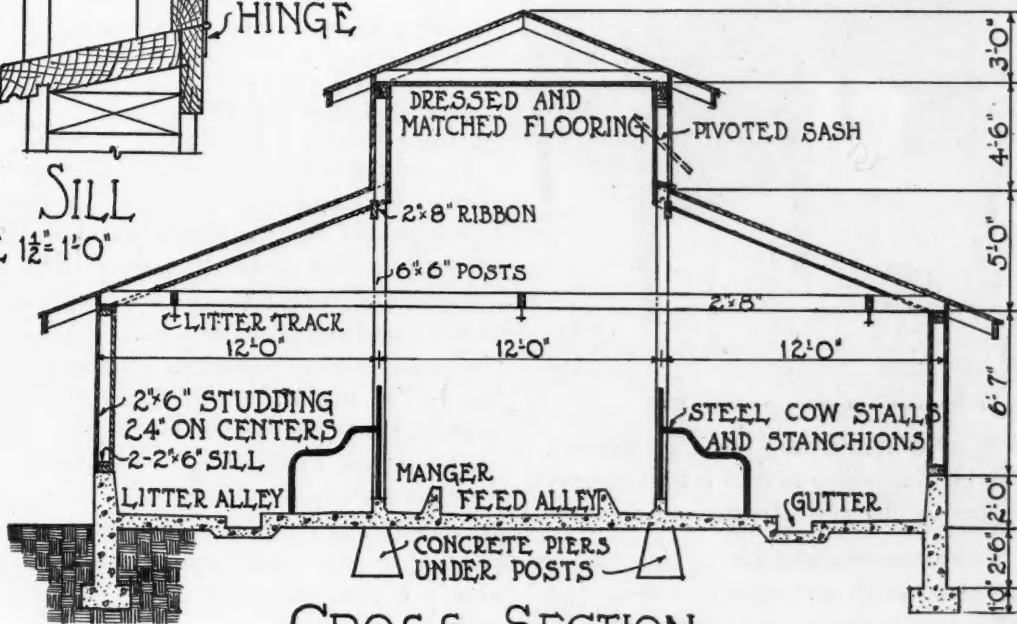

CROSS SECTION  
SCALE  $\frac{1}{8}$ " = 1'-0"

WORKING DETAIL DRAWINGS OF SEPARATE DAIRY STABLE  
(DESIGN A301) ILLUSTRATED ON OPPOSITE PAGE.

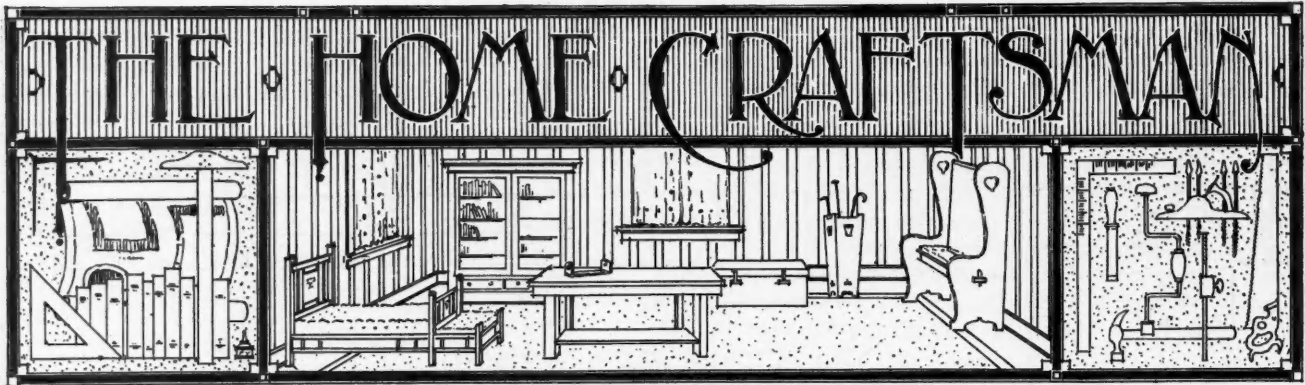

## A Homecraft Office Desk

HOW TO MAKE AND FINISH THIS SERVICEABLE, GOOD-LOOKING PIECE OF FURNITURE FOR THE BUILDER'S OFFICE

By George E. Chandler

**W**HAT man is there to whom an office desk does not appeal? Whether his needs be great or small, there is a peculiar charm about a desk different from any other article of furniture. Its very appearance prompts its owner to be more systematic and more business-like. Might not we, as carpenters and builders, profit by the business-like air which it produces? Our business may not be extensive enough to require a down-town office, yet in almost every home there is some nook or room which might be fitted up for an office. It need not be large—a desk, two or three chairs and a small bookcase would suf-

Oak is perhaps the material best suited to the desk, although birch or maple might be used.

The following pieces will be needed:

### STOCK BILL, GIVING FINISHED SIZES

Top, 1 piece,  $1\frac{1}{4}$  by 30 by 52.

Legs, 8 pieces,  $1\frac{1}{4}$  by  $1\frac{1}{4}$  by  $27\frac{3}{4}$ .

Rails—

Front, 7 pieces,  $1\frac{1}{4}$  by  $\frac{3}{4}$  by  $14\frac{1}{4}$ .

Back, 2 pieces,  $\frac{3}{4}$  by  $1\frac{1}{4}$  by  $48\frac{3}{4}$ .

End, 4 pieces  $\frac{3}{4}$  by  $1\frac{1}{4}$  by  $26\frac{3}{4}$ .

Inside—2 pieces  $\frac{3}{4}$  by  $1\frac{1}{4}$  by  $26\frac{3}{4}$ .

2 pieces  $\frac{3}{4}$  by 6 by  $26\frac{3}{4}$ .

Stiles, Inside, back, 2 pieces  $\frac{3}{4}$  by  $1\frac{1}{4}$  by  $18\frac{7}{8}$ .

Panels—

Back, 1 piece  $\frac{3}{8}$  by  $15\frac{5}{8}$  by  $47\frac{1}{4}$ .

End, 2 pieces,  $\frac{3}{8}$  by  $15\frac{5}{8}$  by  $25\frac{1}{2}$ .

Inside, 2 pieces  $\frac{3}{8}$  by  $11\frac{5}{8}$  by  $24\frac{1}{2}$ .

Drawers, Side—

Fronts, 4 pieces  $\frac{3}{4}$  by 5 by  $12\frac{1}{2}$ .

1 piece  $\frac{3}{4}$  by  $10\frac{3}{4}$  by  $12\frac{1}{2}$ .

Sides, 8 pieces  $\frac{1}{2}$  by 5 by 22.

2 pieces  $\frac{1}{2}$  by  $10\frac{3}{4}$  by 22.

Bottoms, 5 pieces  $\frac{3}{8}$  by  $11\frac{3}{4}$  by 22.

Drawers, Center—

Front, 1 piece  $\frac{3}{4}$  by 4 by  $18\frac{1}{2}$ .

Sides, 2 pieces  $\frac{1}{2}$  by  $3\frac{1}{2}$  by 24.

Bottom, 1 piece  $\frac{3}{8}$  by  $17\frac{3}{4}$  by 24.

Slides, 2 pieces  $\frac{3}{4}$  by  $12\frac{1}{2}$  by 22.

In making out the stock bill all tenons have been allowed  $\frac{7}{8}$  of an inch long. See detail sketch.

The rabbet for the panels has been figured  $\frac{5}{16}$  of an inch deep, thus allowing  $\frac{1}{16}$  of an inch for expansion of the panel.

Six posts are provided—four in front and two at the back, making possible a continuous panel in the back. The two lower right-hand drawers have been combined into one, which forms an excellent vertical file for letters. The center of this drawer may be run over the dado saw and a thin spline the same width as the other rails glued in place and allowed to project  $\frac{1}{32}$  of an inch. This greatly improves the appearance and gives the effect of the two drawers instead of one.

Note that the inside rails at the top are made 6 inches wide to provide a support for the drawer run-



Photo of Desk, as Completed, Built of Oak.

fic. Yet think what this would mean to the busy builder—a quiet place in which to transact his business affairs unmolested by the rest of the family.

### Construction of Desk

We present this month a homecraft office desk. While the design is simple, it is in excellent taste; and the construction may be easily handled in the home workshop.

ners. The drawer runners are not listed in the stock bill; but they may be made of any light material. The drawer sides and bottom may be made of white pine or basswood. The sketch shows a simple yet durable form of drawer construction. The photo shows the internal construction of drawer slides and guides. It also illustrates a locking device by which all drawers may be locked with the center drawer. As the center drawer, "A," is pushed in the wedge-shaped blocks at the end raise the iron rod which is connected to the plungers, "B," on each side. As the plunger rises, the screws come in contact with the hook on the end of each drawer, thus effectually locking the drawers until the center drawer is withdrawn, allowing the plungers to fall slightly and disengage the hooks. While this may or may not be put in, it is a great convenience as well as a saving in locks, where it is desirable to keep all the drawers locked.

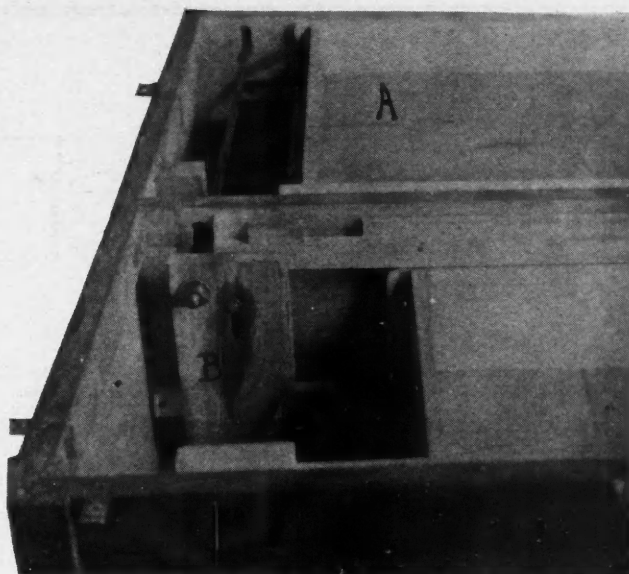

Desk Top Removed to Show Drawer Locking Device.

### Finishing the Desk

If the desk is made of oak a light oak finish closely resembling the natural oak is very handsome. Among furniture dealers it is known as "office golden," although much lighter than the usual golden oak. The stain and filler should be mixed and applied together. A 1-pound can of natural oak filler diluted to a thin paste with a light oak stain should give the required amount as well as the proper color. The filler should

be allowed to dry until it looks flat or dead on the surface—then rubbed across the grain with excelsior and smoothed down with the bare palm of the hand. After standing 36 hours a thin coat of shellac should be applied. This may be followed by several coats of good rubbing wax or two to four coats of varnish. If varnished, the last coat should be rubbed down to a dull finish, using a heavy piece of felt and pumice stone and oil.

If birch is used as a material, a dark mahogany stain

## OFFICE DESK

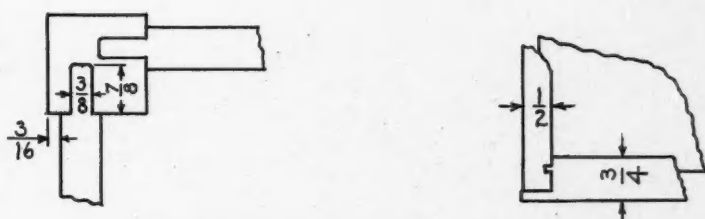
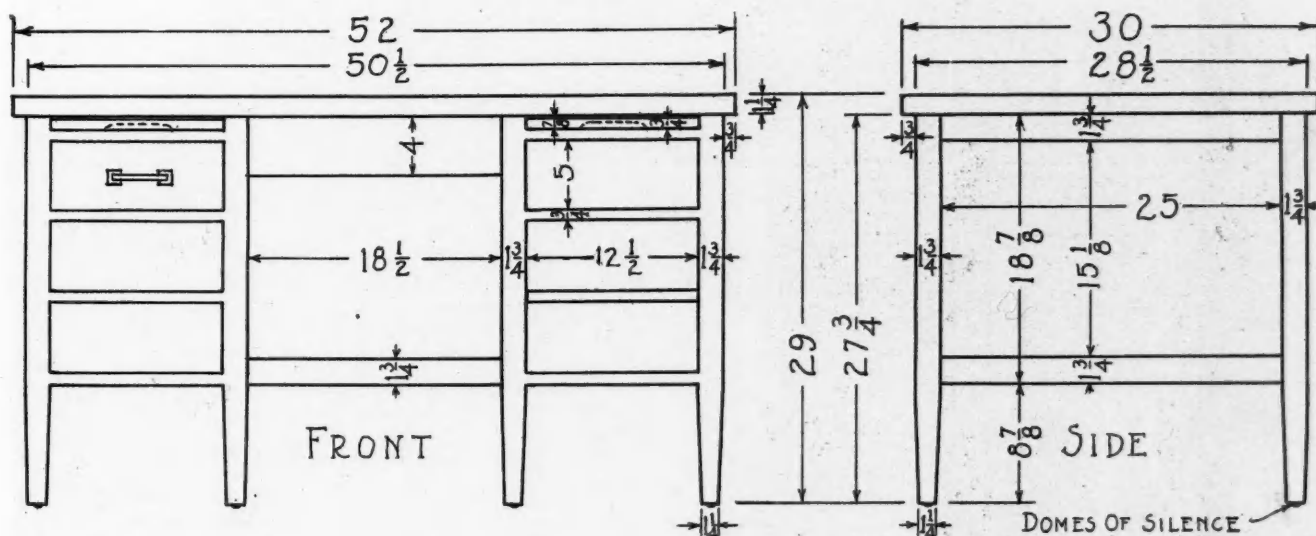

Working Drawings of Desk.

may be applied, followed by the shellac and wax or varnish.

For the drawer pulls dull brushed brass are perhaps the most elegant, although wooden pulls finished similar to the desk are very simple and attractive.

# The Editors Drawer

*New things  
worthwhile*

## New Kitchen Door Has Parcel Boxes

Milwaukee has contributed the latest appliance for the up-to-date home in the form of an automatic servant, or mechanical maid to answer the kitchen door for delivery men, and to save the housewife or the servant much valuable time in replying to calls of tradesmen.

The new device, originated by the man who invented the vacuum cleaner, Frank J. Matchette, is called a "Servidor," for it is a door which is its own door maid.

The Servidor has just been put on the market and several apartment houses are arranging for its installation.

The door is freakish in its description, but intensely practical in its operation, for it is simply a door, thicker than the ordinary door, sufficiently thick to have instead of panels, box compartments.

The secret of the new device is its unique interlocking device, for it is, according to its description, "always open and always closed, always locked and always unlocked."

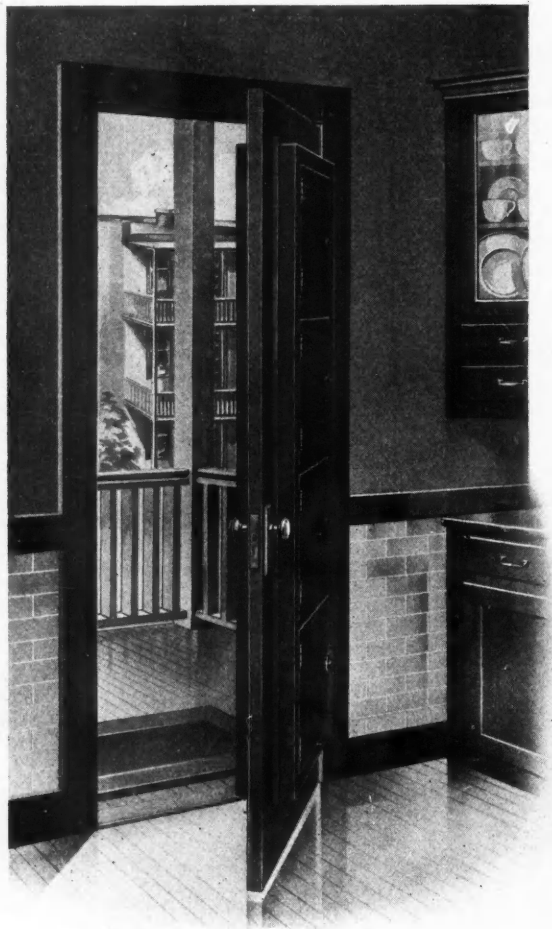

The Kitchen Door Carries Four Boxes; Each with Locking Cover on Both Inside and Outside Face.



The Grocer Leaves His Parcels and Locks the Compartment.

By the interlocking device, this door, with its four compartments, each of which operates separately, can not be opened on the outside and the inside at the same time. By a spring catch, when a tradesman arrives with groceries, he finds the outer door of the Servidor compartment open. He places the goods in the compartment, closes the door, and though it is without a lock, it can then be opened only from the inside.

With this device it is unnecessary for a maid or housewife to go to the door to receive delivered goods, and she can place milk bottles, or soiled laundry, in the different compartments, and leave the compartments open for the laundryman or milkman to collect without calling her.

WARREN B. BULLOCK.



## A Creosoted Wood Block Floor

The accompanying illustration shows the installation of a creosoted wood block floor in the plant of the National Transit Company, Oil City, Pa. The blocks in service in this plant are 3½ in. thick and are laid on concrete foundation with a ½-in. sand cushion and filled with pitch. There is approximately 2,500 yards of floor space covered in this manner. These blocks were manufactured from air-seasoned long leaf yellow pine, treated with creosote oil under what is known as the Reuping Process. This makes a block that is clean, dry, sanitary, durable and economical in every respect.

A good floor is just as necessary for the proper and economical handling of a shop as proper space, light, ventilation or sanitation. A satisfactory floor should have a low annual charge with little or no maintenance expense and should be



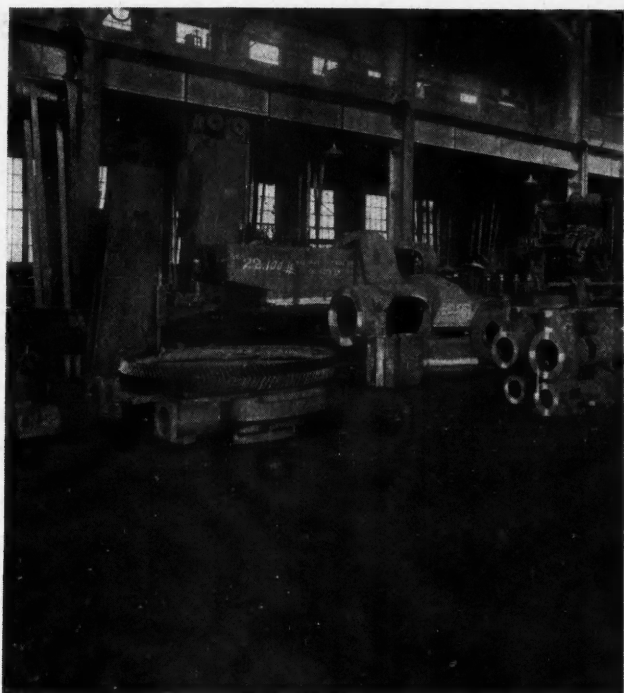

Creosoted Yellow Pine Block Floor for Shops and Factories.

easy to replace in case of openings for conduits, piping, or new machinery.

The ease of trucking is of importance—a smooth surface yet free from slipperiness; while it should also be noiseless and sanitary, warm, easy on the feet, without dust, and having low reflection of heat and light.

FRANK C. PERKINS.



**Does the Radiator Valve Leak on the Floor?**

A Brooklyn concern has recently placed on the market a device that will prevent the valve on steam radiators from spoiling the rugs and carpets by spouting water.

The device consists of a glass receptacle that fits over the air valve as shown in the accompanying illustration. It will fit over any valve and catches the condensing steam and the water that is forced out through the valve when the radiator is being filled. It also reduces the hissing sound that valves often make.

This receptacle is made of glass in one piece and should be very useful in many places.

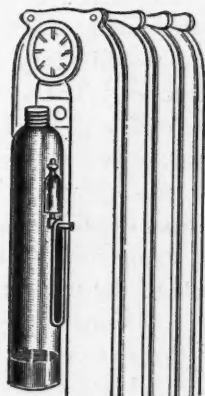

Glass Bottle Catches Valve Drip.



**Pan-American Road Congress**

Invitations are being sent by the Executive Committee, the Chairman of which is Hon. Charles W. Gates, Governor of Vermont, to the governors of each state, to the lieutenant-governors of the Canadian provinces, and to the presidents of the South American republics, asking them to attend in person and to name delegates to the Pan-American Road Congress which is to be held in Oakland, California, September 13-17, 1915. This Congress will be held under the joint auspices of the American Road Builders' Association and the American Highway Association, in co-operation with the

Tri-State Good Roads Association, the membership of which covers the states of California, Oregon and Washington.

It is expected that delegates from every state and Canadian province, and a large number of the South American republics will attend this great gathering in the interest of good roads. The program which is being prepared covers thoroughly the subject of road building and street improvement. It is believed that the Congress will bring together the largest number of men interested in highway and street improvement ever assembled at any time or place. Special trains are being arranged for the accommodation of delegates from the East.



**Federal Buildings to be Standardized**

Hereafter, public buildings erected by the Government will be economically constructed. Where savings can be made on the total amount authorized by Congress it will be done, and fancy ornamentation hereafter will not feature federal buildings.

This is made certain, at least during the present administration, by orders just issued by Secretary of the Treasury McAdoo to the Supervising Architect. The Secretary points out that standardization is necessary; that plans should be so made as to shorten the contract time of construction, and finally that the Government hereafter will not be moved by sentiment in using local material in the construction of buildings, but to buy where the best price is obtainable.

E. G. DOUGHERTY.



**Efficient Band Saw Guard**

A band saw guard which completely covers all points of danger, including the part of the saw between the upper and lower wheels, is now offered. The frame is made of angle iron over which is attached a strong 1/2-inch wire mesh. This is bolted into place. These frames are attached to the machine itself by means of adjustable joints. The guards close in the danger side of each wheel, and being of wire, allow the operator to see clearly the saw at work.

It will be noted that they do not entirely enclose the saw wheel, because in case the saw breaks, if the wheel were closed in on all sides, the saw would be broken into many pieces. The guards close in the one side of the wheel, and should the saw break, the guard prevents it from flying, and at the same time prevents it from breaking into pieces, by giving it room to drop out easily on the opposite side from the operator.

There is attached to the frame of the top wheel a sliding piece of steel which drops down over the saw to the saw guide, thus leaving no part of the saw exposed, save that part where the lumber is being run.—FRANK C. PERKINS.

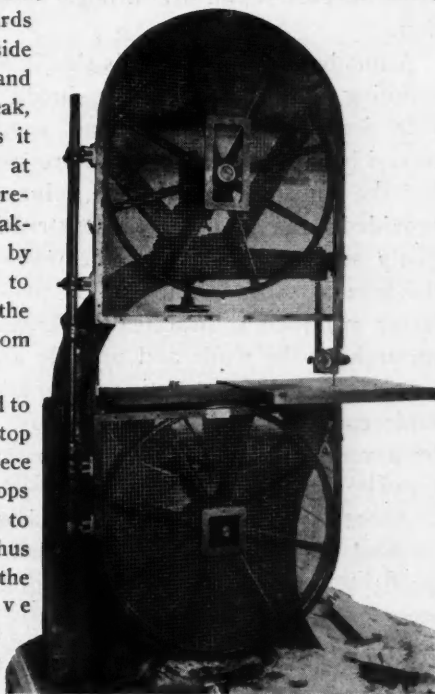

Jones Saw Guard Completely Protects Dangerous Band Saw.



**EDITOR'S NOTE**—Our readers are urged to make full use of this Department. Put your concreting problems up to us; also write us your experiences and accomplishments in the Cement field for publication here.

## A Concrete Block Ice House

HOW TO BUILD AND INSULATE IT

By H. Colin Campbell, C. E.

**W**HEREVER ice is abundant, the cost of harvesting and storing is usually very small compared with the advantages of having a sufficient supply for the needs of the average family. If a small stream of water is nearby, an ice pond can be constructed by building a crude dam or digging out a pool to which back water will find entrance and in which it will stand quiet, so clear, solid ice will be frozen.

Although ice houses are commonly constructed of wood, such a building is not always slightly, nor is it by any means durable, for it will soon warp out of shape and the sills and lower timbers decay rapidly. Concrete construction represents good foresight, because, when properly constructed, such an ice house will last indefinitely and will neither blow down when empty nor rot, neither will it be destroyed by fire, and protection against fire is desirable because occasionally ice houses are set on fire through spontaneous combustion.

A number of fundamentals should be observed when planning an ice house. Care should be taken to provide for proper drainage and ventilation. Drains should be efficiently trapped to prevent air from entering the house through them. Insulation should be provided; and in concrete construction this is most easily secured by building the walls of some one of the several types of hollow or two-piece block; the latter produce a practically continuous air space throughout the walls and provide all necessary insulation. If such construction is not adopted and monolithic concrete used instead, it must be supplemented by a veneer coating of hollow tile or block that will provide the necessary insulation.

About 40 cubic feet of space should ordinarily be allowed for a ton of ice. A cubic foot of ice weighs about 57 pounds. When storing ice, about 50 per cent more should be packed than is actually needed. This amount allows for considerable shrinkage and will insure a sufficient supply.

An ice house that will hold 20 tons is illustrated

in the accompanying drawing. Such a supply will be enough to take care of an average consumption of 500 to 700 pounds per week for six months, allowing for shrinkage.

The outer walls of the structure illustrated are built of hollow concrete block. The inner wall is solid concrete veneer block. The floor and roof are also of concrete. The foundation should go down below possible frost penetration and should extend up to within 16 inches of the surface of the ground, where the first course of block is started. In this way the air space in the wall is brought down to below ground line, insuring better insulation than would otherwise be possible. Eight inches of air space is left between the two blocks. Inner and outer walls must be tied with metal ties, but such ties should extend only to the air space in the outer block, not through to the outer surface, because steel is an excellent conductor and would carry heat from the outside into the ice chamber. The space between the block may be filled with mineral wool, ground cork, dry shavings or sawdust, or left without filling. Dry shavings will usually be the cheapest insulator. Mortar joints between blocks should be carefully filled to prevent penetration of dampness, while a coating of tar or pitch on the side of the wall next to the insulating material affords an additional safeguard.

Preparatory to laying the floor, dirt should be excavated to a depth of a foot or more to reach firm soil. Cinders should then be filled in and well packed to within 8 inches of the ground line. Two 4-inch layers of concrete are placed on this cinder base with an intermediate layer of cinders between as shown in the drawing. The floor should slope toward the drain in the center. A trap is necessary in the drain to prevent air entering and circulating up through the ice. No part will rust except the plate and bell, both of which are removable. The box opening is made with a wooden box form and a 4-inch concrete tile should project about 3 inches through the center to the bottom. A plate 14 inches square permits the

water to pass through. The bell which hangs over the top of the tile is riveted to the center of the plate. Water will stand in the box to the level of the top of the tile, effectually sealing the drain. The space above the plate is to be filled with pebbles or broken stone. The floor should be laid in slabs similar to a concrete sidewalk, covered with wet straw to a depth of a foot as soon as possible without injuring the surface, and allowed to cure for ten days or two weeks before being subjected to use. A 1:2:3 concrete, laid as a one-course mixture is desirable.

Two concrete slabs with a layer of cinders between compose the roof, the lower slab of which is designed to carry the load, being 4 inches thick and reinforced

Two doors are provided. The inner one is built up similar to a silo door, sawdust and ice being piled against it during filling, while the outer one is built in three sections, each made on 2-inch skeleton frame, covered on both sides with two thicknesses of tongued and grooved boards with tar paper between. The middle section opens first and then either the upper or lower as desired, making it unnecessary to open the door to its full height at one time, and consequently protecting the interior from warm drafts. Each door should have a latch of the type that will press the door inward in locking it.

This plan could be adapted to the construction of a monolithic concrete ice house. Forms must in that case be erected for the walls and the concrete should be combined in proportions of 1:2½:4 and mixed with enough water to form a quaky consistency.

In building of monolithic concrete, either of two methods of insulation may be employed. By the first method several layers of cork board or waterproofed fibre board may be placed in the forms in advance of placing the concrete and the concrete then deposited on both sides of this insulation. By the second method the outer wall may be constructed and after it has been completed and the inner form removed, then insulation is applied to the interior and an inner wall of hollow tile or concrete block then laid in cement mortar.

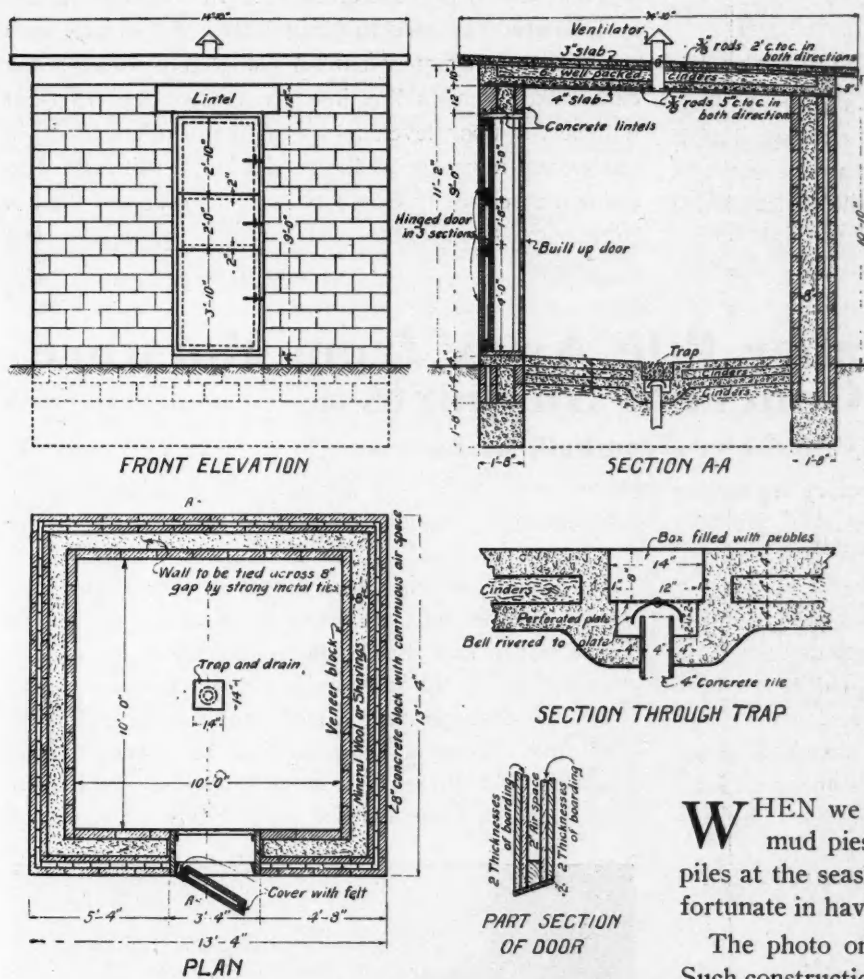

## CONCRETE BLOCK ICE HOUSE

Working Drawings of Small Well-Built Ice House.

with 3/8-inch round rods, spaced 5 inches apart in both directions. For larger spans the designs will need suitable modifications. After the concrete in this slab has hardened sufficiently, 6 inches of cinders are placed upon it and covered with a 3-inch concrete slab reinforced with 3/8-inch round rods spaced 24 inches apart in both directions. A 6-inch galvanized iron ventilator should be placed in the center of the roof. As soon as the roof has been completed it should be protected in the same manner as the floor to permit proper curing, for a week or ten days.

## Sand Boxes of Concrete for the Children to Play in

WHEN we were young, most of us liked to make mud pies; likewise we hated to leave our sand piles at the seashore. But many children nowadays are fortunate in having a sand pile at home.

The photo on page 84 shows concrete sand boxes. Such construction has a number of decided advantages, and if many people knew how cheaply such a permanent pleasure spot for the children could be made there would be more of them in use.

A box having inside dimensions of 5 by 10 feet will be sufficiently large. Construction follows the requirements of curb and pavement or sidewalk, or the entire box may be built as a monolith on top of the ground. In this case a proper subbase must be prepared with compacted gravel or cinders, and floor and curb be reinforced. In the first method a trench should be dug so that the curb will extend at least 18 inches below the surface of the ground, and forms should be set so that the curb will be, say, about 5

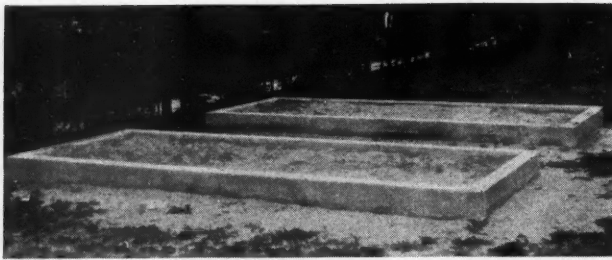

Two Concrete Constructed Sand Boxes for Children.

inches thick. Quaky concrete of a 1:2½:4 mixture will permit one-course construction that will have a smooth finish if coarse aggregate not larger than 1 inch is used. At any rate, if careful spading is done next to the forms when concrete is placed but very little touching-up will be necessary after the forms are removed.

Having built the curb, the next step is to place the floor. Some people might think that a concrete floor within this curb was an unnecessary expense, but if a floor is not built the sand contents will eventually become mixed with natural soil, for the children will not stop digging in the sand but will go right down through the underlying earth and soon make the play

site a mudhole. A 1:2:3 mixture should be used for the floor. Before laying, the area should be excavated and filled in with clean, well tamped cinders or gravel and the concrete laid upon this subbase. If the floor slab is built in two 5-foot square sections, reinforcement will not be required, but if built in one slab it should be properly reinforced with suitable mesh fabric. Reinforcement will not be necessary in the curb except at the corners, and a ¾-inch rod 4 feet long can be bent around each corner and embedded along the center of the concrete curb to "tie in" corners against possible cracking. As the curb should only extend 5 or 6 inches above ground level, one such rod placed 3 inches from the top of the curb should be sufficient to prevent cracking. In constructing the curb it would be well to place pieces of ½ or ¾-inch gas pipe so that they extend completely through the curb wall and to a line inside corresponding to what will be the floor level, so as to form outlets to drain out excess moisture in the sand after a rainfall. For the same reason it would be well to give the floor a slight slope toward the side in which the pipe outlets are placed.

## Keeping the Lumber Pile Away from Moisture on Concrete Supports

By H. Colin Campbell, C. E.

NO doubt many of our readers carry in stock a considerable quantity of lumber, and probably like many lumber dealers, they have suffered considerable loss of timber and lumber through rot. Timber supports such as 4 by 8's laid on the ground to support lumber piles soon rot out and in turn communicate fungi to the pile of lumber which, if stored for any length of time, begins rotting as a result.

The accompanying photograph and sketch illustrate a concrete support extensively used in some large lumber yards for a foundation for lumber piles. The con-

beyond each end, this dowel point engaging with a hole made in the concrete beam and in the wood stringer.

The fact that this construction is very simple and can be cast in separate units is of advantage, as of course is the fact that supports like these for lumber piles will never rot and are permanent in every sense.

The photograph reproduced shows a large lumber yard near Toronto, Canada, that has been entirely equipped with these permanent supports, which have been found to represent the highest type of economy.

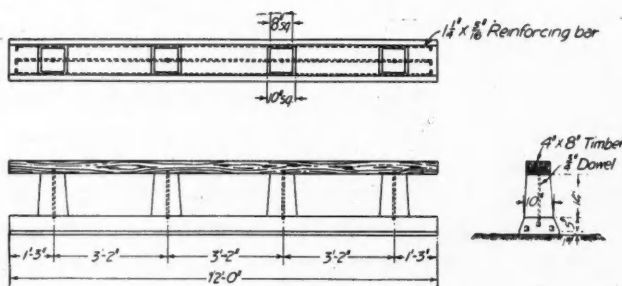

Concrete Foundation for Lumber Piles.

crete beams supporting the pedestals upon which the 4 by 8 stringer lies are reinforced in a manner similar to fence posts, except that bars instead of rods are used, and these are spaced as shown in the drawing. A 1:2:3 mixture should be used. The pedestals are cast as separate units with a steel dowel extending through their center and projecting a half inch or more



View of Lumber Yard Near Toronto, Showing Concrete Pile Supports.

# CORRESPONDENCE



Questions Answered and Ideas Exchanged.

Our Readers Are Requested and Urged to Make Free Use of These Columns for the Discussion of All Questions of Interest to Carpenters and Builders.

### How About Architecture by Mail?

To the Editor: Morse, Sask., Can.  
I would like to see some discussions on "Can a Good Carpenter Learn to be a Good Architect by Correspondence, etc.?"  
H. R. BIGELOW.



### Ideas for Sun Parlor Addition

To the Editor: Gull Lake, Sask., Can.  
I want to build a small conservatory onto my house. However, I am puzzled as to the roof; would like to make it half round; also as to the construction of the walls. Of course, the whole thing would have to be double glass.  
J. HUTCHINSON.

Answer—We have prepared the accompanying drawings for you, giving our suggestions as to design and construction for a conservatory. We trust they will prove helpful to you, giving you the assistance you desire. All sash can be obtained double glazed, if you think it necessary. The details show ordinary cement plaster wall construction.  
EDITOR.

### Building Small Concrete Culverts

To the Editor: Rochester, N. Y.  
I have increased my contracting business by building culverts for the county roads. I started in a small way as an experiment.  
A side road was crossed by several outlets of farm drains. Ditches were dug across the road and these ditches were covered with stringers and a few planks. Every year traction engines broke the stringers or planks or squeezed the little

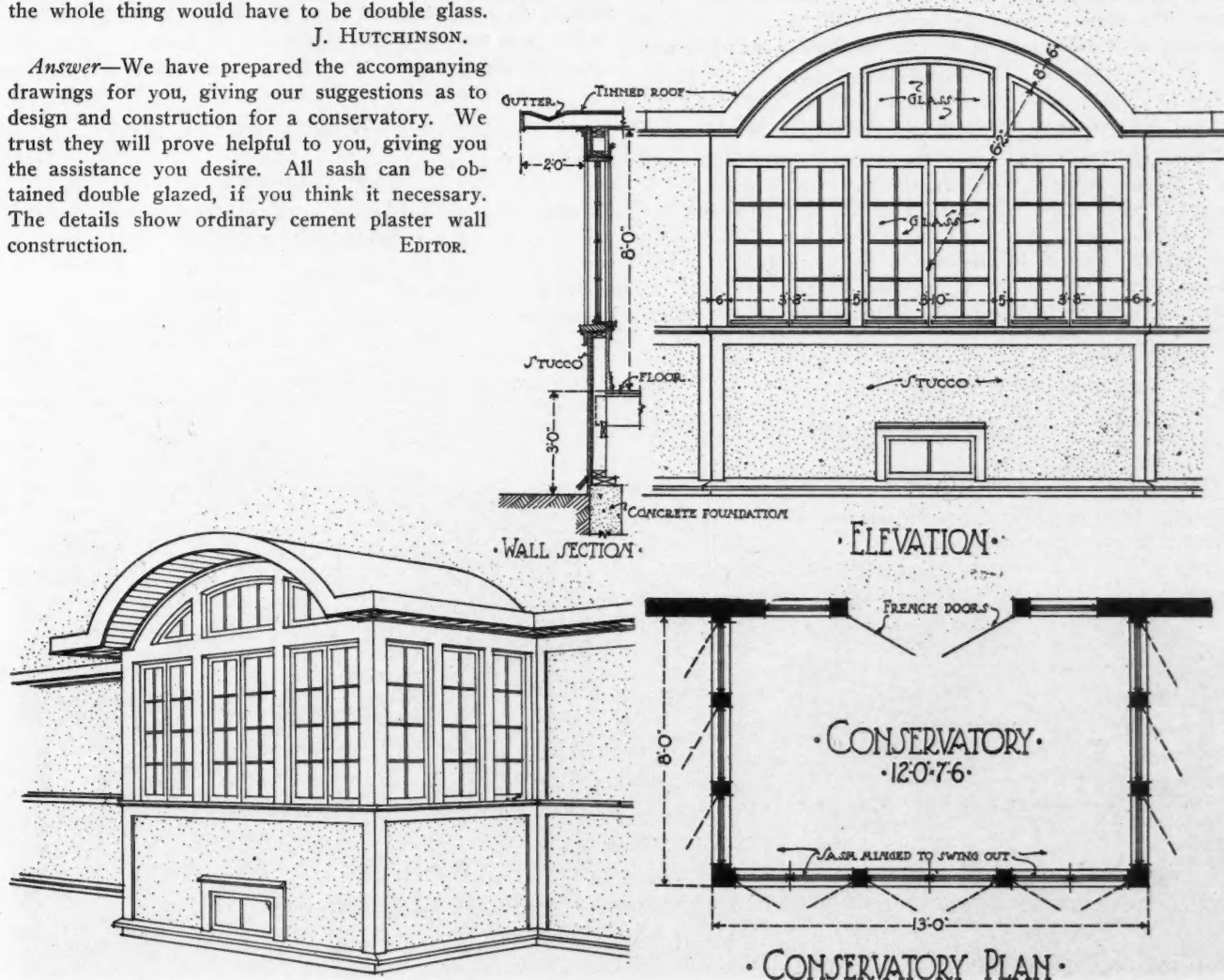

Perspective Sketch, Floor Plan and Details of an Artistic Sun Parlor or Conservatory Addition to be Built onto a Stucco House.

bridges down into the mud, so there was an endless amount of trouble in a small way in connection with a few miles of roadway. I proposed to the commissioners to build small concrete culverts that would be permanent. I offered to put in the first culvert at double the cost of a wooden bridge. My proposition was accepted. I did not expect to make anything out of the deal, but I wanted to try my hand at concrete contracting and I wanted the road improved.

I was careful to make the wooden form in sections, so that I could use it in other places. I was particular about the cement, sand and aggregate and about the reinforcing. I knew the culvert would be severely tried with the heavy traction engines, and I had no intention of making a failure. Well, the result was that I have since put in twenty-seven culverts and am now building a bridge on the same plan. I have made a profit on twenty-four of these jobs. The other three ran into difficulties that cost me more than I figured on, but I have a carload of forms that cost me nothing because they are all figured into the different bids, some of which have been paid for in this way two or three times over.

My success with the first culvert is what developed all this business. Other contractors have offered to do the work cheaper, but I have the reputation for doing the best work.

H. A. FRANKLIN.



### Longest Barn in Lancaster County

To the Editor:

Lancaster, Pa.

I have been a reader of your paper for seven years, but have not written or sent you anything of our work. Enclosed is a small snapshot of a barn we are building just now. The dimensions of the barn are 50 feet wide by 120 feet long by 18 feet to the plate. Size of timbers is as follows:

Sills	7 x 12 inches x 50 feet.
Posts	7 x 10 inches x 18 feet.
Girders	8 x 10 inches x 50 feet.

There are three mows and three drive floors with corn barn in one of them, and five stables, three entries and a chopping cellar in the basement. The barn is weather boarded with beaded pine siding, and covered with slate. The lumber was furnished by B. F. Hiestand & Sons of Marietta. The owner of the barn is H. C. Horner, Cashier of the First National Bank of Lancaster, Pa. The builder is the writer.

This is the longest barn in Lancaster County. The raising was started at 7:00 o'clock and the snapshot was taken at 12:50, just as the last rafters were put in place. 120 men helped to do the work.

This is the way the Lancaster County barns are framed.

S. E. EBERSOLE,  
Carpenter and Builder.



### Forms for Concrete Tub and Roller

To the Editor:

Altavista, Va.

I want to suggest to you for economy sake my way of making horse or cow watering tub. Take an empty barrel for outside form, a candy bucket or small barrel according to size wanted. Dump in a little concrete in first barrel, mixture 1-3-5, then put in inside form and fill to depth desired. After dry take out form and form of outside also.

For lawn roller use barrel about the same size, perhaps 18 inches long and about 16 inches in diameter, cutting off both ends of barrel to length and fill in with above mentioned mixture of concrete, 1-inch hollow pipe being placed and kept in center of barrel. Take old wagon tire (iron); punch a hole in the end for  $\frac{3}{4}$  by 24 inch bolt through roller; spring around each end to handle taken out of lawn mower, with holes punched in this end of irons to suit handle. When dry knock off form and roller is ready for use.

I am planning to build a small shop and storage plant for lumber. I would like a suggestion as to how to place machinery. I am thinking of putting in surfacer, moulder, rip saw, band saw, jointer, and borer. I want about 40 feet of my 50 by 90 foot lot for storage next to track. I had thought then of 24 by 40 shop, one side open to driveway, 10 feet, and the remaining 16 feet for lumber to be worked. Any suggestions will be appreciated.

W. B. ENGLISH,  
Contractor and Builder.



### Who Knows?

To the Editor:

Capetown, Ont., Can.

I appreciate the magazine very much, but would like to see more articles in our line, viz., articles on methods of applying different kinds of work, imitation marble, tile, stucco, etc.

NORMAN HOLDEN.

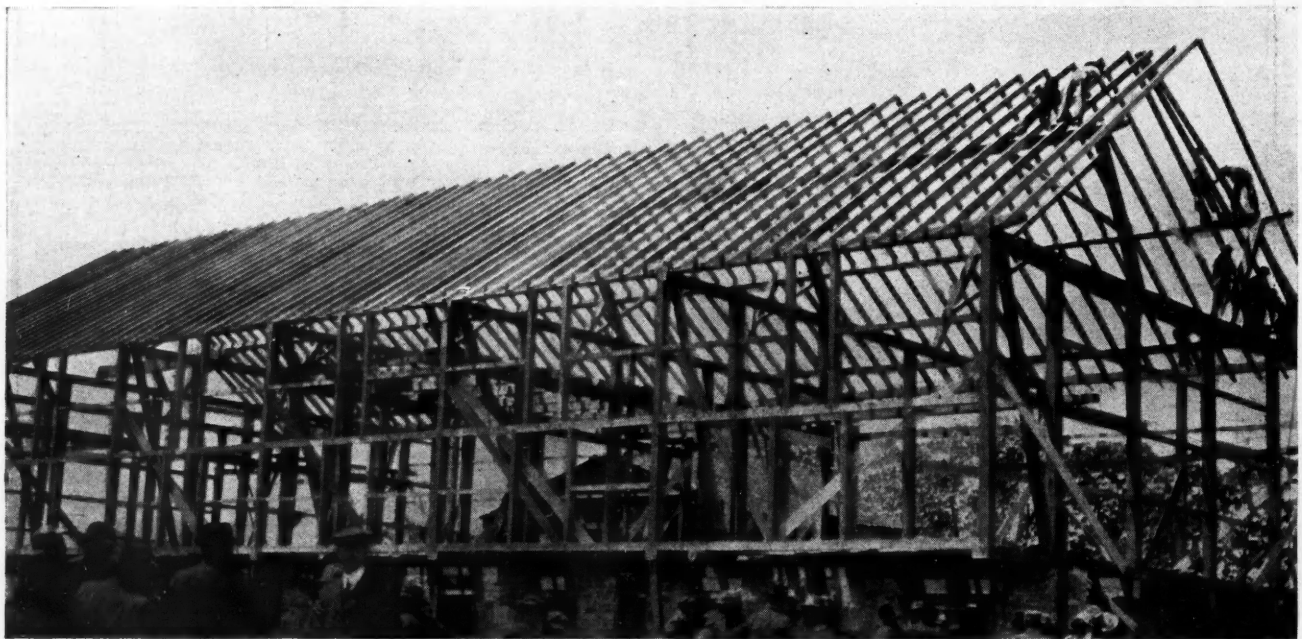

S. E. Ebersole and Gang Completing Frame Work of Longest Barn in Lancaster Co., Pa.—Size 50 by 120 feet.

**Difficult Proposition to Sink Well**

To the Editor: Weyburn, Sask., Canada.  
 In the June issue of the A. C. & B. there is an article headed "Water Supply Question." I have for the past 3 years been engaged in the construction of water works, and a little information in regard to Mr. B. C. Browning's proposed well will certainly be of great benefit to him. Speaking from my own personal experience, the undertaking is impossible, a well 6 ft. in diameter leaves no room for the accommodation of pumps, hoisting apparatus and buckets, or whatever apparatus is adopted for excavating. A concrete well 4 in. thick would crumble like an egg shell if it ever was sunk very deep. The pressure at 75 or 100 ft. would be very considerable, and it is very probable that large rock would be struck, putting the entire stress at one time on one place of the concrete. However, the worst trouble would be this; suppose quicksand was struck at a point 60 or 70 ft. from the surface; it would be found that the quicksand would enter the well far quicker than anything could excavate it (that is, if the quicksand is wet, as I presume it is). What would be the remedy? You could not sheet pile the well around the outside, as interlocking piling is not made in such lengths; I do not see, either, that it would be possible to drive the sheetings in several lengths. To sink a well through the strata described would require to be constructed as follows (that is, if I was to undertake the work): Concrete shell to be 18 in. thick, heavily reinforced, the shell not to be less than 16 ft. inside diameter. The concrete, of course, could be reduced to 12 in. and 8 in. towards the surface. If, however, quicksand of a bad nature was encountered, other means of sinking the well would have to be adopted and, unless a very abundant supply of water was struck, the enormous expenditure would not warrant the construction.

ALFD. SPARKS.

**Placing Concrete Well Lining**

To the Editor: Elyria, Ohio.  
 The enclosed clipping from the "Rural New Yorker" will doubtless be of interest to Mr. B. C. Browning, of Merna, Neb., who asks regarding a water supply.

**Pit Silo in the Sand**

"In regard to details of construction of a concrete silo below the ground, permit me to consider this as a shaft-sinking proposition to be handled from a mining engineer's point of view. This is the identical problem which has confronted some of the mining companies in this region during the last few years, and I think I am safe in saying that any professional mining man would consider it a rare form of recreation to direct the sinking of a concrete 'drop shaft' eight feet in diameter to a depth of only 25 feet through dry sand. Depths of over 150 feet have been attained in this part of the State by concrete shafts put down through quicksand and boulders against such fearful odds that even among the mining fraternity the results often appeared doubtful until the final water tight seal was made several feet in the solid ledge.

"One will be agreeably surprised with the results obtained and the ease with which the concrete will descend as the excavation beneath progresses. The idea of a cutting edge at the bottom of the concrete will do no harm, but is entirely unnecessary. At the start, I would suggest that an excavation be made to a depth of four feet, thus bringing top of the forms level with the original surface of the ground. Most of this material would have to be excavated anyway, so that a distinct advantage will be gained in facilitating the handling of the wet concrete between the mixing floor and the forms. It is doubtful if any weighting or loading will be necessary to assist the descent of the concrete after excavating is started, although as depth is attained the speed of descent may be somewhat lessened.

"Michigan.

HARRY T. HULST."

The idea of stating the price in advertisements is excellent. It will save time and postage of readers and advertisers. People often do without articles because they think the cost to be more than it actually is.

W. J. MILLER.

**Hood Rafters**

To the Editor: Wellman, Iowa.  
 Please explain how to cut hood rafters on a barn 10 to 12 pitch, also 8 to 12 pitch.  
 A. M. Y.  
 Answer—As usually constructed, the hood is set with its

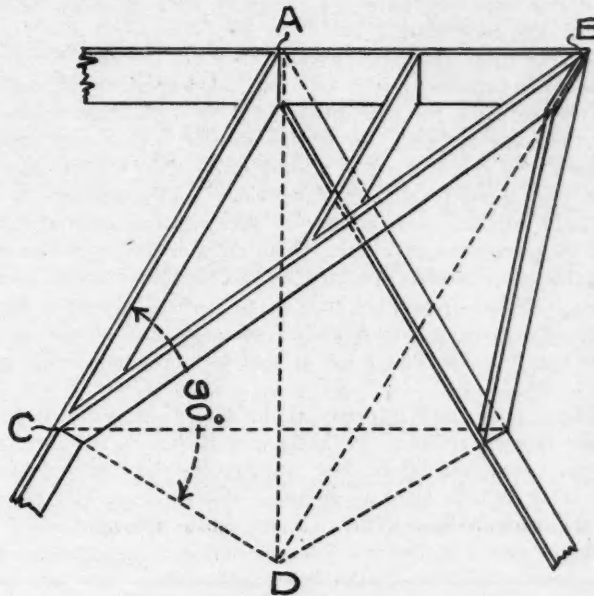

How to Frame Hay Door Hood.

back in the same plane with the roof. The lower end cut is simply a miter and is found by taking the length of the projection, A-B, and the length of the main common rafter down to where the foot of the hood rests, as at A-C, and the cut will be on the side of the square in which the latter length is taken. The upper end cut is found by taking the tangent, C-D, and the length of the hood rafter, C-B, and the cut will be on the side of the square on which the latter length is taken. The side cut of the jack is a miter cut and the same proportions as used for the lower end cut of the hood.

This is a general rule and applies to any pitch; therefore it is not necessary to take a specific example.

A. W. WOODS.

**Finishing Floors**

To the Editor: La Grande, Ore.  
 After the floors have been laid, let them stand just as long as possible, if you have a good way to work on them without marring or scratching in any way. It gives the floor a chance to work and become set. Seven or eight days in a warm room is quite sufficient. Use an electric sander if possible. Start your machine at about a 45-degree angle to the lay of your floor; continue cutting the floor, "setting the machine at right angles to the former cut" until you have the floor dressed to an even surface. Then set the machine to cut lengthwise of the flooring, using No. 1½ paper. Continue cutting lengthwise until you have every marr and cross scratch out. Your last time over, use No. 00 paper. This gives you a polish. Now, you have about 6 inches around the edges to dress, that can't be dressed with a machine. Take a hand scraper, cut the edges down to a surface with the center of your floor, then sandpaper it by hand, using fine paper on a cushioned block, until you have the same finish as the center.  
 Clean off the floor thoroughly, the last sweeping should be done with a flannel cloth fastened over a brush broom, and dampened (not soaked) with linseed oil. This picks up all the fine dust that is left from sweeping.

**LIQUID FINISHINGS.**—This is the most particular part of floor finishing, and a matter that has a very wide scope of different ideas. Each contractor has his own idea, and thinks it the best. Then the contractor has customers who have their ideas, and in doing their work you don't dare deviate from their way—at least not and let them know it! In doing work you have two things to keep in mind—satisfaction and good work.

Get the color and finish wanted, then get the best material possible and start to work. Use your best experience in applying; by so doing you can always do good work without altering the color or finish, for wherever there is poor and cheap material for floors, there is a good material to take its place. The best thing to show and convince your customers is a panel of samples, made entirely by you with the material used and the price per square foot. Don't use a manufactured panel.

After all you will find patrons that will not accept your ideas. Perhaps you have had years, perhaps almost a lifetime of experience; you have had successes and failures, and have carefully noted each job in your memorandum book, and know best.

There is no finish so pretty as the natural finish, regardless of the finish over head. In laying your floors you can sort out all the colors and lay in your main rooms the best and keep the color as near alike as possible; and use your odd pieces in the back rooms. Then, if you finish properly, when a stranger comes in, the first thing he notices is the greeting of the floor: "Mr. So-and-So built me." Then you have another job.

I have laid, dressed and finished floors for the past ten years. The following finish has proven the best for me and given me the greatest success:

After the floor has been properly cleaned, apply crack filler if necessary, then apply one coat of the best floor varnish obtainable. Let this dry as long as possible—not less than five days—so it will become hard and cased. Then sandpaper it down and apply the second coat, and continue working it until you have the desired color and finish, sanding between each coat. I have often applied four coats of varnish and not darken the floor except very little.

For a dull finish, rub the last coat with pumice stone. For a wax finish, after you have applied the second coat of varnish and have sanded down, apply the wax. Then put Brussels carpet on your sander drum and buff the floor until you have accomplished the finish wanted. Don't allow your machine to become too hot; it will burn streaks on the floor that will not come out. Handle carefully but brisk. The varnish under the wax gives it the body. For a porous flooring you will have to use a paste filler. You can also use your machine for sanding down the varnish, using fine paper and touch lightly.

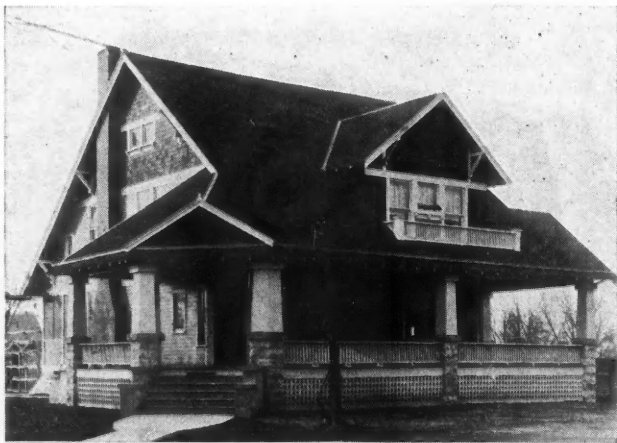

Residence Designed and Built by Chas. A. Lawson, Monroe City, Mo.

I never use any shellac, as I find it is too hard and more likely to become scratched and marred. I never use any stain, as it darkens the floor, and if the floor ever needs dressing again, it is almost impossible to cut deep enough to get out the stain.

I have floors five years old, finished as mentioned above, that are just as good today as the day I completed them.

Old floors can be treated the same way, by using a paint remover to raise the paint or varnish before sanding. Sometimes a light streak will show around the edge where the hand scraping was done, but should not cause any alarm. It will blend out the same as the center in three or four weeks. It is caused by not having the pressure on the sandpaper that is given by the machine.

CHAS. B. MILLER.

### House with Cobblestone Trimmings

To the Editor:

Monroe City, Mo.

The feature we all like best about this house is the cobblestone work, the only work of this kind in Monroe City; it

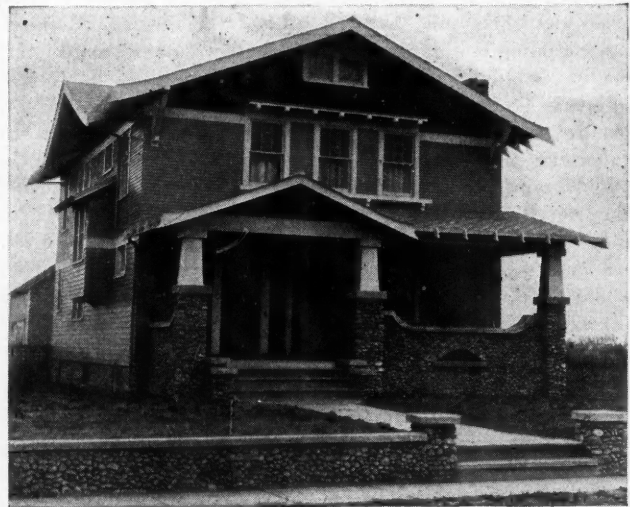

Artistic Use of Cobble Stones by Contractor Chas. A. Lawson, Monroe City, Mo.

grows prettier with age, unlike brick or cement walls. Other features of this house are: Sleeping porch at the back of house, cement shingle roof, two windows in each bedroom, abundance of light and ventilation, oak floors first story, Douglas fir finish throughout, doors two panel, rotary cut, laminated panel, all paneling of stairs, buffet and other built-in work the same. These laminated panel boards are a great help to the finisher, making a beautiful finish, and they never warp or crack.

The back porch in this plan has kitchen and dining room doors opening outward. Try this where you have an enclosed or screened porch; also lavatory and wardrobe on the back porch, just the thing for convenience, as well as the outside icer, where the iceman can go just so far.

If you want a letter on cobblestone work, I will tell your readers how I did the job shown in photo. I could find no one here who had any experience in this kind of work, so it is my first "offense." I found some help in a back number of your valuable paper (AMERICAN CARPENTER AND BUILDER). An inquiry to other building journals failed to help any. As I always do what needs to be done, the photo shows my first attempt. Where cobblestone can be found, the work can be done almost as cheap as concrete, with better effect.

Our town of less than 2,500 is known as "The Town of Beautiful Houses." As I plan and superintend all work, as well as buy all material and do my own bookkeeping, I have no leisure time. I think your paper is O. K.

CHARLES A. LAWSON,

Contractor and Builder.



**More About the Falling Line System**

To the Editor: Balmy Beach, Toronto, Ont.

In answer to a request from one of your subscribers for a drawing and explanation of the "Falling Line" system of handrail, the accompanying drawing is a very good example of that system, showing the use of the dihedral angle. It will be noticed in plan that the rail starts square off the newel posts and turns round three winders before reaching the straight length. I have the twist and casing in one worked piece, which of course requires a little extra thickness of stuff; but that is a small consideration.

To get the development of the stretch out, draw lines from the apex of a triangle (right angle) having the radius for base, the hypotenuse being inclined at 60 degrees, cutting through the several points on plan and produced until they meet the opposite tangent, then erect vertical lines and mark the height of the risers. Then draw a graceful curve coinciding with the nosings, as near as possible. Extend bottom joint an inch into the newel and take the top joint at a position where the rail commences to be straight, at points 4 and 5.

We must now get the plane of plank which will be obtained as follows:—from point 4, draw a line to the swell of curve and with greatest departure as radius describe a circle at the lower joint on plan. Then do the same from point 5

and with this departure, describe a circle at top joint on plan. Sides of the two circles just drawn. A line to be drawn parallel to top of circles, then draw an indefinite line at right angles to this line through bottom joint on plan.

We will now deal with Fig. 3; continue line from point 4 and reproduce the plan. I have enlarged this, so as to make the lines easily understood.

No. 1, twist bevel for bottom joint, No. 2 dihedral for the same, No. 3 twist bevel for top joint, No. 4 dihedral for the same.

At 4 is section of rail with application of bevels; note allowance at each end is required for lapping at joints.

Fig. 5 shows face mould; this is done in the usual way and I will not go into detail, as this figure is simplicity itself.

JOHN MACLACHLAN.



**Hay Doors for Barn**

To the Editor: La Fargeville, N. Y.

One of the handiest ways to unload hay is to take it in through a door at the end of the barn. Even though you have a floor to unload from, it may pay you to make a door in the end and take part of the hay in there, as it will save time.

The track can be extended out and held up by a rod passing over a block on the peak and back to the second rafter;

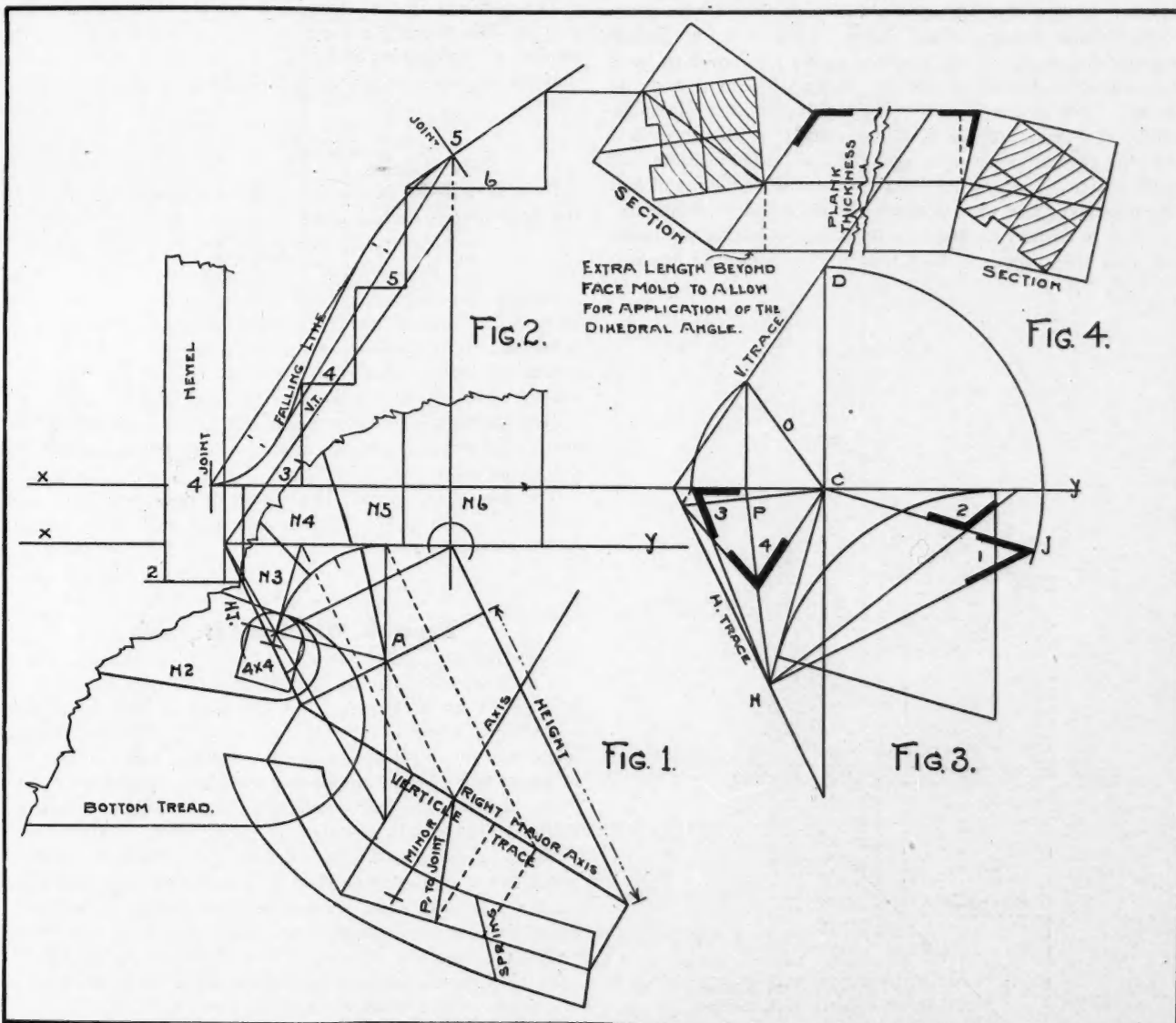

Essential Features of "Falling Line" System of Hand Applied to Simple Stair.

or the hay may slide up against the end of the barn.

The door may be single or double. One good way is to make a large door, and have it slide down in a track or groove like a window and raised by ropes running over pulleys and having weights at their ends.

Another way is to have two doors running on slanting tracks just under the cornice. Sometimes the doors are just above the loft floor and then the track may be level. It is well to avoid hinges on the doors when you can.

When a barn is being built or repaired is the time to put in a track and build these doors, for the work on the track may be done from the roof without any staging being built.

Steel track is much better than wood, as it works better and is more easily put up.

JOHN UPTON.



**To Find the Length of Jacks**

To the Editor: Malta, Mont.

I have been greatly benefited by reading the AMERICAN CARPENTER AND BUILDER, so here I am for more information. I would greatly appreciate it if you would kindly explain some simple rule for finding the length of jacks. I have a book which treats on the subject by dividing the length of the rafter into one or more spaces than the number of jacks wanted, but it is not clear to me just how it is done, so I turn to you for help.

F. M. N.

Answer—A jack rafter is but a part of a common rafter. In other words, the hip crossed its path and cut it short of its natural length. The system referred to is simple. Suppose the length of the common rafter is known to be 9 feet, and it is desired to use two jacks between it and the corner. Then divide 9 by 3 (three spaces) and the quotient will be the length of the first jack, which in this case is 3 feet; the second jack 6 feet, and the third would be the full length rafter. The spacing on the plate will be equal and will naturally take care of this part without further calculation; but if it is desired to know in advance of setting up jacks, just what the spacing is, then this may be found by dividing

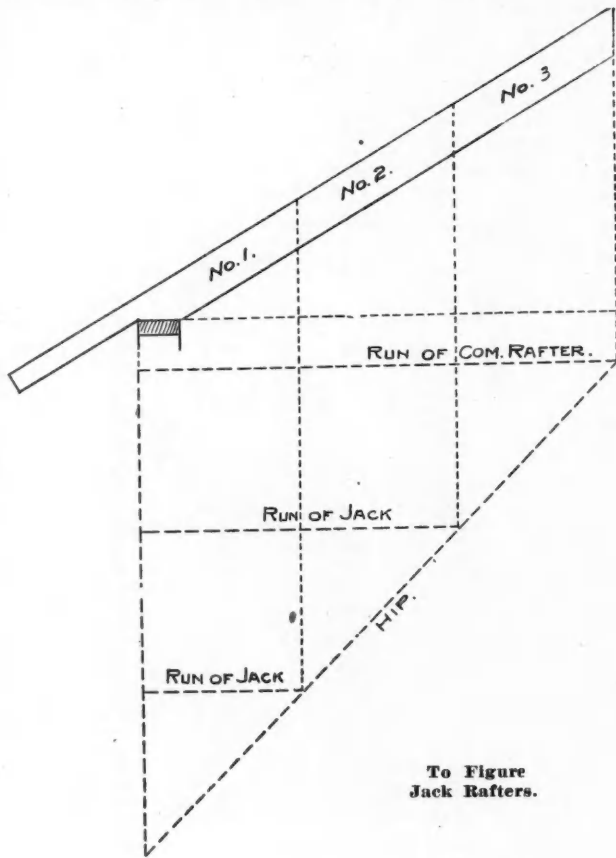

To Figure Jack Rafters.

the length of the plate from the center of the seat of the common rafter to that of the hip into the same number of parts as above described; and the quotient will represent the spacing from center to center of the jacks.

A little study of the accompanying illustration will, we trust, make the subject clear.

A. W. WOODS.



**Why? Mr. Figurer?**

Dear Editor: McCook, Neb.

A missionary, long a resident of Russia, reveals a curious method by which the Russian peasants manage to avoid the difficulties of the multiplication tables. They do away with them entirely—in fact, multiplying altogether through the processes of addition and division.

To illustrate: If a Russian peasant wishes to multiply 22 by 12 he goes about it in this way:

12.	22.
6.	44.
3.	88.
1.	176.

That is to say, he repeatedly divides the multiplier by two, neglecting fractions, and as regularly adds the multiplicand to itself.

He now strikes all even numbers from the first column and with them the corresponding numbers in the second column. Out of the two columns this leaves him:

3.	88.
1.	176.

The numbers in the second column are now added. The sum is 264, which he very correctly concludes to be the product of multiplying 22 by 12.

If the numbers are reversed, the columns stand:

22.	12.
11.	24.
5.	48.
2.	96.
1.	192.

Striking out the figures indicated by the even numbers in the first column, there is left:

11.	24.
5.	48.
1.	192.

Adding the second column again results in 264. The process, no matter what the numbers to be multiplied, is infallible. It is much more tedious, to be sure, than the one ordinarily employed in multiplication, but all the steps are easier, especially to a low order of intelligence.

Nevertheless, it is quite apparent that it required mathematical genius of a high order to discover and apply the principles upon which it is based.

The missionary himself is ignorant of these principles, and, so far as is known, they do not appear in any of the modern works on mathematics.

P. M. BELL,  
Architect & Engineer.



**French Window Details**

To the Editor: Greensboro, Fla.

I am a subscriber to the AMERICAN CARPENTER AND BUILDER and wish some information. A customer of ours is to build a dwelling with, I suppose you would call them, French windows. We expect to make the frames, and the sash are to hinge to the side and swing inside, the screens to hang from top outside and no blinds. It is a common wood frame building with shingled or siding walls.

We would like to know just how these frames should be made, what arrangement should be made to keep water out at the sill, also what arrangement of hardware to use to hinge the sash and to hold it in place when open and closed.

These things are, of course, very simple to those who are used to it, but we have never made frames for that kind of windows, and we want to be right about it.

JAS. A. DEZELL,  
Pres. Dezell Enterprise Co.

Answer—We illustrate herewith details for a pair of French windows to open in, combined with a pair of screen doors hinged at the side to swing out. We cannot be sure from your letter whether it is the French window, as you say, or an inward opening casement that you are called upon to produce. The French window extends clear to the floor; the inward opening casement window only part way.

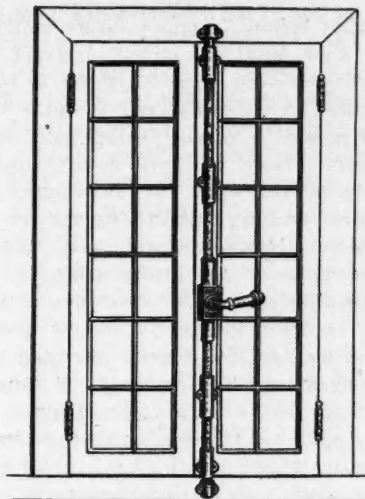

A French Window "Set Flush" Properly Trimmed with a Cremorne Bolt. When Lever Handle is Pulled Down it Throws the bolts.

If it is an inward opening casement you want, refer to the April, 1912, issue of the AMERICAN CARPENTER AND BUILDER. The details there were prepared by an expert hardware man, and can be relied upon to work out properly with standard builders' hardware for work of this kind. You will find both the details and text matter of this article very helpful.

With respect to builders' hardware required, Cremorne bolt is the approved fastening for double French windows. These windows are held open in any position by ordinary door holders. If it is, however, the casement window proposition, other hardware will be needed, and of this, there are several standard sorts on the market, comprising adjusters, fasts, etc.

EDITOR.

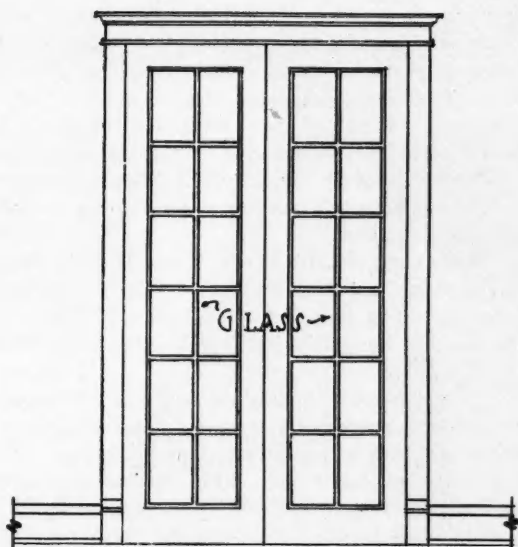

▲ INTERIOR VIEW ▲  
OF FRENCH WINDOWS.

FRENCH WINDOWS OPENING FROM BALCONY OR PORCH

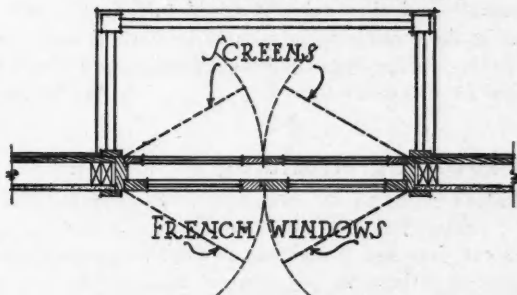

▲ PLAN VIEW ▲  
SHOWING FRENCH WINDOWS OPENING IN AND SCREENS OUT

Scale 3/8" = 1' 0".

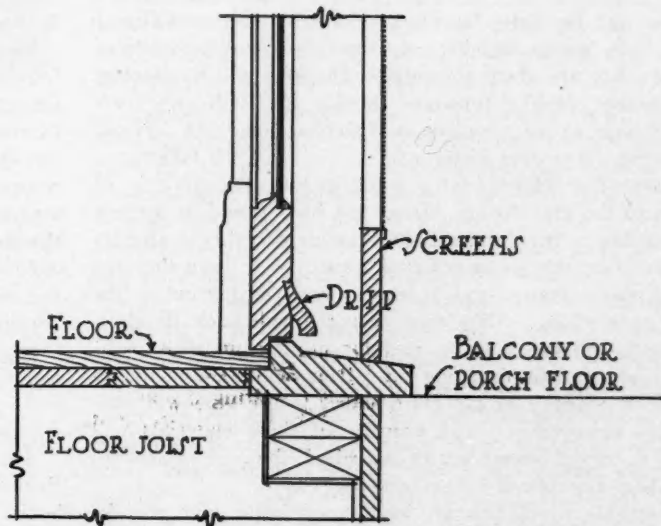
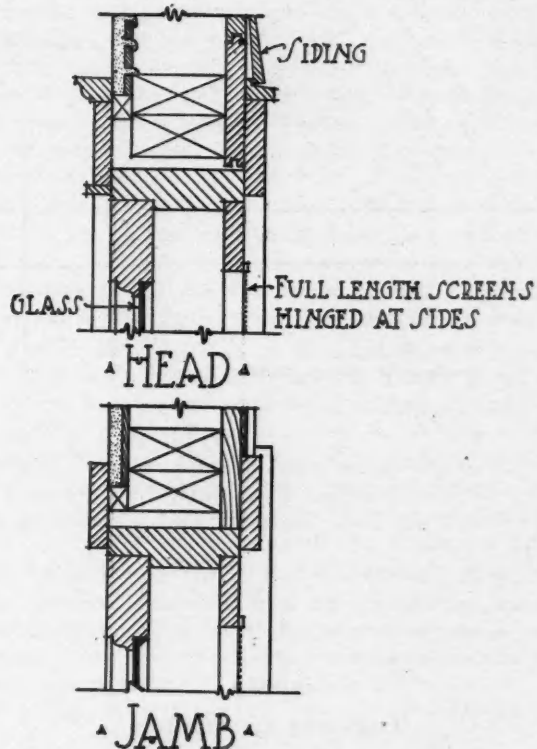

▲ SECTIONAL VIEW ▲  
THRU FRENCH WINDOWS AND FRAME CONSTRUCTION

Scale 1/2" = 1' 0".

Details of Pair of French Windows.

### Purlin Brace

To the Editor:

Freeport, Maine.

I am enclosing a draft for a purlin back brace. I would like to ask if it is used much and if this is the right way to frame it in?

J. B. SYDLEMAN.

*Answer*—This is a type commonly used in solid timber framing, but the growing scarcity of timber is causing this style of framing to be one of the lost arts, especially in the vast farming sections of the country, where practically all building material has to be brought from a distance and

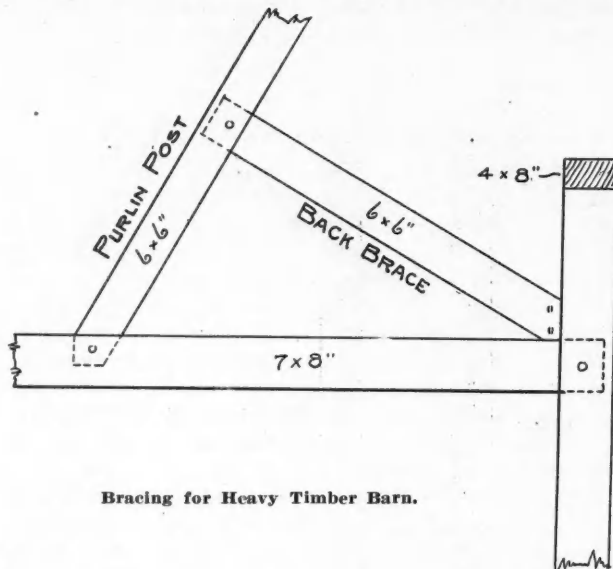

Bracing for Heavy Timber Barn.

where freight rates are quite an item. Heavy timbers are not kept in stock, and even the ordinary 2 by 4 is not a full-fledged 2 by 4 any more, and the same holds good all along the line.

The sketch referred to is such as was used back in Indiana, years ago, and perhaps still used in timbered sections; but its day is doomed and eventually must give way to latter-day plank frame construction.

EDITOR.

### Success in Gluing

To the Editor:

Herington, Kans.

I have had but little success in gluing. It happens that I have to join boards together, and have used various kinds of glue, but they are about the same. The glue will hold better at times but not like furniture should. In Radford's Estimator it says to use Chloride of Calcium, Page 854. Please explain the use of this material.

E. F. WENDT.

*Answer*—The addition of a small quantity of chloride of calcium to the glue during mixing has been found to prevent cracking due to the fact that the chloride of calcium attracts moisture from the air in sufficient quantities to keep the glue in its proper condition and prevent it from drying out to the extent of cracking. Glue thus prepared will stick to glass, metal, etc., and can even be used for putting on labels without danger of their dropping off. It is also claimed that a very small quantity of glycerine added to the glue will produce this same effect. The quantity of these materials will depend upon the circumstances for which the glue is desired, and is best determined by experiment.

The trouble which you are having with your glue may be due to other causes than drying out. Good glue should be a light brown color, semi-transparent, and free from waves or cloudy lines. Glue loses much of its strength by frequent remelting; therefore, glue which is newly made is preferable to that which has been reboiled. The hotter the glue the more force it will exert in keeping the joined parts glued together. In all large and long joints it should be applied immediately

after boiling. Apply pressure until it is set or hardened.

Glue, being an animal substance, must be kept sweet. To do this keep it cool after it is once dissolved, and not in use. In all cases keep the glue kettle clean and sweet by cleaning it often. Good glue requires more water than poor. Good glue will require from one-half to more than double the water that is required with poor glue, which is clear and red; the quality can be discovered by breaking a piece. If good it will break hard and tough, and will be irregular on the broken edge. If poor, it will break comparatively easy, leaving a smooth, straight edge.

In dissolving glue, it is best to weigh the glue, and weigh or measure the water; otherwise there is a liability of getting more glue than the water can properly dissolve. It is a good plan, when once the quantity of water that any sample of glue will take up has been ascertained, to put the glue and water together at least 6 hours before heat is applied, and if it is not soft enough then, let it remain longer in soak, for there is no danger in letting good glue remain in pure water, even for 48 hours. If glue is of first-rate quality, it can be used on most kinds of woodwork very thin, and will make the joint as strong as the original.

EDITOR.

### He Wants the Why in the Case

To the Editor:

University Place, Neb.

I have been studying the octagon frame on Page 73 of the January number of the AMERICAN CARPENTER AND BUILDER, and I see in the second paragraph, 69.58 inches (5'-9 $\frac{5}{8}$ "') is given as the length of one of the sides of the octagon. This amount taken from the diameter, which is 14 feet, leaves 8' 2.42"; and this divided by 2 equals 4' 1.21", which represents the distance at either side from the square corner to locate the corners of an octagon.

It is not clear to me, because in each phase of the quotation comes the question,—why? I am not one of the fellows to whom, because a thing is a fact, therefore it is a workable fact, but I want to know why? Therefore my why in this case.

E. BRADY.

*Answer*: It is true, after finding the length of the required sides of the octagon, there is no need of going any further, as far as the frame work is concerned; but this being a mathematical problem, we carried it a little further as proof to show that the measurements for the three sections equal the diameter of the quadrangle, containing the octagon.

Then again, in laying out the octagon full size for the foundation work, it is more convenient to know the part to set off from the corner of the quadrangle, than to calculate from the center of its sides.

It should be borne in mind that as a mathematical problem, we have treated it as such. The same results may be obtained without entering into mathematics beyond the laying out of the quadrangle and then take  $\frac{1}{2}$  of its diagonal length as radius and strike a circle from each of its corners and where the said circle cuts the lines of the quadrangle, will locate the corners for the octagon.

A. W. WOODS.

### Applying Moulding to Circle

To the Editor:

Ottawa, Kan.

When I subscribed for the AMERICAN CARPENTER AND BUILDER, some time ago, I received as premium a handsomely bound book on estimating and general information. It is a good book, chuck full of good things from front to back. The AMERICAN CARPENTER AND BUILDER is always a welcome visitor. It is a live, up-to-date paper. Am much interested in the Correspondence Department.

Would like some brother workman to show the best way to put a moulding on a circle. If this has appeared before, I have failed to notice it.

WM. M. WILSON.

### Calcimine on Damp Walls

To the Editor:

Boone, Iowa.

I have a contract on my hands to calcimine the basement in a church, but at the Board meeting tonight they thought it would not do, as the basement is too damp. If there is any mixture or sizing which I can use, please let me know about it.

JOHN LEDGERWOOD.

Answer: It is hard for us to advise you in a matter of this kind, since we have no way of telling the cause for this dampness. If it is desired to waterproof this wall against dampness coming from the back side of the wall, the following process will be of service to you:

Take  $\frac{3}{4}$  lb. of castile or any other good white soap and shred and melt in one gallon of hot water. Then dissolve  $\frac{1}{2}$  lb. of pulverized alum in 4 gallons of water. Keep these solutions in separate vessels and when cold they are ready to apply. Use a separate calcimining or sizing brush for each. Be careful the soap solution does not froth as you rub it in. Apply the soap solution first and let it dry 24 hours. Then apply a second coat of the soap solution and let it dry 24 hours. Finally apply another coat of alum solution.

This work should be done in dry weather and when the walls are dry.

If the moisture comes from condensation from the air, it may be even necessary to lath and plaster over the walls, thus making an air space behind the surface which is to receive the calcimine. This is costly and is not often necessary.

EDITOR.

### Ornamental Concrete Side Line

To the Editor: Plainville, Conn.

I am sending you a cut of one of our urns, which we think are very neat. We make them as a side line.

N. S. DEANE, of DEANE & COE.



Concrete Vase Made by Deane & Coe.

### School Room Lighting in Indiana

To the Editor: Clinton, Ind.

In reply to H. R. Bigelow, I would say that I make the area of my windows one-sixth of the floor space. The law in Indiana requires that the light be brought into the room over the pupil's left shoulder, which places all the windows on one side of the room. The windows should be placed  $3\frac{1}{2}$  or 4 feet from the floor, and the tops not over one foot from the ceiling. Twelve or thirteen feet is a good height for the ceilings. Divide the cubic contents of the room by 225 or 250 for the seating capacity of the room.

CHARLES M. THOMAS,

Architect.

### Jasbury Soreheads About Systems, Bosses, etc.

To the Editor:

Speaking about the carpenter and the building business, I once heard a man remark he had never known a contractor that had made any money, or one that had made sufficient to repay him for the strenuous task to which he was subject while carrying on the building business. That may seem a broad assertion, but when you consider the anxiety, disappointments, mistakes, accidents, and other trials, a builder

is confronted with, it may work out all right at that.

In order for a man to carry on the carpenter and builder business, in the first place, he should be a good mechanic and also a good executive man, two traits, or gifts, rarely found in the same person. Some contractors, like some factory owners, have so much system (Taylor and others) to their methods, it seems a wonder they ever get a building finished. Others start out about half cocked and wind up in jig time.

Speaking about system, the old saying, "A place for everything and everything in its place," is all right; but when a man will install all the new-fangled contrivances to keep tab on every minute article and act, what he is saving at the spigot he is losing at the bung. Time clocks, time slips and such are all right; but when a man puts a stipulated time on boring a  $\frac{3}{8}$ -inch hole, or putting in one dozen  $1\frac{1}{2}$ -inch screws, and many other such tricks, it seems as though the business world was system crazy. Not only is he taking time that could be put to actual mechanical use, but is souring the mechanical milk, or in other words, the men who are so much pestered with this over-abundance of tab on them, get so sore they naturally hang back in the harness, thereby causing the labor bill to run up on Mr. Boss, so that he has troubles of his own at the windup making his ends meet.

Still he will go back at it again, using the same oppressive measures, thinking he has a new brand of dope (system). He will tell you he has figured the problem out and it is this and thus—that figures do not lie—but liars do figure.

If a contractor has made up his mind to make a success of the building business, he cannot buy a high priced automobile and hang out at some liquid cooling station during the working hours, or any other, as far as that goes; he must keep down on earth, stay at the job, except only when he has to go on business and business only. It may be all right in some cases to hire a good foreman to look after things, but until Mr. Contractor gets his business on a reinforced base, and on good terms with the banks, he ought to stay there like a mother watching a croupy child.

The ordinary builder has it figured out how many bushels of siding, weather-boards, etc., how many township of shingles a man can put on (or rather should put on), how many doors a man can hang in a day, square miles of flooring, etc. When the contractor finally totals up his labor bill, he discovers some woman's male offspring has been putting slate into the fire of daysworkism. Of course he threatens to re-systematize his methods; import a whole mess of foreigners, defy the laws of union and gravitation, etc.

To institute system to any business is all right, but there must be something of the "To suppress an evil you must start at the root" style; commence with the contractor and shop manager and his high-collared, non-producing colleagues. I have seen men in business with a big gang of men take some high-speed man, let him set the pace, and the others, not being able to keep up, would all be condemned. This is a very narrow view to take, because many a man has been in wrong that could have made Mr. Fastman look like a swiss cheese with the holes plugged up with frog spawn.

Every man's capacity is not the same. (Mine has stood many a bartender test.) Some men that are working at the watchmaker's trade would have made a better blacksmith; many long-shoremen would have made a crack-a-jack Dominion! Now and then a fellow will get at the line of business he has a natural bent for—and presto! We have Mr. Expert.

Some bosses claim to have their business trimmed to such a degree of perfect system they can tell how many men on the job have amalgam filling in their teeth. Some contractors have their office on the corner of Main Street and Etcetra Avenue. Saturday nights their man can be seen

chasing around town, looking for the pay-car until nearly church-bell time next morning.

I have seen contractors with such an air of Marie Antoinette they would hold their heads so high above those working for them one would think they were floating around on an ocean of champagne in a flotilla made of radium. Such business men are of the *a la* Russia type—two classes—the upper and the extreme lower. They have a private office fitted up to suit their lofty sphere, giving orders as though there was no other power or authority on earth over them, but when a gang of ill-treated mechanics huddle together for the true American workingman's share, the air current shifts its quid to the other side of System's mouth.

I have known mill managers—one in particular—who never used to have any certain style about his charging. He had fallen into the game from the craftsman ranks and had not had time or opportunity to prepare an elaborate mesh bag full of system. He made both kinds of money—the brand that killed Bryan, and the kind that a steerage passenger pins on the inside of his undershirt.

On the other hand, I know men that have the most clock-work kind of way of conducting their business; always seem to have time to listen to reason, and respect the ideas and suggestions of practical mechanics.

Is there anything more pitiful than to see a wife of a contractor (who has emerged from the ranks and makes some money) trying to be a real Paris person? I have known men when they reached the pinnacle of boss, to be so enlarged above the shoulders, they had to have a hat as large as the roof of an Indiana silo. Some take prosperity by the hand and make a neighbor of him and treat him with all courtesy, but still sleep with one eye open, like a Mexican sniper, because Mr. Pros. is apt to give you the idea that the men working for you are only living on leased time; that they are supposed to take their hats off on Thursday when the Boss is coming down on Saturday.

Some bosses will stand for hours in one of the places that have a brass rail about 8 inches from the floor, and rip off the "heifer dust" by the yard about the self-made, hand-made, and other hot-air adjectives, describing their rise in the business world. They will spend the U. S. silk paper pieces like they had a row of ice houses filled with them; but the moment an apprentice or a mechanic who has a reinforced brood of come-alongs, asks for a raise of two bits a day, he will put up a squeal louder than the brakes on a Wabash freight engine entering the Logansport yard.

Some of these bosses are so opposed to the progress of those on the flight below, they buy the air they breathe, in tanks, compressed so as to be distinctive. I have worked for bosses that would actually speak to me if they chanced to meet me on the street. Others would look as though they would have me indicted at the next grand jury if I spoke even Chinese to them. Some bosses carry system away from the shop and home with them; they would not sit down to a meal unless a doctor's certificate had been produced, showing that all had been sterilized, massaged, manicured and baptized. Such men miss about seven-sixteenths of the world's comforts; they live in such a narrow sphere they become mentally fragile and bodily thin; so thin, in fact, you could stand them up against a brick wall and erase them with a lead pencil.

WM. C. JASBURY.



### Two and Three Family Houses Wanted

To the Editor:

Bristol, Conn.

Would suggest that you take up the matter of plans of two and three-family houses. I think it would help your paper, especially in this locality where land is so high that a working man can't afford to build a single house.

W. L. STEWART.

### Meeting the Competitor Who Underbids You

By R. Newbecker

WHERE is there a contractor that has not often run across the man who was trying his level best to "underbid" him? No doubt you have all been up against a proposition of this kind from time to time. No doubt you have often figured on contracts where it was specifically stated that the job would go to the lowest bidder. Conditions like these certainly have discouraged you at times, and it is truly regrettable that conditions like these do exist in certain communities. Luckily, however, such conditions can be remedied to a certain extent.

Mr. Contractor, there isn't a line of business that you could enter where you will not find the fellow who always sells his goods or services cheaper than you. If you try to meet his figures in a fair and square manner, he will again and again underbid you, until the last vestige of profit is wiped out, and business is done at a loss. How to convince the building public that they are hurting themselves by engaging in a contest by having one contractor underbid the other, and that in the end they usually suffer the just penalty they deserve, in having bum work done or poor material put into their houses, the building of which in the majority of cases is their life ambitions, is not such an easy task to do, especially if Mr. Underbidder's figures amount to a difference of a week or several weeks' salaries.

One thing, however, that would help considerable to keep work away from Mr. Underbidder, and convince the building public that they are really losing money by patronizing him, would be to make the building public well aware of the fact that a man generally gets what he pays for and no more. This holds true both in the case of cheap labor, or cheap labor and cheap materials combined. Another thing is that when a man tries to save a few dollars by the use of cheap labor and material, he, as a rule, generally gets much more inferior labor or materials than what he bargained for. Besides, mistakes made in this way will show up through the life of the house and cause no end of annoyance and costly rectifying.

If contractors would keep these few rules in mind and thoroughly convince their clients-to-be of these facts, so that they plainly understand the difference between the grade of labor and materials Mr. Underbidder furnishes and the kind of labor and material he will get if he gives his building to some bona fide contractor whose bid may not be lowest in price, but whose workmanship and material ranks highest, many jobs would be secured which Mr. Underbidder now secures. The time will not be long before Mr. Underbidder would die a death of business starvation caused by his own cut-throat methods.



A TWO-CENT smile gets more for you than a ten-dollar frown.

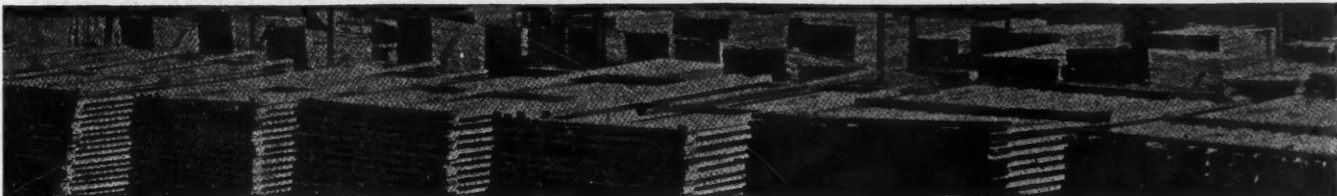

# HIGHEST GRADE LUMBER AT LOWEST PRICES!

Lumber is the backbone of all building. **YOUR BUILDING COSTS ARE IN PROPORTION TO THE LUMBER PRICES YOU PAY.** Save from \$100 to \$300 a car! Buy direct of Gordon-Van Tine. Pocket the savings you make through our "wholesale-to-builder" prices. Get your shipment from Gordon-Van Tine mills at the edge of the great timber forests. Let our "24-HOUR-SERVICE" add to your profits as it is already adding to the profits of over 10,000 other shrewd builders. Cut out all middlemen's rake-offs! It is a physical impossibility for others to equal our prices without lowering standards. We ship anywhere that railroads go.

Our shipping service is ideal. Our stocks are so complete, always, that no building job is ever held up because of delay on a few items. We carry in stock hundreds of bargains that cannot be bought elsewhere except on special order at high prices. Quality, Quantity, Safe, Prompt Delivery and Satisfaction Guaranteed or Money Back.

Three Strong Banks and over 100,000 satisfied customers among home-owners vouch for our honesty and square-dealing.

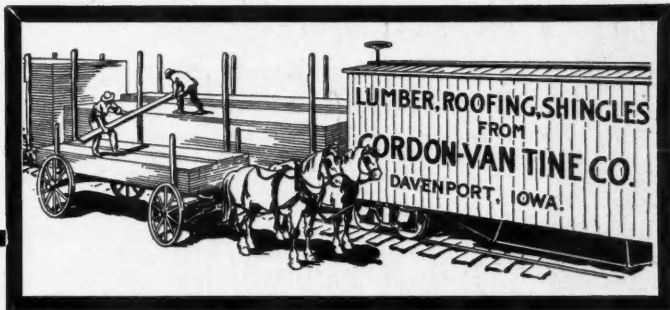

## WE SHIP ANYWHERE

Get all your shipments direct from the biggest standard lumber stock in America. All your needs supplied at a moment's notice. Dimension, Heavy Joists and Timber, Drop Siding, Bevel Siding, Ceiling, Flooring, Partition, Wainscoting, Finishing Lumber, Lath, Shingles, Boards, Posts, Poles and Battens. All graded in accordance with Rules of the Lumbermen's Association. All standard, bright, clean, new. Kept protected from the weather.

### Safe, Prompt Delivery and Full Satisfaction Guaranteed or Money Back!

Rush orders are a specialty with Gordon-Van Tine! No other concern in America can give you the quick action, quality and low prices that Gordon-Van Tine Co. offers. Our immense plant has for years been built up with the main idea of getting materials to our customers quickly and right in every particular. We actually carry everything our carpenter and contractor customers want—with ample facilities for also making special stuff quickly. "Guaranteed Right Estimates" furnished free. What do you need?

## GORDON-VAN TINE CO.

773 Federal St.     ::     Davenport, Iowa  
ESTABLISHED HALF A CENTURY!

### Send the Coupon for This FREE Book of 5000 Building and Remodeling Bargains

We want you on our Free Mailing List, so we can send you our Special Bargain Price Bulletins from time to time. Thousands of the most successful contractors and carpenters, expert judges of values, keep our great catalog, valuable books and special bulletins on hand as a check and guide on buying orders and estimates. We also want to send you at once (if you have not a copy already) our big, illustrated, 156-page Bargain Catalog. Over 5000 separate items. Everything for building. All sold by mail at "direct-to-builder," wholesale prices. Get this price-maker! It can save money for you. Send the coupon. NOW!



### FREE CATALOG REMINDER

GORDON-VAN TINE CO.  
773 Federal St., Davenport, Iowa

Put my name on your Carpenters' and Contractors' free mailing list for Special Price Bargain Bulletins. Also send me your 1915 Grand 5000 Building Bargain Catalog and Lumber List FREE.

Name.....  
Address.....



**T**HIS SYMBOL of J-M Responsibility is more than a device to attract your attention.

J-M Responsibility, for which it stands, is more than a phrase to arouse your interest.

J-M Responsibility is the expression of the principle upon which this business is founded—the principle that every J-M Product must render Full Service—that it must give satisfaction. But, responsibility is useless if it is not readily available. So, to make our responsibility, both to you and to your customer, direct and personal, “J-M Service covers the Continent”.

If J-M Asbestos Ready Roofing were merely another “Ready Roofing” we would not ask you to consider it



Deep Run Stock Farm, near Birmingham, Mich. J-M Asbestos Roofing.

A carpenter and builder with a business such as yours, has little or no use for the ordinary “ready” roofing, which is sold by any hardware or general store, and which anyone with ordinary mechanical intelligence can apply.

J-M Asbestos Ready Roofing is a Quality Roofing and is coming into more or less extensive use on many classes of buildings where metal roofing would be used ordinarily.

Note the substantial character of the building shown here—covered with a J-M Asbestos “White Top”. This roof is water-proof, fire-retardant and time-proof. It is the

cheapest-per-year of all prepared roofings, for it will never need coating or painting or any other attention. And it will last thirty to forty years!

**J-M Roofs pay Two Profits—one profit on the Sale and another profit on the Application. You can make both.**

J-M Asbestos Ready Roofing will last longer and present a better appearance if you lay it, because putting it on is really a “roofing job” and you know how it should be done. We want it done **right** because J-M Responsibility **must** stand back of it.

Why not supply this roofing and thus make one profit? Why not lay it and so make another? Others are doing it. Why not you? We can “show you”.

*Ask for Literature, Prices, Terms, etc., and let us show you how to “Round Up” this Two-Profit Business in Your Community.*

## JOHNS-MANVILLE PRODUCTS

J-M Drinking Water System  
J-M Transite Asbestos Wood  
J-M Asbestos Cloth and Vitribestos Theatre Curtains  
J-M Architectural Acoustics  
J-M Waterproofing Materials  
J-M Mastic Flooring  
J-M Asbesto-Sponge Felted Pipe Covering and Sheets

J-M Asbestocel Pipe Covering and Sheets  
J-M Sectional Underground Conduit “Noark” Enclosed Fuse Devices  
J-M Corrugated Asbestos Roofing  
J-M Regal Roofing  
J-M Asbestoside  
J-M Asbestos Slate's Felt  
J-M Asbestos Roofing and Insulating Felts  
J-M Sound Deadening Felts

Cold Storage Insulation  
J-M Weathertite Paper  
J-M Asbestos Fire- and Damp-proof Flooring Felt  
J-M Cork Floor Tiling  
J-M Washerless Faucet  
J-M Sanitor Drinking Fountain  
Audiffren-Singrun Refrigerating Machine



## J-M Transite Asbestos Shingles supply a need filled by no other roofing material



**P**RACTICALLY every dwelling, school or public building that goes up in your section, is a good prospect for a contract to sell and apply this "Everlasting Roofing".



*Residence of C. A. Gormley, Kansas City, Mo.  
Covered with J-M Transite Asbestos Shingles*

There are two profits in every J-M roofing job. We can help you to get both for **your** business.

J-M Transite Asbestos Shingles are made of Asbestos Fibre and waterproofed Portland Cement. They are moulded in one piece under hydraulic pressure and will not warp, curl or split. They are fast color—Gray, Brown and Red—and may be put on in three effective styles. They are fire-proof, lighter and more durable than slate and will last as long as the building you put them on—for they are practically indestructible.

*Ask us for Information that will show you  
the profits in these shingles*

## J-M Fire-Proof Cold Water Paint makes shops and factories brighter and your profits better

J-M Fire-Proof Cold Water Paints are in demand for both inside and outside work. They increase the light reflecting capacity of interior walls to a point where lighting bills are often cut 25%.

They are "good business" for you, both to sell and apply—by brush or spray. They are widely specified and every specification is backed by J-M Responsibility.

They contain no oil, alkali, lime or chemicals and are mixed with ordinary water. They are endorsed by Underwriters as an approved fire retardant. Spreads farther and better than oil paints and does not discolor.



*Euclid Garage, 13th St. near Euclid Ave., Cleveland. "Largest in the World".  
J-M Fire-Proof Cold Water Paint*

*Send for Literature, Colors, Prices, etc.*

# H. W. JOHNS-MANVILLE COMPANY

Akron  
Albany  
Atlanta  
Baltimore  
Birmingham  
Boston  
Buffalo

Chicago  
Cincinnati  
Cleveland  
Columbus  
Dallas  
Dayton

Denver  
Detroit  
Duluth  
Galveston  
Houghton  
Houston

Indianapolis  
Kansas City  
Los Angeles  
Louisville  
Memphis  
Milwaukee

Minneapolis  
Newark  
New Orleans  
New York  
Omaha  
Philadelphia

Pittsburgh  
Portland  
Rochester  
St. Louis  
St. Paul  
Salt Lake City  
San Francisco

Seattle  
Syracuse  
Toledo  
Washington  
Wilkesbarre  
Youngstown  
3100B—3072D

THE CANADIAN H. W. JOHNS-MANVILLE CO., LTD., Toronto, Winnipeg, Montreal, Vancouver



A Nova Scotian residence of Herringbone. Home of Frank A. Gillis, Halifax. Architect. H.E. Gates, Halifax.

## How to Figure Close on a Contract

If it's a Herringbone job, you can use 25% less studding, for the spacing can be 16 inches.

You can figure on saving a goodly per cent on your scratch coat, for Herringbone spreads rather than cuts the plaster. You can count on rapid plaster work over

## Herringbone

### • Rigid Metal Lath

for it does not give under the trowel. Herringbone goes up fast. No wiring between studs. Has interlocking selvage edges. Always comes painted—protected from the weather if left exposed. Other cut-cost features are given in

### Our Herringbone Book Free

Send for your copy today. Tomorrow you may want to know all about working with Herringbone. Take this opportunity and learn now.

### The General Fireproofing Co.

6800 Logan Ave., Youngstown, Ohio

Makers also of Self-Sentering—the concrete reinforcing that eliminates the need of forms

Herringbone Rigid Metal Lath was used in the Hotel Plaza, New York. H. G. Hardenbergh Architect.



Trade Mark  
Reg. U. S. Pat. Off.



HOTEL PLAZA  
NEW YORK CITY

## Power Rig for Barn Raising

To the Editor:

Fredonia, Wis.

I am sending you a picture of a barn I raised last summer. It is 40 feet wide by 70 feet long. As you see, it is being raised by machine, with about twelve men without my gang.

I am going to send you a picture of my machine later, and

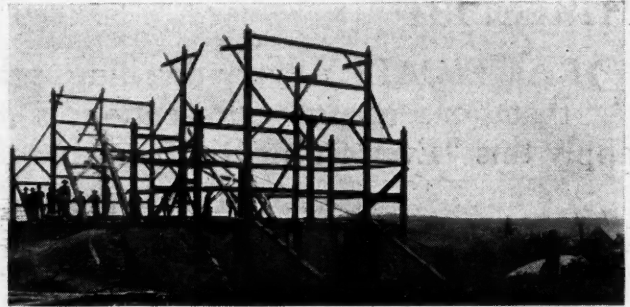

Mr. Lares and His Barn Raising Rig Shown at Extreme Right of Photo.

I hope some of the readers will be interested in barn raising by power. You will see the machine on the right-hand side of the picture.

JOHN LAURES, JR.



## On Fussy Shingling

To the Editor:

Morse, Sask.

I've got something sticking in my neck and I've got to get it out, so here goes: Brother Pierce gives us a few cues on fast shingling which I appreciate, and a brother chip makes a slam at him. Maybe he thinks he's right, but I can't see it that way. I'm only a boomer wood butcher, but have seen some territory and some stunts, so naturally I have a vision of Brother Hogg's gang. I think he must employ some old grey-whiskered friend of the family who has thumbs for fingers to do his shingling, and would be able to pick up at least 1000 nails around in the grass for every 2152 he'd give him to put in 1000 shingles, as I have never seen a man yet who would put a nail every 16/7 inches in shingles. Whenever I used to meet with a boss with such a comical idea, I'd wait till I got about 6 feet up the roof and slide the surplus down the gable planceer, and I'd be sure to get his next job.

HANK ROCHAT,

Modern Builder and Designer.



## Quit Your Kidding!

To the Editor:

Delta, Ohio.

I have read with great interest the April number, about Mr. Pierce, his weighty loads of transportation, and fast shingling: I have noticed that it has brought out in the different issues of the AMERICAN CARPENTER AND BUILDER suggestions and ideas from all over the continent, and I am led to believe that many a carpenter has felt discouraged because to do his best he couldn't begin to come up with some of the fast shinglers that we have read about.

But you haven't heard from Northwestern Ohio yet. Now, listen: One of our workmen was carrying two bunches of shingles up onto a barn; just as he went to step on the roof the ladder broke; he grabbed hold of the eaves of the roof with his teeth and hung there until they could take the ladder down to the blacksmith shop and get it fixed.

One rainy spring when work was scarce this same man made a rain gauge. He took a barrel, knocked out both heads and turned the bung hole up; the water ran in the bung hole faster than it could get out of both ends, so that it busted the hoops off.

WILL BARCOCK,

Contractor and Builder.

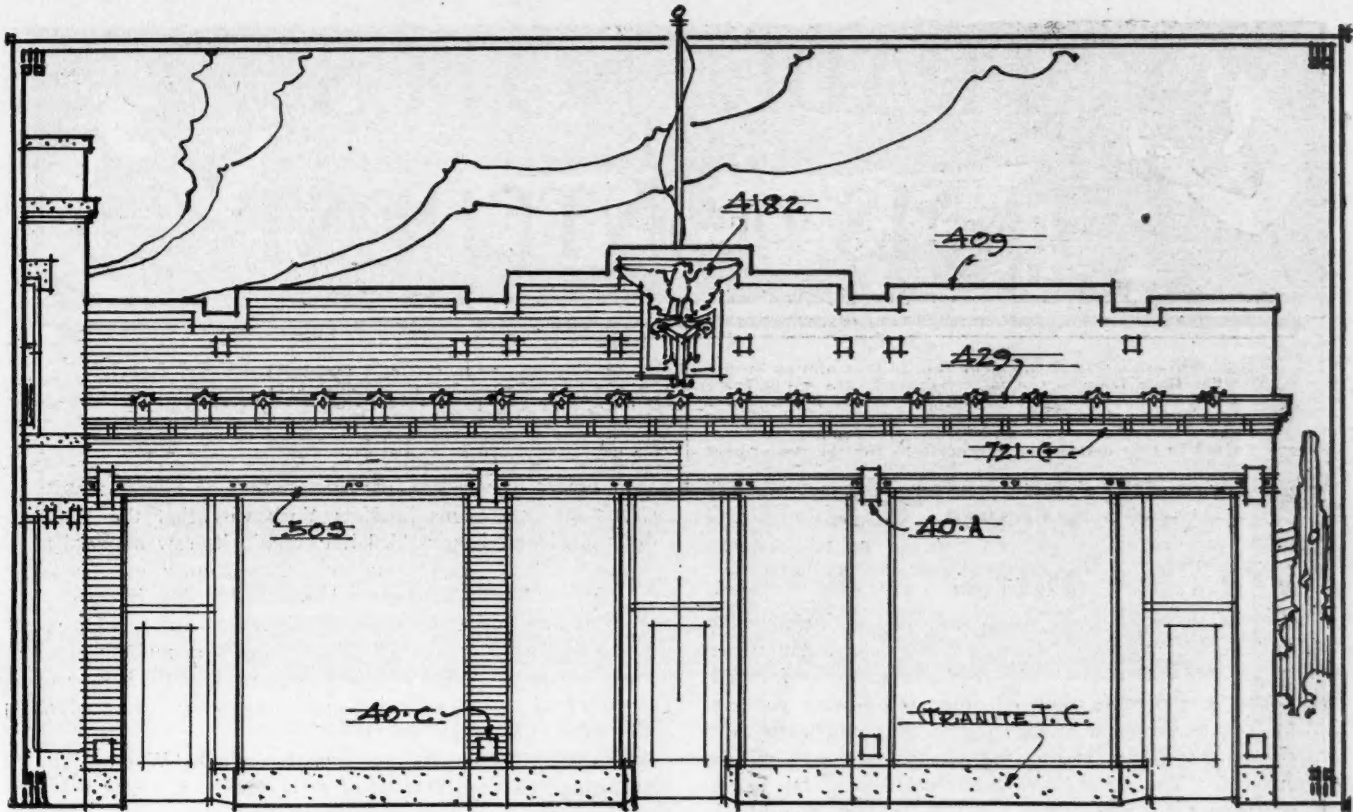

Stock terra cotta used in this sketch  
is shown in our 1915 Portfolio.  
WRITE FOR IT



3'-4" W. x 5'-4" H. Wings, 5'-4" W.

¶ MIDLAND enamel terra cotta is an income producer for the property owner—because of the individuality and prominence it lends to his building.

¶ Such a store building is seldom, if ever, vacant and the "reason-why" is, that progressive tradespeople

know an attractive exterior has a decided advantage over its dull-appearing, time-worn neighbor.

¶ If you are thinking of building or intend remodeling an old front—write MIDLAND—ideas and estimates will be cheerfully furnished.

# MIDLAND TERRA COTTA CO.

1515 LUMBER EXCHANGE BUILDING  
CHICAGO, ILLINOIS



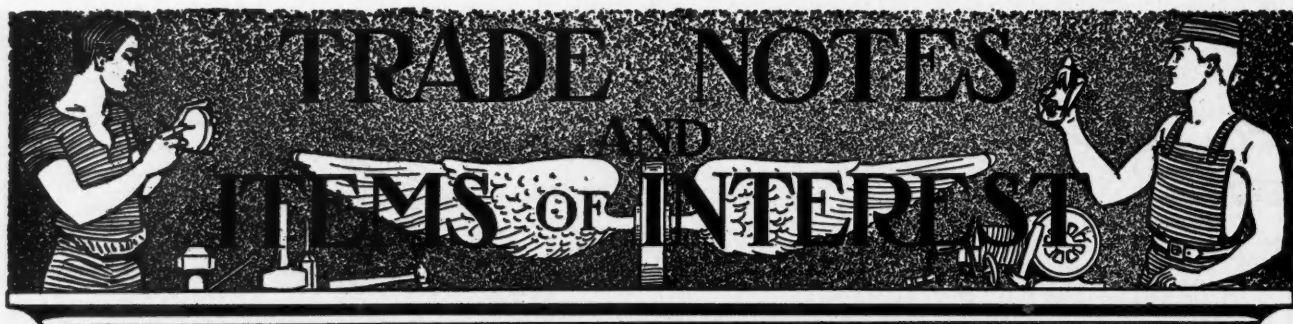

Through this department the Editors aim to keep builders, contractors, carpenters and architects in touch with what their friends, the manufacturers, are doing for them in new or improved tools and machinery, methods and materials—pertaining to building. Items for these columns must have real news value; they are offered here as interesting information for our readers; they are not advertising. No matter will be printed here simply because some advertiser wishes it. Likewise, no matter will be excluded simply because the article described is not advertised in this magazine. Suggestions for the betterment of this department are requested of our readers.

### More Than 200 Firms Now in Wood Waste Exchange

FOREST SERVICE ENABLING FACTORIES TO DISPOSE OF EACH OTHER'S WASTE MATERIAL TO MUTUAL ADVANTAGE

Since the inauguration of its Wood Waste Exchange, on April 15 last, the Forest Service has been requested to list 147 mills and factories as having waste material for sale, while during the same time 76 other wood-using concerns have asked to be listed as desiring to purchase waste of a wide range of species in specified dimensions or as mill or factory run. The latter have been included in the list of "Opportunities to Sell Waste," which is sent monthly to concerns which have waste material for sale. This list is growing steadily, but the Forest Service is anxious to accelerate its rate of growth inasmuch as it comprises only about half as many buyers as there are sellers listed under "Opportunities to Buy Waste."

The Forest Service has just been notified by a large novelty manufacturing concern in New York City that the Wood Waste Exchange has enabled it to obtain its raw material at a considerable saving of money. This factory uses small, semi-finished blocks of dogwood, which it makes into patent spool holders. The factory's requirements were published under "Opportunities to Sell Waste" and a manufacturer of shuttle blocks promptly seized the opportunity to dispose of the pieces of dogwood which previously were discarded as waste in his factory.

Similarly, other buyers are now, through the Wood Waste Exchange, obtaining material of good quality at a cost lower than they had been paying for raw material in the form of logs or standard lumber, and without themselves having to accumulate waste by cutting raw material into required sizes. On the other hand, many mills and factories which were burning their waste or disposing of it at firewood prices are now selling it at a fair profit.

## (Stucco Walls and Swimming Pool) (Waterproofed with CERESIT)

*In This Beautiful Residence*—as in thousands of others, the stucco walls are made permanently impervious to moisture by the use of CERESIT Waterproofing Compound; cracking and discoloring are prevented.

The beautiful tile swimming pool in this home is also made water-tight with CERESIT.

Endorsed by thousands of architects and engineers as the ideal waterproofing for basements, foundations, swimming pools, boiler pits, aqueducts, underground passages, dams, etc.

CERESIT Compound is a plastic paste that readily mixes with the water used to temper cement and concrete, thus does not retard hydration and insures uniform distribution throughout the entire mass.

To experiment is expensive. Use CERESIT and be sure of permanent and economical results. The fact that CERESIT was awarded 10 gold medals in three years, is proof of its exceptional merit.

You should not delay any longer in finding out all about CERESIT and what it does. Our engineers—*waterproofing experts*—will gladly give you full details and assist you in every possible way. *Write us today.*

**Ceresit Waterproofing Co.,**

910 Westminster Bldg., Chicago

*Residence of Mortimer L. Schiff,  
Oyster Bay, L. I., New York,  
C. P. H. Gilbert, Archt.*

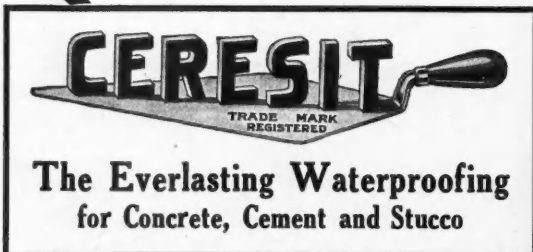

**The Everlasting Waterproofing  
for Concrete, Cement and Stucco**

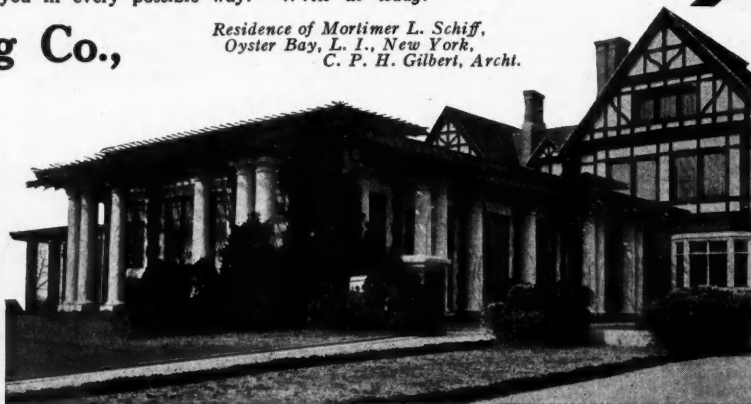

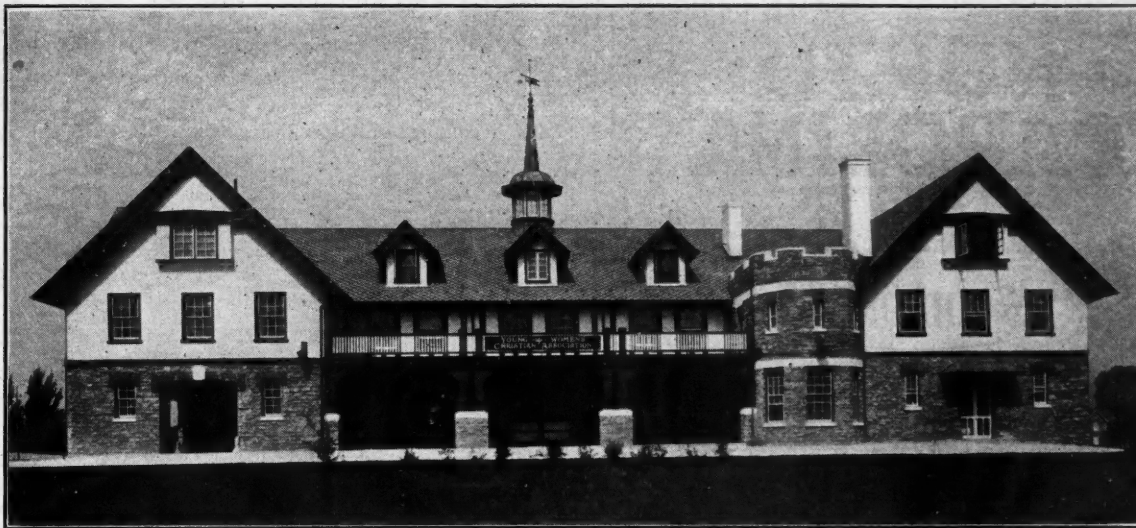

*Hershey Garage, Hershey, Pa., Roofed with Asbestos "Century" Shingles*

Architect, C. E. URBAN, Lancaster, Pa.; Contractor, J. C. REICHLEY, Paxtang, Pa.

## Asbestos "Century" Shingles

*The Fastest Growing Artificial*  
*Roofing Slate on the Market*

**H**ERE are two significant facts about the roofing business.  
First, property owners know more about the value of roofing material than ever before.

Second, Asbestos "Century" Shingles are the fastest growing roofing material, whether natural or artificial, on the market.

Property owners are buying intelligently. They are getting the facts. In every community they see the proofs of the durability of Asbestos "Century" Shingles—the way they stand up year after year without painting or repairing.

In view of these facts every contractor who is looking forward to live and growing business, should be in position to furnish his clients with Asbestos "Century" Shingles.

Write us today for terms and trade prices. We will also furnish samples.

**Keasbey & Mattison Co., Factors**  
Dept. B., Ambler, Pa.

*Branch Offices in Principal Cities of the United States*

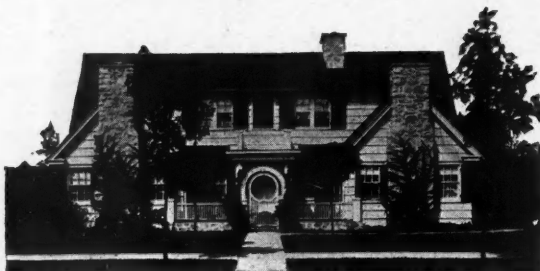

Showing the handsome exterior effects possible with North Carolina Pine.

## Gives a "High-Price" Look to a Low-Priced Building

If your client desires an attractive, comfortable home at a low cost, yet possessing the refinements and appearance of a much more expensive dwelling, North Carolina Pine will meet his wishes.

North Carolina Pine is not "Yellow Pine," but whiter and softer in texture, and is the best pine wood on the market today for interior wood-work, floors, etc.

Durable, attractive, easily worked, and, above all, economical.

### Write for Architects' and Builders' Reference Book

Write for Architects' Reference Book, prepared in convenient form for filing. Describes the many uses of North Carolina Pine and the beautiful effects obtainable.

Specimen panels on request.

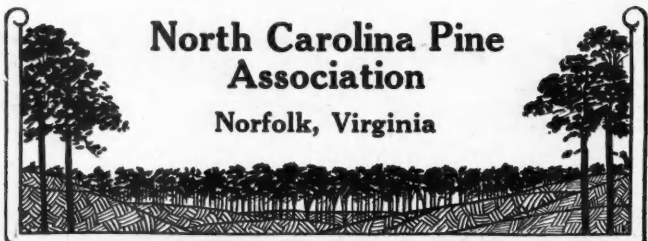

**North Carolina Pine Association**  
Norfolk, Virginia

The Forest Service desires the co-operation of all manufacturers of small wooden commodities and invites them to list their requirements with the Wood Waste Exchange. There is no charge for this service.



### The Backbone of the Wall

A mighty handy booklet for contractors and builders is being issued by the Sykes Metal Lath and Roofing Co., which contains full specifications for stucco when applied on

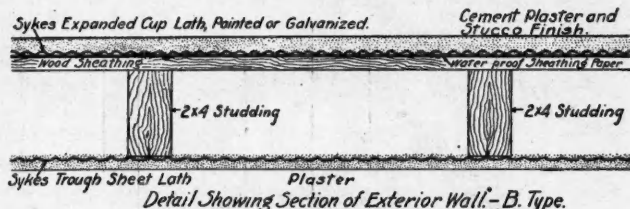

Reduced Detail Illustration from Sykes Specification Booklet.

metal lath. Metal lath is often called the backbone of the wall when used in this way, as it holds up the stucco, providing reinforcement for it.

The booklet contains many useful illustrations showing details and cross sections of properly constructed walls. There are also exterior views of houses that have been finished in this way. The accompanying illustration shows one of the detail drawings given in this booklet.

A copy can be obtained by writing to the above mentioned firm at 504 River Road, Warren, Ohio.



### Three Styles of Number Five Mixer

The accompanying illustration shows the No. 5 Knickerbocker mixer equipped with a power loader which is one of the three ways in which this mixer is furnished. It is also made with the standard charging hopper and the third way has a stationary batch hopper.

All these mixers are equipped with the "Bull Pup" engine

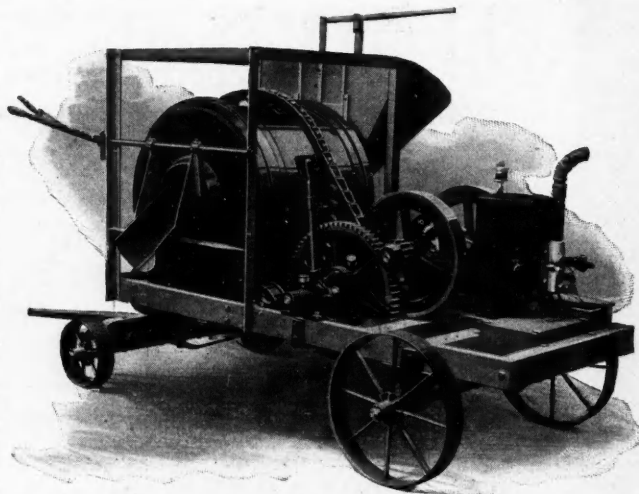

Stationary Batch Hopper and Hoisting Sheave.

which is guaranteed by the manufacturers to have plenty of power. The engine is covered with a steel housing which will protect it from dust and dirt.

The Knickerbocker Company has issued a very interesting circular describing this mixer most completely in its various styles. A copy can be obtained from them by writing to their address, Jackson, Mich. Contractors will find this mixer worth investigating.

# H-L-F LUMBER

has 'em all skinned for quality as well as price

Who says so?

These 22 users and several thousands of others

**DIRECT TO YOU**

For houses and barns that give permanent satisfaction to owners, use H-L-F quality lumber.

Every board, every timber, every shingle is backed by the famous H-L-F Million Dollar Guarantee as to quality, count and safe delivery.

Every job in which you use H-L-F lumber means a better profit for you, because of the saving on cost of lumber, and builds your reputation, because H-L-F quality sticks out on the finished job.

**You get H-L-F lumber clean, fresh—straight from the producer**

You get only the very cleanest and choicest of lumber from H-L-F, not lumber that is left over after two or three middlemen have finished sorting.

Through our officers, we own and control large tracts of choice forest lands. In our own mills we work this fine timber into lumber and millwork that makes the boss carpenter smile with joy, because it means lumber that is easy to work with and lumber that will more than satisfy the owner.

**Find out how much you can save on this highest quality lumber**

Why should you pass up the chance to make \$300 to \$3000 extra profit each year, that might just as well as not be cinching you a home on easy street. Make up your mind, right now, to find out what a lot more of money the same work that you are now doing can just as well earn you.

Send us today the lumber bills that you now are figuring—see how much more profit H-L-F lumber will mean. Also send the coupon for the H-L-F Prize Plan Book—costs you only ten cents—and contains at least ten dollars' worth of good ideas. 100 mighty good homes in it.

H-L-F lumber is cut from giant trees, like the one that is represented in silhouette at the right.

These trees often grow to the height of 300 feet, with not a limb for 200 feet from the foot. These big trees of old-growth yellow fir and cedar make the very finest lumber—lumber with few knots, with little sap and wonderfully lasting.

These big trees are often twelve feet thick, and average more than three feet thick. Some difference! when compared to the small trees that are now all that is left in the eastern forests, where most of the trees are no larger than telephone poles.

Wise buyers are demanding this wonderful western lumber in preference to everything else. Your customers will be glad if you suggest this better lumber, and you will be able to make more money as well as give the owner a better building.

**H-L-F No. 2 good as dealers' No. 1**  
 "Your No. 2 is as good as the No. 1 in our lumber yards at Waitsburg."  
 "JOHN T. PETTICHORD,  
 "Waitsburg, Wash."  
**Nothing like it 'round here**  
 "Everybody that has seen it says no person could get any such good lumber around here."  
 "CARL G. MILLER,  
 "Miltona, Minn."  
**Couldn't believe the low price**  
 "All made remark about it being fine lumber, but when they asked me what I had to pay for the lumber, they would not believe me, so I had to show them."  
 "SWAN OLSON,  
 "Atwater, Minn."  
**Nicest lumber they ever saw**  
 "Those that have seen the lumber say it is the nicest lumber they ever seen."  
 "JOHN SKOG,  
 "Wadena, Minn."  
**Simply grand!**  
 "Must say I am very much pleased with the lumber. It is simply grand, especially the finished lumber."  
 "A. G. WEST,  
 "Ryegate, Mont."  
**Very fine!**  
 "We like the lumber very fine. One old man said it was the best shingles that ever came to Ethan, and I am surely well pleased with the lumber."  
 "VICTOR MOQUIST,  
 "Mitchell, S. D."  
**Finest lumber ever!**  
 "Everybody says it is the finest lumber that ever came into the town."  
 "J. L. T. WATTERS,  
 "Duncan, Ariz."  
**Building is a credit to town**  
 "This building is a credit to the town also the firm that furnished the material."  
 "E. L. KENYON,  
 "Brighton, Colo."  
**Much satisfied**  
 "I am very much satisfied with the lumber, and the shingles were the best I ever saw."  
 "ALBERT ROCKSWOLD,  
 "Oakwood, N. D."  
**—And this is a lumber region, too**  
 "The finest lumber that Sparta people have seen in a long time."  
 "MAT SHAUFL,  
 "Sparta, Wis."

**Quality better—price lower**  
 "The lumber is of better quality than they handle here and the price was seven dollars per M cheaper."  
 "EDWARD M. OWEN,  
 "Parkman, Wyo."  
**Best he ever saw**  
 "I never saw as fine lumber in my life."  
 "W. W. DURAND,  
 "Powell, Wyo."  
**All good**  
 "It is all good lumber. The best I have ever seen."  
 "CHAS. E. COLLINS,  
 "Sorrento, Colo."  
**Another bouquet for No. 2**  
 "The No. 2 lumber is better than any No. 1 lumber that ever came to Lucan before."  
 "JOHN GOBLIRSCH,  
 "Milroy, Minn."  
**Best ever seen**  
 "The best grade of lumber we have ever seen."  
 "JOHN SCHRAM, JR.,  
 "Fedora, S. D."  
**Nothing but praise**  
 "I have heard nothing but praise for your lumber."  
 "J. L. FLOWMAN,  
 "Oldham, S. D."  
**Proud of it**  
 "I am proud of this lumber as it is the best and better than I could get at local yards."  
 "GEO. GUNDERSON,  
 "Vega, S. D."  
**Another "best" car**  
 "All my friends say it is the best car of lumber ever shipped into this country."  
 "E. B. McCORKLE,  
 "Kanawha, Iowa."  
**Exceptionally good**  
 "I found the lumber of exceptionally good quality."  
 "M. A. THOMETZ,  
 "Twin Falls, Idaho."  
**Everybody delighted**  
 "I have had a number of people see the lumber. They were delighted with it."  
 "C. CHRISTENSEN,  
 "Burley, Idaho."  
**Carpenter says "fine"**  
 "My carpenter says it is a fine load of lumber."  
 "SCOTT A. WILES,  
 "Bostwick, Neb."  
**Well pleased**  
 "Everyone who has looked at the lumber is well pleased with it."  
 "J. W. McMANIS,  
 "Ansley, Neb."

**Hewitt-Lea-Funck Co., 1208 Crary Bldg., Seattle, Wash.**

Gentlemen:—Please send me the following:

- Barn Builder's Guide (four cents)
- H-L-F Plan Book (ten cents)
- Delivered, freight-paid price on enclosed list of materials (no charge for quotation)
- Millwork Catalog (free)
- H-L-F House Pricer (free)

Name .....

Post Office .....

State..... R. F. D.....

### "Red Devil" Expansive Bits

There are all prices, kinds and descriptions of expansive bits. It remained for the "Red Devil" people to bring out an expansive bit with a large clearance in the throat, a tough lip that can be honed and re-sharpened and a heavy screw to do its work. This bit is not made of a rod of iron but is honed from tool steel the entire length of the bit. The cutters are sharpened and scored, and set at the proper angle

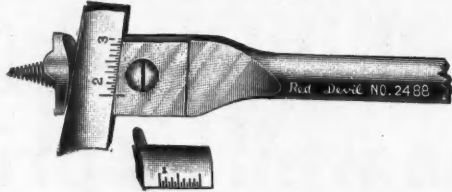

New member of the "Red Devil" Family.

so that it will do its work most satisfactorily. It is known as style No. 2488.

They have adopted the old Clark pattern for the reason that any Clark cutter will fit their bit, which makes it a very handy tool for the carpenter should he ever break a bit and not have time to wait and get it from the "Red Devil" factory. This expansive bit has two cutters with it, boring holes from  $\frac{7}{8}$  to 3 in. in diameter.

One of these bits in the hands of a carpenter makes it possible for him to bore all size holes from  $\frac{7}{8}$  up to 3 in. Just think of this range of work. The makers are Smith & Hemmway Co., Inc., 156 Chambers Street, New York City.

### United Steel Sash Book

Anyone interested in steel sash will find that the new book, which has recently been issued describing United Steel

Sash, is one of the most interesting and instructive on this subject.

It is a book of 128 pages,  $8\frac{1}{2}$  inches by 11 inches—which is the size page recommended by the American Institute of Architects. Many good illustrations, showing installations of steel sash of all the various kinds, are shown, together with detail drawings of the sash.

All builders who are interested in this phase of modern building will find this book extremely valuable for reference purposes. A copy can be obtained from the Trussed Concrete Steel Co., Dept. H 44, Youngstown, Ohio.



### New Branch of Witte Engine Works

On August first the Pittsburgh, Pa., branch office of the Witte Engine Works will be placed in the charge of their own men. Mr. E. D. Voorhis, who has been connected with the Kansas City office, will be in charge. This new branch will receive inquiries and carry on its own sales work the same as the Kansas City office. The branch will be located in the Empire Building, corner Liberty Ave. and Fifth St.

The object in establishing this new office is to give their customers in the east direct factory service. Quicker service can be furnished to all the present Witte customers in the east and better care can be taken of future customers.

The Pittsburgh branch will carry a full line of engines and spare parts and is prepared to make prompt shipment of all orders, whether large or small, thus giving all customers every advantage of less freight and less time on shipments.

All inquiries in the Pittsburgh territory should be addressed to that office even though some of the printed matter should only carry the address of the Kansas City office. Customers in this territory will find that they can save considerable time by writing the Pittsburgh office.

## Going to Build, Remodel or Repair?

Get these TWO valuable books FREE

**SAVE \$5 to \$500 on Every Order** for building material. Our big Catalog tells you how. It shows 8,000 PRICE BARGAINS and contains illustrations, prices and descriptions of every conceivable article that enters

into the construction of a building. It tells you how to buy lumber, flooring, roofing, doors, windows, mouldings, cabinet work, colonnades, porchwork, hardware, tile, paints, wall board, metal work, plumbing and heating equipment, water supply outfits and thousands of building specialties and interior fittings at WHOLE-SALE prices. Everything is sold direct to YOU and YOU save all middlemen's profits.

This book is more than a mere Catalog. It is an encyclopedia of building information and will prove of the utmost value to you every day in the year. Write for a copy today. It is sent absolutely free, postage prepaid, and places you under no obligation whatever.

**Also ask for our Plan Book of Modern Homes.** Every carpenter and contractor will find this superbly illustrated Plan Book an

invaluable aid in securing more work and a key that opens the way to greater profits. You can show your customers newer and better designs of modern homes, bungalows, handsome suburban residences, town houses, practical country homes and barns. You can also learn from this book how to secure

architect's blue print plans and specifications without one cent of cost. We shall gladly send you a copy of this book free, postage prepaid. Ask for it.

**Free Estimate.** Send us your lumber and millwork bill for our FREE ESTIMATE. Let us quote prices including all freight charges direct to your railroad station, so that you can tell in actual dollars and cents what we can save for you on your present requirements. This service is FREE.

WRITE FOR OUR  
**FREE ESTIMATE**  
Don't Buy Until You  
Get Our Prices

**Screen Doors and Windows** are among the hundreds of reasonable articles that you can buy here at wholesale prices. No matter what you want in screen goods—from complete screened-in porches to a small piece of screen wire cloth, you will find it in our book at money-saving prices. Write for your copy of the Catalog today and tell us if you wish a Plan Book also. Both are free.

**CHICAGO MILLWORK SUPPLY CO.**  
AMERICA'S GREATEST SASH AND DOOR HOUSE

1422 West 37th Street

CHICAGO, ILLINOIS





Photo by Mary H. Northend, Salem, Mass.

JOHN WARD HOUSE  
at Salem, Mass. Built in 1684.

Words could not portray the lasting qualities of White Pine as graphically as this remarkable photograph. The exact date of the unpainted, weather-beaten siding is not known, but it is certain that the siding on the main portion of the house is from 150 to 200 years old, and stands now as originally built, with practically no repairs. The siding on the lean-to is of a considerably later date, but it will be noted that there is no appreciable difference between it and the siding on the main portion of the house. Both are in splendid condition today and good for service for many years to come.

**F**OR the outside covering of a building exposed to the attack of time and weather, no other wood gives such long and satisfactory service as

## WHITE PINE

Every carpenter knows that from his own experience. But every carpenter does not know that he can get White Pine today, for in some way the impression has gained footing that the supply of White Pine is practically exhausted.

The fact is — White Pine is still abundantly available today, as it always has been, in all grades and in any quantities desired, and can be purchased in all markets at reasonable prices, when considering its value as a structural wood.

If the Lumber Dealers supplying the material for those for whom you are building are at any time unable to furnish it, we would appreciate the opportunity of being helpful in securing it.

### A Free Magazine for Contractors

The first issue of the bi-monthly architectural White Pine Magazine has been mailed to contractors. Every issue will be full of valuable and helpful information for contractors and builders.

If this magazine does not reach you, kindly advise and we will be pleased to place your name on our mailing list.

Representing  
The Northern Pine Manufacturers'  
Association of Minnesota, Wisconsin  
and Michigan, and the Associated  
White Pine Manufacturers of Idaho

Address, *WHITE PINE BUREAU,*  
*1835 Merchants Bank Building, St. Paul, Minn.*

# Another Kellastone Home Finished

More Friends Made



That's the universal feeling of satisfaction experienced by every contractor the minute he turns over the keys of a **Kellastoned** Building to the owner. For he knows that that beautiful, unmottled attractive looking exterior that so highly pleases his client today will remain just as beautiful and attractive in years to come. He knows that

## KELLASTONE

IMPERISHABLE STUCCO

does not embody any Portland cement, lime or gypsum and that it will successfully withstand the ravages of time and weather long after ordinary stuccos have gone to ruin.

**Kellastone** is moistureproof and fireproof and a non-conductor of heat, cold and dampness. It possesses far greater tensile and tension strength than cement stuccos and will withstand far greater settling strains without cracking.

It can be successfully applied over wood lath, metal lath, byrket sheathing, hollow tile, brick and stone walls at any time of the year, winter or summer.

It is especially valuable in remodeling old buildings, and as an interior plaster. The many beautiful finishes and effects to be secured are fully described in our Free **Kellastone Imperishable Stucco Book**.

### Kellastone Composition Flooring

is composed of materials in powder and liquid forms, which, when mixed and spread, form a tough, seamless mass over the entire floor including cove and base, if desired, thus providing a sanitary, durable floor without joints and easy to keep clean.

It can be laid on bases of concrete, wood or steel. Beautiful border designs and terrazzo effects can be secured and its lightness, warmth, resilience and quietness make it especially adapted for hospitals, schools, theatres, office buildings, public buildings, private homes, apartments and manufacturing establishments.

Our **Kellastone Composition Flooring Book** goes into details in a brief, interesting way. If interested, ask for a copy. It's yours for the written word.

**Kellastone** is carried in stock by leading building material dealers. If your dealer cannot supply you, write us direct.

**The National Kellastone Co.**

504 Association Bldg.  
CHICAGO, ILL.

### Adaptability of Compo-Board

Nearly all progressive builders are familiar with the use of wall board for finishing the inside walls and ceilings of houses. Now comes the Northwestern Compo-Board Company with several suggestions for the use of Compo-Board that are out of the ordinary.

They say that boxes and chests of various kinds used to keep winter clothes in and the summer moth out—can be made with Compo-Board much easier than with wood. Boxes made of this material will be light and can be made vermin proof and will be mighty handy to have around the house.

The Northwestern Compo-Board Company will be very glad to give further particulars to anyone desiring them. Their address is 5777 Lyndale Ave., No., Minneapolis, Minn.



### Comfort in the Home

Not so very long ago furnaces were considered a luxury and were too expensive for most people. The great comfort and convenience provided by them and their reduced cost has made them available now to many who formerly would not and could not consider them.

Now is the time for the contractor to get his friends to install furnaces before the winter starts in. The Hess Warming and Ventilating Co. have an engineering department that will be glad to take up any problems with the builder and they can give him the benefit of their years of experience. A letter to them at 1220 Tacoma Bldg., Chicago, will bring all the details of their special concession to contractors. With their help, the contractor should be able to install several furnaces in old buildings or in ones that are under construction.

### Levels That Last

A level is called on to do much close, accurate work and at the same time it always has to stand more abuse than any other instrument of precision. In order to stand the handling and also do accurate work, it is necessary for the level to be strongly built.

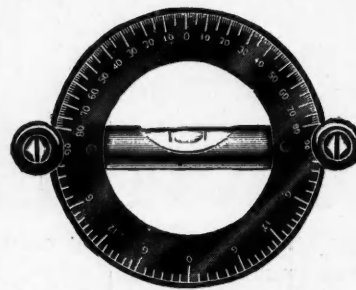

No. 6 Casing and Graduated Ring.

The Acme Level Co. make a line of levels that are designed to stand up under the treatment they generally get, and also to do the right kind of work. These levels are made of cold rolled steel strips fastened together to make a strong substantial body.

This company also make a casing and graduated ring that can be fastened to any level and is used on their levels. It has two scales on the ring. One of these shows the grade in degrees and the other shows the rise per foot. Illustration shows the appearance of this ring.

The Acme Level Co., 2014-A Detroit Ave., Toledo, Ohio, have a booklet describing their levels, that they will be glad to send on request.



### Albrecht Excavator and Loader

The T. L. Smith Co. announce that they have purchased the exclusive manufacturing and selling rights of the Albrecht Excavator and Loader and are in position to make prompt shipment of machines.

This means that one of the largest and oldest concrete mixer companies has entered the dirt-moving field. As this company manufactures a broad line of contractors' equipment, the Albrecht Excavator and Loader can be handled to splendid advantage.

Crown Your  
Buildings with



Ornamental  
Roofing and  
Shingles

A Most Pleasing  
Variety of Effects Obtainable in Colors and Designs

**SAFETY AND BEAUTY**

Heretofore, safety has been secured by the wealthy by using slate and tile roofs. The man of moderate means had to take chances and has repeatedly seen all he possessed destroyed by a flying spark or a fire brand.

Temporary color effects have only been possible by the use of stains and paints, but these did not withstand sun and rain for any length of time.

It has remained for the Patent Vulcanite Roofing Co. to give the public a roofing material that perfectly combines the qualities of safety, comfort and beauty at so low an initial cost, that no one now needs to put over his home such a flimsy, highly combustible and temporary covering as a wood shingle roof.

Vulcanite Roofings are an unfailling weather-proof and fire-resisting material. Twenty years' service is a reasonable expectancy. Vulcanite comes in rolls and shingles in several patterns that can be worked into a large variety of truly artistic effects.

We shall be very glad to send you our large illustrated catalogue which will show you some of our popular roofings and how they add to the appearance of a building. We'll also tell you just what we do for Builders to help them lay more "Vulcanite." Sit down and write us now. Address main office, Chicago.

**PATENT VULCANITE ROOFING CO.**

Birmingham, Ala.; Cincinnati, Ohio;  
San Francisco, Cal.; Kansas City, Mo.;  
New York City, N. Y.  
CHICAGO, ILLINOIS

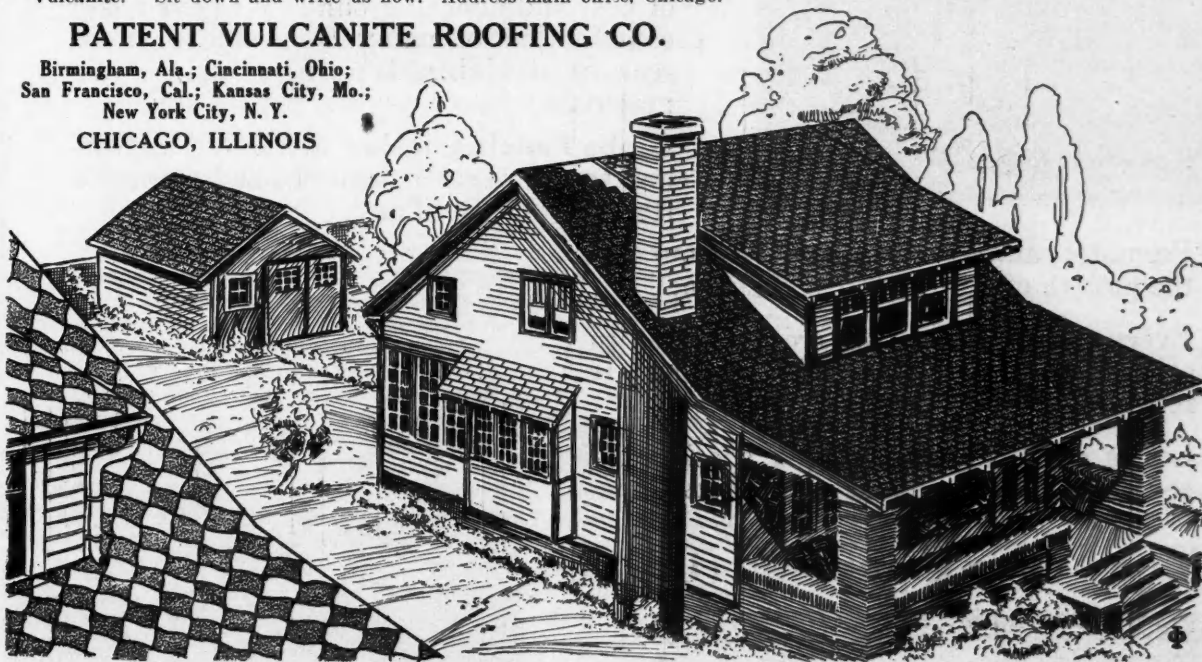

For over five years the inventor, John H. Albrecht, has tried to market this really wonderful machine. A number of these Albrecht Excavators and Loaders were sold and are being successfully used in different parts of the U. S. Lack of capital, however, prevented the successful development of the business. Realizing the immense field in which this machine could be used to advantage, the T. L. Smith Co. took over the entire business of the Albrecht Excavator Co. Backed by their world-wide selling organization and with their immense resources, the T. L. Smith Co. will be able to handle the ever-increasing demand for this machine.

The Albrecht Excavator and Loader is well described by a man prominent in engineering circles: "This machine is half way between a hand shovel and a steam shovel and will do the work of both." It does away with the big gang of shovelers. The wagons do not have the long, heavy pull out of the pit and the snatch team is done away with for the loading is done on the surface. Two men only are required to operate the equipment—one man in the pit to handle the scraper and one man to run the machine. A 12-H.P. horizontal gas engine, heavy duty type, provides ample power to dig and load 20 cu. yds. per hour. This machine will dig at a distance of 100 ft. from the machine and at any desired depth for ordinary excavations at the rate of about one round trip per minute. With this loader you can plow faster than with horses and load as fast as 10 men. It will dig at any point either above or below its level and over a big area covering a half circle back of the machine.

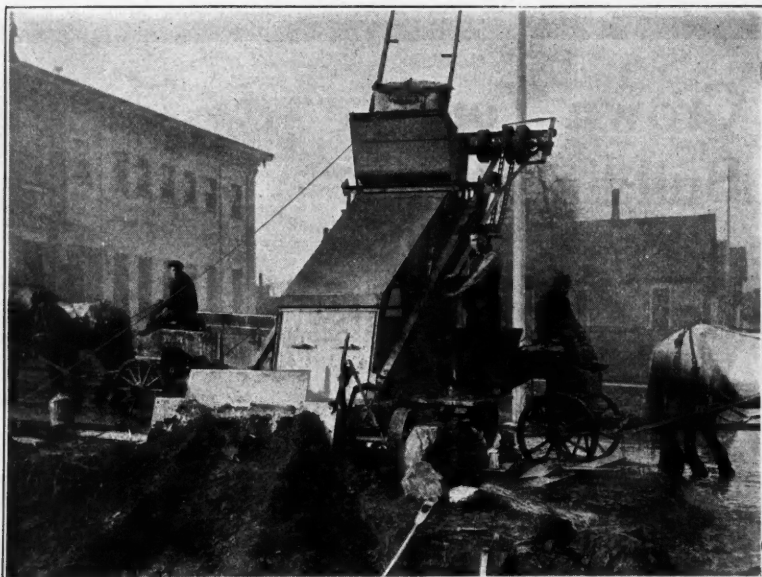

Albrecht Excavator and Loader at Work.

The Albrecht Excavator and Loader can be used for excavating for big foundations, basements, and drainage ditches, for back filling, for loading sand, gravel and other similar materials, and it is an economical investment for the contractor who handles street and highway paving. It can be used to splendid advantage on the ordinary roadway in place of the regular horse scraper.

Additional information, prices, etc., can be secured by writing to the T. L. Smith Co., 1107-A 32nd St., Milwaukee, Wis.



## You Can Make More Money

**Globe Fencing** is Profitable for you and will appeal to your customers.

Easy to erect. Can be mounted on any style of post and uneven ground. We have many combinations of materials suitable for front, rear or division fencing—all of A1 materials.

**Globe Fencing** makes attractive appearing yards. Lets in the sun and permits a freer circulation of air.

Promotes sanitary conditions. Encourages the growth of flowers and vegetation.

Every **Globe Fence** you erect will lead to other orders from neighboring owners. It recommends itself on sight.

Let us send you catalog and special discounts to carpenters and contractors.

**Globe Fence Company, (Un-Inc.)**

20-22nd St., North Chicago, Ill.



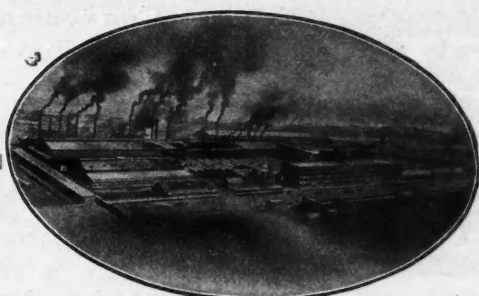

*Our Immense Manufacturing and Shipping Facilities enable us to give you the Utmost in*

*Quality and Service as well as the Benefit of Economical Production.*

**"The Largest Sheet Metal Works in the World"  
Canton, Ohio**

**Two Business Builders at Your Service**



**Berger's Metal Shingles**

Berger's "Classik" Steel Ceilings will please your customers and help increase your business. They have many desirable qualities (some of them exclusive) which are well worth your consideration:

**1. No Tamping—No Calking:** Our improved pressed bead and button construction (see cut) makes an absolutely tight joint without tamping or calking. A better job in less time—and you save from 25% to 40% on every job. Note particularly the self-centering, self-guiding, never-slip nailing point. The nail simply can't slip and mar the design or injure the workman. *These advantages are too important to be overlooked.*



**2. Beauty of Design:** More than 500 of the most beautiful designs to choose from, representing every style and period of architecture.

**3. Perfect Workmanship:** The artistic beauties of each design are brought out in that characteristic manner which has put Berger's "Classik" Steel Ceilings in a class of their own.

**4. Other Important Qualities:** A Perfect Fire Retardant—Can't crack or fall—Sanitary—Easily erected in old or new buildings of any size—Good for a lifetime of supreme ceiling satisfaction.

You will find our Special Catalog *D. A. C.*, with its hundreds of attractive illustrations, a powerful help in your business. *Better send for a copy today.*

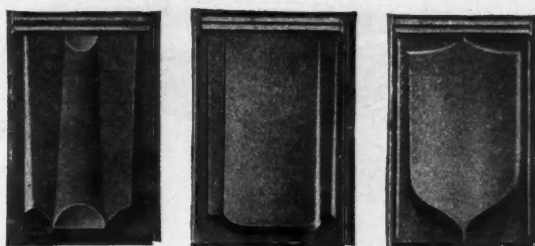

**Berco Chieftain Swanee**

Erect Berger's Metal Shingles *now*—and in future years you will have the satisfaction of pointing out those roofs as evidence of your skill and judgment.

**Material**

Heavy gauge metal that lasts, resists fire, and (if properly erected) affords full protection against lightning.

**Design**

Three pleasing and artistic designs to choose from, which add to the appearance and increase the value of any building.

**Construction**

Three-point contact side lock closes the joint perfectly. Also, extra high corrugations with knife-edge finish at the top further insure a wind and water tight roof.

**Application**

Being automatically interlocking and self-aligning, any one can apply them quickly and neatly with a hammer, a pair of snips, and nails.

Berger's Metal Shingles will also prove a powerful trade puller for your other lines. Every roof becomes a standing advertisement for both the material and the man who erected it.

*Ask us today to send you our Special Catalog E. A. B.*

**The Berger Mfg. Co., Canton, Ohio**

*Our Nearest Branch for Best Service:*

Boston Chicago Minneapolis New York Philadelphia St. Louis San Francisco

**Export Department: Berger Building, New York City U. S. A.**

**We also make:** Berger's Metal Lumber System of Fireproof Construction—Reinforcing and Metal Building Materials—"Raydiant" Sidewalk and Vault Lights—Sectional Steel Stock Room Equipment—Steel Lockers—Corrugated Steel Pumps—Roofing and Siding—Eaves Trough, Conductor Pipe, etc.—Steel Filing Cabinets and Office Furniture, etc. *Write for Information.*

# GOODELL-PRATT

1500 GOOD TOOLS

## This High Speed Breast Drill No. 279

is a marvel of mechanical ingenuity and expert workmanship. It is an absolutely new tool different from anything else on the market. By turning the knurled ring between the crank handle and the gear casing the speeds can be changed or the spindle locked for opening and closing the chuck.

Instead of the usual breast drill speeds, the fast speed on this tool is 7 revolutions of the chuck to one turn of the crank, and on the slow speed 2 to one. The gears, which are enclosed in an aluminum casing and packed in grease, are all machine cut like the gears in every other Goodell-Pratt tool. The chuck holds all sizes of round shank drills up to 1/2 inch in diameter.

The construction of the tool is absolutely up-to-date with every convenience for the operator; the saddle breast plate is much easier on the chest than the old style iron head; the aluminum casing and hollow steel tubes make it as light as possible; the ball bearings make the spindle run easier. All the aluminum parts are polished and the steel parts polished and nickel plated. The list price is \$7.50.

If you are interested in this tool ask any progressive dealer to show you one, or write to us for our new pocket catalog No. 12, which shows over 1500 tools, 80 of them new!

Goodell-Pratt Co.

*Toolsmith's*

Greenfield, Mass., U.S.A.

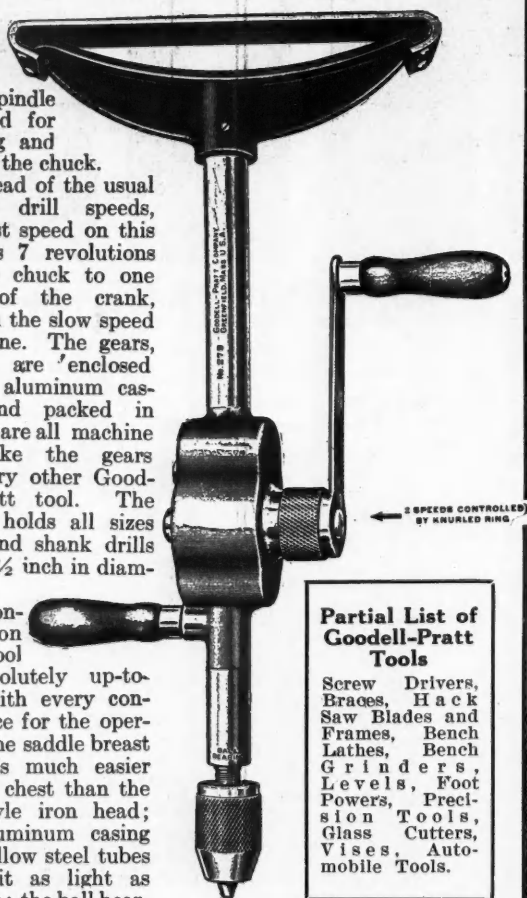

### Partial List of Goodell-Pratt Tools

Screw Drivers, Braces, Hack Saw Blades and Frames, Bench Lathes, Bench Grinders, Levels, Foot Powers, Precision Tools, Glass Cutters, Vises, Automobile Tools.



## A Convenient Well-Designed Saw Rig

A circular has recently been issued by the C. H. & E. Manufacturing Co., Inc., 322 Mineral St., Milwaukee, Wis., showing in detail their No. 6 portable saw rig. This rig is supplied with built-in power under the table, either gasoline or electric, or complete without power.

The table has a large unobstructed space for timber that is being cut with the circular saw. The ripping capacity is 3-inch stock with the 12-inch saw and 4-inch with the 14-inch saw. The band saw can handle stock that is 20 inches wide and 8 inches high. The table can be tilted to 45 degrees and can be locked in position. Hollow chisel mortiser can be applied to the boring attachment. Square chisels up to 3/4 inch can be used for cutting perfect mortises of any length. The jointing capacity is up to 6-inch stock.

Further details can be found in the illustrated circular which will be supplied on request.

## Overhead Carrying Equipment

Many contractors have been called on at some time or other to install overhead trolleys or carrying equipment for factories of various kinds. It is a line that every contractor should have reference catalogs on.

A catalog called "Overhead Trolley and I-Beam Carrying Equipment" has recently been issued by the Richards-Wilcox Manufacturing Co. It contains illustrations of the many kinds of equipment used in this work and also illustrations of completed installations. Directions are given for furnishing information to their engineering department, so that they can recommend the best sort of a system to be used.

Those interested in this sort of work will find this a valuable reference volume and can obtain copies from the firm by writing to them at their address, Aurora, Ill.

## New Swivel Base Vise

A vise that can be mounted on a bench by means of swivel base and can also be detached from the base to be used on a drill press or a shaper ought to be mighty valuable to many of our readers.

Such a combination has recently been placed on the market by North Bros. Mfg. Co., Philadelphia, Pa. This vise



"Yankee" Base and Vise a Useful Outfit.

is known as the "Yankee" No. 1993. The vise is separate from the base which is fastened to the bench. A lever on the side controls the turning of the vise on the base and will lock the upper part in any position. The makers say it is as rigid as any solid vise, when locked.

The appearance of the arrangement is shown in the accompanying illustration. In writing for full particulars, address Dept. A.

## Parks New Swing Saw

The new portable Swing Cut-Off Saw of the Parks Ball Bearing Machine Co. has proven to be of great value and convenience, being set ready for instant use, and especially in working long material. One man can lay it in position

# Cut Nails



## You Can't Drive a Cut Nail into a Hidden Knot

It simply won't go in and you can't spoil the floor. Hasn't this often happened to you when you were laying a floor and weren't using Cut Nails? You're laying a board, everything is clear sailing and the nails are being driven home every shot. All right, here goes a nail in. You start hammering, the first two strokes in as usual, but on the third stroke, "Zowie!" you meet resistance. You deliver a couple more strokes before it dawns on you that you've struck a hidden knot. You then try to yank it out, the nail having zig-zagged around the knot refuses to budge, and off comes the nail head. You then have to saw out a piece containing the snake nail with the result that you have a patched floor. Moral: Use Cut Nails for Flooring and have a perfect floor.

### CUT NAILS They Hold—They Grip They Cost No More

Cut Nails are becoming more and more popular every day with Carpenters and Builders who want their work to last, to stand and be as solid and sound in 20 or 30 years as the day they were driven in. They resist rust and possess from 147 to 135 per cent more holding power than any other nails. They prevent flooring from warping and springing up, always keeping the floor true and level.

### Be Sure and Ask for CUT FLOORING NAILS

the next time you Buy Nails—If your Dealer doesn't carry them, write to nearest manufacturer listed below and he will send you Free Samples and see that you are supplied.

#### Cut Nail Manufacturers

E. & G. Brooke Iron Co., Birdsboro, Pa.  
Tremont Nail Co., West Wareham, Mass.  
Van Alen & Co., E. G. Van Alen, Northumberland, Pa.  
Williamsport Iron & Nail Co., Williamsport, Pa.  
La Belle Iron Works, Steubenville, O.  
Geo. B. Lessig Co., Pottstown, Pa.

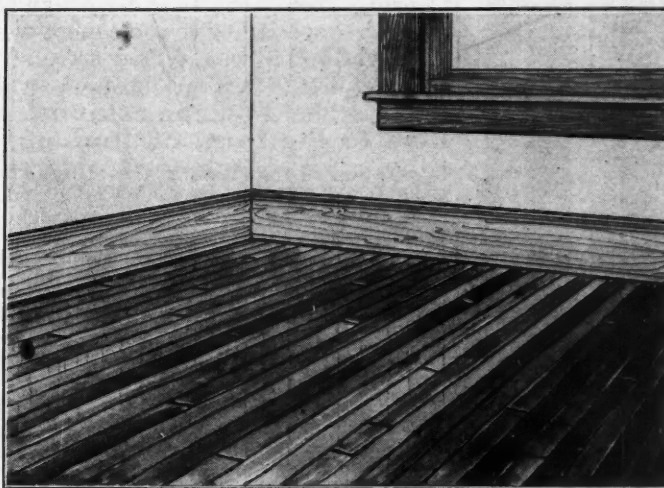

This patched floor is the result of nails (not cut nails) striking hidden small knots making the nails zig-zag and having to saw that piece out of the floor.

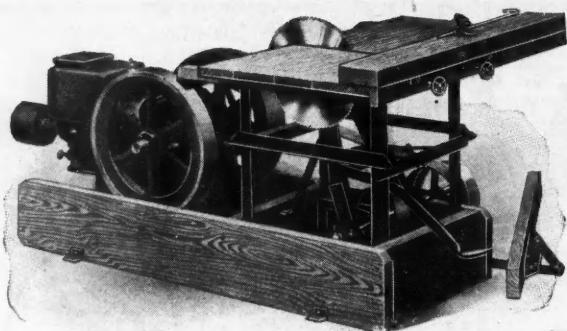

Parks Portable Swing Cutoff Saw.

to get special cut desired, and the swinging frame being short and rigid, you get a clean square cut. This machine will be often used where a regular saw bench on which you have to change the saw and guides would not be.

The saw drops below the table when not in use, unless it is set for ripping, in which case the swinging frame is hooked up, so saw remains above the table. The cross-cut guide is held in place with dowel pins and can be instantly lifted off and the rip guide put on, which is held in line with the saw by the two hand wheels in front.

A 12-inch saw will cut 1-inch stuff 20 inches wide, or 3-inch stuff 15 inches wide, swings back below table surface. also has an adjustable stop so as not to swing back further than necessary to take in width desired to work.

For complete data on this new machine, address the Parks. Ball Bearing Machine Co., Fergus St. & C. H. & D. Ry., Cincinnati, O.

### Metal Roofing Designs

A temporary roof may be all right for a shed, but if you want your house to be comfortable and to stay comfortable you will have a permanent roof put on—one that is durable, artistic, and water-proof.

Metal roofing has been suggested as one of the solutions of this problem and many artistic and pleasing designs have been developed for this class of work.

The Montrose Metal Roofing Co. make a specialty of metal

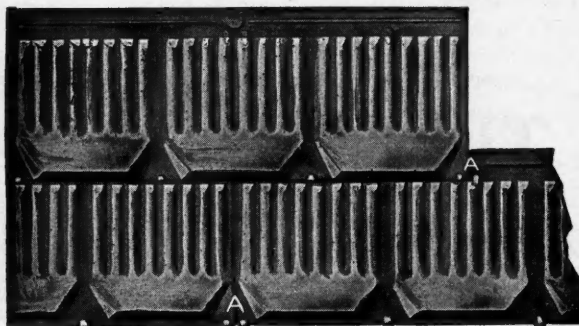

A Popular Montrose Metal Shingle Co. Design.

shingles and tiles, and are presenting their many different types in a new booklet that has recently been issued. Many illustrations show the appearance of these metal roofings and full descriptions are given showing the methods used for inter-locking and rain-proofing. The book contains full directions to be followed in getting the best results with metal shingles and tiles.

The name of this instructive little booklet is: "Montrose Metal Shingles—The best roof under the sun," and can be obtained from the Montrose Metal Roofing Co., 102 Erie St., Camden, New Jersey.



# ACME STEEL LEVELS

Are Truly the Best Value to be Found in Levels

Consider these features and you can readily understand why. They cost no more than wood Levels and cannot warp. They are cheaper than Aluminum, yet Light and Strong. They are practically unbreakable and are as Durable as Steel itself—but the most important and popular feature about ACME Levels is this—**You can establish any grade in degrees or inches Rise to the foot, or find any Grade already established.**

In addition to our various sizes Levels we also make ACME Try Squares and a Casing and Graduated Ring to use on long levels or straight edges. Ask your Dealer for ACME Steel Levels. If he doesn't carry these improved Levels we'll supply you Direct. Write for Prices and our Booklet explaining "ACME" construction.

**THE ACME LEVEL COMPANY**

2104-A Detroit Ave.

**TOLEDO**

**OHIO**

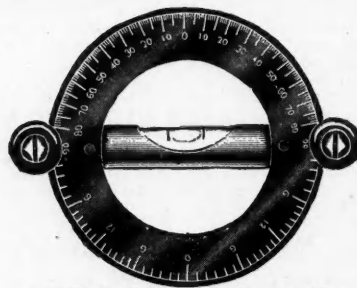

ACME Casing and Graduating Ring



WHEN WRITING ADVERTISERS PLEASE MENTION THE AMERICAN CARPENTER AND BUILDER





# Highest Award

*Panama-Pacific  
International Exposition*

**HENRY DISSTON & SONS, Inc.**  
Philadelphia, U. S. A.

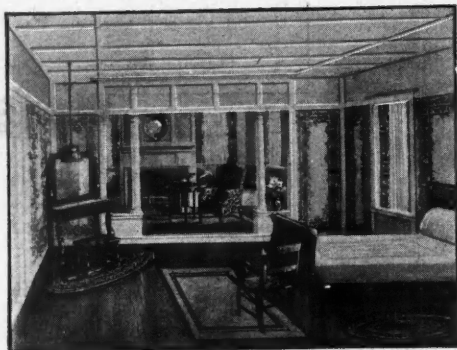

This gives you an idea of the superior appearance of Fiberlic

## Dealers Wanted Quickly

From all sections of the country the demand for **Fiberlic** is showing such a splendid increase that we have immediate need of first-class dealers to look after local business and inquiries.

## Fiberlic

### Is an improvement over Wall Board

It is strong, tough, root-fiber product. Its use retains the absolutely sound wall-board idea, but **Fiberlic** is a vast improvement over any ground wood-pulp material in strength, rigidity, permanence and character.

This proposition should interest lumber dealers, contractors, builders — in fact, any individual or concern which desires to handle a strictly high-grade building material that offers good investment.

*Samples and prices free.*

### Fiberlic Paints and Stains

Realizing the importance of the effect produced by well finished work, we made thorough and complete tests for the benefit of all users of **Fiberlic**, with the result that we have developed a line of paints and stains which will insure the best results on our product. We manufacture **Fiberlic** Paints and Stains in many colors and tints. **Write for Color Card.**

## THE FIBERLIC CO. CAMDEN, N. J.

NEW ENGLAND BRANCH:  
140 Washington Street North, Boston, Mass

NEW YORK BRANCH:  
Fuller Bros. Co., 139 Greenwich Street

LONDON (England) BRANCH:  
MacAndrews & Forbes, Ltd., Finsbury Court, E. C.

### The Material Elevator Has Been Christened

The name that has been selected for the material elevator of the Sackett Screen and Chute Co. is the "Little General." A Los Angeles contractor suggested this name and as a result will get one of the hoists free.

The name, as chosen, is distinctly typical of this machine. It is small and is intended for all general work, and we congratulate the company on the choice of the name.

Full information describing the many features of the "Little General" can be obtained from the Sackett Screen and Chute Co., 1683 Elston Avenue, Chicago, Ill.



### Practical Steel Ceilings

In the new catalog of the Northrop, Coburn & Dodge Co., one is impressed with the many artistic designs that are shown which cover all classes of buildings such as churches, schools, theatres, business houses, residences, etc.

The joints are made very carefully, being formed in an ornamental bead in the panel designs and along appropriate lines of the designs in the continuous patterns. The material used in their ceilings is the best quality of mild steel, cold rolled, annealed and free from scale.

In this catalog there are also shown examples of installations of various kinds which show clearly the artistic appearance and practicability of metal ceilings for many types of buildings. Up-to-date builders should be familiar with metal ceilings and walls. The address of the Northrop, Coburn & Dodge Co. is 40 Cherry St., New York.



### It's All in the "V"

Various methods have been suggested and used to stiffen wire lath and to hold it away from the wall so as to provide a keying space behind. One of the best methods is shown in the accompanying illustration; it consists of a series of "V" shaped corrugations.

These corrugations are spaced 6 inches apart and hold the

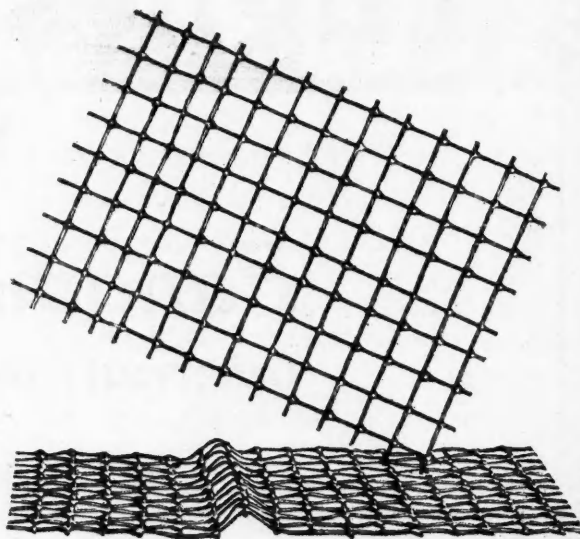

Buffalo Wire Works Co. Lath with Furring "V."

wire lath away from the wall so that an air space can be formed behind. This insures a dry wall and a good key for the plaster. The wire lath is galvanized.

The lath shown in the illustration is known as Grimm's Galvanized Corrugated Wire Lathing and is made by the Buffalo Wire Works Co., 413 Terrace, Buffalo, New York. Further details of this lath and many other styles can be obtained from this company.

“An architect  
tipped *me* off”

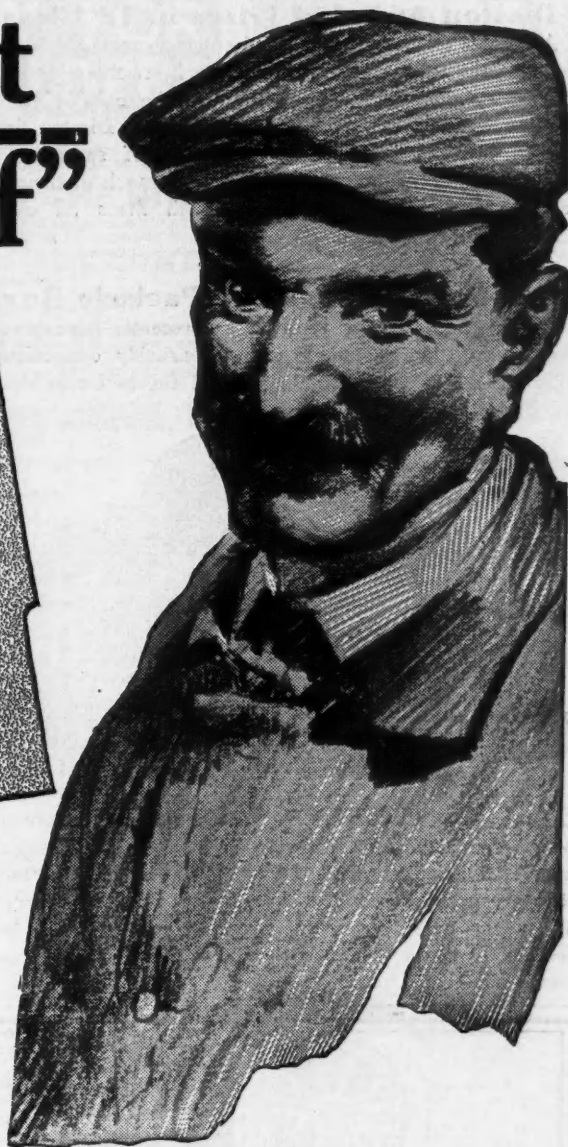
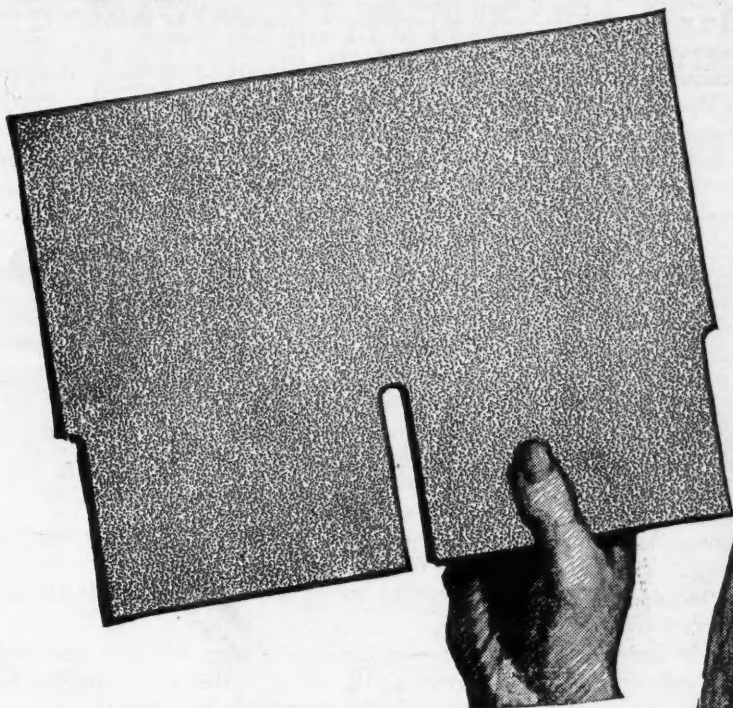

“Before I saw it, I thought, just as a great many others have thought, that the

## Neponset Shingle

was a composition shingle, cut or stamped from rolls of ready roofing.

“One day an architect tipped me off—said he considered the shingle made a better looking roof than slate. I got a sample—*saw* that heavy butt and special construction and got in line.

“I’ve got nothing against wooden shingles but I can make more money on these and every roof is an *advertisement*.”

“Every progressive carpenter should look into this very carefully—doesn’t cost anything to find out.”

**Bird & Son, East Walpole, Mass.**

I am “from Missouri.” I want you to *prove* to me that the NEPONSET Shingle is really all they say of it. This doesn’t obligate me in *any way whatever*.

Name.....

Address.....

**Disston Awarded Prizes in 12 Classes**

A notable tribute to the manufacturing superiority of Philadelphia was the award of first prize in twelve classes made by the Panama-Pacific Exposition to the exhibit of Henry Disston & Sons, saw and toolmakers. The Disston firm exhibited in twelve of the many classes of saws and tools and won on every one. In not a single branch of their manufactures were they excelled, although firms all over the United States competed.



**"Majestic" Milk and Package Box**

A milk and package receiver has recently been placed on the market that is unique and remarkably convenient and practical. It is placed in the wall of the house as shown in the illustration.



"Majestic" Safety Package Box.

It consists of two cast iron frames and doors that are joined together with a body of varying length to suit the thickness of the walls.

Both the doors lock

when shut and can be opened only from the inside. The inside door can thus be locked and the outside door left open so that packages can be placed in the body of the receiver. When the outside door is shut the packages can be only reached from the inside and are thus protected from possible loss.

This specialty is manufactured by The Majestic Company, 505 Erie Street, Huntington, Indiana, makers of the "Majestic" line of hardware specialties. Full particulars concerning their latest device can be secured from them.



**Dependable Barn Door Hangers**

A barn door hanger has several duties to fulfill beside running the door back and forth. It should be so constructed that it will not jump off the track on all occasions and it must be flexible or it is sure to be broken.

The "Big Four" hanger has been especially designed to accommodate all conditions that are encountered in barn doors.

The accompanying illustration shows the flexible hanger that is used. The makers say that when the door is hanging in its normal position there is no vibration; but, if anything runs into the door, the flexible hangers will permit it to swing out. The two studs as shown and the hook turned under the rail prevent the hanger from jumping the track. The studs also serve as guides when the hanger is attached to the door.



National Mfg. Co.'s "Big Four" Door Hanger.

Further information can be obtained from the National Mfg. Co., Sterling, Ill., who are the makers of this hanger and many other items of building hardware.

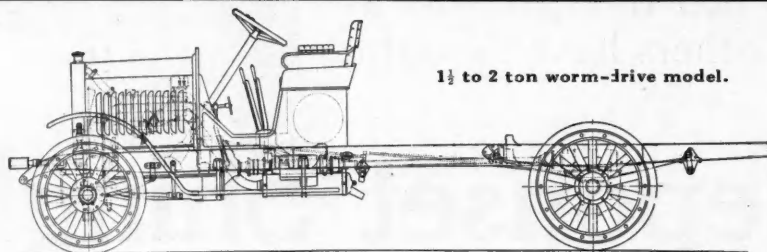

1 1/2 to 2 ton worm-drive model.

**The new line now includes 7 models  
1000 lbs. to six tons—\$950 to \$4350**

After a careful and scientific study into all phases of hauling requirements, we announce an increase in our line to 7 models—ranging from a 1000 lb. delivery body to a 6-ton truck. The new line of KisselKar Trucks is designed to supply most economical delivery under every haulage condition which may arise.

**KISSELKAR TRUCKS**

**SEVEN GREAT MODELS.**

Here is the new line and chassis prices:—

1000 lb. delivery.....	\$ 950
3/4 to 1 ton truck.....	1500
1 to 1 1/2 ton truck.....	1750
1 1/2 to 2 ton truck.....	2100
2 1/2 to 3 ton truck.....	2750
3 1/2 to 4 ton truck.....	3350
6 ton truck.....	4350

The specifications and details of this wonderful range of trucks are so important that it is impossible in this announcement to more than ask that those interested write at once for complete literature.

**For Your Business** Learn in detail the construction of these great trucks—both worm and chain drive models—and their adaptability to your peculiar problem. They are the most modern trucks on the market.

**Kissel Motor Car Company**

**546 Kissel Ave., Hartford, Wis.**

New York, Boston, Chicago, Philadelphia, St. Louis, Milwaukee, Minneapolis, St. Paul, Dallas, San Francisco, Los Angeles, Oakland, Omaha, Cleveland, Detroit, Toledo, Columbus, Rochester, Buffalo, Baltimore, Pittsburgh, Duluth, Seattle, New Orleans, Nashville, Hartford, Conn., New Haven, Troy, Norfolk, Providence, Marshalltown, Ia., Madison, Montreal, Toronto, Calgary, Victoria, and three hundred other principal points in the United States and Canada.

# A BIG OPPORTUNITY FOR CONTRACTORS & BUILDERS



Our reports from all sections of the Middle West show that building operations will be more active than in many years past. The farmers in your neighborhood need more barns and bigger barns to take care of bigger crops and more livestock.

### DuxBak Roofing

We can save you from 50 to 75 per cent and give you the highest grade, longest guaranteed roofing on the market.

- 1-Ply \$1.15 per sq. Guaranteed 5 Years.
- 2-Ply \$1.40 per sq. Guaranteed 10 Years.
- 3-Ply \$1.70 per sq. Guaranteed 15 Years.

### GET YOUR SHARE OF THE BIG WORK

Tell your friends that you are going to build with the highest grade lumber, along the most modern lines, at the lowest possible cost, and finish the job promptly on time.

**YOU DON'T HAVE TO WAIT**, or take troublesome substitutes, when you buy lumber from us. We supply you on short notice with everything you need for any kind of building—from sills to roofing—and millwork of every description.

We guarantee every shipment and our direct-to-you factory prices will save you money, not only on car lots but even on small orders.

### We Will Pay Your Railroad Fare to Dubuque and Return

We want you to come and pick out the material you need, in our big yards and sheds—see every piece loaded before you pay for it. If you have a carload or more, we will pay your railroad fare both ways. You will have a pleasant trip and save money, too. Write for our Home Builder's Guide.—It is Free.



Let us send you our big, new, 1915 Home Builder's Guide. It gives illustrations, descriptions and prices. It's a valuable book of reference for builders. Shows you how much money you can save. Write for it today.

**PETER J. SEIPPEL LUMBER CO., 212 S. Locust Street, DUBUQUE, IOWA**



*The result of 23 years' successful experience in building motor cars*



## America's Greatest "Light Six" \$1385

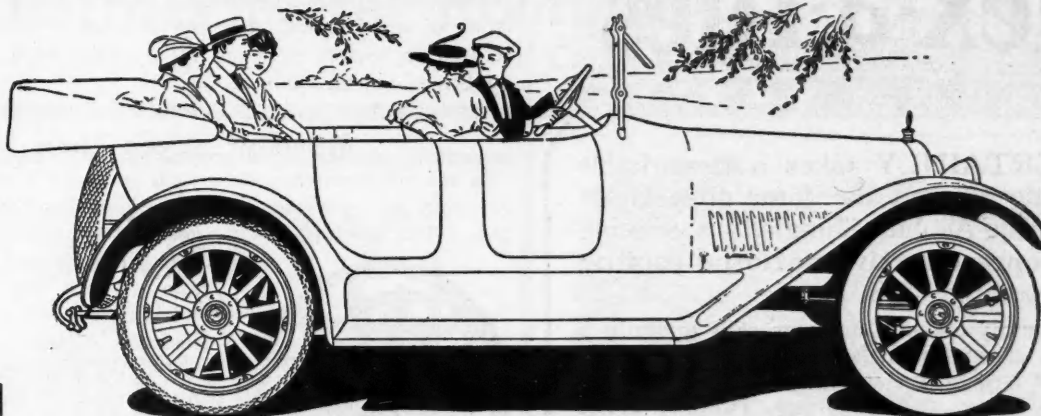

Model 34—Five Passenger Touring Car, Price \$1385, f. o. b. Kokomo, Ind.

### The Car You Can Afford to Own

The Haynes "Light Six" is so simple and accessible that you can care for it yourself. It is a pleasure you can afford.

# THE HAYNES

## America's Greatest "Light Six"

Two Models—Three Body Styles

Model 34—America's Greatest "Light Six"—5-passenger Touring Car, 121" wheelbase, weight 2950 lbs.	\$1385
Model 34—The Prettiest Roadster in America—3-passenger, "Sho-Sha-Belle" design	\$1485
Model 35—The Kokomo "Six"—7-passenger Touring Car, 127" wheelbase, weight 3050 lbs.	\$1495

All Prices f. o. b. Kokomo, Ind.

## THE HAYNES AUTOMOBILE COMPANY

14 South Main Street

KOKOMO, INDIANA



**I**T CERTAINLY takes a remarkable roofing to win the fame that Giant Flex-A-Tile Asphalt Shingles are winning as the representative national roofing of the good old U. S. A.

It certainly takes a superior skill to build a roofing that withstands without a whimper the torrid sun of Arizona and the arctic cold of Northern Maine—a roofing like Giant Flex-A-Tiles that has the stand-up quality to out-weather any weather.

Whenever you have a shingle roofing job on which you want to put in your best licks—a shingle roofing job that you want to be able to point to with pride as a sample of your best work—be sure to use Giant Flex-A-Tiles.

If you don't know all about the Giant Way in which we build Giant Super-Quality into Giant Flex-A-Tiles, the rigorous tests we give every Giant Flex-A-Tile before it measures up to our strict requirements, you ought to know right now. Send us your name and address and we will send you the entire Giant Flex-A-Tile story—and a big, man's size sample of a Giant Flex-A-Tile Shingle. No obligation on your part. Be sure you write today.

## The Heppes Company

1010 So. Kilbourne Ave. Chicago

Utility Wall Board No-Tar Asphalt Paint  
Standard Flex-A-Tile Shingles Rubbertex Roll Roofing

Other Guaranteed Heppes Products

### Roofs of Metal Tile

The catalog of the W. H. Mullins Co. shows a new design in metal tile that has an unusually attractive appearance. This design is the "Alcazar." It is a reproduction in sheet metal of the mission tiles that were used quite extensively in the early Spanish districts in America. Its appearance is shown in the illustration.

The tile is made up in clusters of eight which are applied to the roof by means of strong cleats riveted to the water guard at the side of each sheet and nailed to the roof sheathing. The other end of the cleat is turned over the edge of

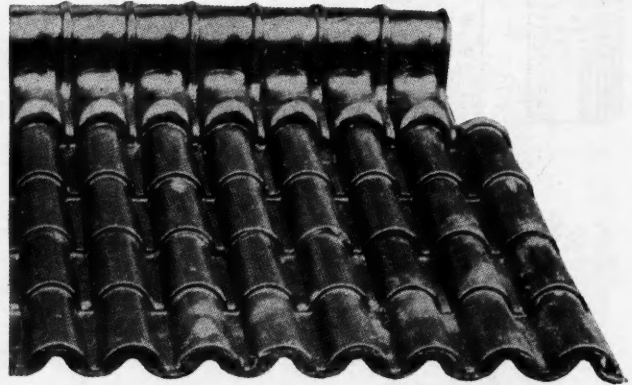

"Alcazar," New Mullins Co. Metal Tile Design.

the next overlapping course of tiles. This makes a secure and storm-tight joint.

The catalog shows in addition to this design many other types of architectural sheet metal work. A copy can be secured on request from the W. H. Mullins Co., 214 Franklin Street, Salem, Ohio.



### Mortiser Saves Time

In the accompanying illustration is shown a mortiser that has many good features. It is known as the Champion mortiser. This machine has a wide range in its uses. It will

cut anything from a round hole to a 6¼-inch slot. No other tool is needed either to start or finish the work.

The machine is equipped with an automatic feed that moves the bit forward 1/16 inch for each complete operation. The feed is operated by a cam. There is an automatic stop also that can be set so as to stop the bit at the required depth. The manufacturers say that the machine will cut a mortise that is perfectly straight on the sides and the bottom, and will require no finishing.

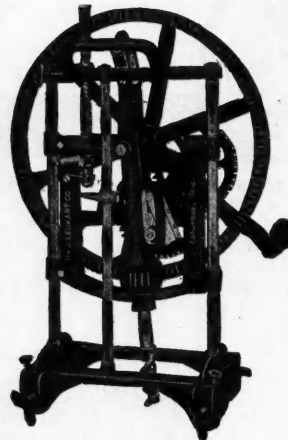

"Champion" Mortiser.

The Champion mortiser is made by the Colgan Machinery & Supply Co., 616 New Hayden Bldg., Columbus, Ohio. They will be glad to furnish further details concerning this machine.



### "What Constitutes a Good Roof"

The title above is the name of a booklet that has been gotten out by the National Hardware Association of the United States.

This association has been conducting a contest for prize winning articles on the subject of "The advantages of terne plates and sheet metals over other materials for roofing."

Three of these articles have been incorporated in this



# LIGHTNING

Fire and storm proof, plus architectural beauty, are the two main features about Montross Metal Shingles.

But the prices we quote you, Mr. Reader, is the compensating fact that makes

## MONTROSS METAL SHINGLES

the most popular metal roofing on the market. They answer every requirement of safety, beauty and service. In addition they are economical in price and easily laid.

Every Montross Metal Shingle is an advertisement for you. It means more business.

We are giving one man in every section exclusive rights for his territory, with business enough to make him independent within a short time.

Write for trade terms. We have a department devoted exclusively to estimating and will furnish you with Engineering advise FREE.

**Montross Metal Roofing Co.**  
102 Erie Street, Camden, N. J.

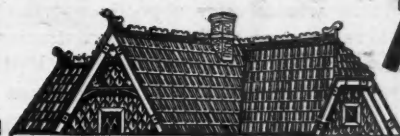

# SAFETY



# FIRST

## Reynolds Shingles

Don't buy shingles by price alone—there are other years to come when you may have to pay for repairs or even a new roof if you neglect QUALITY now.

**Reynolds Shingles** are guaranteed to be perfect in manufacture, and of the best materials obtainable. You cannot buy better, and any small difference in price will be forgotten in a few days and you are assured of a beautiful, lasting roof.

If your dealer does not carry them in stock we will send samples of colors and mineral finishes on request.

**H. M. Reynolds Asphalt Shingle Company**  
Originators of the Asphalt Shingle Grand Rapids, Mich.



"Those are without exception the best Shingles I have ever laid—and the color is wonderful."

They wear longer and always look better than any other kind of roofing I have ever used."

17 Different Grades — 16, 18, 24-inch — 30 Different Colors  
"They come in bundles ready to lay"

We keep several mills busy supplying us with selected Cedar Shingles of best British Columbia stock. No wedge-shaped shingles — all thoroughly seasoned.

We preserve them in pure creosote—no kerosene or benzoin—and stain them any color desired. Our method of handling is secret. The pure creosote and pure earth pigment stains give best color effects.

We are responsible for both quality of Shingles and quality of stains.

Save the muss, waste and time of staining on the job.

Sold by good lumber dealers everywhere. Write for book of 100 "CREO-DIPT" Homes. Get your lumber dealer to stock with our greens, reds and browns.

**Standard Stained Shingle Company**  
1028 Oliver St. N. TONAWANDA, N. Y.  
Factory for Western Trade in Chicago

booklet. The titles of these three articles and their authors are as follows: "A Durable Weather and Fireproof Roof," by John Troland, Norwich, Connecticut; "The Importance of a Good Roof," by H. A. Daniel, Newburgh, N. Y.; and "The Superiority of Metallic Roofs," by Charles D. Puckett, Dallas, Texas.

A copy of this booklet can be obtained from Mr. George A. Fernley, Secretary of the Association, at 505 Arch St., Philadelphia, Penn.



### Money in Amusement Devices

All of our readers have seen the Ferris wheels in operation at fairs, amusement parks, etc., but probably know very little about them. Mr. W. E. Sullivan, President of the Eli Bridge Co., probably knows more about them than anyone, as he has spent 15 years in improving them and also in manufacturing them.

He first started as a carpenter and then he went into the road machine business. After this, he developed the "Big Eli" Ferris wheel and spent about five years in exhibiting it and in studying the needs of the amusement public. During all this time he was inventing new tools and appliances for improving the qualities of these wheels and in making their manufacture practical. He finally perfected the socket and pin coupled "Big Eli" wheel.

A stock company was then organized which started making these wheels in a commercial way. The public had become acquainted with them by this time so they were in big demand at amusement parks and fairs.

These wheels offer a good opportunity of making money at fairs to many builders and contractors. They are easy to erect and economical to operate. Full particulars showing various sizes and prices can be obtained from the Eli Bridge Co., Box C.B., Roodhouse, Ill.

### Thurman Stationary Vacuum Cleaners

This illustration refers to the latest model Thurman Number 2 Stationary Vacuum Cleaner for residences, bungalows, apartments and buildings of all kinds. It is placed in the basement, and a 1½-inch to 2-inch pipe line, according to the size of the building, is run from the vacuum cleaner to the upper floor with suitable hose connections. By pushing an electric button on each floor, the vacuum cleaner is started to work, and all the dust, dirt and germs from carpets, rugs, draperies, furniture, etc., are gathered in the sealed tank of the vacuum cleaner. The novel feature of this machine is the large dust capacity of the cleaner, its automatic relief valve to regulate the vacuum from any predetermined point and the

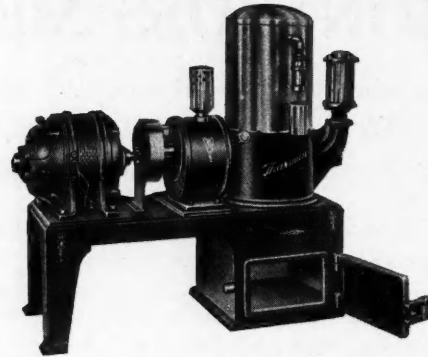

Thurman  
No. 2 Stationary  
Vacuum Cleaner.

pump and motor being placed outside of the dust separating chamber, which keeps them free from dust, thus enabling the company to give a ten-year written guarantee. This machine is up to the minute in design and workmanship.

These machines are sold direct by the manufacturers. Write to the Thurman Vacuum Cleaner Co., Dept. N, St. Louis, Mo., for their book "I Can Make Yours a Dustless Home."

## AN MF ROOF—

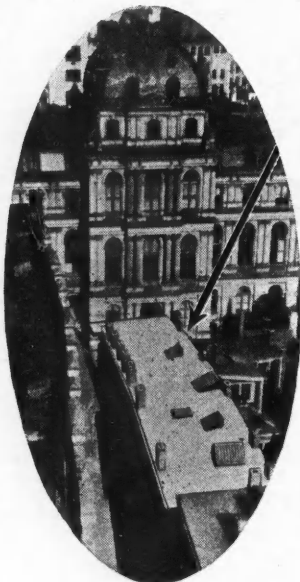

adds service to protection. Carefully manufactured and high in quality—these plates enable your roof to attain an honorable old age. This roof at Boston, made of MF thirty-five years ago, is still good.



C.B. OPEN HEARTH  
15  
32 POUNDS COATING

# Copper Bearing Open Hearth Terne Plates

insure the fullest measure of durability and unquestioned satisfaction. Specify for "C. B. Open Hearth" plates exclusively. Read the proof of superiority in our booklet "*Copper—Its Effect Upon Steel for Roofing Tin.*"

## American Sheet and Tin Plate Company

GENERAL OFFICES: Frick Building, PITTSBURGH, PA.

DISTRICT SALES OFFICES:

Chicago Cincinnati Denver Detroit New Orleans New York Philadelphia Pittsburgh St. Louis  
Export Representatives: UNITED STATES STEEL PRODUCTS COMPANY, New York City  
Pacific Coast Representatives: UNITED STATES STEEL PRODUCTS COMPANY, San Francisco, Los Angeles, Portland, Seattle



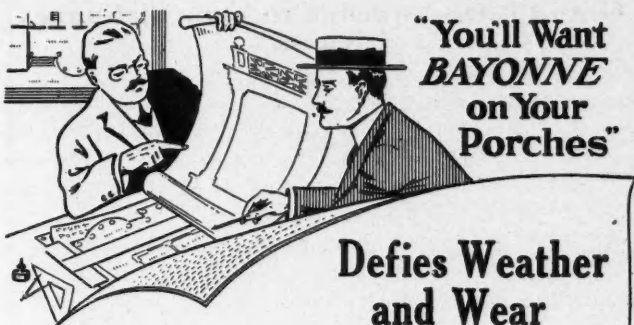

**"You'll Want  
BAYONNE  
on Your  
Porches"**

**Defies Weather  
and Wear**

Make a list of all the qualities that a roof and deck covering must have and you will be surprised to find that BAYONNE leads all metals and prepared materials—and costs less to buy and lay. It is positively waterproof under all conditions—will not leak and does not expand, contract, peel or crack with cold or heat.

With ordinary care as to painting, BAYONNE will last indefinitely—in fact, due to the special treatment of the fabric, it suffers no deterioration from exposure to the elements—while it will stand footwear to a wonderful degree. Full particulars in

*Sample Book "N." Write for it today.  
See Sweet's, page 539.*

**JOHN BOYLE & COMPANY, Inc.**

112-114 Duane St.  
70-72 Reade St.

New York City

Branch House: 202-204 Market St., St. Louis

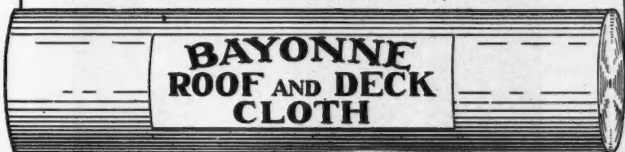

**It is Nice to Get a Letter Like This  
FROM SATISFIED CUSTOMERS**

Asphalt Ready Roofing Co., 9 Church St., New York, N. Y.  
Sirs:—Please find enclosed Postal Money Order to pay for shingles shipped to us by you. Shingles came in good condition and are on the roofs and give splendid satisfaction. Many thanks, yours for business.

(Name and original letter shown on request.)

Would you like to know more about

**HUDSON SHINGLES**

and other  
**HUDSON ASPHALT  
ROOFING PRODUCTS**

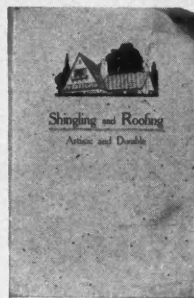

Won't you be one of our satisfied customers, too. Just mail us the coupon, with your name and address filled in and we will send free copy of our new book "Shingling and Roofing," and samples of Hudson Shingles.



**ASPHALT READY ROOFING CO.**  
9 Church St., New York, N. Y.

Dept. 453

**ASPHALT READY ROOFING CO.,**  
9 Church St., New York

Please send free copy of "Shingling and Roofing" and large samples of "Hudson Shingles"—with no expense to me.

Name.....  
Address.....

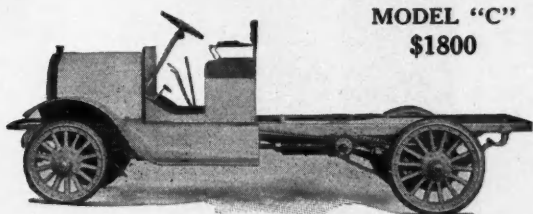

**MODEL "C"  
\$1800**

Capacity 3000—4000 lbs.

The simplicity of operation, durability of construction and general efficiency, together with the low maintenance cost, are factors which have made "DART" Trucks so universally popular.

A "DART" Truck will enable you to reach out for more business, and handle it at a lesser cost per dollar than you can possibly do with horse-drawn vehicles.

It will pay you to investigate.

**"SOLD ON SIX CONTINENTS"**

**DART MOTOR TRUCK CO.**  
Dept. "C-8" WATERLOO, IOWA

**Dart  
MOTOR TRUCKS**

The "DART" is built in 3 models—

- Model "A"—1000 lbs.  
Complete.....\$1875.00
- Model "B"—1500-2000 lbs.  
Chassis..... 1400.00
- Model "C"—3000-4000 lbs.  
Chassis..... 1800.00

Bodies built to order. Sold on Deferred Payments, if desired.

Mail the coupon to us, Dept. "C-8," and you will receive catalog and full data by first mail.

**DART MOTOR TRUCK CO., Dept. "C-8"**  
Waterloo, Iowa

Gentlemen:—Please send full particulars on "DART" Trucks:

FIRM.....

TOWN.....

STATE..... BUSINESS.....



## “What y’ Doin’ Now, Bill?”

You don’t have to ask that question of the **trained** man, because you know what he is doing — you know his position is a permanent one — and you know his position is one that pays a good salary. You also know that the **trained** man is not at the mercy of conditions that affect the untrained man.

How many **untrained** men are constantly watching the “want” columns of the newspapers — only to be painfully reminded of the positions they can’t fill and the work they can’t do! Engineers are wanted; Mechanics are wanted; Electricians are wanted; Builders are wanted; Draftsmen are wanted; Advertising Men are wanted; and the Government offers big pay to those qualified for Civil Service positions. But there is seldom a chance for the **untrained** man. Because of his lack of training he must stay at uncongenial and unprofitable work.

For more than 20 years the I. C. S. have been helping men to qualify for more congenial occupations and better salaries.

To learn how the I. C. S. can help **you** and how you can easily qualify for success in your chosen occupation, mark and mail the attached coupon today. Doing so costs you only postage and will bring to you stories of success of thousands of I. C. S. students. You assume no obligation in asking for information.

**But Mark the Coupon NOW**

### INTERNATIONAL CORRESPONDENCE SCHOOLS

Box 910A2 SCRANTON, PA.

Please explain, without further obligation on my part, how I can qualify for a larger salary and advancement to the position, trade or profession before which I have marked X.

- |   |   |  |
|---|---|--|
| <input type="checkbox"/> Architect            | <input type="checkbox"/> Estimating Clerk     | <input type="checkbox"/> Automobile Running    |
| <input type="checkbox"/> Arch'l Draftsman     | <input type="checkbox"/> Civil Engineer       | <input type="checkbox"/> Motor Boat Running    |
| <input type="checkbox"/> Contract'g & Build.  | <input type="checkbox"/> Surveying            | <input type="checkbox"/> Foreman Machinist     |
| <input type="checkbox"/> Building Inspector   | <input type="checkbox"/> Mining Engineering   | <input type="checkbox"/> Sh.-Met. Pat. Drafts. |
| <input type="checkbox"/> Structural Eng.      | <input type="checkbox"/> Mechanical Eng.      | <input type="checkbox"/> Bookkeeper            |
| <input type="checkbox"/> Structural Draftsman | <input type="checkbox"/> Mechanical Drafts'n  | <input type="checkbox"/> Stenographer          |
| <input type="checkbox"/> Plum. & Heat. Con.   | <input type="checkbox"/> Stationary Engineer  | <input type="checkbox"/> Advertising Man       |
| <input type="checkbox"/> Supt. of Plumbing    | <input type="checkbox"/> Electrical Engineer  | <input type="checkbox"/> Window Trimming       |
| <input type="checkbox"/> Foreman Steam Fit.   | <input type="checkbox"/> Electric Lighting    | <input type="checkbox"/> Commerc'l Illustrat'g |
| <input type="checkbox"/> Plumbing Inspector   | <input type="checkbox"/> Electric Railways    | <input type="checkbox"/> Civil Service Exams.  |
| <input type="checkbox"/> Heat. & Vent. Eng.   | <input type="checkbox"/> Concrete Construct'n | <input type="checkbox"/> Chemist               |

Name \_\_\_\_\_

Street and No. \_\_\_\_\_

City \_\_\_\_\_ State \_\_\_\_\_

Present Occupation \_\_\_\_\_

## Grand Prize Awarded to Tuec Stationary Cleaners

Word has just been received that the “Tuec” has been awarded the highest score in *every one* of the many competitive, engineering tests it entered at the Panama-Pacific Exposition. Thus the supreme international court of awards has confirmed the verdict of the nation’s most eminent engineers.

Many people, when they are building a house or having it altered, could be persuaded to see the advantages of a stationary cleaner, they could be convinced that it would be mighty useful and convenient in keeping the house clean. Here is an opportunity for the contractor or builder to suggest that one be installed in the house that is being built.

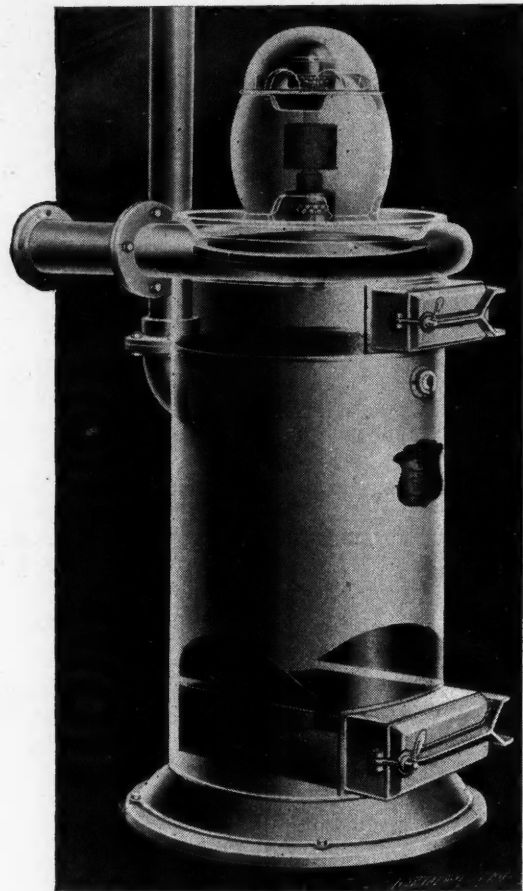

The Heart (or should we say lungs) of the “Tuec” Vacuum Cleaner.

The United Electric Co., makers of the “Tuec” stationary cleaner, have an attractive proposition for contractors that is well worth investigating. Their cleaner is operated by a ½ horse power motor that is located in the basement and is connected to the various rooms by piping with openings into the rooms, where a hose can be attached.

A card addressed to this company at 30 Hurford St., Canton, Ohio, will bring full particulars.



### Disposition Uncertain

“What does this sentence mean?” asked the teacher. “Man proposes, but God disposes.” A small boy in the back of the room waived his hand frantically. “Well, Thomas,” said the teacher, “what does it mean?” “It means,” answered Thomas, with conscious pride, “that a man might ask a woman to marry him, but only the Lord knows whether she will or not.”—*Melbourne Leader*.

## A PORTER PLANNED BARN

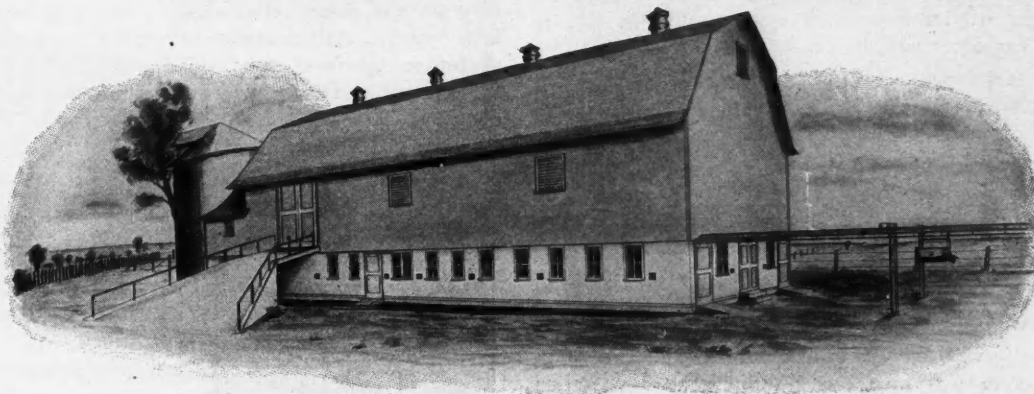

### PORTER PERFECT BARN EQUIPMENT

The enormous increased demands for American farm products has caused all modern farmers to realize the importance of obtaining the maximum yield for the next few years at least; that this may be accomplished it will be necessary to build new barns and remodel many others. Needless to say, this work is of a profitable nature, and with the assistance we offer, should prove attractive to all contractors.

We maintain a **Free Service Bureau** for the benefit of the farmers in particular, but all contractors and parties interested in modern farm buildings as well. Send us your barn problems, as we can assist you greatly; remember that we manufacture **Complete Barn Equipment** and every phase of your work in this connection has been carefully considered. **Detailed Floor Plans** are sent free of charge, and we co-operate with you in every possible way.

**Porter Steel Stalls, Cow Stanchions, Litter Carriers, Barn Door Hangers, Hay Carriers, Forks, Hay Slings and Pulleys are acknowledged leaders everywhere**

Don't overlook this chance to begin a profitable business for yourself, and send us today the names of parties expecting to build or remodel barns in your vicinity.

Complete Catalogue will be forwarded free upon request.

**J. E. PORTER COMPANY,**

**620 Fremont Street,**

**Ottawa, Ill.**



Put Good Equipment  
in Good Barns

### HARRIS Barn Equipment

because of its simplicity, its durability and many improvements is becoming most popular with farmers. Harris Barn Equipment because of its profit-making possibilities and ease of installation is finding great favor with builders.

The Harris line includes the famous HARRIS Stanchion, several styles of Stalls, Feed and Litter Carriers, Hay Tools, Ventilators and miscellaneous equipment. In order to get clear ideas of our products and their installation you should write for our large catalogue—it shows and tells all.

**HARRIS MFG. CO.**

Box 224

Salem, Ohio



## Helpful Ideas On Dairy Barn Building FREE!



If you learn more about the **newest, best, most economical** and most **sanitary** methods of Dairy Barn Construction,— you will make more money. Our free book "Building the Dairy Barn," tells about proved principles that it will pay you to know about. It tells facts about plank frames; King system of ventilation; proper width and arrangement; lighting; stable floors; site; size; appearance; design; drainage; and sanitary barn equipment with floor plans. The valuable, interesting book will be mailed to you free if you tell us these facts: "For whom do you expect to build or remodel Dairy Barns? (Give names and addresses.) When? For How Many Cows?" Address—



### Special Blue Print Offer

We have complete blue prints, specifications, floor plans and lumber bills for several different types and sizes of modern dairy barns. Ask about them. Also ask how to get the free help of our Architectural Dept.

**James Mfg. Co.**

8575 Cane St.

FT. ATKINSON, WIS.

### Good Saws Pay

A saw that will last and keep a good cutting edge, so that it does not need sharpening often, and can still be set easily without danger of fracturing the teeth should be mighty useful to the carpenter and builder.

Vanadium steel saws are said to fulfill these specifications because the blades are made of vanadium high speed steel, which possesses these qualities.

The Pennsylvania Saw Co. are offering our readers a special reduction on their high grade saws which they send on trial. This proposition is well worth investigating. The address of this company is Frackville, Pennsylvania.



### How to Please the Housewife

Any housewife will tell you in a minute how much drudgery a dumbwaiter will save her. A dumbwaiter operating just between the kitchen and cellar travels—so it has been estimated—an average of 61 miles a year and in that time carries about seven tons of kitchen necessities up and down; which, without it, the tired housewife would have to pack up and down the cellar stairs.

The "Sanitary Automatic Dumbwaiter" developed by the York Automatic Dumbwaiter Works, 639 W. Market St., York, Pa., has proven itself a great blessing. For nine years they have been in use, so they are no longer an experiment. Improvements have been made from time to time and the latest one permits the dumbwaiters to be iced; their refrigerated dumbwaiter.

Carpenters and builders are acting as agents for these dumb waiters, and are making both good profits and satisfied customers. Here is what John L. Welch, contractor and builder, R. R. No. 2, Rolle, Mo., has to say about this:

"Sanitary Automatic Dumbwaiters purchased a short time

ago and installed at Steelville, Mo., are giving full satisfaction. They are easy to put up, and as for convenience, are a perfect success, saving many steps for the housewife, running up and down cellar steps; everything is at hand with little effort. Will continue to specify your machines in all operations wherever possible."

Some nice territory is still open. Write the company at once for full particulars.



### Good Proposition for Contractors and Builders

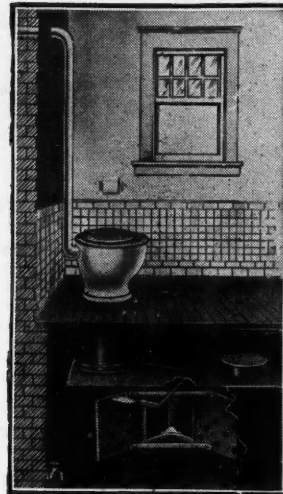

Dail Chemical Closet Installed with Basement Vault for Easy Clean-out.

The progressive builder has more influence in modern sanitary conditions than anyone else. The builder who has the confidence of his customers can make many suggestions concerning sanitary and convenient devices that will be followed by many people.

The chemical closet is one of the modern sanitary improvements that is needed in many localities. The contractor can benefit himself and also the community by installing these.

The Dail Steel Products Company, 830 East Main Street, Lansing, Michigan, have an agency proposition that would be mighty beneficial to many contractors. Write to

them for their descriptive catalog and agency plan. It will bring you business and help your community at the same time.

## Here's another big advantage -it resists heat and cold

We have already told you how Cornell-Wood-Board is the *right* material for walls and ceilings of wooden buildings, because it adapts itself to the changes in the timbers, while plaster cannot do so, causing it to crack and eventually fall.

A further advantage is the wonderful *insulating qualities* of

## Cornell-Wood-Board

The heat-retaining qualities of plaster are very slight, while those of Cornell-Wood-Board are much greater. A house with walls and ceilings of Cornell-Wood-Board is *warm in winter and cool in summer*. This means a big saving in coal bills and far greater summer comfort.

This, in addition to the fine artistic effects made possible, makes Cornell-Wood-Board highly attractive to the owner. Tell him about Cornell-Wood-Board. But first, get posted.

Write, and let us tell you how Cornell-Wood-Board is given superior quality by the exclusive

*Cornell fibre-sizing process*, and how it is sealed through and through against the effects of weather changes.

The largest wall board factory in the world—the only wall board made complete in one plant, from raw material to finished board—power in abundance from our own 20,000 H. P. Dam—raw material at our very doors. All of this means uniformly high quality at consistently low prices for you in Cornell-Wood-Board.

WRITE FOR SAMPLES AND FULL INFORMATION

Cornell-Wood-Board Dept. A-2 Cornell, Wis.

**THIS IS THE PROOF YOU WANT!!**



H. P. Kehr, Architect, Buffalo, N. Y.  
Plastergon was applied all through this brick block a year and a half ago and today it is in better shape than when applied.  
The Owner and the Architect are both pleased with Plastergon

**PLASTERGON**  
TREATED WOOD FIBRE  
**WALL-BOARD**  
"Every Panel Guaranteed"

Ordinary wall-boards in brick buildings usually cause trouble and most manufacturers discourage their use, but if the board is TREATED WOOD FIBRE it will stand up under any conditions of building.

**THAT'S WHY PLASTERGON IS USED SO MUCH IN ATLANTIC CITY AND OTHER DAMP PLACES.**

You might better use the best—the cost of applying is the same and the up-keep less.

**COSTS NO MORE THAN ORDINARY BOARDS**

Plastergon is the home owners choice nine times out of ten. By using it, you increase your chances of business just that much. Our samples and literature are free—your kit isn't complete without them. A postal brings them.

**PLASTERGON WALL BOARD CO.**  
101 Fillmore Ave., Tonawanda, N. Y.

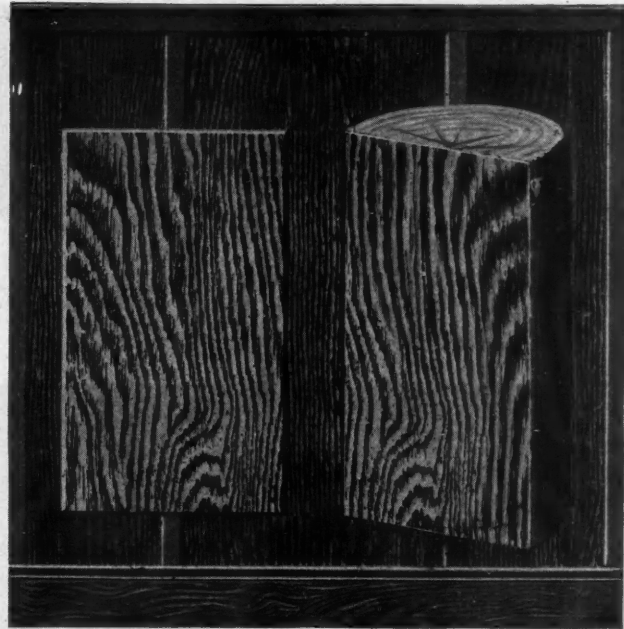

# Utility Board Graining Is True Graining

In reproducing the beauty of the natural wood grains in Utility Board, nothing is left to chance. There is no guesswork about the graining.

The special Heppes process for reproduction accentuates the grain in the wood and the printing plates are made DIRECT FROM THE WOOD ITSELF. If you could come to our plant and see the ingenious machinery devised for the perfect reproduction of the flat and quarter-sawed oak, mahogany and circassian walnut in its true beauty, you would understand why Utility Board graining is superior to any machine or hand graining—just as plain Utility Board itself stands up better than any other Wall Board made.

But don't take our word for it. Write for samples and familiarize yourself with this modern improved wall covering that other contractors are using with success and profit.

Grained Utility Board cuts the contractors' decorating expense.

## The Heppes Company

"Giant" Flex-A-Tile Shingles  
Standard Flex-A-Tile Shingles

No-Tar Asphalt Paint  
Rubbertex Roll Roofing

Other Guaranteed Heppes Products

4503 Fillmore Street

Chicago

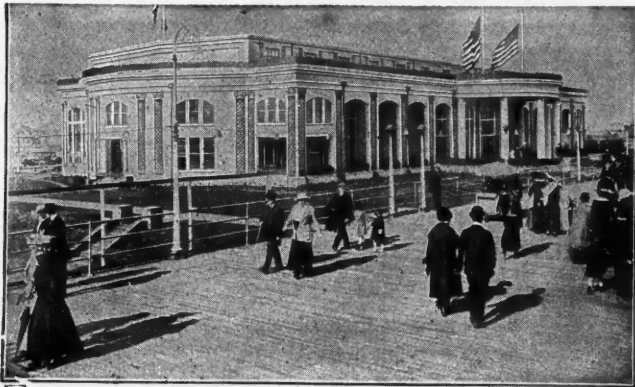

"Castles-by-the-Sea," the summer dance hall of Mr. and Mrs. Vernon Castle at Long Beach, N. Y., the finest building of its kind in the country, the finish chosen for walls and ceiling was

**CAREY**

**Ceil-Board**  
SUPERSEDES PLASTER FOR WALLS AND CEILINGS

The nearness of the sea demanded that the board used in this building be most thoroughly proof against moisture.

Carey Ceil-Board was found by the architects, Messrs. Kirby & Pettit, to be proof against all moisture, not only at the sides, but what is much more important, at the edges.

You can learn in a few minutes all you need to know about Carey Ceil-Board by writing for illustrated booklet and samples.

**THE PHILIP CAREY COMPANY**  
General Offices 1021 Wayne Ave., Lockland Cin., Ohio  
OFFICES & WAREHOUSES IN PRINCIPAL CITIES.



## No Checking—Splitting —Rotting or Warping

Here is a column for porches, pergolas and interiors which is made from one piece of heavy galvanized steel.

Photograph showing detail of stopped flute and end of shaft. Note sharp, clear cut flutes.

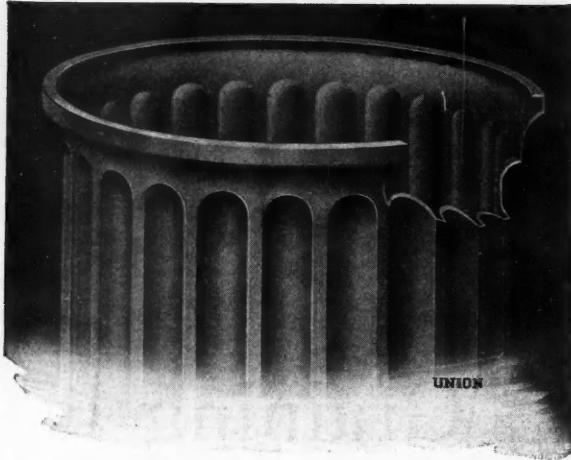

# UNION

## METAL COLUMNS

### "The Ones that Last a Lifetime"

settle the column question for all time and free you from the troubles which always occur in a year or two after wood columns are installed.

They are correct in design, easy to install and a source of satisfaction to both you and the man you build for.

Write for our folder of designs and sizes and a book showing hundreds of installations.

**THE UNION METAL MFG. CO.**  
CANTON, OHIO

## Becomes Oldest Traveling Salesman

Arthur K. Ingraham, seventy-eight years old and forty-five years a salesman in the employ of the Joseph Dixon Crucible Company of Jersey City, N. J., received a long letter the other day from his friend, "Uncle George" Olney, in which the latter relinquished his claim to the title of Dean of Traveling Salesmen on account of his retirement over a year ago from active service with the Irving Pitt Manufacturing Company of Brooklyn, N. Y. Mr. Ingraham is two years the junior of his friend, "Uncle George," and in a photograph taken two years ago at a convention of the National Association of Stationers, he stands erect with a look of mental keenness which promises the satisfaction of holding for several years to come his newly acquired honor.



## More Honors for "Impervite"

At the Panama-Pacific Exposition the Committee of Awards has just handed down its decisions. In certain instances, thousands of dollars have been invested in displays, but although a charming arrangement may attract the casual passer-by, the Judges consider merit only. For Cement Waterproofing Compounds, a careful series of tests were made, each one duplicating the other as regards proportions used and method of handling. As a result of these tests, "Impervite" made by the Standard Paint Co., Woolworth Bldg., New York City, proved so excellent that it was given the gold medal (highest award).

In 1909 the invention of "Impervite" was the climax of a brilliant research. All types of raw and finished materials were studied, and a very broad patent has since been allowed. Indeed the twenty-three claims cover such a wide scope that five years elapsed from the application for the patent to its final granting.

Up to the discovery of "Impervite," practically all waterproofing compounds were based on the old Sylvester process of soap and alum. Our grandfathers used to take alum solution and soap suds and apply these alternately to a brick or masonry wall, where they reacted to form aluminum stearate (alum soap).

Years later aluminum stearate was supplied ready-made, and then calcium stearate (lime soap) became popular because cheaper.

Getting away entirely from the soap idea, "Impervite" was perfected. It is an "Asphaltic Emulsion," free from stearates and other soaps.

It should be explained, that although soaps have a certain amount of water-proofing effect, they tend to reduce the strength so that not more than two pounds can be used to the bag of cement. This is enough to assist the workman, but it is insufficient to give a "factor of safety." "Impervite" does not injure mortar, therefore larger quantities can be used, which will make waterproofing sure, even under unfavorable conditions.

It is possible to take a sample of cement mortar without any compound and by excessive work make it nearly as waterproof as a sample containing compound. If, however, the same amount of workmanship is done in both cases, the advantages of the compound are apparent. Nowadays, when labor is expensive, anything which will give satisfactory and positive results, with less expenditure of time, is of economic importance.

Mr. Logan Waller Page of the U. S. Department of Agriculture, found that in a five-hour test, plain mortar leaked 17 cubic centimeters, whereas similar specimens of "Impervite" mortar were absolutely tight.

When it is considered that "Impervite," being an asphaltic emulsion, can be sold at the same or a lower price than the older class of waterproofings, its value is evident.

# Everywhere Parquetry

**NOT A LUXURY NOWADAYS  
BUT A STANDARD**

In all kinds of good buildings—residences, hotels, apartments—the best architects specify Parquetry Flooring.

Federal Parquetry—the finest Kentucky White Oak—is just about the same price as a good strip flooring—but Federal Parquetry has a uniformity of character and design, a beauty and distinction—you never find in any strip flooring.

Federal Parquetry is a profitable floor for you to lay—and it means future business—because it gives unflinching satisfaction.

Get the facts about this thoroughly kiln-dried, high-class flooring.

Write for Special Circular No. 19.

**Agents wanted where we are not now  
represented**

## Federal Parquetry Mfg. Co.

Flat Iron Building, New York City

# When You Want — Tiles and Mosaics

**Write**

**Artistic Designs and  
Superior Quality**

**For**

**Bathrooms, Kitchens, Hallways  
Etc.**

We carry a most complete line of Ceramic Mosaic Floor Tile and Sanitary Glazed Wall Tile for every purpose. Our designs are unusually artistic and correctly executed. The quality is **Lorenzen**—the best guarantee a builder can get. You can depend upon our prices being right.

Let us estimate on your next job or furnish you with an original design. At any rate, write for our Catalog No. 51 on Tiles and Mosaics. A postal will bring it and it is invaluable for your files.

Our large catalog "**Vogue in Fire Places**" is now ready, the most comprehensive and complete catalog ever issued on Fire Places in Tile, Brick and Wood. Write for it.

*Send for our Discount Proposition to  
Carpenters and Builders*

**Chas. F. Lorenzen & Co.**  
103 Washington St. CHICAGO



Trademark Reg. No. 94745.

## Is More Than a "Wall Board"

because it handles so easily, saws smooth and clean, does not warp, shrink, crack or break, always lies flat and straight. It is the ideal material for:

- lining garages and outdoor sheds for warmth.
- lining summer cottages (helps keep them cool).
- quick repair partitions.
- enclosing rooms in attic or cellar.
- building dust-proof closets and cabinets.
- panels in wainscoting or beamed ceiling.
- shelves, drawer bottoms, cabinet backs, and 1001 other purposes.

It's the center core of kiln-dried wood slats that makes **Compo-Board** so strong, durable and satisfactory in so many ways.

It's this same patented feature of construction that makes genuine **Compo-Board** so easily identified. Look for this wood core when you buy and avoid disappointment.

Sold by dealers everywhere in strips four feet wide and in lengths one to 18 feet long, as desired.

Write for interesting book and free sample piece.

**Northwestern Compo-  
Board Company**

5777 Lyndale Ave., No.  
MINNEAPOLIS, MINN.

## YOU'RE MISSING A BET

MR. CARPENTER  
IF YOU ARE PASSING UP THE  
**METAL SHELTER GAME**



### IT'S THE BEST BET YET

The **METAL SHELTER** Agency gets you more business, more customers, more work for your men, more money for you, better and quicker results, and—get this—

#### A REAL BUSINESS OF YOUR OWN

Don't wait. Get the agency for Metal Shelter Garages, Cottages, Bungalows, Stores, etc., before the other fellow beats you to it. You can sell 'em, and it's a cinch to set 'em up—a building a day. **THINK!** Investigation costs you nothing. Write right now.

## Metal Shelter Co., Inc.

Whitehall Bldg. --:-- New York City

A 3/4-inch facing of cement mortar containing "Impervite" will waterproof any leaky masonry. It may be applied *inside*, even where the pressure comes from the outside.

It is a mistake for waterproofing manufacturers to claim that cement needs waterproofing in every case. There are many uses of cement where no addition of compound is required. On the other hand, if a waterproofing is needed, it is cheaper to use "Impervite" than to attempt to get the results with expensive workmanship.



### The Pipeless System of Warm Air Heating

Everyone would like to have a furnace in the place of the stove because of its convenience and cleanliness. It's mighty unpleasant to have all the dirt of the stoves in the rooms. The cost of a complete system of heating, with the pipes going to each room, has kept many people from having this convenience.

A warm air heater has recently been developed that will heat a small house by one large register, or in a large house it will heat the big living room. It is called the "Pipeless System" and is a design of the Ravenna Furnace & Heating Company of Ravenna, Ohio.

As can be seen from the illustration, the register is placed directly above the heater in the basement so that only a short length of pipe is necessary. The pipe being vertical and short, the loss of heat is very small, which will give remarkable heating ability. The cold air pipe can be placed either along-

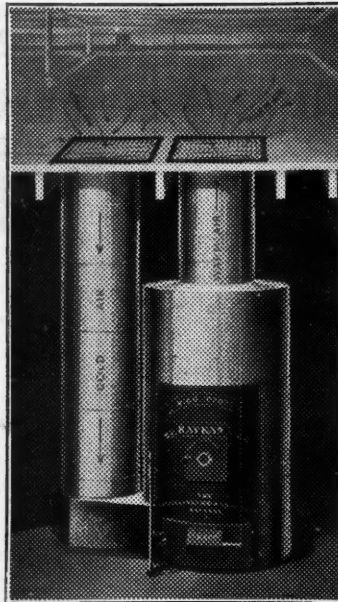

"Pipeless" System Furnace Installed.

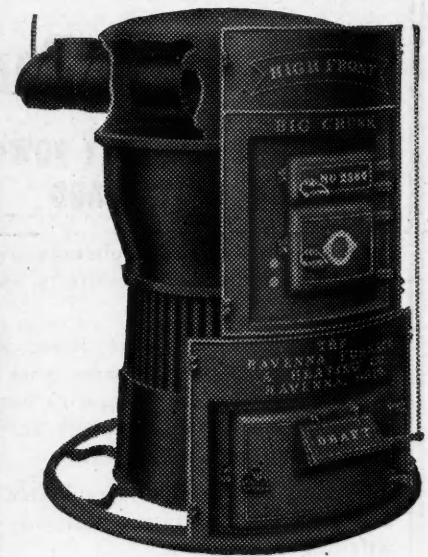

"Big Chunk" Furnace which burns either wood or coal.

side the warm air pipe or in any way that is convenient.

This design should be interesting to the man who has a small house and wants to get away from the stove that fills the rooms with dirt.

This company also handles a complete line of warm air furnaces of the usual type. Full information concerning their pipeless system and also their other furnaces can be obtained on application.

View Shows electric motor drive.

**BERLIN**

Woodworkers also come with Gasoline Engine Drive Either 4 H. P. or 6 H. P.

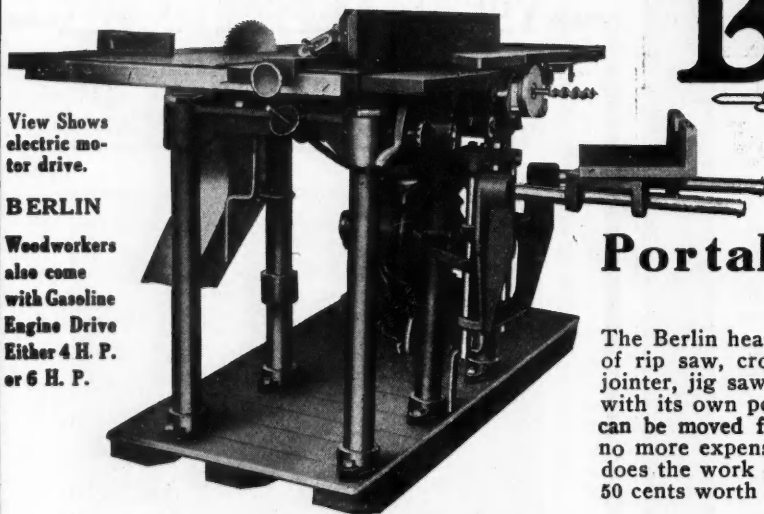

# BERLIN



## Portable Woodworking Mills

The Berlin heavy duty portable Saw Rig is a combination of rip saw, cross cut saw, dado saw, grooving machine, jointer, jig saw, boring machine, sander and emery wheel with its own power plant so conveniently arranged that it can be moved from job to job in a light spring wagon at no more expense than a carpenter's tool box. It actually does the work of twenty men with one operator and 20 to 50 cents worth of gasoline.

### Designed and Built for Durability plus Portability

The Berlin Saw Rig is easily moved from job to job—but strong and rugged enough to withstand the hardest service building contractors may put it to. Frame and main bearings are cast semi-steel, made in one piece without joints. Frame is then supported by two-inch extra heavy pipe legs on wood skids, which makes a very strong, rigid construction. "Berlin" Gasoline engines are four cycle, horizontal water cooled engines and have built-in magnetos, eliminating battery and ignition troubles. These engines are easily started in cold weather and are accessible by simply raising the wooden table. Machines are equipped with highest grade saws, knives and accessories.

#### Guaranteed for Two Years

All Berlin Saw Rigs are guaranteed against defective workmanship or material for a period of two years. During this time any broken or defective part will be replaced free of charge. Write for detailed specifications and information. The BERLIN Saw Rig is unsurpassed for combined durability and portability.

**SCHAEFER MFG. CO.**

**BERLIN, WIS.**





# ALPHA

on a bag stands for the finest Portland Cement that the experience of 24 years can produce. It means that the Cement was tested hourly by chemists, and that—in the grade of raw materials, and in exact proportioning, thorough burning, fine grinding, and correct ageing—the Cement represents

**The High-Water Mark of Quality**

Every bag of ALPHA, the guaranteed Portland Cement, is warranted to more than meet the U. S. Government standard for strength and all other recognized tests. Specify ALPHA and be SURE.

Six great plants on six trunk line railroads. Capacity 25,000 barrels daily.

Send for the ALPHA Book No. 10, giving valuable information about cement and concrete work generally.

**Alpha Portland Cement Co.**  
 General Offices: Easton, Pa.  
 Sales Offices—Boston, New York, Philadelphia, Baltimore, Savannah, Buffalo, Chicago, Pittsburgh



**Kept Young with White Lead**

Here, in 1775, Patrick Henry expressed the undying sentiment of America in his words, "Give me liberty or give me death."

These words have consecrated the little church, and it is fitting that it be kept young despite its hundred and seventy-four years.

**Dutch Boy White Lead**

and pure linseed oil are the materials that preserve it. You can make the houses you plan laugh at time by specifying that they be painted with Dutch Boy White Lead and Dutch Boy Linseed Oil. It is the economical, long-wearing paint.

Write for folders "B" which tell why. They include specifications and color chart.

**National Lead Company**

New York, Boston, Cincinnati, St. Louis,  
 Buffalo, Chicago, Cleveland, San Francisco.  
 John T. Lewis & Bros. Co.,—Philadelphia.  
 National Lead & Oil Co.,—Pittsburgh.



TRADE-MARK

**holds hardware to walls  
with a bull-dog grip**

Holds fast to hollow tile, laths-and-plaster, expanded metal laths, metal window frames and sashes, and concrete walls.

The screws can't work loose, but they can be taken out and replaced at will, without losing Bolt. Ankyra is a permanent screw-hold. It can't work loose. The nut is an integral part of the Bolt. Insures safety of fixtures.

Ankyra combines the principles of the expansion bolt, toggle bolt and anchor bolt. It is the most efficient and economical screw-hold ever invented. Made of special steel, in sizes for No. 6, 8, 10, 12, 14, 16, and 18 Wood Screws.

Especially valuable to architects, builders, plumbers, steam-fitters and electricians. You can't afford to miss their economy. Investigate without delay.

Fill out coupon and send **FREE** for samples and booklet

**ANKYRA  
MFG. CO.**  
149 Berkley St.  
PHILADELPHIA

**Ankyra Mfg.  
Co.**

Please send without cost or obligation to me, samples and booklet describing Ankyra.

Name.....

**Philadelphia**

Address.....

State.....

# Save Coal Money for Clients

## Saving of 1/2 to 2/3 Coal Cost Guaranteed the New Feed UNDERFEED Way

Your work will continue to advertise you, and your clients will always commend you wherever you install a **Williamson New-Feed UNDERFEED Furnace or Boiler**. For the **New-Feed UNDERFEED** gives more and better heat. Gives cleaner heat. Saves time. No other heater is so easy to operate. Transforms all smoke, dust and ashes into live, clean, usable heat. No clinkers. Few ashes. And, on top of it all, it effects a guaranteed saving of 1-2 to 2-3 in coal cost. Read the letters. They tell why. These were casually selected from hundreds of such others.



Gentlemen—I have fourteen rooms and all are heated from the furnace at a uniform temperature. I have no gas or smoke, and it gives perfect satisfaction. I use buckwheat hard coal in my furnace.

My coal bills for the past year have not exceeded \$30.00 where last year I heated only six rooms and it cost me over \$60.00.

There are not nearly as many ashes as from other furnaces. We feed our furnace morning and evening in severe weather. At one time this spring when the weather was somewhat mild, it ran for a week without any care and still there was fire.

Yours very truly,  
Mrs. Carrie G. Yaples,  
239 Oak St., Binghamton, N. Y.

### WILLIAMSON CUT COAL BILLS NEW-FEED UNDERFEED Furnaces and Boilers 1/2 to 2/3

In the **UNDERFEED**, the clean, live fire is always on top. Fresh coal is fed from below. And the **New-Feed UNDERFEED** burns all sizes of coal, and the cheaper grades. Adds to the comfort of any building—large or small—whether heated by hot air, hot water or steam. The operation is simplicity itself—a boy of 12 can handle it with "expert" results.



Gentlemen:—In regard to my experience with the **Williamson UNDERFEED Furnace** would state that I have heated eight rooms the entire season at a cost of \$18.00. Have had uniform heat and plenty of it in all the rooms, with a little attention, no gas and very few ashes. It has cost me less to run the furnace than to run my cook stove.

Yours very truly,  
O. A. ELWELL,  
R. F. D. 3, Binghamton, N. Y.

The guaranteed saving in coal bills of 1-2 to 2-3 is backed by a million dollar corporation.

To learn more about it—how the **New-Feed** means more business and utmost satisfaction, send for helpful book and for information regarding free plans for builders and owners. Doing this costs nothing and involves no obligation. Send the coupon today—NOW!

**THE WILLIAMSON HEATER CO.**  
(Formerly Peck-Williamson Co.)  
257 Fifth Avenue  
Cincinnati, Ohio

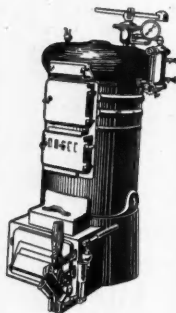

Underfeed Steam Boiler

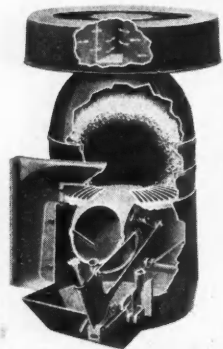

Cut-Out View of New-Feed UNDERFEED Furnace

**THE WILLIAMSON HEATER CO.,**  
Fifth Ave., Cincinnati.

Send me full particulars of the **Williamson New-Feed UNDERFEED**, and how it reduces coal bills 1-2 to 2-3.

Warm Air..... Steam or Hot Water.....  
(Mark an X after System interested in.)

Name.....

Address.....

My Dealer's Name is.....

**DEALERS!**—Let us tell you about the **New-Feed UNDERFEED** and our new Proposition. Both are winners.

## The "Dart" Motor

The motor as used on the "Dart" Motor truck is made as simply as possible so as to eliminate all useless parts, which cuts down repairs to a large degree. The illustration shown is of their Model "C" chassis.

In the Model "C" truck the motor is of the high power "L" head type, four cylinder and four cycle. The bore is 4 1/8 inches and the stroke 5 1/2 inches. The connecting rods have babbit lined, bronze shelled bearings and three bearing crank shaft. The main bearings are of Parson white metal. The lubrication is self-contained in the crank case. Oil

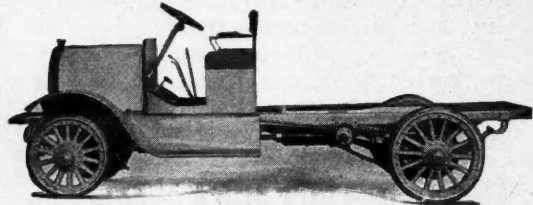

"Dart" Model "C" Truck.

is forced through to the upper part of the crank case by a positive pump, where a constant level is maintained.

The Eiseman high tension ignition system is used with a set spark so that there is no danger of the motor kicking back when it is started.

The carburetor used is the Stromberg, 1/4 inch size, which is set at the factory and cannot be tampered with except to change the air adjustment.

The motor is water cooled through positive circulation by a centrifugal pump.

More complete details with regard to the transmission, clutch, drive, etc., can be found in the catalog of the Dart Motor Truck Co., Dept. "C-7," Waterloo, Iowa. A copy can be had for the asking.

## We Recommend the Pipeless System

as shown by model to possess efficiency, especially for heating churches, halls, cottages and bungalows.

It is your interest to cooperate with us in the sale and installation of our line of up-to-date modern made furnaces. Illustrated catalog and trade discount furnished on application.

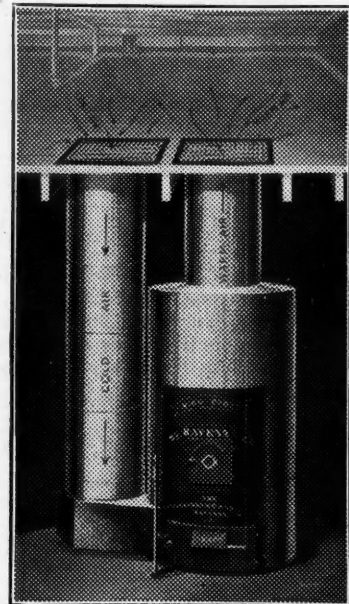

**The Ravenna Furnace & Heating Co.**  
Ravenna, Ohio

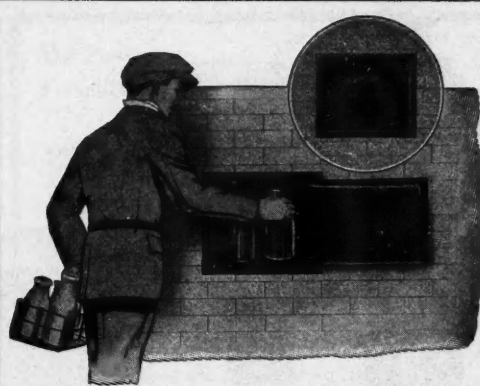

Outside view open and closed.

## The Latest "MAJESTIC" Building Specialty

A Milk and Package Receiver that is 100% efficient.

Consists of two cast iron frames and doors joined by a body adjustable to different thickness of walls. Locks with a gravity latch and can be unlocked only from inside.

Can be easily installed in house already built as well as in new construction. Finished in baked enamel, nickel trimmed. Costs but five dollars.

If you have not received your 1915 edition of *Majestic* Catalog, please write us and we will send you another.

**THE MAJESTIC COMPANY**

505 Erie Street

Huntington, Indiana

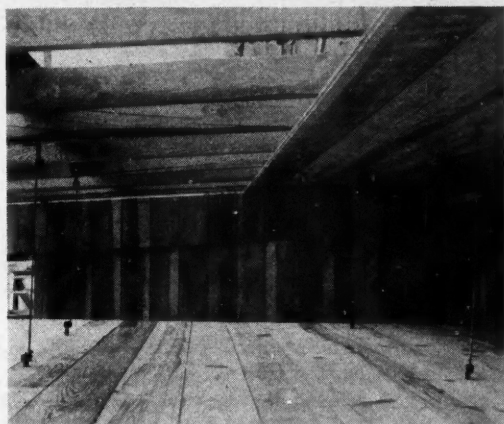

Patented Dec. 29, 1914

## TYSCRU

Trade Mark

### WHAT IT IS—

A form tie that remains in the concrete, leaving a screw socket for future use. Made in all lengths of No. 5 hard spring steel wire—diameter, 0.207—no stretch—strength equals  $\frac{1}{8}$ -inch steel rod.

### WHAT IT DOES—

Saves labor—one-fourth as many to place and four to eight times as speedy as wire ties—can be used where other methods spell loss—no holes left for leakage. Supports forms, draws forms together, acts as spacer. Can be used on roof plates.

### WHAT IT COSTS—

3 to 8 cents per cubic yard.

Write **UNIT-WALL CONSTRUCTION CO., 1328 Broadway, New York.**

**It's an Established Fact**  
That nearly every building needs a  
Coal Chute

**The Question now is—**

Which Coal Chute is Best for my customers  
and which is best for me.

## The CANTON COAL CHUTE

should appeal to your customers because: It looks neat and ornamental on any building. It can be opened from the inside or outside whichever is most convenient. It is absolutely burglar-proof. It is durable and substantial and will protect the foundation and do its duty as long as the building lasts—no glass to break—nothing to get out of order.



Closed

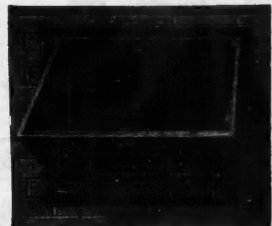

Open

**Canton Coal Chutes** should appeal to the Builder because: They add to his reputation as a builder who gives his customers the best. They are easily installed and come in three convenient sizes. Because they are reasonable in price and are profitable for the builder to handle and install.

We would be glad indeed to send you our Catalog of Builders' Iron Work, quoting prices on our Coal Chutes.

Ask for Catalog "E-3"

**Canton Foundry & Machine Co.**  
Canton, Ohio

## The Window Chute

**For  
Your  
Coal  
Bin**



Ready for the Coal Man

The Window Chute is a selling feature for any Residence or Building.

**THOUSANDS IN USE---  
THE VERY BEST**

**If You Build,  
Buy, Own**

**Be up to date and  
Have the World's  
Best**

**Write for  
Booklet C**



A Light Basement

**HOLLAND FURNACE CO. :: Holland, Mich.**

World's Largest Direct Installers of Furnaces.

**All-Steel Artistic Bungalows**

One of the developments in the building field that the wide awake contractor should be posted on is the construction of sheet metal buildings. This phase of building has come to the front until many beautiful designs are now available, showing the artistic effects that can be obtained with steel construction.

In connection with a summer colony that is being built at Beachwood, New Jersey, the Metal Shelter Company has recently issued a little booklet showing some of their artistic bungalow designs. It shows the remarkable possibilities in this class of work and the distinctive effects that can be obtained.

This company offers an agency proposition to contractors that is well worth investigating. Write for this booklet and get acquainted with this class of work. A card addressed to the Metal Shelter Company, Inc., Whitehall Building, New York City, will bring full particulars.



**A Small Practical Mixer for Builders**

A new concrete mixer, the "Berlin Six," has just been announced by the Schaefer Mfg. Co. This firm is already well known to our readers through their "Berlin" portable saw rig.

The illustration shows the appearance of this new mixer. Its weight is only 1300 pounds, so it can be trailed behind a wagon from place to place. It will mix from 30 to 90 cu. yds. of concrete per day and has a batch capacity of 4½ cu. ft. of mixed concrete.

The frame is made of 5-inch steel tubing and an angle iron that serves as the engine frame and also as the rear axle for the mixer. The drum is cone shaped with the bottom level and the top inclined toward the discharge end.



Showing Man Shovelling into "Berlin Six."

The mixer drum revolves on two ball bearings that are protected by a dust proof case. A worm drive is used.

The concrete is discharged through a gate at the small end of the cone which is the opposite side of the mixer from the charging. The shutter through which the concrete is discharged is water tight, so that there is no slopping, even with a very wet mixture.

The power is furnished by the 2½-H.P. "Berlin" engine which is made especially for contractors' machinery.

Further details and information can be secured by writing to the Schaefer Mfg. Co., at Berlin, Wis.



**Why YOU Should Recommend THE VICTOR FURNACE**

Mr. Carpenter and Builder:—It will pay you and make contented customers wherever you install Victor Furnaces. I have been making furnaces for 20 years, and know just how much help a practical furnace builder can be to a contractor, if he really knows his business.

**My Furnace will give more WARMTH WITHOUT WASTE**

is easier to operate, easier to install, lasts longer without repairs, costs less and has the best appearance of any furnace that I know of on the market today. If I knew of one that was better in any of these points, I wouldn't rest a minute until I had found a way to beat it.

I have been dealing direct with carpenters and contractors for many years, and we don't need much of an introduction to get together pretty quickly if you have a job to figure on.

Write to me for my special terms and let me post you on the Victor Furnace. Then when I have an inquiry from anyone near you, who wants a furnace, I can help you to make the sale.

Just drop me a postal with your name and address and say "Send me your furnace talk."

Address:

**W. R. Simons, Manager, SIMONS-LEEDLE FURNACE COMPANY**  
404 RIVER ST. MARSHALL, MICH.

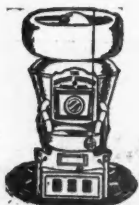

**BE OUR AGENT—**

Builders and Contractors can make good money acting as our agents. You can save the buyer 30% in Fuel Bills. Why not sell

**Jahant Down-Draft Furnaces**  
On 30 Days' Trial

In your business you have the opportunity to make the sales. *Jahant Down Draft Furnaces* have a record for merit behind them. You are selling a first class article at a saving to your customer.

Send for Free Catalog

**The Jahant Heating Co.,** 300 Steiner Ave AKRON, OHIO

Jahant Down Draft gives perfect combustion. Gives more heat. Saves one-third fuel. Burns from above. Ashes can't clog.

**THE FOOS**

Gas and Oil Engines for Pumping, lighting, hoisting and power service.

1½ to 400 H. P.

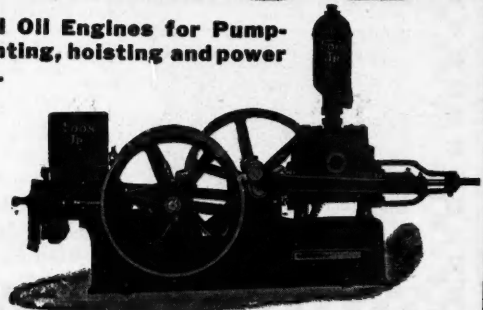

THE FOOS GAS ENGINE CO. SPRINGFIELD, OHIO

**We Pay Freight**

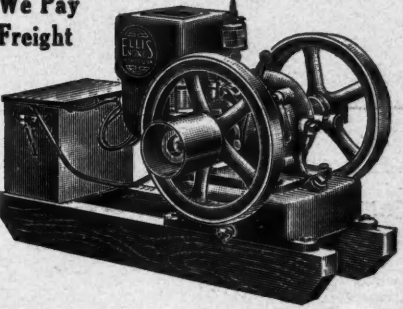

## Don't Pay For Your "Ellis" without getting it

Every carpenter or contractor who does not use a reliable engine is paying for the engine without getting it. He pays for it in lost time, and in labor costs. You can buy an Ellis Engine out of two weeks' wages to one workman; and your Ellis will give you reliable service for many years.

Ellis Engines are America's favorite with carpenters, contractors and builders. Very compact in design; light in weight in proportion to power. Easy to operate; no cranking. Run either way; reversible while running. They work successfully on common cheap lamp oil at a fuel cost of

**6 cts. for 10 hours**

for each horsepower developed. Just the thing for wood-workers, rip-saws, planers, cement mixers, hoists; in fact for every job where power can be used. Write for free book "Engine Facts" giving valuable information and full details of our 30 Days' Free Trial Offer, with opinions of users from all parts of the world.

**Ellis Engine Co., 2863 E. Gd. Boulevard, Detroit, Mich.**

All sizes for all purposes. 1½ to 18 H. P. Vertical and horizontal. Guaranteed 10 years

## "NEPTUNE" Pneumatic Water Supply Systems and "NEPTUNE" Gasoline Storage Tanks

### Big Money Makers for Builders

Our Neptune Gasoline Storage Tank is easily sold to building owners who have automobiles. Install it in building your next garage. Quick profits. Tank galvanized in and out; covered outside with preservative paint. Rivetless construction. All brass pump, lock, key, hose bibb, 2-inch fill pipe with hinged cap and lock. Approved by Underwriters. Low price makes the Neptune a ready seller.

**Write today for prices and Catalog V. A. B.**

Bbl.	
1..	\$15.00
2..	22.00
3..	33.00
4..	45.00

**Fleck Brothers Co.**  
40 N. 5th St. Philadelphia, Pa.

Plate 62V

This Water Supply System is easily and profitably installed by contractors. For country and suburban homes. For hand or power—electrical or gasoline engine. This outfit is gearless, noiseless, automatically controlled, compact, operated with minimum amount of current. Furnished in any size. Write for complete information and terms.

Plate 63V



## Get My Latest Engine Offer

Let a WITTE earn its cost while you pay for it. Take full 60 days' Free Trial to prove its big value.



### WITTE Engines

Gasoline, Gas, Kerosene, Distillate

Besides lower prices, WITTE engines use less fuel per horsepower hour, by one-fourth to one-third—enough saving to pay entire cost of engine in a year. Easy starting; no cranking; steady running. My 28 years at one thing, making WITTE engines, makes my higher quality.

<b>BUY DIRECT</b>	2 H. P., \$34.95	8 H. P., \$139.65
	3 H. P., 52.45	12 H. P., 197.00
<b>Cash or Easy Terms</b>	4 H. P., 69.75	16 H. P., 297.70
	6 H. P., 97.75	22 H. P., 359.80

WRITE FOR MY FREE BOOK, and all about my New Liberal Offer BEFORE you arrange to try any engine. I save you money, besides giving you the easiest chance to get the best engine service. Write me to show you.

**Ed. H. Witte, Witte Engine Works**  
1779 Oakland Avenue, Kansas City, Mo.  
Office 177, Pittsburgh, Pa.

Five-Year Guaranty  
I unqualifiedly guarantee every WITTE engine for five years against defects, and consequent faulty operation. I carry the risk, as I have done for my thousands of customers during 28 years.  
Ed. H. Witte.

## MYERS ELECTRIC HOUSE PUMP

FOR USE WITH OPEN OR PNEUMATIC PRESSURE TANKS

A MODERN EQUIPMENT FOR CITY OR SUBURBAN HOMES. AN OUTFIT THAT WILL SUPPLY ANY HOUSEHOLD WITH WATER WITHOUT LABOR or ATTENTION.

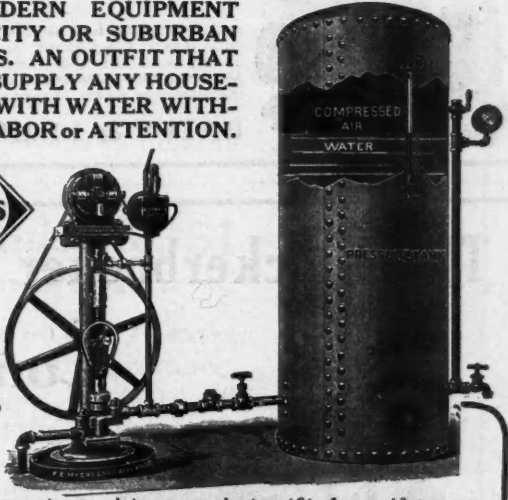

A compact, complete, convenient outfit, for residence or other service, especially designed to be operated by a small motor. Can be used to pump water from cisterns or shallow wells into open or pneumatic pressure tanks. Pump and motor are mounted on one base, occupying a space of 16 by 20 inches. Motor required to operate is 1/6 or 1/4 H.P. Can be driven direct from electric light wire. Furnished with or without automatic pressure switch. With the automatic switch no attention whatever is required, for this device will stop the motor at any given pressure and start it again when the pressure becomes too low. If not equipped with automatic switch, motor can be started or stopped, at will, by an ordinary switch, located at any convenient point.

For additional information and catalog address

**F. E. MYERS & BRO., Ashland, Ohio**  
Ashland Pump and Hay Tool Works

**Harris Sanitary Dairy Barn Equipment**

The Harris Manufacturing Company has developed a line of dairy barn equipment that has many good features. The stalls are made of 1 7/8 inch, outside diameter, standard weight steel pipe. The stanchion is made of steel drop forged into a "T" shape which is lined on the inside with wooden strips, which may be made of various sizes so as to fit the cow's neck.

The illustration shown is of the dairy barn at the Kansas State Experiment Station, which is furnished with the Harris No. 10 stalls and stanchions. The clean cut, simple construction is clearly shown in this example. The manger partitions that can be folded back out of the way are among the many desirable features of this equipment.

The manufacturers are conducting a Harris Service and Co-operative Plan for Builders and are prepared to show contractors the advantages of their system and the ease of installing it. The Harris Company says that its equipment is extremely easy to put in and will save contractors much time and money.

This company also handles a complete line of labor-saving barn equipment of all kinds; such as litter and feed carriers, hay forks and carriers, horse barn fixtures, ventilators, spray pumps, etc. Write to them concerning their line and get the

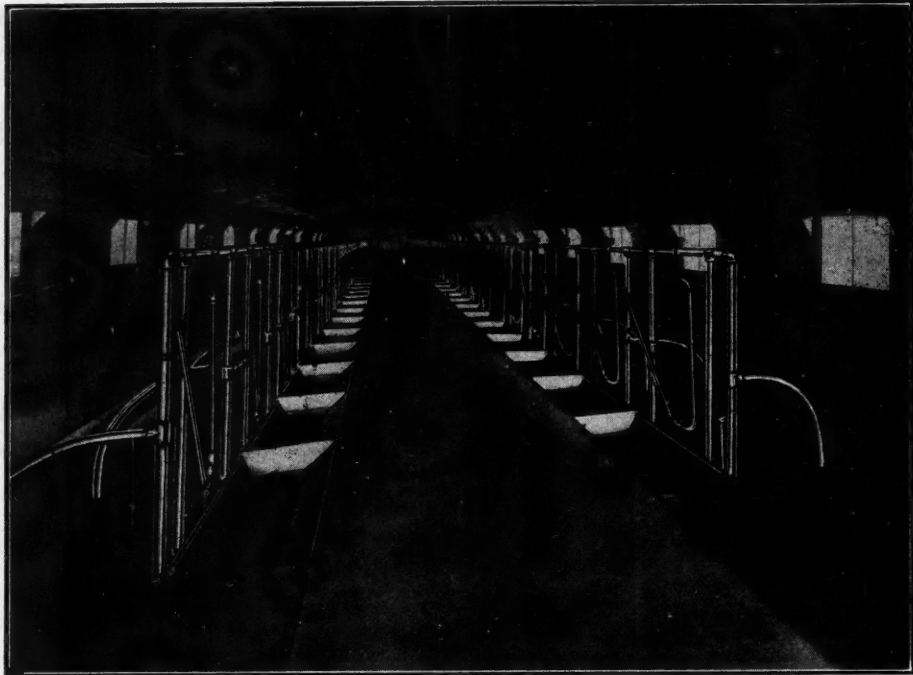

Interior of Kansas State Experiment Station Barn Equipped with Harris Stanchions.

benefit of their service and cooperative system. A card to the Harris Manufacturing Co., Box 224, Salem, Ohio, will bring full particulars, including their big catalog.

**Real Difference**

"Pop, what's a monologue?"  
 "A monologue is a conversation between husband and wife."  
 "I thought that was a dialogue?"  
 "No, a dialogue is where two persons are speaking."

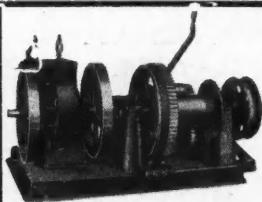

**"BULL DOG" MATERIAL HOISTS**

For Contractors and Builders a "Bull Dog" Hoist and Material Elevator is a money saver. It cuts down your labor and operating costs wonderfully. Our "Bull Dog" Engine is unsurpassed for the Contractor being built to withstand hardest usage and service. Material Elevators come in several sizes and are easily and speedily erected. We also manufacture Power Hoists and Diaphragm Pumps. Our Catalogue shows all. Write for it.

**BATES & EDMONDS MOTOR CO., Lansing Mich.**

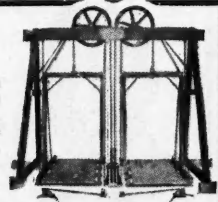

**The Knickerbocker Company, Jackson, Michigan**

Manufacturers of

**Concrete Mixers**

Write for Catalog



Stationary Batch Hopper and Hoisting Sheave

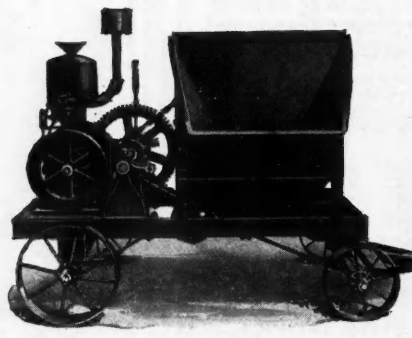

Standard Hopper

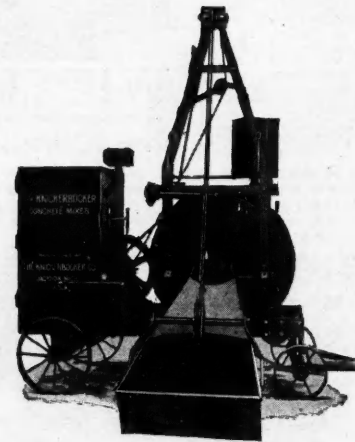

Power Loader

# 10 points scored in favor of The **REX** CONCRETE MIXER

**\$275** F.O.B. MILWAUKEE

**BUY "THE REX" CONCRETE MIXER \$275** F.O.B. MILWAUKEE

**3 H.P. MOTOR GAS ENGINE**  
**CHAIN BELT DRIVE**  
**SEMI STEEL DRUM**  
**HIGH DISCHARGE**  
**CHILLED ROLLERS**  
**LARGE DIAMETER ROAD WHEELS**  
**STANDARD ROAD GAUGE 4'8"**  
**LOW CHARGING**  
**21" OPENING**  
**STEEL ENGINE HOUSE**

**CAPACITY 6 CU. FT. UNMIXED**

**WHEELS**—We have considered very carefully the fact that a machine of this type will be used over all kinds of roads and made the design of the road wheels the standard engine design. The wheels are 23 inches in diameter with a 4 inch tread.

**TESTING**—Every machine is thoroughly tested under its own power and is rigidly inspected before leaving our plant.

**GUARANTEE**—The REX mixer is guaranteed for a period of one year against all defects in workmanship and material and we will replace any parts that are defective. F. O. B. Milwaukee. This guarantee does not include the New Engine Co., Lansing, Mich.

**PRICE**—The price of this machine is \$275 F. O. B. Milwaukee.

**GASOLINE ENGINE**—The Rex is furnished with a New Engine Co. engine which is a reliable outdoor engine, made in accordance with and particularly adapted for use in contractors' machinery. The New Engine is a vertical, light weight, water cooled, 4-cylinder engine and is fully enclosed by a steel housing. This engine is front cover and is designed for use by a steel housing. This engine is front cover and is designed for use by a steel housing. This engine is front cover and is designed for use by a steel housing.

**CLUTCH**—The clutch which the engine drive is equipped with a friction clutch so that the engine can be started without turning the mixer drum. Very few manufacturers of the smaller mixers use a friction clutch but rely for the most part on the ordinary jaw clutch.

The reasonably priced, high quality, low charging mixer for both small and big concrete construction work — which has a capacity of six cubic feet of loose material or five cubic feet of mixed concrete per batch, and which thoroughly mixes and discharges a batch of concrete in forty-five seconds.

## These 10 features are fully described in our new Rex Mixer Bulletin

Get a copy of this bulletin and see for yourself the essential features in this mixer that make it the best on the market for the money.

The **Rex Mixer** has the same superior workmanship and material as that entering the **Chain Belt Mixers**, which are known the world over for service and reliability.

Ask for a copy of Bulletin 61D today

**CHAIN BELT CO.**  
730 Park St. Milwaukee, Wis.

## JOURNEYMAN You Should Have in Your Kit The "Standard" Take-Down Square



They take apart or put together easily and quickly, yet cannot slip at the joint and are absolutely accurate in every way.

Packed in water-proof cases in the following finishes:—

- Polished.....each \$2.25
- Nickel Plate....." 2.50
- Blue....." 2.50
- Copperplate....." 2.50
- Galvanized....." 2.50

The Prices Include Delivery to You

**The Southington Hardware Co.**  
Southington, Conn.

Also Makers of "HOLD-FAST" Bevel—Send 50c for Sample

## This is no "cheap John" Saw.

Its price is \$3.00.

It represents the best of the art of saw making up to date.

## Simonds No. 51 No-Set Saw

Requires no set, is extra ground for clearance. Made only in 24 or 26 inch length, 10 points to the inch. At your Dealers or sent express paid for \$3.00. Try it for 30 days. Your money refunded if not satisfactory.

Carpenter Guide Book free to any reader

**Simonds Manufacturing Co.**  
"The Saw Makers"  
Fitchburg - - Mass.



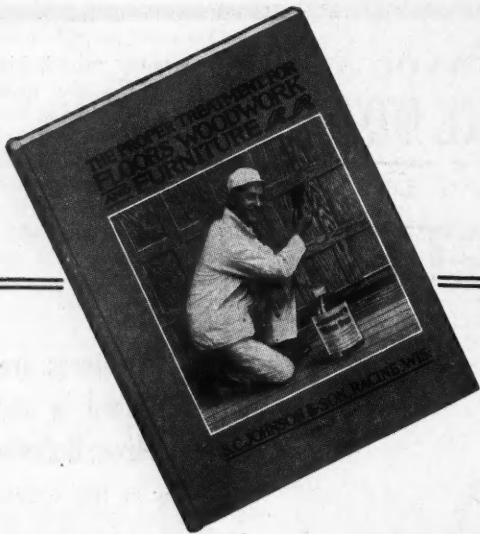

**JUST OFF THE PRESS**  
**NEW INSTRUCTION BOOK**  
**ON WOOD FINISHING**

This new book is 100% more beautiful and comprehensive than former editions—it is the work of famous experts—beautifully illustrated in nine colors. It gives complete specifications for finishing new woodwork and floors, and for refinishing old work of this character.

Every Architect, Contractor and Builder is entitled to one of these books absolutely free—we even pay the postage.

You will find this book full of valuable information—use it as a hand-book on interior finishing and your specifications will never go wrong.

**JOHNSON'S WOOD DYE**

is made in 17 beautiful shades for artistically coloring wood. With it your inexpensive jobs of soft wood can be finished just as attractively as hardwood. Specify it on your next job and convince yourself.

Johnson's Wood Dye is very easy to use—it does not lap or streak—any good brush hand can apply it with perfect results. Johnson's Wood Dye penetrates deeply into the wood without raising the grain—is economical and permanent.

If you are not familiar with Johnson's Wood Dye we shall be glad to furnish you with good size samples for experimental purposes.

*Use the coupon for your book.*

Please send free and postpaid my copy of your new 25c Instruction Book, "The Proper Treatment for Floors, Woodwork and Furniture."

NAME .....

ADDRESS .....

CITY & STATE.....

*Fill out this coupon and mail to*

**S. C. JOHNSON & SON**

*"The Wood Finishing Authorities"*

**RACINE, WIS.**

AC&BS

**Little Things that Count**

Most any contractor can hang a door that will work right, at least we are sure that any of our readers can. That is often the trouble with garage doors—they work too easily. The wind shuts them before the driver can get out, with the result that there are broken fenders, lamps, etc.

Suggest a door holder to the next man you build a garage

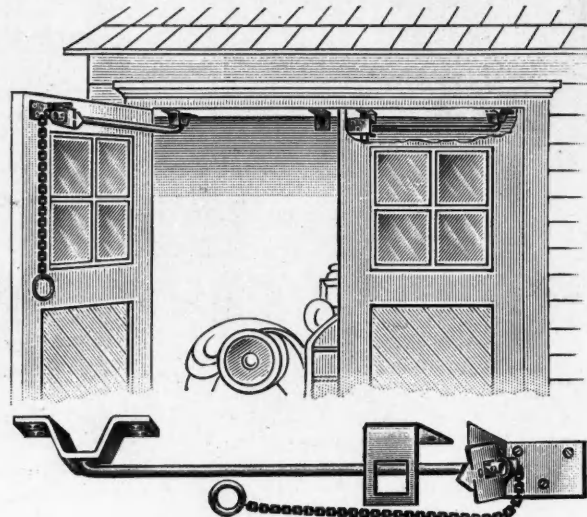

The Shelby Garage Door Holder.

or barn or warehouse for. He will thank you for the saving that results.

The Shelby Garage Door Holder has been designed for doors of the type named above. It automatically locks the door open and the catch can be released by a slight pull on the chain shown in the accompanying illustration.

Full particulars of this holder can be obtained from the Shelby Spring Hinge Co., Shelby, Ohio.



**Says Good Quality Asphalt Shingles are O. K.**

"Good asphalt shingles are a success. Inferior shingles have not been and never will be," said the manager of the International Roofing Manufacturing Company to a representative of this magazine.

"International asphalt shingles are not only a permanent and satisfactory roof covering for pitched or slanting roofs," he continued, "but they add charm and elegance to the building they cover. They give a touch of style, finish, and appearance to all buildings at a surprisingly low cost, and increase their selling and renting value.

"On the roof practically depends the life of a building. The roof either makes or mars the beauty of the finished structure. Therefore, investigate 'International' asphalt shingles before you decide on your roof covering.

"Don't select a shingle that is low in price. You don't get anything for nothing nowadays. You pay according to what you get. Don't use so-called seconds. Their appearance on the roof will be a perpetual annoyance to you.

"A better roof covering than a good asphalt shingle cannot be had today at twice their price. Therefore, be a booster of the better grade only and discourage the use of the inferior. The International Roofing Manufacturing Company of 5305-21 Western Avenue is willing to prove at their expense that a roof of 'International' asphalt shingles, properly laid, will add charm, elegance and dignity to any building on which they are applied. Furthermore, they agree to guarantee 'International' shingles to wear for many years."

It will pay you to investigate "International" shingles and get prices on them.



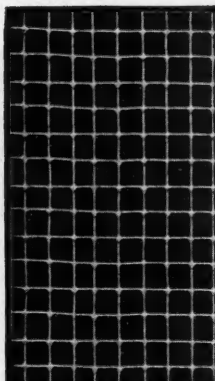

## Let Your Specifications Read WRIGHT WIRE LATHING

Many of the country's foremost architects specify Wright Wire Lathing. It was used in the Grand Central Station and many other famous structures, as well as costly residences, because it resists the ravages of time and fire as no other lath can.

Wright Wire Lath is made in three finishes—Plain, Japanned and Galvanized. The illustration at the left shows Wright Galvanized Lath.

Our Catalogue W, describing Wright Wire Lathing in detail, is an intelligent guide for architects and builders. Send for a copy of this book today. Free on request.



WRIGHT WIRE COMPANY

WORCESTER, MASS.

## FRESH AIR AND PROTECTION!

### The Ives Window Ventilating Lock



A Safeguard for Ventilating Rooms, allowing windows to be left open at the top, the bottom, or both top and bottom, with entire security against intrusion.

*Descriptive circular mailed on application.*

## THE H. B. IVES CO.

SOLE MANUFACTURERS

NEW HAVEN - - CONNECTICUT

## Plan for Outside Icing

### THE HERRICK WAY

It's the modern way. Once shown to the housewife, she will have no other. It keeps the iceman on the outside, thereby keeping floors clean and saving time and trouble. Another popular feature is that it is an all year around refrigerator as it keeps the food cool during the cool months as well as when using ice.

**Our Service FREE to Builders**  
Send us your plans or a sketch and let us figure and give you an idea of what the cost will be and add to your reputation by recommending Herrick Outside Refrigerators to your customers. It won't cost you anything. Or write for details and catalog of Herrick Refrigerators.

Herrick Refrigerator Co.  
Waterloo, Iowa

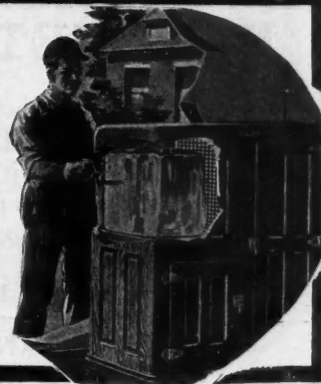

## The Opening Door

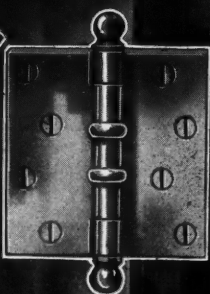

Will swing softly on

## STANLEY'S BALL BEARING HINGES with Non-Rising Pins

Write for Booklet "Properly Hung Doors"



To Department "A"  
**THE STANLEY WORKS**  
New Britain, Conn.  
New York Chicago



An Oil Checking Hinge  
that is  
applied  
to the  
top  
of the  
door

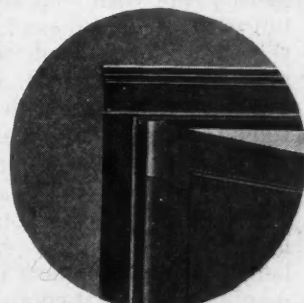

## THE SMITH CHECKING HINGE

A "THOBEN" Specialty

This Checking Hinge possesses more individual features of merit than any other on the market and sells at a lower price.

It closes the door quickly and silently. Needs no adjustment. Works in the radius of the door. Cannot wear out, as it only checks the door—weight of door rests on simple case-hardened ball and socket joint. This Hinge is a preventer of accidents. No babies are knocked down and injured, no fingers crushed or dishes knocked from hands. It is also splendid hinge for single or double-acting office gates.

Ask your Dealer for Thoben Hardware. If he will not get it for you we will supply this hinge direct to you at these prices. Price for 1 3/4" door—\$4.20, for 1 1/2" door—\$4.80. We also manufacture the Smith Double-Acting Door Hinge (Non-checking), the Smith Sliding Door Lock and the Smith Sliding Door Hanger for Sliding barn doors.

We'll be glad to send our Catalogue showing the complete Thoben line.

**THOBEN MANUFACTURING CO.**  
115 E. South Water St., Chicago, Ill.

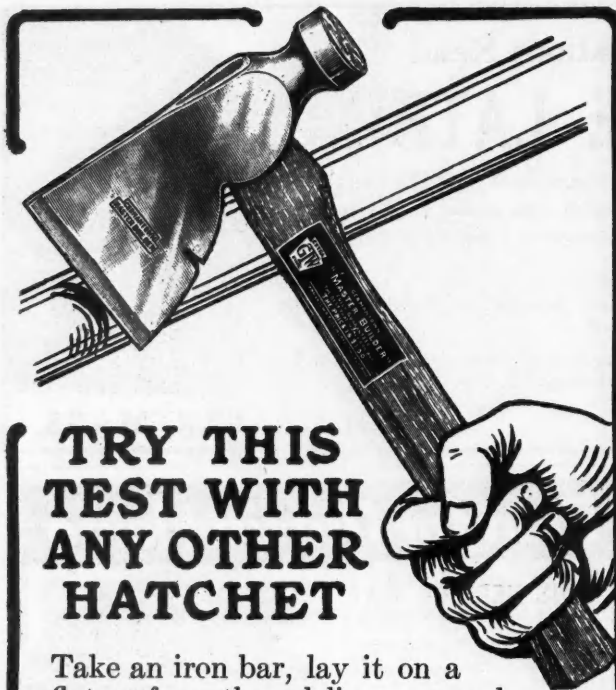

## TRY THIS TEST WITH ANY OTHER HATCHET

Take an iron bar, lay it on a flat surface, then deliver a smashing blow upon it with a hatchet—and see what happens to the cutting portion of your tool. Disaster itself.

But you can do it with a

**GERMANTOWN  
MASTER BUILDER**

and never turn the edge

This is a test that is frequently made in our factory, not with a specially constructed tool, but with any one in stock. The result is always the same—for of such superior quality steel, and so finely tempered, are the blades of our hatchets, that even such violent use is unable to chip, or even turn the edge.

For every process that they go through—from the initial forging to the final packing—there is a system of inspection through which they must successfully pass. Each Tool is personally handled and examined after each stage of its manufacture. If it contains the slightest defect it is unhesitatingly discarded.

It is just such quality and manufacturing care that have given GERMANTOWN MASTER BUILDER Tools the international prestige they hold today among those who recognize and demand the BEST.

**Famous Master-Builder Hatchet.** Thin bit, splendid balance, perfect cutting edge. Handle of second growth hickory, octagon-shaped and swell-ended to prevent slipping. Drives nails like a hammer. No. 319, Size 1; and No. 320, Size 2. Each... **\$1.50**

**Germantown Tool Works**  
Philadelphia, Pa.

Branch: 62 East Lake Street - CHICAGO

### Artistic Alterations

There are many houses that are finished over every year and many builders get considerable work of this kind. One of the best ways to alter the exterior of a building is to add columns so as to form an imposing entrance. The change in the appearance of a house that is remodeled in this way is often remarkable. It gives a stately, attractive look to a building that was formerly unpleasant and plain.

Columns for this sort of work and also for new houses can be had in many different styles. Union metal columns are particularly well adapted to this. They are made in the styles of the classic order of architecture. The body is made of pressed steel, specially galvanized and has plenty of supporting power, as demonstrated by the installations pictured in the book of their designs. Any contractor can find considerable application for these columns in his work. Full information can be secured from the Union Metal Mfg. Co., Canton, Ohio.



Column of  
Pressed Steel.

### Metal Lumber Construction

The accompanying illustration shows the floor construction in a building that is made of metal lumber. This is a type of construction that builders should be familiar with, as it being used in many cases.

Light I-beam joists, as shown in the illustration, are spaced on 16-inch centers. They are braced by the diagonal bridging. The studs are U-shaped members, that carry prongs to hang the metal lath on. These prongs can then be bent back to hold the metal lath in place.

The floor can be finished in any way—concrete (as shown in the illustration), tile, or wood. In case a wood floor is wanted, a nailing strip is placed over the joist and is nailed securely to the web. This strip is 2 by 2 inches and comes up flush with the top of the concrete, which is placed in between the strips on the metal lath.

For framing around openings, the manufacturers say that the metal joists are easier to handle than wooden ones.

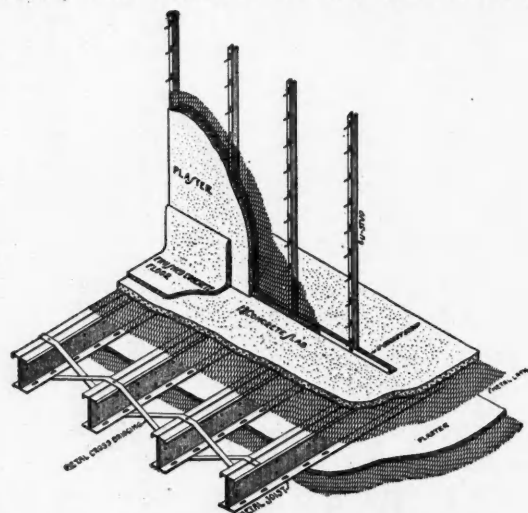

Detail of Berger's Metal Lumber Standard Floor  
Construction, Total Dead Load per Square  
Foot, Less than 40 Pounds.

The Berger Mfg. Co., Canton, Ohio, who make this material, have a special catalog describing this method of construction. Copies can be obtained by writing to them. Ask for special catalog L. A. B.

## A New SYKES Product Lohmannized Lead-Coated Metal Lath

(Coated after expansion)

Lead Coating will resist acid better than any other coating, better than galvanizing. This is, we believe, the best metal lath that can be produced at reasonable cost. It is, of course, on the famous



model and so saves money and time because no furring strips are required. This type of lath is much heavier than other makes cut in the same gauge—therefore stronger, for added weight gives rigidity and durability.

Architects ∴ Contractors ∴ Dealers

Send for free sample of this new

## Lead-Coated Sykes Metal Lath

—prove for yourself by any test that the lead will not peel or scale; remember that lead adds durability.

Best for Interior Work—Best for Exterior Work. Sykes Metal Lath is approved by U. S. Government for Post Office work. Endorsed by architects.

Write for Free Sample and Booklet—there's both durability and a saving to be gained by using Sykes Metal Lath.

**Sykes Metal Lath and Roofing Co.**  
504 Walnut St., WARREN, OHIO

## Let it be the "Camp" Grain Elevator

Of course you want to install and recommend only such grain elevating equipment that you know is 100% efficient.

Let us send you our FREE illustrated Catalog, also FREE plans showing how this Machine should be installed. The "CAMP" is the only Hydraulic make on the market—be sure to make comparisons before deciding.

You will see at a glance that the "CAMP" is the "always service and result giving" GRAIN HANDLING EQUIPMENT.

**Camp Brothers & Co.**

Dept. 15 Washington, Illinois



# Up-to-Date Ideas for Up-to-Date Builders

## GENERAL SUMMARY OF CONTENTS

Radford's **DETAILS OF BUILDING CONSTRUCTION** is a complete manual of Building Practice, as applied to carpentry, construction and the use of millwork. It is a remarkable collection of full-page plates, accurately drawn and reproduced to exact scale, showing clearly every detail of modern building construction and finish. These plates make plain the framing and construction of residences of every type—frame houses, brick houses, brick-veneer houses, "stucco" or cement-plaster houses, cement block houses, etc.

### 200 Pages of Live Information

200 pages of illustrations, with thousands of details, including a section showing home furniture making.

Every part of a building is shown in Radford's **DETAILS OF BUILDING CONSTRUCTION**. All dimensions, angles, curves, measurements and joints are made so plain and are so well illustrated that the "man on the job" will have no trouble or difficulty in doing the work. It has all been figured out by men who have made a lifelong study and success of architecture and building.

This book and a year's subscription to the American Carpenter and Builder for only \$2.00, the regular price of the magazine alone.

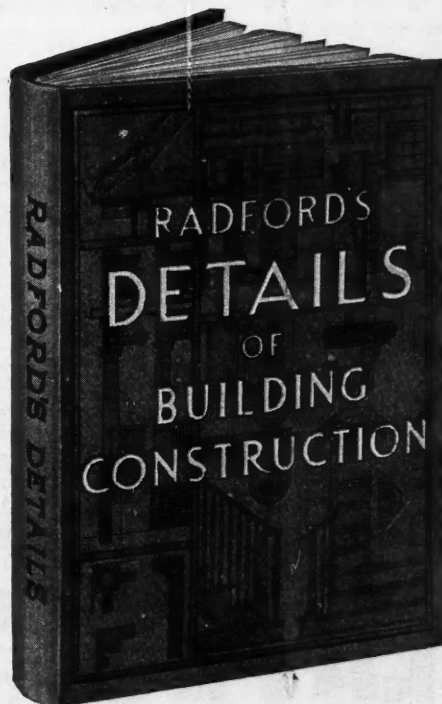

### PART I. Details of Construction and Finish

**38 Full Page Plates**, showing complete details of interior trim, with special "built in" features for every room and part of a modern residence.

### PART II. Details of Frame and Masonry Construction

**44 Full Page Plates**, presenting a graded series of 197 figures detailing completely every point in frame, brick and stone construction.

### PART III. Details of Miscellaneous Building

**57 Full Page Plates**—A veritable Treasure House of practical and reliable information for carpenters and builders—especially those working in the country—working drawings and details which solve completely every building problem.

### PART IV. "The Handy Man's Friend"—How to Make a Thousand and One Useful Things

**61 Pages**, packed full of practical helps for doing all the various pieces of work that the carpenter and the "handy-man-about-the-house" is called upon to do. Details and working drawings with brief explanatory text.

**AMERICAN CARPENTER AND BUILDER --- 1827 Prairie Ave., CHICAGO**

# SLATE FOR ROOFING

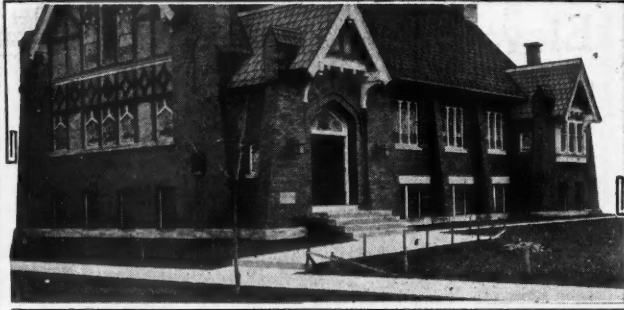

Slate Pointers, Chapter 1

**F**OLLOWING are a few condensed facts pertaining to slate roofing:

*Strength of Building for Slate*—It is the prevailing opinion of people not familiar with the use of slate for roofing purposes, that a building should be constructed very much stronger for slate than for other roofing materials. This is a mistake, as any building strong enough for shingles, tin or iron is strong enough for slate, for the following reasons:

The weak points of any roof are the valleys or other breaks in the roof where the snow drifts in and lodges, and when the snow melts with rain, the weight at points where the snow has drifted is much heavier than any two slate roofs. It is well known that snow will not stick on a slate roof, as it will on shingles or on a metal roof; as the slate, being of a warmer nature, causes the snow to melt and slide off, while with shingles or metal it freezes on, causing greater weight than a slate roof is ever called on to bear. Two by six rafters, 18 feet long, 2 feet from centers, give a roof all the strength necessary for a slate roof. The writer has seen hundreds of houses roofed with slate where the rafters were 2 by 4, 2 feet from centers 16 feet long, with collar beam nailed across one-third of the way down from the top.

*Pitch of Roofs*—Slate can be depended upon to make a roof perfectly water-tight on any pitch down to one-fifth. Half pitch or steeper makes the best roof, both for looks and strength, as it throws the weight on the walls more than on the rafters, and causes the snow to slide off clean, thereby never overloading any one part of the roof.

Slate should not be laid on a roof of less than one-fifth pitch unless laid in composition.

*Measuring Roofs*—It is very desirable that a slater should be able to understand and measure architects' drawings, as many of the largest and best jobs of slate roofing are let by contract from the architect's office. The greatest advantage derived by the slater in being able to measure drawings is the fact that his competitor does not know every job he bids on; just how much per square he figures at, as the variation in prices may be caused by measure and not price. Some roofers adopt the mistaken plan of not measuring hips and valleys extra; this is wrong, for while it may give a small margin of profits on a plain roof, at the same price per square it will cause considerable actual loss on a roof badly cut up by hips and valleys. There is no more reason or sense in leaving off the measure of hips and valleys than there would be to leave off the measure of the porches, as both take a great amount of extra time and material, which the owner gets the benefit of, and should pay for, as he does for windows, doors or any other part of his house.

(To be continued)



## Save the Gutters

You have probably seen the snow, which collects on the roof of houses, come down with a rush and loosen the gutter at the eaves so that it is almost useless. The gutter then rattles back and forth to the discomfort of the house owners.

Of course a gutter could be built that would stand this sort of treatment, but there is a better way. Put snow guards on the roof. They will prevent this and also save the snow so that it is easy to fill the cistern if there is one to be filled.

The "Clason" snow guard will save this snow and also prevent it from injuring the gutter. A card addressed to the Clason Metal Works, Providence, Rhode Island, will bring full particulars. Snow time is a long ways away yet but don't wait. Now is the time to build in satisfaction for next winter's use.

**SLATE WE HAVE WHAT YOU WANT**

*In Roofing Slate. Slate Blackboards  
Structural and Plumbers' Slate*

**SATISFACTION GUARANTEED IN QUALITY AND PRICE**

**ASK FOR DELIVERED PRICES**

**J. K. HOWER, Station, C., Danielsville, Pa.**

**R. J. KICHLINE, Sales Agent**

## ROOFING SLATE SINCE 1869

Miners, Makers and Shippers of all Styles and Colors of Roofing Slate. Write for Prices.

### RISING & NELSON SLATE CO.

Main Office: West Pawlet, Vt.

Branch Offices:

1140 Singer Bldg., New York City. 4 Post Office Sq., Boston, Mass.  
Office and Yard, 2554 W. Harrison St., Chicago, Ill.

**An Ounce of Prevention SNOW GUARDS**

prevent snow sliding off the roof, tearing away and damaging gutters and injuring passers-by. They are easily and quickly applied—low in cost. They are damage-suit insurance. For old or new roofs. **FREE SAMPLES** together with various styles and prices on request.

**CLASON METAL WORKS** :: :: **"Clason" Guard for New Roofs Providence, R. I.**

# ROOF SLATES

## STRUCTURAL SLATE BLACKBOARDS

**E. J. JOHNSON**

38 Park Row New York

## Quarry Operator

BLACK, GREEN, PURPLE, RED

Booklet, Samples and Prices on Application