

AUGUST 1916

AMERICAN CARPENTER AND BUILDER

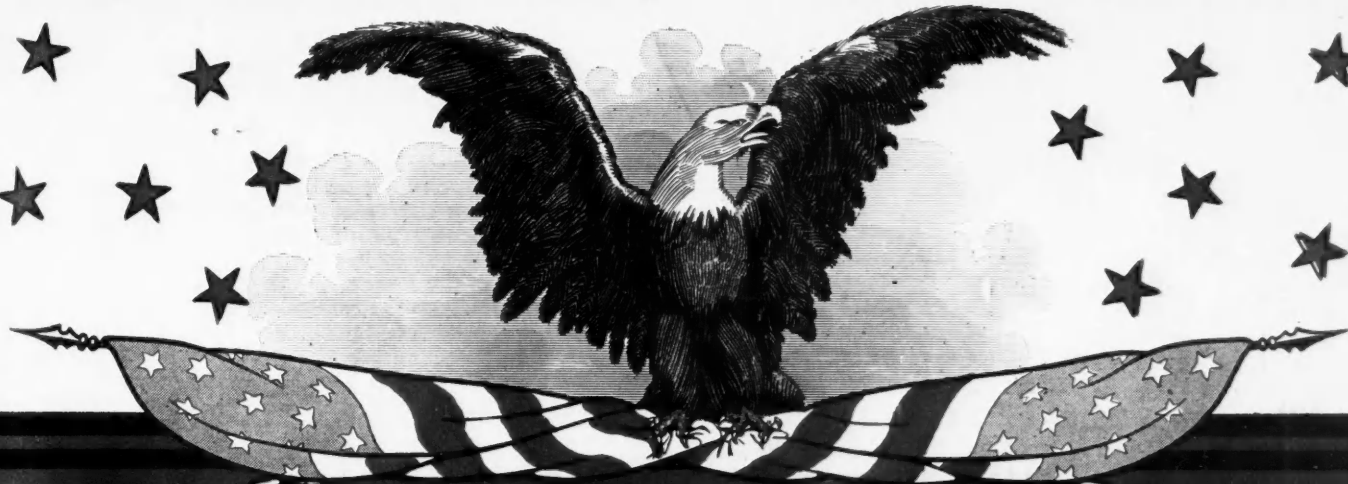

THE WORLD'S GREATEST BUILDING PAPER

THE KAMEHAMEHA SCHOOLS
WOODWORKING DEPARTMENT
HONOLULU HAWAII July 3rd, 1916.

The American Carpenter and Builder,
1827 Prairie Avenue,
Chicago, Illinois.

Gentlemen:

In renewing my subscription to the "American Carpenter and Builder", I want to express my appreciation of your efforts to produce a trade paper which meets the many needs of the man engaged in modern building construction.

From cover to cover, your periodical contains nothing but clean reliable advertising matter, and helpful discussion, suggestion, and information, valuable alike to the man in the mill and the man on the job.

I feel that I owe much to the publishers; for not a number comes to hand from which I cannot derive information worth many times the money value of a year's subscription.

Very sincerely yours,
W. E. Crozman
Woodworking Department,
THE KAMEHAMEHA SCHOOLS.

*-a Letter
from
Hawaii*

We venture to hope that every one of our 40,000 Readers located in every part of the Union, from Maine to the Philippines and from Alaska to Porto Rico---are of the same Conviction.

Publishers
American Carpenter
& Builder.

Price 20 Cents



Get the idea. Not thin back—but taper ground—an Atkins exclusive process. Tapered clear through the blade from the toothed edge to the point on the back. The blades are stiff, but run with less set—therefore they cut smoother—easier—faster.

Silver Steel Holds Its Edge

It's as fine as razor steel. Takes hard, tough temper—not brittle. Holds its sharp cutting edge. That's another reason why they run easier.

ATKINS SILVER STEEL SAWS

You run no risk with an ATKINS SAW, if our name is on the blade. It must give you satisfaction, or your dealer will give you a new Saw or your money back.

FREE OFFER We are going to give away two hundred carpenter's aprons during August. Send us ten cents for postage and get yours—with a Saw Sense Book and Time Book free besides. Ask for Special August Offer.

E. C. ATKINS & COMPANY, Inc.
Indianapolis, Indiana

Cash for Best Power Shop Photos and Ideas

Sixty Dollars in Prizes—Four Contests

Act Quickly—Contests Close Friday, September 1, 1916

The October "American Carpenter and Builder" will be our **Power Shop Number**. We want to illustrate the best ideas in **Woodworking Shops and Small Planing Mills in Connection with the Building Contractors' Business** as worked out by our readers. Many builders already are using power saw rigs and variety woodworkers, and have found them to be a great help. Many others will be getting into this line and adding to their machinery wood-working equipment; and we want to present a great variety of practical, helpful suggestions and ideas for their benefit.

In order to make it interesting for all of our readers to contribute their experience and ideas to this **Power Shop Number**, we announce the following Contest subjects.

Contest A. Best photos and layout of small (two-man) power shop.

Contest B. Best photos and layout of large power shop or planing mill.

Contest C. Most practical ideas for establishing and building up a power shop business in connection with general building work.

Contest D. Best kinks and methods for doing work on portable saw rigs, variety woodworkers and other light woodworking machines.

Four first prizes of \$10.00 each will be awarded.

Four second prizes of \$5.00 each will be awarded.

One dollar each will be paid for all other photographs published.

If you have a woodworking machine, call in your local photographer and get it photographed. If you have a woodworking shop, call in a photographer and have him

take several pictures of it, both inside and outside, and of some of the work you are turning out.

Make a drawing of your shop that will show the arrangement of the machines.

Write us a letter or brief descriptive article telling about some of your woodworking methods and how you handle this business.

Make a neat working drawing of any special jig or rig that you have devised to help your machine work in any way.

All these prize winning photographs, layouts, diagrams, ideas and methods will be published in the October American Carpenter and Builder.

October is the month when carpenters and builders begin to figure on getting into winter quarters. Many will be fitting up power woodworking shops and adding to their machinery equipment. We want to present a model layout for a good sized power shop or planing mill, also a model layout for a two-man shop.

Many lumber yards are putting in a power saw rig, variety woodworker or other light power equipment so that they can furnish lumber practically **ready-cut**. We want to feature this proposition from several helpful angles. Many valuable shop kinks for the use of power woodworkers will be presented.

Let every man who has a power woodworker and a power shop, no matter how small or how large it is, come in on one or more of these power shop contests. Get some good photographs taken and tell us in simple language how you handle your work.

Don't Delay. All material must be in by Friday, September 1st. Address, Power Shop Contest, American Carpenter and Builder, 1827 Prairie Ave., Chicago, Ill.

Yours for power,
Editor American Carpenter and Builder.

Contents For August, 1916

| | Page | | Page | | Page |
|---|------|--|------|---|------|
| Accident in Barn Raising..... | 82 | Improved Screen Wire Stretcher..... | 83 | Should Details be Furnished Before a Contract is Signed?..... | 80 |
| Artistic Nine-Room Home..... | 43 | Latest Recommended Working Unit Stress for Structural Timbers..... | 79 | Six-Room Square Colonial House..... | 46 |
| Carpentry Details..... | 60 | Lots of House for \$1800..... | 85 | Small Barn for Small Farm..... | 71 |
| Cement Building Construction..... | 77 | Making an Inlaid Walnut Bedstead..... | 78 | Small House with Large Rooms..... | 40 |
| Combined Poultry and Incubator House | 72 | Man From the Lumber Yard..... | 48 | Steel Square..... | 57 |
| Correspondence | 81 | Methods of Covering a Curved Surface with Beveled Siding..... | 75 | Three Low Cost Churches of Good Design | 54 |
| Distinctive Brick Bungalow..... | 44 | Miscellaneous Building Plans..... | 52 | Trade Notes and Items of Interest..... | 90 |
| Dormer Window | 60 | Noon Hour Talks by the Boss Carpenter | 64 | Two-Story Garage | 52 |
| Easy Lessons in Stair Building..... | 62 | Our Popular Farm Barn..... | 73 | Unique Ironing Board..... | 82 |
| Elegant Church..... | 51 | Pleasant Home of Colonial Design..... | 41 | Unique Method of Placing Ironing Board | 50 |
| Enough for a "Five Foot Shelf"..... | 81 | Pleasing Stone and Shingle House..... | 45 | Unit School System Has Many Distinct Advantages | 86 |
| Farm Buildings Arranged for Convenience | 71 | Plumbing and Sanitation..... | 66 | Useful Knots and How to Tie Them.... | 58 |
| Fees for the Privilege of Estimating... | 37 | Posts or Columns..... | 64 | Wants Cabinet Designs..... | 83 |
| Floor Finishing | 85 | Practical Carpentry | 75 | Wants Eastern Type Houses..... | 81 |
| Getting Property Back After It Has Been Put in Somebody Else's Name.. | 74 | Repairing Leaks in Concrete Troughs, Tanks and Cisterns..... | 77 | Wants Ideas for Slaughter House..... | 82 |
| Guaranteed Building Plans..... | 39 | Seven-Room Bungalow of Unusual Beauty | 47 | What Kind of Wood is This?..... | 81 |
| Home Craftsman | 78 | Sewage Disposal for Country Homes... | 66 | Who Knows? | 81 |
| Hot Shot from Parkhill..... | 82 | | | Window Frame Construction..... | 84 |
| How to Build a Platform Stairway..... | 62 | | | Yours for Safer Building..... | 64 |

TRADE
CHICAGO
MARK

**SPRING HINGES
A SUGGESTION**

Do you specify a spring hinge with distinctive features which will appeal to your client and assure satisfaction to all concerned?

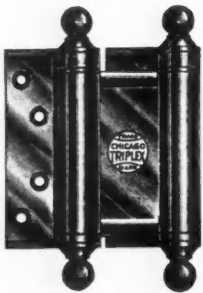

**Chicago "Triplex"
Spring Butts**

offer this advantage to you. The appearance, durability and finish of this article are unsurpassed, and in consideration of prices that are conservative in respect to value, the up-to-date builder cannot afford to risk his reputation for goods that are unsatisfactory.

Send for Catalogue C 32. It illustrates and describes the most complete line of Spring Hinges manufactured.

Chicago Spring Butt Company,

CHICAGO



NEW YORK

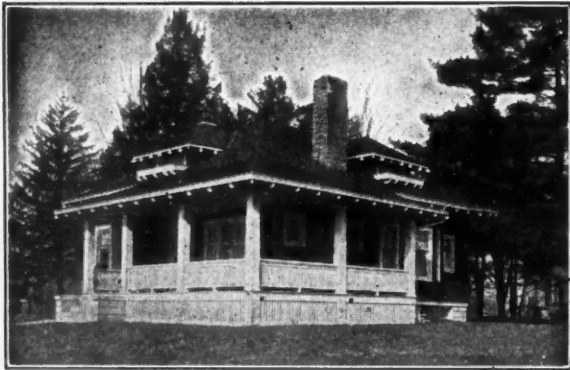

A Bungalow for Permanent Occupancy. Charles E. Anderson, designer, White Plains, N. Y. "The roof is covered with shingles dipped 10" in Cabot's Creosote Shingle Stains; the body is stained a rich brown with Cabot's Creosote Stain."

**You Can Pick Out
the houses that have been stained with
Cabot's Creosote Shingle Stains**

The colors are so soft and rich and lasting that all other stains look cheap and tawdry in comparison. They go farther, last longer, preserve the wood better and are vastly more artistic—and every gallon is guaranteed. Imitation stains smell of kerosene or benzine and are dangerously inflammable. Cabot's Stains are the genuine Creosote, wood-preserving stains, and they make the wood less inflammable.

CABOT'S QUILT

A scientific heat insulator and sound-deadener that makes houses warmer in winter and cooler in summer and deadens sound in floors and partitions. Not a mere felt or paper, but non-conducting mat that is about thirty times warmer than common papers.

You can get Cabot's Stains and Quilt all over the country. Send for samples and names of nearest agents.

SAMUEL CABOT, Inc., Mfg. Chemists

BOSTON, MASS. 24 W. Kinzie St., Chicago
1133 Broadway, N. Y.

BOMMER

**Floor Surface Spring Hinge
For Double-Acting and Single-Acting Doors
Release and Holdback Ball Bearing
Alignment Device**

Every moving part of this hinge can be oiled from a single hole on outside of side-plate.

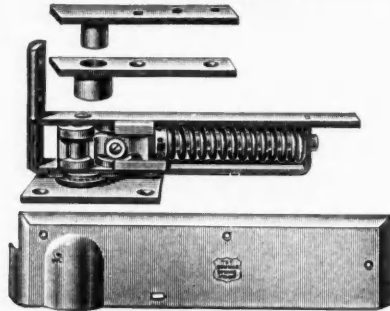

The most durable hinge of its type; holds the door open when swung to 90 degrees at either side. The spring-action can also be entirely released as long as desired so that the door will swing free, without spring-action, in either direction, by inserting a wire nail (when the door is open) into a hole provided in the side plates for that purpose. The spring-action can be restored by withdrawing the nail.

Your Hardware Merchant Can Supply Them

Bommer Bros., Manufacturers Brooklyn, N.Y.

Why Guess?

and make wrong cuts, when it is possible for you to be exactly right in figuring and cutting common rafters, hip or valley, jack or cripple rafters, projecting braces, bevels, stairs, towers, columns, circular tanks, silos, etc., with the

A B C Protractor Square

Prevents mistakes because you know just what you are doing. It's a real necessity for every carpenter and is just what you have been looking for.

Made of steel, graduated and well finished. Nothing to get out of order.

The saving in time and lumber will pay for it in one day. You can go about your work with certainty.

Price \$2.00, postage paid
Full particulars sent Free on request

STAMPING & TOOL CO.
La Crosse, Wisconsin

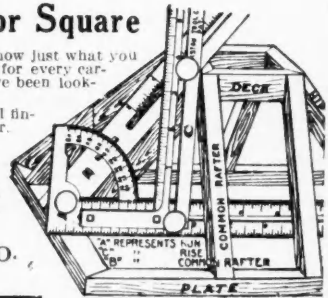

Worth Much to You

Morrill

Saw Set

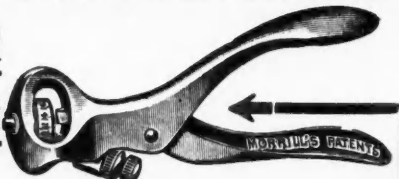

All master carpenters are using this Saw Set. In one operation it takes out the wrong set and puts in the right one. Write for FREE booklet "Saw Points". It tells how to properly joint, set and file hand saws.

CHAS. MORRILL

94 Lafayette Street
NEW YORK

Copyright 1916 by American Carpenter and Builder Company



Member of the Audit Bureau of Circulations
Circulation Audited and Verified March 27, 1916

| | | |
|--|---|--|
| The World's Greatest Building Paper | Important Notice When your subscription expires, renew at once, using the blank enclosed in your final copy. If it expires with this issue your renewal must reach us before August 25 to avoid missing the September number. Use P. O. or Express Money Order if possible, but bills or 2-cent stamps may be sent at our risk. | The World's Greatest Building Paper |
|--|---|--|

American Carpenter and Builder
Entered as second-class matter July 1, 1905, at the postoffice at Chicago, Ill., under the act of Congress of March 3, 1879.

Published on the first day of each month by
AMERICAN CARPENTER AND BUILDER COMPANY
PUBLICATION OFFICE:
RADFORD BUILDING, 1827 PRAIRIE AVE., CHICAGO
EASTERN OFFICE: 345 FIFTH AVE., NEW YORK CITY

EDITORIAL DEPARTMENT

WILLIAM A. RADFORD, *Editor-in-Chief*
BERNARD L. JOHNSON, B. S., *Editor*
WM. REUTHER, A. W. WOODS, . . . } *Associate*
CHAS. E. PAUL, S. B. H. M. WARD, . . . } *Editors*
H. W. LINDSAY, B. S.

BUSINESS DEPARTMENT

WM. A. RADFORD, *President and Treasurer*
E. L. HATFIELD, *Vice-President and General Manager*
ROLAND D. RADFORD, *Secretary*
C. R. W. EDGCUMBE, LOUIS H. REICH . . . } *Advertising*
DELBERT W. SMITH, E. B. WOLFROM . . . } *Staff*

SUBSCRIPTION RATES
One year, \$2.00; six months, \$1.00; payable always in advance.
Single Copies, 20 cents. Canadian Subscriptions, \$2.50. Foreign Subscriptions, \$3.00.

ADVERTISING RATES
Furnished on application. Advertisements, to insure insertion, should reach our Chicago office not later than the 15th of the month preceding date of publication.

PROTECTION FOR OUR READERS
The publishers of the American Carpenter and Builder will not knowingly accept advertising from any individual, firm or corporation that is misleading in any way. They also reserve the right to edit advertising copy and to change or eliminate any statements that reflect or cast discredit upon any other building products.
The American Carpenter and Builder Company will use every legitimate means to safeguard the interests of its readers and its advertisers. It will use every effort to protect them from concerns whose business methods are open to question. Where the slightest doubt exists write the publishers for complete information. It may save money, time and worry.
In all cases in writing to advertisers inquirers should say: "I saw your advertisement in the American Carpenter and Builder."

VOL. XXI August, 1916. No. 5

Fees for the Privilege of Estimating

THE secretary of the Master Builders' Association of Boston calls attention to the practice of some architects' offices charging for plans and specifications used in estimating. On a recently figured job, five dollars was charged each of eighteen contractors invited to figure.

It is realized that there is a burden upon the architect in an instance like this, where the bidding list is so large, but what has that to do with the contractor? The owner should pay for any such expense caused by an unreasonable list of bidders.

Some architects feel that invited bidders should be paid a fee for estimating; not a sum large enough to pay the considerable total cost of making an estimate, but enough probably to cover actual expenses of travel, etc. Many feel that to charge a contractor even a small sum for the privilege of estimating, even in this indirect way of paying for blueprints and specifications, is adding to a burden already heavy, already

full of faults which should be corrected, and already commonly defeating its own purpose.

This is the burden of a system of price competition wherein all suffer—architect, contractor, and owner—especially the owner.

Illegal Employment of Architects for School Work

THE State Supreme Court, New Jersey, has decided that the employment of architects by the Board of Education of Bayonne, to prepare plans and supervise the construction of a new school to cost about \$600,000, before the City Commission made an appropriation for the work, was illegal. The Court sustains the City Commission in refusing to sign a resolution engaging the architects, and holds that the appropriation for the construction should be made and approved before the architects are selected and retained.

DON'T overlook important contest announcement on page 35.



A Very Interesting Bungalow Interior, Showing Emphasis of the Straight Line in Standing Trim and Built-in Furniture. Strength, Utility and Comfort is the Key note. The Field Stone Fireplace, and the Hammered Metal Light Fixtures go Well with This Room.



A Desirable and Inexpensive Bungalow

This little bungalow has a strong appeal to the man who wishes a home of his own which he may be proud of and at the same time one which will not be so expensive as to take all the pleasure of ownership away from him. It is a simple structure of wood, but its exterior is very neat and the arrangement of rooms is especially attractive. The outside walls are finished with wide siding, except for a small space under the porch roof, which is finished with shingles. The body of the house should be painted some dark color and the trim should be white. In this finish the windows produce a very pleasing effect.

The porch is a feature of the exterior design, being set back into the house under the small gable, which is supported by two solid wooden columns. Two windows and the door are built with small paneled panes of glass.

The front entrance leads into a reception hall lighted thru one of the porch windows. This hall is provided with a closet fitted with shelves, which is a handy place to hang wraps. The reception hall is open to the living room on one side. In this room there is a seat set under the window in the little bay. The living room is open to the dining room, in which a similar bay has the buffet built into it. The kitchen is handily equipped with two sets of cupboards.



Floor Plan of Bungalow. Size 27 Feet by 40 Feet.



Five-room bungalow of moderate cost. Size, 27 feet by 40 feet. We can furnish complete set of blueprinted working plans and typewritten specifications for only \$6.00 per set. Blueprints consist of basement plan; roof plan; main floor plan; front, rear, two side elevations, and all necessary interior details. Specifications consist of twenty-two pages of typewritten matter. When ordering, ask for Design No. 6832.

A Small House With Large Rooms

This little house is given an outside finish, which is unique, in that it employs three of the recognized materials used in the best building construction today. The porch and outside chimney are of dark colored brick laid with white mortar. The top course of the porch rail is laid with the brick on edge, the white stone cap being placed above this course. A very pleasing effect is produced in this way. The porch columns are square, built of wood, and the sides of the house are finished up to the top of the first floor windows with beveled wood siding. This wooden portion of the house is preferably finished with a light body and darker trim in order to harmonize properly with the brick of the porch and chimney. The upper portion of the house is finished in stucco, which may be given a color to suit the desire of the owner. Window trim will match that of the lower portion of the house. The portion of the foundation wall which extends above the ground level is built of rough rock-faced concrete blocks. The ends of dormer rafters are exposed, as are those of the main roof, extending over the porch. A concrete floor is placed on the

front porch, which is drained thru four openings left in the brickwork of the railings.

The interior scheme of this little home is characterized by the intent to eliminate all possible waste space and thus increase the size of rooms. The living

room extends across the entire width of the house. A fireplace with brick mantel is built into the wall at the left of the entrance, and the staircase is situated along the wall at the other end of the room. Bookcases are built into the side of the staircase.

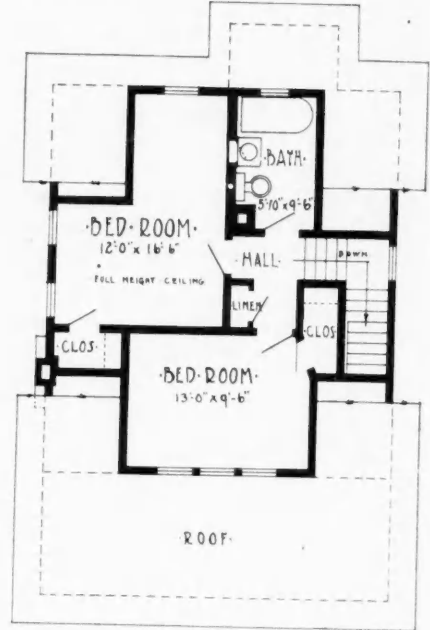
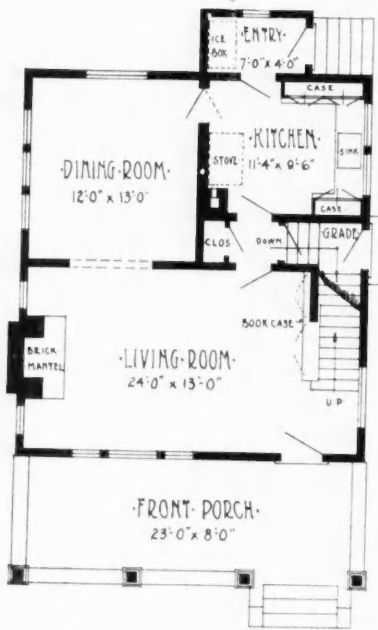

Arrangement of House. Size, 25 Feet by 27 Feet 6 Inches.



Cozy home of five rooms. Size, 25 feet by 27 feet 6 inches. We can furnish complete set of blueprinted working plans and typewritten specifications for only \$8.00 per set. Blueprints consist of basement plan; roof plan; first and second floor plans; front, rear, two side elevations; wall sections; and all necessary interior details. Specifications consist of twenty-two pages of typewritten matter. When ordering, ask for Design No. 6813.



Comfortable Eight-room Home. Size, 37 feet by 32 feet 6 inches. We can furnish complete set of blueprinted working plans and typewritten specifications for only \$12.00 per set. Blueprints consist of basement plan; roof plan; first and second floor plans; front, rear, two side elevations; wall sections; and all necessary interior details. Specifications consist of twenty-two pages of typewritten matter. When ordering, ask for Design No. 6826.

Pleasant Home of Colonial Design

Those who admire the beauty of the homes of the men whose names have come down to us from the earlier history of our country will be pleased with this Design No. 6826. These early American homes were all framed in a manner which brought their beauty out from their simplicity. Wide clapboards were used for siding and the many windows were built up with small panes of glass and provided with shutters. An outside chimney of brick was used, carried up wide at the bottom to provide for a fireplace and narrowed down near the second floor. The finish was invariably white with some dark shade of green for the shutters. The contrast of the shutters and the chimney with the white body of the house was always pleasing.

In the design shown here, the front entrance leads into a reception hall from which the stairway leads to the second floor. Cased openings lead into the living room and library near the front of the house, and into the dining room farther back. A door at the end

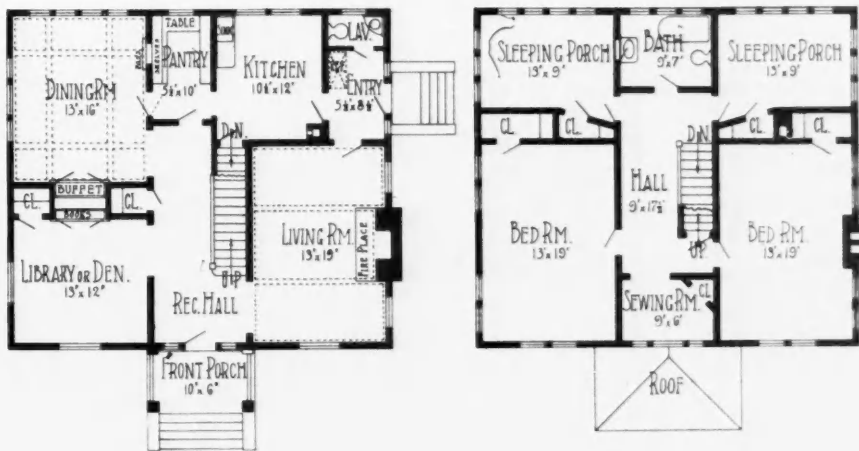

Arrangement of Home. Size, 37 Feet by 32 Feet 6 Inches.

of the hall opens into the passage thru the pantry.

The living room contains the fireplace, and the ceiling is finished with exposed timbers. The library or den is a very attractive room with its built-in bookcases. The dining room ceiling is paneled and a buffet sets into the wall between this room and the den. The

rear entrance is into an entry in which the refrigerator is placed. A small lavatory is provided off of this entry. The kitchen is handily arranged and well-lighted. The serving pantry is an important feature.

Two large bedrooms and two enclosed sleeping porches, a sewing room and a bath are provided on the second floor.

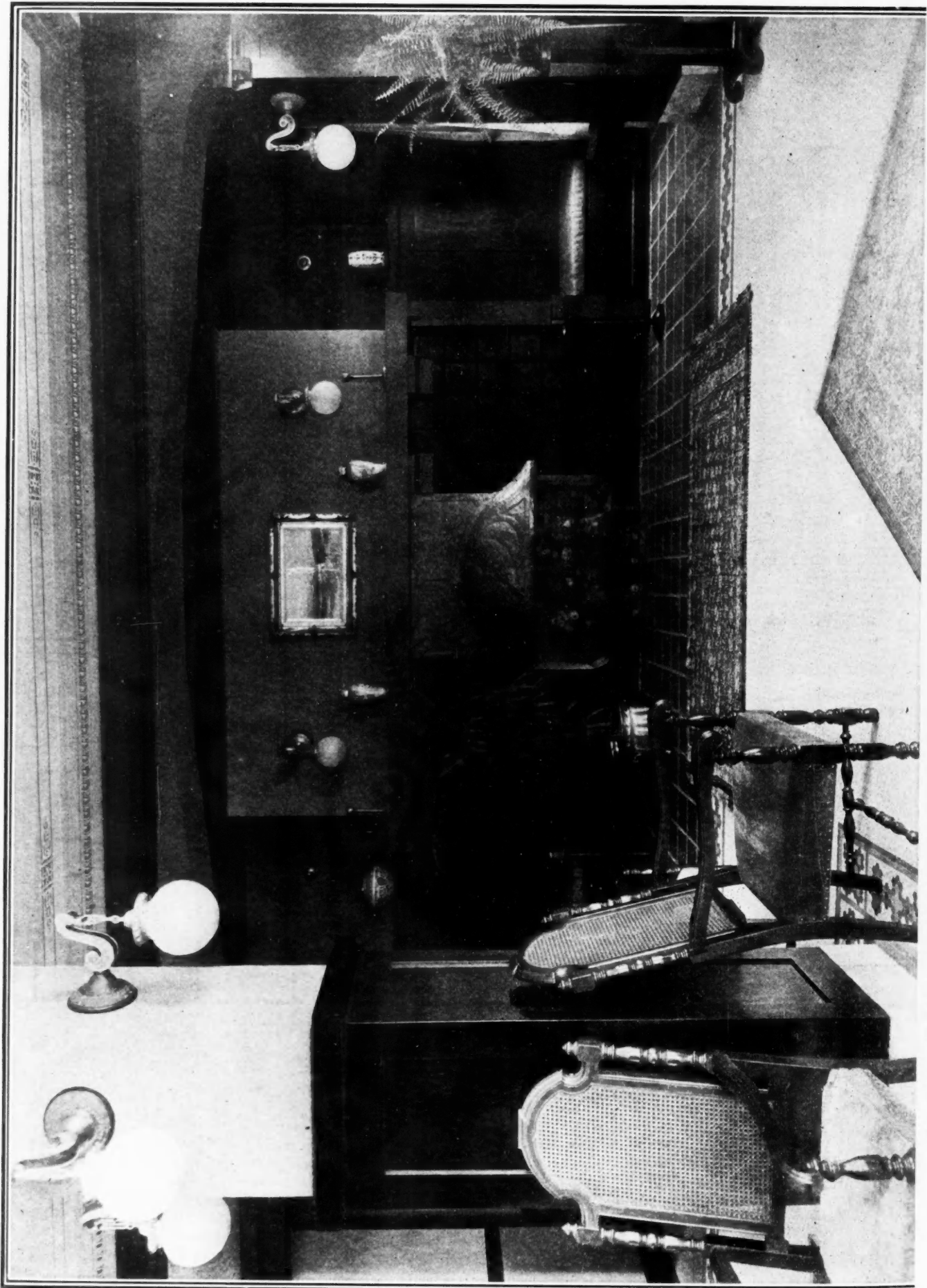

A Fine Hotel Interior That Offers Many Suggestions for the Handling of Large Reception Halls in Private Residences as Well as in Public Buildings.

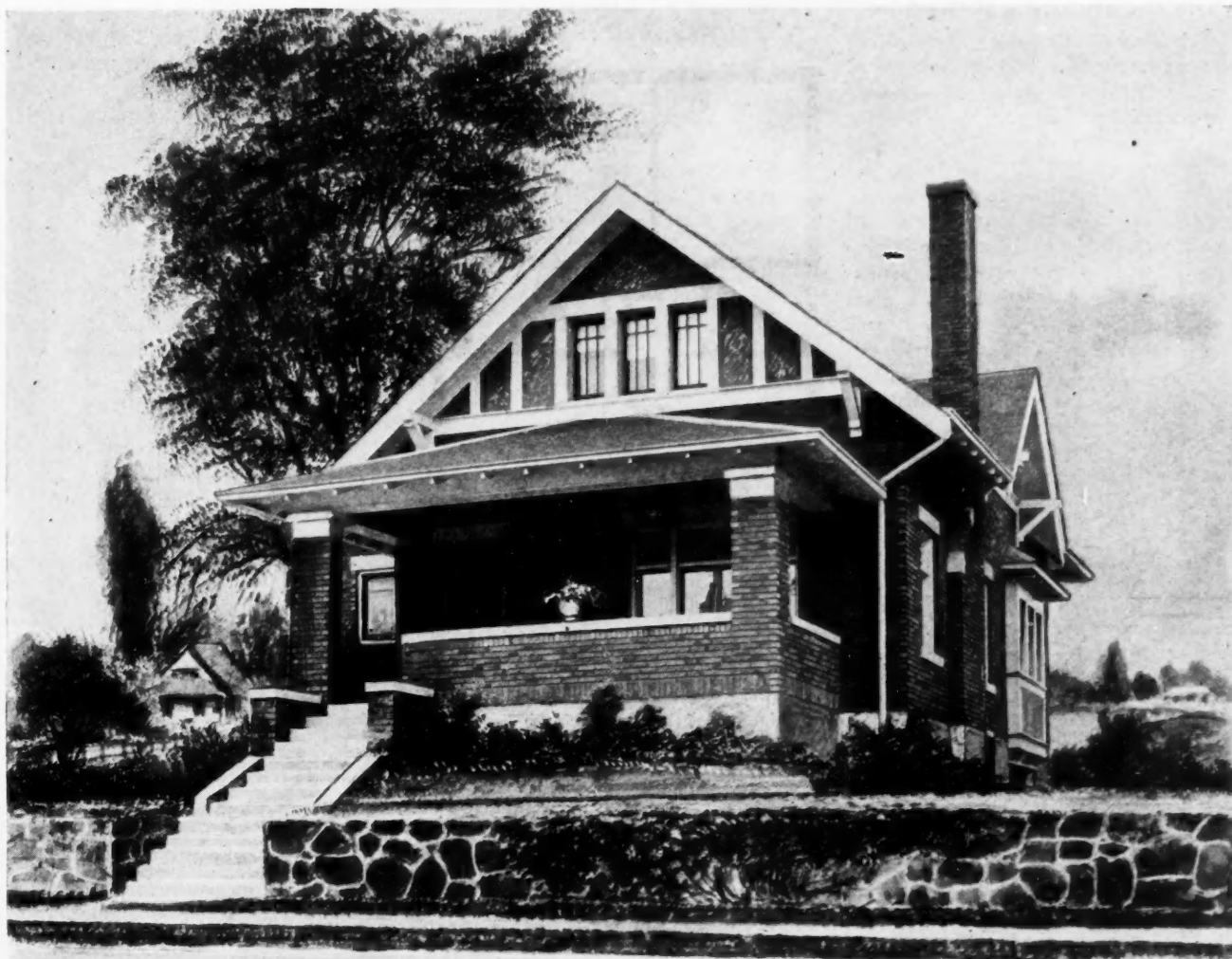

Well designed nine-room house. Size, 31 feet by 49 feet 6 inches. We can furnish complete set of blueprinted working plans and typewritten specifications for only \$12.00 per set. Blueprints consist of basement plan; first and second floor plans; front, rear, two side elevations; wall sections; and all necessary interior details. Specifications consist of twenty-two pages of typewritten matter. When ordering, ask for Design No. 6827.

Artistic Nine-Room Home

The exterior of this house is finished in brick and stucco. The panel work under the gables is artistic, especially if the house is trimmed in white. The wide front porch is a pleasing feature and is given an air of privacy by the solid brick rail built rather high with the entrance placed at the side. The high chimney is very appropriate in giving a finishing touch to the roof.

The arrangement of rooms is all that could be asked for in convenience and nicety of finish. The front door opens into a hall which has a cased opening to the right into the living room. Doors in this hall also lead to the stairway and one bedroom. The living room and dining room are finished with exposed timber ceilings. A large fireplace is built into the outside wall in the living room. A three-window bay furnishes the dining room with an abundance of light.

Double doors lead from the dining room into the breakfast porch, which has six windows and is sure to be a pleasant feature of this house. The pantry is handy to both the dining room and breakfast porch and is fitted with table and shelves.



First Floor Plan. Second Floor Plan. Arrangement of House, Size 31 by 49 Feet 6 Inches.

Distinctive Brick Bungalow

The many pleasing color combinations and the low upkeep and permanence of brick construction have recommended this material as one very desirable for building construction. The original bungalow idea seemed to imply the use of some form of distinctive wooden siding, but this idea has long since passed out of existence and the modern bungalow is just as attractive with a permanent type of construction and a great deal less expensive in the long run. The details of the brick exterior of this Design No. 6812 are very pleasing, and the fact that its appearance will not change as the years pass by is an assurance which means a great deal to its owner. The white trim of the woodwork furnishes a good contrast to the brick and its maintenance will require the expenditure of very little money and energy. The peculiar method of porch roof support adds a note of distinction to the front of the house, which is carried out to greater degree by the exceptional expanse of wall taken up by windows.

The arrangement of rooms is very convenient, and a great many special devices are employed to make the home as cozy and inviting as possible. A very useful little reception hall is entered from the front porch. This hall has a seat built into the wall to the left of the entrance, and a coat room is placed at one end of the seat. A cased

opening leads off into the living room. The fireplace, with brick mantel and

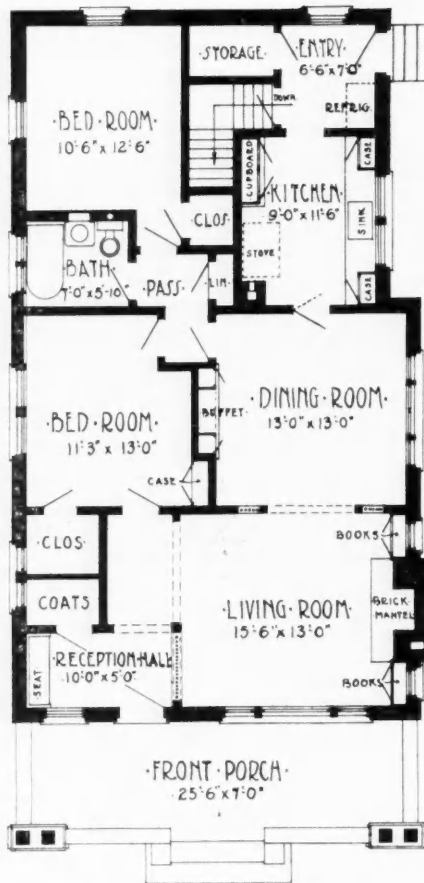

Floor Plan of Bungalow, Size 27 Feet 10 Inches by 47 Feet 10 Inches.

book cases on each side, take up one wall of the living room. Two casement windows are placed above these book cases and nearly the entire wall at the front of this room is taken up by the large windows seen from the street. The living room is sure to be a pleasant, airy room.

A colonnade and cased opening is built between the living room and the dining room. The latter is a pleasant square room and is provided with a buffet built into the center wall. A swinging door leads to the kitchen, which is a special feature of this house. The outside wall of the kitchen has a bench built along its entire length with the sink placed directly below the two windows. Two cases are set into the corners at either end of this bench. Across the room is the cupboard in one corner and the stove in the other. This kitchen is so well arranged that no pantry is necessary. The refrigerator is placed in the rear entry, where it is easily iced, being only a step from the rear door. A storage room is provided which is entered from the rear entry. Stairs leading to the basement also lead from this room.

The other side of the house contains two bedrooms with a bath between. Each bedroom has a large closet and is lighted with two windows. In the passage between the bedrooms is a linen closet. The bathroom is entered from this passage.



Attractive Five-room Home. Size, 27 feet 10 inches by 47 feet 10 inches. We can furnish complete set of blue-printed working plans and typewritten specifications for only \$7.00 per set. Blueprints consist of basement plan; roof plan; main floor plan; front, rear, two side elevations; wall sections, and all necessary interior details. Specifications consist of twenty-two pages of typewritten matter. When ordering, ask for Design No. 6812.

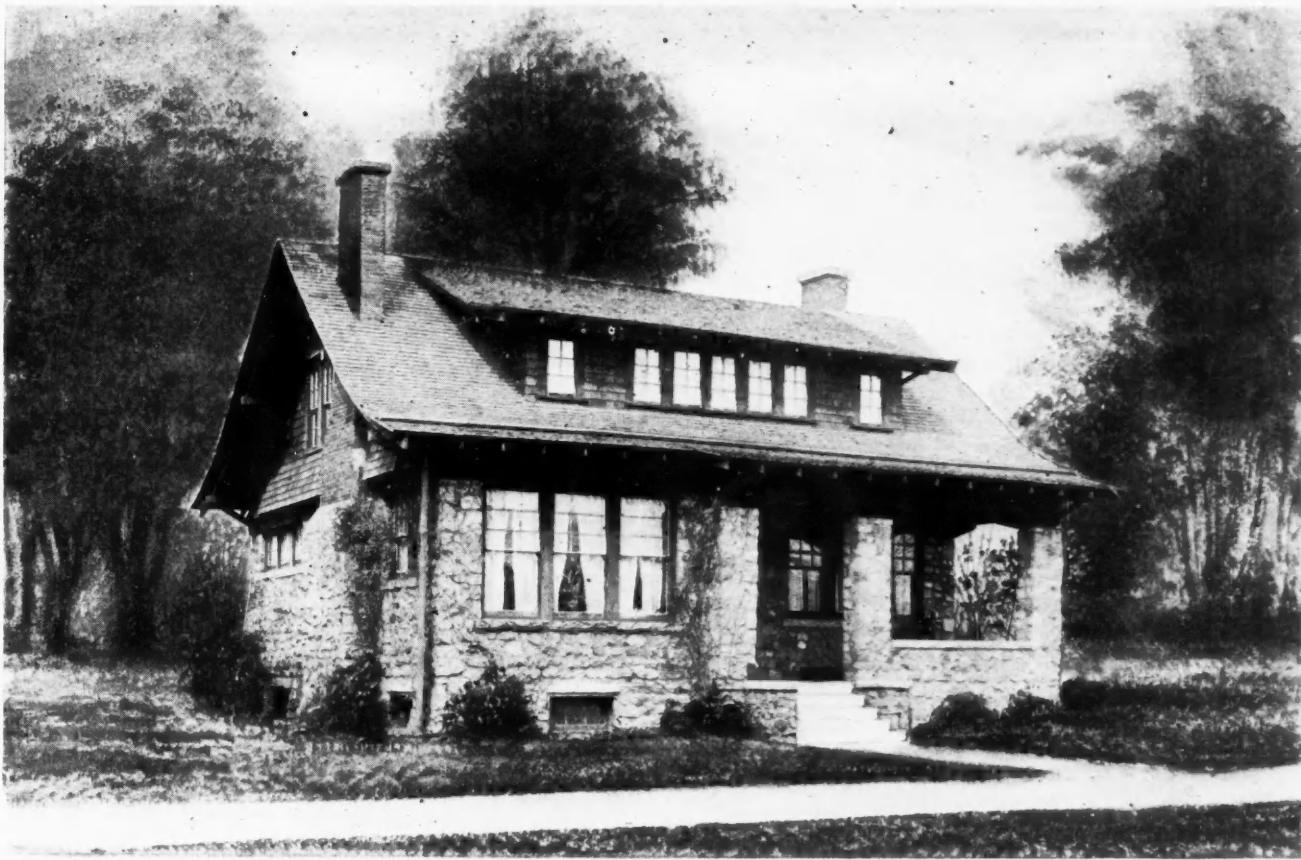

Attractive Seven-room Home. Size 39 feet 6 inches by 38 feet 6 inches. We can furnish complete set of blue-printed working plans and typewritten specifications for only \$10.00 per set. Blueprints consist of basement plan; roof plan; first and second floor plans; front, rear and two side elevations; wall sections, and all necessary interior details. Specifications consist of twenty-two pages of typewritten matter. When ordering, ask for Design No. 6814.

A Pleasing Stone and Shingle House

The exterior of this substantial story-and-a-half house is finished in rough stone masonry up to the tops of the first floor windows, from which it is carried up with shingles under the gables. The chimneys are of brick capped with rough stone. The rafters have their ends exposed and the projecting ends of the purlins are supported by massive brackets. The entire exterior is well-balanced and the lower portion of the house may be made very beautiful by properly training vines and planting shrubs.

The arrangement of the interior carries out the idea of the design employed in external finish. Entrance from the neat front porch with its massive stone masonry columns, is into a hall from which the stair leads off to the right. A feature of this hall is the long seat built along the wall next to the staircase. This seat will be found very convenient and may be built to hold a large quantity of stored books or music in its lower part, thus relieving the living room of clutter.

On the left of the hall, thru a cased opening, is the large living room, with its massive fireplace. Exposed timbers in the ceiling finish are in keeping with the general plan. Three large and four

smaller windows furnish ample light for this room. At the rear of the living room are two handy tiers of bookcases built into the distinctive entrance to the dining room.

This dining room is really a model of Colonial design. Exposed timbers cut the ceiling up into large and small panels, which furnishes the possibility of unique arrangement of the lighting fixtures. A large buffet extends across the entire end wall of the room. Three casement windows are placed over this

buffet and three more windows of larger size are set in the other wall. Double doors lead from the dining room to the living room and the hall, and a double-acting door leads to the kitchen.

The culinary department is made up of a generous sized kitchen, a particularly handy pantry and the rear porch, which in this house may easily be called an extra room during the warm part of the year. The refrigerator is arranged to be iced from the outside.



Arrangement of House. Size, 37 Feet 6 Inches by 38 Feet 6 Inches.

Six-Room Square Colonial House

This frame house, Design No. 6825, is simple in its detail of finish, but it has an appeal which may perhaps be attributed to this simplicity. The sides of the house are finished with beveled siding broken near the sills of the upper floor windows by a broad strip encircling the building. The house may be entered from any one of three porches. The front porch is built on the style of a pergola with heavy round columns. This porch has two entrances into the living room, one thru the single panel plate glass door and the other thru the French doors. A door into the hall has a canopy with two columns and a concrete platform with two steps on the outside, from which a sidewalk is intended to be laid around the corner of the house to meet the sidewalk to the front porch. The third porch is one from which the kitchen may be entered.

The large living room has, as a distinguishing feature, the big fireplace built out from the center of the rear wall. This fireplace may be made a very pleasant part of the room and also a very attractive part by the use of equipment which will be in keeping with the size of the room. Rather heavy and-

irons or a grate fitted with massive decorative posts, together with a standard to hold the various implements needed near a fireplace, will be very appropriate in this room. The living room is further aided by the abundance of light, which is admitted thru the six windows and the doors.

A hall immediately off of the living room contains the stairway leading to the second floor. This hall runs across the width of the house to the kitchen

and pantry. The latter room is equipped with shelves and a work table, one window being directly above the table. The stair into the basement leads from the pantry. The kitchen is large and well lighted. A swinging door leads from it into the dining room. This room is large and is lighted thru four windows.

On the second floor there are three bedrooms and a bath. The stair leads up into the hall, which runs across the width of the house at its center.

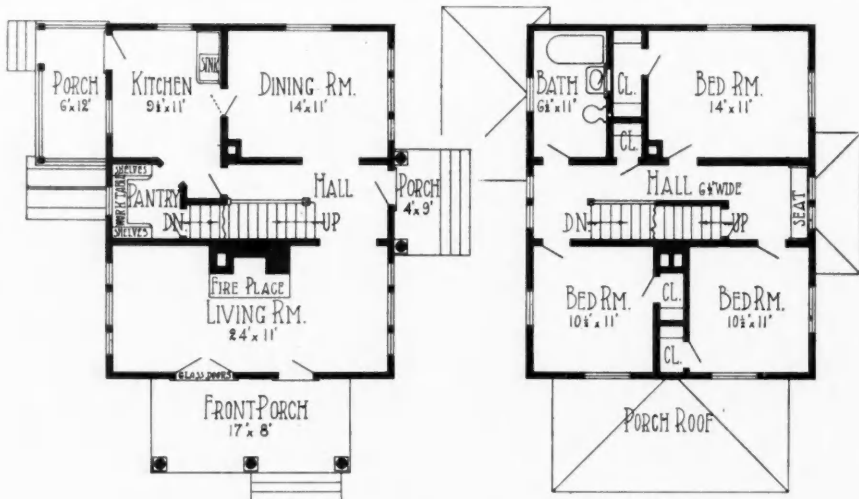

Arrangement of House. Size, 25 Feet by 30 Feet 6 Inches.



Home-like Six-Room House. Size, 25 feet by 30 feet 6 inches. We can furnish complete set of blueprinted working plans and typewritten specifications for only \$10.00 per set. Blueprints consist of basement plan; roof plan; first and second floor plans; front, rear, two side elevations; wall sections; and all necessary interior details. Specifications consist of twenty-two pages of typewritten matter. When ordering, ask for Design No. 6825.

Seven-Room Bungalow of Unusual Beauty

It is a matter of very careful designing to make a rather large house have the cozy appearance of a small bungalow, but it is possible, as may be seen by studying the accompanying perspective of Design No. 6803. This house

has every appearance of a small bungalow, with more than the usual attention paid to details of finish, and yet it has seven large rooms, all of them being of good shape with no suggestion of the fitting in of rooms by cutting off some portion of floor space which rightly belongs unobstructed. The design is

an exceptional one which will attract attention, no matter what its surroundings, and will bring a great many words of praise to its owner from guests who are shown about the home.

A lasting "first impression" is given upon entering the front door into the large living room, which extends across



Seven-room home with many special features. Size, 26 feet by 41 feet. We can furnish complete set of blue-printed working plans and typewritten specifications for only \$10.00 per set. Blueprints consist of basement plan; first and second floor plans; front, rear, two side elevations; wall sections; and all necessary interior details. Specifications consist of twenty-two pages of typewritten matter. When ordering, ask for Design No. 6803.

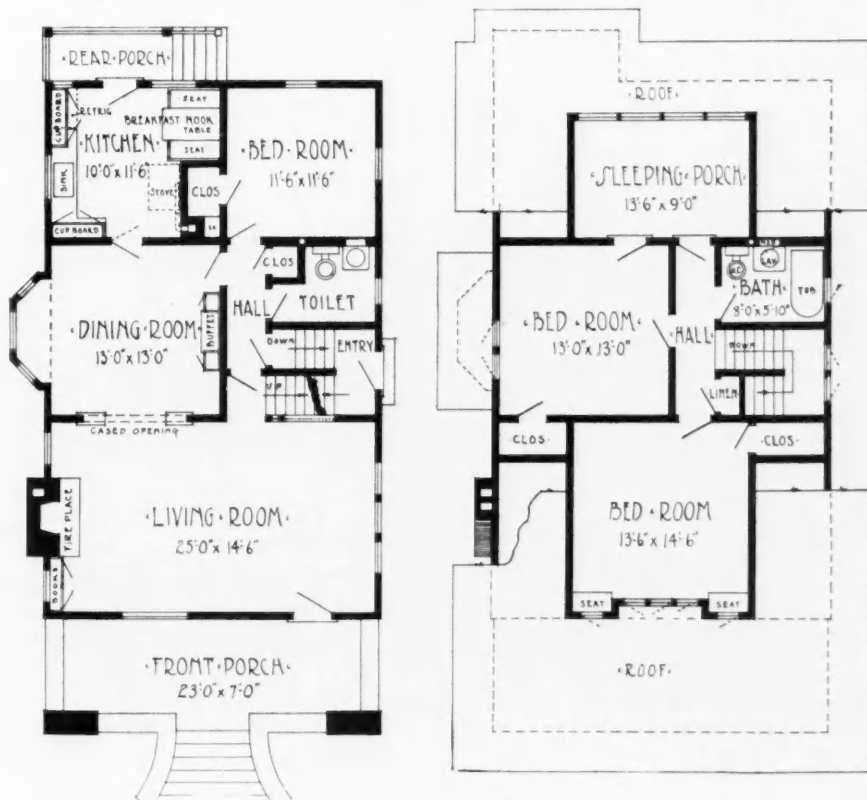

Arrangement of Seven-Room House. Size, 26 Feet by 41 Feet.

the entire width of the house. A fancy balustrade with two square posts is directly in front, where it is built along the side of the stair.

A three-window bay is built into the outside wall of the dining room and a buffet is set against the inside wall. A swinging door opens into the kitchen. This kitchen is the largest feature in the house. Along the side wall is a bench in which the sink is set, there being a cupboard built against the wall out to the swinging door. The outside corner also has a cupboard built above the space occupied by the refrigerator. Across the room is a little breakfast nook table with a seat on each side. There are three windows to light this kitchen, and it is sure to be one of the most useful and most-talked-of rooms in the house.

A bedroom and toilet open from the hall, running thru the center of the first floor. A bedroom and the bath are built under the gables on the second floor. The front dormer room is a bedroom with five casement windows under two of which seats are built. The rear dormer room is a sleeping porch which opens on one side, practically the whole wall being taken up by four windows.

"When an Opinion Differs From Yours Always Consider that the Other Fellow May be Right"

—THE MAN FROM THE LUMBER YARD

We are endeavoring to make the "A. C. & B." so valuable to EVERY reader that each copy will be worth more to him than he paid for the entire year's subscription. We are helping many readers indirectly, as is told of Johnson & Smith in this letter. If you have a difficult problem let us help you.

EDITOR.

FROM the City News, of ———, ———:

"The members of the BUILDERS' CLUB held their monthly feed last Saturday night at the Commercial Hotel. According to their usual custom, they did not meet until seven o'clock and according to their usual custom each one brought with him a good appetite as becomes every one who carries around in a healthy body a self-respecting digestive apparatus. Also, according to their usual custom, the Commercial spread a bountiful table. By the time the Builders' Club was served peaches and cream and cigars were passed they had the dining room to themselves. After a discussion of the usual topic of Better Buildings for Our Town and Country, and other routine business, a paper on 'The Psychology of Sales' was read by the guest of the evening."

First Hand Testimony

Anyone that has not had the opportunity of meeting and knowing a bunch of good, wholesome, right intentioned people, cannot fully appreciate the benefit to even an outsider, of being with the bunch I met at this Builders' Club dinner. It was not all harmony. There were differences of opinion. I have found the same thing at meetings of the Church Board, and directors' meetings of business clubs in the city. It is a good thing. It stimulates action. When an opinion differs from yours, always consider that the other fellow may be right.

It Might Have Been Unpleasant

One pleasant thing I was pleased to see was the frank inquiry made by one contractor of the other as to whether he did not think he had bid too low on a certain large residence. It developed that he had made a mistake in figuring.



THE MAN FROM THE LUMBER YARD Listens to Sound Suggestions on Better Building at a Builders' Club Supper.

A complete list of possible and probable improvements in town and country was gone over and discussed. Notwithstanding the high brow name I gave to the paper I read, it was the least important, possibly the least enjoyable event, of the evening. I had to explain that a paper of little merit had to have

a high-sounding name. Psychology is nothing more nor less than the coming together of the right thing and the right time.

Safety First

It is safe to pat Old Grim on the head any time; but there are only certain times when it is safe to pat that fierce old bull dog that would sooner bite you than eat. Those are the times when the bull dog feels friendly. The time to sell farmer Jones a silo is not the day after a big wind storm, but ten days later, when the corn begins to straighten up.

No matter how much money a young man has, you couldn't get his contract for a house the day after his girl had jilted him.

I have known so-called salesmen to approach puritanical, straight-laced teetotalers with the smell of whiskey on their breath when the devil himself would have as much chance of doing business.

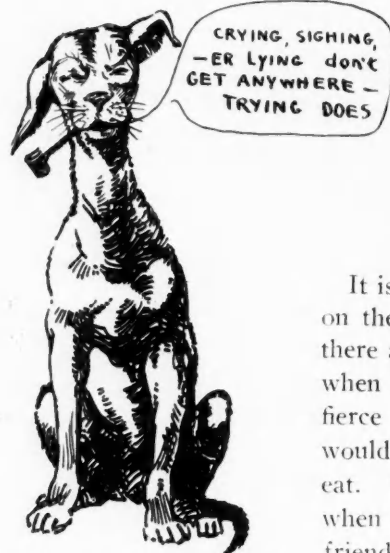

We Don't Know Whether Old Grim Learned This in the Bible or the Koran, But It is True.



If the Man to the Left Will Become a Constant Reader of the "A. C. & B." and the Four People to the Right Will Form a Builders' Club They Would be Able to See the Lady Who Has a Gift for Each.

Was It Psychology or Horse Sense?

In an Iowa city a very valuable corner stood idle for several years after a fire because the owner was a man of moods and he would always fly the track before his name got on the bottom of a contract. It was known to a contractor who had several times come very near securing his signature that he attended to most of his detail office work after ten o'clock. He also knew that he would be drawing a check for the taxes on this property on a certain day. With the contract that had been near acceptance in his pocket, he stepped into the office at 11 o'clock on this day. The man was growling about having to pay out money on a "dead horse."

Mr. Contractor laughed at him, and said: "You can make that corner a big producer by merely placing your name on this line. You'll do it sooner or later, why not sooner, and make that much more money?" The contractor didn't spend fifteen minutes in the office getting the signature. That is what is known as psychology.

The only reason I

sometimes use big words is to impress people with the idea that I know something.

It is Easy to Do That Which One Likes to Do

There is nothing that I enjoy more than helping people. That is why I was delighted to receive within a week after the June issue went out, a letter from a young contracting firm located in a growing suburb of a large city. Their advertising problem was different, possibly more difficult than that of the man located in a smaller town or one who covers the entire

city. We have many other readers who have the same problems that may get a helpful idea from the letter written these people.

"Dear Sirs:

"I am very much pleased to have yours of the 12th.

"I am sure you will succeed, because you read and are quick to go after anything that you think may help you. So many men have their eyes shut that I am especially appreciative of a man who has his eyes open.

"Answering your questions, first, would state as follows:

"(1) The 'A. C. & B.' is not only willing but anxious to serve every one of its readers. This service is without charge.

"(2) Your business name is just as good as if you had

Saw Dust

The stamp of "Integrity" on your dealings is a good trade mark and a good asset.

The man that is always dreaming of past possibilities has none in the future.

To master obstacles, study the conditions.

Procrastination is not only the thief of time, but opportunity.

Scattering embers never make a hot fire. Concentrate the enthusiasm of your fellows into co-operation for the good of all.

Remembering that you are the sum of all you have met, make opportunity for meeting those worth while.

In getting ready for THE big Opportunity you must observe and study.

Don't forget that while there's lots of room at the top, there's no railing to keep you from falling off.

Lack of harmony with business associates throws sand in the gear box and takes profits out of the cash box.

It pays to educate your competitor. Many a bid that is too low is made in ignorance.

"He who has a thousand friends, has none to spare. He who has one enemy meets him everywhere."

'company' in it, and much better than if you were working under a fictitious name, such as the Star Contracting Co., etc. It looks honest and if both of you men are clean people of good reputation, your firm benefits from the personal standing of each.

"I would advise you to have a 3 by 5 introductory card and to use the expression of Contractors and Builders with a slogan:

"No Job too small or too large
For the best Service."

"Have a good grade of card.

"(3) Having only a small capital and as yet limited experience, you are wise to confine your work to such jobs as you can excell in and handle to advantage.

"(4) You should have some letterheads with about the same heading as your introductory card. The letterheads should be the same size as one I am using.

"(5) There is some one in your vicinity that you could have to do your typewriting at very little cost.

"Being equipped as above you are in a position to begin an aggressive campaign. Whenever work is slack, before or after hours, make it a point to get every dealer in the territory you are covering acquainted with the service you can give. Have some small thumb tacks with you when doing this canvassing. Having permission, fasten a card in each shop or office or store where it will not be objectionable, yet be in a fairly permanent position. It will be worth a great deal to you if you can get a dozen people interested in boosting your firm. Have several dependable boys place your cards in every house in your section. The people in the good houses may want to build a garage. The people in the poor houses may want to build better homes.

"Have several short form letters that you can have typed to prospects. For instance, you learn some way that J. Smith expects to build a garage, you might write him:

J. Smith,
411 Kennedy St.

Dear Sir:

We make a specialty of building garages. Let us show you blue print of the best designs, also the best indoor equipment. Make an appointment by phone, Irving 1789, and we will call.

Yours truly,

"Or you learn that H. Perkins contemplates putting up a two-family building, you might write:

Dear Sir:

The success of an apartment building depends on (a) first cost, (b) upkeep, (c) rent-ability. Let us show you how to save on first cost and yet have a building that will require very little upkeep.

We know what to put into a building to make it a good renter.

Please telephone Irving 1789 as to when we can take this up with you.

Yours truly,

"Make a beginning with these suggestions and then write me if you can care for more work than you have.

"Last, but not least, always make good."

Do you know that statisticians tell us that over half of the adult people have the minds of about 20 years? That means that people don't exercise their minds. If they didn't exercise their legs they would not grow in strength. I want every man that has the ginger to read the "A. C. & B.," to grow mentally and be a better man and a better doer.

Let's all go to it for the best things.

Made in Germany

Every thinking man applauds the feat of bringing

an under-sea merchantman across the ocean. It sets a new mark for human ingenuity.

When a competitor executes an especially good job, you will, if you have the right stuff in you, speak well of it and work to go it one better. It is a mighty fine thing to get jerked out of the rut.

Before this submersible could be a reality it had to be a thought in someone's brain. You can't act without first thinking. Yours truly,

THE MAN FROM THE LUMBER YARD.



Unique Method of Placing Ironing Board

WHEN not in use, the ironing board is usually considered a nuisance because it is always in the way unless taken to some remote part of the house. Even if this is not found necessary, the appearance of an ironing board half-hidden behind the kitchen door, or standing sentinel in the corner, is not very pleasing to the critical eye. And yet, how easy it is to provide for the seclusion of this article of necessity when it is not doing its duty in the wake of the wash-tub.

The photograph shows what one ingenious man did to make the ironing board capable of giving the best possible service when called upon, and being at the same time most securely out of sight when off duty. Incidentally, here is a very clever suggestion for a kitchen annex which should make more than just a passing appeal to those who have come to realize that a few exceptional details thrown into the house de-

(Continued to page 56.)

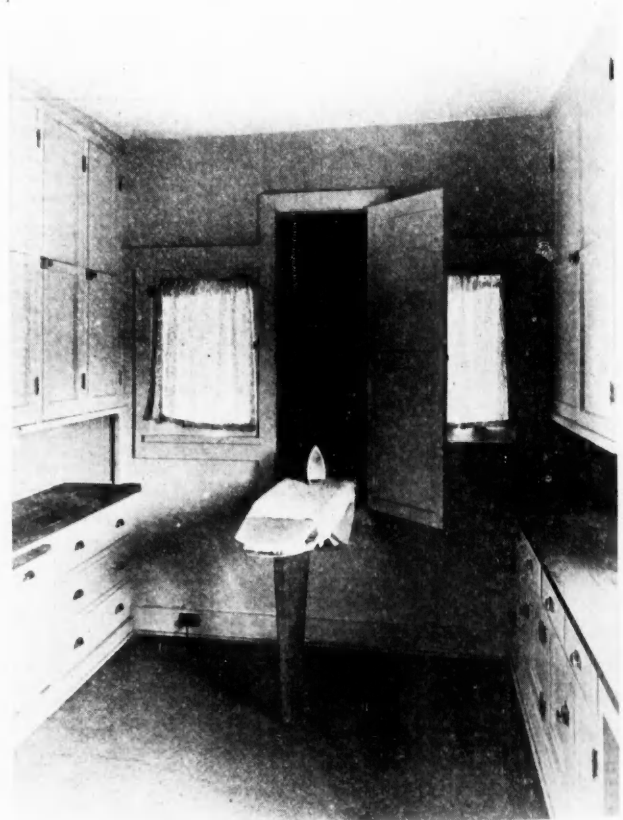

A Unique Method of Disposing of the Ironing Board When It is Not Being Used.

An Elegant Church

THE First Congregational Church, recently completed at Beatrice, Neb., while not as commodious as some, shows a type of building that is becoming quite popular for the house of worship thruout the country, as they are economical from a monetary standpoint with nothing wasted in useless towers and spires, and they reduce the upkeep to the minimum.

It is faced with gray pressed brick and the stone trimmings are of white cement. The large columns are also of this material, cast in one piece with core and reinforced and then shaped up in a lathe, which obliterates season cracking, and at the same time giving them the appearance of being a monolithic stone, yet having much the advantage in weight, as the shell that forms them are cast only about 2 inches thick.

It is well arranged for carrying on the work for which it was intended. The Sunday school and social work are provided for in the basement, while the main floor is arranged for the regular church services.

There is also a gallery running across the front over the corridor.

It is finished in quartered oak thruout and the walls are decorated in keeping with the other work and in all making a very attractive building from any point of view.

The cost of the building ready for use, exclusive of the organ, was about \$19,500.

A. W. Woods, of Lincoln, Neb., was the architect, and Mr. E. M. Atterberry, also of Lincoln, was the contractor.

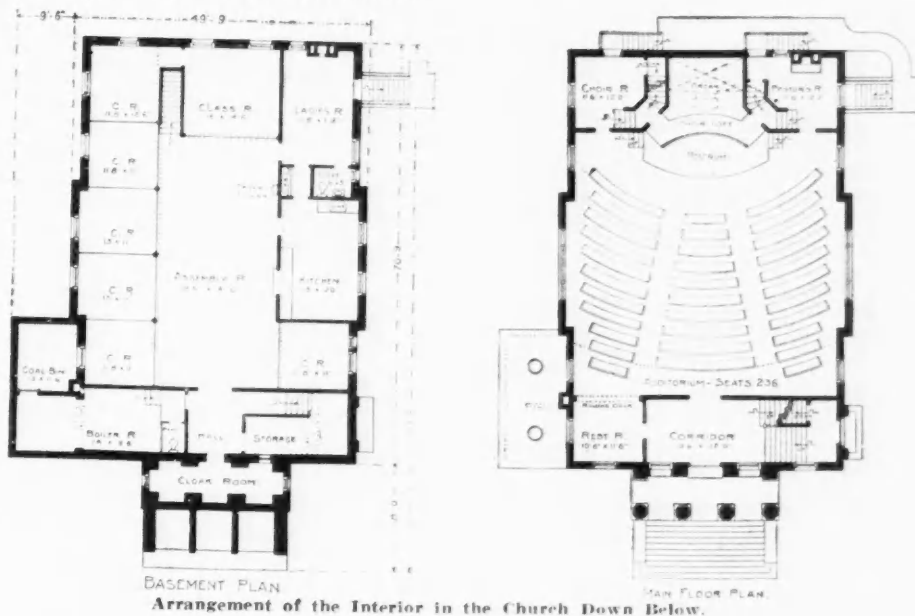

Arrangement of the Interior in the Church Down Below.



The First Congregational Church at Beatrice, Neb., Which is Built of Gray Face Brick with White Cement Stone for Trimmings.



TENTH OF A SERIES OF PUBLIC AND COMMERCIAL BUILDINGS—A FIREPROOF GARAGE BUILDING WITH SIX LIVING ROOMS AT THE FRONT ON THE SECOND FLOOR

IT is particularly desirable, especially in a small city or large village, that the garage buildings have also a portion of the space, available on the second floor, finished as living quarters. Garage service in a growing town almost invariably must include night service. The garage man is rather closely confined to his business. He has the custody of a considerable number of valuable machines, and if he is as conscientious as the owners of these machines would like to have him, the place of his abode will be within the garage. This is not a hardship, for it is possible to arrange a very pleasant suite of rooms in the forward part of the upper floor, where he may live as comfortably as he might in any location, and he has the advantage that he always knows how his business is being conducted.

The two floors with an elevator in the rear furnish a large floor space with a comparatively small ground area required. This is by far the most economical method of garage construction. It is, furthermore, a very handy arrangement, since nearly always the cars may be divided so that those standing in place for the longest periods may be placed on the upper floor, where they will not interfere with the movements of cars being constantly driven out and in.

An attractive front is a good advertisement. The design shown below is an example of what may be accomplished with an ornamental brick trimmed with white terra cotta or stone. The further advantage of the residence rooms is seen in the manner in which the garage front is brightened up by the curtains and shades in the upper windows.

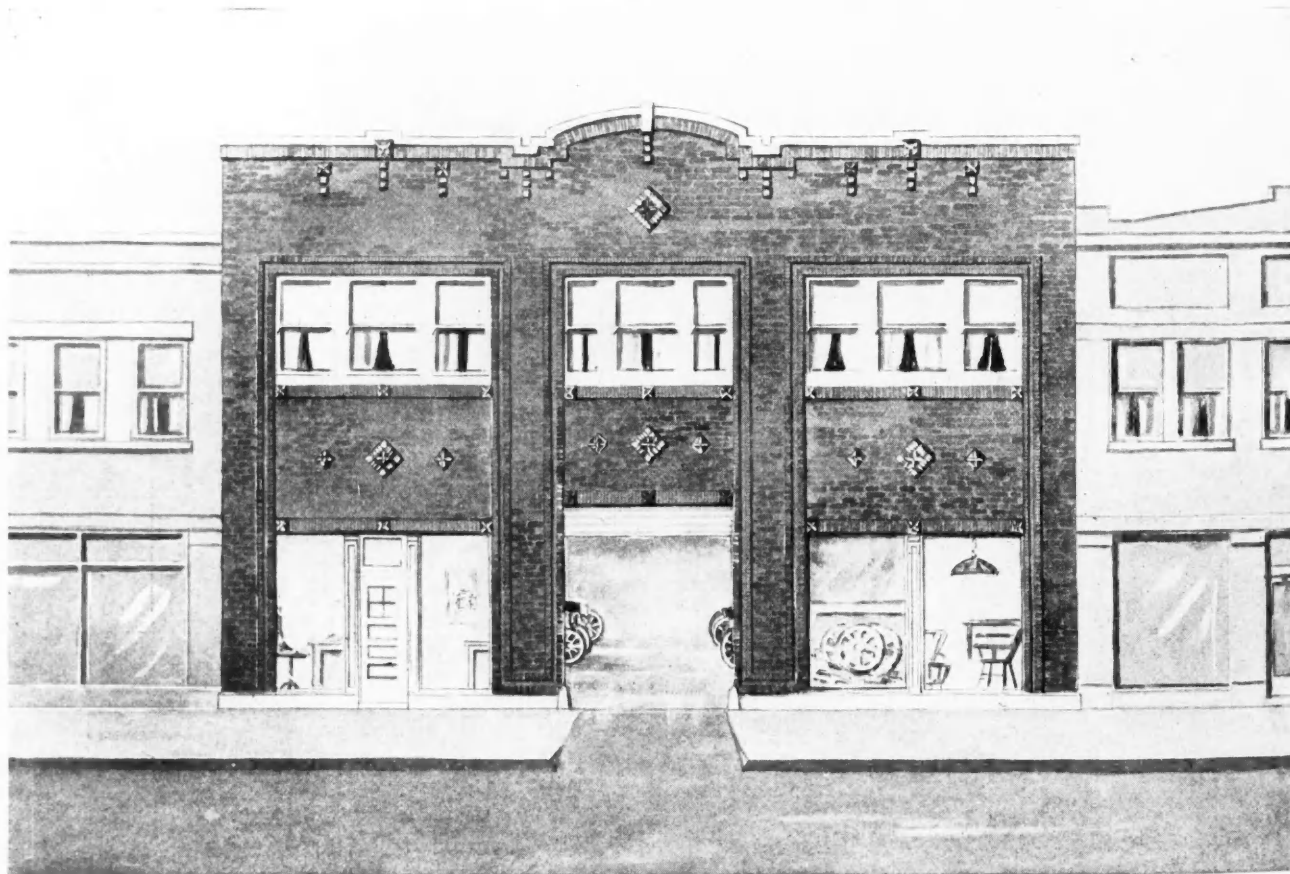

Artistic Front View of Two-Story Garage Building. Size, 50 by 130 Feet. Front Rooms Above are Used as Living Rooms. Ornamental Brick with White Stone or Terra Cotta Trim Used in Finishing Front. Design No. 6824.

Two-Story Garage Design

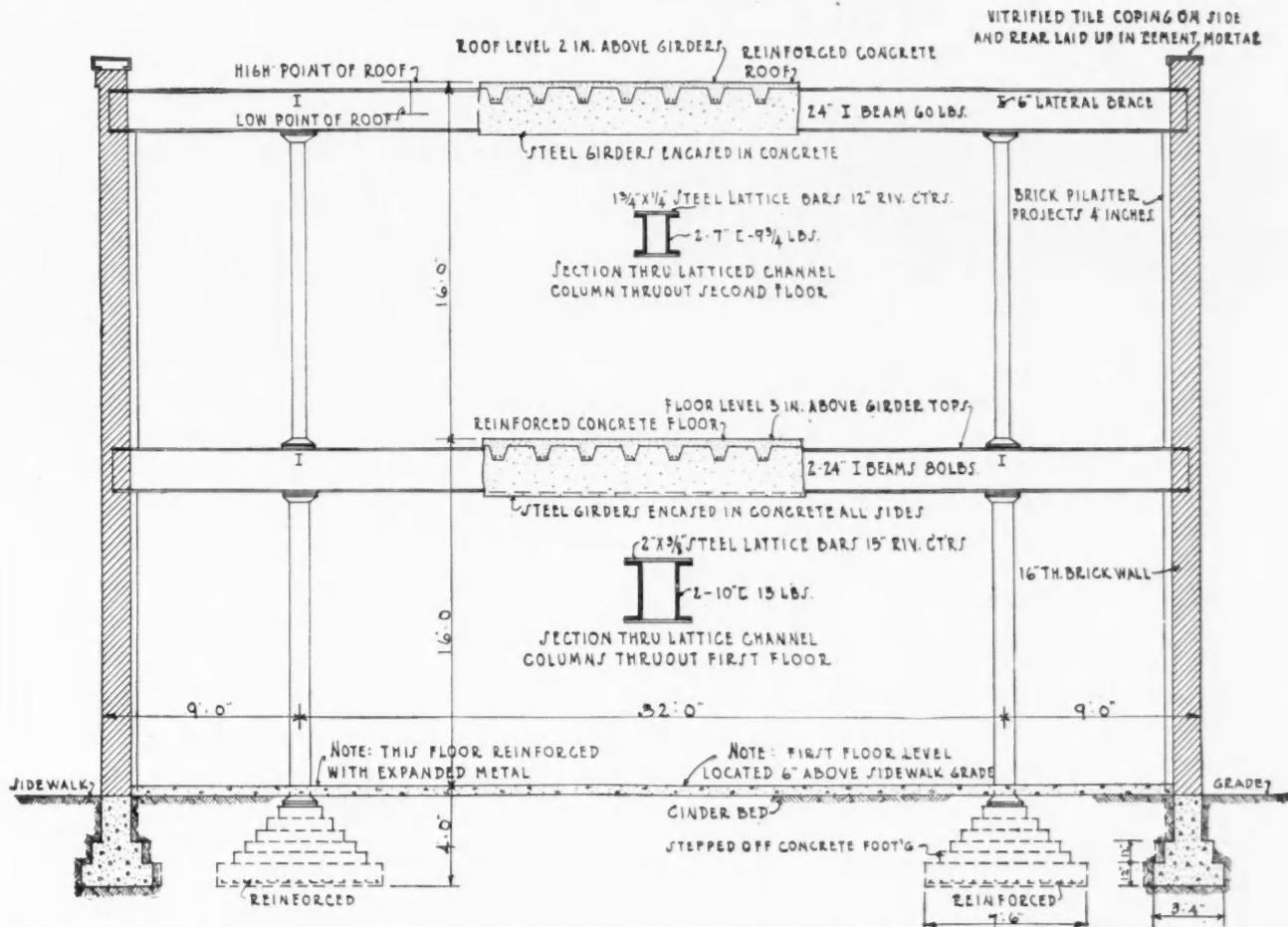

Section Showing Fireproofing and Solid Construction Used in Garage Design No. 6824. Both Floor and Roof are of Reinforced Concrete.

Fireproof construction has long been recognized as a necessity in garage buildings. The section thru the building, shown above, will illustrate how thoroly this design meets the requirements in this respect, and at the same time will show the solid construction employed. The floor and roof are supported by I-beams embedded in concrete. Both the floor and roof are made of concrete reinforced with steel rods. Two rows of lattice channel columns are set nine feet from the side walls, helping to support both the floor and roof. These columns are carried on reinforced concrete footings three feet deep and stepped off from an outside dimension of 7 feet 6 inches at the bottom to the size of the column base at the top. The wall footings are carried to the same depth as those of the columns.

Lateral bracing ties all the floor and roof beams together at the tops of the columns. The floor beams consist of two 24-inch 80-pound I-beams, and the roof beams are single 24-inch 60-pound I-beams. All beams are set into the wall above pilasters, which project four inches out of the 16-inch wall. The construction methods employed in this building assure a structure which will be solid and everlasting and quite free from vibration.

A garage such as the one illustrated here is really a necessity in every small city or progressive village in these days, when the automobile has become so uni-

versally used. It is an evidence of progressiveness which will impress those who travel thru the country and it is the means of furnishing a service which the average community must have if the modern rapid advance of automobile popularity is to continue.

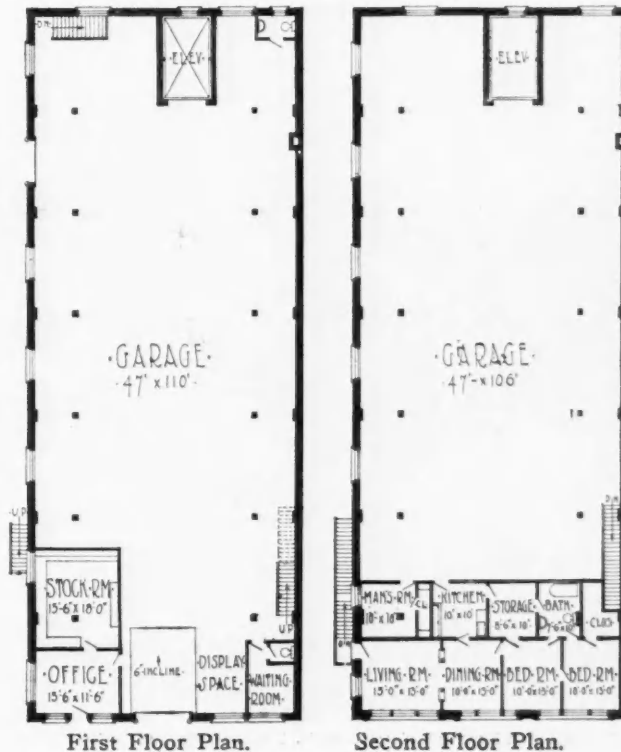

First Floor Plan.

Second Floor Plan.

Three Low Cost Churches of Good Design

Photographed and Described by
Charles Alma Byers

THE attractive church edifice here shown is designed somewhat after the style of the early California Missions and is rather unique, both in outward appearance and in interior arrangement. The gables are especially suggestive of Mission influence, and the whole appears massive and durable. The walls are of cement stucco over metal lath, tinted a rich cream color, while the roof is shingled. The entrance porches are floored with cement, and the foundation is of solid concrete. The introduction of numerous arches about the entrances, which treatment is also carried into the design of the windows, is largely responsible for the structure's exterior charm.

The interior is exceptionally well planned, providing an attractive auditorium of considerable size and excellent Sunday-school facilities. Folding doors enable the main Sunday-school room to be annexed with the auditorium whenever made desirable, and similar doors also intervene between the former and the primary room. Along each side of the Sunday-school room are several class rooms, and sharing the extreme end with the primary room is a larger class room, which is equipped with cupboards, sink, etc., and which becomes a kitchen when-

ever such is required. The speaker's platform extends diagonally across one corner of the auditorium, and back of it is located the pastor's study. Adjoining the auditorium also is a small parlor, which may be shut off therefrom by accordion doors.

The walls of the main auditorium are paneled to a height of 9 feet, and the windows are located above this line. The room is unceiled, there being an interesting arrangement of exposed beams and trusses overhead. The plastered walls thruout are tinted a buff shade, and the woodwork is finished in a dark Mission oak color. The floors are of vertical-grain Oregon pine.

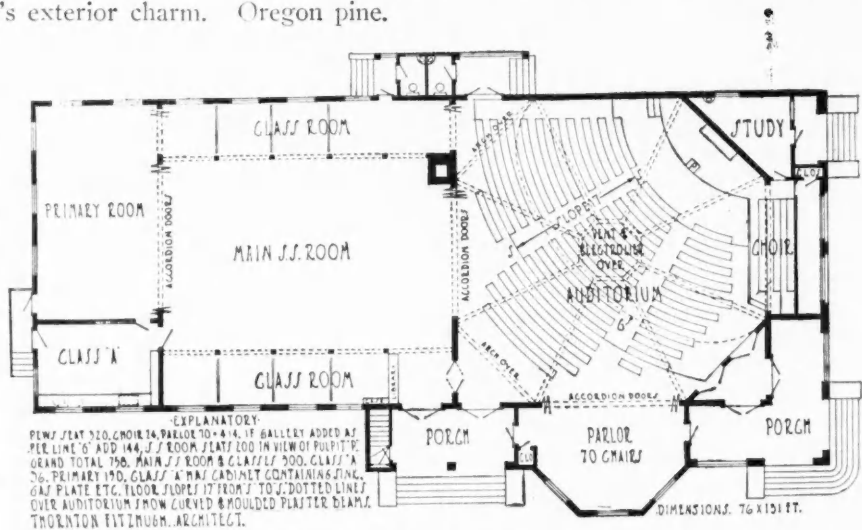

Interior Arrangement of the California Mission Style Church Shown Below.

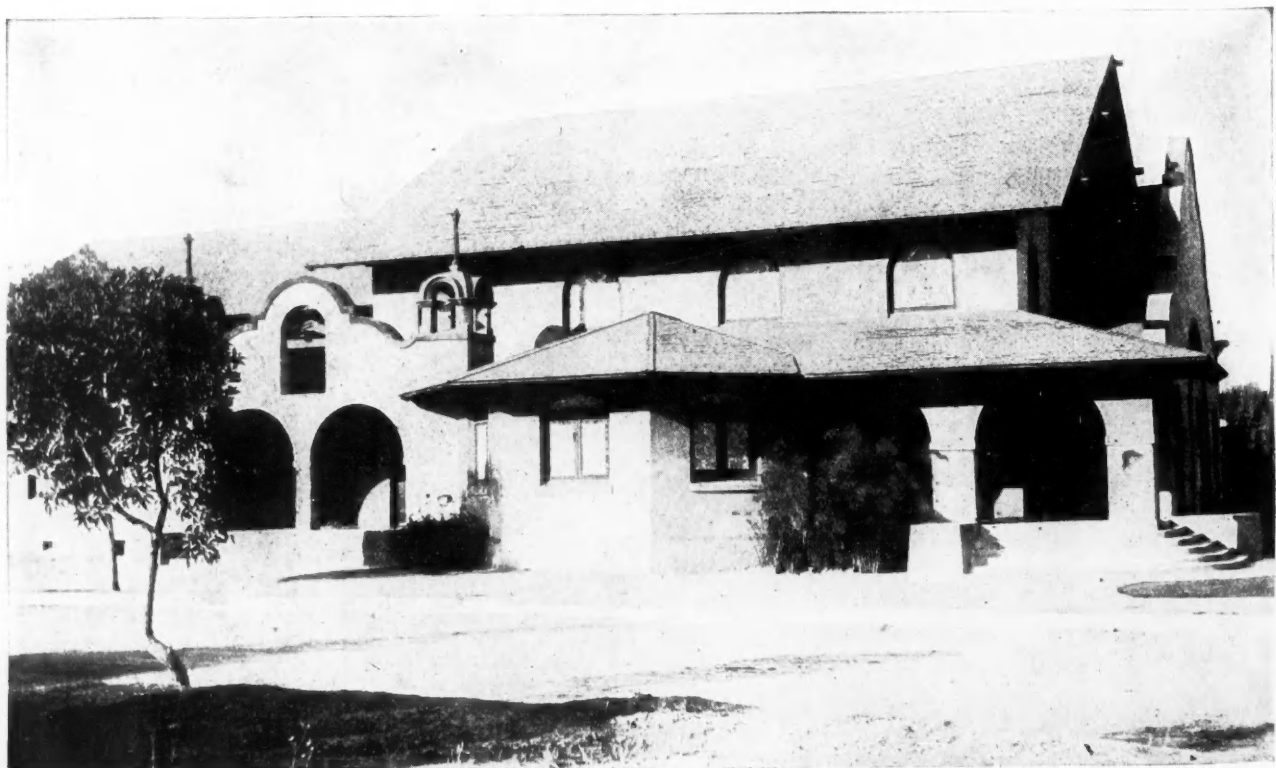

Highland Park Presbyterian Church, Los Angeles, Cal., in Which the Style of the Early California Mission is Embodied in Both External Appearance and Interior Arrangement.

plant, pews, and so forth, was approximately \$18,000.

Long Beach Church was Built for \$2,925

This attractive little church was built in Long Beach, California, at a total cost of \$2,925. Its outside walls are covered with narrow weatherboarding, painted a light lead color, and the roof, which is shingled, is painted gray, while the trimming is done in white. It possesses two towers, of different heights—one at each of the two front corners—and therefore two entrances.

The interior arrangement is quite simple, and yet very good. It contains a Sunday-school room, fourteen by twenty-four feet in size, which has a seating capacity of 56; a main auditorium, thirty by forty feet in size, with a seating capacity of 200; a ten by thirteen-foot choir room; a ladies' rest room, and toilets, as well as the usual platform, choir and organ spaces. Folding doors enable the Sunday-school room being consolidated with the main auditorium. All in all, it is a very practically planned church, and is quite attractively finished inside. Calvin Abbott was the architect.

Estimate of Cost of Long Beach Church

| | | | |
|-------------------------|---------|--------------------|------------|
| Excavating | \$40.00 | Painting | 275.00 |
| Foundation | 45.00 | Cement | 60.00 |
| Rough Lumber | 600.00 | Tin Work | 45.00 |
| Labor | 550.00 | Rough and Finish | |
| Sash and Doors..... | 380.00 | Hardware | 135.00 |
| Finish Lumber | 300.00 | Maple Floors | 150.00 |
| Plastering | 175.00 | Plumbing | 70.00 |
| Wiring | 40.00 | | |
| Electric Fixtures | 60.00 | | |
| | | | <hr/> |
| | | | \$2,925.00 |

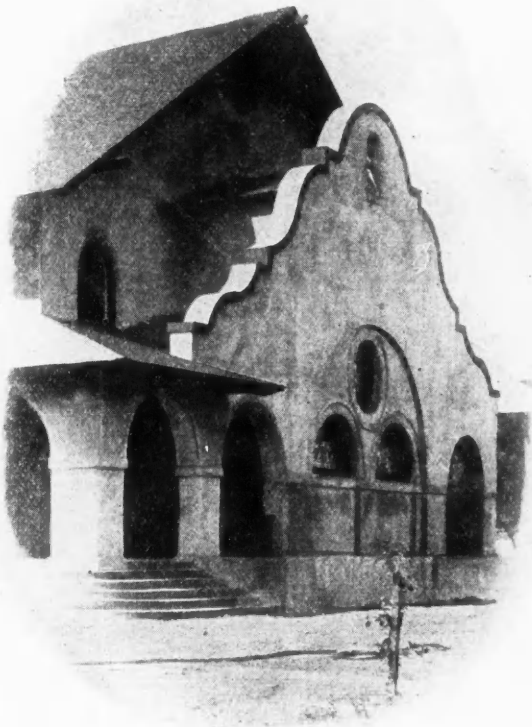

The Exterior Charm of the Highland Park Church is Largely Obtained by This Distinctive Mission Entrance.

The main auditorium seats 320; the parlor, 70; the main Sunday-school room, 200; the primary room, 150, and the other class rooms a total of 136. Including the choir of 24, 758 of these seats are within view of the pulpit, when the folding doors are open.

The outside dimensions of the building are 76 by 131 feet. Underneath is a basement 17 feet 3 inches by 29 feet in size, which is walled and floored with concrete. An excellent heating and ventilating plant, with vents beneath every seat, is located here.

Known as the Highland Park Presbyterian Church, this edifice is located in Los Angeles, California, and was designed by Thornton Fitzhugh, architect, of that city. The total cost, including heating and ventilating

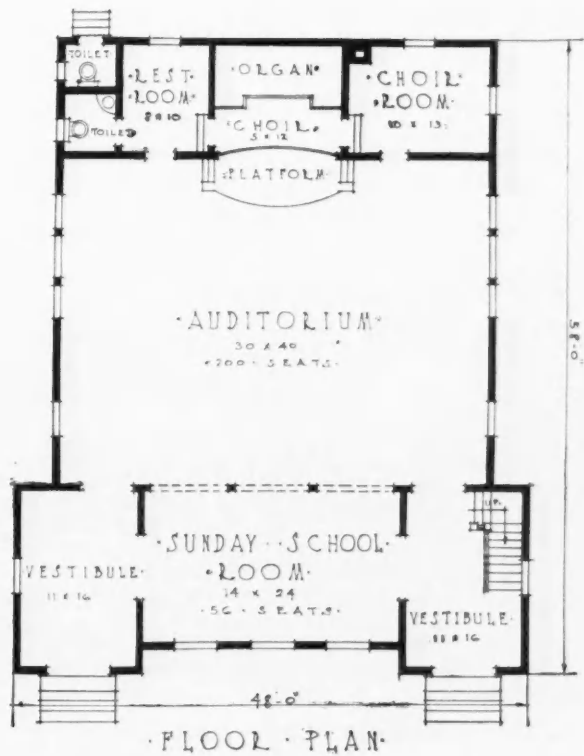

FLOOR PLAN



Photograph and Floor Plan of the Bethel Friends' Church, Built at Long Beach, Cal., at Low Cost, Showing a Very Practical Arrangement Whereby the Sunday School Rooms May be Consolidated with the Auditorium.

This Imposing Little Church for \$3,180

With its high steeple, the little church here shown is quite imposing and very attractive, being an especially handsome structure for the sum for which it was constructed. The lines, aside from the steeple, are rather simple, and yet the effect as a whole is very satisfactory indeed. The building is located on a corner lot, and in each of the gables facing the streets is a very attractive but comparatively inexpensive window group. The entrances are by way of arches underneath the tower, one door opening directly into the main auditorium and the other directly into the Sunday-school room.

The auditorium is thirty by forty feet in dimensions, and has a seating capacity of 200. The Sunday-school room is sixteen by twenty-seven feet in size, and has a seating capacity of 72. Folding doors separate these two rooms, and make it possible to convert the two into one large room whenever desired. There is an 8 by 10-foot choir room, a pastor's study, a ladies' rest room, toilets, and the usual platform, choir and organ spaces. The interior is well finished, and conveniently arranged. The church is located in Los Angeles. The estimated cost of construction, as here given, is \$3,180.

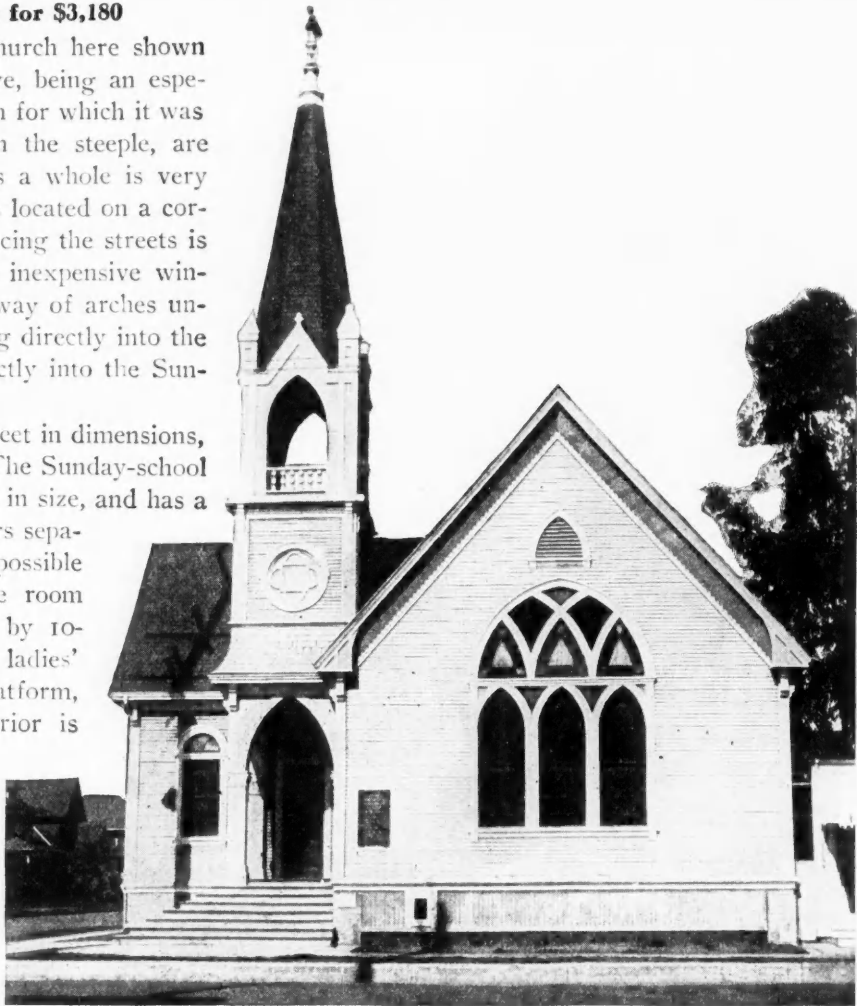

The First Norwegian-Danish Methodist Episcopal Church at Los Angeles, Cal. This is an Imposing Little Structure Which Was Built at a Reasonable Cost.

Estimate of Cost of Los Angeles Church

| | | | |
|-------------------------|----------|--------------------|------------|
| Excavating | \$ 40.00 | Cement | 65.00 |
| Foundation | 50.00 | Tin Work | 50.00 |
| Rough Lumber | 650.00 | Rough and Finish | |
| Labor | 650.00 | Hardware | 145.00 |
| Plastering | 180.00 | Maple Floors | 150.00 |
| Sash and Doors..... | 420.00 | | |
| Finish Lumber | 310.00 | | |
| Wiring | 40.00 | | |
| Electric Fixtures | 75.00 | | |
| Painting | 280.00 | | |
| Plumbing | 75.00 | | |
| | | | \$3,180.00 |

The demand of the housewife of today must be met with up-to-the-minute ideas embodying every possible device which will aid in making the kitchen and its attached rooms a pleasant part of the home rather than a dreary work-room.

Ironing Board Closet

(Continued from page 50.)

sign to please the housewife is a mighty sensible way to produce satisfaction.

Since ironing is, as a rule, warm work, where could the ironing board be better situated than directly in front of the two casement windows? Furthermore, fine work cannot be done, even with a flat iron, in the dark. When the board is folded up and the door closed upon it, a nicely balanced effect is produced, which carries out the general idea of the entire design. Both side walls have cupboards and drawers along their entire length. No need of a confusion of kitchen utensils packed tightly into a few small compartments in this room. There is plenty of room for the most elaborate array of equipment and yet everything is within easy reach.

There is truly a suggestion offered here which will bear careful study by the designer of modern homes.

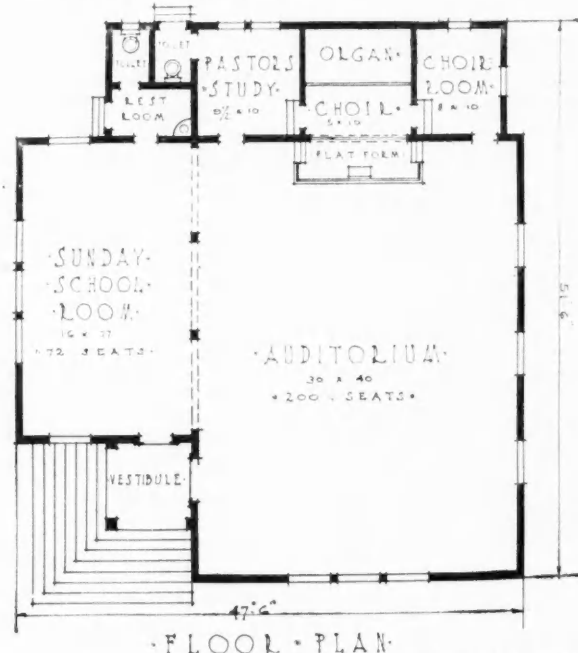

The Arrangement of the Church Shown Above in Which a Large Congregation May be Assembled by Opening Folding Doors.

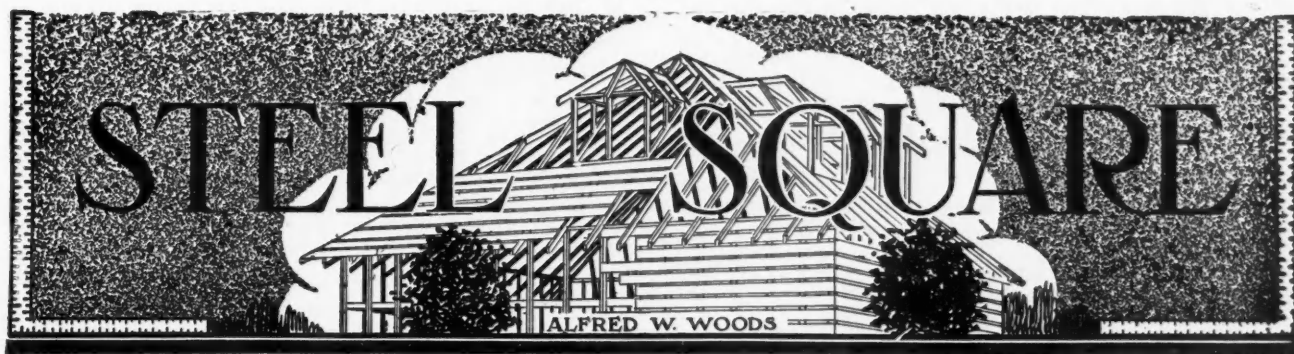

Possibilities of the Steel Square

By A. W. Woods

ILLUSTRATING IRREGULAR ROOF FRAMING BY THE TANGENT SYSTEM AND HOW THE TANGENT MAY BE READILY FOUND BY SCALE IN CONNECTION WITH THE STEEL SQUARE

WHEN we closed, last month, we promised to take up the subject of tangents as applied to the steel square for unequal pitches, but really there is not much to be said beyond what was covered in our last article, as the operation is the same as for a roof of equal pitches.

In the even pitch, the seat line of the hip rests at the midway point between the angle formed by the plates, but when the pitches are not of the same, then the seat line veers to the steeper side; and just where it should rest on the plane of the plate level furnishes a problem of no small means for the novice to determine just where it should be. But of course it is directly under the hip, which must rest at the intersection of the two roof planes and the question is to first find where this takes place. This may be readily found by taking one-half of the length of the side to be roofed and the run of its respective common rafter. These dimensions set at right angles will furnish the base and altitude for a triangle that will represent the plan from which to base the calculations from which to work. The hypotenuse side of the triangle will represent the run of the hip, while the other sides will represent the tangent and the run of the common rafter in the order mentioned.

In the case of the even pitched roof, the same plan will answer for all corners, but where there are different pitches, it requires a plan for each pitch the roof may have; but as we said before, the same

principal is involved as for the even pitch and applies to all alike, and we can do no better than refer the reader to our article in the July number, where we discuss the use of tangents in roof framing.

However, in the case of uneven pitches, it is not so easy to arrive at the exact length of the tangents because the intersection of the two pitches governs the angle that the seat of the hip rests from the plates and is therefore not determined by circular measure, as in the case of even pitches. It would therefore require a complicated problem in higher mathematics to determine just what the angle of the seat of the hip would rest at in degrees from the plates, but by laying off a diagram as above described, the length of the tangent can be arrived at nearly enough by scale (full scale per one foot run) for practical purposes.

Having thus obtained the length of the tangent, proceed as described under the First, Second and Fourth heads, as given in the July number; but there are other things that enter into uneven pitched roofs that will trap the inexperienced if he is not very careful. One of them is a projecting cornice formed by tail rafters. In that case, the reckoning of the sides should be taken at the cornice line instead of along the outer edge of the plate. Where there is a cornice of this kind, the hip will not pass directly over the corner, but will veer to the side, having the steeper pitch and will also require a different depth of the seat cut or else the plate on the side having the steeper pitch will have to be raised to make up the difference, which is equal to the difference in the two rises in the width of the cornice.

For instance, to show this in its simplicity, if one pitch has a 10-inch rise and the other has 9-inch rise to the foot and if the cornice is one foot wide, there would be a difference of one inch, which must be added to the top of the plate on the side having the steeper pitch. This is a point that is usually passed over without knowing the real cause and effect; that is, if the rafters do not make a passable fit, why they

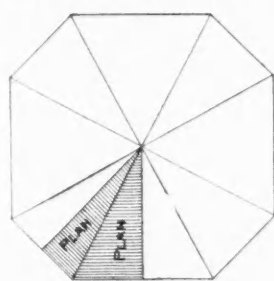

FIG. 1.

Fig. 1. Plan of an Irregular Octagon Roof.

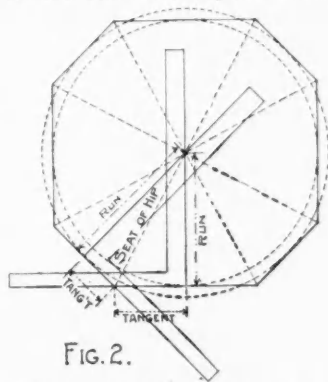

FIG. 2.

Showing the Proportion to Take on the Square.

just cut off a little more or slip in a dutchman, as the case may be, and let it go at that.

Mistakes are common, but it is next to criminal to keep on making the same mistake without an effort to find out the cause. One cannot be too careful in laying out his plate lines, to see that they are level and true, because if one side is a little longer than the other, or the plates are out of level, it is bound to show up in the roof framing, tho perfect lengths and cuts of the rafters may have been made.

We knew a carpenter that had an octagon tower to roof, but instead of it being regular, it was irregular; that is, while it had true octagon corners, four of its sides were of one length and four of another and with the roof running to a common center, as shown in Fig. 1, yet he tried to use the proportions on the square for the framing of the rafters, as tho it was for a

regular octagon roof, and of course they did not fit. He was ready to swear to all that was good and bad, that the rule was at fault because he knew he had true octagon corners, but it never occurred to him that he did not have a true octagon roof. This furnishes a good example for the subject of this article.

It is an easy matter to arrive at the proportions to use on the square, since knowing the length of the sides of the tower, and its diameters by taking one-half of the respective dimensions on the square to scale, as shown in Fig. 2.

With this we close, but next month we will come again and will take up the vertical proportions to use in connection with rafter framing. So far in this and the two preceding articles we have dwelt only on the governing proportions derived from circular and scale measurement on the level plane.

Useful Knots and How to Tie Them

PUTTING THE ROPE TO WORK FOR CARPENTERS AND BUILDERS

By H. J. Blacklidge

To the Editor: New Canton, Ill.
Please don't take this for a kick, because the old magazine is all to the good. But what is the matter with devoting a little space to explaining some of the hitches and knots that every builder meets up with and that but few can tie correctly? RAYMOND MINTON.

THREE men were on the roof. One "cub" was on the ground. And it was certainly amusing to hear the combined efforts of those three men trying to tell that youngster how to throw a timber hitch around a roll of P. & B. roofing paper. It must have taken very nearly ten minutes for him to get the hang of it. He was a sensitive youngster and the jibes during the remainder the day stung him keenly.

That evening he got out the old encyclopedia and hunted up "KNOTS." Then he got some shoestrings and proceeded to demonstrate those knots. Next morning I—or rather "he"—was able to throw a timber hitch, a rolling hitch, builder's knot, and a good many others with the swiftest of them. That lesson *stuck!*

It seems strange that so many country builders and farmers are not familiar with such common, useful, almost I might say, imperative necessities as the *timber hitch*, *square knot*, *boxline*, *clove* and *Blackwall hitch*, and so forth. Only the other day I saw a man who has followed the trade for twenty years use a *granny* in tying up some stuff to send aloft. I would advise every apprentice who sees this to get a piece of rope, and, taking Figs. 3 and 4 for a guide, practice until

he can tie a *square knot* in any position in which he can get his hands on the rope.

There is a modified form of timber hitch shown in Fig. 2, that is known as the *Killick Hitch*. It is very handy when you have occasion to send up something short and bulky. The figure shows it very clearly.

Did you ever see an electrician gather up six or seven feet of wire, "wopse" it all up in a bunch, and take a turn around it to get it out of the way? I saw a man do it not long ago. The foreman came along a few minutes, saw it, and—exploded. "For the love of Mike! can't you tie a *sheepshank*?" The poor fellow had never even heard of a *sheepshank*. Fig. 5 shows how it is made. It is pretty hard to beat for shortening a rope or flexible wire. Catch up a loop of the rope and lay it back along one way or the other, making three parallel sections. Now throw a hitch around each end and you have it. If there is to be a heavy strain on the rope it is best to toggle it as shown in Fig. 6. With the standing part of the rope, just beyond each half hitch, make a bight through the end loops of the shank and slip a stick through. It is better shown in the figure than described.

Another method of shortening is to make a chain and toggle the last loop. Simply tie a single bow knot and then tie another through the loop of the first—and keep it up until you have taken up as much as desired. Still another method, and very handy for taking up just a short amount of slack, is shown in Fig. 7. It is

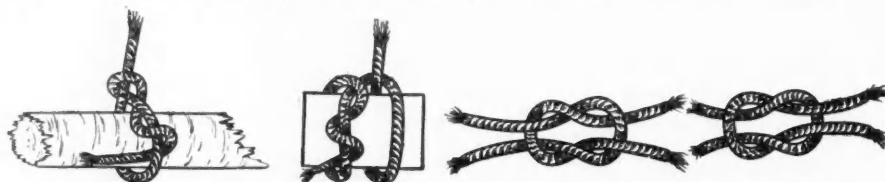

Fig. 1. Timber Hitch. Fig. 2. Killick Hitch. Figs. 3 and 4. Square Knots.

merely a single bow knot with a toggle in the loop of the bow.

Don't think because these knots are so simple that they are beneath your notice. It is the knowledge and ability to tie just the right, simple, non-slipping knot at the right time that counts. Better have half a dozen different — good — knots, and have them thoroly

The *Blackwall* hitch is a very clever fastening for a large hook. It is a sort of "slippery hitch," but at the same time is secured as long as there is a strain on it. And the harder the strain the tighter it holds. It is clearly shown in Fig. 11, and is so simple that no directions are required for making it.

A neat and rapid way of fastening to a ring is shown

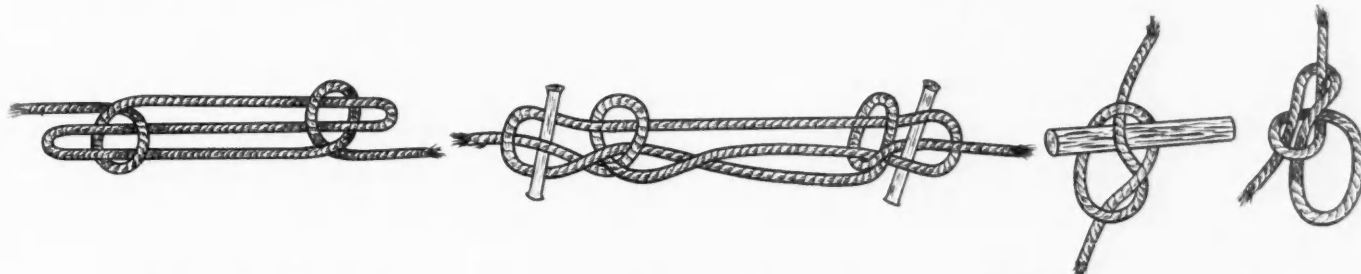

Fig. 5. The Sheepshank.

Fig. 6. Sheepshank Toggled.

Fig. 7. To Shorten. Fig. 8. Bow Line.

than to have a head full of complicated ones that are not particularly useful. There are any number of ornamental knots that are interesting, even fascinating to tie and it is good to know them. But a man wants a few that are *exactly* what he *needs* in his business.

Figure 8 shows the good old reliable *bowline*, next to the square knot, the most useful and universal knot we have. Make a small loop or half hitch, hold in the left hand, take the end and put through this loop, around the standing part and through the loop again. Hold the rope or cord just as it is shown in the sketch and it will be perfectly easy. The only trouble in making a bowline is in getting the end through the loop from the proper side. *Try it*, and you will quickly find that it will make only a tangle if put through from the wrong side. It is a good knot. It never slips, it always distributes the strain equally, it never balks when you are ready to untie it (unless it has been made with very soft cordage, in which case any knot will stick). Practice till you can tie it almost with one continuous motion.

Builder's Knot or Clove Hitch. It is claimed that this is used by builders in lashing together the uprights in scaffolds. I do not know, I am sure, because we mostly use *nails* out here in California. Be that as it may, there are many places where the clove is just the hitch one needs. It is simply two half hitches made in opposite directions. Fig. 9 shows it very distinctly. In Fig. 10 the two half-hitches are made in the *same* direction. This is not so good, it slips too easily. It is known as the running knot or hitch. The clove will not slip laterally.

in Fig. 12. It is better than the usual custom of tying a slip knot or single bow. And is exceptionally useful if you should happen to have occasion to fasten a rope in the middle, allowing both ends to be free.

Now and then there are times when it is very necessary to have one or more non-slipping loops along in the middle of a piece of rope. The bowline cannot be beaten if the rope is not too long and at least one end is free. But if both ends happen to be fast the bowline is out of the question. In this case the *artillery knot* is used. See Fig. 13. Lay the rope into this shape, then reach through the bight C, behind the standing part B, grasp A, and haul it back through C. Grasp both E and D while you haul the knot taut and do it very carefully else you will have nothing but a decidedly tangled slip knot. This knot requires a little care in making at first, but it is well worth knowing. You have gotten along so far without using it, you say. Yes, surely you have, but that was simply because you did not know it. Had you known it you might have used it many and many a time.

The following, Fig. 14A, and Fig. 14B, is apt to be useful to *anybody*. It is called the *can sling*. Put the rope around the can and tie a single knot at the top as in Fig. 14A, which represents a top view. Then spread the bights until they will drop down over the edge of the can. Pull tight and knot above, as shown in Fig. 14B. If using this sling on a bucket which is minus the bail—pulling water from a well, for instance—it is well to tie the two ropes together at the points where they cross. Otherwise they are apt to slip when flipping the bucket to fill it.—San Rafael, Calif.

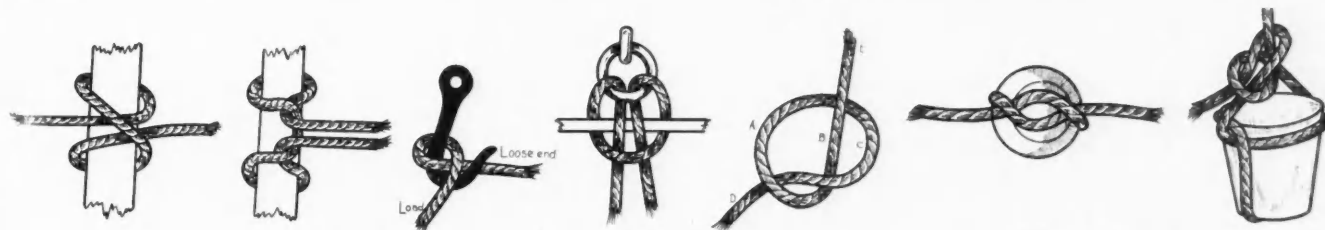

Fig. 9. Builders' Knot.

Fig. 10. The Running Hitch.

Fig. 11. The Blackwall.

Fig. 12. Ring Hitch.

Fig. 13. Beginning an Artillery Knot.

Figs. 14A and B. A Can Sling.

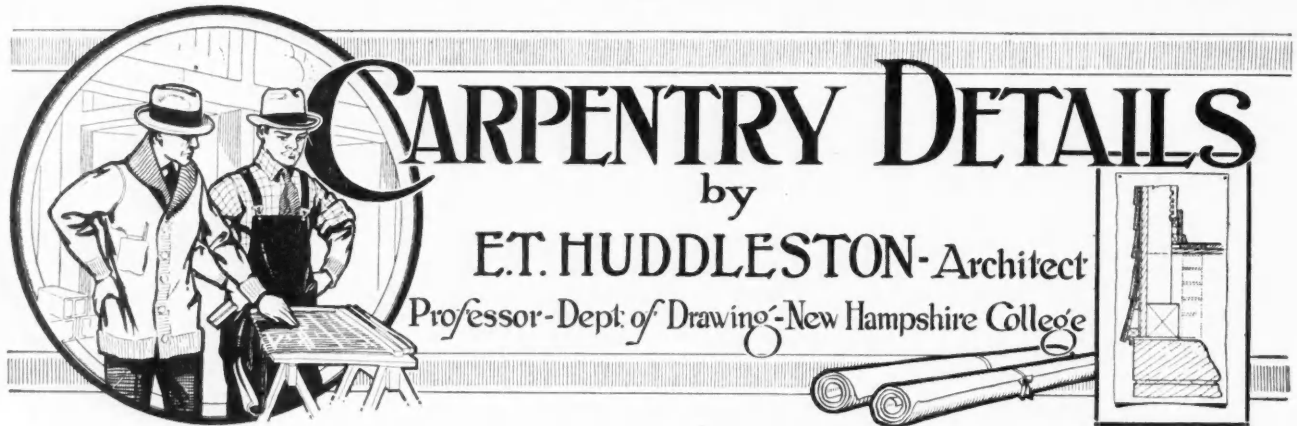

A Dormer Window

THE FIFTH OF A SERIES OF SIX ARTICLES WITH DETAIL DRAWINGS

A PART of the house that is often neglected and wasted is the attic. In probably the majority of houses costing from three to five thousand dollars we find no means of getting into the attic except possibly a scuttle in the ceiling of the second story hall. And oftentimes where there is a stairway to the attic, it is in such a position that the main roof cuts off adequate head room so that one has to stoop in order to pass up the stairs.

Supposing the house under construction is of such a design that the roof affords ample space beneath for rooms in the attic. A stairs from some convenient point on the second floor will make possible the use of a space equal to from one-third to two-thirds the area of the second floor for many useful and convenient purposes, such as storage rooms of all kinds, clothes drying space for rainy days, billiard room or play room for the children, extra sleeping rooms for the accommodation of the unexpected but welcomed guests, and many other purposes that will tend to relieve the crowded condition of the basement and clothes closets.

The one big question that always arises in the mind of the owner when the subject of sleeping rooms in the attic is mentioned is, how can you keep them from getting so hot in the summer and cold in the winter? The latter part of the question is easily answered.

The rooms should have plastered walls and ceilings and heat introduced by registers or radiators the same as on the main floors of the house. For sleeping rooms, it is not required that they be kept the same temperature as a living room unless the room or rooms are to be rented and used as living rooms as well as bed rooms.

As for the first part of the question, there is no doubt but that in the greater part of the United States our summer climate makes the attic rooms almost unbearable, and even the second floor bed rooms get their share of the heat. But with foresight in the construction of the house and the proper installation of a few features, this objection may be at least partially removed.

Where possible, the ceilings of the attic rooms should be furred down to allow for some space between them and the roof. This space should be ventilated by means of screened openings near the apex of the roof and in order to better keep a circulation of air, there should be openings on the under side of the cornice so that the air can travel upward between the rafters and out at the above mentioned ventilators.

As is common with most attic rooms, the windows are very few and small in comparison to those for equally large rooms in the rest of the house. This is due to the fact that the windows must be placed in dormers and they in turn are largely fixed for size by the design of the house.

In the plate opposite are shown details of a dormer suitable for a house of colonial design, in which case the dormer proper is not large and accommodates a pair of casement or swinging sash. Aside from all questions of design, casement sash, when properly made and installed, and especially for rooms that require a great amount of ventilation, are more efficient in every way than the double hung type.

They permit opening the window to its full height and width, giving one hundred per cent ventilating area, while with a double hung window the ventilating space is only fifty per cent of the window space. For that reason alone an attic room is made many times more comfortable and livable by the use of casement sash which, besides affording a maximum of ventilating space, can be so adjusted as to act as shields to catch a breeze coming from the sides and deflect it into the room.

The plate opposite gives suggestions as to features in connection with a dormer window that tend to make it efficient as well as good in construction and design.

E. T. HUDDLESTON, Architect,
Durham, New Hampshire.



The use of osage orange for making dyes promises to be extensive. The Forest Products Laboratory is making a census which shows that the supply of the wood is more than ample to meet present needs.

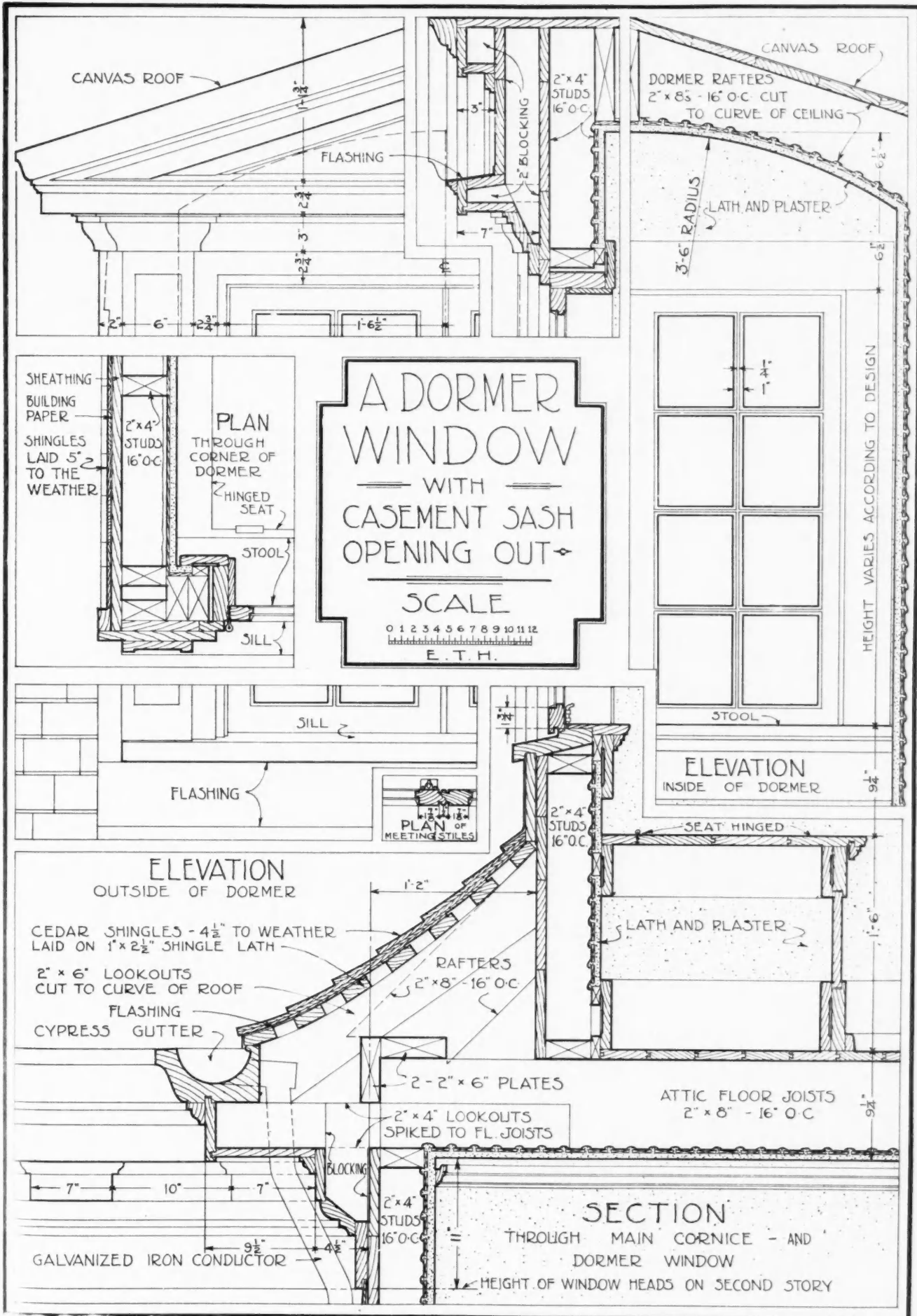

Details of a Dormer Window with Casement Sash Opening Out as Designed by E. T. Huddleston, Architect, Description and Explanation Are on Opposite Page.



How to Construct a Platform Stairway

Lesson 2.

By Morris Williams

A REAL good mechanic, about two months ago got into terrible trouble in trying to put up this stairway. I had to get on the job to put it up; and in this lesson I am explaining all the operations, which is just the thing for most carpenters and cabinet makers to enable them to do the job correctly, etc.

The Author.

THE subject of this lesson, known as "Platform and Newel Stairway," shown in plan, Fig. 6, is made up of a combination of three flights fixed at right angle and meeting upon platforms.

In the elevation, Fig. 7, the flights are shown unfolded, to afford a view of the front stringers, newels, rails and other accessories pertaining to the construction.

To lay out a stairway of this type and to do it right

calls for the most careful consideration of the available step conditions, such as the run for each flight and the relative headroom height for the three combined. We must bear in mind that the steps will have to be the same dimension for the three, because a difference would not alone make the stepping less secure, but would mar considerably the appearance of the stairway in its final stage of completion, for the reason that it would cause different pitch for each

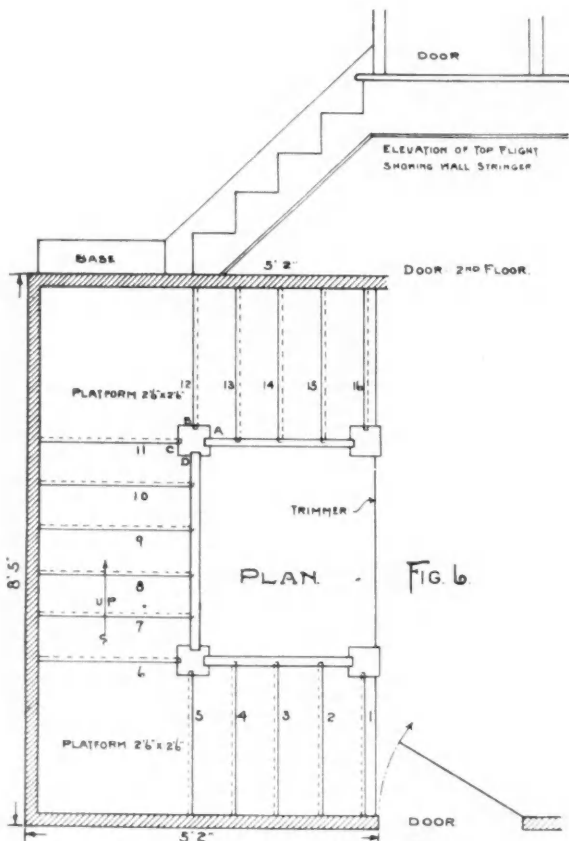

Fig. 6. Plan of a Platform Stairway.

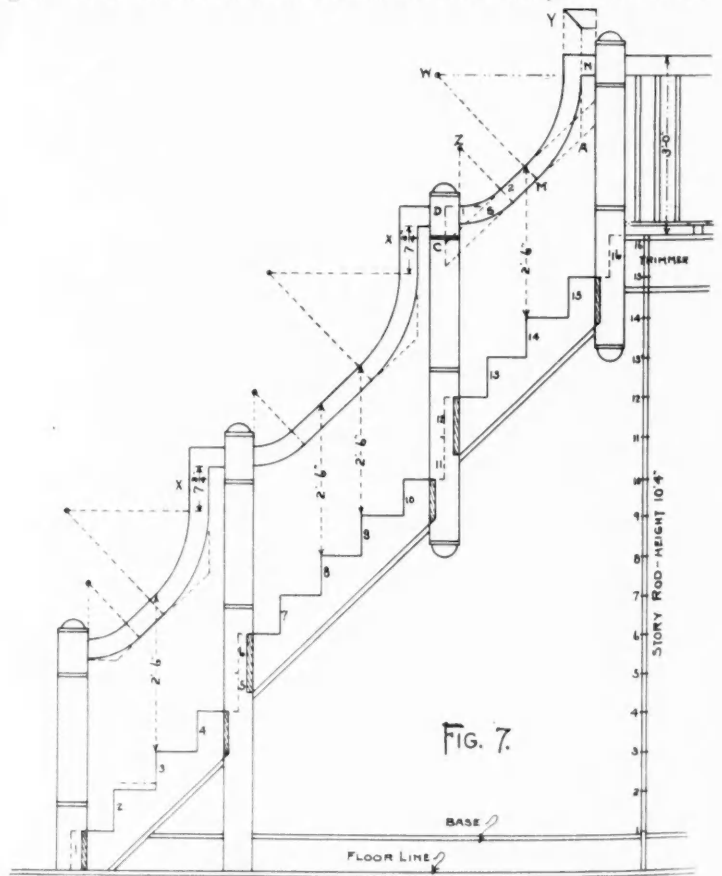

Fig. 7. Elevation of Fig. 6.

flight and thereby lack of uniformity.

For the steps, we have, as shown in Fig. 6, a run of 5 feet 2 inches for both the bottom and top flights, less the width of one platform for each flight, and for the middle flight a run of 8 feet 5 inches, less the width of two platforms.

In the process of laying out, we first decide upon the width of the stairs, which determines the dimension of the platforms, and definitely limits the available run space for the treads to each flight.

Adding the run spaces together, we find a total of 8 feet 8 inches equal 104 inches, which is evidently too small for a height between floors of 10 feet 4 inches, shown upon the story rod in Fig. 7.

To have the best results, we must fix upon the widest riser consistent with a satisfactory stepping, for according to all accepted rules of proportioning

of the stringer, and for the risers on a miter, as shown upon step 2, Fig. 7.

A part plan of the stringer, two steps and a return nosing, is shown in Fig. 8, and in Fig. 9 a tread prepared to receive the dovetailed balusters and mitered for the return nosing.

A template is shown in Fig. 10, applied to the end of a tread, illustrating the method in use to mark the treads for the dovetailed balusters, and as all the figures are self-explanatory, we will now revert to Fig. 7 to explain the operations pertaining to the handrails and the newel posts.

The customary height above the nosing of the steps to the top of the handrail is 2 feet 6 inches, shown in the figure, and the length of the short and long balusters therefore will be 2 feet 4 inches and 2 feet 8 inches respectively, the dimensions corresponding to the stock length of balustrades in all mills all over the country.

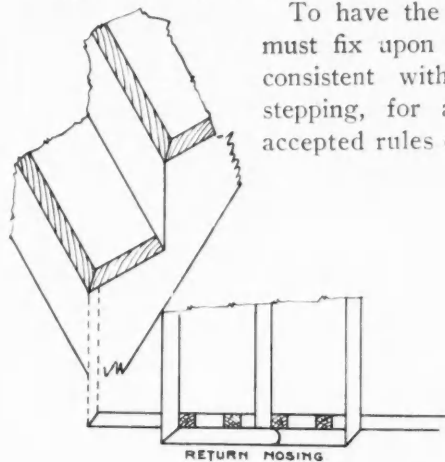

FIG. 8.

Fig. 8—Part Plan of Few Steps, Stringer and Return Nosing.

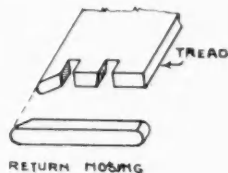

FIG. 9.

Fig. 9—A Tread Dovetailed and Mitered for the Return Nosing.

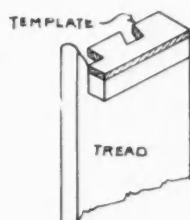

FIG. 10.

Fig. 10—A Template to Mark the Dovetails.

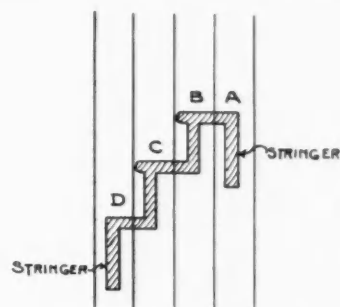

FIG. 11

Fig. 11—Showing How to Mark the Grooves on the Newels for the Stringers and Steps.

steps, it will be the one that will afford the use of the narrowest tread, which is the very thing required in this case.

After some experimenting, we find that a riser $7\frac{3}{4}$ inches wide will be the most suitable, and that we need sixteen of them to reach the height between floors of 10 feet 4 inches.

We find, also, that the best proportional tread width for a $7\frac{3}{4}$ -inch riser is $8\frac{1}{2}$ inches, and know that we need fifteen treads, counting the platforms.

All we have now to do is to distribute the treads as shown in plan, Fig. 6, and feel satisfied that we have succeeded in accomplishing the best arrangement of plan that was possible under such unfavorable conditions.

Having in this manner found out what is the best that can be done regarding the plan, which is certainly the most important item of all the operations, we are now prepared to lay out the stringers, newels and rails.

And as nothing further may be said than was said in the first lesson regarding the wall housed stringer, we will now consider the front cut and miter stringer only. It is shown in plan, Fig. 6, to be tenoned for support about an inch deep into all the newel posts, and in Fig. 7 as it appears in actual position. The cuttings for the treads are made square to the surface

The height from the landing floor to the top of the landing rail should not be less than 3 feet, due to the need of safety.

In laying out the gooseneck for the top rail, draw the knee, N, parallel with the landing rail and drop a line at any distance from the newel decided upon, as shown from N to A. Make A-M equal A-N and draw a line from M to intersect another from N at W, the center point to draw the gooseneck.

To draw the easement at the bottom part of the rail, decide upon the height desired, as from C to D. From D draw a level line to S, make S-1 and S-2 equal, and draw a line from 2 to intersect another from 1, as shown at Z, which will be the center point to draw the easement. Great amount of labor may be avoided by mitering the gooseneck at N, as shown at Y above it, for then the rail may be made in one piece and worked on the shaper machine all along from N to I, while, if made solid, it would have to be worked by hand and in two pieces with a joint at some determined point upon the straight part between the gooseneck and the easement.

These members are similarly drawn for the middle and bottom flight rails, except that the goosenecks will have to be made few inches longer, due to the

(Continued to page 70.)



Noon Hour Talks by the Boss Carpenter

Talk No. 49 Posts or Columns

New Series No. 6

THE BOSS TELLS ABOUT THE DESIGN OF POSTS OR COLUMNS WHEN THEY CARRY ECCENTRIC LOAD

"IN our last talk," said the Boss, "we took up the design of posts or columns which were loaded with centrally applied loads. This time we will consider posts and columns with the loads applied at the top in a line which does not coincide with the center line of the member.

"The effect of a load applied centrally is to crush the member if the length of the post is not more than ten to fifteen times the least side dimension, both measured in the same unit—either feet or inches. If the ratio of the length and least side dimension is greater than that mentioned above, the post may remain straight at the ends and buckle outwards at a point near the middle of its length. It is to prevent this method of failure that the formulas of the previous talk were given. As stated in the last talk, reinforced concrete posts are of a different classification and demand different mathematical treatment.

"When a load is applied at the top of a post in a line which does not coincide with the line downward thru the center of gravity of the

cross-section of the member, the post is said to be subjected to an eccentric loading. An example of this is shown in Fig. 6A. This represents an ordinary square timber post such as is used in any heavy timber construction. The load on the post in this case is carried on a steel or iron side bracket, thus putting the downward line of action of the load quite a distance to one side of the center line of the timber.

"The effect of such an eccentric load is of double importance. It causes a direct downward crushing action on the cross-section of the timber, and also a bending action due to the fact that the load is off-center. A graphical illustration of this effect is shown in Fig. 6B. The first figure (A) shows the effect of the load if distributed uniformly over the cross-section, each line representing graphically the intensity of the crushing stress on a square inch of area. This is found by dividing the total load on the post in pounds by the area of the cross-section in square inches. The second figure (B) shows the bending effect on the cross-section due to the fact that the load is supported to one side on the bracket. This effect on the post is to produce a compressive stress on the side of the cross-section near the load, and a tendency towards tension in the fibers of the material in the cross-section on the side of the center line away from the load. The condition is similar to that met in the cantilevers which we treated when we were studying beams in our earlier talks.

"Since neither one of these actions can occur separately in this case, a combination of the two must be the result. The third figure (C) shows this combination graphically and is formed by adding the compressive effects shown in (A) and (B), and subtracting the tension tendency on the right of (B) from the compression tendency on the right of (A).

"Thus it is seen that the effect of such a loading is to increase the compressive stress on the side of the post near the load, and decrease it on the opposite

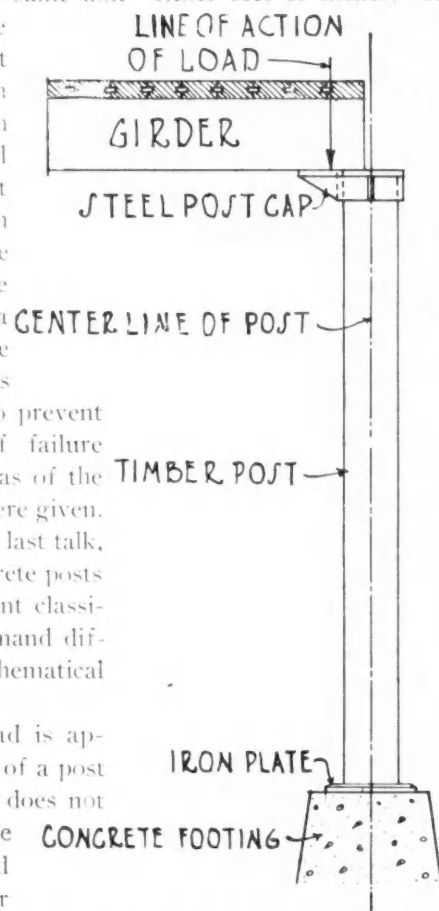

Fig. 6A. Post or Column with an Eccentric Load.

side. In fact, the load may be placed so far away from the center of the post that the material on the side away from the load may actually be put into a state of tension instead of compression, as is the case with posts under central loading. This condition should always be noted and may even be of serious importance, especially in the case of a material such as cast iron or brickwork which has a high compressive strength. The difference in strength on the two sides of the column may lead to a dangerous condition on the tension side, while the compression side is far within the limits of safety.

"The formulas for columns or posts with eccentric loads vary with the ratio of the length of the post and its least side dimension. We will consider two cases which will cover practically all conditions that you are likely to meet.

"The first case includes short posts and brick piers such as may be used in basements on similar places where the load is heavy and the length of the member is not greater than ten to fifteen times the least side dimension. A case of this kind is shown in Fig. 6C. Here an ordinary 13 by 13-inch brick pier bears a load at the top, but the line of action of the load is 2 inches to the right of the center line of the post. This load

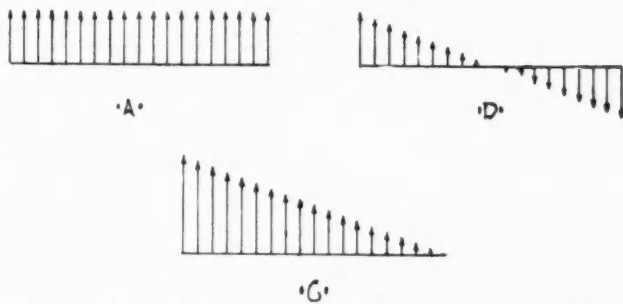

Fig. 6B. A Graphic Illustration of the Distribution of the Stresses on Post Cross-Section Under Eccentric Loading.

comes from the end of a floor beam which rests on an iron or steel plate placed on top of the brickwork. An examination of this pier will show that the greatest compressive stress will occur at the base of the pier, therefore the weight of the pier itself should be added into the weight carried by the pier when direct compressive action is considered. It may also be easily seen that the stress at the point D will be different than at B and that we could put the side B into actual tension by placing the load on the beam far enough away from the center of the pier. Such a proceeding is bad in the case of brickwork, since a tendency to open the joints at the base of the pier develops. The unit stresses at B and D should always be compressive, even if it is necessary to change the size of the pier or the location of the eccentric load.

"Two formulas will be given for the case shown in Fig. 6C. The first one will be for the unit stress at a point on the side of the pier under the load, and the second will be for the unit stress on the opposite side of the pier. The points D and B show these locations.

"For conditions at D, the unit stress may be found from the formula—

$$c = \frac{W}{A} + \frac{W_2 a e}{I}$$

where c is the unit compressive stress at D in pounds per square inch; W is the sum of the load on the pier and the weight of the pier, both in pounds; A is the area of the cross-section of the pier in square inches where the greatest unit stresses are likely to occur; W_2 is the load on top of the pier in pounds; a is the distance in inches from the line of action of the load at the top to the center line of the pier; e is one-half the side dimension of the pier in inches in the direction of the top load, and I is the moment of inertia of the cross-section of the pier in inch units about an axis passing thru the center of the pier and parallel to the side of the pier nearest the load. Values for I were given in a table in Talk No. 48 and should be referred to for use in the problem.

"We will consider that a load of 12,000 pounds is brought to the pier by the beam in Fig. 6C, and that the pier is 7 feet high. If brickwork weighs 120 pounds per cubic foot, then W_1 , the weight of the pier, will be nearly 1,000 pounds. Adding this to W_2 , we will have W equal to 13,000 pounds.

"Filling in the formula with the data given above, we will have—

$$c = \frac{13,000}{13 \times 13} + \frac{12,000 \times 2 \times 6\frac{1}{2}}{\frac{1}{12} \times 13 \times 13 \times 13 \times 13}$$

or, $c = 77 + 65\frac{1}{2} = 142\frac{1}{2}$ lbs. per sq. in. This is a safe value for the crushing strength of brickwork. The value of A is given as 13×13 square inches, and the value of I from the previous talk was $\frac{1}{12} \times 13 \times 13 \times 13 \times 13$.

"To investigate the amount of the unit stress on the side of the pier at B, we will subtract the bending effect from the direct compressive effect as shown at the right in (c) in the graphical diagrams in Fig. 6B. The formula needed to express this condition of stress will be as follows:

$$c = \frac{W}{A} - \frac{W_2 a e}{I}$$

If the values of the previous calculation are inserted, the value of c will be $77 - 65\frac{1}{2}$, or $11\frac{1}{2}$ lbs. per square inch.

"It is seen that this is still a compressive stress and will always be until the value of a in the second part of the right-hand side of the

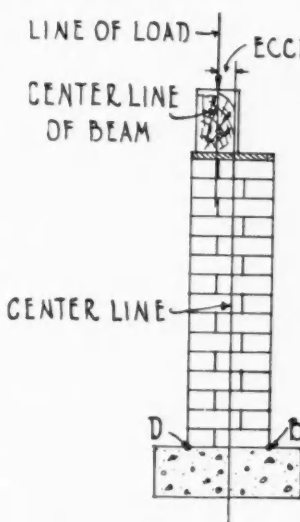
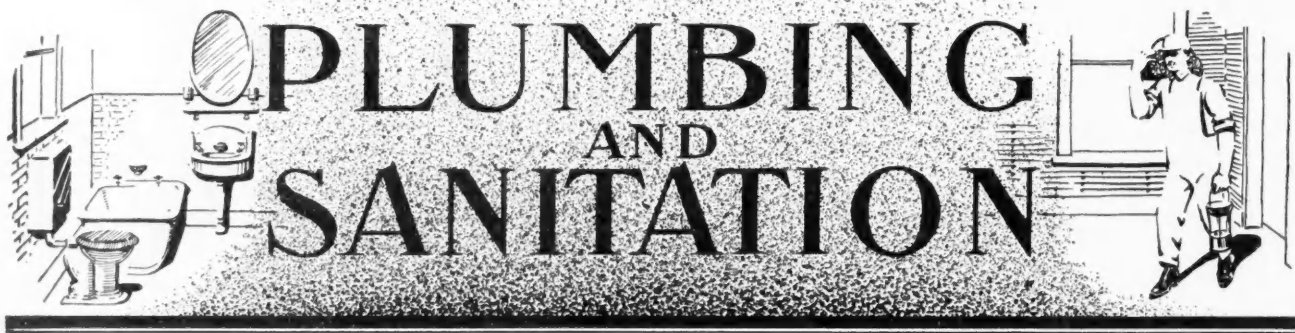

Fig. 6C. An Eccentric Load at Top of a Brick Pier.

(Continued to page 70.)



Sewage Disposal for Country Homes*

By F. M. White and E. G. Hastings

Of the University of Wisconsin College of Agriculture, Agricultural Extension Service.

FOR many years the city home has been supplied with certain conveniences that were thought impossible, or at least difficult, to supply for the country home. Most important among these are running water in the house and some safe and convenient way of disposing of the sewage of the home.

In some respects, it is easier to live in the city than in the country. This is especially true when it comes to furnishing a water supply and to disposing of the sewage. All the city man has to do to get water and dispose of the sewage is to connect his house with the water mains and the street sewers which, of course, requires but little effort and thought. As the farmer cannot have water mains and sewer pipes running past his yard he must plan and furnish his own plant, which must be complete by, and in, itself. At first thought this seems a considerable task, and one of uncertain cost.

The cost, however, is not as great as is commonly believed, nor are country water and sewage disposal plants so difficult to install. In fact, a sewage disposal system for a country home requires no greater expense than is needed to rid the city home of its sewage.

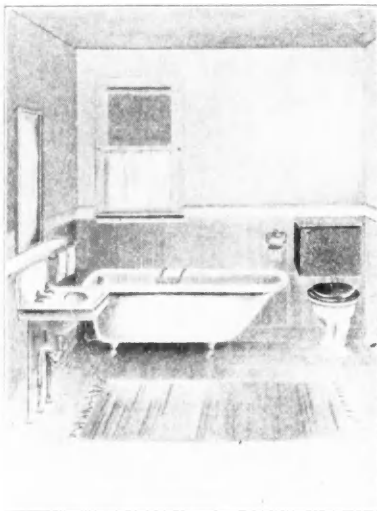

A PART OF A WELL EQUIPPED HOME—WHY NOT?
There is a lot of comfort to be found in having a well-equipped, convenient bathroom in the home. One will cost less to install than you think. Why not have one?

Don't Depend on the Cesspool

The older form of sewage disposal, which has been used to a considerable extent in city homes in districts not yet provided with sewers, consisted of a hole in the form of a cistern, with walls built of brick or stone without mortar. The sewage passed thru the walls into the soil and was more or

less completely decomposed. In very sandy soils such a cesspool might work for years, but denser soils soon would become clogged with the organic matter and the water would not readily leach away. The cesspool would fill up and have to be abandoned. According to the present rules of the Wisconsin State Board of Health, such a cesspool may not be used.

How the Waste Matter Decomposes

Household sewage consists of the water from kitchens and laundries, a small amount of organic matter and the human excreta, all of which, in a disposal system, is carried by water from the house.

It is well known that organic matter (material which comes from plants and animals) will disappear as such, when placed in the soil or in water. This waste material is attacked by bacteria, or very small forms of plants that grow in great abundance in the soil and in water. They use the organic matter as food, obtaining

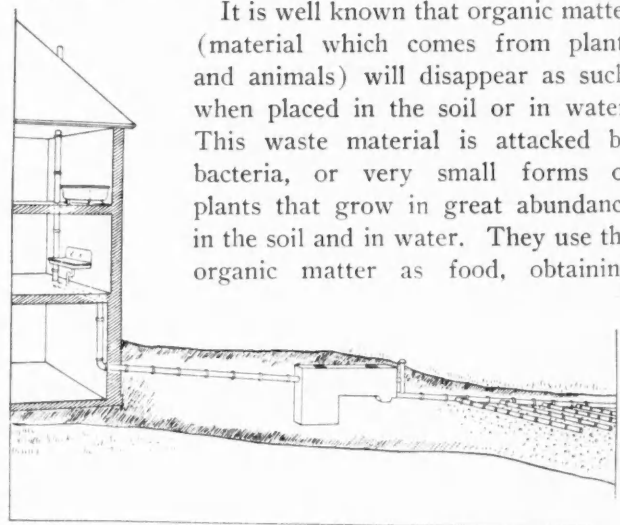

FIG. 2. A SAFE DISPOSAL OF HOUSEHOLD SEWAGE.
The waste from the house runs into the septic tank to be liquefied. It then runs into the underground tile, where it is absorbed and purified.

from it what is needed for their growth and the energy which is required in their life processes.

Two groups of bacteria aid in the decomposition, the second groups using as food the by-products or substances produced by the first. By the continued action of these bacteria, the organic matter is gradually changed to more and more simple forms and finally to water and such substances as carbon dioxide, sulphates, nitrates, and phosphates, which are used by green plants as food.

*Republished by permission from Circular No. 60, issued April, 1916, by the Wisconsin Agricultural Service. Copies may be obtained free by residents of that state.

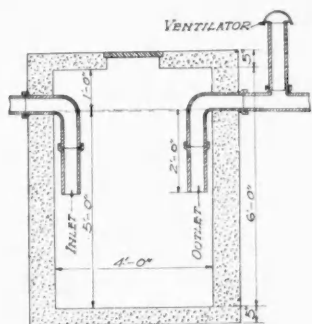

FIG. 3. A SINGLE CHAMBER SEPTIC TANK.

When this style of tank is used it is necessary to have it empty into a stream of running water. It requires a stream of considerable size or the water becomes polluted. The tank measures 3 feet wide and has an 8-inch concrete wall. The intake and outlet pipes are in the center of the end walls.

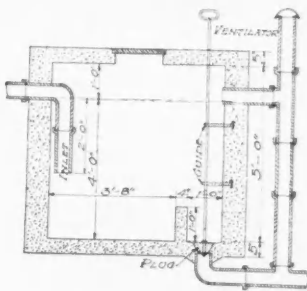

FIG. 4. ONE CHAMBER TANK USED WITH ABSORPTION SYSTEM.

The waste from this tank is disposed of by means of a tile absorption system. It is necessary to pull the plug every two days, making this an inconvenient style of tank. The tank is 3 feet wide inside measurement and the concrete is eight inches thick.

one of which is readily adaptable to the farm and village. Before any of these systems can be used, running water must be installed in the home, and to prevent the water pipes from freezing a central heating plant should be provided.

How to Make a Septic Tank

The container in which the first part of the process takes place is usually called a "septic tank." It should be of masonry construction and, so that it will not freeze in winter, should be placed below the surface of the ground or be surrounded with from three to four feet of earth. It should be of such a size that it will hold the sewage that, under average conditions, will accumulate in from 24 to 48 hours.

The single chamber tank (Fig. 3), is the simplest form of a sewage disposal system that can be installed. The tank is merely a chamber so arranged as to prevent the rapid movement of the sewage and in which the solid organic matter is so changed that most of it will be liquefied. The liquid coming from the tank is not pure or clear, but contains finely divided particles, and would soon "waterlog" any soil if allowed to flow continuously into it.

If the house is located within a short distance of a fairly large stream, which is not used as a source of water supply, the sewage from the tank may be carried into it by a line of glazed tile laid with cemented joints. Should the stream be one which has very little flow during dry summer months, the sewage will, because of the odor, produce a nuisance. As the necessary conditions cannot often be obtained this type of septic tank cannot be recommended generally.

A single chamber tank may also be used in connection with an absorption system which, thru tile, distributes the liquefied sewage in the soil. As there will

Since it is not usually convenient or safe to turn household sewage into a body of water, in which the organic matter will be decomposed unnoticed, it is necessary to provide some way in which the organisms that normally act in the soil can be used elsewhere.

Why a Tank is Needed

The first part of the decomposing process is caused by organisms that grow away from air, while the remainder of the work is done by organisms that demand a large amount of air. It is thus found convenient, under practical conditions, to provide a tank in which the sewage remains for a time away from the air, and then to allow the last steps in the process to take place in the soil where there is an abundance of air. Various arrangements, differing greatly in complexity and cost, have been used to secure these conditions.

In this paper are described three typical methods of installing the septic system of sewage disposal, any

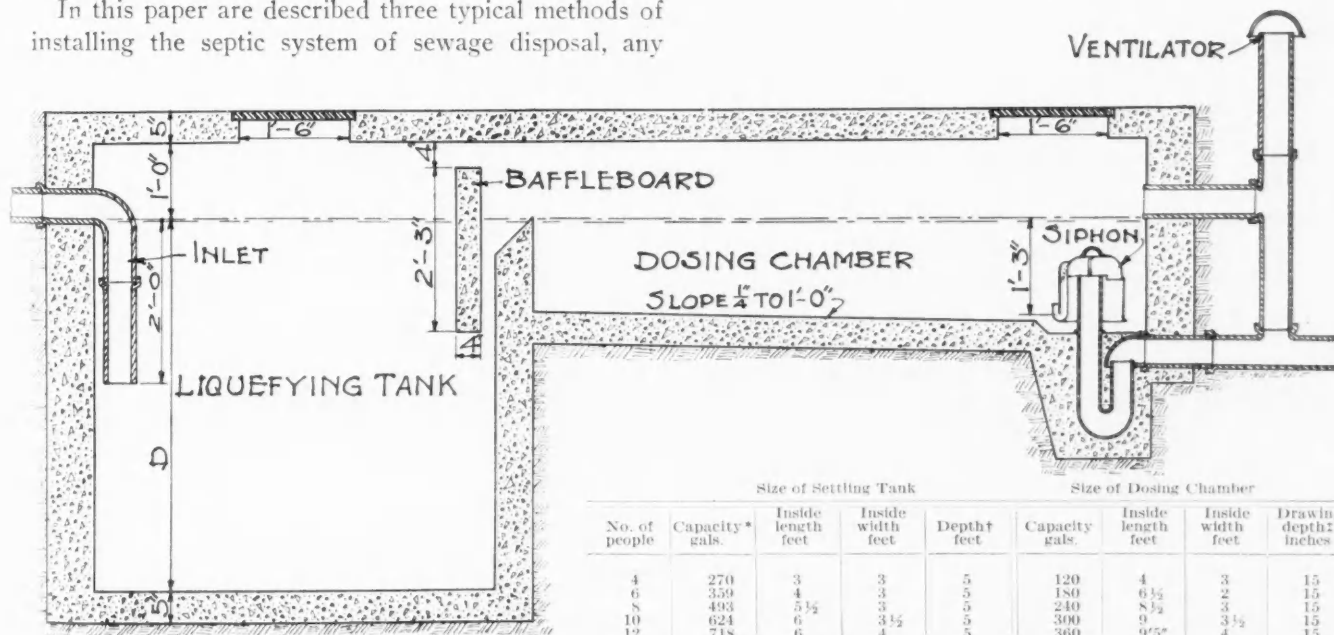

| No. of people | Capacity* gals. | Size of Settling Tank | | | Size of Dosing Chamber | | | |
|---------------|-----------------|-----------------------|-------------------|-------------|------------------------|--------------------|-------------------|-----------------------|
| | | Inside length feet | Inside width feet | Depth† feet | Capacity gals. | Inside length feet | Inside width feet | Drawing depth‡ inches |
| 4 | 270 | 3 | 3 | 5 | 120 | 4 | 3 | 15 |
| 6 | 359 | 4 | 3 | 5 | 180 | 6 1/2 | 2 | 15 |
| 8 | 493 | 5 1/2 | 3 | 5 | 240 | 8 1/2 | 3 | 15 |
| 10 | 624 | 6 | 3 1/2 | 5 | 300 | 9 | 3 1/2 | 15 |
| 12 | 718 | 6 | 4 | 5 | 360 | 9 5/8 | 4 | 15 |

*Capacity is given for a depth one foot less than specified to allow for sludge and scum
 †Below bottom of inlet. ‡Of siphon.

FIG. 5. STANDARD TWO CHAMBER SEPTIC TANK.

This siphon works automatically, emptying the tank whenever it reaches a certain level. It requires little or no attention. The size to build will depend upon the amount of sewage handled.

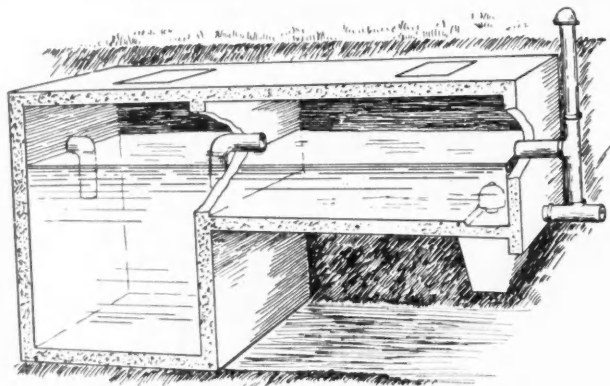

FIG. 6. INTERIOR OF TWO-CHAMBER TANK.

The two chambers may be connected either with a baffle board or by means of a tile. The second tank is shallow so that the system can be installed on level ground. The concrete walls are eight inches thick, the partition six inches thick. The capacity depends on the length and width of the tank.

be little mineral matter in household sewage, and as all the organic matter will be dissolved by the bacteria, the sludge or remaining solid matter will accumulate very slowly, making it necessary to clean the tank but once in several years.

In order to apply the sewage in intermittent doses it will be necessary to empty it every two days. This can be done by plugging the hole in the bottom of the tank and opening it every other day. An automatic siphon, described later, cannot be used in the single tank sewage disposal system, for the raw sewage would soon clog the siphon.

It would be impossible, in most cases, to install this system on small lots where there is little slope and expect to run into it the waste water from laundry tubs located in the basement. The laundry tubs would be so far below the level of the ground that the tile could not be placed in the upper two feet of soil so that the bacteria can purify the liquid.

One Chamber Type Not Wholly Satisfactory

While the single chamber type of septic tank is very simple and inexpensive, being built for \$25.00, including all labor and materials, it requires too frequent attention. The two chamber or compartment tanks are much more satisfactory.

The first chamber of a two compartment tank serves the same purpose as does the single tank. The second is merely a storage tank from which the liquid can be applied in intermittent doses so that the soil will not become waterlogged. The first chamber should hold about two days' flow and the second one day's flow. In order to prevent the scum, which forms on the surface of the liquid in the first chamber, from passing into the second chamber, a 6-inch pipe should be provided that extends eight inches below the surface of the sewage in the first compartment. A baffle board made of concrete or iron extending across the tank will answer the same purpose. As sewage enters the first compartment, a like amount will be discharged into the second, from which it is emptied by the siphon, which begins to act when the sewage has reached a certain depth in the second compartment. The second

compartment may be shallower than the first. This is often demanded on account of the slope of the ground.

The tank may be located close to the house, since the odors from it will not be objectionable. In case it is placed some distance from the house, 50 feet or more, it is desirable to have the waste from the kitchen sink first pass into a grease trap. The only object in this is to prevent the grease from stopping up the pipe leading from the house to the tank. This is likely to happen in cold weather if a considerable amount of fat is poured away in the dish water. If the tank is placed close to the house, no grease trap will be needed.

If the sewage from the tank is not to cause trouble, it must be discharged at intervals of 24 hours or more and be distributed thru a considerable area of soil. In this way before another quantity is applied, the water will have had a chance to leach away, the air to be drawn in and the bacteria given an opportunity to change the organic matter in the sewage into minerals that will be leached from the soil by the water. The soil will thus remain in such condition that the process can continue indefinitely; grass and other vegetation will grow luxuriantly and no objectionable features will ever be noticed. This explains why the tank must be emptied at intervals rather than constantly.

Soil Must Not be Waterlogged

Everyone has noticed that if waste water from the kitchen is thrown onto the ground in the same spot from day to day, the grass will soon die and the soil become waterlogged and has a bad odor. This is due to the fact that the soil is kept saturated with water and no air is present to favor the growth of the second group of bacteria. Without them the organic matter cannot be completely decomposed, hence it accumulates in the soil and kills all vegetation. The same will be true at the end of a kitchen drain which is flowing constantly. This creates a nuisance.

The general arrangement of the absorption system is shown in Fig. 8. The layout of the tile will depend entirely upon the contour or lay of the ground so that no exact arrangement can be given. The top of the tile should be placed in the ground from 10 to 24 inches below

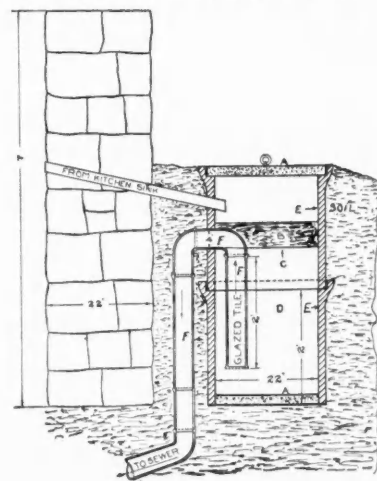

FIG. 7. PLAN OF A GREASE TRAP.

When the dish water and other kitchen wastes are emptied into the sewage system the grease may clog the tile leading to the septic tank. A grease trap prevents this trouble. A, A, concrete cover and bottom; B, grease floating on water; C, water level; D, occupied by water; E, E, glazed sewer tile 22 inches in diameter; F, F, F, 4-inch glazed sewer tile arranged so that the water and grease are separated; the grease being kept above the water and out of the sewer by placing the tile as shown in figure.

the surface of the ground as indicated in Fig. 9. It may be necessary to have the first few tile too deep in the ground to have them aid greatly in purifying the sewage. The character of the soil will govern the depth, to a certain extent, but the tile must not be laid too deep or else the final stages of purification will fail to take place because of insufficient supply of air.

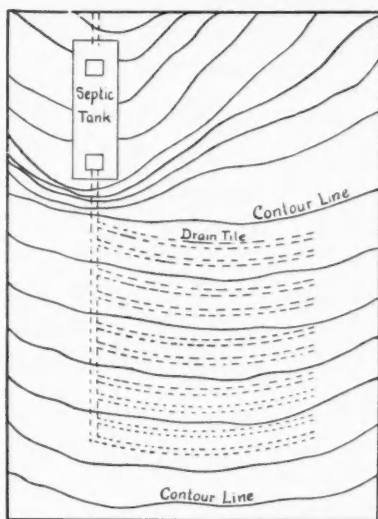

FIG. 8. TILE FOLLOWS SLOPE OF LAND.
The tile should follow the grade of the land. The tile are placed from 8 to 10 feet apart and should have six inches of fall in 100 feet.

When the tile is so arranged that the air has an opportunity to circulate around and thru them the absorption of the water and the bacterial action is hastened. In all installations, cinders or coarse gravel, should be laid around the tile (Fig. 9), more of this material being used in heavy than in light soils.

Double Tile System Sometimes Used

If there is an excess of water passing thru the tank, as may be the case when the washings from the dairy houses are run into it; in a very tight clay soil; or when the ground water is near the surface; a second line of tile should be laid below the first. The upper run of tile (See Fig. 10) is the true absorption system and is connected with the outlet of the septic tank. The other end is closed. The lower run of tile B, should be placed about one foot below and from 3 to 5 feet to one side of the absorption tile. These tile are closed at the end next to the septic tank and may empty into the general farm drainage system, a combination rock and gravel dry well, or a small stream.

The disposal tile in the absorption system should not have very much fall, otherwise the water will all rush to the outer end and in a short time the soil at the end of the system will become water-logged. The fall should vary from 4 inches in 100 feet in a tight clay to 8 inches in 100 feet in a sandy soil.

The tile used for the absorption system are the ordinary 4-inch farm drain tile and should be laid about $\frac{1}{4}$ inch apart. Broken pieces of tile should be placed over each joint as a cap to prevent loose sand and dirt from filtering into the system. One foot of 4-inch tile should be provided for every gallon of water discharged into the system. In the case of heavy clay soils 2 feet of tile to the gallon should be provided together with the double tile system.

The tile will work even when the ground is frozen. A considerable quantity of sewage will be emptied

into the tile at once and before it has time to freeze, it will have drained out of the tile and into the soil, from which it will likewise leach away.

On very level land it may be impossible to dispose of sewage thru an absorption system. Under these conditions the sewage from the septic tank can be discharged into a "dry well." The dry well ought to be at least 100 feet from a surface well.

The Automatic Siphon

While the automatic siphon is not a necessity in a sewage disposal system, yet the pulling of a plug to empty the tank every other day is uncertain at best. The automatic siphon requires no attention and is easily installed. It insures the emptying of the tank at the moment the liquid in the dosing or second chamber reaches a certain point.

As the working depth cannot be varied on the siphon, careful attention must be given to placing the siphon according to directions given by the manu-

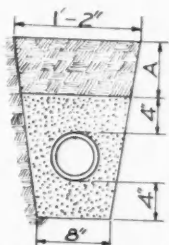

FIG. 9. SINGLE TILE SYSTEM.
A 4-inch drain tile surrounded by cinders or gravel works best. The joints are not fitted closely.

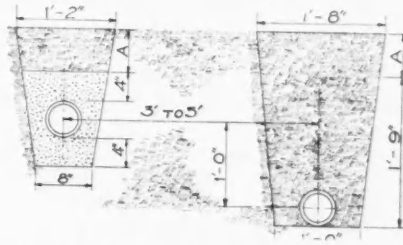

FIG. 10. DOUBLE TILE ABSORPTION SYSTEM.
It is sometimes necessary to use the double tile absorption system in heavy clay or moist soils, where the condition of the ground does not afford sufficient drainage for a single tile. A varies from 6 to 20 inches.

facturer. A 3-inch automatic siphon is the size suitable for the average system.

Some Questions and Answers on Sewage Disposal

1. "Why not use a cesspool?"—The cesspool is condemned by all who know of the trouble and danger connected with its use. The sewage from a cesspool is not purified to any considerable extent so that there is danger of contaminating a near-by water supply. The cesspool cannot be expected to last

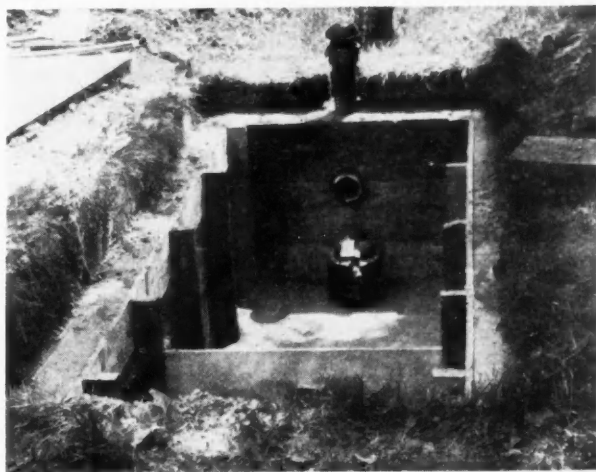

FIG. 11. A SEPTIC TANK IS EASY TO BUILD.
The forms are easily made but need to be well braced. (Note the placing of the siphon. It works automatically.)

indefinitely. When it fills up it may be cleaned out, but will never give satisfactory results for any length of time. The cost of the cesspool is very little, if any lower than a septic tank.

2. "Will a septic tank contaminate a well?"—Not from the tank itself, but there is danger from the absorption system if laid too close to the well. Much depends upon the character of the soil. To be on the safe side the absorption system should be at least 100 feet from a surface well. There is practically no danger of contaminating a "driven" or a deep well.

3. "Is the water pure after it goes thru the tank?"—No, not until it passes thru the absorption system.

4. "Will the septic tank and absorption system freeze in winter?"—No, the tank is constantly supplied with warm water from the house. The sewage going into the tile is warm. Experience has shown that there is no danger from frost in Wisconsin if the directions given are carefully followed.

5. "Why use an automatic siphon?"—The sewage must be applied in intermittent doses, otherwise the absorption system will become waterlogged. Pulling a plug is very uncertain and should not be depended upon.

6. "How would it be possible to provide a successful absorption system in certain sections where the soil is practically impervious?"—It is very exceptional to find conditions where the soil will not take care of the sewage emptied into it by an absorption system. The double tile absorption system, previously described, will best meet the needs under such conditions.

7. "If the water level is within one to two feet of the surface of the ground, would an absorption system give satisfactory results?"—No, the water level must be lowered by tile drains. The double tile absorption system should be installed and the lower tile connected with the drainage system.

8. "What becomes of the sewage in a sewage disposal system?"—The bacteria which live in the septic tank and the soil change it into harmless clear water.

9. "What is the advantage of the two-chamber septic tank?"—This type of tank can be installed on a small, rather level piece of ground, and prevents the placing of tile near the surface of the ground where more of the soil purifying organisms live. Also the automatic siphon can be used which relieves the owner from having to give the system constant attention.

It should be recognized that a tank similar to that described in these pages can be constructed by the farmer himself with ordinary help, after the necessary plumbing is installed in the house. It is certain that it will add much to the convenience and health of the farm home.



DO you operate a power woodworker?—or do you know anything about running a power shop? We want your assistance. See page 35.—EDITOR.

Posts and Columns

(Continued from page 65.)

formula becomes so large that the second part becomes larger than the first part of the righthand side.

"The limiting value of a in order that tension may not occur at B , will be found by placing c equal to zero in the last formula and solving for a . If this substitution is made, we find a as follows:

$$0 = \frac{13,000}{13 \times 13} - \frac{12,000 \times a \times 6\frac{1}{2}}{\frac{1}{12} \times 13 \times 13 \times 13 \times 13}$$

$$= 77 - 32.8a$$

Then $32.8a = 77$, or $a = 2\frac{5}{16}$ inches (nearly). This means that if the center of the beam carrying the load had been about $\frac{5}{16}$ of an inch farther away from the center of the pier there would have been a tendency for the mortar joints on the other side of the pier to open up.

"If the tension calculations had been made for a section at the top of the pier instead of at the bottom, the compressive stress due to the weight of the pier would disappear and the 77 value in the calculations

would be changed to $\frac{12,000}{13 \times 13}$, or 71. This would

reduce the unit compression on the B side of the pier and also change the value of $a = 2\frac{5}{16}$ inches to about $2\frac{5}{32}$ inches.

"Next time," said the Boss, "we will investigate the second kind of column referred to above, or a long column or post with an eccentric load."



Building a Platform Stair

(Continued from page 63.)

platform risers 5, 6 and 11, 12 being perpendicular to one another, as shown in Fig. 7, upon the newel posts.

It will be best to have the additional length in a straight piece, as shown at X, so that all the curves be made uniform and one template suffice for all.

Regarding the newels, their position in relation to the steps and rails, respectively, as shown in the figure, so definitely determines the length of each one as to make explanation unnecessary. If made to a scale of $1\frac{1}{4}$ inches to the foot, it will be large enough to guarantee accurate measurements.

However, in practice, each newel is treated separately and made full size, making use of the steps adjoining only.

A method in use to mark the grooves for the stringers and steps is shown in Fig. 11. It consists in unfolding the sides of the newel, as shown at A, B, C, D, the measurements of the grooves for each side being taken from the plan, Fig. 6, as there shown upon the top platform newel.

This method is especially of value to a beginner to avoid mismarking, which happens to many old hands that occasionally allow themselves to be careless.

FARM BUILDINGS

Arranged For Convenience

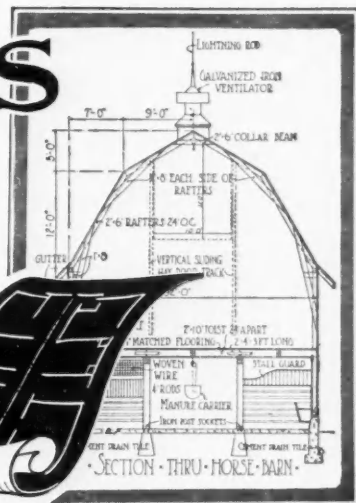
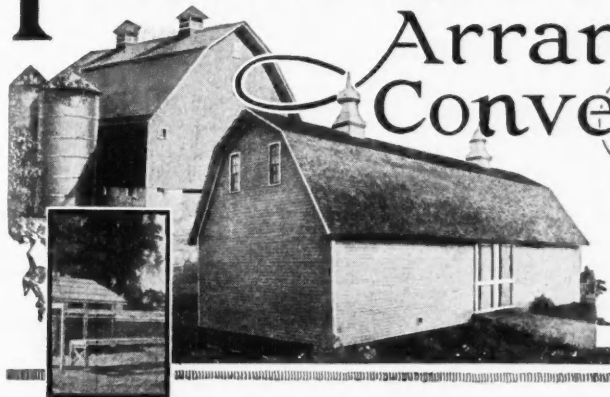

Small Barn for Small Farm

A general purpose barn for a farm of 20 or more acres is shown in Design A332. It is 30 by 28 feet in size and is built to stable eight cows and four horses.

The barn has a concrete foundation wall and a concrete floor. The stalls are of the approved kind used in the best dairy stables. The stanchions are of the turning or swinging pattern, and the stall partitions are of iron. Each cow stall is three feet three inches wide. This width measures out even, and it is about right for the average cow.

board partition that reaches to the ceiling. The two doors opening into the horse end of the barn are hung with weights, so they always pull shut. Most farmers like to have the horses and cows entirely separate.

The ceiling over the horse department is 9 feet in height. The ceiling over the cow stable is the same level, but the cow stable floor is built differently so that the head room over the feed alley is only a little over 8 feet. Eight feet of head room in a cow stable is about right for ventilation, but most horsemen prefer a nine-foot ceiling in a horse stable.

Over the stable is a good sized mow which is used for hay and bedding, put in with a horse fork through the large door in the end. The hay and straw are let down through a chute which opens into the horse stable near the center partition to avoid scattering dust through the cow stable.

Horses probably do not enjoy breathing dust any more than cows. Milk is injured by bacteria that float about the room on dust particles. In large stables special provision is made for handling hay and straw to avoid contamination from the dust.

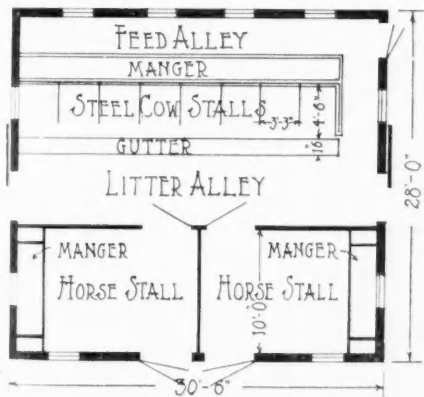

Ground floor plan of 30' 6" by 28' barn No. A332.

The length of the floor from the manger to the gutter is four feet 6 inches. The gutter is 16 inches wide. These sizes are about what dairymen prefer, although there are dairy farms where the cows average extra large. For instance, some Holstein breeders prefer large cows and they breed with that end in view.

In building a dairy stable a dairyman is governed by local conditions. The stalls given in this plan are plenty wide and long enough for Jerseys or other breeds of cows weighing up to 1,000 pounds.

The alleyway in the center of this stable is built wide to drive through with the manure spreader and for the handling of bedding and other litter.

The horse department is partitioned away from the cow stable by a good



Small, compact barn to house 8 cows and 2 teams of horses. We can furnish complete set of blue printed working plans and typewritten specifications for only \$4.00 per set. When ordering, ask for Design No. A332.

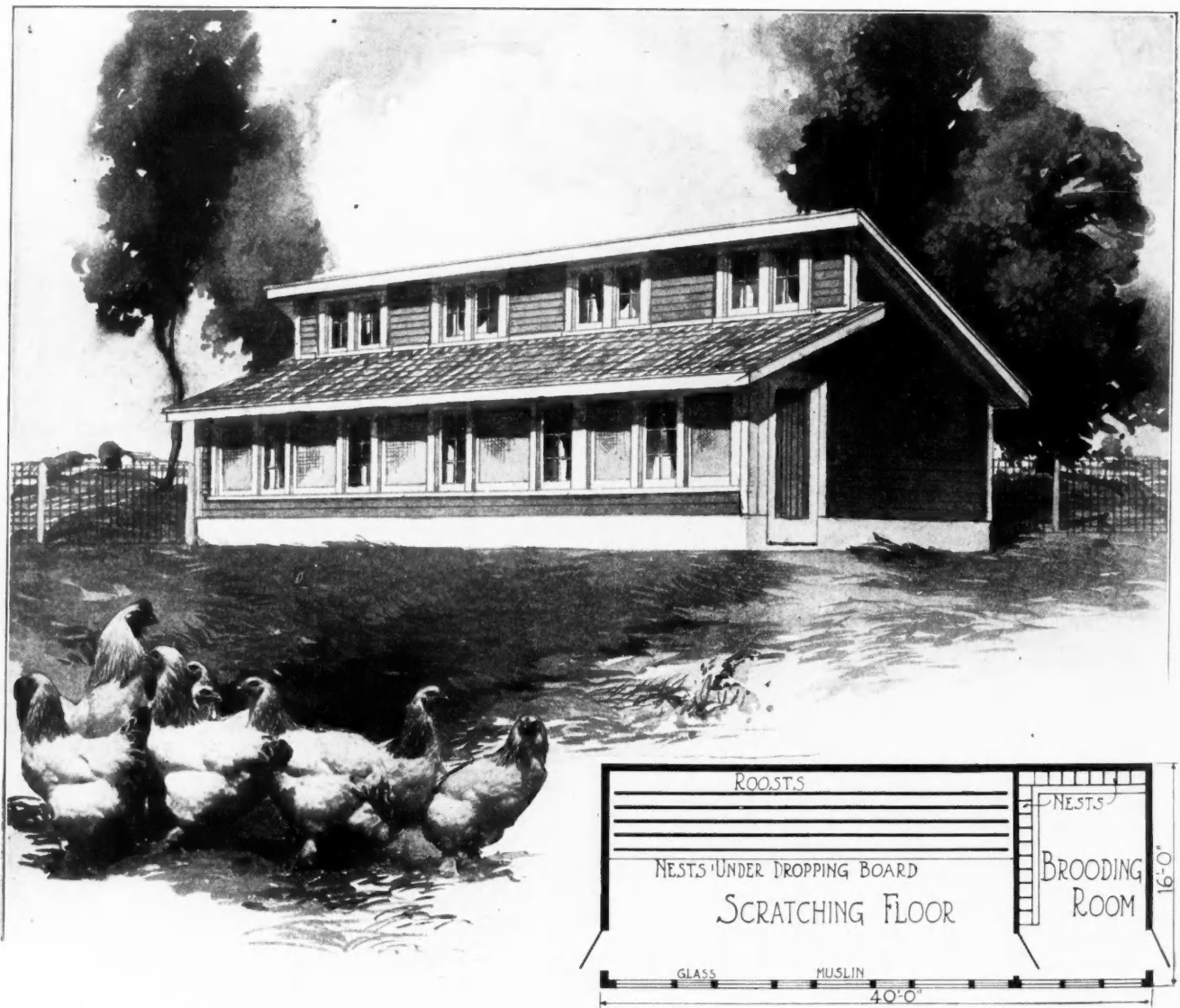

Combined poultry and brooder house. Size, 40 by 16 feet. We can furnish complete set of blue printed working plans and typewritten specifications for only \$5.00 per set. When ordering, ask for Design No. A324.

Combined Poultry and Incubator House

A solid, well-built poultry house, 40 by 16 feet, is shown in Design A324.

It is built higher than other poultry houses and is fitted with high windows to let in the sunshine in the winter time. These windows are hinged at the top and are fitted with ropes and pulleys, so that any one or all of them may be opened according to the condition of the weather. Outside the upper window openings are covered with wire netting to prevent fowls from flying out when the windows are open.

Like all other good poultry houses the foundation is of concrete with a floor that is ratproof. One of the greatest advantages of concrete in any climate is that it discourages rats and other vermin. This fact applies with greater emphasis in the south.

The manner in which poultry scatter the grain offers special encouragement for rats and mice to burrow and make their nests under or close to a poultry house, for they get a variety of food and there always is water, so that rats and mice find the most ideal conditions

to make rat life pleasant. The greatest rodent discourager ever invented is concrete.

The building of the poultry house above the foundation walls is better made of wood if the work is well done.

Poultry houses demand special attention to see that the building is constructed for easy cleaning. Poultry carelessly housed are infested with insects. The warm days of spring and summer help to bring out colonies of the same kinds of trouble by extending the breeding season. Unless a poultry house is well built vermin will infest the fowls at night and hide in the cracks in the building by day and it is almost impossible to get rid of them.

For this reason a smooth inside finish is recommended, built in such a way as to exclude first all kinds of poultry mites and lice. The material should be suitable for spraying with crude oil or whitewash, or other liquid disinfectant. Also it is very necessary that the inside surface shall be free from open joints. Carelessness on the inside of a poultry house leads to endless trouble.

A poultry house must be so constructed as to keep the fowls warm in winter.

Our Popular Farm Barn

A well built general farm barn, 34 feet in width by 52 feet in length, is shown in Design A343. It is well liked on moderate sized farms where 20 or 30 head of horses and cattle stock are kept during the winter.

When this barn is built in the colder sections well to the north, particular attention is given to the walls and ceiling of the lower story.

There is a concrete foundation which reaches down from 3 to 3½ feet into the ground and extends up just above grade. The connection between the concrete foundation and the built up plank barn sills are made in such a way as to prevent draughts of cold air. Sometimes two half inch furring strips are nailed to the underside of the lower plank in the sill. Fresh cement mortar is spread on top of the wall and the plank sill is pressed down into the soft mortar, so that the two furring strips act as stops to make a joint that is absolutely air tight.

It is better to lay the sills several days before putting up the studding to give the cement mortar time to set and become solid before nailing the bottom

ends of the studding into the sill.

The water table reaches down about an inch below the bottom of the sill and if the work is well done it fits close against the outer surface of the concrete wall, which also helps to make an air tight sill joint.

Outside of the studding there is a layer of building paper that is carefully fitted around each door frame and window frame. It is cut into shape instead of depending on tearing the strips. Pieces are also cut and fitted in where necessary to make the proper connection without leaving any chinks or cracks to admit cold air.

Inside of the studding the stable is finished very much in the same way. The only difference is that plain matched ceiling is used, put on in narrow widths and well nailed to the studding and joists.

The joists rest on furring strips, which are gaged into the studding about $\frac{7}{8}$ of an inch, so that the outside of the furring strips come even with the surface of the boarding, thus making a square corner where the side walls join the ceiling.

The floor of the storage barn is built in the same way except that regular dressed and matched flooring is laid over the building paper and is blind nailed to the joists. To make a stable ceiling with a floor overhead in this manner requires that the joists shall be resawed to bring them all to the same size, but the work when finished makes a stable that is practically air tight and the benefit is noticed both in cold weather and hot weather.

A stable built in this way to be com-

fortable and practical requires a good ventilating system to supply fresh air and remove foul air. This plan provides for intake pipes in the outside walls and foul air shafts in the center partition, which connect with the cupola on top to draw the foul air from near the stable floor and to send it out through the roof. Careful work like this ensures a dry warm stable in winter and a dry cool stable in summer.

The reason why ordinary stables are damp is that air becomes saturated with moisture from the breath of so many animals. Some means to carry off the dampness together with the impurities is necessary.

No other plan equals the one described in this design. The stable is cooled at night in the summer time by leaving

the upper one-half of the dutch doors open. They should be closed up before the sun gets hot in the morning. The stable will then remain cool all day.

There is a great deal of room for feed in this barn when the big mow and silo are filled, so that fodder is convenient and may be dealt out comfortably under cover in stormy weather.

The feed room between the dairy stable and the silo answers for both hay and silage. The hay goes into storage through the big hay doors by means of a horse fork and the same device carries it back to the feed room chute when it is wanted for feeding. This idea works the horse fork in winter as well as in summer.

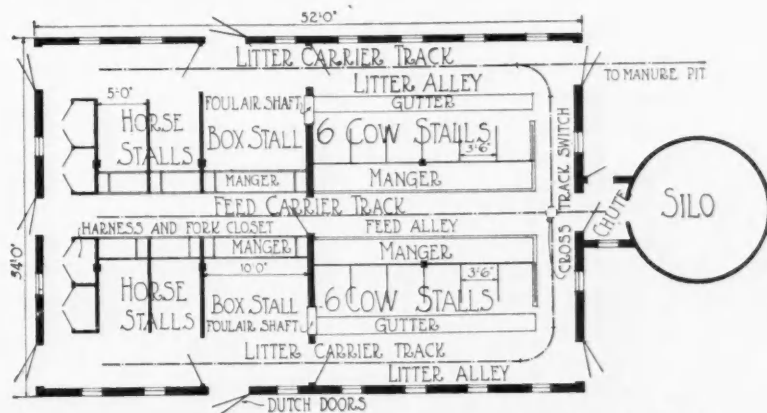

Ground floor plan of 52' by 34' farm barn, Design No. A343.



Our popular farm barn measuring 52 by 34 feet on the ground. Arranged to stable 12 cows and 14 horses. We can furnish complete set of blue

Printed working plans and typewritten specifications for only \$8.00 per set. When ordering, ask for Design No. A343.

Getting Property Back After It Has Been Put In Somebody Else's Name

By Elton J. Buckley

Attorney-at-Law.

EVERY reader of this article who has real or personal property in somebody else's name, or who is liable to have, will be interested in the following. For obvious reasons I do not give the name and address of the writer:

Here is a ticklish situation, which by common consent of all of the members of this firm, we are putting before you. About two years ago one of the members of this firm became involved in a way which I need not go into, and it seemed advisable that he transfer everything he had to his wife's name. That included some real estate, some stocks, and his partnership interest in this business. In fact, the other members insisted that he do this, not wishing to see the business involved in a purely personal matter. The transfer was therefore made and for two years this partner's wife has been the legal owner of all his interests. There was no change otherwise, the partner himself getting the rents and the profits.

A difficulty has now developed between the partner and his wife, and she refuses to retransfer any of her holdings. She has also served notice on us, through a lawyer, not to pay any share of the profits of the business to anybody but her. Our lawyer says she has a right to do this. Meanwhile her husband, who I may say is an extremely valuable member of this partnership, is getting disgruntled at our statement that we shall have to pay the profits to his wife, and altogether it is an uncomfortable situation. Can you suggest any way to straighten it out?

I am not at all sure that it can be straightened out in the way this firm wants it to be. This is just another illustration of the danger of putting your property in the name of another. I have seen it done so often—husbands putting their property in the names of their wives; parents in the names of children; men in the names of brothers and sisters, and so on. Of course everybody assumes that the people to whom the property is transferred will do the right thing and give it back when it is called for, and most of them do, perhaps. But there is always a chance that they may not, and when they do not, a very serious situation may develop. Holding property has a peculiar and unfortunate effect sometimes on people, especially people who have not been accustomed to hold it.

Not long ago I was interested in a case in which a husband went into court with a petition to compel his wife to turn over to him certain building association shares, certain bank books, and certain bank accounts. He foolishly had turned over control of everything to her. She handled it entirely as if it was her own individual property, and spent most of it, as it afterward developed, entertaining other men. When the break came she refused to turn over what was left, hence the petition. The case has not yet been decided, and the issue is therefore uncertain. I predict, how-

ever, that he will get his injunction.

Now getting back to the correspondent's case, the only hope for the partner who is tied up is to take the same course, i. e., apply to the court for an order commanding his wife to turn over the property to him. Whether he will get it depends upon several things.

Was the property turned over to protect it from his creditors? If it was, he will probably not get it back now, for the court would say that he perpetrated a fraud upon his creditors, and they will not help him to get out of it now. But even if the court did make the wife turn it over it would probably do him no good, for it would then come within his creditors' reach again. If it was not turned over to protect it from his creditors, he still may not get it back, if the court thinks he intended to give it to his wife. It is of course perfectly legal for a man to make a gift to his wife, and if he does it he cannot take it back again. He would have to prove that it was not intended as a gift before the court would think of making the wife give it back.

The owner of property who has put it in somebody else's name can get it back under practically one condition only—if he can prove that it was put in somebody else's name for perfectly legitimate reasons upon the arrangement that the person to whom it was transferred was to act as trustee for the real owner. If that can be proven, the trustee will never be permitted to claim the property as his or her own, for that would be a gross fraud.

How can that be proven? It always ought to be proven by a written trust agreement. Such matters should never be left to verbal understandings, speaking especially from the standpoint of the actual owner, for it is he that runs the risk rather than the other man. There ought to be a carefully drawn agreement stating why the property is turned over, describing it, and on what conditions it is to be turned back. In many cases this is not done because it would defeat the object of the owner, which is to place his property beyond his creditors' reach. Where a man merely transfers his property to a trustee, he continues to have an interest in it, and his creditors can reach it. But where he does the other thing, and makes an absolute transfer without any tangible string to it, he always runs the risk, as I have pointed out, of not being able to get it back. It is always a risky matter to turn property over to another merely to keep your creditors from getting it.

(Copyright by Elton J. Buckley.)



Methods of Covering a Curved Surface with Beveled Siding

By Edward H. Crussell

COVERING a circular tower, or corner, or a semicircular bay window with beveled siding, is a theme that has received considerable attention from the technical writer, yet every once in a while we hear a call for help from someone who has either missed the instruction or been unable to understand it.

The difficulty of putting beveled siding on a curved surface arises from the fact that the siding does not lie flat on the surface, but is held at an angle by the upper portion of the piece of siding immediately below it. This angle at which the siding is held, changes the surface—or rather, the back of the siding—from cylindrical to conical form, and the lower edge of the siding must be cut to a convex curve if it is to show a horizontal line when in place.

The method of finding the radius of this curve

as usually described, is shown in Fig. 1. Project the line of the back surface of one row of siding upward until it intersects the center line of the tower, or until it intersects the line of the same row of siding from the other side of the tower. This point will give the length of the radius rod for marking the curve to which the lower edge of the siding must be cut. Mention should be made of the fact that if Fig. 1 had been correctly drawn to scale, the lines representing the radius rod, would have run clear up to the top of the page and stuck out beyond it like a flag staff from an upper balcony on the 4th of July.

The writer knew of this rule a long time before he ever had occasion to apply it in practice, and was rather startled the first time he attempted to apply it, to find that he needed a radius rod over 100 feet long. That this is not an exaggerated length of rod, the reader can easily prove for himself by an examination of Fig. 2, which gives a much easier way of finding the length of the radius.

This method of obtaining the true radius should be at once evident to anyone who has ever calculated the true length of a common rafter by first finding the length for one foot run and then multiplying by the number of feet in the run.

In the diagram we can at once see that for every

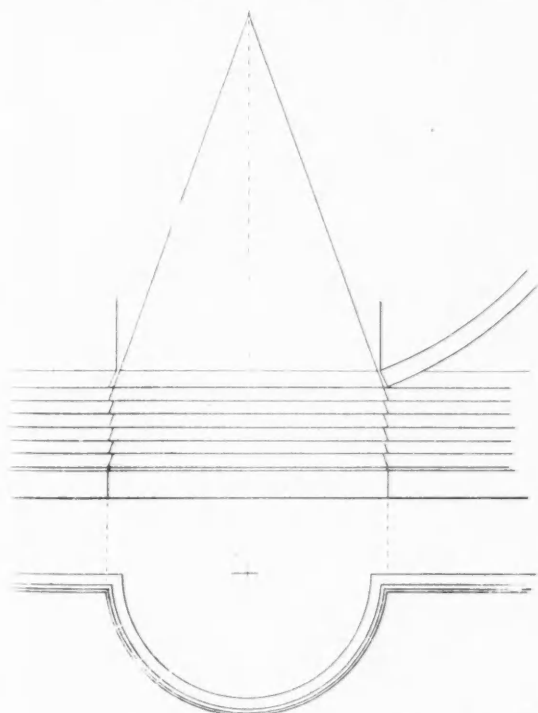

Fig. 1. Plan and Part Elevation of Semicircular Bay Window, Showing One Method of Finding Length of Radius Rod. Not Drawn to Scale.

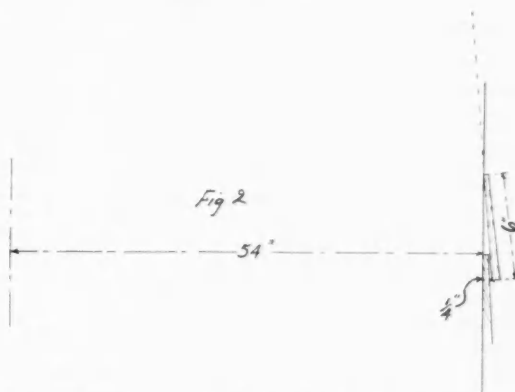

Fig. 2. Another Method of Finding Length of Radius Rod.

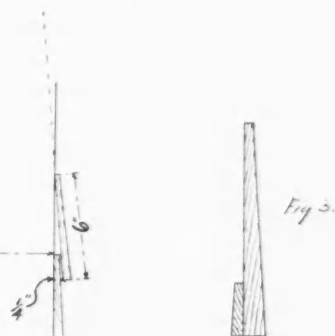

Fig. 3. Section of Beveled Siding, with Strip Tacked on Back, Ready to be Bent Around Circle.

$\frac{1}{4}$ inch of the short radius, we get 6 inches as the length of the true radius; or in roof framing terms, for every $\frac{1}{4}$ inch run, 6 inches as the true length of the rafter, and a little simple arithmetic will at once show us, that under the conditions pictured in Fig. 2, that is, 6-inch siding held at $\frac{1}{4}$ inch from the vertical on a radius of 4 feet 6 inches. The length of the radius to which the siding must be cut is 108 feet 6 inches. Is it necessary for the writer to say anything more in an effort to prove this method impractical?

The practical method is to take a straight piece of siding, and to the lower edge of it on the rear side, tack a strip of wood of the same thickness as that portion of the siding which is covered by the "lap," as shown in Fig. 3. Now, bend this prepared piece of siding around the tower, keeping the two ends level, and scribe a horizontal line on the lower edge of it, marking from the base as watertable.

This will give us the shape to which the siding is to be cut, but far from being the end of our troubles, it is only the beginning of them. A moment's reflection will show that a beveled siding is considerably thinner on the upper edge, as soon as we commence cutting anything off the bottom of it we reduce it in thickness and if much is taken off the siding near every joint will show hollow on the surface. The only remedy is to cut the siding in short lengths which is objectionable.

Fortunately, most of the surface of these circular corners or bays, is often taken up with windows so that the amount of curved material needed is only a few pieces which can quite easily be made with draw-knife and plane from some square-edged boards of the proper thickness. The boards, of course, being cut to the proper curve before they are beveled. Or again, where only a few curved pieces are needed, and a large supply of siding is on hand, it is sometimes possible to pick out a few crooked pieces of siding that have just about the right curve for our purpose.

Where much curved surface is to be covered, the easiest and indeed only logical way is to procure a sufficient quantity of rabbeted siding that will have the same appearance as the beveled siding when it is in place. The back of the rabbeted siding will, of course, lie flat on the tower and by using it we overcome, or rather sidestep, all the difficulties attending the use of the beveled material.

If the architects who design wooden buildings with round corners, would specify that rabbeted material was to be used for the curved portions of the wall surface, it would make life easier for the man in charge of the job.

There is one more point in connection with this work which it can do no harm to mention, altho it is obvious to the experienced workman, viz: Put the piece of siding on the curved surface first then scribe and fit the piece for the straight wall and butt it against it.—3917 Ames Ave., Sacramento, Cal.

Protection for Packages and Milk

By C. D. Gilbert

AMONG the conveniences being added to modern apartments and houses is provision for protection to packages and milk. Sanitary considerations demand that milk and provisions should not be exposed to heat and cold and to the visits of animals and insects.

The illustrations show a simple arrangement con-

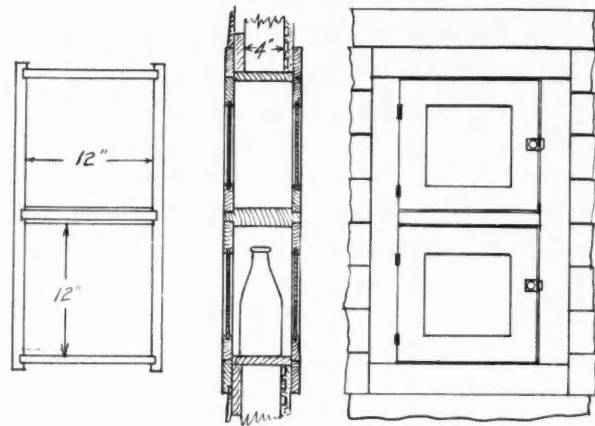

Fig. 1. Details of a Double Cupboard Adapted to Two Families.

sisting of a small frame provided with doors opening on the porch and inside the house. Figure 1 gives construction details for a double cupboard adapted to two-family houses.

The frame can be made of $\frac{7}{8}$ -inch lumber except the middle shelf, which is $1\frac{3}{4}$ -inch stock, rebated for jambs. The casings form the remainder of the jamb.

The size shown will fit between studs and easily receive a milk bottle.

Figure 2 shows a different arrangement. The brick



Fig. 2. Box for Sliding Cupboard Which May be Drawn up to the Second Floor.

vener house permits a deeper box, and the one illustrated was arranged with a sliding cupboard counterbalanced with a sash weight to be drawn up to the second floor.

Variations of the same idea will readily suggest themselves to suit circumstances.



Repairing Leaks in Concrete Tanks and Cisterns

SIMPLE DIRECTIONS FOR DOING THIS WORK

By H. Colin Campbell, C. E.

LEAKY concrete troughs, tanks or cisterns result from one or more of several conditions: The concrete mixture may not have been properly proportioned so as to reduce voids to a minimum; too little water may have been used, thus making it impossible to puddle the concrete in the forms to maximum density; too little reinforcing may have been used, resulting in cracks due to settlement, earth pressure, or expansion under temperature changes; or the concreting may not have been carried on continuously, thus producing construction joints or seams through which leakage could take place. Although prevention is better than cure, nevertheless some of these faults of construction can, in a measure, be remedied by various treatments.

When leakage from a cistern or a tank consists merely of slight seepage of contents through the walls, a coating of cement plaster may be applied to the interior of the tank as a preventive. Preparatory to applying this coating, the surface to be treated should be thoroly cleansed by scrubbing with a good stiff brush, and water, or better still, wash the surface with a solution of 1 part of hydrochloric acid to 3 or 4 parts water, allowing this to remain for a few moments and then thoroly rinsing off the concrete surface with clean water. The acid treatment will remove the cement coating from the particles of sand, thus exposing clean surfaces, to which the cement plaster will more readily bond or adhere.

Immediately before applying the cement plaster, the cleansed surface should be painted with a grout of neat cement mortar mixed to the consistency of cream. This grout can be applied with an ordinary brush, but should not be used very far in advance of the plastering, so that the grout paint will not have had opportunity to commence hardening before the plaster is applied.

Plastering mortar for this purpose should be mixed in the proportion 1:1½. No more mortar should be mixed than can be used within 30 minutes. It can be applied with a steel trowel and the surface should subsequently be worked thoroly as soon as possible with a wood float, to make a dense, impervious coating. Final finishing may be done with a steel trowel. After having finished the plastering, the

surface must be protected from too rapid drying out, by being kept wet for several days to insure uniform curing or hardening of the mortar, and hence preventing cracks.

Another method sometimes used to repair leaky tank walls consists in applying to the inside of the structure a solution of what is known as sodium silicate, commercially called "water glass." This chemical is dissolved in water in the proportion of 1 part silicate to 3 or 4 parts of water, depending upon the porosity of the wall surface. Two or three coats of this solution applied at intervals of 24 hours may be necessary to fill up the pores in the concrete. Effectiveness of the sodium silicate application depends upon a chemical combination between the silicate and alkalis present in the concrete, resulting in the formation of insoluble compound.

Cracks in tank, trough or cistern walls may sometimes be repaired by cutting out on each side of the crack so as to form a V-shaped groove, say 1½ inches deep and about an inch wide at the surface. After having been thoroly cleansed out, this groove may be calked with oakum soaked in tar, so that about one-half of its depth is filled. The remainder of the groove should be filled with cement mortar mixed 1:2. Or, after having calked the bottom of the crack with oakum, a plastic mixture consisting of pine tar and Portland cement combined in proportions so as to make a paste as stiff as can be conveniently handled, can be worked into the groove. This preparation may harden slightly while being used, but can be kept plastic by subjecting it to moderate heat in the metal receptacle in which mixed.

Where cracks are due to insufficient reinforcing or to lack of reinforcing, the repair methods suggested will be of little or no avail. About all that can be done in such case is to build a new structure or at best, to use the old one as an inner or outer form and deposit a new shell of concrete inside or outside of the old structure. This may be from 2 to 4 or more inches thick, depending upon conditions, and to prevent a recurrence of the cracking, should be properly reinforced. 1:2:3 mixture of properly graded materials mixed with the right amount of water and properly placed, is insurance against leaky construction.

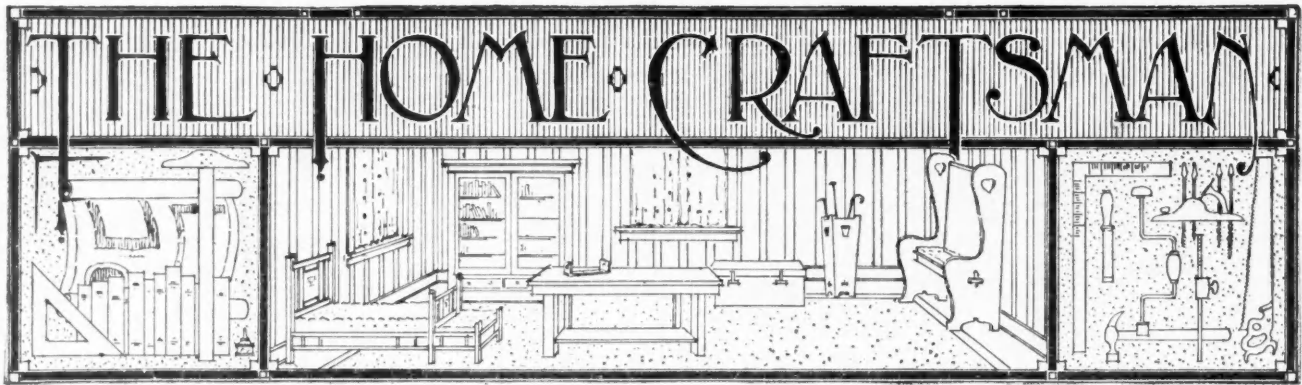

Making an Inlaid Walnut Bedstead

HOW THIS BEAUTIFUL PIECE OF CABINET WORK SHOULD BE MADE AND FINISHED

By M. H. Brigham

Dept. Manual Arts, Univ. of Mo.

THE most refining feature of the bedstead about to be described is the little line of inlaid material that decorates each of the broad panels in the ends. This bed has been worked out in black walnut, but would look equally as well made of oak and stained one of the deep, rich browns that are so popular at present. The strip of inlay is mostly red in color, and after having been oiled, blends properly into the reddish brown of the walnut.

The mill-bill and drawings are self explanatory with the exception of the bed-fasts that are used. These are stock articles that can be procured from any good hardware store, and are made especially for wood bedsteads. To the writer's knowledge, there is no better method of putting the bed together than by the use of a good set of bed-fasts.

In framing up the ends of the bed, blind mortise and tenon joints are used, altho a thru mortise and tenon joint would not be a bad feature for the upper and lower end rails. The stock used, must be

selected free from sap-wood so as to take the oil finish properly.

Begin by squaring up the posts to size. Lay off and cut the mortises, fit the rails and cut proper mortises to receive the slats. The slats are then cut and dressed to size. If you are doing your own cutting, re-saw $2\frac{1}{2}$ -inch material for the slats. The panels are then prepared and the grooves for the inlay cut. There are two ways to cut these grooves, either on the machine saw, or by using a double knifed marking gauge and then chiseling out by hand the stock between the two knife lines thus made. Make these channels for the inlay a little shallow, so as to allow for scraping down of the inlay after gluing.

The material for inlay can either be made up by a competent workman to suit his own tastes, or a selection can be made from the large stock put out by several manufacturers over the country.

In gluing the strips in place, be sure that the corners are neatly mitered, and use heavy strips of wood to cover the inlay, so as to give uniform pressure in clamping. Be sure to place some paper over the inlay to prevent the clamping strips from sticking fast, if any glue happens to get mis-placed.



Artistic Black Walnut Bedstead in Which a Novel Decorative Inlaid Strip is Used in the Broad Panels.

| Stock Bill. | | |
|---|---|-----------------|
| No. of Pieces. | Finished Sizes. | Material. |
| 2 Posts | 2' x 2' x 48" | Walnut or Oak. |
| 2 " | 2' x 2' x 36" | " |
| 2 Top Boards | $\frac{5}{8}$ " x 3" x 59 $\frac{1}{2}$ " | " |
| 2 End Rails | $\frac{5}{8}$ " x 5 $\frac{1}{2}$ " x 57" | " |
| 2 " | $\frac{5}{8}$ " x 3 $\frac{1}{2}$ " x 57" | " |
| 10 Slats | $\frac{3}{8}$ " x 2" x 21 $\frac{1}{4}$ " | " |
| 10 " | $\frac{3}{8}$ " x 2" x 33 $\frac{1}{4}$ " | " |
| 1 Panel | $\frac{3}{8}$ " x 8" x 21 $\frac{1}{4}$ " | " |
| 1 " | $\frac{3}{8}$ " x 8" x 33 $\frac{1}{4}$ " | " |
| 2 Side Rails | 1" x 6" x 76" | " |
| 7 Bed Slats | $\frac{3}{4}$ " x 4" x 55" | Pine or Poplar. |
| 14 Blocks | 1" x 1 $\frac{1}{2}$ " x 6" | " |
| 2 $\frac{1}{2}$ Dozen * 10 Flat Head Screws 1 $\frac{1}{2}$ " Long. | | |
| 1 Set of Bed-Fasts and Screws. | | |

Total Material Used in the Construction of the Bedstead.

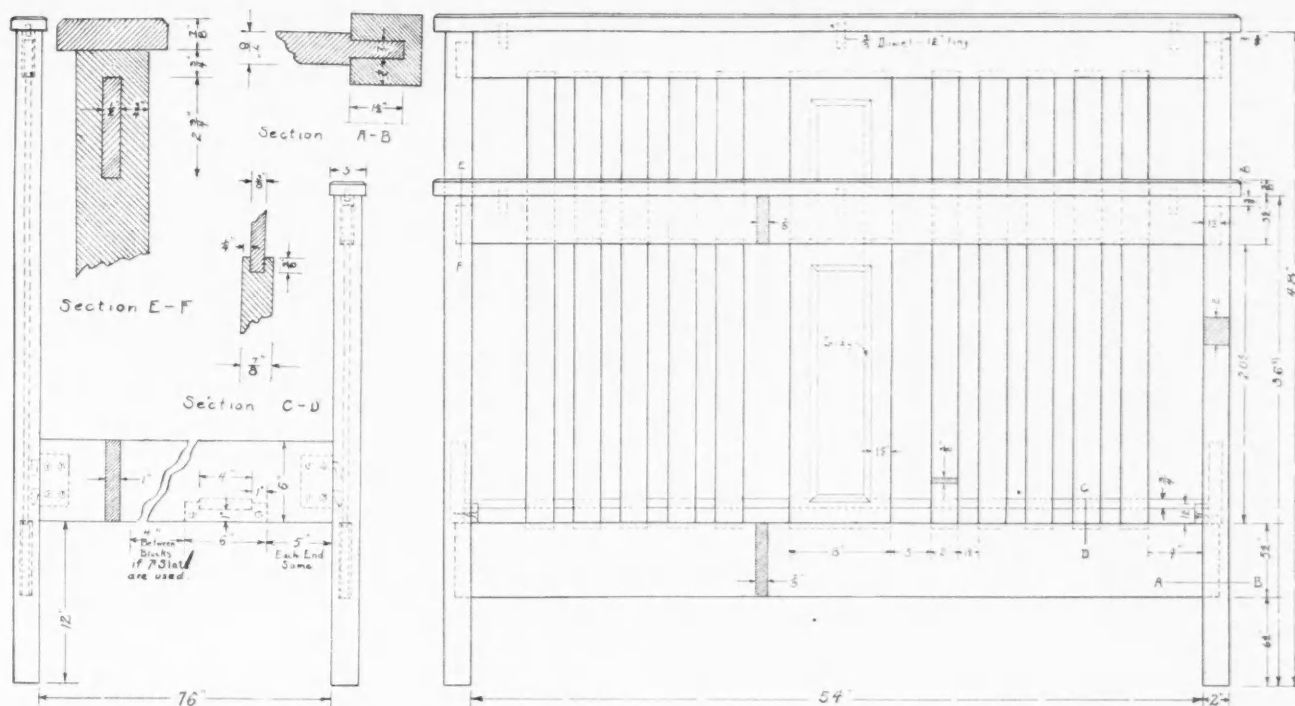

Showing Details of the Joints and Methods of Attaching Fixtures.

While the glue is setting, get out the stock for the side rails and the top boards for the ends. Scrape the inlay down smooth after the glue has properly set. Scrape and sand all slats and rails, and then frame up each entire end of the bed by gluing. Set on the top boards by use of glue and dowels.

If ordinary springs that come without a frame are to be used, then seven evenly spaced slats are used to hold the springs. If springs having a frame are to be used, two slats are all that are necessary for support. One about 12 inches up from the foot, and the other the same distance down from the head. The blocks to hold these slats are screwed in place with two screws each.

Set the bed-fasts in place, and after seeing that all surfaces are properly sanded, the bed, if it is made of walnut, is ready for a coat of linseed oil. This should dry for twenty-four hours. Next, a coat of shellac is given, and after drying and lightly sanding, a second coat of shellac is given. If the result is not satisfactory, a third coat may be given. Proper time should be given between coats of shellac for drying—about six hours between the last two coats.

The surfaces are then gone over lightly with a fine grade of steel wool, and finally some wax is applied. All that is necessary to keep up the elegant appearance, is to apply some more wax wherever needed. If the bed is made of oak, the wood should be given a coat of filler, suitably stained, shellaced and waxed. This appearance can also be kept by an occasional rubbing with a waxed cloth.



About 700 million feet of timber was cut on the National Forests in 1915.

The Latest Recommended Working Unit Stresses for Structural Timbers

THE unit bending stress may be taken from this table, according to the kind of timber used. This table gives working unit stresses for structural timbers used in dry locations, and is compiled in the main from material furnished by the Forest Products Laboratory, Madison, Wis. Other values of unit stresses for use in the various formulas will be found in this same table.

WORKING UNIT STRESSES FOR STRUCTURAL TIMBERS USED IN DRY LOCATIONS.

| Species of Timber | BENDING | | COMPRESSION | |
|-------------------------|---|---|---|--|
| | Stress in extreme fibre Lbs. sq. in. | Horizontal shear stress Lbs. sq. in. | Parallel to grain "Short Columns" Lbs. sq. in. | Perpendicular to grain Lbs. sq. in. |
| *Fir, Douglas— | | | | |
| Dense Grade..... | 1,600 | 100 | 1,200 | 250 |
| Sound Grade..... | 1,300 | 85 | 900 | 300 |
| Hemlock, Eastern.... | 1,000 | 70 | 700 | 300 |
| Hemlock, Western.... | 1,300 | 75 | 900 | 300 |
| Oak | 1,400 | 125 | 900 | 400 |
| Pine, Eastern White.. | 900 | 80 | 700 | 250 |
| Pine, Norway | 1,100 | 85 | 800 | 300 |
| *Pine, Southern Yellow— | | | | |
| Dense Grade..... | 1,600 | 125 | 1,200 | 250 |
| Sound Grade..... | 1,300 | 85 | 900 | 300 |
| Spruce | 900 | 70 | 600 | 200 |
| Tamarack | 1,200 | 95 | 900 | 350 |

*NOTE: The safe working stresses given in this table are for timbers with defects limited according to the sections on defects in the rules of the Southern Pine Association for Select Structural Material. "Dense" Southern yellow pine and "dense" Douglas Fir should also conform to the other requirements of this rule. "Sound" Southern yellow pine and "sound" Douglas fir require no additional qualifications, whereas the other species should, in addition to being graded for defects, have all pieces of exceptionally low density for the species excluded.

Experiments with jack pine have shown that it is well suited for making kraft paper. On some of the National Forests this tree is used to plant land which is too poor to grow other timber.

A new fire-fighting tool has been invented by a Forest ranger in California which consists of an interchangeable hoe and rake. It is said to be the best tool of the sort yet devised.

Should Details be Furnished before a Contract is Signed?

By G. Alexander Wright, Architect

THE difficulty of obtaining full detailed information of what is really wanted when bidding upon work is one of the serious problems which confronts the contractor today, for it is largely the "detail" which determines what work is really worth.

Ordinary small scale drawings and specifications which are sometimes lacking in information certainly do not sufficiently disclose what may possibly be insisted upon, in detail, after a bidder has signed a contract—some owners imagine they do, and that they tell a bidder all that is necessary. Others are indifferent. It's up to the contractors they think; whilst still others may secretly hope that some things may slip through without being noticed. This is the particular type of owner who is ever ready to profit by a bidder's error.

Of late years, however, there has arisen among contractors a strong desire, arising partly from numerous sad experiences to know more of what is required "before" a contract is signed, rather than be obliged to await the details afterwards, as so often happens. In common fairness there should be some way of disclosing the details beforehand, or at least as far as may be possible so that all bidders may receive reliable and identical data to figure upon. Not only that, but if for any reason the character of any of the details should be simplified after a contract is let, it would be more likely to serve to check against any possible unfairness.

In estimating cost of building work, the writer knows of no legitimate reason why all the cards should not be laid upon the table face side up.

Fortunately for the building industry there are many architects who give as well as expect a square deal. These gentlemen are well known by bidders and they are very properly honored and respected as men and as members of an honorable profession. But it seems to be now very generally understood that there are others, and it is from the offices of this latter class principally that the contractors obtain a more accurate idea of what is wanted, "after" the contract is signed, than it is possible for them to get before. Then it is too late. Many a contractor has been caused financial difficulty because of the, shall we say (?) peculiar temperament (?) or business viewpoint (?) such architects display, not provided for of course by any clause in the contract. These men are well known and scheduled in the contractor's mind just where they belong. The better type of contractors avoid such offices, or when invited to figure, they discreetly raise their bids high enough to cover possible contingencies, and in the long run somebody suffers.

But the point under consideration is, whether details should be furnished before or after a contract is let? To fair minded men it is obvious there can be only one answer to this question. If details are not ready when the job is being figured they should certainly be in the hands of the contractor before he is called upon to sign up. It would surely be a more equitable way of letting a contract. Now as details must be prepared and furnished at some time, is there any logical reason why this should not be done at a time when such information would be of the greatest value to the bidder? *i.e.*, when he is making up his prices. Why this keeping back of vital information at that time? It is not to the bidder's advantage of course. Who is it that benefits? Is it the owner? Or is it for the greater convenience of the architect? But whatever the reason, can it be regarded as fair to the bidder? It is obvious that an individual bidder is helpless. He cannot force the issue himself in any particular instance. But collectively through their organizations, contractors might make reasonable and proper representations of these facts to their local architects with a view to betterment of the conditions named.

Certain remedies have been suggested from time to time. One is the quantity system which would go a long way towards determining all details beforehand, but pending the general adoption of this modern method of inviting bids, some other remedy is necessary. One that would seem to afford desired relief without causing hardship to anyone, would be the passage of a city ordinance providing that applications for building permits, for work above a certain estimated cost, should be accompanied, not only by the usual plans and specifications, but by details to a scale of say, not less than 1½ inches to the foot, or sufficient to indicate the character of the work which is to be performed in detail.

It takes no longer to study the details of a structure before a contract is entered into, than afterward. It has to be done sometime. The owner who is now so often unduly impatient to see his building started, would soon learn to adapt himself to the new condition, if he realized his architect was simply conforming to the law. There would be just as many buildings erected, and bidders would understand more clearly what it was they were bidding upon.—San Francisco, Cal.

(Editor's Note: Our columns are open to readers for a full discussion of this subject.)

CORRESPONDENCE



Questions Answered and Ideas Exchanged.

Our Readers Are Requested and Urged to Make Free Use of These Columns for the Discussion of all Questions of Interest to Carpenters and Builders

Who Knows?

To the Editor:

La Fargeville, N. Y.

Allow me to thank you for the book sent with my subscription. I find pleasure and help in reading this magazine and your books; but I have some questions that I do not find answered in any books that I have. People tell me that one cannot use malleable fittings on iron pipe where they are to be exposed to the fire, as in a water heating coil in a fire box. I wonder why this is, especially as I have had such fittings in satisfactory use in a cook stove for some five years.

In heavy timber framing we hear of a relish. What is it? One man says it is the piece cut off from the tenon which goes into the mortise at the end of the plate. Another says it is the part left in the plate, so that the mortise does not go way to the end. Who knows, and why is it so called?

Some of us believe that the self-supporting roof is the proper roof for barns, and that a dairy barn should be built with a balloon frame and have the joists run across, but the farmers are apt to want the old style timber frames, and purlin posts and plates. What can we do to show them that the modern ideas are better than the old ones?

Regarding the present high prices of building materials, I have a letter from a prominent manufacturer of white lead which says that we need not look for any reduction in price of this for some time, so need not wait if we really need the goods, and I suppose the same would apply to some extent to all other materials.

JOHN UPTON.



What Kind of Wood is This?

To the Editor:

Algoma, Wis.

We are enclosing herewith a photograph of some special panels that we manufactured for the interior trim of a resi-

dence. We wonder how many of your readers are wise enough woodsmen to identify the kind of wood this is. We will be glad to receive "guesses" and will write to any who guess wrong.

These panels were placed in a high class residence and evidently when placed produced a beautiful effect. The photograph will show you what thirty years of experience will do in matching and joining up fancy wood face veneers. Our help is all thoroly trained in this work and the photograph will show that we have got beyond the amateur stage. Attention might be called to the fact that we use a hide stock glue in all work of this character.

AHNAPEE VENEER & SEATING CO.,
N. W. PERRY, Sec. and Gen. Mgr.



Enough for a "Five Foot Shelf"

To the Editor:

Angleton, Texas.

I am a constant reader of the AMERICAN CARPENTER AND BUILDER. My father has a stack of them that would be a good lift for any man. Some of them date back to 1905.

P. A. McMILLAN.



Wants Eastern Type Houses

To the Editor:

Bridgewater, Va.

I have been a reader of your valuable paper for nearly four years, and do not see how I can get along without it. I have all my papers filed away for reference. I get many points of short cuts to do better work. I would like to see you print pictures of buildings from the eastern part of the U. S. A., as they differ some from the western style. Hope to be able to send you a kodak picture soon of a house I am working on now.

JACOB T. CLICK.

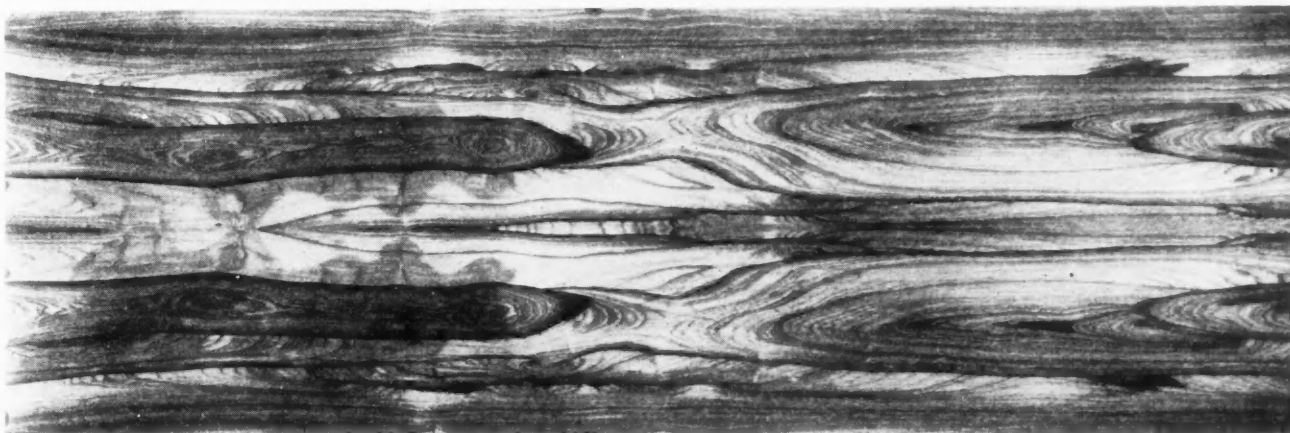

What Kind of Wood in This Panel? A Very Good Example of Matching and Joining with a Wood of Unique Figure.

Hot Shot from Parkhill

To the Editor: Rochester, Minn.

Any one who tries to help remedy some other fellows' mistakes is apt to get more thumps than thanks. It was, therefore, a great gratification to me recently to receive from the head of a large manufactory—perhaps the largest—his thanks for calling attention to their mistakes on a tool used by every carpenter. This they also corrected.

In your May magazine, my reference to wrong rafter-lengths, which appeared in April, was intended to induce the author of them to correct them.

But from his letter in your July number it would appear that he is unable to do so, altho he admits they are wrong. He could not do otherwise. He says, "I have gone over a lot of these figures, and cannot yet find any that are more than one-tenth inch off." Of the first five hip lengths he gives, two have each an error of at least double that. So his admission that he has been unable to discover these errors greatly intensifies the unreliability of his table of rafter lengths; for undoubtedly there are many more of them wrong. He was evidently sincere when he said, "Figuring always was my bugbear."

Accuracy is the essence of good workmanship; yet in some cases a very slight inaccuracy may be excusable for the convenience of avoiding a small fraction and using even inches. But even this excuse does not apply to these lengths. For his first eight hip lengths as given—and more—the correct length for each is in even inches. Yet in every instance the author of them not only gives them wrong, but also introduces needless complications by giving fractions where no fractions belong. He gives his opinion, however, that the men on the job are not worrying over such things.

His supposition that "a manufacturer must have his figures exactly right" is, unfortunately, not always the fact, tho it should be.

On my Universal Pitch Gauge, however, all lengths are figured to less of an error than one-thousandth of an inch; and lengths per foot run are given for eighty different pitches—not four only.

There are quite a number of wrong lists of rafter lengths in use, but these under consideration are much the farthest wrong of any that have come to my notice. It would be just fine to have them all corrected—or suppressed; and if their authors cannot figure them out correctly, there are any number of AMERICAN CARPENTER AND BUILDER readers who can.

JOHN PARKHILL.



Wants Ideas for Slaughter House

To the Editor: Savannah, Ga.

We are trying to get hold of some publication that shows plans for a small community abattoir—not a city packing house, but something on a small scale that one butcher killing about fifty head of cattle per week and who wants to cold storage them for a few days at a time.

GEORGIA REAL ESTATE CO.,
W. A. STURTEVANT, Pres.

A Unique Ironing Board

To the Editor: Wenatchee, Wash.

I am enclosing a sketch of our ironing board, which you may publish, if you think it worthy.

It is made to fold up in the partition when not in use, and by means of a swivel bolt and by turning the board half way around, it can be used in the kitchen or on the back porch, which is screened in.

A door encloses the board from either side and by having an electric plug located at the top, it can be used from one side as readily as the other.

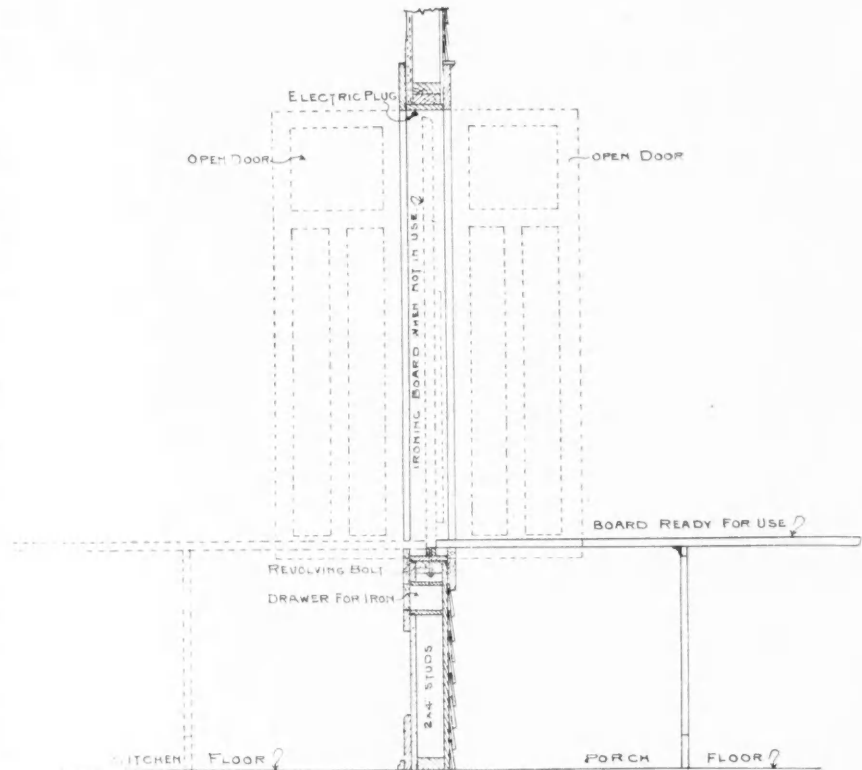

Ironing Board Cabinet Opening on to Porch as Well as Into Kitchen.

A compartment is also arranged to store the iron, so that everything is always in place, ready for use, and when not in use, it is out of sight; at least that is what they all say.

MARVIN C. GRIFFITH.



An Accident in Barn Raising

To the Editor: La Fargeville, N. Y.

There was an accident recently in raising a barn frame, where I was working, and a few words about it may help others to avoid such ones. The timber was large and heavy, posts 9 by 9 inches, 20 feet long, all beech. The bent which caused the trouble consisted of a main post, a purlin post 28 feet long, two 10-foot beams, short braces, and a long brace 6 by 6 inches some 12 feet long. At first there was a shortage of men, and some bents were set up by using rope and tackle; but this one was being raised by hand, without even a snub rope. It may be that the men got too close to the foot, and those with the pike poles did not lift enough, or that there should have been more men to hold the feet of the posts; anyway, one of them slipped, and the timbers swung around, carrying the men off their feet and to the ground.

By good luck no one was seriously hurt, but we did not try it again the same way. The next morning two tackles were put on to this bent and hitched to the one last set up,

which had been guyed back with a large rope. In raising a bent with tackle there is a great pressure at the foot of the post, and no man should ever try to hold this with a bar, as is done in raising by hand. The proper way is to lay a large timber in between the posts or else set up a piece of plank and brace well.

After the men found out what was to be done, it did not take long to shift the tackle from one bent to the next. The other men blocked the feet while this was being done, and so the frame was set up.

If you will figure out the contents of this bent you will see that it was some timber—two posts 9 by 9 inches, 20 feet, and two 28-feet, a 6 by 8-inch beam 20 feet long, on top of the long posts, three 6 by 8-inch beams, eleven 4 by 6-inch girths, all 12 feet, 14 braces 4 by 4 inches, 4 feet long. This was all beech, not too dry, either.

JOHN UPTON.

Wants Cabinet Designs

To the Editor: Blytheville, Ark.
I would be glad for some of the readers to send in some designs of cabinets that can be made and sold reasonable, like W. M. Alvord's medicine cabinet and the writing desk in April, 1914, number, by Mr. F. A. Shilling. Also would like plans and description of some inexpensive church pews or seats.

W. T. RHEA.

An Improved Screen Wire Stretcher

To the Editor: Milton, Iowa.
Looking thru the May issue of the AMERICAN CARPENTER AND BUILDER I notice how Mr. W. T. Rhea, of Blytheville, Ark., stretches wire over screens. I think that he has gone at it in the most awkward way one could think of.

In the first place, I notice he says he has a bench top that he places on top of a pair of trestles long enough to receive the length of two screen frames, still he does not mention the length, but he would have to have it long enough to catch the longest screens, to say nothing of having a place to put this out of the way when not in use, and the material that he has in the top to be used for just this one article. Then again, I take notice that he tacks the wire at the end of one screen, then raises it up to the required height to get the tension of the wire, and tacks it to the far end of the other screen; then lets the other frame down to give it the tension.

Now, after you have done this, there is a space in the middle of the two frames that he has wired that is of no use, and

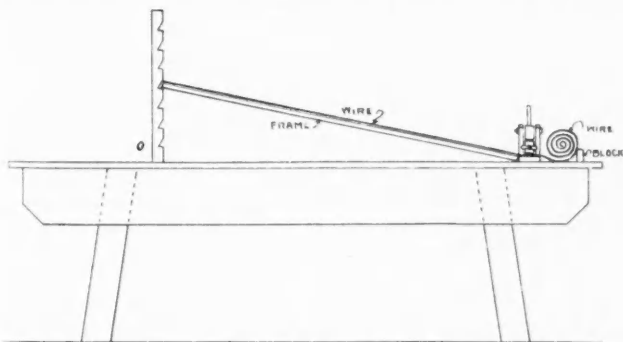

Fig. 1. Showing Method of Stretching Screen on Frame by Use of the Height of the Frame.

he has to cut it off and throw it away. This is a waste of wire, and at the high prices of wire nowadays it pays to save all that one can, and therefore, he is cutting off 4 inches of wire at each operation. What would this amount to if he kept wiring screens all day? He would lose considerable profit as well as wire, even if the other man pays for it.

What would he do if he had a job consisting of various widths, or just a very few screens not any two of them the same width, and some of them being 1 1/8 inch thick while others would be 7/8 inch thick? It is an up-hill business getting it tight by stretching the wire across the last end where the roll of wire is.

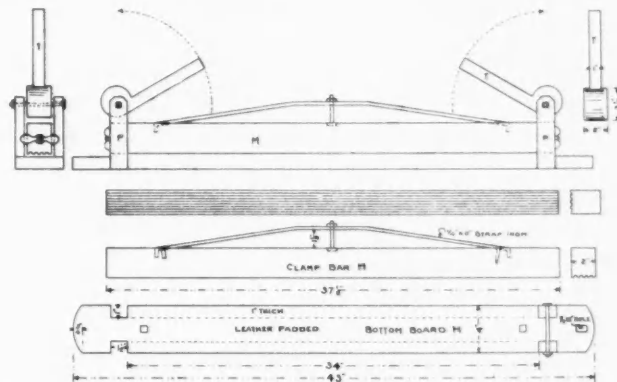

Fig. 2. Showing Details of Clamp Bar and Method of Its Operation in Holding the Screen.

I take notice he uses a block to set the other end of the other screen on to get the tension height. Now, in different length screens, one has to have the screen elevated at different angles to give the desired tension that the wire should have. For instance, for a long screen it will have to be raised up quite a bit, while the half screen or transom screen will not have to be raised but an inch or two. Therefore, I consider that Mr. Rhea is working at a disadvantage to himself, as well as a loser in wire and time, and room for the equipment.

I have been a reader of the AMERICAN CARPENTER AND BUILDER since it was first published, and hope to continue same. I notice you request the readers to make use of these columns for the discussion of all questions of interest to carpenters and builders, so will describe how I do this kind of work, and if they have anything that will beat my way of stretching wire, I will gladly accept same, and make kindling out of the one I have.

I noticed a stretcher on the market some time ago, and sent for their circular. Upon investigating, I found that it had to be fastened to a bench top supposed to be permanently fastened, and it was then necessary to remove the cores of wood from roll of wire, fasten the wire to a wood rod that ran thru the wire, and a crank was so arranged that when turned, the wire would stretch. This may be all right for a factory that makes screens only, but it is no good for the general woodworker as it takes up too much room and too much time to place it on the bench each time that one wants to use it.

Now I am going to tell you how I do this work. In the first place, there is not a carpenter shop without a bench, and if it is any shop at all, he should have a good bench. Fig. 1 shows my bench with the holder and screen in position, and I will describe this so that you can understand it.

My bench is 10 feet long, and at the extreme back end I have a short board fixed so that I can place it on top of the bench so that it will not permit the wire to fall off of the bench; and the holder is fastened to the bench about 18 inches from the back end with two handwheels so that the holder can be quickly and easily removed. All that is required to fasten the holder to the bench is just to bore two holes, 3/8 of an inch thru the top of the bench, the handwheels being underneath.

Now I will describe the holder, and we will start from the bottom. First of all, we will get a good board that is

4 inches wide by 43 inches long, 1 inch thick, as shown at N. Cut two notches in each side 1 inch deep by $1\frac{1}{2}$ inches long, with a distance of 34 inches between the posts so that 34-inch wire can be used. If you want to use wider wire, make the bottom to suit. At one end you will notice a hole, this is to hang it up by when not in use, and take two machine bolts and countersink them in the wood so that they will be flush. These are the bolts that you fasten the holder to the bench with. Round the ends as shown. Now we will make four posts, 1 by $1\frac{1}{2}$ by 6 inches long, so that they will be like legs, and a space of 2 inches between the posts at each end then we will get another stick of wood that will be, when finished, $2\frac{1}{2}$ inches wide by 2 inches thick by $37\frac{1}{2}$ inches long, so that it will just be on the outside of the legs, and just fit in between them nicely. We will bolt the legs or posts to the bottom piece, N, with a $\frac{1}{4}$ -inch bolt, and bore a hole near the top for the eccentric lever. This piece that fits between the legs we call the clamp bar, M. On the bottom of this bar plow $\frac{1}{4}$ -inch grooves, about $\frac{1}{8}$ inch deep, four or five of them as shown. This is to form a better grip on the wire, and on each end of this bar is placed a thumb button so that when it is in use the button can be turned so that the bar cannot creep out of place, and when you want the bar out, all that is required to remove same is to turn the button.

I have a truss that is made of iron as shown, so that when the clamps press on the wire the truss will have the same grip in the center as if the bench top is not rigid. It will not hold the wire tight enough in the middle unless you have this bar a little crowning in the center. Now, as this bar, M, lies on top of bottom, N, between the posts, the wire passes between the two. Now we will get another piece of wood, say, 2 inches thick by $2\frac{1}{2}$ inches wide by $9\frac{1}{2}$ inches long, two pieces of these, and at one end of the stick make a circle $2\frac{1}{2}$ inches in diameter as shown at B, form a handle on the rest of the stick as shown at T, bore a hole $\frac{1}{4}$ inch or $\frac{3}{8}$ inch off center, so that it will form an eccentric wheel, and bore a $\frac{1}{4}$ inch hole so that when the handle stands vertically it presses on bar, M, and stays there, holding the bar on the wire. This is done at both ends when the levers are at rest. The handle lies back on bar M.

Now we are ready to wire a screen. First fasten the tightener to the bench, place the desired width of wire between the little block at end of bench and the holder; now turn one of the thumb buttons so that you can slip the bar M back past the posts, and pass the end of wire between M and N, slip bar M back past posts P, and turn button.

Now take a screen and lay it on the bench flat down, draw the wire to the far end of the screen, and fasten with tacks, placing the screen against the front edge of bottom N. Now with a little stick with notches cut in it as shown at O in Fig. 1 raise the screen to the desired height and place the notched stick under the edge of the screen. This holds the screen up. This notched stick is for different length screens, as this will suit all of them. Now step to the rear end of the bench where the roll of wire is, and pull up the slack in the wire (do not try to tighten). See that the wire is the same on both sides of the screen. When you have the slack taken up, raise the eccentric levers at both ends and this will grip the wire and hold it fast. Now go to the other end and release the stick, letting the screen down gradually or you will pull the wire loose from the frame. If it should not be tight enough, raise the screen higher on the stick and do the same thing as before.

I will call your attention to one particular thing while I think of it. You will notice on the bottom board, N, at the dotted lines, under the bar, M, place a piece of very thin leather, tuck the leather very closely all around the full length between the posts, but it does not need to be any wider

than the bar, M. This is so arranged that when you put the pressure on the wire it will seat in the leather, and by bar, M, being grooved out at the bottom it has a very strong grip on the wire. Now then, nail the wire across the bottom, then up the sides, then release the levers, pull screen up a little, and with a straight edge cut the wire, and you have a screen on which the wire is so tight that it will sing, and when you are thru in an instant you can release it from the bench, hang it up at the hole S, and go on. Twenty-five cents will buy all the bolts and the iron to make the truss with, and any good carpenter can make this in a short time, and it will be time well spent. Money could not buy mine. There isn't any patent on this, neither is there any pending, still there could be a patent secured, so go ahead and make one of these for yourself and let me know the results.

I also got up a clamp to file circular saws with, and it is a dandy, too. I will discuss this later on if there is anyone that wants one of these.

J. E. DONAHU,

Contractor and Builder.

✦ Window Frame Construction

To the Editor:

Youngstown, Ohio.

The accompanying detail drawings show sections of window frames for both wood and brick construction. The sills

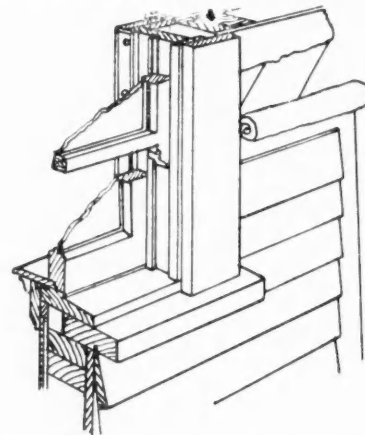

SECTION OF FRAME CONSTRUCTION

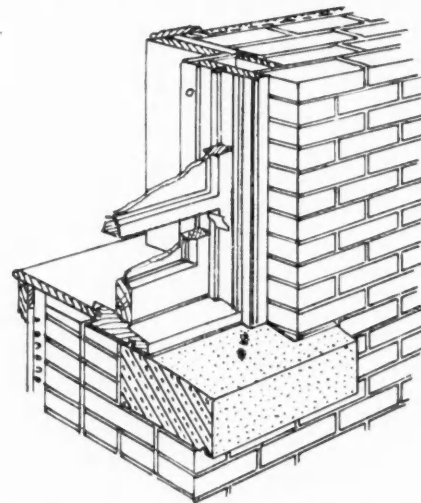

SECTION OF BRICK CONSTRUCTION

are arranged so as to shed the water freely.

The one for frame construction has a sub-sill and show sill, while for brick construction, has only one sill, which has a plow in same to take care of the open vents, to prevent the circulation of air; at the same time, the window stool is fitted in the sill, making it one piece and this prevents joints for water to soak in and cause the sill to rot.

S. I. WILLIAMS.

Lots of House for \$1800

To the Editor: Arlington, Ill.
Enclosed please find photograph of a house designed and built by myself. It is 28 by 30 feet, contains 8 rooms, and



House Designed and Built by W. M. Graham, Arlington, Ill.

cost \$1800. It has a 7-foot basement under the whole house.
W. M. GRAHAM.

❖
Floor Finishing

To the Editor: Calistoga, Calif.

Kindly let me know from your shop records the best means of finishing a pine floor T. & G. No. 1, without painting, so as to make a natural and durable finish similar in effect to oak floor. I am doubtful whether to oil the floor and then varnish it, or use wax only. Any information on the subject will be appreciated by your reader. W. H. JOHNSTON.

Answer—The first thing necessary in order to obtain a good job of floor finishing, is to get a perfectly smooth surface. Until recently the only way to do this was the tedious, back-breaking method of planing and scraping, the latter being done usually with the edge of a freshly cut piece of glass. When the cutting edge wears down a fresh piece must be taken. Sandpaper bent over a flat wooden block is also used to cut down any roughness or raised grain. Steel wool is preferable for this purpose, on account of the greater rapidity with which it cuts. While this method is still very generally practiced, modern invention has come to the aid of the floor finisher and has produced a planing machine or surfacer that is pushed across the floor like a lawn mower.

The first operation is filling the wood. Oak and other open-grained woods require filling with a paste filler; and while many painters laugh at the idea of a paste filler upon woods as yellow pine and maple, experienced floor finishers say that a better job can be done by using paste filler as a surfacer. The method of using is to apply the filler to a strip, say, six or eight boards wide, running the entire length of the room. Use a short, stiff brush, and apply across the grain. By the time this strip has been completed the filler will probably have set sufficiently to rub. It must not be rubbed before setting, or it will be rubbed off the wood; nor must it be allowed to set too hard, or it will be impossible to rub it at all or even to scrape off the filler. When the strip has set just enough, it must be rubbed well into the grain of the wood with burlap, always rubbing across the grain of the wood. After filler has been thoroughly rubbed, any surplus material must be carefully wiped off with a soft rag. Before anything further can be done, the filler must be given time to dry—not less than 24 hours, and preferably two days.

If the natural color of the floor boards is not satisfactory they should be stained before filling, and the filler should be colored with pigment ground in oil to bring it to the same color tone.

If there are cracks or nail-holes in the floor, they must

next be filled, in order to make a smooth and perfectly uniform surface. This filling may be done by using a pure whitening and linseed oil putty, tinted to match the floor boards; or it may be done better with a whitening and white lead putty made by mixing one part of white lead in oil with two or three parts of bolted whitening and enough coach varnish to make a stiff paste. This putty will resist moisture; and, when dry and hard, it may be sandpapered or rubbed. For large cracks, an excellent unshrinkable putty can be made by soaking blotting paper in boiling water until it forms a pulp, then mixing it with glue dissolved in water. To this, bolted whitening is added in sufficient quantities to make a fairly stiff paste, and thoroly kneaded. This paste must be pressed into the cracks and smoothed off with a putty knife.

For those who do not care to make their own putty, there are excellent prepared crack-fillers on the market.

WAX FINISHING. By far the best material for finishing hardwood floors is wax, altho this involves a little more trouble to keep in good condition. It gives a smooth, satiny luster, without the glaring effect of new varnish, and is not marred by heel-prints such as varnish is subject to. When wax grows dim it can readily be polished again.

Some painters advocate the application of the wax directly upon the paste filler, but the best practice is first to give one or two thin coats of pure shellac varnish. Where a slight darkening of the tone of wood is no objection, orange or brown shellac is preferable to the bleached, since it is stronger. Shellac should be cut with grain alcohol, and not with wood alcohol. It is especially adapted where a hard and quick-drying undercoat is required. On a close-grained wood where a paste filler has not been used, either a thin coat of a first-class liquid filler, or a coat of one part of linseed oil to which from five to ten parts of turpentine have been added, should be given before applying the shellac. Unless there is an undercoating of some kind, it is very difficult to apply the shellac so that it does not show laps. Even then it requires skill and rapidity of work. In shellacking a floor, the plan of following down a space one or two boards wide should be followed. The shellac coat should be put on before the oil or liquid filler coat is absolutely dried.

After shellac has become dry, the wax, in paste form, is applied with a rag or brush, and, after a short time, is brought to a polish by means of a weighted brush or by rubbing with a cloth. Only a very thin coat of wax is necessary, a very little more being occasionally added.

Quite a number of specially prepared floor-polishing waxes are on the market, and care should be taken to select a material of this kind that will give a hard polish and will not remain soft and sticky. It was the softness of the old-fashioned beeswax and turpentine that caused the almost endless labor needed to keep floors in perfect condition. Modern wax finishes are made by combining beeswax or paraffine with some of the fossil waxes, or from the latter alone, giving a much harder surface. In general the wax which has the highest melting point is best for the manufacture of floor waxes, because it is the hardest after application. Carnauba wax has a high melting point (185 deg. F.), and may be used alone as a floor wax by melting it in a suitable kettle and thinning it with spirits of turpentine so that in cooling it has the consistency of soft tallow. In this condition it can be applied with a large brush.

Two coats of wax on a new floor are better than one—the first coat being required to fill up, and the second to give luster—altho if sufficient polish is obtained by the first coat, the second will be found unnecessary.

VARNISH FINISH. A large number of floor varnishes are on the market. These varnishes, as a rule, are designed to harden over night. The surface should be prepared in the same way as for wax finish; and after the

filler is bone dry, two or more coats of varnish should be applied. If desired, the varnish may be rubbed to a dead surface with pumice stone or kerosene. Nearly every varnish will show heel marks, and will mar white by use. When the surface becomes worn, the old varnish requires to be either scraped off or removed with a varnish remover before a new coat of varnish can be applied, while with a wax all that is necessary to restore the surface to a good condition is to apply a little more wax and use the polishing brush.

OIL FINISH. A very satisfactory finish for rooms that have hard wear, such as schoolrooms, stores and rooms in public buildings, is first to fill the floors and then give them two thin coats of shellac, finally applying a very thin coat of paraffine oil or of a rubbing and polishing oil with a brush or a rag, and thoroly wiping off any surplus remaining on the surface. This oiling should be repeated every few days, according to the amount of wear the floor gets. This same treatment is especially adapted to kitchen floors, dining rooms and other floors in private houses that are subject to hard wear. It is also well adapted to the cheaper floors, such as yellow pine or spruce. If mud has been tracked on the floor it should first be mopped up with water, and this should be allowed to dry before oiling. One advantage of the oiled floor is that it is ready for use as soon as the oiling is finished. This same method of oiling can be used over a varnished floor and will preserve it from marring.

Besides paraffine oil, crude petroleum may be used, or any of the so-called polishing oils or furniture polishes. Such oils can be made from machine oil or sweet oil and oil of lemon.

EDITOR.



The Unit School System Has Many Distinct Advantages

To the Editor:

Tulsa, Oklahoma.

The interest in the Unit School System, which had its origin in this city, is spreading rapidly over both the Eastern

and Western states. We have built quite a number of these schools and have found the system to be the most economical of any we have tried, both in construction and operation. I am enclosing a picture of one of the schools in this city.

We claim this system of schools is absolutely proof from fire stampede and other confusion of the pupils. They have proved very satisfactory in our thickly populated district, from the fact that the play grounds are enclosed. There are no dark halls which constitute a loss of space and are conducive to improper department.

Inside of the enclosure, next to the buildings, there are sidewalks ten feet wide sheltered by columned porticos but not enclosed. These sidewalks serve as a corridor connecting all of the buildings. In the center of the large court is the playground equipment and the drinking fountains. There is plenty of room for play, a 300-foot city block being used to accommodate 800 pupils. Any teacher may stand in his own schoolroom and observe the entire field, a feature which aids very much in the control of a large number of pupils.

Each building contains two school rooms. These rooms are lighted from the side facing the street. Each room is provided with its own toilet and cloak room. The heating plant is contained in a separate building, this arrangement providing safety and cleanliness.

The Horace Mann school, which is the largest in the city built according to this system, has twelve buildings. The administration and manual training buildings are of two stories each. The lower floor of the former contains the offices of the principal and the upper floor is occupied by the custodian and his family. The workshops for the boys are on the first floor of the latter, and the kitchen and sewing room for the girls is on the upper floor.

The Unit School System has given so much satisfaction in this city that its further use is assured. I have no doubt that many other cities will find it a very satisfactory system and that its use will be quite extensive in future school planning and remodeling.

H. O. McCLURE,
Pres. Board of Education.

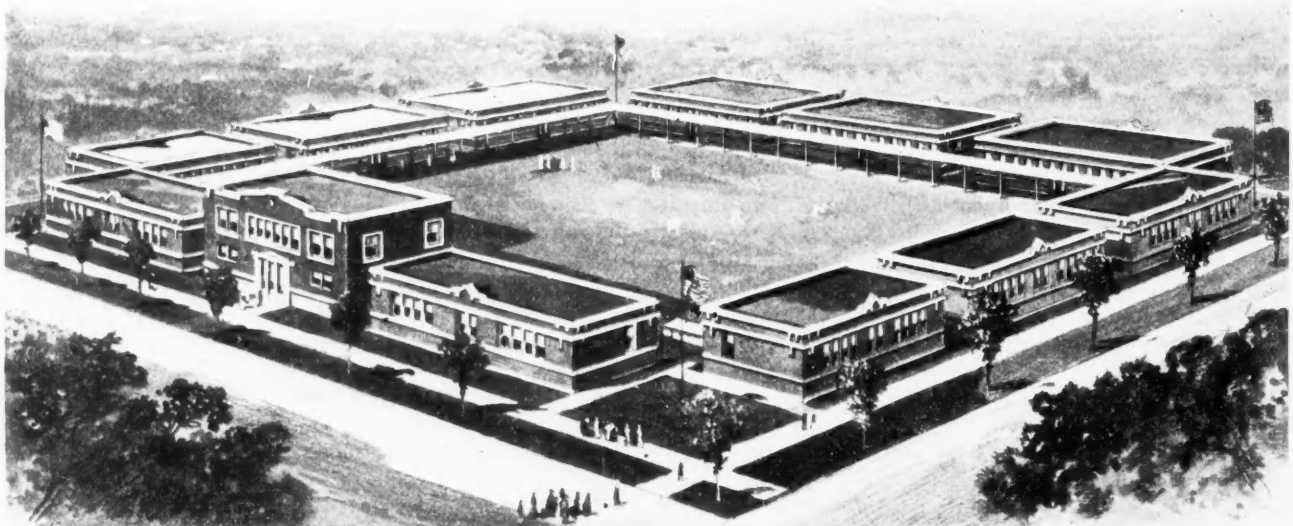

Playground Court and Separate Buildings. Each Building Contains Two Class Rooms. Auditorium is in Two-Story Building at the Front.

MEDUSA WATERPROOFING

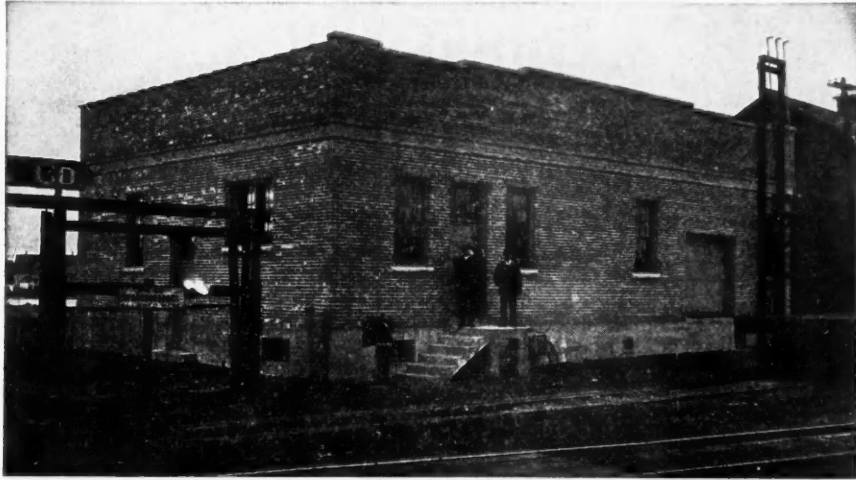

Standard Oil Company's Warehouse, Fond du Lac, Wis., Made Water Tight by Medusa Waterproofing

You've *Got* to Make Them Waterproof

BASEMENTS, warehouses, block houses, silos, feeding floors, etc., are only *half built* unless they are waterproofed. No matter how fine the quality of cement may be in your concrete--it's got to contain a tested waterproofing if it's going to keep the dampness away.

Medusa Waterproofing

Makes concrete absolutely damp-proof and weather-proof. For concrete mortars, exterior facings, basement floors and monolithic walls--in fact in any job where the water must be kept out--a little Medusa Waterproofing in the mix will insure perfect results. Medusa Waterproofing has stood the test of years--it is the original patented waterproofing for concrete.

Home builders are demanding that basement walls, etc., be made damp-proof. Our big national advertising campaign to home builders is showing them how they can get these results. We are referring all the inquiries we get to dealers and contractors. It means a lot for your reputation as a builder to be able to build damp-proof structures--and the one sure way to do it is by using Medusa Waterproofing. *Samples sent on request.*

HERE'S A BOOKLET FOR YOU

"Medusa Waterproofing" is an interesting little booklet which shows many instances where Medusa Waterproofing has done real jobs for contractors all over the country. We shall be glad to send it to you on request.

The Sandusky Cement Company

Waterproofing Dept.

Cleveland, Ohio

THE SANDUSKY



CEMENT COMPANY

MODERN STORE FRONTS

Their Design and Construction

By
Francis J. Plym, President
 of KAWNEER MFG. CO., NILES MICH.



IN 17 PARTS, PART 7. (SEE FEBRUARY, MARCH, APRIL, MAY, JUNE AND JULY ISSUES FOR OTHER DETAILS.)

NOTE: Mr. Plym desires this Department to be of greatest practical benefit to contractors and builders. He will gladly answer letters of inquiry, giving any special store front information desired. He has also prepared a very instructive illustrated booklet on modern store fronts which he will mail free of charge to any architect, contractor or builder desiring a copy. Under this heading is appearing a series of 17 typical store front designs, also a series of 17 plates of half size details of Kawneer store front construction.



TYPE NO. 51 TYPICAL ELEVATION OF HABERDASHERY STORE COPYRIGHTED BY KAWNEER MFG. CO.

TO take a seventeen-foot store and design a front absolutely different, but not freakish, which will sell haberdashery, is quite a feat. That this front solves the problem you will unquestionably acknowledge. It is planned to trim this with alternate suits of clothing or overcoats, and units of men's furnishings. The spacious vestibule provided will invite the passerby to stop and look, and the trim will unquestionably induce them to cross the threshold. The unique sign in the transom glass will help toward creating an effect of distinction and individuality.

The Kawneer Manufacturing Company will show "up-to-date" KAWNEER STORE FRONT designs, for various other types of business, such as Grocery, Drug, Millinery, etc., etc.

The details on the opposite page, drawn half full size, show some of the members which constitute KAWNEER STORE FRONTS. Readers are asked to cut these out, as they will prove to be a valuable reference asset to them in the future.

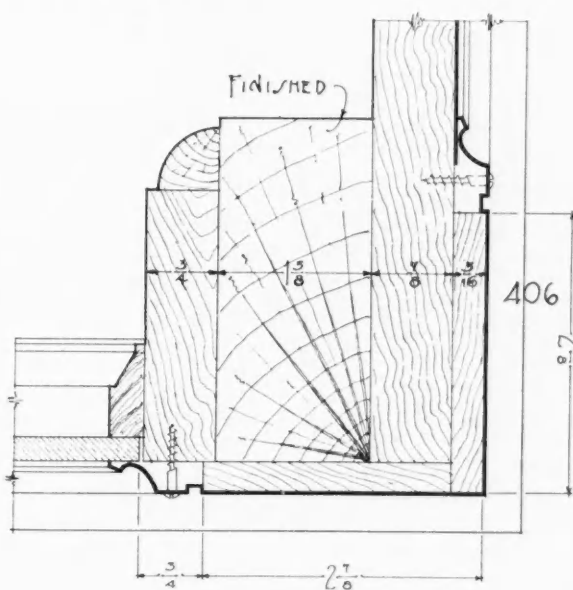
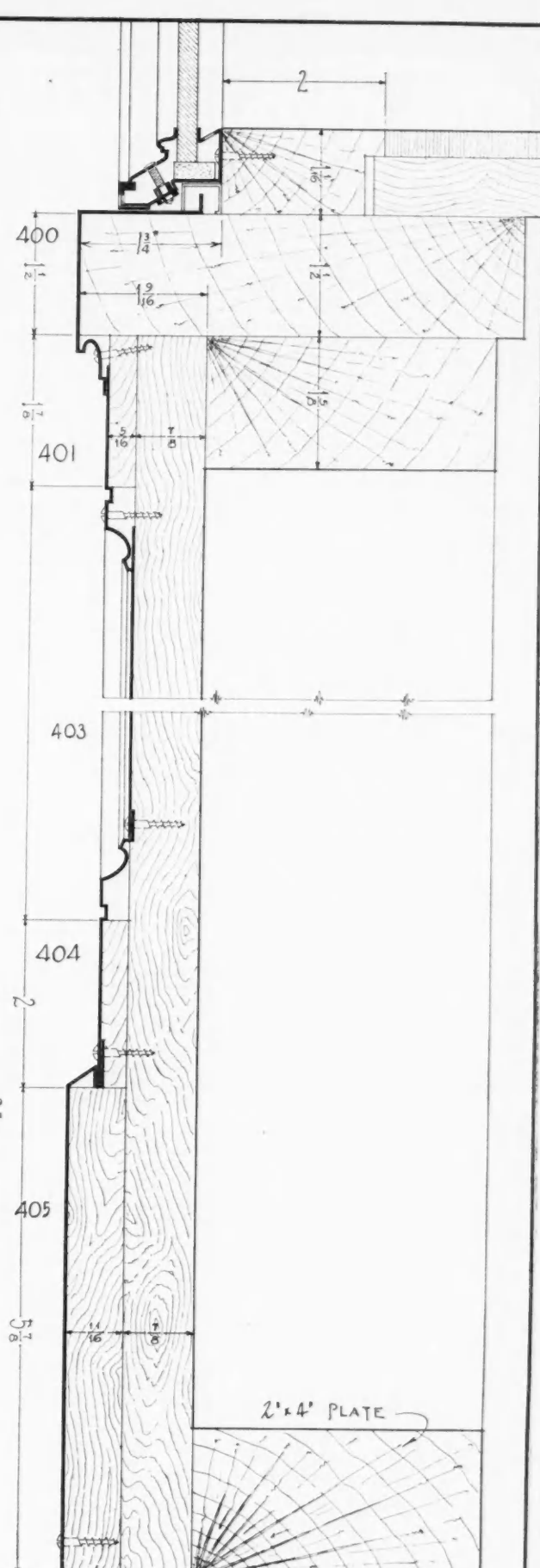
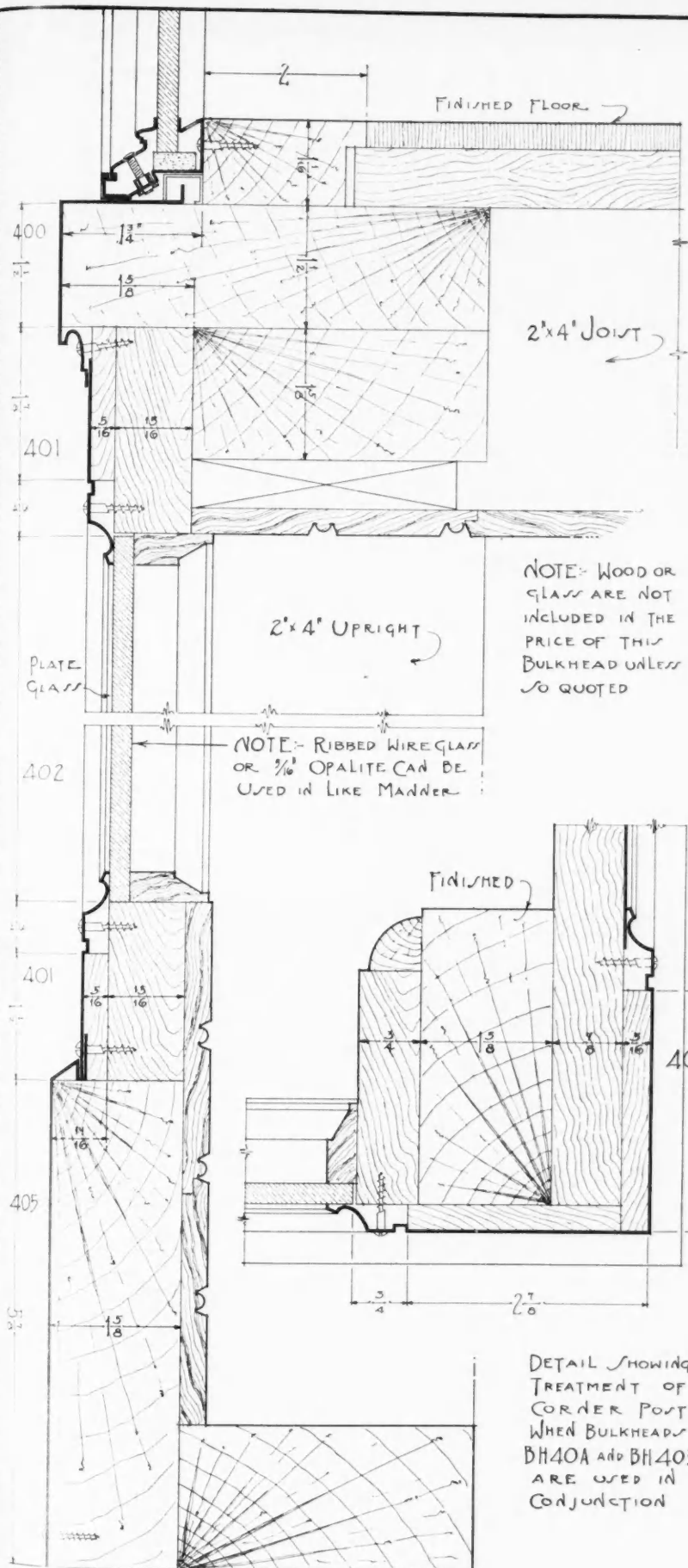

VERTICAL SECTION OF BULKHEAD BH-40-A

VERTICAL SECTION OF BULKHEAD BH-40B

PLATE No. 7



KAWNEER MFG. CO. — NILES, MICH.
MANUFACTURERS OF KAWNEER PATENTED STORE FRONT CONSTRUCTION.



Kawneer
STORE FRONTS

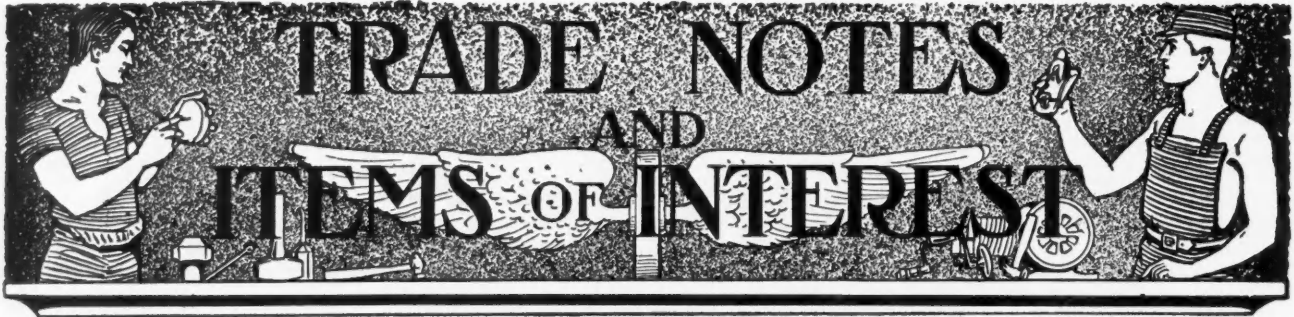

THROUGH this department the Editors aim to keep builders, contractors, carpenters and architects in touch with what their friends, the manufacturers, are doing for them in new or improved tools and machinery, methods and materials—pertaining to building. These items are offered here as interesting information for our readers; they are not advertising. Take full advantage of the Bargains offered. Write for catalogs and booklets, and become thoroly familiar with these Improvements and New Goods.

The Eveleth Door Strip

The accompanying illustration is a cut-away front view of a door with a most efficient weather strip at the bottom. This is a felt locked into its metal carrier in such a manner that there is no possibility of its coming out. The value of a yielding felt has long been recognized, but the old methods of retaining it under all weather conditions proved a failure.

This is an automatic strip with a quick action obtained by the use of a well designed lever in conjunction with a push-rod which makes contact with the jamb at the hinge edge of the door. On account of the quick action and the fact that the end farthest from the hinges is the last to drop, there is very little drag of the strip on the sill.

(Continued to page 92.)

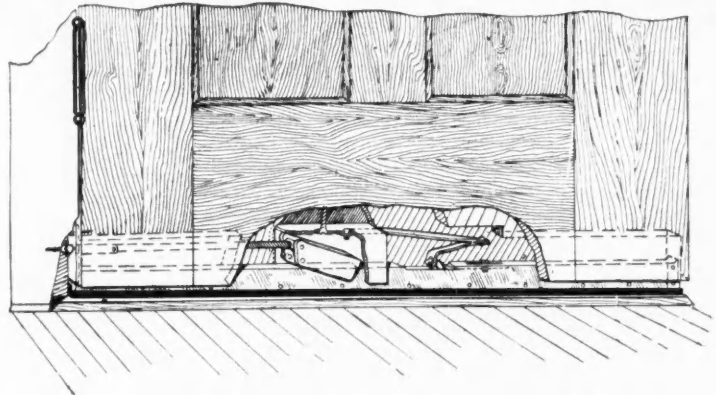

Door Cut Away to Show Operating Device that Presses Felt Down When Door is Closed.

Cellular Lath Company.

I used your Keezon Cellular Lath on the new Institutional Building of the Kingshighway Presbyterian Church, and have found it so satisfactory that I take great pleasure in commending it to others.
 GEORGE F. BERGFELD,
 President Bergfeld Realty Company.

St. Louis, Mo.



Get the Facts About Keezon Cellular Lath

Write us now for catalogue and full particulars regarding the lath that—according to a leading plastering contractor—is going to revolutionize the lath industry. The lath that saves 20% in time, labor and material. The lath that assures a job unexcelled from a quality standpoint.



Keezon Lath is fire-resisting and can be specified in slow-burning construction. Keezon Lath can't rust. It will not warp, buckle, expand or contract. These qualities make Keezon Lath ideal for outside stucco work.

Owing to capillary attraction of the cells, the plaster clings to Keezon Lath with great tenacity. That's why Keezon can be applied to flat surfaces without furring; and why it is so well adapted to ceiling work. The plaster just can't help

but stick. In a test made to demonstrate the holding strength of the Keezon Key, water to the depth of two inches was poured on top of a Keezon ceiling and allowed to remain for twenty-four hours. At the end of that time most of the water had soaked through the plaster without causing the slightest loosening or sagging.

In a word, Keezon is in the unique position of combining many advantages of every other lath (wood, composition or metal) and yet in addition of being very reasonable in price.

USE THE COUPON

Cellular Lath Company,
 5128 N. 2nd St.,
 St. Louis, Mo.
 Please send full particulars.

My dealer is.....

Name.....

City.....State.....

Get full particulars
Cellular Lath Company
 5128 N. 2nd St.
 St. Louis, Mo.

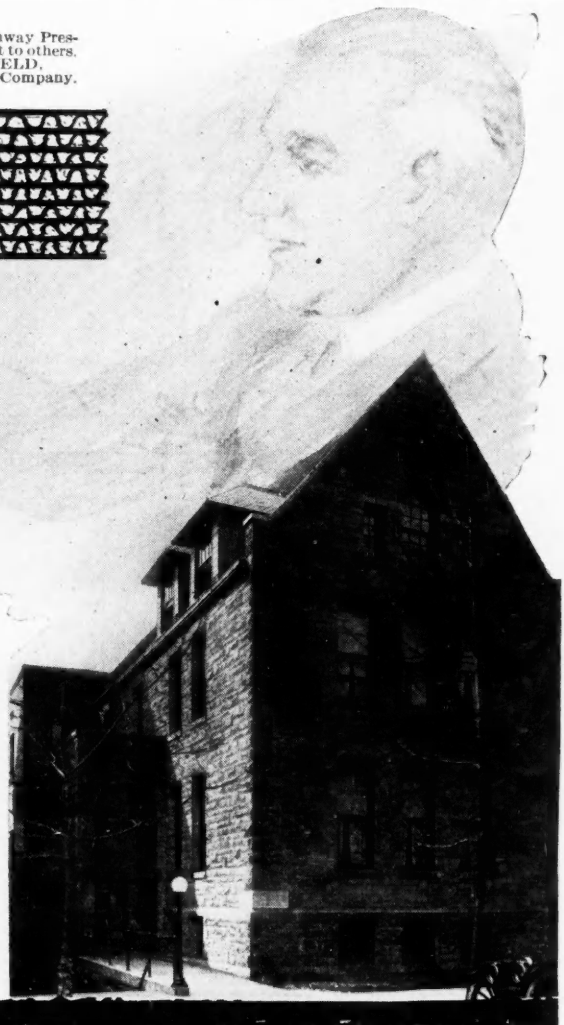

TERRA COTTA

MAKES YOUR BUILDING STAY YOUNG

☐ Maintenance expense is unknown to the man who builds with Midland Terra Cotta ---there are no paint or repair bills to meet year after year as time and weather does not effect it.

☐ USE TERRA COTTA and your building will always look as new as on the day it was completed.

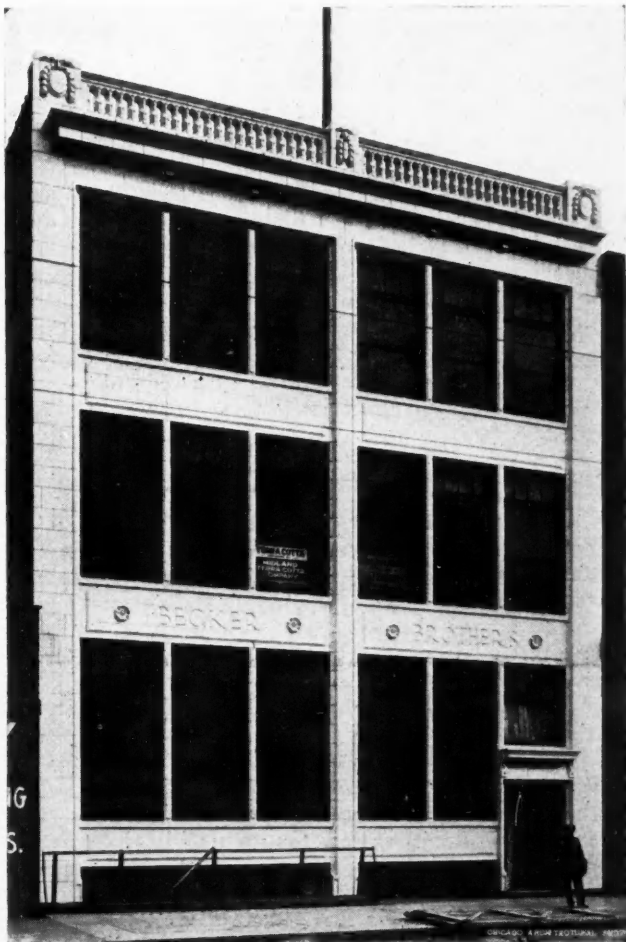

MIDLAND TERRA COTTA CO.
1515 LUMBER EXCHANGE BUILDING, CHICAGO, ILL.



Two Kinds of Profits

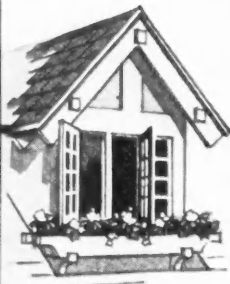

By recommending Curtis Woodwork, you can be sure of the profit on a speedy job and also of a boost from your satisfied client.

1866 CURTIS WOODWORK

"The Permanent Furniture for Your Home"

Doors
Windows
Window and
Door Frames
Storm Doors
and Windows
Screen Doors
and Windows
Stairways
Newels
Sideboards
Colonnades
Book Cases
Mantels
Window Seats
Wall Panels
Ceiling Beams
Mouldings

We help you to greater profits by sanding materials at the factory and by making them as nearly ready to put in place as possible. Then our "On-Time" deliveries do away with expensive waiting on your part. There are many features of Curtis Woodwork about which it will pay you to learn more. Drop us a post-card today and we will put you in touch with a Curtis dealer.

THE CURTIS COMPANIES

Service Bureau

1404-1504 S. Second St. Clinton, Iowa

Manufacturing and Distributing Plants at

Clinton, Iowa Sioux City, Iowa Wausau, Wis. Lincoln, Neb. Topeka, Kans. Oklahoma City Minneapolis Chicago Detroit Eastern Offices at Pittsburgh and Washington

The Makers of CURTIS Woodwork Guarantee Complete Satisfaction to its Users. "We're not satisfied unless you are."

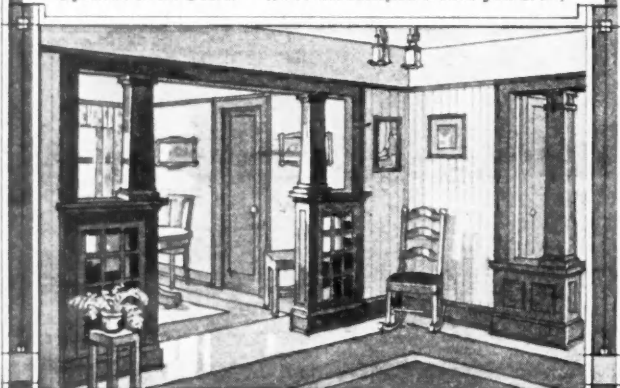

Among other features which are making this strip so favorably received are the following:

A shallow groove in comparison with the height of the opening it will fill; the practical way in which the strip can readily be made to conform to all uneven and crooked sills; the advantage of an ever ready, quick and efficient adjustment to take care of any sagging of the door or sill, and the enclosed-in-the-groove feature, making the device entirely invisible when door is closed (unless the closed space is unusually large), and showing only small pieces of highly polished lacquered brass when door is open.

In operation this weather strip is very simple and yet efficient in its fulfillment of the exacting demand on a device for this purpose.

The Eveleth Manufacturing Company of River Forest, Illinois, whose advertisement appears elsewhere in this issue, are manufacturers of the article and will be glad to give prompt attention to all inquiries.



"The Use of the Slide Rule"

A book written by Prof. Allan R. Cullimore has recently been published by the Keuffel & Esser Company, 127 Fulton St., New York City, with the title given above.

Unlike most books on the subject of slide rules it is not based on purely theoretical considerations, but it has a very practical foundation evolved from sets of notes utilized in the class work of the author, who is Dean of the College of Industrial Science, Toledo University.

Professor Cullimore has stated that his aim in writing this book is to "develop the ideas of the operator rather than to give empirical rules." He has taken up in very clear, terse language the conditions under which a slide rule may be used to advantage. The theory of the slide rule is dealt with briefly, as is the method of using it, and the greatest stress is laid on an explanation of the various principles of slide rule practice. Thru a careful study of the numerous examples worked out in this book, it is possible to obtain an excellent understanding of the principles involved, thus forming a good foundation for the independent solution of other problems. Experienced users of the slide rule as well as beginners will find benefit in a thoro study of this book.



The Little Whirlwind Concrete Mixer

A great many contractors who do not specialize in concrete work, but who nevertheless have found occasion to place concrete in connection with their other work, have always mixed the material by hand. Even tho they were not satisfied with this method of doing the work, the expense of buying a concrete mixer did not seem to them to be a profitable investment. Perhaps this has been due to the high cost of some of the earlier mixers. If this reason has been the determining factor, there is no reason now why a contractor in this position should not equip himself with a mixer. Each year there has been a tendency toward more reasonable priced mixers, suitable for use by the man whose work does not require the placing of very large quantities of concrete.

The Little Whirlwind Concrete Mixer is one which is well suited to this type of service. Altho it is not as large as its bigger brothers, yet it is made in much the same way. Its capacity is three cubic feet and its makers claim a batch a minute for it. It may be operated either by hand or by power. The size is right for foundation walls, basement floors and sidewalks. Since it only weighs 375 pounds, transportation from one place to another is easy. The machine is fully guaranteed by the manufacturers who have expressed their desire that every owner of one of their machines who

(Continued to page 94.)

The Handsomest Roofing You Can Use Asphalt Shingles

These Beautiful Colors Add Charm To The Roof

Rich looking shades of red, green, gray and brown are possible when you roof with Asphalt Shingles. By using them you can give the houses you build as beautiful an appearance as though the cost were a thousand dollars or so greater.

With this roof beauty goes a thorough protection against the elements that is maintained year after year because this roofing *stays young*. It does not dry out or change. It is just as permanent as the unchangeable color of its surfacing of crushed slate or rock products. Water cannot get through a single layer no matter what the conditions. Yet these shingles form a *triple thick* layer that means three fold protection.

We have a book of new ideas on roofing from which you can get many suggestions that will aid you. Write for your copy of "The Roof Distinctive."

**Asphalt Shingle
Publicity Bureau**

Your Customers Will Like Asphalt Shingles Better

There is a strong appeal in Asphalt Shingles that will interest your customers. They will be quick to see the advantages of a roofing that is handsome, leak proof and repairless. You will have a still greater measure of their confidence for having suggested them.

Every standpoint of roofing value is covered by Asphalt Shingles. From every standpoint of yours, too, they are better. You can apply them faster and at less cost for labor.

They are so much better looking that they make the house you build even more attractive than others near it which are covered with a drab-looking, ordinary roof.

Our other new booklet, "Fire Protection," shows some remarkable tests of various roofings. Proves which roofing gives best protection. Copy sent free on request.

955 Marquette Bldg.
Chicago, Ill.



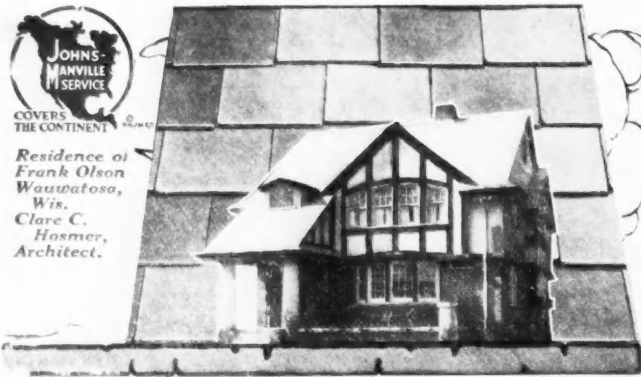

The Safety Movement has reached the home roof—meet the demand with J-M Transite Asbestos Shingles

In your community, as in all others, homes are being planned to include a fireproof roof. You should be prepared to meet this with

Johns-Manville Transite Asbestos Shingles

These shingles offer positive protection. They are more than fire-retardant—they are fireproof, and when laid American method take the base rate of insurance.

J-M Transite Asbestos Shingles never warp, shrink or split, but actually toughen with exposure and never need stain or paint.

They are examined, approved and labelled by the Underwriters' Laboratories, Inc., under the direction of the National Board of Fire Underwriters.

By filling out the registration blank accompanying every order of J-M Roofing Materials, J-M Responsibility will vouch for their satisfactory service.

H. W. JOHNS-MANVILLE CO.

Executive Offices: 296 Madison Ave., New York City

| | | | | |
|------------|-----------|--------------|--------------|----------------|
| Akron | Columbus | Houston | New Orleans | Salt Lake City |
| Albany | Dallas | Indianapolis | New York | San Diego |
| Atlanta | Dayton | Kansas City | Omaha | San Francisco |
| Baltimore | Denver | Los Angeles | Philadelphia | Seattle |
| Birmingham | Detroit | Louisville | Pittsburgh | Syracuse |
| Boston | Duluth | Memphis | Portland | Toledo |
| Buffalo | El Paso | Milwaukee | Rochester | Tulsa |
| Chicago | Galveston | Minneapolis | St. Louis | Washington |
| Cincinnati | Havana | Nashville | St. Paul | Wilkesbarre |
| Cleveland | Haughton | Newark | Sacramento | Youngstown |

THE CANADIAN H. W. JOHNS-MANVILLE CO., Limited
Toronto Montreal Winnipeg Vancouver

*If it isn't a Fireproof Shingle
It isn't a J-M Asbestos Shingle*

is not satisfied with it shall return it and get his money back.

Readers who are interested in small mixers may obtain more complete information from the Little Whirlwind Concrete Mixer Co., LaCrosse, Wisconsin.



A Special Flooring Pattern Hand Axe

A hand axe made especially for laying floor is manufactured by the L. & I. J. White Company. This hand axe is made with the end perfectly straight and at right angles with the handle, so that either in pounding or cutting, the handle clears itself from the floor, which does away with a great many bruised knuckles. The axes are fitted with the best hickory handles and a very good quality of steel is used in their construction. Perhaps the strongest quality which the axe has is the fact that it is made by a company which has had nearly eighty years' experience in the manufacture of edge tools.

The White Company prefer that all orders for their tools come to them thru their dealers, but if any of our readers are unable to get information in regard to these tools, from their local dealer, it may be obtained by addressing the L. & I. J. White Company, 10 Columbia St., Buffalo, N. Y.



Fifteen Years of Rapid Progress

In the early summer of 1901, in a little two-story building in Sterling, Illinois, three men united their efforts in the establishment of a hardware manufacturing organization. This organization was called the National Manufacturing Company, and in fifteen short years it has grown to be one of the most prominent and highly respected concerns in the trade.

This remarkable growth is not the fruit of chance, but it has been due to the fearless application of principles of honesty and square dealing combined with a clear knowledge of what is what in the hardware business.

Today this firm has salesmen in every state, and their products are for sale in over fourteen thousand hardware stores. Few are the contractors and builders who have not heard—or who do not know from personal experience—of the thoro reliability of National products.

Aside from quality production there are other outstanding features of the organization which indicate the reason for its rapid progress. Among these are the service policy which has assured a one-day delivery of all mail orders, and the policy of dealing directly with the hardware merchants. The builder has grown to know that when he sees an article advertised by the National Manufacturing Company he may be sure that when he goes to his local hardware dealer to inspect that article it will not fall down in his estimation, and if he places an order it will be delivered in the shortest possible time.

Those who have watched the growth of this organization and are acquainted with the policies which it represents cannot help but feel that the success of the past fifteen years is well earned, and that the future may bring even greater accomplishments.

A very interesting photograph of the prize-winning float which appeared in a big Industrial Parade held at Sterling on July 4th appears on page 96. The float took first prize.

The float was decorated in the National colors—red, white and blue. The big door on either side, was 8 by 12 feet, and different articles which they manufacture were tacked on the map, as you will notice. A young lady costumed as Columbia was placed on each of the four corners. A drum corps in colonial costume occupied the canopy space on top of the float, while a young man representing Uncle Sam drove the horses.

Ribbons were tacked in each state and centered at Sterling, showing the territory which the National Mfg. Co. cover.

Build For Reputation As Well As Sure Profits



Home of W. Oerther, Monroe, Mich.
Contractor and Builder, Godfrey Goetz

My first job to use "CREO-DIPT" Stained Shingles was on Mr. Walter Oerther's bungalow (see accompanying illustration). That is about two years ago and there isn't a faded shingle on the house today. I have also used on about six other jobs your "CREO-DIPT" Stained Shingles and they are all pleased with them.

I always advise my customers to use them when they want dipped shingles, as I know by experience that the quality of shingles is very good and the colors non-fading. I want to say that I have just finished a house where I used your shingles from your Chicago plant and will always recommend your shingle.

Yours respectfully,

(Signed) **GODFREY GOETZ.**
Contractor and Builder.

You Are Not Taking Any Chances With

"CREO-DIPT" STAINED SHINGLES

17 Grades 16, 18, 24-inch 30 Color Shades

BECAUSE—We take entire responsibility for quality of shingles, quality of stain, permanence of color and quality of workmanship that make even stains.

REASON—If you dip shingles on the premises, lumber dealer surely is not responsible for inferior quality of stain a paint dealer may sell you. You cannot blame the stain manufacturer if your lumber dealer does not supply the best grade of shingles to take the stain. You certainly cannot blame the workman when he does the best he can with material supplied him.

SAVE WASTE—"CREO-DIPT" Stained Shingles are cut from first growth British Columbia Cedar—no stumpage—no wedge shapes—all vertical grains.

SAVE LABOR—Handling such shingles saves time in laying. You save cost of extra men to stain.

SAVE TROUBLE—With "CREO-DIPT" Stained Shingles you always please your customers. You know that the manufacturer stands behind his guarantee that every order will be entirely satisfactory in every respect.

Colors are all ground twice in pure linseed oil and suspended in fine creosote oil—no kerosene, benzine or other cheapener used. Process of staining fills the pores. Shingles last twice as long as brush-coated shingles or natural wood. Colors never fade out in streaks.

Literature, Dealer Helps, Book of Houses, Sample Colors on Wood, on Request

*You Cannot Afford to
Substitute for Quality*

Standard Stained Shingle Co.

Originators and Sole Manufacturers

General Office, Warehouse and Factory, 1028 Oliver Street
NORTH TONAWANDA, N. Y.

Factory in CHICAGO for Western Trade



"They Come in Bundles Ready-to-Lay Without Waste"

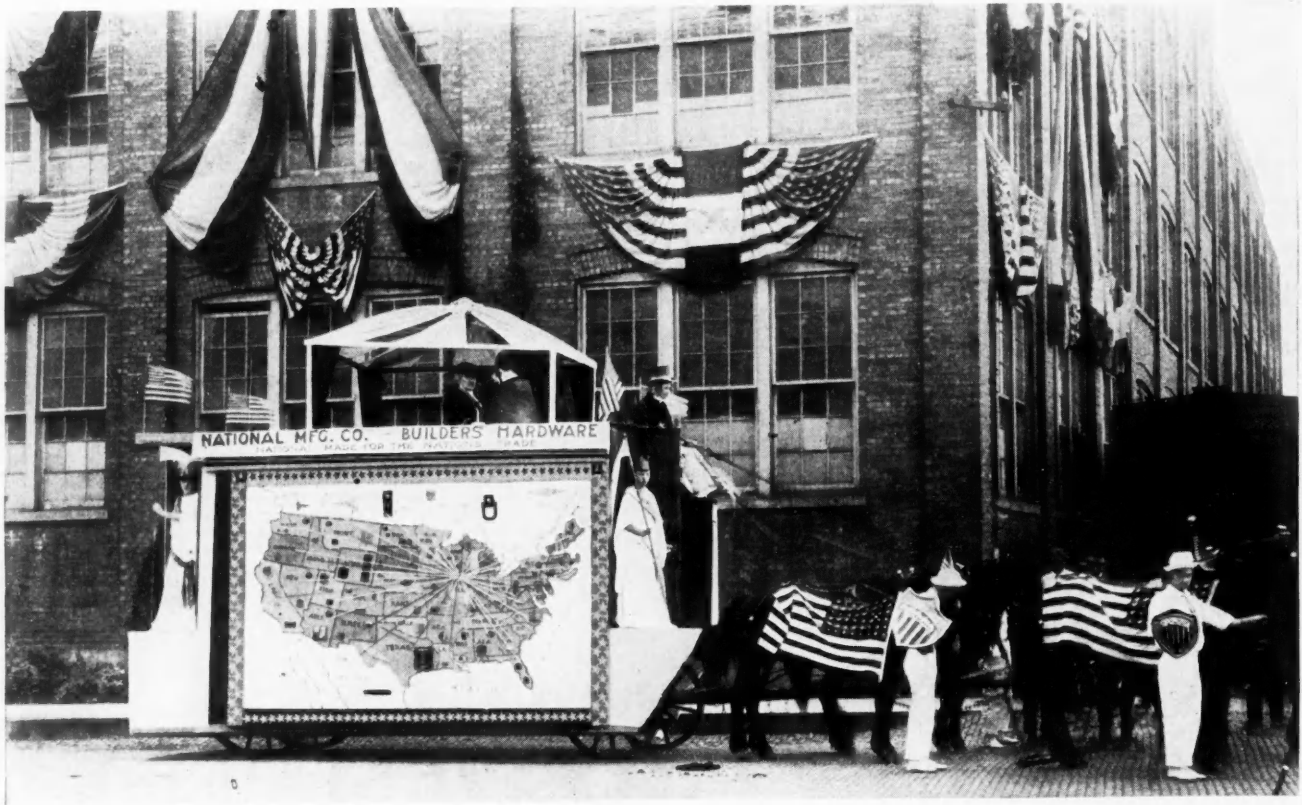

The Float That Won First Prize in the Fourth of July Parade at Sterling, Ill. The National Mfg. Co. Shows How True to Fact Its Name is.



The Fire Loss of this Country Now Amounts to **\$250,000,000** per Year

Approximately \$2.50 per capita loss—
a most eloquent argument for fire-
proof roofs made from

Keystone Copper Steel Roofing Tin

Our booklet "Copper—Its Effect Upon Steel for Roofing Tin" contains facts and information of value to architects, builders, and property owners. APOLLO-KEYSTONE Copper Steel Galvanized Sheets are unequalled for all forms of exposed sheet metal work. Time and service have proved it.



Look for the
Keystone
added to brand

American Sheet and Tin Plate Company

GENERAL OFFICES: Frick Building, PITTSBURGH, PA.

DISTRICT SALES OFFICES:

| | | | | | | | | |
|---------|------------|--------|---------|-------------|----------|--------------|------------|-----------|
| Chicago | Cincinnati | Denver | Detroit | New Orleans | New York | Philadelphia | Pittsburgh | St. Louis |
|---------|------------|--------|---------|-------------|----------|--------------|------------|-----------|

Export Representatives: UNITED STATES STEEL PRODUCTS COMPANY, New York City
Pacific Coast Representatives: UNITED STATES STEEL PRODUCTS COMPANY, San Francisco, Los Angeles, Portland, Seattle

WHEN WRITING ADVERTISERS PLEASE MENTION THE AMERICAN CARPENTER AND BUILDER

Vulcanite

Ornamental Roofing and Shingles

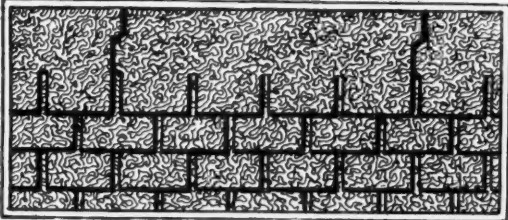

Vulcan Slab Shingles Self Locking in Red or Green 10"x32" or 12 1/2"x32"

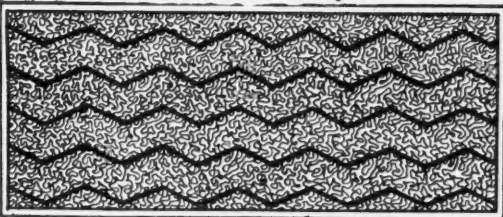

Vulcanite Strip Shingle Style B Either in Red or Green

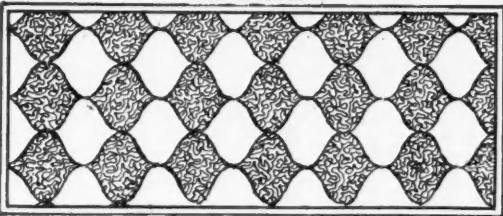

Vulcanite Mosaic Style H Two Colors Red or Green

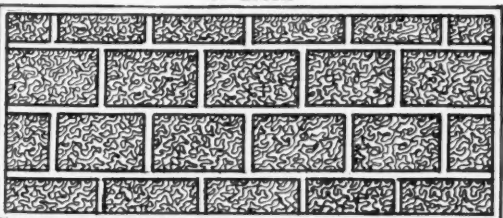

Vulcanite Mosaic Style K Two Colors on One Roll

For permanency, durability, beauty, economy, fire and weather protection, they have no equal.

Heretofore, lack of something better has necessitated the use of wooden shingles, in spite of the fact that they crack, warp, draw the nails, and burn up like tinder.

But now, **Vulcanite Roofing** furnishes a material that perfectly combines the qualities of safety, comfort and beauty at so low an initial cost as to prohibit such a flimsy, highly combustible and temporary covering as a wood shingle Roof. **Vulcanite** roofing outlives wood shingles, two to one. Twenty years' service is a reasonable expectancy.

And you can obtain a most pleasing variety of effects in colors and designs. **Vulcanite** comes in rolls and shingles in several patterns that can be worked into any number of artistic finishes. The colors will withstand sun and rain for any length of time. They are as permanent as the granite itself from which they are made.

*We would like to send you our catalogs and samples; and show how you can use **Vulcanite** to boost your business, and increase your profits.*



Patent Vulcanite Roofing Company

CHICAGO, ILL.



Interior of Home Finished in North Carolina Pine

Your Customers Demand Interior Woodwork

There is an insistent and ever-increasing demand for paneled walls, beamed ceilings, inglenooks and other forms of interior craftsmanship.

And you must meet this demand — or overlook a most profitable outlet for your service.

North Carolina Pine

"The Wood Universal"

is most excellently adapted to interior trim. Its natural beauty and variety of grain, as well as its paint-retaining qualities, recommend it most highly for this purpose. And it is as low in price as any other wood of equal worth.

Its use will give your customer complete satisfaction. And by recommending it you earn a reputation for good business judgment and a sound knowledge of values.

Our Free Reference Book Shows Interior Finishes in Colors

A variety of the finishes possible with North Carolina Pine are shown in our new Reference Book in full colors. Send for Book A today.

North Carolina Pine Association
Norfolk, Va.

NORTH CAROLINA PINE



The New "Easy Replace" Feature of Sidewalk and Vault Light Construction

This new construction provides the easy replace feature of broken glass, whereby the original glass, broken by accident or other cause, can be readily knocked out by several good blows from the top, leaving a clean-cut opening or socket in the concrete into which the smaller glass is inserted.

The space between the smaller glass and the wall of the socket is then filled with a fine grout (composed of one part cement and one part sand), which fills the space half way up from the bottom to the top of the glass. The remaining space is then calked with a waterproofing compound of tar, sulphur and zinc.

The size of the original glass is 3 inches, either square or round, and the replace glass is 2¾ inches; however, both glass are designed to fit the same opening in form, the latter providing a definite bearing ledge supporting the glass.

While the glass used in the "Raydiant" system is of the highest quality obtainable, yet it is impossible to entirely eliminate cracked and shaled glass, which makes the replace feature an important one.

The "Easy Replace" feature of the "Raydiant Special" system is not confined to the round glass, but may be used with

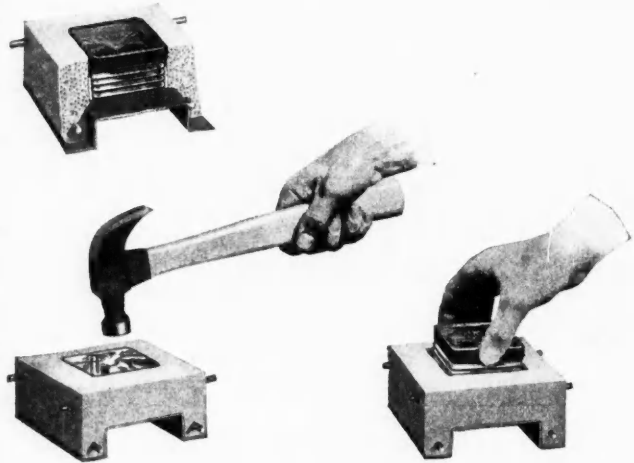

Showing Ease with Which Glass may be Replaced in the "Easy Replace" Method of Construction.

equally good results in the plain square, three-point prism, and deep pendant prism.

An especially appealing point in this construction is the fact that no extra charge is made for this replace feature.

Full particulars and blueprints of the "Raydiant Special" construction may be obtained from the manufacturers, The Berger Mfg. Co., Canton, Ohio.



New "Red Devil" Bolt Cutters

The heavy demand for a very strong compound cutter has prompted the Smith & Hemenway Co., Inc., to bring out a tool with a leverage power of thirty to one. The handles are made of malleable iron and the jaws are of drop forged tool steel. The new model No. 154 is made very light for cutting concrete binders, stove bolts and large size wire. This tool is 8½ inches long, cutting ¼-inch bolts, and should be very

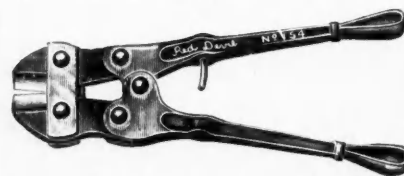

Strong and Light "Red Devil" No. 154 Light Work.

(Continued to page 100.)



DOORWAY,
ISAAC ROYALL HOUSE
at Medford, Massachusetts.
Built of White Pine in 1732.

While the Royall House as it now stands was built in 1732, a section of it—which was originally the Winthrop Farm House—was built in 1631. This is the oldest section of any house now standing in this country.

CARPENTERS, lumber men and architects have for generations agreed that no other wood gives such long and satisfactory service, when exposed to the weather, as

WHITE PINE

Despite an impression that it is scarce there is still plenty of "Good Old White Pine," in all grades, and it can be purchased in all markets at reasonable prices, when considering its value as a structural wood.

If the lumber dealers supplying the materials for those for whom you are building are at any time unable to furnish it, we would appreciate the opportunity of being helpful to you in securing it.

A FREE MAGAZINE FOR CONTRACTORS

We are now publishing a bi-monthly architectural magazine, every issue of which will be full of valuable and helpful information for contractors and builders. If you would like this magazine, write us and we will be pleased to place your name on our mailing list.

Representing
The Northern Pine Manufacturers'
Association of Minnesota, Wisconsin
and Michigan, and The Associated
White Pine Manufacturers of Idaho

Address, *WHITE PINE BUREAU,*
1835 Merchants Bank Building, St. Paul, Minn.

handy and serviceable for the kind of work to which it is adapted.

This company also puts out another compound cutter, which is intended for rapid work in close places, and has a leverage of forty to one. The jaws spread at the end to engage wire. A high grade of crucible tool steel is used in the cutting jaws, which makes it very dependable. This is a new tool and one that will find favor with



A Light Work Compound Cutter, the "Red Devil" No. 145.

people who have concrete binders, small rods, bolts and heavy wire to cut. The leverage makes it one of the most useful tools for light work cutting. It is known as style No. 145 and is 13 inches in length.

Still another bolt cutter, with a malleable iron handle and forged steel jaws is Style No. 4155. This has a leverage of thirty to one and is intended for heavy work. It comes in the following lengths: 12 inches, 18 inches, 24 inches and 36 inches, and cuts wire respectively three-sixteenths,



"Red Devil" No. 4155, Intended for Heavy Work.

five-sixteenths, three-eighths, one-half and five-eighths inch in diameter. Any of our readers who are interested in these cutting tools should address the manufacturers, Smith & Hemenway Company, Inc., 106 Chambers Street, New York City.

Now the Demand for Cement Drain Tile is Created

No doubt many men who are considering the manufacture of cement drain tile as a business, have wondered whether or not it was difficult to sell the product. It is NOT difficult for two reasons, one being the fact that a natural demand for good cement tile already exists in most farming com-



USE CEMENT TILE

The efficiency of the drainage depends upon the nature of the tile used. Practical tests have proven Cement Tile is by far the most efficient and economical. For one thing, Cement Tile is frost and weatherproof; clay tile is not. Another point is the Cement Tile will actually get better with age, while clay tile deteriorates. A third reason is that Cement Tile is always uniform in shape and thickness of walls, while clay tile warps and is consequently more difficult to lay. Yet—Cement Tile is as cheap, or cheaper, than clay tile.

Careful Drainage Means Better Crops

—and increased value to the land. Drained land can be worked earlier and easier, and produces more. Drainage is the best investment you can make.

Machine, which makes the strongest tile ever marketed, with walls of an even thickness and extra strength at the ends.

A free booklet called "Farm Drainage" will be mailed to any farmer upon request.

PRICES:

| | |
|-------------|-----------------|
| 4-Inch Tile | \$ 17.00 per M. |
| 6 " " | 30.00 " " |
| 8 " " | 50.00 " " |
| 10 " " | 75.00 " " |
| 12 " " | 100.00 " " |

(NOTE: Space covers for most tiles in the local catalog and prices, and the distributor is authorized to allow for this.)

Copy of Advertising Matter Furnished by a Leading Manufacturer of Tile Machinery to Users of Their Machines for Use in Local Newspapers.

munities; the second reason being that tile machine manufacturers offer very close co-operation in introducing cement tile to local users.

In this connection it is interesting to note what the W. E. Dunn Mfg. Co. are doing to help users of their tile machines make maximum profits. In many localities the demand for cement tile is so large that no advertising is necessary to

(ed to page 102.)

WATERPROOF PLASTERGON WALL-BOARD



(See how this 10 ft. panel stands straight without bending! Send for actual photo.)



Comes Sized---

Saving you \$4 to \$6 per M. sq. ft. Waterproofed—sized—"lumberized" all in one process. Genuine wood fibre—nothing else. Nothing to hide or color over. Try Plastergon on some job where no other wall board will do. Our users say it has no equal at any price.

Your Safeguard in Buying (No. 2)

"I think Waterproof Plastergon is one of the best pieces of goods on the market today. The quality is good, the board is stiff when applied. . . . The price of Plastergon appeals to the trade."

W. J. ALEXANDER, Steubenville, Ohio.

Samples and our "Contractors' Practical Working Guide" sent free. Send the name of your Lumber or Builders' Supply Dealer. Write today.

Plastergon Wall Board Company
No. 1 Philadelphia Ave. Buffalo, N. Y.

Which is the Bad Egg?

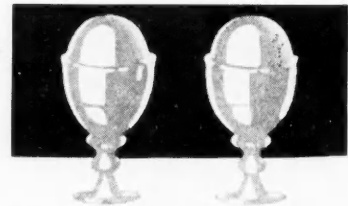

We'll give you two guesses.*

With only the picture before you it's a guess at the best.

If you had the actual eggs in your hand, there would be two ways to find out which was the bad one.

You could hold them up to the light and tell.

Or you could bake each one into a cake and tell the bad egg by tasting the cake.

But why spoil the cake?

There are good wall boards and bad. You can't tell a poor piece of wallboard by its looks any more than you can a bad egg. Defects in wallboards only show up on the finished wall and then usually they are glaring defects. You can't afford to spoil the room in order to test the wallboard. There is one way and only one way to be sure. There is only one standard and that standard is Beaver Board—the pioneer in its field.

Beaver Board gives you handsome, permanent, serviceable walls—better than lath, plaster, steel or wood.



But you can't expect Beaver Board results unless the Beaver trade-mark is on the back of the board you buy.

Write for booklet and sample.

THE BEAVER BOARD COMPANIES
566 Beaver Road - - Buffalo, N. Y.

Branches in Principal Cities

*You were wrong. Both were bad eggs.

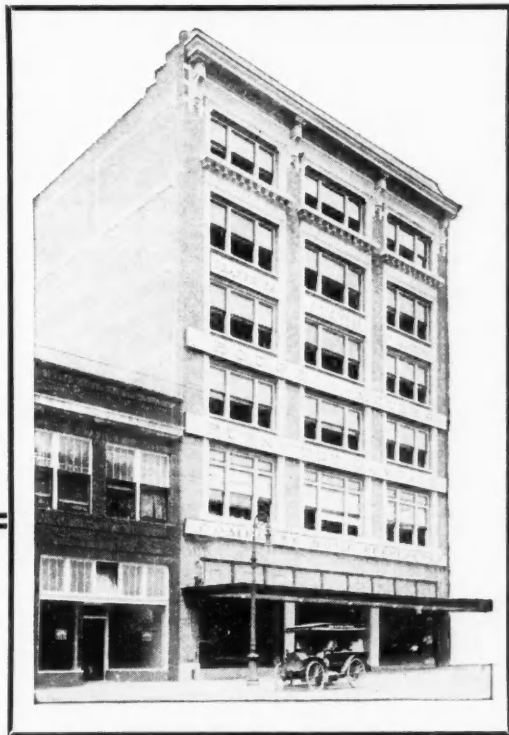

This Job Awarded on Cornell Free Plans

The Cornell Department of Design draws up Free Plans and Specifications for the use of Cornell-Wood-Board for the walls and ceilings of any job, large or small, *absolutely without cost or obligation on the part of the contractor.*

More than ninety per cent of these Free Plans actually land the jobs for the contractor who submits them. The contract for the building shown here was awarded on the strength of the Cornell Free Plans.

Cornell-Wood-Board

FOR WALLS, CEILINGS, PARTITIONS

All that is necessary for you to do to get these Free Plans and Specifications is to send us blue prints or rough dimension sketches of the job you are figuring on. It makes no difference whether it is one room or a big business block. The plans will be drawn up immediately and sent to you.

Cornell-Wood-Board is *the superior wall board*. The ideal wall and ceiling material for homes, stores, offices, theatres, churches, schools, display windows, etc. It is applied direct to the studding or right over old walls. Decorates perfectly with paint or kalsomine.

Send for the Free Plans and Specifications today. Cut the Coupon.

Cornell Wood Products Co.

C. O. FRISBIE, President

173-175 W. Jackson Blvd.

Mills: Cornell, Wisconsin

CHICAGO

Cornell Wood Products Co.,
Chicago, Ill.
Herewith Blueprints (or Dimension Sketches) of job on which I want Free Plans and Specifications for paneling with Cornell-Wood-Board. I understand that I am not obligated in any way.



Again! Another New FLEX-A-TILE

It's simply a variation of our Diamond Slab. Identical in quality, materials and wearing properties—but different in shape and appearance.

Style 4 Slabs

This newest style Flex-a-Tile Asphalt Shingle meets the requirements of those who prefer the appearance of rectangular shaped single shingles but who want the economy and convenience of Flex-A-Tiles in slab form.

As the illustration shows, this Flex-A-Tile Style 4 Slab is really four shingles in one. The 4-inch long slits act as a score to lay to, as well as to mark the usual spaces that occur between single shingles. You simply cannot distinguish a roof of Flex-A-Tile Style 4 Slabs from a roof of single shingles. And of course these Style 4 Slabs are laid quicker, cheaper and last at least as long as single shingles. Size of each slab 32x10 inches. Surfaced with the usual Flex-A-Tile red or green stone surfacings.

THE HEPPES COMPANY

Dept. H 1010 Fillmore Street
Chicago, Illinois

*Flex-A-Tile Roll Shingles
No-Tar Asphalt Paints, Utility Board
Other Guaranteed Heppes Products*

Write today for samples of the new Flex-A-Tile Style 4 Slabs as well as the Diamond Point Slabs. Some attractive agency territory still open.

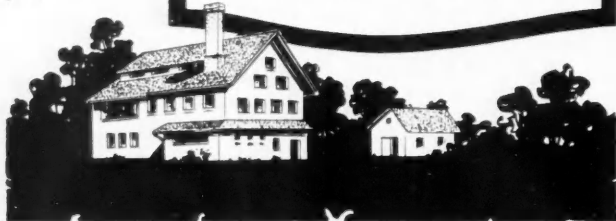

make sales, but in other parts it is desirable for the tile manufacturer to let farmers know he is "on earth."

One of the mediums thru which this is done is by local newspaper advertising. Electrotyped advertisements, two or three columns wide, are furnished mortised for tile maker's name and address (note illustrations). Space in local newspapers is very cheap and the advertisements can be run once or twice a week.

In case tile users are not thoroly familiar with the advantages of cement tile, the W. E. Dunn Co. furnish a supply



Newspaper Advertisement Furnished by Makers of Concrete Tile Machinery to Stimulate Demand for Concrete Tile.

of booklets called "Farm Drainage." These have the local tile maker's name printed on the front cover, and are for distribution to local farmers.

The next on the list is stationery. The Dunn Co. furnish neatly designed and illustrated letterheads and envelopes, with the name, address, business, etc., of the customer printed on. Should the tile maker wish to circularize a list of farmers, the Dunn Co. will undertake to write, print and typewrite a supply of letters, and address the envelopes, all ready for the tile maker to mail.

Lantern slides, for use in the local moving picture theatre, is another effective means of advertising tile. The Dunn Co. will furnish such slides. These, and many other methods of helping to create sales, is a clear indication that the business relations between the W. E. Dunn Mfg. Co., and users of their tile machines, do not end with the purchase of the equipment, but continues along lines of common benefit. Further information can be obtained by writing to this company at 415 24th St., Holland, Mich.

✦ "The Ideal Mortar for Brick Masonry" ✦

The above title is given Bulletin J, published by the Hydrated Lime Bureau of the National Lime Manufacturers' Association, Arrott Building, Pittsburgh. It contains the results of an investigation conducted by James S. Macgregor, Professor of Civil Engineering at Columbia University, New York City, who has found that the maximum strength with minimum expense in laying brick masonry can be obtained with a mortar mixture composed of ½ cubic foot of Portland cement, ½ cubic foot of hydrated lime and 3 cubic feet of sand, or proportions of 1:1:6.

The first eight pages of this bulletin contain a discussion of the important properties of hydrated lime, the ultimate resistances of the different piers tested in carrying on the investigation, the object of the investigation, an outline of the investigation, a description of mortars and a summary of ultimate resistances for piers built of face brick. The central portion of the pamphlet is filled with photographic illustrations of the tests made, stress-strain and set diagrams for

(Continued to page 104.)

A Beautiful Book Free

The 1916-17 edition of "Repairing and Building" is now ready

It is beautifully lithographed and has many illustrations in colors, and in black and white. It shows exteriors and interiors of all kinds of buildings. Its object is to demonstrate to carpenters and builders the many attractive features of

NEPONSET Shingles and Wall Board and other Neponset Products

which are fully illustrated and described

Will you write for your copy today? It is absolutely Free, and your sending for it does not imply the slightest obligation. Use the coupon below.

BIRD & SON, (Established 1795) Dept. C, East Walpole, Mass.
CHICAGO: 1434 Monadnock Bldg. NEW YORK WASHINGTON
Canadian Office and Plant: Hamilton, Ont.



BIRD & SON, Dept. C, East Walpole, Mass.

Send me free of cost a copy of the 1916-17 edition of "Repairing and Building." The sending for this book does not obligate me in any way.

Name

Address

the several piers tested, and graphs of collected set readings. The last six pages contain a copy of the investigator's complete report.

The following, taken from the bulletin, are given as the reasons for conducting the investigation:

"1. To indicate what value, from the standpoint of strength, the better bearing surface given to the bricks would possess when laid up with cement-lime mortars of varying proportions.

"2. To determine the practical effect on strength when bricks absorb a portion of the moisture from the mortar and thus rob the mortar of the moisture needed to hydrate and harden the cement. This was to indicate whether the water carrying capacity of hydrated lime had a value in retaining moisture in the mortar which would be passed off to the cement and taken up in subsequent hydration, thus resulting in increased strength. The results shown in the 'Summary of Ultimate Resistances' proves this reasoning established beyond doubt."

This bulletin contains information which should be of great value to all brick masons, for it settles definitely all questions of debate as to the use of hydrated lime in mortar and furnishes a fund of information in regard to the correct proportions to be used to produce the most desirable results.



Planes with Automatic Set

Sargent & Company have recently put on the market a line of iron bench planes that meet the demand for a plane which will save the time of the carpenter in setting the cutter and cap. These new planes are made with a single cutter instead of the double or spring cap cutter commonly used in iron planes. The most important feature of the new planes is in the construction of the clamp, which combines the cap and clamp found on the spring cap type of planes.

The user of the plane can make his adjustment of the clamp, by means of the regulating screw, to whatever point is suitable for the class of work on which he is using the plane. For a coarse cut, he raises the clamp, leaving a considerable space between the extreme lower end and the cutting edge; for a fine cut, he reduces this distance to a minimum. When, however, the clamp is once adjusted to his satisfaction, it is not necessary to change the adjustment until the user wishes a finer or coarser cut than the one he orig-

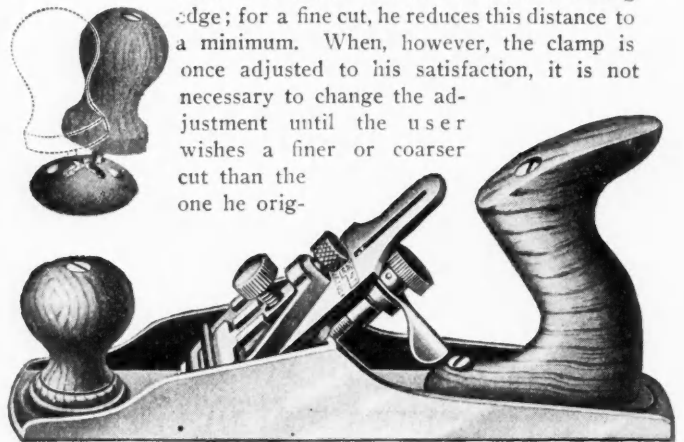

A Time-Saving Plane with Many Special Adjustment Features.

inally planned for. When the clamp is removed so that the cutter can be ground or honed, it will always drop back into its original position without further adjustment. This means a very considerable saving of time for the carpenter.

In addition to the features described, these new planes have the advantage of lightness and stability of construction. The frog is not adjustable, but is held firmly in the bed of the plane by two machine screws.

All adjustments are conveniently arranged and are quick acting. In the case of the up and down adjustment for the

(Continued to page 106.)

We have at last a Vise that is good enough for the House Carpenter

THE Carpenter Vise swings perfectly free on its base in any of its many positions. The

workman places his work in the vise in the best position for working to get the best light, with his body in a natural position so that he can work direct from the shoulder. The vise locks automatically in any position. This means greater efficiency for the workman, increased output, better and truer work with less labor. This tool is a profit booster for the contractor, a labor saver for the workman. If your hardware dealer cannot show you a vise in action send for full information direct.

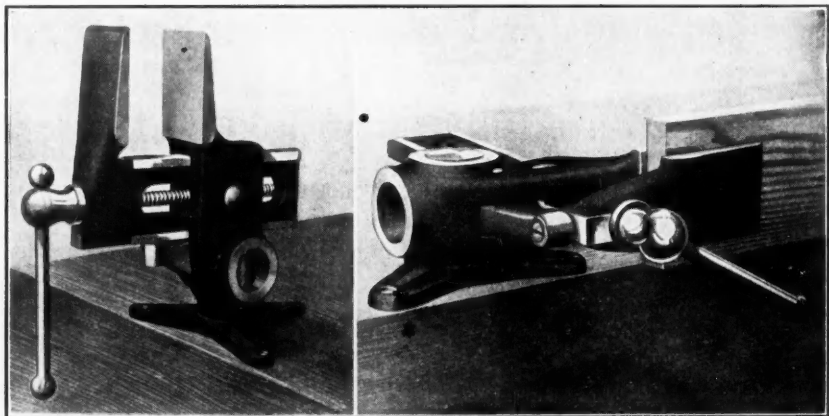

THE WILL-BURT COMPANY, Orrville, Ohio

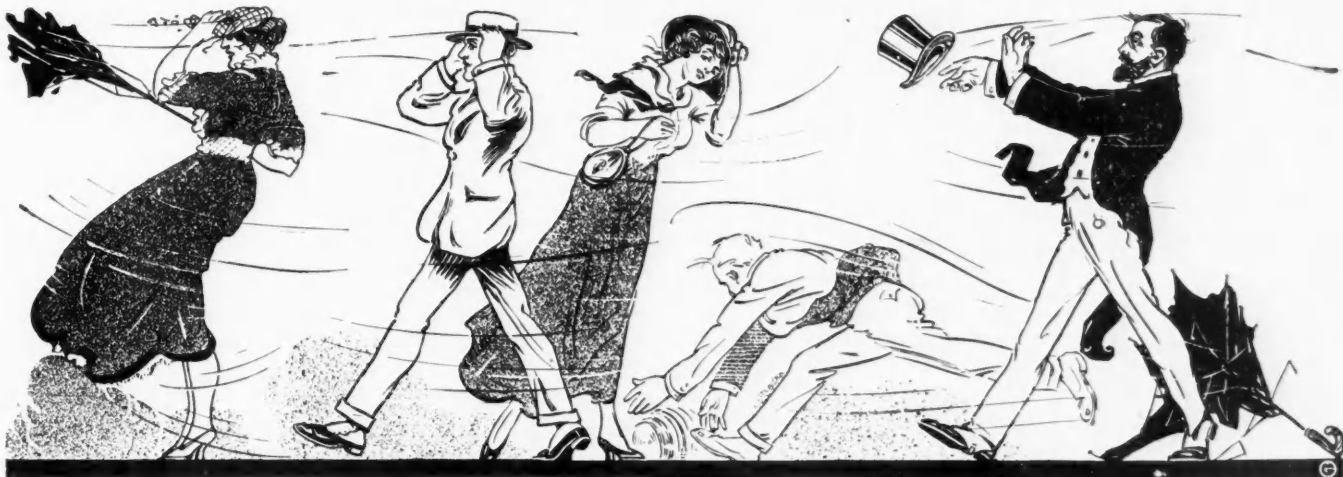

When the Wind Plays Capers Your Clients Flock to Tell You of Their Broken Store Windows

That is, if you haven't taken the precaution to specify — *Safety Window Settings.*

The wind pressure only completed the work that was started when the window was set. The glaziers didn't line up the glass against the rabbet evenly. And when they got busy with their big screw-drivers in the outside moulding, the glass at the ends and middle was forced home against the rabbet, while the part immediately above the setting blocks stuck to the blocks.

The result was a distortion of the glass — putting it under a dangerous tension. The stress caused by the wind started a crack, and—good-bye, glass.

We urge comparison of illustrations of construction and invite comparison of samples. We illustrate Zouri Construction in all our advertising. We even urge comparison of our cheaper lines with copper moulding effects.

Comparison will speedily show you why we can't and won't sell Zouri Key-Set Store Fronts at the price of copper moulding effects.

Insist on Samples—We'll Gladly Send Them

Zouri Drawn Metals Company

1811-1821 East End Avenue

Chicago Heights, Illinois

Our New Book—

"GETTING THE PEOPLE IN"—is the most sensible and interesting non-technical book ever published on the subject of show-windows and their crowd bringing value. It is of interest to every retail merchant, and every builder who has anything to do with store building or remodeling. Send us the names of merchants in your territory who need better store fronts and have both the capital and courage to buy the best. We will gladly mail them copies of the book.

Use Coupon Below

COUPON

Zouri Drawn Metals Co.
1811-1821 East End Ave.
Chicago Heights, Ill.

Gentlemen: I have just read your ad in the American Carpenter and Builder.

Please send me the items checked below—free of charge. Postage prepaid.

Set of Detail Drawings on Store Fronts.

Copies of the book for merchants called "Getting the People In."

Name.....

Firm.....

Business.....

Address.....

Cut No. 1 The Zouri Safety Key-Set Sash (with Union Covering) No. 900 is free from dangers of direct screw pressure, or a resilient rabbet. Its inner member is rigid. The Union Sill Covering, extending from inner side of plate glass to lower edge of sill, has no joints, no perpendicular screws, no sill-deterioration because leakage is impossible. Made in solid copper.

Cut No. 1

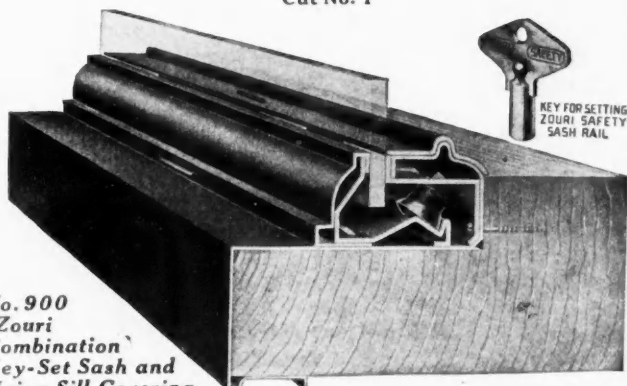

No. 900 Zouri Combination Key-Set Sash and Union Sill Covering

Zouri Safety Corner and Division Bars

Cuts Nos. 2 and 3 These corner and division bars are free from direct screw pressure. They are proof against the carelessness of workmen. They can be set only with the small special socket key shown, so that undue pressure cannot be exerted by the tools used in the building line, the power of which is beyond control. These bars are specially constructed so that the edges of the glass cannot come in contact with the metal.

Cut No. 2

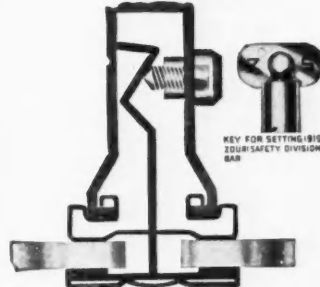

No. 300 Safety Key-Set Division Bar

Cut No. 3

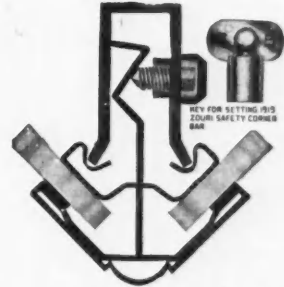

No. 200 Safety Key-Set Corner Bar

WHEN WRITING ADVERTISERS PLEASE MENTION THE AMERICAN CARPENTER AND BUILDER

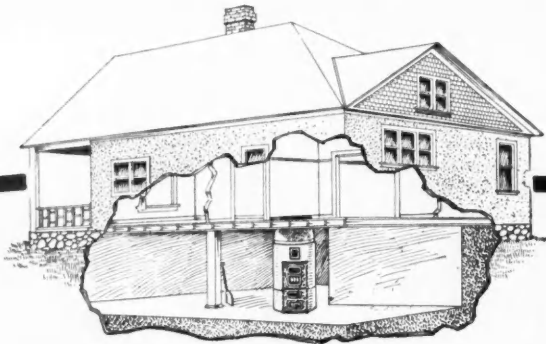

Better Heating— Healthier Living

with the

MUELLER PIPELESS FURNACE

Thousands of installations prove the Mueller "Pipeless" the most economical and satisfactory method of heating the small and average sized home everywhere. Its single register directly over furnace provides rapid circulation of **pure, warm air** throughout entire house.

This is a **real** furnace—made of heavy, solid cast iron—no sheet iron used in its construction—and it gives a lifetime of satisfactory service. Burns hard or soft coal, coke or wood. As easy to install as a stove, but cleaner and easier to run. Also saves fuel, labor, time, trouble. The best "pipeless" furnace for the best heating results.

A "Mueller" System for every Heating Requirement

For very large homes and other buildings, for which the "pipeless" furnace is not best suited, contractors and builders have choice of a Mueller system adapted to their every building requirement, covering Warm Air Furnaces, Hot Water and Steam Boilers and Vapor Systems.

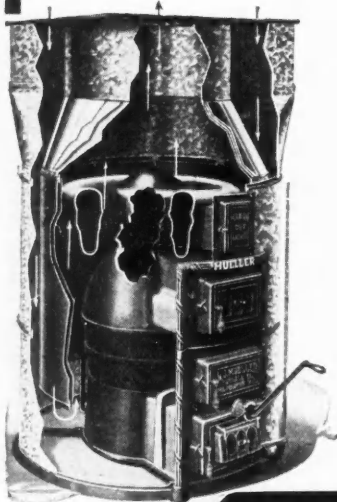

Mueller Leads Since 1857

Let us help you solve your heating problems with our nearly 60 years of successful heating experience and unbeatable line of heating appliances.

Send for Catalog

and full information on all Mueller Heating Systems. Dealers positively protected.

**L. J. MUELLER
FURNACE CO.**
218 Reed St., Milwaukee, Wis.

cutter, a direct action is used instead of indirect, as on other types of iron bench planes.

These planes, which are tools of the highest grade, are made in six sizes as follows: Smooth planes, Nos. 707, 708 and 719; Jack, No. 714; Fore, No. 718; Jointer, No. 722; as is usual with Sargent planes, the terminal figure indicates the length of the plane. They are made with both smooth bottom and corrugated bottom, a terminal letter "C" being added to the above numbers to indicate the corrugated.

On the larger sizes, Nos 718 and 722, there is an added feature which consists of a high knob on the front of the plane, which is adjustable to permit the user to change his grip on the plane when for any reason he becomes tired after constant use. It also enables the user to swing the knob to the right or to the left to avoid any possible obstruction.

These planes are adapted for use in cross-grained hard wood, but they can be used to equal advantage on soft wood. The fact that they are light makes them particularly convenient for the journeyman carpenter.



Dixon Guardsmen Will Get Full Pay

Since the National Guard has been called out by the President, several manufacturing concerns have been confronted with a problem similar to the one which the Joseph Dixon Crucible Company, Jersey City, N. J., solved in a manner indicated by the following, which is the substance of a notice distributed recently by this firm:

"Those employees of the Joseph Dixon Crucible Co., who had joined the National Guard prior to its being called by the President and subsequently sworn into the Federal Service in June, 1916, will receive full pay while away doing military duty. These men will have their places kept open for them. This provision holds good until future developments make it necessary to change or modify it."



You Don't Have to be a Sheet Metal Man to Handle this Furnace

The pipeless furnace lets the carpenter and builder in on the furnace business in a way we never before thought possible. With the One-Register or Pipeless Furnace there are no pipes to be cut and fitted, no complicated sheet metal work of any kind. The pipeless furnace is, therefore, the logical heating plant for the builder to interest himself in.

The Monitor Stove & Range Company, Cincinnati, Ohio, that famous old business house now passing its ninety-sixth year in the stove and furnace manufacturing business, are offering AMERICAN CARPENTER AND BUILDER readers an unusual opportunity in connection with their "Caloric" Pipeless Furnace. It is a high-grade furnace agency proposition that will work right in with a builder's regular work. What makes it especially interesting is the fact that the Monitor Company is spending thousands of dollars in advertising the "Caloric" furnace to farmers as well as to prospective home builders—a publicity campaign that is developing thousands of live inquiries from home owners who think of putting in this furnace.

These inquiries are being turned over to the local "Caloric" man, and he is supplying the furnaces and installing them.

You know that there are thousands of people who would like to put in a furnace if they could afford to. They can afford to have a "Caloric" Pipeless Furnace since with it there are no pipes to cost, no heavy labor expense for installing, no outrageous bill for deepening and enlarging the cellar, or for cutting floors and walls. These thousands of people are being reached and interested by the widespread "Caloric" Pipeless Furnace advertising. Some of these pros-

(Continued to page 108.)

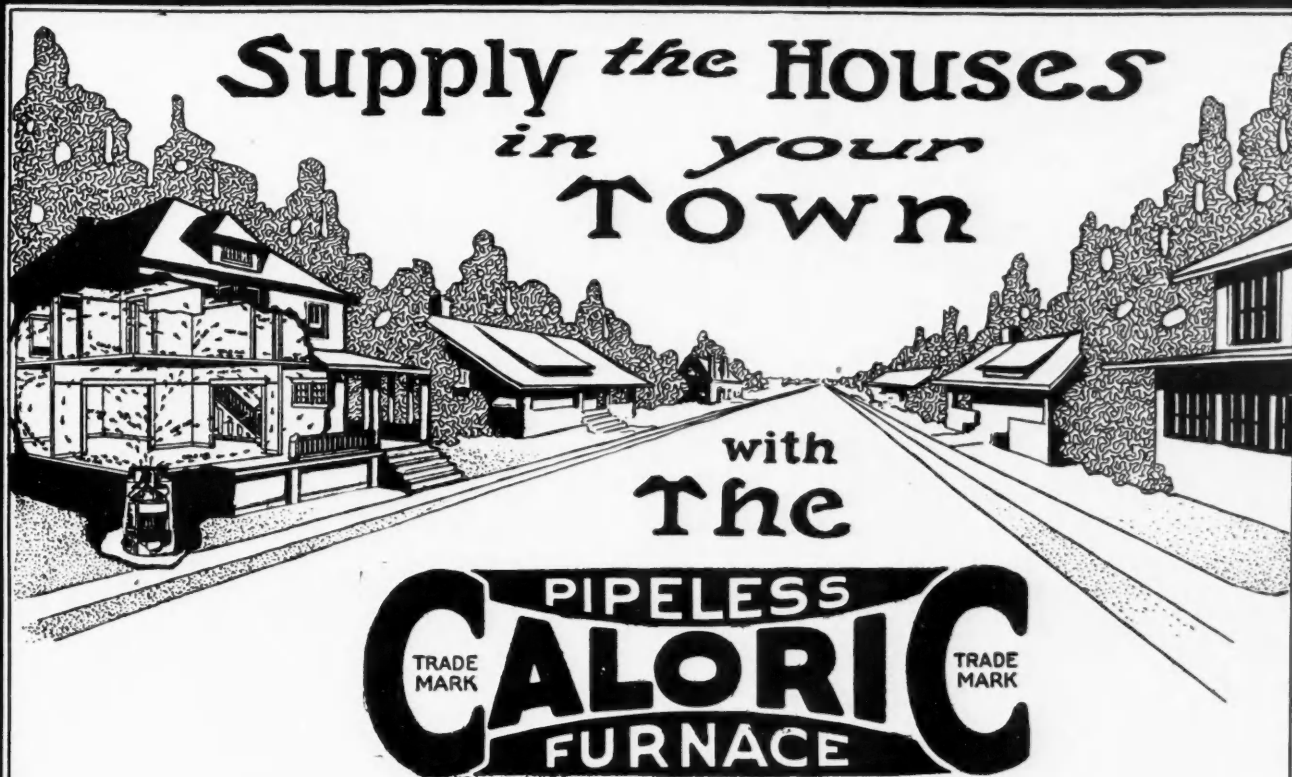

We have a high-grade furnace agency proposition for one builder in every town. Last year we sold the Caloric Pipeless Furnace as fast as we could make them. This year we will make ten times the number of furnaces, and are going to get *one* live contractor in every community to act as our representative.

Hundreds of your neighbors will be interested in the Caloric Pipeless because the price and the furnace are right. There are no pipes to cut, and no holes for them; no heavy expense for installing; no outrageous bill for deepening and enlarging the cellar or for cutting partitions.

We will stimulate the interest in your neighborhood by means of an extensive advertising campaign that goes into the home of every prospect and by furnishing in every possible way sales help of practical workable value. All inquiries will be turned over to the agent who supplies the furnaces and installs them.

For the right man this is an opportunity to cash in on a growing public demand; to ally himself with one of the oldest manufacturing concerns in the country.

We have made furnaces for 96 years, and guarantee every one to be just as sturdy, substantial and low-priced as it is possible to build a furnace.

You have been looking for just such a proposition, which enables you to supply your customers with the assurance of satisfaction. We will be glad to send you full information about the Caloric and how our Advertising Counsel Department and Engineering Experts make the selling and installation of this furnace a simple proposition.

**THE MONITOR STOVE
AND RANGE COMPANY**
4317 Gest St. CINCINNATI, OHIO

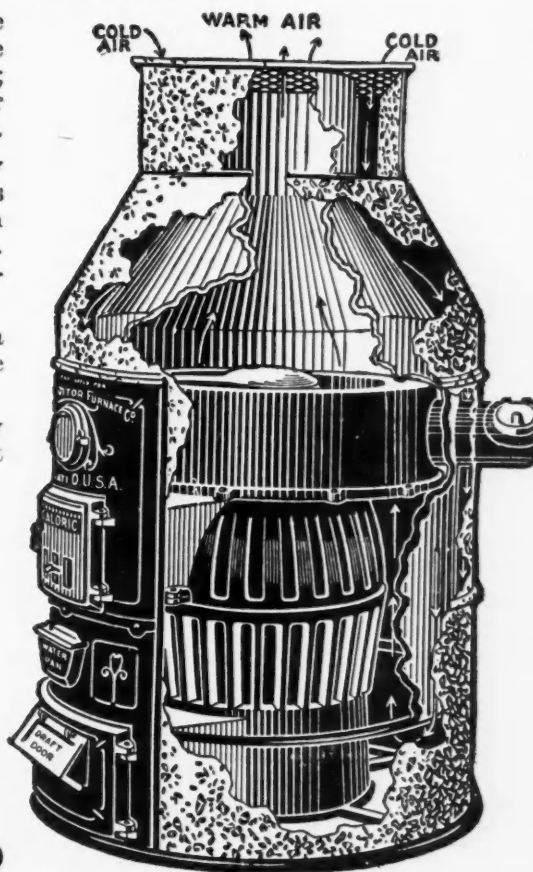

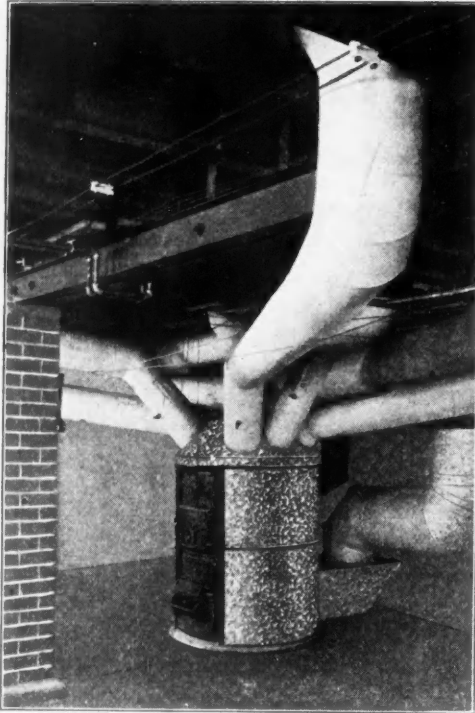

Heating System Using Pipes to Different Rooms.

pects live near you, and you can just as well as not handle this business and cash in on it.

It is the pride of the Monitor Stove & Range Company that their furnaces are made sturdy, substantial and just as good as it is possible to build a furnace. The huge quantities in which they turn them out brings the price low down. Every



Showing Simplicity of the Pipeless System of Heating.

this furnace work with confidence and at a good profit.

Many of our readers are satisfied that the Pipeless Furnace is the ideal heating plant for the farm home, for cottages, and for remodeling jobs. Write the Monitor Stove & Range Company, Cincinnati, Ohio, today, and get the details of the "Caloric" Pipeless Furnace and their proposition to act as agent in your territory.

(Trade Notes Continued to page 112.)

24 HOUR ON-THE-JOB-SERVICE

IN getting materials, ladders, men, etc., on the job at anytime, painters, decorators, roofers, contractors and carpenters in every part of the country are saving time and money with this KisselKar "Tonner."

In the quick transfer of special workmen, tools, etc., from one job to another, KisselKar Trucks are proving a boom to general building contractors.

If you have cement, stone, sand, lumber and millwork hauling—let us show you the larger sized KisselKar Trucks built with special devices for quick dumping if needed.

We have data on how KisselKar Trucks with the matchless Kissel-built motor, perfected worm drive rear axle and sturdy chassis, backed by Kissel reputation, are solving the same transportation and delivery problems that are wasting money for you now.

Let us send you this truck information today

KISSEL MOTOR CAR CO., 546 Kissel Avenue, Hartford, Wis.

Branches, Display Rooms and Service Stations in all Principal Cities and Towns

KISSELKAR TRUCKS



**New KisselKar Worm Drive Truck
"Built to Carry a Ton"**

Four new sizes... Chassis prices \$950 to \$2850

Overland

TRADE MARK REG

MODEL 83-B

\$695

f. o. b. Toledo

Completely Equipped

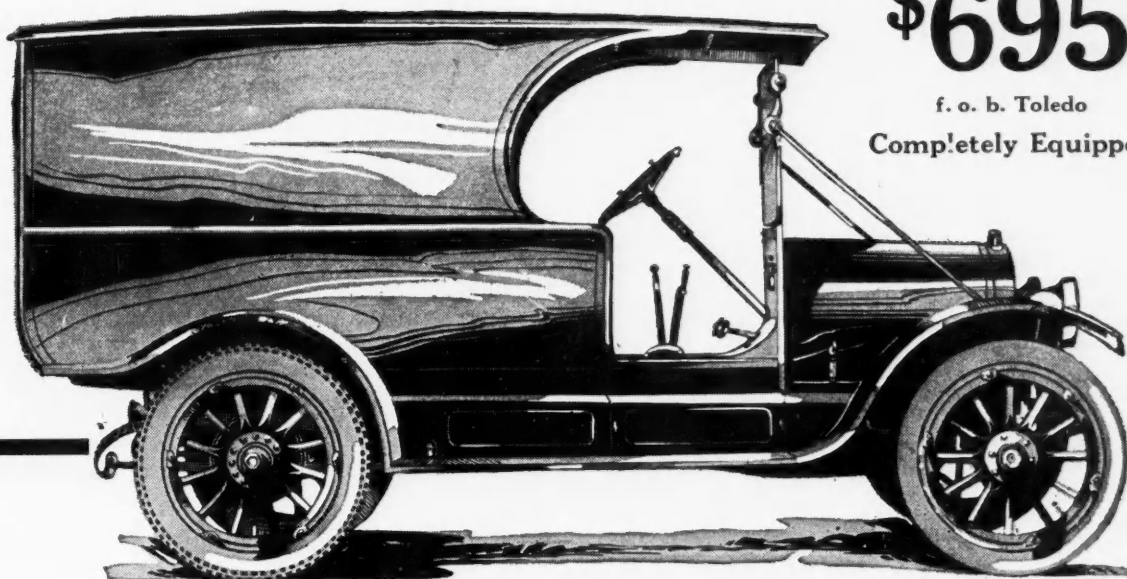

Eliminate Distance---Save Time ---Increase Results With This Overland

Distance is nothing to this speedy, easy-to-handle, Overland.

Construction work in neighboring towns need not be held up because of delay in the arrival of tools, men and materials---if you have an Overland.

With this car you can visit **each** job **every** day. You can make more frequent and more thorough inspections. You can talk things over with your various foremen---all with so little fuss and so economically---and in addition to the car's regular work.

The motor---of the latest en bloc design---gives ample power and speed for all

requirements---yet uses a surprisingly small amount of fuel.

And the operating cost stops when the car stops.

Electric starting and lighting and all the other conveniences of control are incorporated in the Overland Delivery Car.

Yet the complete cost is only \$695.

The dealer in your community will be glad to demonstrate an Overland. He'll be glad to show you just how the car can effect a substantial saving in **your** business. Phone him today.

Catalog on request. Please address Dept. 734

The Willys-Overland Co., Toledo, Ohio

"Made in U. S. A."

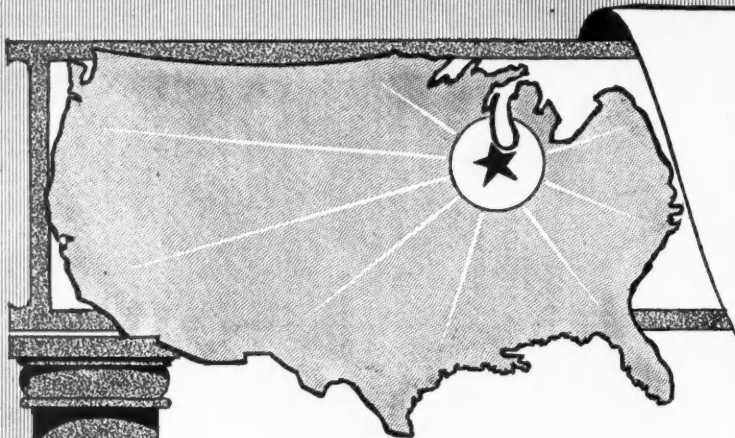

Look Before You Build

Get the habit of writing to us in regarding to your building wants. This exhibit is a regular clearing-house of building information—the market where you can do your buying to the best advantage.

We Are Saving Builders Thousands of Dollars

HUNDREDS of builders, architects and contractors are visiting Chicago's great **Building Material Exhibit** every day.

They recognize its unique value—have found by personal experience that they can save not only time but hard cash by coming to the **Exhibit**, where they can see the actual products they need—compare various makes side by side—pick the best for their purpose—secure the lowest figure without loss of valuable time—and be **sure** that it is the lowest.

They do all this at this vast Building Exposition—why not **you?**

Over 200 elaborate and interesting displays by America's leading manufacturers of building material and equipment. This great permanent **Exhibit** is one of the showplaces of Chicago—worth coming far to see. For those who cannot come we have a special market-investigation Service. Send us your plans and we will secure bids on any material or equipment for you without charge. Write us today.

BUILDING MATERIAL EXHIBIT, Entire Second Floor, Insurance Exchange
CHICAGO, ILL.

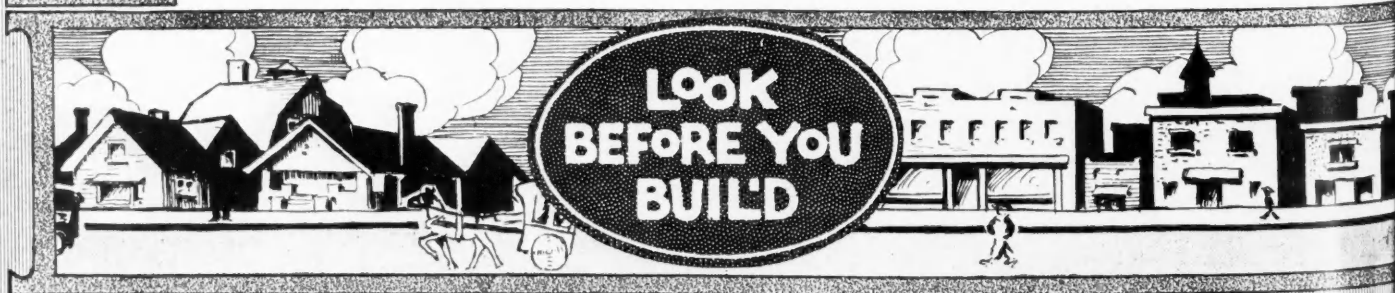

Look Before You Build

Here is your opportunity. Under one roof and on one floor all your building wants can be supplied. Here you can get in direct touch with the manufacturer and effect big sales.



Let Us Show You Where You Can Save Money on All of Your Building Materials—Send Coupon Today

This huge permanent building material exhibit is established primarily for your benefit. Here 200 manufacturers have come together under one roof—condensed their business into 200 intensely interesting displays, and invite you—for your own profit—to come and see and learn.

As a builder you are invited to make our beautiful display rooms your Chicago headquarters. We are here for that purpose. If you cannot come to Chicago yourself, get acquainted with us by mail, and let us be your Chicago representative. This service will cost you nothing, and will add materially to your financial welfare..

BUILDING MATERIAL EXHIBIT
Insurance Exchange
CHICAGO

Gentlemen:—I am in the market for the following. Please put me in touch with manufacturers.

.....
.....

Name.....

Street.....

Town..... State.....

BUILDING MATERIAL EXHIBIT, Entire Second Floor, Insurance Exchange
CHICAGO, ILL.

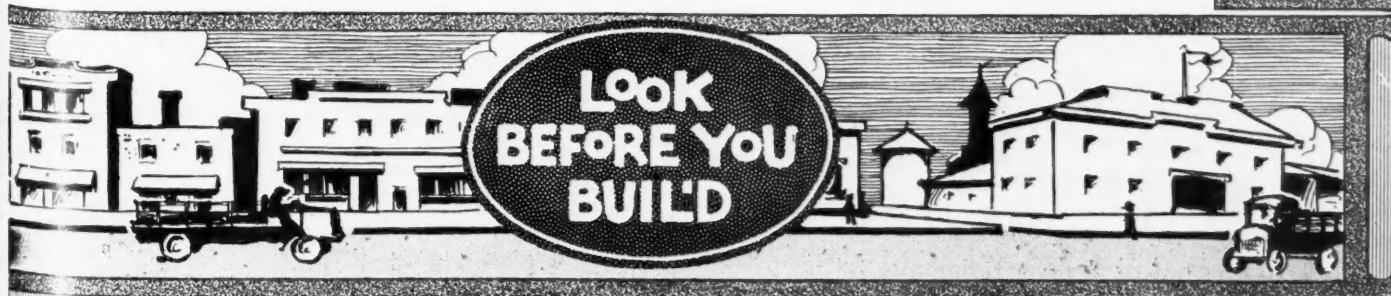

A Water System

So complete it requires only to be attached to the supply.

So reliable it has been used by hundreds for years.
So economical your customers will want it at once.
So efficient that it has the preference always among the knowing.

So advertised that your customers will want to get them.

Standard Pumping Units

are in all particulars the system the careful architect will specify and the thoughtful builder install. They have all the elements necessary to give satisfaction, and they are very durable. Electric light plants may be furnished to run from the same engine.

Mr. Dealer, a Standard agency has no drawbacks. It means prestige as well as business, for it handles the one system that always pleases the user in efficiency, reliability and economy. You and the builder should know more about these machines. Our engineer service will answer your questions scientifically, and our pumping units will do the work thoroughly.

Special line for greenhouses, market gardeners, institutions, etc.

Get our special dealer and builder offers. They mean profits and satisfaction. Write for catalog.

**The Standard Pump
& Engine Co.**
745 Carroll St. Akron, Ohio

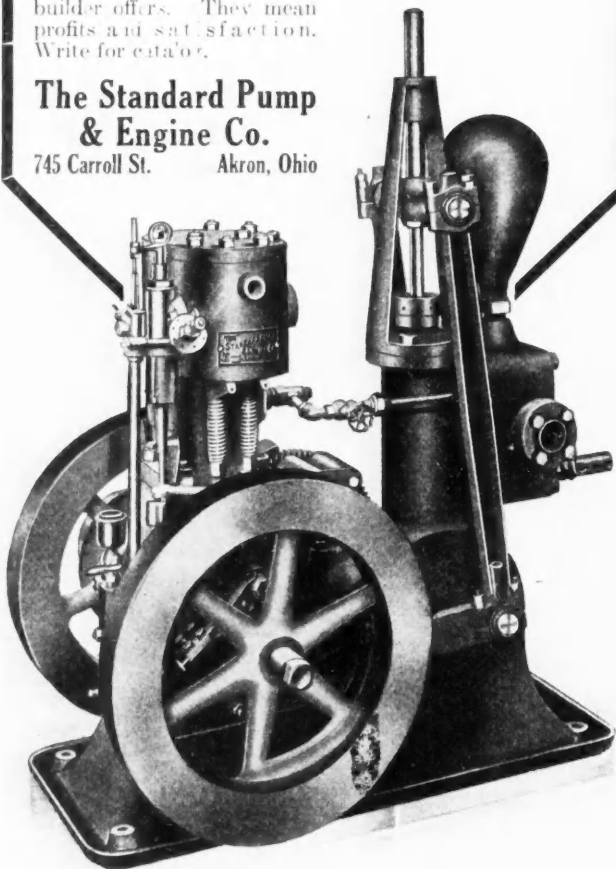

T. L. Smith Company Have New Milwaukee Office

A new office has been opened at 609 Wells St., Milwaukee, Wis., by the T. L. Smith Company, in charge of Mr. E. R. Marker, who has been made their Wisconsin representative.

This office has been equipped with a full line of Smith mixers and a complete list of contractor's supplies is also carried in stock.

It is believed that this office will greatly facilitate the service which the firm wishes to extend to contractors and builders throughout the state.



Inexpensive Solution of Cartage Problem

There is no doubt but that the modern contractor or builder must be equipped with some means of rapidly transporting his men and equipment from one place to another. A great many of these men have already realized the utility of an automobile and have provided themselves with a machine, which solves the problem of transporting the men and furnishes a means of getting around quickly and easily in carrying on the details of their business. Contractors

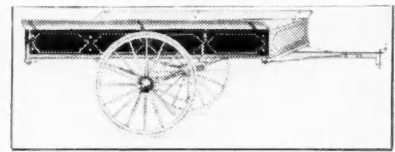

The "Kalamazoo" Trailer with Drop End Gate and Flare Sides.

and builders are now just beginning to realize that the utility of the automobile does not end here. Any automobile may be made to furnish a valuable additional service by means of a trailer capable of carrying, say, a one-half ton load, which may be made up of materials and equipment. Not only is this a convenient means of handling the transportation, but it is also an economical means. Once provided with a good trailer, built solidly of good material, there is practically no expense of upkeep other than the very small amount needed to provide lubrication and an occasional coat of paint.

In order to satisfactorily meet the requirements placed upon it, the trailer must be constructed in such a manner as to possess the qualities of both an automobile and a buggy. In the first place it must be strong enough to withstand the strain of twisting and jarring at fairly high speed and must not be forced to run with any of its parts near the breaking limit. In other words, it must be designed with a factor of safety corresponding to that used in an automobile. At the same time, it is a vehicle which is to be drawn by some force not a part of itself, and it must follow the impulse of this force no matter how it is directed. In this respect it resembles a buggy.

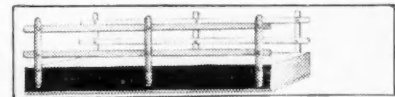

Special Body Which May be Fitted to the Kalamazoo.

A trailer which has given excellent satisfaction wherever it has been used in one called the "Kalamazoo" trailer. This vehicle has a bolted type body, 40 by 72 inches, well braced, strong and durable, and is provided with drop end gate and flare boards. The springs are long and elastic, specially heat and oil tempered. The 32-inch wheels are of selected hickory, riveted, with 1 3/4-inch spokes. The Kelly-Springfield hard rubber tire is used.

The device for connecting the trailer with the car allows a free up, down, sideways, and twisting movement without cramping. A self-locking pin makes a quick connection. A support also is provided so that the vehicle will stand level when not connected to the automobile.

This trailer is very liberally guaranteed by its makers, the Kalamazoo Carriage and Harness Co., Kalamazoo, Michigan, who will be glad to furnish interesting information to any of our readers concerned in the transportation problem.

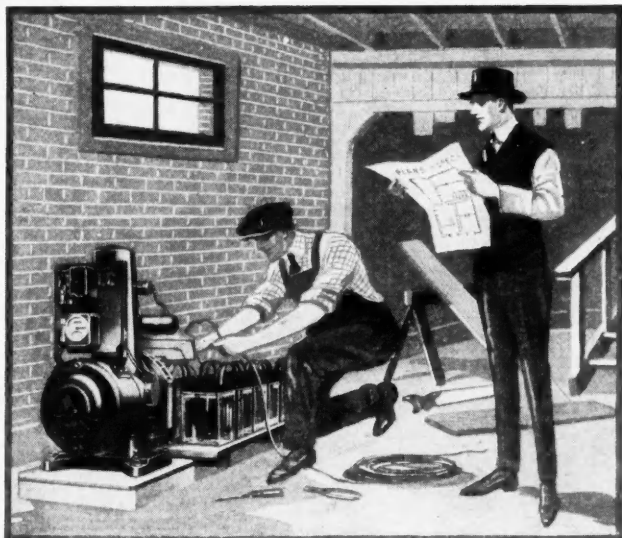

DELCO-LIGHT

Electric Light and Power for Village and Farm Homes

NEVER build a house anywhere without wiring it for electricity.

Delco-Light makes electricity so easily and economically available that no one need be without the comfort and convenience that it affords.

Delco-Light is a complete power plant—Gas Engine, Dynamo and Switch Board in one compact unit—and specially constructed batteries of unusual efficiency.

It has a capacity of 40 to 50 lights and also furnishes power for operation of small machinery, simple—trouble-proof—sturdy.

Write today for illustrated folder

The Domestic Engineering Company
Dayton, Ohio

Offices in all principal cities

Price complete with batteries \$250

Developed by the same engineering ability that has made Delco Cranking, Lighting, and Ignition for automobiles the standard of the world.

The Sensation of the Times

A high grade, well constructed, practical 30-volt, MAIN ELECTRIC LIGHTING PLANT now within the means of all who desire better light.



Write for particulars on larger sized plants. A complete line of MAIN PLANTS up to the 20,000 light size.

Write for Bulletin No. 41

\$76.95

**30-VOLT MAIN MIDGET
TYPE XX
SEVEN LIGHT SIZE**

MAIN ELECTRIC MANUFACTURING COMPANY
500-520 Aiken Avenue PITTSBURGH, PENN., U. S. A.
Largest Exclusive Manufacturers of Isolated Electric Lighting and Power Plants in the World

Here's YOUR Chance to Learn **DRAFTING**

This Complete \$15 Drawing Outfit and Full Instructions in Mechanical Drawing **FREE**

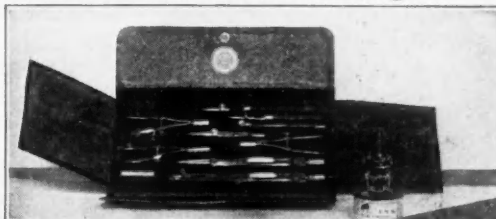

There's a good job waiting for you. The country is facing greater prosperity than it has ever before experienced. Far-seeing men are getting ready for boom times. Get this training now and share in the coming prosperity.

A WONDERFUL CHANCE for Carpenters, Bricklayers, Plasterers, Foremen, Superintendents, Contractors and all other men in Building Lines.

STUDY AT HOME Devote your spare hours for a short time only and get in the class drawing the big pay envelope. Hundreds of men are in daily attendance at this old established college. In your own home you can do the same work these men are doing, and the same experts that teach them will guide you toward the big job. They will prepare your instruction matter. Your work is examined and approved by them. No books to sell. Live, up-to-date blue prints of work in actual construction. These men know exactly the practical training you need because they are in constant charge of big work.

ACT NOW—FILL OUT COUPON TODAY

Mark "x" opposite work in which you are interested. Without obligation on your part we will send full information.

- | | |
|---|---|
| <input type="checkbox"/> Architectural Drafting | <input type="checkbox"/> Plan Reading |
| <input type="checkbox"/> Builders' Course | <input type="checkbox"/> Estimating |
| <input type="checkbox"/> General Contracting | <input type="checkbox"/> Building Superintendence |

Name

Address

Town..... State.....

College or Home-Study Course

CHICAGO TECHNICAL COLLEGE
1017 Lake View Building, Chicago, Illinois

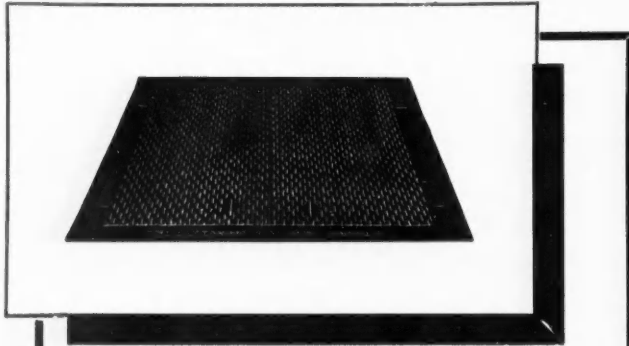

—Here is the
CANTON
Sidewalk Door

The sidewalk door that provides a firm foothold in all kinds of weather. Its corrugated surface prevents slipping; and there are no projections of any kind on which to trip or stumble.

Canton Sidewalk Doors are made of the highest grade materials and will outlast the walk itself. The frame of the Canton is cast in one solid piece. The top is reinforced diamond plate steel, unequalled for durability, appearance and safety. When open, it has stay rods and chains to protect the opening; when shut it is absolutely burglar-proof.

And the price is attractive. Write for our catalogs of sidewalk doors—"B-17", coal chutes—"B-4", gratings, and Builders' iron work.

Canton Foundry and Machine Co.
CANTON, OHIO

Fox Floor Scraper

The American people are rapidly discarding carpets and rough pine floors, replacing them with highly polished oak, maple and other popular grades of hardwood.

The home builder of the most modest means will specify hardwood floors in his home. New hardwood floors are replacing pine and soft wood in old buildings.

This great change was made possible by modern equipment. Hardwood floors necessarily must be smooth; some say the smoother the better, for then they are beautiful. Smoothing these floors was a long and tiresome process—as every carpenter knows who has got down on his hands and knees, using the plane, sandpaper and glass. Now carpenters have a modern floor scraper



The Sturdy Fox Floor Scraper Ready for Action.

which does the work quickly, perfectly and at a great saving in labor.

The Fox Floor Scraper will do this work both satisfactorily and at a minimum cost. One man and a machine will do the work of five, and best of all, this man can save enough money in one day to pay for the machine.

An interesting leaflet will be mailed by the manufacturers, the Fox Supply Company, Brooklyn, Wis., upon request.

"Father of them All"

The Great Bell
The Original Pipeless Furnace

We have thousands in use. Sizes, styles, and prices to suit all, \$38.00 to \$94.00.

This furnace will heat any one or two-story building in the most efficient manner; with the least effort, and the lowest relative cost. It is made for the building where a furnace is needed, but where the cost has been prohibitive.

Our methods of production and sales have reduced the cost so low that no builder can afford to overlook our proposition.

Write for our catalogs, describing the various styles, prices and specifications of the Great Bell Furnace. We guarantee them to be and do all we claim for them in both catalog and correspondence.

American Bell & Foundry Company, Northville, MICH.

The Hero Pipeless Furnace

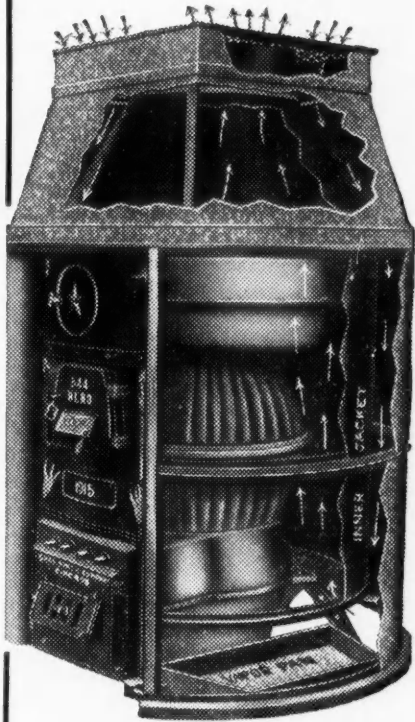

Heavy Cast Iron
Good for 20 years

Let us help you
with your

Heating and Ventilating

We make a complete line of warm air furnaces and room heaters.

Good commissions paid to Contractors and Builders.

CHAS. SMITH COMPANY

180 N. Dearborn St.
Chicago, Ill.

WOLVERINE FURNACES

and the **WOLVERINE SYSTEM** of Heating and Ventilating are something you want to investigate. You buy direct from our factory at manufacturers' prices—furnace, registers, cold air faces, pipe and fixtures already cut and ready to put together. We send our own mechanics to install complete if you are in our local territory. If not we send complete plans and specifications that any good mechanic can follow

We have been making furnaces and nothing else for 36 years. Our experience is at your command.

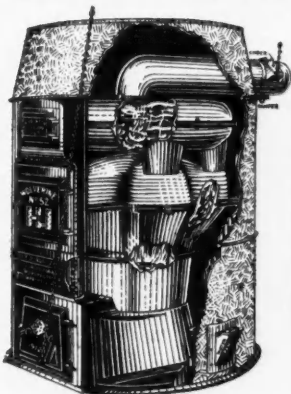

It costs you nothing to get our plans for your building and receive our written proposal.

Wolverine Furnaces are constructed on scientific principles which makes them durable and economical in fuel. Easy to clean and operate and sold under the most liberal guarantee ever given with heating apparatus. Write for large 32-page illustrated catalog that describes and shows these furnaces. It is **FREE**, a postal card will fetch it. Ask for catalog No. 63.

MARSHALL FURNACE COMPANY
12 Dobbins St. - - Marshall, Mich.

-a different heater proposition

Even builders, contractors, and architects are sometimes at sea when it comes to recommending or specifying a heater.

The many extravagant claims that are made by most heating companies don't give a contractor any sound basis for a recommendation—or to combat "come-backs."

The Williamson **New-Feed UNDERFEED** has changed all this—it is a proposition that is good all through. You can actually **guarantee** a customer that if he will install the **UNDERFEED**, it will cut his coal bills $\frac{1}{2}$ to $\frac{2}{3}$.

We back you. A million dollar corporation is behind your guarantee. Now that's pretty plain, isn't it? You can easily see how that guarantee boosts you.

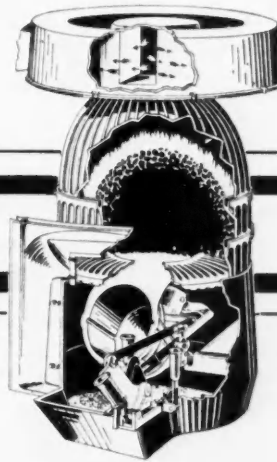

Cut-out view Underfeed Furnace

-and the heater

The **UNDERFEED** is heating over 35,000 American homes and buildings at a coal saving of from $\frac{1}{2}$ to $\frac{2}{3}$. And here is the reason:—

In an **UNDERFEED**, the fire is **above** the fuel, not smothered by it. This simple principle means practically no smoke, gas, dust, smell, or clinkers, no matter if warm air, steam hot water or vapor is used.

WILLIAMSON CUT COAL BILLS
NEW-FEED UNDERFEED
Furnaces and Boilers $\frac{1}{2}$ to $\frac{2}{3}$

The coupon below brings special data of interest to you.

The Williamson Heater Co.
77 Fifth Avenue, Cincinnati, Ohio

This Coupon Brings the Facts!

The Williamson Heater Company,
77 Fifth Ave., Cincinnati, O.

I would like to know how to cut customers' coal bills from one-half to two-thirds with a Williamson **New-Feed UNDERFEED**.

Warm Air Steam or Hot Water
(Mark X after System Interested In)

Name

Address

My Dealer's Name Is

My Business Is



KOHLER

The factory, the product, and the trade-mark

Kohler, Wisconsin, where KOHLER WARE is made, is a community which is devoted solely to this industry.

It has no divided interests. Its single activity is the production of enameled plumbing ware of one quality—the highest.

KOHLER WARE

is notable for its beauty

Every KOHLER bathtub, lavatory and sink is distinguished by the trade-mark KOHLER permanently incorporated in faint blue in the enamel.

This trade-mark is our guarantee of KOHLER quality—always the highest.

KOHLER designs are modern and hygienic. The enamel on KOHLER WARE is beautifully white.

Write for a free copy of our new book "KOHLER of KOHLER", which contains a full description of the "Viceroy" one-piece bath, the most popular built-in tub ever constructed. Specially low price due to manufacturing economies.

"It's in the Kohler Enamel"

KOHLER CO.
Founded 1873
Kohler, Wis. U.S.A.

BRANCHES

Boston
Pittsburgh
Detroit
San Francisco
Los Angeles

New York
Chicago
St. Paul
Houston
Seattle

Philadelphia
Atlanta
St. Louis
Denver
London

"Viceroy" Bath Plate V-12-A
(Patent Applied For)

Filmore Lavatory



The A. B. C. Protractor Square

An instrument manufactured by the Stamping and Tool Company, La Crosse, Wisconsin, is given the above name and is intended to save time and make certain the determination of all angles used in cutting lumber for the various members of angle roofs, projecting bracing for hay tracks, stairways, stringers, circular or tank work, and many other forms of construction.

The instrument consists of the three members marked A, B and C in the illustration. At one end of A is a quarter segment of a circle carrying divisions of a right angle from zero to ninety degree on two scales, running in opposite directions. The divisions on the inner edge of the segment give the number of degrees in the angle between A and B, and at any adjustment. The divisions on the outer edge of the segment give the degree to any angle between B and C when C is fixed on A at ninety degrees. By means of thumb screws the members may be held in any desired position with respect to one another. The member C may be set at right angles to A by means of two lugs on the little guide at right angles to and a part of C. When these lugs are set in the slot on A, the members B and C are at right angles to one another.

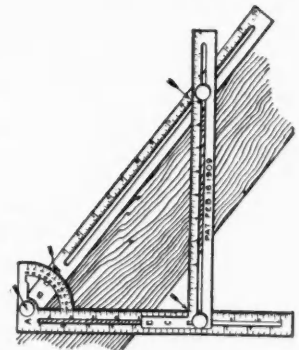

Showing the Appearance of the Protractor Square When Set for Rafter Measurement.

To illustrate the use of this instrument, the procedure in determining rafter measurements, degrees and bevels is given here:

Suppose that rafters are to be cut for a house 14 feet wide, with a rise of 9 feet. Set C on A at 7 (one-half the width of the building). Now set B on C at 9. The graduation on B will now read 11 5/12, which shows that the length of the rafter is 11 feet 5 inches. A will give the lower and C the upper bevel of the rafter. The inside figures on the degree circle show that the rafter will be cut to build a roof with a 52-degree pitch. By laying B against the edge of the timber, A and C give the bevels.

If specifications for rise and run are being followed, with the square set at the dimensions given, it will form it into the shape of a triangle, which will give you the correct angle for all bevels.

Suppose that specifications for the pitch of the roof are given in degrees. Set C on A at one-half the width of the house. In this case, suppose that the house is 16 feet wide. You therefore set C on A at 8. Your specification calls for a 40-degree roof. The degree of pitch is shown on the inside numbers on the degree circle. Set A at 40 degrees and fasten down on C with thumb screw. We now have the width of the house shown at 16 feet, the rise at 6 feet 8 1/2 inches, and the length of rafters, 10 feet, 5 1/2 inches.

No calculations are needed in determining the angles and the lumber may be marked by using the instrument as a guide after the adjustments have been made. There are a great variety of uses to which it is equally adaptable. In fact, any construction in which lumber must be cut to some definite angle will furnish a field for the use of the instrument.

Any of our readers who are interested in the A B C Protractor Square may obtain full and valuable information from the Stamping and Tool Company, LaCrosse, Wisconsin.

**Contractors
and
Builders**

You owe it to the interest and satisfaction of your clients to investigate the Majestic Building Specialties.

Write for
Catalog



MAJESTIC Coal Chutes

A device that forms one of the most complete protections for the home. It keeps the coal man from musing the side of the house. It prevents the lawn, walk, flowers and shrubs from being littered up and ruined with coal dust and stray lumps. It minimizes depreciation on the home.

A glass door serves as a window when the chute is not in use for coal, giving splendid light to the basement.

The Majestic locks from the inside and is absolutely burglar proof. It is extra durable, has a heavy steel body—semi-steel door frame and boiler plate hopper. It will last as long as the building.

We make the Majestic in all types for houses, hotels, store and office buildings, apartment and public institutions.

In addition to coal chutes we also make Majestic Garbage Receivers, Milk and Package Receivers, All Metal Basement Windows, Rubbish Burners, Street and Park Refuse Cans, Hose Reels, Metal Plant Boxes, Pipe and Pipeless Warm Air Furnaces.

THE MAJESTIC CO.

610 Erie St.

Huntington, Ind.

The 1-Register Pipeless

Sanit-Air System

THE Heating System with 20 important features that you can't afford to overlook. It is the one system that produces more heat and distributes it just where you want it—with a distinct saving of one-half the fuel expense over any other heating method. Occupies small space and saves the basement for storage. Write for the "20 big points" and tell us what you want to heat.

Absolutely Guaranteed by Standard Bond

Standard School Heater Co.
CHICAGO

You Can Make Money by Securing Agency

Comfort Indoor Closet

ODORLESS—SANITARY—GERM-PROOF
No Sewer, No Waterworks, No Plumbing Needed

This modern home necessity is fast taking the place of the unsightly, unhealthy, inconvenient out-house in the back yard. Thousands now in use and all giving complete satisfaction. Can be put wherever convenient in the house. No odor whatever. Gives city convenience in the country or town.

Costs Less Than Out-House

Anybody can afford one. May save cost in doctor's bills first month. Saves those cold night trips out-of-doors. Impossible to get same amount of comfort for the money another way. Sold on 30 days' trial and under sworn guarantee to refund all money if not entirely satisfactory. Send for description and prices today. Be fair to your family.

Agents Make Big Money Easily

Comfort Indoor Closets sell themselves as fast as people understand about them. Contractors and carpenters are making big money by merely suggesting this closet. Write for details of our exclusive agency offer. Send postal now before somebody else gets your territory.

Comfort Chemical Closet Co., 308 Factories Bldg., Toledo, Ohio



BOVEE'S PIPELESS CENTRAL

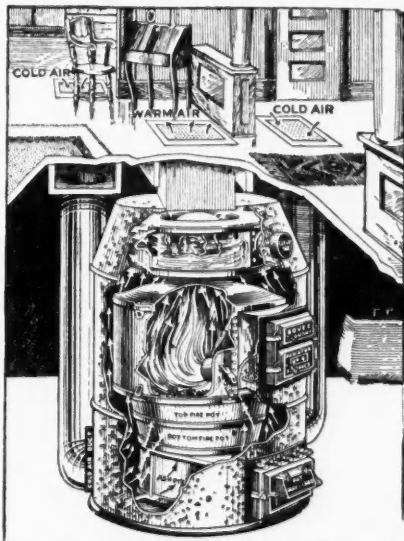

**HEATING
SYSTEM
AND
OTHER
FURNACES**

Every home can now have a **first-class high-grade heating system** in an old house as well as new. Heats as much as **three large stoves**. Costs but little more than a good stove.

We furnish either our **UPRIGHT FURNACE** for burning hard coal, soft coal or wood; or our **HORIZONTAL FURNACE** with large doors 16x16 inches for burning 4-foot wood or soft coal.

Either style furnace furnished in any size necessary to heat the house.

UNUSUAL SYSTEM WITH PIPING TO EACH ROOM FURNISHED WHEN DESIRED. Write for our three color catalogue, free.

BOVEE FURNACE WORKS

210 Eighth St.

Waterloo, Iowa

Our Pipeless System of heating is the only practical single, warm air conveyor system, in line with scientific principles. The system provides for advantages as follows: warm air velocity, which saves both fuel and furnace, requires little basement room; lowest cost of installation.

Send for descriptive circular. Also get circulars on our Window Chute

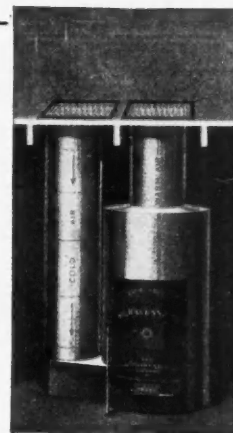

for coal. Absolutely air-, water- and burglar-proof. No catch, screw or bolt to make it possible to be opened from outside. Simplest cast construction made. Sizes 20x15" and 20x18".

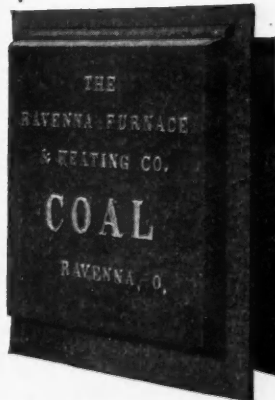

**The RAVENNA
FURNACE &
HEATING CO.**
RAVENNA, OHIO

A New Development in [Asphalt Shingles

Bird & Son, East Walpole, Mass., are now putting on the market a shingle which contains features not found in their original Neponset shingle. It is an outgrowth of the built-up Neponset Twin.

It is called the Double Surfaced Neponset Shingle and retains the twin shape which is characteristic of all Neponset shingles. In construction it is quite different than the original Neponset shingle, altho the same materials are used.

This shingle consists of a layer of regular Paroid felt which has been thoroly saturated with asphalt. To the surface of this is added an asphalt coating in the regular way. Then into this coating is rolled a solid surface of crushed rock. At this stage the shingle is not unlike the ordinary rock-surfaced shingles, which are on the market, except that these various processes are planned for what is to follow. The next process is the application of a solid coat of asphalt over the rock surface, and then into it a final surfacing of crushed slate is rolled. This final surface is a rather fine crushed slate and a slate that has a high color, red or green. This results in a very attractive surface and a color that is distinctive and out of the ordinary.

The composition of this shingle makes it extremely flexible. It will bend without breaking and will therefore lie very flat on the roof, and is especially adapted for use over a curved hip or other similar place. It is a very easy shingle to lay, on account of its twin form and can be laid in about half the time of ordinary shingles.

The shingle is 20 inches wide, instead of 16 1/16 inches, as was the original Neponset. Each shingle, therefore, covers more surface, and so from the view point of ease in laying, it goes further even than the original Neponset, yet it is not too large a shingle but that it may be handled easily by one man.

There are three nails to the shingle and the shingles can

be slapped down just as fast as a man can drive the nails. The special Neponset cut-out enables one to put the shingles side by side very close, the spacing being automatically taken care of.

Every architect and builder will be very much interested in this type of shingle. A sample may be obtained from Bird & Son upon application.



Barn Improvements

Twenty years ago tuberculosis was almost unknown among live stock, but its prevalence has steadily increased with the coming of tightly-built buildings for the housing of animals. The divine profusion of air and light are nature's preventatives and curative remedies for a vast number of diseases.

They also are two among the most important of physical facts which render existence possible. The proper use of

(Continued to page 120.)

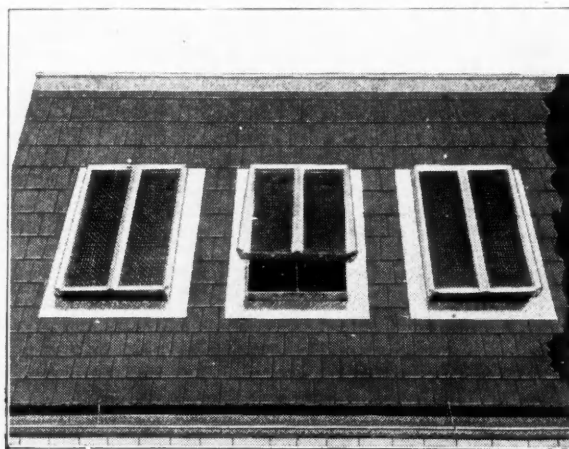

The Tip Top More Sun Ventilation Window.

Compare These Scaffolds

The illustration at the left shows a "Trouble Saver" Steel Building Bracket. The arrows indicate the points of rigidity and stability. The second illustration shows the old fashioned, unreliable wood scaffold with every joint a weak one.

This is the first point in comparing the old style scaffold with the

"Trouble Saver" Building Bracket

Then there are no nails to drive in erecting the "Trouble Saver" Bracket. It is simply hooked around a studding and can be erected or removed in one minute. It will never wear out and can be used on every job.

It also stands to reason that two legs are better than one. The "Trouble Saver" Bracket is made with two legs braced against each other at the outer ends making it absolutely rigid.

And finally "Trouble Savers" are by far the least expensive brackets on the market, paying for themselves in time and labor saved on the first two or three jobs.

Write for our proposition offering 30-day Free Trial to carpenters to prove these Scaffolds are really an investment.

THE STEEL SCAFFOLDING COMPANY
EVANSVILLE, INDIANA

Fiberlic

For Walls and Ceilings

Fiberlic Wall Board—a root fibre product.

A chemically cleaned, tenacious fibre made into board. Solves the requirements of wall board construction.

Not an experiment.

We have never changed our brand.

Fiberlic Wall Board means one standard only. It was made right first.

Note: All our samples are cut from stock and truly represent what we ship

Fiberlic Department,
MacAndrews & Forbes Company
Camden, N. J.

—and nothing else

On every can of DEVOE Marble Floor Finish, DEVOE Pale Interior and DEVOE Vernosite Spar Varnish there is printed an exact formula of the contents—ending with the unequivocal statement:

and nothing else

These three words are our final and clinching assurance to dealer, consumer, architect and painter—that no benzine, rosin, naphtha, lime, hardening powder, or any other adulterants are used in these varnishes.

DEVOE

The oldest manufacturing concern in the United States
Founded in New York 1754

F. W. DEVOE & C. T. RAYNOLDS CO.
New York
DEVOE & RAYNOLDS CO.
Chicago



Your Reputation Demands

UPSON PROCESSED BOARD

---the Most Dependable Wall Board

Made in America

Contains no dirty, black materials or cheap, punky "jack pine" fibers.

Write for Samples and Information

THE UPSON CO. Fiber Board Authorities 16 Upson Point, Lockport, N. Y.

LOOK FOR THE FAMOUS BLUE CENTER

CAREY Ceil-Board

SUPERSEDES PLASTER FOR WALLS AND CEILINGS

comes in panels ready for the job. No muss or dirt. Easily applied. Hammer and nails are the only tools necessary. Plain or hardwood finishes, can be papered or painted. Samples and booklets on request.

The Philip Carey Company

1021 Wayne Avenue, Lockland
Cincinnati, Ohio

Offices and Warehouses in Principal Cities



Have You Made The Mistake

of thinking that Compo-Board is the name for any composition wall board?

Have you overlooked the fact that the genuine



Trade Mark Reg. No. 94755

is made with a center core of the kiln-dried wood slats—is the only wall board so made—and as a result of this unique patented construction possesses a strength, durability, cold, heat and moisture-resisting quality, decorative adaptability and other features that made it far more satisfactory than lath and plaster or other wall boards?

Do you know also that it does not have to be paneled, because it saws with such smooth edges, and that it is so stiff it can be papered? Thus two of the greatest objections to giving up the traditional lath and plaster are overcome.

If you would be modern in your ideas about building, you owe it to yourself to get acquainted with Compo-Board. Write for free samples and interesting book.

The Compo-Board Company

5777 Lyndale Ave. No.

Minneapolis, Minn.

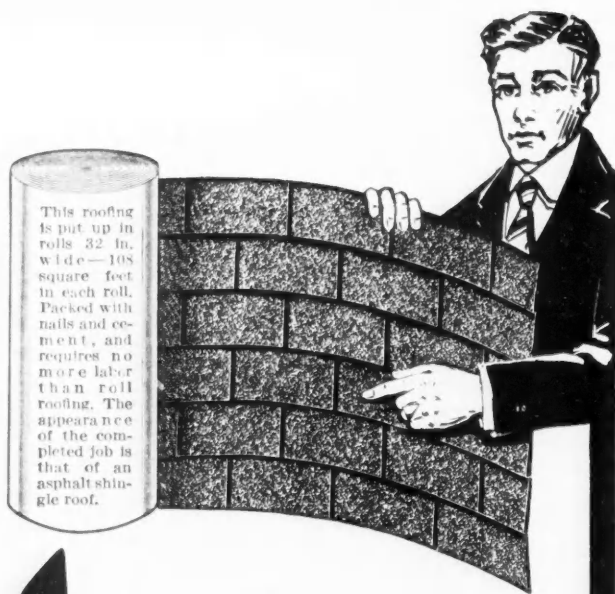

This roofing is put up in rolls 32 in. wide—108 square feet in each roll. Packed with nails and cement, and requires no more labor than roll roofing. The appearance of the completed job is that of an asphalt shingle roof.

See That Roll?

Yes, that's a roll of roofing but it isn't ordinary "roll roofing"—not by a long shot. It's a roll of asphalt shingles—Flex-A-Tile Asphalt Shingles. Gives the effect and the appearance of individual asphalt shingles with the economy and ease of application of roll roofing.

FLEX-A-TILE Roll Shingles

(PATENTED)

Of all the big roofing successes put out by The Heppes Company, never has any met with such instantaneous and widespread approval as this Flex-A-Tile Roll Shingle. You can't begin to get an accurate idea of it from a picture. See the roll—examine it—test it in every way for yourself. Nothing imitation about it. It's the actual stuff—the same identical material that goes into our Flex-A-Tile Shingles.

Write Today for Samples and Full Details

Don't delay—our capacity is limited. Make sure of getting in on this big demand for Flex-A-Tile Roll Shingles now. Write today.

THE HEPPE'S COMPANY
Dept. H 1010 Kilbourne Avenue
Chicago, Illinois

Flex-A-Tile Diamond Slabs
Flex-A-Tile Style 4 Slabs
No-Tar Asphalt Paint *Utility Board*
Other Guaranteed Heppes Products

them is most profitable, especially to those raising stock, as animals breathe more than twice the weight in air that they consume in both food and water. Therefore, well-lighted and properly-ventilated quarters mean more young stock, better general and health conditions, and greater vitality among animals, better returns from them in work, production or market value, in less time and with less cost

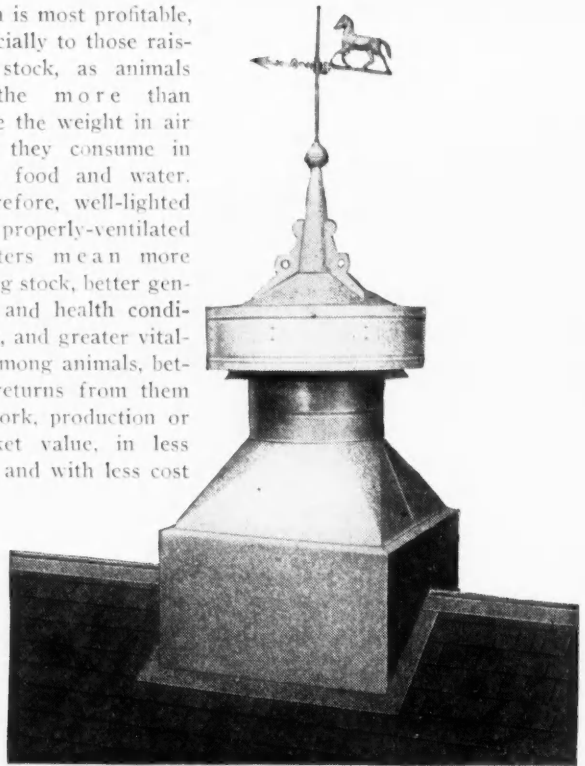

The Sheet Metal Tip Top Ventilator with Weather Vane Attached.

and with the certainty of greater comfort to both animals and care-takers.

During recent years many barns have been constructed with wood cupolas more for appearance than for ventilating efficiency. The open slat-work of these cupolas allows more or less rain and snow to blow in and this moisture causes mould and decay.

The well-made and scientifically constructed ventilator which keeps out storm and birds is a splendid investment. A ventilator to give the best service should extend two feet above the ridge of the building, but should not be unnecessarily high to cause extra strain on the roof during storms.

Carpenters, contractors and dealers recommend the use of ventilators and windows in the roof to admit sunshine, not only for the profit but because they realize that these articles are beneficial and profitable to the users, and therefore add to the thrift and prosperity of the community.

Two methods of proper ventilation and admission of sunshine are illustrated here. The Tip Top Ventilator is a sheet metal ventilator made to operate at all times at its full capacity. It is so constructed that no rain or snow can enter the structure, but the heat and bad air are allowed to pass out freely. Screens prevent the entrance of birds. This ventilator is a great improvement over the old wooden cupola for it costs less, weighs less, and is more effective in ventilation.

The Tip Top More Sun Ventilation Windows allow the sunshine to pass freely into the building and give nature a chance to brighten up things. These windows make it easier to keep the building clean on account of the increased amount of light that finds its way into the corners that are ordinarily neglected. The frames and wide flashings are of metal and each is made to receive two 10 by 30-inch sheets of double strength glass. The windows are easily opened and are automatically held in the proper position to admit just the right amount of fresh air.

Those who are interested in the improvements being made in lighting and ventilation will find the Anderson Manufacturing Company, Des Moines, Iowa, well equipped to furnish them with valuable information.



There is no better Covering than

CON-SER-TEX CANVAS ROOFING

CON-SER-TEX is the most economical material to lay on porch roofs, floors, sleeping balconies. It is the deal covering for all flat surfaces or wherever the pitch is less than four inches to the foot. CON-SER-TEX is a scientifically treated cotton fabric that will not

ROT, SHRINK, STRETCH, CURL OR PEEL

It's easy to lay, clings to the surface, makes a neat clean, smooth durable covering. When properly laid it will last as long as the house itself.

SEND FOR OUR NEW ILLUSTRATED BOOKLET

"Roofing Facts and Figures." It will show you where CON-SER-TEX can be used to advantage—how you can save money by installing it—and will give you some new ideas on lining wood box gutters, covering valleys and hips and making durable, cheap satisfactory flashings.

WILLIAM L. BARRELL & CO., 8 Thomas St., New York City

Chicago Distributor

GEORGE B. CARPENTER & CO., Wells & Michigan Sts.

California Distributors | WATERHOUSE & PRICE, Los Angeles
PACIFIC BUILDING MATERIAL CO., San Francisco

Mr. Carpenter You Can Make a Lot More Money

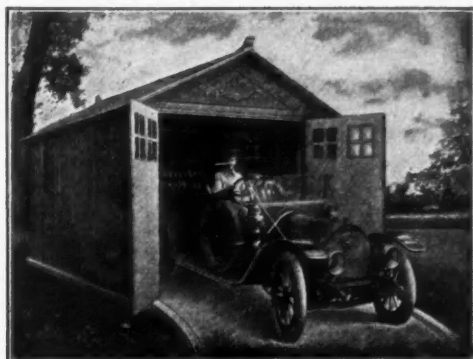

An Agency for the METAL SHELTER CO., Inc., will bring you more business, more profits, more customers, better and quicker results all along the line, and it will be

A REAL BUSINESS OF YOUR OWN

Don't wait until someone else gets the agency for our garages, cottages, bungalows, stores, etc., etc.

It is easy to sell them and easy to set them up—a building a day. An investigation will cost you nothing. Write NOW for our descriptive circulars and proposition.

Metal Shelter Co., Inc.

Whitehall Bldg. New York City

HUDSON

TREAT THE OWNER RIGHT

Cover the Roofs—With



that will not rot, rust or crack, that will not catch fire from sparks; Beautiful, natural, unfading colors. No painting or staining.

Mineral surfaced, Red, Green, Brown or Mottled, furnished in Individual Shingles or in Strips, which greatly reduce the labor expense, requiring only 6 nails to lay 6 shingles. Send for free samples and book, "Shingling & Roofing," today.

Asphalt Ready Roofing Co.

Dept. 53, 9 Church Street, New York



Don't Lay Another Roof Until We Send You a

Winthrop Tapered Asphalt Shingle

Just ask for a sample shingle. See how tough, how pliable and how durable it is. See how it is made like a wooden shingle—thick at the butt and thin at the top. See how easy to lay it is. See what a beautiful roof it will make—red, green or slate-black. Then you will understand why owners want the Winthrop when they know about it.

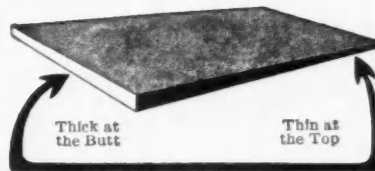

Winthrop Tapered Asphalt Shingles will enable you to get most of the roofs in your town. They win out with less argument than anything you ever tried to sell, for they look better than wood shingles and they have all the protection of asphalt.

The Beckman-Dawson Company

ASPHALT SHINGLES

Factory: Argo, Ill.

1413 Y. M. C. A. Bldg., Chicago, Ill.

The Only Tapered Asphalt Shingle

Heppes Square Butt Slab Shingle

So successful has been the new line of asphalt shingles in diamond point slab form which The Heppes Company has recently placed on the market, that it was only natural that a demand for an asphalt shingle of the same quality but different in shape and appearance from the diamond point would be created.

Accordingly, this announcement that The Heppes Company are now ready with their new Style 4 or Square Butt Slabs is widely welcomed in the building industry. Like the diamond slab, this new Style 4 Flex-A-Tile is really four shingles in one, and it saves considerable time over the old way of laying single shingles. No time is wasted in chalk lining, because the slabs automatically space and gauge themselves. They give the effect and appearance of single rectangular asphalt shingles with the economy of the slab.

The Heppes Company will gladly supply any interested

contractor, builder or carpenter with a liberal sample and full information about the new Style 4 Square Butt Slab. Their address is Fillmore St. and Kilbourne Ave., Chicago, Ill.



Ransome Opens St. Louis Office

The Ransome Concrete Machinery Company, with executive offices at 115 Broadway, New York City, and an enlarged factory at Dunellen, N. J., has just established another office at St. Louis, Mo., No. 12 to 18 S. 12th St. The agent there is Mr. E. Gwynn Robinson. He will have a show room where the latest type of all kinds of mixers, from the smallest bantam to the road paver will be on exhibition.

This should be appreciated by the contractors at St. Louis and the middle west.

Do You Get Absolute
RUST PROOF NAILS
?

When you buy nails for exposed work are you sure you get genuine "zinc coated nails"? There are many coated nails on the market under the name "galvanized" but they are not all rust proof. The only genuine galvanized nails are those coated with "pure zinc" applied by the "hot process."

M. I. F. CO. ZINC COATED IRON CUT NAILS
are genuine galvanized nails and absolute rust resisting.
Write for sample and price list.

Malleable Iron Fittings Co.
Branford, Conn.



Linclad
SHINGLE NAILS
WRITE FOR SAMPLES AND PRICES
W. H. MAZE COMPANY
PERU, ILLINOIS

SLATE WE HAVE WHAT YOU WANT

*In Roofing Slate, Slate Blackboards
Structural and Plumbers' Slate*

SATISFACTION GUARANTEED in QUALITY and PRICE
Ask for Delivered Prices

J. K. HOWER ^{Station} _C Danielsville, Pa.
R. J. KICHLINE, Sales Agent

BLUE VALLEY SLATE MFG. CO., Ltd.

Miners and Manufacturers of

Unfading Roofing
Clear Structural
Electrical

SLATE

World's Fair
Premium
Blackboards

SLATE SINK TOPS A SPECIALTY
Write for Prices. Address: Box 472, Slatington, Pa.

ROOFING SLATE SINCE 1869

Miners, Makers and Shippers of all Styles and Colors of Roofing Slate. Write for Prices.

RISING & NELSON SLATE CO.
Main Office: West Pawlet, Vt.

Branch Offices:
1058 Marbridge Bldg., New York City. 4 Post Office Sq., Boston, Mass.
Office and Yard, 2554 W. Harrison St., Chicago, Ill.

ROOF SLATES
STRUCTURAL SLATE BLACKBOARDS

E. J. JOHNSON
38 Park Row New York

Quarry Operator
BLACK, GREEN, PURPLE, RED

Booklet, Samples and Prices on Application

SAN-TI-LITE
Easy to Lay

SAN-TI-LITE
Easy to Lay

THE all mineral Composition floor material that is the standard from coast to coast. Sold only to builders and contractors under positive guarantee.
The best all purpose sanitary floor in the world. Attractive profits. Write us today for samples.

THE SANTILITE CORPORATION
166 PLUM STREET SYRACUSE, N. Y.

UNFADING
ROOFING SLATE
 and Slate Blackboards
Best to be had and made in
Slatington — Buy from us
Slatington-Bangor Slate Syndicate, Inc.
 Slatington, Penna.



July 1, 1916.
G. F. T.
 Hand Rubbed
BLACK BOARD
 and
ROOFING SLATE
 Catalogue
 and
 Price List

Manufactured Only By
SLATINGTON SLATE CO.
 SLATINGTON, PA.

THE ROCK OF AGES CLEFT FOR YOU

SHELDON'S
 RED PURPLE SLATE BLACK

THE ROOF FOR AGES ALWAYS NEW

ECONOMICAL — ARTISTIC — FIREPROOF
 Outlast the building. First cost, only cost. The only roof you can afford to consider for a permanent investment. Artificial substitutes bring endless expense for upkeep. Post a postal and get posted.
F. C. SHELDON SLATE CO., Granville, N. Y.

JUST OFF THE PRESS
 OUR NEW JULY 1, 1916, CATALOG
 Brimful of interesting and valuable information on roofing slate and slate blackboards. Surpasses all previous editions in points of usefulness.
 Write today for your copy, so as to be sure to get one.
 Address the
SLATINGTON SLATE COMPANY
 SLATINGTON, PA.

There Is
 a
Metal Lath
 for
 Every Type
 of
 Construction
 in the
 North
 Western
 Line

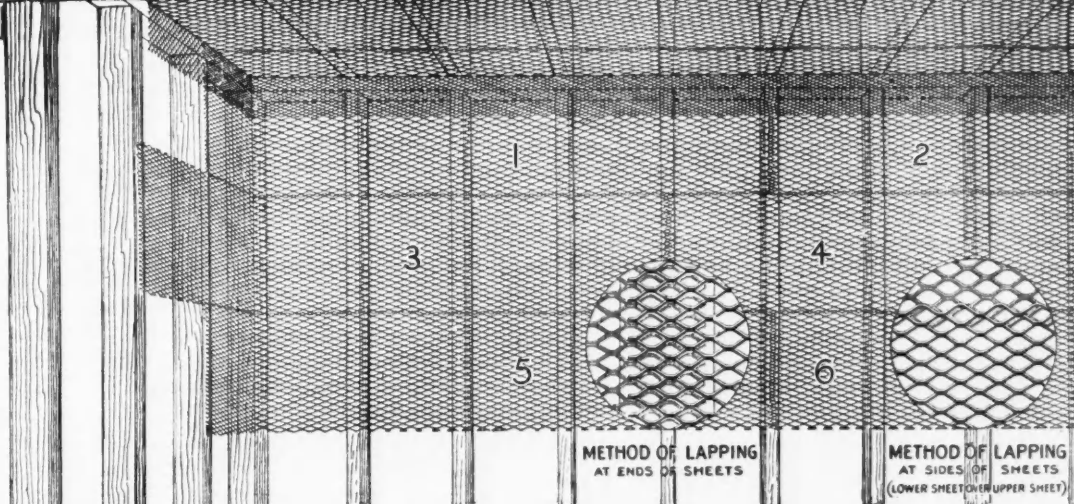

1
2
3
4
5
6

METHOD OF LAPPING
 AT ENDS OF SHEETS

METHOD OF LAPPING
 AT SIDES OF SHEETS
 (LOWER SHEET OVER UPPER SHEET)

*Mr. Contractor:-
 You Can Use this
 Sheet Every Working Day
 in the Year! Tear off
 this Coupon this Minute
 and Send it to the*

North Western Expanded Metal Co.
 Manufacturers all types Expanded Metal
 903 Old Colony Bldg., Chicago, Ill.

COUPON
 Please send me "Metal Lath Details" and information about
 your full line—no obligation to me.
 Name..... Street..... Town..... State..... No. 903

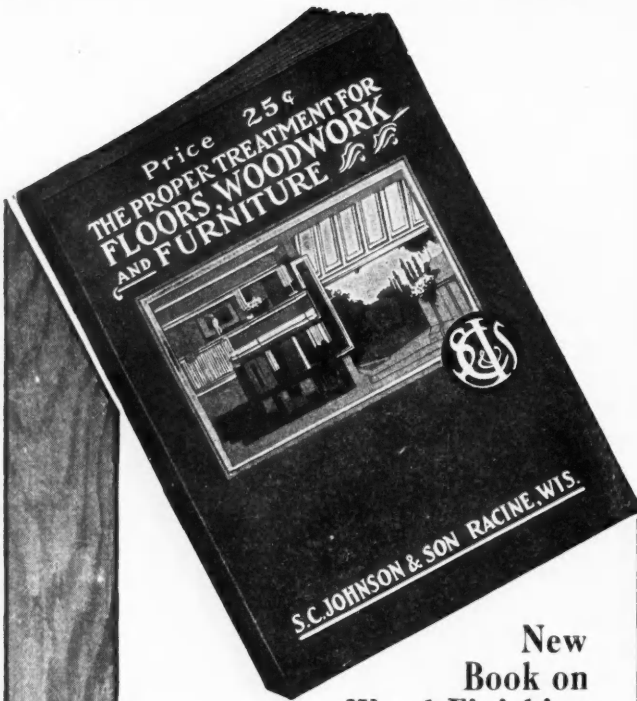

New Book on Wood Finishing

EVERY architect, contractor and builder is entitled to one of these new books free for the asking. It is a valuable handbook on interior finishing, beautifully illustrated in nine colors.

It tells how to finish inexpensive soft woods as beautifully as hardwoods and gives complete specifications for finishing woodwork and floors with

Johnson's Wood Dye

These dyes are not pore-filling varnish stains but coloring matter that penetrates deeply into the wood without raising the grain.

Johnson's Prepared Wax

is the most extraordinary polish for interior woodwork and floors. It gives a hard, dry, glass-like surface that does not collect dust.

If you are not familiar with Johnson's Wood Dyes and Prepared Wax we shall be glad to send you samples for experimental work or finished wood panels showing the various shades of Johnson's Wood Dye.

A.C.B.-8

Please send me free and postpaid my copy of your new 25c Instruction Book, "The Proper Treatment for Floors, Woodwork and Furniture."

Name _____

Address _____

City and State _____

Fill out this coupon and mail to

S. C. JOHNSON & SON

"The Wood Finishing Authorities"

RACINE

WISCONSIN

Puts "Blame" on Advertising

"The call for extreme comfort, quiet, convenience and refinement in motor cars makes one wonder why, in the old horse-drawn carriage days, there was so comparatively little advance in respect to the details," says H. P. Branstetter, of the KisselKar.

"Contrast the deep cushion-tired, wide-spring, thickly upholstered 'pussy-footing' automobile, with the iron-shod, noisy, hard riding horse-drawn buggy; yet the latter used to be a luxury.

"Why was there so little improvement in coach building then? The easy reply would be that the people were not so particular, but that answer is not complete. If they called for less luxury, it was because they had not been educated to the present conception of it.

"In these days, advertising is the basis of nearly every successful manufacturing business, and naturally each manufacturer strives to advertise something better than his rivals. That is why he is constantly endeavoring to build into his product new and better features to distinguish it. Reading of these creates a desire for them. Modern advertising methods therefore are primarily responsible for the higher standards of taste and living that now prevail."



Concrete Construction in Chicago Parks

The South Park Commissioners of Chicago now have near completion two groups of recreation buildings, one each in two of the smaller parks under their jurisdiction, which are not only more complete in equipment than previously has been attempted in the city park structures, but attain more artistic effects in the molded concrete surface of the buildings than has been accomplished before in this kind of construction.

The unique feature of this construction is a rough surface in which fluted pilasters and a wide ornamental cornice of classic Doric design have been cast without showing the impressions of the forms, giving the entire exterior walls a monolithic effect of remarkably pleasing and harmonious appearance. This style of construction was first introduced by the South Park Commissioners in conjunction with D. H. Burnham, the architect, about ten years ago. Since that time it has been developed by them until they have been able to produce a remarkably artistic treatment of the present structures.

The standard thickness of the walls of these buildings, not considering pilasters and cornice, is 18 inches. This is composed of a 4-inch tile center with 7 inches of dry mixed concrete on the outside and 7 inches of wet mixed concrete on the inside. The dry mixed concrete is composed of 2 parts cement, 3 parts of torpedo sand, and 9 parts of from 1/2 to 3/4-inch stone. The interior side of the wall is composed of regular wet mixed 1:3:6 concrete. The walls were built in 8-inch layers, the tile being laid first, then the surface concrete and the wet mixed concrete on the inside of the wall last. In placing the surface concrete it was tamped very hard for a width of about 5 inches next to the tile and very little at the front. By using very small stone of nearly uniform size and a dry mix, tamped in this manner, it was possible to crowd the concrete forward into the molded design of the forms, bringing out every detail of the design and presenting a uniform rough exterior finish. In mixing the concrete for the surface only about one-third as large quantity of water was used as for the wet mixed interior part of the wall.

The inspectors of the South Park Commissioners say that the artistic results obtained in placing concrete in this manner depend upon the uniform small size of the stone, great

(Continued to page 126.)



BAYONNE

Ten Years' Good Service

For ten years now BAY-ONNE has been used by Architects wherever decks, verandas, sleeping porches, etc., required a covering of tested quality, a covering positively waterproof and wearproof—at the same time neat, attractive and economical.

BAYONNE

has been given preference by architects ever since its superior process of preparing was made known to them. This process renders it impervious to water—it never leaks; impervious to heat or cold—it does not shrink or expand, blister or crumble; impervious to the most constant use—it does not corrode.

And, in addition, it is the simplest and cheapest to lay.

Write for Sample Book "N" giving prices and laying instructions. See Sweet's, Page 426

JOHN BOYLE & CO., Inc.
112-114 Duane St.—70-72 Reade St., New York
Branch House 202-204 Market St., St. Louis

Absolutely Weatherproof

We have positive proof from scores of architects and builders that Bay State Brick and Cement Coating *does* give permanent protection to concrete and stucco, and beautifies them without losing their distinctive surface.

Bay State Brick and Cement Coating

Write for "The Protection and Decoration of Cement Construction," our new booklet No. 30, illustrating types of cement buildings.



WADSWORTH, HOWLAND & CO., Inc.

Paint and Varnish Makers

BOSTON, MASS.

New York Office:

Architects' Building



Get FREE Finished Samples and Big Door and Trim Book

They show you how you can produce the most beautiful effects and finishes in hardwood trim, doors and floors in "beautiful birch." No wood finer though many cost more. birch furniture is standard, ask your dealer. Send postal card TODAY.

NORTHERN HEMLOCK & HARDWOOD MANUFACTURERS ASSOCIATION
201 F. R. A. Bldg. - - - Oshkosh, Wis.

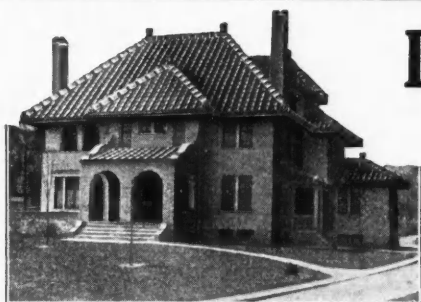

Don't Miss This Opportunity

We Want One Representative in Every Community to Demonstrate, Take Orders for and Apply Our EDWARDS METAL SPANISH TILE ROOFING on a Liberal Commission.

Here is a chance to build up an independent, profitable business for yourself right at home. Many are now devoting their entire time to selling our metal roofing. Others have made big profits simply devoting part of their time to selling and laying our Metal Spanish Tile.

Edwards Metal Spanish Tile

Is being advertised in the leading magazines and is now known to thousands of home builders and owners everywhere. Wherever it has been used it has made a decided "hit" because it shows off to good advantage on the roof and has numerous points of superiority over any other style of roofing.

Architects are specifying Edwards Metal Spanish Tile, for they know it will do away with roofing "troubles." Builders like it because of the finished appearance it gives any house on which it is used.

Our Metal Tile are stamped out of the highest quality Worcester terne plate in exact imitation of the most expensive Terra Cotta Spanish Tile. They come either "dip" painted or heavily galvanized size 10 x 14 inches. Our patented interlocking side lock makes it possible to make a perfectly moisture-proof roof without soldering. Edwards Metal Spanish Tile afford the fireproof advantages of Terra Cotta Tile, but are much lighter in weight, cost but a trifle more than ordinary roofing and will last a lifetime.

WRITE US TO-DAY ABOUT YOUR TERRITORY. Our business is growing so rapidly that it is necessary to have an agent in every community. The territory is going fast. One day's delay may mean that some one else will be given your territory. DON'T DELAY. WRITE TO-DAY FOR OUR SPECIAL AGENTS' PROPOSITION.

THE EDWARDS MANUFACTURING CO.

"THE SHEET METAL FOLKS"

401-417 Eggleston Ave.

Cincinnati, Ohio

THE WORLD'S LARGEST METAL ROOFING, METAL SHINGLES AND METAL CEILING MANUFACTURERS

NEW YORK OFFICE, 81-83 Fulton St. BRANCH OFFICE and Warehouse, 1625-27 Pacific Av., Dallas, Tex.



Note the construction of patented interlocking device, protecting nail heads from weather and providing perfectly for expansion and contraction of the metal.



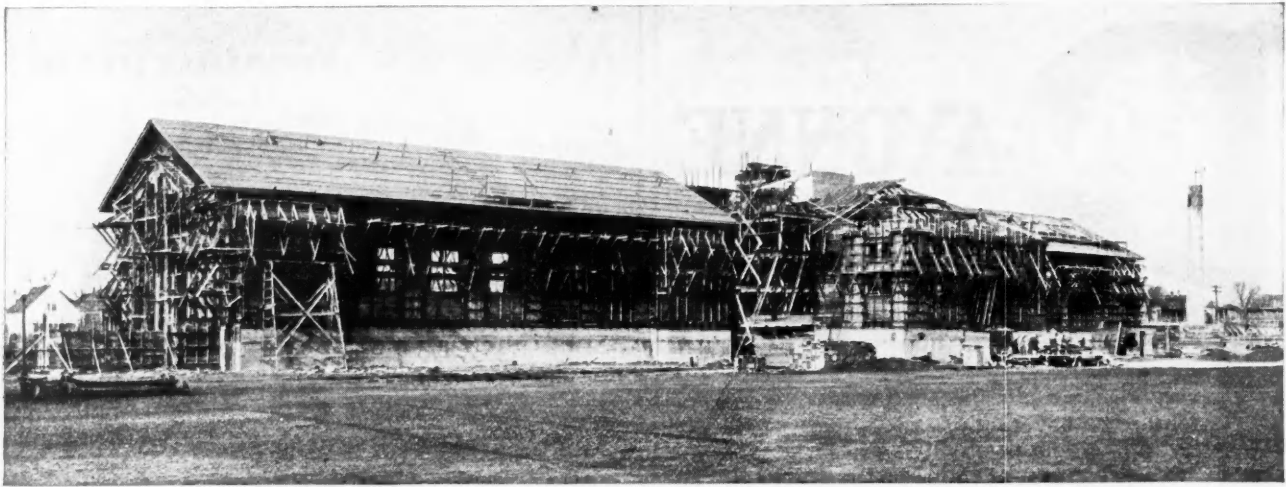

One of the Large and Well Arranged Concrete Buildings Which Are Being Built in Chicago Parks. The Molded Concrete Surface Will Be a Feature.

care in securing evenly mixed concrete of uniform moisture and the skill in tamping, to crowd the concrete forward into the molded design of the forms. All concrete used in this group of buildings was mixed in a half-yard "The Standard" Low Charging Mixer, made by The Standard Scale & Supply Co., Chicago and Pittsburgh. The mixer was placed at the ground level about the center, close to the side of the main group of buildings, and most of the concrete delivered in barrows from this position. This mixer is peculiarly adapted for this kind of construction, since it has a large open end, which permits the inspector to watch the concrete during the

entire mixing operation, and obtain more uniform concrete with the amount of water varied as required than would be otherwise possible.

These buildings were designed and their erection supervised entirely by the Engineering Department of the South Park Commissioners under the direction of Linn White, Chief Engineer. J. D. Barber, Asst. Engineer, was in immediate charge of the work on both groups of buildings. The general contract for all structures in both parks was handled by The John J. Brittan Co., 1401 Fort Dearborn Building, Chicago, who make a specialty of concrete work of this character.



THE STANDARD LOW CHARGING MIXER ON CONCRETE FIELD HOUSE AT GRAND CROSSING PARK, CHICAGO.

View Taken During the Construction of Concrete Field House at Grand Crossing Park, Chicago. This Building Will Be a Model for Completeness and Artistic Design.

Evans "Almetl" Fire Doors and Shutters

PATENTS PENDING

APPROVED BY UNDERWRITERS' LABORATORIES, INC., CHICAGO

The Evans "Almetl" Fire Doors and Shutters are of rigid, all steel and asbestos, non-warping, indestructible construction and prevent passage of flame. No wood to rot, no tin to rust, no seams to open, no thin covering to bruise. If you have had the costly experience of replacing wood core, tin-clad doors and shutters, you will welcome these new all-efficiency Fire Doors and Shutters.

INSTALLED ANYWHERE

Other Fire Prevention Lines Are

FIRE RETARDING "STAR" VENTS AND HIGH GRADE ROOFING PLATES

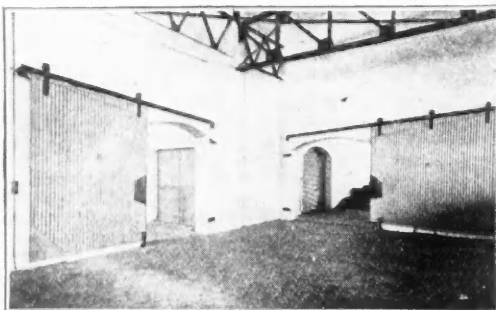

1866 — MERCHANT & EVANS CO. — 1916

New York
Baltimore

PHILADELPHIA

Cleveland

Wheeling
Chicago
Kansas City

Last A Lifetime

With No Repair Expense

THAT'S a great deal to expect from a shingle roof, but it's the very service that can be expected from **CORTRIGHT METAL SHINGLES**.

Over 25 years ago Cortright Shingles were placed on the market, and today many of the first Cortright Roofs laid are still in successful use. That's proof conclusive as to their durability.

The shingles are made of red, green or galvanized tin-plate, and tight coated galvanized sheets. They can be laid as easily as wood shingles. Once laid there is no patching or repairing—just a permanent roof that gives perfect satisfaction year after year.

Cortright Shingles are an excellent trade maker for the Contractor to recommend. They are most serviceable, permanent and inexpensive. They cost no more than wood and less than slate and make satisfied customers.

You should get our proposition. It's a most liberal one. Write us today—there is no obligation in asking for terms.

CORTRIGHT METAL ROOFING CO.
Philadelphia and Chicago



Building a Barn

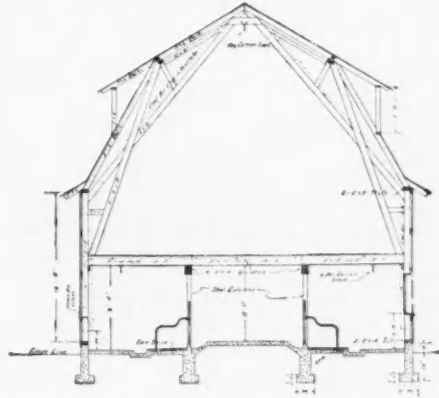

CONTRACTORS can obtain a large working drawing of the above cut, this being sent *free of charge*. Merely mail us the names of parties who expect to build or remodel barns.

Porter barn equipment, haying tools or barn door hangers are recommended by practical men because of the reliable and simple construction, which means efficient service.

Ask for latest catalogue No. 62—just out

J. E. Porter Company
620 Fremont St. Ottawa, Ill.

Our Free Plans Will Help You—

Meadows
TRADE MARK REGISTERED

Don't figure on any crib or granary without consulting our Free Plans. They will show you how to get greatest capacity at least expense by installing **Meadows Inside Stationary Cup Elevators**.

The most convenient and economical elevators, carrying small grain as well as ear corn.

The picture shows a 40-foot Crib. Cupola need not be as large as shown in picture; and cribs 36 feet or less in length with half-pitch roofs require no cupola.

Elevator is confined to one side of driveway. No pit is necessary for dumping grain, just a hole 16 inches deep into which boot of elevator is set. The wagon jack is entirely overhead, fastened to the joists.

But write in today for our free Crib and Granary plans, catalogs and large posters telling all about our outfits and their application. Valuable information for the builder, and writing for it obligates you in no way.

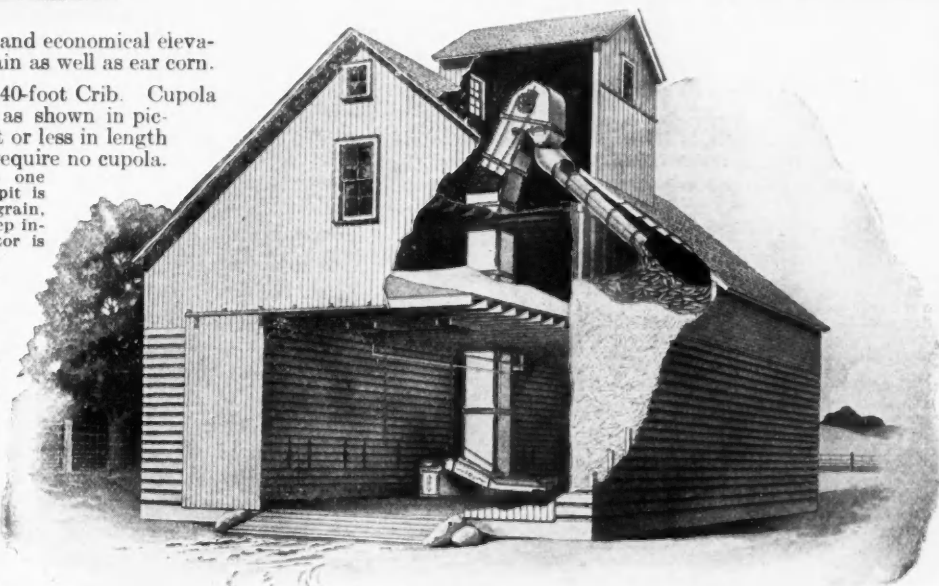

Meadows
Mfg. Co.
Pontiac, Illinois

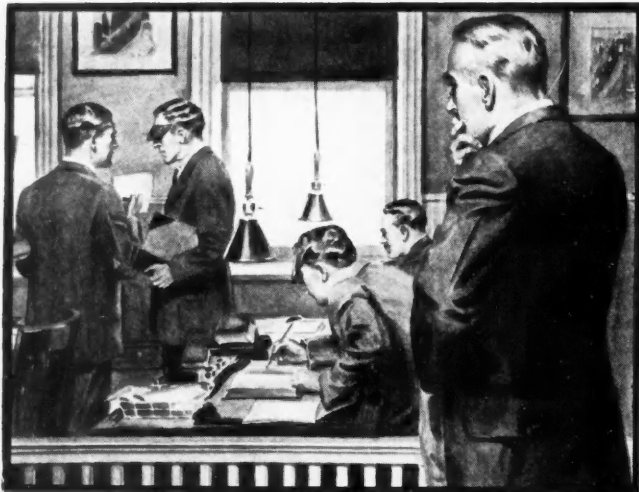

The Boss is Sizing You Up

Whether you know it or not, he's on the lookout all the time for men he can promote. He's ready and anxious to give YOU bigger work with bigger pay once you prove you can handle it.

If you *want* to get ahead, if you want to be somebody, to climb into a position of responsibility and good money—

Get Ready—Your Chance Will Surely Come

Choose the position you want in the work you like best—then train for it. You can do it in spare time in your own home through the International Correspondence Schools.

More than 130,000 men *right now* are putting themselves in line for promotion through the study of I. C. S. Courses. This way to success is always open. All the I. C. S. ask is the chance to tell you about it. No cost to find out. Just mark and mail this coupon now.

TEAR OUT HERE

INTERNATIONAL CORRESPONDENCE SCHOOLS

Box 8133, SCRANTON, PA.

Explain, without obligating me, how I can qualify for the position, or in the subject, before which I mark X.

- | | |
|---|---|
| <input type="checkbox"/> ARCHITECT | <input type="checkbox"/> Law for Contractors |
| <input type="checkbox"/> Architectural Draftsman | <input type="checkbox"/> BUSINESS (Complete) |
| <input type="checkbox"/> Contractor and Builder | <input type="checkbox"/> BOOKKEEPER |
| <input type="checkbox"/> Building Foreman | <input type="checkbox"/> Stenographer and Typist |
| <input type="checkbox"/> Concrete Builder | <input type="checkbox"/> Higher Accounting |
| <input type="checkbox"/> Plumber and Steam Fitter | <input type="checkbox"/> GOOD ENGLISH |
| <input type="checkbox"/> Heating and Ventilation | <input type="checkbox"/> Common School Subjects |
| <input type="checkbox"/> Plumbing Inspector | <input type="checkbox"/> Mathematics |
| <input type="checkbox"/> Foreman Plumber | <input type="checkbox"/> SALESMANSHIP |
| <input type="checkbox"/> CIVIL ENGINEER | <input type="checkbox"/> ADVERTISING MAN |
| <input type="checkbox"/> Surveying and Mapping | <input type="checkbox"/> Window Trimmer |
| <input type="checkbox"/> Structural Engineer | <input type="checkbox"/> Show Card Writer |
| <input type="checkbox"/> Structural Draftsman | <input type="checkbox"/> CIVIL SERVICE |
| <input type="checkbox"/> ELECTRICAL ENGINEER | <input type="checkbox"/> Railway Mail Clerk |
| <input type="checkbox"/> Electric Lighting | <input type="checkbox"/> AGRICULTURE |
| <input type="checkbox"/> Electric Wiring | <input type="checkbox"/> Poultry Raising |
| <input type="checkbox"/> Electric Car Running | <input type="checkbox"/> MINE FOREMAN OR ENGINEER |
| <input type="checkbox"/> MECHANICAL ENGINEER | <input type="checkbox"/> Metallurgist or Prospector |
| <input type="checkbox"/> Mechanical Draftsman | <input type="checkbox"/> Chemical Engineer |
| <input type="checkbox"/> Shop Practice | <input type="checkbox"/> Gas Engineer |
| <input type="checkbox"/> Sheet Metal Worker | <input type="checkbox"/> AUTOMOBILES |
| <input type="checkbox"/> STATIONARY ENGINEER | <input type="checkbox"/> Auto Repairing |
| | <input type="checkbox"/> Spanish |
| | <input type="checkbox"/> German |
| | <input type="checkbox"/> French |
| | <input type="checkbox"/> Italian |

Name _____

Occupation & Employer _____

Street and No. _____

City _____ State _____

If name of Course you want is not in this list, write it below.

New KisselKar Agencies

Following up their policy to constantly increase the service which they are able to extend to the public, the Kissel Motor Car Co., 546 Kissel Ave., Hartford, Wisconsin, have established recently the following agencies: N. W. Kamitz, Hoquiam, Washington; City Hall Garage, Inc., Paterson, N. J.; Chas. E. Conrad Motor Co., 518 Wyoming Ave., Scranton, Pa.; Tenney & Co., Decatur, Ill.; McConnell Implement Co., Green Lake, Wis.; Davis & Decke, Lansing, Mich.; Woodsworth Motor Co., Hartford, Conn.; Newland-Delaney Motor Co., 364 Livingston St., Brooklyn, N. Y.; J. E. DuBois, DuBois, Pa.; Myers Carriage Co., Franklin, Pa.; Kincaid Auto Gar. Co., Steubenville, Ohio.



A Handbook on Fireproofing

The fifth edition of "The Fireproofing Hand-Book," a book dealing with the problems of low cost fireproof construction using as a basis the reinforcing materials Self-Sentering, Trussit and expanded metal, products of the General Fireproofing Company, Youngstown, Ohio, contains a very liberally illustrated fund of information which offers a suggestion for practically every type of fireproof construction ordinarily necessary in building construction.

This book contains a description of Self-Sentering, which is a form of expanded metal, followed by a detailed discussion of the forms in which it may be had and the methods of its use. The results of fire and load tests show what may be expected of this form of reinforcing. A great number of illustrations show clearly both by details of the application and also by photographs of the work being done on the job, how this material is used in roofs, floors, and ceilings. The drawings are especially clear in giving a good idea of the possibility of eliminating form work in the construction of the various units mentioned, in building work, and also illustrate the flexibility of this method of obtaining a fireproof structure.

As an example of the method of using Self-Sentering and incidentally to show the excellence of the drawings used in the Handbook, the three illustrations shown on page 130 are taken from this book. The first is a detail of a flat roof built with all metal and concrete construction thruout. The Self-Sentering is fastened to the channels by means of special clips, the concrete being placed directly on top of the reinforcement with no forms of any kind required. On the under side of the metal a layer of cement plaster is applied, which completely encloses and protects it. The walls are built up by applying cement plaster to the Self-Sentering which has been previously clipped to the metal frame-work of the building. A tar and gravel roof is then applied over the concrete.

The second illustration is of a type of floor having for its reinforcement sheets with curved ends, placed with the ends resting on the lower flanges of steel beams, where they also act as forms for the fireproofing of the sides of the beams. The cement plaster is used to enclose the lower flange of the beams by means of Diamond-Rib lath bent around the flanges. These sheets may also be had in such a form that an arch form of construction may be used. The Handbook contains several tables of data in regard to this form of floor.

The third drawing shows a method which is claimed to eliminate the common difficulty of cracking of mosaic or terrazzo work when laid in the old manner. This construction consists in laying a layer of tar paper over the wooden joists, over which the reinforced concrete slab is placed, the special flooring material being laid over this slab. This illustration also shows the use of Herringbone lath, a product which the General Fireproofing Company describes fully in

(Continued to page 130.)

FUTURE ORDERS

and your reputation as a builder of barns depend upon the barns you build today.

Sanitary Barn Equipment

meets the approval of every owner, and a satisfied customer is always the best argument in soliciting his neighbors' business.

Every barn builder will find many helpful suggestions in our book "Modern Barn Equipment" which shows our complete, up-to-the-minute stable equipment, for every stable, large or small.

We'll send it for the asking.

Glor Bros. & Willis Mfg. Co.
E. Main St., Attica, N. Y.

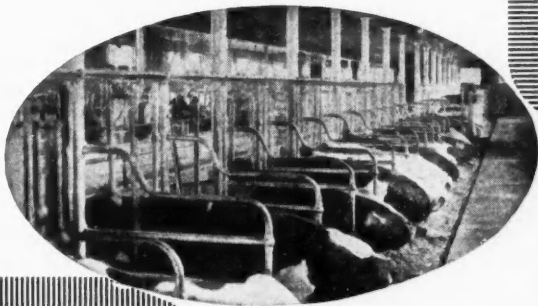

Don't Order Wall Ties—Order
Whalebone Wall Ties
The Quality Tie with the Bull Dog Grip



If your dealer cannot supply "WHALEBONE," wire at our expense the following:

(Name of dealer) can't supply Whalebone. Express } (number) boxes. (Your name.) Freight }

We will ship same day from our factory or from the nearest dealer handling. Samples mailed upon request.

Allegheny Steel Band Co.
886-888 Progress St. N. S. Pittsburgh, Pa.

Get FREE Plans of this Modern Crib with the Famous National Giant Inside Elevator

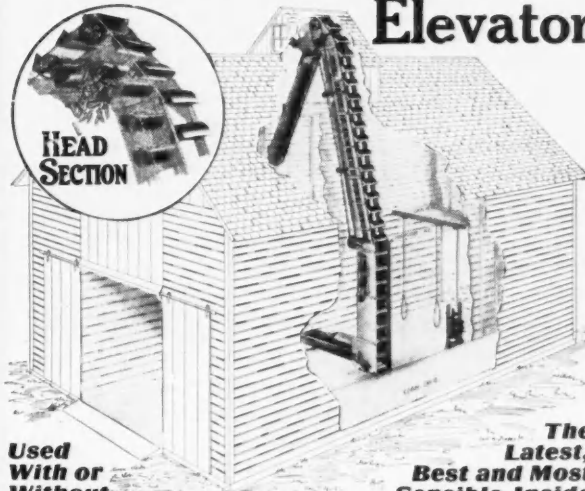

Used With or Without Cupola

The Latest, Best and Most Sensible Inside Machine Ever Invented

Carpenter-Contractors drop us a postal, please, and we'll be glad to tell you how to make big extra profits by recommending and installing our National Giant Bucket Elevators in your crib jobs.

The "National Giant" has more desirable features for you to base your recommendation upon and more sensible features for the FARMER than can be found on any other make of inside grain elevator. Why? Because on cribs 28x38 ft. or less, with half pitch roof, it is not necessary to have a cupola. Saves the farmer money. When cupola is necessary, we can save the farmer from \$15 to \$30 with the National Giant. Ask us why, please. We also save the farmer the cost of digging a pit, and on the length of elevator required. The "National Giant" leaves the corn on the cob, where it belongs; more money in the farmer's pocket.

Get Full Details of Proposition to Carpenter-Contractors

Ours is a good proposition for you and the farmer. It will pay you to look into it. It will bring in more business, greater profits for you. One satisfied customer will bring you many more crib jobs. Write us today—we will give you full details and assist you in any way with plans, specifications, etc. Write now for full details.

Portable Elevator Mfg. Co., 854 East Grove St. BLOOMINGTON, ILL.



Best Roof Under the Sun

Montross Metal Shingles for House or Barn or buildings that require durable, economical roofs. Easily applied. Fire, lightning and storm proof. Nine different designs. Write for illustrated catalog and testimonials from satisfied customers who have used Montross Roofing for a "Quarter Century." Liberal commission to good, live agents.

Montross Metal Roofing Co., 110 Erie St., Camden, N. J.

The Caldwell Auger Bit is an Efficient Tool

To the ordinary user, all bits are much alike until they are put into use. When this is done the superiority of The CALDWELL is evident.

This is because of the exclusive mechanical features in its construction.

The construction, as shown in detail in illustration, enables The Caldwell to work several times faster and with less friction than any other known bit.

| | | | | | | | | | | | |
|---------|----|----|----|----|----|----|----|-------|-------|-------|-------|
| Regular | 4 | 5 | 6 | 7 | 8 | 9 | 10 | 11-12 | 13-14 | 15-16 | 16ths |
| Prices | 35 | 35 | 40 | 40 | 45 | 50 | 55 | 60 | 65 | — | cents |

COMPLETE SET OF 13 BITS, \$6.00
Until your dealer is supplied, remit direct to us. We will deliver without further cost to you. Send for Catalog.

The LEBANON MACHINE CO., Lebanon, N. H.



another pamphlet bearing the title, "Herringbone Rigid Metal Lath."

The Fireproofing Handbook also has a very complete discussion of Trussit, which is another expanded metal product of this company, made for use in walls, partitions, and similar work. It is possible to use either this or the Self-Sentering in most work, the choice being largely determined by some local condition of the particular work to be done. The illustrations show many examples of work in which Trussit has been used, with drawings to explain how special problems have been met in securing the metal to framed portions of the structures.

The general information contained in this book may be used in connection with problems of construction where concrete reinforced with these expanded metal sheets may be used to very good advantage. The possibility of securing a fireproof construction and at the same time eliminating the trouble and expense of building forms, the many kinds of work which may be done and the permanent character of this type of construction are grouped together to form the recommendations of this product in the construction of fireproof buildings.

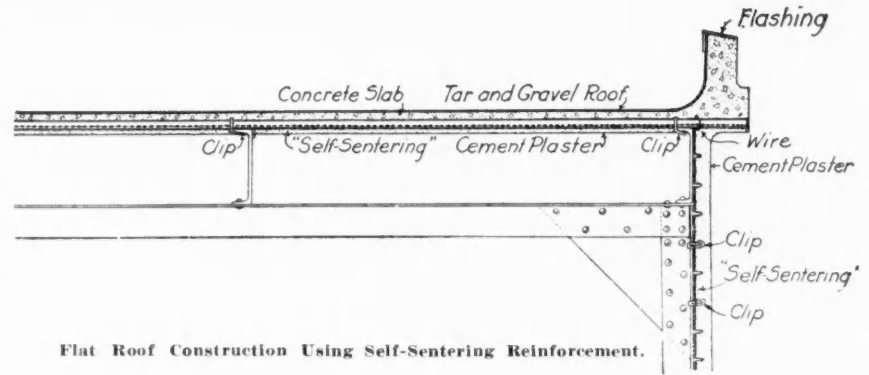

Flat Roof Construction Using Self-Sentering Reinforcement.

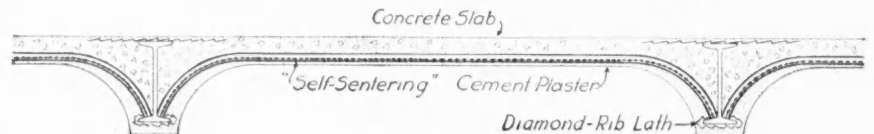

A Concrete Floor Reinforced with Specially Shaped Self-Sentering Sheets.

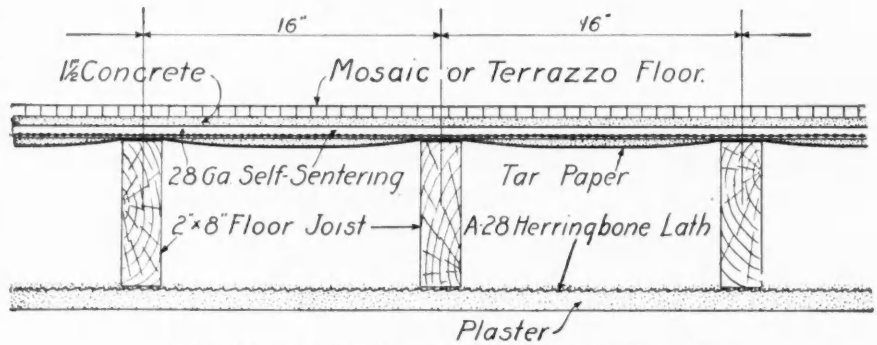

This Mosaic or Terrazzo Floor Will not Crack or Bulge.



A Liquid Hardener

For Concrete Floors

INDURITE Liquid Concrete Hardener hardens, dust-proofs, oilproofs, waterproofs, and permanentizes concrete floors.

It changes concrete surfaces into a flinty, granite-like substance of extreme hardness. A concrete floor treated with two applications of INDURITE will stand heavy service and be permanently protected against wear.

When concrete floors grow old before their time, INDURITE makes them young again.

It is easy to use; if applied at night the floor is ready for use the next morning. The expense of application is no greater than that of ordinary scrubbing.

CONTRACTORS: Write for the INDURITE folder and prices.

Send your business card or write on your letterhead and let us mail you our complete new catalog of CERESIT Products.

Ceresit Waterproofing Co.,

910 Westminster Building
CHICAGO



WHEN WRITING ADVERTISERS PLEASE MENTION THE AMERICAN CARPENTER AND BUILDER



NEW and distinctive markings have been adopted for the sides of all packages of Dutch Boy white lead. Instant identification of this reliable paint material is now easy.

Each black steel keg has the familiar figure of the Dutch Boy Painter and our guaranty on the side in brilliant orange. In addition, the words DUTCH BOY WHITE LEAD, in large legible type, appear between two bright orange stripes as shown in the illustration.

NATIONAL LEAD CO.

New York Boston Buffalo Chicago
 Cincinnati Cleveland St. Louis San Francisco
 Philadelphia (John T. Lewis & Bros. Co.)
 Pittsburgh (National Lead & Oil Co.)

When the big guns roar

their foundations and surroundings are forced to withstand unusual concussion and strains. In constructing the fortifications at Egmont and Mullet's Keys, Forts Hancock, Wadsworth, Slocum, Monroe, Strong, Mott, Totten and Schuyler and in making concrete improvements at the Brooklyn, Portsmouth, Boston, Norfolk, Charleston, and Philadelphia Navy Yards; at West Point, Annapolis and elsewhere, the United States Government has used hundreds of thousands of barrels of the cement that is tested hourly by chemists.

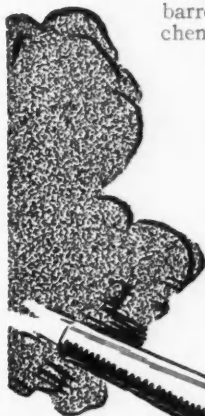

ALPHA
 THE GUARANTEED PORTLAND
CEMENT

Write for the ALPHA Book and Art Envelope No. 10 which contain valuable information about concrete work and show views of many notable concrete structures.

ALPHA PORTLAND CEMENT CO.

General Offices: Easton, Pa.

Sales Offices: New York, Philadelphia, Boston, Pittsburgh, Baltimore, Savannah

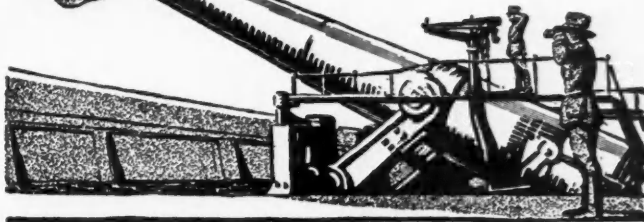

CONCRETE FOR PERMANENCE

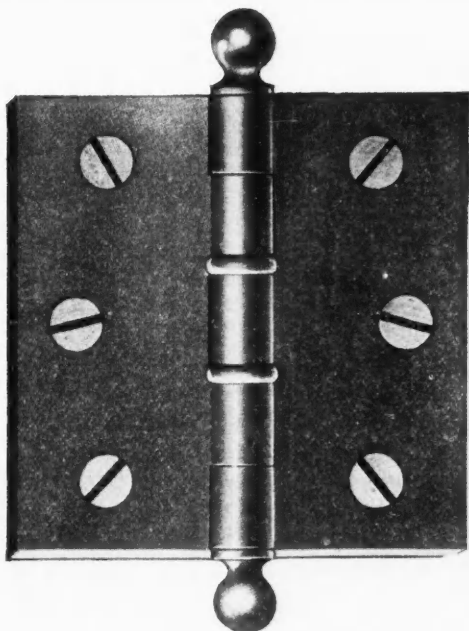

McKINNEY
 "Anti-Friction"
BUTTS

Appearance alone, although important, is not the deciding factor in the selection of finishing hardware. Owners build with an eye to the future. Permanence is desired as well as attractiveness.

Adding to the charm and beauty of the doors they swing, McKinney Anti-Friction Butts can be depended upon to render a life-time of satisfactory service. By reason of two small washers of special anti-friction metal, friction is reduced to a minimum and the nerve-racking "squeak" is eliminated. Oiling becomes unnecessary and the pins, owing to their special construction, will not work up under the action of the door.

McKinney Anti-Friction Butts are made of wrought steel and can be had in all standard finishes or special finishes to match any color you may desire. Ask your hardware dealer to show these durable and attractive butts.

May we send you a copy of our Architects' and Builders' Catalog. Ask for Catalog A-11.



McKINNEY MFG. CO.
 PITTSBURGH, PA.

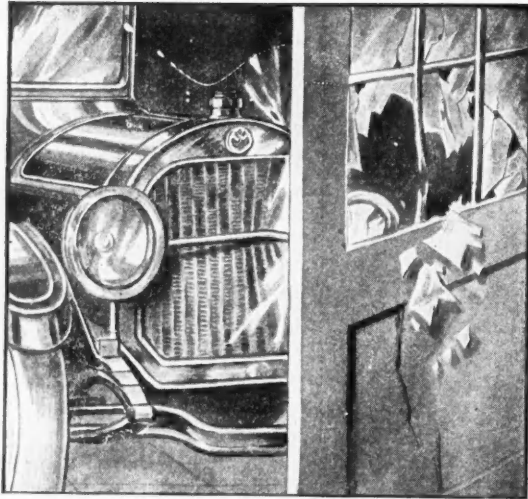

An Unnecessary Accident—

On the garages you build, whether they are simple or elaborate, you will find it wise to use Stanley Garage Hardware and the

STANLEY GARAGE DOOR HOLDER

The Holder is strong and simple in construction, holds the door open against the heaviest gusts of wind, preventing damage to car lamps, bending of the fender or scratching of paint.

Our book "A" on Stanley Garage Hardware is really interesting, and contains much data of value to architects, carpenters and builders. May we send it to you?

Stanley Works

New Britain, Conn., U. S. A.

100 Lafayette St. 73 East Lake St.
New York Chicago

Good Hand Book on Heavy Timber Building

"Heavy Timber Mill Construction Buildings" is the title of a comprehensive and highly instructive publication just issued for architects, engineers and builders, by the National Lumber Manufacturers' Association, and written by C. E. Paul, construction engineer, Chicago. All the introduction that Mr. Paul needs to readers of the AMERICAN CARPENTER AND BUILDER is to state that he is the author of the series of "Noon Hour Talks by the Boss Carpenter," that has been such a popular department of this magazine during the past four years.

"The term 'mill construction' as commonly used is the name given to that type of building construction in which the interior framing and floors are of timber, arranged in heavy solid masses, and smooth flat surfaces, so as to expose the least number of corners, and to avoid concealed spaces which may not be reached readily in case of fire.

"A broader interpretation of the term includes the meaning given above and adds the specification that the building shall be so constructed that fire shall pass as slowly as possible from one part of the structure to another. This means that each floor should be separated from all others by incombustible walls or partitions, and by doors or hatchways which will close automatically in case of fire near them. Stairways, belt passages, and elevator shafts are encased, or preferably located in fireproof towers. Openings in floors for passage of belts, etc., are either avoided or fully protected against passage of fire or water. The proper installation of an approved automatic sprinkler system is of great importance. Ceilings in rooms where highly inflammable stocks are kept or where hazardous processes are followed, should be protected by the use of a fire-retardant material such as plastering laid on wire lath or expanded metal. The ceiling should follow the lines of the timbers without an air space between the two surfaces.

"Mill construction has always been looked upon with favor for buildings in which ordinary manufacturing industries are carried on. Warehouses and buildings for storage of merchandise, stores, office buildings, factories, shops, and all buildings of moderate height which are not to be used for extremely hazardous purposes from a fire protection standpoint, are later developments of this type of construction. City building codes limit the height of building and size of open spaces in buildings. They also specify the minimum sizes of timber which shall be used, and other similar details."

It has chapters as follows: Exterior Walls, Fire Walls and Enclosures, Floors, Posts or Columns, Roofs, Fire Protection, Cost of Mill Construction Buildings, Standard Mill Construction, Quality and Kind of Timber Used, and Data for Design.



Stanley's New Garage Hardware

Up to the present time when a man wished to secure hardware particularly fitted for a garage, the store salesman had to use his best judgment, hunt thru the stock, and pick out pieces which might make a suitable collection.

The new garage catalog just issued by the Stanley Works recognizes that garage hardware is important enough to be classed by itself. This book is of interest and value to the garage owner, dealer, carpenter, builder and architect. This, the first catalog issued on hardware for garages with swinging doors, covers garages at all prices, from modest ones costing \$100 to very elaborate ones forming part of the country estates or city establishments, costing \$30,000 to \$50,000.

One of the novel items included in this catalog is the new Stanley No. 1774 Garage Door Holder. Realizing as every one does that hinges are the usual way to hang a door (because

(Continued to page 134.)

Get Samples of this Composite Metal Lath

A wire mesh, covered with brick-clay, under heavy pressure and baked presenting a surface of TERRA COTTA upon which to plaster. Very flexible and easily handled. **THE ONLY LATH WITH SUCTION** assuring a positive and permanent bond and eliminating DROP. Superior for STUCCO and all outside work as danger from rust is overcome. Low original cost and positive saving in labor and material.

Write for Samples and Full Information to

COMPOSITE METAL LATH CO., 128 Broadway, NEW YORK, N. Y.

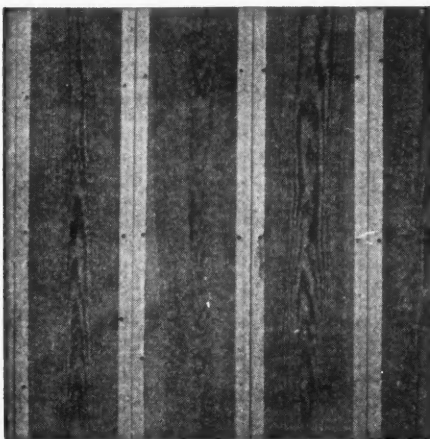
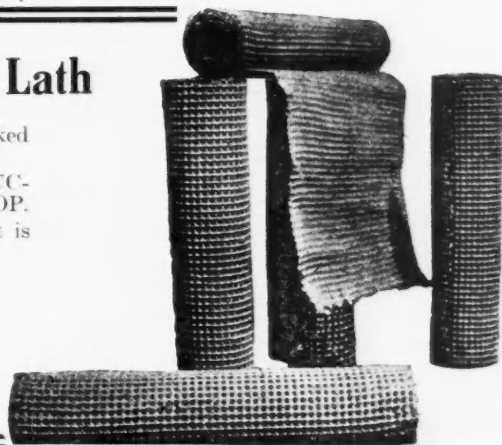

METALLIC BATTEN STRIPS

PRACTICAL—EVERLASTING—ECONOMICAL

These Batten Strips of Galvanized Metal will never warp, split, or draw away from the boards. Offer no obstruction to sliding doors. Allow for expansion and contraction of the siding. Made in 6, 7, 8, 9 and 10 foot length with interlocking joint. Easily cut; no waste. Nailed directly to siding with small nails.

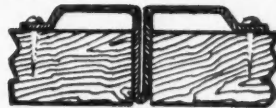

End view showing joint closed. A perfect fitting Batten at all times, in all weathers. Beautifies any building.



End view showing joint open. Provides for expansion or contraction of the siding so nails will not work loose.

Metallic Batten Strips make strong, neat joints. They make the building wind-proof, weather-proof and rat-proof. Also valuable for lining grain bins or wagon boxes.

Write for Free Sample and see for Yourself
METALLIC BATTEN COMPANY Owensville, Indiana

That Ugly Open Space Under the Door!

Who in the wide world can fix that wide space under the door? You can, whether it be wide or narrow, if you are in the weather-strip business. You can fix it right, too, with the **Eveleth Door Bottom Weather Strip**. It is being used more and more each year in many of the leading cities by the leading weather-strip men. It is being specified by the ablest architects the world knows, for the most expensive doors made. We will furnish prices, larger cut showing mechanical operation, and other interesting information.

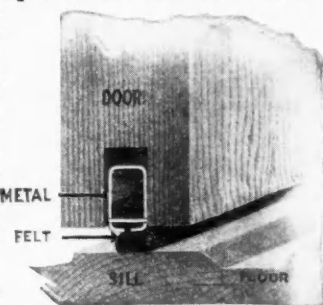

EVELETH MFG. CO.
(Not Inc.)
12 Ashland Ave., River Forest, Ill.
(2 miles west of Chicago City Limits)

Note "That Positive Grip" in Felt. Don't Write Today, But Tomorrow

Wind-Proof—Rain-Proof—Rot-Proof Chief Galvanized Iron Barn Bats

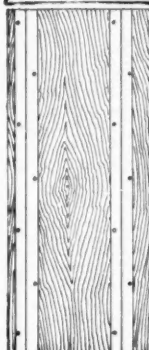

Make your buildings tight. Chief Galvanized Steel Strips fill the cracks between boards and make strong, neat, weather-proof joints. Keep out vermin. Cannot rot, warp or split like wooden batten. Always fit. Allow for contraction and expansion of boards without loosening nails. Furnished in 6-7-8-9-10 ft. lengths with interlocking joints. Write for full information.

SHRAUGER & JOHNSON
430 Walnut St. :: Atlantic, Ia.



Shows end view of Chief Galvanized Batten with joint closed. Siding expanded. Note position of the batten in the crack.



Shows end view of Batten with the joint open and siding contracted. Chief Battens automatically accommodate expansion and contraction.

"MILCOR"

Metal Building Corners

Made From Tight Coated Galvanized Steel

Metal Corners are being very extensively used and are very popular with the carpenter. They

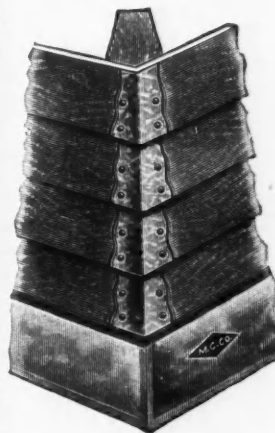

Showing Outside Corner Applied.

take the place of corner boards to finish the corner of the building when weather-board or lap siding is used. Time and expense is saved because it is not necessary to mitre the weather board siding. The mitre effect is perfect and the appearance superior to wood corner board.

Made in three sizes:—

- No. 4—3½ in. long
- No. 6—4½ in. long
- No. 8—5½ in. long

Furnished with beaded or plain edges and countersunk nail holes.

SAMPLES ON REQUEST

Milwaukee Corrugating Co.

Branch at
Kansas City, Mo.

MILWAUKEE,
WIS.

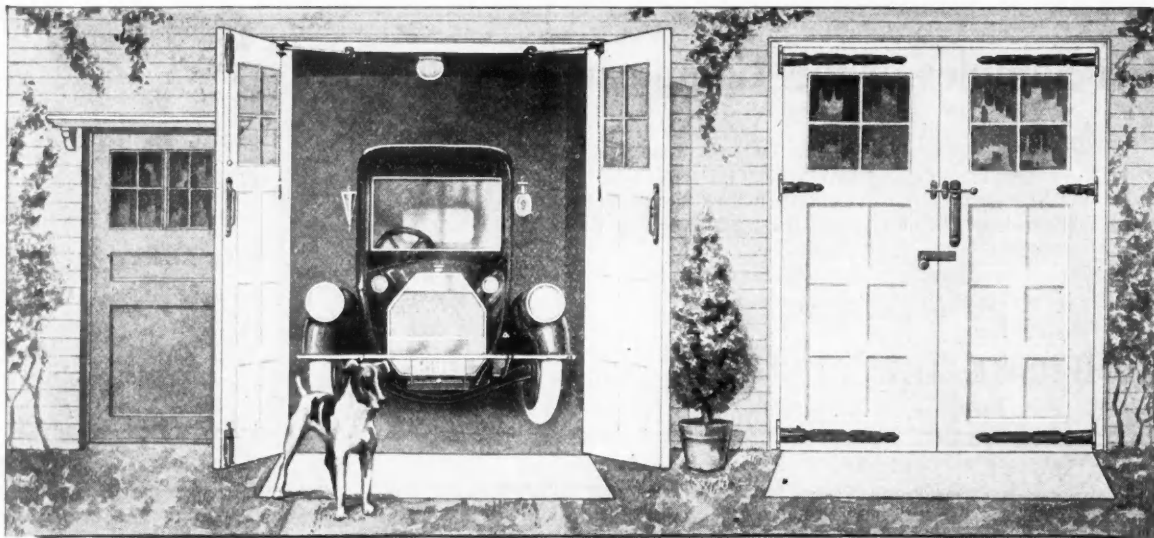

The "Stanley" Fitted Garage Door, Open and Closed. The Open Door Can't Slam Shut.

a door so equipped closes weather tight, is easy to open and close, doesn't sag or bind, has nothing to get out of order, and is not expensive. The Stanley Works nevertheless knew that a door left free to swing on hinges is liable to slam shut, and a valuable automobile may be seriously injured by such a smash due to a sudden gust of wind.

The latest garage door holder was developed after a long and careful series of experiments and tests. It consists principally of an arm of wrought steel, one end of which is pivoted on a plate attached to the top of the door. As the door opens, the arm of steel is drawn thru a slot in a bumper which is attached to the top of the door frame. The top end

of the bar or arm is turned up. At the end of the bar, on the underside, are two notches. When the door is opened somewhat over 90 degrees, the bar is pulled thru the plate to a position where the turned up top piece hits the bumper and the notches drop over the bottom edge of the slot, thus checking the motion of the bar and the door in both directions. To release the door, all that is necessary is to pull a chain which lifts the notched arm over the slot, permits the bar to slide, and the door to swing.

The handsome Stanley Garage Hardware catalog is free to anyone requesting it of the Stanley Works, New Britain, Conn.

An offer to "American" readers only Write for Circular

A trailer will
PAY you—
You Can **Make Your**
Own Trailer
Bodies

"Kalamazoo"
Trailer Gear
\$29.90

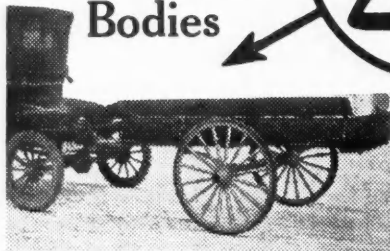

Buy a Gear
complete—
ready to set
on any style
body

Buy a sturdy "Kalamazoo" trailer gear—and build your own bodies from odd pieces of lumber. You recognize the merit of an automobile trailer—how it eliminates waiting for slow deliveries, how it lets you handle tools, saw rigs, cement mixers, materials, ladders, scaffolding, etc. in a hurry. Now—buy a reliable gear for \$29.90 and build your own trailer. The "Kalamazoo" gear is complete—all ready for the box. It takes a body any length you want, with any width up to 43 inches. Carries 1,000 pounds. Gear consists of Sheldon refined steel axles, Sarven patent wheels with heavy round-edge steel tires, best open-hearted steel springs, hickory tongue equipped with a support that will drop down to balance load and a safe Universal coupler permitting twisting motions without injury to car or trailer, cross pieces and braces. Gear is black auto finished, decorated with fine stripes. Tell us what car you drive, mail us the factory-to-user price of \$26.90 and we will promptly ship you a complete gear, fully guaranteed for a year. If rubber or special tires, axles or ready-made bodies are desired, write for prices.

Kalamazoo Carriage & Harness Company
Vehicle Builders for 35 years
Kalamazoo, Michigan

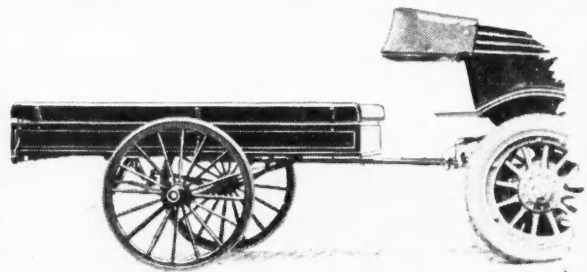

You do not need an expensive truck when you have an automobile.

Let us tell you how much you can save by using the

Page Auto Trailer

We use three-quarter platform springs and trailer is coupled to auto by a Universal Joint and Shock Absorber Combination that is positive and does not disfigure your car. No tugging or jolting of car with this attachment. Trailers built in three sizes, with or without Ball Bearings.

Send a postal now asking for full particulars and prices.

PAGE BROS. BUGGY CO.
(Established in 1869)
MARSHALL, MICHIGAN

MYERS MOTOR DRIVEN PUMPS

FOR PRESSURE AND OPEN TANKS

When the specifications call for a first class water supply system, put in the MYERS for it will satisfy the most particular people. The different kinds of Myers Pumps make it possible to install a pump adapted to the individual need.

The motor driven pumps are popular on account of their convenience. They are furnished, if desired, with a controlling switch which makes them automatic. Ease of installation and economy of operation make Myers Pumps popular favorites. They are made for operation by hand, gasoline engine or motor.



For shallow or deep wells

Water cooled air compressor

Fig. 1713 No. 378AB

Write for Catalog of Myers Water Supply Systems

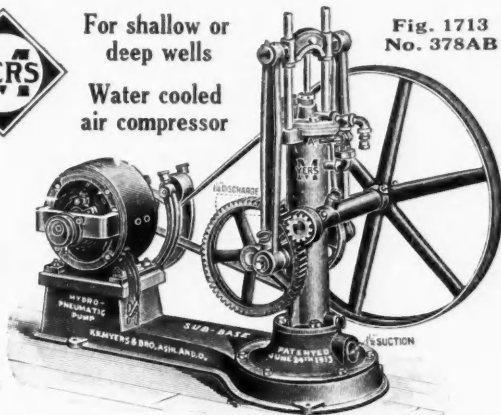

F. E. MYERS & BRO., 360 Orange St. Ashland, Ohio
Ashland Pump and Hay Tool Works

THE TRAILER WAY MAKES CARS PAY

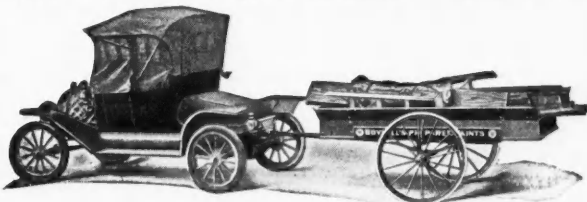

A MODEL FOR EVERY NEED

Adjustable Draw Bar and a Coupling which takes care of every movement even to the most severe twist.

Catalog ready—ask for it.

THE MILES MANUFACTURING CO.
309 Franklin St. Jackson, Mich.

Famous Chief Cellar Windows Will Not Stick, Warp or Rot

The solution of the cellar window problem—a modern, 20th Century Cellar Window made right for service. Made of steel-window, casing and all. No rotting, shrinking or swelling. Fits perfectly all the time. Trouble proof, easy to open and close, leak-proof and fire-proof. Will not rust. Nothing about it to wear out. Fitted with special, inside steel latch—cannot be opened from outside except by breaking the glass. Glass held in place without putty—can be replaced in minute's time.

Chief Cellar Windows will please your customers. Cost no more than wooden windows—last twice as long. Can be painted any color desired or left unpainted. Give more service and better service. Write for complete description, prices and terms.

SHRAUGER & JOHNSON
430 Walnut St. Atlantic, Iowa

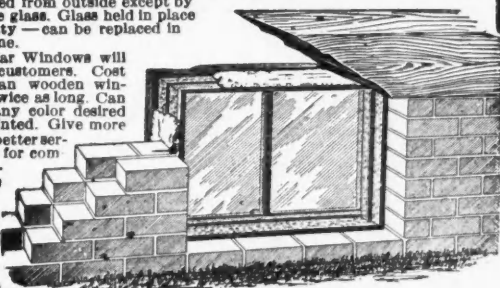

Ankyra Ankor Bolts

THIS one illustration suggests a thousand ANKYRA uses—

How you can use them for mouldings— for grounds— for furring strips— for fixtures in bathrooms or kitchens or pantries or anywhere in the house—

How you can attach anything to hollow tile, stucco, concrete, lath-and-plaster, compo-board, hollow-sheet metal, expanded metal, etc.

ANKYRA'S big wing nut— which forms inside the wall when the bolt is expanded— has so much bearing surface that it will hold in lath and plaster, for instance, even if it should happen to catch but a very small portion of a lath.

Thousands of ANKYRAS have been specified by architects and used by builders in many of America's most prominent buildings—the Equitable and Woolworth in New York, the Widener, Bellevue-Stratford and Bell Telephone in Philadelphia, the Traymore in Atlantic City and many others are good examples.

We will gladly send you a box of sample Ankyra Bolts for your examination, together with a booklet outlining clearly their many money and time-saving uses.

Ankyra Mfg. Co.

151 Berkley Street
Wayne Junction
Philadelphia

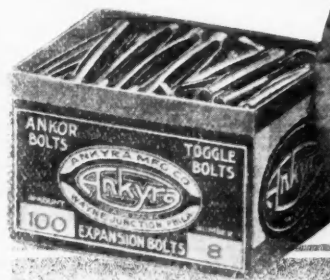
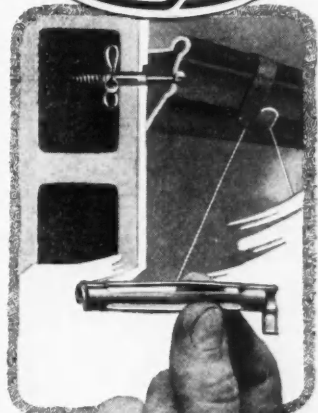

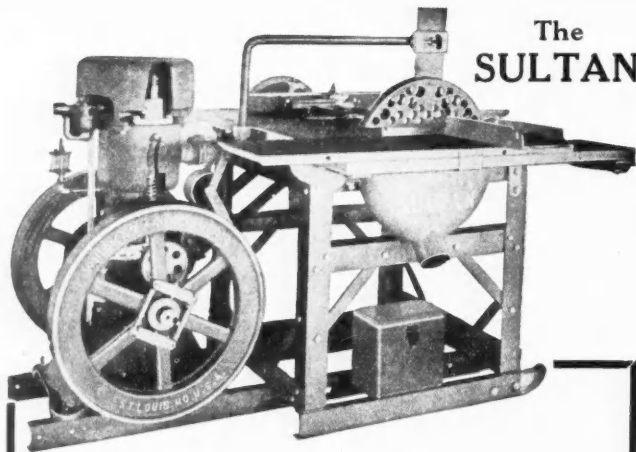

The
SULTAN

Note the Difference of This Portable Rig Saw!

Nothing on the market to equal the Wonder-Worker SULTAN. Does all kinds of work usually done by two or more machines. Has patent gauge for any angle—octagon or hexagon, or mitre right or left. You don't have to mark the lumber for cut-off work. On cross cutting, guide table slides material through without moving material. For ripping, lock table and work without interference. Note that power plant is behind the saw and not underneath. Keeps engine free from dust and grit. Furnishes extra power for the hardest "pulls."

Write for Low Prices and Free Catalog

Write for special low prices and get catalog describing this SULTAN Portable Rig Saw in full. Catalog also contains other Contractor's Equipment. You owe it to yourself to learn all about the SULTAN outfit. It will make and save money for you on every job. The SULTAN is built entirely of best grade steel. Frame is very strong, rigid—yet comparatively light and easy to move about. Fully equipped for all kinds of work. Write today for further important facts and catalog. No obligation to you. A postal will do.

WHITMAN A. CO., 7303 So. Broadway, St. Louis, Mo.

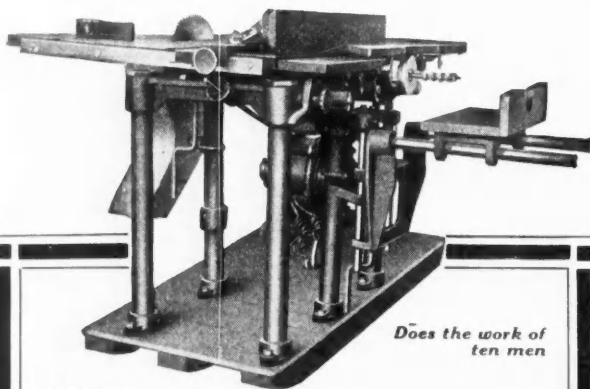

Does the work of
ten men

A Machine
for all
purposes

BERLIN

Portable Woodworking Mill

is the biggest labor-saver you can buy. Because of the present labor shortage, good men are at a premium. Don't let high-priced labor eat up your profits. This mill will do the work of ten men, and soon pays for itself in money saved.

Consists of a Rip Saw, Cross Cut Saw, Dado Saw, Grooving Machine, Jointer, Jig Saw, Boring Machine, Sander and Emery Wheel. Comes equipped with either gasoline engine or electric motor mounted on its own base. Guaranteed for two years. Write for information on this machine.

SCHAEFER MFG. CO.
American St. Berlin, Wis.

Caldwell Auger Bit Company Becomes the Lebanon Machine Company

Announcement has just been made that on July 1, the Caldwell Auger Bit Company, Lebanon, N. H., changed their corporate name to the Lebanon Machine Company. They manufacture the Lebanon High Speed "Z" Twist Auger Bit and other high grade wood-boring tools.



Concrete Construction Methods

In the Building Number of Alpha Aids, a useful pamphlet published at intervals by the Alpha Portland Cement Company, a great deal of information is given relative, for the most part, to methods of concrete construction. Good practice in form building is well illustrated in its application to various types of walls and to a water trough, manure pit and underground storage tank or cistern. The correct reinforcement for various forms of concrete fence posts is contrasted to common and undesirable methods of reinforcement. The importance of correct aggregates is emphasized and some useful instruction, intended for the small user of concrete, is given.

A detail drawing showing the construction of a concrete driveway used in conjunction with a small concrete culvert is a feature of this issue. The construction of the forms needed in building the culvert is shown. This drawing would be of immediate value to any contractor or builder who anticipates the construction of an entrance to a farm or other estate where it is necessary to provide for the flow of water down the gutter of the main highway.

Under the title, "Good Types of Concrete Buildings," are shown sections and plans for a combination fireproof barn, a concrete icehouse, a poultry house and a greenhouse with concrete walls, floors and benches. A full discussion of each structure is given and some valuable general information is thrown in for good measure.

The man who would like to do a little concrete work but who doesn't feel that he is able to stand the expense of renting a mixer will find a good suggestion in two photographic illustrations of a concrete mixer which may be built for five dollars.

Several other interesting features are included in the Building Number of Alpha Aids, and the contractor or builder who does any work with concrete will do well to communicate with his dealer or with the Alpha Portland Cement Co., Easton, Pa., in regard to obtaining a copy of this issue.

KEROSENE ENGINES

WITTE 1916 MODEL

90 DAYS TRIAL EASY TERMS



FREE BOOK ← Greatest Engine value I ever offered.—Ed. H. Witte.

Pulls 30 to 50 percent over factory rating. Sturdy, dependable; Lowest priced; Lowest cost of operation; Better built. My 30 years' engine experience and a \$500,000 factory behind every engine I sell.

Inside Facts about the engine business are told in my Free 4-color book. Don't buy any engine at any price till you read it. Full of interesting information.

Ed. H. Witte Engine Works
1777 Oakland Avenue, Kansas City, Mo.
1777 Empire Building, Pittsburgh, Pa



Stearns

No. 10



Try This Scraper on Your Floors at Our Expense

Here's a Scraper that scrapes clean and smooth, in the corners, close up to the walls, and scrapes without those wavy lines so often caused by "chatter". Our knife with double edge wears twice as long as any other Scraper knife. Our adjustable handle, rubber tires and the way the weight is thrown on the knife are all exclusive features of the Stearns No. 10.

We don't ask you to "beware of other Scrapers", but we do ask you to accept this machine on a fifteen day FREE TRIAL OFFER, so you may "compare it with other Scrapers," for by test the Stearns is best.

There are fifteen days in which you can test its easy running, smooth shaving and sturdy qualities at our expense.

Write us about it.

Sold by dealers, direct from the factory or on fifteen days' trial. Particulars will interest you.

E. C. STEARNS & CO.

500 Oneida St.

Syracuse, N. Y., U. S. A.

This Mitre Box Won't Break—It's All Steel

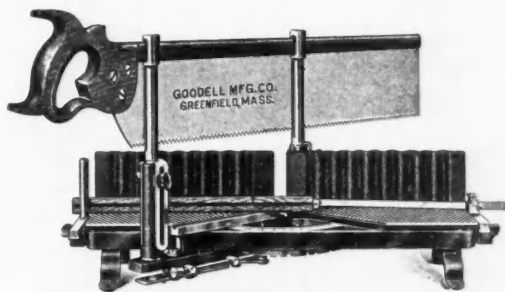

THE best evidence that this Mitre Box is virtually unbreakable is the fact that the makers have not received \$15 in ten years for replacements. The few replacements have been for small lost parts.

This Mitre Box is made entirely of steel. It has a rigid steel bed, heavy corrugated back, and all parts are skilfully put together to insure absolute accuracy. This Mitre Box belongs to the family of

GOODELL-PRATT

1500 GOOD TOOLS

You cannot injure the "Goodell" with strains and blows as you can a cast iron box. A special feature about the "Goodell" is the automatic lock for holding saw elevated, which allows the placing of work with both hands.

Send for circular which gives the whole story of this wonderful Mitre Box. In addition we will send you

Our Free Catalog

which lists over 1500 of the finest tools in the country.

Goodell-Pratt Company

Toolsmiths

Greenfield, Mass., U. S. A.

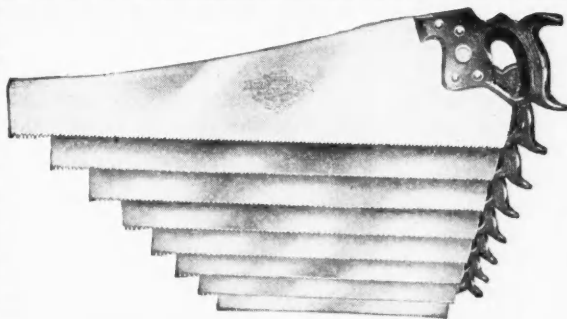

85 Years of Saw-Making Experience Guarantee

SIMONDS SAWS

Guarantee them to be as perfect saws as time, human skill, and best material can produce.

The steel is made in our own plant to get the best and toughest steel possible; every tooth is as sharp as a needle; the hang of the saw is "just right"; and the Simonds simply slides through wood.

Write for our valuable free book "Simonds Guide for Carpenters."

SIMONDS MFG. CO.
Fitchburg, Mass.
(Established 1832)



"I tell you it's a great saw"

PROCLAMATION

To Contractors:—

The RANSOME CONCRETE MACHINERY COMPANY, on May 1st, 1916, acquired the exclusive rights of manufacture under the Caniff Patents for Concrete Pneumatic Mixers and Placers.

The Caniff Patents Are Basic

They are the only patents that have been validated by the courts.

The Ransome Concrete Machinery Company is now prepared to turn out on short notice:

- 1--THE RANSOME PNEUMATIC MIXER AND PLACER
- 2--THE RANSOME-CANIFF GROUT MIXER
- 3--THE RANSOME GROUT GUN

THE DEGNON CONTRACTING CO. THE FLINN-O'ROURKE CO.

Two of the largest contracting firms in the United States and many others are using the Ransome Pneumatic Mixer and Placer.

THIS DEPARTURE on the part of the RANSOME CONCRETE MACHINERY COMPANY is the MOST IMPORTANT THING that has happened to the CONTRACTOR AND HIS BUSINESS IN YEARS.

A PNEUMATIC DEPARTMENT—As some doubt may exist in the minds of contractors as to the feasibility of using the pneumatic mixers or grouters or placers to advantage, the RANSOME CONCRETE MACHINERY COMPANY has established a PNEUMATIC DEPARTMENT. This department is in charge of experts and they will attend to all correspondence on this subject. We want you to write us.

Address: PNEUMATIC DEPT.
Room 700
115 Broadway, New York City

RANSOME CONCRETE
MACHINERY COMPANY



To the Building Trade:—The Ransome Sudden Service is being maintained throughout the country in the delivery of our Bantam Mixers—no bag splitting—let us send you the name of the nearest agent.

"The Roof of Eternal Youth"

The advantages to be gained by the use of slate in roof construction are ably set forth in the pamphlet, bearing the above title, which is being distributed by the F. C. Sheldon Slate Company, Granville, N. Y.

The importance of the roof as a unit in the complete building has been established. It must not only furnish protection from the elements, but it must also give a reasonable degree of satisfaction in appearance. During recent years it has been recognized that a roof must also offer resistance to fire in order to meet the highest possibility of utility. The slate roof is a very satisfactory solution of the roofing problem, since such a roof is long lived; does not become unsightly on account of shrinking, warping, decaying or showing other marks of old age; never needs painting; does not increase the roof load on account of becoming water-soaked; insures clean cistern water, and resists the spread of fire due to sparks falling from adjacent buildings. Altho slate is a natural rock, a roof made of this material is not an exceedingly heavy load on the rest of the building. The appearance of a slate roof may be made very attractive by the use of a distinctive color scheme, or special sizing of the slates. The Sheldon Company is able to furnish slates of various attractive shades of red, green, purple, and also the black. These slates may be either unfading or weathering. The symmetrical effect of vertical and diagonal lines produced by using slates of the same size may be eliminated by the use of their special graduated sizes which, together with all the possibilities of color scheme, make a variety of designs capable of satisfying a wide field of desire.

The process used in taking the rock from the earth and preparing it for the market is interesting:

The solid rock formations were deposited deep down in the earth ages ago, and from these formations huge blocks of slate are cleft by the skillful use of explosives.

"From the mines or quarries they are conveyed by overhead cableways to buildings located on the properties where skilled workmen with mallet and chisel 'split' then into 'sheets' of required thickness. These sheets are then trimmed to size on a machine, completing the process of manufacture. The finished product is piled in the yard or railway siding, ready for shipment."

In keeping with the trend of the times, it has required the work of those who have devoted their entire time to the roofing problem—the work of specialists—to produce the modern high grade of roof which is coming to be recognized as a necessity on even a humble little cottage. The F. C. Sheldon Slate Company has some very carefully worked-out methods of using their slate to produce results yielding the maximum satisfaction to the owner of a building using the roof which they prescribe.

If You Don't Know the Difference

Between RIGHT and WRONG

as Regards FLOORING

Write us for information about the right kind.

Kuhn Patent Tongue and Groove Flooring

THE INTERIOR HARDWOOD CO.

1321 Beecher Street INDIANAPOLIS, IND.