

PRICE 20 CENTS

AMERICAN BUILDER

THE WORLD'S GREATEST BUILDING PAPER



Annual
**INDEXED
REFERENCE
NUMBER**



Published in Chicago

Atkins Silver Steel Saws in Service



Quality

THE QUALITY CARPENTER makes the most money and stands in greater demand. Each job he completes acts as a recommendation for the next.

Good tools are a necessity in quality work. Atkins Silver Steel Saws are good. They are taper ground, file easier, run with less set and hold their edge longer than any saws made.

This is why your next saw should be an Atkins. It's "pure gold value" for every cent you spend. Ask your dealer.

*Send 10 Cents for Nail Apron, Monthly
Time Book and Saw Sense*

E. C. ATKINS & CO., Inc.
INDIANAPOLIS - - - INDIANA

Make Your CONTRACTS *More* PROFITABLE

Save that lost time and labor—do away with the waste of odds and ends. With an Eveready Saw Rig you can make your door and window frames right on the job, make them when needed—no more waiting for the other fellow, and then besides you make the extra profit.

No matter what kind of work you want done, it will do it and do it right—eleven different operations—the most practical saw rig ever built.



is light and portable—can be moved anywhere—yet is strong and sturdy and capable of standing the heavy strains of contracting work.

You can set it up in your barn or shop in the winter—it never need be idle.

Moderately priced—a quality product in every respect—a machine the contractor cannot afford to be without.

Write today for prices and information.

OSHKOSH MFG. COMPANY

123 Amber St.

Oshkosh, Wis.

Also Manufacturers of Oshkosh Mixers and Back Fillers.

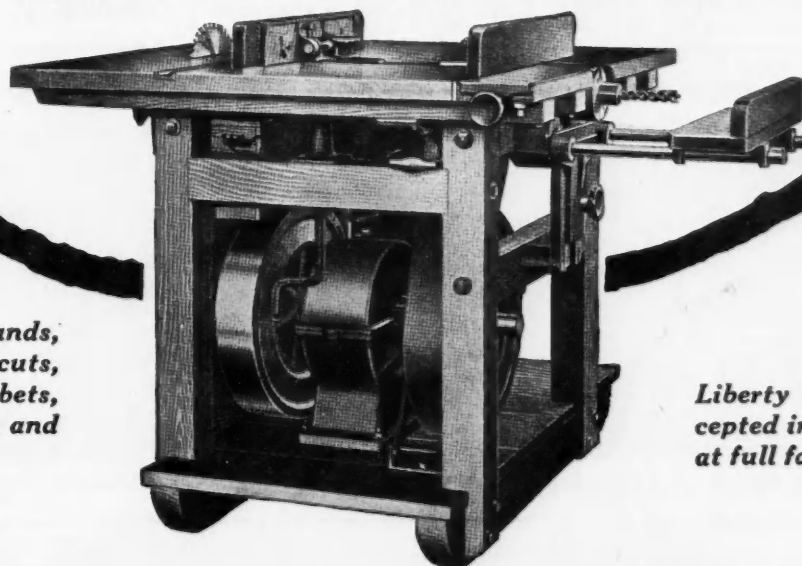

*Joints, bores, sands,
rip-saws, crosscuts,
jig saws, rabbets,
bevels, tenons and
grinds.*

*Liberty bonds ac-
cepted in payment
at full face value.*



THIS BIG BOOK

The CRESCENT catalog of WOOD WORKING MACHINERY will solve your problems. On some of the 143 pages you will find exactly the Universal wood worker, band saw, saw table, planer, planer and matcher, borer, reversible single spindle shaper, double spindle shaper, hollow chisel mortiser, swing cut off saw, post borer or variety wood worker you will need to keep your shop busy this winter.

If you are accustomed to doing your work by hand, you owe it to yourself to investigate the merits of power driven machines. Your competitors are using them. The machines will make up in a measure for shortage of labor, which you will soon have to face. For instance, on the CRESCENT Universal wood worker you can do scroll sawing, cross cutting, ripping, resawing, panel raising, grooving, disk grinding, sanding, jointing, boring, tenoning, dadoing, knife grinding, mortising. You can make moulding and in fact this one machine will help you turn out a large part of the mill work you have been accustomed to buy.



Ask today for the Crescent catalog. It is free.

The Crescent
Machine Co.
224 Main Street
LEETONIA, OHIO

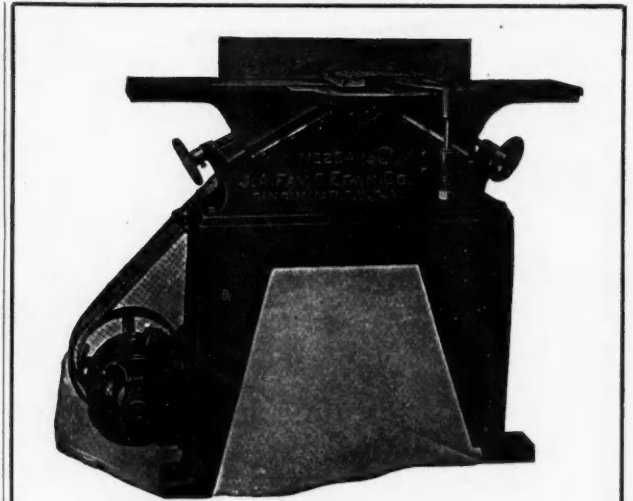

—a really practical Carpenter's Hand Planer —bench or pedestal—with or without motor

DON'T buy a toy, get a real machine: 6½-inch safety head, thin air hardened steel knives, adjustable bevel fence, removable steel lips, rabbeting arm, pedestal that gives your feet clearance; easy to keep clean under the machine; a practical time-saver and money-maker. Write for Bulletin H-7.

J. A. Fay & Egan Company
545-565 W. Front St., Cincinnati, O.

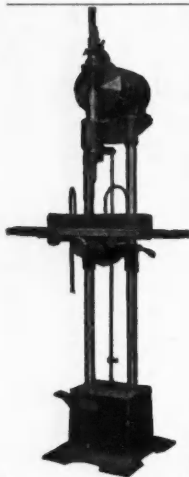

SUPERIOR HOLLOW CHISEL MORTISER and BORING MACHINE

SPEED and ACCURACY

account for the rapidly growing popularity of the SUPERIOR. This picture shows the Style C.F., also made without motor, with countershaft on base for belt drive. Style C.V. has vertical motor direct-connected to bit shaft.

WRITE TODAY FOR
FREE TRIAL

Warren W. Morse, The Low-Priced
Mortiser
1308 West Lake St. Minneapolis, Minn.

CARPENTERS

In these days of close competition need the best possible equipment, and this they can have in

Barnes' Hand and Foot Power Machinery

Our new foot and hand power Circular Saw No. 4, the strongest, most powerful and in every way the best machine of its kind ever made. For ripping, cross cutting, boring and grooving.

SEND FOR OUR
NEW CATALOGUE

W. F. & John Barnes Co.
74 RUBY ST. ROCKFORD, ILL.

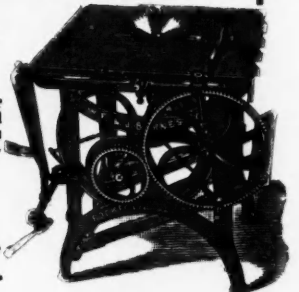

Write for catalogue showing full line of Wood Working Machinery for Carpenters and Builders. Also Bargains in second hand Machinery.

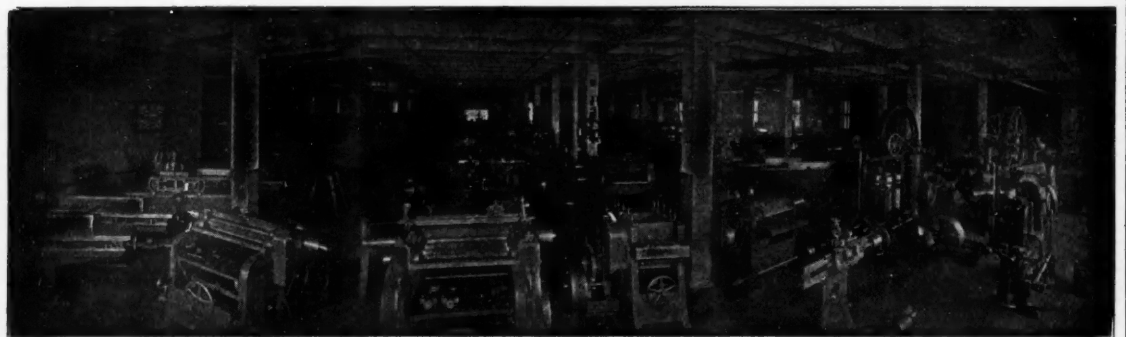

CHICAGO MACHINERY EXCHANGE

1215-1223 WASHINGTON BOULEVARD
CHICAGO, ILLINOIS

C.
H.
&
E.

Portable SAW RIGS

8 COMPLETE SIZES

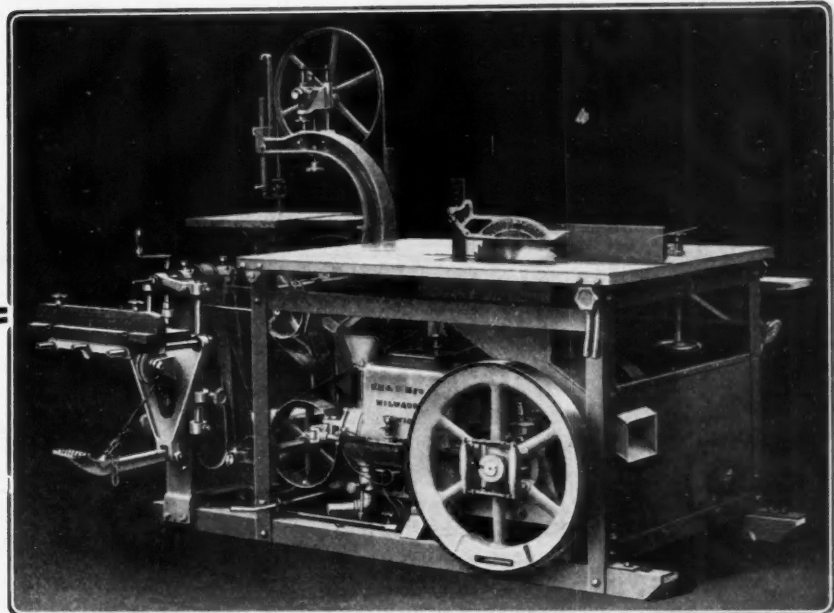

THE C. H. & E. No. 6 SAW RIG

WRITE
FOR
CATALOG

ALL of the sixteen large national army cantonment camps were built with the aid of CH&E Portable Saw Rigs. Seventy-two Portable Saw Rigs shipped to one camp job alone.

If the United States Government uses our rigs, you should feel assured that the machines are O. K. Let us mail you a special illustrated folder showing views of our machines on these large camp jobs.

—DO IT TODAY!—

C. H. & E. Manufacturing Co., Inc.
322 MINERAL ST. MILWAUKEE, WIS.

Put Huther Tools on your saw rig!

THEY are guaranteed to do your work satisfactorily and will more than double the output of your saw rig. In order that you may prove to yourself the value of Huther tools, we will ship them to you, on ten days' free trial at our expense.

The Huther Dado Head can be used on any ordinary saw arbor and cuts any width groove from $\frac{1}{8}$ to 2 inches or over.

The outside cutters can be used singly, together or in connection with as many inside cutters as the cut requires.

The Huther Cutter Head is a valuable tool for jointing or sticking moldings for sash, stops, etc.

It is made of steel and can be used on any ordinary arbor. Knives adjusted to gauge by headless screws and securely fastened by hexagon bolt head.

If you are interested in making your saw rig more valuable, write for prices and catalog 34

Huther Bros. Saw Mfg. Co.
1101 University Ave. Rochester, N. Y.



Patented Nov. 29, 1892.
Feb. 19, 1910

Cuts perfect grooves of any width either with or across the grain.



Patented Dec. 30, 1913



Grooves cut with Huther Dado Head.

We also manufacture Regular Circular Saws, Band Saws, Hollow Ground Circular Saws, etc.

SEND TODAY FOR CATALOG NO. 34

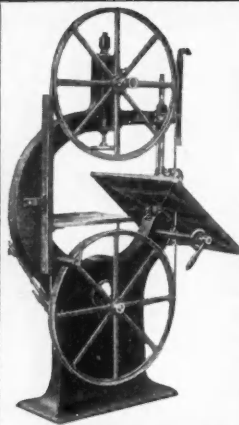

Get Our Attractive Catalog Covering

The Silver Line of Band Saws, Jointers Saw Tables, Swing Saws, Etc.

The simplicity of design—the light and easy running qualities and the safety in operation of Silver's splendid line of Woodworking Machines appeal to anyone looking for fast, strong, well-made machines for modern woodworking shops. They are reasonably priced for such high quality machines. For full particulars write

The Silver Mfg. Co., Box 345, Salem, Ohio

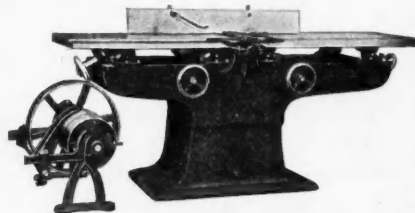

Planing by
Electricity
Ends Hard Labor

Motor or Belt Driven,
4 in. Knives, Weight,
50 lbs., Portable

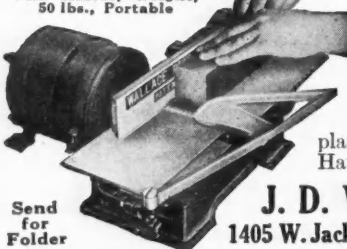

Send
for
Folder

Use the Wallace Bench Planer

"Our man is so well pleased with your Wallace Bench Planer that he tells us he would now sooner lose his job than lose the planer."—So says W. A. Hart, Lawrence, Mass.

J. D. Wallace & Co.
1405 W. Jackson Blvd., Chicago, Ill.

Miller's Lock Mortiser TWO MINUTES

Will cut an opening in a door for a mortise lock
IMPROVED AND UP-TO-DATE
cuts true in any kind of wood for any size lock
from $\frac{1}{2}$ " to $1\frac{1}{2}$ " thick. Easy to operate; durable in
construction. Builders use
it everywhere.



Sent subject to trial.

A. W. Miller Mfg. Co.
Riverside, Calif. Cincinnati, Ohio
Our Best Mortiser and Rule Gauge for 75c., Postpaid

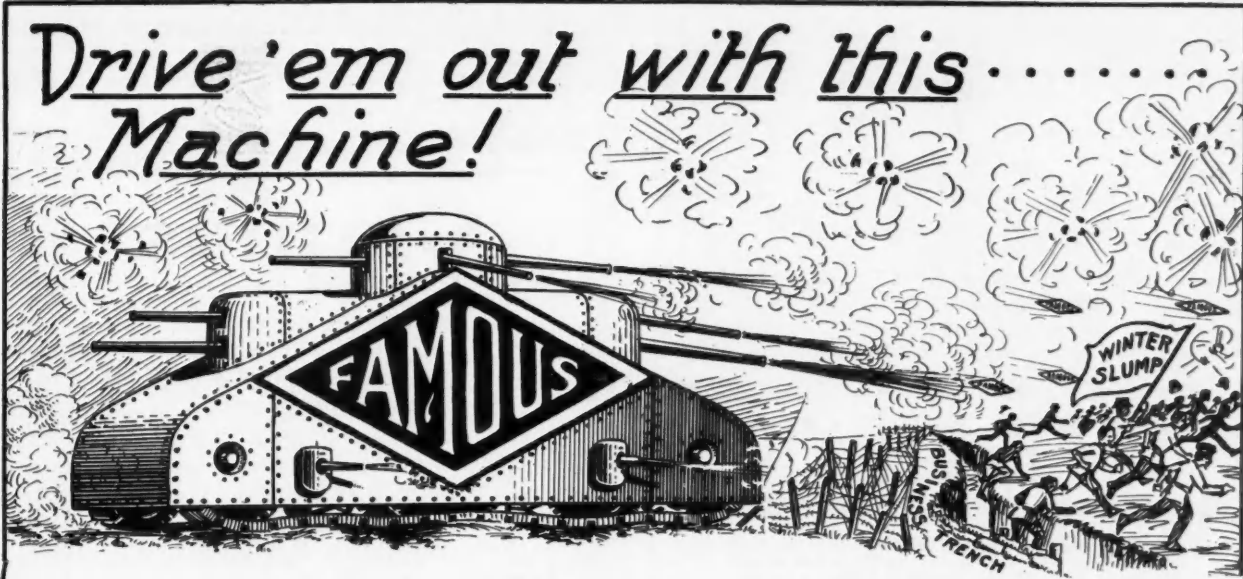

Maybe you think conditions are again conspiring against your making a profit this winter. They are not. You can make progress and bank profits this winter IF YOU PLAN FOR IT RIGHT NOW and don't put it off. You can put one or more "FAMOUS" woodworking machines into your territory and they will route the Winter Slump ranks for you.

It is no small trick to keep profitably busy all winter—depending on hand work—you know that. But a woodworker makes the task very much easier.

You can handle a greater variety of work—you can cut the cost of working up lumber—you can more than double your capacity without extra help—you can put on extra speed when needed, winter or summer. You can use a "Universal" in a shop during the winter or all the year around. You can move it from job to job outside.

**An Equipment of "FAMOUS" Woodworking Machines
causes your labor problem to fade away**

Never was there a time when these machines save more actual cash for their owners—and they cost very little more to buy than when labor was cheaper. The wages of even ONE man represents a neat little profit. Drop us a line—or mail the coupon and let's talk this over and see what FAMOUS machines will save for you and how they will pay you this winter. Don't put it off.

Winter is almost here. If you act right now you can turn these guns on the annual slump and drive it out.

THE SIDNEY TOOL COMPANY

SIDNEY, OHIO

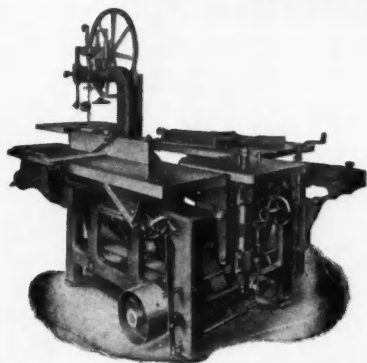

THE SIDNEY TOOL COMPANY
Sidney, Ohio

Gentlemen:

Send me Catalog No. 12, and Bulletins on Woodworking machines. I am interested.

Name.....

Address.....

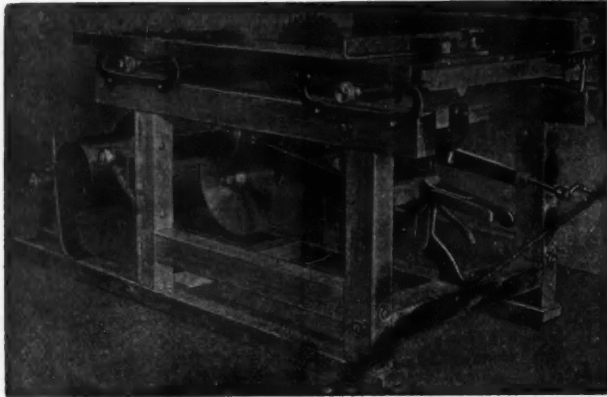

**NOW IS THE TIME TO GET A
BEACH
DOUBLE ARBOR RIP AND CUT-OFF MACHINE**

Get this money-maker on the job. This portable wood-worker will handle all your fine sawing, as well as your dimension stuff. Either gasoline engine or electric motor drive. Has our patented rolling table, making it the most efficient machine on the market. Don't delay—make this year the most profitable and successful of your career. Write for descriptive catalogue.

BEACH MFG. CO., Montrose, Pa.

This view shows extension with rolling table. This allows you to handle lumber up to 20 ft. and slides easily with 1000 lbs. weight in it. Locks instantly for ripping or beveling.

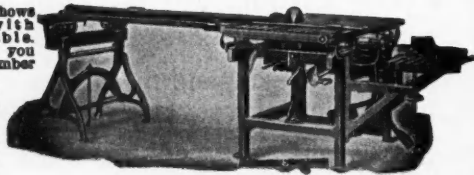

QUICK ACTING *The Taylor* SELF LOCKING

Clamps

**An Investment
Not an Expense**

The quickest and strongest clamps made. That's why they're the standard in U. S. Government Works and in such concerns as General Electric Co., Singer Sewing Machine Co., Victor Talking Machine Co., etc.

We can PROVE it in your own shop. Write today.

James L. Taylor Mfg. Co.
Poughkeepsie, N. Y.

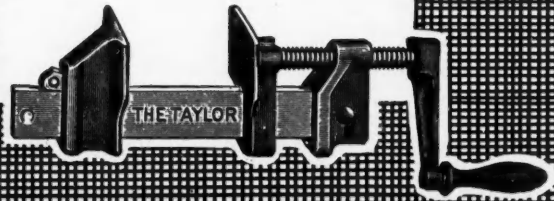

100 Lafayette St.,
NEW YORK

THE JAMES SWAN COMPANY, Seymour, Conn.



Manufacturers of all kinds of BITS, CHISELS, DRAW KNIVES, GOUGES, GIMLETS, AUGERS, NAIL SETS, SCREW DRIVERS, COUNTER-SINKS, BORING MACHINES and EXPANSIVE BITS.

Buy only Carpenters' Tools bearing the Trade Mark which stands for Quality.

Awarded Medal of Honor on Mechanics' Tools at Panama-Pacific Exposition.



Caldwell Sash Balances Uniform Mortises

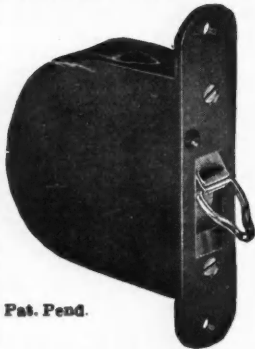

Pat. Pend.

For use in all classes of new work. Box frames unnecessary. Mortises cut at mill reduces cost of installing. Counterbalance sashes perfectly unaffected by atmospheric conditions. Cheapest method for modernizing old window, as alterations in sashes and frames are not necessary. Sashes should be weighed before ordering.

Write for Circular
CALDWELL MFG. CO.
2 Jones St. Rochester, N. Y.

Parks Planing Mill Combination

The most complete machine for getting out all kinds of mill work, and sold at a price which any progressive builder can afford to pay. During the season, this machine will pay for itself in couple weeks.

Rip saw, 12" Jointer, 22" Band saw, Swing cut off saw, Shaper, Upright mortiser, Tension, Sand disk.

All ready for instant use without having to make any changes. Machine can be furnished with long base with engine mounted in rear so it can be taken right out on the job.

PARKS BALL BEARING MACHINE CO.
Fergus St. & C. H. & D. Ry., Cincinnati, Ohio

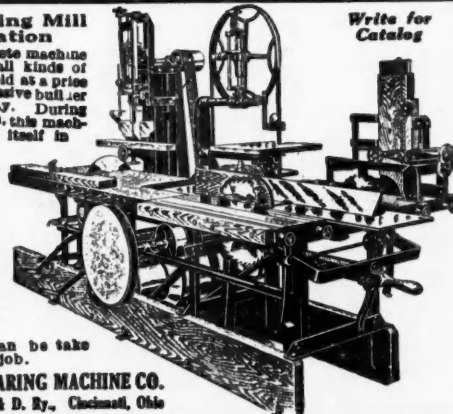

Write for Catalog

New! Different! Better!

The "AMERICAN" No. 4 CONTRACTORS' HOIST

Single Drum Reversible.
Capacity, 1000 lbs.
Speed, 100 feet per minute.
Floor Space, 32x47 inches.
Weight 645 lbs.

Gasoline Engine,
Electric Motor,
or Belt Drive.

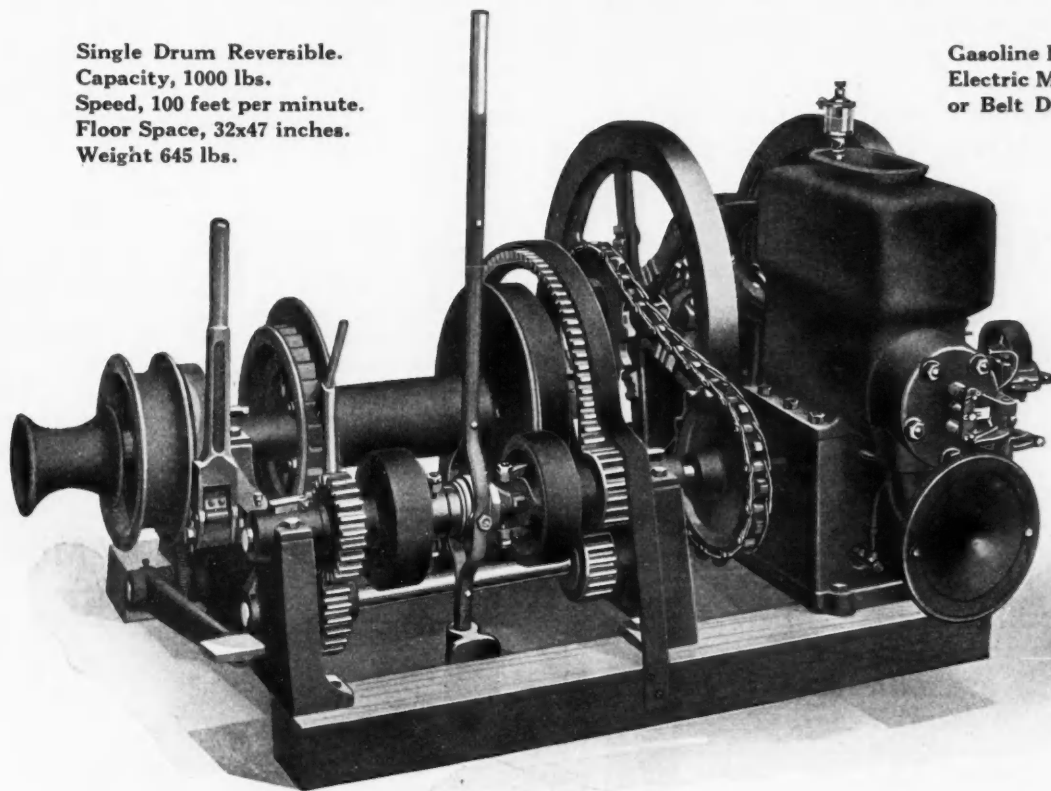

LABOR shortage makes machine help more essential than ever before. Up-to-the-minute refinements in this new "American" Hoist help solve the labor problem, speed up your work, cut your costs. It's made for service, speed, and safety—it will be a permanently profitable investment—a year-after-year worker that you can depend upon. Look at the picture—sturdiness, compactness, simplicity show in every detail. All controls are conveniently placed. Drum, sheave and winch head are reversible and independent of one another. Gears are well guarded. Powerful brakes keep everything safe. Safety ratchets hold the load at any desired point.

Write for the "American" No. 4 Bulletin—get the whole story. Ask also for Bulletin 67 on the "American" Contractors' Woodworker

American Saw Mill Machinery Company
1360 Hudson Terminal NEW YORK CITY

STARRETT TOOLS

A Good Equipment is the Best Aid to Accuracy

Every carpenter and builder who wants to do better and more efficient work should add all of these tools to his kit. No matter how complicated the measurement is he will find that a good equipment of

Starrett Tools

will enable him to work faster and more accurately and with less effort. The deeply etched graduations stand out clearly and permit very accurate readings. Some Starrett Tools include many tools in one. There are many tools for the carpenter described in our free catalog No. 216. Write for a copy today.

For Sale at All Good Hardware Stores

The L. S. Starrett Co.
The World's Greatest Toolmakers
 Athol, Mass.
 42-656

DIETZGEN T SQUARES

are accurate, dependable, and perfect in workmanship.

Only the most carefully selected and thoroughly seasoned stock is used in their manufacture. As an additional strength and rigidity precaution, the size and thickness of the heads and width and thickness of the blades are greater than customary.

Each T Square is unsurpassed for nicety of balance and ease in handling. *Made in various styles.*

Send for T Square Booklet

Eugene Dietzgen Co.
 Manufacturers
 Chicago New York San Francisco
 New Orleans Pittsburgh Philadelphia

NICHOLLS FRAMING SQUARES

Gives All Lengths and Cuts of All Rafters for Sixteen Pitches of Roof.

Full Directions Stamped on Back of Square.

Send for Our Little Book Explaining This Rule

Nicholls Mfg. Co., Ottumwa, Ia.

A POPULAR PRICED STEEL TAPE

LUFKIN "BANNER"

Accurate, standard size steel line 25 to 100 ft., put up in metal lined auto leather case. A tool you need at a price you can afford. Ask your hardware man.

Measuring Tapes, Boxwood and Spring Joint Rules

Send for Catalog

THE LUFKIN RULE CO.
 Saginaw, Mich. 106 La Fayette St. New York

Nail Set only
12^c
 Sent postpaid



No-Rol
 made square to
 prevent rolling, 15c

**Syracuse
 Twist Drill Co.**
 Syracuse, N. Y.

INTERLOX RULE
 ACCURACY AND CONVENIENCE

The Interlox Rule is always ready. There is no guesswork or mistakes with this rule. It makes all the "hard to get at" inside or outside measurements quickly and accurately. Measurements are easy to read.

Made in all lengths, from 2 to 8 ft. of selected boxwood, finished with water-proof lacquer and solid brass trimmings.

Ask your dealer to show you this rule, or send 20c per lineal foot and we will ship you one promptly.

DAHL MANUFACTURING CO.
 51 E. 42nd Street New York, N. Y.



Sand's Aluminum Levels

Always Tell the Truth

The standard of accuracy. And not only the most accurate—but easiest to read, even in the dark. Never rusts—cannot warp, split or crack—and are easily handled. The lightest levels made—strong and durable because the greatest strength is placed where most needed. Ask your dealer to show you these levels, and also write for our new circulars showing full size levels.

J. SAND & SONS Originators of Aluminum Levels 1023 - 29 Rivard Street, Detroit, Michigan

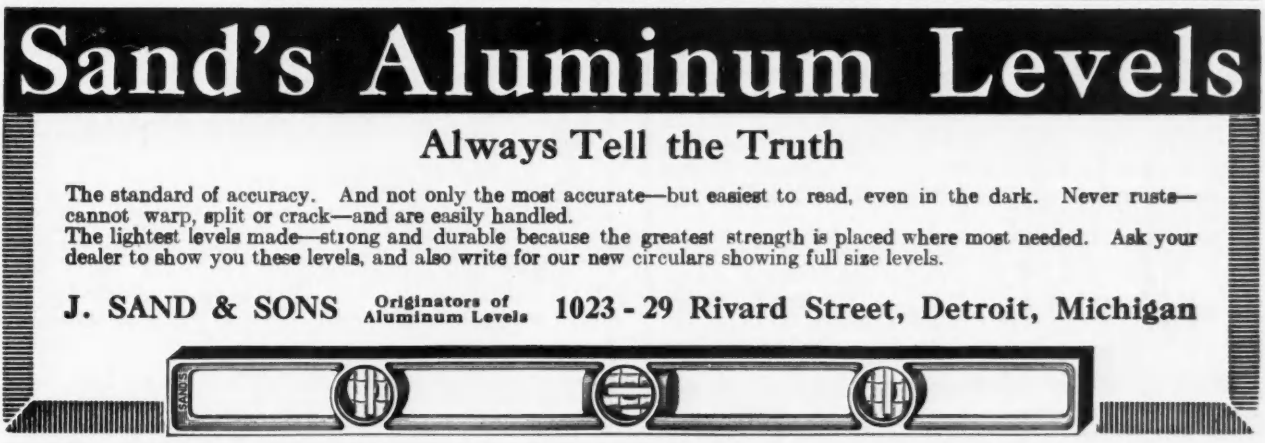

"Grand Rapids"
Ball Bearing
ALL STEEL
Sash Pulleys



Fasten Automatically
No Nails—No Screws
Just Bore Four Holes

No. 10 Ball Bearing

The automatic saw tooth fastening feature and the simple and easily made mortise will save in labor enough to pay for the pulleys. The bearing contains eleven 1/4-inch Solid Steel Balls running in lubricant, insuring a noiseless, easy running wheel under any load.

NOISELESS—EVERLASTING
 Write for **FREE** Samples
 Fifty Different Styles

Grand Rapids Hardware Co.
 Manufacturers
 158 Eleventh Street - Grand Rapids, Mich.

"YANKEE"
Ratchet Driver No. 10
Saves Time
at Every Turn



Here you have—an easy working ratchet, right hand, left hand (and rigid), a comfortable handle and withal a strong and serviceable driver.

Made in 8 lengths of blade, from 2 inch for small screws, up to 12 inch suitable for all kinds of high power house carpentering.

Your Dealer Can Supply

Let us send you a "YANKEE" Tool Book.

North Bros. Mfg. Co.
 Dept. A, Philadelphia, Pa.



Special Drawing Set
No. 450
Price \$4.65
Sent parcel post prepaid
Cash with order

We have also a full assortment of large sets of instruments

PEERLESS BLUE PRINT CO.
341-347 FIFTH AVE. NEW YORK CITY

YOUR OPPORTUNITY! HOUSE MOVING



YOU can clean up big money in the house-moving business. Let me show you how you can get started. You can have the benefit of my experience. I've cleaned up a lot of money in the past 15 years moving houses.

Bigger Demand Now!

People see that buildings can be moved with ease and quickly at a lower cost—with practically no damage to the building. The property owner of today moves his house to a cheap lot—fixes it up and rents it. This method brings him an income. He can sell it for a good big profit. Wrecking a building brings only a few loads of dimension lumber—a small profit.

Carpenters and Builders—here is a chance for big profits. It's easy to start—plenty of work. Write me now. I'll show you how to make \$500 to \$2,000 extra every year. Ask for my book "B."

*E. W. LaPlant, President
LaPlant-Choate Mfg. Company
620 Eastlark Court, Cedar Rapids, Ia.*

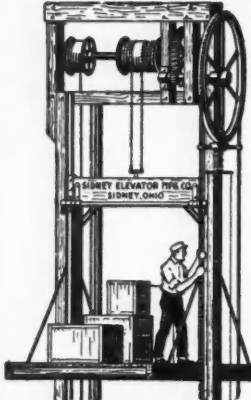
SIDNEY ELEVATORS

Will reduce your handling expense, and speed up your work.

Our machines are easily installed from our complete plans and instructions which are sent with each elevator.

The Reasonable Cost Will Interest You

Write us today, stating requirements, giving style of machine wanted, size of platform and number of feet travel, and we will quote a money saving price on equipment to serve you well.

SIDNEY ELEVATOR MFG. WORKS
SIDNEY, OHIO

"A Convertible Level With No Loose Parts"



Here is a convertible level without any loose parts to become lost or out of adjustment. The cross-bar is drop-centered and cast integral with standards. You will appreciate this improved convertible level once you let it give you your lines and levels. Let us ship you one to use on your own work in your own way for ten days without obligation. You'll be delighted with it. Ask for circular and trial offer.

DAVID WHITE CO., Inc.
419 E. Water St., Milwaukee, Wis.

G & B TWO LEVELS IN ONE

Has all the features of a Builder's Transit and Architect's Level. Durable, accurate and economical. You can use the G & B under all conditions. A quality instrument for \$67.50.

Write for circular "B."

Geier & Bluhm -- Troy, N.Y.

CARPENTERS WANTED AS AGENTS

Now is the time to act. Big Money. Ready Seller

Sanitary Automatic Dumbwaiter saves carrying food to and from cellar. Perfectly ventilated; screened openings; finished inside with durable white enamel. Keeps food perfectly. Top lies flush with kitchen floor. You can walk over it. Operates with push button or lever. Also furnished as a Refrigerated dumbwaiter. Assembled complete ready to install. But three hours required to place our waiters in actual operation; old or new homes. Quotations include every needed supply. \$19.11 apiece. Illustrated catalogue.

York Automatic Dumbwaiter Works 639-645 West Market Street, York, Pa.

STOP THOSE RATTLING WINDOWS

Do away with sash weights, cords, pulleys and pocket frames and save money by using **AUTOMATIC SASH HOLDERS**

Proved by Use—Unexcelled for windows without pocket frames. Excellent for new windows.



Send for circular and price, or \$1.00 for trial set prepaid; state approximate weight of sash.

HARDWARE SALES CO., Inc. 52 Church St., New York

DUMBWAITER COMPLETE \$19.50 READY TO INSTALL

Includes all necessary material, not knocked down—machine, machine timbers, bolts, boxes, car, counterweight, ropes, guide ways, etc., all ready to set in hatchway and erection instructions. Length up to 20 feet. All material guaranteed. Money back if not satisfactory. Write for further particulars.

Highwood Dumbwaiter Co., Grand Ave., Leonia, N. J.

DUMBWAITERS TO FIT—

Storm Company engineers will devise you the most practical and economical dumbwaiter equipment for **YOUR PARTICULAR JOB** whether it be electric or hand apparatus. Our organization has the advantage of twenty five years experience in this field. Our engineers are competent to handle any dumbwaiter problem to give the best results. Write for the Storm Catalog listing a complete line

The Storm Mfg. Company of high grade dumbwaiters and elevators. 50 Vesey St., Newark, N. J.

KIMBALL ELEVATORS PASSENGER AND FREIGHT

We manufacture an improved line of Electric, Hand or Belt Power Elevators, Dumbwaiters, Hatch Gates, etc. Send for full information.

Address **KIMBALL BROS. CO.,** 1050 9th Street Council Bluffs, Iowa

THE COLUMBIA
DUMB WAITERS ELEVATORS
CELLAR HOISTS
JUMPER DISAPPEARING DUMB WAITERS
CHAIN HOISTS, CRANES AND TROLLEYS
SEND FOR CATALOGUE

J. G. SPIEDEL, Reading Pa.

Sedgwick Hand-Power Dumbwaiters and Elevators

Manufactured by Specialists and guaranteed. Send for Catalog and information.

SEDGWICK MACHINE WORKS 132 LIBERTY ST. NEW YORK



Showing Sun-Shade Attachment

Try This Aloe Level 10 DAYS—FREE

Easy Monthly Payments If You Buy

Prove the superior quality of the Aloe Convertible Level by testing it out for 10 days. Use it on your every day work laying out buildings, locating foundation piers, leveling up foundations, walls and floors, aligning, shafting walls, piers, etc., for getting angles, or levels anywhere and the hundred and one other things for which you would use a level or transit. Then, if you decide to keep it, you may pay for it in easy monthly payments so small that you will scarcely feel them.

Aloe Convertible Level

is more than a mere level. It is a modified transit permitting double the range of work possible with an ordinary architect's level. Its construction is such that sights above or below the horizontal can be taken, making it the finest instrument ever offered at anywhere near the price. For taking vertical sights the instrument is provided with a special convertible bracket rigidly and permanently attached to the cross-bar thus eliminating the extra time that other instruments require for changing the telescope in position to take vertical readings. The telescope which is fitted with a permanent axis, rests in the bracket bearings and owing to our special constructed clips the instrument can be used for leveling while in

this position if desired, although the bracket clips are easily and quickly released from the telescope axis when levels only are to be taken. The telescope is then set in its normal position in the wyes and you have overcome the old method of attaching and detaching the convertible bracket.

Your Own Time To Pay—No Interest

Remember, you are under no obligation whatever to keep the Aloe Convertible Level. We do not even ask you to promise to buy. But you owe it to yourself to see and try it. If it isn't all you expect you may return it at our expense. If you do keep it, you will find the small monthly payments easier than paying rent for an instrument—and at the end of a few months you will own it—absolutely. There's no red tape about this offer—we ask no embarrassing questions—everything is confidential—we charge no interest. You have practically your own time to pay.

Mail Coupon for Descriptive Circular

It explains the Aloe Convertible Level in detail and shows how easily the man without the training of the engineer or surveyor may secure the same accurate results as the expert. Send your name on coupon or postal for free copy and full particulars of our original, unique and popular selling plan.

A. S. ALOE CO., 621 Olive St., St. Louis, Mo.

Mail Coupon NOW

A. S. ALOE COMPANY,
621 Olive St., St. Louis, Mo.

Please send free descriptive circular about the Aloe Convertible Level and complete details of your easy payment plan. This request in no way obligates me.

Name.....

Occupation.....

City..... State.....

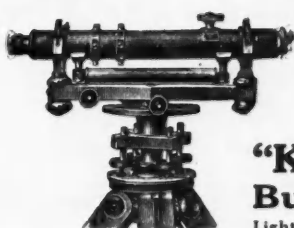

As This Level

was made to meet your especial requirement, it should be worth investigating

"KOLESCH" Builders' Level

Light in weight, built for hard usage and reasonable in price

The purchase of a "Kolesch" Transit or Level isn't an expense—it's an investment that pays big



Send for full particulars TODAY
KOLESCH & COMPANY
138 Fulton Street New York



From Level to Transit in a Few Seconds

By means of the patented axis (our own exclusive feature) this level can be instantly converted into a transit. No screws to adjust; accurate, reliable, durable; moderate in price.

For Builders, Contractors and Architects

Write for Catalog of Convertible Levels, Drawing Materials, etc.

New York
Blue Print Paper Co.
102 Reade St., New York

Let Us Send It on Approval

In these times of high prices think of securing a accurate, reliable Builder's Transit for \$35.00! And then think of our being willing to have you make a thorough test of the instrument before you decide whether to purchase it.



Ask us to give you further information about our free trial offer. Also ask for our brand new catalog No. 6. It's the finest instrument catalog ever printed. Write us now.

The L. Beckmann Co.
500 Adams St. Toledo, O.

We have some excellent territory still open and a good agency proposition for the largest and most complete line of Order-Made

Window and Door Screens

on the market. We supply you with a complete agent's outfit, consisting of models, contract blanks, advertising matter, etc. We give exclusive agencies to ones who mak. good. No regular agencies established in towns less than 10,000 population. This is a splendid opportunity for Carpenters, Contractors, Builders and Material Dealers. Write Now.

ADDRESS

Standard Screen Company
1858 Hastings Street, Chicago, Ill.

I'm proud of you!

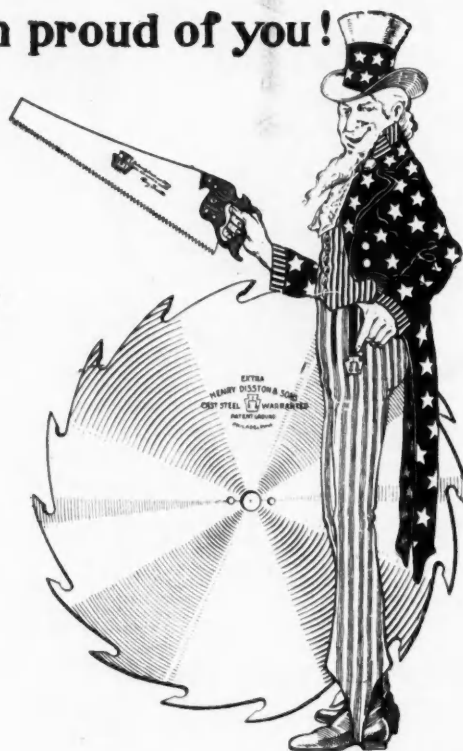

DISSTON SAWS
 have done more to upbuild
 America and America's
 reputation than any other
 brand of tools.

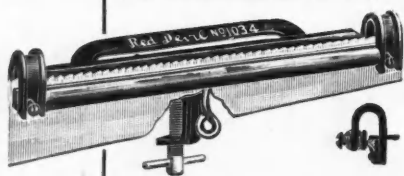

"Red Devil" Carpenter's Adjustable Saw Vise
Saves Your Saw — Pays for Itself

Solid steel—noiseless rubber jaw—eccentric lock. Instantly clamped anywhere or folded into tool kit. Files hand or rip saws. Sample \$1.50, Style No. 1034. *Tool literature free.*

SMITH & HEMENWAY CO., Inc.

106 Coit St., Irvington, N. J.



We can offer something SPECIAL in the way of PRICE. Write for catalog and particulars.

"A Bit of Utility"

FORSTNER BITS are DIFFERENT from all other wood boring tools. Being guided by the outer rim they may be turned in any direction. The work is left smooth and polished.

Unequaled for Delicate Work

Practical for use as gouges or chisels, suitable for scalloping, fancy scrolls, twists, columns, newels, ribbon mouldings, mortising, etc.

Cabinet and pattern workers are enthusiastic over them. They do more work and cost no more than other bits.

The Progressive Mfg. Co.
 Torrington, Conn.

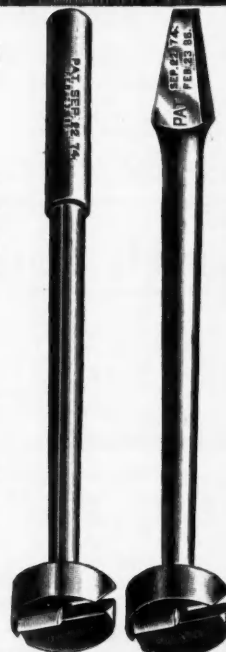



We will send you this machine for 10 days' FREE TRIAL. If you don't like it ship it back.

Write for Our Prices and Special Offer

Fox Supply Co.
Brooklyn, Wis.

Saved \$400.00 on One Job of Floor Surfacing

J. C. Ivory of Altoona, Pa., writes us that the "American Universal" Floor Sander has finished the floors of the St. Mary's Home for Girls at Cresson, Pa., and has saved him over \$400.00 as compared with hand scraping.

How much will YOU save on your next job? Better write us for particulars.

American Floor Surfacing Machine Co.
515 So. St. Clair St.
Toledo, Ohio
"The Oldest Concern in the Business"

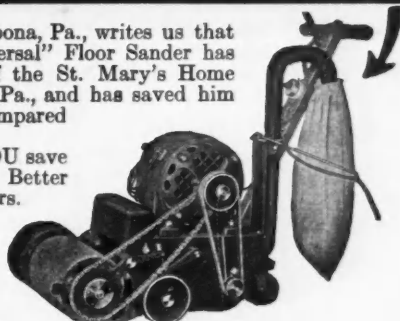

Wire Window Guards



Counter Railings
Elevator Enclosures
Tubular Hand Rails
Brass and Bronze Work

DON'T FAIL
to get our catalog and full information for your own benefit!

The Cincinnati Mfg. Co., Cincinnati, Ohio

FREE to YOU—For 10 Days

The Triple "A" Spring Driven Floorsmoothen



To enable you to try our machine out, and learn for yourself its many superior qualities, we will send you one of our BRAND NEW Triple "A" SPRING DRIVEN Floorsmoother for 10 days' free trial, freight prepaid.

The Triple "A" is the only floor scraper on the market equipped with a SPRING MOTOR DRIVE—the only convenient motive power. Requires neither fuel nor current—always on tap when wanted. It lessens the work fully two-thirds. Only one motion required—the push forward. This winds the SPRING MOTOR which automatically stops the machine and sends it back on the cutting stroke.

Will save its cost on one job. Write today for full particulars regarding our special trial offer.

Triple "A" Machine Co., Room 100, 4125 Ravenswood Ave., Chicago, Ill.

The IMPROVED Rapid Floor Surfacer



will surface right up to the wall or baseboard without the use of Edge Roller. Just the machine you would want for surfacing all kinds of wood floors, whether old or new. Will smooth down rapidly and easily all joints or warped edges. Perfect results guaranteed. More than 20,000 of our machines now in use. Guaranteed against defect in material and workmanship for five years.

Send for our Free Trial Offer. It will interest you.

M. L. Schlueter
225-27 W. Illinois St., Chicago, Ill.

Made in several sizes

Stop Making "Borderwork"

around your baseboards—which results when you use a narrow edge roll attachment, as its work is uneven and looks different from the rest of the room when finished. Get the same uniform work right up to baseboards that you do throughout the room by using

The Improved Type Automatic Ball-Bearing Electric Floor-Surfacing Machine



The sanding roller is mounted so one end extends just beyond the side of the machine—easily adjustable to either side so that the wall all around the room can be reached. And the Little Automatic Electric Surfacing Machine (shown below) is a wonder for removing old varnish from desk tops, tables, counters, etc., as well as for dressing up new work.

FREE TRIAL OFFER
on either of these machines. Write today for full information.

Wayvell Chappell & Company
356-358 W. Madison Street Dept. D Chicago, Illinois
Phone Franklin 4160



1853 **Buck Bros.** 1917



Fine Beveled Edge Shank and Socket

Chisels

Tang and Socket Butt Chisels

Plain and Beveled Edges
Send for illustrated Catalog

Buck Bros., Millbury, Mass.

WHY not use the particular size, shape and grade of pencil or crayon suited to your work? You will find it among

Dixon's Pencils

Send us the name of your dealer from whom you purchase pencils and crayons together with sixteen cents (\$0.16) in stamps and we will send our liberal sample assortment No. 183-J, as illustrated.

Made in Jersey City, N. J. by the

Joseph Dixon Crucible Co.



LUMBER CITY N.J.
K No 997
1802
N'S 410
ERS, 538

WHITNEY
CASEMENT
WINDOW HARDWARE

Opens
up
a New
and
Profitable Field for You

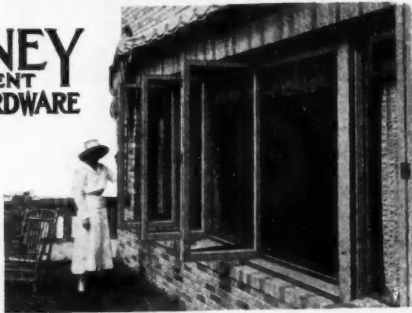

WHITNEY Casement Window Hardware overcomes the faults of the ordinary hinged casement window and **also** the regular double-hung, sliding sash windows. Increases the desirability of casement for sun rooms and porches and **also** makes them practical for **all** rooms and **all** types of buildings. Write and let us tell you its many unique features.

We manufacture only the patented hardware—in three grades, to suit all requirements—also screen fittings. If you cannot get the sash locally, we will quote you on your requirements complete, f. o. b. Minneapolis.

Our Service Department has some interesting and profitable information on remodeling work. Write for it. They will help you, without charge, to adapt Whitney Windows to any unusual requirements. Interesting portfolio sent upon request. Special prices to contractors and builders where we have no dealers.

Whitney Window Corporation
309 Fifth Street So. Minneapolis, Minn.

Money Saving Specialties

For Carpenters and Builders

Use Kees' Gosset Hinges on your screens. Tight fitting, easy swinging, made either of wrought steel, japanned; solid brass or galvanized iron. Quickly attached, hold securely. Cheap, simple, neat and durable.



Kees' Building Corners
Save Beveling Expense

Kees' Metal Building Corners give strong, neat, permanent and weather-proof corners. Save time and cost of beveling. Easily attached. They improve the appearance and durability of any building. Treated to hold paint, with nail holes already pierced. They form a perfect and lasting mitred corner. Write for prices and free samples.



Make Your Building Rain and Rot Proof

Make your building tight with Kees' Batten Strips. They always fit and allow for contraction of the siding without loosening the nails. Old, shrunken and out of square openings made weather- and vermin-proof. They make neat, strong and permanent joints.

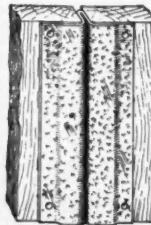

When first attached



After shrinkage

F. H. Kees Mfg. Co.

BEATRICE, NEBR. Box 552

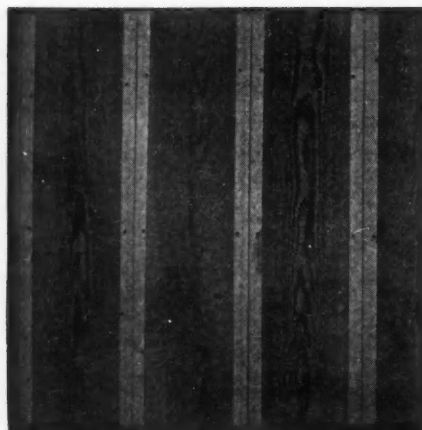

METALLIC BATTEN STRIPS
PRACTICAL—EVERLASTING—ECONOMICAL

These Batten Strips of Galvanized Metal will never warp, split, or draw away from the boards. Offer no obstruction to sliding doors. Allow for expansion and contraction of the siding. Made in 6, 7, 8, 9 and 10 foot length with interlocking joint. Easily cut; no waste. Nailed directly to siding with small nails.



End view showing joint closed. A perfect fitting Batten at all times, in all weathers. Beautifies any building.

Patent
Feb. 18,
1913



End view showing joint open. Provides for expansion or contraction of the siding so nails will not work loose.

Metallic Batten Strips make strong, neat joints. They make the building wind-proof, weather-proof and rat-proof. Also valuable for lining grain bins or wagon boxes.

Write for Free Sample and see for Yourself

METALLIC BATTEN COMPANY Owensville, Indiana

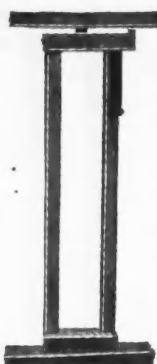

Wilder Steel-Latch Cattle Stanchions

have special, patented features every contractor and stock owner should know about. All hardwood construction except for our Steel Latch. They're smooth—rustless—easy to adjust. Automatically rigid when open—swing freely when closed. *Cheaper and more efficient than steel. Write for full information.*

WILDER-STRONG IMPL'T CO.
Box H, Monroe, Mich.

Chief Metal Building Corners
Warp-Proof—Rust-Proof—Fit Anywhere

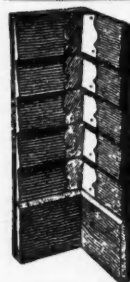

They make a corner with the smoothness and neat appearance of a "mitred corner" and save the time and labor of beveling down the siding. Made of heavy galvanized steel. Fit any corner—inside or outside and make a smooth corner that does not hold dust or moisture. Cannot warp or split, and prevents warping of the siding.



Chief Corners protect buildings from injury and are practically indestructible. Furnished ready perforated for nailing to the siding. Put on easily and quickly. Can be painted any color or left unpainted as desired.

Write for free sample and full information

SHRAUGER & JOHNSON :-: 430 Walnut St. ATLANTIC, IOWA

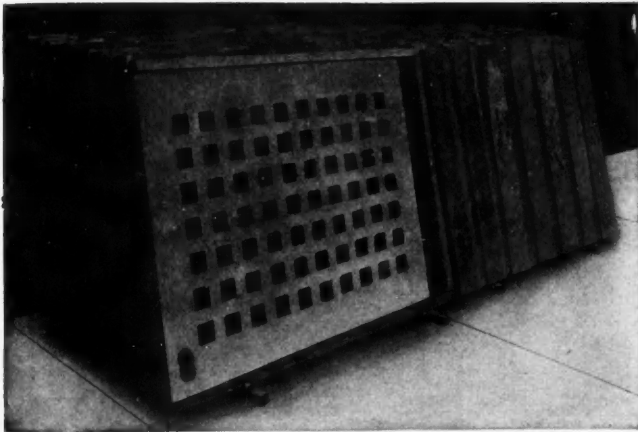

Labor is Scarce!

Make quick work of your sidewalk light installation by using American 3-Way factory finished SLABS

FORMS, staging, high-priced cement finishers and the attendant muss and trouble is eliminated when

American 3-Way Factory Finished Sidewalk Light Slabs are used. You merely take the slab out of the crate, slip it into its seat in the sidewalk and caulk the joint. ¶ All our lenses are made of specially annealed LAZALITE GLASS with plastic malleable coating on side walls to take care of expansion. ¶ We have several shapes and sizes based on the 3-Way principle.

ASK FOR CATALOGUE 16-L

American 3-Way Prism Company

Manufacturers of Prism Products, Sidewalk Doors, Coal Hole Covers

Main Office and Factory: LA PORTE, IND.

Branch Office and Factory: Spring and Wooster Sts., New York, N. Y.

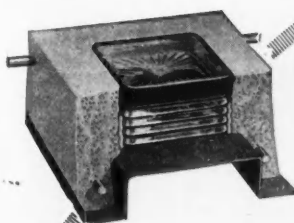

BERGER'S
Raydiant

Sidewalk Light
SYSTEM

Deserves Your Investigation

Above is shown a single lens in position. Note how it is supported by the steel base plate. Note also the elastic cushion about the lens which guards against breakage from expansion and contraction of the concrete.

With the Berger System the walk need be supported on two sides only in most cases. This does away with unsightly, light-obstructing cross beams.

The ease and speed with which the Berger System can be installed is always an advantage and the owner will appreciate the extra light from the clear, tough, Lazalite glass used for all Berger lenses, and the easy re-place feature if breakage through accident should occur.

Our New Catalog T. A. B. is yours on request
See Sweet's PP 834-837



The Berger Mfg. Co., Canton, Ohio

Branches: Boston, New York, Philadelphia, Chicago
St. Louis, Minneapolis, San Francisco

Export Dept.: Berger Bldg., New York City, U. S. A.

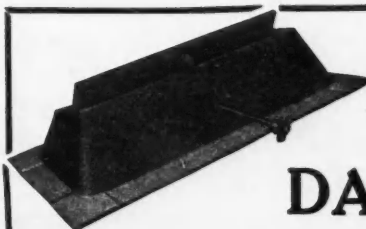

Improved Fireplace DAMPERS

Stover Dampers make the building of fireplaces easy. The labor saved by their use reduces the cost considerably.

Catalog 1590-X describes these and other new style dampers in detail, gives valuable suggestions as to fireplace construction and shows a large assortment of other fireplace fixtures.

If you build fireplaces, send for this catalog. *It's free.* We manufacture builders' and household hardware, windmills, feed mills, gasoline engines.

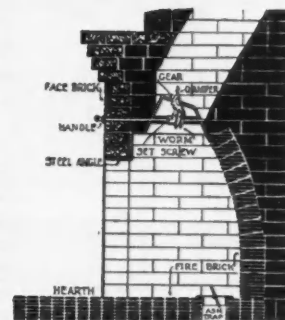

Stover Mfg. & Engine Co.

725 East Street

Freeport, Illinois

STOVER MFG. & ENGINE CO., 725 East St., Freeport, Ill.
Send us Catalog 1590-X.

NAME.....
BUSINESS.....
CITY.....STATE.....

Ideal Elevator Door Hardware

Makes Elevator Operation an Easy Occupation



Elevator doors hung on Ideal Hangers suspend from a rider bar which rolls over steel balls. The balls in turn roll over steel track.

To get the idea clearly, put a marble on your table and roll a ruler over it. The marble rolls over the table and the ruler rolls over the marble.

Friction Is Eliminated

and at the same time the ruler travels at double speed. In the case of Ideal Elevator Door Hangers, the ruler is represented by the rider bar from which the doors are suspended.

Ideal Hangers run easily and noiselessly. Protected from dust and dirt. Regularly made for single doors, two-speed doors, three-speed and combination elevator doors, doors in pairs. The ball retainer keeps the balls properly spaced. Length of hanger is equal to width of door, making an even distribution of the load.

*Specific information and prices furnished without obligation
Write for illustrated folder*

Richards-Wilcox Manufacturing Co.

SAN FRANCISCO
LOS ANGELES
NEW YORK
CHICAGO

AURORA, ILLINOIS, U.S.A.

PHILADELPHIA
MINNEAPOLIS
BOSTON
ST. LOUIS

Richards-Wilcox Canadian Co., Ltd. London, Ont.

"A hanger for any door that slides"

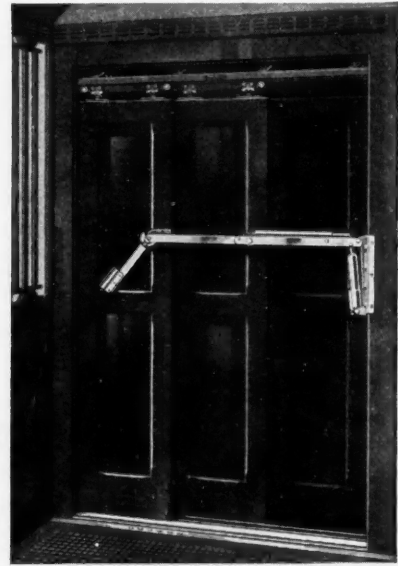

Linclad

SHINGLE NAILS

Made for wood, asphalt and asbestos shingles in both cut and wire styles. All standard sizes carried in stock for prompt shipment.

*Write for Samples
and Prices*

W. H. MAZE COMPANY
PERU, ILLINOIS

Carpenter's Tool Trunk

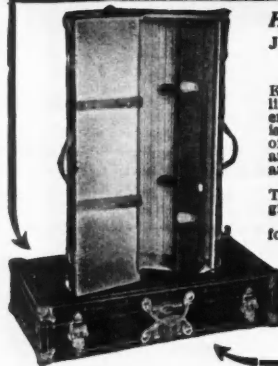

Handy—Practical—Economical
Just the thing in which to carry your tools.

It can be carried anywhere—like a suitcase. Keeps your tools in good shape, and lasts a lifetime. Made of basswood, covered with enameled steel. Has a steel binding, and is lined with paper. Locks and bolts are of brass. Contains drawer for small tools and an arrangement for holding steel square, level and three saws. Size 34 inches. Price \$7.50.

If your dealer doesn't handle this "Handy Tool Trunk", we will credit you with 50c for giving us his name when you order your chest. Simply send us his name and your check for \$7.00 and we will send you chest at once.

F. ENDEBROCK TRUNK CO.

1417 South 14th, ST. JOSEPH, MO.

Famous Chief Cellar Windows Will Not Stick, Warp or Rot

The solution of the cellar window problem—a modern, 20th Century Cellar Window made right for service. Made of steel-window, casing and all. No rotting, shrinking or swelling. Fits perfectly all the time. Trouble proof, easy to open and close, leak-proof and fire-proof. Will not rust. Nothing about it to wear out. Fitted with special, inside steel latch—cannot be opened from outside except by breaking the glass. Glass held in place without putty—can be replaced in minute's time.

Chief Cellar Windows will please your customers. Cost no more than wooden windows—last twice as long. Can be painted any color desired or left unpainted. Give more service and better service. Write for complete description, prices and terms.

SHRAUGER & JOHNSON
430 Walnut St.
Atlantic, Iowa

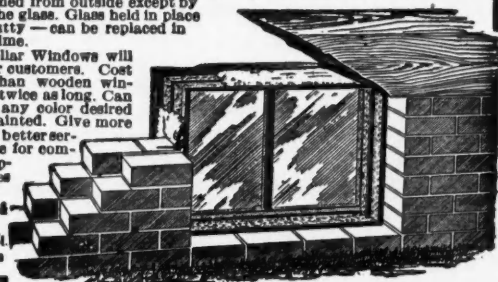



Make it easy for the women

"Mother and the girls" in most every automobile-owning family drive the car nowadays—at all times of day and in the evening, to do errands, shop, meet trains or for pleasure purposes.

Make it easy for the women folks to open and shut up the garage by putting in doors equipped with Topping Hangers.

Women like them

Topping Doors open and shut easily—noiselessly—they roll smoothly on the track—automatically lock when open—or closed—they fold back compactly against the garage when open and do not take up needed space inside. The Topping Garage Door Hanger is extremely simple in design—cannot get out of order. It is well made and good for many years of hard service.

Send for Our Catalog for Full Details

Safety Door Hanger Co.

309 Top ping Bldg.

Ashland, Ohio

JIFFY! →

Just the hinge your clients have been looking for. Once installed, the Jiffy Hinge enables the housewife to put up or take down the screen doors or windows without the use of screws or tools of any kind.

Ask Your Dealer to Show You a JIFFY HINGE

They are inexpensive, made in a variety of finishes and are sure to make a neat satisfactory job. If your dealer cannot supply you, write for samples and prices.

ROCK CITY MFG. CO.
Wabash, Ind.



SILVER LAKE A Sash Cord

The Best Cord adds nothing to the cost of a house, is guaranteed to wear twenty years, and your client is saved the annoyance and expense of replacing broken cord. Made in all sizes to fit all pulleys. Silver Lake A is printed on every foot of cord. Guaranteed full lengths.

Don't Blame the Window Put in the Right Sash Cord **FIRST**

SILVER LAKE CO., Newtonville, Mass.



Write now for illustrated folder and copy of our catalog A11.

An Easy Running Door ---Even in Winter

Even in winter when ice and snow cover the track of the average door, your customer's barn or garage door positively will not stick if hung with

The PITTSBURGH Door Hanger

The trolley track in which this hanger runs is covered on top, sides and ends. Snow and ice cannot reach the runways. Doors will not catch on the floor nor scrape against the side of the building because of the several adjustments.

The PITTSBURGH Door Hanger and Track are made substantially of tested iron and steel and can be installed easily and quickly on any style of sliding door. Ask your hardware dealer for this equipment by name—McKinney's PITTSBURGH Door Hanger and Track.

McKinney Mfg. Co.

Makers of Hardware

Pittsburgh, Pa.

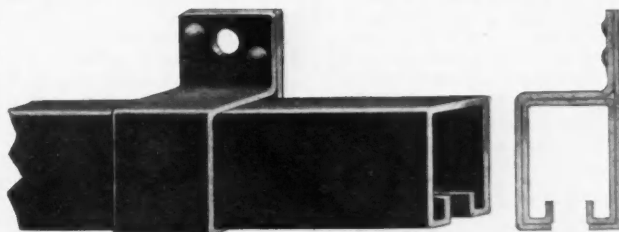



TYPEWRITER SENSATION! \$2.50 a Month Buys a VISIBLE WRITING L. C. SMITH

Perfect machines only of standard size with keyboard of standard universal arrangement—has Back-spacer—Tabulator—two color ribbon—Ball Bearing construction—every operating convenience. **Five Days' Free Trial.** Fully guaranteed. Catalog and special price sent **free.**

H. A. SMITH, 300—231 North Fifth Avenue, CHICAGO, ILL.

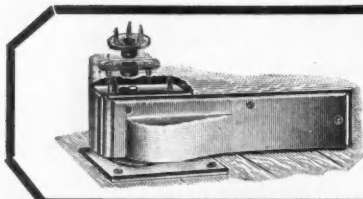

The "Shelby CHIEF" Floor Hinge WITH IMPROVED PIVOT AND SOCKET

The installation of the Shelby Chief greatly simplified. Mortising for pivot and socket entirely eliminated. To install bore a 1 1/2-inch hole 1/8-inch deep in top jamb for rim of pivot and 1/4-inch in top of door for socket. Secure with wood screws, allowing the thickness of metal of socket for clearance between door and top jamb. Insist upon having genuine Shelby Chief Hinges.

THE SHELBY SPRING HINGE CO. SHELBY, OHIO

Carpenters, Builders, Attention!

You owe it to yourself, as well as to the property owner for whom you are working, to see that his buildings are adequately equipped with proper protection from loss by lightning. His confidence in your judgment will make it easy for you to secure this additional work.

The Barnett System of Guaranteed Lightning Protection is the easy way to more profits on the same job. Our rods are in big demand and there is a big profit in selling them. They are made of pure copper cable, with attractive fixtures that are easily put on any building.

Why not equip yourself to take advantage of the opportunities for this work which are continuously arising? Let us show you the way to more profits on the same job.

FREE -- Cable Samples, Price List and Catalog. Write for them today.

JOS. L. A. BARNETT & CO. CEDAR RAPIDS, IOWA



ANCHOR BLOCKS

YOUR LOGICAL BUILDING UNIT

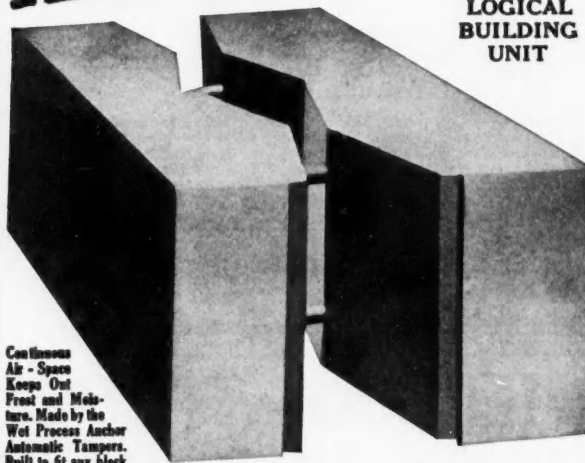

Continuous Air - Space Keeps Out Frost and Moisture. Made by the Wet Process Anchor Automatic Tampers. Built to fit any block machine. Write for Big Catalog and Special Offer to Contractors & Lumber Dealers

ANCHOR CONCRETE STONE CO. ROCK RAPIDS, IA.

IF YOU DO NOT FIND WHAT YOU WANT

in the AMERICAN BUILDER, write us and we will try to get it for you.

No Ice Needed—in Winter Filled From the Outside in Summer The Herrick Outside Icing Refrigerators

Most Popular for Modern Homes

Saves more ice, gives more space in the kitchen and does away with the tracking of floors.

This refrigerator requires no ice in the winter. It is cooled by cold air. The Herrick is so constructed that a compartment may be opened from the outside of the house. Cold air thus enters the opening, forces circulation and keeps the contents of the refrigerator cold and pure.

And we furnish **FREE PLANS** showing how the Herrick saves a great deal of kitchen space by being built into the wall so that only the front is visible. The housewife will appreciate this saving just as much as the ice-saving feature. And here is another point equally important: The Herrick does away with the annoyances of the iceman's visits to the kitchen and the soiling of the floors by his always muddy feet and dripping ice. Any woman who takes pride in a tidy kitchen will not only be interested in—but will demand the Herrick.

No progressive builder can afford to be without information on this modern convenience. Suggest it to your customers before they suggest it to you. It will add to your reputation as a conscientious, up to the minute builder and will get you more jobs. Write for our free plans and our complete catalog.



HERRICK DRY AIR SYSTEM REFRIGERATOR

The Herrick is Approved by Good House Keeping and New York Tribune Institutes

Herrick Refrigerator Company,

Waterloo, Iowa



THERE are hundreds of new and better devices and products at the Building Material Exhibit that every live carpenter and builder should know about.

Isko, "the electric ice-man," is only one of them. "My first visit to the Exhibit was a positive revelation," says one man. "To say that I was well repaid for my trip would be putting it mildly. Every man who is interested in building is passing up his one best bet if he is not making use of this Building Material Exhibit.

*"Look
Before
You
Build"*

It's For YOU

The great time-saving,
labor-saving, permanent

Building Material Exhibit

Entire Second Floor
Insurance Exchange Bldg.
Jackson Blvd. and Fifth Ave., Chicago

Over 200 building products displayed on one immense floor, where you can see, compare, select and order materials with a minimum of time and effort.

12,000 visitors monthly.

It's Free to See

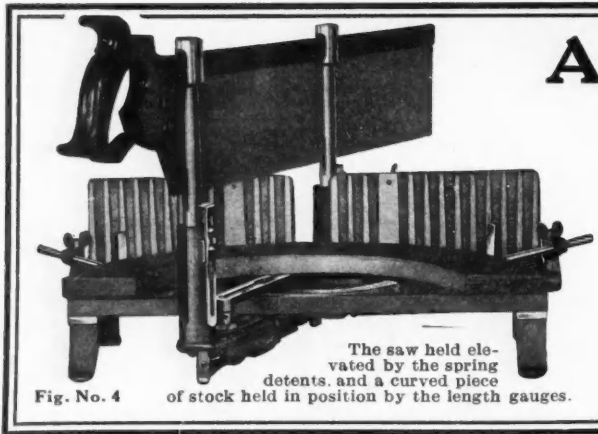

Fig. No. 4 The saw held elevated by the spring detents, and a curved piece of stock held in position by the length gauges.

An Offer to You

Carpenters and Builders

Dealers' price to Carpenters and Builders in every district where they are not handled by the dealers.

The "Marsh Ayer" Miter Box

The very latest type of an up-to-date miter box. Strong, Convenient and Practical.

Do you appreciate fine tools? Show us. Write us for information about this introductory offer. Judge for yourself.

H. C. Marsh Company

606 Race St.

Rockford, Ill., U. S. A.

Crescent Tool Mfg. Co.

Manufacturers of

**Granitoid, Cement, Concrete
Plumbers' and Bricklayers'
Tools**

400 Designs

1002 Cass Avenue

St. Louis, Mo.

A Miter Box Bargain

IN order to extend the sale of Honey-comb Miter Boxes we are offering a box at wholesale price to carpenters and builders in communities where we have no dealers.

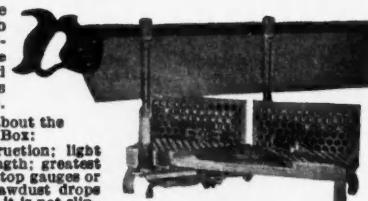

Consider these points about the Honey-comb Miter Box:

Unexcelled design in construction; light weight without loss of strength; greatest range of places for moving stop gauges or duplicate length gauges; sawdust drops through box out of the way; it is not slippery and will not mar the finest work; saw is elevated in such a way as to be free from bearings of guides; the highest grade materials and workmanship used throughout.

Snap this up! Get this high-grade miter box at an extremely reasonable figure

Let us send you further information on the Honey-comb. Get our prices and Circular "A"

Rockford Miter Box Co., 99 Forbes St., Rockford, Ill.

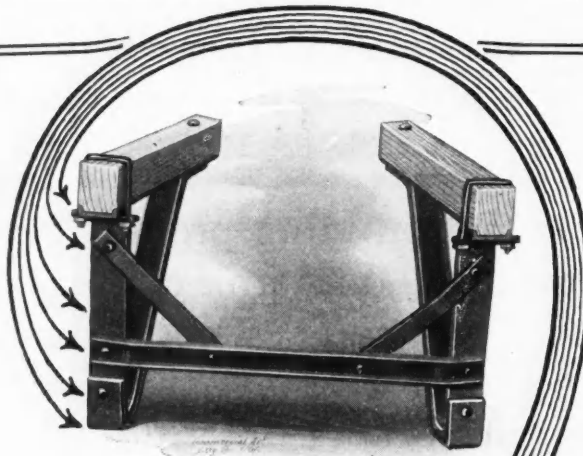

**What
Makes
Sterling
Barrows
Last
Longer**

Warehouses:
NEW YORK
CLEVELAND

Sterling

Superior Leg Construction

The leg is the most important part of any barrow. On it depends the rigidity of the entire construction.

The Sterling leg gear always remains rigid, because all of the braces are riveted, and it is constructed of channel which snugly fits the handle.

The foot-rest is bent into a broad square bearing surface and is equipped with steel shoes.

THE RIVETED LEG

Is just one of many Sterling improvements



Write for the
Sterling Barrow
Catalogue

Sterling Wheelbarrow Co.
MILWAUKEE, WISCONSIN

Warehouses:
CHICAGO
DETROIT

More Than He Expected

"I received your shipment of Ankyra bolts in good order. I have used some today and find them *more than I expected*.

"I wouldn't be without them if their only use was for bathroom fixtures (that is what I used those for), but I can easily see they are good for anything you say." So wrote a contractor and builder.

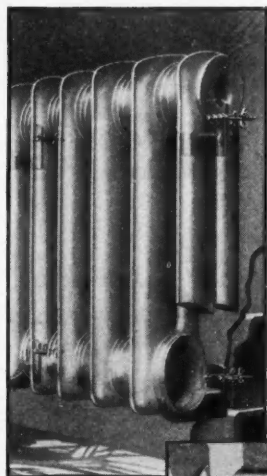

Ankyra Ankor Bolts are *time, labor and material savers* on building construction or repair work.

Glazed tiles are not cracked and broken when you use Ankyras. The fixtures never come loose, yet they may be removed and replaced as often as you like.

Ankyras hold in any wall, hollow or solid, regardless of the material. They hold rivet-tight.

The whole story with sample bolts will be sent on receipt of your request.

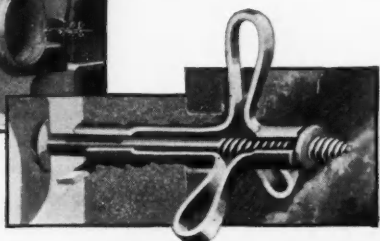

ANKYRA MANUFACTURING CO.
151 Berkley Street
WAYNE JUNCTION, PHILADELPHIA

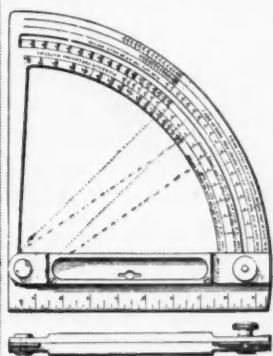

THE CALHOON RAFTER AND POLYGON BEVEL

Prompt Delivery by Parcel
Post on Receipt of

Price \$3.50 Each

A. O. CALHOON & CO.
PERRY, MO.

Modern Carpenters Tools



Unbreakable
Steel Folding
Saw Vises



Selfsetting Iron
Planes

\$1.00



\$1.75

Progressive men
will appreciate



something new and better in planes, they will not want to use the old style planes just because their ancestors learned their trade with them, but will demand something better. Let us send you circulars explaining why our tools are better.



Buckeye Manufacturing & Foundry Co.
Successors to Buckeye Saw Vise Co.
9401 Lake Avenue, Cleveland, Ohio



STORE FRONTS

MAKE DULL MONTHS PRODUCTIVE

WHEN building slows up, when new construction is postponed or abandoned, it does not necessarily mean that your business must be curtailed.

Desco Store Front construction, if properly pushed, will fill the gap profitably. For many stores, in your city, forced to abandon their building plans, will remodel to increase the attractiveness of their present quarters. Desco construction is simple and easily installed and the price allows you to meet competition profitably.

Write us for details TODAY.

Detroit Show Case Company
491 Fort Street, West
DETROIT MICHIGAN

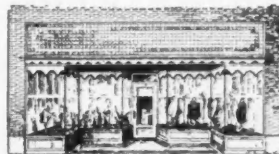

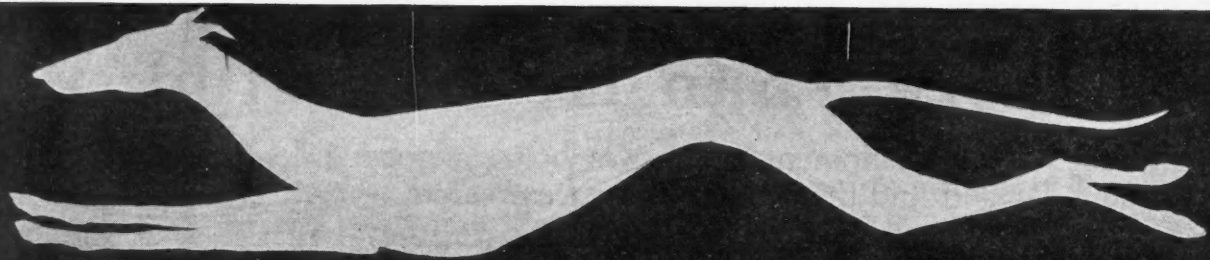

GREYHOUND SAWS

Speed—Toughness—Easy Running

If you want a saw with the above features and one that will hold its set and sharpness longer than any other good saw, buy the Geo. H. Bishop Co.'s Greyhound Saw.

30 Days' Free Trial

We are so positive that the Greyhound will satisfy you that we offer it on 30 Days' Free Trial. During that time use it on all kinds of wood. If it does not run easier, cut faster than any other saw you have ever used, we will gladly refund your money.

Prices: Made in Both Straight and Skew Back also Ship Carpenters' Pattern.

Length,	18	20	22	24	26	28	inches
	\$2.85	\$3.00	\$3.15	\$3.30	\$3.50	\$3.85	net
	Packed one in a Box.						

**Geo. H. Bishop
& Company**
Lawrenceburg, Ind.

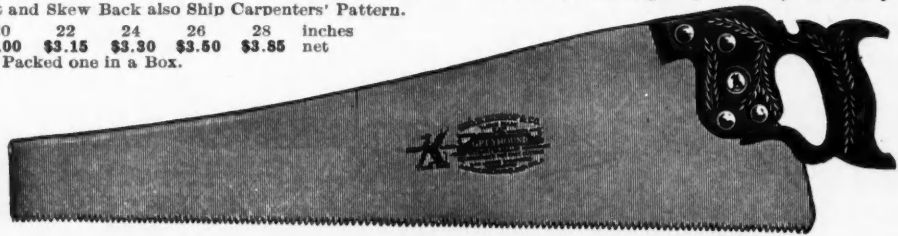

ADZE

Why not have the best? Cost but little more, wear twice as long. Send for our catalogue or ask your dealer to get you our prices. Do it today.

THE L. & I. J. WHITE CO.
10 Columbia St. BUFFALO, N. Y.

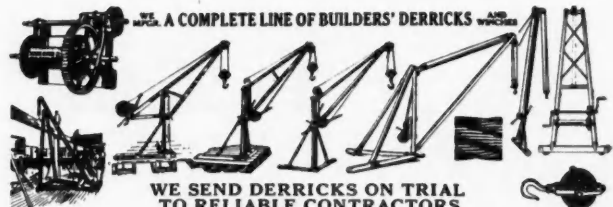

A COMPLETE LINE OF BUILDERS' DERRICKS

WE SEND DERRICKS ON TRIAL TO RELIABLE CONTRACTORS

Our Motto is SATISFACTION or DERRICK RETURNED

Write for circular No. 2 with illustrations, descriptions and best prices on our complete line. The Sasgen Builders' Derricks are built of best Crucible Steel and Malleable Iron Fittings, which makes them light, strong, safe and durable. The derricks will please you and probably more than pay for themselves on the first job. Get one on trial.

SASGEN DERRICK CO., 3101-3125 W. GRAND AVE.
CHICAGO, ILL.
NEW YORK OFFICE—GRAND CENTRAL TERMINAL



VAUGHAN'S Vanadium Nail Hammer

Vanadium is a purifier of steel. The best vanadium obtainable is used in making the Vaughan Hammer. Each hammer is tested and tempered individually. The handle is carefully shaped for the hand and has a wax hole in the end for waxing nails to be driven in hardwood. The claw of this hammer grips—it never slips.

If your dealer does not carry the Vaughan Vanadium Hammer we will send it to you prepaid. Let us have the dealer's name, too.



The Toughest, Strongest
Hammer Made

\$1.50
EACH

WAX HOLE

No. 41 16 oz. Full Polished No. 42 13 oz. Full polished

Vaughan & Bushnell Manufacturing Company
2114 Carroll Avenue Chicago, Ill. *Makers of Fine Tools*



Lane Beam Hangers



Style A

Style D

20,000 in stock ready for immediate shipment.

Send for catalog and free sample.

Lane Brothers Company
Cherry Street
Poughkeepsie, N. Y.

One-Ton with Three-Ton Efficiency

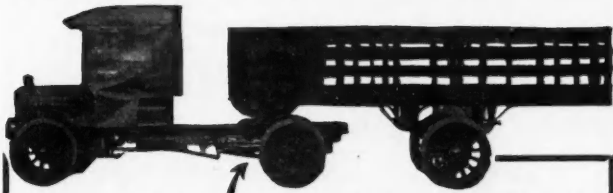

The Martin Fifth Wheel

makes possible this combination of a 1-ton Packard and a 3-ton Fruehauf trailer.

Write for further information

MARTIN ROCKING FIFTH WHEEL CO.
SPRINGFIELD, MASS.

\$3,000.00 IN ONE YEAR

This Bunch of Tires Will Make Several Dollars Profit

Make it repairing automobile tires. Punctures and blow-outs are common. Tires need retreading and vulcanizing.

EACH AUTO SOLD MEANS MORE TIRES TO MEND.

Auto tire repair field a hundred times bigger and better than old bicycle days. Johnson, Tex., writes, "I made as high as \$18 profit in one day." Investigate today. Ask for FREE catalog.

Haywood Tire & Equipment Co.
260 CAPITOL AVE. INDIANAPOLIS, IND.

Stanley Tools

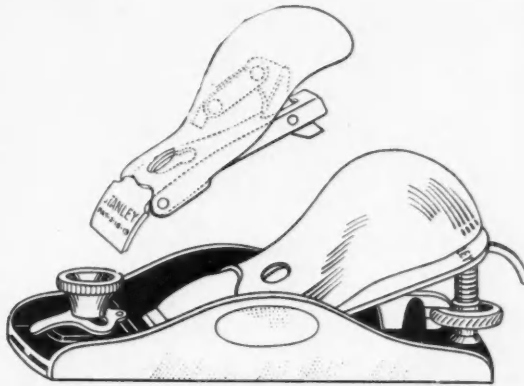

Stanley Knuckle Joint Block Planes

Now have a new and patented form of lever or cap, which, being made entirely of steel, is practically indestructible. This New Knuckle Joint permits of great leverage, consequently the lever can be placed in position or removed with very little effort—a great improvement over the old form of Knuckle Joint lever. When clamped in place it will hold the cutter firmly to its seat, and, being securely locked on the lever screw, will not move when the cutter is being adjusted.

The small cut at the left shows in detail the construction of this new style lever.

Two Sizes

No. 18—6-in. long, 1 5/8-in. Cutter

No. 19—7-in. long, 1 5/8-in. Cutter

AT ALL HARDWARE DEALERS

STANLEY RULE & LEVEL CO.
NEW BRITAIN, CONN. U.S.A.

**A New Marvel
in Sargent
Design**

**A Thin Cutter
That Doesn't Chatter**

That's what you want in a plane. You can depend on it that the new Sargent Automatic-Set Bench Plane never chatters—not even in the toughest, hardest wood. The specially designed Clamp, Frog and Bed eliminate all possibility of chattering—combining solidity, compactness and simplicity. See the six sizes of this plane at your dealer's today, or write for full descriptive catalogue.

SARGENT & COMPANY
51 Water Street New Haven, Conn.

SARGENT

REG. U.S. PAT. OFF

"The Plane with a Wood Bottom and Iron Throat"

**GAGE
SELF-SETTING
PLANES**





The plane that can be changed from a SINGLE iron to a DOUBLE iron plane in 2 seconds; that is, from fine-finish work to roughing work instantly, or vice-versa. If your dealer does not have them in stock for your inspection ask him to order Gage Self-Setting Planes for you. A postal will bring you descriptive circular and list prices.

GAGE TOOL CO., Inc., "A", Vineland, N. J.
*"The Gage Self-Setting Plane will not stutter, stammer or chatter."
 "It don't even hesitate."*

C. G. HUSSEY & CO.
Pittsburgh, Penna.

MANUFACTURERS OF **COPPER**

In Sheets, Plates, Rolls

CORRUGATED COPPER CONDUCTOR PIPE



Copper Nails, Copper Rivets, Conductor Pipe, Eaves Troughs, Elbows, Shoes, Mitres, Soldering Coppers, Gaskets, Etc.

*Pays for itself on the
First Job*

**The Pearson
Automatic Shingle Nailer**



SEE THAT NAIL

Do your nailing fast—faster than ever before. You can use the Pearson's Nailer on any pitch roof. Wear mittens, gloves, etc. This "Hand Nailer" is the only Nailer—throw nails in by the handful—then start nailing. Nails easily driven through tin or quite heavy sheet iron. These nailers are made in two sizes—The BLUE Nailer for 3d, common No. 14 gauge wire nails. The RED Nailer for 3d galvanized No. 13 gauge 1 1/2-in. wire nails. The regular price is \$7.00 but if you order from this ad, we will send it prepaid parcel post for \$5.00. This offer is liable to be withdrawn, so act now.

PEARSON MFG. CO. - ROBBINSDALE, MINN.



BARTON TOOLS

The steel capped double plane iron illustrated is one of the celebrated Barton Tools. For many years these tools have been known for their unequalled, keen, hard, smooth-cutting edges. Barton Tools last a lifetime and give satisfaction to the end. Ask your dealer to show you our tools or send direct for catalogs and free story book—True Stories. Specify "Carpenters Catalog."

**MACK & COMPANY 100 BROWNS RACE
ROCHESTER, N. Y.**



We are not Playing Checkers

Every man-jack of us at the Carborundum plant is working like the proverbial beaver, for never before has there been such a demand for Carborundum and Aloxite Products.

We are doing our level best to meet this big demand—enlarging our plants, increasing our forces, speeding up production—we are even building a big 20,000 horse power furnace plant in Canada in our efforts to keep up with things. We have a definite service to perform for we are helping to produce the necessities of war.

Carborundum and Aloxite Products are Doing Their Bit

They are grinding shrapnel shells, high-explosive shells, rifle barrels and parts—grinding bayonets and sabers. They are grinding a hundred and one different parts of the aeroplane and the auto truck, the machine gun and the field gun. They are shaping armor plate and grinding car wheels; grinding plowshares, and the tools of the metal-working trades of the world. They are grinding torpedo tubes and torpedoes, grinding submarine engine bases; beveling the lenses of periscopes and buffing the soles of the army shoes and grinding the shears for the pocket kits of the "Sammies." They are doing a thousand and one war tasks quicker and better than they have ever been done before.

Carborundum and Aloxite products are surely doing their bit, but with it all we haven't neglected for one instant our regular patrons—we are doing all in our power to keep up with the pace; to keep up to the standards of Carborundum service.

THE CARBORUNDUM COMPANY NIAGARA FALLS, N. Y.

NEW YORK CHICAGO BOSTON PHILADELPHIA CLEVELAND CINCINNATI
MILWAUKEE PITTSBURGH GRAND RAPIDS

Put a SHELDON Concrete Mixer to Work on Your Next Concreting



Job at My Risk

\$11.50 Up

DON'T send me one cent. Just put your money in your own bank. Try a Sheldon on your next job entirely at my risk. Send for the style Sheldon Mixer you need today. When it arrives put it to work. Give it the toughest test you can think of. Keep track of the amount and kind of work it will do. Keep track of what it saves you over hand mixing. Then at the end of 30 days if you think you can possibly get along without it, ship it back. That's my no-string, free trial offer in a nutshell. Accept it today.

Don't Pay \$200 to \$500 for a Mixer

You don't need to. The Sheldon will do just as good work for 1/10 to 1/20 the cost. The Sheldon will mix 2 1/2 cubic feet (2 wheel-barrow loads) to a batch. Will keep one to six men busy. Will save the labor of one to three men. Pays for itself on your first small job. Thousands in use.

Write for Catalog and Special Offer

Let me show you what the Sheldon is like. My catalog will tell you a lot—but nothing like putting a machine to actual work on your next concreting job. Take me up on my offer today. Address **GEO. C. SHELDON, President**

SHELDON MFG. CO. Box 003, Nehawka, Neb.

WINTER CONCRETING

Demands speed—speed in mixing and speed in placing the wet mix in the forms. The one machine having the greatest speed is the

ARCHER MIXERS

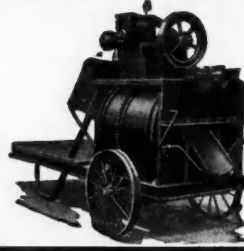

The 30 second mix and the end discharge direct into the form, without any exposed handling, practically banishes all danger of frost in the mixture. For your winter job you must have an Archer. Write for folder of details and prices.

Archer Iron Works
2442 W. 34th Place, Chicago

Make Your Basements WATER TIGHT

by using Bitu-Mortar Waterproofing Compound. Liquid, for waterproofing cement coatings—powder for waterproofing mass concrete—damp-proofing, for interior surfaces of masonry walls. Inexpensive and everlasting. Write for our catalog.

The Bitu-Mortar Waterproofing Co., Inc.



Engineers, Contractors and Manufacturers
340-344 East 27th Street New York, N. Y.

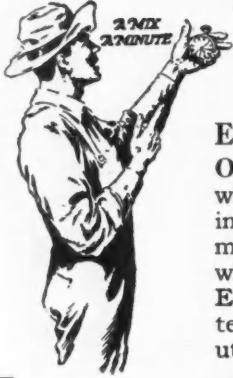

3c per hour
"mix-a-minute"

Efficiency and Economy

One man can complete the whole operation of loading, mixing and dumping a batch in one minute; one batch being mixed while another is being dumped. Each batch is turned from fifteen to twenty times every minute. Use the Jaeger Mixer.



Write for Folder

Jaeger Machine Co.
318 W. Rich Street Columbus, Ohio

Northwest
BUILDING MATERIAL EXHIBIT

Look Before You Build **SERVICE** It's Free to See

COME to this Exhibit when selecting materials for that new building of yours. It will give us pleasure to show you all the best materials to use.

If you cannot visit us, then write us. Our service is free to you.

Send us your plans and specifications and we will gladly secure such figures as you may desire. No obligation.

Many Exhibitors combine their Minneapolis City office with their displays, making this floor your time saver.

NORTHWEST BUILDING MATERIAL EXHIBIT
4th Floor First National Soo-Line Building
MINNEAPOLIS, MINNESOTA

Look before you build

Right Now is Drain Tile Time

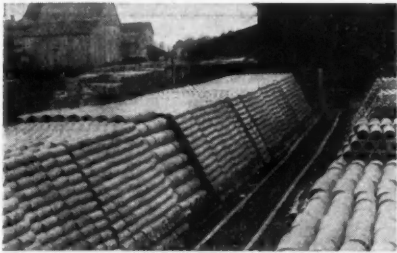

The investment is small; the returns are big. Get in the cement drain tile business now.

Tile bought in the spring must be made in the winter; get ready now for the biggest cement drain tile business in history.

The necessity of bigger crops is forcing the farmer to drain his land. Bumper crops at good prices have given him ample funds to buy tile.

For many reasons clay tile is difficult to secure; besides being better in use cement tile is easier for him to buy. There is room for tile plants in all farming communities.

We have specialized on tile-making equipment. We know the possibilities of the tile business. We cooperate with the tile-maker in putting his business on a sound paying basis, and without investing a large amount of money.

Complete data is given in the book "Cement Drain Tile." A copy is sent free upon request.



Everything in Concrete Machinery

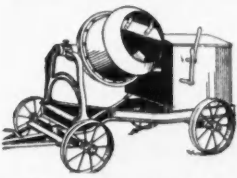

Dunn Concrete Mixers. The biggest labor-saver in the field. Insures the highest quality of mix, a speed of a batch per minute, ease and simplicity of operation. Built strong and durable. Bulletin No Eight gives sizes, styles and prices.

Sewer Pipe Molds. Supply the big demand for cement sewer pipe. Manufacturing is easy, profits are large. Dunn molds make all sizes of pipe from 6" to 36" diameter, without tamping or other difficult work. Ask for bulletin No. Seven.



Block Machine. Makes high grade blocks at the rate of 150 per day. Requires little tamping. Durable construction; moderate in price. Write for bulletin No. Ten.

Ornamental Molds. Concrete porches, vases, flower boxes and other ornamental concrete work is in big demand and pays big profits. Molds cost very little. Ask for bulletin No. Six.



Sill and Step Mold. Simple in construction and operation. Needed by every concrete manufacturer. Adjustable to many sizes. Prices and other information in bulletin No. Six.

W. E. Dunn Mfg. Co. 415 24th St., Holland, Mich.

RANSOME

Registered U. S. Patent Office

Well Mixed Concrete for Permanence—Ransome for better mixing
(Member National Association Mixer Manufacturers)

The Ransome Bantam Mixer line, from the Ransome Bantam Junior to the Ransome Bantam Paver is the most efficient line of mixers ever produced. The Ransome Bantam is practically the American Standard. It means rapidity, efficiency, long life, low original cost, and economic operation. No waste and no time lost. Write for particulars.

RANSOME CONCRETE MACHINERY CO., 115 Broadway, New York City
Agents in every large City

This Light Weight Republic
Has Larger Capacity
Power Loaders or Low Platform
Most mixers have an excess of weight that serves no other purpose than to increase the cost. New improvements and inventions enable us to make this sack size Republic lighter with more capacity and at a greatly reduced price. Republic Mixers are of high quality, dependable construction, and good design—built in 3½, 5, 7 and 10 cu. ft. capacity. Get our Catalogs, prices and terms. State size.

REPUBLIC IRON WORKS, Box 445, Tecumseh, Mich.

ROAD BUILDERS' EQUIPMENT

Write for Engineering Bulletin No. 36, Steel Forms for Culverts, Tiles and Sewers, Engines, Holsts, Concrete Mixers and Pavers.

NORTHWESTERN STEEL & IRON WORKS
Eau Claire, Wis.
Engine Builders and Manufacturers.

NORTHWESTERN MIRACLE
TYPE-FORMS

Turn Losses Into Profits

You should own one of these profit makers.

Built for Business

Low charger—5 and 7½ cubic foot capacities. Continuous or Batch. Mortar Mixers and Hoists.

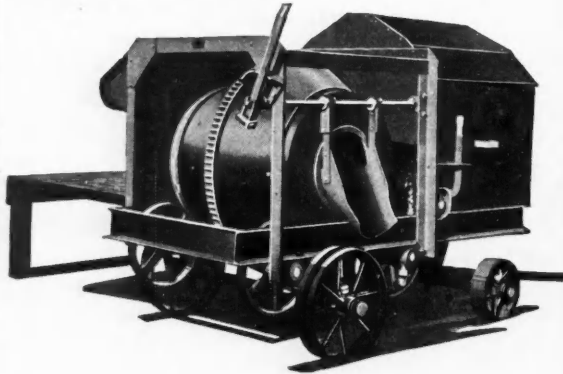

Write for Catalog---Today

EUREKA MACHINE CO.

103 Handy Street

Lansing, Mich.

Take this tip— all you lumber dealers

INQUIRE among your farmer customers. You'll find they have concrete work they'd like to do this spring—if they can **rent** a mixer to lighten the labor and lower the cost.

Here is the mixer so many dealers are buying for just that purpose—to **rent** to their customers—the **BLYSTONE**.

It will boost your sales of cement, lime, sand, gravel, brick, etc. It mixes concrete, mortar and plaster.

*Prompt shipment guaranteed
Write for Catalog and Prices*

Blystone Manufacturing Co.

1017 Carpenter Street Cambridge Springs, Pa.

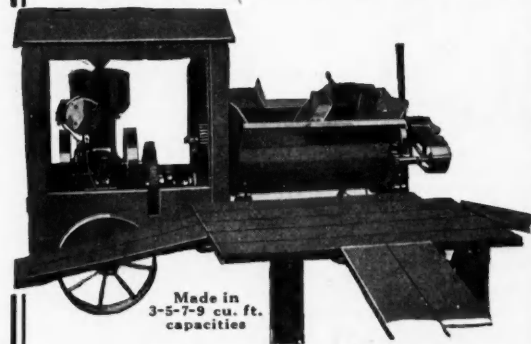

Made in
3-5-7-9 cu. ft.
capacities

Austin Drum Mixer Features

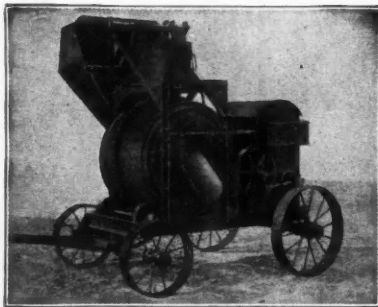

Wide loader and opening into drum permit fast charging without clogging.

Design of mixing blades such that the mix is carried over on discharging chute very wet, allowing rapid discharge, either entire batch or part.

4-H. P. hopper cooled gasoline engine, or steam or electric power. Twenty gallon steel water tank and steel engine housing.

One position control. Capacity 60 to 80 cu. yds. per day.

Write for Bulletin 7-D

Municipal Engineering & Contracting Co.

Main Office: Railway Exchange Building, Chicago
New York Office: 30 Church Street



"Concrete for
Permanence"

Always on the Job—

LITTLE "DEVIL" MIXER

A Bigger, Better Mixer for the Same Money

Capacity 8 cubic feet of loose material. Low Charging—End Discharge—May be used for Paving, Grouting Brick Pavements, Foundations, Sidewalks and will mix and place concrete quicker and at less labor cost than any mixer on the market. Write today for catalogue, prices and terms.

Chicago Builders' Specialties Co.

1461 Lumber Exchange Bldg., 9 So. LaSalle St. Chicago, Ill.

Packard Low Charger

BUILT OF STEEL

The choice of the most successful contractors. A high-speed, high-efficiency mixer especially made for fast work on stiff concrete for Curbs, Sidewalk, Gutters and Foundations. Light, Strong and Durable. Has Hinged Low Loading Platform only 24 in. high. Power Loader or Batch Hopper if wanted. Sold with our "Money-Back" Guarantee—cash or easy payments—price astonishingly low. Prompt delivery from stock carried in all large cities. Write for catalog today.



MIXES
MORTAR and
PLASTER as
Well as
CONCRETE

6 and 11 Ft. Sizes

AMERICAN CEMENT MACHINE CO., Inc.,

Keokuk, Iowa

THE DAWN OF A NEW NAME



"Built on the Square"

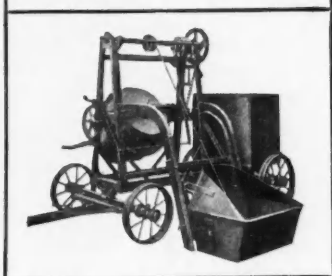
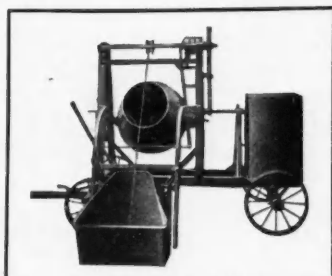

"Sold on the Square"

FOR fourteen years the name STEWART has been identified with the Concrete Machinery business.

Throughout our big plant—at the fairs—on the road—at the Cement shows—in the publications—on the job—everywhere, STEWART has always been in evidence.

Thousands of contractors have met STEWART, talked with STEWART, bought from STEWART and used STEWART products and inventions.

Yet—as a name for a firm and as a brand for a line of Concrete Machinery—STEWART is really a new name.

It's a good name, though—because it stands for honesty, integrity, and a policy of building and selling goods strictly "On the Square."

We thank the thousands of customers who have helped make STEWART a success and write this message as a greeting and an invitation to all readers to get acquainted with STEWART and the STEWART way.

The Stewart Mixer

The STEWART Mixer is a new machine, or rather a new model, built along old principles, by an old firm. In fact, it's built by STEWART with fourteen years of Concrete Machinery building and a lifetime of engineering and contracting experience as a foundation.

It has been tried and tested in every possible manner.

It is a mixer you can count on to start a job and finish a job with a perfect score.

In fact, it is "Built On The Square" and "Sold On The Square" and is guaranteed to give satisfaction.

Five sizes and fifteen styles give you a big line to choose from so you are bound to find a STEWART Mixer for your own individual needs.

Write today for prices and information. Let us tell you about this machine and the STEWART way.

Stewart Manufacturing Company

Successors to The Cement Tile Machinery Company

46 Rath Street, Waterloo, Iowa

Builders of Concrete Mixers, Block Machines, Block Tempers, Sand Screens, Sand Elevators, Tile Cars, Block Cars, Brick Cars, Dump Cars, Transfer Cars



Remember the Name — Lansing No. 5 Mixers

Solves all Mixer problems of the Average Builder. Sidewalk, curbing and foundation work done with the *least* possible expense. Be sure—investigate No. 5 before buying. Don't forget—first cost is small, and they are easy to move from job to job.

LANSING COMPANY 22 Cedar Street LANSING, MICHIGAN

CHICAGO167-169 W. Lake St. MINNEAPOLIS . 517-519 N. Third St.
 NEW YORK288-289 West St. KANSAS CITY . 1413-1415 W. Tenth Street
 BOSTON78 Cambridge (Charleston District) SAN FRANCISCO . 338-348 Brannon St.
 PHILADELPHIA . . Corner North American and Willow

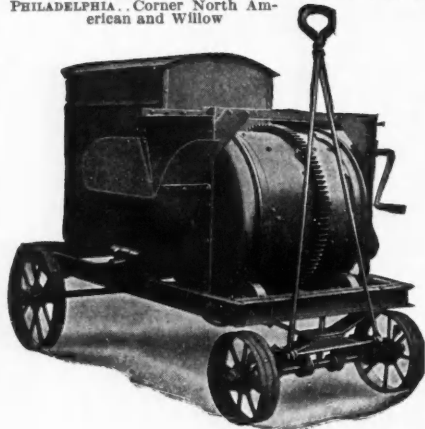

Lansing No. 5 "half-sack" batch mixer.

Also many other sizes

"THE STANDARD" Low-Charging Concrete Mixer

Cuts Costs—Increases Production

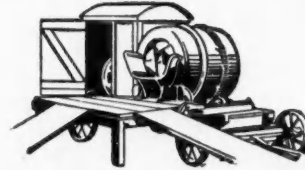

Contractors all over the country have found that "The Standard" Low-Charging Mixer actually reduces concrete costs one-third.

Our latest catalogue (just off the press) is full of interesting pictures and data. Write to our nearest office today for your copy.

Ask for Catalogue No. 44

Complete line of Contractors' Equipment, Hoists, Pumps, Engines, etc.

The Standard Scale & Supply Co.

PITTSBURGH 1631 Liberty Avenue
 CHICAGO 163 N. May Street
 NEW YORK 145 Chambers Street
 CLEVELAND 1547 Columbus Road
 PHILADELPHIA 523 Arch Street
 BALTIMORE 409 N. Gay Street

WONDER MIXERS and HOISTS



WONDER JUNIOR Mixer is our Special for Builders—has all the profitable features of the larger sizes with particular adaptations to your needs and at price you can afford. 3 to 4 cu. ft. per batch. Fast, thorough mix, dependable power, durable, easily cleaned. Get the real facts of WONDER superiority—the big reason leading contractors **standardize** upon it, viz., greatest value per dollar of investment—before deciding on any mixer.

WONDER BUILDERS' HOIST—Ruggedly built, specially adapted for single or double elevators. Reversible drum and efficient sheave. Two line speeds and load capacities. 5-7-9 H. P. Remarkably efficient, moderate priced. **Send for catalog.**

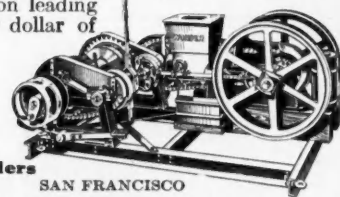

Waterloo Cement Machinery Corporation, 103 Vinton Street, Waterloo, Iowa

Mixers NEW YORK Pavers PHILADELPHIA Hoists CHICAGO Pumps KANSAS CITY Backfillers SAN FRANCISCO

SWING CROSS-CUT AND RIP SAW RIG

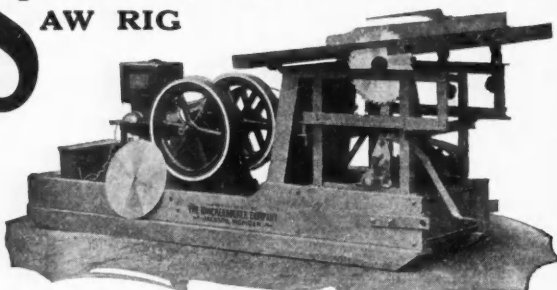

We build Woodworking Machinery, Concrete Mixers, Mortar Mixers, Hoists, Pumps
 The Knickerbocker Company, 525 Liberty St., Jackson, Mich.

Capacity—Economy

The Frank, low price mixer will produce a full batch a minute. The mixing is always in plain sight and the machine is simple, nothing to get out of order.

Sold in 3, 5 and 7 foot sizes. Every mixer guaranteed.

INVESTIGATE TODAY **Frank Mfg. Co.**

241 Century Bldg. DES MOINES, IOWA



Inside View, Showing Door for Unloading

SOMETHING NEW

THE

SMITH UNDER-SLUNG CHAIN DRIVE

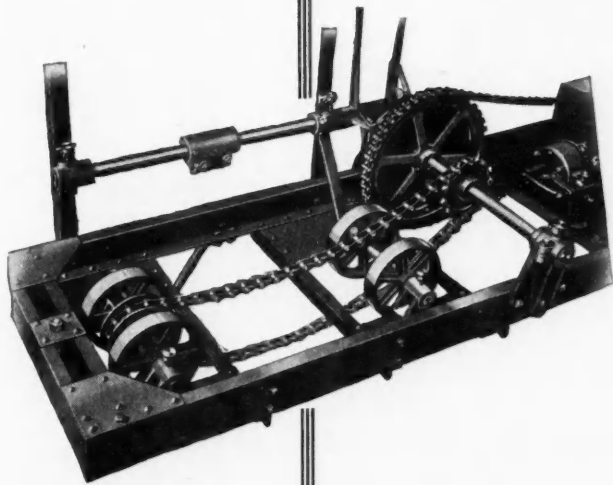

Right now, when price "boosting" is an everyday occurrence, it will be refreshing to read about a "LOWER" price.

What is more to the point is this: this "lower" price is for a NEW type of mixer—the 7-S Smith-Chicago Mixer, equipped with the **Smith Under-Slung Chain Drive**.

Do you get the full significance of the **Smith Under-Slung Chain Drive**? Instead of the chain passing around the drum, it goes **under** it.

The S-7 Smith-Chicago Mixer with the **Smith Under-Slung Chain Drive** is peculiarly adapted to highway work. Its use means Dollars in your pocket when building bridges, culverts, approaches, etc. MAIL THE COUPON.

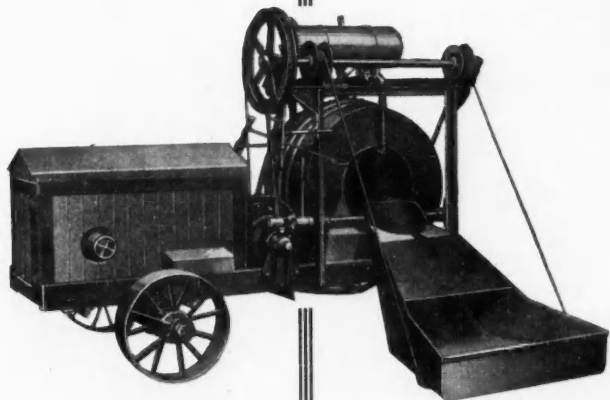

THE T. L. SMITH CO.

3123-J Hadley St., MILWAUKEE, WISCONSIN

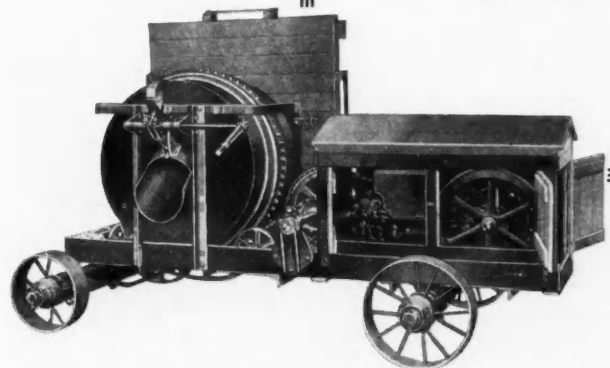

MAILING COUPON

Send me, without obligation on my part, copy of your

FOLDER NO. 164-J

describing your new 7-S Smith-Chicago Mixer with the UNDER-SLUNG CHAIN DRIVE.

Name

St. No.

City.....

State.....

The Creosoted Lath



Built with
Bishopric
Stucco
Board

Jno. C. Cameron
Contractor
and Builder
Arlington, Mass.

The wood lath in Bishopric Stucco or Plaster Board are thoroughly creosoted. Why?

Because creosoting preserves them, prevents swelling, shrinking, warping, and they withstand exposure to all kinds of weather.

The Union Pacific, the Northwestern, and other railways creosote their ties and telegraph poles for the same reason.

The creosoting of wood is nothing new. It has been done for many years — more than long enough to prove that it does what it's intended to do. And so it is with every other part of this product—the dovetailed lath, the Asphalt Mastic lining, the fibre board backing—all ages-old in principle and acknowledged to be unsurpassed for the various purposes intended.

It's the combination of these principles and materials into the Bishopric

Bishopric Stucco or plaster Board costs less than other backgrounds and saves in both material and labor. From any and every viewpoint it's an economical proposition.

Our free book illustrates homes, apartments, factory and public buildings on which Bishopric Board has been used. It contains letters from builders, architects and users, and furnishes facts and figures



Stucco Board that accounts for the dependability, efficiency and uniform satisfaction under all conditions, of that product.

The dovetailed lath hold the stucco so it can't let loose—the Asphalt Mastic is moisture proof and fire-resisting, dampness can't penetrate it—the sized fibre board protects against heat and cold and is an effective sound-deadener. And all these in combination meet the most exacting requirements of a successful background for stucco, cement or plasters.

to prove the stability of Bishopric Board. Don't take our word for this—investigate for yourself—be convinced!

Send today for Book and Free Samples of Bishopric Stucco or Plaster Board

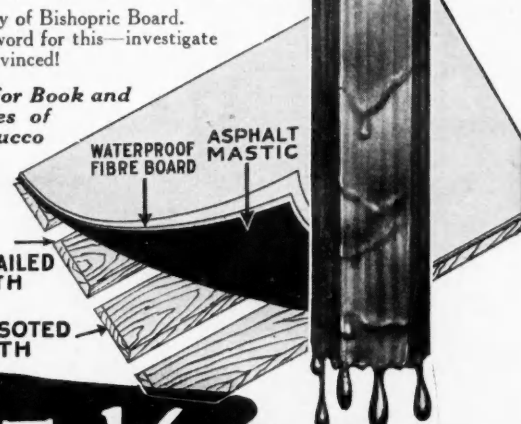

The Bishopric Manufacturing Co.
903 Este Ave., Cincinnati, Ohio

CUTS THE COST 1/4

Short Talks With Our Subscribers

A Bigger Unit of Measure Needed

THE board foot is a very small slice of timber. When you attempt to measure the lumber production of the United States or the lumber requirements for any large undertaking in terms of board feet, you quickly reach figures that are away beyond the comprehension of the human mind.

Recently the newspapers have been thrilling and scaring the general public with figures on Uncle Sam's lumber requirements for ship building.

Six hundred million board feet, it was scareheaded, would be needed!—and the newspaper paragraphers drew the conclusion immediately that hardly a stick would be left over for home building, barn building, etc.—six hundred MILLION! Gee whiz! That's certainly a lot of lumber!

Well, so it is. But how much of our total lumber production is it? Exactly 1½ per cent!

The total lumber cut for this year will be forty BILLION board feet—which is another quantity that no mind can grasp!

The lumbermen and the builders ought to get

together and devise a new unit of measure for bulk transactions.

The M (1000 f. b. m.) would be none too large.

Or better still, take as the unit the amount of lumber in an average sized house—say, 25,000 bd. ft.

The government's requirements for ship building would then read, not six hundred million feet, but twenty-four thousand "houses," or whatever the term might be. Certainly it would be more easily grasped by the public mind.

Some will say that this is nonsense. Maybe it is; but we want to use it to emphasize the fact that the construction of necessary buildings is being prevented right now because the public has been fed up on big figures that they don't understand. They have been and are being scared out.

It is the duty of every lumberman and every builder to kill these rumors about lumber shortage, labor shortage, car shortage, etc. Go ahead and keep business going. The local builder can best serve his country right where he is, and at his regular line of work of preserving the nation's resources and furnishing proper housing for food crops, live stock and laboring men.

EDITOR AMERICAN BUILDER.

Contents for December, 1917

	Page		Page
Editorials	37	New Field Garage Building Has	
Team Work Wins.....	37	Opened Up.....	67
Sane Building Code Recommendations	37	Scriber for Carpenters and Joiners.....	67
U. S. Finds Industrial Housing Improves Labor Conditions.....	38	What's New?	68
The Seductive Advertisement.....	38	Swivel Arm Garage Door Hanger.....	68
A Well Built Stable Is Worth a Feed a Day	38	Shade Adjuster Which Cannot Sag at End	68
One Million Little Jobs Are Just as Good as One Thousand Big Ones.....	39	Light on Saw Guard Eliminates Accidents	68
Reducing the Cost of the Workman's House	40	Window Sleeping Berth.....	69
One Hundred Concrete Dwellings Built at Donora, Pa.....	42	Farm Buildings Arranged for Convenience	70
A Portfolio of Beautiful Homes	44	One-Story Dairy Stable	70
Modern Living Room.....	44	Building On a New Dairy Stable.....	71
Beautiful Stuccoed Tile Residence.....	45	Gambrel Roof Dairy Barn.....	72
Frame House with Pleasing Gable Roof Treatment	46	Steel Square	73
Stucco Dwelling with Large Living Porch	47	Possibilities of the Steel Square.....	73
Sensible Low-Cost House of Five Rooms	48	Correspondence Department	74
Modern Brick Bungalow.....	49	Bolted Crib Frame.....	74
A Little Colonial Gem.....	50	Good Lumber Yard Layout.....	74
"American Builder" Information Exchange	51	Thinks We Have Won the Race.....	74
Brick Construction for Modern Carpenters and Builders	53	Indorses Ad Reading Habit.....	75
Building on a Two-Story Brick Porch	53	How Camp Devens Was Built at Ayer	76
The Builder as a Fireguard.....	54	Reference Data on Building Subjects	77
Details of Fire-Retarding Construction	55	Fresh Air Required by Live Stock.....	77
Narrow-Lot Brick Bungalow.....	56	Figuring Size of Out-Take Flues.....	77
Structural Tile Work	57	Intake Flues	77
How to Estimate the Cost of Tile Structures	57	Intake Register Face.....	77
Dealer-Contractor Good-Will Section	58	Hay Mow Capacity Per Foot Length of Barn in Cubic Feet and Tons of Hay	77
Retail Lumber Advertising I Have Met	58	Strength of Rectangular Beams.....	78
Accounting, Credits and Display.....	60	Strength of Wooden Columns Over Ten Diameters in Length.....	78
Display Building Materials to Encourage Building	61	Thickness of Bearing Plates.....	79
The Man From the Lumber Yard	62	Thickness of Washers.....	79
Model Home Designs	64	Safe Resistance to Lateral Force on Mild-Steel Lag-Screws.....	80
Artistic Shingled Bungalow.....	64	Force Required to Draw Lag-Screws Out of Yellow Pine.....	80
Out on the Job	66	Quantities of Materials for Concrete Basement Walls	80
What Builders are Finding Good.....	66	Ingredients in One Cubic Yard of Concrete	80
Electric Glue Pot Saves Time.....	66	Weights and Areas of Round and Square Bars	80
Miter Box with One-Piece Bed and Back	66	Materials for 100 Square Feet of Concrete Floor	81
High Grade Cellar Window Hardware	67	Capacity and Number of Bricks Required for Cisterns Per Foot of Height of Wall.....	81
		Approximate Sizes of Chimney Flues For Steam and Hot Water Heating in Residences and Other Buildings..	81
		Pressure of Water in Pounds Due to Height in Feet.....	81
		Carrying Capacity of Sewer Pipes in Gallons Per Minute with Varying Fall in Inches Per 100 Feet.....	81
		Bearing Power of Various Soils.....	81
		Covering Capacity of Shingles.....	81
		Weights of Roofing Materials.....	82
		Safe Speed of Emery Wheels.....	82
		Speed of Circular Saws.....	82
		Allowable Carrying Capacities of Copper Conductors	82
		Space Required for Various Articles of Furniture and Plumbing.....	82
		War Conditions Favor Heavy Timber Construction	82
		Classified Index to Advertised Goods	83
		Index to Advertisements	94
		Helps to Bigger Business	99
		Modern Office Methods Help the Contractor	99
		Architectural Details	101
		A Dining Room Interior.....	101
		Yours for Safer Building	102
		Noon Hour Talks by the Boss Carpenter	102
		Calculation for Small Factory Building	102
		Ventilation of Cantonment Barracks.....	104
		Suggestion for a Tool Grinder.....	104
		Fire Resisting Residence.....	106
		Question for Door Hanging Experts.....	106
		South Dakota Barn.....	106
		Urge Level Crossings—They Will Save Lives	108
		Speed in Increasing the Seating Capacity of the World's Largest Ball Park	112
		Long Distance Freight Handling by Motor Truck	114
		News of the Field	124
		Oshkosh Company Extends Service to Contractors	124
		Highly Developed Plant Produces Enameled Plumbing Ware.....	124
		Catalogs, Bulletins and Books Received	134

TRADE
CHICAGO
MARK

**SPRING HINGES
A SUGGESTION**

Do you specify a spring hinge with distinctive features which will appeal to your client and assure satisfaction to all concerned?

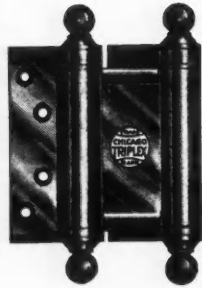

Chicago "Triplex" Spring Butts

offer this advantage to you. The appearance, durability and finish of this article are unsurpassed, and in consideration of prices that are conservative in respect to value, the up-to-date builder cannot afford to risk his reputation for goods that are unsatisfactory.

Send for Catalogue C 32. It illustrates and describes the most complete line of Spring Hinges manufactured.

Chicago Spring Butt Company,

CHICAGO



NEW YORK

BOMMER

Floor Surface Spring Hinge

Double or Single Action, Holdback, Ball Bearing. Every moving part of this hinge can be oiled from a single hole on outside of side-plate.

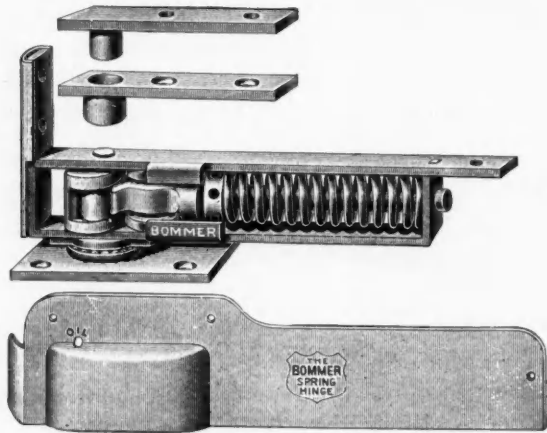

The most durable hinge of its type; holds the door open when swung to 90 degrees at either side

Your Hardware Merchant Can Supply Them

Bommer Bros., Manufacturers, Brooklyn, N.Y.



Rufus D. Wood, Architect, Pittsburgh, Pa.
Read what this Architect says about his own house, which is stained with

Cabot's Cresote Stains

"The shingles of the roof and second story are stained with your brown stain and the plaster on the outside columns with your white Waterproof Cement Stain. A number of the shingled houses in my neighborhood have been stained with cresote (?) stains manufactured by local concerns and their colors are very muddy and disagreeable and do not seem to stand the weather, while mine has retained the original nut-brown color which I desire." (Signed) RUFUS D. WOOD.

Cabot's Stains have been the standard for more than twenty-five years, and are specified by nine-tenths of the architects, who know them from experience. Their colors are soft, rich and beautiful, and guaranteed fast. Their vehicle is Cresote, which thoroughly preserves the wood, and they contain no kerosene or other cheapener. Why experiment with unknown stains, when you are sure of Cabot's?

Cabot's Stucco Stains

are the only artistic cement finishes. They give soft, natural coloring effects, without covering the surface with a painty coating. They are also cheaper than coatings and easier to apply, and they cannot crack or peel.

You can get Cabot's goods all over the country. Send for samples and name of nearest agent.

**SAMUEL CABOT, Inc., Mfg. Chemists
BOSTON, MASS.**

1133 Broadway, N. Y. 24 W. Kinzie St., Chicago
Cabot's Conserve Wood Preservative, Stucco Stains, Brick Stains, Damp-proofing.

Worth Much to You

**Morrill
Saw Set**

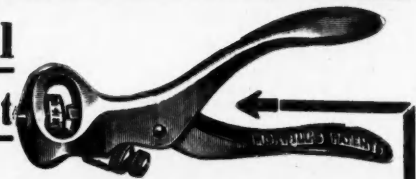

All master carpenters are using this Saw Set. In one operation it takes out the wrong set and puts in the right one. Write for FREE booklet "Saw Points". It tells how to properly joint, set and file hand saws.

CHAS. MORRILL

84 Lafayette Street
NEW YORK

BUILDERS' HARDWARE



No. 546—1 1/4 in. Ant. Cop. Fin. Spring Hinge. Per set.....\$1.20
Weight per set, 4 lbs.

No. 6—Builders' Hardware Catalog sent free. On account of market conditions, we are unable to issue net price list. Send us your hardware list for quotation.

We do not sell to carpenters or contractors in Cook County, Ill.

**Rehm Hardware Company
1501 Blue Island Ave. Chicago, Ill.**

Copyright, 1917, by American Carpenter and Builder Company.



Formerly AMERICAN CARPENTER AND BUILDER

Member of the Audit Bureau of Circulations
Circulation Audited and Verified March, 1917

American Builder

Entered as second-class matter July 1, 1905, at the postoffice at Chicago, Ill., under the act of Congress of March 3, 1879.

Published on the first day of each month by

AMERICAN CARPENTER AND BUILDER COMPANY

Publication Office:

Radford Building, 1827 Prairie Ave., Chicago

EASTERN OFFICE: 345 FIFTH AVE., NEW YORK CITY

SUBSCRIPTION RATES

One year, \$2.00; six month, \$1.00; payable always in advance. Single Copies, 20 cents. Canadian Subscriptions, \$2.50. Foreign Subscriptions, \$3.00.

ADVERTISING RATES

Furnished on application. Advertisements, to insure insertion, should reach our Chicago office not later than the 15th of the month preceding date of publication.

PROTECTION FOR OUR READERS

The publishers of the AMERICAN BUILDER reserve the right to decline any advertising they believe is detrimental to the interests of its readers; to edit advertising copy and to change or eliminate any statements that reflect injuriously or cast discredit upon other building products, machinery, equipment, supplies or tools.

Be sure in writing to advertisers to say: "I saw your advertisement in the AMERICAN BUILDER."

EDITORIAL DEPARTMENT

WILLIAM A. RADFORD, *Editor-in-Chief.*

BERNARD L. JOHNSON, B. S., *Editor.*

H. W. LINDSAY, B. S. A. W. WOODS . . . { *Associate*

WM. REUTHER. CHAS. E. PAUL, S. B. . { *Editors*

BUSINESS DEPARTMENT

WM. A. RADFORD, *President and Treasurer.*

E. L. HATFIELD, *Vice-President and General Manager.*

ROLAND D. RADFORD, *Secretary.*

C. R. W. EDGUMBE, LOUIS H. REICH . { *Advertising*

DELBERT W. SMITH, E. B. WOLFROM . { *Staff*

VOL. XXIV

December, 1917

No. 3

Team Work Wins

THE retail lumber dealer's place of business should be the headquarters for building material information for his community.

Closer co-operation between contractor, architect and the retail lumber dealer will increase the service the community may receive, for suggestions and ideas, not only for attractive and harmonious exteriors, but for designing, furnishing and finishing the interior also.

The artistic mind of the architect, together with the practical mind of the contractor and the financial mind of the retail lumber dealer may all combine to make the home beautiful and to create a demand in the community for more homes.

It is as much the duty of the architect, contractor and retail lumber dealer to improve the homes of a community as it is the duty of the local preacher to improve its morals.—H. R. ISHERWOOD.



Sane Building Code Recommendations

PROPER methods of construction and efficient building inspection will prevent a very large proportion of the fires which annually do so much damage in American cities," says R. S. Whiting, an architectural engineer who has made a compilation and careful study of more than two hundred building

codes. Mr. Whiting sums up his conclusions as follows:

"The allowance of 10 feet between buildings in uncongested districts is about the average found in building codes, altho a greater distance is advisable and often specified; and in some cases the space is increased to 30 feet or more. If an ordinance limiting the distance between buildings had been provided in the building code of Atlanta, Ga., the conflagration of May 21, 1917, might have resulted not so disastrously. It is next to impossible for firemen to fight a fire satisfactorily between two burning buildings, if the space between them is not wide enough for two persons to pass comfortably, which seems to have been the case in Atlanta.

"The width of building lots is a matter that should be carefully thought out and regulated by local authorities and especially in a congested dwelling house district and should not be permitted less than 35 feet; better still, platted with a width of from 40 to 50 feet, thus allowing liberal space on each side of every dwelling.

"Buildings such as public garages, oil houses and refineries, rendering plants, varnish works, etc., as well as buildings used for the storage or handling of large quantities of combustible material, whether of fire resistive or non-fire-resistive construction, should be

erected only in isolated locations, where their contents cannot be considered as a fire hazard for adjoining or nearby buildings.

"Mill construction buildings with heavy interior construction are permitted in the larger cities to a height of 75 to 100 feet, but their interior floor space as well as that of every other type of building is limited in area, depending on whether the exterior of the building is exposed to one, two or three or more streets. An individual building is often subdivided into spaces limited in area having each of these areas separated by a fire wall so as to confine a fire to one compartment as long as possible and make it difficult for it to spread to any adjoining area or compartment. Where openings in exterior walls are exposed to other buildings they should be provided with fire doors or shutters and, if the exposure is not too great, by wire by wire glass windows."



U. S. Finds Industrial Housing Improves Labor Conditions

SPEAKING at the recent National Housing Conference in Chicago, Mr. Liefur Magnusson, Special Agent of the Bureau of Labor at Washington, gave tentative conclusions as to the result of an important Government investigation still in progress. For two years he has been investigating housing conditions for the Government and his report at present covers the work of 700 employers in housing their employees. He stated that 213 firms provided housing facilities for 34 per cent of 467,000 men. For five years sixty companies expended an amount equal to 20 per cent of the total payroll in erecting houses for 42 per cent of their employes. Below are fourteen results of company housing, given in his own words:

- (1) Better class of workmen.
- (2) Greater stability in supplying of labor.
- (3) Reduction in number of "Floaters."
- (4) Better living conditions.
- (5) Greater loyalty from employes.
- (6) More contented employes.
- (7) More efficient employes.
- (8) Better control of labor situation; that is, hir-



Food Conservation Note: A Warm Stable Is Worth an Extra Feed a Day. Repair the Stables and Build New Ones to Save Stock Food and Fodder.

- (9) Attract married men.
- (10) Greater regularity of employment.
- (11) Better house for less money.
- (12) Brings profit to company.
- (13) Facilitates part time employment.
- (14) Advertises company and keeps it favorably before the public.



The Seductive Advertisement

"I'll sell my house," said Hawley Rae,
 "And build another on the Hill
 Where all the fashionables live
 These common districts make
 me ill."
 And so he summoned instantly
 A real estater to his bosom,
 A blithe and elegant young man
 Just bubbling with Enthusiasm.

The real estater saw the place,
 Examined it from stone to slate.

And said: "I'll sell it for you sure,
 The possibilities are great.
 I'll write the ad, this very day;
 Call in tonight and you may read it;
 A house like yours is rather scarce,
 I know a score of folks who need it."

Rae called. He read the ad with care,
 With growing interest and surprise.
 The real estater's polished art
 Brought honest wonder to his eyes.
 The hardwood floor, the noble yard,
 The handy features of the place;
 All these were mentioned in a style
 Of wondrous literary grace.

"It suits?" the real estater said,
 The author's smile upon his lips.
 "You bet it does," responded Rae,
 His hands a-resting on his hips.
 "I didn't think the place was so
 Desirable and fine and fair.
 Look here. It's not for sale, old chap,
 I'm going to keep on livin' there!"

The above, by the "Calgary News," shows what a dash of real salesmanship can do for the home-building business. The real estate man is not the only one who can write a pulling ad. Lumber dealers, builders, carpenters, architects—all can talk and write in a way to create business. NOW is the time to do it.

One Million Little Jobs Are Just As Good As One Thousand Big Ones

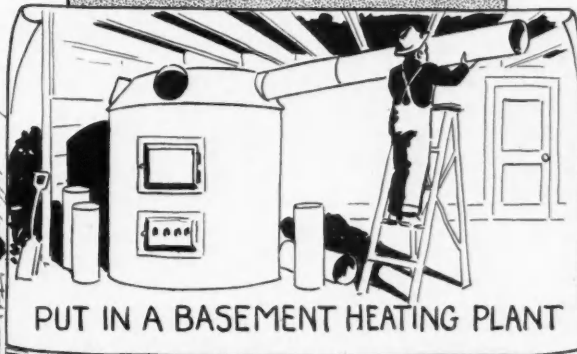
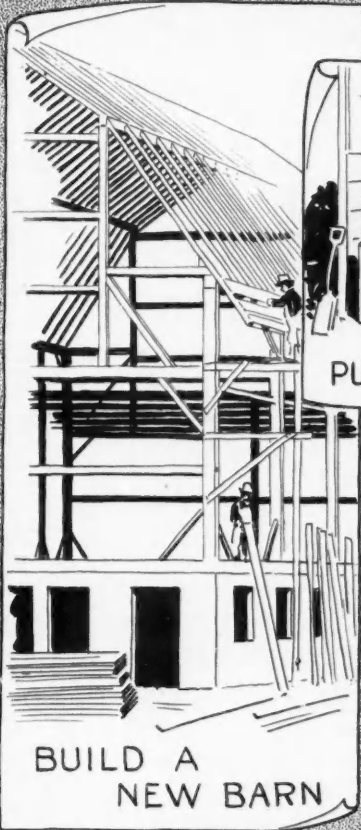

The Patriotic Duty of Every Man in the Building Industry Is to Get Out After the Small Jobs; They Utilize Local Building Materials and Local Labor; They Preserve and Make More Useful the Nation's Wealth. Buildings to House Farm Crops, Homes for Workingmen, and the Repair and Remodeling of Existing Structures Are the Urgent and Patriotic Building Needs Right Now.

Reducing the Cost of the Workman's House

A PAPER READ BEFORE THE NATIONAL HOUSING ASSOCIATION AT THE CHICAGO CONVENTION,
OCTOBER 15, 1917.

By Leslie H. Allen,
Of the Aberthaw Construction Co.



General View of American Steel & Wire Company's Housing Project at Donora, Pa., Handled by the Aberthaw Construction Company, and Exemplifying the Ideas of the Author.

AT THE present time, when the cost of all materials is so high and labor so hard to obtain, a survey of the elements of cost entering into the construction of a workman's house is bound to prove of interest, and any steps which can be taken to reduce costs or point out cheaper methods of construction are sure to be welcomed.

In approaching this subject it seemed to me that it would help to clarify the subject in our minds if we first think of the necessary elements of a house as distinct from the desirable features which are not essential and the luxuries which are usually added.

The essential features of a modern city house may be summarized as follows:

- Water tight roof, walls and floors.
- Bedroom for parents.
- Bedroom for male children, if any.
- Bedroom for female children, if any.
- One or more living rooms for cooking, eating and general day use.
- Private toilet room with sanitary water closet and sewer connection.
- Suitable heating arrangements.



One Hundred Dwellings of Poured Concrete Construction Were Put Up as a Unit at Donora.

- Running water supply fit for drinking.
- Kitchen sink with waste connected to sewer.
- Uninterrupted day light and ventilation thru windows in every room.

Further additions required by the American family and considered by them as essentials are:

- Cellar.
- Closets.
- Bath tub with running water.
- Window screens.
- Separate parlor.

Among the many improvements which are usually included in a house of any kind may be enumerated:

- Porches and piazzas.
- Lavatory bowls.
- Hot water supply to bath and bowl.
- Window shades.
- Window blinds.
- Dining room separate from parlor or kitchen.
- Electric lighting or gas piping.
- Wall paper.
- Laundry tubs.
- Kitchen stove (furnished by builder instead of by tenant).

Any attempt, such as the above, to divide essentials from luxuries must come in for a good deal of criticism, as there is bound to be a divergence of opinion upon the details of such a list. The classification suggested will at least serve to indicate the line on which the planning of a house should be studied in view of the need for strict economy in designing and building necessary to bring the building down to a cost that will not be unremunerative.

Many of the unskilled workmen whose homes we wish to build have come from countries where four walls and a roof are considered a sufficient shelter from the elements to make a home. Altho we do want to see them housed in a better

manner than this, yet it is not necessary to give them six-roomed houses with cellars, furnace heat, running hot water, lavatory bowls, picture mouldings and all the other desirable comforts and luxuries that are required by the higher paid men. We do want to house the lowest paid men in a sanitary and hygienic home. We should give him a house that will not harbor vermin and that will not be damp or unhealthy or unreasonably inflammable. A house in which every room will have a proper amount of light and ventilation and direct sun light and decent privacy in its

Valleys and dormers in the roof not only add to its cost, but to its maintenance, as these are the points where leaks first make their appearance.

Any attempt to beautify the elevation has to be paid for. Each dormer, every valley, each moulding and railing, has to be reckoned up in dollars, and where it becomes a question of sacrificing necessary floor space for internal convenience, for outside embellishment, the tenant, were he given a chance to vote, would almost invariably choose the interior necessities rather than the external luxuries or higher rent.

I am as desirous as any of seeing the working man housed in buildings that are beautiful and artistic; but I do feel that I would rather house him in a building that was plain and unattractive looking on the outside than not house him at all and leave him to exist in the pig sty that too often he has to call home.

The flat roof is very seldom used in housing, partly because the building of a sloping roof is a habit and partly because the flat roof is unattractive in appearance. I think that the last difficulty is one that can be overcome and as the cost of the flat roof, both in first cost and in maintenance is much less than the pitched roof, we ought to accustom

ourselves to its appearance and get the benefit of the resulting economy.

No applied architectural ornament can equal the beauty or permanence of a careful planting of shade trees, shrubs and vines. The cost is considerably less and the result is far more pleasing. It is a great disappointment to visit some of the model villages that are being built and compare them with the original perspective view drawn by the optimistic town planner.

(Continued to page 136.)



Pouring the Roof at Donora.

sanitary accommodations and has sufficient bedrooms for the sexes to sleep apart.

Given these, we may be assured that the essential requirements for the workmen's health, safety, comfort and convenience are taken care of.

In most of our recent housing developments, however, the houses built have been so elaborate and expensive that only the higher paid men in the plant can afford to use them. The really crying need is better housing for the lowest paid unskilled workmen and we must realize this and do something to improve his living conditions, even if we cannot afford to build the ideal houses that our inclinations and theories lead us to.

Planning and Architectural Design

In planning a workman's house, if a single house is being considered, the square house will always be found to be relatively cheaper and more economical. As the plan changes from square to oblong, the ratio of wall area to floor space increases and with it the cost. Any departure from the right angle means increased labor and waste of materials in cutting.



Steel Forms in Place for Pouring the Second Story Walls.

100 Concrete Dwellings Built at Donora, Pa.

ORGANIZATION AND METHODS USED BY ABERTHAW CONSTRUCTION CO. ON HOUSING PROJECT FOR AMERICAN STEEL & WIRE CO.



A.C.CO.NO.1094,5-7-17,NO.5

Progress Photo of Donora Concrete Housing Job, Showing Foundation Work. In the Foreground Tin Tile is in Place for Pouring a First Floor.

AHUNDRED concrete dwellings have just been completed in Donora, Pa., at the rate of one every three days. This brings to our mind vivid recollection of the public statement of Thomas A. Edison that he was going to pour a concrete house in an hour or so.

This accomplishment, made by the Aberthaw Construction Co., of Boston, Mass., establishes a record far above any similar performance, and it shows the possibilities when a contract of this kind is undertaken

organized to do work with efficiency and dispatch. This, however, is the first case on record where one of these companies has applied the same methods to reproduction of a large group of smaller buildings.

Description of Dwellings

The houses were built for the American Steel & Wire Co., being neat and attractive and of eight different styles. They contain four, five or six rooms each with a bath and cellar. A few double houses were erected with party walls; but the great majority of them are detached. The average dimensions are about 26 by 26 feet. The six-room houses contain living room, dining room and kitchen on the first floor, and three chambers and bath on the upper floor. The

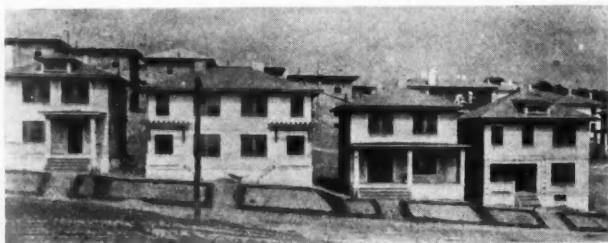

A Street at Donora Nearly Completed.

by a large reputable contractor with abundant equipment, financial resources and with a highly perfected organization.

The large contracting companies have made a specialty of rapid construction in the past and have been

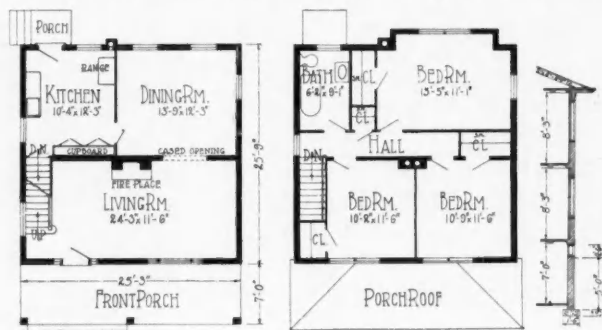

Typical Floor Plans of Concrete Dwellings at Donora.

cost of the houses varied from \$2,000 to \$3,300, these prices including gas, furnaces and cooking ranges, electric lighting and the usual improved kitchen and bathroom equipment.

All houses are of the box type with solid reinforced concrete walls 6 inches thick. There is a flat concrete roof, and on top of this a spruce framing is built up covered with asbestos slate. This gives the house a more artistic appearance than would otherwise be possible. The floors are of the ribbed reinforced concrete type, with the ribs or beams spanning between the outer and interior walls. In the cellar these ribs are left exposed, but in the other floors plaster board is nailed to strips left in the concrete and a finish plaster coat made.

Speed Possible Thru Standardized Designs and Forms

The fact that this work was undertaken and accomplished with such speed and satisfaction was due to the application of methods used on large buildings to the building of 100 individual establishments. The designs were thoroly worked out in the first place, and standardized steel forms and wooden forms were used on successive rows of houses.

The steel forms are of the special channel type patented by the Lambie Concrete House Corporation, and consist of 9-inch channels which are set up vertically and are connected together with clips and wedges. Details of the forms are shown in the accom-

panying illustrations. A 4 by 4-inch steel angle is set up at the corner of the building and the forms are lined up longitudinally by a steel channel used to form a belt course. This not only fastens the forms of the lower floor, but is bolted into the floor reinforcement and remains in place as a support for the second-story forms. It is removed after all the concrete has been poured.

The houses were constructed in groups, a set of forms being used for a group and then taken down as quickly as possible and used for the next group. Usually the forms were set up for one-story wall and floor together, and then concrete was poured for this section all at one time. To complete one story takes about seven days, and working at this rate a house of two floors and a cellar is completely concreted in three weeks, and with twelve sets of forms the same number of form houses are completed in this period. Subsequent to this, plumbing, heating, plastering, roofing and finishing must be completed, requiring about five weeks more. These twelve houses were completed in the first eight weeks, and twelve every three weeks thereafter.

Organization

On this job the organization consisted of a superintendent, assistant superintendent, civil engineer, material clerk, two cost clerks, timekeeper, planning

(Continued to page 156.)

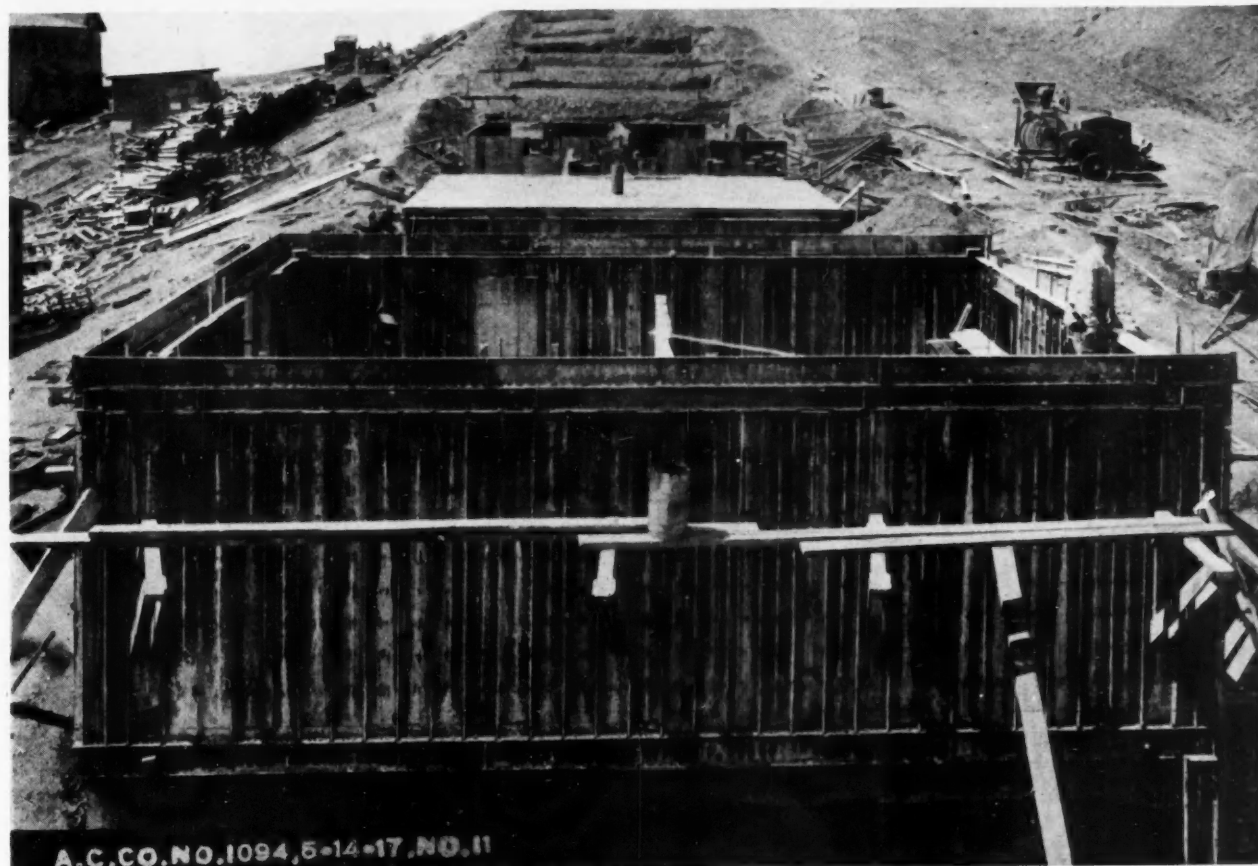

Progress Photo Taken Seven Days After View at Top of Opposite Page.

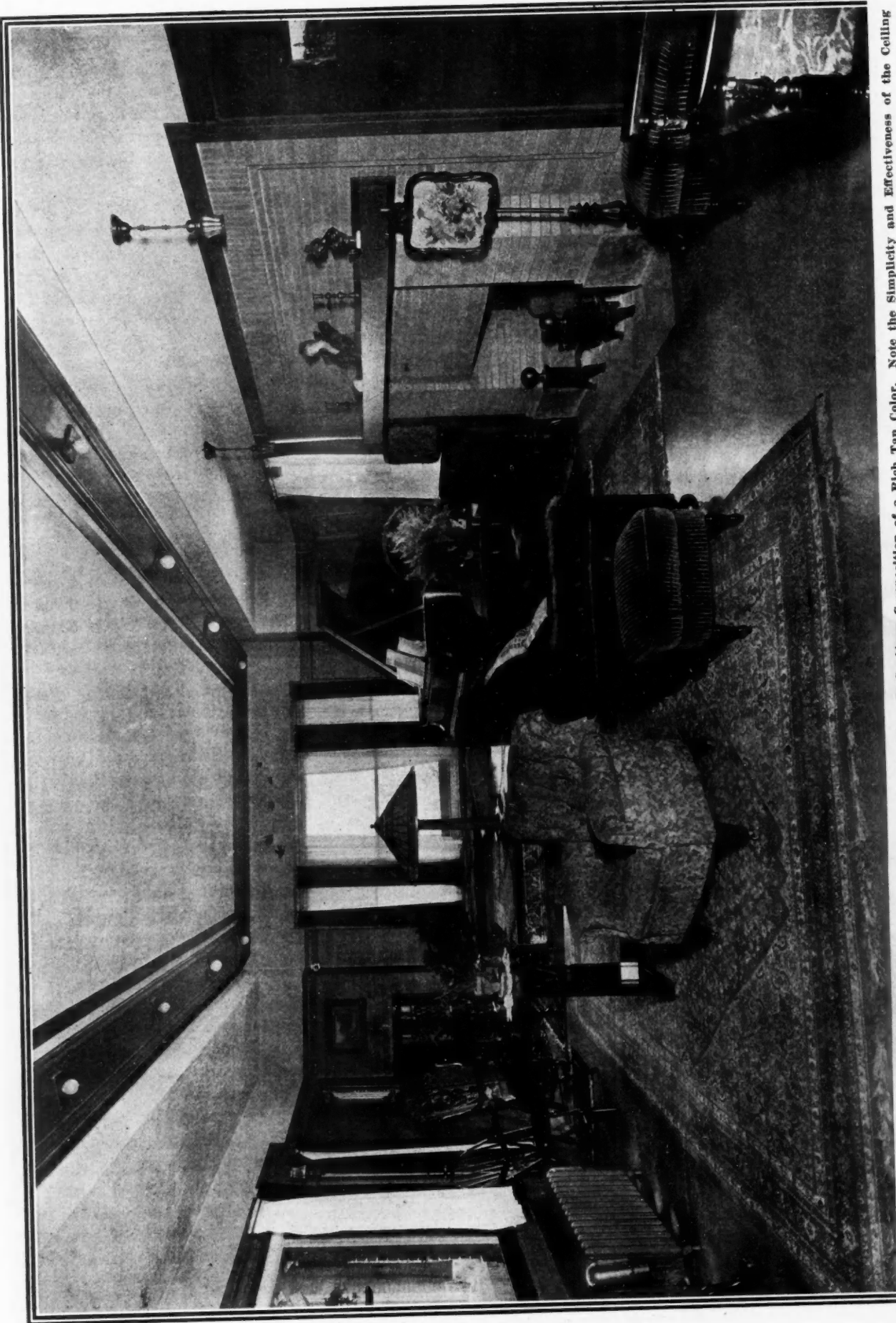

Modern Living Room in a Residence on Chicago's Exclusive "North Shore." The Floor Is Sanitary Composition of a Rich Tan Color. Note the Simplicity and Effectiveness of the Ceiling Lighting and Panel Arrangement.

B
The
inch
a ba

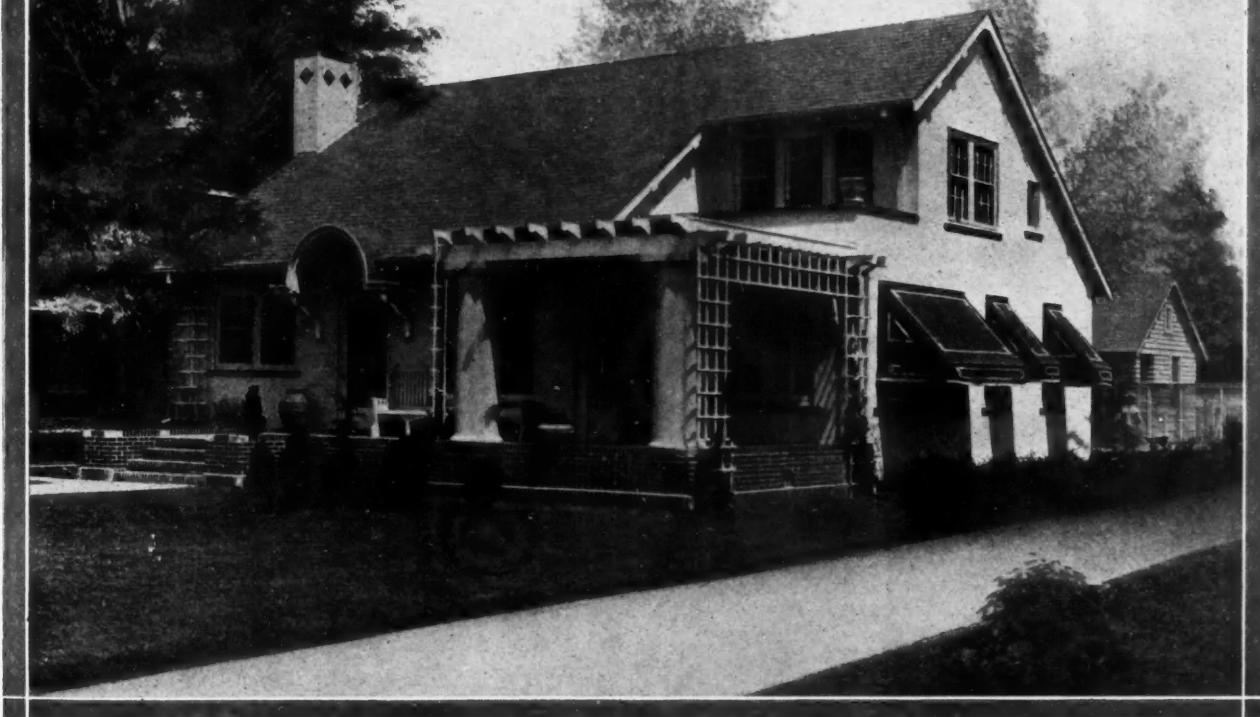
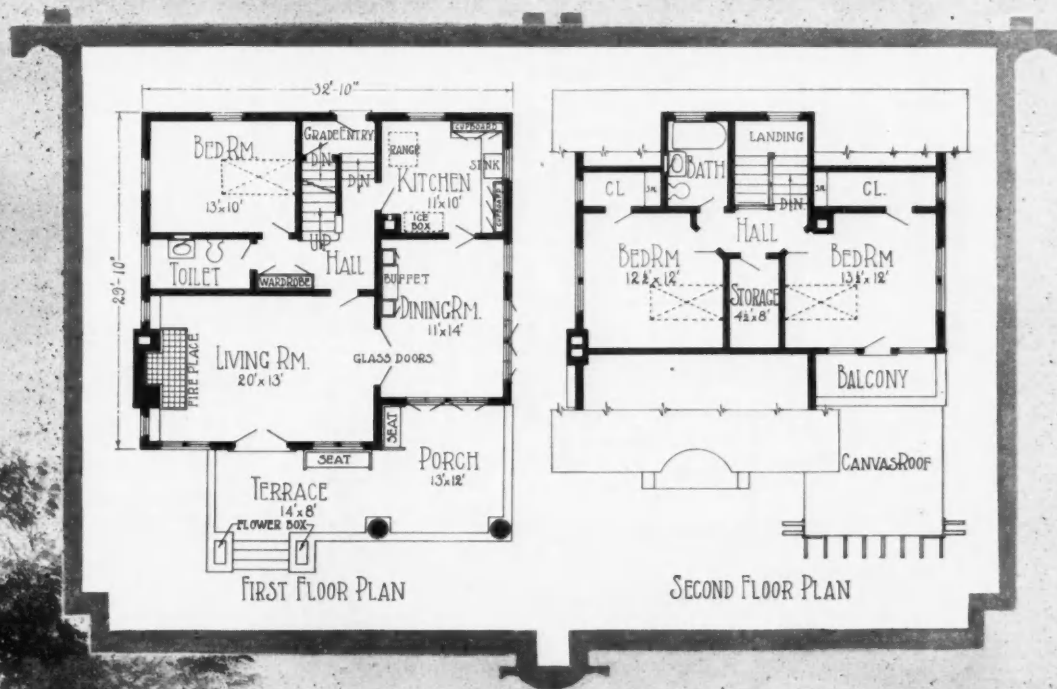

BEAUTIFUL STUCCOED TILE RESIDENCE. This house is an excellent illustration of the architectural possibilities of white stucco and rough texture face brick as a combination for the finishing of residence exteriors. The design shows careful study and a skillful treatment of proportions and ornamental effects. The first floor plan includes a living room, dining room, kitchen, bed room and toilet, and the second floor plan provides two bed rooms, a bath and a storage room. The house is built at Dallas, Texas. Lang & Witchell, Architects.

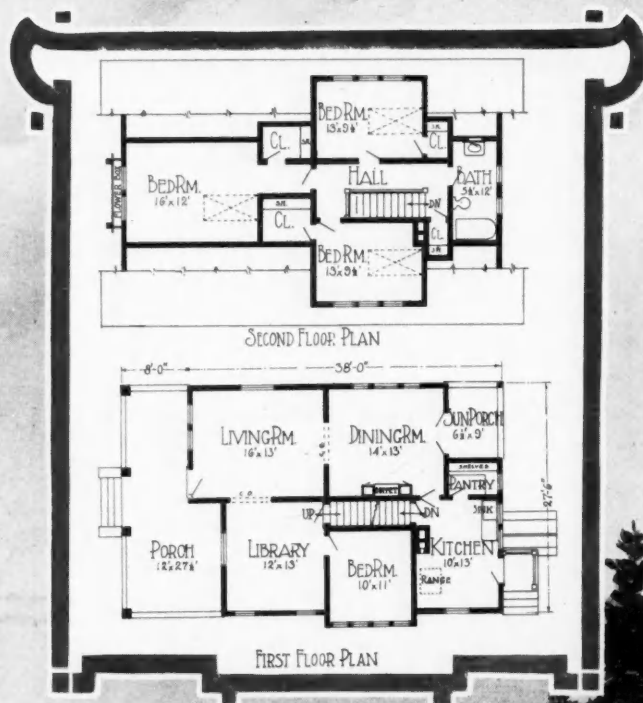

FRAME HOUSE WITH PLEASING GABLE ROOF TREATMENT. This well-proportioned residence is finished with stained shingles and rustic siding. There is a mass of smooth trim which, when painted white, provides a pleasing contrast with the dark stained walls. The gable roof is built with an open cornice and heavy brackets are used to support the overhang above the gables. The roof treatment of the balanced dormers conforms with that of the main structure. There is an intimate connection of the library, living room, dining room and sun porch on the first floor, which also provides a bed room and kitchen with pantry. Three bed rooms and the bath are planned for the second floor.

STU
es
used a
the ro
One o
a mini

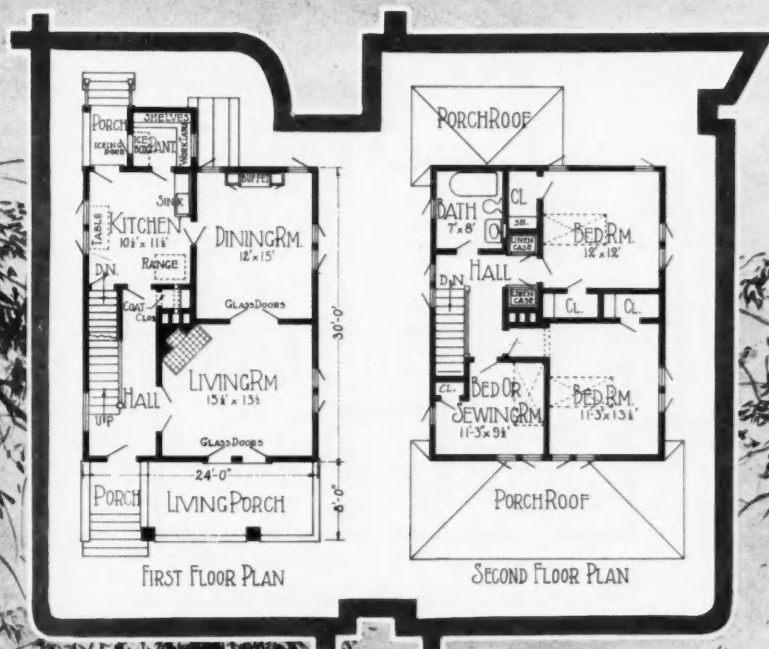

STUCCO DWELLING WITH LARGE LIVING PORCH. The front porch arrangement of this house is interesting. The entrance porch is separated from the main porch, which is entered from the living room and is used as a living porch. The forward edge of the porch roof is supported by two columns which are placed so that the roof width is divided into three equal parts. The ends of the roof are supported by a cantilever beam action. One of the special features of the first floor plan is the fully equipped pantry, which is designed to reduce labor to a minimum. The second floor plan provides an excellent arrangement of bed rooms, each of them handy to the bath.

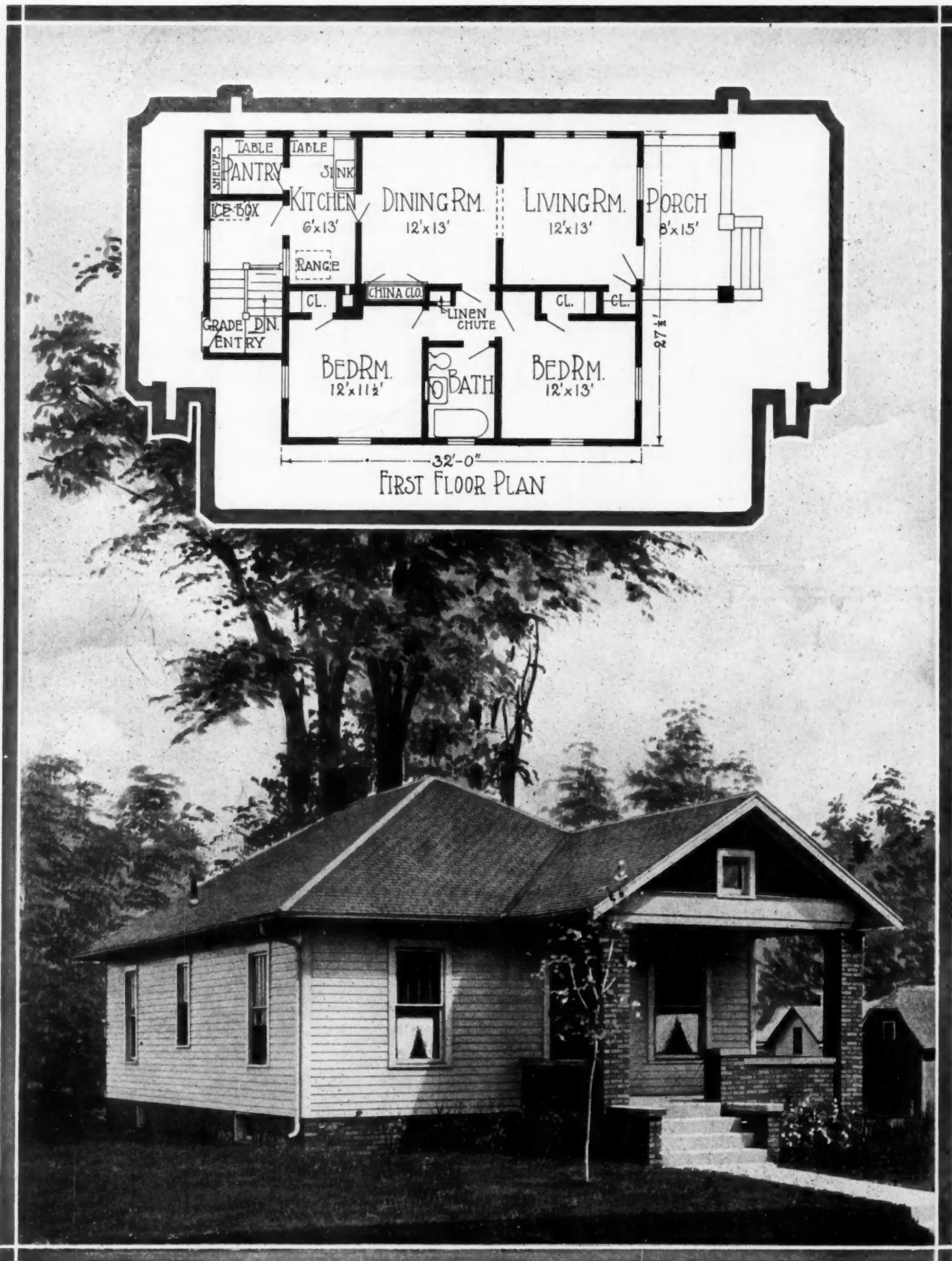

SENSIBLE LOW-COST HOUSE OF FIVE ROOMS. This building is designed for lasting economy, which implies the use of good materials. It provides every comfort and convenience which is ordinarily demanded by critical people, yet it does not waste money in obtaining this result. The plan shows a plain rectangular main structure with projecting front porch and rear entry and pantry. The walls are finished with beveled siding; stained shingles are used on the gables; the foundation, porch columns and rails are of brick; and an asphalt shingle roof is provided. Porch steps and floor are of concrete.

A MO
aff
the mo
lighted

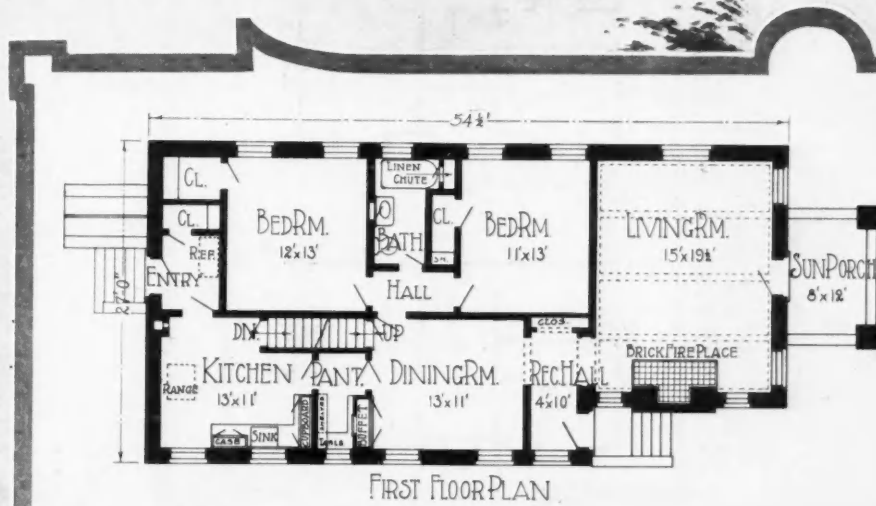

A MODERN BRICK BUNGALOW. The quest today is for the type of home that the man of average means can afford to build and that conforms to building code regulations for buildings inside the fire limits. Here it is—the modern face brick cottage or bungalow. It will go on a narrow lot and make a real home. Five excellent well-lighted rooms are provided; also bath, pantry and plenty of closets.

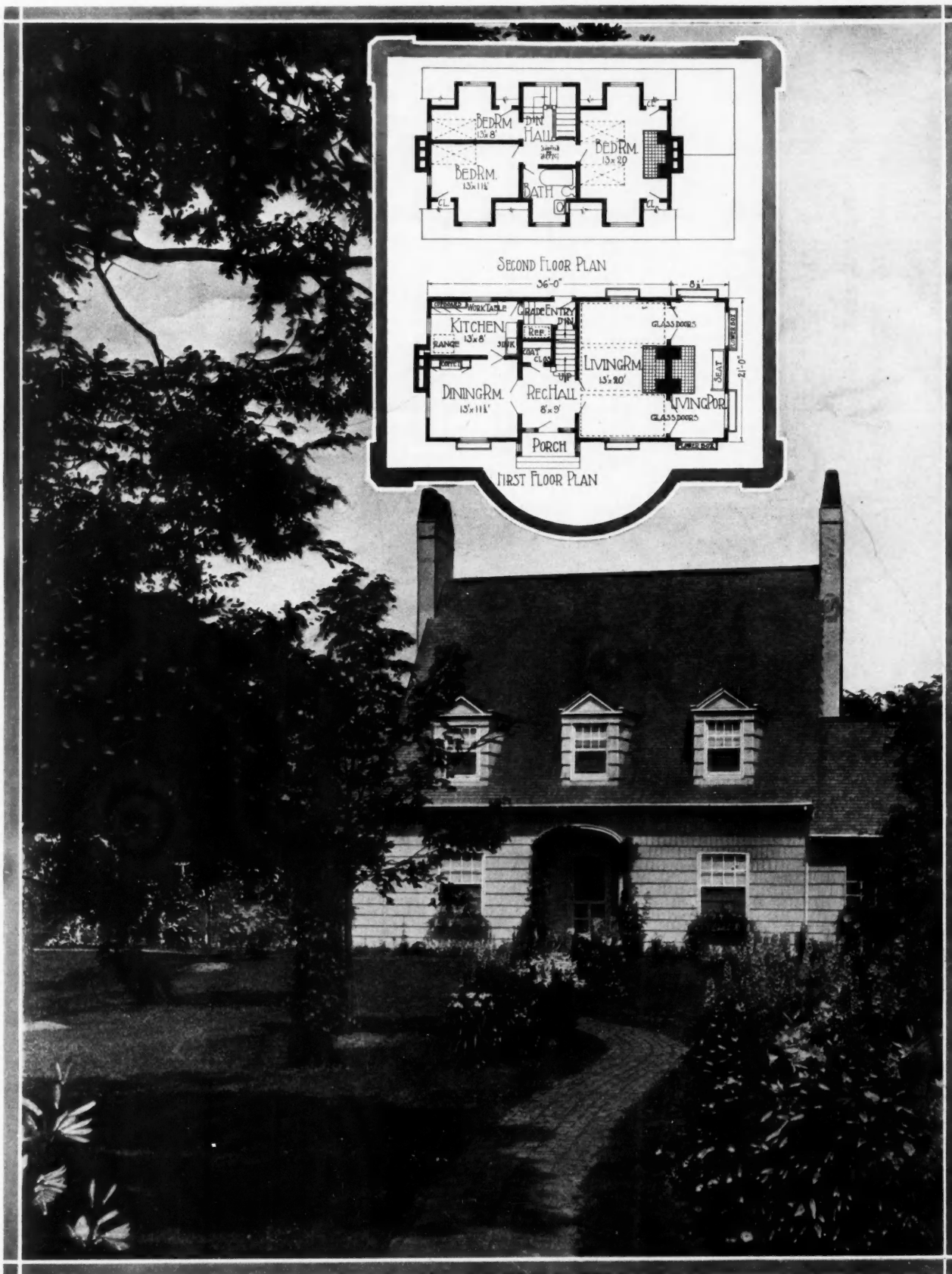

A LITTLE COLONIAL GEM. The popularity of the Dutch Colonial continues stronger than ever. It is in the best of taste and is modest in cost. This one is wide and narrow, has six excellent rooms, besides the fine big sun parlor. The builder doesn't furnish these floral effects, but it's easy to produce them around such a gem of a house.

D
 F
 A
 S
 C
 T
 L
 P
 B
 H
 S
 O
 F
 W
 D
 H
 T
 O
 A

A
 S
 B
 S
 C
 M
 S
 C
 O

HEA
 W
 P
 S
 H
 V
 F
PLU

C
 S
 L
 L
 D
 C

WAT
 W
LIGH
 M
 D
 P
 E
 G

N

 W

 "AM

The "American Builder" Information Exchange

Will Help You With Your Contract Requirements

OUR Information Exchange believes it can render service and save our readers time and money on many of their contracts. We can tell you where to get that unusual item, can place before you full information concerning both standard goods you will need and improved specialties you may want, and can help you to secure prompt deliveries and right prices. Fill in coupon below, pin same to your business letterhead, and we will send all information we think would help you.

We have.....
 We are figuring on.....
 (cross out one not wanted)

entire contract
 heating contract
 plumbing contract
 lighting contract
 painting contract
 masonry contract
 concrete contract
 (cross out those not wanted)

for building checked below and want all data on materials, equipment and specialties we will need.

	SIZE	TO COST ABOUT	Date Work is to Begin or Date Contract is to be Let.
<input type="checkbox"/> Dwelling House (City or Town).....			
<input type="checkbox"/> Farmhouse.....			
<input type="checkbox"/> Apartment House.....			
<input type="checkbox"/> Schoolhouse.....			
<input type="checkbox"/> Church.....			
<input type="checkbox"/> Theatre.....			
<input type="checkbox"/> Library.....			
<input type="checkbox"/> Public Garage.....			
<input type="checkbox"/> Bank Building.....			
<input type="checkbox"/> Hotel.....			
<input type="checkbox"/> Office Building.....			
<input type="checkbox"/> Store Building.....			
<input type="checkbox"/> Factory.....			
<input type="checkbox"/> Warehouse.....			
<input type="checkbox"/> Dairy Barn.....			
<input type="checkbox"/> Hog House.....			
<input type="checkbox"/> Two-Story Granary.....			
<input type="checkbox"/> Other Farm Building (What?).....			
<input type="checkbox"/> Any Other Building (What?).....			

CONSTRUCTION of said building is as checked below:

- | | | | |
|---|--|--|---|
| EXTERIOR WALLS
<input type="checkbox"/> All Frame
<input type="checkbox"/> Stucco
<input type="checkbox"/> Brick Veneer
<input type="checkbox"/> Brick (Solid)
<input type="checkbox"/> Structural Tile
<input type="checkbox"/> Concrete Blocks
<input type="checkbox"/> Monolithic Concrete
<input type="checkbox"/> Stone
<input type="checkbox"/> Glass (Store Fronts)
<input type="checkbox"/> Ornamental Terra Cotta | ROOFING
<input type="checkbox"/> Wood Shingles
<input type="checkbox"/> Asphalt Shingles
<input type="checkbox"/> Asbestos Shingles
<input type="checkbox"/> Metal Tile
<input type="checkbox"/> Clay Tile
<input type="checkbox"/> Slate
<input type="checkbox"/> Composition Roll
<input type="checkbox"/> Built up Tar and Gravel
<input type="checkbox"/> Tin Plate
<input type="checkbox"/> Canvas | SUPPORTING FRAME
<input type="checkbox"/> Stud and Joist
<input type="checkbox"/> Heavy Timber Mill
<input type="checkbox"/> Structural Steel
<input type="checkbox"/> Reinforced Concrete
<input type="checkbox"/> Self Supporting Plank
<input type="checkbox"/> On Concrete Piles
<input type="checkbox"/> Fireproof Floors
<input type="checkbox"/> Fireproof Partitions
<input type="checkbox"/> Metal Lath | INTERIOR FINISH
<input type="checkbox"/> Soft Wood
<input type="checkbox"/> Hardwood
<input type="checkbox"/> Wallboard
<input type="checkbox"/> Marble
<input type="checkbox"/> Metal Ceilings and Walls
<input type="checkbox"/> Metal Doors
<input type="checkbox"/> Metal Windows
<input type="checkbox"/> Metal Trim
<input type="checkbox"/> Metal Grilles, etc.
<input type="checkbox"/> Composition Flooring |
|---|--|--|---|

SPECIALTIES, FIXTURES AND EQUIPMENT NEEDED

- | | | |
|---|---|---|
| HEATING PLANT
<input type="checkbox"/> Warm Air Furnace
<input type="checkbox"/> Pipeless Furnace
<input type="checkbox"/> Steam, Direct Radiation
<input type="checkbox"/> Steam, Blower System
<input type="checkbox"/> Hot Water System
<input type="checkbox"/> Vapor System
<input type="checkbox"/> Fireplaces
PLUMBING
Indicate number of Fixtures needed
Closets..... Bathtubs.....
Shower Baths..... Urinals.....
Lavatories..... Kitchen Sinks.....
Laundry Tubs..... Slop Sinks.....
Drinking Fountains.....
Chemical Closets.....
WATER SUPPLY —for Country Locations
What Capacity Needed?.....
LIGHTING AND LIGHTING FIXTURES
Municipal Service {electricity <input type="checkbox"/>
{gas <input type="checkbox"/>
Do you desire quotation on Fixtures?.....
Private Lighting Plant to be installed,
Electricity..... Acetylene.....
Gasoline..... | ELEVATORS
Passenger..... Freight.....
Dumb Waiters..... Ash Lifts.....
AUTOMATIC SPRINKLER SYSTEM
SCHOOL, CHURCH OR THEATRE EQUIPMENT
Seats, Pews or Opera Chairs.....
Blackboards.....
Library Shelving.....
Rolling Partitions.....
Bank Vaults and Safes.....
Steel Lockers.....
FARM BUILDING EQUIPMENT
Stanchions for..... cows
Stock Pens.....
Stalls for..... horses
Stock Watering Buckets.....
Feed and Litter Carriers.....
Cupola Ventilators.....
Skylights.....
Hay Track and Carrier.....
Barn and Garage Door Hangers.....
Cup Elevators for Corn and Grain.....
Lightning Protection.....
Studding Sockets.....
Roof Windows..... | BUILDERS' HARDWARE
Burglar Alarms.....
Door Checks.....
Casement Adjusters.....
Ventilating Sash Operators.....
Panic Bolts.....
Weatherstrips.....
Coal Chutes.....
Sidewalk Doors.....
Prism Lights.....
Refrigerators, Hotel or Market.....
Refrigerators, Mechanical.....
Fire Escapes.....
Fire Shutters.....
HOUSEHOLD UTILITIES
Garbage Incinerators.....
Package Boxes.....
Disappearing Stairs.....
Disappearing Beds.....
Sleeping Porch Sash.....
Refrigerators, Outside Icing.....
Vacuum Cleaning System.....
Clothes Dryer..... |
|---|---|---|

Note Here Any Special Requirements Not Marked Above.

Name.....

Street No. or P. O. Box.....

Town.....

State.....

We {are are not } acting as Architects as well as Builders on this job.

Mail the above to

"AMERICAN BUILDER" INFORMATION EXCHANGE
 1827 Prairie Avenue, Chicago

See Other Side for Equipment, Machinery, Tools and Building Materials Needed

The "American Builder" Information Exchange

Data Sheet (Continued)

I desire information regarding the Building Materials, Equipment, Machinery and Tools checked, for which I am now in the market.

BUILDING MATERIALS

- | | | | |
|--|---|---|---|
| <input type="checkbox"/> Art Glass | <input type="checkbox"/> Fireproofing | <input type="checkbox"/> Paints, Fire Retardant | <input type="checkbox"/> Sash Pulleys |
| <input type="checkbox"/> Awning Cloth | <input type="checkbox"/> Fireproof Shutters | <input type="checkbox"/> Pipe, Conductor | <input type="checkbox"/> Screen Wire Cloth |
| <input type="checkbox"/> Battens, Metal | <input type="checkbox"/> Flooring, Composition | <input type="checkbox"/> Pipe, Steel | <input type="checkbox"/> Screens, Window and Door |
| <input type="checkbox"/> Beds, Disappearing | <input type="checkbox"/> Flooring, Hardwood | <input type="checkbox"/> Pipe, Warm Air Furnace | <input type="checkbox"/> Sheathing Papers |
| <input type="checkbox"/> Boiler and Pipe Covering | <input type="checkbox"/> Floor Finish | <input type="checkbox"/> Pipe, Vitriified Clay | <input type="checkbox"/> Sheet Metal Work, Galvanized |
| <input type="checkbox"/> Boilers, Heating Plant | <input type="checkbox"/> Floor Hardeners | <input type="checkbox"/> Plaster, Gypsum or Hardwall | <input type="checkbox"/> Shingle Stains |
| <input type="checkbox"/> Bolts, Expansion | <input type="checkbox"/> Floor Hinges | <input type="checkbox"/> Plaster Board | <input type="checkbox"/> Skylights |
| <input type="checkbox"/> Brick, Common | <input type="checkbox"/> Furnaces, Warm Air | <input type="checkbox"/> Plaster Blocks, Partition | <input type="checkbox"/> Slate Blackboards |
| <input type="checkbox"/> Brick, Face | <input type="checkbox"/> Garbage Burners | <input type="checkbox"/> Plate Glass | <input type="checkbox"/> Slate, Structural |
| <input type="checkbox"/> Brick, Fire | <input type="checkbox"/> Garage Door Hardware | <input type="checkbox"/> Plumbing Fixtures | <input type="checkbox"/> Sound Deadeners |
| <input type="checkbox"/> Building Papers | <input type="checkbox"/> Hay Track | <input type="checkbox"/> Prism Lighting | <input type="checkbox"/> Store Front Construction |
| <input type="checkbox"/> Calcimine | <input type="checkbox"/> Heaters, Instantaneous | <input type="checkbox"/> Radiators | <input type="checkbox"/> Structural Steel |
| <input type="checkbox"/> Caulking and Glazing Compound | <input type="checkbox"/> Heaters, Tank | <input type="checkbox"/> Refrigerators, Outside Icing | <input type="checkbox"/> Stucco |
| <input type="checkbox"/> Ceilings, Metal | <input type="checkbox"/> Insulating and Deadening Materials | <input type="checkbox"/> Reinforcing Bars | <input type="checkbox"/> Tanks, Cypress |
| <input type="checkbox"/> Cement, Portland | <input type="checkbox"/> Lighting Fixtures | <input type="checkbox"/> Registers | <input type="checkbox"/> Tanks, Steel |
| <input type="checkbox"/> Coal Chutes | <input type="checkbox"/> Lighting Systems | <input type="checkbox"/> Roofing, built up Tar and Gravel | <input type="checkbox"/> Terra Cotta, Ornamental |
| <input type="checkbox"/> Closets, Chemical | <input type="checkbox"/> Lightning Rods | <input type="checkbox"/> Roofing, Canvas | <input type="checkbox"/> Tile, Clay Structural |
| <input type="checkbox"/> Columns, Porch, etc. | <input type="checkbox"/> Limestone | <input type="checkbox"/> Roofing, Clay Tile | <input type="checkbox"/> Tile, Floor |
| <input type="checkbox"/> Concrete Inserts | <input type="checkbox"/> Linseed Oil | <input type="checkbox"/> Roofing, Ready Roll | <input type="checkbox"/> Varnish |
| <input type="checkbox"/> Creosote | <input type="checkbox"/> Mantels, Wood | <input type="checkbox"/> Roofing, Shingles, Asbestos | <input type="checkbox"/> Ventilators |
| <input type="checkbox"/> Door Track and Hangers | <input type="checkbox"/> Metal Columns | <input type="checkbox"/> Roofing, Shingles, Asphalt | <input type="checkbox"/> Wallboard |
| <input type="checkbox"/> Doors, Hardwood Veneer | <input type="checkbox"/> Metal Lath | <input type="checkbox"/> Roofing, Shingles, Metal | <input type="checkbox"/> Wall Ties |
| <input type="checkbox"/> Doors, Fire-Resisting | <input type="checkbox"/> Metal Lumber | <input type="checkbox"/> Roofing, Shingles, Wood | <input type="checkbox"/> Waterproofing |
| <input type="checkbox"/> Dumb Waiters | <input type="checkbox"/> Mortar Colors | <input type="checkbox"/> Roofing, Slate | <input type="checkbox"/> Water Supply Plants |
| <input type="checkbox"/> Elevating Machinery, Granary | <input type="checkbox"/> Nails, Cut Iron | <input type="checkbox"/> Roofing, Tin | <input type="checkbox"/> Windows, Casement |
| <input type="checkbox"/> Enamel, White | <input type="checkbox"/> Nails, Galvanized | <input type="checkbox"/> Safety Treads | <input type="checkbox"/> Windows, Reversible |
| <input type="checkbox"/> Fireplace Fixtures | <input type="checkbox"/> Paints | <input type="checkbox"/> Sash, Steel | <input type="checkbox"/> Wire Glass |
| | | | <input type="checkbox"/> Wood Dye |

CONTRACTORS' EQUIPMENT

- | | | | |
|---|---|--|--|
| <input type="checkbox"/> Air Compressors | <input type="checkbox"/> Chutes, Concrete | <input type="checkbox"/> Gravel Washing Plants | <input type="checkbox"/> Saw Rigs |
| <input type="checkbox"/> Back Fillers | <input type="checkbox"/> Column Clamps | <input type="checkbox"/> Hoists, Electric | <input type="checkbox"/> Scaffold Brackets |
| <input type="checkbox"/> Bar Benders | <input type="checkbox"/> Concrete Tampers | <input type="checkbox"/> Hoists, Gasoline or Steam | <input type="checkbox"/> Scrapers |
| <input type="checkbox"/> Blocks and Tackle | <input type="checkbox"/> Contractors' Lights | <input type="checkbox"/> House Moving Trucks | <input type="checkbox"/> Screens, Sand and Gravel |
| <input type="checkbox"/> Buckets, Dredging and Excavating | <input type="checkbox"/> Cranes, Locomotive | <input type="checkbox"/> Jacks | <input type="checkbox"/> Shovels, Steam |
| <input type="checkbox"/> Cableways | <input type="checkbox"/> Crushers and Pulverizers | <input type="checkbox"/> Ladders | <input type="checkbox"/> Sidewalk Forms |
| <input type="checkbox"/> Cars, Dumping and Industrial | <input type="checkbox"/> Derricks | <input type="checkbox"/> Loaders, Wagon | <input type="checkbox"/> Tractors |
| <input type="checkbox"/> Carts, Concrete | <input type="checkbox"/> Drills | <input type="checkbox"/> Mixers, Cement and Concrete | <input type="checkbox"/> Trailers, Automobile or Truck |
| <input type="checkbox"/> Cement Block Machines | <input type="checkbox"/> Engines, Gas | <input type="checkbox"/> Mixers, Mortar | <input type="checkbox"/> Transits and Levels |
| <input type="checkbox"/> Cement Ornamental Molds | <input type="checkbox"/> Engines, Steam | <input type="checkbox"/> Motor Trucks | <input type="checkbox"/> Typewriters |
| <input type="checkbox"/> Cement Tile Machines | <input type="checkbox"/> Floor Scrapers | <input type="checkbox"/> Pile Driving Machinery | <input type="checkbox"/> Wagons, Dumping |
| | <input type="checkbox"/> Floor Surfacing, Electric | <input type="checkbox"/> Pumps, Contractors' | <input type="checkbox"/> Wheelbarrows |
| | <input type="checkbox"/> Forms, Steel, for Concrete | <input type="checkbox"/> Salamanders | |

POWER SHOP EQUIPMENT

- | | | | |
|---|---|--|---|
| <input type="checkbox"/> Hand and Foot Power Machines | <input type="checkbox"/> Dry Kiln | <input type="checkbox"/> Grinders | <input type="checkbox"/> Sanders |
| <input type="checkbox"/> Electric Motors | <input type="checkbox"/> Dust Collecting System | <input type="checkbox"/> Jointers | <input type="checkbox"/> Sash Trimmers |
| <input type="checkbox"/> Gas Engines | <input type="checkbox"/> Band Saws | <input type="checkbox"/> Lathes | <input type="checkbox"/> Shapers |
| <input type="checkbox"/> Safety Guards | <input type="checkbox"/> Borers | <input type="checkbox"/> Mortisers | <input type="checkbox"/> Tenoners |
| <input type="checkbox"/> Shop Trucks | <input type="checkbox"/> Saw Tables | <input type="checkbox"/> Moulders | <input type="checkbox"/> Rubbing Machines |
| <input type="checkbox"/> Pulleys | <input type="checkbox"/> Swing Cut Off Saws | <input type="checkbox"/> Planers | <input type="checkbox"/> Cutter Heads |
| <input type="checkbox"/> Glue Pots and Clamps | <input type="checkbox"/> Saw Rigs | <input type="checkbox"/> Bench Planers | <input type="checkbox"/> Machine Knives |
| | <input type="checkbox"/> Combination Woodworker | | |

MECHANICS' TOOLS

- | | | | |
|--|--------------------------------------|---|---|
| <input type="checkbox"/> Augur and Bits | <input type="checkbox"/> Gauges | <input type="checkbox"/> Mortisers, Lock | <input type="checkbox"/> Sharpening Stones |
| <input type="checkbox"/> Braces | <input type="checkbox"/> Gimlets | <input type="checkbox"/> Planes | <input type="checkbox"/> Shingle Nailers, Automatic |
| <input type="checkbox"/> Cement Workers' Tools | <input type="checkbox"/> Grinders | <input type="checkbox"/> Pliers | <input type="checkbox"/> Shovels |
| <input type="checkbox"/> Chests, Tool | <input type="checkbox"/> Hammers | <input type="checkbox"/> Plumbs | <input type="checkbox"/> Squares |
| <input type="checkbox"/> Chisels | <input type="checkbox"/> Hatchets | <input type="checkbox"/> Rules | <input type="checkbox"/> Tape Lines |
| <input type="checkbox"/> Clamps | <input type="checkbox"/> Lanterns | <input type="checkbox"/> Saws | <input type="checkbox"/> Trowels |
| <input type="checkbox"/> Compasses | <input type="checkbox"/> Levels | <input type="checkbox"/> Saw Sharpening Tools | <input type="checkbox"/> Vises |
| <input type="checkbox"/> Files | <input type="checkbox"/> Mitre Boxes | <input type="checkbox"/> Screw Drivers | <input type="checkbox"/> Wrenches. |

Fill in Your Name and Address on Other Side of This Sheet and Mail to

"American Builder" Information Exchange
1827 Prairie Avenue, Chicago

BRICK CONSTRUCTION

for Modern
Carpenters
and Builders

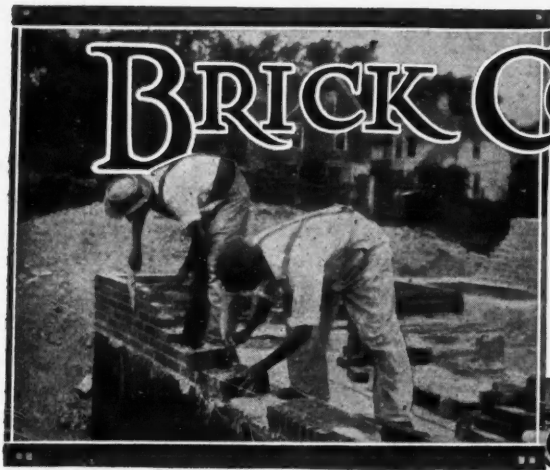
Building on a Two-Story Brick Porch

A BUILDER at Pleasant Plain, Ohio, has put up to us a remodeling proposition that is in considerable demand these days—a two-story porch, the second story to be enclosed for sleeping or sun parlor.

Our Service Department has worked out a very harmonious design in face brick in keeping with the style of the rest of the house. Three square piers support the new porch. The curtain walls are handled in panels to break up

the monotony of so large a blank surface.

The sun porch panels are all glass, so the front rooms are not darkened; in fact, they may be better lighted than formerly. Casement sash are used for these windows.

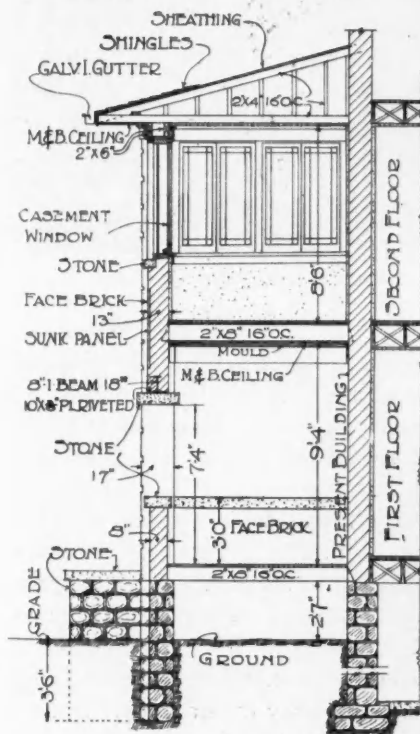
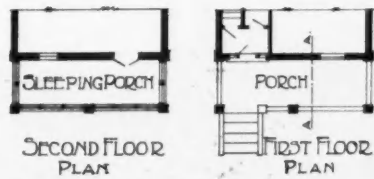

PORCH SECTION A A

Details of Suggested Remodeling Scheme.



Photo of Brick Residence and (Above) Our Suggestion for a Two-Story Brick Porch, the Upper Part Enclosed, as Requested by A. A. Stewart & Son, Pleasant Plain, Ohio.

The Builder as a Fireguard (Second Article)

CONSTRUCTION METHODS HE SHOULD USE FOR RETARDING FIRE—DETAILS OF CHIMNEYS AND FLUES

By Ralph W. Ermeling, Architect

MORE fires in every state in the Union originate in defective chimneys than from any other single cause. This includes flues and stovepipe connections.

Chimneys are built of masonry and metal—both materials excellent conductors of heat. Woodwork is often placed in direct contact with the chimney. Sometimes the chimney is used for support when the woodwork is framed into it. The wood, exposed to constant heat, becomes tinder. When the chimney is old it is not unusual for chinks or open spaces to appear in the joints of the masonry, or the metal rusts out. With red hot sparks passing thru the flue it does not take much imagination to realize that the fire department may be called on at any time. If the house is not within reach of a fire department so much the worse for the house, the people and things in it.

Proper chimney construction is the most important structural feature in reducing the chances of fire.

Another hazard is the use of terra cotta, sewer pipe or other unprotected tile for a chimney, without surrounding this flue lining with brick or stone. A flue lining is a lining only and does not constitute the structure of the chimney. Building chimneys with brick set on edge is unfortunately all too common in some parts of the country, and it is very little better than the unprotected tile chimney. The walls of dwelling house chimneys used for stoves, fireplaces or heating furnaces—irrespective of the fuel used—should never be less than four inches thick, and should always be lined with fire clay or terra cotta lining. The use of sewer tile or other clay or concrete tubes is dangerous, as they are very liable to cracking on account of unequal expansion of the material itself. The lining should start from the bottom of the flue or from the throat of the fireplace, and be carried up continuously the entire height of the flue. The most dangerous part is at the hottest point—hence the need for the best protection where the fire enters the flue.



Brick Masons Lay Up Their Walls Carefully and Fashion Strong Arches Over Temporary False Work or Centers.

One of the reasons why chimneys are such fruitful—if not frightful—sources of fires is the lack of flue linings. Lining of flues prevents the disintegration of mortar and bricks due to fuel gases and temperature expansion. Flue linings should be one inch thick, without collars. They should be set in cement mortar with the joints struck smooth on the inside, the purpose of these precautions being to form a perfectly smooth, tight passage for the heat, flames and gases so that there can be no lodgement of hot soot or sparks to cause trouble. All spaces between the brickwork and lining should be filled with mortar. Rectangular flues are more suitable than round ones for the reason that they fit the flue space better and produce a stronger chimney.

If brick chimneys are not lined they should be at least eight inches thick, and the walls of stone chimneys built at least four inches thicker. This is for the ordinary dwelling house. Increase should be made for larger buildings. Lack of flue linings, however, seem to be almost without reasonable excuse, as their use—when properly installed—is a great protection, and to that extent a form of insurance. To line the chimney is the cheapest in the end. Only lining made for the purpose and adapted to withstand high temperatures should be used.

An illustration, both in section and elevation, is given opposite of standard chimney construction. Build the floor arch and hearth for a fireplace at least 20

(Continued to page 170.)

DETAILS OF FIRE-RETARDING CONSTRUCTION

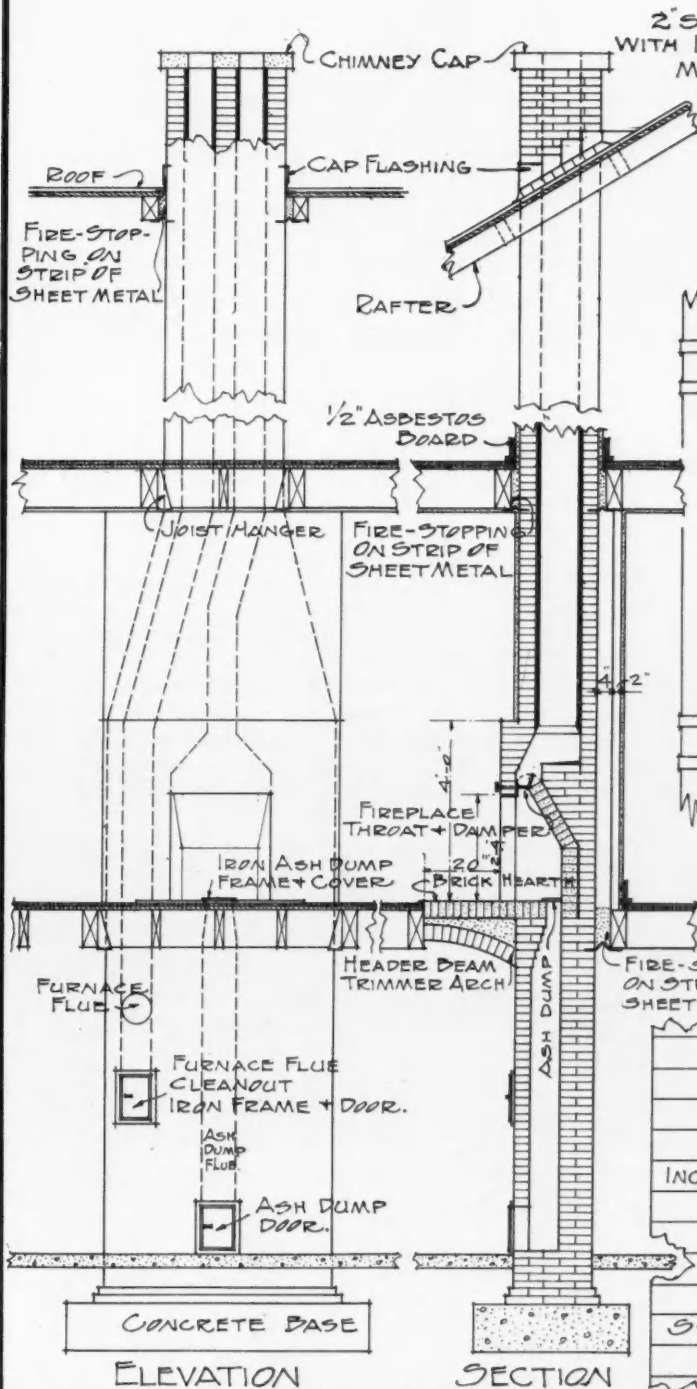

ELEVATION AND SECTION OF AN INTERIOR INDEPENDENT CHIMNEY SHOWING RECOMMENDED CONSTRUCTION.

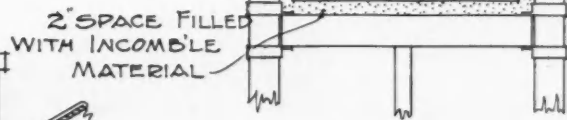

FIG. NO. 1
FIG. #1 SHOWING ORDINARY FLOOR FRAMING AROUND A CHIMNEY ALL TIMBERS 2\"/>

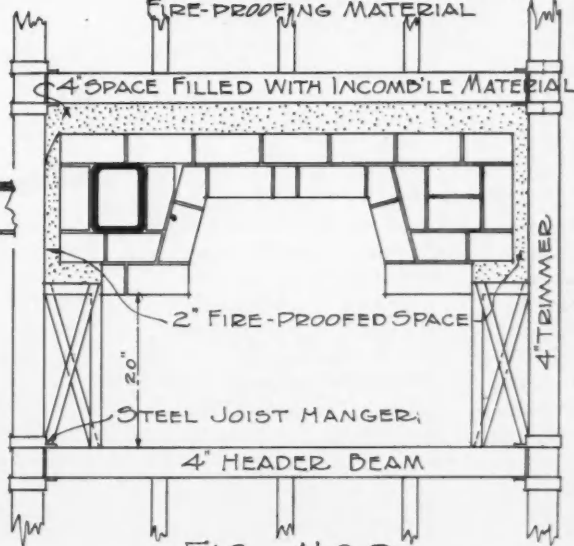

FIG. NO. 2
FLOOR FRAMING AROUND A SINGLE FIREPLACE. NOTE FILLING BETWEEN FRAMING AND BRICKWORK, WHICH SERVES BOTH AS INSULATOR AND FIRE-STOP.

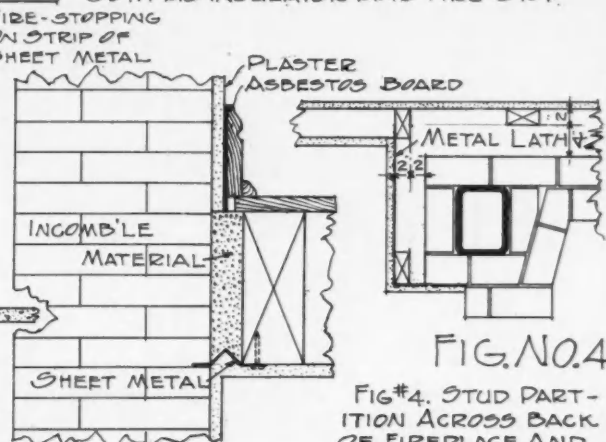

FIG. NO. 3
FIG. #3. SHOWING SUPPORT OR FIRE-STOPPING AROUND CHIMNEY AND PROTECTING WOODWORK.

FIG. NO. 4
FIG. #4. STUD PARTITION ACROSS BACK OF FIREPLACE AND AROUND THE ENDS OF CHIMNEY BREAST, SHOWING PROPER METHOD OF ARRANGING STUDS.

Narrow-Lot Brick Bungalow

Here is illustrated an inexpensive five-room bungalow. The width is 25 feet 6 inches and the length is 54 feet 9 inches, which includes two porches in the rear and a veranda reaching across the whole width of the front.

The bungalow is planned for the north side of the lot facing east, altho it might be placed on the left side of any lot. The idea is to place the living room on the open side of the house, looking towards the sun, on the general plan of admitting all light and sunshine possible to rooms that are used the most.

The plan of this brick bungalow is especially well liked because of the extra large living room, which when open thru to the dining room, makes one grand room 25 feet in length. Many details, such as built-in buffet, book shelves at the side of the fire-place, beam ceilings, recessed windows and special folding doors, add very much to the comfort and attractiveness of this large, airy, sunny room.

One straightaway roof covers the house, front veranda and the two porches in the rear. It is well known by all builders that this style of roof is cheaper to build than separate roofs for the projections. In this design the roof looks well because it is in keeping with the general character of the house.

Brick veneer works well in the construction of this bungalow. Bricks are porous. A four-inch veneer of brick will admit air enough to preserve the inner woodwork. This percolation of air also is sufficient to prevent dampness. For this reason bricks should

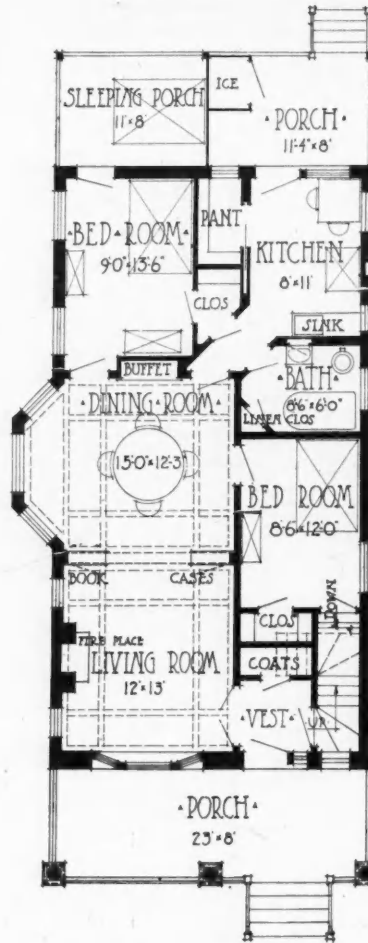

Floor Plan of Bungalow, Size 25 Feet 6 Inches by 54 Feet 9 Inches.

not be painted. One reason for using brick is economy in the saving of paint. At the same time all outside woodwork in connection with a brick house

requires touching up oftener than a wooden house because of the necessary contrast between the rough, dull brick toning and the smooth, polished, bright paint surface of the woodwork.

Red brick gives a warm tone to a house, which is another recommendation for the colder sections of the country. It also looks solid and substantial, which adds a certain sentimental value beyond the additional cost. The brick mason, of course, must thoroly understand the laying and anchoring of brick when it is used for this purpose.

The width of foundation wall is enough greater to allow for the four-inch veneer course, besides a water table rather wider than is usually figured for wooden houses.

The rear sleeping porch in this design is a greath health preserver. Those who sleep every night outdoors seldom or never suffer from colds.

Sleeping porch furniture is simple. It usually consists of a wide swinging seat hung by four chains from the ceiling. It is wide enough and long enough for comfort and it has ends and a back high enough to hold pillows and bedclothes and to keep them from sliding down on the floor.

These are several minor details that will interest both owners and builders.

The sliding pantry door, the ice box in the far corner of the back porch, the arrangement of kitchen furniture, the small front hall with its liberal coat closet and built in stairway, all carefully thought out and adopted because of their fitness in a house of this design.

Another unusual feature is the newel and balluster design of the front steps.

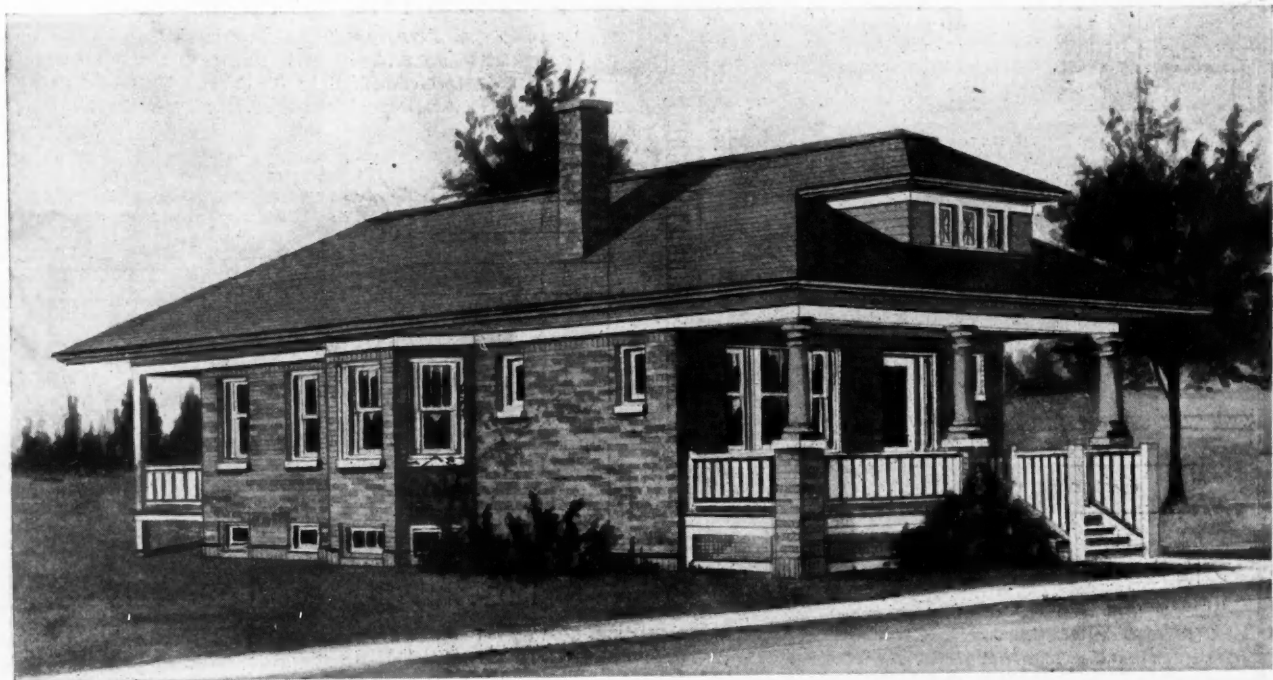

An Attractive Brick Bungalow of Five Rooms Designed to Go on a 30-Foot Lot.

C
cons
mist
able
avail
Co
you
of a
to bu
Th
use in
5 by
After
plan
matin
Sta
walls,
from
result
to Ta
requir
8 by 5
thick.
5½ in
under
require
would
up in
remain
Divic
by the

STRUCTURAL TILE WORK

for Houses, Farm Buildings,
Stores, Garages, etc.

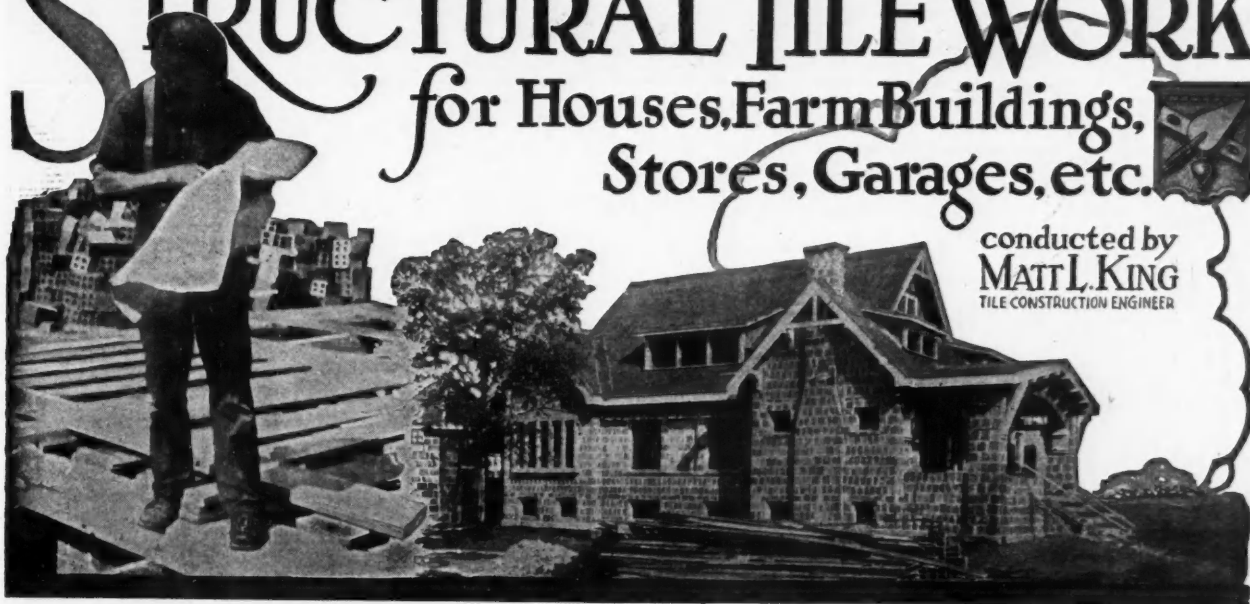

conducted by
MATT L. KING
TILE CONSTRUCTION ENGINEER

How To Estimate the Cost of Tile Structures

By C. A. Willson

Engineering Department, The Permanent Building Society

CONTRARY to the opinion held by a large number of people, the difference in cost between tile and wood structures is very small and is constantly decreasing. One of the reasons for this mistaken belief is the fact that very little, if any, reliable data regarding the cost of tile structures is available.

Consequently, this article has been prepared to enable you to estimate, with considerable accuracy, the cost of any tile structure you might have an opportunity to build.

There are four different sizes of blocks in general use in residence or farm buildings work: namely, 4 by 5 by 12, 4 by 8 by 12, 8 by 5 by 12 and 8 by 8 by 12. After the choice of blocks has been made and the plan decided upon, you are ready to commence estimating.

Start in by figuring the total area of the outside walls, including foundation and footing. Subtract from this the sum of the areas of the openings. The result will be the area of wall surface. By referring to Table I you can easily find the number of blocks required. For instance, suppose you are going to use 8 by 5 by 12 block, to be laid up in a wall 8 inches thick. This would make the height of the course $5\frac{1}{2}$ inches, including the mortar joint. In the table, under $5\frac{1}{2}$ inches, we find 2.1 the number of blocks required per square foot of wall. This same factor would be used in the case of 4 by 5 by 12 blocks laid up in a 4-inch wall, since the height of the course remains $5\frac{1}{2}$ inches.

Divide the number of blocks by 1,000 and multiply by the price per 1,000 (quoted you by your local

dealer), and you will have the cost of blocks.

The next item to be considered is the amount of mortar required to lay up blocks of different sizes in walls of varying thickness. By referring to Table II or Table III you will find the exact amount of cement, sand and lime putty required per 1,000 blocks. In Table II an allowance of 10 per cent is made for waste, while in Table III 20 per cent is allowed. The former should be used when estimating jobs when the work will be done by experienced masons. Table III is used by the writer in estimating material for farm buildings where the services of experienced masons cannot be secured, and should be used only under these conditions. Since 1 cubic yard equals 27 cubic feet and 1 barrel of lime will make 8 cubic feet of lime putty, it is a simple matter to find the total cost of materials, knowing the price per sack of cement, the price per cubic yard of sand and the price per barrel of lime.

Lintels over windows and doors are usually made by placing reinforcing in the lower corners of a row of blocks long enough to span the opening and then filling the blocks with concrete. The following data may be found useful in estimating the cost of these lintels: The lintel should be long enough to span the opening and to have a bearing 1 foot on each side. A lintel spanning an opening 4 feet wide, or under, should be reinforced by $2\frac{3}{8}$ -inch square deformed steel bars; a lintel spanning an opening 8 feet wide, or under, should be reinforced by $2\frac{5}{8}$ -inch square deformed steel bars.

From the foregoing information it is a simple mat-

(Continued to page 146.)

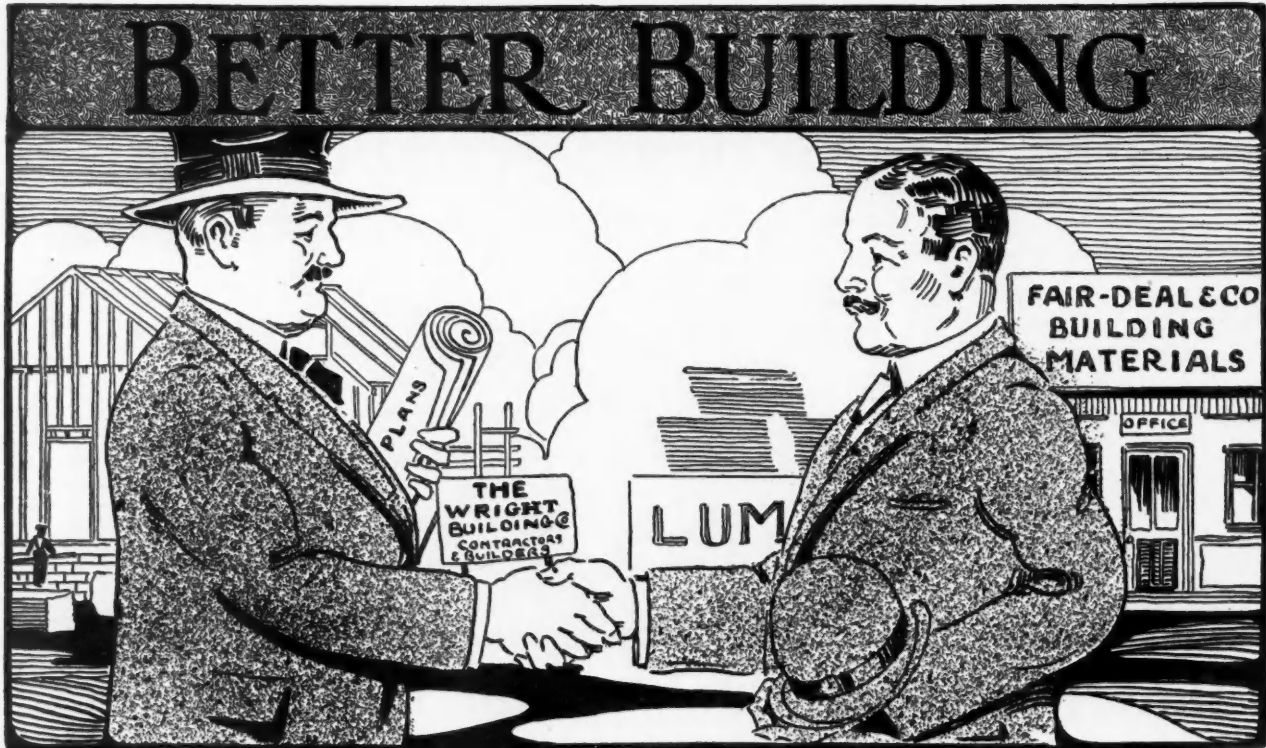

Retail Lumber Advertising I Have Met

By Wm. Reuther

NOT so many years ago, retail lumber advertising was an unknown quantity. They had lumber and millwork to sell and if people wanted it they knew where they could come and get it. In many cases they were like the country grocer who had a small room back of his store where he and one of his friends played checkers to pass away the time. Every time a customer came in, the grocer would say to his friend: "Be quiet; perhaps they won't know we are here."

This condition is rapidly passing away, as the retail dealers are realizing that if they don't go out after the business there will soon be no business to go after. They realize that the old, slow way of waiting for people to come is a thing of the past. They realize that the average man is like the old darkey and his leaky roof. When it rained he couldn't fix it, and when it didn't rain, it didn't need fixing.

As a result, some of the best advertising by retail merchants today is being done by retail lumbermen.

When I say "best advertising," I do not mean they spend the most money, but they are using a good mixture of brains and money in whatever advertising they do. I believe this is largely due to the educational work done by trade magazines. There are but few lumber offices in the country today that do not take one or more magazines pertaining to their work. That

these magazines are being closely read is proven by the more practical and business-producing advertising which is being used by the retail lumber dealers today.

They realize that advertising should result in increased sales and is not merely a way of spending money. I remember one lumber dealer who informed me he had spent all he could afford for advertising, and I asked him what he used. "Well," he said, "I bought a barrel of candy and am going to give it to the children." Now that was good advertising for the local doctor and dentist, as they will get business from it, but I fail to see where it will help him sell more building material.



The Ones Who Complained Most About Advertising Had Never Done Any.

When I first went out among the dealers, talking advertising, I was met with the remark: "Advertising is no good. It never did anything for me."

Upon questioning these dealers closely, I was reminded of the man who always complained about his wife asking for money. "Why," he said, "she asks me for money every morning and every evening. In fact, she bothers me all the time." A friend asked him what she did with all the money. "Well," he said, "I haven't given her any yet."

And so it was with these retail dealers. The ones who complained most about advertising had never done any.

Today retail lumber advertising is being put on a sound business basis. Every dollar that is spent must show results. The advertising that is being done, talks the use of building material. This advertising is in the form of plan books, posters, newspapers, sign boards, circulars and service rooms. Each plays an important part in the building up and the maintaining

a few inquiries for any article, you may be sure there are a large number of people wanting the same thing if they only knew about it.

A dealer in Illinois had two inquiries for implement sheds from these books, so he figured out the exact cost of the material and advertised the complete bill for so much money. He sent out five hundred circulars to his customers and sold eighteen. That is the

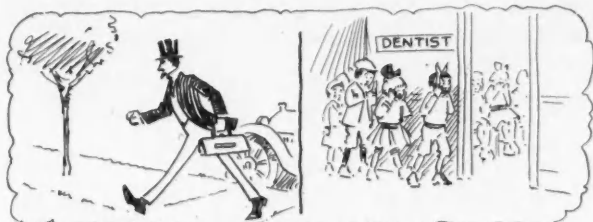

Referring to Advertising—"Well," He Said, "I Bought a Barrel of Candy and Am Going to Give It Away to the Children."



He Was Turning Over His Stock, But Not the Way They Supposed.

principle of advertising. Find out what people want or need, and let them know you have it.

Another dealer in Minnesota had a great reputation among farmers for furnishing clean lumber. I called on this dealer and he told me the secret. He said, when he first started he didn't do much business, but during his spare time he would go into his lumber shed and turn over the lumber so the dust wouldn't settle on any of the boards. As a result he always has clean lumber to send out, and the farmers thought he must be doing an enormous business to always have fresh stock. He was turning over his stock, but not the way they thought. Today he has about ten yards, and makes his men keep the stock clean. That's another way of advertising, and only costs a little work.

of a permanent business. All of these should work together.

As an illustration, I recall a dealer in Iowa who had purchased some plan books on farm buildings, and after distributing them to his farm trade, received, among others, several requests for portable hog houses. The average farmer does not have the time to do much carpentry work, so this lumber dealer made a contract with one of the local carpenters to make a number of these portable hog houses, and the dealer wrote a letter to his farm trade, making a price for them complete, with the result he sold all they could build.

Lumber dealers today are planning their advertising as systematically as any other part of their business. They realize it is just as necessary to get the building material out of their shed as it is to get it in. Many of them are putting aside a certain per cent of their year's earnings for advertising. This puts it on a strictly business basis, as the volume of business they do governs the amount to be spent for advertising. This is also a safeguard against some silver tongued spell binder who has a high priced advertising service to sell which would be as suitable for the town as the Woolworth Building.

Human nature is the same all over, and if you get

Accounting, Credits and Display

PROPRIETORS OF SPAHN & ROSE LUMBER CO. EXPLAIN ACCOUNTING SYSTEM THAT KEEPS STOCKS LEVEL AND SPEEDS UP TURNOVER—TO MAINTAIN VOLUME, LUMBER DEALERS MUST HANDLE OTHER BUILDING SUPPLIES AND SPECIALIZE

THE Spahn & Rose Lumber Co. has twenty-five building material yards located in Iowa and Illinois, with the main yard at Dubuque, Ia. "As a guide in purchasing supplies for the different yards," said G. D. Rose, secretary and treasurer, "we use what we call a Summary Sheet for each yard. The quantity of each item sold is readily ascertained from these sheets, as they show the inventory as of January 1, 1916, plus the purchase for 1916, as taken from the invoices, minus the inventory of January 1, 1917. In addition to this, the sheet shows the average annual sales over a three-year period for each item. When we get ready to purchase, say, a three months' or six months' supply, we instruct our yard managers to send in estimates of the materials needed for that period and to refer to the summary sheets to estimate the amount rather than to guess at it. Then we use copies of the same sheets in the main office to check up the branch managers' estimates. This enables us to keep our stocks level—that is, not to have an over-supply of one item and an insufficient supply of some other item. Incidentally, it speeds up our turnover and cuts out the possibility of dead stock. Our purchasing agent can go down the summary sheet and see item for item just what is needed. For example, we recently reached the conclusion that prices on a specialty we handle were going to advance, and the salesman selling the specialty suggested that we order fifteen cars of this material. Off hand, we would have

thought fifteen cars the right amount, but before ordering we referred to our summary and saw that we had considerable of this stock on hand, as the previous year had not shown sales of the usual amount. A careful check showed that instead of fifteen cars, we needed only four. It is in this way that our summary sheets serve as a guide, not only against over-buying, but also against under-buying, which is equally bad if we are making purchases just as the market is right.

Definite Credit Terms Reduce Losses

"We instruct our branch managers to get definite terms of payment before selling any goods. The cashier in our main office makes a record of these terms and as soon as accounts become overdue, he takes up the matter with the yard managers, while the auditors, who also act in the capacity of advisers, follow them up during their visits to the different yards. These terms must be lived up to, and we are now charging interest on all past due accounts. Instead of employing a special collection agency for old accounts, we have formed an agency of our own which handles these matters.

"We came to the conclusion some years ago that it is up to the lumber dealer to handle other building supplies, specialties and necessities, for unless he does, someone else surely will. With the many sidelines now coming into the market, and with an active

(Continued to page 158.)



Sales Room and Display Room in One of the Spahn & Rose Lumber Co. Yards Where Important Specialties Are Demonstrated to Possible Customers.



Young Bros. of White Plains, N. Y., Make a Very Neat Display Along One Wall of Their Office of Face Brick Panels Laid Up in Various Bonds and Mortar Joints, of Natco Structural Tile, and of Millwork Cross-Sections Tacked to a Display Board.



How Kent Garvin & Co., Canadian Supply Dealers, Make Their Neponset Wall Board and Shingle Display Serve a Double Purpose as Telephone Booth and Information Desk. The Asphalt Shingles Are Shown as They Actually Appear on the Roof; and the Use of Wall Board Panels Is Demonstrated.



DISPLAY LUMBER! Most Dealers Will Tell You That There Is Nothing About Lumber to Display; But When You Come to Think of It There Is No Commodity That Deserves Closer Study. How Many Lumbermen or Builders, to Say Nothing of the General Public, Know Enough About Grades to be Always sure? This Display at an Exposition Was Calculated to Teach Grades of White Pine.

"There's a diligence that arrives regardless of obstacles"

—THE MAN FROM THE LUMBER YARD

Hamlet said, "There is a divinity that shapes our ends, rough hew them tho we may." We believe The Man from the Lumber Yard, not Hamlet, states the truth. EDITOR.

I WAS very much interested in watching the construction of one of Uncle Sam's cantonments, and especially the men doing the manual labor. There was such a rush, so many working; so little of organization, comparatively speaking; so little in the way of incentive for making a record, and no incentive from the standpoint of pay, that the individual effort depended on each workman.

I mixed with the boys a good deal and was generally able to eat my meals with them. You know that all of us animals are the least on the defensive when we feed.

Some of the workmen boasted of the fact that they were having a soft time. One chap stated he could get by and lay only 400 square feet of siding a day. There were many workmen who were proud of their records. One was keeping up an average of 800 square feet per day. This fellow was not pulling down any more coin than the 400-man, but he was developing a WILL, and mental as well as physical vigor, that will count in days and years to come.

The 400-man is tickled because he thinks he is putting it over on the boss. He is too flabby in his top story to know that he is the big loser. Dollars to doughnuts the 800-man will go up the ladder of success.

There is a diligence that arrives regardless of obstacles. Barring a reformation, and the unusual, the 400-man will still be driving nails ten years hence, if he isn't shoveling coal for his majesty of the lower region. He believes in luck and will curse his luck that keeps him down.

The Busy vs. The Tired Builder

Idleness, the theatre, or the chop suey joint are not the only recuperation for brain or body-fag. Not only are these liable to lead into wrong social chan-

nels, but into a wrong attitude toward health. A worker thinks he is worn out and needs diversion.

True, he does, but this diversion may be in lines as beneficial and profitable as his regular vocation. I have met some tired builders and they never were very busy builders.

I have met many busy builders, and very few were ever complaining of that tired feeling.

Big Success in Small Towns

Some people have an idea that large success can come only where large populations are centered.

There are successes, and successes, and I really believe that more real successes are to be found in the medium and small towns, than in the cities.

We have a large number of readers along the Iron Mountain R. R. that hugs the west bank of the Mississippi river as it pokes its nose out of south St. Louis, and goes on its way to Little Rock thru a glass manufacturing section over the mountain of iron from which it took its name. Its feeders reach out to Sikeston, which lies at the head of a valley as fertile as the section of the Nile, to Jonesboro whence comes the handles used in many tools advertised in the AMERICAN BUILDER, to Doniphan, Mo., and Batesville, Ark. There is nothing of special interest in these towns, save the people you would find in the flint hills between. Shoes are not worn by the women, not only because of economy but primarily because of comfort. It is stated that the soles of their feet have acquired such properties that they can sharpen their butcher knives on them, which curtails the sales of Carborundum stones in that section. Don't think for a moment, that

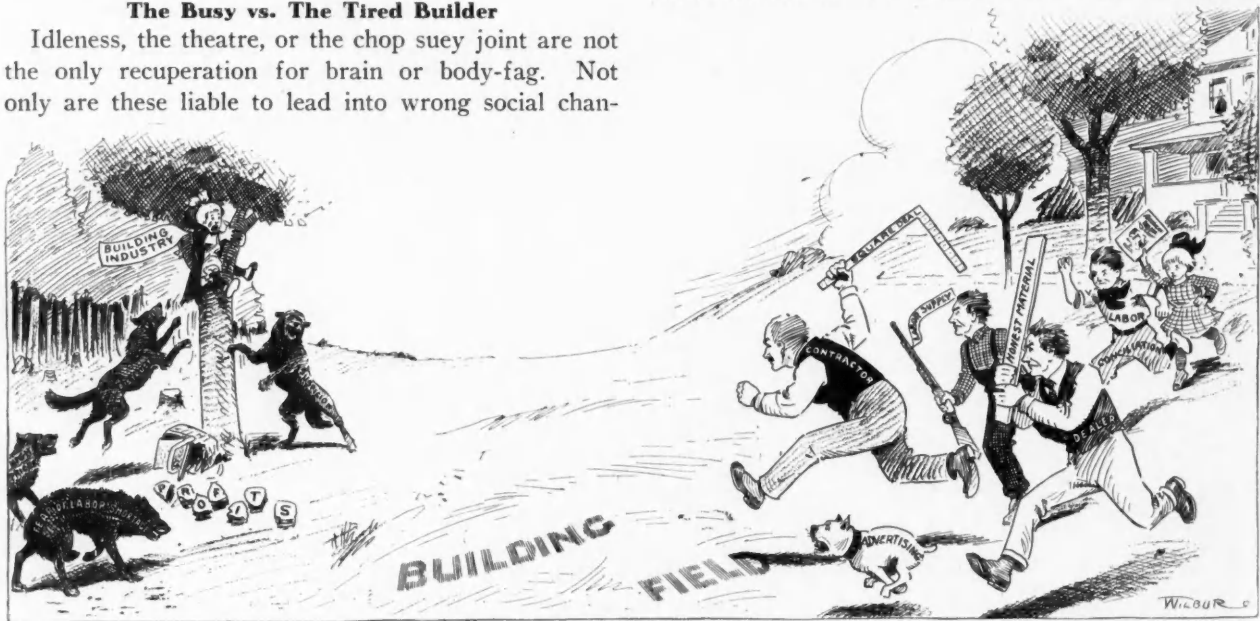

"SAVE THE CHILD." Can Anyone Give a Logical Reason Why There Should Be a Continuance of Conditions That Eat the Profits and Keep the Building Industry "Up a Tree"? A Clean Square Deal, Honesty in Spirit as Well as in the Letter and Sincerity in all Things Will Eventually Free the Building Trade of the Wolves of Suspicion and Distrust.

Missouri and Arkansas don't produce doers.

I met some live propositions. In a town of less than 2,000 people is a live wire builder.

He is not only a live wire but is a wise guy. My friend from the "show me" town not only keeps himself up to date and consequently keeps busy but he knows how to keep from getting stale. He spends some time in fraternizing with his competitors in his own town and adjacent towns, to the benefit not only of himself but also of his competitors. Jobs are not taken in that section at a loss. This fraternizing work is wholesome.

One need not grow stale even when constantly employed with physical work or mental activity, provided only that he learns the value of changing from one type of work to another. The main thing is to set your heart on that which

will aid you on your way to YOUR GOAL, your ambition.

"The Truth of It"

No matter what you believe, no matter how you wish it, facts are facts. Truth doesn't change until facts change.

This thought was emphasized at a recent confer-

(Continued to page 146.)

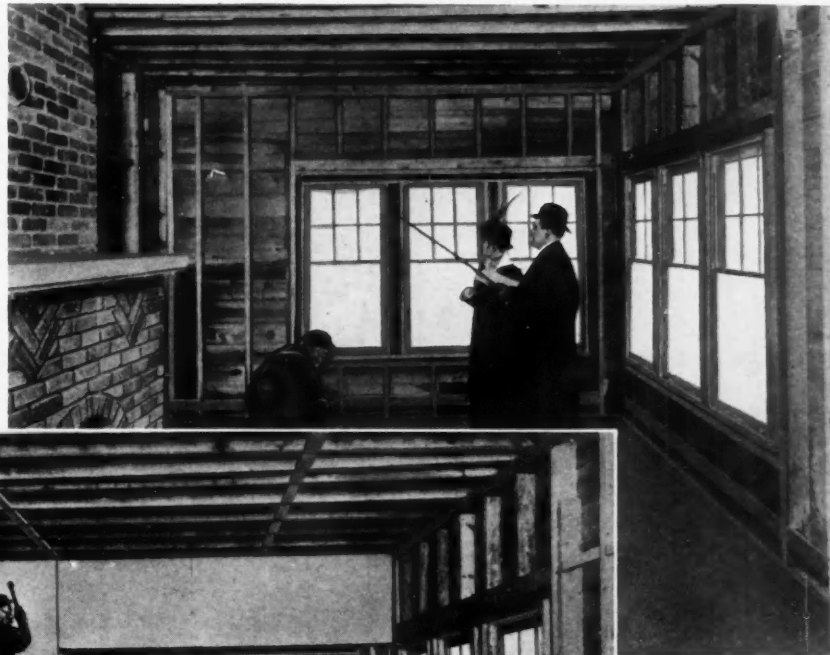

Photo Above — The Carpenter Is All Ready to Begin Putting Up the Wall Board.

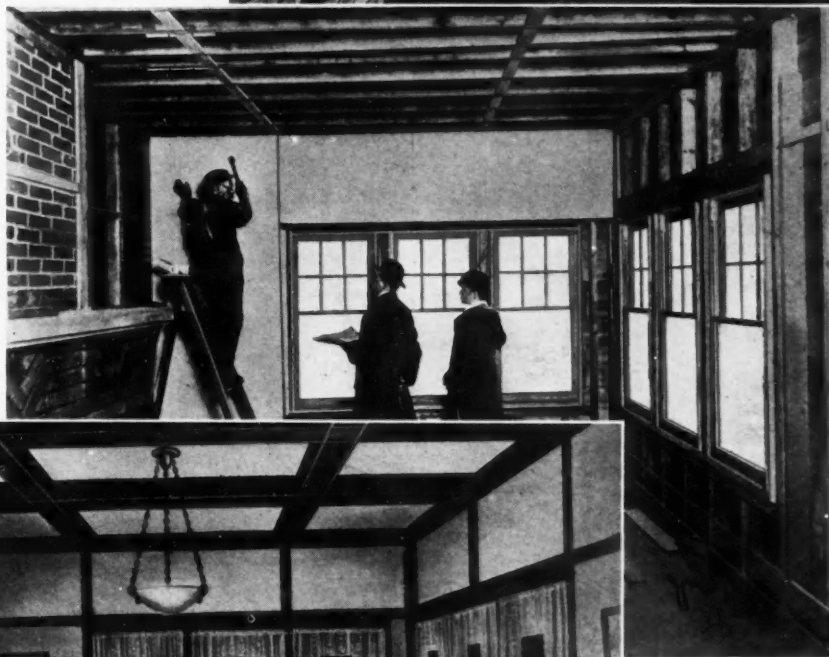

Photo Above — The Wall Board Goes Up Quickly and Easily in Big Sheets.



Photo Above—The Finished Room is Neat, Cheery, Snug, Artistic. Thanks to Wall Board It Was a Quick and Economical Job.

Wall Board for Interior Finish

WE KNOW of several fine homes built this fall and finished thru-out with wall board. They are designed for wall board construction, not for lath and plaster, and so were more than usually successful.

The editor will gladly send blue-prints of wall board details to any reader on request.



Model Home Designs



Artistic Shingled Bungalow

The accompanying perspective view and floor plan present a style of house that has found great favor during recent years. This is a residence style that builds the attractiveness of the bungalow design into a two-story residence. This plan shows some new and pleasing features. Some of the attractive details are the drive with two side entrances; the wide porch, commanding a sweeping view; the folding doors just off the dining room, giving an outdoor eating place; the attractive den; the novel openings between the hall, living room and dining room; the economy of space used in building the main and service stairs; the arrangement of the kitchen, which tends to give maximum efficiency in the preparation and service of meals.

On the second floor the arrangement of the bed rooms and the sleeping porch gives a maximum of usefulness. There are large, roomy closets in each room and a special feature of the front room is the dressing room with a triple mir-

ror. All of the closet doors have bevel plate mirror panels.

The kitchen is fitted with a built-in cooler, bins, wood lift, ironing board and sundry cupboards. There are no cut-up moulds or useless trim to catch dust and make a burden for the housewife to carry.

The exterior finish is spruce siding,

rough side out, stained brown. The interior is Douglas fir, stained golden oak to preserve the figure of the wood. The dimensions, exclusive of the porches, are 34 feet by 43 feet. This house was erected for J. C. Sprague at Corvallis, Oregon, at an approximate cost of \$5,000. It was designed and built by C. L. Heckart, Corvallis, Oregon.

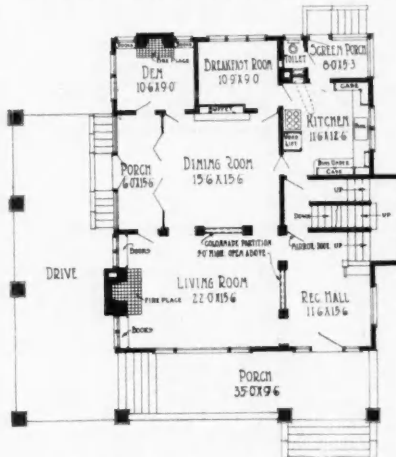

First and Second Floor Plans of House Shown in Perspective Below. Size, 34 by 43 Feet.



Residence in Which the Attractiveness of a Bungalow Has Been Built Into a Two-Story House. Designed and Built by C. L. Heckart of Corvallis, Oregon, for J. C. Sprague.

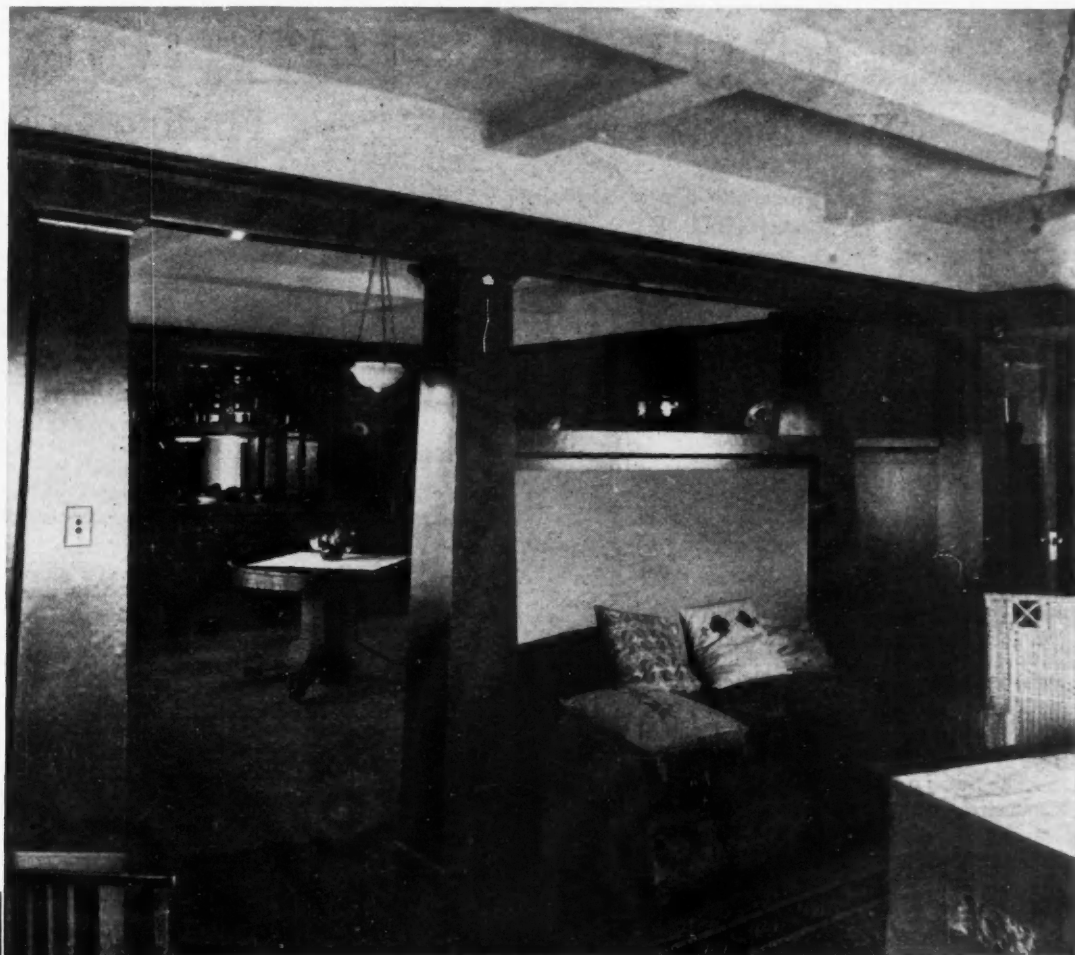

Upper View—Showing Colonnade Partition Between Living Room and Dining Room and the Dining Room Buffet in the House Shown on Opposite Page. Built by C. L. Heckart, Cornallis, Oregon.
Lower View—Kitchen Sink, One of the Built-In Cases and a Portion of the Work Table with Drawers and Cabinets Beneath.

OUT ON THE JOB

What Builders are Finding Good

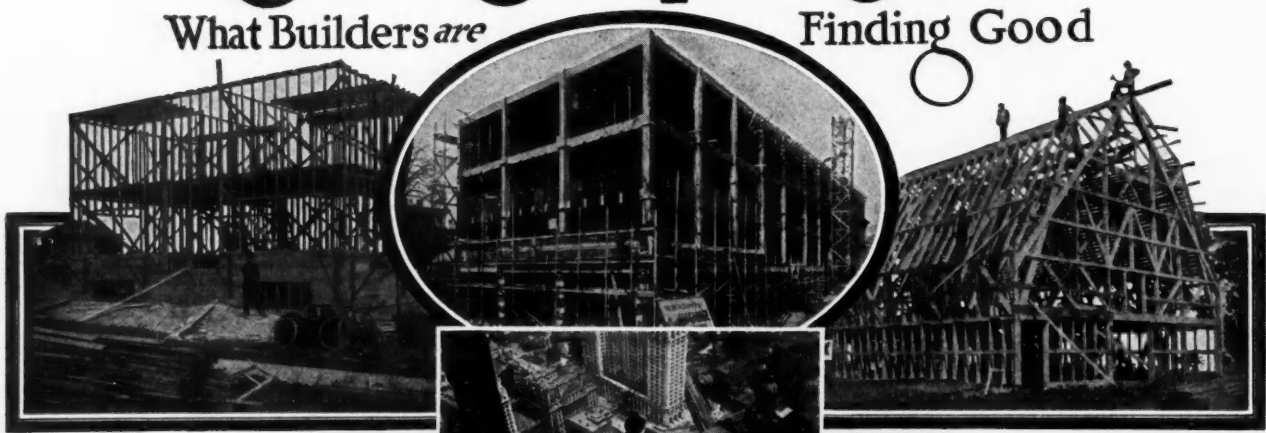

EDITOR'S NOTE: The American Builder does not accept payment in any form for what appears in our reading pages. In order to avoid any appearance of doing so, we omit the name of the maker or

seller of any article we describe. This information is, however, kept on file and will be mailed to anyone interested; address American Builder Information Exchange, 1827 Prairie Ave., Chicago.

Electric Glue Pot Saves Time

The small glue pot shown in the illustration is portable and electrically heated. Its use is an advantage to the workman in a great many gluing operations both because of the fact that the pot may be placed where it is easy to reach, releasing one hand at all times to handle the work, and because the glue is always at the proper temperature. In the case of extensive gluing of small pieces, requiring close attention to the work, it has the added advantage that it eliminates interruption of the work, which is necessary if the glue is heated at some fixed point in the shop.

It is always an advantage to have the best light possible on all work. The portable electric glue pot makes it possible to work for any length of time where the light is best for the work. Wall outlets are installed wherever it might possibly be an advantage to do this work. The glue pot may then be used where it will be most handy. It is possible to connect the pot with any lamp socket, but this is

usually unsatisfactory either because of the difficulty of making such a connection or because it disturbs the lighting of the work. There is a sufficient length of insulated wire connected with the heating unit of the pot to provide a wide working radius about the wall outlet and this wire may be extended if it is necessary.

The operation of the heating unit is similar to that of any portable electrically-heated device such as a coffee pot. In use it is simply connected with the wall outlet or lamp socket and the current is turned on. It is estimated that one cent's worth of electricity at 10 cents per kilowatt-hour will keep a half-pint glue pot hot for five hours.



Miter Box With One-Piece Bed and Back

The frame of the miter box shown in the illustration is of special interest in that the bed and back are cast in one piece. The plates, being machined as an integral part of the frame, must be straight and square, affording a rigid base for the work and insuring accuracy in operation. The ribs are raised $\frac{1}{8}$ inch above the surface to allow clearance for sawdust under as well as behind the work. These ribs are also effective in preventing slipping.

Length gauges, placed at each end of the frame for cutting duplicate lengths up to 18 inches, are set on swivels and may be swung and clamped behind the frame when not required. They may be used as back rests for cutting acute angles,



Small Size Electric Glue Pot Adapted to the Needs of the Average Carpenter's Shop.

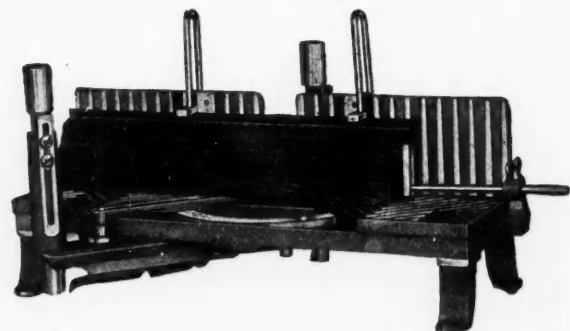

Improved Miter Box, Showing Crown Moulding Held in Place by Stock Gauges and One Length Gauge in Position.

increasing the range of the box. They may also be used for holding curved or irregular shaped pieces. The stock gauges on the back of the frame, which are used to hold crown moulding and long pieces, may also be swung out of the way and clamped behind the box when not required.

The graduations of the scale are large and clear and being cut directly into the frame, will maintain their correct position. The saw guides are provided with detent springs which hold the saw elevated while work is being adjusted and prevent the saw guides from being drawn entirely out of the posts when the saw is raised. The saw may be released by gently tapping on top of the guides. The guides are unusually long and are turned from solid bar steel.

The lock for fastening the swinging lever is operated by a finger latch. The lever is unlocked by an upward movement of the latch. The saw may then be swung to any position, and if there is no corresponding notch on the bottom of the frame, the lever may be securely locked by pressing up on the latch until it catches. The tension of the operating spring may be adjusted to suit any hand by the screw which passes thru the steel plate under the lever. The saw is 20-gauge and has twelve teeth to the inch.



High Grade Cellar Window Hardware

Cellar windows are often given very little attention, yet it is largely dependent upon these windows whether or not the basement is really a useful part of the house. It does

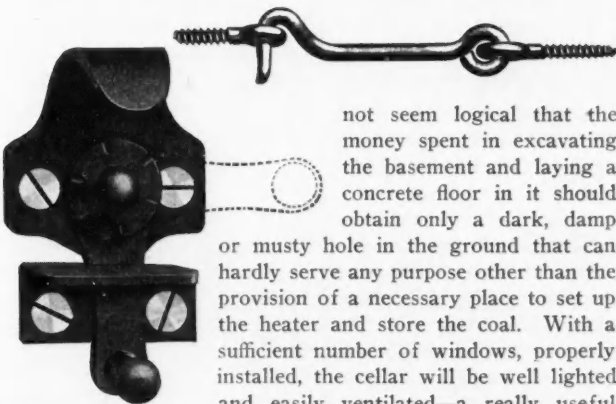
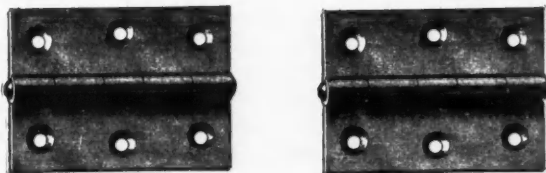

Complete Set of Cellar Window Hardware.

not seem logical that the money spent in excavating the basement and laying a concrete floor in it should obtain only a dark, damp or musty hole in the ground that can hardly serve any purpose other than the provision of a necessary place to set up the heater and store the coal. With a sufficient number of windows, properly installed, the cellar will be well lighted and easily ventilated—a really useful part of the house.

The ability of the cellar windows to bring about this result rests largely upon the hardware used in their installation. In order to meet the requirements satisfactorily and at the same time possess the qualities of simplicity and economy, the cellar window set must include one piece which will combine a window catch, window lifter and lock. The point is well demonstrated in the set shown in the illustration.

The interesting part of this set is a combined fixture of the sort just mentioned. The catch is so designed that a little snow, ice or dirt behind the window does not interfere with the closing, the lever drawing the window tight in the casing and locking it there. When the lever is thrown up, it is automatically locked out of the way. The set includes a hook to hold the window open for ventilation.

The New Field Garage Building Has Opened Up

With the introduction of the automobile into common use, a new channel of profit presented itself to the hardware dealers of America. Progressive dealers in all parts of the country are now carrying various automobile accessories in their stocks and a large number of them are supplying tires, gasoline and oil. During the last few years, with the great increase in the private building of garages to house these cars, additional prosperity, not only for dealers, but also for carpenters and contractors, has made itself felt.

The hardware and implement dealer has always carried in stock hangers for barn doors, but this new and extended field makes it advisable to stock and sell the improved hangers for garage door use. Standardized equipment, which can be utilized under any and every condition, reduces the dealer's investment in this line and increases his profits.



Every one of the Three to Four Million Autos in the U. S. Means a Possible Garage to Be Built.

An interesting type of garage door hanging is shown in the accompanying illustration. The construction of this combination of equipment calls for three doors; one hung separately on T-hinges and the other two connected in series with butt hinges and partially supported by T-hinges. The suspension of these doors is from a hanger operating in a tubular track attached to the wall above. The special hanger, which is adjustable to compensate for swelling or settling, is attached at the end of the center door and travels back and forth in the tubular track as the doors open or close. The action is very smooth, insuring easy operation.

A heavy bracket and permanent spring in conjunction with the center bracket support the track. As the doors fold and slide back, this spring expands, permitting them to be folded flat against the wall. The moment they are stopped, the spring holds them firmly in place. The single door, swinging independently, makes a capital service door for entering the garage when the machine is not to be used. The doors close tightly, and since they fold in, there is no chance for the snow and ice to block their opening.



Scriber for Carpenters and Joiners

There are innumerable opportunities for the carpenter or joiner to use a scriber in laying out work. Its use saves considerable time and greater accuracy is possible than can be expected of makeshift methods of marking lumber for cutting. A scriber which is adaptable for the needs of a carpenter or joiner is shown in the illustration. It is strongly made, can be easily and quickly adjusted and will hold its adjustment when once set.



For Accurate Work.



Swivel Arm Garage Door Hanger

The garage door hanger shown in the accompanying drawing is intended for sliding folding doors and is so designed that the doors will fold back at any angle, requiring very little space. When closed, the doors fit tightly together, which is a necessary feature when the garage is heated during the cold months. The hanging balances the strain on the doors in such a way that sagging is prevented. Any settle-

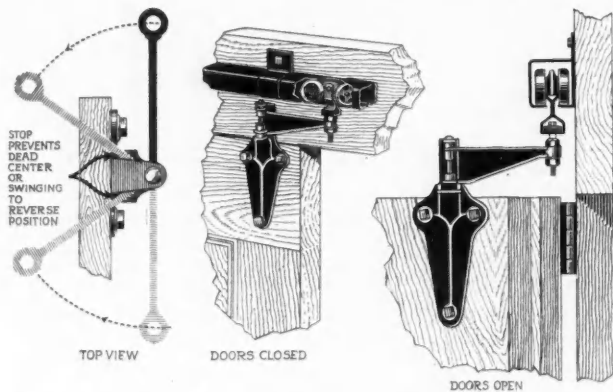

Door Hanger with Swivel Arm Makes a Tight Closing Door.

ment of the building or other cause which would result in the door coming into contact with the floor is easily overcome by a simple vertical adjustment on the hanger. A lock washer prevents this adjustment from working loose.

This system of hanging may be used for openings of any width and with any number of doors from two to six, having a total weight not exceeding 600 pounds. The doors are hinged together and hung to the jamb, the supporting hanger being attached to the second door from the jamb. The hanger operates in a self-cleaning, dirt-proof track. This track is fastened directly to the wall at all points, the same as for ordinary sliding doors. An extended track is eliminated by a swinging arm on the hanger, which permits the door to gradually move away from the wall. The hanger bolt revolves on a heavy-duty ball bearing swivel, which insures easy operation of the doors. The trolley wheels are equipped with large roller bearings which reduce friction and wear. Ordinarily the doors are hung to swing inward, but the equipment may be used on the outside of the building so that the doors will open out, if desired.



Shade Adjuster Which Cannot Sag at End

Ordinarily the shade is permanently installed near the head jamb of the window. There are times, however, when it would be an advantage to have the shade hung at a point part way down the casing, leaving the upper part of the window clear, but shading the lower part of the window. For instance, dur-

ing the day time if the shade could be drawn over the lower sash of the window in the bedroom, there would be plenty of light admitted thru the upper sash, but anyone dressing in the room could not be seen from the outside. At night, in this room, the shade in its lowered position would not "flap" with the upper sash open for ventilating purposes. There are certain parts of the day when such an adjustment of the shades is almost a necessity in school rooms, where proper ventilation and lighting is very important. These conditions cause a demand for a shade adjuster by the use of which the shade may be easily moved up and down the casing and secured at any desired point.

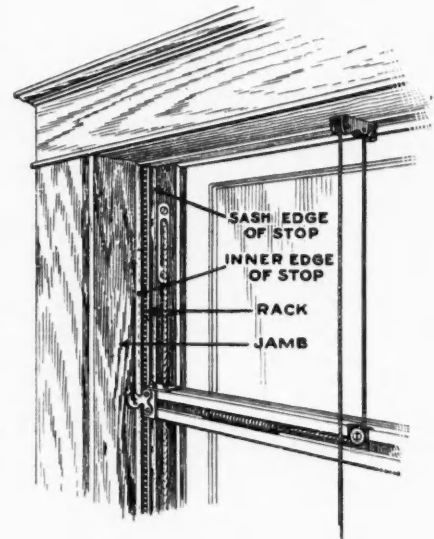

Details of New Shade Adjuster.

The illustration shows the principal features of such an adjuster. The adjuster consists of a shade bar carrying the brackets at its ends and equipped with fittings which operate in racks placed on the window stops or on the stiles, in some cases. The bar is raised and lowered by means of a heavy braided cord which operates thru a pulley hanger secured to the head jamb. The end of this cord at the shade bar is attached to a coiled spring within the bar, so that shade will not drop down.

The advantages of this adjuster, when it is properly installed, are that light and ventilation are under easy control, the fixture cannot get out of level, old or new shades may be dropped into the brackets without filing or other preparation and shades may be removed for renewal or cleaning just the same as ordinary shades.



Light on Saw Guard Eliminates Accidents

One of the objections which workmen have found to the ordinary type of circular saw guard is that, with the light placed 3 or 4 feet above the table where it is out of the

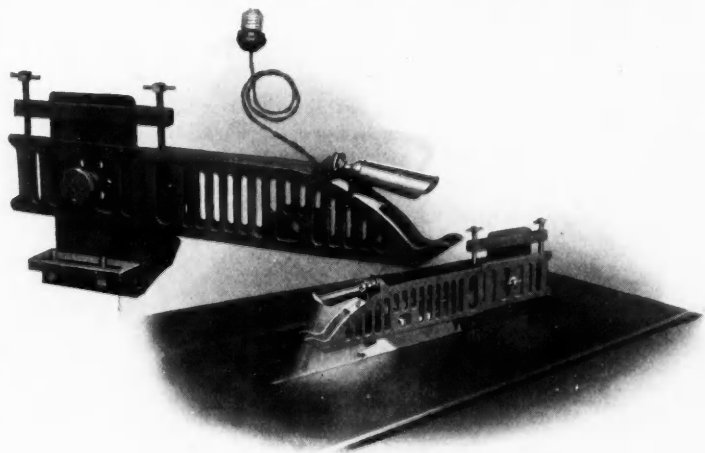

This Saw Guard Is Electric Lighted and Has Other Improved Features.

way, a shadow is cast by the guard upon the part of the saw entering the work. This objection has been removed and the lighting of the work and the saw has been very much improved in a new saw guard shown in the accompanying illustration. This guard is equipped with a two-candle power, 120-volt lamp and reflector, throwing an abundance of light right where it is needed.

The guard is easily attached to any saw table, can be adjusted to any desired thickness of stock and can be moved backward or forward to fit saws of various sizes. The spreader is designed so that it comes close to the saw to prevent pieces from becoming caught between the saw and the spreader. The guard has two screws for adjusting; one to prevent the guard from riding on the stock while the operator is working, thereby eliminating all friction, the other set about 1/4 inch from the top of the guard, allowing a slight up and down movement in case the stock is warped or crooked, but not enough so that the operator is in any danger.



Window Sleeping Berth

It is not often that a person can be found who has given up outdoor sleeping when he has once become accustomed to it. It is common experience that the practice of sleeping out-of-doors has a very decided effect upon the health. People who "take cold easily" find that continuous outdoor sleeping tends to make them immune to colds. Physicians recommend the practice and insist upon it in some cases. Undoubtedly a great many people who now sleep in poorly ventilated bedrooms and find that nine hours' sleep still leaves them with a feeling of weariness, would come into the house after eight hours in the fresh air with a clear head and the feeling of strength and good health, if it were possible for them to do so.

Probably the time will never come when every house is built with a sleeping porch. This need not prevent anyone who wishes to do so from sleeping out-of-doors.



Window Sleeping Berth with Roof Let Down and Sides Up.

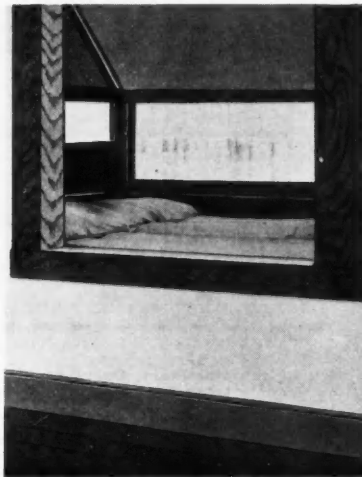

Window Sleeping Berth Viewed from Within.

Any building may have a window sleeping berth of the type shown in the illustration, installed at any window where the circulation of air is unimpaired by surrounding objects. The conditions for outdoor sleeping in one of these berths are even better than those which exist on the average sleeping porch.

The frame of this berth is made of heavy angle and T-iron, varying in thickness from 3/8 to 3/16 of an inch. The outside frame of each end is made of one continuous piece forged into the proper shape. The entire frame is bolted together, is very rigid and substantial and is capable of holding many times the weight ever placed upon it. The metal frame is attached to the building by lag screws and expansion bolts at the top of the frame, the middle and bottom, and

also by braces extending below the bottom. With lag screws or expansion bolts, the berth can be attached to frame, brick, stone or cement buildings. When the building is frame, the principal angle-iron is adjusted so that the bolts may penetrate the center of the studding. Each end is put up separately and the rest is bolted piece by piece to the ends.

The inside measure is 6 1/2 by 4 1/2 feet, which is large enough for the largest bed spring. Since it has a substantial floor, a bed of any size may be placed in it. The height of the berth is 7 feet. The canvas is 10-ounce khaki. The entire top may be raised for sunning the bedclothes during the daytime or for sleeping on very hot nights. The shutters are instantly adjustable for any kind of weather or for any amount of ventilation. The berth is enclosed with heavy wire netting, keeping out flies and mosquitoes and making it perfectly safe for children.

This sleeping berth has been on the market long enough to thoroly prove its success. Carpenters and builders and lumber dealers are acting as sales and installing agents with splendid results.

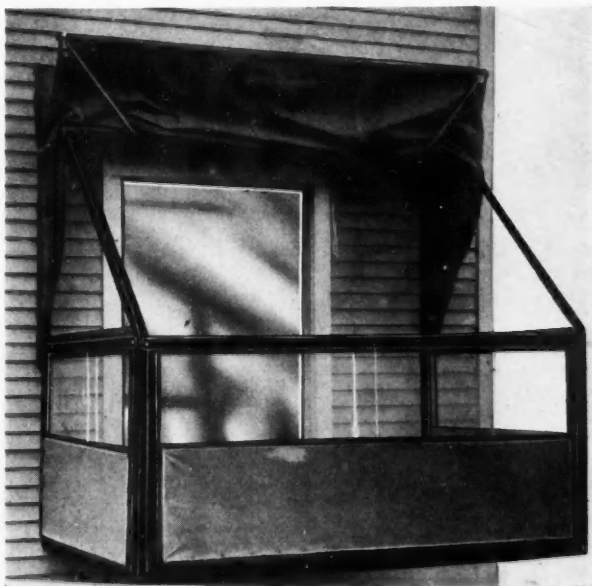

Window Sleeping Berth with Roof Covering Raised and Sides Lowered for Hot Weather.

The American Builder Information Exchange will be pleased to furnish on request the name and address of the parties responsible for any of the interesting novelties or improvements described in these columns.

FARM BUILDINGS

Arranged For Convenience

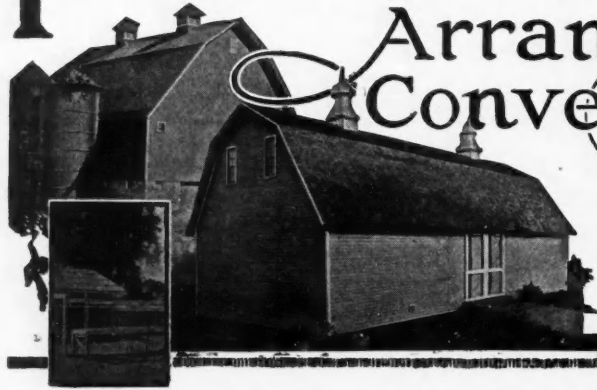

One-Story Dairy Stable

It is not always necessary that the dairy stable be in a building which provides storage for the feed and roughage needed in the stable. Very often a saving is brought about and the general result is an improvement, by building a one-story dairy stable and equipping it with the modern labor-saving equipment in such a way that feed may be easily brought to the stable from the buildings providing storage space.

The proper ventilating and lighting equipment is more easily and more economically installed in this type of building than it is in the standard barn. A good example of a one-story stable is shown in the accompanying illustrations. Accommodations

for forty cows are provided and the arrangements for their care are very extensively worked out. Particular notice should be called to the large number of ventilating nine-light windows and

the adequate system of ventilation. The feed carrier track is extended thru the feed room to the silo, providing an excellent layout for the elimination of unnecessary labor in feeding.

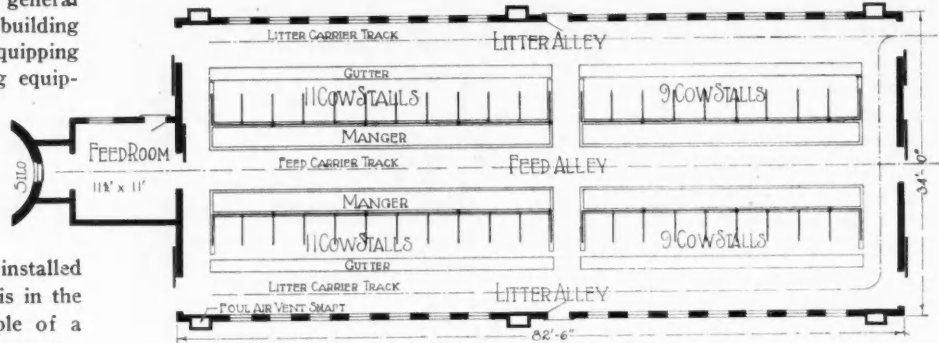

Plan of the One-Story Dairy Stable for Forty Cows, Showing Ventilation and Arrangements for Feeding Cows and Cleaning Stable.

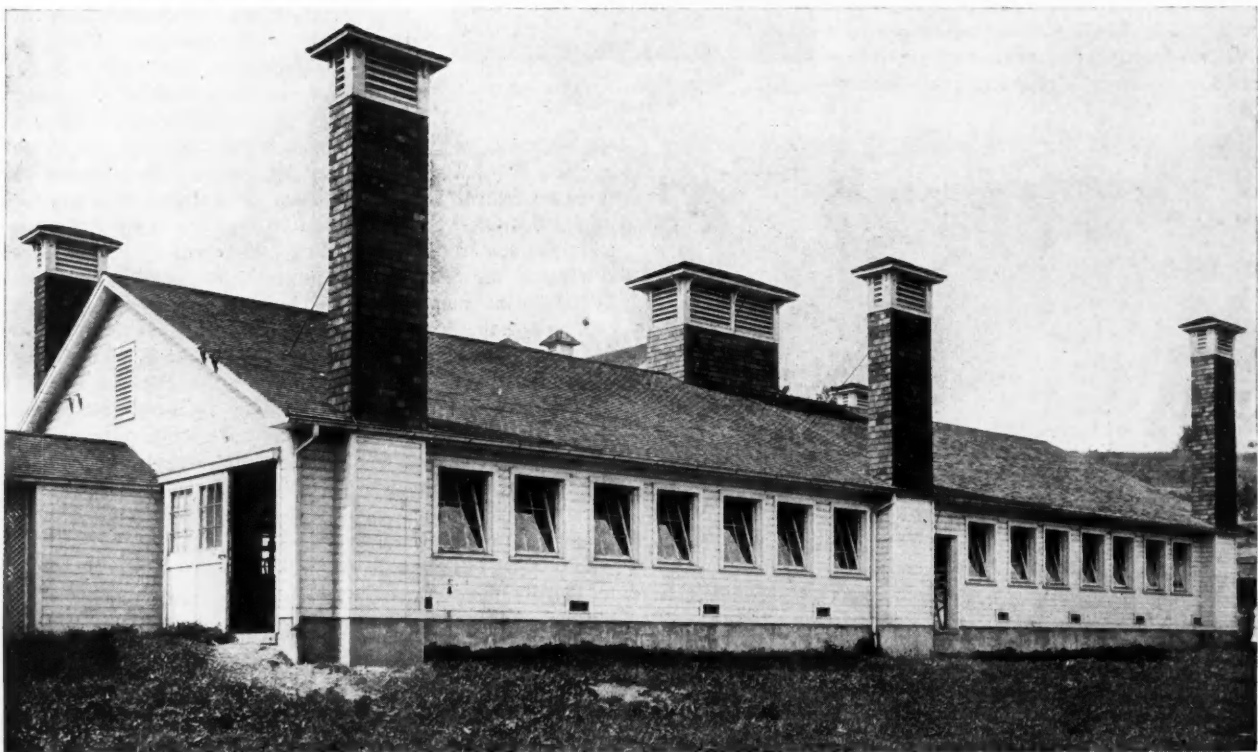

One-Story Dairy Stable Built Near Mentor, Ohio. Ventilation Outlets Are Extended Above Peak of Roof. Intake Flues are Carried Across Above Ceiling to Central Feed Alley. Silo Beyond Feed Room on the Left is Not Shown in This View.

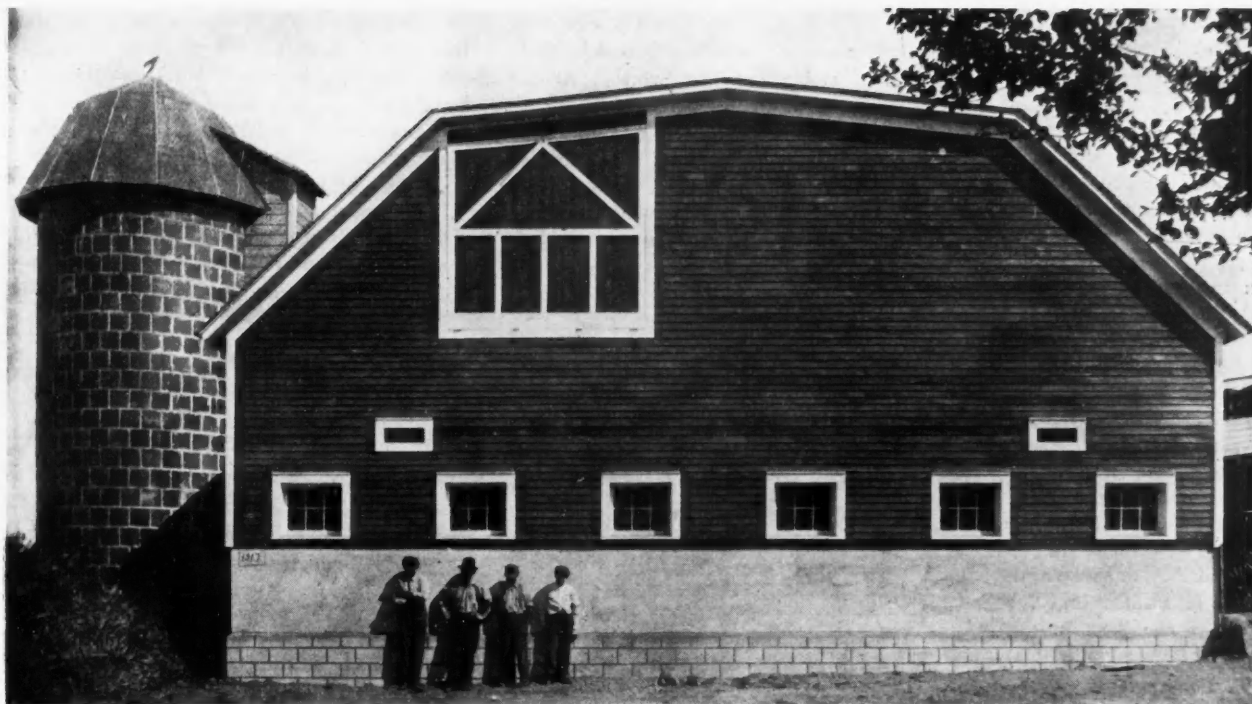

Building on a New Dairy Stable

Here are picture and plan of a cow barn built for McPhillips Bros., Friends Lake, N. Y., by Frank E. Shaw, a building contractor of Pottersville, N. Y. It is equipped with a hollow tile silo and steel stanchions.

In writing about this job, Mr. Shaw said: "We do not very often have a blueprint to work from in this section, but have to do our own pencil sketching. Nearly all work is done by the day.

"As you will see, it was built on the side of an old barn that does not show in the picture. First story studding is 2 by 6-inch, 16 inches O.C. Second story, 2 by 4-inch, 16 inches O.C. Floor

timbers, 2 by 8-inch, 16 inches O. C., bridged each side of girder. Ventilation inlet flues are carried thru to front of mangers and are regulated by sliding doors in the ceiling. Outlet vents are carried down to top of concrete wall, and are regulated by doors at the bottom of the vents. Inside ceiling is No. 2 native white pine. Roof is carried on purlins at peak and angle, supported on posts directly over posts in stable. A double harpoon hay fork is installed, and track goes back to mow in old barn. I

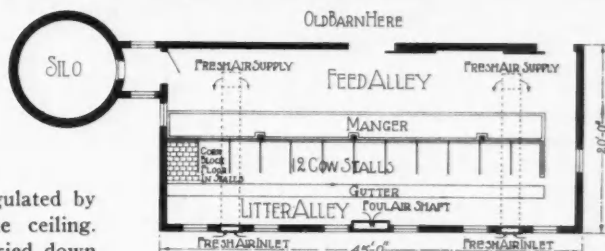

Photo and Floor Plan of New Dairy Stable Added to Old Building by F. E. Shaw and Men.



View of Cow Stalls Before Cork Brick Was Laid.

think it is the best equipped barn in this section.

"We have had a very busy season in this section this year, the only trouble was to get enough help.

"I use a home-made concrete mixer and woodworker in my business, which I keep right on the job. I use a 3 H. P. engine, and don't think it can be beat. I use the bits from my universal plow on a cutter head and they do very good work. For plowing I use the rip saw. I have three sets of collars made from one-half foot basswood which I have ripped in two on a slight bevel. Put one on the mandrel, put on saw and put on the other one, which will make the saw wobble. I have one set to cut a groove 3/8 in., one 1/2 in., and one 5/8 in. They work very well, once you get them the right pitch. Before ripping them in two, I made a mark across the edge, so I would get the two halves opposite each other on the mandrel."

WE would get more enjoyment out of a dollar if it took as long to spend it as it does to earn it.

NOW is the time to make plans for your Spring building.

Gambrel Roof Dairy Barn

A carefully planned and well built dairy barn providing thirty-five stalls for cows, a generous sized calf pen and a bull pen is shown in the view below. This barn is built near Janesville, Wisconsin. The plan calls for a double row of stalls along the central feed alley. On one side of the alley accommodations for eighteen cows are provided in an unbroken line, at the end of which the calf pen is built. The stalls on the other side of the alley are divided into a set of ten and a set of seven, a passageway between the feeding alley and the litter alley being placed in line with a Dutch door in the outer wall at this point. The bull pen is located at the end of this row of stalls. A stairway to the hay mow is framed into the end wall of the barn in the bull pen. The silo is built at this end of the barn and a feed room connects it with the feeding alley in the main structure. The feed carrier track is extended into this feeding room.

The ventilation system utilizes three large-size ventilators connected with foul-air flues carried along the rafters on either side of the ventilator base

and down to near the floor line in the stable. Fresh air is admitted to the stable thru flues which start just above the concrete block basement wall, are carried up the wall to the floor joists and across to registers in the ceiling above the feeding alley. The combined effective area of the intake flues is figured about 10 percent in excess of the combined effective area of the foul-air flues,

found an advantage to slope the stall floors both ways from a point a little less than half-way back from the manger. A slight slope is given from this point to the manger and a greater slope is given from this point to the gutter. The object is to prevent the cows from pushing all of their bedding back into the gutter during the night. Gutter drains are fitted with covers to prevent

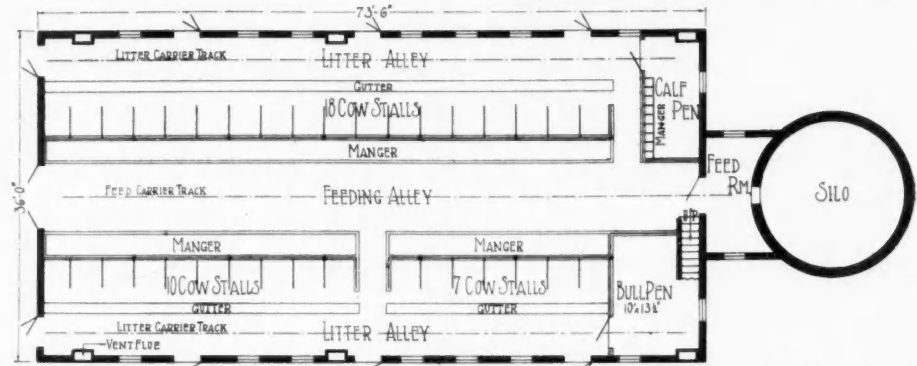

Plan of Dairy Barn with Structural Tile Silo. This Plan Provides Thirty-five Single Stalls, a Calf Pen and a Bull Pen.

which insures an adequate supply of fresh air to the animals at all times.

The foundations of this barn are solidly laid of concrete and the floors are poured of the same material, the mangers and gutters being formed as a part of the floor structure. It has been

loss of valuable fertilizer and clogging of the drainage system.

The stable wall above the concrete blocks is finished with 8-inch boards placed vertically, and the interior is finished with ceiling stock so that the stable will be warm.



Photographic Perspective View of Dairy Barn 76 Feet 6 Inches by 36 Feet, Built Near Janesville, Wisconsin. This Barn Has Concrete Foundations and Floor and Concrete Block Basement Wall. Large Hay Mow Storage Space Is Provided Which, Together with the Tile Silo, Provide Adequate Feed Storage for the Forty or More Animals Which It Is Intended to House.

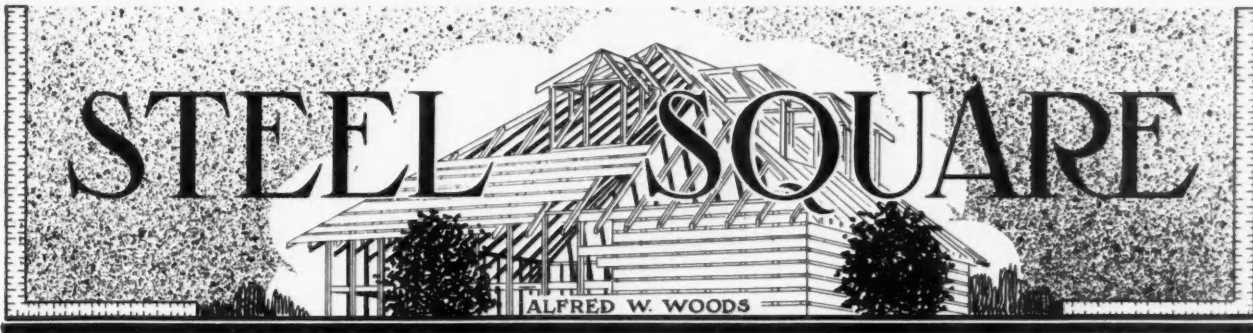

Possibilities of the Steel Square

SHOWING A PRACTICAL WAY FOR THE DEVELOPMENT OF THE HIP FOR ANY SHAPE THE ROOF MAY HAVE

By A. W. Woods

THERE are a number of ways for developing the hip for curved roofs, but the one herewith illustrated presents, we believe, all things considered, about the best solution for arriving at problems of this kind, and especially so where compounded curves enters into the problem. It is known as the stretch rule system, which is simply dividing the run of the common rafter and that of the corresponding hip into the same number of parts, that is, by letting the common standard rule for one foot represent the run of the common rafter, which would be the same as taking 12 on the tongue of the steel square, as shown in Fig. 1.

Now, by taking a straight edge piece of wood and placing one end at 12 with its edge at the angle that the seat of the hip rests from that of the common rafter and where it intersects the blade will represent the length for the stretch rule as from 12 to 4.97 (practically 5); this will be the proper length of the rule for the octagon hip measurements. If the straight edge piece is placed so as to extend from 12 to 12, it would represent the measurement rule for the hip resting on a square corner; and if the straight edge extended from 12 to 20.78 (practically 20¾), it would represent the measurement rule for the hip resting on a triangular corner, and so on for any other corner that the hip may rest from that of the common rafter, it does not make any difference what it is.

In this example we have used regular polygonal corners, that is, they will come around and join, making a roof of equal sides, but that does not matter whether the hip is to be developed for a regular corner or not, just so the straight edge is placed on the square at the angle that the seat of the hip is to rest from that of the common rafter; and divide this improvised

rule into twelve equal parts and by again dividing one of these parts we will have the stretch rule ready for business. In other words, it is just the same as if we were to take a piece of rubber 12 inches long divided into regular standard measurement and by holding one end at 12 on the tongue, laying it along that member without stretching, it will reach to the heel of the square and will represent the length of the run of the common rafter for a one-foot run. Now, by a little pulling on this rubber rule, it can easily be stretched from 12 on the tongue to 5 or to 12 or 20¾ on the blade, and yet in each case its markings would be divided into 12 equal parts, assuming, of course, that its elasticity be the same at all parts. Thus it will be seen that the rubber in its stretched condition represents the gain in the run of the hip over its normal length for the common rafter; but for working purposes it is necessary to have the straight edge rule divided as shown, and we are ready for business.

In Fig. 2 is shown an ogee or compound curve for the common rafter, and in this case the curves are equal and laid off with the trammel, but it does not

(Continued to page 168.)

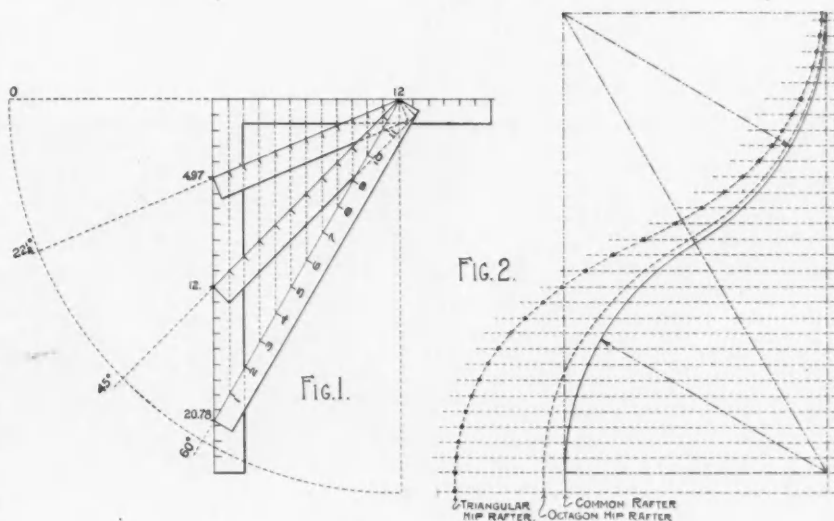

How to Develop Corresponding Curved Hip Rafters.

CORRESPONDENCE



Questions Answered and Ideas Exchanged.

Our Readers are Requested and Urged to Make Free Use of These Columns for the Discussion of all Questions of Interest to Carpenters and Builders

Bolted Crib Frame

To the Editor:

Am enclosing a picture of one of my cribs, built on the Ed. Oberlin farm. This is one of the solid construction kind, all 8 by 8-inch studs, 24 inches on centers. Note the extra roof on oat bin. This crib contains 350 bolts, and I can recommend it to any one. Am constructing one of the same kind but 2 feet higher on the Chas. Bossert farm.

C. C. ROBINSON,
Contractor and Builder.

Reddick, Ill.

A Good Lumber Yard Layout

To the Editor:

Allow me to present for your inspection a plan of office and shed for an up-to-date lumber yard for this section of the country, drawn by the undersigned.

Note the many wide windows in front and on the sides, also the location of the roll top and flat top desks which are placed so as to give the writer the light over the left shoulder. Note the wide counter, arranged for glass cutting, with an assortment of glass underneath. Note the niche for

Ames, Kan.



A Well Framed Two-Story Corn Crib by C. C. Robinson and Men Near Reddick, Ill.

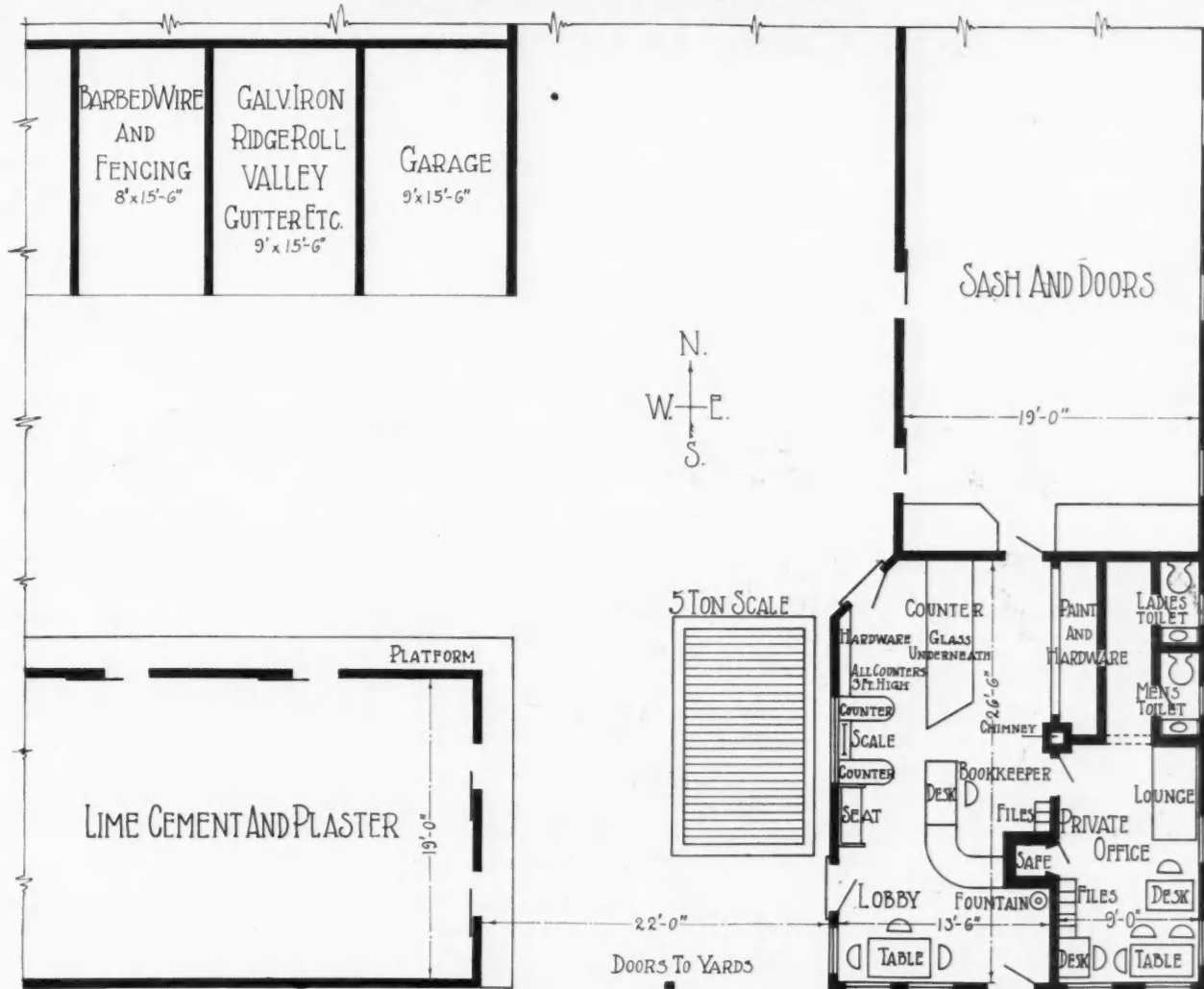

Arrangement of Builders' Supply Sheds and Yard Office as Recommended by Ames, Kans., Manager of Chicago Lumber & Coal Co.

paint and builders' hardware; the spacious lobby with customers' table and chairs, also the large private office with its furnishings. Note the arrangements at the scale window, which from actual experience we have found to be very handy. All counters are 3 ft. high, which makes a nice height to work on, standing up.

The writer believes in the "one opening only" lumber yard, which opening should be at least 20 feet wide; 24 feet is better.

N. NELSON, Local Manager,
Chicago Lumber & Coal Co.

Thinks We Have Won the Race

To the Editor: La Fargeville, N. Y.
Enclosed is a picture of one of the buildings I completed this past year.



First National Bank, Post, Texas. Architect, R. C. Gilmore.

I appreciate the change that has come into the AMERICAN BUILDER. It is the best magazine published now, dealing with the general construction of buildings. The situation in the building journal field reminds me of an auto race; one starts in the lead, and along comes another, leaving it and all others behind. That is what I think of the AMERICAN BUILDER. It is the leading magazine of the day.

With best wishes for its continued success, I am,
R. E. GILMORE, Architect.

Indorses Ad Reading Habit

To the Editor: La Fargeville, N. Y.
I have just received the book, "How to Read Plans." I find it is all right and think it will be very useful to me.

I wonder if I may say a few words to other readers of this magazine in regard to books and home study. We who work with our hands are too apt to think that a book of knowledge is not of much value to us, but in this we are mistaken, for there is no one but can get from books and trade papers something which will help him in his daily work. We find help in the articles in the magazines and may use the correspondence department to ask any question; and perhaps equal to anything else are the ads and the help they offer.

Let us look at these a moment in any recent issue. Notice the ad of the Atkins Saw Company, and the offer of a nail apron and book for ten cents. Perhaps you are interested in drawing instruments or pencils or a framing square, a steel

(Continued to page 104.)

How Camp Devens Was Built

DETAILS OF THE ORGANIZATION AND OF THE HUMAN SIDE OF THIS HUGE CONTRACT: THE METHODS OF SORTING, STORING, MAKING UP, AND DELIVERING MATERIAL TO THE PROPER BUILDING OR SITE; THE EQUIPMENT AND ARRANGEMENTS FOR PREPARING AND CO-ORDINATING THE PLUMBING, CEMENT WORK, LUMBER, ETC.

By Peter F. O'Shea

In 3 Parts—Parts 3

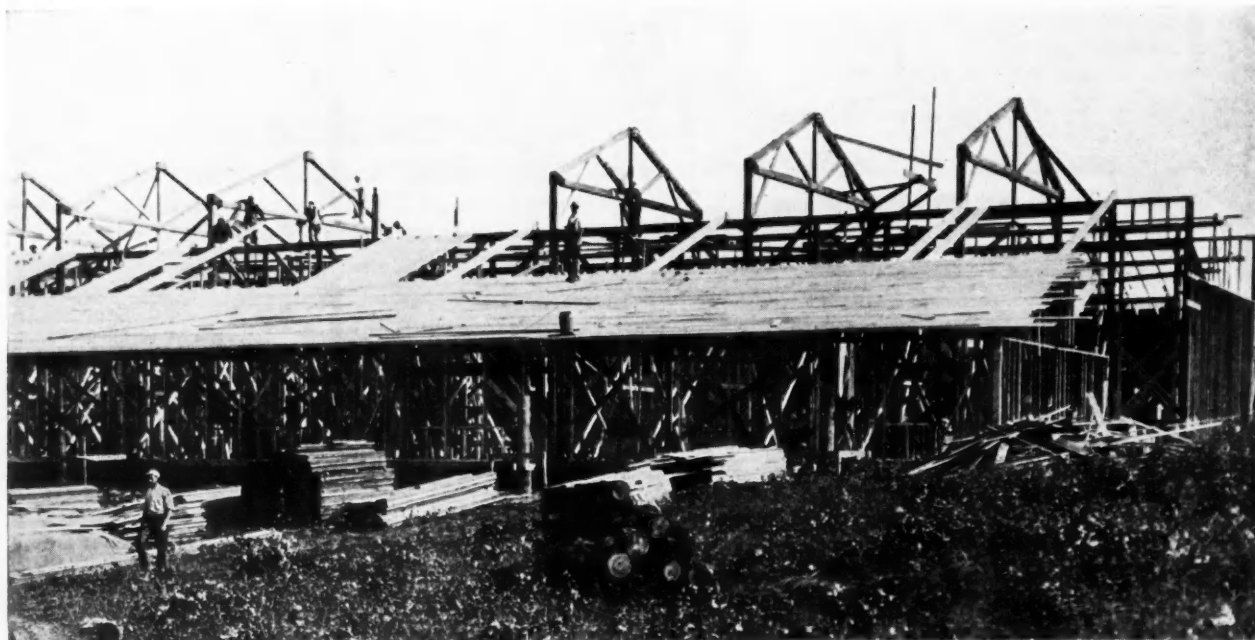

Building the Y. M. C. A. Auditorium at Camp Devens.

(Continued from the November American Builder)

In the shop are five threading machines of different sizes, each set up to cut a given size of pipe. Two of these machines will cut from 1-inch to 4-inch pipe, one will cut from 1 inch to 6 inches, and one from 2 inches to 8 inches. The cutting off of the proper lengths for threading is not done by ordinary machines, but by metallic band saw machines. There are three of these machines, for they work almost twice as fast as the threading machines. One saw is placed between each two threaders. Near the delivery end of each threading machine is a bench for hand work. Usually, however, it is intended to have the threading machines, of the kind in which the dies remain stationary and the pipe revolves, make on their fittings by holding the fitting in place on the newly threaded end of the pipe. The finished pieces, whether with or without fittings made on, are piled in bins between stakes on the ground, in the same manner as water pipe and framing. No sections are assembled at the shop.

From a steamfitter's point of view, the size of this shop and of the job may appear from the fact that one machine was cutting in one day 1,280 6-inch nipples 12 inches long, for connections at the boilers. Each regiment is to be heated from its own central heating plant. But among the 1,700 buildings on the complete cantonment there are, for instance, 154 exactly alike, each 140 feet long by 43 feet wide.

At the end of the enlarged shop there was later added an ell for a blacksmith shop. This is not to be confused with the main blacksmith shop near the

tool house, which has six forges besides grindstones, etc. The piper's blacksmith shop is to make odd sizes of hangers, etc. It is equipped with an iron cutter, forge, drill, and bar stock rack capable of holding a ton of sorted material.

There is also a store room, 40 by 20, for supplies. A glance at the contents will be instructive:

- 100 chain tongs.
- 100 machine band saws.
- 50 Walworth pipe vises.
- 100 pairs of extra jaws for same, and other repair parts.
- 300 Stillson wrenches, 100 each of three sizes.
- 150 Stillson wrenches, 50 each of three other sizes.
- 5 barrels of cutting oil.
- 3 oil stoves to put under machines in cold weather to keep oil warm and flowing.
- 5 bales of cotton waste.
- 1 small handtruck to move these things around.

From the heating units the steam mains are to be brought to the buildings by air lines on a line of pillars. The brackets for these pillars are bought made.

An average of 300 pairs of steamfitters are employed on the job.

A third shop dealt in galvanized iron smokestacks for the heating stoves of the barracks, and other products of the tinsmith. These stacks came in made-up sections from the shop of Friedrichs, Holyoke, Mass. At the switchyard shop the conical cap surmounting the stack is riveted on, and the oblique conical skirt

(Continued to page 174.)

Reference Data on Building Subjects

IN practically every building operation there is involved a certain amount of calculation which must be done quickly and accurately. This preliminary work is very much expedited by the use of tabulated data. Many contractors and builders carry with them constantly, small notebooks in which they have copied tables, formulae and other information which they have found necessary or useful in making such calculations. The contractor who designs the structures which he builds must have a very extensive collection of information in this form. He usually has a number of handbooks and other books on building construction in his office, from which he obtains the data which are needed in connection with his design work. Such a contractor may prepare his pocket notebook from his office books. Every contractor and builder should supplement his general study of building subjects with a careful study of the use of tabulated data and formulae related to these subjects. The ability to make rapid and accurate calculations is best obtained by study of this kind. The user of a handbook, in order to obtain the most good out of its use, must not only be thoroly acquainted with the range of the subject matter which it contains, so that it will be unnecessary for him to refer to the index in order to ascertain whether or not the particular book contains the information which he desires, but he must also be able to apply this information to his particular problem without waste of time.

A limited collection of building information is given on this and the following pages for the benefit of contractors and builders who do not have handbooks at their disposal. This information is intended for reference and should be studied with this idea in mind. Its use will indicate the manner in which a handbook is found useful in this field.

Fresh Air Required by Live Stock

	Quantity Required in Cu. Ft. per Hour per Head	Assumed Weights per Head in Pounds
Horses	4924	1200
Cows	3953	1100
Swine	1510	160
Sheep	929	100
Hens	37	3

Quantities of air required for live stock vary proportionately with the weights.

Figuring Size of Out-take Flues

An out-take flue for twenty cows must be capable of handling $3953 \times 20 = 79,060$ cubic feet of air per hour.

Assume an air movement of 250 feet per minute, which equals 15,000 feet per hour.

Area of out-take flue required for twenty cows is found as follows:

$$79,060 \div 15,000 = 5.28 \text{ sq. ft.} = 790 \text{ sq. in.}$$

Inside dimensions of flue should be 29 by 29 inches.

Intake Flues

For every out-take flue there should be a number of intake flues whose combined area exceeds that of the out-take flue by 10 per cent.

The intake flues for twenty cows should have a combined area of $790 \div 9 = 869$ square inches.

Assume that fourteen intakes will be used, then each must have an area of $869 \div 14 = 62$ square inches.

The intake flues should be 8 by 8 inches.

Intake Register Face

The size of the intake register face should be figured according to the actual ventilating area. Actual areas of commercial registers are given in the following table:

Size of Register Face, Inches	Effective Area Square Inches	Size of Register Face, Inches	Effective Area Square Inches
6x8.....	32	12x12.....	96
6x10.....	40	12x14.....	112
6x12.....	48	14x14.....	130
8x8.....	56	6 round.....	19
8x10.....	42	7 round.....	25
8x12.....	53	8 round.....	33
8x14.....	64	9 round.....	41
8x14.....	75	10 round.....	51
10x10.....	66	11 round.....	62
10x12.....	80	12 round.....	74
10x14.....	93	14 round.....	100

Hay Mow Capacities per Foot Length of Standard Barns

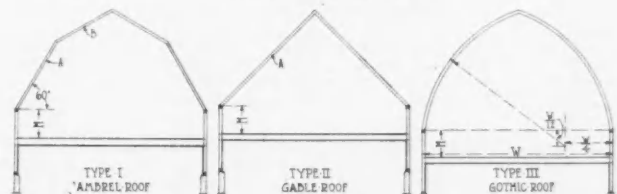

Standard Barn Mow Sections Forming Basis of the Following Tabulated Capacities.

Hay Mow Capacity Per Foot Length of Barn in Cubic Feet and Tons of Hay

	Width	Length "A"	Length "B"	Mow Capacity per Foot Length of Barn*					
				Above Plate	Height "H" Feet				
					5	7	9	11	13
Gambrel Roof, Type I.	34'0"	14'0"	12'0"	354 .708	524 1.05	592 1.18	660 1.32	728 1.46	796 1.59
	36'0"	16'0"	12'0"	417 .835	597 1.19	669 1.34	741 1.48	813 1.63	885 1.77
	38'0"	14'0"	14'0"	428 .855	618 1.24	694 1.39	770 1.54	846 1.69	922 1.84
	40'0"	16'0"	14'0"	492 .984	692 1.38	772 1.54	852 1.70	932 1.86	1012 2.02
Gable Roof, Type II.	34'0"	24'0"		264 .528	434 .868	502 1.00	570 1.14	638 1.28	706 1.41
	36'0"	25'6"		300 .600	480 .960	552 1.10	624 1.25	696 1.39	768 1.54
	38'0"	27'0"		335 .670	525 1.05	601 1.20	677 1.35	753 1.50	829 1.67
	40'0"	28'6"		375 .750	575 1.15	655 1.31	735 1.47	815 1.63	895 1.79
Gothic Roof, Type III.	34'0"			465 .930	635 1.27	703 1.40	771 1.54	839 1.68	907 1.81
	36'0"			530 1.06	710 1.42	782 1.57	854 1.71	926 1.85	998 2.00
	38'0"			590 1.18	780 1.56	856 1.71	932 1.87	1008 2.02	1084 2.17
	40'0"			660* 1.32	860 1.72	940 1.88	1020 2.04	1100 2.20	1180 2.36

*Upper figures are capacities in cubic feet and lower figures are capacities in tons of hay, figured 500 cu. ft. per ton. Clover hay runs about 435 cu. ft. per ton, in the mow. Above capacities are for actual useful volume and do not include the space near the peak of the roof, where hay is not ordinarily placed.

Strength of Rectangular Beams

The load which a rectangular beam of any of the materials listed in the following tables will carry, or the size of beam made of these materials required to carry a given load, may be determined by the substitution of values in the formula corresponding to the character of the load, as shown in the diagrams following the tables.

Values of A in Formulae for Wooden Beams

Materials	New York	Chicago	Baltimore	Boston
Yellow Pine	90	72	100	83
White Pine	67	44	56	56
Douglas Fir	67	72
Spruce	67	44	75	56
Hemlock	44	33
Oak	67	67	83	56

Values of A in Formulae for Stone and Concrete Beams

Materials	Values of A	Materials	Values of A
Granite	10	Bluestone	17
Limestone	8	Slate	22
Marble	7	Concrete, 1:2:4	1.7
Sandstone	6	Concrete, 1:2:5	1.1

Beams Fixed at One End and Loaded at the Other

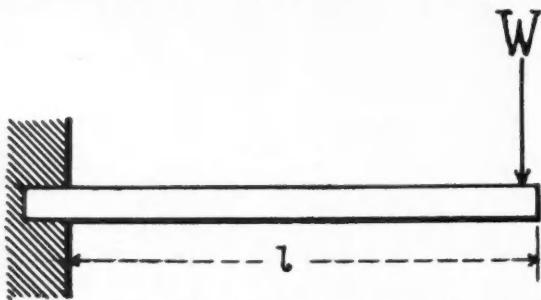

Cantilever Beam with Concentrated Load at Free End.

Safe load, in pounds =
$$\frac{\text{breadth} \times \text{square of depth} \times A}{4 \times \text{length in feet}}$$

Breadth, in inches =
$$\frac{4 \times \text{load} \times \text{length in feet}}{\text{square of depth} \times A}$$

Beams Fixed at One End and Loaded With a Uniformly Distributed Load

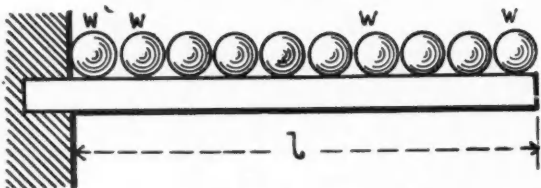

Cantilever Beam with Distributed Load Over Entire Length.

Safe load, in pounds =
$$\frac{\text{breadth} \times \text{square of depth} \times A}{2 \times \text{length in feet}}$$

Breadth, in inches =
$$\frac{2 \times \text{load} \times \text{length in feet}}{\text{square of depth} \times A}$$

Beam Supported at Both Ends and Loaded With a Uniformly Distributed Load Over Entire Span

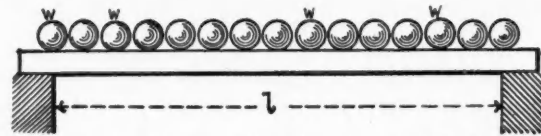

Simple Beam with Uniformly Distributed Load Over Entire Span.

Safe load, in pounds =
$$\frac{2 \times \text{breadth} \times \text{square of depth} \times A}{\text{span in feet}}$$

Breadth, in inches =
$$\frac{\text{span in feet} \times \text{load}}{2 \times \text{square of depth} \times A}$$

Beams Supported at Both Ends and Loaded With Concentrated Load at Any Point Along Its Length

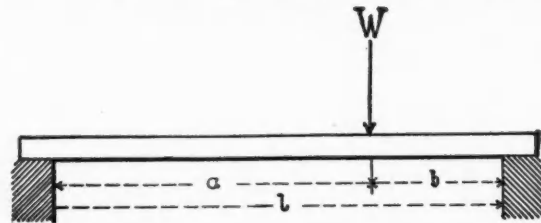

Simple Beam with Concentrated Load at Any Point.

Safe load, in pounds =
$$\frac{\text{breadth} \times \text{square of depth} \times \text{span} \times A}{4 \times a \times b}$$

Breadth, in inches =
$$\frac{4 \times \text{load} \times a \times b}{\text{square of depth} \times \text{span} \times A}$$

In case the concentrated load is at the center of the span, a and b are equal and the equations reduce to:

Safe load, in pounds =
$$\frac{\text{breadth} \times \text{square of depth} \times A}{\text{span in feet}}$$

Breadth, in inches =
$$\frac{\text{span in feet} \times \text{load}}{\text{square of depth} \times A}$$

Strength of Wooden Columns Over Ten Diameters in Length

Columns which are longer than about ten times their least sectional dimension are apt to bend and thus fail under a load which they would carry successfully if shorter and of the same section: The formula for short columns,

Safe Load =
$$\frac{\text{area of cross section} \times \text{crushing strength of materia}}{\text{factor of safety}}$$

must, therefore, be used only in the case of the column having a least sectional dimension less than one-tenth of the length of the column.

For the longer columns, the following straight-line formulae, for columns of various woods, have been deduced:

Safe load per square inch =
$$1000 - 10 \frac{\text{length in inches}}{\text{breadth in inches}}$$

for long leaf yellow pine and white oak columns.

Safe load per square inch = $850 - 8.5 \frac{\text{length in inches}}{\text{breadth in inches}}$
for Douglas fir and spruce columns.

Safe load per square inch = $750 - 7.5 \frac{\text{length in inches}}{\text{breadth in inches}}$
for white pine, shortleaf yellow pine, chestnut and hemlock columns.

Safe load per square inch = $625 - 6 \frac{\text{length in inches}}{\text{breadth in inches}}$
for cedar, cypress, Norway pine, redwood and whitewood columns.

In these formulae the breadth refers to the least sectional dimension or diameter of the column. The actual load in pounds which the column will carry is found by multiplying the safe load per square inch by the sectional area.

Allowable Loads on Standard Bearing Plates on Walls

Bearing on Wall Inches	Size of Plate Inches	Safe bearing of plate on brick wall laid in mortar made of:		
		Lime at 112 lbs. per Sq. In.	Lime and Cement at 162 lbs. per Sq. In.	Cement at 208 lbs. per Sq. In.*
6	6x6	4070	5800	7500
	6x8	5400	7800	10000
	6x10	6700	9700	12500
8	8x8	7200	10200	13300
	8x10	9000	12100	16600
	8x12	10700	15500	20000
10	10x10	11200	16200	20600
	10x12	13450	19500	25200
	10x14	15700	22700	27900
12	12x12	16150	23300	30000
	12x14	18800	27400	35000
	12x16	22000	31200	40100
	12x18	24200	34500	45000
14	14x14	22100	31800	40800
	14x16	25000	36300	46600
	14x18	28200	40800	52400
	14x20	31400	45400	58200
16	16x16	28700	41500	53200
	16x18	32300	46600	59800
	16x20	35800	51900	66700
	16x22	39500	57000	73200

*Values shown in this column may also be used for walls of concrete.

Thickness of Bearing Plates

In figuring the size of the bearing plate required where a beam or truss rests upon the wall, the above table will give the required area of the plate, but the

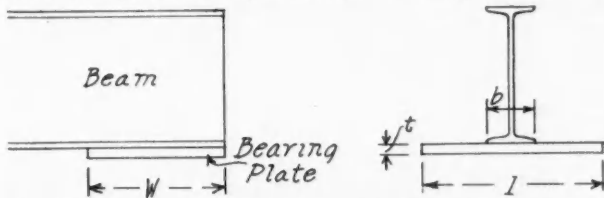

Dimensions of Beam Flange and Bearing Plate Referring to Following Formulae for Plate Thickness.

thickness must be figured for each particular case. This calculation may be made with one of the follow-

ing equations, one being for cast iron bearing plates and the other for steel bearing plates:

Referring to the accompanying diagrams, w is the width of plate bearing on the wall; l is the length of plate, parallel with wall; b is the width of beam resting on the plate, and L is the load on the bearing plate.

The required thickness of cast-iron bearing plate,

$$t = 0.0158 \sqrt{\frac{L(l-b)}{w}}$$

The required thickness of steel bearing plate,

$$t = 0.00685 \sqrt{\frac{L(l-b)}{w}}$$

Safe Bearing Resistance of Washers, in Pounds

Round Washers					
Size, In.	Area, Sq. In.	White Pine, Lbs.	Short-leaf Yellow Pine, Lbs.	Long-leaf Yellow Pine, Lbs.	White Oak, Lbs.
1/2	5.16	1030	1290	1810	2580
5/8	6.89	1340	1670	2340	3350
3/4	7.78	1560	1950	2720	3890
7/8	10.4	2080	2600	3640	5200
1	11.7	2340	2930	4100	5850
1 1/8	16.6	3320	4150	5810	8300
1 1/4	26.9	5380	6730	9420	13500
1 1/2	28.6	5720	7150	10000	14300
1 3/4	38.5	7700	9630	13500	19300
2	49.9	9980	12500	17500	25000
2 1/4	62.8	12600	15700	22000	31400
2 1/2	77.1	15400	19300	27000	38600
2 3/4	92.9	18600	23200	32500	46500
3	110.2	22000	27600	38600	55100

Rectangular Washers					
Size	Area	White Pine	Short-leaf Yellow Pine	Long-leaf Yellow Pine	White Oak
4x6	24	4800	6000	8400	12000
6	32	6400	8000	11200	16000
8	38	7200	9000	12800	18000
6x8	42	8400	10500	14700	21000
8	48	9600	12000	16800	24000
9	54	10800	13500	18900	27000
10	60	12000	15000	21000	30000
8x8	64	12800	16000	22400	32000
9	72	14400	18000	25200	36000
10	80	16000	20000	28000	40000
12	96	19200	24000	33600	48000
10x10	100	20000	25000	35000	50000
11	110	22000	27500	38500	55000
12	120	24000	30000	42000	60000
14	140	28000	35000	49000	70000
12x12	144	28800	36000	50400	72000
14	168	33600	42000	58800	84000
16	192	38400	48000	67200	96000
14x14	196	39200	49000	68600	98000
16	224	44800	56000	78400	112000

Thickness of Washers

Bearing values for round washers are for standard sizes of cast-iron washers, which are made sufficiently thick to develop the bearing resistance shown in this table.

It is necessary to figure the required thickness of rectangular steel plate washers, the thickness being dependent upon the sort of wood which the washer

Safe Loads in Pounds on Round Steel Rods*

Diameter, Inches	Plain Rods		Diameter, Inches	Upset Rods	
	Load in pounds based on area at root of thread	Load in pounds based on full area of rod		Load in pounds based on area at root of thread	Load in pounds based on full area of rod
1/4	432	785	1	8800	12570
5/16	720	1230	1 1/8	11104	15900
3/8	1088	1770	1 1/4	14288	19630
7/16	1488	2400	1 3/8	16910	23750
1/2	2016	3140	1 1/2	20720	28270
9/16	2592	3960	1 5/8	24240	33170
5/8	3232	4910	1 3/4	27900	38480
3/4	4832	7070	1 7/8	32760	44180
7/8	6720	9620	2	38830	50270

*These loads are based on a tensile stress in the steel rods of 16,000 lbs. per square inch.

bears upon. The thickness of any washer of this type may be figured from the following equations in which the letters refer to the accompanying drawing.

- $t = 0.192a$ for bearing on white pine;
- $t = 0.218a$ for bearing on shortleaf yellow pine;
- $t = 0.256a$ for bearing on longleaf yellow pine;
- $t = 0.294a$ for bearing on white oak.

When the size of the rod has been determined to carry the given load, shown as P on the diagram, the dimensions of the nut which will be used on this rod

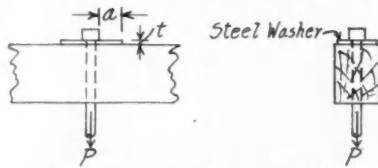

Steel Washer as Used on Wooden Trusses. Sizes Given in Table on Preceding Page. Thickness Given by Above Formulae.

may be determined. From the load, P , and taking into consideration any limitations as to one of the dimensions of the washer, the size of the washer may be determined from the above table. The distance, a , is then the distance from the edge of the plate to the face of the nut. If the washer is not square, this distance, a , is measured parallel to the length of the plate. The square washer is more economical than one which is not square, but the size of the wood member often makes it necessary to use a washer which is not square. When the thickness has been figured by one of the above equations, the next greater standard thickness of plate is selected, unless the required thickness is very close to the next smaller standard thickness.

Safe Resistance to Lateral Force on Mild-Steel Lag-Screws

Size of screw in inches		Safe Resistance in Pounds				Minimum Thickness of Strap in Inches
Diam.	Length	Long leaf Pine	Douglas Fir	White Pine	Oak	
3/8	3 1/2	288	267	255	288	1/4
1/2	4	512	474	454	512	1/4
5/8	4	800	741	709	800	5/16
3/4	4 1/2	1153	1067	1022	1153	5/16
7/8	5	1569	1453	1391	1569	3/8

Force Required to Draw Lag-Screws Out of Yellow Pine

Screw.....	1/2 in.	5/8 in.	3/4 in.	7/8 in.	1 in.
Wood, depth, inches.....	3 1/2	4	4	5	6
Force, pounds.....	4960	6000	7685	11500	12620

Quantities of Materials for Concrete Basement Walls

Proportions: One part portland cement to 2 1/2 parts sand to 5 parts gravel or stone.

Height of Basement, Feet	Depth of Foundation Below Ground Level, Feet	Thickness of Wall at Bottom, Inches	Thickness of Wall at Top, Inches	Cement per 10 ft. of Length of Wall, Bags	Sand per 10 ft. of Length of Wall, Cubic Feet	Gravel or Stone per 10 ft. of Length of Wall, Cubic Feet
6	4	6	6	6	14 1/2	29
8	6	10	8	12	29	58
10	8	15	10	24	57	114

Ingredients in One Cubic Yard of Concrete*

Sand voids, 40 per cent; stone voids, 45 per cent; barrel of portland cement yielding 3.65 cubic feet of paste. Barrel specified, 3.8 cubic feet.

Proportions by Volume.....	1:2:4	1:2:5	1:2:6	1:2 1/2:5	1:2 1/2:6	1:3:4
Barrels cement per cu. yd. concrete.....	1.46	1.30	1.18	1.13	1.00	1.25
Cu. yd. of sand per cu. yd. concrete.....	0.41	0.36	0.33	0.40	0.35	0.53
Cu. yd. of stone per cu. yd. concrete.....	0.82	0.90	1.00	0.80	0.84	0.71

Proportions by Volume.....	1:3:5	1:3:6	1:3:7	1:4:7	1:4:8	1:4:9
Barrels cement per cu. yd. concrete.....	1.13	1.05	0.96	0.82	0.77	0.73
Cu. yd. of sand per cu. yd. concrete.....	0.48	0.44	0.40	0.46	0.43	0.41
Cu. yd. of stone per cu. yd. concrete.....	0.80	0.88	0.93	0.80	0.86	0.92

*These values apply when the cement is measured as it comes packed in the barrel, an average barrel holding 3.8 cu. ft.

Ingredients in One Cubic Yard of Concrete*

Sand voids, 40 per cent; stone voids, 45 per cent; barrel of portland cement yielding 3.65 cubic feet of paste. Barrel specified, 4.4 cubic feet.

Proportions of Volume.....	1:2:4	1:2:5	1:2:6	1:2 1/2:5	1:2 1/2:6	1:3:4
Barrels cement per cu. yd. concrete.....	1.30	1.16	1.00	1.07	0.96	1.08
Cu. yd. of sand per cu. yd. concrete.....	0.42	0.38	0.33	0.44	0.40	0.53
Cu. yd. of stone per cu. yd. concrete.....	0.84	0.95	1.00	0.88	0.95	0.71

Proportions by Volume.....	1:3:5	1:3:6	1:3:7	1:4:7	1:4:8	1:4:9
Barrels cement per cu. yd. concrete.....	0.96	0.90	0.82	0.75	0.68	0.64
Cu. yd. of sand per cu. yd. concrete.....	0.47	0.44	0.40	0.49	0.44	0.42
Cu. yd. of stone per cu. yd. concrete.....	0.78	0.88	0.93	0.86	0.88	0.95

*These values apply when the cement is measured after it has been dumped from the barrel, an average barrel yielding 4.4 cu. ft. of loose cement.

Weights and Areas of Round and Square Bars

Size, Inches	Weight, Pounds per Foot		Area, Square Inches	
	Square	Round	Square	Round
1/16	.013	.010	.0039	.0031
1/8	.053	.042	.0156	.0123
3/16	.120	.094	.0352	.0276
1/4	.213	.167	.0625	.0491
5/16	.332	.261	.0977	.0767
3/8	.478	.376	.1406	.1105
7/16	.651	.511	.1914	.1503
1/2	.850	.668	.2500	.1963
9/16	1.073	.845	.3164	.2485
5/8	1.328	1.043	.3906	.3068
11/16	1.607	1.262	.4727	.3712
3/4	1.913	1.502	.5625	.4418
13/16	2.245	1.763	.6602	.5185
7/8	2.603	2.044	.7656	.6013
15/16	2.988	2.347	.8789	.6903
1	3.400	2.670	1.0000	.7854
1 1/16	3.838	3.015	1.1289	.8866
1 1/8	4.303	3.380	1.2656	.9940
1 3/16	4.795	3.766	1.4102	1.1075
1 1/4	5.313	4.172	1.5625	1.2272
1 5/16	5.857	4.600	1.7227	1.3530
1 3/8	6.428	5.049	1.8906	1.4849
1 7/16	7.026	5.518	2.0664	1.6230
1 1/2	7.650	6.008	2.2500	1.7671
1 9/16	8.301	6.519	2.4414	1.9175
1 5/8	8.978	7.051	2.6406	2.0739
1 11/16	9.682	7.604	2.8477	2.2365
1 3/4	10.413	8.178	3.0625	2.4053
1 13/16	11.170	8.773	3.2852	2.5802
1 7/8	11.953	9.388	3.5156	2.7612
1 15/16	12.763	10.024	3.7539	2.9483
2	13.600	10.681	4.0000	3.1416

Materials For 100 Square Feet of Concrete Floor Stone voids, 45 per cent; barrel specified, 3.8 cubic feet.

	Base Proportioned 1:2½:5					Surface Proportioned 1:1						
	Thickness, Inches					Thickness, Inches						
	2½	3	3½	4	4½	5	½	¾	1	1¼	1½	2
Bbls. of cement.....	1.10	1.30	1.55	1.77	1.99	2.21	0.85	1.28	1.70	2.13	2.56	3.41
Cu. yd. of sand.....	0.40	0.47	0.55	0.63	0.70	0.78	0.12	0.18	0.24	0.30	0.36	0.48
Cu. yd. of stone.....	0.78	0.94	1.10	1.25	1.41	1.56						

	Base Proportioned 1:3:6					Surface Proportioned 1:2						
	Thickness, Inches					Thickness, Inches						
	2½	3	3½	4	4½	5	½	¾	1	1¼	1½	2
Bbls. of cement.....	0.94	1.13	1.32	1.51	1.70	1.89	0.56	0.85	1.13	1.41	1.69	2.26
Cu. yd. of sand....	0.40	0.48	0.56	0.64	0.72	0.80	0.16	0.24	0.32	0.40	0.47	0.63
Cu. yd. of stone....	0.80	0.96	1.12	1.28	1.44	1.60						

Capacity and Number of Bricks Required for Cisterns per Foot of Height of wall

Inside Diameter of Cistern in Feet	Thickness of Side Walls in Inches	Number of Bricks in Side Wall	Number of Bricks in Bottom Laid Flat	Square Feet of Plaster on Side Walls	Square Feet of Plaster on Bottom	Contents of Cistern in Gallons	Cubic Feet of Excavation Required
4	4	84	50	12.5	12.5	94	21
4	8	180	50	12.5	12.5	94	27
5	4	104	80	15.7	19.6	147	30
5	8	220	80	15.7	19.6	147	37
6	4	124	110	18.8	28.2	212	40
6	8	260	110	18.8	28.2	212	48
7	4	145	154	22.0	38.4	288	52
7	8	300	154	22.0	38.4	288	62
8	4	165	200	25.0	50.0	376	66
8	8	340	200	25.0	50.0	376	76
9	8	400	255	28.2	63.5	476	92
9	12	610	255	28.2	63.5	476	104
10	8	450	312	31.4	78.5	588	110
10	12	672	312	31.4	78.5	588	122
11	12	735	380	34.5	95.0	711	143
12	12	800	450	37.5	113.0	846	165
13	12	865	530	40.8	133.0	992	188
14	12	924	616	44.0	154.0	1152	216
15	12	990	705	47.0	176.0	1322	240
16	12	1050	800	50.0	200.0	1504	270

Approximate Sizes of Chimney Flues for Steam and Hot Water Heating in Residences and Other Buildings

Direct Radiation		Size of Flue		
Steam Square Feet	Water Square Feet	Tile flues, standard sizes, round, inside diameter, inches	Tile flues, standard sizes, rectangular, outside dimensions, inches	Brick flues, inside dimensions, inches
200 to 400	300 to 700	8	8½ x 8½	8 x 8
500 to 700	850 to 1200	10	8½ x 13	8 x 12
800 to 1200	1350 to 2100	12	13 x 13	12 x 12
1400 to 2000	2400 to 3400	14	13 x 18	12 x 16
2200 to 3000	3700 to 5100	16	18 x 18	16 x 16
3500 to 5000	5900 to 8500	18		16 x 20

Indirect radiation must be figured as 50 per cent more than direct radiation and a corresponding area of flue must be provided for.

Pressure of Water in Pounds Due to Height in Feet

Feet Head	Pressure in Lbs. per Sq. In.	Feet Head	Pressure in Lbs. per Sq. In.	Feet Head	Pressure in Lbs. per Sq. In.
1	0.43	35	15.16	70	30.32
5	2.16	40	17.32	75	32.48
10	4.33	45	19.49	80	34.65
15	6.49	50	21.65	85	36.82
20	8.66	55	23.82	90	38.98
25	10.82	60	25.99	95	41.15
30	12.99	65	28.15	100	43.31

Carrying Capacity of Sewer Pipes, in Gallons per Minute, With Varying Fall in Inches per 100 Feet

Size of Pipe	Fall per 100 Feet, in Inches							
	1	2	3	6	9	12	24	36
3-inch	13	19	23	32	40	46	64	79
4-inch	27	38	47	66	81	93	131	163
6-inch	75	105	129	183	224	258	364	450
8-inch	153	216	265	375	460	527	750	923
9-inch	205	240	285	508	617	712	1006	1240
10-inch	267	378	463	755	803	921	1310	1613
12-inch	422	596	730	1033	1273	1468	2076	2554
15-inch	740	1021	1282	1818	2224	2464	3617	4467
18-inch	1168	1651	2022	2860	3508	4045	5704	7047
24-inch	2360	3397	4155	5874	7202	8303	11744	14466
27-inch	4407	6211	7674	10833	13257	15344	21771	26622
30-inch	5906	8352	10223	14298	17714	20204	28129	35513
36-inch	9707	13769	16816	23763	29284	33722	47523	58406

Bearing Power of Various Soils

KIND OF MATERIAL	Bearing Power in Tons per Sq. Ft.
	Min. Max.
Rock—the hardest—in thick layers of native bed.....	200
Rock equal to best ashlar masonry.....	25
Rock equal to best brick masonry.....	15
Rock equal to poor brick masonry.....	5
Clay on thick beds, always dry.....	4
Clay on thick beds, moderately dry.....	2
Clay, soft.....	1
Gravel and coarse sand, well compacted.....	8
Sand, compacted and well cemented.....	4
Sand, clean, dry.....	2
Quicksand, alluvial soils, etc.....	0.5

Covering Capacity of Shingles

Exposure to Weather, Inches	Number of Square Feet of Roof Covered by 1,000 Shingles		Number of Shingles Required for 100 Square Feet of Roof	
	4 in. Wide	6 in. Wide	4 in. Wide	6 in. Wide
4	111	167	900	600
4¼	118	177	847	585
4½	125	188	800	534
5	139	208	720	480
5½	153	230	650	437
6	167	250	600	400
7	194	291	514	343
8	222	333	450	300

Weights of Roofing Materials

MATERIAL	Weight in Pounds per Square Foot
Asphalt on felt, without sheathing.....	2
Ceiling, ordinary lath and plaster.....	6 to 8
Ceiling, stamped steel.....	2
Ceiling, wood, ¾-inch.....	2½
Composition, 3-ply.....	1
Concrete, per 1-inch thickness of slab.....	13
Gravel and felt, without sheathing.....	8 to 10
Iron, corrugated, No. 18.....	2½
Iron, corrugated, No. 20.....	2
Iron, corrugated, No. 24.....	1½
Iron, flat, galvanized.....	1 to 3½
Sheathing, hemlock, 1 inch thick.....	2
Sheathing, spruce, 1 inch thick.....	2
Sheathing, yellow pine, 1 inch thick.....	4
Sheathing, white pine, 1 inch thick.....	3
Shingles, wood, cedar.....	1½
Shingles, wood, cypress.....	2½
Shingles, metal, tin, painted.....	1
Shingles, metal, copper.....	1½
Skylight, glass, 3/16 to ¼-inch, with frames.....	4 to 10
Slate, 3/16 to ¼-inch.....	7 to 9
Slate, diminishing courses.....	12
Steel, standing seam.....	1
Tar and gravel, 4-ply.....	5½
Tar and gravel, 5-ply.....	6
Tiles, corrugated.....	8 to 10
Tiles, flat.....	15 to 20
Tiles, Ludowici.....	8
Tiles, on concrete slabs.....	30 to 35
Tiles, pan.....	10
Tin on felt.....	1
Tin, without sheathing.....	¼ to 1

Space Required for Various Articles of Furniture and Plumbing

In planning the size and shape of rooms, the placing of windows and otherwise proportioning the interior dimensions of the building, the following dimensions of furniture will be of assistance:

Lounges are 6 feet long and about 30 inches wide.

Dining tables are made from 3 feet 6 inches to 4 feet wide and extend from 12 feet to 16 feet.

Bedsteads are made in three classes. A single bed is from 3 feet to 4 feet wide inside; a three-quarter bed, from 4 feet to 4 feet 6 inches; a double bed, 5 feet. The lengths are from 6 feet 6 inches to 6 feet 8 inches, inside. Headboards are from 5 feet to 6-feet 6 inches high.

Chiffoniers are about 3 feet wide, 1 foot 8 inches deep and 4 feet 4 inches high.

Wash stands of large size are 3 feet long, 1 foot 6 inches wide and 2 feet 7 inches high. Smaller sizes are from 2 feet 4 inches to 2 feet 8 inches long.

Wardrobes are made 8 feet high, 2 feet deep and 4 feet 6 inches wide, or 6 feet 9 inches high, 1 foot 5 inches deep and 3 feet wide.

Sideboards are from 4 feet to 6 feet long and from 20 inches to 2 feet 2 inches deep.

Upright pianos vary from 4 feet 10 inches to 5 feet 6 inches in length, from 4 feet to 4 feet 9 inches in height and are about 2 feet 4 inches deep over all.

Baby-grand pianos vary from 5 feet 10 inches to 6 feet in length and are about 4 feet 10 inches in width.

Parlor-grand pianos vary from 5 feet 6 inches to 6 feet 10 inches in length and are about 4 feet 10 inches in width.

Concert-grand pianos are about 8 feet 10 inches in length and 5 feet in width.

Billiard tables are 4 feet by 8 feet, 4 feet 6 inches by 9 feet and 5 feet by 10 feet. Size of room required, 13 feet by 17 feet, 14 feet by 18 feet and 15 feet by 20 feet, respectively.

Bath tubs of enameled iron with roll rim and sloping ends are made 4, 4½, 5, 5½ and 6 feet in length, and from 30 inches to 34 inches in over-all width. Usually 1 or 2 inches in length should be allowed for the rim and 2 inches will include an ordinary overflow pipe.

Wash basins and lavatories of enameled iron are made in the following sizes: 16 by 20 inches, 18 by 21 inches and 18 by 24 inches. Backs are 10½ inches high.

Corner basins are 12½ by 12½ inches, 15 by 15 inches, 16 by 16 inches and 19 by 19 inches. The standard height is 2 feet 6 inches.

Water closets require a space of not less than 2 feet 4 inches by 4 feet.

Sinks of porcelain are 20 by 30 inches, 23 by 36 inches and 24 by 42 inches.

Laundry tubs of slate or soapstone are usually 2 feet wide and 16 inches deep. Length of a two-part tub is 4 feet and 4 feet 6 inches; three-part tub is 6 feet 6 inches and 7 feet.

Safe Speed of Emery Wheels

Diameter of Wheel, Inches	Revolutions per Minute	Diameter of Wheel, Inches	Revolutions per Minute
4	5250	12	1750
5	4200	14	1500
6	3500	16	1300
7	3000	19	1175
8	2625	20	1050
9	2325	22	950
10	2100	24	875

Speed of Circular Saws

Size of Saw Inches, Diameter	Revolutions per Minute	Size of Saw Inches, Diameter	Revolutions per Minute
8	4300	24	1450
10	3500	26	1300
12	2900	28	1200
14	2500	30	1150
16	2100	32	1100
18	1900	34	1000
20	1700	36	950
22	1600		

Allowable Carrying Capacities of Copper Conductors

Size Wire, B. & S. Gauge	Sectional Area in Circular Mils	Capacity in Amperes.	
		Rubber-covered	Weather-proof
18	1624	3	5
16	2583	6	8
14	4107	12	16
12	6530	17	23
10	10380	24	32
8	16510	33	46
6	26250	46	65
5	33100	54	77
4	41740	65	92
3	52630	76	110
2	66370	90	131
1	83690	107	156
0	105500	127	185
000	133100	150	220
000	167800	177	262
0000	211600	210	312
Cables	200000	200	300
"	300000	270	400
"	400000	330	500
"	500000	390	590
"	600000	450	680
"	700000	500	760
"	800000	550	840
"	900000	600	920
"	1000000	650	1000
"	1100000	690	1080
"	1200000	730	1150
"	1300000	770	1220
"	1400000	810	1290
"	1500000	850	1360
"	1600000	890	1430
"	1700000	930	1490
"	1800000	970	1550
"	1900000	1010	1610
"	2000000	1059	1670



War Conditions Favor Heavy Timber Construction

IN time of trouble it is natural to turn to old and tried friends for dependable air. Investigations made by C. E. Paul, construction engineer, National Lumber Manufacturers' Association, and our "Boss Carpenter," whose "Noon Hour Talks" are so well known to AMERICAN BUILDER readers, shows that there is an increasing demand for information relating to the proper and economical use of heavy timber in both the mill construction type of commercial buildings and for highway bridges. High prices and uncertain deliveries of steel shapes and reinforcing materials have aided in reminding the designer that wood structures have distinct advantages in standard construction.

Recent reports have shown instances in which a substantial heavy timber highway bridge could be built at a cost less than the difference between a steel bridge at present prices and those of normal times. Mill construction buildings are built at a saving of 20 to 25 per cent as compared with the same building in reinforced concrete, with an additional saving of about 25 per cent in time of erection.

Mack & ton'), Rehm Ha Rockford Sargent & L. A. Say L. & I. J. American Ohio. Atlas Eng Novo Eng Standard Pittsbu Whitman American ("Ping Toledo C Chicago I Western I Chicago I Western I

Directory of Tools, Machinery, and Supplies Used by Builders.

Buyers' Guide

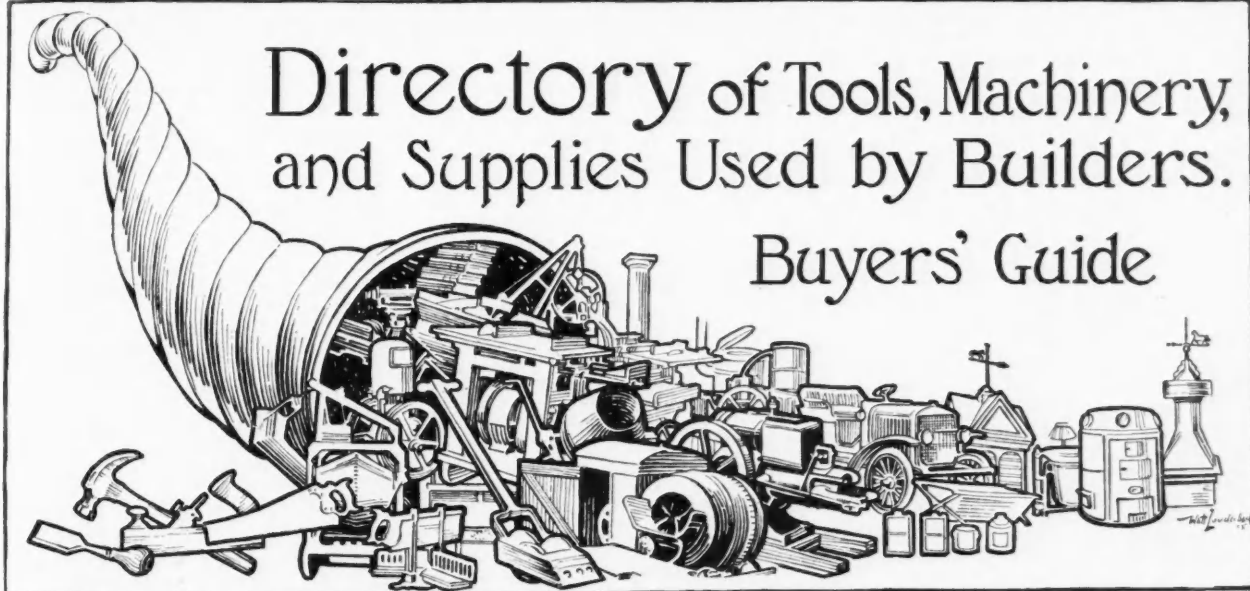

THE Publishers of the **AMERICAN BUILDER** present this Directory with the hope that it will prove really useful to builders. While it is as complete as our limited space has permitted, no doubt some first-rate concerns and some important products have been overlooked; nevertheless, it does cover the principal offerings of the most substantial and enterprising of the manufacturing concerns catering to the building field. We can vouch for the responsibility of every one of the concerns whose goods are listed in this Directory, and we recommend them to our readers. Builders, dealers in building materials, architects, contractors and carpenters in writing to any of these concerns can feel that they will receive most prompt and courteous attention, and that their business will be appreciated.

Valuable Information—Keep it Handy for Reference

This directory contains valuable information boiled down into a few words, and will save time and effort for busy builders and dealers. The various tools, machines, or building materials are arranged alphabetically; the trade name given whenever possible, and the name and address of the manufacturer or general sales agent.

This Directory makes it easy to compare the range of offerings in any particular line you are interested in. Do not hesitate to write for catalogs and circular matter pertaining to any goods new to you, or in which you are especially interested.

Our Information Department at Your Service

If you fail to find in this Directory any item or line of goods in which you are interested, write the **AMERICAN BUILDER**, and we will immediately send you the information and put you in touch with the best concerns who are in a position to furnish what you need. We are glad to serve you in every way we can.

**Editors and Publishers, American Builder
Radford Building, Chicago, Ill.**

- | | | |
|---|---|---|
| Adzes—Carpenters
Mack & Co., Rochester, N. Y. ("D. R. Barton").
Rehm Hardware Co., Chicago, Ill.
Rockford Mitre Box Co., Rockford, Ill.
Sargent & Co., New Haven, Conn. ("Sargent").
L. A. Sayre Co., Newark, N. J.
L. & I. J. White Co., Buffalo, N. Y. | Angle Irons
Archer Iron Works, Chicago, Ill.
McKinney Mfg. Co., Pittsburgh, Pa.
Sargent & Co., New Haven, Conn. ("Sargent")
Stover Mfg. & Engine Co., Freeport, Ill.
Western Iron & Foundry Co., Wichita, Kans. | E. C. Stearns & Co., Syracuse, N. Y.
James Swan Co., Seymour, Conn. ("Swan"). |
| Air Compressors
American Floor Surfacing Machine Co., Toledo, Ohio.
Atlas Engineering Co., Milwaukee, Wis.
Novo Engine Co., Lansing, Mich. ("Novo").
Standard Scale & Supply Co., 1631 Liberty Ave., Pittsburgh, Pa.
Whitman Agricultural Co., St. Louis, Mo. | Anvils—Bench
Hunt, Helm, Ferris & Co., Harvard, Ill. ("Star" anvil and vise). | Augers—Post Hole
Rehm Hardware Co., Chicago, Ill.
Vaughan & Bushnell Mfg. Co., Chicago, Ill. |
| Archers—Corrugated
Berger Mfg. Co., Canton, O.
Edwards Mfg. Co., Cincinnati, O.
Kanneberg Roofing & Ceiling Co., Canton, O.
Milwaukee Corrugating Co., Milwaukee, Wis.
Willis Mfg. Co., Galesburg, Ill. | Art Glass
The Curtis Companies, Clinton, Ia.
Morgan Sash & Door Co., Chicago, Ill. | Automobiles—Passenger
Kissel Motor Car Co., Hartford, Wis. (The "All-Year Car." "Hundred Point Six," "Double Six"). |
| Auto Trailers
Martin Rocking Fifth Wheel Co., Springfield, Mass. ("Martin" semi-trailer).
Miami Trailer Co., Troy, O. | Augers—Boring Machine
J. A. Fay & Egan Co., Cincinnati, O.
Rehm Hardware Co., Chicago, Ill.
Sargent & Co., New Haven, Conn. ("Sargent").
James Swan Co., Seymour, Conn. ("Swan"). | Awls—Brad and Scratch
Goodell-Pratt Co., Greenfield, Mass.
Peck, Stow & Wilcox Co., Cleveland, O. ("Pexto").
Rehm Hardware Co., Chicago, Ill.
Sargent & Co., New Haven, Conn. ("Sargent").
Stanley Rule & Level Co., New Britain, Conn. |
| Auto Trailers
American 3-Way Prism Co., La Porte, Ind. ("Finger Cling" bond anchors).
Toledo Cable Co., Toledo, O. ("Bull Dog"). | Augers—Hollow
Buckeye Mfg. & Foundry Co., Cleveland, O.
J. A. Fay & Egan Co., Cincinnati, O.
Sargent & Co., New Haven, Conn. ("Sargent"). | Awning Cloth
Wm. L. Barrell Co., New York, N. Y. ("Textol Strips").
John Boyle & Co., Inc., New York, N. Y. |
| Chicago Builders' Specialties Co., Chicago, Ill.
Western Iron & Foundry Co., Wichita, Kans. | Chicago Builders' Specialties Co., Chicago, Ill.
Western Iron & Foundry Co., Wichita, Kans. | Awnings—Corrugated Bar
Milwaukee Corrugating Co., Milwaukee, Wis. |

Awnings—Corrugated Steel
Berger Mfg. Co., Canton, O.
Edwards Mfg. Co., Cincinnati, O.
Kanneberg Roofing & Ceiling Co., Canton, O.
Milwaukee Corrugating Co., Milwaukee, Wis. ("Milcor").

Axes—Broad
E. C. Atkins & Co., Indianapolis, Ind.
Mack & Co., Rochester, N. Y. ("D. R. Barton").
Peck, Stow & Wilcox Co., Cleveland, O. ("Pexto").

Rehm Hardware Co., Chicago, Ill.
Sargent & Co., New Haven, Conn. ("Sargent").
L. & I. J. White Co., Buffalo, N. Y.

Axes—Hand
E. C. Atkins & Co., Indianapolis, Ind.
Germantown Tool Works, Philadelphia, Pa.
Mack & Co., Rochester, N. Y. ("D. R. Barton").
Peck, Stow & Wilcox Co., Cleveland, O. ("Pexto").

Rehm Hardware Co., Chicago, Ill.
Sargent & Co., New Haven, Conn. ("Sargent").
L. A. Sayre Co., Newark, N. J.
L. & I. J. White Co., Buffalo, N. Y.

Back Fillers
American Cement Machine Co., Keokuk, Ia. ("Boss" and "Handy").
Chicago Builders' Specialties Co., Chicago, Ill.
Oshkosh Mfg. Co., Oshkosh, Wis.
Standard Scale & Equipment Co., Pittsburgh, Pa.

Waterloo Cement Machinery Corp., Waterloo, Ia. ("Wonder," "Double Quick," "Back-filler").

Bandsaw Machinery
American Sawmill Machinery Co., New York, N. Y. ("American").

E. C. Atkins & Co., Indianapolis, Ind.
Beach Mfg. Co., Montrose, Pa.
Chicago Machinery Exchange, Chicago, Ill.
Crescent Machine Co., Leetonia, O.
J. A. Fay & Egan Co., Cincinnati, O.
Parks Ball Bearing Machine Co., Cincinnati, O.
Silver Mfg. Co., Salem, O.
Sidney Tool Co., Sidney, O.

Bar Benders
American Cement Machine Co., Keokuk, Ia. ("Boss").
Chicago Builders' Specialties Co., Chicago, Ill.
Koehring Machine Co., Milwaukee, Wis.
Standard Scale & Supply Co., Pittsburgh, Pa.

Bar Cutters
Koehring Machine Co., Milwaukee, Wis.
Ransome Concrete Machinery Co., 115 Broadway, New York, N. Y.

Barn Equipment
Philip Bernard Co., Sioux City, Ia.
Griffin Mfg. Co., Erie, Pa.
James Mfg. Co., Fort Atkinson, Wis.
Hunt, Helm, Ferris & Co., Harvard, Ill. ("Star" sanitary).

Lane Bros. Co., Poughkeepsie, N. Y.
McKinney Mfg. Co., Pittsburgh, Pa.
Mitchell Mfg. Co., Milwaukee, Wis.
F. E. Myers & Bro., Ashland, O.
National Mfg. Co., Sterling, Ill.
Shrauger & Johnson, Atlantic, Ia.
Stanley Works, New Britain, Conn. ("Watrous-Acme" barndoor latch, etc.).
Wildner-Strong Implement Co., Monroe, Mich. ("Wildner" stanchions and stall dividers).

Bars—Pry
Rehm Hardware Co., Chicago, Ill.
Vaughan & Bushnell Mfg. Co., 2114 Carroll Ave., Chicago, Ill.

Base—Sanitary (Fireproof)
Franklyn E. Muller Co., Waukegan, Ill. ("Asbestone").

Baseboards—Marble
Hornet Mantel Co., St. Louis, Mo.

Baseboards—Slate
Hornet Mantel Co., St. Louis, Mo.
J. K. Hower, Danielsville, Pa.
E. J. Johnson, Inc., New York, N. Y.
Slatington Slate Co., Slatington, Pa. (Clear black).

Vendor Slate Co., Easton, Pa.

Bathroom Outfits
Andrews Heating Co., Minneapolis, Minn.
Duplex Mfg. Co., Superior, Wis. ("Standard").
Hardin-Lavin Co., Chicago, Ill.
B. B. Karol, Chicago, Ill.
Kohler Co., Kohler, Wis.
Robinson Cabinet Mfg. Co., Toledo, O.

Baths—Foot
Kohler Co., Kohler, Wis.

Baths—Sitz
Kohler Co., Kohler, Wis.

Bathtubs
Andrews Heating Co., Minneapolis, Minn.
Duplex Mfg. Co., Superior, Wis.
Hardin-Lavin Co., Chicago, Ill.
B. B. Karol, Chicago, Ill.
Kohler Co., Kohler, Wis.
Robinson Cabinet Mfg. Co., Toledo, O. (Portable).

Battens—Metal
Edwards Mfg. Co., Cincinnati, O.
F. D. Kees Mfg. Co., Beatrice, Neb.
Metallic Batten Co., Owensville, Ind.

Milwaukee Corrugating Co., Milwaukee, Wis. ("Milcor").
Shrauger & Johnson, Atlantic, Ia.
Willis Mfg. Co., Galesburg, Ill.

Beaders
Peck, Stow & Wilcox Co., Cleveland, O. ("Pexto").
Stanley Rule & Level Co., New Britain, Conn.

Beads—Corner (Metal)
Berger Mfg. Co., Canton, O.
Bostwick Steel Lath Co., Niles, O.
Chicago Builders' Specialties Co., Chicago, Ill.
Edwards Mfg. Co., Cincinnati, O.
General Fireproofing Co., Youngstown, O. ("GF").

Kawneer Mfg. Co., Niles, Mich.
Milwaukee Corrugating Co., Milwaukee, Wis. ("Superior," "Neverbreak," "Milcor").
North Western Expanded Metal Co., Chicago, Ill. ("Kno-Equal").

Rehm Hardware Co., Chicago, Ill.
Shrauger & Johnson, Atlantic, Ia.
Sykes Metal Lath & Roofing Co., Niles, O.
Trussed Concrete Steel Co., Youngstown, O.
Willis Mfg. Co., Galesburg, Ill.

Beds—Disappearing
Holmes Disappearing Bed Co., Chicago, Ill. (Disappearing beds, recess beds, closet beds, portal beds, wall beds, couch beds).
Sorlein Ceiling Bed Co., Minneapolis, Minn.

Bells—Door and House
P. & F. Corbin, New Britain, Conn.
Rehm Hardware Co., Chicago, Ill.
Sargent & Co., New Haven, Conn. ("Sargent").

Benches—Manual Training
Richards-Wilcox Mfg. Co., Aurora, Ill.

Benches—Saw
American Saw Mill Machinery Co., New York, N. Y. ("American").

Bench Stops
Chas. Morrill, Inc., New York, N. Y. ("Apex").
Sargent & Co., New Haven, Conn. ("Sargent").

Bevels
Henry Disston & Sons, Philadelphia, Pa.
Rehm Hardware Co., Chicago, Ill.
Stanley Rule & Level Co., New Britain, Conn.
L. S. Starrett Co., Athol, Mass.

Bins—Concrete
Ransome Concrete Machinery Co., New York, N. Y.

Bits—Auger
Peck, Stow & Wilcox Co., Cleveland, O. ("Pexto").

Progressive Mfg. Co., Torrington, Conn. ("Forstner").
Rehm Hardware Co., Chicago, Ill.

Sargent & Co., New Haven, Conn. ("Sargent").
James Swan Co., Seymour, Conn. ("Swan").

Bits—Sash Pulley Mortising
Grand Rapids Hardware Co., Grand Rapids, Mich. (Multiple).

Bits—Screw Driver
Goodell-Pratt Co., Greenfield, Mass.
North Bros. Mfg. Co., Philadelphia, Pa.

Peck, Stow & Wilcox Co., Cleveland, O. ("Pexto").
Rehm Hardware Co., Chicago, Ill.
Sargent & Co., New Haven, Conn. ("Sargent").
Stanley Rule & Level Co., New Britain, Conn.
James Swan Co., Seymour, Conn. ("Swan").
Syracuse Twist Drill Co., Syracuse, N. Y. ("Syracuse").

Vaughan & Bushnell Co., Chicago, Ill.

Blackboards
Beaver Board Co., Buffalo, N. Y. ("Beaver" blackboards, "Beaver" greenboards").
J. K. Hower, Danielsville, Pa.

E. J. Johnson, Inc., New York, N. Y.
Lignistra Fibre Products Co., Barberton, O.
F. C. Sheldon Slate Co., Granville, N. Y. ("Sheldon's").
Slatington Slate Co., Slatington, Pa. (Natural slate).

Vendor Slate Co., Easton, Pa.

Blocks—Chain
J. G. Speidel, Reading, Pa.

Blocks—Corncrib
Mason City Brick & Tile Co., Mason City, Ia.

Blocks—Cresting
Berger Mfg. Co., Canton, O.

Willis Mfg. Co., Galesburg, Ill.

Blocks—Fireproofing
Mason City Brick & Tile Co., Mason City, Ia.

Blocks—Hollow Building (Clay)
Boone Brick, Tile & Paving Co., Boone, Ia.

Hydraulic Press Brick Co., St. Louis, Mo.

Mason City Brick & Tile Co., Mason City, Ia. ("Denison Load-Bearing Tile").

Vigo-American Clay Co., Terre Haute, Ind.

Whitacre-Greer Fireproofing Co., Waynesburg, O.

Blocks—Hollow Building (Concrete)
Anchor Concrete Stone Co., Rock Rapids, Ia. ("Anchor" continuous air-space block machine).

Blocks—Silo (Clay)
Mason City Brick & Tile Co., Mason City, Ia. ("Denison Everlasting").

Blocks and Tackle
Lane Bros. Co., Poughkeepsie, N. Y.

Sasgen Derrick Co., Chicago, Ill.

Blue Print Paper
Eugene Dietzgen Co., Chicago, Ill.
New York Blue Print Paper Co., New York, N. Y. ("Superior Gold Seal").
Technical Supply Co., Scranton, Pa.

Blowers—Saw Dust
American Saw Mill Machinery Co., New York, N. Y.

Boiler and Pipe Covering
Andrews Heating Co., Minneapolis, Minn.
Duplex Mfg. Co., Superior, Wis. ("Duplex Superior").

Hardin-Lavin Co., Chicago, Ill.
Johns-Manville Co., New York, N. Y. ("J.-M.").
B. B. Karol, Chicago, Ill.

Williamson Heater Co., Cincinnati, O.

Boilers—Heating Plant
Andrews Heating Co., Minneapolis, Minn.
Duplex Mfg. Co., Superior, Wis. ("Duplex Superior").

Hardin-Lavin Co., Chicago, Ill.

L. J. Mueller Furnace Co., Milwaukee, Wis.

Williamson Heater Co., Cincinnati, O.

Boils—Anchor
Ankyra Mfg. Co., Philadelphia, Pa. ("Ankyra").

Boils—Door and Window
P. & F. Corbin, New Britain, Conn.

Griffin Mfg. Co., Erie, Pa.

H. B. Ives Co., New Haven, Conn.

Peck, Stow & Wilcox Co., Cleveland, O. ("Pexto").

Rehm Hardware Co., Chicago, Ill.

Sargent & Co., New Haven, Conn. ("Sargent").

Stanley Works, New Britain, Conn.

Borers—Vertical
Crescent Machine Co., Leetonia, O.

Grand Rapids Hardware Co., Grand Rapids, Mich.

Boring Machines—Post
Grand Rapids Hardware Co., Grand Rapids, Mich.

Boring Machines—Wood
American Saw Mill Machinery Co., New York, N. Y. ("American").

Crescent Machine Co., Leetonia, O.

Grand Rapids Hardware Co., Grand Rapids, Mich.

J. A. Fay & Egan Co., Cincinnati, O.

Warren W. Morse, Minneapolis, Minn.

Rehm Hardware Co., Chicago, Ill.

Sargent & Co., New Haven, Conn. ("Sargent").

Silver Mfg. Co., Salem, O. (Hub boring).

James Swan Co., Seymour, Conn. ("Swan").

Braces—Bit
Goodell-Pratt Co., Greenfield, Mass.

Peck, Stow & Wilcox Co., Cleveland, O. ("Pexto").

Rehm Hardware Co., Chicago, Ill.

Sargent & Co., New Haven, Conn. ("Sargent").

Stanley Rule & Level Co., New Britain, Conn.

Braces, Corner
Goodell-Pratt Co., Greenfield, Mass.

Griffin Mfg. Co., Erie, Pa.

Rehm Hardware Co., Chicago, Ill.

Sargent & Co., New Haven, Conn. ("Sargent").

Stanley Rule & Level Co., New Britain, Conn.

Brackets
Griffin Mfg. Co., Erie, Pa. ("Lavatory, Sink, Shelf and Folding").

Brick—Enamelled
Boone Brick, Tile & Paving Co., Boone, Ia.

Hydraulic Press Brick Co., St. Louis, Mo.

Brick—Face
Alliance Brick Co., Alliance, O.

Beaver Clay Mfg. Co., New Galilee, Pa.

Boone Brick, Tile & Paving Co., Boone, Ia.

Hydraulic Press Brick Co., St. Louis, Mo.

Brick—Fire
Beaver Clay Mfg. Co., New Galilee, Pa.

Boone Brick, Tile & Paving Co., Boone, Ia.

Hydraulic Press Brick Co., St. Louis, Mo.

Whitacre-Greer Fireproofing Co., Waynesburg, Ohio.

Buckets—Dredging and Excavating
Chicago Builders' Specialties Co., Chicago, Ill.

Buckets—Hoisting and Dumping
Archer Iron Works, Chicago, Ill.

W. E. Caldwell Co., Louisville, Ky.

Chicago Builders' Specialties Co., Chicago, Ill.

T. L. Smith Co., Milwaukee, Wis.

Building Paper
Bird & Son, East Walpole, Mass.

Flintkote Co., Boston, Mass. ("Rex" black waterproof).

H. W. Johns-Manville Co., New York, N. Y.

Stowell Mfg. Co., Jersey City, N. J.

Butts—Spring
Bommer Bros., Brooklyn, N. Y. ("Bommer" single and double-acting).

Chicago Spring Butt Co., Chicago, Ill.

Griffin Mfg. Co., Erie, Pa.

McKinney Mfg. Co., Pittsburgh, Pa.

Rehm Hardware Co., Chicago, Ill.

Sargent & Co., New Haven, Conn. ("Sargent").

Shelby Spring Hinge Co., Shelby, O.

Stanley Works, New Britain, Conn.

Cabinets—Bathroom (Metal)
Hess Warming & Ventilating Co., Chicago, Ill.

B. B. Karol, Chicago, Ill.

Cabinets—Bath (Vapor)
Robinson Cabinet Mfg. Co., Toledo, O.

Cable

LaPlant-Choate Mfg. Co., Cedar Rapids, Ia.
(For derricks and hoists).

Calipers

Goodell-Pratt Co., Greenfield, Mass.
Peck, Stow & Wilcox Co., Cleveland, O.
("Pexto").
Rehm Hardware Co., Chicago, Ill.
Sargent & Co., New Haven, Conn. ("Sargent").
L. S. Starrett Co., Athol, Mass. (Calipers and dividers).

Canvas

John Boyle & Co., Inc., New York, N. Y.

Capitals—Carved Wood

Hartmann-Sanders Co., Chicago, Ill.
Morgan Sash & Door Co., Chicago, Ill.

Capitals—Composition

Chicago Grille Works, Chicago, Ill.
The Curtis Cos., Clinton, Ia.
Hartmann-Sanders Co., Chicago, Ill.
Morgan Sash & Door Co., Chicago, Ill.

Capitals—Sheet Metal

Edwards Mfg. Co., Cincinnati, O.
Milwaukee Corrugating Co., Milwaukee, Wis.
("Milcor").

Willis Mfg. Co., Galesburg, Ill.

Carborundum

The Carborundum Co., Niagara Falls, N. Y.

Cars—Industrial

American Cement Machine Co., Keokuk, Ia.
("Boss").
Archer Iron Works, Chicago, Ill.
Chicago Builders' Specialties Co., Chicago, Ill.
Stewart Mfg. Co., Waterloo, Ia.
Whitman Agricultural Co., St. Louis, Mo.

Carts—Concrete

American Cement Machine Co., Keokuk, Ia.
("Boss").
Archer Iron Works, Chicago, Ill.
Chicago Builders' Specialties Co., Chicago, Ill.
Lansing Co., Lansing, Mich.
Standard Scale & Implement Co., Pittsburgh, Pa.
Sterling Wheelbarrow Co., West Allis, Wis.
Whitman Agricultural Co., St. Louis, Mo.

Carvers—Wood

Buck Bros., Millbury, Mass.
Hartmann-Sanders Co., Chicago, Ill.

Casement Adjusters

P. & F. Corbin, New Britain, Conn.
H. B. Ives Co., New Haven, Conn.
Peck, Stow & Wilcox Co., Cleveland, O.
Rehm Hardware Co., Chicago, Ill.
Sargent & Co., New Haven, Conn. ("Sargent").
Shelby Spring Hinge Co., Shelby, O.

Casement Window Hardware

Whitney Window Corporation, Minneapolis, Minn.

Castings to Order

Buckeye Mfg. & Foundry Co., Cleveland, O.
(Grey iron).
S. Cheney & Son, Manlius, N. Y.
Cincinnati Mfg. Co., Cincinnati, O.
Duplex Mfg. Co., Superior, Wis. (Grey iron).
Sterling Foundry Co., Sterling, Ill.
Stewart Mfg. Co., Waterloo, Ia.
Western Iron & Foundry Co., Wichita, Kans.

Catches—Door and Window

P. & F. Corbin, New Britain, Conn.
Hunt, Helm, Ferris & Co., Harvard, Ill. ("Star" gravity barndoor catch).
H. B. Ives Co., New Haven, Conn.
McKinney Mfg. Co., Pittsburgh, Pa.
Rehm Hardware Co., Chicago, Ill.
Sargent & Co., New Haven, Conn. ("Sargent").
Shelby Spring Hinge Co., Shelby, O.
Stanley Works, New Britain, Conn.
Wagner Mfg. Co., Cedar Falls, Ia. ("Wagner").

Ceilings—Metal

American Sheet & Tin Plate Co., Pittsburgh, Pa.
(Beaded sheet steel).
Berger Mfg. Co., Canton, O. ("Classik" steel).
Edwards Mfg. Co., Cincinnati, O.
Kanneberg Roofing & Ceiling Co., Canton, O.
Milwaukee Corrugating Co., Milwaukee, Wis.
("Invisible Joint").
Northrop, Coburn & Dodge Co., New York, N. Y.
Trussed Concrete Steel Co., Youngstown, O.
Willis Mfg. Co., Galesburg, Ill.

Cellar Window Sets

Griffin Mfg. Co., Erie, Pa.

Cement Brick Machines

W. E. Dunn Mfg. Co., Holland, Mich.
Helm Brick Machine Co., Cadillac, Mich.
("Helm").
Lansing Co., Lansing, Mich.
Northwestern Steel & Iron Co., Eau Claire, Wis.
("Northwestern").
Standard Scale & Equipment Co., Pittsburgh, Pa.

Stewart Mfg. Co., Waterloo, Ia.

Cement Post Machines

American Cement Machine Co., Keokuk, Ia.
("Bulldog").
W. E. Dunn Mfg. Co., Holland, Mich.
Helm Brick Machine Co., Cadillac, Mich.
("Helm").
Northwestern Steel & Iron Co., Eau Claire, Wis.
("Northwestern").
Stewart Mfg. Co., Waterloo, Ia.

Cement Sewer Pipe Machines

W. E. Dunn Mfg. Co., Holland, Mich.
Northwestern Steel & Iron Works, Eau Claire, Wis. ("Northwestern").

Cement Shingle Machines

American Cement Machine Co., Keokuk, Ia.
("Boss").

Cement—Portland

Atlas Portland Cement Co., New York, N. Y.
(Also white).

Cement—Roofing

Beckman-Dawson Roofing Co., Chicago, Ill.
Philip Carey Co., Lockland, Cincinnati, O.
("Noah's Pitch").
Heppes-Nelson Roofing Co., Chicago, Ill. ("No-Tar" asphalt cement).
Lehon Co., Chicago, Ill. ("Mule-Hide").
Milwaukee Corrugating Co., Milwaukee, Wis.
("Federal Elastic").
Stowell Mfg. Co., Jersey City, N. J.

Chemical and Sanitary Closets

Comfort Chemical Closet Co., Toledo, O.
Dall Steel Products Co., Lansing, Mich.
Hardin-Lavin Co., Chicago, Ill.
Robinson Cabinet Mfg. Co., Toledo, O.
Rowe Sanitary Mfg. Co., Detroit, Mich. ("Ro-San").

Chimney Caps

S. Cheney & Son, Manlius, N. Y.
Kanneberg Roofing & Ceiling Co., Canton, O.
Midland Terra Cotta Co., Chicago, Ill.
Milwaukee Corrugating Co., Milwaukee, Wis.
("Eventdraft").

National Mfg. Co., Sterling, Ill. ("Best").

Sterling Foundry Co., Sterling, Ill.

Willis Mfg. Co., Galesburg, Ill.

Chimney Tops

Sewer Pipe Mfrs. Assn., Akron, O. (Fire clay).
Sterling Foundry Co., Sterling, Ill. (Revolving).

Chisels—Carpenters

E. C. Atkins & Co., Indianapolis, Ind.
Buck Bros., Millbury, Mass.
Crescent Co., Meriden, Conn.
Mack & Co., Rochester, N. Y. ("D. R. Barton").
Rehm Hardware Co., Chicago, Ill.
Rockford Mitre Box Co., Rockford, Ill.
Sargent & Co., New Haven, Conn. ("Sargent").
Stanley Rule & Level Co., New Britain, Conn.
James Swan Co., Seymour, Conn. ("Swan").
Vaughan & Bushnell Mfg. Co., Chicago, Ill. (All steel).

L. & I. J. White Co., Buffalo, N. Y.

Chisels—Floor

Buck Bros., Millbury, Mass.
Peck, Stow & Wilcox Co., Cleveland, O.
("Pexto").

Chisels—Hollow Mortising

American Saw Mill Machinery Co., New York, N. Y. ("American").
E. C. Atkins & Co., Indianapolis, Ind.
Chicago Machinery Exchange, Chicago, Ill.
J. A. Fay & Egan Co., Cincinnati, O.
Warren W. Morse, Minneapolis, Minn.
Parks Ball Bearing Machine Co., Cincinnati, O.

Chutes—Concrete

Archer Iron Works, Chicago, Ill.
Chicago Builders' Specialties Co., Chicago, Ill.
Ransome Concrete Machinery Co., New York, N. Y.

Clamps—Carpenters

Buckeye Mfg. & Foundry Co., Cleveland, O.
Chicago Machinery Exchange, Chicago, Ill.
Peck, Stow & Wilcox Co., Cleveland, O.
Rehm Hardware Co., Chicago, Ill.
Rockford Mitre Box Co., Rockford, Ill. ("Rockford").
Sargent & Co., New Haven, Conn. ("Sargent").
L. S. Starrett Co., Athol, Mass.
Stover Mfg. & Engine Co., Freeport, Ill.
Jas. L. Taylor Mfg. Co., Poughkeepsie, N. Y.

Clamps—Column

Chicago Machinery Exchange, Chicago, Ill.
Jas. L. Taylor Mfg. Co., Poughkeepsie, N. Y.
Trussed Concrete Steel Co., Youngstown, O.

Clamps—Concrete Construction

Chicago Builders' Specialties Co., Chicago, Ill.
Hunt, Helm, Ferris & Co., Harvard, Ill. ("Star" curb clamps).
Jas. L. Taylor Mfg. Co., Poughkeepsie, N. Y.
Whitman Agricultural Co., St. Louis, Mo.
Western Iron & Foundry Co., Wichita, Kans.

Clamps—Door

Chicago Machinery Exchange, Chicago, Ill.
Peck, Stow & Wilcox Co., Cleveland, O.
Rehm Hardware Co., Chicago, Ill.
Sargent & Co., New Haven, Conn. ("Sargent").
Jas. L. Taylor Mfg. Co., Poughkeepsie, N. Y.

Clamps—Form

Sterling Wheelbarrow Co., West Allis, Wis.

Clamps—Saw

Henry Disston & Sons, Philadelphia, Pa.

Clocks

The Clock Co., Philadelphia (Frames and works).

Coal Chutes

Canton Foundry & Machine Co., Canton, O.

Holland Furnace Co., Holland, Mich.

Kewanee Mfg. Co., Kewanee, Ill. ("Kewanee" all-steel).

Majestic Co., Huntington, Ind. ("Majestic").

National Mfg. Co., Sterling, Ill. ("Best").

Standard Scale & Equipment Co., Pittsburgh, Pa.

Sterling Foundry Co., Sterling, Ill. ("Best").

Wagner Mfg. Co., Cedar Falls, Ia. ("Wagner").

Western Iron & Foundry Co., Wichita, Kans. ("Automatic").

Willis Mfg. Co., Galesburg, Ill.

Coatings—Cement (Colors)

Samuel Cabot, Inc., Boston, Mass.
Clinton Metallic Paint Co., Clinton, N. Y.
("Clinton").

General Fireproofing Co., Youngstown, O. ("GF No. 101" brick and cement coating).

Eugene E. Nice, Philadelphia, Pa.

Standard Paint Co., New York, N. Y.

Coatings—Roof

Johns-Manville Co., New York, N. Y. ("J.M.").

Column Bases

S. Cheney & Son, Manlius, N. Y.
Hartmann-Sanders Co., Chicago, Ill.
Western Iron & Foundry Co., Wichita, Kans.

Columns—Metal

Edwards Mfg. Co., Cincinnati, O.
Hunt, Helm, Ferris & Co., Harvard, Ill.
James Mfg. Co., Fort Atkinson, Wis.
Trussed Concrete Steel Co., Youngstown, O.
Union Metal Mfg. Co., Canton, O. ("Union Metal Columns").
Western Iron & Foundry Co., Wichita, Kans.

Columns—Wood (Built-Up)

Cadillac Lumber Co., Cadillac, Mich.
Chicago Grille Works, Chicago, Ill.
The Curtis Cos., Clinton, Ia.

Hartmann-Sanders Co., Chicago, Ill.

Morgan Sash & Door Co., Chicago, Ill.

Nickerson Mfg. Co., Knoxville, Tenn. ("Nickerson" patent double-lock joint).

Concrete Block Machines

American Cement Machine Co., Keokuk, Ia.
("Automatic" and "Handy").
Anchor Concrete Stone Co., Rock Rapids, Ia.
("Hobbs" face-down).
W. E. Dunn Mfg. Co., Holland, Mich.

Helm Brick Machine Co., Cadillac, Mich.

("Helm").

Lansing Co., Lansing, Mich.

Northwestern Steel & Iron Co., Eau Claire, Wis.

("Northwestern").

Ransome Concrete Machinery Co., New York, N. Y.

Republic Iron Works, Tecumseh, Mich. ("Republic").

Standard Scale & Equipment Co., Pittsburgh, Pa.

Stewart Mfg. Co., Waterloo, Ia.

Waterloo Cement Machinery Corp., Waterloo, Ia. ("Wonder").

Western Iron & Foundry Co., Wichita, Kans.

Concrete Inserts

Chicago Builders' Specialties Co., Chicago, Ill.
Trussed Concrete Steel Co., Youngstown, O.

Conveying Machinery

Chicago Builders' Specialties Co., Chicago, Ill.
Hunt, Helm, Ferris & Co., Harvard, Ill. ("Star" trolley conveyors).
Stewart Mfg. Co., Waterloo, Ia.

Coping

National Fireproofing Co., Pittsburgh, Pa. (Salt-glazed).

Copper—Roll

Brasco Mfg. Co., Chicago, Ill.
C. G. Hussey Co., Pittsburgh, Pa.
Milwaukee Corrugating Co., Milwaukee, Wis.

Corners—Building (Metal)

Bostwick Steel Lath Co., Niles, O.
Chicago Builders' Specialties Co., Chicago, Ill.
Edwards Mfg. Co., Cincinnati, O.
F. D. Kees Mfg. Co., Beatrice, Neb. ("Kees").
Milwaukee Corrugating Co., Milwaukee, Wis.
("Milcor").

Rehm Hardware Co., Chicago, Ill.

Shrauger & Johnson Co., Atlantic, Ia.

North Western Expanded Metal Co., Chicago, Ill. ("Kornerite").

Cornices—Sheet Metal

Berger Mfg. Co., Canton, O.
Edwards Mfg. Co., Cincinnati, O.
Kanneberg Roofing & Ceiling Co., Canton, O.
Milwaukee Corrugating Co., Milwaukee, Wis.
National Sheet Metal Roofing Co., Jersey City, N. J.

Shrauger & Johnson, Atlantic, Ia.

Willis Mfg. Co., Galesburg, Ill.

Cotton Duck

John Boyle & Co., Inc., New York, N. Y.

Countersinks

Crescent Co., Meriden, Conn.
Goodell-Pratt Co., Greenfield, Mass.
North Bros. Mfg. Co., Philadelphia, Pa.
Rehm Hardware Co., Chicago, Ill.
Sargent & Co., New Haven, Conn. ("Sargent").
Stanley Rule & Level Co., New Britain, Conn.

L. S. Starrett Co., Athol, Mass.

James Swan Co., Seymour, Conn. ("Swan").

Syracuse Twist Drill Co., Syracuse, N. Y.

("Clark's").

Vaughan & Bushnell Mfg. Co., Chicago, Ill.

Cranes—Hand-Power
Canton Foundry & Machine Co., Canton, O.
J. G. Speidel, Reading, Pa.

Crayons—Lumber
Joseph Dixon Crucible Co., New Jersey, N. J.
Crestings and Finials
Berger Mfg. Co., Canton, O.
Edwards Mfg. Co., Cincinnati, O.
Milwaukee Corrugating Co., Milwaukee, Wis.
Shrauger & Johnson, Atlantic, Ia.
Willis Mfg. Co., Galesburg, Ill.

Crushers and Pulverizers
Atlas Engineering Co., Milwaukee, Wis.
Chicago Builders' Specialties Co., Chicago, Ill.
Standard Scale & Supply Co., Pittsburgh, Pa.
Wildner-Strong Implement Co., Monroe, Mich.

Cutter Heads
E. C. Atkins & Co., Indianapolis, Ind.
Chicago Machinery Exchange, Chicago, Ill.
Huther Bros. Saw Mfg. Co., Rochester, N. Y.

Dampers—Fireplace
Hornet Mantel Co., St. Louis, Mo.
Stover Mfg. & Engine Co., Freeport, Ill.

Damp-proofing Compounds
Bitu-Mortar Waterproofing Co., New York, N. Y. ("BM 208").
Ceresit Waterproofing Co., Chicago, Ill. (C.W.C02 damp-proof coating; "C. W. Co." plaster bond).

Derricks
Atlas Engineering Co., Milwaukee, Wis.
Chicago Builders' Specialties Co., Chicago, Ill.
Sasgen Derrick Co., Chicago, Ill. (Circle-swing, hand-power, lumber yard, stiff-leg, tripod and truck).
Standard Scale & Equipment Co., Pittsburgh, Pa.

Door Checks
P. & F. Corbin, New Britain, Conn.
Rehm Hardware Co., Chicago, Ill.
Richards-Wilcox Mfg. Co., Aurora, Ill.
Sargent & Co., New Haven, Conn. ("Sargent").
Shelby Sproing Hinge Co., Shelby, O.

Door Hangers—Barn and Garage
Cadillac Lumber Co., Cadillac, Mich.
Griffin Mfg. Co., Erie, Pa.
Hunt, Helm, Ferris & Co., Harvard, Ill. ("Weatherproof," "Cannon Ball," "Flexo," "Star," "20th Century").

Lane Bros. Co., Poughkeepsie, N. Y.
McKinney Mfg. Co., Pittsburgh, Pa.
National Mfg. Co., Sterling, Ill.
F. E. Myers & Bro., Ashland, O.
Richards-Wilcox Mfg. Co., Aurora, Ill.
Safety Door Hanger Co., Ashland, O. ("Top-ping's" folding garage door hanger set).
Sargent & Co., New Haven, Conn. ("Sargent").
Stanley Works, New Britain, Conn. ("S.W.").
Wagner Mfg. Co., Cedar Falls, Ia. ("Wagner").

Door Hangers—Parlor
Wagner Mfg. Co., Cedar Falls, Ia. (Wagner).

Door Hardware
Bommer Bros., Brooklyn, N. Y.
Chicago Spring Butt Co., Chicago, Ill.
P. & F. Corbin, New Britain, Conn.
Griffin Mfg. Co., Erie, Pa.
McKinney Mfg. Co., Pittsburgh, Pa.
National Mfg. Co., Sterling, Ill.
Rehm Hardware Co., Chicago, Ill.
Rock City Mfg. Co., Wabash, Ind.
Shelby Spring Hinge Co., Shelby, O.
Stanley Works, New Britain, Conn.
Sargent & Co., New Haven, Conn.

Door Holders
Bommer Bros., Brooklyn, N. Y. ("Bommer").
Caldwell Mfg. Co., Rochester, N. Y. ("Caldwell").

P. & F. Corbin, New Britain, Conn.
Stanley Works, New Britain, Conn. ("456," garage "1774").

Door Knockers
P. & F. Corbin, New Britain, Conn.

Door Mortisers
A. W. Miller Mfg. Co., Riverside, Cal.
Warren W. Morse, Minneapolis, Minn.

Door Openers—Electric
P. & F. Corbin, New Britain, Conn.
Richards-Wilcox Mfg. Co., Aurora, Ill.

Doors—Bronze and Iron
Cincinnati Mfg. Co., Cincinnati, O.
Kawneer Mfg. Co., Niles, Mich.

Doors—Cellar (Metal)
Canton Foundry & Machine Co., Canton, O.
Cincinnati Mfg. Co., Cincinnati, O.
Western Iron & Foundry Co., Wichita, Kans.

Doors—Copper-Covered
Brasco Mfg. Co., Chicago, Ill.

Doors—Fireproof (Metal-Covered)
Cincinnati Mfg. Co., Cincinnati, O.
Edwards Mfg. Co., Cincinnati, O.
Kawneer Mfg. Co., Niles, Mich.
Lane Bros. Co., Poughkeepsie, N. Y.
Richards-Wilcox Mfg. Co., Aurora, Ill.
Willis Mfg. Co., Galesburg, Ill.

Doors—Fireproof (Hollow Metal)
Cincinnati Mfg. Co., Cincinnati, O.
Edwards Mfg. Co., Cincinnati, O.
Kawneer Mfg. Co., Niles, Mich.
Milwaukee Corrugating Co., Milwaukee, Wis.
Trussed Concrete Steel Co., Youngstown, O.

Doors—Grain Elevator
Philip Bernard Co., Sioux City, Ia.

Doors—Hardwood and Veneered
Cadillac Lumber Co., Cadillac, Mich.
The Curtis Cos., Clinton, Ia. (Doors, windows, window and door frames, storm doors, screen doors and windows).

Morgan Sash & Door Co., Chicago, Ill. (Also pine and soft-wood doors, hardwood and glass doors, blinds, baseboards and wooden bevels).

Doors—Iron and Steel
Cincinnati Mfg. Co., Cincinnati, O.
Edwards Mfg. Co., Cincinnati, O.
Milwaukee Corrugating Co., Milwaukee, Wis. ("Milcor").

Trussed Concrete Steel Co., Youngstown, O.
Western Iron & Foundry Co., Wichita, Kans.

Doors—Sidewalk
American 3-Way Prism Co., La Porte, Ind. (Type C and Type D doors).
Berger Mfg. Co., Canton, O.
Canton Foundry & Machine Co., Canton, O.
Cincinnati Mfg. Co., Cincinnati, O.
Willis Mfg. Co., Galesburg, Ill.

Doors—Silo
Anchor Concrete Stone Co., Rock Rapids, Ia.

Drafting Tables
A. S. Aloe Co., St. Louis, Mo. ("Aloe's Ideal").
Eugene Dietzgen Co., Chicago, Ill.
New York Blue Print Paper Co., New York, N. Y. ("Simplex-Monroe").
Peerless Blue Print Co., New York, N. Y.
Technical Supply Co., Scranton, Pa.

Draftsmen's Scales
Eugene Dietzgen Co., Chicago, Ill.

Drawing Boards
Eugene Dietzgen Co., Chicago, Ill.

Draw Knives
Crescent Co., Meriden, Conn.
Mack & Co., Rochester, N. Y. ("D. R. Barton").

Peck, Stow & Wilcox Co., Cleveland, O. ("Pexto").

Sargent & Co., New Haven, Conn. ("Sargent").
James Swan Co., Seymour, Conn. ("Swan").
L. & I. J. White Co., Buffalo, N. Y.

Drills—Brest and Hand
Buckeye Mfg. & Foundry Co., Cleveland, O. (Chain drills).
Goodell-Pratt Co., Greenfield, Mass.
Griffin Mfg. Co., Erie, Pa. (Chain).
Kohler Die & Specialty Co., DeKalb, Ill.
North Bros. Mfg. Co., Philadelphia, Pa.
Peck, Stow & Wilcox Co., Cleveland, O. ("Pexto").
Stanley Rule & Level Co., New Britain, Conn.

Drills—Twist
James Swan Co., Seymour, Conn. ("Swan").
Syracuse Twist Drill Co., Syracuse, N. Y. ("Syracuse").

Dumbwaiters
Highwood Dumbwaiter Co., Leonia, N. J.
Kimball Bros. Co., Council Bluffs, Ia.
Sedgwick Machine Works, New York, N. Y.
Sidney Elevator Mfg. Co., Sidney, O.
J. G. Speidel, Reading, Pa.
Storm Mfg. Co., Newark, N. J.
York Automatic Dumbwaiter Co., York, Pa. ("Sanitary Automatic").

Dump Carts
Standard Scale & Supply Co., Pittsburgh, Pa.
Whitman Agricultural Co., St. Louis, Mo.

Edgers—Cement
Crescent Tool Mfg. Co., St. Louis, Mo.

Edgers—Double
American Saw Mill Machinery Co., New York, N. Y. ("American").

Beach Mfg. Co., Montrose, Pa.
J. A. Fay & Egan Co., Cincinnati, O.

Edgers—Gang-saw
American Saw Mill Machinery Co., New York, N. Y. ("American").

E. C. Atkins & Co., Indianapolis, Ind.
J. A. Fay & Egan Co., Cincinnati, O.

Elevators—Building Material
American Cement Machine Co., Keokuk, Ia. ("Boss" and "All Oak").
Atlas Engineering Co., Milwaukee, Wis.
C. H. & E. Mfg. Co., Milwaukee, Wis.
Chicago Builders' Specialties Co., Chicago, Ill.
Novo Engine Co., Lansing, Mich.
Oshkosh Mfg. Co., Oshkosh, Wis.
Sasgen Derrick Co., Chicago, Ill.
T. L. Smith Co., Milwaukee, Wis.
Standard Scale & Supply Co., Pittsburgh, Pa.
Stewart Mfg. Co., Waterloo, Ia.
Waterloo Cement Machinery Corp., Waterloo, Ia. ("Wonder").
Whitman Agricultural Co., St. Louis, Mo.
Kimball Bros. Co., Council Bluffs, Ia.

Elevators—Freight and Passenger
Highwood Dumbwaiter Co., Leonia, N. J.
Kimball Bros. Co., Council Bluffs, Ia.
Sedgwick Machine Works, Inc., New York, N. Y.
Sidney Elevator Mfg. Co., Sidney, O. ("Sidney").
J. G. Speidel, Reading, Pa.
Storm Mfg. Co., New York, N. Y.
Western Iron & Foundry Co., Wichita, Kans.

Elevators—Sidewalk
Highwood Dumbwaiter Co., Leonia, N. J.
Kimball Bros. Co., Council Bluffs, Ia.
Sedgwick Machine Works, New York, N. Y.
Sidney Elevator Mfg. Co., Sidney, O.
J. G. Speidel, Reading, Pa.
Storm Mfg. Co., New York, N. Y.

Emery Paper
Carborundum Co., Niagara Falls, N. Y. ("Carborundum and Garnet").

Emery Wheels
Carborundum Co., Niagara Falls, N. Y. ("Carborundum" and "Alaxile").

Enamels—Architectural
Ceresit Waterproofing Co., Chicago, Ill. ("Radiolite").
Keystone Varnish Co., Brooklyn, N. Y. ("Ede-vice" and "Degrah").
Murphy Varnish Co., Newark, N. J.
Patton Paint Co., Milwaukee, Wis.

Engines—Gas and Gasoline
American Saw Mill Machinery Co., New York, N. Y. ("American").
Atlas Engineering Co., Milwaukee, Wis.
C. H. & E. Mfg. Co., Milwaukee, Wis.
Duplex Mfg. Co., Superior, Wis.
Wm. Galloway Co., Waterloo, Ia.
B. B. Karol, Chicago, Ill.
Northwestern Steel & Iron Co., Eau Claire, Wis. ("Northwestern").
Novo Engine Co., Lansing, Mich. ("Novo").
Ottawa Mfg. Co., Ottawa, Kan.
Standard Scale & Supply Co., Pittsburgh, Pa.
Stewart Mfg. Co., Waterloo, Ia.
Stover Mfg. & Engine Co., Freeport, Ill.
Waterloo Cement Machinery Corp., Waterloo, Ia. ("Wonder").

Whitman Agricultural Co., St. Louis, Mo.
Witte Engine Works, Kansas City, Mo.

Engines—Kerosene
American Saw Mill Machinery Co., New York, N. Y.
Atlas Engineering Co., Milwaukee, Wis.
W. E. Dunn Mfg. Co., Holland, Mich.
Duplex Mfg. Co., Superior, Wis.
Wm. Galloway Co., Waterloo, Ia.
Novo Engine Co., Lansing, Mich. ("Novo").
Ottawa Mfg. Co., Ottawa, Kan.
Standard Scale & Supply Co., Pittsburgh, Pa.
Stewart Mfg. Co., Waterloo, Ia.
Stover Mfg. & Engine Co., Freeport, Ill.
Waterloo Cement Machinery Corp., Waterloo, Ia. ("Wonder").

Whitman Agricultural Co., St. Louis, Mo.
Witte Engine Works, Kansas City, Mo.

Engines—Kerosene
American Saw Mill Machinery Co., New York, N. Y.
Atlas Engineering Co., Milwaukee, Wis.
W. E. Dunn Mfg. Co., Holland, Mich.
Duplex Mfg. Co., Superior, Wis.
Wm. Galloway Co., Waterloo, Ia.
Novo Engine Co., Lansing, Mich. ("Novo").
Ottawa Mfg. Co., Ottawa, Kan.
Standard Scale & Supply Co., Pittsburgh, Pa.
Stewart Mfg. Co., Waterloo, Ia.
Stover Mfg. & Engine Co., Freeport, Ill.
Waterloo Cement Machinery Corp., Waterloo, Ia. ("Wonder").

Whitman Agricultural Co., St. Louis, Mo.
Witte Engine Works, Kansas City, Mo.

Engines—Kerosene
American Saw Mill Machinery Co., New York, N. Y.
Atlas Engineering Co., Milwaukee, Wis.
W. E. Dunn Mfg. Co., Holland, Mich.
Duplex Mfg. Co., Superior, Wis.
Wm. Galloway Co., Waterloo, Ia.
Novo Engine Co., Lansing, Mich. ("Novo").
Ottawa Mfg. Co., Ottawa, Kan.
Standard Scale & Supply Co., Pittsburgh, Pa.
Stewart Mfg. Co., Waterloo, Ia.
Stover Mfg. & Engine Co., Freeport, Ill.
Waterloo Cement Machinery Corp., Waterloo, Ia. ("Wonder").

Whitman Agricultural Co., St. Louis, Mo.
Witte Engine Works, Kansas City, Mo.

Engines—Kerosene
American Saw Mill Machinery Co., New York, N. Y.
Atlas Engineering Co., Milwaukee, Wis.
W. E. Dunn Mfg. Co., Holland, Mich.
Duplex Mfg. Co., Superior, Wis.
Wm. Galloway Co., Waterloo, Ia.
Novo Engine Co., Lansing, Mich. ("Novo").
Ottawa Mfg. Co., Ottawa, Kan.
Standard Scale & Supply Co., Pittsburgh, Pa.
Stewart Mfg. Co., Waterloo, Ia.
Stover Mfg. & Engine Co., Freeport, Ill.
Waterloo Cement Machinery Corp., Waterloo, Ia. ("Wonder").

Whitman Agricultural Co., St. Louis, Mo.
Witte Engine Works, Kansas City, Mo.

Engines—Kerosene
American Saw Mill Machinery Co., New York, N. Y.
Atlas Engineering Co., Milwaukee, Wis.
W. E. Dunn Mfg. Co., Holland, Mich.
Duplex Mfg. Co., Superior, Wis.
Wm. Galloway Co., Waterloo, Ia.
Novo Engine Co., Lansing, Mich. ("Novo").
Ottawa Mfg. Co., Ottawa, Kan.
Standard Scale & Supply Co., Pittsburgh, Pa.
Stewart Mfg. Co., Waterloo, Ia.
Stover Mfg. & Engine Co., Freeport, Ill.
Waterloo Cement Machinery Corp., Waterloo, Ia. ("Wonder").

Whitman Agricultural Co., St. Louis, Mo.
Witte Engine Works, Kansas City, Mo.

Engineering and Surveying Instruments
A. S. Aloe Co., St. Louis, Mo. ("Aloe's").
Eugene Dietzgen Co., Chicago, Ill.
Geier & Blumh, Troy, N. Y. ("G. & B.").
New York Blue Print Paper Co., New York, N. Y.

Peerless Blue Print Paper Co., New York, N. Y.
L. S. Starrett Co., Athol, Mass.
Technical Supply Co., Scranton, Pa.
David White Co., Inc., Milwaukee, Wis.

Excavator and Loader
T. L. Smith Co., Milwaukee, Wis.

Expansion Bolts
Ankyra Mfg. Co., Philadelphia, Pa. ("Ankyra").
Richards-Wilcox Mfg. Co., Aurora, Ill.

Fans—Ventilating
General Electric Co., Schenectady, N. Y.

Fasteners—Blind and Shutter
P. & F. Corbin, New Britain, Conn.
Sargent & Co., New Haven, Conn. ("Sargent").
Stanley Works, New Britain, Conn.

Fasteners—Casement Window
P. & F. Corbin, New Britain, Conn.
Griffin Mfg. Co., Erie, Pa.
H. B. Ives Co., New Haven, Conn.
McKinney Mfg. Co., Pittsburgh, Pa.
Peck, Stow & Wilcox Co., Cleveland, O.
Sargent & Co., New Haven, Conn. ("Sargent").
Shelby Spring Hinge Co., Shelby, O.
Stanley Works, New Britain, Conn.

Felts—Deadening
Beckman-Dawson Roofing Co., Chicago, Ill.
Bird & Son, East Walpole, Mass.
H. W. Johns-Manville Co., New York, N. Y.
Standard Paint Co., New York, N. Y. ("Ruber-oid").

Fences—Iron and Steel
Edwards Mfg. Co., Cincinnati, O.
Gilbert & Bennett Mfg. Co., Chicago, Ill.

Files and Rasps
Carborundum Co., Niagara Falls, N. Y. ("Carborundum").
Delta File Works, Philadelphia, Pa. ("Carpenters' Special," "Mechanics' Favorite," "Expert's Choice," Delta auger-bit files, bandsaw files, inserted-tooth files, stave-saw files, planer-knife files).
Henry Disston & Sons, Philadelphia, Pa.
Rockford Mite Box Co., Rockford, Ill.
Simonds Mfg. Co., Fitchburg, Mass. ("Simonds").

Fillers—Wood
S. C. Johnson & Sons, Racine, Wis. (Johnson's wood paste filler).
Murphy Varnish Co., Newark, N. J.
Eugene E. Nice, Philadelphia, Pa.

Fire Escapes
Western Iron & Foundry Co., Wichita, Kans.

Fire Extinguishers

H. W. Johns-Manville Co., New York, N. Y. ("J.M." and "Success").

Fireplace Furnishings

Hornet Mantel Co., St. Louis, Mo.
Peck, Stow & Wilcox Co., Cleveland, O.
Stover Engine & Mfg. Co., Freeport, Ill.

Floor Finish

Franklyn R. Muller Co., Waukegan, Ill.
Murphy Varnish Co., Newark, N. J.
Eugene E. Nice, Philadelphia, Pa.
Patton Paint Co., Milwaukee, Wis.
Standard Paint Co., New York, N. Y.

Floor Hardeners

General Fireproofing Co., Youngstown, O. ("GF 145 Crystalrox," liquid; "GF 140," powder).

Patton Paint Co., Milwaukee, Wis.

Floor Scraper Blades

Fox Supply Co., Brooklyn, Wis.

Flooring—Composition

American Magnesia Products Co., Chicago, Ill. ("Velvet").
Flexotile Floor Co., Rockford, Ill.
Plintkote Co., Boston, Mass. ("Rex Adamant").
H. W. Johns-Manville Co., New York, N. Y.
Franklyn R. Muller Co., Waukegan, Ill. ("Asbestone").
National Kellastone Co., Chicago, Ill. ("Kellastone").
Standard Paint Co., New York, N. Y.

Flooring—Fireproof

Mason City Brick & Tile Co., Mason City, Ia.
Franklyn R. Muller Co., Waukegan, Ill. ("Asbestone").

Flooring—Hardwood

Cadillac Lumber Co., Cadillac, Mich.
The Curtis Companies, Clinton, Ia.
Morgan Sash & Door Co., Chicago, Ill.
Northern Hemlock & Hardwood Mfrs. Asso. (Hard maple, beech and birch).
Oak Flooring Bureau, Cincinnati, O.

Flooring—Parquet

The Curtis Companies, Clinton, Ia.
Southern Pine Association, New Orleans, La.

Flooring—Sanitary

Franklyn R. Muller Co., Waukegan, Ill. ("Asbestone").

Flue Lining

Midland Terra Cotta Co., Chicago, Ill.
Sewer Pipe Mfrs. Association, Akron, O.

Forms—Curb and Sidewalk

American Cement Machine Co., Keokuk, Ia. ("Boss").
Bergner Mfg. Co., Canton, O.
Chicago Builders' Specialties Co., Chicago, Ill.
Crescent Tool Mfg. Co., St. Louis, Mo. (Finishing tools).

Fountains—Drinking (Sanitary)

Philip Bernard Co., Sioux City, Ia.
Hunt, Helm, Ferris & Co., Harvard, Ill. ("Star" sanitary water bowls for barn equipment).
B. B. Karol, Chicago, Ill.
Kohler Co., Kohler, Wis.
Mitchell Mfg. Co., Milwaukee, Wis. (For dairy).

Garage Hardware

McKinney Mfg. Co., Pittsburgh, Pa.
Bommer Bros., Brooklyn, N. Y.
Chicago Spring Butt Co., Chicago, Ill.
Richards-Wilcox Mfg. Co., Aurora, Ill.
Safety Door Hanger Co., Ashland, O.
F. E. Myers & Bro., Ashland, O.
Shelby Spring Hinge Co., Shelby, O.
Stanley Works, New Britain, Conn. ("Stanley").

Garbage Burners

Andrews Heating Co., Minneapolis, Minn.
Hardin-Lavin Co., Chicago, Ill.
Kerner Incinerator Co., Milwaukee, Wis.
L. J. Mueller Furnace Co., Milwaukee, Wis.

Garbage Receivers

The Majestic Co., Huntington, Ind. (Built-in and underground).

Garnet Paper and Cloth

The Carborundum Co., Niagara Falls, N. Y.

Gas Machines

Andrews Heating Co., Minneapolis, Minn.
Chicago Builders' Specialties Co., Chicago, Ill.
Chas. G. Witt, Davenport, Ia. (Cold process).

Gauges—Auger Bit

Sargent & Co., New Haven, Conn. ("Sargent").
Stanley Rule & Level Co., New Britain, Conn.
Sykes Swan Co., Seymour, Conn. ("Swan").
Syracuse Twist Drill Co., Syracuse, N. Y. ("Syracuse").

Gauges—Butt

Buckeye Mfg. & Foundry Co., Cleveland, O. (Steel).
Goodell-Pratt Co., Greenfield, Mass.
Stanley Rule & Level Co., New Britain, Conn.

Gauges—Hatchet

L. A. Sayre Co., Newark, N. J.

Gauges—Mortise

Henry Disston & Sons, Philadelphia, Pa.

Gauges—Saw

E. C. Atkins & Co., Indianapolis, Ind.
Buckeye Mfg. & Foundry Co., Cleveland, O.
Huther Bros. Saw Mfg. Co., Rochester, N. Y.

Gauges—Shingling

F. D. Kees Mfg. Co., Beatrice, Neb. ("Kees").

Glass—Leaded

The Curtis Companies, Clinton, Ia.
Morgan Sash & Door Co., Chicago, Ill.

Glass Wire

The Curtis Companies, Clinton, Ia.
Keasbey & Mattison Co., Ambler, Pa. (Corrugated, for skylights).

Morgan Sash & Door Co., Chicago, Ill.

Glue Pots—Electric

General Electric Co., Schenectady, N. Y.

Gouges—Wood

Buck Bros., Millbury, Mass.

Grain Elevators

Duplex Mfg. Co., Superior, Wis.
Meadows Mfg. Co., Pontiac, Ill. (Stationary inside cup elevators).

Grinders—Disk

Crescent Machine Co., Leetonia, O.

Grinders—Tool

Canton Foundry & Machine Co., Canton, O.
S. Cheney & Son, Manlius, N. Y.
Goodell-Pratt Co., Greenfield, Mass.

Grindstones

J. A. Fay & Egan Co., Cincinnati, O.
Richards-Wilcox Mfg. Co., Aurora, Ill.

Grounds

Ankya Mfg. Co., Philadelphia, Pa. ("Ankya").

Guards—Jamb and Corner

Canton Foundry & Machine Co., Canton, O.

Guards—Safety

E. C. Atkins & Co., Indianapolis, Ind.
Crescent Machine Co., Leetonia, O.
J. A. Fay & Egan Co., Cincinnati, O.
Fox Supply Co., Brooklyn, Wis. (Emery wheel guards).
General Fireproofing Co., Youngstown, O. ("GF" expanded metal).
Sidney Tool Co., Sidney, O.

Guards—Window

Cincinnati Mfg. Co., Cincinnati, O.
General Fireproofing Co., Youngstown, O. ("GF" expanded metal).
Gilbert & Bennett Mfg. Co., Chicago, Ill.
Sargent & Co., New Haven, Conn. ("Sargent").
Western Iron & Foundry Co., Wichita, Kans.
Willis Mfg. Co., Galesburg, Ill.

Hammers

Crescent Tool Mfg. Co., St. Louis, Mo. (Brick and stone).
Germantown Tool Works, Philadelphia, Pa.
Peck, Stow & Wilcox Co., Cleveland, O.
Sargent & Co., New Haven, Conn. ("Sargent").
Stanley Rule & Level Co., New Britain, Conn.
Vaughan & Bushnell Mfg. Co., Chicago, Ill.

Hangers—Joist

Chicago Builders' Specialties Co., Chicago, Ill.
Hunt, Helm, Ferris & Co., Harvard, Ill.
Lane Bros. Co., Poughkeepsie, N. Y.
Trussed Concrete Steel Co., Youngstown, O.

Hangers—Sash

F. D. Kees Mfg. Co., Beatrice, Neb. (Storm and window screen, "Kees," "Gossett").
National Mfg. Co., Sterling, Ill. (80 sash hanger).

Hangers and Track

Rock City Mfg. Co., Wabash, Ind.
Shelby Spring Hinge Co., Shelby, O.
Wagner Mfg. Co., Cedar Falls, Ia. ("Wagner").
Wagner Mfg. Co., Cedar Falls, Ia. (For elevator doors, parlor doors, fire doors, folding doors, accordion doors).

Hardeners—Cement

Ceresit Waterproofing Co., Chicago, Ill. ("Indurite" liquid floor hardener, "C. W. Co. Metallic" floor hardener).
General Fireproofing Co., Youngstown, O. ("GF 140").

H. W. Johns-Manville Co., New York, N. Y.
Keystone Varnish Co., Brooklyn, N. Y. ("Prevento" hardener and binder).
Patton Paint Co., Milwaukee, Wis.

Hatchets—Lathing

Germantown Tool Works, Philadelphia, Pa.
Mack & Co., Rochester, N. Y. ("D. R. Barton").

Peck, Stow & Wilcox Co., Cleveland, O. ("Pexto").
Sargent & Co., New Haven, Conn. ("Sargent").
L. A. Sayre & Co., Newark, N. J.

Hay Carriers

Hunt, Helm, Ferris & Co., Harvard, Ill. ("Harvester," "Peerless").

Hay Track

Hunt, Helm, Ferris & Co., Harvard, Ill. ("Star" double flange, "Peerless" double angle).
F. E. Myers & Bro., Ashland, O.

Heads—Dado

American Saw Mill Machinery Co., New York, N. Y. ("American").
C. H. & E. Mfg. Co., Milwaukee, Wis.
Chicago Machinery Exchange, Chicago, Ill.
J. A. Fay & Egan Co., Cincinnati, O.
Huther Bros. Saw Mfg. Co., Rochester, N. Y.
Rockford Mitre Box Co., Rockford, Ill.

Heads—Jointer

American Saw Mill Machinery Co., New York, N. Y. ("American").
Chicago Machinery Exchange, Chicago, Ill.
J. A. Fay & Egan Co., Cincinnati, O.
Huther Bros. Saw Mfg. Co., Rochester, N. Y.
Rockford Mitre Box Co., Rockford, Ill.
Silver Mfg. Co., Salem, O.
Whisler Mfg. Co., Gibson, Ia. ("Woodworkers' Friend").

Heads—Shaper

American Saw Mill Machinery Co., New York, N. Y. ("American").
Chicago Machinery Exchange, Chicago, Ill.
J. A. Fay & Egan Co., Cincinnati, O.
Huther Bros. Saw Mfg. Co., Rochester, N. Y.
Rockford Mitre Box Co., Rockford, Ill.
Whisler Mfg. Co., Gibson, Ia.

Heaters—Garage

Kanneberg Roofing & Ceiling Co., Canton, O.

Heaters—Water (Instantaneous)

Hardin-Lavin Co., Chicago, Ill.
B. B. Karol, Chicago, Ill.

Heating Plants—Hot Water

Andrews Heating Co., Minneapolis, Minn.
Duplex Mfg. Co., Superior, Wis. ("Superior," "Laurel").
Hardin-Lavin Co., Chicago, Ill.
L. J. Mueller Furnace Co., Milwaukee, Wis.
Williamson Heater Co., Cincinnati, O.

Heating Plants—Pipeless Furnace

American Bell & Foundry Co., Northville, Mich.
Andrews Heating Co., Minneapolis, Minn.
Bovee Furnace Works, Waterloo, Ia.
Duplex Mfg. Co., Superior, Wis.
Hardin-Lavin Co., Chicago, Ill.
Hess Warming & Ventilating Co., Chicago, Ill.
Home Furnace Co., Holland, Mich.
B. B. Karol, Chicago, Ill.
The Majestic Co., Huntington, Ind.
L. J. Mueller Furnace Co., Milwaukee, Wis.
Chas. Smith Co., Chicago, Ill.
Standard School Heater Co., Chicago, Ill.
Williamson Heater Co., Cincinnati, O.

Heating Plants—Steam (Blower)

B. B. Karol, Chicago, Ill.
Williamson Heater Co., Cincinnati, O.

Heating Plants—Steam (Direct Radiation)

Andrews Heating Co., Minneapolis, Minn.
Duplex Mfg. Co., Superior, Wis.
Hardin-Lavin Co., Chicago, Ill.
B. B. Karol, Chicago, Ill.
L. J. Mueller Furnace Co., Milwaukee, Wis.
Williamson Heater Co., Cincinnati, O.

Heating Plants—Vapor System

Andrews Heating Co., Minneapolis, Minn.
Duplex Mfg. Co., Superior, Wis.
Hardin-Lavin Co., Chicago, Ill.
B. B. Karol, Chicago, Ill.
L. J. Mueller Furnace Co., Milwaukee, Wis.

Heating Plants—Warm Air Furnace

American Bell & Foundry Co., Northville, Mich.
Andrews Heating Co., Minneapolis, Minn.
Bovee Furnace Works, Waterloo, Ia.
Hardin-Lavin Co., Chicago, Ill.
Hess Warming & Ventilating Co., Chicago, Ill.
Holland Furnace Co., Holland, Mich.
Home Furnace Co., Holland, Mich.
B. B. Karol, Chicago, Ill.
The Majestic Co., Huntington, Ind.

Hinges—Blind and Shutter

Bommer Bros., Brooklyn, N. Y.
P. & F. Corbin, New Britain, Conn.
McKinney Mfg. Co., Pittsburgh, Pa.
Sargent & Co., New Haven, Conn. ("Sargent").
Stanley Works, New Britain, Conn.
Stover Mfg. & Engine Co., Freeport, Ill.

Hinges—Floor

Bommer Bros., Brooklyn, N. Y. ("Bommer").
Chicago Spring Butt Co., Chicago, Ill.
P. & F. Corbin, New Britain, Conn.
National Mfg. Co., Sterling, Ill.
Richards-Wilcox Mfg. Co., Aurora, Ill.
Shelby Spring Hinge Co., Shelby, O.
Sargent & Co., New Haven, Conn. ("Sargent").
Stover Mfg. & Engine Co., Freeport, Ill.

Hinges—Surface

Bommer Bros., Brooklyn, N. Y. ("Bommer").
Chicago Spring Butt Co., Chicago, Ill.
P. & F. Corbin, New Britain, Conn.
Griffin Mfg. Co., Erie, Pa. (Strap, Tee and Ornamental).
McKinney Mfg. Co., Pittsburgh, Pa.
National Mfg. Co., Sterling, Ill.
Rock City Mfg. Co., Wabash, Ind.
Sargent & Co., New Haven, Conn. ("Sargent").
Shelby Spring Hinge Co., Shelby, O.
Stanley Works, New Britain, Conn.

Hoists—Electric

American Cement Machine Co., Keokuk, Ia. ("Boss," "Packard").
American Saw Mill Machinery Co., New York, N. Y. ("American").
C. H. & E. Mfg. Co., Milwaukee, Wis.
Chicago Builders' Specialties Co., Chicago, Ill.
Eureka Machine Co., Lansing, Mich. ("Eureka").

Standard Scale & Supply Co., Pittsburgh, Pa.
Whitman Agricultural Co., St. Louis, Mo.

Hoists—Gasoline

American Cement Machine Co., Keokuk, Ia.
('Boss,' 'Packard')
American Saw Mill Machinery Co., New York,
N. Y. ('American')
Archer Iron Works, Chicago, Ill.
Atlas Engineering Co., Milwaukee, Wis.
O. H. & E. Mfg. Co., Milwaukee, Wis.
Chicago Builders' Specialties Co., Chicago, Ill.
Eureka Machine Co., Lansing, Mich. ('Eureka')
Lansing Co., Lansing, Mich.
Northwestern Steel & Iron Co., Eau Claire,
Wis. ('Northwestern')
Novo Engine Co., Lansing, Mich. ('Novo')
Standard Scale & Supply Co., Pittsburgh, Pa.
Stewart Mfg. Co., Waterloo, Ia.
Waterloo Cement Machinery Corp., Waterloo,
Ia. ('Wonder')
Whitman Agricultural Co., St. Louis, Mo.

Hoists—Hand

Hunt Helm, Ferris & Co., Harvard, Ill. ('Giant
Star')
J. G. Speidel, Reading, Pa.

Hoists—Rope

Lane Bros. Co., Poughkeepsie, N. Y.

Hoists—Steam

American Saw Mill Machinery Co., New York,
N. Y. ('American')
Atlas Engineering Co., Milwaukee, Wis.
Chicago Builders' Specialties Co., Chicago, Ill.
Standard Scale & Supply Co., Pittsburgh, Pa.

House-Moving Trucks

La Plant-Choate Mfg. Co., Cedar Rapids, Ia.
('Steel Giant')

Humidifiers

Home Furnace Co., Holland, Mich.

Ice Chests

Herrick Refrigerator Co., Waterloo, Ia.

Insulation—Cold Storage

Beckman-Dawson Roofing Co., Chicago, Ill.
Bird & Son, East Walpole, Mass.
Samuel Cabot, Inc., Boston, Mass. ('Cabot's
Quilt')

Flintkote Co., Boston, Mass. ('Rex' black
waterproof paper).
H. W. Johns-Manville Co., New York, N. Y.
Lehon Co., Chicago, Ill. ('Perbona' insulating
paper and 'Seal-Skin' waterproof paper).
Standard Paint Co., New York, N. Y. ('Giant',
'Universal', 'Hercules').

Instruction by Correspondence

Chicago Technical College, Chicago, Ill. (Agricultural
drafting, builders' home-study courses,
plan reading, estimating courses).
International Correspondence Schools, Scranton,
Pa.
Maack's Academy of Architecture, St. Louis, Mo.

Interior Trim—Hollow Metal

Detroit Show Case Co., Detroit, Mich. ('Kalamined')
Kawneer Mfg. Co., Niles, Mich.

Iron—Architectural

Cincinnati Mfg. Co., Cincinnati, O.
Western Iron & Foundry Co., Wichita, Kans.

Iron Work—Builders'

Canton Foundry & Machine Co., Canton, O.
Cincinnati Mfg. Co., Cincinnati, O.

Jacks—House-Moving

La Plant-Choate Mfg. Co., Cedar Rapids, Ia.

Joiners

Crescent Machine Co., Leetonia, O.
Silver Mfg. Co., Salem, O. ('Silver')

Joiners—Masons

Crescent Tool Mfg. Co., St. Louis, Mo.
Henry Disston & Sons, Philadelphia, Pa.

Kalsomine

Devoe & Reynolds Co., New York, N. Y.

Knives—Moulding

Henry Disston & Sons, Philadelphia, Pa.
(Moulding and planer).

Ladders

Cadillac Lumber Co., Cadillac, Mich.
Kewanee Mfg. Co., Kewanee, Ill. (All steel).
Lane Bros. Co., Poughkeepsie, N. Y.
F. E. Myers & Bro., Ashland, O.
Richards-Wilcox Mfg. Co., Aurora, Ill. (Rolling).

Lanterns—Contractors'

Akron Gas Lamp Co., Akron, O. ('Akron Gas
Lamp')

Latches

Chicago Spring Butt Co., Chicago, Ill.
P. & F. Corbin, New Britain, Conn.
Hunt, Helm, Ferris & Co., Harvard, Ill. ('Canon
Ball')
F. D. Kees Mfg. Co., Beatrice, Neb. ('Kees'
barndoor')
McKinney Mfg. Co., Pittsburgh, Pa.
Peck, Stow & Wilcox Co., Cleveland, O.
('Pexto')
Richards Wilcox Mfg. Co., Aurora, Ill.
Sargent & Co., New Haven, Conn. ('Sargent')
Shelby Spring Hinge Co., Shelby, O.
Stanley Works, New Britain, Conn.
Stover Mfg. & Engine Co., Freeport, Ill.
Wagner Mfg. Co., Cedar Falls, Ia. ('Wagner')

Lath—Expanded Metal

Berger Mfg. Co., Canton, O.
Bostwick Steel Lath Co., Niles, O.
Chicago Builders' Specialties Co., Chicago, Ill.
Edwards Mfg. Co., Cincinnati, O.
General Fireproofing Co., Youngstown, O. ('Her-
ringbone')
Kanneberg Roofing & Ceiling Co., Canton, O.
Milwaukee Corrugating Co., Milwaukee, Wis.
('Netmesh')
North Western Expanded Metal Co., Chicago,
Ill. ('Kno-Fur,' 'Diamond Mesh')
Sykes Metal Lath & Roofing Co., Niles, O.
('Expanded Cup')
Trussed Concrete Steel Co., Youngstown, O.
('Hy-Rib')
Willis Mfg. Co., Galesburg, Ill.

Lath—Metal

Berger Mfg. Co., Canton, O. ('Rib-Plex')
Bostwick Steel Lath Co., Niles, O. ('Truss
Loop')
Chicago Builders' Specialties Co., Chicago, Ill.
Cadillac Lumber Co., Cadillac, Mich.
Edwards Mfg. Co., Cincinnati, O.
General Fireproofing Co., Youngstown, O. ('Gen-
fire' sheet lath).
Milwaukee Corrugating Co., Youngstown, O.
('Netmesh')
North Western Expanded Metal Co., Chicago,
Ill. ('No-Burn,' 'Eureka,' 'Kno-Burn
Corrugated,' 'T-Rib Chanelath')
Sykes Metal Lath & Roofing Co., Niles, O.
Trussed Concrete Steel Co., Youngstown, O.
Western Iron & Foundry Co., Wichita, Kans.

Lath—Metal (Ribbed)

Bostwick Steel Lath Co., Niles, O.

Lath—Wire

Gilbert & Bennett Mfg. Co., Chicago, Ill.
Lathes—Woodworking
American Saw Mill Machinery Co., New York,
N. Y. ('American')

J. A. Fay & Egan Co., Cincinnati, O.
Sidney Tool Co., Sidney, O.

Laundry Tubs

Duplex Mfg. Co., Superior, Wis.
Hardin-Lavin Co., Chicago, Ill.
B. B. Karol, Chicago, Ill.
Kohler Co., Kohler, Wis.
Slatington Slate Co., Slatington, Pa.
Vendor Slate Co., Easton, Pa.

Lavatories and Fittings

Duplex Mfg. Co., Superior, Wis.
Hardin-Lavin Co., Chicago, Ill.
B. B. Karol, Chicago, Ill.
Kohler Co., Kohler, Wis.

Letters

Toledo Cable Co., Toledo, O. ('Bull Dog'
enameled steel).

Levels—Builders'

A. S. Aloe Co., St. Louis, Mo.
L. Beckmann Co., Toledo, O.
Eugene Dietzgen Co., Chicago, Ill.
Geier & Blumm, Troy, N. Y.
Kolesch & Co., New York, N. Y.
New York Blue Print Paper Co., New York,
N. Y.

L. S. Starrett Co., Athol, Mass.
David White Co., Milwaukee, Wis.

Levels—Carpenters'

A. S. Aloe Co., St. Louis, Mo. ('Aloe's Con-
vertible')
Goodell-Pratt Co., Greenfield, Mass.
Peerless Blue Print Co., New York, N. Y.
Rockford Mire Box Co., Rockford, Ill.
J. Sand & Son, Detroit, Mich. (Also masons',
bricklayers', plasterers', millwrights' levels;
spirit level glasses and sights; glasses for
straight-edge levels).
Sargent & Co., New Haven, Conn. ('Sargent')
Stanley Rule & Level Co., New Britain, Conn.
L. S. Starrett Co., Athol, Mass.
David White Co., Inc., Milwaukee, Wis.

Library Shelving—Metal

Berger Mfg. Co., Canton, O.
Edwards Mfg. Co., Cincinnati, O.
General Fireproofing Co., Youngstown, O.

Lighting Fixtures—Gas and Electric

Hardin-Lavin Co., Chicago, Ill.
B. B. Karol, Chicago, Ill.
Moore Bros. Lightning Rod Co., Maryville, Mo.
(Acetylene gas).
Union Metal Mfg. Co., Canton, O. ('Union
Metal' exterior lamp standards, entrance
standards, wall brackets, exterior newels).

Lighting Systems—Acetylene

Hardin-Lavin Co., Chicago, Ill.
Moore Bros. Lightning Rod Co., Maryville, Mo.

Lighting Systems—Electric

Jos. L. A. Barnett & Co., Cedar Rapids, Ia.
Duplex Mfg. Co., Superior, Wis.
Waterman Motor Co., Detroit, Mich.
Whitman Agricultural Co., St. Louis, Mo.

Lighting Systems—Gasoline

Akron Gas Lamp Co., Akron, O. ('Akron Gas
Lamp')

Andrews Heating Co., Minneapolis, Minn.
Whitman Agricultural Co., St. Louis, Mo.

Lighting Rods

Jos. L. A. Barnett & Co., Cedar Rapids, Ia.
Moore Bros. Lightning Rod Co., Maryville, Mo.

Shinn Mfg. Co., Chicago, Ill. ('National Flat'
copper cable conductors; also concealed sys-
tem of installation with short points).
Toledo Cable Co., Toledo, O. ('Bull Dog')

Litter Carriers

Hunt, Helm, Ferris & Co., Harvard, Ill.
('Star')
Mitchell Mfg. Co., Milwaukee, Wis. (Feed, lit-
ter and manure carriers).

Lock Mortising Machines

A. W. Miller Mfg. Co., Riverside, Cal.
Warren W. Morse, Minneapolis, Minn.

Locks and Knobs—Door

P. & F. Corbin, New Britain, Conn.
Peck, Stow & Wilcox Co., Cleveland, O.
Shelby Spring Hinge Co., Shelby, O.
Sargent & Co., New Britain, Conn. ('Sargent')

Loaders—Wagon

T. L. Smith Co., Milwaukee, Wis.
Standard Scale & Supply Co., Pittsburgh, Pa.

Lockers—Metal

Berger Mfg. Co., Canton, O.
Edwards Mfg. Co., Cincinnati, O.
Hess Warming & Ventilating Co., Chicago, Ill.
Lignistra Fibre Products Co., Barberton, O.
Lumber—Asbestos
Keasbey & Mattison Co., Ambler, Pa.

Lumber—Metal

Berger Mfg. Co., Canton, O.

Lumber Manufacturers

Great Southern Lumber Co., Bogalusa, La.
('Bogalusa' yellow pine).
Northern Hemlock & Hardwood Mfrs. Assn.,
Oshkosh, Wis. ('Old Faithful' hemlock
'Beautiful Birch' maple, ash, elm, bass-
wood, beech, tamarack, white and Norway
pine).
Oak Flooring Manufacturers' Assn., Cincin-
nati, O.
Southern Pine Association, New Orleans, La.
Southern Cypress Mfrs. Assn., New Orleans, La.
White Pine Bureau, St. Paul, Minn.

Mantels—Brick

Alliance Brick Co., Alliance, O.
Hydraulic Press Brick Co., St. Louis, Mo.
Midland Terra Cotta Co., Chicago, Ill.

Mantels—Tile

Hornet Mantel Co., St. Louis, Mo.

Mantels—Wood

The Curtis Companies, Clinton, Ia. (Sideboards,
colonnades, bookcases).
Heitland Grate & Mantel Co., Quincy, Ill.
Hornet Mantel Co., St. Louis, Mo.

Marble

Hornet Mantel Co., St. Louis, Mo.

Marquees

Edwards Mfg. Co., Cincinnati, O.
Milwaukee Corrugating Co., Milwaukee, Wis.
('Milcor')

Willis Mfg. Co., Galesburg, Ill.

Milwork—Wholesale

Cadillac Lumber Co., Cadillac, Mich.
Curtis Companies, Clinton, Ia.
Morgan Sash & Door Co., Chicago, Ill.

Mitre Boxes

Goodell-Pratt Co., Greenfield, Mass.
H. C. Marsh Co., Rockford, Ill.
Rockford Mitre Box Co., Rockford, Ill. ('Honey-
comb,' 'Teddy')

Stanley Rule & Level Co., New Britain, Conn.

Mitreing Machines

American Saw Mill Machinery Co., New York,
N. Y. ('American')

Goodell-Pratt Co., Greenfield, Mass.
H. C. Marsh Co., Rockford, Ill.
Rockford Mitre Box Co., Rockford, Ill. ('Honey-
eycomb,' 'Teddy')

Mixers—Cement (Batch)

American Cement Machine Co., Keokuk, Ia.
('Boss,' 'Packard,' 'Builders')

Archer Iron Works, Chicago, Ill. ('Archer')

Atlas Engineering Co., Milwaukee, Wis.
Blystone Mfg. Co., Cambridge Springs, Pa.
('Blystone')

Chicago Builders' Specialties Co., Chicago, Ill.
('Little Devil')

W. E. Dunn Mfg. Co., Holland, Mich.
Eureka Machine Co., Lansing, Mich. ('Eureka')

Frank Mfg. Co., Des Moines, Ia. ('Frank')

Jaeger Machine Co., Columbus, O. ('Jaeger')

Knickerbocker Co., Jackson, Mich. ('Knicker-
bocker')

Koehring Machine Co., Milwaukee, Wis.
('Dandie')

Lansing Co., Lansing, Mich. ('Lansing')

Municipal Engineering & Contracting Co., Chi-
cago, Ill. ('Austin Cube,' 'Austin Drum')

Northwestern Steel & Iron Co., Eau Claire,
Wis. ('Northwestern')

Oshkosh Mfg. Co., Oshkosh, Wis. ('Oshkosh')

Ransome Concrete Machinery Co., New York,
('Ransome')

Republic Iron Works, Tecumseh, Mich. ('Re-
public')

T. L. Smith Co., Milwaukee, Wis. (Hand
power).

Standard Scale & Supply Co., Pittsburgh, Pa.
('Standard Low-Charging')

Stewart Mfg. Co., Waterloo, Ia.

Waterloo Cement Machinery Corp., Waterloo, Ia. ("Wonder").

Mixers—Cement (Continuous)

Elite Mfg. Co., Ashland, O.
Eureka Machine Co., Lansing, Mich. ("Eureka").
Helm Brick Machine Co., Cadillac, Mich. ("Little Giant").
Knickerbocker Co., Jackson, Mich. ("Coltrin").
Lansing Co., Lansing, Mich. ("Lansing").
Ransome Concrete Machinery Co., New York, N. Y. ("Ransome").
Republic Iron Works, Tecumseh, Mich. ("Republic").
Standard Scale & Supply Co., Pittsburgh, Pa. ("Standard").

Mixers—Mortar and Plaster

American Cement Machine Co., Keokuk, Ia. ("Boss").
Archer Iron Works, Chicago, Ill. ("Archer").
Atlas Engineering Co., Milwaukee, Wis.
Blystone Mfg. Co., Cambridge Springs, Pa. ("Blystone").
C. H. & E. Mfg. Co., Milwaukee, Wis.
Chicago Builders' Specialties Co., Chicago, Ill.
Eureka Machine Co., Lansing, Mich. ("Eureka").
Frank Mfg. Co., Des Moines, Ia. ("Frank").
Jaeger Machine Co., Columbus, O. ("Jaeger").
Knickerbocker Co., Jackson, Mich. ("Knickerbocker").

Lansing Co., Lansing, Mich. ("Lansing").
Ransome Concrete Machinery Co., New York, N. Y. ("Ransome").
Republic Iron Works, Tecumseh, Mich. ("Republic").

T. L. Smith Co., Milwaukee, Wis.
Standard Scale & Supply Co., Pittsburgh, Pa.
Stewart Mfg. Co., Waterloo, Ia.

Molds—Cement Burial Vault

Northwestern Steel & Iron Co., Eau Claire, Wis. ("Northwestern").

Molds—Cement Column

W. E. Dunn Mfg. Co., Holland, Mich.
Hartmann-Sanders Co., Chicago, Ill.
Northwestern Steel & Iron Co., Eau Claire, Wis. ("Northwestern").
M. L. Schleuter, Chicago, Ill.

Molds—Cement Drain Tile

W. E. Dunn Mfg. Co., Holland, Mich.
Northwestern Steel & Iron Co., Eau Claire, Wis. ("Northwestern").
Pioneer Mfg. Co., Waterloo, Ia. ("Easy").

Molds—Cement Fence Post

American Cement Machine Co., Keokuk, Ia. ("Bulldog").
Helm Brick Machine Co., Cadillac, Mich. (Adjustable Mold).
Northwestern Steel & Iron Co., Eau Claire, Wis. ("Northwestern").

Molds—Cement Silo

Anchor Concrete Stone Co., Rock Rapids, Ia. ("Anchor").
Chicago Builders' Specialties Co., Chicago, Ill.
M. L. Schleuter, Chicago, Ill.

Mortar Colors

Clinton Metallic Paint Co., Clinton, N. Y. ("Clinton").

Mouldings—Metal

Cadillac Lumber Co., Cadillac, Mich.
Kawneer Mfg. Co., Niles, Mich.

Motors—Electric

Choralcon Co., Elkhart, Ind. (Electric motors and springs for phonographs).
General Electric Co., Schenectady, N. Y.
Sidney Tool Co., Sidney, O.
Standard Scale & Supply Co., Pittsburgh, Pa.

Motor Trucks

Kissel Motor Car Co., Hartford, Wis. ("Flyer," "General Utility," "Freighter," "Heavy Duty," "Dreadnought").
Stewart Mfg. Co., Waterloo, Ia.

Nailing Machines

Pearson Mfg. Co., Robbinsdale, Minn.

Nails—Galvanized

Edwards Mfg. Co., Cincinnati, O.

Nails—Roofing and Slating

Beckman-Dawson Roofing Co., Chicago, Ill.
Bird & Son, East Walpole, Mass. (Roofing).
Cadillac Lumber Co., Cadillac, Mich.
W. H. Maze Co., Peru, Ill. ("Zinc City," solid zinc, "Zinclad," zinc-coated).
Milwaukee Corrugating Co., Milwaukee, Wis.
Slatington Slate Co., Slatington, Pa.
Vendor Slate Co., Easton, Pa.

Nails—Shingle

W. H. Maze Co., Peru, Ill. ("Zinclad," zinc-coated for wood, asphalt, asbestos).

Nail Sets

Goodell-Pratt Co., Greenfield, Mass.
Rockford Mitre Box Co., Rockford, Ill.
Sargent & Co., New Haven, Conn. ("Sargent").

L. A. Sayre Co., Newark, N. J.
Stanley Rule & Level Co., New Britain, Conn.
L. S. Starrett Co., Athol, Mass.
James Swan Co., Seymour, Conn. ("Swan").
Syracuse Twist Drill Co., Syracuse, N. Y. ("Syracuse").
Vaughan & Bushnell Mfg. Co., Chicago, Ill.

Ornaments—Sheet Metal

Edwards Mfg. Co., Cincinnati, O.
Kanneberg Roofing & Ceiling Co., Canton, O.
Milwaukee Corrugating Co., Milwaukee, Wis. ("Micolor").
Willis Mfg. Co., Galesburg, Ill.

Ornaments—Wood

The Curtis Companies, Clinton, Ia.

Package Receivers

The Majestic Co., Huntington, Ind.

Paint and Varnish Removers

Devoe & Reynolds Co., New York, N. Y.
Murphy Varnish Co., Newark, N. J.
Eugene E. Nice, Philadelphia, Pa.
Patton Paint Co., Milwaukee, Wis.

Paints

Bird & Son, East Walpole, Mass. (Roofing).
Philip Carey Co., Cincinnati, O. ("Magnesia" roofing).
Ceresit Waterproofing Co., Chicago, Ill. ("Cembri" cement waterproofing).
Devoe & Reynolds Co., New York, N. Y.
Joseph Dixon Crucible Co., Jersey City, N. J. (Graphite paint).
Flintkote Co., Boston, Mass. ("Rex" roof paints).
Heppes-Nelson Roofing Co., Chicago, Ill. ("No-Tar" asphalt paint).
H. W. Johns-Manville Co., New York, N. Y. ("J-M").

Keystone Varnish Co., Brooklyn, N. Y. ("Keystone 23," "Keystona," "Flat Finish," "Zinolin," all zinc, for outside use).
Lehon Co., Chicago, Ill. ("Stay-Lastic" asphalt paint).
Eugene E. Nice, Philadelphia, Pa.
Patton Paint Co., Milwaukee, Wis.

Standard Paint Co., New York, N. Y. ("Flexite" metal preservative, colored "Rubberine" for prepared roofings, black "Rubberine" for recoating prepared roofing, "Peacock" black ready roofing paint, "S. P. C. Flexible" iron paint, "Star" asphaltum paint, "Special" asphalt paint, "S. P. C." non-inflammable paint, "S. P. C." damproofing paint, "S. P. C." cement floor paint, "P. C." graphite paint and structural paint, "P. C." graphite and structural paint).

Paint Spraying Machines

Devoe & Reynolds Co., New York, N. Y.
H. W. Johns-Manville Co., New York, N. Y.

Paper—Roofing and Sheathing

Beckman-Dawson Roofing Co., Chicago, Ill.
Cadillac Lumber Co., Cadillac, Mich.
Edwards Mfg. Co., Cincinnati, O.
Flintkote Mfg. Co., Boston, Mass.
Johns-Manville Co., New York, N. Y.
Lehon Co., Chicago, Ill. ("Mule-Hide").
Standard Paint Co., New York, N. Y. ("S. P. C.").

Stowell Mfg. Co., Jersey City, N. J.

Partitions—Fireproof Hollow Tile

National Fireproofing Co., Pittsburgh, Pa.

Partitions—Steel

Edwards Mfg. Co., Cincinnati, O.
General Fireproofing Co., Youngstown, O. ("Trussit" and "Self-Sentering" steel and cement-plaster partitions).
Trussed Concrete Steel Co., Youngstown, O.

Pencils—Carpenters

American Lead Pencil Co., New York, N. Y.
Joseph Dixon Crucible Co., Jersey City, N. J.

Pencils—Drafting

American Lead Pencil Co., New York, N. Y.
Joseph Dixon Crucible Co., Jersey City, N. J.
New York Blue Print Paper Co., New York, N. Y. ("Detail Criterion").

Pergolas

Union Metal Mfg. Co., Canton, O. ("Union Metal" pergolas, garden fixtures, sun dials, bird baths, flower bowls, drinking fountains).

Planers—Power

American Saw Mill Machinery Co., New York, N. Y. ("Triumph," "Jewel," "Pony").
Chicago Machinery Exchange, Chicago, Ill.
Crescent Machine Co., Leetonia, O.
Standard Scale & Supply Co., Pittsburgh, Pa.
J. D. Wallace & Co., Chicago, Ill.

Planes—Carpenters

Buckeye Mfg. & Foundry Co., Cleveland, O. ("Buckeye").
Gage Tool Co., Inc., Vineland, N. J. ("Gage Self-setting").
Mack & Co., Rochester, N. Y. ("D. R. Barton").
Sargent & Co., New Haven, Conn. ("Sargent").

Stanley Rule & Level Co., New Britain, Conn.

Plaster Boards

Bishopric Mfg. Co., Cincinnati, O.
Cadillac Lumber Co., Cadillac, Mich.
Philip Carey Co., Lockland, Cincinnati, O. ("Ceil-Board").
Edwards Mfg. Co., Cincinnati, O.

Plaster—Interior

National Kellastone Co., Chicago, Ill. (Magnesite).

Plates—Door (Kick and Push)

Bommer Bros., Brooklyn, N. Y. ("Bommer").
Brasco Mfg. Co., Chicago, Ill.
P. & F. Corbin, New Britain, Conn.

Plumbing Fixtures

Crescent Tool Mfg. Co., St. Louis, Mo. (Plumbing tools).
Duplex Mfg. Co., Superior, Wis.
Hardin-Lavin Co., Chicago, Ill.
B. B. Karol, Chicago, Ill.
Kohler Co., Kohler, Wis.
White Steel Sanitary Furniture Co., Grand Rapids, Mich.

Preservatives—Wood

Philip Carey Co., Lockland, Cincinnati, O. ("Universal Coating").
Ceresit Waterproofing Co., Chicago, Ill. ("Kram-oil").
General Fireproofing Co., Youngstown, O. ("GF 550").
Patton Paint Co., Milwaukee, Wis.

Prism Lighting

American 3-Way Prism Co., La Porte, Ind. ("American").
Berger Mfg. Co., Canton, O. ("Raydiant").

Pumps—Contractors

American Cement Machine Co., Keokuk, Ia. ("Boss").
Atlas Engineering Co., Milwaukee, Wis.
C. H. & E. Mfg. Co., Milwaukee, Wis. (Triplex, piston, centrifugal).
Chicago Builders' Specialties Co., Chicago, Ill.
The Deming Co., Salem, O.
Duplex Mfg. Co., Superior, Wis.
F. E. Myers & Bro., Ashland, O.
Novo Engine Co., Lansing, Mich. ("Novo").
Oshkosh Mfg. Co., Oshkosh, Wis.
Standard Scale & Supply Co., Pittsburgh, Pa.
Stewart Mfg. Co., Waterloo, Ia.
Waterloo Cement Machinery Corp., Waterloo, Ia. ("Wonder Improved Diaphragm").
Whitman Agricultural Co., St. Louis, Mo.

Pumps—House

Atlas Engineering Co., Milwaukee, Wis.
Berger Mfg. Co., Canton, O. ("20th Century").

The Deming Co., Salem, O.
Duplex Mfg. Co., Superior, Wis.
B. B. Karol, Chicago, Ill.
Milwaukee Air Power Pump Co., Milwaukee, Wis.

F. E. Myers & Bro., Ashland, O.
Standard Scale & Supply Co., Pittsburgh, Pa.
Whitman Agricultural Co., St. Louis, Mo.

Putty—Roof

Philip Carey Co., Lockland, Cincinnati, O. ("Noah's Pitch").
Johns-Manville Co., New York, N. Y.

Radiators—Hot Air

Hardin-Lavin Co., Chicago, Ill.
B. B. Karol, Chicago, Ill.
Williamson Heater Co., Cincinnati, O.

Radiators—Hot Water and Steam

Andrews Heating Co., Minneapolis, Minn.
Duplex Mfg. Co., Superior, Wis. ("Minnesota").
Hardin-Lavin Co., Chicago, Ill.
B. B. Karol, Chicago, Ill.

Williamson Heater Co., Cincinnati, O.

Railings—Brass

Brasco Mfg. Co., Chicago, Ill.
Cincinnati Mfg. Co., Cincinnati, O.

Railings—Iron

Cincinnati Mfg. Co., Cincinnati, O.
Duplex Mfg. Co., Superior, Wis. ("Duplex").

Rails—Altar

Brasco Mfg. Co., Chicago, Ill.
Cincinnati Mfg. Co., Cincinnati, O.

Rails—Barn-door

Griffin Mfg. Co., Erie, Pa.
Hunt, Helm, Ferris & Co., Harvard, Ill. ("Star," "20th Century," "Flexo," "Weatherproof," "Cannon Ball").
Lane Bros. Co., Poughkeepsie, N. Y.
National Mfg. Co., Sterling, Ill.
Sargent & Co., New Haven, Conn. ("Sargent").
Wagner Mfg. Co., Cedar Falls, Ia. ("Wagner").

Raisers—Panel

Huther Bros. Saw Mfg. Co., Rochester, N. Y.

Reamers

Sargent & Co., New Haven, Conn. ("Sargent").

Vaughan & Bushnell Mfg. Co., Chicago, Ill.

Refrigerators—Outside Icing

Herrick Refrigerator Co., Waterloo, Ia.

Registers—Hot Air Furnace

Bovee Furnace Works, Waterloo, Ia.
Hess Warming & Ventilating Co., Chicago, Ill.
L. J. Mueller Furnace Co., Milwaukee, Wis.

Williamson Heater Co., Cincinnati, O.
Willis Mfg. Co., Galesburg, Ill.

Regulators—Heat

Andrews Heating Co., Minneapolis, Minn.
F. D. Kees Mfg. Co., Beatrice, Neb. ("Kees").
R. J. Schwab & Sons Co., Milwaukee, Wis.
Williamson Heater Co., Cincinnati, O.

Reinforcing

Berger Mfg. Co., Canton, O. (Plates).
North Western Expanded Metal Co., Chicago, Ill. ("Econo" expanded metal steel fabric).
Trussed Concrete Steel Co., Youngstown, O. (Bars).

Western Iron & Foundry Co., Wichita, Kans. ("Bars").

Resaw Machines
Chicago Machinery Exchange, Chicago, Ill.
J. A. Fay & Egan Co., Cincinnati, O.

Ridging—Ventilated
Globe Ventilator Co., Troy, N. Y. ("Globe").

Rollers—Barndoor
Griffin Mfg. Co., Erie, Pa.
Hunt, Helm, Ferris & Co., Harvard, Ill. ("Canon Ball," "Weatherproof," "Star," "20th Century," "Flexo").
Lane Bros. Co., Poughkeepsie, N. Y.
National Mfg. Co., Sterling, Ill.
Sargent & Co., New Haven, Conn. ("Sargent").
Wagner Mfg. Co., Cedar Falls, Ia. ("Wagner").

Rollers—House Door
Hunt, Helm, Ferris & Co., Harvard, Ill. ("Canon Ball").
Lane Bros. Co., Poughkeepsie, N. Y.
National Mfg. Co., Sterling, Ill. (No. 82 silent parlor door hanger).
Sargent & Co., New Haven, Conn. ("Sargent").
Wagner Mfg. Co., Cedar Falls, Ia. ("Wagner").

Rollers—Moving Machinery
LaPlant-Choate Mfg. Co., Cedar Rapids, Ia.

Roofing—Asbestos
Beckman-Dawson Roofing Co., Chicago, Ill.
Philip Carey Co., Lockland, Cincinnati, O. ("Careystone").
H. W. Johns-Manville Co., New York, N. Y. ("J.M.").
Keasbey & Mattison Co., Ambler, Pa.

Roofing—Asbestos Shingles
Cadillac Lumber Co., Cadillac, Mich.
Johns-Manville Co., New York, N. Y. ("J.M.").
Keasbey & Mattison Co., Ambler, Pa. ("Century").

Roofing—Asphalt (Ready)
Asphalt Ready Roofing Co., New York, N. Y. ("Protection," "Arrow," "Rockland," "Fulton," "Hudson").
Beckman-Dawson Roofing Co., Chicago, Ill.
Bird & Son, East Walpole, Mass. ("Neponset").
Cadillac Lumber Co., Cadillac, Mich.
Philip Carey Co., Lockland, Cincinnati, O. ("Philo").
Edwards Mfg. Co., Cincinnati, O.
Flintkote Co., Boston, Mass.
Heppes-Nelson Roofing Co., Chicago, Ill. ("Flexatile" roofing, "Flexatile" diamond-edge roofing).
Johns-Manville Co., New York, N. Y. ("J.M.").
Lehon Co., Chicago, Ill. ("Mule-Hide").
Standard Paint Co., New York, N. Y. ("Rubber-oid").
Stowell Mfg. Co., Jersey City, N. J. (Slate-surfaced).

Roofing—Asphalt Shingles
Beckman-Dawson Roofing Co., Chicago, Ill.
Bird & Son, East Walpole, Mass. ("Neponset").
Cadillac Lumber Co., Cadillac, Mich.
Philip Carey Co., Lockland, Cincinnati, O. ("Asfaltslate").
Edwards Mfg. Co., Cincinnati, O.
Flintkote Co., Boston, Mass. ("Rex" strip shingles, "Rex" diamond strip shingles, "Rex" reversible strip, "Rex" wide-space, "Rex" inlaid roofing, "Rex" slate-surfaced roofing, "Rex" starting strips).
Heppes-Nelson Roofing Co., Chicago, Ill. ("Flexatile" asphalt, 4-slab, diamond, reversible slab, wide-space, giant).
Johns-Manville Co., New York, N. Y. ("J.M.").
Lehon Co., Chicago, Ill. ("Mule-Hide").
Standard Paint Co., New York, N. Y. ("Rubber-oid" gray and red individual, "Rubber-oid" strip).
Stowell Mfg. Co., Jersey City, N. J.

Roofing—Built-up
Standard Paint Co., New York, N. Y. ("Rubber-oid").

Roofing—Canvas
Wm. L. Barrell Co., New York, N. Y. ("Conser-tex" canvas roofing).
John Boyle & Co., New York, N. Y. ("Bayonne" and "Gulf Stream").
Flintkote Mfg. Co., Boston, Mass.
Lehon Co., Chicago, Ill. ("Mule-Hide").

Roofing—Composition
Asphalt Ready Roofing Co., New York, N. Y. ("Hudson" asphalt felts, asphalt cement, asphalt strip shingles, gravel-surfaced roofing, "Protection," "Arrow").
Bird & Son, East Walpole, Mass. ("Neponset").
Flintkote Mfg. Co., Boston, Mass. ("Rex").
Lehon Co., Chicago, Ill.
Standard Paint Co., New York, N. Y. ("Rubber-oid," "Imp," "Zylex," "Starex," "S. P. C." slate-surfaced, "Rubber-oid Shadow").
Stowell Mfg. Co., Jersey City, N. J.

Roofing—Corrugated
American Sheet & Tin Plate Co., Pittsburgh, Pa. ("Apollo").

Berger Mfg. Co., Canton, O.
Edwards Mfg. Co., Cincinnati, O.
Johns-Manville Co., New York, N. Y. ("J.M.").
Kanneberg Roofing & Ceiling Co., Canton, O.
Milwaukee Corrugating Co., Milwaukee, Wis. ("Milcor").
Willis Mfg. Co., Galesburg, Ill.

Roofing—Mastic
Beckman-Dawson Co., Chicago, Ill.
Flintkote Mfg. Co., Boston, Mass. ("Rex").
Johns-Manville Co., New York, N. Y. ("J.M.").

Roofing—Metal (Sheets)
American Sheet & Tin Plate Co., Pittsburgh, Pa. ("Apollo" formed metal).
Berger Mfg. Co., Canton, O.
Edwards Mfg. Co., Cincinnati, O.
General Fireproofing Co., Youngstown, O. ("Self-Sentering" metal and concrete roofing).
Kanneberg Roofing & Ceiling Co., Canton, O.
Milwaukee Corrugating Co., Milwaukee, Wis. ("Milcor").
National Sheet Metal Roofing Co., Jersey City, N. J.
Willis Mfg. Co., Galesburg, Ill.

Roofing—Metal Shingles
Berger Mfg. Co., Canton, O. ("Chieftain," "Swanee," "Bercor").
Cortright Metal Roofing Co., Philadelphia, Pa.
Edwards Mfg. Co., Cincinnati, O.
Kanneberg Roofing & Ceiling Co., Canton, O.
Milwaukee Corrugating Co., Milwaukee, Wis. ("American," "Titelock").
National Sheet Metal Roofing Co., Jersey City, N. J. ("Walter's & Cooper's").

Roofing—Rubber
Asphalt Ready Roofing Co., New York, N. Y. ("Fulton").
Beckman-Dawson Roofing Co., Chicago, Ill.
Bird & Son, East Walpole, Mass. ("Neponset").
Cadillac Lumber Co., Cadillac, Mich.
Philip Carey Co., Lockland, Cincinnati, O. ("Lastile").
Flintkote Co., Boston, Mass. ("Rex" Flintkote roofing, "Zarex," "Minado" double-sanded, "Rex" red).
Heppes-Nelson Roofing Co., Chicago, Ill. ("Rubbertex," "Ebonite," "Monarch," "Flexo," "Success").
Johns-Manville Co., New York, N. Y.
Lehon Co., Chicago, Ill. ("Mule-Hide").
Standard Paint Co., New York, N. Y. ("Rubber-oid").
Stowell Mfg. Co., Jersey City, N. J.

Roofing—Shadow
Standard Paint Co., New York, N. Y.

Roofing—Slate
J. K. Hower, Danielsville, Pa.
E. J. Johnson, Inc., New York, N. Y.
F. C. Sheldon Slate Co., Granville, N. Y. ("Sheldons").
Slatington Slate Co., Slatington, Pa. (Genuine Franklin Tunnel).
Vendor Slate Co., Easton, Pa.

Roofing Tile—Metal
Edwards Mfg. Co., Cincinnati, O.
General Fireproofing Co., Youngstown, O. ("GF" steel tile).
Kanneberg Roofing & Ceiling Co., Canton, O.
Milwaukee Corrugating Co., Milwaukee, Wis. ("Titelock," "Spanish").
National Sheet Metal Roofing Co., Jersey City, N. J. ("Cooper's Spanish").

Roofing Tin
American Sheet & Tin Plate Co., Pittsburgh, Pa. ("Keystone" copper steel).

Roofing—Wood Shingles
Cadillac Lumber Co., Cadillac, Mich.
Creo-Dipt Co., North Tonawanda, N. Y. ("Creo-Dipt" stained shingles, siding shingles, "Creo-Dipt" thatched roofs with stained shingles).
Northern Hemlock & Hardwood Mfrs. Assn., Oshkosh, Wis. (White cedar shingles).
Southern Pine Association, New Orleans, La.
West Coast Lumbermen's Assn., Seattle, Wash. ("Rite-Grade" inspected red cedar shingles).

Roofing and Siding—Iron and Steel
American Sheet & Tin Plate Co., Pittsburgh, Pa. ("Apollo").
Berger Mfg. Co., Canton, O.
Edwards Mfg. Co., Cincinnati, O.
Kanneberg Roofing & Ceiling Co., Canton, O.
Milwaukee Corrugating Co., Milwaukee, Wis. ("Milcor").
Willis Mfg. Co., Galesburg, Ill.

Roofing and Siding—Slate
E. J. Johnson, Inc., New York, N. Y.
F. C. Sheldon Slate Co., Granville, N. Y.
Slatington Slate Co., Slatington, Pa.
Willis Mfg. Co., Galesburg, Ill.

Router
Sargent & Co., New Haven, Conn. ("Sargent").
Stanley Rule & Level Co., New Britain, Conn.

Rubbing Bricks
Carborundum Co., Niagara Falls, N. Y.

Rules—Boxwood
Lufkin Rule Co., Saginaw, Mich.

Rules—Caliper
Lufkin Rule Co., Saginaw, Mich.
Peerless Blue Print Co., New York, N. Y.
Stanley Rule & Level Co., New Britain, Conn.

Rules—Extension
Eugene Dietzgen Co., Chicago, Ill.
Lufkin Rule Co., Saginaw, Mich.
Dahl Mfg. Co., New York, N. Y. ("Interior Master Slide Rule").
New York Blue Print Paper Co., New York, N. Y.
Peerless Blue Print Co., New York, N. Y.
Stanley Rule & Level Co., New Britain, Conn.
Technical Supply Co., Scranton, Pa.

Rules—Lumbermen's
Dahl Mfg. Co., New York, N. Y. ("Interior" folding rule).
Lufkin Rule Co., Saginaw, Mich.
Peerless Blue Print Co., New York, N. Y.

Rules—Spring Joint
Lufkin Rule Co., Saginaw, Mich.

Rules—Steel
Eugene Dietzgen Co., Chicago, Ill.
Goodell-Pratt Co., Greenfield, Mass.
Lufkin Rule Co., Saginaw, Mich.
Peerless Blue Print Co., New York, N. Y.
Technical Supply Co., Scranton, Pa.

Salamanders
Chicago Builders' Specialties Co., Chicago, Ill.
R. J. Schwab & Sons Co., Milwaukee, Wis.

Sanders
American Saw Mill Machinery Co., New York, N. Y. ("American").
Beach Mfg. Co., Montrose, Pa.
Chicago Machinery Exchange, Chicago, Ill.
J. A. Fay & Egan Co., Cincinnati, O.
H. C. Marsh Co., Rockford, Ill.

Sandpapering Machines
Beach Mfg. Co., Montrose, Pa.
Chicago Machinery Exchange, Chicago, Ill.
J. A. Fay & Egan Co., Cincinnati, O.
Parks Ball Bearing Machine Co., Cincinnati, O.

Sash—Hollow Metal
Detroit Show Case Co., Detroit, Mich. ("Desco").
Edwards Mfg. Co., Cincinnati, O.
Willis Mfg. Co., Galesburg, Ill.

Sash—Steel and Iron
Brasco Mfg. Co., Chicago, Ill. (Copper covered).
Shrauger & Johnson, Atlantic, Ia.
Trussed Concrete Steel Co., Youngstown, O.

Sash—Storm
Standard Screen Co., Chicago, Ill. ("Standard").

Sash Balances
Caldwell Mfg. Co., Rochester, N. Y.

Sash Cord
Cadillac Lumber Co., Cadillac, Mich.
Samson Cordage Works, Boston, Mass.
Silver Lake Co., Newtonville, Mass.

Sash Holders
Hardware Sales Co., New York, N. Y. ("Automatic").
H. B. Ives Co., New Haven, Conn.
F. D. Kees Mfg. Co., Beatrice, Neb. ("Kees").
Stanley Works, New Britain, Conn.
Wagner Mfg. Co., Cedar Falls, Ia. ("Wagner").

Sash Lifts
Cadillac Lumber Co., Cadillac, Mich.
P. & F. Corbin, New Britain, Conn.
Griffin Mfg. Co., Erie, Pa.
H. B. Ives Co., New Haven, Conn. ("Ives" patent window-stop adjuster).
McKinney Mfg. Co., Pittsburgh, Pa.
Peck, Stow & Wilcox Co., Cleveland, O.
Sargent & Co., New Haven, Conn. ("Sargent").
Shelby Spring Hinge Co., Shelby, O.
Stanley Works, New Britain, Conn.
Stover Mfg. & Engine Co., Freeport, Ill.

Sash Locks
Cadillac Lumber Co., Cadillac, Mich.
P. & F. Corbin, New Britain, Conn.
H. B. Ives Co., New Haven, Conn. ("Ives" patent window ventilating lock).
McKinney Mfg. Co., Pittsburgh, Pa.
National Mfg. Co., Sterling, Ill.
Peck, Stow & Wilcox Co., Cleveland, O.
Sargent & Co., New Haven, Conn. ("Sargent").
Shelby Spring Hinge Co., Shelby, O.
Stanley Works, New Britain, Conn.
Caldwell Mfg. Co., Rochester, N. Y. ("Caldwell").

Sash Pulleys
Cadillac Lumber Co., Cadillac, Mich.
P. & F. Corbin, New Britain, Conn.
Grand Rapids Hardware Co., Grand Rapids, Mich. ("All Steel").
Sargent & Co., New Haven, Conn. ("Sargent").
Stover Mfg. & Engine Co., Freeport, Ill.

Saw Arbors
American Saw Mill Machinery Co., New York, N. Y. ("American").
E. C. Atkins & Co., Indianapolis, Ind.
Duplex Mfg. Co., Superior, Wis. ("Superior").
Goodell-Pratt Co., Greenfield, Mass.

Huth
Rock
Simon
W...

Ameri
N. Y.
E. C.
J. A.
Parks
Rockf
Sidney
Standa

Ameri
N. Y.
E. C.
Beach
H.
Chicago
Chicago
Duplex
J. A.
Knicke
erbo
Northw
Wis.
Novo F
Oshkosh
ready
Parks I
Rockfor
Sidney
Standar
Whitma

Americ
N. Y.
E. C. A
George
Buckeye
("Bu
Henry I
Goodell
Chas. M
hand)
Peck, S
Rockfor
Sargent
gent"
L. A. Sa
Sidney T
Simonds
monds
Stanley

E. C. At
Henry D
J. A. Fay
Huther I
Sidney T

American
N. Y.
Beach M
C. H. &
Chicago
Crescent
J. A. Fay
Parks Ba
Rockfor
Sidney T
Silver Mf
Standard
Whitman

American
N. Y.
E. C. Atk
Chicago
Crescent
Henry Dis
A. Fay
Oshkosh
Parks Ba
Rockfor
Sidney T
Silver Mf
proved I
monds I
monds I
Standard

American
N. Y.
E. C. Atki
Chicago
Crescent
Henry Dis
A. Fay
Oshkosh
Parks Ba
Rockfor
Sidney T
Silver Mf
proved I
monds I
monds I
Standard

American
N. Y.
E. C. Atki
Chicago
Crescent
Henry Dis
A. Fay
Oshkosh
Parks Ba
Rockfor
Sidney T
Silver Mf
proved I
monds I
monds I
Standard

Huther Bros. Saw Mfg. Co., Rochester, N. Y.
Rockford Mitre Box Co., Rockford, Ill.
Simonds Mfg. Co., Fitchburg, Mass.
Whisler Mfg. Co., Gibson, Ia.

Sawdust Conveyors

American Saw Mill Machinery Co., New York, N. Y. ("American").

Saw Mill Machinery

American Saw Mill Machinery Co., New York, N. Y. ("American").
E. C. Atkins & Co., Indianapolis, Ind.
J. A. Fay & Egan Co., Cincinnati, O.
Parks Ball Bearing Machine Co., Cincinnati, O.
Rockford Mitre Box Co., Rockford, Ill.
Sidney Tool Co., Sidney, O.
Standard Scale & Supply Co., Pittsburgh, Pa.

Saw Rigs

American Saw Mill Machinery Co., New York, N. Y. ("American").
E. C. Atkins & Co., Indianapolis, Ind.
Beach Mfg. Co., Montrose, Pa.
C. H. & E. Mfg. Co., Milwaukee, Wis.
Chicago Builders' Specialties Co., Chicago, Ill.
Chicago Machinery Exchange, Chicago, Ill.
Duplex Mfg. Co., Superior, Wis. ("Duplex").
J. A. Fay & Egan Co., Cincinnati, O.
Knickerbocker Co., Jackson, Mich. ("Knickerbocker").

Northwestern Steel & Iron Co., Eau Claire, Wis. ("Northwestern").
Novo Engine Co., Lansing, Mich. ("Novo").
Oshkosh Mfg. Co., Oshkosh, Wis. ("Ever-ready").

Parks Ball Bearing Machine Co., Cincinnati, O.
Rockford Mitre Box Co., Rockford, Ill.
Sidney Tool Co., Sidney, O. ("Famous").
Standard Scale & Supply Co., Pittsburgh, Pa.
Whitman Agricultural Co., St. Louis, Mo.

Saw Sets

American Saw Mill Machinery Co., New York, N. Y.
E. C. Atkins & Co., Indianapolis, Ind.
George H. Bishop & Co., Lawrenceburg, Ind.
Buckeye Mfg. & Foundry Co., Cleveland, O. ("Buckeye" foot-power).

Henry Disston & Sons, Philadelphia, Pa.
Goodell-Pratt Co., Greenfield, Mass.
Chas. Morrill, Inc., New York, N. Y. ("Apex" hand).

Peck, Stow Wilcox & Co., Cleveland, O.
Rockford Mitre Box Co., Rockford, Ill.
Sargent & Co., New Haven, Conn. ("Sargent").

L. A. Sayre Co., Newark, N. J.
Sidney Tool Co., Sidney, O.
Simonds Mfg. Co., Fitchburg, Mass. ("Simonds").

Stanley Rule & Level Co., New Britain, Conn.

Saw Swages

E. C. Atkins & Co., Indianapolis, Ind.
Henry Disston & Sons, Philadelphia, Pa.
J. A. Fay & Egan Co., Cincinnati, O.
Huther Bros. Saw Mfg. Co., Rochester, N. Y.
Sidney Tool Co., Sidney, O.

Saw Tables

American Saw Mill Machinery Co., New York, N. Y. ("American").

Beach Mfg. Co., Montrose, Pa.
C. H. & E. Mfg. Co., Milwaukee, Wis.
Chicago Machinery Exchange, Chicago, Ill.
Crescent Machine Co., Leetonia, O.
J. A. Fay & Egan Co., Cincinnati, O.
Parks Ball Bearing Machine Co., Cincinnati, O.
Rockford Mitre Box Co., Rockford, Ill.
Sidney Tool Co., Sidney, O.

Silver Mfg. Co., Salem, O. ("Silver's").
Standard Scale & Supply Co., Pittsburgh, Pa.
Whitman Agricultural Co., St. Louis, Mo.

Saws—Band

American Saw Mill Machinery Co., New York, N. Y. ("American").

E. C. Atkins & Co., Indianapolis, Ind.
Chicago Machinery Exchange, Chicago, Ill.
Crescent Machine Co., Leetonia, O.
Henry Disston & Sons, Philadelphia, Pa.
J. A. Fay & Egan Co., Cincinnati, O.

Huther Bros. Saw Mfg. Co., Rochester, N. Y.
Oshkosh Mfg. Co., Oshkosh, Wis.
Parks Ball Bearing Machine Co., Cincinnati, O.
Rockford Mitre Box Co., Rockford, Ill.
Sidney Tool Co., Sidney, O.

Silver Mfg. Co., Salem, O. ("Silver's" improved power).
Simonds Mfg. Co., Fitchburg, Mass. ("Simonds").

Standard Scale & Supply Co., Pittsburgh, Pa.

Saws—Circular

American Saw Mill Machinery Co., New York, N. Y. ("American").

E. C. Atkins & Co., Indianapolis, Ind.
Chicago Machinery Exchange, Chicago, Ill.
Crescent Machine Co., Leetonia, O.
Henry Disston & Sons, Philadelphia, Pa.
Duplex Mfg. Co., Superior, Wis. ("Duplex").

J. A. Fay & Egan Co., Cincinnati, O.
Huther Bros. Saw Mfg. Co., Rochester, N. Y.
Parks Ball Bearing Machine Co., Cincinnati, O.
Rockford Mitre Box Co., Rockford, Ill.
Sidney Tool Co., Sidney, O.

Simonds Mfg. Co., Fitchburg, Mass. ("Simonds").
Standard Scale & Supply Co., Pittsburgh, Pa.

Saws—Drag

American Saw Mill Machinery Co., New York, N. Y. ("American").
E. C. Atkins & Co., Indianapolis, Ind.
Henry Disston & Sons, Philadelphia, Pa.
Rockford Mitre Box Co., Rockford, Ill.
Simonds Mfg. Co., Fitchburg, Mass. ("Simonds").
Whitman Agricultural Co., St. Louis, Mo.

Saws—Grooving

American Saw Mill Machinery Co., New York, N. Y. ("American").
E. C. Atkins & Co., Indianapolis, Ind.
Beach Mfg. Co., Montrose, Pa.
Chicago Machinery Exchange, Chicago, Ill.
Henry Disston & Sons, Philadelphia, Pa.
Huther Bros. Saw Mfg. Co., Rochester, N. Y.
Parks Ball Bearing Machine Co., Cincinnati, O.
Rockford Mitre Box Co., Rockford, Ill.
Sidney Tool Co., Sidney, O.
Simonds Mfg. Co., Fitchburg, Mass. ("Simonds").

Saws—Hand

E. C. Atkins & Co., Indianapolis, Ind.
Geo. H. Bishop & Co., Lawrenceburg, Ind. (Also backsaws and mitre saws).
Crescent Co., Meriden, Conn.
Henry Disston & Sons, Philadelphia, Pa.
Rockford Mitre Box Co., Rockford, Ill.
Simonds Mfg. Co., Fitchburg, Mass. ("Simonds").

Saws—Jig

American Saw Mill Machinery Co., New York, N. Y.

E. C. Atkins & Co., Indianapolis, Ind.
Beach Mfg. Co., Montrose, Pa.
Chicago Machinery Exchange, Chicago, Ill.
Henry Disston & Sons, Philadelphia, Pa.
J. A. Fay & Egan Co., Cincinnati, O.
Huther Bros. Saw Mfg. Co., Rochester, N. Y.
Parks Ball Bearing Machine Co., Cincinnati, O.
Rockford Mitre Box Co., Rockford, Ill.
Sidney Tool Co., Sidney, O.
Simonds Mfg. Co., Fitchburg, Mass.
Standard Scale & Supply Co., Pittsburgh, Pa.

Saws—Swing

American Saw Mill Machinery Co., New York, N. Y. ("American").
E. C. Atkins & Co., Indianapolis, Ind.
C. H. & E. Mfg. Co., Milwaukee, Wis.
Chicago Machinery Exchange, Chicago, Ill.
Crescent Machine Co., Leetonia, O.
J. A. Fay & Egan Co., Cincinnati, O.
Huther Bros. Saw Mfg. Co., Rochester, N. Y.
Knickerbocker Co., Jackson, Mich. ("Knickerbocker" combination swing cut-off and rip saw).

Oshkosh Mfg. Co., Oshkosh, Wis.
Parks Ball Bearing Machine Co., Cincinnati, O.
Rockford Mitre Box Co., Rockford, Ill.
Sidney Tool Co., Sidney, O.
Silver Mfg. Co., Salem, O.
Simonds Mfg. Co., Fitchburg, Mass.
Standard Scale & Supply Co., Pittsburgh, Pa.
Whitman Agricultural Co., St. Louis, Mo.

Scaffold Brackets

American Steel Scaffold Co., Detroit, Mich.
Elite Mfg. Co., Ashland, O.
John Faragher, Madison, Wis.
Neville Mfg. Co., Kewanee, Ill.
Richards-Wilcox Mfg. Co., Aurora, Ill.
Standard Scale & Supply Co., Pittsburgh, Pa.
Steel Scaffolding Co., Evansville, Ind.
Jas. L. Taylor Mfg. Co., Poughkeepsie, N. Y.
Wagner Mfg. Co., Cedar Falls, Ia. ("Wagner").

Scaffolds—Steel

Chicago Builders' Specialties Co., Chicago, Ill.
Elite Mfg. Co., Ashland, O.
John Faragher, Madison, Wis.
Neville Mfg. Co., Kewanee, Ill.
Richards-Wilcox Mfg. Co., Aurora, Ill.
Standard Scale & Supply Co., Pittsburgh, Pa.
Steel Scaffolding Co., Evansville, Ind.

Screens—Bank and Counter

Cincinnati Mfg. Co., Cincinnati, O.
Screens—Sand and Gravel
Lansing Co., Lansing, Mich.

Screens—Window and Door
Cadillac Lumber Co., Cadillac, Mich.
Cincinnati Mfg. Co., Cincinnati, O.
The Curtis Companies, Clinton, Ia.
Morgan Sash & Door Co., Chicago, Ill.
Standard Screen Co., Chicago, Ill. ("Standard").

Screw Drivers

Crescent Co., Meriden, Conn.
Henry Disston & Sons, Philadelphia, Pa.
Goodell-Pratt Co., Greenfield, Mass.
Hollander Mfg. Co., Cleveland, O.
North Bros. Mfg. Co., Philadelphia, Pa.
Peck, Stow & Wilcox Co., Cleveland, O. ("Pexto").

Sargent & Co., New Haven, Conn. ("Sargent").
Stanley Rule & Level Works, New Britain, Conn.

L. S. Starrett Co., Athol, Mass.
James Swan Co., Seymour, Conn. ("Swan").

Scribers

Hollander Mfg. Co., Cleveland, O.
Sewage Disposal Plants

Dail Steel Products Co., Lansing, Mich.
Sewer Pipe—House Drain

National Fireproofing Co., Pittsburgh, Pa.
Sewer Pipe Mfrs. Asso., Akron, O.

Shafting and Hangers

American Saw Mill Machinery Co., New York, N. Y. ("American").

W. E. Caldwell Co., Louisville, Ky. ("Caldwell").

Sidney Tool Co., Sidney, O.
Western Iron & Foundry Co., Wichita, Kans.

Shaping Machines—Wood

Crescent Machine Co., Leetonia, O.
J. A. Fay & Egan Co., Cincinnati, O.

Sidney Tool Co., Sidney, O.
Sheathing—Asbestos

Keasbey & Mattison Co., Ambler, Pa. (Corrugated).

Sheets—Iron and Steel

American Sheet & Tin Plate Co., Pittsburgh, Pa. (Black and galvanized).

Atlas Engineering Co., Milwaukee, Wis.
Berger Mfg. Co., Canton, O.

Edwards Mfg. Co., Cincinnati, O.
Kanneberg Roofing & Ceiling Co., Canton, O.
Milwaukee Corrugating Co., Milwaukee, Wis. ("Milcor").

Willis Mfg. Co., Galesburg, Ill.

Shields—Radiator

Williamson Heater Co., Cincinnati, O.

Shingle Nailers

Pearson Mfg. Co., Robbinsdale, Minn. ("Pearson's").

Shingling Brackets

Elite Mfg. Co., Ashland, O.
Stanley Rule & Level Co., New Britain, Conn.

Steel Scaffolding Co., Evansville, Ind.
Wagner Mfg. Co., Cedar Falls, Ia. ("Wagner").

Shower Receptors

Kohler Co., Kohler, Wis.

Shutters—Fireproof

Berger Mfg. Co., Canton, O.
Edwards Mfg. Co., Cincinnati, O.

Kanneberg Roofing & Ceiling Co., Canton, O.
Milwaukee Corrugating Co., Milwaukee, Wis. ("Milcor").

Richards-Wilcox Mfg. Co., Aurora, Ill.
Willis Mfg. Co., Galesburg, Ill.

Silos

National Fireproofing Co., Pittsburgh, Pa. (Hollow tile).

Northern Hemlock & Hardwood Mfrs. Asso., Oshkosh, Wis. ("Old Faithful" creosoted hemlock "Korn-keep Silo").

Silo Machines—Cement

Anchor Concrete Stone Co., Rock Rapids, Ia. (Anchor four-inch slab silo machine).

Atlas Engineering Co., Milwaukee, Wis.
Chicago Builders' Specialties Co., Chicago, Ill.

Helm Brick Machine Co., Cadillac, Mich. ("Helm").

Northwestern Steel & Iron Co., Eau Claire, Wis. ("Northwestern").

T. L. Smith Co., Milwaukee, Wis.

Sinks—Factory Wash

Kohler Co., Kohler, Wis.

Sinks—Kitchen

Kohler Co., Kohler, Wis.

Skylights

American 3-Way Prism Co., La Porte, Ind. ("Simplex" double-reinforced concrete skylight construction).

Berger Mfg. Co., Canton, O.
Edwards Mfg. Co., Cincinnati, O.

Kanneberg Roofing & Ceiling Co., Canton, O.
Milwaukee Corrugating Co., Milwaukee, Wis. ("Torpedo").

National Sheet Metal Roofing Co., Jersey City, N. J.

Shrauger & Johnson, Atlantic, Ia.
Willis Mfg. Co., Galesburg, Ill.

Slate—Structural

J. K. Hower, Danielsville, Pa.

E. J. Johnson, Inc., New York, N. Y.
Slatington Slate Co., Slatington, Pa. (Clear black).

Vendor Slate Co., Easton, Pa.

Slicks—Carpenters'

Peck, Stow & Wilcox Co., Cleveland, O. ("Pexto").

Sargent & Co., New Haven, Conn. ("Sargent").

Sound Deadeners

Samuel Cabot, Inc., Boston, Mass. ("Cabot's Quilt").

Spoke Shaves

Buckeye Mfg. & Foundry Co., Cleveland, O.
Peck, Stow & Wilcox Co., Cleveland, O. ("Pexto").

Stanley Rule & Level Co., New Britain, Conn.
James Swan Co., Seymour, Conn. ("Swan").

Spouting

Ransome Concrete Machinery Co., New York, N. Y.

Springs—Door

Bommer Bros., Brooklyn, N. Y. ("Bommer").

Sargent & Co., New Haven, Conn. ("Sargent").

Wagner Mfg. Co., Cedar Falls, Ia. ("Wagner").

Squares—Bevel

A. O. Calhoun & Co., Perry, Mo. ("Calhoun Steel Rafter and Polygon Bevel").

Henry Disston & Sons, Philadelphia, Pa.

Goodell-Pratt Co., Greenfield, Mass.

Squares—Combination

A. O. Calhoun & Co., Perry, Mo. ("Calhoun Combination Steel Rafter and Polygon Bevel Carpenters' Framing Square").

Goodell-Pratt Co., Greenfield, Mass.

Squares—Steel

Nicholls Mfg. Co., Ottumwa, Ia.

Peck, Stow & Wilcox Co., Cleveland, O.

Peerless Blue Print Co., New York, N. Y.

Sargent & Co., New Britain, Conn. ("Sargent").

Stanley Rule & Level Co., New Britain, Conn.

L. S. Starrett Co., Athol, Mass.

Technical Supply Co., Scranton, Pa.

Squares—"T"

A. S. Aloe Co., St. Louis, Mo. ("Aloe's").

Eugene Dietzgen Co., Chicago, Ill.

Peerless Blue Print Co., New York, N. Y.

Stanley Rule & Level Co., New Britain, Conn.

Technical Supply Co., Scranton, Pa.

Squares—Try and Mitre

Sargent & Co., New Britain, Conn. ("Sargent").

Stanley Rule & Level Co., New Britain, Conn.

Stable Fixtures

S. Cheney & Son, Manlius, N. Y.

Gilbert & Bennett Mfg. Co., Chicago, Ill.

Mitchell Mfg. Co., Milwaukee, Wis.

Wildner-Strong Implement Co., Monroe, Mich. ("Wildner" stanchions and steel stall dividers, cast-iron mangers and salters, feed cutters and shredders for hand and power).

Stains—Cement

Samuel Cabot, Inc., Boston, Mass. ("Cabot's" waterproof cement stains).

Clinton Metallic Paint Co., Clinton, N. Y. ("Clinton").

Eugene E. Nice, Philadelphia, Pa.

Patton Paint Co., Milwaukee, Wis.

Stains—Shingle

Samuel Cabot, Inc., Boston, Mass. ("Cabot's" creosote stains).

Creo-Dipt Co., North Tonawanda, N. Y. ("Creo-Dipt").

Devoe & Reynolds Co., Inc., New York, N. Y.

Eugene E. Nice, Philadelphia, Pa.

Stains—Wood

Samuel Cabot, Inc., Boston, Mass. ("Cabot's" creosote stains).

Creo-Dipt Co., North Tonawanda, N. Y. ("Creo-Dipt").

Devoe & Reynolds Co., New York, N. Y.

S. G. Johnson & Son, Racine, Wis. (Johnson's "Wood Dye").

Patton Paint Co., Milwaukee, Wis.

Stair Treads

Franklyn R. Muller Co., Waukegan, Ill. (Composition).

Stairways

Bessler Movable Stairway Co., Akron, O.

Stanchions

Hunt, Helm, Ferris & Co., Harvard, Ill. ("Giant," "Boss," "434," "434-W" steel tubular, "Star" non-adjustable wood, "Star" adjustable wood).

James Mfg. Co., Fort Atkinson, Wis.

Mitchell Mfg. Co., Milwaukee, Wis.

Wildner-Strong Implement Co., Monroe, Mich. ("Wildner's" stanchions and stall dividers).

Stirrups and Hangers

Lane Bros. Co., Poughkeepsie, N. Y.

Stones—Sharpening

Carborundum Co., Niagara Falls, N. Y.

Store Fixtures

Detroit Show Case Co., Detroit, Mich.

Store Fronts

Brasco Mfg. Co., Chicago, Ill.

Detroit Show Case Co., Detroit, Mich. ("Desco" solid metal, "Petz" wood molding covered with copper or brass).

Heitland Grate & Mantel Co., Quincy, Ill. (Marble).

Kawneer Mfg. Co., Niles, Mich.

Milwaukee Corrugating Co., Milwaukee, Wis.

Straight Edges

Technical Supply Co., Scranton, Pa.

Stucco

Bishopric Mfg. Co., Cincinnati, O.

Bostwick Steel Lath Co., Niles, O.

Flexotile Floor Co., Rockford, Ill.

Johns-Manville Co., New York, N. Y. ("J. M." asbestos).

National Kellastone Co., Chicago, Ill. (Magnesite).

Standard Paint Co., New York, N. Y. ("Impervite").

Stucco Board

Bishopric Mfg. Co., Cincinnati, O.

Studs—Fireproof

Chicago Builders' Specialties Co., Chicago, Ill.

Studding Sockets

Sterling Foundry Co., Sterling, Ill.

Wagner Mfg. Co., Cedar Falls, Ia. ("Wagner").

Surfacers

American Saw Mill Machinery Co., New York, N. Y. ("American").

Chicago Machinery Exchange, Chicago, Ill.

Crescent Machine Co., Leetonia, O.

J. A. Fay & Egan Co., Cincinnati, O.

M. L. Schleuter, Chicago, Ill.

Sidney Tool Co., Sidney, O.

Surfacing Machines—Floor (Electric)

American Floor Surfacing Machine Co., Toledo, O. ("Big American," "American Universal," "Heavy Duty," "American Champion").

Wayvell Chappell & Co., Chicago, Ill.

Chicago Builders' Specialties Co., Chicago, Ill.

Sargent & Co., New Haven, Conn. ("Sargent").

M. L. Schleuter, Chicago, Ill.

E. C. Stearns & Co., Syracuse, N. Y.

Surfacing Machines—Floor (Hand)

Fox Supply Co., Brooklyn, Wis. ("Fox").

Triple A Machine Co., Chicago, Ill.

Switchboards—Slate

General Electric Co., Schenectady, N. Y.

Johns-Manville Co., New York, N. Y. ("J. M." ebony asbestos).

Tampers—Concrete

Anchor Concrete Stone Co., Rock Rapids, Ia. ("Anchor") automatic tampers to fit any block machine).

Chicago Builders' Specialties Co., Chicago, Ill.

Crescent Tool Mfg. Co., St. Louis, Mo. (Eight designs).

Ransome Concrete Machinery Co., New York, N. Y.

E. C. Stearns & Co., Syracuse, N. Y.

Stewart Mfg. Co., Waterloo, Ia.

Tanks—Closet

Kohler Co., Kohler, Wis.

Tanks—Pneumatic Water

W. E. Caldwell Co., Louisville, Ky. ("Caldwell").

Duplex Mfg. Co., Superior, Wis. ("Duplex").

Hardin-Lavin Co., Chicago, Ill.

B. B. Karol, Chicago, Ill.

Tanks—Steel and Iron

Atlas Engineering Co., Milwaukee, Wis.

Philip Bernard Co., Sioux City, Ia.

W. E. Caldwell Co., Louisville, Ky. ("Caldwell").

Duplex Mfg. Co., Superior, Wis. ("Duplex").

Edwards Mfg. Co., Cincinnati, O.

Schrauger & Johnson, Atlantic, Ia.

Standard Scale & Supply Co., Pittsburgh, Pa.

Tanks—Wood

W. E. Caldwell Co., Louisville, Ky. ("Caldwell").

Duplex Mfg. Co., Superior, Wis. ("Duplex").

Standard Scale & Supply Co., Pittsburgh, Pa.

Tapes—Measuring (Steel)

A. S. Aloe Co., St. Louis, Mo. (Steel and metallic).

Eugene Dietzgen Co., Chicago, Ill.

Lufkin Rule Co., Saginaw, Mich.

Peerless Blue Print Co., New York, N. Y.

L. S. Starrett Co., Athol, Mass.

Technical Supply Co., Scranton, Pa.

Tenoners

American Saw Mill Machinery Co., New York, N. Y. ("American").

Chicago Machinery Exchange, Chicago, Ill.

J. A. Fay & Egan Co., Cincinnati, O.

Terra Cotta—Architectural

Midland Terra Cotta Co., Chicago, Ill.

Sewer Pipe Mfrs. Assn., Akron, O.

Thresholds—Metal

Brasco Mfg. Co., Chicago, Ill.

Tile—Board

Lignitra Fibre Products Co., Barberton, O.

The Upson Co., Lockport, N. Y.

Tile—Drain

Mason City Brick & Tile Co., Mason, Ia.

National Fireproofing Co., Pittsburgh, Pa.

Tile—Floor and Wall

General Fireproofing Co., Youngstown, O. ("GF" steel tile).

Heitland Grate & Mantel Co., Quincy, Ill.

Hornet Mantel Co., St. Louis, Mo.

Hydraulic Press Brick Co., St. Louis, Mo.

Lignitra Fibre Products Co., Barberton, O. (Fibre bathroom).

Mason City Brick & Tile Co., Mason, Ia. ("Denison Fireproofing").

Tile—Hollow Building

Hydraulic Press Brick Co., St. Louis, Mo.

Mason City Brick & Tile Co., Mason, Ia. ("Denison Load-Bearing").

National Fireproofing Co., Pittsburgh, Pa. ("Nateo").

Trussed Concrete Steel Co., Youngstown, O.

Vigo-American Clay Co., Terre Haute, Ind.

Whitacre-Greer Fireproofing Co., Waynesburg, O.

Tile—Partition

Mason City Brick & Tile Co., Mason, Ia.

National Fireproofing Co., Pittsburgh, Pa. ("Nateo").

Vigo-American Clay Co., Terre Haute, Ind.

Tile—Steel

General Fireproofing Co., Youngstown, O. ("GF").

Trussed Concrete Steel Co., Youngstown, O. ("Floretyle").

Tile Machines—Drain (Cement)

W. E. Dunn Mfg. Co., Holland, Mich.

Lansing Co., Lansing, Mich.

Pioneer Mfg. Co., Waterloo, Ia. ("Schenck").

Tints—Wall

Patton Paint Co., Milwaukee, Wis.

Toggle Bolts

Ankyra Mfg. Co., Philadelphia, Pa.

Berger Mfg. Co., Canton, O.

Richards-Wilcox Mfg. Co., Aurora, Ill.

Tool Cases and Chests

F. Endebrock Trunk Co., St. Joseph, Mo.

James Swan Co., Seymour, Conn. ("Swan").

Wedell & Boers, Detroit, Mich.

Tools—Carpenters' (See Specific Article)

Tools—Carving

Buck Bros., Millbury, Mass.

Tools—Cement Workers'

Crescent Tool Mfg. Co., St. Louis, Mo.

Lansing Co., Lansing, Mich.

E. C. Stearns & Co., Syracuse, N. Y.

Towers—Concrete Placing

Archer Iron Works, Chicago, Ill. ("Archer").

Ransome Concrete Machinery Co., New York, N. Y.

T. L. Smith Co., Milwaukee, Wis.

Standard Scale & Supply Co., Pittsburgh, Pa.

Towers—Steel

Archer Iron Works, Chicago, Ill. ("Archer").

W. E. Caldwell Co., Louisville, Ky. ("Caldwell").

T. L. Smith Co., Milwaukee, Wis.

Standard Scale & Supply Co., Pittsburgh, Pa.

Transits and Levels

A. S. Aloe Co., St. Louis, Mo. ("Aloe's").

L. Beckmann Co., Toledo, O.

Geier & Blumh, Troy, N. Y. ("G. & B.").

Peerless Blue Print Paper Co., New York, N. Y.

L. S. Starrett Co., Athol, Mass.

David White Co., Inc., Milwaukee, Wis.

Trolleys and Tramways

J. G. Speidel, Reading, Pa.

Transom Lifts

P. & F. Corbin, New Britain, Conn.

Sargent & Co., New Britain, Conn. ("Sargent").

Shelby Spring Hinge Co., Shelby, O.

Trowels

Geo. H. Bishop & Co., Lawrenceburgh, Ind. (Brick, plastering and cement).

Henry Disston & Sons, Philadelphia, Pa.

Nicholls Mfg. Co., Ottumwa, Ia.

L. A. Sayre Co., Newark, N. J.

Tubing

Brasco Mfg. Co., Chicago, Ill. (Brass, copper and bronze).

Turntables—Automobiles

Canton Foundry & Machine Co., Canton, O.

Typewriters

Harry A. Smith, Chicago, Ill. ("L. C. Smith," "Remington," "Underwood," Typewriters reconstructed).

Urinals

Hardin-Lavin Co., Chicago, Ill.

E. J. Johnson, Inc., New York, N. Y. (Slate).

Kohler Co., Kohler, Wis.

Vendor Slate Co., Easton, Pa. (Slate).

Varnishes—Architectural

Devoe & Reynolds Co., Inc., New York, N. Y.

Keystone Varnish Co., Brooklyn, N. Y. ("De Grah," "Floorstone," "Trimalite," "Mulleproof").

Murphy Varnish Co., Newark, N. J. (200 kinds).

Eugene E. Nice, Philadelphia, Pa.

Patton Paint Co., Milwaukee, Wis.

Ventilating Systems

Milwaukee Corrugating Co., Milwaukee, Wis. ("Milcor").

Ventilators—Exhaust

Globe Ventilator Co., Troy, N. Y. ("Globe").

Kanneberg Roofing & Ceiling Co., Canton, O.

Royal Ventilator Co., Philadelphia, Pa.

Schrauger & Johnson, Atlantic, Ia.

Willis Mfg. Co., Galesburg, Ill.

Ventilators—Roof

Badger Steel Roofing & Corrugating Co., La Crosse, Wis.

Berger Mfg. Co., Canton, O. ("World").

Philip Bernard Co., Sioux City, Ia. ("O. K.").

Edwards Mfg. Co., Cincinnati, O.

Globe Ventilator Co., Troy, N. Y. ("Globe").

James Mfg. Co., Fort Atkinson, Wis.

Kanneberg Roofing & Ceiling Co., Canton, O.

Milwaukee Corrugating Co., Milwaukee, Wis. ("Milcor," "Milwaukee," "Nu-Air").

Royal Ventilator Co., Philadelphia, Pa.

Schrauger & Johnson, Atlantic, Ia.

Willis Mfg. Co., Galesburg, Ill.

Ventilators—Sidewalk

Canton Foundry & Machine Co., Canton, O.

Ventilators—Window

Philip Bernard Co., Sioux City, Ia.

Hunt, Helm, Ferris & Co., Harvard, Ill. ("Star").

H. B. Ives Co., New Haven, Conn. ("Ives" patent window ventilating lock).
 James Mfg. Co., Fort Atkinson, Wis.
 Kawneer Mfg. Co., Niles, Mich.
 Shrauger & Johnson, Atlantic, Ia.

Vises

Buckeye Mfg. & Foundry Co., Cleveland, O. ("Buckeye" saw vise).
 Henry Disston & Sons, Philadelphia, Pa.
 Goodell-Pratt Co., Greenfield, Mass.
 Huther Bros. Saw Mfg. Co., Rochester, N. Y.
 H. C. Marsh Co., Rockford, Ill.
 North Bros. Mfg. Co., Philadelphia, Pa.
 Peck, Stow & Wilcox Co., Cleveland, O.
 Richards-Wilcox Mfg. Co., Aurora, Ill.
 Rockford Mitre Box Co., Rockford, Ill.
 E. C. Stearns & Co., Syracuse, N. Y.
 Stanley Rule & Level Co., New Britain, Conn.
 Stover Mfg. & Engine Co., Freeport, Ill.

Wainscoting—Sanitary

Franklyn R. Muller Co., Waukegan, Ill. ("Asbestone").

Wallboard

The Beaver Board Companies, Buffalo, N. Y. ("Beaver Board").
 Beckman-Dawson Roofing Co., Chicago, Ill.
 Bird & Son, East Walpole, Mass.
 Bishopric Mfg. Co., Cincinnati, O.
 Cadillac Lumber Co., Cadillac, Mich.
 Philip Carey Co., Lockland, Cincinnati, O. ("Cellboard").
 The Compo-Board Co., Minneapolis, Minn. ("Compo-Board").
 Cornell Wood Products Co., Chicago, Ill. ("Cornell Wood Board").
 The Curtis Companies, Clinton, Ia.
 Edwards Mfg. Co., Cincinnati, O.
 Heppes-Nelson Roofing Co., Chicago, Ill. ("Utility Board").
 Lignistra Fibre Products Co., Barberton, O. ("Lignistra").
 MacAndrews & Forbes Co., New York, N. Y. ("Fiberlic").
 Plastergon Wallboard Co., Buffalo, N. Y. ("Waterproof Plastergon").
 The Upton Co., Lockport, N. Y. (Fibre tile, building board, fibre strips for wallboard).

Wall Coping

National Fireproofing Co., Pittsburgh, Pa. ("Nateco").

Wall Plugs

Berger Mfg. Co., Canton, O.
 Bostwick Steel Lath Co., Niles, O.
 F. D. Kees Mfg. Co., Beatrice, Neb. ("Kees").

Wall Tiles

Berger Mfg. Co., Canton, O.
 Philip Bernard Co., Sioux City, Ia.
 Bostwick Steel Lath Co., Niles, O.
 Chicago Builders' Specialties Co., Chicago, Ill.
 Helm Brick Machine Co., Cadillac, Mich.
 F. D. Kees Mfg. Co., Beatrice, Neb. ("Kees").
 Milwaukee Corrugating Co., Milwaukee, Wis. ("Milcor").
 Sykes Metal Lath & Roofing Co., Niles, O.
 Union Metal Mfg. Co., Canton, O.
 Willis Mfg. Co., Galesburg, Ill.

Washstands

Rowe Sanitary Mfg. Co., Detroit, Mich. (Hot and cold running water without plumbing).

Water Closets

Duplex Mfg. Co., Superior, Wis. ("Duplex").
 Hardin-Lavin Co., Chicago, Ill.
 B. B. Karol, Chicago, Ill.
 Kohler Co., Kohler, Wis.

Waterproofing—Cement

Bird & Son, East Walpole, Mass.
 Bitu-Mortar Waterproofing Co., New York, N. Y. ("BM" liquid, "BM 123" powder).

Samuel Cabot, Inc., Boston, Mass. ("Cabot's" clear waterproofing).

Philip Carey Co., Lockland, Cincinnati, O. ("Noah's Pitch").

Ceresit Waterproofing Co., Chicago, Ill. ("Ceresit" waterproofing compound); also "Ceresitol," a transparent liquid waterproofing for cement and stone work).

Flintkote Co., Boston, Mass. ("Rex Flintkote Plastic").

General Fireproofing Co., Youngstown, O. ("GF 10" integral waterproofing paste; "GF 11" integral waterproofing powder).

Lehon Co., Chicago, Ill. ("Damp-Tite" paint, for dampproofing foundation walls).

Standard Paint Co., New York, N. Y. ("Impervite").

Trus-Con Laboratories, Detroit, Mich.

Water Supply Plants

The Deming Co., Salem, O. (Also hydro-pneumatic water systems).

Duplex Mfg. Co., Superior, Wis. ("Duplex").

B. B. Karol, Chicago, Ill.

Milwaukee Air Power Pump Co., Milwaukee, Wis.

F. E. Myers & Bro., Ashland, O.

Waterman Motor Co., Detroit, Mich.

Wax—Floor

Devoe & Reynolds Co., New York, N. Y.

S. C. Johnson & Co., Racine, Wis. ("Johnson's Prepared Wax").

Patton Paint Co., Milwaukee, Wis.

Weatherstrips

Allmetal Weatherstrip Co., Chicago, Ill. ("Allmetal").

Bird & Son, East Walpole, Mass.

E. I. Church & Co., West Hanover, Mass. ("Axtell").

Diamond Metal Weatherstrip Co., Columbus, O. ("Diamond").

Eveleth Mfg. Co., River Forest, Ill.

Henry Airtight Weatherstrip Co., Crawfordsville, Ind.

Shogren Weatherstrip Co., Chicago, Ill. ("Shogren").

Shrauger & Johnson, Atlantic, Ia.

Wagner Mfg. Co., Cedar Falls, Ia. (Weatherstrips for hinged and sliding doors).

Weather Vanes

Edwards Mfg. Co., Cincinnati, O.

Milwaukee Corrugating Co., Milwaukee, Wis.

National Sheet Metal Roofing Co., Jersey City, N. J.

Shrauger & Johnson, Atlantic, Ia.

Willis Mfg. Co., Galesburg, Ill.

Wheelbarrows

Lansing Co., Lansing, Mich.

Sterling Wheelbarrow Co., West Allis, Wis.

Winches—Boom (Tower)

Sasgen Derrick Co., Chicago, Ill.

Whitman Agricultural Co., St. Louis, Mo.

Windmills

W. E. Caldwell Co., Louisville, Ky. ("Caldwell").

Duplex Mfg. Co., Superior, Wis. ("Duplex-Superior").

Stover Mfg. & Engine Co., Freeport, Ill.

Windows—Casement

The Curtis Companies, Clinton, Ia.

Kawneer Mfg. Co., Niles, Mich.

Shrauger & Johnson, Atlantic, Ia.

Whitney Window Corporation, Minneapolis, Minn.

Windows—Hoghouse

Philip Bernard Co., Sioux City, Ia.

Shrauger & Johnson, Atlantic, Ia.

Willis Mfg. Co., Galesburg, Ill.

Windows—Reversible

Shrauger & Johnson, Atlantic, Ia.

Windows—Wire Glass

Keasbey & Mattison Co., Ambler, Pa. (Corrugated wire glass for skylights).
 Willis Mfg. Co., Galesburg, Ill.

Wire Cloth

Cincinnati Mfg. Co., Cincinnati, O.

Gilbert & Bennett Mfg. Co., Chicago, Ill.

Reynolds Wire Co., Dixon, Ill. ("Sun-red Edge" rustproof alumina, "Sun-red Edge" black, "Sun-red Edge" alumi-namel, "Sun-red Edge" noxide bronze).

Woodwork

The Curtis Companies, Clinton, Ia.

Woodworker—Variety

American Saw Mill Machinery Co., New York, N. Y. ("American").

C. H. & E. Mfg. Co., Milwaukee, Wis.

Chicago Machinery Exchange, Chicago, Ill.

Crescent Machine Co., Leetonia, O.

J. A. Fay & Egan Co., Cincinnati, O.

Novo Engine Co., Lansing, Mich.

Oshkosh Mfg. Co., Oshkosh, Wis.

Parks Ball Bearing Machine Co., Cincinnati, O.

Sidney Tool Co., Sidney, O.

Standard Scale & Supply Co., Pittsburgh, Pa.

Whitman Agricultural Co., St. Louis, Mo.

Woodworking Machinery—Foot and Handpower

W. F. & Jno. Barnes Co., Rockford, Ill.

Beach Mfg. Co., Montrose, Pa.

Chicago Machinery Exchange, Chicago, Ill.

J. A. Fay & Egan Co., Cincinnati, O.

Parks Ball Bearing Machine Co., Cincinnati, O.

Sidney Tool Co., Sidney, O.

Jas. L. Taylor Mfg. Co., Poughkeepsie, N. Y.

Woodworking Machinery—Power-Driven

American Saw Mill Machinery Co., New York, N. Y. ("American").

Beach Mfg. Co., Montrose, Pa.

Wayvell Chappell & Co., Chicago, Ill.

C. H. & E. Mfg. Co., Milwaukee, Wis.

Chicago Machinery Exchange, Chicago, Ill.

Crescent Machine Co., Leetonia, O.

J. A. Fay & Egan Co., Cincinnati, O.

Knickerbocker Co., Jackson Mich. ("Knickerbocker").

Warren W. Morse, Minneapolis, Minn.

Novo Engine Co., Lansing, Mich. ("Novo").

Oshkosh Mfg. Co., Oshkosh, Wis.

Parks Ball Bearing Machine Co., Cincinnati, O.

M. L. Schleuter, Chicago, Ill.

Sidney Tool Co., Sidney, O.

Silver Mfg. Co., Salem, O. ("Silver's").

Standard Scale & Supply Co., Pittsburgh, Pa.

J. D. Wallace & Co., Chicago, Ill.

Whisler Mfg. Co., Gibson, Ia.

Whitman Agricultural Co., St. Louis, Mo.

Woodworking Machinery—Second-Hand

Chicago Machinery Exchange, Chicago, Ill.

J. A. Fay & Egan Co., Cincinnati, O.

Standard Scale & Supply Co., Pittsburgh, Pa.

Woodworking Machinery—Universal

American Cement Machine Co., New York, N. Y. ("American").

Beach Mfg. Co., Montrose, Pa.

Chicago Machinery Exchange, Chicago, Ill.

J. A. Fay & Egan Co., Cincinnati, O.

Parks Ball Bearing Machine Co., Cincinnati, O.

Oshkosh Mfg. Co., Oshkosh, Wis.

Sidney Tool Co., Sidney, O.

Standard Scale & Supply Co., Pittsburgh, Pa.

Wrenches

B. B. Karol, Chicago, Ill.

Peck, Stow & Wilcox Co., Cleveland, O.

Richards-Wilcox Mfg. Co., Aurora, Ill.

Rockford Mitre Box Co., Rockford, Ill.

We Will Put You in Touch with the Best Markets

If you want to buy machinery, tools, equipment, materials or supplies or if you want to know more about something that is or is not advertised in this paper just use the coupon below. We will send your inquiry to manufacturers or dealers who will furnish you with just what you want and at the best prices. To get this information quickly, fill out the coupon below, mail it to the address given and your inquiry will receive prompt attention.

AMERICAN BUILDER, 1827 Prairie Ave., Chicago.

Gentlemen:—We are in the market for the articles specified below. Please put us in touch with manufacturers whom you know are reliable and will furnish goods promptly and at the best prices.

ARTICLES.....Name.....
Street and No.....
Post Office.....State.....

INDEX TO ADVERTISERS

December, 1917

ON this and the following four pages will be found a list of concerns using display advertising space in this number, giving the page number on which their advertisement appears, followed by a summary of the products they make or sell for the building industry. On the preceding eleven pages will be found a classified list of those products arranged alphabetically. Many of our readers will be surprised to learn the extensiveness of the lines offered by some of these concerns, as their advertising has usually been centered on some one product. It will be seen that it is not necessary for our readers to remain long in doubt as to where they can obtain building materials, equipment, tools, specialties and supplies for their building needs, because here is a world's market place in which they can do their shopping and buying. The firms named below are responsible manufacturers or distributors and we recommend them and vouch for their reliability. Write them for catalogs and information at any time and you can be sure of receiving a courteous, prompt response.

A	
Akron Gas Lamp Co.....181	American 3-Way Prism Co.....17
Contractors' lanterns, "Akron" gas lamps, air-pressure gasoline lighting systems.	Sidewalk doors, prism lighting, "Simplex" double-reinforced concrete skylight construction and sidewalk lights.
Alliance Brick Co.....140	Anchor Concrete Stone Co.....20
Face brick.	"Anchor Continuous Air-space" concrete block machines, "Anchor" steel sash doors, "Anchor Continuous Air-space" silo block machines, "Anchor" four-inch slab cement silo machines, "Anchor" automatic tampers to fit any block machine, "Hobbs" concrete block machine (cement-tied blocks, face-down).
Allmetal Weatherstrip Co.....168	Andrews Heating Co.....182
Metal weatherstrips.	Bathroom outfits, bathtubs, boiler and pipe covering, heating plant boilers, garbage burners, gasoline gas machines, hot water and steam heating plants, pipeless furnaces, vapor heating plants, warm air furnaces, gasoline lighting systems, hot water and steam radiators, heat regulators.
Aloe Company, A. S.....13	Ankya Manufacturing Co.....23
Wood of metal sectional drawing cabinets, "Aloe's Ideal" drafting tables, "Aloe's" engineering and surveying instruments, "Aloe's" convertible carpenter's levels, leveling rods, "Aloe's" T-squares, steel and metallic measuring tapes, "Aloe's" transits and levels.	"Ankya" anchor bolts, "Ankya" expansion bolts, "Ankya" grounds, "Ankya" toggle bolts.
American Bell & Foundry Co.....182	Archer Iron Works.....28
Pipeless furnaces, warm air furnaces, church bells.	Angle irons, hoisting and dumping buckets, industrial cars, concrete carts, concrete chutes, "Archer" batch cement mixers, "Archer" mortar and plaster mixers, "Archer" concrete placing towers, "Archer" steel towers, auto-truck bodies and hoists.
American Cement Machine Co.....30	Ashby, G. W.....184
"Boss" and "Handy" back fillers, "Boss" bar benders, "Boss" industrial cars, "Boss" concrete carts, "Automatic" and "Handy" concrete block machines, "Boss" and "All Oak" building material elevators, "Boss" curb and sidewalk forms, "Boss" and "Packard" electric hoists, "Boss" and "Packard" gasoline hoists, "Boss" "Packard" and "Builders" batch cement mixers, "Boss" mortar and plaster mixers, "Bull Dog" cement fence post molds, "Boss" contractors' pumps.	Specialist in schoolhouse architecture.
American Floor Surfacing Machine Co.....15	Asphalt Ready Roofing Co.....159
Air compressors, "Big American," "American Universal," "Heavy Duty," and "American Champion" electric floor surfacing machines.	Deadening felts, asphalt ready roofing, asphalt shingles, "Hudson" asphalt felts, "Protective" brand roofing, with 6-inch lap laid with all nails covered, "Hudson" asphalt.
American Magnesia Products Co.....163	Atkins & Co., E. C.....2
"Kragstone" magnesite stucco, "Velvetile" composition flooring.	Broad axes, hand axes and hand saw machinery, carbondum, carpenters' chisels, hollow mortising chisels, cutter heads, gangsaw edges, saw gauges, safety guards, saw arbors, sawmill machinery, saw rigs, saw sets, bandsaws, circular saws, drag saws, grooving saws, jig saws, swing saws, saw tables, variety woodworker, power-driven woodworking machinery, universal woodworker.
American Sawmill Machinery Co.....9	Atlas Engineering Co.....190
Bandsaw machinery, wood boring machines, gangsaw edgers, gas and gasoline engines, kerosene engines, steam engines, jointer heads, hoists (electric, gasoline, steam), woodworking lathes, mitering machines, power planers, saw arbors, sawmill machinery, saw rigs, saw sets, hand saws, circular saws, drag saws, grooving saws, jig saws, swing saws, saw tables, variety woodworker, power-driven woodworking machinery, universal woodworker.	Air compressors, crushers and pulverizers, derricks, building material elevators, gas and gasoline engines, heavy oil engines, kerosene engines, gasoline and steam hoists, batch cement mixers, mortar and plaster mixers, contractors' pumps, house pumps, iron and steel sheets, cement silo machines, steel and iron tanks.
American Sheet & Tin Plate Co.....161	Barnes Co., W. E. & Jno.....4
Beaded sheet steel ceilings, "Apollo" galvanized corrugated roofing, "Apollo" formed metal roofing, tin roofing, "Keystone" copper-steel roofing, "Apollo" iron and steel roofing and siding, black and galvanized iron and steel sheets, "Keystone" copper-steel tin roofing.	Foot and handpower woodworking machinery.
American Steel Scaffold Co.....188	Barnett & Co., Jos. L. A.....20
Scaffold and scaffold brackets.	Electric lighting systems, lightning rods.
	Barrell Co., Wm. L.....158
	"Textol" striped awning cloth, "Con-ser-ter" canvas roofing.
	Beach Manufacturing Co.....8
	Bandsaw machinery, double edgers, sandpapering machines, sanders, saw rigs, grooving saws, jig saws, saw tables, foot and hand power woodworking machinery, power-driven woodworking machinery, universal wood workers.
	Beaver Board Companies (The).....157
	"Beaver" blackboards, "Beaver" greenboard, "Beaver Board" wallboard.
	Beaver Clay Manufacturing Co.....142
	Face brick and fire brick.
	Beckman Co., L.....13
	Builders' and architects' levels, transits and levels.
	Beckman-Dawson Roofing Co.....113
	Roofing cement, deadening felts, cold storage insulation, roofing and slating nails, roofing and sheathing paper, asbestos roofing, asphalt ready roofing, asphalt shingles, mastic roofing, rubber roofing, wallboard.
	Berger Mfg. Co. (The).....17, 181, 186, 187, 193
	Corrugated arches, corrugated steel awnings, metal corner beads, cresting blocks, "Classik" steel ceilings, "Reliance" "Rotary" and "Berger's Revolving" chimney tops, sheet metal cornices, sheet metal cresting and finials, sidewalk doors, flashing, curb and sidewalk forms, metal office furniture, expanded metal lath, metal lath, metal shelving, metal lockers, metal lumber, "Raydiant" sidewalk lights, "Twentieth Century" house pumps, reinforcing plates, corrugated roofing, sheet metal roofing, "Chieftain," "Swanee" and "Berco" metal shingles, iron and steel roofing and siding, iron and steel sheets, fireproof door and window shutters, skylights, metal tables, toggle bolts, "World" ventilators, wall ties, wall plugs.
	Bernard Co., The Philip.....165
	Barn equipment, sanitary drinking fountains for stock, steel and iron tanks, cupola ventilators, window ventilators, wall ties, hog house windows, grain elevator doors.
	Bessler Movable Stairway Co.....187
	Movable folding stairways.
	Bishop & Co., Geo. H.....24
	Saw sets, hand saws, back saws, mitre saws, brick trowels, plastering trowels, cement trowels.
	Bishopric Mfg. Co. (The).....34
	Plaster boards, stucco board, wall board.
	Bitu-Mortar Waterproofing Co.....28
	"B. M. 78" liquid waterproofing, "B. M. 123" powder cement waterproofing, "B. M. 208" dampproofing compound.

Blystone Mfg. Co...... 30
 "Blystone" batch cement mixers, "Blystone" mortar and plaster mixers.

Bommer Bros...... 36
 Single and double-acting spring butts, door holders, door stops, kick and push door plates, water closet door indicator bolts, builders' hardware, hinges (double-acting and single-acting spring hinges; jamb; fire engine house door; office gate; screen door; bank office-railing; spring hinges for hardwood doors, for interior marble work, for iron metal railing makers, for closing doors automatically, all in wrought steel, bronze or brass); door floor pivots.

Boone Brick, Tile & Paving Co......142
 Clay hollow building blocks, face brick, fire brick, enameled brick.

Bostwick Steel Lath Co......124
 Metal corner beads, metal building corners, expanded metal lath, metal lath, stucco, wall ties, metal wall plugs, ribbed metal lath.

Bovee Furnace Works......195
 Pipeless furnaces, horizontal radiator furnaces, central heating systems, warm air furnaces, registers, furnace piping.

Boyle & Co., John......159
 Awning cloth, cotton duck, "Bayonne" and "Gulf Stream" canvas roofing, and canvas.

Brasco Mfg. Co......110
 Roll copper, brass railings, store front construction, metal thresholds; brass, bronze and copper tubing, copper-covered steel and iron sash; brass, bronze and copper-covered kick plates, copper-covered doors.

Buck Bros......15
 Wood carvers, carpenters' chisels, Brad and scratch awls, countersinks, draw knives, nail sets, reamers, carpenters' slicks, wood gouges, carving tools, floor chisels, plane irons.

Buckeye Mfg. & Foundry Co......23
 Hollow augers, chain drills, steel butt gauges, "Buckeye" carpenters' planes, "Buckeye" foot-power saw sets, spoke shaves, "Buckeye" saw vises.

Building Material Exhibit......21
 A permanent exhibit of all kinds of building materials, contractors equipment, home comforts and conveniences.

Builders' Hardware Sales Co......115-122
 Twelve leading builders' hardware manufacturers who have standardized designs for door hardware.

C

Cabot, Inc., Samuel......36
 Cement coatings (colors), Cabot's "Quilt" for cold storage insulation, Cabot's "Quilt" sound deadeners, Cabot's waterproof cement stains, Cabot's creosote shingle stains, Cabot's creosote wood stains, Cabot's clear cement waterproofing.

Cadillac Lumber Co......162
 Built-up wood columns, barn and garage door hangers, hardwood and veneered doors, hard wood flooring, ladders, metal lath, sash lifts, sash locks, lumber, roofing and slating nails, roofing and sheathing paper, plaster board, asbestos roofing, asphalt ready roofing, asphalt shingles, rubber roofing, wood shingles, sash cord, sash pulleys, window and door screens, wallboard, millwork.

Caldwell Mfg. Co......8
 "Caldwell" sash balances, sash locks, door holders.

Caldwell Co., W. E......181
 Hoisting and dumping buckets, "Caldwell" shafting and hangers, "Caldwell" pneumatic water tanks, "Caldwell" steel and iron tanks, "Caldwell" wooden tanks, "Caldwell" steel towers, "Caldwell" windmills.

Calhoun & Co., A. O......23
 "Calhoun" combination steel rafter and polygon bevel, carpenters' framing square.

Canton Foundry & Machine Co......177
 Coal chutes, hand-power cranes, metal cellar doors, sidewalk doors, tool grinders, automobile turtable, conductor pipe, jamb and corner guards, stack and asphalt doors, sidewalk ventilators, garage drains, coal vault covers, valve covers.

Carborundum Co., The......27
 "Carborundum" and garnet papers, "Carborundum" and "Aloxite" wheels, "Carborundum" files, sharpening stones, "Carborundum" rubbing brick for concrete, "Carborundum" garnet paper and cloth.

Carey Co., Philip......156
 Roofing cement, "Magnesia" roofing paints, "Cell-Board" plaster boards, "Universal Coating" wood preservative, roof putty, "Carey-stone" asbestos roofing, "Phileo" asphalt ready roofing, "Asfaltlate" asphalt shingles, "Las-tile" rubber roofing, "Cell-Board" wallboard, cement waterproofing.

Ceresit Waterproofing Co......179
 "Indurite" liquid floor hardener, "C. W. Co." metallic floor hardener, "Kram-oil" wood preservative, "Ceresit" waterproofing compound, "C. W. Co." damp-proofing coating, "C. W. Co." plaster bond, "Cem-Bric" decorative and waterproofing paint for cement floors, and exterior of brick, concrete and cement work, "Radiolite" white enamel for interior decorative purposes, "Ceresitol" transparent liquid waterproofing for exterior super-structure cement and stone work.

C. H. & E. Mfg. Co......5
 Building material elevators, gas and gasoline engines, dado heads, electric hoists, gasoline hoists, mortar mixers, contractors' pumps, triplex pumps, piston pumps, centrifugal

pumps, portable saw rigs, swing saws, saw tables, variety woodworker.

Chappell & Co., Wayvell......15
 Electric floor surfacing machines, power-driven woodworking machinery.

Cheney & Son, S......190
 Castings to order, chimney caps, tool grinders, stable fixtures.

Chicago Builders' Specialties Co......30
 Joist and wall anchors, back rollers, bar benders, metal corner beads, dredging and excavating buckets, hoisting and dumping buckets, industrial cars, concrete carts, concrete chutes, concrete construction clamps, concrete inserts, conveying machinery, metal building corners, locomotive cranes, crushers and pulverizers, derricks, building material, elevators, curb and side forms, gasoline gas machines, joist hangers, electric, gasoline and steam hoists; expanded metal, metal and wire lath; batch cement mixers, mortar and plaster mixers, cement silo molds, pile driving machinery, contractors' pumps, industrial railways, salamanders, saw rigs, steel scaffolds, cement silo machines, fireproof studs, electric floor surfacing machines, wall ties.

Chicago Grille Works......180
 Built-up wood columns, colonnades, book-cases, grilles, wood ornaments.

Chicago Machinery Exchange......4
 Bandsaw machinery, belt sanding machines, wood-boring machines, hollow mortising chisels, carpenters' clamps, door clamps, cutter heads, dado heads, jointer heads, shaper heads, power planers, resaw machines, sand-papering machines, sanders, saw rigs, bandsaws, grooving saws, jig saws, saw tables, surfacers, tenoners, variety woodworker, foot and hand-power woodworking machinery, power-driven woodworking machinery, second-hand woodworking machinery, universal woodworkers.

Chicago Spring Butt Co......36
 Spring butts, door pulls, door stops, gate spring pivot hinges, floor hinges, surface hinges, latches, closet seat spring hinges.

Chicago Technical College......183
 Architectural drafting home study courses, home study courses, home study plan reading courses, home study estimating courses, correspondence course for builders.

Choraleon Co......163
 Electric motors and springs for phonographs, "Choraleon" phonograph accessories.

Church & Co., E. I......190
 "Axtell" all-metal weather strips.

Cincinnati Mfg. Co., The......15
 Castings to order, bronze and iron doors, metal cellar doors, fireproof hollow metal doors, iron and steel doors, sidewalk doors, architectural iron, brass railings, iron railings, altar rails, bank and counter screens, window and door screens; brass, bronze and copper wire cloth; wire window guards, ornamental iron and bronze work, mausoleum doors.

Clay Products Co......140
 Hollow building tile, interlocking building tile, tile silo blocks, salt glazed conduits, foundations.

Clock Co., The......146
 Blue prints for making hall and grandfather's clock; also complete clocks and clock works.

Comfort Chemical Closet Co......171
 Chemical and sanitary closets.

Compo-Board Co., The......156
 "Compo-Board" wallboard.

Cornell Wood Products Co......128-129
 "Cornell" wallboard.

Cortright Metal Roofing Co......185
 Metal shingles.

Creo-Dipt Co., Inc......161
 "Creo-Dipt" wood shingles, "Creo-Dipt" shingle stains, "Creo-Dipt" stained shingles, "Creo-Dipt" shingle siding, thatched roofs with "Creo-Dipt" stained shingles.

Crescent Co......179
 Carpenters' chisels, countersinks, draw knives, handsaws, screw drivers, glass cutters, hacksaw blades and frames.

Crescent Machine Co......4
 Bandsaw machinery, vertical borers, wood boring machines, safety guards, power planers, hand saws, circular saws, swing saws, saw tables, wood shaping machines, surfacers, variety woodworker, power-driven woodworking machinery, universal woodworkers, jointers, mortisers, disk grinders.

Crescent Tool Mfg. Co......22
 Straight and curved cement edgers, curb and sidewalk finishing tools, brick and stone hammers, masons and bricklayers jointers, cement workers' finishing tools, cement indentation rollers, concrete tampers.

Curtis Companies (The)......131
 Art glass, composition capitals, built-up wood columns, hardwood and veneered door, hardwood flooring, parquet flooring, leaded glass, wire glass, wood mantels, millwork, wood ornaments, plate glass, window and door screens, wallboard, casement windows, woodwork, doors, windows, window and door frames, storm doors and windows, screen doors and windows, stairways, newels, sideboards, colonnades, bookcases, mantels, window seats, wall panels, ceiling beams, moldings, porch columns, porch rail, porch balusters, everything in woodwork.

D

Dahl Mfg. Co......11
 "Interlox" master slide rule, "Interlox" folding rules.

Delta File Works......127
 "Carpenters' Special," "Mechanics' Favorite," and "Experts' Choice" saw files; "Delta" auger bit files, band saw files, inserted tooth files, stove saw files, planer knife files.

Deming Co., The......176
 Contractors' pumps, house pumps, water supply systems, hydro-pneumatic water systems.

Detroit Show Case Co......23
 "Desco" hollow metal sash, "Desco" store front construction, kalsomine moldings, show cases, store fixtures.

Devoe & Reynolds Co., Inc......179
 Kalsomine, paint and varnish removers, paint spraying machines, paints, shingle stains, wood stains, architectural varnishes, floor wax.

Diamond Metal Weatherstrip Co......169
 "Diamond" metal weatherstrips.

Dietzgen Co., Eugene......10
 Drafting tables, engineering and surveying instruments, extension rules, steel rules, T-squares, measuring tapes, drawing instruments, blue print paper and cloth, drawing boards, draftsmen's scales, architects and builders' surveying levels.

Dixon & Sons, Henry......14
 Bevels, cabinet scrapers, saw clamps, files and rasps, mortise gauges, masons' jointers, saw-tooth jointers, moulding knives, planer knives, carpenters' levels, plumb and levels, rifflers, saw sets, band saws, circular saws, cross-cut saws, drag saws, grooving saws, hand saws, jig saws, screwdrivers, bevel squares, saw sages, trowels, saw vises.

Dixon Crucible Co., Joseph......15
 Graphite paints, carpenters' pencils, lumber crayons, lubricants, graphite, belt dressing.

Dunn Mfg. Co., W. E......29
 Cement brick machines, cement post machines, cement sewer pipe machines, concrete block machines, kerosene engines, batch cement mixers, cement column molds, cement drain tile machines.

Duplex Mfg. Co......175
 "Standard" bathroom outfits, "Standard" bathtubs, "Duplex-Superior" boiler and pipe covering, "Duplex-Superior" heating plant boilers, gray iron castings to order, "Duplex-Superior" granary elevating machinery, "Alamo" gas and gasoline, kerosene and heavy oil engines; "Duplex-Superior" built-in grain elevators, "Superior" hot water heating systems, "Laurel" pipeless furnaces, "Superior" steam heating systems, vapor heating systems, "Duplex" laundry tubs, "Duplex" lavatories and fittings, "Duplex" electric lighting systems, "Duplex" plumbing fixtures, "Duplex" contractors' pumps, house pumps, "Minnesota" hot water and steam radiators, "Duplex" iron railings, "Superior" saw arbors, "Curtis" circular saws, "Duplex" tanks (pneumatic water, iron and steel, wood), "Duplex" water closets, "Duplex" water supply plants, "Duplex-Superior" windmills.

E

Edwards Mfg. Co......185
 Corrugated arches, corrugated steel awnings, metal battens, metal corner beads, sheet metal capitals, metal ceilings, metal columns, metal building corners, sheet metal cornices, sheet metal cresting and finials, fireproof hollow metal doors, fireproof metal-covered doors, iron and steel doors, iron and steel fences, expanded metal lath, metal lath, metal shelving, metal lockers, marquees, galvanized nails, sheet metal ornaments, roofing and sheathing paper, steel partitions, plaster boards, asphalt ready roofing, asphalt shingles, corrugated metal tile roofing, iron and steel roofing and siding, hollow metal sash, iron and steel sheets, fireproof shutters, skylights, steel and iron tanks, cupola ventilators, wallboard, weather vanes, steel rolling doors and shutters, "Keyridge" lath and stud combined, galvanized steel tanks, Spanish shape metallic tile, metallic window frame and sash.

Elite Mfg. Co......188
 Continuous cement mixers, scaffold brackets, steel scaffolds, shingling brackets.

Endebrock Trunk Co......18
 Tool cases, tool chests, tool trunks.

Eureka Machine Co......30
 "Eureka" electric hoists, "Eureka" gasoline hoists, "Eureka" batch cement mixers, "Eureka" continuous cement mixers, "Eureka" mortar and plaster mixers.

Eveleth Mfg. Co......169
 "Eveleth" door clamps, weatherstrip grooving, "Eveleth" shade adjusters, "Eveleth" metal and felt door bottom weather strips.

F

Faragher, John......188
 Scaffolds and scaffold brackets.

Fay & Egan Co., J. A......4
 Boring machine augers, hollow augers, bandsaw machinery, belt sanding machines, wood boring machines, hogsaw edgers, saw gauges, double edgers, dado heads, jointer heads, shaper heads, woodworking lathes, resaw machines, sandpapering machines, sanders, sawmill machinery, saw rigs, bandsaws, circular saws, grooving saws, jig saws, swing saws, saw tables, wood shaping machines, surfacers, saw swages, tenoners, variety woodworker, foot and hand-power woodworking machinery, power-driven woodworking machinery, second-hand woodworking machinery, universal woodworkers.

M

McKinney Mfg. Co. 19
Angle irons, barn equipment, door and window catches, barn and garage door hangers, door pulls, casement window fasteners, blind and shutter hinges, surface hinges, latches, sash lifts, sash locks, garage door sets, sash brackets, door bolts, door butts, garage door holders, gate hinges, garage door hinges.

MacAndrews & Forbes Co. 157
"Fiberlic" Wallboard.

Mack & Co. 26
"D. R. Barton" carpenters' axes, "D. R. Barton" broad and land axes, "D. R. Barton" carpenters' chisels, "D. R. Barton" draw knives, "D. R. Barton" hatchets, "D. R. Barton" carpenters' planes.

Majestic Co., The. 173
Coal chutes, pipeless furnaces, warm air furnaces, package receivers, underground garbage receivers, built-in garage receivers.

Marsh Co., The H. C. 22
Mixing machines, sanders, vises and mitre boxes.

Martin Rocking Fifth Wheel Co. 25
"Martin" semi auto trailer.

Mason City Brick & Tile Co. 138
Clay hollow building blocks, common brick, fireproof flooring, hollow tile partitions, floor tile, hollow building tile, silo blocks, drain tile, fireproofing blocks for partitions, floors, foundations, side walls, etc.; corn crib blocks.

Maze Co., W. H. 18
"Zincclad" zinc-coated roofing and slating nails, Zinc City solid zinc roofing and slating nails, asphalt and asbestos.

Meadows Mfg. Co. 151
"Meadows" stationary inside cup elevators for granaries.

Metallic Batten Co. 16
Metal battens.

Miami Trailer Co. 165
Auto trailers.

Midland Terra Cotta Co. 112
Chimney caps, brick mantels, architectural terra cotta, flue lining, flower boxes, garden furniture.

Miller Mfg. Co., A. W. 6
Lock mortising machines.

Milwaukee Air Power Pump Co. 177
Contractors' pumps, house pumps, pneumatic water tanks, steel and iron tanks, water supply systems for country homes.

Milwaukee Corrugating Co. 154-155
Corrugated arches, corrugated steel awnings, "Milcor" metal battens, "Superior" metal corner beads, sheet metal capitals, "Invincible Joint" metal ceilings, chimney caps, "Milcor" metal building corners, sheet metal corners, sheet metal cresting and finials, fireproof hollow metal doors, iron and steel doors, "Netmesh" expanded metal lath, "Netmesh" metal lath, marquees, roofing and slating nails, sheet metal ornaments, "Milcor" corrugated roofing, sheet metal roofing, "American" and "Titelock" metal shingles, "Titelock" iron and "Spanish" metal tile roofing, "Milcor" iron and steel roofing and siding, "Milcor" iron and steel sheets, fireproof shutters, skylights, store front construction, "Milcor" and "Milwaukee" cupola ventilators, wall ties, weather vane, "Interlock" conductor pipe, "Crimpedge" eaves trough, zinc ornaments, "Evedraft" chimney extensions, metal roof trimmings.

Mitchell Mfg. Co. 164
Barn equipment, sanitary drinking fountains for dairy barns, stable fixtures, stanchions, cow and horse stalls, feed and litter carriers, manure carriers, bull, cow and calf pens, salting systems, watering systems.

Moore Bros. Lighting Rod Co. 177
Acetylene gas lighting fixtures, acetylene lighting systems, lightning rods.

Morgan Sash & Door Co. 158
Blinds, wooden baseboards, wooden bevels, art glass, carved wood capitals, composition capitals, built-up wood columns, pine and softwood doors, pine and hardwood (glass) doors, hardwood flooring, leaded glass, wire glass, sheet and plate glass, wooden interior trim, wooden mouldings, wooden railings, millwork, casement sash, stairways.

Morrill, Inc., Chas. 36
"Apex" hand saw sets, "Apex" bench stops.

Morse, Warren W. 4
Wood boring machines, hollow chisels and bits, power mortising machines, power-driven wood-working machinery, "Superior" hollow chisel, electric mortiser and multiple-speed boring machines.

Muller Furnace Co., L. J. 144-145
Heating plant boilers, garbage burners, hot water heating plants, pipeless furnaces, steam heating plants, vapor system heating plants, warm air furnaces, hot-air furnace registers.

Muller & Co., Franklyn R. 132-133
"Asbestone" composition flooring, "Asbestone" wallscoting, "Asbestone" sanitary fireproof base.

Municipal Engineering & Contracting Co. 30
"Austin Cube" batch cement mixers, "Austin Drum" batch cement mixers.

Murphy Varnish Co. 104
Architectural enamels, wood fillers, floor finish, paint and varnish removers, architectural varnishes (200 kinds).

Nera & Bros., F. E. 167
Barn equipment, barn and garage door hangers, hay track, ladders, contractors' pumps, house pumps, water supply plants.

N

National Fireproofing Co. 139
Salt-glazed coping, drain tile, fireproofing, hollow tile fireproof partitions, sewer pipe, hollow tile silos, hollow building tile, wall coping.

National Kellastone Co. 105
Composition flooring, magnesite interior plaster, magnesite stucco.

National Mfg. Co. 196
Barn equipment, "Best" chimney caps, "Best" coal chutes, barn and garage door hangers, storm sash hangers, floor and surface hinges, sash locks, barndoor rails, barndoor rollers, house-door rollers.

National Sheet Metal Roofing Co. 185
Sheet metal cornices, "Walter's & Cooper's" metal shingles, sheet metal roofing, "Cooper's Spanish" metal tile roofing, skylights, weather vanes.

Neville Mfg. Co. 188
Steel scaffolds and scaffold brackets.

New York Blue Print Paper Co. 13
"Sixtex" and "Monox" drafting tables, "N. Y. B." engineering and surveying instruments, extension rules, "Detail" and "Criterion" drawing pencils, "Superior" and "Gold Seal" blue print paper.

Nice, Eugene E. 165
Cement coatings (colors), wood fillers, floor finish, paint and varnish removers, paints, cement stains, shingle stains, wood stains, architectural varnishes.

Nichols Mfg. Co. 10
Steel squares and trowels.

Nickerson Mfg. Co. 180
"Nickerson Patent" double lock-joint built-up wood columns, "Knox-made" garment hangers.

North Bros. Mfg. Co. 11
Screwdriver bits, countersinks, breast and hand drills, screwdrivers, vises.

Northern Hemlock and Hardwood Mfrs. Assn. 185
Hard maple, beech and birch flooring; lumber manufacturers, "Old Faithful" hemlock, "Beautiful Birch" maple, ash, elm, basswood, beech, tamarack, white pine and Norway pine lumber; white cedar shingles, veneers, "Old Faithful" hemlock creosoted Kern-keep silos.

Northrop, Coburn & Dodge Co. 163
Metal ceilings.

North Western Expanded Metal Co. 186
"Kno-Equal" metal corner beads, "Kno-Fur," "Diamond Mesh," "Kno-Burn," "Eureka" expanded metal lath, "Kno-Burn" corrugated and "T-Rib Chancelath" metal lath, "Kornerite" expanded metal corners, "Econo" expanded metal reinforcing steel fabric.

Northwestern Steel & Iron Works. 29
"Northwestern" cement brick machines, "Northwestern" cement post machines, "Northwestern" concrete sewer pipe machines, "Northwestern" concrete block machines, "Northwestern" gas and gasoline engines, "Northwestern" cement burial vault molds, "Northwestern" gasoline hoists, "Northwestern" batch cement mixers, "Northwestern" cement burial vault molds, "Northwestern" cement mold columns, "Northwestern" cement drain tile molds, "Northwestern" cement fence post molds, "Northwestern" cement sewer pipe molds, "Northwestern" cement silo machines.

Novo Engine Co. 175
Air compressors, building material elevators, gas and gasoline engines, kerosene engines, gasoline hoists, contractors' pumps, saw rigs, variety woodworker, power-driven woodworking machines.

Oak Flooring Mfrs. Association. 152
Hardwood flooring.

Oshkosh Mfg. Co. 3-194
Back fillers, building material elevators, batch cement mixers, contractors' pumps, saw rigs, band saws, swing saws, variety woodworker, power-driven woodworking machinery, universal woodworkers.

Ottawa Mfg. Co. 191
Gas and gasoline engines, kerosene engines, windmills.

O

P

Parks Ball-Bearing Machine Co. 8
Bandsaw machinery, hollow mortising chisels, sandpapering machines, sawmill machinery, saw rigs, band saws, circular saws, grooving saws, jig saws, swing saws, saw tables, variety woodworker, foot and hand-power woodworking machinery, power-driven wood-working machinery, universal woodworkers.

Fatton Paint Co. 106
Architectural enamels, floor finish, floor hardeners, cement hardeners, paint and varnish removers, paints, wood preservatives, shingle stains, wood stains, surfacers, wall tints, architectural varnishes, floor wax.

Pearson Mfg. Co. 26
"Pearson's" shingle nailers.

Peck, Stow & Wilcox Co., The. 167
Brad and scratch awls, broad axes, hand axes, beaders, auger bits, screwdriver bits, window and door bolts, bit braces, calipers, casement adjusters, door and window catches, carpenters' chisels, carpenters' clamps, door clamps, door pulls, draw knives, breast and hand drills, casement window fasteners, fireplace furnishings, hammers, lathing hatchets, latches, sash lifts, sash locks, door knobs and locks, saw sets, screwdrivers, carpenters' slicks, spoke shaves, steel squares, vises, wrenches.

Peerless Blue Print Co. 12
Cabinet and patternmakers' benches, drafting tables, engineering and surveying instruments, carpenters' levels, calliper rules, extension rules, lumbermen's rules, steel rules, steel squares, T-squares, measuring tapes, transits and levels.

Plastergon Wallboard Co. 157
"Plastergon" wallboard.

Progressive Mfg. Co. 14
"Forstner" auger bits.

R

Ransome Concrete Machinery Co. 29
Concrete chutes, concrete block machines, batch cement mixers, continuous cement mixers, mortar and plaster mixers, concrete tampers, concrete placing towers, spouting, pneumatic concrete mixers, pneumatic grout mixers, reinforced concrete bar cutters, concrete bins.

Rehm Hardware Co. 36
Everything in carpenters' tools, builders' hardware and roofing.

Republic Iron Works. 29
"Republic" concrete block machines, "Republic" batch cement mixers, "Republic" continuous cement mixers, "Republic" mortar and plaster mixers.

Richards-Wilcox Mfg. Co. 18
Manual training benches, door checks, barn and garage door hangers, electric door openers, door pulls, door stops, brick and stone drills, expansion bolts, grindstones, floor hinges, latches, scaffold brackets, steel scaffolds, fireproof shutters, toggle bolts, vises, wrenches, automatic fire-door hardware, elevator door hangers, elevator checks and closers, elevator locks, house door hangers, hangers for sliding partitions in schools, churches, etc.; foot scrapers, rolling ladders.

Robinson Cabinet Mfg. Co. 167
Bathroom outfits, portable bathtubs, chemical and sanitary closets, Turkish and vapor bath cabinets.

Rock City Mfg. Co. 19
Detachable screen door hinges, storm window hangers, plain spring hinges.

Rockford Mitre Box Co. 22
Mitre boxes, mitreing machines, saws, wood-working machinery.

Rowe Sanitary Mfg. Co. 171
Chemical and sanitary closets, washstands (hot and cold running water without plumbing).

Royal Ventilator Co. 165
Exhaust ventilators, roof ventilators.

S

Safety Door Hanger Co. 19
"Red Rib" door hangers and track, "Storm King," "World's Best," "Wizard," "Safety" and "U. S. Standard" door hangers, "Topping's" folding garage door hanger set.

Samson Cordage Works. 191
Sash cord.

Sand & Sons, J. 11
Levels for carpenters, masons, bricklayers, plasterers, millwrights; glasses and sights for spirit levels, glasses for straight-edge levels.

Sargent & Co. 26
Carpenters' adzes, angle irons, boring machine and hollow augers, bead and scratch awls, broad and hand axes, door and house bells, auger and screwdriver bits, window and door bolts, wood boring machines, bit and corner braces, spring butts, calipers, casement adjusters, door and window catches, carpenters' chisels, carpenters' clamps, door clamps, countersinks, door checks, barn and garage door hangers, door pulls, door stops, draw knives, blind, shutter and casement window fasteners, auger bit gauges, window guards, hammers, lathing hatchets, blind, shutter, floor and surface hinges, latches, carpenters' levels, sash and transom lifts, sash locks, door locks and knobs, nail sets, carpenters' planes, barn door rails, reamers, barn door and house door rollers, routers, sash pulleys, saw sets, screwdrivers, carpenters' slicks, door springs, steel and T-squares, try and mitre squares, bench stops, hand-power floor surfacing machines.

Saagen Derrick Co. 24
Blocks and tackle, derricks, building material elevators, winches, tower booms, truck pullers, circle-swing derricks, tripod, truck, stiff-leg and lumber yard derricks.

Sayre Co., L. A. 191
Carpenters' adzes, hand axes, hatchet gauges, lathing hatchets, nail sets, saw sets, trowels.

Schleuter, M. L. 15
Wall forms, cement column molds, cement curb and gutter molds, cement silo molds, surfacers, electric floor surfacing machines, power-driven woodworking machinery.

Schwab & Sons Co., R. J. 175
"Gilt Edge" heating plant boilers, castings to order, "Schwab" concrete block machines, "Gilt Edge" hot water heating plants, pipeless furnaces, direct radiation and blower system steam heating plants, vapor heating systems, warm air furnaces, house moving jacks, heat regulators, salamanders.

Sedgwick Machine Works. 12
Hand-power dumbwaiters, freight and passenger elevators, sidewalk elevators.

Sewer Pipe Mfrs. Assn. 143
An association composed of twenty manufacturers of the following clay products: Architectural terra cotta, sewer pipe for house drains, fire-clay chimney tops, fire-clay flue lining, sewer pipe fittings of all kinds.

Shelby Spring Hinge Co. 20
Spring butts, casement adjusters, door and

window catches, door checks, door pulls, door stops, casement window fasteners, storm sash hangers, floor hinges, surface hinges, latches, sash lifts, transom lifts, sash locks, door locks and knobs.	
Sheldon Mfg. Co.	28
Cement mixers.	
Sheldon Slate Co., F. C.	159
"Sheldon's" blackboards, "Sheldon's" roofing slate, "Sheldon's" slate roofing and siding, crushed slate for surfacing asphalt shingles.	
Shinn Mfg. Co.	148
"National Flat" copper cable conductor lighting rods; also concealed system of installation with short points.	
Shogren Weatherstrip Co.	169
"Shogren" metal weatherstrips.	
Strauger & Johnson	16, 18, 165, 169
Barn equipment, metal battens, metal corner beads, metal building corners, sheet metal cornices, sheet metal cresting and finials, iron and steel sash, iron and steel sheets, skylights, steel and iron tanks, cupola ventilators, exhaust ventilators, window ventilators, metal weatherstrips, weather vanes, casement windows, hoghhouse windows, reversible windows.	
Sidney Elevator Mfg. Co.	12
Hand-power dumbwaiters, "Sidney" freight and passenger elevators, sidewalk elevators, freight elevators, electric elevators, "Semco" hand-power elevators, automobile elevators.	
Sidney Tool Co.	7
Band saw machinery, safety guards, wood-working lathes, electric motors, sawmill machinery, saw rigs, saw sets, band saws, circular saws, grooving saws, jig saws, swing saws, saw tables, shafting and hanger, wood shaping machines, surfacers, saw swages, variety woodworker, foot and hand-power woodworking machinery, power-driven woodworking machinery, universal woodworking machines.	
Silver Lake Co.	19
Sash cord, chalk lines, masons' lines, dumb-waiter rope, awning cord, clothes lines.	
Silver Mfg. Co., The	6
Bandsaw machinery, hub boring machines, "Silver's" new jointers, jointer heads, "Silver's" improved power bandsaws, "Silver's" swing saws, "Silver's" saw tables, "Silver's" power-driven woodworking machinery, "Silver's" portable forges.	
Simonds Mfg. Co.	126
"Simonds" files and rasps, saw arbors, "Simonds" saw sets, "Simonds" bandsaws, "Simonds" circular saws, "Simonds" drag saws, "Simonds" grooving saws, "Simonds" hand saws, "Simonds" jig saws, "Simonds" swing saws.	
Slatington Slate Co.	159
Clear black slate baseboards, natural slate blackboards, clear black slate laundry tubs, roofing and slating nails, "Genuine Franklin Tunnel" roofing slates, slate roofing and siding, clear black structural slate, slate switchboards, clear black slate sink tops.	
Smith Co., Chas.	173
Pipeless furnaces and warm air furnaces.	
Smith, Harry A.	20
L. C. Smith, Remington, Underwood reconstructed typewriters.	
Smith & Hemenway Co.	14
Auger bits, screwdriver bits, wood boring machines, brick and stone drills, saw sets, screwdrivers, vises, wrenches.	
Smith Co., The T. L.	33
Lifting and dumping buckets, building material elevators, slate loaders, cement mixers, mortar and plaster mixers, cement silo machines, concrete placing towers, steel towers, excavator and loader, hand batch mixers.	
Sorlein Ceiling Bed Co.	181
"Sorlein Ceiling Bed," a disappearing bed wound up by means of a winding device, into the ceiling.	
Southern Cypress Mfrs. Association	188
An association composed of manufacturers of Southern Cypress.	
Southern Pine Association	125
The Southern Pine Association does not manufacture or sell lumber itself, but represents some 200 mills making and selling parquetry flooring, wood block flooring, wooden shingles and all kinds of yellow pine interior finish, timbers, etc.	
Speidel, J. G.	12
Chain blocks, hand-power cranes, electric and hand-power dumbwaiters, freight and passenger elevators, sidewalk elevators, hand chain hoists, tripods, trolleys and tramways.	
Standard Paint Co., The	171
Cement coatings (colors), deadening felts, floor finish, composition flooring, cold storage insulation, paints, roofing and sheathing paper, asphalt ready roofing, asphalt shingles, "Rubberoid" rubber roofing, "Impervite" stucco, cement waterproofing, "Shadow" roofing.	
Standard Scale & Supply Co.	32
"Novo" air compressors, back fillers, bar benders, industrial cars, concrete carts, coal chutes, concrete block machines, locomotive cranes, crushers and pulverizers, derricks, dump carts, granary elevating machinery, building material elevators, gas and gasoline engines, heavy oil engines, kerosene engines, steam engines, electric hoists, gasoline hoists, steam hoists, wagon loaders, "The Standard" low-charging batch cement mixers, continuous cement mixers, mortar and plaster mixers, electric motors, power planers, contractors' pumps, house pumps, sawmill machinery, saw rigs, saw sets, circular saws, hand saws, jig	
saws, swing saws, saw tables, scaffold brackets, steel scaffolds, steam shovels, steel and iron tanks, wood tanks, concrete placing towers, steel towers, variety woodworker, power-driven woodworking machines, second-hand woodworking machinery, universal woodworker.	
Standard School Heater Co.	175
Pipeless furnaces, warm air furnaces.	
Standard Screen Co.	13
"Standard" window and door screens, "Standard" storm sash, "Standard" storm doors.	
Stanley Rule & Level Co.	25
Brad and scatch awls, benders, bevels, screw-driver bits, bit braces, corner braces, carpenters' chisels, countersinks, breast and hand drills, floor scrapers, auger bit gauges, butt gauges, hammers, carpenters' levels, nail sets, carpenters' planes, routers, calliper rules, extension rules, saw sets, screwdrivers, spoke shaves, steel squares, T-squares, try and mitre squares, vises, mitre boxes, trammel points, boxwood rules, folding rules, clapboard tools.	
Stanley Works (The)	103
Various "Acme" barn-door latches, window and door bolts, spring butts, door and window catches, blind and shutter fasteners, casement window fasteners, blind and shutter hinges, surface hinges, sash holders, latches, sash lifts, sash locks, "Stanley" garage hardware, "456" door holders, "1774" garage door holders, "Stanley" garage hinges, ornamental hinges, "Schroeder's Peerless" storm sash hardware, screen door hardware, outside blind and shutter hardware, cellar window hardware, shelf brackets, strap and "T" hinges, ball-bearing butts.	
L. S. Starrett Co. (The)	10
Bevels, builders' tools, calipers and dividers, rule clamps, countersinks, stair gauges, inclinometers, levels, nail sets, plumb bobs, shrink rules, scrapers, squares, steel tapes, carpenters' tools, trammels.	
Steel Scaffolding Co. (The)	188
Scaffold brackets, steel scaffolds, shingling brackets.	
Sterling Foundry Co.	176
"Best" coal chutes, studding sockets, chimney caps.	
Sterling Wheelbarrow Co.	22
Concrete carts, wheelbarrows, form clamps.	
Stewart Mfg. Co.	31
Industrial cars, castings, cement brick machines, cement post machines, concrete block machines, conveying machinery, building material elevators, gas and gasoline engines, gasoline hoists, batch cement mixers, mortar and plaster mixers, contractors' pumps, revolving screens, concrete block and brick tappers, sand elevators, truck units, tractor units.	
Storm Mfg. Co.	12
Electric dumbwaiters, handpower dumbwaiters, freight and passenger elevators, sidewalk elevators, hand elevators, electric elevators.	
Stover Mfg. & Engine Co.	17
Angle irons, carpenters' clamps, fireplace dampers, door pulls, gas and gasoline engines, fireplace furnishings, blind and shutter hinges, floor hinges, latches, sash lifts, sash pulleys, vises, windmills, house numbers, ash pit doors, double-acting jamb hinges, screen door hinges.	
Stowell Mfg. Co.	158
Building paper, roofing cement, roofing and sheathing paper, asphalt ready roofing, asphalt shingles, granite roofing, rubber roofing, slate-surfaced asphalt roofing.	
Swan Co., The James	8
"Swan" boring machines and hollow augers, "Swan" auger and screwdriver bits, wood-boring machines, "Swan" carpenters' chisels, "Swan" countersinks, "Swan" draw knives, twist drills, "Swan" auger bit gauges, "Swan" nail sets, "Swan" screwdrivers, spoke shaves, "Swan" tool cases and tool chests.	
Sykes Metal Lath & Roofing Co.	187
Metal lath, wall ties and corner bead.	
Syracuse Twist Drill Co.	11
"Syracuse" screwdriver bits, "Clark's" countersinks, "Syracuse" twist drills, "Syracuse" auger bit gauges, "Syracuse" nail sets.	
Taylor Mfg. Co., Jas L.	8
Carpenters' clamps, column clamps, concrete construction clamps, scaffold brackets, foot and hand-power woodworking machinery.	
Toledo Cable Co.	164
"Bull Dog" lightning rods, "Bull Dog" enamelled steel letters, "Bull Dog" fence anchors.	
Triple "A" Machine Co.	15
Hand-power floor surfacing machines.	
Trussed Concrete Steel Co.	130
Reinforcing bars, metal corner beads, metal ceilings, column clamps, metal columns, concrete inserts, hollow metal fireproof doors, iron and steel doors, joist hangers, metal lath, steel partitions, iron and steel sash, hollow building tile, "Floretyle" steel tile, "Truscon" steel buildings, armor plates, curb bars, pressed steel joints and studs.	
Union Metal Mfg. Co.	180
"Union Metal Columns," exterior gas and electric lighting fixtures, "Union Metal" lamp standards, "Union Metal" entrance standards, "Union Metal" wall brackets, "Union Metal" exterior newels.	
Upon Company (The)	156
Wallboard, building board, fibre tile, fibre strips for wallboard.	
Vaughan & Bushnell Mfg. Co.	24
Foot hole augers, dry bars, screwdriver bits, carpenters' all-steel chisels, countersinks, hammers, nail sets, reamers.	
Vendor Slate Co.	123
Roofing slate, structural slate, blackboards, slate switchboards, and everything in slate.	
Vigo-American Clay Co.	140
Clay hollow building blocks, fireproofing, floor tile, partition tile, hollow building tile, drain tile, book tile.	
Wagner Mfg. Co.	135
"Wagner" door and window catches, "Wagner" coal chutes, "Wagner" barn and garage door hangers, "Wagner" door pulls and door stops, "Wagner" storm sash hangers, "Wagner" sash holders, "Wagner" latches, "Wagner" barn door rails, "Wagner" scaffold and shingling brackets, "Wagner" door springs, "Wagner" studding sockets, "Wagner Star" elevator door hangers and track, "Wagner Star" elevator locks, "Wagner" parlor door hangers and track, "Wagner" fire door hangers and hoists, "Wagner" sliding door stops, "Wagner" sliding door guides, "Wagner" barn door latches, "Wagner" weatherstrips for hinged and sliding doors, "Wagner" shingle gauges, "Wagner" hangers and track for folding and accordion doors.	
Wallace & Co., J. D.	6
Power planers, power-driven woodworking machinery.	
Waterloo Cement Machinery Corp.	32
"Wonder Double Quick" back fillers, "Wonder" concrete block machines, "Wonder" building material elevators, "Wonder" gas and gasoline engines, "Wonder" gasoline hoists, "Wonder" batch cement mixers, "Wonder Improved Diaphragm" contractors' pumps.	
Waterman Motor Co.	100
Water supply systems.	
Wedell & Beers	190
Tool cases and tool chests.	
Western Iron & Foundry Co.	177
Joist anchors, wall anchors, angle irons, metal column bases, castings to order, concrete construction clamps, automatic coal chutes, metal columns, concrete block machines, metal cellar doors, iron and steel doors, freight and passenger elevators, fire escapes, window guards, joist hangers, architectural iron, metal lath, reinforcing bars, shafting and hangers, steel and iron tanks.	
Whisler Mfg. Co.	191
"Woodworkers' Friend" jointer heads, shaper heads, saw arbors, power grindstone shafts, disc sander shafts with saw arbors, drill chucks to hold brace bits.	
Whitacre-Greer Fireproofing Co., The	140
Clay hollow building blocks, fire brick, hollow building tile.	
White Co., Inc., David	12
Engineering and surveying instruments, carpenters' levels, "White's Improved" transits and levels, "White's Improved" convertible levels, surveying instruments repaired.	
White Co., L. & I. J.	24
Carpenters' adzes, broad axes, hand axes, carpenters' chisels, draw knives.	
White Pine Bureau	185
An association of manufacturers of white pine lumber.	
White Steel Sanitary Furniture Co.	182
Metal medicine cabinets.	
Whitman Agricultural Co.	166
Air compressors, industrial cars, concrete carts, clamps for concrete construction, dump carts, building material elevators, gas and gasoline engines, kerosene engines, electric hoists, gasoline hoists, electric and gasoline lighting systems, contractors' pumps, house pumps, saw rigs, drag saws, swing saws, saw tables, variety woodworker, winches or crabs, receiving hoppers.	
Whitney Window Corporation	16
Patented casement hardware and screen fittings for Whitney windows.	
Wilder-Strong Implement Co.	16
"Wilder" cattle stanchions, "Wilder" stall dividers.	
Williamson Heater Co.	175
Boiler and pipe covering, heating plant boilers, hot water and steam heating systems, pipeless furnaces, vapor heating systems, warm air furnaces, hot air radiators, hot water and steam radiators, hot air furnace registers, heat regulators, radiator shields, pipe and fittings for warm air furnaces and hot water and steam heating systems, laundry dryers, laundry stoves and heaters, tank heaters, floor and ceiling plates, asbestos paper and asbestos paste powder for warm air pipe covering.	
Willis Mfg. Co.	149
Corrugated arches, metal battens, metal corner beads, metal cresting blocks, sheet metal capitals, metal ceilings, chimney caps, coal chutes, sheet metal cornices, sheet metal cresting and finials, metal-covered fireproof doors, sidewalk doors, window guards, expanded metal lath, marquees, sheet metal ornaments, hot-air furnace registers, corrugated roofing, sheet metal roofing, iron and steel roofing and siding, hollow metal sash, iron and steel sheets, radiator shields, fireproof shutters, skylights, cupola ventilators, exhaust ventilators, wall ties, weather vanes, hoghhouse windows, wire glass windows.	
Witt, Chas. G.	177
Cold process gasoline gas machines for lighting systems.	
Witte Engine Works	191
Gas and gasoline engines, kerosene engines.	
York Automatic Dumbwaiter Works	12
"Sanitary Automatic" dumbwaiters.	

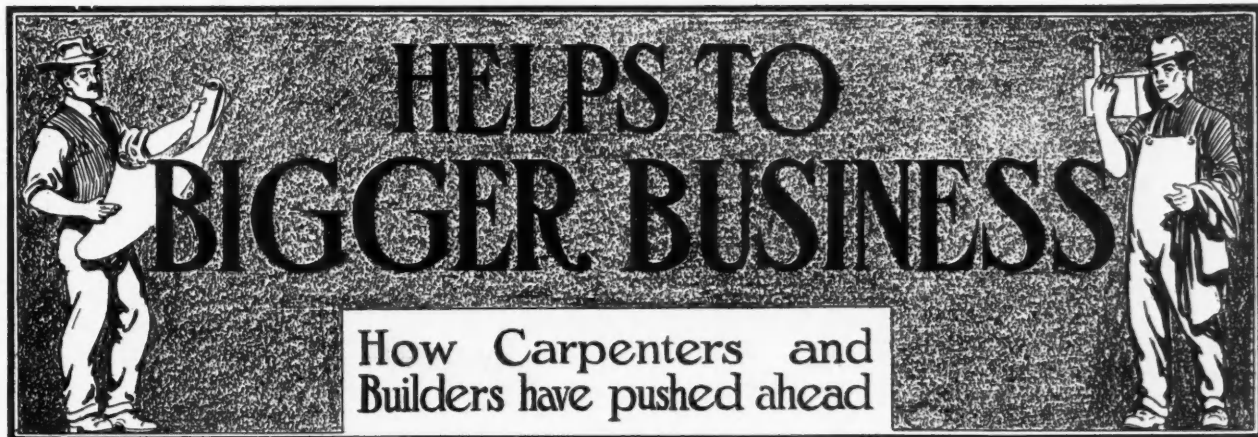

Modern Office Methods Help the Contractor

By Victor Lauriston

NOT long ago a small building contractor found his account for construction work on a residence disputed by the owner. He had, so the owner alleged, failed to put in the cement floor for the basement; 8-inch base had been used where 12-inch base was promised; a promised plate-rail in the dining room had not been put on—and so on.

"You promised to put them all in, and I'll hold back your money till you do," declared the owner, warmly.

"They were discussed before I quoted my price," returned the builder, in effect, "but they were not included in the figure I gave."

"They were. They were included in your letter quoting that figure," insisted the owner.

"Have you the letter?"

"I—I guess I've mislaid it, but—well, I can swear those things were all included in the specifications. I'll go right into the witness box and swear to it."

"You'd better not do that, friend," commented the builder calmly. "You mayn't have the original letter, but I have my carbon copy. If you don't mind, we'll look it over."

The bluffer collapsed instantly, and wrote out a check for the amount in full. The builder silently congratulated himself that, on rainy days when he was an ordinary carpenter, he had seized the opportunity to learn to run a typewriter.

For once that an out-and-out case of bluff is met with in the building business, there are a dozen cases probably where the objecting owner sincerely believes that he has not been given what the builder promised. Plain misunderstandings of this nature are all the more dangerous, in that both sides to

such disputes are perfectly sincere and, in their sheer sincerity, are willing to go to law rather than yield their point. Human memory is exceedingly fickle, particularly in regard to technical details with which the average individual is unfamiliar. The carpenter-contractor who has written evidence to back up his claims will avoid many a regrettable dispute and many a lawsuit; and the owner who has in his hands a type-written copy of the builder's tender with full specifications is far less likely to make unjustified claims or to misunderstand what the contractor has undertaken to do.

Of course, practically all large contracting firms use modern methods, modern office equipment and modern record-keeping systems; but among small contractors there are still many who trust to long hand, and still more who rely on verbal agreements. These contractors feel that with a small business a heavy invest-



"Well I Swear Those Things Were All Included in the Specifications."

ment in office equipment is not justified.

In a sense they are right. Modern equipment rapidly runs up into money. At the same time, one law suit regarding a comparatively small job will usually cost more than a very elaborate equipment of office furniture.

This does not mean that the young contractor who is just graduating from his carpenter's bench into the wider field should at once rush out and buy an office desk, a filing outfit, a protectograph, a swivel chair, a typewriting machine and a host of other things, and hire a stenographer and a book-keeper to look after



His Office Equipment Was Just a Secondhand Typewriter and a Few Carbon Sheets and a Supply of Printed Envelopes and Letter Heads.

the details of his business. Far from it. But it does mean that the budding contractor will do well to give the office end of his business careful attention.

I recall one young man who developed very rapidly as a contractor, just thru the possession of this business sense. He started with his trade as carpenter, plus larger ambitions. So, he looked ahead. He realized that to be a contractor on a large scale he must have a business equipment. He could not afford the time or money to attend commercial college, but with the assistance of a friend engaged in office work he taught himself to operate a typewriter. He had the good carpenter's skill in calculating materials and preparing estimates.

When he took his first contracting job he bought a second hand typewriter and ran off the specifications in duplicate when submitting his price. In the comparatively small town where he lived, typewritten estimates were a new thing then, even with the larger contractors. More than this, the young man had had neat letter heads printed with his name, address and business indicated. His office at that time was merely

(Continued to page 152.)

A Dining Room Interior

Designed by Ralph W. Ermeling

IT often happens that when a family moves into a new house they wish to use the old sideboard—an heirloom perhaps. Or it may be that Mrs. Owner wishes to buy a new buffet instead of having one built in. The dining room treatment shown is for just such cases. The fact is, that movable sideboards, either as pieces of furniture or as a part of the house furnished by the builder, are very much in vogue just now. And they are of the long low type, without mirrors. When mirrors are used they are framed and hung detached from the sideboard beneath.

The buffet shown here might serve as a model for the builder who wants to produce something different from the usual styles commonly seen, and who wants to build it without any unnecessary expense. There are drawers as usual. There is a top shelf that is usual except for the beveled edges. There is a simple moulded rail at the back. There are side doors with plain leaded glass in rectangular panels that harmonize with the glass of the case above and with the windows. Behind these doors are the usual movable shelves. The corners of the buffet, however, have brackets that are not usual nor are they complicated nor difficult to manufacture. The large scale detail illustrates in dimension the simple yet graceful form.

Another detail is that of the brackets supporting the china-case above. At least two of them nearest the center should be framed into the wall to stiffen the case above. This case consists of five compartments with shelves behind leaded glass doors. It is housed back in the recess in the wall and becomes a permanent fixture regardless of the fate of the buffet below it.

The oriel window has something of the English domestic feeling with its small casements and seat. The seat performs a practical function by concealing the radiator. The front of the radiator enclosure is brought out beyond the face of the plastered wall. This was desirable on account of the size of the radiator and the shape of the space under the seat, and to make it a slight architectural feature of the room. The corners of the seat are supported by brackets similar to those of the buffet, only smaller in scale. The front has louvres made of inclined slats fastened at the ends and placed to throw the heat outward. The open space at the bottom provides an intake for cool air from the floor and the slots at the top are additional outlets. The top shelf is also beveled at the outer edge in keeping with the buffet top.

The paneling of the walls results naturally from the use of a stock continuous moulding and the division of the walls by door and window openings. Some of the feeling of the popular formal dining room is obtained, but the sunken space for the sideboard, and the homely though refined china cabinet, and the casement windows and seats add a domestic air to the composition.

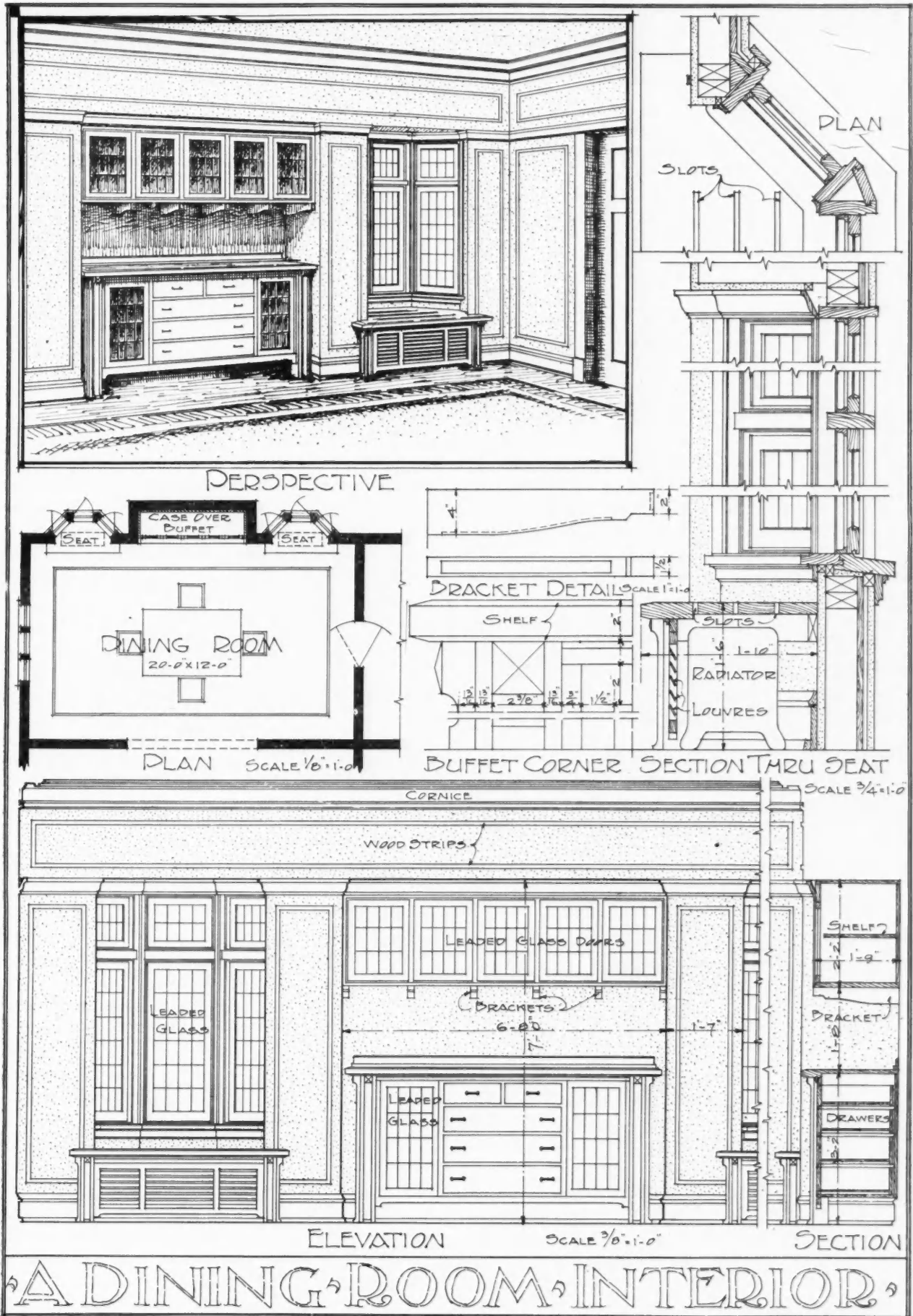

A DINING ROOM INTERIOR

Sketch, Floor Plans, Elevations and Details of Interesting Dining Room Interior; Designed by Ralph W. Ermeling, Architect.



Noon Hour Talks by the Boss Carpenter

Talk No. 65.—Calculation for Small Factory Building

THE BOSS TELLS ABOUT THE DESIGN OF THE INTERIOR FRAMING, FLOOR AND ROOF FOR A SMALL FACTORY

“ONE of our brothers,” said the Boss, “has been asked by a concern in his town to lay out the interior framing of a small factory which is to be used for light manufacturing purposes. He wants us to help him in suggesting different methods of construction, and show him how to apply the principles that we have covered in our previous talks. “He states that the footings and foundation walls are to be concrete, while the walls of the building will be of brick. These are to be taken care of by a local mason contractor. Our friend is to figure the size of all posts or columns, girders, beams, the thickness of floors and roof, and lay out the general interior arrangement. The business is of such a nature that

which fits his needs and his pocketbook the best. These types are as follows:

- “1. Heavy timber mill construction using timber posts, girders, beams, floors and roof.
- “2. Steel and timber construction with steel or cast iron columns or posts, steel girders and beams, and wood floors and roof.
- “3. Reinforced concrete columns, girders, beams, floors and roof.

“I believe that the best way to handle this matter is to take each type in the order named and discuss it by itself. Today we will figure out the mill construction type. Since we have described the meaning of the term ‘mill construction’ in detail in one of our earlier talks, it will not be necessary to repeat at this time.

“We can plan to use either the girder and beam, or ‘semi-mill’ type, or the laminated floor method of construction. We will show the ‘semi-mill’ calculations first.

“The spacing of the posts in the building will be as shown in the floor plan, Fig. 2. The main girders extend across the width of the structure, as shown in Fig. 3, dividing the width into four spans. The spans next to the walls are 16 feet from center of post to center of wall bearing, while the two center

spans are 17 feet from center of post to center of post.

“Along the length of the building the girders and posts are spaced 16 feet apart in all spans except the two ends, which are 14 feet from center of post to center of beam support at end wall. The beams shown in Figs. 2 and 3 are either supported on the tops of the girders, or hung in stirrups at the sides. In this latter method of support, the top of the beam is on a level with the top of the girder. One beam is

(Continued to page 160.)

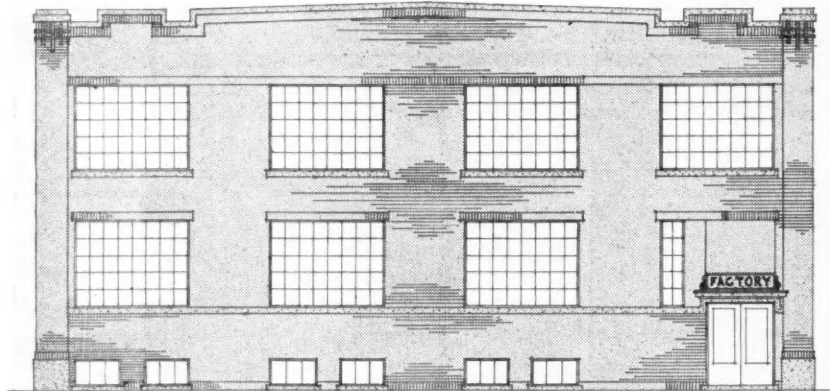

Fig. 1. Exterior of Small Factory Building, the Calculations for Which Are Explained in This Talk.

125 pounds per square foot of floor area is ample for use as the live load in our calculations.

“The lot is of such a size that a building 66 feet wide by 126 feet long will be used. This building consists of two stories, each 12 feet high, and a basement 10 feet 4 inches from cellar floor to top of first floor. The roof will be flat with a slight slope to allow proper drainage. Figure 1 shows a general exterior view of the proposed structure.

“This building can be designed in three different types in order that the owner may choose the one



STANLEY GARAGE HARDWARE

In snowy zero weather garage doors that are swung on STANLEY Garage Hinges close snugly and weather-tight like the front door of your home. They help to keep the garage warm. The door doesn't bind and stick but swings as easily as the day it was hung.

A sudden blast of the north wind can't send the door smashing against the car leaving the garage—not when the doors are held open by STANLEY Garage Door Holders No. 1774.

During the dark nights prowlers will find the doors locked firmly and securely when STANLEY Bolts are used.

The STANLEY Door Pull is adaptable to winter weather, because it is roomy, convenient, easy to grip even when you are wearing a heavy pair of driving gloves.

When you need Garage Bolts, Butts Hinges, Latches, Pulls or Door Holders, use STANLEY and you'll get better results than if you spent time hunting up "special" material.

*Catalog and complete
information on request.*

THE STANLEY WORKS
NEW BRITAIN, CONN., U. S. A.

NEW YORK:
100 Lafayette Street

CHICAGO:
73 East Lake Street

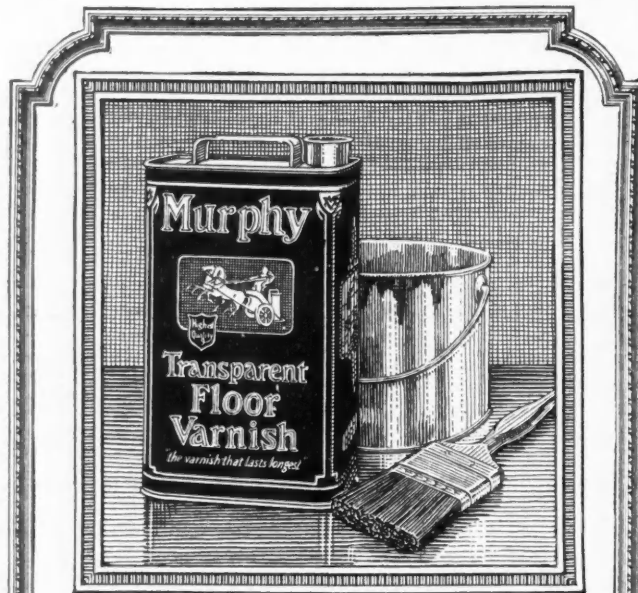

The can that insures the job

First Impressions

Your prospective customers are apt to inspect work that you have done, before employing you.

They lack sufficient technical knowledge to appreciate the deep-seated merits of your work.

They judge your jobs by looks. That's why you should be careful that the first impressions made by your work are favorable.

Murphy Varnish

"the varnish that lasts longest"

will give an especially beautiful long-lasting finish. Everyone who sees it will realize that you have finished your work well. It's human nature to accept good-looking work. You know, and everyone knows, that a good finish usually indicates good work throughout.

Murphy Varnish costs no more in the can but a good deal less on the job. It works easier, goes farther and saves labor and money.

Our principal house-finishing products are:

- Murphy Transparent Interior
- Murphy Transparent Floor
- Murphy Transparent Spar
- Murphy Nogloss Interior
- Murphy Semi-Gloss Interior
- Murphy Univernish
- Murphy White Enamel
- Murphy Enamel Undercoating

Write for full information

Murphy Varnish Company

Franklin Murphy, jr., President

Newark

Chicago

Dougall Varnish Company, Ltd., Montreal
Canadian Associate



WHEN WRITING ADVERTISERS PLEASE MENTION THE AMERICAN BUILDER

Correspondence Department

(Continued from page 75.)

tape or tools for laying out work with accuracy.

What do you know of the rule for getting inside measurements? They are all right.

Another good ad to answer is that of the Dixon pencils. And did you get the idea of the wax hole in the end of the hammer handle? Everybody is building a garage and putting rolling doors on their barn. Why not learn something about the hardware for these?

Now that steel is so high, people are using shingles. You might do well to find out about the red cedar shingles and get the booklets that are offered, or perhaps the other kinds of roofing that are offered will be what you are looking for.

With lumber prices soaring high, you may want some information regarding concrete construction, or perhaps it is wall board in which you are interested.

If it is lumber there are several ads offering valuable information. Or, is it sanitary barn equipment you wish? Do you want to know about the pipeless furnace and indoor closets?

If it is paint you may learn by using a few stamps. You will need to pay an extra cent now for each letter, but you will get several times that in return. If you need more tools you can find ads of almost anything you could wish for.

If it is books for study you will find them advertised. Do not overlook those of the publishers of this magazine.

JOHN UPTON.



Ventilation of Cantonment Barracks

Emerson, N. J.

To the Editor:

I was delighted to read the articles in the October and November issues of the AMERICAN BUILDER regarding the construction of Camp Devens, which is certainly very interesting.

I work at Camp Merritt at Dumont, N. J., and I notice

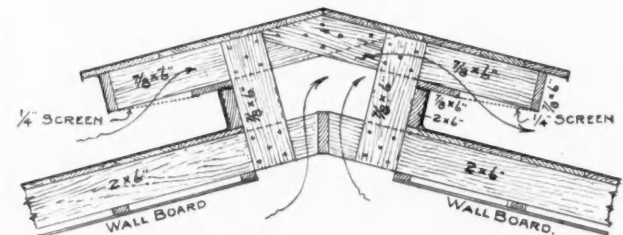

Ventilating Monitor Along Ridge of Camp Barracks.

that the same style is carried out in other cantonments. Enclosed you will find a sketch of the ventilators that are used in the roof of the barracks which are very simple and I believe the best for the purpose.

NATALE LUCIA.



Suggestion For a Tool Grinder

To the Editor:

Mount Clemens, Mich.

I am a carpenter and have been for some time a reader of the AMERICAN CARPENTER AND BUILDER and the new AMERICAN BUILDER, which I buy from the news-stand, and I always look forward to your monthly magazine, as I would rather read it than any of the others because of the more useful things it contains.

In the April number I saw an article on tool grinders by Mr. D. R. Sanford. I, too, am with him for a good tool grinder.

I use a Niagara with a 1 by 6 wheel, because I have found

(Continued to page 106.)

KELLASTONE
IMPERISHABLE STUCCO



**SUPREMELY IS
SUPERIOR IS
KELLASTONE**
IMPERISHABLE STUCCO

FOR EVERY STUCCOING PURPOSE

ALMOST MIRACULOUS

are the results of covering or overcoating old frame or brick houses with Kellastone Stucco. This work may be done in winter or summer, without disturbing the occupants of the property and at a surprisingly reasonable outlay.

KELLASTONE STUCCO contains no Portland cement, lime or gypsum, is not mixed with water, **WILL NOT FREEZE** in zero weather, is waterproof and never looks unsightly in wet weather; is flexible and may be bent without injury and is practically immune to expansion and contraction and therefore crack-free.

If you are interested in learning about the **strongest, most beautiful and most durable** stucco on earth, write for our booklet.

National Kellastone Co.
1330 Mallers Bldg.
CHICAGO



CRAFTON
STUDIOS

This book makes you the Upper-class Decorator



You are Known by your color schemes

—it's the *color schemes* that make your work exceptional

—that give you a reputation as a *decorator*, as well as a painter.

This book gives you *distinctive* color schemes for *exteriors* and *interiors*.

The illustrations are all *in color*.

They include living rooms, library, hallways, sleeping rooms, etc., with several color schemes for each character of *interior*, as well as for every character of *exterior*.

Floor plans give you decorative schemes for the entire home—so that every room will be *distinctive*.

25c for a \$2.00 Book

This book costs nearly two dollars apiece to print—it shows in color the best color schemes of the leading American decorators—but we are practically giving it away free, when we send it for twenty-five cents in stamps to cover postage. This charge is also intended to do away with curiosity seekers. We know that every responsible painter contractor or decorator will not begrudge 25c for this book, and it is only those whom we want to have it.

Here is our proposition—send 25c in cash or stamps, get this Portfolio of Color Schemes, and if you are not delightfully satisfied, tell us and we will return the money, and you can still keep the Portfolio. Send for it today.

PATTON PAINT COMPANY

Milwaukee Wisconsin



The interiors and exterior shown in color with specification to show how to get the decorative effect



Correspondence Department

(Continued from page 104.)

nothing better; but it is not my ideal grinder.

I would like a grinder with two wheels cemented together, one like my 1 by 6 carborundum and the other very fine for removing rough edge left by the coarse wheel, these to be with a gear ratio of one to twenty-five, this will make a

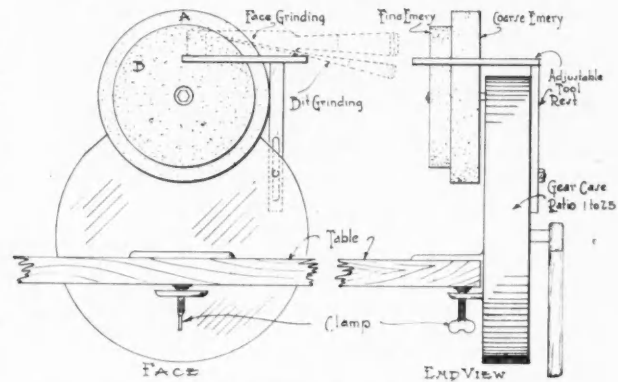

How Brother Smith Wants His Tool Grinder Made.

smaller grinder and I do not object to the 1 by 6 hollow grinding.

I am also enclosing a sketch of same. The main grinder. If you would publish this in your magazine I would like to have this grinder discussed.

Yours for better grinders,

EDWIN S. SMITH.



Fire Resisting Residence

To the Editor:

Amboy, Ill.

Here is a photo of a fine residence I put up of brick and hollow tile.

FRANK HUBBELL,
Contractor and Builder.

A Question for Door Hanging Experts

To the Editor:

Yuba City, Cal.

I would like to have you print in a number of the AMERICAN BUILDER, the quickest method of hanging a door, described from start to finish. By so doing you will greatly oblige.

G. W. DONALDSON.

A South Dakota Barn

To the Editor:

Frankfort, S. D.

Here is a picture of the kind of barns we built in South Dakota. This barn was built by me for Fred Bickness. It is a frame barn.

I am also enclosing a floor plan sketch of same. The main

(Continued to page 108.)

JOHNS-MANVILLE ASBESTOS ROOFING



You can bring this Fire-Safe Roofing to your town

If you will take over the sale and application of Johns-Manville Asbestos Roofing, you can bring **fire-safe roofing** to your town. You can sell roofing of the type that covers many of the country's biggest and most important buildings.

And there's a double profit for you in every job—one on the sale and one on the application.

Asbestos Ready Roofing is an all-mineral roof covering, supplied in rolls and easily applied with Johns-Manville Roofing Clamps, packed with the roofing. Resistant to fire, to the wear of time and the elements, this roofing gives long years of service with practically no upkeep expense.

Ask, too, about Johns-Manville Asbestos Shingles—an ideal fire-safe roofing for homes. Supplied in several colors, of shape, size and finish to suit every customer's roofing taste. Easily applied.

H. W. JOHNS-MANVILLE CO.
NEW YORK CITY

10 Factories - Branches in 55 Large Cities

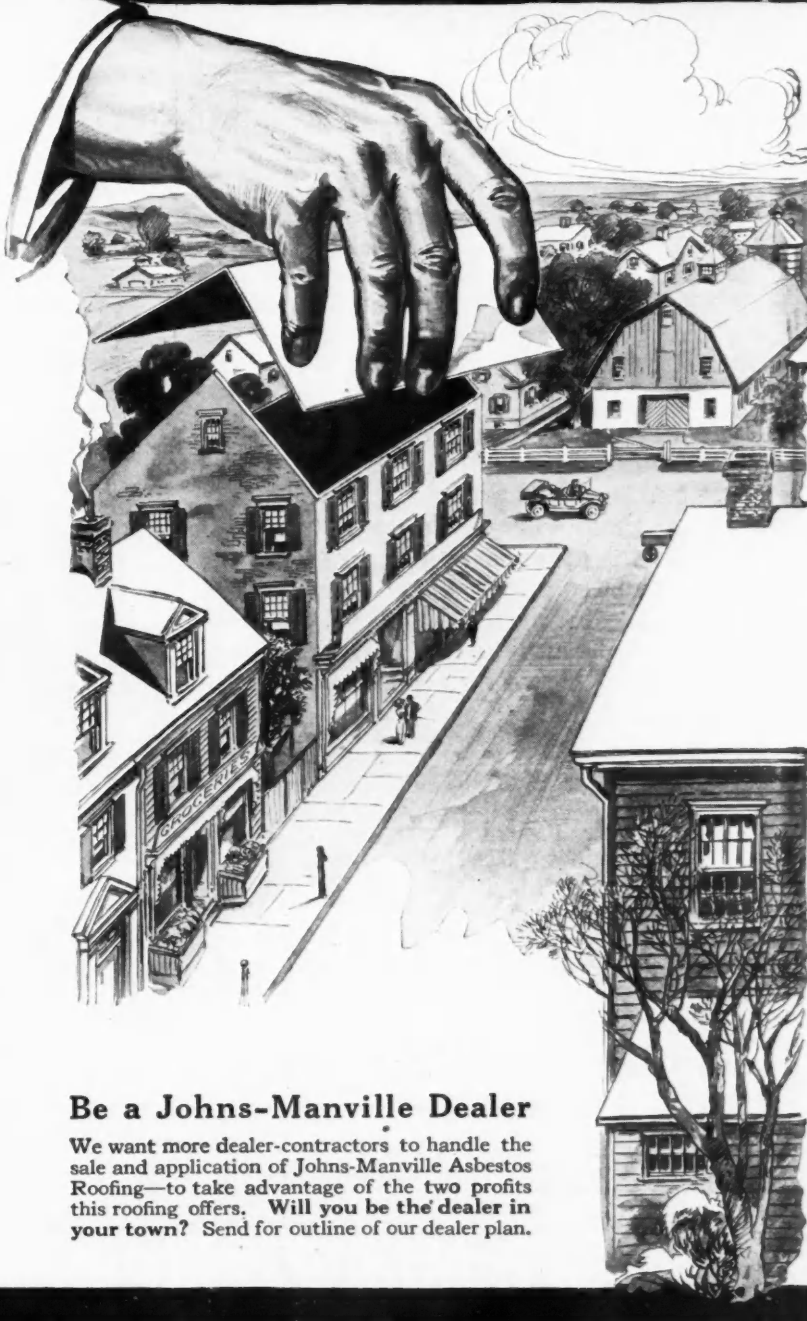

Be a Johns-Manville Dealer

We want more dealer-contractors to handle the sale and application of Johns-Manville Asbestos Roofing—to take advantage of the two profits this roofing offers. **Will you be the dealer in your town?** Send for outline of our dealer plan.

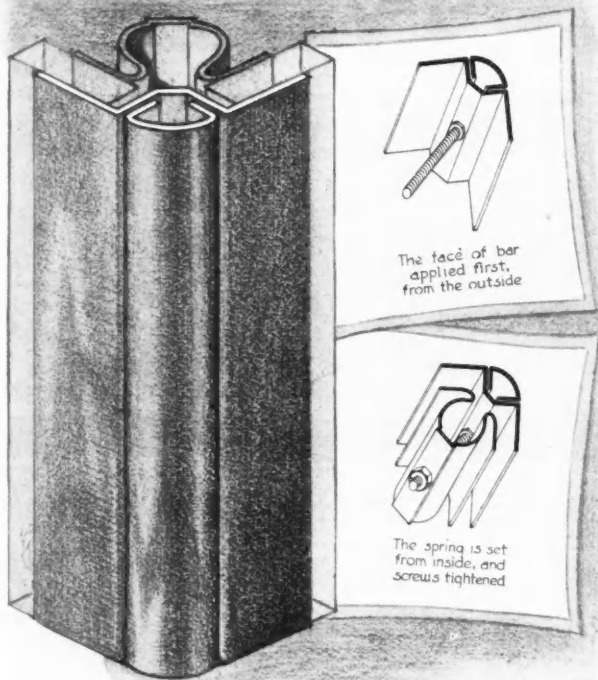

The face of bar applied first, from the outside

The spring is set from inside, and screws tightened

Are You Interested in Store Fronts

YOU no doubt are. In selecting a certain Store Front Construction, be sure that you select one that will prove satisfactory—a construction that will *finish up* well, and which affords the greatest possible safety for the glass; a construction that will be easy to install, saving you time and labor, *besides* being permanent and of a lasting, good appearance. All these merits are embodied in

Kawneer STORE FRONTS

Make one good Store Front Job sell another. Merit will tell. Two good jobs will sell the *third one*, and you will soon find yourself firmly established in your community, doing a profitable Store Front Business.

You have been looking for short, clean and well paying jobs. Here's your chance. Write for our Catalog "H," containing half size details of our Store Front Construction. It is yours for the asking.

Kawneer Manufacturing Company
Niles, Michigan

PIN THIS COUPON TO YOUR LETTERHEAD

Please send me a copy of Catalog 'H'

WHEN WRITING ADVERTISERS PLEASE MENTION THE AMERICAN BUILDER

Correspondence Department

(Continued from page 106.)

barn is 40 by 56 feet and the lean-to is 16 by 56 feet, making it 56 feet square on the ground. The stalls were all run crossways of the barn, in order to face the barn south and have the litter carrier go east. It is all of heavy timber framing of 6 by 8 and 6 by 6 timbers.

W. R. SCHLOTTER,
Contractor and Builder.

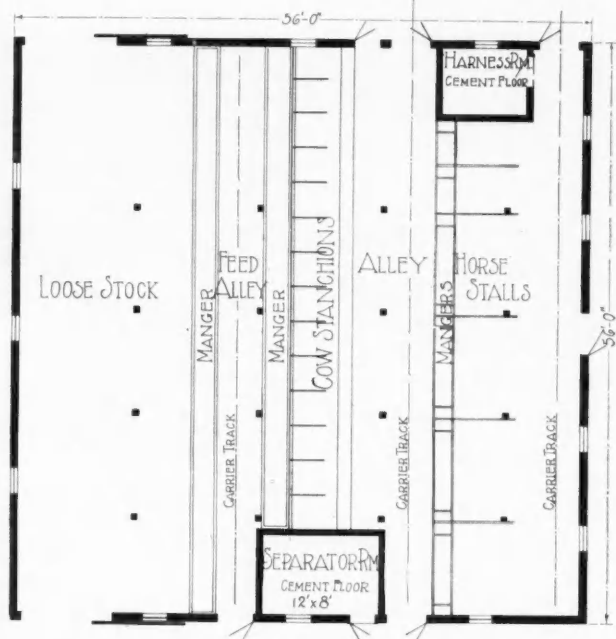

Photo and Floor Plan of Stock Barn Built by W. R. Schlotter Near Frankfort, S. D.



Urge Level Crossings—They Will Save Lives

A CONSIDERABLE number of our readers are concerned with road construction and a great many others are in positions of influence relative to matters of local public policy such as road improvements. We, therefore, feel justified in taking space in the AMERICAN BUILDER for the presentation of the following from the Portland Cement Association's Highway Magazine.

It advances a suggestion which we indorse heartily—an important matter for the co-operation of all.

(Continued to page 110)



**“Not a Kick
in a
Million
Feet”**

**For Beauty
Strength and Service**

There is a difference in Asphalt Shingles, just as there is a difference in any manufactured article. In order to satisfy your customers, use **MULE-HIDE Asphalt Shingles**. “Not a kick in a million feet.” *Because of their beauty and fire-resisting properties they are demanded by owners of beautiful homes in practically every state, and the price is easily within reach of all.*

The surface of natural slate is thoroughly imbedded in high-grade asphalt, and **MULE-HIDE Shingles** are made rigid enough to withstand all kinds of weather conditions, yet sufficiently pliable to meet every necessity of modern architecture and add a finished appearance to any kind of building, giving it a richness impossible with other types of roofing.

The colors are nature’s own without the aid of chemical dyes or stains and retain indefinitely their beauty and durability.

“Quality Users Are MULE-HIDE Choosers,” and you will agree with us after using same that they will help retain your reputation by giving unusual service and satisfaction to your customers

Manufactured in individual shingles, both Standard and Double-Thick Weights, size 8x12¾ inches. Also made in Strip Form (four shingles to a unit), 10x32 inches known as “MULE-HIDE Four-in-One Shingles.”

We have an interesting booklet showing photographic views of fire tests made on Asphalt Shingle roofs. This booklet gives other valuable information for every dealer and contractor, and you are entitled to a copy without cost to you, upon request.



MULE-HIDE Shingles made in colors—either Grey-Green or Red

THE LEHON COMPANY, Mfrs.

4421 South Oakley Ave., CHICAGO

Address Shingle Department

We also make MULE-HIDE
ROLL ROOFING

in either smooth surface or stone-coated

**PORCH DECK CANVAS ROOFING
WATERPROOF BUILDING PAPERS
FLEXIBLE CEMENT**

for putting around skylights, chimneys,
vent pipes, boilers, etc.

ROOF PAINTS

for re-coating old composition or
metal roofs

Urge Level Crossings

(Continued from page 108.)

"Bad railway crossings cause many serious and fatal accidents. Constructing the road with a decided rise or fall just at the track contributes largely to the danger for automobiles at such crossings; but this construction is common where the railroad is above the normal level of the highway. To eliminate all grade crossings is out of the question; therefore, efforts to decrease loss of life must be directed largely toward making necessary grade cross-

ings reasonably safe. Instead of the crest at the track there must be substituted a level section even tho steeper approaches are necessary. In most instances a satisfactory profile can be obtained at a moderate cost.

"The level stretch should begin at least 30 feet in front of the first rail. Since a railroad right-of-way is usually 100 feet wide, the improvement might well extend for this distance. Where the railroad fill is high enough to hide machines approaching from the opposite side, it is imperative that conditions be improved, for here there is the additional danger of two automobiles colliding. Road engineers are recommending a minimum sight distance of 300 feet at every point along the road. Especially is this desirable at a grade crossing and a level section here will aid in fulfilling this requirement.

"Sufficient width should be provided for two automobiles to pass without slowing down for that purpose—20 feet at least. Then if the crossing

itself is made as even as possible there will be no congestion at this most dangerous place.

"Attempts are often made to get over bad crossings on 'high.' The steep ascent, combined with the necessity of slow speed over the rails to avoid jolting may cause the driver to 'kill' his engine just as he reaches the rails. With the rear wheels perhaps still on the grade, there is no chance for momentum to carry the car over. A fast train bears down upon it—the crash is inevitable. Another accident is added to the long list.

"The increased safety from such improvements is more than worth the cost, even tho considerable. Crossings must be such that if an automobile is to stall, it shall be somewhere other than in front of a train. Co-operation between county or township authorities and the railroads, working under the State Railroad Commissions, where they exist, will do much to make for safety. Continued neglect means more accidents."

"The remedy is simple. A level stretch of road provided on each side of the track and an unobstructed view will result

People usually ask advice merely to have their opinion confirmed.

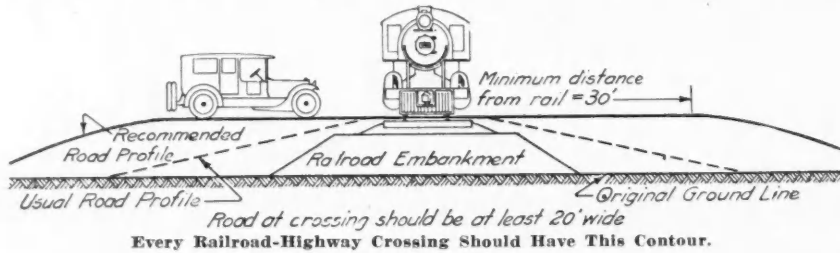

Every Railroad-Highway Crossing Should Have This Contour.

A TYPICAL BRASCO INSTALLATION

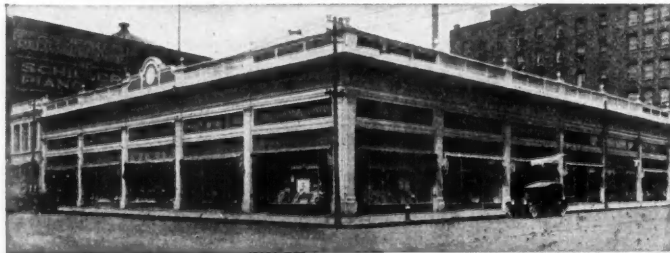

Big Profit

- is yours *right now* in installing business bringing store-fronts,
- because thousands of store-fronts are being installed right now;
- because every Brasco copper store-front you install brings business in volume from neighboring envying merchants, who want to **keep up**.

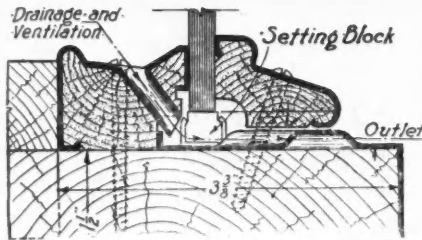

Brasco Copper Covered Creosoted Sash

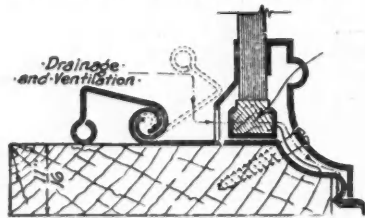

Brasco-Hester Hollow Type Sash

You will doubtless wish to be the Brasco Store-Front man of your community

- after you've gotten a line on the thousands of Brasco Fronts in actual use;
- and when you see that Brasco gives you the "edge" on every job—in mechanical merit, in beauty, in price.

Write for our detail portfolio and information about our agency plan.

BRASCO MFG. CO.

1455 South Michigan Avenue
CHICAGO, ILL.

Write your name and address in coupon tear out, mail to us for copy of detail portfolio.

BRASCO MFG. CO., Chicago
 1455 S. Michigan Ave., Chicago
 Please send your detail portfolio and information about your agency plan
 Name
 Address

Careful inspection



Res. Mrs. Melaine Levy,
Napoleon Avenue and
Ferret Street, New Orleans
Arch. Steven & Nelson Co.
New Orleans

of this roof will reveal these facts. That it is **fireproof**, that it is **everlasting**, and that is the most **economical** roof that could be on a house.

AMBLER Asbestos Shingles

Nothing to Burn

are **fireproof** because composed of the fire resisting materials—Asbestos and Cement.

Everlasting because they are as permanent as the foundation.

Economical because the first cost is the only cost. There is no need of paint or repairs.

Ambler Asbestos Shingles are composed of Asbestos and Cement—two products made unburnable by Nature. Are made in many designs and three non-fading colors: Newport Grey, Indian Red and Blue Black; and will harmonize with any design or color scheme.

Facts, figures and pictures will be gladly furnished on request.

Keasbey & Mattison Company
Dept. B-I, Ambler, Pa., U. S. A.

Manufacturers of Ambler Asbestos Shingles, Asbestos Corrugated Roofing and Siding, 85% Magnesia Pipe and Boiler Covering, and Asbestos Building Lumber.

MIDLAND

STOCK WHITE ENAMELED

TERRA COTTA

WAS USED ON
THIS BUILDING



MIDLAND TERRA COTTA ©
1515 LUMBER EXCHANGE CHICAGO

WHEN WRITING ADVERTISERS PLEASE MENTION THE AMERICAN BUILDER

Hog In No Hurry

A Southerner, riding thru the White mountains, came up with Mr. Shaw leisurely driving a herd of pigs.

"Where are you driving the pigs to?" asked the rider.

"Out to pasture 'em a bit."

"What for?"

"To fatten 'em."

"Isn't that pretty slow work to fatten 'em on grass? Where I come from we pen them up and feed them on corn. It saves a lot of time."

"Yaas, I s'pose so," said Mr. Shaw. "But—what's time to a hawg?"



Every time some people accept a favor they look for the price mark.

It is not what you get, but what you expect to get that makes life worth while.



Speed in Increasing the Seating Capacity of the World's Largest Ball Park

The American League ball park in Chicago, more familiarly known as the "Sox Park," covering a ground area of approximately fourteen acres and having a regular seating capacity of about 29,000 has been widely heralded as the largest ball park in the world. In preparation for the recent world's series games, beside the construction of 3,000 temporary seats, it was decided to increase the permanent seating capacity by building 1,000 additional box seats around the front of the first floor of the grand-stand. This made the permanent seating capacity 30,000 and the temporary capacity approximately 33,000.

Rapid construction was required as the entire work had to be completed in eleven working days. The work consisted in building four rows of box seats around the entire front of the grand-stand, 578 feet in length, the construction of two new shelter houses, each 30 feet long by 6 feet

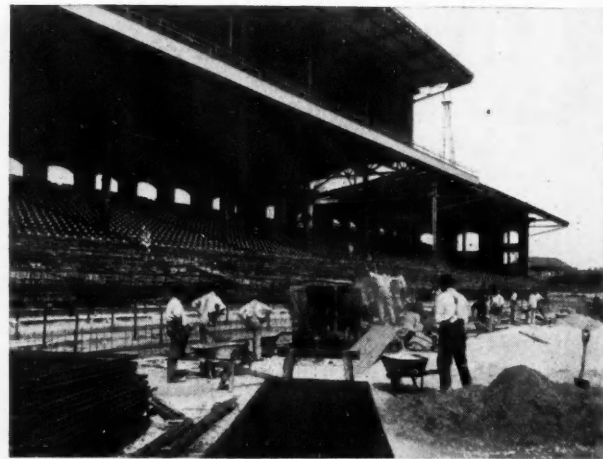

Concreting Gang Putting in 1,000 Additional Box Seats at White Sox Park Before the World's Series.

wide with walls 8 feet deep and a new front foundation footing 3 feet deep surmounted by a solid reinforced concrete rail 3½ feet high along the entire front of the grand-stand. A base for the concrete work was made back of the front footing by filling with cinders. All metal piping separating the boxes was set into the concrete and concreting was done in alternate sections to provide for contraction and expansion.

The general contract for this work was let to Standard Concrete Construction Co., Chicago, who used for mixing

(Continued to page 114.)

One Contractor Writes

"I have been thoroughly pleased with the shingles on all of the different jobs, and if they continue as they have for the past three years, I am satisfied they are unequalled by any other shingle of the same cost. The shingles lay perfectly tight to the roof and do not leak."

One Home Owner Writes

"Have had Winthrop Tapered Asphalt Shingles on my roof since June 12, 1913, and am more than pleased with them. I do not consider them an expense, but an investment. They are neat, durable non-breakable—therefore do not need repairing. At this time I would consider no other."

Don't Lay Another Roof Until You Investigate

**Winthrop
TAPERED**

**Asphalt
Shingles**

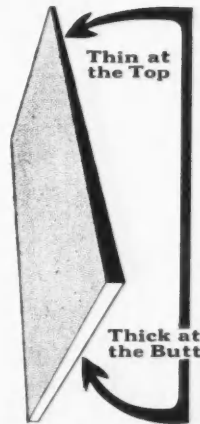
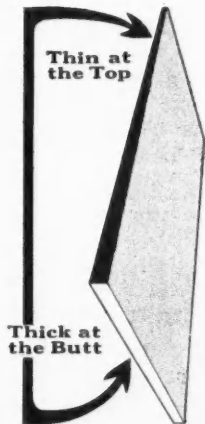

CONTRACTORS everywhere report the greatest satisfaction on the part of their customers with the buildings that have been roofed during the past five years with this wonderful shingle—the only Asphalt shingle tapered like wood.

Wherever the Winthrop Tapered Asphalt Shingles are introduced, they sell themselves. They win out with less argument than anything you ever tried to sell, for they look better than wood shingles, and they have all the protection of asphalt and slate.

Thick at the butt—thin at the top—they lay in just the same smooth even way as wooden shingles, yet have permanent, fire-resisting properties. Just ask for a sample shingle. See how tough, how pliable and how durable it is. See how it is made, like a wooden shingle—thick at the butt and thin at the top. See how easy it is to lay. See what a beautiful roof it will make—red, green or slate-black. Then decide.

Send the coupon.

BECKMAN-DAWSON ROOFING CO.
Asphalt Shingles
1413 Y. M. C. A. Bldg., Chicago, Illinois
Factory: Argo, Illinois

Just Send Your Name
BECKMAN-DAWSON ROOFING CO.
1413 Y. M. C. A. Bldg., Chicago
Gentlemen: I'm interested, send me a sample shingle.
Name.....
Town.....
State.....

Speed in Concreting

(Continued from page 112.)

the concrete two $\frac{1}{3}$ Yard "The Standard" Low Charging Mixers. Material was delivered in wagons and motor trucks and distributed along the front of the stand, leaving only enough room to set the mixers between the supply piles and the front footing. The portability of the mixers enabled them to be easily moved along as the work advanced so that the entire operation of delivering aggregates to the mixers and the mixed concrete to the forms was accomplished by hand-wheeling the shortest possible distances.



Only 28 Miles of Dirt Road.



Concrete Roads Make Overland Freighting Possible.

Long Distance Freight Handling by Motor Truck

Highway freight trains are now running in the United States—running over country roads, from Akron, Ohio, to Boston, Mass., and return, covering a distance of 1510 miles in a week.

Thus, what all the good roads propoganda for the past 15 years has failed to achieve, the freight car shortage and a national crisis have accomplished. The public has been forced to make greater use of its greatest transportation asset—the country road.

The truck line from Akron to Boston is being operated by the Goodyear Tire & Rubber Co. It is called the "Akron & Boston Express." The present equipment consists of two White and two Packard trucks, of 1 $\frac{1}{2}$, 3 and 5-ton capacity. It is planned to increase the equipment; and, according to J. L. Sydnor, the company's efficiency specialist, additional trucks are already ordered.

A regular schedule is maintained. M. D. Scott, manager of garage, says they are usually on time. The schedule calls for the round trip (1510 miles) in less than one week. Mr. Sydnor says that the express companies do not deliver stuff as rapidly as that, and that the truck costs are competing with express rates. Tires are loaded for their eastern branches and cotton fabrics and machinery for their plant in Akron are carried on the return trip. Several trips have been made to Washington, D. C., with "war orders," and good time was made.

Messrs. F. A. Seiberling, president, and P. W. Litchfield, factory manager, are the instigators of the movement. Service was started last April and Mr. Sydnor hopes to continue thru the winter unless stopped by too much ice and snow. There is only 28 miles of unimproved road, which bothers considerably in muddy weather. The poor condition of some of the old wooden and steel bridges is another handicap. Pneumatic tires are used exclusively, at a greater cost per tire mile, says Mr. Sydnor, but with less wear and tear on trucks and roads.

The country road is at last coming into view as "the railroad of tomorrow."—H. COLIN CAMPBELL.

A Serviceable Ornament

The demand for a strong, serviceable door stop that will stand up under the bumps and jams, abuses such as it gets and yet ornament the base board is not overlooked in the

Griffin Pressed Steel Door Stop



No. 640
Patented
Cut Full Size

a beautiful, plain and ornamental door stop.

This Door Stop is made from the highest quality cold rolled strip steel, drawn into shape from one piece of material. The rubber bumper is so fastened that it absolutely cannot work out. It is the strongest Door Stop ever placed on the market and we guarantee it to be indestructible. When fastened in place with three round head screws will hold a weight of 250 pounds hung on the end.

Finished in any of the Griffin hardware finishes; wrapped and packed with screws.

The GRIFFIN MANUFACTURING CO.

30 Warren St.
NEW YORK

ERIE, PENNA.

17 E. Lake St.
CHICAGO

DETAILS TO WHICH STANDARD HARDWARE CAN BE APPLIED

FOREWORD

Through long study of the requirements of Architects in reference to Builders' Hardware and Locks, certain standards of size and spacing have been established and recognized by Architects and Builders and adopted by Manufacturers.

These manufacturers have felt the necessity for a series of easy reference details, clearly fixing the dimensions to which Standard Hardware can be applied; and it is with the view and desire of co-operation with Architects and Builders to the end of a quicker, less expensive and more satisfactory service that, after a great deal of care and consideration, this series of plates has been issued.

The information given covers the minimum requirements for hardware for the various types of doors and windows that have become standard in the class of work in which they are used. It is not intended to suggest any architectural or constructional design; the sole purpose being to fix required dimensions.

INDORSED BY HIGHEST AUTHORITY

Thomas Nolan, F. A. I. A., Professor of Architectural Construction, University of Pennsylvania, writes as follows relative to the publication of these detail plates:

"As Chairman of the Committee on Materials and Methods of the American Institute of Architects, I am glad to have this opportunity of expressing approval of this much desired publication."

THE FOLLOWING ARE THE HARDWARE MANUFACTURERS UNDER WHOSE AUSPICES THESE DETAILS ARE ISSUED

BARROWS LOCK CO., Lockport, Ill.

CHANTRELL HARDWARE & TOOL CO.,
Reading, Pa.

P. & F. CORBIN, New Britain, Conn.

THE LOCKWOOD MFG. CO., South Norwalk, Conn.

NORWALK LOCK CO., South Norwalk, Conn.

THE PECK, STOW & WILCOX CO., Cleveland, O.

PENN HARDWARE CO., Reading, Pa.

RUSSELL & ERWIN MFG. CO., New Britain, Conn.

SAGER LOCK CO., North Chicago, Ill.

SARGENT & CO., New Haven, Conn.

THE TAYLOR & BOGGIS FOUNDRY CO.,
Cleveland, O.

THE YALE & TOWNE MFG. CO., New York.

DETAILS FOR STANDARD HARDWARE

SINGLE ENTRANCE AND VESTIBULE DOORS
 WITH FLAT FRONTS: NOT BEVELED
 USING CYLINDER OR BITTED KEY LOCKS
 REGULAR BACKSET $2\frac{3}{4}$ "
 FLAT FRONT LOCKS WITH $2\frac{3}{4}$ " BACKSETS
 ARE USUALLY CARRIED IN STOCK
 CYLINDER LOCKS MAY BE HAD IN OTHER BACKSETS
 ON SPECIAL ORDER AT AN ADDITIONAL PRICE
 FOR THICKER DOORS LOCKS WITH BEVELED FRONTS
 MAY BE HAD ON SPECIAL ORDER AT AN ADDITIONAL PRICE

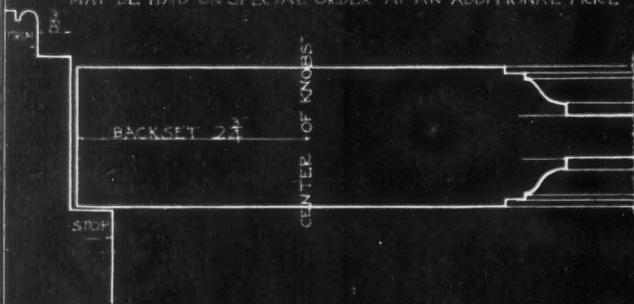

DRAWING IS HALF SIZE

PLATE NO 1

SINGLE ENTRANCE AND VESTIBULE DOORS
 WITH BEVELED FRONT
 USING CYLINDER LOCK
 FRONT BEVELED $\frac{1}{8}$ " IN 2"
 REGULAR BACKSET $2\frac{3}{4}$ "
 OTHER BACKSETS MAY BE HAD ON SPECIAL ORDER
 AT AN ADDITIONAL PRICE

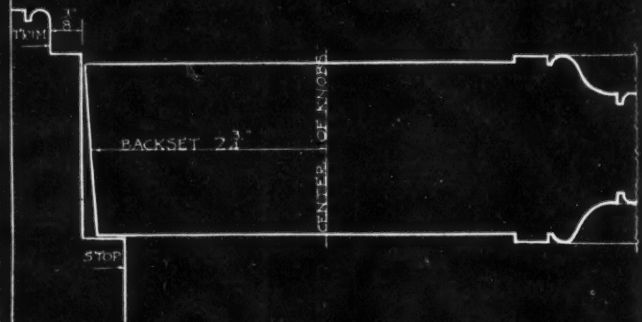

DRAWING IS HALF SIZE

PLATE NO 2

DOUBLE ENTRANCE AND VESTIBULE DOORS
 WITH RABBETED MEETING STILES
 USING CYLINDER LOCK
 FOR LOCKS WITH STANDARD BACKSETS
 STILES SHOULD BE NOT LESS THAN
 $4\frac{1}{2}$ " ON NARROW SIDE

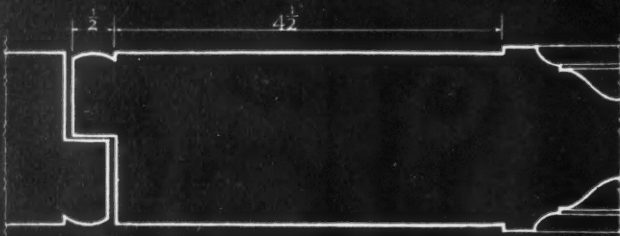

DRAWING IS HALF SIZE

PLATE NO 3

DOUBLE ENTRANCE AND VESTIBULE DOORS
 WITH FLAT ASTRAGAL MEETING STILES
 USING CYLINDER LOCK
 FRONT BEVELED $\frac{1}{8}$ " IN 2"
 REGULAR BACKSET $2\frac{3}{4}$ "
 OTHER BACKSETS MAY BE HAD ON SPECIAL ORDER
 AT AN ADDITIONAL PRICE

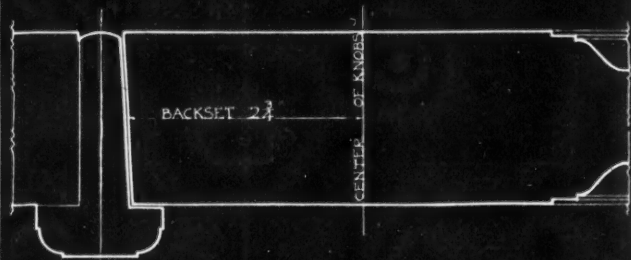

DRAWING IS HALF SIZE

PLATE NO 4

DETAILS FOR STANDARD HARDWARE

SINGLE INTERIOR DOOR
 WITH FLAT FRONT - NOT BEVELED
 USING BITTED KEY LOCK

FOR LOCKS WITH STANDARD BACKSETS
 STILES SHOULD BE NOT LESS THAN $4\frac{1}{2}$ "
 FOR THICKER DOORS - LOCKS WITH BEVELED FRONTS
 MAY BE HAD ON SPECIAL ORDER - AT AN ADDITIONAL PRICE

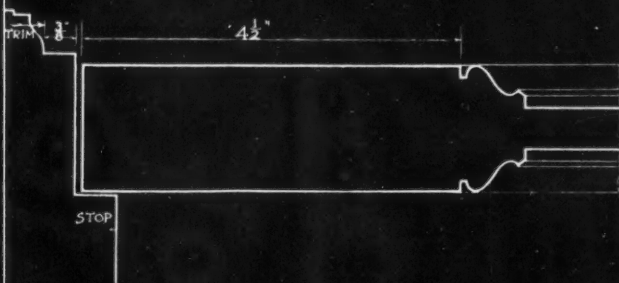

DRAWING IS HALF SIZE

PLATE NO 5

DOUBLE INTERIOR DOORS
 WITH RABBETED MEETING STILES
 USING BITTED KEY LOCK

FOR LOCKS WITH STANDARD BACKSETS
 STILES SHOULD BE NOT LESS THAN
 $4\frac{1}{2}$ " ON NARROW SIDE

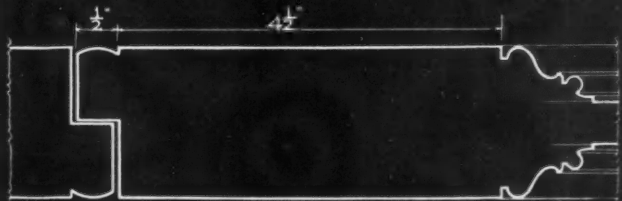

DRAWING IS HALF SIZE

PLATE NO 6

SINGLE SLIDING DOOR
 WITH FLAT FRONT

THE STILE AS SHOWN IS SUITABLE
 FOR LOCK WITH STANDARD BACKSET

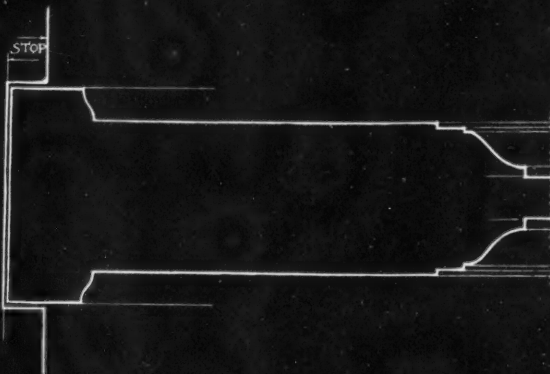

DRAWING IS HALF SIZE

PLATE NO 7

DOUBLE SLIDING DOORS
 WITH FLAT ASTRAGAL MEETING STILES

THE STILE AS SHOWN IS SUITABLE
 FOR LOCK WITH STANDARD BACKSET



DRAWING IS HALF SIZE

PLATE NO 8

DETAILS FOR STANDARD HARDWARE

SINGLE NARROW STILE DOOR

WITH BEVELED FRONT
 USING CYLINDER LOCK
 FRONT BEVELED $\frac{1}{8}$ " IN 2"
 REGULAR BACKSET 2"
 THE STILES SHOULD BE NOT LESS THAN 3"
 NARROWER BACKSETS MAY BE HAD ON SPECIAL ORDER AT AN ADDITIONAL PRICE

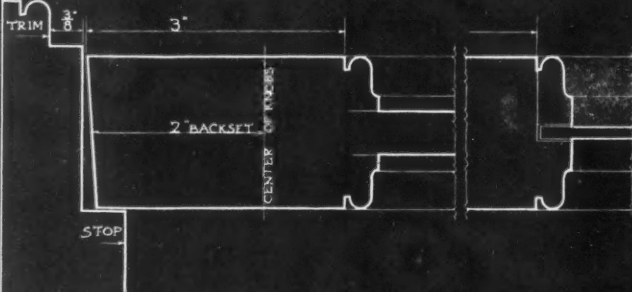

DRAWING IS HALF SIZE

PLATE NO 9

DOUBLE NARROW STILE DOORS

WITH FLAT ASTRAGAL MEETING STILES
 USING CYLINDER LOCK
 FRONT BEVELED $\frac{1}{8}$ " IN 2"
 REGULAR BACKSET 2"
 THE STILES SHOULD BE NOT LESS THAN 3"
 NARROWER BACKSETS MAY BE HAD ON SPECIAL ORDER AT AN ADDITIONAL PRICE

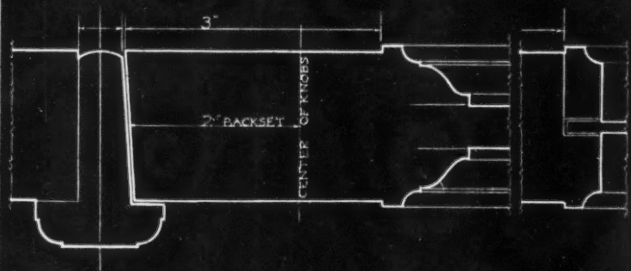

DRAWING IS HALF SIZE

PLATE NO 10

DOUBLE NARROW STILE DOORS

WITH RABBETED MEETING STILES
 USING CYLINDER LOCK
 THE STILES SHOULD BE NOT LESS THAN 3"
 ON NARROW SIDE
 LOCKS FOR NARROWER STILES MAY BE HAD ON SPECIAL ORDER AT AN ADDITIONAL PRICE

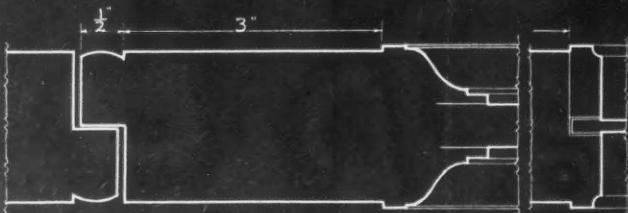

DRAWING IS HALF SIZE

PLATE NO 11

SINGLE NARROW STILE DOOR

WITH FLAT FRONT (NOT BEVELED)
 USING BITTED KEY LOCK
 REGULAR BACKSET $1\frac{1}{2}$ "
 THE STILES SHOULD BE NOT LESS THAN 3"
 OTHER BACKSETS MAY BE HAD ON SPECIAL ORDER AT AN ADDITIONAL PRICE
 FOR THICKER DOORS LOCKS WITH BEVELED FRONTS MAY BE HAD ON SPECIAL ORDER AT AN ADDITIONAL PRICE

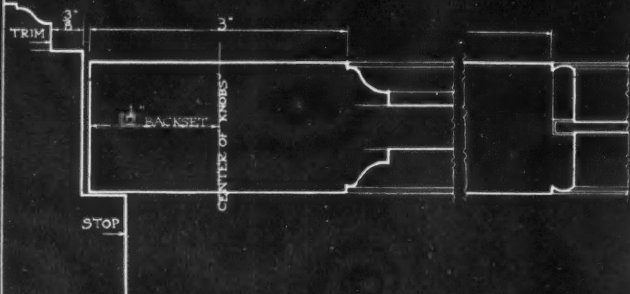

DRAWING IS HALF SIZE

PLATE NO 12

DETAILS FOR STANDARD HARDWARE

DOUBLE NARROW STILE DOORS
 WITH FLAT ASTRAGAL MEETING STILES
 USING BITTED KEY LOCK
 WITH FLAT FRONT - NOT BEVELED
 REGULAR BACKSET 1 1/2"
 THE STILES SHOULD BE NOT LESS THAN 3"

OTHER BACKSETS MAY BE HAD ON SPECIAL ORDER AT AN ADDITIONAL PRICE

FOR THICKER DOORS LOCKS WITH BEVELED FRONTS MAY BE HAD ON SPECIAL ORDER AT AN ADDITIONAL PRICE

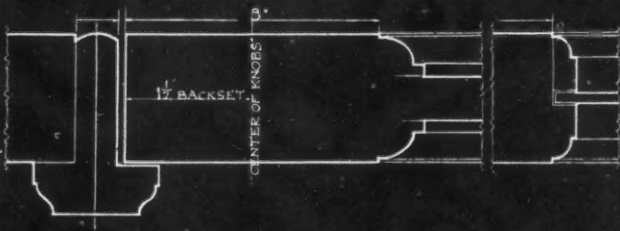

DRAWING IS HALF SIZE

PLATE NO 13

DOUBLE NARROW STILE DOORS
 WITH RABBETED MEETING STILES
 USING BITTED KEY LOCK
 THE STILES SHOULD BE NOT LESS THAN 3"
 ON NARROW SIDE

LOCKS FOR NARROWER STILES MAY BE HAD ON SPECIAL ORDER AT AN ADDITIONAL PRICE

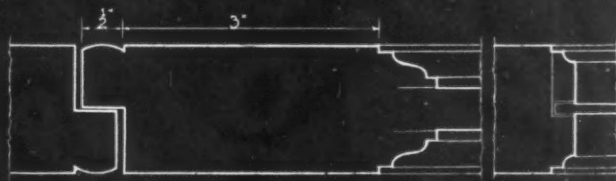

DRAWING IS HALF SIZE

PLATE NO 14

SINGLE CASEMENT SASH OPENING IN
 USING RIM OR MORTISE CASEMENT FASTENER
 OR TURNBUCKLE AND ADJUSTER

FOR SASH NOT OVER 4'0" HIGH
 OUTSIDE JAMB

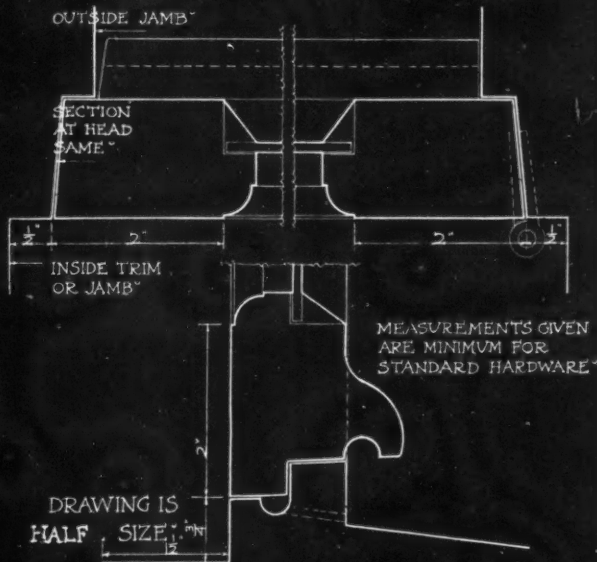

DRAWING IS HALF SIZE

PLATE NO 15

SINGLE CASEMENT SASH OPENING OUT
 USING RIM OR MORTISE CASEMENT FASTENER
 OR TURNBUCKLE AND ADJUSTER

FOR SASH NOT OVER 4'0" HIGH

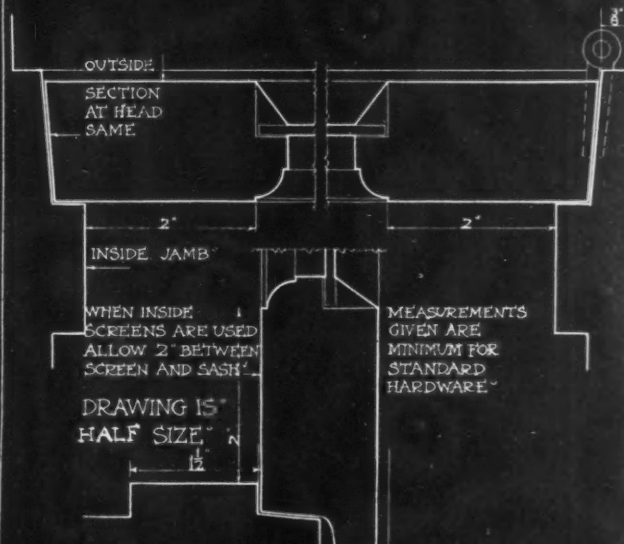

DRAWING IS HALF SIZE

PLATE NO 16

DETAILS FOR STANDARD HARDWARE

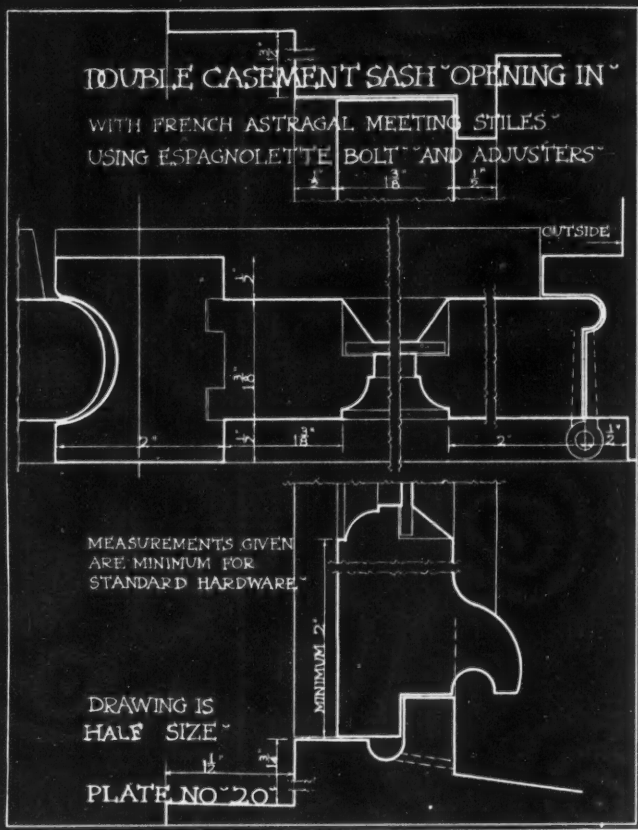
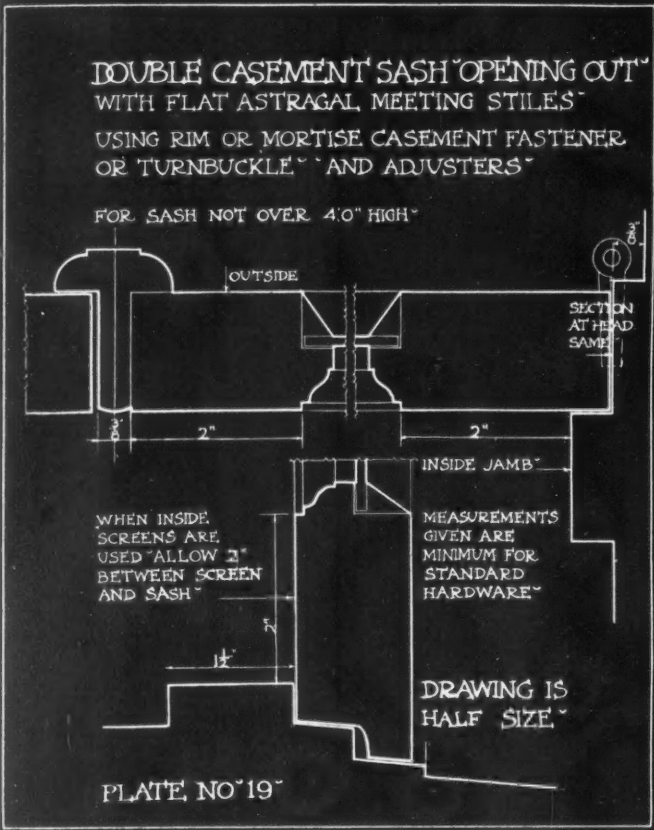
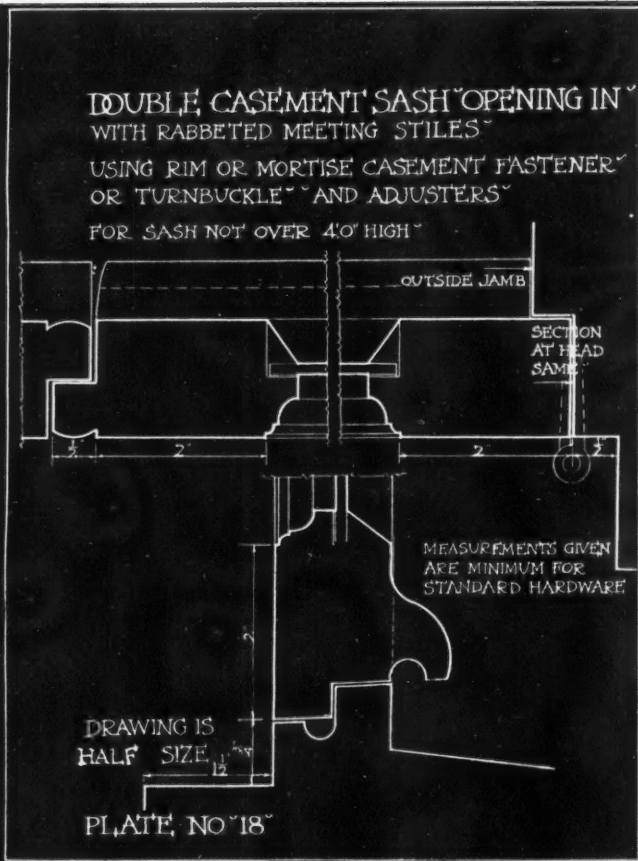
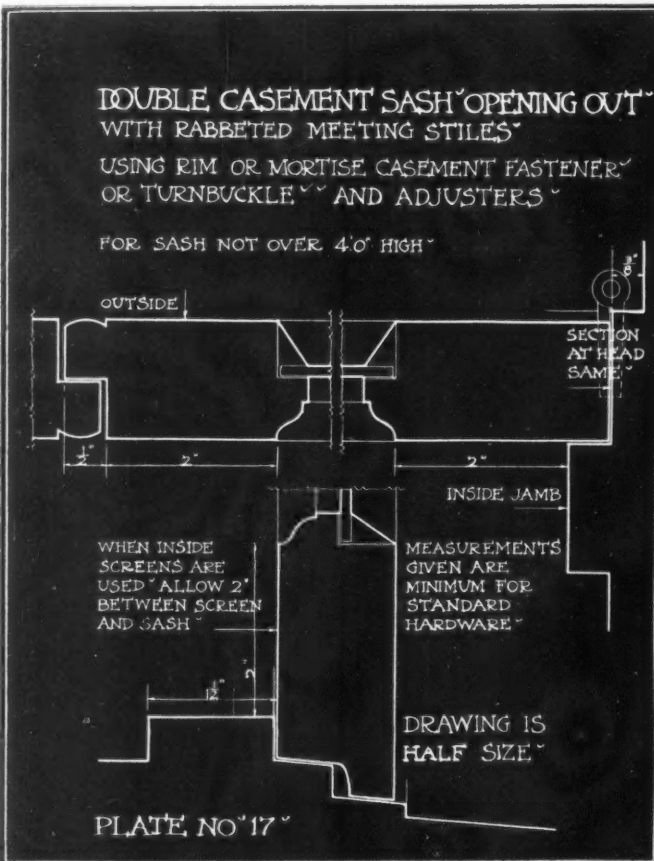

DETAILS FOR STANDARD HARDWARE

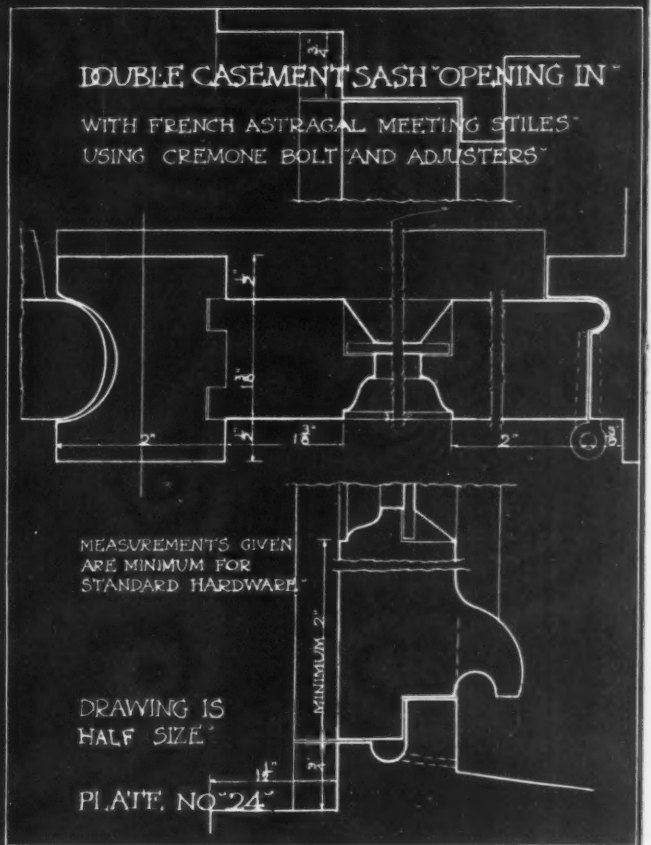
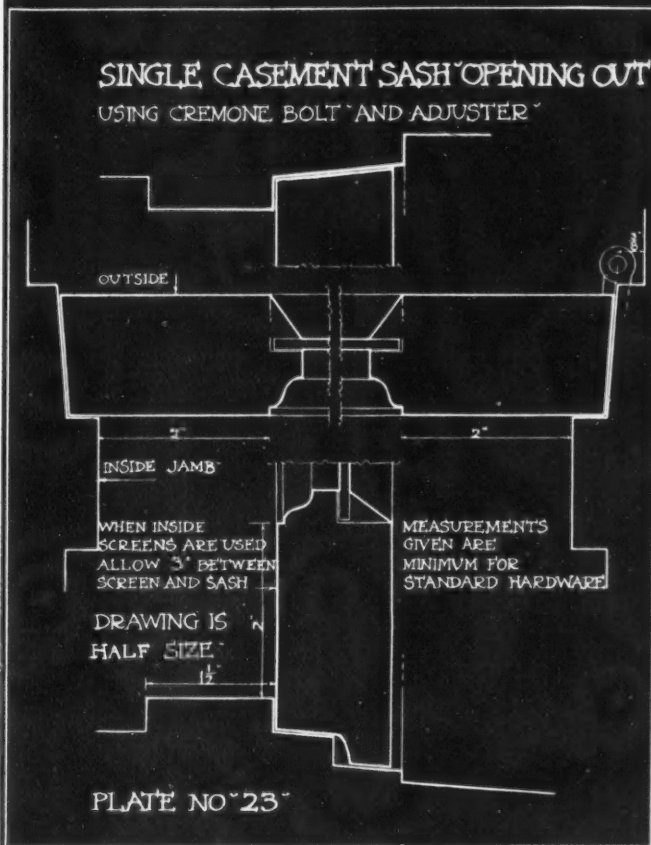
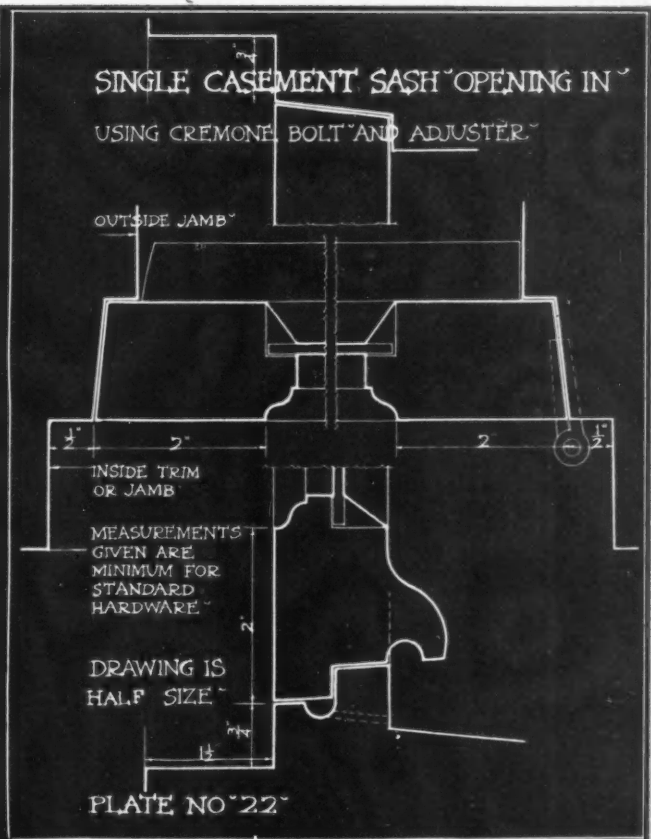
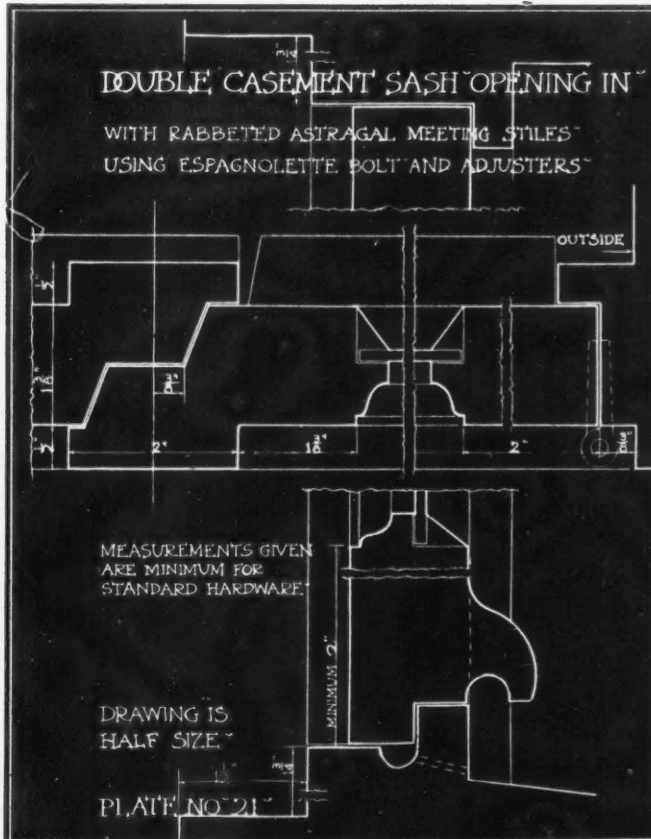

DETAILS FOR STANDARD HARDWARE

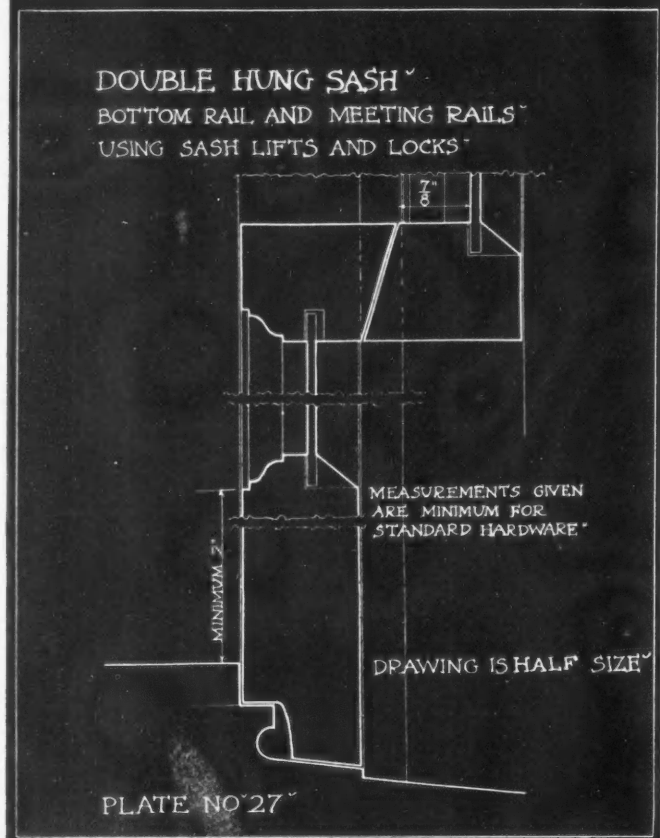
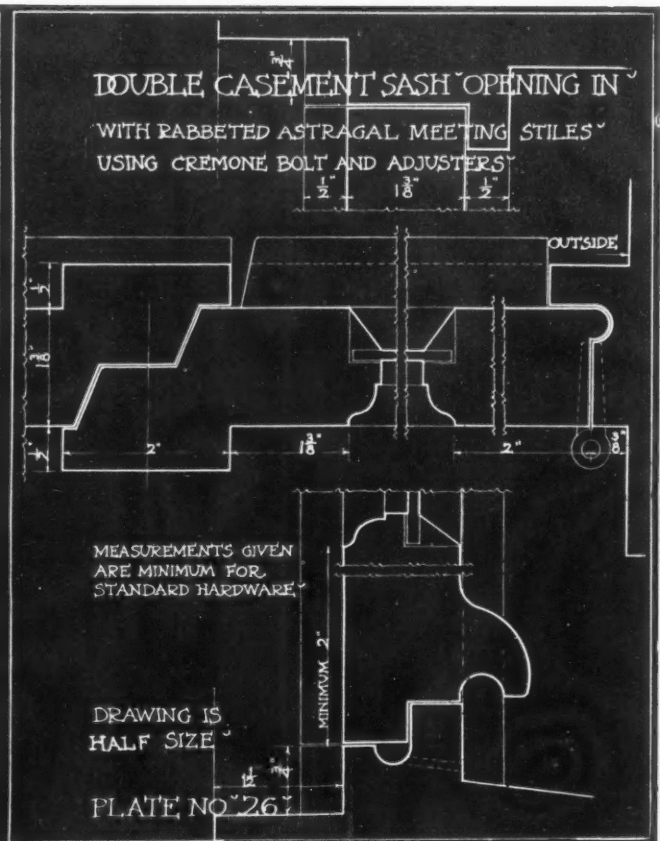
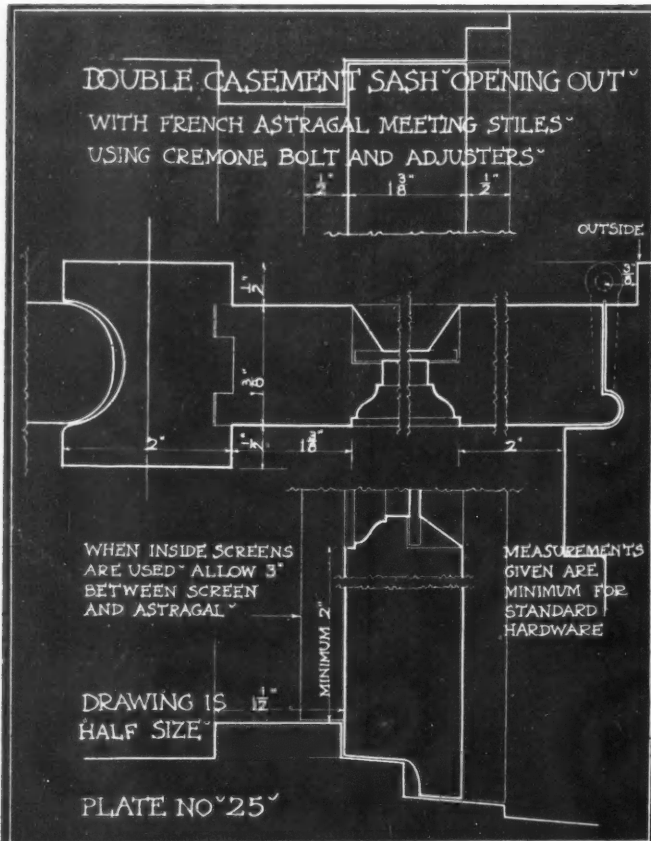

These 27 Detail Plates,
Copyright, 1917,
by
W. R. Hill, Trustee.

ROOFING SLATE SERVICE

THAT YOU NEED==

We can make immediate shipments in any quantity—in any size—in any quality of

Genuine Bangor
Albion Bangor
Jackson Bangor
No. 1 Pen Argyl

Slatington Big Bed
Washington Big Bed
Trout Creek Big Bed
Franklin Big Bed

The various qualities of Roofing Slate quoted above are the product of the quarries of the following companies and are sold *exclusively* through the Vendor Slate Company.

<u>GENUINE BANGOR</u>	<u>ALBION OR JACKSON BANGOR</u>	<u>SLATINGTON BIG BED</u>
Genuine Bangor Slate Co. Old Bangor Quarry American Bangor Quarry Bangor Excelsior Quarry Star Quarry Royal Quarry	Jackson Bangor Slate Company United States Quarry Valley Quarries No. 5 and 6 Jackson Bangor Quarries	<u>WASHINGTON BIG BED</u>
North Bangor Slate Company North Bangor Quarry Bangor Washington Quarry	Albion Vein Slate Company Stoddard Quarries	<u>FRANKLIN BIG BED</u>
Bangor Quarry Company Bangor Union Quarry	Genuine Bangor Slate Company Albion Quarries	<u>TROUT CREEK BIG BED</u>
East Bangor Consolidated Slate Co. East Bangor Consolidated Quarry	M. L. Tinsman Slate Company Tinsman Quarries	Provident Slate Co. Genuine Washington Slate Co. Genuine Franklin Slate Co. Prudential Slate Co. Washington Slate Co. Trout Creek Slate Co. Blue Mountain Slate Co. Blue Valley Slate Mfg. Co. Custard Slate Co. Carbon Slate Co. Thomas Slate Co. Ellis Owens Slate Co. Lobb, Parry & Co. Henry Quarries Co. Royal Blue Slate Co. Highland Slate Co. Manhattan Slate Co. Roberts Bros. Blue Vein Slate Co. Ellis Owens Sons Slate Co. Pennsylvania Slate Co.
Bangor Central Slate Company Bangor Central Quarries	<u>PEN ARGYL No. 1</u>	
Bangor Supreme Slate Company Grand Central Quarries	Hercules Slate Company Hercules Quarries	
New Bangor Valley Slate Company New Bangor Valley Quarries	Hammann Slate Company Northampton Quarries	
Bangorvein Slate Company Peerless Quarries	Shimer Slate Company Alpha Quarries	

We are the largest shippers of Roofing Slate in the World



VENDOR SLATE CO.
 I N C O R P O R A T E D
EASTON, PENNSYLVANIA





NEWS OF THE FIELD

Oshkosh Company Extends Service to Contractors

During the past few months a development has been brought about in the sales plan of the Oshkosh Manufacturing Company, of Oshkosh, Wis. This development is of vital interest to every contractor who owns a concrete mixer of this company's manufacture or who expects to purchase one in the future. It consists in the establishment of a service plan which will enable any owner of one of these mixers to obtain, on short notice, any repair part which might be needed.

In no other business is the unforeseen accident more liable to happen than in the contracting trade. A runaway team takes off a mixer chute; a careless workman drops a shovel into a sprocket wheel. Petty accidents to be sure, but they loom large in the contractor's eyes, for, unless he can get immediate repairs, they mean idle men, wasted time and lost profits.

The service policy is an old one with the Oshkosh Company, but in the establishment of this broader, more thoro plan, the contractor is given very greatly increased protection. By the new plan, every Oshkosh dealer is in a position to

furnish a full line of parts and is prepared to give prompt service to every Oshkosh owner in his territory. A hurry-up messenger, a new discharge chute or sprocket wheel, a quick repair, and the wheels are grinding again. Contractors should bear this development in mind and take advantage of the protection which is afforded them, when the need for this service arises.



Highly Developed Plant Produces Enameled Plumbing Ware

In Kohler, Wis., the large plant shown in the accompanying view is located. This plant, which is that of the Kohler Company, well-known manufacturers of enameled plumbing ware, is an interesting study for the person who has an opportunity to spend a day passing thru its various departments and tracing the manufacture of its product from the great pile of pig iron to the crated output on the shipping platform.

It is an inspiration to anyone to watch the precision with which the numerous processes follow one another as the raw materials are formed into the beautiful, pure white ware for the kitchen, bathroom and laundry. At this plant the pig iron is handled by large electric cranes which, at the throw of a switch, pick up a heavy load with an ease that is almost uncanny. This pig iron is melted in the foundries to a blazing white and is then automatically poured into the great molds. All about this immense foundry there are automatic machines for handling the heavy castings. Large cranes swing the casting in its mold along to machines which strip off the parts of the mold and expose the gray iron shell. This shell is carried down the long room on a moving platform and is then slid into a specially built room where a powerful sandblast drives away all dirt and leaves the casting clean. It is then ground to an even smoothness, outside and

(Continued to page 126.)

FOR overcoating frame buildings, renewing their appearance, increasing their life, making them strongly fire resistive — whether over weather boarding, sheathing or on stripped frames.

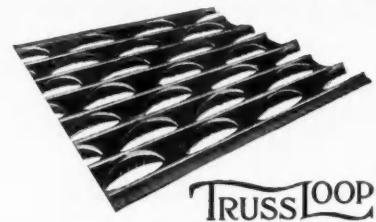
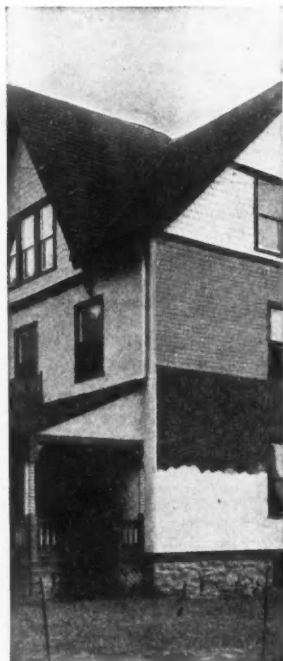

TRUSS-LOOP

Bostwick "Truss-Loop" Metal Lath

gives results and the lowest finished cost

There Are

Some kinks to successful overcoating. Better get our specifications. Write for them today or mail this ad. with your name and mailing address—they cost you nothing.

The Bostwick Steel Lath Co.
Niles, Ohio

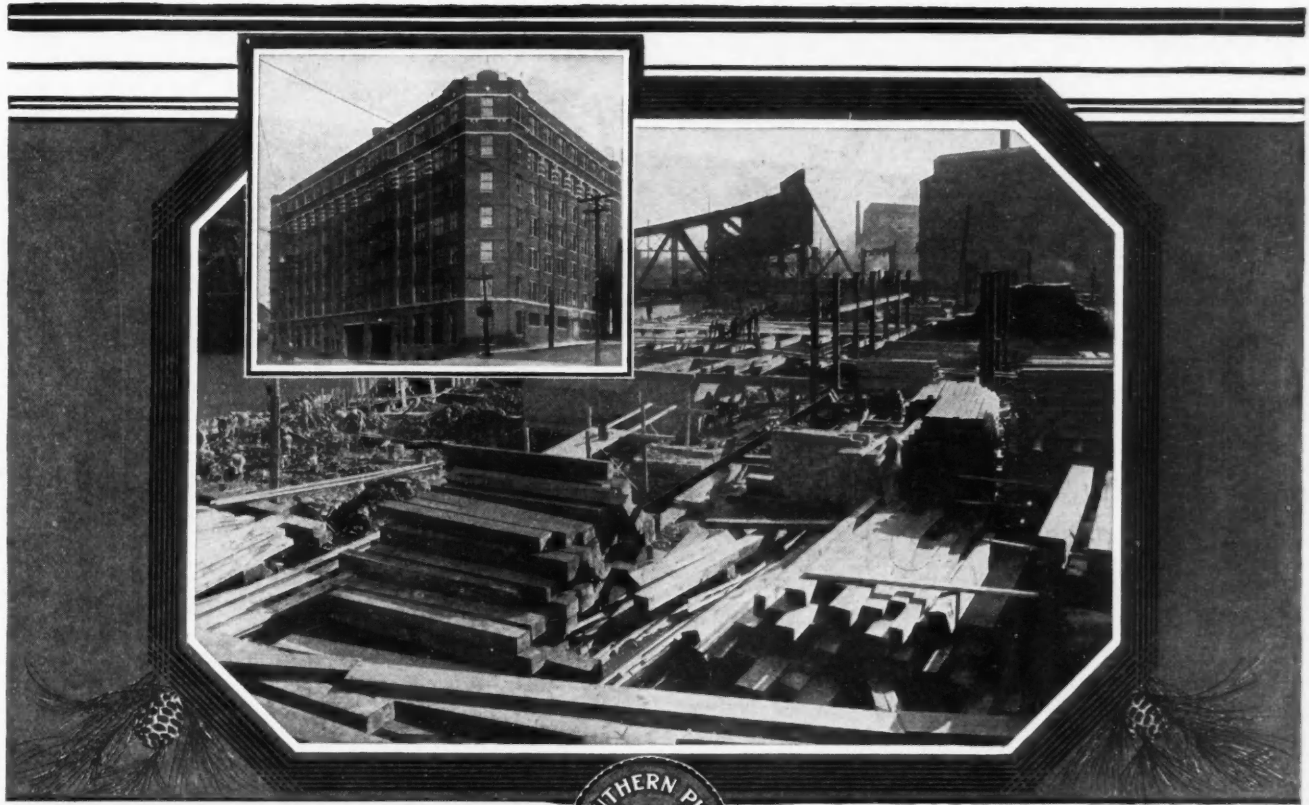

The Thompson & Taylor Spice Company's Plant, Chicago, under construction and completed.

Mill Construction—Now!

WARTIME conditions have added two more important reasons to the many that make Modern Mill-Construction the type chosen by experienced builders of industrial plants:

(1)—The timbers and lumber required for Mill-Construction are today by far the most plentiful and most available building material.

(2)—The wartime advance in the price of lumber has been insignificant—almost negligible as compared with the soaring prices of competitive materials.

Southern Pine

"The Wood of Service"

is the standard wood used in Standard Mill-Construction, and dense, durable, dependable, perfectly manufactured Southern Pine may be had in all its forms TODAY. When your Southern Pine comes from a Southern Pine Association mill, its quality is *guaranteed* under the most rigid grading rules ever devised. And it costs far less than any other structural material of anything like the same high quality.

"Mill Construction," a valuable and instructive booklet, and copies of the Density Rule and Standard Grading Rules will be mailed gratis, promptly on request, if you address Department I-22.

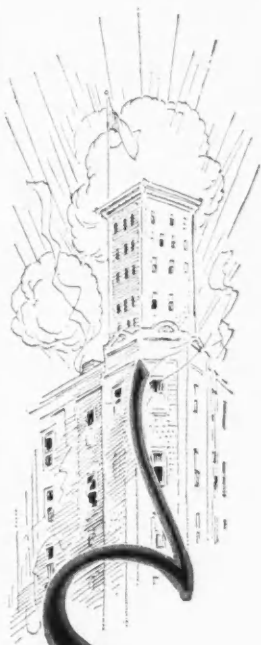

Southern Pine Association

NEW ORLEANS, LA.

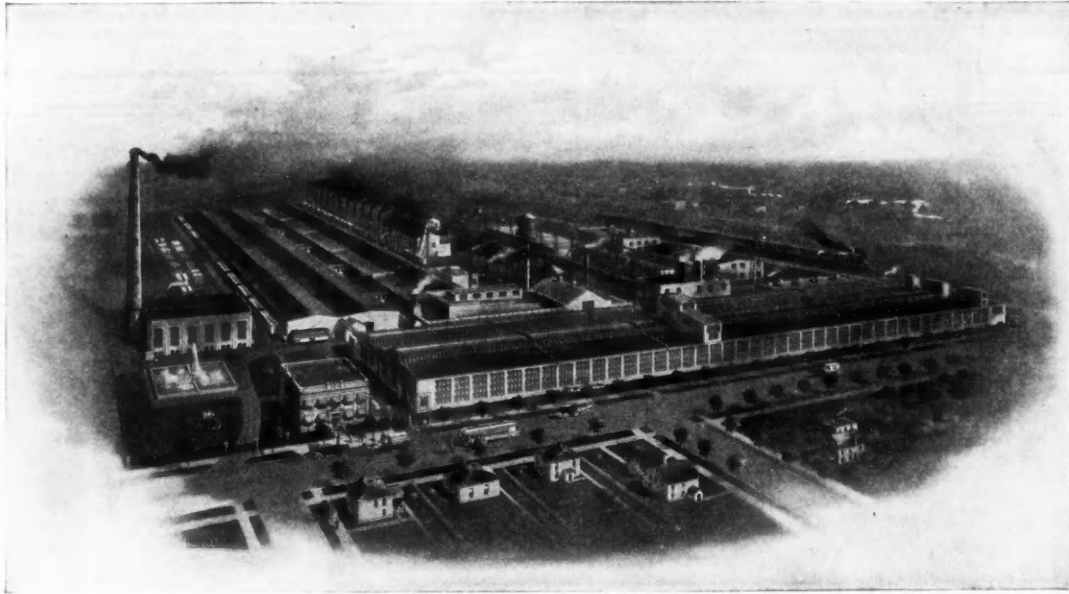

General View of Big Kohler Plant at Kohler, Wis.

(Continued from page 124.)

inside, under an abrasive wheel whirling at high speed. The casting is then ready for the enameling process.

The enamel used in this process is the result of a large amount of research and experimental work. One of the departments of the Kohler plant is devoted to the preparation of the enamel, which is a very finely ground, soft, dry powder. The casting is heated to a white heat in a large furnace. Then a big fork pulls it out and the enamel powder is sifted on. The enamel fuses with the white hot iron, forming a

protecting glaze. The piece then goes into the furnace again, it is removed and more enamel is applied and finally it is placed in the furnace for the third time, completing the process. During the time when the second coating of enamel is being sifted on a device is applied to the surface which incorporates the name Kohler in faint blue letters in the white enamel.

During the entire process everything is carefully and critically inspected by a force of men who work entirely independent of the production organization.



**Your
Best Selection**

**Simonds Blue Ribbon
No. 51 \$3.00 Saw**

No-set Finishing Saw.

Carved and polished Applewood handle. Large hand hole. Four brass screws. Simonds Special Crucible Steel Blade. Straight back. 26 inch. 10 point.

Sold at your dealers or sent direct on receipt of price.

Simonds Mfg. Company
 "The Saw Makers"---Established 1832
FITCHBURG, MASS.

Five Factories **Eleven Branches**



The Expert's Choice File

Does twice the work of the ordinary file — in half the time.

Figure this out:—

How much of your time is worth 25 cents? How long does it take you to file a saw with an ordinary file? By cutting your filing time in two, and still enabling you to file twice as many saws, the **EXPERT'S CHOICE** increases the value of your time by over 50%. By spending 25 cents you can make it back on your first filing job alone.

It's in the Quality—in the cut of the tooth and in the length of strokes

Frank Luther, Chicago, says:

"The Expert's Choice file, files 18 hand saws and is cheaper at a cost of 50 cents than the ordinary file at any price."



Delta Hand Saw Files can be found at the best tool stores at prices quoted on this card

"THE HIGHEST GRADE FILE MADE"

DELTA "HAND SAW" FILES

CARPENTER'S SPECIAL 15¢ EACH

MECHANIC'S FAVORITE 20¢ EACH

EXPERT'S CHOICE 25¢ EACH

DOES TWICE THE WORK IN HALF THE TIME

THE FILE YOU WILL EVENTUALLY USE

A
Trial Will
Convince
You

Look for This Sign at Your Hardware Store

You get your money back if the Expert's Choice does not prove to be the most economical file you have ever used.

DELTA SAW FILES are made for fine or coarse teeth, also for that extra hard saw. BUY YOUR TOOLS of the DEALER who sells **DELTA FILES**. HE is a quality MAN.

TRIAL OFFER

If your dealer cannot supply you, send us 15c, 20c or 25c for trial file, sent prepaid. Do this today—find out what a real file is.

DELTA FILE WORKS, Philadelphia, Pa.

The best Auger Bit File made—we will deliver on receipt of 30 cents each

WHEN WRITING ADVERTISERS PLEASE MENTION THE AMERICAN BUILDER



Every Building Needs

Do you know of the many uses to which Cornell-Wood-Board can be adapted?

Supreme as a Remodeling Material.

Make the waste space—your *unfinished* attic or basement—into *serviceable* rooms. All children need playrooms. The attic finished artistically and practically with Cornell-Wood-Board makes both an *ideal* playroom and additional sleeping rooms.

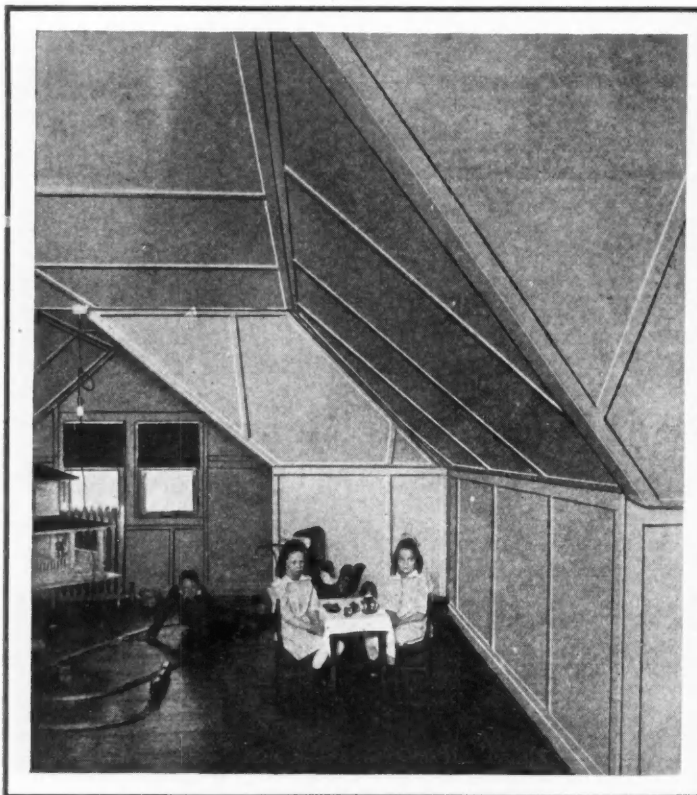

Coal Bills are High. **Cornell-Wood-Board** properly installed means a great saving, adds value to the home, makes the home more comfortable, and pays for itself in living comfort alone. Makes rooms warmer in winter and cooler in summer.

Our exclusive Cornell fibre sizing process positively and permanently *seals* Cornell-Wood-Board against all damaging atmospheric changes which are all so destructive to plaster and wood.

But Cornell-Wood-Board stands all tests because it is not affected by moisture.

It is Durable—Artistic—Economical. Just think!—Put up in half the time—saving in labor—no dirt and litter.

Read about our big Free offer described on next page.

Cornell-Wood-Products Co.
173-175 Jackson Blvd., Chicago, Ill.



Cornell-Wood-Board

1000 Uses of Cornell-Wood-Board

Cornell-Wood-Board is the ideal and practical material for Homes, Stores, Offices, Schools, Churches, Theatres, Garages, Farm Buildings, Repairs and Alterations and for One Hundred Different Emergency Uses.

Ask Yourself This Question

Does this ad suggest any uses of Cornell-Wood-Board to you? If it does why not use Cornell-Wood-Board on your next job?

Read Our Big Free Offer---Below.

Free to YOU

Panel Suggestions with Cost Estimates

Send us dimension sketches or blue prints and our Department of Design will draw up panel suggestions with cost estimates all **FREE of charge.** Our blue prints, showing how the rooms will look when finished in Cornell-Wood-Board will help you get the business. Try us—be fair to yourself. Act now.

Cornell-Wood-Products Co.

C. O. Friebie, President
173-175 Jackson Blvd., Chicago, Ill.

Cornell Wood Products Co., Dept. T5, Chicago
Please send me sample and complete information—or send Panel
Suggestions as per dimensions enclosed. I am placed under
no obligation by this service.
Name.....
Address.....

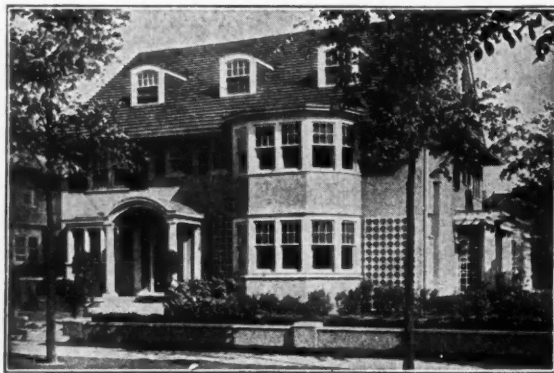

Big Economy in Metal Lath Construction

The man who builds will appreciate the reasonable cost at which you can construct modern, strong, fire-proof homes by utilizing our metal lath products. You can save the owner time, material and labor expense.

Use Hy-Rib and Rib Lath—and you save forms, stiffening channels and labor. The metal lath is so stiff and rigid that supports may be placed a greater distance apart—saving in the cost of supports and the labor and time necessary to attach the lath. Moreover, streaked and cracked plaster is prevented.

Hy-Rib furnished in four depths of ribs and various gauges.



Hy-Rib

A steel sheathing, stiffened by rigid deep ribs. Manufactured from a single sheet of steel. Its use is decidedly simple. The easily handled sheets are fastened to the supports and the plaster or concrete applied. No forms, stiffening channels nor wiring required.

Rib Lath

A superior metal lath with beaded ribs that span between the studs, making it exceptionally stiff and rigid and permitting the wider spacing of studs. Provides a perfect clinch for plaster and prevents cracking or streaking. Saves time, labor and material in erection.

Begin now to build with Hy-Rib and Rib Lath. The line is complete, including Diamond Lath, Channels, Studs, Corner Beads, Base Screeds, etc.

Write today for free copy of Hy-Rib Handbook, with specifications, tables, illustrations, etc. Very valuable to builders. Address Dept. H-44.

Trussed Concrete Steel Co.
YOUNGSTOWN, OHIO



Representatives in
Principal Cities



Statement of the Ownership, Management, Circulation, etc., Required by the Act of Congress of August 24, 1912

Of AMERICAN BUILDER, published monthly at Chicago, Ill., for October, 1917.

State of Illinois }
County of Cook } ss.

Before me, a Notary Public in and for the State and county aforesaid, personally appeared E. L. Hatfield, who, having been duly sworn according to law, deposes and says that he is the business manager of the AMERICAN BUILDER, and that the following is, to the best of his knowledge and belief, a true statement of the ownership, management (and if a daily paper, the circulation), etc., of the aforesaid publication for the date shown in the above caption, required by the Act of August 24, 1912, embodied in section 443, Postal Laws and Regulations, printed on the reverse side of this form, to wit:

1. That the names and addresses of the publisher, editor, managing editor, and business managers are:

Publisher, AMERICAN CARPENTER & BUILDER Co., Chicago, Ill.

Editor, WM. A. RADFORD, Chicago, Ill.

Managing Editor, BERNARD L. JOHNSON, Chicago, Ill.

Business Manager, E. L. HATFIELD, Chicago, Ill.

2. That the owners are: (Give names and addresses of individual owners, or, if a corporation, give its name and the names and addresses of stockholders owning or holding 1 per cent or more of the total amount of stock.)

AMERICAN CARPENTER & BUILDER Co., Chicago, Ill.

WM. A. RADFORD, Chicago, Ill.

H. M. RADFORD, Chicago, Ill.

ROLAND D. RADFORD, Chicago, Ill.

WM. A. RADFORD, JR., E. L. HATFIELD, Chicago, Ill., and

G. W. ASHBY, Berwyn, Ill.

3. That the known bondholders, mortgagees, and other security holders owning or holding 1 per cent or more of total amount of bonds, mortgages, or other securities are: (If there are none, so state.)

There are no bonds, mortgages or other securities outstanding.

4. That the two paragraphs next above, giving the names of the owners, stockholders, and security holders, if any, contain not only the list of stockholders and security holders as they appear upon the books of the company, but also, in cases where the stockholders or security holder appears upon the books of the company as trustee or in any other fiduciary relation, the name of the person or corporation for whom such trustee is acting, is given; also that the said two paragraphs contain statements embracing affiant's full knowledge and belief as to the circumstances and conditions under which stockholders and security holders who do not appear upon the books of the company as trustees, hold stock and securities in a capacity other than that of a bona fide owner; and this affiant has no reason to believe that any other person, association, or corporation has any interest direct or indirect in the said stock, bonds, or other securities than as so stated by him.

5. That the average number of copies of each issue of this publication sold or distributed, through the mails or otherwise, to paid subscribers during the six months preceding the date shown above is: (This information is required from daily publications only.)

E. L. HATFIELD, *Business Manager*.

Sworn to and subscribed before me this 25th day of September, 1917.

F. R. DUSENBURY.

(My commission expires Feb. 11, 1919.)



You cannot push a man up a ladder unless he is willing to do a little climbing himself.



“Show me where
I can profit?”

1866
CURTIS
WOODWORK
“The Permanent Furniture for Your Home”

Doors
Windows
Window and Door
Frames
Storm Doors and
Windows
Screen Doors and
Windows
Stairways
Newels
Sideboards
Colonnades

Bookcases
Mantels
Window Seats
Wall Panels
Ceiling Beams
Mouldings
Porch Columns
Porch Rail
Porch Balusters
Everything in
Woodwork

Go to a Curtis dealer and put that question to him.

He will tell you that **CURTIS** represents a definite standard of quality in woodwork to thousands of people. He will tell you how **CURTIS** Woodwork saves you labor costs and how Curtis “On Time” delivery eliminates the delay bugaboo. In case you cannot locate a Curtis dealer, write us.

THE CURTIS COMPANIES, SERVICE BUREAU
1642-1742 S. Second Street, Clinton, Iowa

Manufacturing and Distributing Plants at
Clinton, Iowa Lincoln, Neb. Minneapolis Wausau, Wis. Chicago
Oklahoma City Sioux City, Iowa Detroit Topeka, Kan. Dayton, Ohio
Eastern Offices at Pittsburgh and Washington
The makers of **CURTIS** Woodwork guarantee complete satisfaction to its users. “We’re not satisfied unless you are.”

CURTIS

Woodwork

is advertised in these strong National and State Farm Papers:

- Country Gentleman
- Michigan Farmer
- Farmer's Guide
- Farmer's Mail & Breeze
- Wisconsin Agriculturist
- The Farmer
- Nebraska Farmer
- Dakota Farmer
- Oklahoma Farmer & Stockman
- Wallace's Farmer
- Successful Farming
- Prairie Farmer
- Ohio Farmer
- Hoard's Dairyman
- Oklahoma Farmer
- Farmer's Review
- Iowa Homestead
- Wisconsin Farmer
- 20th Century Farmer



OVER THE TOP—

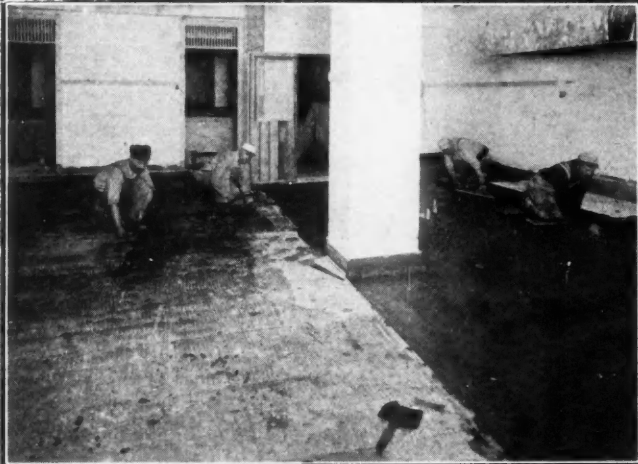
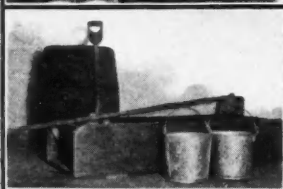

You can go over the top of any floor, whether wood or concrete, with a half inch of



In new buildings or on top of old worn floors in old buildings and produce a surface in warm, soft, attractive colors that is fireproof, sanitary, durable, easy to the tread and at a low cost, combining all the necessary features for an ideal floor covering.

Think of the enormous scope of profitable jobs this opens up for any wide-awake contractor. Then think of the thousands of building owners who, for years have been looking for a material of just this kind for use in corridors of public buildings, schools, court houses, churches, hospitals, office buildings, show rooms, stores, barber shops, restaurants, drug stores, theatres, etc. In the home on porch, dining room, kitchen, bathroom, and entrance floors, etc.

You can realize at a glance that the sooner you get started putting in Asbestone, the sooner you will be in a high class profitable all-the-year around business.

We have given you a very clear idea of how Asbestone is installed in our *OVER THE TOP* progression of photographs of carrying on the work as shown on these pages, and the excellent results obtained. With our detailed instructions you can get the same results and we will help you land the order as well.

Just order us to fire our Broad-side, Samples and Co-operative Proposition to you.

FRANKLYN R. MULLER & CO.

7124 Madison Street, WAUKEGAN, ILLINOIS

WHEN WRITING ADVERTISERS PLEASE MENTION THE AMERICAN BUILDER

WITH ASBESTONE

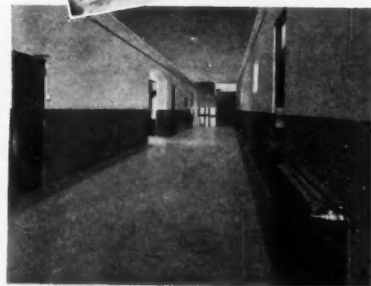
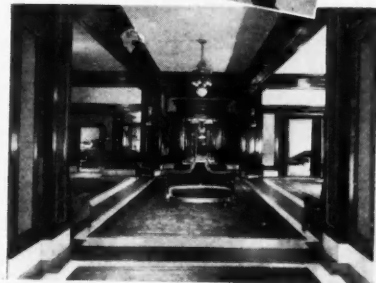
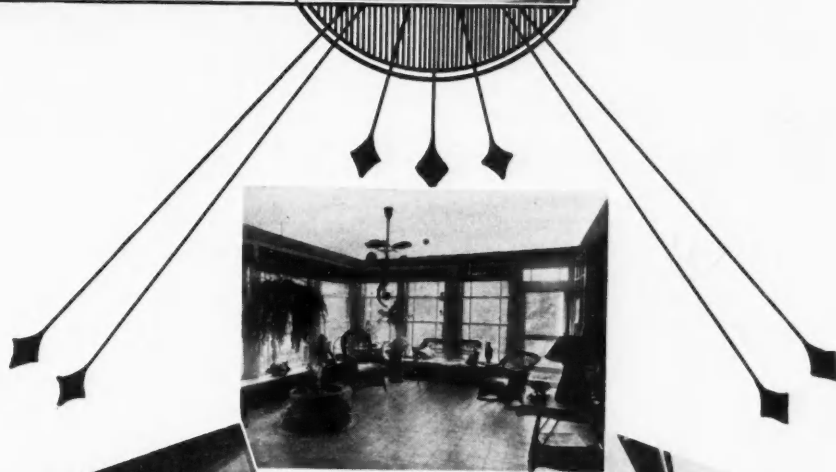

FRANKLYN R. MULLER & CO.

7124 Madison Street, WAUKEGAN, ILLINOIS

WHEN WRITING ADVERTISERS PLEASE MENTION THE AMERICAN BUILDER

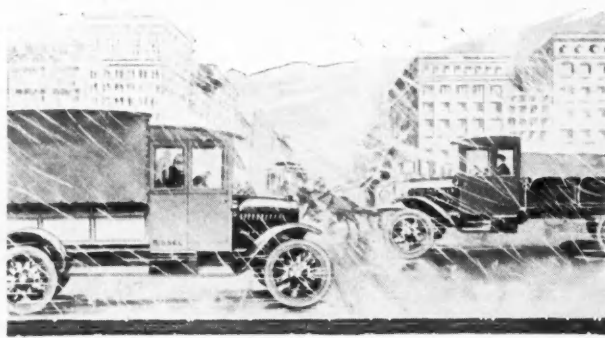

Don't risk costly lay-ups or delayed schedules this winter

THE ALL-YEAR Cab gives drivers in the building business full protection during cold, rainy or stormy weather—increasing their efficiency and decreasing the possibility of accidents.

In winter, the ALL-YEAR Cab is entirely closed—warm and dry in stormy and cold weather—giving drivers complete protection and increased results for you. In summer, it becomes a cool, open housing by removing the winter attachments.

KISSEL TRUCKS

FIVE NEW SIZES

A Truck for Every Purpose

The exclusive Kissel combination of perfected worm drive rear axle—superior front axle—sturdy Kissel-built power-plant—reliable brakes—dependable springs and special heat treated frame—insures continuous service at low operating cost.



Open for Summer
Gives drivers a cool, open shady housing. Rain curtains are provided for sudden showers.

Kissel ALL-YEAR Cab

Never before in the history of American business has the necessity for uninterrupted haulage and delivery schedules become such a national necessity. Kissel Trucks with the ALL-YEAR Cab insure continuous service all year round.

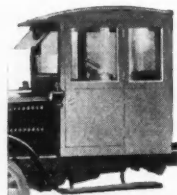

Closed for Winter
The winter attachments turn the open cab into a warm, dry, and leak-proof cab.

Investigate Kissel Trucks and the new ALL-YEAR Cab. Send for literature.

KISSEL MOTOR CAR COMPANY
HARTFORD, WIS., U. S. A.

CATALOGS BULLETINS & BOOKS RECEIVED

The following literature, dealing with subjects of interest to builders, is now being distributed:

Enameled plumbing ware manufactured by the Kohler Company of Kohler, Wisconsin, is discussed in a very interesting manner in an illustrated booklet, the 1917 edition of "Kohler of Kohler," sixty-six pages, 5½ by 8 inches.

Steel lockers, shelving and shop equipment of The Hart & Hutchinson Company, New Britain, Connecticut, is beautifully illustrated and carefully described in their Catalog C, forty pages, 8 by 11 inches.

"Watertight Concrete," is the subject of Bulletin F-3 by the Hydrated Lime Bureau of the National Lime Manufacturers' Association, Pittsburgh, Pennsylvania. This bulletin contains a great many facts relative to water-tightening in general, together with specific information on hydrated lime. The size is 6 by 9 inches, twenty-two pages.

"A and L" interior wood block floors of the Ayer & Lord Tie Company, Railway Exchange Building, Chicago, Illinois, are presented in their twelve page book printed in two colors with inserts showing several notable installations of this creosoted wood block floor.

"Morgan Cold Weather Protection," has been used as a slogan in the preparation of the details of a campaign for "Doubling Your Winter Profits" by the Morgan Sash and Door Company, 2275 Blue Island Avenue, Chicago, Illinois. The results of their analysis of the proposition is being presented to building material dealers in the form of "New Ready-to-Use Advertisements and Selling Plans," from which dealers may select the material for a progressive sales plan to extend thru the winter months.

"The Proper Treatment for Floors, Woodwork and Furniture" is the title of a thirty-two page booklet, 6¼ by 8¼ inches, beautifully illustrated in colors, published by S. C. Johnson & Son, of Racine, Wisconsin.

Safety panels and cabinets, which have become important factors in the safety first movement in connection with the control of electric devices, are discussed in the illustrated Bulletin No. ID of the Crouse-Hinds Company, Syracuse, New York. The bulletin contains twelve pages, 8 by 10½ inches.

"Saws: Their Care and Treatment" by Harry W. Durham provides a reliable book of reference for those who are learning the art of saw fitting, or who may be interested in the proper methods of sharpening and keeping saws in order. This is a book of 272 pages, 5 by 7½ inches, carefully illustrated. It is published by the D. Van Norstrand Company, 25 Park Place, New York City. Price, \$2.50.



It is easier to appear worthy of a position one does not hold than of the office which one fills.



WAGNER CLOZTITE HANGER

For Folding-Sliding Doors

Here is the hanger that fills a long-felt want. It is the practical solution of the big-doors-in-little-space problem. By the use of this hanger two or three doors are hinged together and operate as **one door**. When open, the doors fold up compactly and are entirely out of the way. When closed, the door fits just as snug and tight as an ordinary hinged door in your home, making it dirt-proof, storm-proof and water-proof.

Doors are hinged together and hung to the jamb, being supported at the opposite side by one Wagner Cloztite Hanger operating in Wagner, self-cleaning, dirt-proof track. In four and six door openings, two hangers are used—one hanger for each set of two or three doors hinged to either side of jamb.

Saves Space—Works Easily

The great advantage of this hanger is that very little clearance room is required—not more than the width of one single door, usually about 30 to 34 inches. By putting the track on the **outside**, no clearance room whatever is required. The hanger and track work just as efficiently on the **outside** of building as on the inside. No sagging, no chance for trolley to come off track, no sticking of doors. The Wagner Cloztite Hanger is the **ideal** hanger for garage doors.

For 2, 3, 4, 5 or 6 Door Openings

The Wagner Cloztite Hanger is adapted for openings of any width and may be used with any number of doors, from two to six, having a total weight not exceeding 600 lbs.

Wagner Cloztite Hanger is simpler, stronger, easier to attach than any other hanger or device designed for folding-sliding doors. It has a decided advantage over the extended track or adjustable bracket method in that it is much simpler and there are no adjustments to get out of order. There is less strain on the track and brackets, for the track is fastened directly to the wall at all points the same as for ordinary sliding doors. When attaching there is no complication or difficulty adjusting brackets. It has a simple vertical adjustment that cannot get out of order.

The Wagner Cloztite Hanger is simply and substantially constructed of malleable iron. Has roller-bearing trolley wheels and the hanger bolt revolves on a heavy-duty ball bearing swivel, insuring silent and easy operation of the doors at all times.

Ask Your Hardware Dealer

Leading hardware dealers sell the Cloztite and other Wagner Door Hangers and Tracks. In the Wagner line you'll find the right type of hangers and tracks for garages, barns, warehouses—any purpose. Ask your dealer.

Write today for illustrated folder on the Wagner Cloztite Hanger. Shows plans and arrangements for 2, 3, 4, 5 and 6 door openings of any width.

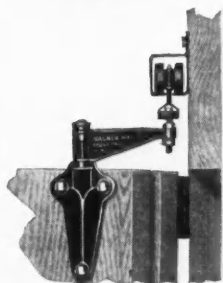

Doors Open



Doors Closed



Track
One-Half
Actual
Size

Wagner Mfg. Company

Dept. M, Cedar Falls, Iowa



JOHNSON'S FREEZE-PROOF

Prevents Frozen Radiators

THE only way you can be positively sure that your radiators won't freeze up is to use a non-evaporating anti-freeze preparation. You can never be sure of alcohol or any other product which evaporates with the water.

Does Not Evaporate or Steam

Johnson's Freeze-Proof does not evaporate with the water. One application is sufficient for the whole winter unless the solution is weakened by leakage of the radiator or hose connections—or by boiling over.

Absolutely Harmless

Johnson's Freeze-Proof does not injure rubber, cloth, packing or metal of any kind. It does not rust or corrode metal. There is less rust with Johnson's Freeze-Proof than there is with water alone or with a combination of water and alcohol.

Raises the Boiling Point of Water

The boiling point of water is 212°. The boiling point of alcohol is 131°. The boiling point of Johnson's Freeze-Proof and water is from 225° to 250° depending upon the amount of Freeze-Proof used.

Economical and Easy

Johnson's Freeze-Proof is the most economical anti-freeze compound on the market. It is very easy to use—simply dissolve in water and pour into the radiator. One package is sufficient to protect a Ford to 5° below zero; for large trucks use two packages to protect to 5° below zero, and three packages to protect to 20° below zero.

Insist upon your dealer supplying you with Johnson's Freeze-Proof. It is readily procurable as practically all jobbers have it in stock. Johnson's Freeze-Proof is put up in packages containing 6½ lbs. net which retail at \$1.50 each in U. S. A.

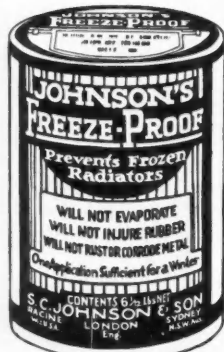

If your dealer cannot supply you we will fill your order direct by prepaid Parcel Post to all points in U. S. A., East of the Rockies. Use attached coupon.

S. C. JOHNSON & SON, Dept. ACB 12, Racine, Wis.

-----USE THIS COUPON-----
S. C. JOHNSON & SON, Dept. ACB 12, Racine, Wis.

I enclose \$1.50 for which please send me prepaid one package of Johnson's Freeze-Proof, enough to prevent 3½ gallons of water from freezing at 5° below zero.

Name.....
Address.....
City and State.....
My Dealer is.....

Reducing Cost of Workmen's Houses

(Continued from page 41.)

By the time the houses are built and the sewers have been put in, the interest to the owner has disappeared or his pocketbook has been emptied, and the result, in spite of careful attention to architectural details, is bare and disappointing.

Number of Rooms in a House:

The building of the six-roomed house seems to be a habit that is so firmly fixed in the minds of industrial managers, builders and others, that it has become like the "laws of the Medes and Persians, which cannot be altered." In very many cases, however, the chief demand is for five and four-roomed houses. And if the tenant has to occupy a house larger than he can afford to rent for his own use, he has to take in lodgers, which we have all agreed is such an evil and a social menace.

Layout of Town Sites:

The importance of a careful study of the town sites with a view to laying out the streets to give as little cut and fill as possible and take advantage of natural contours cannot be over estimated. On a recent job that we built, over \$50,000 had to be spent on grading and filling, deep foundations, etc., because the owners insisted on placing a regular gridiron of streets on the slope of a steep hill. The extra money spent brings him in no return at all, and is money that is purely wasted.

Building Regulations:

In a good many of our cities burdensome restrictions are placed on the building of small houses by the cast-iron regulations which we have to follow.

I do not question for a moment the wisdom of extending the zones in which fireproof construction is insisted upon, but in these cases some latitude should still be allowed in the choice of material. We should not be limited to the inevitable brick wall if local conditions make the building of a concrete wall or tile wall cheaper. Some cities still call for a 12-inch brick wall, whereas for the two-story house, 8 inches is thick enough, and is passed by most cities. Building regulations have not yet discovered the possibilities of reinforced concrete, and if walls are built of concrete they also have to be 12 inches thick. A 6-inch concrete wall is perfectly satisfactory, and the houses we recently built at Donora have walls of the upper story 6 inches thick, and cellars 9 inches thick. A concrete wall, of course, has to be furred and plastered on the inside just the same as a brick wall would have to be, in order to eliminate the condensation of moisture on days when the humidity is high.

Concrete being a comparatively new material for house construction, the tendency is to cover it up and make it look like something else. Stucco is hard to apply to a concrete wall, and is quite unnecessary, as with the present development in the manufacture of steel forms it is possible to get a concrete wall that is perfectly true and smooth, and only needs rubbing

(Continued to page 138.)

GOODELL PRATT

1500 GOOD TOOLS

For the Home Workshop

WHETHER used in the line of business or for amusement, a lathe in your workshop opens up a new world of possibilities—a sort of fourth dimension. It enables you to make models, patterns, small machines, in wood or metal, that were utterly impossible before. The Amateur Bench Lathe fills this need at the least expense consistent with quality. It is well made, of good materials, excellent design, and accuracy sufficient for all ordinary uses. It takes work up to 12 inches in length and has a swing of 7 inches. The lathe proper is furnished complete as shown, with a saw arbor and a three-jawed chuck in addition.

With various attachments that you can get from us or make yourself, it is possible to do almost any wood or metal work within the capacity of the machine.

For more information about the lathe, or about the 1500 other good tools, send for the complete catalog.

GOODELL-PRATT COMPANY

Toolsmiths

GREENFIELD, MASS., U. S. A.

*Partial List of
Goodell-Pratt Tools*

Hacksaws	Screw-drivers
Drills	Micrometers
Levels	Calipers
Grinders	Mitre Boxes
Vises	Bit Braces
Squares	Glass Cutters

*Amateur
Bench Lathe
No. 125*



Reducing Cost of Workmen's Houses

(Continued from page 136.)

with carborundum stone in order to give a perfectly even texture and color, which is every bit as satisfactory as the face of a brick wall.

The hollow tile wall should not be less than 8 inches thick, and is being used extensively in better class residence construction. Hollow tile is a somewhat uncertain material to use, and it is necessary to exercise great care to see that well burnt hard tile are used and that all the joints are properly filled with mortar.

If this is done and a portland cement stucco applied to the outside, the furring may be safely omitted on the inside, and the tile plastered direct.

Where frame construction is permitted, the cheapest wall is, of course, the walls of 4-inch stud, lathed on the inside with wood laths and plastered, and finished on the outside with rough boarding and shingles. Clapboarding costs a very little more per square foot, but is usually painted, whereas shingles are often left bare, and the annual expense of repainting also has to be considered.

Stucco has not been used much in workmen's dwellings, but is desirable on account of the omission of the annual repainting. One of the troubles to be met with in stucco is the cracks which inevitably appear as the building settles. There is always a certain amount of shrinkage in the timbers of a house, and in the settlement which occurs, as these shrinkages are

made cracks are caused in the stucco, whereas, in clapboarded or shingled houses these do not appear. The use of stucco is attended with some difficulties, as it is not an easy material to apply. None but plasterers who are expert at this sort of work should be engaged to apply it.

Altho no accurate cost data can be given at the present time on the foregoing material, the following figures are, however, given in order to indicate the relative costs of these materials based on present prices.

As prices do not vary consistently, these figures may not hold good for very long. In certain localities where clay for tile making is abundant the prices of tile would be cheap and would indicate that this is the cheapest material to use. In other places where there is a good gravel supply right on the ground, the relative cost of concrete would be reduced.

Assuming the cheapest construction a wood framing, wood lathed and plastered on the inside and rough boarded and shingled on the outside as our standard or 100 per cent, the relative costs of various houses would be as follows:

- Wood framing, inside wood lathed and plastered, outside rough boarded and clapboarded and painted..102 %
- Wood framing, inside wood lathed and plastered, outside wire lathed and stuccoed.....108½%
- Six-inch concrete wall, inside furred and lathed and plastered, outside rubbed smooth.....112 %
- Six-inch concrete wall, inside furred and lathed and

(Continued to page 140.)

Conserve Steel

For the army and navy by building with Hollow Clay Blocks.

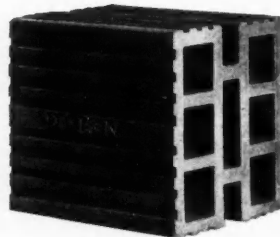

Patented July 31st, 1917

The Strongest Tile Made

Carries load of over 70,000 pounds to the square foot of bearing surface.

DENISON Load-Bearing Tile

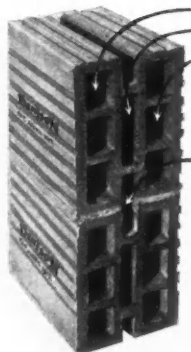

Three separate tiers of dead air spaces insulate against outside heat or cold.

Broken mortar joint prevents frost or moisture penetrating to inside wall.

Sides grooved to clinch plaster—no furring necessary.

Suitable for all classes of building from farm buildings to skyscrapers. Can be finished with face brick, plastered with stucco, or left with the tile exposed.

The tile lays up easily and quickly, bedding surfaces are on the same level, and each unit is complete in itself. Jamb, corner and fractional blocks simplify construction.

There is a good profit for you and an assured, satisfied owner.

Send for portfolio of construction details and prices at your nearest shipping point.

MADE BY THE

Mason City Brick & Tile Co.

Mason City, Iowa 900 8th St., S. W.

Brick facing bonds at any desired interval.

Each tile four brick and three mortar joints high.

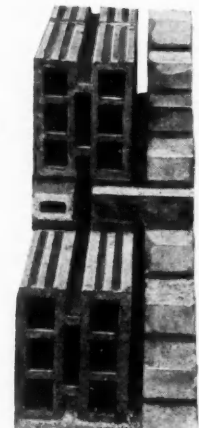

Get
your
copy



THE popular two apartment house is authoritatively treated in this 72-page book of designs entitled "THE NATCO TWO APARTMENT HOUSE."

The 40 designs shown are the very latest ideas in exterior designs and interior arrangements.

All those interested in modern methods of fireproof residence construction are entitled to a copy, mailed with our compliments.

If you didn't get your copy, clip the coupon and send it to us now, before our limited supply is exhausted.

NATIONAL FIRE PROOFING COMPANY
690 FEDERAL ST., PITTSBURGH, PA.
New York · Chicago · Boston

NATIONAL FIRE PROOFING COMPANY,
690 Federal Street, Pittsburgh, Pa.
Please send me your book "THE NATCO TWO APARTMENT HOUSE."

Name

Address

Business

Interlocking Tile

Matt Face—Standard—Vitrified Salt Glazed and Silo Tile, all interlocking.

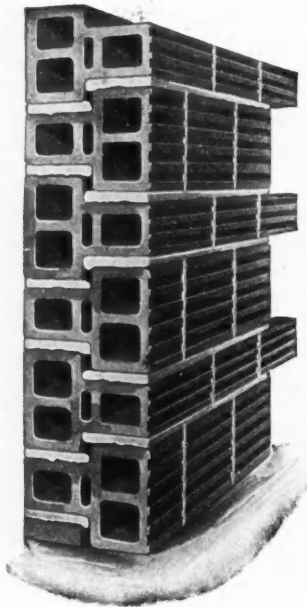

Eight-Inch Wall

Horizontal air spaces insure warm dry walls. Used to advantage in:

- Silos**
- Barns**
- Dairy Houses**
- Hog Houses**
- Chicken Houses**
- Residences**
- Garages**
- Warehouses**
- Ice Houses**
- School Bldgs.**
- Tile—Building conduit for Moisture
- Proof Foundations

THE CLAY PRODUCTS COMPANY
Indianapolis Indiana

Reducing Cost of Workmen's Houses

(Continued from page 138.)

plastered, outside stuccoed.....	116 %
Eight-inch hollow tile, inside plastered direct, outside stuccoed	111 %
Eight-inch brick wall, inside furred and lathed and plastered	115½%
Wood framing, veneered with 4-inch brick, inside lathed and plastered.....	113 %

The roof generally put on is the sloping roof; and the cedar shingle, while still in common use, is slowly giving way to other materials. Many cities have legislated against it, and as the asphalted felt shingle, which is a good deal more fire resisting, can be put on for about the same price, it is coming into general use.

The asbestos shingle costs about twice as much, and is not so commonly used, altho it is probably more permanent than the asphalted felt shingle. Either of these two materials, however, have been in use long enough for us to form a final judgment as to their lasting quality.

The flat roof boarded and covered with 5-ply built-up tar and gravel roofing is considerably cheaper than any of the preceding, but its appearance is so often objected to that it is not used very frequently. In localities where heavy snow is experienced it is not so suitable, especially if the roof is designed with an overhang that does not get the warmth of the house to melt falling snow. The flat roof should, of course, be furred on the under side so that a dead air space can be secured for insulation, and if this is done it is cooler in summer and warmer in winter than the sloping ceiling under the pitched roof that is usually put into the bedroom. Various types of "ready" roofing are used as substitutes for the built-up roof; but, on account of the difficulty in making good, water-tight joints, they are not much used in spite of their lower first cost.

Wood lath and plaster continue to be the customary method of finishing walls and ceilings. There is no money saving in the use of the various prepared plaster boards covered with finished coats, but as they dry out more quickly they are much used if speed is essential. The various wall boards made of wood

(Continued to page 142.)

WITHOUT OUR ESTIMATE YOU HAVE NO COMPETITION

The Whitacre-Greer Fireproofing Co.

Manufacturers of
**HOLLOW TILE FIREPROOFING
and BUILDING BLOCK**

Waynesburg, Ohio

Chicago Office:
538 South Dearborn St.

Pittsburgh, Office:
7138 Jenkins Building

FIREPROOFING MADE OF PURE FIRE CLAY

"HEAVY DUTY" INTERLOCKING TILE

The **STRENGTH** of BRICK and the **DRYNESS** of TILE are combined in Vigo American Heavy Duty Interlocking Tile to make a **BETTER** wall than solid brick and at two-thirds the cost.

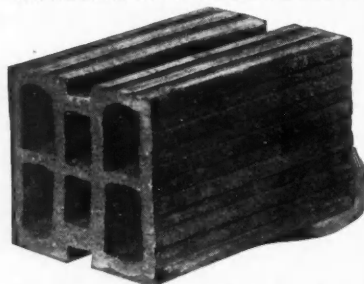

We also manufacture Fireproofing, Building, Arch, Partition and Drain Tile, Hollow Brick and other shale products. Send for our literature.

VIGO-AMERICAN CLAY COMPANY
7th and Ohio Sts., TERRE HAUTE, IND.

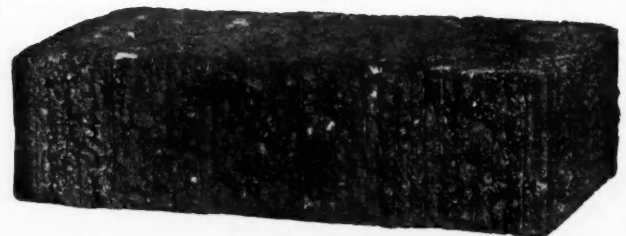

ALLIANCE MULTI-COLOR RUFF BRICK

EXCEL ALL OTHER BRICKS as to beauty of coloring. The chromatic scale of colors runs through the beautiful rough-texture faces, most of the individual brick showing on the face of each brick three or four or more of the seven primary colors or their shades—gas-metals, wines, chocolates, browns, ox-blood reds, blue tones and multi-colors.

Mr. Dealer: If you want the best seller among the many brick made today ask for the agency for Alliance Multi-Color Ruff Brick—beautiful rough-texture and all the colors of the rainbow. Samples and prices on request.

The ALLIANCE BRICK CO., 25 South Linden Ave., Alliance, Ohio



Maritz & Henderson, Architects

B. F. Charville, Builder

Residence of H. L. Sallenback, Saint Louis
Built of Kiln Run Hy-tex Chaldeans.

Don't encourage your customers to put off building. Every building-material man knows that prices cannot go down during the war, or for some time after the war.

For some years to come there will be no more favorable time for building than the present.

And don't forget to tell your customers of the advantages in a brick house—beauty, comfort, safety against fire and economy against depreciation.

Every one of our offices is ready to cooperate with you.

Hy-tex

The Standard of Quality in Brick

Hydraulic-Press Brick Company

Saint Louis

Branch Offices: Baltimore, Chicago, Cleveland, Davenport, DuBois, Pa., Indianapolis, Kansas City, Minneapolis, Omaha, Philadelphia, Roseville, Ohio, Toledo, Washington

Largest Manufacturers of Face Brick in the World

Send for these Booklets

"Hy-tex Brick" tell you the many advantages in building with brick, and something about the completeness of the Hy-tex line and the benefits you can derive from Hy-tex Service.

"Suggestions for Small Hy-tex Homes"—shows the possibilities of brick in small homes. It is illustrated with perspectives and floor plans of small brick houses.

Mail the Coupon NOW

Hydraulic-Press Brick Co.
St. Louis, Missouri

Send me "Hy-tex Brick" and "Suggestions for Small Hy-tex Homes."

.....

Name.....

Street.....

City..... State.....

Reducing Cost of Workmen's Houses

(Continued from page 140.)

fibre are offered as a substitute for plastering, but are not satisfactory for industrial homes. The cost per square foot is low, but the waste in cutting is very great unless especially ordered, and the result is often not a permanently satisfactory one.

Another point in which our building regulations in most of our cities are unduly severe is the matter of plumbing. Specifications usually call for extra heavy soil pipe, whereas, standard weight is sufficient and where two houses are built side by side with kitchens and bath rooms on either side of the party wall, one soil pipe and sewer connection for the houses would be an economy that would not in any way make the house or plumbing installation less sanitary. In building a row of houses it is usual to plan the bathroom and kitchen sink at the back of the house, so that the soil pipes come at the back instead of the front; and in such case it would be much better to run a drain pipe just outside the back wall of the houses with one connection to the sewer at the end of the row and put separate sewer connections under the houses for each house. Akron pipe could be used for this instead of iron pipe and a potential source of unsanitary condition due to soil pipes going under the house would be eliminated.

It is usual in building regulations to call for paving in a cellar. This is, altho very desirable, not a neces-

sity on soils where there is good drainage thru sand and gravel, even if the cellar is required.

The size of rooms is frequently restricted by building regulations which call for at least one room in the house to have an area exceeding anywhere from 120 to 150 square feet, and that no bedrooms will have a less area than 90 square feet or a less width than 7 feet. Altho in general these restrictions are desirable there are cases on awkward shaped lots where they work some hardships.

The loads prescribed for floor construction by building regulations are usually 40 to 50 pounds per square foot. Some cities run as high as 70 and even 100 pounds per square foot, which are most unreasonable. I do not think, however, that less than 50 pounds per square foot is a safe load to allow for, because altho the average load on a dwelling house is under 12 pounds per square foot, there is a possibility of much heavier concentrated loads sometimes being placed on the floor, as in the case of an auction sale, funeral or wedding. It is usual to prescribe a factor of safety of 4 in the figuring of floor timbers. I do not believe that this should be changed, because altho smaller floor joists would carry the load they would not be rigid enough to bear a normal load without some sagging and cracking of plaster ceilings below. A good deal of economy is always gained when a large number of houses are built at one time by one organization.



Drop us a line and tell us what you are figuring on building this Spring

HUNDREDS of progressive contractors are finding that brick construction is as easily handled as frame; and it has many advantages — the principal one is, that it gives your client a more permanent home and relieves him of the continual expense of painting and upkeep.

Then we will tell you how "Artfashioned" Brick can be used to advantage

Artfashioned Brick are made in a wide range of colors and textures. There is a Nuvoque Brick for every style of architecture — from the modest bungalow to the best building in town.

You can get "Artfashioned" Brick from your Local Dealer

We have hundreds of lumber dealers in the Middle West now handling "Artfashioned" Brick. If your local dealer does not carry our line ask him to write us. We prefer to furnish it through his yard.

DOONE BRICK TILE & PAVING CO., Manufacturers of Artfashioned Brick, Beems, Iowa
Sales Offices all through the Middle West

MADE IN IOWA!



Build with Beaver Brick

Beauty and permanence of construction can be obtained with this brick at a cost but slightly greater than for frame.

Well burned face brick is universally recognized as the most beautiful and durable building material in existence, and the advantages of brick construction are many.

¶ Brick homes are practically indestructible. Insurance rates are low and the cost of upkeep such as painting and repairs are reduced to a minimum.

¶ Houses of brick maintain an even temperature at all times. Cool in summer and warm in winter.

Beaver Brick is made in a variety of colors and textures. Beaver Clay, Turkestan Vertex and Volcanic Extreme Rough Texture represent the best in facing brick. Our catalog shows them in their natural colors.

Write Today

BEAVER CLAY MFG. CO., NEW GALILEE, PA.
SALES OFFICES IN ALL CITIES



The Underlying Reason for a
Happy Home—

Correct installation is important. Write for descriptions of latest and best methods.

Vitrified Clay Pipe
"THE PERMANENT PIPE"

It never rusts or corrodes. Electrolysis and acids do not affect it.

Its use in house drainage promotes the constant serviceability of bathroom, kitchen and laundry.

THE SEWER PIPE MANUFACTURERS'
JOHN L. RICE **ASSOCIATION** **SECOND NATIONAL BLDG**
FIELD COMMISSIONER **AKRON, OHIO**

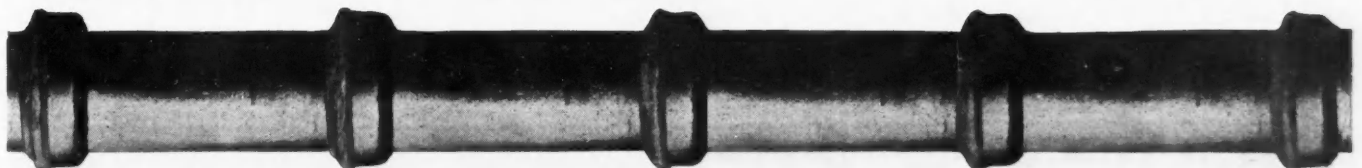

WHEN WRITING ADVERTISERS PLEASE MENTION THE AMERICAN BUILDER

Mueller Heating

THE builder who installs Mueller Heating Systems has all the advantages of the Mueller name and reputation of sixty years—the Mueller skill and experience. There are more than 119,000 Mueller Heating Systems of various types giving perfect satisfaction today in homes and buildings in all parts of the United States. Since 1857 the name Mueller has been associated in the public mind with reliable and dependable heating. People naturally have confidence in any heating system bearing the name Mueller. Why not profit by this confidence?

If you are not already familiar with the Mueller Heating Systems, write for complete illustrated catalog of the type in which you are interested—Warm Air and Pipeless Furnaces, or Hot Water and Steam Boilers, or Vapor System—and our prices and terms to dealers and builders.

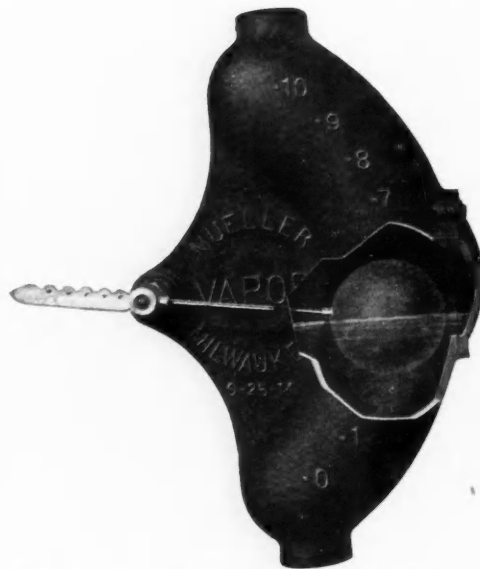

Mueller Vapor Regulator, Showing Copper Float and Stem

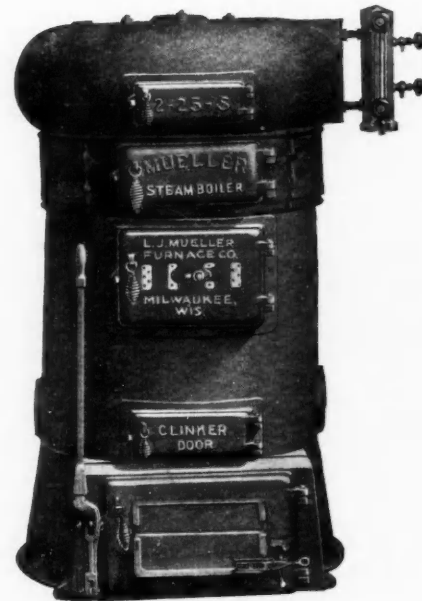

Mueller Steam Boiler

L. J. MUELLER

Makers of Heating Systems

218 Reed Street,

ating Systems

MUELLER Heating Systems include Warm Air, Hot Water, Steam and Vapor, and the Mueller Pipeless Furnace. Each is easy to install, because each is designed correctly and built right. The builder makes a good profit on every job and he has the satisfaction of knowing that if he puts in the type of Mueller Heating System best adapted to the building it will give perfect satisfaction. The Mueller expert heating engineers are always at the service of builders who desire advice as to the type of system most desirable for certain installations.

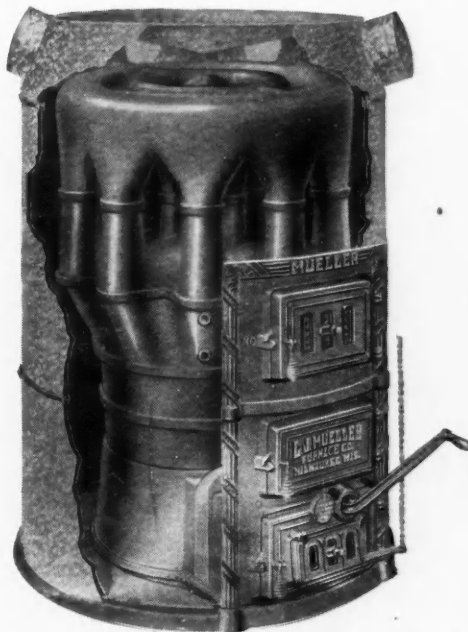

Mueller Double Radiator All-Cast Furnace



Sectional View of Mueller Pipeless Furnace

FURNACE CO.

Of All Kinds Since 1857

Milwaukee, Wisconsin

Turn the Winter Months to Good Profit Building Grandfather's Clocks

Any Handy Man with a few simple tools can do it and sell them as rapidly as he can turn them out.

You can build one of these clocks complete for \$25 and you have only to see the prices retail stores charge for Grandfather's Clocks to appreciate how easy it is to get \$75 for every one you turn out. The demand for them is universal. Every home needs one. We sell you the case in the knockdown and it can be put together in a jiffy—works and all.

We Sell Complete Works as Low as \$5

With each one, we provide complete instructions, blue prints, finishing material etc. The work is extremely easy and very interesting.

Free Drawings, Etc.

Write today for our catalog, "The Tinker," free blue prints, and other valuable information on Grandfather's Clocks and works, and see for yourself how profitably you can use your spare time this winter. *Write today.*

CLOCK COMPANY
1677 Ruffner St. Philadelphia, Pa.

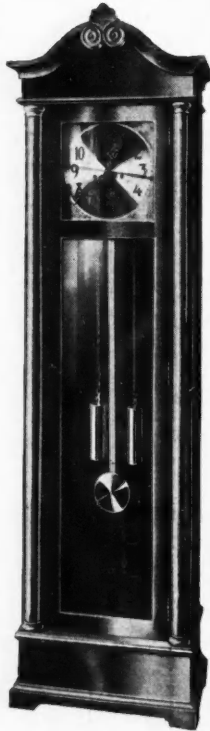

How to Estimate Cost of Tile

(Continued from page 57.)

ter to find the total cost of reinforcing bars for the job. The amount of concrete per lineal foot of lintel for the various sizes of blocks will be found in Table IV. With the aid of this table you will be able to estimate, with a high degree of accuracy, the total amount of concrete required.

Table I.

....Table I....

NUMBER OF BLOCKS PER SQUARE FOOT OF WALL SURFACE.			
Height of course.....	4½"	5½"	8½"
Number of blocks per sq. ft.....	2.56"	2.1 "	1.36"

Table II.

AMOUNT OF MORTAR REQUIRED TO LAY UP BLOCKS OF THE VARIOUS SIZES, ALLOWING 10% FOR WASTE.

Sizes of Block	Width of Wall	Cement Sacks	Sand Cu. Ft.	Lime Putty Cu. Ft.
4x5x12	4"	7.01	15.40	3.85
4x5x12	5"	7.07	15.54	3.88
4x8x12	4"	7.39	16.24	4.06
4x8x12	8"	13.29	29.20	7.30
8x5x12	5"	9.00	19.78	4.94
8x5x12	8"	13.37	29.38	7.35
8x8x12	8"	13.77	30.24	7.56
8x8x12	8"	14.26	31.35	7.84

Table III.

AMOUNT OF MORTAR REQUIRED TO LAY UP BLOCKS OF THE VARIOUS SIZES ALLOWING 20% FOR WASTE.

Sizes of Block	Width of Wall	Cement Sacks	Sand Cu. Ft.	Lime Putty Cu. Ft.
4x5x12	4"	7.64	16.80	4.20
4x5x12	5"	7.71	16.97	4.24
4x8x12	4"	8.06	17.71	4.43
4x8x12	8"	14.49	31.80	7.95
5x8x12	5"	9.81	21.56	5.39
5x8x12	8"	14.58	32.04	8.01
8x8x12	8"	15.00	33.00	8.25
8x8x12	8"	15.55	34.08	8.52

Table IV.

AMOUNT OF CONCRETE REQUIRED PER LINEAL FOOT FOR LINTELS.			
Size of Block.....	4x5x12	4x8x12	8x8x12
Cement sack0065	.0104	0.234
Sand, cu. ft.....	.0320	.0515	.1152
Stone, cu. ft.....	.0641	.1408	.2304



The Man from the Lumber Yard

(Continued from page 63.)

ence in the Editor's room.

I told the Editor that one of the handicaps of the building trade was the almost universal feeling of distrust of the contractor and supply dealer.

Our Editor isn't a milk and water chap. He has good red blood in his veins. He can deliver a hard blow with fist or tongue. But he is an amiable fellow and likes to think only good of every one and everything.

I drew his attention to the fact that we give jobs to the surgeon amounting to hundreds of dollars without a question; that we entrust our banker with thousands of dollars because of our confidence in him; that we place our lives in the hands of the engine driver with no more thought than we give in eating peanuts; that a man goes into a clothing store and buys a suit of clothes suited to his purse that will fit his person, yet when one buys \$17.69 worth of building material he takes his specifications to all avail-

(Continued to page 148.)

Grilles All-Steel All-Purposes



Class 590—Illus. of grille 4"x4" extreme dimensions.

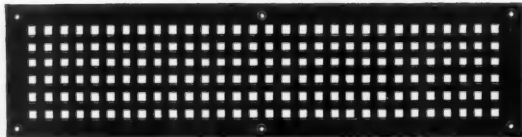

Class 570—Illus. of grille 6"x26" extreme dimensions—¼ inch holes. Also furnished with larger holes ½ inch square (class 575.)

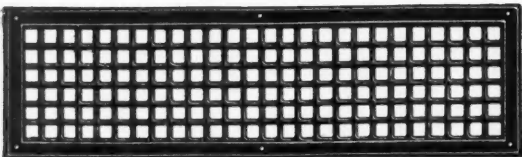

Class 550—Illus. of grille 8"x40" extreme dimensions.

Write us today

The Hart & Cooley Co.
New Britain Conn.

"Viceroy" Bath, Plate F-12-TL
(Pat. Applied for, and Name Reg. U. S. Pat. Off.)

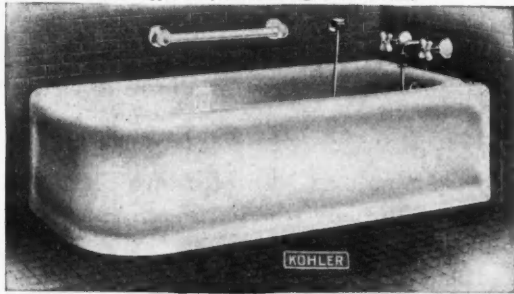

"Colonna" Bath, Plate F-64-WN

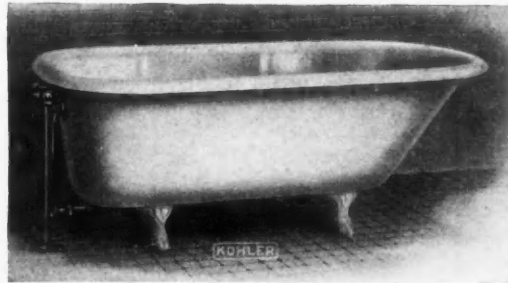

An Assurance of Satisfaction

Contractors and builders throughout the country recognize in KOHLER WARE the qualities that make satisfied customers. Largely through the efforts of the KOHLER institution, plumbing ware has been developed from the crude, unhygienic fixtures of a few years ago to the high quality represented by

KOHLER WARE

Always of one quality—the highest

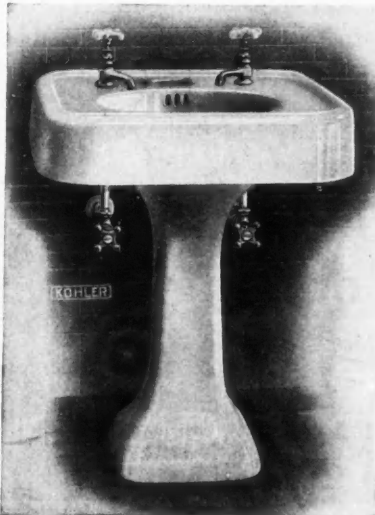

"Columbia" Lavatory, Plate F-205-A

The *one-piece* construction and simplicity of design make KOHLER WARE hygienic. The KOHLER pure white enamel is the crowning feature that contributes to the beauty and durability of KOHLER WARE. Our permanent trade-mark, the name KOHLER, is your guide to excellence and our pledge of quality.

KOHLER CO.

Founded 1873

Kohler, Wisconsin



"Bretton" Lavatory, Plate F-580-A
(Name Reg. U. S. Pat. Off.)

BRANCHES

Boston
New York
Philadelphia
Pittsburgh
Detroit
Chicago
Indianapolis

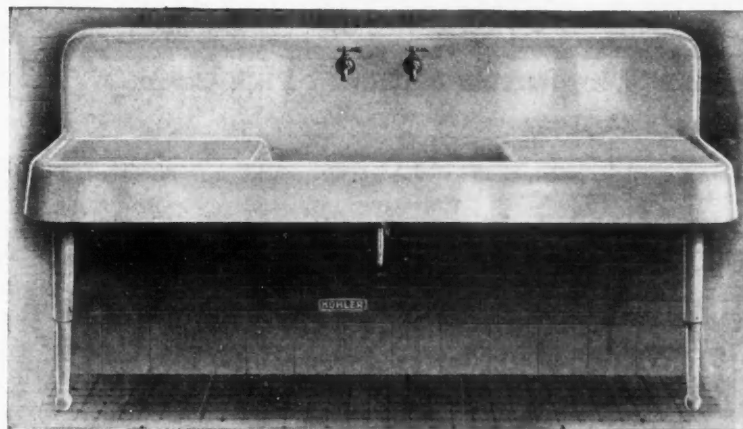

Plate F-1003-A Sink

BRANCHES

St. Paul
St. Louis
Houston
San Francisco
Los Angeles
Seattle
London

The Man from the Lumber Yard

(Continued from page 146)

able bidders. If perchance he is going to invest several thousand dollars in a building, he and his wife and his mother-in-law sit as a court before which each contractor is tried—not as to his honesty, his ability, his good intentions, but only on the basis of the price submitted.

Members of the Ananias Club

Our law holds that a man is innocent until proven guilty.

The prospective builder holds that a contractor is a thief and a liar until he is proven honest, or at least less dishonest than some other contractor by having a lower bid than the other fellow.

"I ain't got any too much brains," but I know from experience that the lowest bidder was frequently the biggest liar. Some times I was the lowest bidder. Some feeble minded fellow sufferers will smile internally and know I am right, altho we wouldn't admit it out loud.

When I got all these facts in front of him, the Editor asked me why all this was thus. I couldn't give the answer, but we studied the question, discussed it from various angles and finally arrived at the conclusion that this state of affairs has existed and does exist because of *heredity, stupidity, cupidity* and *inertia*.

Heredity

Some of us are very chesty when we think we

have discovered a new idea. There are no new ideas. No two men are alike but every man is a composite of 32 ancestors maternal and paternal and countless people with whom he has rubbed shoulders.

I meet all sorts of people in the supply and building fields; some are anxious for a broader view point; some feel as if they know infinitely more than all other minds combined.

But there is no man born of woman that is not in partnership with those who have been and those who are to be.

The habits and customs of those who have been have so inoculated the system that they are the system. Some time I would like to discuss this more but every one who thinks knows that the unfortunate condition which I have mentioned exists. How can it be changed?

No Apologies

Some of my good friends would take me to task for assenting that *stupidity* and *cupidity* have aught to do with it. I have no apologies. I want such a one to think it over, study the question with open eyes and get under the hide. I have only space now to consider the fourth angle, *i.e.*, the *inertia* of those interested in the building trade. It is so easy to drift, to follow precedent, to do a thing in a certain way because it has always been done that way.

The more I have thought of it the more is my sur-

(Continued on page 150.)

His Roofing Business Went to the Bad But Shinn-Flat Business is Booming

Rutherford G. Young, New Galilee, Pa., writes:

"My roofing business went to the bad this year on account of high cost of materials, but the Lightning Conductor business is booming. It is the easiest and most honest money I can make. I have handled Shinn-Flat for 8 years and am convinced that you have the best system of Lightning Protection on the globe. It's no trick to make \$50 to \$100 extra a week."

Shinn-Flat

Formerly known as National Flat Cable.

Shinn-Flat is the greatest scientific Lightning Conductor ever devised. It is endorsed by scientific authorities, in preference to all round or other old-style cables or rods.

Shinn Short Points are very popular with owners of fine homes. They are inconspicuous and readily harmonize with the architecture.

With Shinn-Flat you can not only sell Protection for every building you build, but you can get the job of protecting every unprotected building in your community. It sweeps the field of all competition. We help you get the business. Write us.

W. C. SHINN MFG. CO.

1635 Monadnock Bldg., CHICAGO

Get the Extra
Profit by "Pro-
tecting" the Build-
ings You Build.

Lightning Can't Strike if
SHINN Gets There First

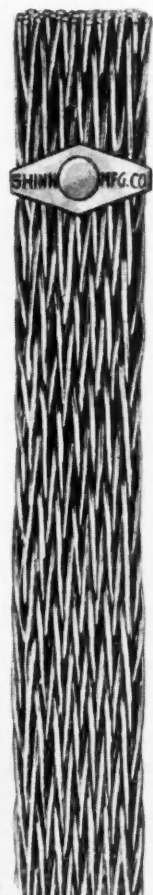

Willis Products

Simple construction and an attractive appearance are two big qualities the Willis Ventilators are gifted with. After 25 years of careful experimenting we have learned that it pays us to make our ventilators of the best quality heavily galvanized iron, in gauges best adapted to the size of the ventilator.

Today we are able to point with great pride to the efficiency of our ventilators. While we have secured the best possible results in the ventilators, yet they are simple. All of the mechanism so commonly used is eliminated, leaving absolutely nothing to get out of order.



VENTILATORS

Willis Batten Strips



Willis Batten Strips cannot be excelled. They are easy to apply; the edges lay tight; they are made of galvanized iron and never warp, split or draw away from the boards. They make neat, absolutely tight joints allowing for expansion or contraction of siding so nails will not become loose.

They do not interfere with sliding doors. They are a valuable lining for grain bins, etc. The strips are easy to cut, so there is no waste. Made in 6, 7, 8, 9 and 10 foot lengths.

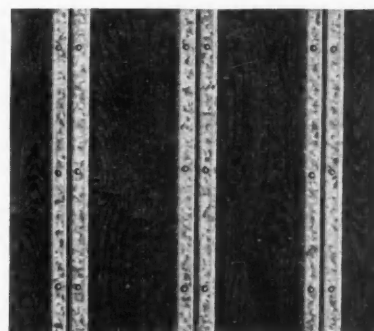

Willis Skylight-Ventilator

Any person of ordinary ability can set up our skylights without the use of soldering outfit or tools, except a hammer and screw driver.



The bars are so constructed that the largest possible glass area is obtained. The bars for large skylights are reinforced and we guarantee them not to sag. They are built for lasting service.

The Willis line of sheet metal building products is complete. Our large illustrated catalog is very interesting. Write for it—today.



Willis Turret Skylight



Detail drawing of this hog house will be mailed to you upon request



Hoghouse Skylight

Dept.
"C"

WILLIS MFG. CO. GALESBURG, ILL.

Erecting Good Dairy Barns Brings Big Profits To Builders



Dairy barns so built and equipped that they make for more milk, better milk, cleaner milk—and less work for the dairyman, are in big demand. Dairymen all through the land are either erecting new and better barns or are remodeling their old ones.

James Barns and James Equipment are known to these dairymen. We advertise heavily in farm and dairy papers.

We will be glad to cooperate with you and help you land contracts for building barns in your vicinity the "James Way." We will send you the 312 page

book "The James Way," illustrated below—**FREE**. It is packed with valuable dairy barn building facts and directions.

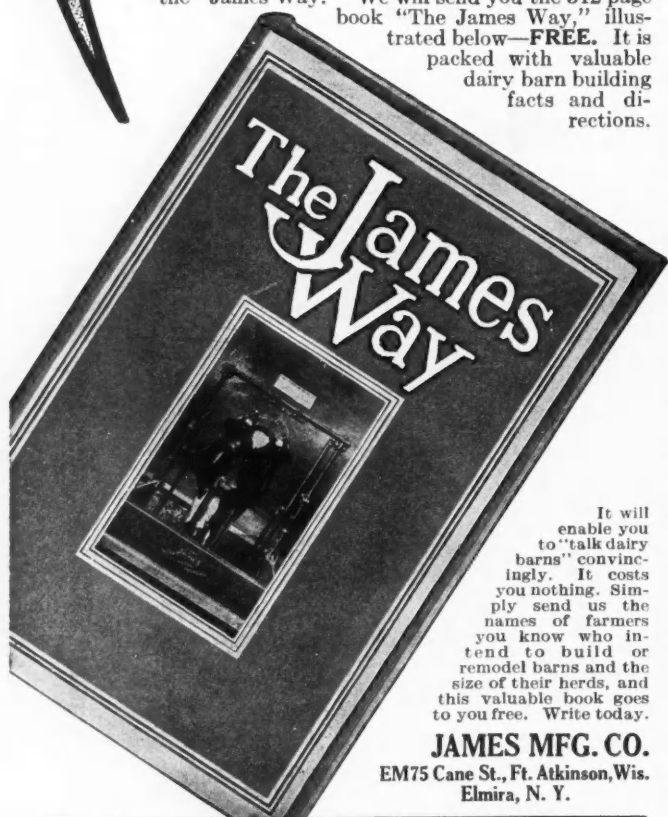

It will enable you to "talk dairy barns" convincingly. It costs you nothing. Simply send us the names of farmers you know who intend to build or remodel barns and the size of their herds, and this valuable book goes to you free. Write today.

JAMES MFG. CO.
EM75 Cane St., Ft. Atkinson, Wis.
Elmira, N. Y.

The Man From the Lumber Yard

(Continued from page 148.)

prise that men as aggressive and enterprising as those engaged in the building industry should continue year after year, decade after decade, to submit to conditions which are enervating and hampering to growth. There is only one thing that is free and easy, viz., failure.

I wish that you could have stood with me the 15th of November and watched the boys at the cantonment at Rockford. To the ordinary man who is accustomed to the ordinary slow movement of civil life, and the slow up building of our public school training which is about the only thing in the way of training that we have been acquainted with, it was a great revelation to note what had been done with these young men in such a short space of time.

A lesson in unity of action was taught in a way that I had never had before. These men, whether officers or privates, are going to come back into constructive and commercial life after the war with a force and a zip beyond comprehension.

Each one will have a schooling that will make him a power along side of any of us fellows that have been either too old to go or too weak physically or too weak in the back bone.

Every man that is not in the army must begin intensive training for himself today or he is going to be out-classed so very badly by these competitors who have had such magnificent training that he will not be able to hold his own.

Dog in the Manger Type

We in the building trade do not want to sit down and criticize these people; because we have been just as weak as they have. I want to ask every reader in the building line what he is learning from the lessons of the war?—and also do I want to ask him what he is doing to profit by the lessons of the war? The one big lesson up to the present minute has been that of necessity of co-operation.

I want to emphasize for the 57th time the fact that the AMERICAN BUILDER has been preaching this propaganda of unity in the building industry and the need of co-operation thru some such medium as the Builders' Club in each locality.

All of us have a feeling of disgust at the insistence of each of the leaders of the various factions in Russia on his supremacy.

Each one practically says that if he cannot rule he will ruin.

I recently heard of a man reported to have considerable ability who failed to secure an officer's commission and vented his pique in saying, "I don't care now if Germany does win." It is fortunate that cattle like that don't get into positions of responsibility.

The one great trouble with a large percentage of those interested in the building trade is the fact that

(Continued to page 152.)

The *Meadows* Stationary Inside Cup Elevator

Our Free Plans

will show you how to get the greatest capacity for the least expense by installing the *Meadows*.

They will show you how to save both labor and building material.

Send for a copy at once.

THE MEADOWS
Manufacturing Company
PONTIAC ILLINOIS

will make YOU an extra profit and save the FARMER time and building material. When you figure on a new crib or granary, figure it complete with the *Meadows* stationary Inside Cup Elevator.

This elevator will handle any kind of grain—is easy to install—takes up little space, and with ordinary care will last a lifetime. It is a permanent crib equipment and never fails to satisfy.

*Write today for catalog
and free crib plans.*



The Man from the Lumber Yard

(Continued from page 150.)

there are too many chips carried on a shoulder, and too much dignity has to be preserved.

There has been too much of the "If I can't make a profit you shan't."

"Why"

Can any one give a logical reason why there should be a continuance of conditions that eat the profits and keep the building industry "up a tree." A clean square deal, honesty in spirit as well as in the letter and sincerity in all things will eventually free the building trades of the wolves of suspicion and distrust.

One man working by himself can eventually make a personal reputation.

All the men of allied interests can pool their advertising interests thru the medium of the Builders Club and quickly turn the current of popular distrust. I am asking YOU if you are dissatisfied with the present dog eat dog way of doing to make a move.

THE MAN FROM THE LUMBER YARD.



Modern Office Methods Help the Contractor

(Continued from page 100.)

the living room of his own inconspicuous cottage; his office equipment was just a second-hand typewriter and a few carbon sheets and a supply of printed envelopes and letter heads—but his show of modern methods where such things had never been known

before impressed the people to whom he submitted estimates. Estimates with complete specifications in typewriting—this looked business-like and progressive. It was not long before the newcomer in that particular contracting field was on a par with his older competitors in point of business handled.

He did good work. That was a primary essential in any case. But the older firms also did good work. The young carpenter-contractor's rapid advance must have been in a great part due to his adoption of business methods.

Thus, when he promised anything verbally in connection with a job, he made a point of confirming the undertaking in writing. He never gave verbal figures on a job. Whatever cropped up might be discussed verbally at great length, but always there was the typewritten, signed confirmation—and there was also the carbon copy in the contractor's drawer, as protection against disputes.

Similarly, in ordering materials, orders were always in writing with full particulars, and duplicates were always retained.

Early in his experience, the young man decided to make his typewriter pay extra dividends. To this end he compiled a mailing list of prospective customers in town and throuout the surrounding country, and whenever he got a new job, he sent out a letter notify-

(Continued to page 156.)

Beautiful Oak Floors



Oak Floors are the only floors that combine *beauty*, *durability* and *distinctiveness*, three very vital reasons why so much *Oak Flooring* is in use today.

Oak Floors are always the source of *unlimited satisfaction* and *pride*. Nothing is prettier, or more artistic than *floors of Oak* and a few choice rugs.

Oak Floors mean *better selling* and *renting values*, and it *attracts a better class of tenants*.

More Winter Work for the Carpenters

Three-eighths inch Oak Flooring offers an *excellent* side-line for *carpenters* or *contractors* during the winter season. It can be laid over old pine floors in old houses at a very *low cost*. All that is necessary to secure jobs is some *soliciting*. Every woman wants *Oak Floors* as *beautiful Oak Floors* and rugs simplify housekeeping and house-cleaning.

Three-eighths inch Oak Flooring can be laid successfully by any carpenter or handy man. The work is very *agreeable* and very *profitable*.

Write for folders that tell all that is worth knowing about *Oak Flooring*.

All good lumber dealers sell Oak Flooring

OAK FLOORING SERVICE BUREAU

1603 Union Trust Bldg.

Cincinnati, Ohio

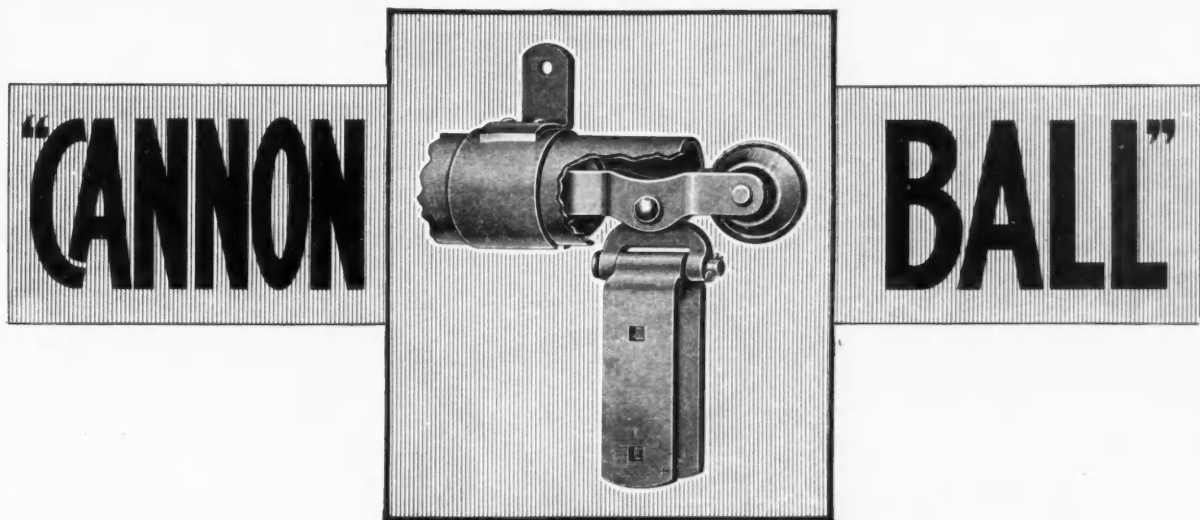

The Best "Buy"

The simple construction and the wonderful durability of the Cannon Ball Hangers, plus their established reputation, make them an almost self-selling line.

You do not have to do service work after installing Cannon Ball Goods—once up, they are there to stay and satisfy.

Time, weather and wear have little effect on a Cannon Ball Hanger.

In the Cannon Ball Line there are Hangers and Track which will fit every conceivable need, so far as is concerned the hanging of doors for houses, barns or garages.

Our booklet tells an interesting story—send for it—it shows the complete line with description and full information. If you are interested in garage door hangings, mention it and we will send you details of Cannon Ball Hangers for that purpose.

If you want profits, plus satisfied customers, send for a catalog of the easiest selling line of Door Hangers in America—**Cannon Ball**.

HUNT-HELM-FERRIS & COMPANY
16 HUNT STREET, HARVARD, ILL.

For **Particular**

**Quality
Sheet Metal
Products**

Metal Roofing and Siding

"MILCOR"
Prestige the Reflection of Quality

Tin Plate

Canopies

**Theatre
Fronts**

Skylights and Ventilators

Ventilating Systems

90% of Our Invoices



Bear This Stamp

This links service with quality

Corner Beads

- “Superior”
- “Never-break”
- “Milcor”

Showing inside corner bead. Also make outside corner bead.



FIRE-REINFORCED
A PERFECT
INTERIOR
EXTERIOR

Milwaukee Corrugating

Branch: Kansas City, Mo.

MILWAUKEE, WIS.

Branch:

Builders

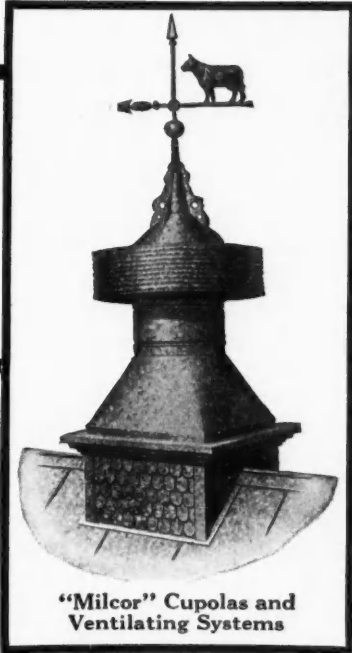

"Milcor" Cupolas and Ventilating Systems

EVEN DRAFT
Chimney Extensions

Finials, Weather Vanes



"MILCOR"

Metal  Style V
Barn Batten Strip

Allows for expansion and contraction of siding, making building wind and weather proof



ASSISTANT
KEY FOR
PLASTER OR
STUCCO WORK

Co.

Kansas City, Mo.

AMERICAN
Metal Shingle

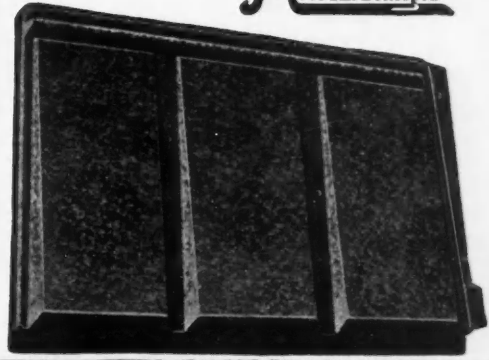

More Quality Brands

NUZAR
VENTILATOR

"SUPERIOR"
CORNER BEAD

"MILLOCKS"
METAL SHINGLES

GUTTER CRIMPEDGE

"MILCOR"
METAL BUILDING CORNERS

"MILCOR"
Self-Cap Roll Roofing

"MILCOR"
Galvanized Sheets



"MILLOCKS"
Spanish Tile



INTERLOCK CONDUCTOR
Pipe

"NETMESH"
Expanded Diamond Metal Lath

Certified
Pressed Standing Seam Roofing

"MILCOR"
Galvanized Embossed Cornices

DIRECT LIGHT IRON
CONDUCTOR PIPE



The Factory Behind These Quality Products



This Test

proves that
Moisture
cannot
injure—

Ceil-Board

SUPERSEDES PLASTER FOR WALLS AND CEILINGS

A New Haven Builder says:
"The writer has made comparative tests of various ceil and wall boards to determine which would absorb the least moisture, with the result that your Ceil Board 'won out.'"

A. H. Frothingham

This test shows that a good sized drop of ink remained on the broken edge of a piece of Ceil Board for 1 hour and 35 minutes.

Write for samples of fine finishes, booklet and "Special Service" proposition for builders.

THE PHILIP CAREY COMPANY
1021 Wayne Ave., Lockland Cincinnati, Ohio

Modern Office Methods Help Contractor

(Continued from page 152.)

ing every prospect, and inviting the recipient to keep his eye on the work, to observe the careful, honest methods employed in building, to study the new ideas he employed—and there was the clinching assurance that when the recipient of the letter was ready to build, the same business-like methods and careful attention to detail would be at his disposal.

This follow-up system, facilitated by the use of the typewriter and the employment of a stencil duplicator subsequently purchased, appears to have impressed prospective builders to a marked degree. The young contractor of other days has long since outgrown the parlor-office, secondhand typewriter stage of his career; but he assured me the other day that he is still as strongly in favor of modern methods as he was at the start.

VICTOR LAURISTON.



100 Concrete Houses at Donora, Pa.

(Continued from page 43.)

department and stenographer. The formwork was under supervision of one carpenter foreman, five squad bosses, two stripping foremen, two move foremen, one reinforcing steel boss, one finish carpentry boss, three concrete bosses and one excavation boss.

It was found advisable to have a squad boss in

(Continued to page 158.)



Saves 15 to 30 Days' Time in Building

THINK what it means to you to be able to go right ahead with your interior finish without having to wait for plaster to dry. But that's not all—there's no running back to refit windows and doors, as the house is free from moisture. And when the last nail is driven, the house is ready for occupancy, free of all odors or dampness caused by new plaster.

But the saving in first cost of building is not the only thing in favor of Compo-Board. First cost is last cost. It cannot fall off, crack or dent and if the wall happens to get bumped with the corner of a table, chair or door knob, when the door is thrown open suddenly, there will be no hole.

The wood core of the genuine Compo-Board is what gives it such great strength, durability, moisture-proof, non-warping and non-shrinking qualities. No other wall board is made with the wood core, so be sure you get Compo-Board when you ask for it.

Sold by dealers in strips four feet wide by one to 18 feet long.

Write for sample and interesting booklet.

The Compo-Board Co.,
5777 Lyndale Ave. N.,
Minneapolis - Minnesota



Your Reputation Demands

UPSON PROCESSED BOARD

---the Most Dependable Wall Board

Made in America

Contains no dirty, black materials or cheap, punky "jack pine" fibers.

Write for Samples and Information

THE UPSON CO. Fiber Board Authorities 16 Upson Point, Lockport, N. Y.

LOOK FOR THE FAMOUS BLUE CENTER

A SAMPLE

Is all that should be necessary for you to determine whether our

Lignistra Wall Board

OR OUR!

American Artificial Lumber

would meet your requirements

SAMPLES ON REQUEST.

LIGNISTRA FIBRE PRODUCTS CO.
Barberton, O.



You can't expect Beaver Board results unless this trademark is on the back of the board you buy.



The Handwriting on the Wall

What does it mean? Faulty construction, poor plaster, rainy weather, green lumber or what?

Any one of these will cause it. When all work together, the message is more vigorous. The exact cause may be a mystery, but the clear jagged writing is sure to follow a lath and plaster job.

"Use Beaver Board the next time" is the interpretation thousands of carpenters and contractors give this "handwriting on the wall." Experience has taught them that Beaver Board is as permanent as woodwork and floors, and that once up, it's always up.

We've innumerable illustrations of results that we'll gladly send. Write today and let us tell you about our helpful Design and Decoration Service. It's free.

THE BEAVER BOARD COMPANIES
142 Beaver Road Buffalo, N. Y.

Branches in Boston, New York, Baltimore, Cleveland, Detroit, Chicago, Minneapolis, Kansas City, San Francisco

Manufacturers also of Beaver Greenboard and Beaver Blackboard

Distributors in Principal Cities Dealers everywhere

BEAVER BOARD

FOR BETTER WALLS & CEILINGS



PLASTERGON WALL BOARD

pays a big dividend in time and money to the live-wire carpenter, contractor or builder. Winter is never a dull season for the Plastergon man. He is kept too busy making old attics beautiful, old-fashioned rooms modern, permanently repairing damp, cracking plaster and a hundred other odd jobs that are easily adapted to the use of Plastergon Wall Board.

Plastergon makes the best job of wall boarding you ever saw—and the Plastergon Sales Plan makes jobs of wall boarding easy to get. No one can successfully compete with a Plastergon man—in quality—in service—in price.

Let us send full particulars about Plastergon and the free service we render

Plastergon Wall Board Co.
201 Philadelphia Ave., Buffalo, N. Y.



Fiberlic Wall Board

Fiberlic Wood Grain Panels

The material from which it is made, the fact that the pulp is chemically cleansed and that the fibre lengths give the finished product that natural reinforcement that is lacking in ground wood boards, is in itself a guarantee of the superiority of Fiberlic from strong, permanent, economical and sanitary construction.

MacAndrews & Forbes Company
200 Fifth Avenue, New York City
Factory: Camden, N. J.

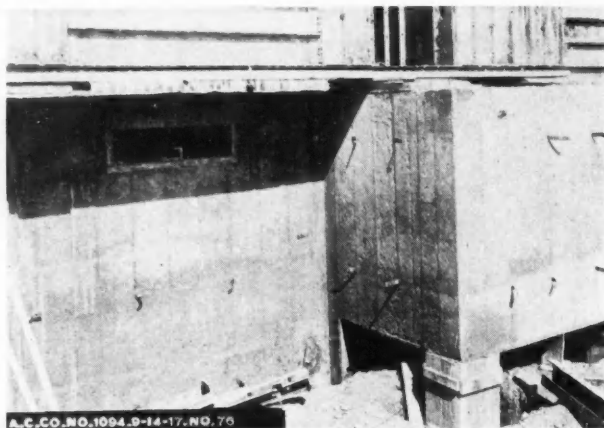

Detail of Foundation Work at Donora.

100 Concrete Houses at Donora, Pa.

(Continued from page 156.)

charge of the carpenters and helpers working on each house. This boss has four carpenters and four helpers on the smaller houses; and on the large double houses, up to seven carpenters and seven helpers. The work has been most economically done when the carpenters and helpers worked in pairs; that is, each carpenter has a helper to assist him in moving the forms, etc. It will be noticed that the reinforcing steel boss comes under the carpenter foremen. This has been found desirable, as the steel must be placed rapidly whenever the carpenters are ready for it. The planning department on the job laid out progress each day for the next three days and showed which

foreman was to erect forms on each house and which concrete gang would pour them.

In a concrete gang the number of men varied from 13 to 15, according to the type of house and the amount of concrete to be poured. The number of gangs at work at the same time is five carpenter gangs erecting forms, two concrete gangs concreting forms, two stripping gangs stripping forms, one concrete gang concreting footings, pavings, porch floors, floor steps, chimneys, etc., one digging gang, and one finish carpentry gang, doing the furring, roof framing and roof boarding, erecting door and window frames, sash doors, inside and outside trim, stair laying, floors, etc.

On a large-type, six-room-house group this force has taken approximately one and a half days to erect basement walls and first-floor forms, including all boxes, window frames, flues, etc. Concreting basement walls takes about 2½ hours, and 1½ hours to pour the floor. Stripping and erecting the basement wall forms on the first story takes one and a half to two days. The stripping of the first-story walls and erecting the second story and putting on the floor takes about one and a half days, but the putting on of the cornice is a slower operation and adds from half a day to a day to this. Concreting the walls takes about 2½ hours, and the roof about the same length of time.



Accounts, Credits and Display

(Continued from page 60.)

demand for these, particularly steel barn equipment, cement, wallboard and special kinds of roofing, we must sell these and consider them as a part of our business if we wish to keep up with the volume of past years, to say nothing of increasing it.

Display Rooms a Big Selling Help

"The first year we handled steel stanchions one of our branch managers sold so many more than any other branch that we sent a man to him to learn the reason. He reported that instead of storing his sample stanchion in the outer shed he had it erected in the office where every farmer who came in could see it. We then sent this investigator to a number of other branches and had him set up displays of

(Continued to page 160.)

SLATE WE HAVE WHAT YOU WANT

*In Roofing Slate, Slate Blackboards
Structural and Plumbers' Slate*

SATISFACTION GUARANTEED in QUALITY and PRICE

Ask for Delivered Prices

J. K. HOWER Station C Danielsville, Pa.

R. J. KICHLINE, Sales Agent

ROOF SLATE

Of every kind. Black—also the varying delicate shadings and rich tones of Red, Green and Purple—clear and in mottled effects.

Structural Slate — Slate Blackboards

E. J. JOHNSON, Inc.

Quarriers of Slate

West 44th Street, NEW YORK



HONESTLY MADE
Clean Through to the Centre

Asphalt Shingles

STOWELL MFG. CO. Red and Green
Asphalt Prepared Roofing
42 CULVER AVE., JERSEY CITY, N. J.

MORGAN DOORS

because of their

**WHITE PINE CORE, WEDGE DOWEL CONSTRUCTION,
EXTRA THICK VENEERS and GUARANTEE**

For complete information, write

Dept. C-77 **MORGAN SASH & DOOR CO., Chicago**
MORGAN MILLWORK CO., Baltimore **MORGAN CO., Oshkosh, Wis.**



The PERFECT MATERIAL

BAYONNE Roof and Deck Cloth contains all the advantages found in other materials and eliminates their disadvantages.

BAYONNE is Wear and Weather-proof. It is impervious to the elements; it will stand constant walking upon.

BAYONNE is easy to lay. Saves paint, time and labor. Is laid on dry boards and painted afterwards to conform to any desired color scheme.

BAYONNE will not crack, peel or scale. Always retains its smooth, neat appearance. Can be kept perfectly clean by sluicing with water, like cement.

Satisfaction is assured when Bayonne is used. Specify it to be certain of the job measuring up to your high standards.

Let us send you our Sample Book N and booklet giving opinions of builders. We feel certain you will find them most interesting to peruse.

JOHN BOYLE & CO., Inc.

112-114 Duane Street, 70-72 Reade Street, New York City
St. Louis Branch—202-204 Market Street

for
**SUN PARLORS,
PLAZZA FLOORS
and ROOFS**

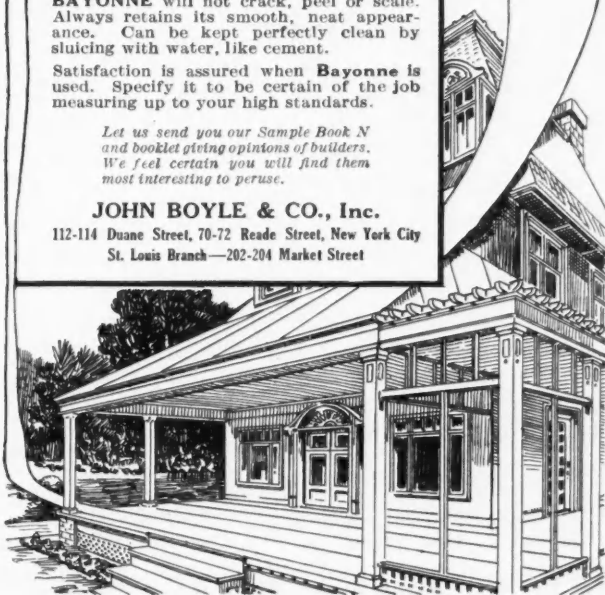

ROOFING SLATE

"they were represented to be as good as GFT slate but after we used them we know POSITIVELY that they were NOT AS REPRESENTED. Hereafter we will use GFT slate. We are done with 'Just as Good' brands." This is the experience of all who buy UNKNOWN brands of roofing. Insist on GFT slate. They are the best and cheapest in the end. Price List and Catalogue on request.
Sole Manufacturers
Slatington Slate Co.
Slatington, Pa.



The Roof of Eternal Youth
SHELDON'S
RED, GREEN, PURPLE, BLACK
SLATES

Custom made to "fit" your Roof. A wide choice of distinctive Color Combinations. Quality, Price and Service unequalled.

F. C. Sheldon Slate Co., Granville, New York

WE ARE NOT DEPENDENT UPON GERMANY FOR COLORING MATERIALS

Used in the Manufacture of

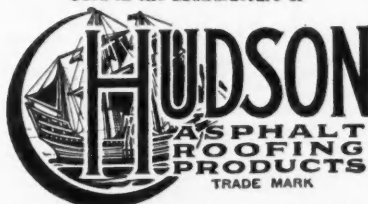

FOR ANY KIND OF BUILDING

Hudson Asphalt Shingles

Mineral Surfaced Red, Green Mottled furnished in Individual Shingles 8x12 1/4 inches and in strips 10x40 inches with 5 shingles to a strip. Hudson Strip Shingles can be very quickly laid.

Protection Brand Roofing

Mineral Surfaced; has 6-inch lap. (Pat. Nov. 18, 1902.) Laid with all nails covered. Joints absolutely tight.

The mineral Surfaces used in the manufacture of Hudson Shingles and Protection Roofing are in their natural unfaded colors. No artificial coloring used.

Hudson Brand Asphalt Felts

For built-up roofs. For sheathing buildings and reinforcing slate and tile roofs. You will like Hudson Felt. It is pliable will not dry up or crack, as it does not stick at the butts. You can use every inch of it.

ASPHALT READY ROOFING CO.

9 Church Street Dept. 453

New York

Cut out this advertisement and put an X in the alongside of the material you are interested in. Mail it to us and we will gladly send samples.

Name

Address

CON-SER-TEX



This Is Your Opportunity to Make Extra Profits This Fall

Use roofing material that gives service and satisfaction, that costs less than most others, is easy and inexpensive to lay, and that makes a neat and durable surface.

On Repair Jobs or New Buildings

your estimates will be much lower, your profits bigger if you use

CON-SER-TEX CANVAS ROOFING

It is a canvas roofing chemically treated to protect the fiber from mildew, and the detrimental action of the oil in paint. It's water-proof, weather-proof, wear-proof.

INVESTIGATE—samples showing widths, weight, prices and complete details sent upon request.

Wm. L. Barrell & Co.

8 Thomas St., New York City

Branch Offices

Chicago Distributor: Geo. B. Carpenter, 430-40 Wells St.

California Distributors: Waterhouse & Price Co., Los Angeles; The Pacific Building Materials Co., San Francisco.



HOLMES DISAPPEARING BEDS

BRING added comfort, value and usefulness to homes now erected. A five-room cottage can be made into a six or even seven-room home, at a cost that is within the reach of anyone. A "Holmes Equipped Home" is a ready seller and truly represents financial economy.

EVERY one realizes that the average bedroom is a room wasted for the greater part of each day. The ordinary bed is not sanitary. The space underneath is a resting place for all the surplus dust in the home, and the constant moving of the bed for cleaning purposes is hard work and quickly spoils the varnish or carpet.

DO AWAY with the old-fashioned methods. The wise contractor is today building homes along more modern lines. Fewer rooms means lesser expenses for the owner and more contracts for the builder. "Holmes Equipped Homes" minimize the drudgery of housework.

SEND today for our literature describing fully our various types of disappearing beds, couch beds, in-a-closet beds, recess beds. It will show you a way to get business and make satisfied clients at the same time.

HOLMES DISAPPEARING BED CO.

175 W Jackson Boul.

Chicago, Illinois

Accounts, Credits and Display

(Continued from page 158.)

various goods. This policy has been broadened until now we are contemplating devoting a special room to displays at a number of the yards. Our branch managers go out among the farmers to sell these specialties and this creates a market not only for these goods, but for all other materials we sell.

"In addition to our permanent office displays we have exhibits at county fairs, carnivals and similar affairs. Last fall we had a large display at the Industrial Exposition of the Dubuque Commercial Club.

"This publicity is supplemented by weekly ads in the smaller town papers and two or three ads per week in the larger papers. We also send out regularly a variety of circulars, bulletins and building plan books.

Every Yard Has Adequate Cement Warehouse

"We do not consider any of our yards complete unless it has a cement warehouse that is adequate. When we buy a new yard, one of the first things we do is to erect such a building or put the old one in shape. All our warehouses are built on piers and adjacent to railroad tracks."

C. J. Spahn, the president, has developed a standard cement warehouse design and the Spahn & Rose Lumber Co. has a reputation for maintaining adequate supplies in suitable warehouses at each of its yards.

Stocks Up to Guard Against Car-Shortage Delays

"To avoid the possibility of being short on supplies this season," continued Mr. Rose, "we have already received and are keeping shipments coming for large amounts of cement and other materials which we store in our warehouses. Last year we ordered cement shipments well in advance of needs and on many occasions served customers of other dealers who were sold out or could not get shipments."



Calculation for Small Factory Building

(Continued from page 102.)

used at the middle of each span and one at each post and wall. The loads from the beams at the ends of the girders are carried direct to the post or wall and do not add to the bending effect in the girder.

"Since the center spans of the girders are 17 feet long, a girder large enough for this span will do for the end spans. This will make the spacing between beams $8\frac{1}{2}$ feet. If the floor planks are laid flat on the beams and are long enough to extend across two beams, breaking joints over the beam at frequent intervals, the length of plank to use in our formula for strength will be the distance between centers of supports, or $8\frac{1}{2}$ feet.

"To find the thickness of the floor plank, take a floor area one foot wide and $8\frac{1}{2}$ feet long, loaded with 125 pounds per square foot. This gives a uniformly distributed load of 1,063 pounds. If this strip

(Continued to page 162.)

The Endurance Test —

has definitely proved by actual exposure, that the user can place *Keystone Copper Steel Sheets* anywhere that sheet metal is used and be assured of the maximum of wear and resistance to rust.



The copper-steel alloy has established its superiority for Black and Galvanized Sheets and Roofing Tin Plates. Every builder interested in highest quality metal roofs, spouting, cornices and steel metal work needs to know about Keystone Copper Steel. When this material is used it is indicated by the Keystone added below regular brands. Look for it.

American Sheet and Tin Plate Company

General Offices: Frick Building, Pittsburgh, Pa.

Chicago Cincinnati Denver Detroit DISTRICT SALES OFFICES: New Orleans New York Philadelphia Pittsburgh St. Louis
 Export Representatives: UNITED STATES STEEL PRODUCTS COMPANY, New York City
 Pacific Coast Representatives: UNITED STATES STEEL PRODUCTS COMPANY, San Francisco, Los Angeles, Portland, Seattle

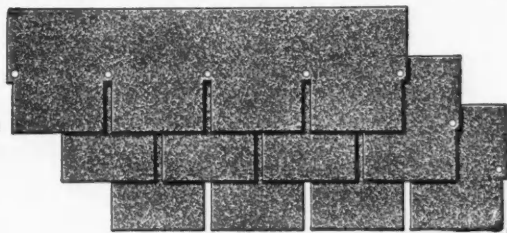

Save At Both Ends

— DEALERS who sell and builders who use Rex Strip Shingles save in many ways.

These shingles cost less than individual shingles, and weigh only 185 pounds. Thus the dealer saves, even in freight, and passes his saving along to the builder—who in turn requires less nails and less labor of nailing than with individual shingles.

This combined saving and our broad guarantee makes it easier to sell the roof to the house owner.

Our Big Catalog No. 20 that tells all about Rex Strip Shingles—and other Rex Products—will be mailed (samples included) on request.

The Flintkote Company

Incorporated

90 Pearl Street, Boston

NEW YORK CHICAGO NEW ORLEANS
 1102 Equitable Building 659 Peoples Gas Building Hennen Building



Home of Arch. Carl E. Morrison, Erie, Pa. 24-inch "CREO-DIPT" DIXIE WHITE Stained Shingles on side walls. 16-inch "CREO-DIPT" Stained Shingles (moss green) on roof.

For Roofs and Side Walls

To create more charming effects—build new or reshingle with

"CREO-DIPT" STAINED SHINGLES

You also save annoyance, muss and waste of staining on the job. You get a protective covering on roof and side walls that lasts a lifetime. Save painting and repair bills.

Only selected live cedar shingles used. Preserved in creosote against dry-rot, worms and weather by our own special factory process.

Write for Sample Colors on Wood and Book of "CREO-DIPT" Homes

CREO-DIPT COMPANY, Inc.

1028 Oliver St., N. Tonawanda, N. Y.

Factory in Chicago for West

Calculation for Small Factory Building

(Continued from page 160.)

of floor is considered as a beam 12 inches wide and 8½ feet long, we can find the thickness from our beam formula,

$$p \times 1/6 \times b \times h^2 = 1/8 W l$$

where *p* is the allowable unit bending stress for timber in pounds per square inch; *b* is 12 inches in this case; *h* is the thickness that we want in inches; *W* is the total load on the strip, or 1063 pounds, and *l* is the length in inches, or 8½ × 12.

“Using a good grade of yellow pine or Douglas fir flooring, the value of *p* may be taken as 1,000 pounds per square inch with ample safety. Putting these values into the above formula, we have

$$1,000 \times 1/6 \times 12 \times h^2 = 1/8 \times 1,063 \times 8\frac{1}{2} \times 12$$

$$h^2 = 6.8$$

$$h = 2.6 \text{ inches.}$$

This shows that 3-inch tongued and grooved planking should be used for these floors if of the semi-mill type. The actual thickness of this stock is 2⅝ inches.

“The load carried by the beams between girders is found by assuming that each beam supports an area of floor equal to the length of the beam multiplied by the distance between centers of beams. The beam at the wall carries only one-half of this load, owing to its location. All beams except those at the walls will carry a load of 16 × 8½ × 125 = 17,000 pounds of uniformly distributed load. These beams will be

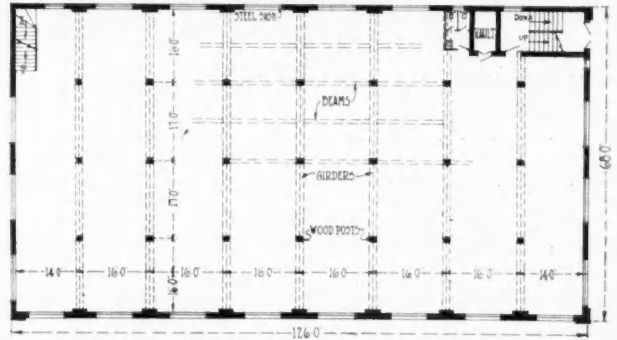

Fig. 2. General View of Floor Plan of Small Factory Building.

used as a basis for calculation, and those under a lighter load made the same size. We will use a good grade of yellow pine or Douglas fir which will allow a unit bending stress of at least 1,300 pounds per square inch.

“Again using the formula which we explained above, and assuming that the width of these beams will be 8 inches, we have

$$\frac{1,300 \times 8 \times h^2}{6} = 1/8 \times 17,000 \times 16 \times 12$$

$$h^2 = 235$$

$$h = 15.3 \text{ inches.}$$

This means that our beams will be 8 by 16 inches in size.

“The girders receive the load from the beams at
(Continued to page 164.)

At Last!

The Screen

Problems in Hand "No Sag"

Superior to any on the market. Positively will not sag.

Ask your dealer to show you "No-Sag"—the better screen door—or write us for full information and prices. It will repay you many times in satisfied customers.

WRITE US NOW.

Cadillac Lumber Company
CADILLAC, MICH.

THE MORE YOU KNOW ABOUT

BOGALUSA

Trade-Mark Reg. U. S. Pat. Office

EXTRA DENSE LONG-LEAF PINE

THE MORE YOU'LL REALIZE THE VALUE TO YOU OF RECOMMENDING IT.

“BOGALUSA” is the name *BY WHICH TO BUY* the BEST LONG-LEAF PINE THAT GROWS. **FOR ALL STRUCTURAL USES, SPECIFY “BOGALUSA”—that is your guaranty.** And unless you can identify the lumber delivered as real “Bogalusa,” you’ll refuse it as “not per order.”

WRITE US. (Cutting 1,000,000 feet a day still leaves us time to take an interest in YOU.) There’s a real value for you in the *Bogalusa Book*. (Free.)

GREAT SOUTHERN LUMBER COMPANY,
1600 Fourth Avenue Bogalusa, La.

BOGALUSA

“THER’S A DIFFERENCE”

BUILD Your Own Phonograph

It's easy with our help

A few hours interesting work saves many dollars and gives you a machine exactly to suit your ideals. We furnish motors, tone arms, case material, blue prints and full instructions. Plays any record. You can make fine profit building phonographs for your friends.

"Agents wanted for our ready built Choraleons"
Write today for our free blue print offer

Choraleon Company
112 Monger Bldg., Elkhart, Ind.

AND SAVE OVER HALF

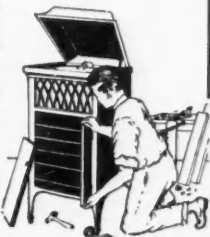

The Boss is Sizing You Up

Whether you know it or not, he's on the lookout all the time for men he can promote. He's ready and anxious to give YOU bigger work with bigger pay once you prove you can handle it.

If you *want* to get ahead, if you want to *be* somebody, to climb into a position of responsibility and good money—

Get Ready—Your Chance Will Surely Come

Choose the position you want in the work you like best—then train for it. You can do it in spare time in your own home through the International Correspondence Schools.

More than 130,000 men *right now* are putting themselves in line for promotion through the study of I. C. S. Courses. This way to success is always open. All the I. C. S. ask is the chance to tell you about it. No cost to find out. Just mark and mail this coupon now.

GET THIS FREE STUCCO BOOK **KRAGSTONE STUCCO**
AMERICAN MAGNESIA PRODUCTS CO. CHICAGO

A special book for builders—tells all about this beautiful, permanent and economical magnesite stucco.



For residences, garages, barns, etc.—new or old buildings. Wonderful elasticity—cannot check or crack—can be applied in winter.

Write for figures and book and prices—today.

American Magnesia Products Co.
413 W. 12th Place, Chicago, Ill.

Dealers Wanted

Northrop's Steel Ceilings

Beam Ceilings and choice small patterns for Residences

A large line suitable for Commercial Buildings, Schools, Churches, Theaters, etc.

A number of plain patterns, usually of Nos. 26 and 28 gauge, to put up direct to the joists in factories, garages, etc.

A line of sidings, brick and other patterns, for exterior use.

Tilings of Heavy Stamped Steel for Bathrooms and Kitchens.

Send for our catalogue and quotations.

Northrop, Coburn & Dodge Co.
41 Cherry St., New York

INTERNATIONAL CORRESPONDENCE SCHOOLS

Box 8149 SCRANTON, PA.

Explain, without obligating me, how I can qualify for the position, or in the subject, before which I mark X.

- | | |
|---|---|
| <input type="checkbox"/> ARCHITECT | <input type="checkbox"/> Law for Contractors |
| <input type="checkbox"/> Architectural Draftsman | <input type="checkbox"/> BUSINESS (Complete) |
| <input type="checkbox"/> Contractor and Builder | <input type="checkbox"/> BOOKKEEPER |
| <input type="checkbox"/> Building Foreman | <input type="checkbox"/> Stenographer and Typist |
| <input type="checkbox"/> Concrete Builder | <input type="checkbox"/> Higher Accounting |
| <input type="checkbox"/> Plumber and Steam Fitter | <input type="checkbox"/> GOOD ENGLISH |
| <input type="checkbox"/> Heating and Ventilation | <input type="checkbox"/> Common School Subjects |
| <input type="checkbox"/> Plumbing Inspector | <input type="checkbox"/> Mathematics |
| <input type="checkbox"/> Foreman Plumber | <input type="checkbox"/> SALESMANSHIP |
| <input type="checkbox"/> CIVIL ENGINEER | <input type="checkbox"/> ADVERTISING MAN |
| <input type="checkbox"/> Surveying and Mapping | <input type="checkbox"/> Window Trimmer |
| <input type="checkbox"/> Structural Engineer | <input type="checkbox"/> Show Card Writer |
| <input type="checkbox"/> Structural Draftsman | <input type="checkbox"/> CIVIL SERVICE |
| <input type="checkbox"/> ELECTRICAL ENGINEER | <input type="checkbox"/> Railway Mail Clerk |
| <input type="checkbox"/> Electric Lighting | <input type="checkbox"/> AGRICULTURE |
| <input type="checkbox"/> Electric Wiring | <input type="checkbox"/> Poultry Raising |
| <input type="checkbox"/> Electric Car Running | <input type="checkbox"/> MINE FOREMAN OR ENGINEER |
| <input type="checkbox"/> MECHANICAL ENGINEER | <input type="checkbox"/> Metallurgist or Prospector |
| <input type="checkbox"/> Mechanical Draftsman | <input type="checkbox"/> Chemical Engineer <input type="checkbox"/> Spanish |
| <input type="checkbox"/> Shop Practice | <input type="checkbox"/> Gas Engineer <input type="checkbox"/> German |
| <input type="checkbox"/> Sheet Metal Worker | <input type="checkbox"/> AUTOMOBILES <input type="checkbox"/> French |
| <input type="checkbox"/> STATIONARY ENGINEER | <input type="checkbox"/> Auto Repairing <input type="checkbox"/> Italian |

Name _____
Occupation & Employer _____
Street and No. _____

City _____ State _____

If name of Course you want is not in this list, write it below.

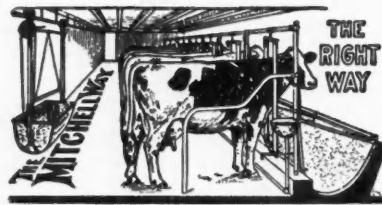

STANCHIONS

Adjustable to fit Cow or Calf

STEEL STALLS

with Stationary or Folding Sure-Stops

CARRIERS

for Milk, Feed or Manure

26 STYLES

Send for Complete Catalogue

MITCHELL MFG. CO.

29th and Forest Home

MILWAUKEE,

WISCONSIN

BARN BUILDERS Make Good Money
and Add to Their
Reputations by Recommending and Installing
Mitchell Barn Equipments

Write for "HOW TO DO IT"



County Agents Wanted

"Everlasting" Steel Signs and
"Bull-Dog Lightning Rods

FARMERS have started a movement to "name the farm." Dead easy for you to sell them our baked-enamel steel letters. Make any name. For barns or home. Arranged together they form a handsome sign with border. Enhance the appearance of any building. Easily put on. Removable if necessary. Last a lifetime. Will not fade. Low price. Get our proposition quick—means big profit for you as County Agent.

"Bull-Dog" Lightning Rods

Protect the home and buildings. \$500 guarantee against damage from lightning. Install them any time. Big chance for sales is when barn is being built, and this extra money you make will be "soft." Some of our agents are simply coining money on our proposition. Don't fail to write for details. Do it today. You'll be glad you did.

THE TOLEDO CABLE COMPANY

6 Davis Building

TOLEDO, OHIO

Calculation for Small Factory Building

(Continued from page 162.)

the center and at the ends, as shown. The beams at the center bring a total load of 17,000 pounds to the girder. This acts as a single load and causes a bending moment of $\frac{1}{4} W l$, instead of $\frac{1}{8} W l$, where l is 17×12 in this case. If the timber used has a bending strength of 1,300 pounds per square inch, as in the beams, we can make a similar calculation for the depth of girder after we have assumed a width. We will first try a 14-inch width, as we can get 14 by 16-inch timbers without difficulty. If this size is not large enough, we will use a double girder.

"From the formula, we have

$$\frac{1,300 \times 14 \times h^2}{6} = \frac{1}{4} \times 17,000 \times 17 \times 12$$

$$h^2 = 285$$

$$h = 17 \text{ inches.}$$

This shows that a 14 by 16-inch beam would be a little too light. Using a double beam consisting of two 8-inch pieces placed side by side and bolted together, we would have a width of 16 inches. Placing this value of the width in the formula and solving again, we have

$$\frac{1,300 \times 16 \times h^2}{6} = \frac{1}{4} \times 17,000 \times 17 \times 12$$

$$h^2 = 250$$

$$h = 15.8 \text{ inches.}$$

Therefore, a girder made up of two 8 by 16-inch timbers will be used.

"The roof load may be taken as 40 pounds per square foot of roof without the weight of the roof itself. If the weight of the roof plank and roofing material is taken as 12 to 15 pounds per square foot of roof, the total roof load will be about 55 pounds per square foot.

"A calculation for the thickness of the roof plank similar to that made for the floor plank gives the equation,

$$1,000 \times \frac{1}{6} \times 12 \times h^2 = \frac{1}{8} \times 8\frac{1}{2} \times 1 \times 55 \times 8\frac{1}{2} \times 12$$

$$h^2 = 2.98$$

$$h = 1.73 \text{ inches.}$$

This indicates that the roof planking should be at least 2 inches thick, and 2½-inch stock will give a stiffer roof.

"The roof beams will be assumed to be 6 inches wide and the depth calculated. These beams carry a uniformly distributed load of $16 \times 8\frac{1}{2} \times 55 = 7,480$ pounds. Our formula then gives

$$\frac{1,300 \times 6 \times h^2}{6} = \frac{1}{8} \times 7,480 \times 16 \times 12$$

$$h^2 = 138$$

$$h = 11.7 \text{ inches.}$$

This shows that the roof beams should be 6 inches by 12 inches in size.

(Continued to page 166.)

Your Home, Dairy, Barn and Poultry House



can be properly ventilated at small cost by the use of

ROYAL VENTILATORS

Foul, vitiated air in your home, barn, etc. is just as poisonous now as in the summer and more likely to breed diseases. It is necessary to have a proper amount of fresh air to insure proper health.

The **ROYAL** System of Ventilation is adapted to every purpose. Write for particulars.

ROYAL VENTILATOR CO.
417 Locust St., PHILADELPHIA, PA.

You Can't Afford to Be Without "Nice" Liquid Filler

BECAUSE it means an economy of both time and material to dry hard in 8 to 12 hours, allowing one-coat-a-day work to be done with safety.—It will enable you to make first-class jobs on close grained woods with one coat of filler and one coat of varnish.—It will hold out varnish better than shellac and will cover 800 sq. ft. to the gallon.—It will make the very best Flat Stain by simply shading with colors in oil or a varnish stain by adding a little good mixing varnish. It is very valuable as a first coat for floors to bring them up to an even surface.—It helps the user over many a difficult place and adds to the quality of his work.

Be sure you get the genuine "Nice" Filler. Ask your dealer to show you Nice or write for our prices and catalog of varnishes, paints, coatings, fillers, enamels, etc.

Eugene E. Nice Philadelphia, Pa.

CHIEF ALL-STEEL CUPOLA

New-improved, scientifically designed ventilating cupola for all buildings. Up-to-date in design, material and construction. Used and approved on hundreds of farms. Made of heavily galvanized steel with base strongly braced. Can't rust, rot, or blow off. Absolutely storm-proof and bird's-nest proof.

Easy to Install—Sure to Please Your Customers

Chief Cupola saves time and labor installing—base bolts directly to roof and cupola bolts to the base. Only six bolts needed. Meets all requirements—insures adequate ventilation—satisfies all users. Write for full description, prices, etc.

Shrauger & Johnson Co.
430 Walnut Street, Atlantic, Iowa

GET ALL THE PROFIT



Shipped Ready to Install

Easy to Erect

Your reputation and future orders depend upon the equipment you recommend. Don't take a chance. Get the present and future profit by recommending and equipping the barns you build with

O-K Cupolas

Every one you erect adds to your reputation. They solve the barn ventilation problem and sell themselves. **O-K Cupolas** are neat in appearance. Bird, storm, rust and rot proof. Made of heavy galvanized steel. Cost no more than the ordinary kind.

Special Prices to Contractors and Builders where we are not represented

Write for full particulars of this and other money-making specialties

Phillip Bernard Co.
2400 Floyd Ave. Sioux City, Iowa



Modern home builders appreciate the value of proper ventilation for comfort and health.

Carpenters find it very profitable to demonstrate the advantages of

"GLOBE" VENTILATORS

They may be installed easily on any residence, summer cottage, garage, bungalow, store, office or factory building, and give thorough satisfaction.

Every installation gives the carpenter a good margin of profit on the ventilator itself, plus the profit on his time and the material used in the construction of base and flues.

Our Booklet "F" gives many suggestions which will be helpful in securing additional work. Send for it today.

Globe Ventilator Co.
TROY, N. Y.



WE CAN assure you prompt delivery on a Miami Trailer if we get your order in good season.

This Miami Trailer was designed and built for Contractors and Builders. Body of Ohio Oak, steel lined, double end gate dropping to floor level which permits the hauling of material up to twenty feet in length.

Special shock absorbing draw bar which protects your machine from all sudden shocks and vibration. Special constructed chassis that insures perfect trail with car.

The busy season is here and we are in position to make immediate shipments. Ask for prices and complete description of fourteen different models.

Miami Trailer Company Troy, Ohio



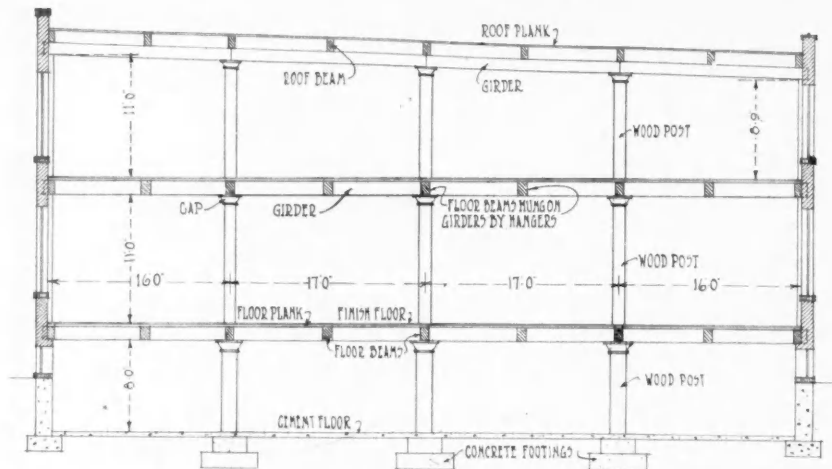

Fig. 3. Cross-Section of Small Factory, Showing Arrangement of Posts and Girders.

Calculation for Small Factory Building

(Continued from page 164.)

"A calculation for the roof girders similar to that made for the floor girders, using the loads from the roof beams, shows that the roof girders should be made of two pieces of 6 by 12-inch timber bolted together.

"The size of the posts or columns will be found from the Winslow formula given below:

$$s = c \left[1 - \frac{l}{80d} \right]$$

where *s* is the unit stress on the column cross-section

in pounds per square inch, *c* is the allowable crushing strength of the timber in pounds per square inch, *l* is the length of the column in inches, and *d* is the least side dimension of the post in inches.

"Each post or column on the top floor supports a load of about 15,000 pounds. Assume a square post *d* inches by *d* inches in size. The formula filled in with proper values will be

$$\frac{15,000}{d^2} = 1,200 \left[1 - \frac{12 \times 12}{80d} \right]$$

where 1,200 pounds per square inch is the allowable crushing strength of the timber, and 12 × 12 is the length of the post. Solving, we find *d* = 5 inches (nearly), therefore, we should use posts for this floor at least 6 by 6 inches square as the nearest safe commercial size, but an 8 by 8-inch post will give better fire resistive qualities.

"The posts on the first floor carry a load of 15,000 pounds from the post on the floor above and a load of 34,000 pounds from the floor beams and girders, making a total load of 49,000 pounds. Filling in the

(Continued to page 168.)

Sultan Portable Saw Rigs

solve your saw problems. Time hammers on them continually and hard but Sultan Saw Rigs come up smiling, still rendering their usual perfect service.

Several Sizes—Attractive Prices.

You are naturally interested in the quickest and most economical way to accomplish your mill work. The Sultan solves this problem.

Your next move is to cut out coupon below. We are making many special propositions now so do not delay! Every moment counts! Do it now!

Whitman Agriculture Co.
ST. LOUIS, MO.

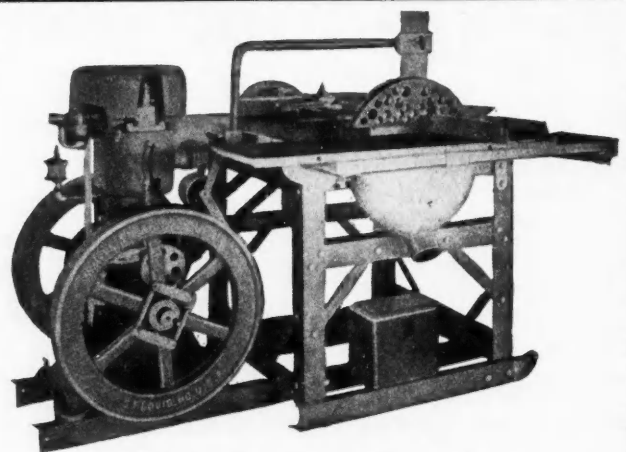

3-B Sultan Saw Rig

CUT HERE



Here's the Coupon for Quick Action

Please send special low prices, also your new catalog of Sultan Builders' Equipment.

Name

City..... State.....

MYERS Garage Door Hangers



SPECIAL FEATURES

Heavy Malleable Iron Frame with Crank Shaped Stem. Vertical and Lateral Adjustments. Double Stayon Device. Tandem Trolleys and Steel Roller Bearings—They push, they pull easily, and "Stayon" the Track.

Afford a Simple, Complete and Highly Satisfactory Door System for Garages, Barns and Other Buildings.

They have a triple service alliance which is appreciated by dealers, contractors and builders—Myers Garage Hangers can be used for inside sliding doors with curved section of track in corner—they work equally well for hinged folding doors, give just as good service for regular sliding doors, and note particularly,



operate satisfactorily on any 1 1/4-inch Flat Steel Track. Catalog tells more about them—Ask for a copy today

F. E. MYERS & BRO., Ashland Pump and Hay Tool Works, Ashland, Ohio

PEXTO

MECHANICS' HAND TOOLS

Manufactured by

The Peck, Stow & Wilcox Company



Mfrs. Mechanics' Hand Tools, Tinsmiths' and Sheet Metal Workers' Tools and Machines, Builders' and General Hardware



Southington, Conn. Cleveland, Ohio

Just The Thing! Low Price

At last we have a Scriber that we want. A good efficient scriber at lower price.

The "Acme Scriber"

Every carpenter and joiner needs it. Ask your dealer or send 25c and we will mail postpaid.

Hollander Mfg. Co.
2618 E. 53d St. Cleveland, O.





THIS IS
THE HAMMER
WITH THE
PEDIGREE

OF COURSE
IT'S A

GERMANTOWN
MASTER BUILDER

Price
\$1.50

Germantown Tool Works

PHILADELPHIA, PA.
Branch: 62 East Lake Street, Chicago

Expert workmen the country round know and use this hammer. The finest possible quality in material, design and workmanship. Octagon shaped handle of second growth hickory, ideal hardness, and a claw that will grip all size nails with a grip that holds. Positively the **only** hammer for the workman who wants the **BEST**. Three sizes, Nos. 745, 11 oz., 746, 16 oz., 747, 20 oz., at \$1.50 each.

\$60 A WEEK AND THIS FREE AUTOMOBILE

Backed by
10-Year
Gold Bond
Guarantee



Exclusive Territory
100% Profit

I OFFER this Big Money and a FREE Automobile to one hustling Representative in each county in the U. S. This is not a contest. Every agent can get a FREE Automobile and \$60.00 a week. You don't need experience. I want you to advertise. Sell and Appoint sub-agents for the **Robinson Folding Bath Tub**. It's a whirlwind seller. Solves the bathing problem. No plumbing, no waterworks needed. Full length baths in any room. Folds in small roll. Won't leak. Self-emptying. Ten-year Guarantee. Rivals \$100 bathroom. Never such a big seller; never such a big money maker. Never such a liberal offer as this. Think, \$60.00 a Week and FREE Automobile.

Sensational Sales Successes

It's easy. You can do it. J. H. Brown, N. J. says: "14 calls, 14 sales. How's that?" (\$70 profit). R. C. McCartney, Mich., says: "Sold 5 tubs in 15 hours." (\$25 profit). "Sold 6 from noon to night," says J. A. Hembd, S. D. (\$30 profit). Ned Bolle, of Idaho, sold 8 first afternoon. (\$40 profit). H. M. Veizy, N. D., sold 10 in 3 days. (\$50 profit). W. A. Gloeckler, S. D., sold 11 in three days. (\$55 profit). A. R. Engle, Mont., got 11 orders in 2 1/2 days. (Addresses furnished on request). You can do as well as these men. You can sell 2 a day. That means \$60 a week, clean profit, and a big, speedy Touring Car Free. Little capital needed. I grant credit to deserving men. Furnish you with a Demonstrating Tub, on liberal plan. You can't lose. 70 per cent of the homes have no bathroom. They need the Robinson Tub. Just show tub; take the order. Quick sales and immense profits. This is YOUR chance. Don't delay. Get busy. Write today for Demonstrating Tub and FREE Automobile offer.

H. S. Robinson, President, The Robinson Cabinet Mfg. Co.
4757 Factorles Building TOLEDO, OHIO

Calculation for Small Factory Building

(Continued from page 166.)

formula again, we have

$$\frac{49,000}{d^2} = 1,200 \left\{ 1 - \frac{12 \times 12}{80 d} \right\}$$

"In this case, d is found to be about $7\frac{1}{2}$ inches. This means that an 8 by 8-inch post could be used, but a 10-inch square post would give better results.

"The basement posts if of wood should be figured as above, using a length of $10\frac{1}{3}$ feet, or $10\frac{1}{3} \times 12$ inches, and a load of 83,000 pounds.

$$\frac{83,000}{d^2} = 1,200 \left\{ 1 - \frac{10\frac{1}{3} \times 12}{80 d} \right\}$$

Solving, we find d to be about 9 inches. This means that a post 10 by 10 inches will be needed for the basement.

"Next time," said the Boss, "we will design the steel and iron members which might be used in the place of timber."



The Possibilities of the Steel Square

(Continued from page 73.)

matter what the shape is or how it is developed, the real question is how to develop the hip to coincide with it. The method is as follows: Select a floor or level space, on which lay off the full size of the run,

rise and desired curve for the common rafter, then lay off parallel lines with the seat, as shown, letting them extend beyond the curve for the common rafter, as shown. These lines do not necessarily have to be evenly spaced, say not more than 4 inches apart, and when the curve is receding it is well to have them even closer than that amount because the measurement checks, as we will show, will not be so far apart, thereby making the measurement checks more accurate for running the offhand curve for the corresponding hip.

We are now ready to proceed with the measuring process as follows: First, measure the parallel lines with the standard rule from the rise line to the curve line of the common rafter; then go over the same line and measure off the same amount with the stretch rule for the desired angle and check. After thus measuring all of the lines, run an offhand curve thru the checks and the required curve will be defined for the corresponding hip.

There is another problem in connection with the hip that should not be overlooked, and that is the backing of the hip. Someone has said that this is a lost art, and from long personal experience we believe the saying is not very far out of the way.

Of course, in the case of the reasonably low, straight pitch, it does not matter so much when the seat cut is made to allow for the backing, that is, so

(Continued to page 170.)



How about F A L L business?

Do you expect a slump during the coming Fall and Winter season? Are you interested in a proposition that would keep you busy every working day of the season? In other words do you want to spend a little more energy now and line up business that will carry you through the dull season?

If so, you will want to find out about

ALLMETAL WEATHERSTRIP

It's a live specialty! Why not work up a fine substantial business with Allmetal Weatherstrip by the assistance of our carefully devised, sure-fire, sales plan. Allmetal Weatherstrip, owing to its simplicity of design, is the easiest to install—it is the best known and therefore easiest to sell.

Allmetal has Uncle Sam's Approval

It is the one strip that will not crack, rust, decay or disfigure the woodwork. He has selected it for his defense against leaky, balky windows and high cost of fuel. It is the perfect, the modern, the only strip to use.

We show You how to get quick results

Our short cut methods get live prospects quickly. We give you the benefit of our experience. Supply you with advertising material adapted for your particular purpose. Write—get started NOW!

Allmetal Weatherstrip Company, 230 West Madison St., Chicago

Diamond Metal Weather Strips and Diamond Calking and Glazing Compound

Have built up a permanent, profitable business for a large number of *contractors* and *carpenters* who took the agency as a side line and developed enough business to devote their entire time to it, some making from \$3,000 to \$5,000 per year clear profit. *Why? Because* the goods are *the best on the market*—which makes satisfied customers. If you're not a Diamond agent you're missing something. Write for agency proposition—now—today.

Address C. J. PARSONS, Manager
The Diamond Metal Weather Strip Co. Columbus, Ohio

That Ugly Open Space Under the Door!

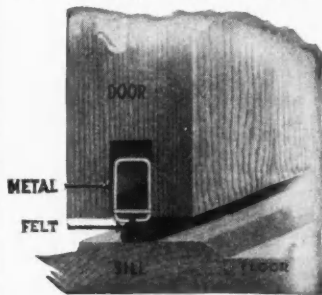

Note "That Positive Grip" in Felt.
The Heavy Felt is Warranted to Stay.

Who in the wide world can fix that wide space under the door? You can, whether it be wide or narrow, if you are in the weather strip business. You can fix it right, too, with the **Eveleth Door Bottom Weather Strip**.

It is being used more and more each year in many of the leading cities by the leading weather strip men.

It is being specified by the ablest architects the world knows, for the most expensive doors made. Write today for prices, large cut showing mechanical operation, and other interesting information.

EVELETH

MFG. CO., (Not Inc.)
2 miles west of Chicago City Limits

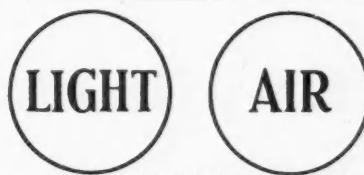

A SUCCESSFUL SHADE ADJUSTER

Light and air at your window may and should be controlled. Do it with the **Eveleth Shade Adjuster**, the ONE adjuster that remains absolutely level, and one that is warranted to give you long service without attention. The **Eveleth Shade Adjuster** is just as good as **Eveleth Weather Strip**. Write and let us verify this statement.

Installed in Chicago by the
WM. ST. CLAIR SHADE CO.,
6 E. Lake Street.

12 Ashland Ave., River Forest, Ill.

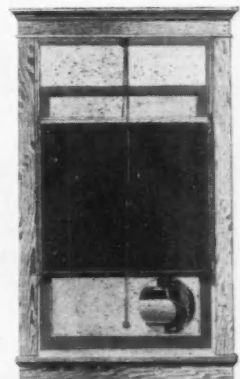

Carpenters Wanted

THE HENRY AIRTIGHT WEATHERSTRIP for the bottom of DOORS and CASEMENT WINDOWS. A perfect protection against rain, cold, snow, and dust. Approved by architects, contractors, and builders wherever known. Carpenters and others are making big money selling them.

Write today for our proposition.

The
**Henry Airtight
Weatherstrip Co.**
Crawfordsville,
Indiana



Wind-Proof—Rain-Proof—Rot-Proof Chief Galvanized Iron Barn Bats

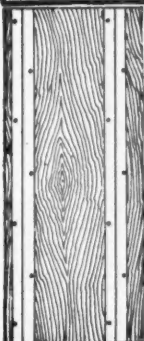

Make your buildings *tight*. Chief Galvanized Steel Strips fill the cracks between boards and make strong, neat, weather-proof joints. Keep out vermin. Cannot rot, warp or split like wooden batten. Always fit. Allow for contraction and expansion of boards without loosening nails. Furnished in 6-7-8-9-10 ft. lengths with interlocking joints. Write for full information.

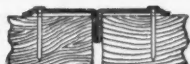

Shows end view of Chief Batten with joint closed. Siding expanded. Note position of the batten in the crack.



Shows end view of Batten with the joint open and siding contracted. Chief Battens automatically accommodate expansion and contraction.

SHRAUGER & JOHNSON

430 Walnut St. :: Atlantic, Ia.

—Attention CARPENTERS AND BUILDERS!

SHOGREN Metal Weatherstrips

will make an extra profit for you in your business, if you write us immediately regarding information on installing Shogren Metal Weatherstrips in your locality.

The Shogren Metal Weatherstrips are by far the most superior on the market today and are also the easiest to install. You can install Shogren Metal Weatherstrips in half the time of any other make. They embody every advanced idea plus an exclusive method of operation which has no equal and the prices are no higher than what every customer on your list can well afford.

Write us now for information

Without obligation, we will gladly send you complete data on the Shogren Metal Weatherstrips and how you can cash in on our proposition now. Write today.

SHOGREN WEATHERSTRIP CO.
14 East Jackson Blvd. CHICAGO, ILL.

Possibilities of Steel Square

(Continued from page 168.)

that the edges of the hip will be in the plane of the back of the common rafter, but this allows a hollow space between the roof boards and the top of the hip which should not be in a first-class job.

In the case of the curved roof it is more of a problem of how to find the backing line on the side of the rafter on account of the ever changing curvature of the roof, but this should not be allowed to worry one, as the amount to set off on the parallel lines is exactly the same on all the lines and by running off-hand curve thru these points will give the proper gauge line on the side of the rafter from which to remove the wood to a center line along its back.

The proportion is found in Fig. 1 as follows: Let 12 on the tongue represent one-half of the hip's thickness, then as the figures shown on the blade are to 12, this will be the proper amount to set back on the parallel lines to obtain the proper gauge line. Thus, for the octagon hip it would be practically five-twelfths of one-half of the hip's thickness. For the square

corner it would be twelve-twelfths of one-half its thickness and for the equilateral angle it would be practically twenty-one-twelfths of half the hip's thickness, which in this case is equal to 1 3/4 inches.



The Builder as a Fire Guard

(Continued from page 54.)

inches out from the face of the chimney breast. A space of from 2 to 4 inches should be left around the brickwork to separate it from all wood framing. This is very clearly shown in Fig. 4. The air space is a protection. If uneven settlement takes place the lath and plaster are on an independent framework and to that extent free from cracking. Metal lath is the proper material to use around all flues, both as a fire retardant, and to prevent cracking of plaster which may result from shrinkage of the wooden framework and wood lath which surround the chimney.

Figure 1 illustrates a better method, that of filling the space with incombustible material. This is held in place by a strip of sheet metal at the bottom of the

(Continued to page 172.)



THE H. B. IVES CO.

NEW HAVEN, CONN., U. S. A.

ESTABLISHED 1876

INCORPORATED 1900

MANUFACTURERS OF

BUILDERS' HARDWARE

HIGH GRADE WINDOW AND DOOR SPECIALTIES

Write for Illustrated Folder

**CONTRACTORS - BUILDERS - CARPENTERS
DO YOUR OWN PLUMBING-HEATING**

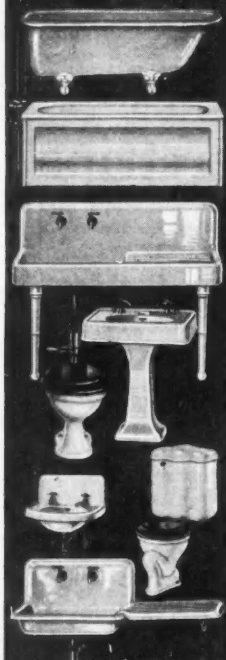

Our New Hardin Easy Way

Any handy man with a few ordinary tools can easily install our plumbing or cut to fit heating outfits with the aid of our plain installing plans and instruments and **SAVE** one-half. Our new method is perfect, simple and easy. You save high cost of skilled labor; save unnecessary material.

Our New Cut-to-Fit Easy Way

Send for our new valuable complete Handy-Man book catalog. It shows and describes over 10,000 different plumbing and heating fixtures and supplies. Separate wholesale discount sheet applying to prices quoted in the catalog is inclosed. This book clearly explains and shows **our new Hardin simple method**. Shows you how easily you can install any kind of plumbing or heating plant our new, original, practical, cut-to-fit easy way. No loss or waste. Gives many practical suggestions on what fixtures to select and how to install them, also the proper heating plant to meet your requirements. Tells you how to save on material, time and labor by installing plumbing and heating this new, original, practical and economical way.

Every carpenter, contractor and builder needs this free, complete and valuable Handy-Man Book.

WRITE TODAY

Hardin-Lavin Co.

40 years at

4532-42 B, Cottage Grove Ave., Chicago



Hardin-Lavin Steam or Hot Water Boiler.

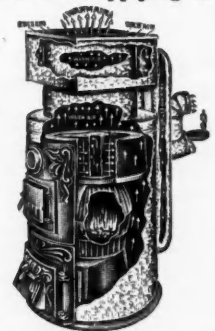

New Hardin-Lavin Pipeless Furnace.

GF Waterproofing Service

GF Waterproofing Products and Technical Paints effectively and economically waterproof, dampproof and harden concrete and all forms of masonry both above and below grade—preserve decorative effects—protect finished surfaces, whether wood, plaster, concrete or metal, against water, wear and stains.

Mr. Builder: Increase Your Income Right Now—This Month

Here's something right in your line—a Chemical Closet that you can sell to a home builder cheaper than a wooden privy and make a bigger profit for yourself. Here's something you can sell at odd times or turn over to your son or your foreman to sell.



RO-SAN Chemical Closet

An absolutely sanitary, odorless indoor closet that may be placed anywhere in the house. Abolishes the germ breeding out-door vault. A comfort and convenience when there is no sewer connection. Germs killed by chemical. Easily emptied as the ash pit of a stove.

AGENTS WANTED

We want one live carpenter contractor in each town to act as our agent. Hundreds of builders are selling these fixtures. Good profit for little work. We help you sell them. Write today for complete details.

ROWE SANITARY MFG. CO.
912 Rowe Building Detroit, Mich.
Ask about the Ro-San Washstand. Hot and cold running water without plumbing.

Comfort Indoor Closet

Odorless Sanitary Germ-Proof
No Sewer — No Waterworks — No Plumbing Needed

This modern home necessity is fast taking the place of the unsightly, unhealthy, inconvenient outhouse in the back yard. Thousands now in use and all giving complete satisfaction. Can be put wherever convenient in the house. No odor whatever. Gives city convenience in the country or town.

Abolish Outdoor Closet

Anybody can afford one. Saves those cold night trips out-of-doors. Impossible to get same amount of comfort for the money another way. Sold on 30 days' trial and under sworn guarantee to refund all money if not entirely satisfactory. Send for description and prices today. Be fair to your family.

Agents Make Big Money Easily

Comfort Indoor Closets sell themselves as fast as people understand about them. Contractors and carpenters are making big money by merely suggesting this closet. Write for details of this exclusive agency offer. Send postal now before somebody else gets your territory.

Comfort Chemical Closet Co.
312 Factories Bldg. TOLEDO, OHIO



Pass on, Mr. Repair Man!

For years and years—
This RU-BER-OID Roof will need no repairs.

For RU-BER-OID is sparkproof, rotproof, rustproof and weatherproof.

It contains nothing that can crack, warp, melt or leak.

Many imitations LOOK like RU-BER-OID. Ask your dealer to show you the genuine, with the "Ru-ber-oid Man" on the roll.

Made in Slate Gray, Tile Red and Copper Green.

THE STANDARD PAINT CO.
587 Woolworth Building, New York
BOSTON CHICAGO

Also makers of Ru-ber-oid Shingles and Impervite Waterproofing for Concrete



Pronounced "RU" as in RUBY
RU-BER-OID
ROOFING
COSTS MORE - WEARS LONGER
MADE BY THE STANDARD PAINT COMPANY, NEW YORK BOSTON CHICAGO
Look for the "Ru-ber-oid Man" on every roll of genuine Ru-ber-oid

Make Your Own Brick

and
\$20 to \$50
Extra Daily Profit

10000 Brick
or
1000 Blocks
Daily



The Helm Press

Be independent of the clay brickmaker and dealer. Put yourself in a position to make more money on your contracts, to take bigger jobs—more profitable jobs without worry of delays or lost time eating into your profits. With a Helm Press you can make 10,000 Brick or 1,000 Blocks a day—\$20 to \$50 daily profit. Operates under 80,000 pound pressure. No tamping—no burning—every brick or block perfectly true. A big demand in your own community for this superior kind of building. Equip yourself to supply it.

Helm "Dry Wall" Building System

Appeals to builders, contractors and architects. It overcomes the opposition to concrete because it offers absolutely Dry Wall construction. It saves money for builders, as no furring and lathing are required, and it makes rigid walls and fireproof walls. This is the system which is bound to get you business and give you the advantage over all other products.

Send for Our Valuable Book FREE

Let these FREE books tell you all about this great opportunity which is open to you today. It will tell you all the details of this system, about the Helm Press and the Dry Wall building system. It will show you how easy it is to start a profitable business. It tells how each product is made, how it is cured and sold. Write today. Use a post card or coupon.

Helm Brick Machine Co.
470 Mitchell Street
Cadillac, Mich.

Gentlemen—Please send FREE your book on Concrete and Helm Presses.

Name.....
Address.....

HELM BRICK MACHINE CO.
470 Mitchell St.
CADILLAC, MICH.

Builder as Fire Guard

(Continued from page 170.)

floor joists as shown also in the section of an interior independent chimney. Figure 2 shows a fireplace plan with floor framing and method of insulating the hot masonry flues. The incombustible filler also acts as a firestop from the floor below. If for any reason it becomes necessary to plaster directly on a chimney it is recommended to put asbestos board back of the trim and flooring, and a fire protective material below between the floor framing and the brickwork. This is well illustrated in Fig. 3.

A place often overlooked is in the attic where the chimney projects thru the roof. The section shows firestopping between the chimney and framing. When flashing is being considered there is nothing better to use than copper. It is true that it is somewhat more expensive than other sheet metals but it is permanent, whereas tin or sheet iron will rust out. It is difficult to replace a flashing after it has given out. Zinc resists corrosion well but melts easily, and in case of fire would quickly disappear leaving a draft opening around the chimney. This tends to spread the fire. For the same reason it is not wise to use lead flashing.

There should be but one connection for each flue. This will prevent sparks passing from one opening thru another. On account of its ability to resist the action of heat and flue gases, portland cement only should be used in constructing chimneys and

flues. Lime mortar disintegrates in time and is likely to fall out of the joints, choking the flue and producing holes thru which fire may originate.

There are two other causes of fire which should be in the list of construction "DON'TS."

DON'T support a chimney on timber construction of any building, on floors, beams, wooden rafters or brackets, nor on inadequate masonry foundation when the chimney rests on the ground. Wooden construction is certain to shrink, and beams carrying heavy loads always deflect in time. When settlement occurs such movement not only injures the walls and ceilings of the house, but is very likely to crack the chimney and render it dangerous. Such chimneys are always several feet in height above the roof and will sway in a heavy wind due to surface exposure and unstable support. This also tends to produce open joints at the roof line which is a most hazardous place for sparks to issue as they come in direct contact with the woodwork. A small fire around the base of the support, be it on wooden or metal brackets, may drop the chimney and cause a draft for the rapid spread of the fire.

DON'T place wooden joists in the wall of a chimney, nor studding, furring or other woodwork in contact with the wall of the chimney. As an added protection a coat of cement plaster applied directly on such parts of the chimney as are to be encased by a

(Continued to page 174.)

The Home Hot Blast Pipeless System

is the only practical and scientific way of heating with a pipeless furnace. There is no draft over the floor, so common with other pipeless systems.

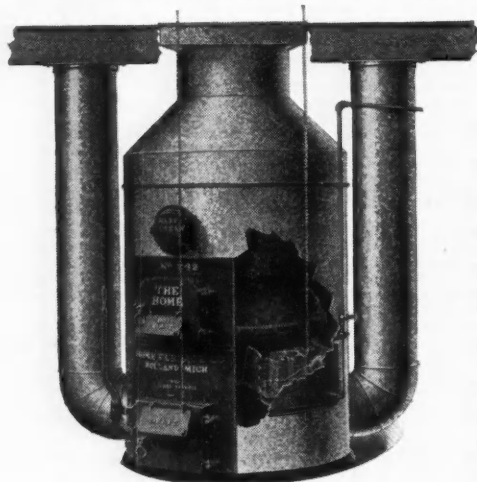

The Home Pipeless is in a class by itself with its distinctive features. It has anti-clinker grates—hot blast smoke consuming combustion chamber, burning the smoke and saving the fuel. It has the only practical patented automatic Humidifier on the market, giving constant flow of clean, moist air automatically, which is so essential for the health of the occupants.

Write us at once for our agency proposition to contractors and builders. We can give the agency to only one party. Do not delay but write at once.

Home Furnace Company, Holland, Mich.

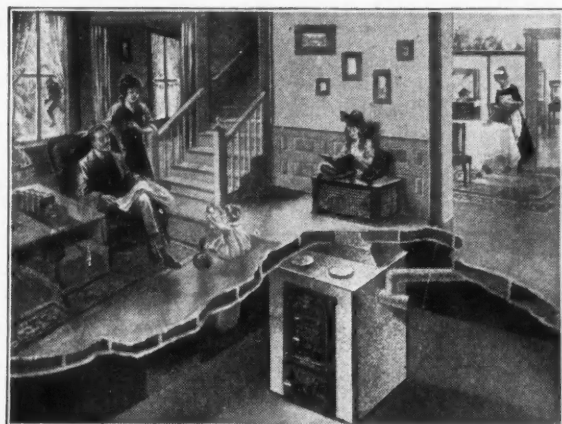

Majestic

Duplex Heating System

IT will be well worth while for you to investigate thoroughly the Majestic Duplex Heating System before you decide what heating system to put in that new house or store.

The Duplex draws the cold air from the floor through the cold air duct while pure warm air is discharged from the main face of the register. And the register itself makes an excellent bench or table.

The Majestic Duplex furnishes more heat, uniformly distributed and at two-thirds the cost of the old-fashioned methods. Easily installed in new or old home. Write today and get the facts about this modern, efficient heating system.

The Majestic Co., 702 Erie St., Huntington, Ind.

Furnace Contracts



You can pile up a nice profit without interfering with your regular business by taking up our Agency Proposition for installing

Hero Pipeless Furnaces

They are easily and quickly installed; they are the simplest, most practical furnaces for heating homes, stores, or halls; they represent an economy in installation as well as "First Cost;" and they are sure to give complete satisfaction to users.

Chas. Smith Company

57 W. Lake Street Chicago, Ill.

We Take **LIBERTY BONDS** at Full Face Value, Plus Interest, the Same as Cash



If your money is busy, you can buy a **HESS WELDED STEEL FURNACE** with a bond or two and that furnace will earn more for you in saving of fuel, in labor, in solid comfort and in **HEALTH**; than your bond would earn. Let us tell you more by mailing you our latest edition of "**MODERN FURNACE HEATING**," a 48-page book of real education in furnace heating. It's free.

Hess Warming & Ventilating Co.

1220 Tacoma Building, Chicago, Ill.

Special Rates to Contractors

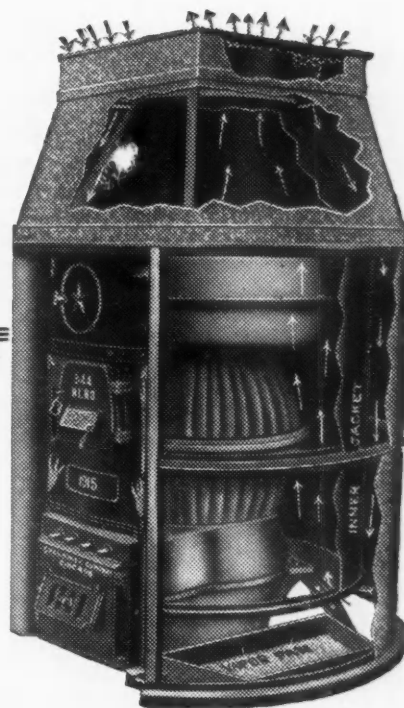

Builder as Fire Guard

(Continued from page 172.)

wooden partition or other combustible construction is recommended to help seal all possible openings in the joints.

The principal conditions to keep in mind in building a chimney are to isolate it as thoroly as possible from all combustible materials, to build it as firmly as possible to prevent cracking from any cause, and to make the chimney as nearly a sealed passage for fire and heat as possible.



How Camp Devens Was Built

(Continued from page 76.)

which protects the joint thru the roof from the weather is soldered on. Also the outer protecting pipe with its clay pipe lining, the whole to surround the stack where it goes thru the floor and the roof, is fitted with brackets to hold up the upper half of the pipe. The products are trucked to the buildings, where all that has to be done is to connect up the sections with each other and with the stoves. Each stove has a galvanized iron drum around it, arranged so that the maximum amount of air will be heated. Where the stack goes thru the second story floor also, the hole is cut several inches too large and fitted with a collar drum thru which heated air circulates into the room.

The contractor whose organization was hired to handle this work as individuals is Joseph A. Nelson, of Boston.

As for the carpenter work, that was done in the ordinary way. After the sills or main joists were down, the cross joists were delivered by the unloading laborers exactly on the pencil marks where they were to go. All the carpenters had to do was turn them on edge and nail them. A gang of laborers under a foreman was attached to each general foreman of carpenters. Carpenters were forbidden to carry any lumber. They were supposed to use themselves and their tools in a more valuable way. Studding was framed on the floor and afterwards the whole side of the building was hoisted into place by stringers attached to the top. On some of the roofs there was a carpenter to every rafter, and enough left over to put the boards in place. The roofers were a separate gang. There was also a separate gang of form-builders for the concrete foreman. Forms were used over and over again.

The concrete superintendent put his twenty-two mixers in charge of one foreman, similar to the master of trucks. He had to see that the moment a mixer was thru on a house, the transporting gang was ready to move it to a definite next place. This made it possible for the mixers to do about twice the ordinary amount of work.

Doors were made in a special shop down beside the switchyard. Sash and windows were bought in car loads, all manufactured. Doors and windows were the only things painted.

(Continued to page 176.)

Learn to Be a Draftsman and Draw Your Own Plans

By means of these two books the contractor, builder or carpenter can advance by easy steps from the first principles of drafting room practice to the complete work of an architect's office, including drawing to scale, tracing, detailing, lettering, rendering, designing, etc. He can combine the work of the architect and builder. He will learn not only how to plan the structure, but how to lay out the work, specify the materials and finish, make the contracts, and take complete charge. A complete set of plans with every dimension, all sizes of windows, doors, etc., is shown in these books. This serves as a guide as it shows the process from the preliminary sketch to the finished plan.

Radford's "**Mechanical Drawing**" is a book of 272 pages, with 165 illustrations, and a supplement showing perspective views and floor plans of 41 brick, cement and frame residences.

Radford's "**Architectural Drawing**" is a book of 304 pages, with 147 illustrations and a supplement showing perspective views and floor plans of 41 brick, cement and frame residences.

Each book is printed on high-grade paper, bound in cloth, is 6x9 inches and has a beautiful illuminated cover.

Don't Depend on Another Man's Brains

Develop your own ideas. Be in a position where you can work a customer's hazy suggestions into a tastefully arranged, complete plan, showing all dimensions.

* One of these books and a year's subscription to the American Builder for only \$2.00, the regular price of the magazine alone. Both volumes and a year's subscription for \$3.00.

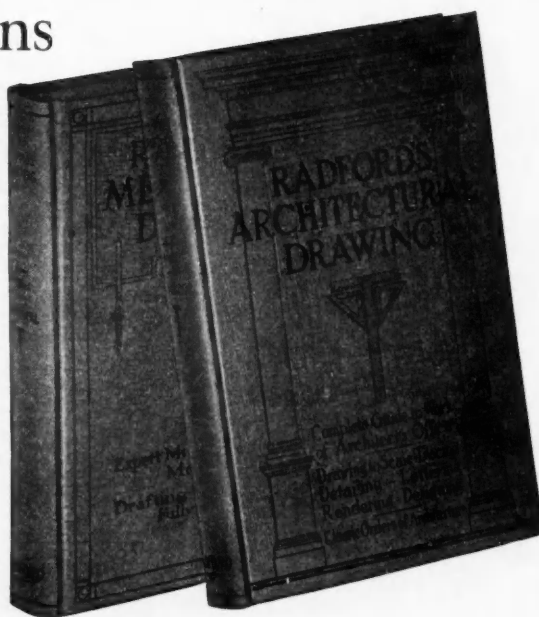

American Builder, 1827 Prairie Ave.
CHICAGO

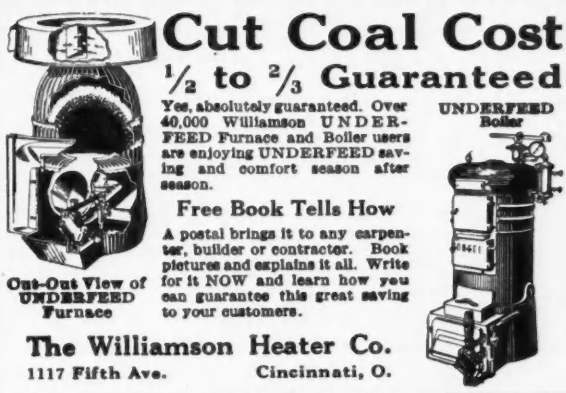

Cut Coal Cost

$\frac{1}{2}$ to $\frac{2}{3}$ Guaranteed

Yes, absolutely guaranteed. Over 40,000 Williamson UNDERFEED Furnace and Boiler users are enjoying UNDERFEED saving and comfort season after season.

Free Book Tells How
A postal brings it to any carpenter, builder or contractor. Book pictures and explains it all. Write for it NOW and learn how you can guarantee this great saving to your customers.

The Williamson Heater Co.
1117 Fifth Ave. Cincinnati, O.

"The Engine for every purpose"

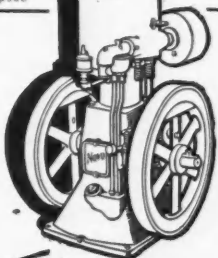

Send for Our Book—
"Reliable Power" and read the Novo Way of reducing power costs through standardization.

NOVO

Reg. U.S. Pat. Off.

ENGINES AND OUTFITS

"Reliable Power" lists Novo outfits—all types of Pumps, Hoisting Outfits, Saw Rigs, Air Compressors, etc. Tell us your requirements and our engineering department will figure on an installation that we will guarantee.

Novo Engine Co. Clarence E. Bement, 800 Willow St., Lansing, Mich.
Vice-Pres. and Gen. Mgr. Chicago Office: Lytton Bldg.



The Superior Heating Boiler for Hot Water Vapor or Steam

The Modern Method of heating your residence. Insures comfort in every corner of the house in the coldest zero weather.

It Will Pay You to investigate this Boiler before buying.

Our Estimates and Plans are Free
"A Complete Line of Plumbing and Heating Material"

DUPLEX MANUFACTURING CO.
Send for Free Catalog SUPERIOR, WISCONSIN

How Many Board Feet in 68 Pieces, 2x4-14?

DON'T figure Lumber by Pencil

Which is shorter, surer, SAFER?—to figure board feet laboriously by pencil, risking profits on an error—OR to take 10 seconds to find the RESULT in this book, a copyrighted "short cut" for lumber users. Gives at a glance the number of feet in any number of pieces, any size. Send \$1.50 for this 106-page time saver. Use 5 days—if it's not worth to you three times its cost to you your money will be gladly refunded.

BENJAMIN L. JENKS, Publisher,
1202 Marshall Building Cleveland, Ohio

ON **5-day trial** - SEND **\$1.50** today

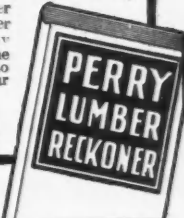

MADE IN MILWAUKEE

GILT EDGE

BOILERS
FURNACES
R. J. SCHWAB & SONS CO.

FIND OUT WHAT GILT EDGE HEATING SYSTEMS HAVE FOR YOU

It's to your advantage every way, Mr. Builder, to make sure that the heating systems installed in the homes you erect will give kick-proof satisfaction. Insure this by putting in the time-tried Gilt Edge heaters (Warm Air, Hot Water, Steam or Vapor.) Experienced builders endorse them highly for practical construction, ease of operation and fuel economy.

Write For Our Proposition

We'll show you how, with our co-operation, the right man in your territory can make Gilt Edge Heating Systems pay "gilt-edged" profits.

Send for Literature and Details Today

R. J. Schwab & Sons Co.
273 Clinton St., Milwaukee, Wis



Clean Air Heater

One Register System Big Money for You

One installed sells many more. Buy direct from Manufacturer — Save Money — Secure Satisfaction.

- Efficient
- Economical
- Practical

Guaranteed by Two Year Trial Bond.

Write Today for our Special Proposition to Contractors

MAIL TODAY

Standard Heater Co.
438 W. Ontario St., Chicago

Send me your Special Agency Proposition to Contractors.

Name.....
Address.....



STANDARD HEATER CO.
438 West Ontario Street
CHICAGO

How Camp Devens Was Built

(Continued from page 174.)

Each superintendent of carpenter foremen had an inspector who immediately went over the buildings finished. Later a force of inspectors attached directly to the general superintendent of construction went thru to check the first inspector. The small defects thus listed were repaired by a special repair crew.

Time was kept by one hundred timekeepers. One was assigned to each regular foreman, and was to follow him wherever he went. The half dozen timekeepers attached to the half dozen foremen under the same superintendent were looked after by a "squad chief" on a saddle horse. The foreman also turned in a report to the central timekeeper's office. Unless his agreed with the timekeeper's, both were looked up and the correct time found.

Carpenters were paid on Friday for the week ending the preceding Tuesday; laborers on Tuesday for the week ending the preceding Saturday; mechanics, water boys, timekeepers, on Thursday for the week ending the preceding Tuesday.

To co-ordinate all the phases of the construction work thruout the camp, daily reports were made to the heads of departments by foremen. These were then tabulated by the superintendent's office assistant and made into a report to the general manager. The figures of completed results were posted daily on various progress charts, some in the chief engineer's

office, some in the office of the general manager. As these two offices adjoined, the general manager could at any time see exactly the amount of work done, in any department. Also, the slant of the curve gave him the present rate at which work was being done, so that if that department seemed a little behind, he could tell whether it could now be trusted to make up the deficiency by keeping up the same speed. If so, he let it alone. If not, he advised that they get more men. Also, by examining the difference between roughing work and finished work, he could tell whether the roughing was far enough ahead of the finishing to avoid collisions, and to enable reasonably good management on the part of the superintendents to get efficient results.

For instance, one curve was kept of the number of buildings for which the foundation posts had been driven and cut off level, ready for the floor joists. From the beginning, this curve ran up fast. During the first of August it was about 325 houses ahead of the finished houses of the carpenters. Of course the carpenters had already been working on most of the remaining 325, but had not got the roofs on. This margin was ample, and did not need to be maintained. A week before the first of September, the date set for completion of the original contract, posts had been cut level for all the required number of buildings. This gave the carpenters a week's margin, which was,

(Continued to page 178.)

Profits for you and your local plumber—

Send For Free Bulletin

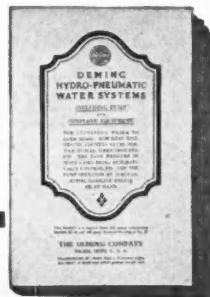

FREE

DON'T consider the job as finished for you until a water system is installed. You sell your customer the idea, your plumber makes the installation—you both get a profit from

DEMING WATER SUPPLY SYSTEMS

Write for us for explanation of this co-operation
THE DEMING CO., 1299 Depot St., Salem, Ohio
Chicago: Henion & Hubbell Pittsburgh: Harris Pump & Supply Co.

Hydro-Pneumatic No. 2010 Capacity—570 gallons per hour

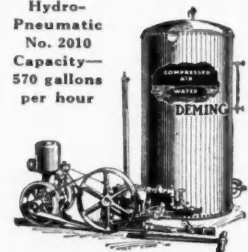

Agencies in All Principal Cities

Please send Water Supply Handbook and explain how I can cooperate with my local plumber.

Name.....
Address..... (1299)

KEWANEE ALL-STEEL COAL CHUTES

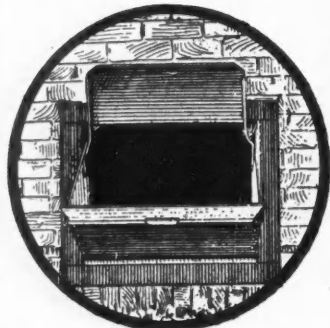

Five good reasons for installing the Kewanee. It locks automatically on the inside. Can be opened from the first floor by means of a chain in the lock. All steel construction, and cannot be broken. Guaranteed for five years. Easy to install in an old building as well as a new.

Write today for Contractors' and Dealers' Prices

KEWANEE MFG. CO.
KEWANEE, ILL.

"The Best" is ready

To be shipped to you today. Solid cast iron door or wire glass door. Made in two styles, three sizes. Write for Catalog

Sterling Foundry Co., 8 Avenue A
STERLING ILLINOIS



The "Best" Fuel Chute



Bottle up the Sunshine

with Victor Acetylene Generator

MR. CONTRACTOR—Induce them to install the Victor Acetylene Generator. Hundreds of homes are in need of better lighting. Big profit to you. **EASY** to install; easy to operate; no adjustments to make; simple; foolproof—nothing to get out of order.

SMOKY KEROSENE LAMPS are now a thing of the past. This system works automatically making gas only when lights are turned on. It is outdoors, away from the house and is protected against temperature changes by an outer jacket.

DETAILED explanation is contained in our catalog, Victor Outdoors, above ground, Acetylene Generators. Send for it and the testimonial circular.

Moore Bros. Lightning Rod Co.
Maryville, Mo.



The Victor Generator

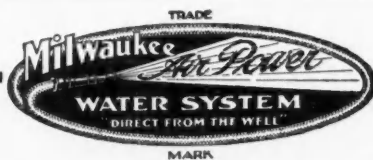

Add to Your Profits

by selling private water systems to suburban and farm homes, schools and institutions. The MILWAUKEE is a "Direct from the Well" System—no water storage tank. Exceptionally complete line of remarkably simple pumps to meet all conditions. The whole system is thoroughly reliable and gives full satisfaction.

Write for catalog and complete information

Milwaukee Air Power Pump Company
872 Third Street Milwaukee, Wisconsin

THE AUTOMATIC COAL CHUTE

Will Answer Every Requirement

- Opens Automatically
- Closes Automatically
- Locks Automatically
- Fool Proof

Order one from your dealer or direct from

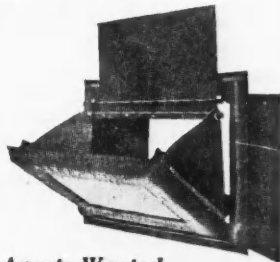

Agents Wanted

THE WESTERN IRON & FOUNDRY CO.
Wichita, Kansas

Be a "Canton" Booster

IT WILL MORE THAN PAY



You are entitled to our Big Free Catalogue telling about the CANTON SIDEWALK DOOR CANTON COAL-CHUTE

Write us—Today

They have a world-wide reputation. Absolutely burglar proof, made of best wrought steel and protected when open by stay rods and chains.

Send for prices and Catalogue B-4

CANTON FOUNDRY & MACHINE CO.
CANTON, OHIO

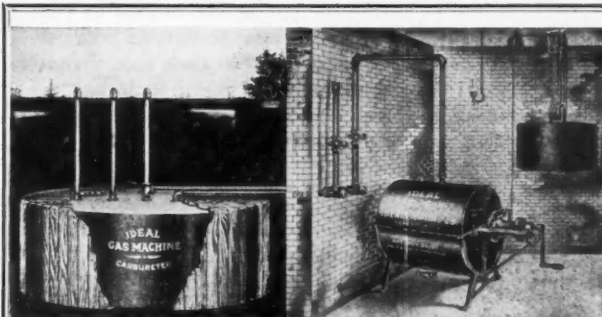

Individual Gas Plants

Here is the surest, simplest, cheapest and most efficient method of lighting and cooking for country clubs, country homes, churches or public halls. Its convenience is readily appreciated by the average person. The country home equipped with an Ideal Gas System will always have an abundance of light (any time of day or night) that is the nearest approach to sunlight of any known method of illuminating.

Gas lighting by our method is the cheapest means of illumination in existence. One barrel of gasoline (about \$15.00) will furnish gas for the average sized family for from six to eight months. The lighting need not be confined to the house. The system can be run to the garage, barn or any out building. Gas irons, water heaters, gas ranges can be operated by it.

Write us stating your requirements or have one of our representatives call on you. No contract too small for us—none too large.

We have a Special Agency Plan for contractors. Write for prices.

CHARLES G. WITT

Successor to
Ideal Lighting Co., 510-512 W. 3rd St.
DAVENPORT, IOWA

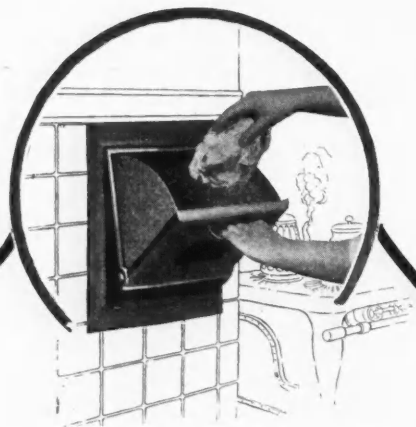

Can the Garbage Can!!!

Can the garbage can ever be a desirable feature in a residence or apartment?

THE

KERNERATOR

The Built-In-the-Chimney
INCINERATOR SYSTEM

IS THE

**CLEANEST, QUICKEST and
CHEAPEST**

equipment for the complete and instantaneous elimination of garbage and waste.

Cleanest—because the garbage is burned to cinders by a method that also renders the wastage odorless. Garbage cans and rubbish piles with their flies, vermin and the like are eliminated. All waste including tin cans, garbage, broken crockery—everything that is not wanted, disappears forever through the little door in the kitchen (shown in cut above).

Quickest—because as soon as waste accumulates it is placed in the hopper door shown above and falls down the flue to the incinerator in the basement.

Cheapest—because its first cost is its last. No commercial fuel is required. The garbage "consumes itself" when ignited, as there is plenty of paper, rags and other dry combustible material to burn and to dry out moisture in garbage, which, when dried, is readily combustible and burns to harmless ashes. Garbage haulage is eliminated.

Consider This, Mr. Contractor

Satisfied clients are your greatest asset. If you show them a way of eliminating all garbage and waste, without a penny of expense other than the nominal first cost, you will have solved for them one of their most disagreeable and annoying problems. No one wants garbage cans and waste piles around their homes. Here is a simple, efficient and economical method of eliminating these intolerable and unhealthful nuisances.

Your buildings will be more desirable than any others in your community. Your clients will be grateful.

Send for our two big books which describe the Kernerator completely and state what users have to say about them.

Address Dept. A

THE KERNER INCINERATOR CO.
592 Clinton Street, Milwaukee, Wis.

How Camp Devens Was Built

(Continued from page 176.)

according to the slant of progress they had been making for the two weeks immediately preceding, sufficient. The value of these charts was especially evident coming into the home stretch, when anybody could see by looking at them that it was only necessary to keep on as things had been going, and the goal would be crossed a little ahead of time. This saved anxiety and helter-skelter work which would probably have been inefficient and failed to produce the results.

Among the curves kept to show speed was one on water supply mains per 1000 linear feet, divided into two class of 8-inch and over and 6-inch and under, totalling 61,000 feet of the former and 56,000 feet of the latter; another for linear feet of electric wire strung, totalling in less than a month 470,000 feet; the number of electric poles set, which average about 100 poles a week. Among the charts of results attained, kept by the number of buildings done, was one for the electric light installations, divided into two separate curves for the wiring and the fixtures; one for service connections, divided into three curves for water, sewers and electricity; and one for houses complete in every particular.

These charts not only showed speed and results already attained, but they helped to get more results. The fact that not the difficulties in the path, nor partially completed work, but only results, showed made each of them a never ceasing voice which called for results in spite of everything, not next week or at the end of the contract, but every day. And it was only by putting so much work behind them with the disappearance of every day these men could get the total work done. Without charting their course and setting up milestones, by which they could gain not only confidence, but knowledge that they were being guided aright by the general manager who was at once hand on the wheel and a mechanic, and a clearing house for the brains of them all, they could not have come so swiftly thru the woods which was Ayer on the 19th of June to the vastly attractive wooden city which is now Camp Devens.

In conclusion, the writer in self defense would like to ask the readers of this article not to adopt wholesale on ordinary sized jobs the methods used on this camp. A contractor who should install one of these methods life-size might find it too big for his job, like the man whose foot grew so big that when he went to kick with it was swung onto his back. Then he might remember the name of the writer of this article, and send a flame of cuss words to light on his head. But there is food for thought in the camp methods, as regards every contractor. This job was accomplished by necessitating co-operation between every man, and by giving every man, be he superintendent, foreman, sub-foreman, workman, clerk, or chauffeur, a definite job or a definite part of a job to be responsible for and to deliver.

HOW TO READ PLANS
AND TAKE OFF BILLS OF MATERIAL
 Illustrated by Examples of Fifty House-Plans and Fifty Full-Page Details of Construction
 By Wm A. RADFORD

This book contains the latest and most reliable, practical information on original drawings, tracings, blue prints, and rough sketches. It shows how to figure inside and outside dimensions, heights, openings, take off quantities, and a vast amount of other data that is indispensable to the man who has to do in any way with construction or the use or estimating of materials.

Price, \$1.00, Postpaid
American Builder, Chicago, Ill.

Paint DEVOE Paint
 Guarantee formula on every can

DEVOE LEAD AND ZINC PAINT
 GUARANTEE - PURE WHITE LEAD, PURE WHITE ZINC, PURE LINSEED OIL, PURE TURPENTINE DRYER
AND NOTHING ELSE

DEVOE & RAYNOLDS CO., Inc.
 New York—Chicago

CWC WATERPROOFING PRODUCTS

Ceresit Waterproofing Compound
Cem-bric Covering Compound
Indurite Concrete Hardener
Radiolite White Enamel

Get the Ceresit Waterproofer and learn about these waterproofing products.
CERESIT WATERPROOFING CO.
 910 WESTMINSTER BLDG., CHICAGO

CERESIT
 TRADE MARK REGISTERED

When You Need Men

consult the Opportunity Page of the American Builder. Men—the right kind—are always open for opportunities to advance themselves. Do you want the ambitious kind—the kind that can do things?

An advertisement at 5 cents a word per insertion on the page headed “Opportunities” will put you in touch with such men.

AMERICAN BUILDER, 1827 Prairie Ave., Chicago

Grasp This Big Saving

Enclose coupon below or mention the American Builder, with money and an order for some of our saws and we will deduct 25 cents from the price of each saw ordered. If your dealer cannot supply you we will send the saw for trial purposes.

“Better Saws at Less Money” is the basis for our success. Every saw is absolutely guaranteed. Money refunded if not O. K. in every particular.

Prices	
22 inch	\$1.25
24 inch	1.50
26 inch	1.75

Gentlemen: Enclosed find money and an order for:
 NAME _____ ADDRESS _____
THE CRESCENT CO. Meriden, Conn.

HORNET MANTELS

The salability of any house is doubled when you show the purchaser the beauty and comfort of

Hornet Mantels

They add 100% to any interior. The model shown here gives an idea of our line and prices. It is offered in selected Oak or Birch, Mahogany finish, Piano Polish. Stands 7 feet high. Note beveled mirror, enameled tile and grate.

Priced at Only \$29.00

Study our full line of Gas Logs, Fire-sets and Screens in helpful catalog. Gives directions for installing. Get this book for future reference.

Hornet Mantel Co.
1147 Market Street
St. Louis, Mo.

Below:-
One of 40
styles
shown in
Our Big
FREE Catalog



World's Largest Mantel House

UNION METAL COLUMNS

"THE ONES THAT LAST A LIFETIME"

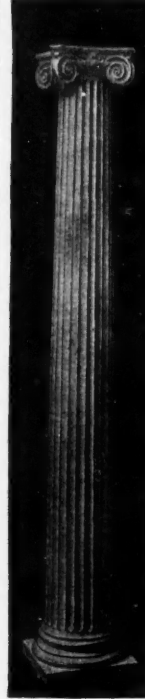

Union Metal Columns for Porches, Pergolas and Interiors.

Union Metal Columns are constructed on the same principle as the famous Union Metal Lamp Standards used for the country's finest street lighting systems and awarded the Grand Prize at the Panama Pacific Exposition.

Write for Column Book No. 101
Lighting Standard Book No. S-103

The
Union Metal Mfg. Co.
CANTON, OHIO

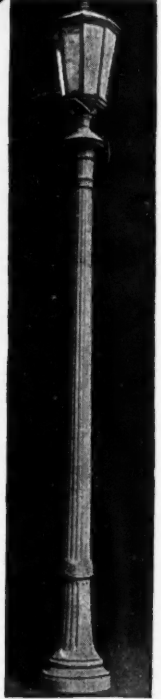

Union Metal Lamp Standard on Cleveland's famous Euclid Ave.

THE BEST COLUMNS

for Porch, Interior and Pergola use the
NICKERSON Patent DOUBLE LOCK JOINT
THEY CANNOT COME APART

We Specialize on Detail-work. "Vignola" is our Standard for proportions when Architect's details are not furnished.

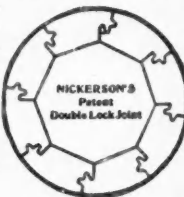

Clinch you Trade by giving them the very best Columns. Ours have the best Construction and correct shape.

All kinds of interior trim to detail.
Write for Catalogue No. 4.

NICKERSON MFG. CO.
KNOXVILLE - TENNESSEE
Members Knoxville Builders' Exchange

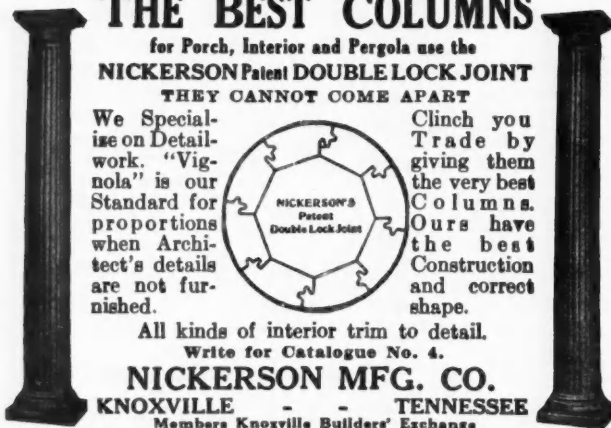

The most profitable Side Line for all Winter Business is

FLEXOTILE FLOORING AND STUCCO

Write us today for full particulars

FLEXOTILE FLOOR COMPANY
ROCKFORD, ILLINOIS

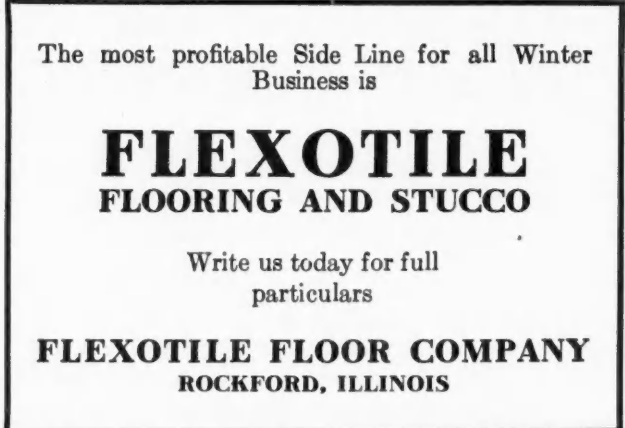

"Garage with Pergola Features"

and other suitable things for beautifying home grounds.

If interested enclose 10c and ask for Catalog No. "U-30"



Hartmann-Sanders Company
Chicago Office, 2155 Elston Ave. New York City Office, 6 E. 39th St.



Beam Drops 15" at Ends, 4" in Center

Posts 7" x 54" in Height.

Book Case Dimensions

Height . . . 42"

Length . . . 21"

Face . . . 11"

Send for Our New Catalog

See Our New Designs

in

Some new attractive modern Grilles, Parlor Columns, Colonnade Openings, Consoles and Sideboards.

All of our work is made from strictly kiln-dried lumber.

Chicago Grille Works, Loomis & 21st Sts.
CHICAGO, ILL.

Lowest installation cost



Easily installed in either old or new buildings by any good carpenter

SORLIEN CEILING BED CUTS COST OF BUILDING

A sleeping porch equipped with Sorlien Ceiling Beds is a valuable addition to your home. You can install one or more "Sorliens" in your present porch without detracting from its usefulness by day. The "Sorlien" gives to small homes the convenience of a den, library or sewing room by day, and converts these rooms into comfortable bed rooms by night. If you are planning on building and wish to reduce costs without omitting convenience, put your problem up to us. Price of bed \$15.00, f. o. b. Minneapolis. Write today for booklet.

Sorlien Ceiling Bed Company
406 Sixth Ave. South Minneapolis, Minn.

"The Tank with a Reputation"



Cypress, of course, is the king of woods when it comes to tanks. But it takes more than wood to build a satisfactory tank. It is the application of approved engineering principles in the construction of the Caldwell Cypress Tank that has established it as "The Tank With a Reputation."

We know that every Caldwell Tank is mechanically correct before it leaves our factory.

Send For Catalogue
W. E. CALDWELL CO.
INCORPORATED
1990 BROOK STREET
LOUISVILLE, KY.

Caldwell
TANKS AND TOWERS

Earn \$27⁵⁰ A Day Easily



Carpenters and builders can earn this money by working all or spare time. Start now to own a business of your own. Akron Lighting Systems are wanted in homes, stores, churches and public buildings. Best and cheapest light known. Uses common gasoline. Absolutely safe. Permitted by Insurance Companies.

Sell Akron Lighting Systems
They are simple, dependable and durable. Have latest patented improvements. Give an abundance of bright, clear, soft, steady light which is restful to the eyes. Complete line of portable lamps and lanterns. Lamps are clean—no smoke, no wicks to trim and odorless. They will burn in any position whether standing erect or upside down. Lantern is storm-proof, bug-proof and wind-proof. Gives a 400 c. p. light. Is absolutely safe; can be dropped or rolled without danger of exploding. Fully guaranteed. Exclusive territory to Agents. Outfit Free. Write NOW for catalog and agent's proposition all Free.

Sold direct at Wholesale Price in open territory.

AKRON GAS LAMP CO., 312 Gas Building Akron, Ohio

Blackboard talks by the professor

No. 9
"The Answer Is Important"



What's Behind Your Plaster



"CAREFUL designers and builders are educating their clients to the fact that it is false economy to scrimp on the fundamentals in building. The 'insides' must be right or expensive internal repairs will be necessary later.

Berger's Metal Lath

Makes a building stronger; prevents cracking and falling of plaster; makes it safe to apply decorations as soon as the plaster is dry; resists fire; reduces insurance cost; and keeps rats and mice from gnawing thru. You might like our new booklet to hand to some client you are educating to better construction."

Send for Booklet F. A. B.

The Berger Mfg. Company, Canton, Ohio
BRANCHES: Boston, New York, Philadelphia, Chicago, St. Louis, Minneapolis, San Francisco, Los Angeles. EXPORT DEPT.: Berger Building, New York City, U. S. A.
Members Associated Metal Lath Manufacturers.





The Great Bell

-original-Pipeless-Furnace

Father of Them All

We have thousands in use. Sizes, styles and prices to suit all. \$38.00 to \$94.00.

Made for the building where a furnace is needed, but where the cost has been prohibited.

The GREAT BELL PIPELESS FURNACE will heat any one or two-story building in the most efficient manner with the least effort and the lowest relative cost. While **Cost** is secondary to **Service** in this furnace, our methods of production and sales have reduced the cost so low that no builder can afford to overlook our proposition.

And we guarantee our furnaces to be and do all we claim for them in both catalog and correspondence.

Write for our catalogs, describing the various styles, prices and specifications of the Great Bell Furnaces.

American Bell & Foundry Co.

27 Cody Street, Northville, Mich.



WHITE STEEL

REGISTERED

"White-Steel" Sanitary Medicine Cabinets are made in many sizes and models, both to inset and to hang on the wall.

High Quality—Moderate Prices.

Write for our new Black and White Catalogue, illustrating and describing our line of sanitary bathroom equipment.

"WHITE-STEEL" SANITARY FURN. CO.
55 Mt. Vernon Ave. N. W.,
GRAND RAPIDS, MICH.

HESS MEDICINE SANITARY LOCKER

CABINET

The Only Modern, Sanitary STEEL Medicine Cabinet

or locker, finished in snow-white, baked everlasting enamel, inside and out. Beautiful beveled mirror door. Nickel plate brass trimmings. Steel or glass shelves.

Costs Less Than Wood

Never warps, shrinks nor swells. Dust and vermin proof. Easily cleaned.

Should be in Every Bath Room. Four styles—four sizes. To recess in wall or to hang outside. Send for illustrated circular.

HESS, 920L Tacoma Bldg.
CHICAGO

The Recessed Steel Medicine Cabinet Makers of Steel Furnaces Free Booklet

Get Our Free Estimate For Hot Water Heat In that new or old house



GOOD PROFIT FOR CONTRACTORS

The Andrews Contractor Plan enables you to net more from the heating price and gives your customers the best system. We furnish free estimates on complete plants ready to screw together. Steel Boilers alone if desired.

\$200.00

Get Our Proposition and Big Heating Book

ANDREWS HEATING CO., 1524 Heating Bldg., Minneapolis, Minn.

Plumbing, Heating and Pneumatic Waterworks Supplies at Wholesale



When in the market for Plumbing, Heating and Pneumatic Waterworks Supplies and you wish to

Save 20 to 40%

on every article, write for my free illustrated Catalog. The only house that sells first-class guaranteed goods at wholesale prices direct. Shipments are promptly made from a very complete stock.

Small orders are as carefully handled as large ones.

B. B. KAROL, 800-802 S. Kedzie Ave., Chicago, Ill.

Free Lesson



In Plan Reading

Accept this offer while it lasts. Send for this FREE Lesson which will show you how quickly you can learn Plan Reading by our new easy method. Not a penny to pay for it—and no obligation upon you for asking.

This knowledge is what you must have to become a foreman or superintendent in charge of building work or to go into the contracting business on your own account. Without a good knowledge of plans your opportunities are limited. The man at work doesn't get the chance to study the blue prints himself or to have their meaning explained. We make the chance for you. We place in your hands plans used in actual building work by contractors in Chicago and other cities. We explain every detail. We make it as easy for you to read a plan as it is for you to read this advertisement. Your lessons will be given by practical contractors—men in charge of building work in Chicago and they will show you how to get the knowledge that brings advancement and more money. To get full information sign and mail the coupon below.

A Few Things We Teach

PLAN READING

How to read a building plan. Floor plans and elevations. Use and meaning of different lines on the plan. Sections and section lines. Cross Sections. How different materials are shown on the plan. How to read dimensions. Detail drawings. How to lay out work from the plans. Tracings and blue prints—how they are made. Practice in reading complete plans from basement to roof, etc., etc.

CONSTRUCTION

Brickwork: Footings and foundation walls of brick, concrete and stone. Brick laying, joints in brick work, pointing, tuck pointing, etc. Brick and stone arches. Use of different kinds of stone.
Carpentry: Kinds and uses of woods, cornices, interior details, framing, roof construction, bridging, miter joints, butt joints, etc. How plans are made. Complete instructions illustrated by working blue prints. Plans and specifications. Residences, apartment buildings, factory buildings, school houses, hospitals, stores and office buildings, bank buildings.

ESTIMATING

Practical rules. Problems worked out from the plans. Brickwork and carpentry. Excavations. Labor and material for footings in brick, concrete and rubble stone. Methods of practical builders. Re-inforced concrete—full plans and specifications for re-inforced concrete buildings. Estimates of labor and material required. Labor and material for brick work; figuring common and pressed brick walls of different thicknesses, etc. Chimneys, fire places and cisterns. Fire proofing, tile flooring, arches, partitions, furring, terra cotta, etc. Lumber and timber; figuring board feet. Estimating posts, girders, sills, joints, studs, bridging, rafters, etc. Estimating all kinds of roofs, floors, siding, cornices, etc. Labor for rough and finished carpentry. Estimating mill work. Labor and material for window and door frames, sash, blinds, base board, wainscoting and all kinds of closets, cupboards, etc. Lathing and plastering, sheet metal work, exterior and interior marble jointing and decorating, glazing, plumbing, heating, wiring, etc.

ARITHMETIC

A complete but condensed course in arithmetic expressly arranged for contractors and builders. Teaches all a man in this business needs to know.

ARCHITECTURE COURSES IN DRAFTING

We also offer complete home-study courses in Architectural and other branches of Drafting. If interested in any branch of Drafting mention subject and ask for special catalog.

Builders' Course on Easy Payments

Read at the left the partial list of subjects we will teach you in this Builders' Course. This is a course that gets right down to the things you need to know. Every lesson gives you information that will make you worth more in the building business. And you can get all this on easy payments. We don't ask you to pay all down when you enroll. A small first payment—then payments monthly—so small you will never feel the cost. Don't put off enrolling. At least send for the Free Lesson and see for yourself what this Course really gives you and how easily you can learn.

Learn By Mail

Keep your present job while studying this Course. Use your spare time at home to learn how to be a better workman, a better foreman or a better contractor. In only a few months you can complete the Course under the direction of our experts and then be ready to make a larger income. Once enrolled you have the privilege of consulting us at any time even after you have completed your studies. Our experts will always be ready to help you.

Send the Coupon

Get this information now. Learn how to make more out of your work or out of your business by knowing more about it. All this information is free. Send while the offer lasts. Whether you decide to take the course or not you ought to get this Lesson and see what it teaches in Plan Reading. Just sign and mail the coupon.

CHICAGO TECHNICAL COLLEGE,

1236 Chicago "Tech" Building, Chicago

Without obligation on my part, send me the Free Lesson in Plan Reading, also information on your Builders Course in Plan Reading, Estimating, etc.

Name

Address

City..... State.....

Present Occupation

Chicago Technical College

1236 Chicago "Tech" Building, Chicago

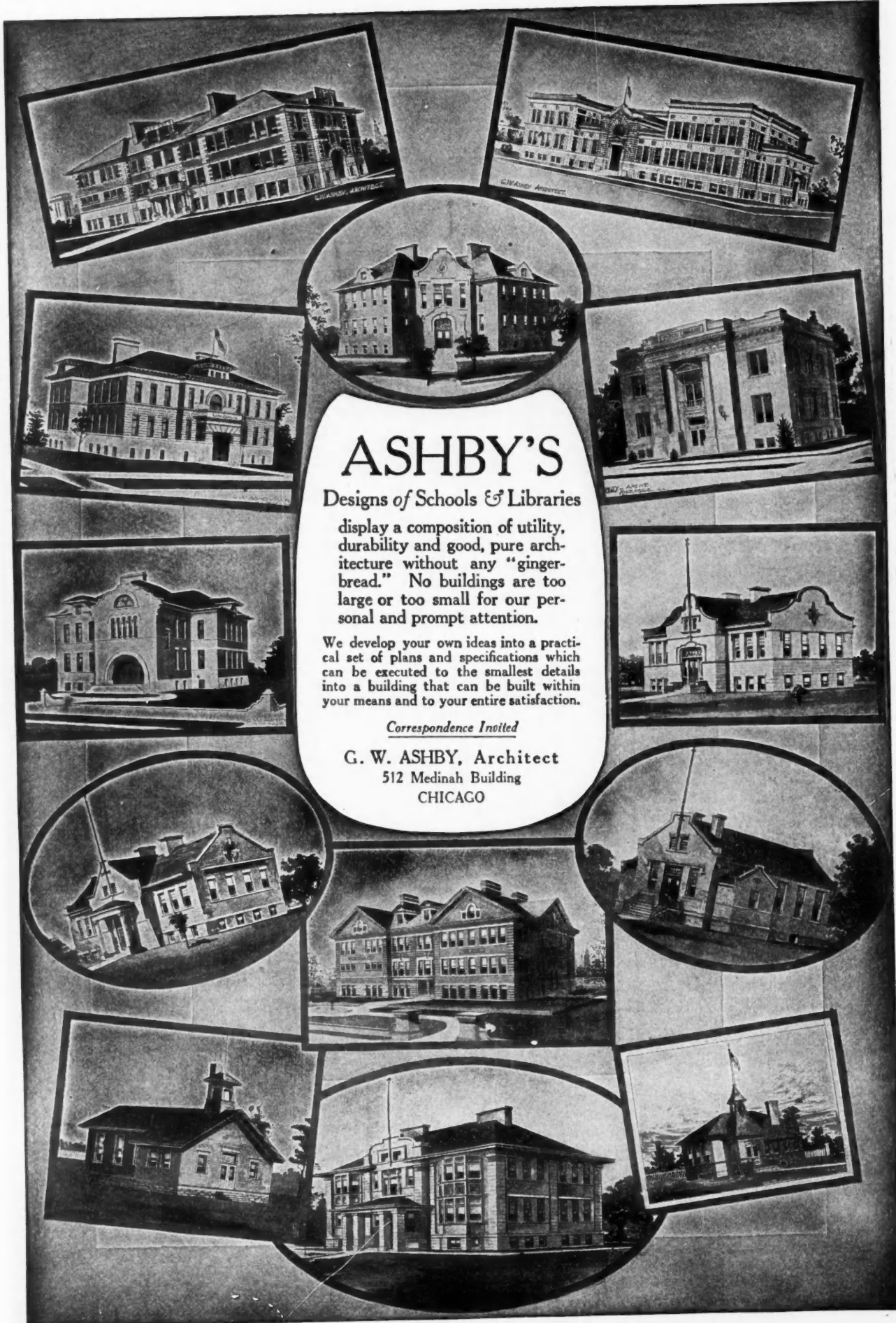

ASHBY'S

Designs of Schools & Libraries

display a composition of utility, durability and good, pure architecture without any "gingerbread." No buildings are too large or too small for our personal and prompt attention.

We develop your own ideas into a practical set of plans and specifications which can be executed to the smallest details into a building that can be built within your means and to your entire satisfaction.

Correspondence Invited

G. W. ASHBY, Architect
512 Medinah Building
CHICAGO

WALTER'S & COOPER'S METAL SHINGLES

*The
Shingles
That
Last*

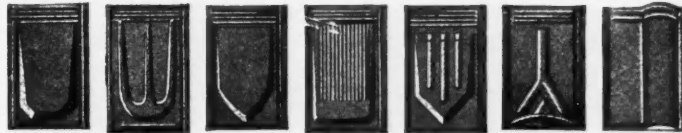

*The
Shingles
That
Last*

The Most Complete Line of Designs The Best Quality Workmanship and Finish
Made in Painted Tin or Genuine Re-dipped Galvanized Tin
SOLD AT THE RIGHT PRICE

May we send you full-size samples and prices?

NATIONAL SHEET METAL ROOFING CO. 339-345 GRAND STREET
JERSEY CITY, N. J.

**Asked for Your Copy Yet?
If Not, DO IT NOW**



Others are reading the story of **birch**, and you will have to be well posted on the subject when they begin to talk **birch** to you—for the new house. We'll mail booklets and finished samples to your customers up to 25. Send us list of names.

NORTHERN HEMLOCK & HARDWOOD MFRS.' ASSN.
201 F. R. A. Bldg. Oshkosh, Wis.

WRITE TODAY  DO IT NOW

For the outer covering of a building no other wood gives such long and satisfactory service as

WHITE PINE



**Edwards
Metal
Shingles
Will Out-
last Your
Building**

**Rot-Proof
Fire-Proof
Lightning-Proof**

We want a good, live man to represent us in each locality—to push our surpassing line of Metal Shingles and other up-to-minute metal roofings.

WRITE US TODAY ABOUT YOUR TERRITORY. Our business is growing so rapidly that it is necessary to have an agent in every community. The territory is going fast. One day's delay may mean that some one else will be given your territory. **Don't delay. Write today for our special Agents' Proposition.**

THE EDWARDS MANUFACTURING CO.

"The Sheet Metal Folks"

401-417 Eggleston Ave., CINCINNATI, OHIO

World's Largest Manufacturers of Metal Roofing, Metal Shingles, Metal Spanish Tile, Metal Ceilings, Metal Garages, Portable Buildings, Metal Lockers, Rolling Steel Doors, Partitions, etc.

**CORTRIGHT
METAL
SHINGLES**

offer the Contractor and Builder a "double-barreled" profit—there is a profit provided on the sale of the shingles as well as on the application of the roof.

The right kind of activity on your part with our co-operation, both in general advertising and direct work with your prospects will enable you to add very materially to your profits.

Cortright Metal Shingles are suitable for your regular run of work and can be easily applied with entire satisfaction to your clients.

Our illustrated book of roof facts we believe would interest you. May we send it?

Cortright Metal Roofing Company
Philadelphia Chicago

NEVER NEED REPAIRS

Are You the Leader in Your Community?

The building contractor who is best known has invariably built his reputation by using reliable trade-marked building materials.

It will help *you* to win leadership if you use our line of trade-marked expanded metal products.

In your plastering and stucco work

Kno-Burn Expanded Metal Lath

will help establish your reputation as a good builder.

North Western
Expanded Metal Co.

903 Old Colony Building
CHICAGO

USE THE
Kanneberg

FREE SERVICE
For Builders

A ceiling design of Steel for a butcher shop would be hardly suitable for a bank or a theatre, yet if only a few designs are available such a mistake is liable to happen. To prevent such errors we offer Kanneberg Service Free of charge to suggest appropriate designs in harmony with the surroundings at the most reasonable prices. We do not need an architect's drawing—the roughest sort of a layout will do. Send us a drawing of your next job and let us show you the possibilities of Decorative Sheet Metal. It won't cost you a cent or obligate you in any way.

"Decorative Stamped Metal" is the name of our large handsomely illustrated 114 page Book on Steel Ceilings. Your Free Copy is waiting for you.

We also manufacture Metal Shingles, Roofing, Store Fronts, Skylights, Ventilators, in fact everything in Sheet Metal.

The Kanneberg Roofing and Ceiling Co.
25-31 Robin Ct., S. E. Canton, Ohio

Come to Us for Everything in Sheet Metal

BIG STRIP OF PLASTER FALLS AT SUMNER SCHOOL

Pupils Are Frightened, but None Is Hurt—Teacher Quickly Restores Order.

A portion of plaster, six feet wide and twelve feet long, fell from the ceiling of one of the rooms in Sumner School in Bassett street at 2 o'clock yesterday afternoon, and missed striking several of the pupils by only a few inches. The children were badly frightened and rushed into the hall. The teacher, Miss Teresa Seiler of No. 150 E. 15th street, was not hurt.

Protect Your Clients

This item appeared in the Syracuse Standard September 19, 1917. It reminds us of many similar accidents. Where will the next one occur? You don't want it to happen in any of your buildings—that's certain.

"BERGER'S" Classik STEEL CEILINGS Cannot be Jarred Loose

Neither will they chip, crack or fall down—and they are fire retardant.

Our Big Book of Distinctive Designs Will Help You in Your Work. Ask for Catalog D. A. B.

The Berger Mfg. Co., Canton, Ohio
Branches: Boston New York Philadelphia Chicago St. Louis Minneapolis San Francisco Export Dept.: Berger Bldg., New York City, U. S. A.



The Clutch That Holds

Sykes Expanded Cup Metal Lath clutches the Stucco— or plaster—and holds it.

That peculiar cup formation makes a perfect key and a rigid wall **sure**. There is a positive saving of time, labor and material achieved, if you use

SYKES EXPANDED CUP METAL LATH

Self-Furring. Heavier than other metal laths of same gauge because cut with wider strands. Best for interior as well as for exterior work.

Sykes Metal Lath is a favorite with contractors who know its distinctive merits. It is endorsed by the U. S. Government for Post Office work and is approved by architects.

Let us send you free booklet of specifications and also a sample of this famous lath.

Sykes Metal Lath & Roofing Co., 504 Walnut Street NILES, OHIO



Building in Winter

Has its advantages—and its problems. One of these is the uncertainty, increased expense and inconvenience of using concrete in freezing weather. The solution for this and for many other building problems is the use of

Berger's *Metal Lumber*

Metal Lumber Joists and Studs come to the job cut to size. They can be placed very quickly as needed, after which the building of the walls can be continued.

Send for our Catalog L. A. B. which gives detailed description of this economical and flexible system of fire-proof construction, also see Sweet's, Pages 244-50.

The Berger Mfg. Co., Canton, Ohio

Branches: Boston New York Philadelphia
Chicago St. Louis
Minneapolis San Francisco
Export Dept.: Berger Bldg., New York City, U. S. A.



The Bessler ^{Movable} Stairway



Don't Waste Space

The upper half story was made into a bedroom, instead of lying idle, by installing a **Bessler Movable Stairway**.

Write for Illustrated Catalog

The Bessler Movable Stairway Co.
Akron, Ohio

RELIABLE folding scaffold bracket

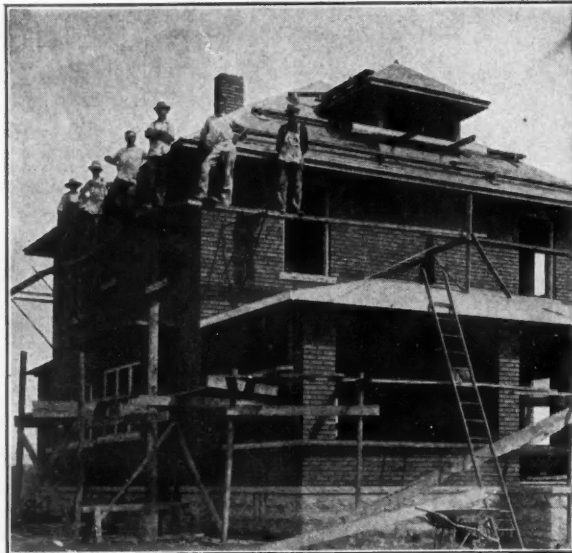

The Only

Bracket on the market which can be used just as easily on Brick and Stucco Construction as on Frame.

Write us today

Elite Manufacturing Co.
Ashland Ohio

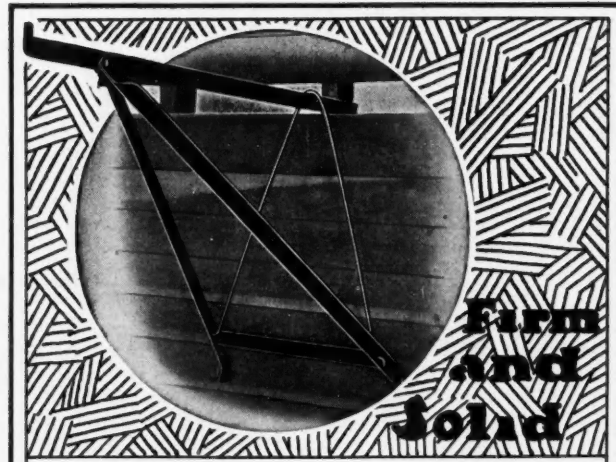

Firm and Solid

Men Work Better

and more efficiently on a firm and solid scaffold.

Buy "Trouble Savers"

They last a lifetime and are easy to move around. Only five minutes to put up.

Big 30 Day FREE Trial

You do not have to stand the expense and responsibility. We do that. You just write us for Free Trial Proposition and we'll do the rest. You won't send Trouble Savers back—you'll order more of them.

WRITE US TODAY.

THE STEEL SCAFFOLDING CO., EVANSVILLE, IND.



Wheeler Safety Scaffold Brackets

Save Lumber—Save Labor—Save Nails—Save Accidents

Pay for themselves on two jobs and last a lifetime. Lock automatically. Men cannot be careless putting them up. Are rigid and firm when in place. Scaffold cannot swing. Write for our

FREE TRIAL OFFER

AMERICAN STEEL SCAFFOLD Co., 550 Grand River Ave., Detroit, Mich.

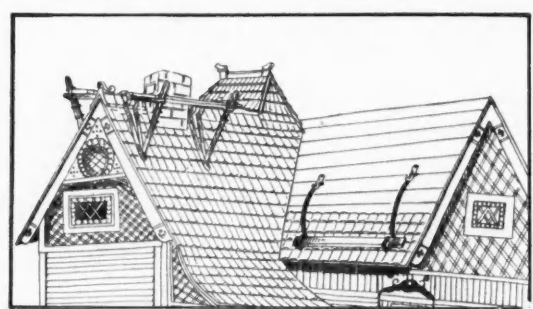

The Neville Adjustable Chimney Scaffold and the Neville Roofing Brackets are sold on a positive guarantee. If not satisfactory after ten days' trial they may be returned at our expense and we will return your money. Send for descriptive circulars. NEVILLE MFG. CO. KEWANEE, ILLINOIS

—The key to Confidence

"Safety First"

SCAFFOLDS

Assure absolute protection to yourself and your workmen. You cannot fall off. They can be attached as fast as one man can hand them to another man, as there are no holes to bore or nails to drive. It is not even necessary to have your building sheeted. Equipped with tool shelf. Folds up flat for storing. Write for catalog and trial proposition.

John Faragher, 811 So. Brooks St., Madison, Wis.

"SIGNED LUMBER IS SAFE LUMBER"

FOR BEST LUMBER INSIST ON TRADE-MARKED "TIDE-WATER"

CYPRESS

LUMBER—BECAUSE IT'S "THE GENUINE WOOD ETERNAL". AND LASTS—AND LASTS—AND LASTS—AND LASTS

Look for this on every board—

Accept no Cypress without this mark.

Trade Mark Reg. U.S. Pat. Office

ROOFING

THE HEPPE-SNELSON ROOFING COMPANY has unsurpassed facilities for the manufacture and delivery of roofing materials, asphalt shingles, roll roofing, paint and wall board adapted to all kinds of work. It stands ready not only to fill the largest or the smallest order, but also to give practical advice on roofing problems. It is an aggregation of *roofing experts*.

One branch of the HEPPE-SNELSON factory has a thirty years' reputation in the making of high class building papers and roofing felts. The other branch has for the past sixteen years turned out roofings and asphalt shingles of the greatest excellence.

The HEPPE-SNELSON ROOFING COMPANY enjoys a nation-wide reputation in the roofing business. Builders know that its name back of a roofing and building line is certificate of its excellence and worth.

The following names on roofing materials are guarantees of durability and value:

FLEX-A-TILE Slab Shingles	RUBBERTEX Whale Roofing
FLEXO Roofing	SUCCESS Roofing
NO-TAR Asphalt Paint	UTILITY Wall Board
NUROID Roofing	

Samples of the Heppes-Nelson products may be had at any time, together with prices and practical suggestions as to the creating of new roofing business.

THE HEPPE-SNELSON ROOFING CO.

Dept. M-1010. Marshall Street, N. E. MINNEAPOLIS, MINN.

Dept. M-1010. Kilbourne Avenue, CHICAGO, ILL.

FACTORIES: CHICAGO and MINNEAPOLIS

"Opportunities"

Have you anything to Sell, Barter or Exchange,
Want Help, Agents, or a Situation? Use our

Classified Department

RATES 5 CENTS A WORD. CASH WITH ORDER

No Display Type Allowed in Classified Advertisements

Patents

PATENTS SECURED OR FEE RETURNED—Actual search and patentability report free. Send sketch or model. 1917 edition, 90-page patent book free. My patent sales service gets full value for my clients. **GEORGE F. KIMMEL**, 223 Barrister Building, Washington, D. C.

C. L. PARKER, PATENT ATTORNEY. Formerly member Examining corps, U. S. Patent Office. McGill Bldg., Washington, D. C. Pamphlet of instructions sent upon request.

PATENTS THAT PROTECT AND PAY—Books and advice free. Highest references; best results. Send sketch or model for search. **Watson E. Coleman, Patent Lawyer**, 624 F St., Washington, D. C.

Agents Wanted

AGENTS—500 per cent Profit. Free Sample Gold and Silver Sign Letters for store fronts and office windows. Anyone can put on. Big demand everywhere. Write today for liberal offer to agents. **METALLIC LETTER CO.**, 447 N. Clark St., Chicago, U. S. A.

Miscellaneous

DEALERS IN CONTRACTORS' EQUIPMENT—If you are absolutely responsible and are interested in selling a successful, high-grade line of contractors' equipment, including five popular sized concrete mixers, paving mixers, mortar mixers, hoists, and barrows manufactured by a firm established 35 years, let us know at once. We are now making new contracts for 1918 and need a few reliable dealers and agents in unoccupied territories. **LANSING COMPANY**, Lansing, Mich.

Lightning Rods

LIGHTNING RODS that are guaranteed protection; \$250.00 to find a building burned by lightning with our rods. **L. F. DIDDIE CO.**, Marshfield, Wisconsin.

For Sale

FOR SALE—New machines; immediate delivery; 13-in. hand planer or jointer, \$55.00; other size, 5, 7 and 9-in. cutter head. Also combined cutter heads and saw arbors for wood tables. Catalogue of full line for the asking. **W. L. SHERWOOD**, Kirksville, Mo.

Instruction

DRAFTSMEN'S, BUILDERS' AND FOREMEN'S COURSES. **MAACK'S ACADEMY OF ARCHITECTURE**, 1742 Chouteau Ave., St. Louis. Joist and Rafter List, 10 cts.

DANDIE MIXERS

The Big Value in 5 and
10 cu. ft. Light Mixers

KOEHRING MACHINE CO., Milwaukee, Wis.

Write Today **Degrah** A New and Wonderful Wood Finish
for Free Sample

TRADE MARK REGISTERED
Quick drying and non-penetrating like Shellac. Glossy, smooth and tough as Lacquer. Less expensive and more durable than Varnish. Takes the place of all three. Dries in three hours. A fresh coat can be applied and sand papered each day. **DEGRAH** also comes as a white enamel. Also as an enamel varnish. To the latter you merely add zinc in oil to make your own white enamel. **DEGRAH** white enamel saves you big money on contracting work.

KEYSTONE VARNISH CO., 2006 Keystona Bldg., Brooklyn, N. Y.

Carpenters—Sell Our Axtell "All Steel" Weather Strips

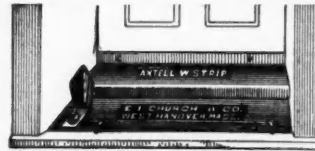

For bottom of doors and casement windows. Applied in 15 minutes, at 100 to 150% profit. Sample 36 in. strip, 75c. 50c. each in 2 to 4 doz. lots, less in gross lots. Model free with 2 doz. or more. Write for territory.

E. I. CHURCH & CO.
West Hanover, Mass.

UNI-ELECTRIC Light and Power for the farm and summer home. Delivers standard 110 volt current. Uses no belts—no batte es Makes a profitable side line for carpenters and can also be used to furnish light for night work on rush jobs.

WATERMAN MOTOR COMPANY
152 MT. ELLIOT AVE., DETROIT, MICH.

Indestructo Carpenters' Tool Cases. Stronger than any wooden chest, much lighter, holds tools better, much easier to carry. Same shape as a suitcase when folded and carried like one. Made of 3-ply veneer, covered with heavy canvas and painted. Edges and corners are bound and reinforced with steel. Two brass catches and locks. Contains a place for every tool. Two sizes—31 in. for 26-in. saws; 33 in. for 28-in. saws. Will last a lifetime. Write for booklet and prices now.

Wedell & Boers, 157 Jefferson Ave., Detroit, Mich.

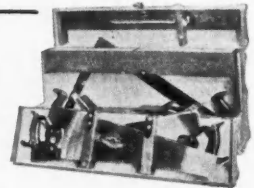

The Atlas Concrete Mixer

Made in 5 sizes and many styles Prices \$48.00 and up. Send for Circular
"CONCRETE FACTS"
ATLAS ENGINEERING COMPANY
3009 Lisbon Avenue Milwaukee, Wis.

THE ZIMMERMAN IRON BASE

allows the air to circulate between the porch column and the floor, keeping both perfectly dry and preventing rot.

Have your architect specify from page 958 of 5 west's catalog or write for circular "G."
S. CHENEY & SON, Manlius, N. Y.

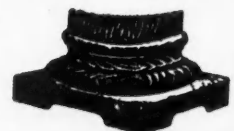



ARTISTIC HOMES

A book of 280 (8 x 11 inch) pages showing perspective views and floor plans of 250 artistic modern homes. A large variety of designs are given so as to meet the taste of the majority of home builders. There are artistic houses for people of moderate means and others for the more wealthy, but in every case the design is made with reference to comfort and economy.

Every design shown has been made by best architects in the world, who have made a study of home architecture and that alone.

Price \$1.00 Postpaid

American Builder

1827 to 1833 Prairie Avenue, Chicago, Ill.

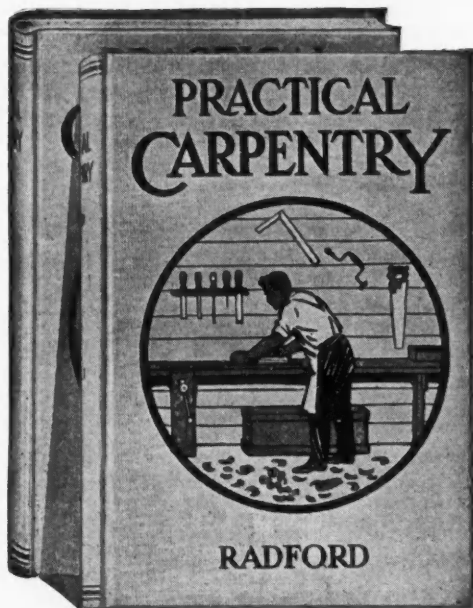

Two volumes of reliable textbooks to which to refer in work that is new and unusual. **PRACTICAL CARPENTRY** is the most complete, most accurate, most practical and most up-to-date work of its kind. It describes the best and quickest methods for laying roofs, rafters, stairs, flooring, mitering, coping, splayed work, circular work, and, in fact, for forming all kinds of joinery and carpentry work.

Bound in cloth, over 600 pages of useful and necessary information. Complete information from foundation to roof.

Price \$2.00 Postpaid

American Builder

1827 Prairie Ave., Chicago

WITTE Kero-Oil ENGINES

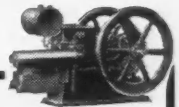

Immediate Shipment

2, 3, 4, 6, 8, 12, 16 and 22 H.-P.—Direct from the Largest Exclusive Engine Factory in the world, selling by mail. Nothing but engines. Quick Service—Big Saving—90-Day Trial. 5-Year Guarantee. Fuel cost one-half less using kerosene. Write for new book (copyrighted) "How to Judge Engines", printed in colors and fully illustrated, showing how I can save you \$15 to \$200—sell you on practically your own terms—Cash, Payments or No Money Down.—Ed. H. Witte.

WITTE ENGINE WORKS

1776 Oakland Ave., Kansas City, Mo. 1776 Empire Bldg., Pittsburgh, Pa.

SAVE MONEY ON ENGINES

Buy direct from my factories, where I build a powerful, economical, reliable, perfectly designed Galloway Masterpiece Engine from the highest quality materials and sell to you at lowest manufacturers' price. Tens of thousands in satisfactory use. All sizes from 1 1/2 to 16 h.p. portable, stationary, saw rigs, pumping outfits. They operate on

GASOLINE OR KEROSENE

Also build mangle spreaders, cream separators. 300,000 satisfied customers, some near you. Close shipping points save freight. My free catalog describes Galloway goods. Get it before buying. WM. GALLOWAY CO., Box 945, Waterloo, Iowa



GILBERT & BENNETT
PEARL
WIRE CLOTH

CANNOT BE SUCCESSFULLY IMITATED

Many competitors have tried and failed. This is due to the fact that the metallic coating from which the genuine PEARL derives its rust-resisting qualities is a secret process, exclusive with The Gilbert & Bennett Mfg. Co. Consumers everywhere are keeping on the safe side by insisting on seeing the two copper wires in the selvage and the Round Tag on the roll which identifies the real article.



THE WOOD WORKER'S FRIEND

Get directions for building table and operating our Jointers. This information is valuable to wood workers. We manufacture 20 styles and sizes. Try a Jointer Head 30 days, if you are not pleased, return at our expense. Get price.

Manufactured by WHISLER MFG. COMPANY, Gibson, Iowa

OTTAWA KEROSENE ENGINES

Latest design. Durable. Powerful. Reliable. Massive. Built to do hard, heavy work—to give lasting service. Uses Cheapest Fuel. Pulls 25 to 50% more H.P. than rated. Shipped three months' trial. Easy terms. Sizes 1 1/2 to 22 H.P. 10-Year Guarantee. Book free—A postal brings it to you.



OTTAWA MFG. CO., 1771 King St., Ottawa, Kans.

SAMSON SPOT SASH CORD



SAMSON CORDAGE WORKS, BOSTON, MASS.

Faster Shingling—More Money

Carpenters and Builders! That's what it means when you use a

Sayre Shingling Hatchet

with Positive Gauge—Get One Today! Gauge is positive—cannot slip. Clamps on with screw—is readily changed. Unequaled for fast shingling. Ask for No. 144 made (with oval head, 169 points) price, prepaid, \$2.00. Also with flat head, No. 44, 81 points, milled. Price, \$2.00, prepaid.

J. E. Coates, Prairie Du Chen, Wis., writes: "Never had a tool that I got so much good out of and wouldn't be without one for \$10.00."

We also make a complete line of lathing hatchets. Sayre Shingling or Lathing hatchets are the best your money can buy.

L. A. SAYRE CO. 8 OLIVER STREET NEWARK, N. J.



See That Gauge

He Waited Too Long



"If I only had this set of books twenty or thirty years ago, they might have changed my whole life. The knowledge in the big CYCLOPEDIA would have enabled me to increase my earning power, to take on big work, paying big money, and possibly have helped me to make a fortune in the building business."

Hundreds of letters like the above have come to us, breathing between the lines the same pathetic story of regret—showing how hard it is for the untrained man to really get ahead in life. **The opportunity is yours NOW**, and the way is easy. **Don't wait too long. Don't wait at all.** Read the terms of our **NO-RISK, Guarantee Offer** over again, and **sign and mail coupon today.** You risk absolutely nothing, and you will reap the benefit ever afterward.

VERY BRIEF LIST OF CONTENTS

To realize their tremendous scope, you must see the books—you can get the books for five days' examination without cost to you.

A.B.
12-17

**Radford
Architectural
Company,
1827 Prairie Ave.,
Chicago**

Please send me, express prepaid, your 12-volume Cyclopedia of Construction, for five days' free examination, with privilege of return at your expense. I enclose \$1.00 deposit, which you agree to return if I decide not to keep the books after examination. If I keep the books, I will pay \$2.00 a month until the special price, \$23.80 is paid, otherwise I will notify you within five days after receipt of books. Your offer also includes Radford's Portfolio of Plans (over 300 designs), and one full year's subscription to the American Carpenter and Builder. You also agree to furnish set of Blue Prints and Specifications, if ordered within 2 months after acceptance of books.

Name.....
Town.....State.....
Street.....

Carpentry.
House Framing
Uses of Steel Square
Rafter Cuts
Strength of Timber
Roof Trusses
Stair Building
Drafting and Design
Working Drawings
How to Read Plans
Blue-Printing
Architectural Forms
Architectural Lettering
Construction Contracts
Forms of Contract
Architect and Owner

Specification Writing
Inspection of Work
Cost Estimating
How to Bid with Safety
Timekeeping, Superintendence
Cement Construction
Origin of Portland Cement
Advantages of Concrete
Common and Hydraulic Lime
Cements (Portland, Natural, etc.)
Proportions for Mixing
Aggregates (Sand Gravel, Crushed Stone, etc.)
Mixing by Hand and Machine
Depositing Concrete
Concrete Troubles
Waterproofing Concrete
Concrete Blocks and Brick
Cement Mortar
Stucco and Plaster
Concrete Machinery and Tools
Concrete Mixers

Block Machines
Number of Blocks Required
Brick and Tile Machines
Forms (Wood, Metal)
Cement Houses
Foundations
Floors and Walls
Roofs and Chimneys
Fireproof Construction
Concrete Sidewalks
Ornamental Use of Concrete
Surface Finishes
Art Tile and Mosaics
Terrazzo Floors
Concrete on the Farm
Fence-Posts and Gate-Posts
Sewer and Drain Pipe
Concrete Silos
Reinforced Concrete
Principles of Design
Reinforcing Materials and Systems
Industrial Buildings
Concrete Piles
Sewer and Tunnel Work
Bridges and Viaducts
Culverts, Reservoirs

Estimating Concrete Work
Standard Specifications
Masonry Construction
Building Stone
Brick and Brickwork
Mortar for Masonry
Bonds and Joints
Steel Construction
Steel Shapes
Use of Handbook Tables
Allowable Stresses
Rivets, Tie-Rods
Columns, Beams and Girders
Floor and Roof Arches
Roof Trusses and Coverings
Mill Building Construction
Steel Bridges
Heating, Ventilation
Furnaces and Pipes
Plumbing
Sewers and Drains
Electric Wiring
Painting
Paperhanging
Furniture Making
Useful Tables, Rules, etc.

PIN A DOLLAR BILL TO THIS COUPON AND MAIL IT AT OUR RISK TODAY

**12 Big Volumes—Free Premiums—No Risk
SENT FOR ONLY \$1.00
RADFORD ARCHITECTURAL CO.
1827 Prairie Ave., CHICAGO, ILL.**

Detail Section is
1/4 Actual Size

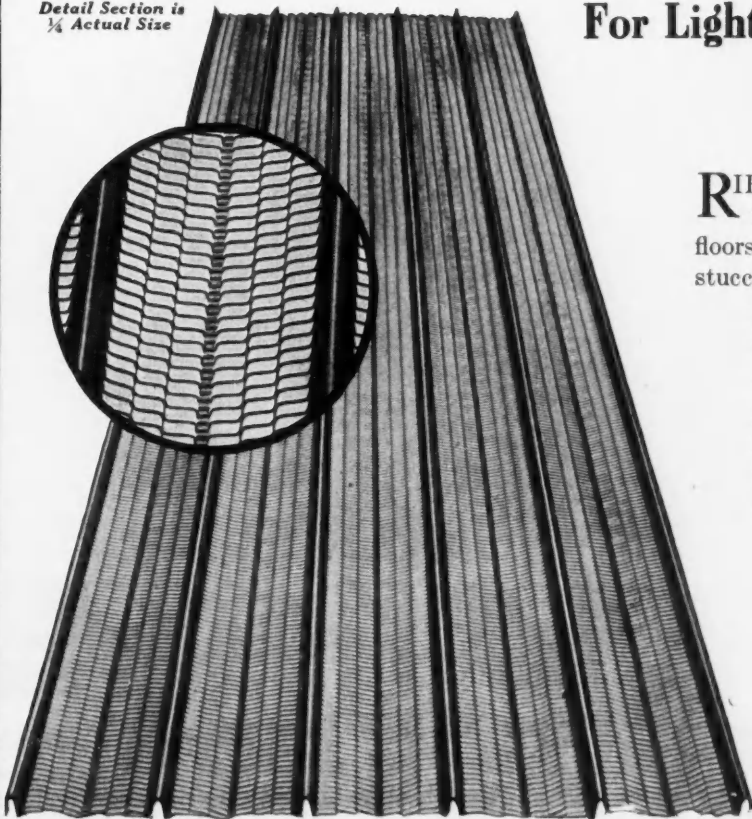

For Light, Fireproof Construction

RIBPLEX

RIBPLEX is a combined centering and reinforcing plate for use in constructing floors, roofs, partitions, sidewalls, ceilings and stucco work.

It is easy to erect and reasonable in cost. Its use eliminates expensive centering work. The mesh of expanded metal gives a perfect bond with plaster or concrete while the ribs help to hold the wet material in place, and give rigidity and strength to the structure.

Write for sample and
Bulletin K. A. B.

The Berger Mfg. Co.
CANTON, OHIO

BRANCHES:

Boston New York Philadelphia
Chicago St. Louis Minneapolis
San Francisco



Export Dept.: Berger Bldg., New York City, U.S.A.

PHOTOS WANTED of Advertised Goods in Use on the Job

THE EDITOR will pay \$2.00 each for good photographs that show interesting tools, machinery or equipment in use by builders or that show advertised building materials, fixtures, or building specialties being installed on the job.

We want human interest pictures—close-up photos that show the details of the tool, device, machine, or material. We want it posed true to life, just as actually used.

On the back of each photo submitted jot down your name and address, trade name and manufacturer's address of proposition illustrated, and some data regarding the building where photo was taken.

Address Photo Contest Editor

American Builder
1827 Prairie Ave. CHICAGO

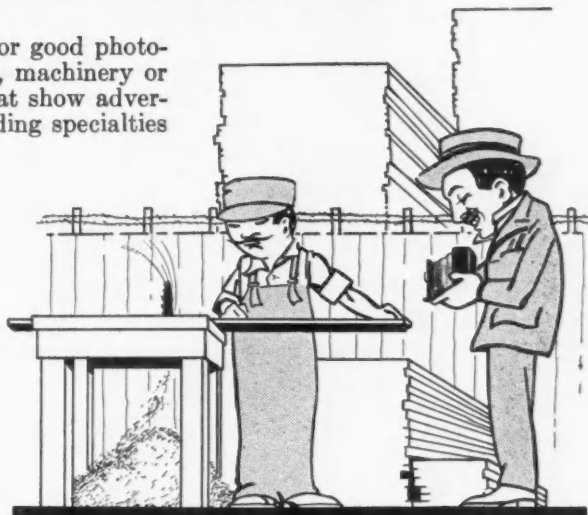

"I'll Send this Photo to American Builder and Get \$2.00"

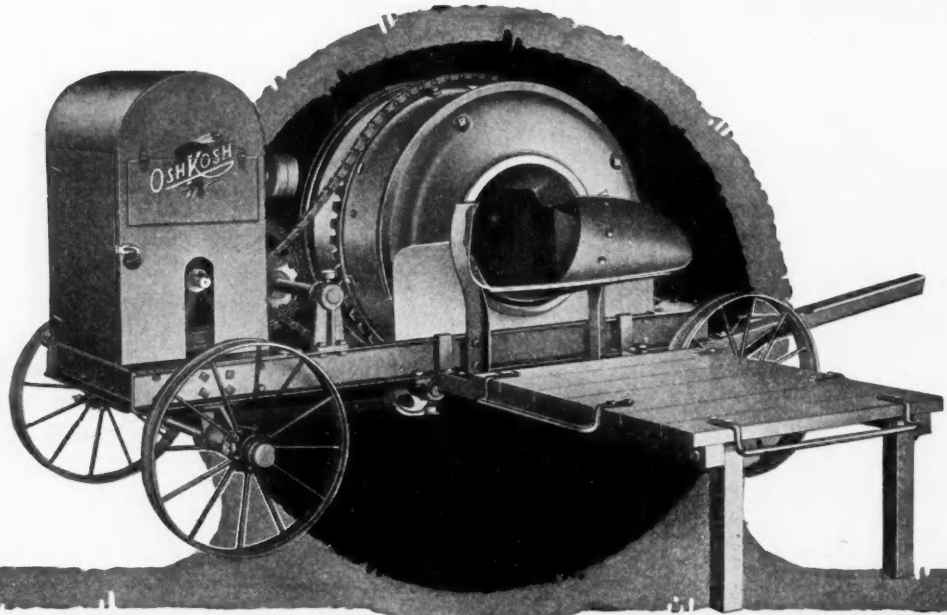

SERVICE

at the **RIGHT TIME—**
WHEN YOU NEED IT

The dread of every contractor is the unforeseen accident. It means expensive delays, idle men, idle power, every lost hour a decrease in the expected profit.

A few days wasted waiting for repairs may even mean a forfeited contract, but you will have a minimum delay if you own an



Low Loading MIXER

A telephone call to your dealer, a hurry-up messenger, a speedy repair, and the wheels are grinding again. That is the kind of service you will appreciate. Oshkosh manufacturers and dealers believe you are entitled to that kind of service.

The Oshkosh Low Loading Mixer is economical, simple and durable. It is easy to load and quick to discharge. A quality machine—fast and perfect mixing, plus a service that is invaluable.

Write today for catalog and prices and the name of your nearest dealer and service station

OSHKOSH MFG. COMPANY 122 Amber Street
OSHKOSH, WIS.

Liberty Bonds accepted in payment at full face value



Bovee's Upright Furnace



Bovee's Cast Iron Pipeless Furnace

ing and there is nothing more economical of fuel. With this system of piping the basement is always cool.

The Central Heating System

With this system of piping but one large warm air register is used directly over the furnace. It also has two cold air returns that may be taken from other rooms which greatly aids in the circulation of heat in the different rooms and also prevents the cold air moving over the floor to reach the one central register as used with the pipeless furnace. This also allows using a rug in the room as the openings in the floor are not as large as when both hot and cold air registers are one. With the CENTRAL HEATING SYSTEM we use any style of our furnaces and of suitable size to heat the building. With this system a separate pipe can easily be run to a bath room or to any other rooms, which is often very desirable.

We ship everything prepared so that any handy man can install any of the Bovee Furnaces quickly and without the aid of a tinner.

Send us a rough plan of your building for estimate on best system of heating plant.

Bovee Furnace Works
50 8th Street Waterloo, Iowa

Old Reliable Bovee Furnaces



Large numbers used by the U.S. Government. We can make prompt shipments of any size furnace required.

At Special Prices to Contractors

**The Pipeless Furnace With One Register
The Central Heating System With One
Warm Air and Two Cold Air Registers**

Regular Piping to Each Room

We MANUFACTURE a full line of furnaces, both UPRIGHT AND HORIZONTAL, which we furnish with regular piping to every room where the buildings are not arranged to be properly heated by one register. We have had a very wide experience and can tell at once on receipt of a pencil sketch of the building to be heated the best style of furnace and piping to use. The BOVEE FURNACES are well made of the best heavy material and actually use very much less fuel than other furnaces.

The Pipeless Furnace

This style of furnace is especially adapted to houses having large openings between rooms and open stairway to allow free circulation of the warm air. Also for old houses where it is difficult to cut piping into the walls. We use only furnaces having ample capacity to heat the building as we make different sizes suitable to heat any building from a cottage to a large church. They are very easy to install as there is but one register to cut in the floor directly over the furnace and no piping in the basement. The heat is delivered instantly in the build-

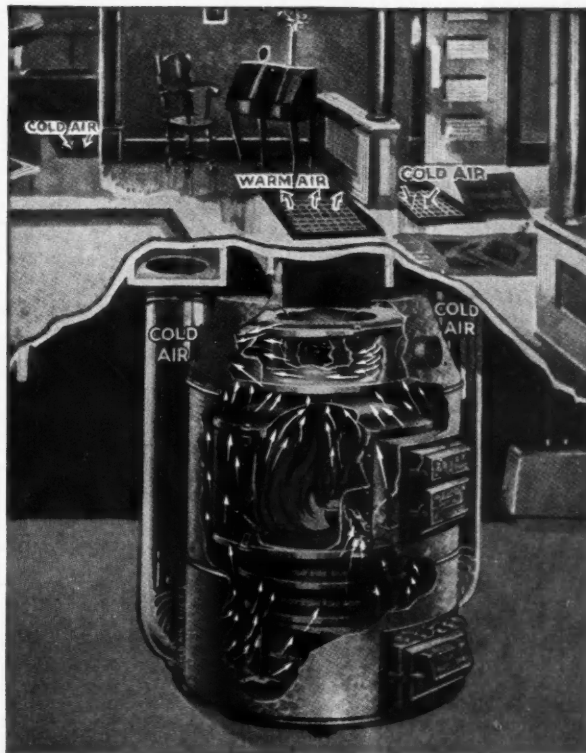

Bovee's Upright Furnace With Central Heating System



The Hanger operates on a swivel and turns on the track without sticking or binding in any way



Combination

- Slide
- Swing
- Fold

Your customers will thank you for telling them about how to equip their garages with the National Garage Hardware.

Every car has to have a home

and that's where you men who sell garage hardware come in.

Every car sold in your territory means garage hardware business for somebody. Why not you?

Specialize on National

They Economize Time—Labor—Money—Space—and Materials. These are big selling points, for they all mean Economy. National Hardware is "it."

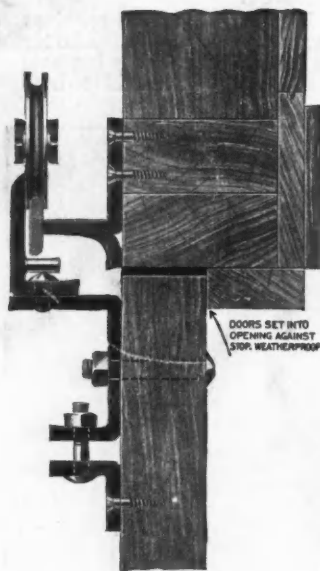

Sectional View of Swivel Hanger

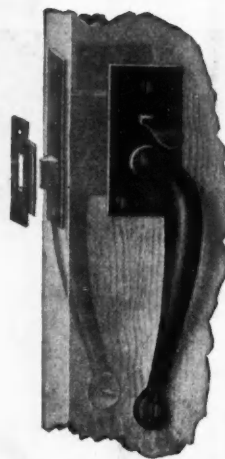

The No. 27 Latch has no complicated parts to get out of order

**Write today for catalog
National Mfg. Company
Sterling, Ill.**

BERMICO

Sheathing Paper

A strong and durable sheathing—
the standard in its field.

Made from pure wood *fibre*, with-
out filler, it gives *permanent*
protection.

Furnished in colors.

Every dealer should carry an
ample stock of **BERMICO**. It
gives satisfactory service to the
builder—and full value to his
client.

Brown Company

Formerly Berlin Mills Company

Founded 1852

Portland, Maine

N. Y. Office: 233 Broadway

Chicago Office: 110 S. Dearborn St.



104 PAGES
in our New 1918 Catalogue

HAVE YOU
received your copy?
Order it today—it is FREE!

Every contractor and builder should have a copy on hand ready for instant action when figuring contracts. It shows a complete line of Builders' Hardware. Everything! All illustrated clearly and described fully.

Our Service

is the best. Our policy is to ship all mail orders the same day they are received.

Excellent Methods of Packing are a part of our service.

Illustration shows one pair of National "B-4"

Hangers packed in a box neatly labeled in a very attractive manner.

Your dealer's name will be appreciated.

**NATIONAL
MANUFACTURING
COMPANY**
STERLING, ILL.

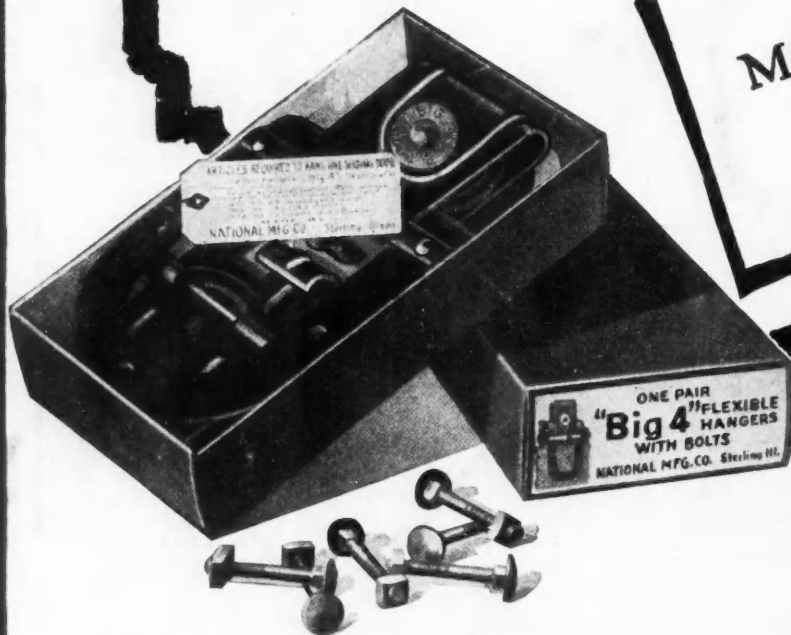

WHEN WRITING ADVERTISERS PLEASE MENTION THE AMERICAN BUILDER

