



Formerly AMERICAN CARPENTER AND BUILDER

Member of the Audit Bureau of Circulations
Circulation Audited and Verified March, 1919

American Builder

Entered as second-class matter July 1, 1906, at the postoffice at Chicago, Ill., under the Act of Congress of March 3, 1879.

Published on the first day of each month by

AMERICAN CARPENTER AND BUILDER COMPANY

Publication Offices:

Radford Building, 1827 Prairie Ave., Chicago

EASTERN OFFICE: 261 BROADWAY, NEW YORK CITY

SUBSCRIPTION RATES

One year, \$2.00; six months, \$1.00; single copies, 25 cents. Special rates for two or more subscriptions when received together, to be sent to different addresses—Two subscriptions, \$1.75 each; three subscriptions, \$1.50 each; five subscriptions, \$1.25 each; ten or more subscriptions, \$1.00 each. Extra postage to Canada, 50 cents; to foreign countries, \$1.00.

ADVERTISING RATES

Furnished on application. Advertising forms close on the 15th of the month preceding date of publication.

PROTECTION FOR OUR READERS

The publishers of the AMERICAN BUILDER reserve the right to decline any advertising they believe is detrimental to the interests of its readers; to edit advertising copy and to change or eliminate any statements that reflect injuriously or cast discredit upon other building products, machinery, equipment, supplies or tools.

Be sure in writing to advertisers to say: "I saw your advertisement in the AMERICAN BUILDER."

EDITORIAL DEPARTMENT

WILLIAM A. RADFORD, Editor-in-Chief.
BERNARD L. JOHNSON, B. S., Editor.
J. D. EDDY W.M. REUTHER . . . } Associate
CHARLES G. PEKER A. W. WOODS . . . } Editors

BUSINESS DEPARTMENT

WM. A. RADFORD, President and Treasurer.
E. L. HATFIELD, Vice-President and General Manager.
ROLAND D. RADFORD, Secretary.
DELBERT W. SMITH L. H. REICH . . . } Advertising
C. R. W. EDGCUMBE E. B. WOLFROM . . . } Staff

VOL. XXVII

May, 1919

No. 2

The Builder in the Limelight

NEVER before have the eyes of the nation been so centered on the building industry. Every governmental department that has to do with the economic welfare of the country is urging a quick resumption of building, as a means of giving employment to the workers of the country.

"Build homes; build buildings of all kinds, private and public; build roads!" These are the commands that are being issued in every conceivable way. And the public is responding, but so far not to the degree the officials could wish.

This propaganda for building is as welcome to the building industry as was the armistice to the tired and impoverished nations of Europe. For a year and a half we had been suffering from exactly the opposite command. "Do not build, the country needs the materials and men usually employed in building," was the program. Unfortunately, however, the government had the power to enforce the latter, but can only urge the former.

There is a pleasant duty that every member of the building industry and especially every member of the American Builder family now can perform. He can do his part toward making this campaign a success. And he is actuated by the best of motives, for no matter if he does personally profit, as he profits so will

his neighbors and the people of the country generally.

Urging building at this time is a duty that every contractor, carpenter, material and hardware dealer, and all the other trades and businessmen can perform. Do it in every way you know how. You and the country will be the gainers.



No Chance of Prices Being Much Less

IF everyone refused to buy food because it cannot be purchased at the prices charged a year or two ago, only a person with an active imagination could tell what would happen. Still, that is the attitude some individuals are taking toward building. They are waiting for the prices of material and labor to come down, and are going "hungry" for buildings.

There is every reason to believe that the cost of building will not be lowered—in the immediate future, at least. In the meantime the people of this country need homes, and need them badly.

When you are consulted about building and the question of cost comes up, do not be afraid to confidently assert that the person who puts off construction work with the idea that such action will be economy will have to wait for a few years at least. And then there is assurance that prices never will be where they were five years ago.

Congress Expected to Help Home Building With New Banking System

BILL ADVOCATED BY BUILDING AND LOAN ASSOCIATIONS WOULD ESTABLISH HOME LOAN BANKS. THAT WILL ISSUE BONDS TO AID HOME BUILDERS

CONGRESS, at its next regular session, will be asked to help home building in a practical way.

A bill, authorizing the establishment of a system of government controlled home loan banks has been prepared and will be presented to the house and senate. It is backed by the U. S. Department of Labor.

The banks this bill would establish are similar to the Federal Reserve and the Farm Loan banks. The former discount commercial paper for banks that are members of the Federal Reserve Banking system, while the latter loan money to farmers.

The bill was prepared by the U. S. League of Building and Loan Associations, whose headquarters, in charge of H. F. Cellarius, secretary, are in Cincinnati. K. V. Haymaker, recently appointed building association specialist of the Division of Public Works and Construction of the U. S. Department of Labor, is representing the loan association league in furthering the bill at Washington. Mr. Haymaker has been identified with building and loan association work for several years, formerly having been with the National Lumber Manufacturers' Association, promoting these associations.

What the Bill Provides

Regarding the bill and its objects Mr. Haymaker says:

"The building and loan associations of the United States are about equal in number to the national banks, having total assets of about \$2,000,000,000 invested in first mortgage securities. The chief business of these associations is lending money to aid in building homes.

"It is believed that a great revival in home building is about to commence in this country. In many communities the building associations have not funds sufficient to finance an unusual demand along this line of activity. The building association men of the coun-

try, at a recent conference called by the Secretary of Labor at Washington, asked that Congress permit the building associations to organize regional institutions, capitalized and operated by the associations themselves under careful government supervision; that they be permitted to deposit with these regional institutions the mortgages taken in the usual course of business and use them as collateral against which the institution would issue and sell bonds, turning the proceeds over to the associations depositing the mortgages.

"Such a measure would largely supplement the ordinary income and resources of these associations and enable them to correspondingly increase the aid which they can render in stimulating the building of homes. It is believed that this measure adequately safeguards the institutions, the associations and the holders of the bonds; that it is a sane, safe and practical measure and will result in great good. It will require no government aid to finance and operate these institutions, the government merely bearing the expenses of supervision."

How the Bank Will Operate

The bill in its present state provides for the establishment of a National Home Loan Board to be composed of the Secretary of the Treasury and four appointive members. This board will divide the country into eleven home loan bank districts.

A central home loan bank may be established in each of these districts when ten or more building and loan associations, with aggregate assets of \$5,000,000, or more, agree to become members. Each regional bank must have a paid-up capital of \$100,000 thru the sale of stock to the building and loan associations. These regional banks will be managed by a board of directors chosen by the members.

(Continued to page 170.)



The Proposed Federal Home Loan Banks Are Designed to Bring the Small Investor and the Home Builder Together to the Advantage of Both of Them.

Uncle Sam is Backing Up the Building Industry

EVERY builder is doing a patriotic work when he builds a home.

Uncle Sam has recognized this fact and is giving his unqualified support to the building industry.

"I want to see every wageworker own his own home," says W. B. Wilson, secretary of the U. S. Department of Labor.

"Build Your Home Now," is the slogan that the government is using to stimulate building.

To make this period of readjustment a prosperous one the newspapers, business and civic associations, farmers' granges and all the other agencies have taken up this work of urging home building.

Thus is Uncle Sam backing up the building industry.

This extensive help that the building industry is getting is unprecedented in the industrial life of the

country. Never before has the government done such a service for any peace-time industry. And the builder and material dealer has his part to perform.

"Let everyone employed on this job help set a pace that will make building profitable and popular," is the wording of one of the posters which Secretary Wilson has sent out to the workers on buildings.

"One good turn deserves another. Good work here will encourage others to build," is another suggestion.

The contractor who gives his client the best that he knows how in a home will be meriting the boost the government is giving his business. Thus will he be deserving of what is being done for him.

The country needs thousands of homes. Building puts money into circulation. Building absorbs labor. And when labor is employed everyone is prosperous.



"Go to It, My Boy, I'm Backing You Up."

How I Came to Sell Electric Light Plants

HERE IS THE STORY OF A BUILDER WHO HAD AN OPPORTUNITY THRUST UPON HIM, AND HAD THE BUSINESS FORESIGHT TO SEIZE IT

Believing that there is a profitable field for the rural builders in the sale of electric light plants to their clients, past, present and future, we asked a builder who has been successful in this line to tell us some of his experiences. Here they, are as told to—THE EDITOR.

“HOW did I come to sell electric light plants? Well, you've probably heard the story about the man who was fished out of the well, and when someone asked him how in the world he got in it, replied: 'Why, I just fell in.' That's the way I came to be selling electric light plants along with my contracting business—I just fell into it.

"It was about seven years ago that I sold and installed my first electric light plant and it came about in this way:

"I was going over the plans for a new house and barn with one of my clients. He is a man who had inherited his farm from his father and it was, and is today, a mighty good place. This client is a progressive man; in fact, he was one of the first from hereabouts to take advantage of the education in scientific farming offered by the state university.

"I always did believe in better buildings for all the animals that live on a farm—human and dumb. And I didn't have much sympathy, altho I was careful not to say so at the time, with a lot of farmers around here who scoffed at this college man's ideas of how a farm should be run.

How He Made His First Sale

"But, anyhow, while we were talking over these plans he asked me if I knew how much it would cost and what size electric light plant he would need to light his house and put three or four lights in his barn. Mind you, electric light plants for the farm were somewhat of a new idea then—so new, in fact, that I had to admit that I didn't know anything about them. He knew little more than I did, except that he had learned that they are as far over kerosene lamps as the sunlight is over moonlight.

"To tell you the honest truth, I didn't even know who made such a plant, neither did I have an idea of what they cost. But I told my friend that I'd find out.

"It seems funny to me now to think of the trouble I had getting in touch with the manufacturer of a light system, but when I did and let that concern know that I had a client who was interested, say! I got

plenty of co-operation. A salesman came and helped me a lot with his knowledge of what sort of a plant was needed and how the house and barn should be wired. And the upshot of it was that my client ordered one of those plants, and I put it in. But what was



How One Contractor Sells Electric Lighting Plants. The engine and generator are mounted on the back of the runabout and the prospect is shown what he is buying. This has proven to be an excellent method of selling plants in country districts.

most pleasing to me was the nice commission I got on the sale.

The Profit Made Him Enthusiastic

"You know there is nothing so interesting to a business man as something that is profitable. So when this company offered me the agency and volunteered to help me sell electric light plants in my territory, I grabbed it, altho then I wasn't convinced that I'd ever sell another. And that second sale didn't come easy, but I had a plant installed and could show it, and that is what did the business. Since that time I have sold fourteen electric light plants around here, and the field isn't even scratched. And some of the farmers who were hardest to convince that they needed electricity, are the most enthusiastic about it now, and are constant advertisements for me and the system I sell.

"That's how I came to be selling electric light plants, but what my experience has taught me in this: No one is in a better position to sell and install these systems than the building contractor.



Country Home at Charlevoix, Mich.—All the Buildings Are Supplied with Electric Light from a Private Plant.

Building Contractor is Logical Plant Agent

"I figure it out that a building contractor—that is the right kind of a contractor, one who believes in helping his clients get the right kind of building by advice and what he has learned thru experience—stands in about the same relation to his clients as the family doctor does to his patients. If he has helped plan and has built for them satisfactory buildings, they have confidence in what he says. So when I talk electric lights to a customer he knows that I am advising him for his own best interests.

"There is no reason why farm homes nowadays should not have the same conveniences as city homes. Neither is there any reason why the farmer's barn should not be equipped so that he can do his work easily and comfortably. A man in the city wouldn't think of building a house without planning to have electric lights in it; a manufacturer would not think of lighting his new plant with kerosene lamps. The only difference between the farmer and the city man is that the city man looks on electric lights as necessities and the farmer looks on them as luxuries.

"The automobile, however, has changed the farmer's viewpoint somewhat. Most of them own automobiles now and are familiar with gasoline engines and the price of gasoline. They wouldn't do without automobiles. And when they get a taste of these other conveniences like light and running water, they won't do without them, either.

Boys and Girls Must be Given City Comforts

"You hear a great deal of talk about keeping the boys and girls on the farm. One would think that every boy and girl, as soon as they get old enough to go to work, rush off to the city. This, of course, isn't so. But a great many of them do. And the reason they go is that the city offers them a chance to enjoy the many things that civilization has developed. They don't like taking a bath in a wash tub; they don't like living in a poorly lighted house; they enjoy the companionship of other youths. The automobile has given them a chance to get much of this companionship, thru the elimination of distance, but in order to hold all of the youngsters, their parents will have to compete with the allurements of the city.

"That is the social side of it. Now take the business side. Look what a farmer and his womenfolks can have with the installation of an electric light plant. This not only provides lights for the house and the barn, but it furnishes power to do a lot of the work



Some Idea of the Size of This Electric Lighting Plant Can Be Gained from This Picture. Placed in a Corner of the Basement, This Little Plant Supplies the Home and Other Buildings with the Greatest of Modern Conveniences.

that formerly was done by hand. One of the old, old stories about the boy who ran away from his home on the farm tells that what determined him to leave was having to turn the grindstone for hours at a time. Another said that never from March to November had he seen his bed, except by the dim light of a candle. Electric light, or rather the electricity that the plant produces, furnishes power to run the grindstone, the

(Continued to page 160.)



This Lighting Plant Was Installed Seven Years Ago in the Country Home of Henry Libben, Near Port Clinton, Ohio, and Has Given Him Excellent Satisfaction.

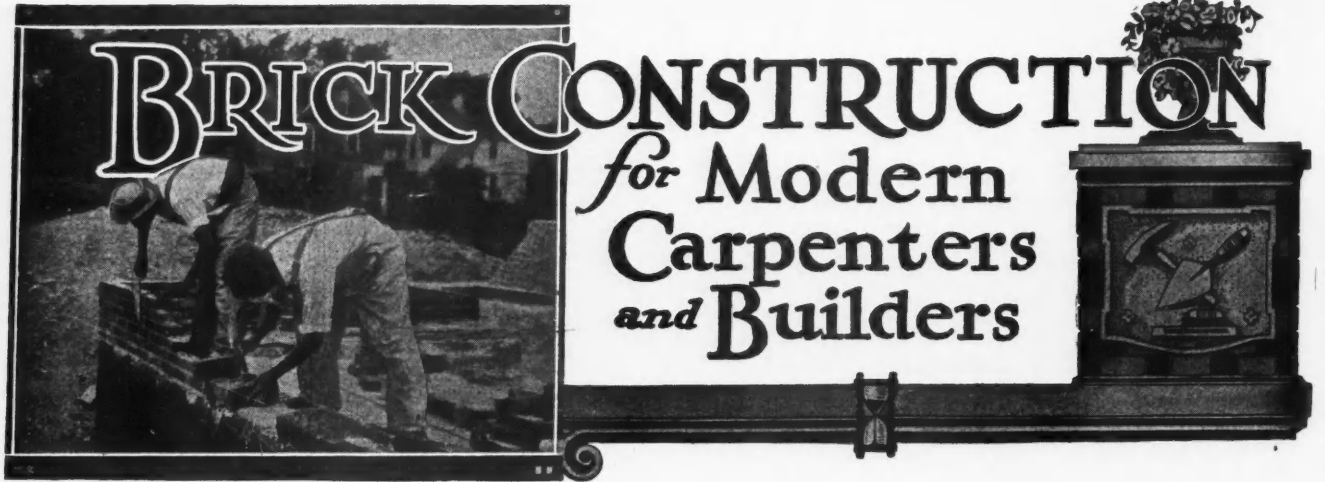

Building With Brick Brings Satisfaction to Many Clients

MODERN BUILDER KEEPS IN TOUCH WITH WHAT'S NEW IN METHODS OF CONSTRUCTION AND IS ABLE TO SATISFY THE DEMANDS AND HELP HIS CUSTOMERS

AFTER two years of practical inactivity in the brick industry, manufacturers of this building material now are able to supply the needs of the building industry. The clay products industry was one of the first to be restricted by the U. S. Fuel Administration, which decreed that manufacturers could have only from 25 to 50 per cent of their normal requirements of fuel. This restriction, coupled with the scarcity and high price of labor, of course, worked a hardship on the brick industry, but it was borne as a necessary part of winning the war. Now, however, all restrictions have been removed and building brick is available for all needs.

The present-day carpenter and builder, especially in

the smaller cities and towns, does not confine himself to any one type of materials for the buildings he erects. He is equipped to give his clients the kind of buildings they want. And brick buildings is one of the type that he is called on to construct.

It is following its broad policy of advocating among its readers better buildings of all kinds, that the AMERICAN BUILDER now resumes its Brick Construction department. Building such homes as is shown in the accompanying illustration of a fine example of colonial brick house gives the builder a reputation for excellent work. And such houses as this always are in demand.

Keeping up with the times as to materials and methods of construction is what has brought pros-

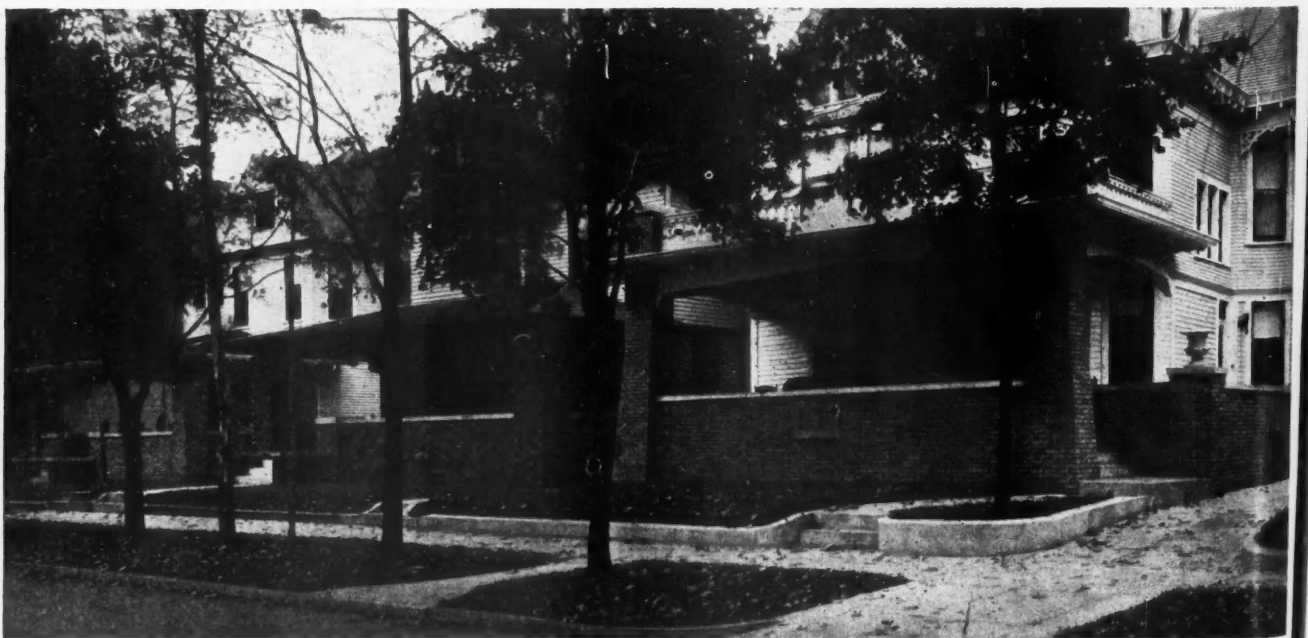

Here Are Three Houses That Have Been Made Modern by the Addition of Porches of Face Brick. By Changing the Style Slightly These Porches Can Be Converted Into Sun Parlors, Giving the Owner an Extra Room, Usable the Year Around.

perity and a good business to many who began as carpenters. Constant study of materials and methods, and styles of architecture keeps the contractors in touch with what is best in building and increases his business.

Porches of Face Brick Make Great Improvement in Old Houses

The extraordinary improvement the addition of a face brick porch will make to old houses has been a great boon to builders. It has been discovered that when one such porch is built on a street, the neighbors all are real live prospects for similar improvements. As many as 50 or 60 such porches have been built on a single street. The accompanying illustration shows three houses side by side that were so improved, one following closely on the others.

Modern home owners want porches. They are features of homes that have an extraordinary appeal to everyone. But there are hundreds of houses constructed a few years ago that have not porches of a size that there is space for. Every owner of such a house is a good prospect for the builder.

Open porches are usable only a part of the year, but when they are constructed of brick there is an oppor-

tunity to convert them into sun parlors, which can be used the year around, by the installation of windows. By constructing the porch so that it can be enclosed with sash in the winter time and by screens in the summer, the builder gives his client twelve months of satisfaction, and that is what good builders are seeking to do.

There are many other uses to which the builder can put face brick that will bring satisfaction to his client. They make a most artistic chimney; they are used extensively in fire-place construction and because of their many beautiful colors produce attractive effects: for any exposed surface, such as the front wall of a house or flat building, they generally are specified.

Buildings of brick are always in demand. They were used before there was much civilization and undoubtedly will be used until the end of time. The reason is they always give satisfaction.

✦
It is human nature to blame one's own mistakes to another. How many builders have blindly followed a client's impractical ideas and have ended with a botched job and a dissatisfied customer? Insisting on doing a job right sometimes loses a client, but the builder is the gainer in the long run.



A Fine Example of a Brick Colonial House, Designed by Charles F. White, Jr., Architect, Oak Park, Ill. Face Brick Put on as Veneer to Any Other Material, Such as Hollow Tile, Wood or Common Brick Can Be Used to Produce a House Like This.

Story and a Half Brick and Stucco House and Garage

DESIGN OF HOME GROUP ON NEXT PAGE WILL MEET THE APPROVAL OF BUILDERS WHO WANT BETTER CLASS BUILDINGS.

IN the era of home building that is here, there will be many who will want an attractive brick and stucco house with a garage of the same architectural style. On the following page is shown a design that is exceptionally good. A more attractive and artistic exterior could not be designed, while the interior arrangement of the house is exceptionally good. The dimensions of the house are 31 feet 10 inches by 39 feet 10 inches, with a living porch 18 by 8 feet 6 inches. The house contains eight rooms, besides the glassed-in porch.

This house can be constructed in three different ways—of face brick over wooden sheathing and studding, over rough brick or over hollow clay tile. Cross-sections showing the methods of construction of the different materials are shown on this page, together with a cross-section and floor plan of the garage.

This is an unusual design and one that will appeal to the builders' clients who want a high-class home, with or without a garage. It is a home group that will sell itself.

The practical builder will be more than ordinarily interested in the construction methods the architect has shown in the cross-sections. These illustrate what a substantial and fine residence he will be able to give his clients.

Using this design will help get contracts for high-class homes.

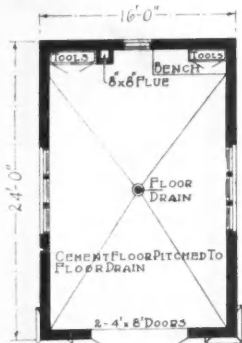

GARAGE PLAN

Floor Plan of Garage and Cross-Section of Wall of Face Brick Over Hollow Clay Tile.

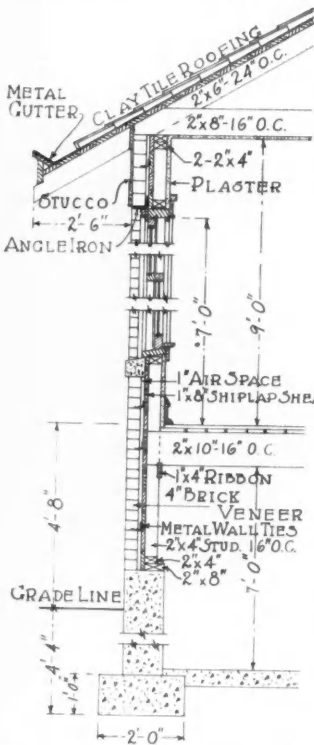
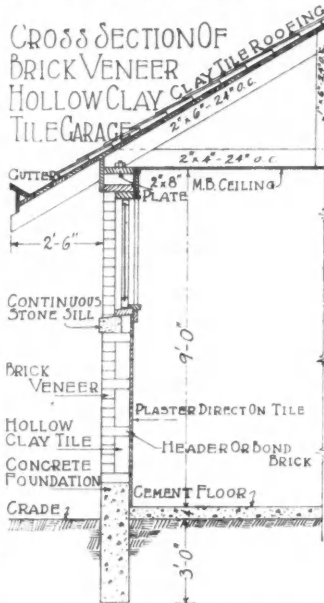

Cross-Section of Wall of Face Brick Over Wooden Sheathing and Studding.

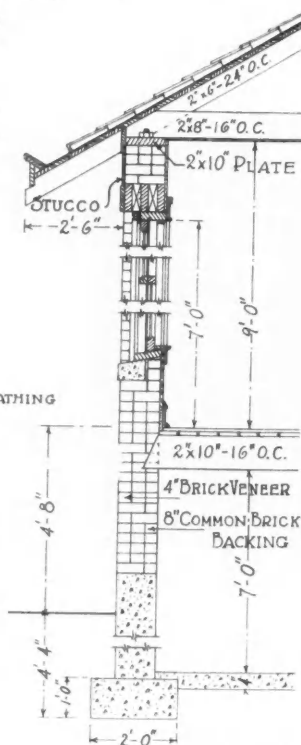

Cross-Section of Wall of Face Brick Over Common Brick.

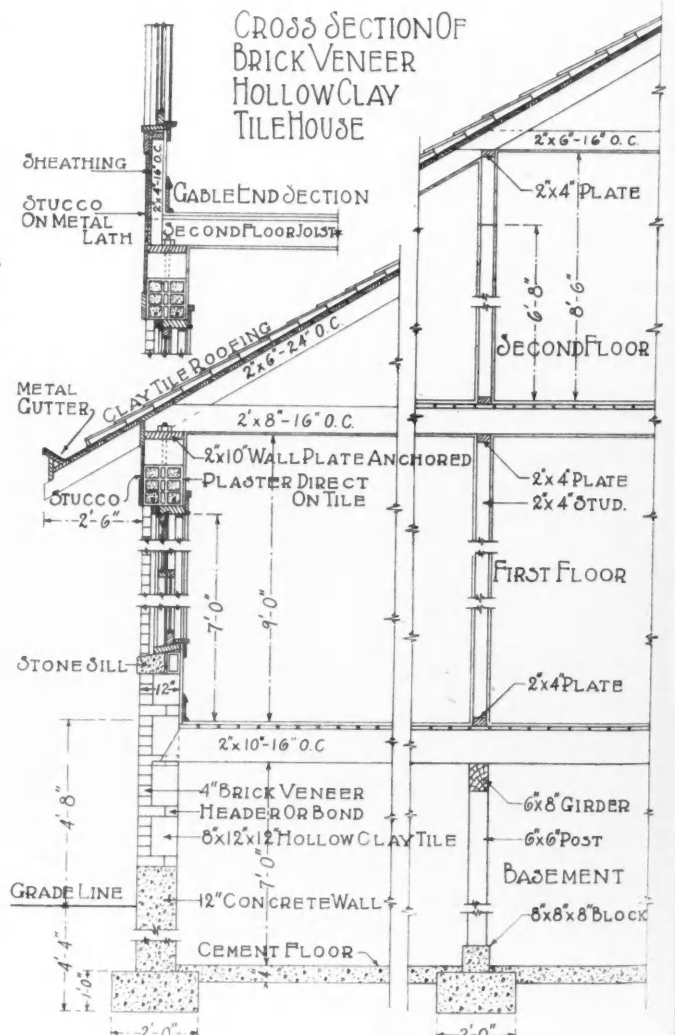

Cross-Section of Wall of Face Brick Over Hollow Clay Tile.

Cross-Sections of House Wall, Showing Construction with Face Brick Over Three Different Kinds of Materials.

BEA...
gar...
make it...
large, v...
Such ho...

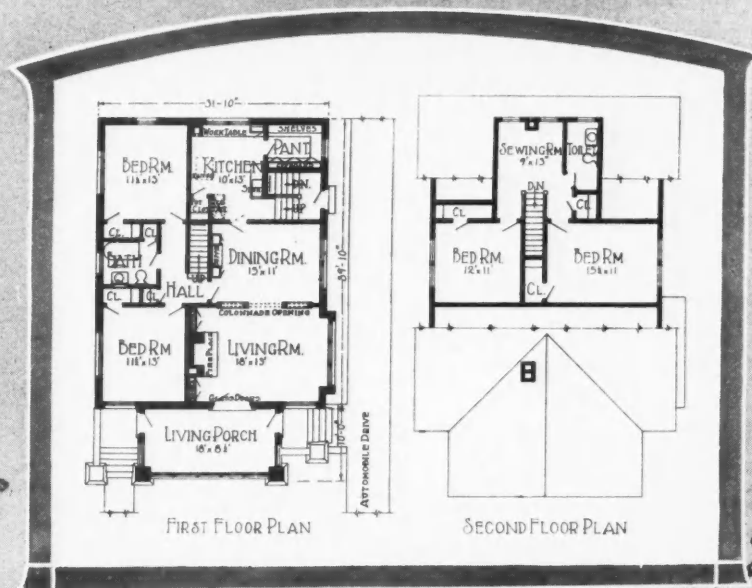

BEAUTIFUL BRICK AND STUCCO HOUSE AND GARAGE. Here is a design for an eight-room house with garage adjoining that is a beauty. The graceful lines of both buildings and the living porch projection of the house make it an ideal home group. The house contains eight rooms besides the living porch. All are well arranged and large, with two bedrooms and bath on the first floor and two bedrooms, sewing room and toilet on the second floor. Such homes as this are always in demand.

Electric Woodworkers Are Little, But Oh My!

ELECTRICALLY DRIVEN INDIVIDUAL MACHINES AND TOOLS ARE SMALL, BUT THEY ACCOMPLISH A LARGE AMOUNT OF WORK

THERE are sound reasons why every carpenter and every woodworker has his own set of tools. Experience, not of this generation of workers, but of generations of the past, has taught that having needed tools at hand saves a lot of steps—and steps mean time and effort—and that two persons cannot use the same tool at the same time.

However, as power machines were developed one was deemed sufficient for a number of workers, on the theory that the men would not be doing the same kind of work at the same time. And one machine is sufficient now, when certain kinds of work are to be performed. In the larger shops one man usually performs one kind of work almost constantly. His job is to do a certain thing, and he has the machine that will do it ever so much better and ever so much quicker than it can be done by hand. This is true of the saw bench, the planer, the band saw, the jointer—and in many shops these machines are combined in a single unit, so constructed that the different operations can be performed by different men at the same time.

But on the woodwork that goes into the modern building there is a large amount of work that is delicate and is not easily performed on the large machines. For this reason much of it is done by hand at the bench. The latter method, however, is out of date. New types of machines and tools, little electrically driven machines and tools that are right at the workman's elbow, have been devised to do this small, delicate work better, faster and more cheaply, just as the big machines are more efficient for the larger work.

These machines have been made possible by the development of the small and powerful electric motor and the fact that now there are few places where electric current is not available. Manufacturers of woodworking machinery have taken advantage of the

latter fact and have produced small duplicates of the large machines and have invented tools that do the work formerly done by hand. These machines and tools have been hitched up to small electric motors,

which in turn are attached to the electric light sockets. Thus does the woodworker have on his bench tools and machines that will perform 50 per cent of the work of the shop.

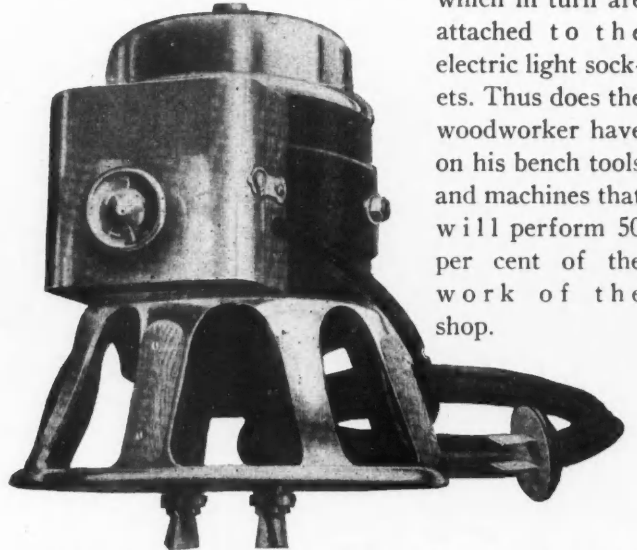

A Small Electric Router, with the Motor in the Head. It Does a Great Amount of Work in the Shop That Usually Is Done by Hand.

The Story in Pictures

Pictured in the accompanying illustrations are some of these small electrically driven machines and tools, scenes in shops where they are in operation and the work they will turn out.

Small bench jointers are practical machines for the carpenter shop, pattern shop, woodworking factory and interior finish factory. One of them is 17 inches high, 39 inches long, 17 inches wide and weighs 257 pounds. The power required is furnished by a motor of one-half to one horsepower, making 1,200 revolutions per minute. It will take six-inch stock and will do any variety of work that can be done on larger machines.

This machine is made to sit on a bench of either wood or iron. Small wheels, attached to the legs of the bench, make it portable. The tables are 10½ inches wide and 38 inches long. The short table is grooved for rabbetting. The bed is made in one piece and cored out, with partitions on both sides of the cylinder to cause the shavings to drop into a receptacle or shaving pipe. The slides or inclines are planed to a 20-degree bevel, and always draw from the cylinder when lowering. The fence is 3½ inches high and 25½ inches long,

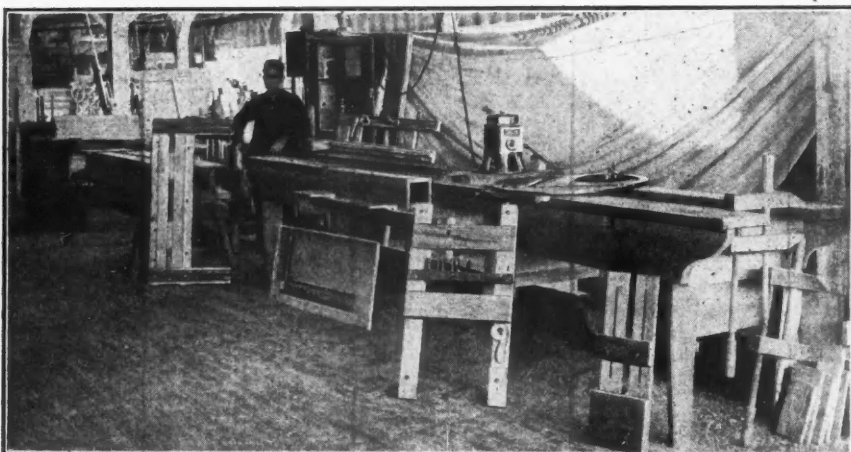

The Variety of Work Done in the Curtis & Yale Shop, Wausau, Wis., by an Electrically Driven Router Is Shown.

and is on the short table. The cylinder head is of the circular safety type, with two knives. These are of two types, one with a slotted knife and the other with a thin knife.

Another is a bench planer and jointer, with an electric motor in a single unit. This little machine is designed to do the work on small stock. The cutting knives are 4 inches wide; the length of the front table is 10 inches and of the rear table 9 inches; the length over all is 19 inches, and the planer weighs 50 pounds,



Routing a Stair Stringer. The Operator Is Guarded by the Skirt of the Machine, Which Makes It Impossible to Come in Contact with the Cutters.

making a handy machine, one that can be easily moved and is right at the elbow of the operator.

This planer is operated on an electric light circuit, the motor being of one-fourth horsepower, but because of the direct drive it has more power per inch

of knife than the two and five horsepower belt-drive machines.

Routing Made Easy

The little electrically driven portable router shown in the accompanying illustration has been in general use a number of years and tests have shown surprising results in time saving on work of all kinds of interior finish. One was on a curly birch stringer. It required 20 minutes to make each one of the 15 cuts on this stringer by hand, a total of 5 hours. The router did the same work in 5 minutes, making each cut in 20 seconds.

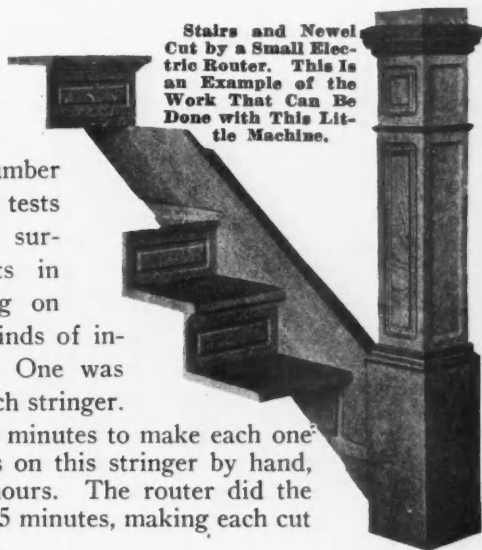

This little machine is used with a framing plate, also shown, which enables the operator to cut threads or risers $\frac{7}{8}$ to 2 inches thick, right or left hand, to any angle required. The riser pictured was cut by Hower & Stender, Scranton, Pa. Another illustration shows an interior view of the plant of the Curtis & Yale Co., Wausau, Wis. Here may be seen a



The Planer in the Foreground of This View of the Interior of a Woodworking Shop Is Equipped with a Little Sharpener Tool That Keeps the Knives in Fine Condition. They Are Sharpened in Place Which Saves Time It Would Require a Workman to Remove the Knives and Also Keeps the Planer in Operation Practically Continuously.

variety of work done on this machine, including wooden patterns for paneling newels, stair winders, newel housings, balustrade spindle cuts and column fluting.

A 30-inch dado frame is another piece of equipment which can be used with this router and which obtains excellent results in shelf housing, cabinet work, dovetailing, sunken panels, edge moulding, church bench work and general interior finish.

Grinds Knives Without Removing Them

To be able to grind the knives of planers and jointers without removing them is recognized as a saving of time and labor. One of the illustrations shows a small electrically driven grinding tool that performs this service. This machine gets its power from a motor

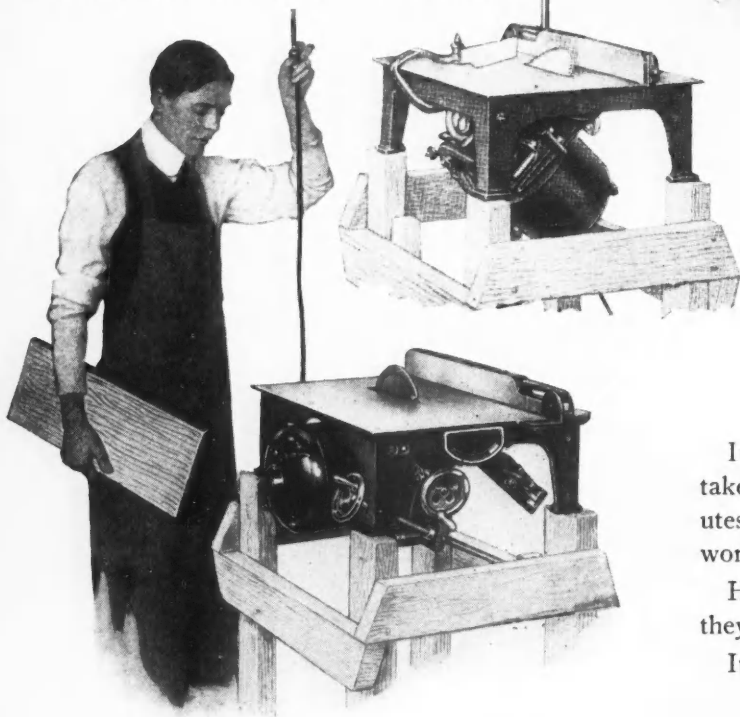

The Motor and Saw of This Small Machine Tilt so That Cuts May Be Made at an Angle of 45 Degrees Without Disturbing the bench.

mounted in the grinder head, the current being taken from an ordinary electric lamp socket. The grinder is mounted on a bridge supported at the ends, or other convenient points, by two angular brackets, which are bolted to the bed of the jointer, holding the grinder rigid. The saddle can be fed the length of the bridge in either direction and at any speed desired. The grinding wheel is cup-faced, can be set to grind the required amount from the knives and automatically feeds itself to a positive stop.

Working on a pivot, the grinder can be tilted either way, and is held in place against a stop, grinding the same angle on either side, the tilted head giving a concave grind to the knives. Each knife is held in the same relative position to the wheel, and therefore must be ground true to the bed.

The advantages of using this grinder and some of its features are:

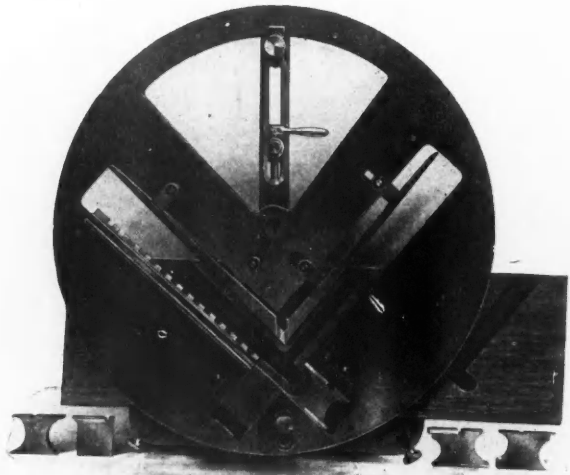

Framing Plate That Is Used in Connection with the Electrically Driven Router.

The machines will take care of considerably more work when the sharpening is done by a file and oil stone, with a reduction in the cost of knives.

A pair of knives put into a machine are not usually taken off until worn out.

The knives always are in perfect alignment with the bed and with each other. Thus each knife does its share of the cutting.

If a nail or gravel is struck, instead of having to take the knives out and adjust a new pair, a few minutes with the grinder will clean up the gap and the work will be started again without serious delay.

Harder knives can be used than is possible when they are sharpened by hand.

It will grind knives 18 to 60 inches long.

(Continued to page 170.)

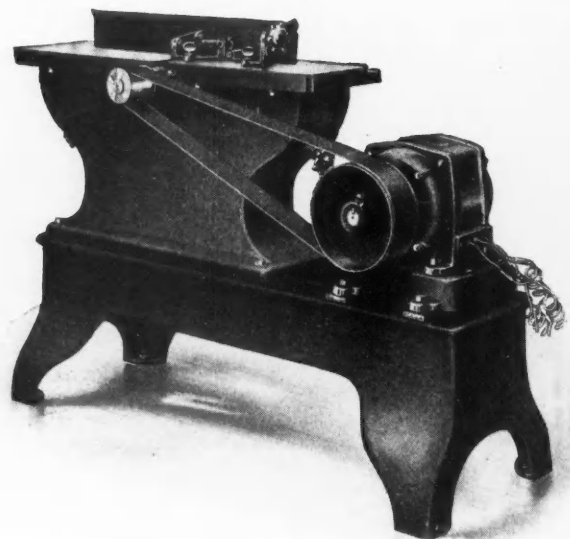

This Little Jointer, 17 Inches High and 39 Inches Long, Will Take 6-Inch Stock and do All Kinds of Work. The Power Is Supplied by a 1/2-Horsepower Motor.

Remodeling Old Houses Is Profitable Work

BUILDERS TURN OUT-OF-DATE HOUSES INTO MODERN HOMES BY OVERCOATING WITH STUCCO AND CHANGING THE ROOF LINES AT A COMPARATIVELY SMALL COST

THE opportunities for builders that lie in remodeling old homes are testified to by H. A. Stoecker, a contractor at Stanwood, Iowa: "I have no trouble getting all this kind of work I want, as it makes practically a new house of the old one at a comparatively small expense," says Mr. Stoecker. The accompanying illustrations show a house before and after Mr. Stoecker remodeled it with stucco on wooden lath over the old siding. How Mr. Stoecker changed the roof and porch designs and what a fine residence he made of this ordinary appearing old house are shown by the illustrations.

Overcoating old houses with stucco is bringing to builders an increasing amount of work. While original construction is taking the lead this year because of the need of houses, there will be many who want their old homes remodeled into modern ones. Stucco is particularly adapted to this work, because particularly fine effects can be gained at comparatively little cost.

The methods of construction employed in overcoating houses with stucco are comparatively simple. As Mr. Stoecker did it, the old siding is covered with wooden or metal lath and the stucco applied. There are several brands of stucco on the market that give excellent service, both as to appearance and durability.

What appeals most to the owners of old homes is that a modern structure can be obtained without sac-

rificing the present building. This saving is large, especially in those buildings that were well constructed. What appeals to the builder is that overcoating with stucco gets him many profitable jobs.

Every builder can, as Mr. Stoecker says, get all the remodeling jobs he can take care of if he only goes

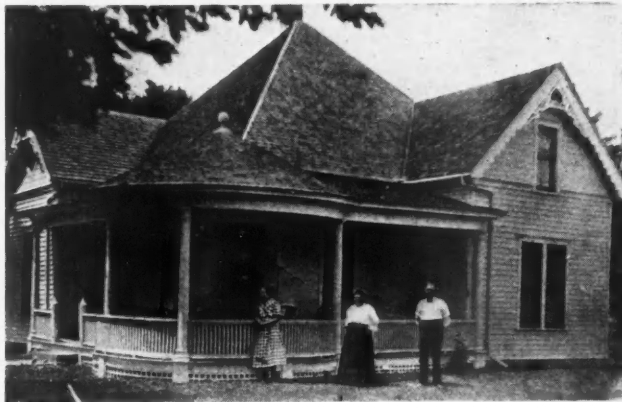

The Old House Before It Was Remodeled and Overcoated with Stucco.

after them. No one wants to tear down a substantial dwelling, just because his ideas of the exterior arrangement have changed since the house was built. But since the modern methods of overcoating with stucco have come into general use there is no sense in destroying what still is good. Remodeling saves for the house owner and creates profitable jobs for the builder, which is a good combination.



Here Is the Same House After It Had Been Converted Into a Modern Home of Attractive Appearance by Changing the Roof and Porch Lines and Applying Stucco to Wooden Lath Over the Old Siding. The Work Was Done by A. H. Stoecker, of Stanwood, Iowa.

ANNOUNCING A PORTFOLIO OF BLUE PRINTED BEAUTIFUL HOMES

New and Costly Feature in the Supplement That Follows Made Possible By Recently Perfected Method of Printing, Called "Planogravure Lithography"—Will Be a Permanent Feature of the American Builder



FOLLOWING its policy of giving its readers the best in suggestions that will help promote building, the AMERICAN BUILDER, in the four page supplement that follows, presents a new feature, the Portfolio of Blue Printed Beautiful Homes. The designs shown are of a Dutch colonial house, a story-and-a-half tile and stucco house, a white bungalow and a modern two-flat building of brick and terra cotta.

We take particular pride in calling the attention of our readers to this two color supplement—pride, with gratitude added. This is a costly feature, prohibitive for a magazine of small circulation, but with the present circulation of the AMERICAN BUILDER, we are able to give our readers this expensive feature. The supplement has been made possible by the rapid growth recently of the AMERICAN BUILDER family, a growth that would startle most heads of large families, with the cost of living as high as it is. During the last three months more than 10,000 names have been added to the AMERICAN BUILDER subscription list, and we want our readers to know that we appreciate their interest in our magazine.

Will Help "Build Your Home" Campaign

This new feature, also, is our contribution to the "Build Your Home" campaign, which is now sweeping the country and which the government is endorsing and actively promoting. While others are urging that people build a home, we are making it possible for our readers to show them what to build and make them want to build thru the very beauty of these home designs. There is no way to make home owning and home building so attractive as to illustrate artistic and practical homes in a striking manner.

The AMERICAN BUILDER long has advocated better buildings. Thru our Portfolio of Beautiful Homes, the members of the AMERICAN BUILDER family have done much to stimulate building. They have been able to show their customers just what their new home will look like when it is constructed, and how the different rooms will be arranged and the size of each room. The designs have been a great aid to contractors and building material dealers: but this new departure will have even greater merit as selling helps.

Use These Designs to Promote Building

These beautifully printed pictures are for the readers of the AMERICAN BUILDER to use. They are valuable in the several ways already pointed out. They will help every member of the building industry to promote home building in his own community. Show them to prospective clients and whet their desire for a home of their own.

This is a great work that builders and material dealers can do in helping to promote the "Build Your Home" campaign. They can co-operate with the government and the local organizations that are putting on such campaigns. And again let it be said that nothing will stimulate building more than to show the prospective home builder such designs as are contained in this Portfolio.

Here are a variety of designs, all excellent, that will suit the ideas of a great majority of the home builders. Let them see these designs and both home building and your own business will be benefited by them.

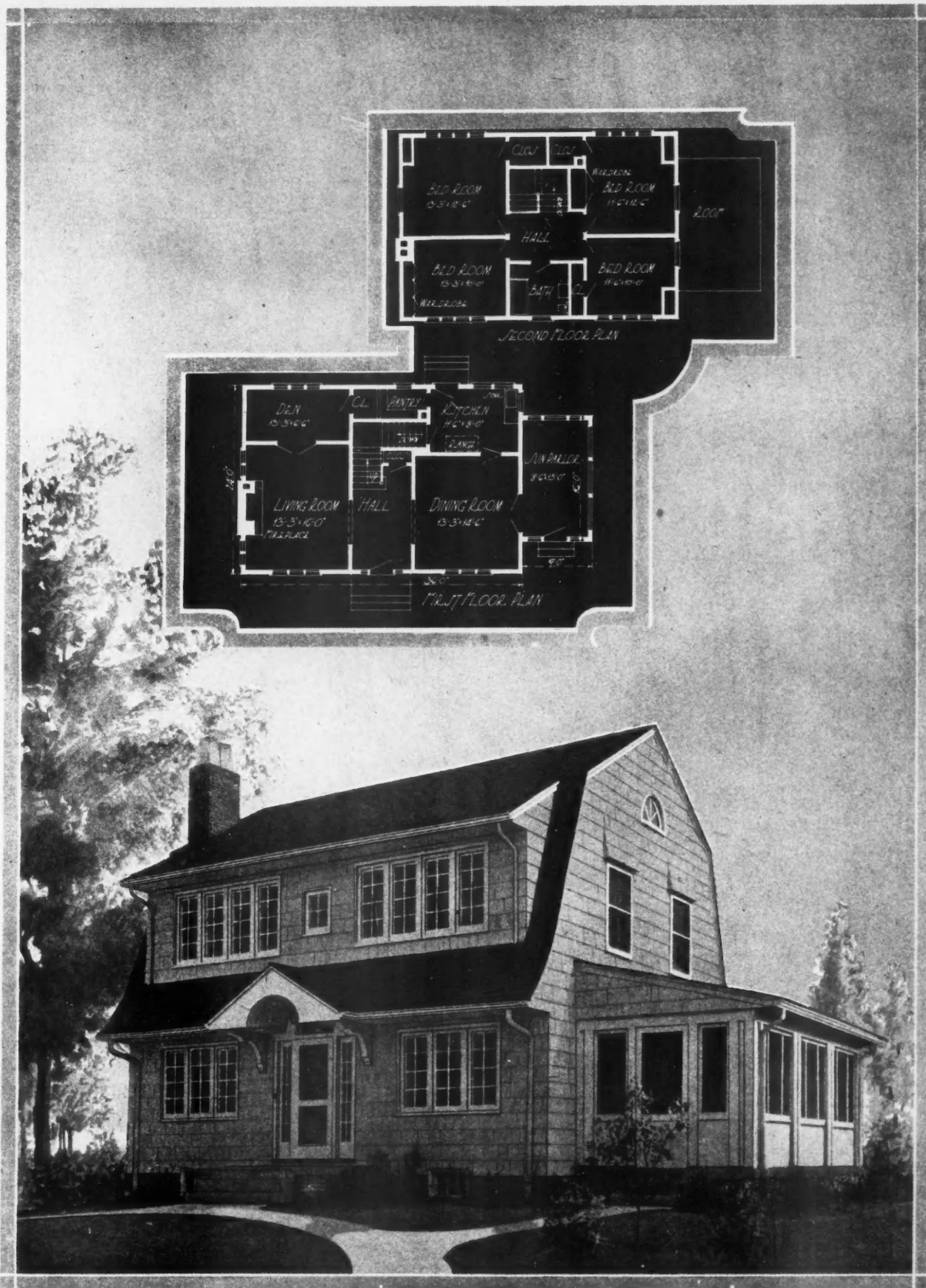

A FINE DUTCH COLONIAL HOUSE. Here is a Dutch Colonial that will challenge the attention of every prospective home builder. Its graceful lines and pleasing exterior, combined with the convenient interior arrangement make this an exceptional design — one that will arouse the home-building idea in every person. There are three remarkably fine rooms on the first floor besides the big sun parlor. Upstairs there are four square bedrooms, a large bath room and abundant clothes closet space. Size of house is 24 by 36 feet.

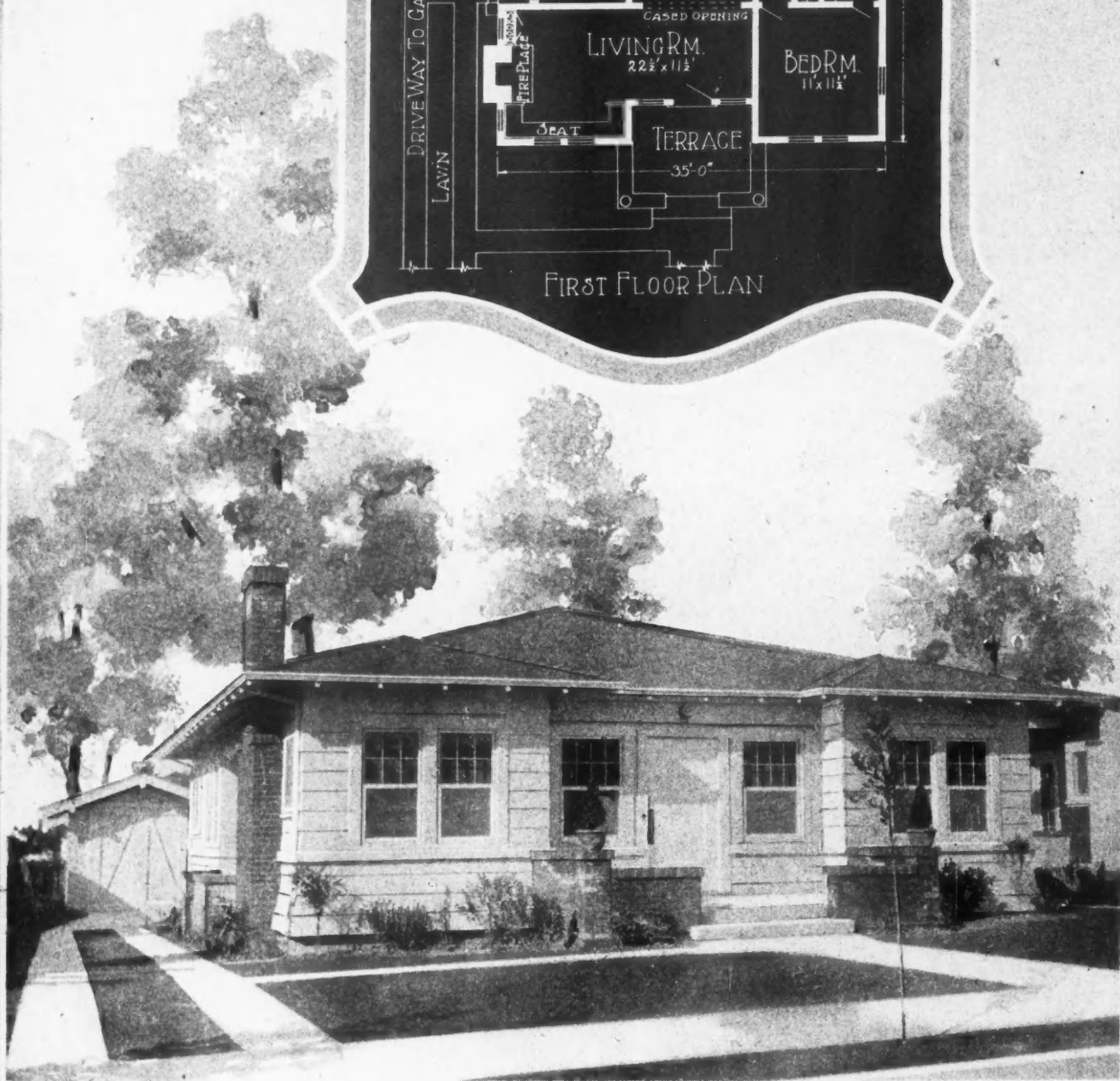
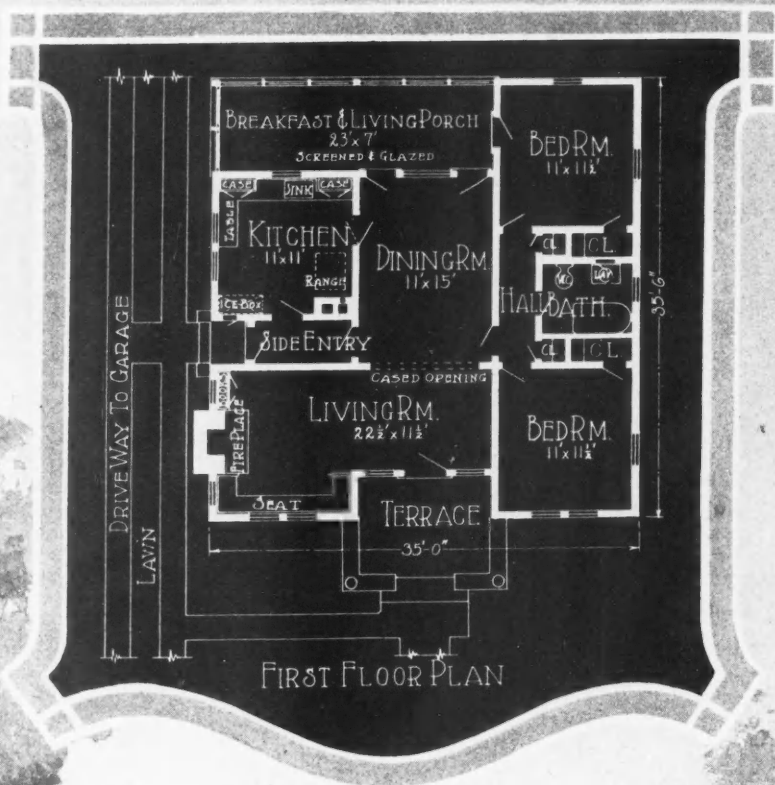

WHITE BUNGALOW THAT'S A BEAUTY. This little white bungalow is just what many home builders want — a small house with every modern feature. It has five rooms and a large living and breakfast porch, besides the terrace at the front. The dimensions of the bungalow are 35 by 35½ feet. Put this little home down in any suburb or residential town and it will grace its surroundings, doing credit to the builder who put it up as well as the home owner who occupies it. Such a home is a pleasure to build and a pleasure to own.

S
room
room

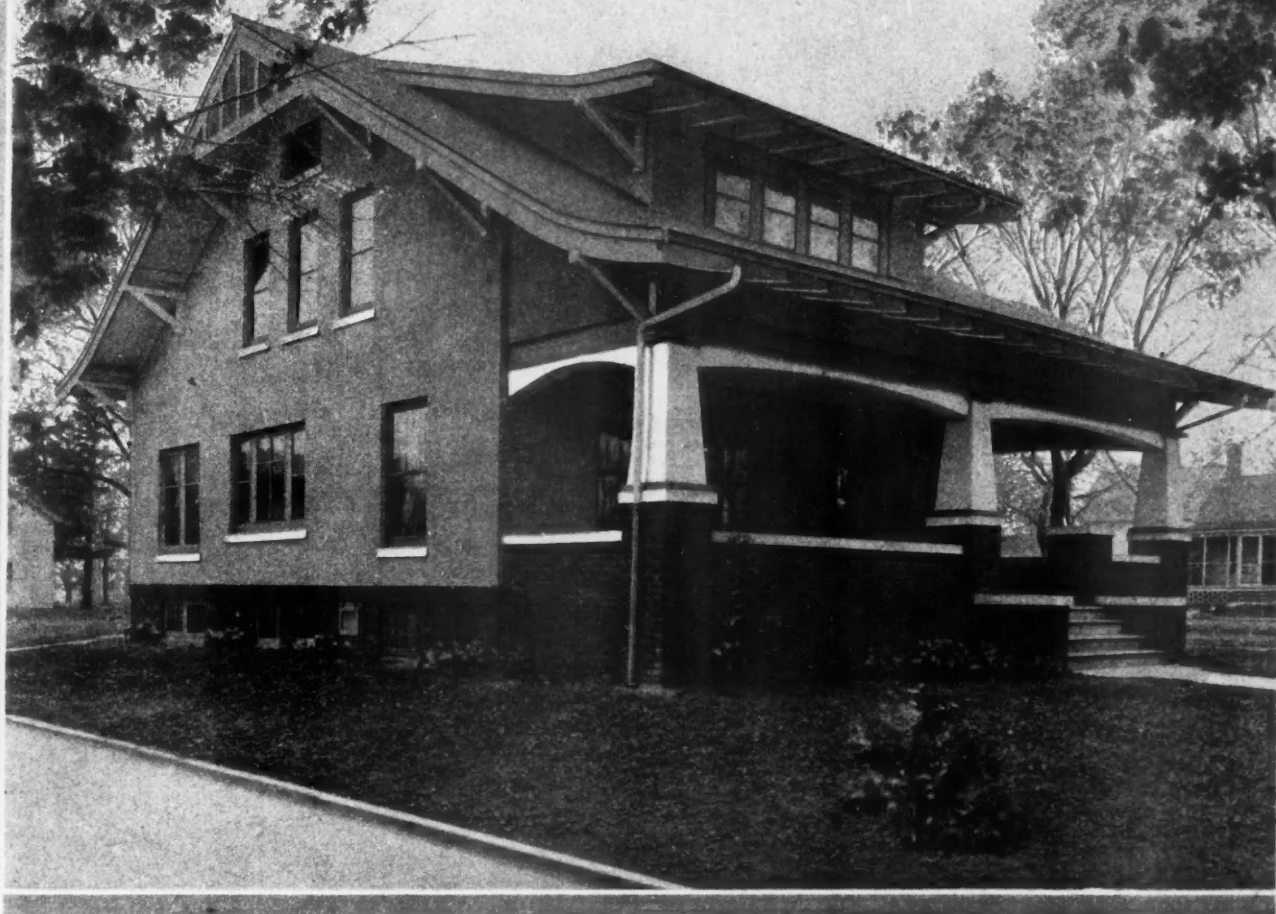
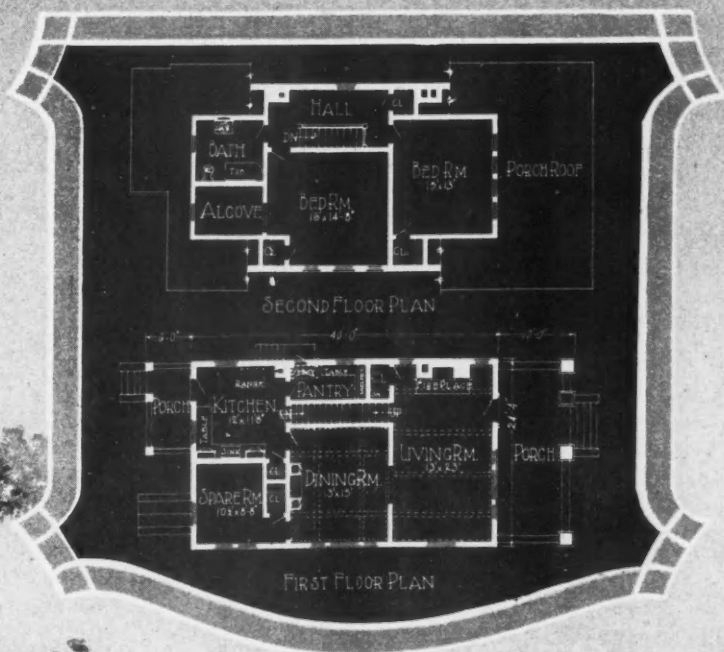

STORY AND A HALF STUCCO HOUSE. This design of a story and a half house of stucco over hollow tile will appeal to many who intend to build a home this year. The graceful roof lines and the spacious porch both give it a fine appearance. Its dimensions are 24 feet, 4 inches, by 40 feet. It contains six rooms and bath. The first floor shows four fine rooms, the living room and the dining room being especially attractive with their beamed ceilings. On the second floor are two rooms, alcove and bath.

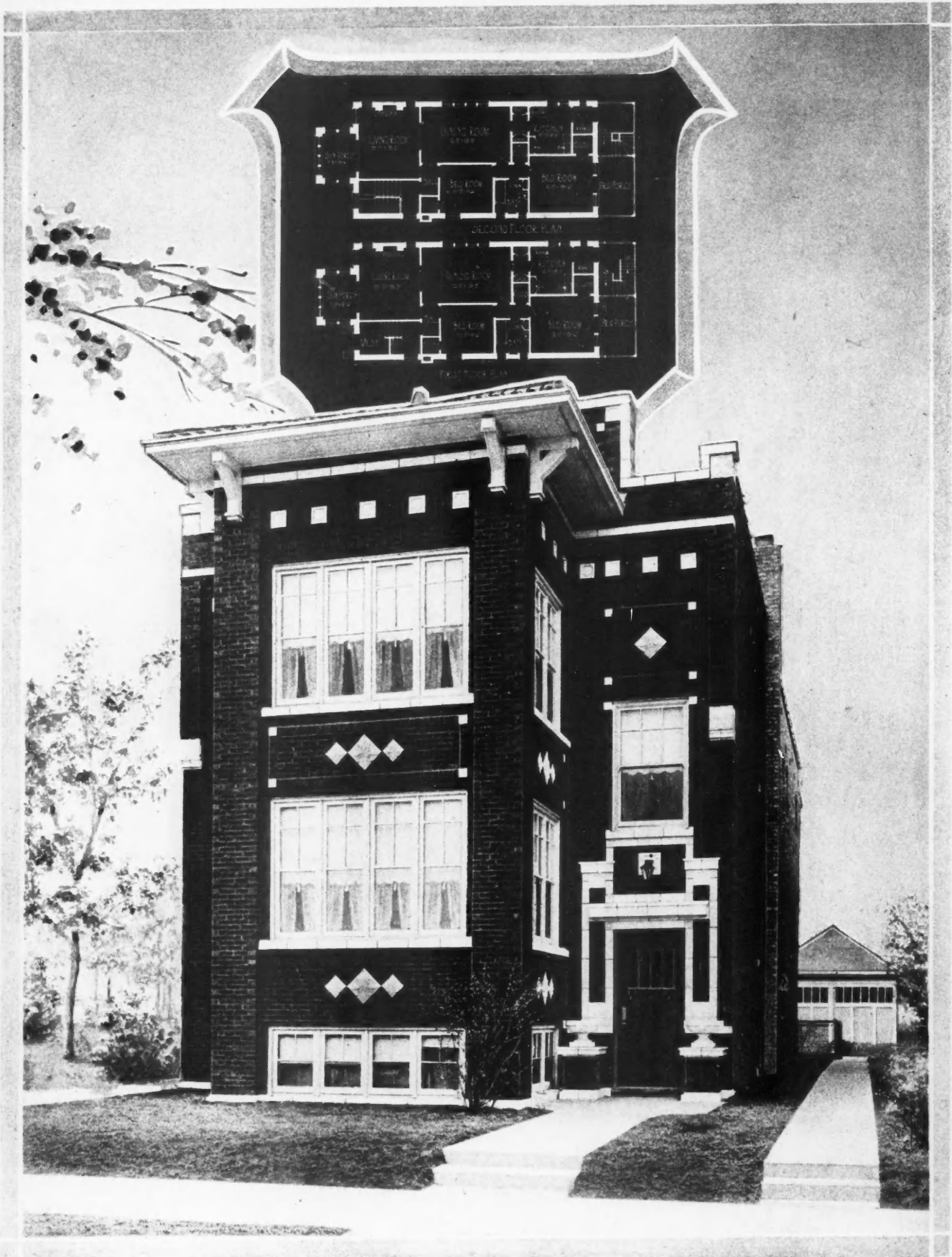

TWO-FLAT BUILDING OF BRICK AND TERRA COTTA. Many home builders want to make their building help pay for itself thru rent. To them this two-flat building will have a strong appeal. The building is modern in every respect. It is constructed of brick with terra cotta trim. Each flat has five rooms, sun parlor and bath. This is the residence type of flat building which goes best in the suburbs and in the smaller cities. The sun parlor bay at the front is the most popular feature today in apartments.

T
sta
po

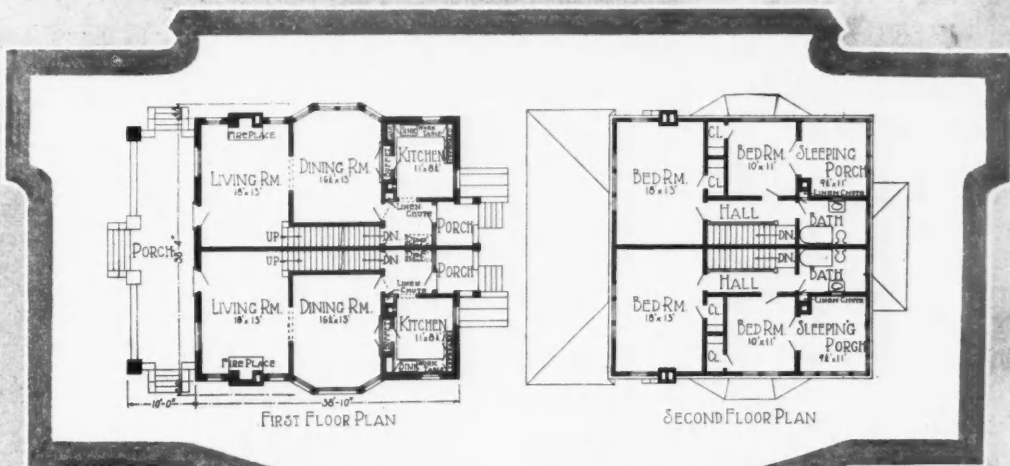

TWO-FAMILY HOUSE OF BRICK AND STUCCO. This is an exceptional design of a house for two families. Each side contains five rooms and bath besides the sleeping porch on the second floor. The hip roof and substantial attractive porch are exterior features. This is an up-to-date design for such a building and it affords the greatest possible value for the home-building funds invested in it.

How to Hang Garage Doors to Save Space

ECONOMY IN BUILDING HOMES FOR AUTOMOBILES RESTS LARGELY IN PUTTING IN DOORS THAT CAN BE OPERATED IN THE LEAST AMOUNT OF ROOM—SUCCESSFUL CONTRACTORS STUDY CAREFULLY THE DOOR PROBLEM

WITH the strong resumption of home building, which is reported by contractors everywhere, especially in the middle western states, there will be an exceptional demand for garages to round out the home building group this season. To many home owners, who derive most of their pleasure from the ownership of an automobile, a garage is almost as essential as the house itself.

There was a time when almost any building that had four walls and a roof was deemed suitable to house an automobile. That time is past, however. When the automobile owner has an investment of several hundreds of dollars, he calculates that it is economy to have a modern building in which to house his car. Experience in handling automobiles, also, has made most owners comparatively expert mechanics and they want a place where they can not only keep the machine, but do the many little things, of lesser and greater importance, that the proper upkeep of the car requires.

Added to these important features, the garage must be attractive in exterior appearance and in keeping with the design of the house to which it belongs. All of these requirements put on the contractor and builder no inconsiderable job—one that is not so simple as it would seem, but, at the same time, a profitable one. And as many thousands of garages will

be erected this year, this field offers great opportunities to the members of the building industry.

In garage building, as in house building, economy is what counts. To give the garage owner the right kind of a building, with the conveniences that he re-



A Two-car Garage, Parallel Doors

quires at the least cost is what the builder aims for and to do this architects have been devoting a great deal of thought to the designs of these structures.

Doors Important Garage Features

It is because of this feature of economy of space, both as to site and the size of the building that there have been designed many types of garage doors. The automobile requires a considerable part of one side of the building in order to get in and out of it. Where

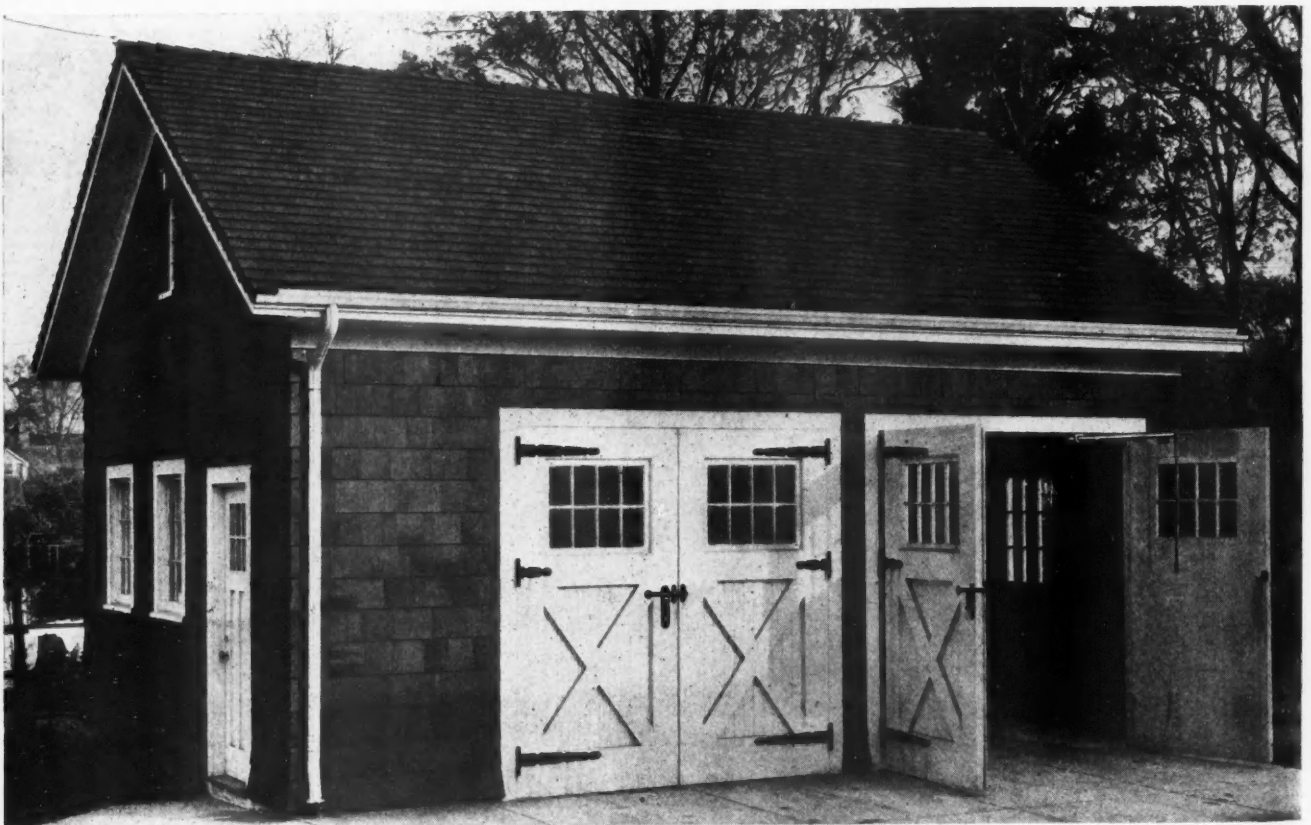

A Garage That Any Automobile Owner Would be Proud to Have in His Yard. This Single Building Is Made Exceptionally Attractive by the Artistic Door Hardware. The Open Doors Are Held by an Arm That Locks Automatically and Are Released by Simply Pulling a Chain.

there is plenty of clearance for them, the swinging doors are much in demand; where the space for the building is limited, interior folding and sliding doors are favored.

Materials for garage construction are as varied as those for buildings for any other purpose. The simplest is the frame construction. A type that makes an attractive appearance is frame with shingle siding and roof. Such a building is constructed with a gable roof, covered with wood shingles, and shingled to the foundation. This makes an exceptionally attractive building, especially when the doors and windows are white and the shingles their natural color.

The hip-roof garage of rock face cement blocks is another type that makes a fine appearance and a sturdy structure. Hollow tile, brick and stucco over any of the mate-

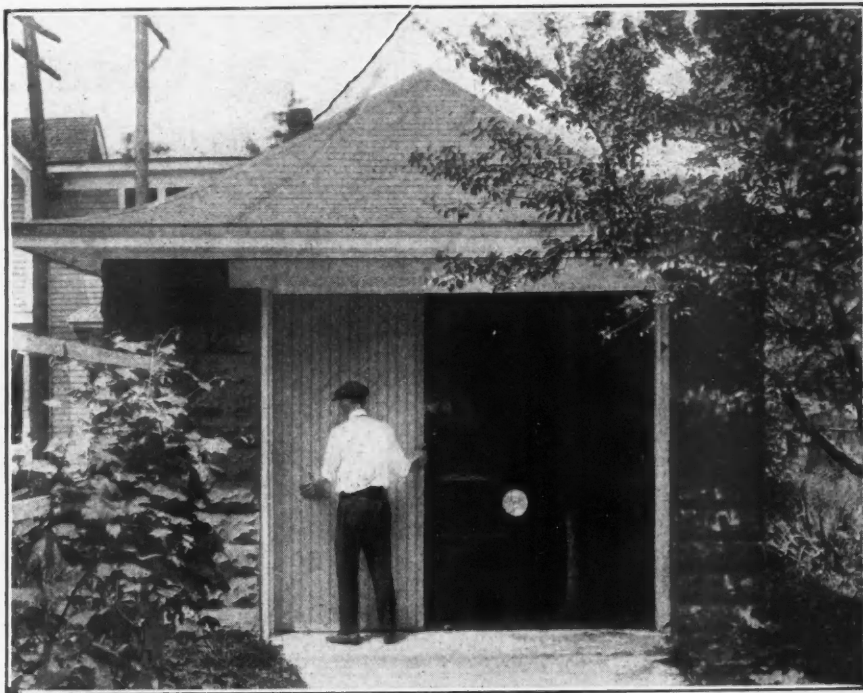

An Attractive Small Garage, Equipped with a Right Angle Door That Is Hung on a Track. The Room Required for the Door Is Only As Much as Is Needed to Get Around the Car.

Single Door for One-Car Garage

A single door that closes the opening in a one-car garage is popular. This type of door slides on a trolley and track and when opened is flush against the side wall of the garage. The space required is about half its width from both the front and side wall. This, however, is not much more than must be allowed in planning the dimensions of the building so as to allow the free passage of a person around the car. To hang this door requires a track that extends across the upper door sill and along the side wall. The hangers are on a swivel and as the door moves toward the side wall, they follow the track. When the door is open it takes up only its width against the wall.

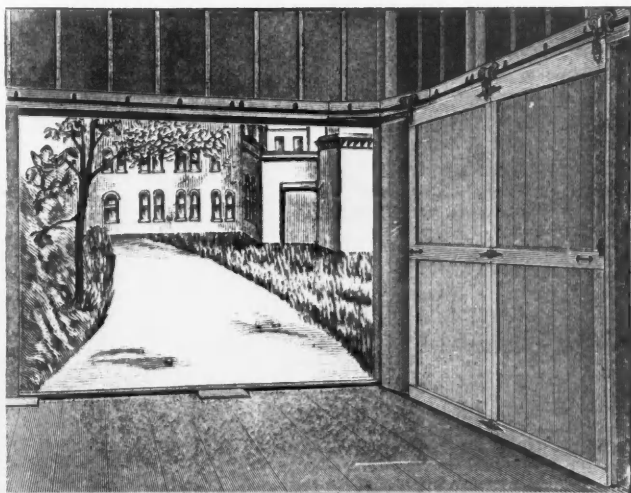

Two Hinged Doors That Slide Around the Corner and Entirely Out of the Way. They Occupy Little Space.

rials to which it clings also are in demand; in fact, there are as many types of garages as there are of homes.

But, as has been said, the doors and the hangers are important features of every garage. Accompanying this article are illustrations showing a number of different types of doors, hung in various ways. There are the doors which open out on hinges. These are made attractive by the use of artistic hardware. Long straps hold the doors rigid, while they are equipped with arms that lock them open automatically when they are at right angles with the door casing. These arms are released by pulling a chain inside the building. The locks have done away with the danger of the doors being blown against the automobile as it is leaving or entering the garage.

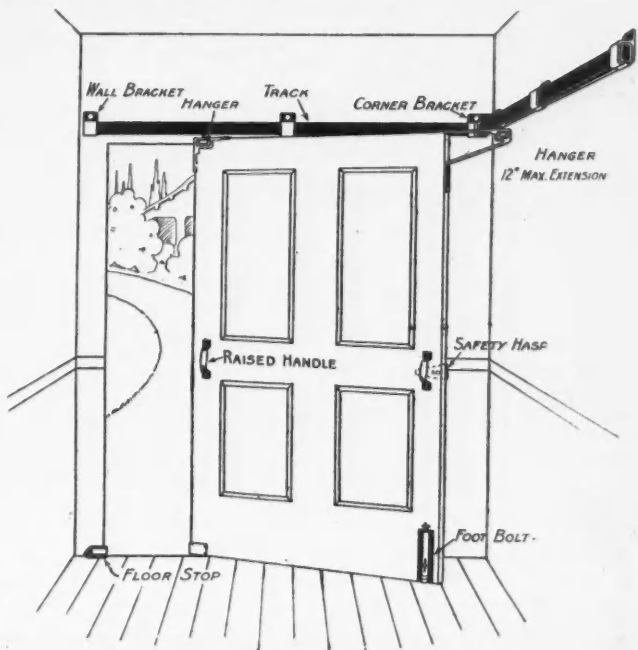

Single Door Sliding Onto Wall at Right Angle to Opening.

Similar in operation are the double folding doors. These doors are hinged together tightly and hung to the track with a single hanger placed at the edge of the door farthest from the wall against which the two fold when open. Hung with swivel hangers, which have ball bearings, the doors open easily and take up little space; in fact, only as much as the width of the door.

Similar to the single right angle door, first described, is the operation of double-hinged doors, which, when open also are at right angles with the side wall. These doors are hung on a curved track, the hangers being placed on the extreme edge of each door and on the edge of one of the doors in the center. The doors swing around the corner and require little room to be operated in.

Folding Doors Solve Many Problems

Folding doors have solved the problem for many builders who were limited as to space, especially in the garages that were designed for two or more cars. These folding doors are in series of two, three, four, five and six doors, one of them being so hung as to be a service, or entrance door.

In the three-door installation, one door is hung on hinges to the jamb. The other two are hinged together and hung on a track, which extends only two-thirds of the way across the door opening. The service door opens the same as any single door on hinges; the other two fold as they slide toward the other wall. In four-door installations of the folding type, two fold and slide each way; in the five-door type, three go one way and two the other, while six doors are hung in groups of three, folding in opposite directions.

The manner of hanging all of these doors is simi-

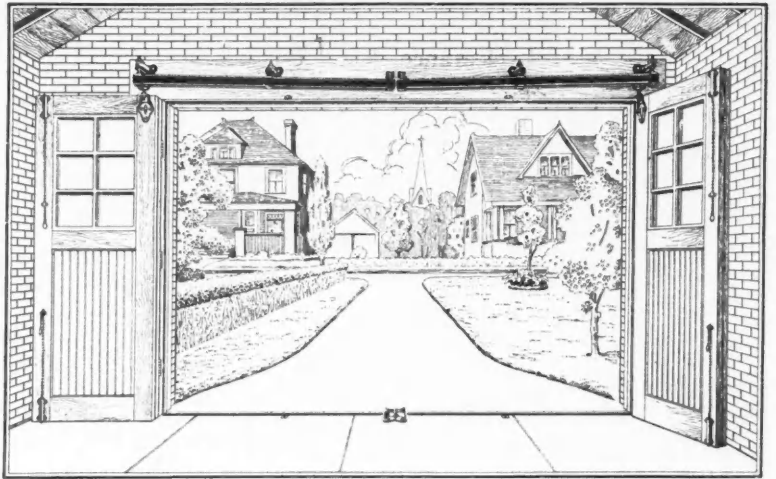

Four Doors Are Hinged Together in Pairs, Two of them Sliding and Folding Each Way. Two Swivel Hangers Are Required.

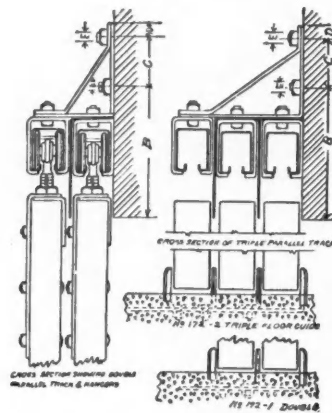

Sections Showing Double and Triple Parallel Tracks for Side-wall Attachment.

handles and locks.

The Sliding Parallel Door

One other type of door that is used extensively in wide single car garages, or in two or three-car garages is that which slides. These doors are carried on single track and require, for one door, double the amount of this width in space. However, it is the two and three-door installations that are generally used. Two doors require parallel tracks and the three doors triple tracks.

It will be readily seen from these rather meager descriptions of various types of doors and the hangers they require that there is one or more of them that will solve any problem that may confront the builder of garages. It is familiarity with all of these kinds of doors and their hangers that make the builder efficient to take any kind of a garage building job that comes his way. Besides, the manufacturers of the hangers have engineering departments that are always ready to co-operate with the contractor in this work and only have to be called on to furnish the required information.

As the AMERICAN BUILDER has said before, there are thousands of garages to be constructed this year. The automobile manufacturers have prepared to



By Hanging One Door So That It Swings Free, Access to the Garage May Be Gained Without Trouble.

supply an unprecedented demand for the so-called pleasure cars. It is estimated that 2,000,000 automobiles and more than 200,000 trucks will be built and sold during 1919. A great majority of these motor vehicles will require new homes. This promises to be the greatest of all years for the builders in erecting garages.

Garage Building Starts

During the month of March building of every description took a jump. Figures, fathered by the U. S. Department of Labor, show that the contracts let in March were greater than in the same month during the last seven years. These figures also give an idea of what percentage of this building is garage construction. Every twelfth building contracted for was a garage and they were to cost three per cent of the total. More than half of the building permits during the month



Swinging, Sliding Doors Are Easy to Open and Close, a Feature That Appeals to the Women Automobilists.

It is to fortify builders with a knowledge of the different types of garage door hangers and hardware that this article was prepared. Make use of it. Secure from the various manufacturers such information as you require. Then when you build a garage for a client you will be in a position to give him the most satisfaction and the best building for his money.

This is what the successful builder should aim to do. It will mean more business for him in the future. For nothing ever was said that is more true than that "a satisfied customer is the best advertisement." Satisfied garage owners will mean more garages for the builder to erect.

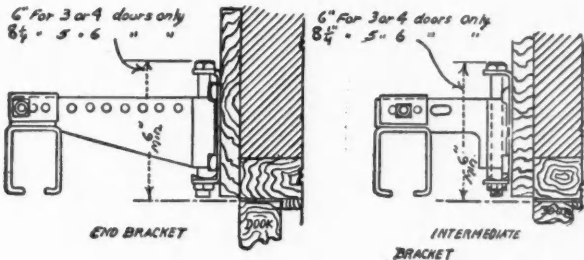

Details of the End and Intermediate Bracket.

were for homes, and many of these also had garages in connection.

This gives an idea of how much garage construction the building contractors will be called on to do this year.

How important it is to properly hang the garage doors and select the type that will best fit the building to be constructed already has been emphasized. The methods of installing the hangers to get the best results have been carefully worked out by the manufacturers of the hardware and details can be secured for the asking.

Building good looking, serviceable garages, with properly designed and hung doors is a source of profit to the building contractor and by keeping on the look-out for this type of work he can secure many good jobs. Keeping in touch with the local automobile dealers is one way of finding out who are buying automobiles and who are in the market for garages. That is the way to get business—go after it.

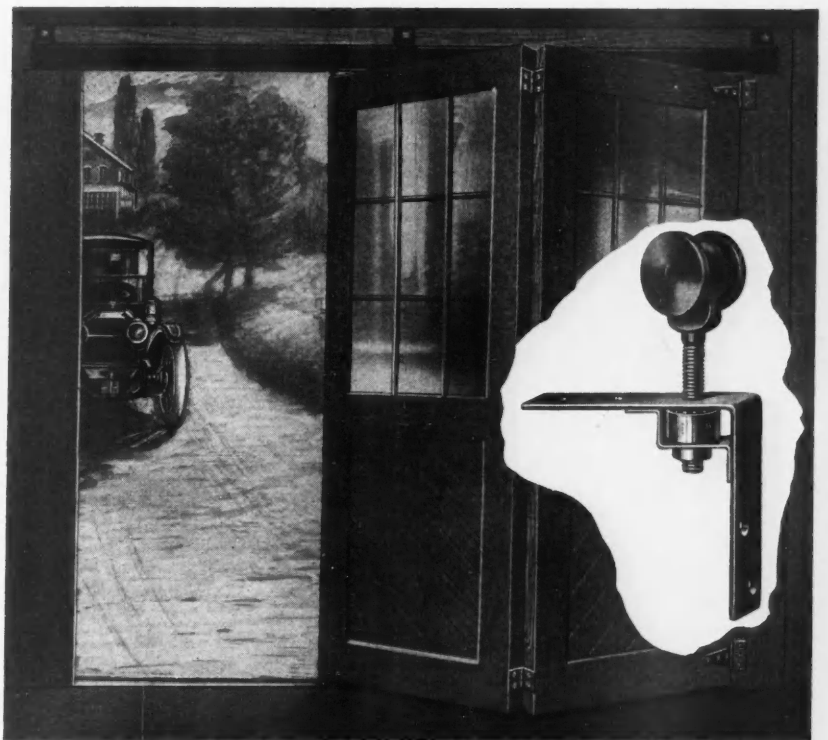

Double Swinging and Sliding Doors for a One-Car Garage and the Ball-Bearing Swivel Hanger on Which They Are Hung. The Doors Hold Back Parallel with the Side Wall and Leave the Opening Clear.

Three-Story and Basement Brick Hospital

PUBLIC building is taking the lead in the building permits issued in the United States, reports of the U. S. Department of Labor say. Builders everywhere will be called on to submit plans for hospitals. Here is shown an excellent design for a modern brick hospital. A study of the floor plans will show the convenience and completeness of the arrangement of the many different rooms required in an up-to-date hospital. The design follows the best

architectural practice in hospital construction.

The building contains 19 private rooms and six wards. The sun parlor for convalescent patients, 18 feet, 8 inches, by 11 feet, 10 inches, is a modern feature. The design provides for every convenience in caring for the patients and for their comfort. This is an exceptionally good design for a hospital in a medium-sized city.

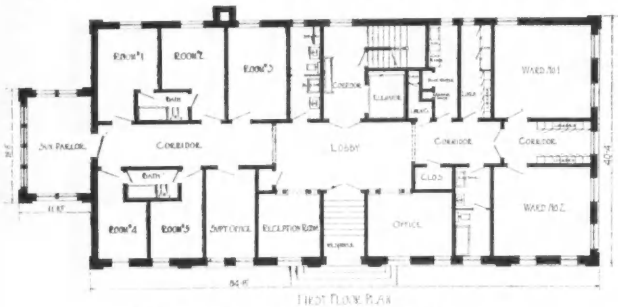

Main Floor Plan of Modern Hospital.

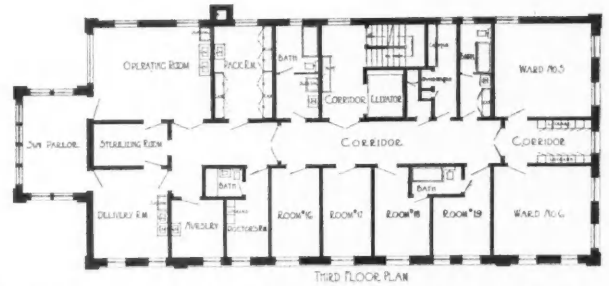

Third Floor Contains Operating Rooms and Maternity Ward.

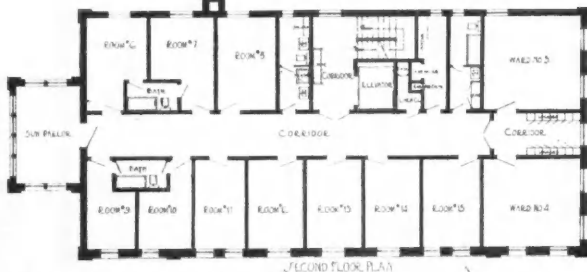

Second Floor Has Ten Private Rooms and Two Wards.



Every Facility for Hospital Operation Is Provided in the Basement.

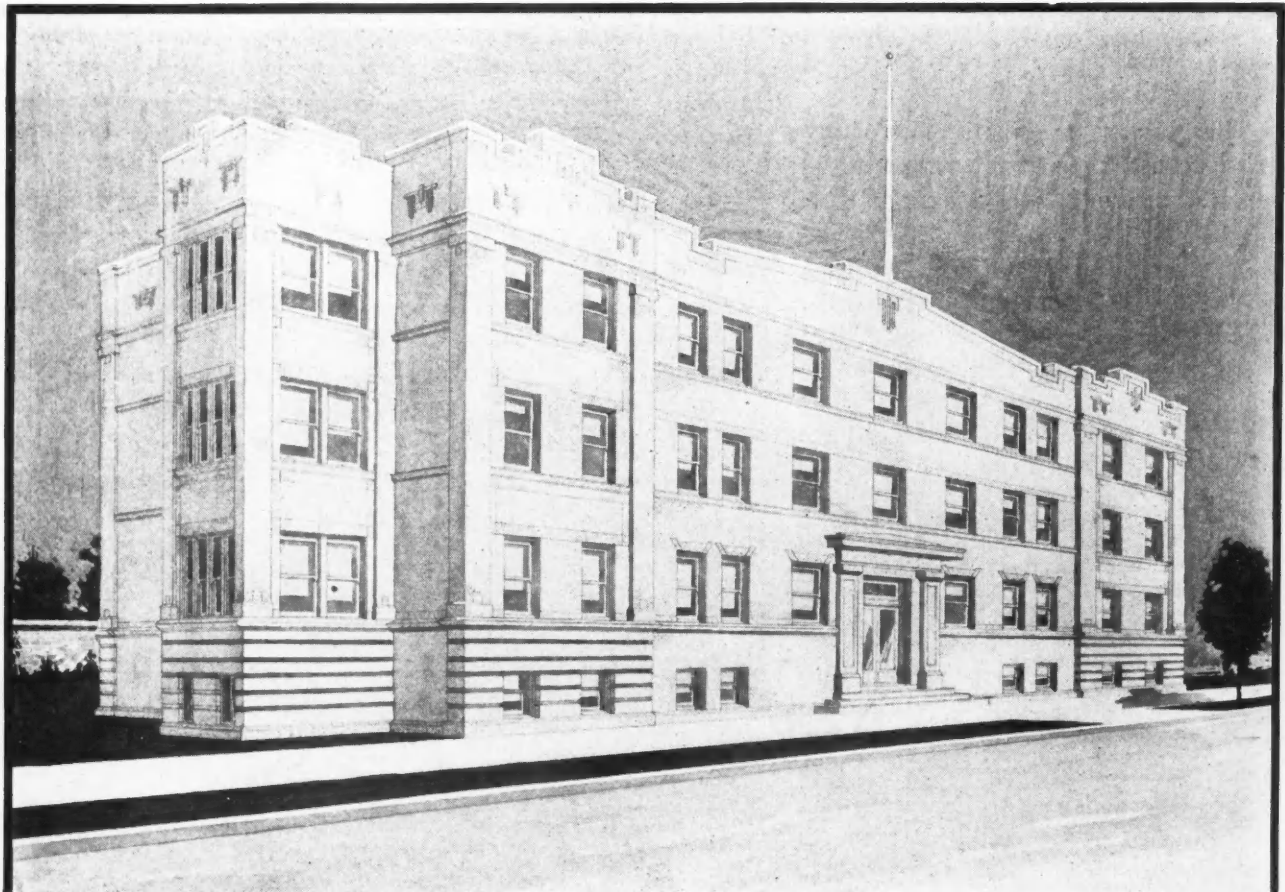

Perspective of a Modern Three-Story and Basement Brick Hospital Building. The Dimensions Are 84 Feet 8 Inches by 40 Feet 4 Inches, with a Sun Parlor Projection of 11 Feet 10 Inches. The Plan Provides for Nineteen Private Rooms and Six Wards. This Is the Most Up-to-Date of Hospital Designs.

One-Story Brick Store Building

CONTRACTORS NOW HAVE A LARGE DEMAND FOR BUILDINGS SUCH AS THIS—DESIGN SHOWN MAKES AN ATTRACTIVE AND SERVICEABLE BUSINESS PLACE

ONE-STORY business buildings will make up a considerable part of the building activity this year. Property owners in cities and towns want these buildings for the simple reason that without a great deal of expense they can construct stores that will earn enough in rent to pay the taxes and a small part of the interest on the investment in the property, which, when vacant, is a considerable expense. Many owners also build the first floor unit of a larger building, and wait until later to put up the other stories.

Here is illustrated by perspective and floor plan a fine design for a one-story business building. The exterior is attractive; there is a fine expanse of display windows, which extend across the front of the corner store thru the placing of the entrance. The floor plan shows the large expanse of salesroom, with the stock and rest rooms and toilets in the rear.

This is a substantial building that will appeal to many owners of vacant property who now are ready to put up such a revenue-producing structure. Builders can use this design to advantage in discussing plans with their clients. It has been a long time now since business property could be improved and there will be many opportunities for building jobs of this kind.

The dimensions of the building shown in this design are 50 by 80 feet, making either a single or double store building.

Building for the Future

In constructing a one-story business building, the structure should be planned so that other stories can be added in the future, if desired. This building will be sufficient to earn the fixed charges on the real

estate; and yet it is not large enough to make the property profitable from an investment standpoint. By laying the foundation so that it is capable of sustaining a larger structure, the builder is securing for himself a job in the future, as it is only natural that the owner should turn the work over to the man who erected the one-story building.

Property suitable for business buildings is too valuable to be lying idle. The owner knows this and

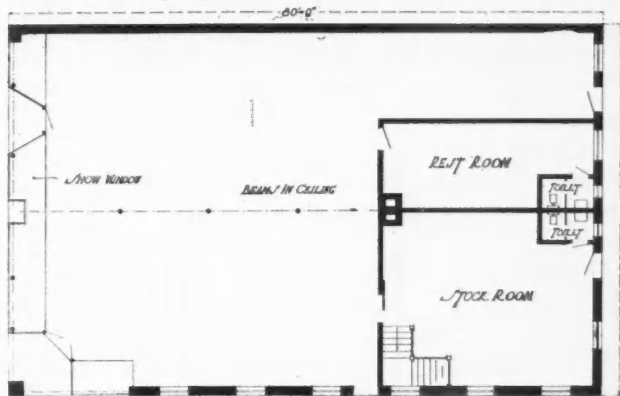

FLOOR PLAN

Floor Plan of One-Story Store Building.

many times a suggestion that it can be made to pay expenses thru the erection of a small building, deferring the balance until a more suitable time, the contractor will land a building job.

Watching for these opportunities and making the most of them has been the foundation of the success of many contractors. By using the design shown here as an argument with the property owner as to why he should build now, the contractor will increase his business.

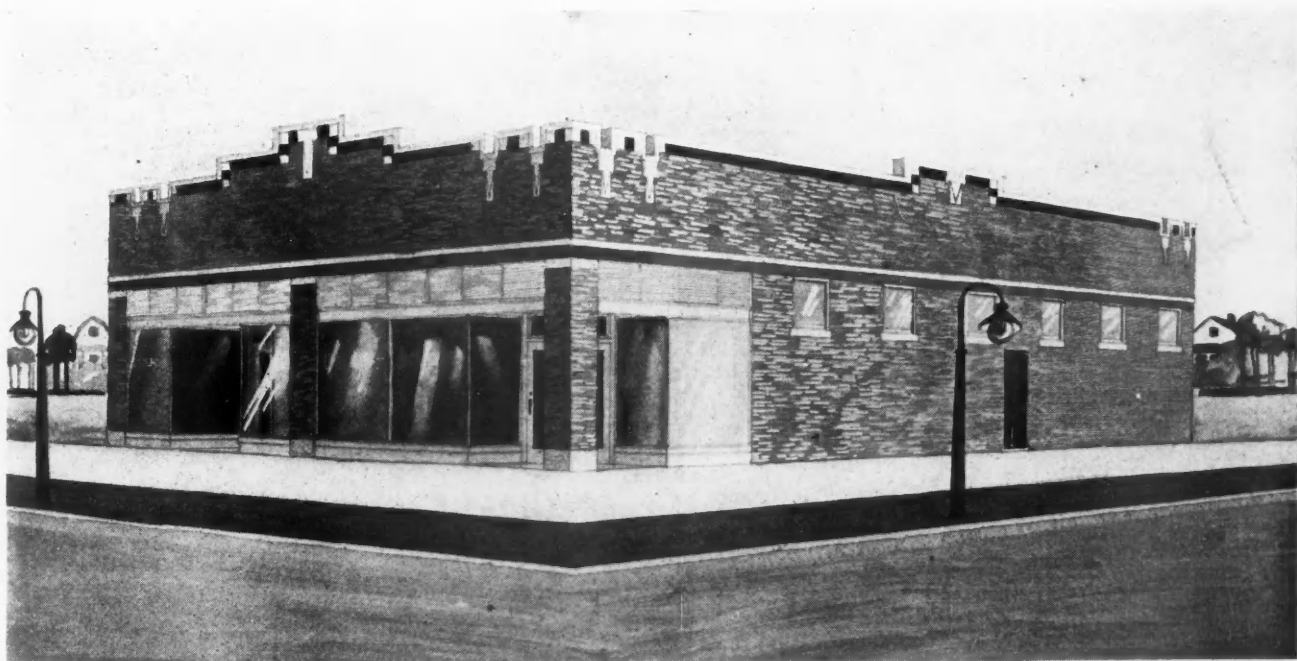

One-Story Store Building of Brick. The Dimensions Are 50 by 80 Feet.

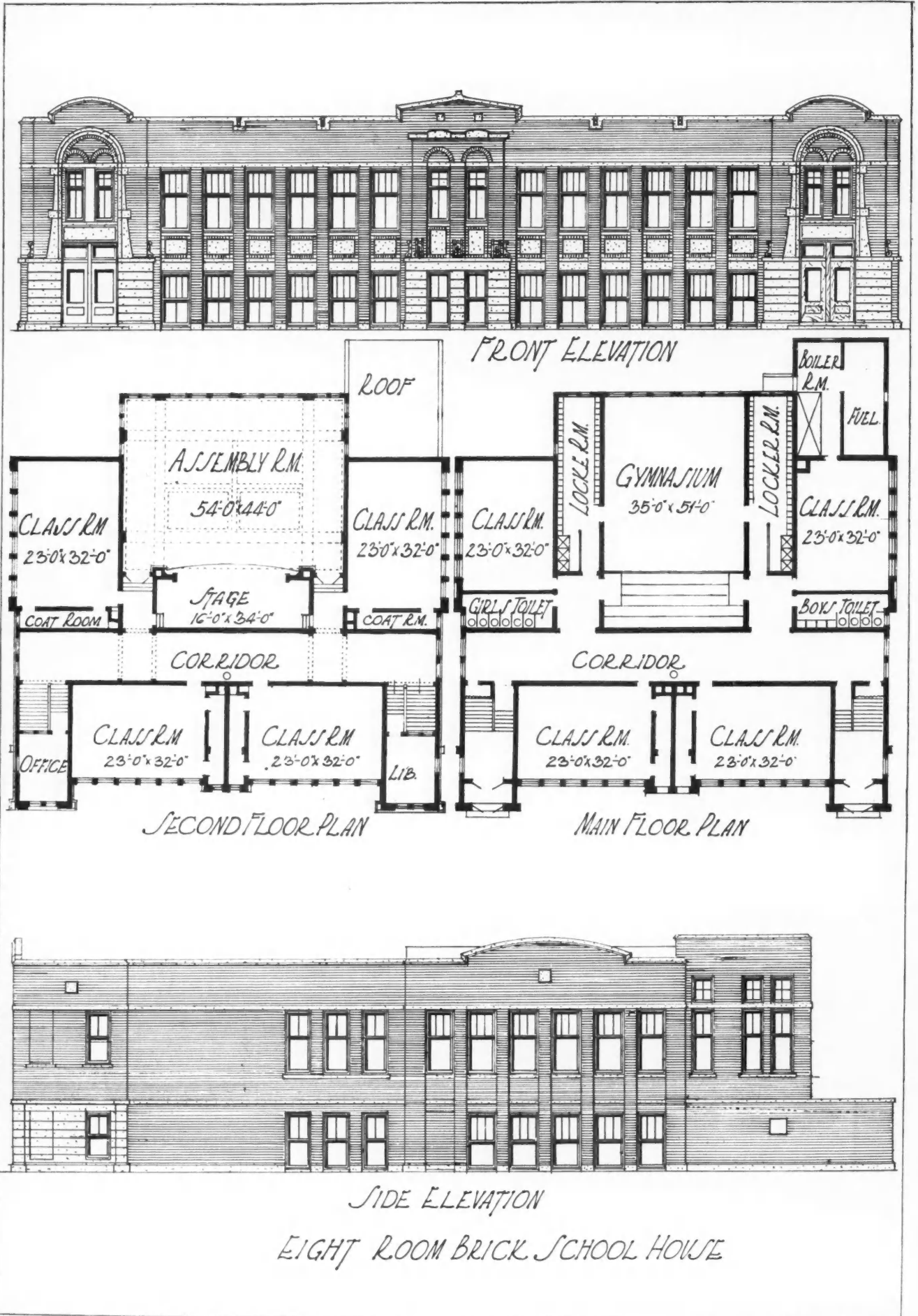

SIDE ELEVATION
EIGHT ROOM BRICK SCHOOL HOUSE

EIGHT-ROOM SCHOOL HOUSE OF MODERN DESIGN. Here are front and side elevations and floor plans of a secondary or consolidated school building that will be in big demand. It was designed by G. W. Ashby, Architect, Chicago.



FRONT ELEVATION
A



SIDE ELEVATION

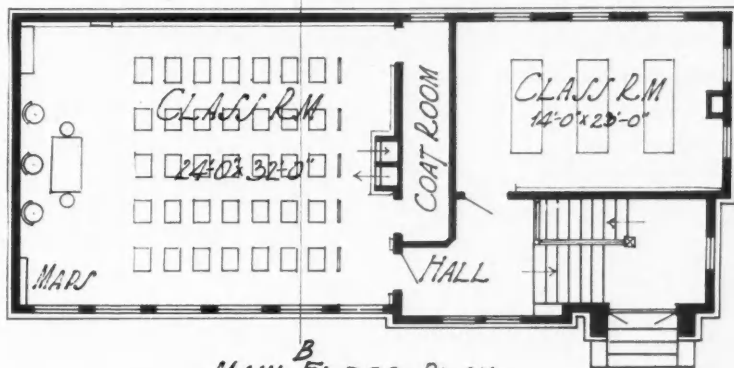

MAIN FLOOR PLAN
B

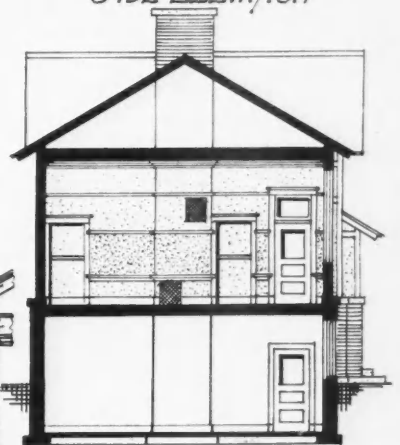

SECTION A-B

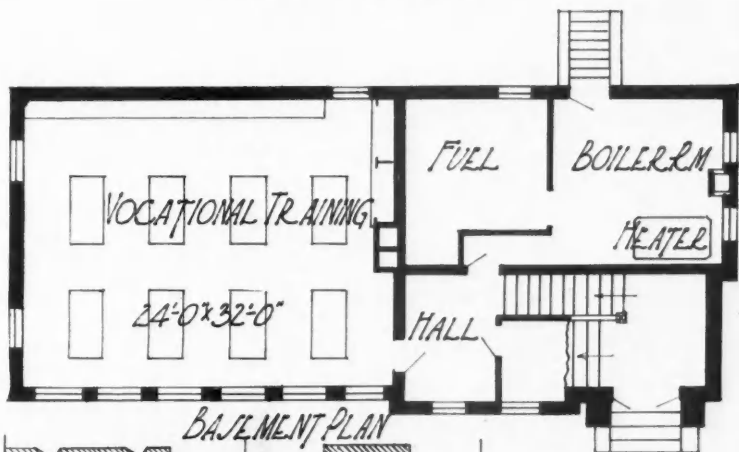

BASEMENT PLAN



SECTION THRU WALL

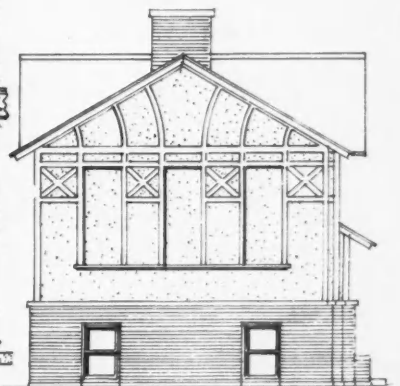

SIDE ELEVATION

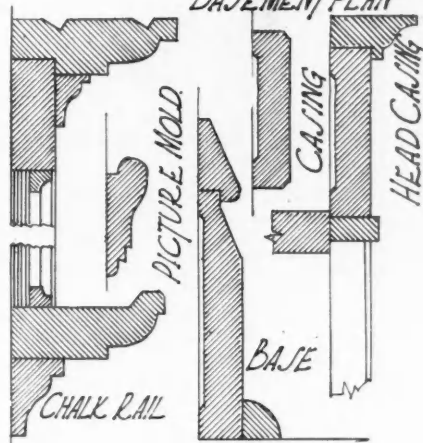

PICTURE MOLD
CHALK RAIL

CASING
HEAD CASING
BASE

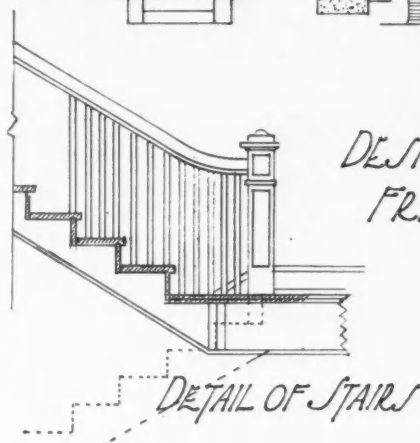

DETAIL OF STAIRS

DESIGN OF ONE ROOM
FRAME SCHOOL HOUSE

TWO-ROOM SCHOOL BUILDING OF FRAME CONSTRUCTION. This building was designed especially for rural builders, who will be called on to erect many such structures this year. G. W. Ashby, Chicago, is the architect.

Fred Beard Tells Chamber of Commerce How to Put On a "Build a Home" Campaign

AND INCIDENTALLY HE DISCOVERS THAT BELONGING TO THE BUSINESSMEN'S ASSOCIATION OF HIS HOME TOWN IS WORTH WHILE

FRED BEARD stood near the door of his hardware store, with hands in pockets and a satisfied expression on his face. He was looking diagonally at the plate glass of his show window and at the faces that were gazing thru it. Some of the people were concealed from his vision by a high panel of wall board that was in the rear of the window. But Fred Beard knew what was on the other side of the board, for it had been his idea that the pictures of beautiful homes that were hung on the panels would help stimulate home building in his town. So far his opinion had been correct. Nothing that he had ever displayed in that window had attracted so much attention. In fact, now, as he gazed, he saw the faces of people well known to him, but who had always passed his place without a glance.

One of these persons was Jack Crisp, real estate dealer and prominent member of the local chamber of commerce. Crisp's name described him exactly. He was small in stature, but his every movement showed that he was an alert business man. Crisp's interest in the window display held Beard's attention. He speculated on that interest, and as he did so the thought came to him that Crisp was just as much interested in the promotion of home building as was he, or Ed. Maple, the lumber and building material dealer, or Sam Edwards, the building contractor, both of whom had helped get up the display that now was holding the real estate man's attention.

Fred Beard Sees His Chance

"Here," thought Beard, "is a man who should be doing a share toward stimulating interest in home building."

And with this in mind, he stepped to the door and called to Crisp.

"What do you think of my window, Jack?" asked Beard, as the real estate dealer entered the store.

"Great," responded Crisp. "A

fine thought, not only a business getter, but it is right in line with the talk I heard at the meeting of the chamber of commerce last night. You know the government is urging the chamber of commerce in every town to do what it can to promote building, so as to keep business good during the time our industries are being returned to their peace-time activities."

The Chamber of Commerce Interested

"I know that," responded Beard. "That's one of the reasons I put in the display. I figured that you'll get farther making people hungry for a home than you will by commanding them to build a home for patriotic reasons."

"Certainly," agreed Crisp.

"Does the chamber of commerce really want to help this build a home movement?" asked Beard.

"Yes, but the members, in talking the matter over last night, didn't seem to have any fixed ideas on how to go about it," replied Crisp.

"Well, if they're really in earnest, I can tell them where they can get full particulars about a plan that has been tried out and has proven to be a winner. Not only is it producing results now, but it made the town where it was used a year ago the leader in the state in the building of new homes."

"I'm interested, go ahead and let me in on this good thing."

Fred Beard went back to his office and returned with a copy of the AMERICAN BUILDER. It was opened to a page that told about the Huntington, Ind., Community Development Club and what it had accomplished in Huntington in the spring of 1918, when in Beard's town the building business had been dead, and what it is accomplishing this year.

"There's just the plan for us," said Beard, enthusiastically. "You see they got together in Huntington and accomplished results. It's not only the builder, lumber dealer, hardware man and real estate agent who profit



Fred Beard Showed the Real Estate Man a Plan for a "Build a Home" Campaign.

(Continued to page 164)

Get a Good Job Remodeling That Old Store Front

BUILDERS WHO SEEK OUT OWNERS OF BUSINESS PLACES AND SHOW THEM WHAT A NEW FRONT WILL DO ARE MAKING LARGE PROFITS

REMODELING store fronts has become an important part of the building business, because it is right in line with the modern idea of conservation. There are many business buildings that are too good to be torn down to make way for new structures and yet the construction of the front is such that the owner has hard work finding a tenant, or if he has a tenant cannot get the rental that his property should earn. This is not an unusual condition and builders who are on the lookout for stores such as have been described will get many profitable remodeling jobs.

How such buildings can be transformed is shown in the accompanying illustrations. The one at the top of the page shows a men's clothing and furnishings store as it appeared before a builder put in a new front. The illustration at the bottom of the page shows the same store, but it is hardly recognizable. In its remodeled state, this store is a modern, trade-inviting place, while its unobstructed windows give the tenant an opportunity to display his goods to the best advantage.

This front was designed by a manufacturer of store fronts, who took from the builder the measurements of the store and furnished the plans and the materials all ready to be put in place by the contractor.

Profitable Work for the Builder

However, as will be seen by the lower illustration, the builder had much work to do. The brick pillars at the ends of the windows, and the tearing out of the old front both furnished him profitable employment,

while there was a good margin in the purchase and installation of the front.

The local building contractor is the logical man to seek out such jobs as this and sell the idea of putting in a new front to the store owners. He gets the contract and, aided by the store front manufacturers, makes a job that pleases his client and saves him much



The Ed. Mellon Co. Store Before Remodeling.

money. Usually one remodeling job leads to another.

How many store front remodeling jobs there are in every town is easily ascertainable if the builder only keeps his eyes open as he walks along the business streets. When it is suggested to the store owner that a new front will help his business, many contractors have found that the merchant already has been considering doing so. Thus are many such jobs procured without much difficulty.

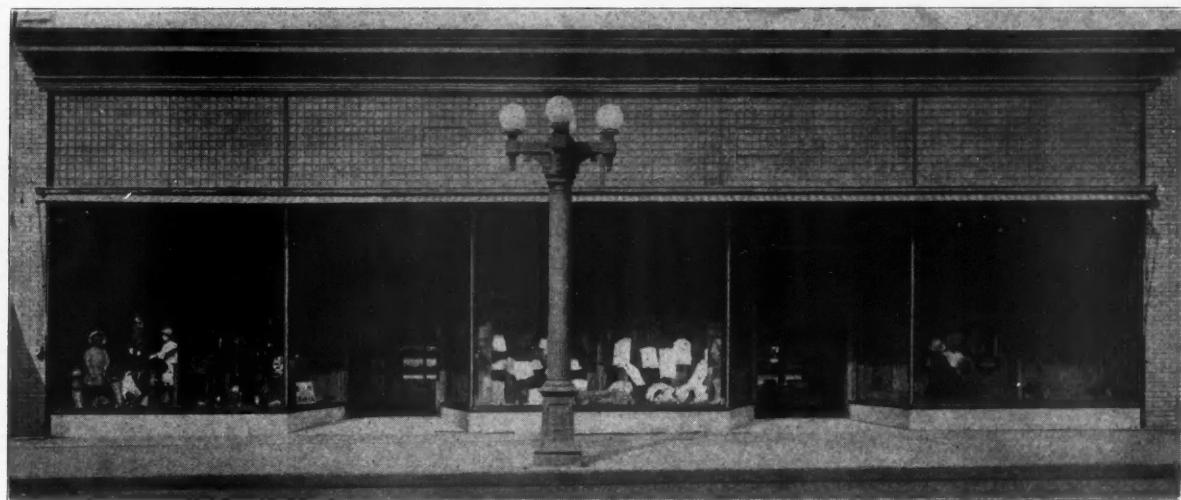

What a New Front Did for the Mellon Store.

STRUCTURAL TILE WORK

for Houses, Farm Buildings,
Stores, Garages, etc.

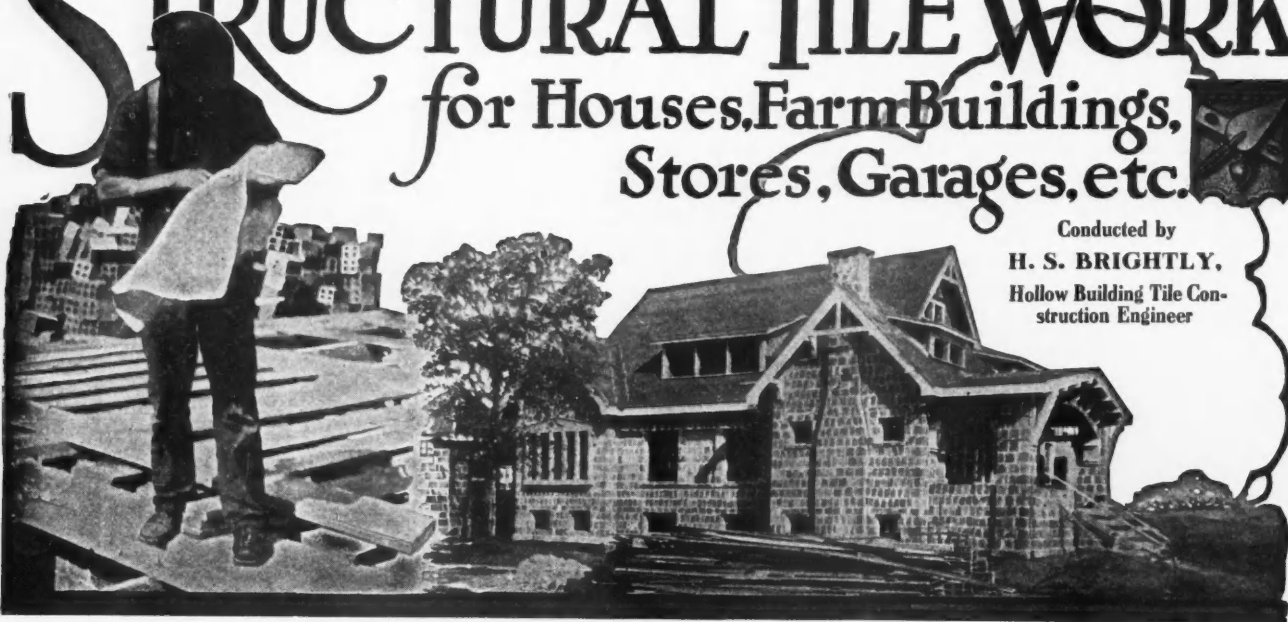

Conducted by
H. S. BRIGHTLY,
Hollow Building Tile Con-
struction Engineer

If you will send us a plan or sketch of the building you are thinking of erecting, Mr. Brightly will tell you about the sizes, shapes and quantities of hollow building tile that will best serve your requirements.—EDITOR.

Anchoring Frames and Other Features to Hollow Tile Walls

By H. S. Brightly

THERE is a general feeling prevalent among many contractors and builders that the attachment of frames for doors and windows, and the anchorage of wall plates in connection with hollow tile construction presents some difficulty; and the general lack of knowledge of the simple details which provide secure fastening for same we believe warrants the following articles.

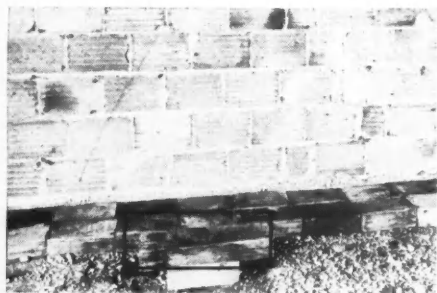

Fig. A. Tile Foundation for Hog House Floor, Showing Proper and Improper Methods of Laying the Tile. The Proper Method is Shown Within the Rectangle, Where the Tile Are Laid with All Joints Broken Between the Courses, Half Tile Being Used for Starters at the End of Alternate Courses.

For the fastening of wood plate or cap piece on top of hollow tile wall the simplest method is shown by Fig B. For 8-inch tile walls built of 5 by 8 by 12-inch tile laid flat way, use a $\frac{1}{2}$ or $\frac{5}{8}$ -inch anchor bolt 20 inches in length which will extend down thru three courses of tile. This should be arranged to pass thru two mortar joints, making it necessary to cut only one tile. For 5-inch walls of the 5 by 8 by 12-inch tile laid on edge, use the same size bolt extending thru two courses; one mortar joint and one cut tile. It

will usually be found easier to punch holes in the shell of tile with a narrow cold chisel so that the tile block can be slipped down over the anchor bolt, than to cut tile to fit around the bolt.

For walls of 4 by 12 by 12-inch or 6 by 12 by 12-inch tile laid with the cells vertical, any length bolt over 18 inches may be used, as the bolts are set in the cells of tile and grouted in solid by filling the cell with mortar. An 18-inch length of bolt will give anchorage into the two top courses. The best method of building in these bolts is to shove a wad of stiff paper down into the cell in which the anchor bolt is to be built and after setting the anchor in its proper position to fill the lower 2 or 3 inches with cement mor-

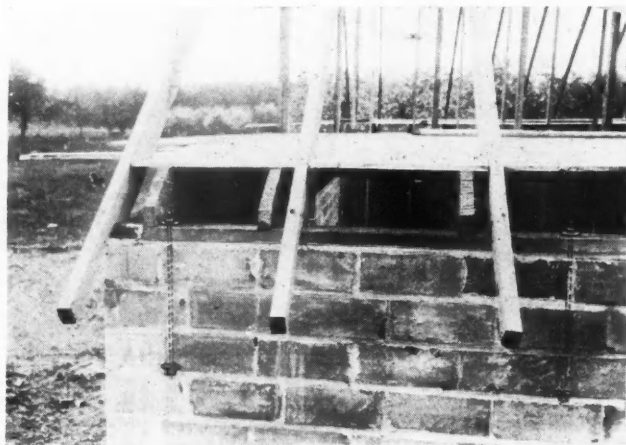

Fig. B. Method of Anchoring Roof Plate to Tile Walls.

tar, allowing this mortar to set before filling up the cell to the top, as the weight of the wet mortar might push down the wad and allow the mortar to run down into the wall.

For 5-inch walls of 5 by 4 by 12-inch tile laid on the 4-inch bed the anchor bolt will be the same as for 5 by 8 by 12-inch tile above referred to, and for the 5 by 4 by 12-inch tile laid on the 5-inch bed use an anchor bolt 16 or 18 inches long. The 16-inch length will be just sufficient if the mortar joints are not quite 1/2 inch in thickness, the tile not over-

size and the wall plate of 2-inch stock dressed down to 1 3/4 inches or less in thickness, otherwise the 18-inch length should be used. The screw thread should extend down at least 3 or 4 inches and bolts with as flat a head as can be obtained are best, as those make it possible to bed the head and a washer, where the latter is used, in the thickness of the mortar joint without making it necessary to cut into the tile. Thus a little thought in purchasing the anchor bolts will save mason's time and trouble and facilitate the work of erection.

For heavier walls and for large buildings such as dairy barns, large granaries and particularly where a heavier plate or cap piece and roof framing of considerable area is to be anchored it is better to use 3/4-inch bolts of greater length, and in some few instances 7/8-inch bolts may be required; but it is seldom necessary to use any bolt larger than 3/4 inch, and it is better practice to use a greater number of this size spaced closer together than to use a larger size. The stiffness and stability of the plate

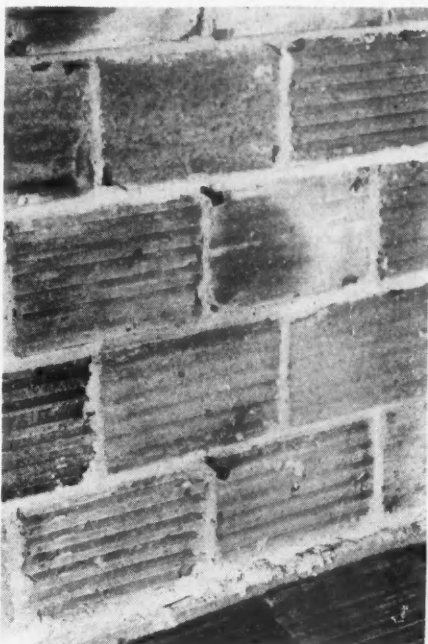

Fig. C. For Nest Racks, Roof Supports and Shelving in Poultry Houses and for Fenders and Stall and Partition Fastening in Hog Houses, Ordinary One-half Inch Bolts May Be Built in the Mortar Joints, as the Tile Walls Are Erected.

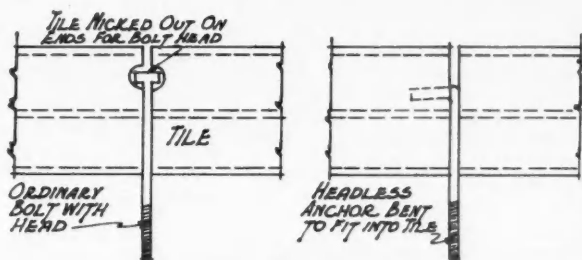

Fig. D. Anchor Bolts in Tile Walls.

piece and the need for anchorage which is to some extent determined by the type of roof, should determine the spacing of these plate anchor bolts, also the length between splices in plate. The type or scheme of roof framing should always be considered in connection with roof framing on large buildings and for such buildings it is usually desirable to have the bolts 30 inches or more in length. This matter will be treated on more fully in a later article.

For the present we are only considering small buildings, residence structures, and such farm buildings as hog houses, poultry houses, sheds, pump houses, etc., and for these the usual practice of placing plate anchor bolts from 4 to 6 feet apart is a good one to follow. For instance, if the side walls were from 10 to 16 feet in length three bolts would be used—one near each end and one in about the center. For an 18 to 22-foot length of wall four bolts should be used, and so on up. Usually the end bolts are placed at from 8 to 20 inches from the corner wherever the more convenient vertical joint in the tile courses occurs.

A simple method for the fastening of nailing piece or support for nest racks, roost supports and shelving in poultry



Fig. E. Wood Nailing Blocks for Door and Window Frames Should Be Driven in the Ends of the Tile as Here Shown.



Fig. F. Proper Method of Driving in the Nailing Blocks. Vertical Wedges Cannot Split the Tile; Horizontally Placed Wedges Might Do So.

houses and for fenders, feed rails and stall or partition fastenings in hog houses is shown by Fig. C. Ordinarily $\frac{1}{2}$ -in. bolts may be built in the mortar joints as the walls are erected. A couple of nicks are made in the ends of the two lower tile to provide for the bolt head as shown in Fig. D, or a headless bolt bent and hooked into the tile may be used. The length of bolt here required will be determined by the thickness of the tile wall and the nailing strip or support that is to be fastened to same.

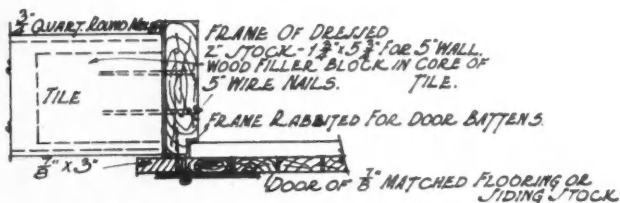

Fig. G. Method of Fastening Garage and Other Door Frames Where Anchor Bolts Are Not Used.

Usually the bolt should extend into wall to within about 2 inches of the outside face.

Another very satisfactory method of fastening wood nailing strips, roost and nest supports to hollow tile walls is with special expansion bolts or sockets which take an ordinary wood screw. These sockets are not built in the wall, but are placed wherever required after the walls are erected, and thus for the fastening of certain equipment and fittings are particularly well adapted. They are applied as follows: A small hole is punched or drilled into the tile, which may be done in several ways. If the tile is hard a small rose or star point cold chisel is used. With some tile it is possible to punch satisfactory holes with an ordinary nail set or other sharp pointed steel tool, and for the softer grades of tile an old twist drill, such as the marble setters use for drilling into marble can be used.

A simple and most satisfactory method of providing nailing blocks for door and window frames is shown by Fig. E. The wood nailing blocks should be driven into the ends of the tile as shown. Vertical wedges cannot split the tile, whereas horizontally placed



Fig. H. Garage Having Door Frames Made and Fastened as Shown in Detail in Fig. G.

wedges might do so. The proper method of driving these wedges is shown by Fig. F.

Fig. G shows a very satisfactory method of fastening garage and other door frames for medium weight doors where anchor bolts are not used. The frames shown in this figure are securely nailed into blocks shown by Fig. F. For heavy wagon doors that are hinged to swing open it is generally more satisfactory to build anchor bolts in the mortar joints and bolt the frame to the tile walls. Fig. H shows a view of garage having door and frame fastened as shown in Fig. G. This garage shows the bull nosed corner block made by some manufacturers and which gives a very pleasing effect and a good 4-inch bond to the corner. This is a very practical corner that will further serve as a buffer to wagon or implement hubs that may be carelessly driven around the building and prevents the chipping off of corners.



Fig. I. Hollow Tile Hog House. The Hog Entrance Door Frames Are of Concrete, Cast in Place with a Simple Wood Form. See Fig. K.

Where window and door frames are fastened against the open ends of tile that is laid with the cells horizontal, as shown by the figures referred to, it is advisable to close up these open ends and seal in the dead air spaces in the walls, otherwise the leakage of cold air into these interior spaces to some extent offsets the insulation advantage of this product and where effective insulation is not obtained it is invariably due to careless workmanship and not the material used. A simple method of accomplishing this is to have a level platform made of a couple of planks dressed smooth, the surface of which should be coated with oil or a soft soap. A number of tile blocks that are to be used at the window and door jambs are stood up on end on this platform the day before they are to be used in the wall and half an inch to an inch of cement mortar poured into each one of the cells. This is a simple operation and one of the laborers can in a short time prepare all of the closer tile that the masons will require the day following. When these tile are lifted it will be found that the mortar has formed a shell closing the end of the cells. When built in the wall the closed end of such tile as are to receive the nailing blocks is turned away from the frame, and for all other blocks the closed end is turned out against the frame. The wood nailing blocks

should not be more than 6 or 8 inches in length.

In the hog house illustrated by Fig. I is shown another type of door frame that is well suited to the hard usage which this type of door is constantly subjected to. These frames are of concrete cast in place as the walls are built and are, therefore, a permanent part of the permanent hollow tile wall. This frame will be found absolutely tight against air leakage and one that also enables the doors to be made tight, so as to prevent cold air drafts on the sleeping hogs, by the simple expedient of tacking felt on the edges of door that fit against the concrete. As these doors are usually hinged at the top and lift up out of the way when open, the hogs cannot get at and destroy the felt either when the door is open or closed. These doors should be made of fairly heavy stock, 1 1/4-inch matched hard pine flooring is probably the best material, where it can be obtained, 1 1/4-inch thick ship-lap siding or a double thickness of 3/4-inch matched partition or common flooring being the second choice.

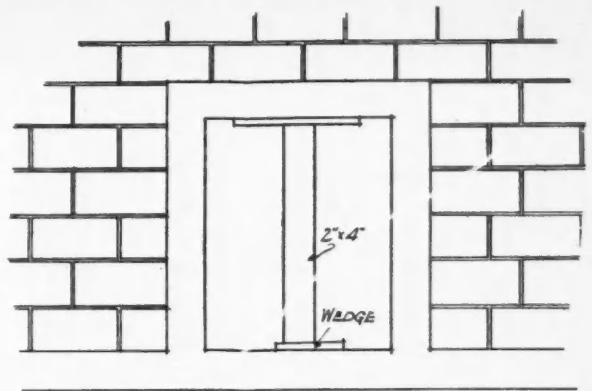

Fig. L. Temporary Support for Concrete Door Frame.

which in warm weather may be in the afternoon of the same day. Care should be exercised, however, in removing the form from green concrete, which must not be jarred while in this state; it is better to leave the form in over night if possible and when removed a temporary support should be immediately erected under the lintel (see Fig. L). If it is necessary to immediately put additional weight on the lintel by carrying up the wall over same, in order to avoid interruption in the work, see that this temporary support is ample and in such cases it may be advisable to secure further strength by placing two or three pieces of heavy iron wire or strap in the lintel as reinforcement.

While on the subject of hog houses, we are showing detail of the proper method of laying hollow tile foundation for hog house floors (see Fig. A), which indicates both the proper method in which all joints are broken between the courses, and the improper method where no effort is made to stagger the joints. It is becoming a well recognized fact that hollow tile foundations for hog house floors provide considerable comfort for the hogs by reason of the dead air spaces, and this type of floor is rapidly coming into more general usage. Staggering the joints will also tend to prevent cracking of the floor in case of some uneven settlement of the earth foundation under same. Several schemes have been proposed for using the cells in the tile under floor as warm air ducts and as this idea appears to have considerable merit and proven successful it will be treated on in a later article.

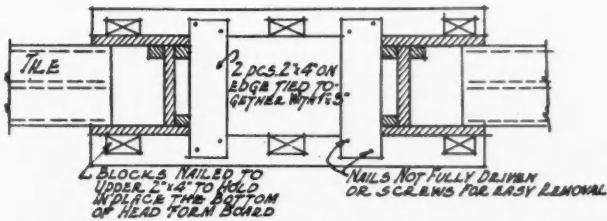

Fig. K. Detail of Removable Wood Forms for Casting Concrete Hog Door Frames. One Set of Forms Will Serve for All.

If the double thickness of flooring is used the outside layer should be run vertical, the inside layer being first laid horizontally across the battens. Fig. J gives detail of this type door and frame. Note that wads of newspaper are stuffed into the open ends of the tile so as to let the concrete run in a few inches for anchorage and also prevent same from running in too far and filling up the tile. Two bolts are set in the form for head piece to which the hinge piece is bolted after the forms are removed. This makes the door and hinge piece removable for repair or replacement of hinges or felting.

Fig. K gives the detail of the forms for these door frames. It is better to carefully make one form of dressed lumber than to attempt to nail together rough boxes for all frames required. The one form properly made can be erected or removed in a few minutes' time and it will also insure better fitting doors and the erection can usually be carried on so that one set of forms will serve for all the doors. This is accomplished by carrying up the wall at the doors first, pouring a door frame and then working on another section of the wall until the form can be used again,

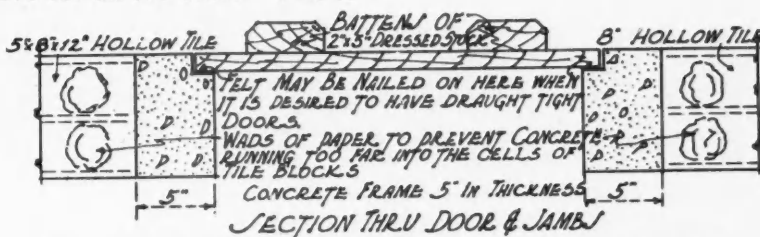
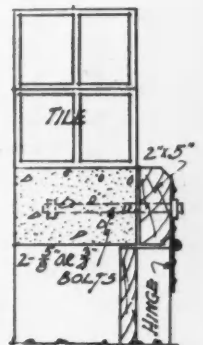

Fig. J. Section Thru Door Jambs and Thru Head Showing Door Hinged at Top, or, if Preferred, Door Can Be Hung at Side by the Same Method.



AMERICAN BUILDER BUILDING PLANS



Blue Prints of a Seven-room House

EXCEPTIONALLY GOOD DESIGN OF AN INEXPENSIVE HOME SHOWN IN THE BLUE PRINT SUPPLEMENT THAT FOLLOWS

THE blue print section this month shows plans and details of the type of home that will be largely built this year. It is a seven-room wooden house of popular design that is inexpensive to build. The perspective shown on this page gives a front view. The hip roof gives the house a graceful appearance, altho it is practically a square building. The dimensions of the house proper are 28 by 32 feet, making it of good size for the ordinary city or town building lot. The porch is nine feet wide and has brick pillars and a concrete floor.

The interior arrangement provides for three rooms,

living and dining room and kitchen on the first floor, and four bedrooms and bath on the second floor.

Houses of this type are most popular with a majority of home builders, as they are not only less expensive to build, but always are readily saleable. Contractors give their customers the best in comfort and satisfaction for the money expended by using such designs as this.

While the plans provide for frame construction, either stucco or brick can be substituted. This house is a good, substantial building, one that will appeal to a great many of the prospective home builders.



Seven-Room House of Moderate Cost. Here Is a Hip-Roof House, 28 by 32 Feet, That Is Popular. There Are no Frills About This Building, But It Is of the Type That Is Popular and Makes an Attractive and Comfortable Home. This Design Equally Suitable for Brick or Stucco. A Broad Porch with Brick Pillars Adds Greatly to the Beauty of This House.

PLANS AND DETAILS SHOWN IN THE BLUE PRINT SUPPLEMENT FOLLOWING.

AMERICAN BUILDER BUILDING PLANS

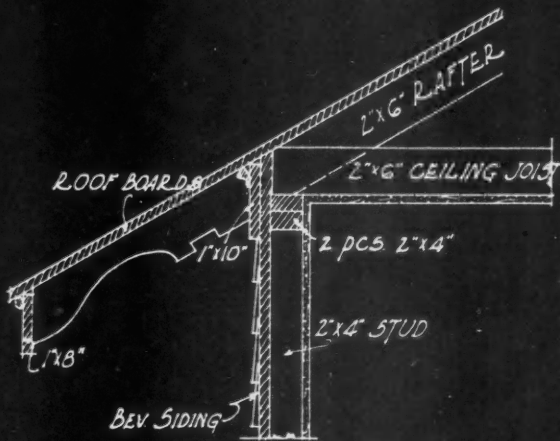

CORNICE DETAIL

SCALE $\frac{1}{2}$ "=1'-0"

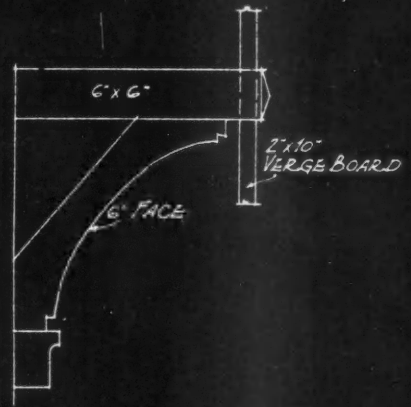

PORCH BRACKET

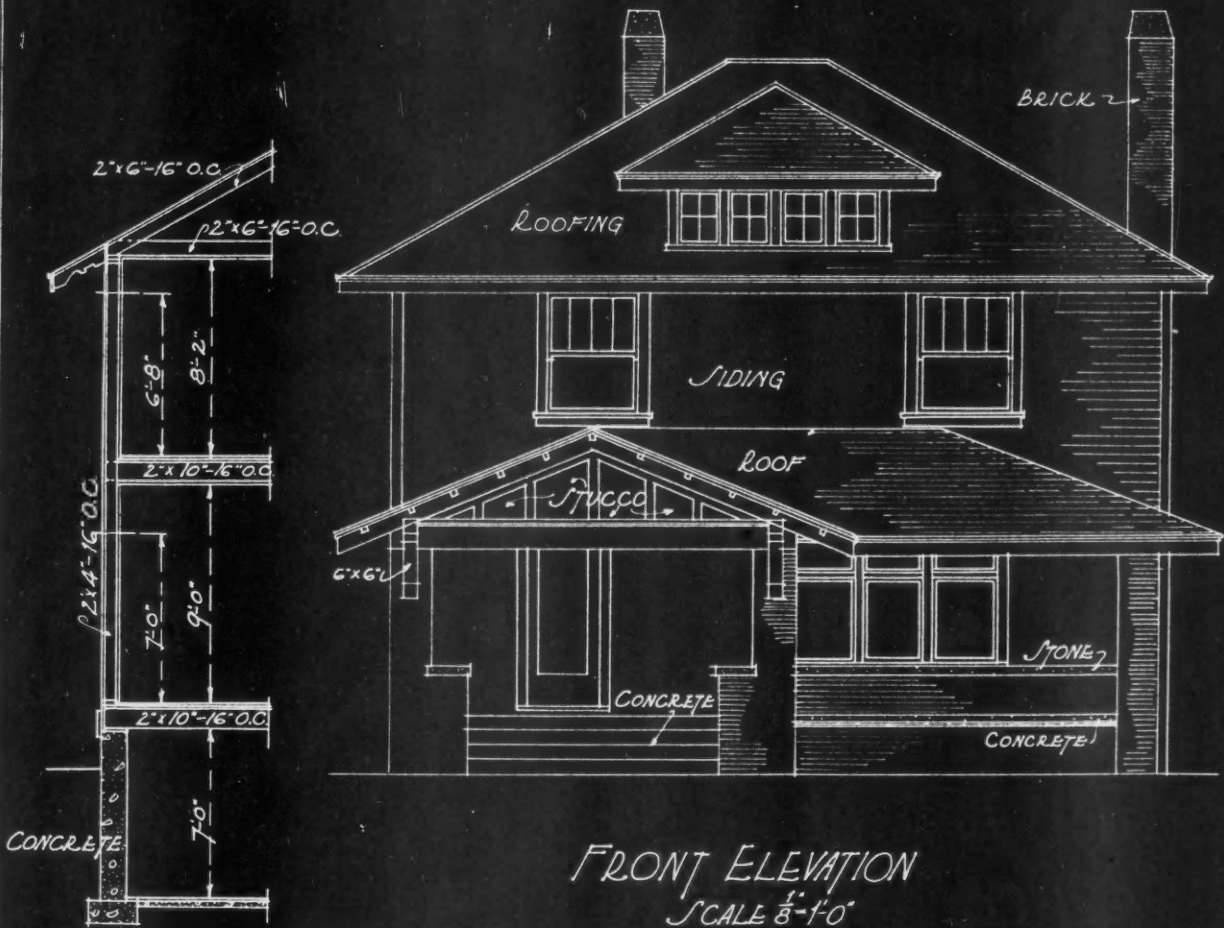

FRONT ELEVATION
SCALE $\frac{1}{8}$ "=1'-0"

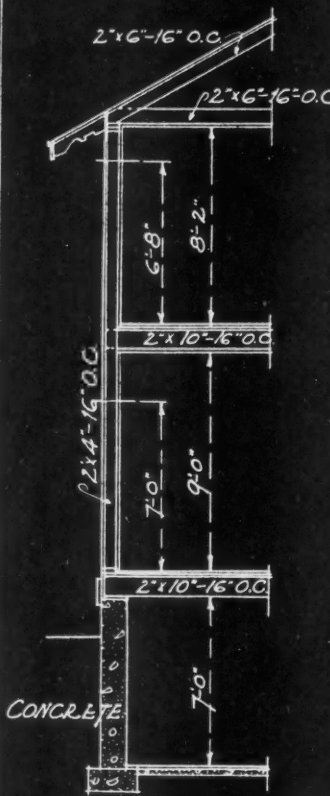

CROSS SECTION

TWO STORY SEVEN ROOM RESIDENCE SHEET NO. 1

AMERICAN BUILDER BUILDING PLANS

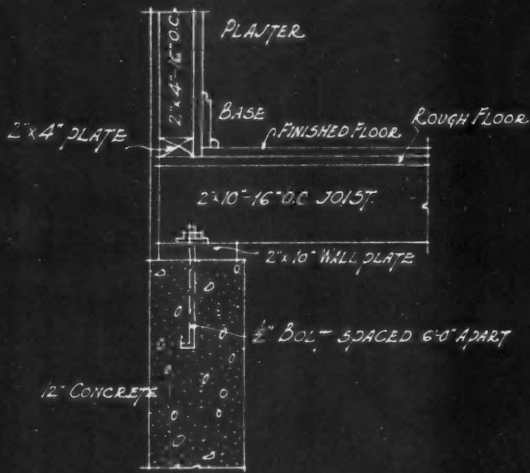

WALL SECTION

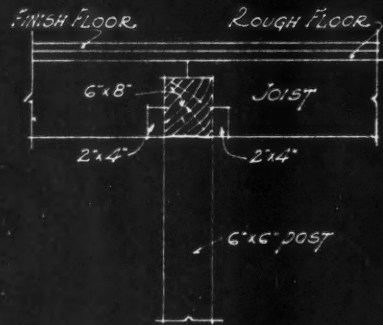

JOINT FRAMED TO GIRDER

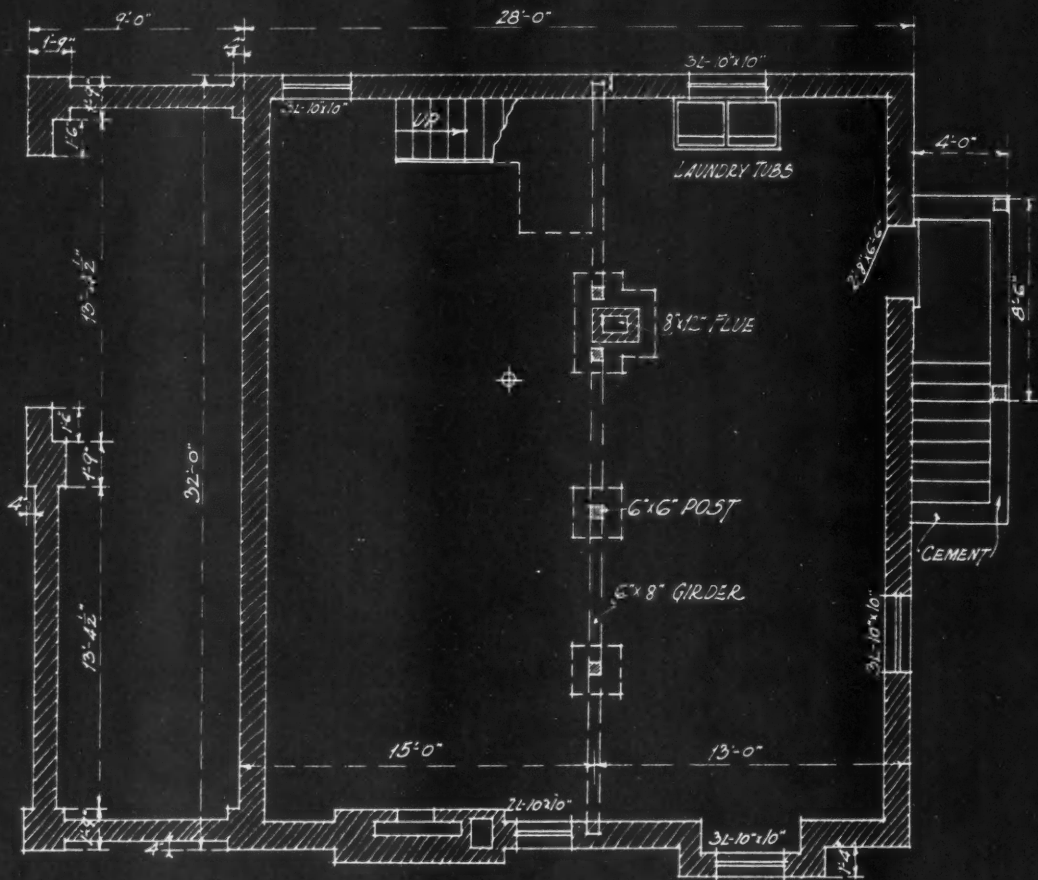

BASEMENT PLAN
SCALE $\frac{1}{8}'' = 1'-0''$

TWO STORY SEVEN ROOM RESIDENCE SHEET NO. 2.

AMERICAN BUILDER BUILDING PLANS

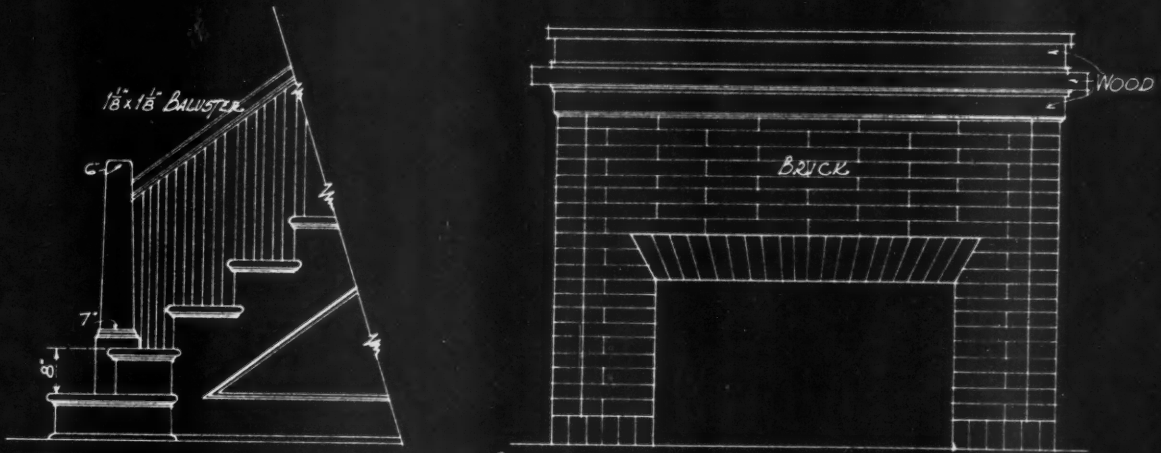

STAIR DETAIL - SCALE $\frac{3}{8} = 1'-0"$ - DETAIL OF FIREPLACE

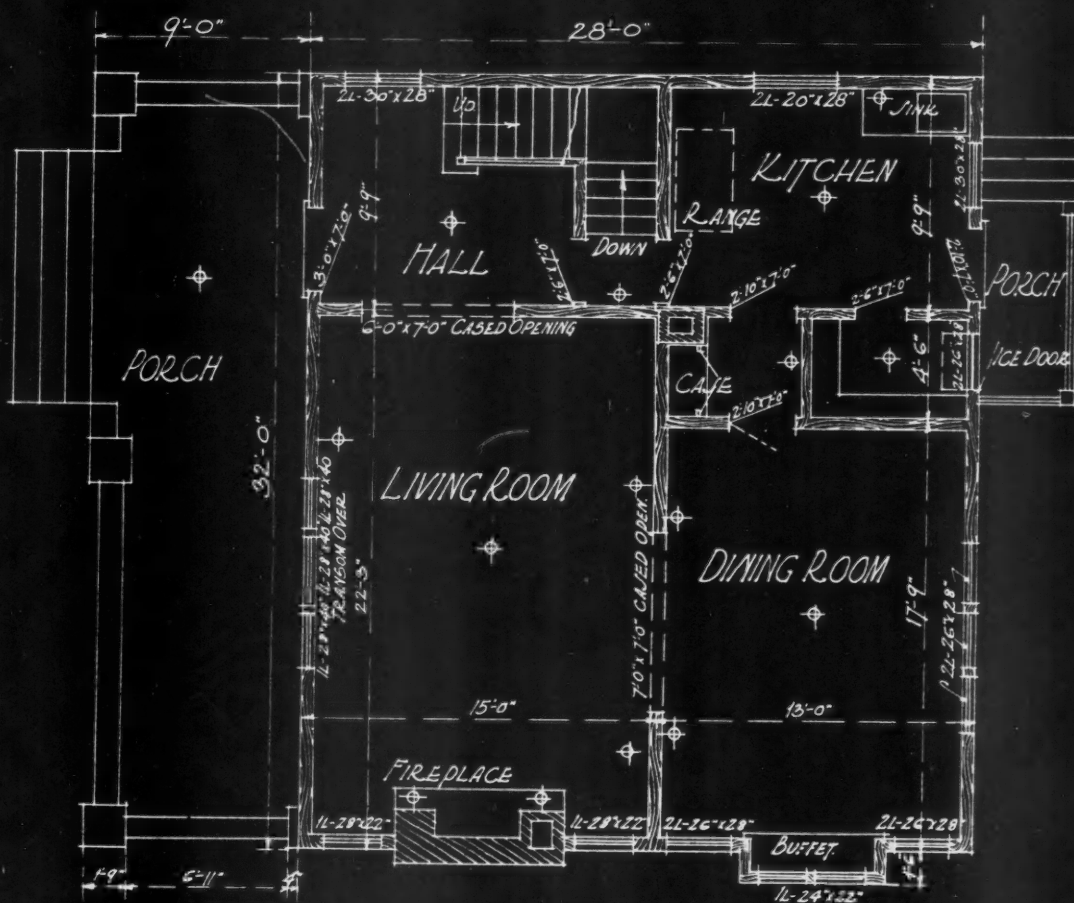

FIRST FLOOR PLAN
SCALE $\frac{1}{8} = 1'-0"$

TWO STORY SEVEN ROOM RESIDENCE SHEET NO. 3

AMERICAN BUILDER BUILDING PLANS

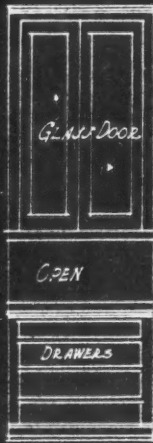

CHINA CASE

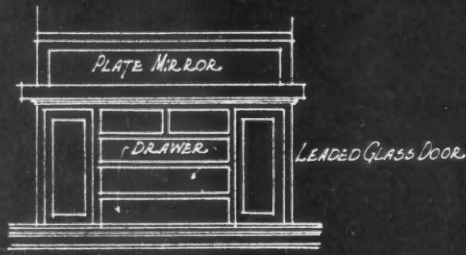

BUFFET

SCALE $\frac{1}{4}'' = 1'-0''$

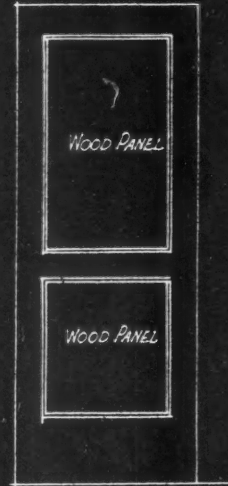

TYPICAL DOOR

SCALE $\frac{3}{8}'' = 1'-0''$

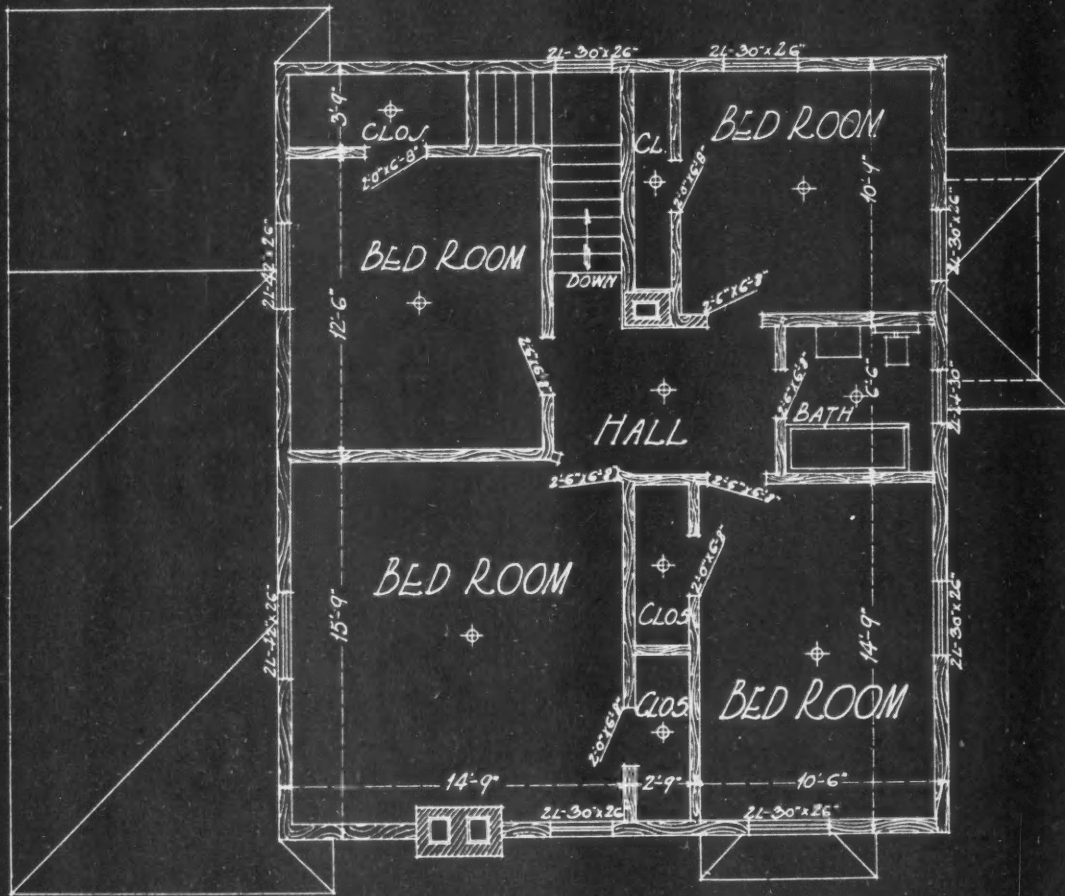

SECOND FLOOR PLAN

SCALE $\frac{1}{8}'' = 1'-0''$

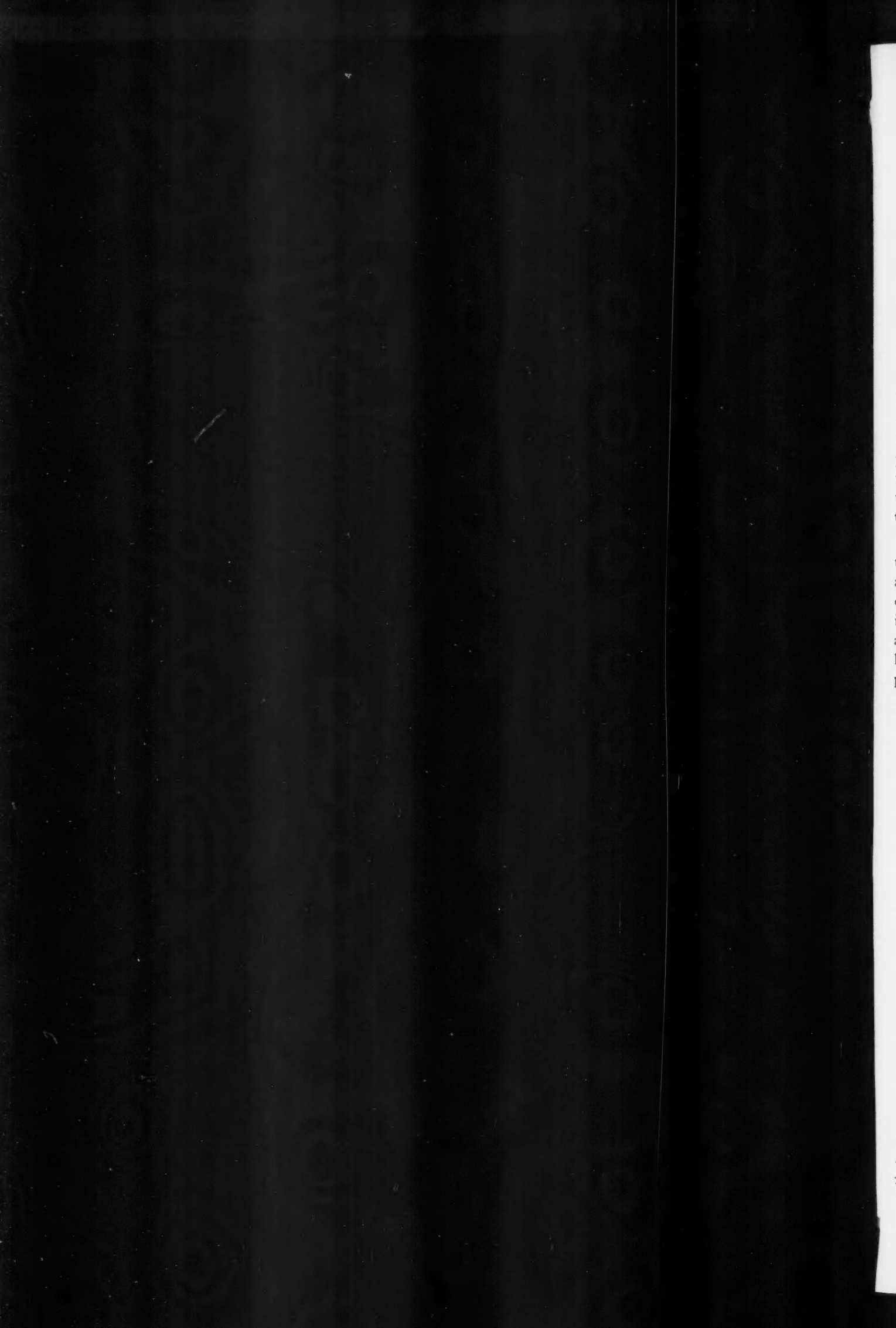

Some Aspects of Jobbing Work

By A Jobbing Carpenter

THE work of the jobbing carpenter is largely varied. One day he has a contract erecting a store, factory or dwelling. The next job may be a dairy barn out in the country. He must necessarily be familiar with the details of most any building project. Yet here and there a puzzling situation regarding some intricate detail confronts him; only monetarily, however, for using his head coupled with years of experience he soon overcomes the most vexing obstacle.

I've often heard the remark, "A porch is half the house" and I believe this to be so. A porch gives a dwelling a setting, and creates an effect both symmetrically pleasing and useful. Helping erect many porches from the most sumptuous down to those costing as low a sum as \$150, it has been my experience to observe closely the different manner in constructing them.

The porch roof should be at least quarter pitch so the water will run off readily. However, this cannot always be done, for the reason that there are many old one story houses where the elevation is so low that it is next to impossible to give the roof as steep a pitch as the carpenter knows it ought to have. Some of these houses have a porch which is narrow and of a style prominent forty years ago, but now in a very dilapi-

dated condition, and the owner wishes to improve the property by building a new porch 8 or 10 feet wide of modern design. Invariably these houses have box cornices, and to conform with the house the porch is built similarly.

I ran across one such instance recently. The distance from underside of cornice soffit to top of 10x10 sill was only 7 feet 5 inches. The columns ought to be at least 7 feet in length, including plinth from floor to bottom of porch cornice in order to have plenty of head room. It will readily be seen from Fig. 1 there was no chance to give the roof any pitch, or a decent depth of frieze, and as the owner did not want the porch roof built on connecting the house roof, a concrete floor was built up to bottom of sill 10 inches below line A; also a concrete step with rounded corners before entrance door. This arrangement giving more height, providing room for a 10 inch frieze.

There was a time when the use of concrete was looked on with skepticism by carpenters. However, that's long passed, and now everyone recognizes its importance in the building line, and I for one always recommend its use in places where I know it superior to wood.

Concrete for porch floors should slope away from

(Continued on page 162.)

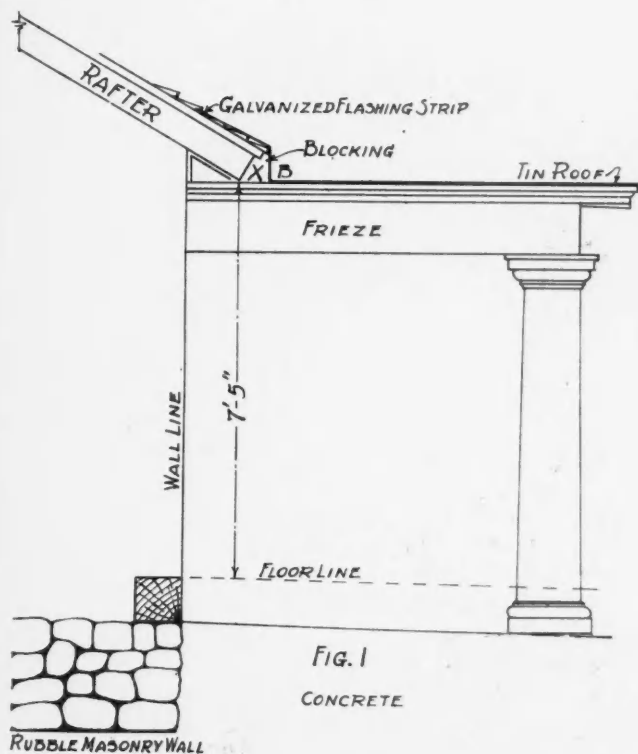

DETAILS OF PORCH CONSTRUCTION TO BUILDINGS OF LOW ELEVATION

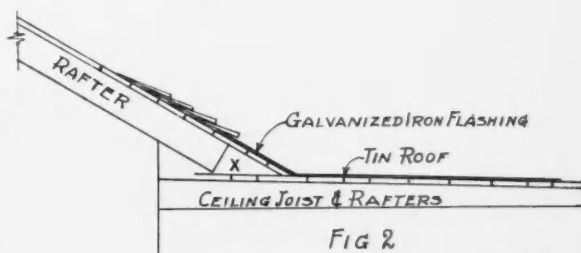

IMPROVED METHOD OF CONSTRUCTING PORCH ROOF

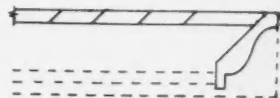

FIG. 3

WRONG METHOD IN PLACING MOULDINGS FOR TIN ROOFS

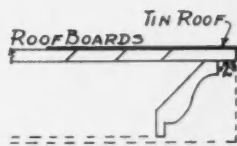

FIG. 4

RIGHT METHOD IN PLACING MOULDINGS FOR TIN ROOFS

Some Helpful Details Suggested by the Author for Jobbing Work on Porches.

FARM BUILDINGS

Arranged For Convenience

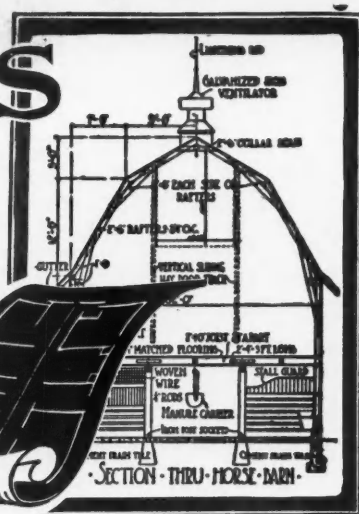
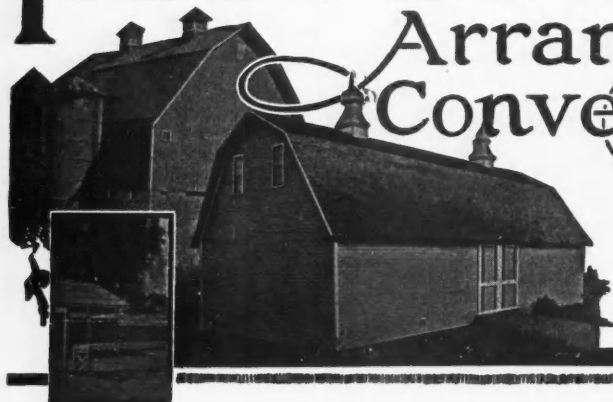

Building for the Future

A BARN BUILT FOR HORSES AND IMPLEMENTS THAT CAN LATER BE USED FOR DAIRYING

MANY farmers, when it comes to putting up a barn, throw together a makeshift to take care of their present needs rather than go to great expense to provide for a type and scale of farming that they expect soon to outgrow.

Progressive farmers who have no cows often feel themselves gravitating toward dairying. They realize that dairying is the best guarantee of permanent and increasing soil fertility. They feel that they will go into dairying as soon as they can figure out how to

get into it the right way and make it pay.

With this condition in mind we have designed a barn to take care of horses and machinery on a good sized farm, and that later on can be converted into a dairy barn without additional expense except for equipment.

The barn is 93 feet by 36. Forty feet in one end is taken up by horse stalls, tool room and grain bins, leaving over fifty feet in the other end for the cows to come. This space can be used to house machinery

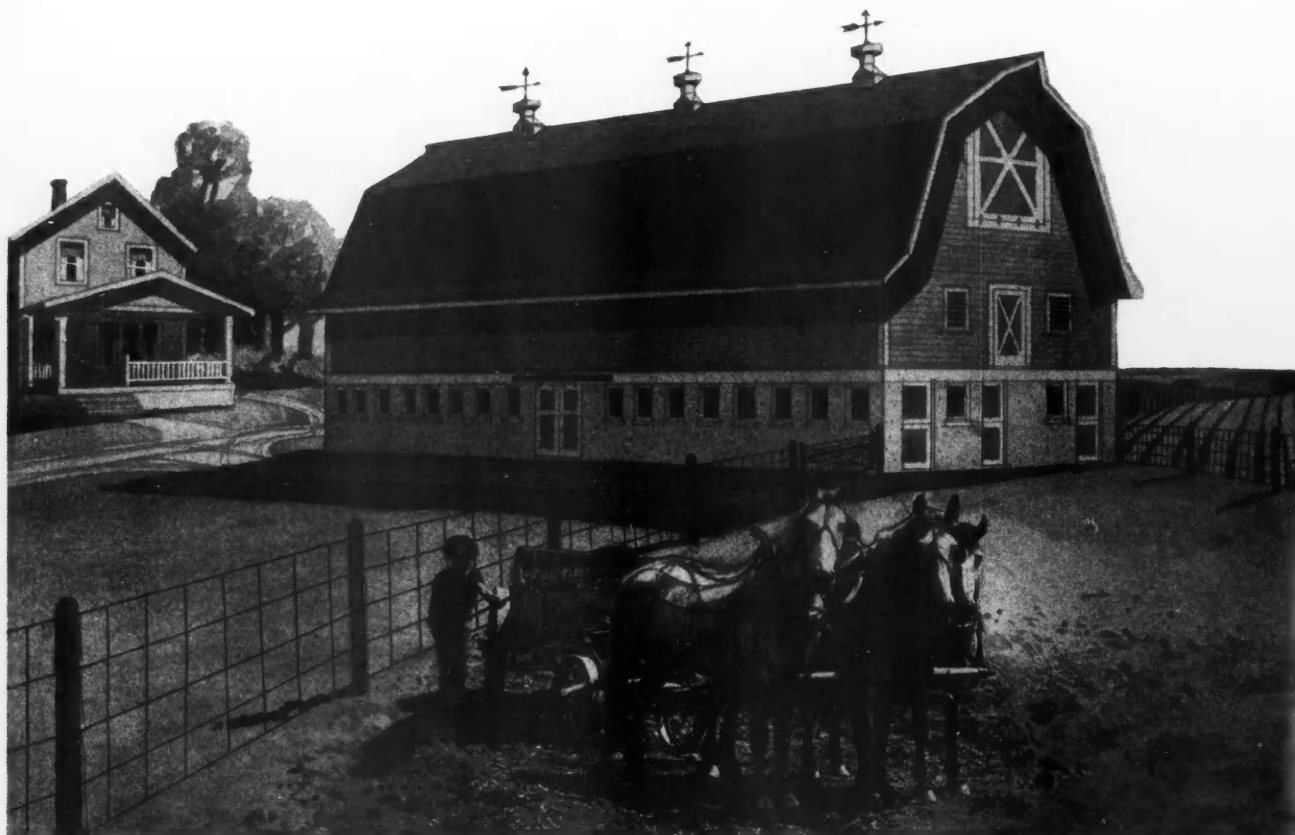

A Barn Built for the Horses That Are and for the Cows That Are Yet To Be. One End of It Is Fitted Up with Stalls and Grain Bins for Work Stock. The Other End Can Be Made Into a Dairy Barn Without Extra Expense of Construction.

and for various purposes till the time comes to rig it up for cattle. Machinery of the largest type can easily be run in and out, as there are large sliding doors in the middle of the barn and at the dairy end.

A barn like this would be more expensive to put up, of course, than one of just sufficient capacity for present needs. But it would be a money saver in the end. It would be cheaper to construct, and far more convenient, than separate buildings put up as the need for them arose. A fine plan for the farmer who has his farm figured out years ahead.



Let Gravity Do the Work

CORN CRIB IS SO BUILT THAT LOADS ARE DRIVEN TO UPPER FLOOR AND DUMPED

By Geo. K. Adams

THIS corn crib was designed by J. W. de Back and built for P. J. Van Loben Sells at Vorden, Calif.

It was built in this manner to save labor and keep rats out. It is 96 feet long, 22 feet wide at the bottom and 30 feet wide at the top or the widest part of the building. It is built on a concrete foundation two feet off the ground. It has a solid floor of 1 1/4 x 6 No.

1 Com. Oregon Pine surfaced one side one edge.

You will notice in the sketch that the floor is raised in the center of the building like a roof. This is to allow the corn to come out easily. There are sixteen cribs, eight on each side and a door on the outside of each crib as in the picture. These doors are made of three pieces of 2x12, and are put together so that each piece of 2x12 can be taken out separately. This is done to keep the corn from coming out too fast at first.

There is small gauge wire all around the outside of the building from the floor up to the projection. This projection is six feet above the floor and projects one foot from the building to keep the rats from getting in.

Wagons and auto trucks drive into the building

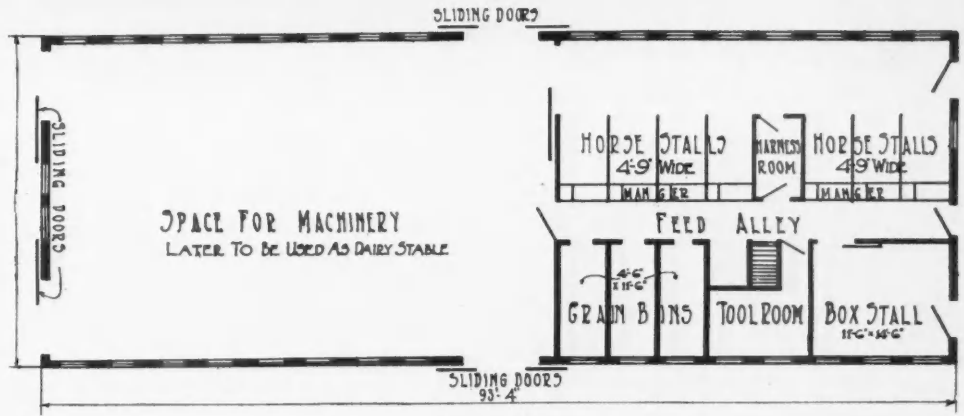

FLOOR PLAN
Ground Floor Layout of Big Barn, 36 by 93 Feet 4 Inches, Illustrated on the Opposite Page.

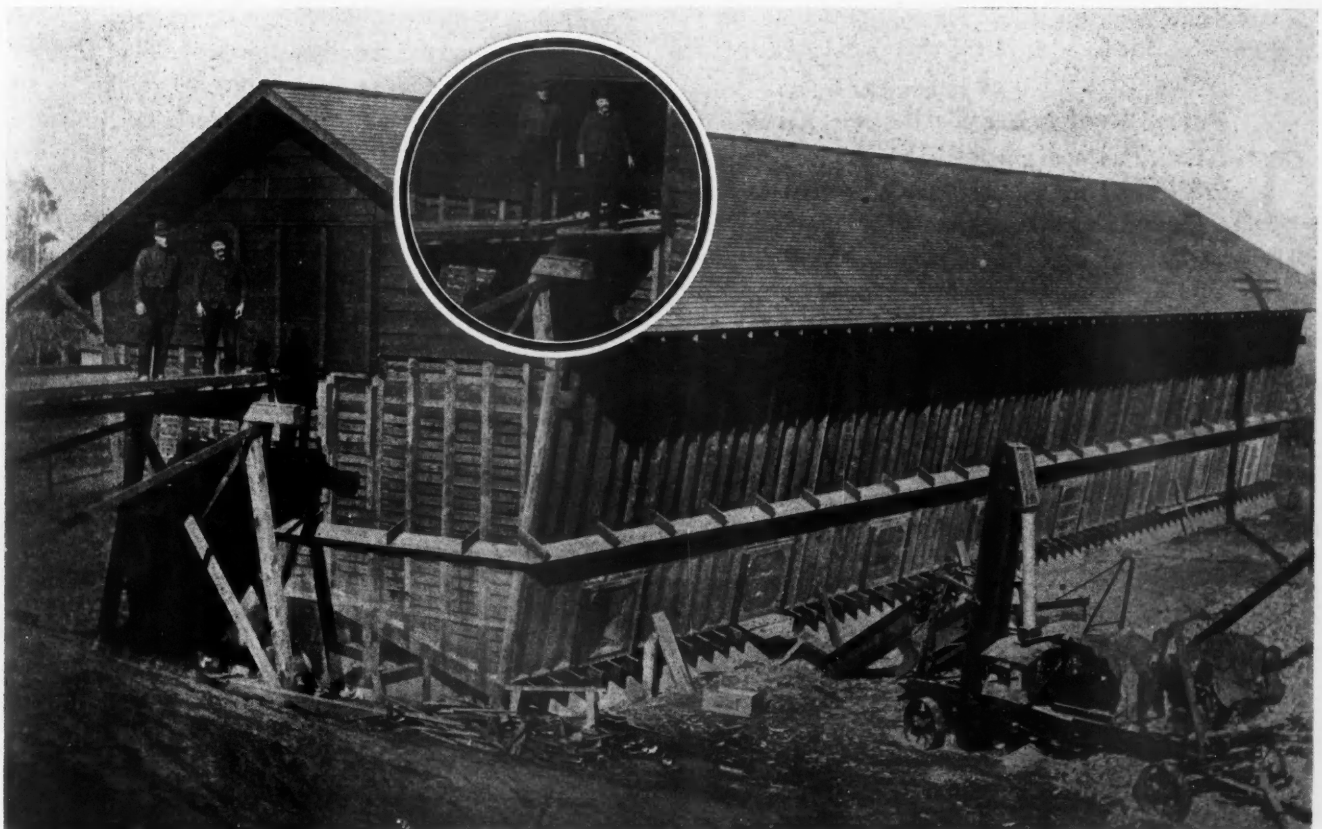

Corn Crib Where Loads Can Be Driven in and Dumped into Bins on Either Side. Inset Shows Door Let Down for a Bridge.

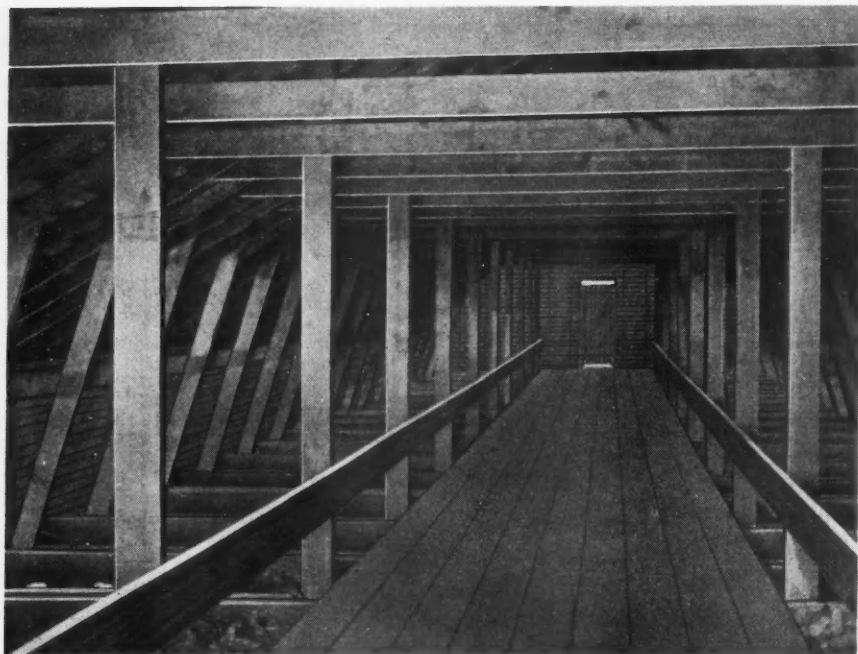

Elevated Driveway Thru the Crib. The Wagon Is Driven in and the Grain Dumped Into the Bins on Either Side.

from the platform in front of the building and dump the corn into the cribs. After unloading they back out. The door of the building acts as door when it is raised up and acts as bridge when it is let down for the teams to drive in on. By raising the door or bridge it keeps the rats from getting in.

When the corn is ready to be shelled they open the doors and the corn comes out of itself. They shell two sacks a minute with an Appleton sheller. There is a large air space the entire length of the building, as can be seen in the sketch.



Farm Profitable Building Field

THE U. S. Department of Labor, in its campaign to secure a greater amount of building, now is concentrating a part of its efforts on the farmers. Thru the newspapers and granges, the department is showing the owners of farm property that it is not only an act of patriotism to erect needed buildings—homes, barns, granaries, hog houses and other farm buildings—but that it is economical to build now. The

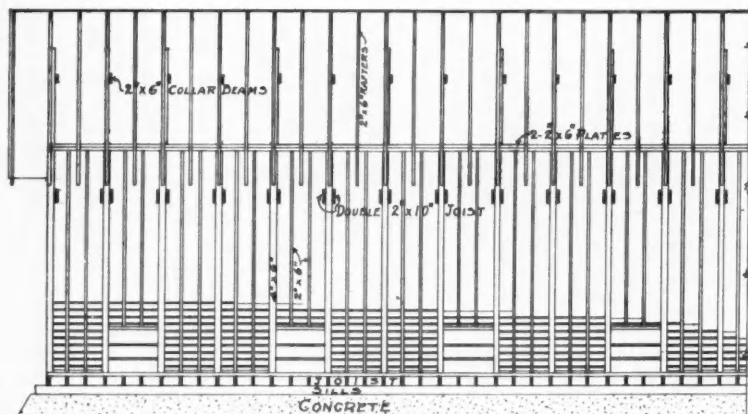

SIDE FRAMING OF CORN CRIB

How the Corn Crib Shown on the Preceding Page Is Framed and a Cross-Section, Showing Construction Methods.

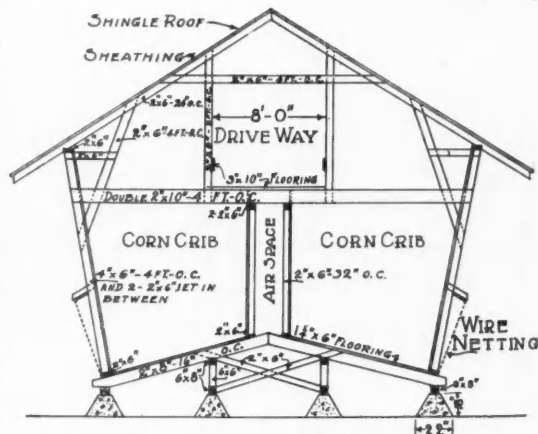

CROSS SECTION OF CORN CRIB

prices of farm products, the federal officials point out, have increased in a much greater proportion than has the cost of building and prices of materials and labor will not come down until after the prices of food-stuffs drop.

This campaign is having a good effect for the building industry, as reports of building for April show that farmers are heeding the call. Campaigns of all sorts, such as silo building, milk house construction, etc., also are being waged in a number of states. All of these help the builders who are located in rural districts.

In this connection, the builders and material dealers can do good work for themselves and their country by getting in touch with their best farmer customers and

make them want to build that new house, or barn, or whatever the prospect has been considering. Literature dealing with farm buildings should be placed in the hands of those who are able to build and need to build. Personal contact, of course, is the better way, but just now it is difficult to get the attention of the farmer customers during the working hours.

If contractors and material dealers will devote a portion of their time to this work now, they will have a busy and profitable summer.

Reverting to the buying power of the farmer's products; recent statistics gathered by the U. S. Department of Labor show that a certain amount of farm products will buy 25 per cent more building materials than it would before the war. In other words, the price of farm products has increased that much more than has the price of building materials.

With this fact in mind, the contractor or the material dealer need have no hesitancy in urging farmers to build now. They have the money and need the buildings.

fu
re
ta
gi

sh
gr
hi
tin

The

and
tion
beco
in to
debr
surf
mat
awa
vent
U
atten
foun
to in
bette
Solid
used
shou
24 in
block
wet g
the a
antise
concr
mater
woul

Hints on Storing Timber to Prevent Decay

Prepared by the
FOREST PRODUCTS LABORATORY, U. S. FOREST SERVICE, MADISON, WISCONSIN

MANY serious losses from decay in wooden structures are due to the fact that the timbers used were infected with wood-destroying fungi while in storage. These losses can be greatly reduced by keeping lumber storage yards in a sanitary condition. Some hints as to how to do this are given below:

Store on Well-Drained Ground—Strong efforts should be made to store the product on well-drained ground, removed from the possible dangers of floods, high tides, and standing water.

Remove Debris and Keep Down Weeds—All rotting debris scattered about yards should be collected

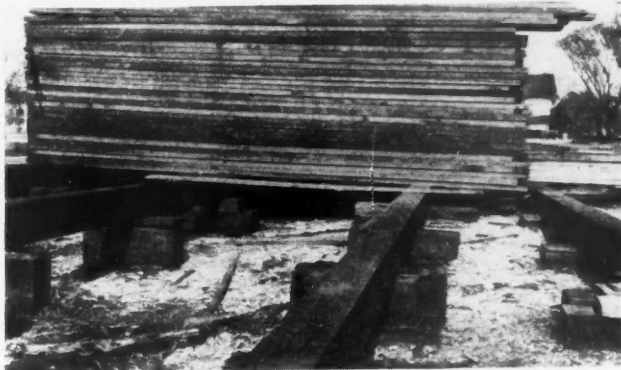

The Decaying Debris in the Foreground Is Sufficient to Start Infection.

and burned, no matter whether it be decayed foundation and tramway timbers or stored lumber which has become infected. In the case of yards already filled in to considerable depths with sawdust and other woody debris the situation can be improved by a heavy surfacing with soil, slag, or similar material. Weeds should be cut away from the piles to allow good ventilation.

Use Proper Foundations—More attention should be given to the foundations of lumber piles in order to insure freedom from decay and better ventilation beneath the stacks. Solid foundations should never be used. In humid regions the stock should not be piled less than 18 to 24 inches from the ground. Wood blocking used in direct contact with wet ground should be protected by the application of creosote or other antiseptic oils or else replaced by concrete, brick, or other durable materials. Treated skid timbers would also be highly advantageous.

Slope Lumber Piles—Foundations should be built so that the piles will slope approximately 1 inch to every foot of length.

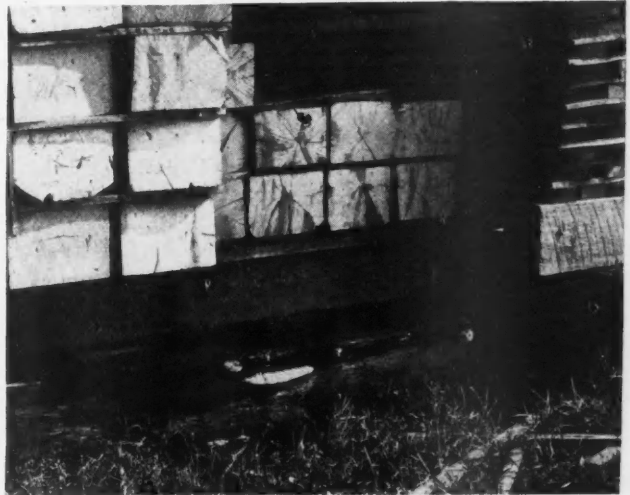

Decay Is Almost Certain to Occur in Continuous Foundations Like This.

Assist Ventilation by Avoiding Close Piling in the Open—In most regions lumber should not be close piled in the open, but should be "stuck" with crossers at least 1 in. thick. Lateral spacing is also very desirable. Roofing or cover boards on the piles should not be neglected, and should extend over for several inches in front and back.

Take Care of "Stickers"—Instead of throwing the "stickers" about on the ground to become infected with decay, they should be handled carefully and when not

(Continued to page 168.)



Foundations Are Strong and Properly Sloped, But Piles Are Too Close Together.

CORRESPONDENCE



Questions Answered and Ideas Exchanged.

Our Readers are Requested and Urged to Make Free Use of These Columns for the Discussion of all Questions of Interest to Carpenters and Builders

Wants to Build a Gothic Roof Barn

To the Editor: Tyndall, S. D.
Will you please tell me where I can get information about building a gothic roof barn? I am going to build a barn 36 by 60 feet, with a gothic roof. What I would like to know is from what point is the round part of the roof started.

MATT PLOCEK.

the ground; a foot and a half is better. The joists, sunk into the concrete foundation, are very liable to rot quickly. Undoubtedly there are many builders who would be glad to help Mr. Eppel with their experiences in constructing hog house floors in this way.

EDITOR.



Floor for a Colony Hog House

To the Editor: Graymont, Ill.
I have a client who is going to build a large hog house of the colony type. He wants a wooden floor in it. I have suggested a concrete sub-floor, but that entails too much expense to suit him, tho he wants a concrete driveway. The dimensions of the building are 30 by 80 feet. One part, 16 by 30 feet, is to have a concrete floor and will contain a furnace and cooking plant on one side and feed bins on the other.

Why An "Architect's Level" and a "Builder's Transit?"

To the Editor: Whitehall, Mont.
I am about to buy a transit or a level, and am undecided which to get. I notice the manufacturers who advertise in the AMERICAN BUILDER make various statements, such as: "First-class architect's level as well as builder's transit." I would be obliged if you would answer the following questions, so as to help me decide which to buy:

What is a transit's chief peculiarity?

Why can an architect's needs be met by the use of a level?

Why should a builder be better served by a transit?

T. C. MICKLETHWAITE.



Why Do the Windows Freeze

To the Editor: Appleton, Wis.
I would like to ask a question in regard to windows freezing. Last June I put up a bungalow, 26 by 40 feet. The walls are stuffed with shavings. I have storm windows on every window. In cold weather the storm windows are completely frozen and the inside windows are very wet. Even in mild weather the storm windows are wet.

I have spoken to several carpenters and contractors about the trouble, and they thought it was because I had no floor in the attic. So I laid a good matched floor there, but instead of improving the conditions it seemed to make them worse.

I have a hot air furnace, so went to the furnace manufacturer and inquired about the amount of water the furnace is supposed to consume. He seemed to think it consumed the right amount, but suggested that I try running the furnace without water. I tried this, but it did not help. I have no trouble keeping the house warm. I certainly would appreciate advice in this matter.

We have been taking the AMERICAN BUILDER for five or six years in the wood-working department of the Appleton Vocational School; where I am instructor, and consider it the most valuable magazine in our school.

JAMES CHADEK.

(Correspondence Department continued to page 66)

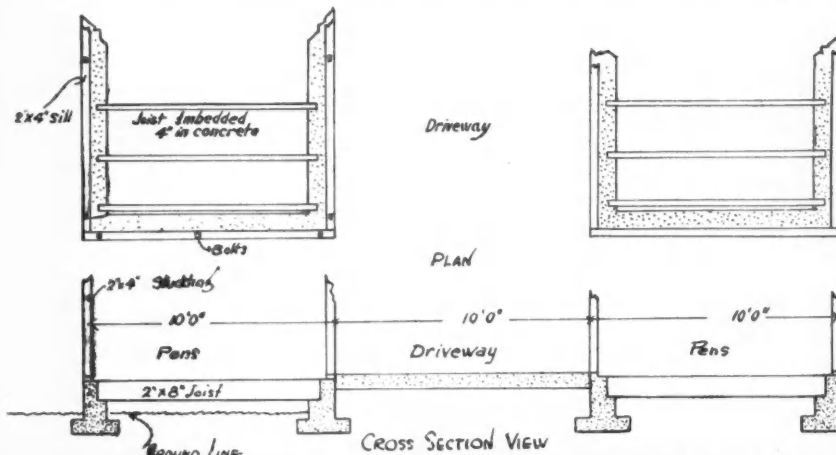

Cross Section and Floor Plan of Hog House with Wooden Floor Laid on Joists Set In Concrete Foundation.



YOU will please the owner, in building a garage, when you use

Stanley Garage Hardware

Every item is designed especially for garage use and is handsome, suitably and exceptionally strong and easily operated.

The heavy doors as here illustrated are swung on three extra heavy 36-inch ball-bearing garage door hinges—the strongest hinge made.

Send for catalogue E5 of the complete Stanley Garage Hardware line

USE BALL BEARING BUTTS FOR PERMANENCE

THE STANLEY WORKS
NEW BRITAIN, CONN., U. S. A.

New York
100 Lafayette St.



Chicago
73 East Lake St.



**Lesson in
Plan Reading**

FREE!

Send now for this FREE lesson which we will send to prove how quickly you can learn Plan Reading by our new, easy method. Not a penny to pay for this lesson. Just ask for it. Without a good knowledge of plans your opportunities are limited. At work you don't get the chance to study blue prints or to have their meaning explained. **We make the chance for you.** We place in your hands plans used on actual construction by contractors in Chicago and other cities, and you get lessons by men in charge of building work who will help you at every step and make you an expert plan reader.

**Builders' Course
On Easy Payments**

Our Builders' Course gets right down to the things you need to know. And you can get it on easy payments. A small first payment when you enroll—then payments monthly—so small you will never feel the cost. At least write and find out what this course really offers and how you can make more money by learning what we will teach you in a short time.

Learn By Mail

Use your spare time at home to learn how to be a better workman, a better foreman or a better contractor. Even after you complete the course you have the privilege of consulting us when you want suggestions. We will always be ready to help you.

Some Things We Teach

Plan Reading Use and meaning of all the lines. Plans and elevations. Reading dimensions. Detail drawings. Laying out work from plans. Practice in reading plans from basement to roof, etc., etc.

Construction Brick work, stone work, carpentry, plans and specifications. Every detail explained for residences, office buildings, factory buildings, school houses, apartment buildings, bank buildings, etc., etc.

Estimating Figures on every kind of building work fully explained. Labor and material. Problems worked out from plans. Practical builders' methods studied from plans and specifications of actual building of every kind.

Arithmetic A complete course arranged especially for builders and contractors.

Architectural Drafting Also other branches of drafting. Send for special catalog on these courses.

Send the Coupon

Get this information now. Learn how to make more out of your work or out of your business by knowing more about it. All this information is free. Send for Free Lesson and this information—now. Just send request on the coupon below.

Chicago Technical College

536 Chicago "Tech" Building Chicago, Illinois

Without obligation on my part, send me the Free Lesson in Plan Reading, also information on your Builders' Course in Plan Reading, Estimating, etc.

Name

Street

City State

Present Occupation

Correspondence Department

(Continued from page 64.)

Formula for Blue Print Paper Solution

To the Editor: Story City, Ia.

I would like to ask some questions regarding blue printing. I formerly used commercial printing paper, but as I do not require much, and some of it spoiled, during the last few years I have been preparing my own paper, and find it fairly satisfactory. However, there are some drawbacks in using it. Sometimes it gets a dark blue, while at others it is a lighter color with the same exposure. I use the following formula for making the solution: One ounce of green citrate of iron and ammonia in four and one-half ounces of water; three-eighths ounce of cyanide of potassium in four and one-fourth ounces of water. The two solutions are mixed at the time they are applied. The question I would like to ask is: If I increase or decrease the strength of the ingredients, what effect will it have on the finished print? It takes eight or ten minutes to print in the bright sunlight. Is there an agent that will hasten the printing?
ANDREW LANGLAND.



To Keep Ventilating Flues From Sweating

To the Editor: Port Allegany, Pa.

From time to time you have invited me to make use of your Correspondence Department. Will you kindly advise me about the following problem?

In a public hall here there are two ventilating flues, 15 inches in diameter and about 10 feet high. They are of galvanized iron. These flues sweat, and the water has spoiled the carpets and wallpaper. I would like to know if my method of remedying this condition is correct. I propose to line the flues with either galvanized iron or wood, leaving about a two-inch air space between the lining and the walls of the flues. Will this prevent sweating?

Answer—We would say this method would have the desired result. However, perhaps some of our readers know a better way.
EDITOR.



Weather-Tight Sleeping Porch Windows

To the Editor: Murphysboro, Ill.

Please tell me the best way to arrange for a single sash to drop or slide down into the wall of a sleeping porch. I have one to build, and the owner wants all the sash hung on weights and to disappear down in the wall. I want to know how to arrange the sash so that water will be kept out when the windows are closed.
GEORGE W. STAFFORD.

Answer—A number of different methods have been used to construct sleeping porch and other windows in this way, but we have heard of none that would keep out the rain. Perhaps some of the members of the AMERICAN BUILDER family have been more successful and will furnish the information.
EDITOR.



Asks for Tile Roofing Facts

To the Editor: Elmwood, Wis.

The articles you had in the AMERICAN BUILDER on clay building tile were very interesting to me. I was hoping that they would be continued to roofing tile, especially Spanish tile. If these articles do not continue in the near future, can you refer me to a good book on roofing tile, showing foundations for same, methods of laying, time required to lay a

(Continued to page 68.)

Which will last longer —
Rock or Rags?

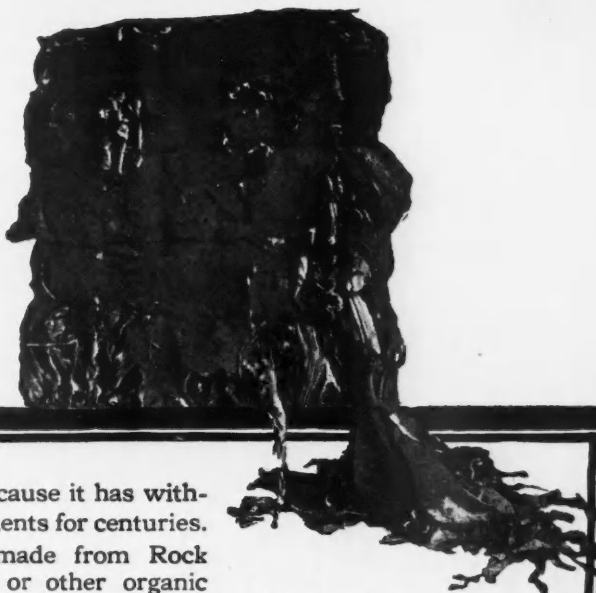

You will say rock — of course — because it has withstood the destructive action of the elements for centuries. Then why not insist on a roofing made from Rock fibre instead of roofing made from rags or other organic material. Asbestone is the only known mineral fibre from which roofing can be made. It will permanently resist the destructive action of time and the elements and the ravages of fire.

ASBESTONE

(Approved by Underwriters' Laboratories)

Asbestone is a Johns-Manville Roofing made of Asbestos rock fibre which repels fire and resists the action of fumes, acids and varying weather conditions. Being all mineral, it cannot rot, disintegrate or dry out. Therefore painting is never required.

Asbestone is a mineral fabric, composed of imperishable Asbestos fibre, waterproofed with natural asphalts. It has a gray mottled Asbestic finish on one side, smooth, black surface on the other. Can be laid either side to the weather. Rolls contain all necessary fasteners for laying.

Lowest Cost-per-year Roofing

You do not buy roofing for a week, or a month, or a year. You buy roofing to last as long as the building itself. To make sure that you get such a roofing insist on Asbestone. Ask your dealer to show it to you. Examine it carefully, and remember that you have our assurance that on a cost-per-year basis Asbestone is the most economical roofing you can buy. The first cost is the only cost.

Register Your Roof With Us

Our responsibility to you does not end with the sale. You can register your roof with us, which puts it on our records as Johns-Manville Roofing in service. Whether it's Asbestone or any one of the other Johns-Manville Asbestos Roofings, our Responsibility does not end until you get the service promised.

Other Johns-Manville Roofings

Johns-Manville Asbestos Roofings are made in great variety for all roofing needs. Johns-Manville Asbestos and Colorblende Shingles. Johns-Manville Ready Asbestos Roofing. Johns-Manville Built-Up Asbestos Roofing for flat surfaces. Johns-Manville Corrugated Asbestos Roofings.

To the Trade:— Address nearest branch for particulars

H. W. JOHNS-MANVILLE CO.
New York City

10 Factories—Branches in 63 Large Cities



Send for Booklet
"Rock or Rags"

And also through—
Asbestos

and its allied products

JOHNS-MANVILLE
Serves in
Conservation

Heat Insulations, High
Temperature Cements,
Asbestos Roofings,
Packings, Brake
Linings, Fire
Prevention
Products

JOHNS-MANVILLE ASBESTOS ROOFING

1890 - 1919

Bostwick Metal Lath In 1893

THE World's Fair at Chicago in 1893 was the greatest exposition which had ever been held up to that time and more manufactured products were exhibited there than at any World's Fair before or since.

The Bostwick Steel Lath Company was awarded the only Medal and Diploma given for Metal Lath.

Thirty years' experience continuously manufacturing Metal Lath has enabled us to produce a better Metal Lath today than we did in 1893.

Building Supply Dealers carry Metal Lath in stock the same as cement or plaster.

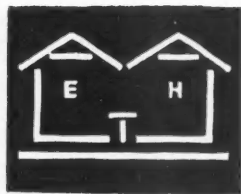

METAL LATH
Because Metal Lath

The Bostwick Steel Lath Co.
Niles, Ohio
Made the First Metal Lath in 1890

Correspondence Department

(Continued from page 66.)

square, average size, weight per square or per thousand, the flattest roof they are practical on, valleys, etc.?

I would also like a table of safe center loads for different sizes and lengths of concrete beams and girders, giving number and size of reinforcing rods in them.

K. T. THOMPSON.



Quantities of Materials in Plaster and Concrete

To the Editor:

La Fargeville, N. Y.

V. E. Clow asks about figures for material for plaster and concrete and as others may be interested I offer the following. The old rule is that 8 bushels of good lime, 16 bushels of sand and a bushel of hair will make mortar to plaster 100 square yards.

In mixing cement mortar and concrete much depends on the richness and this depends on the work to be done. The table shows the cubic feet resulting from some mixtures:

	Sacks cement	sand	Cu. ft. gravel	mortar
Extra rich	1	1	..	1½
Rich	1	1½	..	1¾
Rich	1	2	..	2¼
Good	1	2½	..	2½
Good	1	3	..	2¾
Fair	1	4	..	3¾
Weak	1	5	..	4½
				Concrete
Rich, dense	1	1½	3	3½
Rich	1	2	3	3¾
Rich	1	2	4	4½
Rich, porous	1	2	6	6
Good, dense	1	2½	4	4¾
Good	1	2½	5	5½
Good porous	1	3	5	5¾
Fair	1	3	9	8¾
Fair	1	4	7	7½
Weak	1	5	9	9½

One sack of cement is called one cubic foot.

JOHN UPTON.



Suggests Articles on Woodworking

To the Editor:

Boston, Mass.

I would suggest that you have a page or two for woodworkers, if possible.

EARLE W. MASTERS.



Wants Man to Lay Cobble Stones

To the Editor:

Roberts, Ill.

I am planning to build a bungalow that has a rough stone-work porch with posts, and the material I have to use is field stone or nigger heads. I want to get in touch with a man who is experienced in splitting and laying such stone.

JOHN GONWA, Contractor.



Wants Small Septic Tank Plan

To the Editor:

Canton, Ill.

What is the best and cheapest way to construct a septic tank that will care for a family of six persons?

ROBERT W. TYLER.



Planning Septic Tank for Large School

To the Editor:

Kaysville, Utah.

I would greatly appreciate information as to the number of gallons of sewage per day flowing from a grade school class room that accommodates 40 pupils. I have to plan a

(Continued to page 70)

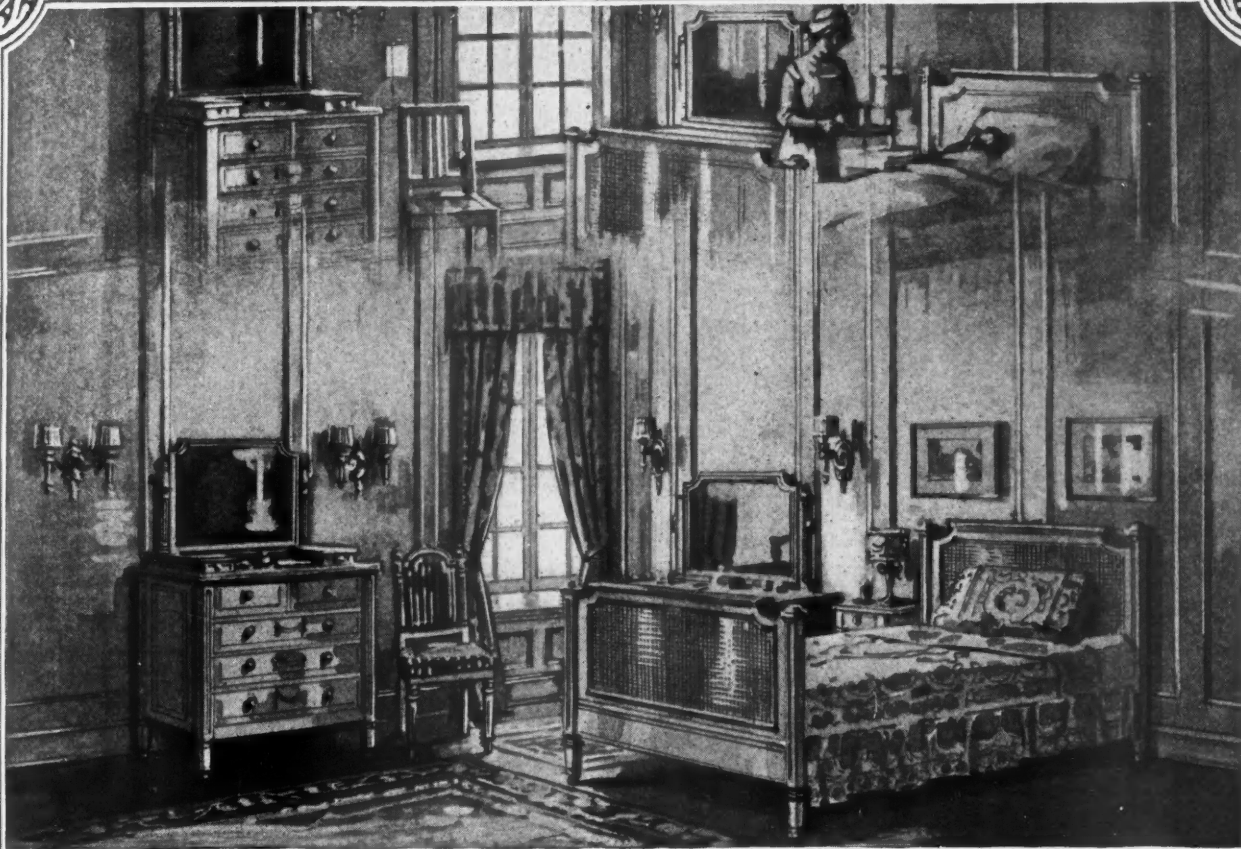

Every Bedroom May Become a Hospital

The Sanitary Varnish because it can be scrubbed with boiling water

A bedroom may become a sick room. Then absolute sanitary cleanliness becomes of vital importance.

Your clientele will appreciate an interior finish that will stand such thorough cleaning as is resorted to in a regular hospital—without turning white or being injured in the process, when strenuous treatment is demanded by unexpected crises.

Woodwork and floors in bed-room and bath-room, if finished with Murphy Univernish or Murphy White Enamel, will stand such cleaning and also prove resistant to boiling water. Univernish is likewise an admirable finish for kitchen and butler's pantry, where hard scrubbing is in order. For Univernish is as durable as glass, and as easy to clean.

It is rare to find a varnish combining such thoroughly practical and reliable qualities with so superior and lustrous an effect upon woodwork. Please write for specifications and samples.

Murphy Varnish Company

Franklin Murphy, jr., President

NEWARK

CHICAGO

The Dougall Varnish Company, Ltd., Montreal, Canadian Associate



Correspondence Department

(Continued from page 68)

septic tank, and it must be large enough to hold one day's sewage from 12 class rooms for 24 hours in the receiving chamber. We have a city waterworks system and a plentiful supply of water. All I need to know is how many gallons of sewage per day per pupil must the tank be made to hold. I have a number of books on sanitation and sewage disposal, but none of them gives facts regarding schoolhouse requirements.

WILLIAM ALLEN.



Building Construction Details

To the Editor:

Omaha, Neb.

Fig. 1 represents the general construction of the sill and joist framing by a method frequently used in Omaha, where 6x6 sills must be used to conform to the city building regulations. The 6x6 sills are halved together at the corners. The joists are simply notched out about half their width, just so that a 2x4 set on top of the sill will come flush with the top of the joist, the joist sitting on top of the sill. A 2x2 is then spiked to the sill directly under the joists as shown. This method gives the full strength of the joist at its bearing and avoids the necessity of cutting gains into the sills. It neither weakens the joist or the sill in the framing and saves all the laborious job out of the sills. We like this way much better and can see no reasonable excuse for anyone wanting the joists gained into the sills.

Another advantage of this method is that of laying the

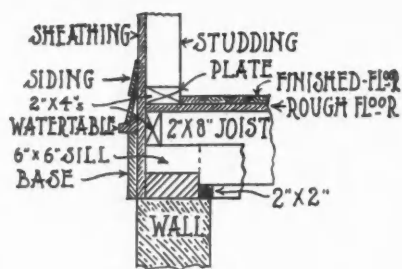

▲ FIGURE 1 ▲

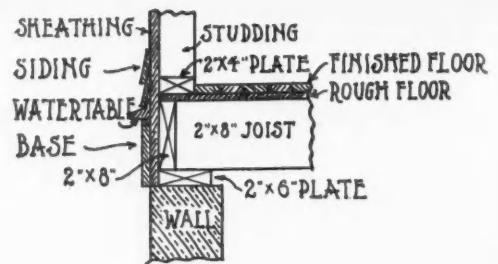

▲ FIGURE 2 ▲

rough floor and placing a plate on top of this for the superstructure to sit on, by this method you gain almost 6 inches in height and it is very often this 6 inches is wanted to make up the story height. This is especially true of a two-story house using 18 foot studding where every inch in story height is wanted to make the required heights. The sketch shows the general arrangement of the rough floor, finish floor, sheathing, siding, base, water-table, etc.

There is still another advantage in this method. It enables you to use 2x8 joists for the porch floor to a much better advantage, because setting the joists partly above the 6x6 sill brings the finish floor high enough to use the 2x8 joists. Where the main floor joists are not set partly above the 6x6 sill, 2x6's are mostly used for porch joists, and they do not work out so well, besides a 2x6 is sadly lacking in strength sufficient to make a good porch floor. Doubtless you have noticed a large number of very springy porch floors. In such look for the 2x6 construction and you will find the cause.

Fig. 2 shows a box sill method of framing. In this a 2x6 is laid flat on the wall, a 2x8 sits on top of this and the floor joists are cut off square, resting on top of the 2x6 wall plate

(Continued to page 72.)



“BARCREST” Quality Shingles

Fine shingles of uniform quality play a most important part in Building. In the small house or bungalow everything depends on the quality of shingles used.

The “Barcrest” shingles are sawn from the finest live cedar—sorted into 12 grades—sizes 16”, 18”, 24” in length.

They may be had in any of our 20 beautiful shades or any special color you desire.

Write today for our roofing suggestions, color samples and catalog. It is of importance to you.

H. S. BARBER CRE-SOTE STAINED SHINGLE CO.

173-193 Beaufait Avenue, Detroit, Michigan

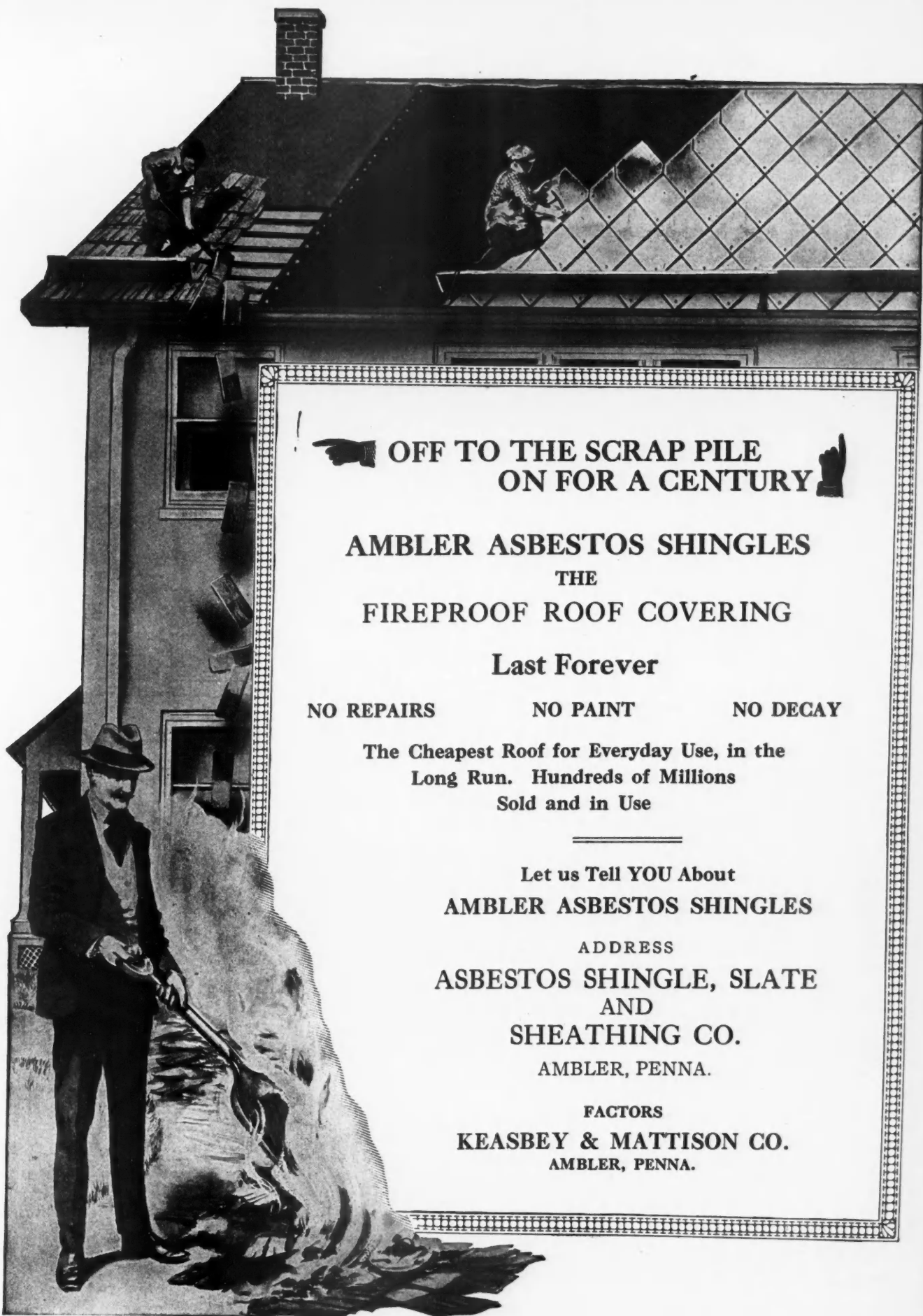

**OFF TO THE SCRAP PILE
ON FOR A CENTURY**

**AMBLER ASBESTOS SHINGLES
THE
FIREPROOF ROOF COVERING**

Last Forever

NO REPAIRS NO PAINT NO DECAY

**The Cheapest Roof for Everyday Use, in the
Long Run. Hundreds of Millions
Sold and in Use**

**Let us Tell YOU About
AMBLER ASBESTOS SHINGLES**

**ADDRESS
ASBESTOS SHINGLE, SLATE
AND
SHEATHING CO.**

AMBLER, PENNA.

**FACTORS
KEASBEY & MATTISON CO.
AMBLER, PENNA.**

Correspondence Department

(Continued from page 70.)

and are spiked thru from the face. This makes a strong form of construction, thought by many to be fully as good as the 6x6 sill method and with much less labor. However, this method cannot be used in Omaha on account of the city building regulations. It is a saving in lumber, requiring 1 2/3 less feet board measure, per lineal foot of sill than the former method. This will figure up to about 200 feet less board measure on an average size house, making a saving of about \$5.00 in the lumber bill.

✦ I. P. HICKS.

Design of a Small Tool Chest

To the Editor: Decatur, Ill.
 In the past few numbers I have noticed several designs of tool chests and requests for more.
 Enclosed is a sketch of a handy box the writer has been using for some time. The lid is partitioned off for various things. In the upper left hand corner is a small place for the end of the square to slip into when closed. The lid of this till fits inside and forms the bottom when the box is closed. A leather flap fastens over a screw to keep it closed. The long till down in the box is for level. This may be put in the till above and the space used for drawings. The front lid will accommodate four saws.

Four trunk hasps and a Yale hasp lock are fitted to it. Detail "B" shows a 1/8 inch by 1 inch iron strap, set in to reinforce the end as a crack might develop along the grain. The handle may be procured from a trunk store and fastened to two U-shaped irons that fit inside of the lid and are fastened to the sides. Without these the handle would pull thru the wood.

(Continued to page 74)

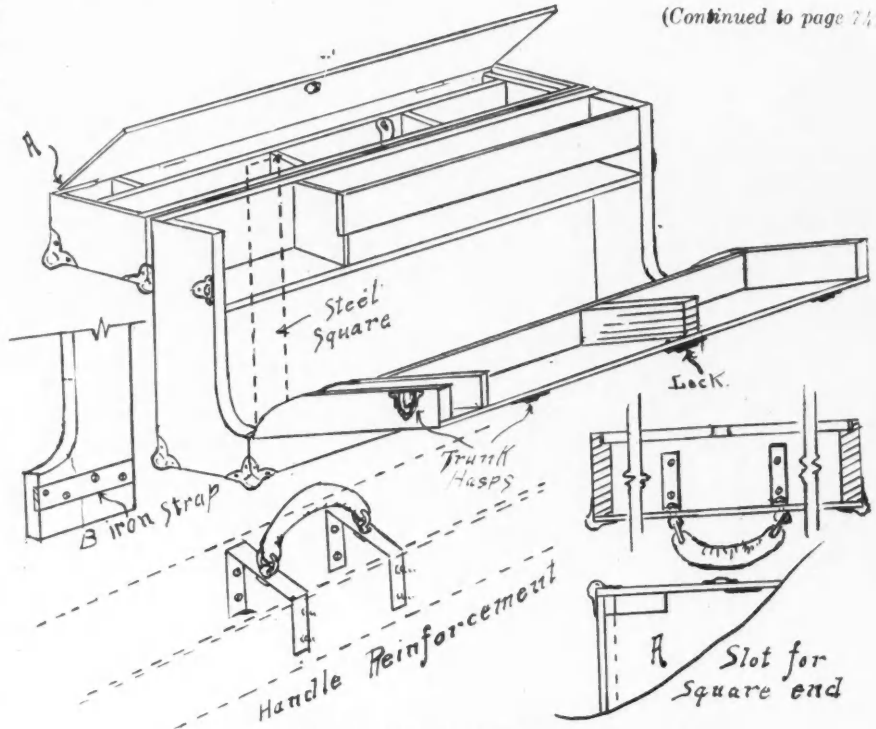

Sketch of Handy Tool Case.

You Get \$90,000.00 Contract

BIG Business is just ahead. Prepare for it. Be ready to take advantage of opportunities.

Make Your Own Bricks and Blocks

Manufacture pressed concrete blocks and bricks for yourself or for others, both pay **Big Profits**

One man in town of 375 earned \$2,430 in 90 days, \$27 a day actual clear cash profit. Another gets \$90,000 contract. Owners of Helm Brick and Block Presses making money everywhere. A small investment starts you making

10,000 Bricks or 1,000 Blocks Daily With This Helm Brick and Block Press

Lack of experience is no handicap. With this Helm brick and block press you make pressed cement bricks and blocks that are perfectly true and uniform, make them in various colors and shades, including granite effect; make them without tamping—no burning—this machine gives 80,000 lbs. pressure; easy work.

We are approaching a big era of prosperity in the building trade. Manufacturing your own pressed brick and blocks places you in a position to command business.

Helm DRY WALL Building System

A feature that will influence business your way. Absolutely dry walls. Saves money. No furring or lathing required. Makes fireproof and rigid walls.

You Should Have This Valuable Book

FREE This valuable book about concrete. Write for it today. Simply fill in coupon here, or address us a letter. This book will start you right, show you the big profits you can make, tell you all the details of operating Helm Press and Dry Wall building system; how each product is made, how it is cured, how it is sold. Write today.

Helm Brick Machine Co., 575 Mitchell St., Cadillac, Mich.

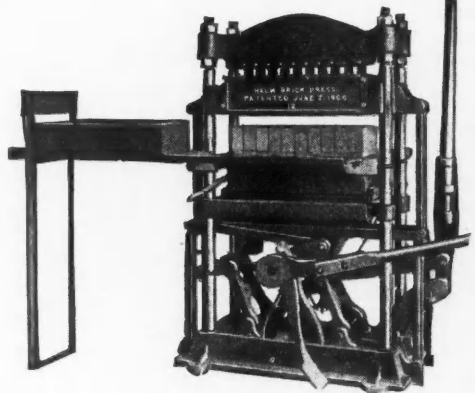

HELM BRICK MACHINE CO.
 575 Mitchell St., Cadillac, Mich.

Please send Free the book on concrete and Helm Presses.

Name

Address

B



You can't expect Beaver Board results unless this trademark is on the back of the board you buy.

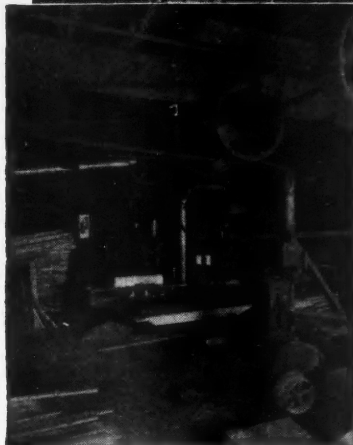

This shows a small corner of the work shop of the Linkenheil Planing Mill Co., Columbus, Ohio.

Linkenheil Says:—

Beaver Board Helps Us Complete Jobs in Record Time

"Yours for satisfaction, plus profit," concludes a very interesting letter from Mr. E. C. Linkenheil to us. In those five words he sums up the whole Beaver Board proposition as it affects the builder and contractor. For with Beaver Board in stock, or otherwise available for ready use, the most attractive of show windows, offices, cottage interiors, billiard rooms, libraries, bed-rooms, etc., can be readily built with *satisfaction and with profit to yourself.*

Mr. Linkenheil's letter reads in part:—"It is our desire to complete every job we undertake *in record time.* Our aim in this is to give our customers absolute satisfaction in quality of work performed and in saving of labor. We are convinced that Beaver Board has helped us immensely in attaining this aim.

"With our customers, Beaver Board paneling effect has given more satisfaction than the straight plastering and in consequence more satisfaction less a greater expense, time and rubbish."

This same customer-satisfaction and the Beaver Board profits are waiting for you. Full details on request.



E. C. Linkenheil, Sec'y-Treas. of the Linkenheil Planing Mill Co.

THE BEAVER BOARD COMPANIES

60 Beaver Road

Buffalo, N. Y.

Branches in Boston, New York, Baltimore, Cleveland, Detroit, Chicago, Minneapolis, Kansas City, San Francisco, Ottawa, Can., and London, Eng.

Manufacturers also of Beaver Greenboard and Beaver Blackboard.

Distributors in principal cities, dealers everywhere.

BEAVER BOARD

FOR BETTER WALLS & CEILINGS

WHEN WRITING ADVERTISERS PLEASE MENTION THE AMERICAN BUILDER



-GOT YOURS YET ?

**We Want the Kno-Burn
Catalog of
Fire-Proof Construction**

In the hands of every Contractor and Builder

It is so full of valuable building information, detail sketches, photos, specifications, etc.

We know of no better reference book—our engineers have spent many months in compiling data that is of especial interest to builders, contractors, and engineers this spring, because of the building boom and the nation-wide demand for building material that embodies new progressive ideas.

Now you need this hand-book, for it covers so many topics that are of vital interest to you every day,

Send us a three-cent stamp and you will receive a copy.

Write today, for the edition is limited.

**NORTH WESTERN
EXPANDED METAL CO.**

**903 Old Colony Building
CHICAGO, ILL.**

Correspondence Department

(Continued from page 72.)

For the ends, $\frac{3}{4}$ -inch oak was used. The rest is $\frac{1}{2}$ -inch poplar. The partitions are of $\frac{3}{8}$ -inch stuff. The dimensions inside are $5\frac{1}{2}$ inches by $16\frac{1}{2}$ inches by 34 inches. The lid is $3\frac{3}{4}$ inches deep and saw compartment $2\frac{1}{2}$ inches deep. Of course, these measurements can vary to suit builder. This does not make a very large or heavy chest, yet it will hold all the tools a modern job requires.

Can be carried on the street car, or, if you are going out of town, just rope it up and tag it.

J. E. GLADFELTER.



How to Find the Run of Rafters in a Gambrel Roof

To the Editor:

Kiron, Iowa.

In the March issue of AMERICAN BUILDER Mr. John Upton gave his solution for "Steel Framing a Gambrel Roof" in which I was much interested. Solving the problem by degrees was a new way to me, as I have not thought of using that method. He, however, seemed to be uncertain as to the possibility of finding the runs for the rafters, for he says he can see no other way but to measure the drawing. He evidently overlooked the very easy way to solve this, as it is only a matter of a little figuring. The upper rafter length is given as 12 feet, and the rise can be taken as 7 in 12, which is near enough, then dividing 12 feet (in inches) by the diagonal of 7 and 12 (in inches) gives the run for this rafter. Another way would be to use the steel square, using the figures 7 and 12 and seeing how many times the diagonal of these figures can be laid off on a 12-foot rafter. To get the run of lower rafter subtract the run of upper rafter from half the width of the building.

My work has been mostly in connection with house building, but in the fall of 1917 I was called on to build a barn, 36x64, with a gambrel roof and I designed the roof almost identical with the one illustrated in the February, 1918, number, page 71. I used the same pitch as illustrated, but the length of the upper rafter was a little less than 12 feet. I made a very careful and accurate drawing of the roof, using a $\frac{1}{4}$ -inch scale, and from this I made all my measurements and figured the different cuts, etc., and in framing the members I checked my figures and calculations with the steel square. In getting the runs for the rafters I drew a vertical line thru the point where the rafters meet down to a line drawn from plate to plate. Measuring this line and using these measurements as the run for the rafters worked out to my entire satisfaction. I always try to arrive at a result in two different ways as a check and I hardly ever have any trouble.

I remember having seen a solution for framing hood rafters in some of my trade papers, but after hunting in vain for it I wondered if I could not figure it out without reference to the drawing I had seen. I knew I had to solve the problem some way, as I had no one on whom I could shift the responsibility, so I sat down at my drawing board and in a short while solved the problem to my satisfaction and it worked. Some other time I may send in my solution, hoping it may be of some interest and help to some troubled carpenter having such problems to solve.

J. A. ENGBERG.



THE builder who asks questions is the one who learns the best methods of doing his work. The Correspondence department is the place to ask questions.

Are You The Man?

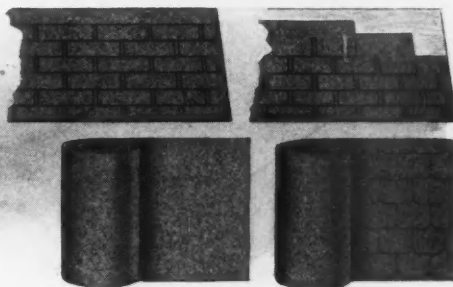

WE are looking for a man—in your community—who wants to increase his business by selling McHenry Millhouse Asphalt Shingles and Prepared Rolled Roofings.

The dealer—

who isn't interested in saving money for his customers, who does not believe that satisfied customers will boost his sales.

who is satisfied with a roofing sale now and then, *is not the man we are looking for.*

We want a man who would like to double or treble his roofing business for 1919.

McHENRY-MILLHOUSE
STANDARD SHINGLES
(Individual Type)

Our Standard Shingles have character. They are made of high grade felt, thoroughly water-proofed, surfaced with crushed slate—either Red or Green. They add permanent and artistic beauty to any home. For permanency, durability, beauty, economy, fire and weather protection they have no equal.

McHENRY-MILLHOUSE
SLAB SHINGLES
(4 in 1)

This shingle is made to satisfy and endure. It is a continuous strip shingle. It can be laid in one-half the time required to lay ordinary shingles. These Slab "4 in 1" Shingles are manufactured especially for sensible thrifty folks. They appeal to every man's judgment as being especially meritorious.

McHenry-Millhouse PREPARED ROOFING in Rolls

McHenry-Millhouse Asphalt Prepared Roofing in Rolls is unquestionably the most economical and durable roofing material manufactured. **Insurance Companies make the same rates on it as on metal or slate.** It is practical, exceedingly durable and will render splendid service for years. The best roofing on the market for the price.

Your customers will demand our high grade asphalt roofings if you let them know that you are handling our line because our goods meet every requirement of the exacting demands of the times. You owe it to your business to at least investigate our splendid line of Asphalt Roofings for 1919. We are helping hundreds of dealers to increase their net profits. We believe we can help you. Would you be interested in knowing more about our line? May we not send you our prices and illustrated literature?

McHenry-Millhouse Mfg. Co., Inc.

General Offices South Bend, Indiana

Plants: South Bend, Ind., and Fulton, N. Y.

Regional Warehouses

Portland, Me. Fulton, N.Y. Pittsburgh, Pa. Louisville, Kentucky Peoria, Ill. South Bend, Ind.

You are not



Look for famous Blue Center

The distinctive construction of wall board with two light colored surfaces and a colored center originated in Upson Board five years ago.

Imitators are now seeking to approximate the distinctive construction and appearance of Upson Board with its famous BLUE center. Buyers are, therefore, cautioned against deceptive imitations "made to look" like genuine Upson Board.

How U. S. Tested Upson Board

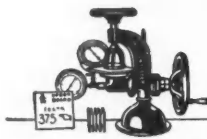

The Mullen Testor, used by the U.S. Government, shows that Upson Board will withstand a pressure of nearly 400 lbs. per square in.

A well-known competitive board tested only 240 lbs.—another competitive board tested 220 lbs.

Upson Board is nearly twice as strong as the average fibre board.

This Trade Mark protects you

The Upson Trade-mark on every piece of Upson Board, is your sure protection against inferior imitations. If the imitation had merit of its own, it would not be necessary to make it look like Upson Board—the board that will help both your reputation and your pocketbook.

When you see a colored center, think of the originator—
UPSON PROCESSED BOARD.



UPSON

THE PROCESSED BOARD

color-blind -

*And even if you were -
you could not be deceived
by imitations of Upson Board*

—that some manufacturers would like to foist upon you.

Any fair comparison of Upson Board—the trail blazer of wall boards—with any other board, quickly proves its superiority.

Test its greater strength by breaking a piece of Upson Board with your fingers. You will see Upson Board is stiff and hard, like a piece of soft pine. Most wood pulp boards, however, are soft and break like a graham cracker. They are “fluffed” to scrimp on the quantity of raw material because air is cheaper than fiber.

Cuts Like Wood

Or whittle a piece of Upson Board! You will find it cuts with a smooth, clean edge like wood. The greater strength and stiffness of Upson Board explain why carpenters say they can apply one-third more in a day's work than they can of weak, spongy wall boards.

Have a piece of Upson Board tested on the standard Mullen tester. It will prove that Upson Board is nearly twice as strong as other wood pulp boards.

Upson Board is different in every way. It has ten other points of superiority besides strength, stiffness and hardness. These exclusive qualities make possible the wonderful record of less than one complaint to every three million feet sold and used.

The famous BLUE center of Upson Board is simply an easy mark of identification for the protection of the buyer against imitations made to “look like” Upson Board.

Protect Your Reputation

Your reputation is your biggest asset. When you install wallboard, be sure that it is going to give the lasting service that will really protect your reputation.

You cannot afford to use cheap wallboard.

Upson Board has a reputation of its own—based on real performance—less than one complaint for every three million feet sold and used.

And it means easy work—for Upson Board looks, feels and works like lumber. Carpenters tell us they can apply one-third more of Upson Board in the same time.

Let Upson Board guard your reputation. Then you can be sure that the most dependable board made is back of you.

We'll be glad to send you samples so that you can test Upson Board yourself. Write for them today.



Secretary

THE UPSON COMPANY, LOCKPORT, N. Y.

BOARD

WITH THE BLUE CENTER



U. S. Training Service Preparing Pamphlets for Foremen

THAT the foreman occupies a strategic position in modern industry and hence should be a man thoroly trained in approved methods is strongly emphasized by the U. S. Training Service of the Department of Labor, which has just announced that it has in preparation a series of monographs dealing with the special training of foremen.

The material in these discussions is being assembled from all parts of the country and from a great number of different industries. The pamphlets will endeavor to set forth in concise and yet sufficiently detailed form the approved practices for foremen in the performance of their various duties. The monographs promise to be a valuable addition to the literature dealing with industrial efficiency, since they will take up in a practical way each of many problems that the foreman must face.

Too little thought is given by many foremen to the proper handling of workers of various temperaments and types.

The Value of Production Charts

Too few understand how to make production charts and hence fail to appreciate their value. The great importance of setting properly determined standards of production for their departments and systematically endeavoring to attain these standards is too little understood among foremen. These are but a few

suggestions of the problems which the coming monographs will treat in a beneficial way.

Aside from a limited number of instances, no systematic effort has been made to determine what is standard practice for foremen. Indeed, the field is so vast it is not to be wondered at that few have tried to cover it. But the Training Service, with the facilities of a well-organized research department and a group of field experts at its command, has felt itself in just the position to undertake this much needed study. What it now has in preparation is based not only on foremanship courses now in operation for the benefit of a limited number, but on the best information from all other possible sources. The aim of the monographs will be to "make clear the path to better foremanship."

When the literature now being prepared is ready for free distribution further announcement will be made in the various trade papers. The Training Service, whose office is in Washington, has already completed several other pamphlets dealing with other phases of industrial training which are free for the asking.



Advertised Prices Restore Confidence

CONFIDENCE in the quoted prices of building materials will restore the confidence of the buyer. The way to establish this confidence is to adopt a

(Continued to page 82.)

"THE DOMINANT WOOD OF AMERICA"

LONG LEAF **SOUTHERN PINE** (DENSER THE BETTER)

The World's Standard Structural Material—Now as Always.

Its Element of Comparative Value is Density.

TRADE
MARKED

BOGALUSA

EXTRA
DENSE

Trade-Mark Reg. U. S. Pat. Office

is the Standard of Quality in Long-Leaf Southern Pine.

THE BOGALUSA BOOK IS INTERESTING—VALUABLE—FREE.
FULL OF PINE STATISTICS. AUTHORITATIVE. WRITE FOR IT.

GREAT SOUTHERN LUMBER COMPANY 1600 FOURTH AVE. BOGALUSA, LA.



Meadows

TRADE MARK REGISTERED

Carpenters! Builders!

Our FREE PLANS

are yours for the asking. They should always be in your hands and your farmer customers should know about them. They give complete instructions and working drawings showing how to get the greatest possible capacity at the lowest expense by installing Meadows Stationary Inside Cup Elevators.

THE MEADOWS ELEVATOR

is convenient and economical and essential. It can be confined to one side of the driveway or it can set back in the crib leaving the driveway clear—no pit is necessary for dumping grain. The Wagon Jack is fastened overhead. For ear corn and all kinds of small grain. Complete outfit is easily installed.

Write Today for our plans and catalog—you will find them both useful and profitable.

**MEADOWS
MFG. CO.**
Pontiac Illinois

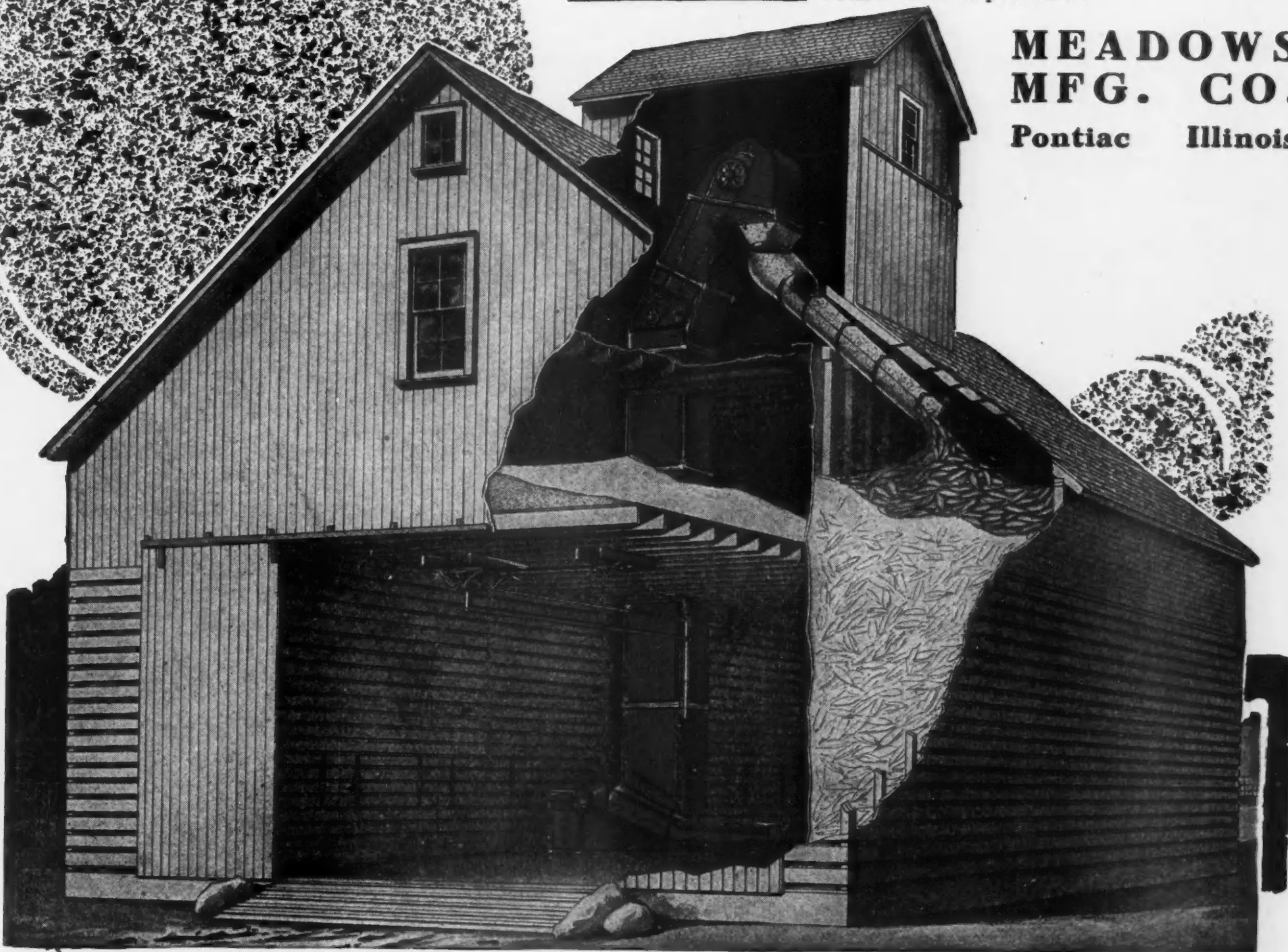

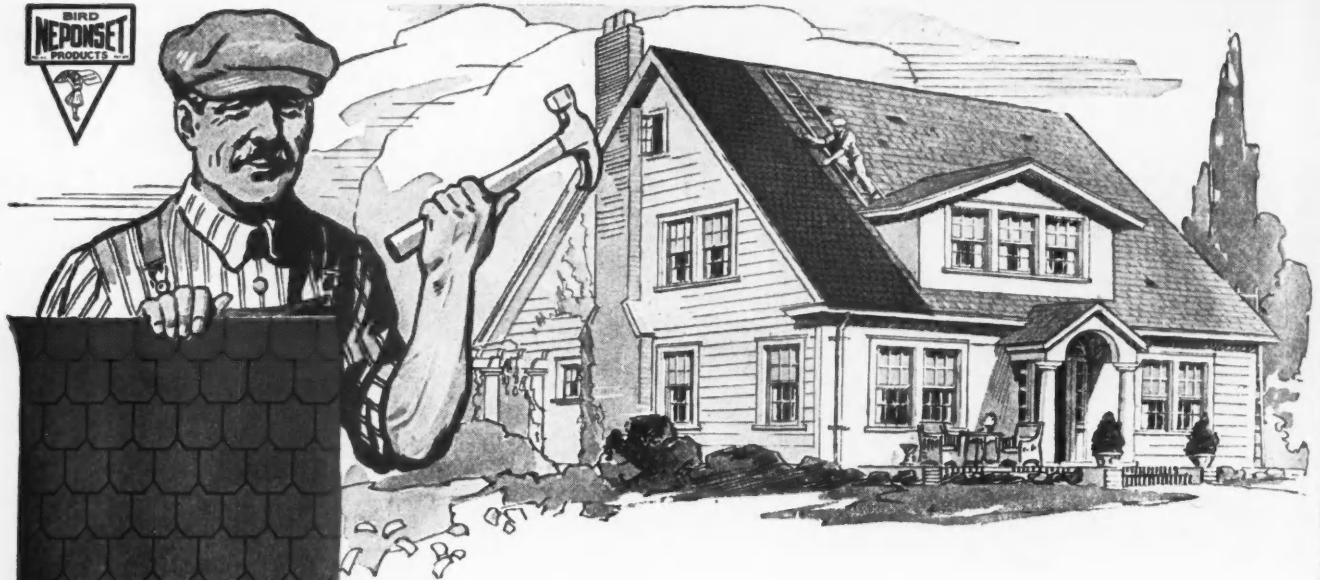

The Real Economy Roof

Art Craft is the real Economy Roof.

Easily laid over old wooden shingles, it saves the expense and litter of ripping off the old roof. It is fire-safe. It gives lasting service. It comes in beautiful patterns of slate-red and slate-green.

Again we leave you with this one thought—Art Craft is a real economy roof. Ask us to tell you how Art Craft will bring you more business.

BIRD & SON, Inc., Dept. C, East Walpole, Mass.

Established 1795

1472 West 76th St., Chicago

New York

Washington, D. C.

Canadian Office and Plant: Hamilton, Ont.



Art Craft Roof

BIRD & SON, Inc., Dept. C, East Walpole, Mass. I want to learn how Art Craft will bring me more business. Send complete information. Name..... Address.....

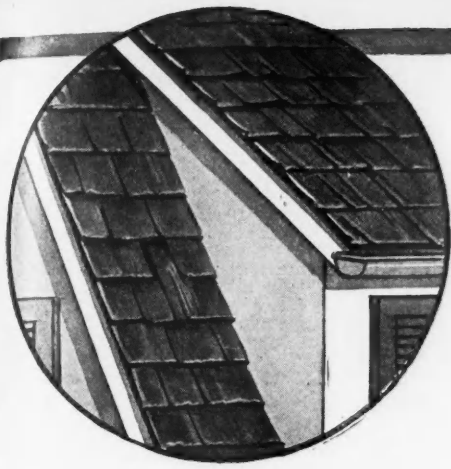

Proof!

FOR more than twenty years Neponset Roofs have proved themselves quality products. They have defied time and the elements. They have resisted fire. They have stayed useful and beautiful into old age.

Thousands of Neponset Roofs that have proved their value to property owners have helped to build sterling reputations for as many carpenters, builders, and architects.

There's a double profit in Neponset Building Products — that which is measured in dollars and cents, and that which is measured in terms of good will.



BIRD & SON, INC., Dept. C, East Walpole, Mass.

Established 1795

Chicago

New York

Washington, D. C.

Canadian Office and Plant: Hamilton, Ont.



Laying Neponset Slate-Surface Roll Roofing over shingles

NEPONSET ROOFS

BIRD & SON, INC., Dept. C, East Walpole, Mass. Send me, without obligation, Selling Plan and directions for laying NEPONSET Roofing over wood shingles.

Name..... Address.....

WHEN WRITING ADVERTISERS PLEASE MENTION THE AMERICAN BUILDER

Advertised Prices Restore Confidence

(Continued from page 78.)

price at which materials can be sold for a given period of time and let the public know what that price is.

These are the ideas for counteracting the feeling that building material prices will come down that are advanced by Roy G. Owens, general sales manager of the Lakewood Engineering Co., Cleveland. Mr. Owens has addressed a letter to members of War Service committees and business executives outlining his plan and putting forth arguments for it. The letter follows:

Mr. Owens' Letter

"If the value of things people buy were established in the minds of the people would there be the hesitancy in business we are now facing?

"The individual producer is the one to say what price he must receive for his wares. His business judgment will not permit him to ask an excessive profit, as that would invite competition and perhaps excess production with destructive results, and he certainly dares not quote prices which cannot return proper compensation to the capital and labor invested in his product.

"Satisfactory sales are based on confidence between the buyer and seller.

"It is our belief that prices made effective for specified periods or seasons will establish confidence in prices.

"We are therefore telling our buying public what our prices are and that there will be no change for definite periods. To make the plan effective, we have deemed it advisable to make price periods of not less than six months.

"If every producer who is not already doing so will adopt this plan, making his prices known to the public by advertising as well as by individual quotations, we believe that confidence will be restored and that the present enormous potential demand will be brought into action.

HOW THE PLAN OPERATES

"Perhaps the best examples of this PUBLISHED, OPEN-PRICE PLAN ARE:

"1—The retail drygoods business of the country whose prices are known to every individual through publication in advertisements and through tags on the goods in the stores.

"2—The automobile industry which once every season names its price to the public for that season so that every individual, possible customer or not, is made familiar with the value of the article.

"These two industries are perhaps the only two large industries whose business has been and is now active since the Armistice.

"If the manufacturers of cement, of steel, producers of lumber and other building materials, manufacturers of clothing, food products and machinery, had followed this PUBLISHED-PRICE-FOR-THE-SEASON method and the prices of these commodities were established in the minds of the public, there would not now be the marked halting in business.

"If you agree with this reasoning, will you not reply to this letter saying that you will assist by every means at your command to induce your company, your industry, other businesses and industries to help stabilize business promptly by adopting a plan of action over this slogan—PRICES EFFECTIVE FOR SPECIFIED PERIODS OR SEASONS WILL ESTABLISH CONFIDENCE BETWEEN BUYERS AND SELLERS."



Woodwork Satisfaction

You are not satisfied unless your customer is. Beautiful **birch** satisfies you both to perfection, by enabling you to do a creditable job at a good profit while still giving your customer a reasonable price—the price that gets the contract.

NORTHERN HEMLOCK & HARDWOOD MFRS. ASS'N.
201 F. R. A. Building Oshkosh, Wis.

We send handsome book and six finished samples to your prospects. Send names.



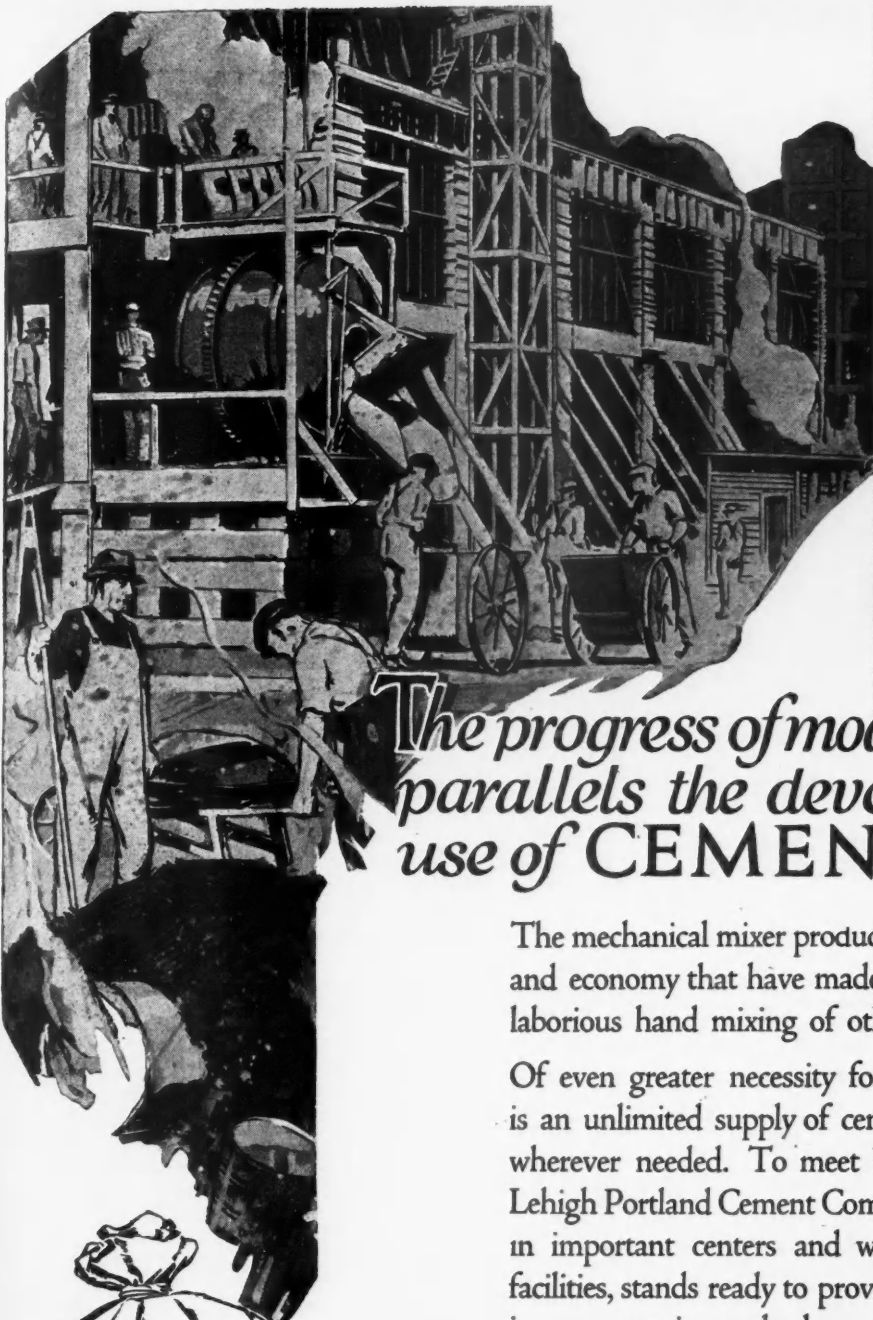

*The progress of modern engineering
parallels the development of the
use of CEMENT*

The mechanical mixer produces concrete with a speed and economy that have made obsolete the slow and laborious hand mixing of other days.

Of even greater necessity for concrete construction is an unlimited supply of cement instantly available wherever needed. To meet these requirements the Lehigh Portland Cement Company, with mills located in important centers and with unexcelled railroad facilities, stands ready to provide Lehigh for any job, in any quantity, and whenever needed.



LEHIGH PORTLAND CEMENT CO.
ALLENTOWN PA. CHICAGO ILL. SPOKANE WN.

NEW YORK, N.Y. KANSAS CITY, MO. OMAHA, NEB.
BOSTON MASS. MINNEAPOLIS, MINN. PITTSBURG, PA.
PHILADELPHIA PA. NEW CASTLE, PA. MASON CITY, IOWA.
JACKSONVILLE, FLA. RICHMOND, VA.

The National Cement

**LEHIGH
CEMENT**

The Editors Drawer

*New things
worth while*

EDITOR'S NOTE: The American Builder does not accept payment in any form for what appears in our reading pages. In order to avoid any appearance of doing so, we omit the name of the maker or seller of any article we describe. This information is, however, kept on file and will be mailed to anyone interested; address American Builder Information Exchange, 1287 Prairie Ave., Chicago.

Hollow Tile Silo With a Water Tower Atop of It

An idea that is becoming more and more popular is that of placing a water tank on top of the silo, and many builders are having a demand for this type of silo construction. The tank is built of the same materials as the silo and there is nothing about the outside walls to denote that the silo is serving the double purpose of housing both the food and water supply of the livestock.

Here is shown a hollow tile silo that has a water tank at the top. This silo and tank are constructed of hollow tile, such as is also shown. The ship-lap structure of the tile

makes it ideal for silo and tank purposes.

There are many advantages in placing the water tower on top of the silo. By this method the walls of the silo act as the supports for the tower, while the space in the farm yard that a tank and its supports would take up is saved. Also, this is a more economical method of construction.

The merits of a substantial and attractive silo are known to every farmer and to the builders who have much farm building work. The hollow tile silo is as near a permanent

(Continued to page 86)

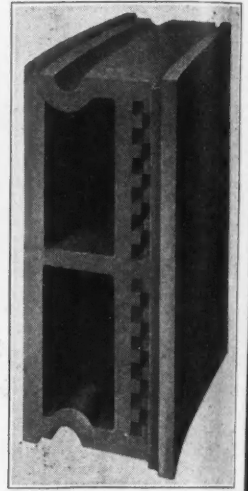

Hollow Tile Silo with Water Tank on Top; Also Detail of Tile Used.

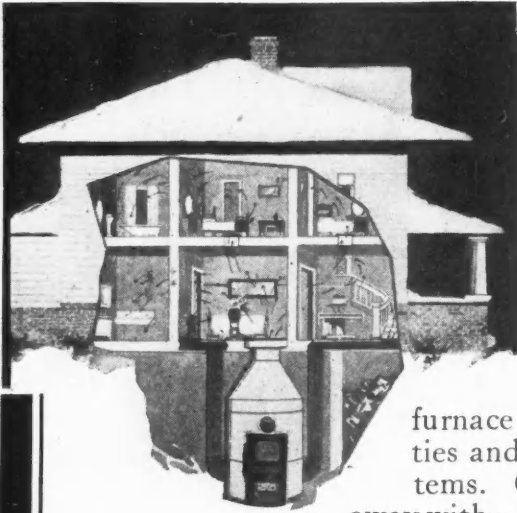

HOME HOT BLAST TRIPLEX SYSTEM

Solves Every Heating Problem

IT is a 100 per cent more efficient and costs much less than the ordinary single register furnace or pipe furnace. It embodies all the good qualities and none of the faults of single register heating systems. Cold draughts over the floor are entirely done away with—the heat is distributed evenly throughout the house.

It is by far the most easily installed furnace made today and requires less floor space for heating register.

We ship it ready to install—our illustrated circular will convince you.

We are offering a special proposition to live Builders in unoccupied territory. Write today.

HOME FURNACE COMPANY, Holland, Michigan



Who made this Lumber?

Almost everything you buy is trade-marked. You call for goods by their trade-mark names. You do so because you know that the manufacturer who puts his name on his products backs them with his reputation; that a well known trade-mark not only identifies the manufacturer but that it stands for quality. You can know something about the lumber you buy. You can know who made it. This trade-mark—

LONG-BELL

on lumber products tells you that the largest manufacturer of Southern Pine in the United States made them. You can be sure that effort and expense were not spared in maintaining their well established reputation for uniform high quality. **LONG-BELL** lumber products are made of good timber in up-to-

date manufacturing plants where quality is the first consideration. Specify and buy lumber that bears this quality assurance mark—**LONG-BELL**. Lumber and timber manufactured by **THE LONG BELL LUMBER COMPANY** are so marked.

*Ask your dealer for **LONG-BELL** brand lumber*

The LONG-BELL Lumber Company

R. A. LONG BLDG.

KANSAS CITY, MO.

Manufacturer of Southern Pine, Hardwood, Oak Flooring; Creosoted Lumber, Ties, Posts, Poles, Piling and Wood Blocks



The Editor's Drawer

(Continued from page 84.)

building as can be erected. It is attractive in appearance and has many good points from a construction standpoint. The tile laps, so that it makes a solid wall, while double air spaces are provided and there is a groove in which to place the bonding rods, which act as hoops.

In several states this season silo building campaigns are being waged, while in others there is a good demand for silos. By combining in the one structure a silo and a water tower, the contractor makes a satisfactory job and one that will get him others in the neighborhood.



Three-Piece Wing Beams as Strong as Solid Beams

Bending tests conducted by the Forest Products Laboratory, of the U. S. Forest Service, Madison, Wis., upon DeHaviland-4 I-beams built up of three parts, two flanges and a web, and solid beams of same cross section indicate that the two types have practically the same strength.

Ten test beams of each type were constructed as shown in the accompanying sketch. The specimens were made of closely matched material, the solid beams and the flanges of the three-piece beams being cut side by side from planks of clear Sitka spruce. Cold casein silicate glue was used in making the built-up beams.

Under four-point loading, which simulates the actual loading in service, the average maximum loads sustained by the two types were nearly the same. The difference was in favor of the built-up beams, but was too slight to be significant.

The construction of I-beams of three pieces as suggested offers certain obvious advantages. It permits the utilization

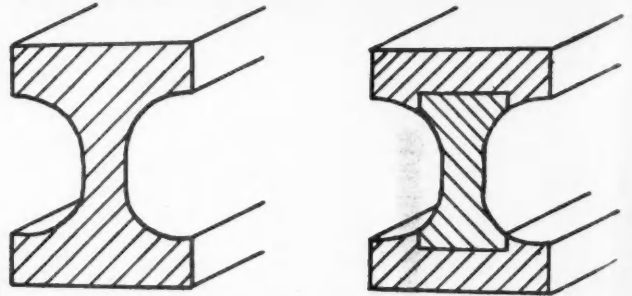

This Three Piece Beam Is Just as Strong as the One Piece Beam.

of cross-grained material in the web, and since smaller pieces are required than in the case of the one-piece I-beam, it is probable that from two to four times as many beams could be produced from a given amount of lumber.



What a Chemical Closet Consists Of

The chemical closet is a convenience that is growing in popularity among those who live in the communities where there are no water systems. This popularity has been gained because chemical closets are not only convenient but are sanitary and require little care and expense. What a chemical closet consists of is shown in the accompanying illustration. There is the seat, the bucket, the can of chemicals, which transform the excretions into harmless liquids, and the vent pipe.

Many builders are making a nice profit placing chemical closets in country homes. They give the conveniences of the city, without the costly plumbing that must be used to attach them to the city water systems. They occupy only a

(Continued to page 88.)

FOR PUMPING OUT TRENCHES and EXCAVATIONS GOULDS FIG. 1687 DIAPHRAGM FORCE PUMP

This pump has a decided advantage over the ordinary Diaphragm pump in that being a force pump it can be placed in the Trench or Excavation and the water forced to the top. It is good for a force of 15 feet, has a large capacity and is capacity built. The Diaphragm is $12\frac{3}{4}$ inches in diameter and is made of the best quality rubber. The valves are metal, rubber faced, and are easily removable. The waterways are large and permit an easy flow

of the water. The pump is fitted with an air chamber to insure a steady flow. The discharge elbow is designed so that it can be bolted on with the discharge pointing in any one of four different directions. Furnished either with long wrought-iron lever for hand operation or with short arm for connection to our Fig. 1589 Jack for belt drive from gasoline engine.

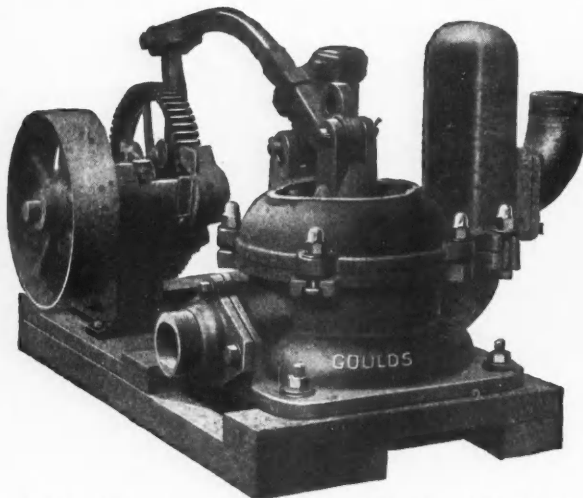

FIG. 1687 MOUNTED ON FRAME AND CONNECTED TO FIG. 1589 JACK. FRAME NOT FURNISHED UNLESS SPECIALLY ORDERED

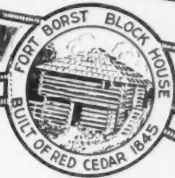

FIG. 1687 WITH LEVER FOR HAND OPERATION

Prices on Request

THE GOULDS MANUFACTURING CO.

Branch Houses:	Main Office and Works:	District Offices:
Boston	New York	Pittsburgh
Philadelphia	Chicago	Atlanta
	Seneca Falls, N. Y.	Baltimore
		Houston



Distinctive Homes of Red Cedar Shingles

This BOOK Will Give YOU VALUABLE BUILDING IDEAS

A beautiful booklet containing a wealth of building information and many valuable suggestions for the builder.



-----CUT OUT AND MAIL-----

Gentlemen: Please send me copy of your 24-page book, "Distinctive Homes of Red Cedar Shingles," for which I enclose 2c in stamps to cover cost of mailing.

Name.....

Address.....

I am a
(Check mark proper word)

- Prospective Builder
- Contractor
- Carpenter
- Lumber Dealer

Shingle Branch, West Coast
Lumbermen's Ass'n
426 Henry Bldg. Seattle, Wash.

The Shingle Agency of
British Columbia
1026 Standard Bank Bldg., Vancouver, B. C.

The Editor's Drawer

(Continued from page 86.)

small space—the one here shown takes up only 26 inches of square space—and can be located in a hall, unused room,

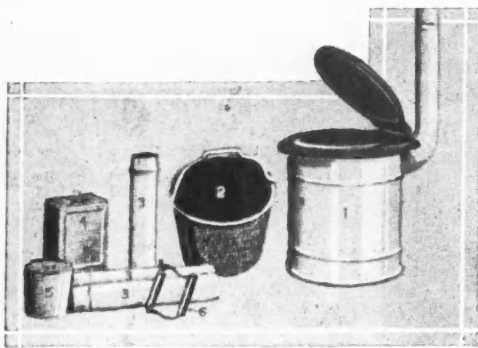

Chemical Closet and Its Parts

clothes closet, basement or wood shed. It has an all-steel container, with mahogany seat and cover. The chemicals used kill all life in the matter and the odors are carried

out of the building thru the vent pipe. All the attention needed is an occasional emptying of the container, but there is no odor to the contents.

The closet can be moved at any time; requires no paint, no vault, or repairs.



Casement Windows for Sun Parlor and Sleeping Porch

So few homes or apartment buildings now are planned that do not include sun parlors or sleeping porches, or both, that the problem of putting in windows that are easily opened and that will provide the proper ventilation is an interesting one to contractors and builders. One type that has been adopted by many builders is the casement window.

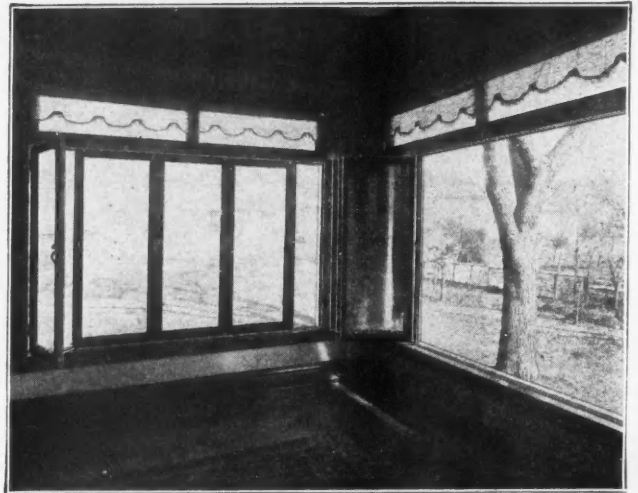

Interior of Sun Parlor with Front Windows Wide Open and End Window Partly Open.

In putting in casement windows probably the most important feature is the hardware that is used to operate them. Herewith are shown exterior and interior views of a sun parlor equipped with windows of this kind. The interior view shows the sash at the front wide open, leaving the window opening clear of obstruction, as the sliding mullion moves to the end of the opening and stands against the sliding window sash. The grooved track in which the sash slides is shown in the illustration. This track is installed above as well as below the sash and is so constructed that rain cannot come thru. The window at the end of the sun parlor stands open at an angle of 90 degrees. The sash links that con-

(Continued to page 92.)

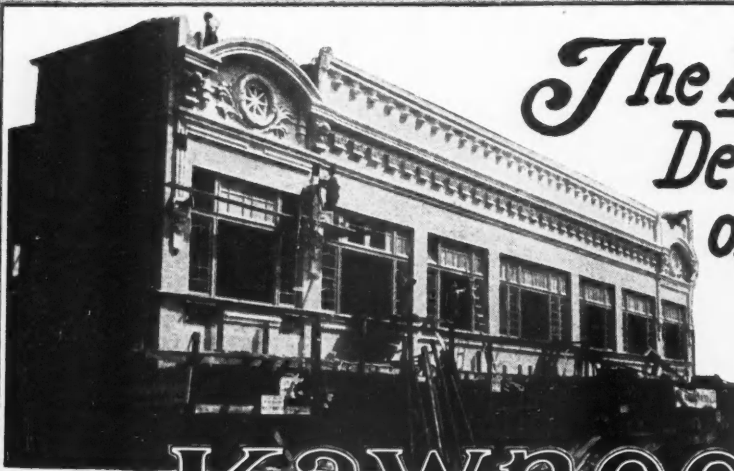

The Store Fronts will Determine the Effect of this Modern Building

Kawneer

Store Front Construction

will show up this building—ar any other—at its best. Since Kawneer Fronts were invented, some twelve years ago, over 75,000 have been installed. This proves their worth from an architectural and sales-pulling standpoint.

You can easily realize that the profitable installation of Kawneer Store Fronts is not confined to new buildings. The more antiquated the structure, the more receptive the owner is to the idea of modernizing it by the Kawneer method.

We help you in every way possible to make the job satisfactory. Service has been a big reason for Kawneer progress. Besides putting out the best material, we make every effort to design the proper front for the building in question.

Our designers—expert—are ready to cooperate with you in every problem of store front installation.

Write for Beautiful Catalogue

KAWNEER MFG. COMPANY,

1126 Front Street

NILES, MICHIGAN

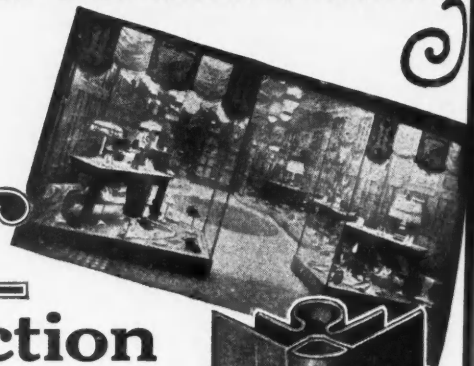

This shows a patent Kawneer fastener. The corner bracket holds the plate with a rugged resilient grip that defies all winds.

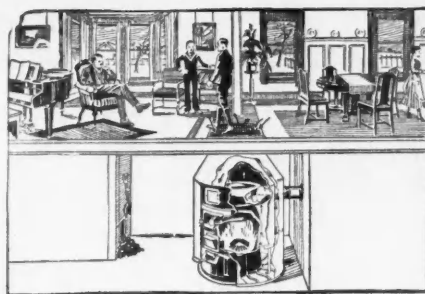

The Holland Pipeless



The Holland Improved Pipeless



The Holland Complete System

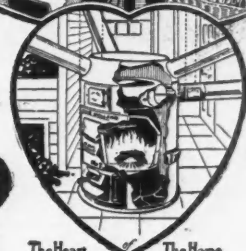

The Heart The Home

The World's Best Heating Plant. Fills every desire for Heating and Ventilation with Fuel Economy — Cleanliness — Durability and ease of operation, second to none

What Type of Heating Plant Fits Your Home Best?

THERE are three ways to install a furnace. One way is the pipeless installation, where all the warm air comes up through the center of one big register placed directly over the furnace and with cold air going back to the furnace down between the inner and outer casings; —another way is the improved pipeless installation with one big register for warm air, and allowing cold air to go back to the furnace through separate flues—intakes for which are placed at the coldest parts of rooms; —and another way is the complete pipe furnace installation with a warm-air register for each room, giving individual room heating and ventilation.

Which type fits your home best? Write us and let us tell you. You can get any of these three types of installation with a

HOLLAND

The Furnace with the Cone Center Grate

Here's the furnace that is built without bolts and with less joints than any other furnace made. It's the furnace with the famous cone center rocking grate; the easiest grate in the world to operate; rests on a center pivot; you can shake it with one finger. The grate throws the fuel to the outer walls of the firepot where it burns from the sides and over the top—the natural way for a fire to burn—compels 100% heat radiation. Burns the soot and gases—gets all the heat from the fuel. Burn any fuel without changing grates. Backed with a permanent guarantee covering all material and workmanship. HOLLAND Furnaces have warm friends out of over 100,000 satisfied owners and are outselling any other furnace in America. Over half the homes in Holland, Michigan, are heated with HOLLAND Furnaces. That shows how HOLLANDS are used where people know them best.



MR. V. W. CHERVEN
Chief Heating Engineer
Holland Furnace Co.

Formerly Superintendent and General Inspector of Warm-Air Heating for United States Industrial Housing Dept.

Don't Let Someone "Guess" a Furnace Into Your Home

HOLLAND Furnaces are not sold like ordinary heating plants. Before a HOLLAND Furnace goes into your home, the HOLLAND heating engineers must approve the type of installation. Millions of tons of coal are wasted every year in improperly planned heating systems.

Over half the sickness, coughs, colds, etc., can be traced to poor home heating. You don't want your home over-heated or under-heated. You don't want cold floors and hot ceilings. You don't want to shoot coal bills up the chimney.

Get the Free Service of a Great Heating Engineer

Have your heating system planned by Mr. V. W. Cherven, our Chief Heating Engineer, who has just returned to this company after serving as Superintendent and General Inspector of Warm-Air Heating for Industrial Housing for the United States during the war. He has designed and supervised the installation of more than 3,000 complete

warm-air heating systems for the Industrial Branch of the Government.

Send us a rough sketch of your floor plans and let him show you the best type of heating system for your home. You will save money—and own a more comfortable home.

We have a Special Proposition for Contractors, Builders and Carpenters. Write and let us tell you about it

150 Branches

HOLLAND FURNACE COMPANY

World's Largest Installers of Furnaces

Two Factories: Holland, Michigan, and Cedar Rapids, Iowa

Metaform

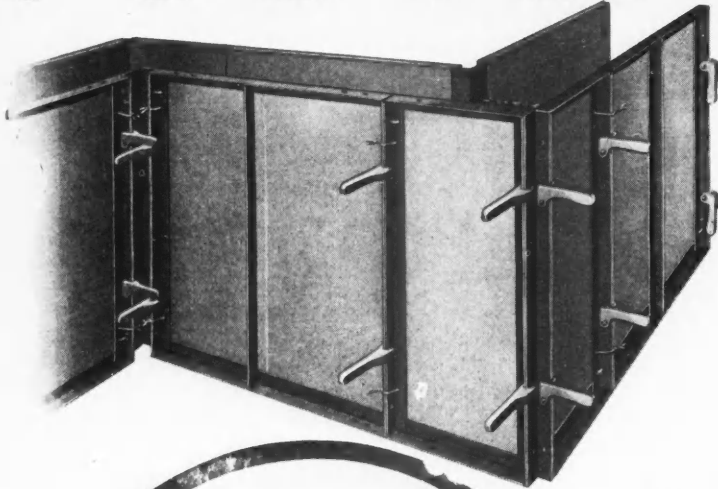

DO YOU still stick to old-fashioned, wasteful, wood-form methods for erecting monolithic concrete jobs? Why employ the costly labor of skilled carpenters for something that must be torn down again almost as soon as it is put up? Why, with lumber so expensive, spoil such a terrific amount of it for only a few hours' use?

The answer is: You *wouldn't* do any of these things if you knew of a better way of doing the work.



A Metaform System of adjustable metal molds for building concrete forms will stop the waste of lumber and labor. It will enable you to pour more concrete, to pour it faster and to pour it better. And it will add to your profits on all concrete jobs—large or small.

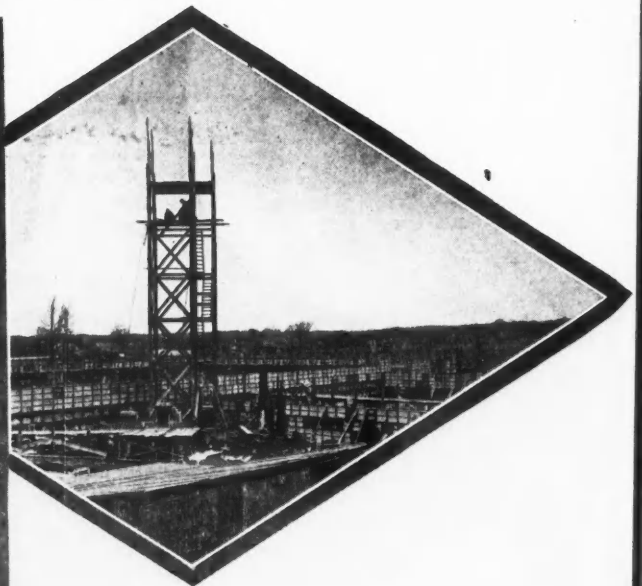

Metal Forms Co

WHEN WRITING ADVERTISERS PLEASE MENTION THE AMERICAN BUILDER

You
cour
sures
make
ning

Systems *for* Faster, Cheaper Concrete Work



MAKE no mistake about Metaforms. They were devised to take care of *all* jobs—not one job. Whenever you face the problem of erecting forms for monolithic concrete, a Metaform System will enable you to do the work faster, better and cheaper. One ordinary laborer can erect more square feet of forms by the Metaform System than five or six skilled carpenters can build out of wood. Your Metaforms will be useful on job after job, while lumber for forms is a constant heavy expense.

This Eye-Opening Folder Proves What Metaforms Did on Just Six Small Jobs

ONE thousand and twenty-six dollars saved by a Metaform System on six ordinary residence foundations—put right into the contractor's pocket. Is that worth while? Send for the folder that tells how it was done. Whatever you build in concrete—tanks, chimneys, silos, foundations, walls, pillars—square work or round work, straight or tapered—Metaforms will make money for you.

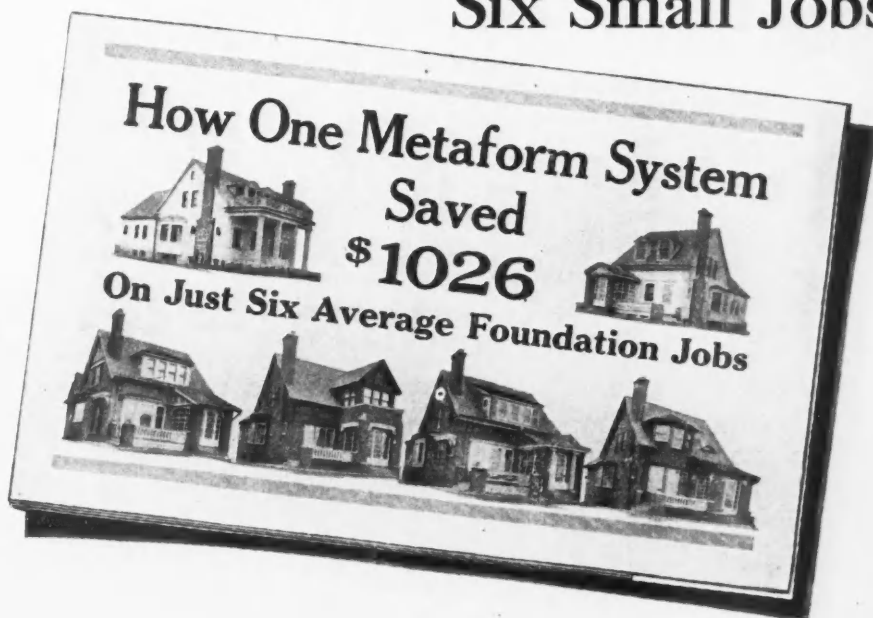

You'll buy Victory Bonds, of course, because they are the surest investment you can make. They herald the beginning of the big prosperity era.

Corporation (Formerly Reichert Mfg. Co.) 2223 Booth St. Milwaukee

The Editor's Drawer

(Continued to page 88.)

nect each sash at the top and bottom also are visible at the opening between the open and closed sash. The other picture shows an exterior view with half of the front windows open and half closed.

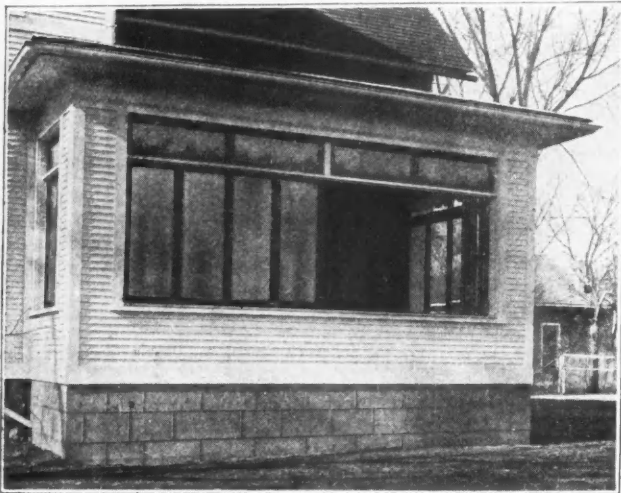

Exterior of Sun Parlor Shown on Page 88 with Half of Front Windows Open, Half Closed.

Each sash is opened by grasping the bow handle, which, with the rubber tipped bumper on each sash, is the only hardware visible, and then pulling. The back sash, or the one hinged to the frame, is pulled first and then each succeed-



The Hardware that is required to Hang the Windows in the Sun Parlor.

ing sash, until all stand side by side at the end of the window opening. If only a slight opening is desired, this may be had at either end of the string of sash. Beginning with this small opening, any desired quantity of ventilation can be obtained by opening additional sash. The position of one sash does not determine that of an adjacent sash, as one may stand wide open, the next partly opened and the next all but closed. The windows operate easily, and as they are on the inside of the building, can be readily cleaned.

The hardware required for this installation are sash links, which connect the sash at the top and bottom; metal track for top and bottom guides; butts for sash adjacent to the fixed jamb; combination fastener and handle; brass chafing plates; rubber stops, and safety locks for each sash.

The manufacturer of this hardware has prepared complete directions for builders to follow in installing this type of casement window.

TRADE MARK

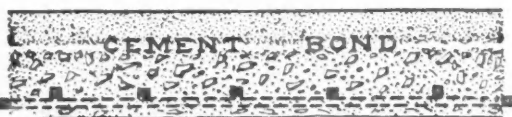

OUR TRADE MARK SINCE 1905

NO MORE BONDING TROUBLE!

Every builder knows how difficult it is to bond new concrete to concrete that has already set. They know, too, the dissatisfaction experienced from patchy, unsatisfactory work to both themselves and their customers.

"LIVING-STONE"—

is the only non-acid preparation yet discovered that positively overcomes this trouble. Consider its comparatively reasonable price (one gallon is sufficient to bond from 250 to 300 sq. ft.), and the wonderful work it performs. Is there a conscientious builder in the field who can afford to do unsatisfactory work?—who can afford not to investigate Living—Stone methods?

Write today for catalogs, bonding data, prices, etc.,—it will profit you.

THE LIVING-STONE CO.
703 LAW BUILDING, BALTIMORE, MARYLAND

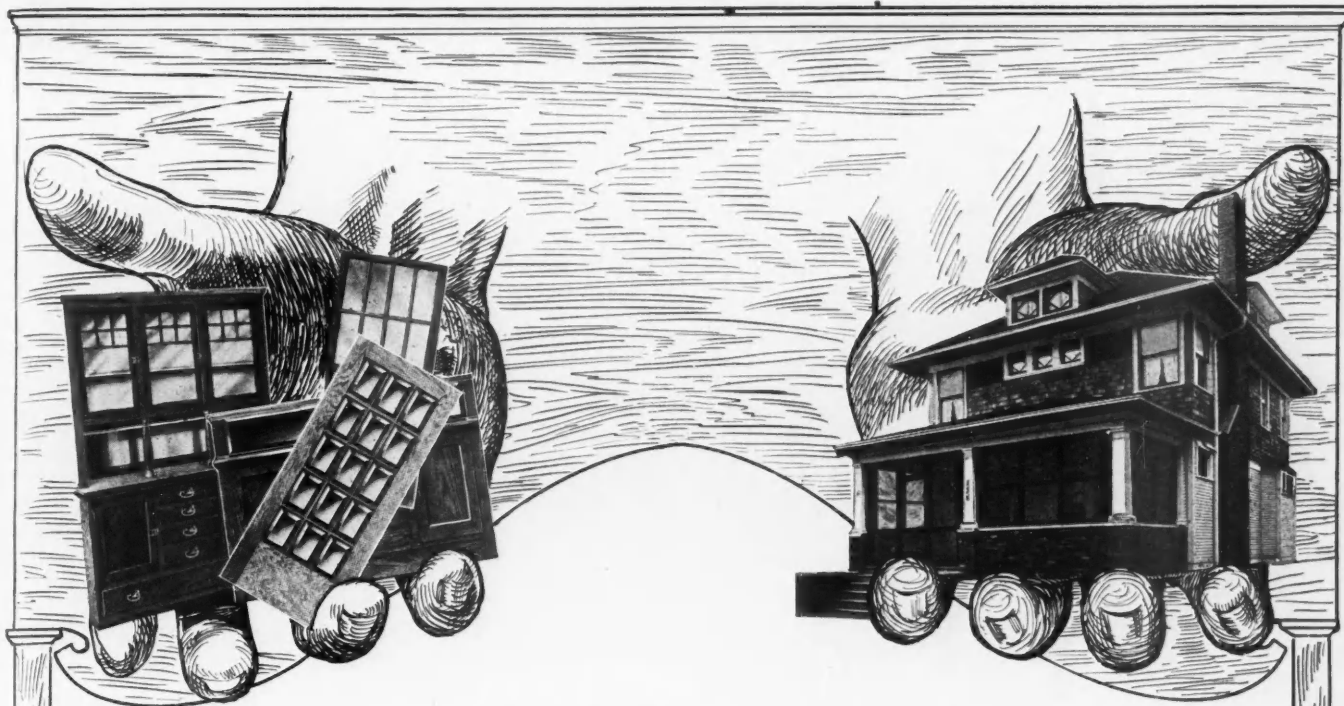

BILT + WELL
MILL WORK

means

"Homes of Comfort"

From the time of completion of the superstructure to the last of the interior finish, "Bilt-Well" millwork plays the most important part in making just a "House" a "Home of Comfort."

Wherever millwork is needed, whether it is doors, windows, mouldings or cabinet work, "Bilt-Well" millwork of standard patterns will meet the most exacting requirements.

"Bilt-Well" millwork installed on your next job is your guarantee of customer satisfaction.

The nearest "Bilt-Well" millwork distributor listed below will be glad to receive your inquiry for information on "Bilt-Well" millwork.

ADAMS & KELLY CO. - - - Omaha, Neb.
ADAMS-ROGERS CO. - - Indianapolis, Ind.
CARR & JOHNSTON CO. - - - Peoria, Ill.
CARR & BAAL CO. - - - Des Moines, Ia.

COLLIER-ADAMS MFG. CO. - St. Joseph, Mo.
CARR-CULLEN CO. - - Minneapolis, Minn.
CARR-TROMBLEY MFG. CO. - St. Louis, Mo.
COLLIER-BARNETT CO. - - - Toledo, Ohio

CARR, RYDER & ADAMS CO. - Dubuque



EDITOR'S NOTE: The American Builder does not accept payment in any form for what appears in our reading pages. In order to avoid any appearance of doing so, we omit the name of the maker or seller of any article we describe. This information is, however, kept on file and will be mailed to anyone interested; address American Builder Information Exchange, 1827 Prairie Ave., Chicago.

General Utility Hand Saw and Heavy Duty Saw

There recently was patented and placed on the market a hand saw that fills a long required demand for a general utility saw, inasmuch as it may be used either in cross-cutting, ripping or mitreing. The original pattern, which has been on the market for some time, has been advanced in this improved pattern. In either cross-cutting, ripping or mitreing it performs the operation with surprising speed and accuracy and is said to be one of the fastest cutting saws on the market.

Special mention should be made of the smooth cutting done by it. It is speedy and efficient in either light or

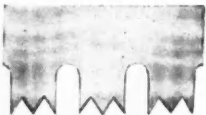

The Teeth of New General Utility Hand Saw.

heavy work; yet it is especially adapted for the latter. The accompanying illustration gives a section of the teeth showing plainly the large roomy gullets required in carrying the dust from the kerf also gives a better idea of the tooth arrangement. The filing of these saws is the secret of their success. Complete instructions are furnished with each saw in order that the most inexperienced filer will have no difficulty in refitting them.

Another new pattern of hand saw is one for heavy duty. It is of a special high grade crucible steel of heavy gauge, with coarse teeth especially adapting it for fast sawing in the heavier class of work around docks, car shops, lumber yards, farms, bridge and railroad, mine and in fact any heavier work where fast cutting is appreciated. The construction of the saw thruout, linked with high grade steel produces a saw that will take and retain a keen, sharp cutting edge a remarkable length of time, and will stand up to the heavier class of work with much less refitting. The handle is of malleable iron-tinned-riveted to the blade by two rivets. This saw is proving exceptionally satisfactory where a fast cutter in heavy work is required.



Adjustable Scaffolds for Masons and Roofers

Scaffold brackets have come into general use among builders because of the facts that they save time and material in erecting them and provide safe places on which the men can work. Since their inception several different kinds have been manufactured and all have gained great popularity.

Here are pictured brackets designed for the use of masons while building chimneys and for roofers. The advantages

(Continued to page 98.)



Western Face Brick and Western Hollow Tile

Western Face Brick are made to satisfy your fondest fancy. They are made in many colors and textures to satisfy the tastes of the man who can afford a luxurious home, as well as the man who prefers a modest bungalow. And the changing seasons of the passing years leave no traces on this everlasting Building Material. Frame build-

ings decay, get old and run down, but the building that is constructed of Western Face Brick grows even more beautiful as time goes on.

Our line covers every building need—Brick of all kinds—and Hollow Tile that is fast becoming the standard for farm buildings.

TELL YOUR DEALER TO WRITE FOR SAMPLES AND PRICES,
IF HE DOES NOT ALREADY CARRY THE "WESTERN LINE"

WESTERN BRICK COMPANY

DANVILLE, ILLINOIS

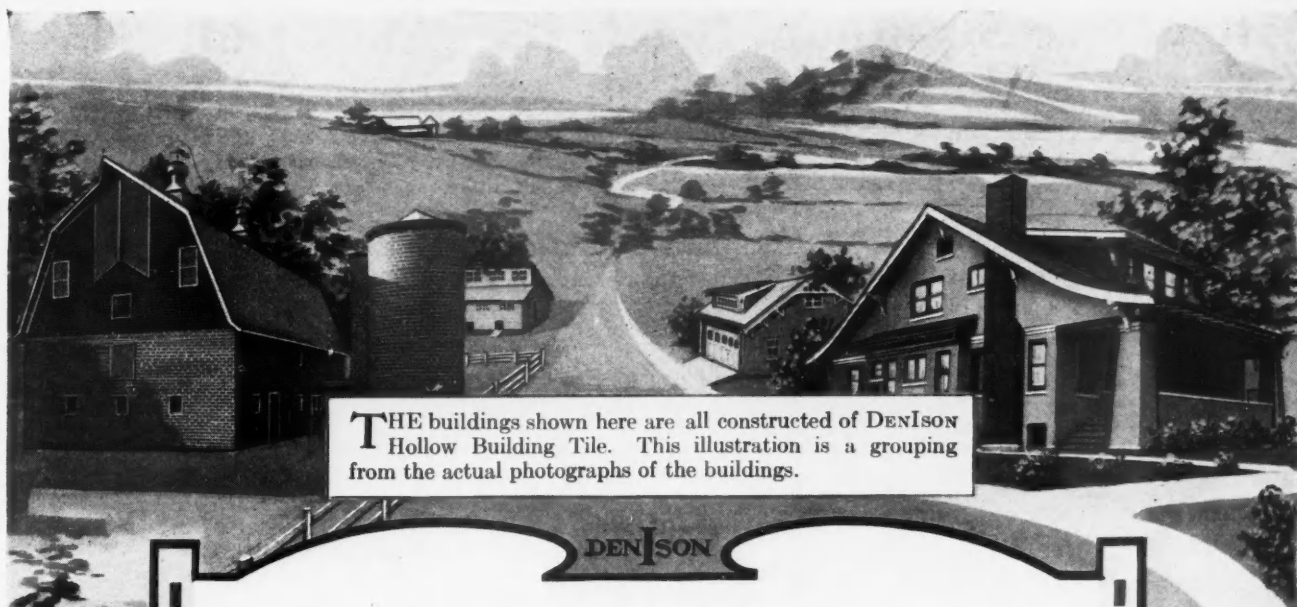

THE buildings shown here are all constructed of DENISON Hollow Building Tile. This illustration is a grouping from the actual photographs of the buildings.

DENISON

Build "Everlasting" Buildings

Comfort, Economy, Fire Protection and Permanence—these are the building qualities that most completely satisfy your customers.

The building material that best combines these four qualities—that means more business, profit and good will for you is

DENISON Hollow Building Tile

Its superiority is due to our raw material—a particularly fine shale clay deposit, and our double process of manufacture. It is a wonderfully fine-grained, close-textured, strong, uniform and durable building tile.

DENISON Hollow Building Tile is more easily and quickly laid than brick. It cannot be placed wrong or plastered wrong by careless masons. Has a guaranteed crushing strength of 700 lbs. to the square inch. All load bearing webs are in vertical alignment—strength where strength is needed—no weight where strength is not needed. Corner, jamb and fractional tile save labor and make construction easy.

Buildings constructed of DENISON Hollow Building Tile cost no more than when built of other substantial materials. They are fire-resisting and never require painting; are warmer in winter, cooler in summer and always have dry inside walls.

From every consideration—economy of labor, present profits, future business and good will—it is decidedly to your advantage to build with DENISON Hollow Building Tile. Write us for prices and full information. FREE—comprehensive construction details.

*DENISON Hollow Building Tile is Sold
by the Best Lumber Dealers*

MASON CITY BRICK & TILE CO.

900 Eighth Street, Mason City, Iowa

*Largest Manufacturers of Clay
Products in the World*

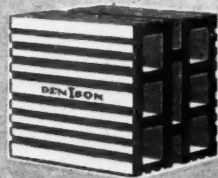

DENISON LOAD BEARING TILE NO. 47

Easily laid—builds up rapidly. Each tile is four brick courses high, double wall. Non-continuous mortar joint insures absolute dryness on inside walls. Each tile a complete unit—stands on its own base, either side up. Corner, jamb and fractional tile supplied at same basic price.



Attractive Six-Room Brick Bungalow Built Three Times at Uniform Cost of Less Than \$3000.00

DESIGNED AND BUILT BY CHAS. M. GATES, OF DENVER, COLO. AN EXCEPTIONALLY WELL PLANNED HOME, AWARDED FIRST PRIZE IN A RECENT "SMALL RESIDENCE COMPETITION"

By C. L. Rorick

THE appearance, convenience of arrangement and economy of construction of this beautiful little bungalow will at once appeal to every contractor and builder who is planning homes for his townspeople. It is permanent, fire-safe and more substantial than frame.

Examples in home building of this kind are doing much to overcome the general belief that brick construction is much more expensive than frame and can only be used in "the rich man's home."

Denver is truly a City of Brick Homes. The contractors and builders there learned long ago the value, comfort and economy of such homes. Denver people won't have anything else now.

The average home builder in any town would prefer to live in a home built of brick but rarely ever considers its use for he feels that its first cost is prohibitive, yet he knows that over a period of years it becomes the least expensive and has many economies and comforts not obtained in any other type of construction.

This natural inclination on the part of the home building public offers a splendid opportunity to contractors who will acquaint themselves with brick construction and talk it to their prospective builders—it

will eliminate competition in many cases where other contractors are not informed regarding its advantages and use.

The time is not far distant when all prospective home builders are going to be told about brick. Contractors who take steps at this time to become familiar with its use will be in a position to secure many contracts for brick houses with but little effort.

We want to work with you to this end. Use the coupon on the next page and let us tell you how you can build brick houses at about the cost of good frame constructions. Become a general contractor—don't be known any longer as a "Carpenter-Contractor." It will pay you. The people are demanding better homes.

The beautiful bungalow here illustrated has six lovely rooms and a den and sleeping porch. The sun parlor, living and dining rooms are done in oak and with oak floors. The balance of the house is in white enamel. A pair of French doors, glazed with twelve beveled plate glass each, connect the living room and sun parlor. An abundance of heat makes the sun parlor a splendid conservatory for flowers. Built-in bookcases, massive colonnades, cozy fireplaces, up-to-the-minute interior cornices and a buffet make the living and dining rooms a real homey home for the most fastidious.



This Attractive Six-Room Brick Bungalow Is the Work of Chas. M. Gates, Architect and Real Estate Builder, of Denver, Colorado.

WHEN WRITING ADVERTISERS PLEASE MENTION THE AMERICAN BUILDER



View Taken from the Living Room, Looking Into the Dining Room in the Gates Brick Bungalow. The Attractive Proportions and Arrangement Are Clearly Shown.

The bath, with all high grade fixtures, located between the two bedrooms, makes for the greatest possible convenience. The sleeping porch is just off the family bedroom.

The kitchen has extra large cupboards, with all usual conveniences of doors, bins and drawers, and has also a California cooling closet that does away with ice except in the very warmest weather. —Advertisement.

Your town, state and date

**The Permanent Buildings Society
Chamber of Commerce, Chicago, Ill.**

Gentlemen: I am very much interested in the Gates Brick Bungalow shown in the May issue of the American Builder and would like to receive free floor plans of same together with further information about the costs and uses of brick.

Use this space to ask for any further information you may desire.

Tell us what other buildings you are planning

Do you want to know where to get the necessary permanent building materials for these and similar buildings?

(Your name)

(Your business)

(Your Town)

(Your State)

WHEN WRITING ADVERTISERS PLEASE MENTION THE AMERICAN BUILDER



TO BUILD BUSINESS CONSIDER HER

ULTIMATELY it is the woman who makes the most use of the home. It is she who knows best the need of the screened sun and sleeping porch, and the benefits derived from out-of-door living and open-air sleeping, and the need of protection against disease-carrying flies and mosquitos.

UPON HER AND HER MANAGEMENT depend "Domestic Efficiency." Consideration of her when you call for porch work will build business for you. Our blue print plan, sent free for the asking, will aid you in securing the order. An early season warrants prompt action. SEND FOR IT NOW.

A MOST IMPORTANT APPEAL is cleanliness. PEARL Wire Cloth, because of its smooth coating and even meshes, allows no accumulation of dust, dirt or germs. It is due to this metallic coating, a special process owned and controlled by us, that PEARL is longest lasting—therefore costs less in the long run besides needing no painting or repairs.

INSIST UPON THE GENUINE.

It has two copper wires in the selvage and our red tag on every roll.



Call on our local dealer or write direct for samples and literature if you're interested in screen material.

Address Dept. "A"

The Gilbert & Bennett Mfg. Co.

New York Georgetown, Conn. Chicago Kansas City

G & B PEARL is made in two weights—regular and extra heavy The best hardware dealer in your city sells "PEARL"

What's New?

(Continued from page 94.)

claimed for the former are the convenience in use and in transportation and the protection of the roof and safety to the workman. The outfit consists of two pairs of brackets, one of which is placed on either side of the chimney.

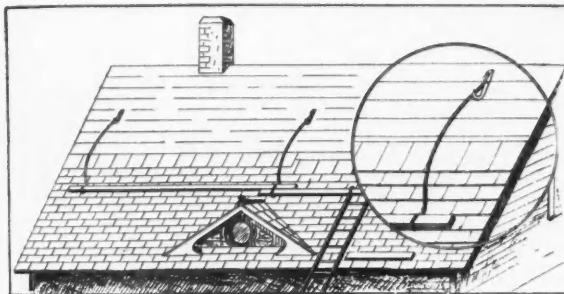

Brackets for Roofing Scaffolds.

They are put in position by hanging them over the ridge of the roof, fitting equally well over the ridge board or a metal ridge roll. They are so constructed that no weight comes on the roll itself. These being in position, the horizontal bar is raised to a level with the ridge. Then both brackets are connected with the supporting posts, the boards placed across them and the scaffold is completed.

The bracket to be used in roofing is shown in the second of the illustrations. It can be used over either wood shingles, metal, slate, composition or roofing in rolls. The bracket consists of a five-eighths inch bar, five feet, six inches long made in the form of an arch to allow the roofing to be laid

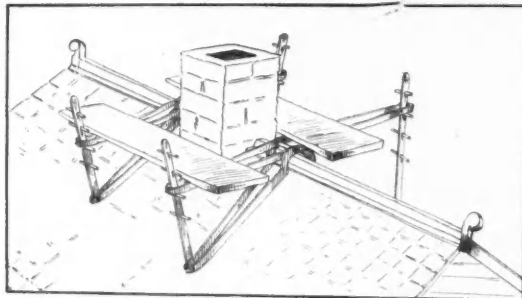

Showing Scaffold on Ridge of Roof.

under it. It is looped at the lower end to take a 2 by 4 studding and the top end is fitted with a reversible hook to catch a ten or twenty-penny nail driven into the roof when it is close sheathed. However, it may be used in any style of sheathing and is readily movable as the workman proceeds.

When this staging is used the workman shingles up as high as possible from the ground staging, then puts up the bracket, securing the hook over the edge of the roofing board, drops a 2 by 4 studding into the loop and it is ready for use.

The scaffold equipments are now in use by many builders, all of whom assert that they perform the services for which they were designed in an excellent manner.



A Screen Door That Can't Sag

No door in a building gets such hard use as a screen door, yet a majority of the doors hung are so constructed that they do not stand the wear and tear. Poorly constructed doors sag and the joints spring apart. Then the builder is blamed.

It was to meet this defect in screen doors that the manufacturers of one brand devised a metal-braced joint that will keep the door from sagging. This metal brace is made

(Continued to page 100.)

**HERO
PIPELESS
FURNACES
MAKE WARM HOMES**

**HERO
PIPELESS
FURNACES
MAKE WARM HOMES**

**HERO
PIPELESS
FURNACES
MAKE WARM HOMES**

NOW IS THE TIME To Get the Biggest Business on **HERO PIPELESS FURNACES**

The public wants pipeless furnaces.

They are convinced of their superiority—and their economy.

This means that there is a big business awaiting the contractor who goes after it. And now is the time to get it, while people remember the discomforts of last winter's stove heat.

Someone is going to get this business in your city—why shouldn't it be you? To be successful you must sell the Hero.

But Why the HERO?

The Hero is scientifically designed and constructed by heating engineers of 30 years' furnace experience. We've built room heaters for over a quarter of a century—and the pipeless furnace is but a variation of this form of heater.

The Hero heats faster—more uniformly—because the air passages are properly proportioned and the radiation surfaces are larger.

The Hero washes and moistens the air better because the water pans are scientifically shaped and placed.

The Hero will give greater all around satisfaction to you—as installer—and to your customer because built of the finest materials by the best workmen; it will last a lifetime.

The Hero—installed in a day—gives you a handsome profit.

Write for Exclusive Territory and Ask
About Our Co-Operative Sales Helps

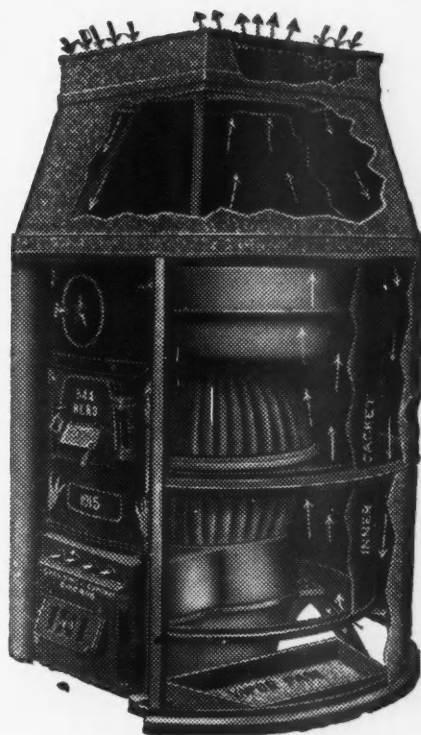

HERO FURNACE COMPANY

59 West Lake Street, CHICAGO

4901 Thirty-Seventh Ave., MINNEAPOLIS, MINN.



LET'S FINISH THE JOB

Invest Your Profits in

Victory Liberty Bonds



What's New?

(Continued from page 98.)

of steel and is fastened to the center brace and side rails of the door, and nailed with steel barbed brads. The stiles and rails are joined at each corner with a mortise and tenon and both are secured with a steel dowel. This latter brace and how it is attached are shown in the accompanying drawing.

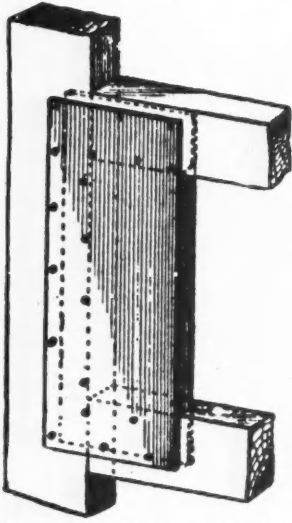

Metal Brace that Keeps Screen Door from Sagging.

This brace is a feature of a door constructed of northern pine and by the use of this wood a light, durable door, that can be finished in almost any tone, is secured. The latter also is a desirable feature for the reason that a screen door is the first thing a visitor to a building sees, and more often than not it mars the exterior appearance.

Builders are finding that a non-sagging, well-constructed door, one that will take a good finish is making satisfied customers.



Portable Folding Bath Tub with Heater Attached

In homes where there is no bath room, bathing is considerable of a problem and the tired person who wants a bath foregoes it rather than take the troubles of heating the



Portable Folding Bath Tub with Tank and Heater.

water and doing the other things that are necessary to get it. Most of this trouble is eliminated by the use of the portable folding bath tub shown in the accompanying illustration.

This tub is mounted on a platform to which wheels are attached, so that when it is not in use it can be wheeled to some convenient and out-of-the way place. The tub is let down easily. The tank holds 12 gallons of water and has a heater attached. The heater consists of a burner and coil.

(Continued to page 104.)

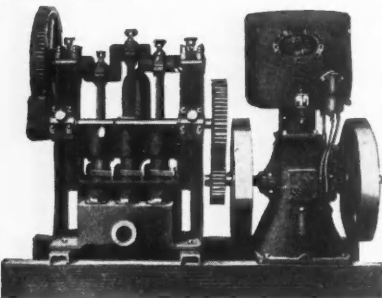
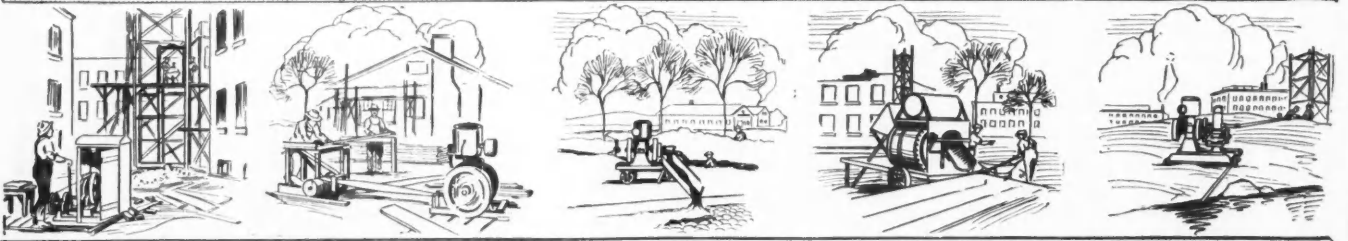

Triplex Pumping Outfit
2½, 3½, 4½, 6 to 8 and 10 H. P., with capacity of from 900 to 4800 gallons per hour.

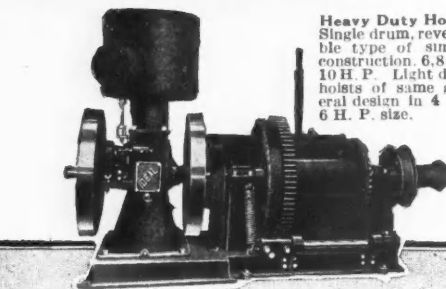

Heavy Duty Hoists
Single drum, reversible type of simple construction. 6, 8 and 10 H. P. Light duty hoists of same general design in 4 and 6 H. P. size.

Buying for the Present and Future

The far sighted purchaser of mechanical equipment does not buy for present requirements only, but also gives full consideration to the future needs.

For there is no economy in saving a few dollars on equipment now that will not fully meet your power needs a few months hence.

Ideal power and Ideal equipment is furnished in various types and sizes to meet practically every requirement of

contractors and builders. If you will consult us in regard to your requirements we can undoubtedly render some valuable service in helping select the equipment that will deliver maximum service over the greatest period of time.

Our complete line includes engines, hoists, pumping outfits, air compressors, etc., of various types and capacities.

Catalog and price estimates sent free on request.

IDEAL ENGINE COMPANY

R. E. OLDS, Chairman

630 E. Kalamazoo Street, Lansing, Michigan

DISTRIBUTORS:

Boston
Chicago

New York
Minneapolis

Philadelphia
Kansas City

Pittsburg
Omaha

Cleveland
Atlant

IDEAL POWER





*McKinney Anti-Friction Butts
No. 2742
used throughout*

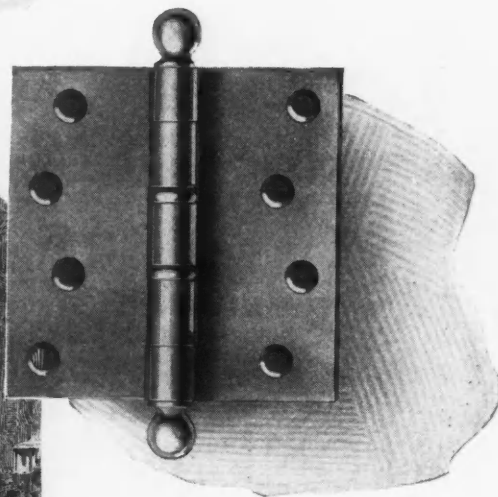

McKINNEY BUTTS *for all doors*

*Southern Hotel
Baltimore, Md.*

*Otto G. Simonson, Architect
Longacre Construction Co., Contractors*

THE beautiful Southern Hotel in Baltimore furnishes an excellent example of the high grade of buildings in which McKinney Wrought Steel Butts are to be found. In this particular instance the doors are hung with McKinney Anti-Friction Butts, the style most generally employed for hanging large heavy doors in public buildings and the better class of residences.

Point for point McKinney Hinges and Butts are second to none. They are made of the best steel obtainable for the purpose, and, despite the careful selection of materials, rich finish and superior workmanship, are inspected many times before they are finally permitted to leave our shipping platform.

The uniformly high quality of every piece of McKinney-made hardware—the result of 50 years' manufacturing experience—is but one of the many reasons that architects like to specify McKinney Butts For All Doors.

Have you received a copy of our new Butt Booklet? Write for it.

McKINNEY MANUFACTURING COMPANY
PITTSBURGH, PENNSYLVANIA



The Overbalancing Argument

for KEYSTONE COPPER STEEL Sheets and Terne plates is the fact that this material lasts longest under actual service conditions—because *actual time* and *weather* have proved it.

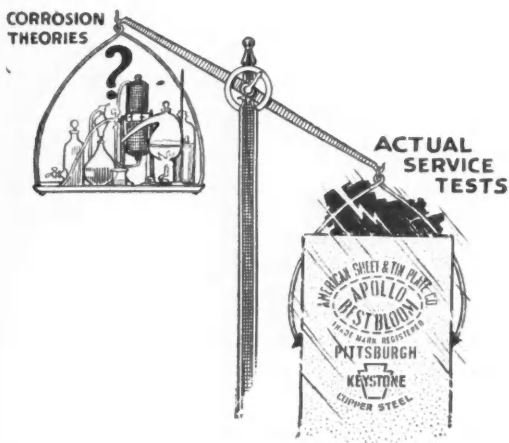

Send for interesting booklet entitled
"Research on the Corrosion Resistance of Copper Steel"

APOLLO-KEYSTONE Copper Steel Galvanized Sheets are highest in quality and rust-resistance, and are adapted to a diversified field of utility. When *Apollo-Keystone* is used for Cornices, Spouting, Eave Troughs, Conduction Pipes, etc., you are assured the maximum degree of durability and satisfactory service. The excellence of *Apollo-Keystone* Galvanized is everywhere recognized by leading builders.

American Sheet and Tin Plate Company

General Offices: Frick Building, Pittsburgh, Pa.

MANUFACTURERS OF

Sheet and Tin Mill Products of every description, including Black Sheets, Galvanized Sheets, Tin and Terne Plates, Electrical Sheets Corrugated and Formed Roofing and Siding Materials, Special Sheets for Stamping, Keystone Hammered Polished Steel Sheets, Automobile Body Sheets, Stove and Range Sheets, Black Plate, Etc.



Here is an example of the rust-resistance of uncoated copper-steel sheets.
Your own tests will show similar results.

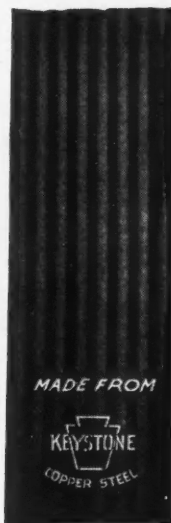

These sheets were exposed side by side for the same length of time. They were identical in manufacture—the same gauge, and from the same heat, the only difference being the *alloy of copper*.

When you specify for copper-steel Sheet and Tin Mill Products—remember **KEYSTONE**. It signifies not only the quality imparted by the addition of copper, but the *super-quality* which comes only from experience in its manufacture. Supplied in Black Sheets, Galvanized Sheets, Formed Roofing and Siding Products Roofing Tin Plates, Long Ternes, Etc.



This special mark is added below regular brands. It indicates the Copper Steel is used—and is placed there for your protection

American Sheet and Tin Plate Company

General Offices: Frick Building, Pittsburgh, Pa.

DISTRICT SALES OFFICES:

Chicago Cincinnati Denver Detroit New Orleans New York Philadelphia Pittsburgh St. Louis
 Export Representatives: UNITED STATES STEEL PRODUCTS COMPANY, New York City
 Pacific Coast Representative: UNITED STATES STEEL PRODUCTS COMPANY, San Francisco, Los Angeles, Portland, Seattle



“Here’s an Extra \$50!

“I’m making *real* money now! Yes, I’ve been keeping it a secret until pay day came. I’ve been promoted with an increase of \$50 a month. And the first extra money is yours. Just a little reward for urging me to study at home. The boss says my spare time training has made me a valuable man to the firm and there’s more money coming soon. We’re starting up easy street, Grace, thanks to you and the I. C. S.”

Today more than ever before, money is what counts. You can’t get along on what you have been making. Somehow, you’ve simply got to increase your earnings.

Fortunately for you there is an unailing way to do it. Train yourself for bigger work, learn to do some one thing well and employers will be glad to pay you real money for your special knowledge.

You can get the training that will prepare you for the position you want in the work you like best, whatever it may be. You can get it at home, in spare time, through the International Correspondence Schools.

It is the *business* of the I. C. S. to prepare men for better positions at better pay. They have been doing it for 28 years. They have helped two million other men and women. They are training over 100,000 now. And they are ready and anxious to help you.

Here is all we ask—without cost, without obligating yourself in any way, simply mark and mail this coupon.

TEAR OUT HERE

INTERNATIONAL CORRESPONDENCE SCHOOLS

Box 8166, SCRANTON, PA.

Explain, without obligating me, how I can qualify for the position, or in the subject, before which I mark X.

- | | | |
|---|--|---|
| <ul style="list-style-type: none"> <input type="checkbox"/> ARCHITECT <input type="checkbox"/> Architectural Draftsman <input type="checkbox"/> Contractor and Builder <input type="checkbox"/> Building Foreman <input type="checkbox"/> Concrete Builder <input type="checkbox"/> Structural Engineer <input type="checkbox"/> Structural Draftsman <input type="checkbox"/> Ship Draftsman <input type="checkbox"/> Plumber and Steam Fitter <input type="checkbox"/> Heating and Ventilation <input type="checkbox"/> Plumbing Inspector <input type="checkbox"/> Foreman Plumber <input type="checkbox"/> Sheet Metal Worker <input type="checkbox"/> CIVIL ENGINEER <input type="checkbox"/> Surveying and Mapping <input type="checkbox"/> ELECTRICAL ENGINEER <input type="checkbox"/> Electric Lighting and Rys. <input type="checkbox"/> Electric Wiring <input type="checkbox"/> Telegraph Engineer <input type="checkbox"/> Telephone Work <input type="checkbox"/> MECHANICAL ENGINEER <input type="checkbox"/> Mechanical Draftsman <input type="checkbox"/> Machine Shop Practice <input type="checkbox"/> STATIONARY ENGINEER <input type="checkbox"/> CHEMIST | <ul style="list-style-type: none"> <input type="checkbox"/> SALESMANSHIP <input type="checkbox"/> ADVERTISING <input type="checkbox"/> Window Trimmer <input type="checkbox"/> Show Card Writer <input type="checkbox"/> Sign Painter <input type="checkbox"/> BOOKKEEPER <input type="checkbox"/> Stenographer and Typist <input type="checkbox"/> Higher Accounting <input type="checkbox"/> COMMERCIAL LAW <input type="checkbox"/> Common School Subjects <input type="checkbox"/> Mathematics <input type="checkbox"/> GOOD ENGLISH <input type="checkbox"/> ILLUSTRATING <input type="checkbox"/> Railway Mail Clerk <input type="checkbox"/> CIVIL SERVICE <input type="checkbox"/> MINE FOREMAN OR ENGR <input type="checkbox"/> Metallurgist or Prospector <input type="checkbox"/> Gas Engine Operating <input type="checkbox"/> Textile Overseer or Supt. <input type="checkbox"/> TRAFFIC MANAGER <input type="checkbox"/> AUTOMOBILE OPERATING <input type="checkbox"/> Auto Repairing <input type="checkbox"/> Navigation <input type="checkbox"/> AGRICULTURE <input type="checkbox"/> Poultry Raising | <ul style="list-style-type: none"> <input type="checkbox"/> Spanish <input type="checkbox"/> French <input type="checkbox"/> Italian |
|---|--|---|

Name _____
 Present _____
 Occupation _____
 Street _____
 and No. _____
 City _____ State _____

WHEN WRITING ADVERTISERS PLEASE MENTION THE AMERICAN BUILDER

What’s New?

(Continued from page 100.)

Either gasoline or kerosene is used where gas is not available.

The tub is finished in white enamel and the tank is of nickeloid. As the tub is lowered the tank and heater slide up along the frame. When the tub is raised to an upright position, they slide down and the tub covers them. After the bath the tub can be emptied with a short piece of garden hose.

This is a mighty convenient piece of furniture for any home that has not plumbing. While it is new, there already is a strong demand for this tub and heater.



A Pure Copper Cable Lightning Rod

Rural builders always have an active demand for lightning rods, especially on farm buildings, because they are an insurance that the building will be protected from fire caused by the elements. The farm building is so far from the protection of a city fire department that when they once catch fire they usually are a total loss, both building and contents.

There are numerous types of lightning rods manufactured, but all are based on the same principle—a metal conductor of electricity that grounds in the earth. The accompanying illustration shows one that is unique in many of its features and has been proven to be an efficient protector of buildings from lightning. Its manufacturers claim that it is installed on 100,000 buildings, and not one has been lost from fire.

This rod is made of copper. The center is in the form of a tape, while around it is closely woven copper cable. The shape of the tape and the surrounding cable make it a tube thru which rain is carried to the ground. This keeps the ground rod moist, which is an essential aid to the function of a lightning rod. The construction and how it carries the moisture is shown in the illustration, which is of a cross-section of the rod, somewhat enlarged.

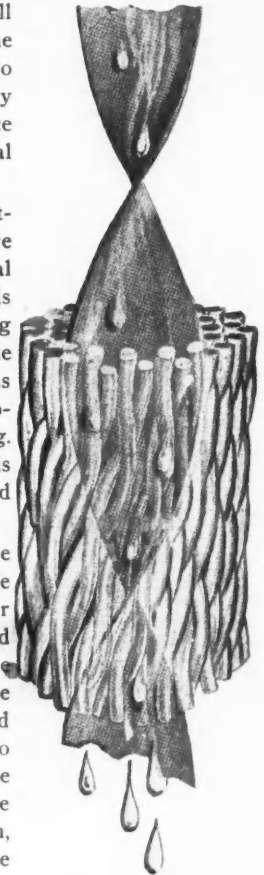

Cross Section of Lightning Rod, Showing Ever-Moist Feature.



Triple Registers With This Pipeless Furnace

Ever since the pipeless furnace first came into use and was found to be an economical and efficient heater for small homes and other buildings, the manufacturers have devoted their attention to methods of drawing out of the rooms the less warm air, that is forced to the floor by the heated air. Many methods to accomplish this purpose, which is the basis of the operation of a pipeless furnace, have been devised.

Recently, however, there has been placed on the market a new type of furnace; that is, new from the standpoint of its operation. Herewith is illustrated a furnace that has triple registers, one directly over the furnace for the discharge of

(Continued to page 106.)

i
t
t
c
c
y
P

b
E
al
re
g

co

str
fr
tic
mis
sav
you



You Can Make Money Remodeling Store Fronts

THERE always has been good money in remodeling store fronts (every live retailer wants modern, attractive show windows) and by dealing direct with us, instead of through traveling salesmen, you can make even a greater profit.

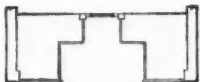

1919 is bound to be a record-breaker in the store front business. Every small town and large city is alive, retailers who have held off remodeling their fronts are now going ahead.

This means a big opportunity for contractors.

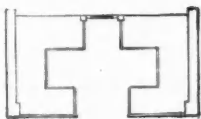

You are the logical man to sell store front construction.. You are on the job, the retailers know you personally and they will take your word for the detail construction of the fronts.



Selling "Desco" store front construction direct to you—shipments from the factory—is the most practical plan. It saves time, prevents mistakes, simplifies ordering and it saves money for both you and your customers.

Selling direct is the new way. The war proved that it is the right way to sell many products. It eliminates traveling salesmen and costly branch offices. By cutting this big expense we save you money.

Desco
METAL
STORE FRONTS

A COMBINATION OF STRENGTH AND SIMPLICITY SOLD AT A MODERATE PRICE

And "Desco" is now better in quality than ever—it is stronger, safer, easier to order, easier to install and better looking. The moment you show it to your prospect he likes it. It is easy to sell "Desco", especially at such a moderate price.



We want you to look into "Desco"—make us prove its superiority to you. Check up on the general design—note the safety features. Compare the weight and quality of the copper; see how it is given extra strength and reinforcement; note how easy it is to install and how easy the glass is set into it. Also see how ventilation and drainage is provided for. "Desco" is a permanent construction, too.

In fact, when we made the latest improvements in "Desco" we profited by our 29 years of actual experience. Dealing with contractors and architects throughout the

country for such a long time has shown us exactly what the require-



ments are. We know what you prefer and we know what store owners and retailers expect of a good store front construction.

SAVE MONEY MAKE MONEY

Be the contractor in your town to cash in on the store front remodeling to be done this year. Be the first man to talk to the store owners and retailers. First prepare by reading the book we have prepared on store fronts. It shows illustrations of modern types of fronts and contains other valuable data.

By sending in this coupon we also will mail you details of "Desco" construction, price list and quote you a special discount. Don't put off using this coupon—it's an opportunity to make a bigger and more profitable business—with no investment.

DETROIT SHOW CASE CO.,
491 Fort Street W.
DETROIT, MICHIGAN

Send me a copy of the store front book advertised in "American Builder" also details of "Desco" construction with price list and special discount. This does not obligate me:

Name.....

Street Address.....

City..... State.....

5 Hand-Brushers to Equal This ONE Sprayer's Speed

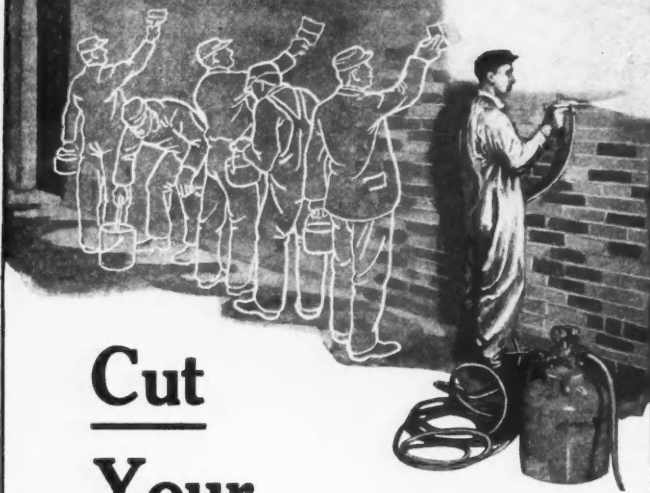

Cut Your Painting Costs

Painting outside and inside work with wood, brick, stucco, concrete or plaster surfaces can be done

- with at least four-fifths LESS the usual amount of labor;
- without waste of paint;
- without costly brushes which wear out quickly;
- with less scaffolding, by using

Aeron ^{Painting} *System*
Surpasses Paraffine

Portable Painting Equipment

This is part of the experience of contractors in spray-painting all types of construction with the Aeron. The slow, laborious brush-painting method has been discarded.

Further experience proves that the highest quality of work is obtained on each individual job. Regardless of kind of work or kind of paint used, the coating applied is uniform on every part of the surface and thoroughly covers it.

The ease with which the operator handles the machine and can move the outfit around, enables him to get these results under practically every condition.

How your painting costs can be cut and the best work done with Aeron method and Aeron equipment, will be gladly explained in detail.

The De Vilbiss Mfg. Co.
1276 Dorr Street Toledo, Ohio

*All Aeron Equipment sold on a strictly
guaranteed-to-make-good basis*

What's New?

(Continued from page 104.)

hot air into the room above and two thru which the cold air is taken from the living rooms.

It will be noted that the two cold air pipes are connected with wooden flues underneath the floor. These flues, which are built by the carpenter, connect with cold air registers placed near the outside walls in the rooms above. The cold air thus is taken out of the house at points remote from the register that discharges the heated air into the rooms.

There are several other features to this furnace that are claimed to be excellent by the manufacturers. Instead of

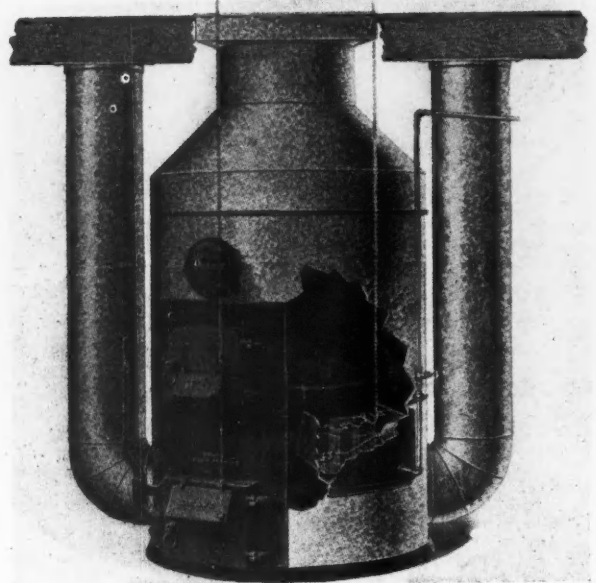

This Furnace Is Connected with Three Registers, One Directly Above It for the Discharge of Hot Air and Two Placed Near the Outer Walls to Draw Out the Cold Air. The Cold Air Flues Are of Wood and Are Built by the Contractor Between the Floor Joists.

taking all the air for combustion thru the grates, some of the air travels thru the hot blast in the feed door. The air is preheated in the channel around the combustion chamber and is discharged into the fire-pot thru small openings over the fire, mixing with the smoke and making a very high carbon gas, which is consumed. This, it is asserted, saves much fuel.



Compact Electrically Driven Water Pump

There recently was placed on the market an electric house pump for cisterns and shallow wells, which can be operated by electric current from either the city or trolley lines, or from the farm lighting plant. The pump is controlled by an automatic switch and is provided with large oil pockets for all bearings. The driving mechanism is wholly enclosed, and runs in grease with felt washers to prevent the grease from escaping or dirt getting into the bearings. Roller bearings of a special type are used, insuring easy starting, the minimum amount of power for operation, perfect alignment and durability.

The outfit has a capacity of 180 gallons per hour, which is sufficient to supply all the water needed for the bathroom, kitchen and laundry of an average dwelling. It is equipped with an air chamber and vacuum chamber to prevent water hammer and to insure a steady flow of water. The valves are faced with rubber to eliminate noise in operation. The outfit requires little floor space, because the pump is of the vertical type, with the motor and driving mechanism directly over the pump proper.

This pump makes an excellent water supply outfit to connect with the individual lighting system.

Some Record Scores

Clough-Bourne Corp., New York

Selden-Breck Constr. Co., St. Louis

U. S. Government---in U. S. and overseas

The Austin Company, Cleveland

Snare & Triest, New York

E. I. Du Pont de Nemours Co., Nashville

James Stewart Co., New York City

Mason & Hanger Co., New York

39 machines

16 machines

267 machines

14 machines

11 machines

19 machines

16 machines

18 machines

BOSS PAVERS
High drum type,
one and two bag.
Gas, steam, electric.

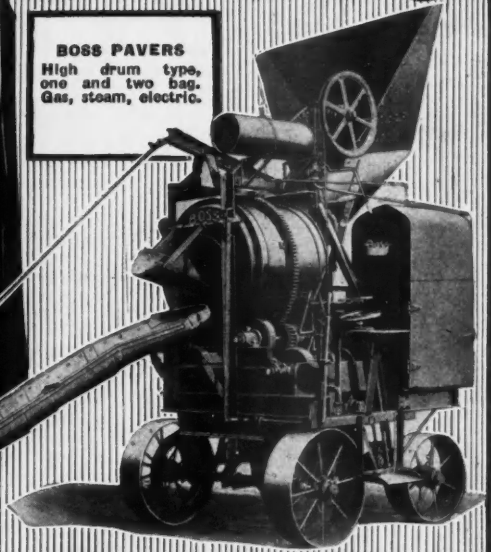

BOSS HOISTS
Single and double drum,
gas or electric.

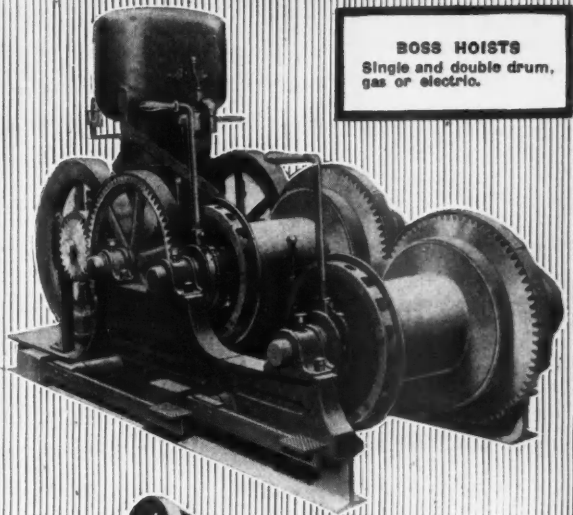

Others using two to ten BOSS mixers—James Black Masonry and Contracting Co., Lord Construction Co., New York; Degnon Contracting Co., New York; Boyle Robertson Construction Co., Richmond; Chas. J. Wacker, Indianapolis; Minneapolis Steel & Machinery Co., Minneapolis; General Construction Co., Spokane; A. C. Norton, Denver; Harrison Construction Co., Charleston; John A. Hunt Co., New Orleans.

Over 5,000 Contractors Use BOSS EQUIPMENT

LABOR SAVERS FOR CONTRACTORS

Get Our Astonishingly Low 1919 Prices. Also Terms

BUILDING MIXERS
(Concrete or Mortar)
PAVERS
GROUTERS

BACKFILLERS
HOISTS
CARTS
MATERIAL ELEVATORS

Write or Wire

The American Cement Machine Co Inc

Keokuk Iowa
THE 300,000 HP ELECTRIC CITY

PROMPT DELIVERIES FROM STOCKS IN FOLLOWING CITIES:
New York, Pittsburgh, Richmond, Cambridge, Mass.; Indianapolis, Chicago, New Orleans, Minneapolis, Seattle, Spokane, El Paso, St. Louis, Louisville, Atlanta, Springfield, Ohio.

BUILDERS' HANDY MIXER
\$100 up—half-bag size, low chargers.

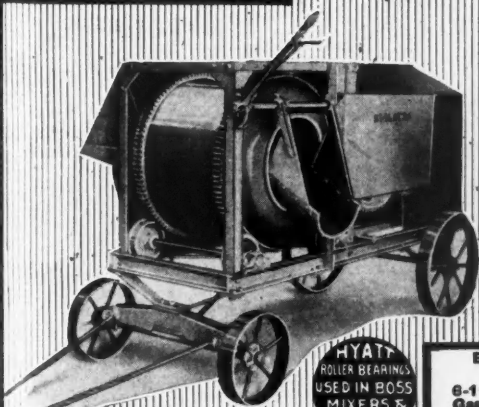

HYATT
ROLLER BEARINGS
USED IN BOSS
MIXERS &
HOISTS

BOSS BUILDING MIXERS
6-11-15-22 ft. sizes.
Gas, steam, electric.
Also low chargers.





THE CONTRACTOR WHO DONT GET ON

Will usually find that it is because he clings to old methods, and the modern way of doing things has left him way behind.

The live wires, the men who know how to spend money, in order to make more, would not dream of mixing mortar by main strength and awkwardness, you will find the EUREKA MORTAR MIXER on their pay-roll, and if you will ask about it, you will find that in every case the machine has paid for itself in the first sixty days of operation. Besides that, it makes stronger mortar with 25% less lime than could be made in the old way.

Up to date methods have made the Larowe Construction Co., of Detroit, one of the leading building concerns of the country. Read their letter—

"We use it for mixing all the mortar for the entire construction and found that the machine stood the wear and did the work in a very satisfactory manner. WE BELIEVE IT PAID FOR ITSELF SEVERAL TIMES OVER. The above is typical of our experience with the three EUREKA MORTAR MIXERS which we have had in operation the past two seasons, and we have nothing but praise for their ability to stand up under continued service and live up fully to all claims made by you."—Larowe Construction Co.

And Go and do Likewise.

Write today for catalogue describing and illustrating the EUREKA line of Concrete and Mortar Mixers.

EUREKA MACHINE COMPANY
103 Handy Street Lansing, Michigan

CATALOGS BULLETINS & BOOKS RECEIVED

The following literature, dealing with subjects of interest to builders, is now being distributed:

Blue Prints Showing Methods of Highway Construction have been put into book form by the Koehring Machine Co., Milwaukee. Each blue print is 36 inches long and together they embrace the results of the investigations made by the company's engineers on the problems of haulage, central loading stations, mixer equipment, water supply and the distribution of materials.

The use of protective products for construction work is covered in a new specification folio issued by the Ceresit Waterproofing Co., Chicago. The folio describes basements, sub-basements, pits, reservoirs and all sub-structures where waterproofing is demanded.

"**The Lighting and Ventilating of a Modern Building**" is the title of a series of 12 bulletins, issued by the J. G. Wilson Corporation, New York City, manufacturers of the Diffuselite blind and awning. These bulletins are well illustrated and contain much valuable information on the subjects they cover. Each bulletin contains 12 pages.

Hand Power Elevators for the Home are illustrated and described in a 6-page folder, issued by the Sedgwick Machine Works, New York City. Stress is laid on the fact that these elevators "remove the stairway barrier" for invalids and that they are easily operated.

Knives for Woodworking Machines is the subject of a 20-page booklet, just issued by the L. & I. J. White Co., Buffalo, N. Y. The results of 81 years of experience in tempering woodworking tools are set forth in this booklet, which is illustrated with cuts showing the knives this concern makes.

Sliding Door Hardware of all descriptions are described and illustrated in an exceptionally comprehensive catalog, issued by the Coburn Trolley Track Manufacturing Co., Holyoke, Mass. The catalog contains 80 pages and cover and describes garage, barn and house door hangers and hardware.

Lightning Rods of a new type are described in a folder issued by the Burkett Lightning Rod Co., Fremont, O. The folder shows by illustration and the text describes the copper cable lightning rods this company manufactures.

Blue Printed Plans and Details of Screened Porches are now being distributed by the Gilbert & Bennett Manufacturing Co., Chicago. These plans show how to construct and erect porch screens of G. & B. Pearl wire cloth, and also show views of porches so treated.

The Use of Flat Paints for Interiors is described in an artistic folder, just issued by the paint and varnish department of E. I. Du Pont De Nemours & Co., Wilmington, Del. This folder contains valuable information for painters and paint dealers.

(Continued to page 110.)

Three All-Important Points to Be Considered by Contractors Intending to Purchase Equipment

CONSTRUCTION—The Lansing line of contractors' equipment assures dependable, standardized quality—the best design, materials and workmanship that can be produced by an organization that has specialized in the manufacture of concrete mixers, hoists, carts, elevators, wheelbarrows, etc., for 38 years.

PRICE—The Lansing Company buys thousands of tons of steel annually. Other raw materials are purchased on a big quantity basis. A tremendous saving is effected. Then, too, with our own foundry and machine shop, the entire Lansing line is built in our own plant. You receive the benefit of our low manufacturing cost, which brings our selling price down to a level that cannot be reached by the smaller manufacturer.

SERVICE—Besides large repair stocks in our seven branches, Lansing dealers in all sections of the country are required to carry spare parts. As a result, owners of Lansing Mixers and other contractors' equipment are enabled to take advantage of service arrangements which for extent and thoroughness are unequalled. The Lansing Company insures prompt service to all contractors—in New England as well as on the Pacific Coast.

Write for Catalog

Let us send you complete information about the Lansing line of contractors' equipment. Our engineers are particularly well qualified to co-operate with contractors intelligently. Write for our 48-page mixer catalog.

Lansing - Company

22 North Cedar Street, Lansing, Michigan

Branches:

New York Philadelphia Boston Chicago
 Minneapolis Kansas City
 San Francisco

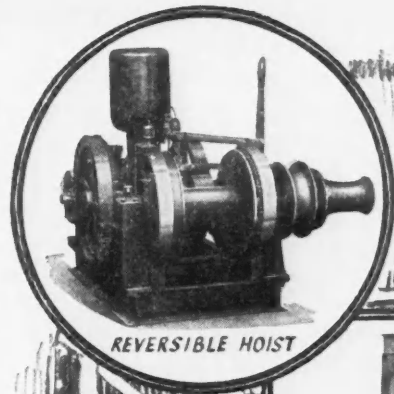

REVERSIBLE HOIST

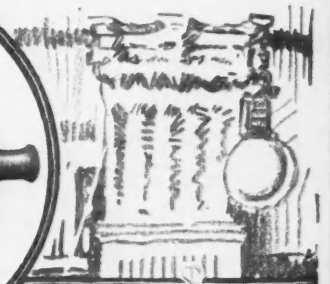

HALF SACK MIXER WITH WHEELBARROW HOPPER

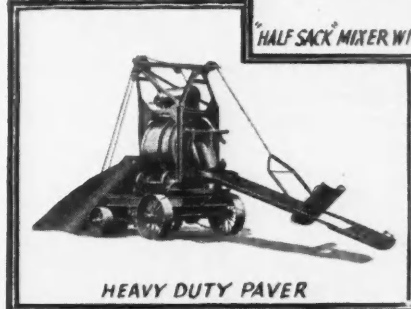

HEAVY DUTY PAVER

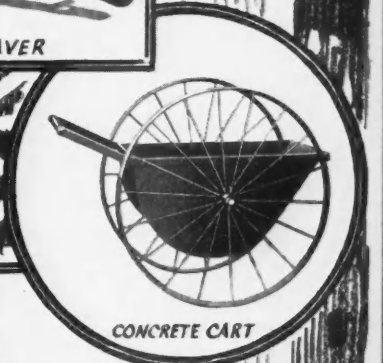

CONCRETE CART

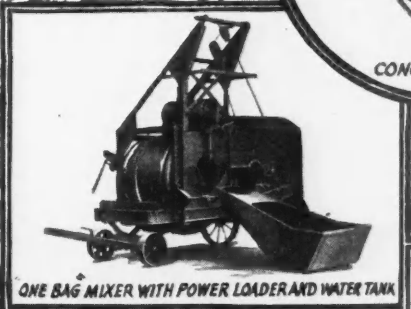

ONE BAG MIXER WITH POWER LOADER AND WATER TANK



LANSING MORTAR MIXER

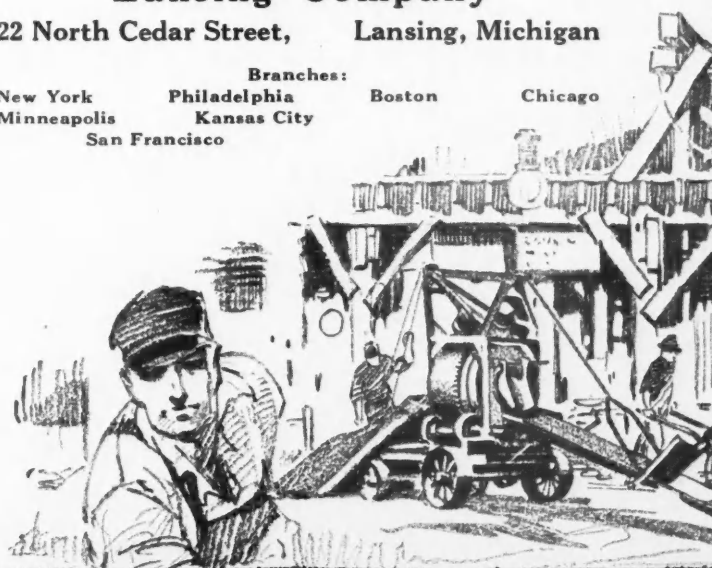

LANSING

COMPANY

"KEEP YOUR PRODUCT ON WHEELS"

Catalogs, Bulletins and Books Received

(Continued from page 108.)

"**Model Making**" is the title of a new book on workshop practice, design and construction of models, by Raymond F. Yates, editor of *Everyday Engineering Magazine*. The book contains 400 pages and 303 illustrations and is bound. Published by The Norman W. Henley Publishing Co., New York City. Price \$3.

A Handbook of Fire-proof Construction, using "Knoburn" expanded metal lath, is issued by the North Western Expanded Metal Co., Chicago. The book contains 72 pages and cover devoted to specifications and methods of construction with metal lath and is well illustrated.

Helps for the "Build a Home First" campaign now are being distributed by the Southern Pine Association, New Orleans, La. They consist of advertisements and reading notices for newspapers and a folder telling what members of the building industry can do to help this good work along.

"**Electricity—Man's Most Dependable Servant**" is the title of a 16-page and cover booklet describing the electric light systems manufactured by the General Gas-Electric Co., Hanover, Pa. The booklet is illustrated with sketches showing the many uses of electricity on the farm and with pictures of the plants the company makes.

Two-wheeled Auto Trailers for contractors and lumber and building material dealers are described and illustrated in a 32-page and cover catalog, issued by the Miles Manufacturing Co., Jackson, Mich. Many of these inexpensive trailers are shown in actual use by the illustrations.

Why Electricity Is a Necessity in the Rural Home is the subject of an interesting 16-page and cover booklet issued

by the Alamo Farm Light Co., Chicago. This booklet tells of the many uses besides lighting the plants the company makes may be put to and is well illustrated.

"**Glass for Every Industry**" is the title of an exceptionally interesting book on the manufacture and use of glass, issued by the Hires Turner Glass Co., Philadelphia, Pa. One of the most interesting features of this book, which contains 170 pages and cover, is a description of the various operations in producing glass. The book is well illustrated, some of the pictures being in color.

"**The King System of Ventilation**" is the title of the 1919 catalog of the King Ventilating Co., Owatonna, Minn. The book contains a description of the ventilating service and equipment of the King company and the 64 pages are profusely illustrated with reproductions of photographs of farm buildings, some of them being in four colors.

"**Electricity Makes a Safer and Better Barn**" is the title of a folder describing the Marron power and light plant, manufactured by the Marron Manufacturing Co., Rock Island, Ill. The folder contains specifications of the electric lighting plant and shows some interesting farm scenes.

Equipment for Manual Training Schools is described and illustrated in a 72-page and double cover booklet, entitled "The Christiansen Line," issued by C. Christiansen, Chicago. The booklet also contains descriptions of the other school furniture and equipment this concern makes.

Gas for Light and Heat produced from gasoline is the subject of a folder, issued by J. E. Whitacre & Co., Rockford, Ill., manufacturers of the Whitacre lighting and cooking system. This folder contains a description of

(Continued to page 112.)

This Could Never Have Happened If ANKYRAS Had Been Used

"I want the bolts in order to convince the management of the building in which we have offices, that the toilet room fixtures would *stay put* if they were fastened with

ANKYRA ANKOR BOLTS"

(From a letter we received recently.)

Get the One Dollar Trial Package

of 25 No. 8 Ankyras, one collapsing tool (an addition to your tool kit) and complete instructions.

ANKYRA MANUFACTURING CO.
151 Berkley St., Wayne Junction, PHILADELPHIA

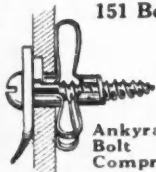

Ankyra
Bolt
Compressed



Self-
Riveting

Self-
Adjusting

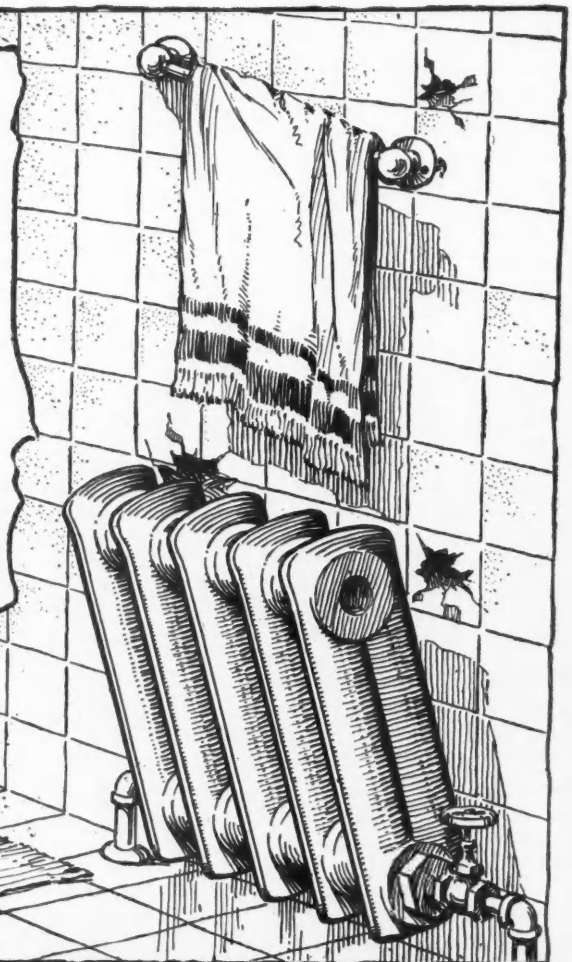

ORIGINAL WONDER MIXERS STRONG - FAST - DURABLE

With a hoisting drum built in, over the center of gravity, so that the machine cannot possibly be pulled out of place.

This machine is especially designed for concrete work where hoisting is necessary.

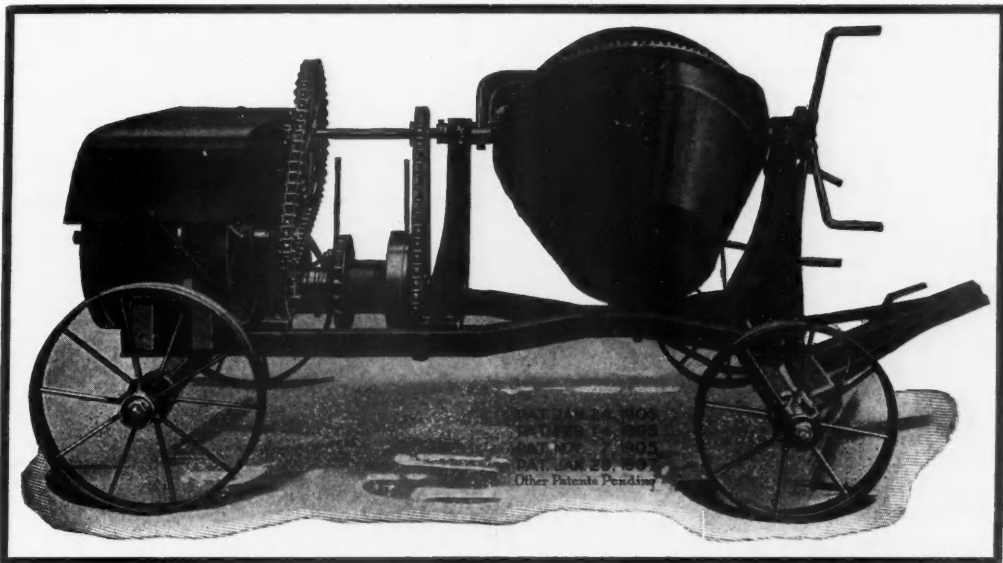

Thousands of them are in use by Contractors and Builders. They have proven themselves to be the best of their kind—for speed and quality of mix—ease of operation—strength and durability.

You can't go wrong on a Wonder Mixer.

The Waterloo Line includes several sizes of hoists—there is one to fit your particular needs.

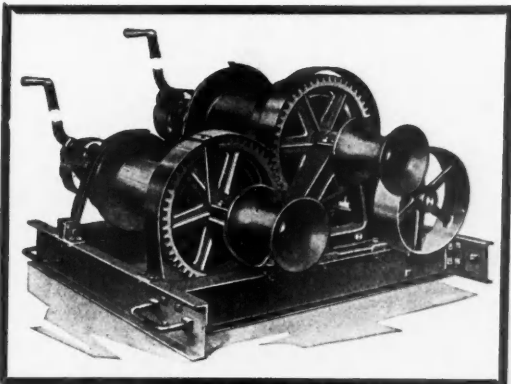

We want you to become familiar with Waterloo Construction Machinery.

Write us today for your copy of our new catalog. It will be of interest and value to you.

WATERLOO CEMENT MACHINERY CORP.

103 VINTON ST.

WATERLOO, IOWA



Quick, Sure Profits! Sell Pipeless Furnaces

It's always easy to sell the Williamson Pipeless Furnace—and easier this year than ever before. Just as we predicted, our sales for 1919 are running 'way ahead of all previous records. You should be getting your rightful share of this profitable business. Many of your clients are ready right now to make the change from the wasteful stoves and grates to the economical and efficient Williamson Pipeless Furnace. As a matter of fact there is considerable business now waiting for you to solicit and close.

WILLIAMSON Pipeless
Furnace
Saves In Many Ways

The country's leading farm publications are carrying the advertisements of the Williamson Pipeless Furnace. Many of your clients are reading these advertisements. Now is the time for us to follow up prospects and clinch the sales. Let's work together and do it. We'll assist you in every possible way—with letters, booklets, catalogs, folders, and plenty of selling aids. And our efficient Engineering Department is also fully at your service in making plans and estimates. Other advantages are: The Williamson Pipeless Furnace is easily installed, fits any cellar, and is sold at a very reasonable price. For further details of this sure money-maker, mail the coupon. Do it—today!

The Williamson Heater Company
78 W. Fifth Street, Cincinnati, Ohio

THE WILLIAMSON HEATER CO.
78 W. Fifth Street, Cincinnati, Ohio

Send full details regarding your plan to help me make money selling and installing the Williamson Pipeless Furnace. This request is to involve no obligation on my part.

Name.....

Address.....

Business.....

Catalogs, Bulletins and Books Received

(Continued from page 110.)

how this plant produces gas and tells of its many uses in rural homes.

"Some Points on the Proper Care of Band Saws" is the title of one of the interesting and instructive articles in the March issue of the "Simonds Guide for Millmen," the monthly magazine published by the Simonds Manufacturing Co., Fitchburg, Mass. The magazine contains 16 pages and is well illustrated.

A New Portable Folding Bath Tub is described in a pamphlet, issued by the Leech Metallic Bath Tub Co., Detroit, Mich. The booklet also contains a description of the portable water heater and the indoor chemical closets this company manufactures.

Details of the Concrete Poured Industrial Houses, erected at Union, N. J., are contained in a service sheet issued by the Alpha Portland Cement Co., Easton, Pa. The sheet also describes the houses and the methods used in building them.

"Class and Convenience in Casement Window Hardware" is the title of an interesting article on windows for sun parlors and sleeping porches, contained in the April issue of "DooR-Ways," published by the Richards-Wilcox Manufacturing Co., Aurora, Ill. Illustrations show how these windows are installed and the hardware used.

How to Set Up, Operate and Care For the Garford Homelite Plant is described in a 64-page and cover booklet, issued by the Garford Manufacturing Co., Elyria, O. This booklet also contains a description of the lighting plants this company makes.

"Magic Sanitary Chemical Closets" is the title of a 12-page and cover booklet, issued by the Chemical Closet Supply Co., Manistee, Mich. The booklet contains a description of the closets this company produces and of their installation.

An Electric Light Plant for Rural Homes is pictured and described in a well illustrated four-page circular issued by Essandee Corporation, Chicago, Ill. Besides a description of the electric light system this company makes, there are shown many fixtures to go with it.

"Safe Homes" is a title of one of the articles contained in the March Issue of "General Fireproofing," the monthly magazine published by General Fireproofing Co., Youngstown, O. This issue contains 24 pages and is well illustrated.

Painting Metal in Buildings is the subject dealt with principally in the April issue of "Graphite," the monthly magazine of the Joseph Dixon Crucible Co., Jersey City, N. J. While the magazine contains but 12 pages, it is filled with interesting facts about painting buildings.

"Henricks Generators for Lighting Outfits" is the title of an 8-page and cover booklet, issued by the Henricks Magneto & Electric Co., Indianapolis, Ind. The booklet describes by text and illustrations the magnetos the Henricks company manufactures.

Store Fronts and Their Construction are described and illustrated in the 40-page and cover catalog, issued by J. W. Coulson & Co., Columbus, O. The booklet contains many illustrations showing store fronts constructed of the patented materials this concern produces.

"Standard Re-inforced Spiral Pipe" is the title of the catalog of the Standard Spiral Pipe Works, Chicago. The catalog contains 40 pages and cover and descriptions of the manufacture and uses of spiral pipe and has many illustrations.

Specifications for Water Supply Systems, electric plants

(Continued to page 114.)

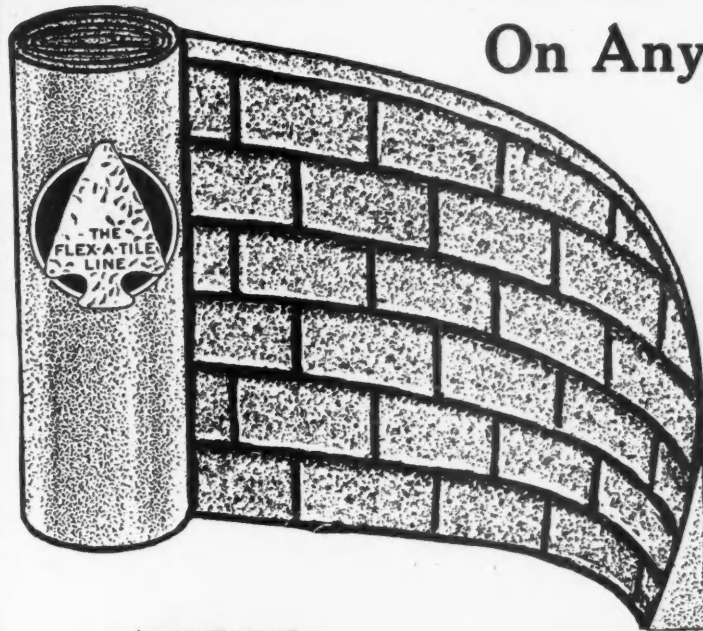

On Any Roofing Job

There is satisfaction in Flex-a-Tile Roll Shingle Roofing. As distinct as the name.

For the Owner—Who wants a pleasing shingle effect combined with wearing qualities.

For the Contractor—Who *must* have a roofing he can recommend and know is best from his own standpoint.

For the Dealer—Who is looking for a profit-making, fast-selling, dependable proposition.

Flex-a-Tile

HOUSE TOPS

Flex-a-Tile Roll Shingle Roofing is one of the most popular of the Flex-a-Tile roofing group. It has all the *enduring, artistic and ornamental* features of the whole Flex-a-Tile family, but is easier to apply and cheaper. It gives that perfect satisfaction which comes from a thing well yet inexpensively done.

Any Mechanic can apply a Flex-a-Tile Roof quickly and easily. In the case of an old roof to be reshingled, simply roll the Flex-a-Tile Roll Shingle Roofing over the old shingles and nail down. No bother and dirt from tearing off the old shingles. On a new building it is nailed down right on to the sheathing. Requires no skill. The saving in labor alone is great.

Perfect Shingle Effect—By our patented process each 5"x7" shingle butt is raised so noticeably that it can be felt with the hand. This makes the shingle effect finished and pleasant, not a crude imitation, and yet *the shingles are all in one roll.*

Flex-a-Tile Quality—with all its well-known resistance to water, heat, cold, wind—goes into each roll. When a dealer sells a Flex-a-Tile Roof he has made a permanent customer; when a man uses it for *his house* he is its best advertisement.

Flex-a-Tile Roll Shingle Saves:
35% on Freight, 38% on Nails, 50% on Labor.
Reduces insurance, because it is in Class "C" as approved by the Fire Underwriters' Laboratories

Flex-a-Tile has no Superior in Waterproofing Qualities.

Send for sample. Ask us to help you on your roofing problems. We want to serve you. Ask us for Bulletins 1511 and A-23

THE HEPPE'S ROOFING CO.
Dept. L, 4500 Fillmore Avenue, Chicago
Roofing Division of the Richardson Paper Company
Mills at Chicago, Ill., Lockland, Ohio, Rutherford, N. J.

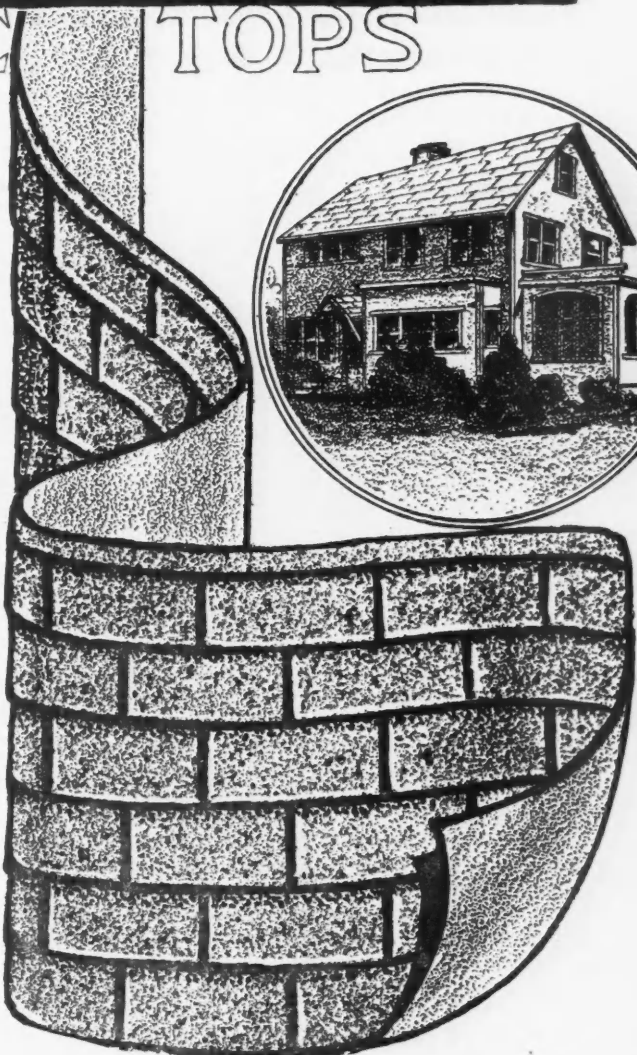

Catalogs, Bulletins and Books Received

(Continued from page 112.)

and sewage disposal systems are given in a 46-page booklet issued in conjunction with a 24-page booklet on electric lighting plants by the Kewanee Private Utilities Co., Kewanee, Ill. The specifications booklet contains much valuable information on the installations of these systems, while the catalog describes those manufactured by the Kewanee Co.

United Electric Lighting Plants are described in a four-page folder, issued by the United Engine Co., Lansing, Mich. The uses of lighting systems and the plant this company manufactures are shown in the folder, which is illustrated.

Trailers for Every Industry are described in a folder issued by the Warner Manufacturing Co., Beloit, Wis. The folder shows the trailers the Warner company manufactures and describes them in text and by illustrations.

How Electricity Will Keep the Boys and Girls on the Farm is portrayed in a booklet, entitled "Electricity and Agricultural Preparedness," issued by the Domestic Engineering Co., Dayton, O. This company also puts out an attractive booklet describing the "Delco-light" it manufactures.

How the Government Used Its Electric Light Systems is shown in a book of information, prepared by the Matthews Engineering Co., Sandusky, O., for the American International Shipbuilding Corporation. The book also describes the electric light systems the Matthews company manufactures. ❖

Profitable Opportunity in Screening Porches

In some sections of the country practically every porch

is screened in the summer, while in others few are protected from flies and mosquitos. However, if those who do not have their porches screened knew the many comforts that enclosing them with meshed wire brings they would not hesitate about having it done.

There is a profitable opportunity for builders in screening porches at this season of the year, as many home owners would have this improvement made if they knew how little it costs in comparison with the comfort attained, and that with the use of high-grade wire mesh the screens will last for a number of years.

Using panels that rest on the floor of the porch, either inside or outside the rail, and locking the frames together is recognized as the best method of screening porches. The screen frame is made of door stock, 1 $\frac{1}{8}$ -inch straight grained white pine, with moulding strips to form a rabbet $\frac{1}{2}$ by $\frac{3}{8}$ inch, and a locking strip $\frac{1}{8}$ inch in width. The panels are locked together with a $\frac{1}{8}$ -inch strip, fastened to the post with a $\frac{1}{8}$ -inch hook and anchored to the floor by corner braces. The panels should not be more than 30 inches in width and should run to the top of the porch. All the hardware that is needed are the floor brackets and hooks.

By adding screens to the porches, the house owner secures an extra outdoor room that will repay its cost in comfort many times during each season. The screens ward off disease-carrying insects, as well as keeping out these pests.

Screened porches are real money makers for builders and there are many such jobs in every community.



WHEN you have a question to ask about building send it to the Correspondence department. The Editor and the readers of the AMERICAN BUILDER are always ready to lend their assistance.

Who Gets the Business?

The contractor who recommends the best article usually gets the best jobs. The contractor who does not is usually idle or looking for business.

The King System of Ventilation "makes good barns better," satisfies the owner, and advertises the man who built the barns.

Recommend the King Systems for the barns you build. If your customer doesn't want the complete King System, suggest that he put the King Aerator on the roof. It is the first unit of the King System. It is used by many farmers simply to beautify their buildings. The other units can be installed later.

Write for our book on the King System.

KING VENTILATING COMPANY
1202 Cedar Street, Owatonna, Minn.
Ventilating Engineers for Farm Buildings
and Creameries

KING Aerators



The King Aerator is the first part of the King System and can be used with or without the other parts of the system on any farm building, new or old. Because of its unusual beauty many farmers put the King Aerator on their barns simply to beautify the buildings.



Unless the ventilating system bears this diamond King trade-mark it is not a King System



Dickey Flashing Block

The ideal fastening for prepared roofing. Allows roofing material to expand and contract without cracking or breaking.

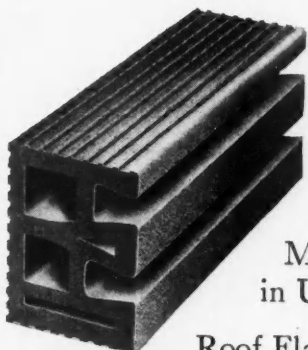

Size 4" x 5½" x 12"

Metal Flashing Anchored in Upper Groove.

Roof Flashing tucked in, but not fastened in Lower Groove.

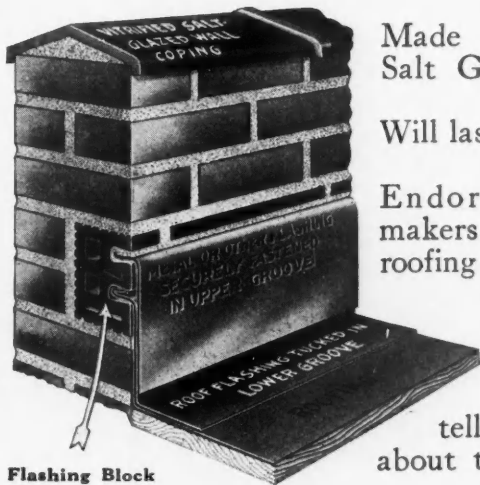

Flashing Block

Made of Vitrified Salt Glazed Clay.

Will last forever.

Endorsed by all makers of prepared roofing who have used them.

Let us tell you more about this block.

Dickey Vitrified Salt Glazed WALL COPING

Keeps the moisture out of the mortar joints at the top of the wall.

Gives the wall a finished appearance.

Why build an expensive wall and then leave it unprotected.

DICKEY VITRIFIED SALT GLAZED COPING is made in 9", 13" and 18" sizes.

Will not deteriorate like other material.



Double Slant Straight Coping



Starter



Closed End

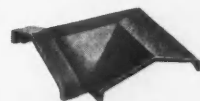

Right Corner

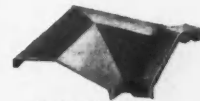

Left Corner

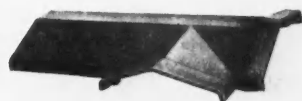

Tee

Dickey Fire Clay Flue Lining

No fires from Defective Flues where this lining is used.

Gives the Chimney a smooth interior. Soot will not collect. Makes better drafts.

All of the better building codes include Fire Clay Flue Lining.

Made also with openings for pipes and registers.

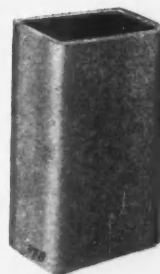

Straight Flue Lining

Dickey Windguard Chimney Tops (Plain or Fancy)

Made in nine different styles. Helps the Chimney and gives it a finished appearance.



On the left an unlined Chimney with the customary crack. These are the Chimneys which cause fires. On the right a properly built Chimney, protected with Dickey Fire Clay Flue Lining. Note the attractive and finished appearance the Tops give this Chimney.

We Have Been Making Clay Products Since 1885. DICKEY VITRIFIED SALT GLAZED CLAY PRODUCTS Will Give You the Maximum Service at the Minimum Cost

W. S. DICKEY CLAY MFG. CO., Dept. C.

Kansas City, Mo.

Macomb, Ill.

Chattanooga, Tenn.

San Antonio, Texas

MOTOR TRUCKS IN THE BUILDING INDUSTRY



Special Trailer for Lumber Loads

TRUCKS equipped with trailers and semi-trailers have been proven to be the best economical means of handling loads of lumber—the truck because it has speed and a much greater carrying capacity than a wagon; the trailer and semi-trailer because they enlarge the capacity of a truck. With this sort of an equipment, lumber dealers can save much of their trucking expense.

However, since the trucks, trailers and semi-trailers came into general use in the lumber industry many improvements have been made. These are designed to make the work of handling lumber easier and quicker. Here is pictured a new semi-trailer with a quick lumber unloading device. The one illustration shows the lumber about to be unloaded. The other with the load half off the semi-trailer.

The construction of this semi-trailer and the unloading device are simple. Each side of the semi-

trailer has a steel track. On this track roll two bolsters, each equipped with small roller wheels. There is a large roller at the rear of the chassis. A crank is attached to this roller, and as it is turned the bolsters slide toward the rear of the truck. This carries the entire load until the first bolster comes in contact with

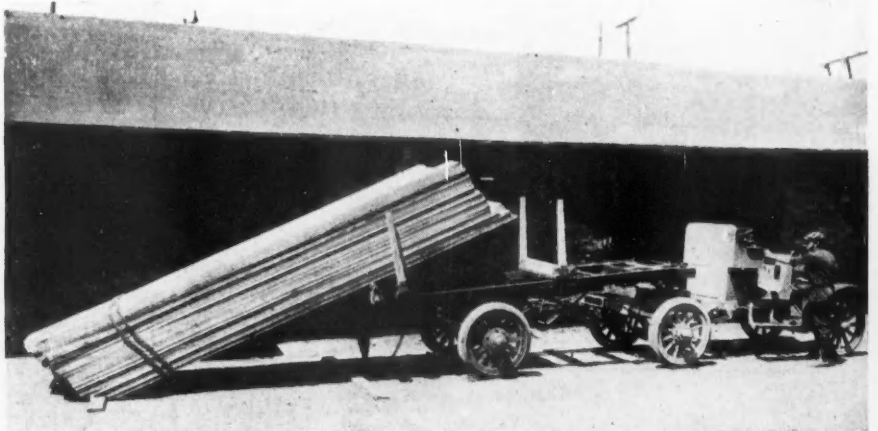

As the Load Gets Off Center at the Rear of This "King" Semi-Trailer, It Drops to the Ground of Its Own Weight. The Outfit Then Is Slowly Driven from Underneath It.

the rear roller. Then a few more turns and the load falls to the ground, as is shown in one of the illustrations. When the load is half off, the truck and semi-trailer are moved slowly ahead and the lumber drops to the ground.

An added feature of this semi-trailer is the standard, or support that is shown underneath the rear of the body. When unloading is being done the standard is dropped to the ground and relieves the trailer springs from the weight of the load. Thus is the structure of the truck protected from strains. As the semi-trailer is driven out from under the load, the standard slides along the ground on its

(Continued to page 118)

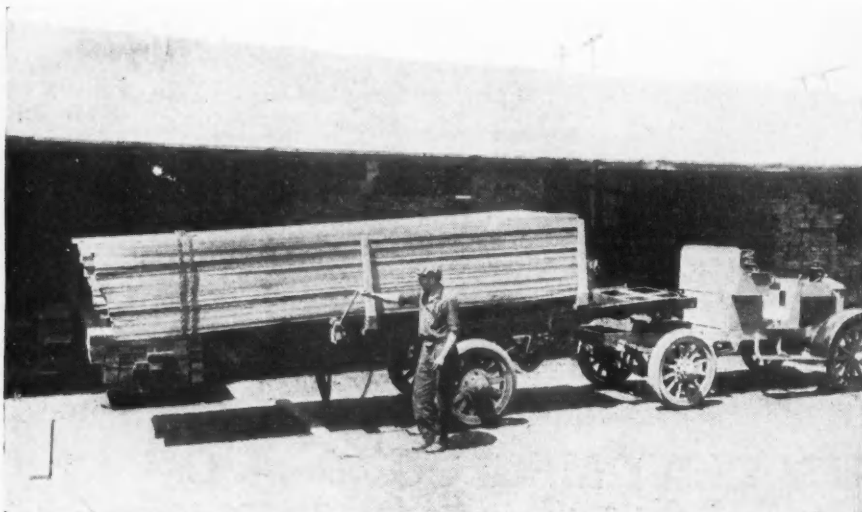

To Unload This "King" Semi-Trailer, the Driver Merely Turns a Crank and the Load Is Drawn Toward the Rear of the Chassis.

-and SEATTLE endorses Republic Trucks

Seattle probably has more miles of steep grades than any other city in America. The constant up-hill grind is trying on motor trucks.

But it is in the face of such obstacles that Republic quality shows itself most significantly.

Frye & Company, well-known packers, bought their first Republic several years ago and have steadily added more until they now have eleven. They say: "The satisfactory service which our first Republic Truck gave us has been duplicated by every Republic we own."

Cudahy Packing Company operate 15 Republic Trucks. They say: "Our Republic Trucks are the most satisfactory trucks which we have in service."

E. B. Holmes Lumber & Fuel Company say: "Our hauling problem is a difficult one, but Republics have solved it absolutely, handling overloads of heavy materials economically over all sorts of roads."

Whiz Fish Company have used Republic Trucks

for four years and they say: "The first Republic we bought is still working perfectly. As our business has expanded we have added more and expect eventually to use nothing but Republics."

From practically every Seattle user have come similar expressions of approval. They are buying more Republics whenever they add to their fleets. The number of Republics in Seattle is growing at a rate that is significant to the truck buyer who seeks an answer to the question of the best truck to buy.

Not only in Seattle but wherever trucks are used you will find Republic performance emphatically endorsed by the repeat orders for Republic Trucks which owners consistently continue to place.

More than 1400 Republic Service Stations, so located that every part of the United States is served efficiently, contribute to the satisfaction of Republic Truck users.

REPUBLIC MOTOR TRUCK CO., INC.
Alma, Michigan

The "Yellow Chassis" Trucks—that serve so well

Republic Special, with body.....	\$1295	Model 12: 2 Ton, chassis.....	\$2275
Model 10: 1 Ton, with Express body...	1535	Model 19: 2-2½ Ton, chassis.....	2395
Model 11: 1½ Ton, chassis.....	1885	Model 20: 3½ Ton, chassis.....	3450

All Prices F. O. B. Alma, Michigan

Some Seattle Users of Republic Trucks

- Pacific Telephone & Telegraph Co.
- The Renton Hill Fuel Co.
- The Pioneer Transfer Co.
- Standard Oil Co.
- Western Coöperage Co.
- The Erickson Eng. Co.
- L. B. Peck Fuel Co.
- Elyvester Bros. Co.
- South Park Lumber Co.
- Washington Fish & Oyster Co., Inc.
- Main Fish Co., Inc.
- A. Magnano Co.
- Italian Importing Co.
- Puget Sound Traction Light & Power Co.
- T. G. Fox & Co.
- Frye & Company
- Standard Confee. Co.
- The H. F. Norton Co.
- Parisian Chocolate Co.
- Wet Wash Laundry, Inc.
- Fobes Supply Co.
- Green Lake Transfer Co.
- Elliott Bay Mill Co.
- H. Latter & Co.
- Leschi Dairy Co.
- Blackstock Lumber Co.
- E. B. Holmes Lumber Co.
- Occident Lumber & Timber Co.
- Pacific Door & Mfg. Co.
- Coast Conserve Co.
- Oriental Express Co.
- South Seattle Tallow Co.
- Three Girls Bakery
- The Togo Company
- West Seattle Dairy
- Smith & Bloxom
- Paper Warehouse Co.
- Schwabacher Hdw. Co.
- Barrett Company
- Enterprise Furniture Co.
- Gray Bros.
- St. Marie Fuel Co.
- Rovig Lumber Co.
- Rainier Junk Co.

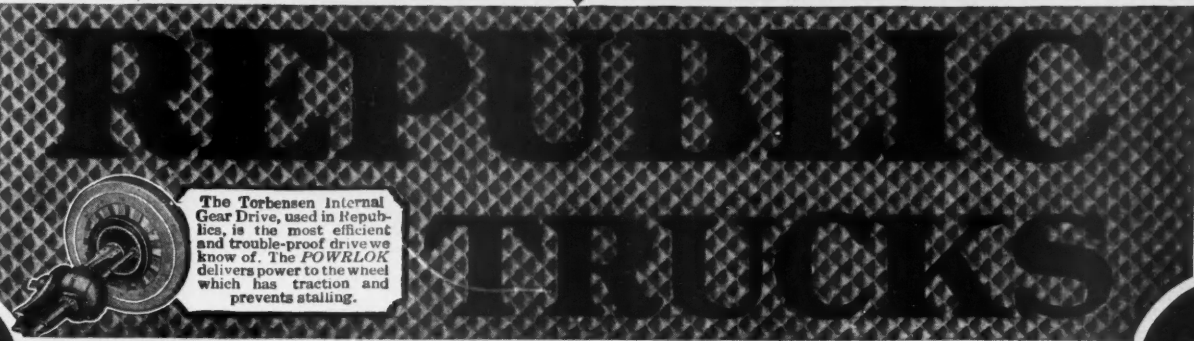
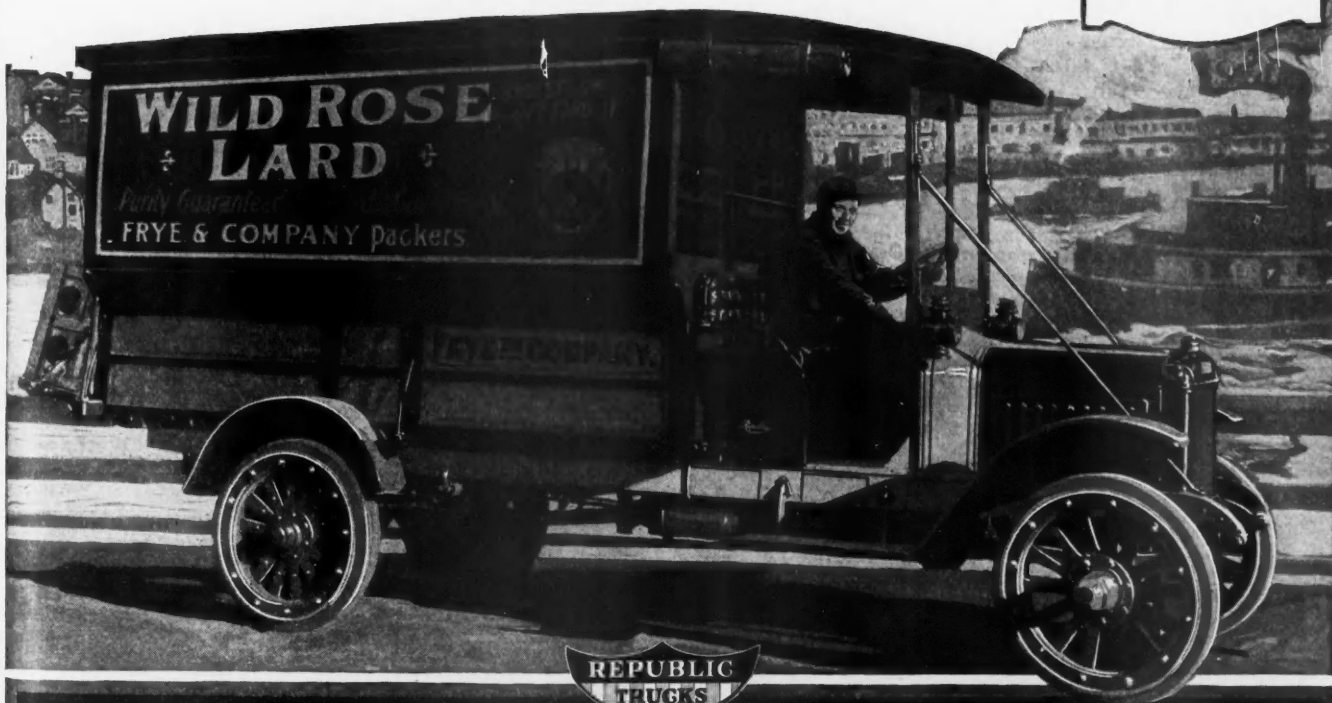

The Torbensen Internal Gear Drive, used in Republics, is the most efficient and trouble-proof drive we know of. The POWLOK delivers power to the wheel which has traction and prevents stalling.

Built by the Largest Manufacturers of Motor Trucks in the World

WHEN WRITING ADVERTISERS PLEASE MENTION THE AMERICAN BUILDER

KISSEL TRUCKS

In 1918 Production was the Question of the day
In 1919 Distribution is the Problem of the day

TO meet the unusual demands now being made on motor trucks in the Building business, it was necessary for Kissel to arrive at the proper combination of moving and fixed units, together with structural and mechanical features, tested and counter-tested through eleven years' experience in motor truck designing and construction.

RESULT—Well balanced power transmission from motor to rear tires—good performance on levels and grades and a low fuel consumption.

Every Kissel Truck dealer is virtually a transportation expert. Every business house in his territory with transportation problems to solve is a logical and nine times out of ten an ultimate Kissel owner.

This ability to properly select and combine the governing factors in design has been applied to the entire line of Kissel Truck Models. Specifications and 1919 catalogue may be had at the nearest Kissel Truck headquarters or direct from the factory.

KISSEL MOTOR CAR CO , Hartford, Wis., U. S. A.



WHEN WRITING ADVERTISERS PLEASE MENTION THE AMERICAN BUILDER

Special Trailer for Lumber Loads

(Continued from page 116.)

curved shoe until the trailer is free. Then the standard is hooked up underneath again.

It is estimated that two men spend at least three-quarters of an hour unloading such a semi-trailer as is here shown. With the lumber unloading device, one can do the same amount of work in two minutes. This is a considerable saving in labor alone.



Trucks On the Building Job

OUT in California they have a strong liking for permanent construction, especially in San Francisco. The builders go on the principle that there is



The R. C. Storrie Co., San Francisco, Cal., Used Four "White" Trucks in Hauling the Materials for This Building. Trucks Handle Heavy Materials Easily and Economically.

no telling when another "fire," such as struck that city some fifteen years ago, will come and they want to be prepared. Consequently, a great deal of the new construction is of concrete, with stucco exteriors.

The accompanying illustration shows such a building in its almost completed state, erected by the R. C. Storrie Co., San Francisco. Hauling the heavy materials that went into this building, which, it will be seen, is in the outskirts of the city, was considerable of a task, but the Storrie company has a fleet of four trucks with dump bodies, which made the hauling operations comparatively simple.

Building contractors, who handle heavy materials, and material dealers both find motor trucks the most economical means of conveying building materials to the job. They have speed and power and are capable of carrying heavy loads. The cost of operation, when the amount of work they will accomplish is taken into consideration, is considerably lower than when horses and wagons are used.

(Continued to page 120.)

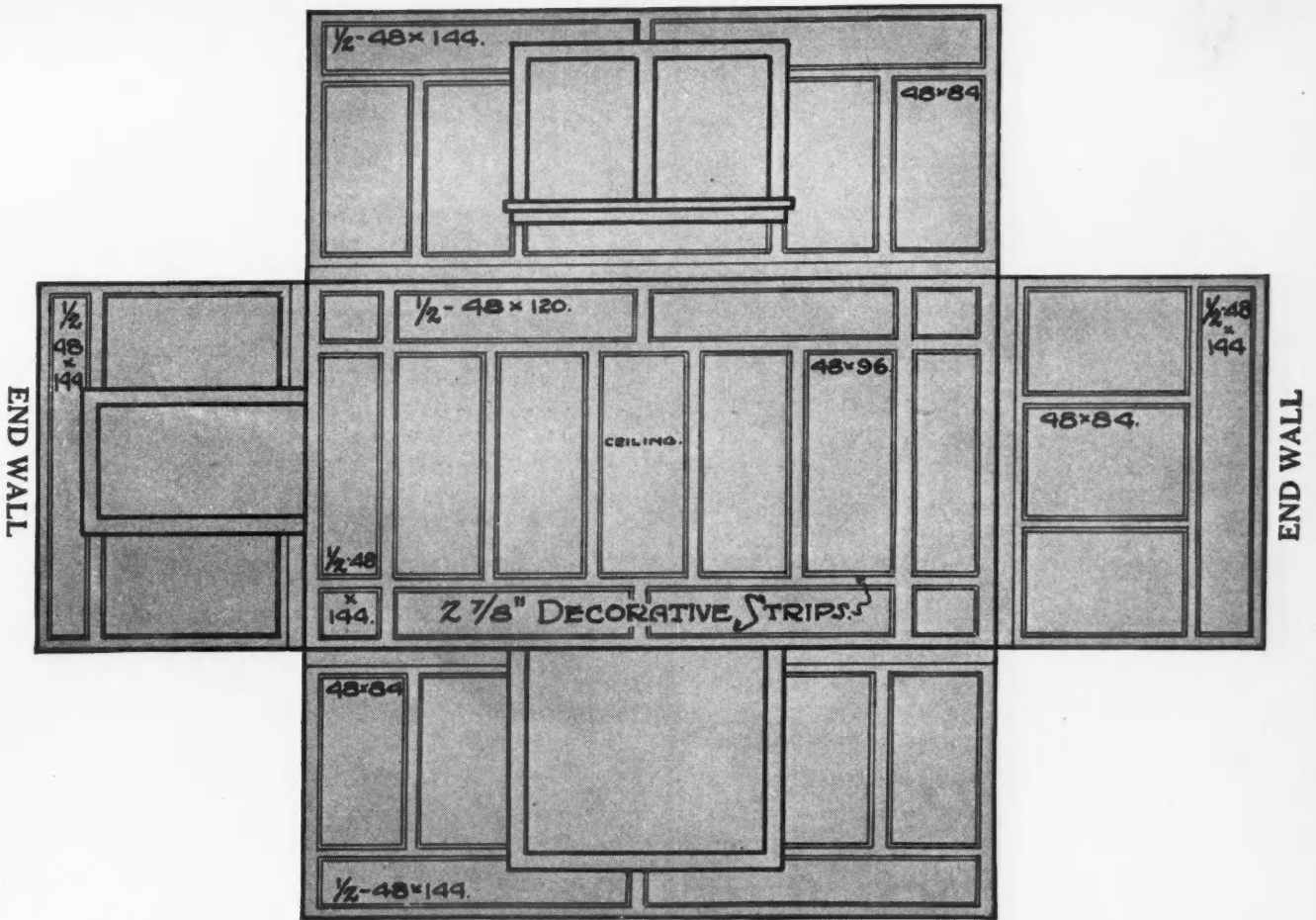

SIDE WALL

An example of Black Rock Plan Service. Send us rough charts for each room, showing sizes and locations of doors, windows, etc., with room dimensions, and attractive suggestions will be sent you promptly.

The First Step Towards a Profitable Wallboard Job

Use our free Plan Service and you will not only get the advantage of years of study by experts, but it will help you get that variety in your work which means repeat business.

Our designers submit blueprints of complete jobs, whether for whole houses, theatres, stores, or for the building of a single room in the attic.

Send us a rough sketch show-

ing dimensions of walls and ceilings, locations of doors, windows and their sizes, etc., and we'll suggest color schemes and decorative effects to harmonize to best advantage. Special charts sent on request to assist you.

Black Rock Wallboard is the only wallboard with the moisture-repellant black center, and is surface-sealed and sized as well.

Let us give you the name of the Black Rock dealer in your vicinity. He is a good man to know.

THE BLACK ROCK WALLBOARD COMPANY
67 Ontario Street Buffalo, New York

Dealers—Write for details of our exclusive sales plan.



BLACK ROCK WALLBOARD

BLACK CENTER

WHEN WRITING ADVERTISERS PLEASE MENTION THE AMERICAN BUILDER



Let us send you portfolio of wood panels

free. With it you can show your clients just how their woodwork and floors will look when finished with Johnson's Wood Dye, Prepared Wax, Under-Lac, Flat Wood Finish, etc.

In this portfolio the Johnson finishes are shown on all popular woods—panels of other woods sent on request. The portfolio also gives full specifications and instructions, as well as covering capacities. Any good painter can successfully use Johnson's Artistic Wood finish.

JOHNSON'S WOOD DYE

is a dye in every sense of the word—it is made in twelve different shades—it goes on easily and quickly without a lap or streak—and it is put up in glass jars so there is no possibility of color changing.

We will also be glad to send you free a copy of our booklet, "The Proper Treatment for Floors, Woodwork and Furniture." It is full of valuable ideas and information for any one interested in the proper finishing of wood. Its practical suggestions may mean money to you.

Use attached coupon

S. C. JOHNSON & SON
 "The Wood Finishing Authorities"
 RACINE, WISCONSIN

Coupon

S. C. JOHNSON & SON
 "The Wood Finishing Authorities"
 Racine, Wis.

Please send me free and postpaid your portfolio of wood panels and booklet, "The Proper Treatment for Floors, Woodwork and Furniture."

Name

Address

I buy from
 S. C. JOHNSON & SON, Dept. AB5, Racine, Wis.

Trucks on the Building Job

(Continued from page 118.)

These facts have made trucks popular with contractors and material dealers and new trucks are daily being placed in commission for this work.



How Retail Lumber Dealers Save Hauling Expense

PRACTICALLY everything sold by retail lumber and building material dealers is delivered to the job. That expense is a part of making the sale and, of course, must be figured into the price charged. Taking this fact into consideration, it is apparent that



B. Brady, Buffalo, N. Y., Lumber Dealer, Finds This Two-Ton "Acme" Truck Valuable in Delivering Lumber. Its Speed Gets the Lumber to the Building Job Quickly and Economically.

the dealer who can deliver his materials at the least expense will be able to make the most profit.

Experience in delivering building materials of all kinds has taught the progressive men in the business that the motor trucks cut this overhead expense. A truck is loaded as quickly as a wagon. A truck, because of its speed and ability to travel over or thru bad roads, gets the load to its destination more quickly than a horse drawn vehicle. And many of the trucks now have special bodies to make the unloading of lumber and other building materials easy.

However, it is in the delivery of small loads that the truck is a great money saver. Herewith is shown the two-ton truck operated by B. Brady, a lumber dealer at Buffalo, N. Y. This truck, fitted with a special body, gets small loads of materials to the job in about the same time it would take a team to travel a quarter of the distance. This saves the time of the driver, which, in these days of high wages, is no small item.



Hauling Tile and Heavy Building Materials

TEN tons of hollow building tile is considerable of a load, but that is what is being carried by the heavy-duty trailer shown attached to a truck in the accompanying illustration. This is a five-ton truck

(Continued to page 122.)

Model 1-D Portable Drill

\$45⁰⁰

Complete
with
10-foot
Cord



HANDY—ECONOMICAL—EFFICIENT

Specifications:

Length—10 inches.

Weight—4¾ pounds.

Capacity—Steel, 0 to ⅜". Wood and alloys, 0 to ⅜".

Motor—Universal, on either direct or alternating current.

Diameter of Motor—3⅜ inches.

Spindle—Offset from center ⅜".

Helical Gears.

Aluminum Handle.

Complete with 10-ft. cord, plug, switch and chuck.

Jacob's Chucks used as a regular equipment.

FOR speed in drilling and counter-sinking small holes, this tool is just what you need. It can be used on any kind of material—steel, iron, brass, aluminum or wood—and gives lasting service.

If your dealer cannot supply you with the Model 1-D, tell us about your requirements.

Wisconsin Electric Company
6711 Sixteenth Street, Racine, Wisconsin, U. S. A.

DUMORE GEARED ELECTRIC DRILLS

Hauling Tile and Heavy Materials

(Continued from page 120)

with a ten-ton trailer, operated by the Delta Brick & Tile Co., Detroit, Mich. This company has five such outfits of this to haul tile and brick to its Detroit customers.

What a revolution the motor truck made in the hauling of heavy building materials is a matter of history. It was only a few years ago that wagon loads of a ton or a little more of materials was a good one, and then it required considerable time to get the load to its destination. Then along came the motor truck, which would speedily carry as many as five tons. The trailer, such as is shown herewith, has doubled the capacity of the five-ton truck.

The building industry was one of the first to recognize the value of motor trucks as means to haul materials and equipment. And the building industry has taken to the trailers as another efficient method of doing the heavy work required of the hauling equipment. The value of a trailer lies in the fact that a truck can pull a great deal more than it can carry with the same amount of power. Then, too, by the



There Are Ten Tons of Bricks on This "Fruehauf" Trailer, Attached to a Five-Ton "Packard" Truck, Owned and Operated by the Delta Brick & Tile Co., Detroit, Mich.

use of two trailers one can be left for loading or unloading, while the other is being hauled to its destination, thus keeping the truck busy and cutting down the overhead expense.



Small Trailers Handy for Hauling

FEW lumber dealers and still fewer contractors and builders now do not own automobiles. The very

(Continued to page 124.)

"Ideal"—In Fact as in Name



"Ideal" elevator door hangers run easily and noiselessly. Bearings protected from dust and dirt. Regularly made for single doors, two-speed doors, three-speed and combination elevator doors; doors in pairs.

"Ideal" Automatic Door Closer and "Ideal" Automatic Checking Device eliminate slamming, prevent accidents, and assist operator.

Specific information and prices furnished without obligation. Write for illustrated book, "Richards-Wilcox Ideal Elevator Door Equipment and Checking Devices"

Richards-Wilcox Manufacturing Co.

SAN FRANCISCO
LOS ANGELES
NEW YORK
CHICAGO

AURORA, ILLINOIS, U.S.A.

Richards-Wilcox Canadian Co., Ltd., London, Ont.

"A hanger for any door that slides"

PHILADELPHIA
MINNEAPOLIS
BOSTON
ST. LOUIS

Homes of Hollow Building Tile Cost Only About Thirty Per Cent More Than Pre-War Construction

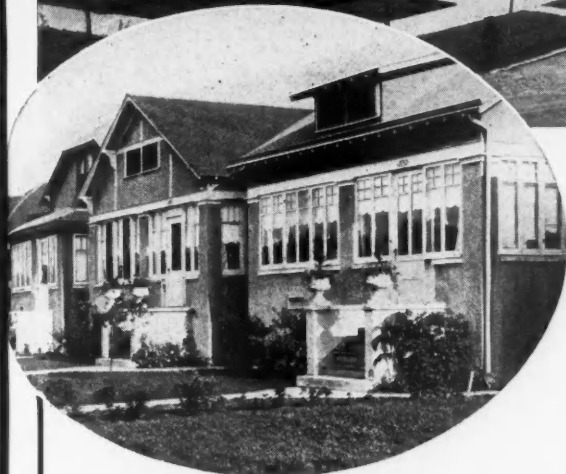

IN 1914, Neils Buck, one of Chicago's pioneer architects and builders, designed and built this group of fifty, four and five room bungalows of Hollow Tile on the exclusive "North Side", and sold them at a profit for forty-five and fifty-five hundred dollars, including all plumbing, hot water heat and electric lighting fixtures.

It was Mr. Buck's first experience with Hollow Tile. He was so well pleased with it and it gave the people who purchased these little homes so much real home comfort and economy that he has built exclusively of tile ever since.

Mr. Buck is now building another group of these bungalows in the same part of the city. He says that the people who bought the little homes shown on this page are so well pleased with them that they are already telling their friends about the new ones he is building and that he expects to sell all of them in this way without an effort whatever.

These Beautiful Little Hollow Tile Bungalows Built in 1914

WHEN Mr. Buck designed and built these bungalows in 1914 he did not know a great deal about Hollow Tile construction, but being a man of wide building experience he thought he saw many advantages to be gained through

They Are Being Duplicated NOW at About a 30% Increase in Cost by the Same Contractor

MR. BUCK'S first experience with tile was so highly satisfactory that he immediately planned more of these attractive little homes, but the war came on and further building was restricted.

He is now starting another group and finds that they are not going to cost over thirty per cent more than they did

its use in producing a home that would be inexpensive but attractive, permanent, warmer in winter with less fuel required, cooler in summer because of the dead air spaces in the tile, and with less up-keep cost for repairs and paint.

in 1914, which should be of interest to every contractor who is confronted with a building public believing that building costs have doubled in the last four years.

If you want to know more about Mr. Buck's Hollow Tile costs, use the coupon below.

Finds Many Advantages Over Frame

WE HAVE talked to many of the people who purchased and now live in these homes—people who had always lived in frame houses before, and they say, without hesitation, that they are far more comfortable, both summer and winter, require absolutely no up-keep

expense, easily and inexpensively heated and take a very low insurance rate.

The stucco has never cracked on any of these bungalows and never will—Hollow Tile cannot shrink.

The Hollow Building Tile Association

Use This Coupon and Get More Information About These Bungalows

The Hollow Building Tile Association
1409 Conway Building, Chicago, Ill.

Gentlemen: I would like to have further information about the Hollow Tile Bungalows shown in your advertisement in the May issue of The American Builder. I am planning to build the following buildings in frame (give sizes and number of stories) but would like to know how to use Hollow Tile instead, if the cost is about the same.

Your Name

Your Business

Your Town

Your State



Yesterday The thought of acquiring a bright trade-winning storefront usually brought with it the impression that the cost would necessarily be exceedingly high if in fact not prohibitive.

Even before the war many merchants considered the Copper Front beyond their reach, largely because they had failed to investigate *Brasco*.

Today With the ascendancy of *Brasco*, the sturdy yet thoroughly practical and economical construction, a gradual change is taking place. Elaborate layout and unnecessary embellishment adds little to the trade-pulling power of the front but cost.

For those seeking real storefront value through rich harmonious architectural lines, true simplicity and economy, the one big word is

Brasco

For your own interest and clients' benefit write it into your contract.

Brasco Manufacturing Co.
5029 Wabash Ave.
Chicago

Brasco Mfg. Co., Chicago

Please forward Special Store Front Book No. 24, and oblige.

Name.....

Town.....State.....

Business.....

Small Trailers Handy for Hauling

(Continued from page 122.)

nature of their business makes the automobile almost a necessary part of their equipment. When the contractor has more than one job in progress, he must be able to get from one to another in quick time; the lumber dealer has much the same need for an automobile.

Besides using automobiles to carry themselves and

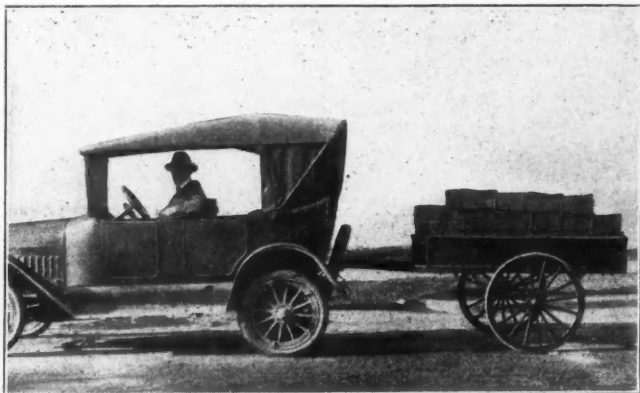

This Shows How a Retail Lumber Dealer Makes All His Small Deliveries and Some of His Large Ones with a "Jackson" Two-Wheeled Trailer Attached to His "Maxwell" Automobile.

their men, contractors very often need to haul small quantities of materials and equipment. Putting these things in the back part of the body of the automobile is a common method, but lack of space prevents carrying any amount of them. Also, they are apt to damage the machine and the upholstery.

Here is where a small trailer is most useful. It can be quickly attached to the rear axle of the automobile and will carry a considerable load.

In the accompanying illustrations there are shown how a contractor and builder and a lumber dealer use a two-wheeled trailer in connection with their automobiles. One shows a trailer loaded with materials and equipment the contractor is using on a house building job. The other shows a retail lumber dealer delivering a number of bundles of shingles.

The trailer here shown is small and inexpensive, but it does the work it is capable of in an efficient manner.

(Continued to page 126.)

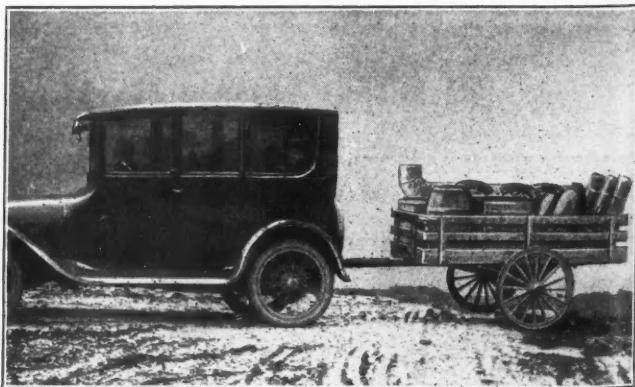

How a Contractor and Builder Hauls Materials and Tools to the Building Job with a "Jackson" Two-Wheeled Trailer Attached to His Dodge Limosine.

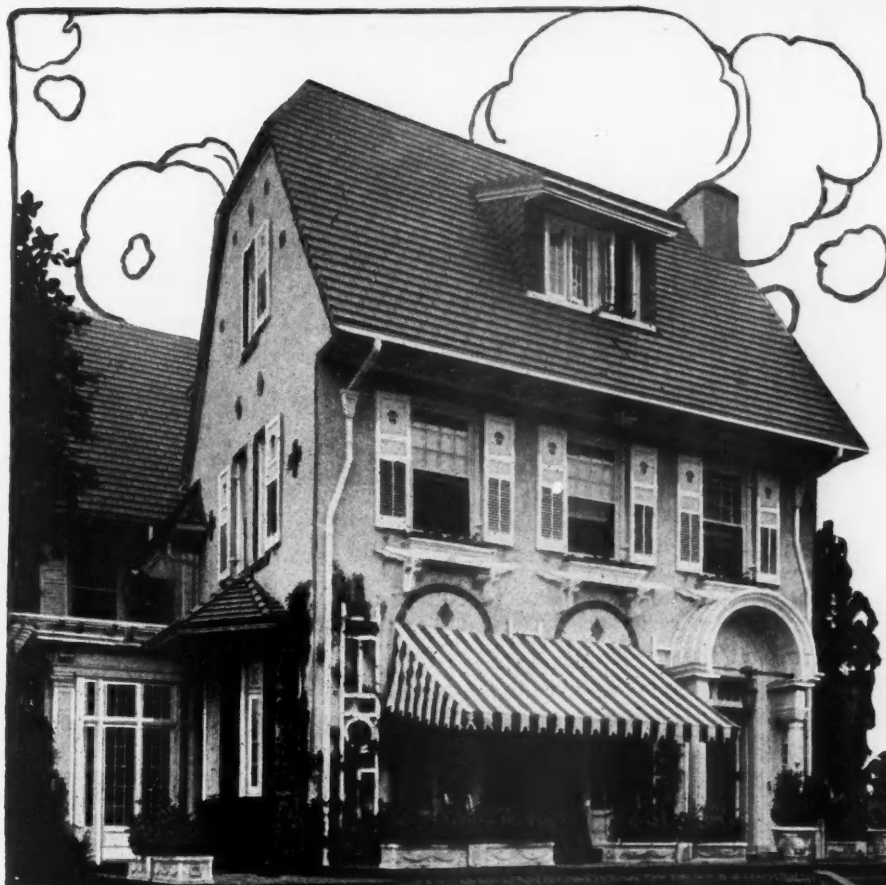

This House Sold Ten Others

Here is a KELLASTONE house which created \$87,000 in business for the contractor who built it. Yes, sir! This one house sold ten others.

It's the same old story—get one KELLASTONE job finished and you then and there strike a responsive chord with every home builder.

In KELLASTONE you have the real fulfillment of the home beautiful—a building material which instantly appeals to the present generation of particular home owners. When it comes to essential qualifications KELLASTONE possesses every cardinal selling argument that is necessary to clinch the sale.

KELLASTONE IMPERISHABLE STUCCO

Is a scientifically balanced composition which doesn't contain a particle of gypsum, lime or portland cement. Unlike ordinary stucco, it does not contract, chip or crack. It sets as hard as granite—not affected by wear or weather—a perfect insulator—always maintains its original brilliancy.

Learn the truth about KELLASTONE—hear about our 1919 advertising campaign that is making history in the building world. Join us now and cash in on our broad sweeping co-operative efforts. Send for full particulars—meet us half way and we will unfold a story that will more than meet your expectations.

NATIONAL KELLASTONE CO.

1315 Mallers Building

Chicago, Illinois

Small Trailers Handy for Hauling

(Continued from page 124)

The body of the contractor's trailer is 42 inches wide, 70 inches long and 11 inches deep. It has a capacity of 800 pounds. This trailer will stand much hard usage; it will carry light or heavy loads and will track perfectly with the rear of the car. The excess power of the automobile thus is used to advantage.



Trucks Help Build Road for Themselves

PRACTICALLY every state now is going ahead with its program of building good roads, and contractors who specialize in road construction have a busy year ahead of them. Road building requires considerable equipment, such as concrete mixers, scrapers and water pumps. But one of the prime essentials is the motor truck, which is one of the power-driven vehicles that has prompt progress in road construction.

Thru the nature of the work and its location, road building requires long hauls of heavy materials. And nothing is so suited to this work as the motor truck.



Louis Hoffman, Contractor, Hauled 33 Yards of Crushed Stone Daily Four and One-half Miles to This Road-Building Job, at Belgium, Wis., with This 3½-Ton Acme Truck.

The accompanying illustration shows a truck delivering crushed stone to a road-building job near Belgium, Wis. Louis Hoffman, the contractor on the job, says this truck daily hauled thirty-three yards of crushed stone four and one-half miles from the source of supply and dumped it in place on the road, replacing seven teams and six men that would have been required to perform the same amount of service.

It is such performances as this that has made the

(Continued to page 128.)

CONTRACTORS - BUILDERS - CARPENTERS DO YOUR OWN PLUMBING-HEATING

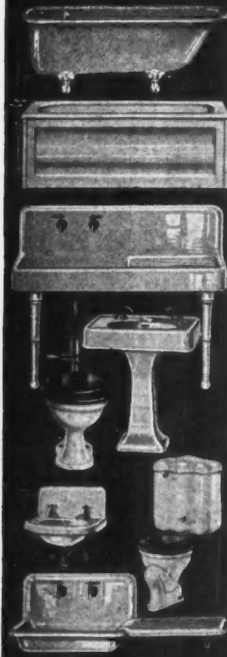

Free Handy Man Book

we will mail you one. Besides being our wholesale catalog, this able, instructive Handy Man Book also contains many pages of plans, elevations, diagrams, etc. It gives many suggestions of what fixtures to select and how to install them, etc. Shows how to save unnecessary material, hard labor and time by doing your plumbing and heating this new original

Cut to Fit Method This new way enables any contractor with a few tools to install a complete plumbing, water supply, hot water, air or steam plant at low cost.

We furnish a special contractor's and builder's wholesale discount sheet applying to this big book.

Water Supply Systems Our new electric, gasoline or hand operated water supply systems are up to the minute. Write us just what you have in mind.

Our Handy Man book describes over 10,000 different plumbing and heating fixtures and supplies, including plumbing outfits, water supply systems, warm air, hot water and steam heating plants and everything else pertaining to plumbing and heating supplies exclusively. Write today and save.

Hardin-Lavin Co.

\$500,000 Plants Behind Our Guarantee

40 Years at

4522-34F Cottage Grove Avenue, Chicago

A copy should be in the hands of every contractor, builder, carpenter and mechanic. Send the coupon to us and big, valuable, practical

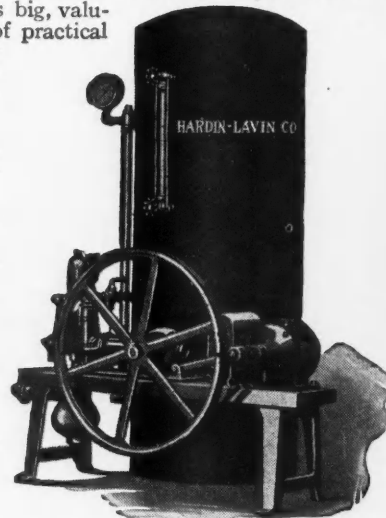

Hardin-Lavin Water Supply System

Power on Wheels

Novo Engines and Outfits are Reliable, first of all. They are also simple in operation, efficient, economical. And—a point of great importance to most contractors today—they furnish Portable Power. Being light, compact, self-contained, a Novo Engine or Outfit can be easily and quickly put to work wherever power is needed.

The accompanying photograph shows a Novo D. H. Hoist at work on a pier which is being built for the Government by Snare & Triest Company, Contractors, at Greenwich Point, Philadelphia. Like many other Novo Outfits used by these contractors, the hoist is mounted on wheels, for convenience in moving it from place to place.

Novo Hoisting Outfits are made for every kind of lifting and hauling, in construction work, mining, lumbering, pile-driving, excavating, grading, conveying, etc. Write for Bulletin No. 11—it will tell you all about our complete line of hoists.

NOVO ENGINE CO.

Clarence E. Bement, Vice-Pres. & Gen. Mgr.
888 Porter Street, Lansing, Mich.

New York: 1617 Woolworth Building Chicago: 800 Old Colony Building

Canadian Distributors

London Concrete Machinery Co., London, Ontario

NOVO

RELIABLE
POWER

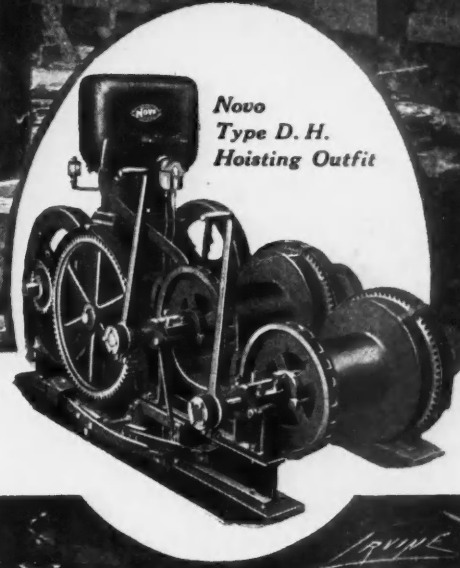
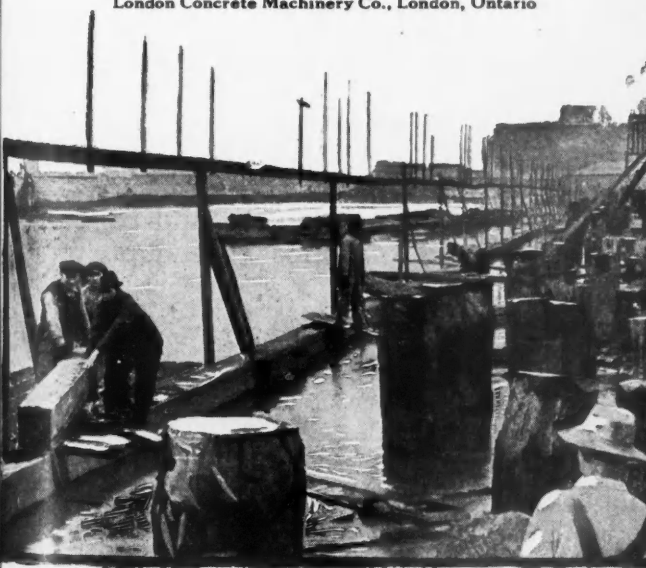
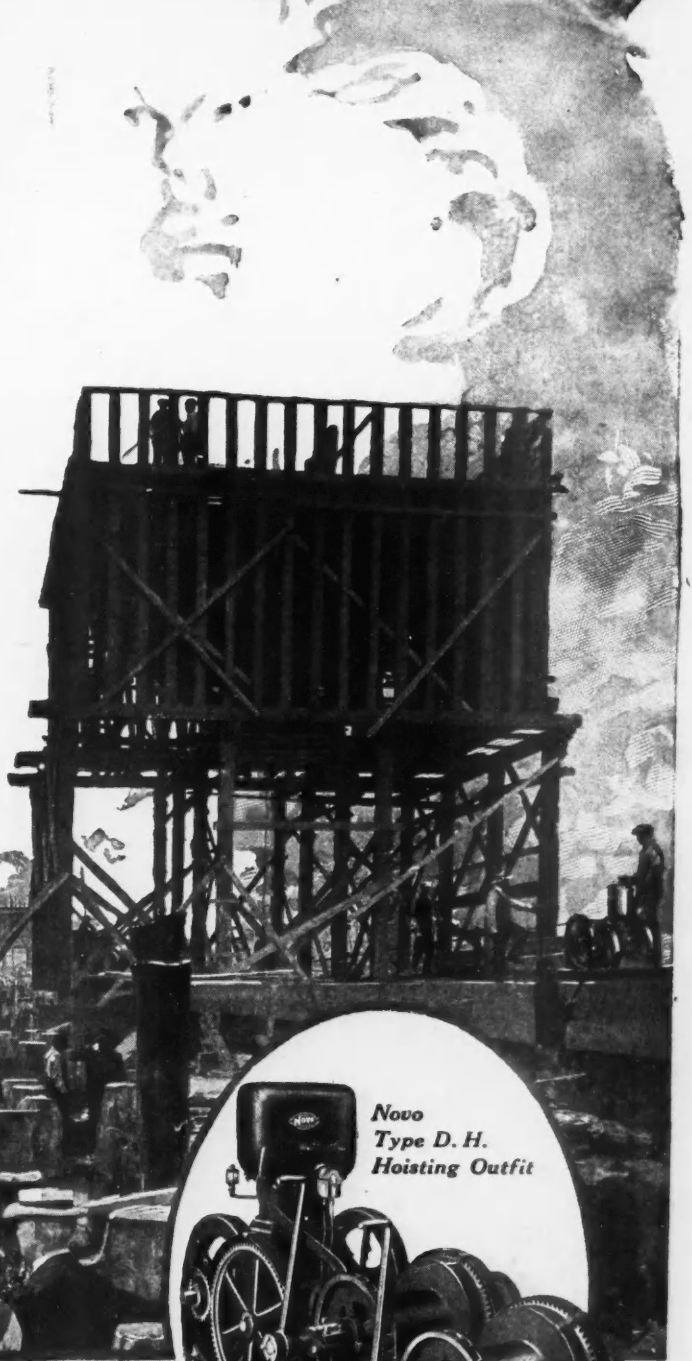

Novo
Type D. H.
Hoisting Outfit

Novo Engines, 1½ to 15 H. P. Outfits for Hoisting, Pumping, Air Compressing, Sawing. Furnished to operate on gasoline, kerosene, natural or artificial gas. Catalog showing complete line sent on request.

Trucks Help Build Road for Themselves

(Continued from page 126.)

motor truck exceptionally valuable to the building industry. The materials used in building of all kinds is heavy and bulky. The small capacity of a wagon when compared with a truck makes the use of the former an expensive proposition, now that other means are available.

There will be several thousand miles of road construction begun this season, and much of it will be finished before next fall. Thus will the motor trucks aid in constructing that which will make them more valuable to the public. It is only the limitations of the roads that have put limits on the usefulness of trucks, a large percentage of which now are operated only in the cities. As this situation is remedied, the building industry will profit.



Motor Truck Dump Bodies Earn Big Dividends

DUMP bodies, operated by the engine, have gone a long way toward winning favor for auto trucks with building contractors and material dealers. These bodies and the hoisting device are not expensive when compared with the amount of work they do and in less than a year pay for themselves in the saving of labor.

When the driver of a truck can in about ten min-

utes dump a load of five or six tons of crushed stone, sand or lime, there is a large saving in labor, not to consider the loss that is caused when the truck is idle while men with shovels are unloading it.

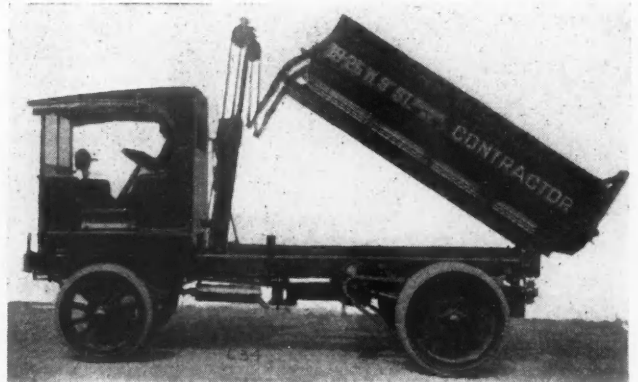

John Muldoon, Building Contractor, Brooklyn, N. Y., Uses This Six-Ton "Garford" Truck in Hauling Building Materials. The Dump Body Saves the Labor of One or More Men in Unloading the Truck.

John Muldoon, a Brooklyn, N. Y., contractor, uses such trucks and has found that they increase his profits greatly. The driver takes the truck to the exact spot the material is needed and, without leaving his seat, connects the hoist with the motor and in two minutes the material is deposited on the building job. One of the trucks Mr. Muldoon uses is shown in the accompanying illustration.

Speed, dependability and imperviousness to road

(Continued to page 130.)



Why Not Economize?

Why waste time and money to build scaffolds, of \$50.00 lumber when "Reliable Folding Steel Scaffold Brackets" will pay for themselves, on the first job?—and they are better!—because they are stronger, safer; they fold and carry easily, and require the least possible time to mount, ready for work.

Mr. Contractor:

We are offering you a ten-day trial of these wonderful scaffold brackets; you will find them indispensable money-saving devices, as thousands of users all over the country have; but if for any reason you are dissatisfied, you may return them without cost or obligation.

Write today for particulars.

Elite Manufacturing Company
Ashland, Ohio.

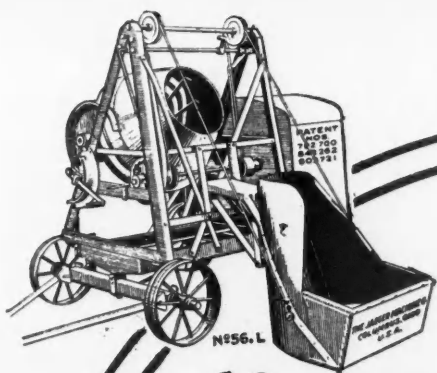

“JAEGER”

for *SPEED*

MECHANICAL PERFECTION

EFFICIENCY

and *ECONOMY*

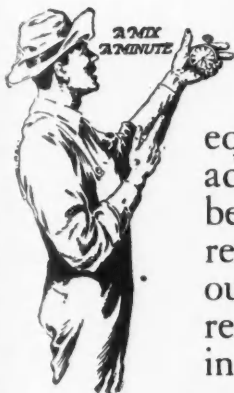
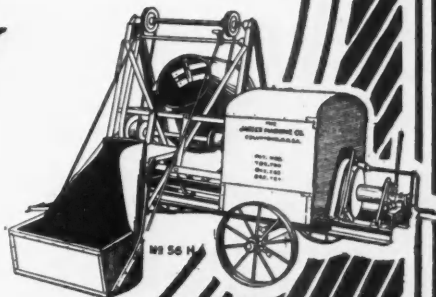
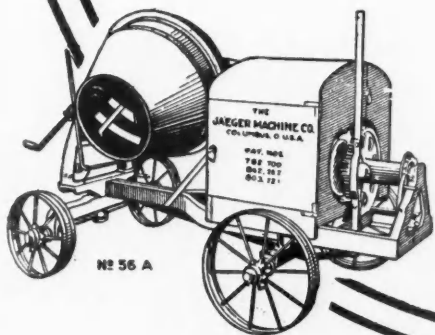

It is a well-known fact among contractors that Jaeger mixers and other equipment possess peculiar advantages that are not to be found elsewhere. The reason is simple—throughout our manufacturing career our efforts have been inspired by a vision of per-

fection. We have taken the contractor's problems to heart, and so by successive improvements we have created and are offering him just the machine he wants.

“The Jaeger Mix-A-Minute”

is made in all sizes to answer every purpose; whether you wish to build a silo or a skyscraper, you will find a “Jaeger” for the job.

Write today for catalogs covering our complete line

The Jaeger Machine Company

521 DUBLIN AVENUE

COLUMBUS, OHIO

WHEN WRITING ADVERTISERS PLEASE MENTION THE AMERICAN BUILDER



Griffin Pressed Steel Door Stops

No. 640

Are drawn into shape from one piece of high quality Cold Rolled Steel making them extra strong—guaranteed **indestructible**.

The rubber bumper is made from the best rubber and is backed up by a metal disc, which in turn is knurled, "ENTRENCHED," in place—and will stand all the "Banging" one can possibly give it, and absolutely cannot work out of place.

Beautiful Yet Plain

Compare this beautiful, plain door stop with the ordinary kind. It is modern and when finished in any of the various Griffin Hardware Finishes, it harmonizes with the beautiful interior finish of the Modern Home or Building.

No sharp edges or corner to cut the hand on, catch the clothes, as the woodwork is dusted. This is the door stop your customer is looking for. Have your Hardware Dealer show them to you.

*Send for complete circulars
and information at once*

The Griffin Mfg. Co.
Erie, Pennsylvania

30 Warren St.
NEW YORK

17 E. Lake St.
CHICAGO

Motor Truck Dump Bodies Earn Big Dividends

(Continued from page 128.)

conditions are three points that make the motor truck valuable in the building industry. Building materials and equipment have to be taken over all sorts of roads and thru all kinds of soil to reach the building site. The high power of the truck engines makes it possible to accomplish this. ❖

The Building Industry and the Victory Loan

THE RETURN to normal conditions in the United States made possible by our participation in the war will benefit no other class of workers more than the builders thruout the coutry. For virtually two years building has been at a standstill, but the signing of the armistice meant the beginning of an unprecedented amount of construction. In gratitude for these conditions, it behooves every builder in the country to subscribe generously to the Victory Loan which now is being offered to the public.

It must be borne in mind that the money subscribed to preceding Loans already has been spent and billions of dollars borrowed by Uncle Sam for the purpose of bringing the war to a victorious close. It is these huge sums which Uncle Sam has pledged his honor to repay and which must be raised by the Victory Loan. This is the primary purpose of the Victory Loan, but there are additional reasons why a complete and speedy subscription must be made. While the United States lost the comparatively small number of 70,000 men in the war, there are still two million American soldiers in Europe with the army of occupation engaged in the enormous task of reconstructing the devastated country. These boys must be supported as long as there is need for their remaining over there and they must be brought home when their big work is completed.

The Best Investment on Earth

The arguments in favor of the Victory Loan bonds as an investment are irrefutable. When you lend your money to Uncle Sam you are assured that you will get it back when it is due, and in the meantime, you will be drawing a good rate of interest. These bonds will be issued May 20, 1919, and will mature May 20, 1923. They bear interest at the rate of 4¾ per cent and are exempt from normal income tax, state or local taxes. At any time they may be converted into 3¾ per cent bonds which are exempt from all taxation with the exception of estate or income taxes. Altho the date of maturity of the Last Liberty Loan—the Victory Loan—bonds is May 20, 1923, they may be redeemed at par with accrued interest on June 15 or December 15, 1922, at the option of the government.

Victory Loan notes may be purchased on the install-

(Continued to page 132.)



Standing alone in the field of building activity you find

“The Standard” Low Charging Mixer

These pictures tell you better than any words, the important part “The Standard” Mixer plays in construction projects (large or small) throughout the entire country.

When you see a big construction job progressing with rapidity and precision—you will generally find that “The Standard” Mixer is on the job.

Write today and ask for Catalog 44. It explains very clearly the advantages—the economy of using “The Standard” Low Charging Mixer. Catalog 44 is yours for the asking. Write today.

THE STANDARD SCALE AND SUPPLY COMPANY

1631 LIBERTY AVENUE, PITTSBURGH, PA.

NEW YORK
145 Chambers Street

CHICAGO
163-171 N. May Street

PHILADELPHIA
523 Arch Street

CLEVELAND
1547 Columbus Road

BALTIMORE
409 N. Gay Street

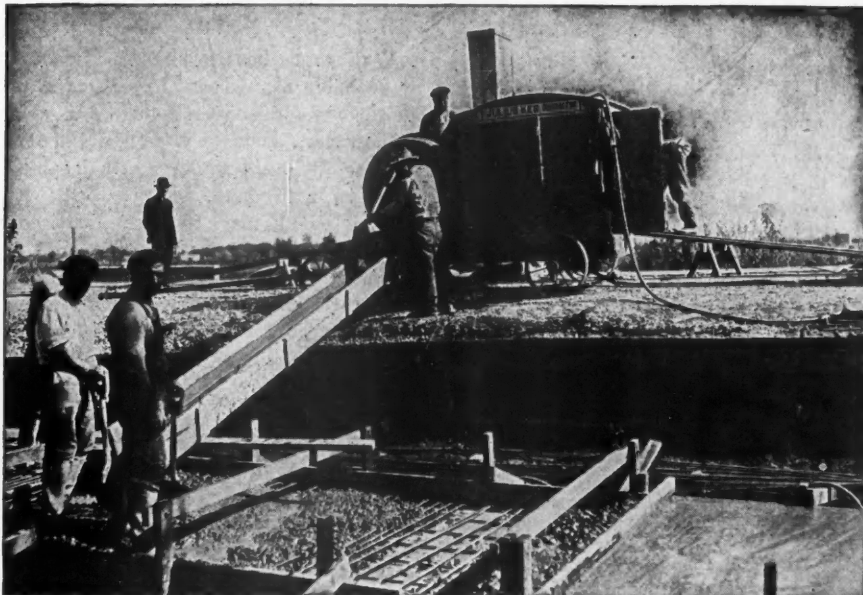

WHEN WRITING ADVERTISERS PLEASE MENTION THE AMERICAN BUILDER



STRAIGHT-AWAY

No Sag'
Garage Door Track & Hanger

HERE'S a new device—a J. E. Porter product—handily installed, complete in itself without extra fixtures, absolutely satisfactory in its working, with a half-dozen exclusive advantages, each one solving a problem for every man with a garage on his place.

The big feature shows in the picture—the elbow principle that makes possible a straight track from end to end—no extra arm needed for a curve—no space lost.

Designed for use with three standard "2-foot-8 by 8" doors. Making a sagless weather-proof combination, folding and sliding on the inside.

Straight-Away Set Complete

With 6 feet of Porter flat track are supplied all the needed attachments, packed in a carton—the Porter tandem truck that can't jump the track and that reduces friction to zero; chain latches and hooks for top and bottom; door latch that makes absolute sealing against jamb and all hinges and screws.

Specify the **STRAIGHT-AWAY** and you've named the satisfactory hanger. Write for illustrated information and name of your local dealer.

J. E. PORTER COMPANY
473 Guion Street, Ottawa, Ill.

48

The Building Industry and the Victory Loan

(Continued from page 130.)

ment plan. When you sign your subscription you will be required to pay 10 per cent of the purchase price. The second installment of 10 per cent falls due July 15; and the remaining installments of which there will be four of 20 per cent each are payable on August 12, September 9, October 7, and November 11.

Remember, builders, that if Uncle Sam is obliged to have the Loan taken up by the banks, it will mean that plans for construction now under way will have to be discontinued, and that no wages or low wages will result. In helping Uncle Sam by subscribing to the Victory Loan, you are merely helping yourself to prosperity.



The Rapid Increase in Building

Since the ban was removed the building industry has slowly and steadily revived until the record of contracts for the week including the first four days of April surpassed even the most sanguine estimates made with preceding advances as a basis, says the U. S. Department of Labor. For this week, ending April 4, contracts amounting to \$60,864,085 were awarded. In the preceding week the contracts totaled \$43,590,325 and for the first week in March they were \$27,751,076.

That the amount of contracts awarded in the week ending April 4 presents a really remarkable evidence of increasing activity in the construction field may be emphasized by the following statement. Ordinarily a month contains 26 business days or $4\frac{1}{3}$ weeks. If the amount involved in contracts awarded during each week was \$60,000,000, as in the week for which complete statistics are just received, the total for such a month would be \$260,000,000. The last named amount is in fact larger than in any month on record during the nine years for which statistics for this territory have been compiled. This actually is the same as saying that it is larger than any figure ever reached. The nearest approach in the records is the month of June, 1918, when the amount was \$248,000,000, a considerable portion of it undoubtedly being government contracts.



Paint vs. Wall Paper

Wall paper has its place in the home decorative program. It probably always will have because its use undeniably adds to the attractiveness of the room.

However, its place is not in kitchens, bathrooms, or playrooms. It is not sanitary nor durable in such rooms. Their function in the home calls for walls decorated in a high gloss enamel which may be washed, without injury, as often as necessary. The use of this material makes it easily possible to keep the walls bright and clean without expense and with very little labor.

Architects, builders, paint dealers and master painters owe it to their clients and customers to bring these points to their attention when they are building new homes or renovating old ones.

In the better class of homes, it is seldom one sees anything else than a gloss enamel on the walls of bathrooms and playrooms and kitchens, but there is still much to be done to extend the practice to the cheaper houses, wherein, as a rule, first cost is given the preference in making a decision rather than ultimate cost; also over sanitary considerations and over appearance.

The Ransome BANTAM

The Fast Working One-Bag Mixer

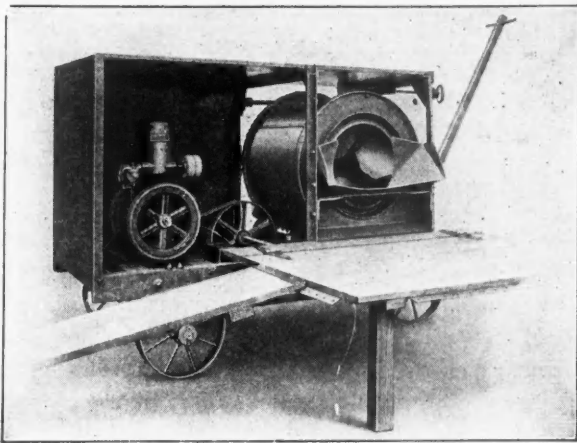

Front View. Note the Low Platform 27" Above the Ground

That's why Bantams were used on cantonment work for the U. S. Army. They proved their worth, reliability and speed when daily yardage meant more than dollars and cents to the contractor. One cantonment job used twenty-one Bantams.

At the present price the Bantam is the great bargain in the mixer field today.

\$475 F. O. B. Dunellen

Complete with Gasoline Engine and Platform. Weight with Platform, 2500 Pounds

Just try to think of another mixer for \$475 that will handle a **full one-sack batch**, 7 cubic feet of wet mixed concrete or 10 cubic feet of loose aggregate to a batch, or turn out 6 cubic yards of mixed concrete per hour.

Altogether, there are over 2,000 Bantams in the field and if you'll ask for a copy of "What the Other Fellow Says," you'll probably find in it a pretty strong endorsement of the mixer from some one you know.

Bantam orders are filled from stock at distributing points throughout the country or from the factory.

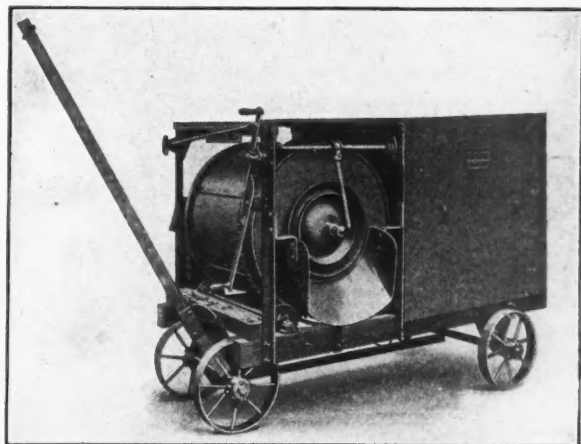

Discharge View. Discharges in Three Revolutions of the Drum

Ransome Concrete Machinery Co.

Main Office and Works 1764 Second St., DUNELLEN, N. J.

Branch Offices: Boston, New York, Chicago, San Francisco Philadelphia, Atlanta

Canadian Representatives: F. H. Hopkins & Co., Montreal and Toronto

Agencies in All Principal Cities Manufacturers of Mixers, Pavers, Hoists, Hoisting Buckets, Bins, Spouting Plants, Carts, Cars, Barrows, Chutes, etc.



31-65

“Build a Home” Idea Spreads Rapidly

TOWNS, CITIES AND STATE JOIN IN PROMOTING BUILDING—ENTIRE CONSTRUCTION INDUSTRY WILL HAVE A GREAT SEASON

NO IDEA that has been put forth since the war ended has taken such a hold on the public as the “Build a Home” campaign. The U. S. Department of Labor, the state and local chambers of commerce and civic and labor organizations of all kinds now are conducting intensive campaigns to bring about home building in every city, town and rural community in the country.

The building industry already is reaping the benefits of these campaigns. Reports from every section of the country show that home building is taking the lead in the construction field. And it is a source of gratification to the members of the American Builder family that the homes this organized effort is seeking to have built are the types of houses that the American Builder has been showing in its Portfolio of Beautiful Homes for a number of years. Thus, thru long familiarity with such houses, artistic, but not costly, the readers of the American Builder are equipped to do this work.

Such campaigns as are being put on in many cities, should be waged in every community of the country. So that the readers of the American Builder may have a basis on which to work in advocating such plans, here are some of the recent developments.

At the meeting of governors and mayors, held at Washington recently, Ernest T. Trigg, president of the National Federation of Construction Industries said, in part:

How Communities Can Get Results

“Specifically what can a community do to be helpful in this essential revival of private building? There is one concrete program which deserves your earnest consideration, a simple program and yet one of unlimited possibilities. I refer to a local “Own Your Home” campaign. There seems to be a logical step in every community because:

“1. It meets a fundamental need. The nation is short of homes. Conservative estimates say we are short 500,000 homes since the war began. Some authorities place the shortage at one million.

“2. The campaign is of a character that will call to it every substantial business and civic element in your community. Your Chamber of Commerce, Board of Trade, general business organizations, your financial institutions, your religious and labor organizations, every element in your community interested in community improvement can be brought to co-operate en-

(Continued to page 136.)

IT'S A “MEYER”

says the Farmer proudly when speaking of his elevator. The name “MEYER” means so much more than the ordinary on a cup elevator. They are so much more satisfactory—shell less ear corn, waste less grain, and require less power to operate than any other elevator.

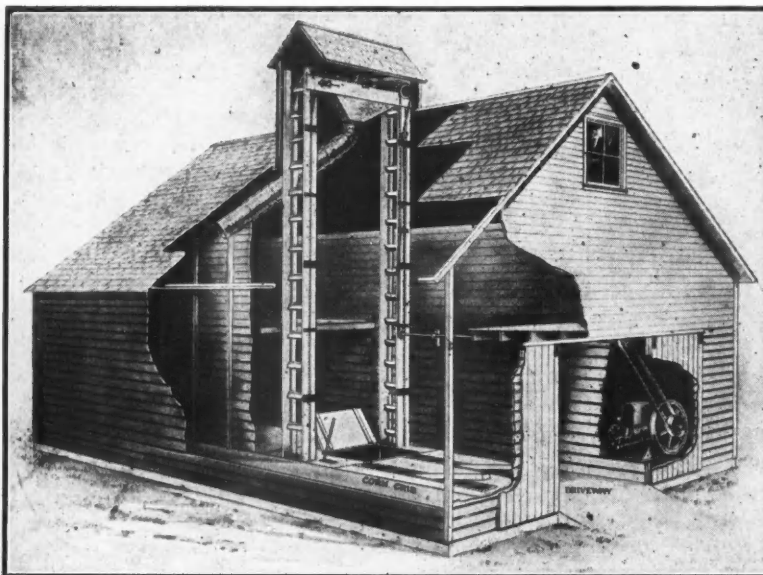

The “Meyer” set the standard years ago because of their mechanical construction. Their simplicity and durability make it possible for them to render the greatest service at all times. That is why Farmers want the “Meyer” in preference to any other. Furnished with pit also lifting jacks.

Carpenters and Builders

Write at once for our free crib plans and illustrated catalog, which show eight styles. Protect yourself on your territory and reap a handsome profit.

A. F. Meyer Mfg. Co.
301 Wilson Street - Morton, Ill.

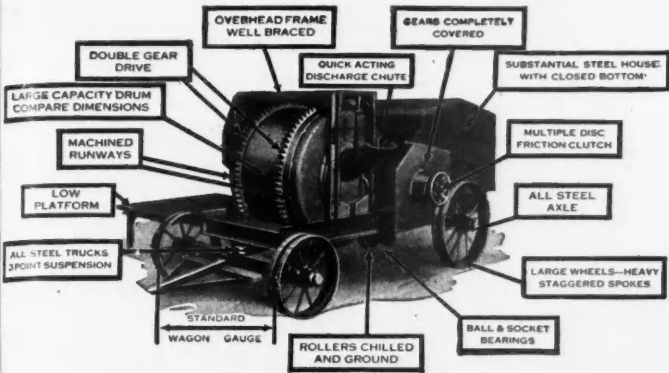

DANDIE

The Big Value Light Mixer

Send back the coupon at the bottom of this page—and get the full facts about the remarkable value of the light mixer field—the light mixer built first for **reliability**, and then built in **volume** to keep the price down.

No, sir, the Dandie is not the cheapest mixer—it is the first light mixer built as strong as a light mixer can be built. It stands up to all the work you can give it—is dependable to stick on the job without costly delays.

But the price is within the range of light mixer prices—that is why it is the **remarkable value**—you are surprised that you could get such construction for the price. It is only made possible by scientific design,

big production and standardization of every part. This is how we get the price down, not by skimping.

Get the Dandie Catalog—get the full details of how volume production has put new reliability into the lighter mixer field—see for yourself why the Dandie is the remarkable value of the industry.

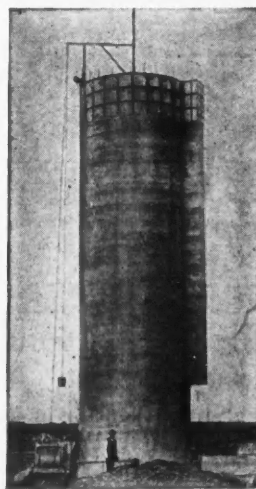

Koehring Capacities

- in cu. ft. wet batch rating
- Pavers 12 cu. ft., 18 cu. ft., with or without loading crane to lift batch boxes from industrial cars. 8 cu. ft., without loading derrick.
- Construction Mixers, 7, 10, 14, 21, 28 cu. ft.
- Hot Mixers for bituminous work, 9, 14 cu. ft. side charging type; 18 cu. ft. paver type.

Gasoline, Steam and Electric Power

SEND BACK THIS COUPON

KOEHRING MACHINE CO., Milwaukee, Wis.

Please send, without obligation, your Dandie Big Value Catalog K-5, and advise me where I can see a Dandie Mixer.

Also send me information on items marked X in Bar Benders Bar Cutters

Name _____

Address _____

"Build a Home" Idea Spreads Rapidly

(Continued from page 134.)

thusiastically in this campaign. Now, a campaign in which everybody can and will participate is the sort of a campaign we need at this time.

"3. Frankly, your investment builder, the so-called speculative builder is and will continue to be the cautious builder. But the home is built for use and service and comfort. It is, in fact, the world's greatest investment, but those who build homes look more to comforts, conveniences and fuller life as their returns."

Statewide Campaign in Indiana

The Indiana State Chamber of Commerce was the first to inaugurate a state-wide "Own a Home" campaign. A. W. McKeand, of this organization, has outlined the plan his organization will follow:

"Briefly, our campaign is to use \$150,000 paid space in the newspapers and operate a general publicity department for news stories, preparations of posters, window dressing, speaker's bureau, traveling exhibits, etc," said Mr. McKeand.

"We have organized a state-wide committee consisting of one man from each line of business whether directly or indirectly interested in the "Own a Home" movement. There are thirty-one organizations now actively working with us, and there are a number of others that are fairly well organized that we will have as soon as their executive committees have passed

upon the plan. We have four sub-committees studying the problems of finance, survey, city planning and advertising. These committees are made up of well known people from all lines of business in all parts of the state, and they are actively at work on their plans at this time. We are then building a complement to the state-wide organization in each town in the state. The state-wide organization passing down to the local communities its plans and suggestions and working with the local communities to make such changes as are needed to suit local conditions. From our long experience in the commercial organization field we know that no plan set up in any one place will suit all local conditions in another, so for this reason we are going to place our plans in charge of special committees in each town in the state and help them fit the plan to local conditions."

Build a Home is Urged in Many Cities

Many cities also have organized such campaigns. Among them recently reported to the Department of Labor are: Billings, Mont.; Charleston, W. Va.; Chicago, Ill.; Cleveland, Ohio; Denver, Colo.; Jacksonville, Fla.; Johnstown, Pa.; Lynchburg, Va.; Middletown, Conn.; Milwaukee, Wis.; Philadelphia, Pa.; Portland, Oreg.; Salt Lake City, Utah.; Seattle, Wash.; Staunton, Va.; St. Paul, Minn. and Toledo, Ohio.

(Continued to page 138.)

A HUTHER BROS. DADO HEAD



enables you to do the most intricate cutting easily. It consists of two outside cutters and enough inside cutters to make the required cut. It will cut perfect grooves of any width either across or with the grain. Is easily kept in condition and has a simple quick adjustment. Will fit any saw mandrel. Send for one on approval and return at our expense if not satisfactory.



Pat. Nov. 29, '02
July 19, '10

Illustrated catalog on request.

HUTHER BROTHERS SAW MANUFACTURING CO.
Rochester, New York



Grooves cut with Huther Bros. Dado Head

“Barn Framers Delight”

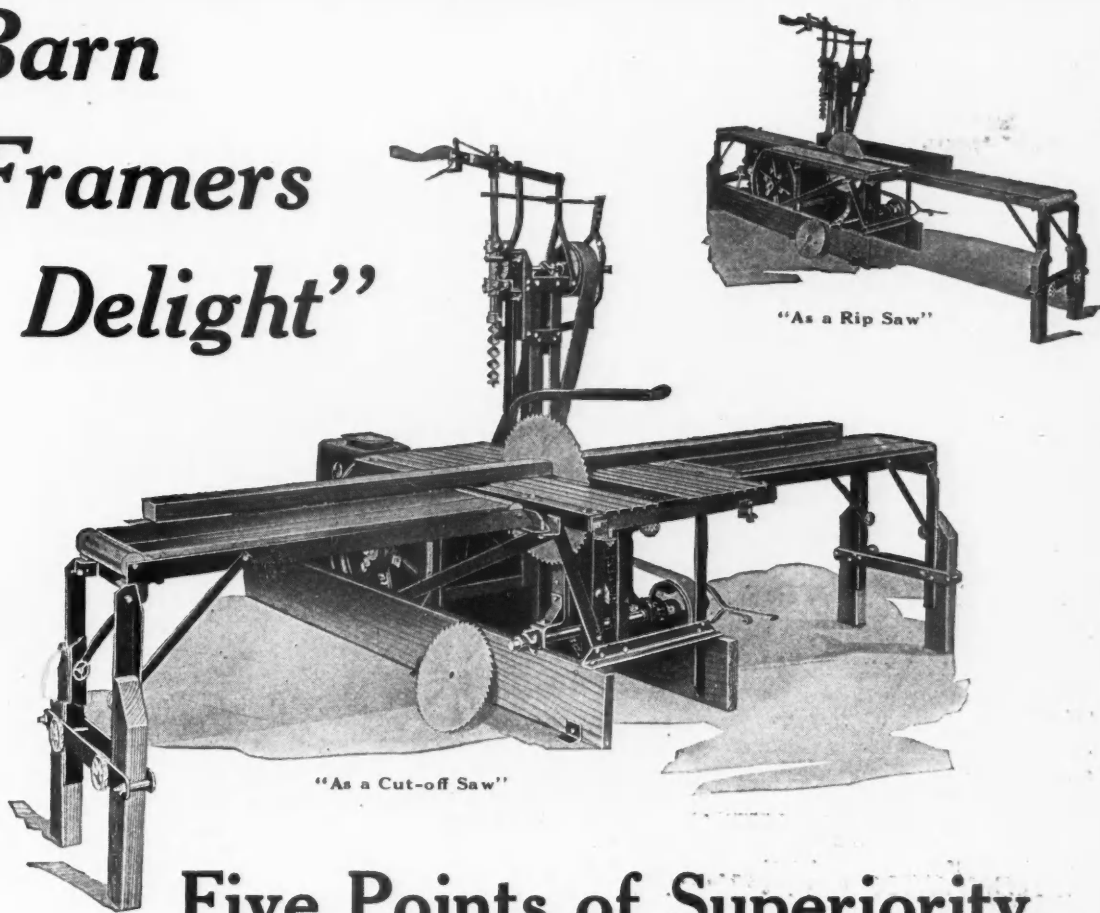

Five Points of Superiority

- Strong**—Frame is made of 2-inch angle steel.
- Rigid**—Frame is double riveted on power press.
- Durable**—Absolute guarantee for 10 years.
- Portable**—Long bases with engine in the rear make the ideal portable Saw Rig.
- Low Price**—Our large output enables us to make up parts in large quantities. All parts are standardized.

DETAILS

- Cut-off Saw**—
 - Rip Saw**—
- } Any diameter saw up to 32-in., can be used.
- Boring Attachment**—Will take any size bit up to 2-in. in diameter.
 - Extension Tables**—Are used either for cutting-off or ripping and are convenient for boring heavy timbers. Each table has two rollers, which adds greatly to the efficiency of the machine.

New Catalog just ready to mail—It's yours for the asking.

THE PARKS BALL BEARING MACHINE CO.

Fergus St. and C. H. & D. Ry.

CINCINNATI, OHIO

Canadian Factory: 333 Notre Dame East, Montreal, Que.



There's Real Money in Barn Building For You

Think of the barn jobs in your community that you could get with the help of James service. Farmers are today awake to the needs of better built barns and are finding exactly what they want in James Barns and James equipment. They are reading our advertisements in their leading farm papers—and they know through years of service the matchless quality of anything in barn equipment bearing the James trademark.

Send us the names of farmers you know who wish to build or remodel their barns, and mention the size of their herds. We will circularize the farmers whose names you send us, and will send you our book

The James Way—FREE

Our book should enable you to suggest to your customers the most practical way to handle their barn problem—how they can save time and work about the barn—get the right plans—avoid mistakes in building—best ways to arrange equipment—provide lighting, ventilation, make good use of floor space, etc.

Take advantage of our service and get more and better barn contracts

James Manufacturing Co.
EP-76 Cane St., Ft. Atkinson, Wis.
Elmira, N. Y.

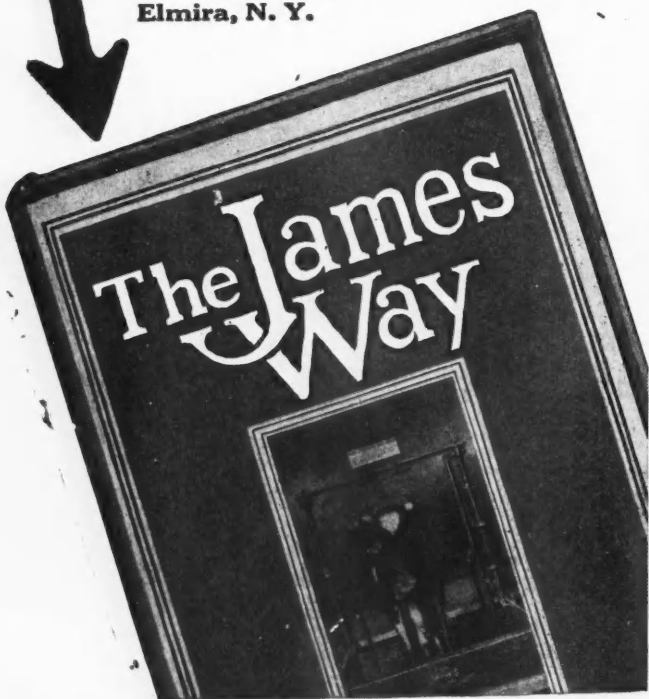

“Build a Home” Idea Spreads Rapidly

(Continued from page 136.)

In each of these cities there is a determined shortage in dwellings and the Own-Your-Own-Home campaign is being waged as a civic movement with the co-operation of every organized element interested in municipal and social problems.

In sixteen other cities tentative plans are under way and from them will come, doubtless, many more vigorous campaigns for home owning and home building. In all these cities the club women, the clergy, financial interests, municipal officials and the labor organizations are being appealed to by the U. S. Department of Labor to do their utmost in assisting the campaigns to get under way. In the cities where campaigns now are on the women are proving invaluable as missionaries for the “Own-Your-Own-Home” gospel.

Y. M. C. A. Takes Up Work

How popular this movement has become is shown in a letter to the American Builder from Arthur M. East, one of the secretaries of the International Committee of the Young Men's Christian Association, which has headquarters in New York City. Mr. East says:

“The Y. M. C. A. is handling the welfare work in 500 industries. We are having calls from isolated plants to conduct “Own Your Home” campaigns, promoted to draw workers within walking distance of the plants.”

It sure looks like a busy season ahead for the building industry.



Painted Interiors in Demand

THE day of the gaudy, flowered wall paper is waning, except in low-priced houses. Several years ago an attempt was made to get away from the giddy wall coverings by substituting the plain cartridge papers. These produced beautiful effects, but it did not seem possible to produce them in fast colors. After a few weeks, if a picture were taken down or its location in the room changed, it would be found that the paper back of it had retained its original color; whereas, the paper exposed to the light had faded so that the artistic appearance of the wall was ruined.

The paint manufacturer has solved the problem by producing a so-called “flat” paint, that is, one having no gloss or shine. When on the wall it presents a soft-toned, velvet-like appearance, not equalled by the best of the old cartridge papers even when bright and new. The colors of the flat paints are fast. Spots and smudges can be washed off it with cloth, soap and water; hence it is much more durable and longer-lived than the best grade of wall papers.

A home builder, once having seen a flat painted interior, is seldom thereafter ever satisfied with papered rooms. Side walls, borders, friezes and ceilings can be painted in different contrasting, yet harmoniously blending colors, producing beautiful effects.



THE Correspondence department is a market place for ideas. Bring yours to market and exchange them for the ideas of others.

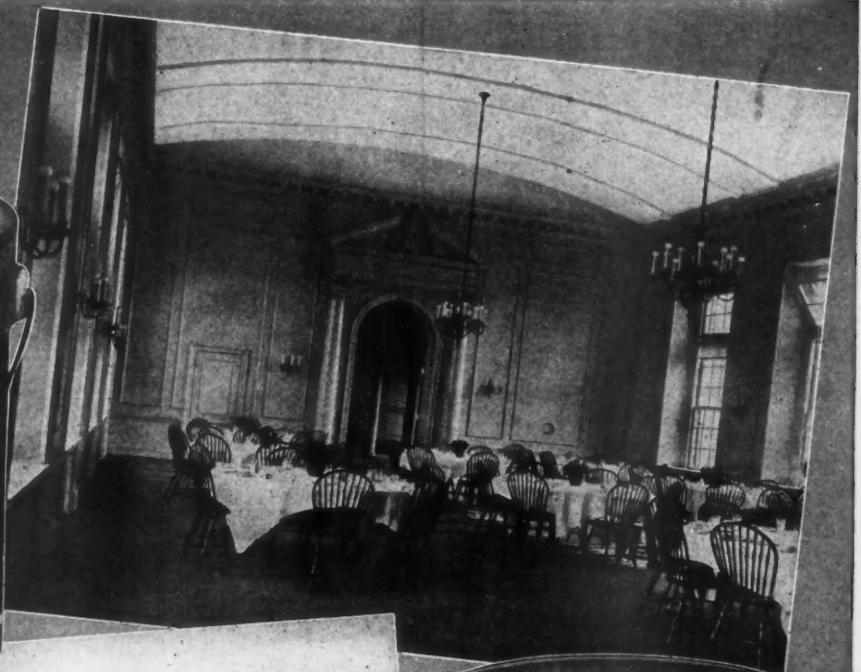

MURPHY & DANA
ARCHITECTS
331 MADISON AVENUE NEW YORK CITY
TELEPHONE—MURRAY HILL—2899
CABLE ADDRESS—MURDAN

HENRY KILLAM MURPHY
RICHARD HENRY DANA, JR.
W. L. SOMERVILLE
H. J. MCGILL
J. D. FORSYTH

April 7, 1919.

RE LOOMIS INSTITUTE.

Devoe & Reynolds,
101 Fulton Street,
New York City.

Gentlemen:-

We are very much pleased with the results of your "Velour" paint that we used several years ago on the buildings of the Loomis Institute at Windsor, Connecticut. As you can realize, buildings in a Boys' Boarding School of this sort; especially the Dormitories, have very rough usage; but in spite of that, the "Velour" paint has held out very well, as it can be so easily washed down. We are also very much pleased with the flat water-color effect and the soft tones that this "Velour" gives.

Very truly yours,-

Murphy & Dana

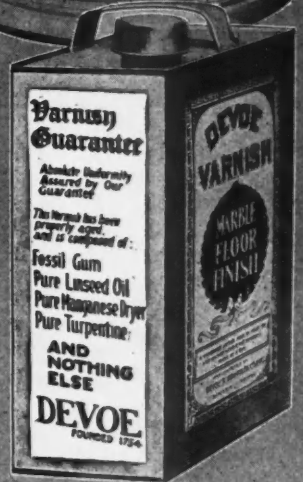
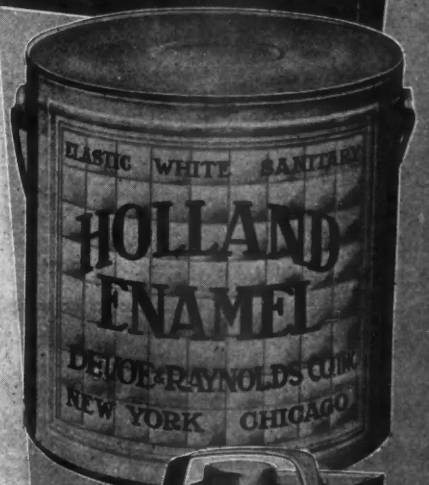

DEVOE

The oldest paint manufacturing concern in the United States
Founded in New York in 1754

DEVOE & RAYNOLDS CO., Inc.
New York Chicago

Conditions in Building Field Are Improving

A DECIDEDLY optimistic tone is found in reports and statements issued by the Department of Labor during the last ten days in so far as they deal with building and construction work. Data gathered from all parts of the country speak convincingly of an increase in building and construction work, especially in the middle west where private interests are decidedly active.

F. T. Miller, Director of the Division of Public Works and Construction Development of the Department of Labor, makes the following summary of conditions:

"Building statistics indicate very clearly there is a gradual improvement. Municipal building permits in November last were but 6 per cent of normal, in December they were 10 per cent, in January 20 per cent, while in February and March they were from 35 to 40 per cent.

"However, the revival is more marked outside the larger cities and is especially noticeable in the middle west. Allowing for the differences in money values, the contracts awarded for construction thruout the country in February, 1919, are 97 per cent of the five-year average for the same month. Of these, February contracts 91 per cent were for private projects and 9 per cent for public. Of the private con-

tracts 55 per cent were residential property, 25 per cent mercantile and 20 per cent industrial.

"It is still difficult to get a realizing sense of the effect of present inflation upon prices of building materials and labor and to realize that neither have increased in proportion with other commodities or with the cost of living and yet, it appears, the investing public generally is coming to an understanding of these facts. While other commodities and the cost of living have increased one hundred per cent and more since the beginning of the war, the advance in construction costs on such buildings as do not require steel is only about 48 per cent; on such buildings as require steel the advance approximates no more than 87 per cent. Construction costs, therefore, in their upward tendency, have not kept pace with other commodities and the cost of living."

The Money for Building

A significant development, according to the Department of Labor, is the interest being taken by financial and building interests thruout the country in the problem of financing the unprecedented building activities which are essential to make up the building deficiency growing out of the curtailments in this field during the war. A representative of the Information and

(Continued to page 142.)

What Is the Contractor's Business?

What the mark



stands for

Up-to-Date Designs
Selected Woods
Extra Thick Veneers
White Pine Core
Wedge Dowel Construction
Quick Service
Positive Guarantee
of Satisfaction

Send today for "Morgan Millwork Handbook." Free for the asking and a handy book to have around.

People expect two things of a contractor—knowledge of construction and knowledge of building-materials.

Of all the material that goes into a house, nothing can cause more trouble and inconveniences than poor doors. They swell in damp weather—shrink in dry weather.

Retrimming and rehangng don't help, for with the changes of seasons the diseases of poor doors keep coming back. Not very good advertising—not apt to build good will for the contractor.

The sure way to win the confidence and good will of your customers is to install trouble-free Morgan Doors. They stay put, season in and season out.

Morgan has for years held the leadership in the door field. Held it on merit. Because Morgan Doors are architecturally right in design—built only of finest selected woods—and because the exclusive Morgan construction features make a door that gives perfect service.

Morgan Sash & Door Co., Dept. 75, Chicago
Morgan Millwork Co., Baltimore
Morgan Company, Oshkosh, Wis.

Knickerbocker

A COMPLETE LINE

Built to meet the needs of the User

THE Built-in-Merit of Knickerbocker product is what has made it popular. It gives the user what he wants.

And what most of the users of equipment want isn't far from just what is the right thing to have.

Service Points are built into this product instead of talking points, therefore it is dependable. Ask for our General Catalog.

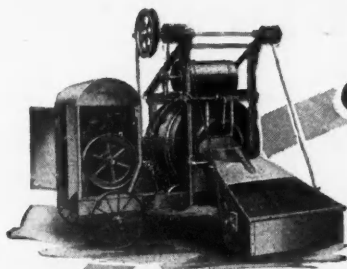

Power Loader and Water Tank.
Sizes 5-7-10-21 cu. ft.

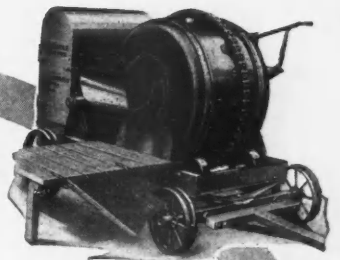

Low Chargers
Sizes 5-7-10 cubic feet.
With Ideal or Novo Engine.

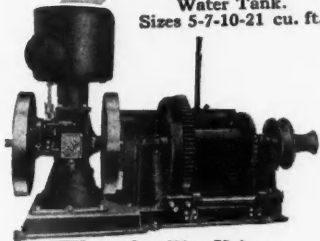

One Way Hoists
—Single Drum.
Reversible Hoists
—Double Drum.
Hoists—a complete Hoist Line.



A complete line of Diaphragm, and Force Pumps on Skids or Trucks.

The Knickerbocker Company
525 Liberty St. Jackson, Mich.

Quick Deliveries from Stock in All Principal Cities in U. S. and Canada.

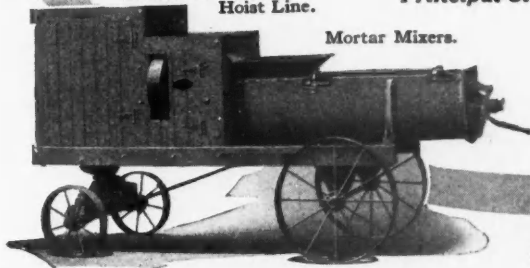

Mortar Mixers.

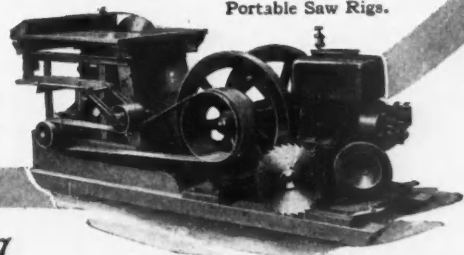

Portable Saw Rigs.

Send for
our
Catalog

1853  1919

Fine Beveled Edge Shank and Socket Chisels

Tang and Socket Butt Chisels

Plain and Beveled Edges

Send for Illustrated Catalog

Buck Bros., Millbury, Mass.

C. G. HUSSEY & CO.
Pittsburgh, Penna.

MANUFACTURERS OF **COPPER**

In Sheets, Plates, Rolls

CORRUGATED COPPER CONDUCTOR PIPE



Copper Nails, Copper Rivets, Conductor Pipe, Laves Troughs, Elbows, Shoes, Mitres, Soldering Coppers, Gaskets, Etc.

Furnish The Best

The farmer knows that contented cows insure bigger profits; they give more and better milk when housed in comfortable ventilated barns.

Badger Cupolas satisfy because they do what a cupola should do—ventilate. They're strong, handsome, durable and highly efficient. Light in weight and shipped complete ready to erect. No need to build framing of any kind. Made of high grade galvanized steel—rain, rust and snow-proof. Screened to exclude birds.

Write for free catalog and prices.

Badger Corrugating Co.
La Crosse, Wis.



MIDLAND
TERRA COTTA

Quality and Service
Our Motto

MIDLAND TERRA COTTA CO.
Lumber Exchange CHICAGO

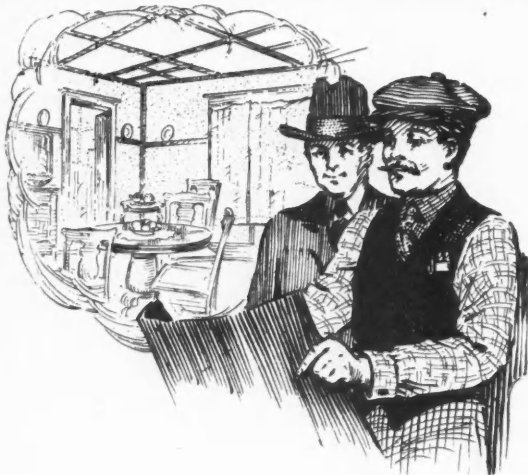

Carpenters, Builders and Contractors

Cornell Plans Will Help You Get More Business

YOU can make your prospective customer see just how that remodeled home will look, if you show him the attractive plans we furnish free of charge. Cornell-Wood-Board is solving the problem for hundreds of carpenters, contractors and builders, who have had to meet the statement, "I can't afford these improvements now."

Cornell-Wood-Board is guaranteed not to crack, warp or buckle. Easily and quickly put up. Comes in standard sized boards. Nails right to the framework or over the old walls. Requires less paint or calomine than other interior finishing materials. Resists heat, cold and moisture. Finished on both sides.

FREE

Send room measurements for Panel Suggestions and Cost Estimates. Also for Cornell Wood-Board Samples.

Cornell Wood Products Co.

C. O. Frisbie, President

Dept. 105. 190 N. State Street, Chicago, U. S. A.

Largest exclusive wall-board mills in the world at Cornell, Wis.

Cornell-Wood-Board

Excels for Walls, Ceilings and Partitions
Repairs, Alterations or New Work

Conditions in Building and Construction Fields Are Improving

(Continued from page 140.)

Education Service of the Department of Labor reports that the Newark, N. J., Board of Trade has appointed a committee to devise ways and means of financing the building of 2,500 homes. This finance will be drawn from private sources rather than from banks and will be made available on long-time loans to home builders.

This is but a concrete example of the way localities are attacking the problem of financing home building in the United States. Equally interesting and important is the recent bulletin of the savings bank section of the American Bankers Association in which is discussed and recommended a plan for amortization of mortgage loans. Here again is shown a disposition to depart from conventions of the banking business and devise new ways to meet the new problem in the building field.

Along the same line is the agitation for the Federal Home Loan Bank system, a bill for the establishment of which has been prepared and will be introduced in the next Congress with the backing of the Building and Loan Associations of the country.

Probably there is no better index to present activities than the building permit tabulation just issued by the Portland Cement Association. The figures, it is stated, are from Bradstreet's and the group totals on building permits issued in the month of February are as follows:

Group—	1918	1919
New England	\$ 2,017,000	\$ 1,900,000
Southeast	1,138,000	1,788,000
Middle Atlantic	4,093,000	4,236,000
New York City	4,238,000	7,968,000
Middle West	10,801,000	9,656,000
Southern (west of Mississippi) ..	173,000	120,000
Northwest	679,000	588,000
Southwest	1,335,000	919,000
Rocky Mountain	231,000	324,000
Pacific Coast	3,537,000	5,444,000
Grand Total	\$28,242,000	\$32,943,000



Renovating Floors

If a wooden floor that has been stained or varnished begins to show signs of wear, apply a good floor varnish, containing a color pigment. It will, thereafter, probably look as good as new.

If the floor is covered with linoleum or oilcloth, the same kind of a varnish will lengthen the life of the covering, and if it has begun to show signs of wear and the design or pattern is wearing off, a coat of buff floor or deck paint will renovate it and give a very pleasing and durable finish.

This suggestion will save the cost of a new floor covering unless the linoleum or oilcloth is actually wearing thru.



WHILE "it is more blessed to give than to receive," the Correspondence department is the place where we can both give and receive. Here the members of the AMERICAN BUILDER family help others and receive help, and all are better for it.

Natural Slate Blackboards



A Million Square Feet
On Hand Constantly

BEFORE the inauguration of this company, many Slate Quarries did not carry sufficient stock.

Hundreds of orders could not be filled when needed, because of lack of special sizes—and occasionally the regular sizes ran out.

Now, however, this organization keeps *one million square feet* of blackboards on hand in thirty-five storehouses. Every order can be filled *promptly*.



Natural Slate Blackboard Co.
Pen Argyl, Pennsylvania

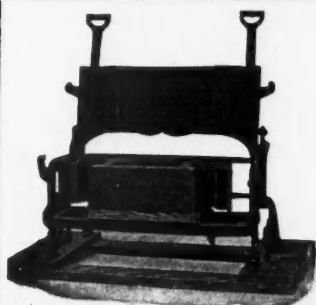

MILES CONCRETE MACHINERY

No. 5 Miles Block Machines
No. 4 Singer Block Machines
AUTOMATIC TAMPERS
CONTINUOUS MIXERS
BATCH MIXERS

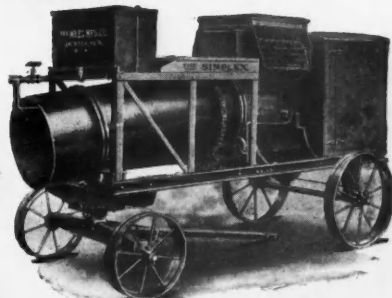
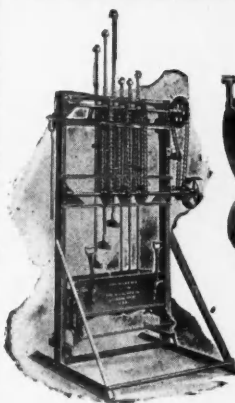

UNIVERSAL ADJUSTABLE SILL-CAP
AND STEP MOLD



Write for Catalog
and complete information. Dept. 6.

THE MILES MANUFACTURING CO.

JACKSON, MICHIGAN, U. S. A.

FRANK MIXERS The Contractor's Best Investment

The Frank Mixer is the logical machine for the average builder. It is simple, strong and efficient, and requires so little attention. It can be used on all jobs and mixes mortar or concrete.

A batch a minute, no tilting or tipping, no slop over or spill, no waste.

Let us tell you why the Frank is just the one for you. Write us today.

FRANK MANUFACTURING CO.

221 Century Building
DES MOINES, IOWA



World Shortage of Lumber Revealed by Investigation

UNITED STATES EXPECTED TO BECOME GREATEST EXPORT NATION OF WOOD PRODUCTS—RECONSTRUCTION ERA FINDS EUROPEAN AND AMERICAN STOCKS DEPLETED

EUROPE'S reconstruction requirements are expected to make the United States the leading lumber exporting nation of the world, according to a statement by J. E. Rhodes, secretary-manager of the Southern Pine Association, New Orleans, La.

"With every country on the globe entering a great building period, reports from foreign investigators received by the Association indicate a serious shortage of lumber in practically all centers of consumption abroad," said Mr. Rhodes.

"Cut off largely from their normal sources of main supply because of economic and political demoralization in Russia and Austria-Hungary, and the natural limitations of Sweden's production Great Britain and the rest of the continent are looking to America to make up the deficiency caused by the virtual elimination of these three nations, which before the war contributed more than half of the world's total lumber exports. Foreign buyers are already arriving in the United States in considerable numbers, not only from Europe, but from South America, Australia and Africa, which have been practically without lumber supplies for four years, due to curtailed ocean transportation facilities.

"Russia, before the war, held first place as a lumber exporting country, and in 1913, the last normal year, sold to foreign buyers 5,513,618,000 feet, or 26 percent of all lumber exports, according to figures compiled from a report of Dr. Edward Ewing Pratt for the Bureau of Foreign and Domestic Commerce. Second in importance at that time

was Austria-Hungary, whose exports in 1913 aggregated 3,635,473,000 feet, 17.1 percent of the whole. Sweden contributed 15 percent with 3,167,549,000 feet, while Canada supplied 13.3 percent, or 2,833,546,000 feet. In spite of her immense forest sources and unequalled manufacturing equipment, the United States in 1913 ranked fifth in the list of important lumber-exporting nations, with only 12.7 percent of the total exports to her credit. This amounted to 2,700,575,000 feet, only a little more than Finland's exportations, which were 2,531,281,000 feet.

Baltic Stocks Almost Exhausted

"Advices received by the Southern Pine Association show that stocks of lumber as late as last November were practically negligible in Russia and the Baltic countries, except in Finland, where there was about 2,000,000,000 feet, after four years of almost no export trade at all. Two hundred and twenty million feet of lumber were said to be then available at the port of Archangel, 60,000,000 feet of which had been purchased by the British government. Sweden, whose manufacturers have been working under the greatest possible hardships since the beginning of the war, with costs of production very excessive, had only about 700,000,000 feet in all stocks on hand.

"Baltic lumber is, generally speaking, what is known in America as spruce, and, altho much inferior to Southern pitch pine and other species shipped from the United States,

(Continued to page 146.)



Now for Reconstruction

HENRY DISSTON & SONS, Inc.
Keystone Saw, Tool, Steel, and File Works
PHILADELPHIA, U. S. A.

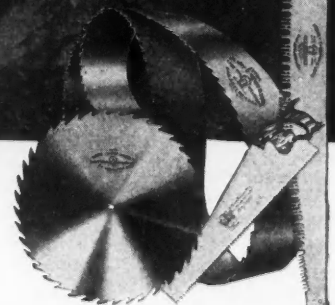

WHEN WRITING ADVERTISERS PLEASE MENTION THE AMERICAN BUILDER

Northwestern Engines

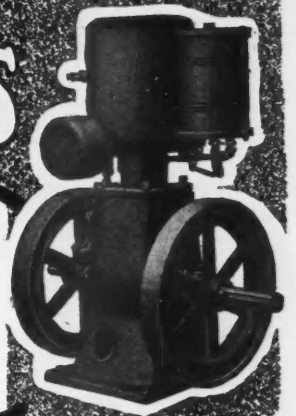

Compact, Strong, Few Parts.
 Light, easy to mount and move. Four piston rings insure perfect compression and full economy of power and fuel. Water jacket completely envelops the cylinder.

Built upright, the Northwestern delivers on unusual percentage of rated power. Easy starting, smooth running and fully guaranteed to give satisfaction to the user in price and performance.

Write for Bulletin No. 4 and Prices

Northwestern Steel & Iron Works Eau Claire, Wisconsin

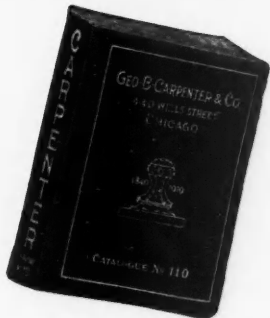

A Remarkable Catalogue Free

OVER 1100 pages—thousands of equipment items; prices that are right. Lists most everything—from adzes to zig zag rules—hundreds of things you use in your business.

That's why we call it a remarkable book and you'll agree when you receive your copy. Send for it today. It's free. Address Dept. 1.

Equipment for Contractors, power plants, mills, mines, railroads, steamships, machine shops and all forms of industrial activity.

GEO. B. CARPENTER & CO 440 NO. WELLS ST. CHICAGO



The Sheldon Mixer COST SO LITTLE Pays for itself on the First Small Job

Stop letting the profits on the foundations and other concrete work go to somebody else! Buy a reliable, time-tried Sheldon Mixer and Bid on the Whole Job. Any carpenter-builder who has a Sheldon Batch Mixer can get extra profits to be made on sidewalks, walls, floors, and plaster work.

Sheldon Concrete Mixers

Save Time, Save Labor, Save Money

Sheldon Mixers are compact, easy to move, sturdy and efficient—will work one man or six, and do the work of a \$400 mixer at only a fraction of the cost. Hand or power, mounted on frame, skids, or truck. Continuous chain drive, handy tilting discharge, sand proof bearings, all parts guaranteed.

Write for Catalog Today

It tells you all about the Sheldon Mixers and gives all the wonderfully low prices. The 30 days' trial privilege offer makes it possible for you to try the machine at our risk. You take no chances when you put a Sheldon Mixer to work on any concreting job. Write today, a postal will do. Address

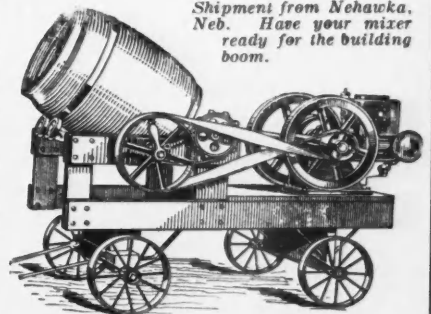

Shipment from Nehawka, Neb. Have your mixer ready for the building boom.

Sheldon Mfg. Co., Box 2003, Nehawka, Neb.

THE IDEAL CONCRETE MACHINERY CO.

1308 Monmouth Ave. CINCINNATI, O.

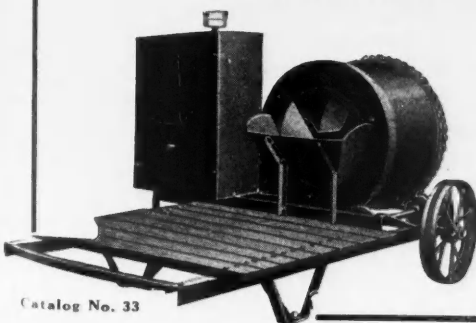

Catalog No. 33

EVERY-THING in Concrete Machinery
 "Concrete Mixers"
 "Machinery for Concrete Blocks"
 "Ornamental and Architectural Molds"



Catalog No. 30

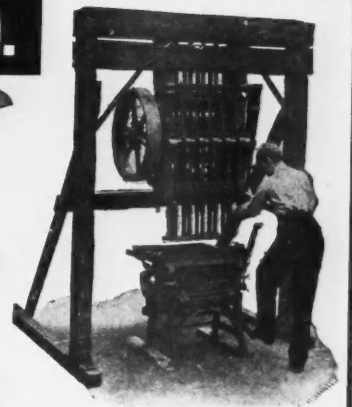

Catalog No. 28



WHEN WRITING ADVERTISERS PLEASE MENTION THE AMERICAN BUILDER



Hotel Commodore, New York City; Warren & Wetmore.
Architects; George A. Fuller Co., Builders; J. D.
Johnson Co., Jobbers; W. G. Cornell Co., Plumbers.

KOHLER

And HOTEL COMMODORE

Twelve hundred and sixty-five Kohler "Viceroy" Built-in Baths—each white as a fresh collar because Kohler Enamel cleans so easily—invite Hotel Commodore guests to their morning dips. These immaculate, hygienic baths—low-sided, full-sized, yet occupying less than usual space—compliment the particularness of host and guest alike.

* * *

Is that valuable reference aid—the illustrated book of Kohler Ware—in your file? If not, please write.

KOHLER OF KOHLER

Kohler Co., Kohler, Wis.
Shipping Point, Sheboygan, Wis.

AND TWELVE AMERICAN BRANCHES

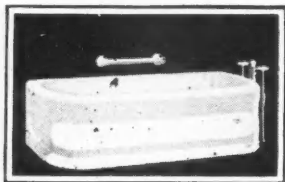

Kohler "Viceroy" Bath
Plate F-10-A

MANUFACTURERS OF ENAMELED PLUMBING WARE

World Shortage of Lumber Revealed by Investigation

(Continued from page 144.)

is now commanding about \$60 a thousand feet in Finland.

"Russia's virtual elimination from the export situation is due to the fact that early in the war all the mills in the Galician district were burned or destroyed by the Germans. Since that time the Bolsheviki have wrecked practically every mill in other sections, taking away in many cases fittings, oil cups and copper. Machinery which could not be readily transported was wantonly destroyed.

"Austria-Hungary has suffered in a physical sense less than any other of the warring nations, from actual loss of her forests and mills, but she emerges from the conflict economically and politically impotent, and investigators report she will be too busy for a long time straightening out her home affairs to concern herself much with foreign markets. Besides, there is reported a disinclination on the part of the allied nations, which were Austria's principal lumber customers before the war, to purchase materials from any of the Teutonic countries if they can be obtained elsewhere.

Southern Pine Stocks Under Normal

"In the fact of this world-wide need for American lumber, present stocks at Southern pine mills are nearly 25 percent below normal, and, altho mills in this country will doubtless always be able to take care of domestic needs, the home demand, coupled with anticipated abnormal exports this year and possibly for several years to come, is expected to tax the capacity of manufacturing plants. The general situation with reference to stocks at American mills is reflected by conditions prevailing in the Southern Pine producing territory, which normally supplies 40 per cent of all the lumber of all kinds consumed in the United States. Two hundred and thirty-five mills reported to the Southern Pine Association March 1, 1919, total stocks on hand of 1,265,900,115 feet. This compared with 1,601,416,665 feet a year previous, and 1,986,037,460 feet on March 1, 1917, when conditions were approximately normal. Present output of American mills which in ordinary times aggregates about 40,000,000,000 feet a year, is slightly under 70 per cent of normal, due principally to labor shortage. This situation will doubtless improve later.

Big Orders Already Placed

"Foreign buyers now in the United States declare that the amount of lumber which America can ship abroad will be dependent solely on the number of ships available for its transportation. As soon as Europe is supplied with food and clothing, the next large movement will consist of lumber and other building materials.

"Orders aggregating 750,000,000 feet of lumber have already been made up by buyers of France. Greece wants several hundred million feet as soon as it can be delivered. Italy, which recently purchased over 3,700,000 feet of Southern pine, would like to buy hundreds of millions of feet, while England has already placed an order with Canada for a billion feet. Supplies in Spain, Portugal and other consuming countries are entirely exhausted, while South America and Africa are wondering where they are going to get the lumber they need, and when."

Demand to be Large, Says Government Investigator

Another interesting insight into the foreign situation with reference to present lumber requirements abroad is given by Nelson C. Brown, foreign lumber trade commissioner of the Bureau of Foreign and Domestic Commerce, Department of Commerce, who has just returned after nearly two

(Continued to page 148.)

You Can Make Tile —and Still Build Houses!



THERE are not enough tile makers to handle all the business. Certainly, hundreds of new plants are opening, but **thousands** are needed. Concrete products plants are doing their best, but it is not sufficient. Tile makers must be recruited from other ranks.

A thousand or more building contractors can earn more than liberal profits by using their plants and equipment for manufacturing cement drain tile. Not all the year, but just for part of it—when their regular business is slack. Average profits are 47%.

A large part of your present equipment can be utilized. Your present unskilled labor can be used. Your building can probably be adapted to tile making. And your reputation and good will are valuable. Special tile making equipment does not necessitate a large investment.

Get more information on the tile business—find out how we can make your tile plant a highly profitable proposition.



—and Sewer Pipe!

You should be equipped to make sewer pipe—whether you make drain tile or not. Equipment costs little, manufacturing is easy, demand is permanent, and profits are large.

Dunn Sewer Pipe Molds are used for making all sizes of pipe up to 36" diameter, without tamping, hard labor or guesswork. No better quality of pipe is possible, and no method is more simple.

Write for bulletins on Sewer Pipe Molds, also on Concrete Mixers, Brick Machines, Block Machines, Porch, Post, Pier and Chimney Molds and whatever other concrete machinery you may need.



W. E. DUNN MFG. CO.

415 24th St., Holland, Mich.



MR. BUILDER

do you know that to install Murphy "In-A-Dor" beds actually cuts original costs in building and boosts your profits and reputation? Do you know that an Apartment House, Hotel, or Home equipped with "In-A-Dor" Beds is far more desirable, both to the investor and the tenant, than without?

FACT!

But, if you do not, call personally or write today. The Murphy Technical Service Department is equipped to supply you with suggestions that will prove the above facts.

MURPHY DOOR BED COMPANY

Entire Fourth Floor
Majestic Building
Chicago

Chemical Building
St. Louis

WATER PAUL SYSTEMS

Mr. Builder:

Did You Ever Lose a Job

because you didn't know
how to figure on a

Water System?

The Paul Systems of Water Supply, which are "as easy to install as a hand pump," have grown to be the great favorite with thousands of builders, because we make everything as plain as day, so you can figure on a job and know it's right.

Send for information showing how we cooperate to make your business more successful.

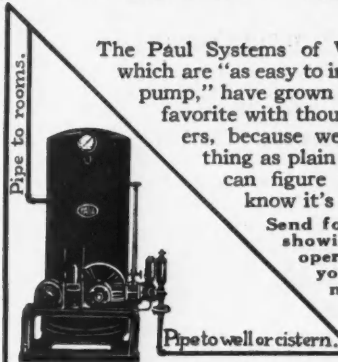

Fort Wayne Engineering & Manufacturing Co.

1709 N. Harrison St.
Fort Wayne, Ind.

**AS EASY TO INSTALL
AS A HAND PUMP**

World Shortage of Lumber Revealed By Investigation

(Continued from page 146.)

years investigation of this subject in the allied and neutral countries of Europe.

"There is every reason to believe that the foreign demand for American lumber is going to be very large," says Mr. Brown, "and I may say that the amount those countries will buy is limited only by the available tonnage, by the rates at which the ships will carry the lumber abroad, and the ability of those people to pay for it." Other government investigators confirm Mr. Brown's views in this respect.

Says Europe's Stocks Short 105 Billion Feet

One of the leading lumber economists in the world is Chas. S. Keith, of Kansas City, Mo., until recently president of the Southern Pine Association. Discussing the reconstruction problem as it relates to Europe's probable lumber needs, Mr. Keith said in a recent address:

"While during the past four and a half years production has been depleted, it must be borne in mind that the world's supplies have also been exhausted. Normally the consuming centers of the world import from the producing countries twenty-one billion feet of lumber annually. For five years these imports have practically ceased. As a consequence the stocks of those countries are today short one hundred and five billion feet of lumber. A like condition exists in connection with iron and steel.

"When you consider that 53 per cent of the said 105 billion feet of lumber is normally produced in Austria-Hungary, Russia and Finland, and that the repeated campaigns of the Russian forces into Galicia have resulted in the destruction of mills, forests and stocks, with a similar condi-

tion existing in the Baltic sea territory outside of the Scandinavian Peninsula, it is manifest that the United States and Canada must, for the next three to five years supply the deficiency which cannot be supplied by Russia, Finland and Austria-Hungary, as well as supply the requirements of reconstruction, in addition to its normal percentage of production. * * *

"It is plain that the near future demand for lumber will be unprecedented."



Model House as "Build a Home" Campaign Aid

AN experiment made by an Ohio city proves what an effect a model house may have on a local "Own-Your-Own-Home" campaign. The real estate board of the city selected a most attractive plan. This was quite out of the ordinary, in colonial style, the entrance being at the side thru a portico, while the wide porch extended across one end, the outside chimney going up thru it and affording an opportunity for an outside as well as an inside fireplace.

Most of the contractors and material men worked at cost. A number of builders and merchants made substantial donations. When the house was finished \$400 were spent in advertising, and one afternoon 5,000 persons went thru the house, while as many more stopped to admire it from the outside. It was sold at a reasonable price, but at a profit, and, as a result of the demonstration in home building, many

(Continued to page 150.)

Marshall & Stearns Portal Wall Beds Received the Gold Medal at the Panama-Pacific International Exposition



Bryson Apartments, Los Angeles, Calif.

THE bungalow, residence or apartment building with a Portal bed in the living room, dining room or sun porch contains the accommodations of a much larger building.

W. L. VAN DAME COMPANY

58 East Washington St., CHICAGO

MARSHALL & STEARNS CO., San Francisco, Calif.

**A \$1,000,000
Apartment Hotel and Not
a Bed Room in It**

Still People Sleep Here—and in Comfort, Too

PORTAL WALL BEDS

are installed in living rooms and sun parlors, providing double efficiency—living rooms by day—sleeping rooms at night.

PORTAL WALL BEDS can be successfully used in any type of building where sleeping accommodations are provided. They are space savers and money makers.

SEND FOR DESCRIPTIVE CATALOG

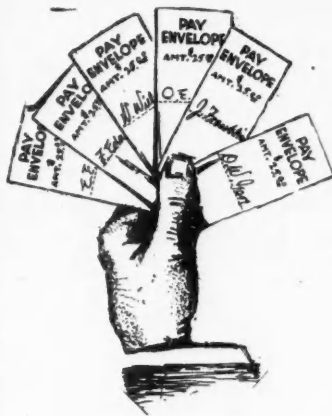

The old way of Scraping Floors and what it costs to do the work

\$125.00 SAVED IN ONE WEEK

on wages alone, and when this saving is considered along with the better quality of work done

The American Universal Sander

becomes at once the most indispensable part of a contractor's equipment.

Contractors in all parts of the country have taken advantage of this fast and economical way of surfacing floors.

If you are still doing your work the old way—better write us; it saves the labor of five men. It does the work better—your customers are more pleased.

Let us tell you about our five days' trial offer—no obligations.



The American Universal way of Floor Surfacing. It only takes one pay envelope instead of six.

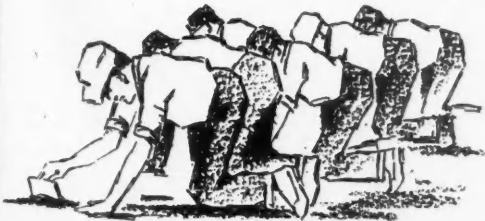

American Floor Surfacing Machine Co.

515 South St. Clair St.
Toledo, Ohio



(Copyrighted, 1918, A. E. Chappell)

THE WAYVELL CHAPPELL AUTOMATIC BALL BEARING ELECTRIC FLOOR SURFACING MACHINE is what you need to finish your new or old wood floors quickly and just the way you want them.

Patented roller eliminates vibration, also reaches all baseboards, doing away with unsatisfactory work of narrow edge roller. Four sizes—for the largest areas or the smallest rooms. Built to last.

The **LITTLE AUTOMATIC ELECTRIC SURFACING MACHINE** (on desk) is a wonder for removing varnish from desk tops, counters, etc., or for new work.

Write for folders. Accept our free trial offer

Manufactured by
Wayvell Chappell & Company
408 W. Grand Ave.
Dept. D, Chicago, Ill.



Pat. 1912-1916



Pat. 1916



The IMPROVED Rapid Floor Surfer

will surface right up to the wall or baseboard without the use of Edge Roller. Just the machine you would want for surfacing all kinds of wood floors, whether old or new. Will smooth down rapidly and easily all joints or warped edges. Perfect results guaranteed. More than 20,000 of our machines now in use. Guaranteed against defect in material and workmanship for five years.

Send for our Free Trial Offer. It will interest you.

M. L. Schlueter
222 W. Illinois St., Chicago, Ill.

Made in several sizes



We will send you this machine for 10 days' FREE TRIAL. If you don't like it ship it back.

Write for Our Prices and Special Offer

Fox Supply Co.
Brooklyn, Wis.

O. K. POWER HOISTS

Are made to satisfy the needs of every contractor. Single, Double or Reversible Hoists to fill each demand. Their extreme simplicity makes for excellent service and cuts the costs of repairs and upkeep to practically nothing.

You will find in O. K. Hoists the quality that up-to-date contractors demand. Send for our catalog. It describes our complete line of hoists.

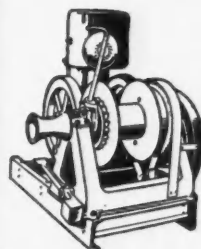

Type A Single Drum

O. K. Clutch & Machinery Co.
Florence St., Columbia, Pa.

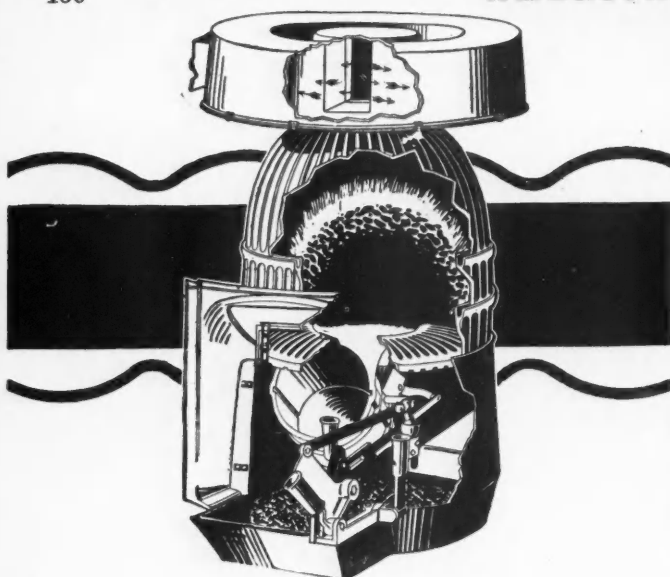

Your Opportunity to Cash In—Big!

You don't have to create a demand for the Williamson UNDERFEED Furnaces and Boilers. The demand is being created for you. Our big advertising campaign in the leading national publications is increasing that demand month after month. Home owners and home builders are beginning to think mighty seriously about protection against another winter of insufficient heat and high coal prices. So let's line up together quick to get this profitable business.

WILLIAMSON
UNDERFEED FURNACES & BOILERS
Cut Coal Bills Way Down

We'll give you close practical co-operation in following up prospects, closing the sales and in making installations. We'll write letters for you, send out interesting literature and keep you supplied with attractive booklets and folders. We will furnish you with electro-types for newspapers, picture slides and other selling aids. Also at your service is our well organized Engineering Department which will prepare your heating plans and estimates without cost to you. Mail the coupon for further details regarding our co-operative selling plan. You'll be glad you did.

The Williamson Heater Company
 74 W. Fifth Street, Cincinnati, Ohio

THE WILLIAMSON HEATER CO.
 74 W. Fifth St., Cincinnati, Ohio

Please send me full details regarding your plans to help me sell and install Williamson UNDERFEED Furnaces and Boilers. This request is to involve no obligation on my part.

Name

Address

Business

Model House as "Build a Home" Campaign Aid

(Continued from page 148.)

persons were interested to the point of taking steps to own their own homes.

This model-house idea is suggested as a first-rate method of centering interest in a local campaign, for it affords a means of showing exactly what construction at present-day prices of material and labor costs in a special place, and the house, inevitably much advertised, is readily sold. ✻

What Every Disabled Soldier and Sailor Should Know

THAT the government is resolved to do its best to restore him to health, strength, and self-supporting activity.

That until his discharge from hospital care the medical and surgical treatment necessary to restore him to health and strength is under the jurisdiction of the Military or Naval authorities.

That the vocational training which may be afterwards necessary to restore his self-supporting activity is under the jurisdiction of the Federal Board for Vocational Education.

That if he needs an artificial limb or other orthopedic or mechanical appliance the Bureau of War-Risk Insurance supplies it free upon his discharge and renews it when considered necessary.

That if, after his discharge, he again needs medical treatment on account of his disability the Bureau of War-Risk Insurance supplies it free.

That any man whose disability entitles him to compensation under the War-Risk Insurance Act may be provided by the Federal Board with a course of vocational training for a new occupation.

That the government strongly recommends each man who needs it to undertake vocational training and put himself under the care of the Federal Board, but the decision to do so is optional with each man.

That if his disability does prevent him from returning to employment without training and he elects to follow a course of vocational training provided by the Federal Board, the course will be furnished free of cost and he will also be paid as long as the training lasts a monthly compensation equal to the sum to which he is entitled under the War-Risk Insurance Act or a sum equal to the pay of his lost month of active service, whichever is the greater, but in no case will a single man or a man required by his course of instruction to live apart from his dependents receive less than \$65 per month, exclusive of the sum paid dependents; nor will a man living with his dependents receive less than \$75 per month, inclusive of sum paid to dependents.

That if his disability does not prevent him from returning to employment without training and he elects to follow a course of vocational training provided by the Federal Board, the course will be furnished free of cost to him, and the compensation provided by the War-Risk Insurance Act will be paid to him, but no allowance will be paid to his family.

All disabled soldiers, whether in or out of the hospital, should address their communications either to the Federal Board for Vocational Education, Washington, D. C., or to the district office of the Federal Board of the district in which he is located. The district offices of the Board are located at the following points respectively:

District No. 1: Maine, New Hampshire, Vermont, Massachusetts, and Rhode Island. Office: Room 483, Tremont Building, Boston, Mass.

District No. 2: Connecticut, New York, and New Jersey. Office: Room 711, 280 Broadway, New York.

(Continued to page 152.)

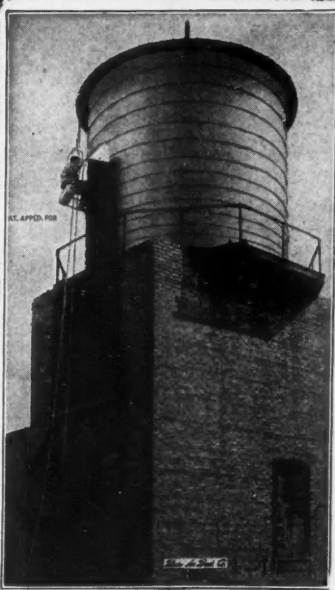

PAASCHE PORTABLE PAINTING OUTFITS

SAVE TIME, LABOR AND MONEY

Contractors will find no modern labor-saving invention that really makes them as much money as the Paasche Painting Equipment. With this equipment one man does the work of from four to eight men. This immediately reduces the cost of both exterior and interior painting.

QUICKER--BETTER--CHEAPER

From thirty to forty square feet of paint is easily applied per minute, and being applied by compressed air a cleaner, smoother and more uniform finish is obtained. The same smooth finish is given the roughest corners and edges, hollows, laps, and irregular joints.

The Paasche Painting Outfit is equipped to do all general painting, calcimining, varnishing of floors and all around decorating and finishing. From largest battleship or building to the smallest job of decorating, the Paasche Outfit will do it better and at a great saving.

The United States Government uses Paasche Portable Painting Equipment in all railroad and shipbuilding yards and wherever paint is needed.

CONTRACTORS

Can you afford to do less than investigate a proposition that offers you such an opportunity? Write today for complete information. It will make you money.

Paasche Air Brush Co. 1230 W. Washington Blvd., Chicago, Ill., U. S. A.

The American Builder

Guaranteed Circulation 36,000

Publishes More Pages of Advertising
Has the Largest Number of Advertisers
AND
Many Thousands More Subscribers
Than Any Other Building Paper
in the World.

Caldwell Sash Balances Uniform Mortises

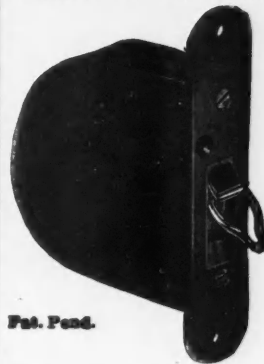

For use in all classes of new work. Box frames unnecessary. Mortises cut at mill reduces cost of installing. Counterbalance sashes perfectly unaffected by atmospheric conditions. Cheapest method for modernizing old window, as alterations in sashes and frames are not necessary. Sashes should be weighed before ordering.

Pat. Pend.

Write for Circular
CALDWELL MFG. CO.
2 Jones St. Rochester, N. Y.

YOU CAN PAINT ALL HEART CYPRESS ALL HEART

"THE WOOD ETERNAL"
EVERY 91 YEARS JUST FOR LOOKS
but it don't need paint to preserve it.

Use it where you want a non-rot wood. Try it. But be sure to INSIST on Tidewater-Cypress — identified by the Assn. Trade-Mark as shown below.

 It's Your Guarantee. Ask Your Lumberman.

For the outer covering of a building no other wood gives such long and satisfactory service as

WHITE PINE

What Every Disabled Soldier Should Know

(Continued from page 150.)

District No. 3: Pennsylvania and Delaware. Office: 1000 Penn Square Building, Philadelphia, Pa.

District No. 4: District of Columbia, Maryland, Virginia, and West Virginia. Office: 606 F Street N. W., Washington, D. C.

District No. 5: North Carolina, South Carolina, Georgia, Florida, and Tennessee. Office: Room 1404 Chandler Building, Atlanta, Ga.

District No. 6: Alabama, Mississippi, and Louisiana. Office: 822 Maison Blanche Annex, New Orleans, La.

District No. 7: Ohio, Indiana, and Kentucky. Office: 906 Mercantile Library Building, Cincinnati, Ohio.

District No. 8: Michigan, Illinois, and Wisconsin. Office: 1600 the Westminster, 110 South Dearborn Street, Chicago, Ill.

District No. 9: Iowa, Nebraska, Kansas, and Missouri. Office: 517 Chemical Building, St. Louis, Mo.

District No. 10: Minnesota, North Dakota, and South Dakota. Office: Room 742 Metropolitan Bank Building, Minneapolis, Minn.

District No. 11: Wyoming, Colorado, New Mexico, and Utah. Office: 909 Seventeenth Street, Denver, Colo.

District No. 12: California, Nevada, and Arizona. Office: 907 Monadnock Building, San Francisco, Cal.

District No. 13: Montana, Idaho, Oregon, and Washington. Office: Room 539 Central Building, Seattle, Wash.

District No. 14: Arkansas, Oklahoma, and Texas. Office: 810 Western Indemnity Building, 1000 Main Street, Dallas, Texas.



Scratched Joints Versus Smooth Joints in Gluing

The common assertion that scratched surfaces make stronger glued joints than smooth surfaces seems hard to prove. Comparative tests made on several occasions by the Forest Products Laboratory, Madison, Wis., all indicate that the strengths of these two types of joints are practically the same.

The test specimens used by the Laboratory were pairs of hard maple blocks, some with smooth and some with tooth-planed contact surfaces. These blocks were glued with a high grade hide glue, allowed to stand for a week, and then sheared

apart in an Olsen universal testing machine. Four joints of each type were compared in a single test.

Eleven such tests were made and in seven of them smooth surfaces gave the better adhesion. Consequently it would seem that there is no advantage in tooth-planing wood for gluing purposes.



Famine in Bicycles Predicted

From the pleasure vehicle of twenty years ago, the bicycle has become a means of locomotion that is used by many thousands of persons engaged in the building industry. Consequently the announcement made by bicycle manufacturers that a "bicycle famine is coming" is of more than ordinary interest.

"Practically all of the big manufacturers of bicycles cooperated with Uncle Sam by devoting their plants to the production of munitions—airship parts, hand grenades, '75' shells and military bicycles of a special pattern that very materially cut down the normal output of regular models," says the report.

"The lost production on account of war work, and inability to get steel, has already caused a serious shortage. More time will be lost while the factories are changing their equipment back to a bicycle basis. There is also a tremendous export demand for bicycles. In the meantime, the existing shortage of bicycles is daily becoming more acute and a veritable bicycle famine seems inevitable.

"Men in the industry who know the actual capacity of the plants, estimate that it will take at least a year for the output of bicycles to catch up with demand. A good many thousand boys and a sizeable army of men, who have been looking forward to owning new bicycles this season may have to walk."

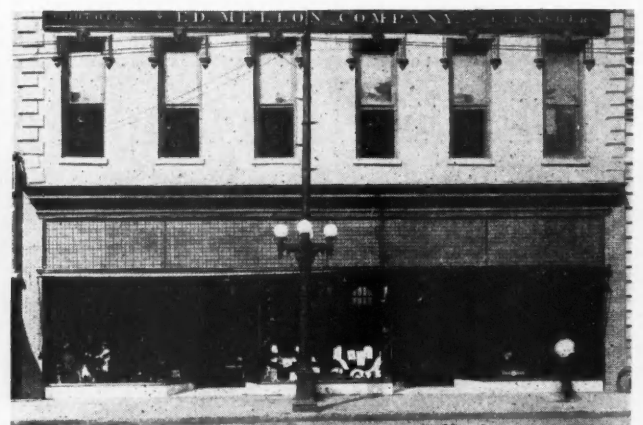

COULSON STORE FRONTS

THE sale and installation of Coulson Store Fronts insure an unusual profit to contractors. Look at the striking contrast illustrated above; you see an old-fashioned dilapidated store, transformed as if by magic, into a bright, modern, progressive store! Only a Coulson front could make this possible.

The contractor, who sold and installed this front, made a handsome profit; the owner of this store is not only satisfied, but very grateful because the increase in his business has more than convinced him of Coulson value.

Get Busy

Look around; there are hundreds of old stores in your district, that needs new fronts; isn't it time you went after them?

Our illustrated catalogs and prices are waiting for you; they will show you how to make more money and win more business friends. A postal will bring full particulars—

Write today!

THE J. W. COULSON COMPANY

95 W. Spring Street, Columbus, Ohio

This Modern CLOSET

Is convenient, sanitary and beautiful. It is the equal of the modern flush closet of city homes.

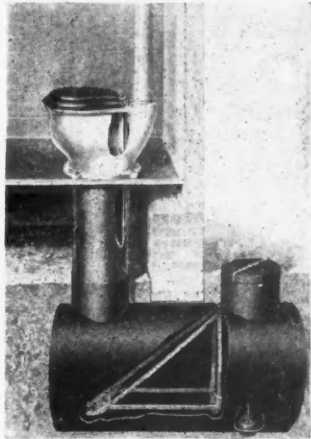

The Waterbury SANITARY SCAUSTIC CLOSET

affords modern closet convenience for homes, schools, factories, churches and all buildings where water and sewers are not available.

Town and farm families are demanding the convenience and comfort of indoor closets. The "Waterbury" so completely supplies this need that it surmounts all competition.

CONTRACTORS

Introduce this modern standard of closets in your community and you will uncover an active demand for hundreds of them. There's real profit in the "Waterbury" too.

Write us at once for information on exclusive agency offer.

The Waterman-Waterbury Co.
Minneapolis, Minnesota

Semi-Centennial
of
YALE

Fifty Years
of
Service



"There is no legacy so rich as honesty"
—All's Well that Ends Well

WITH entire sincerity I can say that I believe the guiding principle of those by whom this company has been built up has been Honesty, of purpose and of endeavor. Honesty in design and production, that each article shall be right for its purpose. Honesty in representation, that the buyer shall not be misled. Honesty in pricing, that quality shall not be sacrificed to cheapness. Honesty in all relations, with employees, customers and the public.

This statement by the Company's Chairman, forms the concluding page in a Semi-Centennial booklet just published. A copy will be sent to you free upon request.

While it is true that this business has grown because it has prospered, it is equally true that it has prospered because it has grown.

Henry R. Towne
Chairman of the Board

The Yale & Towne Mfg Company 9 East 40th Street, New York City
Chicago Office: 77 East Lake Street Canadian Yale & Towne Limited, St. Catharines, Ontario

RAIN, snow, sun and sleet! They are Time's workers of ruin to houses. If you are working with brick, concrete or stucco make the job waterproof and attractively brilliant with Bay State Brick and Cement Coating. Either a clear, crisp white or one of the many alluring Bay State tints on the walls, will swell you with pride.

Our Book No.20 and samples will surely convince you.



Wadsworth, Howland & Co., Inc.
PAINT AND VARNISH MAKERS
Boston, Mass.

New York Office Architects' Building Philadelphia Office Weightman Building



FLOORS

The Wood-Mosaic Kind



For every home—Old or New. Can be installed by your mechanics. Our 5/16" flooring can be laid in old or new houses. We make all kinds and thicknesses; Wood-Carpet, strips Plain and Ornamental Parquetry, Tongue and Groove Flooring.

Send accurate measurements of rooms for sketch with exact estimate of cost of the flooring required. Instructions for laying and finishing accompany all orders shipped.

Send for free catalogue in natural wood colors.

Wood-Mosaic Company
New Albany, Indiana



NEWS OF THE FIELD

Dennison, Ohio, Building Co. Formed

The Dennison Building Co. has been organized at Dennison, O. The company is capitalized at \$75,000 and will handle building materials and do a general contracting business. W. H. Angel, formerly superintendent of the Dennison schools, is secretary and manager of the company.

Cornell Wood Products Company Moves Offices

The Cornell Wood Products Co., manufacturers of Cornell Wood Board, with mills at Cornell, Wis., has for the fifth time since 1914, when it entered the wallboard field, found it necessary to increase its offices. In August, 1915, the executive offices were transferred from Cornell, Wis., to Chicago, where space was taken in the Insurance Exchange building. Since then the offices have been enlarged four times, and, at present, the organization has expanded to such a capacity that April 16 they moved into larger quarters, which occupy practically the entire ninth floor in the new State-Lake building, 190 North State street.

The Cornell Wood Products Co. has also opened offices in

New York City and established branches in Melbourne, Australia, Wellington, New Zealand, and Johannesburg, South Africa.

National Lumber Manufacturers' Association Elects Officers

At the annual meeting of the National Lumber Manufacturers' Association, held at Chicago, April 17, the following officers were elected: President, John H. Kirby; first vice-president, J. W. Blodgett; second vice-president, J. H. Bloedel; secretary-manager, Wilson Compton. In place of C. H. Worcester, who resigned as treasurer, George N. Harder, of Rib Lake, Wis., was chosen. Nine new directors were appointed, making the total membership of the board 32. President Kirby will appoint the executive committee.

Simonds Foremen Have Banquet

The annual foremen's banquet of Simonds Manufacturing Co., Fitchburg, Mass., factory took place at Sterling Inn., Thursday evening, March 27, with seventy foremen and guests present. Mayor Frank H. Foss of Fitchburg was a guest of honor, while President Alvan T. Simonds, General Manager Gifford K. Simonds, Vice-President T. F. Howarth and Harlan K. Simonds, treasurer of the company, were present and helped enliven the occasion. J. E. Kelley, general sales manager, acted as toastmaster, and a program of after-dinner speeches, music and dancing was enjoyed. A company of professional vaudeville artists, secured by Superintendent J. J. Eberhard, and an orchestra, provided appropriate entertainment.

Mayor Foss spoke on the question of labor distribution

(Continued to page 156.)

Underwriters' Labeled FIRE WINDOWS AND FIRE DOORS

We manufacture a complete, economical and distinctive line of HOLLOW METAL WINDOWS. Built according to the specifications of the Underwriters' Laboratories and bearing their label. We have a design for every type of building, to meet every requirement.

We manufacture wood core, tin clad FIRE DOORS according to the Underwriters' specifications and bearing their label. We are prepared to furnish fire doors and fire door hardware for any type or style of opening.

Our HOLLOW METAL WINDOWS and TIN CLAD DOORS can readily be installed in old buildings where it is the desire to provide perfect fire protection.

We are manufacturers of a complete line of Architectural Sheet Metal Building Products including SKYLIGHTS, VENTILATORS, etc.

The Trade Mark of Quality



WILLIS MANUFACTURING CO.

105 N. Academy Street
GALESBURG, ILLINOIS

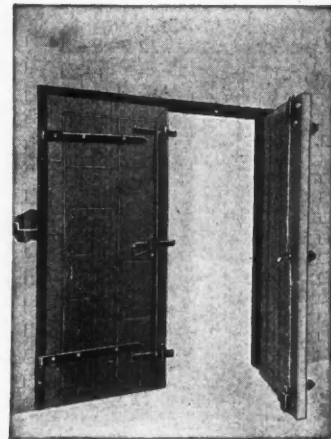
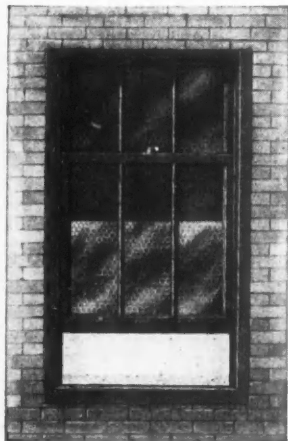

Stewart



IF you want a mixer that is both built and sold on the square, and that will render you satisfactory service over a long period of time, you want a STEWART!

We build a mixer to suit every contractor's purpose and pocket-book; you choose from no less than five sizes and fifteen models

when you choose a Stewart, and every one a perfect machine!

ECONOMY

In economy tests, the Stewart has proven its supremacy; that is, in determining which machine can, in a given time, mix most, best and cheapest per man, with the least amount of repairs and wear. Can any contractor ask for greater proof than this?

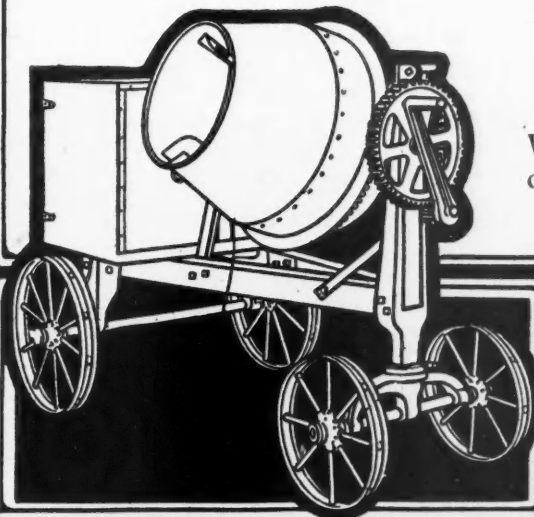

Write today for booklet and prices and become acquainted with Stewart Equipment

STEWART MFG. CO.

49 Rath Street, Waterloo, Iowa

EXCELSIOR WIRE LATH

is woven of steel wires of great tensile strength. The small amount of exposed metal surface permits the plaster to go through to the back and key tightly, making a wall of a solid sheet of stone with a rigid steel core, a fire retarding wall—itsself unburnable. When properly put up, rust and disintegration cannot take place. A strong, even selvage permits easy handling and tying.

Write for Booklet

WRIGHT WIRE COMPANY

Excelsior Wire Products

Worcester, Mass.

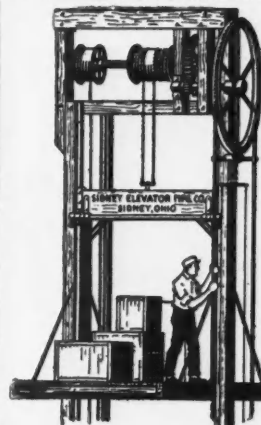

SIDNEY ELEVATORS

Will reduce your handling expense, and speed up your work.

Our machines are easily installed from our complete plans and instructions which are sent with each elevator.

The Reasonable Cost Will Interest You

Write us today, stating requirements, giving style of machine wanted, size of platform and number of feet travel, and we will quote a money saving price on equipment to serve you well.

**SIDNEY ELEVATOR MFG. WORKS
SIDNEY, OHIO**

News of the Field

(Continued from page 154.)

and predicted the adoption of the 48-hour work week in factories thruout the country in the near future. The prospect of increased demand for American manufactured products was also mentioned. Construction of public buildings and road improvements, which are to be extensively carried on this year, the mayor said, would give enjoyment to many who are now idle. He also averred that capital and labor must meet on common ground, and each must give way to the other on points which may be for the good of the country.

E. B. Saunders, welfare director, gave an interesting talk on the spread of Bolshevism in Europe, and explained its objects.



H. H. Lucas Joins the Ideal Sales Force

The Ideal Engine Co. of Lansing, Mich., manufacturers of Ideal power and equipment recently added H. H. Lucas to the sales force. Mr. Lucas before joining the U. S. Navy, where he became an ensign, was with a Lansing company, and as soon as his honorable discharge from the service was received early in April took up his active duties in the sales department of the Ideal company.



Architects to Study Problem of Service

How best can the architects of the country serve during the period of reconstruction is being investigated by a post-war committee on architectural practice, which has headquarters at 1741 New York Ave., Washington, D. C. The committee has issued an eight-page circular setting forth what its aims are and asks every architect in the country, whether or not he is a member of any of the established professional organizations, to co-operate with it "in an effort to work together on a common ground for the common good."



The Spring Clean-Up

PAINTS and painters have both been rather scarce during the war. As a consequence owners who were in the habit of keeping their buildings properly protected with paint in pre-war times, were of necessity forced to let them go unpainted during ex-Kaiser Bill's orgy of fire and blood. Now, as a result of the neglect many such buildings are badly in need of painting, not only to prevent deterioration, but because they present an untidy appearance. Even their value, in the event it were desired to sell them, would be appreciably lessened.

The time is now ripe for a grand spring clean-up. Painters are available and paints again in plentiful supply.

There were many painters in the military service; many were employed in industrial war work. It would be an act of patriotism to give these men employment. And it's a two-sided proposition at that. The owner of the building improves his property; the painter is offered work; the paint manufacturer can keep his factory running, and unemployment, recognized as a bad thing for the country, is to some extent, at least, reduced.

By all means, let's get busy with our painting. **LET'S DO IT NOW.**



He Should Worry

Lumber Dealer—"I won't stand for these high repair bills on that truck any longer."

Driver—"I don't care whether you stand for them or not as long as you foot them."

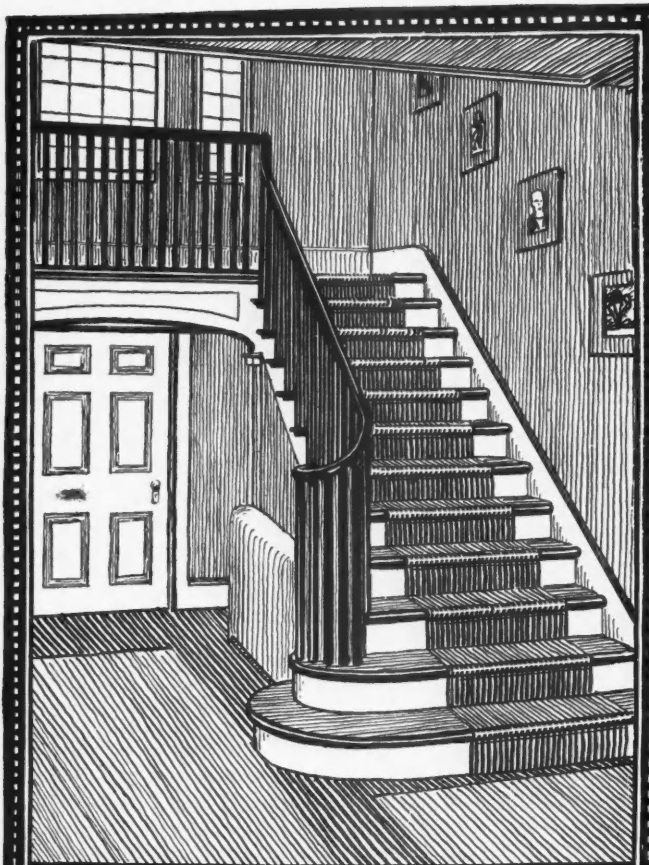

Starrett Scrapers



For the Finishing Touches on Stairs, Floors and Other Interior Work

THE simplest and best all around scrapers on the market. They have eight sharp, smooth cutting edges—any one of which can be brought into use by a simple turn of the handle.

Blades can be set any angle to enable the user to get into corners without bruising knuckles.

Write for catalog No. 216. It shows many other styles and sizes of fine Starrett Tools.

The L. S. Starrett Co., Athol, Mass.

*The World's Greatest Toolmakers
Manufacturers of Hack Saws Unexcelled*

New York
London
Chicago



42-920

WE DON'T SELL SAW DUST

But Manufacture a Saw That Makes It Mighty Fast

It's the New 20th Century Ultra Speed, with the first real noticeable improvements in hand saws since they have been in existence.

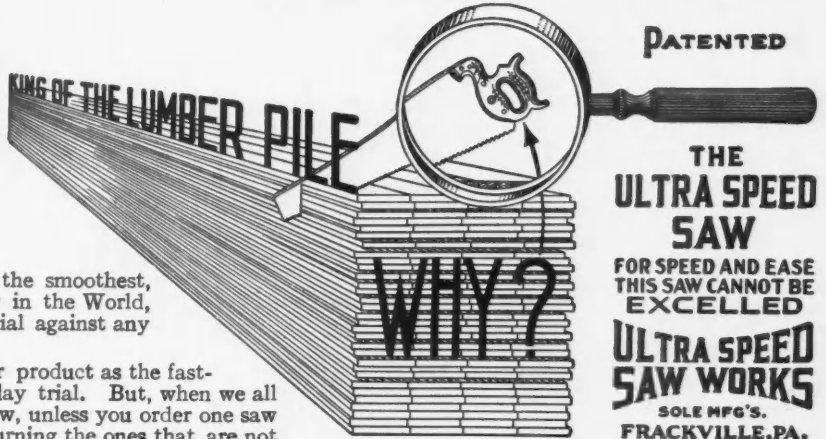

PATENTED
THE ULTRA SPEED SAW
 FOR SPEED AND EASE THIS SAW CANNOT BE EXCELLED
ULTRA SPEED SAW WORKS
 SOLE MFG'S. FRACKVILLE, PA.

We guarantee the *Ultra Speed* to be the smoothest, cleanest, easiest and fastest cutting Saw in the World, and back it to the extent of a 30-day trial against any Saw regardless of Manufacturer.

All Good Saw Manufacturers sell their product as the fastest and easiest operating saws, on a 30-day trial. But, when we all claim the same thing, how are you to know, unless you order one saw from each Firm under their guarantee, returning the ones that are not what is claimed of them.

The great cutting quality of a 7 point 26 inch *Ultra Speed* was demonstrated by cutting off a 6 1/2 x 12 inch piece of timber in 67 seconds. *Think of it!* Try a piece of the same size with the saw you are using today and see what the result will be.

The question of steel for holding a keen cutting edge is a thing of the past. WE pay the price and get the BEST that can be obtained, heat treating it with a *secret process*, which is also one of our new discoveries.

Write for Pamphlet giving full details, such as: *The Life of the Ultra Speed, Why the Ultra Speed Saw is in Existence and 12 Reasons Why the Ultra Speed Saw is Superior to All Others.*

It will pay you to send a Post Card NOW.

ULTRA SPEED SAW WORKS 317-355 Broad Avenue Frackville, Penna.
 Main Office and Factory

Sand's Aluminum Levels

Always Tell the Truth

The standard of accuracy. And not only the most accurate—but easiest to read, even in the dark. Never rusts—cannot warp, split or crack—and are easily handled.

The lightest levels made—strong and durable because the greatest strength is placed where most needed. Ask your dealer to show you these levels, and also write for our new circulars showing full size levels.

J. SAND & SONS Originators of Aluminum Levels 1023 - 29 Rivard Street, Detroit, Michigan



Build the Fireplace Right

Don't try to reduce the cost by leaving out a good damper. It results in an expensive fireplace to operate and allows rain, wind, birds, and other objectionable things to enter the room when the fireplace is not in use.

Stover Dampers support the brick work, form a smooth throat, regulate the draft perfectly, and reduce the labor cost of erecting fireplaces.

The price is low enough so a Stover Damper can be used in every fireplace. Made in several styles for all size openings. The Improved style shown above is one of the most popular.

Send for catalog No. 1740 showing our fireplace fixtures and giving information as to the best fireplace construction.

We also make wind mills, feed mills, gasoline engines, hinges, pulleys, saw vices, latches, sink brackets, and other hardware.



No. 16 Improved style Made in 7 sizes

Stover Mfg. & Engine Co.
 Freeport, Illinois

Stover Mfg. & Engine Co., 725 East St., Freeport, Ill.
 Send us Catalog 1740.

Name..... Business.....
 City..... State.....

Attractive Proposition TO Carpenter-Contractors

HERE is a mighty good proposition. Look into it. You will make **more money—give your customers more satisfaction**—putting up modern cribs equipped with the National Giant Inside Bucket Elevator and it will cost your customer less money, too. Send postal now and let us explain why.

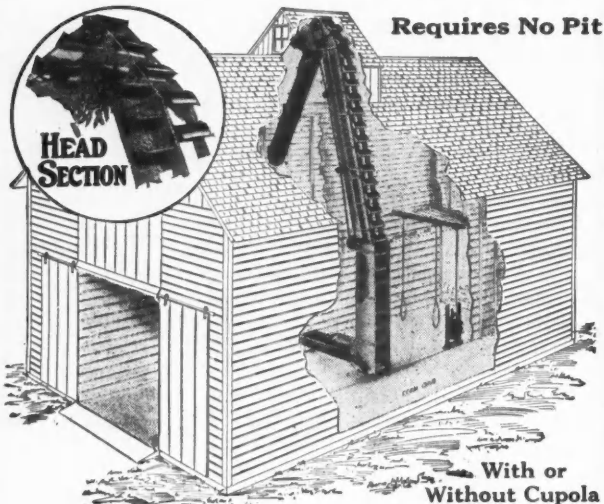

The National Giant

Is the Best and Most Sensible Inside Elevator Ever Made

On cribs 30x32 ft. or less with half pitch roof, it is not necessary to have a cupola. Saves the farmer money. When cupola is necessary we can help you save the farmer from \$15 to \$30 with the National Giant. And no special width driveway is required. You build whatever kind of crib your customer likes and put the National Giant in it. Not necessary to build the crib to suit the elevator. We also save cost of digging a pit and on the length of elevator required. Dump logs will be furnished when pit feeder is desired.

Other features are: The National Giant Inside Bucket Elevator is equipped with large No. 77 chain. Buckets hold a peck. Does not shell corn because feeder empties directly into the mouth of bucket. Short distance delivery means lightest draft. Has no overhead gearing.

Simple and Easy to Install

Nothing technical in our elevator. Can be set up in a very little time by any practical carpenter. Everything explained in our catalog.

Send for Crib Plans and New Catalog FREE

We have just issued a wonderful new Elevator Catalog containing pictures and a description of every type of elevator. Don't miss getting this catalog. Also, new book of crib plans—just out—which we send free with catalog. Contains latest tried and successful cribs, all good sound and simple construction, write us at once. We will be pleased to cooperate with you. Get details at once. Address

Portable Elevator Mfg. Company

834 East Grove Street, Bloomington, Ill.



Some Use in the World

"Nobody will be brighter or better for such a sour old fellow as George Mason, the bricklayer."

"I don't know about that. Glum husbands make merry widows."



Eligible

"If I marry a man he must have a fortune with at least five ciphers in it," declared the girl to the apprentice carpenter.

"Then I've got you," he replied. "My fortune is all ciphers."



None to Brighten Life

"Is your wife superstitious?"

"Very, but in a one-sided manner only."

"I don't get you."

"The signs she believes in are all bad ones. There seems to be no good luck whatever in her superstitions."—*Detroit Free Press.*



Where to Be Careful

Miss Huggins—"My father is very good at reading faces."

Mr. Kissam—"Then I had better not print any kisses on yours!"—*Pearson's Weekly.*



False Doctoring

"What is the meaning of 'false doctrine,' Willie?" asked the Sunday School teacher.

"It's when the doctor gives the wrong stuff to a sick man," replied Willie.—*Pearson's Weekly.*



Right in His Line

Sympathetic Lady (to doughboy on a hike)—"Doesn't that 60-pound pack make you awfully tired?"

Doughboy—"No, ma'am; you see I was a hod carrier before I joined the army."



Misread His Hand

A negro in one of the stevedore regiments at a base port in France saw an officer approaching him while patrolling his beat on sentry duty, whereat he drew himself up stiffly and gave a flourishing salute, saying, "Good morning, General!"

"But I'm not a general," rejoined the smiling officer.

"Beg yo' pardon, Colonel," said the darky.

"But I'm no colonel," protested the captain.

"'Scuse me again, Major," came back the dusky sentinel.

"Look here, man, I'm only a captain," was the officer's reply.

"Well, sah! I knew you wuz one of de face cards of de pack, anyway," said Rastus, with a confiding grin.—Prize story in Judge, by Corporal R. V. Bucher.

"It Lasts Like the Pyramids"

REILLY'S WEATHERWAX

The Liquid Wax Paint

Builders! Use this paint and save money

It waterproofs permanently and prevents decay. Fills pores. One painting outlasts five of linseed paint. Costs less. Spreads twice as far with one-fourth the labor. Won't blister or peel. Flat, even finish. Made in Red, Maroon, Dark Brown, Natural Brown (clear), Black.

Color chart on request. Send for sample can.

THE REILLY COMPANY, Indianapolis, Ind.
Plants: Indianapolis Minneapolis Mobile Seattle Norfolk

Make \$1500 to \$2000 A Year



I Can Show You How

by the investment of only \$400 to \$500, you can engage in a profitable business in which there are big opportunities, little competition and generous profits for the work you do. Many make \$3,000 to \$4,000 a year in this business. You can do as well. With a set of our

LA PLANT-CHOATE TRUCKS

and a little other equipment you are prepared to tackle any job of house raising or moving. Also handle contracts for moving big machinery, etc. I cleaned up \$50,000 in less than ten years. You can do it, too. Let me show you how. Write today for catalog (B) and my special proposition.

E. W. La Plant, President.
La Plant-Choate Mfg. Co.,
620 Eastlock Court,
CEDAR RAPIDS, IOWA.





Bulletin No. 4 Gives Complete Information. Write for it Today.

Northwestern Steel & Iron Works

EAU CLAIRE, WIS.

NORTHWESTERN MIXERS

Price and Performance Will Please Every Buyer

Simple, safe, strong and sturdy. Unequaled for speedy, thorough, economical mixing. Anyone can operate these mixers. **Engine** is frost-proof, fool-proof and durable. Burns gasoline or kerosene. Cuts down fuel bills. A try-out will demonstrate the speed and service. We have distributors in every state.

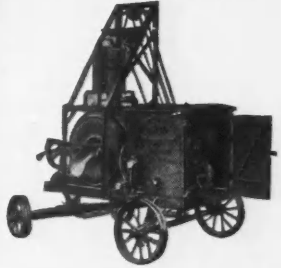

HESS MEDICINE SANITARY CABINET LOCKER



The Only Modern, Sanitary STEEL Medicine Cabinet

or locker, finished in snow-white, baked everlasting enamel, inside and out. Beautiful beveled mirror door. Nickel plate brass trimmings. Steel or glass shelves.

Costs Less Than Wood

Never warps, shrinks nor swells. Dust and vermin proof. Easily cleaned.

Should be in Every Bath Room. Four styles—four sizes. To recess in wall or to hang outside. Send for illustrated circular.

HESS, 920L Tacoma Bldg. CHICAGO

The Recessed Steel Medicine Cabinet Makers of Steel Furnaces Free Booklet

Plumbing, Heating and Pneumatic Waterworks Supplies at Wholesale



When in the market for Plumbing, Heating and Pneumatic Waterworks Supplies and you wish to

Save 20 to 40%

on every article, write for free illustrated Catalog. The only house that sells first-class guaranteed goods at wholesale prices direct. Shipments are promptly made from a very complete stock. Small orders are as carefully handled as large ones.

B. B. KAROL, 800-802 S. Kedzie Ave., Chicago, Ill.

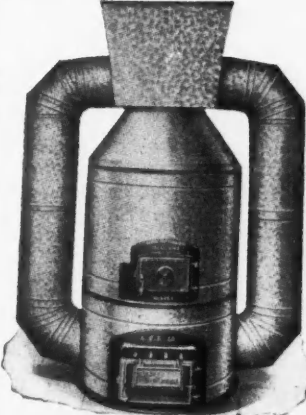

Mr. Builder

The Ideal King Pipeless System is the Ideal system for farm house, store, church or school.

Write for circular and prices. Deal direct with manufacturer.

KANSAS CITY FURNACE COMPANY
2429 Independence Ave.
Kansas City Missouri

LUFKIN

SPRING JOINT

WOOD RULES,

BOXWOOD RULES



All of the same high quality as our Measuring Tapes. On Sale Everywhere Send for Catalogue

THE LUFKIN RULE CO.

SAGINAW, MICH.
New York
Windsor, Can.



Save \$43.00 This Easy Way

Here is your opportunity to own a genuine Oliver, Model 9, for \$57. The identical model formerly priced at \$100. Not a single change has been made in the machine in order to make this astounding reduction in price.

Only our sales plan has changed. We learned new economies during the war. We found it unnecessary to have great numbers of traveling salesmen and numerous, expensive branch houses throughout the country. We were able to discontinue many other superfluous, costly sales methods. You benefit by these savings.

Free Trial

We ship the Oliver for free trial. You can keep it for five days. Use it as if it were your own. All without paying one cent in advance.

If you agree that it is the finest typewriter regardless of price, and want to own it, merely pay us \$3 per month until the \$57 is paid.

If you want to return it, ship it back, express collect. We even refund the out-going transportation charges.

During the trial you are the sole judge. No eager salesman need influence you.

\$3 Per Month

Our easy plan makes it possible for all to own a typewriter. And to use it while paying. There is no need to rent.

You obtain the same wonderful mode used by such big concern as U. S. Steel Corporation, Pennsylvania Railroad, Encyclopedi Britannica, Otis Elevator Company, Nat'l City Bank of N. Y., and others of equal rank. Over 700,000 Olivers have been sold!

No Typewriter is finer. It is noted for its workmanship, speed and durability. It is easy to learn. It has a standard keyboard. And all the latest improvements. If any typewriter is worth \$100 it is this splendid Oliver.

Mail the coupon now for our remarkable booklet entitled "The High Cost of Typewriters—The Reason and the Remedy," sent free, together with details of our plan. Then you may order a FREE Trial Oliver.

Canadian Price, \$72

The Oliver Typewriter Co.

2405 Oliver Typewriter Bldg., Chicago, Ill.

(48.03)



THE OLIVER TYPEWRITER COMPANY, 2404 Oliver Typewriter Building, Chicago, Ill.

Ship me a new Oliver Nine for 5 days' free inspection. If I keep it, I will pay \$57 at the rate of \$3 per month. The title to remain in you until fully paid for.

My shipping point is _____

This does not place me under any obligation to buy. If I choose to return the Oliver, I will ship it back at your expense at the end of five days.

Do not send a machine until I order it. Mail me your book—"The High Cost of Typewriters—The Reason and the Remedy," your de luxe catalog and further information.

Name _____

Street Address _____

City _____ State _____

Occupation or Business _____

How I Came to Sell Electric Light Plants

(Continued from page 25.)

churn, the washing machine, the feed grinder, the corn sheller and all the other machines that the farmer must have.

"I don't hesitate about telling some of these farmers

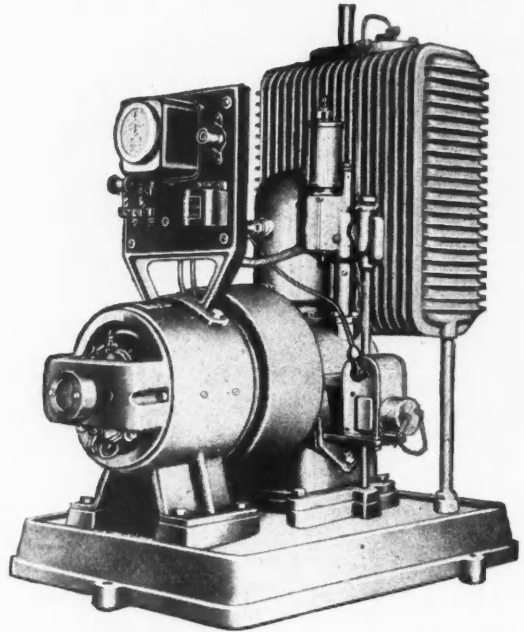

A Single Unit Lighting Plant, with All Parts Mounted on One Base; 19½ by 26 Inches and Weighs 525 Pounds.

these things when I get a chance. And they are beginning to believe that what I say is true. Farming is the greatest business in this great country, and there is no reason why this business should be run in slipshod and expensive ways.

"As I said before there is a great opportunity for builders to make big profits by selling electric light plants. But before they can sell them, they've got to learn something about them. I have found that the manufacturers welcome inquiries from builders and always are ready to help make a sale."

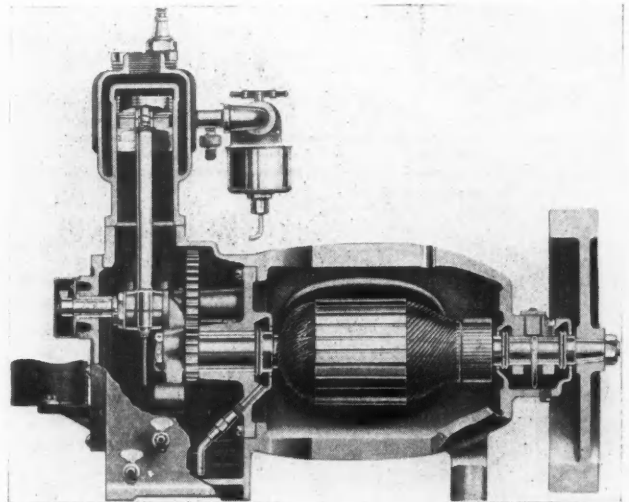

Here is a Cross-Section of a Little Lighting Plant That Was Used on Some of the Submarine Chasers That Helped End the War. This Plant is Capable of Supplying the Needs of All Farm Homes and Other Buildings.



**The "PERFECT"
BARN VENTILATOR**

Special Prices to dealers for April
AN EXTRA PROFIT FOR YOU

KLAUER MANUFACTURING CO.
Dubuque, Iowa

There's a Place for
**UNIVERSAL
INSULITE**

"The Board of a Thousand Uses"
In Every Building Constructed

Insulation—
Plaster Board—
Wall Board, Etc.

Dealers—Contractors—Consumers
Write us for full particulars.

International Insulation Company
Subsidiary of
Minn. and On-
tario Paper
Company

GENERAL SALES
OFFICE
2362 University
Ave., St. Paul,
Minn.

Crex Columns

Overcome all the objections to the old style wood columns. They are fire-proof, occupy much less space than a wood column, interfere less with light and with circulation of air, are neater, more sanitary, up-to-date in appearance, costing less in the long run than wood.

The Crex Column consists of a steel shell filled with the highest grade of concrete.

Especial care is taken in filling these columns so that the concrete filling shall be perfectly solid and uniform throughout. A special formula is used and the filling is done under hydraulic pressure.

Write us Today for descriptive catalog

Crex Patent Column Co.
2300 S. Springfield Ave. CHICAGO

THE "INTERLOX" THINKS

With this rule you can take the most difficult measurement (inside or outside), without a moment's delay for calculation. It does all the figuring mechanically for you, and can be read at a glance.

THE "INTERLOX"

Is a most necessary addition to every worker's tool kit. It is made in 2 to 8 feet lengths—of the finest box-wood with waterproof Lequer—solid brass trimmings. If your dealer does not have them, send us 20 cents per lineal foot, and we will send you one promptly.

MASTER RULE MFG. CO., Inc.
Formerly Dahl Mfg. Co.
841 E. 136th Street, New York City

"There It Is!"

STOCK FIRE PROOF DOORS

METAL AND METAL COVERED
Standard Sizes in Stock of all Designs
Write for Booklets and Price Lists

A. C. CHESLEY CO. 279 RIDER AVE.
INC. NEW YORK, N.Y.

Some Aspects of Jobbing Work

(Continued from page 59.)

building one-quarter inch to the foot, using a 1-2-4 mix when the sand is fine and a 1-2-5 mix when the sand is coarse placed over a gravel or cinder sub-base carried below the frost line, so the frost will not upheave, crack and break up the floor.

After the sub-base is well tamped the aggregates are mixed, placed in the form, divided in slabs not over six feet square, each slab having a contraction joint cut clear thru the thickness of concrete, and the concrete should be four inches thick, each batch being placed and tamped directly after mixing. Before the mass begins to set the top finish of 1 of cement, 2 of screened sand is put on, using enough water for it to spread easily, going over the top with wooden float until the surface is trowled smooth. The joints cut thru and edges finished in the regular way. To prevent the top being slippery, the surface is gone over with a stiff brush, before the concrete is entirely hard, removing any trowel marks and giving the concrete a better appearance.

Many different styles of tiles, marble, etc., are now largely used for the wearing surfaces of porch floors generally laid in some ornamental design. They are made in pieces about 1 inch thick, composed of various shapes and sizes, being set in a floating of cement mortar over the concrete base. This style of floor is known

as terrazzo and mosaic work.

Porches with flat roofs or nearly so must necessarily have a tin or prepared roofing covering, and there are certain features when placing this covering material one should pay particular attention to. One point is the flashing. The angle at B in Fig. 1 is a dangerous proposition. If care is not exercised in placing the flashing, the ice and snow will back up and evenly leak, causing trouble. I've seen the clapboards rotted out in a short time due to careless methods in flashing. One method used is shown at B where the tin is seamed with a sheet of galvanized iron, letting the galvanized strip lie over three course of shingles and shoving it under the fourth course as far as possible. A slater's tool called a ripper is used to advantage in pulling and cutting the old shingle nails.

A better way is shown in Fig. 2. Three courses of the shingles are torn off, the opening X blocked out and the roof boards continued down to meet those of porch roof. A galvanized iron strip is seamed to tin the same as in Fig. 1 laid on the roof boards and re-shingled. It is not necessary to paint the strip of galvanized iron, but the tin should be painted two coats. One reason tin gutters often leak is because they are not kept properly painted. Tin roofs and gutters should be painted one coat, at least every four years, using a good grade of linseed oil without turpen-

(Continued to page 164.)

A ROOF OF CHARACTER

With Lines and Shadows

STUDY this picture carefully. It tells such a wonderful story of progress in Roofing construction. Note the artistic appearance; the elimination of the costly galvanized gutter; no exposed metal or nails; no painting or preservatives of any kind.

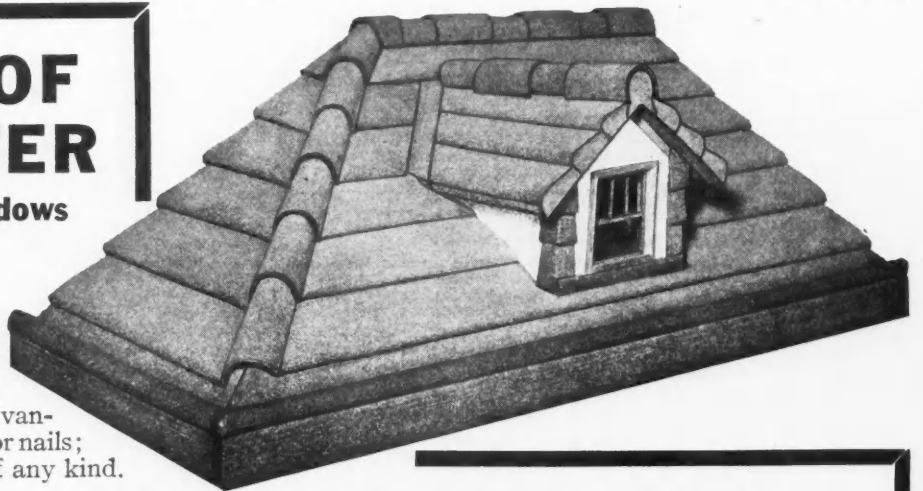

THE MOST MODERN ROOF AT A MODERATE PRICE

Statler's Patented Flexible Tile Roof is a seal tight roof—nothing to get loose and flop in the wind like ordinary roofs. This exceptional roofing is as applicable to old roofs as it is to new ones, and adds greatly to the value of any building.

It is fire-resisting and takes the same rate of Fire Insurance as Slate or metal roofs.

Any Contractor can put this roof on from Drawings Furnished.

Contractors! If your dealer does not already handle Flexible Tile Roofing, send us his name and address and a pencil sketch of your roof measurements, and we will at once advise him regarding prices, etc. **Write Today.**

FLEXIBLE TILE ROOFING CO.

C. A. STATLER, Patentee

505-507 UNITY BLDG., 127 N. DEARBORN ST. CHICAGO

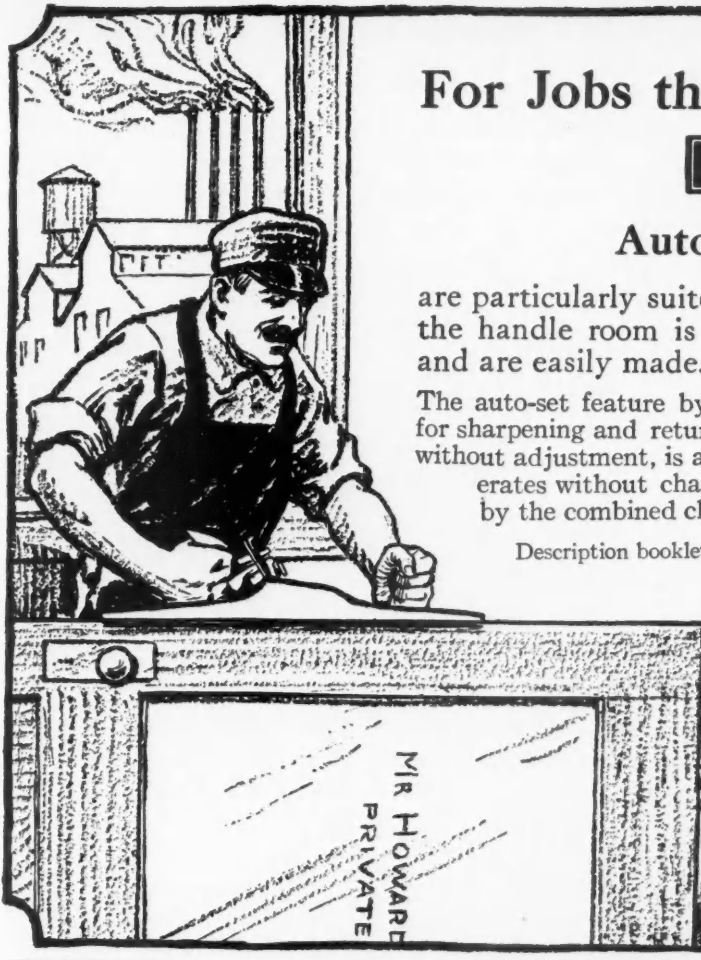

For Jobs that Require Extra Care

SARGENT

Reg. U. S. Pat. Off.

Auto-Set Bench Planes

are particularly suited. They are light but sturdily built; the handle room is ample; the adjustments are positive and are easily made.

The auto-set feature by which the cutter can be removed for sharpening and returned to exactly the same position without adjustment, is a great time-saver. The cutter operates without chattering, being firmly held in place by the combined clamp and cap.

Description booklet sent free on request.

Sargent & Company
 51 Water Street
 New Haven, Conn.



Shinn-Flat

PREVENTS LIGHTNING LOSSES



SHINN-FLAT is the one Lightning Rod that is scientifically designed and constructed, and guaranteed to prevent Lightning damage. It has 36 per cent more conducting surface than any round rod or cable containing an equal amount of material.

You Can Sell
Shinn-Flat
In Your Community

There is a big opportunity in every community for a contractor or builder to make considerable extra money protecting property already built from the danger of Lightning. This business will fit in nicely with your building business, and fill in the gap caused by a light building season.

We teach you the business and cover your installations with a cash bond guaranteeing that Lightning will not strike. Write for information.

W. C. SHINN MANUFACTURING CO.
 1659 Monadnock Bldg., Chicago, Ill.

Lightning Can't Strike IF Shinn Gets There First

Mr. Contractor-

More Heat
Less Trouble
Less Expense

is the verdict of hundreds, yes, thousands, of satisfied users of **Standard Clean-Air Systems.** Can be installed by one ordinary workman in a single day. Carpenters and Contractors find it a great proposition for a side line. (Quick sales; big profits.)

Washes Air and Purifies It



STANDARD HEATING CO.
 438 W. Ontario St.
 CHICAGO

Mail the coupon. It will open up new means of profits.

I am interested in your proposition.

Name.....
 Address.....

Some Aspects of Jobbing Work

(Continued from page 162.)

tine or any patent driers. A very suitable paint for tin roofs is mixed in the proportion of five pounds of ventian red, one-half pound of red lead and one gallon of pure linseed oil.

When cramped for elevation room a slight pitch is given a porch roof by using a 2x6 piece and ripping from one end across to 3 inches on the other end, making the 2x6 answer for both rafters and ceiling joists. Another way is to rip strips the required slant, nailing the strips on top of the rafters.

Sometimes the mistake is made in putting on the crown moulding as in Fig. 3, which is all right for shingles, but not for tin. The moulding for tin roofs should be placed underneath the roof boards, as shown in Fig. 4, letting the roof boards project over two inches, so there will be a good nailing edge for the tin, protection for the moulding and facilitate the work of hanging the gutters and down spouts.

Dayton, N. Y.

RAY W. WOOD.



Fred Beard Starts "Build a Home" Campaign

(Continued from page 48.)

who profit by building, but every business in the community. New homes need new furniture and carpets and curtains and all the other things that a family needs. So, all the businessmen down there chipped

in, not much, anything from \$10 to \$25, and with the money used the same method that put over the Liberty loans—advertising. They didn't go out of town to spend that money, either. They spent it in the local newspapers. And now the committee that put this idea over is ready and willing to help any other community do the same thing by telling how it was done.

The Real Estate Man Turns the Tables

"Let me take this article, will you?" asked Crisp. "I want to study this plan, and I'll write to Huntington and get some more dope, so I can put this up to our members at the meeting next week. It looks good to me."

"By the way, Fred, why weren't you at that meeting last night? We could have heard all about this plan from you and could have got into action more quickly."

"Well," responded Beard to Crisp's inquiry, "one reason I wasn't there is because I'm not a member of the chamber of commerce."

"You aren't? Why not?" was Crisp's quick comeback.

"I have been asked to join many times," replied Beard, rather ashamedly, "but I have never been particularly impressed with the value of the chamber of commerce. But if they talk about and plan to do such things as put on a 'Build Your Home' campaign, I am certainly going to join."

(Continued to page 166.)

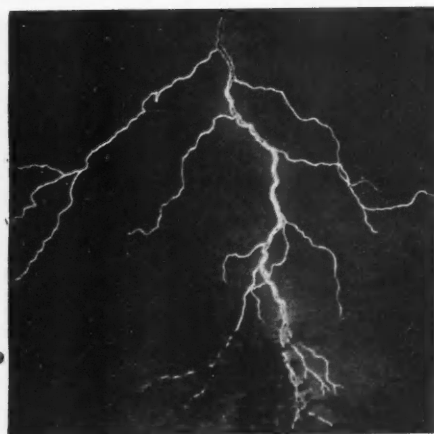

Taken from Actual Photograph

Lightning Rods

CARPENTERS — BUILDERS

MAKE BIG EXTRA PROFITS WITH

BARNETT SYSTEM GUARANTEED Lightning Protection

Why let the big extra profit go to the other man after you have done the hard work erecting the buildings? This easy profit belongs to you. You are the logical man right on the job to install this protection on every building you erect. The owner's confidence in you will make it easy to secure this additional work and profit on the same job. Why not make \$50.00 to \$75.00 per week extra?

Our Rods are in big demand. Made of pure copper endless cable, no rust (no joints) with attractive fixture. Easily put on buildings. Two hours extra work rods the building, and puts profit in your pocket. Money back guarantee with each job. Hundreds of our Carpenter agents began in a small way, now doing a big business. Secure the agency now. Write today for free Catalog, Cable Samples, and Prices.

Complete set of tools furnished free with first order of 500 feet or more.

JOS. L. A. BARNETT & CO., Cedar Rapids, Iowa



Advise Your House Customer on the Water System

You can save your client money and give him a better home. Take the order yourself and install the system when the plumbing goes in. The low cost of a

DEMING Marvel System

—the "cent or two a day" cost of operation and the automatic "self-operating" features make the Marvel the ideal system for the home.

Write for catalog of Water Supply Systems

THE DEMING CO.
99 Depot St., SALEM, OHIO



Comfort Indoor Closet

Odorless - Sanitary - Germ-Proof

Every home without sewerage needs one. No plumbing or running water needed. Anyone can install. A boon to sick people. Placed in any room in house, in town or country. 10,000 now in use.

U. S. Health Bureau Approves

Says: "Chemical Closet complies satisfactorily with requirements of sanitary system. Abolish cold outdoor closet. Put a warm Comfort Toilet in your home, a guarantee of healthy, sanitary conditions. Has all the latest improvements. Germ-life killed by chemicals. Efficacy in a month. Needs no other attention. State Boards of Health endorse it. Third successful year."

REPRESENTATIVES WANTED. No Capital needed. Men now making \$50 to \$75 weekly. Exclusive territory. FREE! Handsome Catalog. COMFORT CHEMICAL CLOSET CO., 305 Factories Bldg., Toledo, O.



Slate Urinals are Non-Absorbent

THE ABSOLUTE non-absorption of slate is the most important consideration regarding urinals from a sanitary standpoint.

And slate will outlast any building, so the wearing qualities need not be questioned. Furthermore, slate

looks clean, is clean and is in every way highly suitable for the purpose.

Made in a great variety of types, either plain or double, single or any number of stalls, ventilated or otherwise.

Literature mailed on request.



The Structural Slate Co.
Manufacturing Five Carloads Daily
Pen Argyl, Pennsylvania

R. H. Co. ESTABLISHED 1849
STAR SECTION
GALVANIZED AND COPPER COVERED
LIGHTNING RODS
100 PER CENT EFFICIENT

Greater Profits

For contractors who wish to utilize their time and build up a wide reputation. By installing Star Section Lightning Rods you are doing the utmost for your customer and pocketing a big profit each month.

Seventy years of successful manufacturing of lightning rods guarantees to the contractor that he is handling the product that will give his customer the most complete satisfaction. There is no greater asset than satisfied customers. We have some "territory" in which we want more reliable representatives. You can serve your own best interests by writing us at once regarding this unoccupied territory.

You cannot afford to delay—it is territory that yields great profits to wide awake contractors.

WRITE FOR OUR PROPOSITION

The Reyburn-Hunter-Foy Co.
815-819-821 Broadway Cincinnati, Ohio

Successors to
REYBURN-HUNTER & CO. PHILADELPHIA-CHICAGO
E. A. FOY COMPANY CINCINNATI



TROUBLE SAVERS

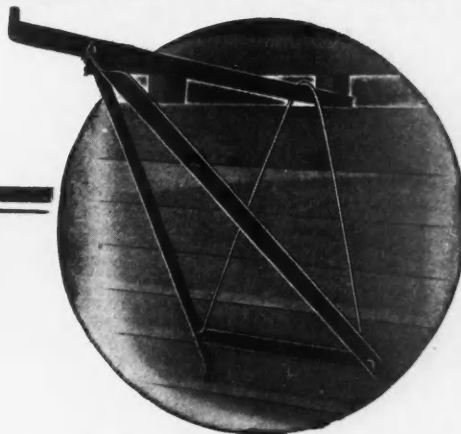

The "Trouble Savers" steel scaffolds will save enough time, lumber, and nails on the first job to pay for themselves. They are safer, too! And because they are light and fold compactly, they are convenient to handle.

MR. BUILDER:—

This scaffold can be used in all kinds of construction work where scaffolding is necessary;—upon the first trial it is sure to win your satisfaction, as it has thousands of others throughout the country.

Send for circular illustrating and describing "Trouble Savers."

THE STEEL SCAFFOLDING CO.
EVANSVILLE, IND.

How Can Glass Be Fastened to Galvanized Aquarium Frame?

To the Editor: Passaic, N. J.
 I would like a little advice from someone who knows how to make glass stick to the galvanized frame of an aquarium. I have tried white lead and different things, but it doesn't seem to get hard and leaks thru in places.

✦ JOHN DE VRIES.

Asks Formula for Re-Silvering Mirrors

To the Editor: Cumberland, Md.
 I would appreciate it very much if you could give me a formula for silvering mirrors, thru your Correspondence Department. I usually find my troubles answered in the Builder, but have failed to see anything on mirrors. Thanking you in advance, I am,

R. C. CLOWER.

Fred Beard Starts "Building a Home" Campaign

(Continued from page 164.)

"You'd better do that. And I'll take your application in now, so that you can be at the next meeting."



Stimulating Building by Advertising

THE builder is usually a poor advertiser. If by chance he does contract for a little advertising space, he is likely to be satisfied to let it say, "John Smith, Carpenter and Builder. Jobbing a Specialty"—and then forget about it.

And the reader forgets it also. He is looking for punch and news value in the advertising, as well as the reading matter, of his favorite newspaper.

An enterprising builder in Louisville, Ky., is working along different lines. He has employed an expert advertising man to get up some good snappy copy

THREE IN ONE LIGHTNING RODS

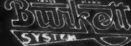
fo the  make are backed by a half century of successful business and a guarantee, ASSURING ABSOLUTE PROTECTION on EVERY INSTALLATION.

The illustration shows you definitely the construction of BURKETT RODS.

Around the tape are closely woven a series of soft copper strands. Each strand is a surface conductor and in contact with the spiral tape core. This method of construction forms a

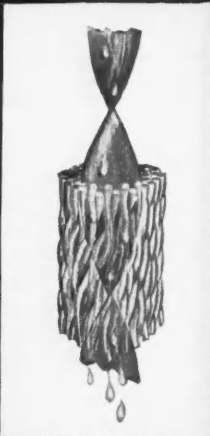

PERFECT Tube. Convince your prospective customer that BURKETT RODS are the BEST he can buy.

We still have some exceptional openings in Big Paying territory for good live Builders.

IT WILL PAY YOU TO WRITE US TODAY.

BURKETT LIGHTNING ROD CO.
 FREMONT, OHIO

Don't Put Off Building— Do It Now!

PRICES OF BUILDING MATERIAL TO STAY UP
 WASHINGTON, March 12.—(By Associated Press)—An indication that prices of building materials will not be reduced at present was seen today by Labor Department officials in reports that building activities were increasing this month without waiting for reduction.

IT'S A mistaken idea that building material and labor will be cheaper. Read what the Labor Department Officials report.

Other authorities, such as Professor Irving Fisher, of Yale, this country's most eminent economist, confirm the conviction that the high price level is not temporary but permanent.

We, too, are of the same opinion and are substantiating it by building four cottages for our own use. You know that residences, especially medium sized ones, are almost impossible to buy or rent. If you want to get your home in time it is advisable to build now, but be sure to build right.

FREE COPY
 Of
Professor Fisher's
 Address

"The New Price Revolution"
 before Conference of
 Governors and Mayors
 at the White House,
 March 3-5, 1919.

Every business man should read it. Let us mail you a copy.

Call
 Either Phone
 Main **40** City



Built Buildings

are dependable and have stood the test of time. They have a bigger market value and are easier to rent or sell because of their honest workmanship and highest quality material.

Let us advise with you regarding your Building and Repair Needs. Call, phone or write us.

ALFRED STRUCK CO.
 (Incorporated)
 Established 1860
 Garden and Chestnut Sts., Louisville, Ky.

How the Alfred Struck Co., Louisville, Ky., Promotes Building in That City. This Is One of a Series of Advertisements That Appeared in the Louisville Newspapers.

which will get people to thinking and then make them act.

This builder knows that there is work to be done, that it is simply a matter of overcoming the hesitancy incident to high prices. So in one of his advertisements he offers to send to those who ask for it a copy of the address given by Prof. Irving Fisher, of Yale university, before the conference of Governors and Mayors, held recently at Washington, D. C. He is distributing several hundred of these in this way.

"Our campaign is sufficiently broad to be of general value to the building interests of the city," said an

(Continued to page 168.)

STAR equipment keeps cows contented and owners satisfied. Easier to put in—saves time and work.

Write for the STAR Barn Book.

HUNT, HELM, FERRIS & CO.
 Harvard, Ill. Albany, N.Y.

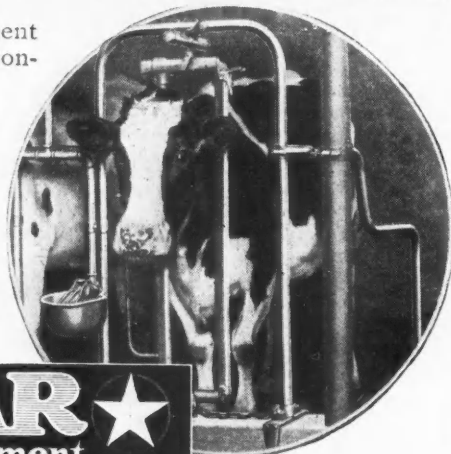

STAR ★
 Equipment

REX STRIP SHINGLES

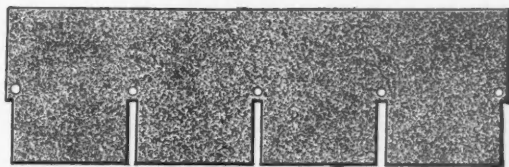

Asphalt-Slate Covered

STRIP SHINGLES cost less than Individual Shingles, and according to definitely established figures there is a saving of 37½% on nails and on the labor of nailing.

Samples and Catalog on Request



The Flintkote Company

Asphalt Shingles Prepared Roofing

90 Pearl Street, Boston

New York Chicago New Orleans

Don't Lay Another Roof Until We Send You a

Winthrop Tapered Asphalt Shingle

Just ask for a sample shingle. See how tough, how pliable and how durable it is. See how it is made

like a wooden shingle—thick at the butt and thin at the top. See how easy to lay it is. See what a beautiful roof it will make—red, green or slate-black. Then you will understand why owners want the Winthrop when they know about it.

Winthrop Tapered Asphalt Shingles will enable you to get most of the roofs in your town. They win out with less argument than anything you ever tried to sell, for they look better than wood shingles and they have all the protection of asphalt.

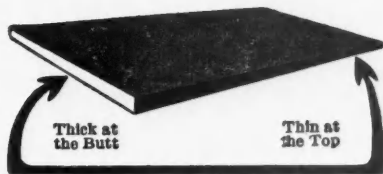

Thick at the Butt

Thin at the Top

Beckman-Dawson Roofing Co.
ASPHALT SHINGLES

Factory: Argo, Ill.

1413 Y. M. C. A. Bldg., Chicago, Ill.

BOYLE'S BAYONNE

ROOF AND DECK CLOTH

If you are about to build a new house or repair an old one investigate

Boyle's Bayonne Roof and Deck Cloth

before closing your contracts.

As a covering for a low pitched or flat roof or for a porch floor or roof or any roof or deck that is exposed to the weather or to constant wear, it has no equal. This statement is based on testimonials from *carpenters* and *builders* who have used *Bayonne* for years.

It is guaranteed waterproof, it will not crack or peel, it can be painted any shade to conform to color scheme of house or porch, it is economical because it will outlast two to one any other floor or roof covering.

Write for sample book with prices and directions for laying

JOHN BOYLE & COMPANY, Inc.
112-114 Duane St.—New York—70-72 Reade St.
Branch House: 202-204 Market St., St. Louis, Mo.

Where **CONSERTEX** Should be Used

Economical Serviceable Artistic and Profitable

The ideal material to use wherever a flat surface is to be covered or where the pitch is less than 4" to the foot.

- Costs very little.
- Is easy and inexpensive to lay.
- Makes a neat, smooth, durable surface.
- Will not leak, rot, stretch or shrink.

Send for booklet "Roofing Facts and Figures"

William L. Barrell Company
8 Thomas St. New York

Chicago Distributor:
GEO. B. CARPENTER & CO., 430-440 North Wells St

California Distributor:
WATERHOUSE-WILCOX CO., San Francisco—Los Angeles

Stimulating Building By Advertising

(Continued from page 166.)

official of the Alfred Struck Co., the concern which is doing this advertising. "While we of course are featuring Struck-built buildings in our newspaper space, every other builder in the city will profit from this campaign, as well as ourselves. We want them to do so, for we have gone into this not merely to pick up a few scattering jobs, but to give an impetus to the entire building industry in our city. Once things get well under way, we are perfectly willing to take our chances at getting our share of the work."



E. S. HANSON.

Hints on Storing Lumber to Prevent Decay

(Continued from page 63.)

in use piled on sound foundations and kept as dry as possible. If pine, saturated with resin, or the heartwood of such durable species as white oak or red gum be employed, the danger of possible infection will be greatly decreased.

Keep Sheds Dry and Well Aired—In storage sheds the necessity for piling higher from the ground is very apparent in many cases. The same remedies apply here as for pile foundations in the open. The sheds should be tightly roofed and the siding should not be run down below the bottom of the foundation sills. Free air circulation should be allowed from all sides

beneath the inclosure. Only thoroly dry stock should be stored in close piles under cover.

Check Fungous Outbreaks—Should fungous outbreaks occur in storage sheds not constructed to meet sanitary needs the infected foundation timbers should all be torn out and replaced with wood soaked in an antiseptic solution or by concrete or brick. In all

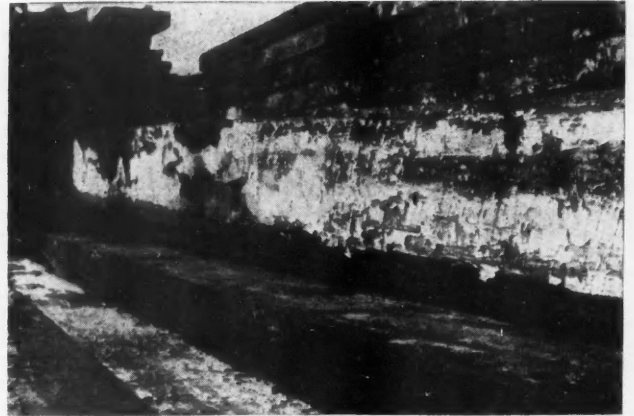

This Fungus Growth Is Due to the Failure to Use Stickers.

cases the new foundations should be so constructed as to keep the lumber well off the ground, and the soil and timber immediately adjoining the infected area should be sprayed or painted with an antiseptic solution of a water-soluble salt, like sodium fluorid, mercuric chlorid, zinc chlorid, or copper sulphate.

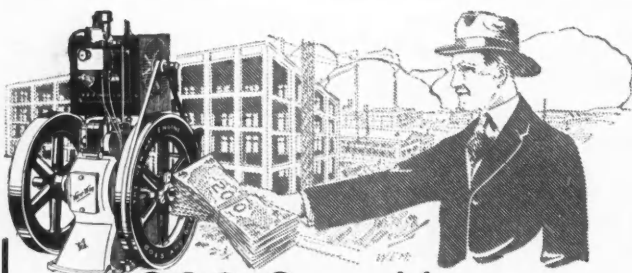

**\$200 Saved by a
"New-Way" KEROSENE ENGINE
IS MONEY EARNED BY GOOD JUDGEMENT**

CONTRACTORS figuring on saving operating cost will wisely demand the "New-Way" Kerosene Engine as the proper power unit for his new outfit.

Using kerosene in a 6 H. P. "New-Way" Engine for 300 working days, saves over \$200.00 yearly on each engine used—other sizes in proportion. **You cannot afford to use any other fuel than kerosene for your power.**

The "New-Way" Patented Vaporizer changes kerosene oil into a perfect gas before it reaches the cylinder.

The engine is throttle governed, which is absolutely necessary for successful operation on kerosene. It uses no water and is years in advance of all other engines.

Increase the efficiency of your new outfit by equipping it with the "New-Way" Kerosene Engine.

**THE "NEW-WAY" MOTOR COMPANY
LANSING, MICHIGAN, U.S.A.**



Public Garages

Do not let the construction of the modern garage worry you. Our garage department will relieve you of these cares.

Steel Roof Trusses

We will submit designs and prices free of charge. Give dimensions of building, style and pitch of roof and kind of roofing.

Steel Sash

Fireproof and giving plenty of light and ventilation are especially adapted for use in garages. We can ship promptly from stock.

Skylights and Roof Ventilators

Non-leaking metal skylight frames and standard types of roof ventilators can be supplied promptly.

Show Windows and Doors

Our specialty is the construction of attractive store fronts. Our garage fronts are standard everywhere.

Write for Catalog

George L. Mesker & Company
Complete Store Fronts EVANSVILLE, INDIANA

\$10
BRINGS IT
TO YOU

DO YOUR OWN LEVELING WITH YOUR OWN LEVEL

Sold On Easy Monthly Payments



Now you have the opportunity to own a strictly high-grade, accurate Convertible Level on Aloe's Easy Rental Purchase Plan—and without previous experience, or technical knowledge, you can put it to work so that it will make big money for you. Only \$10.00 brings it to you—then put it to every possible test. If you are pleased with it, pay the small monthly installments and the level is yours.

Aloe Convertible Level

It is a combination transit and level, quickly converted to the use of either. It is absolutely accurate—satisfies the requirements of the most exacting contractors—yet is so simple that anyone, without technical education can use it. Sights above and below the horizontal can be taken. You can use it for leveling up foundations, walls, piers, running boundary lines, fences—in fact, a thousand and one jobs you meet every day that require an accurate level.

You Learn To Use It In An Hour

No technical knowledge necessary. No previous experience is needed. With our simple and complete instruction book included free with every level, you can immediately put the instrument to work. It starts to pay for itself immediately and continues to be a permanent money-making investment.

Write For Free Book

It tells you how to increase your income, how to get the profitable jobs and become a bigger man in your community. Don't doubt or delay—write for this book at once.

A. S. ALOE CO.

621 Olive St.,
St. Louis, Mo. U.S.A.

FREE
Write
for
This
Book

**BE A
BIGGER
BUILDER**

MAIL COUPON TODAY

A. S. ALOE CO. 621 Olive St., St. Louis, Mo.
Without obligation, send me your free book, "Be A Bigger Builder". Also full particulars about the Aloe Convertible Level and details of your easy payment plan.

Name

Address

Ten Days' Free Trial

Order the Aloe—try it for 10 days—put it to the most rigid tests. If you are not pleased, return it at our expense and your \$10.00 will be refunded. If satisfied, pay for it in small monthly payments.

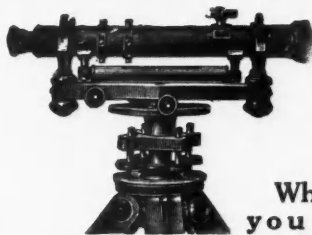

Is Your Work? Level!

Why not be sure that you are protected against mistakes? They are sometimes costly. A Kolesch Architects' and Builders' Level is a sure guarantee. We have made a specialty of this class of instruments for many years and can suit you in quality and price. Write today.



KOLESCH & COMPANY
138 Fulton Street, New York

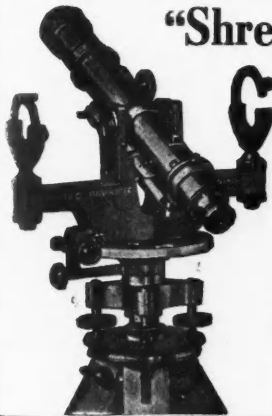

"Shrewd Contractors"

Select "WHITE" Convertible Levels because it eliminates guess-work. They know what to expect of these sturdy dependable instruments and are never disappointed. Model shown here is our latest creation. It covers all phases of building work. Contractors everywhere recognize it as standard equipment. Get fully posted. Send for circular and trial offer today.

David White Co., Inc.
419 E. Water St., Milwaukee, Wis.



No. 5110

OUR Levels and Transits for Architects, Builders and Contractors meet their most exacting requirements.

K & E Quality is the standard of discriminating buyers.

Send for literature

• KEUFFEL & ESSER Co. •
NEW YORK, 127 Fulton St. General Office and Factories, HOBOKEN, N. J.
CHICAGO 218-22 S. Dearborn St. ST. LOUIS 319-321 Second St. SAN FRANCISCO 319-321 Second St. MONTREAL 319-321 Second St.
Drawing Materials • Mathematical and Surveying Instruments • Measuring Tapes

Roofing Tin Cannot Burn!

The Philadelphia Daily Papers on April 11, 1919,
announced as follows:

PITCH USED ON ROOF OF OFFICE BUILDING BURSTS INTO FLAME

Fire was discovered early today on the roof of the nine-story new office building being erected for the William Cramp & Sons Ship and Engine Building Company, Richmond street above Norris. The fire is thought to have been caused by spontaneous combustion in the pitch which had been applied to the roof. The loss has not been determined.

Buy

"Merchant's Old Method"

The Fire Resisting Roofing Tin

Unexcelled for Durability, Pliability and Rust Resistance

Important—Mark your inquiry for Department 16

MERCHANT & EVANS Co

NEW YORK PHILADELPHIA WHEELING
BALTIMORE ATLANTA CHICAGO
CLEVELAND ST. LOUIS
KANSAS CITY

FLOOR RENOVATION

MULLER
ASBESTONE
COMPOSITION FLOORING

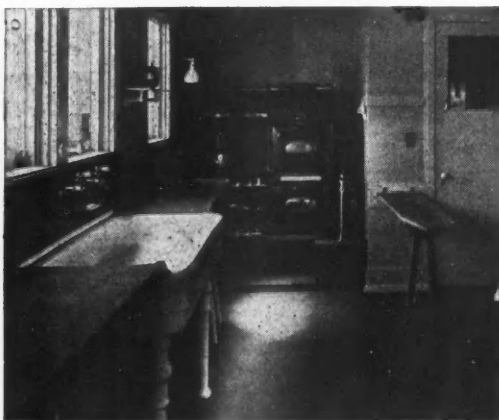

ASBESTONE SANITARY FLOOR AND DRAIN-BOARDS

A glance at the many worn and unsightly floors in Residences, Stores and Public Buildings reveals the need of New, Sanitary and Attractive Flooring.

ASBESTONE, laid over the old wood or concrete, produces a surface smooth, resilient, fireproof and of handsome appearance—at a moderate cost.

It is to be had in a variety of rich colors.

Some excellent territory is still open for reputable Contractors and Building Material Dealers

Let us send you samples and information.

FRANKLYN R. MULLER & CO., 954 Madison St., Waukegan, Ill.

Electric Woodworkers Are Little, But Oh My!

(Continued from page 32.)

The portable saw bench is driven by an electric motor and stands on the bench or alongside of it, is a machine that will be appreciated in any shop, whether it be large or small. Such a machine is shown in one of the illustrations. The size of the table is 17 by 20 inches; the seven-inch saw will cut a full two inches and the total weight of the machine is 115 pounds. The bench saw is equipped with a shutter saw guard and cross cut fence that slides and may be swung off the table and be out of the way. The motor is swung underneath the table and is so constructed that it may be tilted, at the same time tilting the saw, which is adjustable to a 45-degree angle. This is accomplished in an easy manner by turning the wheel shown underneath the front of the table. The dial at the side indicates the angle of the saw tilt.

There are other electrically driven tools for the carpenter and woodworker, among them being an electric drill for wood, electrical tenoning machines for small work and an electric screw driver. An electric door fitter also is being used by many carpenters.

All of these machines and tools have been given thoro tests in the building industry. They save many steps and much time of workmen; they consume power only when they are at work and can be used anywhere that electric lights are installed. They are not designed to supplant the larger woodworking machines, but to supplement them for small work. They are now being found useful by many carpenters and in many woodworking shops and their popularity is steadily increasing.



Congress Expected to Aid Home Building with New Banking System

(Continued from page 22.)

After their establishment, the banks can issue 5 per cent bonds, secured by real estate mortgages, government bonds or home loan bank bonds. The bonds may be in denominations of \$20, \$40, \$100, \$500 or \$1,000, thus making them available for both small and large investors.

Any building and loan association that is a member of the regional home loan banks can borrow from the banks 75 per cent of the face value of the mortgages it holds. In this way the building and loan associations will be able to utilize their assets several times.

The bill is a lengthy one, prescribing how this banking system shall be conducted.

As it is expected that President Wilson will call a special session of congress as soon as he returns from Europe, the backers of this bill are confident that action will be taken on it in time to get the home loan banking system into operation within a short time.

SHORT TALKS WITH OUR SUBSCRIBERS

AS rents go up, so will buildings go up. Shrewd investors never overlook a profitable field.

RIGHT now the biggest demand is for low and medium-priced houses. Those who have been taught to save thru the necessity of their country are realizing that there is no better investment than a home.

ONE way to cut the cost of hauling materials and equipment is to attach a trailer to an automobile or a motor truck. The trailer doubles or triples the truck's capacity, with but little additional operating expense.

THE experience of the government in using hollow building tile in its housing projects has made this material more popular for all kinds of buildings.

THE war caused a building deficiency amounting to about \$5,000,000,000 in the United States. The building industry faces the era of its greatest prosperity.

THE present cost of building makes it necessary that contractors use the most efficient methods and equipment. In this way costs can be reduced without sacrificing the quality.

RAPID increase in building is reported from all parts of the United States, especially in the north central states. Property owners apparently are recognizing the fact that the cost of materials and labor is not going to be reduced during the next few years and that there is no good reason for delaying the construction of needed buildings.

RURAL builders are finding that their farmer customers now are satisfied only with the most modern buildings, fully equipped to make the work easier and their livestock more profitable. Their wives, too, are demanding conveniences in their homes, such as running water and electric lights.

TURN about always is fair play. A year ago the government was enforcing heavy restrictions on the building industry. Today the government is exerting every energy to promote building. What builders lost thru war-time inactivity will be regained during the next few years.

NOTHING so beautifies a plain old house as a porch of face brick. This sort of remodeling is profitable for the builder and gives the owner the maximum in satisfaction for his money.

Contents for June, 1919

	Page		Page		Page
Editorials	47	Hollow Clay Tile Farm Buildings	86	How to Construct Hay Carrier Track	136
Practice Economy on the Building	47	Save Feed.....	86	in a Round Barn.....	136
Crystallizing the Home-Building Sentiment	47	The Use of Face Brick Gives Many Artistic Effects	89	Thanks, Brother, Thanks.....	140
How to Cut the High Cost of Building or Making the Home Space Work Double.....	48	Fine Example of Modern Dairy Barn..	90	Comments on Our Make-Up.....	140
"Always on the Job" Is This Contractor's Recipe for Success.....	50	Brick Construction for Modern Carpenters and Builders	90	Estimating Carpenter Labor	142
Fine Homey Bungalow Design.....	52	Promoting Building and Material Sales in the Yard Salesroom.....	92	Regarding a Number of Questions and Things	144
"Marine Architecture" in a Summer Cottage	54	Power on the Job Earns a Profit	94	A "Rub" for Bricklayers.....	144
Sun Parlor and Sleeping Porch Modernize Old Homes.....	56	Easy Now to Sell Electric Light Plants to Farmers	100	Easy Method of Removing Finishing Nails	144
Portfolio of Blue Printed Beautiful Homes	58	Estimating Paint Requirements.....	108	Here Are Two Tips From a Carpenter	144
Hip-roof Shingle House.....	59	"Get 'Em Envious and You've Got 'Em"	110	Wants Plans for an Implement Shed.....	144
Artistic Five-Room Bungalow.....	60	Compromise Between Private and General Offices.....	114	How Is the Price of Labor on a Building Figured?.....	144
Beautiful White Bungalow.....	61	How True—How True!.....	114	What Will Stop Discoloration of Chimney?	146
Two-Flat Building of Brick and Terra-Cotta	62	Out on the Job	118	One for the Concrete Sharks.....	146
The Builder at Work.....	63	What Builders Are Finding Good.....	118	Wants Suggestions for Building Stairs	146
All Sorts of Building Plans	64	Augur and Bit Stops of Aluminum.....	118	How to Estimate on Matched Board Flooring	146
Design for Brick Theater Building..	64	Stairway Disappears in Ceiling, Saving Space.....	118	Some Ideas on Filing Magazine Clippings	146
A Fine Movie Theater.....	65	Automatic Electric Bowl Flusher.....	120	Selling the Farmers the Idea of Building Silos	148
Public Garage.....	66	Rubber Foot Grip Prevents Ladder Slipping	120	How to Build the Concrete Floor of a Water Tank on Top of a Silo.....	150
Design for Public Garage.....	66	Portable Powerful Rip and Cross-Cut Saw Rig.....	120	Motor Trucks in the Building Industry	150
Public School.....	67	Portable Saw Rig With Engine or Separate Skids.....	126	Contractors Accomplish the Seemingly Impossible With Trucks.....	154
Public Library.....	68	Correspondence Department	130	Trucks and Trailers for Lumber Dealers	156
Design for a Beautiful Village Church	69	Has Anyone These Rules?.....	130	Keeping the Motor Truck Busy.....	158
Design for a Village Church.....	69	Never Stops Learning.....	130	Trailers for Lumber and Material Dealers	160
Make Every Nook in the New Home Useful	70	Built Six Big Gothic Barns in Two Years	130	Haulage Costs Reduced by Trailer.....	162
Renovating the Refrigerator.....	71	Water-Tight Windows for Sleeping Porch	130	Catalogs, Bulletins and Books Received	164
Building a Rustic Bridge.....	71	Skylight Trouble Diagnosed.....	130	News of the Field	168
"Let's Go"	71	Running Rafters for Gothic Roof Barn	132	Wayvell, Chappell & Co., Chicago, Move Offices.....	168
Good Homes and How to Paint Them	72	Letting Go Some of Our Pent-Up Feelings	132	Lime Association Annual Meeting at Pittsburgh	168
How the Contractor Can Help Finance the Home Building.....	73	How to Resharpener Files With Acid.....	132	Dealers Remaining Loyal to Manufacturers Who Helped Win the War.....	168
How to Build With Stucco Over Metal Lath and Expanded Metal	74	Seeks Retail Lumber Prices.....	134	Milwaukee Corrugating Co. Enlarges Plant	168
American Builder Building Plans	78	Wants Specifications for Carpenter's Tool Box.....	134	Entertain Texas Lumbermen's Association	170
Blue Prints of a Seven-Room Stucco House	78	Working Plans for a Tool Chest.....	134	Cement Price Reduced.....	170
Blue Printed Plans.....	79 to 82	Asks Design for Library Furniture.....	134	Water Resistant Glues.....	174
Farm Buildings Arranged for Convenience	83	Finds It Valuable.....	134		
All the Chores Under One Roof.....	83				
Structural Tile Work	86				



Stained with Cabot's Creosote Stains -
C. M. Hart, Architect, Bay Shore, N. Y.

Stained Shingles

The Warmest, Most Artistic and Most Economical of all House Finishes

Wood shingles are two or three times warmer than the gummed-paper substitutes, and they are cheaper, last longer and are incomparably more artistic and attractive. When stained with the soft moss-greens, bungalow-browns, tile-reds and silver-grays of

Cabot's Creosote Stains

they have a richness and beauty of tone that no other finish can equal, and the creosote thoroughly preserves the wood. Use them also on siding, boards, sheds and fences. Anyone can apply them with best results at least expense.

Cabot's "Quilt"

makes floors and partitions sound-proof by breaking up the sound-waves and absorbing them. It makes walls and roof cold- and heat-proof by a cushion of minute dead air spaces that prevents the conduction of heat. From 28 to 50 times as efficient as cheap building paper.

You can get Cabot's goods all over the country. Write for samples and name of nearest agent.

SAMUEL CABOT, Inc.

Manufacturing Chemists BOSTON, MASS.
1133 Broadway, New York 24 W. Kinzie St., Chicago
Cabot's Brick Stains, Stucco Stains, Conservo Wood Preservatives, Damp-proofing, etc.

BOMMER

Floor Surface Spring Hinge

Double or Single Action, Holdback, Ball Bearing. Every moving part of this hinge can be oiled from a single hole on outside of side-plate.

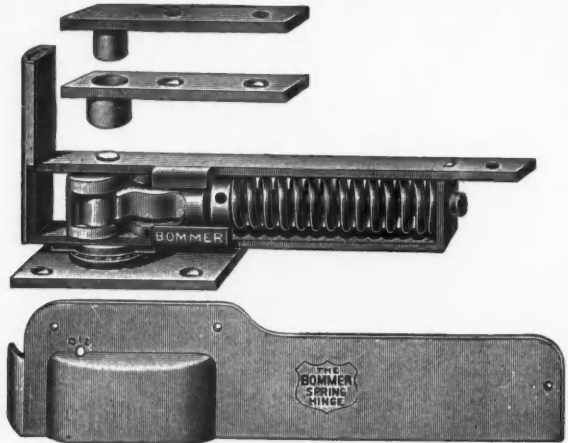

The most durable hinge of its type; holds the door open when swung to 90 degrees at either side

Your Hardware Merchant Can Supply Them

Bommer Bros., Manufacturers, Brooklyn, N.Y.

TRADE MARK CHICAGO SPRING HINGES

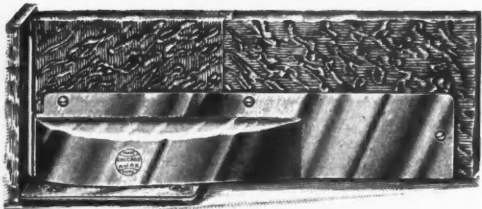

Appearance — Economy — Durability The "AJAX"

In the "Ajax" we offer a Floor Spring Hinge with **Ball Bearings** at the top of the Hinge, away from dust and moisture. **Alignment Adjustment** that is easily accessible. **Roller Bearings** for the piston, to overcome friction. **Durability, Economy and Appearance**, backed by our **REPUTATION.**

Send for Catalogue C 36.

Chicago Spring Butt Company
CHICAGO NEW YORK

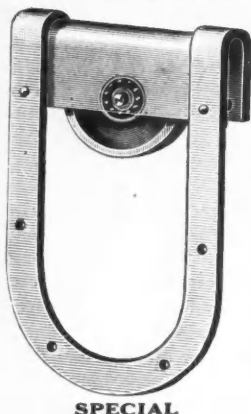

LANE'S SPECIAL Barn Door Hangers

These Hangers have U-Shape frame, the form of the original Lane. The wheels are completely covered and will run on any length of track.

Sold by the hardware trade everywhere.

Manufactured by
LANE BROS. COMPANY
Carroll St. Poughkeepsie, N. Y.

SPECIAL

Worth Much to You

Morrill Saw Set

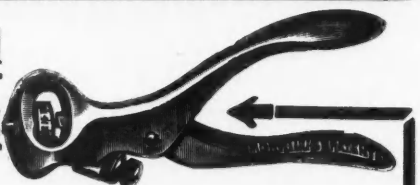

All master carpenters are using this Saw Set. In one operation it takes out the wrong set and puts in the right one. Write for **FREE** booklet "Saw Points". It tells how to properly joint, set and file hand saws.

CHAS. MORRILL

94 Lafayette Street
NEW YORK