

# AMERICAN BUILDER

## THE WORLD'S GREATEST BUILDING PAPER

Vol. 40.

CONTENTS FOR NOVEMBER, 1925

No. 2.

COPYRIGHT, 1925, BY AMERICAN CARPENTER &amp; BUILDER CO.

Around the Family Table.....	107	Two Well Planned Small Homes..	Colorplate VIII
Editorial Page.....	109	The Needham, a Six-Room Home.	
Better Homes in America Contest Sets High		The Nutley, a Six-Room, Story-and-a-Half Cottage.	
1925 Standard.....	111	Two Well Designed Narrow Lot Homes.....	Colorplate IX
<b>ART SUPPLEMENT OF NOTABLE</b>		The Newberry, a Pretty English Cottage; Size,	
<b>ARCHITECTURE</b> .....	115-118	22 by 28 Feet.	
Portland Cement Association Headquarters, Chicago,		The Nugget, Pure Gold in a Small Residence, Four	
Illinois; Holabird & Roche, Architects, Turner		Rooms with Five Room Efficiency.	
Construction Company, Builders.		<b>The Normandy</b> .....	Colorplate X
Kohler Company Office Building, Kohler, Wisconsin;		French Style Cottage with Five Rooms—Color Sketch	
Brust & Philipp, Architects, Milwaukee, Wisc.		of Convenient Kitchen.	
The Packard Building, Philadelphia, Pa.; Ritter &		<b>The Newark</b> .....	Colorplate XI
Shay, Architects.		Small House with Attached Garage.	
Eastern Offices Inc. Building, New York, N. Y.;		Two Pages of Beautiful Gardens.....	Colorplates XII-XIII
Sloan & Robertson, Architects.		The Norwich.....	Colorplate XIV
<b>From Our Daily Foreign Mail</b> .....	119	An English Colonial Cottage—Color Sketch of Re-	
Gene Sarazen, Noted Golf Player, Had This		ception Hall.	
House Built.....	120	<b>The Nerlan</b> .....	Colorplate XV
Definite Laws Control Color.....	122	Artistic House with Thatched Roof—Color Sketch	
The Roanoke Rapids House Built from an		of Home-like Living Room.	
American Builder Front Cover Wins First		<b>The Nara Vista</b> .....	Colorplate XVI
Prize for Small Town Homes.....	124	A Spanish Design of Five Rooms—Color Sketch of	
National Retail Lumber Dealers Hold Success-		Bedroom with Antique Canopy Bed.	
ful Meeting.....	126	<b>Our Front Cover Home</b> .....	151-155
Landscape Architecture and the Home.....	128	Photograph and Full Set of Building Plans Drawn	
Save the Surface Department.....	130-133	to Eighth Inch Scale of the Beautiful Home Pic-	
The "Different" House is Seldom Distinctive.		tured in Full Colors on Our Front Cover.	
Color for the Fireplace.		<b>Details of Home Building</b> .....	156
Mechanical Painting Devices Aid the Builder and		Detail 8—The House Stairs.	
Home Owner.		<b>Full Page Plate of Stair Details</b> .....	157
A Little Touch of Color.		<b>Heavy Timber Mill Construction</b> .....	158
<b>Homes in Colors</b> .....	134	Plate Number Three of a Series of Six.	
<b>BLUE RIBBON HOMES IN COLORS</b> ..	135-150	<b>A West Coast School of Spanish Charm</b> .....	160
<b>The Norfolk</b> .....	Colorplate I	Freemont Grammar School at San Luis Obispo, Calif.	
An English Home of Striking Beauty—Color Sketch		<b>Sheet Metal Details—Full Page Plate</b> .....	163
of a Bedroom.		<b>Unobstructed Floor Space</b> .....	164-166
<b>The Newport</b> .....	Colorplate II	<b>Better Plastering</b> .....	167-168
A Substantial Brick Residence—Color Sketch of Bath-		<b>How Dan Does It</b> .....	169-170
Room with Tile Walls.		<b>What's New?</b> .....	172
<b>The New Castle</b> .....	Colorplate III	Efficient Concrete Heater.	
An English Cottage with High Living Room—Color		Wood Worker with Power Take-Off.	
Sketch of Furniture and Draperies for High Living		Two to Three-Bag Mixer.	
Room.		Luminous Light Switch Plates.	
<b>Photographs of the Atlanta, Ga., First Prize</b>		A New Flush Receptacle.	
<b>Home, Better Homes in America Competition</b>		Rafter Cutting Mitre.	
<b>for 1925</b> .....	Colorplates IV and V	Inserted Tooth Saw and Groove.	
<b>The Navajo</b> .....	Colorplate VI	Colored Rubber Flooring.	
A Delightful Spanish Bungalow of Six Rooms—Color		<b>News of the Field</b> .....	188
Sketch of Dining Room with Refectory Table.		<b>Theory of Roof Framing</b> .....	190
<b>The Northampton</b> .....	Colorplate VII	<b>Advertising Index</b> .....	273-275
Combination Brick and Stucco Home of English De-			
sign—Color Sketch of a Dining Room.			

Published on the first day of each month by American Builder and Carpenter Co.; Wm. A. Radford, *President, Treasurer and Editor-in-Chief*; Wm. A. Radford, Jr., *Vice-President*; E. L. Hatfield, *Vice-President and General Manager*; Bernard L. Johnson, *Vice-President and Editor*; Roland D. Radford, *Secretary*; S. C. Kellenberger, *Dealer Service*; Paul N. Rothe, *Circulation Manager*; Delbert W. Smith, E. B. Wolfrom, C. R. W. Edgcumbe, L. H. Reich, O. H. Sutter, Cecil W. Blashill, H. P. Sessions, *Advertising Staff*.

#### Publication Offices:

**Radford Building, 1827 Prairie Ave., Chicago**

Telephone: Calumet 4770

**Eastern Office: 250 Park Ave., New York City**

Telephone: Vanderbilt 3185

Entered as second-class matter July 1, 1905, at the post office at Chicago, Ill., under the Act of Congress on March 2, 1879

**SUBSCRIPTION RATES**—One year, United States, Canada, Mexico, and U. S. Possessions, \$2.00; six months, \$1.00; single copies, 35 cents. Foreign countries, \$4.00.

**PROTECTION FOR OUR READERS**—The publishers of the AMERICAN BUILDER reserve the right to decline any advertising they believe is detrimental to the interest of its readers; to edit advertising copy and to change or eliminate any statements that reflect injuriously or cast discredit upon other building products, machinery, equipment, supplies or tools.

Be sure in writing to advertisers to say: "I saw your advertisement in the AMERICAN BUILDER."

**ADVERTISING RATES**—Furnished on application. Advertising forms close on the 15th of the month preceding date of publication.

MEMBER OF THE AUDIT BUREAU OF CIRCULATIONS

# AMERICAN BUILDER

## THE WORLD'S GREATEST BUILDING PAPER

Vol. 40.

CONTENTS FOR NOVEMBER, 1925

No. 2.

COPYRIGHT, 1925, BY AMERICAN CARPENTER &amp; BUILDER CO.

Around the Family Table.....	107	Two Well Planned Small Homes..	Colorplate VIII
Editorial Page.....	109	The Needham, a Six-Room Home.	
Better Homes in America Contest Sets High		The Nutley, a Six-Room, Story-and-a-Half Cottage.	
1925 Standard.....	111	Two Well Designed Narrow Lot Homes.....	Colorplate IX
<b>ART SUPPLEMENT OF NOTABLE</b>		The Newberry, a Pretty English Cottage; Size,	
<b>ARCHITECTURE</b> .....	115-118	22 by 28 Feet.	
Portland Cement Association Headquarters, Chicago,		The Nugget, Pure Gold in a Small Residence, Four	
Illinois; Holabird & Roche, Architects, Turner		Rooms with Five Room Efficiency.	
Construction Company, Builders.		<b>The Normandy</b> .....	Colorplate X
Kohler Company Office Building, Kohler, Wisconsin;		French Style Cottage with Five Rooms—Color Sketch	
Brust & Philipp, Architects, Milwaukee, Wisc.		of Convenient Kitchen.	
The Packard Building, Philadelphia, Pa.; Ritter &		<b>The Newark</b> .....	Colorplate XI
Shay, Architects.		Small House with Attached Garage.	
Eastern Offices Inc. Building, New York, N. Y.;		Two Pages of Beautiful Gardens.....	Colorplates XII-XIII
Sloan & Robertson, Architects.		The Norwich.....	Colorplate XIV
From Our Daily Foreign Mail.....	119	An English Colonial Cottage—Color Sketch of Re-	
Gene Sarazen, Noted Golf Player, Had This		ception Hall.	
House Built.....	120	<b>The Nerlan</b> .....	Colorplate XV
Definite Laws Control Color.....	122	Artistic House with Thatched Roof—Color Sketch	
The Roanoke Rapids House Built from an		of Home-like Living Room.	
American Builder Front Cover Wins First		<b>The Nara Vista</b> .....	Colorplate XVI
Prize for Small Town Homes.....	124	A Spanish Design of Five Rooms—Color Sketch of	
National Retail Lumber Dealers Hold Success-		Bedroom with Antique Canopy Bed.	
ful Meeting.....	126	<b>Our Front Cover Home</b> .....	151-155
Landscape Architecture and the Home.....	128	Photograph and Full Set of Building Plans Drawn	
Save the Surface Department.....	130-133	to Eighth Inch Scale of the Beautiful Home Pic-	
The "Different" House is Seldom Distinctive.		tured in Full Colors on Our Front Cover.	
Color for the Fireplace.		<b>Details of Home Building</b> .....	156
Mechanical Painting Devices Aid the Builder and		Detail 8—The House Stairs.	
Home Owner.		<b>Full Page Plate of Stair Details</b> .....	157
A Little Touch of Color.		<b>Heavy Timber Mill Construction</b> .....	158
Homes in Colors.....	134	Plate Number Three of a Series of Six.	
<b>BLUE RIBBON HOMES IN COLORS</b> ..	135-150	<b>A West Coast School of Spanish Charm</b> .....	160
<b>The Norfolk</b> .....	Colorplate I	Freemont Grammar School at San Luis Obispo, Calif.	
An English Home of Striking Beauty—Color Sketch		<b>Sheet Metal Details—Full Page Plate</b> .....	163
of a Bedroom.		<b>Unobstructed Floor Space</b> .....	164-166
<b>The Newport</b> .....	Colorplate II	<b>Better Plastering</b> .....	167-168
A Substantial Brick Residence—Color Sketch of Bath-		<b>How Dan Does It</b> .....	169-170
Room with Tile Walls.		<b>What's New?</b> .....	172
<b>The New Castle</b> .....	Colorplate III	Efficient Concrete Heater.	
An English Cottage with High Living Room—Color		Wood Worker with Power Take-Off.	
Sketch of Furniture and Draperies for High Living		Two to Three-Bag Mixer.	
Room.		Luminous Light Switch Plates.	
<b>Photographs of the Atlanta, Ga., First Prize</b>		A New Flush Receptacle.	
<b>Home, Better Homes in America Competition</b>		Rafter Cutting Mitre.	
<b>for 1925</b> .....	Colorplates IV and V	Inserted Tooth Saw and Groove.	
<b>The Navajo</b> .....	Colorplate VI	Colored Rubber Flooring.	
A Delightful Spanish Bungalow of Six Rooms—Color		<b>News of the Field</b> .....	188
Sketch of Dining Room with Refectory Table.		<b>Theory of Roof Framing</b> .....	190
<b>The Northampton</b> .....	Colorplate VII	<b>Advertising Index</b> .....	273-275
Combination Brick and Stucco Home of English De-			
sign—Color Sketch of a Dining Room.			

Published on the first day of each month by American Builder and Carpenter Co.; Wm. A. Radford, *President, Treasurer and Editor-in-Chief*; Wm. A. Radford, Jr., *Vice-President*; E. L. Hatfield, *Vice-President and General Manager*; Bernard L. Johnson, *Vice-President and Editor*; Roland D. Radford, *Secretary*; S. C. Kellenberger, *Dealer Service*; Paul N. Rothe, *Circulation Manager*; Delbert W. Smith, E. B. Wolfrom, C. R. W. Edgcumbe, L. H. Reich, O. H. Sutter, Cecil W. Blashill, H. P. Sessions, *Advertising Staff*.

#### Publication Offices:

**Radford Building, 1827 Prairie Ave., Chicago**

Telephone: Calumet 4770

**Eastern Office: 250 Park Ave., New York City**

Telephone: Vanderbilt 3185

Entered as second-class matter July 1, 1905, at the post office at Chicago, Ill., under the Act of Congress on March 2, 1879

**SUBSCRIPTION RATES**—One year, United States, Canada, Mexico, and U. S. Possessions, \$2.00; six months, \$1.00; single copies, 35 cents. Foreign countries, \$4.00.

**PROTECTION FOR OUR READERS**—The publishers of the AMERICAN BUILDER reserve the right to decline any advertising they believe is detrimental to the interest of its readers; to edit advertising copy and to change or eliminate any statements that reflect injuriously or cast discredit upon other building products, machinery, equipment, supplies or tools.

Be sure in writing to advertisers to say: "I saw your advertisement in the AMERICAN BUILDER."

**ADVERTISING RATES**—Furnished on application. Advertising forms close on the 15th of the month preceding date of publication.

MEMBER OF THE AUDIT BUREAU OF CIRCULATIONS

# AROUND THE FAMILY TABLE



## Enthusiastic Over 1925 Annual

**INDIANAPOLIS, IND.**  
July 14, 1925.

AMERICAN BUILDER:  
Permit me to thank you very kindly for your courtesy in sending a de luxe copy of the AMERICAN BUILDER June issue.

This is truly a fine piece of work and great credit is due to your organization for its progressiveness in getting out a piece of literature of this character.

We are particularly impressed with the Malloy embossed cover in which the book is bound and I will put it in my library as a sample of good printing and good advertising.

E. C. ATKINS & Co.,  
T. A. Carroll,  
Mgr. Advertising Dept.

**CINCINNATI, OHIO**  
July 14, 1925.

AMERICAN BUILDER:  
We are in receipt of the annual June reference number of the AMERICAN BUILDER, and wish to congratulate you upon the artistic appearance of this annual.

THE BISHOPIC MANUFACTURING Co.,  
A. Bishopic, Jr.,  
Vice-President.

**ERIE, PA.**  
July 2, 1925.

AMERICAN BUILDER:  
We received our copy of your annual reference number and wish to congratulate you on its excellence.

We have used last year's annual reference number many, many times and it will still be preserved in our files.

Your reference number is an almost complete record of the needs of the building industry.

The care with which it is examined by builders was shown to the writer this week when one of our clients (a builder) spoke of noticing our firm listing in this number. He must have been looking it over closely when he found our name among the 181 advertising agencies listed therein.

STERRETT ADVERTISING SERVICE,  
Per W. M. Lias.

**CLEVELAND, OHIO**  
July 10, 1925.

AMERICAN BUILDER:  
I was very happy to receive the beautifully bound copy of your June issue and will keep it on file here at the office so that all the members of our department may have the benefit of its suggestions.

THE SHERWIN-WILLIAMS Co.,  
N. A. Schuele,  
Advertising Manager.

**JACKSON, MICH.**  
July 11, 1925.

AMERICAN BUILDER:  
We have to congratulate you upon the splendid way in which this book is gotten up, and wish to thank you for having favored us with a copy for our files.

THE KNICKERBOCKER COMPANY,  
D. E. Faye.

**CHICAGO, ILL.**  
July 14, 1925.

AMERICAN BUILDER:  
The writer has received the bound copy of the June AMERICAN BUILDER and wishes to compliment you on the attractiveness of this issue.

UNITED STATES GYPSUM COMPANY,  
C. O. Powell,  
Advertising Manager.

**AURORA, ILL.**  
July 11, 1925.

AMERICAN BUILDER:  
Mr. Fitch has referred to me your letter of July 8th and I am very glad to acknowledge receipt of the de luxe issue of the June AMERICAN BUILDER which you so kindly sent to Mr. Fitch. We are placing it in our files, as we consider it a valuable issue, and one to which we will refer from time to time.

RICHARDS WILCOX MFG. Co.,  
C. A. Rasey,  
Advertising Dept.

**CHICAGO, ILL.**  
July 10, 1925.

AMERICAN BUILDER:  
We have just received the Malloy leather bound copy of the June AMERICAN BUILDER and thank you very much for sending it.

This is one of the very interesting things that the writer will take home with him for future references.

FAIRBANKS, MORSE & Co.,  
S. T. Scofield,  
Manager, Advertising Dept.

**DOWAGIAC, MICH.**  
July 15, 1925.

AMERICAN BUILDER:  
I can assure you it will be put to use often and will be an asset to our library.

THE BECKWITH COMPANY,  
Jack R. Gardner,  
Advertising Manager.

**MILWAUKEE, WIS.**  
July 14, 1925.

AMERICAN BUILDER:  
This book is indeed a very beautiful one and we sincerely appreciate your sending it.

KOEHRING COMPANY,  
O. C. Dahlan,  
Advertising Department.

**LANCASTER, PA.**  
July 13, 1925.

AMERICAN BUILDER:  
We will be very glad to add it to our files as a valuable compendium on building and building materials. Thank you for sending it.

ARMSTRONG CORK COMPANY,  
Kenyon Stevenson,  
Linoleum Division.

**COLUMBUS, OHIO**  
July 14, 1925.

AMERICAN BUILDER:  
This is indeed a credit to your publication and we will be very glad to place it in our library for future reference.

THE DIAMOND METAL WEATHERSTRIP Co.,  
C. J. Parsons,  
General Mgr.

**ATHOL, MASS.**  
July 14, 1925.

AMERICAN BUILDER:  
The book is certainly a splendid one, finely gotten up in every way and very interesting.

THE L. S. STARRETT COMPANY,  
A. N. Newton,  
Sales Dept.

**NEW YORK CITY**  
July 14, 1925.

AMERICAN BUILDER:  
The de luxe copy of the June issue of the AMERICAN BUILDER reached the writer this morning and is very much appreciated. The cover is particularly serviceable and prompts one to retain the copy in a permanent file.

TOCH BROTHERS, INC.,  
A. C. Reid.

**WATERLOO, IOWA**  
July 13, 1925.

AMERICAN BUILDER:  
I desire to thank you for the de luxe copy of the June AMERICAN BUILDER just received. If you continue this practice with your annual reference numbers, we will soon have a five-foot shelf on the building business that will be of definite value not only from a reference standpoint but likewise from a historical point of view.

We believe the idea a good one and hope you will find it possible to continue the policy.

STEWART MANUFACTURING COMPANY,  
W. H. Stewart,  
Sales Manager.

**CHICAGO, ILL.**  
July 13, 1925.

AMERICAN BUILDER:  
Your beautifully bound copy of the June copy of the June AMERICAN BUILDER has been received and we appreciate it very much. This will be placed in our library for future reference.

INTERNATIONAL HARVESTER Co. OF AMERICA,  
E. J. Fries.

**The 1926 Annual**

will be issued

**March 1, 1926**

Right at the beginning of the active building season.

*A Book of 1,000 Pages  
No Increase In Price*

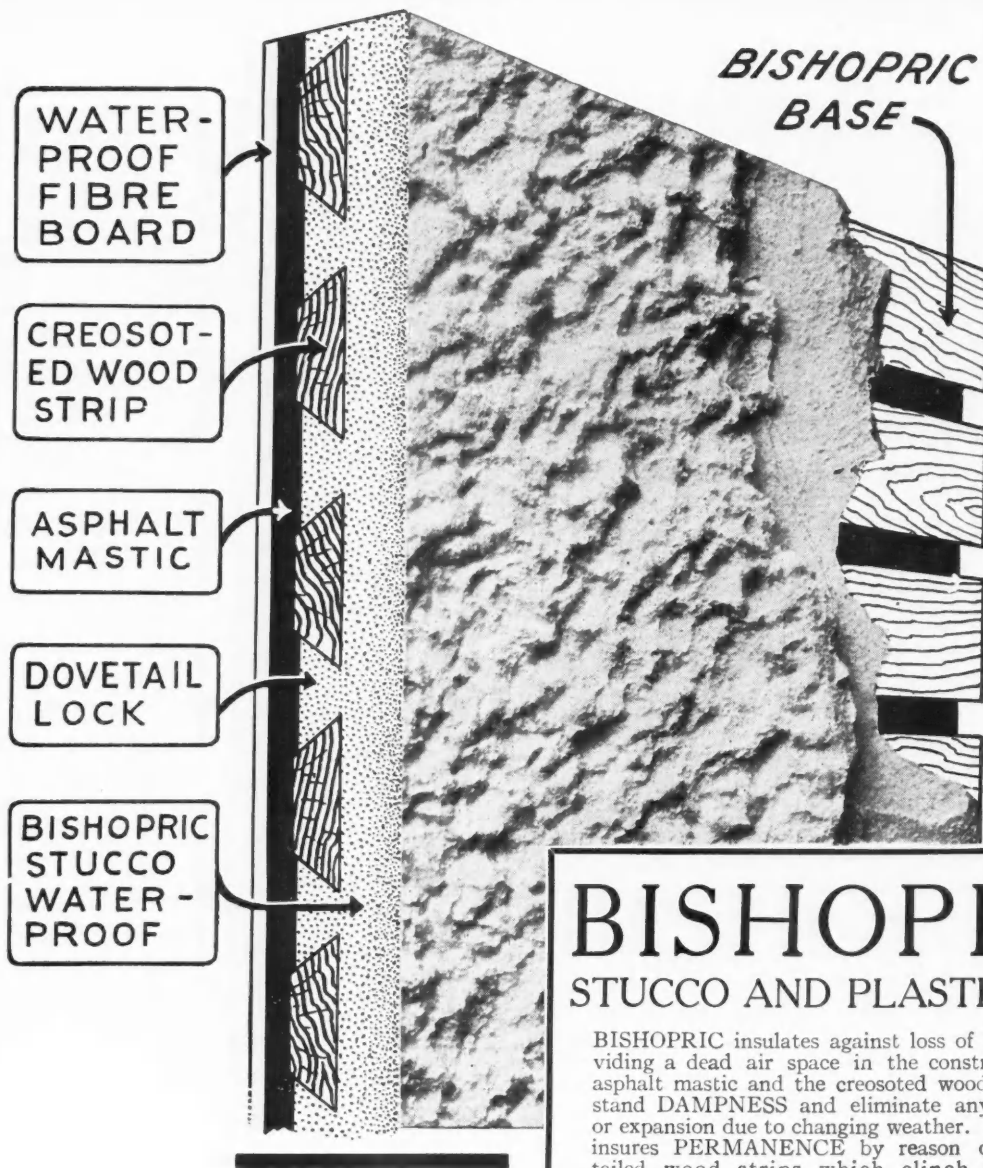

**THE ROLL**

Bishopric Inter-Locking Base comes to the building operation in large rolls containing 100 square feet. It is easily handled, quickly cut to desired size without waste — Bishopric Base saves 25% in plaster or stucco material and increases the strength of the building.

# BISHOPRIC

## STUCCO AND PLASTER BASE

BISHOPRIC insulates against loss of heat by providing a dead air space in the construction. The asphalt mastic and the creosoted wood strips withstand DAMPNES and eliminate any contraction or expansion due to changing weather. BISHOPRIC insures PERMANENCE by reason of the dovetailed wood strips which clinch the stucco. BISHOPRIC is stronger than lumber sheathing. BISHOPRIC is RESISTANT against FIRE, VERMIN, DECAY, because of the nature of its material.

BISHOPRIC INTER-LOCKING BASE comes to the building operation in large rolls containing 100 square feet. It is easily handled, quickly cut to desired size without waste—BISHOPRIC INTER-LOCKING BASE saves 25% in plaster or stucco material and increases the strength of the building.

Write for catalogue, "Working Details and Specifications," and let us help you with your Building Problems.

*Bishopric Is Sold by Dealers Everywhere.*

The BISHOPRIC MANUFACTURING CO.  
5 ESTE AVE. CINCINNATI, OHIO.

NEW YORK CITY CINCINNATI OTTAWA, CANADA

The BISHOPRIC MFG. CO. OF CALIFORNIA  
LOS ANGELES

# BISHOPRIC

*For All Time and Clime*

WHEN WRITING ADVERTISERS PLEASE MENTION THE AMERICAN BUILDER



# AMERICAN BUILDER

Formerly AMERICAN CARPENTER AND BUILDER

## Importance of Construction

SOME idea of the magnitude and importance of the construction industry may be gained from a statement recently made by Secretary of Labor Davis, in which he said: "More than 11,000,000 of our people are dependent for their living upon the construction industry, and 22 per cent of all the skilled and unskilled labor of the country is engaged in the building branch alone. Some 250,000 freight cars are required to handle the materials. Our building bill is \$200 per year for each family in the United States. It is truly the chief barometer of the business of the country. When construction gains, prosperity is with us. It is the great outstanding influence for good or bad in our financial progress."



## Prospective Home Owners' Class

A COURSE in home ownership is the newest form of education in real estate matters. Such a course, designed to give unbiased information to those contemplating the purchase of a home and to home owners who want to learn the principles underlying home values, has been organized for the general public in Washington, D. C., by the Y. M. C. A. The course is sponsored by the Washington Real Estate Board.

Those taking the course will be given an elemental outline of the basic principles of real estate practice and custom involved in the purchase of a home. In addition to the economic and social advantage of home ownership the responsibilities and obligations assumed will be completely analyzed.

Title examination, building construction, mortgages and the various methods of financing the purchase of a home will be some of the subjects discussed. The course will be given through five lectures by recognized real estate authorities.



## Construction Costs Stable

DESPITE the enormous amount of building under way, the average of construction costs in the principal cities of the United States was lower in August than at any time during the past twenty-eight months, the index figure, based on 1913, showing a drop of three points to 198, according to statistics compiled by the Associated General Contractors of America. During the past two years fluctuations of this average cost figure have remained within five points, the limits being 200 and 205.



## Will Aid Grade Marking

THE Central Committee on Lumber Standards, Washington, D. C., has announced that the Southern Pine Association has offered to the entire lumber industry, through Secretary of Commerce Hoover, and the Central Committee on Lumber Standards, the benefit of its expe-

rience thus far gained in grade marking lumber. The committee has endorsed the grade marking movement and wishes to urge the interested manufacturer's association to take prompt advantage of the offered experience and knowledge.

The committee also urges manufacturers generally to adopt the American Lumber Standard designs and universal sizes of wood mouldings as approved by the General Standardization Conference last May.



## Another Big Month

THE largest September building record and the second largest month on record, is the F. W. Dodge Corporation's report for construction work started last month. Building and engineering contracts awarded in thirty-six states (which include about seven-eighths of the total construction volume of the country) amounted to \$549,216,700. This was only 7 per cent under the high record figure of August, and it represented a 59 per cent increase over September of last year. A seasonal decline of about 7 per cent is customary in September.

The month's record included the following important items: \$250,417,000, or 46 per cent of all construction, for residential buildings; \$80,171,800, or 15 per cent, for commercial buildings; \$79,668,000, or 15 per cent, for public works and utilities; \$43,297,700, or 8 per cent, for industrial buildings, and \$35,217,300, or 6 per cent, for educational buildings.

In three big districts the construction volume of the past nine months has already exceeded the total construction volume of last year. These districts are New England, Pittsburgh District (Western Pennsylvania, West Virginia, Ohio and Kentucky) and the Central West (Illinois, Iowa, Indiana, Wisconsin, Michigan, Missouri, Kansas, Oklahoma and Nebraska). In the entire thirty-six states, the nine months' volume is less than 4 per cent behind the 1924 total and is greater than the total for any year previous to 1924. New construction started in the thirty-six states from January 1 to October 1 has amounted to \$4,327,008,700, an increase of nearly 29 per cent over the corresponding period of last year.

Contemplated new work reported for these states last month amounted to \$661,397,100, a decrease of 19 per cent from August, but a 54 per cent increase over September of last year.



## Says Building Shortage Not Met

F EARS that the United States is being over-built are premature and not founded on fact, is the conclusion reached in a recent report by the Indiana Limestone Quarriesmen's Association. The report states that in only a very few cities is there a surplus of buildings. The gigantic shortage caused during and after the war has not been overcome and in the opinion of the officials of the association there is no danger of general over-building for the next two years.

$$\begin{array}{r}
 \$2.00 \times 250 = \$500 \times 5 = \$2500 \\
 \$500 \times 5 = \$2500
 \end{array}
 \left. \vphantom{\begin{array}{r} \\ \\ \end{array}} \right\} \$5000$$

## Saved Yearly By These Autocars



Fleet of five 4-cylinder Autocars owned by The Liberty Sand & Gravel Co., Cleveland

Autocar trucks do cut hauling costs. Many Autocar users, naturally, cannot reveal such intimate business figures. The Liberty Sand & Gravel Company, of Cleveland, Ohio, are so situated that they can.

Mr. H. Young, their manager, says that their Autocars have effected a saving on every item that enters into motor truck costs. This statement is based on prior experience with several other makes of trucks on exactly the same work in their sand pit.

“Our Autocars average ten loads per day as against eight loads a day with other trucks. We can operate our Autocar trucks on \$2.00 less per day on gas and oil and figure that we are saving \$500.00 a year per truck in addition to the above. By reason of the short wheel-base advantage in Autocar construction, we are able to make deliveries in places where previously it was impossible with our other trucks. Our next additional equipment will be Autocars.”

(Send today for copy of Mr. Young's complete statement.)

## The Autocar Company, Ardmore, Pa.

ESTABLISHED 1897

Direct Factory "Autocar Sales and Service" Branches or Affiliated Representatives in

- |                |            |               |              |               |                |                 |
|----------------|------------|---------------|--------------|---------------|----------------|-----------------|
| *Albany        | *Buffalo   | *Detroit      | *Memphis     | *Paterson     | *San Francisco | Tampa           |
| *Allentown     | *Camden    | *Erie         | *Miami       | *Philadelphia | *San Jose      | Trenton         |
| *Altoona       | *Charlotte | *Fall River   | *Newark      | *Pittsburgh   | *Schenectady   | *Washington     |
| *Atlanta       | *Chester   | *Fresno       | *New Bedford | *Providence   | Scranton       | West Palm Beach |
| *Atlantic City | *Chicago   | *Indianapolis | *New Haven   | *Reading      | Shamokin       | *Wheeling       |
| *Baltimore     | *Cleveland | *Jersey City  | *New York    | *Richmond     | *Springfield   | Wilkes-Barre    |
| *Binghamton    | *Columbus  | *Lancaster    | *Norfolk     | *Rochester    | *St. Louis     | *Williamsport   |
| *Boston        | *Dallas    | *Lawrence     | *Oakland     | *Sacramento   | *Stockton      | *Wilmington     |
| *Bronx         | *Denver    | *Los Angeles  | *Orlando     | *San Diego    | *Syracuse      | *Worcester      |
| *Brooklyn      |            |               |              |               |                | York            |

\* Indicates Direct Factory Branch

# Autocar

gas and electric trucks

EITHER OR BOTH - AS YOUR WORK REQUIRES

# Better Homes in America Contest Sets High 1925 Standard

First Prizes Awarded to Atlanta, Ga.; Santa Barbara, Cal.; Port Huron, Mich.;  
and Roanoke Rapids, N. C.

**A**TTLANTA, GA., and Santa Barbara, Cal., divided the \$500.00 first prize for the best urban demonstrations in the fourth annual Better Homes in America campaign of 1925. Port Huron, Mich., winner of this first prize two years ago, was awarded the special prize of \$300.00 for the best school practice, home demonstration. As Atlanta, Santa Barbara and Port Huron all conducted campaigns of first merit, this form of award was adopted for this year instead of granting first, second and third prizes as has been done in previous years.

The Better Homes in America organization is an entirely non-commercial one which aims to make convenient, attractive and wholesome homes accessible to all American families, especially those with modest incomes. It has won the approval and support of prominent people and organizations everywhere and the country has shown an increasing interest in its activities.

Specifically the aims of the organization can be summed up as follows:

1. To put knowledge of high standards of house building, home furnishing and equipment, and home life within the reach of all citizens.

2. To encourage the building of sound, attractive, economical, single family houses in which the highest type of wholesome and private home life may be possible, to en-

courage the reconditioning and remodeling of old houses to render them sanitary, attractive and convenient, and to encourage thrift for home ownership.

3. To encourage general study of the housing problem and of problems of family life, and to help each community, as a result of its study, to demonstrate each year the best types of house construction, home furnishing, and labor saving devices for the home which are within the reach of families in moderate circumstances.

4. To encourage sensible and appropriate furnishings for the home and the elimination of needless burdens in house-keeping.

5. To encourage instruction in home economics and home life in the public schools, and particularly the construction of school practice cottages through which the girls and women of the community may receive continuous instruction in the ways of facilitating and improving household activities.

6. To promote the improvement of house lots, yards and neighborhoods, with particular attention to the beautification of premises, the promotion of home gardens, and the home playground.

7. To extend knowledge of the ways and means of making home life more attractive and happier through the development of home music, home play, home art, and the



Home No. 1 of the Atlanta, Georgia, Demonstration Which Divided with Santa Barbara, California, the \$500 First Prize in the 1925 Better Homes In America Contest. It was built from Architects' Small Home Service Bureau plans for \$6,750, exclusive of the land, and furnished for \$2,150.

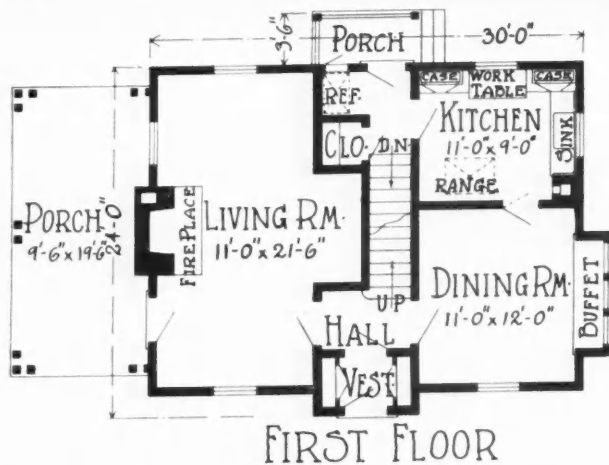

FIRST FLOOR

The First Floor Plan of This Atlanta, Georgia, Home Shows a Compact and Efficient Use of Floor Space.

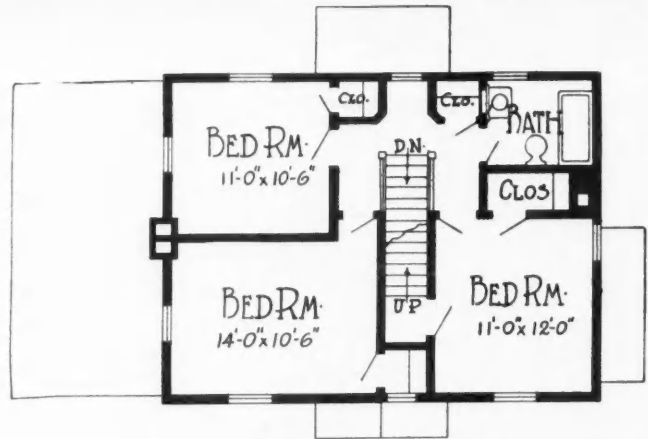

SECOND FLOOR

The Second Floor Plan Is in Keeping with the First Floor Plan Showing Three Bedrooms and Bath.

home library and to encourage special study and discussion of the problem of character building in the home.

8. To serve as a clearing house of sources of information on home problems; to conduct research on problems of home improvement; and to co-ordinate the activities of national, state and local organizations which deal with any aspect of home life.

The organization employs specialists for research work, issues educational publications and organizes demonstrations throughout the country, through local volunteer committees, during a period set aside in May of each year. This Better Homes Week was observed during the week of May 11 to 17, inclusive. The demonstrations compete for cash prizes and the competition has become increasingly keen. But even more satisfactory than this is the fact that this year's demonstration showed a far higher average standard than ever before.

A number of demonstrations were just below the prize-winning class and received honorable mention from the committee of judges. The observance of Better Homes Week this year was more widespread than ever before, nearly 1,900 cities, towns and rural communities taking part in the active work, under the guidance of local volunteer committees. Every state in the union was represented in the demonstrations and even Alaska and Hawaii had a part in the campaign. The judges found that many demonstrations this year which would have taken prizes in past years could not be considered because of the higher standards set in the 1925 demonstrations.

In this year's campaign the committee of judges consisted of Dr. John M. Gries, chief of the division of building and housing of the U. S. Department of Commerce; Dr. Louise Stanley, chief of the bureau of home economics of the U. S. Department of Agriculture; Mrs. Charles Bradley Sanders, a specialist in house decoration and furnishings; Dr. Hugh S. Cumming, surgeon general of the U. S. Public Health Service, and Victor Mindeleff, a well-known Washington, D. C., architect.

The Atlanta Better Homes Committee this year, because of the comprehensiveness of its program as well as its quality, was unanimously determined by the committee on awards to be clearly worthy of first place in the 1925 campaign. Mrs. Newton C. Wing, who was chairman in

1924 when Atlanta was awarded second prize, being second only to Kalamazoo, Mich., was again chairman this year.

Atlanta had a multiple demonstration, showing the public three houses adapted to the use of families in varying walks of life, and two school practice apartments. Two of the homes shown were built for the purpose from plans of the Architects' Small House Service Bureau, and selected by the committee. One of these homes, containing six rooms, was designed for occupancy by a white family and cost \$6,750.00. This is the house illustrated on these pages and other interior views, in colors, will be found on Color-plates IV and V following page 134. The other, a four-room house costing \$2,150.00, was in the colored section of the city. It was demonstrated exceedingly well under the direction of a colored sub-committee.

All the Atlanta demonstration homes were furnished on a strict budget, drawn up to comply with the average incomes of families of the type for which they were intended. An interesting feature of the Atlanta demonstration was its "Americanization apartment," furnished in the immigrant quarter of the city. There it was stressed to the immi-



Front End of the Living Room in Atlanta's House No. 1. The furnishing of this room was completed at a cost of \$400.



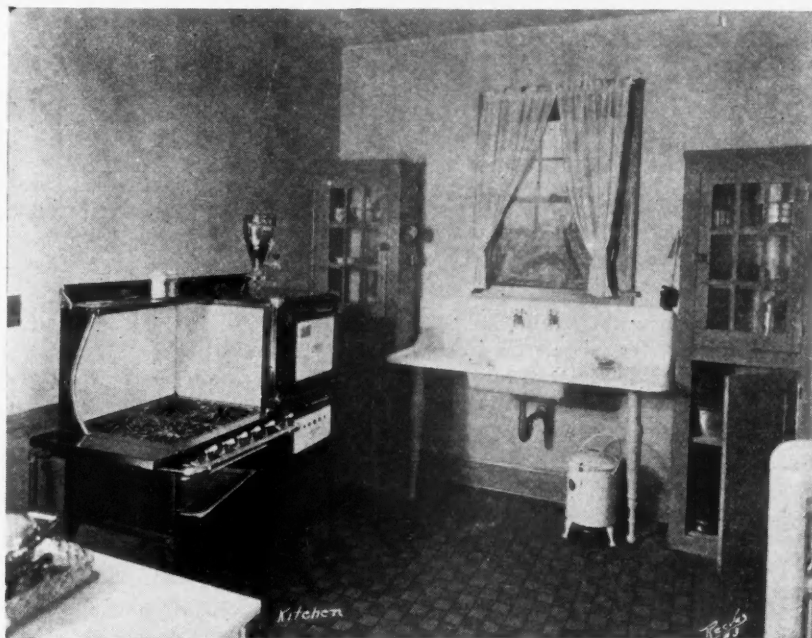

**The Kitchen in the Atlanta House Was Furnished for \$200 and Is Complete, as Shown, with Double Drain Sink, Stove, Work Table, and Built-in Cupboards.**

grant portion of the city's population that it was important and desirable for them to retain, in their adopted country, their native arts and handicrafts, pottery and home life.

In Santa Barbara the local better homes chairman was Miss Pearl Chase, secretary of the Community Arts Association. Five homes were demonstrated in Santa Barbara by Miss Chase's committee, all of them being outstanding examples of excellence in architecture and furnishings.

Two of the houses, of four and five rooms, costing \$3,800.00 and \$6,200.00, exclusive of the lots, were not furnished. Of the others, one contained six rooms and cost \$6,109.00, a second three rooms and cost \$1,544.00, and a third, which was located on a hillside and contained three separate apartments, cost \$8,200.00. The public interest aroused by the demonstration was notable, resulting in extraordinary attendance at the demonstration homes throughout Better Homes Week.

The agencies co-operating with the Santa Barbara Better Homes Committee covered a wide range and included Women's Club Chamber of Commerce, the municipal government, building and loan associations, schools, churches, the real estate boards, newspapers, Boy Scouts, Girl Scouts, American Legion, the public library, merchants, a housing association, industrial corporations, colleges and universities, the Parent-Teacher Association, Home Bureau, civic clubs, and business men's clubs.

Port Huron, under the leadership of Miss Elizabeth Carlisle, head of the civics department of the Washington Junior High School, achieved a notable triumph two years ago in carrying off first prize. This year, under the same leadership, a Dutch Colonial house, of five rooms, costing \$4,811.00, was demonstrated. The students of the high schools had a hand in planning the house, the city architect supervising and completing the work.

Students tore down the old house which stood on the site of the new demonstration home, and vocational students in the high school assisted in much of the work of putting up the house, such as the electric wiring, plumbing, and so on. This work was done, of course, under the direction of their teachers.

Pupils of the school selected the furnishings of the house, all of which were donated by local clubs, organizations of various kinds, and individuals.

The Port Huron demonstration home has the value of being a permanent demonstration. Its origin was strictly educational, and as a school practice house it will provide continuous education in "better homes" for those who can profit most by it, those in the formative period of their lives, who have not yet set up homes of their own.

The whole community was involved in the Port Huron demonstration, co-operation by every local organization having been secured by the students. Next year it is planned to erect a school practice home at another one of the Port Huron schools.

Fourth prizes of \$50.00 each were awarded to Greenville, S. C.; New Rochelle, N. Y.; Cleburne, Tex., and Birmingham, Ala. The six-room better homes demonstrated at Greenville this year cost \$3,500.00, less than its 1924 home which was a prize winner also, the house shown being one within the reach of the pocketbook of the family of a skilled worker. Next year it is planned to demonstrate a house costing even less. The local Better Homes Com-

tee planned the house and picked out the furnishings with strict observance of a budget in keeping with the cost of the house.

A second set of prizes is given each year by the national headquarters of Better Homes in America for excellence of the demonstrations in communities having populations of less than 10,000. The first prize of \$200.00 went to Roanoke Rapids, N. C.; the second prize, \$150.00, to Gaithersburg, Md., and the third prize of \$100.00 to Bergenfield, N. J.

The Roanoke Rapids Better Homes Committee, under the leadership of Mrs. F. M. Brown, demonstrated a new, detached five-room frame house, the house lot being planned and planted. The cost of the house, exclusive of the lot, was put at \$4,000.00, the furnishings costing \$1,311.50.

A number of lectures were conducted as part of the program, the topics including art appreciation, home furnishings, yards and gardens, kitchen improvement, better babies, and better homes. In addition to the talks in the demonstration home, there were talks in the schools and at meetings of mill employes. A home garden contest with 150 entries was conducted, as was a model kitchen contest, a home library contest in the schools, a poster contest, a contest for the best kept home premises, health and better babies contests. Also, there were demonstrations of home play, home music, and household labor-saving devices.

A large amount of publicity was given to this educational undertaking, and community support was excellent. Invitations to nearby towns to witness the demonstrations were sent out, which brought many visitors to the house and meetings. The chairman reported that the results have been so deep and far-reaching that "we shall not ever be able to drop this idea. It is planned to continue the work during the 1926 Better Homes in America campaign."

Gaithersburg, Md., a community of about 800, demonstrated a six-room stucco house, costing \$5,580.00, with fine built-in features. Better Homes Week was marked by an excellent lecture program, the activity reaching the entire county. So much interest was aroused that the visitors to the demonstration home numbered 851, more than the entire population of the town.

Bergenfield, N. J., with a population of 9,000, registered 4,300 visitors, at its "better home," which was a frame house of six rooms, costing about \$6,800.00. The demonstration home was furnished with taste, for \$1,875.00.

# World's Largest Office Building Planned for New York

To be Built in the Grand Central District and Connected with Station and Subways

By **BERNARD L. JOHNSON**  
*Editor, American Builder*

**B**UILDING records are being surpassed so fast these days that a record for size or height does not stand very long. For the present, however, the record for the world's largest office building, planned, rests with Eastern Offices, Incorporated, in New York City. The building will not be as high as the Woolworth Building but will have a greater floor area.

The Portland Cement Association are to be congratulated upon their plans for a permanent new home of their own. This is undoubtedly one of the greatest service institutions in the United States responsible for much of the research and progress made in all kinds of concrete formulae, engineering and construction.

## Portland Cement Association Headquarters Chicago, Ill.

Holabird and Roche, Architects,  
Turner Construction Company, Builders

The new Portland Cement Association building, to be erected at Grand Avenue and Dearborn Street, Chicago, will embody the most advanced ideas in concrete engineering and construction.

The new building is to be five stories in height, resting on foundations designed to carry the greater load of a higher building whenever it shall be found necessary. The architects, Holabird and Roche, have furnished a pleasing design with long vertical lines intended to accentuate the height and symmetry of the building. Liberal use will be made of precast art stone composed of concrete for facing the outer walls.

All floors will be of two way reinforced concrete slabs supported upon reinforced concrete beams. In some of the rooms the concrete floor slab will be finished with terrazzo, cement tile, or art marble, all demonstrating the latest word in the concrete maker's art. Portland cement plaster applied directly on the concrete surfaces or on brick or tile will be used on the interior where the finish is other than cast stone, and will display workmanship of artisans in the plastering craft illustrating the wide variety of surfaces and texture possible through the use of portland cement.

## Kohler Company Office Building Kohler, Wisconsin

Brust & Philipp, Architects, Milwaukee, Wis.

Kohler, an industrial village near Sheboygan, Wisconsin, has many attractive homes with settings of well kept lawns, shrubbery and flowers. It is a community of executive, office and factory workers in the big Kohler plant from which it takes its name. Our plate, from the architect's perspective drawing, shows the company's fine new office building with a tower which dominates the town, reaching to a height of 110 feet above the ground.

The building is constructed of reinforced concrete, faced with vitreous red brick. It is 211 feet long, 65 feet wide and contains 51,380 square feet of floor space. It is a simple, dignified structure and completely in harmony with the general beauty of Kohler Village. There is a splendid entrance hall, 45 by 60 feet in size. Visitors must immediately be impressed with the beauty of this room. The floor is composed of square blocks of red Namadji tile, with a border of blue Moravian tile. The

wainscoting is Columbian Travertine and the main stairway and baseboards of Italian Travertine.

On the walls above the wainscoting are seven large mural paintings by Arthur Covey, depicting processes employed in the plant. Two of these paintings—"Tapping a Cupola" and "Pouring a Mould"—were exhibited prior to installation in New York and won a gold medal awarded by the Architectural League of New York.

## The Packard Building Philadelphia, Pa. Ritter and Shay, Architects

This fine perspective is reproduced from the original drawing which, with the plans, was exhibited at the Philadelphia Exhibition of Arts and Crafts in the new Art Museum on the Parkway. Howell Lewis Shay, Chapter member of the firm of Lewis and Shay, was awarded the gold medal of the Philadelphia Chapter of the American Institute of Architects for "Their skillful solution of a bank and office building problem—the Packard Building, 15th and Chestnut Streets, Philadelphia."

The jury of awards for 1925 consisted of: William Andrews Delano, New York; Theodore W. Pietsch, Baltimore; John A. Pempwolf, York, Pa.

This twenty-five story bank and office building is well proportioned, with a strikingly beautiful entrance, marked by an ornamental grille and bronze lanterns. The problem in design here was largely due to the restricted size of the site, which is about 50 by 130 feet, but extremely valuable, and the necessity for spacious banking quarters and adequate lobby and elevator space for the upper, or office, floors of the building. The bank, lobby and corridors are beautifully finished and decorated.

## Eastern Offices, Inc., Building New York, N. Y.

Sloan and Robertson, Architects

The proposed Eastern Offices Inc. Building, to be erected at Lexington Avenue and 43rd Street, New York City, at a cost of \$19,000,000, is to be the largest office building in the world.

It will be thirty stories in height and rest on a seven-story sub-structure reaching 80 feet below the street level. The building will contain 21,000,000 cubic feet and about 1,350,000 square feet of rentable office space, including 26,227 square feet of banking and shop space. The structure will be the first of its kind buried to such a depth in the earth and rock, reaching far below the bottom of the underground streams which cross Manhattan Island in this section.

The building will be constructed of limestone to the third story, and face brick above, with terra cotta trim. It will have its first setback at the seventeenth floor, of 25 feet 3½ inches; the second at the twenty-third floor of 16 feet.

The main entrance will be located on Lexington Avenue and will serve as a passageway to the grand concourse of the Grand Central Terminal. And there will be direct subway and suburban access to the building.

Some idea of the size of the proposed building may be conveyed by the fact that thirty-two automatic signal, push button control elevators in four groups, traveling at a speed of 800 feet per minute, have been designed.

# ART SUPPLEMENT *of* NOTABLE ARCHITECTURE

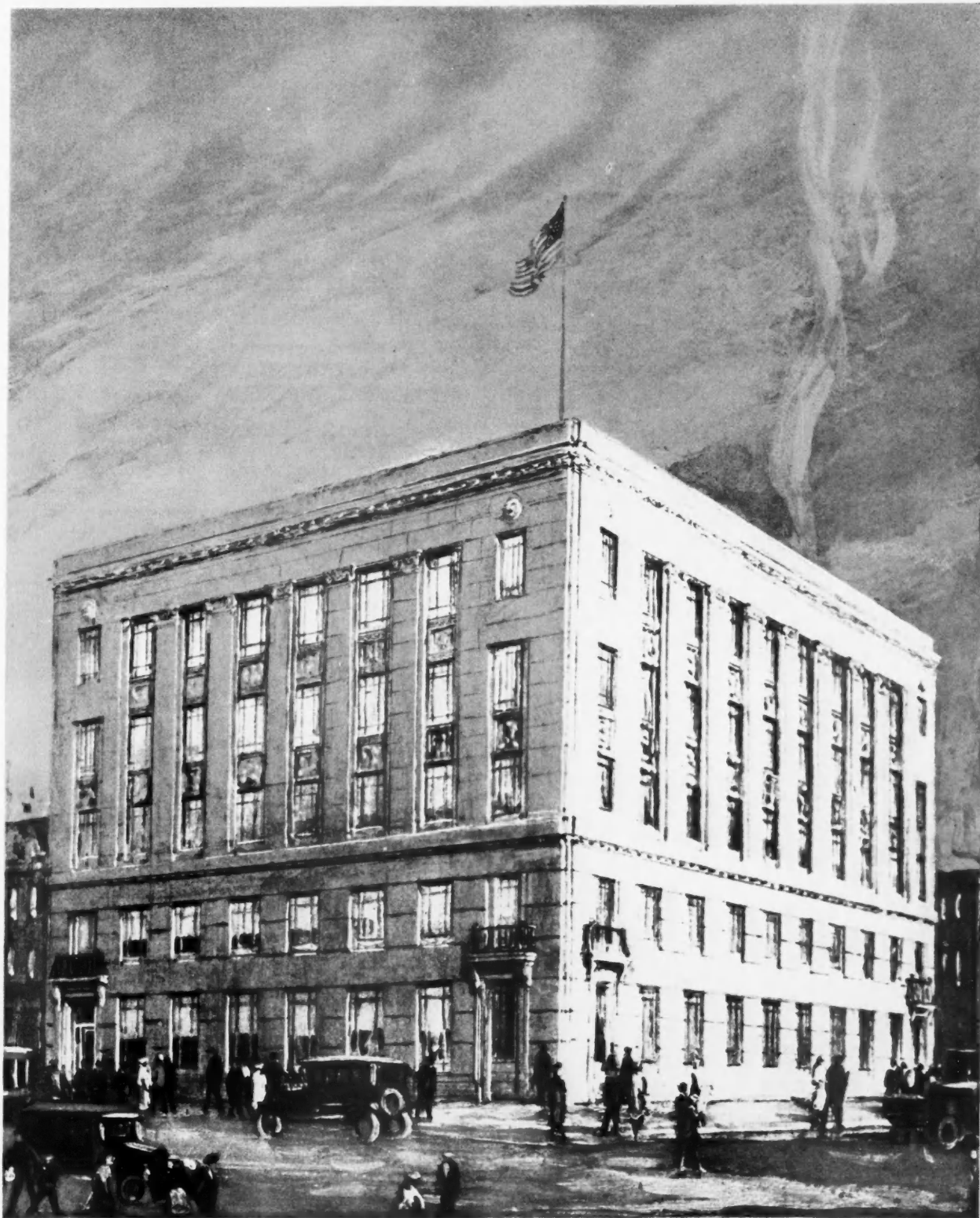

PORTLAND CEMENT ASSOCIATION BLDG.  
- HOLABIRD & ROCHE - ARCHITECTS -

PLATE 57

*The* PORTLAND CEMENT ASSOCIATION'S NEW HOME, Grand Avenue and North Dearborn Street, Chicago; Holabird & Roche, Architects.

*The AMERICAN BUILDER, November, 1925*

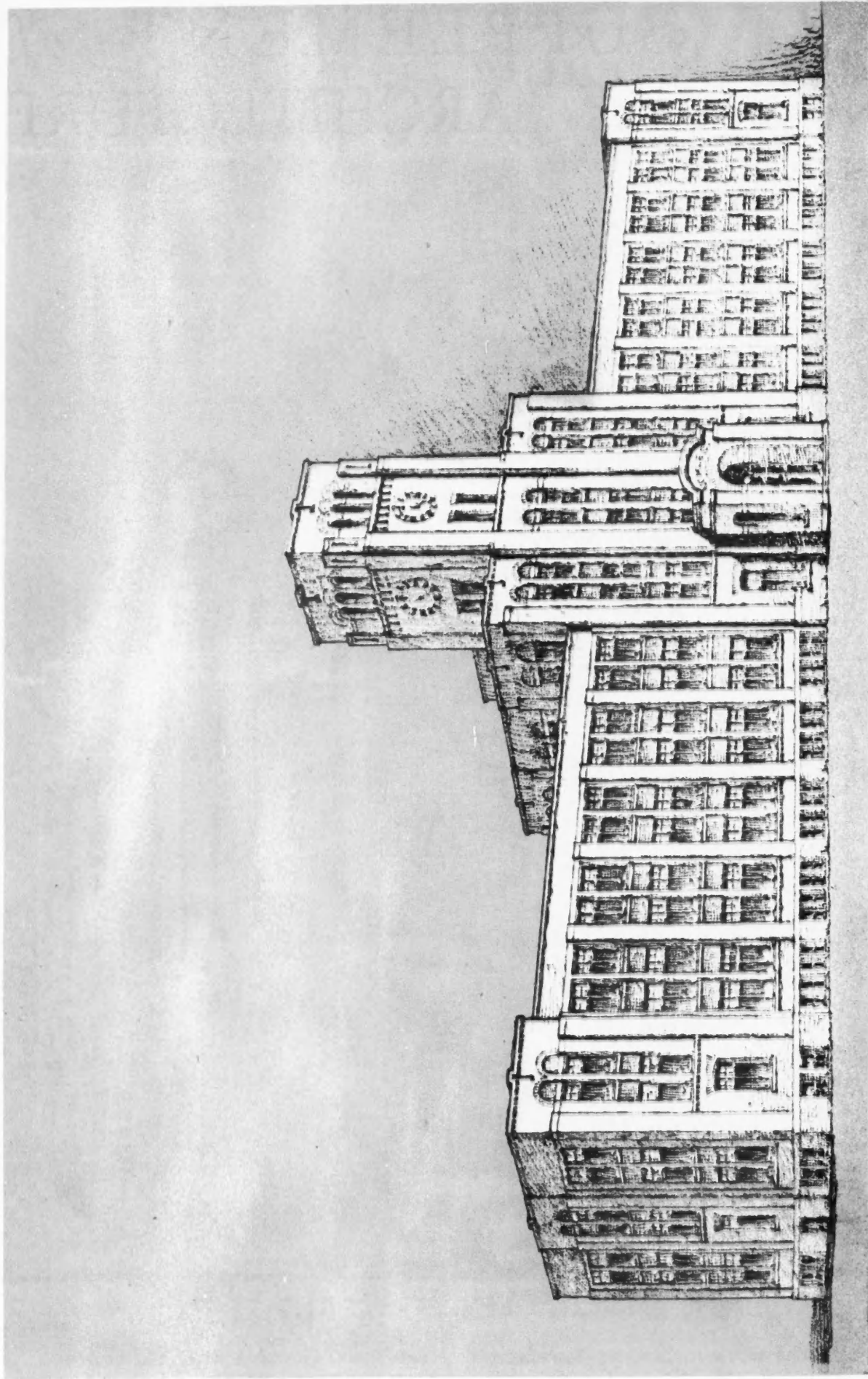

*The* ADMINISTRATION BUILDING OF THE KOHLER COMPANY, Kohler, Wis.;  
Brust & Philipp, of Milwaukee, Architects.



PLATE 59

*The* PACKARD BUILDING, Philadelphia, Penn.; Ritter & Shay,  
of Philadelphia, Architects.

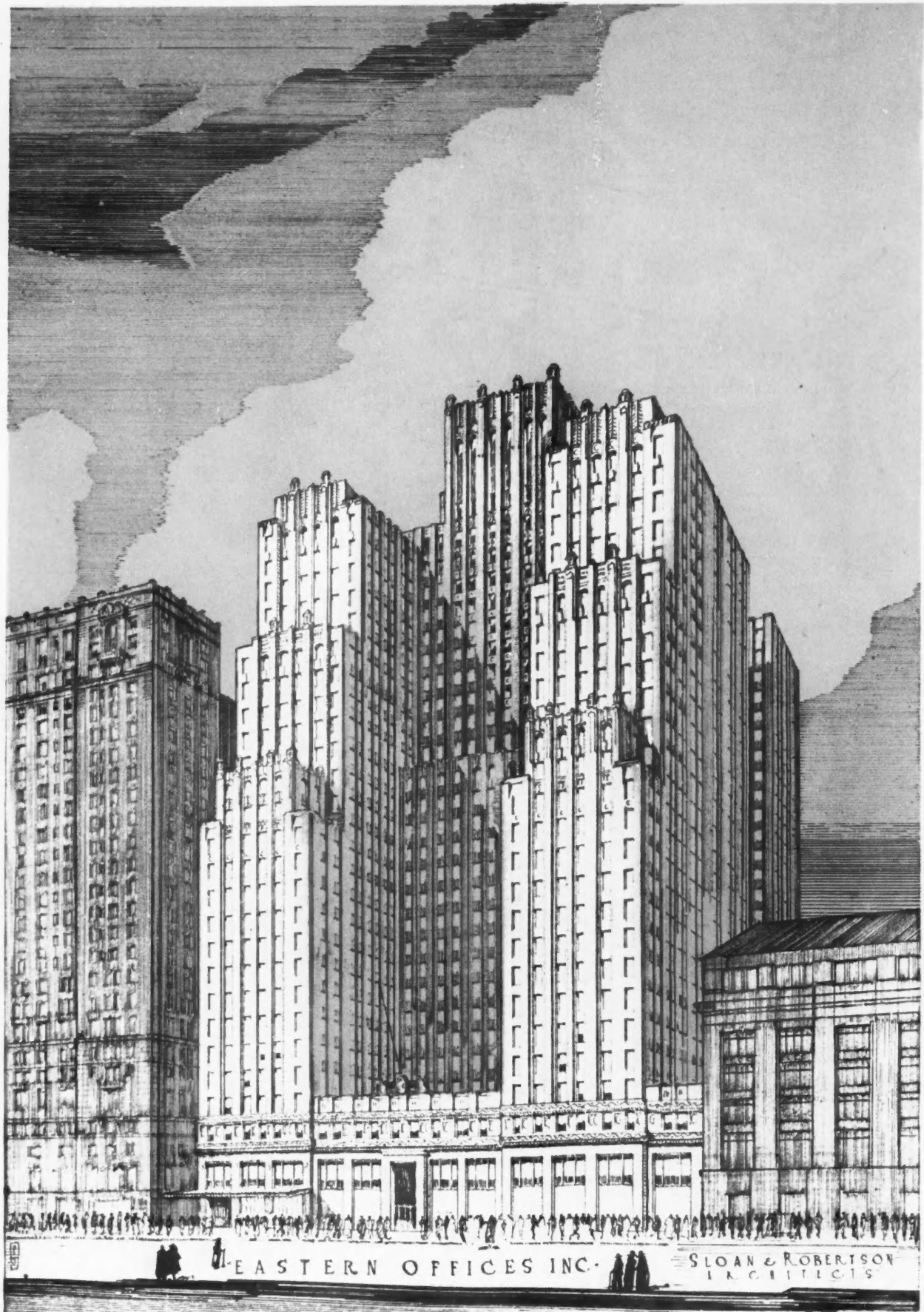
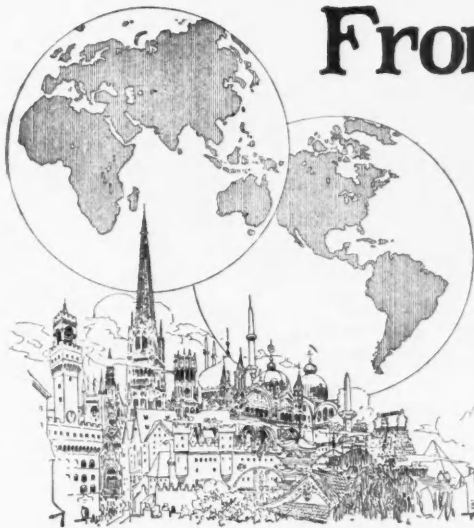

PLATE 60

*The Eastern Offices, Inc., to be erected on Lexington Avenue, between 43rd and 44th Streets, New York; Sloan & Robertson, Architects. This will be the world's largest office building.*



# From Our Daily FOREIGN MAIL

Conducted by Wm A. Radford, Jr.



William A. Radford, Jr., Vice-President of the Radford Publications, in a two-year investigation, has personally visited forty-nine foreign countries in the interest of the American Builder and World Trade for our advertisers.

**T**HERE is an unmistakable appearance of fundamentally improved conditions in Europe," said J. Walter Drake, Assistant Secretary of Commerce, who has just returned from an extensive trip through Great Britain, France, Belgium, the Netherlands, Germany, Switzerland and Italy, where he made a study of economic conditions affecting American trade and conferred with field officers of the Department of Commerce.

"This improvement," Mr. Drake continued, "varies from country to country, but none the less there is a gain in industry, in transportation and in commerce, in spite of the adverse factors that have held these countries back since the armistice.

"Generally speaking, the agricultural population is all employed with good prospects for successful results this year. In the industrial field, while it is apparent that progress is being made, particularly in some localities, yet as a whole there is nothing that should cause the American

business man to be stamped into the fear of European competition. Typical American production methods have been copied to a somewhat larger extent than formerly, it is true, but there are many reasons why European countries cannot compete in a productive way with American industry.

"American business men, however, cannot afford to rest on their oars in the belief that this implies easy going for American products in foreign markets. While we have great advantages in our advanced industrial methods and should not underestimate the fine strategic position we occupy in the competition for foreign trade extension, we should not ignore the fact that restored economic activity in Europe means sharper competition for the United States. Our highly developed industrial methods, our strong financial position and sound economic conditions are great elements of strength in support of our foreign trade development."

## FROM THE BAHAMA ISLANDS

Nassau, Bahama Islands.

AMERICAN BUILDER:

The Bahama Islands are now in the throes of a great real estate boom, second only to that of Miami, Fla., our neighbor, and this is only the beginning. In a few short years this will become the central winter resort of the South in the West Indies. Therefore, I would be very much pleased if you would get me in touch with the manufacturers desiring to get in on the ground floor with their products and who want a live agent to represent them in this colony. Trucks, tractors, building materials and every conceivable product find a market here now. Please make plain to the manufacturers that they must act promptly as the field will soon be covered. I am situated to be of great service to any firm or firms that I may represent for this locality. I have the advantage of knowing what the public wants.

(Signed) EDWIN A. FERGUSON,  
West St. South.

## FROM CHILE

(Translated from the Spanish)

Santiago, Chile.

AMERICAN BUILDER:

We have received the sample copy of your magazine and it has had our full attention. At present we are not engaged in building, but devote ourselves entirely to the sale of land. We shall, nevertheless, with great pleasure make your interesting publication known to the builders affiliated with us.

(Signed) HOLZMANN I ARAYA.

## FROM CUBA

Habana, Cuba.

AMERICAN BUILDER:

We received a recent copy of AMERICAN BUILDER, together with the checking sheet forwarded by your service department. We will welcome information on all construction materials and supplies.

(Signed) LATA & PUJALS CONSTRUCTION  
Co.,  
Engineers and General Contractors.

## FROM PANAMA

Panama, Rep. of Panama.

AMERICAN BUILDER:

We are glad to study carefully the copy of the AMERICAN BUILDER you have sent us. We would like to have information and quotations now on the items checked: Metal ceilings, softwood doors, cut iron nails, reinforcing, floor tile, structural tile, wall tile, wallboard, wire glass, bar benders, cement block machines, cement brick machines, cement tile machines, water closets, shower baths, lavatories, laundry tubs, bath tubs, floor drains, drinking fountains, chemical closets, urinals, kitchen sinks, slop sinks, sewer pipe, bathroom fittings, water tanks, electric lighting plants, school seats, school desks, blackboards, cattle stanchions, horse stalls, building plans, store fixtures and show cases.

(Signed) AMERICAN TRADE DEVELOPMENT Co.,  
A. J. Ariay, Treasurer.

## FROM MEXICO

(Translated from the Spanish)

Tlaxco, Mexico.

AMERICAN BUILDER:

We have had the pleasure of receiving your favor; and now the copy of your publication which you were good enough to send us has also come into our hands. Will you be good enough to put us in touch with manufacturers who could supply us with plans and complete cost estimates for buildings of wood and iron, suitable for humid tropical climates, of a simple type, in different styles and various sizes.

The prices should be calculated, if possible, for merchandise placed on board steamer at New Orleans, all packed ready to be put up here without any difficulty in accordance with the corresponding plan.

We desire to have these plans and estimates of prices ready in our hands in order to be able to show them to interested parties and with their aid obtain orders.

We are also interested in the following articles which we are accustomed to carry in stock: Portland cement, linseed oil, cut iron nails, galvanized nails, paints, screen cloth, varnish, water closets, house pumps, electric fixtures, carpenters' tools, paint brushes and building plans.

(Signed) ALVARO F. PEREZ LUCS.

## FROM ITALY

Milan, Italy.

AMERICAN BUILDER:

Kindly put us in touch with American manufacturers of the following commodities who can handle export orders: Water systems, registers, instantaneous water heaters, lavatories, bathroom fittings, door hangers, door checks, hardware doors, disappearing beds, vacuum cleaners, augers and bits, braces, compasses, files, grinders, levels, lock mortisers, miter boxes, planes, pliers, rules, saws, screwdrivers, shovels, squares, tool chests, vises, wrenches, hotel equipment, restaurant equipment, carpenter tools and hardware and sanitary equipment for bath room.

(Signed) ENRICO ROCCA,  
Agents, with stock for hardware, tools, fittings.

## FROM MANCHURIA

Dairen, Manchuria.

AMERICAN BUILDER:

I have your letter informing me that you have placed this Consulate on the subscription list of the AMERICAN BUILDER and FARM MECHANICS, in response to my request for journals or catalogs relative to building materials and home architecture.

Permit me to express my appreciation of your prompt courtesy. Callers at the Consulate have already expressed much interest in these magazines. I can consider them a valuable addition to the commercial reference files of the Consulate.

(Signed) LEO D. STURGEON,  
American Consul.

## FROM BRAZIL

Rio de Janeiro, Brazil.

AMERICAN BUILDER:

We are pleased to advise that we have been for a few years constant readers of your highly appreciated, excellent technical revue. We always go through the pages of this great publication thoroughly and we many times have made use of its information.

We are now in the market for the following commodities checked on your service blank: Hardwood doors, metal doors, composition flooring, hardwood flooring, metal lath, metal lumber, plaster blocks, clay tile roofing, ready roll roofing, structural steel and stucco.

(Signed) T. M. VEIGA & Cia.

Note: For the benefit of our advertisers we will, without charge, translate any foreign language letters referred to us.

AMERICAN BUILDER.

# Gene Sarazen—Noted Golf Player Had This House Built

But a Call for His Services as Professional at the Fresh Meadow Club, Coldstream, L. I., Called Him Away Before the House was Completed

EVERYBODY who knows golf knows Gene Sarazen, who won the U. S. professional championship in 1922, 4 up and 5 to play, and who again won in 1923 by defeating Walter Hagen 1 up at the 38th hole. This victory was all the more notable because the loser had won the British open championship during the previous year.

It is, in a way, unfortunate that Mr. Sarazen was unable to occupy the attractive home he had had built and which is illustrated herewith. Just as the house was completed at Pondfield Crossways, near Pelham Manor, one of New

York City's most attractive suburbs, he accepted a call from the Fresh Meadow Club at Coldstream, Long Island, where he is now professional.

The house was built from plans by Mr. D. A. Summo, of New Rochelle, architect, by Richard Marchione, of New Rochelle, builder. All the building material, including mill-work, was furnished by the J. A. Mahlstedt Lumber Company, who have yards at New Rochelle, Rye and Mamaroneck.

Mr. Summo has worked out a very pleasing design in the English style of architecture which is most attractive

in its rural setting. The half-timbering over the porte cochere, the steep roof, the rough texture, the stuccoed-over chimney with the rubble stone effect at the corners, the casement windows and the ogee arch of the solarium entrance are noteworthy.

One feature of this house is that, while it is of wood frame construction, with door and window frames of wood, the stucco finish and the slate roof create an outer appearance admirably in keeping with its English architecture. The odd shaped window in the gable next to the chimney is a deft architectural touch and one which is in entire harmony with the style, creating an effect which could have been gained in no other way.

The decked roof of the solarium forms an outlook, or balcony, from the main bed room which is recessed so as to provide a half sheltered outlook of a sort to delight any one who likes to throw open the casement and step out in the soft moonlight or to inhale the cool breath of early morning.

The interior features of this design are admirable from the standpoint of well proportioned room sizes and convenient and comfortable arrangement. The solarium has a wide cased opening from the living room and a smaller opening into the dining room with double French doors opening outdoors at grade.

Both living room and dining room are of generous size and the house has several unique features. For in-



Gene Sarazen in Action. The camera here records the almost perfect golfing form of this famous player just after one of his long drives.



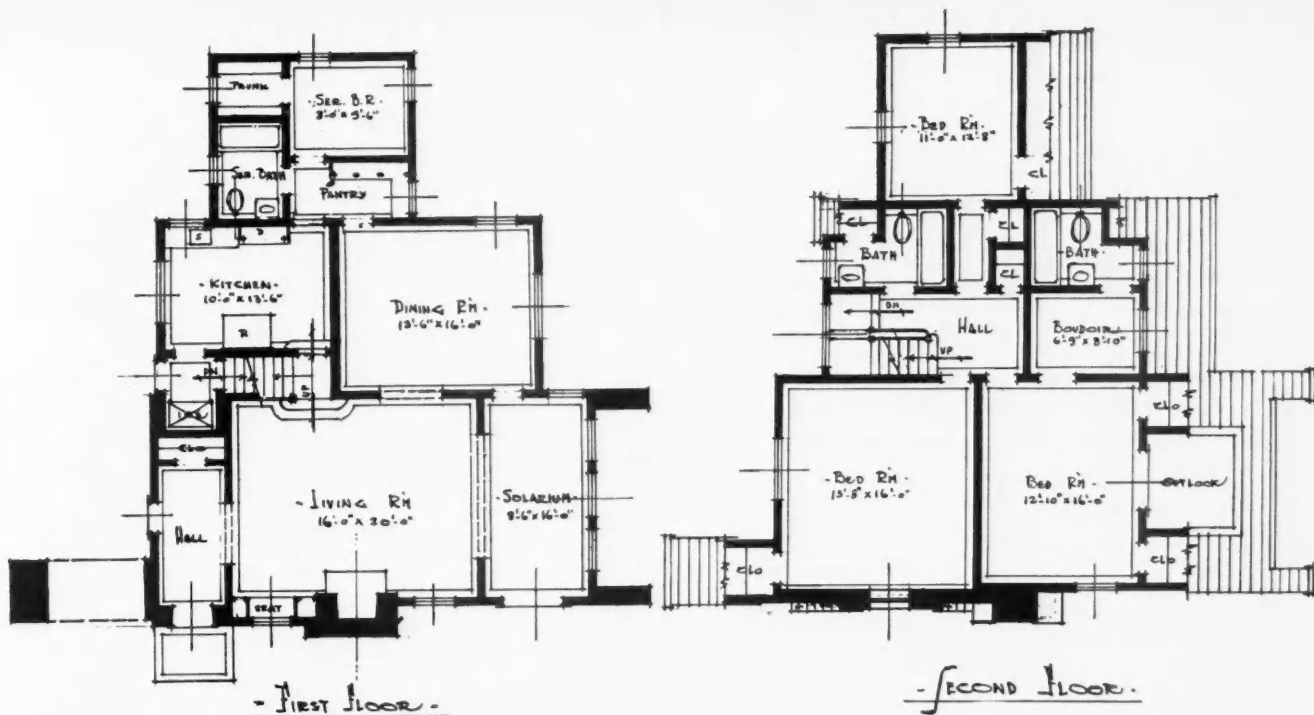

This First Floor Plan Calls for Spacious Living and Dining Rooms with a Convenient Arrangement of Kitchen, Pantry, Maid's Room and Bath.

A Well Planned Second Floor Is Revealed by This Plan with Its Two Bath Rooms and Boudoir and Bath en Suite.

stance, the stairway ascends from the living room instead of from the entrance hall. There are three bathrooms—one down and two upstairs. The main front bedroom has two closets and boudoir and bath are en suite. The sec-

ond bathroom is readily accessible from the other two bedrooms, with entrance from upper hall.

There is much to admire in the comfort, convenience and appearance of this suburban home.



This Residence, Designed for Gene Sarazen by D. A. Summo, Architect, of New Rochelle, N. Y., Is a Fine Example of a Modern Suburban Home in the English Type of Architecture Which Is Becoming So Popular.

# Definite Laws Control Color

In Order to Obtain Fullest Advantage From Use of Laws of Color,  
Laws of Harmony Must be Understood

By Julia W. Wolfe

**C**OLOR these days is a far more complicated subject than it appears to be at first sight. There are many definite laws and principles concerning and controlling it. Some experts in interior decorating deny the wisdom of the saying, "when in doubt, be neutral," and dispel the idea that dust-proof tones are required in dingy atmosphere; on the contrary they claim dust and gloom must be conquered by gay hues. In other words, do not use color which absorbs and conceals, but one which overcomes and dominates.

The mistake so often made is the one regarding a color sense as a natural and universal attribute as common as the possession of eyes to see with or a tongue to taste with. With many persons it never dawns upon them that color is as much a science as mathematics.

The salient principle of color, with regard to its application to interior decoration, is harmony. Harmony of color is always essential. It is impossible to employ color as a factor in decoration with success and ignore harmony.

Colors arranged in harmony in a scheme of decoration beautify and assist its intention and meaning, and, therefore, in order to obtain the fullest decorative

value out of color, the question of harmony must be thoroughly understood. The value of color in decoration is reduced, if not actually annulled, if harmony is absent, because color alone has only a primitive beauty. Harmony civilizes it. Consequently, when dealing with color as a factor in interior decoration, a knowledge of the part that harmony must play is requisite.

You no doubt know that there are three colors to which all other colors owe their origin: red, blue and yellow. These three colors are "primary" colors.

If any of the primary colors are mixed together a third color is obtained. For instance, red and yellow mixed give orange; red and blue give purple, and blue and yellow give green. These second resultant colors are called binary or secondary colors.

In addition to these there are black and white, which, together with gray (the result of mixing black and white) are termed neutrals. A neutral color is one that has no definite apparent color in it.

The primary colors, red, blue and yellow, in their natural state are not in harmony, but green, which is the union of blue and yellow, is consequently related to both and hence in harmony with each. It follows therefore that blue-green, which has more blue than



Every Room, on Being Entered, Should Convey the Idea of One Predominating Color, and this Color, Whatever it May be, should Cover Walls, Woodwork and Doors. In this room the color—brown—is high-lighted by the built-in bookcases full of brightly colored bindings.

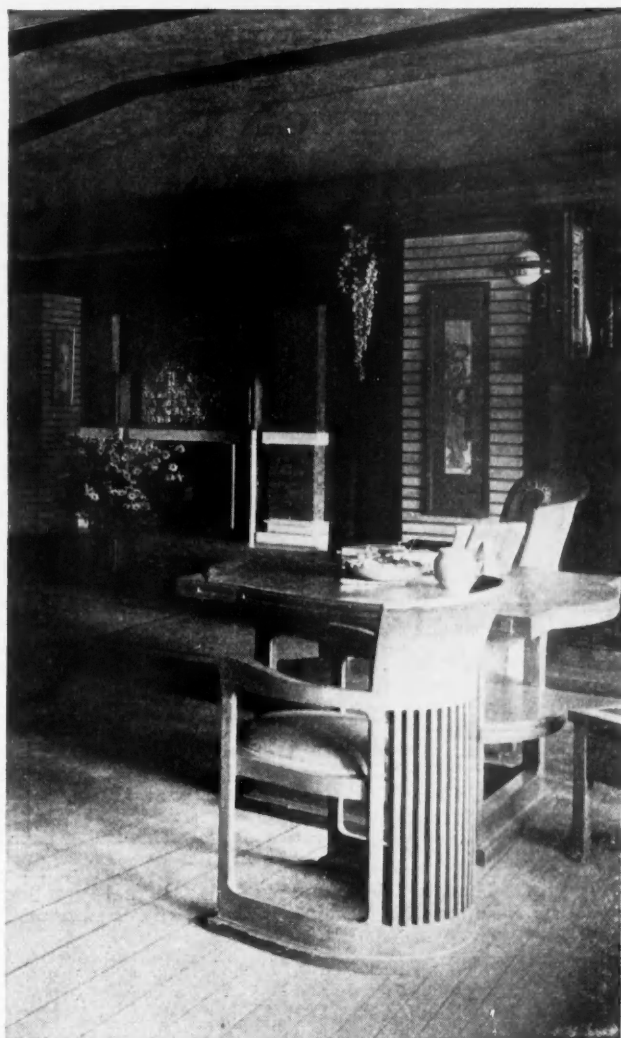

**Intense Colors Should Play Small Part in the General Color Scheme.** In a room like this the Japanese color print, bowl of flowers and brightly tiled fireplace supply all the color needed.

yellow in its composition, is consequently in closer harmony with blue than it is with yellow. It is still, however, in harmony with yellow because it is related to that color.

Remember that graying and toning down of the primary or secondary colors from their normal intensity in order to obtain color harmony is more effective in a room, so far as interior decoration is concerned, than where only colors which are in related harmony are employed.

Every room when first entering it should convey the idea of one predominating color, whether it be gray, green, yellow, and this color, whatever it may be, should cover walls, woodwork and doors. No other colors should be used in so great a quantity as to challenge the supremacy of the predominating colors.

Bright or intense colors should not be placed in juxtaposition to each other. It is quite essential then when designing the color scheme of a room to remember that walls, which offer the largest color space, should be the background intended to show off the subsidiary colors of the room, primarily the curtains, which, as

a rule, should supply the most definite note of color. The carpet and upholstery of the chairs, couches, etc., should be second in importance to the curtains and should never conflict.

Intense colors should play a small part in the general color scheme. In a room with gray walls, the intense colors should be introduced through the medium of the pictures, ornaments, cushions, etc.

Now harmony of tone is important also, and should be studied along with harmony of color, because it is inseparable. And upon the successful application of the two depends the possibility of obtaining the fullest decorative value out of a room.

Every note of color, including black and white is a color tone. Harmony of tone is obtained by the proper keying of the values of the color tones. The value of the color tone depends upon the position it occupies in the scale of even sequence between white and black. For instance, in a cream colored room dark blue curtains may, strictly speaking, achieve harmony of color, but harmony of tone will be lacking, since the value of blue is at the opposite end of the scale to the value of the color tone of the cream. Light blue curtains, however, would be quite in harmony, both as regards color and tone, because their tone values are properly keyed. This tone value is not only of importance as regards curtains and walls, but the floors and ceilings as well.

Of course, the ceiling is the least to be regarded, but the walls and floors must always be considered. The walls are always an important background to show off the contents of a room. Every room should contain one predominant background color and against this background the other subsidiary colors should be set off. The background color should be a neutralized one such as, for example, beige, pale-yellow, or gray-green. Against this should be arranged the more intense—and consequently less neutralized—colors of the curtains and upholstery of the furniture. The more intense a color is the smaller and quieter should be the note it strikes in the general scheme, and therefore, conversely, the more neutralized the color the more predominant it should be made.

It will be seen, therefore, that to give the rooms of the house their fullest decorative value the color scheme should be formed by a combination of grayed or softened colors. Contrasts in tone should be avoided. Therefore, tones should be keyed to one another.



### Pass Real Estate License Law

**A** LAW providing for protection of the public in real estate transactions by requiring the licensing of real estate brokers and salesmen has just been passed by the legislature of Georgia. With the signing of the bill by its governor, Georgia became the twenty-first state to have enacted a real estate license law. One Canadian province, British Columbia, also has such a law.

The purpose of the law as stated in its text is "to establish a standard of efficiency and moral qualification of applicants for licenses for real estate brokers and salesmen."

# Another Better Homes Winner

Roanoke Rapids Demonstration Home Built from AMERICAN BUILDER  
Front Cover Plans Awarded Prize

By MRS. F. M. BROWN

*Chairman of Roanoke Rapids, N. C., Better Homes Committee*

THE house illustrated lent itself most effectively to "The Better Homes Campaign," held in Roanoke Rapids last May and helped very materially in winning the prize of \$200.00 offered for towns under ten thousand. It was built with only slight modifications from plans published in the AMERICAN BUILDER as one of its Front Cover Homes.

The house was constructed of white weather-board with a green roof and cost \$4,000.00 to build. For a small place it gave one a curious feeling of space, with its soft gray walls in the front rooms which opened into each other with curved openings.

The furniture was simple and chosen with great care. In the living room, a lounge, a couple of easy chairs, a desk, two small tables, a stool, lamp, a few pictures and ornaments with a rug in colors of taupe with yellow. In the dining room, a small old-fashioned drop-leaf table, windsor chairs and a side table which served as a buffet. In these rooms and hall (in which there was a mahogany table, one brass candle stick and mirror), the flower scheme was carried out in pink roses and blue delphinium, soft cream curtains at all windows.

In the front bedroom, the furnishings were a double mahogany bed, dresser, high-boy, bed-table, easy chair and

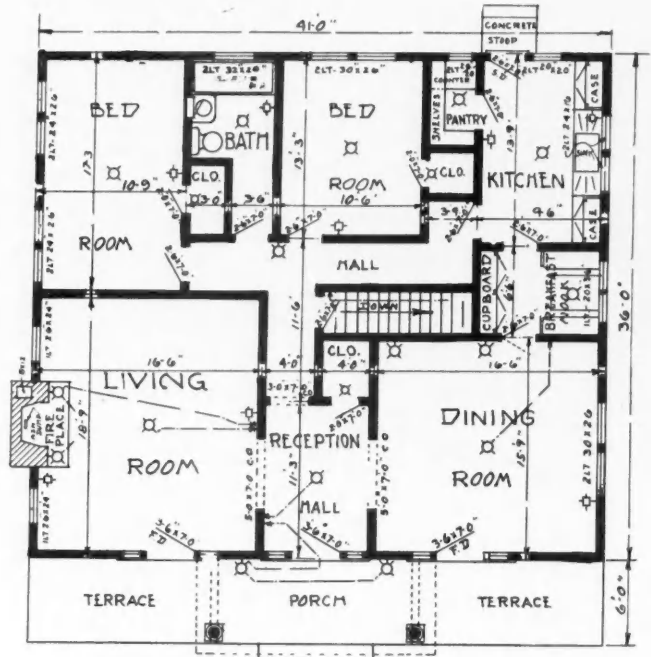

Only Slight Changes Were Made in This Original Plan Such as the Addition of a Window in the Corner Bedroom.

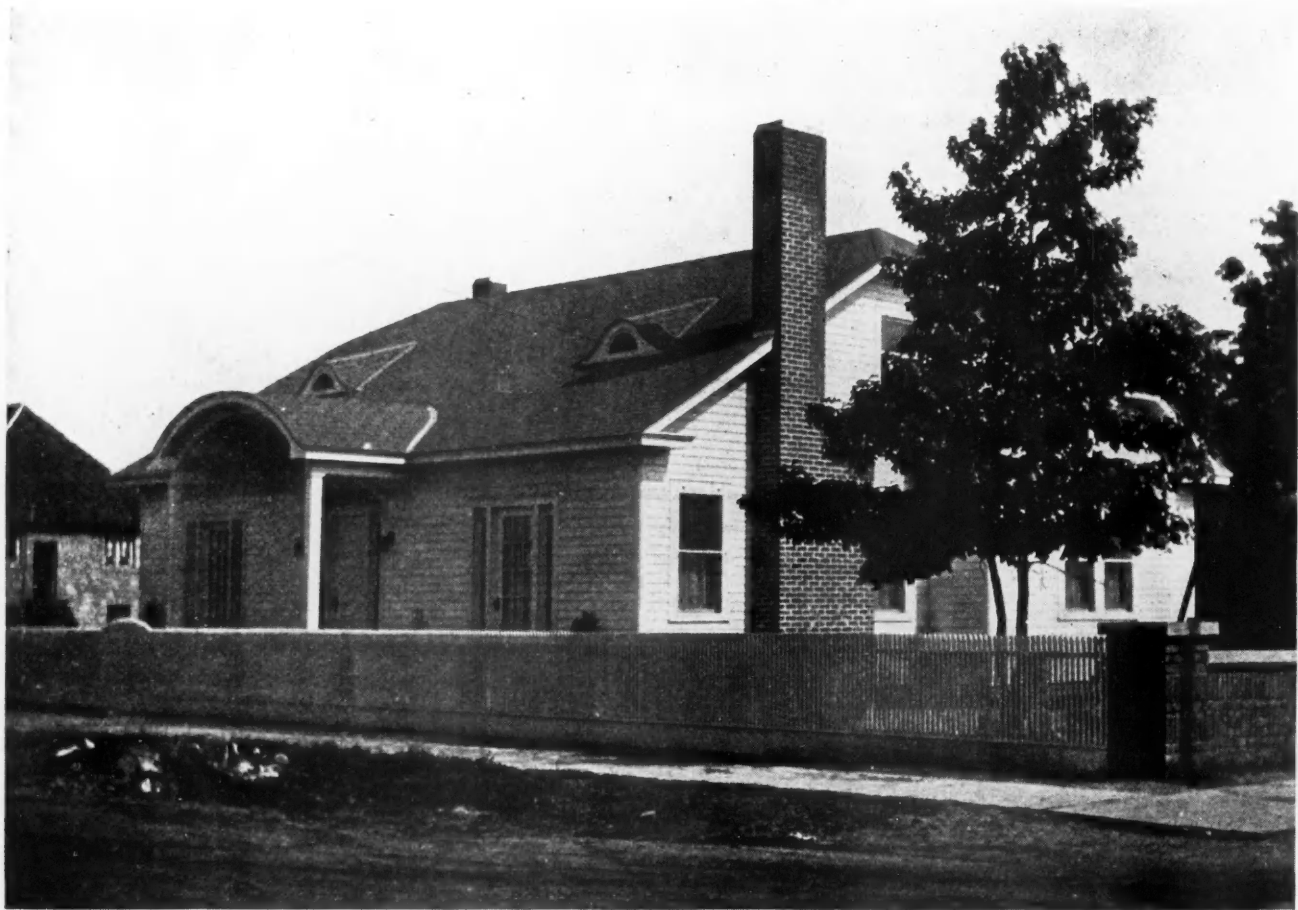

Demonstration Home in Roanoke Rapids, N. C., Winner of the \$200 Prize Offered for Towns Under 10,000 Population, in the 1925 Better Homes in America Contest. It was built from plans published in the March, 1924, American Builder as one of our popular Front Cover Homes.



The Living Room of the Roanoke Rapids House is Typical of the Simple, Attractive Furnishing Which Cost, in All, Only \$1,311.50.

sewing basket, more blue in the walls with pale pink ruffled curtains.

Bath room and kitchen effect was in yellow and blue. The spare room had two single cream beds, dresser covered with soft blue sateen, ruffled pink curtains with bedspread to match. In the small breakfast room, yellow and blue was used for color scheme with poppies sitting on the little cream table. The total cost of furnishings was \$1,311.00.

For several months before the opening of the house, work was carried on in the schools, mills and rural districts. In the evenings the committee in charge met the women in the village and instructed them on many things, but stressed gardens and plantings particularly. The women were told what to plant for high or low effect, color schemes were worked out, perennial beds drawn, cuttings were exchanged and literally car loads carried to them. Planting of grass in yards and trellis vines was suggested to hide out-houses. Bulbs were sold at cost.

We found the greatest interest in contests which were held in cooking and during the week of the campaign we had a "Better Babies Contest." One hundred and eighty-seven kitchens were scored by the Rural Demonstrator. For the children we had garden contests in every mill village.

Through the rural district the same ideas in kitchens and gardens were followed. In the three schools dozens of contests went on, miniature houses were made, poems and essays were written on home subjects, drawings were made of interiors of houses. The Girl Scouts contested for home making prize badges. Bird houses and furniture were made and dresses and sewing in Home Economics Department. In all 135 prizes were given.

Most of the prizes were donated, in fact the campaign did not really cost anything. Actually \$50.00 was given, and \$25.00 of this by the Women's Club, which really sponsored the movement.

The program used for the week of the campaign consisted in "Opening of the House," community songs at night, radio concerts, judging of all contests, "The

Better Babies Show," which was a new feature in this campaign, and a wonderful success. Talks each night by prominent men, proclamations from the mayor and clergymen, lectures on the "Home" and rural demonstrations in cooking. On Saturday, the last day, we all met with the rural women in the public park, had luncheon and distributed the prizes and showed off the "Better Babies."

This campaign reaches a great many women who otherwise do not meet their city cousins. When they came in from the country to see the houses, they were met each day with a warm welcome and by the end of the week each woman felt that she owned the place herself. The house was open from 8 A. M. until 10:30 P. M. There were 1,018 visitors, though it rained hard and steadily for three days.

For small places the "community songs" were the most successful. The women could bring their babies and sit on the grass. They were held in the parks and the most old-fashioned and best known songs were sung. We struck off some

programs of the words so all might join in.

As this great movement goes on more and more of the smaller places will be interested. Roanoke Rapids won for North Carolina this year, but the Federation of Women's Clubs throughout the state expects to work this program in every town and city in the coming years.

A local merchant furnished the house without any cost to us and as nothing was advertised or commercialized in any way this was a most generous thing to do. The house could be built for much less money, excessive cost of sewerage and plumbing with water in the house, made the price high. Sufficient room was left in the attic to make another beautiful bedroom.

Altogether this little "House Beautiful" made us a very comfortable home for our "week" and the owner is much pleased with her choice of these plans seen in the AMERICAN BUILDER of March, 1924.



A Corner of One Bedroom in the Prize Home Built in Roanoke Rapids, N. C., from American Builder Plans at a Total Cost of \$4,000.

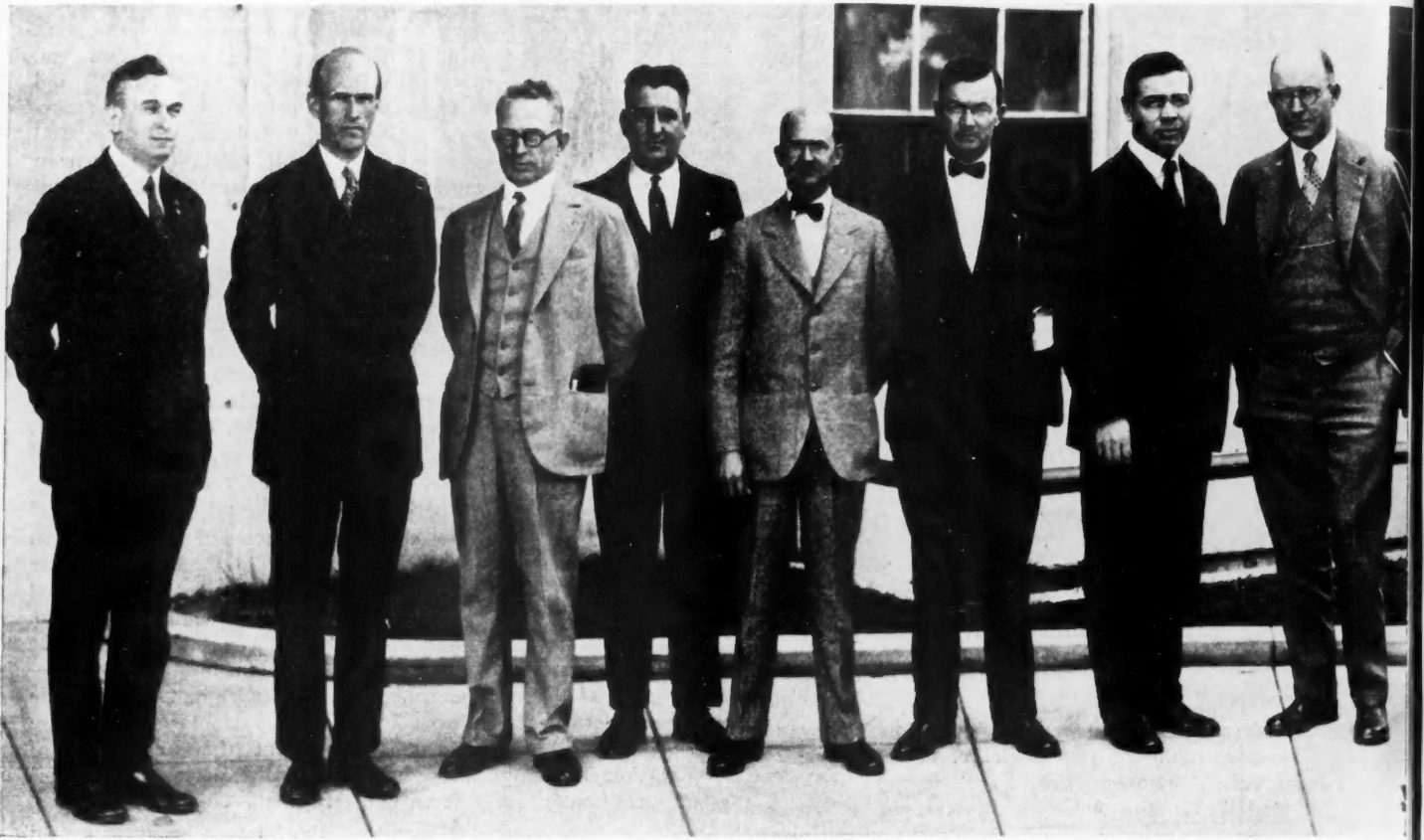

PROMINENT PARTICIPANTS IN STATE SECRETARIES' CONFERENCE AT THE

Left to Right: B. E. Line, Secretary Southwestern Association; Findlay Torrence, Secretary Ohio Association; J. A. Minnich, Secretary Tennessee Association; William Lucas, Manager Eastern Millwork Bureau; W. B. Willingham, Jr., Secretary Georgia Association; E. A. Davis, President Kentucky Association; Paul Collier, Secretary Northeastern Association; Don Montgomery, Secretary Wisconsin Association.

## Lumber Secretaries Meet at Washington

National Retail Lumber Dealers' Association Hold Successful Convention,  
October, 7, 8 and 9 at Mayflower Hotel

**T**HE ninth annual convention of the National Retail Lumber Dealers' Association recently held at the nation's capital was pronounced one of the best ever held; best in all essentials, and particularly from the standpoint of purpose intended—constructive work for the retail lumber industry as a whole. It was a convention filled with



Adolph Pfund,  
Chicago;  
Secretary-Manager.

distinguishing features, each succeeding the other with well-timed regularity from opening to close and all of comparable importance to the trade as a whole, each business session sharing equal value with the others. Throughout them all, however, the dominant note was "maximum distribution through the retail yard" and discussion of each related subject further emphasized the fact that efficient merchandising is the road to that goal.

The resolutions adopted at the close of the convention show the trade topics discussed and the result of the

discussion upon each—the opinion of the trade as a whole on matters affecting it.

From the first to the final session each discussion was full of interest and some disclosed some surprising reflects and information. Particularly was that true of the comprehensive presentation of the movement for a Model Lien Act, by Frank Day Smith, of Detroit, the industry's representative on Secretary Hoover's committee.

Discussion of the installment plan of selling also developed some information surprising to many lumber dealers in view of the publicity—some of it misguided—that has been given the subject during recent months, for it was disclosed that no retail lumber dealer is opposed to the installment plan as a sales plan; that many are using it and have been using it for years with great success; that all realize its necessity in meeting certain costly forms of competition, etc.; that, in fact, all its harmful effects can be eliminated by the dealer handling the finances.

Aside from the practical discussion of practical problems, there were other features of the business program of the National's ninth annual that contributed greatly to the success of the convention. Principal of these was an explanation and demonstration by J. B. Cuno, of the U. S. Forest Products Laboratory, of how to easily ascertain the moisture content of lumber, and a talk on forest conservation by Col.

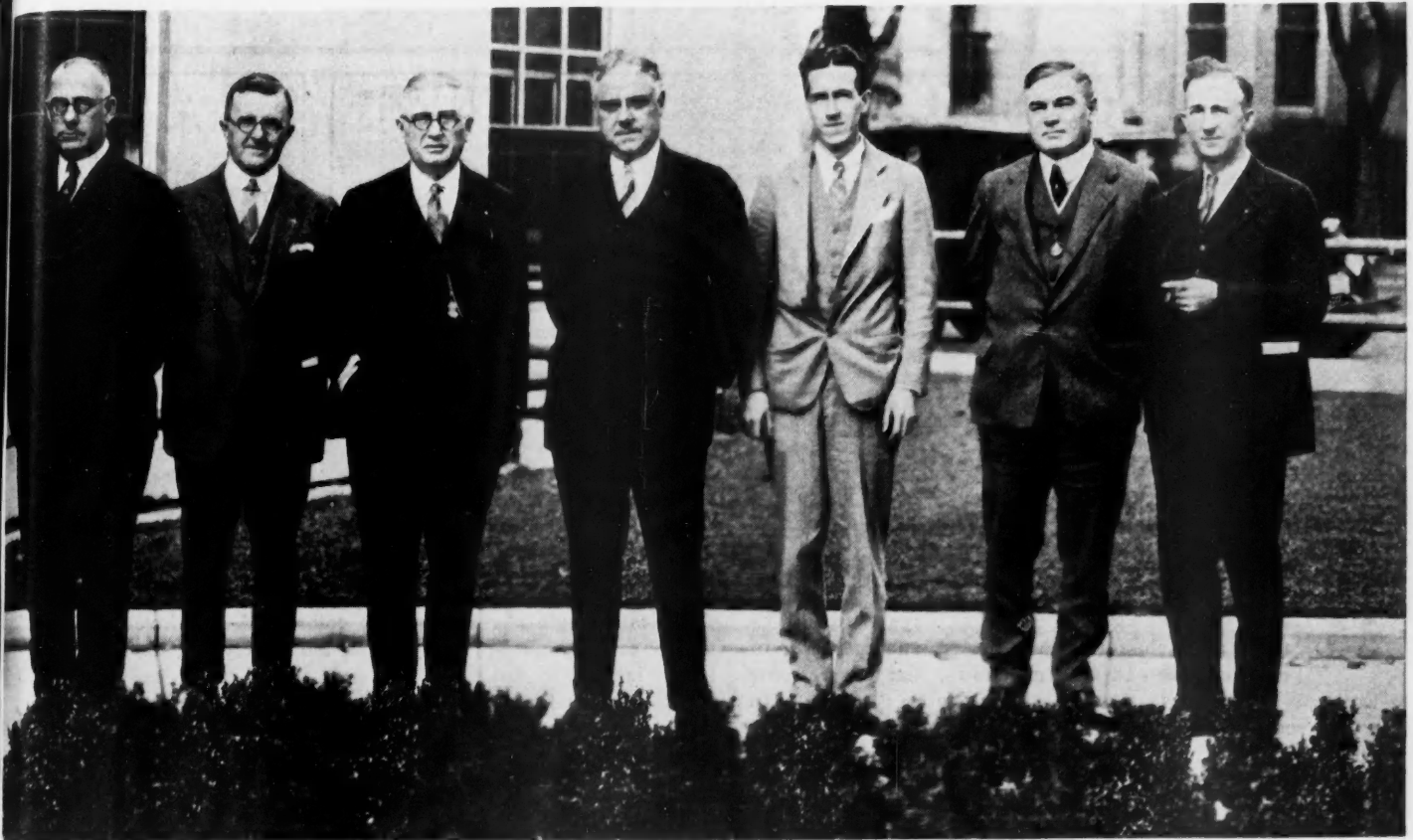

#### WASHINGTON MEETING OF THE NATIONAL RETAIL LUMBER DEALERS' ASSOCIATION

Clayton D. Root, Secretary Indiana Association; Arthur M. Manning, Secretary Michigan Association; J. F. Bryan, Secretary Illinois Association; Erwin Ennis, Secretary New Jersey Association; J. L. Buckley, Field Secretary Pennsylvania Lumbermen's Association; W. B. Stayer, Secretary Retail Lumber Dealers' Association of Pennsylvania; J. Ben Wand, Secretary Florida Lumber and Millwork Association.

W. B. Greeley, chief of the U. S. Forest Service. With the aid of inexpensive devices in the shape of a small electrically-heated oven and a small set of scales such as are used in an apothecary shop, Mr. Cuno made an actual test during his talk and showed how, with similar equipment, it is possible for the retail dealer in lumber to minimize if not actually eliminate disputes as to moisture content by supplanting opinions with actual facts.

Col. Greeley confined his talk on the forestry problem largely to the economical aspect, urging dealers to get other business men interested in it from the commercial or business standpoint, saying that in no other way, in his opinion, would it be satisfactorily solved.

Brief reports by committee chairman—J. E. Lloyd, on National Affairs; Guy Gray, on Standardization; Fred H. Ludwig, on Arbitration, and J. A. Mahlstedt, on Cost Accounting—were followed by an interesting and informative report of the last annual meeting of the U. S. Chamber of Commerce by C. Frank Williamson, the National's representative at the meeting.

Following the report of the Nominations Committee, the following officers were elected to serve the National Retail Lumber Dealers' Association during the ensuing fiscal year:

President—Fred L. Lowrie, Detroit, Mich. (second term).

Vice-president, Eastern Region—Amos Y. Leshner, Philadelphia, Pa.

Vice-president, Central Region—Edmund Goedde, East St. Louis, Ill.

Vice-president, Western Region—Fred Berry, St. Paul, Minn.

Vice-president, Southern Region—W. A. Robinson, Shreveport, La.

Directors, terms expiring Oct. 1, 1928, representing sustaining members—Thomas R. Brown, Louisville, Ky.; Harry W. Smock, Asbury Park, N. J.; O. D. Haskett, Indianapolis,

Ind.; W. H. Williams, Pittsburgh, Pa.; R. P. Paddison, West Palm Beach, Fla. Representing Affiliated Associations—Walter Pettit, Huntington Station, N. Y., Northeastern Association; L. P. Lewin, Cincinnati, O., Ohio Association; Claude Hortman, New Orleans, Louisiana Association; C. E. Byers, Hastings, Neb., Nebraska Association; J. P. Williams, Orlando, Fla., Florida Association.

Added to terms expiring Oct. 1, 1926—Hawley W. Wilbur, Milwaukee, Wis., representing sustaining members; C. L. Marshall, Johnson City, Tenn., representing Tennessee Association.



Immediately following adjournment of the convention the board of directors met and unanimously re-elected John Clane, of Chicago, treasurer, and Adolph Pfund, of the same city, secretary-manager.



J. E. Lloyd,  
Philadelphia, Pa.;  
Ex-President.

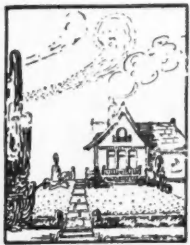

F. L. Lowrie,  
Detroit, Mich.;  
President.

	<p><b>LANDSCAPE ARCHITECTURE</b> AND <b>THE HOME</b></p> <p>A DEPARTMENT CONDUCTED BY</p> <p>F.A.CUSHING SMITH LANDSCAPE ARCHITECT CHICAGO</p>	
---	--	---

## Autumn Foliage on the Small Home Grounds

This Is Number Nine of a Series of Articles  
By F. A. CUSHING SMITH, Landscape Architect

**W**ITH the coming of the autumn days there bursts upon us such a wealth of color, such a blaze of flaming reds and golden yellows, that we welcome the season of overcoats and coal with more pleasure than would seem possible. We may long before have forgotten our gardening enthusiasms of the spring months, but may again take some little interest in the neglected borders as this season advances. In the northern states there is no season which is so full of opportunities for beautiful color effects.

Perhaps that is the reason for the colorful bleachers at the football games, with the bright sweaters, brilliant hats, and still more charmingly colored gowns. There is in the

American people a real love for color, and this love can at no other time of the year be so surely satisfied as in the fall.

As the wood matures and the sap ceases its constant flow to the leaves and branches, there is a certain chemical action which takes place within the leaf walls which causes the outside surface of the leaf to take on a great range of color in different varieties of shrubs and trees, from the russet browns, through the yellows, orange, reds and scarlets, to the purple tones.

Suggestions for the selection of varieties of shrubs and trees which might be planted with their fall colors in mind, are given here in the hope that more readers will

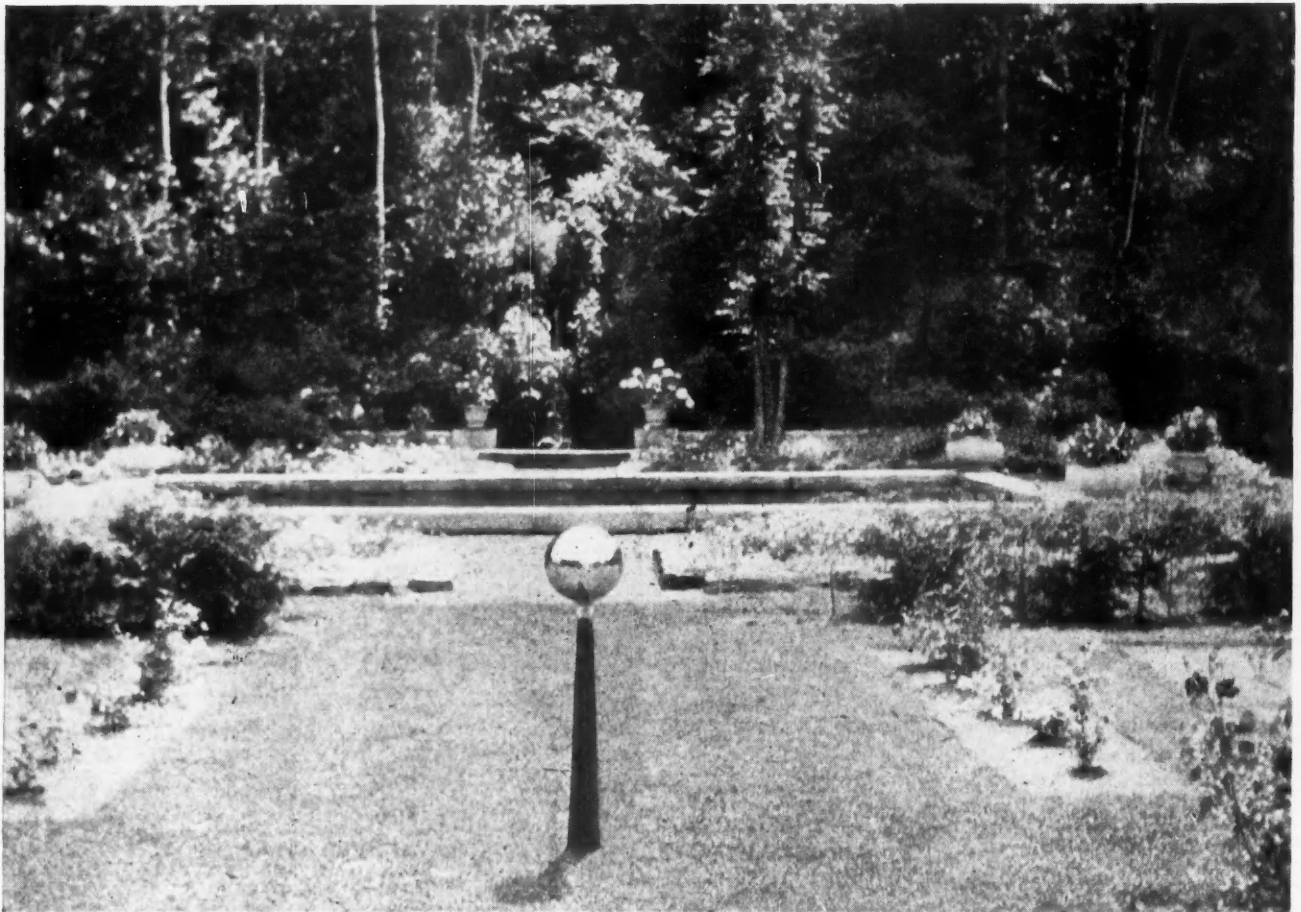

With Its Vivid Garb of Autumn Colors the Home Garden Takes on a New Charm and Again Revives the Interest Which the Spring Season Always Brings to the Home Owner Who Takes Pride in the Beauty of His Grounds.



realize that the floral characteristics of the shrubs and trees, and their height and habit of growth are not the only factors to be considered in selecting shrubs or other plants to embellish our home grounds.

In not all of the plants does the foliage change in color at the same time, some of the varieties maturing early in October, and still others hanging on the tree or shrub and gradually taking on tones of red or orange and yellow in the middle of November. Thus a continuous color effect is assured from early fall, when the red maple, the sassafras and the sumac show the first autumn colors, as the wood matures early, to a period late in the season, even after snow flies, when the scarlet and crimson shades of the cork-barked euonymus mark a brilliant section of the garden border.

The maple family is replete with members which should find a niche on every home grounds. The box elder early gives a yellow spot in the landscape, and as a quick-growing tree deserves more consideration in home use. The red maple and the Siberian maple have scarlet foliage in early October. The maples, particularly the hard maple, and the box elder as rather formal trees lend themselves to use at either side of an entrance walk. The box elder can also be clipped into a round-headed, or globe-shaped tree of medium height. The Siberian maple is useful in the shrub border where a small tree is needed to screen an unsightly object, and in combination with the Japanese maples marks a bright area in the garden border then lacking in flowers. The sugar maple brings the first show of red, a duller tone than the red maple, and the color stays on the tree a little longer before the leaves fall.

Among the larger shrubs which early take on a yellow tone is the red-bud, so called because of the red buds which appear early in the spring, before the leaves are formed. Thus this shrub serves a double purpose in the landscape scheme from the first days of spring to the last days of fall in the northern garden. The countryside is ablaze with another shrub of about the same size, as along the fence rows and in the edge of the woodland the staghorn sumac early flaunts its scarlet cloak. This is rather coarse-textured, and for that reason should be used only at points rather far from the house, where its open and awkward base is not so evident against the closer foliage and branches of its neighbors.

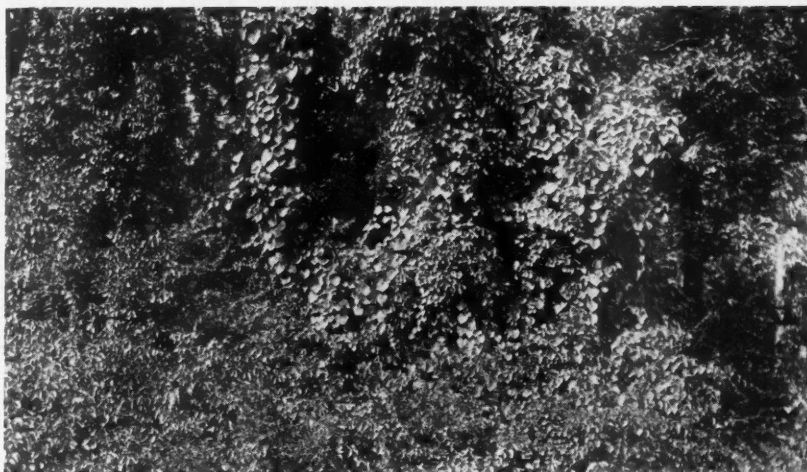

**Bittersweet, Ivy and Dutchman's Pipe Festooning a Forest Hillside Suggest What Can Be Done with the Garden in the Season of Autumn Colors.**

A tree which looks especially well alone, or as a single specimen, which best matures under such conditions, is always in great demand. Even on the small lot there may be room for a sweet gum with its scarlet fall glory, or for the tulip tree which has a yellow leaf in autumn, and as the name implies, an attractive and novel tulip-like blossom in early summer.

Touring at this time of year is full of thrills as one picture after another is painted in the broad strokes of nature's paint-filled brush. Have you ever stopped to admire a hillside where the Virginia creeper has festooned from tree to tree and has covered the branches with a crimson and yellow stain? Have you ever strolled across a bridge, looked down upon a dark valley, and seen the bright yellow leaves of the shad-bush brightening the gloom? It is the shad-bush, you know, which in the early spring blossoms long before the leaves appear with white butterfly-like petals at the tips of the long slender branches.

The thorn apple in great variety brings all the shades of color from orange to red, and should be used for these effects as well as for its fruits and horizontal habit. The flowering currant, a shrub about four feet in height, turns a clear yellow, and with the arrow-wood, a viburnum dentatum, with its red leaves, makes a striking combination of color on the average home place.

The late fall is rich with shrubs and trees whose leaves hang on the branches much later than any of those varieties mentioned before. The leaves of these varieties seem to have even brighter colors, possibly because many of the forest trees are bare, and because there may be snow on the ground.

The Norway maple is a little difficult to tell from its brother, the sugar maple. The former has a milky sap when the stem of the leaf is broken, while the sugar maple has a green or clear fluid. The sugar maple has red leaves in the fall, while the Norway maple gives us a rich green background for the blaze of color about it.

The woodland edges are alive with the scarlet of the flowering dogwood, and on the small place the cork-barked euonymus turns its deep green leaves to touches of scarlet, yellow and orange. The dark green golden bell is one of the few shrubs which have purple tones as the wood matures. Witch-hazel with its yellow coat makes a pleasing foil to the sassafras with its tints of orange and scarlet. The leaves of the

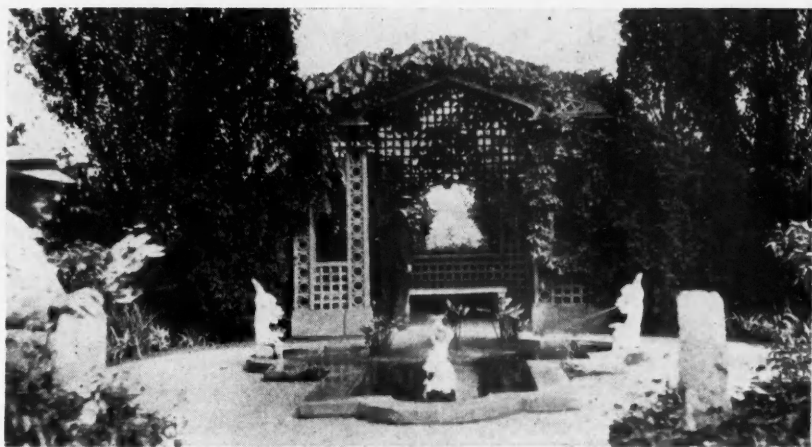

**When the Vines Over the Garden Seat Take on the Brilliant Red of Fall This Outdoor Living Room Is Perhaps Even More Attractive Than Ever.**

*(Continued to page 168.)*

# SAVE THE SURFACE DEPARTMENT

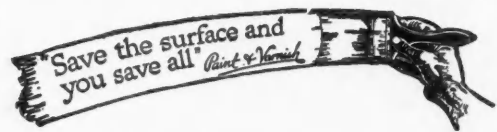

Written, Illustrated and Edited by the Headquarters  
Staff, SAVE THE SURFACE CAMPAIGN

## The "Different" House Is Seldom Distinctive

**T**HE architect and builder usually have their hands full when the owners of houses get architectural bees in their bonnets.

One of the leading architects of the country expressed a timely truth very well when he said:

"The reason that the majority of small houses built in America today are ugly or without architectural merit is that everyone has been trying to do something 'different' from his neighbor. He has given more thought to how he could accomplish this than to the idea that it was of importance to obtain a really good design for himself. So it is that you find houses of all sorts and colors and all periods of architecture, and each house containing as many projections as it was possible to stick onto it."

It is not hard to understand the desire to have one's house different when we remember how monotonous and

depressing is a row of identical houses. Every one wants his home to have some individuality. The error is not in the desire but in the means taken to obtain it.

Everywhere we see little houses that at heart are very much the same, but whose owners have insisted on making them "different" by some such guileless addition as a conspicuous bay or dormer, or huge porch posts. Perhaps they have increased the width of the cornice or added a gable. Maybe the addition consists of a strange-shaped window or two, or ornate brackets supposedly supporting the roof. Possibly large sheets of plate glass appear where small ones were before. Such little houses as these are a very practical demonstration of the fact that beauty is more likely to be a matter of subtraction than of addition.

Sound building, good design, and tasteful decoration make a house not only a monument to the architect and

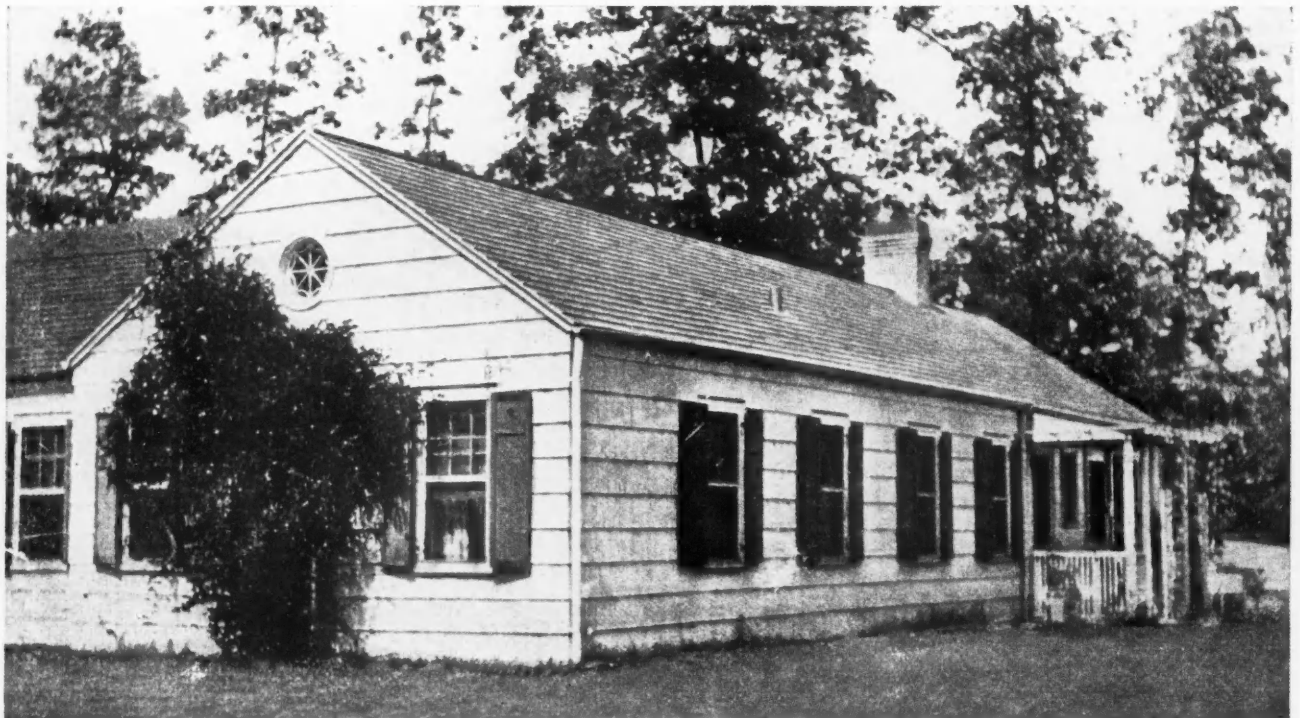

The Charm of this House Lies in Its Handsome Proportions and Appropriate Decoration. It is a cream color with blue shutters and roof. It has no extraneous architectural or decorative features.

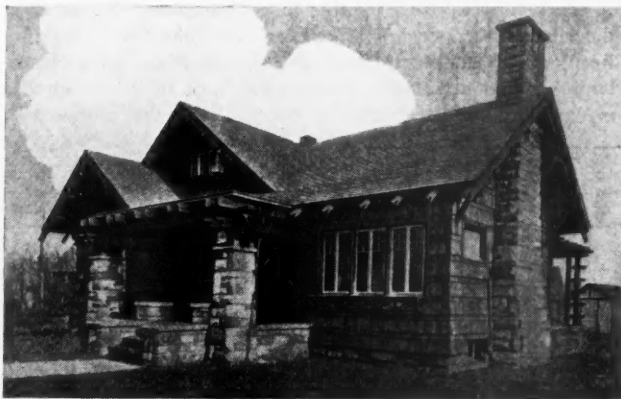

**The Gingerbread Effect of this House Combined with Its Rather Dull Atmosphere Make it Conspicuous Only By Its Defects, Both of Design and Decoration.**

builder, but also a financial asset to the owner. A "faddish" house goes out of style quickly and its value depreciates rapidly; a well-designed house, on the other hand, never becomes antiquated, since good design is permanent, whatever its period.

As implied by the architect just quoted, the best way to build homes that are not commonplace is to have them well designed. "When you boil it down," he added, "good design is very largely merely a use of materials in an economical way and under the direction of one who knows what is good proportion."

Good taste is not to be obtained by adding external features to an ugly house, any more than an ugly picture is made beautiful by adding a good frame. An axiom that is constantly disregarded is that the smaller the house, the fewer architectural features it should have.

Simple materials, used in the simplest possible manner, with due regard for good proportions—and always, of course, kept well painted and repaired—will produce a home that is distinguished and in good taste. This result could

not be produced by copying another house and then adding some distinguishing features.

Simple materials and methods are economical; a commonsense arrangement of rooms and good proportions cost absolutely nothing; sound construction and careful upkeep are the wisest sort of economy.

In the quest for individuality and distinction choose a simple type of house, such as Colonial, and adhere strictly to the type selected. Let us not add extraneous features, but make the most of those that the house necessarily has. The pitch and shape of the roof, the grouping and design of windows, the style of the entrance, the placing of the porch—these often make all the difference between an ordinary house and one that stands out from its neighborhood for its character and style.

The use of color in painting the house is a good way to make the house distinctive, provided good taste is used. The plainest little cottage becomes delightfully individual when painted attractively with shingle roof stained an appropriate contrasting color and shutters painted to match.

Simplicity and good taste are permanent qualities which make a home more easily rented or sold, where one that has merely a few added brackets or porches or bays will be a drug on the market when its fads and frills begin to pall on the public taste.

To produce a house that is different, it is not necessary to use special materials, but to use common materials uncommonly well.

Another mistake that many people make in trying to be "different" is to adopt inappropriate color schemes for their houses. A Dutch Colonial house, for instance, will not be improved or made individual by applying to it the decorative scheme of an English half-timber house. The effect would not be "different"; it would be ridiculous. Touches of color properly applied can conceal architectural defects; likewise, an awkward use of color will emphasize all the faults.

## Color for the Fireplace

**T**HE fireplace usually dominates the room. It is the center of interest and, for that reason, often sounds the decorative keynote. But it sometimes happens that the fireplace, instead of being the chief point of interest, becomes a discordant feature.

If walls, woodwork and mantel are painted in a color with which the color of the brick of the fireplace does not harmonize, the new decoration is not satisfactory in its effect. With the old decoration the color of the bricks may have blended nicely. The bricks form a color spot of fairly large area which is in a prominent location.

In a room where the predominating color is green, dull red brick would be quite suitable. But the same bricks in a room done in one of the shades of blue might look a great deal better were they painted gray. Bricks may be outlined with white or some color, or they may be given a solid tone.

Fireplace bricks can be painted. That is the important fact and the answer to the problem outlined above, a problem that, realized or unrealized, worries many people. By merely changing the color of the brick, the entire aspect of a room may be improved.

The painting of brick requires no special technique, but it is well to remember that brick is more absorbent than wood, and, therefore, paint for the first and second coats needs more oil than does paint to be used on wood. Then,

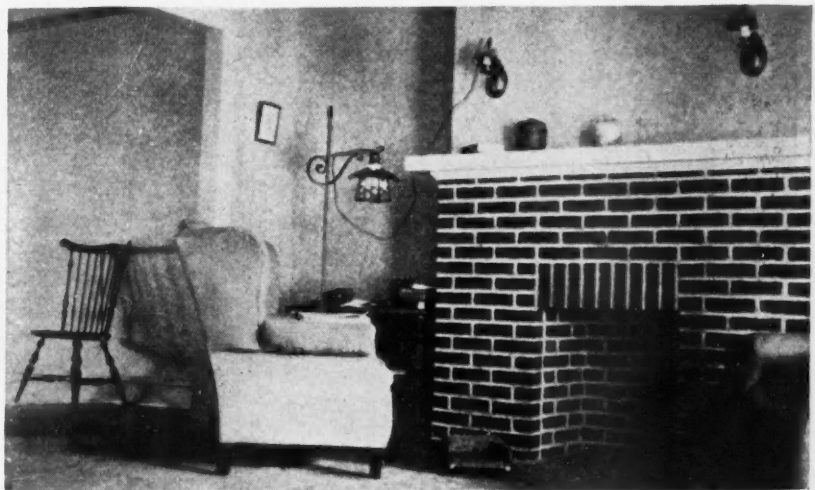

**Suppose the Mottled Walls Were Gray and Yellow or Cream and Blue, What Color Should the Fireplace Be? This one is red, because the walls are green and cream, but if they were not the fireplace might be all out of harmony.**

four coats will ordinarily be required rather than the conventional three coats prescribed for wood.

Paint that is good for wood is, generally speaking, good for brick, and in the selection of colors and tints the range is as wide. If we prefer a white, a gray, or a pea-green surface to "brick-red," we can get it with paint. In paint-

ing fireplace brick, however, do not expect paint to adhere to surfaces exposed to the direct heat of the fire. For discriminating persons, however, the practice of painting fireplaces to match the decorations of the room is extremely laudable and attractive, and for brick of fairly smooth face is easily done.

## Mechanical Painting Devices Aid the Builder and Home Owner

**S**PRAY painting is an old story now. The gasps that greeted its first performances have subsided into clucks of approval, for, although the machine does not entirely replace the skillful work of the brush, it makes paint possible in places that were hitherto impractical or impossible for handwork.

The rapidity with which the side of a house, for example, can be painted with the spray gun is of great advantage to all concerned—the painter himself, the owner of the house and the builder, too. Nowadays speed is exigent in most construction work. The finishing touches—interior and exterior decoration—take time. The spray machine may be used for painting the roof, the siding, and even the interior walls, where various mist and spatter effects may be obtained by regulating the air pressure of the gun. Exterior trim, interior woodwork, and all fine painting, must, of course, be done by hand, but the time saved on the big unbroken surfaces to be covered is more than considerable.

Much building is done in the fall and spring, two of the painter's busiest seasons. Naturally the warmer weather makes out-door work possible, and so every one who has been planning to paint his house expects to have it done during these seasons. Without reasoning about it, they also have their interior work done then, disregarding



Exteriors of Small Houses May Be Painted With the Spray Gun in a Fraction of the Time Required for Brush Work.

the fact that it could have been done much better during the winter.

But even when home owners realize the advantages and economy of having interior work done during the winter, the demands put on the painter's time will be decreased only in part. With new houses being completed, old houses being renovated and every one refinishing his home, the painter would have his hands much too full if it were not for mechanical aids.

The spray machine will do a day's work in a few hours. The side of a barn can be painted in about one-third the time required to do it by hand. The results are quite as good as brush painting. It is especially practical on big jobs, such as factories, office buildings, hospitals, schools, or apartment houses, but it can be used to great advantage on small homes, especially during a rush season. Of course, since the time needed to paint a small house with a machine is so much less than if done by hand, the cost is materially decreased.

The time and labor-saving aspects of spray painting are important to painter, builder and home owner, since mechanical devices are almost invariably more economical than human labor.

Many times a builder is unable to give a house adequate paint protection because of pressure of time. The rapidity and



The Speed With Which Office and School Interiors Can Be Painted With Mechanical Equipment Reduces the Length of Time Necessary to Complete the Job.

thoroughness of spray painting makes it unnecessary to skimp on the painting of a house, which procedure is dubious and unprofitable from any angle. Paint is both the final touch and the fundamental protection—since the entire structure of the house depends upon the strength of the paint armor. If wood is left unpainted, or inadequately painted, it weathers and decays rapidly. After

all, a house deserves a chance against the elements.

The spray painting machine affords a device by which more houses can be painted, more homes protected, and more houses properly finished, in a surprisingly short time. It enables the builder to deliver his goods promptly, with every little "extra" completed—no matter what difficulties have arisen in the progress of building.

## A Little Touch of Color

**T**HE house most noticed and admired is the house where a little color has been used intelligently on the exterior. Nothing will bring a house out of the ranks of the unnoticed so successfully as a little touch of color.

In European countries, especially Great Britain, homeowners pay particular attention to the decoration of their front doors.

There is no good reason why doors should be unattractive. As the main entrance to the house the front door holds an important position. One may express considerable individuality in the front door finish; contrariwise, one may sink the whole aspect of the house into mediocrity by painting the front doorway exactly as forty-nine other doorways are painted, without considering whether or not the color scheme hides or detracts from its architectural beauty.

As the door is surrounded by large areas of conventional hues, it is very easy to enhance the appearance of the whole structure by a colorful treatment.

As a matter of fact, painted doors, lightened by contrasting colors, are becoming popular. Shutters, too, are coming into their own, so far as color is concerned.

The simplest way to treat a six-panel, Colonial exterior door is to emphasize the panels with color. Assuming that the window and door frames are painted green, the panels should be painted a dull citron green to add interest and warmth. If a chocolate brown trim is used, the door panels might be finished in the same color, while the stiles and rails might be a rich cream. Blue trim is enjoying considerable popularity these days. Door panels in strong, warm gray would go nicely with such trim. The gray should be made by mixing blues with raw umber, Venetian red and white. The same effect can be carried out in the finish of planked and paneled shutters, and even for slatted blinds.

Another way of embellishing the exterior door is to add a strong contrasting color to the mouldings. A striking effect may be achieved on white French casement doors by painting the mouldings a dark color.

Mouldings on a six-panel Colonial door may also be outlined in color. It is frequently a good practice to put in two colors on a wide moulding. Where window and door frames are green the mouldings may be painted a rich brown with a red strip running on the most prominent part of the moulding. Where the trim is gray the door

panel mouldings would be very effective if done in orange.

Doors are very often antiqued with glaze colors. A good varnish is nearly always used as a finish.

Even more interesting effects are secured when both panels and mouldings are decorated. A house finished with Colonial green exterior trim might have a door whose stiles and rails are green. The panels might be chocolate brown and the mouldings stone gray. Where the trim is cream the door panels might be cream, the stiles and rails green-blue, and the mouldings rich orange. With a brown trim, the door panels might be dull blue, the stiles and rails brown and the mouldings a flat black.

Dutch half doors are regaining popularity. For those half door with large strap hinges a blended treatment of browns and reds, with the hinges painted black, is interesting and suitable. Chinese vermilion with black striping over the plank joints is another good treatment for this type of door.

The oak studded door with its Gothic top looks well if treated with silver gray stain and filled with a strong colored filler—black, dull red or white. The studs may be bronzed or finished in flat black. The studded door may be painted effectively in strong colors, such as bright red, blue or green; in such cases the treatment of the studs forms a necessary relief for the bright color.

Where hoods, columns, porches or portes cocheres surround the decorated doors, they should be painted the color of the body of the house. All decorated doors should be finished with at least two coats of good varnish which both enhances and preserves the finish.

The trim on a red brick house lends itself to interesting color treatments. Imagine sage green on the window and door frames, blinds or shutters and cornicing, a salmon pink on the window sash, and green of a slightly darker shade carried to the door, the mouldings of which are outlined in pink. Should the house have a dentilled cornice, the dentills can be picked out in orange. If the cornice is of the plain, heavy moulding type, the vertical members may be treated with French gray.

Decorated front doors are neither radical nor expensive. They are unusual for this day and age, but an examination of many old houses will show that the now revered Colonial door was treated very liberally to two or three colors. The very austere type of decoration is suitable only for doors of very rare type—seldom used in modern architecture or building.

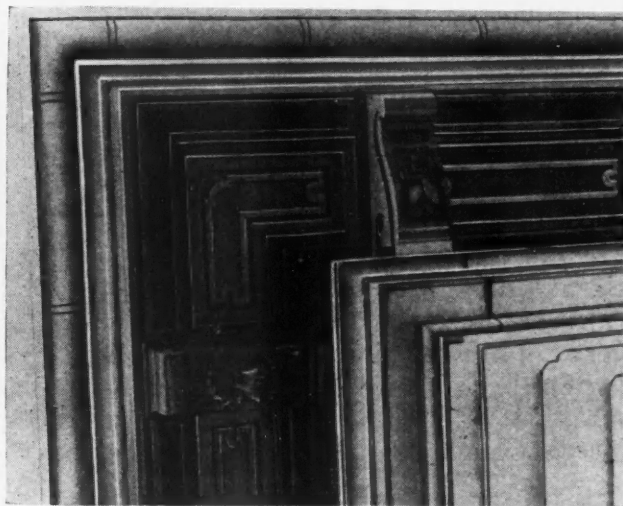

**In the Pan-American Building, One of the Most Beautiful in Washington, Conspicuous Use is Made of the New Theory of Bringing Out Architectural Features by the Use of Pure Color. Such features as this cornice, picked out in pure color, offer many hints for the home.**



# Homes in COLORS

## Building Looks Bright for 1926

By WILLIAM A. RADFORD,  
*President and Editor-in-Chief of American Builder*

**L**EADING authorities are agreed that all indications point to a year of great building activity during 1926; in fact, the outlook in our opinion is more favorable than during any previous year.

There have been pessimistic predictions from certain quarters ever since 1922. Each of the past three years has proven these pessimists wrong and we see no more reason to accept their views as to 1926 than we did in 1923, 1924 or 1925.

Building is a great permanent industry—a necessity caused by depreciation, obsolescence, fire loss and population increase.

The only years when citizens of Uncle Sam do not build on a large scale are those years when financial and other conditions are extremely unfavorable or when there is some national crisis, such as war.

The American Builder forecast is optimistic for 1926 because the national prosperity has never been so great nor the foreign situation so favorable.

### When Is a "Shortage?"

The word "shortage" in connection with housing has been greatly abused.

When a man has been unusually prosperous and wants a better home, he is in the market for a new house regardless of any so-called housing shortage.

So, also, if young people get married, they are apt to buy or build a home.

Houses do not last forever and, if they did, American owners would not continue to be content with their old design, equipment and finish.

People becoming more prosperous are moving into the newer and better apartment houses and hotels.

With business buildings, there is an even greater trend towards new enterprises—from

the smallest retail shop to the largest factory building.

School building continues active, not alone because of the increasing number of pupils, but also because new educational, sanitary and community ideas are demanding better buildings and newer and more advanced equipment.

Somewhat similar causes underlie the building of churches, libraries and state and public buildings. Congregations demand improvement and new quarters when they outgrow the old. County, state, court and municipal buildings become old and inadequate.

Fire takes its toll to the extent of half a billion a year and new structures of all sorts are required for replacement.

Practically all of the requirements touched on help to create a "shortage," but are not, strictly speaking, what is meant by "shortage" by those who refer to the "shortage" as having been filled.

Under these conditions, about the only condition which might cause a decrease in building would be a serious decline in the national prosperity. Instead of this, the indications are all the other way and point to increased national prosperity during 1926.

We think your judgment should be little affected by the alarmists or pessimists who occasionally work their way into print. Every year since 1922 they have predicted a decline in the following year; and we think they are even less apt now to be right than they were in 1923, 1924 or 1925.

As long as the means are at hand, we believe that the business and social activity which characterizes American life is bound to result in building activity as a great permanent institution.

Check through the advertising pages of this magazine and take note of all the different concerns that are offering samples and books, catalogs and circular matter calculated to interest the home building public. Write to these manufacturers; you will be surprised and pleased at the help they stand ready to give you in your big job of selling, planning and constructing homes and other buildings.

# The NORFOLK

AN English home of striking beauty and impressiveness for a house of this size. It is really not very large, 28 by 28 feet, 6 inches; but the high gable and the commanding chimney give this home a real air of distinction. Six well-arranged rooms are provided. The color sketch to right suggests a charming treatment for one of the bedrooms.

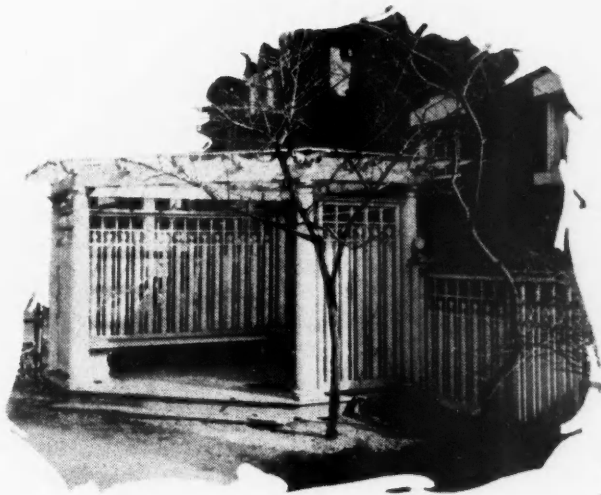

Pat. March 15, 1921 and Sept. 30, 1924.

Copyright 1925, Wm. A. Radford, Chicago.

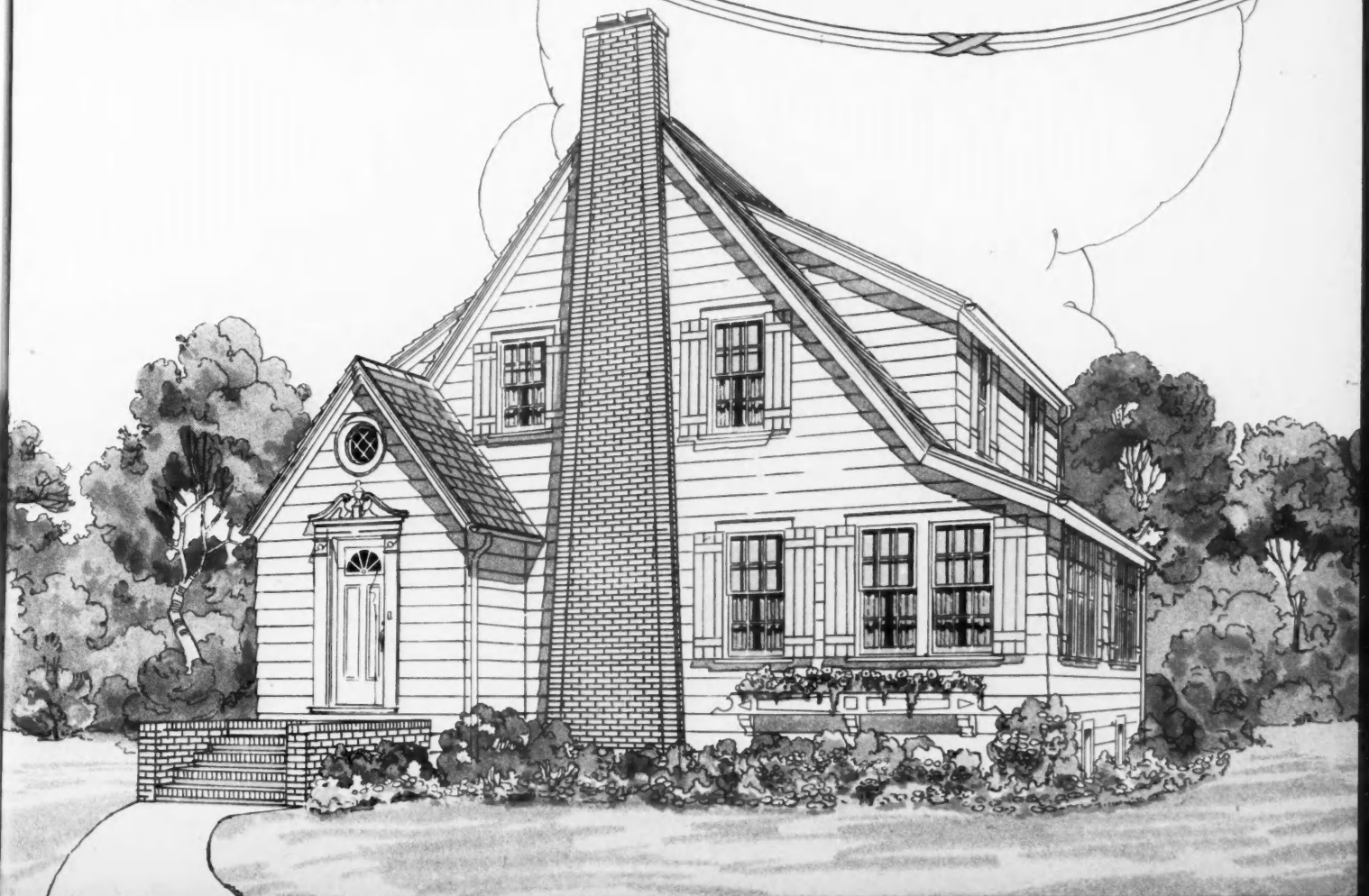
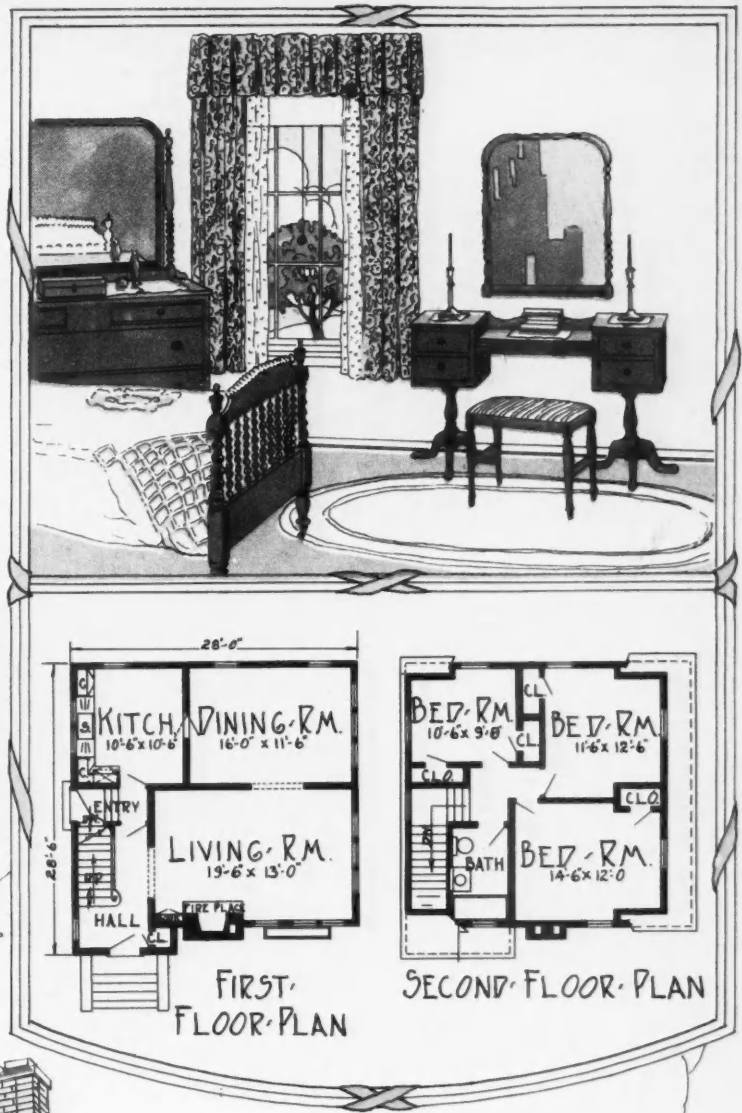

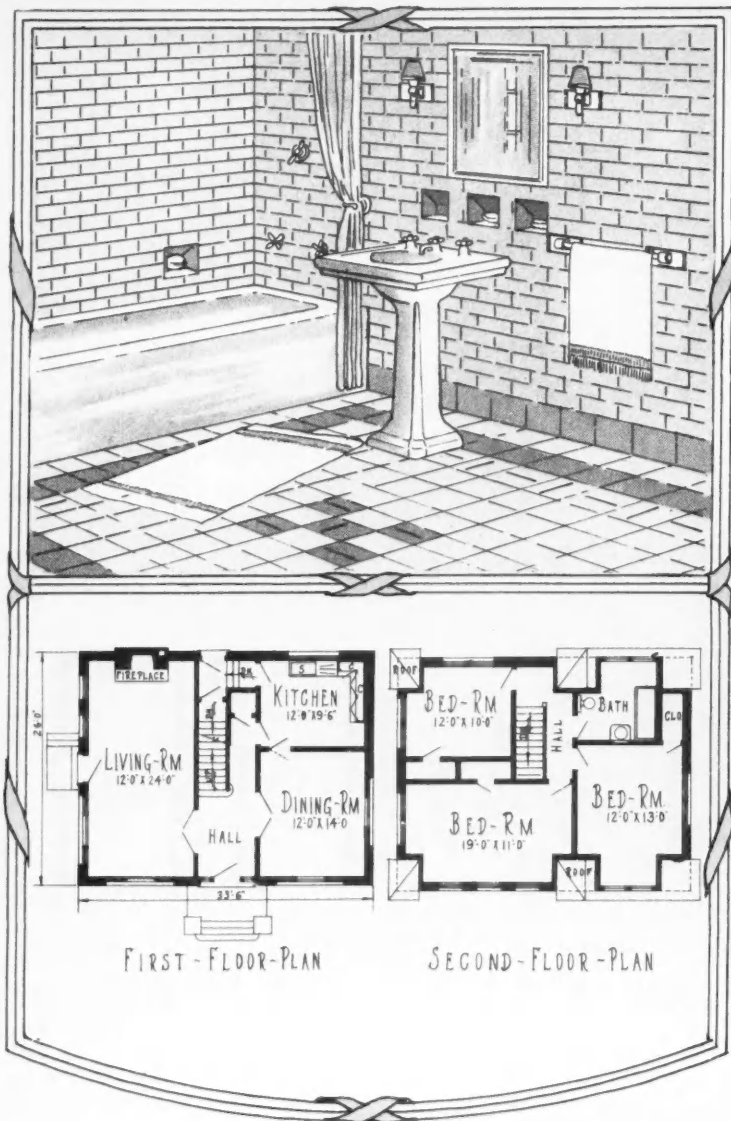

## The NEWPORT

A SUBSTANTIAL brick residence with automobile drive with canopy in the graceful pergola style reaching the side door of the living room. This would be an ideal design for a corner lot as it presents an equally good appearance from all directions. Color sketch to left shows a well-appointed bathroom with tiled walls.

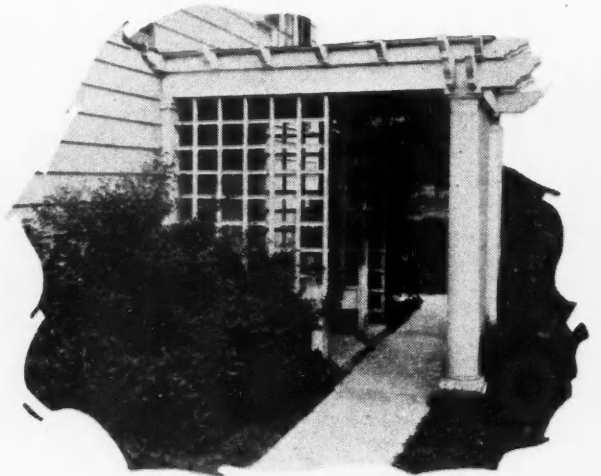



# The NEW CASTLE

THE studio type living room with a 12-foot ceiling and a window group reaching far up is the dominant feature of this English cottage with stucco walls and gables paneled in the Elizabethan style. The convenient arrangement of the five rooms and bath in this charming little house makes good the artistic promise of the exterior. Color sketch to right suggests appropriate furniture for the living room and suitable draperies for the big window.

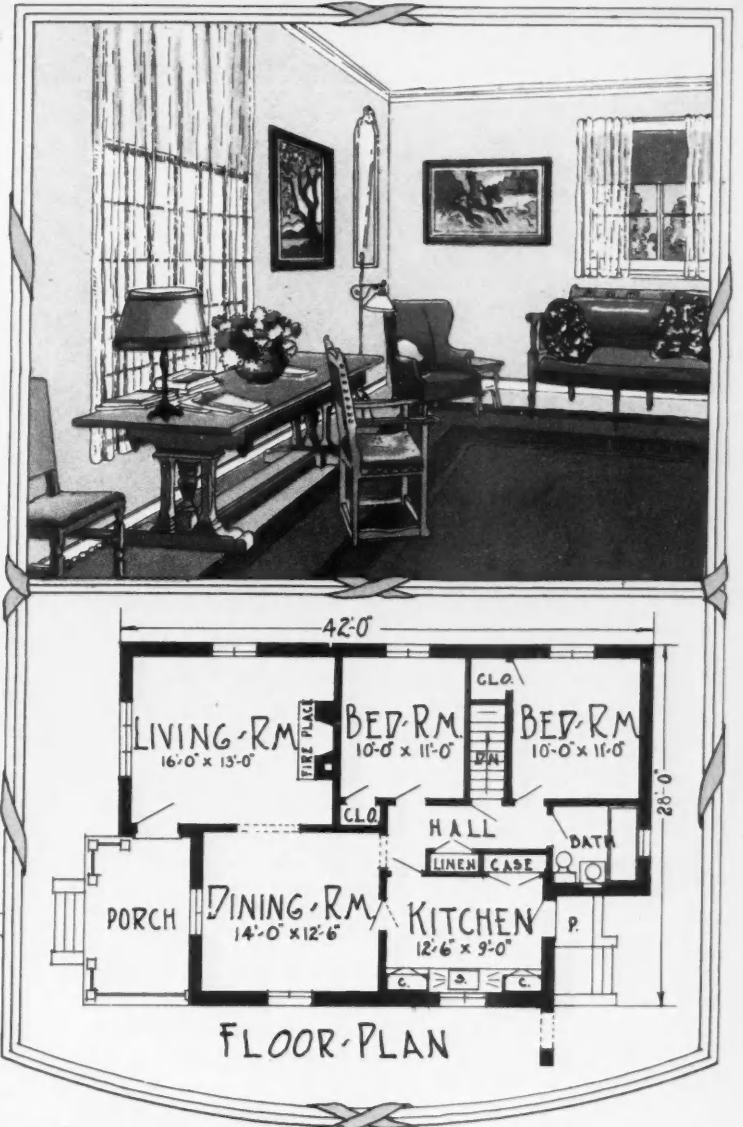
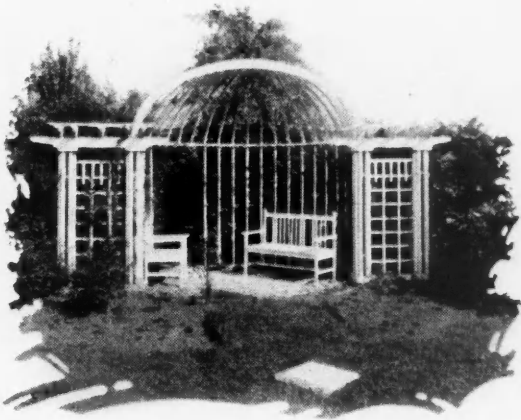

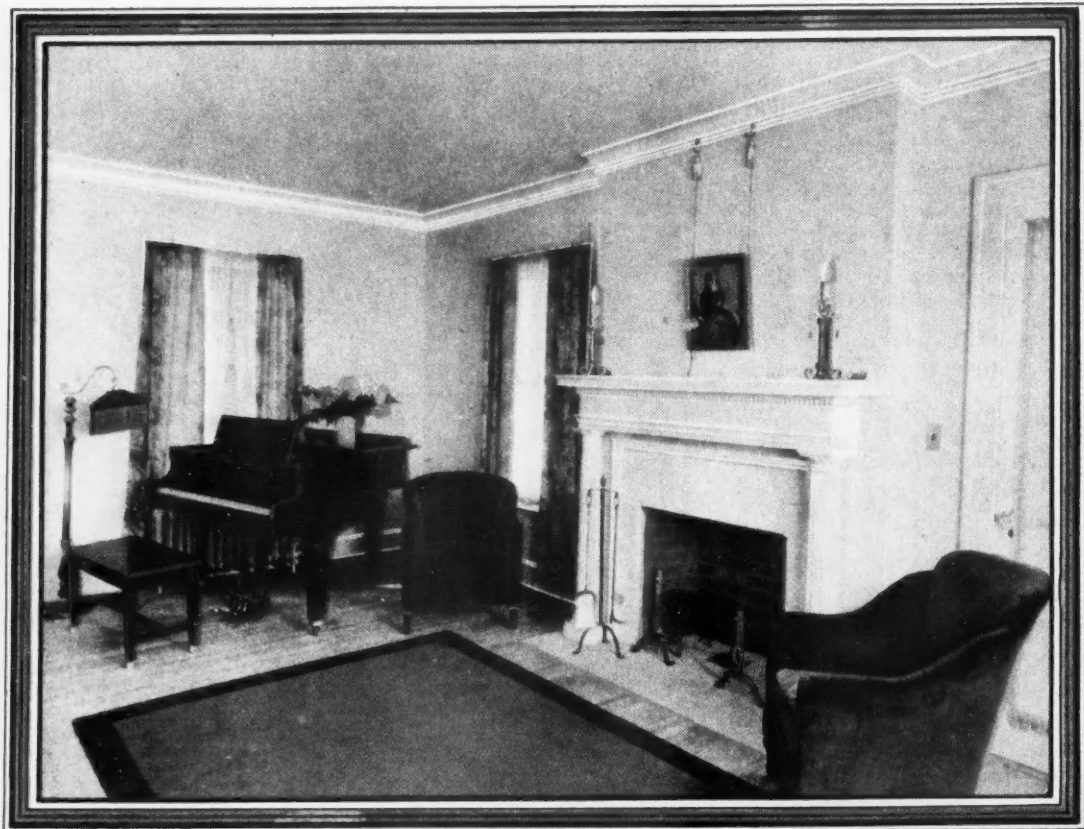

# First Better Homes 1925



Beautifully but simply furnished living room in the Atlanta first prize home.



A group of photographs from the 1925 First Prize House, The Better Homes in America Competition. This house was built in Atlanta, Georgia, The Architects Small House Service Bureau, Architects. The first prize was shared with Santa Barbara, California. The photograph above shows a glimpse of the dining room.

# Prize in America Competition



A glimpse of the nursery in the first prize home.

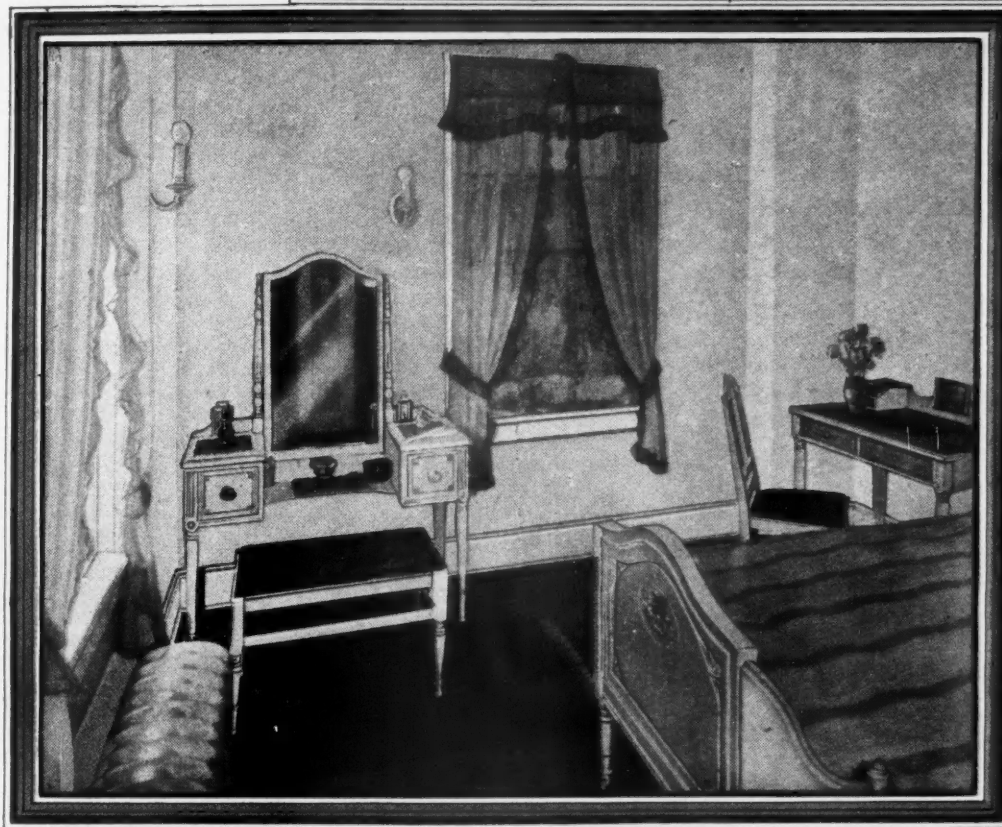

One of the bedrooms in the Atlanta, Georgia first prize home, 1925 Better Homes in America Competition. The demonstration committee from local women's clubs staged a week of helpful home making demonstrations centered around this home.



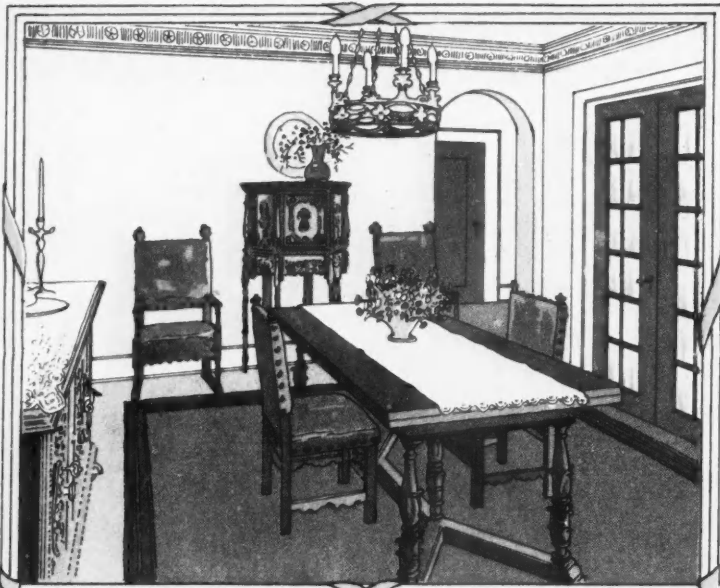

## The NAVAJO

A DELIGHTFUL Spanish bungalow of six rooms and two baths. The house measures only 34 by 48 feet, but gives a much wider impression from the street because of the covered driveway to the left and the projection of the front wall to the right to include the garden gate. The color sketch to left suggests appropriate furnishings for the dining room featuring a refectory table and high cabinet.

FLOOR PLAN

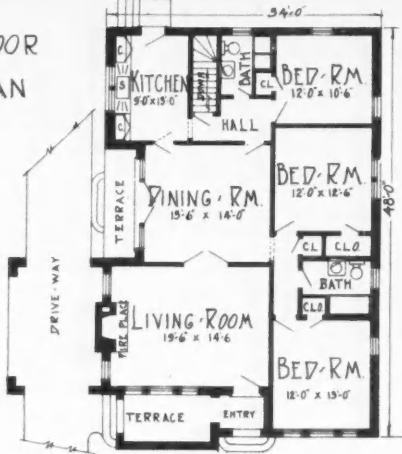

# The NORTHAMPTON

AN interesting brick study illustrating the pleasing combination of brick, stucco and slate in the English manner. There are seven well-arranged rooms in this substantial home. Color sketch to right shows an interesting dining room.

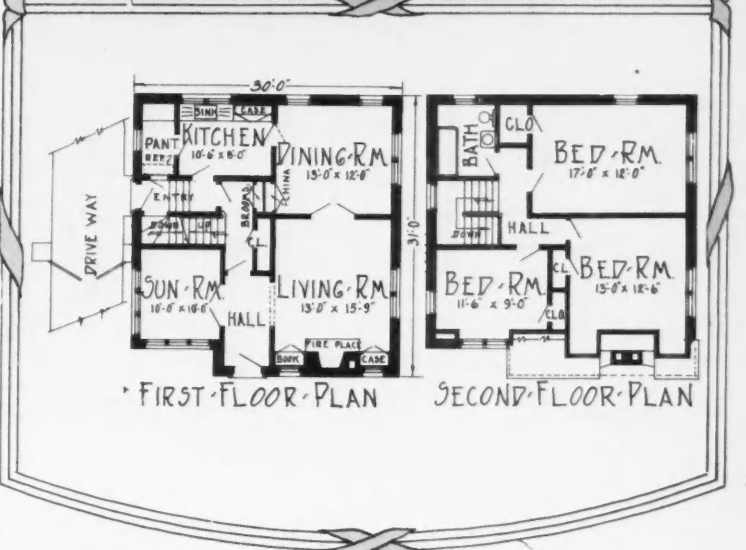
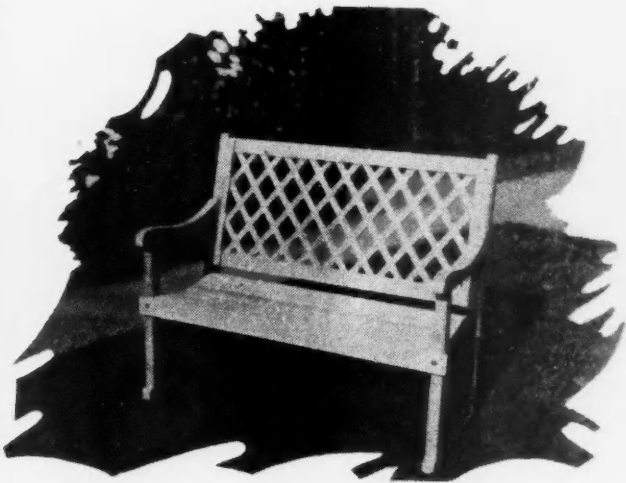



The NUTLEY

The floor plan and perspective sketch below illustrate a well-designed bungalow, four rooms and bath downstairs, and two rooms and bath upstairs.

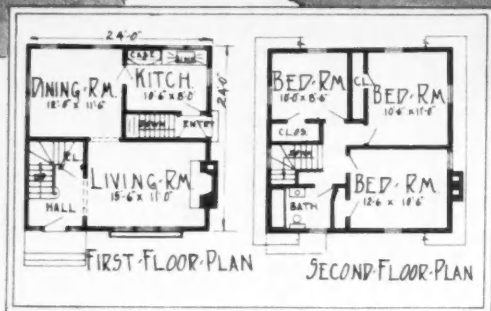

The NEEDHAM

The floor plan and perspective sketch immediately above illustrate a delightful six-room house, size 24 by 24 feet.

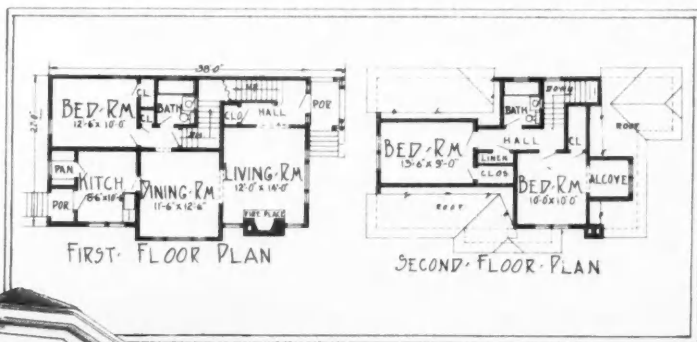



**The NUGGET**

The floor plan and perspective sketch below make clear the good points of this little cottage 24 by 32 feet—four rooms with five room efficiency.

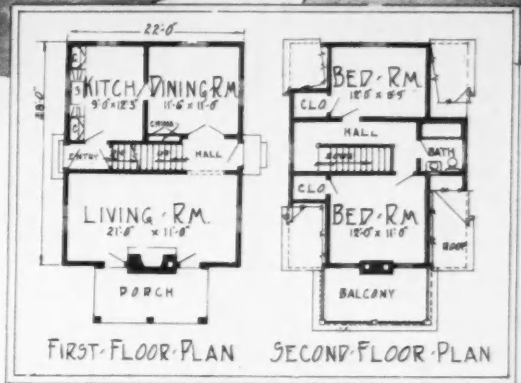
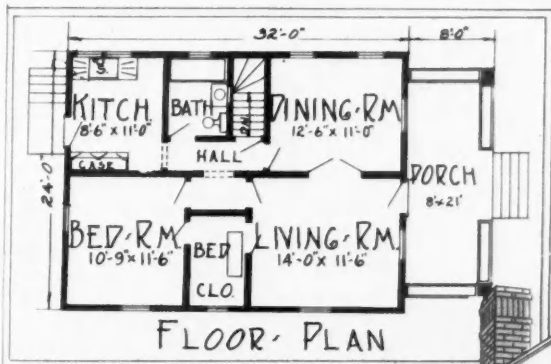

**The NEWBERRY**

The floor plans and perspective sketch above show a pretty English cottage in shingles—a narrow lot design 22 by 28 feet and containing five rooms and bath.



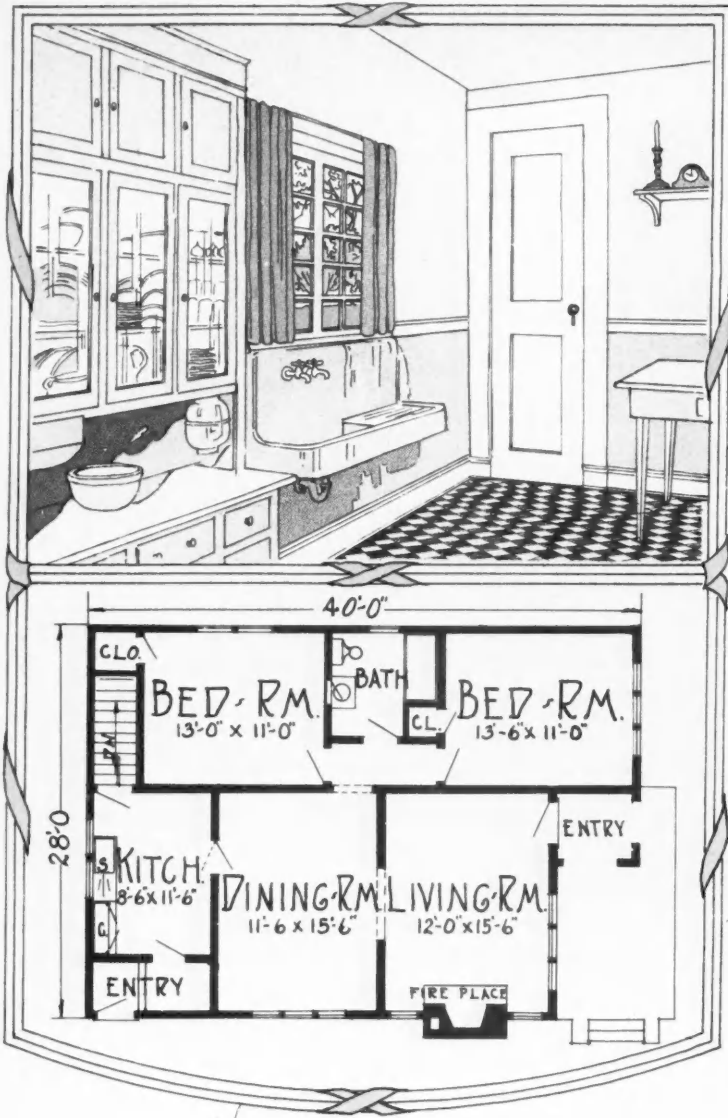

## The NORMANDY

A FRENCH cottage with a dash of old world charm is presented in this cozy bungalow of five rooms. Such houses are a satisfaction to build and a joy to live in. They never lack for a buyer or a tenant. The color sketch to left shows how conveniently the kitchen in this home is arranged.

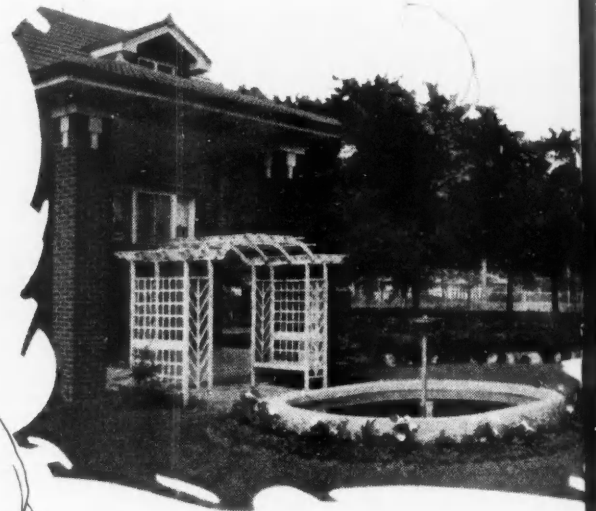



# The NEWARK

THE house with attached garage is coming in very fast; and this arrangement, placing the garage under the sun parlor, is one of the most successful plans. The attached garage is warmed by the house heating plant and there is a feeling of security in having the expensive car close by and behind locked doors. A fireproof floor over the garage or at least plaster on metal lath or gypsum board is a good precaution required by many building codes to offset the supposed extra fire hazard. An ample drain for storm water must be provided in front of the garage doors.

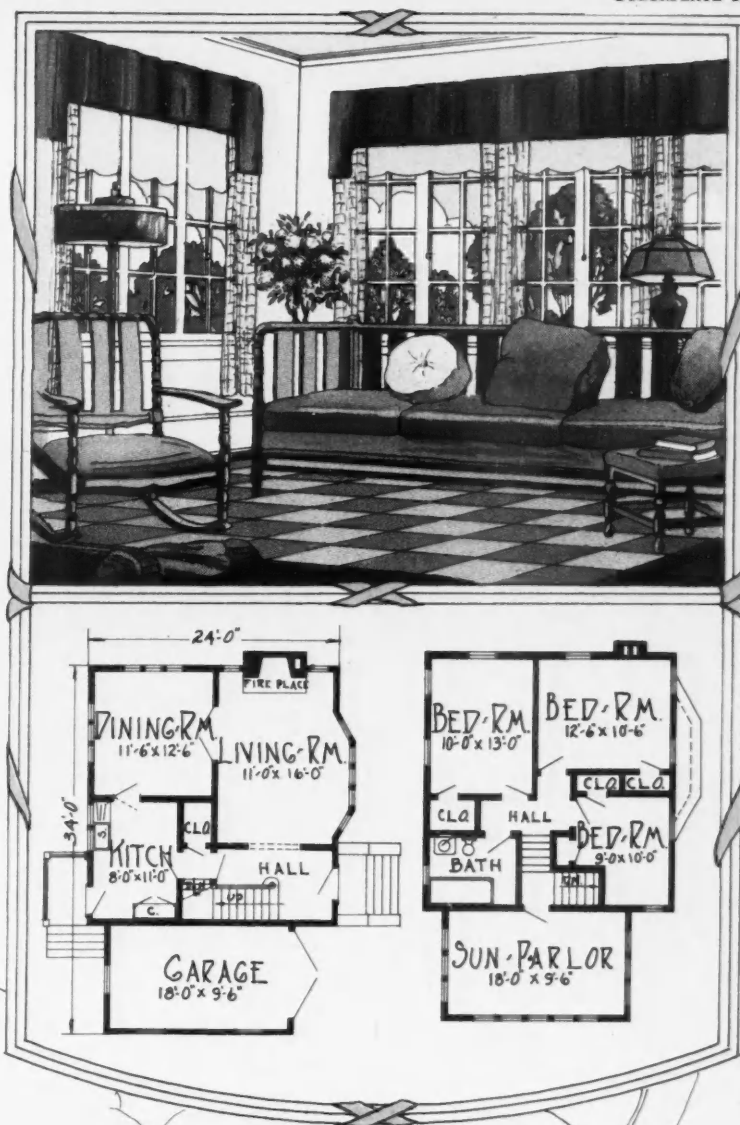
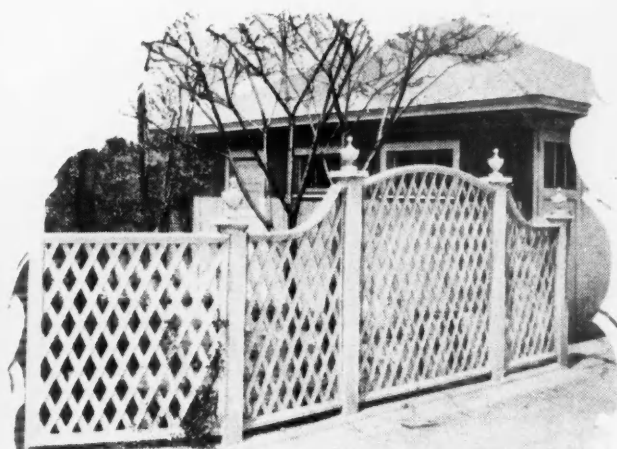



Not everyone can have flower gardens and pools of such magnificence, but every home can have its small garden.

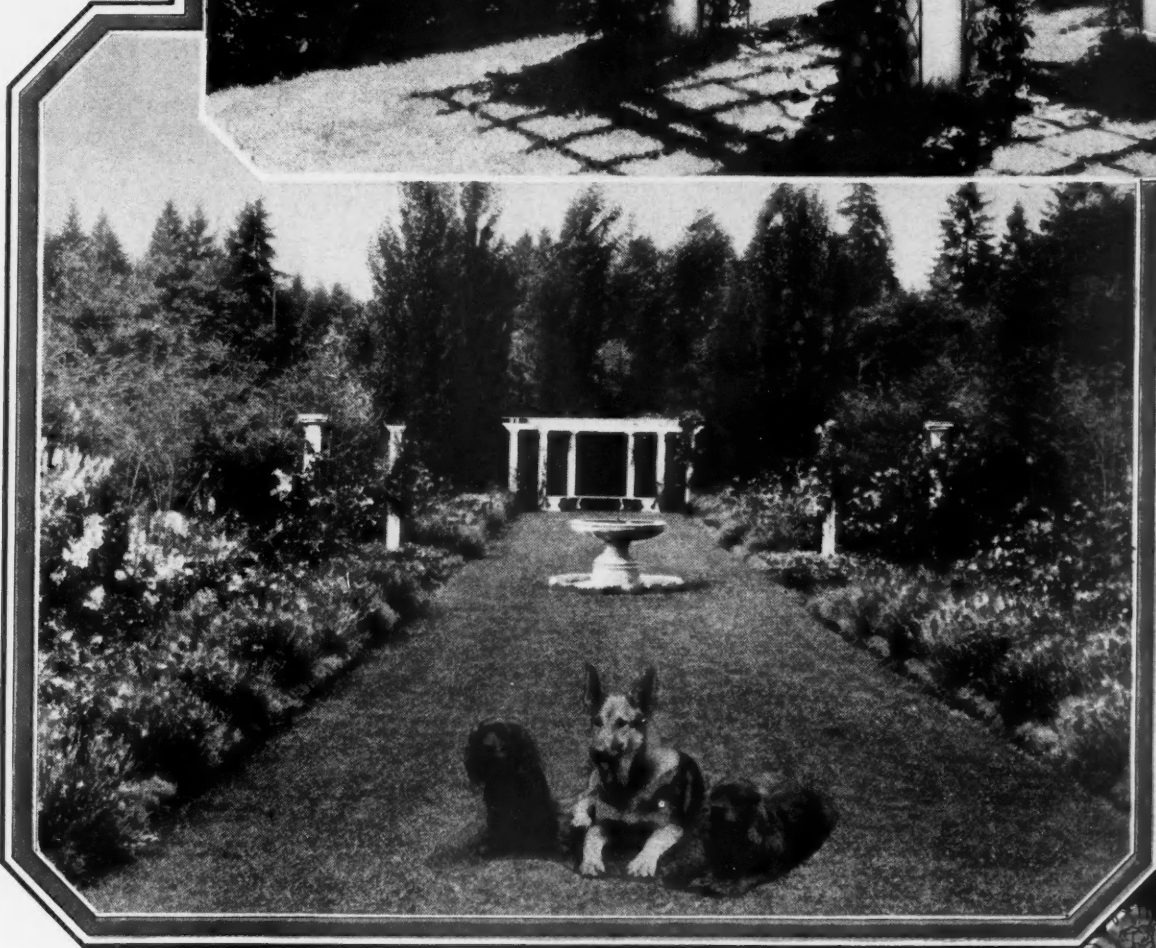
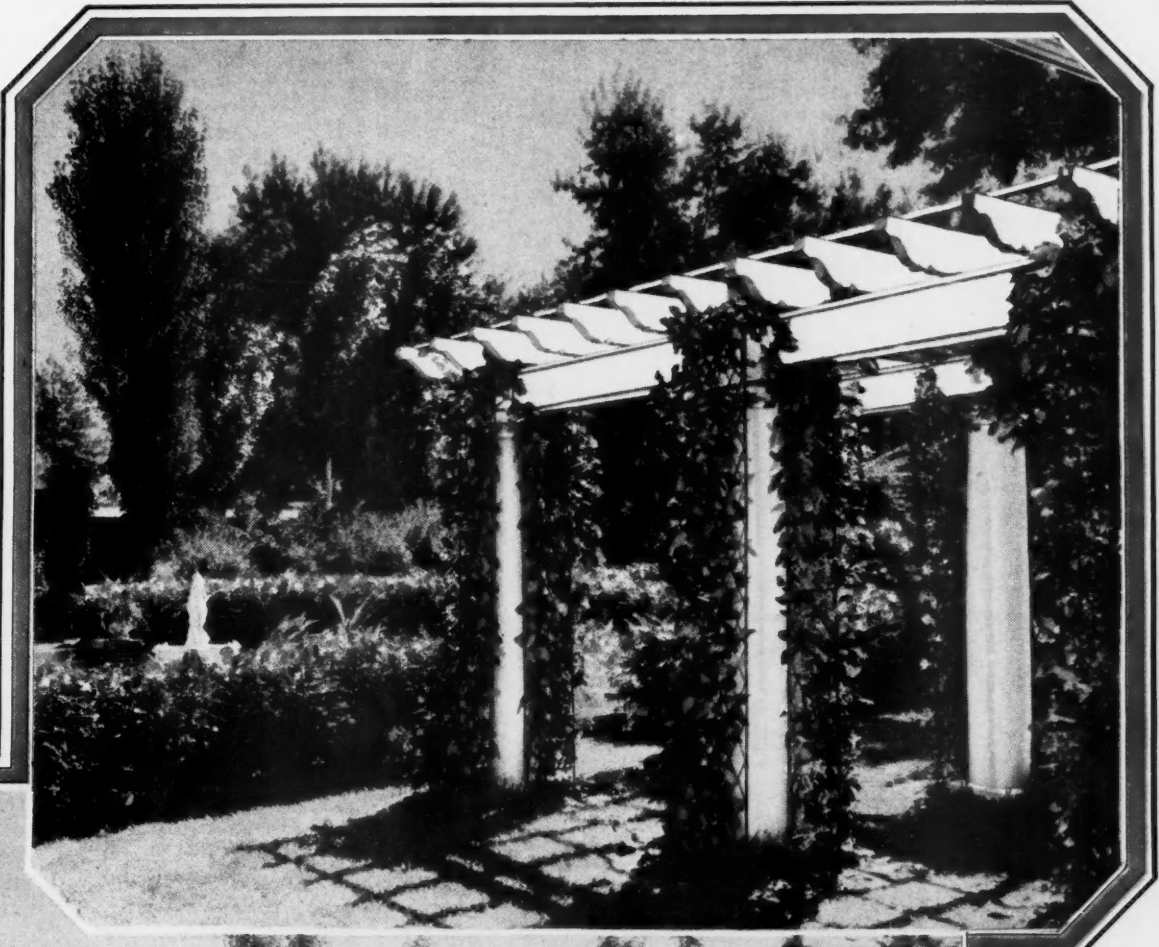

A garden vista with graceful pergola at the end is the acme of the landscape gardener's endeavor.

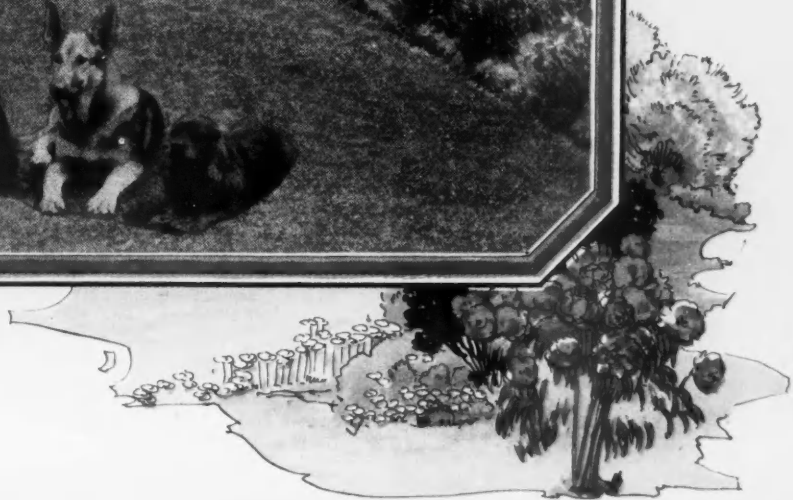

# The NORWICH

AN English Colonial cottage of large shingles laid irregularly. The house contains six fine rooms besides the big sun room opening off the dining room and the reception hall of generous dimensions illustrated in the sketch to left.

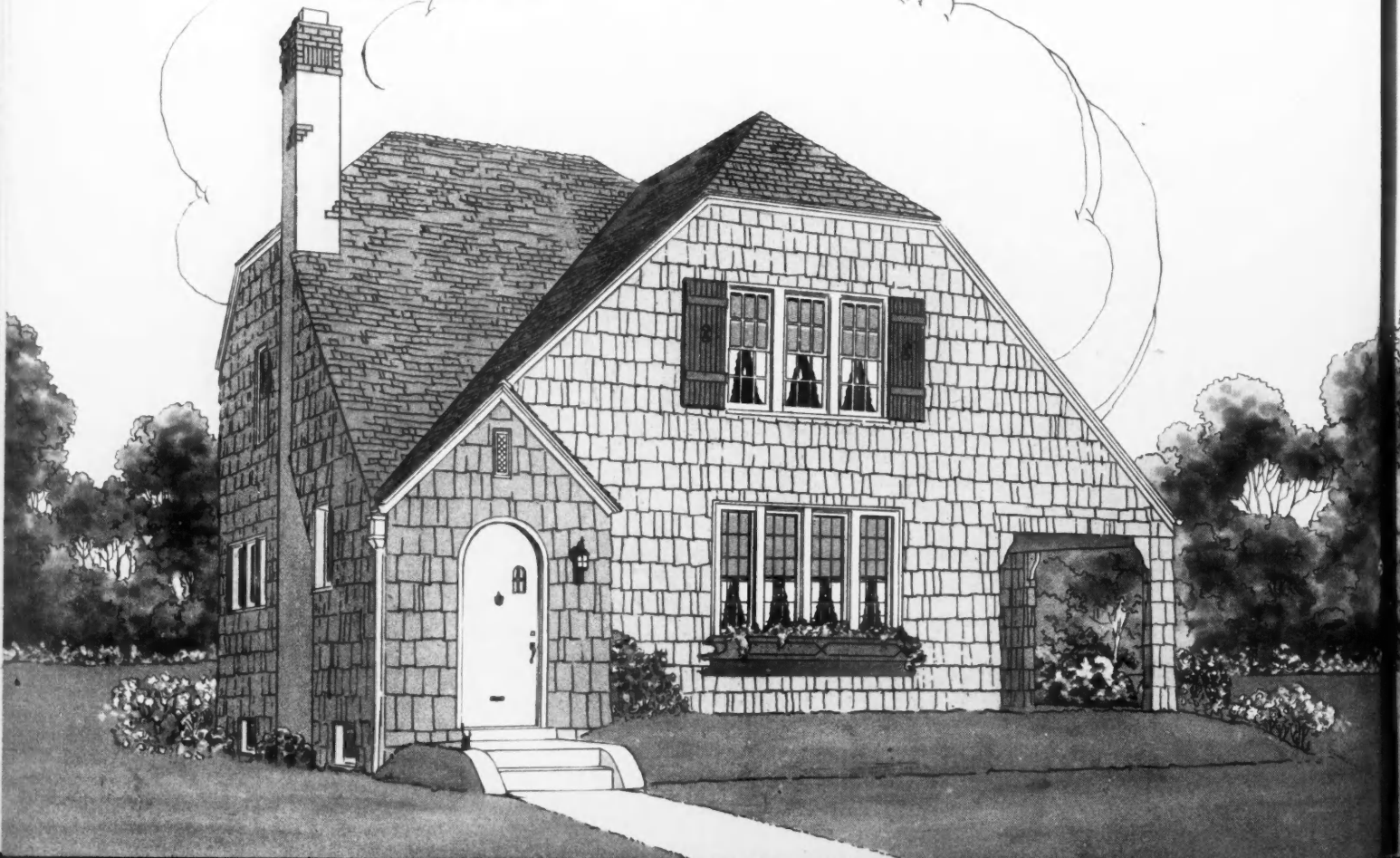
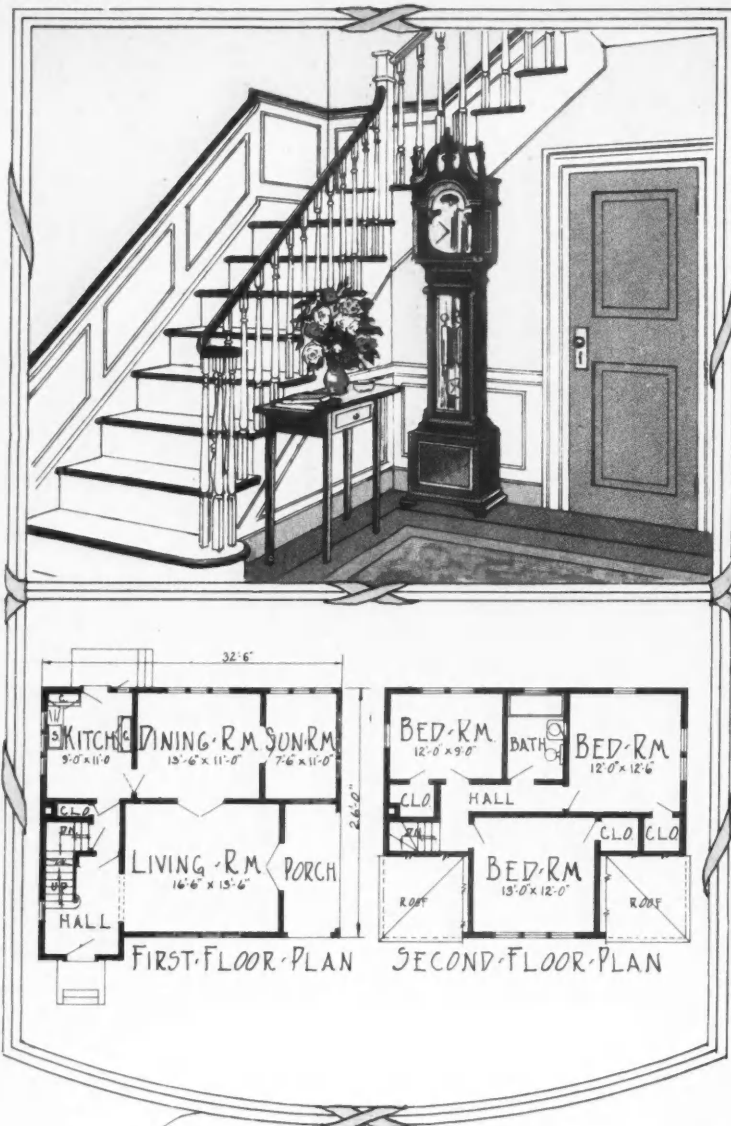

# The NERLAN

THIS home design with shingles in the thatched roof effect is a favorite and deserves to be. The interior is arranged very cleverly to take advantage of all the space. The color sketch to right indicates the real home-like charm of the living room.

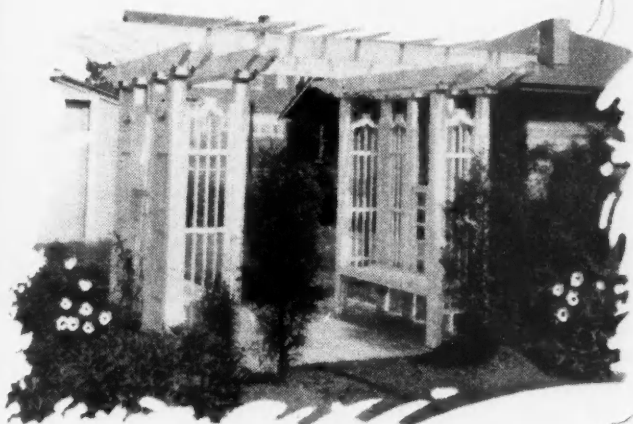
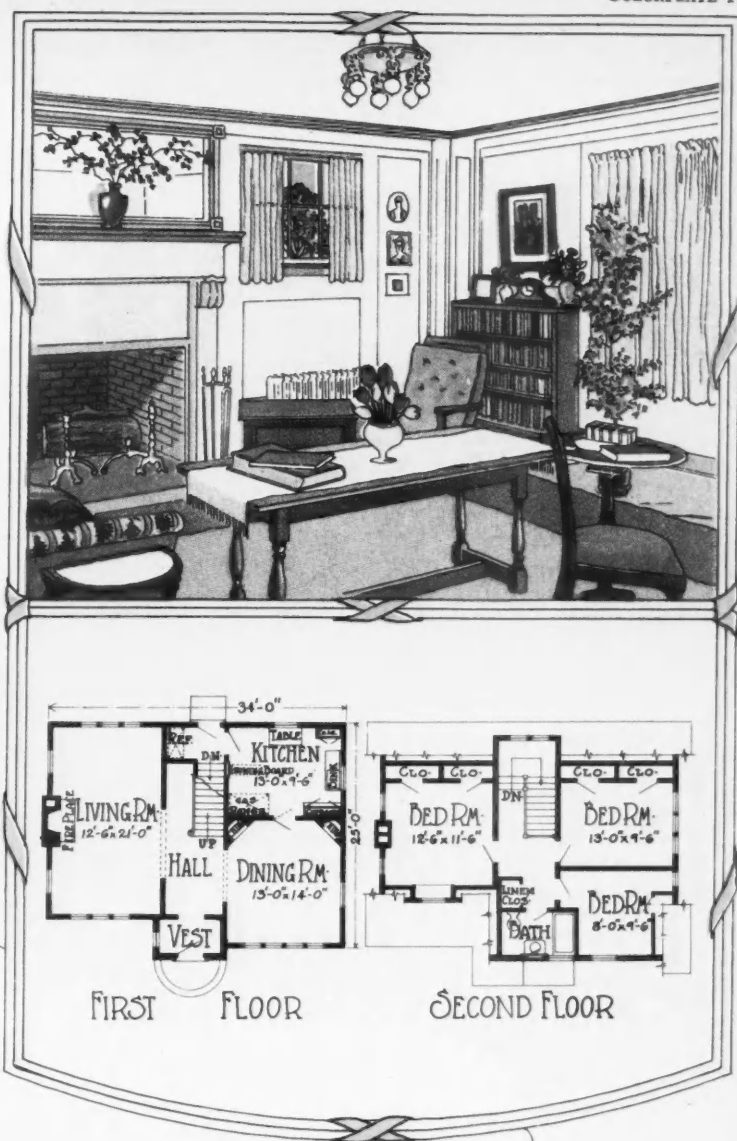

## The NARA VISTA

A SPANISH design more simple and direct than most, yet carrying a unique charm all its own. This house measures 30 by 36 feet; contains five rooms and bath. Color sketch to left shows a bedroom with antique canopy bed.

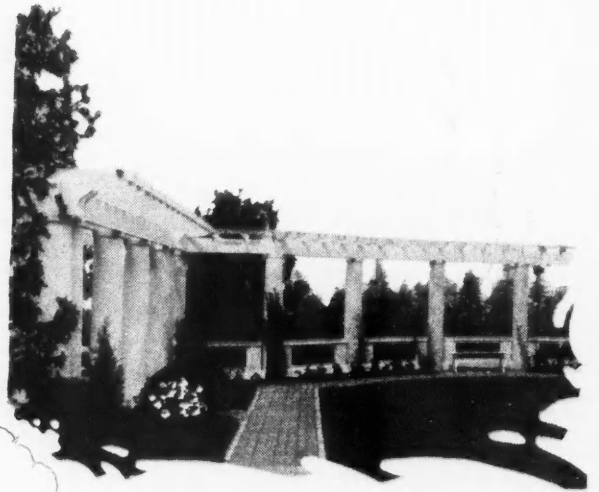
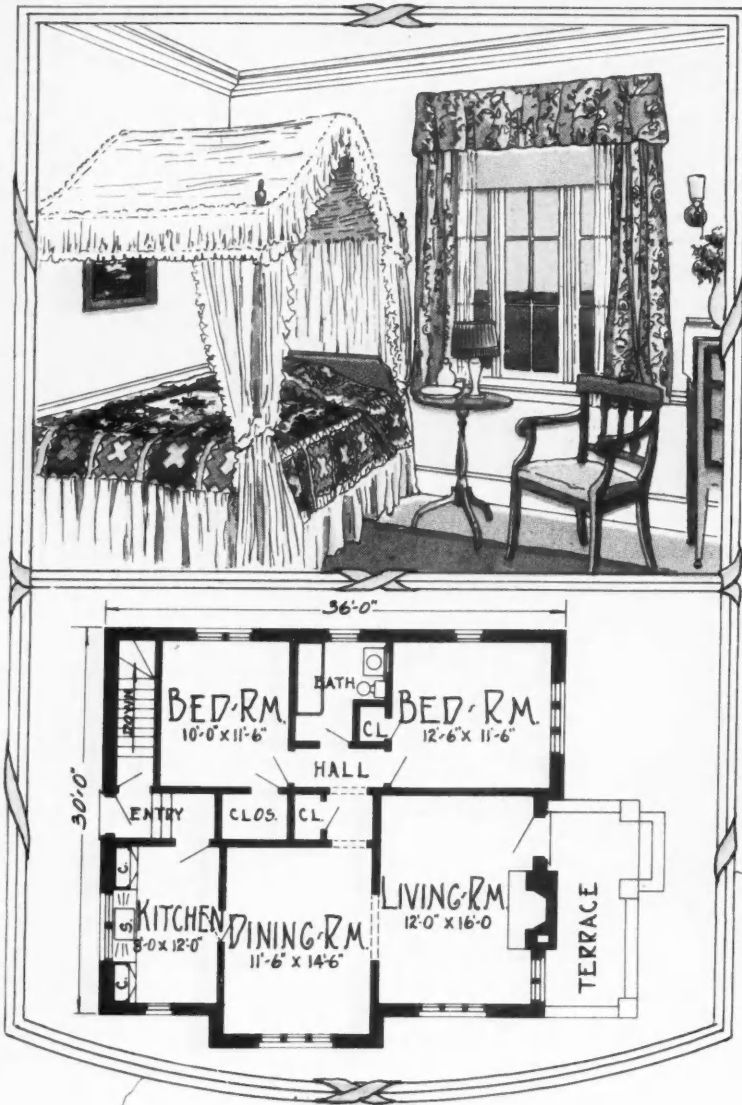

# OUR FRONT COVER HOME

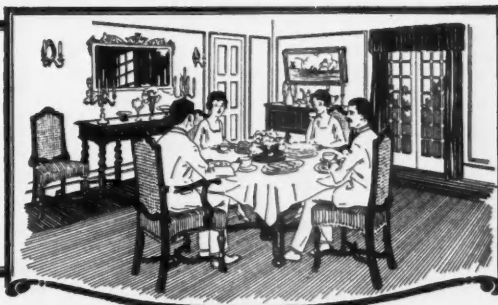

## *Beautiful Elizabethan Residence with Two-story Living Room Presented in Complete Working Plans*

ONE of the beautiful modern homes recently erected at Palmer Woods, Detroit, Richard H. Marr, architect, has been made the subject of our front cover painting this month, and complete working drawings showing arrangement and construction of this fine home in detail are presented on the four pages following.

This is a striking example of the use of steel casements. The big window group, as in an artist's studio, lights the immense living room which is the outstanding feature of the interior of this home. There is also a spacious stair hall laid out with dignity and effect.

Dining room, kitchen and service quarters complete the first floor, while on the second floor are three large bedrooms and two baths. The second story hall forms a balcony overlooking the living room. This living room is

carried up through full two stories and is finished with a plaster cornice at the ceiling line. The lower portion of the walls is paneled in wood, a treatment which is most effective in a room of this size, 17 feet wide and 30 feet long. Even this size may be practically increased, for adjoining this room there is a sun porch extending the entire length of the room and 11 feet wide. It is connected with the living room by two sets of French doors placed at either side of the fireplace, and in fine weather this space all may be thrown together.

A stairway leads up to the third floor where several good rooms can be finished off if at any time the extra space is desired. On the first floor there is a den, not previously mentioned, which is so well cut off from the ordinary house noises that its occupant can always work undisturbed.



Photograph of Residence at Palmer Woods, Detroit, Illustrated in Full Color Painting on Our Front Cover and Complete Working Plans Presented on the Four Pages Following.

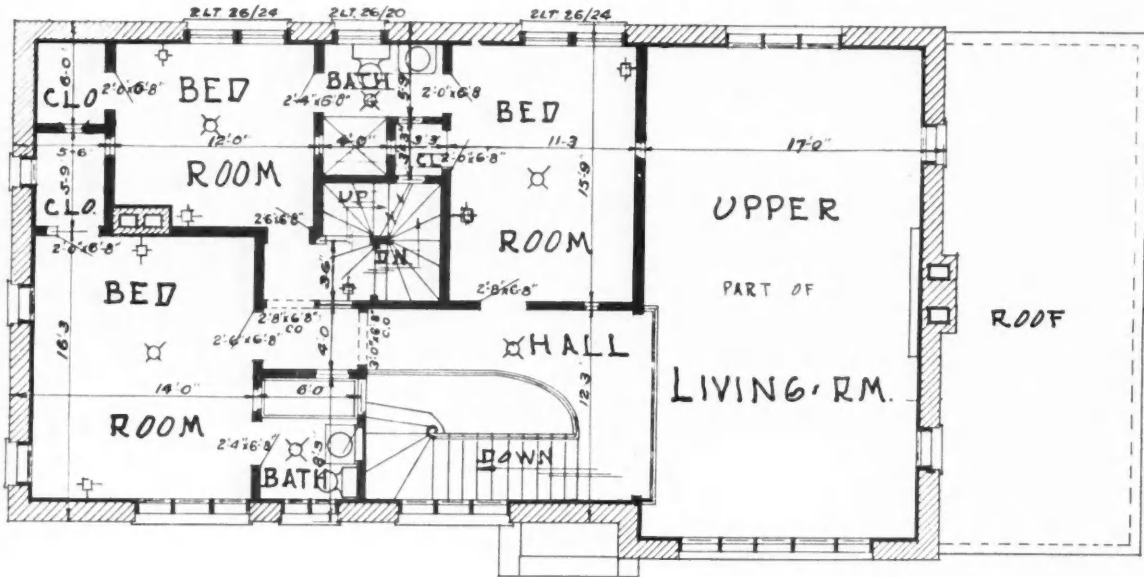

NOTE  
ALL WINDOWS TO BE STEEL  
CASEMENTS UNLESS OTHERWISE  
MARKED

SECOND FLOOR PLAN

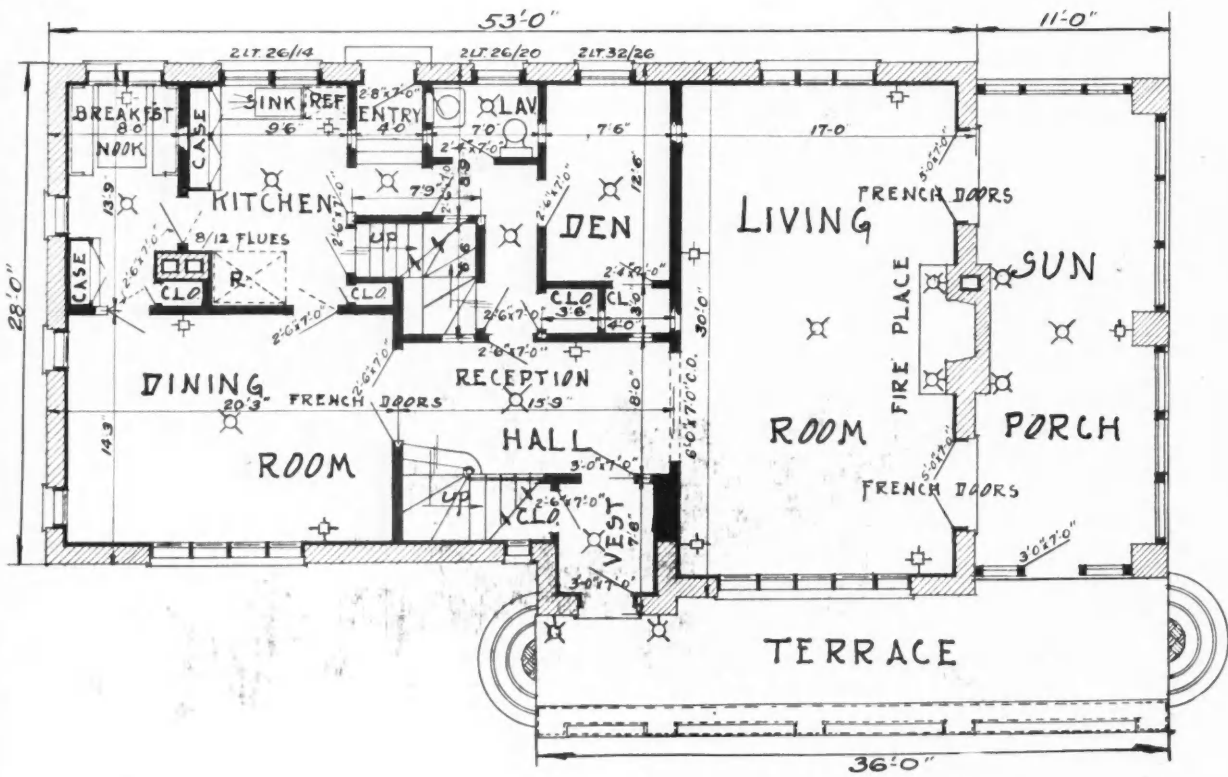

SCALE  $\frac{3}{32}'' = 1'-0''$

FIRST FLOOR PLAN

SHEET NO. 1

The First and Second Floor Plans of Our Front Cover Home Show the Big Studio Type Living Room and the Seven Other Convenient Rooms of This Fine Residence.



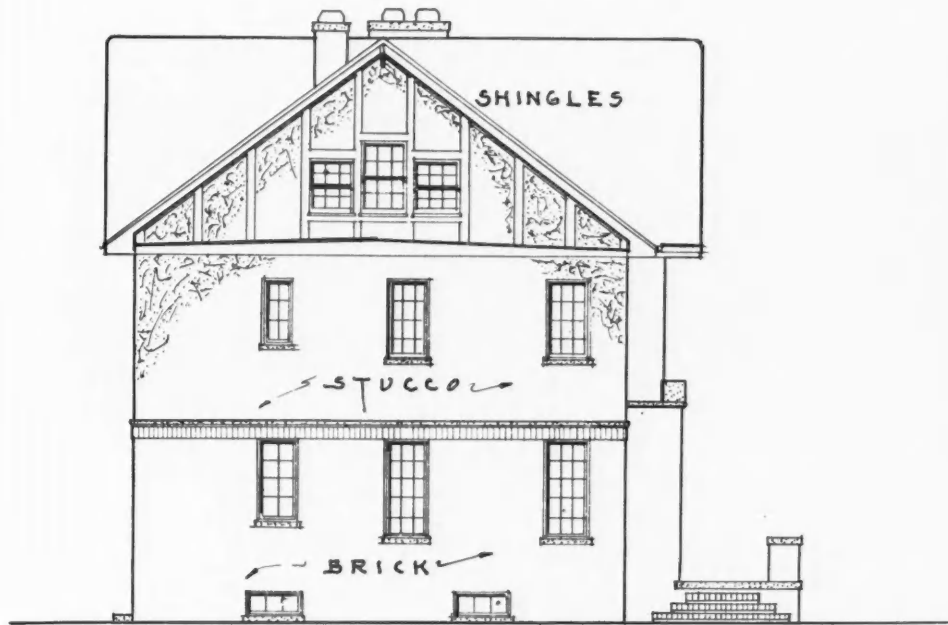

LEFT SIDE ELEVATION

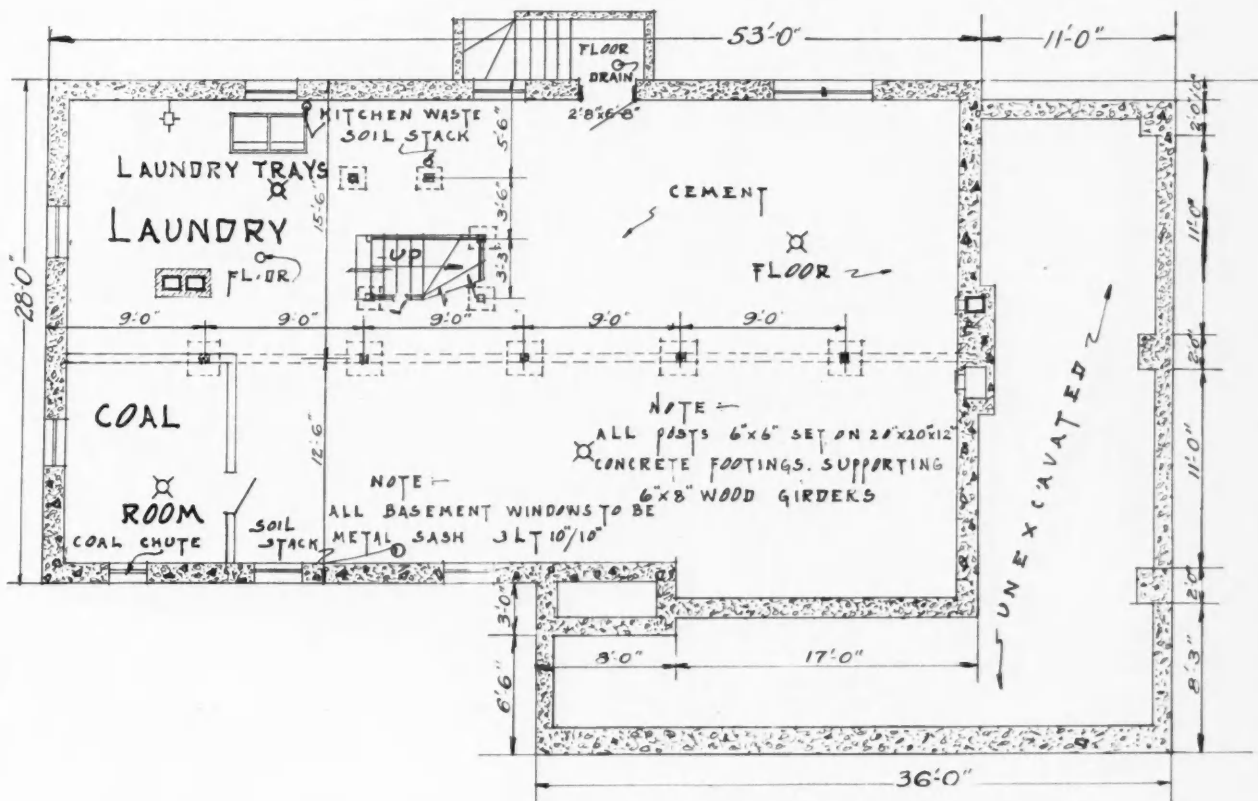

BASEMENT PLAN

SCALE  $\frac{3}{32}'' = 1'-0''$

SHEET NO. 2

Basement Plan and Left Side Elevation of Our Front Cover Home. Other working plan sheets on the two pages following.

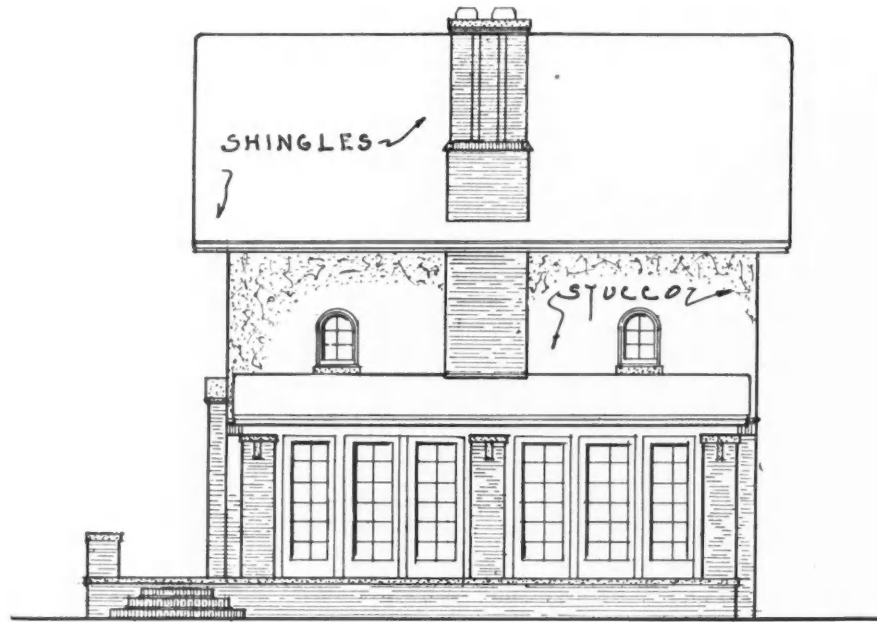

RIGHT SIDE ELEVATION

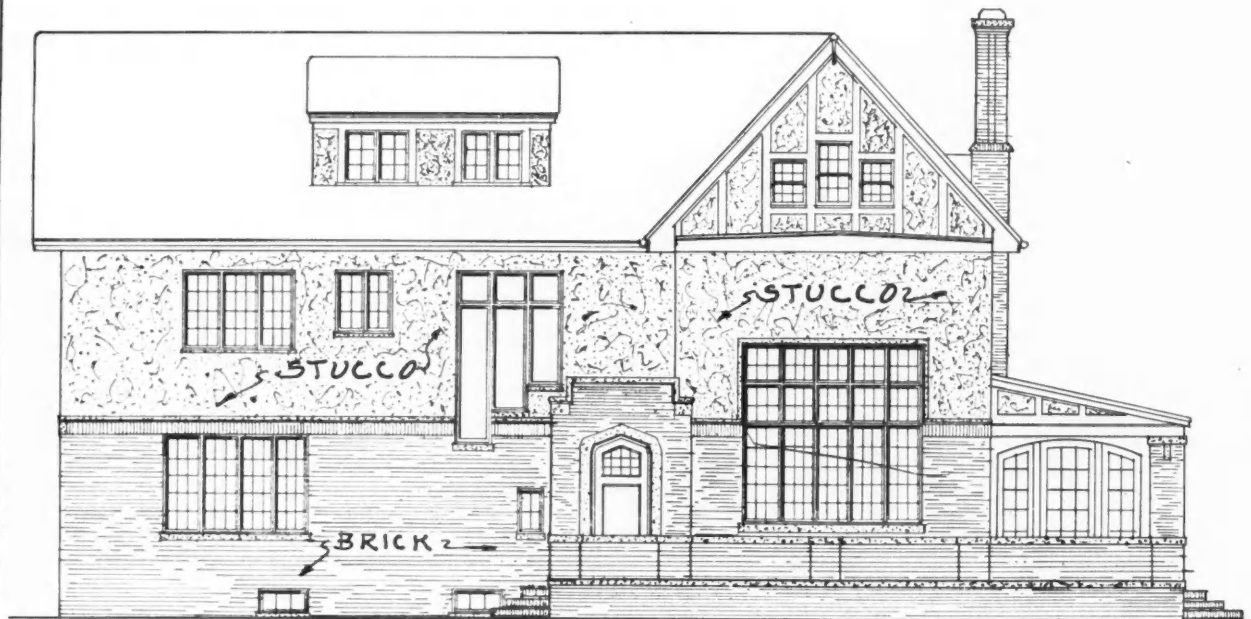

FRONT ELEVATION

SCALE 3/32"=1'-0"

SHEET NO. 3

Front and Right Side Elevations of Our Front Cover Home. For photographs of the completed house see page 151.

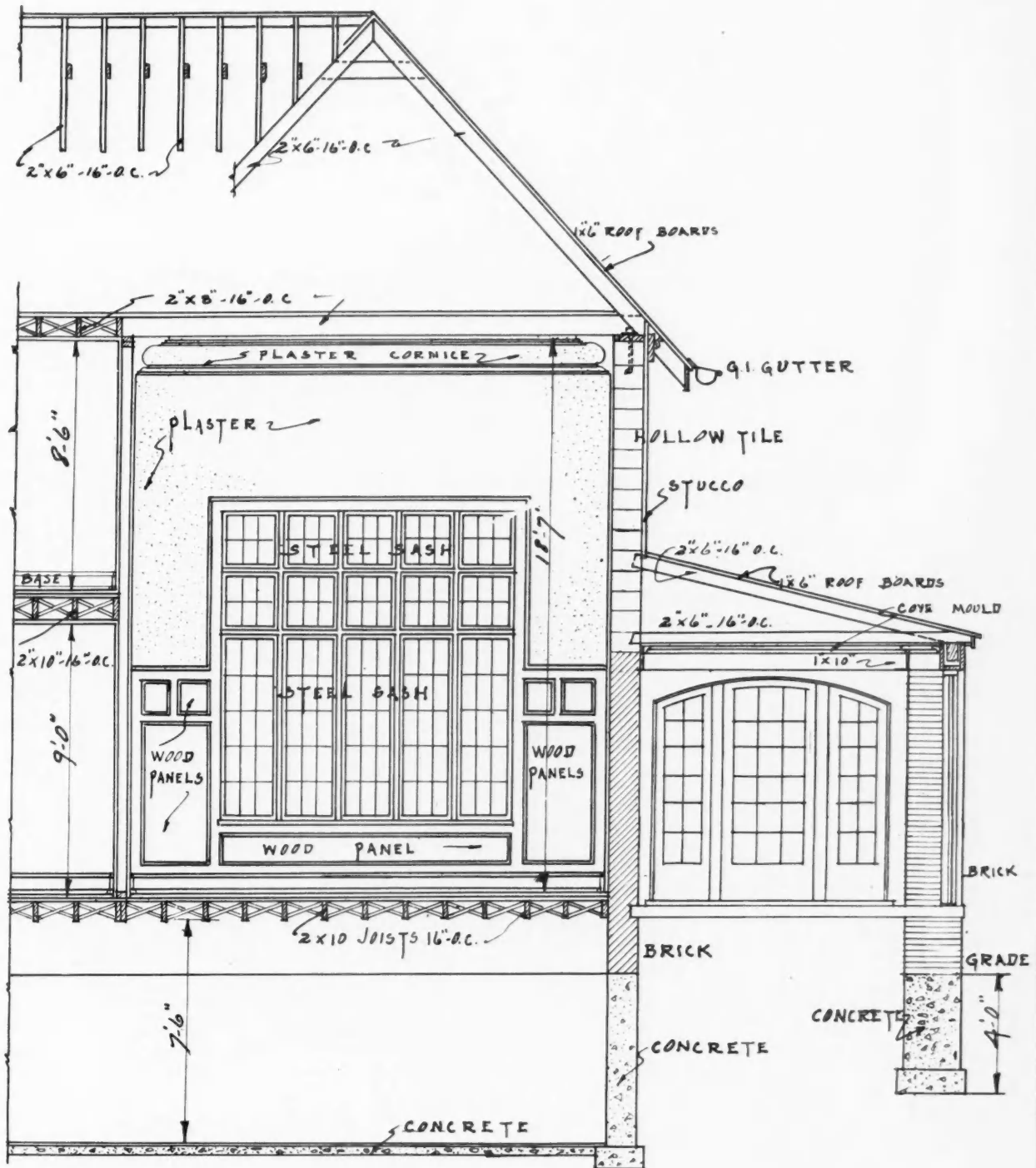

SECTION THRU LIVING - RM  
AND  
SUN - PORCH

SCALE 3/16"=1'-0"

SHEET NO. 4

Detail of Our Front Cover Home Showing Section Through the High Ceiling Living Room at the Front of the House.

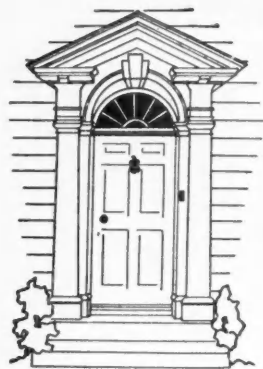

# DETAILS of HOME BUILDING

by V. L. SHERMAN  
Lewis Institute of Technology

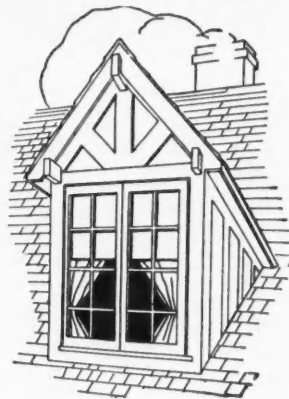

## Detail 8—The House Stairs

IT is one of the privileges of most professions to be able to disagree with one's fellows with impunity. The opportunity offered here is somewhat tempting. Before me is a tabular form of:

Cellar stairs.....	7-inch tread	8 -inch riser
Back stairs.....	8-inch tread	7½-inch riser
Front stairs.....	9-inch tread	7 -inch riser
Entrance steps.....	10-inch tread	6½-inch riser

This form will show that regardless of the riser height treads are put down less than ten inches deep on the theory that the sum of two risers and a tread should equal twenty-three inches. It brings to mind an incident in a shipyard where the designer of a small ship, a trawler, was instructed to replace a ladder hatch with stairs even steeper than those of the cellar variety on the theory that ladders were dangerous. As a matter of fact the feet are more secure on the rungs of a ladder than on shallow treads. Therefore in our humble opinion the last item in the tabulation is the only one to stand.

So far as making allowance for cellar stairs the times are even more against it than formerly. Risers may run from 6 inches to 7¾ inches, but the riser must be an exact factor of the total rise. If there is anything more risky than short treads it is an odd riser. The last rule is only one to bank on.

As the intent of these articles is toward small house design, the next point concerns the open stairs as against the stair case. Open stairs may be taken to mean either the sort shown in Fig. 5, with railed stair well, or the type open to the ceiling only. There is no question but that the enclosed flights are occasionally attractive, convenient, sometimes cheaper, etc. A steep flight, enclosed and mysterious, and in an old house, may give a certain undefinable touch. An open stair may lead invitingly into a cased stair. And if the stairs are not intended as part of the picture they may be obliterated altogether. As a last excuse we sometimes build stair cases with a door at the first floor to confound burglars. We have left, then, the open stairs.

Constricting visible space in a small house is a serious thing. So is failure to grasp every means to provide an attractive interior. Stairs are now very well made, plans of decoration usually include the stairs as a unit, present-day heating systems give us no excuse for casing them, and they are safer when well lighted. No two-story house should be built so small that a comfortable run cannot be made, and with the lessened ceiling height of the times we have shorter runs. A total rise of 114 inches and a total run of 140 inches, 15 risers and 14 treads, is a sane one if not in a straight flight, and is one that does not come within the old rule. There we come to another

point. Straight flights are not comfortable, and they are not safe. One or two turns should go into every flight.

When we take up turns we are concerned with landings and winders. Landings are best, but winders save enough in the total run to give them some advantage. Rules hardly suit here, either, but there is one which seems to stick in my mind. If my memory is correct, this one, laid down by the authorities during the housing period of the war was: "A winder must be at least 10 inches wide, 20 inches from the center." Get three winders in that.

Aside from the question of ease the balance between a landing and winders depends on the chances of making the landing a feature. If that sounds as though the stairs are too important think a minute of some of the best small homes you have seen and recollect the arrangements of the stairs. If the breadth was 3 feet 4 inches or better and the stairs fitted in with what might be termed the motif, then the chance of a spoiled effect was small. There is that chance nevertheless, and one type of stairs comes to mind which should be mentioned but which is too dark to illustrate. This layout comprises three to five risers to a turn, followed by a straight flight. The turn, or landing, is railed or masked or screened and is likely to be placed opposite the front door. Below the rail at the turn and facing the door is a hall seat or bench or locker. This layout makes it necessary to come down the stairs facing a railed turn.

Stairs in small homes ordinarily run 3 feet 4 inches broad inside the rail. This breadth can be carried snugly on two stringers if the treads and risers are housed and wedged, or cut horses can be used and three is the customary number. But the more pieces that go into the structure the more chance for slight errors, the less constant the bearing qualities, the more chance of shrinkage, and the less likelihood of firm, quiet treads. Mill work today on stairs is fully worth its cost.

Surely some builders hesitate on the use of open stairs because of the expense of rail balusters and newels. In one case there was a pretty warm discussion when the drawings showed a simple newel such as is shown in Fig. 4. When the decorators came to start work one member of the family held him up a long time considering whether that newel, which she saw come to fit the room so exactly, should be enameled the trim ivory or saved for its pretty grain. She agreed presently the grain was not to be considered.

Stairs are not for elaboration. Form or individuality has more to do with their beauty than has fancy work. But there are stairs even in small houses that can readily

(Continued to page 158.)

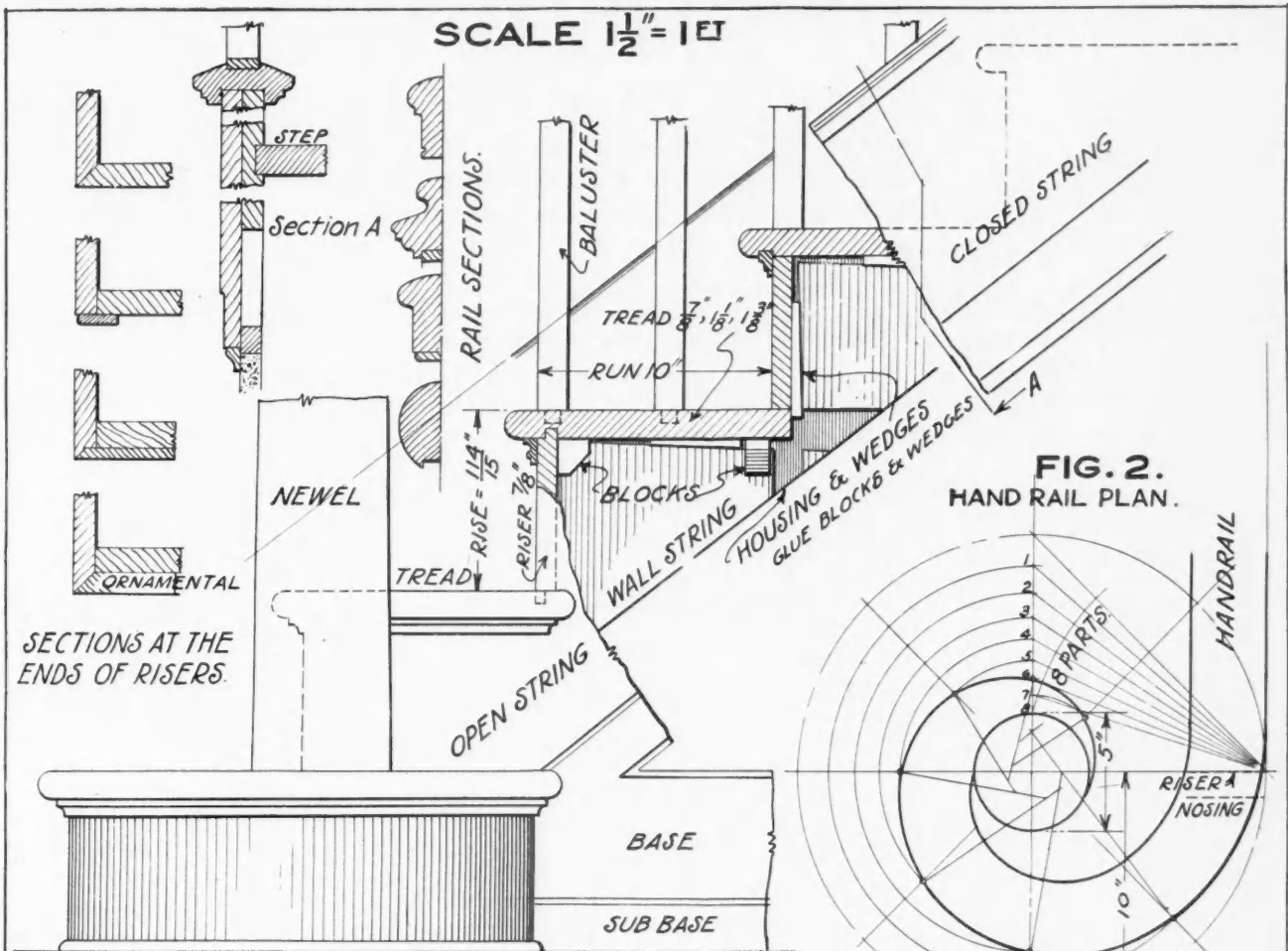

FIG. 1. BROKEN STAIR & DETAILS



*U. P. Leman 10-6-25*



# HEAVY TIMBER MILL CONSTRUCTION

*Details prepared and copyrighted by  
The National Lumber Manufacturers Ass'n*



## Plate No. 3 of a Series of Six

With Explanation and Discussion by Dudley F. Holtman, Construction Engineer of the National Lumber Manufacturers' Association

**F**IRE WALLS and party walls should be built of hard-burned brick or of concrete, preferably reinforced. Local ordinances usually regulate the thicknesses and general design. In no case, however, should such walls be less than 12 inches thick if of brick, or less than 8 inches thick if of concrete; when local ordinances permit walls of minimum requirements less than these the recommendations of the National Board of Fire Underwriters should be consulted for the requirements of proper design. Fire and party walls should extend at least 3 feet above the roof; higher parapets should be used when skylights or monitors are nearby.

Openings in fire walls should be avoided as much as possible; if they are required they should be equipped with automatic or self-closing fire doors. Openings in side walls within 10 feet of fire walls should be provided with approved fire windows, shutters or doors. Wooden beams should not enter walls more than required for sufficient bearing, and in all cases there should be at least 8 inches of brick at the sides and ends of these beams.

As a matter of economy, floor areas between fire or exterior walls should be as large as permitted, since the cost of fire walls and the necessary protection of openings add materially to the cost of the building. The maximum floor areas between fire walls or exterior walls of mill construction buildings not over 65 feet high without sprinklers, or over 75 feet high with sprinklers, as recommended by the National Board of Fire Underwriters, are as follows:

	Without Sprinklers Sq. Ft.	With Sprinklers Sq. Ft.
Building fronting on one street.....	6,500	13,000
Building fronting on two streets.....	8,000	16,000
Building fronting on three or more streets .....	10,000	20,000

It is further recommended that these areas may be increased for buildings three stories or less in height, if sprinklered and of non-hazardous occupancy.

Local building ordinances should be consulted in every case, as they may differ from the above allowable areas. Many examples may be found in the cotton and woolen mills of the New England states in which these areas have been exceeded, even in the practice of leading engineers and architects. The weave room of one large mill is said to have a floor area of five and one-third acres of undivided space.

Walls which serve as enclosures for stairways, elevators, etc., should be self-sustaining and of incombustible material. The same general conditions as to thickness, parapets, etc., apply as for fire walls. In special cases where the wall is less than 8 feet on a side and has no openings, a brick wall

8 inches thick may be used if it does not extend more than one story in height.

No interior windows should be permitted in stairway or elevator enclosures. All openings from the different floors should be equipped with automatic fire doors and all stairways doors should be self-closing.

Belts or power drives should be located in a special tower or shaft constructed of incombustible material, as in the case of stairways and elevators. Openings to such shafts should be self-closing.

### Arrangement of Beams

Instead of having the intermediate beams supported by I-beams running between pilasters (see wall section, Plate No. 3), the I-beam may be used only as a support for the brick curtain walls and window sashes. The beams in that case would be supported by a girder running parallel to the I-beam and having its ends secured in the pilasters. In this event the strap anchor may be omitted, the beams being supported entirely by the stirrups. This method of framing the beams in the side walls provides a wall construction which is thoroughly independent of the floor construction so that any failure of the latter would not affect the stability of the wall. This construction is used to a considerable extent as the so-called Rochester type, developed in Rochester, N. Y.



### The House Stairs

*(Continued from page 156.)*

justify the expense of turned rails and spirals. No doubt they are expensive, considering, but a touch of craftsmanship is to be encouraged. The diagram, Fig. 2, is taken from an old colonial layout for a straight newel. The pitchboard is not shown, but if one considers the spiral he will be considerate of the pitch.

Fig. 3 is only a part of the stair question. Thanks to the growing tendency of fitting a house to its needs and surroundings we can not place the first floor rooms on more than one level without too much censure. Dropping the living room floor from the entrance hall may give more ceiling and a better contact with the garden or lawn. This is merely to indicate that steps are aids in planning some homes and should be considered.

From the practical side we wish to restate that stairs or stair halls are not now as they once were in regard to heating. Heat losses are greatly reduced and more uniform throughout the house, are better regulated, and cold air drafts are becoming negligible. More than one green owner has remarked to me his discovery of a comfortable stair hall. This is due to the great improvements in heating, in insulation of walls and in mill products.

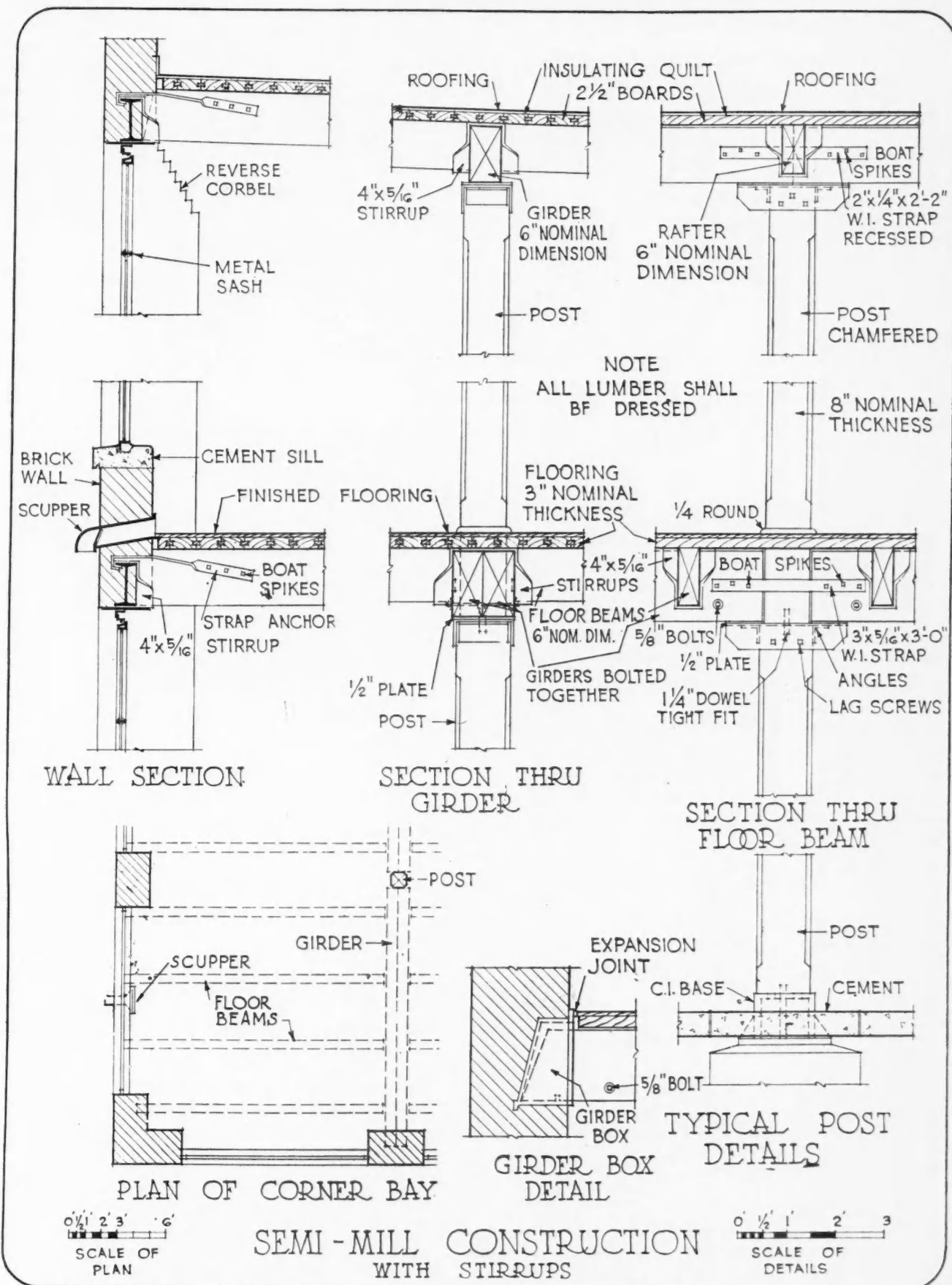

MILL CONSTRUCTION DETAILS—PLATE NO. 3.

Presenting the Various Standard Types of Mill Construction Buildings, Together with Details of Posts, Post Connections, Beams, Beam Supports, Etc.

# A West Coast School of Spanish Charm

The Fremont Grammar School of San Luis Obispo, Calif.

By J. HAROLD HAWKINS



The Fremont Grammar School of San Luis Obispo, California, Is Beautifully Situated, with Towering Mountain Peaks Entirely Surrounding It. Orville Clark, of Los Angeles, Architect.

As the Spanish Padres rode northward through southern California a hundred and fifty years ago, they followed a trail that later came to be known as *El Camino Real*, or The King's Highway. Along this route these gray-robed fathers established a string of missions, separating them by an average day's travel on horseback, or about forty miles.

In what is now the town of San Luis Obispo they built one of these adobe structures which during the period of these fathers, was the headquarters of the district. Indians were taught to till the soil of the mission grounds, a highway around the mission protected the foreigners from assault, worship was conducted within

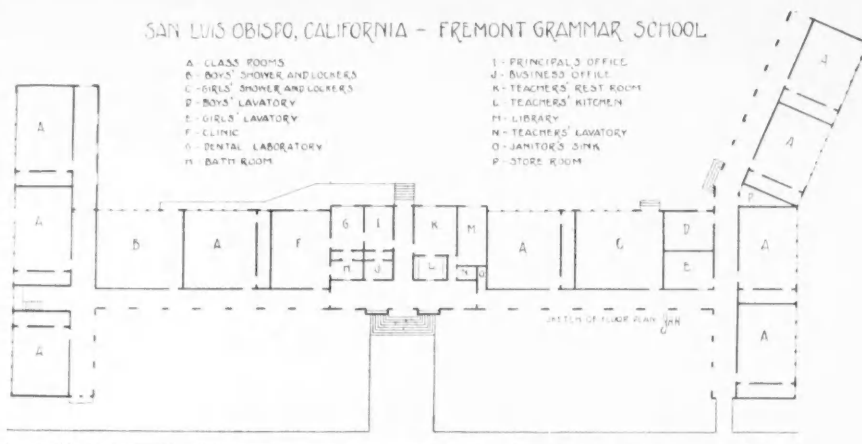

A Cloistered Corridor Takes the Place of an Interior Hallway as an Approach to the Class Rooms in the Fremont Grammar School.



Adequate Foundation Plantings, Graceful Arches, a Roof of Red Tile, and Tall, Swaying Eucalyptus Trees Unite to Make This School Building a Work of Art.

the chapel, and civilization was taught to all natives who would submit to it.

Gradually California became populated with "outsiders"; adventurers from the eastern states. Spanish rule gave way to Mexican, and the Mexican reign over California gave way to an independent government. Then came the American flag, and rapid progress. The missions were gradually forgotten—schools took their places, and churches of different denominations. Now, only a few blocks from the old mission of San Luis Obispo, there stands a delightful, modern school building.

This Fremont Grammar School echoes the best of mission architecture, and its lines in general remind one of sunny Spain. Red tiles cover the roof. Stucco, not unlike the mud-plastered walls of the mission, is the medium used to properly emphasize the graceful arches. The color of the exterior walls is a putty gray, a natural background for foundation planting,



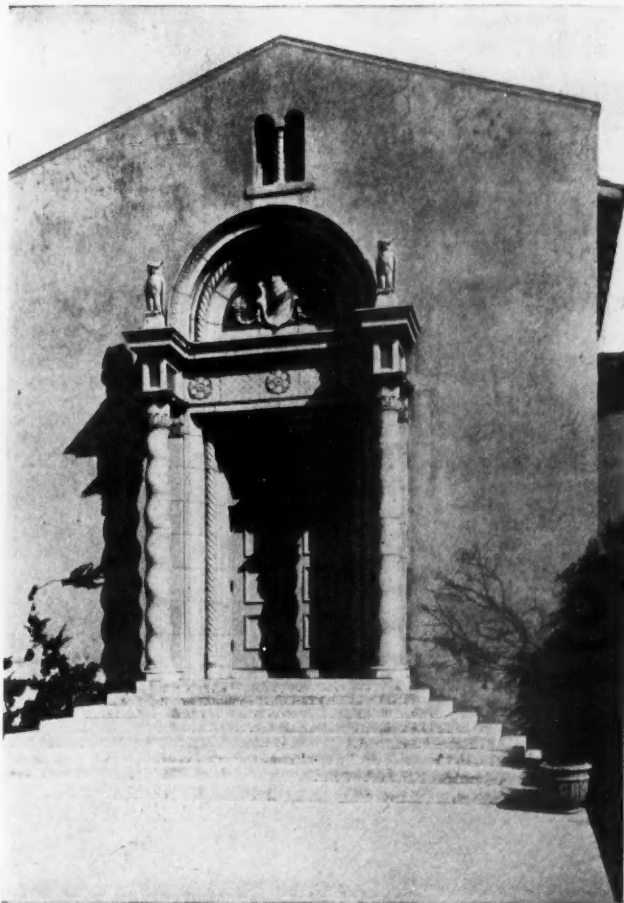

The Main Entrance Facade of the Fremont Grammar School, Is Mainly Moorish in Style. It is approached by a short flight of broad steps.

and for creeping vines. The surface is slightly rough, though not so much that the effect is artificial.

The soft, flat coloring of the exterior woodwork lends an artistic touch to the whole and does not over-emphasize it as would a glossy or hard finish. The hue, a pastel sea-green, is applied to the doors, the railings across the arches, and the window trim. The iron grilles over the windows and the ornamental hinges are flat black. The ceilings of the cloisters are beamed, and the coloring is a soft, sky blue. The floors are red cement, smooth and squared into blocks like Spanish tile.

The main entrance facade is done in a yellow-cream pressed stone. The twisted columns suggest Moorish origin, and bits of brilliant color echo the Oriental, as the shield, upon which is carved the name, "Fremont," has a background of green, and the under side of the square

capitol is colored a bright blue. The frieze that runs around the circular hood also has the background of its conventional pattern done in bright blue. The main doors are soft sea-green, in keeping with the rest of the scarcely less interesting outer doors. Two stone owls perch knowingly on either side of the entrance, as though declaring the wisdom to be garnered within.

All the class rooms, excepting for that portion of the building that is two stories, are entered from the open cloisters. The class room doors are exquisite in themselves. Each has a small, grilled window cut in its plain, dignified surface. The rooms themselves are adequately lighted by five or more large windows which take up practically the entire side of the room opposite the entrance. A closet for wraps runs across one end of each room. These closets are equipped with two doors so that they can be entered



Where the Cloisters Join the Inner Corridor of the Central Portion of the Building, Rigidly Plain Doors Are Perfect Foils for Exquisite Wrought Iron Hinges.



This Spacious Playground, Covered with Fine White Gravel, Is an Excellent Place for the Children to Work Off Their Surplus Energy When the Bell Rings for the Recess Hour to Start.

from each side of the room. The ceilings are white, while the side walls are done in a light buff. A blackboard runs around three sides of the rooms. The floors are hardwood, and oiled.

Where the two cloisters that extend along the front of the building join the central portion, there are wide, double doors. These doors are exceptionally pleasing, their ornamental hinges giving just the acme of artistic feeling needed. The cloisters are connected by a wide corridor through the central or executive portion of the school. There is also a corridor leading from the front entrance to a door at the rear. On the left of this corridor is the business office, and the office of the principal. Adjoining the principal's office is a dental laboratory with a complete equipment for caring for the teeth of the pupils. Off this laboratory, as well as the clinic and nurse's headquarters, is a completely equipped bath room.

The space to the right of the corridor that leads to the rear door of the school is divided into a teachers' rest room, a teachers' kitchen, a library, and a teachers' lavatory. A separate door leading from the main corridor opens into a small hall from which may be entered any of this group of rooms.

There are two large shower and locker rooms, one for the girls and one for the boys. Both of these rooms have doors leading from the rear of the building to the spacious playground. This playground is equipped with apparatus suitable for the elementary grades which the school embodies. The ground is covered with fine, white gravel, and the view in any direction from this delightful spot is nothing short of marvelous—towering mountains meeting the gaze at every angle.

A most important feature of this delightful school building must not be overlooked—the foundation planting. Luxuriant shrubs and bushes completely hide the founda-



Artistic Simplicity Is the Note in the Doors of the Class Rooms Which Open Onto the Cloisters.

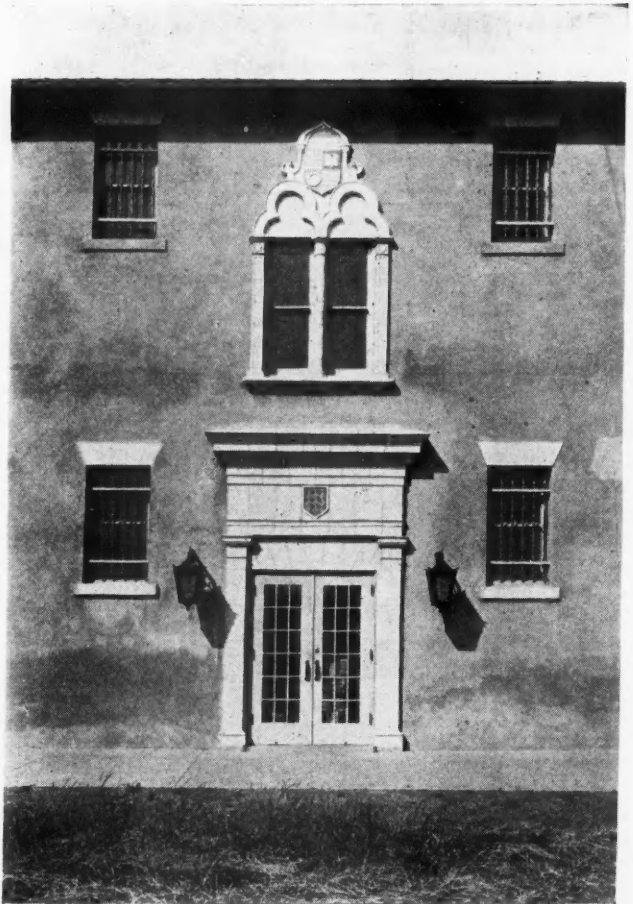

Greek and Moorish Architecture Have Been Combined in the Side Entrance Facade, Producing a Most Happy Result.

tion, and vines are trained up the walls at various places to form delicate and artistic traceries against the stucco.

The left wing of the building is two stories in height. The plot of ground upon which the school stands falls away at one end thus making a lower level possible at that end. A very unusual and well executed entrance is located here, giving access to the lower class rooms independent of the main entrance.



## Sheet Metal Details

Sheet 13—Figure 67, 68, 69, 70 and 71

*EDITOR'S NOTE: This is the thirteenth and last of a series of articles, presenting authentic details for flashing and metal work problems in building. The drawings, presented on the opposite page, were prepared by the Copper and Brass Research Association, and may be applied in the use on all roofing metals.*

### NOTES FOR DRAWINGS ON OPPOSITE PAGE

THESE drawings represent the standard details and practice of the Master Sheet Metal Roofers' Association of Boston, Mass., and are reproduced by their permission. They show the methods used by this association for flashing the copings as well as the front and rear faces of parapet walls as found on factories throughout New England.

Where heavy snowfalls and sudden thaws are to be expected, and it is fundamental in the design of a factory that the temperature and humidity of the interior be kept nearly constant, the problem of flashing must be studied with great care. Ordinary flashing methods are insufficient, for they do not completely damp-proof the interior. It is necessary to devise means of cutting off any dampness or moisture which might seep down through the brick work during a driving rain or when the roof is covered with a foot or more of water-soaked snow.

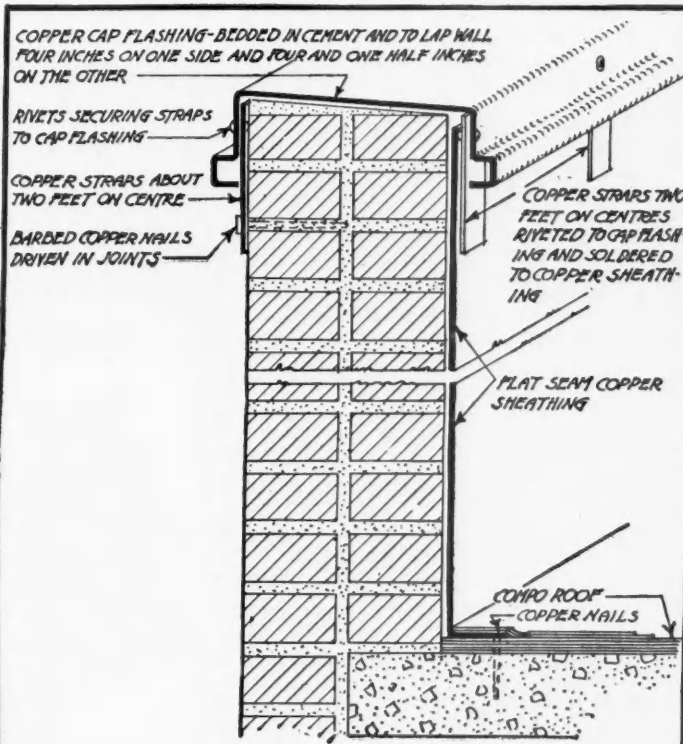

FLASHING FOR A BRICK WALL LESS THAN TWENTY FOUR INCHES HIGH (67)

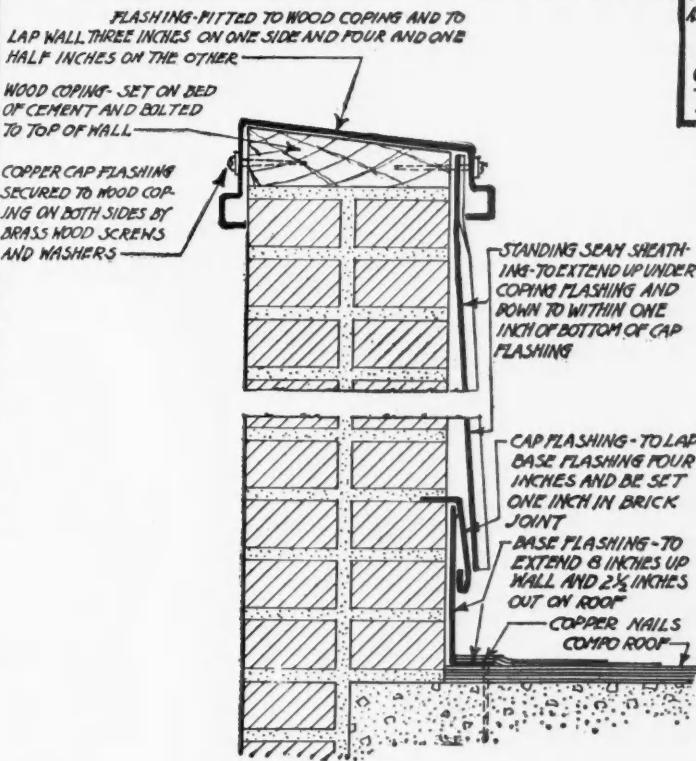

FLASHING FOR A BRICK WALL MORE THAN TWENTY FOUR INCHES HIGH (70)

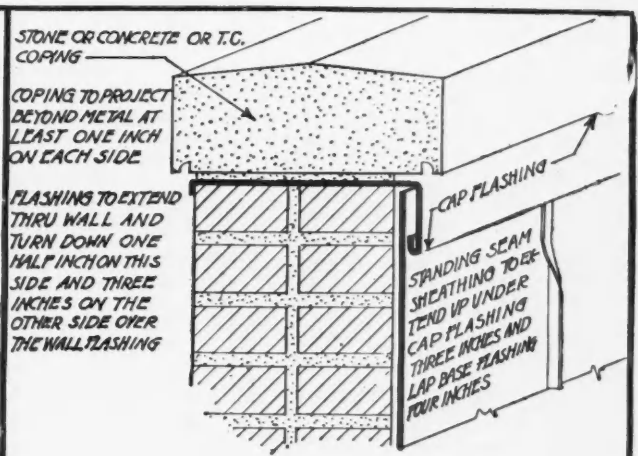

FLASHING FOR A BRICK WALL MORE THAN ONE FOOT HIGH ABOVE COUNTER FLASHING (68)

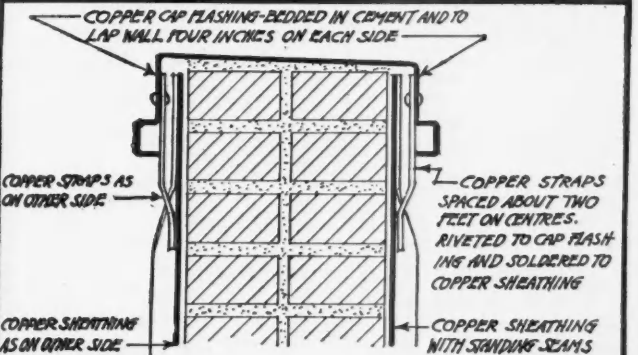

COPPER COPING AND FLASHING FOR THE TOP OF A BRICK WALL (69)

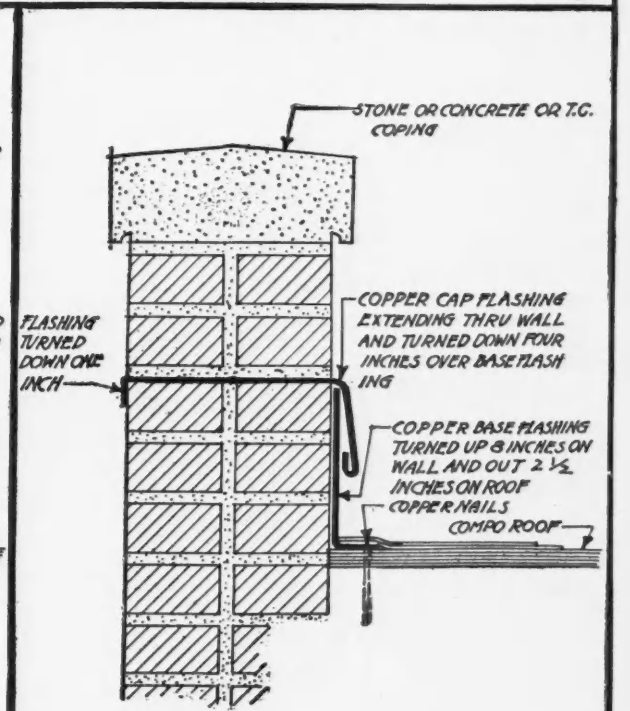

FLASHING EXTENDING THROUGH A BRICK PARAPET WALL (71)

# Unobstructed Floor Space

When Should Trusses Be Used and What Type of Truss Should Be Selected?

By H. G. TREGILLUS, Structural Engineer

**I**N the September issue we discussed the general use of trusses, and the object of the present article is to assist the architect or builder in deciding, for a specific building, whether to use posts or trusses, and if the latter, what type of truss to select.

The first question naturally is, whether trusses are available within the time allowed. Wood trusses, of course, are frequently built by the carpenter contractor and so there is no delay on that score, but it is perhaps wise to point out that the building or designing of roof trusses should never be entrusted to one who has only a superficial knowledge of this work.

Any qualified architect or structural engineer can, of course, design a roof truss, but it is not profitable for anyone to design roof trusses unless he has tabulated data at hand. This is why the standardized truss can be purchased more cheaply than one can be designed and built by local talent.

If the engineer is careful to consider all stresses, primary and secondary, for uniform load as well as all conditions of partial loading, he will have a large task on his hands to design just one truss, and the carpenter who is to build that truss from his design will have much studying and laying-out to do before the work is complete.

On the other hand, the concern making a specialty of trusses has all the designs, stresses, etc., tabulated for all sizes and conditions of trusses. It has standard drawings, templates, list, etc., ready to put into service at a moment's notice; thus it not only eliminates considerable expense but it practically does away with the chance for error by the overlooking of some critical condition of loading that would give excessive stresses.

With such source of supply there is now little reason why trusses can not be procured, no matter how isolated the locality. Both steel and wood trusses are now available in the knocked-down form, so simple that any mechanic can assemble them with a monkey wrench and horse-sense;

and ordinarily two or three men can place them on the walls with a single gin pole.

Being knocked-down these trusses are convenient to transfer from freight cars to trucks or wagons and to distribute in the building. With the types of trusses that are shipped either in one piece, or in the case of very long trusses two or three sections, the matter of handling is quite a problem. It generally means the erection of a gin pole at the side-track where the car is spotted and another one at the building site for unloading; and if the work is in a hurry still a third one for raising. It also requires special trailer trucks or long-reach wagons that are not always available. It will be seen, therefore, that the small cost of assembling the knocked-down truss more than offsets the costly handling of the assembled truss.

So then, having determined that if required trusses are available, the next question is that of cost and delivery. Generally speaking, for moderate spans, standardized wood trusses cost less than steel trusses. For the sake of the present discussion, we will assume that a group of five or six 50-foot trusses will cost \$90.00 to \$100.00 each, erected on wall, for wood and \$110.00 to \$120.00 each for steel. We will also assume that the trusses are to be spaced about 18 feet apart in the building. Let us compare this with post and timber construction similarly spaced.

To replace each truss, there would be two columns at about \$10.00 or \$20.00 each, three beams about 16 feet long at \$10.00 each, and two column footings which with excavation would cost us \$20.00 each. The roof construction, that is, joists and sheathing, would be the same in either case as would also be the number of pilasters where the beams or trusses rest.

It will be seen, then, that there is practically no saving in initial cost by the use of posts, and certainly the floor space would be rendered less valuable on account of their obstruction. When the width of the building is less than 30 or 35 feet beams may be used to span the entire

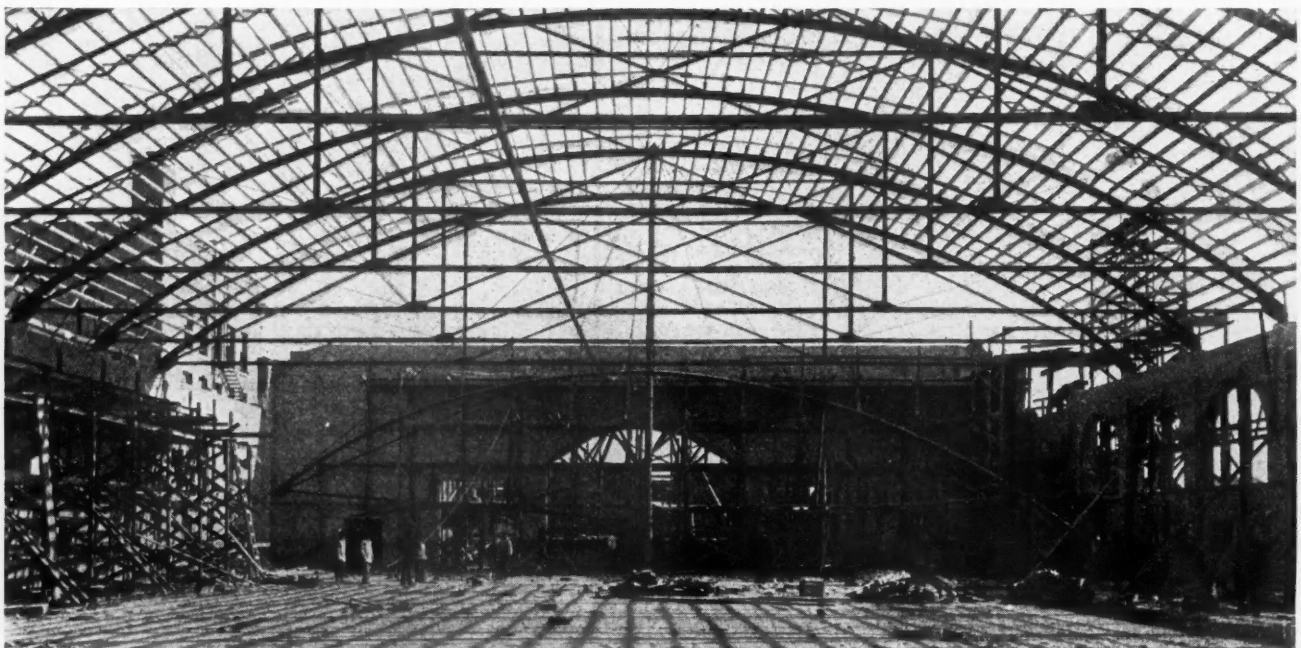

In the Construction of the Municipal Recreation Building at Chisholm, Minn., 112-Foot Steel Trusses Were Used. They are shown here being raised by means of a single gin pole.

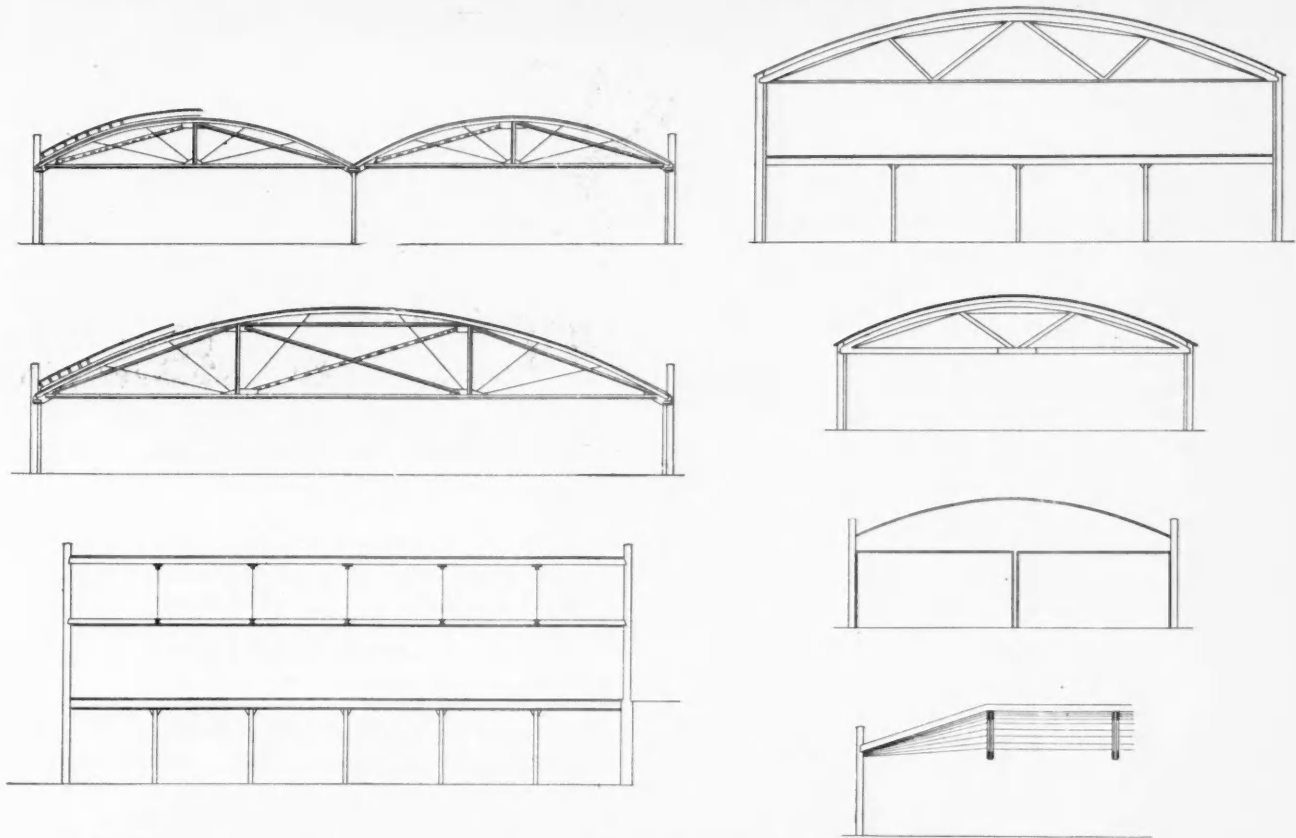

At Left, Top to Bottom: Typical Cross-Section of a Building Having Two Aisles, for Spans Greater Than 60 Feet the Trusses Should Be of the Type Shown Next Below. Typical cross-section of a building 60 feet or more in width; this construction has been used up to 145 feet. Longitudinal section through two-story building in which the first floor is ground level at one end and the second floor ground level at the other end. The metal ceiling is supported on joists resting on the lower cord of the truss, special hangers being provided to take care of this load.

At the Right, Top to Bottom: Transverse Section of a Plant in Which it Cost Less to Install Combination Wood and Steel Trusses Over the Second Story Than to Increase the Column Footings and Run the Columns Up to the Roof Level. It also gave clear floor space in the second story. Typical cross-section of a building from 40 to 60 feet wide spanned with wood trusses. Cross-section of a building divided into two rooms by a stud and plaster partition which can be taken out or moved to suit the tenants. One 50-foot building has two such partitions, making three 16-foot stores. Longitudinal section through front or rear wall showing how the roof joists may be sloped to save brick work when desired.

width and very seldom are trusses less than 30 feet used, except in the case of a tapered building to maintain the same type of construction throughout.

Similarly, it is not advisable to use two truss spans in a building less than 70 feet wide. When a building is over 80 or 90 feet and there is no objection to a single row of columns down the center, it is generally more economical to use two spans. Theoretically the cost of trusses should increase in proportion to the square of the span, but in actual practice this increase is reduced by some 30 per cent, so that a 100-foot truss instead of costing four times as much as a 50-foot truss is liable to cost only three times as much. However, in order to be exact in these matters inquiry should be made of the manufacturers.

**Note**—All of the trusses shown in the sketch on this page are of patented construction and are shipped in parts of convenient size for handling. While the steel trusses may be riveted, if desired, all three types, steel, combination wood and steel, and all wood, may be bolted throughout with safety, making them very convenient for use in isolated districts where it would be difficult to get good riveting done. The steel trusses have two angles for the top chord with sufficient space between them to allow bolts to pass between them for securing a wood nailing strip to which is attached the roof joists. In wood trusses the joists are nailed directly to the top chord.

Skylights and monitors may be placed on these trusses provided their width is not so great as to produce a tendency in the trusses to buckle sideways. If the monitors are wide, special struts should be installed to give lateral stability to the trusses.

In deciding whether to use wood or steel trusses the first question is as to fire risk together with the use to which the building is to be put. A great deal has been said concerning steel trusses being susceptible to fire damage at comparatively low temperatures, as compared with the fire resisting qualities of timber trusses. It is now generally conceded that wood trusses with lattice web members are undesirable in most instances and their manufacture has been practically discontinued as far as the writer is informed.

In garages, where the conflagration of the building is generally started by the explosion of gasoline tanks on the cars, there seems to be little doubt that a steel truss reduces the fire risk even when supporting a good roof. Burning

In many instances trusses are required to support special loads, in addition to the roof and ceiling. The nature and amount of these loads frequently determine the best type of truss. The trusses at upper left are well adapted to support considerable loads at their centers while the trusses at center left and upper right can support loads at the one-third points. Small concentrated loads can be provided for at any point on all of the trusses shown, but it is most important in supplying the designer with information from which to design trusses to specify all the loads which will ever be applied to the trusses, no matter how insignificant they may seem.

With a complete knowledge of all the loads and an intelligent consideration of the loading and the primary and secondary stresses, trusses of any reasonable span can be made as safe as any other construction, but no novice should ever be allowed to design or build trusses.

gasoline propelled through the air by the force of the explosion, may alight on the steel member and quickly burn off without doing any damage whatsoever. The same amount of gasoline alighting on a wood member would impregnate the wood and cause it to ignite more readily and the fire is started.

If the steel trusses support a non-combustible roof, nothing but an intense heat from the burning contents of the building can cause damage. The city of Milwaukee and perhaps other cities require steel trusses in garages and a non-combustible roof; although the trusses need not be fire-proofed. In the case of a building containing large quantities of inflammable materials there would probably be little difference in the salvage from the fire, whether the trusses were wood or steel.

Another factor in selecting wood or steel is the size of the span and the consequent stresses. There is apt to be greater uniformity in the texture of steel than in lumber, although it is impossible to avoid occasional flaws in either. As a general rule when the span exceeds from 80 to 100 feet, the writer feels a little more safety in the use of steel than wood.

Another item for consideration in selecting the type of truss is lighting and ventilation. With post and beam construction, there is generally less headroom than with trusses, although the clearance may be the same. This fact alone decreases the circulation of air and it is further retarded by the roof being flat. With roof trusses, whether they be parabolic or triangular, there is always a circulation toward the highest point, and if a ventilator is placed at the crown, good ventilation is assured.

In cold climates a ceiling is sometimes necessary for insulation, and while the ceiling is often put at the level of the lower chords of the trusses it is probably better to attach it to the under side of the roof joists in order to secure circulation and at the same time eliminate the cost of ceiling joists.

The matter of lighting is self-evident from the inspection of the elevation of the trusses. The truss which presents greatest area in elevation will obstruct the most light—another reason for the decrease in popularity of the lattice truss.

It is customary to combine the lighting and ventilation unit in most trussed buildings and several makes of these ventilator-skylights are on the market. The standard widths vary from 6 to 10 or 12 feet. The most popular seems to be 10 feet wide. A continuous skylight 10 feet wide is adequate for a building 50 to 60 feet wide. It is good

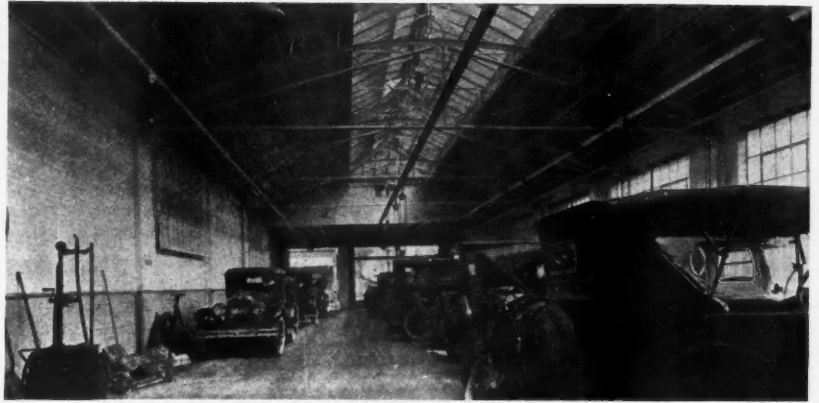

These Trusses, with a 45-Foot Span, Were Especially Designed to Support Trolley Runways in This Automobile Repair Shop in Chicago.

practice to use two such skylights when the building is up to 100 feet wide. For a building 125 feet wide, with a single span truss, three 10 or 12-foot skylights give excellent light. In some cities the amount of light and ventilation is governed by the building ordinance.

All of the trusses in the illustrations are particularly adapted to save as much brick as possible in the walls. In the steel trusses the top chord runs down even below the clearance line of the bottom chord so as to bring the roof line as low as possible. The wood trusses also are made as shallow as possible at the heel. Occasionally the lowest two or three joists are notched down on the truss, lowering the roof line still more, but this is a questionable advantage, because it increases the slope of the roof.

Another common practice is to reduce the height of the end walls by sloping the joists in the end panel as illustrated on the preceding page. Contrary to expectation the carpenters have no difficulty in laying the roof boards on this surface of peculiar contour. If there is a parapet on the end wall, the gutter thus formed drains to the corner of the building as do the gutters along the side.

Gutters on these trusses may be formed in two ways, one is to build up a saddle on top of the roof proper, the other is to slope the last two or three joists nearest the wall by notching in some cases and blocking up in other cases, thus providing the proper water shed without additional material.

The erection of these trusses is not a difficult problem. Whether wood or steel, it is best to assemble them each in the spot from which it is to be lifted onto the walls. The gin pole is set up in proper position to lift the first truss and the truss is assembled across the building (but skewed somewhat because its length is greater than the clearance across the building), with the lower chord nearest the gin pole. When the truss is assembled the top chord is hoisted until the truss is standing up and so on until it rests on the walls. The pole is then backed off into position for the next truss.

For light trusses two or three men can do the work, but the most efficient gang consists of five men. This is chiefly for moving the gin pole providing as it does one man on each of four guy lines and one man to move the pole. The most effective way of doing the latter is to lay a plank over the timber dolly as a pry under a cleat provided for the purpose near the bottom of the gin pole. Thus with his improvised wheel barrow, one man can wheel the pole over a plank runway as fast as the men on the guy lines can pay out or take up the slack.



Here Is an Example of the Combination Wood and Steel Truss as Used in a Public Garage in Chicago. The span is 50 feet.

# Better Plastering

Stucco Homes Prove Their Worth Where Good Materials and Good Workmanship Are Combined

*This Is the Seventh of a Series of Authoritative Articles on This Subject*

**S**TUCCO homes are by no means a modern development, since some of the earliest habitations of man were structures of this type, where a framework was covered with a plastic material, often on a base of woven twigs. Early in the history of the human race plastic materials were developed which had the permanence requisite to make such stucco habitations practicable. Many examples of such construction still exist, with a history of thousands of years behind them in Egypt, Greece, and other ancient lands.

In the United States we now find stucco homes, after a rather unfortunate period, again becoming one of the predominating forms of construction. The unfortunate time for homes of this type was when they fell into the hands of unscrupulous, and sometimes uninformed, builders. These homes, skimmed in materials and erected by inefficient and uninformed workmen, failed to give the satisfaction to which their eventual owners believe they were entitled. Too often they were erected for the immediate profit they offered, and this in a period when the so-called speculative builders gained the dubious reputation which is now rapidly being cleared up by operators of the better class.

Now, persons who contemplate building have learned that stucco construction, like every other form of building, must be well done, and when so done is very satisfactory. It has been learned that it is no easier to hide defects under a coat of stucco than it is under coats of paint.

The popularity of stucco is manifest by the predominance of this type of construction on the Pacific coast, where the number of homes so built exceeds that of any other type. This is not so surprising as is the fact that in such cities as Minneapolis, stucco homes fast are gaining the lead over other types of houses. And this in a climate as trying to building materials as any in the United States.

The reasons for the success of stucco in these two spots, which are typical examples, are quite similar and have a common origin—good workmanship. In California the handling of this finish has engaged the interest of craftsmen of the highest type, and through much experience, the builders refuse to tolerate inferior workmen or materials. In Minneapolis, a rigid building code limits the materials to those approved and three plastering inspectors keep the workmanship up to a high standard.

In building good stucco structures, the responsibility, as is the case in plastering, starts before the plasterers get on the job. This is so well recognized in California that the best of the stucco workers refuse to take jobs where the structural elements of the building will not measure up to the requirements of good workmanship. They know that nothing but dissatisfaction can result and refuse to shoulder the blame for faults which they know are bound to appear.

There are today a number of bases used for stucco. Among the more familiar ones are stone, concrete, concrete block or tile, hollow clay building tile, and in another division, lath of metal or wood especially prepared for a stucco base. This latter class is applied over a framework of wood and will be dealt with in this article, other bases being left for future discussion.

In buildings of this type, the foundation is of primary importance. With the now general use of concrete and concrete blocks, good foundations have become universally

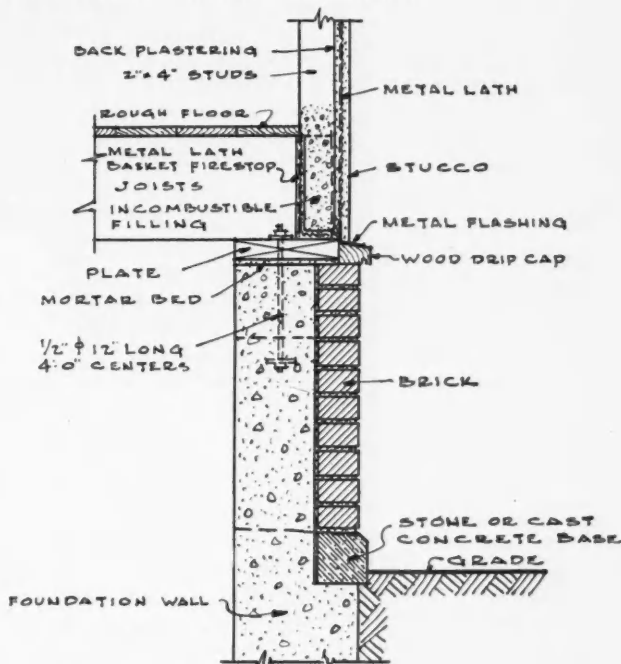

Fig. 1. Sill Construction, Balloon Frame, Joists Resting on Wood Sills.

demanding for all types of construction, even where natural stone is not readily available. But in building the stucco home, while the rigidity and the load bearing qualities of the foundation are of utmost importance, there is another requirement which must not be overlooked.

The foundation must be at least 12 inches above the ground. This is to guard against placing the framework of the building so close to the ground that the stucco will absorb moisture through capillary attraction to its eventual detriment. It is important to remember at all times in stucco construction that if the stucco surfaces are so designed that they will shed water instead of retaining it and that capillary action is prevented, no amount of moisture will be injurious.

Fig. 1 shows a commonly used system of basement wall construction where there is no objection to the basement windows showing. The masonry walls run up to the level of the under side of the joists which lie directly on them or on wooden sills laid on the masonry. Basement windows in such a plan must have the rough frame cast in place when the wall is poured and the brick veneer should be supported on an angle iron lintel.

In this, as in all other foundation details, anchor bolts or beam filling have been specified to insure a good job. The house must be more than casually set on the foundation, it must be fastened. This has been demonstrated recently in tornado and earthquake disasters, where the advisability of making the entire structure a unit was proven. For solid or timber sills, bolts  $\frac{1}{2}$  inch in diameter and 12 inches long, 4 feet on center, should be cast in place in the concrete or imbedded in the brick, concrete block or tile, with enough of the bolt projecting so that the timber can be bolted quickly to the masonry. Before bolting the sill down a layer of mortar should be spread on the masonry so that the joint between it and the sill will be sealed effectively.

A box sill type of construction, such as is shown in Fig. 2, does not conveniently permit the use of bolts and in this instance the space between the wooden parts is filled to the underside of the joists with cement, known in this use, as beam filling. One inch boards are cut in between the joists to complete the box on the joist bearing walls. On the end walls two inch planks are used for both the inner and outer sides of the box.

The concrete used for beam filling should be mixed with only a little water. This insures an early set and eliminates the possibility of rotting the planks, which may occur if a "sloppy" mix is used. Besides making a more rigid base for the structure above, the beam filling seals the joint between the framework and the foundation, keeping out moisture and cold.

Fig. 3 shows a way of building a wall so that it presents a uniform appearance, down almost to the ground. In this construction, stucco can be run down to the line of the water table, which should be at least one foot above grade. In this case, the portion of the foundation which is above grade for joist bearing is set back to be flush with the lath above. The stucco is then applied at the same time on the foundation and the lath above. Because of the variation in thickness in this foundation, it is easier to build it of poured concrete than of masonry units, although it is feasible to use 10 inch concrete blocks for the lower portion and eight inch blocks for that above.

This drawing also illustrates the box sill combination typical of western frame construction which has two excellent features. The first is the equalizing of the shrinkage in the interior partitions which permits the building to settle uniformly as the lumber dries out. This prevents plaster cracks and does not open unsightly cracks at the baseboard and quarter-round and cause the doors and windows to bind. Secondly, there is the header to which all joists are nailed, which, in conjunction with the rough flooring, which runs out to the edge of the joists, serves as an admirable fore stop.

True Colonial and English types of houses hide their basement windows, and, therefore, windows for the base-

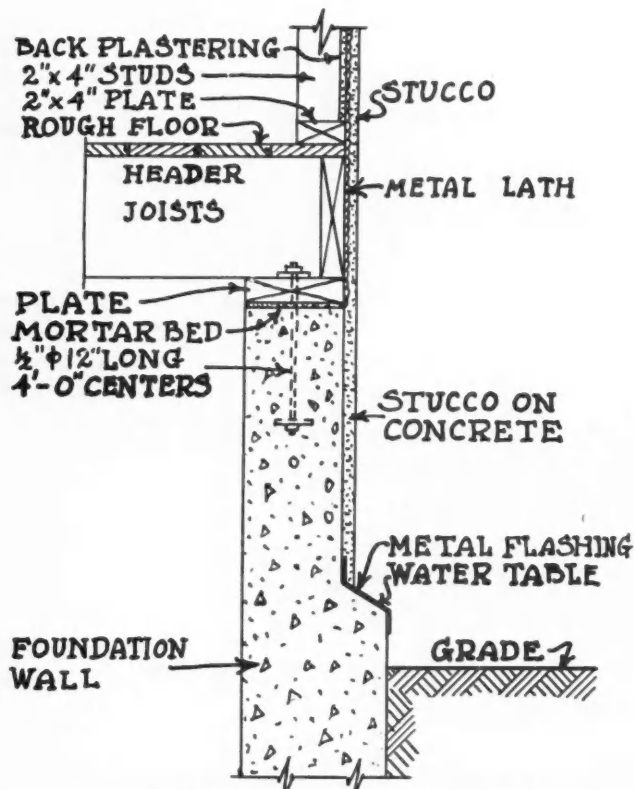

Fig. 2. Box Sill Construction, Western Frame.

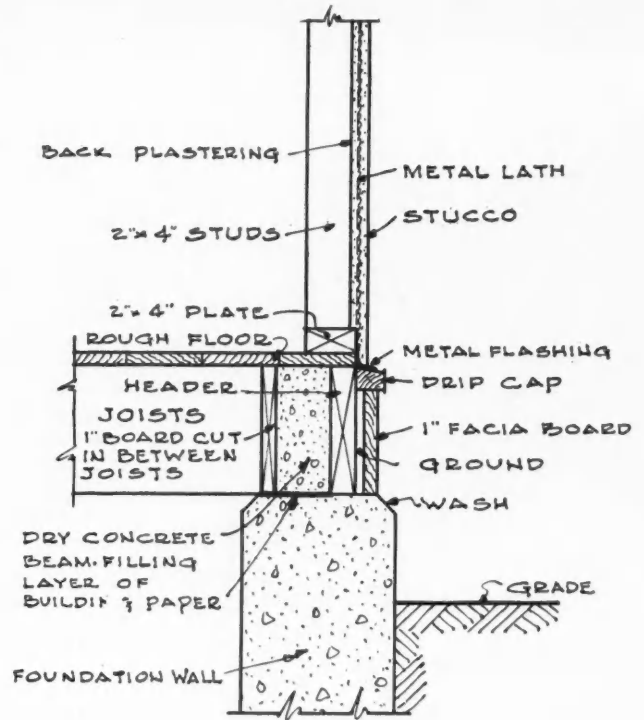

Fig. 3. Box Sill Construction, Joists Resting on Masonry.

ment must be placed, for the greater part, below the ground line and a cement area built around to allow light to enter the basement. The wall details already described may be modified without difficulty to meet this condition. It is important that each area way have a drain connected to the sewer or that other provision be made so that melting snow and rain will not overflow into the basement.

No apology is offered for this amount of detail in discussing the basement and foundation walls of the stucco home, since the foundation, as stated earlier, is a vital factor in the durability of the home. Later articles will take up correct framing details, flashing, stucco mixtures, and their application and other important points in this type of construction.

### Autumn Foliage

(Continued from page 129.)

sassafras are fragrant when crushed and have shapes which are both interesting and novel. Seldom do we find any two leaves alike in shape or cutting, and the mitten-shaped leaf vies with the three-lobed, or sometimes almost entire edged leaf, all growing upon the tame shrub.

There is a large group of shrubs which may serve as a background for the blaze of color which we have been discussing, because of their ability to retain their leaves until late in the season, and because their leaves are uniformly a dark green until they drop off. Among these varieties for the use of the small property owner, are the privet family, which in the north is represented by a very hardy member, the Amoor River privet, and by the California privet which so many people admire. The dark green rather thick leaves of the wayfaring tree or viburnum lantana serve the same purpose, further improved by the fruit of dark bluish black.

### New Asphalt Association Offices

MAIN offices of The Asphalt Association are now located at 441 Lexington Ave., New York City. The telephone numbers, Murray Hill 4707 and Murray Hill 1119, remain unchanged.





# HOW DAN DOES IT.

*A Department for Passing "Life Savers" along to other Builders.*

**\$2 for an Idea**

Dan is an ingenious cuss. Nothing ever stumps him. He always knows the way out when he runs into a tough problem out on the job or in the office. Dan is going to edit this Department and will pay \$2.00 each for every good idea he can use here to show and tell other builders "how to do it." Send him a rough sketch and a short description of what the tough job was and how you handled it.

Address Dan-Do-It, care of American Builder, 1827 Prairie Avenue, Chicago, Ill.

## Finding the Cheek Cut

I HAVE noticed a number of discussions about cutting the cheek cut on jack rafters and thought possibly other people would be interested in the method which I use. I have found it both simple and practical.

Lay a rule, or any tool with parallel edges, along the line of the plumb cut as shown in A to B in the illustration. Make a check mark at the point C. Square the back of the rafter from this check mark. Using the same tool, lay out the line D—E on the back of the rafter. Draw a line from A through D and you have the line of the cheek.—GLENN E. EDGERLY, Hallowell, Maine.

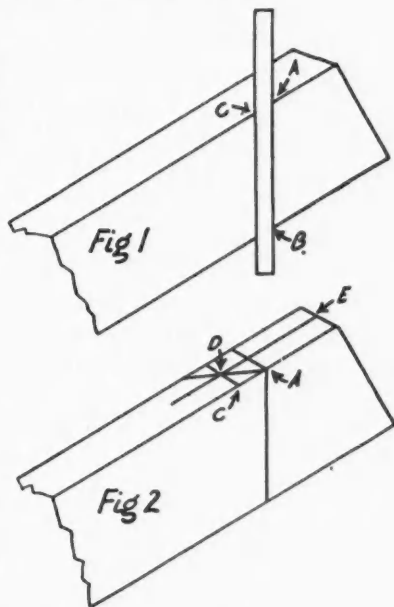

Here Is Illustrated a Simple and Practical Method of Finding the Cheek Cut on Jack Rafters.



## Waterproof Against Flooding

IN case it becomes necessary to apply waterproof mortar to a cellar floor which is continually flooding, with water rising to various heights, special care must be taken. If a concrete floor is already in place, it is necessary to make sure that the floor is strong enough to withstand the water pressure after being waterproofed. For every foot of depth the water stands outside it exerts an upward pressure of 62½ pounds to the square foot against the floor. Roughly, one foot of concrete will hold back two feet of water. For pressure over two feet, reinforce the concrete.

Assuming that the floor is sufficiently thick, dig a hole outside the cellar wall, about 18 inches deeper than the

cellar floor. If the cellar is a large one it may be necessary to dig another hole on the opposite side. Install pumps in these holes, thus drawing the water from the inside of the cellar. It will then be practical to proceed with the waterproofing in the usual way.—From *Practical Cement Waterproofing*, The Bitu-Mortar Waterproofing Co., 280 Madison Ave., New York City.



## Setting Up Large Studding

THE problem of setting up studding some of these for the corners being 6 by 6 inches and 22 feet long, was accomplished by securing the timber to the side of the drive wheel of the tractor by means of snubbing it close with a log chain.

The tractor first was driven to the proper position so that when backed the timbers would stand vertically in position to be set on the sill and braced until the top plate could be spiked to them. The smaller timbers for the wall of the building were raised five at a time in the same manner. After the corner posts and one center post had been erected and braced the plate was lifted to the tops of the posts as follows:

Two 24-foot, 2 by 6-inch timbers were attached one to the outer side of each of the drive wheels after the tractor had been placed at the proper position. The plate was then tied by means of ropes to the ends of these two timbers, it lying at right angles to them. When the tractor was backed so that the two 2 by 6 timbers stood vertical, the plate was in a position about 6 inches above the top of the posts. Workmen on ladders set against the braced posts then easily set the plate in place and spiked it.—GEORGE G. McVICKER, North Bend, Neb.

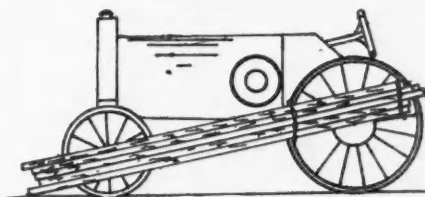

The Tractor Can Be Used to Good Advantage for Raising Heavy Studding Into Place Quickly and Without the Need of Other Special Equipment or Heavy Labor.

### Ceiling a Porch

THESE same ideas will work as well for ceiling a room. Suppose the porch is 20 ft. long, and the material is of random lengths. Take a strip of the material or any board more than 10 ft. long, hold it up against the joists and mark where they come. Do the same from the opposite end of the porch with another strip, then lap these and tack

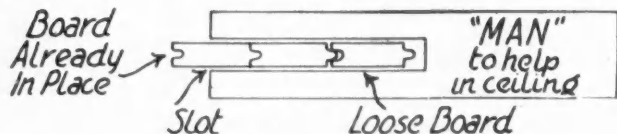

When Working Alone This System of Ceiling a Porch or Room with Wood Will Make the Work Much Easier.

them together. This gives you the location of all joists and the distance between the ends of any one of them. Have three or more horses to lay the measure and material on, then do all the measuring from the marked strip, keeping one or more strips marked and cut ahead all the time, so as to break joints easily.

You will get better joints if you cut them all in a mitre box.

To help you in putting the strips in place, make a "man"; that is, a piece of board say two inches wide and some 15 inches long with a slot cut out of the middle and open at one end. This will slip on over the loose board and onto the last one nailed and hold the loose one up so you can nail one end of it.—JOHN UPTON, La Fargeville, New York.

### Nailing Kinks

IT is the usual practice among carpenters to lubricate nails and brads with tallow before driving them into hardwood, but it is inconvenient to carry around a can of lubricant, especially when laying flooring. To overcome this inconvenience, a hole may be bored in the end of the hammer handle and this hole filled with tallow where it is always handy.

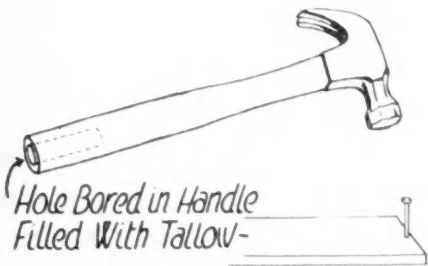

A Simple Idea for Nailing in Hardwood, But Not One That Is Familiar to Everyone Is This Tallow Lubricator.

When driving small brads very close to the end of a thin board it nearly always causes the board to split. This may be prevented by sharpening the brad to a chisel edge and driving it with this edge at right angles to the grain of the board.—W. J. EDMONDS, Whitehall N. Y.

### Working Kinks

OCCASIONALLY one runs onto a hard board which will not take a nail without splitting, especially on built-in work where Oregon pine is used. One always hates to go and get a drill for just one or two nails and I have found an easier way is to nip off the point of the nail and drive as if it was a soft wood board. In this way the nail cuts its way instead of splitting the wood.

Not long ago my oil stone had become hollowed out by use and I did not know anything to do with it except throw it away and get a new one till a fellow workman told me to rub it on a cement walk till it was ground off smooth. I expected this would be a slow job but was surprised to find that the cement quickly cut the oilstone down. In this

way it is easy to keep a smooth stone all the time.—O. G. DEXTER, Wilmar, Calif.

### Installing Window Weights

A MAN who had become old and feeble owned a house which was about 50 years old. He could hardly handle

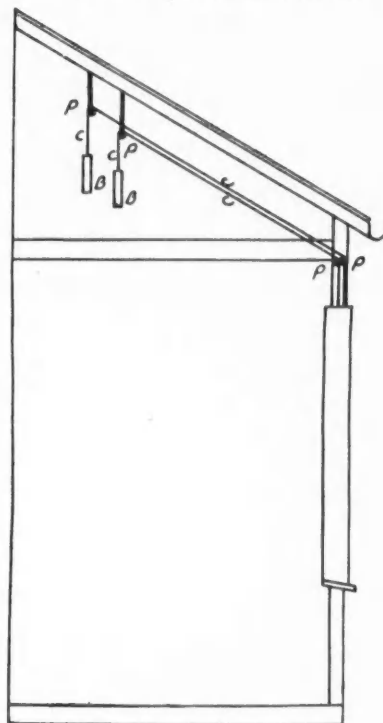

This Man Solved the Problem of Easily Handled Window Sash Set in Plank Frames Without Making the Cost Too Great.

the window sash which were set in plank frames and wished to have them equipped with weights so that they would be more easily handled. He also wished to have the work done as cheaply as possible. I was able to satisfy him by using this method.

I plowed the old sash for cords in the same way as is done for box frames, bored holes through the head of the frames and wall plate with a long  $\frac{3}{4}$ -inch bit, and cut holes to get in under the roof. I then placed pulleys and cords as shown in the drawing and the windows operated as well as those set in box frames.—S. H. BLASHINGHAM, Madison, Ind.

### Squaring Small Foundations

I HAVE a handy method of squaring up small foundations quickly. Three lines 20, 16 and 12 feet long are tied in the form of a triangle with a loop at each corner large enough to slip over the head of a single nail. Three

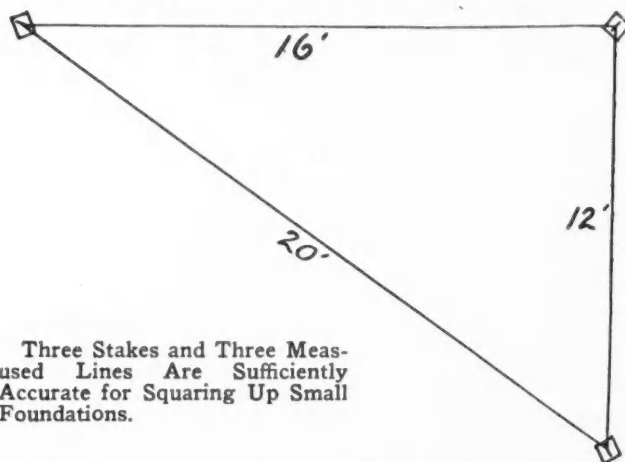

Three Stakes and Three Measured Lines Are Sufficiently Accurate for Squaring Up Small Foundations.

stakes, sharpened at one end for driving into the ground, are provided with shingle nails protruding from the blunt ends.

I first locate one corner, drive a stake and slip the loop between the 12 and 16-foot sides over the nail. I then stretch the 16-foot side along the proper line, drive a stake and slip the loop over the nail. Then I stretch the other side, and stake the other corner. This gives me a right angle corner sufficiently accurate for a small job and it is only necessary to measure from this corner and fix the other corners in the same way.—RUDOLPH EKSTROM, Farwell, Minn.

# Floors Sell Houses

A new and empty house! Floors in their unaccustomed bareness literally fascinate your prospect's eyes.

Don't show them dull and lifeless floors. Nor don't lead them over a glossy brittle surface that they tread gingerly for fear it will scratch.

Show them the mellow durable lustre of beautiful Waxed Floors.

## JOHNSON'S WAX *Electric floor Polisher*



Makes the *finest* finish in the world, the *easiest* to obtain. The wonderful new machine is a tool every builder needs. For all wood, linoleum and composition floors. Small, handy, a child can operate it. Imparts a burnished, durable lustre impossible by hand and does it five times as fast. Saves Time, Labor, Money—and makes floors that sell your houses.

### Special Offer to Contractors and Builders

For established contractors and builders we have a special money-saving offer. Clip this coupon to your letter-head or card, check what you want, and mail it NOW.

S. C. JOHNSON & SON,  
Dept. A. B. 11, Racine, Wis.

- Please tell me about your Special Offer to Contractors and Builders on the new Johnson's Wax Electric Floor Polisher.
- We also do our own painting and are interested in best net prices on Varnishes, Enamels, Stains, Wax, Wall Finishes, etc.

Name .....

Address .....

City..... State.....

# WHAT'S NEW?



**EDITOR'S NOTE:** *The AMERICAN BUILDER does not accept payment in any form for what appears in our reading pages. In order to avoid any appearance of doing so, we omit the name of the maker or seller of any article we describe. This information is, however, kept on file and will be mailed to anyone interested; address AMERICAN BUILDER Information Exchange, 1827 Prairie Ave., Chicago.*

## An Efficient Concrete Heater

**T**HE problem of pouring concrete in cold weather is always a serious one and some means of heating the material must be provided in order to keep the concrete from freezing before it sets. This is efficiently taken care of by means of a kerosene concrete heater, the operation of which is well demonstrated by the experience of one construction company which has three of these in regular use.

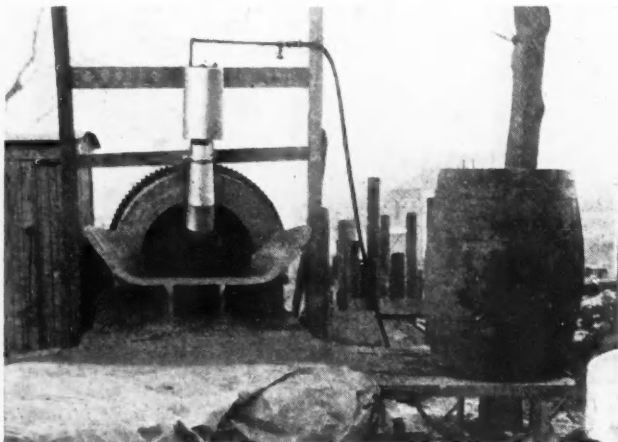

**Concrete Heater Installed on a Mixer.** In actual use this heater showed a great economy over the ordinary method of heating sand and gravel.

The heater is used on a  $\frac{1}{2}$  cubic yard mixer which has an average output of 14 cubic yards an hour with a 1-2-4 mix. Whenever the temperature falls below 40 degrees the heater is put into operation, requiring only 15 minutes for attachment. The flame plays directly into aggregate, as it is being mixed in the drum and the average temperature is raised to 65 degrees, which has proved satisfactory. No concrete is poured when the temperature is below 10 degrees.

The water used is heated to from 70 to 100 degrees in a boiler whenever the temperature is below 32 degrees in order that the water may not freeze before it gets to the mixer. None of the other materials are heated before being charged into the mixer drum unless, of course, the piles are frozen.

Before these heaters were adopted sand and gravel were heated by means of wood fires. The handling involved requires the

services of three men and the most amounted to \$15.00 per day. With the use of the heater the cost of heating amounts to \$2.90 per day. This includes depreciation, interest, repairs, labor and fuel. Depreciation is figured on the basis of three years' life because of the rough handling involved in handling construction equipment and moving it from job to job. The main item of repair is a new hose each year.

When mixers are not operated continuously during the day the heaters are turned off while the mixers are not running. The average amount of fuel consumed in a 10-hour day by one burner is ten gallons. These heaters are used about 60 days per year and the cost of heating is 6 cents per cubic yard. After deducting the cost of operating the heater from the labor cost of the old method, the saving amounts to \$12.01 per day and in a year totals \$720.60 for each heater.



## Woodworker with Power Take-Off

**O**NE of the most highly portable, flexible and economical wood working machines on the market is designed as an automobile trailer and takes its power from the same car which is used in moving it from place to place. The outfit is made throughout of the best materials, but is not an expensive piece of equipment. It has been thoroughly tested out and proven to be a money and labor saving investment.

The machine is carried on two pneumatic tired wheels and the truck is of heavy wood construction. When the wood worker is to be used it is a simple matter to drop the trailer, slip the take-off beneath the rear axle, press down on two levers and apply power from the car. No tools or adjustments are required and it is a one man job. It will operate from the wheels of any car and the average car will deliver eight to ten horsepower more than is needed to operate the wood worker to its maximum capacity.

The wood worker has a cast iron frame in two pieces to insure rigidity. The saw table is a separate unit, solidly built, hinged at one end and with screw device for adjusting depth of cut. It has a milled groove for the mitre cut-off gauge and is fitted with cast iron rail.

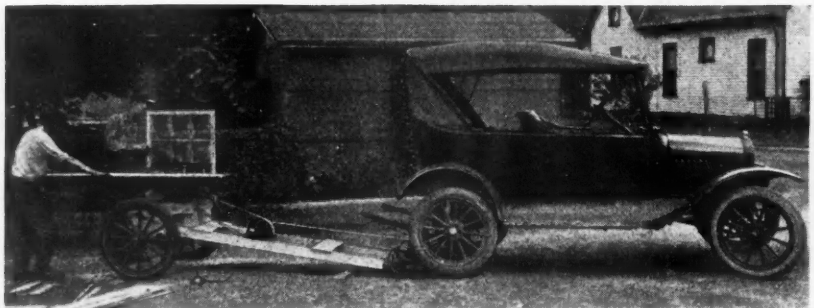

**This Woodworker, in Operation as a Groover, Is One of the Most Portable and Economical Machines Offered to the Builder.** It will take its power from any type of car.

# Send 75c for These Six Books

Brick homes are easiest to sell. People prefer the permanent beauty of brick—its lack of painting and repairing. They know that a brick home has highest resale value.

Feature 100% brick homes — brick foundation walls, side walls, fireplace and chimney. Send 75c for these six books—ask for the new folder "Hollow Walls of Brick." It's free.

## All for Only 75 Cents

Two plan books showing 120 brick homes in picture and plan — "Your Next Home" and "The Home You Can Afford." All practical designs by prominent architects, actually built and lived in. Working drawings for each home shown as low as \$10 a set.

"Brick, How to Build and Estimate" is an illustrated hand book on brick construction, giv-

ing details of wall construction, tables of materials and other useful information. (25c.)

"Brick Silos and How to Build Them" is a bargain at 10c, as is "Farm Homes of Brick" at 5c. "Skintled Brickwork" shows those rough texture walls you've heard so much about. Dimension details for seven effects in this 15c book.

## Free Folder on Hollow Walls

Lower cost brick hollow walls, using fewer brick and encouraging faster work, are described and pictured in a new 24-page folder free on request. Keep in step with progress in brick. Just ask for your copy.

We have hundreds of requests for names of good masonry contractors. If you'd like us to refer prospective builders to you send us your name and address and a brief outline of experience for our reference file.

**The Common Brick Manufacturers' Association of America**  
2131 Guarantee Title Building  
CLEVELAND

Chicago.....	Chamber of Commerce Bldg.
Denver.....	1735 Stout St.
Detroit, Mich.....	400 U. S. Mortgage Trust Bldg.
Hartford, Conn.....	226 Pearl St.
Los Angeles.....	342 Douglas Bldg.
Nashville, Tenn.....	804 Harry Nichol Bldg.
New Orleans, La.....	904 Carondelet Bldg.
New York City.....	1710 Grand Central Terminal Bldg.
Philadelphia.....	City Centre Bldg.
Portland, Ore.....	906 Lewis Bldg.
Salt Lake City.....	301 Atlas Bldg.
San Francisco.....	811 Sharon Bldg.
Seattle, Wash.....	524 Burke Bldg.
Springfield, Mass.....	310 Tarbell-Watters Bldg.



Highest Resale Value - Beauty in Brick is Permanent

**The 100%**

No Painting or Repairing - Almost no Depreciation

# BRICK HOME

The Common Brick Manufacturers' Association of America,  
2131 Guarantee Title Building, Cleveland, Ohio.

Enclosed find ..... cents. Please send me the books marked below.

"The Home You Can Afford" (10 cts.)  
 "Your Next Home" (10 cts.)  
 "Brick—How to Build and Estimate" (25 cts.)  
 "Farm Homes of Brick" (5 cts.)  
 "Brick Silos and How to Build Them" (10 cts.)  
 "Skintled Brickwork" (15 cts.)  
 FREE: 24-page folder "Hollow Walls of Brick and How to Build Them."

Name .....

Address .....

### A New Two to Three Bag Mixer

A NEW "two to three" bag concrete mixer has been placed on the market. The new machine is not an addition to the line, but represents the company's latest development in concrete mixers of this size.

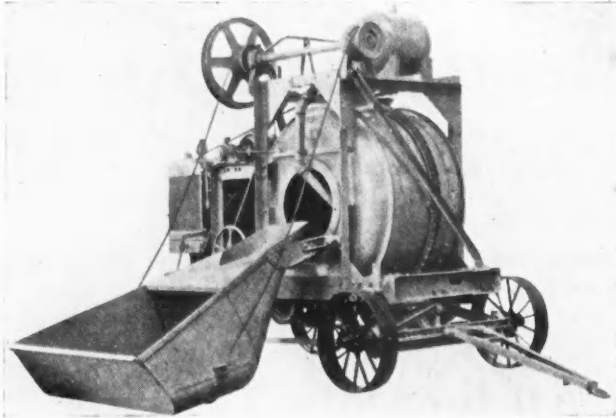

**A New Two to Three-Bag Mixer Which Represents the Latest Development in Mixers Announced by a Well-Known Mixer Manufacturer.**

Synchronized action between charging skip and discharge chute, which means the machine can discharge concrete while the skip is charging the drum with fresh aggregates, and bigger mixing blades and buckets to get material into and out of the drum openings are among the new features. It also has an improved countershaft, which is self-adjusting, and equipped with an automatic clutch knockout for the charging skip. The countershaft itself is mounted on self-aligning bearings; a ball and socket arrangement which easily adjusts itself to shaft misalignments caused by working on uneven ground. The automatic clutch knockout is so arranged that when the loaded skip reaches its proper discharging height, the clutch is disengaged and a brake automatically set. This feature relieves the operator and allows him to devote all his time to discharging, thereby taking full advantage of the synchronized action.

The skip is built on the stream line principle. The discharging of the material can be operated from either side of the mixer through a geared discharge mechanism with a large handwheel. A quick turn of the handwheel puts the chute in discharging position. A new short compact chassis, with automobile type steering knuckles, was designed for great strength and easier portability. Power consists of a 15 H.P., 4 cylinder LeRoi gasoline engine.

This new model was actually turned over to a contractor for hard usage for more than a year before being placed on the market.



### Luminous Light Switch Plates

THE difficulty of finding electric light switches in a dark room, especially in unfamiliar surroundings, has created a demand for a practical luminous device, of attractive appearance which will point the way to turn on the light.

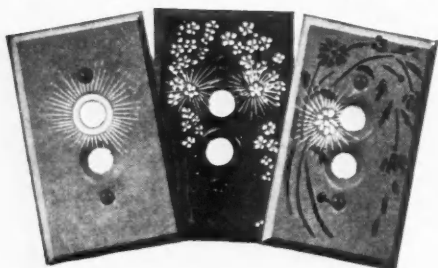

**These Luminous Light Switch Plates Are a Great Convenience Which Is Available at a Very Small Cost.**

Luminous switch plates are now available which solve this problem. They are made in six different types, in a variety of colors to match any dec-

orations, and in plain and flowered designs.

These plates can be attached in the place of any existing switch in a few moments' time by the use of a screw driver. They retain their color indefinitely and require no polishing as do brass plates. If the color scheme of the room is changed they can be changed to match.

They are illuminated with a high grade radium material which glows in the dark and instantly shows where to turn on the light.



### A New Flush Receptacle

A LEADING manufacturer has announced the new 30 Ampere Polarized Flush Receptacle, illustrated herewith. The body of this receptacle is of rugged construction and is made throughout of a special black porcelain, the face of which is finished with a clean black glaze. Supporting lugs are of heavy metal, and have mounting holes suitably spaced to fit a standard two-gang outlet box 2 inches deep or over. Terminal springs are of heavy phosphor bronze, and entrance slots, to receive cap blades, are arranged to prevent the reversing of polarity.

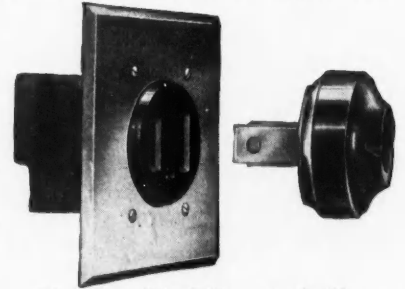

**The New Flush Receptacle Shown Here Has a Number of Improved Features.**

The cape is made of black porcelain with clean black glazed surface. Cord hole of suitable size to take cords up to  $2\frac{3}{32}$  inch in diameter. Binding screws are extra large and are protected by insulating disc which fits down over the blades, completely closing in the wiring terminals. Contact blades are of heavy gauge copper.

Plate is of .060-inch brass of standard two-gang size,  $4\frac{1}{2}$ -inch by  $4\frac{9}{16}$ -inch. Standard finish is brush brass.



### Rafter Cutting Mitre

A RAFTER mitre, which makes laying out rafters as simple as marking studding, is being put on the market by its inventor.

The tool automatically and accurately gives every angle of any roof, no matter what its pitch is. By inserting a pin in a certain hole designed for the rise in inches of foot of run it brings the arms into correct position to form the correct angle for plumb cut, side cut and seat cut. By inserting the pin in any of another series of holes one gets the proper angles for plumb cut, side cut and seat cut of common or jack rafter.

This tool also gives the proper angles of cuts on sheath-

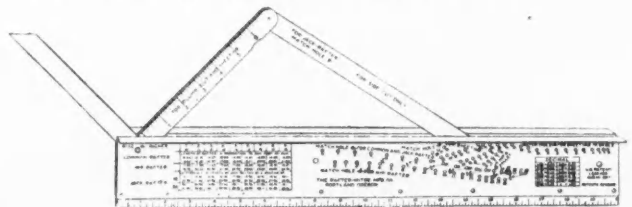

**Here Is a Mitre Which, It Is Said, Makes the Proper Cutting of Rafters a Simple Mechanical Operation.**

ing for hip or valley roofs, the exact cut of sheathing in gables and the correct angle following the rafter lines in the gable. To obtain the length of any rafter it is only necessary to refer to the table on the left-hand side of the tool, find the proper rafter and proper pitch and multiply this figure by the run of the building. The product is then shown in inches.

# CARNEY

*for Brick and Tile Mortar*

## BUILT BY THOMAS JEFFERSON

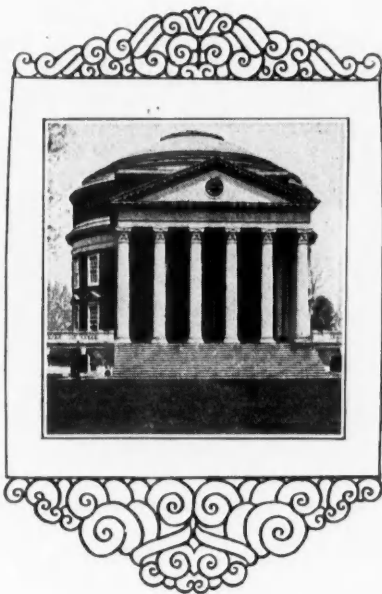

LIBRARY OR ROTUNDA,  
University of Virginia,  
Charlottesville, Va.  
Planned and built by  
Thomas Jefferson  
in 1826

WHEN Thomas Jefferson planned the building at the left, he had more in mind than the fulfillment of a timely need—to him this meant the beginning of a great and permanent culture. Today the University Library of Virginia, or Rotunda, still stands—a beautiful tribute to the far sighted confidence of a noble man.

Little wonder that today, Virginia folk take pride in their University. Little wonder that every forward step in its development and expansion is guided by cherished ideals.

The Gymnasium below is the most recent addition, and well worthy of its predecessors. All the brick, tile and terra cotta in this building was laid up in Carney.

*Carney is the perfected cement for brick and tile mortar.*

## THE CARNEY COMPANY

*Cement Makers Since 1883*

MANKATO, MINNESOTA

Mills at [ Mankato, ] Minn.  
                  [ Carney, ]

DISTRICT SALES OFFICES: Leader News Building, Cleveland; Chamber of Commerce Building, Chicago; Omaha National Bank Bldg., Omaha; Syndicate Trust Building, St. Louis; Book Building, Detroit; Builders Exchange, Minneapolis.

*Specifications: 1 part Carney to 4 parts sand.*

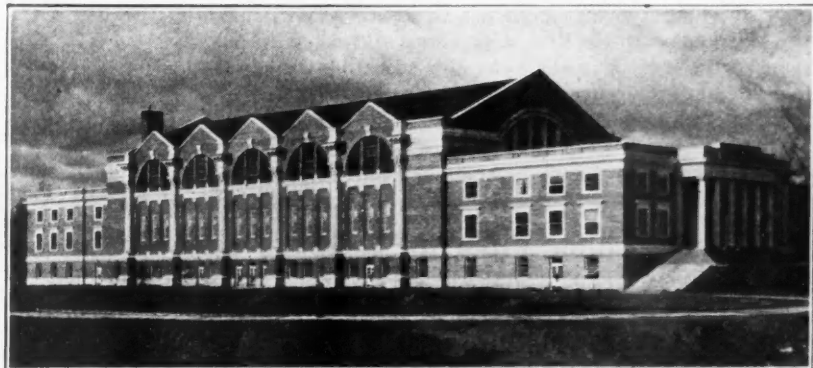

GYMNASIUM BUILDING, University of Virginia,  
Charlottesville, Va.

Architects: John Kevan Peebles, Walter D. Blair,  
R. E. Lee Taylor, Fiske Kimball, William A.  
Lambeth, Architectural Commission. Fiske Kim-  
ball, Supervising Architect.

Contractors: King Lumber Co., Charlottesville, Va.

*All brick, tile and terra cotta laid up in Carney*

### Inserted Tooth Saw and Groover

**A**N improved saw in which the inserted tooth principle is employed for the production of grooving, molding, heading, tenoning, has been developed by a well known manufacturer. The teeth, of special high-speed tool steel, are locked in sockets arranged spirally in the blade and any tooth can be inserted or removed in a moment. Teeth may be had with any form of cutting edge, so that by choosing the proper tooth any desired shape or size of groove or slot can be cut. This enables the user to build up a saw for his special requirements or the work in hand and to change it at will.

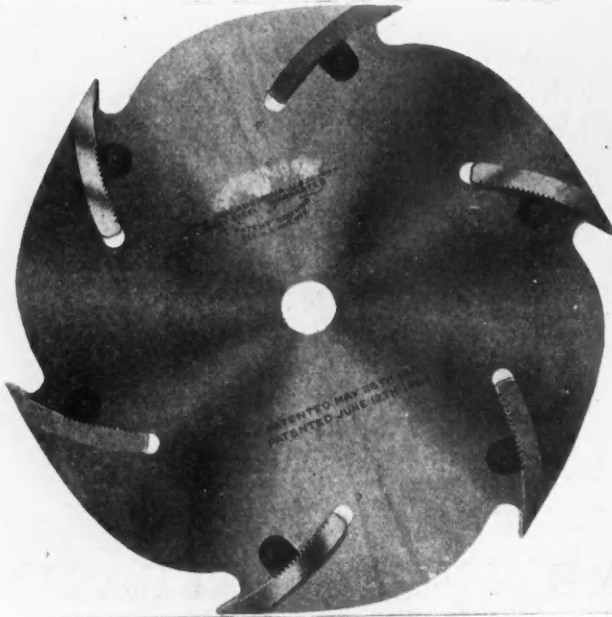

The Very Latest Thing in High Grade Saws Which Gives a Wide Variety of Uses.

The teeth are set in the blade to provide clearance without swaging or setting. This insures that regardless of the amount of wear they will always cut the same width groove. Wear on the teeth is compensated for by moving the teeth outward  $\frac{1}{16}$  inch or  $\frac{1}{32}$  inch. A rack cut in the tooth fits a special lock and provides exact adjustment without troublesome measurements.

With this type of saw, a tooth of such hardness and toughness can be used that when sharpening is necessary it is not filed but touched up in the saw with a whetstone or removed and sharpened on a grinding wheel. Nothing is touched but the teeth in sharpening or adjusting them and their width and clearance always remain the same. The blade never changes in diameter as it does when an old style saw is sharpened. New teeth, or teeth of a different pattern can be inserted without removing the saw from the mandrel.



### Colored Rubber Flooring

**T**HE interior of various institutions such as churches, hospitals and other public buildings can be greatly improved in appearance as well as from an economical and healthful standpoint, by the installation of non-destructible rubber flooring. This flooring, of inlaid blocks, comes in strips as wide as 72 inches and of any length desired. The sheets are continuous without any insanitary seams and can be laid without cement and without the aid of expert labor.

There are four thicknesses,  $\frac{3}{16}$ ,  $\frac{1}{4}$ ,  $\frac{3}{8}$  and  $\frac{1}{2}$ -inch, and 13 standard colors. The block or tile effect can be obtained by combining any of the plain colors and the border may be



For Churches and Other Public Buildings This Colored Rubber Flooring Has Many Advantages Beside Its Fine Appearance.

of a still different color. Blocks may be had in any size over eight inches. Pieces can be furnished with or without block design to fit any step or staircase, without brass nosings, as the edges are beveled to prevent tripping.



### A Light Efficient Steel Roof

**T**HE ideal roof should be, primarily, waterproof, fire-resistant and permanent. On the other hand, as it has nothing to carry but its own weight and occasional loads of snow, lightness should be counted as a salient feature for the lighter the roof the less weight the building has to carry, which means a saving throughout the entire structure. Roofs should also afford a high degree of insulation to keep heat in or out according to the weather conditions.

A roof which is highly efficient in all these points is designed on an entirely new principle. The complete unit consists of three component parts. There is a steel supporting member fabricated by a special process. This is a permanent light roof deck reinforced by closed triangular ribs, each rib a complete girder beam. It is built in sheets of various lengths to form a continuous roof surface.

This fire resistive supporting member is insulated with any standard, pressure resisting, insulation material, over which may be applied any standard, built-up, bituminous waterproofing, which affords outside fire protection.

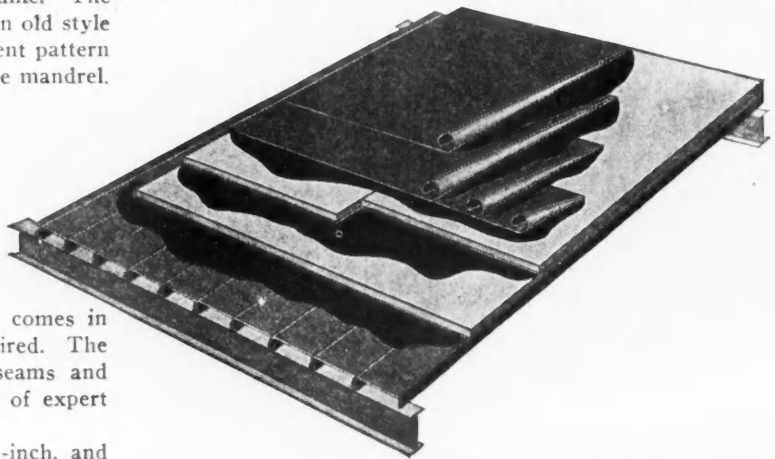

An Exceedingly Light but Efficient Type of Steel Roof Developed on an Entirely New Principle.



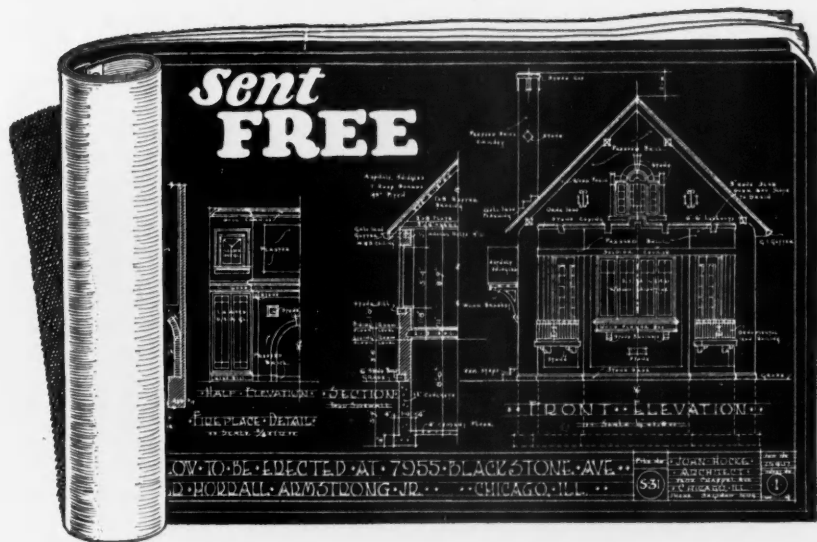

**Mail the coupon for Blue Print Plans and 24-page Book:**

**“How to Read Blue Prints”**

Blue Prints are interesting to every man in the building trades. And more! They are the key to every builder's success. For until you can read and understand blue prints you will probably have to be satisfied with only a scale wage. The man who can read blue prints can become foreman, superintendent, or have a business of his own. To help every man who really wants to make money and get ahead in building, Chicago Technical School for Builders offers absolutely free these Blue Print Plans and a 24-page book “How to Read Blue Prints.”



**You Can Become a Building Expert**

**Plan Reading.** Every man who has got very far ahead in any building trade can read blue prints. No man can expect to be a first rate foreman or superintendent until he knows what every line on a plan means and how to lay out and direct work from the architect's plans. By the Chicago Tech. Method you quickly learn to read any plan as easily as you read these words.

**Estimating.** Of course a man who wants to be a contractor or to hold a big job in a contracting organization must know how to figure costs of labor, material, and everything else that goes into any kind of building. The Chicago Tech. Course covers every detail of this important branch —shows you just how it is done from actual blue print plans.

**Superintending.** How to hire and direct men, how to keep track of every detail of construction as it goes on, how to get the work done in the least time at the lowest cost is also fully covered in the Chicago Tech. Builders' Course.

Also special courses in Architectural Drafting for builders, taught by practical men. These explained in Special Catalog “D” sent on request.

**What this book is**

This book is written by an expert ... a practical builder who knows the game from top to bottom. It tells how different materials are shown on blue prints, how “sections” and “elevations” are shown on plans, how to lay out a building from a plan, how to take off quantities ... and all the other interesting and important facts regarding blue prints. The book is as easy to read as your newspaper ... written in plain, everyday English that everyone can understand. “How to Read Blue Prints” will be mighty helpful to you. Aside from the real help it gives you it will show you how clear and plain and easy the Chicago Technical Builders Course is ... how quickly you can learn in your spare time .. at home ... to become a building expert.

**Learn at Home to make more money**

For 20 years the Chicago Tech. School for Builders has been training men to advance and make more money in building. Hundreds of successful men, superintendents

and contractors, owe their success to their Chicago Tech. training. We train you by mail ... in your spare time ... at home.

**Send the Coupon ... Now**

With the free Blue Print Plans and our book “How to Read Blue Prints” we will send you another book ... also sent absolutely free. It tells all about the Chicago Tech. Builders course ... directed by practical building experts ... tells what others say this course has done for them ... shows pictures and gives all the facts about our method of training men ... quickly ... for the jobs that pay most money. This may be your golden opportunity. It costs you nothing to find out all about it. So send the coupon in now ... for the free plans and books.

**Mail the Coupon—NOW**

**CHICAGO TECHNICAL SCHOOL FOR BUILDERS**  
 Dept. 1136, Chicago Tech. Bldg.,  
 118 East 26th St., Chicago, Ill.

Please send me your Free Books and Blue Prints for men in the Building Trades. Send postpaid to my address below.

[Write or print name plainly]

Name.....  
 Address.....  
 City..... State.....

**CHICAGO TECHNICAL SCHOOL FOR BUILDERS**  
 Dept. 1136, Chicago Tech. Building, 118 E. 26th St., Chicago, Ill.

### Versatile Sander and Grinder

**A** VERSATILE belt sander and grinder which is available at small cost is characterized by its portability and instant readiness for quickly putting a straight grain finish on metal, wood, fibre, bone, celluloid, bakelite or almost any material. It saves much time and energy and gives an even true finish. One reason for this is the flat metal bed under the belt which serves as firm backing, preserving the straight lines and sharp edges. This is especially true when the table is used as a stop which

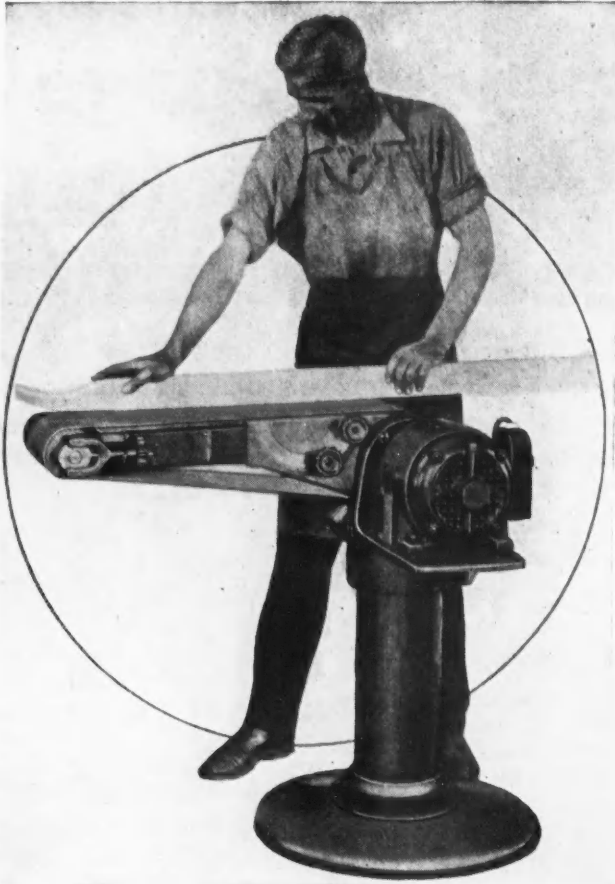

**A Most Versatile Belt Sander and Grinder, the Table of Which May Be Used as a Stop to Allow Grinding and Squaring at One Operation.**

allows surfacing one side and grinding it square with another at one operation.

By adjusting the angle gauge and the table, compound angles may be positively and quickly obtained. The universality of this machine is increased by an uncommon feature, which is the ability to easily change the position of the bed from horizontal to vertical and back again in two or three minutes' time. The belt slips easily on and off without removing anything but the upper guard.

Ample power is supplied by a continuous rating motor and the drive coupling is guaranteed against breakage. Strength and rigidity are secured from the simple, well-balanced design. These machines are made in two sizes with grinding belts  $6\frac{1}{4}$  inches by 18 inches and  $10\frac{1}{2}$  inches by 23 inches.



### Smokeless Soft Coal Burner

**A** NEW round smokeless boiler burns soft coal without smoke or soot and makes this cheap type of fuel available for the home without the disadvantage of dirt which is usually associated with it. This boiler is simple, requiring no special skill for operation, merely feeding, shaking and

removing of ashes. The fire is made as in any other boiler, the air entering the bottom shaft through the ashpit door and working up through the coal produces the ordinary combustion of coking which liberates the gases and other products of combustion.

It is here that the hot blast of super-heated air gets to work and, raised to a minimum temperature of 800 degrees, unites with the liberated gases, smoke particles, etc., and produces a blue-white flame of great intensity. The result is that instead of the flues being covered with soot, all exposed surfaces of this boiler become and remain prime heating surfaces.

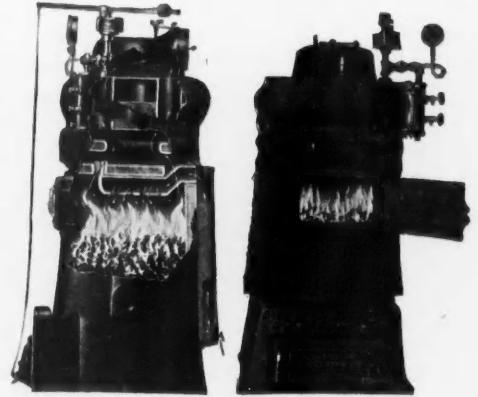

**Two Views of a New Boiler Which Permits the Use of a Soft Coal for House Heating Without Smoke or Soot.**



### A New Plumbing Fixture

**A** NEW and popular plumbing fixture is the bidet pictured herewith, which is now considered indispensable in better class homes, as well as those public buildings where women's rest and toilet rooms are a feature. It is a great contribution to comfort, cleanliness and hygiene.

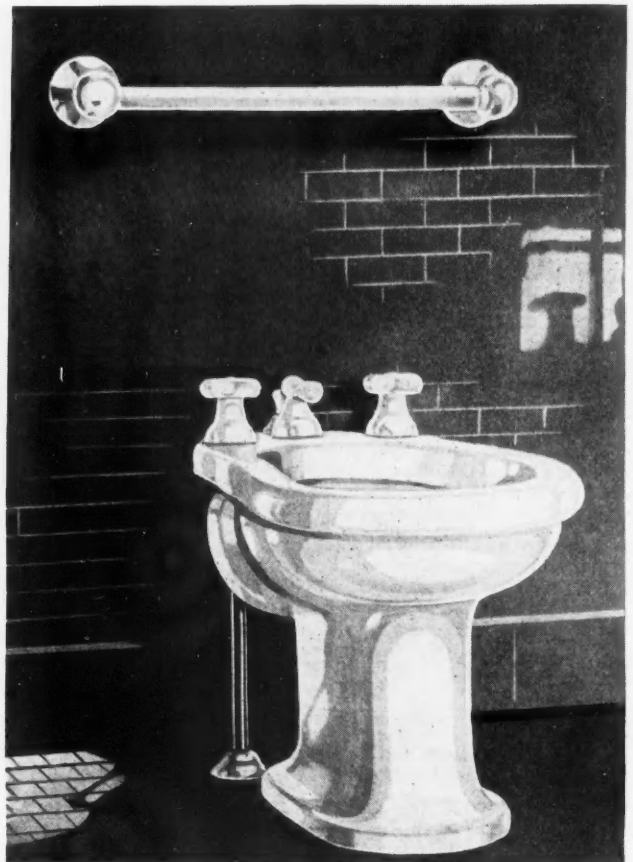

**An Institution of the Bidet Showing How Perfectly It Fits with the Finest Fixtures in Addition to Being an Extremely Practical and Sanitary Fixture Itself.**

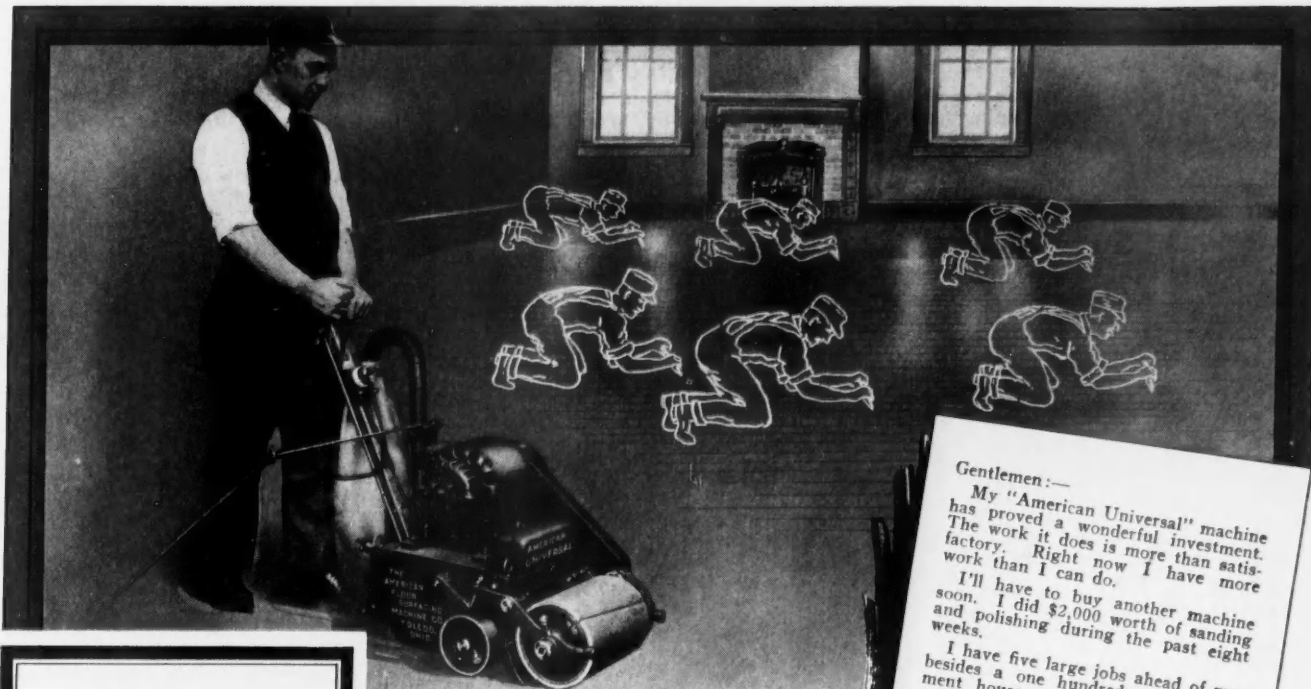

## 6 Reasons Why It Will Make Money for You

- 1—Saves the wages of four to six men scraping by hand.
- 2—Saves costly labor turnover by keeping your organization together the year around.
- 3—Makes each man an individual producer.
- 4—Increases volume of work, making possible more rapid turnover of capital.
- 5—Produces perfect work—sanding down floors as smooth as a table-top.
- 6—Low maintenance costs—low labor costs.

# Thousands of Dollars made by "American Universal" owners

Contractors everywhere in the United States have realized the opportunity opened to them by the use of the American Universal Floor Surfacing Machine to actually add thousands of dollars a year to their incomes. It not only makes them big money during the busy season, but adds greatly to their profits during the slack, winter months.

Any contractor without an American Universal Floor Surfacing Machine is increasing his payroll by six men

each day he pays his men for scraping floors by hand.

Think what it means to your payroll over a period of a year, and what it would mean in profits over the same year if you owned an

## American Universal FLOOR SURFACING MACHINE

### Not Only New Buildings, but Old Buildings

must have their floors resurfaced. You are the logical man to handle this business. With your acquaintance and knowledge, and an American Universal you can secure enough business to keep the money rolling in the year 'round.

#### WRITE US FOR FREE DETAILS

and full particulars regarding the wonderful, money-saving, profit-building possibilities "American Universal" machines offer to the live contractor and builder. Have us send you descriptive literature and letters from dozens of enthusiastic users.

**The American Floor Surfacing Machine Co.**  
515 South St. Clair Street Toledo, Ohio

Gentlemen:—  
My "American Universal" machine has proved a wonderful investment. The work it does is more than satisfactory. Right now I have more work than I can do.  
I'll have to buy another machine soon. I did \$2,000 worth of sanding and polishing during the past eight weeks.  
I have five large jobs ahead of me, besides a one hundred room apartment house, a church, and several smaller jobs. It looks like my "American Universal" will be kept three days and night for the next three weeks.  
There is \$10,000 a year in an "American Universal" if the man has the "guts" to work it out—and that's just what I'm doing.  
**C. M. DICKENS,**  
198 Ocean View Ave.  
Norfolk, Va.



## Send for this Folder To-day



The American Floor Surfacing Machine Co.  
515 So. St. Clair St., Toledo, Ohio

Gentlemen:—  
I want to know how I can make more money with the "American Universal" Floor Surfacing Machine.

We do our own floor surfacing work.  We sublet all our floor surfacing.

Firm Name.....  
Address.....  
City..... State.....  
My Name is.....

### Garage Door Controller

ONE pull will open both of the garage doors when they are equipped with a new garage door controller. It is merely necessary to grasp the handle and pull back on one door. After this door is about half way open the other door

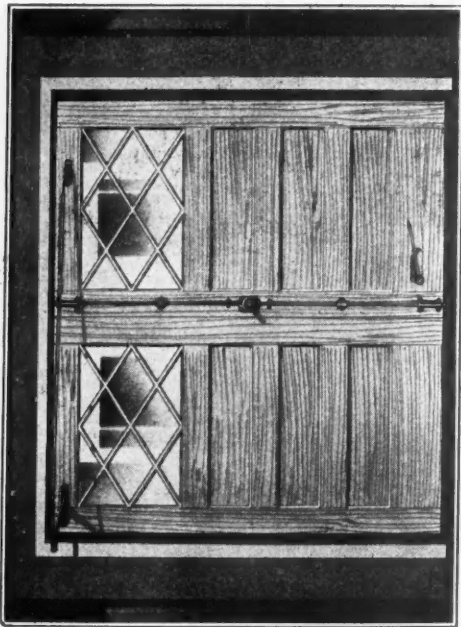

This Garage Door Controller Makes It Much Easier to Handle the Large Swinging Doors Either When Both Are Opened or When One Merely Wishes to Enter the Garage.

starts to swing. When both doors are open a door dog holds them firmly in place with no danger of smashing fenders or breaking headlights. It is not necessary, however, to open both doors to gain entrance to the garage. One door will open wide enough for a person to enter before the movement of the other door starts. When the doors are closed there is always a slight spring pressure on them which holds them tight. When an astragal is used on one of the doors overlapping the other one, it is only necessary to lock one door and the other is also locked in place. The locking bolt is on the inside of the garage, but is operated from the outside. The handle on the outside is arranged so that it can easily be padlocked. The controller is adjustable for any width opening from 7 feet to 9 feet wide.



### Effective Friction Door Catch

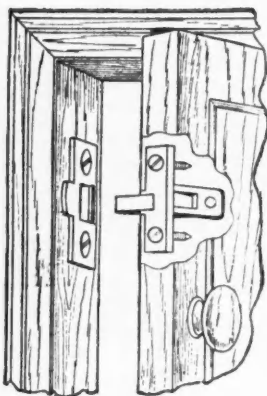

Friction Catch Suitable for All Types of Doors Up to 1 3/4-Inch Thickness.

AN economical, durable and efficient friction catch is especially designed for application of cupboards, closets, wardrobes, refrigerator doors or any other hinged part. It is made in two sizes, the smaller adapted to doors from 3/8 inch to 1 1/8 inch thick and the larger size for doors 7/8 inch to 1 3/4 inch thick. The former is for small doors in cupboards, medicine closets, cabinets and common refrigerators, while the larger is for wardrobes, case-ment windows, screen doors and warped front doors.

This catch prevents the warping of new doors and doors already warped are, by its action, drawn back to normal. It prevents rattling and the entrance of dust by holding the doors tightly closed. It also remains effective after the door has shrunk considerably. It is made of bronze metal and is very easily applied.

### Cedar Plaster for Closets

A NEW method of making closets mothproof and insect and vermin repellent will be of interest both to those who contemplate building new homes and those who merely wish to improve their old homes. This method consists of the application of a special type of plaster which is a patented composition of plaster with aromatic red cedar and with a cedar odor which is, according to the manufacturers, more pungent than that of the original red cedar wood.

This plaster can be applied over any plastered surface, either old or new, in the same manner as for applying ordinary wall plaster. It comes complete in sacks and when clean water is added in the right proportion is ready for use. The cost of this coating for a closet is said to be about one-fourth of the cost of cedar wood lining and very little more than ordinary plastering. The result is as effective as a cedar chest and also possesses the advantage of being dust-proof.

When applied this material makes a beautifully finished wall with a strong and permanent cedar odor which acts as a deodorizer as well as moth and vermin repellent. No stain or paint should be used over it because it will destroy or reduce the strength of the cedar odor. It is applied on new work, over the first or scratch coat of ordinary plaster, 3/8 inch thick and trowelled smooth. One sack will cover a surface of 126 square feet (14 square yards).



### Sanitary Bakelite Seats

TOILET SEATS, made all in one solid piece of molded bakelite under a pressure of 500 tons per square inch, thus insuring them to be non-breaking, non-warping, non-cracking, non-discoloring and non-inflammable, are one of the newest improved products for making the modern home more comfortable, sanitary and attractive. These seats are made with a permanent color which will successfully resist acids or disinfectants and so preserve their fine appearance indefinitely.

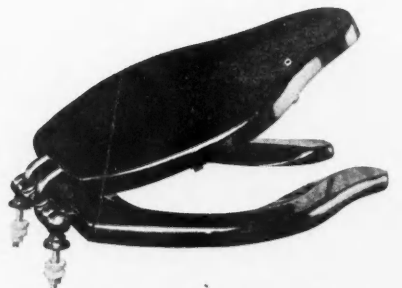

These Bakelite Seats Are Made in Two Styles. This is the open type and both styles are furnished with or without covers.



Here Is the Ring Type Seat. These seats have hinges of the same material as the seat itself.

They are made with a hinge of the same material as the seat itself, replacing the metal hinges which require polishing and are likely to rust and become unsightly. They are made in standard colors, ebony and mahogany, and in sizes to fit the present standard bowls and are a guaranteed product. They may be obtained in either the ring type, or in the open type and with or without covers. The material of these seats, bakelite, is one which makes possible the highest degree of sanitation.

It is just as important to have *per-*  
*manent* conductor pipes, eaves-troughs,  
gutters, and roofs, as to have perma-  
nent foundations, side walls, and floors.

And you can—with Horse  
Head Zinc.

Zinc equipment will last a life  
time. It requires no attention and no  
replacement. It is artistic as well as  
practical and its first cost, figured  
over the years of service it gives,  
makes it by far the most economical  
metal you could use.

**The New Jersey Zinc Company**

*Established 1848*  
*Products Distributed by*

**The New Jersey Zinc Sales Company**

160 Front Street, New York City

CHICAGO • PITTSBURGH • CLEVELAND • SAN FRANCISCO





## American Delegates Report

**M**EMBERS of the American delegation appointed by Secretary Kellogg to attend the Fourth International Congress of Building and Public Works, held at Paris, France, on arriving in New York, outlined the benefits which builders of small homes in this country may expect to obtain from a world-wide movement initiated at the conference.

Bankers of the forty countries represented at the conference are to be asked to devise a means of supplying prospective home owners with a safeguarded form of investment security that will be sound, elastic and more liquid than the present form of security applied to building operations.

The entire movement, in which the strength of the International Chamber of Commerce has been enlisted, is inspired by the expressed belief of the 760 delegates to the conference that, under present general banking practice, only a limited amount of the savings and thrift accumulations of those who desire to build homes are made available over a protracted period, for building purposes.



## New Le Roi Company Plant

**T**HE new, modern plant of the Le Roi Company, at Milwaukee, Wis., is one of the largest in the country devoted exclusively to the manufacture of small gasoline engines. Le Roi Company manufactures only gasoline engines in sizes 1, 2 and 4 cylinders ranging in horsepower from 3 to 15.

This new, spacious plant is most modern and is outstanding for its complete and thorough lighting features. It is equipped with the best of manufacturing facilities, all



**This New, Modern Plant of the Le Roi Company, at Milwaukee, Wis., Is Devoted Exclusively to the Manufacture of Small Gasoline Engines.**

tending to work harmoniously to maintain the same high standard of engines that Le Roi is known for.



## Power Take-off Effects Economy

**T**HE Wichita Union Stock Yards Company has developed a most satisfactory means of utilizing a power take-off on the truck which is employed in disinfecting and

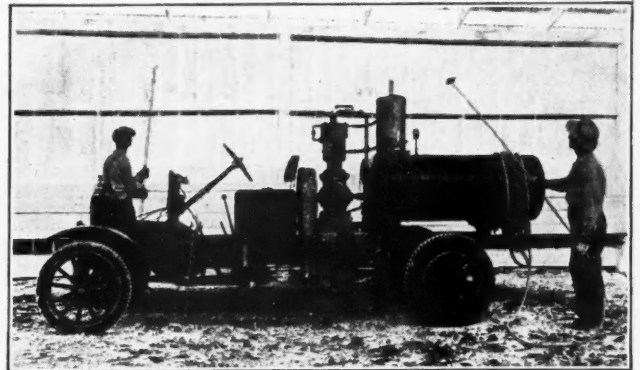

**Equipped with Air Compressor and Two Tanks This Truck Is Ready at All Times to Do Quick Work in Disinfecting Stock Yards Pens or to Apply Paint to Preserve the Various Structures in the Yards.**

sanitary work and combining this with a spray painting unit. The power take-off is installed on a Ford truck, on which are mounted two 100-gallon tanks, one containing paint and the other disinfecting fluid. It operates a large air compressor which is used in connection with either tank.

This truck is kept busy most of the time applying paint to preserve the surfaces of buildings, fences and equipment about the yard but it is ready at any moment to respond to a call for disinfecting work. This is necessary because whenever a load of infected stock is received the government inspectors shut down operations until all pens and passages through which they have passed have been treated. With the new equipment this requires less than 30 minutes while in the past the shutdown often lasted half a day. This has already effected a substantial saving to the company.

It usually takes the truck about five to ten minutes to get on the job when a call comes and after the disinfecting work is completed it is back at its regular job of painting with little loss of time.



## Making Disston Saws and Tools

**M**R. S. HORACE DISSTON, vice-president in charge of sales of Henry Disston & Sons, Inc., Philadelphia, addressed the Purchasing Agents' Association of Pittsburgh at its regular meeting and dinner September 15 and exhibited a three-reel motion picture showing how Disston saws, tools and files are made.

The film showed the various operations from the pouring of the special steels used in the manufacture of Disston saws and files to the polishing and inspecting of the finished products, and concluded with a passing in review on the screen of the hundreds of different tools made by Disston, ranging from the finest jeweler's files and delicate surgical saws to the huge bands and discs of steel that slice the redwoods of the Pacific coast.

## Reducing Operating Costs

John F. Rahn, general contractor of East Chicago, Ind., has used Fordson power for three years hauling supplies to his various jobs, and states that it has effected many reductions in his operating costs. Other contractors using Fordson power have had the same experience, and many utilize it still further to carry on the work of hoisting, excavating, and various other power operations.

Before estimating on your next contract, plan to see your nearest Authorized Ford Dealer and secure from him reliable figures covering the various uses of Fordson power in building operations.

*Fordson Tractor \$495 f. o. b. Detroit*

*Ford Motor Company*  
Detroit, Mich.



# Fordson

# "HOLT BID"

*Another Big, New Unit Added to the Radford Organization*

**William A. Radford Now Heads the HoltBid Service Company and with A. W. Holt Forms a Big, New Organization to Make This Marvelous Method of Estimating Available to the Building Industry**

By **JOSEPH D. EDDY**

**W**ILLIAM A. RADFORD now heads the Holt-Bid Service Company, of Minneapolis, and has moved the HoltBid Service Organization to Chicago. A. W. Holt, who developed the HoltBid method of estimating building costs, and his staff of experts have been retained and will continue to give "HoltBidders" their expert assistance. This adds another big unit to the Radford organization.

The officers of the HoltBid Service Company are:

William A. Radford, President.

Roland D. Radford, Vice-President and Manager.

A. W. Holt, Vice-President and Director of Service.

William A. Radford, Jr., Secretary and Treasurer.

The offices of the HoltBid Service Company are at 1827 to 1901 Prairie Avenue, Chicago, Ill.

Negotiations for the acquisition of the HoltBid Service Company have been pending for several months. During that time

Mr. Radford made exhaustive investigations of the service among the prominent members of the building industry and among building material dealers. Everyone who has been using the HoltBid method is enthusiastic about it, Mr. Radford says, and many letters from users bear out this statement.

Eleven years ago Mr. Holt determined to find a method of arriving at the cost of buildings without the necessity of spending nights and Sundays making up bills of materials and figuring estimates. The method he devised, which has been developed into the present perfected HoltBid system, has been used by Mr. Holt on thousands of buildings and has been proven accurate, simple, reliable, and a time and money-saver. Interruptions made no difference, as the HoltBid method is mistake-proof. What is most important, it has been found to be a valuable aid in selling jobs.

So successful was Mr. Holt's system of estimating that those who had seen him use it asked for instructions. These numerous requests led him to make instructions for using the HoltBid method simple so that anyone at all familiar with the building business could learn them in a comparatively

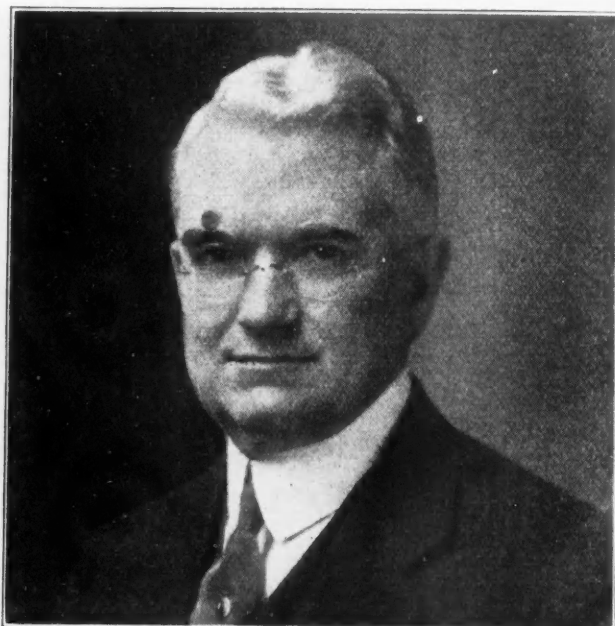

William A. Radford, President, HoltBid.



Roland D. Radford, Vice-President and Manager, HoltBid.



few hours. One operator said that after studying the instructions seven or eight hours he was enabled to make his first "HoltBid" which on checking he found to be within a few cents correct.

"What will it cost?" is a question that everyone in the building industry has been called upon to answer thousands of times. To arrive at the approximate cost of a building under the old method used for many years, it was necessary to have blue prints, a set of architect's plans, draw off a bill of materials and with these arrive at an estimate of costs. This old method requires time, is so complicated that mistakes are easy to make and is a job that is difficult and requires many hours of close attention. The HoltBid method is rapid and accurate and interruptions are not an annoyance.

The HoltBid method takes the drudgery out of estimating building costs. It is simple. It is easy to learn, the time required to become an efficient "HoltBidder" being only sixty hours. It is accurate, as has been proven by thousands of estimates. It saves the time of the estimator and is so simple that the "HoltBidder" is enabled to secure an accurate estimate of costs of most buildings in from thirty to fifty minutes as against sometimes two or three days under the old method.

Mr. Radford's investigations of the HoltBid system of estimating over a period of months brought forth many enthusiastic commendations of it. In fact, every user of the HoltBid estimating method had demonstrated to his own satisfaction what a wonderful system it is. Here are some of the opinions given by users of the HoltBid method:

"We never finish up a HoltBid and then wonder how many things we have missed, as was always the case before. The time saved enables us to put more effort into making sales. It has been worth far more than its cost."

"Over a year's use has proved that the HoltBid system is fool-proof, both from the standpoint of fooling oneself or being fooled by contractors. We are as sold on the HoltBid as it is possible to tell."

"The knowledge gained is worth its cost to me. If I could not replace it I would not sell it for twice the cost."

"Many of our HoltBids have been less than \$5.00 off and in one instance only 7 cents. The more I use it the more time I save and the better I like it."

"Roofs, dormers, etc., were 'Greek' to me before getting the HoltBid. Now it comes easy. I have utmost confidence in my HoltBid figures and feel repaid many times for the sixty hours, or so, that it took to finish up."

"I haven't finished the HoltBidder's Instructions yet, but

am using the HoltBid almost every day. It is easy to learn and a real time-saver."

"The HoltBid instructions are so plain that I had not put in more than 7 or 8 hours' time on them before I made by first HoltBid and sold the job. We came out about 2 per cent to the good."

"I consider the money I invested in the Holtbid system the best money I have ever spent. You make roofs so simple it almost makes a man feel foolish."

"From all I have learned about HoltBidding," said Mr. Radford, "I believe that it is a wonderful aid to the building industry. I am told it is the only system that is dependable. We all know the hard work that has been put in drawing off bills of materials from plans and then figuring the estimates of costs. Items are forgotten. Extensions are not made. Interruptions cause many hours of extra work. And in many instances all of this work is lost because the bill is not sold. Again, many successful bidders have found to their sorrow that 'they forgot something' and have been compelled to complete jobs at a loss."

"Users of HoltBid tell me that there is no likelihood of making a mistake in estimating by this method. Also there are no bills that can be peddled. They also tell me that by using the HoltBid an accurate cost estimate may be secured in from thirty to fifty minutes on most buildings. These are men who I know have had years of experience in estimating, and are conservative business men. Their enthusiasm over the HoltBid method convinced me that the widespread use of the HoltBid system of estimating will save time and money and is the only system that can be safely used in selling jobs, especially to the prospective owners."

"Mr. Holt has developed his method of bidding through actual and constant experience during the last eleven years, much of the time as chief estimator. He has the confidence of hundreds of men in the building industry, all of whom give him their unqualified personal indorsement."

"Mr. Holt comes with the new organization as Vice-President and Director of Service. He and his staff of experts on the HoltBid method will give those who want to become efficient 'HoltBidders' their personal assistance."

This large organization has been formed and financed to place HoltBid in the hands of everyone in the building industry at a remarkably low, introductory price and on convenient terms.

The acquisition of the HoltBid Service Company adds another big unit to the Radford organization.



A. W. Holt, Vice-President and Director of Service, HoltBid.



William A. Radford, Jr., Secretary and Treasurer, HoltBid.

### Long-Bell Undertakes Forest Management Program

AS a result of an exhaustive study of its southern cut-over acres begun in September, 1923, and completed in December, 1924, the Long-Bell Lumber Company, Kansas City, Mo., has instituted forest management and protection upon more than 200,000 acres of cut-over lands in Arkansas, Louisiana and Texas.

These areas, which are designated as temporary forest reserves, are receiving intensive fire patrol and strategically located fire lanes are being developed somewhat along the lines of European practice. Experiments are being conducted in the use of carpet grass for fire lanes and also in the use of plows and spring tooth harrows for keeping the lanes clear of leaves and debris during the dry periods. It is expected that by such experimentation methods of fire protection will be developed which will combine economy of operation with maximum effectiveness.

The possibilities of selective logging and improvement thinnings for increased production are being tested by actual practice. Growth and yield data are obtained periodically from permanent sample plots. An experimental planting of long leaf pine on a commercial scale has been approved for this fall.

J. B. Woods, forester for the Long-Bell Lumber Company, is now engaged in a comprehensive study of the company's western holdings with the aim of formulating plans for future management of cut-over lands in Washington, Oregon and California.



### Details of Home Building

AN error was made in the October issue in the article "Details of Home Building—Detail 7—The Fireplace," by V. L. Sherman. The continuation of this article, which should have appeared on page 174, was omitted entirely. It reads as follows:

A cold flue should not rest against a warm one. While on the subject of soot collection it might do to add that round chimney pots are not the best to cap a rectangular flue. The soot collects at the base of the cap and will burn in time. This, of course, tends to crack the chimney pot.

Figure 3 is a sketch showing how inside chimneys can be carried into the walls in such a way that the chimney proper does not project into the room. In a small house, or even in a moderately large house, where the ceilings are nine feet or under, the chimney breast often takes up too much room. Its relative size seems to diminish the floor space, and seems to impose on the whole room. For this reason a chimney which does not project into the room will often furnish more opportunity for just proportions.

The brick manufacturers have followed this same thought in one way, realizing that ordinary sizes run too large for interior modules they have gone into the study of brick for fireplaces with surprising results. Most of us play safe now by facing the chimney piece with brick up to the mantel, and in some cases facing the entire chimney piece with brick.

At the beginning it was said that fireplaces are common to all. We have in this country homes of all types. Lately

there has been a venture in a new type of fireplace. With the Spanish type of architecture there is no reason why we should not abide the fireplace of the old Moors. This style of fireplace as shown in Fig. 5 goes us one better for openness and unity. Its promotion adds one more type and brings closer to us the old hearths, the real domestic centers. Surely there is much to be gleaned from the California and Florida homes.



### A. G. C. Meeting in Dallas

THE meeting of the Executive Board, the Advisory Board and President's Council, of the Associated General Contractors, at Dallas, Texas, October 5, 6 and 7, was characterized by a record breaking attendance and a spirit of progressive accomplishment. The chief subjects of discussion and action were the day labor problem and lien laws, surety bonds and questionnaire forms in relation to the elimination of irresponsible bidders.



### Reward Craftsmanship

WHILE the last brick was being laid and the last stone set on the Barclay-Vesey Building on Sept. 10, 1925, all trades on the job stood by at the dedication of the largest telephone building in the world. Following the dedication, certificates of award were presented to Matthew D. Mahoney, bricklayer, and George S. T. Bain, stone cutter, in recognition of superior craftsmanship shown by them on the job.

The certificates were not awarded to the men who laid the greatest number of brick, but to men who put spirit and energy as well as muscle into their work.

Certificates of award have also been presented to J. D. Murphy, brick mason on the new Building Loan Building, and to A. J. McIntosh, plumber, and John McMahan, plasterer, working on the National Bible Institute. Certificates will be presented to other workers from time to time during the progress of building construction in New York.



Presentation of Certificates of Award for Superior Craftsmanship by President Stephen F. Vorhees to Matthew D. Mahoney, Bricklayer, and George S. T. Bain, Stone Cutter. Above is a reproduction of the certificate awarded to Mr. Bain.

---

# A GRAHAM BROTHERS Truck Chassis for \$995!

This exceptional new price of the 1-ton chassis is the result of economies of mass production—economies passed directly on to the buyer.

Graham Brothers now produce in *larger* quantities than any other exclusive manufacturer of motor trucks.

1-ton chassis, \$995—1½-ton chassis, \$1280, F. O. B. Detroit

**GRAHAM BROTHERS**

Evansville — DETROIT — Stockton  
A DIVISION OF DODGE BROTHERS, INC.  
GRAHAM BROTHERS (CANADA) LIMITED—TORONTO, ONTARIO

# GRAHAM BROTHERS TRUCKS

*SOLD BY DODGE BROTHERS  
DEALERS EVERYWHERE*

---

# INSTRUCTIONS IN ROOF FRAMING

*This Department Appears Every Month in American Builder*

## Framing an Octagon Roof

By JOHN T. NEUFELD

**I**N our last discussion we compared the square, hexagon and octagon roof in plan. We will now take a more definite problem and show how each part of the octagon roof is figured and cut. The roof illustrated by plan and isometric view in Figs. 36 and 37 will be used as a problem. This roof is 12 feet 0 inch wide and 4 feet 0 inch high. This gives the common rafter a run of 6 feet and a rise of 4 feet 0 inch in 6 feet 0 inch or 8 feet per foot. The pitch is the rise over the span =  $\frac{4}{12} = \frac{1}{3}$ . Our first problem is to find the length and cut for the plate.

In Fig. 36 at A we show a small triangle, one side of which is equal to 1 foot or 12 inches of run of the common rafter. We note that the side that is parallel to the plate is 4.97 inches long and that the length corresponding to the run of the hip is 12.98 inches long. As we learned in our last discussion, the line perpendicular to the run of the common rafter is called the tangent. For every foot of run we have 4.97 inches, length of tangent. The total run in this case is 6 feet. Therefore the tangent is  $6 \times 4.97 = 29.82$  inches. The length of the plate of each side is two times this =  $2 \times 29.82$  inches = 59.64 inches = 4 feet 11 $\frac{5}{8}$  inches.

Some of our readers may have difficulty in changing decimal parts of an inch to ordinary fractions. This is quite simple. To show this we will change the above .64 of an inch into a fraction that can be measured with an ordinary rule. Changing .64 to sixteenths we multiply .64 by 16 and get 10.24. Therefore, .64 inch is equal to  $\frac{10.24}{16}$  inch, say  $\frac{10}{16}$  or  $\frac{5}{8}$  inch.

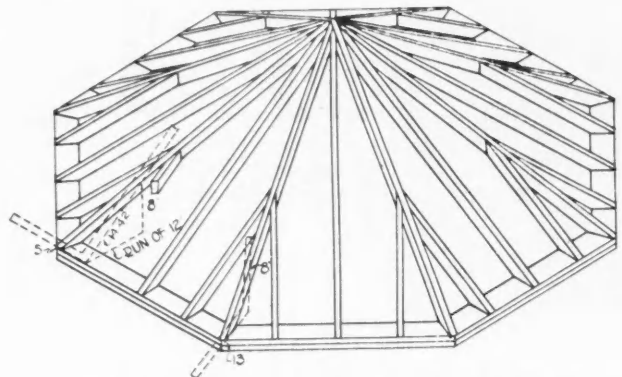

Fig. 37. Isometric View of Octagon Roof.

The joint at the corner of the plate is parallel to the run of the hip rafter. Therefore the triangle which is described by the run of the common rafter, the plate and the run of the hip rafter, also describes the cut for the plate. This would be laid out by using 12 on the blade and 4.97 or 5 on the tongue of the square. See Fig. 36.

### The Hip Rafter

The next number in order for framing is hip rafter No. 1. The hip rafter has a run of 12.98 inches for every foot run of the common rafter. The length of hip per foot of run of common rafter is generally taken from a table similar to the one given here. Note carefully that the length of hip is given per foot of run of common rafter and not per foot of run of hip rafter. For a one-third pitch the length of hip is given as 15.26 inches per foot of run of common rafter. The total length of the hip rafter is  $6 \times 15.26$  inches = 91.56 inches = 7 feet 7 $\frac{1}{16}$  inches.

In laying out the cut for the hip rafter we use the same principle as we have been using on a square-cornered roof. The run of the hip and the rise will describe the cut for the top and bottom. We may take the total run and the total rise in feet and use these numbers on the square or we may use the run of hip per foot run of common rafter, which is 12.98 or 13 inches and the rise per foot run which is 8 inches. Thus 13 and 8 taken on the square will lay out the seat cut and also the top or plumb cut for the hip rafter. There is no side cut for the two hips numbered "1."

The two hips numbered "2" will be the same in length with the exception of one-half the thickness of the first hip. This can be deducted as shown by Fig. 38. One-half the thickness of a rafter 1 $\frac{1}{2}$  inches thick is  $\frac{1}{4}$  inch. This is measured horizontally as shown. The hips numbered "3" on the plan are also similar in length, but a deduction must also be made as shown in Fig. 39. First we measure the

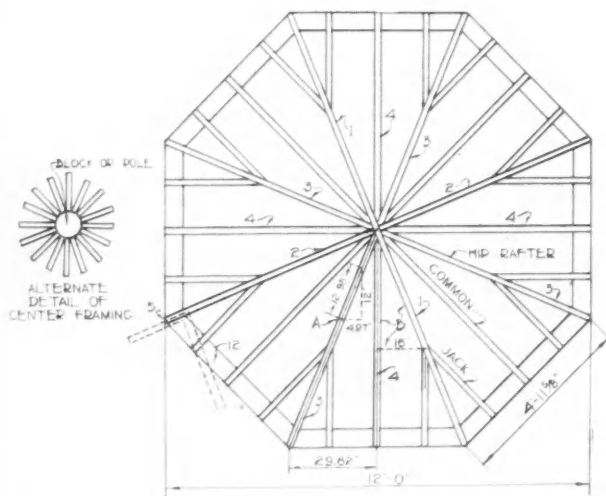

Fig. 36. Plan of Octagon Roof Solved in this Lesson.

# Treasure dug from a lake



Trinidad Lake Asphalt is dug from the surface of Trinidad Lake with mattocks, broken into lumps, loaded into small iron cars and transported direct to vessels at the loading pier for shipment.

"It melteth not in the sun"—wrote Sir Walter Raleigh in describing Trinidad Lake Asphalt, with which he had caulked and waterproofed his ships while at Trinidad more than three centuries ago.

The same Trinidad Lake Asphalt—first used a quarter century ago in the manufacture of prepared roofing—is today the foundation of the great line of Genasco Roll Roofing, Shingles and Waterproofing Products.

Millions of squares of Genasco Roll Roofing, Built-up Roofing and Shingles are visible proof of the extraordinary waterproofing and wear-resisting properties of this remarkable material.

Genasco Products are supplied exclusively by the Barber Asphalt Company, the world's largest miner, refiner and distributor of native-lake asphalts.

A partial list of the Genasco Products is shown on the right. A complete list—also interesting descriptive booklets—will be mailed to architects and builders upon request.

## The Barber Asphalt Company

New York   Pittsburgh   Philadelphia   St. Louis   Kansas City  
Chicago   San Francisco

# Genasco

Genasco Latite Shingles

Genasco Sealbac  
Shingles  
(Individual and Strip)

Genasco Roll Roofing  
(Smooth and Slate Surface)

Genasco Standard  
Trinidad

Genasco Hextab  
Strip Shingles

Built-up Roofing  
(For Factories, Schools, Hotels,  
Office Buildings, etc.)

Genasco Waterproofing  
Asphalts, Felts and  
Fabrics

(For Waterproofing Subways,  
Reservoirs, Basements, etc.)

Genasco Asphalt Mastic  
(For Industrial Flooring)

Genasco Paints  
(Roof Coating, Asphalt Fibre  
Coating, Industrial Paint, Acid-  
Proof Paint, Battery Paint, etc.)

Genasco Insulating and  
Sheathing Papers

Genasco Stucco Base

Genasco Asphalt Putty  
(Roofing Cement)



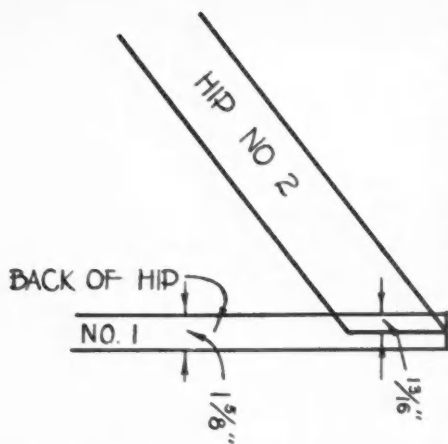

Fig. 38. Deduction to Be Made at Upper End of Hip Rafter No. 2.

length of deduction on a horizontal plan. This distance,  $1\frac{7}{16}$  inches, is then measured on a horizontal line on the side of the rafter shown in Fig. 39.

The length of deduction on a horizontal plan. This distance,  $1\frac{7}{16}$  inches, is then measured on a horizontal line on the side of the rafter shown in Fig. 39.

**The Common Rafter**

Rafter No. "4" on the plan may be considered as a common rafter and can be figured the same as on a square-cornered building. The

pitch is one-third and the rise per foot of run is 8 inches. The length per foot of run as given on tables is 14.42 inches. The run is 6 feet. The length, therefore, is  $6 \times 14.42$  inches = 86.52 inches = 7 feet  $2\frac{1}{2}$  inches. This is the length up to the center point of the roof. A deduction must be made at the center the same as for the hip rafters. The distance to be deducted in plan is  $2\frac{7}{8}$  inches, see Fig. 39. This is again measured off on the side of the rafter the same as the  $1\frac{7}{16}$ -inch on the hip No. "3."

There is also a side cut to be made for the common rafter. This is the same as the side cut for jack rafter and is illustrated in Fig. 37.

A square is placed so that the blade is parallel or in the same plane as the common or jack rafter and the tongue lies along the edge of the plate. The length of jack or common rafter is 14.42 inches per foot of run and the plate length is 4.97 inches or 5 inches. The square in this position gives us the numbers to be used for laying out the side cut, 5 and  $14\frac{1}{2}$ . The side cut is marked on the back of the rafter along the arm of the square on which the  $14\frac{1}{2}$  is taken.

**The Jack Rafter**

The length of the jack rafter is found in a similar way to the length of the common rafter. First we must find the run of the jack, we will see how much shorter the run of the jack is than the run of the common rafter. The

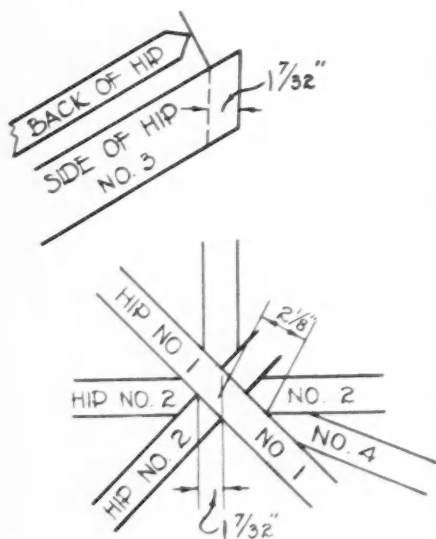

Fig. 39. Deduction to Be Made at Upper End of Hip Rafter No. 3.

jack is set 16 inches to the side of the common rafter. We have found that for every 12 inches of run there is a tangent length of 4.97 inches or 5 inches. If the jack rafter were set 5 inches to the side of the common rafter then the run would be 12 inches less. Therefore, for every 5 inches that the jack is set to one side its run is 12 inches less. It is set to the side  $16 \div 5 = 3\frac{1}{5} \times 5$  inches and, therefore, the run

is  $3\frac{1}{5} \times 12 = 3\frac{3}{5} = 3.2$  feet less than the run of the common rafter. The run of the jack is 6 feet less 3.2 feet = 2.8 feet. The length is  $2.8 \times 14.42$  inches = 40.376 inches = 3 feet  $4\frac{3}{8}$  inches.

Seat and plumb cuts are obtained the same way as for the common rafter, using 12 and 8 on the square.

The side cut is the same as explained under the common rafter, using the numbers 5 and  $14\frac{1}{2}$  on the square and marking along the arm on which the  $14\frac{1}{2}$  is taken.

In Fig. 36, at the left-hand side, we illustrate how the framing at the center may be simplified. A big block or pole from 6 to 8 inches in diameter is used at the peak of the roof to which all the rafters frame. By using this block the side cuts on the rafters are avoided. This simplifies the framing.

**Table for Octagon Rafters**

Pitch—	Rise Per Foot Run	Length of Common Rafter Per Foot Run	Length of Hip Rafter Per Foot Run
One-sixth	4 inches	12.65 inches	13.59 inches
One-fourth	6 inches	13.42 inches	14.30 inches
One-third	8 inches	14.42 inches	15.26 inches
Three-eighths	9 inches	15.00 inches	15.80 inches
Five-twelfths	10 inches	15.62 inches	16.40 inches
Eleven-twenty-fourths	11 inches	16.28 inches	17.03 inches
One-half	12 inches	16.97 inches	17.69 inches
Two-thirds	16 inches	20.00 inches	20.61 inches
Three-fourths	18 inches	21.63 inches	22.20 inches

**Problems**

1. An octagon roof has a span 20 feet 0 inch. What is the length of the plate for one side?
2. What numbers on the square will give the cut for the plate at the corner?
3. If the above roof has a one-half pitch, what would be the length of hip rafter No. 1?
4. What would be the length of the common rafter, not deducting any for the center framing?
5. What numbers on the square would lay out the plumb and seat cut for the common rafters?
6. What numbers would lay out the side cut for the common rafter?
7. What numbers would lay out the plumb and seat cut for the hip rafter?

**Answers**

1. The length of the plate on one side is  $10 \times 4.97$  inches  $\times 2 = 99.40$  inches = 8 feet  $3\frac{3}{8}$  inches.
2. The numbers 5 and 12 taken on the square will give the cut for the plate.
3. The length of hip per foot run of common rafter is 17.69 inches for a one-half pitch roof. The run is 10 feet 0 inch. The total length of the hip is  $10 \times 17.69 = 176.9 = 14$  feet  $8\frac{7}{8}$  inches.
4. The length per foot run of common rafter is 16.97 inches; the run is 10 feet 0 inch and the length is  $10 \times 16.97$  inches = 169.7 inches = 14 feet  $11\frac{1}{16}$  inches.
5. The numbers 12 and 12 will lay out the plumb and seat cuts for the common rafter.
6. The numbers 12 and 17 will lay out the side cut for the upper end of the common rafter.
7. The numbers 13 and 12 taken on the square will lay out the plumb and seat cut for the hip rafters.

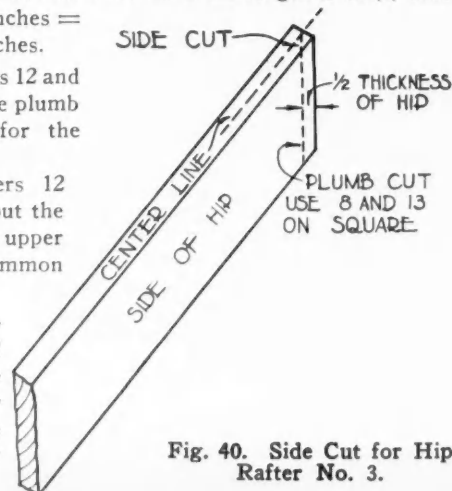

Fig. 40. Side Cut for Hip Rafter No. 3.



# Multiply your shingle profits by five

**D**ON'T stop at re-roofing. By covering the four sides of a house with Johns-Manville Asbestos Shingles as well as the roof you multiply your shingle profits.

And it is just as easy to sell re-siding as re-roofing. The same sales arguments hold true: permanent protection from fire, weather and time, no need to tear off the old siding, no need to paint, and unequalled economy. There is even an additional point: re-siding improves the appearance and fire protection of the *entire* house while re-roofing changes only the top.

Combining re-siding with re-roofing brings in five times the profit to you. Let us tell you more about it.

JOHNS-MANVILLE INCORPORATED  
292 Madison Avenue at 41st Street, New York City  
*Branches in 62 Large Cities*  
For Canada: CANADIAN JOHNS-MANVILLE CO., Ltd., Toronto

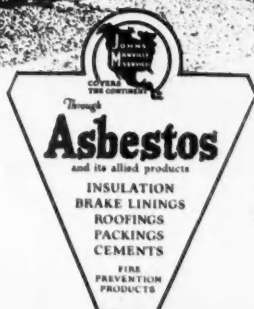

# JOHNS-MANVILLE Asbestos Shingles

# Cromar can be laid and used the same day

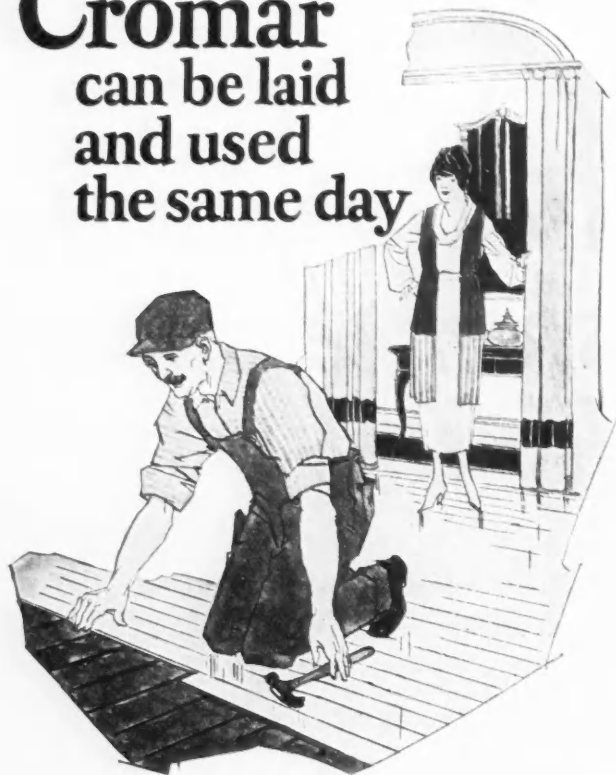

**T**HAT, Mr. Contractor, is your clinching argument when you sell homeowners a relaying job! To them it means the very minimum of inconvenience—smaller expense, too.

To you, it means more jobs with the same number of men. Quick and more frequent profits.

How? CROMAR is completely (*completely!*) finished at the factory—by patented machines. Nail it down and the job's done.

Write for free sample, full particulars, and the name of the nearest CROMAR Dealer.

The Crooks-Dittmar Company  
Williamsport, Pennsylvania

# CROMAR

READY FINISHED  
OAK FLOORING  
LAID AND USED THE SAME DAY

#### The CROMAR Ten Points of Prime Importance

1. Factory finished—like furniture.
2. Finish stands hardest wear.
3. Coating four sides protects against moisture.
4. V-typetongue and groove easy to lay.
5. Beveled tongue prevents damage in nailing.
6. Cleanable surface groove.
7. Convenient and damage-proof bundle.
8. Laying contracts need not be subtle.
9. Promotes extra sales for occupied houses.
10. Laid and used the same day.



## Annual Mueller Picnic

**T**HE annual picnic of Mueller Co., Decatur, Ill., was held at Fairview Park, Decatur, on September 19, and was the culmination of a week of special activities for the company employes. From September 14 to 19 the entire sales force of the company was in session at Mueller Lodge. The mornings were devoted to business and the afternoons to a handicap golf match in which Mr. Adolph Mueller, president of the company, finally won from his son, W. E. Mueller, assistant treasurer.

During the week the American Society of Sanitary Engineers met in its annual session at Decatur and on Wednesday noon were guests at dinner at the Lodge. Friday night the engineers were again guests of the company at a stag party at the Lodge, where an entertaining program was given.

A beautiful silver service was presented to the company by the members of the 49 Club, an organization of members of the Mueller Company and their salesmen; a gold watch was presented to L. M. Ross, retiring president, by the members of the club.



## Chain Belt Representative in Tampa

**T**HE Burress-Clark Company has been appointed the Florida West Coast representative of the Chain Belt Company, Milwaukee, manufacturers of Rex Concrete Mixers and Pavers. Wayne C. Clark was formerly a western representative of the Boebck Machinery Company and has a varied experience in contractors equipment. Headquarters will be in care of the Tampa Warehouse Company, located at Morgan and Water Streets, Tampa, Fla., where Mr. Clark will specialize on the service and distribution of Rex Concrete Mixers.

Fred G. Syburg, assistant to the export manager of the Chain Belt Company, will spend a year touring the Orient and countries of the Far East in the interests of the company. Mr. Syburg will spend several months with foreign representatives in China, Japan, India, Australia, Dutch East Indies.



## To Study Building Problems

**G.** L. MILLER & CO., nationally known investment bankers specializing in building construction financing, have announced the appointment of Guy W. Seem as director of their Educational Department and Building Construction Research Bureau. He will make his headquarters at the Miller Company's general offices, 30 East 42nd Street, New York.

The Building Construction Research Bureau will continue and extend the scope of its work and will prepare comprehensive sectional and national building surveys, compile statistics and data showing the trend of building labor and material costs, and disseminate information regarding building construction financing.



## Change Company Name

**T**HE corporation known since 1906 as The Transfer Lumber & Shingle Company, has changed its name to Weatherbest Stained Shingle Co., Inc. It will continue to conduct the stained shingle industry which has heretofore been run primarily in the name of The Transfer Lumber & Shingle Company at North Tonawanda, N. Y., and Minnesota Transfer, Minn. The same officers remain in charge and the same policy will be continued, headquarters still being at North Tonawanda. The corporation's present net worth is \$250,000.00. Application has been made and granted to increase the company's authorized capital to \$500,000.00.



# Economical—Fireproof—Soundproof Construction



*The Butler Memorial Hospital,  
Butler, Pa.  
E. Tilton and E. P. Mellon, Archts.  
Truscon Steel Joists and Hy-Rib  
throughout. Structural design by  
Truscon Steel Company.*

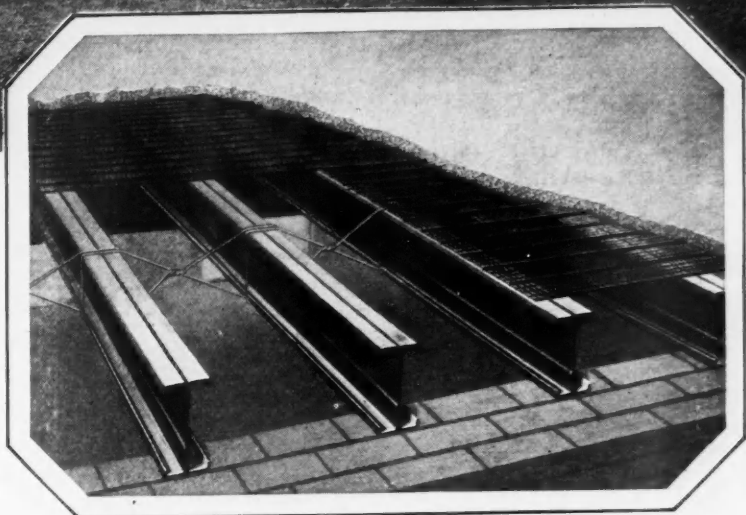

Truscon Steel Joists allow rapid construction, give ample room for placing of pipes, and can be had punched with 2-inch holes for transverse running of conduit and piping.

You can build better for the owner with Truscon Steel Joists and greatly increase your construction profits. You give the owner the structural advantages of rigidity, soundproofness and firesafety wanted in modern buildings, yet, because Steel Joists are light in weight, easy to handle, do not have to be fitted, and require less weight in the secondary numbers you actually build at a saving of time, labor and materials. It will pay you to investigate.

*Write for catalog and information.*

**TRUSCON STEEL COMPANY, YOUNGSTOWN, OHIO**

*Warehouses and Sales Offices in Principal Cities  
Foreign Div.: New York Canada: Walkerville, Ont.*

# TRUSCON

TRUSCON STEEL CO.

# STEEL JOISTS

### Open Chicago Office

THE Union Metal Manufacturing Co., Canton, Ohio, has announced the opening of its Chicago district office for October 1, 1925, at room 1935 Illinois Merchants Bank Bldg. Mr. E. M. Peake, district manager, and Mr. F. Thomas Turner, manager of the street lighting department, will be in charge of this office.

Mr. Peake has had long executive and selling experience in the steel business and Mr. Turner has been street lighting specialist for the General Electric Company in the Chicago territory.

This office will supervise the sale of all Union Metal products including ornamental street lighting standards, architectural steel building columns, pergolas and rose screens and metal buildings. Attached to the office will be specialists in all the company's various lines.



### Federal Cement Tile Co. Branch

RECENTLY Federal Cement Tile Company, whose home office is at 608 South Dearborn Street, Chicago, with works at Hammond, Ind., has established a branch sales office at Indianapolis under the direction of Mr. C. B. Baird, who has for many years been affiliated with the company in various important capacities.



### 100 Per Cent Production Schedule

THE National Enameling and Stamping Company through its Steel Division, the Granite City Steel Works, reports its sheet steel mills running at practically 100 per cent capacity.

Company officials attribute the increased orders for Nesco Sheets to a generally improved business outlook, but more particularly to the fortunate location of the Nesco mills

which permits unusually prompt shipments to the West and Middle West.

They believe that the hand-to-mouth buying policy coupled with a better demand for sheet steel in this territory has naturally impelled buyers to seek better deliveries to fill immediate needs with the result that the Nesco mills are enjoying the fruits of strategic location.



### Fire Destroys Warehouse

THE galvanized sheet warehouse of the St. Louis mills of the National Enameling & Stamping Co., Inc., was destroyed by fire on the night of October 9. The stock was so damaged by fire and water that it cannot be salvaged. Fortunately the buildings which contained the mills and galvanizing departments were not injured in any way.

Outside of the loss of the stock the fire will cause little or no inconvenience, as, in addition to the St. Louis mills, the company has a very modern galvanizing department located at the new addition to its Granite City plant.



### Changes in Personnel

JOHN K. BLITZ, for the past three years merchandise sales representative in the Pittsburgh territory of the Detroit Steel Products Company, was transferred September 1 to the Advertising Department of the home office at Detroit.

Mr. Blitz, a one-time newspaper man, has charge of publicity and dealer advertising work for which he is well fitted by his close contact with Fenestra dealers in his previous position.

Maurice W. Wood, formerly Detroit salesman for the Weyerhaeuser Company, Forest Products Division, succeeds Mr. Blitz at Pittsburgh.



## Advantages of High Speed and Low Cost Spray-painting

One DeVilbiss spray operator does the work of 4 to 5 brush painters. This high speed of spray-painting effects a substantial reduction in labor costs per job—it makes possible doing more jobs in present working time.

Additional advantages painting the DeVilbiss way are: a thorough coating of the entire surface to be painted; no brush marks or other defects; no dripping and spattering of paint; painting more easily done.

Get the facts—detailed information will be gladly mailed to you. Address—

THE DEVILBISS MFG. CO., 238 Phillips Ave., TOLEDO, O.

**DeVilbiss**  
**Spray-painting System**

# Fenestra Casement Windows

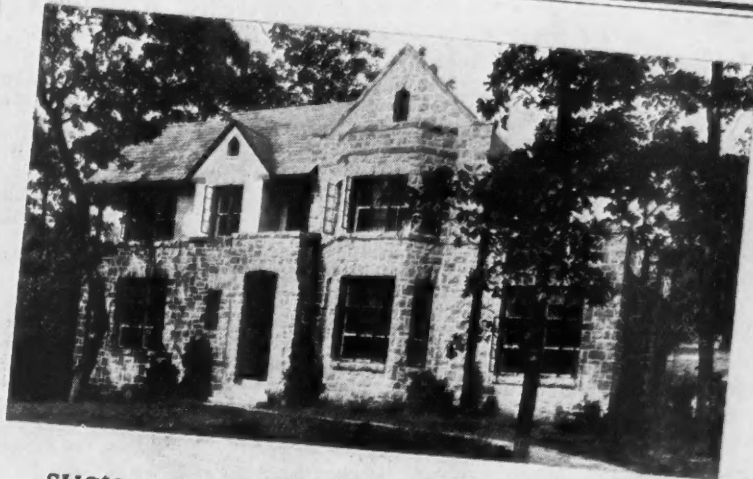
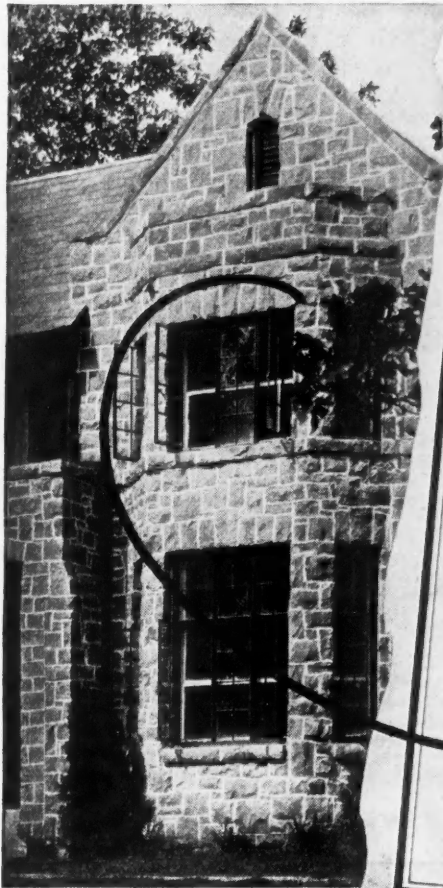

## SUCH A HOME IS SELDOM PLACED ON SALE

This magnificent home in Forest Park, at the corner of Conroy Road and Tenth Avenue, South, is just completed. There are very few homes in Birmingham that can compare with it. Built throughout of Sewanee stone, with slate roof—every nail, every flashing and every valley on the roof of solid copper. **Fenestra steel casement sash** throughout. As nearly fireproof as a house can be made and will endure for centuries. Downstairs, it has an entrance hall, living room, sun parlor, dining room, breakfast room, tiled kitchen with rubber tile floor, lavatory and toilet. Upstairs, four delightful bedrooms and two baths, with built-in electric heaters and full-tiled walls and floors in each bath. Has oil-burning **Nokor** heating system, built-in safe for valuables, all clothes closets cedar lined and 39 lineal feet of built-in wall cabinets from floor to ceiling. Price, \$37,500.

Main 2574

**PARRISH & BYRD**  
REALTORS

120 No. 21st St.

## They'll Help You Sell The Houses YOU Build

Investment builders are relying more and more on nationally advertised products such as Fenestra Windows to help sell the houses they build.

Fenestra advertising is teaching home buyers everywhere to recognize the merits of Fenestra Steel Windows—the better light and ventilation

they afford; the cozy, attractive effects they produce; their freedom from sticking and warping; their easy cleaning advantages; their security from bad weather; and finally, their *surprisingly low cost*. Ask your lumber or building supply dealer for prices, or mail the coupon for literature or a demonstration.

DETROIT STEEL PRODUCTS COMPANY, C-2260 E. Grand Boulevard, Detroit, Mich.  
Factories in Detroit, Mich., Oakland, Calif., and Toronto, Ont., Canada  
For Canada: Canadian Metal Window & Steel Products, Ltd., 160 River Street, Toronto, Ont.

# Fenestra

for homes, large and small  
shops and small factories  
garages and service stations  
stores and other buildings

DETROIT STEEL PRODUCTS COMPANY  
C-2260 East Grand Boulevard, Detroit, Mich.  
Please send us information on:

- Fenestra Casement Windows
- Fenestra Basement Windows
- Fenestra Garage Windows
- I would like to see a sample.

Address \_\_\_\_\_  
Name \_\_\_\_\_

**Books, Bulletins and Catalogs for You**

THE literature and publications listed here are available to readers of the American Builder. They may be obtained from the firms mentioned and will be forwarded without cost except where a price is noted.

The Allied Architects' Association of Los Angeles, Cal., in the August issue of its bulletin reports the results of various investigations of the effect of Santa Barbara earthquake.

The Mead-Morrison Manufacturing Company, Boston, Mass., offers a new catalog, No. 26, of its tractors, which is most complete and fully illustrated.

The Marietta Manufacturing Company, Indianapolis, Ind., offers a most attractive and interesting booklet, "The Story of Sani Onyx, a Vitreous Marble, for Hospitals," which includes specifications.

The E. L. Bruce Company, Memphis, Tenn., is publishing a monthly periodical under the name "Bruce" which contains a great deal of interesting and valuable information on flooring.

The American Abrasive Metals Company, 50 Church Street, New York City, has issued two circulars showing the importance of anti-slip treads in the prevention of accidents.

The Associated Tile Manufacturers, Beaver Falls, Pa., has just published the third of its series of Architectural Monographs on Tiles and Tilework. It is by Rexford Newcomb and covers The Architectural Ceramics of Persia, Ancient, Medieval and Modern. Price, \$1.50.

The Portland Cement Association, Chicago, Ill., has published a Review of Opinion on Winter Construction, designed to aid in the elimination of the slack season in the construction industry.

**Garcy Equipped Clothes Closets**

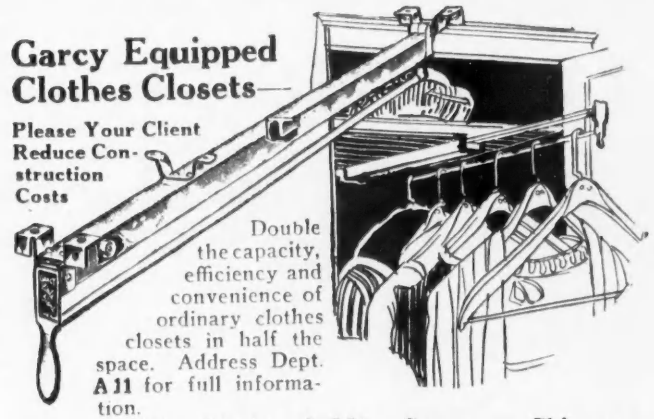

Please Your Client  
Reduce Construction Costs



Double the capacity, efficiency and convenience of ordinary clothes closets in half the space. Address Dept. A11 for full information.

**Garden City Plating & Mfg. Company, Chicago**  
1430 So. Talman Ave.

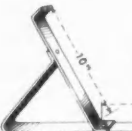
**NEWARK**  
LADDER AND BRACKET MANUFACTURING CO.  
Manufacturers of  
Clear Spruce, Extension, Straight and Mason Ladders  
4 NAIL, NUT AND BOLT FOLDING BRACKETS  
Offices and Salesrooms  
317 SPRINGFIELD AVE. NEWARK, N. J.

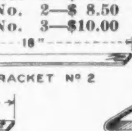
 <p>SHINGLE BRACKET NO. 1</p>	 <p>SHINGLE BRACKET NO. 2</p>	 <p>SHINGLE BRACKET NO. 3</p>
--	---	---

Shingle Brackets for Laying Paper—Wood—Slate or Asbestos Shingles.  
We stock Hetzel Mixing Boxes, Ajax Roof Brackets, Elite Scaffold Brackets. Price same as quoted in this catalogue. Send check with order. Immediate shipment.  
*Write for catalogue on complete line of tools.*

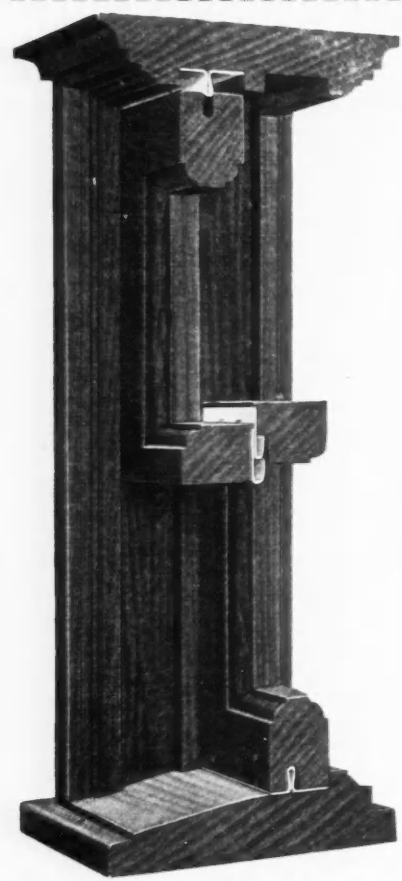

**ALLMETAL WEATHERSTRIP**

Thousands of feet of Allmetal Weatherstrips have been sold and installed throughout the United States. Not a single complaint or criticism have we received as to their installation, operation and service. This is a record of satisfaction that should commend Allmetal Weatherstrips to every architect and every builder in the country.

If you are not acquainted with the fine quality and service of Allmetal Weatherstrips, we will be glad to send you full information.

**We Want New Dealers**

In certain localities we are looking for reliable, hard-working men to handle Allmetal Weatherstrips. This is a paying business—right now is the time when Allmetal Weatherstrip should be installed. No experience required. No stock to carry. Send us the coupon and we will send samples and full particulars.

ALLMETAL WEATHERSTRIP CO.,  
231 W. Illinois St., Chicago, Ill.

GENTLEMEN:—

Without obligation, please send me samples and literature.

NAME .....

ADDRESS .....

CITY..... STATE.....

# Eternit Rigid Asbestos Shingles are priced to let you compete with substitute roofings

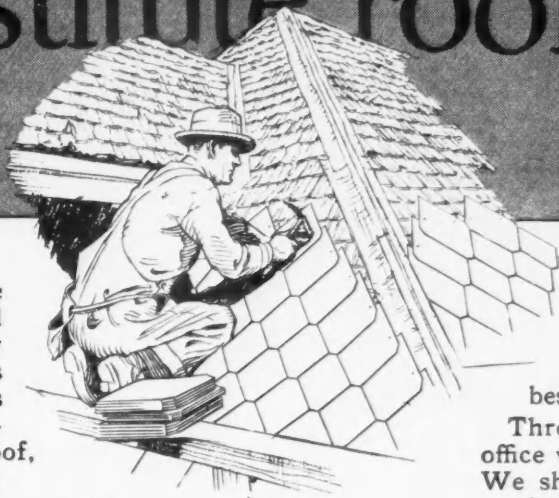

EVERY dealer has noticed the increasing popularity of rigid asbestos shingles. It's easily explained. Everyone realizes that these shingles make roofs that never need repairs or replacement—that are fire-proof, weather-tight and everlasting.

There are many good asbestos shingles. But now comes Eternit, the improved rigid asbestos shingle, so *moderately priced that you can compete with substitute roofings and still make a fine profit.* Eternit is a shingle you can be proud to sell. It will more than justify every claim you make for it.

In addition to quality and price, you have a simple, workable finance plan that lets you sell roofs on an easy-payment basis. It is no longer necessary for you to pass up prospects simply because they have not the ready cash. Neither need you carry them along on your books.

Because of our exclusive dealer policy, you know that all business developed in your territory will

**Eternit**  
Reg. U. S. Pat. Off.

**RIGID ASBESTOS SHINGLES**  
Make your first roof last

Ask about Eternit Asbestos Building Lumber—the same materials made up in sheet form.

come to you. So you profit directly from our national advertising—full color pages in magazines that reach your best prospects.

Through our field force and home office we co-operate with you closely. We show you how to develop your territory—and then help you do it. We realize the necessity of prompt

service and carry enormous reserve stocks to assure you the best kind of service even in the busiest seasons.

Other dealers tell us their Eternit franchise has brought them more roofing business than they ever did before. As the Eternit Shingle Man in your territory there is the same opportunity for you. Return the coupon today.

AMERICAN INSULATION COMPANY  
Roberts Ave. and Stokley St., Philadelphia, Pa., or Hibernia Bank Building, New Orleans, La.

Send me details of your exclusive sales plan on Eternit Asbestos Shingles.

Name.....

Business.....

Address.....

City..... State.....

We can give you more definite information if you will also tell us what kind of roofing you now carry.....?

And whether you buy in C/L or L/C/L.....?

**Books, Bulletins and Catalogs for You**

THE literature and publications listed here are available to the readers of American Builder. They may be obtained from the firms mentioned and will be forwarded without cost except where a price is noted.

"Architectural Acoustics" is the title of an attractive small book published by Johns-Manville, Inc., New York City. It is a reprint of an article by Clifford M. Swan, and is beautifully illustrated throughout.

The Structural Service Bureau, 112 S. Sixteenth Street, Philadelphia, Pa., has published a reprint of a paper by D. Knickerbacker Boyd, dealing with the use of brick in construction.

The Southern Cypress Manufacturers' Association, 507 Carondelet Street, New Orleans, La., offers the following pamphlets: The Manufacture and Use of Cypress, Painting and Decorating Cypress Dwellings and Structures, Tide-water Cypress (U. S. Dept. of Agriculture Bulletin No. 95 and Forest Products Laboratory Technical Note No. 173 combined) and Tupelo, a Versatile Wood.

The Gypsum Industries, 844 Rush Street, Chicago, Ill., has issued a third edition of the pamphlet, Gypsum Plaster Affords Fire Protection, by Virgil G. Marani, which includes additional data secured since the earlier editions.

"Practical Accounting for General Contractors," by H. D. Grant, published by the McGraw-Hill Book Company, Inc., 370 Seventh Avenue, New York City, has been published in a second and revised edition containing material specially adapted to the small contractor's needs. Price, \$3.00.

"Keolite News" is published periodically by the Jennison-Wright Company, 2463 Broadway, Toledo, Ohio, and is devoted to the betterment of industrial floors, bridge floors, piling fence posts, railroad ties, structural timbers and street pavements by Kreolite treatment.

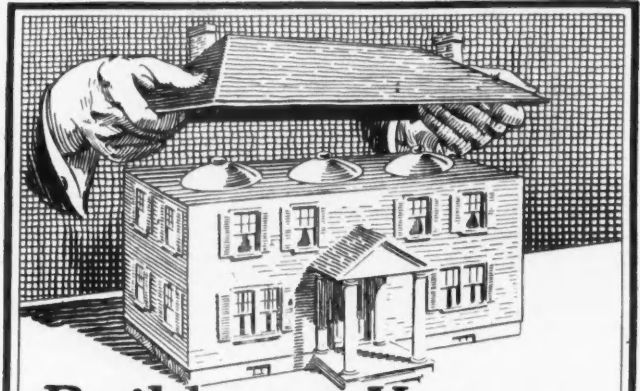

**Build your House like a Fireless Cooker**

A fireless cooker keeps hot because it holds the heat. It cooks foods with only a fraction of the heat required in a stove, because that heat cannot escape.

**CABOT'S Heat ~ "QUILT" Insulating**

keeps your whole house warm the same way. It holds the heat of your heater by insulation. It saves coal enough to pay for itself in two hard winters, besides keeping the house warm and comfortable for all time and reducing doctor's bills. "Build warm houses, it is cheaper than heating cold ones."



Send for a sample of Quilt. Free. It's a "comforter" that keeps the whole family warm.

**SAMUEL CABOT, INC.**  
Mfg. Chemists  
141 Milk Street Boston, Mass.  
312 Madison Avenue, New York  
500 Bloomingdale Avenue, Chicago  
San Francisco, Portland  
Cabot's Creosote Stains, Stucco Stains, Old Virginia White, Double-White, etc.



**FREE Engineering Counsel to Contractors and Home Builders**

The nation-wide KEWANEE organization is always ready to give expert counsel FREE on problems of private water-supply, electric light or sewage disposal.

KEWANEE men are not salesmen nor ex-plumbers; they are hydraulic-electric engineers, carefully selected and KEWANEE trained. Back of them is the quarter century of KEWANEE engineering and manufacturing experience in private systems.

Today the KEWANEE line covers over 200 models of such systems.

Send in the coupon below for helpful KEWANEE literature — FREE.

KEWANEE PRIVATE UTILITIES COMPANY  
424 Franklin Street, Kewanee, Illinois



Kewanee Private Utilities Co.  
424 Franklin St., Kewanee, Ill.

I am a.....  
} Contractor  
} Dealer  
} Home Owner

Gentlemen: Please send me complete information on the following:  
[ ] Kewanee "Bungalow Model" Water Supply System } Kewanee Sewage Disposal  
[ ] Kewanee Line of Water Supply Systems } Kewanee Electric Lighting

Name.....  
Address.....

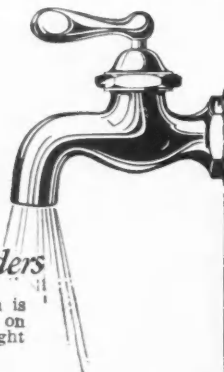

**KEWANEE**

"Bungalow Model" Water Supply System

Now \$140.00

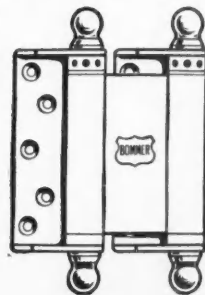
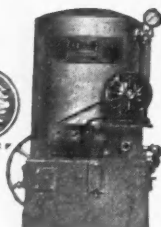

**Buy the Best HARDWARE For Hard-wear**

For more than 48 years Bommer Spring Hinges have maintained their leadership and proven their superiority over all others.

They have kept pace with the times, because they have been kept up with the times whenever improvement was possible.

**BOMMER SPRING HINGES ARE THE BEST**

They are in universal demand—easiest to apply and the most satisfactory spring hinges made.

Your Dealer handles them.

Send for New Catalog 47. It is a big help in ordering.

**Bommer Spring Hinge Company**  
MANUFACTURERS  
BROOKLYN, N. Y.

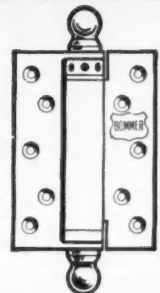

Frantz Quality  
Proves Its Sterling Worth



Distinguish the hardware by the label

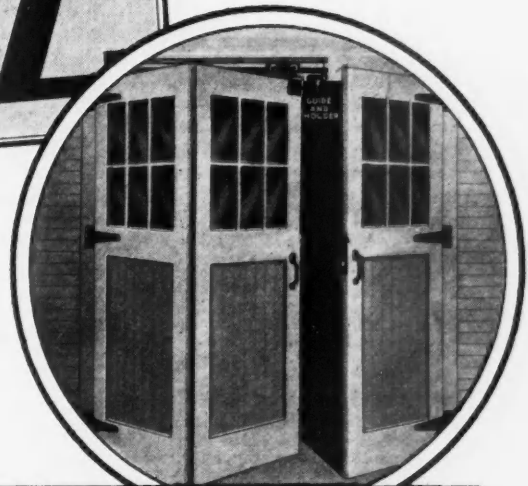

Don't let your customers  
skimp on garage hardware  
Insist on using  
**Frantz E-Z Fixtures**

The most important single thing about a garage is the doors. They are in constant use—and if they work well, they are an everlasting source of satisfaction, if they don't, you lose your reputation.

Insist on good garage hardware. Pick a line where you know the manufacturer will back you up, where design, appearance, and honest workmanship insure well hung, easy-working doors. Insist on FRANTZ E-Z Fixtures and you will never fail to satisfy your customers.

**Head and Shoulders Above the Ordinary**

FRANTZ E-Z Fixtures are superior in design, in principle, and in practical utility. They are easy to install; accommodate any weight of doors, and may be applied inside or outside of building.

The original flat side track is easily put up, requires no track brackets, and permits doors to fold flat against front wall of garage if desired. Doors can be hung in 2, 3, 4, 5, or 6 door combinations. Japan finish.

Sold only by our authorized dealer in every city.  
Write for his name.

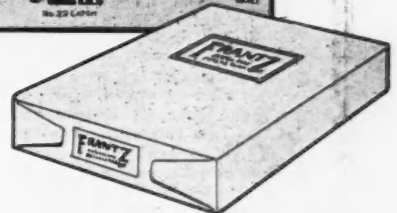
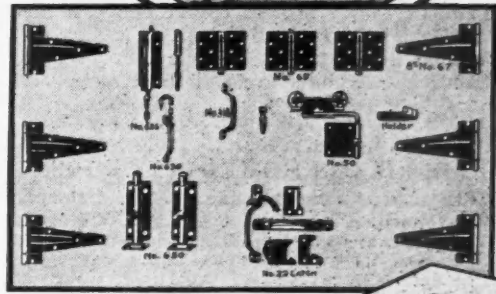

**Complete E-Z Set Packed in This Strong Fibre Box**

3-door set includes hanger and bolts; 3 pairs 8" No. 67 hinges; 3 offset butt hinges; chain bolt; 2 foot bolts; chain pull; latch; 2 padlock eyes; all necessary screws; socket wrench; end stops for track; directions.

The bright red FRANTZ Label on the end of the box is your guarantee of satisfaction.

Frantz Manufacturing Company  
Sterling, Illinois

