

AMERICAN BUILDER

THE WORLD'S GREATEST BUILDING PAPER

Vol. 42.

CONTENTS FOR FEBRUARY, 1927

No. 5.

COPYRIGHT, 1927, BY AMERICAN CARPENTER & BUILDER CO.

	Page	Page	
Around the Family Table.....	135	Builders Can Promote Orders for Concrete Jobs.....	184
Introducing ColorKeeD Home Plans.....		Better Plastering	186
Editorial Page	137	Plaster Cornices and How They Are Made.....	
The Building Prospect.....		Instructions in Roof Framing.....	190
This Demonstration Is Effective.....		A Discussion of Roof Pitches.....	
1926—A Record Year.....		Furnace Heating	192
Scientific Ventilation Demanded.....		Gas in Domestic Heating.....	
A Call for Help.....		A Colonial Hallway and Stair in the Modern Home	195
Progress in Wood Utilization.....		Law for the Builder.....	196
House History	139	Right of Contractor to Mechanic's Lien Upon Property for Improvements Made Upon Orders of Lessee or Tenant in Possession.....	
A "Honeymoon Cottage".....	141	Hot Air Furnace Heat in a Basementless Bungalow	198
New Buffalo Terminal to Cost \$14,000,000.....	142	New Clothes for Old Buildings.....	200
ART SUPPLEMENT OF NOTABLE ARCHITECTURE	143-146	Modern Building Methods Are the Arch Enemy of the Rat.....	202
New York Central Terminal, Buffalo, N. Y.....		Plate Glass for Window Glazing and Many Other Purposes	206
The Roxy Theatre, New York City.....		How Dan Does It.....	210
Lincoln Park West Apartments, Chicago.....		More Use for the Level.....	
The Ozark Athletic Club, St. Louis, Mo.....		Another Studding Jimmy.....	
A Three-Man Team Wins Success.....	147	Repairing Roll Roofing.....	
This Service Station Backs Up the Name "Super-Service"	151	Trailer-Tool House with Wheels.....	
Details of Norman Architecture.....	152	Bench Nail Puller.....	
Insulation—"It Pays for Itself".....	154	What's New Department:.....	
Real Estate and Subdivision Work.....	156216, 218, 220, 222, 224, 226, 228	
The Model Home That Brought a Subdivision to Life.....		A New Electric Dishwasher.....	
Rescue Equipment Aids in Construction Accidents	159	Industrial Heating Units.....	
Details of Home Building.....	160	Flush Type Doors Now Made with Sound Insulation.....	
The Chimney Detail.....		Windows That Swing and Slide.....	
Chips and Quips.....	162	A Powerful Door Check.....	
COLORKEED HOME PLANS.....	163-178	Complete Line of Winches.....	
The Delwood	Colorplate II	Doubly Strong Folding Rule.....	
The Defiance	Colorplate IV	Furnace Draft Regulator.....	
The Dalton	Colorplate V	Hollow Gypsum Section Construction.....	
The Dearborn	Colorplate VII	Improved Saw Filers.....	
Three Good Garages.....	Colorplate VII	Portable Draft Gauge.....	
The Daisy Garage—The Dale Garage—The Dain Garage.....		Spring Sash Sustainers.....	
The Dartmoor	Colorplate VIII	Permanent Electric Radiator.....	
The Darwin	Colorplate VIII	A Complete New Line.....	
The Dauphin	Colorplate IX	Handy Rafter Reckoner.....	
The Dawson	Colorplate IX	Mixers Are Improved.....	
The Delaware	Colorplate X	The Sliding Door Comes Back.....	
The Danvers	Colorplate XI	Efficient Portable Elevator.....	
Four Tiled Bathrooms.....	Colorplates XII & XIII	Motor Trucks and Trailers.....	230
The Delphi	Colorplate XIV	Some ideas on Garage Equipment.....	
The Darien	Colorplate XV	Correspondence Department	236
The Deedsville	Colorplate XVI	An Interesting Hay Chute.....	
Our Front Cover Home.....	179-183	"The Pittsburgh Plan".....	
Photograph and Full Set of Building Plans Drawn to Eighth Inch Scale of the Elizabethan Cottage Pictured in Full Colors on Our Front Cover.....		From AMERICAN BUILDER Plans.....	
		Wide Span Porch Construction.....	
		Building in Mexico.....	
		News of the Field.....	240
		Advertisers' Index	315-317

Published on the first day of each month by American Carpenter and Builder Co.; Wm. A. Radford, *President, Treasurer and Editor-in-Chief*; Wm. A. Radford, Jr., *Vice-President*; E. L. Hatfield, *Vice-President and General Manager*; Bernard L. Johnson, *Vice-President and Editor*; Roland D. Radford, *Secretary*; S. C. Kellenberger, *Dealer Service*; Charles G. Pekar, *Eastern Editor*; Delbert W. Smith, E. B. Wolfrom, C. R. W. Edgcumbe, L. H. Reich, O. H. Sutter, Cecil W. Blashill, H. P. Sessions, J. J. Dubro, Glenn Mills, *Advertising Staff*.

Publication Offices:

Radford Building, 1827 Prairie Ave., Chicago

Telephone: Coluinet 4770

Eastern Office: 250 Park Ave., New York City

Telephone: Vanderbilt 3185

Entered as second-class matter July 1, 1905, at the post office at Chicago, Ill., under the Act of Congress on March 2, 1879.

SUBSCRIPTION RATES—One year, United States, Canada, Mexico, and U. S. Possessions, \$2.00; six months, \$1.00; single copies, 35 cents. Foreign countries, \$4.00.

PROTECTION FOR OUR READERS—The publishers of the AMERICAN BUILDER reserve the right to decline any advertising they believe is detrimental to the interest of its readers; to edit advertising copy and to change or eliminate any statements that reflect injuriously or cast discredit upon other building products, machinery, equipment, supplies or tools.

Be sure in writing to advertisers to say: "I saw your advertisement in the AMERICAN BUILDER."

ADVERTISING RATES—Furnished on application. Advertising forms close on the 10th of the month preceding date of publication.

MEMBER OF THE AUDIT BUREAU OF CIRCULATIONS

AMERICAN BUILDER

THE WORLD'S GREATEST BUILDING PAPER

Vol. 42.

CONTENTS FOR FEBRUARY, 1927

No. 5.

COPYRIGHT, 1927, BY AMERICAN CARPENTER & BUILDER CO.

Around the Family Table.....	Page 135
Introducing ColorKeeD Home Plans.	
Editorial Page	137
The Building Prospect.	
This Demonstration Is Effective.	
1926—A Record Year.	
Scientific Ventilation Demanded.	
A Call for Help.	
Progress in Wood Utilization.	
House History	139
A "Honeymoon Cottage".....	141
New Buffalo Terminal to Cost \$14,000,000.....	142
ART SUPPLEMENT OF NOTABLE ARCHITECTURE	143-146
New York Central Terminal, Buffalo, N. Y.	
The Roxy Theatre, New York City.	
Lincoln Park West Apartments, Chicago.	
The Ozark Athletic Club, St. Louis, Mo.	
A Three-Man Team Wins Success.....	147
This Service Station Backs Up the Name "Super-Service"	151
Details of Norman Architecture.....	152
Insulation—"It Pays for Itself".....	154
Real Estate and Subdivision Work.....	156
The Model Home That Brought a Subdivision to Life.	
Rescue Equipment Aids in Construction Accidents	159
Details of Home Building.....	160
The Chimney Detail.	
Chips and Quips.....	162
COLORKEED HOME PLANS.....	163-178
The Delwood	Colorplate II
The Defiance	Colorplate IV
The Dalton	Colorplate V
The Dearborn	Colorplate VII
Three Good Garages.....	Colorplate VII
The Daisy Garage—The Dale Garage—The Dain Garage.	
The Dartmoor	Colorplate VIII
The Darwin	Colorplate VIII
The Dauphin	Colorplate IX
The Dawson	Colorplate IX
The Delaware	Colorplate X
The Danvers	Colorplate XI
Four Tiled Bathrooms.....	Colorplates XII & XIII
The Delphi	Colorplate XIV
The Darien	Colorplate XV
The Deedsville	Colorplate XVI
Our Front Cover Home.....	179-183
Photograph and Full Set of Building Plans Drawn to Eighth Inch Scale of the Elizabethan Cottage Pictured in Full Colors on Our Front Cover.	

Builders Can Promote Orders for Concrete Jobs.....	Page 184
Better Plastering	186
Plaster Cornices and How They Are Made.	
Instructions in Roof Framing.....	190
A Discussion of Roof Pitches.	
Furnace Heating	192
Gas in Domestic Heating.	
A Colonial Hallway and Stair in the Modern Home	195
Law for the Builder.....	196
Right of Contractor to Mechanic's Lien Upon Property for Improvements Made Upon Orders of Lessee or Tenant in Possession.	
Hot Air Furnace Heat in a Basementless Bungalow	198
New Clothes for Old Buildings.....	200
Modern Building Methods Are the Arch Enemy of the Rat.....	202
Plate Glass for Window Glazing and Many Other Purposes	206
How Dan Does It.....	210
More Use for the Level.	
Another Studding Jimmy.	
Repairing Roll Roofing.	
Trailer-Tool House with Wheels.	
Bench Nail Puller.	
What's New Department:.....	216, 218, 220, 222, 224, 226, 228
A New Electric Dishwasher.	
Industrial Heating Units.	
Flush Type Doors Now Made with Sound Insulation.	
Windows That Swing and Slide.	
A Powerful Door Check.	
Complete Line of Winches.	
Doubly Strong Folding Rule.	
Furnace Draft Regulator.	
Hollow Gypsum Section Construction.	
Improved Saw Filers.	
Portable Draft Gauge.	
Spring Sash Sustainers.	
Permanent Electric Radiator.	
A Complete New Line.	
Handy Rafter Reckoner.	
Mixers Are Improved.	
The Sliding Door Comes Back.	
Efficient Portable Elevator.	
Motor Trucks and Trailers.....	230
Some ideas on Garage Equipment.	
Correspondence Department	236
An Interesting Hay Chute.	
"The Pittsburgh Plan."	
From AMERICAN BUILDER PLANS.	
Wide Span Porch Construction.	
Building in Mexico.	
News of the Field.....	240
Advertisers' Index	315-317

Published on the first day of each month by American Carpenter and Builder Co.; Wm. A. Radford, *President, Treasurer and Editor-in-Chief*; Wm. A. Radford, Jr., *Vice-President*; E. L. Hatfield, *Vice-President and General Manager*; Bernard L. Johnson, *Vice-President and Editor*; Roland D. Radford, *Secretary*; S. C. Kellenberger, *Dealer Service*; Charles G. Paker, *Eastern Editor*; Delbert W. Smith, E. B. Wolfrom, C. R. W. Edgcumbe, L. H. Reich, O. H. Sutter, Cecil W. Blashill, H. P. Sessions, J. J. Dubro, Glenn Mills, *Advertising Staff*.

Publication Offices:

Radford Building, 1827 Prairie Ave., Chicago

Telephone: Coluinet 4770

Eastern Office: 250 Park Ave., New York City

Telephone: Vanderbilt 3185

Entered as second-class matter July 1, 1905, at the post office at Chicago, Ill., under the Act of Congress on March 2, 1879.

SUBSCRIPTION RATES—One year, United States, Canada, Mexico, and U. S. Possessions, \$2.00; six months, \$1.00; single copies, 35 cents. Foreign countries, \$4.00.

PROTECTION FOR OUR READERS—The publishers of the AMERICAN BUILDER reserve the right to decline any advertising they believe is detrimental to the interest of its readers; to edit advertising copy and to change or eliminate any statements that reflect injuriously or cast discredit upon other building products, machinery, equipment, supplies or tools.

Be sure in writing to advertisers to say: "I saw your advertisement in the AMERICAN BUILDER."

ADVERTISING RATES—Furnished on application. Advertising forms close on the 10th of the month preceding date of publication.

MEMBER OF THE AUDIT BUREAU OF CIRCULATIONS



Introducing

COLORKEED
HOME PLANS
TRADE MARK

Wonderful New Sales Help for All Home Building Boosters

WE take pleasure in presenting to the active men of the building industry the latest development in the art of illustrating model home designs—Mr. Radford's newly patented "ColorKeeD Home Plans." See pages in colors following page 162.

By this method, for the first time have the floor plans of new home designs been illustrated in a clean cut, interesting and compelling way, which everyone can understand.

Notice that each room has its own distinctive color, in addition to being clearly named and dimensioned. These colors make the rooms, closets, pantries, bathrooms, and all other parts of the house stand out clearly; so that the room arrangement can be studied and the relative sizes of the various rooms can be compared.

Also notice that many interesting items of modern home equipment and labor saving appliances are suggested on these ColorKeeD Home Plans. Some of these you will want to provide for at the start—others later; but whether now or in years to come you have the assurance that the plan provides for all wanted equipment and labor saving appointments.

Most floor plans as illustrated are hard to

puzzle out, and the result is that all too often home building is started and then expensive changes have to be made in the size and arrangement of the rooms. It is very hard for the average person to live—in **imagination**—in a proposed room arrangement before it is actually built into the new home.

Yet it is very important in selecting a home design to do just that—one must **live in the house**, and test it out in every way as to size and number of rooms, convenience, lighting, privacy, etc.; and do this all in advance, in imagination, before deciding. Otherwise there may be dissatisfaction or expensive changes in the plan after the building is started.

With these ColorKeeD Home Plans, however, every part is so clear and easily understood, and the entire plan is so interesting that you will find yourself "right at home" in these designs, and enjoying, in prospect, living in the one that best suits your needs and taste.

Our builder and dealer readers should be active with these home designs. Show them to all possible prospects. They will sell many a good home for you.

Editor, American Builder.

ONLY ONE MOVING PART THE REID-WAY CONVERTIBLE SANDER



*No belts — no chains — no gears.
No lost power. Nothing to wear
out. Does more work. Costs less!*

The Reid-Way Is Unlike Any Other Sander!

Here is a light strong, durable machine weighing only 29 pounds. It is a bench sander, jointer and floor sander with an amazing capacity for hard work.

Everywhere, the Reid-Way is winning over bigger, heavier, more expensive machines.

It is shipped subject to five days trial.

The coupon below will bring a descriptive circular.

THE REID-WAY CO.

712 No. 16th Street
CEDAR RAPIDS,
IOWA

Always On the Job

Why spend hard earned money for a floor sanding machine which will *stand idle three-fourths of the time*, when your Reid-Way will work for you every day at a fraction of the cost.

The Reid-Way with its improved floor surfacing attachment gives you one of the most sensitive and easily controlled sanding units on the market today, regardless of size.

The Reid-Way will eliminate 90% of your hand work, work right up to the base board on both sides, and gets in all the little closets, stair-ways and other inaccessible places.

The Reid-Way must sell *itself*.

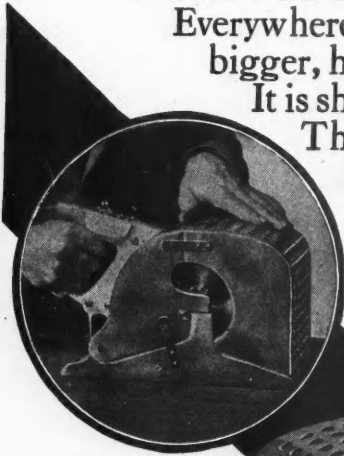

Used as a Bench Sander.

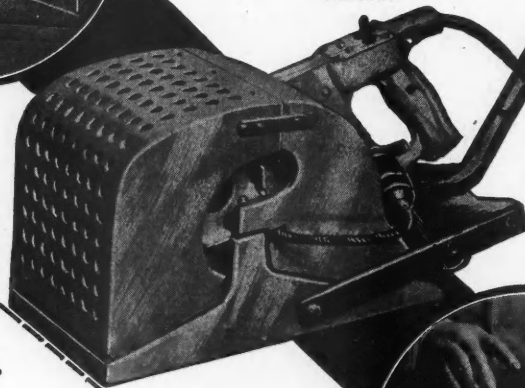

In special base as a Jointer.



Reid-Way Co.,
712 No. 16th Street,
Cedar Rapids, Iowa.

With no obligation on my part you may send circular describing the Reid-Way Sander.

Name.....

Address.....

Just clip this to your letterhead if more convenient.

AMERICAN BUILDER



Formerly AMERICAN CARPENTER AND BUILDER

1827 Prairie Ave., Chicago—250 Park Ave., New York City

1926—A Record Year

THE 1926 construction volume was the highest on record for any year in the history of the country, according to the F. W. Dodge Corporation. Building and engineering contracts were let, during the year 1926, to the amount of \$6,349,914,700 in the 37 states east of the Rocky Mountains, which was an increase of six per cent over the record for the year 1925. For the entire country the total 1926 construction volume must have been well over \$6,800,000,000, with a probable increase of four per cent over 1925.



Scientific Ventilation Demanded

AIR conditions are very definitely deciding the popularity of theaters and those playhouses which do not manufacture their own weather to give the comfortable temperatures and humidities are losing out all over the United States, according to leading theatrical men who have been studying the box office influence of scientific ventilation.

"The American people are insisting on better things and most of all they are beginning to realize the dangers and resent the discomforts of foul, impure air in any theater, school or public auditorium," says one producer who has had a long run of successes. "The latest equipment cools the theater to the correct temperature, carries off body heat and odors and keeps the air supply clean by constant change."

Until two or three years ago, most theaters closed every summer because of the hot weather and the resultant low attendance. Today electrical air control carries off the heat and tempers the air. If it is humid outside, the modern ventilating system keeps at the comfortable point inside. People go to the theaters on the hottest days to keep cool and in winter to keep warm, the theater men say. The theaters have turned a liability into an asset.

Leaders in the American Society of Heating and Ventilating Engineers point to the fact that "manufactured weather" for theaters, or any other type of building, is now an exact science. Tests of air and its psychological effect on human beings have been made in the research laboratories of the society in the United States Bureau of Mines at Pittsburgh. Both scientists of the Bureau and physicians of the United States Public Health Service have aided in these experiments which have furnished the data required for designing proper ventilating systems.

A Call for Help

THE following letter was recently received by the editor of AMERICAN BUILDER:

"I am a carpenter by trade and, like other carpenters, it is necessary for me to do much of my work on scaffolds. Not long ago I apparently lost my nerve for some reason and I find that I can no longer work on a scaffold even as little as 10 feet off the ground. Can you tell me any way in which to overcome this difficulty?"

"No doubt this is an odd question, but any information that you may be able to give me will be greatly appreciated as this situation is a serious matter for anyone in my trade."

Here is a situation which is by no means rare. Many people suffer from this difficulty all their lives, others have it come on as the result of an accident or sickness, while with still others its cause is apparently unexplainable. Often it is only a temporary condition of the nerves. Just what can be done to overcome this condition is information which can well be broadcasted for the benefit of all who may have suffered this difficulty. It seems quite probable that other readers of these pages may have had a similar experience and may be able to offer suggestions as to a remedy. Any suggestions will be appreciated by the editor as well as by this carpenter seeking help.



The Building Prospect

IN the opinion of A. E. Dickinson, president of the Indiana Limestone Company, the building construction industry is standing upon a firmer basis than ever before in its history. He says:

"Nor is the country overbuilt. On the contrary, the swift expansion of commerce and industry, the rapid growth in population and the throwing open of vast suburban districts have placed the industry on a new plane. So it is unwise to use building figures of a few years ago and building 'cycles' of the past decade in attempting to forecast the future. One thing is certain, there is still a considerable unsatisfied demand for more modern construction of all types. It is estimated that \$4,000,000,000 will be spent in 1927 for the replacement of old structures alone."

It is this fact that is overlooked in statements that building shortage has been overcome and that building will show an immediate and decided slump.

TO OUR READERS

FIRE destroyed part of our publication offices at 1827 Prairie Ave., Chicago, the night of Saturday, January 15th, just as this issue was being made up. This, of course, occasioned considerable inconvenience and loss; but our many friends will be relieved to know that by Monday morning, only 36 hours after the fire broke out, every department was settled in new quarters in our other big building next door and doing business as usual.

If your magazine is delayed or if you or any of your friends fail to receive promptly any expected service from us, please be patient and write us again, giving full information, as your letter or subscription record may have been lost.

AMERICAN BUILDER.

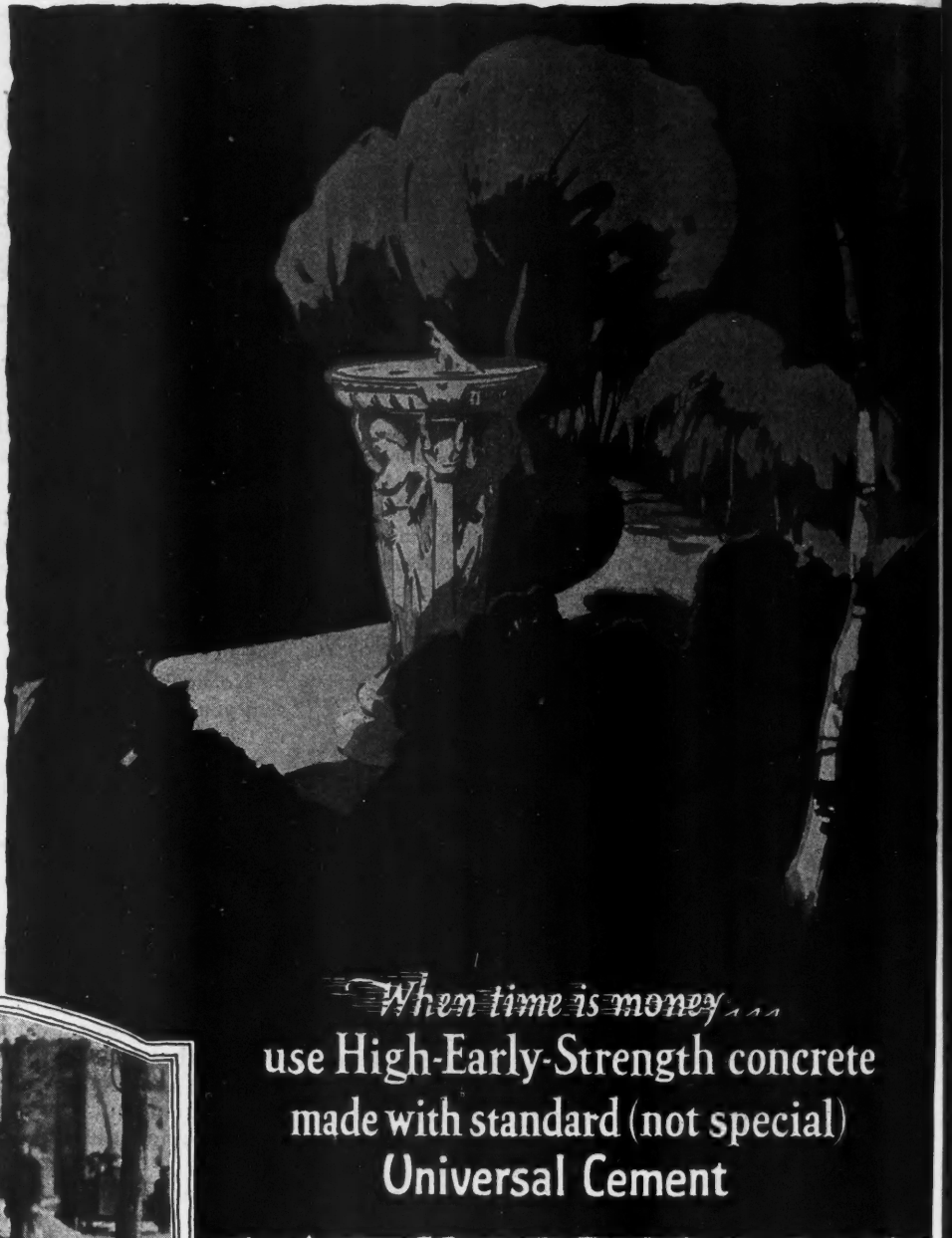

When time is money
 use High-Early-Strength concrete
 made with standard (not special)
 Universal Cement



Sidewalk, Flossmoor, Ill. High-Early-Strength *Universal* concrete obtained by J. D. Smith, contractor, using standard *Universal* (not special) cement, the same quality *Universal* regularly handled and furnished by Darr Coal & Supply Co., Hazel Crest, Ill.

UNIVERSAL PORTLAND CEMENT CO.
 210 South La Salle Street, Chicago.

Without obligation, please send me detailed information on methods for securing strong concrete in 3 days with standard *Universal* [not special] cement, the same quality *Universal* regularly used.

Name

Address

AB 2-27

Use It On Any Job Calling for Early Use or Better Concrete

High-Early-Strength *Universal* concrete is used on all kinds of work from an ornamental sundial to a sidewalk, street or building—

- in 3 days this concrete has the strength of ordinary 28-day concrete;
- it is as workable as you wish to make it;
- it is permanently *better* and *stronger* than ordinary concrete;
- it is made by using fully tested methods and standard *Universal* cement which, being standard—not special—sells at the usual price.

The accompanying coupon will bring full details promptly.

Universal Portland Cement Co.

Chicago Pittsburgh Minneapolis Duluth Cleveland Columbus New York

Concrete for Permanence

Sta
 Tell th
 Remod

 A
 abstrac
 from t
 indicat
 from th
 All t
 then a
 down."
 was fra
 John
 improv
 tore d
 an add
 with b
 The
 old bri
 of the
 before
 ture of
 receive
 identica
 an old
 have st
 solved
 of the
 house



Starting as a Simple Log Cabin This Home Grew by Additions from Time to Time, the Construction of Which Tell the Story of the Changing Fortunes of Its Various Owners and Reveal Their Personal Characteristics to the Remodeling Architect.

House History

How the Construction of a Building Revealed Its History and the Owner's Characteristics—Interesting Facts Discovered When Remodeling a Building in Lower Michigan

By E. A. MARTINI, Architect

AN architect was requested by a prospective owner to inspect an old house to ascertain if its construction and subsequent life would justify buying it. The abstract of title showed that the land had been secured from the government in 1839 but there was nothing to indicate when the house was built. Little could be learned from the early settlers.

All they said was, "Formerly a log cabin stood there, and then a kitchen was added but I think that was all torn down." "I lived on the place when a child and the building was frame then, I remember it was painted white!" "When John bought the land, they made many improvements but I cannot recollect if they tore down the old house or if they built an addition and covered the entire structure with brick."

The house as it now stood was a rambling old brick building. The color and surface of the brick indicated that it had been built before the era in which the color and texture of brick was given the study it now receives. All the brick were practically identical. The discovery of the remains of an old brickyard which was supposed to have stood near there, about 30 years ago, solved the problem concerning the source of the brick. But judging from rumors, the house was much older than the age of the

brickyard. The joints were gray, very neatly struck and not a crack was to be seen in the outside walls.

A huge white pine tree, thrice the height of the house, stood like a protecting sentinel near the front entrance. Perhaps the beauty loving wife of the first settler begged to have this tree preserved as a reminder of early days. An interesting brick pattern ran along the eaves and sides

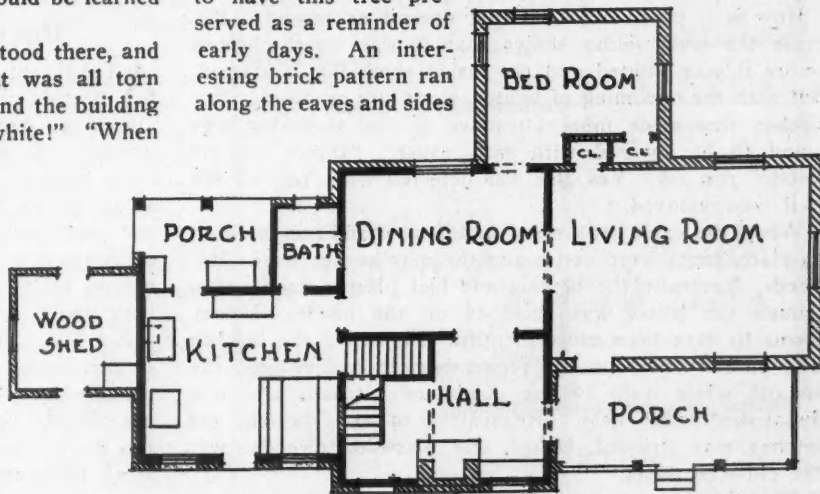

This Plan of the Old Home Shows Its Present Arrangement. The hatched walls indicate the newer work while the solid walls show the older portion of the building.

of the gables. Most of the windows had one panel sash, long and narrow; and typical of many other old houses in the vicinity, a so-called cottage type window graced the front.

The inspection trip first led into the basement. This was found to be under only a part of the house. The 3 by 8 joists were mortised and tenoned into a 10 by 12 sill plate which rested on stone foundation walls. What did this indicate? Originally the house must have rested on posts. What other reason for such a heavy sill could there be? The stone foundation under the plate signified a frame building while the mortise and tenon joints revealed their age to be prior to the modern methods of using nails or joist hangers.

An old well was discovered near the kitchen entrance. It was filled in with stone, a sign of industry. As the stones were a detriment to the land, what better use could they have served than to fill up the old well. Excavations showed the remains of a pipe running to the old kitchen sink but the last owner used city pressure and the kitchen pump was discarded.

On the first floor the kitchen, under which there was no basement, was found to have divided sash in the windows, and the doors were battened in contrast to the panel doors in the balance of the house. This construction gave us a clue to its history. The log cabin was torn down but the kitchen remained, evidence being shown that this room was the oldest part of the entire building. Our conservative pioneer apparently believed in leaving well enough alone. Instead of erecting an entire new home, he removed only the worn part and left the kitchen standing.

Let me describe how this kitchen was constructed. According to the abstract of title, a saw mill driven by the neighboring stream occupied part of the land. Our log cabin owner dragged the trees which he felled on the site to the mill to be cut. A tree probably was a tree to him, so he selected what he considered those best suited in size to his needs, irrespective whether or not they were the same kind of lumber. Consequently the full 3 by 5 studs were ash, pine or hemlock, whatever came first to hand.

If we could only expose some of the fine ash beams which are concealed between the two layers of sheathing both on the inside and outside, and use them as decorative wall beams, how much the interior design would be improved.

This sheathing is made from various kinds of wood and ranges in width from 10 to 18 inches. Several of the boards had no knots. What wonderful trees must have graced the land! The outside sheathing was covered with bevel siding and here building operations appear to have been discontinued. Perhaps spring had arrived and the call of the fields was stronger than that of building the house.

How is it possible to tell that operations ceased? Because the level siding shows that it was weatherbeaten before it was painted and the inside sheathing is stained. But with the oncoming of winter, work was renewed. The kitchen was made more attractive as the sheathing was found to be covered with wall paper. "Direct on the wood?" you ask. Yes, this was detected when part of the wall was removed.

When the cabin was razed and a new addition built in its place, times were better and the new houses were plastered. Naturally the new rooms had plaster finish, even though the house was sheathed on the inside. Money seems to have been more plentiful than when the kitchen was built or perhaps our pioneer's wife had noticed the smooth white walls of the neighbors' kitchens and was dissatisfied with hers. Regardless of the motive, the kitchen was stripped, lathed, and plastered directly over the old wall paper.

The old trim around the doors and windows served as grounds for the plastering and new trim made to cover the joints. Again the wood was taken from the trees on the grounds as some of the trim is oak and other pine

around the same door openings. But as it was all painted white, no one but the owner knew the difference. Thus the house must have stood for many years, frame and all painted white, as remembered by the early settler.

Once more did the house undergo a change when a new owner, who's ideas were more in keeping with modern efficiency, evidently purchased it. A basement was built under the last addition, which accounts for the stone foundation under the heavy wooden sill.

Not only was the basement built, but also two rooms were added, each one a wing, projecting from two sides of the house. Presumably our owner was socially inclined and fond of company because he constructed what was at that time the "largest living room in town." Other people had settled in the community and the old rooms were too cramped to accommodate large neighborhood gatherings.

Lumber undoubtedly was less plentiful and room space more essential because the new walls were built of 2 by 4 yellow pine instead of 3 by 5 ash. The inside was lathed and plastered directly on the studs. It no longer seemed necessary to construct walls as substantially as in early days.

However, one great improvement was accomplished; the entire walls were veneered with brick. How can we tell that part of this brick veneer was not laid sooner? Because the old siding on the kitchen walls beneath the brick was painted several coats and the paint worn off in spots, while the siding under the latest additions showed no evidence of having been painted.

There are numerous old houses similar to this one in our country. Many of them seem only shells about ready to collapse. Close inspection often reveals their age, and the care and interest the owners expended in the upkeep of their homes. The method of construction, the kind of lumber, the masonry, material, design, and size of the windows help to ascertain whether or not an old house is worth remodeling.

To summarize the characteristics of the owners, let us enumerate the points revealed.

Frugality; the use of material on the land, lumber, stones, and bricks.

Patience; satisfaction with the log cabin until his means justified gradually enlarging it.

Industry; the removing of stones and felling of trees on the site.

Love of beauty; the papering of the wooden walls and preservation of the pine tree.

Honesty; the construction of a thoroughly substantial building, in which a great part of the labor is concealed.



Recommends Uniform Code

At a recent meeting of building inspectors of the various Florida cities, held at Ft. Pierce, Florida, Norman M. Stineman, structural engineer for the Portland Cement Association, urged a careful study of the proposed uniform building code for Pacific Coast cities. This code, according to Mr. Stineman, has received more thorough and intelligent study than any other building code now in existence and is thoroughly modern in its treatment of various building materials and places proper restrictions on their use.

An important consideration, of particular interest to smaller cities, the speaker said, is the possibility of adopting this proposed uniform code by reference. If the building officials' conference of Florida were to adopt and print the Pacific Coast Code or a code of their own making, small cities not having the means to prepare and print a code could adopt it by reference. He urged the building officials to prepare a city building code which, though without authority, would be available for adoption by cities and would lead to uniformity of building regulations.

A "Honeymoon Cottage"

WILLIAM A. STICKNEY, Architect



There Is Something About This Tiny House Which Is Remarkably Distinctive and Makes It Stand Out from the Class of Usual Small Homes with an Assurance of Coziness and Individuality Not Often Rivalled.

THIS little home can well be called a "honeymoon cottage" for it was designed especially for a newly married couple and is just large enough to meet the modest requirements of two. Exclusive of the terraced porch and rear entry, it occupies a space but $27\frac{1}{2}$ by $23\frac{1}{2}$ feet and is so compactly arranged that it actually offers all the comfort of a much larger home.

The construction is stucco on metal lath. The stucco is of a pale pink tone while the exterior trim is painted a harmonizing blue and the roof is of cement tile in blues and grays. Although so small this house has a style about it that places it far ahead of the usual small house and this style has been largely achieved by excellent proportioning and by the handling of window and chimney details. The windows are of the in-swung casement type with ornamental shutters. The chimney is worked into the terrace and entrance plan and serves a corner fireplace in the living room.

This corner fireplace is a distinctive and attractive feature fitting well with the compact plan. Besides the living room there is a bedroom of comfortable size with a large closet, a bathroom, kitchen and breakfast nook. The latter is used exclusively for dining purposes. At the rear of the kitchen there is an entry with stairs leading to the basement. An additional feature of the living room is an extra closet which might well serve as a bed closet to provide for the emergency when an extra bed is required.

The interior finish of this cozy little home is stained a silver gray. The living room and bedroom floors are of oak while yellow pine is used in the other rooms.

THEODORE M. FISHER.

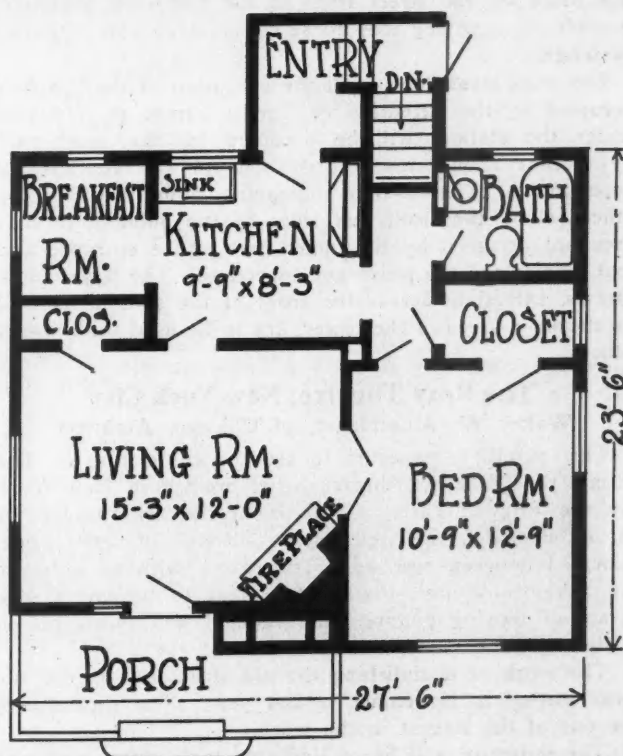

So Compactly Is the Interior Arranged That It Would Be Hard to Believe so Much Living Comfort Could Be Crowded Into So Limited a Space.

New Buffalo Terminal to Cost \$14,000,000

THE traveling public will certainly appreciate the many fine new railroad terminals which have recently been completed or are planned for the near future. One of these huge projects is the New York Central Terminal in East Buffalo, perspective drawing of which is reproduced in duotone on the opposite page. The new Union Station at Chicago, the immense new Cleveland Terminal, and the West Philadelphia Terminal of the Pennsylvania Railroad have been already illustrated in AMERICAN BUILDER. Future large terminal projects include the new electrified station of the Illinois Central at Chicago and the proposed immense new terminal to replace the present LaSalle Street Station, Chicago.

New York Central Terminal, Buffalo, N. Y.

Alfred Feltheimer and Steward Wagner, Architects;
George W. Kitteridge, Chief Engineer

The new terminal of the New York Central Railroad in Buffalo will be situated two and one-half miles from the present Exchange Street Station, on Curtiss Street, in a section known as East Buffalo. The site of the new station will cover an area of 30 acres and the cost of the structure, including its auxiliary facilities, will be approximately \$14,000,000. It will be a steel frame structure faced with an attractive brick. The station proper, as planned, will be six stories high with a twelve-story tower surmounting the main entrance facing down Lovejoy Street.

The main entrance and main floor of the station, including the passenger concourse, waiting rooms, dining rooms and all passenger facilities, are to be above the tracks and approached by grading Lovejoy Street to an extensive plaza which will surround the front of the station building. This will provide an adequate space for receiving and departure of private automobiles and taxicabs. Beneath this plaza on the street level at the east end, provision is made for a trolley loop to serve incoming and outgoing passengers.

The track-level floor, with the exception of that portion occupied by the extension of Curtiss Street as it passes under the station, will be occupied for the most part by storage rooms for records and for the commissary department. The second mezzanine floor provides for offices along the front and sides of the building in that area not occupied by the upper part of the entrance and exit lobbies and the passenger concourse. The upper three stories, extending across the front of the station, as well as the floor areas in the tower, are to be used for railroad offices.

The Roxy Theatre, New York City

Walter W. Ahlschlager, of Chicago, Architect

This month is expected to see the completion of The Roxy, the \$8,000,000 theater being erected in New York by the Roxy Theaters Corporation, the firm headed by S. L. Rothafel, the well known "Roxy" of radio fame. Located between 50th and 51st Streets with an entrance on Seventh Avenue, the theater plans to present a program of moving picture entertainment and music on an elaborate scale.

The work of demolishing the old structures on the site was started in November of last year. The theater will be one of the largest in the world.

The structure will be of Bedford stone, terra cotta and pressed brick, and will present attractive facades on 50th and 51st Streets. Large and elaborate stained glass win-

dows will ornament the front of the building on each of these thoroughfares.

Entrance to the theater will be gained through a large and picturesque foyer opening on Seventh Avenue through the Manger Hotel. The foyer will not be part of the hotel, however, and entrance to the theater cannot be made from the hotel without going to the street.

The building covers an area of 52,250 square feet and will seat more than 6,000 persons when completed. Back of the theater proper will be a six-story building containing dressing rooms, club rooms, kitchen, tailor shop and numerous other conveniences.

Lincoln Park West Apartments, Chicago

Oman & Lilienthal, Architects and Engineers

The general design of this building will be an adaptation of the Adam style with a very attractive exterior of pressed brick and Bedford stone treatment, the first three stories being practically all stone.

The structure will be 17 stories in height with basement, containing 16 typical floors with an elaborate ground floor and roof garden.

The typical floors will contain two apartments per floor, one of which will have seven rooms and the other will consist of six rooms. These apartments have been planned to present the utmost in elegance and comfort equal to the best of apartments in Chicago. The equipment throughout will be of the highest quality obtainable.

High speed automatic and hand-control elevators, vapor or vacuum heating system operated with the best steel boilers which will be equipped to burn oil, incinerators, modern laundry equipment and individual refrigeration will be some of the features of this building.

The apartments themselves will be separated by double partitions of hollow tile and thoroughly deadened against the transmission of sound with insulating material.

Each apartment will be equipped with a private telephone connected with the lines of the Chicago Telephone Company. This phone will be installed in a special telephone booth and connected with an extension from the masters' rooms and butler's pantry. A complete intercommunicating telephone system will be installed in addition.

The building will overlook the most beautiful part of Lincoln Park with an unobstructed view of its famous Zoological and Botanical Gardens, its beautiful lagoons and its winding driveways, in addition to commanding a clear view of Lake Michigan.

The Ozark Athletic Club, St. Louis, Mo.

Mauran, Russell and Crowell, Architects

This new 14-story clubhouse is to be erected on Kings-highway Boulevard, St. Louis. The plans provide for a building with about 200 sleeping rooms with tubs and showers; assembly halls for conventions, private theatricals, musicales, lectures, dancing and banquets; ballrooms, lounges, card rooms, radio room, billiard rooms, bowling alleys, and a separate swimming tank for women.

The building plans provide for an underground garage with ramp entrances containing space for more than 100 cars. Other features include the private dining rooms, accommodating groups of from four to 100 persons; a spacious lounge room, in which a huge log fire will be kept burning; a slumber room, a locker and change room, barber shop and Turkish, Swedish and electric baths. The cost of the site and building will be \$2,000,000.

1927

st

ch of

large
venue
part
cannot

t and
Back
aining
and

ation
essed
stories

base-
round

floor,
will
anned
al to
ough-

vapor
steel
ctors,
ation

ouble
ainst

hone
Com-
hone
sters'
icac-

t of
mous
oons
ding

ngs-
or a
and
cals,
oms,
rling

rage
100
oms,
s; a
l be
om,
The

ART SUPPLEMENT *of* NOTABLE ARCHITECTURE



PLATE 121

The NEW BUFFALO, N. Y., STATION NEW YORK CENTRAL RAILROAD; Alfred Feltheimer & Steward Wagner, Architects; George W. Kittredge, Chief Engineer.



The ROXY THEATRE, New York City; Walter W. Ahlischlager, of Chicago, Architect. This notable structure nearing completion at 50th St. and Seventh Ave. will seat 6,000 persons.

The ROXY THEATRE, New York City; Walter W. Ahlschlager, of Chicago, Architect. This notable structure nearing completion at 30th St. and Seventh Ave. will seat 6,000 persons.



PLATE 123

The LINCOLN PARK WEST APARTMENTS, Chicago; Oman & Lilienthal, Architects; an example of the Adam style.



PLATE 124

The OZARK ATHLETIC CLUB, St. Louis, Mo.; Mauran, Russell & Crowell, Architects.

A

An
Pres
Eng
Com

I

nio,
tural
finan
in th
30 m
gatin
thre
ings
comp
cour

For
of t
state
Flor

With

A Three-Man Team Wins Success

How the Kelwood Company Has Made a Remarkable Building Record in San Antonio, Texas



Arthur A. Seeligson Is President and Supervising Engineer of the Kelwood Company.



Robert B. Kelly, Vice-President and Supervising Architect of the Kelwood Company.

INCORPORATED early in 1924, the Kelwood Company of San Antonio, Texas, offering architectural, constructional and financing services, has done in the brief space of less than 30 months, a business aggregating between two and three million dollars in buildings of various types already completed or now in actual course of construction.

For a corporation in some of the eastern or northern states or in California or Florida, this figure would



H. C. Wood, Secretary-Treasurer and Commercial Engineer, Is the Third Member of the Three-Man Team Which Has Made the Kelwood Company an Outstanding Organization in San Antonio, Texas.

not be a startling one. Neither is it startling for the Kelwood Company when the factors that enter into the rapid success of the company are taken into account. But, while not startling, the figure is certainly remarkable for a city and a section that, while making steady advancement in all material lines, has not experienced any such spasmodic building activity as has swept over Florida during the last two years.

Naturally, builders in



With the Exception of the First House in This Typical Kelwood Row, All Cost Approximately \$8,400, Including Every Detail, Even to the Landscaping, but Exclusive of the Price of the Lot.

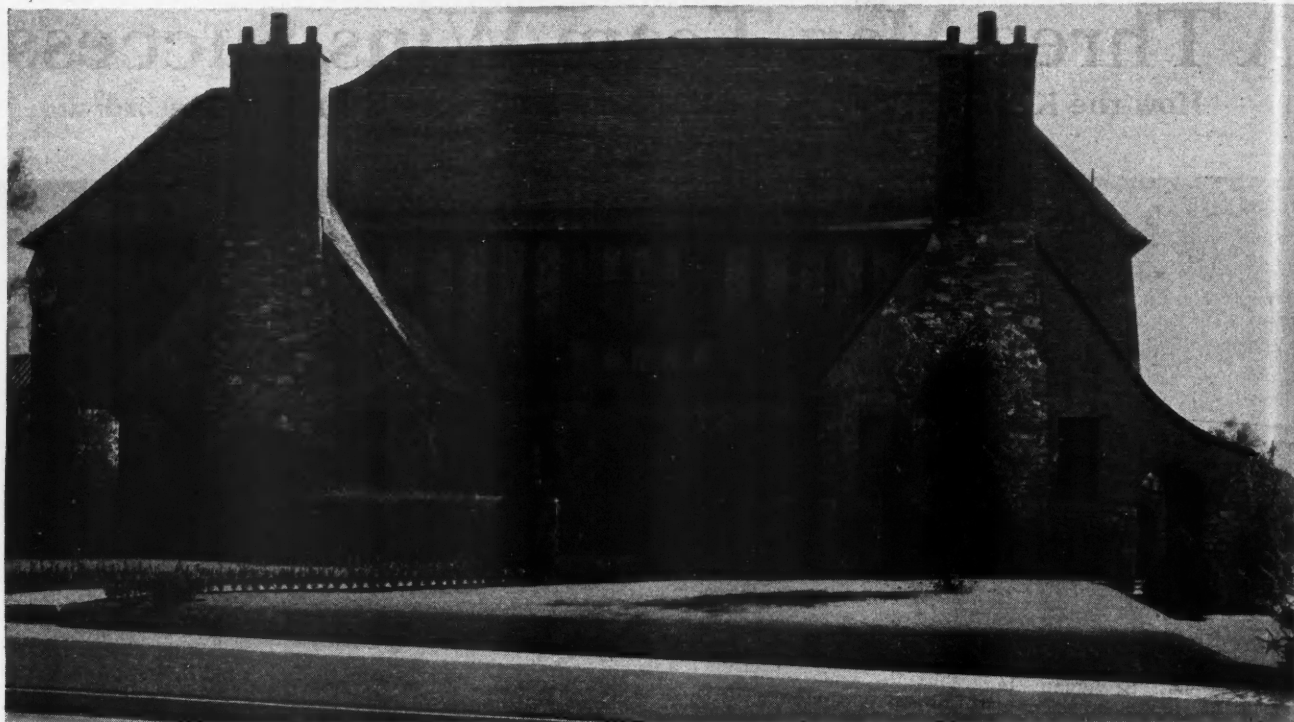

The Kelwood Company Specializes on Better Grade Homes Ranging in Price from \$11,000 to \$45,000, of Which This Beautiful Eleven-Room Residence Is an Excellent Example.

other sections have been interested in the progress of the Kelwood Company. Their interest has been more than idle curiosity. It is with the purpose of setting forth something of the reasons for the success of the organization that this partial survey of the history and methods of the company is made.

Located on the ninth floor of an office building in San Antonio, and occupying the major portion of the floor, the substantial and commodious surroundings of the Kelwood Company are likely to impress even the casual visitor. If the visitor be particularly interested in architecture or building, he will, no doubt, marvel at the completeness with which the suite is furnished.

Here are offices for the three executives of the company; here are tastefully furnished waiting rooms for clients, and here is a drafting room in which twelve draughtsmen may be seen at work at all times. But perhaps the most noticeable thing about the place is the air of quiet assurance, of intangible dignity, that pervades the place and sets it apart from the bustle and hurry of Travis and St. Mary's streets just beneath it.

One finds such executive establishments of architectural and construction corporations in other places, but hardly expects to find one in San Antonio, a city that in 1890 had only 40,000 souls and was known chiefly as being a "cow-punchers' resort" even as late as the beginning of the present century. But San Antonio has grown and changed! Now it boasts 225,000 people and is noted as being a city of homes. Furthermore, it is the logical capital of a rich farming area that lies to the south and southwest of the city, the possibilities and opportunities of which have just been scratched.

The incorporators caught a glimpse of this vision, they took a peep into the future that is to be, early in 1924, and they determined to make of the new corporation an agency for giving to the new South Texas a distinctive

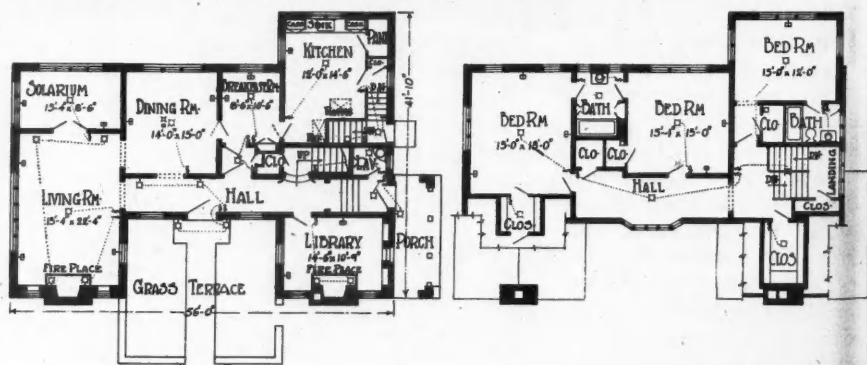

This Floor Plan, of the House Shown Above, Indicates the Completeness with Which Every Detail is Treated in the Planning of Kelwood Houses.

order of architecture that would blend and harmonize and fit into the landscape of the country at the same time that it would carry out the historical traditions of the old Southwest of Indian days.

The visitor from afar has only to continue his tour over San Antonio to become impressed further with the permanent and artistic flowering of the company's ideal just set forth. In almost every street in San Antonio's new north side will be seen new homes, just completed or in the process of construction, placarded with the words, "The Kelwood Company—Architects," or "The Kelwood Company—Builders."

As these words are clicked off on the writer's portable, there is spread out before him illustrated, special Aztec Theater editions of the two San Antonio Sunday papers. These tell the story of the creation of a million and a half dollar theater and office building in San Antonio that is a marvel.

So far as externals are concerned, this combination theater-office building is much like other business structures. It is only when the lobby is entered that one experiences the significance of the term Aztec as here used. Here one is transported back to the times when these early Americans held sway in Old Mexico and when they pro-

duce
as a
new
A
pany
ques
to a
P
foun
of th
part
gen
sup
com
incl
prof
A
hap
the
inqu
Eve

Fou

San
of \$

duced in their pyramid cities just such peculiar buildings as are reflected in the decorations of the interior of the new theater in San Antonio.

And so examples of the accomplishments of the company could be multiplied if space permitted. The next question is: How has the Kelwood Company been able to achieve such results?

Perhaps the first cue to the answer to this query is found in the organization of the company. The officers of the company are all experienced and capable men in their particular line. Arthur A. Seeligson is president and general attorney; Robert B. Kelly, vice-president and supervising architect; H. C. Wood, secretary-treasurer and commercial engineer. The stockholders of the company include many of the leading capitalists and business and professional men of San Antonio.

Attractive designs, more than any other one thing perhaps, have caused people to be interested in the work of the Kelwood Company and have prompted them to make inquiries that have led to more business for the company. Every house that an architect or a builder completes speaks

either for or against its creator. Kelwood houses are the company's best advertisers.

"The ultimate success of any organization of our kind depends upon a high ideal of architecture ever present in the minds of the executives," said Mr. Kelly. "This ideal should keep the practical achievements above the purely commercial phase. We maintain at all times what might be termed an architectural school, the purpose of which is the study of real designs.

"A house for sale, planned by us, goes through the same careful office procedure as does a structure that we design for the most exacting client. We try to set new standards in the building arts for San Antonio and South Texas. We pioneered in Spanish and Italian houses, but we have been careful to tone down both the exterior and the interior finish of such houses in an effort to avoid the flamboyant and ludicrous effects seen in such houses in some localities.

"We believe strongly in advertising as a constructive force in building such a business as ours is," Mr. Kelly said. "We use the newspapers to get our policies before the people, and our real estate department also makes use of display advertising in the selling of homes."

Recently, the Kelwood Company issued an attractive, illustrated brochure that is mailed in reply to all inquiries that the company receives, and also to representative citizens in the cities and towns of South Texas. This booklet is a handsome piece of work. It sets forth the history and policies of the company, and the illustra-

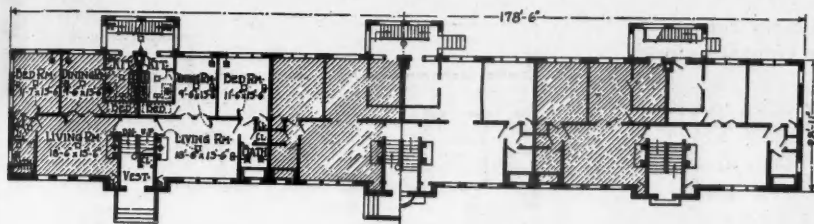

Four-Room Apartments Are Laid Out as Indicated in This Plan, on Both First and Second Floors of the Building Shown Below.



The Operations of the Kelwood Company Are Not Confined to Single Houses. The San Gabriel Apartments, in San Antonio, contain twelve four-room apartments, and a ten-car garage, all handled in the Spanish style, at a cost of \$75,000.

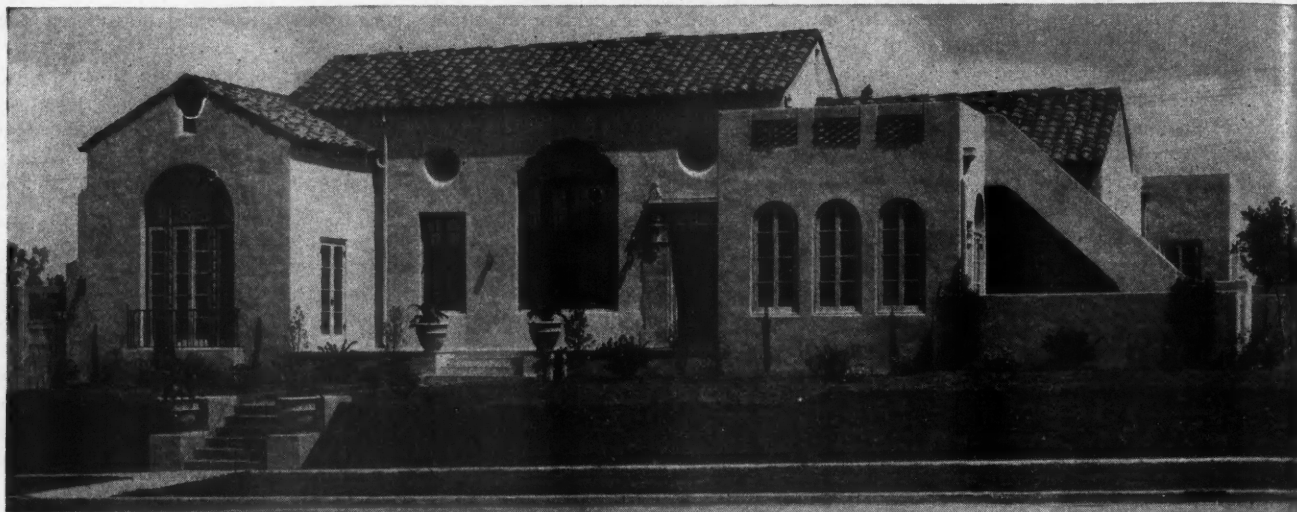

Another Typical Home of the Sort Built by the Kelwood Company. The cost, \$24,698, as in the case of all Kelwood houses, includes all landscaping, shrubbery and drives.

tions are of such beauty and variety that they carry conviction, as to the ability and achievements of the company, to the mind of the reader.

The Kelwood Company has confined its activities to one rather closely articulated territory, namely South Texas. It restricted its building activities to San Antonio at first and to the construction of homes of the better grades, ranging from \$11,000 to \$45,000 in price, but it has since expanded its operations until it maintains, besides the parent office in San Antonio, branches in Brownsville, Corpus Christi and Houston, and builds, in addition to homes, many other types of structure. By limiting the territory operated in, the company has been able to work out orders of design that can be widely used throughout South Texas.

Through its triple architectural, construction and financing service the Kelwood Company has attracted and is able to attract more business than is a company that engages in only one of these essential services to modern building. In Texas it is especially true that many persons desiring to place improvements upon properties, have not the ready cash with which to begin the initial operations. The specialists of the Kelwood Company, through having made a study of commercial buildings, institutions, residences and realty development in other parts of the country, are often able to come to the relief of the client in the matter of financing.

"In many cases property owners have been undecided as to the most suitable improvements to be erected on their particular property," the brochure says. "In conjunction with the owners, the specialists of the Kelwood Company have suggested the most suitable improvements, prepared a careful investment analysis based on a conservative schedule of returns, prepared the plans, handled the construction of the buildings, and arranged the necessary financing at the lowest current rate of interest. This character of service has been of inestimable value to our clients."

The old saying that "two heads are better than one," is a truism the value of which is often seen in business life. Take two men, mediocre successes or absolute failures when working alone, and associate them together in a common business, and often they will make a fine thing of it. The necessary talent or qualification, or it may be financial resources, that one lacks is made up by the other. Thus their efforts become complementary and mutually helpful.

When three executives, each a leader in his field, are associated in the same corporation, the team formed is certainly better equipped for securing and handling busi-

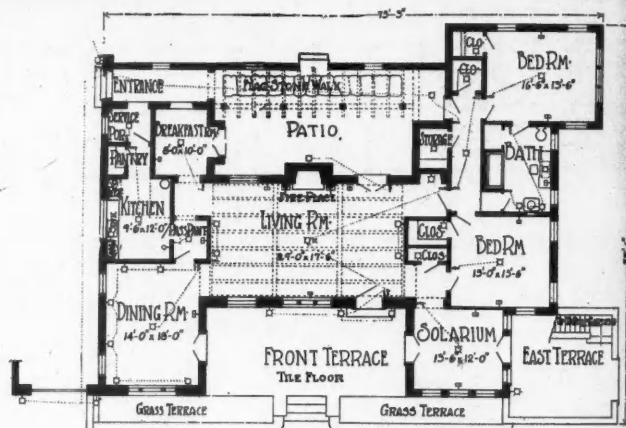

The Arrangement of the Home Shown in the Photograph Is Practical and Attractive with Its Partially Enclosed Patio at the Rear.

ness than is the usual one-man business. While it is true that a successful business man may, if he has the capital, employ experienced men to assume responsibilities and duties for him, it is seldom that the services rendered by employes are as satisfactory as those rendered by men directly associated in the business.

The Kelwood Company has in its president an attorney of such experience that he can pass quickly upon the legal and financial aspects of any business under consideration. The vice-president is an experienced architect, and before the formation of the company was a successful builder of homes. Unusual but tasteful designs have been and are among the things striven for by the Kelwood Company, and the attractive homes in which the company specialized during the first few months of its operation did much to give the company such prestige that the undertaking of bigger and more elaborate building projects came as a natural consequence.

The secretary-treasurer is a man who prior to the formation of the Kelwood Company had had wide experience in manufacturing. He had also built houses for sale. Accustomed to the details of buying and selling, he wields a mighty arm for the company as commercial engineer.

While each executive of the Kelwood Company is a practical business man, the division of labor of the company into the three departments of architecture, construction and financing, makes it possible for each executive to exercise his own peculiar talent in the field of greatest service to both the company and the public.—A. W. Roe.

Give
Four

T

auto
less
what
them
to a

Or
two
bord
a ser
super
ings
color
and

Th
posit
room
are a

At
every
gene
a do
char
tire
front
back
Th

entir

This Service Station Backs Up the Name "Super-Service"

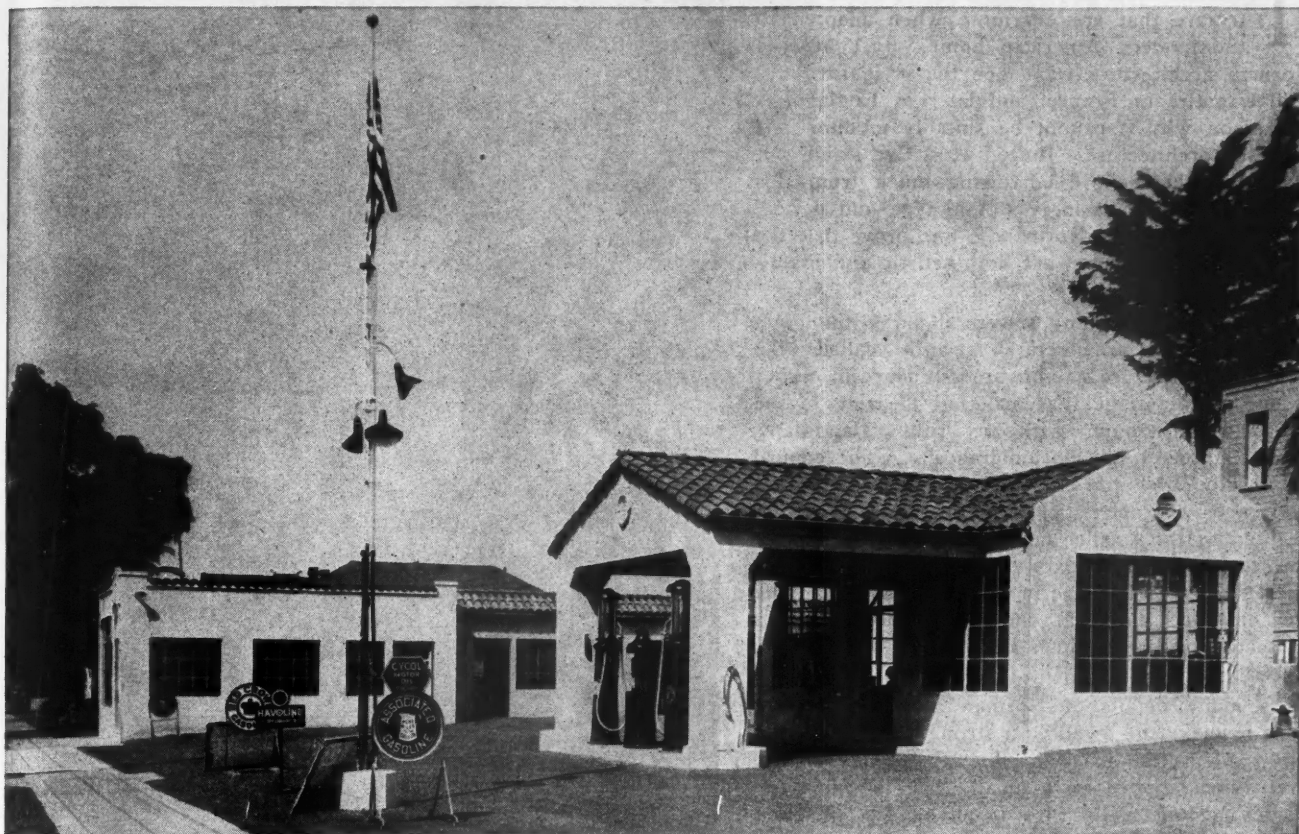

Cream Colored Stucco Walls, Surmounted by Red Roofs of Spanish Tile, and Driveways of Clean White Gravel Give a Neat and Attractive Appearance to One of the Most Completely Planned and Equipped Service Stations to Be Found Along the Highways of California.

THERE are probably a million "super-service" stations scattered over the United States, but few of them are able to back up their assertions. The automobile driver, in the course of his travels, passes countless gas stations and he is as familiar, if not more so, with what constitutes a "super" service outfit as the proprietors themselves. The public can no longer be fooled in regard to anything connected with automobiles.

On the outskirts of San Diego, California, at a junction of two through highways, both leading south to the Mexican border town of Tia Juana, there has just been completed a service station that can rightly lay claim to being a real super-service establishment. In the first place, the buildings and grounds are as neat as wax. The stucco is cream color, and the Spanish tiles on the roofs are red, with here and there a moss-green one.

The corner lot upon which the station is situated makes possible four entrances from two streets. There is ample room to drive entirely around the central building. There are air hoses located at advantageous points.

At one end of the station there is a series of shops where every attention can be given a motor car. A store for general accessories occupies the corner position, and has a door opening to the sidewalk. Next there is a battery charging and repairing shop. In the same large room the tire shop is located. The next shop in line is an open front room where greasing and washing are done. In the back corner there is a repair garage.

The corner lot measures about 134 by 116 feet. The entire surface is covered with fine, washed gravel that is

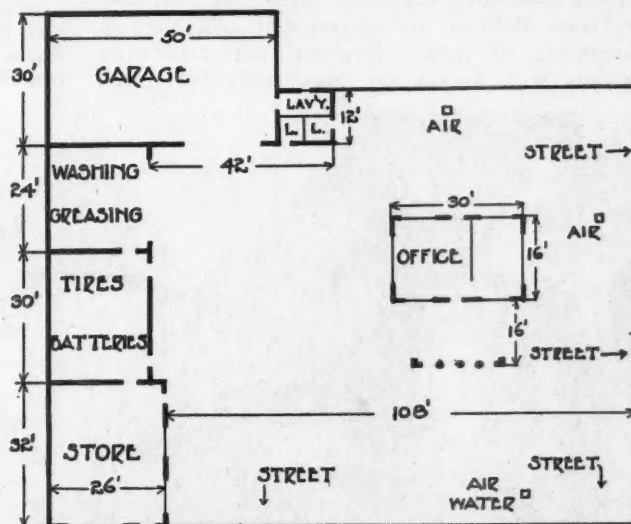

The Layout of the Various Service Units Shows Provision for Every Requirement of the Motorist and an Arrangement that Makes for Efficient Service.

kept clean and smooth by raking with bamboo rakes. At night flood lights, that are attached to the tall steel posts that support the water and air hoses, as well as powerful lights under the canopy of the office building make the white grounds as light as day. By night, then, as well as by day it is obvious to a passing driver that here is a service station which backs up its prefix of "super."

J. HAROLD HAWKINS.

Details of Norman Architecture

A Period Style Offering Many Possibilities for Distinctive Effects in the Designing of Modern Homes

THERE are many features of Norman architecture that are charming when adapted to the modern American home. Just because Norman architecture was once the style for lofty feudal castles in France, and later in England, is no reason why it cannot be suitably modified for domestic architecture. Indeed attractive small, but up-to-date, homes are borrowing much from this picturesque but pleasingly simple type and period. The farm houses of Normandy, too, prove that the castle tower and turret are both artistic and practical for the dwelling.

Because of the many towers flanking the plain walls, Norman architecture is aptly called "the circular architecture." This predominance of curves is one characteristic that makes it pleasing to the eye and harmonious with any rolling landscape, curved street or hillside building site. The conical roofs atop the towers and turrets are another noticeable characteristic, and one that is easily adapted to the smaller home. Often these smaller towers were sentry boxes on the castle moat, wall or battlement. The one in the illustration, flanking the entrance porch at the right, shows how a protective feature becomes a decorative one in times of peace.

As many details of Norman architecture were built to make the dwelling a stronghold or fortress, this explains the massive effect that lends dignity even when applied on a small scale to our latest homes. Stout walls with loopholes for weapons, doors at ground level only and for soldiery, small windows, secret staircases and sturdy building materials made Norman architecture durable for battle and the succeeding centuries. Since the 11th century, when William the Conqueror brought Norman refinements to Saxon England, tall castles or chateaux with towers and plain walls have been

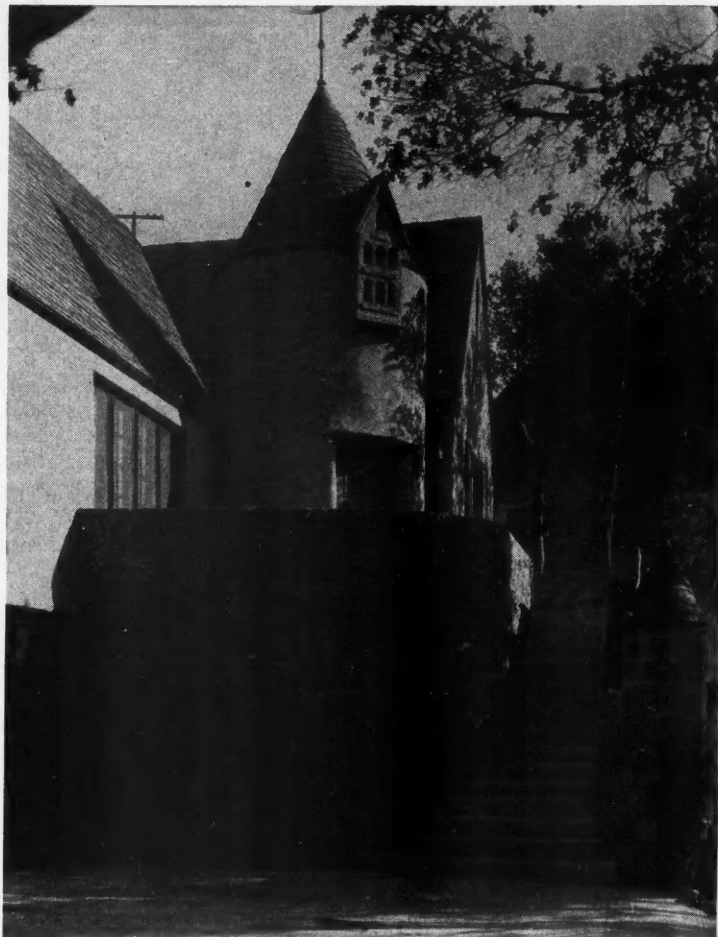

The Little "Watch Tower" Flanking the Porch, the Dove Cote and Weather Vane Illustrate How Both the Norman Castle and Farm House Can Lend Distinctive Details to the Modern American Home.



A Close-up Reveals the Charm of Texture in Building Materials and How Cleverly the Substantial Masonry of the Normans Has Been Simulated in Stucco and Rock. The mullioned windows also emphasize the period effect.

the inspiration of architects.

Half timbering was applied later in the sixteenth century of Elizabethan England. But it frequently makes an interesting variation to modern petite Norman "castles." This is partly because manufactured stucco must be substituted for the sturdy native masonry of the Old World. Some clever effects, however are gained by resourceful modern architects by blending rockwork and stucco. The wall in the Hollywoodland, California, castle, shown in one of the illustrations, is noteworthy and is responsible for much of the solidity and dignity felt in the structure. Texture, too, is akin to the decorative in building materials.

In this home, as well as in the others pictured here, locating the garage has been achieved in such a fashion as to make the doors have the old-time feudal aspect. Lighting fixtures of hand wrought iron emphasize this detail still further.

As the Norman castle inspired the peaceful French farmer of latter day for his manor house, the style took on other pastoral details. The dove cote especially and

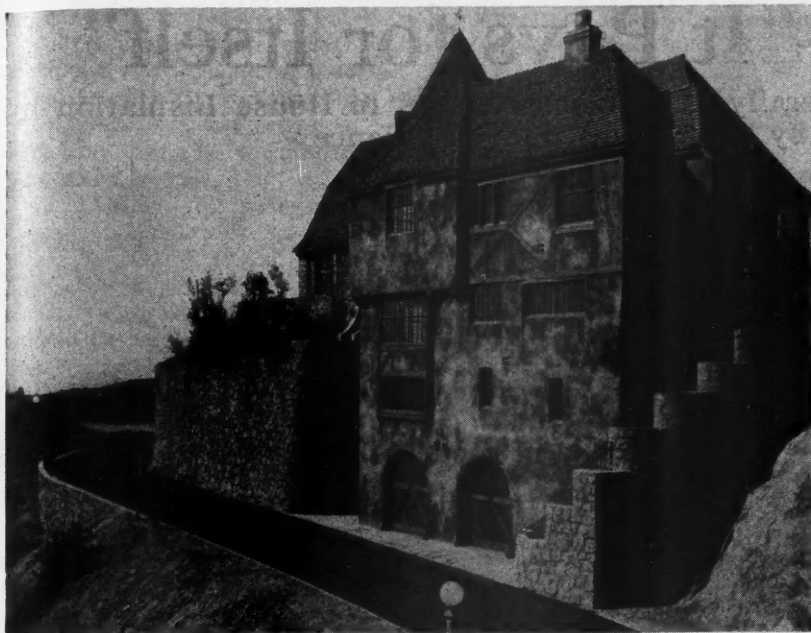

This Norman Type Residence Keeps Faith with the Law of the Castle, with the Protecting Walls and the Garage Doors Built Like the Ancient Portcullis.

tower with its conical roof, giving it a *raison d'être*. It may be built of iron or wood, or have cement treads. Some of these homes illustrated have "secret staircases" that open from the street and lead directly to the second story where dining, living or bedroom may be found, according to the view, which has influenced the floor plan. In addition, a circular staircase, visible, leads from the main hall. Sometimes the entrance hall, however, is little more than a tiled vestibule.

Comfort, with picturesque period effect, is the ideal for an up-to-date home with Norman architecture adapted to it, no matter how large or how small.

MARION BROWNFIELD.



Proper Tools for Economical Work

THE importance of having sharp tools on the job is hard to estimate. In the first place good work with poor tools is impossible; in the second place, the production is greatly reduced. Then there is not

only the wear and tear on the man who uses poor tools but the effect that it has on the whole gang.

The tools that the employer himself finishes should always be in the best of condition. There is, perhaps, nothing that will produce carelessness so surely as run-down tools furnished by the boss. Not enough or poorly chosen tools is another thing the employer should avoid. The money saved by the contractor by not furnishing the necessary equipment for a job represents about 25 percent of the amount that he loses by the practice.

H. H. SIEGLE.

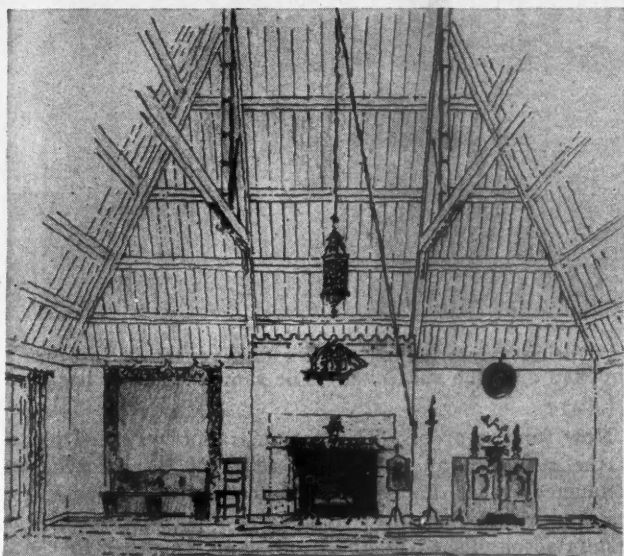

A Suggestion for the Norman Interior, by John S. De Lario, Architect. The cathedral ceiling timbered instead of plastered and the battlement above the fireplace are noteworthy details.

the weather vane have a rural charm that the modern city builder frankly borrows. Steeply pitched roofs were as practical for the long warm summers of southern France as for the snows of England and America. Farm house roofs were thus pitched and thatched or later shingled and the gay colors variegated by time. Casement windows with small mullioned panes are almost invariable.

Within the castle wall, the Normans employed vaulted or "cathedral" ceilings, barren of plaster, but vigorous in beams and carving. The modern builder wisely used this relief for the austerity of neutral plaster walls. But wall hangings are an equal opportunity for the decorative touch. Simple fireplaces, not hooded until the very last of the period, and then copied from Italy, enlivened the combination living and banquet hall. The battlement treatment above the fireplace, seen in the interior sketch, is as harmonious for a Norman period interior as the simple bench to the left.

But probably most characteristic, and yet practical for the modern home, is the circular staircase. This fills in the



This Chateau, at Hollywoodlands, California, Illustrates Both the Solidity and the Semi-circular Characteristics of Norman Architecture, from Which It Has Been Adapted.

Insulation--"It Pays for Itself"

That This Catch Phrase is Literally True When Applied to House Insulation Is Proved Here by Figures Based on Experience

By MARCH G. BENNETT



One of Chicago's Fine North Shore Homes as It Appeared During Construction. The stone veneer is just being applied and the complete wall insulation is still to be seen as applied over the sheathing. The same insulation has been used in the roof as well.

TO borrow a sporting phrase, the statement made in the title of this article, "goes twice." Insulation, properly applied, makes possible a reduction in the size and cost of the heating plant which is easily equal to the cost of the insulation. Once installed, proper insulation effects a saving in the amount of fuel used which quickly equals the cost of the insulation. Here is a double saving.

This is not merely theory but fact which has been proved repeatedly, not only by laboratory tests but also by actual experience in the construction and heating of houses.

What is this insulation and how does it work? Everyone is familiar with the operation of the fireless cooker. This cooker is a chest in which an amount of heat, equal to the amount which actually reaches the cooking pot on an ordinary range, is applied. All this heat is confined in the chest by insulation and the cooking temperature is maintained without appreciable loss, because the heat can not escape through the insulation.

The thermos bottle is another familiar example of the effect of insulation. Hot liquids are placed in such a bottle and they remain hot over a long period because heat can not escape through the insulation. House insulation works just the same way. Insulation is built into the walls and roof and prevents the rapid loss of heat which occurs in an uninsulated house. The insulated house requires a smaller amount of heat and therefore smaller heater and radiator equipment than an uninsulated house because the heat is confined by the insulation.

Now for the proof. The demonstration recorded below is the result of an exhaustive series of laboratory tests conducted under impartial conditions. In making these tests care was taken to avoid any exaggeration of the results accomplished by the insulation. In order to check the laboratory figures, the insulating material used was submitted to the Massachusetts Institute of Technology, and, while the test figures are based on a B.t.u. heat leakage of .40, the check by the Institute laboratory showed an actual leakage of only .26 by this material. It would have been perfectly fair, therefore, to have shown an even greater saving in both fuel and equipment.

Hourly Heat Loss in Normal Frame House Finished in Clapboards

Without Insulation	With Insulation
B.t.u. Loss	B.t.u. Loss
121,512 B.t.u.	93,083 B.t.u.

Percentage of heat saved by insulation is 23.2 per cent.

Saving in Heating Equipment Installation Cost Effected by Insulation, on the Above Basis

Reduction in cost of steam heat equipment.....	\$130.00
Cost of insulation.....	109.00
Saving	\$ 21.00
Reduction in cost of hot water equipment.....	\$279.00
Cost of insulation.....	109.00
Saving	\$170.00

Convincing figures these, but there are some who will say, "yes, but they are merely laboratory figures; what about the results in actual practice?" So here are some examples of what insulation has accomplished in actual houses under ordinary conditions. The buildings described were built, except for the insulation, just as any such buildings would be built.

First observe the case of the St. Thomas Aquinas Church at Halifax, N. S. Here is a cold climate which puts a severe test on the heating equipment and demands high efficiency. The heating plant of the church was planned according to the regular formula, figuring the area to be heated and the proper amount of radiation to heat that area, but no consideration was given to the fact that the building was to be insulated. Perhaps they were skeptical about the value of insulation. If so, they are no longer skeptical, as the following letter from the Reverend T. O'Sullivan proves:

"This building was covered all over with insulating material with the best results. The roof, which is an open one inside, showed no signs of frost. The same amount of radiation was put in the building as the heating engineers usually install. We have removed four radiators already . . . We have retained two which are never used. We attribute this saving to insulation."

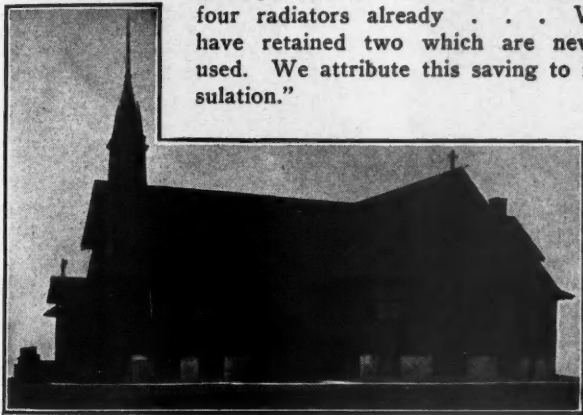

When Built This Church Was Equipped with the Ordinary Amount of Radiation but Because of Its Complete Insulation Four Radiators Were Later Removed and Two Others Are Never Used.

In other words, six radiators and all the heating capacity that six radiators imply could have been cut out of the heating plant for the St. Thomas Aquinas Church and the saving would have equalled the entire cost of the insulation, to say nothing of what is being saved every year in fuel.

The second illustration shows the Westbury, Long Island, cottage built by H. S. Pratt. Mr. Pratt's experience is a really remarkable one. The heating plant for his house was figured at \$675.00. He decided to omit the heating plant and rely on insulation. This was done with such success that his insulated house has been kept warm and comfortable by the heat of the kitchen range and the living room fireplace. Mr. Pratt says:

"We (my wife and small baby and myself) have been very comfortable this winter. The temperature keeps anywhere from 60 to 70 degrees during the day and at night when going to bed I bank the fire and the temperature drops down to around 56 to 58 degrees."

It may be said that this is an extreme case and that some other heating would usually be required. This is doubtless true, but the insulating material for this house cost only about \$50.00, and the cost of the heating plant for an uninsulated house of that size would have been \$675.00. It is easy to figure a saving in the heating plant, under any circumstances, which would amount to considerably more than the \$50.00 cost of insulation.

The results in another house in Yeadon, Pa., are of



Here Is a Remarkable Example of Effective Insulation. This house at Westbury, Long Island, has no heating plant but is kept comfortable at all seasons by the kitchen range and living room fireplace.

particular interest because the owner is a heating engineer and agent for a heating system in Philadelphia. This owner, H. T. Carkeek, says:

"I had my house completely insulated. Insulation covers the entire frame work, including all the roofs.

"I deducted about 10 per cent in the amount of radiation and believe, since my experience last winter, that this could have been increased to 15 per cent.

"During February, workmen from the central heating plant came to remove the meter, with the explanation that it was not properly registering. Permission to do so was refused because of my absence from the city, and upon my return it was demonstrated that the meter was registering properly and that the low registering of the meter was due to the insulation. The same meter is still in the house.

"In my case insulation has made a great saving in my fuel bills and goes a long way to offset the high cost of heating by coal, gas or oil."

Still another example of the effect of insulation, in Portland, Ore., is striking in that it shows a definite comparison between the insulated house and the uninsulated house. This case was discovered and investigated by the Portland Gas & Coke Co., and was unknown to the manufacturer of the insulating material until reported to him by the gas company.

J. H. Hartog, superintendent of the gas company, noticed that the owner of a certain house, a Dr. Holden, paid only

(Continued to page 195)

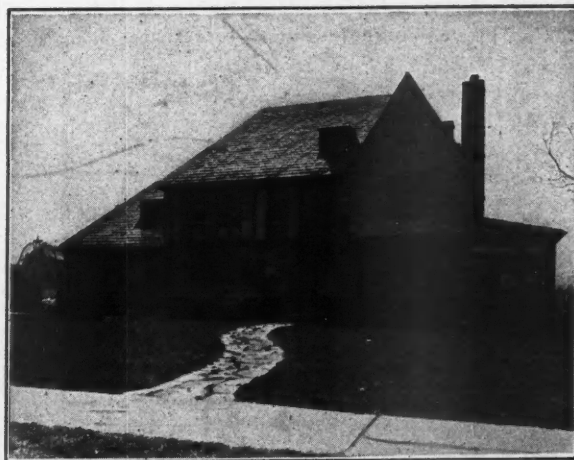

In Building This House, the Owner, a Heating Engineer, Deducted 10 Per Cent of the Radiation Because of the Insulation and Now States that Another 5 Per Cent Could Have Been Omitted with Complete Satisfaction.

REAL ESTATE AND SUBDIVISION WORK

The Model Home That Brought a Subdivision to Life

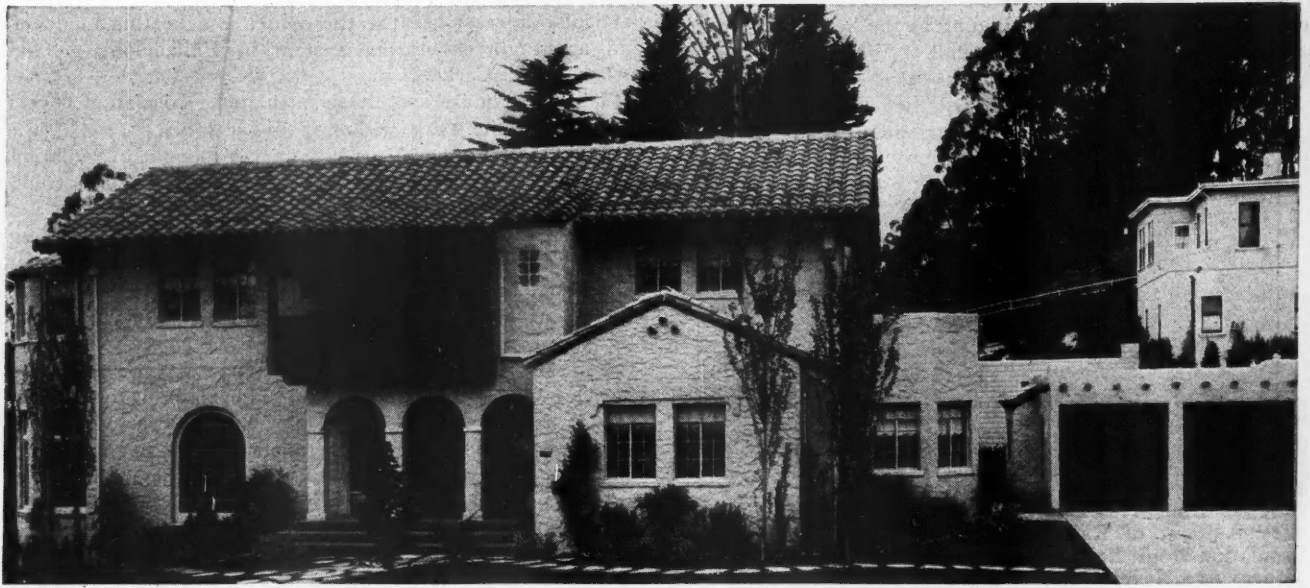

By Means of This Model Home, the Lang Realty Company, of San Francisco, with the Co-operation of Contractors, Material and Equipment Dealers, Newspapers, Furnishers and Decorators, Brought to Life a Subdivision Which Had Lain Dormant for Years.

OVERLOOKING the Pacific Ocean from a range of wooded hills in one of the new residential sections of San Francisco stands a model home, built by a leading real estate firm of the city, under the auspices of a San Francisco newspaper, in a co-operative advertising campaign that proved so successful as to actually bring to life

an exclusive residential tract that had lain dormant since a wartime slump crowded it off the market.

In the three weeks' period when the home was on formal exhibition, 41,000 people were registered, but no record was kept of the additional thousands who followed details

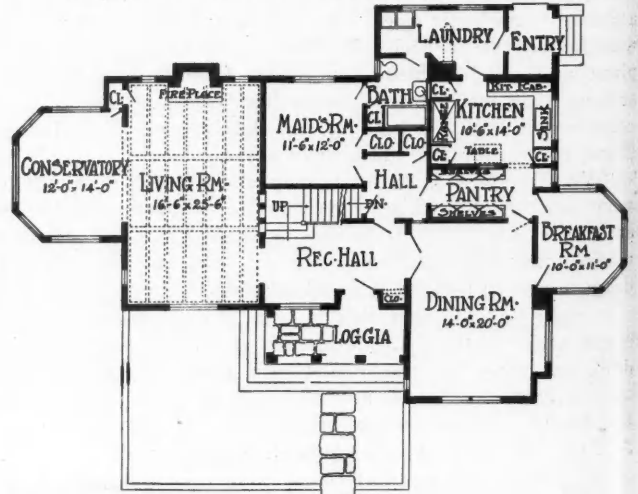
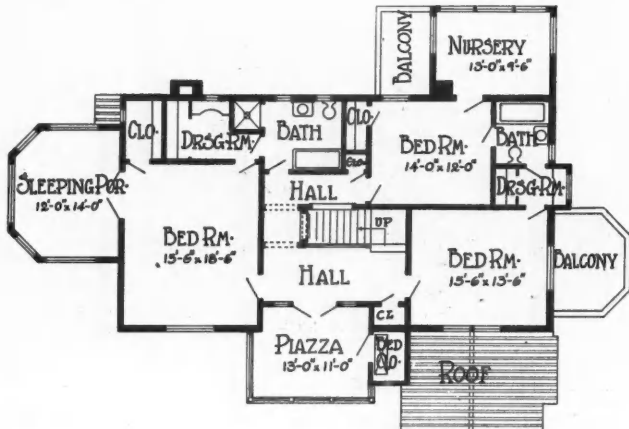

The Model House Was Built from Plans Designed to Be the Last Word in Completeness, Convenience and Attractiveness and Appealing to Every Class of Home Owner.

of construction, inspecting the progress of the work and asking countless questions. On some exhibition days, the crowds were so heavy that those in charge of the exhibition had no chance to register them all, and a special detail of traffic police was assigned to take care of the thousands who flocked to the home in automobiles on two occasions.

The San Francisco Model Home, in tone and atmosphere is typical of California, combining the greatest possible beauty of setting with sturdy and compact construction, well planned economy of space and perfection of unified detail. It is of modernized Spanish type architecture with Moorish influence, and the interior decoration ranges from Italian Renaissance to quaint old English, although the whole effect is one of harmony.

No estimates of cost or figures were used in the publicity, but it was the avowed intention of the builders to produce a truly fine home within reasonable limits of cost. This idea of quality construction, incorporating the newest of improved ideas of interior decoration, made the model home a veritable show place. It attracted the wealthy and those of modest circumstances alike, and attendance was cumulative, many returning a second and third time, bringing others with them.

The plan of campaign was purely co-operative. Material manufacturers, builders, home furnishing houses, plumbing concerns and all who contributed to construction and finishing, pooled their advertising over a period of six months, during construction, with a final splurge during the three weeks' exhibit. In all, there were 17 advertisers. Pages and double pages of advertising were used progressively in San Francisco newspapers (chiefly the Chronicle), following the important stages of construction.

First announcements pictured the house to be built and outlined the educational campaign which was to follow.

Next, the floor plan was published, with notes by the architect. In order, there followed progressive photographs and stories in detail about the methods and materials being used, with helpful hints to the prospective home builder.

It was found that a surprisingly large number of persons were interested in the technical details of construction. The educational stories which accompanied the campaign were prepared with a view to helping prospective home builders, giving practical advice and explaining at length the foundation work, framing, wiring, plumbing, sheathing, plastering and every feature of construction.

Construction completed, the model home was turned over to the decorators, the John Breuner Company, of San Francisco. A double page newspaper spread announced the opening, with everything complete. This was followed up by dominating publicity in San Francisco newspapers which carried the campaign. In all, 28 pages of newspaper publicity were donated with the advertising. Information and directions were also posted on numerous signboards scattered throughout the district.

Originally, it was intended to keep the home open for inspection only two weeks, but attendance the second week proved heavier than the first, so that the third week was added to accommodate the crowds. Sunday afternoons brought lineups of visitors blocks long, and this was when traffic difficulties set in, and when crowds proved too heavy for

proper registration. although they were all guided through the home or allowed to inspect it thoroughly for themselves. Representatives of the Breuner company and other firms who contributed to construction or furnishing, aided in guiding and registering visitors. It was no small job to register 41,000 persons in three weeks.

The whole effect of the home was one of compact and impressive luxury, although the design was such that the



August J. Lang, Oldest of the Three Lang Brothers, at the Left, Consulting with Fred Peterson, Superintendent of Construction, During the Building of the Model House.



More than 41,000 Persons, by Actual Record, Inspected the Model House During the Three Weeks It Was Opened to the Public, but No Record Was Kept of the Additional Thousands Who Visited It All Through the Period of Construction.



When Opened for Inspection the Lang Model House Was Furnished Throughout in Keeping with the Quality and Style of Its Exterior and Interior Design.

model home was not massive enough to suggest prohibitive cost. A battery of 14 searchlights played on the structure during the long evenings when it became the focal point of interest to San Francisco home owners. Considerable attention was paid to the landscaping of the grounds, and with a background of dark trees and the ocean in the distance, the model home stands out like the Washington Monument. Flagged walks, palm trees, flowers and shrubbery contribute to the effect.

The front door is a masterpiece of design, with long wrought iron brackets and a big green latch knob.

In the hallway a large, straight backed chair of Spanish tooled leather, side by side with an antique Spanish treasure chest gave just the right note of atmosphere. The living room was a charming feature, with beamed ceiling, painted walls, a built-in radio cabinet, fireplace and antique finished oak floor.

Just a step down from the living room is a tile floored solarium, giving the full sweep of marine view. All the doorways on the first floor are arched, and the one leading from the hall to the dining room has an effective wrought iron gate. The dining room itself, in Italian Renaissance, with vaulted ceiling and block walls, is a masterpiece. A breakfast room, fully equipped electrical kitchen, maid's room and butler's pantry complete the ground floor.

In the basement, a recreation room was given over to exhibits of manufacturers, notably the motion picture machine showing construction progress on the home itself.

The outstanding feature of the second floor was the master bedroom suite, full carpeted and draped in rose after the manner of Louis XV, leading out to a sun room, a Marie Antoinette dressing room and an adjoining bath, done in rose tile.

The results accomplished by this model home, the most notable of which was the bringing to life of a tract which had lain dormant since the lean years of the World War, are tied up with the interesting history of the Lang Realty Company, a firm of three brothers which has grown in the last six years from a small beginning to an institution which now carries seven large residential developments, of which Forest Hills, the site of the model home, is one.

The three brothers are R. D. Lang, A. J. Lang and W. O. Lang. Before the war, one of them was a real estate sales-

man and two were selling insurance in San Francisco. All of them are young men, and all of them went to war. When they came back, they went to work again at their old jobs, just as millions of other young men did. Gradually they drifted together and entered the real estate business. It was at this time that they became interested in Forest Hills. Originally this became a subdivision in anticipation of the tunnel built by San Francisco, piercing a barrier of hills known as Twin Peaks, which was to open a large and beautiful residence section.

But there was too much competition among newer subdivisions at this time, and combined with a lack of building during wartime years, Forest Hills languished and just about died.

When ordinary advertising failed to produce results, the idea for a model home

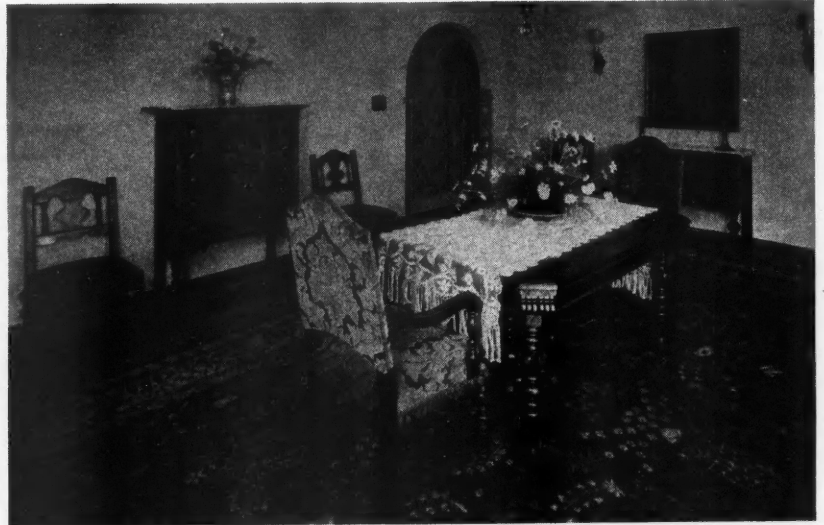

The Arched Doorway Was Used Throughout the Lower Floor and Here, in the Dining Room, It Was Further Beautified by a Grilled Gate of Wrought Iron.

campaign was presented to the Lang company. As has been shown, it was more than successful. At the present time Forest Hills is showing abnormal activity, and scores of new homes are springing up in the district.

The Lang company specializes in building better class homes. Their construction division alone employs more than 100 men, independent of the sub-contractors, and the sales staff numbers 72. The firm maintains a head office in the financial district of San Francisco and 12 branch offices, each under a sales manager. The company builds homes of three classes, bungalows priced from \$7,000 to \$8,000, bungalows ranging from \$11,000 to \$14,000, and residences at \$15,000 to \$30,000.

Harold G. Stoner is the company's senior architect, and there are two others working with him in a building devoted to the architectural work of the company, located in a residence portion of the city.

Credit was given to all the participating firms in the newspaper advertising and on a large sign, attractively lettered, posted at the front door of the model home. In addition to those already mentioned, there were a number of nationally known material and equipment firms represented on the list with their products.

FORD WILKINS.

Rescue Equipment Aids in Construction Accidents

RECENTLY, in San Francisco, a workman on a new building was knocked unconscious by a swinging girder and was rescued from the narrow and perilous scaffolding where he lay unconscious by two daring ambulance stewards who made the perilous trip to the scaffolding at the risk of their own lives.

Such an occurrence serves to call the attention of builders and contractors to the fact that accidents are constantly happening wherein the victim is in a situation which makes rescue difficult and perilous to accomplish. In San Francisco these conditions are alleviated by the use of a flexible stretcher. The San Francisco Fire Department is equipped with this stretcher for use in situations when they are called upon to aid in extricating victims from perilous positions, such as from beneath wreckage, high places, tanks, light wells, elevator shafts, excavation cave-ins, trenches and sewer ditches.

The accompanying illustrations show members of the fire department demonstrating the use of the stretcher. When the injured person is tied into the flexible stretcher the band circles the head, a half hitch is taken with the rope for lowering, the line being passed through the two handles on the part of the stretcher across the chest of the injured person or victim. Enough free end of the line is provided to reach down to the handles on the lower part of the victim's body. Two half hitches are then tied about the lower handles of the flexible stretcher.

When being lowered the victim will hang in a comfortable perpendicular position. Care must be taken that the hands are secured at the side of the stretcher to prevent the victim from grasping any object through fright. The head of the victim is protected by the upper band of the stretcher which prevents the head from falling backward or sideways

in case of injury to the spine or neck. The face is protected by the two handles being crossed in front of the face, which also prevents the head from falling forward and prevents possible injury to the face.

The upper handles actually form a temporary splint for a possible collar line fracture or rib fracture. The arms are held securely at the sides providing temporary splint for arm fracture. The weight of the body is supported just below the hips by the center band. This relieves an injured spine or pelvis, in fact the victim's body is supported at every point preventing compound fractures and complications and, dispensing with temporary bandages and slings.

The body being naturally wedge shaped it cannot fall through and out of the stretcher because the opening at the bottom or at the feet of the victim is too small. The lowering line is either thrown over a rung of a ladder or is part of a snatch block tackle.

While the photos show several men working as rescuers, the flexible stretcher can be applied and the victim tied up in it in situations and under conditions where there is only room

enough for the rescuer to wiggle his way in to the victim with a tow line and there is only room enough for two bodies, something that cannot be done with the ordinary rigid litter.

The patient can be transferred from the ground, bed or any resting place to this flexible stretcher in the same manner as a draw sheet is changed, avoiding unnecessary and awkward handling in lifting, preventing thereby possible compound fractures, internal injuries and complications. In trenches where space is limited and the rigid litter very often cannot be used, the flexible stretcher used independently, provides a practical, expedient

(Continued to page 189)



Here Is How the New, Flexible Stretcher Is Carried When in Use by the San Francisco Fire Department.



Here Is the Method of Fastening an Accident Victim into the Stretcher for Lowering from a Building. This can be done by a single rescuer where required.



While the Victim Is Being Lowered His Face Is Protected by the Handles Crossed Before Him and His Arms Are Held Securely Forming a Temporary Splint.

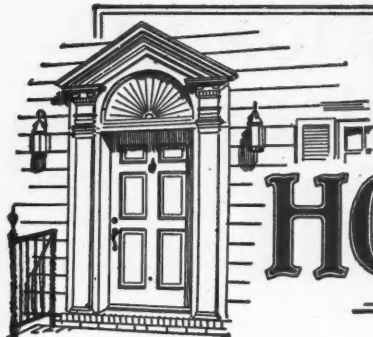

DETAILS OF HOME BUILDING

The Chimney Detail

By V. L. SHERMAN,
Lewis Institute of Technology

THIS is written in the interest of chimneys. To cast in the right direction it would be wise to quote Sam Johnson: "In these halls fireplaces were anciently in the middle of the room till the whigs removed them to one side." There is as much truth as wit in that remark. The common source of warmth was diverted for the sake of comfort and the privilege of a few and then came the chimney. This condition was succeeded, centuries later, by the common invisible heater, greater comfort and what was really a smoke stack. But the memory of an open fire has prevailed and again nearly all of us are seeking the fireplace and many of us are blowing money up the chimney with little smoke for company.

About one-half of the average homes are provided with a fireplace and a chimney to match. The first shows from within and the second shows very much from without. This phase of the matter is worth considering, why must a chimney show itself? Does it make the house more attractive? Is the outer wall the best place for a chimney? Would fireplaces be used if the chimney were not to be seen from the outside? These questions can be answered in two ways. But for those who love fireplaces and chimneys there is a single answer for each. There should be more fireplaces, larger chimneys, and more consideration given to both. A chimney does not have to be a feature of decoration nor does it have to be unsightly. Better, it should be a part of the house.

Or let's put it this way. Arthur, who is long for art, builds a house with an imposing chimney fronting the street. He spends a great deal of time on the drawing and more on the draft (I know a number of the sort). After he has lived in the place long enough to build a roaring fire on the hearth where he can sit in his shirt-sleeves and stocking feet, he hastily reassumes his habiliments and opens the doors and windows to let the smoke out. "Never again." You run across this type right along and they always being with, "a fireplace is so dirty."

Another man builds a house insisting on an open fire and finally gets it. But this time the feature is rendered useless because the traffic about it is congested, and door drafts blow the soot and ashes out to be tracked about everywhere. It is given up as a bad job.

Now try the right side of the question. A chimney or chimneys should be located to provide the best accommodation for house fires and ventilation. They can beautify the walls or enhance the roof, but they will no neither when ill-proportioned for the job or then obviously decorative.

Fireplaces can be clean, cozy, and generous with their heat, facing sufficient floor space to allow this enjoyment without impedance. They can be built two and three into one chimney with enough left over to provide for the heater flue and a ventilating stack. (This does not refer to a soil stack which should never be built into a chimney.)

The resulting chimney or chimneys will look as though it meant something to the householder and in the majority of cases will assume a beauty that doesn't smack of the drafting room. Fireplaces are clean, cozy and generous with their heat. I have enjoyed them since I can remember, still use them with wood and coal, and have never considered them a drudge or a luxury. They are worth many times what they cost and do not deteriorate with age.

Fig. 1 is a sketch of a chimney for three flues. This chimney was erected on a deep concrete slab over unexcavated ground and carries at the top three 8 by 12-inch flues. To increase the frontage in the living room the chimney was set back into the heater room where the space was less expensive per front foot. Since the bulk of the chimney would have been exaggerated in face brick the whole was plastered except for the trim. This is shown to the left in Fig. 6.

Directly over the living room fireplace is one in the bedroom. To avoid corbelling, the hearth is made of steel plate over a layer of cement which runs clear to the back and is lipped. And, to avoid two turns in the fireplace flue, the heater flue was offset above the second floor, the opposite flue rising straight. The exposed chimney could be shifted by reversing the flues, and the fireplaces could, of course, open from either side.

To the right in Fig. 6, is a similar chimney section in which more brick trim is exposed around the opening and the wall is set back. This is done when a chimney can be built within the two walls of a closet as such and gives the appearance of being flush with the main wall. There are many advantages to this arrangement. One is appearance. A small fireplace is much better put forward by being set back into the wall. The floor before the hearth is freed of the angles and turns of foot steps that are so much a part of a small living room. And the mantel may be dispensed with and no harm done. It may be surmised that it is a littered mantel which makes a housewife call a fireplace messy.

A pair of chimneys, each chimney having a little pulpit stair set against it, is very much a part of the house, and throughout the South, where fireplaces are used with real consideration, are these large chimneys of many flues, and, sometimes, many large flues, which take proper care of a hearth such as is shown in Fig. 3.

Some insist that a chimney in a Spanish type house should be hidden from view, feeling that the chimney has no part in such a design. In Fig. 5 the chimney is certainly toward the front and not disreputable. It is only apparently so when the dwelling is excessively decorated.

Each flue of a chimney should be designed for its particular job, neither too small nor too large and round in section if that can be. A circular flue spirals the smoke with less interference than a rectangular flue.

FIG. 1 A COMMON-BRICK CHIMNEY, FUR AND PLASTERED IN THE LIVING-ROOM AND PLASTER ON BRICK IN THE BED ROOM.

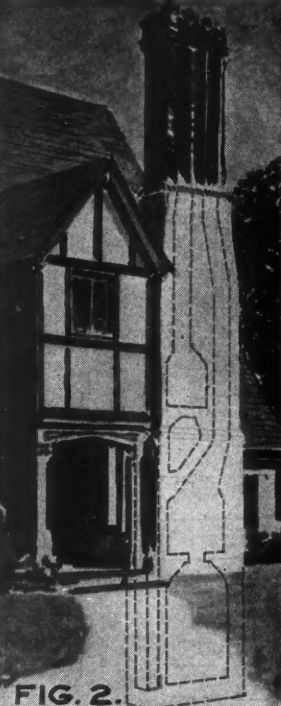
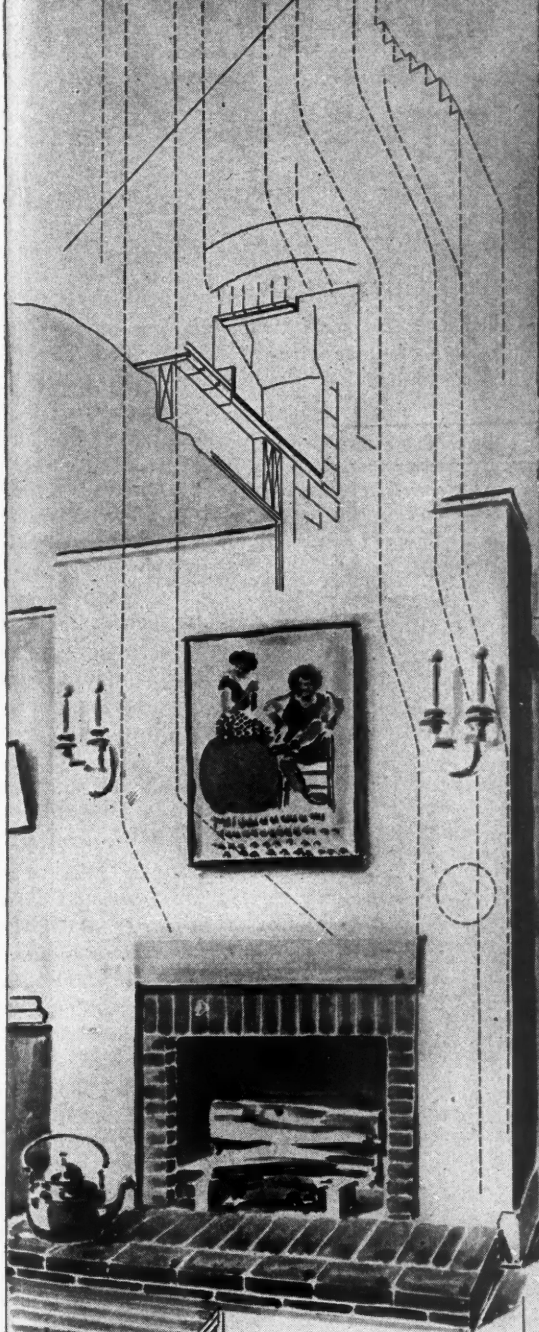

FIG. 2.



FIG. 3 THE WIDE COLONIAL FIRE-PLACE UNDER WIDE FLUE.

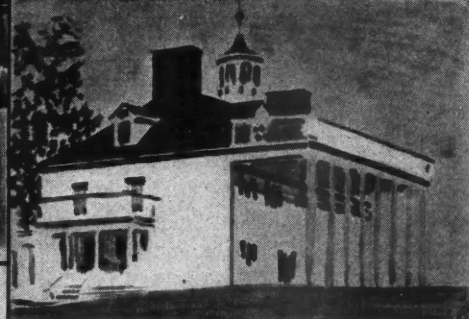

FIG. 4 THE CHIMNEYS AND ROOF PROVIDE COVERING, AND THEY ADVERTISE THE FACT.

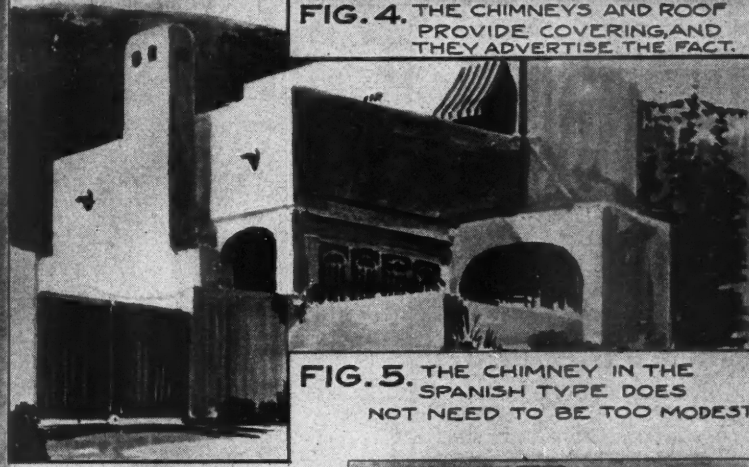

FIG. 5. THE CHIMNEY IN THE SPANISH TYPE DOES NOT NEED TO BE TOO MODEST.

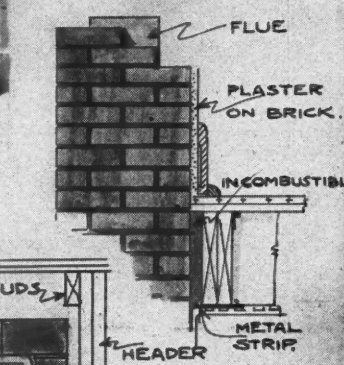
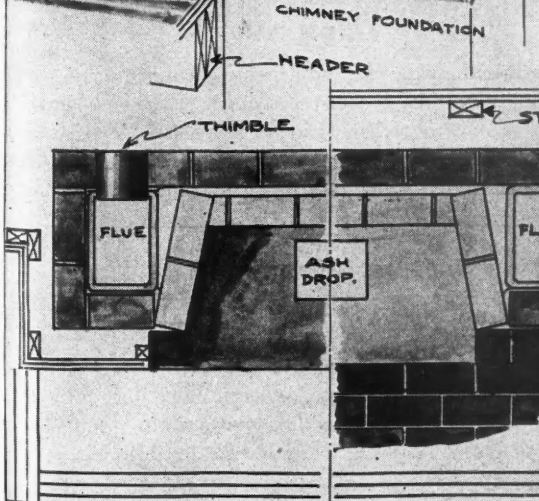

FIG. 6. THIS SECTION TO THE LEFT, AT HEARTH LEVEL, IS TO SHOW TWO WAYS OF COVERING THE CHIMNEY-PIECE TO REDUCE ITS APPARENT BREADTH.

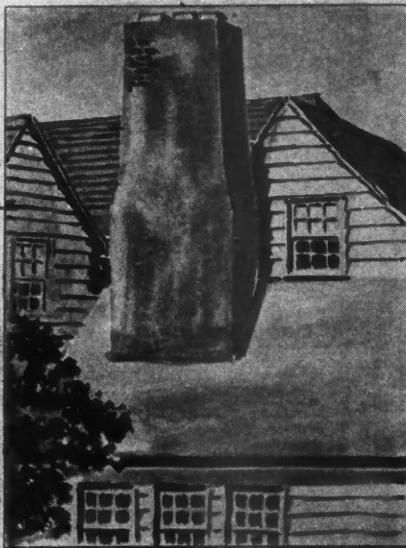

FIG. 7. SOME CHIMNEYS CAN INDICATE AN ACCUMULATION OF FLUES WITH MORE GRACE THAN THIS ONE DOES.

J. P. Sherman 1-4-27



No Place for Children

A contractor who professed to be very fond of children became very angry because some little fellow stepped on a new pavement before it was dry.

His wife rebuked him. "I thought you loved children," she said.

"I do in the abstract, but not in the concrete," he replied.



A furniture salesman in a Michigan store was waiting on a woman customer for linoleum. He had shown her every piece in stock. "I'm afraid, madam," he said, "that we haven't just the piece you are looking for, but we could get more from the factory."

"Well, perhaps you had better," she replied. "You see I want something of a neater pattern and quite small—just a little square for my bird cage."



The wood-workers never made any trouble in this world; it was the wouldn't workers.



Make a Blue Print of This

Architect: "Shall I start your plan using the Georgian Period?"

Client: "Oh, no. I think you should start with a capital letter and end up with a period."



Save the Surface

"Is it true that statistics show that women live to be older than men?"

"They ought to. Paint's a great preservative, you know."
—*Flamingo.*



A lumberjack with a broken leg was taken to a hospital for treatment. After the leg had been set, the nurse asked him how the accident occurred. He replied:

"You see, ma'am, it was this way: I was skyhooking for the Potlatch Lumber Company and I had one ground mole. He sent up a big blue butt and she was a heavy one. I saw her yaw and yelled to him to give her a St. Croix, instead of which he threw a sag into her and gunned her, and that broke my leg."

"Yes," the nurse replied, "but I don't exactly understand."

"Neither do I," said the lumberjack. "That darn fool must have been crazy."



Current Events

"Bill," called the electrician from the top of the mill, "catch hold of two of those wires."

"All right," responded Bill after a moment.

"Feel anything?"

"No."

"Well, don't touch the other two, there's 2,000 volts in them."



Statisticians claim there is only one bath tub in France to every 800 inhabitants. Now we know what they mean by French Dry Cleaning.



Switchcraft

The Bride (at the telephone): "Oh, John, do come home. I've mixed the plugs in some way. The radio is all covered with frost and the electric ice box is singing. 'Way Out West in Kansas.'"
—*Life.*



Any Louis Canns?

Advertisement in El Paso Herald—"Jack-a-Bean dining-room furniture, handsome set."
—*Boston Transcript.*



Dat's All

Rastus Rastlebones was contractor extraordinary to his "Cullud" section below 22nd street in Chicago. His resourcefulness under stress of argument with his customers over "changes," etc., will sound mighty familiar if you have ever built a house and had to thrash out charges for "extras" with your builder. Rastus was remodeling an old "cullud" church and he and one of the deacons were on the job inspecting. There was a plumb line attached to one corner of the roof. The deacon was eyeing it with some anxiety and doubt. "Look heah, Brothah Rastlebones," he questioned, "ain't dat buildin' leanin' ovah—look at dat plumb line!" "No, suh, Deacon, no sah," countered Rastus, thinking fast. "Dat buildin' am all right—dat's jest an old plumb line an' it ain't reliable, dat's all."

The Man Who Believes Everything He Reads - - By H. T. Webster

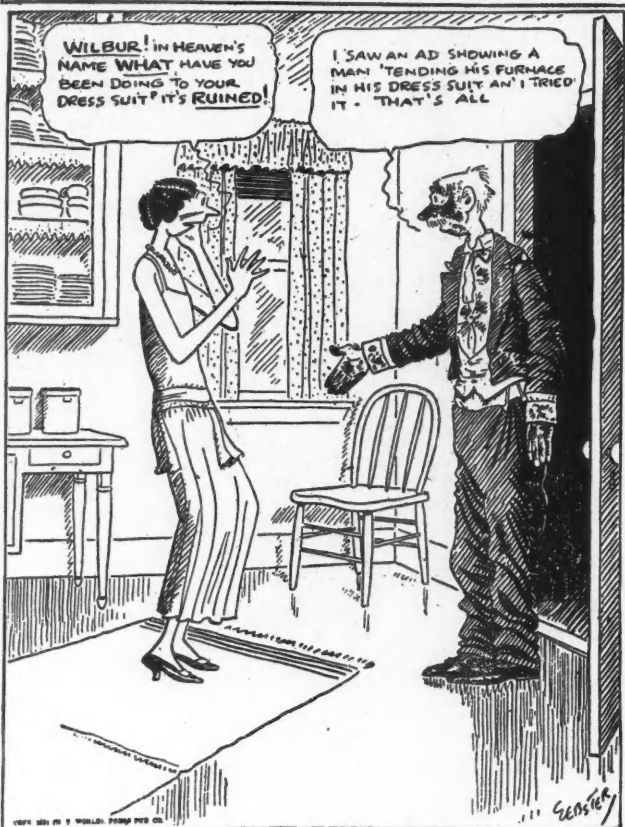

(Reprinted by permission of the New York World.)

COLORKEED

HOME PLANS

TRADE MARK

New Life and Interest in Home Plans

Every Room and Every Feature of Equipment Made Clear and Understandable
by Our Entirely New Method of ColorKeeD Plan Illustration

by WILLIAM A. RADFORD

WE have always believed that home designs should be made as attractive as possible; and accordingly for several years we have been illustrating our model home exteriors in full colors. Now we are adding the final touch—presenting the floor plans also in colors, applied in such a way that each color designates a certain definite part of the house and indicates its use. This is an entirely new idea in illustrating floor plans and is patented.

We feel confident that home builders are going to find these ColorKeeD home plans extremely interesting and useful and that home building of the better type will be greatly stimulated by the study and use of these suggestions. The floor plan has always been the most important part of the home design and yet it has been very hard for the average home builder to read and understand the floor plan clearly enough to judge whether or not it will be satisfactory—the ideal plan for his requirements. Plans have been selected many times that have not proved out as practical and satisfactory after the house is built. This has meant dissatisfaction or expensive changes and alterations.

These ColorKeeD plans are drawn large and clear and the color keying makes the different rooms stand out prominently.

Another novel and useful feature embodied in these plans is the Key to Equipment. Numbered circles on the floor plans show the proper location for the many

items of heating, plumbing, refrigeration and other pieces of efficient equipment and labor-saving appointments which are so important in the modern American home. Some of these you will want to specify and build in at the time the house is put up, others you may want to install later; but in either case the proper spaces should be provided when the house is built. Then these refinements can be added at any time.

New standards in home building and home equipment are demanded today and it is no longer enough for the home builder to simply understand foundation, wall and roof construction. Today these are required, but much more besides. The up-to-date home builder must also be posted on garbage burners, laundry dryers, electric dish-washers, space-saving beds and all the other modern appliances. We have made the ColorKeeD home plans include all of these items of equipment so that our readers will be helped in the planning and design of their new homes.

When building today plan for the tastes and requirements of today and of tomorrow. Some, we are sorry to say, are still building new homes that are twenty years behind the times the day they are finished. There has been a lot of progress in home building. Our ColorKeeD home plans are in step with the times and if you will study them and use them we are confident you will benefit.

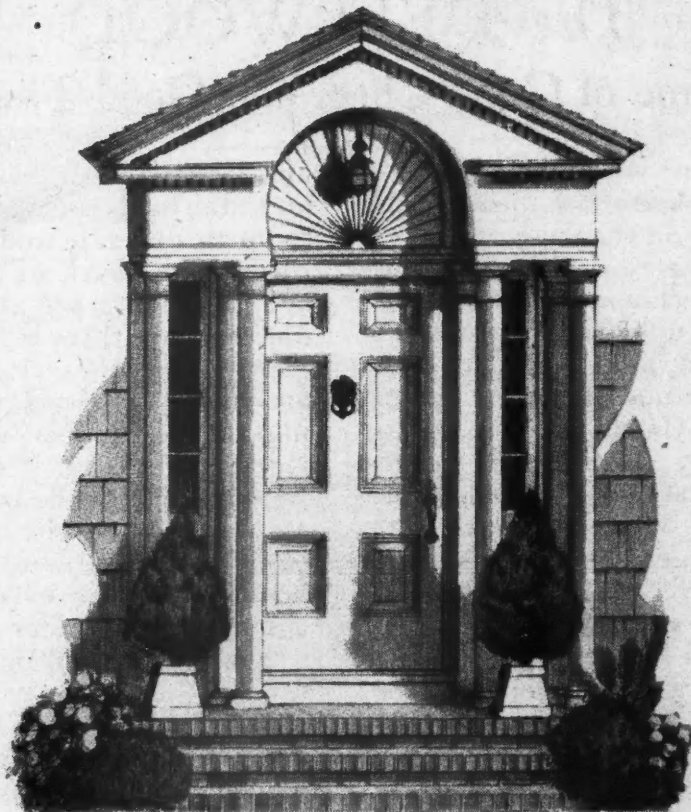

Detail of Colonial Entrance of The Delwood
Illustrated on Colorplates II and III.

COLORKEED

HOME PLANS

TRADE MARK

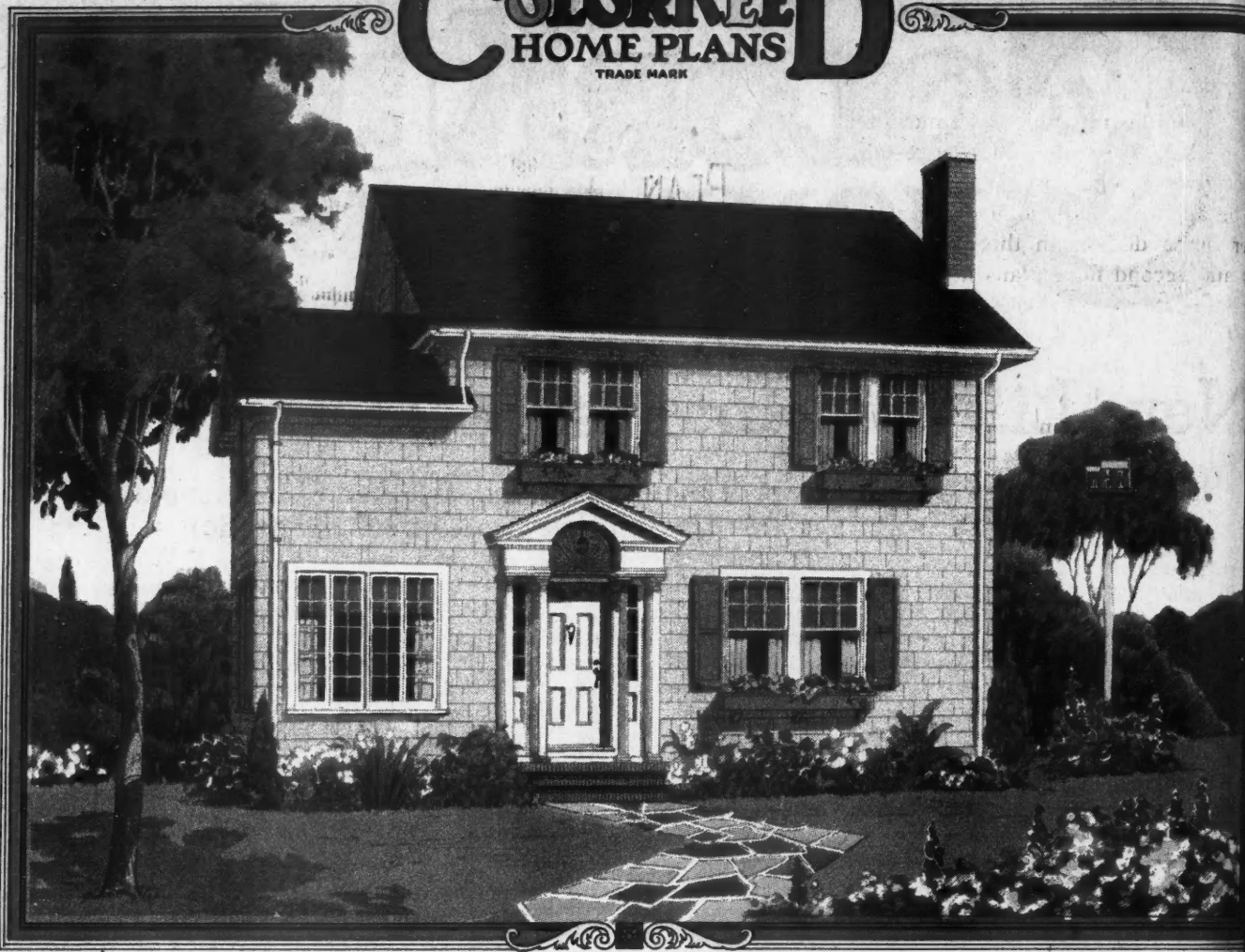

ColorKeeD Plan Patent Applied For

The DELLWOOD

A Home of Good Cheer and Good Taste

A COLONIAL home with many individual features is illustrated above, with ColorKeeD floor plans on the page opposite. This is a design that is almost ideal from the three standpoints of economy in first construction, heating and upkeep, in attractiveness of exterior design, and in the convenience of its arrangement of rooms.

The main section of this house is 24 by 26 feet with a two-story addition, 8 feet 6 inches by 11 feet, containing a sun room on the first floor and sewing room above. In addition to these two rooms, six rooms, bath and reception hall are provided. In the basement the space is utilized for the heating plant, laundry and fuel storage room in the main section and a cold room for fruit and vegetable storage excavated under the sun room addition.

This design follows quite closely the reg-

ular Colonial custom of the central entrance and stairhall, with living room and dining room to one side and a convenient passage through the back of the hall to the kitchen and grade entrance at the side. On the second floor are three big corner bedrooms with plenty of clothes closet space. The ladies are supposed to judge a home plan according to the number of clothes closets provided; and if that is so this plan will please them. Each of the two front bedrooms has a double wardrobe provided with special telescoping garment carriers. The back bedroom has an extra large clothes closet and there is another off the hall.

Notice how well lighted all of these rooms are and how cross ventilation is provided.

This is a design that would grace any community, providing a cheerful homey residence without extravagance of any kind.

HI
w
odel
ade c
n be
her f
st an
amero
ok in
study
nd the
ew ho
re buil

COL

ColorKeeD color chart with various shades of gray and black.

THE ColorKeeD plans of The Delwood illustrated herewith include a model basement plan. The suggestions made covering the basement equipment can be applied equally well to all of the other home designs in this book. The first and second floor plans also suggest numerous items that you will want to look into, recommend, specify and use. Study these ColorKeeD plans carefully and they will help you to live in these new homes in imagination before they are built.

SECOND FLOOR PLAN

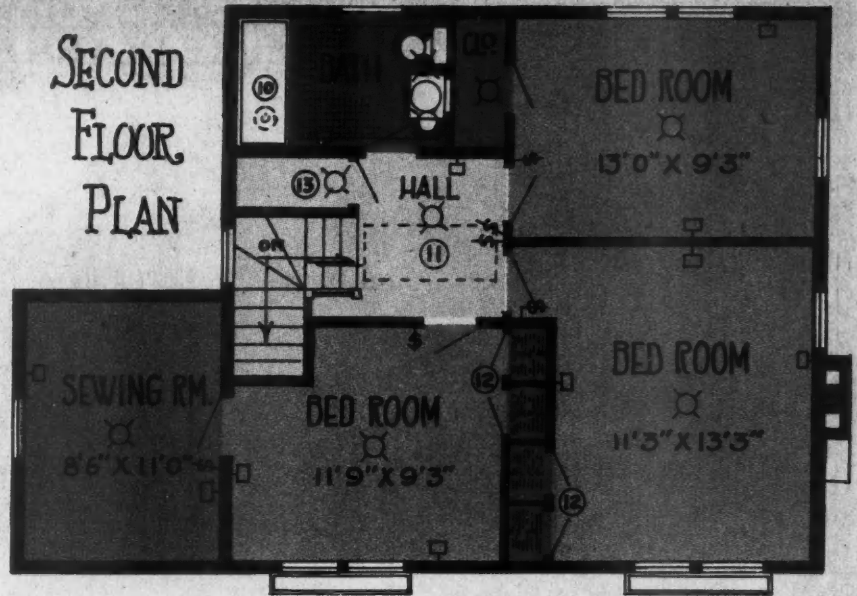

FIRST FLOOR PLAN

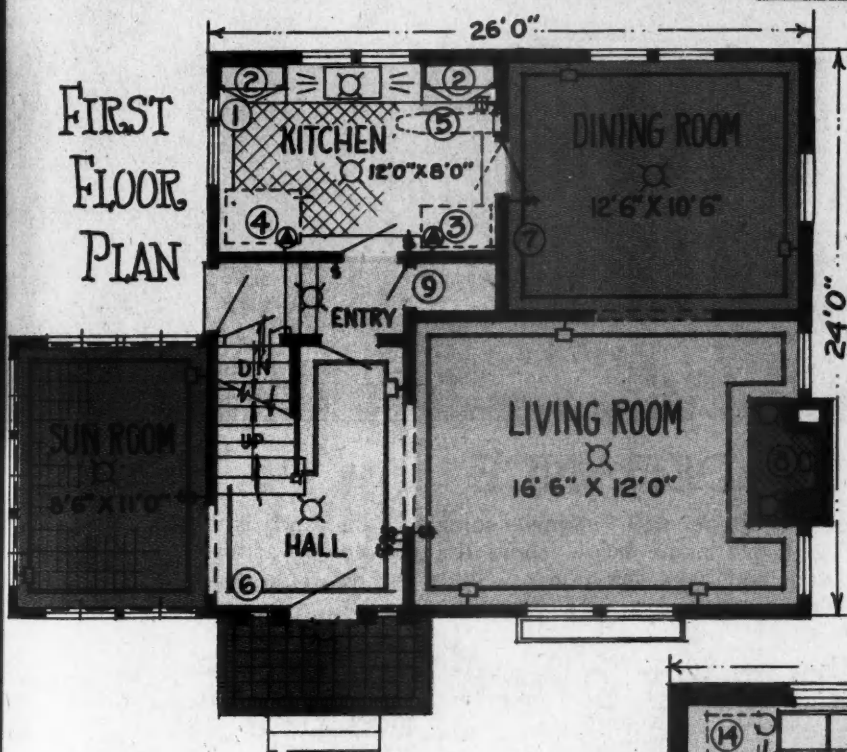

Key to Equipment

- ① Ventilating Fan
- ② Kitchen Cabinets
- ③ Refrigerator
- ④ Range
- ⑤ Ironing Board
- ⑥ Built-in Mail Box
- ⑦ Thermostat
- ⑧ Fireplace Throat and Damper
- ⑨ Broom Closet
- ⑩ Tub Shower
- ⑪ Disappearing Stair
- ⑫ Efficiency Wardrobe
- ⑬ Moth-proof Closet
- ⑭ Stove
- ⑮ Electric Panel
- ⑯ Washing Machine
- ⑰ Ironing Machine
- ⑱ Clothes Drier
- ⑲ Coal Chute
- ⑳ Heating Plant
- ㉑ Hot Water Supply
- ㉒ Water Softener
- ㉓ Water Meter
- Weather Strips
- Storm Sash
- Screens
- Shades
- Electric Fixtures

ColorKeeD Plan Patent Applied For

COLOR KEY TO PLANS

- LIVING ROOM
- DINING ROOM
- KITCHEN
- PANTRY
- HALLS
- CLOSET
- BED ROOM
- BATH AND LAVATORY
- PORCH
- ROOF
- BASEMENT
- FRUIT CELLAR
- FUEL ROOM
- STAIRS

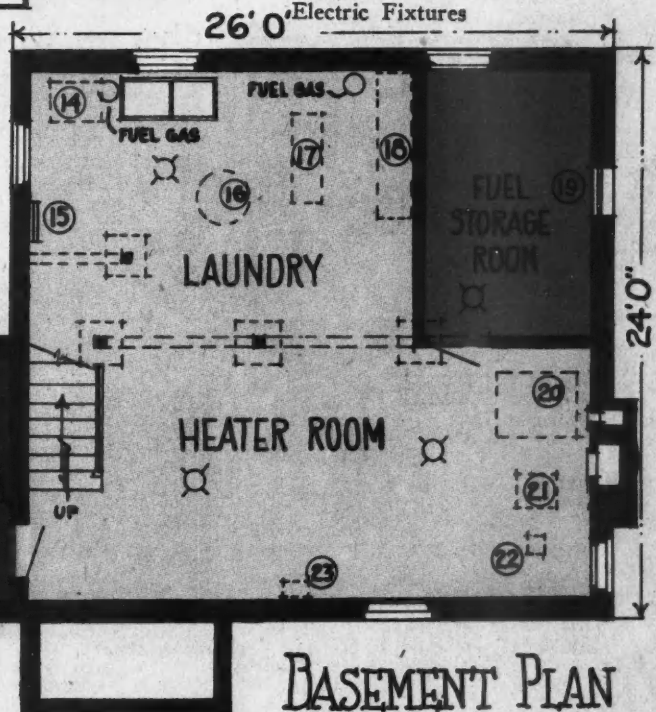

BASEMENT PLAN

COLORKEED HOME PLANS D

TRADE MARK

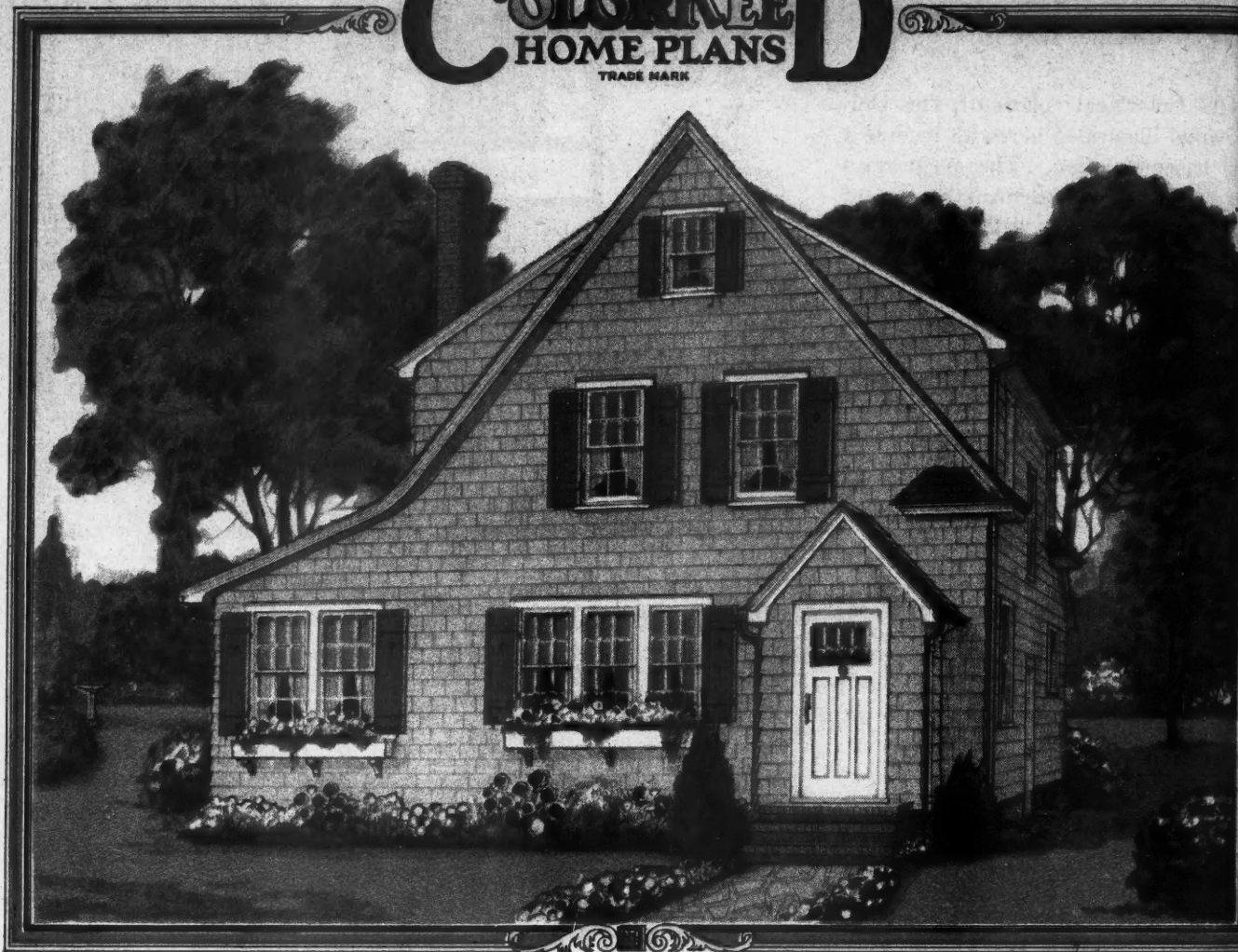

The DEFIANCE

A CHARMING English cottage with stained shingle walls and batten shutters. The ColorKeeD plans below show the convenient arrangement inside—six rooms, bath and large sun porch. Study the desirable equipment suggested to make this home modern and efficient.

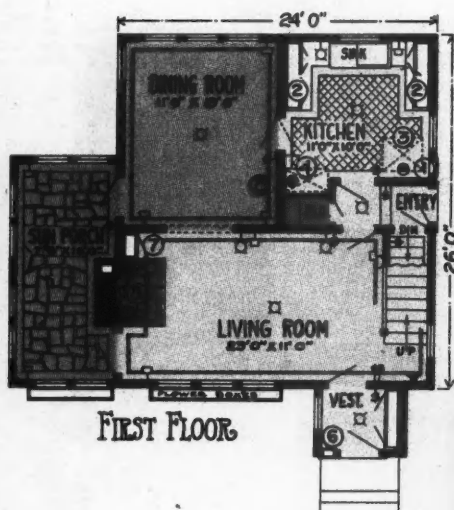

FIRST FLOOR

ColorKeeD Plan Patent Applied For

COLOR KEY TO PLANS

- LIVING ROOM
- DINING ROOM
- KITCHEN
- PANTRY
- HALLS
- CLOSET

- BED ROOM
- BATH AND LAVATORY
- PORCH
- ROOF

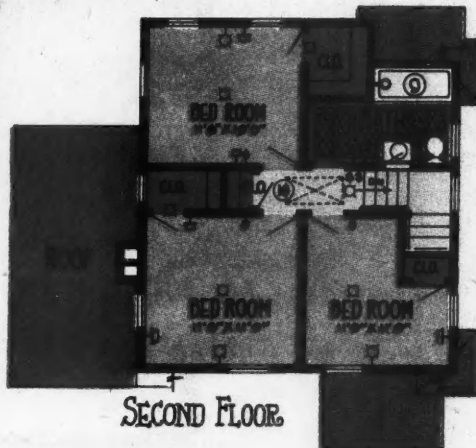

SECOND FLOOR

Key to Equipment

- ① Ventilating Fan
- ② Kitchen Cases
- ③ Range
- ④ Refrigerator
- ⑤ Thermostat
- ⑥ Built-in Mail Box
- ⑦ Radio Outlet
- ⑧ Fireplace Throat and Damper
- ⑨ Tub Shower
- ⑩ Disappearing Stair
- Weather Strips
- Storm Sash
- Screens
- Shades
- Electric Fixtures

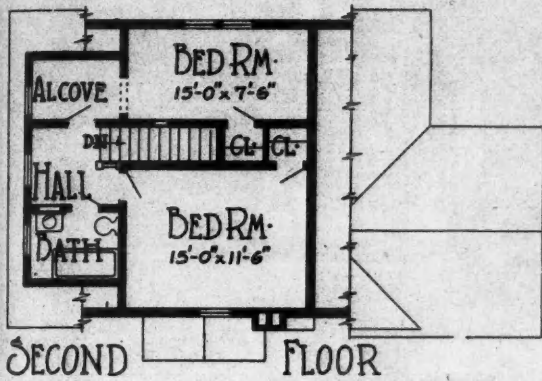
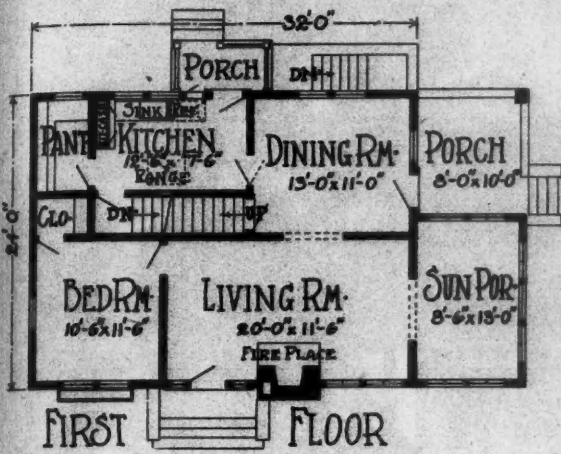

The DALTON

A CHEERFUL bungalow of six rooms including a downstairs bedroom. The big, well lighted living room with sun parlor addition is the feature of this plan. Color sketch above gives a glimpse of this homelike room with fireplace.

ColorKeed Plan Patent Applied For



COLORKEED HOME PLANS

TRADE MARK

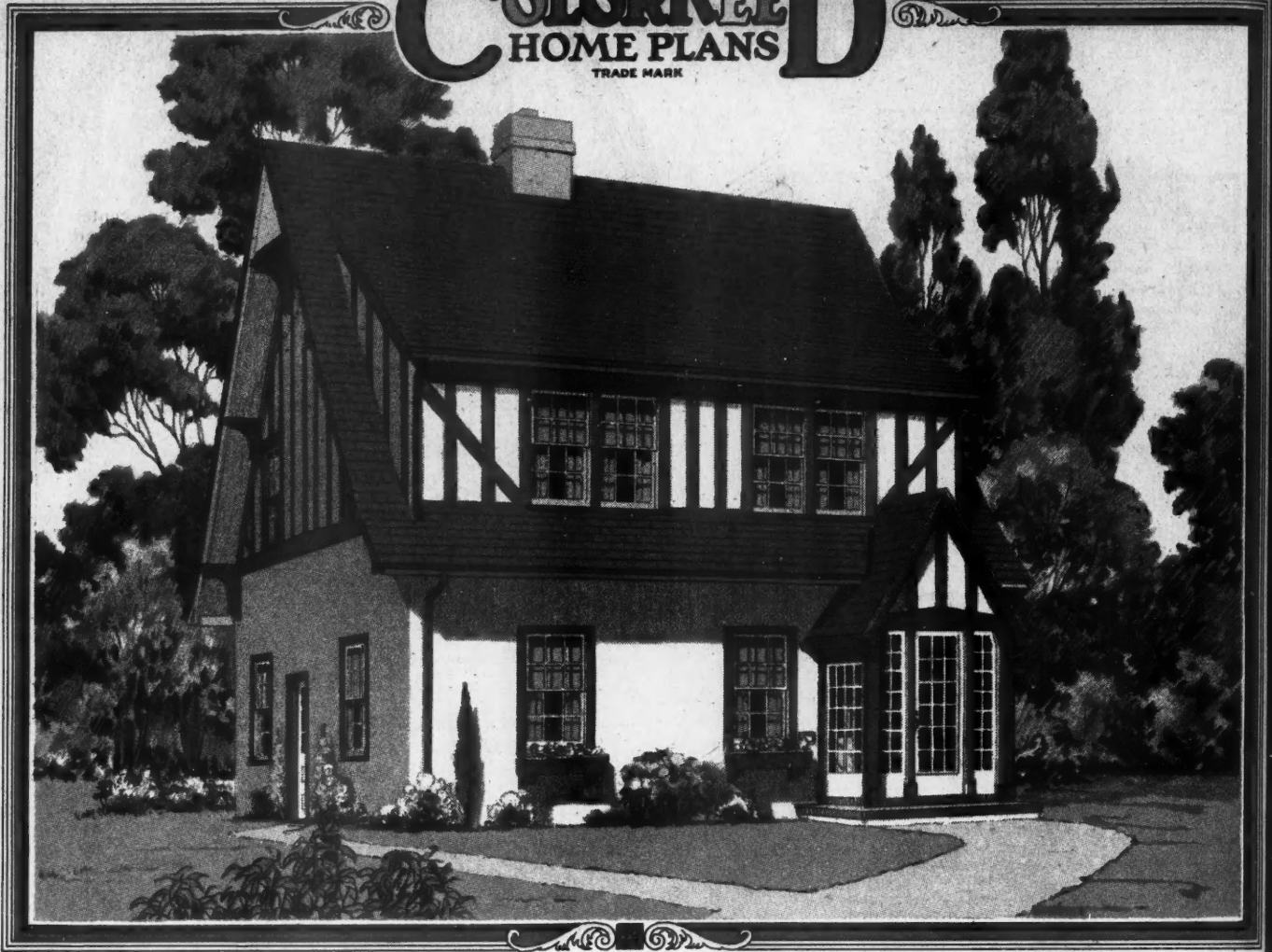

The DEARBORN

AN artistic half timber stucco design, well suited to a small building site. Six rooms and bath are provided with additional usable space on the third floor reached conveniently by means of the space-saving disappearing stairway. Many other desirable features of modern equipment are suggested in the ColorKeeD plans below.

COLOR KEY TO PLANS

- LIVING ROOM
- DINING ROOM
- KITCHEN
- PANTRY
- HALLS
- CLOSET

- BED ROOM
- BATH AND LAVATORY
- PORCH
- ROOF

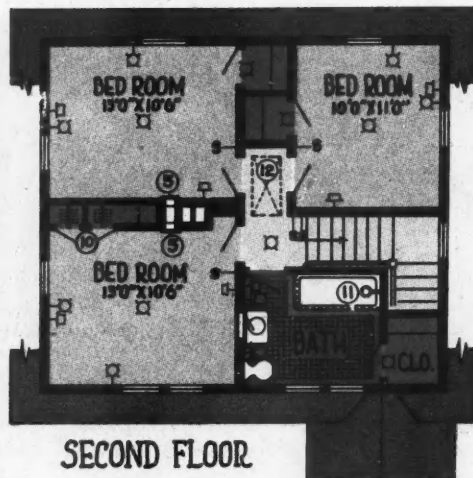
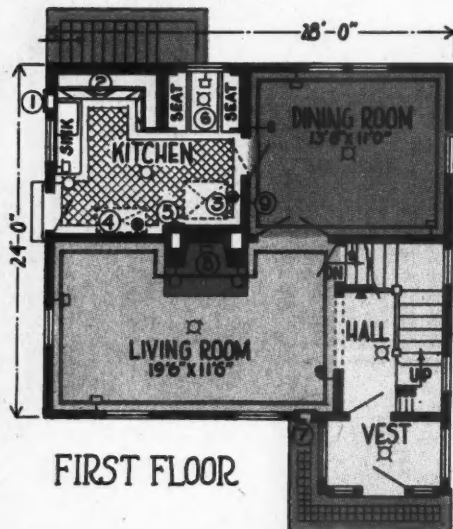

ColorKeeD Plan Patent Applied For

Key to Equipment

- ① Ventilating Fan
- ② Kitchen Cases
- ③ Range
- ④ Refrigerator
- ⑤ Incinerator
- ⑥ Breakfast Nook
- ⑦ Built in Mail Box
- ⑧ Fireplace Throat and Damper
- ⑨ Thermostat
- ⑩ Efficiency Wardrobe
- ⑪ Tub Shower
- ⑫ Disappearing Stairway
- Weather Strips
- Storm Sash
- Screens
- Shades
- Electric Fixtures

The DAISY GARAGE

To the left is illustrated an economical two-car garage with double door opening, no center post. The six panels are arranged to fold and slide, making an easily operated door, and storm-tight.

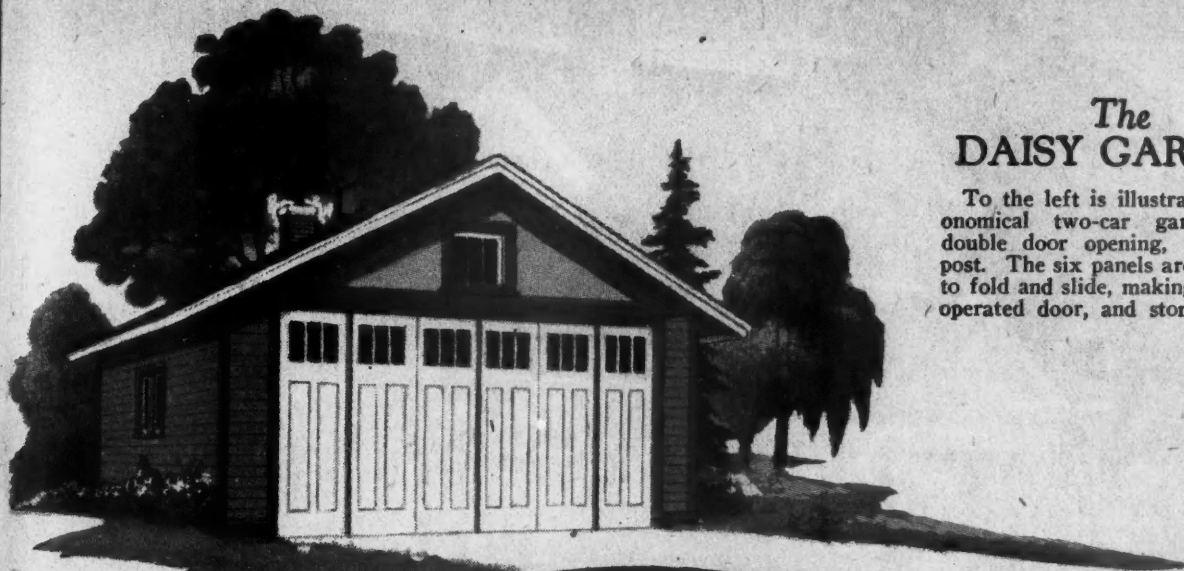

The DALE GARAGE

Photograph to the left shows how attractively the well designed garage can be fitted into its surroundings.

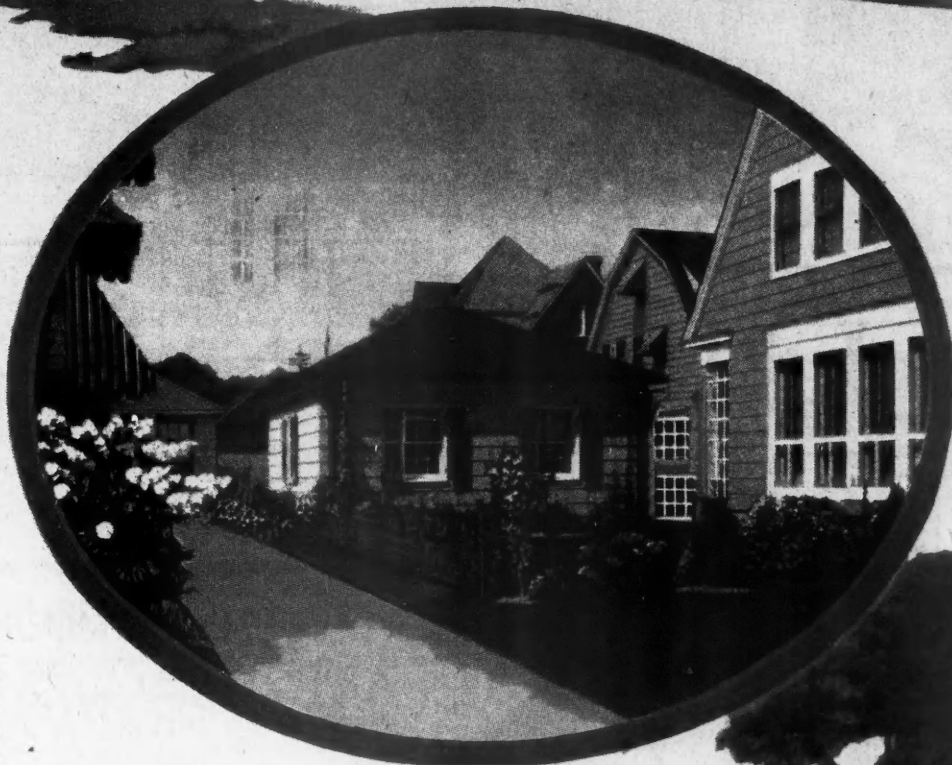

The DAIN GARAGE

To the right is a double brick garage with doors arranged in two groups, hinged.



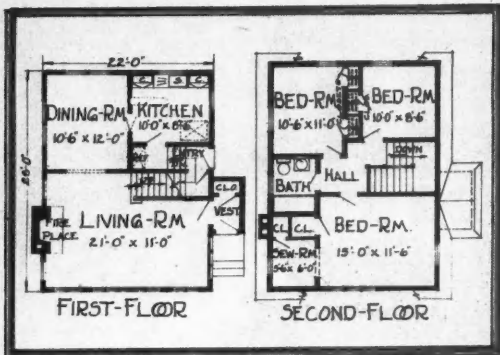

The DARWIN

BELOW and to the left is a popular narrow lot designed 22 x 28 feet, containing six rooms and bath.

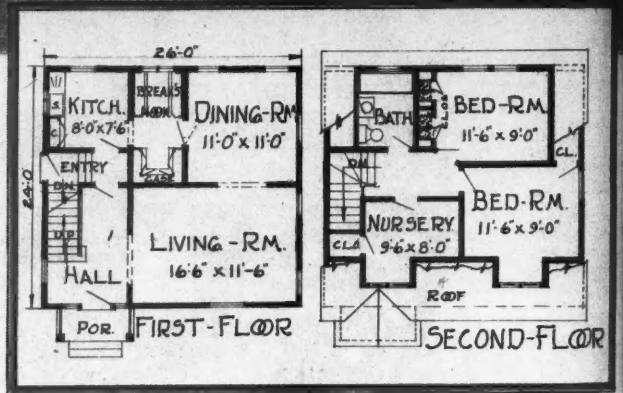

The DARTMOOR

ABOVE we present a five-room gem, 24x26 feet—An inexpensive home yet very satisfactory.

ColorKeed Plan Patent Applied For

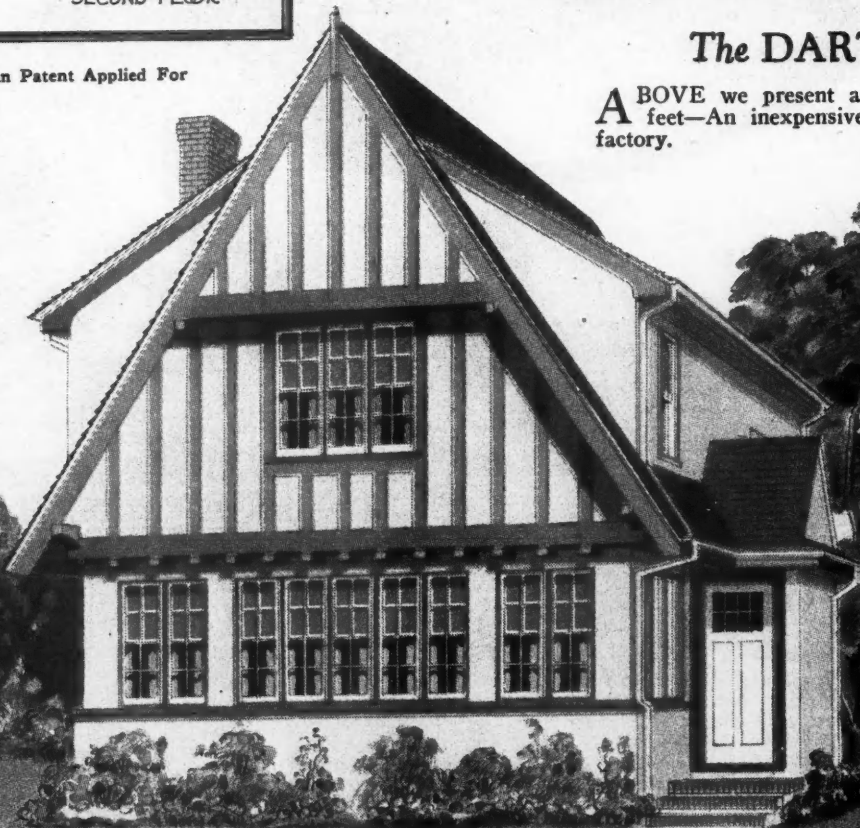

T
B
E
r
o
o
k
i
n
g
r
o
o
m

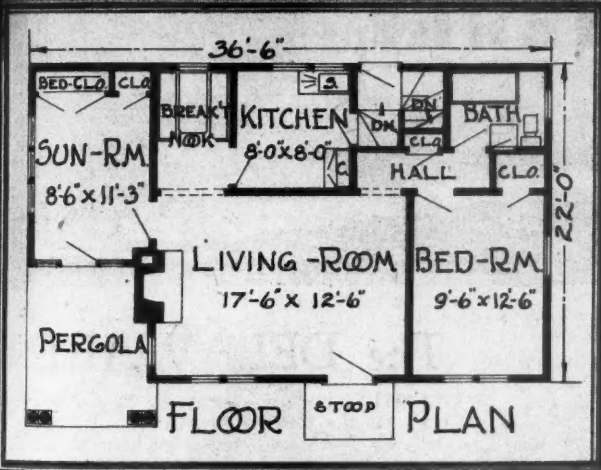
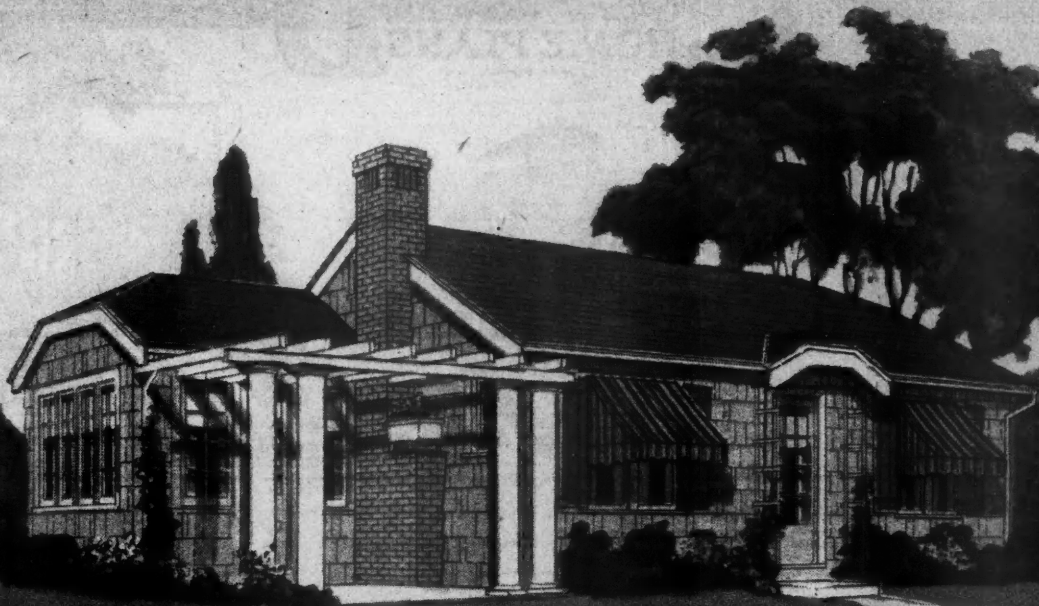

The DAUPHIN
 ABOVE and to the left a charming bungalow, 22x36½ feet.

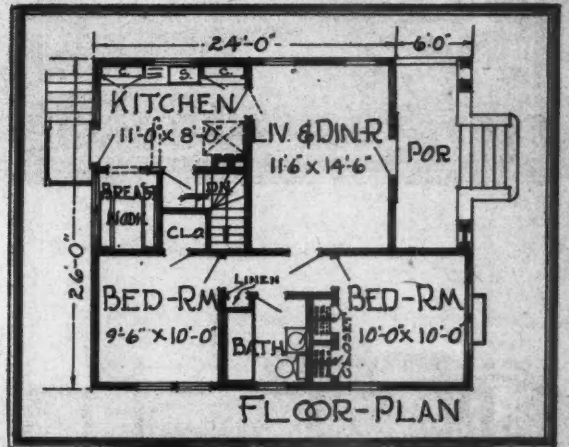

The DAWSON

ColorKeed Plan Patent Applied For

BELOW and to the right is a four-room, two-bedroom design, the breakfast nook making a regulation dining room unnecessary.

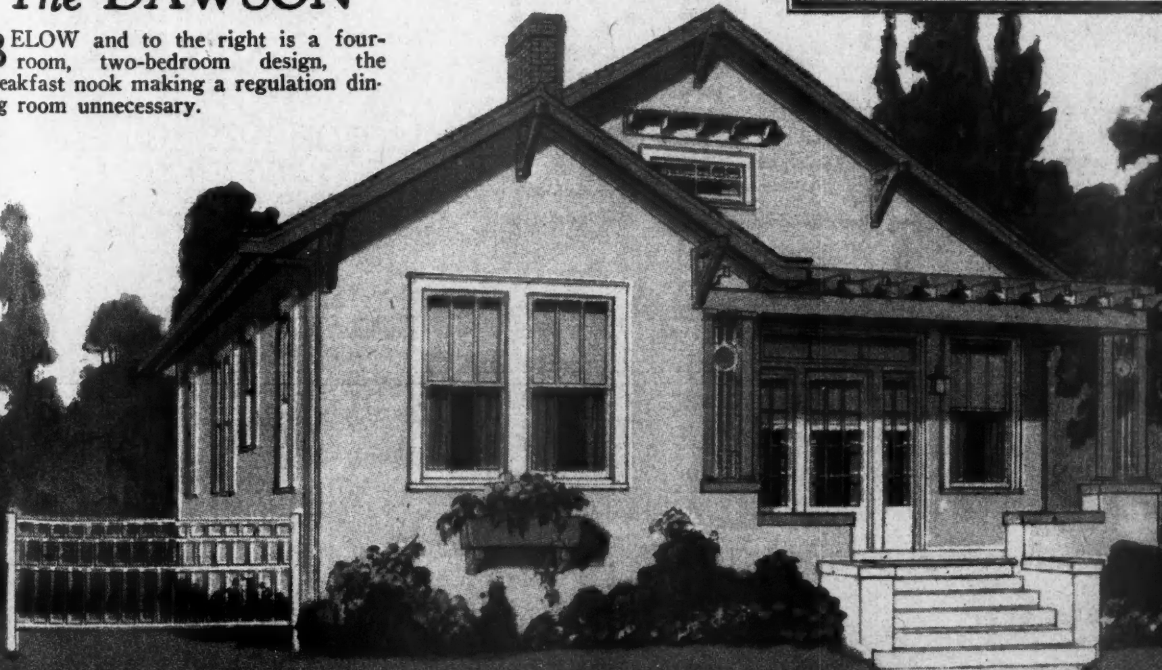

COLORKEED HOME PLANS

TRADE MARK

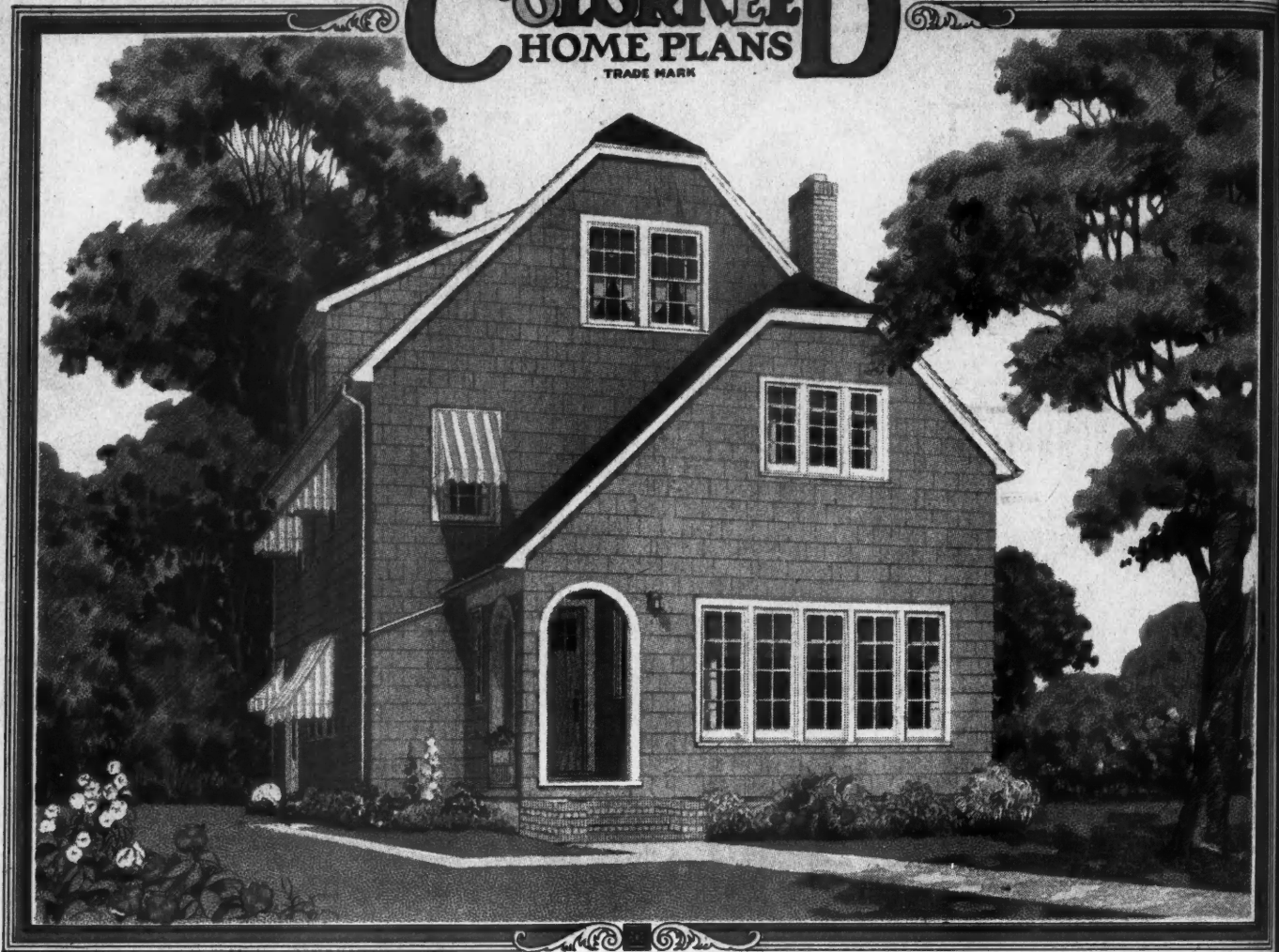

The DELAWARE

THIS modern American home has all the wanted features. Although only 24 feet wide, seven big rooms and bath are provided and the arrangement is indicated to make use of the desirable third floor space. Study these ColorKeeD plans and enjoy the prospect of building a well equipped home like this.

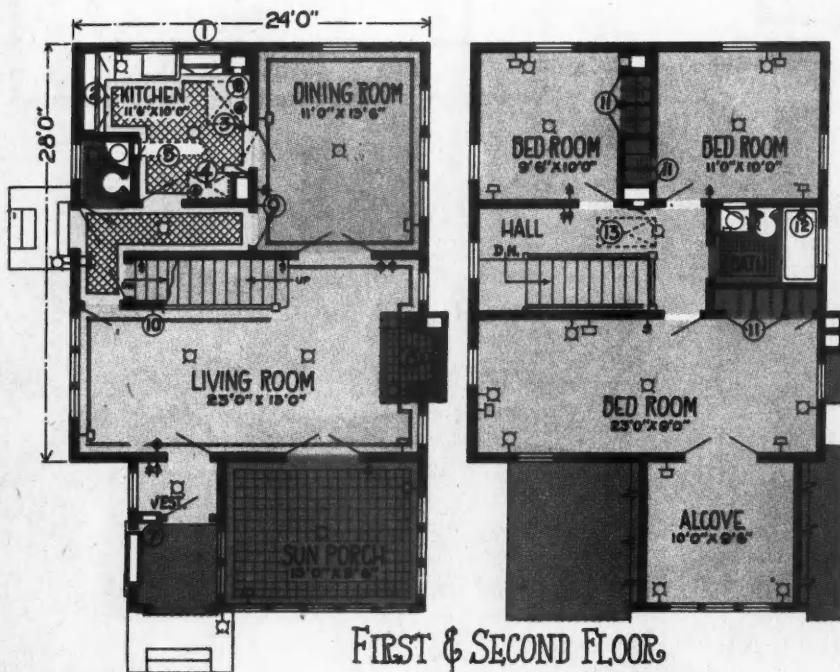

FIRST & SECOND FLOOR

COLOR KEY TO PLANS

- LIVING ROOM
- DINING ROOM
- KITCHEN
- PANTRY
- HALLS
- CLOSET
- BED ROOM
- BATH AND LAVATORY
- PORCH
- ROOF

ColorKeeD Plan Patent Applied For

Key to Equipment

- | | | | | |
|--------------------|-----------------|-------------------------------|-------------------------|-------------------|
| ① Ventilating Fan | ③ Range | ⑦ Built in Mail Box | ⑩ Radio Outlet | Weather Strips |
| ② Kitchen Cabinets | ④ Refrigerator | ⑧ Fireplace Throat and Damper | ⑪ Efficiency Wardrobe | Storm Sash |
| | ⑤ Ironing Board | ⑨ Thermostat | ⑫ Tub Shower | Screens |
| | ⑥ Incinerator | | ⑬ Disappearing Stairway | Shades |
| | | | | Lighting Fixtures |

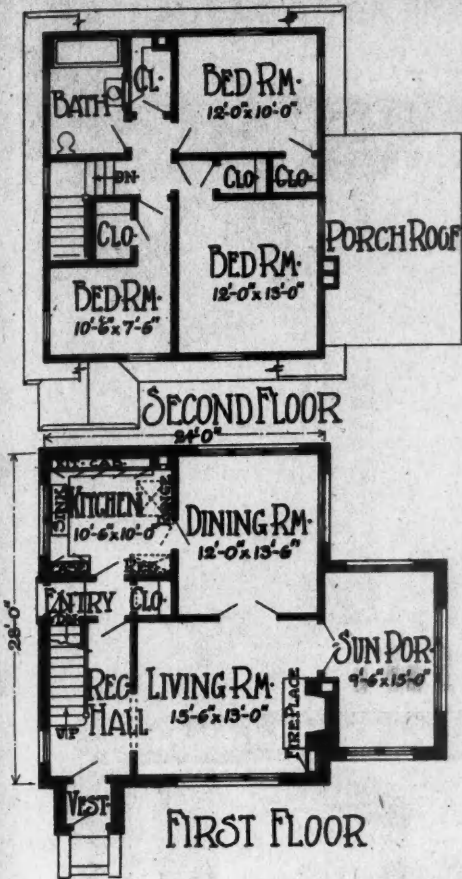

The DANVERS

B RICK for the first story and a low sweeping roof above always assures an attractive, individual home design. The Danvers has a strong Colonial feeling. The interior might well be finished and furnished in a Colonial style as suggested by the color sketch above. The floor plans to left show a very interesting arrangement of the seven rooms included in this design.

ColorKeed Plan Patent Applied For



RE

has
ough
and
ment
esir-
hese
ros-
ome

NS

RY

Strips
h

Fixtures

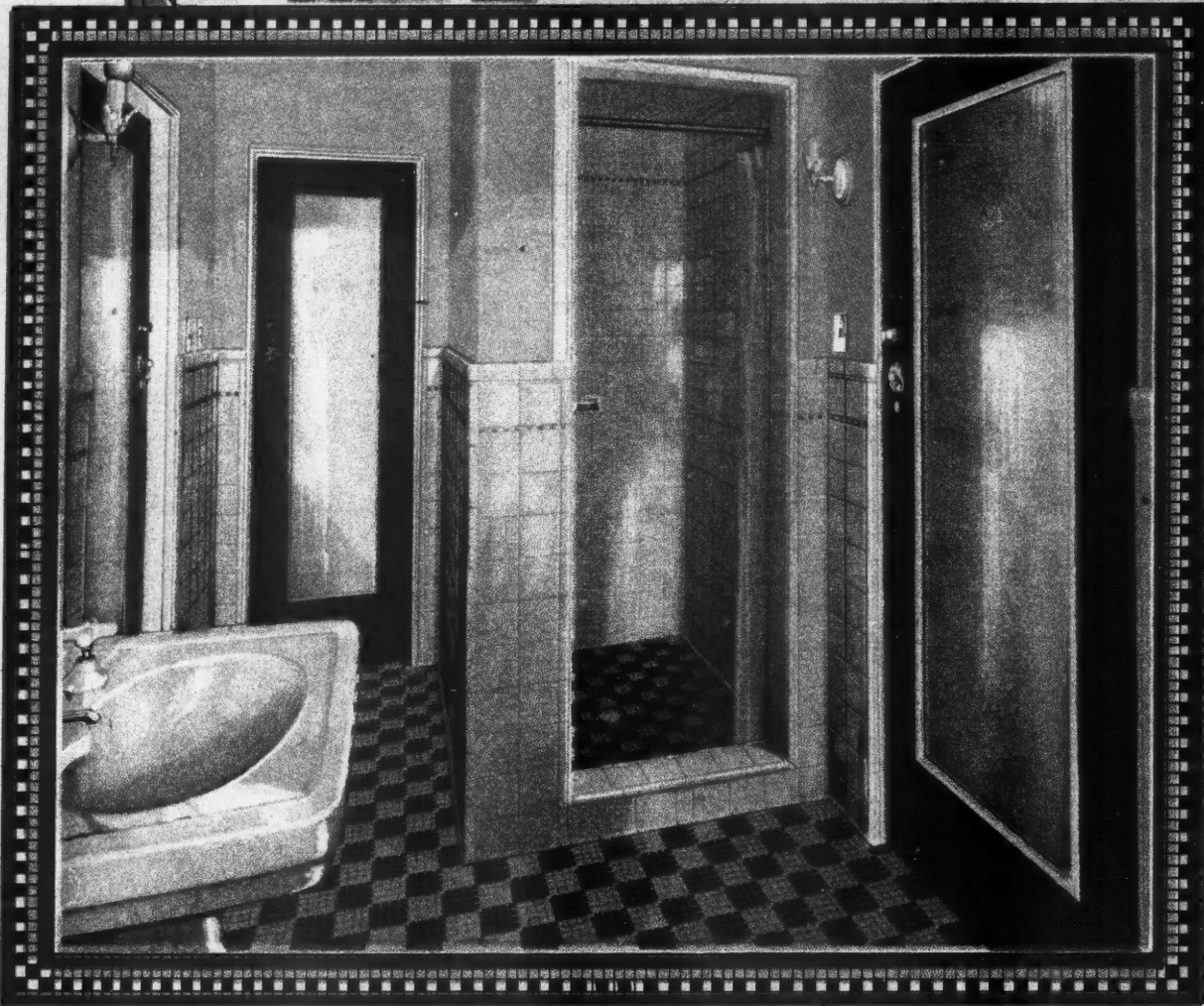
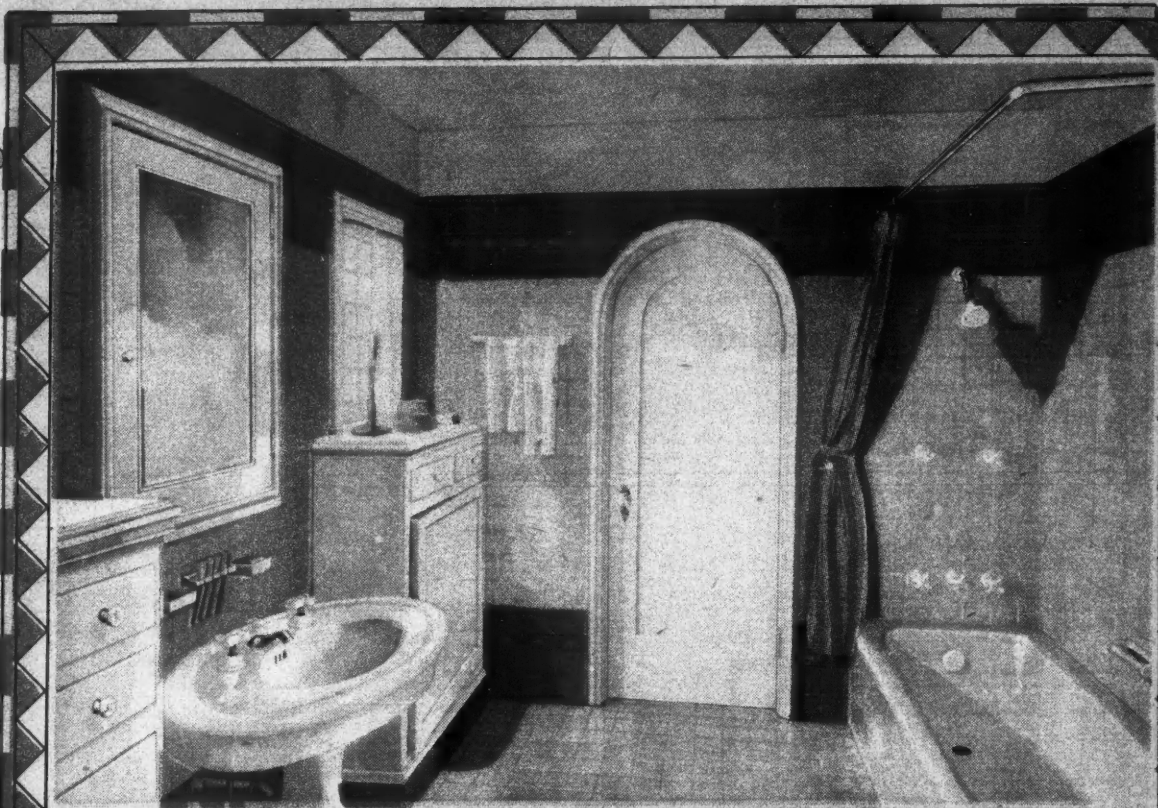

On this and on the page opposite are four recent bathroom achievements with tiled walls, shower baths, built-in china accessories and other interesting features.

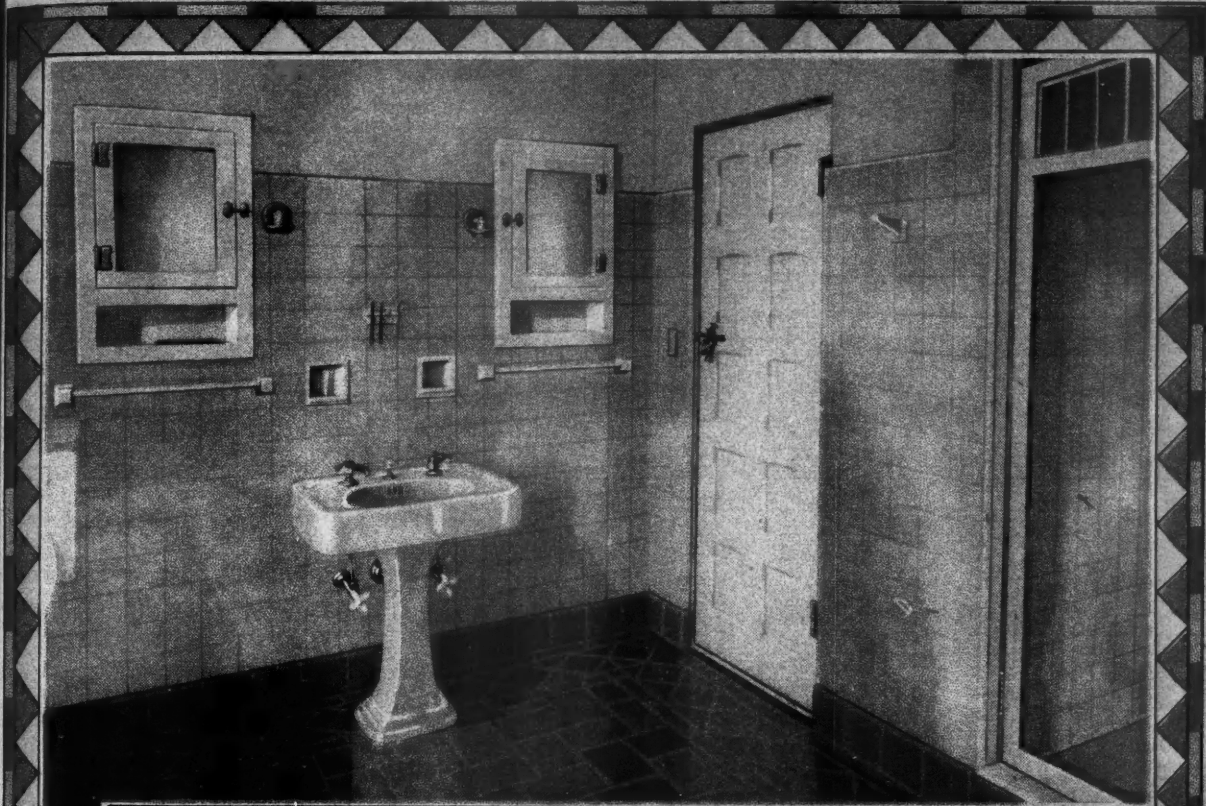

Bathrooms have come into the modern American home as a factor of very major importance. Bathrooms are being planned larger and with more attention to complete equipment.

COLORKEED HOME PLANS

TRADE MARK



The DELPHI

A MODERN stucco home of seven rooms featuring a downstairs bedroom with convenient lavatory. This is a good narrow lot design, being only 28 feet wide. Study the ColorKeeD home plans below for the room arrangement and also the suggestions for desirable modern equipment.

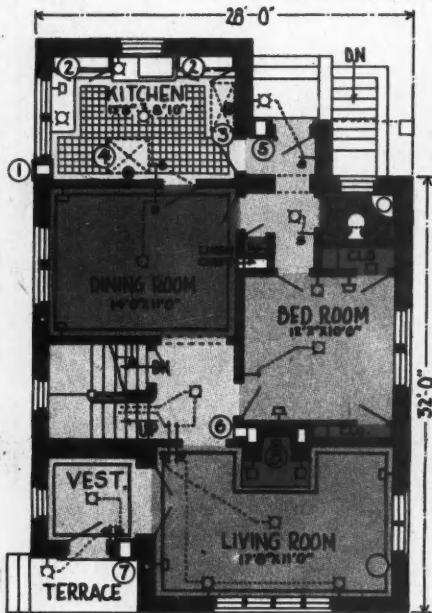

FIRST FLOOR

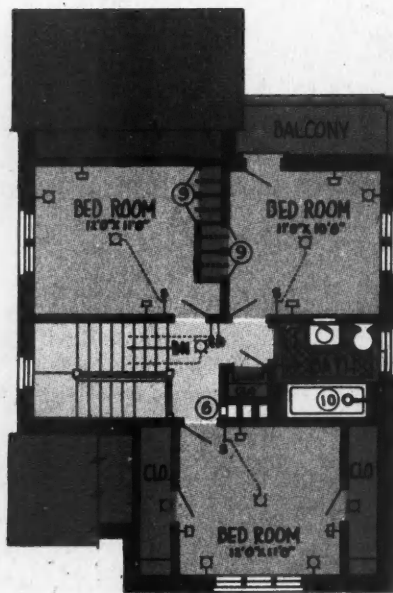

SECOND FLOOR

COLOR KEY TO PLANS

- LIVING ROOM
- DINING ROOM
- KITCHEN
- PANTRY
- HALLS
- CLOSET
- BED ROOM
- BATH AND LAVATORY
- PORCH
- ROOF

ColorKeeD Plan Patent Applied For

Key to Equipment

- | | | | | |
|--------------------|--------------------|-------------------------------|----------------|-------------------|
| ① Ventilating Fan | ③ Refrigerator | ⑦ Built in Mail Box | ⑩ Tub Shower | Shades |
| ② Kitchen Cabinets | ④ Range | ⑧ Fireplace Throat and Damper | Weather Strips | Lighting Fixtures |
| | ⑤ Package Receiver | ⑨ Efficiency Wardrobe | Storm Sash | |
| | ⑥ Incinerator | | Screens | |

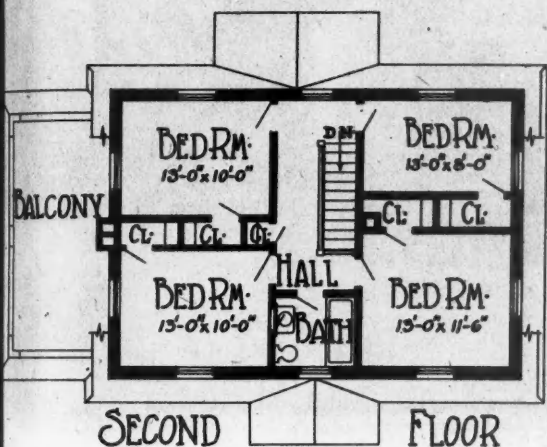
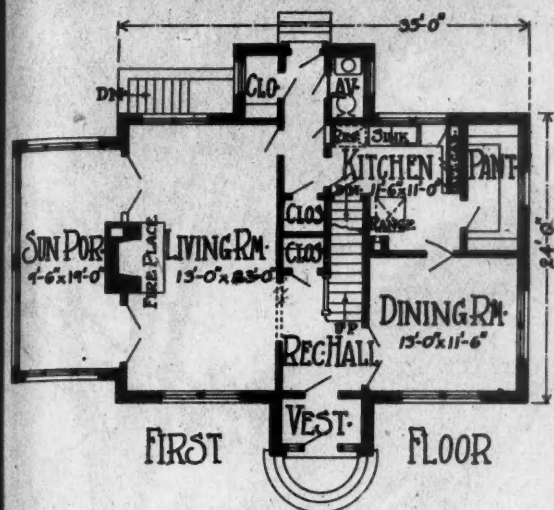

The DARIEN

A SUBSTANTIAL Colonial brick home with asbestos shingled roof. Overall dimensions are 24x35 feet, plus the sun parlor extension which is 9½x19 feet. The arrangement of this house is standard, taking the form that has proved so popular. Color sketch above gives a glimpse of one of the bedrooms suggesting an attractive form of paneled walls, harmonizing with the Colonial furnishings.

ColorKeed Plan Patent Applied For



COLORKEED HOME PLANS

TRADE MARK

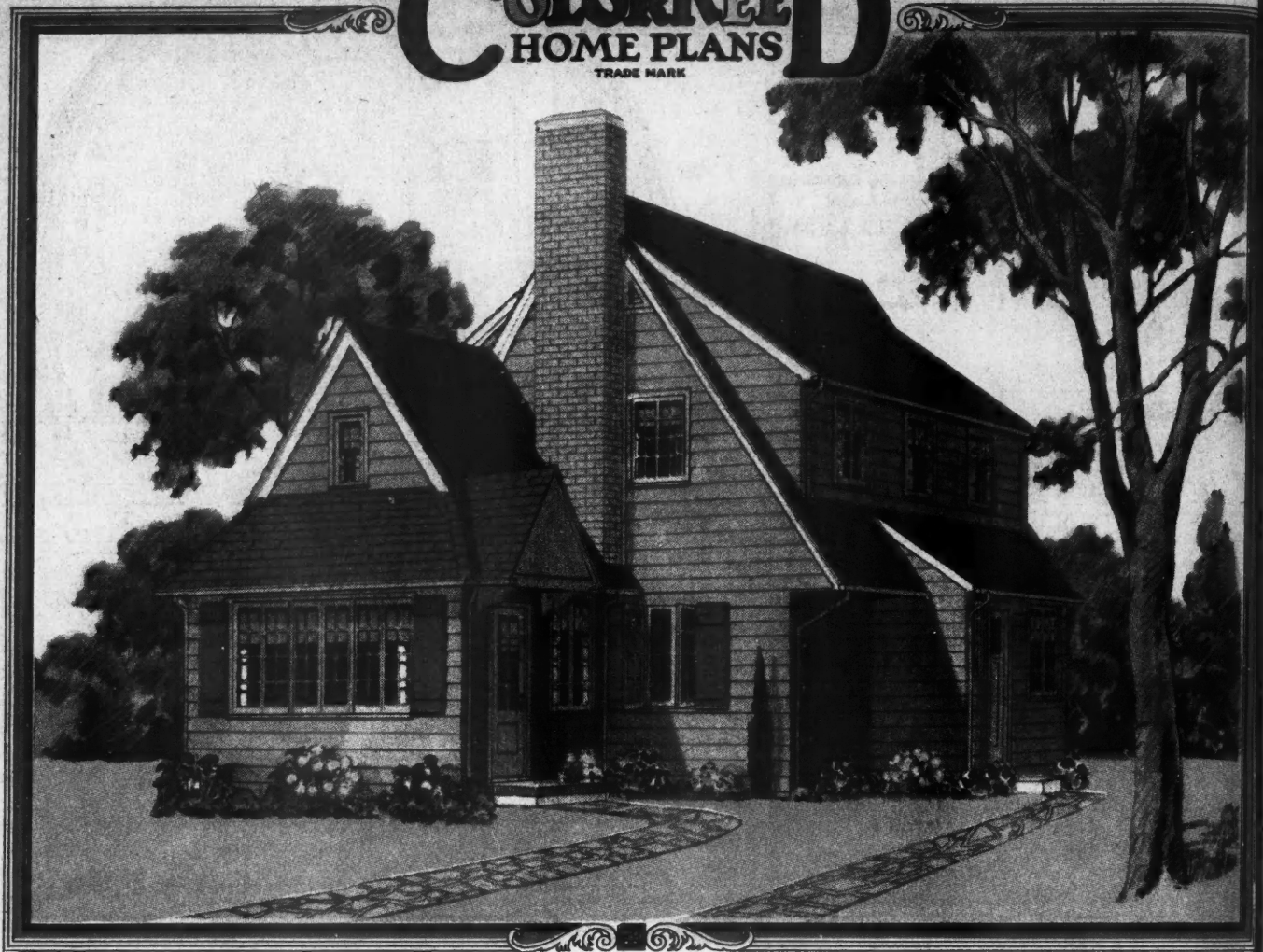

COLOR KEY TO PLANS

- LIVING ROOM
- DINING ROOM
- KITCHEN
- PANTRY
- HALLS
- CLOSET

- BED ROOM
- BATH AND LAVATORY
- PORCH
- ROOF

The DEEDSVILLE

A COTTAGE of rare charm, 24x24 feet in the main section. The ColorKeeD plans show six fine rooms and bath in this part of the house, plus the big sun porch or solarium in the wing. Notice the generous closet space in this home.

ColorKeeD Plan Patent Applied For

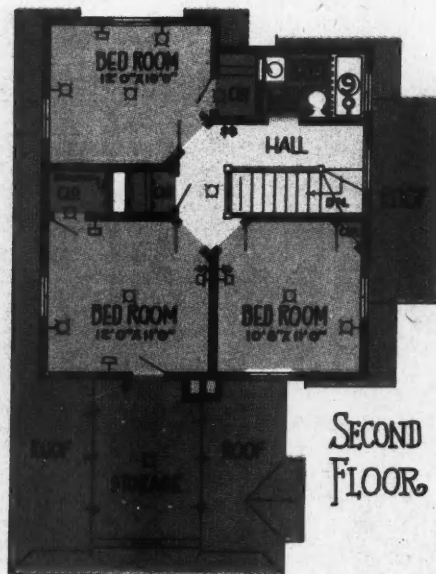
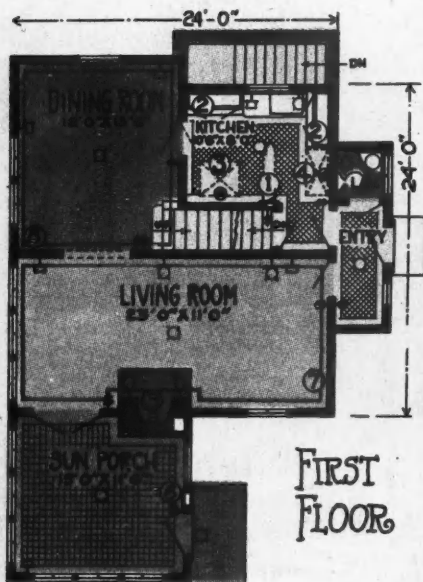

Key to Equipment

- ① Ironing Board
- ② Kitchen Cases
- ③ Range
- ④ Electric Refrigerator
- ⑤ Fireplace Throat and Damper
- ⑥ Built-in Mail Box
- ⑦ Radio Outlet
- ⑧ Thermostat
- ⑨ Tub Shower
- Weather Strips
- Storm Sash
- Screens
- Shades
- Electric Fixtures



Here Is a House in Which Quality and Permanence of Both Materials and Design, Can Be Instantly Recognized by the Home Seeker

WHEN one looks at the picture of our Front Cover Home, reproduced at the bottom of this page, and in full colors on page one, he is immediately impressed with an atmosphere of permanence and feels assured that here is one house which will still hold its charm years from now, when it is no longer new and "the very latest thing." That is the advantage of a house which is wisely planned, the materials for which are well selected and the design for which is along lines of permanent worth rather than momentary style fad.

Here brick and half-timbered stucco have been most judiciously combined in a style which is strongly suggestive of the English cottage architecture. This suggestion is furthered by the use of the thatch type roof which fits down over the building with a protective air and lends a touch of coziness to the whole effect. The small paned, casement windows are in perfect harmony with the other features that make this home what it is.

For those who are fond of a blazing open fire, the massive chimney, forming the central feature of the front elevation, offers a promise of a home-like living room with a broad fireplace. Nor will these be disappointed for a reference to the plans to be found on the pages which follow this, shows us just such a fireplace as we have

dreamed of having in our ideal home.

These same plans, including complete working drawings, to scale, of Our Front Cover Home, show a most satisfactory arrangement of rooms, one which we could hardly improve by any amount of study. Especially interesting is the living room, opening clear through the house from front to rear, and forming a central section with the sleeping quarters in one wing and the living rooms in the other.

In inspecting these plans our attention is caught by the suggestion for utilizing basement space for a billiard room or play room. For many years valuable basement space was allowed to stand idle in our American homes, merely collecting dirt. Today there is a decided tendency to put this space to work and the more modern plans call for billiard rooms, children's play rooms, music rooms, recreation and dance rooms and a multitude of other uses for the extra basement space.

Not only is this an economy of space and an inexpensive addition of convenience and luxury, but it is also an improvement in the house which makes for actual saving of money. When such a space is finished and cared for it helps to keep the dirt from the heating plant from spreading through the house, a fact which will be quite noticeable in the reduction of bills when it comes to redecorating.



An Exterior Which Instantly Attracts and Holds the Attention Is Seen in This Photograph of Our Front Cover Home. An equally pleasing plan is to be seen, together with elevations and details on the pages which follow.

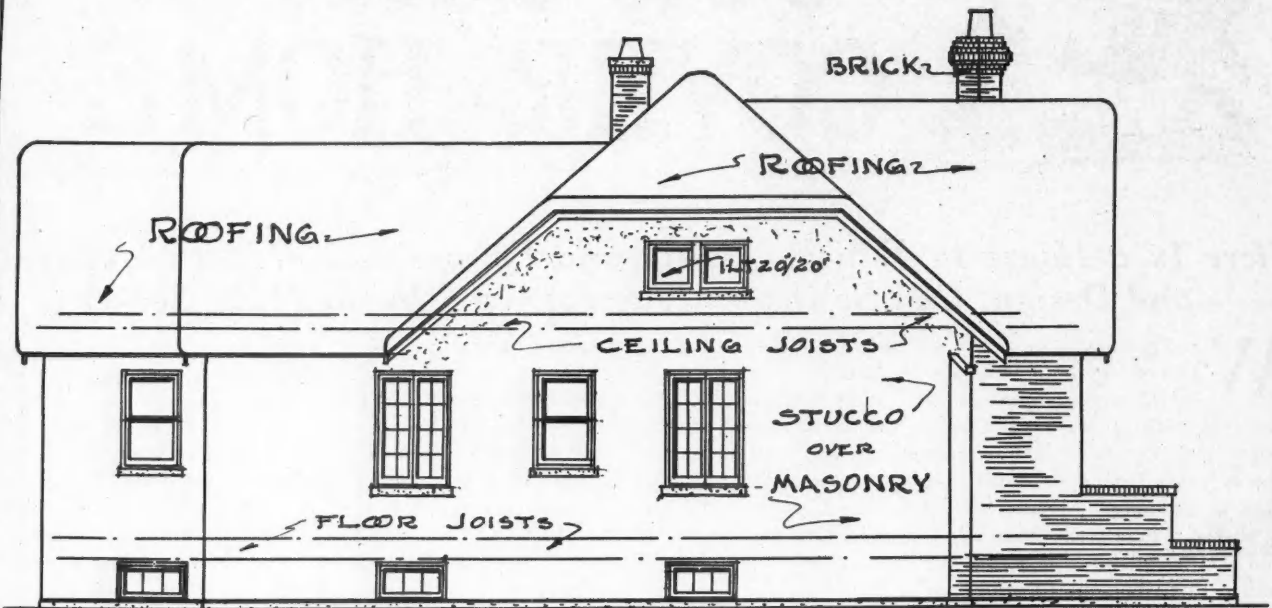

LEFT-SIDE-ELEVATION

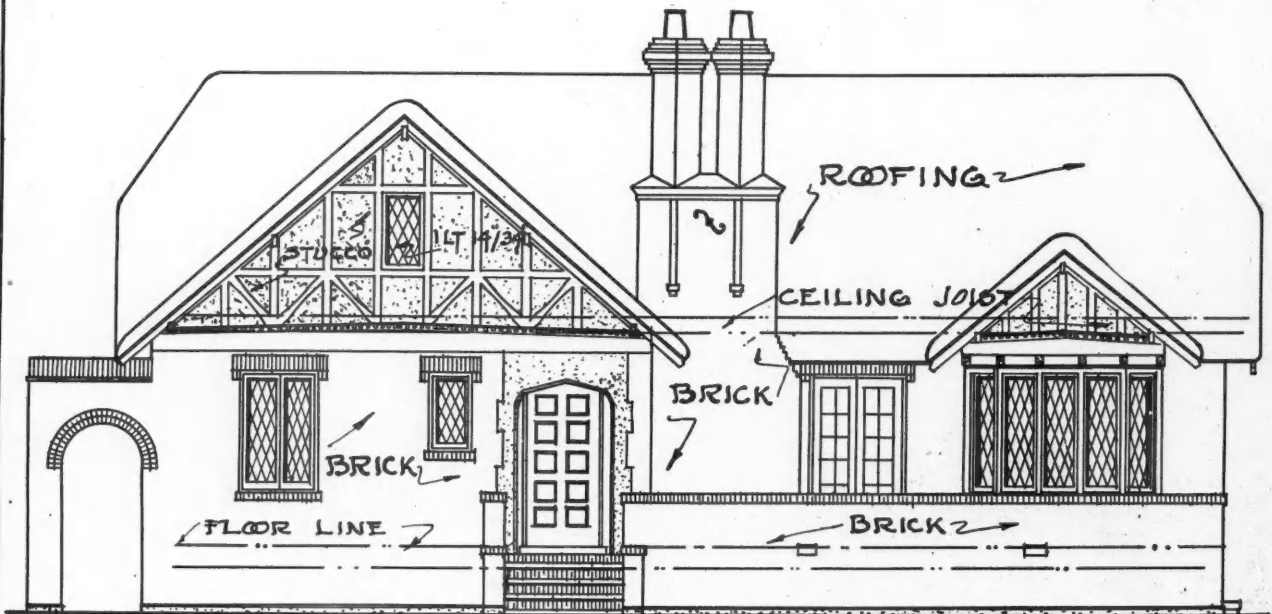

FRONT-ELEVATION

SCALE 1/8"=1'-0"

SHEET-NO-1.

Our Front Cover Home Offers an Interesting Study of Roof Lines and These Elevation Drawings Bring Out the Effective Treatment of This Problem.

Two Mo



↑ REAR-ELEVATION ↑

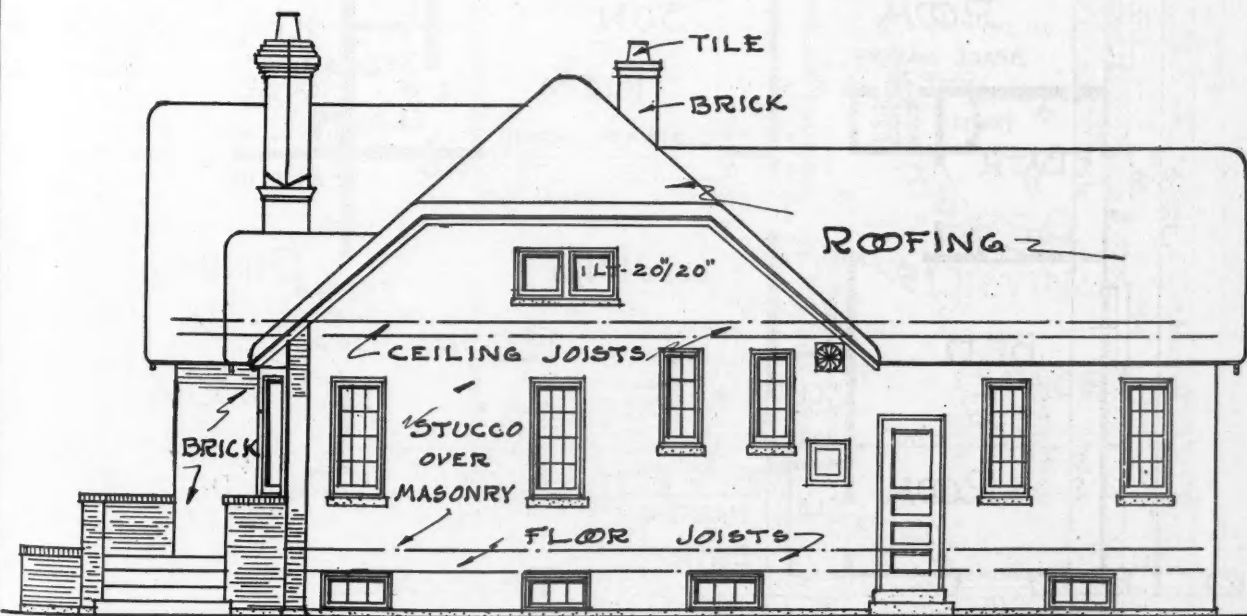

↑ RIGHT - SIDE - ELEVATION ↑

SCALE 1/8" = 1'-0"

SHEET-NO-2.

Two More Elevation Drawings Complete the Series While on the Pages Which Follow Will Be Found the Floor Plans and Detail Drawings.

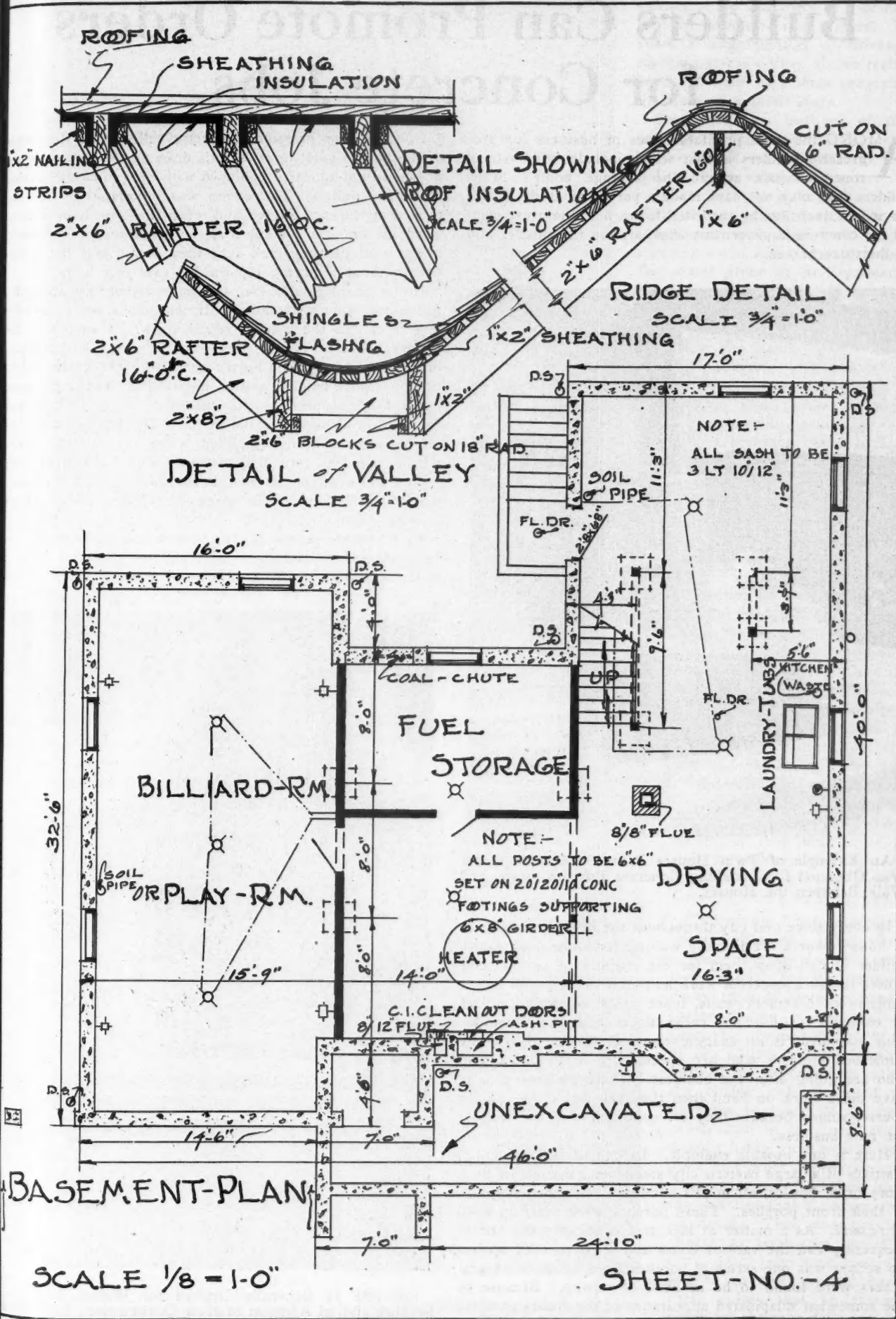

A Basement Plan Which Utilizes Often Wasted Space by Providing a Billiard or Play Room. Above details of valley and ridge construction.

Builders Can Promote Orders for Concrete Jobs

AMONG the most profitable lines of business for progressive builders is that which includes all kinds of concrete work around the average home. Many builders who may not have made a particular study of this line would doubtless be surprised to learn of the great market for concrete improvement work around the smaller and medium-size homes.

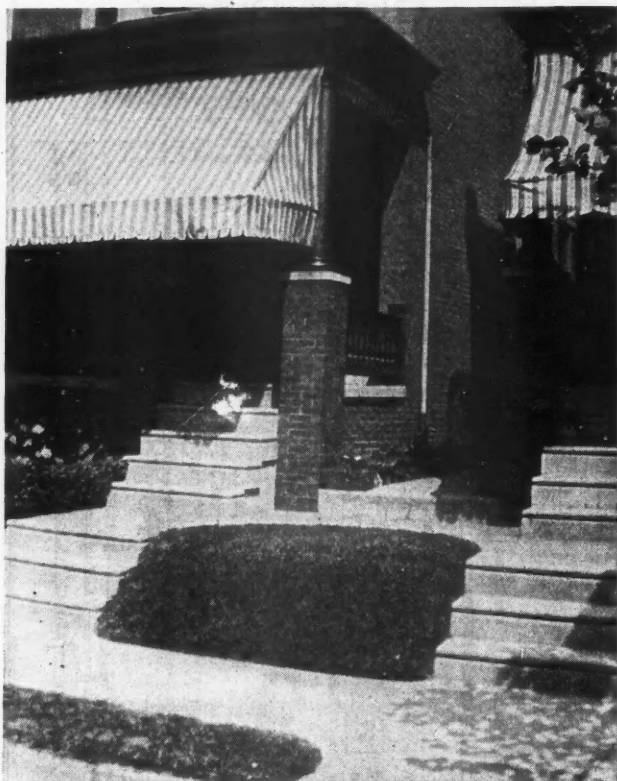

An Example of Twin Houses Where a Double Order Was Obtained for Installing Concrete Porches, Steps and Walk Between the Houses.

In every town and city throughout the country thousands of house owners are literally waiting for some progressive builder to call upon them for the purpose of taking their orders for such concrete work as porch steps, porch floors, damp-proof basement walls, fence posts, sidewalks, pillars or columns for porches, cellar floors and garden walks. This statement is no exaggeration. It can be proven by numerous builders who are specializing in this line, and who are going after the business. These builders usually have more work on hand than they can do in the regular course, simply because they are continually on the lookout for new business.

Here is one notable example. In one of the residential districts of a large eastern city stood several rows of two-story brick houses, all in fair condition with the exception of their front porches. These porches were sadly in need of repairs. As a matter of fact, the owner of these homes frequently had the various floors and steps patched up but no sooner was one series of porches fixed up when several others were found to be in need of repairs. Because of the somewhat dilapidated appearance of the fronts of these houses, several of them were usually vacant, and the immediate neighborhood took on a rather poor aspect.

One day a progressive contractor called upon the owner of the houses with an architect's drawing showing how the houses would appear if equipped with new concrete porches of artistic design. The owner was impressed by the improved appearance offered and when the contractor emphasized the important point that the concrete porches would never need painting, and that they would last for a lifetime without requiring repairs, his case was won.

Although the total cost of this improvement job amounted to several thousand dollars, it was the most profitable investment, in the way of repair work, the owner of the houses had ever made. Not only were the entire fronts of the homes beautified by the concrete porches, their artistic appearance lending quite a dignified air to the property, but the atmosphere of the immediate neighborhood was remarkably changed for the better. The improvement had no more than been completed when the several houses which had been standing vacant for a long time were rented and not long afterwards the owner found it an easy matter to sell some of the houses to families living in them at very substantial prices.

In practically every town and city are many double or twin houses. Where the builder receives an order for new concrete porch steps from an owner of one of these, he can

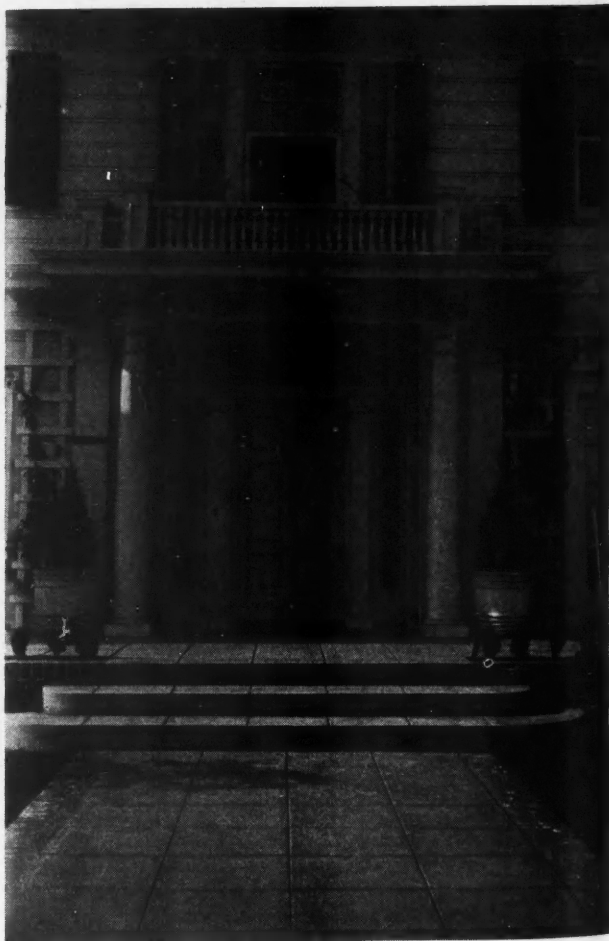

Concrete Is Generally Desired for Walks, Steps and Porches and, in Addition to New Construction, Such Work Offers Wide Possibilities in the Improvement of Old Houses.

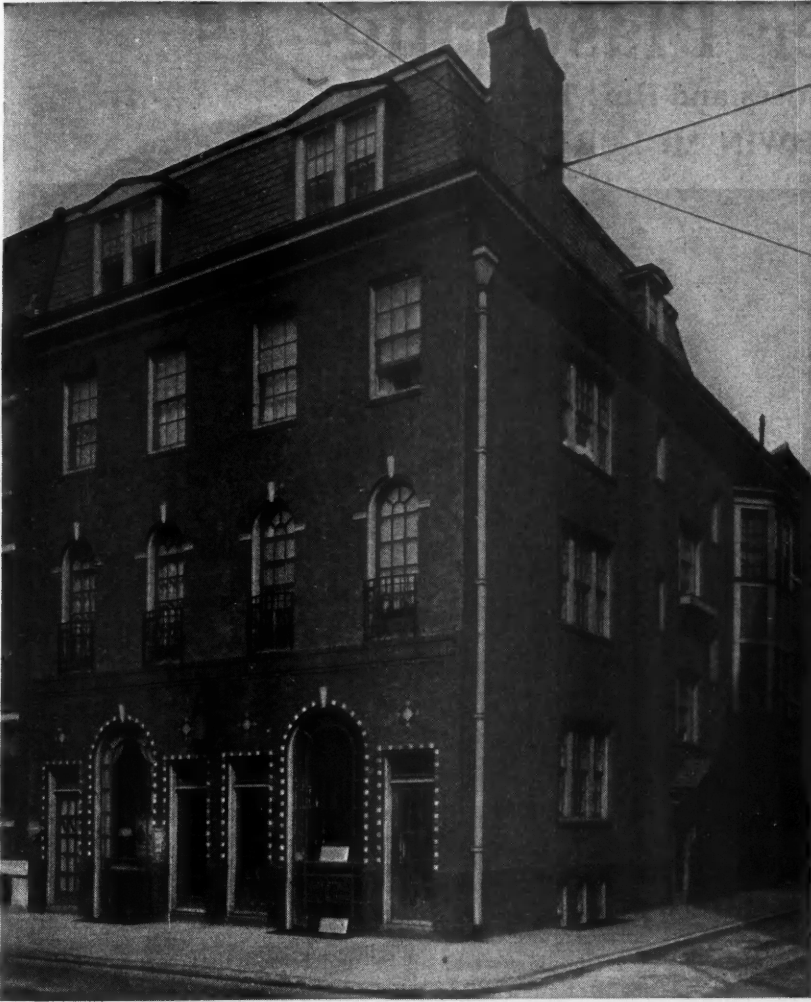

Two Old Houses in Philadelphia Were Remodeled Into This Attractive Building by the Application of Concrete Work, Portland Cement Stucco Front and Tapestry Brick Trimming.

usually make it a double order by interviewing the party owning the house next door. Many builders already are following this idea with successful results, not only as to orders for porch steps but also in the case of single orders for remodeled brick fronts of homes, stucco fronts, covering a bay window with asbestos tile, and so forth. When any job of this kind is to be done on a house in a row the owners of the homes on either side are naturally interested, provided that their property stands in need of the same improvement, and it is the opportune time for the builder to talk business with these owners. Both owners can save expense by having the work on the two houses done at the same time.

The damp-proof concrete wall for the basement kitchen, laundry or regular cellar of a home is another quick-selling specialty that can be successfully pushed by any builder who is experienced in cement work. This kind of wall is especially designed for the basement of a home that is inclined to be damp, and it is of particular advantage in a case where a



The Two Old Houses Shown Above as They Appeared Before the Improvement Work Was Undertaken.

section of the basement of a private house is to be converted into a store. In recent years a large number of private homes, standing at the corner of two main streets, have had their basements reconstructed in the form of a retail store.

There are two methods of making a damp-proof basement wall in a house that has been built with an ordinary foundation wall of rough stone and plaster. The first and best method is to jack up the walls of the house; remove entirely the old stone and plaster wall, then build in its place a new, smooth wall of reinforced concrete. The water from an underground spring, rain or any other sources will never penetrate through a solid concrete wall of this quality.

The other and less expensive method is to remove the plaster from both sides of the old foundation wall, and then surface the remaining stones with a thick covering of cement. This process means that a trench must be dug around the outside of the wall in order to cover both sides of the wall with the cement, but a job of this kind is worth all that it may cost in time, labor and material, as it will not only produce a water-tight wall but also one that will be far stronger than the average cellar wall covered on the inner side with rough plaster.

Several active building firms are specializing in the construction of these damp-proof walls, devoting especial attention to fine private homes of the detached variety, and to large corner houses where the basement is to be transformed into a shop or store. These firms are continually gaining orders for this work by the process of interviewing property owners on the subject and explaining every advantage of the solid concrete basement wall over the ordinary kind made of rough stone and plaster. It should also be mentioned that these firms, in addition to building the concrete walls for old houses, are also erecting reinforced concrete walls for new houses.

One of the firms referred to happened to hear of a doctor who owned a corner house that was not quite large enough for his purpose. His many patients were received in the parlor of the house and at times there was not sufficient room to make all the visitors feel comfortable. The head of the building firm called upon the doctor and suggested that he have the basement of the house reconstructed in the form of a large English living room with an open fireplace and other appropriate features. The doctor was interested but raised the objection that the basement would be damp. That was the builder's chance to boost the merits of the damp-proof reinforced concrete wall, and so convincingly did he explain these points that he received the order for the remodeling job.

(Continued to page 189)

Better Plastering

Plaster Cornices and How They Are Made

By EDWIN M. LURIE, C. E.

IN achieving that distinction in architectural treatment which lends special character to the interior of the home or apartment and sets it apart from others, architects and builders are coming to rely more frequently on the use of plaster cornices, either throughout the building or only in the parts which are most apt to be seen by visitors. Such rooms as the entry hall, living room, dining room and the sun room and in the more pretentious homes, the billiard and music rooms and quite frequently the master's and guest's bedrooms have their charm enhanced immeasurably by the use of plaster cornices, which add the finishing touch to the decorative beauty of plastered walls and ceilings.

No doubt this present day trend is directly traceable to the vast use of ornamental plastering in buildings frequented by the public. The superb vastness and fairy-tale-come-true interiors of the modern motion picture theatres could not have been achieved without the magnificent suspended ceilings of the dome type or of the barrel type, and literally miles of plaster cornices are used in connection with these so that the whole possesses architectural continuity of treatment.

Plaster cornices are merely mouldings with another name. True, some are so intricate and highly embellished that the word "mould" is inadequate to describe them properly. Many are comparatively simple in outline and yet even these are much more attractive than wood mouldings because they blend so much better with the plastered surfaces.

A very important advantage of run-in-place cornices is that they can be built into the building in a plastic state more economically than pre-cast cornices, the sections of which are aligned with difficulty because of irregularities in the wall or ceiling to which they are attached. The problem



Fig. 1. A Dining Room with a Rather Simple Plaster Cornice as Contrasted with That in Fig. 2, Below.

of securing such cornices in place is frequently difficult of solution, thus making the advantages of the run-in-place cornice quite obvious.

It should first of all be understood that cornices can be made of any size, design or detail. As the plastering art has progressed, modern materials such as metal lath and small channels, angles and tees have been developed so that no matter how large or intricate the design it is possible to execute it in plaster. However, the mechanics of running cornices in place makes it advisable to avoid moulds which have complicated re-entrant surfaces. These can be pre-cast in gelatin or loose-piece plaster molds and the same is true of the egg and dart and dentil mouldings or those with rosettes, medallions or similar decorative details.

It is quite common to see cornices run in place with recesses left for pre-cast ornaments to be subsequently set in place by the plasterer. More will be said about this later. The present article will be limited to the running of a small cornice as substantially all of the details encountered in its construction are equally applicable to large ones.

Reference to the illustrations exemplifies what has been said in the foregoing. Note the rather simple cornice mould used in the dining room, shown in Fig. 1, as contrasted with the more intricate one used in the lounge room shown in Fig. 2. The cornice in the latter is a combination of run-in-place and pre-cast cornice as described briefly in the preceding paragraph. The wealth of detail shown here adds the finishing touch to the picture.

With the architect's plaster details in front of him the plasterer considers the relation of the cornice to the other details such as beams, pilasters, etc., especially those parts which are at the level of the cornice and on which, unless the plan speci-



Fig. 2. A More Elaborate Plaster Cornice, a Combination of Run-In and Pre-Cast, in the Lounge of the James Apartments, Designed and Built by T. H. McHale & Son, Syracuse, N. Y.

Fig. 3. D

to the ap
sistency
will not
for this
almost
For the
core, or

Let it
cornice
summed.

of accur
overlook
ous step
wall and

The fi
This is u
ting edg
details p
lines of
this artic

Before
advantag
template
of a ver
backing
piece wi

It is ver
edge to
necessar
identical

used. T

Fig.

Fig.

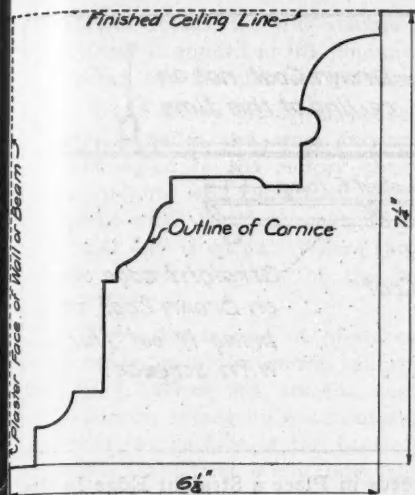

Fig. 3. Detail Outline of the Cornice Described in This Article.

fies otherwise, a portion of the cornice will be run. With this determined, the plasterer is ready to start.

Plaster cornices, briefly, are run in place by running cutting surfaces, with profile corresponding to the outline desired, back and forth along guide strips attached to wall or ceiling or both, while soft plaster is being applied

to the approximate profile. The plaster is of fairly stiff consistency and should have a retarding element in it so that it will not set too rapidly. Moulding plaster especially suited for this purpose can be readily purchased in bags, but almost any gypsum plaster if properly handled will do. For the rough backing of the plaster, sometimes called the core, ordinary sanded gypsum plaster is used.

Let it be said at the outset that the work of running a cornice in place is not nearly so intricate as might be presumed. But attention to details and a considerable degree of accuracy is required and in order that nothing will be overlooked this article will detail carefully each of the various steps taken by the plasterer, proceeding from the plain wall and ceiling construction to the completed cornice.

The first step in cornice work is to make the template. This is usually a combination of wood frame and metal cutting edge. The latter is cut in accordance with full size details provided by the architect. The size and detail outlines of the cornice whose construction will be described in this article are shown in Fig. 3.

Before describing this important tool in detail it will be advantageous to glance at Fig. 4 which shows the completed template ready for use. Note that it consists essentially of a vertical sheet metal cutting edge attached to wood backing which in turn is secured and braced to a bottom piece with wood runner guide attached to its underside. It is very important that the relative position of cutting edge to guide be fixed accurately and securely. This is necessary for jobs on which there are many lineal feet of identical cornice and where a number of templates must be used. The advantages of their interchangeability is readily

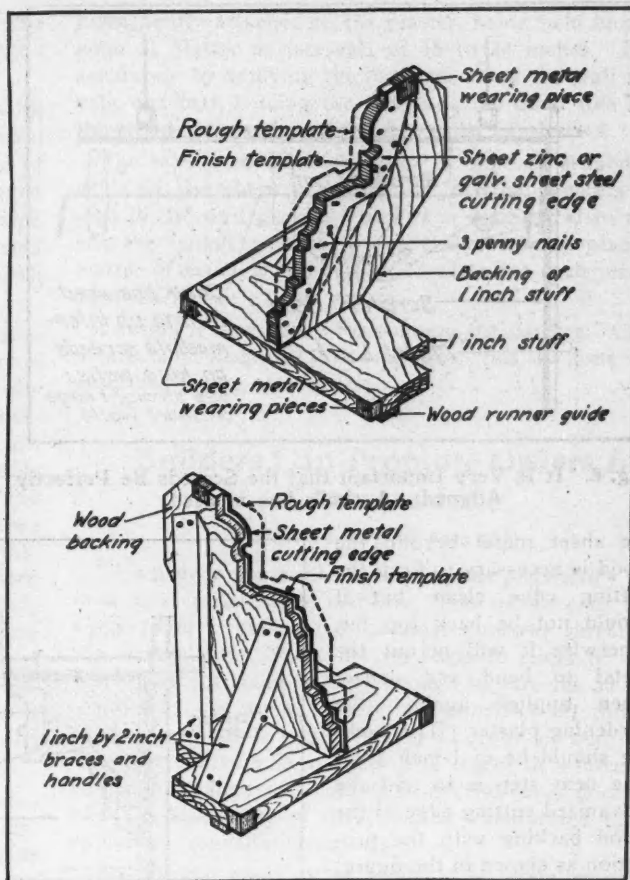

Fig. 4. The Completed Template, Used in Running the Cornice Described.

apparent. Because they are so frequently used on work overhead the frame should be as light as is consistent with rigidity.

Cutting out the sheet zinc or galvanized sheet steel cutting edge is the first step in making the template. The strip need only be a couple of inches wide and can be made of several pieces. It is only necessary that the cutting edge be without break as any gap, V-cut, etc., will form a projection of corresponding size on the finished cornice. The exact outline can be traced directly from the architect's drawing or can be transferred by means of carbon paper from the architect's drawing.

After tracing the outline of the zinc onto the wood, a second line back about three-sixteenths to a quarter of an inch from the outline as shown by the zinc should be drawn. It should then be taken to a carpenter shop and cut out on a band or jig saw to the second line. The projection of

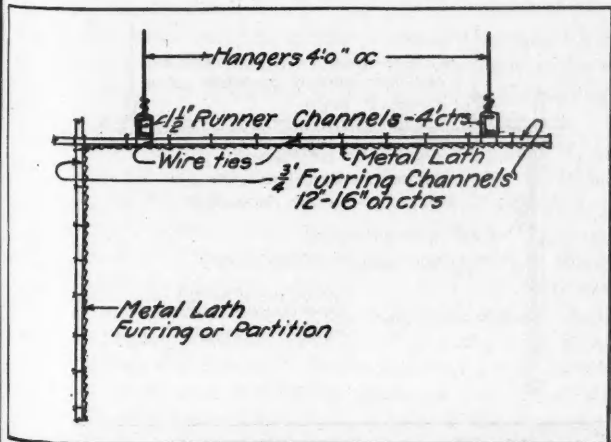

Fig. 6. Typical, Suspended Ceiling Construction.

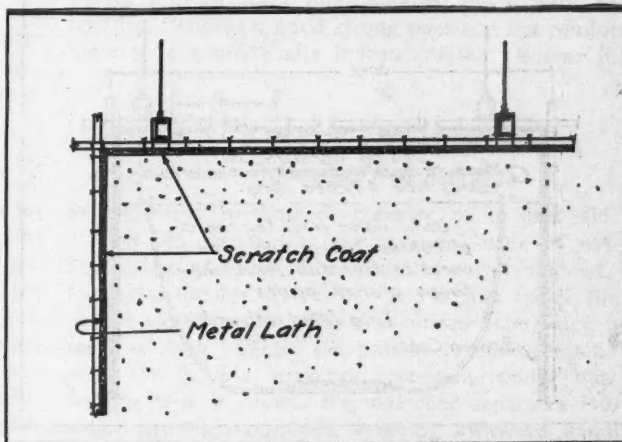

Fig. 7. The Scratch Coat Is Applied in the Usual Manner.

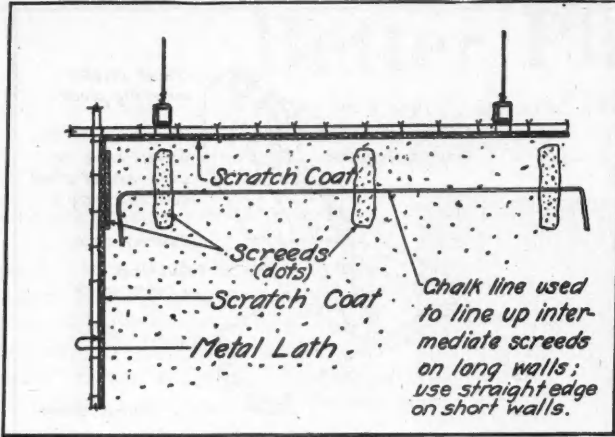

Fig. 8. It Is Very Important that the Screeds Be Perfectly Aligned. A chalk line is used.

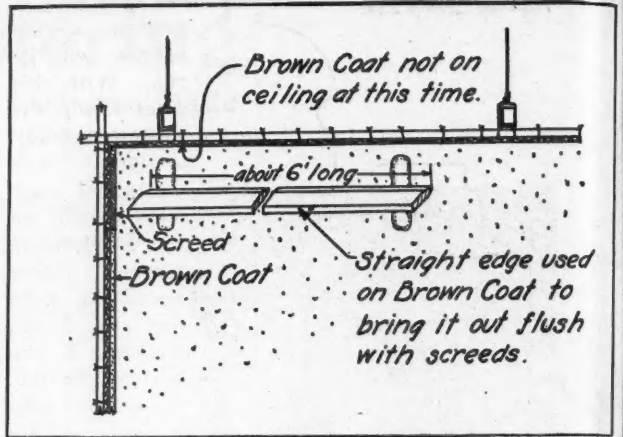

Fig. 9. With the Screeds in Place a Straight Edge Is Used in Applying the Brown Coat Between.

the sheet metal beyond the wood is necessary to keep the cutting edge clean, but it should not be back too far, otherwise it will permit the metal to bend and deflect when applied against the hardening plaster. The backing should be of 1-inch stuff. The next step is to nail the galvanized cutting edge to the wood backing with the projection as shown in the figure; ordinary three penny lath nails should be used.

The making of the rough template is the next step. This is indicated by the dotted line in Fig. 4. Note that it represents the cutting surface of about 1 inch in towards the plaster core and away from the finished edge. This is more clearly shown on the diagram in Fig. 5. The space between the two cutting edges represents the finish coats of plaster. It is not necessary to take extreme care in laying out the outline of the rough template, but in general, it should parallel the finishing cutting surface approximately so that not more than about 1 inch of finish material need be applied.

As a matter of fact, the rough template is sometimes only used for cutting—frequently it is merely a guide by which to worm the plaster core and fill out the surfaces so that they will be kept back the proper distance from the finished surface and allow enough finishing coat to be applied

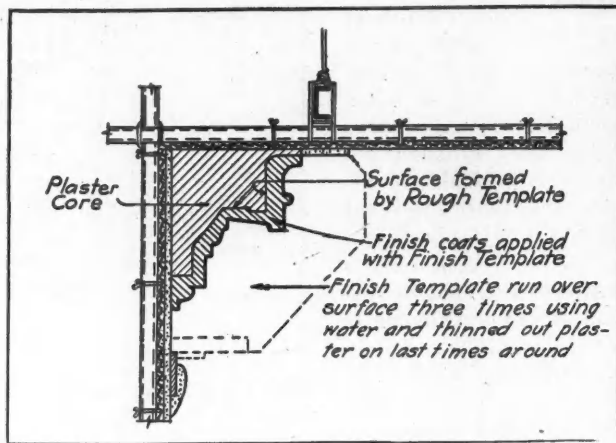

Fig. 5. A Space Between the Cutting Edges of Rough and Finish Templates Represents the Finish Coat.

over every point. The rough template is also made of sheet metal and is tacked over the template with the finished cutting edge on it. It should not be nailed too tightly as it has to be removed when the finishing is to be done.

The rough and finish templates on the wood backing are then nailed to the lower part of the wood frame and braced as shown. These braces also act as handles for pushing the template against the setting plaster and should be securely nailed as the template will be given much usage. It is important that the vertical or cutting edge of the

template be made exactly perpendicular to the lower or runner part and also perpendicular to the wood runner guide which has been nailed to the underside of the bottom piece. Next the sheet metal wearing pieces at the two ends of the bottom running piece and also at the top of the template are nailed on.

With the template completed we are ready to start the preliminary steps necessary to run the cornice. It should be stated here that cornices can be run in angles between ceilings or on walls or partitions of almost any ordinary plaster base such as masonry, plaster block or metal lath. However, as metal lath ceilings are used on ornamental work, and especially on suspended ceilings and ornamental

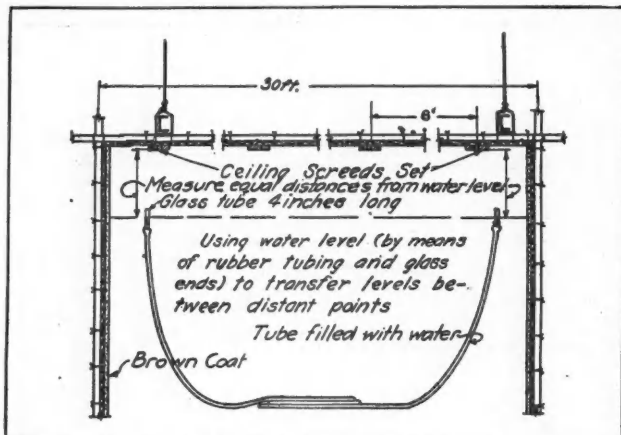

Fig. 10. In a Large Room a Water Tube May Be Used to Align the Screeds.

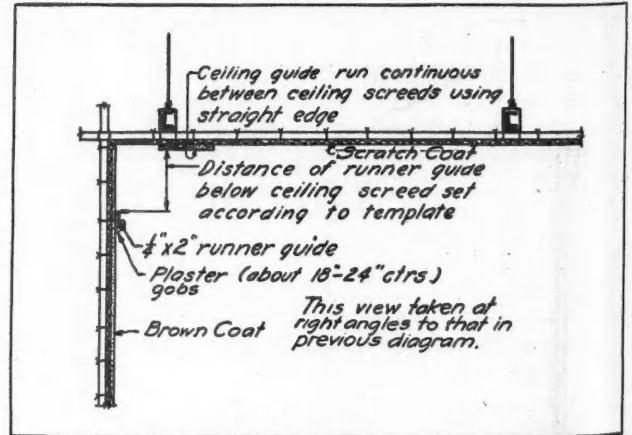

Fig. 11. Wood Guides Are Used on Wall and Ceiling When Applying the Template.

plaster beams, we will assume for this problem that this cornice is applied at the juncture of a metal lath suspended ceiling and a metal lath partition.

Fig. 6 shows typical suspended ceiling construction with metal runner and cross furring channels with the metal lath wired to the runner channels on 6-inch centers in accordance with customary practice. The partition is made up of small metal channels 16 inches on centers to which metal lath is wired. Where the vertical channels intersect the runner channels of the ceiling, the two are wired together.

The scratch coat of plastering is applied in the usual manner over the entire ceiling and walls of the room, Fig. 7. After this, screeds, commonly called dots by the plasterer, whose distance out from the plaster face represents the surface of the brown or straightening coat, are applied at about 6-foot intervals along the wall. Screeds located at either end of the wall are used as guides. The position of these end screeds should be such that the brown coat will at every point clear any humps in the wall. Between these points on a long wall, a chalk line is used and the intermediate dots are brought out to line. It is very important that the screeds be perfectly aligned as any irregularity in the brown coat at the point where the cornice is to be applied will magnify any irregularities in the cornice as they are more easily seen in the latter. With the screeds in place the plasterer's straight edge is used in applying the brown coat between. See Figs. 8 and 9.

Next, the ceiling screeds for the brown coat are set—these are also applied on approximately 6-foot centers using the line of the brown coat on the ceiling at the two ends of the room as guide. As a chalk line is bound to have some sag, it is necessary to use some kind of a water level in order to set the intermediate screeds.

In a long room the easiest way to accomplish this is to use a hose or tube of about $\frac{3}{8}$ or $\frac{1}{2}$ -inch diameter filled with water with small glass tubes about 4 inches long at either end. See Fig. 10. This is merely an extended level line as the location of the water level in the glass tubes at all times indicates a horizontal surface. For short distances not exceeding 8 to 10 feet, the ordinary level used by the plasterer, together with a straight edge where the distance is greater than 4 feet, should be used to level up intermediate screeds or points where special accuracy is desirable.

With the screeds in position along the ceiling, the plasterer then applies the brown coat in between, using his long straight edge to get a ceiling as nearly perfect as possible. It should be noted that it is not essential to set screeds on any portion of ceiling excepting where the cornices are to be run. On better jobs, however, screeds are used quite freely on other places on the ceilings to secure the best results.

The importance of having a straight surface between the screeds, on the portion where the cornice is to be run cannot be overemphasized as this portion of the ceiling acts as the proper guide for the template.

The wall runner guide is next put in place. It serves as a support on which to rest the template as it is pushed back and forth, and at the same time acts as a guide to insure a cornice with true straight lines. It usually consists of a $\frac{1}{4}$ by 2-inch strip of wood which should be as straight as possible. Any pieces that are badly warped or twisted should not be used. The wall runner guide is set the proper distance down from the angle of the wall by applying the template firmly into the angle between wall and ceiling and setting the guide so that it will fit snugly under and against the wood guide on the underside of the horizontal piece of the template (see Fig. 11).

As the wall strip is merely temporary it is firmly but not

permanently attached to the plaster, being held in place by gobs of plaster at intervals of 18 to 24 inches. It is set accurately by applying the template along the wall at intervals, one man holding the template, the other one aligning the wood strip and applying the gobs of plasters.

The setting of the wall runner is done all around on the walls of the room excepting on narrow pilasters and in jogs in the wall surface where it is impractical to manipulate the template so as to run the cornice in place. The matter of running and setting cornices for such places will be discussed in a later article.

The job is now ready for running the cornice. Complete details and diagrams showing how this is done will be described in the next article.



Builders Can Promote Orders for Concrete Jobs

(Continued from page 185)

This proved the means of solving the physician's problem in a most satisfactory manner. The entrance to the spacious room is through a Colonial doorway directly from the street level. There are no steps to climb or descend. The basement room is large enough to care for 50 or more visitors at one time. There are windows on three sides of the room which supply plenty of fresh air and daylight. The place is cool in summer and warm in winter. Since this improvement was completed several other doctors have had the basements of their homes transformed into well-appointed consultation rooms.

Among the many other kinds of concrete work that is needed around a very large number of homes are: Coping for terrace fronts; extensions to cement sidewalks where there is not sufficient space due to grass plots between sidewalk and curb; concrete steps for the back door of a house; cement walks through the garden; concrete fence posts; and concrete steps at the back of a house leading from the yard down to the basement.

During the last few years many old houses have had their basement reconstructed with concrete to provide a separate place for the coal bins and a neat, well-lighted room used as a laundry. The electric washing machine is placed upon a concrete platform about 10 inches above the cement floor proper. Also on this platform, and in close proximity to the washing machine, are modern, stationary wash tubs made of either concrete or soapstone.

Concrete posts in the yards of homes are used either in connection with the old-fashioned board fencing, or with the new-style open iron-work fencing. Concrete posts, when reinforced with steel or iron rods, are in many instances being used for supporting wash lines. The repeated pull of wash line, weighed down with heavy wet laundry, requires a good strong post and the reinforced concrete post is practically indestructible. ROBERT F. SALADE.



Rescue Equipment

(Continued from page 159)

and efficient method of transfer to a first aid station. First aid disposition having been made of the patient, he can be transferred to ambulance cot without removal from the flexible stretcher. It remains under the patient on the cot in readiness to transfer to emergency operating table or bed. When the patient is placed upon the bed with the flexible stretcher remaining under him a steel lashing tape is drawn, the stretcher separates into halves, which are then removed, avoiding awkward handling and possibility of injurious results in the transfer from stretcher to bed.

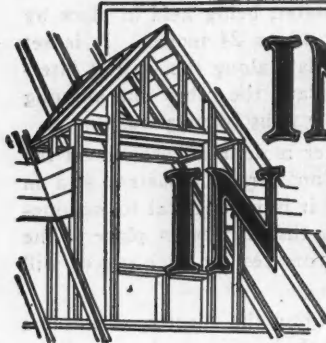

INSTRUCTIONS IN ROOF FRAMING

This Department Appears Every Month in American Builder—Editor

A Discussion of Roof Pitches

By JOHN T. NEUFELD

VERY often the most simple things cause the most confusion. It seems that this is true with the subject of "pitches" in roof framing. There seems to be an endless amount of confusion on this point among beginners in roof framing, partly because of the fact that there are several methods of expressing the pitch of a roof.

By the "pitch" of the roof we mean the slant or slope of a roof; or expressing it the other way the proportionate degree of rise that the roof has. This degree of rise or the proportion of rise is usually expressed as the rise compared to the span, that is, we would call a roof having an 8-foot rise and a 24-foot span, a one-third pitch roof, because the rise is one-third of the span.

This method of expressing the pitch of the roof comes to us from the customs of early builders. They expressed their degree of pitch by comparing the total height of the roof with the width of the roof and then called a roof where the height of roof was one-half of the width, a one-half pitch roof, or where the height of the roof was one-fourth of the width of the roof, it was called a one-fourth pitch roof. The ordinary pitches are one-fourth, one-third, and one-half (and perhaps a few others) but these three are the most common.

At the present time we use this method of expressing the pitch of a roof but we also use another method whereby we compare the rise of the rafter to the run of the rafter. This we usually express by giving the amount of rise in inches per foot of run. Thus a rafter has a 6-inch rise per foot run or an 8-inch rise per foot run, etc. Both of these methods of expressing the pitch of a roof are easily understood by themselves, but when it is desired to change one method to the other, we find some difficulty.

To illustrate this we will assume that the building has a one-third pitch and that it is desired to express this as a certain amount of rise per foot run. For a one-third pitch the rise is one-third as much as the span, therefore, for every foot of the span we would have one-third of 12 equal 4 inches of rise, but the run is only one-half of the span and we wish to express the rise per foot of run. If the rise is 4 inches per foot of span, then it also is 4 inches for every 6 inches of run, or 8 inches per foot run.

A simple rule to follow here is to multiply the pitch expressed as a ratio of the rise of the span by 24. Take, for example, the problem worked above. A one-third pitch has a rise per foot of run equal to one-third times 24 equals 8 inches. To illustrate this further, we will work out a few more examples.

For a one-fourth pitch the rise per foot run is $\frac{1}{4} \times 24 = 6$ inches.

For a one-half pitch the rise per foot run is $\frac{1}{2} \times 24 = 12$ inches.

For a two-thirds pitch the rise per foot run is $\frac{2}{3} \times 24 = 16$ inches.

Now let us suppose that we wish to change from the rise per foot run to the pitch expressed as a ratio of rise to the span. That is, we have given that the roof has a 6-inch rise per foot run and we wish to change this to the other method of expressing the pitch of a roof.

If the rise is 6 inches per foot run, then the rise per foot of span would be 3 inches, or 6 inches for 2 feet of span, since there are 2 feet of span for 1 foot of run. Now if the rise is 6 inches for every 2 feet of span, then the rise is $6 \div 24 =$ one-fourth of the span. Therefore, a one-fourth pitch roof.

A convenient rule to use in changing from the rise per foot to the ordinary method of expressing the pitch is to divide the rise per foot run by 24 (note in this case we divide by 24 instead of multiplying by 24). Thus, if the rise per foot run is 6 inches we divide 6 by 24 and have one-fourth pitch.

For an 8-inch rise per foot we have $8 \div 24 =$ one-third pitch.

For a 12-inch rise per foot we have $12 \div 24 =$ one-half pitch.

The pitch of the roof is also expressed by the number of degrees of the angle that the rafter makes with the horizontal. For example, we may have a 30-degree roof, a 35-degree roof, etc. This method, however, is not commonly used, but no doubt will be used to a certain extent in the future.

In order to compare the three methods of expressing the pitch of a roof we have the following table of comparative pitches.

Rise Span	Rise Per Foot Run	Degrees
1/6	4	18° 26'
1/4	6	26° 34'
1/3	8	33° 41'
2/3	9	36° 52'
5/12	10	39° 48'
11/24	11	42° 31'
1/2	12	45° 00'
5/6	15	51° 20'
2/3	18	53° 08'
3/4	18	56° 19'

Questions

1. A roof has a rise of 10 feet and the span is 30 feet. What is the pitch expressed as a ratio of the rise, and the span?
2. A roof 26 feet wide has a 10-inch rise per foot of run. What is the total rise of the roof?
3. Give the rise per foot run of the following pitches: one-third- three-eighths, five-twelfths.
4. The total rise of a certain building having a one-

(Continued to page 194)

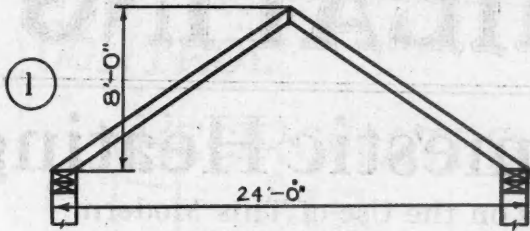

The **SLOPE** or **PITCH** of a roof depends on the **RISE** in comparison to the **SPAN**.
 For this roof the **RISE** compared with the **SPAN** is $\frac{8}{24} = \frac{1}{3}$. The **RISE** is $\frac{1}{3}$ of the **SPAN**.

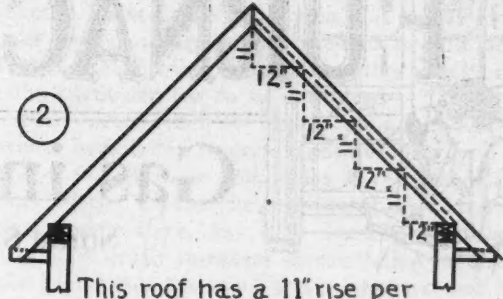

This roof has a 11" rise per foot of run.
 The total rise is $4 \times 11" = 44" = 3'-8"$.

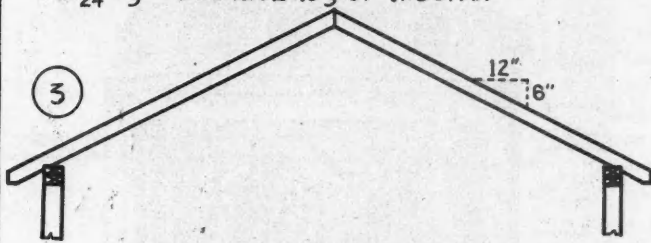

RISE PER FOOT RUN

The **PITCH** of a roof may also be described by giving the **RISE per FOOT RUN**.
 A roof having a 6" rise per foot is $\frac{1}{4}$ **PITCH**.
6" RISE PER FOOT RUN is 6" for every 2 feet of **SPAN**.
 The **RISE** therefore is $\frac{6}{24}$ or $\frac{1}{4}$ of the **SPAN**.

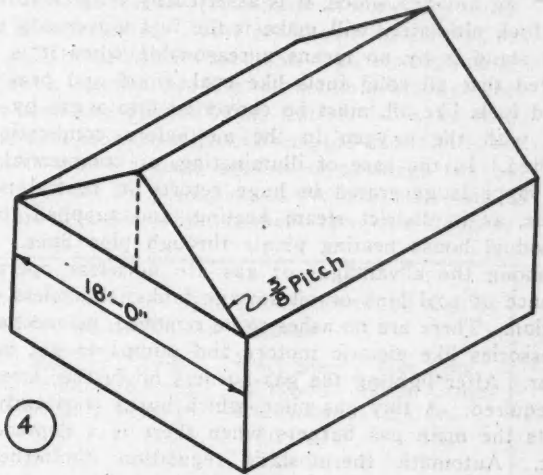

This roof is $\frac{3}{8}$ **PITCH**. The rise therefore is $\frac{3}{8}$ of the **Span**. $\frac{3}{8}$ of 16' = 6ft. or 72in.
 The **RUN** is 8ft.
 The **RISE PER FOOT RUN** is $72 \div 8 = 9"$.

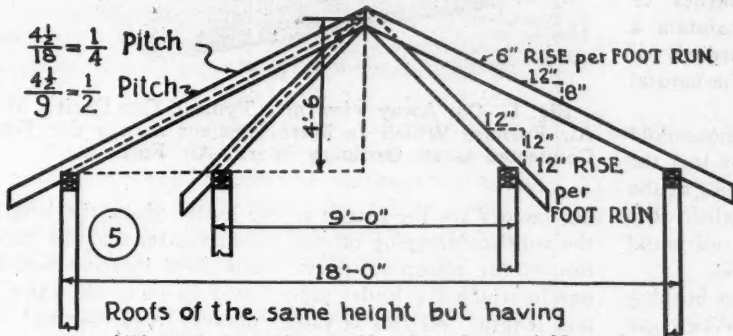

Roofs of the same height but having different widths will also have different **Pitches**.

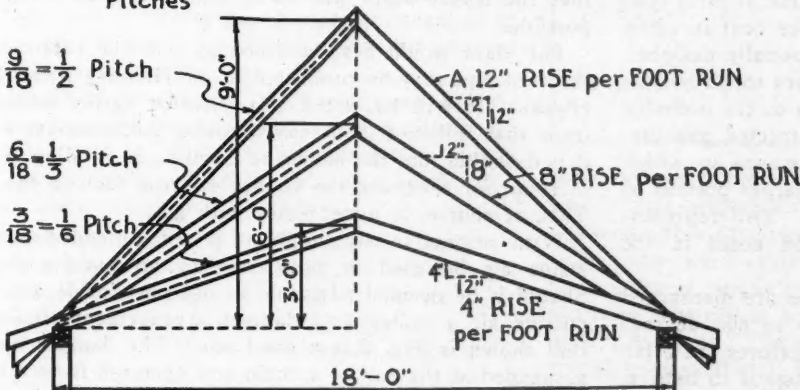

Roofs of the same width having different heights will also have different **Pitches**.

$$\frac{\text{RISE}}{\text{SPAN}} = \text{PITCH}$$

7

23	$\frac{23}{24}$	$\frac{11}{12}$
22	$\frac{7}{8}$	$\frac{5}{6}$
21	$\frac{7}{8}$	$\frac{5}{6}$
20	$\frac{19}{24}$	$\frac{5}{6}$
19	$\frac{19}{24}$	$\frac{5}{6}$
18	$\frac{17}{24}$	$\frac{3}{4}$
17	$\frac{17}{24}$	$\frac{3}{4}$
16	$\frac{16}{24}$	$\frac{2}{3}$
15	$\frac{5}{8}$	$\frac{7}{12}$
14	$\frac{13}{24}$	$\frac{1}{2}$
13	$\frac{13}{24}$	$\frac{1}{2}$
12	$\frac{11}{24}$	$\frac{5}{12}$
11	$\frac{11}{24}$	$\frac{5}{12}$
10	$\frac{5}{8}$	$\frac{1}{3}$
9	$\frac{7}{24}$	$\frac{1}{4}$
8	$\frac{7}{24}$	$\frac{1}{4}$
7	$\frac{5}{24}$	$\frac{1}{6}$
6	$\frac{5}{24}$	$\frac{1}{6}$
5	$\frac{1}{8}$	$\frac{1}{12}$
4	$\frac{1}{8}$	$\frac{1}{12}$
3	$\frac{1}{8}$	$\frac{1}{12}$
2	$\frac{1}{24}$	$\frac{1}{12}$
1	$\frac{1}{24}$	$\frac{1}{12}$

TABLE OF ROOF PITCHES

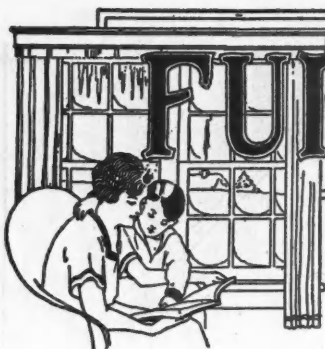

FURNACE HEATING

Gas in Domestic Heating

Some Suggestions on the Use of This Modern Fuel in Warm-Air Heaters

This Department by R. C. Nason, Heating Expert, appears every month in American Builder

AMONG the newer fuels coming into common use in domestic heating illuminating gas offers certain advantages which, it is asserted by those who favor this fuel, ultimately will make it the fuel universally used. This stand is by no means unreasonable when it is considered that all solid fuels like coal, wood and peat, and liquid fuels like oil, must be converted into a gas by mixture with the oxygen in the air before combustion is effected. In the case of illuminating, or commercial, gas the vapor is generated in huge retorts in central power plants, as in district steam heating, and supplied to the individual house heating plants through pipe lines.

Among the advantages of gas are noiseless operation, absence of coal bins or oil storage tanks, smokeless combustion. There are no ashes to be removed, no mechanical accessories like electric motors and pumps to get out of order. After lighting the gas burners no further attention is required. A tiny gas pilot, which burns constantly, re-lights the main gas burners when there is a demand for heat. Automatic thermostatic regulation diminishes or increases the supply of gas at the burner to maintain a constant temperature in the living rooms regardless of exterior temperature. Economical use of fuel is the natural result.

Fuel storage is an important expense in any household budget when coal or oil is used. When gas is the fuel the public utility company sends the householder the bill at the end of the month, *after the fuel has been used*, rather than before. Thus, the owner is not required to make an initial investment other than for the plant and accessories.

The average warm-air furnace installation, when burning coal, operates at about 60 per cent efficiency. When gas burners of an efficient type are in use in coal burning heaters the efficiency remains about the same as with coal or oil. Greater efficiency, as high as 85 per cent in some cases, is possible when warm-air plants especially designed for gas are installed. Hence, these types are to be recommended over the connection of gas burners to the ordinary coal burning furnace. The specially constructed gas furnaces have longer air supply and gas passages in which the products of combustion can give up a larger portion of their potential heat for warming purposes. Two representative types of gas-fueled heaters may be noted in the accompanying illustration.

Whereas in coal furnaces the waste gases are discharged to the atmosphere at something like 400 to 600 degrees Fahrenheit, in gas furnaces the exit temperatures are often as low as 250 degrees Fahrenheit. It is logical to believe, therefore, that when flue gas temperatures are as low as 250 degrees at the point of exit, more of the heat of the fuel has been given up for warming purposes than when final gas temperatures are high.

Selection of the size and location of the heater, size and manner of installation of the ducts and registers, follows rather closely the practice obtaining with coal and oil burning installations. In locating the heater the determin-

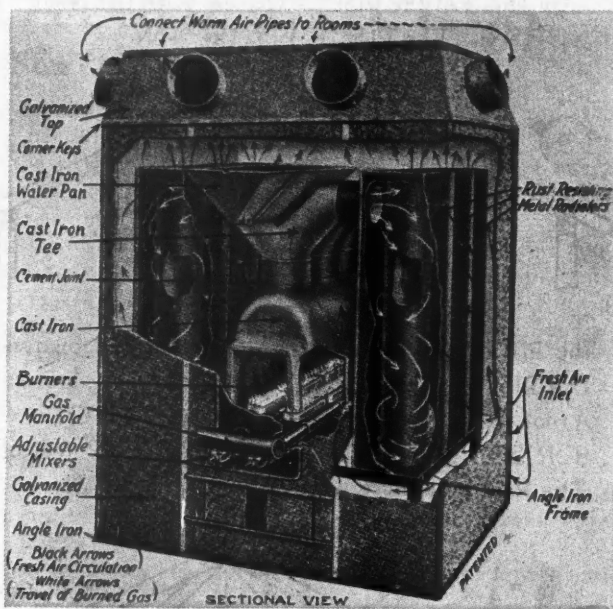

Fig. 1. Cut Away View of a Typical, Gas Fueled, Warm Air Furnace Which Is More Efficient than a Gas Burner Connected to an Ordinary Warm Air Furnace.

ing factors are the length of the leader pipes, the length of the vent for carrying off the exhaust gases and the connection of the return-air ducts. The ideal location would be one in which the leader pipes could all be of the same size and length. As this is rarely possible it is essential, after the register positions are selected, to set the furnace so that the leader pipes will be as near the same length as possible.

The plant would best be faced so that the extension of the vent pipe may be connected to the chimney with use of elbows. It will be noted this practice varies somewhat from that followed with coal burning installations, where it is desirable that the heater be faced so as to allow plenty of room for throwing the charge of fresh fuel on the fire. This, of course, is unnecessary with gas.

With respect to air supply it is recommended that all inside air be used in preference to an outside supply. Should it be deemed advisable to use part inside and part outside air a piping and damper arrangement similar to that shown in Fig. 2 is a good one. The damper here is suspended at the end of a chain and operated from a room above. The supply may be mixed as desired by lowering or raising the chain.

The leader pipes from the basement furnace should have at least a 1 inch to the foot pitch and be as straight and free from obstruction as possible. Take the more important runs from over the burner-box bonnet if possible as this is the hottest part of the furnace. If there are one or more rooms of exceptional exposure or extra large

FURNACE

Fig. 2. Air Supply Used.

glass ar
warm a
burner-b
any run
diameter
increase

When
the case
trunk li
Individual

The co
floor an
floor or
From a
of the ir
inside ai
tion thro
is less th
tial savin

Return
the com
table, Ta
their gri
the grille
areas ov

With
Americ
correct
four 8-in
area of

4-
2-
1-

Fig. 3. Upw

A

Fig. 3. Upw

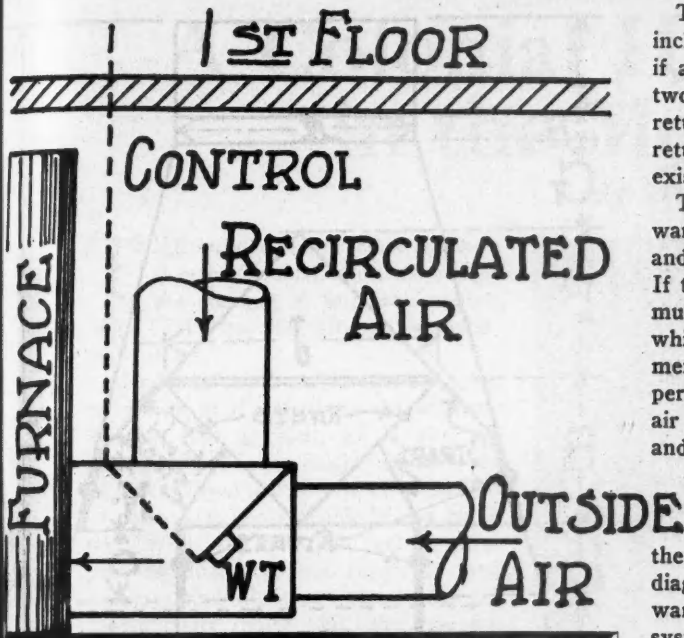

Fig. 2. A Suggested Pipe and Damper Design for Mixed Air Supply, Where Part Inside and Part Outside Air Is Used.

glass area, these rooms may be favored by locating their warm air leader connections over the hottest part of the burner-box. Leaders should not be over 16 feet long and any run over 15 feet would best have 1 inch added to the diameter for each 4 feet or fraction over 15 feet and an increase in the size of the riser to correspond.

When a building covers a great deal of floor area, as in the case of California bungalows, the use of one or more trunk line, distributing mains have been found effective. Individual runs to remote rooms, however, are preferable.

The cool air of the rooms being heated gathers near the floor and falls to the furnace through grilles placed in the floor or baseboards of front halls, or large, exposed rooms. From a heating standpoint one of the greatest advantages of the inside-air return over the outside connection is that inside air will heat more evenly and cause better circulation through the entire building. As the heating increment is less than when there is inside supply there is a substantial saving in fuel.

Return-air connection areas in every case should equal the combined area of the leaders. In the accompanying table, Table 1, suggested sizes of cold-air connections and their grilles are shown. Because of extreme dimensions of the grilles it is best to use two separate returns for required areas over 380 square inches.

With reference to the above table, prepared by the American Gas Association, a typical example illustrates correct sizes of cold air grilles. Suppose a job having four 8-inch; two 10-inch, and one 12-inch heat ducts. The area of these ducts equals:

- 4—8-inch equals 4 x 50, or 200 square inches
- 2—10-inch equals 2 x 78, or 156 square inches
- 1—12-inch equals 1 x 113, or 113 square inches

469 square inches



Fig. 3. The Arrows Show the Paths of Air Travel in Upward and Downward Air Distribution Systems.

There is here required a return duct of at least 469 square inches. Since this would be a larger pipe than is desirable if a single pipe were used, it would be advisable to install two return ducts. From Table I it is seen that one 20-inch return and one 14-inch return can be used or two 18-inch returns. The choice of sizes depends on the conditions existing on the particular job to be estimated.

The use of an electric fan or blower on a gas-fueled warm-air furnace installation insures a positive distribution and circulation of the warm air and, hence, is recommended. If the building is large, a generous quantity of air at maximum practical temperature, say 195 degrees, is used, which quantity is generally in excess of ventilation requirements. If the heat losses are small and a large number of persons are to occupy the rooms at a time the quantity of air preferably would be fixed by ventilation requirements and the temperature of the air by heating requirements.

In forced air heating installations considerable discussion is voiced as to the best method of rotating the air when it is recirculated. These are known, in general, as the upward and the downward methods. The accompanying diagrams, Fig. 3, demonstrate the respective courses of the warm air within the rooms being heated. The upward systems, A and B, are especially well adapted to auditoriums or other places where a large number of openings can be made in the floor for the admission of the heat. The air is introduced through side wall registers near the floor or

TABLE I—Size of Cold Air Connections and Grilles for Inside Air Returns

Free Area Required Sq. In.	Size Round Pipe, In.	Area Round Pipe, In.	Stock Size of Wood Grilles, In.	Net Area Wood Grilles Sq. In.
113 or less	12	113	10 x 22	116
			12 x 18	118
114 to 154	14	154	10 x 28	154
			12 x 24	158
			14 x 20	154
154 to 201	16	201	12 x 30	201
			14 x 26	201
			16 x 24	210
			20 x 20	220
202 to 254	18	254	16 x 30	265
			18 x 26	258
			20 x 24	265
255 to 314	20	314	14 x 42	324
			16 x 36	318
			18 x 32	316
			20 x 30	330
315 to 380	22	380	18 x 40	396
			20 x 36	396
			20 x 30	396
381 to 452	24	452	20 x 42	462
			24 x 36	476
			28 x 30	462

through floor registers and removed near the ceiling. This plan is also adaptable to restaurants or rooms where there is considerable smoking.

The downward system has become increasingly popular in late years, especially in theatres, schools, hospitals and factories, where it is not practical to have numerous openings in the floor. The method shown in D affords the most complete circulation. Here the exhaust grille is placed in the wall near the floor and on the same side as the overhead warm-air inlet.

Precaution

It cannot be inferred that gas-fueled installations, any more than those of any other type, are free from difficulties in installation. These are, nevertheless, usually of a minor nature and can be prevented if proper precautions are taken

Size of Pipe	A	B	C	D	E	F	G	H	I	J	K	L	M
3	6	8 $\frac{3}{4}$	1 $\frac{3}{4}$	3	1 $\frac{3}{4}$	1 $\frac{3}{4}$	1	$\frac{1}{4}$	1 $\frac{1}{4}$	3 $\frac{1}{4}$	3	1	1
4	8	12	2 $\frac{3}{8}$	4	2 $\frac{3}{8}$	2 $\frac{3}{8}$	1 $\frac{3}{8}$	$\frac{3}{8}$	1 $\frac{3}{4}$	4 $\frac{1}{4}$	4	1 $\frac{3}{8}$	1 $\frac{3}{8}$
5	10	13 $\frac{1}{2}$	3	5	3	3	1 $\frac{5}{8}$	$\frac{1}{2}$	2	5 $\frac{1}{2}$	5	1 $\frac{5}{8}$	1 $\frac{5}{8}$
6	12	17 $\frac{1}{2}$	3 $\frac{1}{2}$	6	3 $\frac{1}{2}$	3 $\frac{1}{2}$	2	$\frac{1}{2}$	2 $\frac{1}{2}$	6 $\frac{1}{2}$	6	2	2
7	14	20 $\frac{1}{4}$	4	7	4	4	2 $\frac{3}{8}$	$\frac{1}{2}$	3	7 $\frac{1}{2}$	7	2 $\frac{3}{8}$	2 $\frac{3}{8}$
8	16	23 $\frac{3}{8}$	4 $\frac{3}{4}$	8	4 $\frac{3}{4}$	4 $\frac{3}{4}$	2 $\frac{3}{4}$	$\frac{3}{4}$	3 $\frac{3}{8}$	8 $\frac{3}{4}$	8	2 $\frac{3}{4}$	2 $\frac{3}{4}$
9	18	26 $\frac{1}{4}$	5 $\frac{1}{4}$	9	5 $\frac{1}{4}$	5 $\frac{1}{4}$	3	$\frac{3}{4}$	3 $\frac{3}{4}$	9 $\frac{3}{4}$	9	3	3
10	20	29 $\frac{1}{8}$	6	10	6	6	3 $\frac{3}{8}$	1	4 $\frac{1}{8}$	11	10	3 $\frac{3}{8}$	3 $\frac{3}{8}$

Table of Sizes for Back Draft Diverter. The letters refer to those shown in Fig. 4.

at the start. One of the greatest sources of trouble comes from insufficient care in making the furnace joints tight and, therefore, leak-proof. If all joints are carefully closed with furnace cement and the cement allowed to dry prior to operation of the heater tightness is assured. If this precaution is not heeded the moisture in the cement will be converted into steam and force its way out, leaving the cement porous. Similarly, care should be exercised in making joints in the vent pipe tight. All joints would best be soldered all the way around, rather than tacked, as leakage of exhaust gas is more serious with gas than with coal or oil.

It is said an ounce of prevention is worth a pound of cure and this applies particularly to the condensation basin, or dry well, and unless there are evidences that the soil cannot be depended on to carry off the moisture always present with gas, a dry well is to be preferred. This should be made about 14 inches in diameter and 3 or 4 feet deep, coarse gravel being laid on the bottom.

Chimney draft in a gas fuel heating system is just as important as in a coal-burning plant because if the pilot light should be extinguished because of downward draft the odors of gas would fill the house quickly. For this reason the flue would best be provided with a cone-shaped back draft diverter designed somewhat like the one shown in Fig. 4. This is installed so that the opening immediately surrounding the flue provides a constant updraft. The area between the edge of the inner cone and the apron should be at least equal to the area of the flue pipe and, preferably, slightly greater. It is also suggested that the edge of the inner cone extend over the edge of the lower flue in the manner shown.

Building Insulation Fosters Good Heating

Insulation of building walls and roofs is of great importance because of the resultant saving in fuel. In gas fueled plants the cost of the fuel is greater than with either coal or oil, hence every improvement to conserve heat lessens the cost gap between gas and cheaper fuels.

The examination of numerous fuel costs records indicates that gas fuel plants cost about 50 per cent more than coal fueled ones when the bare cost of the two fuels is considered. If allowance is made for the higher efficiency of the gas plant, relief from ash removal, elimination of labor in caring for the heater, and its value, the fact that gas fueled plants result in adding another room to the house because of their cleanliness, and the rental value of the extra room, and similar considerations it will be found that the cost of running the gas heater averages about one-third greater than a coal burning heater.

The manufacture and sale of gas appliances is sponsored by responsible executives and dealers who know the engineering side of heating as well as the practical phases. At present a representative of the gas company usually inspects each installation before connecting the gas to the heater

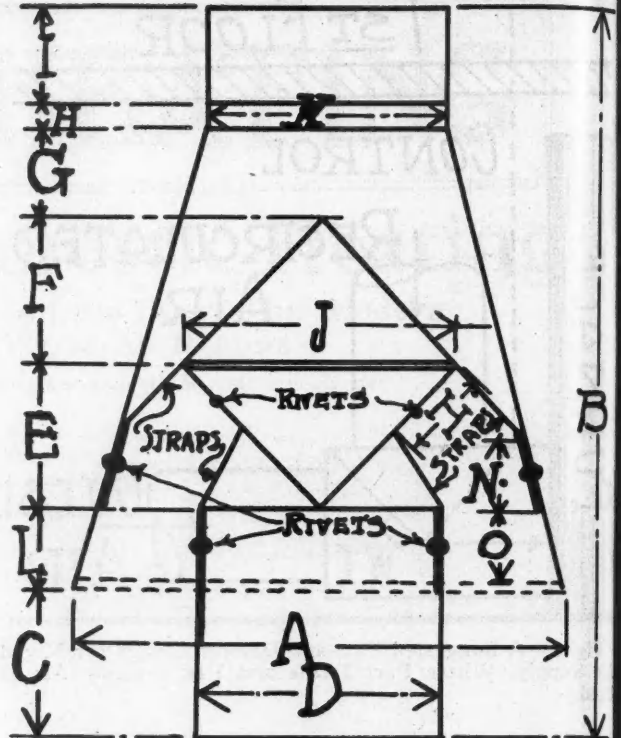

Fig. 4. Diagram of Back-Draft Diverter Which Should Be Incorporated in a Gas-fueled Warm Air Heating System.

burners. Consequently, purchasers can be tolerably sure that they will get the satisfaction for which they pay.

More than 100 gas companies now have special house heating rates covering consumption of their product and these manufacturers produce about one-half of the total gas sent out in the United States. There are about 100,000 installations of gas-fueled heating plants made annually and the demand increases constantly. Over 50,000 such plants have been installed in California alone. Since 1919 the increase in the sale of heaters has averaged over 2,000 per cent, one manufacturer alone having disposed of some 50,000 units in a single year. Last year the demand for gas fueled heaters increased 28 per cent over 1924.

The fact that heating installers now are selling heating comfort instead of merely a furnace and a number of feet of sheet metal pipe is an encouraging sign of the times and augurs well for increased popularity of gas warm-air heating plants in the future.



Instructions in Roof Framing

(Continued from page 190)

fourth pitch roof is 8 feet. What is the total width of the building?

5. Express in degrees the pitch of a roof having a rise of 8 inches per foot run.

Answers

1. The pitch is $10 \div 30 =$ one-third.
2. The building is 26 feet wide and the run is 13 feet. As the rise per foot run is 10 inches we find the total rise by multiplying $13 \times 10 = 130$ inches = 10 feet 10 inches.
3. The rise per foot run for a one-third pitch is 8 inches, for a three-eighths pitch is 9 inches, and for a five-twelfths pitch is 10 inches.
4. The total width of the building, is, the pitch is one-fourth, is $4 \times 8 = 32$ feet.
5. The pitch as expressed in degrees is 33 degrees and 41 minutes.

A Colonial Hallway and Stair in the Modern Home

By H. T. BECKER

THE builder of this home has kept close to Colonial traditions and yet has not had to fall back upon a single bit of "special millwork" or hand-made items.

Slender balusters and newels and great refinement of all details are characteristic of this type of stair, as is also the mahogany-and-ivory finish. Birch is the wood employed and several other designs of stair parts are available in this material. While the twentieth century compact dwelling does not boast the long hallways and flights of stairs that the revolutionary home did, this modern adaptation reproduces the spirit and the beauty of its predecessor.

Notice the carefully moulded baseboards and stair stringers. The door on the platform gives access to the stair from the kitchen. In design it is pure Colonial, of the six-panel type, and is of white pine with solid raised panels and flush moulding. Similar designs are available with ovolo moulding, and in flat yellow pine laminated panel.

Well-chosen trim is an important factor in the interior finish which is often not given proper attention by home-builders. The curves of delicately moulded trim cast shadows which are part of the decoration. Neatly mitred corners make it a frame for door or window.

The light fixtures used in this hallway are especially good and in keeping with the rest of the house.



Insulation Pays

(Continued from page 155)

a little more than half as much for heating his house as he, the superintendent, did. The two houses were equipped with identically the same heating plant. He knew that Dr. Holden's house was almost exactly the same size as his own and that it had a much larger roof area. It would therefore, presumably require more heat because the waste of heat through the roof is far greater than that at any other point. His investigation showed these facts.

The area of the Hartog house is about seven per cent greater than the area of the Holden house but the roof area is only a little over half as great so that the Hartog house should have been easier to heat than the Holden house. It cost 55 per cent more to heat the Hartog house, with exactly the same heating equipment, than it did to heat the Holden house.

These are only typical examples of savings which are being made for home owners by the use of wall and roof insulation. They are founded on economic facts only. No attempt has been made to show the benefit resulting from warm and comfortable houses, freedom from drafts and colds, but these are very great advantages.

In the choice of an insulating material it is, of course,



In This Hall and Stairway Great Attention Has Been Given to Every Detail of Line and Finish. The result is a highly artistic and harmonious effect.

essential to know that you are buying one which will really insulate, permanently and effectively. No one would think of using building materials that would not last, and it is even more important to be sure that your insulation will last because it is in a place where it can not be taken out and replaced if it rots. And when decay takes place it will also communicate itself to the surrounding woodwork.

The insulation must also be sanitary in being repellent to insects and vermin. If it is something that the rats and mice like to eat it will soon lose its value as an insulator. If it is something that they will destroy for nesting the result will be the same. If it will harbor insects, like moths or buffalo bugs, it is objectionable. Nor should the question of fire resistance be overlooked. It should most certainly be fire-resistant so as not to increase the fire hazard. In addition to these things one must, in selecting an insulating material, consider the labor and cost of application to both walls and roofs. With these requirements all met, insulation is a real economy for the home owner.



Law for the Builder

Right of Contractor to Mechanic's Lien Upon Property for Improvements Made Upon Orders of Lessee or Tenant in Possession

THE question of the right of a contractor, to claim a mechanic's lien upon property for improvements made thereon upon the orders of a lessee or tenant in possession, is one of considerable importance to contractors and builders in general. This is true because, generally speaking, a lessee or tenant in possession of property does not have the authority to bind the owner's interests in the property in this manner for improvements. It follows then, that unless the contractor obtains either an express or implied contract from the owner to make the improvements he may be precluded from holding the property liable by virtue of a mechanic's lien.

The danger to the contractor and builder in overlooking this rule of building law is illustrated in a number of well considered cases. Among these cases is the recent Iowa case of Cedar Rapids Sash & Door Company vs. Dubuque Realty Company, et al., 192 N. W. 801. The facts and circumstances which culminated in the action being, as taken from the report, in the main as follows:

In this case a partnership, composed of five persons, rented a certain building from the defendant for the purposes of conducting a restaurant and lunch room. The lease provided that the lessees took the building in its then present condition and agreed to make all changes and repairs at their own expense. After the lease had been executed the parties thereto conducted further negotiations relative to the repairs, and the defendant owner agreed to assume a part of that burden.

Contractor Does Work on Orders of Lessees

Now, one Wall, the plaintiff in this action, was a contractor, as well as one of the five lessees, and he in agreement with his partners undertook to make the repairs. The latter were made and amounted to about \$1,557, which was charged to the lessees. The lessees became insolvent before the bill was paid, and the plaintiff, contractor, instituted the instant action to collect from the defendant, owner, by virtue of a mechanic's lien filed upon the property.

The disposition of the case turned upon the question of the nature of the agreement made by the owner to assume a part of the repair bill. The plaintiff claimed that the owner had agreed to pay \$1,500 of this bill, while the owner claimed that he agreed to allow a credit to that extent on the rent as it accrued, and that as no rent had been paid the lessees owed him more than \$1,500; it was therefore contended that he, the owner, should not be held liable for any part of the repair bill, and that the mechanic's lien did not bind his property.

Upon the trial of the case the court found that the owner had agreed to allow the amount named upon the rent, and that he had not agreed to pay \$1,500 upon the

repair bill. The trial thereupon resulted in the dismissal of the contractor's petition, from which ruling an appeal was prosecuted to the Supreme Court of Iowa where in stating the case before it the court, among other things, said:

"The burden was upon the plaintiff [the contractor] to prove either an express contract with or on behalf of defendant Groeltz [the owner] or else to prove such a state of facts as would give rise to an implied contract with him. Plaintiff does not claim to have had an express contract. He does claim that the facts warrant the finding of an implied contract. These alleged facts are: (1) That Groeltz knew that the plaintiff was furnishing the material; and (2) that he had agreed with his lessees to pay \$1,500 of the costs of the alterations."

Following the above statement of the case before it, the court directed its attention to a consideration of the contentions of the contractor, in connection with the evidence as brought out during the trial. In this connection it was, in part, said:

Owners Held Not Liable

"The fact, if such, that Groeltz [the owner] knew that the plaintiff [the contractor] was furnishing the material is not of itself controlling. He necessarily knew that somebody was furnishing it. This did not deprive him of the right in good faith to enter into a contract with his lessees in the first instance that all alterations should be made by them at their own expense; nor did it forbid that he should later consent to give them a credit upon the rent to the extent of \$1,500 of such expense. If such agreement had been that he would pay \$1,500 of such expense, a somewhat different question would be presented in that an agreement in such form might be deemed to imply authority in the lessees to bind him to such extent in the purchase of materials from the plaintiff. The trial court found against the plaintiff upon the facts at this point. We think such finding is consistent with the conduct of both Groeltz and the lessees. * * *

In conclusion the Supreme Court of Iowa affirmed the decree entered by the lower court. Holding, as outlined in the opinion, that the plaintiff, contractor, had failed to show such an agreement with the owner as to bind him for the materials furnished to the lessees in the repair and alteration of the building.

The foregoing Iowa case is one of value to contractors and builders in general. It illustrates in a striking manner the great importance to the contractor of having an agreement with an owner, when work or materials are furnished for the improvement of his property upon the orders of a lessee, if the contractor proposes to look to the interest of the owner for payment.

LESLIE CHILDS.

**The
SENATE APARTMENTS
St. Louis**

Ambassador Investment Company
Sam Koplar, President
Owners and Builders

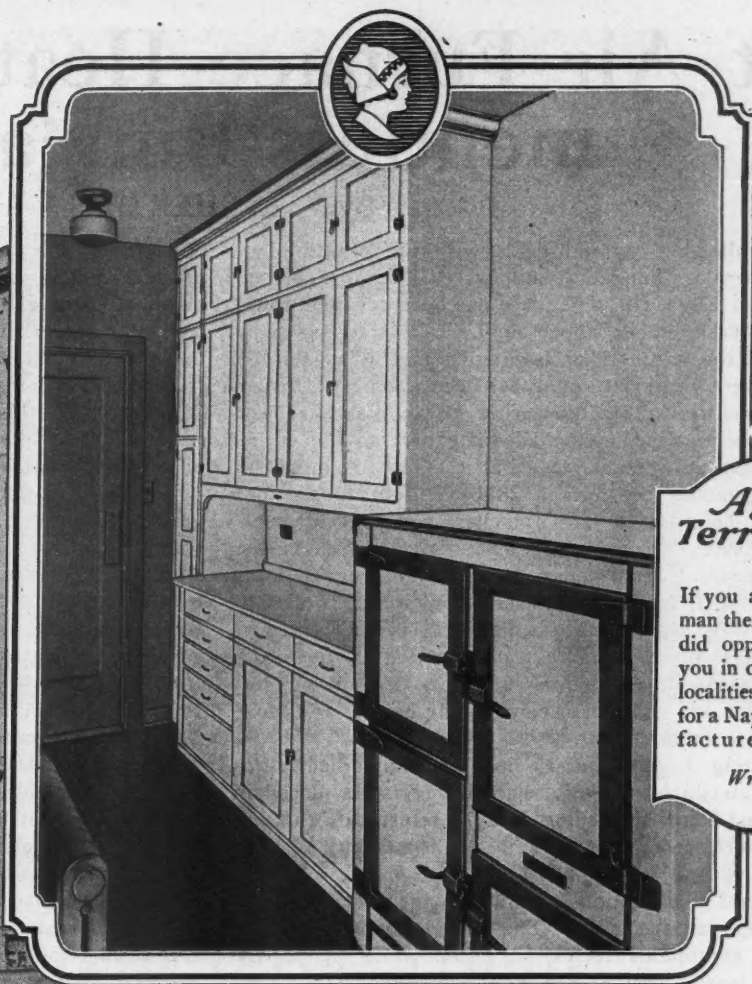

**Agent
Territories**

If you are the right man there is a splendid opportunity for you in one of a few localities still open for a Napanee manufacturer's agent.

Write us

**Napanee Units Chosen Here
for Superior Quality**

THE 16-story Senate, one of the newest and most modern apartment hotels of St. Louis, is known for its superlative equipment.

The kitchens are equipped with Napanee Units. The Napanee is recognized by architects, builders and home owners the country over as the ultimate in kitchen utility and handsome appearance.

That's why so many fine apartments are being Napanee equipped.

Architects and builders, appreciating hidden value, delight in Napanee's sturdy construc-

tion — all hardwood, gained-in corner joints, gained-in shelves, rust-proof hardware, base reinforced front and rear — everything for quality. And those who build for investment understand that the beauty and serviceability of Napanee Units attract and hold desirable tenants.

There is a Napanee Kitchen Unit, or group of units, for all needs—for any size space—for any arrangement of doors and windows. Let our Architectural Service Department assist you in planning or figuring.

COPPES BROS. & ZOOK - Nappanee, Indiana

**NAPANEE
DUTCH KITCHENET**

Built Like Fine Furniture

OUR GOLDEN ANNIVERSARY YEAR

COPPES BROS. & ZOOK, Nappanee, Indiana AB2
Gentlemen:—Please send me your illustrated catalog of Napanee Dutch Kitchenet Units.
(Please check square) I am Builder Architect Home Owner

Name _____
Address _____
City _____ State _____

WHEN WRITING ADVERTISERS PLEASE MENTION THE AMERICAN BUILDER

Hot Air Furnace Heat in a Basementless Bungalow

By V. L. SHERMAN

THE following account deals with the design of a basementless bungalow built last fall, for the writer, in Glen Ellyn, Ill. The place has been occupied since the middle of December, about eight weeks at the present writing, and the weather has been such that a fair test of mild and severe weather running has been practical. During this term two tons and a quarter of Pocahontas has been burned in the furnace, giving adequate heat to the entire first floor and considerable to an attic. The ground floor covers 945 square feet over a 28 by 36-foot foundation. The ceiling height is 8 feet 6 inches, and the cubage a little over 8,000.

The house has been under consideration for at least five years, postponed until adverse opinion was finally overcome. The design answers the ideas of the writer in that it is low on the grade, well provided in operation without a basement, warm all over at a more even temperature, more quickly and more economically heated, and more economical to build.

The heating is, of course, hot air, humidified automatically, introduced through enameled registers placed in the walls just below the ceiling, and the returns are through three cold air faces shown at F in the accompanying floor plan.

The general construction is similar to the average stucco home except at the sills. The foundation walls were poured in continuous forms 12 inches wide up to the first floor level. Inside, a 4-inch ledge provides a seat for the floor joists. The wall plates are double 2 by 6-inch, bolted, but not laid in cement mortar. They were calked with oakum after the framing and sheathing were on. Such a foundation proves very satisfactory in hard clay and this is really hard pan.

The construction was decided on after some considerable argument concerning floors, heating systems, and divers

other things too numerous to mention. For this particular job hot air was selected, and its design and operation may prove interesting because it has proved satisfactory. This does not mean that any bungalow without a basement can be so heated or that such a bungalow is always more satisfactory than a bungalow with a basement. The statements apply merely to this house and the argument only is general.

To begin with, the walls and especially the sills should be sound so that no in-drafts are left unaccountable. The exposed foundation walls must be low enough on the grade so that the air pocket beneath the floors will not chill. The furnace room floor must be low enough to allow for a large cold air return, say about 24 or 26 inches below the first floor, and the space between the furnace room floor and the underside of the joists should be screened to allow some air circulation.

The furnace casing and the hot air ducts must be thoroughly insulated. This should be cellular wrappings. Enough heat losses take place over the fire-box front and smoke pipe to warm the furnace room and keep the attic fairly comfortable in the present instance so it is easy to guess the heat loss in a basement through non-insulation of the heating element and walls. If the ducts are sufficiently well covered the temperature drop between the top of the furnace casing and the registers is little. Last night temperature readings were taken over a dull fire; the casing top at 130 degrees and the average register heat 118 degrees.

We have heat but we need circulation. With a register in the floor or mop board the heat rises along an inside wall, sort of chimney draft if it is unmolested, and spreads along the ceiling to the outer walls where the ceiling air continually drops toward the floor. This air current is the opposite in direction to that in hot water and

(Continued to page 204)

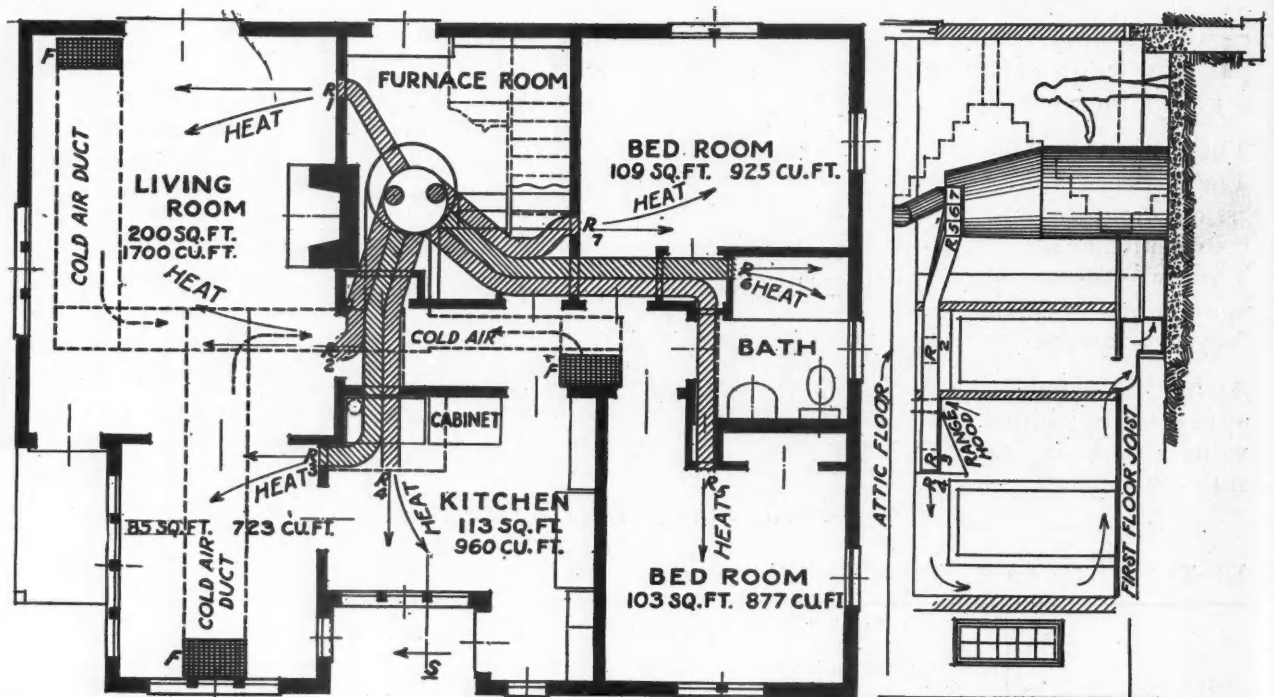

SCALE $\frac{1}{8}'' = 1'-0''$
FLOOR PLAN OF BASEMENTLESS BUNGALOW AND SECTION AT S.



The Kenilworth at Alden Park, Philadelphia. Two buildings, 12 stories high, containing 89 apartments, ranging from seven rooms and two baths to ten rooms with four baths.

They wanted the finest of baths —and they have them!

THE builders of The Kenilworth, Philadelphia's magnificent new cooperative apartments, know what a good salesman a luxurious bathroom can be. So they chose the Woodmere Built-in Bath, the finest "Standard" Bath, which means the finest bath made.

The Kenilworth has features and refinements that make it one of the noteworthy structures in the United States. Cork floors, wood-burning fireplaces, plate-glass windows, cedar closets, canvased walls, mechanical refrigeration—these quality articles call for the best of everything—for plumbing in kitchens and bathrooms that is unsurpassed.

So, besides the Woodmere Built-in Baths in The Kenilworth, there are installed "Standard" Vitreous China Lavatories and the new double-compartment "Standard" Kitchen Sinks. And, of course, these, like all other high quality "Standard" Plumbing Fixtures, are equipped with "Standard" Brass.

"Standard" service is available everywhere. There are Showrooms, Branches, Warehouses in more than 50 of the principal cities from coast to coast.

Write for "Standard" Catalogue.

Standard Sanitary Mfg. Co., Pittsburgh

The Woodmere is exquisitely curved outside, and has straight sides and wide, flat bottom inside. There are 156 Woodmeres in Kenilworth bathrooms.

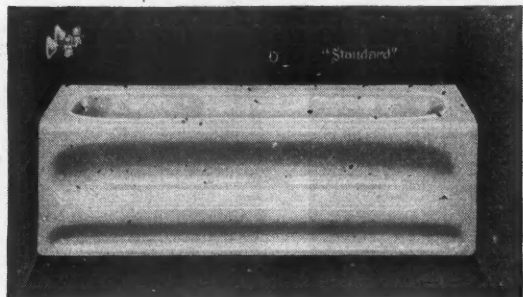

"Standard" PLUMBING FIXTURES

New Clothes For Old Buildings

For 37 Years Hamlin L. Shute, of Indianapolis, Has Been Resurfacing Structures With Stucco, "Imitation of Stone"

By J. D. WILDER

"IN 1888, R. P. Daggett, an Indianapolis architect, asked me if I could build up a stucco coat that would give a building he was remodeling the appearance of having been faced with rough cut stone. I had never attempted such work, but told him that I would try to work it out. In a few days I submitted a sample and he was so pleased with its appearance that I was given the contract. This stucco coating I called 'Imitation of Stone.' I have been putting this stucco stone facing on buildings of all kinds ever since."

Thus briefly is described the first work of applying stucco stone work to old buildings. Since 1888 this contractor has covered hundreds of buildings of all types in seven states of the middle west.

The field which this contractor has developed is unique. It is a work which has added years of useful tenancy to many structures and has made possible the preservation of numerous beautiful old structures which otherwise would have had to be torn down. It also added increased beauty to many buildings that age has made unsightly.

From a few small jobs this contractor has enlarged

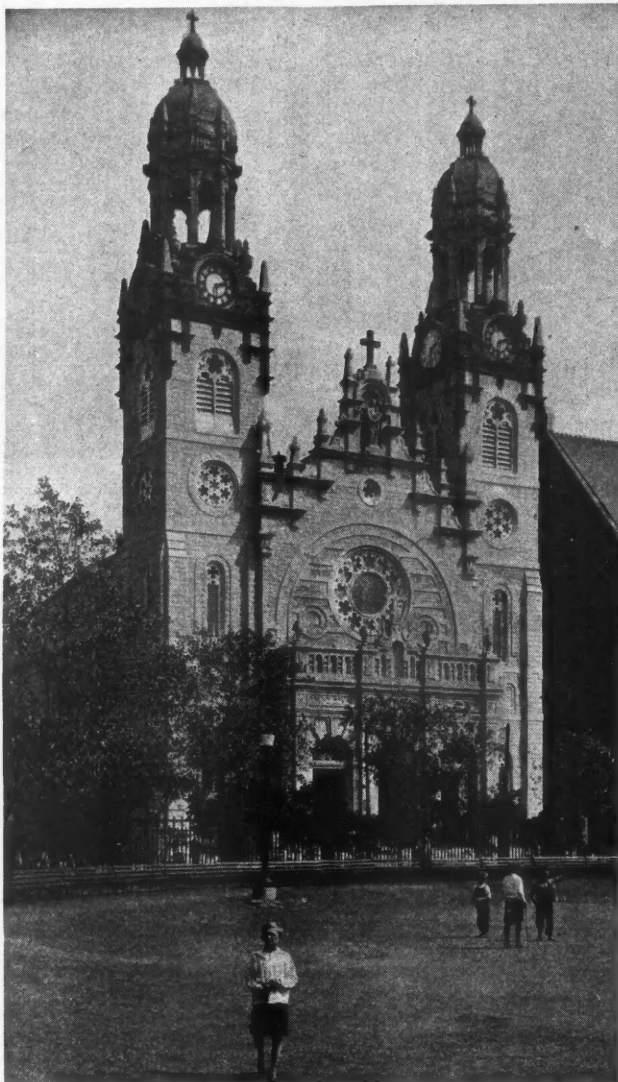

The St. Stanislaus Church, in Chicago, Finished in the Stucco "Imitation of Stone" as It Appeared When the Work Was Completed.

his field of operations until today several gangs of workmen are kept constantly busy over the country. Contracts for work are booked ahead for only men trained in the methods developed by Mr. Shute are able to do the class of work demanded. The entire process is intensely interesting and the steps followed in the work have been developed and improved from year to year.

Most of the jobs consist of resurfacing old brick structures which time and the incrustations of soot and dirt have turned into drab, unsightly buildings which no amount of washing and cleaning will beautify. It might almost be termed a court of last resort for age weary buildings.

Fundamentally the steps taken in applying "Imitation of Stone" to walls follow closely the practice worked out for doing the sound, attractive stucco work most contractors are familiar with. The first need is for a firm mechanical bond between the stucco and the old wall material. To secure this bond the workmen go over the wall surface chipping away the exterior crust and making a deeply cross hatched surface.

Difficulties are sometimes encountered in this part of

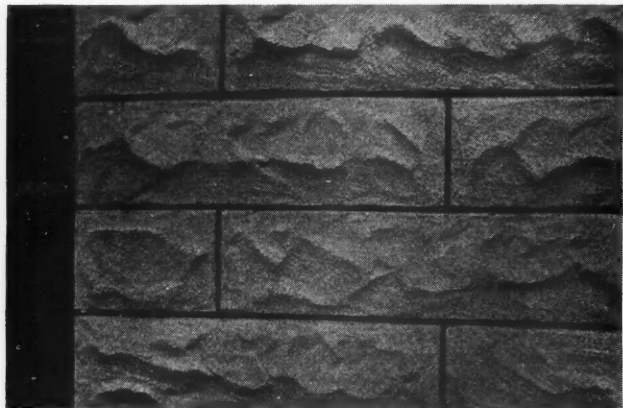

A Close-Up View of the Method of Treating the "Imitation of Stone" on the Lower Base Course as Applied to the Church Building Shown Above.

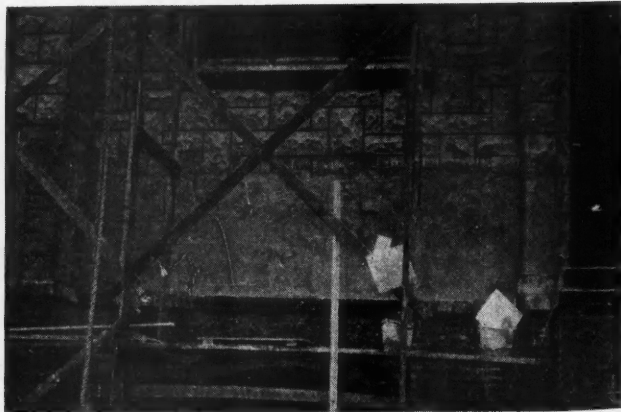

This Shows the Application of the Base Coat, the Cross Hatching of the Base Coat and the Finished Coat with Beading of the "Imitation of Stone."

This Low Cost Protection against Cold and Heat *keeps business coming your way*

Celotex Insulating Lumber satisfies your customers by giving them more comfort summer and winter . . . And it saves time and labor wherever you use it.

BROAD, strong boards of Celotex, light in weight and easy to apply, are fast replacing wood sheathing and lath in modern homes everywhere.

For this amazing insulating lumber satisfies both the home owner and the builder. Properly applied to the average home Celotex gives real protection against the sharp extremes of America's climate—shuts out forever winter's icy blasts and summer's stifling heat.

Home owners are quick to appreciate this additional comfort—their enthusiastic approval is your best source of new business. And Celotex jobs are profitable jobs, for builders know that Celotex is a great time and labor saver.

Celotex is exceptionally easy to apply. It is sawed, erected and nailed just like wood lumber, only with less bother. Celotex boards are uniform—4' wide, 8' to 12'

long, 7/16" thick and weigh about 60 pounds per 100 square feet. There are no short pieces or odd sizes; every board is usable—free from cracks, knotholes or stain.

Because Celotex is not an extra item in building, it adds little or nothing to costs. As sheathing it replaces wood lumber; under plaster it replaces wood lath. There are many other Celotex uses that bring in extra profits on every building job. Interiors finished with Celotex combine attractive appearance with greater comfort. Attics or basements lined with Celotex cut fuel bills and make homes more livable. Celotex makes an ideal garage lining, too.

All lumber dealers can supply Celotex. Mail the coupon for The Celotex Building Book, and Specifications showing how to apply it.

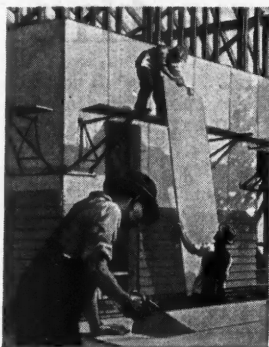

AS SHEATHING. Celotex replaces wood lumber and building paper—adding strength back of wood, brick and stucco exteriors at no extra cost.



UNDER PLASTER. On inside walls and ceilings Celotex replaces lath—forming insulated walls that are stronger, less apt to crack and forever free from ugly lath marks.



IN ROOFS. Celotex supplies insulation where it is most needed. Costs very little and year after year saves fuel.

THE CELOTEX COMPANY, CHICAGO, ILL.

Mills: New Orleans, Louisiana

Branch Sales Offices in many principal cities (See telephone books for address)

Canadian Representatives: Alexander Murray & Co., Limited

Montreal, Toronto, Halifax, Winnipeg, Vancouver

CELOTEX

INSULATING LUMBER

THE CELOTEX COMPANY, Dept. T-502
645 N. Michigan Ave., Chicago, Ill.
Please send me The Celotex Building Book and Specification Book.

Name

Address

City State

Am. Builder, Feb.

WHEN WRITING ADVERTISERS PLEASE MENTION THE AMERICAN BUILDER

the work. Many of the early brick were hard burned and under the great pressures exerted by heavy, high masonry walls bearing the weights of roofs and floors gain additional hardness. In such cases the work of cross hatching the surface develops into a long and arduous task.

Many of these old buildings were painted at a time when painting exterior brickwork was in vogue. Cross hatching serves to remove this paint, which, if allowed to remain on the wall, would render the bond of the stucco questionable, if not impossible.

The first stucco coat applied is about $\frac{3}{8}$ of an inch thick. No attempt is made to smooth out this coat, but it must be heavy enough to provide a firm base and bond for the finish coat that follows. Before this base coat has hardened, it is heavily cross hatched with the edge of the trowel. This cross hatching is immediately followed by the application of the finish coat which is of the same thickness as the base coat.

It is in the application of this finish coat that the most expert workmanship is needed. While the stucco is still plastic it is worked up with stiff brush motions, developed through years of practice, into a surface which resembles rough cut stone. Long practice has made the finishers highly proficient in outlining the individual blocks and forming the stucco into stone-like contours.

As in stone work, some mortar joints are made with the same colored mortar as used in the stucco, while in other jobs colored mortar, such as black, is used to bead off the joints. Different patterns of stone work, conforming to the patterns generally used by stone masons,

are used on the wall. The size of the blocks marked off is governed by the height of the wall and the general size of the mass forming the wall area.

A lime putty stucco especially adapted for the requirements of the work is used. The principal requirements are water-proofness, strength and workability. In preparing the stucco, sand is mixed with lime and enough water to form a putty. This lime putty is then mixed with portland cement to form the stucco batch. Care is taken to insure uniformity of all batches and to prevent streakiness by using only portland cement which meets established standards.

It is claimed that this stucco stone has proved itself as durable as genuine stone and is much cheaper to apply. An example of this age resisting quality is shown in the case of St. Mary's Church, of New Albany, Indiana. This church was covered with "Imitation of Stone" in 1902 when its exterior was rapidly nearing the end of its useful life. After more than twenty-two years of exposure, this stucco shows no loss of surface beauty, the texture is still as distinct as the day the work was done and there are no signs of the surface weathering away.

The Shute Company states that the surface does weather under action of wind, water and temperature but the weathering is very gradual and always uniform. The color of the stucco does not turn black even under exposure to soot and dirt but retains that gray coloring that makes the real stone so popular with builders. Because of this no "Imitation of Stone" surfacing has ever been cleaned.

Modern Building Methods Are the Arch Enemy of the Rat

By JAMES SILVER

THE rat, most wasteful of all animals and more destructive of human life than all wars, has resisted successfully all efforts to control it. It has matched every man-made agency for its destruction with added cunning and with a rapidity of reproduction that has enabled it more than to hold its own down through the centuries. And no reduction in the number of rats has followed the great impetus given to rat destruction by the knowledge that these pests are directly responsible for the perpetuation of that most dread human disease, bubonic plague.

Many intelligent men have devoted their lives to a study of methods of rat control, and countless preparations, devices and contrivances are constantly being made available. Trapping, snaring, trailing, flooding, digging, hunting, ferreting, poisoning and fumigating, and rat limes, rat lures, rat repellents, bacterial viruses and even anti-rat laws, local, state and national, are constantly being employed in a world-wide effort to get the best of this rodent.

These have been a factor in keeping the rat population within bounds, that is, in keeping down the surplus, but all destructive agencies that have ever been used have utterly failed noticeably to reduce what might be called the standing rat population of the world. The total number of rats in the world today is probably as great as it ever has been, and undoubtedly the economic loss caused by



Screened Basement Windows Are a Necessary Part of Rat-Proofing Any Building. Every means of entrance must be closed.

their depredations is greater at the present time than in any similar period in the world's history.

If all this be true, and economic mammalogists are practically agreed that it is, then the situation is indeed serious. But it is in reality not quite so black as painted, for there is a new agency at work which, although in many cases innocent of any design or intent upon the rat, gives promise of menacing its very existence. In progressive regions of the United States at least it has in large measure

W
dardiz
economi
the ot
field a
becom
the co

In
standa
other
in star
shop a

Rug
It ma
bump
three.
shop i

The
buildi
simpli
get an

*Mas
trusse
or any
imme

THE
Cana

N
S

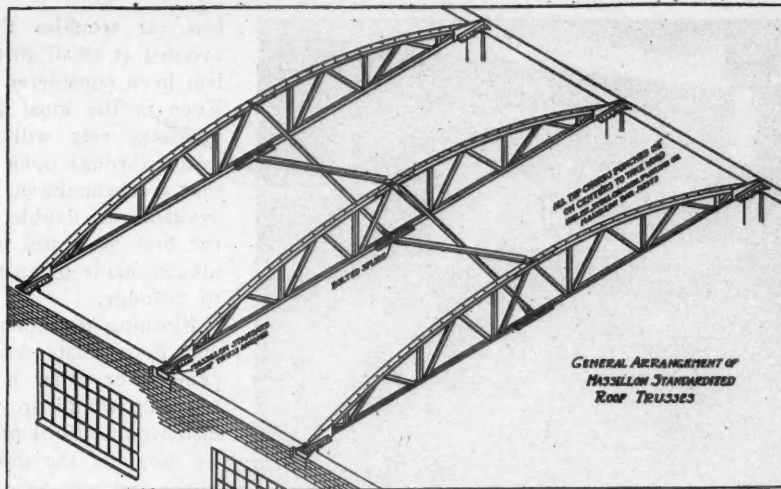

Standardization that Benefits the Building Industry

Steel Building Products that You can Use

WHEN steel joist floor construction was first introduced it was a mystery and avoided by contractors. The standardized features of Massillon Bar Joists made it a practical economical method of building fireproof buildings. Erected by the ordinary building trades, without cutting or fitting in the field and without special plant equipment, Massillon floors have become a standard construction for contractors in all parts of the country.

In the same manner the Massillon Roof Truss has set new standards for the construction of rugged roofs for garages and other buildings requiring clear open floor space. They are built in standardized sizes, to standardized designs with standardized shop and inspection methods.

Ruggedness is an essential part of every Massillon product. It may have to stand a long rail haul, a rough boat voyage, a bumpy truck trip over mountain roads, or a combination of all three. Every step from standardized design to standardized shop inspection insures this ruggedness.

The use of Massillon construction results in good economical buildings. The products are particularly adapted for ease and simplicity in erection. It will pay you to submit your plans and get an estimate based on Massillon construction.

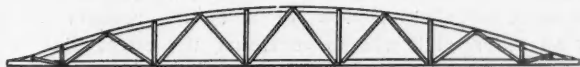

*Massillon Roof Trusses are standardized, shop fabricated trusses especially adapted to garage and factory roof construction or any place where clear spans are desired. Carried in stock for immediate shipment. May also be adapted to concentrated loads.

Massillon Metal Lath—Furnished in all weights and types. Also complete line of corner beads, base screeds and furring channels. Warehouse stocks maintained at convenient points.

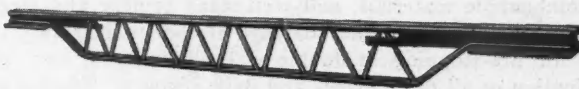

†Massillon Bar Joists—Rugged steel joists that are shipped from stock ready for installation without cutting or fitting in the field. They are used for building fireproof floors and roofs in all types of buildings.

Massillon Steel Windows—Complete line of copper bearing steel sash, architectural and industrial projected windows, double hung windows, casement and basement windows.

Massillon Vault Reinforcing—Standardized reinforcing frames that economically secure the maximum protection in vault construction for Banks—Offices—Oil Stations—Hotels—etc.

For the Contractor—Electric welded steel mixing boxes and mortar boards. Will outlast dozens of wooden ones. Fire can be built right under the boxes for winter mixing.

If you send us a sketch or plans of your building we will be glad to submit an estimate based on Massillon Construction. Descriptive literature sent on request.

*Our "Roof Truss Design Card" carries complete safe loading tables and instructions for the design of roof truss buildings. Sent on request.

†"The Handling and Erection of Massillon Bar Joists" is a contractor's publication. It best illustrates the simplicity and ease of erecting the construction. Sent on request.

Sales Offices in all principal cities

THE MASSILLON STEEL JOIST CO., 909 Belden Ave., N. E., Canton, Ohio
Canadian Manufacturing and Sales Agents: Sarnia Bridge Co., Ltd., Sarnia, Ontario

MASSILLON

STEEL BUILDING PRODUCTS

WHEN WRITING ADVERTISERS PLEASE MENTION THE AMERICAN BUILDER



Unfinished Work Such as This Is Responsible for the Invasion of Rats in Many Modern Buildings Which Are Otherwise Rat-Proof.

made apparent a material reduction in the rat population. This new agency is modern methods of building construction.

Modern construction, even without regard to the rat, is opposed to everything that makes for the best interests of the rat. It calls for the liberal use of indestructible and noncombustible materials, and well-made cement and steel are too much for even the sharpest of rodent incisors. It calls for fire-stopping in double walls and floors, and for elimination of all dead spaces and dark corners. The rat is left no place in which to hide. It embodies sanitary features that provide for hygienic storage of food, and the rat cannot live without something to feed upon.

The rat is dependent primarily upon two things, food and shelter. Its food must be ample and its shelter must afford protection and uninterrupted opportunity for rearing its young, in order that it may maintain its high prolificacy. Such food and shelter were always abundantly available in the buildings of yesterday, and that is why we have the rat with us in such abundance today. Only a small percentage of rats may be found away from the protection of man and his handiwork.

In spite of all of his reputed wisdom man has been less a menace to the rat than the natural enemies which it might encounter in the open. But modern construction is changing this order of things; it is depriving the rat of man-made protection and is forcing it into the open where in the life struggle it will be at a fatal disadvantage.

Modern construction is bringing this about, and to the modern builder goes much of the credit for this desirable condition. That anti-rat considerations did not motivate the modern builder in his use of concrete, and the more pointed truth that most builders are not even aware of the part they are playing in the control of the world's greatest pest, do not lessen the fact that today the modern builder is the greatest enemy of the rat.

If modern construction without regard to rodents has proved so effective in shutting out rats, how much more effective would be construction designed specifically to exclude them. That a modern building is absolutely rat-proof, or is not, is often only the result of chance, thoughtlessness, or carelessness. A small hole may be left in an unobtrusive corner where pipes enter the wall, or a ventilator or sewer opening may lack the proper grating, or a basement window may be left unscreened. Such minor oversights may lead to years of rat trouble for occupants of a building who have not sufficient ingenuity to locate the source of their troubles.

In other cases, double-wall construction may cause end-

less rat troubles that might have been avoided at small cost had the rodent problem been considered in drawing the plans. Even in the most thoroughly rat-proofed buildings rats will occasionally gain entrance through open doors or with supplies that are brought in. If any safe retreat is available, as double walls opening beneath the first floor and in the attic, the beginning is made of an infestation that is hard to dislodge.

Blocking the open spaces between studs and floor joists with bricks, cinders and cement, or other noncombustible material not only would prove a barrier to rats but also would afford protection in case of fire by stopping the drafts and rise of heated gases and also would provide better insulation against heat and cold.

Some buildings, such as those not having full basements or continuous retaining walls, present other problems, but no form of rat-proof construction has proved inconsistent with the best type of construction, nor has it been found to cost in excess of its worth.

About thirty towns and cities have regulations requiring firestops in walls, and many others are known to favor.

Rat-proofing measures should not end with fire stopping, however, but should require, under rigid inspection, that all new structures be so planned and built that rats and mice will not be able to gain ready entrance nor find shelter should they accidentally do so. At least thirteen towns or cities have now passed rat-proofing ordinances, most of which have to do with rat-proofing buildings, and many others are contemplating similar action.

Such regulations would not be so urgently needed if architects and builders would realize the great service they could perform by building the rat out of every new structure, and by so doing build out of the country and possibly out of existence the most vicious and persistent enemy of mankind.



Heating a Basementless Bungalow

(Continued from page 198.)

steam heat and so must cover its circuit at a fairly constant temperature to equal the effectiveness of the radiator.

But this draft of heat from a floor register pulls in floor drafts from around it which, when supplied by an open outer door or window, or when the register is too near an outer wall, will so neutralize the effect that they may stop the warm air current altogether. If they persist the warm register will become a cold air return. By placing the register just below the ceiling these interferences are overcome and the circuit is effective as long as there are any temperature differences in the room.

For instance, you will note that at one end of the house the bath room is placed between two bedrooms. At times the bedroom windows and doors have been left open all night and without chilling the bath room. The upper register in the bath room continues to register since the $\frac{3}{8}$ -inch under door space proves a cold air return for that room.

This heating system is not entirely new. It has been used under a blower in large buildings. If the pipe lengths in a house are to be increased there is no reason why a blower in the shape of an electric fan cannot be placed in the cold air return to kick the circulation along. Two of my acquaintances have used this scheme to good effect, and the expense is really nothing. It should more than save its expense in fuel, and in some cases will correct the heating in chronically cold rooms. But the point to remember is—insulate.

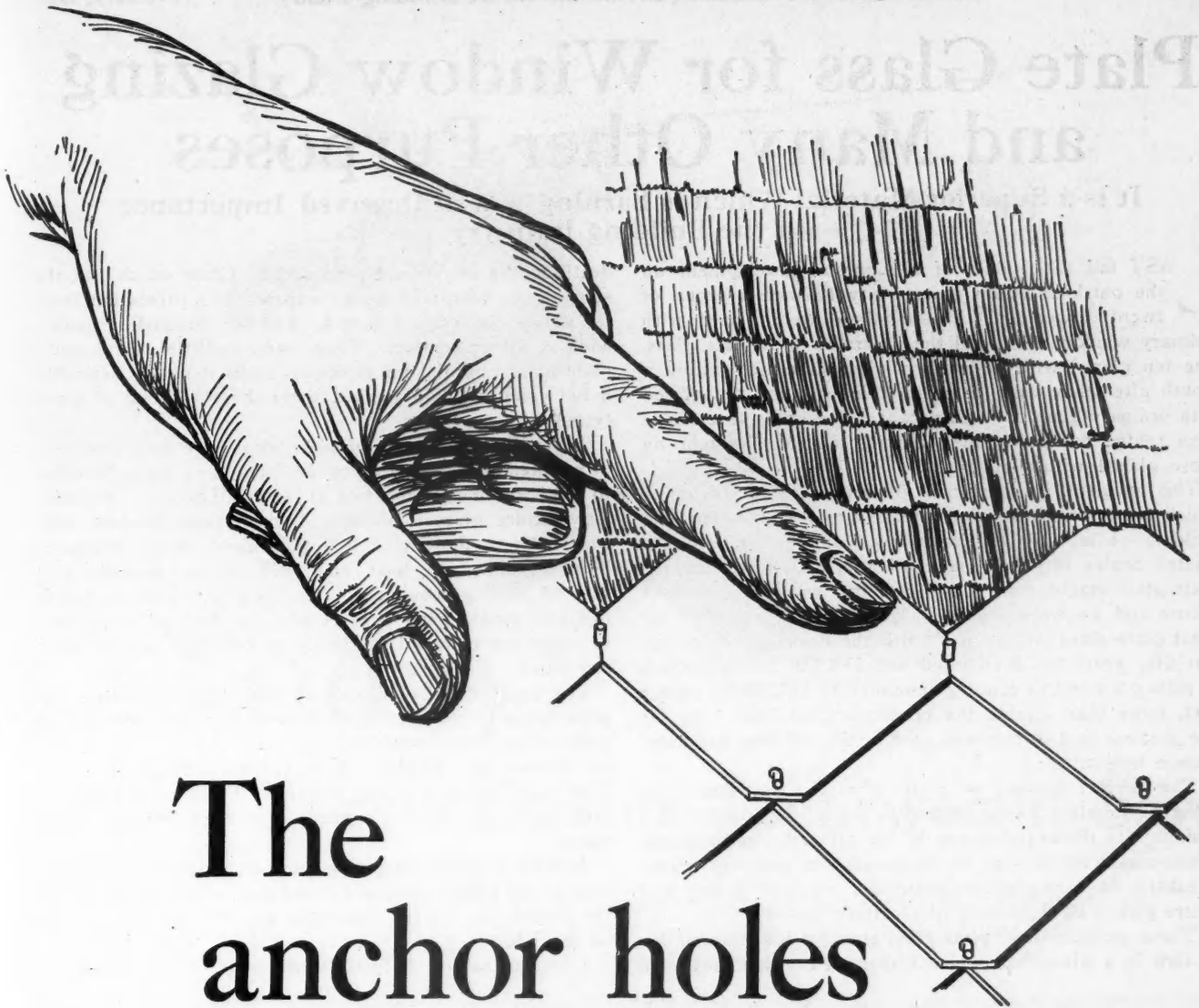

The anchor holes act as guides

THE anchor holes are accurately punched in every Johns-Manville Asbestos Shingle. The nail holes are already punched too. When the first row of shingles is laid the anchor holes point out the place for each successive shingle. The job's so simple and the instructions so clear there's no chance of a mistake. Any carpenter can do the job and do it right the first time.

There are a lot of re-roofing opportunities all around you. Easy work to get and easy work to do when it's done the Johns-Manville way.

JOHNS-MANVILLE CORPORATION, Madison Ave. at 41st St., New York
 Branches in all large cities. For Canada: CANADIAN JOHNS-MANVILLE CO., Ltd., Toronto

Public opinion is swinging to fire-safe roofs. Johns-Manville Asbestos Shingles are steadily climbing in popularity.

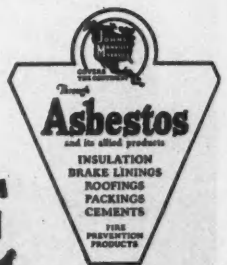

JOHNS-MANVILLE Asbestos Shingles

WHEN WRITING ADVERTISERS PLEASE MENTION THE AMERICAN BUILDER

Plate Glass for Window Glazing and Many Other Purposes

It is a Superior Material Which is Earning a Well Deserved Importance in the Building Industry

LAST fall the builder of a suburban development on the outskirts of an eastern city finished a group of twenty dwellings. Ten of these were glazed with ordinary window glass and the other ten with plate glass. The ten glazed with plate glass were all rented within a month after they were finished. Three of the ten glazed with ordinary glass are still vacant. The other seven have been rented but at a lower rental than that brought by those glazed with plate glass.

This incident is significant in being typical of many which are calling increasing attention to the importance to builders of an industry which was non-existent in the United States fifty years ago. Until 1880 the history of plate glass manufacture in this country was a chronicle of failure and we were dependent on European countries for what plate glass we did use. But the development of the last fifty years has been rapid and in 1925 the production of plate glass in this country amounted to 117,224,295 square feet, more than double the production for 1921. By far the greatest part of this was used in the building and automobile industries.

The perfect texture of plate glass, its freedom from whorls, bubbles, flaws, affords a clear and undistorted vision. Its thickness makes it, for all practical purposes, a non-conductor of heat, its toughness and elasticity reduce breakage to a negligible factor and its high polish and lustre give it all the beauty of a perfect crystal.

These qualities make plate glass essential for automobiles. A flaw in a windshield which distorts the vision may spell

death to the driver and passengers. Glass which has the strength to withstand heavy impacts is a protection from the danger from flying slivers. The non-conducting quality adds to winter comfort. These same qualities which make plate glass essential for motorists make it highly desirable, if not essential, as a glazing material for building of many types.

The polish and luster of plate glass give an added note of architectural distinction to the forty-story office building, to the hotel or apartment or to the small home. The faultless texture gives unobstructed vision and freedom from eye strain to those who live or work in these structures. The resistance to heat and cold makes possible substantial heating economies. The toughness reduces breakage and resists wind stresses of a hundred miles an hour or more, an essential in the great buildings of our modern cities.

The owners and managers of buildings are finding that plate glass is an essential if they expect good rentals for their offices and apartments and the situation in regard to the owners and builders of residences is much the same. The home buyer or renter has learned that plate glass will add materially to the comfort and attractiveness of his home.

Modern builders are giving more attention to the appearance of the edifices they erect, and the impression they make on prospective buyers than they are to any other feature of the job.

One illustration of this is in the vogue for "picture win-



Plate Glass Windows, with Their Clear Crystal Surfaces and Perfect Vision, Add a Note of Cheerfulness and Architectural Distinction to This Typical Suburban Residence.

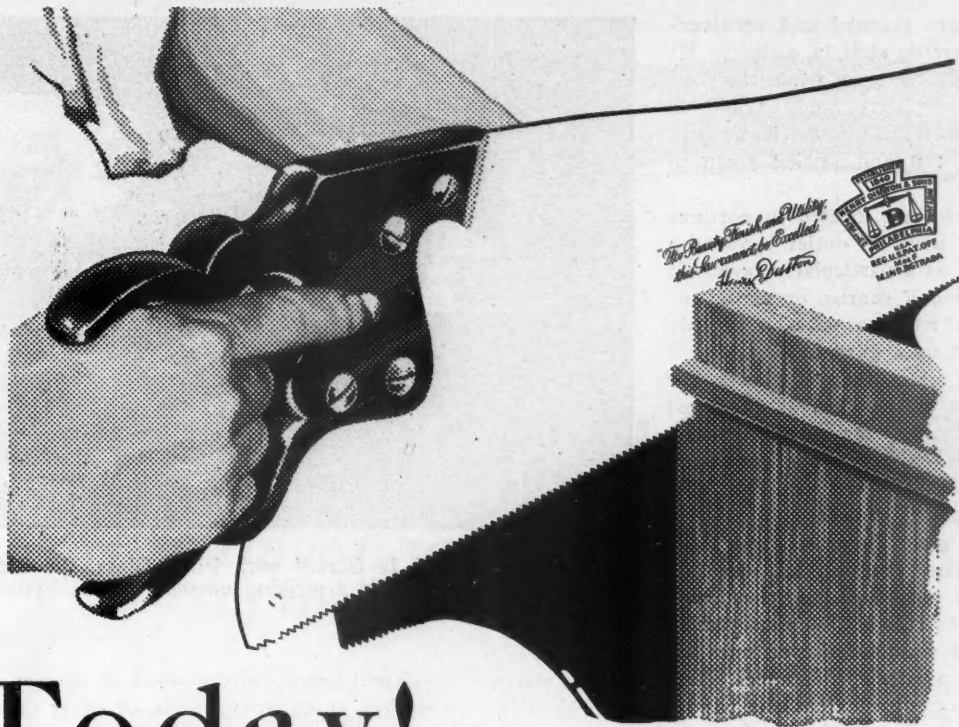

Today!

Try a Disston Lightweight Saw

**See these Disston
Lightweight Saws**

Ask your hardware
man to show you
these Disston
Lightweight
models:

- Disston No. 7 Ship
- Disston D- 8 Ship
- Disston No. 16 Ship
- Disston D- 20
- Disston D- 23
- Disston No. 12 Ship
- Disston D- 115
- Disston D- 15



Your hardware dealer has a stock of those Disston narrow-blade, lightweight Saws that carpenters are finding so desirable.

Stop in and look them over. If you have been using a wide-blade saw exclusively, grip one of the Disston Lightweight models.

Feel the difference in weight! Yet all the usual Disston strength and toughness, spring and keenness are in that narrow blade—and stiffness, to take your hardest thrust.

Feel the way blade and handle are balanced to your hand and arm.

You can get your favorite Disston Saw in a Lightweight model: No. 7, D-8, No. 16, No. 12, and others.

If your hardware dealer has not the saw you want, write us, mentioning his name.

HENRY DISSTON & SONS, Inc.
Makers of "The Saw Most Carpenters Use"
PHILADELPHIA, U. S. A.

DISSTON

WHEN WRITING ADVERTISERS PLEASE MENTION THE AMERICAN BUILDER

dows." These are planned and constructed with considerable skill in order to hit prospects between the eyes when they are looking over a property, and to add to their satisfaction with the dwelling after they have bought it and settled down to live in it.

Picture windows are located in portions of a house that have an outlet towards a good view, such as a particularly favorable spot for observing a sunrise or sunset, or for glimpsing a river, a park, a prettily wooded prospect or a garden.

Naturally the glass that is chosen for such windows is of the clearest and most attractive appearance, for no obstruction in the view can exist without detracting from the effect that is desired. For this reason plate glass is chosen.

The type of glass being chosen there remains the nice question of deciding upon the size of the panes, and the design and setting of the frame. Obviously small panes, or leaded diamond shaped ones are inappropriate in most such instances. Large sheets, sometimes covering the entire extent of a window, are preferable. They give one the impression of being right outdoors in the view, or else produce the illusion of looking not at a view, but at a veritable painted picture. Hence the expression "picture window."

Windows represent the chief use of plate glass about the home, but there are further uses to which it is put because of its absolute transparency and clearness, and its dense structure which makes it impervious to liquids. Owners of fine furniture employ it as covers for tables, buffets, dressers and other furniture which has a finely varnished surface, or even to protect scarves and draperies that are laid upon such furniture. It permits the covers

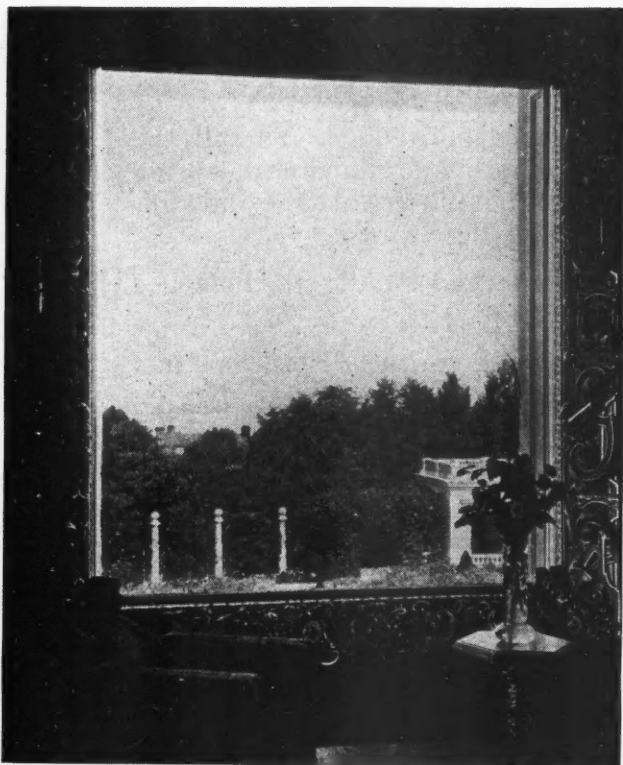

This Plate Glass Window in a Glen Cove, L. I., Residence, Transmits a Perfect View. The frame emphasizes the picturesque effect and the name of "Picture Window" is highly appropriate.



The Windshield Is Glazed with Plate Glass, the Side Window with Ordinary Glass. Here is a striking example of the better vision obtained when plate glass is used.

or natural beauty of the wood to be seen while preventing scratches, spots from liquids, or other damage and it is all but invisible. Its use on dressing tables is one of the most frequent purposes it is made to serve.

In kitchen and bathroom, where absolute cleanliness and order are to be desired, plate glass is made into shelves. They are easily kept clean. They make objects on the shelves easily visible. And, especially in closets, they offer no obstruction to light rays so that every corner of the cabinet or closet is illuminated when the door is opened.

The sanitary kitchen and pantry are equipped with glass shelves. Door pushes on pantry doors are covered with glass so that the varnish shall not be dirtied or marred through constant handling.

The mirror, as an object in itself, attracts the lover of beauty. Its polished plate glass, backed by silver in order to reflect truly and without distortion anything that is within its field, bespeaks cheer and brightness. Some mirrors actually consist of a simple sheet of plate glass, devoid of frame, but mirrors with frames multiply the beauties of the glass. Frames have designs antique or modern appealing to all tastes.

In addition to the mirror itself there are varied reflections and effects that can be gained by its careful location. Over mantels or console tables, mirrors multiply objects that are placed before them, through reflecting their obverse sides. In this way they make vases of flowers or statuettes doubly effective. Or their place may be chosen so that, as when hung opposite a long hallway or series of rooms, they reveal a vista of charm that adds to the apparent spaciousness of the room in which they are. A mirror that reflects the outdoors from a position opposite a window inspires the beholder almost as much as a finely done painting, and presents a more varied scene. Again mirrors are placed in dim hallways to catch light from open doorways and to throw it back into dark corners.

From the viewpoint of practicality mirrors are indispensable. For shaving and dressing they are found in closet and bathroom doors, the doors of medicine cabinets and on dressing table. Mirrors with all these many uses are only one form of plate glass.



Form Clay Products Association

THE recent formation of the Southern Clay Products Association, at a meeting in Macon, Ga., is another constructive step in the development of the southern building material field.



MODEL HOMES

*Have Changed the Viewpoint
of the Home-Buying Public*

The nation-wide Model Homes movement, sponsored by powerful interests and backed by the most elaborate publicity in the history of building, has left a lasting impression on millions. The well-built, completely equipped home has come to stay—bringing with it a new stability for the building business and greater opportunities for consistent profits.

As a cumulative effect of repeated model home demonstrations in many cities, prospective buyers have come to recognize

certain materials and equipment as earmarks of the new regime. Prominent among these is the Minneapolis Heat Regulator, featured in model homes everywhere.

By including the Minneapolis in every home you build, you can identify your houses with the model homes movement and cash in on Minneapolis prestige, built up through years of national advertising, and the enthusiasm of over two million people who are enjoying the benefits of Minneapolis controls.

The Minneapolis Heat Regulator Co. has worked out a program of co-operation with operative builders which is attracting widespread attention and playing a definite part in clinching sales. Write for complete information.

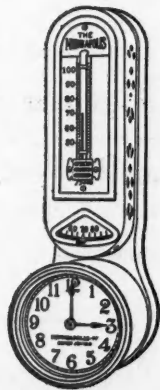

The Minneapolis Model 77 with 8-Day 7-Jewel Clock

Minneapolis Heat Regulator Co.

Established 1885

402 East 28th St., Minneapolis

The "MINNEAPOLIS" HEAT REGULATOR

For Coal—Gas—Oil



HOW DAN DOES IT

A Department for Passing "Life Savers" along to other Builders

\$2 for an Idea

Dan is an ingenious cuss. Nothing ever stumps him. He always knows the way out when he runs into a tough problem out on the job or in the office. Dan is the editor of this Department and will pay \$2.00 each for every good idea he can use here to show and tell other builders "how to do it." Send him a rough sketch and a short description of what the tough job was and how you handled it.

Address Dan-Do-It, care of American Builder 1827 Prairie Avenue, Chicago, Ill.

More Use for the Level

THE idea described here may not be altogether novel to many people but I have never seen any of my fellow workers use it and, as those who have seen me use it have all taken it up, it may be worth passing along. Many carpenters possess a short level to plumb studding for openings such as windows and door jambs or even for partitions that must be plumb. They find it difficult to get these true unless assisted by a straight edge. This method, as we all know, is unhandy because a man must hold the stud straight and also the level at the same time.

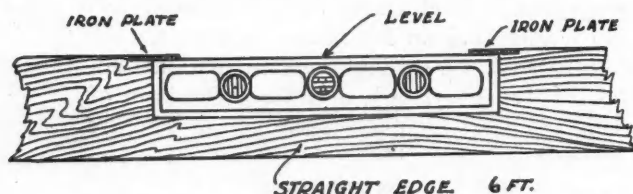

A Level Mounted in a Straight Edge as Shown Is Used for Plumbing Studs and Jambs.

My method eliminates all this difficulty. I simply take a 6-foot oak (or other hard wood) piece 5 or 6 inches wide and $1\frac{1}{4}$ inches thick. I have an 18-inch level. I cut a slot in the center of the 6-foot strip deep enough to take the level allowing it to clear the top edge $\frac{1}{8}$ inch. A piece of sheet iron of that gauge, $1\frac{1}{2}$ inches long and 1 inch wide is screwed to the wood at each end of the level to hold it in place and is set flush with the wood.

On the sides of the wood strip, at each end of the slot, a moulding is nailed to hold the level in place. The lower edge of the wood strip is a straight edge. This is simple to make and very convenient to use.

JOHN M. KOCHIS, Box 54, Cementon, Pa.

Another Studding Jimmy

I HAVE taken note of the studding "jimmies" illustrated in this department, a wooden one in the September, 1925, issue and a steel one, by Mr. Fesler, in the February, 1926, issue. I believe that I have one which is superior to either of these. I recommend a "jimmy" about 30 inches long, made of $\frac{3}{4}$ -inch octagonal tool steel. The opening at the hooked end should be $2\frac{1}{4}$ inches so as to receive a 2 by 4 easily.

Both ends are split for drawing nails and the hooked end is set at any angle of about 45 degrees to the stock,

which makes it very convenient for holding a twisted stud with the leg, leaving both hands free to do the nailing. This angle also makes the tool handy when reaching to

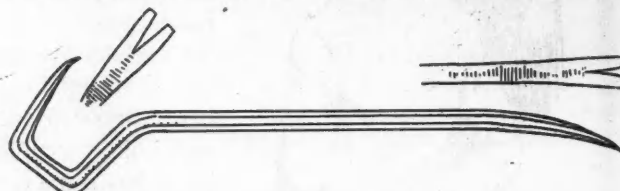

Here Is the Latest Contribution to the Studding Jimmy Field and It Looks Good.

the floor or overhead to loosen a piece of board or draw a nail. The other end has less crook, it being only 25 degrees. The sketch shows the type of jimmy described. —GEORGE F. DYER, Sierra Madre, Cal.

Repairing Roll Roofing

THE sketch shows the method I use for repairing damaged places in roofs covered with roll roofing. I never use anything but a three-cornered piece of roofing, without pitch or cement, and a few galvanized or copper roofing nails. The repair can be made in two minutes and is as thorough as any other method for repairing small holes in the roofing. A slit is cut in the roofing, horizontally, just above the hole. A triangular repair patch is cut and one corner pushed snugly up into the slit and the lower edges are nailed as shown.

D. W. BEERMAN, 229 Lake St., Akron, Ohio.

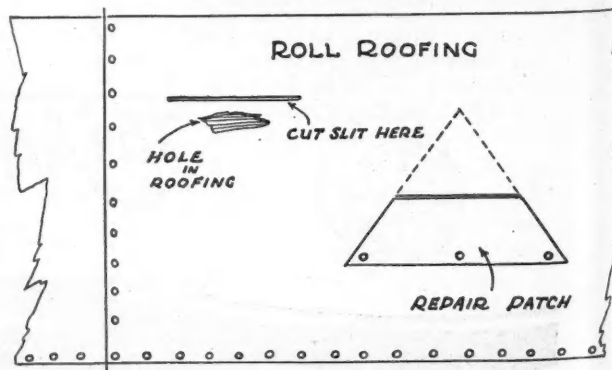

It Is a Simple Matter to Repair Holes in Roll Roofing When This Method Is Used.

(Department continued to page 215)

Trailer-Tool House with Wheels

THE usual trailer construction, for automobile use, rests on the wheels at all times. Trailer users will find in the attached photograph a new idea for trailer construction, in which the wheels are used only during the transportation of the trailer, while one end is used as a foundation or base during its use.

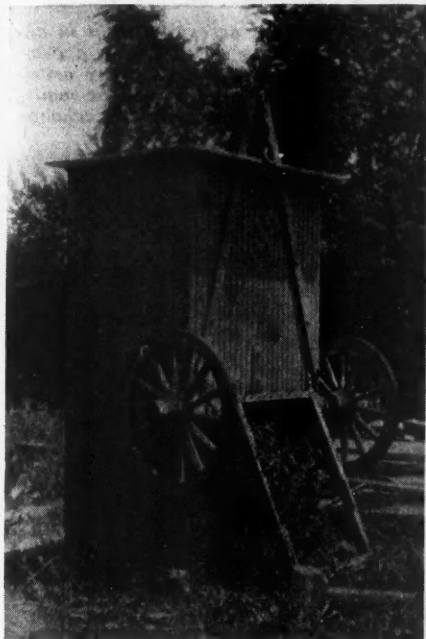

This Tool House Can Be Dropped Onto the Wheels and Handled as a Trailer.

The trailer shown is a tool house construction for a building company. As shown, the wheels, towing attachment and hitch are on the normal bottom. The top is fitted with a door and on the end are ventilating holes. As will be evident from inspection of the picture, it is possible to expand this idea into a house sufficiently large to meet the needs of contractors on various construction projects.—GEORGE F. LUERS, 122 E. Capitol Street, Washington, D. C.

cap to suitable width and bevel it on the thick edge to fit pitch of window sill. Make this piece wide enough to allow about 3/4 inch projection above stool. Nail it into place as at B.

Hang the sash, leaving 1/8 inch at bottom to give clearance and prevent it from dragging over the stool. Tack or prop the sash shut; go outside and mark along the top edge of B. Cut another piece of drip cap, (a), rip about 1 inch from the thick edge, dress and nail on sash 1/8 inch above the mark. This piece should have a channel plowed out on the under side near its outer edge, as at C, to prevent drip water from following the wood back toward the sash.

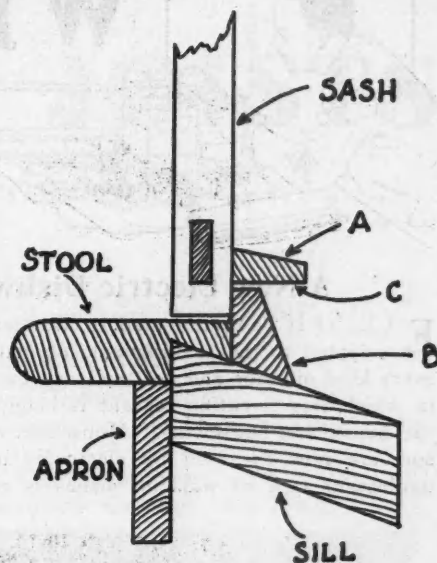

For In-Swinging Casement Windows, This Method of Construction Will Prevent Any Water Leaking In.

E. J. WILSON, Gen. Del., Portland, Ore.

For the Bench Vise

IN using a bench vise one is frequently bothered by having the vise stick because of the fact that the bottom does not move out or in evenly with the top. This can be overcome by the use of two pulleys and chain as shown in the sketch. As the screw of the vise moves out the chain, passing over the two pulleys and attached to the rear of the lower part of the vise, makes the bottom move out at an equal rate.—IVAN CARLSON, Ceresco, Neb.

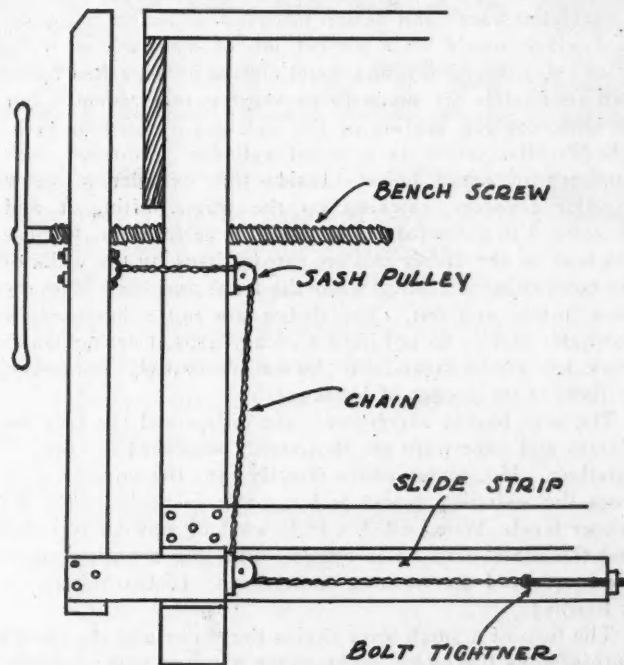

Rigged with a Chain and Pulley, as Shown Here, the Bench Vise Will Never Stick When Screwed In or Out.

Bench Nail Puller

THE idea illustrated in the sketch is used by a Washington mechanic who specializes in the making of patterns, but will be found equally convenient for the contractor. It consists of a nail puller which is fixed onto the bench. With it the use of the claw hammer is eliminated and both hands are left free to handle the work. This speeds up the work sufficiently to repay the small work of making the nail puller. It can be made easily from an old flat file or other strong piece of steel which is ground, filed, drilled and tempered.

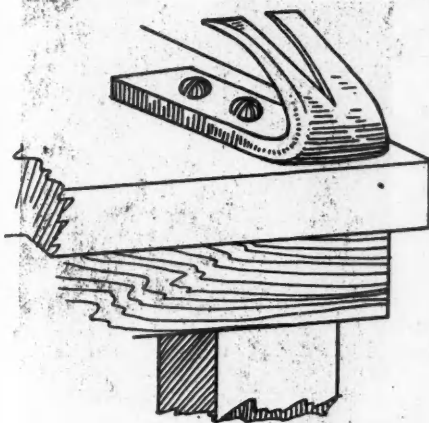

A Simple Nail Puller Attached to the Work Bench Leaves Both Hands Free. It is easily made from an old file or flat piece of steel.

GEORGE A. LUERS, Washington, D. C.

Waterproof Casement Sash

CASEMENT sash that open inward are easily made water and wind proof if fitted up as shown in the accompanying sketch. Before hanging the sash, put on the stool and apron as indicated. Rip a piece of common drip



WHAT'S NEW ?

EDITOR'S NOTE: *The AMERICAN BUILDER does not accept payment in any form for what appears in our reading pages. In order to avoid any appearance of doing so, we omit the name of the maker or seller of any article we describe. This information is, however, kept on file and will be mailed to anyone interested; address AMERICAN BUILDER Information Exchange, 1827 Prairie Ave., Chicago.*

A New Electric Dishwasher

ELECTRICITY, the modern wonder worker, is being adapted to the requirements of man to relieve him of every kind of labor and not the least important of the fields in which this scientific servant is being applied is that of the home, and housework. Household appliances of every sort are now operated by electricity and even that old, unpleasant task of washing dishes is now taken care of.

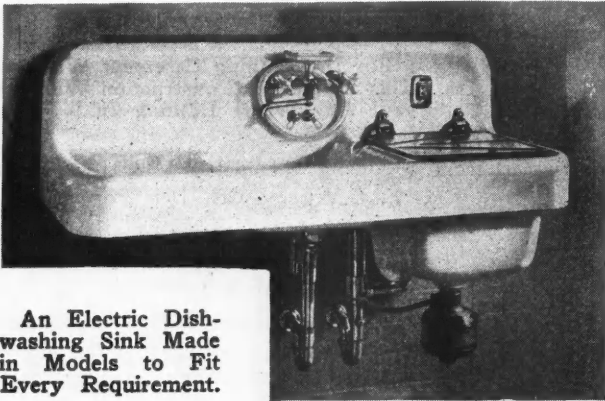

An Electric Dishwashing Sink Made in Models to Fit Every Requirement.

The electric dishwasher is not altogether a new thing today, but the one illustrated here is entirely new, the product of a company long known for its bathroom fixtures and similar products.

This electric dish washing sink is the product of years of careful research and design intended to perfect an appliance which would do a perfect job of dishwashing three times a day, every day, and could always be depended upon. Various models are made to fit varying requirements, but the dish washing portion of the sink is the same in each.

Set in the center is a metal cylinder perforated with hundreds of small holes. Inside this cylinder a screw impellor revolves, catching up the water, lifting it and throwing it in powerful jets through the perforations. These jets beat on the dishes and are thrown back by the walls of the compartment. They wash the front and back of every piece, inside and out. The dishes are not submerged in dishwater and so do not have a greasy deposit or highwater mark left on them and the dishes are entirely stationary, so there is no danger of breakage.

The wire basket which holds the dishes and the tray for glasses and silverware are thoroughly separated for ease of handling. Hot water pours directly into the compartment from the swinging faucet and a water mark indicates the proper level. When filled, a little washing powder is added and the drainboard lid is closed. Pressing a button starts the motor and the washing commences. In two minutes it is finished.

The turn of a small lever drains the water and the switch button stops the motor. The cover is raised and a convenient rinsing hose is used to thoroughly rinse every piece. If really hot water is used for rinsing no drying is necessary, only the polishing of glasses and silver.

The care of this sink is quite simple. The operating mechanism is self-cleansing and a quick rinsing of the baskets and side of the compartment with the spray is sufficient after each washing. More thorough cleaning is required only occasionally. This is an easy process because of the removable cylinder and impellor which can be lifted out and cleaned with a stiff brush. The sink is installed by the plumber just as an ordinary sink is installed, the only difference being that there are two trap outlets instead of one and that a simple wiring connection is made with the house.



Industrial Heating Units

THE manufacturers of a highly successful unit system of heating and ventilating are now producing an industrial heating unit which is made in two sizes and a number of styles to meet varying requirements. This unit can be installed in either new or old buildings. Its installation is simple and much expensive steam piping is eliminated. It consists of a specially designed radiator with fan, operated by an electric motor, incorporated.

Quick and uniform diffusion of heat is obtained with this unit and perfect control of temperature is possible. The room may be heated quickly by starting the motor and if too warm heating can be suspended by stopping the motor.

There is no waste of heat when not needed. An automatic control of temperature can be provided by means of a thermostat which shuts off the heat by stopping the motor and turns it on by starting the motor. This is extra equipment.

It is said that these units affect a big saving in floor, ceiling and wall space and they make a neat appearance. Four units in a large room or workshop will take the place of hundreds of square feet of ordinary radiation. The cost of current for the small electric motors is negligible. Control switches for the motors can be placed wherever most convenient.

Where special provision for ventilation is desired, the necessary extra equipment can be furnished as required—wall boxes or ducts for bringing in fresh air from outdoors, mixing dampers for regulating the volume of ventilation and so forth. A deflector can be added as extra equipment, when wanted, to change the direction of air flow.

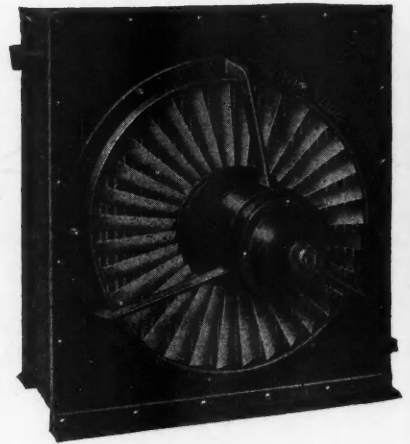

This Unit System of Heating and Ventilating Can Be Installed in Both New and Old Buildings.

TRUSCON PLATE GIRDER JOISTS

for Greater Safety and Economy

THE DESIGN PROVIDES:

Firesafe Floor Construction for Light Occupancy Buildings.

Permanent Floors. Verminproof Floors.

Favorable Cost. Soundproof Floors.

Less Dead Weight. Speed of Erection.

The Most Simple Construction.

Easy Inspection.

A Great Reduction in Supporting Beams and Columns.

Erection as Safely and Easily in Winter as in Summer.

Elimination of all Form Work.

Fewer Elements of Chance in Field Labor.

Erection of Any Number of Floors at One Time.

Minimum Planking.

Simplification of Field Equipment.

Substantially Reduced Cartage and Freight Costs.

Working Platforms for Construction Above.

Storage Space for Construction Materials.

Easy Installation of Plumbing and Electrical Equipment.

A Saving in Construction Time.

Shipment of Proper Lengths, Ready for Installation.

Holes, 2"x4"—24" on Centers, in Standard Sections, for the Passage of Flexible Wire Conduits and Pipes.



Truscon Plate Girder Joists mean utmost economy in all light-occupancy construction.

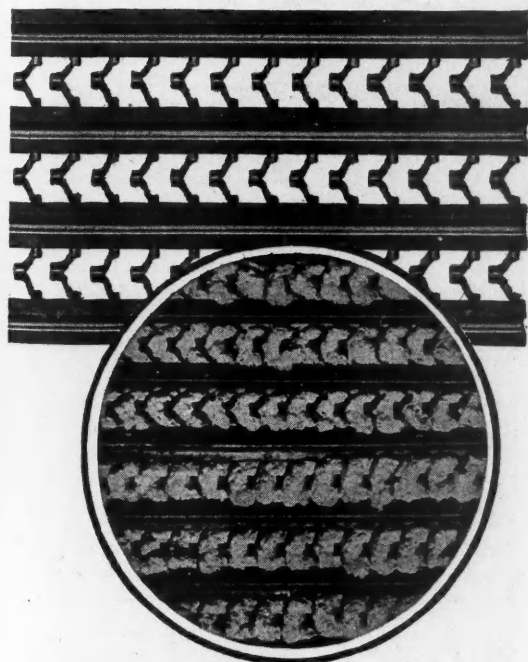

TRUSCON METAL LATH

Contractors and builders everywhere favor Truscon Metal Lath because it can be plastered faster and with less labor. Its small mesh and plaster gripping "key" form a perfect bond, save plaster and make a better job. Truscon Metal Lath means fire-resisting plastered walls of greater rigidity with freedom from cracks and lath marks—all qualities that build permanent owner satisfaction.

Write for catalog and information
sent free on request.

Note how thoroughly the plaster penetrates and locks around the metal "keys" of Truscon Metal Lath. This means utmost permanence.

TRUSCON STEEL COMPANY, Youngstown, Ohio

Warehouses and Offices in all Principal Cities.

WHEN WRITING ADVERTISERS PLEASE MENTION THE AMERICAN BUILDER

Flush Type Doors Now Made with Sound Insulation

ONE of the most outstanding improvements in door construction, in recent years, has been the flush type of door. Its smooth, plain surface, without recesses, panels or mouldings, offers no place for dirt to collect, a sanitary feature which also greatly reduces the work of cleaning. There has now been developed a patented, hollow panel construction providing a sound insulation feature which, combined with the advantages of flush door construction, produces a door of especial value for apartments, hotels, hospitals, schools, residences and other buildings where it is necessary or desirable to reduce sound transmission to a minimum. The insulating qualities of this door have been verified by tests conducted by Dr. Paul E. Sabine, the well known acoustical expert, at the Riverbank Laboratories.

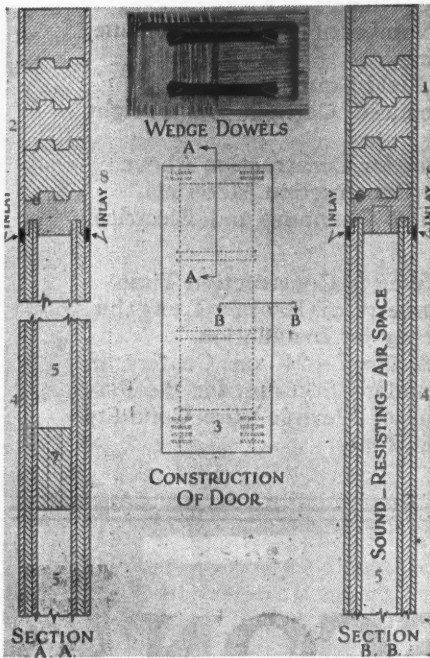

Sectional Views Showing the Construction of the Insulated, Flush Type Door.

Nor is this installation an expensive matter for the door can be purchased at about the same price as the ordinary type of flush door.

This door weighs only two-thirds as much as the ordinary flush door, hence is easy and economical to fit and hang and effects a substantial saving in freight. That it will not warp or crack has been demonstrated by long practical use as well as practical factory tests. It can be obtained in practically any combination of woods and is

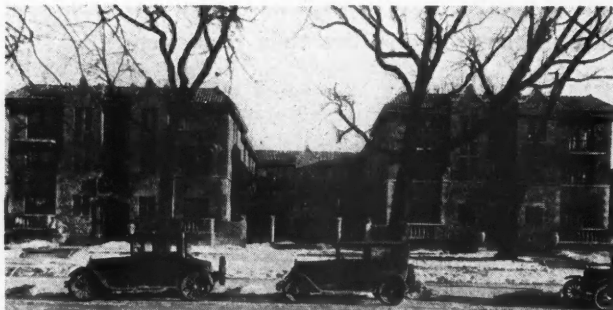

The Rasmussen Apartments, in Oshkosh, Wisconsin, in Which Insulated, Flush Doors Were Specified by the Architect, Russell Barr Williamson.

regularly manufactured in all standard sizes. It may also be obtained with any arrangement of glass openings and with a full length mirror in one side.

A beautiful inlay is furnished in any wood desired though, unless otherwise specified, the combinations which make the best appearance, according to the experience of the manufacturers, are furnished. These combinations are: black walnut inlay with plain red or white oak, quarter sawed red or white oak, brown ash and calico ash; ebony inlay with unselected gum or birch, Philippine or African mahogany; white maple inlay with selected red gum and red birch.

The construction of this door is plainly shown in the drawing which is reproduced here. It consists of two verti-

(Continued to page 220)

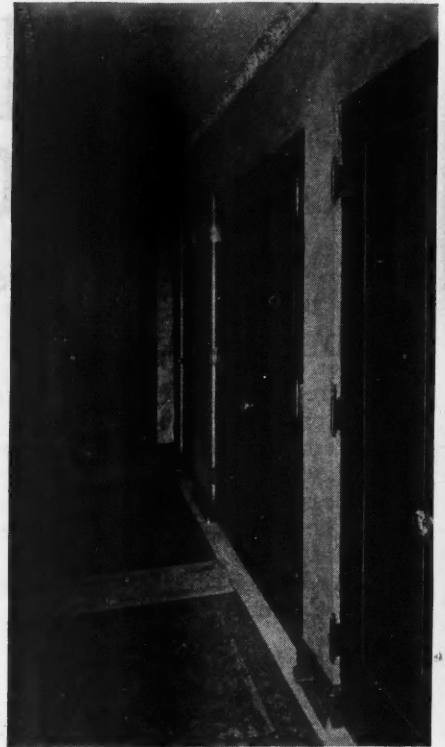

Though These Apartment Doors Are Very Close Together the Use of the Insulated Doors Eliminates the Transmission of Disturbing Noises.

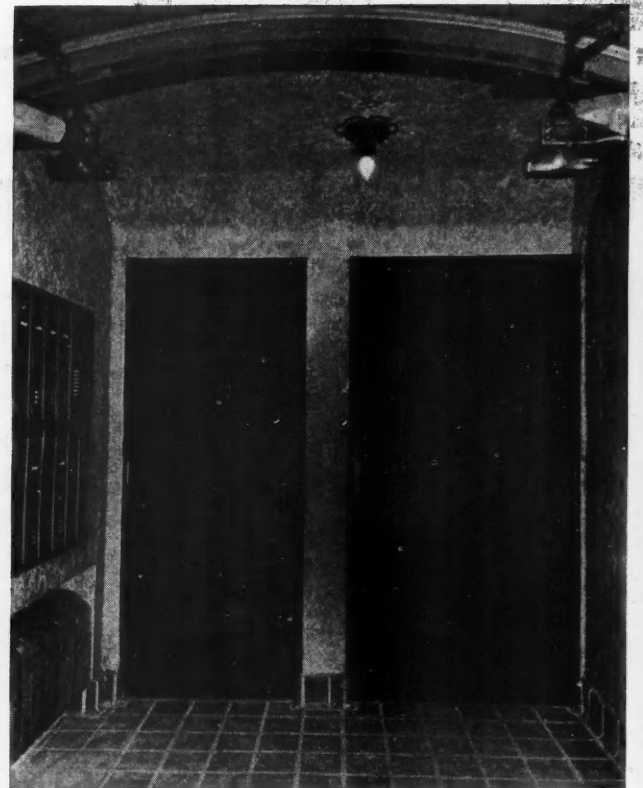

Insulated Entrance Doors in the Rasmussen Apartments Exclude Much of the Street Noise Which Ordinarily Enters Such Buildings.

Us
thi
Co



Living-room . dining-room . sun-parlor

of this \$18,000 Detroit Model Home
(of the Home Owner's Service Institute)

equipped with Riddle Fitments for

\$81.50 RETAIL COST
(less builder's discount)

The Riddle installation in these three major rooms of the Detroit Model Home includes three hanging pieces and three wall brackets. Although the total cost was so low, no effort was made to confine the installation to the lower-priced Riddle Fitments. The selection for each room was made on its merits. The dining-room fitment, for instance, is one of the higher-priced Riddle pieces. And yet the entire cost (at retail) figured only \$86.00, the cost to the builder being further reduced by his special discount.

Ideal for builder's requirements

Riddle Fitments represent the greatest values available in home lighting equipment, plus established reputation that means something to the buyer of your homes. Styles designed especially to meet builders' needs. Prices that permit fine installations at remarkably low cost. Send the coupon below for catalogue with prices.

TOLEDO LIGHTING FITMENTS, RIDDLE-MADE

Living and dining-room outfits as low as \$22.50 retail

Toledo Lighting Fitments, Riddle-made, are specially designed for important home development projects where only a small allowance is available for lighting equipment. Riddle quality throughout, backed by the Riddle name. Five-light pieces, \$12.50 to \$17.50 retail; brackets \$4.50 to \$7.00 retail; all less builder's discount.

THE EDWARD N. RIDDLE COMPANY, TOLEDO, OHIO

E. N. Riddle
DECORATIVE LIGHTING FITMENTS

Here are shown the six fitments used in the three major rooms of the Detroit Model Home—three hanging fitments and three wall brackets. The entire Riddle line offers a wide choice of equally pleasing styles at equally underate—and even lower—cost. All pieces subject to builder's special discount.

The Edward N. Riddle Company, Toledo, Ohio

Interested in knowing more about your builder's proposition. Please send catalogues checked.

Riddle catalogue

Toledo catalogue

Name _____

Address _____ City _____ State _____

Intend to build about _____ homes _____ apartments in 1927.

Use
this
Coupon

(Continued from page 218)

cal stiles (1), a top rail (2), and a bottom rail (3), all of which have vertical grain veneers. The entire door is vertical grain and panels on each side of door (4) are flush with the surface of stiles and rails.

There is a dead air space (5) between the panels, which acts as a sound resisting medium.

The outside edges of the panels are tongued and grooved (6) into the stiles and rails and the backs of the panels are securely glued to separating strips (7) which are mortised into the stiles, giving added strength to the door.

The joint between the outer edges of the panels and the inner margins of the stiles and rails is covered with a decorative inlay strip (8) 5/16 inch wide. This beautiful inlay strip on each side of the door is an essential and outstanding feature.

Panels are 1/2 inch laminated. Stiles and top rail, 5 1/2 inches wide; bottom rail, 12 inches wide; separation strips, 1 3/4 inches wide; veneers, 1/8 inch thick before sanding.



Windows That Swing and Slide

SAFETY, convenience and economy of installation and operation are features of a swing-slide window system which is attracting attention in the building field. This



Here Is a System of Window Installation Which Permits the Window to Either Slide or Swing.

system adapts a standard sash to a special hinge, enabling windows to be swung readily for washing the inside. Beside eliminating the expense of life hooks, and belts and the dangers of old style window cleaning, the makers of this equipment claim a saving on millwork and the labor of installation and weather-tight qualities superior to those of ordinary casement windows.

The equipment consists of two-die-made, metal channels set in one side

of the window frame and, set in the channels, special hinges to which the sash are attached by screws. The hinges are so set that, by a simple and easy movement, either window may be swung into the room for cleaning. The installation may be made for windows to swing either right or left as conditions require. Full screen ventilation for dwellings, offices or other buildings, is possible.

This window operates quickly and easily in any kind of weather and no special hardware, aside from that noted, is re-

quired, all standard sash being used as in ordinary work. Not only is risk avoided in the washing of these windows but there is a saving of time said to amount to from 30 to 40 per cent. The windows slide up and down just like any other window but weights, ropes and pulleys are eliminated on one side.



A Powerful Door Check

THE illustration shows a sectional view of a door check which, it is claimed by the manufacturers, is the most powerful check, size for size, of any on the market. Its construction is simple and it is reliable and easily applied.

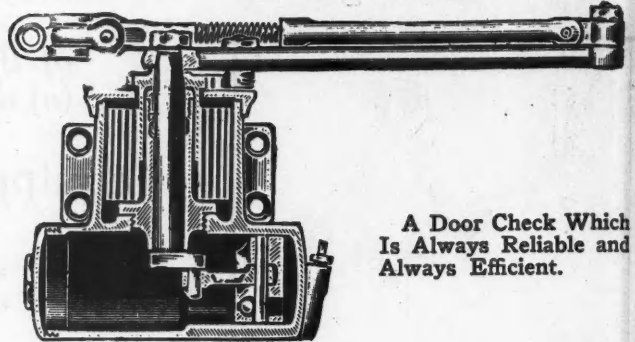

A Door Check Which Is Always Reliable and Always Efficient.

It has accurate adjustments by side screw and also by lever. Brackets and spare parts are kept always on hand by the manufacturer so that 100 per cent service is always available.

This check is made in six sizes for all kinds of doors; No. 1, for light and screen doors; No. 2, for light doors up to 3 by 7 feet; No. 3, for vestibule doors 2 1/2 by 7 feet; No. 4, for heavy vestibule doors 3 by 7 1/2 feet; No. 5, for heavy doors not exceeding 4 by 7 1/2 feet; No. 6, for heavy duty doors. All sizes have a fine bronze finish.



Complete Line of Winches

WINCHES are now being used where they were not thought possible of use in the past and are being manufactured to meet any particular requirement which may be placed upon them. One manufacturer offers a very wide range of styles and sizes one of these styles being shown in the illustration. As may be seen this style of winch is made in six different sizes. The largest winch in this series is equipped with an extra heavy set of gears so that two speeds are obtained, one speed for raising light loads and lowering heavy loads and the other for raising heavy loads.

This two speed provision is offered regularly only on the largest of the winches shown but if desired it can be had on the other sizes at a small additional cost. All of these winches have machine cut worms and worm gears.

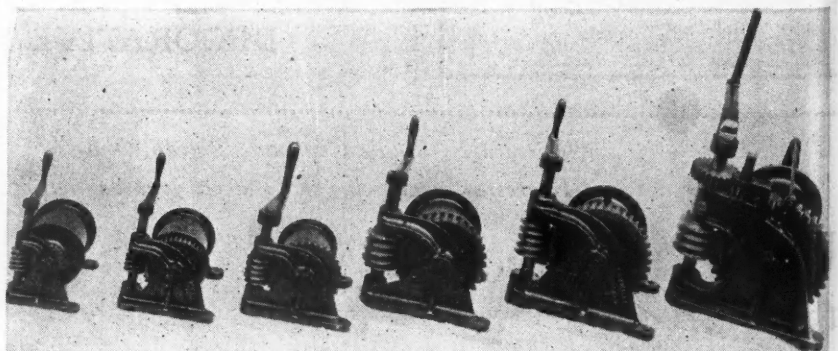

Here Are Six Sizes in This Style Winch Which Is One of a Wide Range of Styles Made by a Leading Manufacturer.

CABOT'S "QUILT"

Will Save This Heat

One layer of "Quilt" will stop as much heat as 28 to 40 layers of cheap building paper! One layer is equal to nearly four inches of solid wood, or nearly twice that thickness of brick wall.

The picture of this house below and the letter from the owner shows that Cabot's Quilt pays for itself in reduced heating equipment, and then continues to pay for itself every few years in reduced fuel bills.

The late Charles P. Steinmetz said:
 "Our present structures are causing annual leakage costs of literally hundreds of millions of dollars' worth of heat. The seriousness of this loss economically is not realized because it is not actually missed and cannot be specifically appreciated. But the loss is there, and it looms as a serious problem."

**"25% Reduction in Amount of Radiation"
 "Fuel Consumption Greatly Reduced"**

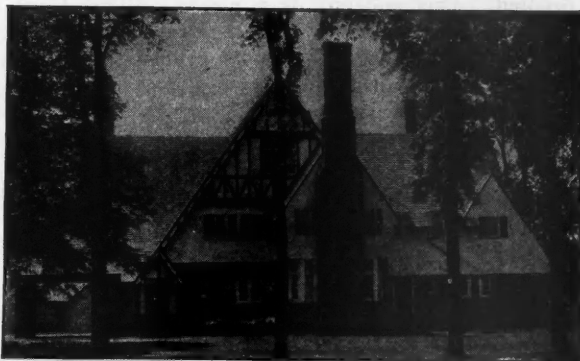

Residence of Frank Lewis, Truro, N. S.
 Andrew R. Cobb, Architect, Halifax

"Results obtained were greater than anticipated. A reduction of 25% was made in the amount of radiation specified by the heating engineers and the fuel consumption was greatly reduced over the original estimate. The results were so satisfactory that this construction has been obtained by us for all heated buildings that we might be building and we used it with the same pleasing results on a factory building."

Frank Lewis

Vice-President, Eastern Hat & Cap Mfg. Co.
 Truro, N. S., Dec. 7, 1926.

A smaller heater and less coal, and a comfortable house with no cold walls or cold drafts across the floors, are what you get for your money when you insulate houses with Cabot's Quilt.

How can you render better service than this to make your clients loyal?

Cabot's Quilt is not only the pioneer and the standard of heat-insulating efficiency, but it has every other necessary quality for a sound building material: It will not get foul or rot, nor harbor insects or vermin; it will not burn, but makes a good fire-resistant; it is flexible, and will fit any surface or around any turn.

Sample of Quilt and illustrated catalog showing methods of application sent free

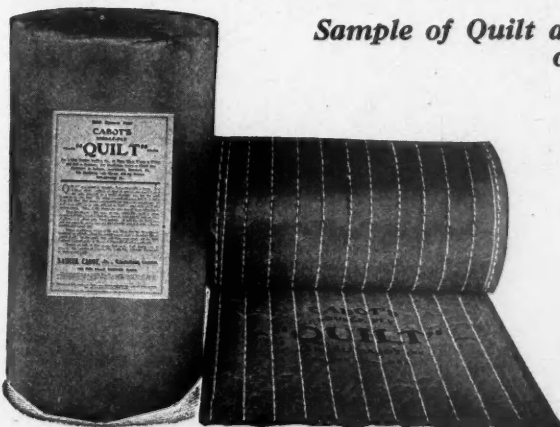

Samuel Cabot

Incorporated

Manufacturing Chemists

BOSTON, MASS.

342 MADISON AVE. -- NEW YORK

5000 BLOOMINGDALE AVE., CHICAGO, ILL.

Philadelphia, Kansas City, Minneapolis, Los Angeles,
 San Francisco, Portland

Manufacturers of the celebrated Cabot's Creosote Shingle Stains,
 Old Virginia White, Double-White, Waterproof Collophanes, etc.

Doubly Strong Folding Rule

THE illustration shows a new type of folding rule. The special feature of this rule is its double strengthened joint which is the result of a long period of experimenting on the part of the manufacturers who are well-known



Double Tubular Riveting Makes This Rule Exceptionally Strong.

makers of rules. The clamps are first riveted together with a tubular rivet. Then the wooden sections and the clamps are riveted jointly with another tubular rivet. This makes a joint which is practically indestructible and the rule can be twisted without breaking the joint. The tubular rivet also serves as a striking plate. This rule is finished in either yellow or white enamel and marked in consecutive inches, to sixteenths, on both sides. It comes in lengths from 3 to 8 feet.

Furnace Draft Regulator

THE appliance shown in the illustration is a simple device for heat regulation which can be used with any ordinary furnace. It consists of a small but accurate thermometer neatly mounted in the wall. On the back of the mounting there is a metal slide to which the furnace drafts are attached. By means of a handle at the bottom of the mounting this slide can be moved up and down and is marked "On," "Half" and "Off," indicating the amount of opening of the draft. With this installed in a home the owner can always be sure that he is regulating his furnace in accordance with the temperature requirements.

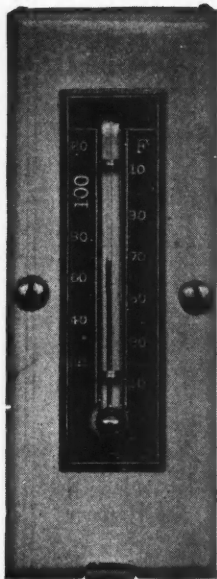

A Simple Draft Regulator to Control the Furnace Heat.

In addition he can do the necessary regulating without making trips to the basement to open or close the drafts.

Hollow Gypsum Section Construction

AFTER seven years of experimentation a method has been developed whereby gypsum, one of the old basic building materials, is now available in hollow shapes and sizes which permit its use, economically, in all classes, types and sizes of buildings. One year of practical application, it is said, shows that this product not only reduces materially the cost of fireproof construction, but at the same time increases the quality, permanence and value of the building.

This new product is cast 13 feet long and in thickness ranging from 3 to 8 inches and width from 6 to 18 inches. There are three distinct divisions of the product: interior partition sections, floor sections and outside wall sections, all of which are considerably lighter per square foot than other products serving a similar purpose.

Partitions are erected vertically, being held together by a tongue and groove lock and are wedged firmly in place. Floor sections are laid with a minimum of form work in practically the same manner as tile. Exterior wall

sections are erected vertically and supply the only needed form for concrete.

The speed with which this material may be erected is due to the amount of floor or wall surface that is laid in one piece. For example: in a wall 10 feet high a man will put up a piece 10 feet long, 4 inches thick and 12 inches wide, making a total of 10 square feet of wall, in one operation. The tongue and groove principle, which is applied to all wall sections, brings them into very accurate alignment and allows a minimum of plaster to be used.

With this material the floor construction is the same type as that employed when hollow tile is used, with the exception that this new gypsum product eliminates all decking, provides the form for the concrete and acts as the filler between the concrete joists at the same time. This method also is advantageous in that a smooth ceiling, which will bond well with plaster, is formed by the under side of the floor section. In cases where this material is used as a floor or ceiling over a garage or for some similar purpose, it is not necessary to plaster as a smooth, white ceiling is already in place.

After the first floor is poured the outside wall sections and interior bearing wall sections are placed thereon. This is done by lightly nailing the sections to stringers until steel can be placed and concrete poured into the indicated openings. In the average residence it is only necessary to pour concrete on each side of each opening. Thus it can be seen that again the gypsum acts as both the form for the concrete and as a filler in the wall.

Exterior walls have a dovetail undercut and are waterproofed. This undercut is a mechanical bond for stucco or for the mortar in laying a brick veneer. Any desired outside finish, however, may be applied inasmuch as this product nails, planes and saws. The partitions are placed after all floors, bearing walls and exterior walls are in place.

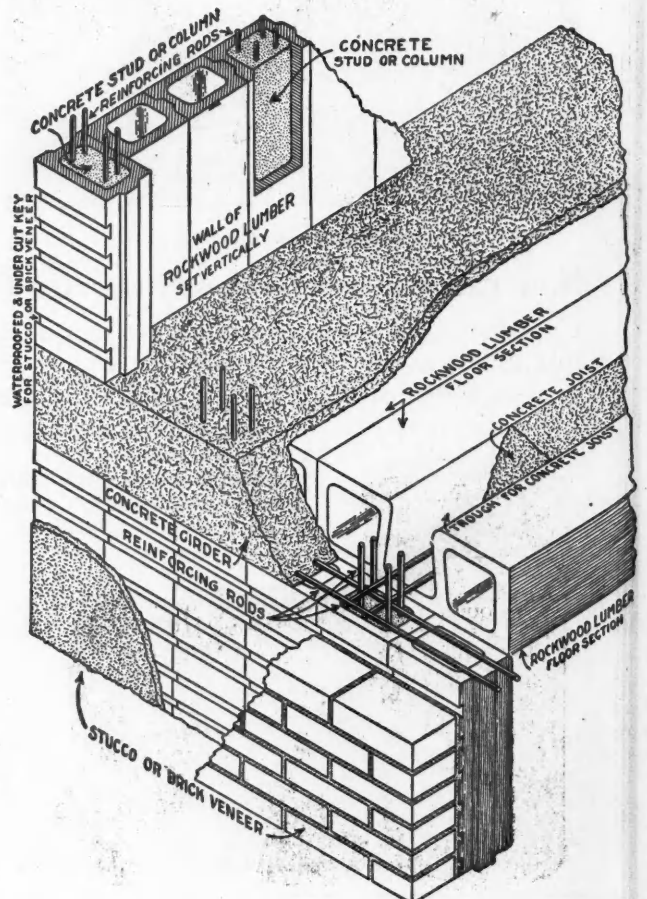

Here Is the Way in Which the Various Shapes and Sizes of the New Gypsum Unit Are Used in Construction.

ected is
t is laid
n a man
2 inches
in one
which is
accurate
sed.

ne same
with the
ates all
acts as
e time.
ceiling,
e under
terial is
r some
smooth,

ections
hereon.
ringers
nto the
is only
pening.
s both
ll.

water-
stucco
desired
as this
placed
place.

LUMBER
SECTION

es of

No DULL SEASONS

For You if You Are a Floor Sur- facing Contractor



Floor surfacing has grown to be a big business. It is clean, healthy—always inside.

It is independent of weather conditions—there are no dull seasons.

No large capital is required. One man and one machine can easily average

\$20 to \$40 a Day

And there is always plenty of work. Every new floor has to be surfaced. Thousands of old floors need resurfacing.

American Universal FLOOR SURFACING MACHINE

electrically operated, does the work of six hand scrapers—does it better and faster.

No special training is necessary. Any man who is willing to work can build for himself a substantial, permanent, money-making business as an American Floor Surfacing Contractor. This is a real opportunity. Let us send you complete information. Mail the coupon today.

The American Floor Surfacing
Machine Co.

515 South St. Clair Street, Toledo, Ohio

Please send me full information about the "American Universal" Floor Surfacing Machine.

- I am a building contractor.
- I am interested in becoming a floor surfacing contractor.

Name

Street

City.....State.....

Improved Saw Filers

A WELL-KNOWN manufacturer has just announced a new model power drive, automatic saw filer and a new model hand drive, automatic saw filer. These machines have been produced after months of research and testing under all possible conditions and are said to represent a marked advance in the art of saw filing. Many new features of importance have been added and every detail is designed for accurate work and long life.

A new and scientific principle in saw filing is an outstanding feature of these machines which automatically joint the saw while it is being filed. By this

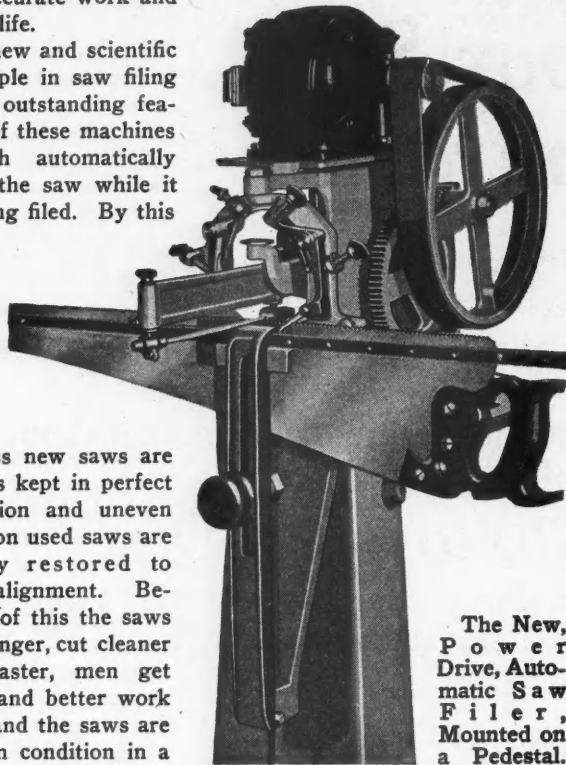

The New, Power Drive, Automatic Saw Filer, Mounted on a Pedestal.

process new saws are always kept in perfect condition and uneven teeth on used saws are quickly restored to true alignment. Because of this the saws last longer, cut cleaner and faster, men get more and better work done and the saws are kept in condition in a fraction of the time required for hand filing, it is stated.

It is claimed that the new power model is the only machine which will file all types of saws. It handles cross-cut and rip, back, mitre box, panel, meat and other hand saws. It files band saws up to 4½ inches wide and circular saws (cross-cut or rip) up to 16 inches in diameter, and any number of points per inch from three up. The new hand drive model will handle all hand saws and band saws up to 2 inches wide but not circular saws.



Portable Draft Gage

A SMALL, compact, rugged, portable draft gage, specially designed for portable testing purposes, has recently been placed on the market by a leading manufacturer of combustion instruments exclusively. This gage is made of polished aluminum and has been especially designed for easy portability. It weighs only 1¾ pounds, complete with case, and measures only 4 by 9 by 1¼ inches.

The scale has a range of ½ inch water and is calibrated to read in hundredths of an inch or in millimeters. The straight glass indicating tube is held without strain by means of compression nuts and special cork washers, one end of the tube connecting with an accurately machined brass oil chamber and the other end with a brass vent. All liability of breakage is thus overcome.

This gage possesses a number of refinements which appeal particularly to those making tests under varying conditions. A removable and adjustable supporting foot is provided for leveling the gage quickly on a box, shelf, table or any flat surface. If preferred the gage can be

mounted on a wall, using the knurled screw which is furnished.

The movable scale facilitates zero adjustment. A needle valve locks the oil in the oil well so that the gage may be carried in any position and quickly placed in service.

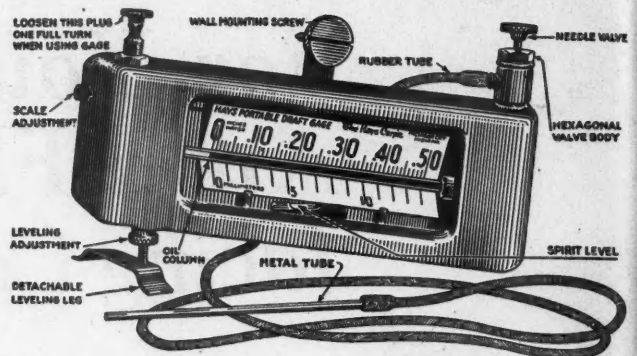

Here Is a Very Compact and Rugged Draft Gage for Portable Testing Purposes.

The case is of such size that the gage cannot be inserted until this needle valve has been closed, making it fool-proof.



Spring Sash Sustainers

WEIGHTS, pulleys and cords are no longer necessary for sliding sash windows if the sustainer shown in the accompanying illustration is used in their place. Two of these sustainers will hold one sash weighing not more than 18 pounds—if the two sash are of light weight, only two sustainers are required, one on the right of the lower sash and one on the left of the upper sash.

These sustainers consist of a spring of specially tempered spring steel, roller of cold rolled steel and pivots of bronze. With the exception of the bronze pivots, the entire fixture is thoroughly electro galvanized. The cost of this device is placed at about one-half to two-thirds the cost of ordinary double hung window equipment and the labor of installing is only one-half that for the ordinary equipment. Because of the small weight and bulk, the cost of handling and storage is greatly reduced over the old equipment.

It is claimed that this sustainer will entirely eliminate the rattling of sash and it makes possible a plank frame construction and narrow mullion. By the use of plank frames the interior trim may be reduced to 2 inches by 2½ inches in width, which is both economical and architecturally desirable.

A mortise ⅞ inch wide, 1¼ inches deep and 4 inches long is cut in the sash opposite, or slightly above, the center. The spring is set flush with the surface of the sash. If additional tension is required it is provided by slightly loosening the upper screw "A" and elevating the lower screw "B," which is an adjusting screw, and then again tightening the upper screw.

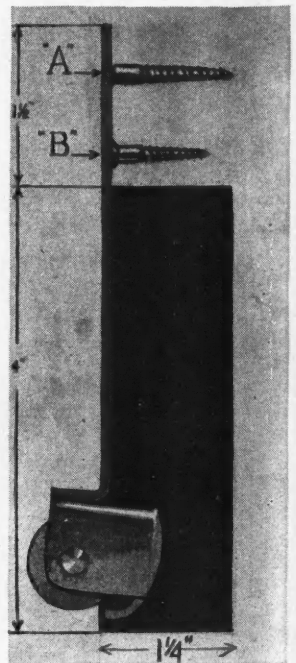

A Sash Sustainer to Replace Ropes, Weights and Pulleys.

FREE BLUE PRINTS

AND FREE BOOK "HOW TO READ BLUE PRINTS"

Show You The Way To

9 BIG PAY JOBS

- | | |
|---|--|
| 1 Building Superintendent—\$5,000 to \$12,000. | 6 Building Estimator—\$6,000 to \$10,000. |
| 2 Building Inspector—\$4,800 to \$8,000. | 7 Real Estate Expert—\$5,500 to \$12,000. |
| 3 Appraiser—\$6,000 to \$10,000. | 8 Construction Foreman—\$4,500 to \$8,500. |
| 4 Material Buyer—\$5,000 to \$7,500. | 9 CONTRACTOR AND BUILDER IN A BUSINESS OF YOUR OWN—\$5,000 to \$12,000. |
| 5 Material Salesman—\$5,000 to \$12,000. | |

FIND OUT HOW
Easy it is to Make
\$4,500 to \$12,000 a Year

Learn to read Blue Prints this amazing new way! See how quickly and easily you can train to make \$4,500 to \$12,000 a year! My FREE Blue Prints and big FREE Book "How to Read Blue Prints" disclose all the so-called "mysteries" of Blue Print Reading—also give some startling facts about the nine best jobs in America—jobs open only to men who can read Blue Prints. Don't send one penny—just mail the coupon!

NO longer need you spend years trying to pick up the "mysteries" of Blue Print Plan Reading—for now a quick, sure practical method has been perfected that has made thousands of men Blue Print Experts in a surprisingly short time.

THE SECRET OF BIG MONEY

This is no ordinary "school course." It is practical from start to finish. It is based on many sets of real Blue Prints—plans that would cost thousands of dollars if purchased from the architects. Twenty famous experts in all lines of construction work talk over these Blue Prints with you in plain, simple language. Show you every detail. Explain every short cut. Tell you the "secrets" of quick, accurate estimating. Explain superintending. Give you for the first time many inside facts and money-making methods used by the "giants" of the Building Industry."

IF YOU LIVE NEAR BY

Visit our big day or evening school attended by over 1,000 Builders. You can get the same training at home by mail—same plans, lessons and instructor. Your spare time is enough.

NO EDUCATION NEEDED

This is the kind of training that quickly puts men into \$4,500 to \$12,000 a year jobs—or into profitable contracting businesses of their own. Yet now you get it right at home in only 2 or 3 months. It requires no extensive education. If you can read and understand what is written here you can easily master it.

See what this training has done for others: Bartholomew, Calif., became a contractor at an increase of over 300% his first year; Blair, Okla., stepped up to Superintendent at 100% increase; Dickerson, R. I., increased his salary 700% in 12 months; Marchand, La., says: "My income has increased 200% and I now have more contracting work than I can do."

AMAZING OPPORTUNITIES

Over seven billion dollars will be spent this year in new construction! No wonder, then, such tremendous opportunities are open to you when you have this "head-work" training in Blue Prints.

If you want more money—real big money—then choose a "Blue Print" job in Building. Here is the one field where there are unlimited opportunities for advancement.

MAIL COUPON TODAY

So accept my FREE gift of a complete set of real working Blue Prints and my

fascinating Book "How to Read Blue Prints" that tells all the interesting and instructive facts about Blue Print Plans. Don't send one penny—pay no C. O. D.—it's all FREE. Just fill out and mail the coupon today—NOW!

TWO BOOKS also FREE

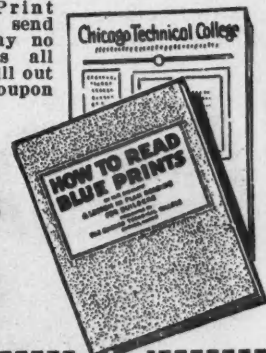

Chicago Technical School for Builders, Dept. B-120, Chicago Tech. Building, 118 East 26th Street, Chicago, Ill.

Please send me your free book "How to Read Blue Prints," and complete set of real Blue Prints. I understand these are mine to keep without obligation. It is also understood that no salesman will call on me.

Name.....
Address.....
City..... State.....

Chicago Technical SCHOOL for BUILDERS



Dept. B-120, 118 East 26th Street, Chicago, Ill.

WHEN WRITING ADVERTISERS PLEASE MENTION THE AMERICAN BUILDER

Permanent Electric Radiator

THE electric radiator shown in the illustration is not a radiant heater but a true electric radiator suitable for permanent installation. It warms a large volume of air and is the convection type of heater, similar to a steam or hot water radiator. It is constructed of cast iron throughout and is substantial and durable and should give a lifetime of service, it is claimed.



This Electric Radiator Is Used Either as a Permanent Installation or as a Movable, Utility Heater.

The heating element is a series of flat surfaces by which air is heated in large volumes to the proper temperature for health and comfort, without overheating and drying the air. A maximum of economy is secured by means of three way

heat switch. The body of the radiator is aluminum finished. This radiator can either be screwed to the floor or employed as a utility heater to be moved about at will. It is also furnished for mounting on wall brackets. It is made in two styles, one having a wattage of 1,000, the other a wattage of 2,000. Both are 16 inches long, 14 1/2 inches high and 4 inches deep.

A Complete New Line

A COMPLETE new line of motor driven, double end grinding machines, buffing and polishing machines with open end spindle extensions, and buffing and polishing machines with encased type spindle extensions has been announced by a leading manufacturer. This line includes a floor stand grinding in five sizes, each for two grinding wheels in 7 to 14-inch diameters and 3/4 to 2 1/2-inch face.

A second type of machine is a floor stand buffing machine with open type spindle extension, made in five sizes, each with two buffing and polishing wheels in diameters of 8 to 18 inches and faces 1 to 3 inches. The last type is a floor stand buffing machine with encased type spindle extension made in four sizes, each for two wheels of 10 to 18-inch diameter and 1 1/2 to 3-inch face.

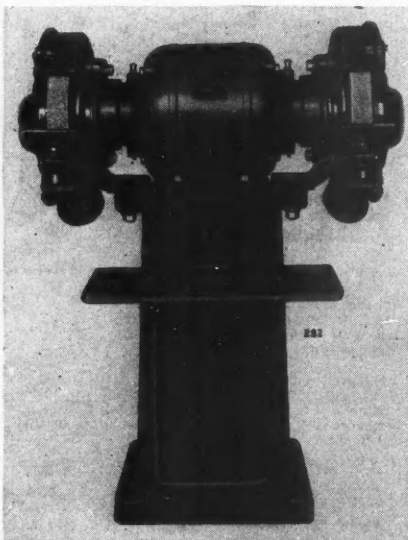

One of a Complete New Line of Grinding, Buffing and Polishing Machines.

In the first series the three smaller sizes, in the second series the two smaller sizes and in the last series the one smallest size are also made with bench base mounting. As all these machines are available for both alternating and direct current, this offers

an assortment of 42 different types and sizes of new products.

Single phase alternating current machines are equipped with improved commutating type, repulsion, induction motors which, unlike the old type split phase motor, has no dragging centrifugal switch. They will start and pick up speed instantly under any load within twice their rated capacity, the starting current under all conditions is unusually low, being less than one-third the consumption of split phase motors. Low voltage, which is often encountered due to line drop and other existing conditions which cannot always be overcome, and which is the cause of much trouble in split phase motors, has no objectionable effect on these machines. Two and three phase alternating current machines are equipped with motors of squirrel cage design. They are ruggedly built with a liberal factor of safety and reserve power. These machines are high quality product throughout.

Handy Rafter Reckoner

THE accompanying illustration shows a simple and handy rafter reckoner, for the use of lumbermen, carpenters and others, to quickly ascertain the length of material which must be purchased. It consists of a small

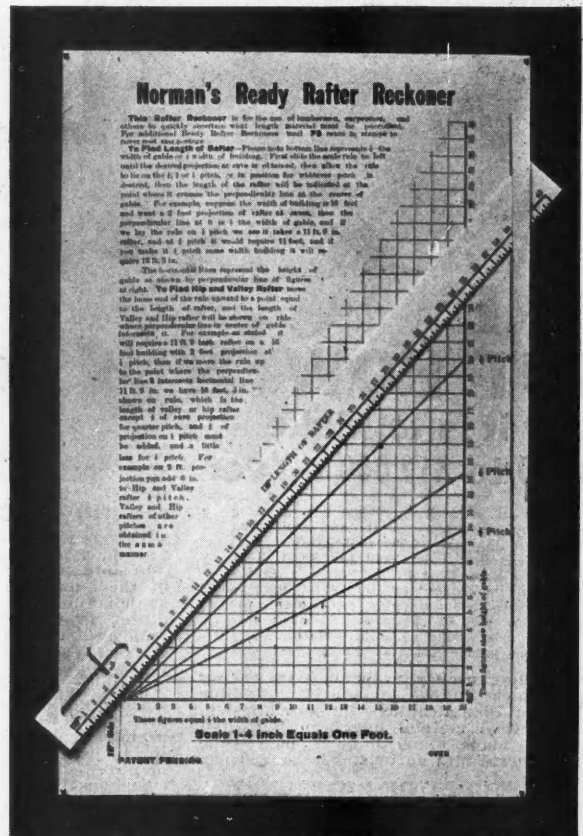

For Carpenters, Lumbermen and Others Who Order Rafter Material This Little Reckoner Is a Handy Device.

card with a slot at one side and a strip so attached that it may be swung to any desired position, printed on the card are two scales. The horizontal scale at the bottom represents half the width of the gable or building, the vertical scale at the side represents the height of the gable.

In use the scale rule is slid to the left until the desired cave projection is obtained and is then swung to the slanting line representing the desired pitch as 1/4, 1/3 or 1/2. The length of the rafter will then be indicated at the point where the rule crosses the vertical height line.

The cost of this handy reckoner is nominal. Full instructions for its use are printed on the card and it should prove a time saver for anyone ordering rafter material.

Something *NEW* in a Fireplace A Double-Barreled Message

To You Builders:

You know the trouble you have had with fireplaces—how they smoke and chill the room. Here's a new idea that saves work and worry. Make your fireplaces useful as well as ornamental. Add to your reputation as a good builder by giving the owner a fireplace that really heats and does not smoke.

There's Profit, Protection, and Satisfaction in the

The principle is similar to a warm air furnace. Made of double walls of heavy steel plate to form the side and back of the fireplace. The smoke damper is included, lending itself to perfect the down draft shelf.

Fresh air from outside enters the shell from the back. It passes around the three sides and top of the fire, takes up the heat that would have been lost up the

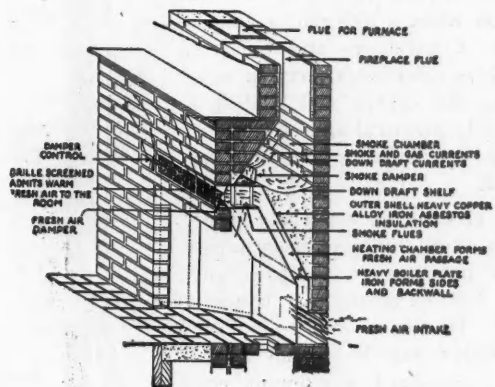

chimney and enters the room through the grille over the fireplace opening. No cold drafts. No smoke. Plenty of pure heated air.

A Government pamphlet says that of all the mistakes commonly made in home building, none is more frequent than faulty designing and construction of fireplaces. Though their use is one of the oldest methods of house heating there are few who understand the principles of their action and even experienced masons frequently fall into errors in building which seriously detract from the efficiency of the installation.

To You Home Owners:

Don't build a fireplace until you learn all about the Heatilator. It will make your new fireplace give out as much heat as range or register. Think what that means in the expense of furnace fires.

The Heatilator will heat the whole room—and without smoke. It ventilates as it heats. It's smokeless regardless of wind or weather. Saves in fireplace construction. Pays for itself in heat saved.

HEATILATOR FIREPLACE

- Throws the heat into the room
- Forces the smoke up the chimney

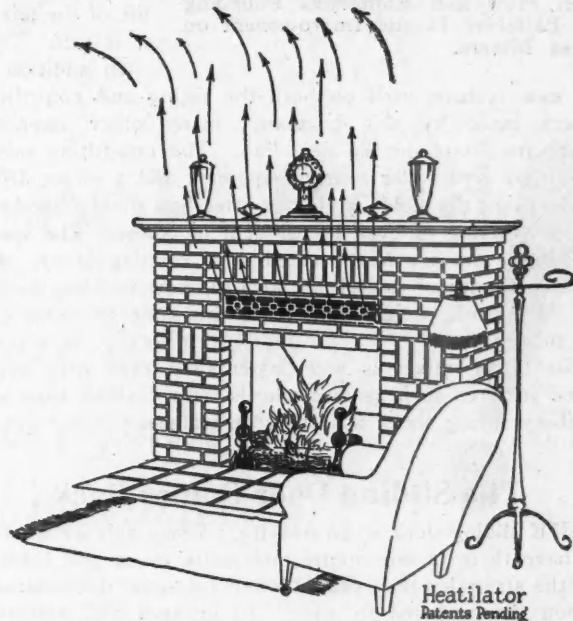

Uncle Sam says—

"All air required for feeding the fire must pass through the room, returning through cracks around windows and doors and producing an uncomfortable temperature in all parts of the room except near the hearth."



Drawing below is made from illustration in Government Farmers Bulletin.

FREE FOLDER—Write today for your free copy of "Fireplace perfection." It tells and proves the whole interesting story.



HEATILATOR COMPANY

611 Glen Ave., Colvin Sta. P. O., Syracuse, N. Y.

WHEN WRITING ADVERTISERS PLEASE MENTION THE AMERICAN BUILDER

Mixers Are Improved

NO more pounding and battering skips to pieces, no more lost time, the old curse of power loaders on all mixers, irrespective of pitch or size of throat on skip, has been overcome, says a prominent

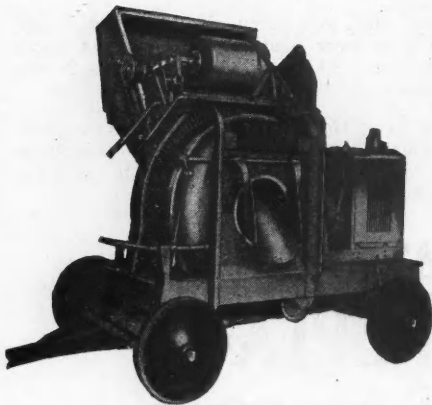

A Skip Shaker Which Maintains an Even Flow and Eliminates Pounding and Battering Is one Improvement on These Mixers.

manufacturer of concrete mixers. A new, patented shaker starts to vibrate the hopper when it is fully raised and maintains a continual flow of materials into the mixing drum. The attachment works automatically and easily increases the speed many more batches a day and adds to the life of the mixer, it is said.

In addition to this new feature, used on both the tilting and non-tilting mixers made by this company, many other improvements are found on the new line. The non-tilting mixer is 100 per cent roller bearing equipped and a direct drive, eliminating the old style countershaft and brackets, makes a saving of over 19 per cent in power. The speed reducing gears are heat treated steel running in oil. By building the mixer entirely of steel the new two bag model, for 1-2-5 work, weighs and costs the same as other one bag mixers.

The tilting mixer is now faster than ever with many added features such as disc wheels with cushion tires and auxiliary spring shock absorbers on trailers.

The Sliding Door Comes Back

THE sliding door is no novelty. Years ago we used to have them in our homes and many of us still remember the struggles they caused when for some unexplainable reason they refused to slide. In garages and industrial buildings we find the sliding door in use today and if we stop to investigate we find them entirely free from the sticking tendencies which caused so much annoyance in the bygone days.

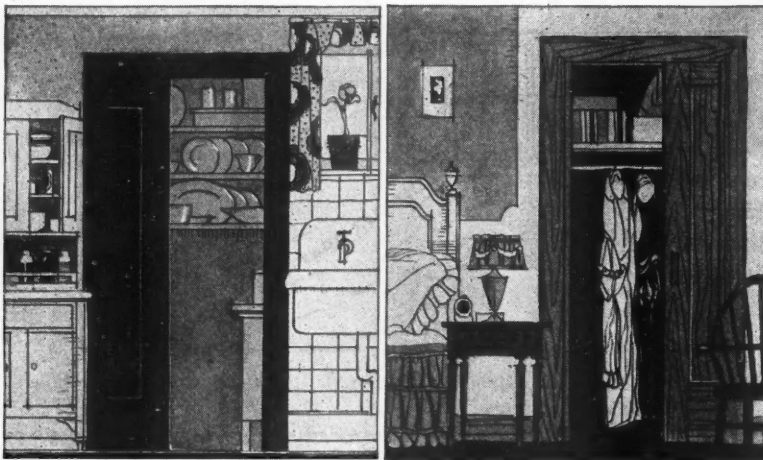

Sliding Doors with Modern, Smooth and Efficient Hardware Are Specially Appropriate for Closets and Pantries and Are Economical of Space.

The same improvements that have made the sliding door efficient and practical for garage and industrial buildings have also been applied to the sliding door for homes and today smoothly running, silent and reliable sliding doors are available. This improvement has been brought about by the perfection of sliding door hardware. The development of this efficient hardware has made the sliding door with all its advantages available for the home and there is a distinct trend toward its use today.

When one considers the waste space which results from the use of the ordinary swinging door, the advantage of the sliding or vanishing door which disappears into the wall is evident. Especially in the modern small home and smaller apartment is this saving of space an important consideration. In some cases as high as 30 per cent of the floor space can be saved by installing sliding doors.

This type of door is particularly adapted to closets and pantries making it possible to open up these storage spaces so that they can be easily gotten at and so that the fullest amount of light will reach them. Hardware is now available which will give complete satisfaction on sliding doors and the company manufacturing this hardware also offers to builders the service of its engineers.



Efficient Portable Elevator

THE illustration shows a portable elevator for hoisting material in wheel barrows or concrete buggies, which is simple and durable in construction and is easily moved from job to job, or from one place to another on the same job when a different set-up is needed. Contractors and builders, bricklayers, plasterers, cement contractors and others will find it a thoroughly practical and economical machine for hoisting and stacking material.

This elevator is especially desirable on small building jobs where it does not pay to erect a hoist tower for elevators or concrete chutes. It comes in 10-foot sections which can be added as required. Standard equipment consists of a single drum hoist with 10 feet of ½-inch cable and powered with an eight horsepower, two-cylinder engine. Its capacity is 1,200 pounds at 125 feet per minute, or a 12 horsepower, four-cylinder engine equipment with a capacity of 1,800 pounds at 150 per minute may be had. Speeds can be changed to suit the conditions of operation. The elevator comes fully equipped ready to set up for operation.

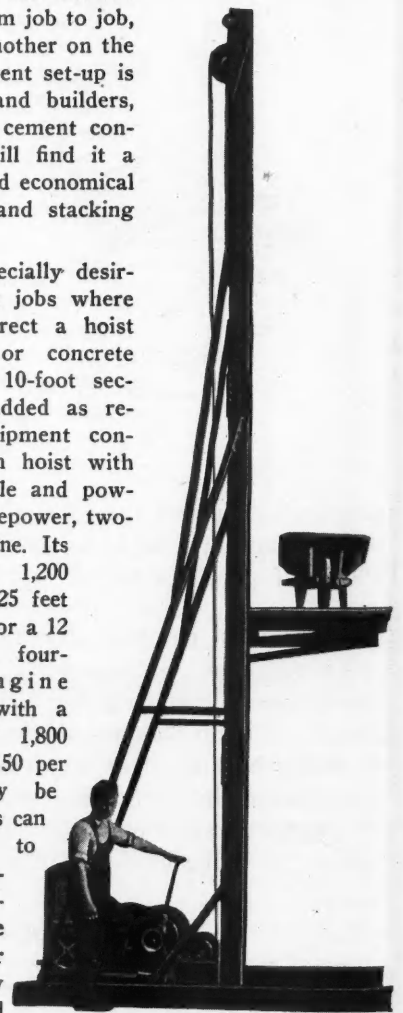

This Elevator Can Easily Be Moved from Job to Job or from Place to Place on the Same Job.

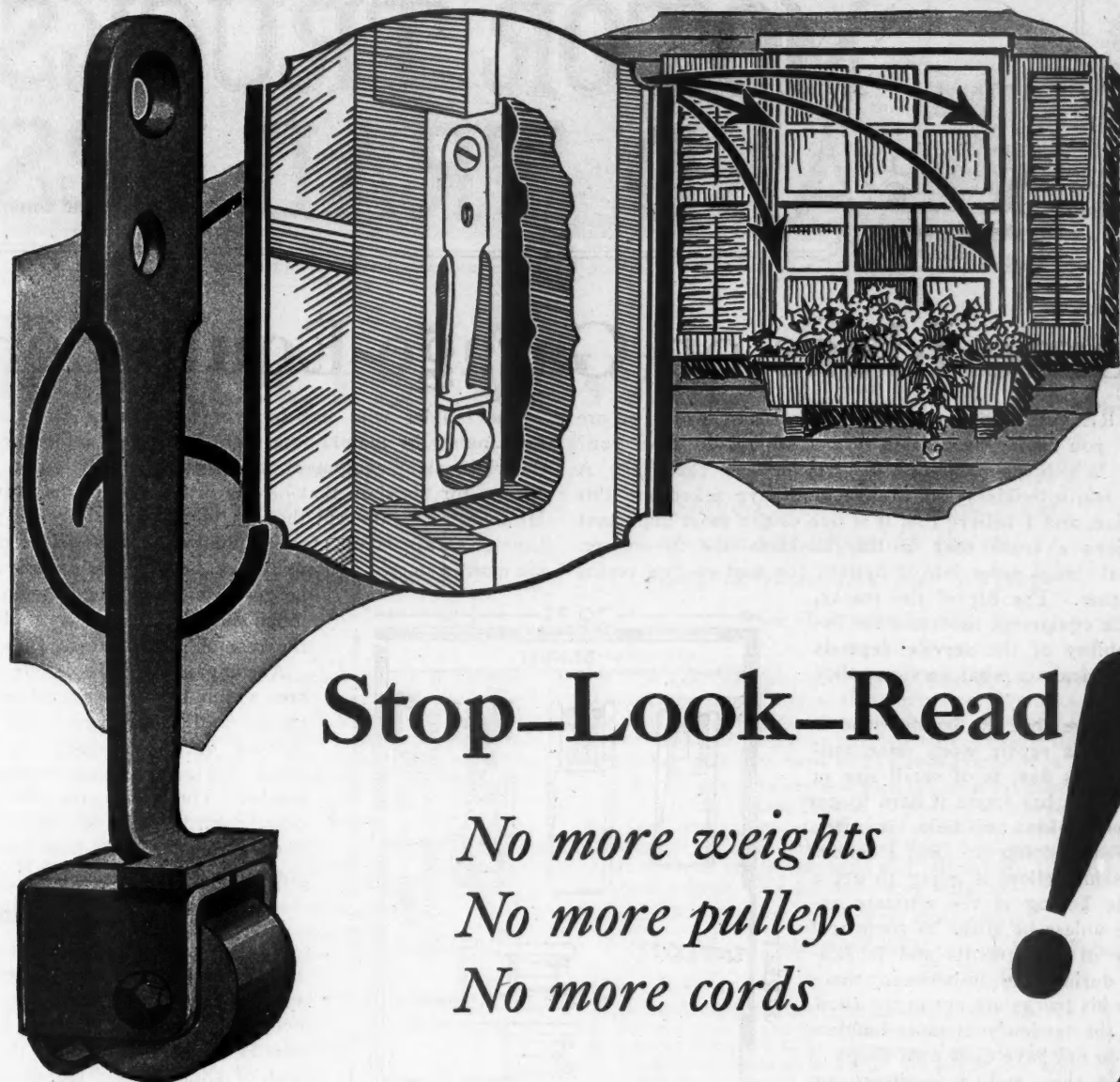

Stop-Look-Read!

*No more weights
 No more pulleys
 No more cords*

THE AUSTRAL SASH SUSTAINER

Used in City Houses, Rural Houses, Bungalows, etc.

STRONG—COMPACT—EASILY OPERATED—CUTS ONE-THIRD OFF THE COST OF YOUR WINDOWS—COSTS ONLY HALF AS MUCH FOR APPLICATION—REQUIRES ONLY HALF THE LABOR—AUTOMATICALLY SUSTAINS THE SASH IN ANY POSITION.

Here's a Big Opportunity
Over 3,000 builders are now using the Austral Sash Sustainer.

SEND FOR A SAMPLE PAIR →

WE WANT TO PLACE THE AUSTRAL SASH SUSTAINER IN THE BUILDER'S HANDS, because when he sees what it is he will appreciate its superior advantages.

Ask your mills for plank frames with sash mortised for AUSTRAL SASH SUSTAINERS and save time and money.

AUSTRAL WINDOW CO.

101 Park Avenue

New York

AUSTRAL WINDOW CO.
 101 Park Avenue
 New York

Gentlemen:

Please send me a sample pair of AUSTRAL SASH SUSTAINERS for which I am enclosing 50 cents (this covers actual production cost together with postage and handling).

Name.....

Concern.....

Address.....



MOTOR TRUCKS AND TRAILERS

Some Ideas on Garage Equipment

ARE you doing your own truck repair work, or are you having an outside service station do it for you? Which should you do? Which is cheaper? A great many builders and contractors have asked me this question, and I believe that it is one of the most important questions a truck user in this business has to answer. Several things enter into it besides the cost of one versus the other. The life of the trucks, the idle equipment time, and the dependability of the service depends a good deal on what service policy is used.

I believe that the builder who is having his repair work done outside, if his fleet is of small size or because he has found it hard to get the right kind of help, is often justified in doing so. But I believe this same fellow is going to get a terrific licking in the ultimate expense unless he sticks to some real policy of adjustments and lubrication during the in-between times when his trucks are not in the shop. It is the tendency of most builders who do not have their own shops to neglect this, and it is disastrous.

Avoid Common Mistakes

A great many builders who operate small fleets of trucks are not doing their own repair work. They take care of minor adjustments and lubrication themselves, but whenever anything serious occurs, the truck is sent to a public garage or to the truck dealer's service station. A glance at the cost records of these concerns show that this is often satisfactory, but that it is decidedly an unprofitable policy in cases where nothing is available in their own system to take care of the trucks from day to day. And these cases are surprisingly numerous.

It is only necessary to examine the policies used by the large department stores, laundries and other concerns who operate large fleets of trucks to understand the importance of this. The trucks owned by these companies are always clean in appearance, thoroughly lubricated, and given a systematic inspection. The reason for this is that these companies have found from experience that any neglect in properly maintaining the vehicles runs up into enormous sums. The man who operates a small number of trucks is no different from the department store that runs a large fleet. The principle is the same, even though the numerical side of it is different.

The builder who has four or five trucks can actually save money by maintaining them himself, provided he uses the right shop equipment, and establishes the same good system for his shop that he has in the rest of his business. He must give sufficient thought to this and study the problems of garage layout, tool equipment, and shop records. If the plan is started in a small way, he will gain experience as he goes along without expending so much time and thought as to disrupt the rest of his business.

Accompanying this article there are a number of suggestions on garage and shop layouts that have worked out successfully for concerns using a varied number of trucks. They will give the truck user, regardless of the size of his fleet, suggestions on how his own conditions can be met.

Ideal Shop Equipment

The best advice that can be given to a builder who maintains its own vehicles is that the owner, or whoever is responsible for the garage should be open-minded on the subject of shop tools. He should be perfectly willing to consider the suggestions of his shop superintendent or chief mechanic. Modern shop equipment has been so scientifically constructed that it actually saves anywhere from 20 to 50 per cent of the mechanic's time. Competition among manufacturers of shop equipment has brought the most modern devices within the reach of all truck users, so that there

is no excuse for poor or inadequate tools to work with.

The writer's experience has been that the truck users, when equipping a shop, buy their equipment too haphazardly. The result is that the most essential things are left out and many unnecessary things installed. For this reason, the following outline is suggested. It is intended to list the more important units of shop equipment as they have been found to be most helpful in the actual experience of truck users within the writer's observation.

Engine Stand—This eliminates waste motion in permitting mechanics to work from all angles. One mechanic can work on an engine without requiring another's assistance for lifting or turning over.

Lathe—For all-utility work. Rigidity is important, and lathe must have correct "swing" to be successful.

Jacks—One or more necessary for quick moving of

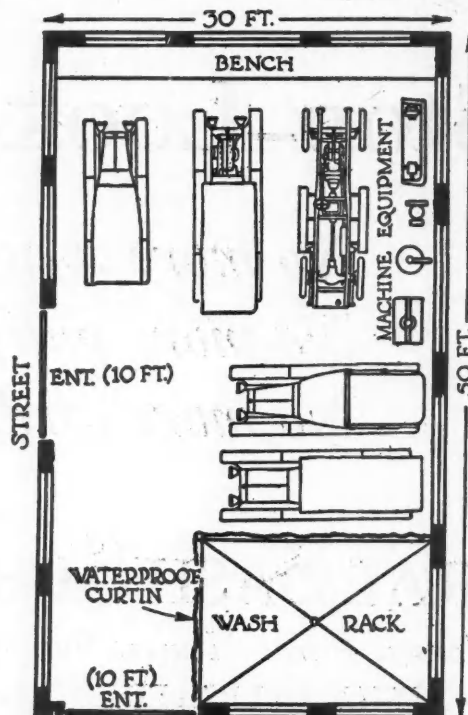

A Thoroughly Practical Layout for a Small Repair Shop with Wash Rack Included.



Four 3-ton Internationals owned by the St. Mary's Construction Company

Builders' Own Stories

"I have used quite a few trucks and must frankly admit that I have never used any make that would come up to the International."

[See illustration above]

Gentlemen:

I have got 100 per cent service out of my trucks and this service has been gotten under very rough use. The work that I have been doing with my trucks the best part of the time is about as hard on a truck as anything one can do. They have done more than I expected a truck would do. They have hauled over roads that were rough—over roads that were slippery and some of the time I have had to use a rough driver on them.

Under the above conditions the trucks have always come through with the loads. I have used quite a few trucks and must frankly admit that I have never used any make that would come up to the International.

I know anyone who buys an International Truck will say the same thing about them as I have said. The service given by the International Motor Truck Agency can not be beat, and this should go a long way in helping one to decide on the kind of a truck to buy.

Yours very truly,

ST. MARY'S CONSTRUCTION CO. by Elmer R. Jarboe
Mechanicsville, Md.

"Our Internationals are always ready to go, and they have stood up wonderfully under the steady day-in-and-day-out service."

[See illustration below]

Gentlemen:

For a concern whose slogan is, "Famous For Service," it must necessarily follow that their fleet of trucks, that chain of transportation upon which they must rely to uphold this slogan, would be selected with the same thought in mind. They, too, must be "Famous For Service."

We are proud to say that such has been our experience with the International Trucks. They are always ready to go, and they have stood up wonderfully under the steady day-in-and-day-out service. They need no attention other than the regular greasing and oiling. No tinkering or tearing down. We are more than satisfied.

Very truly yours.

FABER-MUSSER CO. by F. M. Faber
Peoria, Illinois.

International Trucks will work the same way for you. The full line includes the 3/4-ton "Special Delivery," 4- and 6-cylinder Speed Trucks for 1 1/4-ton and 1 1/2-ton loads, and Heavy-Duty Trucks up to 5-ton. We can fit your needs exactly. Write us or call at the nearest branch showroom; we now have 125 Company-owned branches in the United States

INTERNATIONAL HARVESTER COMPANY
606 So. Michigan Ave. of America Chicago, Illinois
[Incorporated]

International Harvester Trucks

The Faber-Musser fleet of Internationals. Speed Trucks shown at the right and Heavy-Duties at the left.



WHEN WRITING ADVERTISERS PLEASE MENTION THE AMERICAN BUILDER

vehicles to working position. Also used for raising rear end of truck for inspections and adjustments.

Service Rails or Racks—Used in preference to the "pit." Permits access to all parts under chassis. Better light and more working space.

Electric Drill—Replaces many old-fashioned hand tools. Allows quicker work. Adaptable to limitless jobs. Comes in large and small sizes. Most shops require both sizes.

Axle Stands—For repair work on rear axle this is essential. Should be portable and adjustable as to height.

Tire Changing Equipment—Many designs are available, most of which are practical. Permits quick removal of rims, and saves more than half the time of hand-changing.

Power Drill Press—An adjunct to the lathe. Soon earns its cost in permitting mechanics to make parts and prevents tying up job when necessary part is not available. Most shops require a drill press of sufficient size to drill holes up to 1/2 or 3/4 of an inch.

Brake Re-Lining—Many concerns find they can save several hours' time on a re-lining job of either brake bands or clutch facing with device.

Wheel Aligner—Frequent inspections should be made of wheel alignment and this device enables this to be made very quickly.

Portable Work Bench—Time is saved provided one of these, each complete with tools and working apparatus, is furnished for each mechanic. Tools can be brought alongside the job, saving considerable time.

Grinder—Can be mounted on bench or used with floor stand. Essential in many small operations. Sharpens drills, cuts tools, and provides means for finishing rough work.

Press—Helps on many miscellaneous jobs and has numerous time and labor saving attachments. Helps to remove and replace bushings and gears and in removing frozen parts.

Machine Aligner—Necessary for exactness of work on wrist pins, bushings, rods, pistons, etc. These are testing devices necessary for precision.

Hoist—This is rather a large device. Although it requires space, it enables complete motor to be removed from vehicle when necessary, and holds it clear from ground, permitting quick work. Also enables much other heavy lifting and carrying of heavy units.

Measuring Devices—For accurate work, many jobs will need any or all of the following devices, depending on the amount of work done and the character of the work:

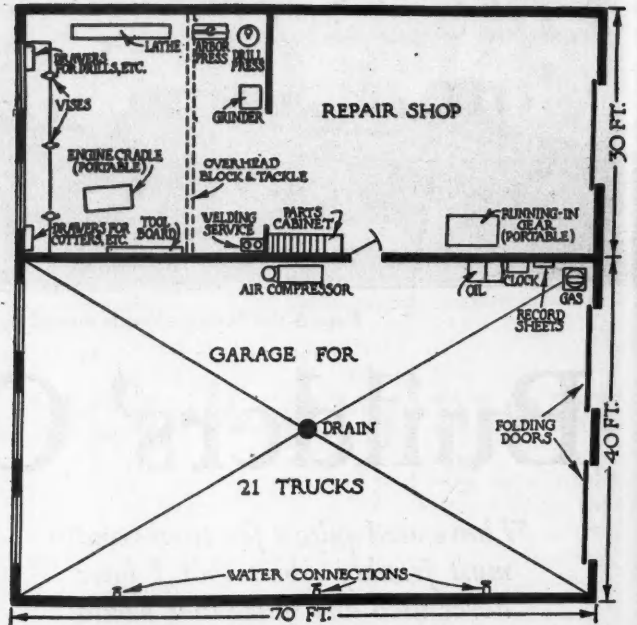

Garage and Repair Shop Combined. This layout provides garage space for 21 trucks but this portion may be altered to suit requirements.

Micrometer, calipers, miscellaneous aligners, scales, pressure and dial gauges, electric testers.

Bench Tools—Every shop needs a completely fitted work bench with commonly used tools too numerous to mention here, such as vise, bench lathe, belt lacer, valve grinder, etc.

Battery Charger—This is an inexpensive and money saving device which should be in every repair shop.

Air Pump.

Washing and Polishing Equipment.

Welding Outfit—Some concerns find it more profitable to install welding equipment than to have this done outside. Its value depends on the amount of work required of it.

Floor Crane—This apparatus is designed to be portable, permitting engine to be lifted from chassis.

Grinding Equipment—Grinders are available for various purposes, usually power-operated, for cylinders, valves, crank shaft, etc.

Burning-In Machine—A process to free tight bearing services. Practical for the Ford and other splash lubricated motors.

Tool equipment should not be purchased necessarily with the idea of price foremost in mind. Neither should tools be purchased alone from the standpoint of constant usage. Especially does this hold true of smaller tools. A few hundred dollars invested by the small fleet owner in special wrenches, micrometers, carbon and valve grinding apparatus will quickly be repaid by the reduction in help required to take care of the maintenance and repair work of the fleet, aside from the fact that more accurate work would be assured.

The writer has heard of numerous instances where the mechanics in repair shops throw up their hands in horror and in some cases refuse to work on certain trucks when they come into the shop, because of the terrible condition into which the vehicles have fallen, on account of the owners' utter indifference. Parts that are to be repaired are found to be in a frozen condition, all because of the fact that the owner has paid no attention whatever to maintenance but thinks only of the subject when a repair bill comes to his desk. It is to this truck owner particularly that we advocate the installation of a small maintenance department. The outlay would be more than repaid by the saving in time lost by sending the truck to the shop, a better check is had on a driver, and an actual saving of dollars and cents will be realized by the owner on repair work.

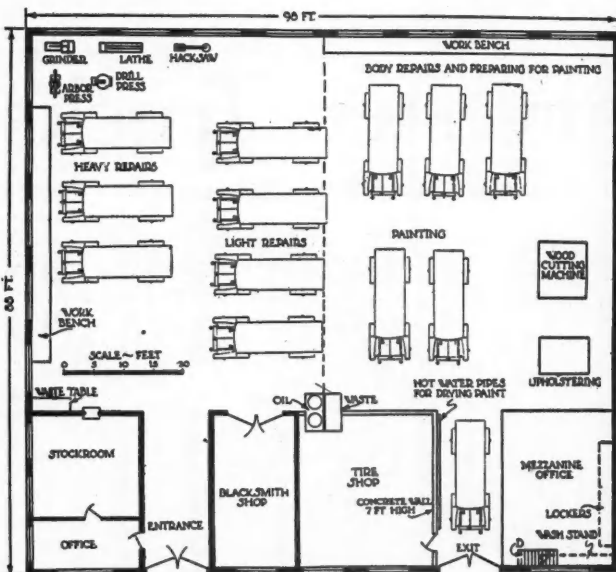

Here Is a Complete Repair Shop Including Provision for Chassis and Body Repairs, Washing, Painting, Stockroom, Blacksmith Shop and Tire Shop.

This Distinctive Residence Is Combined Spanish and Colonial

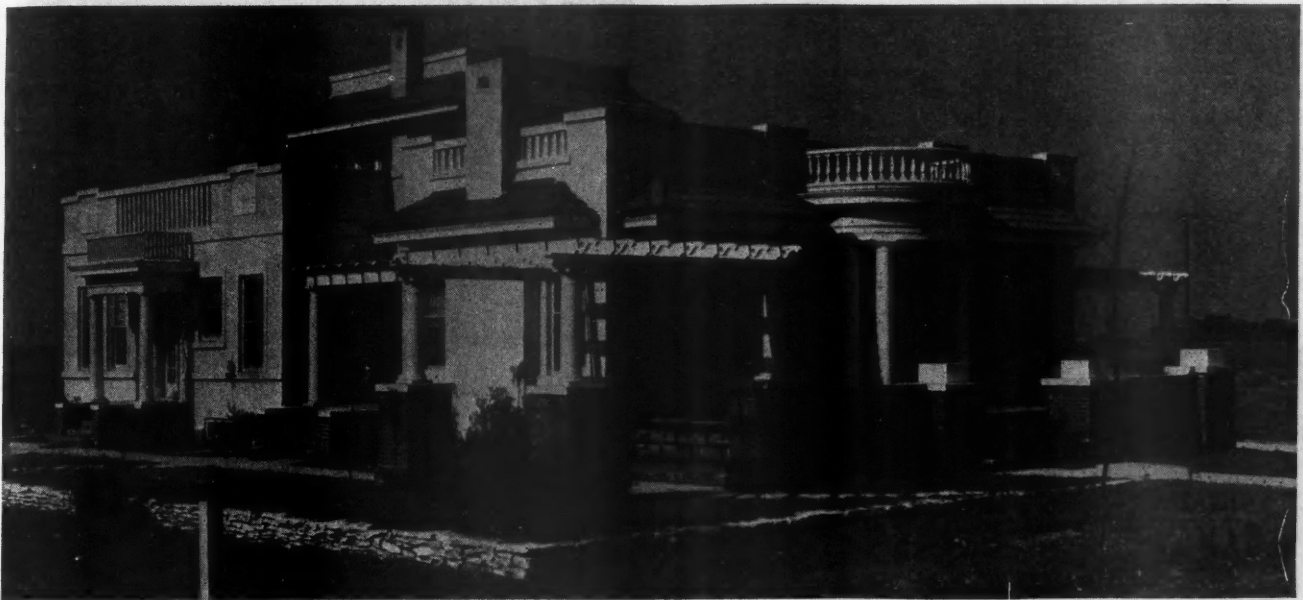

Individual in the Extreme This House, Which Is a Combination of Spanish and Colonial in Architectural Design, at Once Stands Out from Among Its Neighbors and Makes a Pleasing Impression on All Who See It.

AMONG the new homes in the Briargate addition of Joliet, Illinois, the residence of Edward A. Winkler stands out, distinctive and appealing, a house which expresses the personality of its owner and has, quite evidently, been built to endure the passage of years with its beauty and comfort unimpaired. It was designed and built by H. S. Brockway, architect-builder, of Joliet, from snapshots taken by Mr. Winkler during a winter in Florida. The style is described by Mr. Winkler as a combination of Spanish and Colonial and this combination has been handled in a truly effective manner.

After occupying this home through the severe cold of a winter and the heat of the following summer, the owner is convinced that he has hit upon the type of house and construction which is best suited to the climate in which he lives. This construction is of double shell, load bearing tile, with 10-inch walls in the basement and 8-inch walls above. All panels, coping and canopies over windows, are of the same material. The outer walls are covered with three-coat stucco and the inner walls are plastered directly upon the tile without furring. Ample heat is obtained from a vacuum steam plant installed in the large basement.

Ornamental brick work, of a bright red color, has been discreetly used in the porch and trimmings. The red matches that of the concrete, Spanish tile covering the window canopies and contrasts effectively with the white of the stucco walls. The Colonial touch is found in the use of pillars in the porch and entrance details. Spanish tile, in marble design, is laid on a reinforced concrete base on all porch floors.

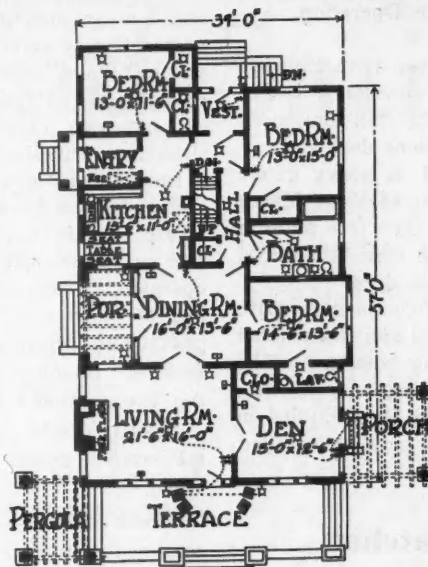

Besides the Rooms Shown in This Plan, the House Contains a Second Floor Bedroom or Sleeping Porch with 15 Windows.

The plan of this house is as original as its combination style. It contains eight rooms, all but one of which are on the first floor. In addition to a large living room, dining room and kitchen, these first floor rooms include a den and three bedrooms. All of the first floor rooms have 9-foot, coved ceilings. The single room on the upper floor is also a bedroom, 14½ by 18 feet, and is practically enclosed with glass, having 15 windows. It can be opened up to serve as a remarkably airy sleeping porch, as well as a cool retreat for the hot summer evenings and it affords a delightful view of the surrounding country. This room as well as two of the other bedrooms contains a private lavatory.

The house is well supplied with outer doors. There is a porte cochere entrance through the den, a front entrance directly into the living room, large French doors from the dining room onto a tile floored portico and side and rear entrances each having an enclosed vestibule. The living room contains a 7-foot fireplace where logs may be used to furnish a cheery blaze on winter evenings. It is built of Tiffany, enameled brick with a mantle piece of wood.

The floors are all of oak with the exception of the kitchen and vestibules which are of magnesite and the bathroom with its floor of Spanish tile. The interior trim of the den is of black walnut while in the living room, dining room and guest rooms a two-toned trim of sand gray with back band, quarter round, window sills, doors and base mould of black walnut. The bedrooms are finished in ivory enamel. The bathroom has an arch and molded dome over the recessed tub with a combination shower and the fixtures are all of the built-in type.

Apartment Telephone Systems

A FIRM which has for many years been known as a pioneer in the field of loud-speaking telephone equipment and other telephone products, especially those employing supersensitive transmitters, has now brought out a new apartment house telephone system. In this new system the company's engineers are said to have achieved a combination of beauty, permanence and trouble-free operation.

This telephone is furnished only in the loud-speaking, cordless style which provides a service free from interruption due to loss of receivers and the bending or breaking of switchhooks. In addition to the protection against damage from carelessness or improper handling which this style provides, it is also considered superior because of its greater simplicity and ease of operation.

To operate the telephone the caller pushes the button of the apartment desired. The answering voice is heard through the loud speaker, clearly and distinctly and the

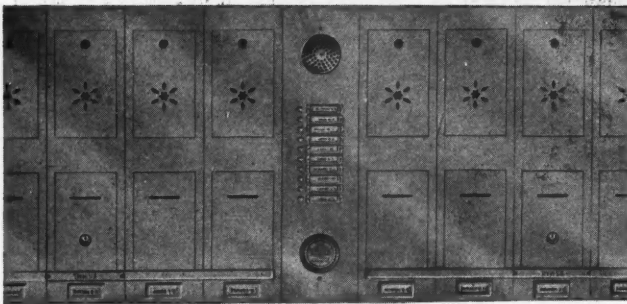

A New Apartment House Telephone System Designed for Beauty, Permanence and Trouble-Free Operation.

conversation is carried on with as much ease as though the party were present. It is not necessary to continue pressing the button through the conversation, the full operation requiring only the signaling of the apartment desired.

The face plates are regularly furnished in heavy gauge brass with a brushed finish. Special finishes to match letter boxes may be obtained on request. The face plate is 5 inches wide and 19½ inches high. The wall box is 3¾ inches wide, 17¾ inches high and 3¾ inches deep.

Mail boxes may also be obtained to match the face plate of the telephone equipment and are designed and constructed according to the same high manufacturing standard. The principal feature of the mail box is its simplicity of construction. It is built on the unit idea and is assembled in gangs of three boxes or more. The boxes may be installed in single or double rows as required.



New Fast Operating Batcher

A NEW development in the field of batchers is shown in the accompanying illustration and is designed to replace the old type of batcher operated by levers, ropes, pulleys, counterweights and other devices. This batcher is operated by one man. By operating a single lever he is able, it is said, to perform the complete operation of filling, cutting off, dumping the batch of sand and stone, closing the lower and opening the upper gates in less than 10 seconds—a speed of six batches per minute by one operator.

The high speed of this unit makes possible a reduction of one-third to one-half in the original batcher investment as well as reducing the maintenance cost and batching time, and speeding up the work.

Hand nuts with four threads to the inch are provided for quick and accurate adjustment to compensate for bulking due to moisture content. The sand batcher capacity is 8 to 14 cubic feet and that of the stone batcher 13 to 28 cubic feet. Loading indicators show when full or

empty and a table of capacity is furnished. The batchers may be separated into individual units by removing four bolts and nuts or may be used in combination. No special

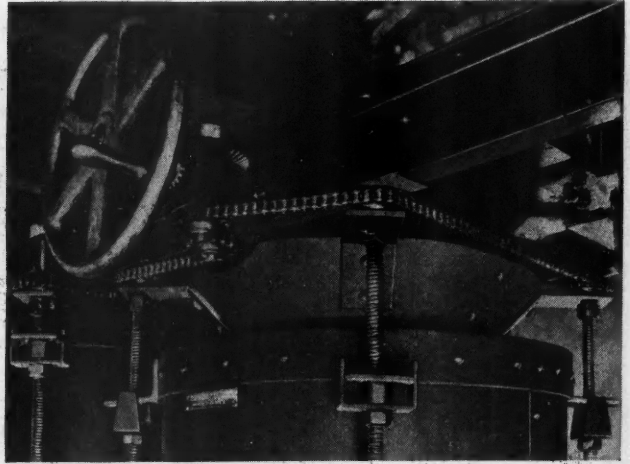

Here Is a One-Man-Operated Batcher Which Is Said to Perform a Complete Operation in Less Than 10 Seconds.

channel supports are necessary, when separated, the only additional cost being an extra control lever. These batchers may be used with either wood or steel bins.



Improved Two Cylinder Engines

A NEW series of engines has been announced by a prominent manufacturer of engines for pumps, hoists and similar purposes. This series includes a six horsepower, two cylinder engine, either radiator or hopper cooled; and a 12 horsepower, two cylinder engine of the radiator cooled type. All these engines are equipped with air cleaners and with Timkin tapered roller bearings, both crankshaft and driveshaft, giving less friction and more power.

Independent power take-off shafts, having four speeds and right and left-hand direction of rotation are provided. These engines have a drive on both sides. The magneto and carburetor are always away from the machine being operated. They are easy to start and have an automatic impulse starter on the magneto. Manhole plates make it possible to adjust or inspect connecting rods or oil pumps without removing the engines. A positive driven oil pump is provided.

These are said to be the only two cylinder engines lower in height than the lowest horizontal engines of equal horsepower and the only two cylinder engines that always crank right hand. They are used as power units to operate the pumps, hoist and compressors made by this company.

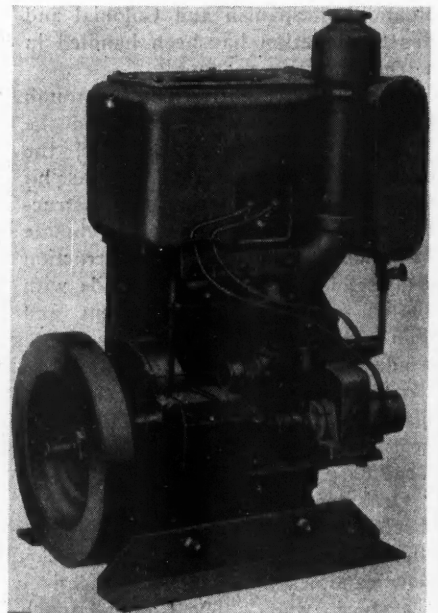

Illustrating One of a New Series of Two Cylinder Engines for Pumps, Hoists and Similar Purposes.

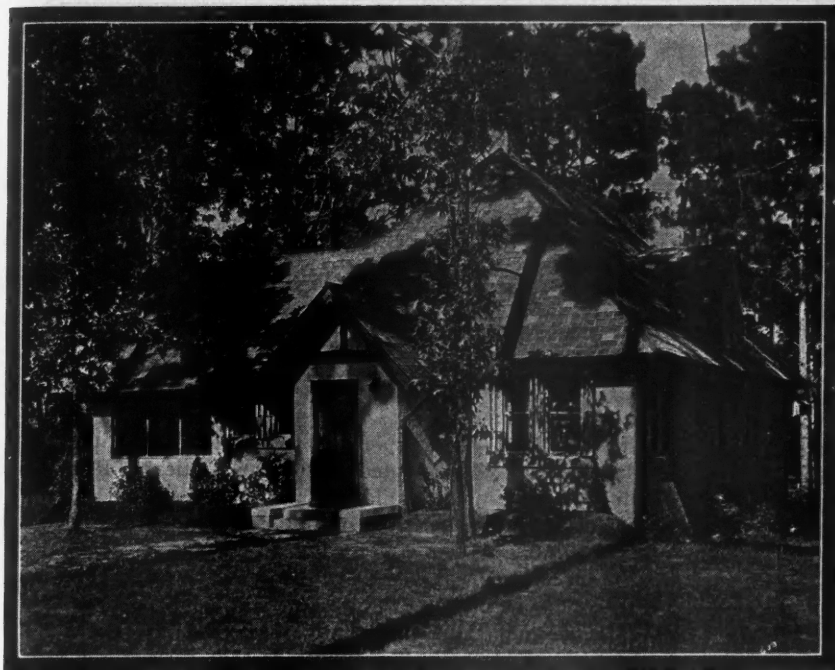

Though brick is permanently beautiful it lends itself to individual tastes and requirements. This design—the Raritan—is an example of Common Brick construction—whitewashed. Working drawings are available at nominal rates.

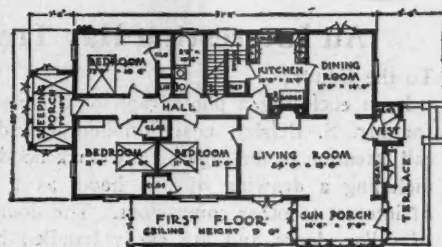

The Brick Home Sells ... and Satisfies

“Our brick homes make the quickest sale. Yes sir, and we find the public knows brick, wants brick, and appreciates brick...”

These are the words of many prominent investment builders.

Our consistent national advertising campaign is

making 1927 a Brick Homes year. Brick homes satisfy—they're in demand.

Above all else, they are saleable and hold their value for years to come.

If you happen to be one of the few needing literature on Brick, mail the coupon below.

At Your Service

These District Association Offices and Brick Manufacturers Everywhere

Boston, Mass.	11 Beacon Street
Chicago	614 Chamber of Commerce Bldg.
Denver	1735 Stout St.
Detroit	400 U.S. Mortgage Trust Bldg.
Hartford, Conn.	226 Pearl St.
Los Angeles	342 Douglas Bldg.
New York City	1710 Gr'd Cen. Term' Bldg.
Norfolk, Va.	112 West Plume Street
Philadelphia	121 N. Broad Street
Portland, Ore.	906 Lewis Building
Salt Lake City	301 Atlas Bldg.
San Francisco	932 Monadnock Bldg.
Seattle, Wash.	913 Arctic Bldg.

The Common Brick Manufacturers' Association of America
2131 Guarantee Title Building
CLEVELAND, OHIO

BRICK
forever

Common Brick Ass'n.
2131 Guarantee Title Bldg., Cleveland, O.
Send me the Books of Brick Beauty and Economy checked below, for which I enclose the price indicated.

- "Your Next Home"—(New Edition) Photos and Plans of 57 homes, 10c.
- "The Home You Can Afford"—62 homes 10c.
- "Brick, How to Build and Estimate"—25c.
- "Skinted Brickwork"—15c.
- "Farm Homes of Brick"—5c.
- "Brick Silos"—10c.
- "Multiple Dwellings of Brick"—10c.
- "Hollow Walls of Brick"—FREE.

Name _____
Address _____

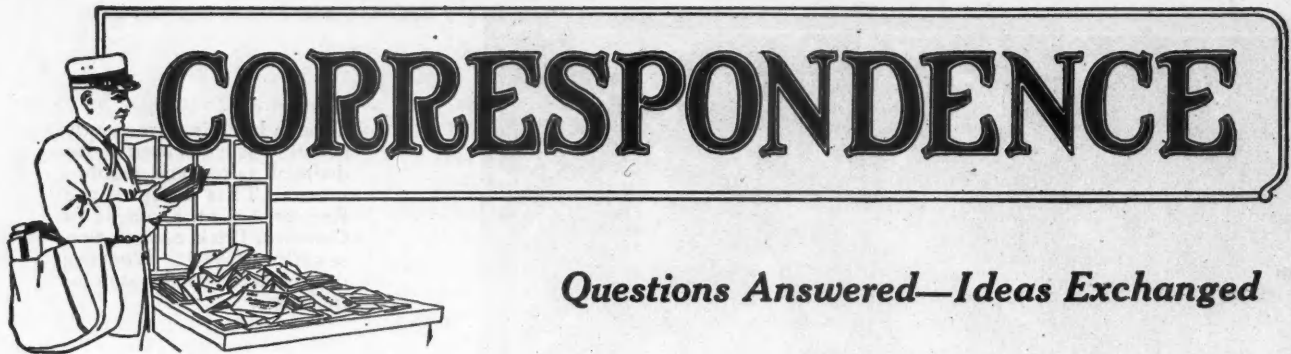

Questions Answered—Ideas Exchanged

An Interesting Hay Track Hood

To the Editor:

Reynolds, Ind.

I am enclosing a photograph of a barn which I have built for Mr. S. Belsley, near Remington, Ind. I would like to call attention to the type of hay track hood used and I am also including a drawing of this hood, as I think it may prove of interest to other contractors. The doors lift up like a pair of cellar doors and are easily handled by one man.

JOHN C. BARDONNER.

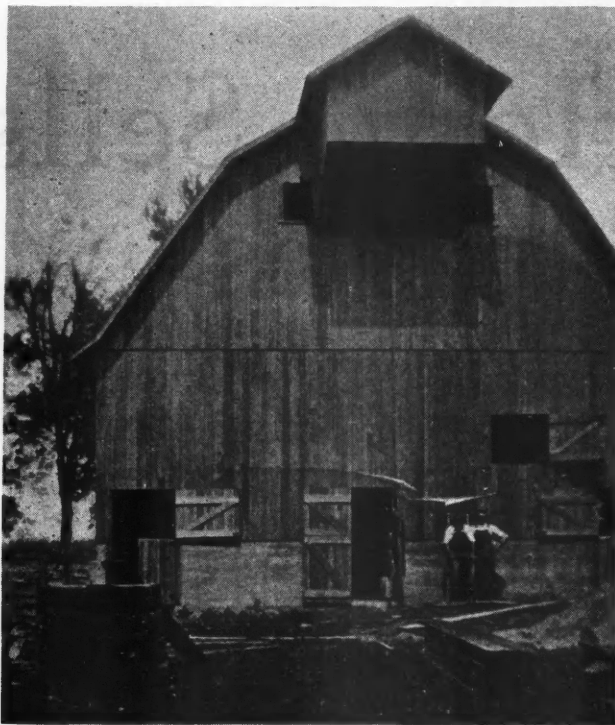

The Hay Track Hood Is the Feature of This Barn Built at Reynolds, Indiana. The doors lift up like cellar doors.

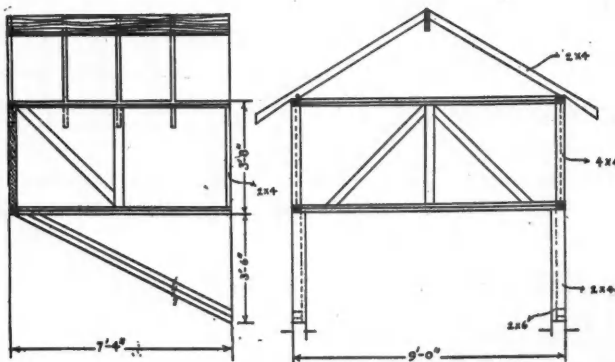

Sketch Showing the Construction of the Hay Track Hood in the Barn Illustrated Above.

"The Pittsburgh Plan"

To the Editor:

New York, N. Y.

Wouldn't it be a splendid thing if "The Pittsburgh Plan" should be adopted in all our cities? Primarily intended to stimulate building and discourage land speculation, the first step has been so successful that its further extension is only a matter of time.

This reform was made possible by an enactment of the Pennsylvania Legislature in 1913, applicable to cities of the second class, providing for a gradual reduction in the tax rate on buildings by 10 per cent every three years until it reached a maximum of 50 per cent of the rate on land. This period was reached last year.

Briefly stated, the plan as it operates in Pittsburgh contains two notable features. First, the entire tax revenue for municipal purposes is derived from taxes on real estate. There are no taxes levied by the city government on any other form of property or income. Second, the municipal tax rate on buildings is fixed at one-half of the tax rate levied upon land. This latter feature is known as the graded tax.

This plan does not cut down the budget in any way, nor does it lessen the amount collected. It is simply a shifting of the burden so as to make industry more profitable and land speculation less profitable.

From an official report recently issued, it is found that in some cases the actual saving in taxes on large apartment houses and office buildings has reached as high as \$10,000. Large annual savings have also been effected by manufacturing plants and dwellings. Ten substantial residences taken at random show an average saving of 21 per cent in 1925 contrasted with the payment that would have been made under the old flat rate system.

Furthermore, large landed estates held intact for several generations, with a fixed "no sale" policy, are now glad to sell land at reasonable prices. This spells employment for both labor and capital.

School and county taxes, however, are still levied on Pittsburgh real estate under the old flat rate system, the aggregate amount for 1925 being \$17,500,000, while the amount raised under the "graded tax" plan was \$15,000,000. But there is a strong movement on foot, supported by many organizations, to levy school and county taxes also on the graded plan.

Thus we are learning, slowly but surely, that our communal growth and development are best encouraged by not taxing labor-created values; and the tendency of the times is more and more in the direction of collecting public revenues from socially created values, namely, those values that attach to land by reason of the presence and activities of all the people in the community. This is the scientific tax of the future, but it is really remarkable, even now, the number of prominent men and women who endorse it.

Pittsburgh has established a precedent which other cities will do well to follow, for nothing succeeds like success. This is not a mere theory, but a concrete illustration of what has and still is being accomplished in a sane and practical manner in one of the most important cities in the United States.

E. B. SWINNEY.



A beautiful Sellers "Installed" Kitchen Unit gives you double value per dollar

HERE is a proposition that can be figured by any man. On one hand is a common built-in kitchen cupboard—some shelves—glass doors—a plain compartment below for pots and pans—an ordinary paint job.

On the other hand is the beautiful modern Sellers "Installed" Kitchen Unit. It is comprised of the Sellers Kitchen Cabinet—augmented by one or two of the new Sellers Utility Closets—to match. A complete, harmonious group with a specially designed base.

This beautiful, modern outfit gives the fine craftsmanship and beautiful finish of Sellers trained crew of artisans.

It provides the many scientific ideas for time- and labor-saving—the many wonderful conveniences created by Sellers. The gleaming white porcelain work table—the flour bin—the extending base shelf—the patented drawers—the many little time-saving touches. It is a complete, proved scientific kitchen helper. And, in addition, it is artistic—an inspiration in any kitchen.

The complete Sellers Unit may be installed close to the wall. Or, where arranged for in the plans, it may be fitted into a suitable recess. In

either case it becomes a definite part of the kitchen.

Yet the cost is much lower

This beautiful modern outfit is built in the Sellers factories where we have specialized in the production of kitchen cabinets for years and years. We buy materials scientifically. We use modern mass production methods. Costs are scientifically reduced.

Where it would cost you \$100 and up to design and build any ordinary outfit of shelves, drawers and cupboards, complete Sellers Kitchen Cabinets sell for \$50 and up.

In other words you save practically 50 per cent when you use a beautiful Sellers "Installed" Unit in place of common "built-in" carpentry.

The woman who wants what she considers "built-in" equipment will be thrilled with the advantages of the Sellers "Installed" proposition. The apartment builder who uses Sellers "Installed" equipment will add a big appeal to the kitchen and save money.

We illustrate only one Sellers "Installed" Unit combination. A wide range of grouping possibilities are shown in our supplement. A copy will be sent upon request. G. I. Sellers & Sons Co., Elwood, Indiana.

SELLERS

KITCHEN CABINETS AND "INSTALLED" UNITS

WHEN WRITING ADVERTISERS PLEASE MENTION THE AMERICAN BUILDER

From American Builder Plans

To the Editor: Bedford, Ind.
 Some time ago one of your representatives called on me in regard to buying a set of your plan books. At the time, I was building a new home for myself which I showed to your representative. The plan I had selected was your design No. 11200-BR, and your representative requested me to send you a photograph of the house when completed as he thought it was a fine job.

As you will see, my wife changed the inside arrangement somewhat and I made some changes in the exterior. The inside still follows your plan quite closely, but I added a large porch and also a sleeping porch. This makes a nine-room house with brick veneer, as shown in the photograph, and there is a brick fence around the entire lot. The cost was \$20,000 and we are very proud of the result and also appreciate your assistance as our ideas were taken from your plan. We feel, however, that we have improved on the plan in the final result.

J. HERSCHEL MOORE

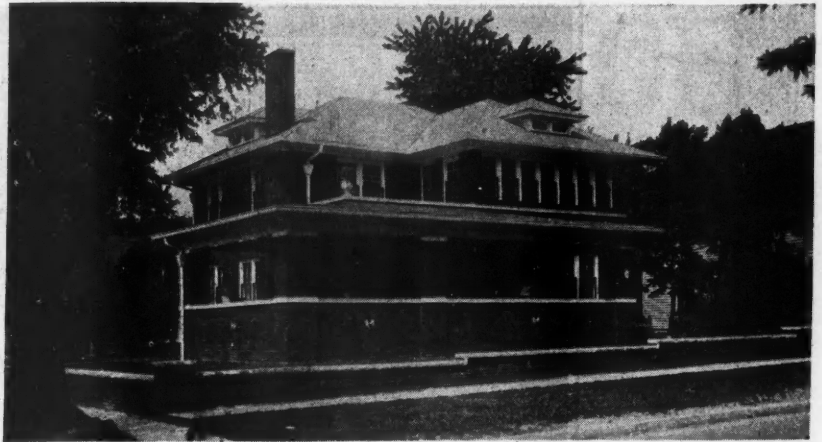

Only a Few Alterations Were Required to Adapt an American Builder Plan to the Requirements of J. Herschel Moore, of Bedford, Ind., and This Is the House Which He Built.

Wide Span Porch Construction

To the Editor: Omaha, Neb.

It is quite a common thing at the present to meet with plans that show only two porch columns for a front porch extending all the way across the front of the building. Many of these having a span of 24 feet and over, making a long span between columns. We have had plans of this kind up to 26 and even 28 feet.

This kind of a plan looks all right on a blue print or as a picture on paper, but when it comes to the actual substantial construction for this kind of a porch it is quite another thing. Ordinary porch beam construction for this kind of a porch will prove a failure, because it will not support the weight of the roof without sagging in the middle of the beam.

In order to make a beam that will not sag, the beam must be of some form of truss construction. It is hardly possible to truss a beam for a porch unless it has a considerable depth. For a 24-foot span we use two 2 by 8's, 24 feet long, placing one on top of the other, on edge, see section in Fig. 1. This equals a 2 by 16 in depth, then we truss the two together,

using 2 by 4 uprights about every two feet and the 2 by 4 truss braces, as shown.

We make two of these trusses as the section shows and thoroughly spike the two together, then we have the combined strength of four 2 by 8's so thoroughly trussed and tied together that such a thing as sagging is not likely to happen. We use 2 by 8's for spans up to 24 feet and 2 by 10's for spans 26 and 28 feet, which is the longest we have ever had to use.

The depth of beam makes it necessary to have a wide frieze. To avoid any kind of bad construction in this work, if it is a bungalow cornice, use a double frieze, letting the top board lap over the lower board about one inch, see Fig. 2. If the double frieze is not wanted on the inside, drop the ceiling joists down on the inside as shown. If it is a box cornice, put in lookouts from the end of the rafter in to the porch beam, then only a single outside frieze will be needed. Those who meet with this kind of work will readily see a well trussed beam such as we have shown will support the roof without the least sign of sagging in the middle. It makes a dependable job.



Building in Mexico

To the Editor: Guadalajara, Mexico.

It would be decidedly difficult to write of building down here and avoid the rather ludicrous, for while they do wonderful work, every phase of it has, to the academic mind, the tinge of comedy. For instance, a workman is given a beautiful piece of carving to do in stone. It may be on a building or on the stone before setting. In our country a perfect drawing, to scale, would be furnished.

Down here the man is handed merely a picture. It may be a newspaper cut, a photograph or a billboard chromo, but nothing more. The workman goes at it with all the methodical action of the Indian, which he is. If he gets tired he stops, lights a cigarette, sits down and surveys the work and the surrounding country. After while he will start work again. Perhaps he may get drunk and lay off for a day, sleeping on the ground and in general having no apparent idea of anything.

But when the work is finished it is always a masterpiece, though the workman is never heard of by name any further than to draw his daily pay.

Because of this the subject of building in Mexico can not be treated with merely economic and material details. It is bound to bring in the curious, especially if illustrated with pictures of construction as the work goes on.—HERMAN DOCK, Mechanical Engineer.

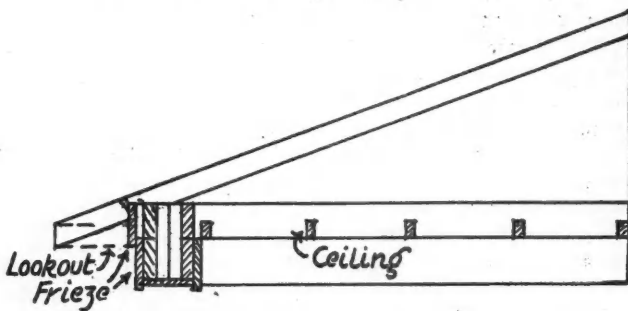

Fig. 2. To Avoid Bad Work in a Bungalow Cornice, Use a Double Frieze, Letting the Top Board Lap Over the Lower Board About One Inch.

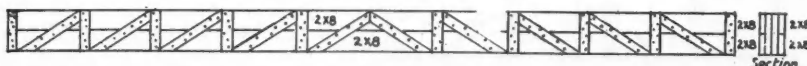

Fig. 1. Two 2x8's, Placed on Edge, one on Top of the Other, Are Used for a 24-Foot Span.

American Steel & Wire Perfected PLASTER-STUCCO Reinforcement Company's



Makes Walls Strong, Rigid, Crack-Proof!



Here is the complete story of Plaster-Stucco Reinforcement—a folder of facts, —a sample of the product for close-up inspection! Send for these now, and have both on file for quick reference.

PERFECTED Plaster-Stucco Reinforcement is a combined lath, reinforcement, and base for plaster, cement and stucco. The construction is a 2-inch Electric Welded mesh of cold drawn galvanized steel wire backed by an extremely tough water-proof kraft paper. Architects and builders, everywhere, proclaim it the ideal lath-reinforcement.

Easy and economical to apply. Shipped in crates of perfectly flat sheets 34 inches by 50 inches (one-man size). Sufficient hook-head galvanized nails included in each package. Plasters quickly and without effort.

The following letter, typical of many

in our files, explains how thoroughly Plaster-Stucco Reinforcement satisfies Architect, Builder, Contractor and Plasterer: "This material is better than any fire-proof lath that we have ever used. It is applied easily and cheaply and requires less mortar per yard than any expanded metal lath. The complete wall is unusually firm and solid and we are well pleased with the results secured with the fabric. We propose to standardize on its use for all plaster work, both interior and exterior."

You will read our new illustrated folder-of-facts with interest. Send for it now! Address nearest office.

SALES OFFICES

- | | | | | |
|--|---|---------------------------------------|---------------------------------------|--|
| CHICAGO . . . 208 So. La Salle Street | ST. LOUIS 506 Olive Street | NEW YORK 30 Church Street | WORCESTER 94 Grove Street | DALLAS Practorian Building |
| CLEVELAND . . . Rockefeller Building | KANSAS CITY . . . 417 Grand Avenue | BOSTON 185 Franklin Street | BALTIMORE . . . 32 So. Charles Street | DENVER . . . First National Bank Bldg. |
| DETROIT Foot of First Street | OKLAHOMA CITY First Nat'l Bank Bldg. | PITTSBURGH Frick Building | BUFFALO 670 Ellicott Street | SALT LAKE CITY . Walker Bk. Bldg. |
| CINCINNATI . Union Trust Building | BIRMINGHAM . . . Brown-Marx Bldg. | PHILADELPHIA . . Widener Building | WILKES-BARRE . Miners Bk. Bldg. | |
| MINNEAPOLIS—ST. PAUL Merchants Nat'l Bk. Bldg., St. Paul | MEMPHIS Union and Planters Bank Bldg. | ATLANTA 101 Marietta Street | | |

UNITED STATES STEEL PRODUCTS COMPANY, San Francisco, Los Angeles, Portland, Seattle

NEWS of the FIELD

Flinkote Buys Roofing Companies

THE Flintkote Company, of Boston, Mass., has purchased the Chatfield Manufacturing Company, of Cincinnati, Ohio, and the entire roofing business of The Richardson Company, of Cincinnati, Chicago and New Orleans, one of the largest manufacturers in the industry. The purchase involved the Richardson felt mills and roofing plant at New Orleans, complete, as well as all equipment, machinery and manufacturing equipment of the Richardson plants at Melrose Park (Chicago) and Lockland (Cincinnati) which latter will be removed to the Flintkote Company's Chicago Heights plant and the Chatfield plant at Carthage (Cincinnati). The transfer of properties together with all brands, trademarks, patents, formulae and good will, took place on January 3, 1927.

Exposition Prize Awards

PRIZES for every product exhibited by them at the Sesqui-Centennial International Exposition in Philadelphia have been awarded the Jones & Laughlin Steel Corporation, Pittsburgh. This constitutes a 100 per cent award and consists of a grand prize, two gold medals and a medal of honor.

A grand prize was awarded Jones & Laughlin for their cold rolled and cold finished steel bars. A medal of honor was awarded to the Junior beam, a new light-weight structural rolled steel building section, brought out this year.

Another prize winner at the exposition was the Warren-Knight Company, 136 N. 12th St., Philadelphia, Pa., which was given a gold medal award for its Sterling transit levels and wire sagging instruments.

The Bommer Spring Hinge Co., 251-71 Classon Ave., Brooklyn, N. Y., was awarded the gold medal for its Bommer spring hinges.

Southern Pine Convention

THE twelfth annual convention of the Southern Pine Association will be held in New Orleans, at the Roosevelt Hotel, March 22 and 23. Coincidental with the convention will be mill managers' meeting from practically all of the 10 southern states in which the subscriber mills are located.

Chain Belt Announcements

THE Chain Belt Company, of Milwaukee, Wis., has built and occupied a new building on its 59 acre tract at West Milwaukee, to house its engineering and structural work. All of the company's engineering work, including Rex traveling water screens and Rex elevators and conveyors, are being built at the new plant.

W. H. Brandt, advertising manager of this company, has been appointed assistant secretary, succeeding George M. Dyke, who has gone to Cleveland, to assume the duties of secretary of the Stearns Conveyor Company, which is

now owned by the Chain Belt Company. Mr. Brandt is succeeded by A. R. Abelt as advertising manager.

Weatherbest Remodeling Contest

THE Weatherbest Old Home Remodeling Contest has just been announced by the Weatherbest Stained Shingle Co., 1122 Main St., Tonawanda, N. Y. In this contest \$2,750.00, in the form of 39 cash prizes, will be distributed for the best example of old houses remodeled and insulated by recovering the walls with edge grain red cedar shingles.

Entries may be made in this contest up to August 1, 1927, for any work planned or started since January 1, 1927, and finished photographs showing the remodeling and reshingling completed, with written data, may be sent in any time during the contest, but not later than September 30, 1927, at which time the contest closes. Awards will be made as soon after the closing date as possible.

Civic Center Competition

AN invitation has been extended by The General Purposes Committee of the Corporation of the City of Birmingham, England, to town planning experts, architects, and surveyors of all countries to submit designs in a competition for the planning of the new civic center which it is proposed to lay out for that city. The sealed designs must be delivered to Mr. Herbert H. Humphries, M. Inst. C. E., Council House, Birmingham, England, not later than June 30, 1927.

Copies of the conditions of competition may be secured from the United States Department of Commerce, Bureau of Foreign and Domestic Commerce, 33 S. Clarke St., Chicago.

New Management of Foley Company

THE new management of the Foley Saw Tool Co., Inc., of Minneapolis, Minn., which purchased the business last May, has been steadily at work studying the saw filing requirements of contractors, carpenters and builders and improving the filers which it manufactures. The present officers and directors of the company are the following Minneapolis business men: Walter M. Ringer, president and general manager; R. N. Pierson, vice-president, also vice-president of the Russell-Miller Milling Co.; C. S. Ashum, secretary and treasurer, also treasurer of the Wells-Dickey Trust Co.; H. S. Wells, director, president of the Wells-Dickey Trust Co.; H. S. Helm, director, president of Russell-Miller Milling Co.



Walter M. Ringer, President and General Manager of the Foley Saw & Tool Co., Inc.

Start Manufacture of Files

AN announcement has been made by E. C. Atkins & Company, of Indianapolis, Indiana, that this company has added files to the line of products which it manufactures. This addition has long been planned because the file business is closely related to the saw business for which the Atkins company is known.



Improved

New Model "R" Automatic Cellar Drainer

*features that
make sales easy*



*More Economical
More Durable
More Efficient
More Reliable*

**PENBERTHY
AUTOMATIC
CELLAR
DRAINER**

There are so many improvements in the new Model "R" Penberthy Cellar Drainer that it opens up tremendous sales possibilities for its sale. Many of these features have never before been available.

Now the Penberthy can be installed under conditions where other cellar drains were useless.

It will remove more water in less time at lower pressures. No delicate parts to wear—copper and brass used throughout—nothing to rust or corrode.

There are many more features which are well worth investigating.

Write today for all the details of construction and operation. Your jobber will supply you.

PENBERTHY INJECTOR COMPANY

Established 1886

New York Office
71 Beekman St.

DETROIT
Michigan

Canadian Plant
Windsor, Ontario

Israel Joins West Coast Bureau

ALBERT R. ISRAEL has recently joined the staff of the West Coast Lumber Trade Extension Bureau, Seattle, Wash., to handle special temporary publicity and field work for the Bureau. For five years Mr. Israel was connected with the New Orleans headquarters of the Southern Pine Association, resigning as director of publicity and trade promotion last August when he removed to the Pacific Coast for a rest and to benefit Mrs. Israel's health. He finally decided to locate permanently in Seattle.



New Building Under Way

PLANS have been completed and work is well under way on a new building, to cost about \$300,000, for the Minneapolis Heat Regulator Co., 402 E. 28th St., Minneapolis, Minn. The new building will be located next to the old factory, supplementing its 70,000 square feet of floor space. By spring an additional 70,000 feet of space will be available in the new structure, as the tower and right wing of the new building are being rushed to completion. The left wing will be finished later.



First Trans-Atlantic Phone Ad

THE J. H. Balmer Company, of Newark, N. J., manufacturers of china bath room accessories, claims the distinction of placing the first advertisement ever placed by means of the new Trans-Atlantic telephone. On January 8, at 9:45 A. M., Joseph E. Hanson, advertising agent for the J. H. Balmer Company, received word that his London call was ready. After greeting W. Lint Smith, advertising manager of the London Times, Mr. Hanson dictated his advertisement for insertion in that paper.

New Ambler Asbestos Plant

THE Ambler Asbestos Company, Ambler, Pa., reports that its new plant at Asbestos Station, near Ambler, has gone into production and is operating 24 hours a day. This plant has been equipped for the manufacture of the new tapered English thatch type of shingles sold by the Asbestos Shingle, Slate & Sheathing Company. The new plant of the Asbestos Shingle, Slate & Sheathing Company, now under construction at St. Louis, Mo., will be ready for operation in the spring.



Will Hold Chicago Convention

AN announcement has been made that the convention of the American Concrete Institute, 2970 W. Grand Boulevard, Detroit, Mich., will be held in Chicago, at the Palmer House, February 22 to 24.



N. L. M. A. Convention

THE dates for the annual convention of the National Lumber Manufacturers' Association have been tentatively set for April 28 and 29. The convention will be held in Chicago.



Architectural Competition

THE First Annual Architectural Competition of the Pencil Points Press, Inc., 419 Fourth Avenue, New York City, has been announced with prizes for a residence and garage design. All architects and draftsmen are invited to participate.

Make 1927 a "DeVilbiss" Year— For You a Bigger PROFIT Year

How to provide for a worth-while increase in your profits for the year ahead: the easier, improved DeVilbiss way of painting will most successfully solve that part of your business problem.

Use of the DeVilbiss Spray-painting System enables you (1) to do more work, without increasing labor costs; (2) to give your customers an improved and cleaner class of work, on a greatly speeded-up schedule; (3) to make the work easier for your men, while increasing the production of each; (4) to become recognized as the progressive, outstanding painting contractor in your community.

There is further assurance of bigger profits for this year, and the years to follow, in using the DeVilbiss Spray-painting System. DeVilbiss equipment is correct and complete in every detail; is built of highest quality materials by skilled workmen; is simple and dependable in every operation; is warranted to give long and satisfactory service. Then there is available to you at all times the unequalled DeVilbiss engineering and service facilities, developed out of over 35 years' manufacturing experience.

Get ready now for a busy and profitable year. We'll promptly mail complete facts on what the DeVilbiss Spray-painting System will do for you. Address—

THE DEVILBISS COMPANY
238 Phillips Ave. TOLEDO, OHIO

New York — Chicago — Detroit — San Francisco
Cleveland — Indianapolis — St. Louis — Milwaukee
Minneapolis — Windsor, Ontario



DeVilbiss
Spray-painting System

Tell them that
Flax-li-num Insulation
cuts heating costs **1/3**

WHEN you build FLAX-LI-NUM insulation into roof and walls, you can tell your prospective buyers that your homes can be kept comfortably warm in winter at a one-third saving in fuel.

What an effective selling point for the builder! What definite assurance of permanent comfort and lasting economy for the buyer!

It is absolutely true that FLAX-LI-NUM assures more comfort and economy than any other building item.

In winter this flax fibre insulation prevents heat losses through the roof and walls. Homes so insulated are easier to keep warm and cost one-third less to heat.

In summer this same FLAX-LI-NUM shuts out the heat of the sun and keeps the interior more comfortably cool. Only genuine insulation can effect this economy and assure this comfort.

Small wonder that people more readily buy



FLAX-LI-NUM insulated homes when the builder points out these practical advantages.

FLAX-LI-NUM has proved its value for more than 17 years, in all kinds of buildings and all kinds of climates. Once installed, it will remain in place, in perfect condition, with undiminished efficiency for the life of the building. There is no maintenance cost.

The method of installing FLAX-LI-NUM is as scientifically correct as the material itself. As heat passes through a wall, some of it is stopped by surface resistances. Hence, the more surfaces in a wall the less heat passes through it. FLAX-LI-NUM is installed halfway between the inner and outer walls, forming two extra surface resistances, six in all.

One-half inch is used in side walls; one inch in roof. Let us tell you *all* about how FLAX-LI-NUM helps hurry the sale to a successful close.

FLAX-LI-NUM INSULATING COMPANY, St. Paul, Minn.

Flax-li-num
 THE CORRECT BUILDING INSULATION AND SOUND CONTROL MATERIAL



Books, Bulletins and Catalogs for You

THE literature and publications listed here are available to the readers of American Builder. They may be obtained from the firms mentioned and will be forwarded without cost except where a price is noted.

"The Study of Architectural Design," by John F. Harbeson, A. I. A., published by The Pencil Points Press, Inc., 19 East 24th St., New York City, has been prepared "with special reference to the program of the Beaux-Arts Institute of Design." It is an authoritative and comprehensive book based on the Atelier System and should be of value to all architects, designers, draftsmen and students of architecture. Price \$7.50.

The Associated Tile Manufacturers, Beaver Falls, Pa., has recently published a booklet illustrating the tile work in "Casa-Bonita, A House of Tiles Built at the Sesqui-Centennial as an Educational Exhibit."

The A. C. Horn Company, Horn Building, Long Island City, N. Y., has issued two circulars describing a new product known as "Horn's no-Freeze" which accelerates the setting action of cement and lowers its freezing temperature.

The American Institute of Steel Construction, Inc., 285 Madison Ave., New York City, has published the report of its 1926 annual convention.

The Cornell Wood Products Co., 190 N. State St., Chicago, is distributing a circular explaining the reasons "Why You Should Make Cornell Prestige Add to Your Profits" by becoming a Cornell dealer.

The Mellish-Hayward Co., 213 W. Austin Ave., Chicago, has published a bulletin, 10-A, containing the general description, construction and specifications for its type A Mel-Rock air washers.

The La Kel Manufacturing Co., Dept. C., Jenkintown, Pa., offers a circular supplying complete information on its

finishing machine which eliminates hand work in floor and other finishing.

The Scutan Company, Inc., 342 Madison Ave., New York City, offers a booklet containing samples of the nine kinds of building paper which it manufactures to meet all requirements in building.

The Sheet Steel Trade Extension Committee, 715 Oliver Bldg., Pittsburgh, Pa., has issued a book on "Standard Specifications for the Fabrication and Setting of Sheet Steel Cornices."

"Clinton Grilles" is the title of a pamphlet illustrating a number of grilles manufactured by the Wickwire Spencer Steel Company, 41 E. 42nd St., New York City.

The National Radiator Company, Johnstown, Pa., has issued a new catalog, No. 36, which supersedes all of its other catalogs and includes prices and technical data on its products.

"Steel for Strength and Security," a speech delivered by George F. Swain before the convention of the American Institute of Steel Construction, 285 Madison Ave., New York City, has been published by this association in booklet form.



Ryerson Buys Steel Plant

JOSEPH T. RYERSON & SON, Inc., Chicago, has purchased the warehouse division and property of the Bourne-Fuller Company at Cleveland. The Bourne-Fuller Company, already a large steel producer, will concentrate on the business of manufacturing steel products. The property consists of a group of large modern warehouses, with 200,000 square feet of ground area. The plant is stocked with a complete line of bars, shapes, plates, sheets, and steel products, totaling about 12,000 tons in all.

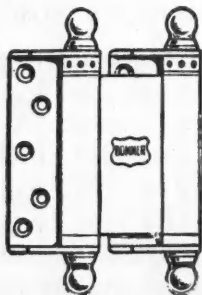

Buy the Best HARDWARE For Hard-wear

For more than 50 years Bommer Spring Hinges have maintained their leadership and proven their superiority over all others.

They have kept pace with the times, because they have been kept up with the times whenever improvement was possible.

BOMMER SPRING HINGES ARE THE BEST

They are in universal demand—easiest to apply and the most satisfactory spring hinges made.

Your Dealer handles them.

Send for New Catalog 47. It is a big help in ordering.

Bommer Spring Hinge Company
MANUFACTURERS
BROOKLYN, N. Y.



OLD EUROPEAN SLATE ROOFS

Exactly duplicate the old slate roofs of Europe with their rich colorings and strong natural texture.

Roof Suggestions on Request

KNICKERBOCKER SLATE CORP'N

E. J. JOHNSON, *President*

153 E. 38TH ST. NEW YORK

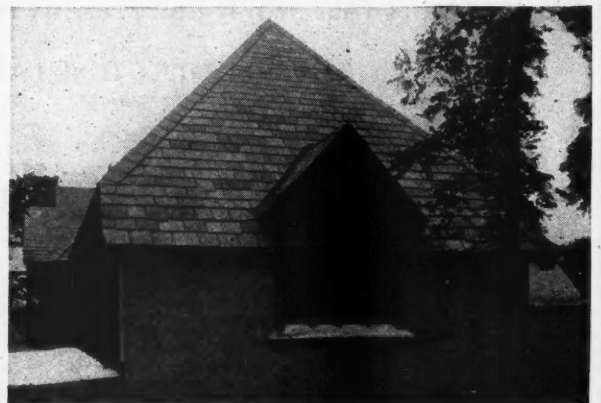

WAGNER

The name "Wagner" stands for a line of hangers for sliding-folding doors that is universally acknowledged to be unsurpassed in every particular. Whether for doors in the finest apartments and residences or for elevator doors or for the heaviest doors in warehouses or farm buildings, there is a Wagner hanger specially designed to meet the need. You will find the Wagner catalog full of practical information about hangers and track, as well as suggestions on how to install them in many different kinds of structures.

The DIX Noiseless Door Hanger

All the world over the DIX Noiseless Door Hanger has the reputation of being the best obtainable for sliding parlor doors and like installations. It has often been imitated, but has never been equalled. Here are a few of the many outstanding DIX features: Composite rail with strip of hard maple—hangers that are provided with rail spacing lugs so as to prevent derailment—vulcanized fibre centers in the wheels—and special devices that make adjustments easy and simple to perform.

The DIX hanger and rail are shipped in complete sets, ready to install. Ask your dealer or write us for detailed information. With the rapid increase in folding-sliding doors for residences and apartments, you will find the DIX Door

Hanger meets satisfactorily every requirement.

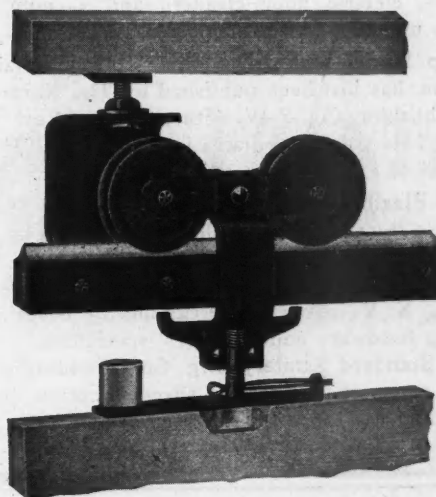

Wagner Cloztitle Garage Door Sets

In any combination from two to ten doors, Wagner Cloztitle Garage Door Sets give superior service. The patented stop, a built-in feature of every Cloztitle Hanger, makes it impossible for the hanger arm to swing to reverse position or stop on dead center. Adjustments are easily made. Simply turn the nut on the trolley bar and the door is raised to provide extra clearance when necessary.

The track comes in full lengths instead of in short sections. It is installed parallel with and close to the side of the garage, thus giving added strength besides doing away with troublesome extension brackets.

Sold in complete sets with every bit of necessary hardware furnished.

Write us for catalog showing the complete Wagner line of hangers, track, studding sockets and many other requirements for buildings

Wagner Manufacturing Co., Cedar Rapids, Iowa

WAGNER Hangers



Used the World Over

Books, Bulletins and Catalogs for You

THE literature and publications listed here are available to the readers of American Builder. They may be obtained from the firms mentioned and will be forwarded without cost except where a price is noted.

The Stanley Works, New Britain, Conn., has issued three new catalogs covering its tools and hardware. These are catalog 34, Stanley Tools; catalog 25, Atha Tools; and catalog 14, Stanley Wrought Hardware. The latter is a general catalog in hard covers.

"Mechanical Drawing," by DeWitt Hunt, published by the Harlow Publishing Company, Oklahoma City, Oklahoma, is a text book presenting drawing problems and informational material in a practical sequence from the easy to the more difficult for the instruction of students of this subject. Price \$1.50.

The Kent Machine Company, Inc., Rome, N. Y., offers a series of booklets covering in detail its line of stationary cleaners, electric floor cleaners and vacuum cleaners in various models to meet all needs.

"Ship Model Making," volume 2, by Captain Armitage McCann, has just been published by The Norman W. Henley Publishing Co., 2 W. 45th St., New York City. Price \$2.50. This volume contains instruction on "How to Make a Model of an American Clipper Ship."

The Flexible Road Joint Machine Co., Warren, Ohio, offers an interesting pamphlet on its Flex-Plane System of Longitudinal and Transverse Joints for road construction.

The A. L. Swett Iron Works, 151 Glenwood Avenue, Medina, N. Y., offers a new catalog, 24, covering its line of building hardware and plumbers' specialties.

The Standard Sanitary Mfg. Co., Pittsburgh, Pa., has issued a group of new catalog sheets covering the revision of its general catalog, which is prepared in loose leaf form.

"Better Sheet Metal" is the title of a new booklet published by the United Alloy Steel Corporation, Canton, Ohio. It is a revised edition of the story of Toncan metal, its production and use, with reference tables and specification data.

The Warner Elevator Mfg. Co., Cincinnati, Ohio, has published a booklet under the title "Elevator Specifications for the Use of Architects and Engineers" which is designed to assist architects and engineers in preparing their own specifications for all types of passenger and freight elevators.

The India Alkali Works, Boston, Mass., has published a booklet entitled "The Superintendents' Exchange" which is a loose leaf compilation of valuable data and statistics for which additional sheets are prepared from time to time.

The Pole & Tube Works, Inc., Avenue D and Murray St., Newark, N. J., offers a catalog of tubular steel flag poles which it manufactures.

The Safe Fire Heating Company, 606 Orange St., Newark, N. J., offers a series of booklets and catalogs describing the Safe Fire oil burner which it manufactures.

The International Casement Co., Inc., 90 Hopkins Ave., Jamestown, N. Y., has published a handsome catalog of its Cotswold casements which include an elaborate series of photographs and drawings of architectural effects achieved with casement windows.

"What's Wrong with Contract Bonds?" is the title of a booklet prepared in the form of an open letter by Edmund J. Donegan, general counsel of The Metropolitan Casualty Insurance Co., 55 Fifth Ave., New York City.

The Roberts & Mander Stove Co., Philadelphia, Pa., offers a small booklet under the title "Menus and Memories" which combines a catalog of its gas ranges, a recipe book and brief sketches of historic buildings.

The Durabilt Steel Locker Co., 462 Arnold Ave., Aurora, Ill., offers a complete catalog in form for filing which covers its entire line of locker specialties.

You Profit In Two Ways!

To help make a new house sell quickly, put "White-Steel" Medicine Cabinets in the bathroom, kitchen and lavatory! Buyers accept their beauty, sanitary features and splendid quality as evidence of the completeness and fineness of the entire home. Result: a speedy turnover of your investment.

The other source of profit lies in the fact that "White-Steel" Cabinets add several times their cost to the selling price of any house.

Investigate! Our Complete Illustrated Catalog demonstrates why hundreds of builders are profiting thru "White Steel".

Send for it NOW.

"WHITE-STEEL" SANITARY FURNITURE CO.
Dept. 32

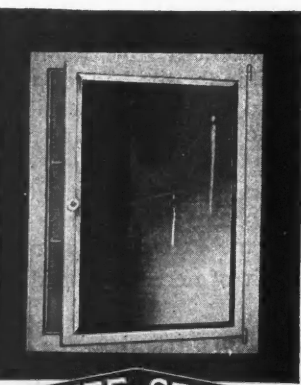

WHITE STEEL

HENZIN METAL

— the base of "White-Steel" Cabinets—made by our secret process, has great adhesive and rust-resisting qualities. Six coats of enamel, each baked separately, produce a lustrous, permanent finish.

GRAND RAPIDS, MICH.

The
AMERICAN BUILDER
is carefully edited with a view of service to you. It tells about American business and goods which you might be interested in.

Save Your Time Installing and Your Customers' Time Opening, Latching and Changing Screen and Storm Windows with this



FRANTZ "Triple Purpose" Set

[Hinges are Reversible—No
Need to Buy "Rights or Lefts"]

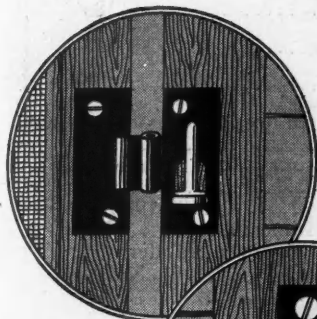

Brass pin eliminates possibility of hinges rusting tight from exposure to the elements.

Easily and quickly detached for cleaning screens or changing with storm windows.

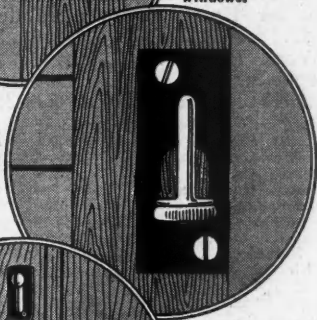

Handle automatically slides up and down over a pin to fasten screen or storm window shut. Makes opening and closing easy.

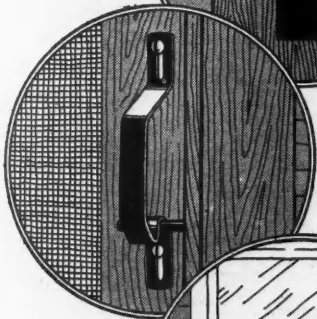

Works equally as well on half screens as on full length because hinges fasten at the side.

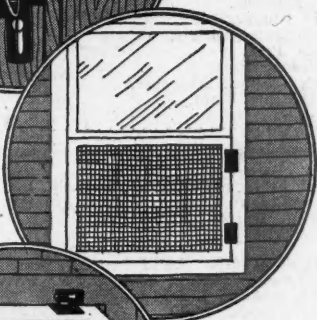

Cellar windows can be removed entirely or the hinges slid half off their pins to hold sash half open, by bracing against the casing.

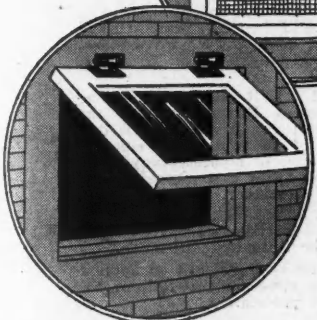

The No. 450 "Triple Purpose" Set has many features that make friends among builders, home owners and housewives as well. With this set, the screens may be swung around against the side wall, leaving the opening entirely clear for cleaning windows, sills, etc., a thing that cannot be done without removing the screen, when the screen is hung with ordinary sash hangers.

The No. 451 Set for cellar windows only differs from the No. 450 in that a sash lock is furnished to fasten the window at the bottom instead of on the side as with the self-latching handle. The detachable feature of the hinges allows the sash to be entirely removed and in this way keeps the sash from being scarred when coal is put into the basement. By sliding the hinges part way off their pins the sash is held halfway open by the casing, for ventilation purposes.

The No. 450 "Triple Purpose" Set is packed complete in a carton with all necessary screws, ready to put on your screens, storm or cellar windows. Sets of half hinges and an extra self-latching handle for making screens and storm windows interchangeable also are furnished.

FRANTZ MANUFACTURING Co., Sterling, Ill.
Dept. A-3



"No Hardware Is Genuine FRANTZ QUALITY Without the Red Label"

WHEN WRITING ADVERTISERS PLEASE MENTION THE AMERICAN BUILDER