

AMERICAN BUILDER

THE WORLD'S GREATEST BUILDING PAPER

Vol. 44.

CONTENTS FOR MARCH, 1928

No. 6.

COPYRIGHT, 1928, BY AMERICAN CARPENTER & BUILDER CO.

	Page		Page
AMERICAN BUILDER Service Department.....	85	How Dan Does It.....	132
Around the Family Table.....	87	A Sliding Door Idea.	
Announcing Our Reference Number for 1928.		To Keep Files Sharp.	
Editorial Page.....	89	Laying Out Arches.	
January Contracts Run High.		Keeping Out Cold and Dust.	
N. L. M. A. to Guarantee Lumber.		To Form Curved Wall Board.	
More Work for the Builder		Mending a Cracked Boiler.	
Financing to Be Centralized.		Nail Box Stops Waste.	
Everybody's Business—By Floyd W. Parsons..	91	Lumber Handling Made Easy.	
Fakers and Fallacies.		Instructions in Roof Framing.....	134
Chicago Civic Opera to Have Magnificent New		The Side Cut of the Jack Rafter.	
Building.....	93	Stair Building.....	136
General Motors Builds Homes.....	94	Interior Stair Work.	
Garages with Doors That Slide Up.....	97	Cement Cells of Special Acoustic Values.....	137
Architectural Service Is Part of the Dealer's		All-Steel House Demonstrated.....	138
Stock.....	98	What's New?.....	140, 144, 146, 148,
Free Information Service for Those About to		150, 152, 156, 159, 160, 162, 164, 166, 174, 176	
Build New Homes.....	100	Forced Draft Blower for Homes.	
KOLORKEED HOME PLANS.....	101-108	Novel Steel Bar Clamp.	
Mr. Radford's Monthly Talk on Home		Buck Anchor for Hollow Tile.	
Building.....	I	Solid Rolled Steel Windows.	
It Is Timely Now to Plan the Home and Its Garden.		A Home Gas System.	
The Pierpont.....	II	Complete Electric Tool Set.	
The Pilot Hill.....	III	Humidifying Radiator Cabinets.	
Two Economy Homes.....	IV	New Improved Metal Lath.	
The Placid.		Inexpensive Combination Saw.	
The Poplar.		Outdoor Incinerator.	
The Pioneer.....	V	These Nails Do Not Split Wood.	
The Cantwell.....	VI	Automatic Stairway Switch.	
The Potomac.....	VII	Improved Screw Jacks.	
The Pritchard.....	VIII	Devices for Better Heating.	
Our Front Cover Home.....	109-113	For Small Tenoning Work.	
Photographs and Complete Set of Working Drawings		Pivoted Built-In Ironing Board.	
to Eighth-Inch Scale of the Attractive English		Ornamental Commercial Lighting.	
Designed Home Illustrated in Colors on Our Front		Built-In Tie and Collar Case.	
cover.		A Keyless Door Lock.	
Prize Winners in Remodeling Contest.....	114	Clip for Ribbed Metal Lath.	
Common Brick Is Supreme in Mass Textures..	118	Combined Rule Level Protractor.	
The Lead Mattress.....	121	Line of Mixers Improved.	
All Foundation Fibration Is Eliminated in the Sky-		New Toggle Joint Base Grinder.	
scraper Type of Construction.		Air-Cooled Stationary Engines.	
Detroit's Finest Apartment Hotel.....	122	For Pulling Electric Plugs.	
Heart of City Block Used for Office Building		New Three Gang Tumbler Switch.	
Garage.....	124	Clean Convenient Garbage Receiver.	
Details of Home Building.....	126	New One Bag Mixer.	
The Western Bungalow.		Improved Paint Spray Gun.	
Furnace Heating.....	128	Mixer Wheels Improved.	
Warm Air for Cellarless Houses.		Four New Engines Announced.	
Painting and Decorating.....	130	Home Ventilating Unit.	
Painting Pointers for Exteriors.		Overhead Rolling Steel Doors.	
Finishes for Woodwork.		Luminous House Numbers.	
		Copper-Steel Boiler.	
		Handy Motor Attachment.	
		Perfect Electric Water Heater.	
		Portable Paint Spray Outfit.	
		Improved Electric Hand Saw.	
		Complete Line of Wheelbarrows.	
		News of the Field.....	178-180-182
		Books, Bulletins and Catalogs for You....	184-186
		ADVERTISER'S INDEX.....	251-253

Published on the first day of each month by American Carpenter and Builder Co.; Wm. A. Radford, *President, Treasurer and Editor-in-Chief*; Wm. A. Radford, Jr., *Vice-President*; E. L. Hatfield, *Vice-President and General Manager*; Bernard L. Johnson, *Vice-President and Editor*; Roland D. Radford, *Secretary*; S. C. Kellenberger, *Dealer Service*; Charles G. Paker, *Eastern Editor*; Juan Homs, *Export Editor*; Delbert W. Smith, E. B. Wolfrom, C. R. W. Edgecumbe, L. H. Reich, O. H. Sutter, Cecil W. Blashill, H. P. Sessions, J. J. Dubro, Dan E. Dunn, R. E. Clement, H. R. Hazard, *Advertising Staff*.

Publication Offices:

Radford Building, 1827 Prairie Ave., Chicago

Telephone: Calumet 4770

Eastern Office, 250 Park Ave., New York City

Telephone: Vanderbilt 3185

Entered as second-class matter July 1, 1905, at the post office at Chicago, Ill., under the Act of March 3, 1879. Additional entry as second-class matter at Binghamton, N. Y.; Columbus, Ohio; Seattle, Wash.; Los Angeles, Calif.; San Francisco, Calif.; Denver, Colo.; Dallas, Texas; St. Paul, Minn., and Kansas City, Mo.

SUBSCRIPTION RATES—One year, United States, Canada, Mexico, and U. S. Possessions, \$2.00; six months, \$1.00; single copies, 35 cents. Foreign countries, \$4.00.

PROTECTION FOR OUR READERS—The publishers of the AMERICAN BUILDER reserve the right to decline any advertising they believe is detrimental to the interest of its readers; to edit advertising copy and to change or eliminate any statements that reflect injuriously or cast discredit upon other building products, machinery, equipment, supplies or tools.

Be sure in writing to advertisers to say: "I saw your advertisement in the AMERICAN BUILDER."

ADVERTISING RATES—Furnished on application. Advertising forms close on the 10th of the month preceding date of publication.

MEMBER OF THE AUDIT BUREAU OF CIRCULATIONS

AMERICAN BUILDER

THE WORLD'S GREATEST BUILDING PAPER

Vol. 44.

CONTENTS FOR MARCH, 1928

No. 6.

COPYRIGHT, 1928, BY AMERICAN CARPENTER & BUILDER CO.

	Page		Page
AMERICAN BUILDER Service Department.....	85	How Dan Does It.....	132
Around the Family Table.....	87	A Sliding Door Idea.	
Announcing Our Reference Number for 1928.		To Keep Files Sharp.	
Editorial Page.....	89	Laying Out Arches.	
January Contracts Run High.		Keeping Out Cold and Dust.	
N. L. M. A. to Guarantee Lumber.		To Form Curved Wall Board.	
More Work for the Builder		Mending a Cracked Boiler.	
Financing to Be Centralized.		Nail Box Stops Waste.	
Everybody's Business—By Floyd W. Parsons..	91	Lumber Handling Made Easy.	
Fakers and Fallacies.		Instructions in Roof Framing.....	134
Chicago Civic Opera to Have Magnificent New		The Side Cut of the Jack Rafter.	
Building.....	93	Stair Building.....	136
General Motors Builds Homes.....	94	Interior Stair Work.	
Garages with Doors That Slide Up.....	97	Cement Cells of Special Acoustic Values.....	137
Architectural Service Is Part of the Dealer's		All-Steel House Demonstrated.....	138
Stock.....	98	What's New?.....	140, 144, 146, 148,
Free Information Service for Those About to		150, 152, 156, 159, 160, 162, 164, 166, 174, 176	
Build New Homes.....	100	Forced Draft Blower for Homes.	
KOLORKEED HOME PLANS.....	101-108	Novel Steel Bar Clamp.	
Mr. Radford's Monthly Talk on Home		Buck Anchor for Hollow Tile.	
Building.....	I	Solid Rolled Steel Windows.	
It Is Timely Now to Plan the Home and Its Garden.		A Home Gas System.	
The Pierpont.....	II	Complete Electric Tool Set.	
The Pilot Hill.....	III	Humidifying Radiator Cabinets.	
Two Economy Homes.....	IV	New Improved Metal Lath.	
The Placid.		Inexpensive Combination Saw.	
The Poplar.		Outdoor Incinerator.	
The Pioneer.....	V	These Nails Do Not Split Wood.	
The Cantwell.....	VI	Automatic Stairway Switch.	
The Potomac.....	VII	Improved Screw Jacks.	
The Pritchard.....	VIII	Devices for Better Heating.	
Our Front Cover Home.....	109-113	For Small Tenoning Work.	
Photographs and Complete Set of Working Drawings		Pivoted Built-In Ironing Board.	
to Eighth-Inch Scale of the Attractive English		Ornamental Commercial Lighting.	
Designed Home Illustrated in Colors on Our Front		Built-In Tie and Collar Case.	
cover.		A Keyless Door Lock.	
Prize Winners in Remodeling Contest.....	114	Clip for Ribbed Metal Lath.	
Common Brick Is Supreme in Mass Textures..	118	Combined Rule Level Protractor.	
The Lead Mattress.....	121	Line of Mixers Improved.	
All Foundation Fibration Is Eliminated in the Sky-		New Toggle Joint Base Grinder.	
scraper Type of Construction.		Air-Cooled Stationary Engines.	
Detroit's Finest Apartment Hotel.....	122	For Pulling Electric Plugs.	
Heart of City Block Used for Office Building		New Three Gang Tumbler Switch.	
Garage.....	124	Clean Convenient Garbage Receiver.	
Details of Home Building.....	126	New One Bag Mixer.	
The Western Bungalow.		Improved Paint Spray Gun.	
Furnace Heating.....	128	Mixer Wheels Improved.	
Warm Air for Cellarless Houses.		Four New Engines Announced.	
Painting and Decorating.....	130	Home Ventilating Unit.	
Painting Pointers for Exteriors.		Overhead Rolling Steel Doors.	
Finishes for Woodwork.		Luminous House Numbers.	
		Copper-Steel Boiler.	
		Handy Motor Attachment.	
		Perfect Electric Water Heater.	
		Portable Paint Spray Outfit.	
		Improved Electric Hand Saw.	
		Complete Line of Wheelbarrows.	
		News of the Field.....	178-180-182
		Books, Bulletins and Catalogs for You....	184-186
		ADVERTISER'S INDEX.....	251-253

Published on the first day of each month by American Carpenter and Builder Co.; Wm. A. Radford, *President, Treasurer and Editor-in-Chief*; Wm. A. Radford, Jr., *Vice-President*; E. L. Hatfield, *Vice-President and General Manager*; Bernard L. Johnson, *Vice-President and Editor*; Roland D. Radford, *Secretary*; S. C. Kellenberger, *Dealer Service*; Charles G. Pecker, *Eastern Editor*; Juan Homs, *Export Editor*; Delbert W. Smith, E. B. Wolfrom, C. R. W. Edgecumbe, L. H. Reich, O. H. Sutter, Cecil W. Blashill, H. P. Sessions, J. J. Dubro, Dan E. Dunn, R. E. Clement, H. R. Hazard, *Advertising Staff*.

Publication Offices:

Radford Building, 1827 Prairie Ave., Chicago

Telephone: Calumet 4770

Eastern Office, 250 Park Ave., New York City

Telephone: Vanderbilt 3185

Entered as second-class matter July 1, 1905, at the post office at Chicago, Ill., under the Act of March 3, 1879. Additional entry as second-class matter at Binghamton, N. Y.; Columbus, Ohio; Seattle, Wash.; Los Angeles, Calif.; San Francisco, Calif.; Denver, Colo.; Dallas, Texas; St. Paul, Minn., and Kansas City, Mo.

SUBSCRIPTION RATES—One year, United States, Canada, Mexico, and U. S. Possessions, \$2.00; six months, \$1.00; single copies, 35 cents. Foreign countries, \$4.00.

PROTECTION FOR OUR READERS—The publishers of the AMERICAN BUILDER reserve the right to decline any advertising they believe is detrimental to the interest of its readers; to edit advertising copy and to change or eliminate any statements that reflect injuriously or cast discredit upon other building products, machinery, equipment, supplies or tools.

Be sure in writing to advertisers to say: "I saw your advertisement in the AMERICAN BUILDER."

ADVERTISING RATES—Furnished on application. Advertising forms close on the 10th of the month preceding date of publication.

MEMBER OF THE AUDIT BUREAU OF CIRCULATIONS

In Keeping with Specifications

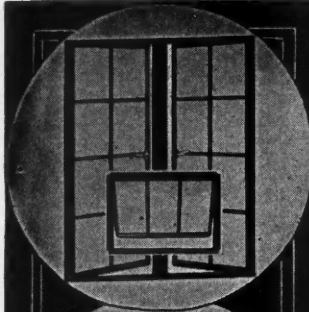

Steel Windows for Every Use

Whatever the type of building—there is a Truscon Window that has been designed to meet the most definite specifications, at a price commensurate with the purpose for which the building is designed.

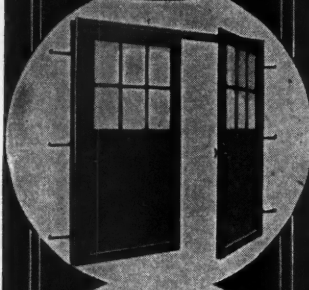

Steel Doors for Every Need

Whether you need a door for a private garage, service entrance, filling station, or a special door for airplane hangar, industrial, railroad, wharf or warehouse building, Truscon can meet all requirements economically.

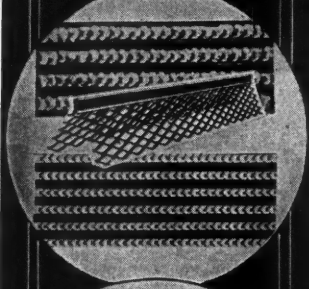

Quality Plaster Bases

For permanent Plaster Work, Truscon manufactures a complete line of Metal Laths, Stucco Steel, Corner Beads, Strip-It, Channels and Clips in addition to a new type of Steel Mortar Box that saves time and labor.

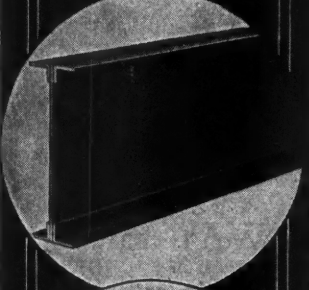

Economical Fireproof Floors

With Truscon P-G (Plate Girder) or O-T (Open Truss) Joists you can build fireproof floors in any kind of weather at low cost. Truscon Steel Joist Construction eliminates all form work.

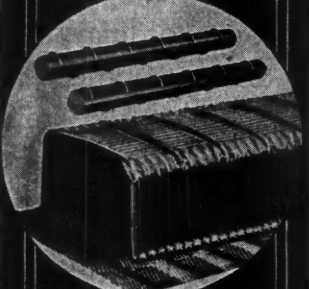

Reinforcing for Permanence

In addition to a complete line of reinforcing products, there is always available the wide experience of Truscon engineers to suggest designs not only economical in Steel but of less cost and labor.

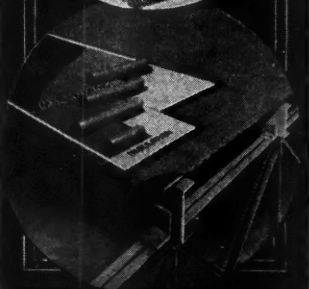

Light Weight Steeldeck Roofs

Truscon "T"-Plate Steeldeck Roofs insulated and waterproofed for all types of buildings where light weight, and economy are essential.

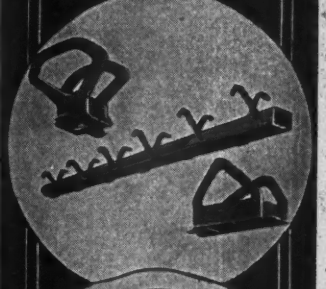
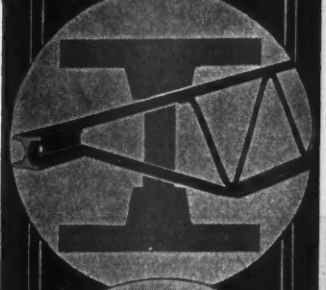
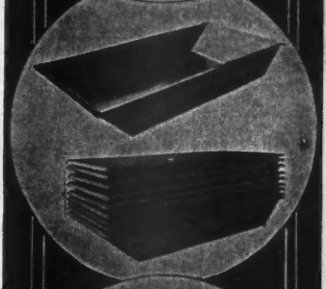
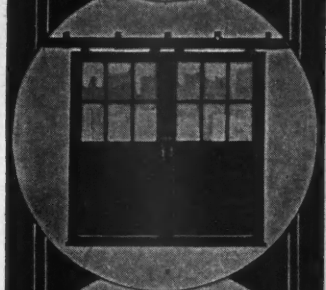
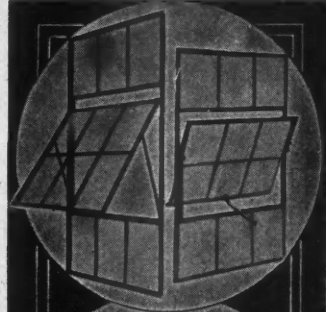

TRUSCON

TRUSCON STEEL COMPANY, Youngstown, O.

BRANCHES AND DEALERS EVERYWHERE

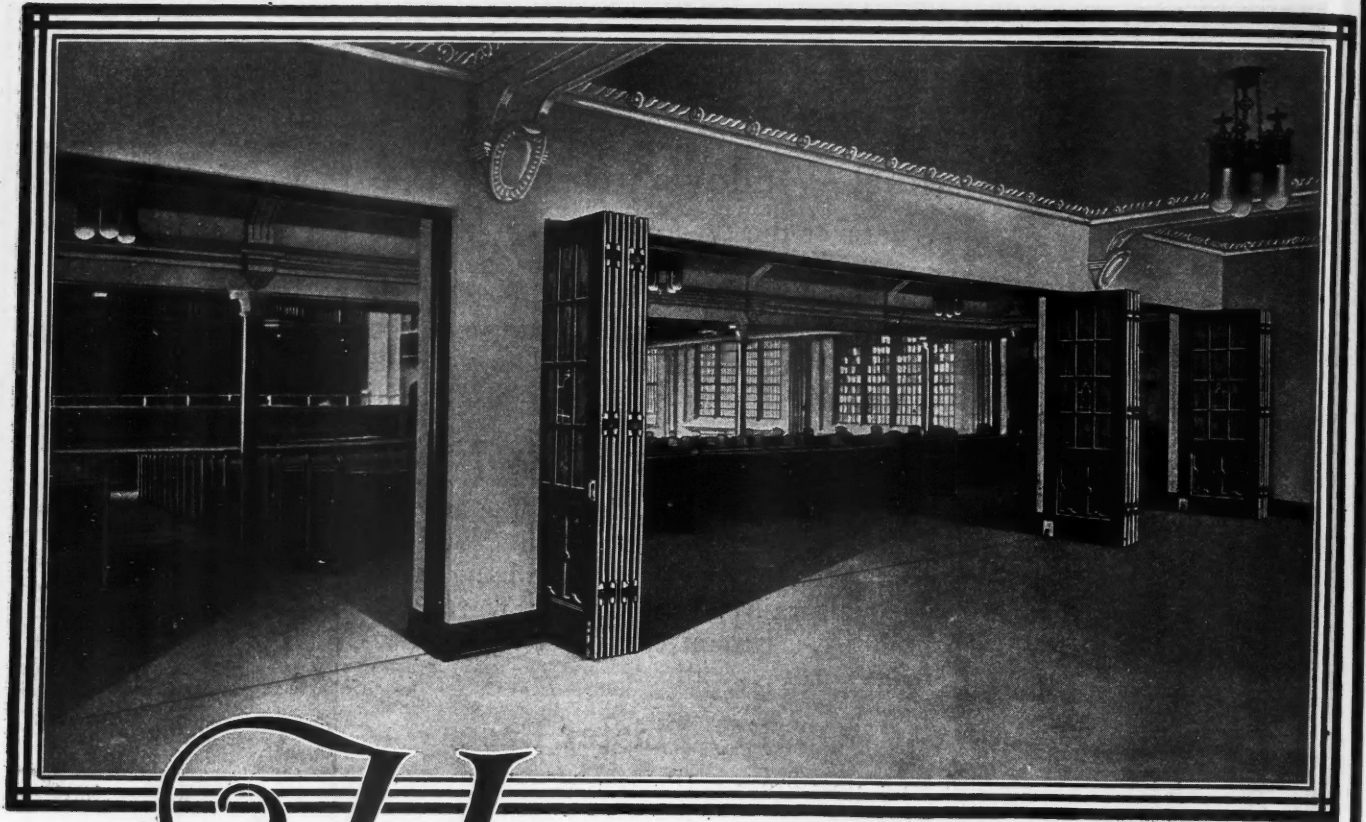

Here's the best for

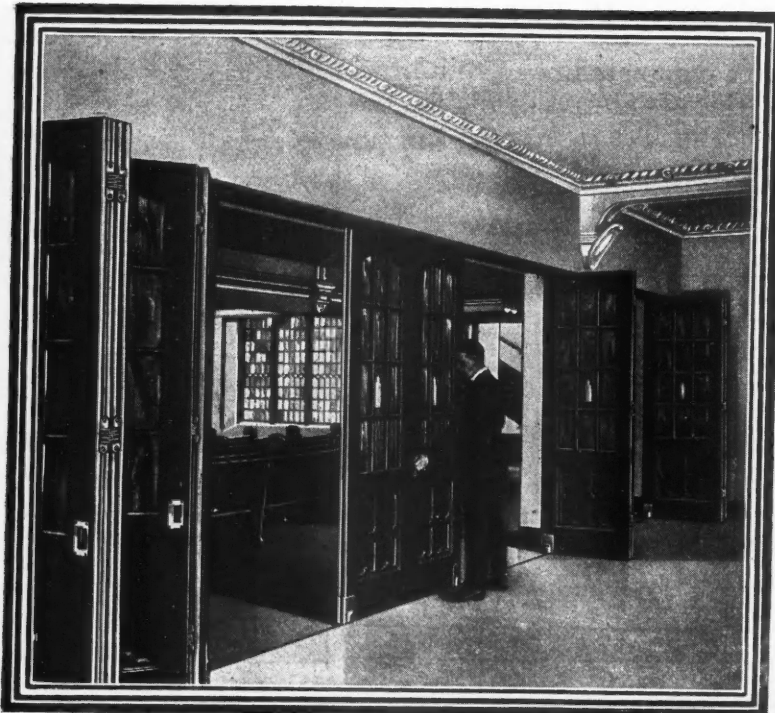

FOLDER-WAY partition door hardware is as much of an improvement over ordinary folding and sliding door equipment as the washing machine is an improvement over old-fashioned tubs and scrubbing-boards.

That is why architects and builders consult Richards-Wilcox about all doorway problems. For Folder-Way brings partition door principles nearer to perfection than any structural development of recent years.

Lodge rooms, churches, hotels, schools, Y. M. C. A.'s—wherever

peop
now
a m
ratt
Fold
You
part

No
Ch
Larg

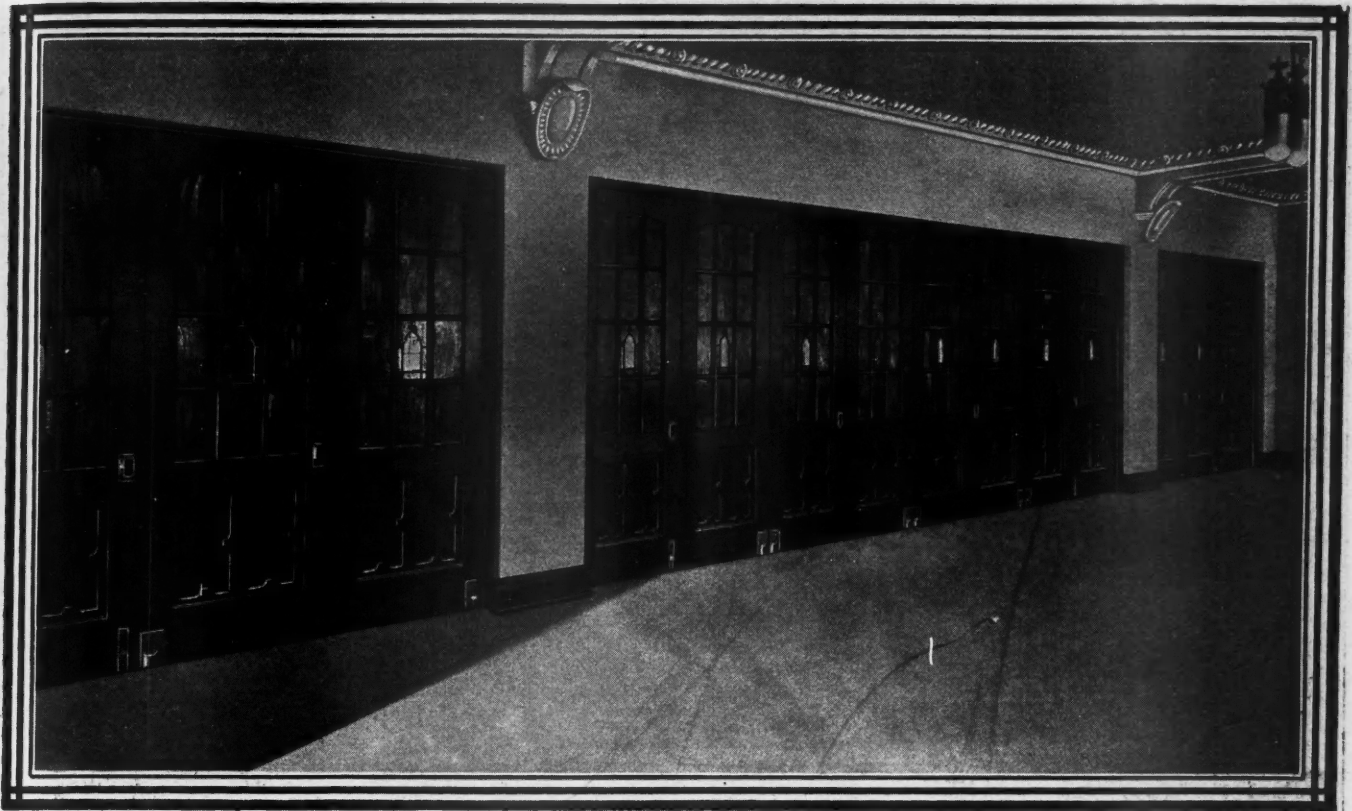

t method r wide openings

people gather in large or small groups—entire walls can now be folded away out of sight noiselessly and with a minimum of effort. There is no sagging, sticking or rattling. Their performance is almost automatic. FoldeR-Way hardware meets all modern requirements. You will find FoldeR-Way installed in buildings in all parts of the United States and Canada.

Write us for full information, and do not hesitate to ask Richards-Wilcox experts to help you solve your doorway problems.

Richards-Wilcox Mfg. Co.

A Hanger for any Door that Slides.

AURORA, ILLINOIS, U.S.A.

New York Boston Philadelphia Cleveland Cincinnati Indianapolis St. Louis New Orleans
Chicago Minneapolis Kansas City Los Angeles San Francisco Omaha Seattle Detroit.
Montreal • RICHARDS-WILCOX CANADIAN CO., LTD., LONDON, ONT. • Winnipeg

Largest and most complete line of door hardware made

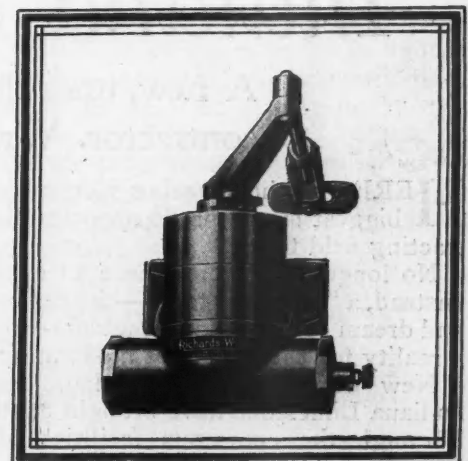

If you will try an R-W Door Closer and Check you'll find a closer without an equal. Its ease of application—no taking check apart—is an exclusive feature. Only true reversible check; positively liquid tight and easily adjusted—simply turn a thumb-screw valve. This beautifully finished check is built for a lifetime of trouble-free service—and that's what it delivers.

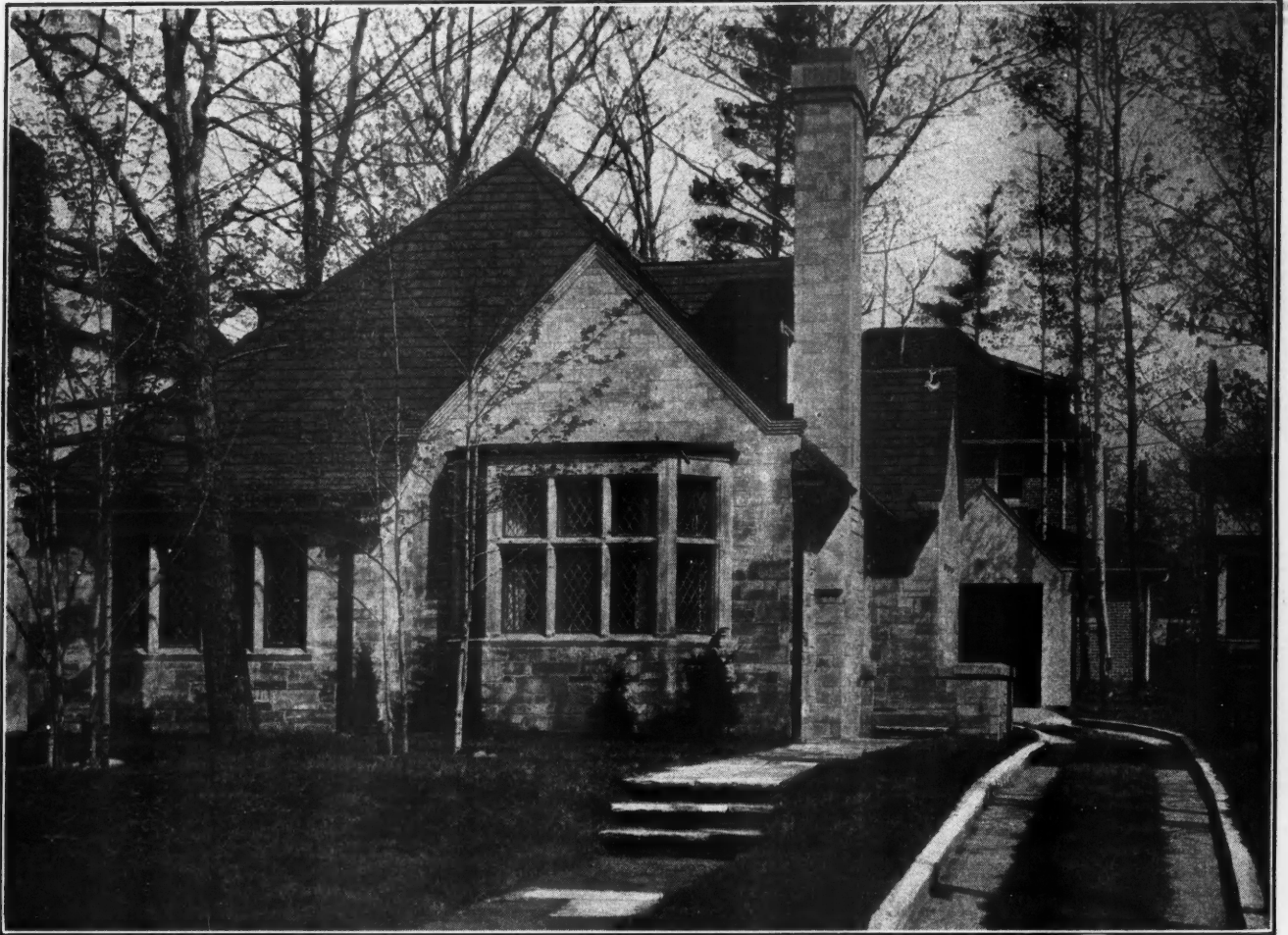

W. J. Skelly residence, Toronto, Canada. At only a small additional cost the owner of this Toronto home has built of Indiana Limestone and obtained a home of outstanding beauty and distinction. It was designed by D. E. Kertland and the construction is the Random Ashlar described on these pages

Houses with Indiana Limestone Facing

A new, unexploited profit opportunity for the live contractor. Write for full information—use coupon

HERE are the amazing facts about one of the biggest single profit opportunities in the contracting field today.

No longer is a stone house an expensive luxury. Instead, a "castle of stone"—the rich man's ambition and dream of every home-builder—can now be made a reality for the person of moderate means.

New ways of producing, handling, and setting Indiana Limestone have brought about this change. Through the enormous facilities of the Indiana Limestone Company, the use of this beautiful natural stone in residence construction has been made just as practicable as that of brick, stucco, or wood.

Big re-sale value

Obviously, a stone house has an attraction that is

not surpassed by any. It immediately stamps its proud owner as having the best there is. A stone exterior is economical—upkeep expense is rarely necessary. The beautiful light color of Indiana Limestone mellows with age, so that as the years pass the house built of it becomes more and more attractive. Thus re-sale value increases.

Stone in strips

Indiana Limestone for Random Ashlar facing is supplied in sawed strips 3 feet 6 inches to 5 feet 11 inches long. The stone is sawed on four sides—face, back, top and bottom.

Right on the job, these strips of Indiana Limestone are broken, jointed and laid up. A stone-mason or a bricklayer can lay this work up. *No expensive*

INDIANA LIMESTONE COMPANY, General Offices: BEDFORD,

stone-cutter is required. Prepared drawings for jointing and laying up are not necessary.

Electric saw for jointing

In place of the old-time mallet and chisel, the stone is now jointed to required length by a remarkably simple operation. A small, portable electric carborundum saw is used to cut a groove in the face of the stone. The stone is turned over and a tap with a hammer breaks it cleanly on a line with the groove.

One laborer on a recent job, by this method, kept six stone-setters busy! Could anything be simpler or easier? Your mason's time by this new method is spent on the wall laying stone, instead of jointing it.

Applied as veneer

Indiana Limestone handled as above is applied as a veneer to the stud frame walls. Or it may be used as a structural facing over hollow tile or brick. It is secured to the frame with galvanized metal ties, the same as a veneer of face brick work. In any case,



Cutting Random Ashlar strips to required length. Quick and easy because this electric carborundum saw is used instead of old mallet and chisel.

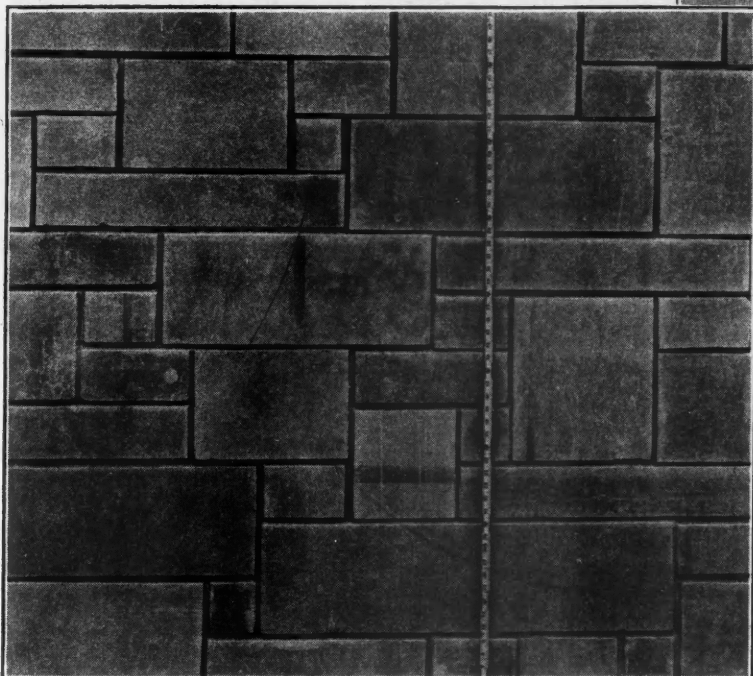

Detail of Random Ashlar wall built of Indiana Limestone showing one of the common schemes for laying up this class of Indiana Limestone.

you can now face walls with Indiana Limestone economically and quickly. So simple is this method, so easy to handle is the material, that construction goes ahead with maximum speed.

We will help you

Indiana Limestone Company is a consolidation of 24 of the largest properties in the Indiana Limestone district. Organized in 1926, our company has assets of over \$46,000,000.00. We have worked out new methods which are revolutionizing the stone industry. Residence construction is a field we are now particularly interested in.

We will furnish plan books, information on construction, and all the other data you need to post yourself thoroughly on this wonderful building

stone. We will give you every bit of help possible in getting started on Indiana Limestone construction. Don't be afraid because you've never used it before. We will stay with your job from start to finish.

The contractors who make a "clean-up" by building homes, stores, apartments, etc., of Indiana Limestone will be those who start at once. Let that contractor be you. Get the jump on your competitor. Just one Indiana Limestone house will advertise you as no construction you've engaged in before has ever done.

Mail coupon at once

We'll submit all the facts about Indiana Limestone facing to you in fullest detail. You will be under no obligation. We just want to spread the cards before you. To show you what an exceptional opportunity exists.

Fill in your name and address on the coupon and mail it at once. Booklets and other information will be sent you immediately.

-----Fill in, Clip and Mail-----

Box 757, Service Department
 Indiana Limestone Company, Bedford, Indiana
 Send me full information on Indiana Limestone for residences.

Name.....
 Address.....
 City.....State.....

INDIANA • Executive Offices: TRIBUNE TOWER, CHICAGO

WHEN WRITING ADVERTISERS PLEASE MENTION THE AMERICAN BUILDER



“Standard” PLUMBING FIXTURES

These advanced conveniences

THE “THREE 8’s” SINK

8-inch low back—
Fits snugly under unusually low windows permitting installation in the direct light.

8-inch deep sink—
Accommodates large size utensils, and prevents over-the-rim splashing.

8-inch wide front—
Adds a finishing touch of beauty.



The directly attached garbage container is another selling feature. It is of vitreous china with removable aluminum receptacle. It may be pushed back under the sink on its folding bracket.

Never before has a kitchen convenience been accorded as hearty an endorsement as the new “Standard” “Three 8’s” Sink. Women everywhere quickly recognized the unequalled advantages of its many exclusive features. They are looking for this ultra-modern sink in the homes they buy or rent.

The 8-inch back permits its installation under a low window. With its deep 8-inch compartment, the tallest vessel fits easily under the swinging-spout. The extended 8-inch front marks this sink as a convenience of beauty and distinction.

The hard, glass-like enamel defies fruit and vegetable acids. The gleaming surface repels dirt. This is easiest of all sinks to clean and keep clean, and the years cannot dim its lustre. The improved fittings are finished in Chromard that will not tarnish, corrode or wear off.

These are the improvements prospective buyers and renters are now seeking. They are features found only in the “Standard” “Three 8’s” Sink. It is made in several styles and sizes and in seven beautiful colors, as well as white.



“Standard”
PLUMBING FIXTURES

make homes more desirable

Another plumbing innovation that makes homes easier to sell and rent is the new “Four-Way” Laundry Tray. Only a woman can appreciate how its improved design lightens the work.

There is no need now to install laundry trays against the wall or in dark corners. The “Four-Way” Laundry Tray is designed for the middle of the room—usable from all sides. It is made of Acid-Resisting Enamel which soaps, powders, and bleaches cannot roughen or discolor.

Faucets are just above the tray, and a single swinging-spout serves both compartments. A separate hose connection

is provided so that the hose once attached, need never be disconnected. The tray is adjustable as to height, and all fittings are finished in Chromard.

The new “Four-Way” Laundry Tray, and the “Three 8’s” Sink are now on display in all “Standard” Showrooms. If you cannot visit one, write for the illustrated book, “Standard” Plumbing Fixtures for the Home” that is mailed FREE on request. Identify “Standard” products by the trademark “Standard” impressed in every fixture.

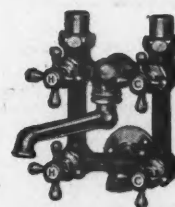

A single swinging-spout faucet supplies hot, cold or tempered water to either compartment of the laundry tray. It may be suspended from ceiling, attached to wall, or fastened to rim of tray. An extra outlet for hose connection supplies the hot or cold water and tempered to the washing machine. This fitting is finished in Chromard. It will not wear off, tarnish or corrode.

Standard Sanitary Mfg. Co.
 PITTSBURGH

WHEN WRITING ADVERTISERS PLEASE MENTION THE AMERICAN BUILDER

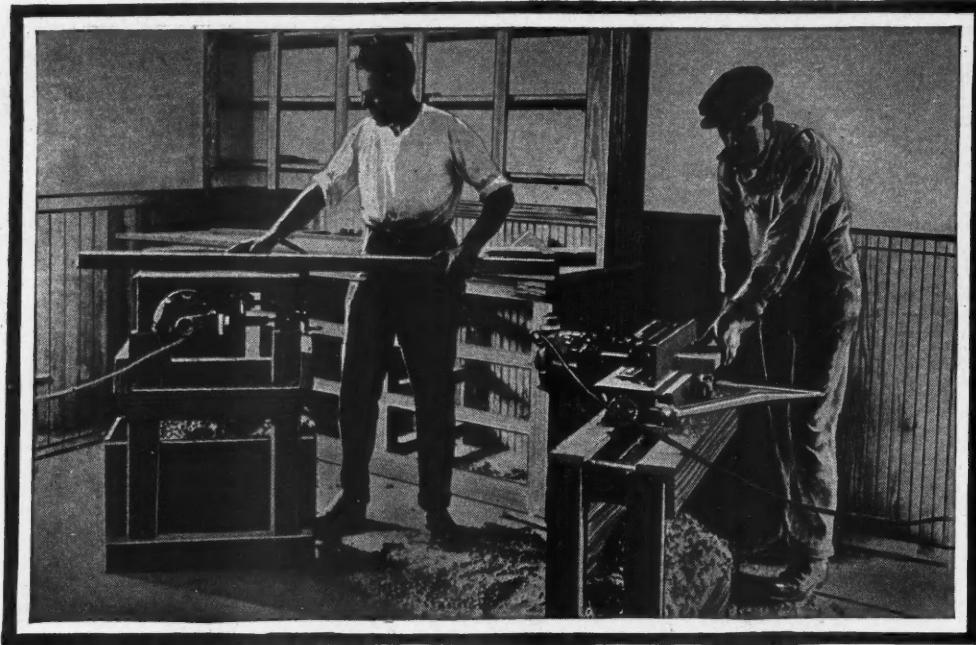

This photograph shows how one contractor saves money by applying "The Wallace Idea" to his business. C. B. Lynde, Jr., of Clinton, Mass., does his own mill work right on the job. Having portable Wallace Machines just about doubles the amount of work done by his men and greatly increases his profits on each job.

Individual

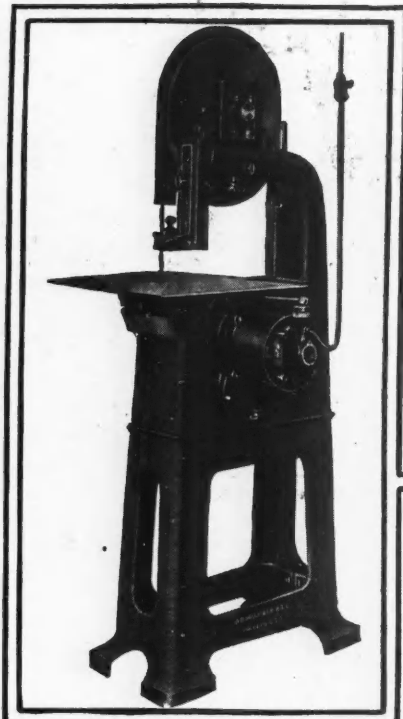

Wallace Portable Band Saw

Contains built-in and directly connected motor with ample power to efficiently handle work within its full capacity.

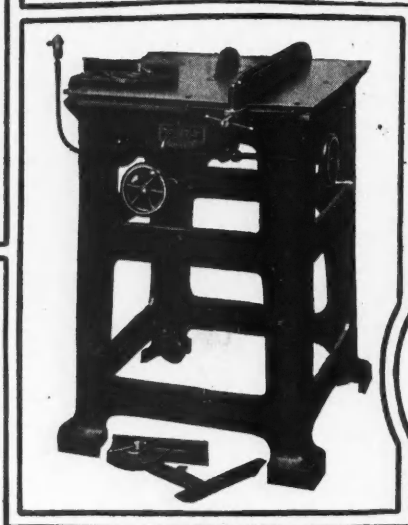

Wallace Portable Universal Saw

A portable floor type of Universal Circular Saw that combines all the advantages of the portable bench machine and the self-contained floor type. The saw can be moved independent of its base.



The Wallace Electric Handsaw is light in weight and easy to handle. Its chief feature is absolute SAFETY. The blade is entirely covered at all times. The motor, the switch, the operator and the saw itself are completely protected against injury.

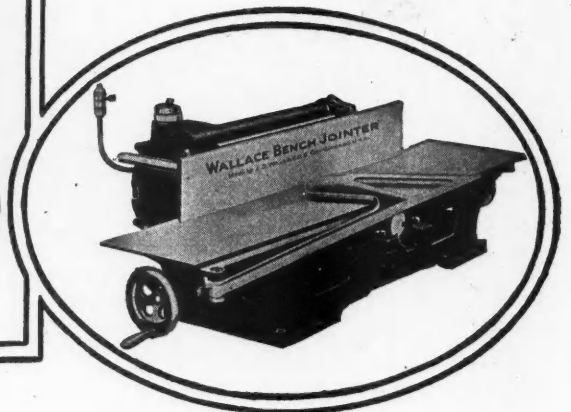

Wallace Bench Planer and Jointer
A compact and highly efficient machine — easily portable with ample power to handle all classes of work.

Portable Machines for every Woodworking Job

SAVE YOU MONEY

THE secret of "The Wallace Idea" is simply having individual portable woodworking machines for each kind of job.

These take the place of the old-fashioned, cumbersome, so-called "all-purpose" machines which too frequently require more time for "make-ready" than for the actual work required of them.

Each individual Wallace Machine is especially designed to do a certain class of work. They can be carried wherever that kind of work is being done. They're always ready for instant use without endless adjusting and regulating.

Being designed for one class of work only, each Wallace Machine is smaller, simpler and lighter. They take up little room, wherever you put them. They can be quickly and easily moved from place to place in the shop and out on the job. All you do is attach the plug to the nearest electric light socket. You just take the machine to the work—never have to haul heavy, awkward, cumbersome materials to where the machine is.

Big jobs and little jobs—heavy jobs or jobs requiring the greatest neatness, accuracy and delicate handling—it's all the same to a Wallace band saw, universal circular saw, planer, jointer, or lathe.

Wallace Machines have more than ample power. There is no belt to slip or cause annoyance. Nothing complicated about setting them up. Everything ready in a jiffy.

The results are amazing. Man power is saved and that means enormous savings of costly time. Materials are conserved and that also means saving money. The work is uniform and done much quicker than by hand. Thousands of contractors and builders say that Wallace Individual Portable Machines have "spoiled" them for anything less efficient.

Free Trial!

You are urged to investigate the money-saving advantages of the Wallace Idea. We will send one or more Wallace Machines to any job you are on or to your shop and there you can find out for yourself how valuable they are, how they will, in a short time, pay for themselves. If you decide not to keep the machines, the trial costs you nothing. Send today for the Wallace Catalog and full details of the free trial offer.



WALLACE
PORTABLE MACHINES

BELTLESS—
Attach to any
light socket

J. D. WALLACE & CO.,
136 S. California Ave., Chicago, Ill.

You may send me your book on Wallace Portable Machines and full details of *Free Trial Offer* and easy terms.

Name.....

Address.....

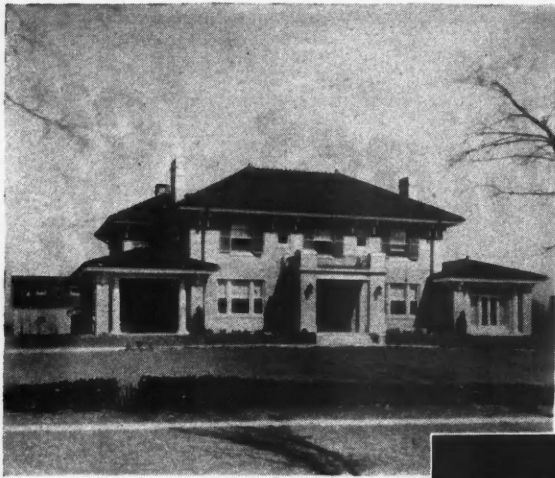

*J. Lee Davis Residence,
Richmond, Virginia. Archi-
tect and General Con-
tractor: Davis Brothers
Heating Contractor: L.
M. Cheatham. Aero Rad-
iation. Novus Sectional
Boiler.*

AERO

installations help
the sale

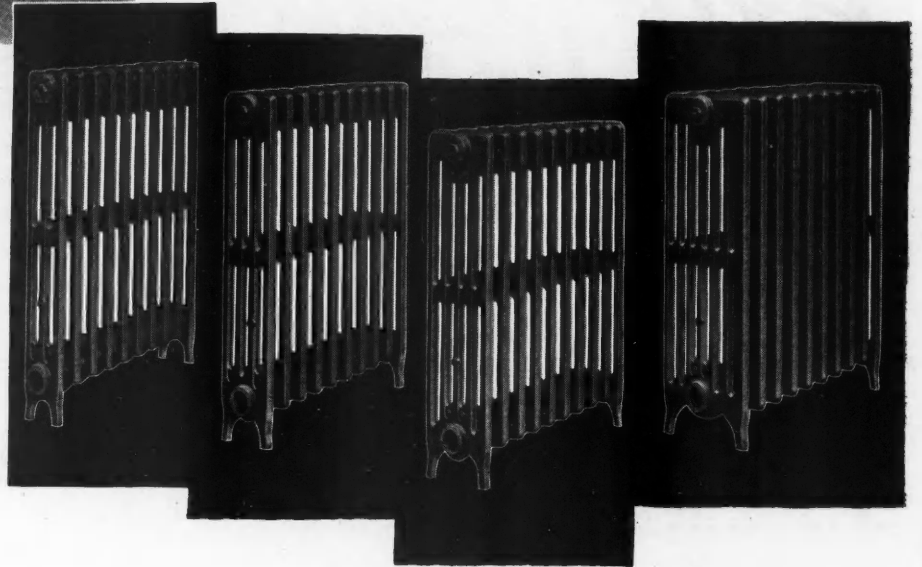

YOU'LL find that Aero equipped homes excite profitable comment, due, of course, to Aero's delightful combination of beauty and warmth.

Aero—the National Radiator—slender and graceful, makes a substantial contribution to the beauty of every room. Brings real fuel economy, and comfort, through its proper proportioning of circulating air space to heating area.

Every Aero installation has behind it a record of many years of proved performance, that guarantees trouble-free service, and permanent customer-satisfaction.

Each Aero installation is a permanent advertisement for the builder responsible for it. One that works continually to bring him better prices, quicker turnover, and increasing goodwill.

NATIONAL RADIATOR CORPORATION

Ten plants devoted to National Service through these Branch Offices and Warehouses:

Baltimore, Md.—2622 Frisby Street
Chicago, Ill.—2445 N. Keeler Avenue
Indianapolis, Ind.—57 S. Bolton Avenue
Pittsburgh, Pa.—1509 Arrott Building

Boston, Mass.—93-97 Oliver Street
Cleveland, Ohio—935 E. 63rd Street
New York, N. Y.—55 W. 42nd Street
Richmond, Va.—3032 Norfolk Street

Buffalo, N. Y.—McKinley Building, Delaware Avenue
Cincinnati, Ohio—Spring Grove and Elmira Avenue
Philadelphia, Pa.—121 N. Broad Street
Washington, D. C.—2205 Fifth Street, N. E.



AERO

THE NATIONAL
RADIATOR



BUILDERS OF AMERICA

ARE USING MORE AND MORE

“SECO” INCINERATORS

BECAUSE “Seco’s” are the most reasonably priced, the most practical incinerator made and fully answers the buyer’s demand for efficient private garbage disposal. An important sales feature indeed, and builders who have learned the selling power of Secos have standardized their entire program upon them. The obvious advantages of SECO Incinerators are leading an increasing number of builders to include them in their plans—because they know “SECO” is a most attractive Sales Feature. Scores of builders order by the dozen. And there is a SECO for every need, ranging from a small sanitary napkin destroyer to units of 100 tons per hour. **Built-in—Basement—Portable—and outdoor types.**

All SECO Incinerators employ the exclusive SECO Secondary air supply port feature, distributing air through and around garbage body, insuring rapid drying and complete destruction of refuse.

Prior to the advent of “SECO” prohibitive costs confined this convenience to high-priced homes. SECO removed the financial barrier. It truly is built for the American housewife of moderate means.

DIRECT CHUTE TYPE

With chute stack built on top of combustion chamber. The exclusive air supply port features of SECO equipment makes this the finest direct drop type incinerator made.

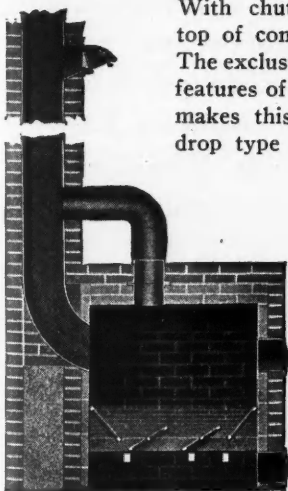

\$78.50 and up

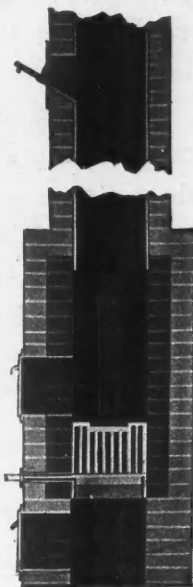

No. 10 Direct Chute Type, \$72.50

No. 50 Unit \$48.50

!

Gas Attachment Extra \$6.50



NO. 50 INCINERATOR

An actual installation of No. 50 SECO Incinerator in moderate priced Bungalow. Note convenient size and height of hopper door. Combustion chamber, 16"x16"x36", is incorporated into base of fireplace or other chimney connecting into heating plant flue, and becomes an integral part of the structure. (Average completely installed cost \$65.00.)

THE No. 90 SERIES “SECO” INCINERATORS

The No. 90 series SECO slide chute, chimney fed incinerator made in various sizes, offers among many practical, exclusive features—

The finest chute type incinerator made, at a complete installation cost lower than ordinary direct drop incinerators.

Impact of falling objects is absorbed by slide chute of solid masonry, throwing garbage into combustion chamber

in a loose bulky mass which dries thoroughly and burns quickly.

Chute stack and incinerator rest on individual bases, relieving combustion chamber of stack burden and permitting arched roof construction of combustion chamber. Employing exclusive SECO secondary equalizing stack.

SECO air supply ports and SECO sloping hearth principles assure complete, odorless destruction of refuse without commercial fuel.

You can rely on SECO Quality—If not fully satisfied return at our expense. Your money will be cheerfully refunded. Open account shipments on approved credit rating.

Order for Your Requirements Today!

Sanitary Equipment Company
MANUFACTURERS and SANITATION ENGINEERS

KANSAS CITY
MISSOURI

“SECO” INCINERATORS

ASBESTOS SHINGLES THAT WILL NOT FADE OR BLOOM!

*Exclusive new Eternit process makes
Eternit Asbestos Shingles absolutely colorfast!*

ASBESTOS shingles that are colorfast! Amazing discovery! Astounding process—exclusive with Eternit! Shingles that will not fade or bloom! Sun, rain, time, can't affect them. The richer, more beautiful colors of Eternits will stay that way—always!

If you are building your own home you want color in the roof! Think of being able to get color that not only makes your home most attractive, but which will last as long as the house stands. If you are an operation or development builder you *must* use color. For some time past, color in roofs has helped the sale of homes. Now—fast color, permanent Eternit color, will be *demanded*. And here is something to think about—the cost is no more than for ordinary colors!

Because of this special treatment, Eternits are really more beautiful than ever! There are Autumn Bronze, Colonial Gray,

Indian Red, Quarry Blue, Emerald Green—colors that harmonize with every type of building. And Eternits are tougher, stronger, more resilient than all shingles. Made of choicest asbestos and Portland cement, built up (not cast or molded) for added toughness and permanence. Absolutely fire-proof, water-proof.

Be sure to see the March 31st
Saturday Evening Post

Look for the announcement in the March 31st *Saturday Evening Post*. Two pages in full colors, illustrating the effects on various types of homes. Advertisements throughout the year will tell more of the great Eternit story. Home owners, builders, contractors, architects and roofing dealers are invited to mail coupon for complete information today. Address Eternit, Inc., Philadelphia, Boston, New Orleans, Houston, Jacksonville, St. Louis.

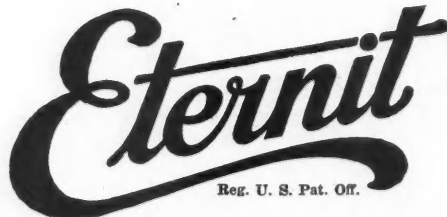

ASBESTOS SHINGLES

ETERNIT, Inc., Dept. A, 15th and Locust Sts., Philadelphia. Please send me full details about the Eternit Dealer Franchise.

Name _____ Street _____

City _____ State _____

Check square if you are a dealer. If you are a builder or roofer give dealer's name here:

“What! That sander finishes as much floor as my big as my big machine?”



Not waiting for an answer, Mackenzie fired another question at Owens. “And do you mean to tell me your 31 pounder sands 800 to 1600 square feet in 8 hours?”

Owens grinned. “I sure do—and, Mackenzie, I’ll bet my CLARKE will do better work.”

“Nonsense!” Mackenzie scoffed. “Now how can it? Look at the size of it—the weight!”

“That’s just it,” Owens broke in, “You don’t need weight to sand floors—that’s the old fashioned idea. What you need is power and correct speed—and the CLARKE’s got them.”

The Scotchman pursed up his lips. “Well, suit yourself, Owens—but you’ve got to show me! If there was a power line up I’d insist on it.”

Owens did not reply. Instead, he uncoiled the extension cord of his sander, and slipped the plug into a light socket above his head.

“What—runs off an ordinary light socket?” asked Mackenzie, and he watched with interest his fellow contractor chalking off a section of flooring.

“Here’s where you’re shown,” Owens remarked good-naturedly. “You’re going to see how much flooring you can do in 15 minutes.”

“Who—me?” Mackenzie’s mouth fell open with astonishment. “No—no! I have never run a sander—it’s too heavy for me at my age.”

Owens shook with laughter. “Come on, you old Scotchman—it’s just as simple and easy to run as a vacuum cleaner.” He took the handle in one hand. “Now watch me,” he said, and he spent a minute or so showing its operation. “Come on, Mackenzie—give it a try.”

Mackenzie caught on right away. Soon he had mastered its operation. He ran the CLARKE up to the farther chalkline, and back again. He forgot all about Owens, and his argument—he even forgot he was actually running a sanding machine. This light-weight, powerful sander fascinated him. “Great Scott!” he chortled. Five minutes later he stopped, got down on his knees and scrutinized the wide expanse of finished flooring behind him. “Wonderful job!” he muttered. Again he went on with the work.

“Time is up,” sang out Owens. Mackenzie didn’t answer—he was beaming at the floor.

“Man!” he suddenly exploded. “That’s the prettiest, smoothest, neatest—ah—ah—slickest flooring I ever saw! And I did it!” He thumped the wall. “And I did it! Owens,” he asked, excitedly, “Where can I get a sander like yours? I’m convinced!”

“Wait, I’m not through with you yet,” Owens chuckled. “That patch of flooring measures about 5 by 9 feet—I’ll measure it.” He took out the tape-line.

“Yes,” he reiterated. “There’s 45 square feet—in only fifteen minutes, too. That’s 180 square feet an hour. Mackenzie—at the rate you were going, you would have finished 1400 square feet in eight hours!”

“1400 square feet!” mumbled Mackenzie. He rapidly figured. “Yes, siree, you’re right!”

“And I’m not through with you yet,” said Owens. Then he showed Mackenzie how the Clarke Vacuum Portable Sander worked in the closets and hallways—showed how it worked up close to the baseboard. Then he put the CLARKE on some old varnished floor in the back of the house, and Mackenzie saw with his own eyes the varnish shattered, and clean, new wood revealed. The old Scotchman was amazed at the rate it was done—300 to 800 square feet a day, he figured.

“And another thing—the CLARKE is absolutely dustless in operation,” summed up Owens. “But what’s the matter, Mackenzie? Why do you look so down in the mouth?”

The old Scotchman nodded his head. “I’m just thinking of all the money I spent on those old sanders—on truck haulage and crew help, on special wiring and big power bills, on hand-scraping. Owens, if I had had a Clarke Vacuum Portable Sander I could have saved every bit of that money!”

“But from now on—I’m going to use the Clarke Vacuum Portable Sander!” Mackenzie announced. “Give me the address of those people—I’m wiring for one of their machines tonight!”

***** Like Mackenzie, you will be amazed at what the Clarke Vacuum Portable Sander can do—and what it can do for you!

Lick a two cent stamp and send the coupon to us. You will like the company, the men, the whole organization, and fast service.

CLARKE SANDING MACHINE CO.

Dept. A-23 3815 Cortland St. Chicago, Ill.

For eleven years, Originators and Manufacturers of Portable Sanding Machines

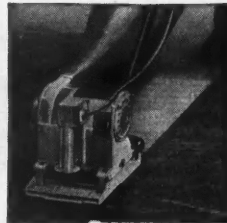

Clarke Sanding Machine Co.
Dept. A-23, 3815 Cortland St.
Chicago, Ill.

Please send me the actual facts on the Clarke Vacuum Portable Sander. No obligation to me.

Name.....

Address.....

City..... State.....

ada
—answers all calls.

There's Profit in remodeling OLD HOMES



REROOFED
WITH STAINED WOOD
SHINGLES

3 DORMERS ADDED
CENTERING OVER
WINDOWS BELOW

ARCHED LATTICE
TRELLIS OVER EACH
FRONT ENTRANCE

WOOD SHUTTERS
ADDED TO TAKE AWAY
BARREN LOOK

NEW COLONIAL
6-LIGHT SASH REPLAC-
ING OLD WINDOWS

SIDE WALLS COVERED
WITH NEW NOVELTY
SIDING

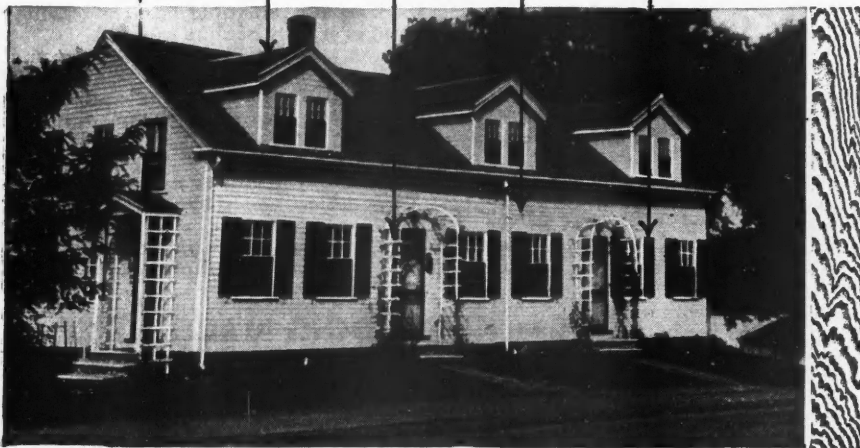

THE landscape is dotted from ocean to ocean with millions of houses that are out of style, unsightly — or both. Millions of rebuilding opportunities — money-makers!

Lumber is the most adaptable, handy, satisfactory and profitable material for remodeling jobs.

It's easy to sign up lumber alteration contracts. Show your townsmen the "before-and-after" illustration on the left — and sell them the idea of making similar transformations. You'll find most of them ready listeners. They'll be surprised at how quickly the work can be done — and how little the cost.

Clinch your selling talk with the big re-sale value that modernizing will give an old house that nobody would buy. Set it off with a touch of sentiment — it's the same dear old home but renewed and revalued.

This illustration is one of many transformation examples shown in this series of advertisements. Every one of them has money-making inspiration. Watch future advertisements for helpful suggestions regarding new homes from old — *with the help of lumber.*

Use properly seasoned lumber, manufactured to American Lumber Standards, endorsed by the United States Departments of Agriculture and Commerce. Made by America's best mills. Your retailer has it or can get it for you.

NATIONAL
LUMBER
MANUFACTURERS ASSOCIATION
WASHINGTON, D. C.

AMERICAN STANDARD LUMBER FROM AMERICA'S BEST MILLS

Avoid Interior Trim Troubles This Spring—Use

TRIMPAK [The Ultimate Interior Trim]



THE TRIMPAK WAY

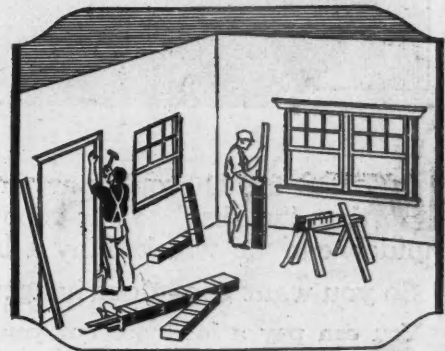

The modern, trouble-proof way of applying trim is shown above. Sturdy cartons protect pieces until carpenters are ready to use them. The right piece is found in an instant, and with only one end to cut, is quickly ready to be nailed up.

Carpenters Prefer TRIMPAK

*No more damaged, dirty trim
No more lost pieces—No more wasted stock*

YOU will save money on the buildings you erect this Spring by specifying TrimPak, the ultimate interior trim for doors and windows, for every opening. When houses are being made ready for the Spring market, every day counts. Mix-ups or shortages in trim orders that result from use of long-length trim hold back the marketing day, the day when you receive payment for your labor. Your money must not be tied up in unfinished buildings a day longer than necessary!

You can be one of the thousands of builders who have freed themselves from expensive delays occasioned by long-length trim troubles, if you will order TrimPak on every job. It's much easier to figure, costs less in the long run, requires less time to erect, makes a better job and eliminates worry over damaged, dirty trim, lost pieces and wasted stock. Sold by lumber dealers everywhere in all woods and patterns. Your request on coupon below will bring full information.



The Old Fashioned Way

Above is a typical scene before the days of TrimPak. Costly long-length trim piled helter-skelter on the floor, and carpenters jostling one another to find the piece each needs next. Expensive incidents like these are eliminated when you order TrimPak.

44 Whitehall Street
New York, N. Y.

TRIMPAK CORPORATION

624 S. Michigan Ave.
Chicago, Ill.

*How Other Builders Save!
Use Coupon at right for
full facts on money-saving
advantages of TrimPak.*

TRIMPAK CORPORATION, 44 Whitehall Street, New York, N. Y.
Please send complete information on TrimPak.

Name _____
Address _____

Please check the square that identifies you, so we may reply most intelligently:

Architect Builder Contractor Retail Lumber Dealer Home Builder AB-328

**A Closed Track Job
At
Flat Track Price**

CANNON BALL JUNIOR

BEATS 'EM ALL

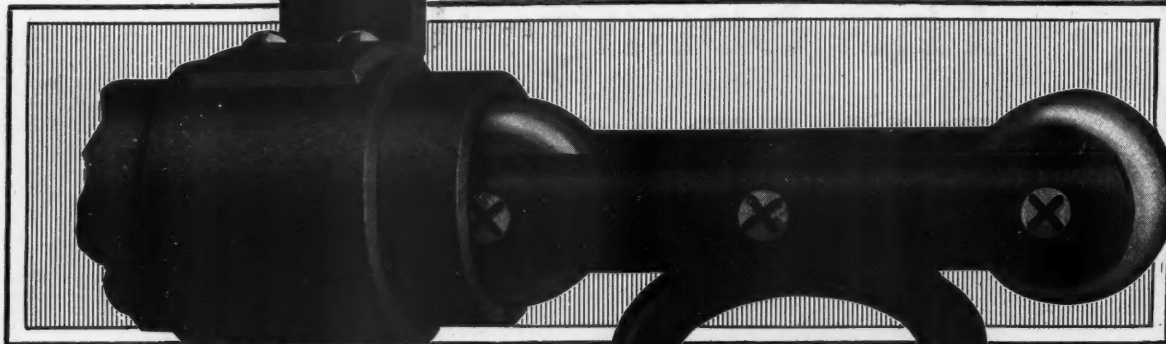

No better closed track job at any price for doors weighing up to 250 lbs. each

DOORS are the only part of a building that "works." Your reputation as a builder can be wrecked by a balky door.

So you want good door hangers.

You can pay a lot more but you can't get a track and hanger that will handle doors up to 250 lbs. any better than Cannon Ball Junior.

You can save the friends you do work for a lot of money by using Cannon Ball Junior; you can make money for yourself; and not risk your reputation.

Cannon Ball Junior is easiest to hang—saves you lots of time and trouble. It runs easy. The track is perfectly round; the wheels are ball shaped with long roller bearings that can't twist or pile up. Cannon Ball Junior hangers never go back on you. They run even, bear even, wear even, for years and years, no matter how the building sags or settles.

TRACK ANY LENGTH YOU WANT

Track comes in 3, 4, 6 and 8 ft. lengths, with brackets for single track or parallel installations to hang from side wall or ceiling.

Send now for big 228-page catalog, which shows all kinds of door fittings and other things you want to be posted on.

Self-Cleaning Round Track 16-Gauge Steel. Solid Ball Wheels (Roller Bearing) Lathe-Turned of Cold Rolled Steel

Illustration below shows how track protects the hangers and how the slot in the bottom of the track lets the dirt, dust, rust and moisture drop out so that

Hangers Can't Clog or Bind



Actual Size

Hunt-Helm-Ferris & Co., Inc.

Established 1893

Albany, N. Y. Harvard, Ill. San Francisco, Calif.



Cannon Ball Junior For Garage Doors

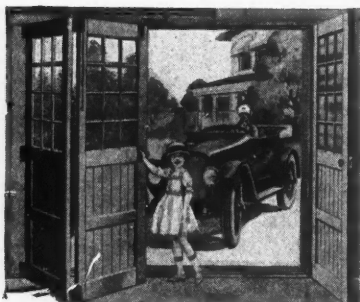

1103 Set for folding-sliding doors

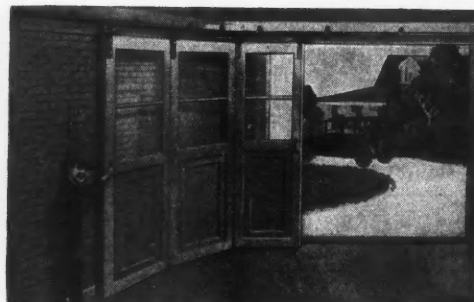

1154 Curve—1162 Hangers take doors around the corners

Complete Set in box or parts as wanted

FOR ADVERTISERS' INDEX SEE NEXT TO LAST PAGE

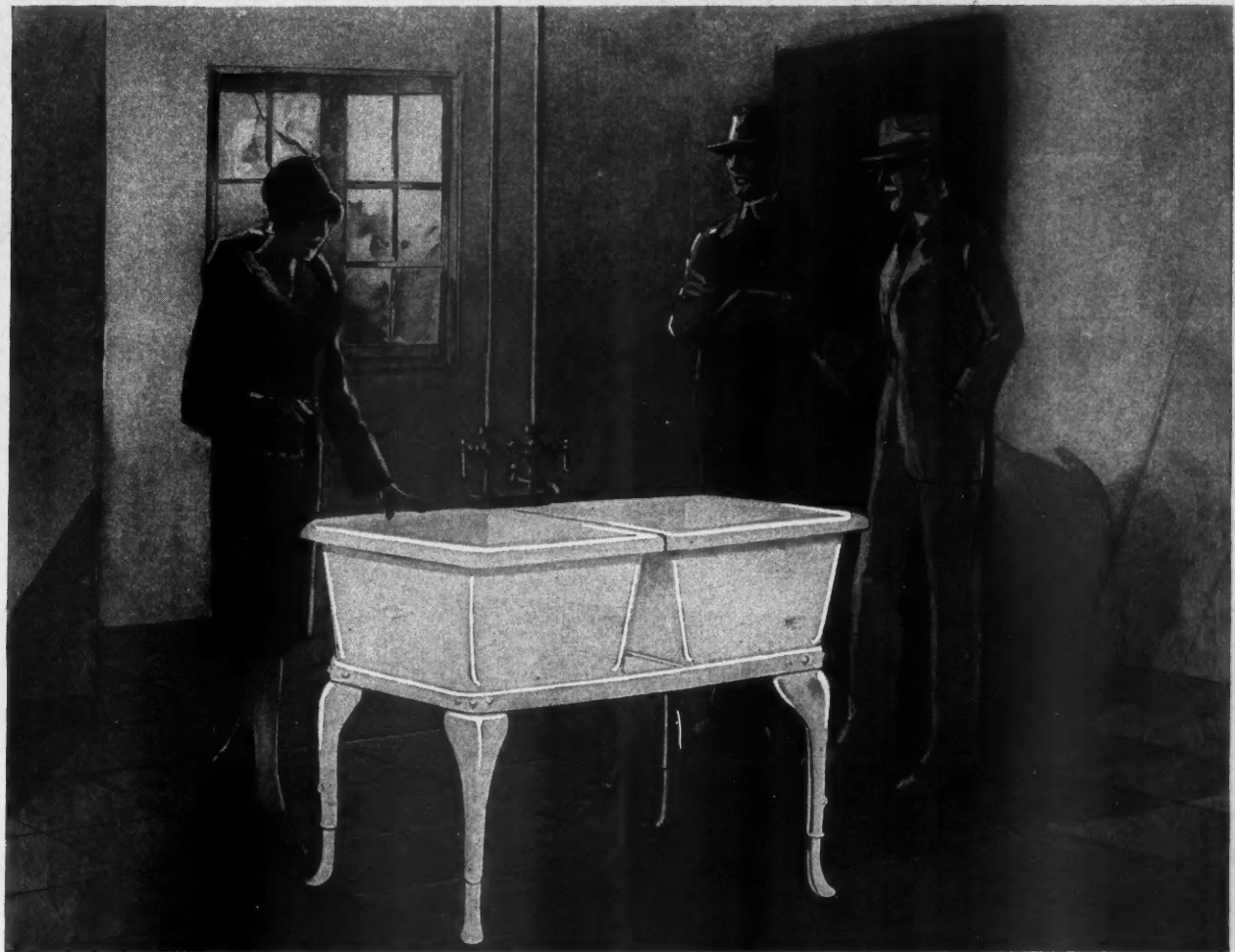

PLEASE the WOMAN—and SELL the HOUSE

MAKE the houses of your next development more salable by making them more *livable*.

Equip the laundries with Porceliron Laundry Trays. Snow white—Sanitary—Attractive—Durable—a feature that will appeal to the housekeeping pride of

every woman at a cost only a little higher than you will pay for laundry trays anyhow.

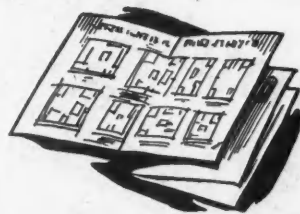

The Porceliron Laundry Tray is full size—26"x50" x14" deep: height adjustable to suit any individual; designed so that it can be set in the center of the floor if desired.

The final touch that turns lookers into buyers.



Write for these free folders. One shows plans for a laundry; the other gives the story of Porceliron.



INGRAM-RICHARDSON MANUFACTURING COMPANY

409 THIRTY-SECOND STREET, BEAVER FALLS, PA.
 Porceliron Factories at BEAVER FALLS, PA. FRANKFORT, IND. BAYONNE, N. J.





Sales and Rental Value

WHEREVER A KITCHEN IS NAPANEE EQUIPPED — whether in apartments or in fine homes — the sales and rental value of the property is increased to a marked degree. Fine kitchens have a hundred times more appeal for the prospect than high-pressure selling talk. Write for catalog of the beautiful and extensive Napanee line.

NAPANEE
DUTCH KITCHENET
Built Like Fine Furniture

Mail This Coupon

COPPEBROS. & ZOOK AB3
Nappanee, Indiana
Gentlemen: Please send me further information regarding styles, sizes and arrangements of Napanee Kitchen Equipment. I am, Architect, Builder, Owner. Check square.

Name _____
Address _____
City _____
State _____

COPPEBROS. & ZOOK, Nappanee, Ind.
New York Office: 415 Lexington Ave.
Detroit Office: General Motors Building
Chicago Office: 308 N. Michigan Ave., Keahn Bldg.
Agents in all Principal Cities

Stanley Ball-Bearing
Garage Hinge No. BB1460



For Your Garages

A STURDY HINGE

BALL-BEARING — GRACEFUL — DURABLE

GARAGE hinges get much abuse. Garage doors are necessarily wide and are subjected to extreme weather conditions. Ball-bearing hinges with long supporting leaves are necessary if the doors are to operate easily without sagging or binding.

This new Stanley Ball-Bearing Garage Hinge has a graceful design that will be an ornament to any garage. Made of extra heavy steel, it will do away with replacements of your garage hinges. Also, it will give your garages a touch of distinction.

Your hardware dealer will be glad to show you these hinges. If he does not have them in stock, he can easily get them for you.

Send the coupon below for a description of the new Stanley Ball-Bearing Garage Hinge No. BB1460.

THE STANLEY WORKS · NEW BRITAIN, CONN.

STANLEY HARDWARE

MADE OF STANLEY STEEL

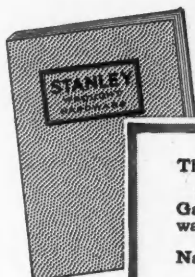

The Stanley Works, New Britain, Conn.

Send me complete description of the new Stanley Garage Hinge No. BB1460; also a copy of your Hardware Catalog No. 41M.

Name _____

Address _____

City & State _____

My hardware dealer is _____

There are thousands of items in the extensive line of Stanley Hardware. You can find just the style and size you need for any condition in the Stanley Hardware catalog No. 41M.

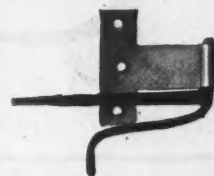
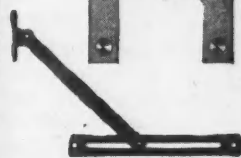
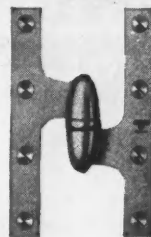
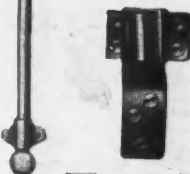
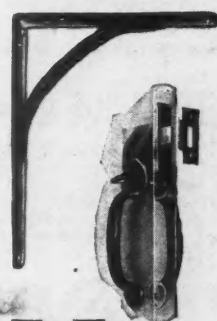
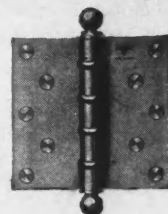

One of the beautiful Webster Groves residences built by Ames & Ames. Season-proofed with the artistic, extra-thick Carey Cork-Insulated Shingles.



“The houses we WINTER-PROOF and SUMMER-PROOF find a readier market,”
says Missouri builder

“WE realize, as every builder does, that a pleased buyer is the best advertisement we can have for our business,” declared Harry C. Ames, of Ames & Ames, Contractors and Builders, Webster Groves, Missouri.

“And we take every precaution,” Mr. Ames continued, “to see that every customer is more than satisfied. Inside and out, from basement to roof, every ounce of material we use is the best that can be obtained.

“Perhaps more than any other single feature, our clients appreciate the added advantages of the *winter-proof* and *summer-proof* home. That is why we have roofed so many of our houses, large and small, with Carey Cork-Insulated Shingles. The extra cost is small, and the houses find a much readier market.”

* * *

As Mr. Ames points out, home-buyers listen attentively to the story of roof-insulation. Carey Cork-Insulated Shingles make the house warmer in winter, at lower cost for fuel. Cooler in summer, too, because the sun's rays cannot beat through. These uniquely beautiful shingles heat-insulate, as well as weather-protect. Ask us for samples and particulars.

The Philip Carey Company

Lockland, Cincinnati, Ohio

Carey
CORK-INSULATED
SHINGLES

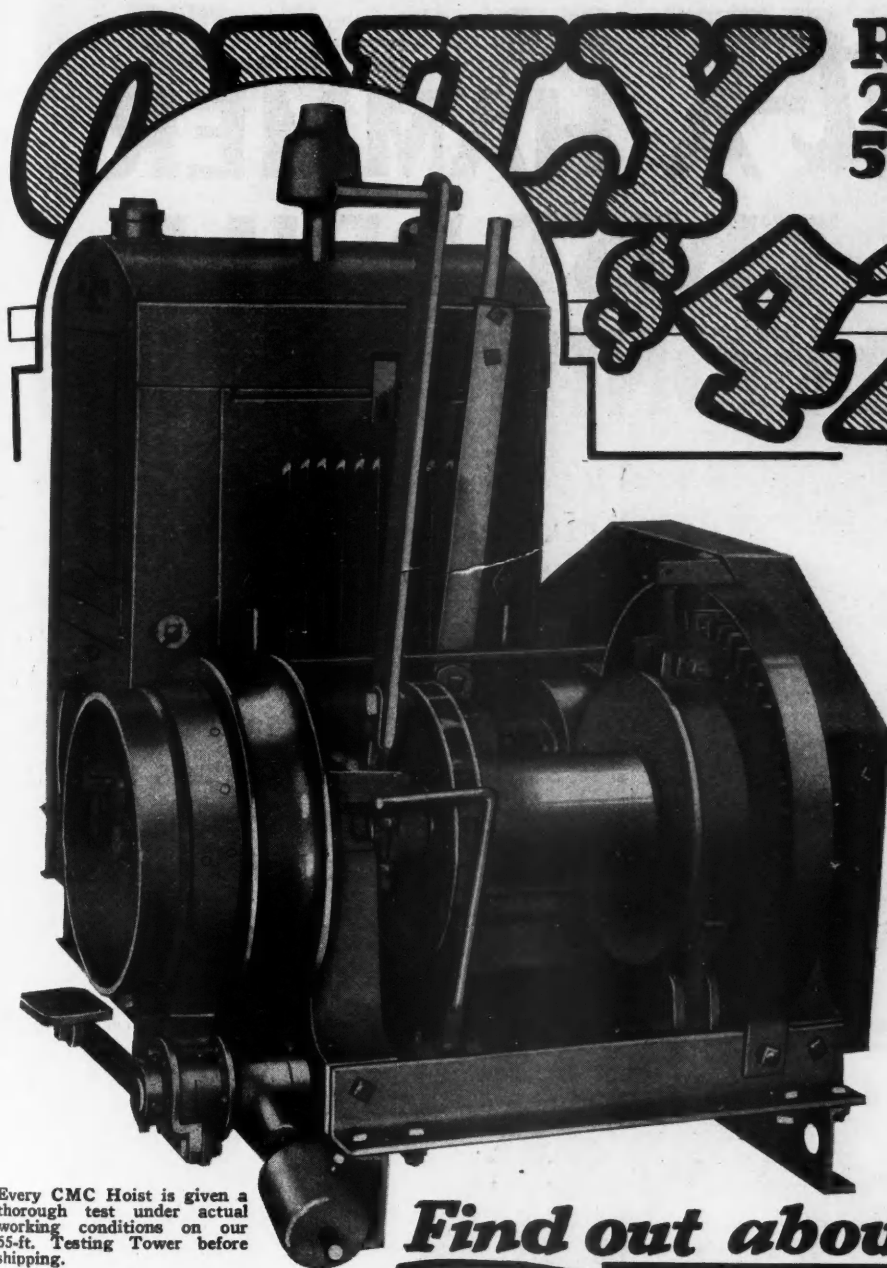

Reversible, 2 - Cylinder 5-8 H.P. Hoist

\$427.50
CASH
F.O.B. WATERLOO

Here is big news for the man with a hoisting job—a genuine CMC Reversible Hoist for only \$427.50! Here is a 2-cylinder, 5-8 h.p. hoist with LE ROI Engine, radiator-cooled, at a new low price.

Compare this hoist with any other in the field—point for point—and you will be even more surprised at the small price.

LOOK AT THIS PICTURE

This is the CMC Hoist that costs you only \$427.50. Consider this: For this price you get a hoist with Large Bronze Thrust Screw—Cone-Type Asbestos Friction—Positive Release—Forged Pawl—Bronze Bushed Drum—Hoisting Drum free on Shaft—Drum and Elevator Sheave Operating Independently.

IT'S A *cmc* HOIST

There's a CMC Hoist for every kind of a hoisting job. Whatever your hoisting problem—in single or double cage elevator work, for concrete tower work, material skips, gravel pit work, or other hoisting duty, there is a CMC Hoist that will do the job for you—efficiently and economically. CMC Hoists have EXCLUSIVE PATENTED NEW FEATURES NEVER HEARD OF BEFORE—that make them the outstanding hoists for any job.

Every CMC Hoist is given a thorough test under actual working conditions on our 65-ft. Testing Tower before shipping.

Find out about *cmc* Hoists

MAIL THIS TODAY

FOR YOUR HOISTING JOB



This illustration shows our CMC Non-Reversible 3-Drum Hoist, with Boom Swinger and Banked Control—a superior hoist, powered and equipped for the heavy duty hoisting job.

CONSTRUCTION MACHINERY COMPANY
103 Vinton St., WATERLOO, IOWA

(Check or fill in spaces below)

- I am interested in CMC hoist illustrated at the new low price. Send detailed information.
- Or send detailed information on CMC Hoists in reversible Unit, Non-Reversible Unit.
- Work requires Single, Double, Triple Drum
- Nature of work is: Building, Single Cage Elevator, Double Cage Elevator, Gravel Pit,
- Pile Driving or work.
- Requires Hoist capable of lifting pounds
..... feet per minute.

**CONSTRUCTION
MACHINERY COMPANY**
103 Vinton St., Waterloo, Iowa

Name.....
Address.....
City..... State.....

BUILT BY THE MAKERS OF THE WANDER — BEST TILTING MIXER

at Last - A HAMMER TWIST DRILL FOR MASONRY DRILLING

Developed for drilling in stone, brick and concrete by hand or electric hammer. Cuts faster. Drills more holes without being resharpened. Easier to operate. Will not jam in the hole as it automatically cleans the cuttings. Retains its diameter longer than other types and can be resharpened on a grinding wheel.

SIZES
Sizes in which twist drills are available range from 3-16 inch to 5/8 inch.

STAR EXPANSION BOLT COMPANY
143 Cedar St., New York City

Write for additional information and special introductory price on Handy Drill Kit.



Gives larger, more comfortable grip. Lessens vibration. Does not cramp the hand. Rubber protecting shield prevents hitting the hand.

Kit contains six twist drill points, one Dryvin drill point holder and knockout pin. Space for spare tools.

Patented and Patents Pending

Manufactured by the makers of Dryvin  **DRYVIN** The Expansion Shield you hammer home

LEACH TILTERS

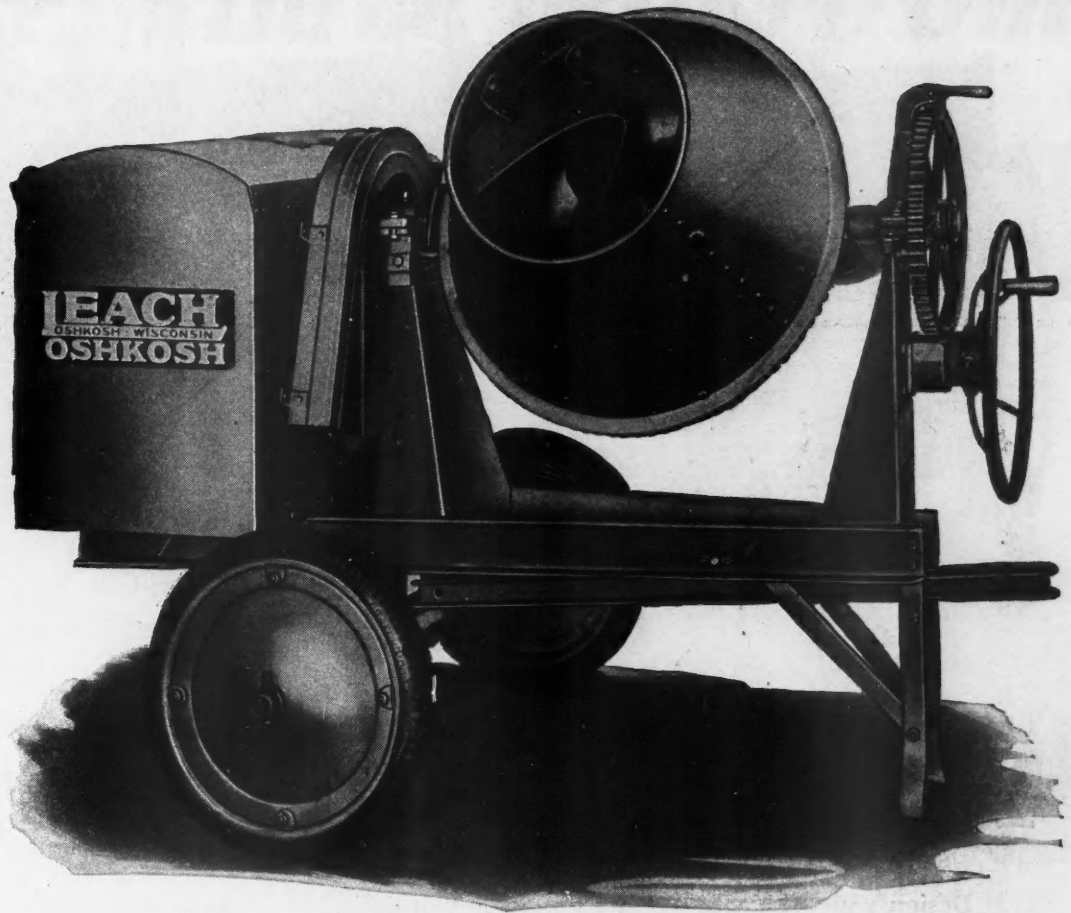

Note the heavy construction of this mixer. It is mounted on rubber tired disc wheels—is dependably powered—has durable steel drum.

LOWEST PRICED TRAILER TILTER OF ITS SIZE ON THE MARKET

The Leach 4 cu ft. Trailer Mixer is the lowest-priced tilter of its size on the market. But further than its low price it has all the advantages of tilting mixers and more.

It has a rare combination of **Portability—Speed—Capacity—Steel Frame—Alemite Lubrication—Power—Ruggedness—Disc Wheels.**

In fact this same mixer was formerly sold for more. **The quality is the same**—in addition it has a few new features. Nowhere will you duplicate this mixer at the price. Send in coupon below for details. Do it now.

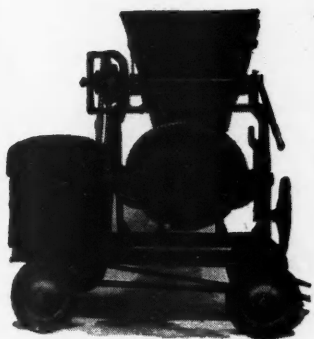

Send in this Coupon

LEACH COMPANY, Oshkosh, Wis.



Leach Company,
Dept. 3, Oshkosh, Wis.

Gentlemen:—Kindly send me without obligation details and prices of your tilting mixers.

Name
Address.....
City

LEACH MIXERS

WHEN WRITING ADVERTISERS PLEASE MENTION THE AMERICAN BUILDER



At Home *in ANY surroundings!*

Design your residence—your garage—as you desire, you may be sure that the “Overhead Door” will harmonize with any arrangement.

And you know, when building private garages, the question of space is always a prime issue. How to economize in space without sacrificing utility and appearance is the problem. The “Overhead Door” is the answer.

A slight pressure puts the “Overhead Door” up out of the way or closes it “tight.” Installed and counterbalanced so that it will “Stay Put” in any position.

In Spring winds, Summer sun, Fall rains, or Winter snows, the “Overhead Door” operates perfectly. In fact, this truly unusual door will withstand all weather conditions.

OVERHEAD DOOR CORP.

3-1003 W. KICKAPOO ST.

HARTFORD CITY, INDIANA

“The OVERHEAD DOOR”

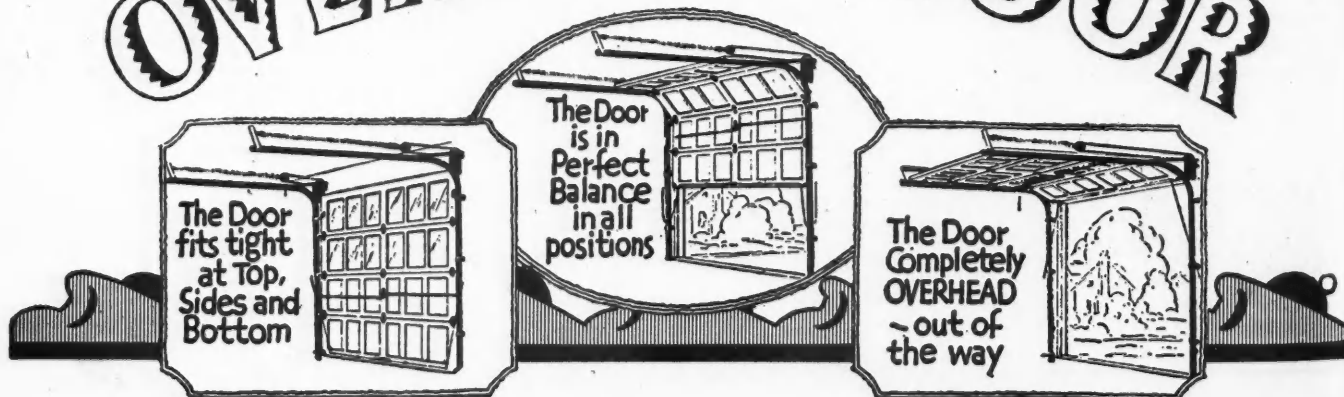

MARCH 1931

Three years from

today - WHAT THEN

Three years ago this Spring, John L. Strandberg and C. E. Swanson organized the Kansas City Duntile Company. In a recent letter they say the following:

"At the outset we installed one of your smallest tile making machines. Inside of three months we had developed such a volume that we were compelled to add an automatic Duntile machine with several times the original capacity. Since the first day, we have enjoyed a steady growth in sales. We purchased a piece of property 100x157 just across from our present plant and are now erecting a two story Duntile factory. It will be ready April 1st and will cost \$25,000, a pretty fair tribute to the money making possibilities of Duntile after having started with but a \$3,000 outfit. While \$100,000 would be an equitable valuation of assets and established business of the Kansas City Duntile Company, we would not accept this amount of money for it."

That's the Kansas City Duntile Company today. From a \$3,000 investment to thirty-three times this amount in three years. The Duntile industry numbers many such manufacturing successes. The Altoona Duntile Company, for instance, started five years ago and from an investment of \$1,700 they have built a business for which they actually refused \$100,000 recently. The St. Louis Duntile Company started a few years ago, and have grown from a small beginning to a hundred thousand dollar business. And so on, an industry of some 400 manufacturers.

Working Specifications in "Sweet's"

DUNTILE

THE PERFECTED ALL-PURPOSE CONCRETE BUILDING TILE.

The use of Duntile, in a little more than ten years, has grown to where today it goes into construction totaling \$150,000,000 yearly.

This success has been attained making plain Duntile. Now, with MAT GLAZING, Duntile is available in full range of color, unfolding a market of undreamed size.

With this greater opportunity today, what will Kansas City Duntile Company, or Altoona Duntile Company, or St. Louis Duntile Company or the Duntile industry be worth three years from today —Or ten—Or twenty years from today?

Ask yourself: Three years from today—WHAT THEN? Will you have achieved independence in a manufacturing business of your own? See what the future holds for you. Get New Book: "Basic Facts". It shows the way. Use COUPON.

W. E. DUNN MANUFACTURING CO.

415 W. 23rd Street

Holland, Michigan

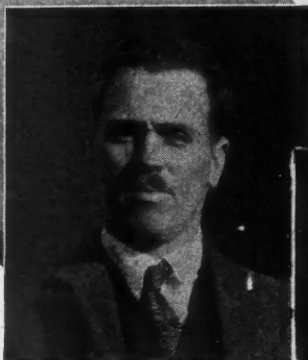

JOHN L. STRANDBERG

"After three years' experience with Duntile, we are more enthusiastic than ever both as to its merits and as a profitable manufacturing business."



C. E. SWANSON

"Planning a visit to Holland, Michigan, soon at which time we can discuss farther our present operations and plans for expansion."

Duntile meets today's need for an inexpensive, permanent building material with a product 30% below the cost of other masonry materials. No higher than frame construction. Strength beyond all requirements. Adaptable to all sorts of buildings—walls, foundations or partitions. Quickly and easily laid, possessing great additional advantages in its full mortar bed. Harmonious color combinations in the new and exclusive MAT GLAZING process. Forty beautiful, permanent shades, rich in texture, ideally meeting popular demand for color in today's architecture. Fill in and mail coupon.

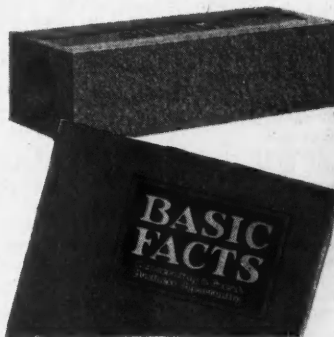

BOOK TELLS HOW to gain manufacturing independence

W. E. DUNN MFG. CO., 415 W. 23rd St., Holland, Michigan.

3-28

Show me through your book, "Basic Facts," how average ability and some capital win manufacturing independence for those supplying DUNTILE in each community. Also show me how I can manufacture DUNTILE in a plant of my own at a profit of 30 to 60%.

Show me how I can build permanent, fireproof masonry walls at cost of frame, or 30% less than brick and make more money for myself.

NAME.....

STREET ADDRESS.....

CITY..... STATE.....



One "TUMBOLIER" Switch for Three Lighting Circuits

TUMBOLIER SWITCH Catalog-Specification Data Schedule S

Cat. No.	List Price	Description
21095	\$0.85	Two-Circuit (2 levers)
21096	1.10	Three-Circuit (3 levers)
21098	.95	Single Pole and 3-Way (2 levers)
21236	.34	Solid Plate for 2 levers
21237	.34	Solid Plate for 3 levers
21234	.18	.060 Plate for 2 levers
21235	.18	.060 Plate for 3 levers
21232	.14	.040 Plate for 2 levers
21233	.14	.040 Plate for 3 levers

Std. Pkg. 10, Carton 2. Rating 10A.
125V., 5A. 250V. National Elect.
Code Standard.

Instead of taking up wall space with three separate switches—with a 3-gang plate—you can concentrate the control of *three circuits* in this *one* H&H "TUMBOLIER" Switch.

One Tumbolier Switch, for example, will give separate control of the living-room lights, the hall lighting-fixtures *and* the porch light. The neatest possible form of a switch-grouping!

Behind the single-gang plate are three miniature switches, all in a porcelain base. The smoothest of switch-actions, the longest-lived, with the "quality touch" you prize in the H&H Tumbler.

*For your immediate reference are specifications at left.
For your permanent files, let us mail you catalogue data-sheet.*

THE HART & HEGEMAN MFG. CO.
HARTFORD, CONN. MAKERS OF ELECTRIC SWITCHES SINCE 1890

ACCEPT NO SUBSTITUTE

Sterling



"perfect balance"—the load is carried over the wheel not on the arms.

More capacity loads per man per day means more work and more real profit.

Sterling designed their barrow to carry the load over the wheel, when in a wheeling position, and not on the arms. With a Sterling the man pushes the load, not carries it. In actual weight-lifting tests it has been proven that it requires less strength per equal load to lift and wheel a Sterling than any other. This feature is not found in ordinary barrows—and is only possible in a Sterling because of scientific designing of tray and supporting braces.

The "perfect balance" gives position—the ease of wheeling is the result of specially designed wheel and axle fitted with "self-lubricating" bearings. The bearings are guaranteed for life—no oil service ever needed. Sterlings wheel as easy when they're old as when they are new.

Wheelers like to work with a Sterling—try them on your next job and see how much more work you get out of them.

Buy by Sterling name—leading hardware and equipment dealers have them or they can get them quickly from our complete stock warehouses at Chicago, New York, Philadelphia, Pittsburgh, Cleveland, Detroit, St. Louis

SPECIAL STERLING FEATURES

Self-lubricating bearings	Selected maple handles
10-spoke wheel	Special tubular steel handles
Malleable iron brackets	Handles clamped—not bolted
Smooth wheel face	Top of tray reinforced
Wrought steel hub	Channel steel legs
Riveted and cast to hub spokes	Riveted leg braces
Fixed rolled steel axle	Extra leg shoes
"V" front tray braces	Wrought iron handle tips
	All parts interchangeable

STERLING WHEELBARROW COMPANY

STERLING ON A WHEELBARROW MEANS MORE THAN STERLING ON SILVER

Milwaukee

Wisconsin

NEW

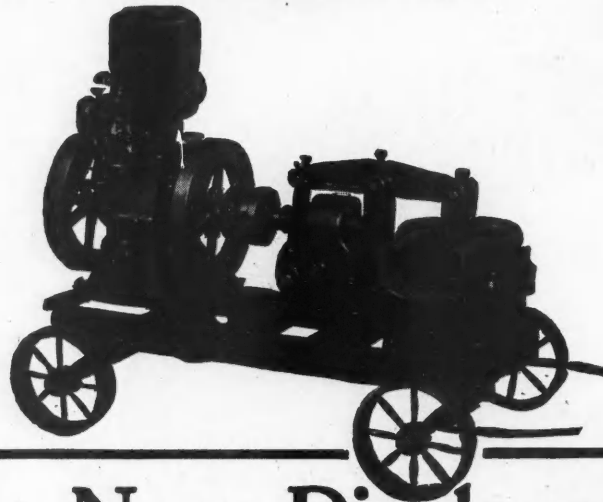

The New Novo Diaphragm Pump

A Bantam in Weight

This new Novo Diaphragm Pump is built to cut water lifting costs.

It is unusually compact. It weighs only 575 lbs. But strength is not sacrificed for lightness.

A new worm gear drive — completely enclosed and running in oil — virtually guarantees constant, trouble-free operation, free from breakdowns and the

heavy expense of repairs and replacements.

And the special Novo "Tripl-Life" rubber diaphragm gives even more assurance of unfailling performance.

Such things put this new Novo in a class by itself. It is low in first cost. Its operating costs are low. And it opens up a new field for contracting profits.

A Giant in Ability

The coupon below will bring you prices and other details on this new money-making Novo Diaphragm Pump. Fill out and send it today. No obligation.

NOVO ENGINE COMPANY, 202 Porter Street, Lansing, Michigan
CLARENCE E. BEMENT, Vice-Pres. & Gen. Mgr. Service, parts and sales in over 60 cities

Novo Engine Company,
202 Porter St., Lansing, Mich.
Please send prices and complete information on the new Novo Diaphragm Pump.

Name
Address
City
State

NOVO THE NEW **NOVO**

DIAPHRAGM PUMPS

Pressure, Diaphragm Centrifugal Pumps

Also Engines and Hoists

HOTEL CRAWFORD
WASHINGTON, DC

SARANAC INN
ON UPPER SARANAC LAKE
HARRINGTON HILLS, WASHINGTON
FRANK BAKER, MANAGER
WILLARD BOYCE, SUPERVISOR

HOTEL HARRINGTON
WASHINGTON, DC

UPPER SARANAC, NEW YORK
December 5th, 1927.

DeWalt Products Company,
1621 Cortelyou Street,
Brooklyn, New York.

Dear Sirs:

On September 12th, we purchased one of your Woodworkers.

With two laborers, we have cut all the joists, studs, sub-flooring and bridging and have erected the frame work of our 106 room addition, each with bath, and closet, covering 6800 square feet of ground, to Saranac Inn, in forty days, Sundays included on which we did not work.

Our carpenters have done no sawing. The joists and studs were cut to size by the saw which was moved to each floor as the work progressed which did not take the two men thirty minutes. For bridging, the carpenters took their measurements to the saw and had the pieces cut to size there immediately.

Our foreman did not take kindly to the fact that the building is up, he says the job is completed.



**“Saved \$10,000.00
in labor on
this one job!”**

Such is the finish to the above letter. It sounds like a lot but the DeWalt Wonder Worker is certainly working wonders on many jobs.

Even on an average 6-room house, builders testify they save \$100. Three or four jobs of that size quickly pay for a DeWalt.

With a DeWalt you can get more effective work from carpenters because it relieves them of practically all the hard, slow hand sawing.

You save material by using up all the odds and ends. You save on erection time—which often decides whether or not you get the job.

It's easy to set up and to change the set-up. Less than a minute to change from cross-cut to rip.

The DeWalt is so light two men can easily carry it anywhere on the job. And you can plug into the nearest light socket for power. Direct drive gives it twice the power of any other saw its size.

It's a speedy, accurate, practical all-round machine—fully guaranteed.

Let us arrange a demonstration on your job—to show you what the DeWalt will do in actual operation. Send the coupon for details.

DE WALT PRODUCTS COMPANY
659 New Holland Ave. Leola, Pa.

DeWalt Products Co.
659 New Holland Ave., Leola, Pa.

I'd like to know how the DeWalt will save money on our job.

Your Name.....
Firm Name.....
Address.....
Type of Business.....

DE WALT
Wonder Worker
The Economy Wood Worker

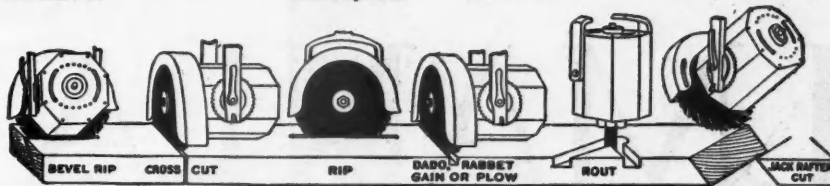

WHEN WRITING ADVERTISERS PLEASE MENTION THE AMERICAN BUILDER

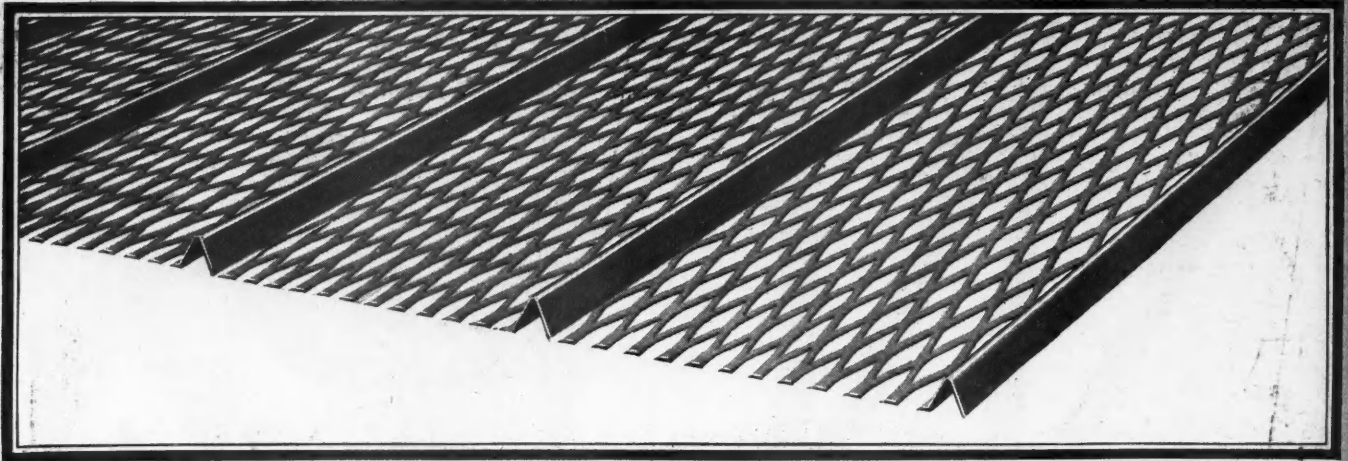

The Only Flat Strand Mesh On the Market Today

This is the new $\frac{3}{8}$ " Rib Kalmanlath—the only flat strand mesh on the market today.

This new Kalmanlath offers many new and distinctive advantages. It is easily and accurately installed. It is rigid, strong and durable. The new flat strand mesh makes plastering easier and quicker. It also gives a perfect key to the plaster imbedding itself in a way that assures complete reinforcement. It preserves the beauty of the architectural finish.

Announcing

The Kalman Steel Company has purchased the plant and equipment of the Sykes Metal Lath Company at Niles, Ohio.

The Sykes organization will be consolidated with that of the Kalman Steel Company in the distribution of a complete line of metal lath and building specialties.

The Complete Kalman Line

For Buildings

Rib Lath	Wall Plugs and Ties
Diamond Lath	Wire Fabric
Cup Lath	Sleeper Anchors
Troff Sheet Lath	Inserts
Wing Corner	Scree Chairs
Bead	High Chairs
Expanded Corner	Beam Bolsters
Bead	Slab Spacers
Base Bead	Column Spirals
Picture Moulding	Corrugated Bars
Kalmantrim	Removable Steel Tile
Metal Trim	Permanent Steel Tile
Channels	Column Forms
Dome Dampers	
Coal Chute Doors	
Ash Pit Doors	
Flue Cleanout	
Doors	

For Roads

Corrugated Bars	Highway Fence
Center Strip	Bar Supports,
Expansion Joint	Spacers
Filler	Accessories
	Steel Fabric

As a result of these things, the new $\frac{3}{8}$ " Rib Kalmanlath provides the foundation for finer, more perfect plastering.

Briefly, $\frac{3}{8}$ " Rib Kalmanlath gives you everything other laths offer *plus* many new and desirable features that make for better results—that boost the contractor's profits.

Sending us your name and address on a simple post card brings you complete detailed information on what this new $\frac{3}{8}$ " Rib Kalmanlath can do for you. Mail the card today.

KALMAN STEEL COMPANY, Chicago

Plants or Offices at

Chicago
Pittsburgh
Kansas City

New York
Syracuse
Dayton

Buffalo
Milwaukee
Minneapolis

Detroit
Philadelphia
Youngstown

Boston
St. Paul
Charlotte

Baltimore
Atlanta
Niles

KALMANLATH

THE SATURDAY EVENING POST

March 17, 1928

THE SATURDAY EVENING POST

March 17, 1928



A Revolutionary Way to Buy an Oak Floor

▲▲ completely finished at the factory ▲▲ like furniture ▲▲

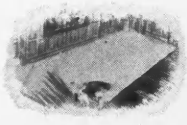
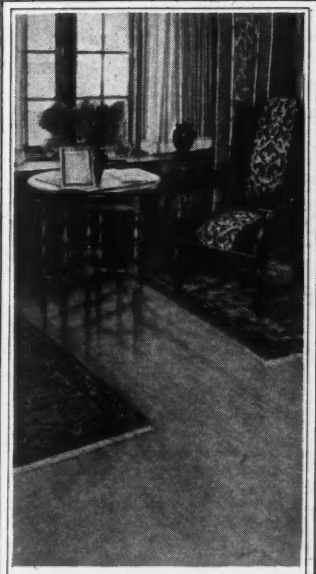

After Breakfast—the room cleared and the carpenter ready to nail down the finished CROMAR Flooring



In the Evening of the same day—the last nail driven and the new CROMAR Floor in use

LIKE furniture, CROMAR is finished at the factory. All the scraping, sanding, filling, varnishing and polishing is done before CROMAR reaches you. It is done by patented machines which insure a better flooring because a more perfectly finished one.

When the beautifully finished CROMAR strips reach you, crated in compact bundles, there is not another thing to do but nail them down—in a new home or right over your old floors.

The complete job (just nailing, remember) is done at the speed of a room a day—fast—completed before

The story of CROMAR Oak Flooring is immensely interesting. For CROMAR is the only finished—ready to use—flooring in the world. And a CROMAR floor costs you no more than a hand-finished oak floor.

Write for booklets which tell of CROMAR's numerous technical advantages in an interesting non-technical way.

CROMAR is sold by lumber dealers, but carpenters and contractors install it. Consult any of these for further information. If you have the slightest trouble in getting satisfaction, write us and we shall give your inquiry immediate personal attention.

THE CROMAR COMPANY, Williamsport, Pa.

CROMAR

FACTORY FINISHED

Oak FLOORING



Send for a free sample of CROMAR and try the famous CROMAR Hammer test on its surface!

THIS is a reproduction of the first Full-Page Cromar Advertisement in The Saturday Evening Post. It appears in the issue of March 17—Watch for it. Month after month, without a break, The Saturday Evening Post will carry the story of Cromar Factory Finished Oak Flooring into Three Million Homes.

That advertising, added to our other forms of National Advertising, WILL create new business, greater profit for you—if you will just go after it.

Read the detailed description of Cromar, the only Factory Finished Oak Flooring in the world, on the other side of this page.

Then write us for free samples.

gs,
th
for
er-

th
er
ew
at
r's

nd
ost
ete
on
al-
u.

I

CROMAR'S Ten Points of prime importance are—

1.—Factory Finished—Like Furniture



CROMAR, an oak flooring, milled exclusively from Appalachian Oak (a medium-textured oak which better takes and holds the finish), is completely scraped, sanded, filled, varnished and waxed at the CROMAR plant by patented machines. Be-

cause CROMAR is completely finished at the factory, like furniture, all there is left to do is to nail it down.

2.—Finish Stands Hardest Wear



CROMAR patented machines apply filler, varnish and wax at the CROMAR plant. Not only is every pore of the wood filled, but the filler is actually driven into the oak, under pressure. This prevents the oil of the varnish from becoming absorbed by the wood. And thus the varnish retains its elasticity and does not flake or scratch white.

3.—“Warping” and “Drying Out” are Prevented

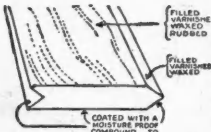

The oak lumber is kiln dried to 4% moisture content. This is practical only because CROMAR receives a moisture-resisting coating on back and edges in addition to its several finishing coats on face. Because CROMAR is 96% dry at the start—and then coated to keep it dry—complaints about “warping” and “drying out” are almost never heard of.

4.—V-Type Tongue and Groove Easy to Lay

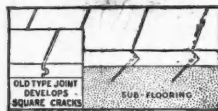

The improved V-joint type of tongue and groove fits quickly and snugly without “blocking.” Each nail-hole is punched. The off-centre cut gives a flexible joint and equalizes unevenness in sub-floors. CROMAR lays satisfactorily over a rougher

sub-floor than ordinary hardwood flooring.

5.—Beveled Tongue Prevents Damage in Nailing

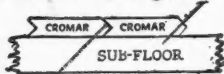

The flat, beveled edge of the tongue permits rapid nailing with no necessity whatever for “setting” the heads and with no sharp edges to show hammer marks. The different shape of the CROMAR tongue prevents damage from breaking or splitting. Specially trained floor-layers are not needed.

6.—Cleanable Surface Seam

The shallow rounded seam, in conjunction with the CROMAR tongue and groove, prevents the opening up of square cracks between the strips. Square cracks pack with dirt, making unsightly dark streaks that cannot be removed. The CROMAR patented seam is only 1/40” deep, and is easily cleaned with a brush or dry mop.



Write for free samples and complete literature concerning the manufacture, the selling and laying of the only factory finished hardwood flooring in the world.

THE CROMAR COMPANY, WILLIAMSPORT, PA.

7.—“Lip” on Groove Side of CROMAR Strip Remains Unweakened Even at Time of Refinishing

CROMAR is made 3/8” thick only. The usual objections to thin flooring are entirely overcome in CROMAR by the different shape of the CROMAR “lip” on the groove side. The ordinary “lip” is weakened and often



broken during installation by the necessary scraping and sanding of unfinished flooring. Of course, there is no scraping or sanding to be done with CROMAR. But even at the time of refinishing, the different shape of the CROMAR “lip” permits cutting down without weakening. And CROMAR’s superior finish makes early refinishing unnecessary.

8.—Convenient and Damage-Proof Bundle

CROMAR Strips are packed face to face, 18 or 24 pieces to a bundle. Bundles are clamped in a press, edges protected with crating, and bound with strap iron to prevent rubbing. Fastened so tightly together, it is impossible for strips to work loose. Thus they are made light-proof, dirt- and dust-proof. Each bundle is stenciled with grade and quantity, so that the material can be stored, without uncrating, until ready for use. Loss from broken tongues and grooves, split ends and damaged faces is completely eliminated.

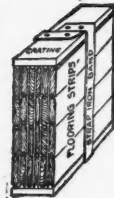

9.—Laying Contracts Need Not Be Sub-let

Because the use of CROMAR eliminates the need of any finishing operation whatever, after it is nailed down; and because it is so easily laid that no specially trained floor-layers are needed, the contractor or builder is enabled to handle the complete job of laying a CROMAR floor himself, instead of sub-letting it.



10.—Promotes Extra Sales for Occupied Houses

Because CROMAR is laid right over the old floors, and without the usual two weeks’ mess and confusion, contractors can sell a CROMAR floor where no sale was possible before. And because of the speed with which CROMAR is laid, contractors can handle a greater number of jobs with the same number of men.



CROMAR

FACTORY FINISHED

Oak FLOORING



Today ~

THOUSANDS OF TRANE CONCEALED HEATERS INSTEAD OF RADIATORS

~ Why?



Cross-section view

More space for arranging furniture — no ugly heating units to spoil the effect — and still greater heating comfort! Prospective buyers and tenants respond immediately to these advanced features.

Hidden and recessed radiators, radiator shields and screens went part way toward solving the old problem of "What to do with the radiator." Trane Concealed Heaters go all the way. They employ an entirely different heating principle which provides instant control and insures maximum heating efficiency — with nothing in sight but the inconspicuous damper grille. No space wasted. The Trane unit hidden between the walls



Send for Bulletin 24

is not a radiator in disguise. Ready to install, it weighs 1/5 as much as equivalent cast iron radiation. The Trane Copper Heating Element makes the difference. It connects with the same piping ordinarily used for radiators — on any make of hot water, steam, vapor or vacuum heating system. Capacities guaranteed.

Write for Bulletin 24, containing complete specifications and photographs, showing various stages of installation.

HEAT TRANE CONCEALED CABINETS TRANE HEATERS
 *** PUMPS AND HEATING SPECIALTIES ***

THE TRANE CO. (Est. 1885)
 276 Cameron Ave., La Crosse, Wis.

Send along your Bulletin 24, "How to Select and Install Trane Concealed Heaters."

Name.....
 Address.....
 City..... State.....
 Type of Building.....

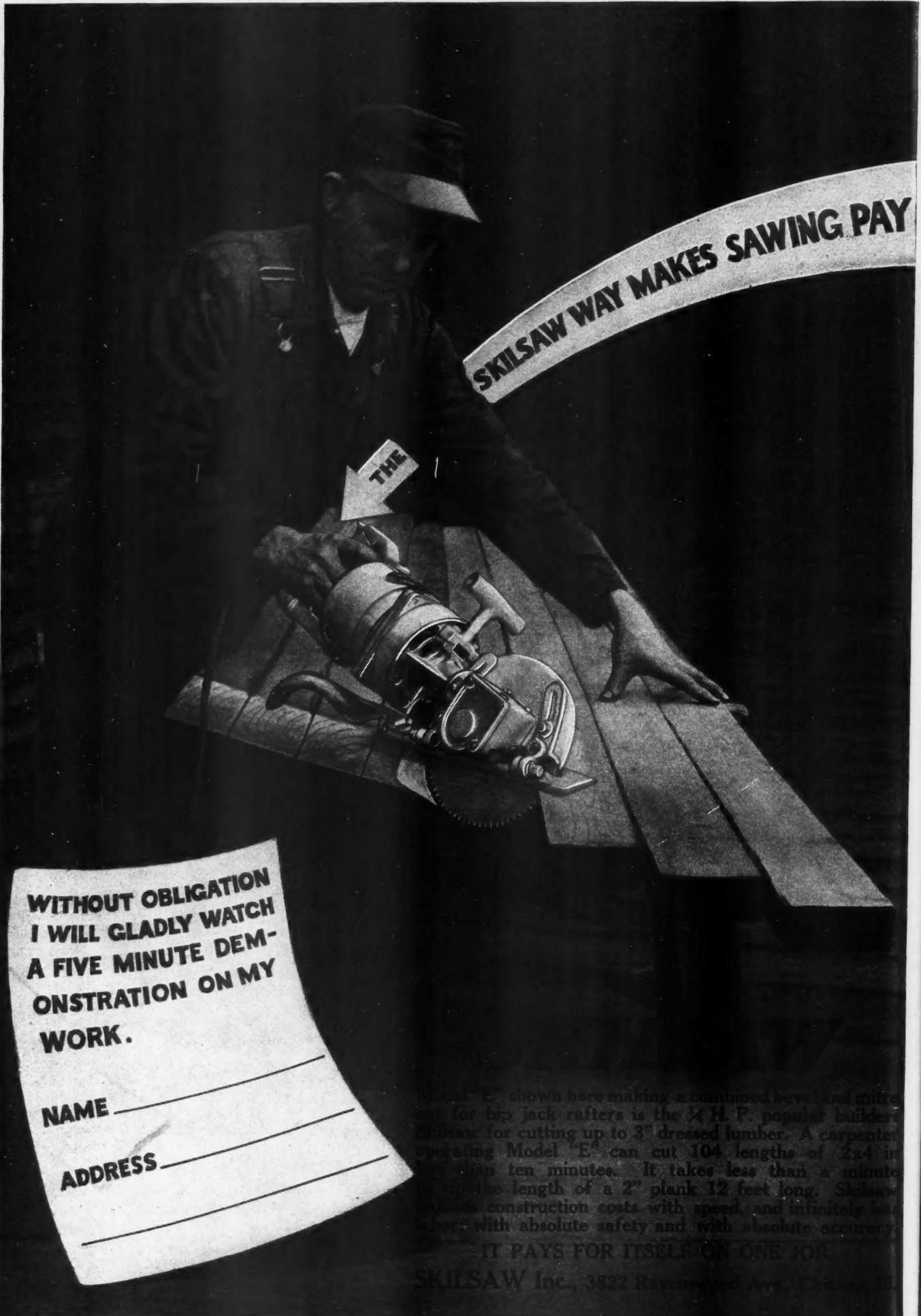

SKILSAW WAY MAKES SAWING PAY

THE

**WITHOUT OBLIGATION
I WILL GLADLY WATCH
A FIVE MINUTE DEMONSTRATION ON MY
WORK.**

NAME _____

ADDRESS _____

Model "E" shown here making a combined bevel and mitre cut for hip jack rafters is the X.H.P. popular builder Skilsaw for cutting up to 3" dressed lumber. A carpenter operating Model "E" can cut 104 lengths of 2x4 in less than ten minutes. It takes less than a minute to cut the length of a 2" plank 12 feet long. Skilsaw reduces construction costs with speed, and infinitely less labor, with absolute safety and with absolute accuracy.

IT PAYS FOR ITSELF ON ONE JOB.

SKILSAW Inc., 3872 Ravenswood Ave., Chicago, Ill.



This dining room is bare, uninteresting, empty-looking . . .

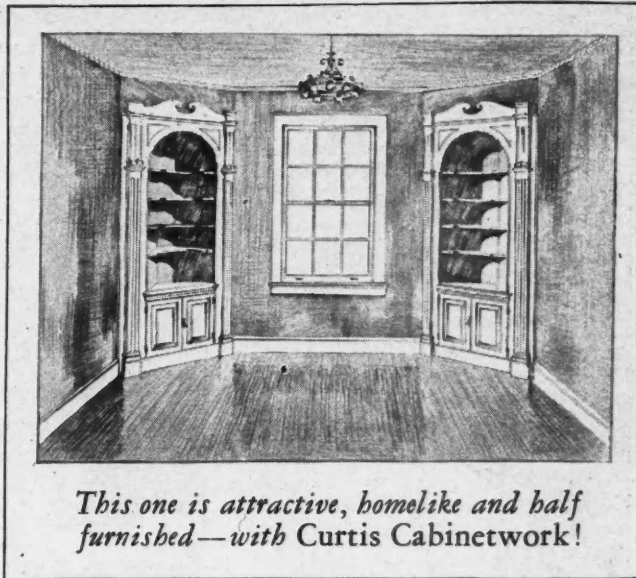

This one is attractive, homelike and half furnished—with Curtis Cabinetwork!

Which of these two Dining Rooms will help to sell the house?

EVEN though enterprising builders are showing one or more houses of a group completely furnished, most houses are sold empty. Yet prospects buy with their eyes! They want to see. What do you show them in the homes and apartments that you sell and rent.

Wise builders know that the average woman—and homes are bought by women, even though it's the men who sign on the dotted line—gets more thrill out of a beautiful piece of cabinetwork than out of all the doo-dads that you can squeeze into a plan. Beautiful corner cupboards . . . open bookshelves . . . handsome, spacious kitchen cupboards . . . a real dining alcove set—these are the things that make sales. Because they are the things that women want. These items of permanent furniture make an empty house or apartment appear half-furnished before ever a chair is moved in or a single curtain hung.

Curtis Woodwork includes half a hundred designs of cabinetwork of amazing variety and desire-creating appeal. Curtis advertising is making them familiar to every prospect.

And there is a complete line of doors, windows, trim, frames and every kind of exterior and interior woodwork to go with them.

The Curtis Dealer will help you

The leading dealer in woodwork in your town (if you are east of the Rockies) is probably a Curtis dealer. No doubt he has some of these designs on display and can show them to you.

If, however, there is no Curtis dealer near you, fill in and mail the coupon and get a FREE copy of our fully illustrated 48-page book on Curtis Cabinetwork. Write TODAY.

*The Curtis Companies Service Bureau
853 Curtis Building, Clinton Iowa*

Representing

Curtis Bros. & Co., Clinton, Iowa; Curtis, Towle & Paine Co., Lincoln, Nebraska; Curtis, Towle & Paine Co., Topeka, Kansas; Curtis Door & Sash Co., Chicago, Illinois; Curtis Detroit Co., Detroit, Michigan; Curtis-Yale-Holland Co., Minneapolis, Minnesota; Curtis & Yale Co., Wausau, Wisconsin; Curtis Sash & Door Co., Sioux City, Iowa.

Curtis Companies, Incorporated, Clinton, Ia.

Curtis Woodwork, Inc., Display Rooms and Sales Office, Room 201, 9 E. 41st Street, New York City.

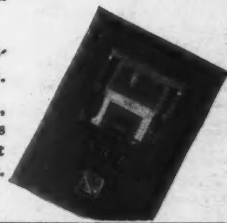

**1866
CURTIS
WOODWORK**

CURTIS COMPANIES SERVICE BUREAU
853 Curtis Building, Clinton, Iowa

Please send me a FREE copy of your new book with complete information about Curtis Cabinetwork.

Name.....
Address.....
City..... State.....



Finished Plastering Costs Prove its Economy!

DUE to its distinctive arch construction, Wheeling Arch Lath grips the plaster from many angles, providing a perfect key. Only the correct amount of plaster is permitted to squeeze through the openings!

Because of perfect keying qualities and rigidity of sheet, the plasterer can follow almost immediately with the second coat. It is not necessary

to remove scaffolds after each coat as in the case with many types of lath. This saving is more than equivalent to the time and material entering into one coat of plaster. No other lath on the market costs so little to erect.

You should have all the facts as well as a sample of the product for close-up inspection. Send for them today!

WHEELING CORRUGATING COMPANY, WHEELING, WEST VA.
New York Philadelphia Chicago Kansas City St. Louis Richmond Chattanooga Minneapolis

Wheeling ARCH LATH

Packed ten sheets to the bundle—20 square yards. Size of sheets 27" x 96". Painted black and pure zinc coated finishes. Weight Painted—4.5 lbs. per square yard. Weight galvanized—5.2 lbs. per square yard.



The Old Way and The New—



THE BLACK & DECKER ELECTRIC HAMMER marks one of the greatest achievements in the history of labor-saving tools. It accomplishes in a few minutes what in the past has required hours of the most laborious work with hand tools. It strikes hard blows at the rate of 2300 per minute and will drive flat wood chisels, corner chisels and all types of special form tools. It operates efficiently on either direct or alternating current of any cycle, no auxiliary apparatus being required. Just plug it in an electric light socket and pull the trigger.

There is no electric tool that will pay for itself so quickly as the Electric Hammer—the saving in labor cost on one job often exceeding the cost of the Hammer.

The Black & Decker Mfg. Co.
TOWSON, MARYLAND

Please send me illustrated pamphlet fully illustrating and describing the new Black & Decker Electric Hammer.

Name

Address

AB. City..... State.....

Three views that tell a simple story of high early-strength concrete with ALPHA CEMENT of the regular quality

THE JOB—Intersection of Morris Pike with Meadow Avenue, Phillipsburg, N. J. Standard type of cement highway.

TIME AND TEMPERATURE—Early part of November with temperature running well below freezing every night.

MATERIALS AND METHODS—Alpha Cement of the usual quality. Proportions of cement, sand, stone; water content; mixing time, all carefully regulated to produce workable concrete, and to meet weather conditions and the time requirement.

RESULT—Pavement stands weight of 17,100 lb. truck at end of 24 hours without injury. Same truck is driven over edge of new job at end of 48 hours with no impairment.

Let us send, with our compliments, pamphlet giving full details of this simple and economical plan of securing high early-strength concrete.

Alpha Portland Cement Company
EASTON, PA. CHICAGO, ILL.

New York

Philadelphia
St. Louis

Boston
Battle Creek, Mich.

Baltimore
Ironton, Ohio

Pittsburgh

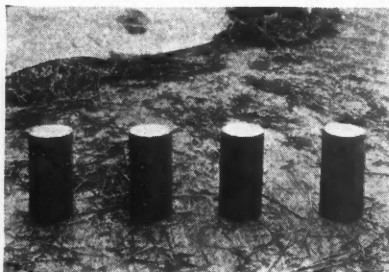

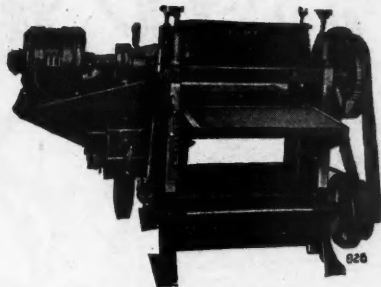

Pony Planer
with electric motor attached

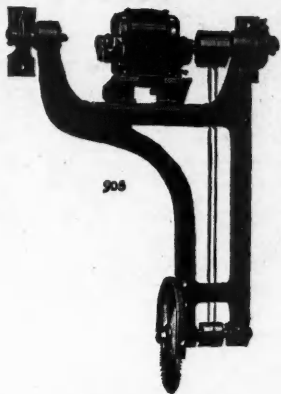

Swing Cut-off Saw
with electric motor attached

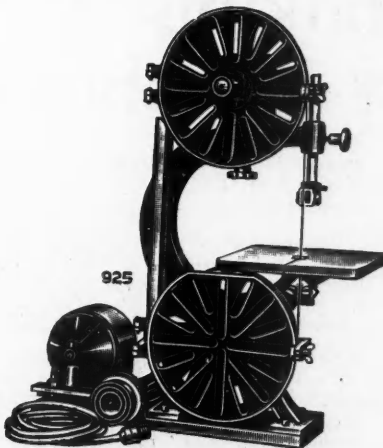

Bench Band Saw
with electric motor attached

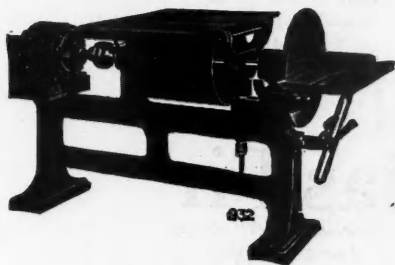

A Drum and Disc Sander,
electric motor attached

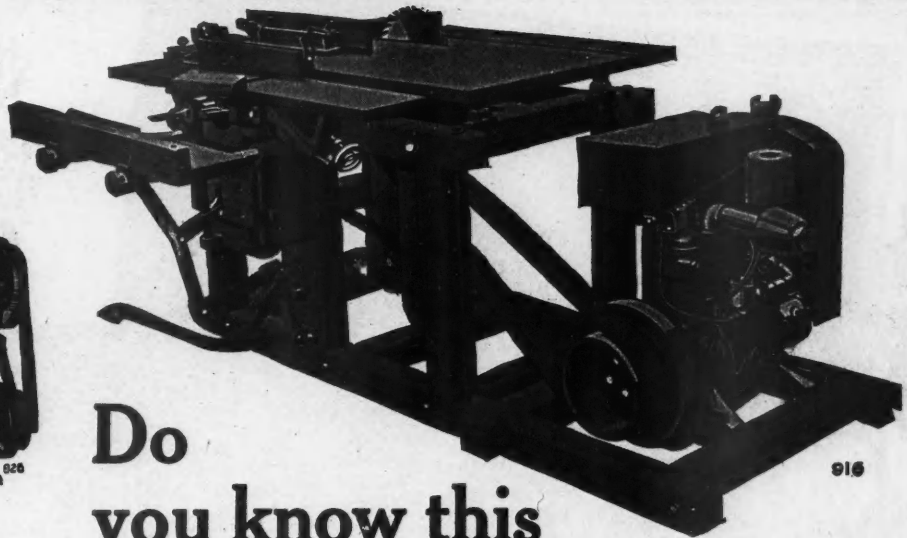

**Do
you know this
portable Woodworker?
It has saved thousands of builders
time and money!**

This machine often pays for itself on the first few jobs. It eats up rush work. And it is built to stand up under heavy strains.

Four men can work on this woodworker at the *same time*, without interference. When you want to do cross cutting, the gauges can be removed in *five seconds!*

Yet this speedy and adaptable machine can be moved anywhere. Take it right on the job, where you need it. Simple and reliable. The arbor, for instance, runs in *self-oiling* babbitted boxes strongly yoked together. This insures strength, permanent alignment and cool-running bearings.

Send for our free catalog giving further particulars of this and other machines. Cut out the coupon below and mail it today. Thousands of builders have cut operating costs and put through rush jobs with these sturdy practical machines.

American Saw Mill Machinery Company
Manufacturers of all varieties of Saw Mills and Woodworking Machines
60 Main Street
Hackettstown, N. J.

Clip and Mail Today

AMERICAN SAW MILL MACHINERY CO.,
60 Main Street, Hackettstown, N. J.

Gentlemen: Please send me free your booklet on—

- | | | |
|--|----------------------------------|---|
| Variety Woodworkers <input type="checkbox"/> | Planers <input type="checkbox"/> | Hoists <input type="checkbox"/> |
| Band Saws <input type="checkbox"/> | Joiners <input type="checkbox"/> | Saw Tables <input type="checkbox"/> |
| Mortisers <input type="checkbox"/> | Sanders <input type="checkbox"/> | Portable Saw Mills <input type="checkbox"/> |

Check the one in which you are interested. (These are only a few from our complete line. Ask for what you want.)

Name.....

Address.....

City.....State.....



The whole country is talking about this first prize home

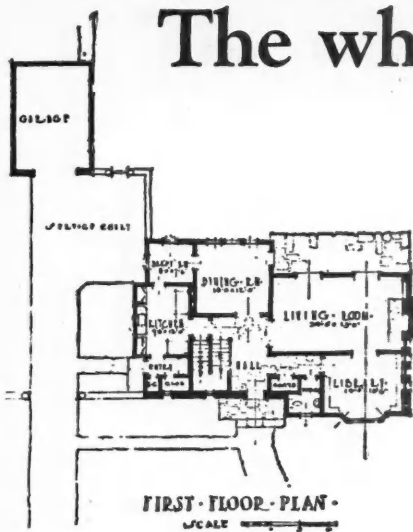

Note the careful planning of this home—its convenience and livability

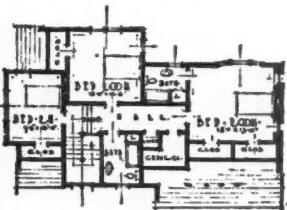

ON March 17 The Saturday Evening Post will carry a double-page advertisement reproducing in four colors the above design in the West Coast woods architectural competition.

These prize home designs of West Coast woods are becoming tremendously popular and from all over the country we are receiving urgent requests for working drawings and construction details.

One realtor in Portland, Oregon, is building the above first prize home as a feature to advertise his sub-division, and many others signify their intention of doing likewise.

Home builders of America are seeking beauty and originality in home building, and this competition has de-

veloped the great beauty and many uses of the four "Big Tree" woods of the Douglas Fir region.

You can obtain from your local lumber dealer wide widths, long lengths, clear grades and beautifully grained boards and panels in Douglas Fir, West Coast Hemlock, Sitka Spruce and Western Red Cedar.

Twelve of the prize homes are illustrated from the original architectural drawings and described by the successful competitors in our booklet, "Prize Homes of West Coast Woods." This and a booklet describing the four West Coast woods will be sent without charge to you. Address West Coast Lumber Bureau of Longview, Washington—11c Mt. Hood Building.

Durable
Douglas Fir
America's Permanent Lumber Supply

Important West Coast Woods

Douglas Fir - West Coast Hemlock - Western Red Cedar - Sitka Spruce

FOR ADVERTISERS' INDEX SEE NEXT TO LAST PAGE

Choice lumber from the forests of the Pacific Northwest — America's permanent lumber supply — is now and always will be available for America's building needs.

This
BOOK
Tells
HOW
 !

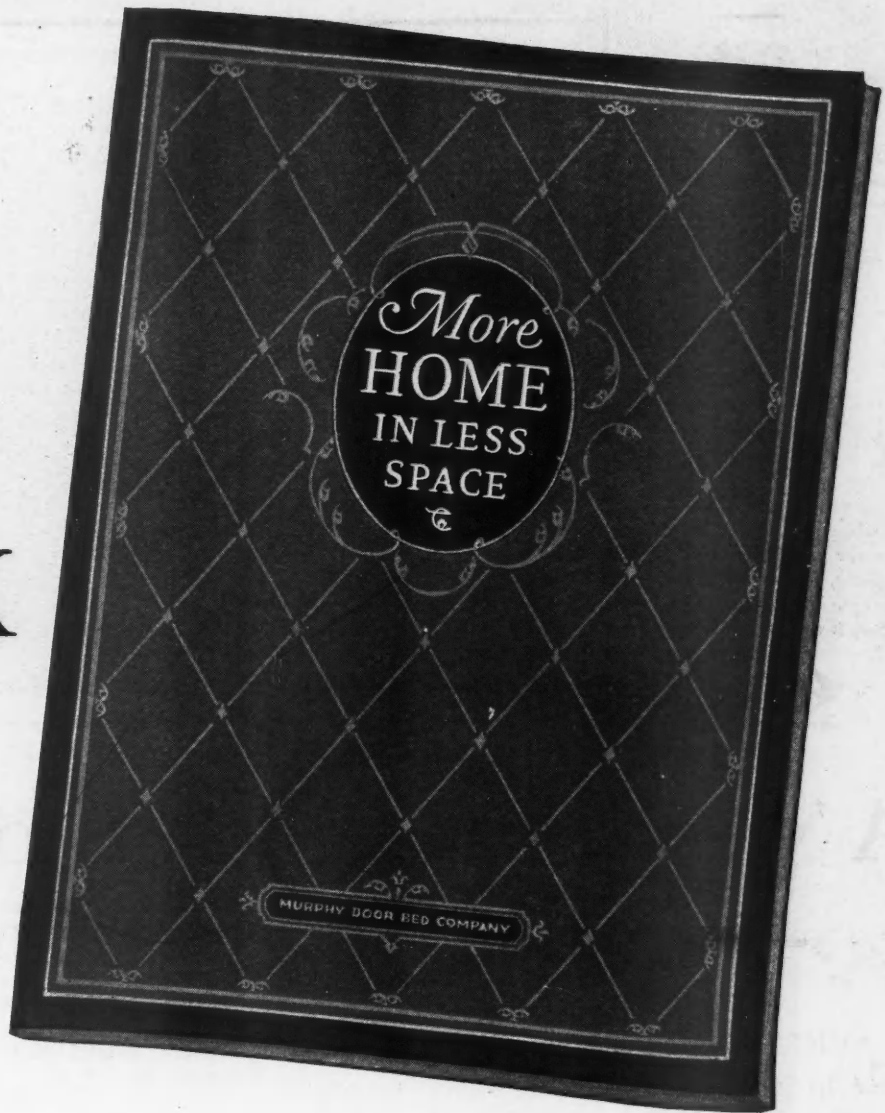

THIS book tells how one room can be made to give the service of two. It shows owners of houses, apartments and hotels how they can save money without decreasing living accommodations and standards.

This book shows architects that they can put more home in less space by planning to use Murphy In-a-Dor Beds. It contains installation plans and shows that the use

of Murphy In-a-Dor Beds allows full play to architectural taste and skill.

Builders can see in this book how simple is the installation of a Murphy In-a-Dor Bed and why, once installed, it needs no readjustments and no service. No special construction is necessary.

"More Home in Less Space" is completely illustrated. It shows the styles of Murphy In-a-Dor Beds and how they fit into the furnishing schemes for various rooms. Handsomely printed in four colors. File size. It is a "reference" book.

You will want a copy. You will use it. Send for it, today. Write to the office nearest you. Murphy Door Bed Company.

THE
MURPHY
 IN-A-DOR BED

New York City 19 W. 44th St.
 Chicago, Ill. 22 W. Monroe St.
 Atlanta, Ga. 33 Luckie St.
 Seattle, Wash. Terminal Sales Bldg.
 San Francisco, Calif. Crocker Bldg.
 Los Angeles, Calif. 1807 S. Main St.
 Denver, Colo. 1534 Blake St.

St. Petersburg, Fla. 121 Second St., S.
 Miami, Fla. 234 Columbia Bldg.
 Orlando, Fla. 14 E. Church St.
 St. Louis, Mo. 315 N. 10th St.
 Detroit, Mich. 7th Fl., Kresge Bldg.
 Birmingham, Ala. 513 N. 21st St.
 Cleveland, Ohio. 1140-42 Hanna Bldg.

Kansas City, Mo. 1114 Grand Ave.
 Dallas, Texas 1919 Pacific Ave.
 El Paso, Texas Neff-Stiles Bldg.
 Houston, Texas 2301 Main St.
 New Orleans, La. 319 Dryades St.
 Montreal 698 St. Catherine St., West
 Toronto 21 King Street, East

WHEN WRITING ADVERTISERS PLEASE MENTION THE AMERICAN BUILDER

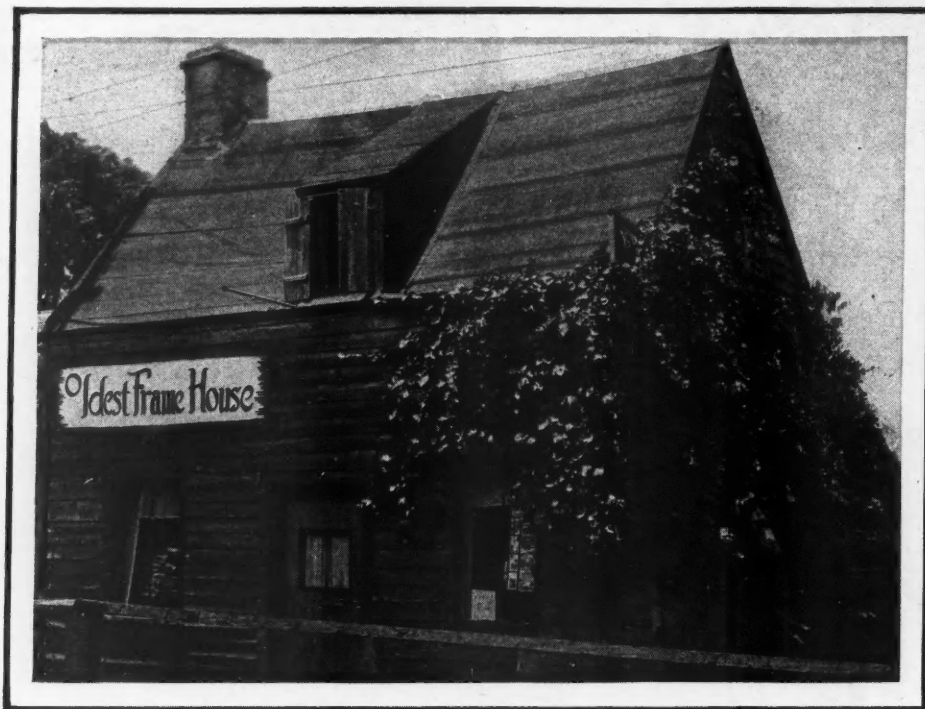

The oldest frame house in the oldest American settlement. Built in St. Augustine, Florida, more than 250 years ago. The original cypress, unpainted, is weathertight today.



A wood that fights its own battles —whether you paint it or not

EVEN without the protection of paint, heart grade Tidewater Red Cypress defeats weather at every turn. To achieve better appearance and even greater dura-

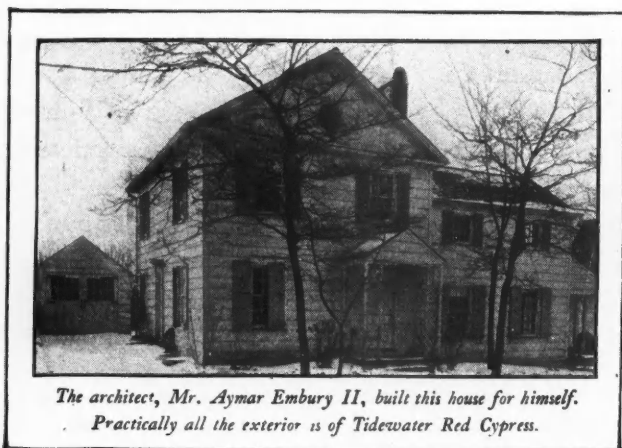

The architect, Mr. Aymar Embury II, built this house for himself. Practically all the exterior is of Tidewater Red Cypress.

bility, paint is, of course, desirable. But artificial protection is not absolutely necessary. For half-timber construction, and for every location where an unpainted effect is desired, Tidewater Red Cypress is an ideal wood to employ. Wherever wood meets weather, it knows no peer in endurance.

For exterior uses the correct specification for this Wood Eternal is "heart grade Tidewater Red Cypress," or "heart grade red cypress, coastal type." For interiors, sapwood may be used to good advantage.

Complete information on this long-lived wood will gladly be sent on your request. Southern Cypress Manufacturers Association, Dept. (AB-3), Jacksonville, Florida.

Specify

TIDEWATER RED CYPRESS



THE WOOD ETERNAL

DURO *Clinches the Sale*

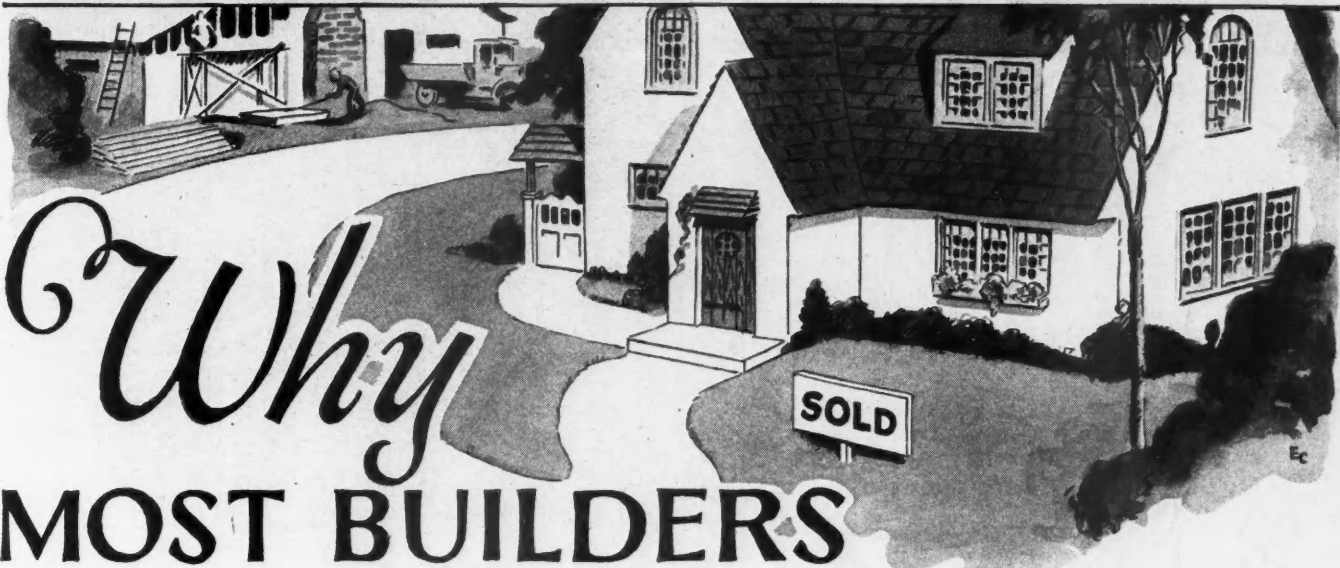

Why
MOST BUILDERS
install **DURO**

Because—

- out beyond the city water mains, thousands upon thousands of Duro Water Systems are faithfully bringing the joy and comfort of fresh running water under pressure to suburban and country homes—automatically, noiselessly, without care or attention.
- Duro specializes in the manufacture of water systems.
- Duro Service is unequalled. . . . No matter where you live Duro Service is as near as your telephone.
- there is a Duro System to fit your requirements exactly. The Duro line is complete.
- Duro makes its pumps, tanks, motors, switches—everything that goes into the manufacture of the Duro Water System.
- in Duro only can you get exclusive, patented mechanical advantages which mean long life and carefree service.
- Duro Water Systems are lowest in first cost, and cost but one cent per 100 gallons to operate!

That's why Duro is the world's largest maker of water systems. That's why shrewd builders install Duro.

Write for descriptive booklets on Electric Water Systems, Water Softeners, Filters and Septic Tanks.

THE DURO COMPANY
 103 Monument Ave., Dayton, Ohio

DURO
Automatic
WATER SYSTEMS

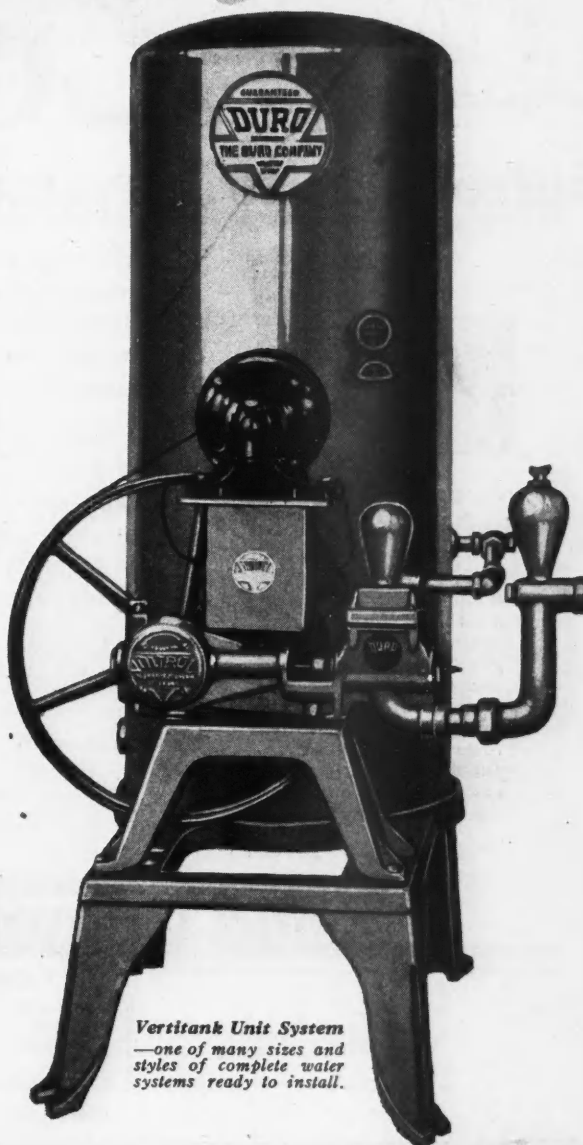

*Vertitank Unit System
 —one of many sizes and styles of complete water systems ready to install.*

A.I.A.-26 B-1

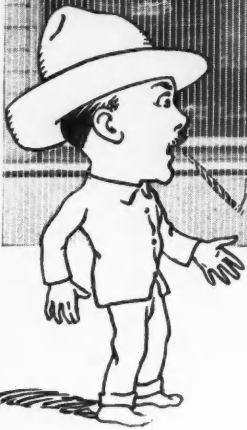

Zouri

introduces to Havana American display methods

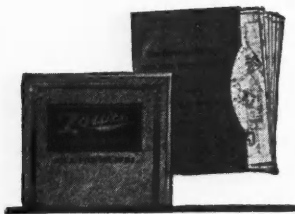

Send for this data book and helpful detail sheets

Written for the practical architect, builder and contractor, this material gives generous plans and diagrams for suggested methods of window and display space. Detailed drawings will prove helpful to specification writers. Valuable to keep on file. Send for your copy.

The imposing Zouri copper Key-Set Sash installation recently completed in the J. Z. Horter Building in the Cuban capital demonstrates American progress to the erstwhile easy-going inhabitant. Zouri alone assured maximum display — maximum structural beauty—minimum worry over glass breakage.

Zouri is proving every day worthy of the recommendation of particular architects, builders and contractors. It practically does away with distortion. It makes installation easier by correctly distributing the setting pressure. For real beauty and safety against unequal pressures of setting, wind and shock, Zouri is the best solution.

Copper and bronze of unusually heavy gauge is used in the fabrication of Zouri sections — gauges that experience proves are necessary. After specifying, Architect and Contractor in considering substitutions should demand samples.

Our large organization of distributors is still another guarantee of Zouri safety service.

Zouri Drawn Metals Company

And Associated Companies:

International Distribution

INTERNATIONAL STORE FRONT COMPANY
STANDARD STORE FRONT CONSTRUCTION CO.
MODERN BRONZE STORE FRONT COMPANY
ZOURI COMPANY OF CALIFORNIA
ZOURI DRAWN METALS CO. OF NEW YORK, INC.

Names on Request

Factory and General Offices: Chicago Heights, Illinois

KOEHRING DANDIE

Mixer



Speed and Strength

10-S

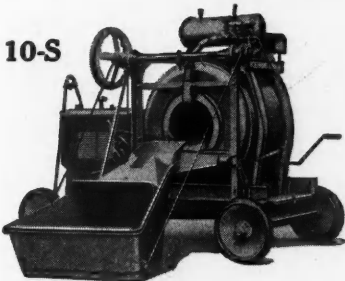

Engine completely enclosed in dust tight steel housing, sides of which raise for fullest accessibility to engine! One-man end-control of mixer.

5-S

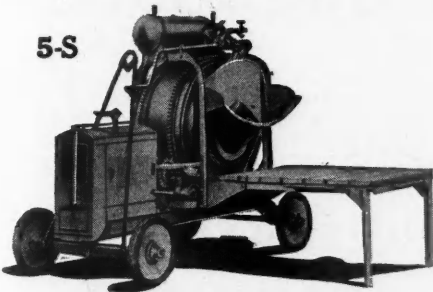

Low charging platform, steel frame of which is hinged to mixer, and can be folded up against mixer-frame for hauling from job to job! Wide, capacious charging hopper makes charging easy.

YOU'LL lose no time getting materials into the drum with this speedy charging skip. Shoots the materials into the drum in one clean swift slide! No clogging! No need for pounding the skip, or shaking it against the frame!

Discharging! Watch it come! Starts on the instant — and keeps coming in big volume until the last shovelful is out of the drum!

Speed! If you want operating speed here it is—in a light mixer that you can take down into excavations or upstairs easily — with rubber tires that let you

hitch it behind your car and get on the next job in a hurry!

Lightness, and operating speed—yes — **AND STRENGTH!** The Dandie *stands up* to all you ask of it! It's a high speed money-maker—and if you want to know why it is the Big remarkable value in the light mixer field, get full detailed information on **HOW** the Koehring Dandie is built. Write for Catalog D—1.

Dandie 5-S, 7-S, 10-S

5-S single cylinder; 7-S and 10-S two or four cylinder radiator cooled Ricardo-head gasoline engine. Rubber tires with disc wheels or steel rimmed wheels. Complies with A. G. C. standards.

A4513-1

KOEHRING COMPANY, MILWAUKEE, WISCONSIN

PAVERS, MIXERS—GASOLINE SHOVELS, CRANES AND DRAGLINES

Sales Offices and Service Warehouses in all principal cities!
Foreign Department, Room 1370, 50 Church Street, New York City
Mexico, F. S. Lapum, Cinco De Mayo 21, Mexico, D. F.

WHEN WRITING ADVERTISERS PLEASE MENTION THE AMERICAN BUILDER

You Get This Big New Book

Absolutely Free!

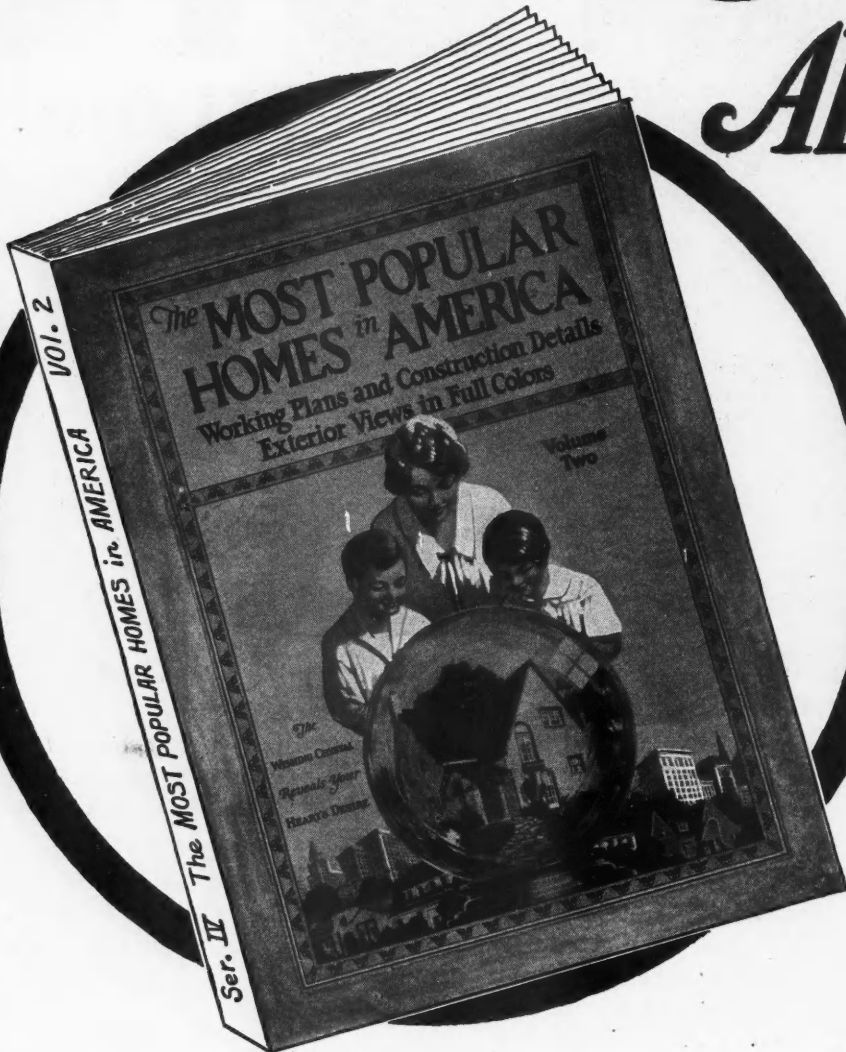

“Most Popular Homes In America —VOLUME TWO”

is a companion book to *Volume One*, which has had a phenomenal sale in the past year. *Volume One* has been repeatedly called the most beautiful and useful home design book ever printed.

The new book, “*Volume Two*”, is even more beautiful in appearance and contains 20 more full color plates than *Volume One*. If you already have *Volume One*, you will certainly be delighted with *Volume Two*.

We have on hand only a limited number of this new book—they are going rapidly. If you want yours, send for it now, *today*, before the supply is exhausted.

15 Sets of Complete Building Plans

FIFTEEN of the home designs in this wonderful book have complete working drawings, scale one-eighth inch and larger. You can build direct from these drawings, thus giving you an architectural service worth a neat sum of money, yet we include them in this wonderful book and send it to you absolutely free of cost.

These working drawings are only one of the many valuable features of this remarkable book. In addition, there are *Twenty Pages* of designs printed in four colors. Many pages of high-class half-tones reproduce actual photographs of beautiful interiors, furnishings, modern home conveniences, etc., etc.

Clip and Mail This Coupon—NOW!

THE AMERICAN BUILDER A.B. 1-28
 1827 Prairie Avenue, Chicago, Ill., 1927

Enclosed find \$2.00 for which **ENTER RENEW** my subscription to The American Builder for one year and send me free and postpaid a copy of your book “MOST POPULAR HOMES IN AMERICA”—Vol. 2.

NAME.....

ADDRESS.....

POST OFFICE.....STATE.....

My occupation is (Check Only One)
 Dealer Builder Architect Real Estate Miscellaneous

How to Get Your Free Book

This useful and handsome book will be sent you Free and Postpaid with a new or renewal subscription to “American Builder” at the regular subscription rate, \$2.00 for one year. \$2.00 pays for the subscription—the book is a gift.

The subscription may be new or renewal, or it can be an extension of present subscription, but in all cases *must be sent direct to “American Builder” and be accompanied by check, money order or currency for \$2.00.* Subscriptions sent in any other way will not entitle sender to free book.

OFFER GOOD IN U. S. AND CANADA
Add \$2.00 to Foreign Countries

Leading Contractors

buy their Cement and Plaster in Bates Multi-Wall Paper Bags as a protection against losses of material and the annoyance of returning empties for credit.

Bates Bags do not have to be returned. They empty out clean; and their 5 tough walls offer the strongest resistance to moisture and rough handling.

Bates Paper Bags are manufactured by Bates Valve Bag Corporation in 8 modern plants throughout the country.

BATES VALVE BAG CORPORATION
35 E. Wacker Drive Chicago, Illinois

—no loss

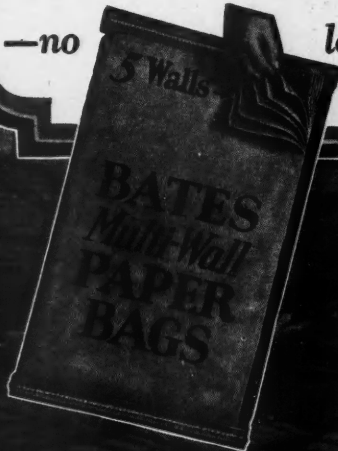

The Great Lakes Construction Company bought the mortar cement for the new Cook County Court House and Jail, Chicago, in Bates Multi-Wall Paper Bags

WHEN WRITING ADVERTISERS PLEASE MENTION THE AMERICAN BUILDER

PEOPLE are coming to realize that brass pipe is the only thing to use for plumbing, for the sake of economy, and because it does away with such discomforts as those illustrated below. It is to hasten the spread of that knowledge and to make known to as many people as possible the unique merits of Alpha Brass Pipe in particular that we are carrying on a consistent and intensive campaign, of which these advertisements in the *Saturday Evening Post* are a part.

Similar advertisements are running in *Time* as well as a campaign in *House & Garden* and *House Beautiful*, appealing to owners of fine homes.

More and more people are asking for brass pipe, especially *Alpha*, which is being brought forcefully to their attention. Plumbers and builders are invited to write for information regarding window displays, showing these cartoons, installation signs, literature to be mailed to their customers and other sales helps.

THE SATURDAY EVENING POST

THE WALLOPS

[No. 8 of a series. No. 9 will appear Feb. 11, 1928]



"If it wasn't so they wouldn't dare do it!"

SINCE there was a leak in the living room both Clara and George found the dining room a little crowded. Two sets of furniture didn't fit well in one room.

"Well," said Clara, "the company wrote back they were sorry, but the breaking wasn't their fault and a new part would cost me \$3.50! The thing was guaranteed too, George!"

"Well, there's all kinds of guarantees, Clara. Some companies talk a lot about 'guaranteed goods,' but you may find that all they guarantee is that a wooden thing is 'positively guaranteed to be of wood', or some such thing."

George Wallop knocked his cigar ash onto the carpet and thoughtfully shuffled it in as he spoke. "Yes," he added, "there are all kinds of guarantees and it pays to read 'em first instead of afterward." He picked up a copy of the *Saturday Evening Post* and began turning through the advertising pages.

"Talking about guarantees," he exclaimed, "here's one that sounds real."

"What's that you are reading?" asked Clara Wallop, looking over her glasses. "Read it to me if it's so good."

"It's an Alpha Brass Pipe advertisement," said George. "It says: 'Alpha Brass Pipe is made from a special mixture of Chase Brass that makes better joints than ordinary brass pipe. Each piece is specially tempered for soundness, and tested to about twenty times normal city water pressure.'

'The Alpha trademark is stamped every 12 inches on every pipe, so even small pieces are covered by our guarantee.'"

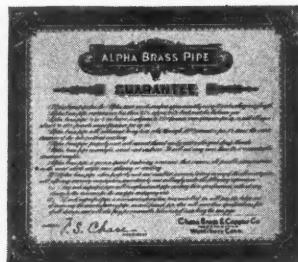

"That sounds good, George, but where is the guarantee part? Suppose the pipe leaks, or does something else wrong, then what?"

"Well, that's right here too, Clara. It says that if Alpha Brass Pipe, when properly installed, does crack, they will pay all reasonable charges for taking out any unsatisfactory pipe, they will give you new pipe free of charge and install it free for you too."

"Well, that's something like it," approved Mrs. Wallop. "I guess their pipe must be all right for them to guarantee it like that. If it wasn't so, they wouldn't dare do it."

"Oh, I guess brass pipe's the thing to use all right. If we'd had it in this house, Clara, we wouldn't have had that leak in our living room."

When using the water downstairs shuts off the water upstairs; when the water gets dirty or flaked with sediment, it's a warning that your old plumbing pipes are choked with rust and need to be replaced with Alpha Brass Pipe. Why not ask your plumber to estimate how much it would be?

ALPHA BRASS PIPE made from a special kind of **CHASE BRASS**

CHASE BRASS & COPPER CO., Incorporated, Waterbury, Conn.

Copyright © C. B. & C. Co., Inc.



Living room in the residence of J. H. Ellison, Minneapolis. H. N. Leighton, Builder. Maurice F. Maine, Architect. Excellent plaster work, plus profitable insulation.

A Beautiful Plaster Job.. Insulite Base... Helps to Make This the Fine Home it is.



Stairway in Ellison residence. Insulite is easily handled and applied; readily adaptable to all curves, coves and other unusual requirements.

THE architect and builder of this charming home insured the owner a fine plastering job and good insulation by using Insulite as a plaster base.

More than 23,500 square feet of Insulite Insulating Plaster Base used.

Note the perfect results in the curved ceiling above the stairway—always a difficult type of ceiling to handle.

Plaster cove used throughout the house, with beautiful straight lines where required.

Good plastering and good insulation sell houses; one of the surest money-back investments you can make. Send for Insulite samples—showing how plaster and Insulite are so firmly united that you can't pull them apart.



Hall in the same residence. Attractive plastered walls and ceiling, plus the most effective building insulation.

THE INSULITE COMPANY
Builders Exchange Minneapolis, Minn.

INSULITE
the Wood-Fiber Insulating Board

Photograph of plaster on Insulite Insulating Plaster Base. Samples like this sent free on request. Use the coupon for your convenience.

Name.....

Address.....

City..... State.....

ALL THAT INSULATION MEANS INSULITE DOES



Inside Keys are out of date!

home buyers
want
MODERN
door locks

SCHLAGE *Button* **LOCKS**

CAN you imagine a modern woman buying a house equipped with old-fashioned oil lamps, and spending her time cleaning dirty chimneys and trimming wicks? You know she would not buy such a house. You put in MODERN electric lights so all she has to do is *press the button*. Why not use the same good judgment in the matter of door locks?

Modern door locks, like modern lights, operate at the touch of a handy button. Never the aggravation or delay of searching for inside keys that are so easy to lose and so hard to find. *Instant action always.*

You know convenience and leisure mean so much to the modern woman. You know how she dotes on modern things, particularly these magical *press-the-button* devices. Give her what she wants, and cash in on it.

In addition to helping you speed up sales, SCHLAGE Locks save you



**TO LOCK: just press
the button in
the knob**

**TO UN-LOCK: just
turn the knob**

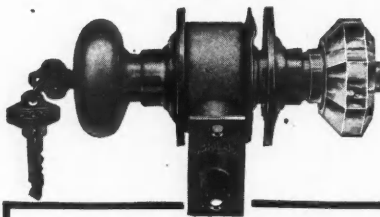

money. Installed in $\frac{1}{2}$ the time required by mortise locks. No complicated mortising, no adjusting, no screws in spindle, knobs, or escutcheons. Simply drill 2 holes, slip in lock, and set plates for latch and strike.

Over a million in use. 8 types. All U.S. standard finishes. Glass, metal, or opal knobs. All metal trims solid brass or solid bronze. Latchbolt reversible for right or left hand doors. Durability, precision, and perfect operation *fully guaranteed*. No building is completely modern without SCHLAGE Button Locks. Over 2,000 dealers in U. S. Made by SCHLAGE LOCK CO., San Francisco, California. Branches in principal cities.

MAIL THIS COUPON NOW—

to SCHLAGE LOCK CO., SAN FRANCISCO, CALIF.,
for prices and complete information on SCHLAGE
Locks for

AB-M

Building _____

Name _____

Address _____

City _____

State _____

Business _____



The MODERN Lock for MODERN Buildings

PURE LEAD - *most beautiful and enduring of materials - is now available for Metalwork in Inexpensive and Workable form*

Tested in the Smoke of Steel Mills and the Salt Moisture of Seacoast Air!

SUPERIOR Lead-Sealed has attracted wide interest simply because it is pure lead actually amalgamated to a special steel. But its practical value for sheet metal work is based on remarkable test results obtained under the severest of conditions.

A Sheet Metal That Endures

As roofing and metalwork on steel mills and other industrial buildings Lead-Sealed has stood up under strongest smoke acid and the corrosive action of seacoast air. It has been shown that Lead-Sealed conductor pipe, eavestrough, etc., are formed without peeling of the protective lead surfaces and without the trouble of working lead sheets when they have no steel to reinforce them.

The base metal in Superior Lead-Sealed is a special analysis, copper content steel, sealed within lead by an exclusive process. It has also been shown that where these sheets are sheared the soft lead carries over so as to protect the new edge effectively.



Two surfaces of Pure Lead seal a core of special analysis, copper content steel.

Test It Yourself

Because Lead-Sealed is fundamentally different from any other sheet

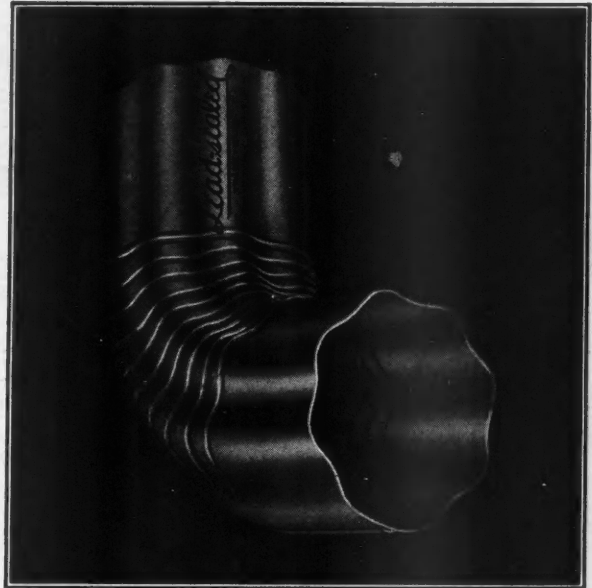

A severe test for any sheet—successfully formed with Lead-Sealed!

Uniformly Level, of High Ductility, very easy to work!



metal, we would like you to examine a sample for yourself along with complete information on its use as roofing and metalwork. It can be installed by any competent sheet metal worker and, for a very few dollars more, furnishes a big selling point over ordinary galvanized work. Send the coupon for a quick reply.

Superior
Lead-sealed

THE SUPERIOR SHEET STEEL CO., Canton, O.,
Division of Continental Steel Corp.—Makers of *Super Metal*
Galvannealed, Galvanized and Long Terne Sheets

Please send sample and detailed information on Superior Lead-Sealed.

Name.....

Address.....



BESTWALL—"the SUPERIOR plaster wall board"—was used for the smooth, seamless walls and ceilings of this beautiful Eastern home. It is the residence of Mr. A. L. Buffington, Fairhaven, Mass. Mr. J. W. Bishop, Bedford, Mass., was the architect and contractor



Walls in finest homes are now made of BESTWALL with the Beveled edge

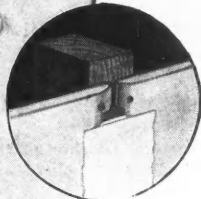

The exclusive Beveled Edge insures smooth, seamless, keyed-in joints.

Beaver BESTWALL is still made with the square edge for those who prefer it.

Now in the living rooms, dining rooms, bedrooms, even in costliest dwellings BESTWALL, with the beveled edge, is used for the walls. Walls that are seamless, smooth, unmarred by "joints" between panels. With the Beveled Edge, not even an expert can find the seamlines. Flat, keyed-in joints are assured, regardless of the variable thickness of sheets or uneven studding.

In the East, where this new feature was first introduced, the demand absorbed our entire production for many months. Now, with increased manufacturing facilities, Bestwall, with the Beveled Edge, is available everywhere.

Bestwall offers great time and labor saving. It is quickly, easily, applied. The cream-colored finish takes any decorative treatment.

Bestwall has a strong fibre binder, made in the Beaver mills, which gives greatly increased strength and rigidity. Very durable. Its fireproof qualities are approved by the Underwriters' Laboratories, Inc.

BESTWALL, with the Beveled Edge, is being advertised nationally, in colors and in large units of space. Let us send you samples and literature so you will be prepared to discuss it with prospective users. Only your name and address required.

Address Dept. 1315

THE BEAVER PRODUCTS CO., Inc.
Buffalo, N. Y.

BEAVER BESTWALL

WITH THE BEVELED EDGE

FOR ADVERTISERS' INDEX SEE NEXT TO LAST PAGE

These 5 reasons explain the soundness of using Sargent Hardware when you build . . .

WHETHER you build low-price, large-volume operations, or individual homes on private specifications, you will find Sargent Hardware the best you can buy. The smoothness and certainty of its operation; the beauty of its design and finish; its durability; the fairness of its price; and the national advertising that backs it up, all make it the best hardware you can use.

Advertisements in consumer publications, such as that from which the illustrations on the right were taken, are telling home owners all over the country of the authentic designs that are standard in Sargent sets for homes built in the Colonial, Spanish, or English styles. They are impressing them with the permanence and the freedom from repairs or replacements of Sargent Hardware of solid brass or bronze. They are showing them that it will operate smoothly and certainly for years because all the moving parts are carefully machined and accurately fitted.

If you build large-volume operations, the use of Sargent locks and hardware will help you sell. The name Sargent on hardware is a guarantee of excellence to house buyers. Prospects will take for granted that the invisible details of your house are as finely taken care of as the hardware detail. Builders have found that the slight extra cost of this carefully made hardware, as compared to the light weight and plated iron goods made to sell at a price, more than pays

for itself by extra quality, service and attractiveness.

If you build from private specifications, of course you want Sargent Hardware, want it in a style suitable to the design and period of the house.

There are representative Sargent dealers in all cities who will help you make selections and will furnish estimates. Write for our book of designs, "Hardware for Utility and Ornamentation." It illustrates a great variety of Sargent Hardware. Sargent & Company, 51 Water St., New Haven, Conn.



Antique hardware of brass is used on this entrance doorway and also in the ballroom from the old City Tavern, now in the American Wing of the Metropolitan Museum. It may be practically duplicated in Sargent Hardware for your own houses.

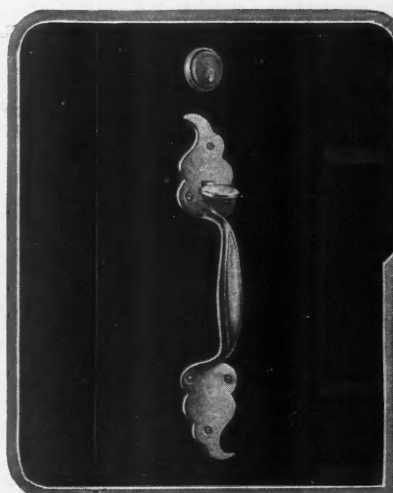

This door handle of solid brass with thumb-latch follows closely the eighteenth century original. It connects with the Sargent cylinder lock. Ask for door-handle No. 2261. Also appropriate for your Colonial doorway is a Sargent brass knocker, No. 28, of faithful antique design. As well as this "S" type, you will find several urn shapes, a popular design in the early days of the republic.

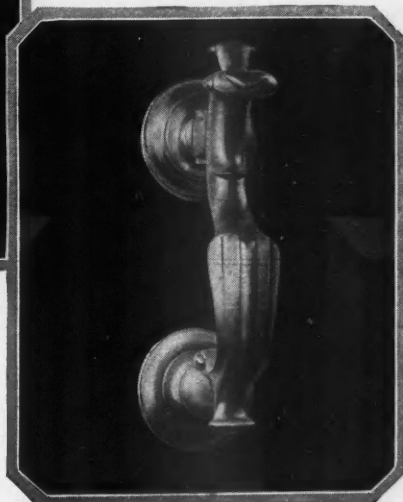

SARGENT

LOCKS AND HARDWARE

WHEN WRITING ADVERTISERS PLEASE MENTION THE AMERICAN BUILDER



Special Notice

The success of Laminex has tempted others to offer guaranteed veneered doors outwardly resembling Laminex doors but lacking the moisture-resistance that only Laminex waterproof cement can give. For your own protection insist on doors that bear the yellow replacement guarantee label and the name "LAMINEX".



This is the famous Laminex door soaking test that you see publicly made in all parts of the country. Retail dealers actually soak Laminex doors in water for weeks at a time to prove that dampness can never make them warp, split or come apart.

Here's a French door that can't sag or stick

A LAMINEX French door cannot sag because the joints between stiles and top rail are double-doweled and quadruple-doweled at the bottom rail. These dowels are longer, thicker and stronger than those used in the ordinary door—and there are more of them!

Scientific construction

Wood expands or contracts, as it becomes wet or dry—that's why doors warp. Laminex construction overcomes this tendency of wood to shrink or swell. Laminex stiles and cross-rails are built up on a foundation of blocks, dove-tailed and cemented to one another. On this foundation or core, flawless layers of wood are cemented. Laminex cement, a secret compound, is waterproof and forms a permanent bond. A Laminex door may even be soaked in water for days at a time without damage—a test that many of our distributors and retail dealers make publicly.

Use Laminex French Doors on your next job

If a door cannot sag and cannot swell, it surely cannot stick. That is why Laminex French doors, as well as any other type of Laminex doors, are absolutely trouble-proof.

Progressive lumber and millwork dealers can supply you with Laminex French doors in a number of popular designs at very moderate prices. If your dealer can't supply you write us and we will send you the name of one who can.

Fill in and mail the coupon today for our new book about the scientific construction of Laminex doors and for a sample of Laminex wood to test.

THE WHEELER, OSGOOD COMPANY, Tacoma, Washington
 Gentlemen: Please send me the illustrated Laminex book and instructions for finishing doors. L113B

NAME _____
 ADDRESS _____
 CITY _____ STATE _____

I buy _____ doors per year.

LAMINEX DOORS

REG. U. S. PAT. OFF.

Will not shrink, swell or warp

The new improved Kawneer Store Fronts are identified by this design

THIS YEAR The Kawneer Company offers a new improved store front—more beautiful in design—more powerful in its sales appeal—and identified for your protection.

NEW members of construction such as—

- NEW BULKHEADS
- NEW TRANSOM BARS (Plain or enriched)
- SOLID NICKEL-SILVER AND BRONZE DOORS
- APPROPRIATE BRONZE SPINDLES
- PROFILED SHAFTS
- ORNAMENTAL GRILLES

and other features of interest can be fabricated into distinctive store front creations to meet the requirements of architects, contractors and merchants.

Through our nation wide advertising of the new Kawneer store fronts we are familiarizing retail merchants with this design as their guarantee of Kawneer high quality construction. They will look for it on the store fronts you install.

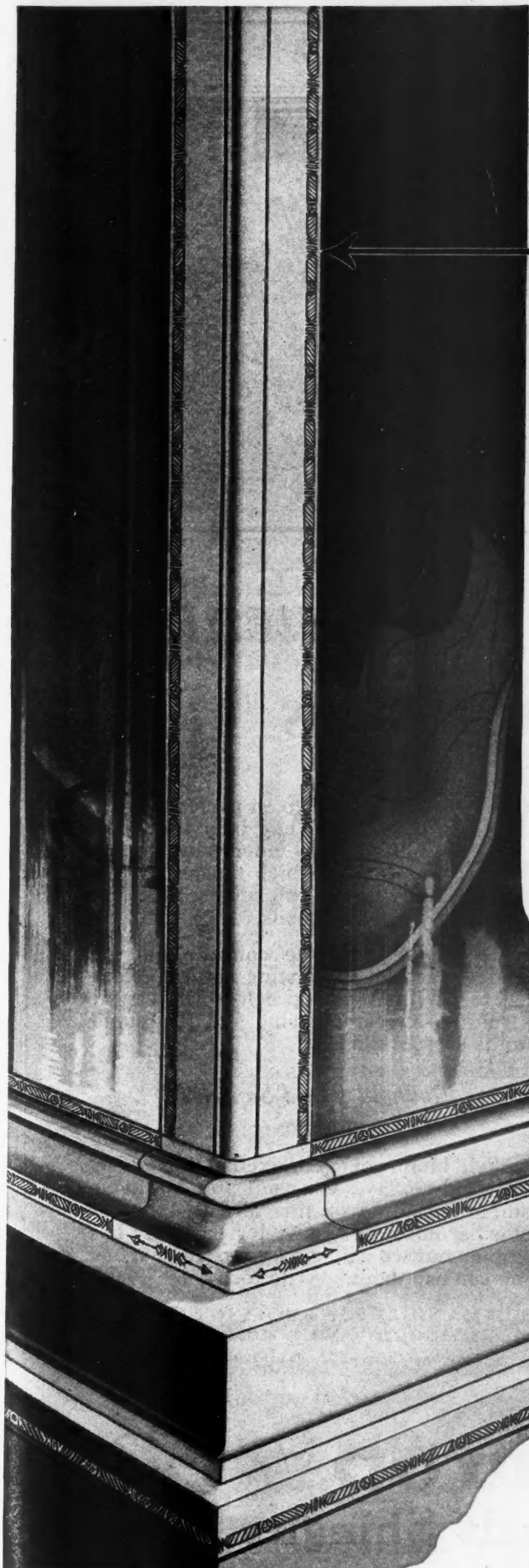

THE
Kawneer
COMPANY

2426 FRONT STREET, NILES, MICHIGAN
Read what Kawneer has done for other merchants in our new book, "Modern Store Fronts for Better Display." It's Free.



Name _____
Address _____
City _____
Business _____



WHEN WRITING ADVERTISERS PLEASE MENTION THE AMERICAN BUILDER

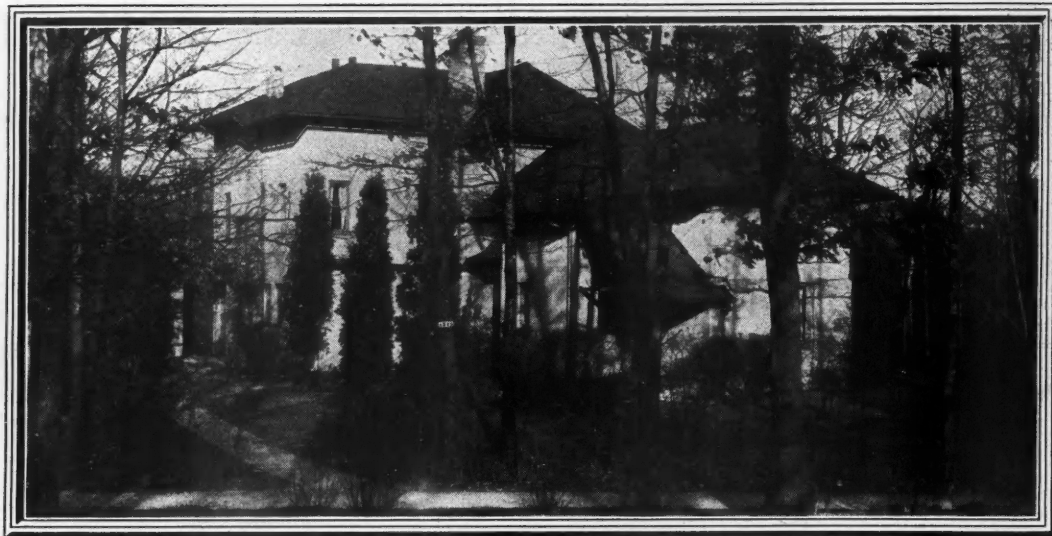

Men of Keen Judgment Select Winthrops

A lumber dealer roofs his own home with Winthrop Tapered Asphalt Shingles. A contractor puts them on his house. An architect selects them for the Armour summer home. An artist helps us work out a new blend for his home.

The residence illustrated above is the Highland Park, Ill., home of Mr. Dana Pierce, the president of Underwriters' Laboratories.

Mr. Pierce's home is roofed with our new Redfield Blend—a warm mixture of Turkey, Brick and Slate reds. This makes a colorful roof for his stucco house and contrasts admirably with summertime's green forest foliage.

Every day men of keen judgment are selecting these exclusive tapered asphalt shingles—not merely for beautiful architectural effects but for their final economy.

No other asphalt shingle has the taper—the thick butt that hugs the roof, that doubles the wearing thickness, that casts attractive shadow lines.



Winthrops go on perfectly over old roofs. They bear the Class C Label of Underwriters' Laboratories, which means low insurance. They do not rot, rust, split, crack nor saw through their nails.

The score of Winthrop colors—solid or blended—are all the lasting natural colors of slate. With Winthrop colors you can fit its roof to any style home and the home into its surroundings.

Redfield Blend Samples —Free

Redfield blend comes—mixed at the factory—all ready to lay. We want you to have a complete sample of this already popular color harmony. Your dealer probably has samples but we will send you samples, too. You can use them. Write today.

BECKMAN-DAWSON ROOFING COMPANY
1032 Brooks Building, 223 W. Jackson Boulevard, Chicago, Illinois
Factories at Chicago, Detroit and Lockport, N. Y.

the Big Butt Shingle
Winthrop
Tapered Asphalt Shingles

Balsam-Wool

—the *flexible* insulating and sound deadening blanket

"I have been using your Balsam-Wool for insulation on houses I am building in Cedar Rapids. It is really an ideal material. It's clean, easy to handle and economical. I am glad to recommend it, as it can be applied at a less cost than many other insulating materials of lower value."

It
tucks
in



Why Conscientious Contractors everywhere are turning to this TRUE Insulation—

Helps to sell the House—Costs almost Nothing

WE could show you scores of letters like the above—Most of them would come down to these three facts. "Balsam-Wool costs almost nothing, because you save so much in the heating plant"—and —"I can always sell a Balsam-Wool Insulated House with a free conscience."

You put it in *extra*—don't take anything out of the framing or soundness of the house.

But—then you find that a *smaller heating plant* is *all* the house could possibly use.

And *here's* where you *save nearly all* that the Balsam-Wool cost.

This *flexible* blanket insulating material —Balsam-Wool—gives you dollar for dollar the best house and the best selling house in the community.

Special Correspondence Invited. Write us for anything you want to know about Balsam-Wool. Our Technical Department will gladly tell you about specifications covering various methods of application, its use for sound-deadening purposes, etc. Balsam-Wool is made in both *full inch* and *half-inch* thicknesses. If your lumber dealer doesn't handle it, let us know. We will direct you to a reliable dealer who does.



*The Weyerhaeuser
Guarantee*

is behind Balsam-Wool. It assures highest quality and lasting satisfaction to users.

SOLD THROUGH
RETAIL LUMBER
DEALERS

WOOD CONVERSION COMPANY, Cloquet, Minnesota

Makers of both flexible and rigid insulations

Sales Offices: MINNEAPOLIS, Baker Building · CHICAGO, 360 North Michigan Avenue · NEW YORK, 101 Park Avenue
DETROIT, 503 Stephenson Building · KANSAS CITY, 3525 Broadway

Twelve Big Numbers of Beautiful Homes Magazine

and

A BIG PLAN BOOK

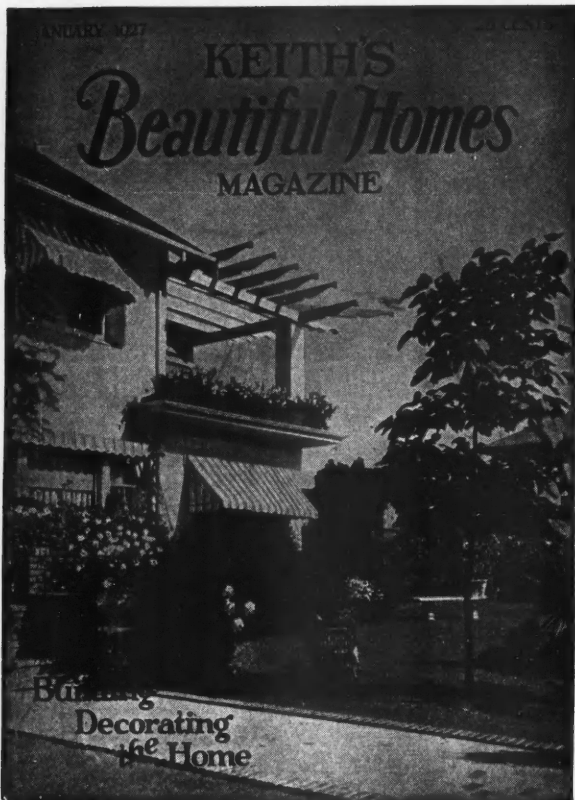

giving you a total of
300 PLANS

HOMES actually built and therefore tested for economy, convenience and good design.

This big plan book is our deluxe edition of Beautiful Homes and with many practical articles on materials and planning the home makes up a splendid book of 278 pages, containing 200 plans.

Keith's Beautiful Homes monthly magazine, the same page size as American Builder, will bring you in the year over 100 absolutely new plans of Beautiful Homes of moderate cost. Just the type and style most persons want to build.

This liberal offer brings you twelve numbers of this well known magazine and a copy of the big deluxe plan book, a total of 300 plans, all postpaid for \$1.75.

----- MAIL TODAY -----

KEITH'S BEAUTIFUL HOMES MAGAZINE
100 North 7th St., Minneapolis, Minn.

Gentlemen:—

Under your Biggest Offer send me a copy of Keith's plan book of **200 Beautiful Homes and Keith's Beautiful Homes Magazine** for one year for which \$1.75 is enclosed.

Name _____

Address _____

City _____ State _____

A B. 3-28

AMERICAN BUILDER
 Building Age
 BETTER HOMES
 RUBEROID
 NG PAPER

5 CENTS THE COPY
 THREE YEARS \$1

The Gentry Gentleman
 SATURDAY

THE SATURDAY EVENING POST

If you intend to build, remodel or re-roof, this advertisement should interest you. It warns you against a serious error that thousands of property owners have made to their sorrow in the past.



OVER three decades ago the...
 This new product because of its quality of service and flexibility...
 Naturally ingenious spring up...
 Other roofs of the Ruberoid type approved and were referred to as "ruberooid" roofs. It was a simple and...
 But the fact that an imitator has ever...
 The Ruberoid Co. itself conscientiously...
 has sought to improve upon its original...
 will remain unchanged and is responsible for the many present-day roofs that...

W...
 WE...
 A word of warning! Do not be...
 "ruberooid" Make certain that the...
 you buy carries the label—Genuine...
 Ruberoid. Other spurious shingles and...
 roofings may look similar but time and...
 weather prove conclusively that there is...
 a difference. There is only one Ruberoid...
 —Genuine Ruberoid. The paragon to...
 the right will tell you how you may be...
 sure to get a Genuine Ruberoid Roof and...
 have it carefully applied.

The RUBEROID Co. Chicago New York
 Montreal
 In Canada: RUBEROID (division of Building Products, Ltd.) Montreal

The RUBEROID Co., Dept. 111
 95 Madison Ave., New York, N. Y.
 Please tell me where I can obtain Genuine Ruberoid
 Shingles and Roofings for the following building:
 House Terrace
 Garage Porch
 Church Barn
 Store Workshop

Name _____
 Address _____

MONTH AFTER MONTH during 1928 over six million families will read over and over again the importance of selecting *Genuine Ruberoid Shingles and Roofings*.

In each community there are many of these families who will build, remodel or re-roof. This is your opportunity to supply them with *Genuine Ruberoid Shingles or Roofings*.

Samples and literature will be gladly supplied you upon request. Simply check the Ruberoid products in which you are interested and mail the coupon.



RUBEROID advertising during 1928 will materially help the most reliable carpenters, contractors and builders in each community to increase their roofing volume.

If you are the type of carpenter, contractor or builder who through the selection of quality materials and careful workmanship has gained a reputation for dependability, you will appreciate what this Ruberoid advertising means to you.

It enables you to get more business, better business and the kind of business that is most profitable to you.

The RUBEROID Co.

Chicago

New York

Boston

In Canada: RUBEROID (division of Building Products, Ltd.) Montreal

The RUBEROID Co. (Dept. 1)
 95 Madison Avenue
 New York, N. Y.

Please send samples and literature of the following *Genuine Ruberoid Products*:

- Ruberoid Strip-shingles
- Octagonal Square Hexagonal
- Ruberoid Unit-shingles
- Massive Standard Lock-down
- Ruberoid Roll-roofing
- Slate-surfaced Smooth-surfaced

Name

Address



The True BUY-WORD in Wallboard

TO the wise judgment of the builder, we submit these plain facts—facts which have made Sheetrock the Buy-Word in Wallboard.

Sheetrock is a strong and rigid structural material which does not warp. It provides a smooth, durable surface. Its core of processed gypsum is fireproof and vermin-proof. It resists heat and cold.

It comes to you all ready for use, with the USG patented folded edge for extra nailing strength. It has the exclusive joint reinforcement which seals and conceals all joints. It provides a smooth, even surface for any decoration such as wallpaper or Textone, the plastic paint.

It is easily and quickly obtainable, sold by nearly every dealer in building supplies or lumber. In buying Sheetrock you have the satisfaction of using a standard material recognized as such by dealer, contractor, carpenter and property owner.

Remember the name Sheetrock as the *buy-word* in wallboard. Send for the facts, use the coupon.

Sheetrock comes in standard sizes 3/8 in. thick, 32 or 48 inches wide, 6 to 10 feet long

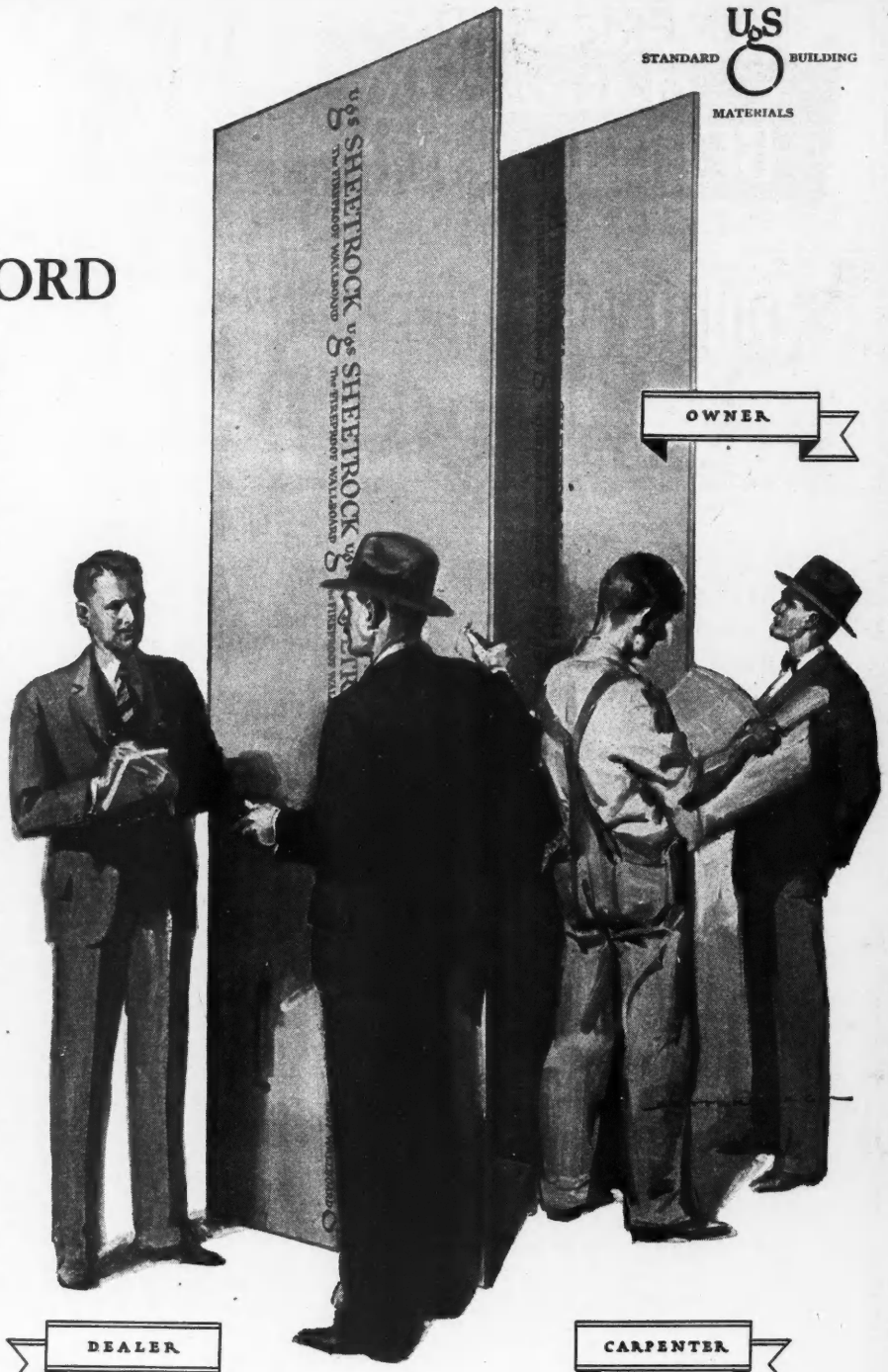

OWNER

DEALER

CARPENTER

CONTRACTOR

UNITED STATES GYPSUM COMPANY
 General Offices: Dept. 1, 300 West Adams Street, Chicago, Ill.

SHEETROCK

FIREPROOF . . . INSULATING

Reg. U. S. Pat. Off.

Made only by the United States Gypsum Company

..... **CLIP AND MAIL THIS COUPON TODAY!**

UNITED STATES GYPSUM COMPANY, General Offices: Dept. 1, 300 W. Adams St., Chicago, Ill.
 Please send me your data on the Sheetrock Reinforced Joint System and other special information on Sheetrock.

Name.....
 Address.....

Big Money For You

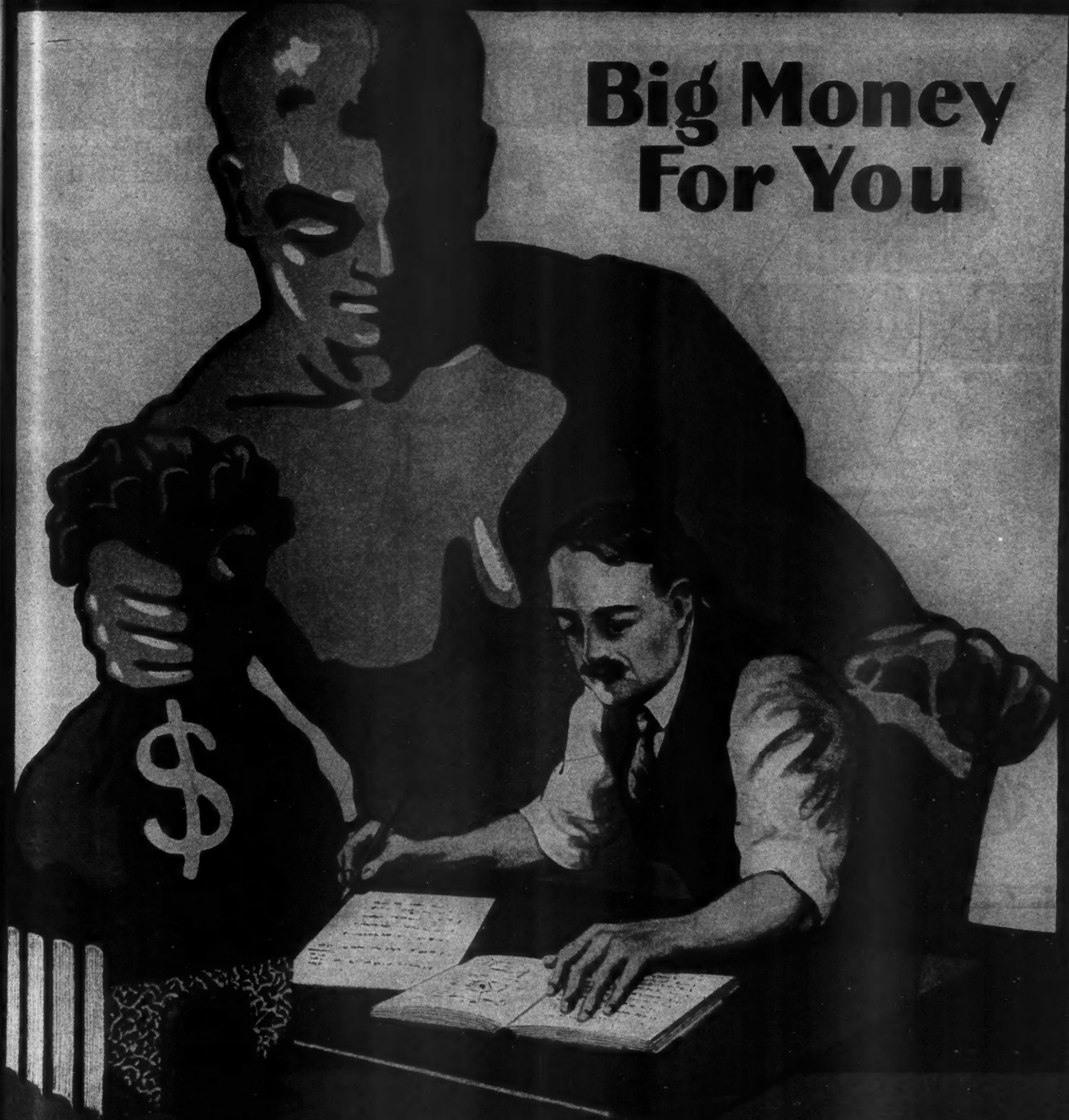

Knowledge Brings
SUCCESS and PROSPERITY

*RAFFORD'S ENCYCLOPEDIA
Building Construction*

**SEE OUR BIG SPECIAL OFFER
ON FOLLOWING PAGES**



RADFORD CYCLOPEDIA OF Carpentry Building and Architecture

**SENT
FOR ONLY
\$100**

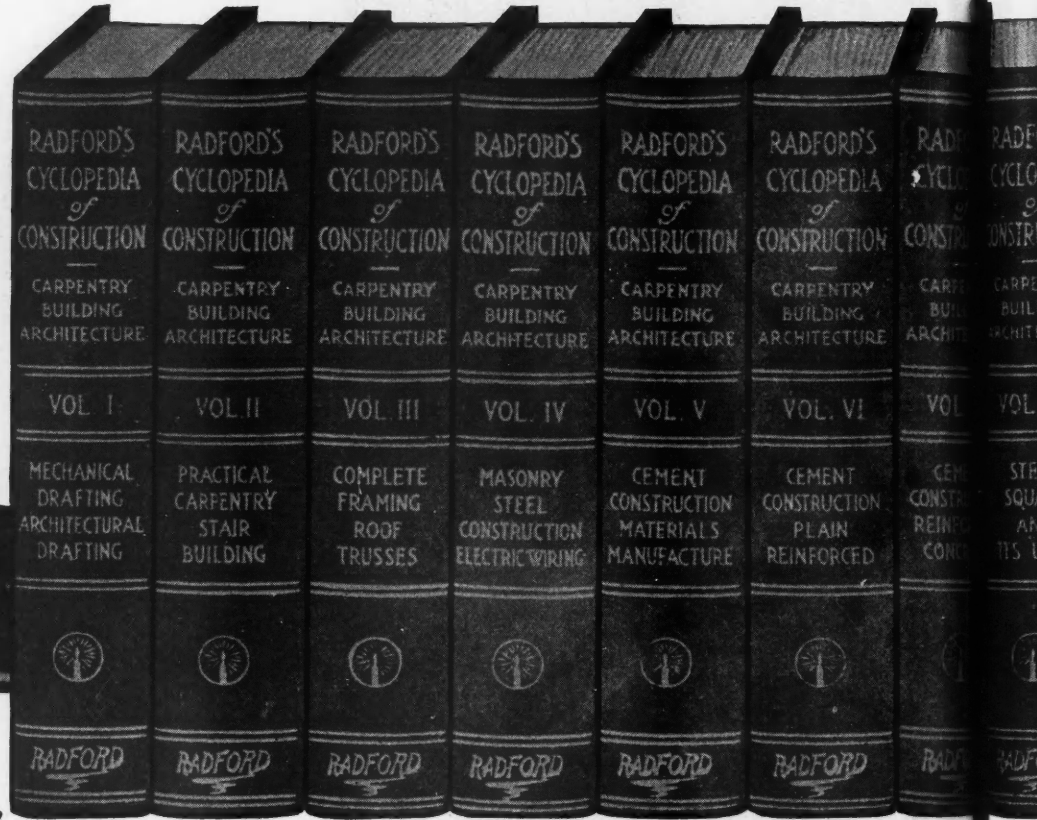

We Pay Express

Exact Photographic Reproduction Bound in Red Morocco Grain Fabrikoid

My Personal Guarantee

If you do not find the Radford Cyclopaedia of Construction just as advertised and entirely satisfactory, or if for any reason whatsoever you do not wish to keep it after having had the free use of it for five days, I personally guarantee to refund your deposit immediately upon receipt of such information from you. I guarantee to prepay all carrying charges. I guarantee you will get this low price if ordered now. I guarantee to send you Three Plan Books of 300 Plans. I guarantee to furnish you with a complete set of blue printed working plans and type-written specifications, as per terms of this offer. I further guarantee you will receive one full year's subscription, twelve numbers, to the American Builder, conceded the world's greatest and best known Building Paper.

Don't hesitate a moment to hold me to this guarantee and notify me within the five-day limit, as we want every set of books we put out to remain only in the hands of appreciative and enterprising purchasers, as this price is made with the sole purpose of placing a set in your town to which we may refer later, and with the understanding that you write us your opinion of it to help secure other business at our regular price.

Paul Radford

President and Editor-in-Chief.

Partial Table of Contents—Radford's Cyclopaedia of Construction Brief List—See

- PERSPECTIVE DRAWING
- Pen and Ink Rendering.
- HOUSE FRAMING
- Good and Faulty Construction.
- Construction of Sills and Joists.
- Studding.
- Cornice.
- Porch Construction.
- Window and Door Openings.
- How to Attach Woodwork to Masonry Walls.
- ROOFS AND ROOF CONSTRUCTION
- Lean-to and Saddle Roofs.
- Forms of Roof Trusses.
- Stresses on Roofs.
- Strength of Beams.
- Dimensioning, Struts, Tie-Beams, etc.
- Roof Braces.
- Rafters and Purlins.
- Hips and Valleys.
- Wall Plates.
- Jack Rafters.
- Dormers.
- Use of Queen Rafter To Support a Gambrel Roof.
- Construction of Circular Porch.
- CONSTRUCTION OF STAIRS
- Pitchboard.
- Treads and Risers.
- Housed and Open Strings.
- Wall Strings.
- Straight and Curved Stairs.
- THE ELEVATION
- Intersections and Developments.
- Lettering.
- Blue-Printing.
- Working Drawings.
- Architectural Drawings.
- BUILDING CONSTRUCTION
- Foundations.
- Girders.
- Cellar Windows.
- TEMPERATURE REGULATION
- Practical House Plumbing.
- The Sewer and Connections.
- Sizes of House Drains.
- THE PIPING SYSTEM
- Layout of Plumbing.
- HOW TO USE THE HANDBOOKS
- Rivets and Riveting.
- Factor of Safety.
- CLASSES OF STRUCTURAL MEMBERS
- Design of Girders.
- MANUFACTURE OF STRUCTURAL MEMBERS
- Forge Shop.
- Painting Structural Steel.
- Cost of Steel Structures.
- Erection of Steel Buildings.
- Bridge and Viaduct Construction.
- USES OF THE STEEL SQUARE
- Uses of the Figures, Lines and Scales.
- Testing the Square.
- Diagonal and Octagonal Scales.
- Adjustable Fence.
- Describing Curves with Square.
- To Find Length of Braces and Other Timbers.
- Steel Square in Roof Framing.
- Pitches.
- Rafter Cutting.
- Common and Jack Rafters.
- Hips and Valleys.
- Projecting Cornice.
- Finding Bevels.
- Framing a Circular Porch.
- Framing a Gambrel Roof.
- Miter Cutting.
- Hip Roof Framing.
- Finding Length of Rafters.
- Bevels for Cuts.
- Hoppers and Hopper Bevels.
- THE SQUARE IN STAIR BUILDING
- Strings and Finishes at Top and Bottom.
- Treads and Risers.
- Square of the Newel.
- Combination Squares.
- Topp's Framing Tool.
- KEY TO THE STEEL SQUARE
- Rafter Table.
- The Revolving Disc.
- Side Cuts.
- Table of Tangents.

Examine These Books

FOR ADVERTISERS' INDEX SEE NEXT TO LAST PAGE

IA OF CONSTRUCTION g and Architecture



SENT FOR ONLY \$1.00



We Pay Express

Oriental Gold-Leaf Letter. Actual size, 6 x 9 inches. 5,000 pages, 3,000 illustrations

yclopedia of Construction—This is a Very Books Yourself

Miters for Polygons.
Five-Pointed Star.
Framing Timbers at Any Pitch.
Ornamental Figures in Miter Work.

Laying Off Degrees with Compasses.
Possibilities of the Steel Square.

HOUSE SANITATION
Heating and Ventilation.
Modern Heating Apparatus.

HOT-AIR HEATING
Size of Furnace Required.
Location and Size of Flues and Registers.

Heat Pipes.
Cold-air Supply.
Air Cleansing.
Furnace Ventilation.

MANUFACTURE OF CAST IRON

The Blast Furnace.
Sand and Machine Casting.
Grades of Cast Iron.
Wrought Iron.

ELEMENTS OF STEEL CONSTRUCTION
The Raw Material—Iron Ore.
Properties of Ore.

COVERING OF ROOFS
Method of Shingling.
Covering of Circular Dome.

MASONRY CONSTRUCTION

Kinds of Stone Work.
Rubble Masonry.
Cut Stone.
Bonds and Joints.
Mortar for Stonework.
Stone Cutting.

Stonemasons' and Masons' Tools.
Dictionary of Masonry Terms.
Foundations.
Walls.

Abutments.
Culverts.
Piers, Arches.

BRICK AND BRICKWORK
Brick Making Machinery.
Strength of Brick.
Porosity, Density, etc.

How to Test Brick.
Mortar for Brickwork.
Bricklayers' Tools.

REINFORCED CONCRETE

Durability.
Fire-resisting Properties.
Cost of Reinforced Concrete.

REINFORCED CONCRETE BRIDGES

Piers.
Abutments.
Viaducts.
Reservoirs.

Water Tanks.
Irrigation Canals.
Headgates and Flumes.
Sea Walls.
Concrete Telegraph Poles.

Concrete Railroad Ties.

Electric Light Standards.
Concrete Garage.
Concrete Sinks.

Mausoleums.
Burial Vaults.
Useful Tables.
Useful Rules.

MANUFACTURE OF CONCRETE

Proportion for Mixing.
Hand Mixing.
Machine Mixing.
Continuous Mixing.

Batch Mixing.
Wetness of Mixture.
Mixing Tools.
Time of Setting.

How to Regulate Setting.
Difference Between Setting and Hardening.
Cost of Concrete.

Strength.
Durability.
Fireproofing.

PLAIN CONCRETE CONSTRUCTION

Collapsible Metal Forms.
Construction of Forms.
Wood Forms.
Metal Forms.

CONCRETE HOUSES

Monolithic Construction.
Concrete Block Houses.
Plaster Work and Stucco.
Foundations.

How to Get Them

All you have to do is to write your name and address plainly on the coupon at the bottom of the next page, pin a dollar bill to it and mail it to us. We trust you as a member of the building trade and send you the entire set of books immediately. We prepay all express charges and thus it does not cost you one penny for examination. When you get the books they are yours for five days to examine them just as leisurely and as carefully as you please. You have the privilege of calling in your family, your friends, your associates to look them over and help you to make a decision. After you have had the chance to go through them page by page, if you should decide that you do not want to keep the books, all that you have to do is drop us a postal telling us so. We will immediately send back to you the payment of \$1.00 which you sent us with the order blank. We do this without any argument, without any red tape and without any haggling whatever. Furthermore, we will remove the set of books without cost to you at once. Therefore, you are nothing out on the deal, you have not spent a cent, you have lost nothing whatever.

AT OUR EXPENSE

WHEN WRITING ADVERTISERS PLEASE MENTION THE AMERICAN BUILDER

Open to New and Old Subscribers--Renewals Extended for One Year

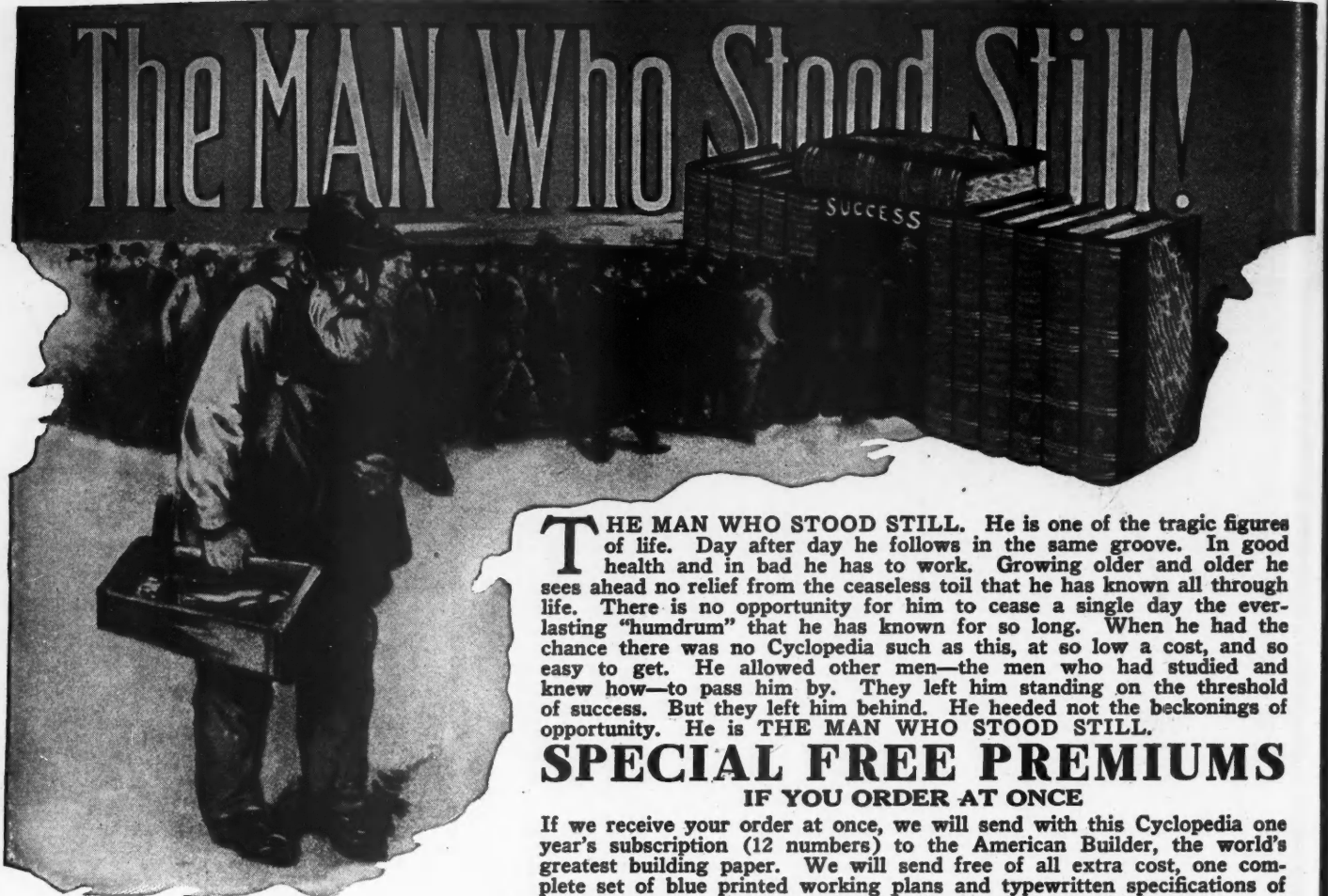

THE MAN WHO STOOD STILL. He is one of the tragic figures of life. Day after day he follows in the same groove. In good health and in bad he has to work. Growing older and older he sees ahead no relief from the ceaseless toil that he has known all through life. There is no opportunity for him to cease a single day the everlasting "humdrum" that he has known for so long. When he had the chance there was no Cyclopaedia such as this, at so low a cost, and so easy to get. He allowed other men—the men who had studied and knew how—to pass him by. They left him standing on the threshold of success. But they left him behind. He heeded not the beckonings of opportunity. He is **THE MAN WHO STOOD STILL.**

SPECIAL FREE PREMIUMS

IF YOU ORDER AT ONCE

If we receive your order at once, we will send with this Cyclopaedia one year's subscription (12 numbers) to the American Builder, the world's greatest building paper. We will send free of all extra cost, one complete set of blue printed working plans and typewritten specifications of any of the houses illustrated in three Books of Plans, which we also send to you free of cost, so that you may make your selection. These plans

and specifications are as complete as those charged \$50.00 to \$75.00 for by many architects. These plans will be very valuable to contractors, builders and draughtsmen. The only reason we can offer to do this is because we have the largest architectural establishment of its kind in the world, and are able to produce these complete blue printed working plans and specifications at the very lowest possible price, and to the purchasers of this big Cyclopaedia we are willing to give the benefit. Without American Builder \$1.00 less.

We make this liberal offer because we want you to have our Cyclopaedia, and we believe by having it in your hands we will have a greater opportunity of disposing of others in your locality, and it is with the distinct understanding that if it is entirely satisfactory, you will write us a letter and assist us in making other sales.

Our special price to you for advertising purposes is only \$37.50, and our liberal terms are only One Dollar down and \$3.00 per month until the amount is paid. We give you five days to look the books over and see if they are entirely satisfactory. If you conclude not to keep them, we will refund your money and pay the express charges both ways. Order today. Fit yourself at once to increase your earning power.

The Radford Architectural Co., 1827 Prairie Avenue, Chicago, Ill., U. S. A.

Pin A Dollar Bill To This Coupon and Mail Today

NO-RISK GUARANTEE COUPON

RADFORD ARCHITECTURAL COMPANY,
1827 Prairie Ave., Chicago.

Please send me, express prepaid, your 12-volume Cyclopaedia of Construction, for five days' free examination, with privilege of return at your expense. I enclose \$1.00 deposit which you agree to return if I decide not to keep the books after examination. If I keep the books, I will pay \$3.00 a month until the special price, \$37.50, is paid, otherwise I will notify you within five days after receipt of books.

Your offer also includes Three Big Plan Books (over 300 designs) and one full year's subscription to the American Builder. You also agree to furnish set of Blue Prints and Specifications, if ordered within 2 months after acceptance of books.

Name.....
Street.....
Town.....
State.....

West of Rocky Mountains and Canada, \$3.00 with this order.
Full amount must accompany all Foreign orders.

3-28

ACCO SASH CHAIN

*Eliminates lost time and
waste of material*

Do you know that you can hang seven windows with ACCO Sash Chain to five with cord? Chain is easier because you have no knots to tie (there are eight to a window).

Tying eight knots wastes on an average of five feet of sash cord per window. With ACCO Sash Chain there is no waste. You simply drop the chain through bore in sash, slip the small but strong hook into end link and draw the hook tightly into hole. The same kind of hook attaches the chain to the sash weight. No carpenter's "mouse" is necessary.

ACCO No. 8 Sash Chain operates freely and silently over pulleys originally intended for cord

Special pulleys are not necessary for ACCO No. 8 Sash Chain. The chain is shaped so it fits perfectly in the round groove of ordinary cord pulleys, operating *freely*. ACCO Sash Chain will not run off the pulley or get jammed in the window casing.

The owner or prospective buyer of the home will agree that ACCO Sash Chain looks better, and that being made of copper-bearing steel it will wear longer. That it is fireproof and waterproof.

Try a bag and satisfy yourself that ACCO No. 8 Sash Chain is the modern way of hanging windows. Ask your hardware dealer for a bag (sufficient for seven average double hung windows). Or drop us a card and we will see that you are supplied.

Send for free sample for testing

AMERICAN CHAIN COMPANY, Inc.
BRIDGEPORT, CONNECTICUT

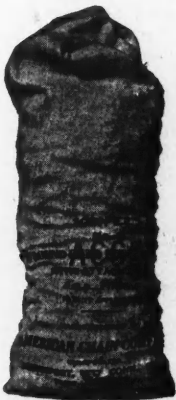

ACCO No. 8 Sash Chain comes in 100 foot lengths, packed in a substantial cloth bag, including a sufficient number of hooks for attaching the chain to sash and weights—convenient for use on the job

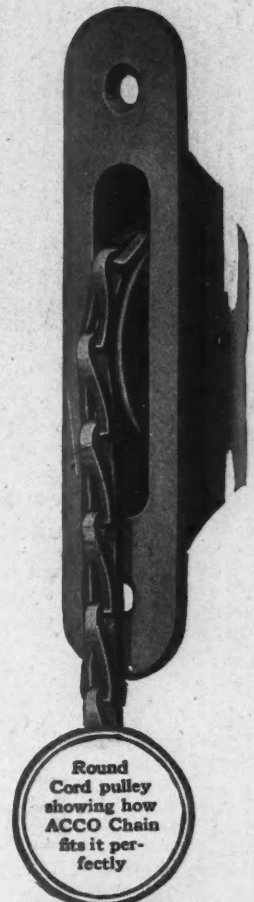

Two-hole sash. Drop chain through bore, slip hook onto end link and pull tight into bottom hole

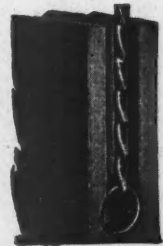

For one-hole sash, coil spring holds securely—cannot work loose. Three sizes— $\frac{3}{4}$ in., $\frac{7}{8}$ in., 1 in.

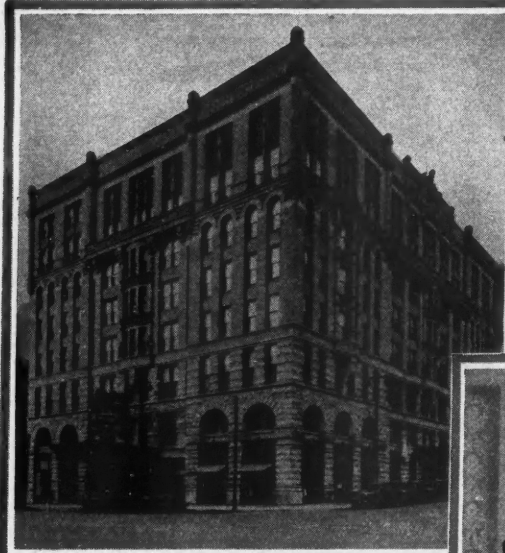

**The New Pfister
Milwaukee, Wis.**

*Owned and Operated by
Ray Smith
Harry Halfacre, Manager*

SANITAS

MODERN
WALL COVERING

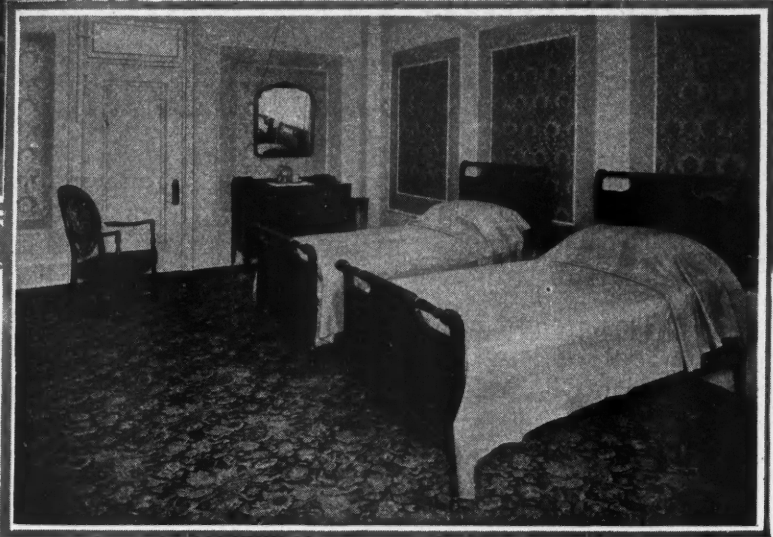

For Homes or Hotels

Architects and builders are more and more recognizing the value of Sanitas not only because it adds beauty to interior walls and ceilings but because it is a protective material as well:

Whether you are designing a model bungalow or remodeling a hotel, consider Sanitas from the viewpoint of a permanent decoration.

Ray Smith,, proprietor of the famous New Pfister, Milwaukee, demanded a wall covering that would enhance the beauty of his house, reduce the cost of cleaning and eliminate the expense of constant redecorating, so he chose Sanitas.

Sanitas is a long-life wall covering made on cloth and finished in colors and designs to meet every decorating requirement, from the simplest to the most elaborate. Sanitas protects plaster walls and ceilings, cracks do not show through it.

Write our Architect's Service Bureau for Samples and Literature

THE STANDARD TEXTILE PRODUCTS CO.

320 BROADWAY, NEW YORK

DEPT. 51



PLUMBING and HEATING

INSTALL Your Own



SAVE 1/2

BY OUR NEW EASY METHOD

BUILDERS SEND PLANS FOR FREE ESTIMATE

OUR MILLION DOLLAR PLANTS BEHIND OUR GUARANTEE

HOT WATER HEATING PLANT CUT-TO-FIT GUARANTEED



Send plan or pencil sketch of your building and our trained Engineers will design a Hot Water, Steam, Vapor, Warm Air or Plumbing Outfit to exactly meet your requirements. This service is FREE.

OUR CUT-TO-FIT NEW EASY METHOD

We are familiar with all local ordinances everywhere and from your sketch or plan, with our Cut-to-Fit New Easy Method, we will build your system to conform with your local sanitary laws. Our products from the smallest fitting to a complete outfit have durability, beauty and ease of installation built in through and through.

We Show You How To Do the Work

With our simplified and correct installing plans and instructions, any handy man can do the work himself with the aid of our free service and planning department. **TOOLS LOANED FREE.**

We keep in touch with you from time to time until your job is finished. Even if you employ a practical plumber or steamfitter the heavy labor and needless material saved will surprise you.

YOU WILL SAVE NEEDLESS MATERIAL and HEAVY LABOR

We carry absolutely everything in Highest Grade New Easy Method Plumbing and Heating—BATHROOM OUTFITS, SINKS, LAUNDRY TUBS, WATER SOFTENERS, WATER HEATERS, SEPTIC TANKS, WATER SUPPLY SYSTEMS, PIPE, FITTINGS, VALVES, ETC. HOT WATER, STEAM, VAPOR, AND WARM AIR HEATING PLANTS with special builders wholesale prices on everything. **WRITE FOR BUILDERS FREE CATALOG TODAY!**

FREE CATALOG



Send for Your FREE Copy Today

LOWEST WHOLESALE PRICES

PLUMBING and HEATING

HARDIN-LAVIN Co.

FULL OF BIG BARGAINS!



VISIT OUR Million Dollar Plant

When in Chicago, we will show you through our Big Modern Plant whether you want to buy anything or not. We want you to know us.

BRANCHES
GARY, INDIANA, 1959 Broadway
MILWAUKEE, WIS., 2201 Fond Du Lac

EST. 1876

Hardin-Lavin Co.

120-30 W. Pershing Road, CHICAGO ILL.

We Are In This Business 52 Years

Hardin-Lavin Co., 120-130 W. Pershing Road, Chicago, Illinois. A.B. 3-28

Gentlemen: Please send me your free bargain catalog with special Builders' Prices on everything. I am interested in:

<input type="checkbox"/> Hot Water Heating Plants	<input type="checkbox"/> Water Heaters
<input type="checkbox"/> Steam or Vapor Heating Plants	<input type="checkbox"/> Water Supply Systems
<input type="checkbox"/> Warm Air or Pipeless Heating Plants	<input type="checkbox"/> Bathroom Outfits and Sinks
	<input type="checkbox"/> Septic Tanks
	<input type="checkbox"/> Water Softeners

NAME.....

ADDRESS.....

CITY.....STATE.....

TRUSCON-I-PLATES

PATENT **I** PENDING

INSULATED AND WATERPROOFED

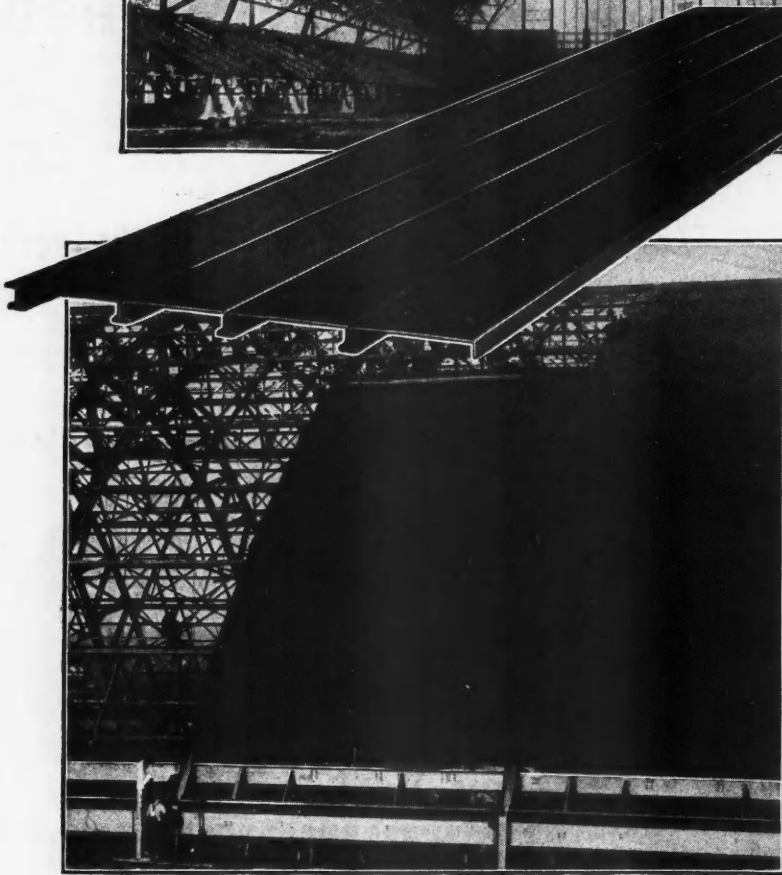

The Largest Athletic Plant in America

The new field house of the University of Minnesota, Minneapolis, Minn., is 446 ft. long, 236 ft. wide and 104 ft. high.

*C. H. Johnston, State Architect
Madsen Construction Co., Contractors*

The arched roof of this great structure is a steeldeck made of Truscon I-Plates, insulated and waterproofed. This permanent, fireproof roof deck is light in weight insuring maximum economy in the supporting structural work.

Truscon Steeldeck roofs can be insulated to any degree to prevent condensation and reduce heat loss, and are waterproofed with any standard roofing. Truscon I-Plates solve the problem of economical permanent roof decks for any type of building.

Write for suggestions,
estimates and catalog,
sent without obligation

TRUSCON STEEL COMPANY
YOUNGSTOWN, OHIO, U.S.A.

Truscon Offices in all Principal Cities

STEELDECK ROOFS

NOT OVER 5 LBS. PER SQ. FOOT

FOR ADVERTISERS' INDEX SEE NEXT TO LAST PAGE

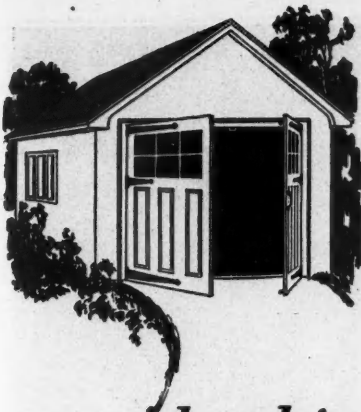

McKINNEY QUICKLOCK

latching bolt for garage doors that swing out

**Quick to open... Quick to close...
and installed in a matter of minutes**

To Open: insert key, turn and both doors are released.

To Close: merely push doors to and everything clicks into place.

McKinney Quicklock latching bolt is the last word in garage locking units—for security, *quick-action* and *quick-application*. The entire mechanism is operated merely by turning a key in the lock, on the outside. This instantly releases the upper and lower gripper jaws, enabling one to open the doors without the annoyance of releasing foot and chain bolts on the inside.

The Quicklock is placed on the active door which closes against two steel plates fastened to the inactive door and which act as an astragal.

As soon as the active door is opened, the inactive door is free to be pulled open.

It is so easy to install that much time is

saved. There are no springs to hamper the installation or to get out of order afterwards.

The vertical rods leading to the upper and lower gripper jaws from the lock case are adjustable for any height of door and they are sufficiently rigid to brace the door and prevent warping. The idea embraced in the Quicklock design keeps the doors in alignment.

Of equal importance is the fact that this lock cannot be picked—a protecting case around the lower jaw makes it impossible for anyone to slip an instrument under the door in an effort to release this jaw.

Send for literature on the Quicklock. It is the solution to the complete locking of a garage—all in one compact unit. Write

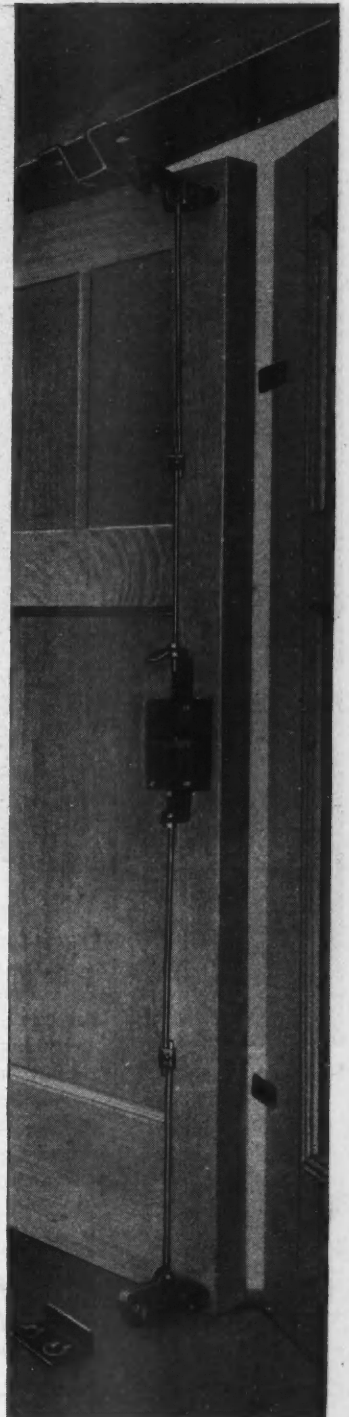
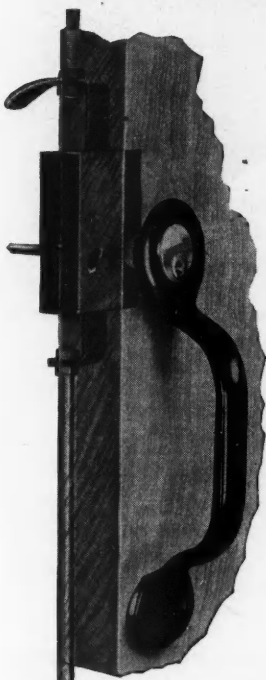

McKINNEY MFG. COMPANY

Pittsburgh, Pa.

Offices in Principal Cities

Makers of McKinney Hinges and Forged Iron Hardware



McKINNEY MFG. CO., Pittsburgh, Pa.

Please send complete literature on the McKinney Quicklock for garages.

Name _____

Address _____

AB 3-28

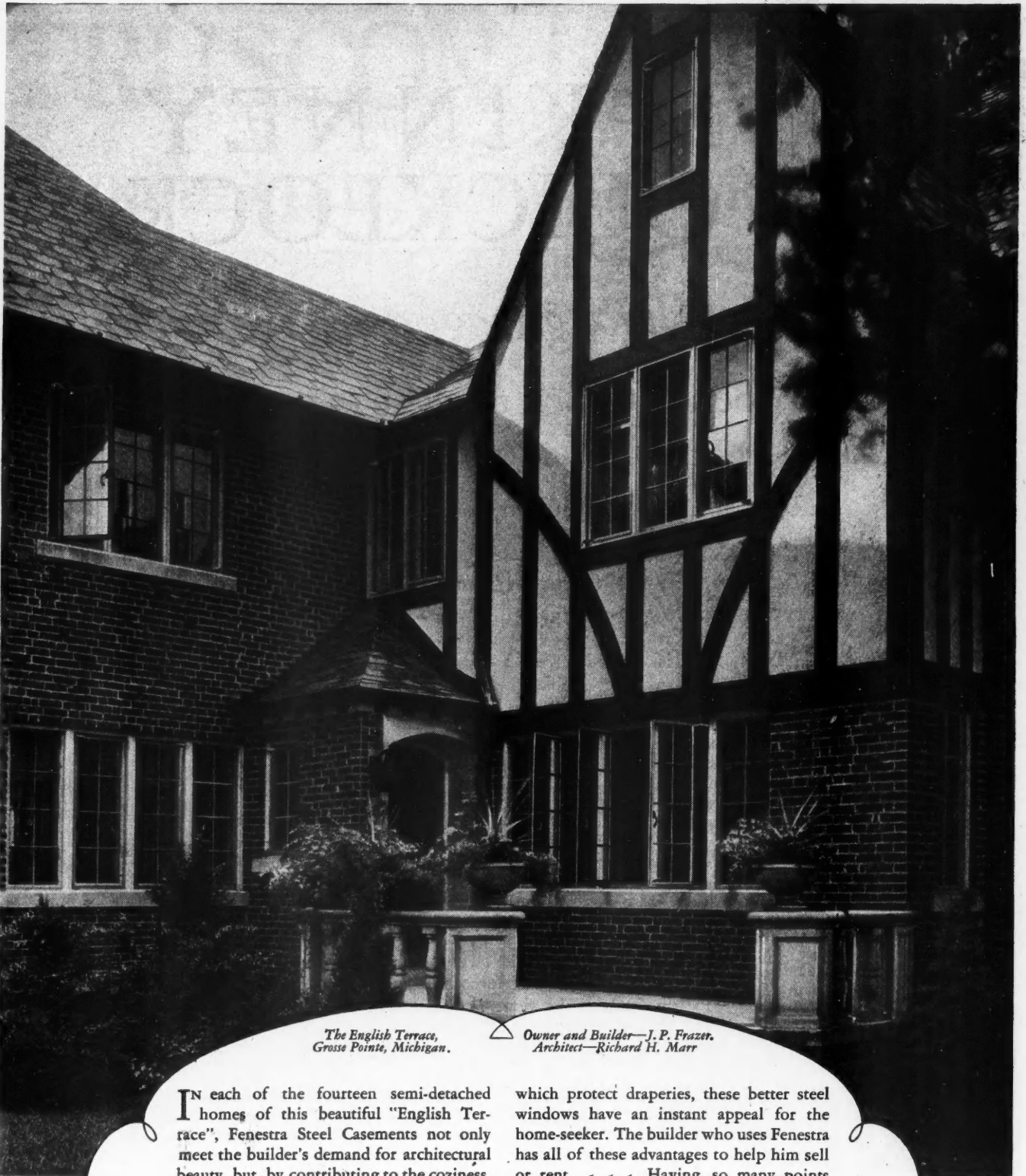

*The English Terrace,
Grosse Pointe, Michigan.*

*Owner and Builder—J. P. Frazer.
Architect—Richard H. Marr*

IN each of the fourteen semi-detached homes of this beautiful "English Terrace", Fenestra Steel Casements not only meet the builder's demand for architectural beauty, but, by contributing to the coziness, comfort, and convenience of the rooms within, they have helped to secure responsible, long-time tenants. With their weather-tightness, smooth operation, easy washing from the inside, and interior screens

which protect draperies, these better steel windows have an instant appeal for the home-seeker. The builder who uses Fenestra has all of these advantages to help him sell or rent. Having so many points of superiority, Fenestra Casements naturally give an impression of high cost, whereas actually they cost little, if any, more than ordinary windows. You can easily afford them in your building operations.

DETROIT STEEL PRODUCTS COMPANY, 2304 EAST GRAND BOULEVARD, DETROIT, MICHIGAN
 FACTORIES: DETROIT, MICHIGAN, AND OAKLAND, CALIFORNIA. CONVENIENT WAREHOUSE STOCKS.

Fenestra CASEMENTS

STEEL

WHEN WRITING ADVERTISERS PLEASE MENTION THE AMERICAN BUILDER

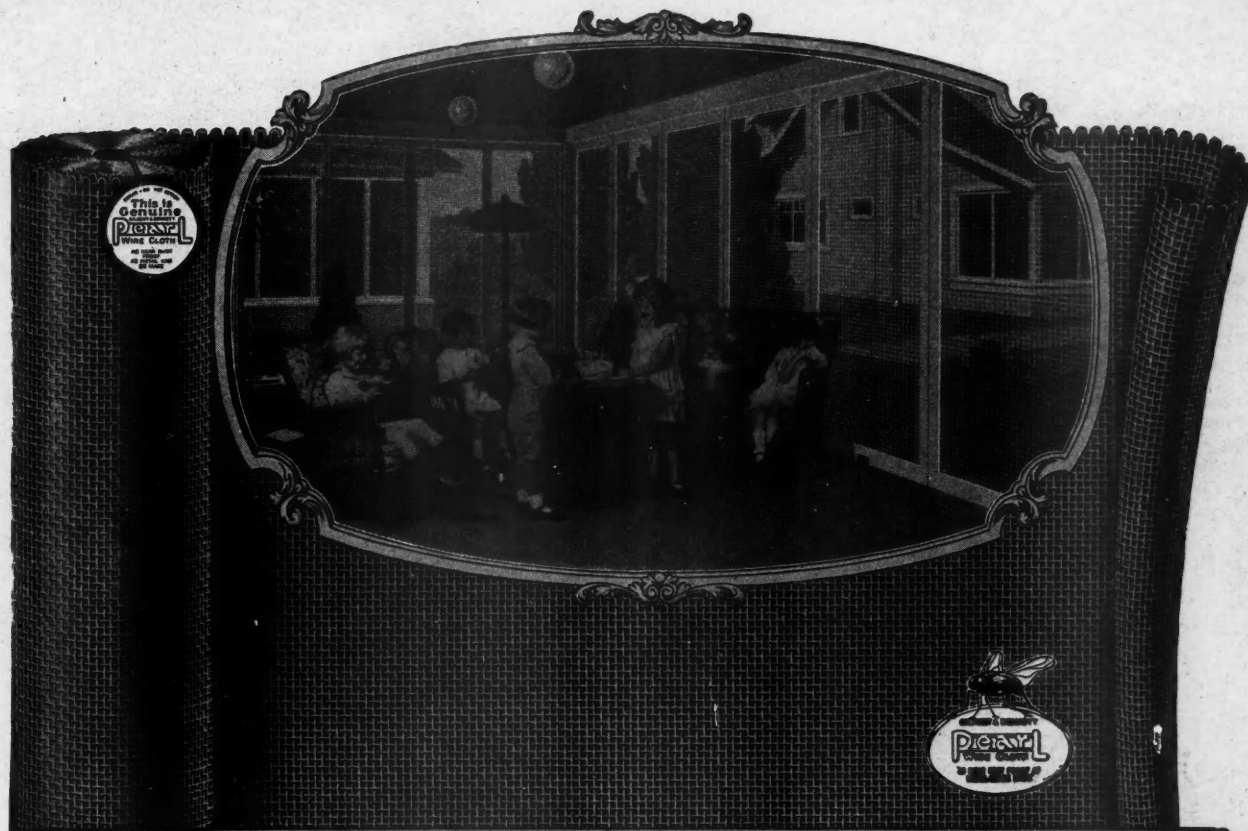

Genuine PEARL Has 2 Copper Wires in the Selvage

Every Unscreened Porch—Every Rusted Porch and Every New Home is an opportunity for you to

Make Money Screening Porches!

SHOW these prospects how simple and economically porch screens can be installed. Submitting a simple floor plan showing portable screen panel construction will aid you in securing more business. **NOW IS THE TIME!**

Home owners prefer PEARL wire cloth because of its beauty and durability. PEARL is highly rust-resisting—made so by a process exclusive with us. No competitor can use this process consequently no imitation of PEARL can be “just as good.”

Clean, Sanitary, Easy on the Eyes, firmly woven so as to make no-bag, no sag screens, requiring no painting, PEARL is the most economical as well as the most handsome, screen wire cloth on the market today.

We have a dealer in your town. See him or write us if you are interested in permanently screening doors, windows, or porches. Samples and literature FREE.

Address Dept. "A"

The Gilbert & Bennett Mfg. Co.

New York Georgetown, Conn. Chicago Kansas City

PEARL is made in Regular Grade [12 x 13 Mesh] and 14, 16, 18, 20, 24 and 30 Mesh; also Extra Heavy Grade [14 Mesh only]

The best hardware dealer in your city sells "PEARL"

MAIL THIS COUPON

The Gilbert & Bennett Mfg. Co.
Dept. "A"—Box 760
CHICAGO, ILL.

Gentlemen:
Please send complete information
on PEARL WIRE CLOTH and
PLAN for screening porches to

NAME.....
STREET.....
CITY..... STATE.....





THE CANTWELL—One of the Forestblend Face Brick Homes Shown in "Beauty in Brick"

THE small English type home shown above, is but one of the fifty model houses shown in the Finzer plan book. It is an attractive dwelling and its face brick walls bring out the beautiful color and marvelous texture of Forestblend. It's a house which is easy to sell or easy to rent. It is fire safe, free from costly upkeep and a constant source of pride to owner and builder alike.

Send in for your copy of "Beauty in Brick." Aside from the fifty homes shown, there are several types of garages and a means of securing free plans is suggested therein. It's well worth the small cost of fifty cents.

Those who build houses to sell or occupy will find in the Forestblend line a face brick not only of unique texture and rare beauty of color, but also one surprisingly low in cost. The Forestblend Dealer will be glad to show you panels of this remarkable brick so that you can appreciate its possibilities. You'll find him able and willing to serve you.



Finzer Bros. Clay Co.
Sugar creek, Ohio

Gentlemen: I am enclosing 50c for which please send me promptly your new plan book, "Beauty and Brick."

Name.....

Street.....

Town.....

THE FINZER BROS. CLAY CO., Sugar creek, Ohio

Forestblend

CLINTON FACE BRICK



THE DISTINGUISHED HOUSE . . . IS BUILT OF FACE BRICK



This is Face Brick House No. 627-A

Face Brick plays a dual role in the business of the modern home builder. The permanent charm of the **Face Brick** house inspires a desire to own it, and its many economic advantages invariably create the decision to buy. In step with the preference for **Face Brick** is the helpful plan service we are prepared to render. Send for the booklets and plan books described and let them work for you in creating sales.

"A New House for the Old," an interesting book on remodeling. Sent free.

"The Story of Brick," a beautifully illustrated booklet for the home buyer and home builder. Sent free.

"A Manual of Face Brick Construction," 116 pages, a text book on all types of Face Brick construction. \$1.00.

"Face Brick Bungalow and Small House Plans"—Four booklets showing designs and floor plans for inexpensive 3 to 4-room, 5-room, 6-room and 7 to 8-room houses. Each 25 cents, the set \$1.00.

"Two Apartment and Double House Plans," 14 attractive designs of duplex and double houses, showing 28 plans of 5 and 6 rooms each. Sent for 25 cents.

AMERICAN FACE BRICK ASSOCIATION
2163 City State Bank Building
Chicago, Illinois

F A C E B R I C K

—requires no paint or whitewash

WHEN WRITING ADVERTISERS PLEASE MENTION THE AMERICAN BUILDER

What GEORGE A. NORDGREN

Chicago Builder and Contractor



says about
Masonite
INSULATING LATH



REGISTERED
TRADE MARK



NEW BRANCH OF
Chicago

Oct. 28, 1927

Mason Fibre Company
111 W. Washington Street
Chicago, Illinois

Dear Sir:

The installation of Masonite in the Sauerman residence was my initial experience with this material. Its application was very simply handled. The convenient sizes and the ship-lap joints in the boards made the wall as tight as a drum upon completion.

I am without question much in favor of your product Masonite for answering and solving the problem of insulating buildings from cold and heat.

I shall be very glad to recommend your product in the future and if I am in position to use your material on my own initiative I shall use Masonite without hesitation.

Yours very truly,

CAN:HBA

Masonite is a combined sound-deadening, insulating and building material whose sales are increasing by leaps and bounds. Send for sample and descriptive booklet.

MASON FIBRE COMPANY
Dept. 138

111 W. Washington St., Chicago, Ill.
Mills: Laurel, Mississippi

Masonite
MANUFACTURED LUMBER FOR
STRUCTURAL INSULATION

© M. Co.

FOR ADVERTISERS' INDEX SEE NEXT TO LAST PAGE



30,000 housewives *hear this Holland Story every day*

Heating comfort and satisfaction are guaranteed wherever there's a Holland. Every day thousands of Holland salesmen explain this to still more thousands of housewives everywhere. Here is one reason that builders find Holland-heated homes sell more easily than others. Whenever prospects come from, they know the Holland favorably.

Holland's co-operation is far-reaching. It supplies you—the builder—with names of prospective home buyers. It shoulders full responsibility for heating comfort after you sell a house. It maintains permanent, day and night service. Get all of the facts. They are worth knowing. Phone your Holland Branch—or use the attached coupon—now!

HOLLAND FURNACE CO., HOLLAND, MICHIGAN
524 DIRECT FACTORY BRANCHES

HOLLAND
vaporaire
HEATING
MAKES WARM FRIENDS



HOLLAND FURNACE CO., HOLLAND, MICHIGAN
Without obligation on my part, please Send me Your Free Booklet, "How To Heat Your Home." Have a Hot

Name _____
Address _____
City _____ State _____
AB-1

"As Good As Good Looking"



The Realization of Anticipation



Ambler Asbestos Shingles

The above photograph of a suburban home shows the definite charm and distinctive effect produced by this sturdy asbestos fire-proof shingle, known as—

English Thatch

The shingles come in random widths and when applied in irregular courses the heavy ragged butts and rough surface produce a texture roof that cannot be duplicated with any other material, they completely fulfill the owners' and architects' desires for a *serviceable, fireproof and artistic* roof.

They are made in a variety of non-fading colors: Green, Red, Brown, Gray, etc.

First of all, Tapered Ambler Asbestos Shingles have the taper of the old wooden shingles. They are $\frac{1}{8}$ in. thick at the upper end, $\frac{1}{2}$ in. at butt and 20 in. long. They are strong, rigid shingles, not paper or rag felt, never curl or warp, not affected by zero blasts of winter, the heavy rains of spring and the blazing heat of summer year in and year out, for they are made of Asbestos and Hydraulic Cement—Nature's imperishable materials.

FIRE-PROOF

Tapered Ambler Asbestos Shingles are absolutely fire-proof, not merely "fire resistant." Ask your fire insurance agent what the difference is, he will tell you and show you the saving in rates—a matter of serious consideration over a term of years and years. It will pay you to write us now for complete information covering these superior shingles.

Made by the **AMBLER ASBESTOS COMPANY**, at Asbestos, Penna., and sold by the

**ASBESTOS
SHINGLE, SLATE & SHEATHING CO.**
AMBLER PENNA.

Pittsburgh, Penna.
Omaha, Nebraska
Washington, D. C.
Wilkes-Barre, Penna.

Boston, Mass.
Buffalo, N. Y.
Chicago, Ill.

Havana
New York, N. Y.
Philadelphia, Penna.

Cleveland, Ohio
Milwaukee, Wis.
Detroit, Mich.
Minneapolis, Minn.

There's a **MORTON** Steel Cabinet for every type of Bathroom



"Out of the carton into the wall." Installed in a few minutes. No upkeep. Made to last as long as the building.

The "Venetian," "Vanitie Venetian" and "Georgian" Models, illustrated above, are especially recommended to those who wish to add a touch of unusual distinction to the bathroom. They have all-mirror doors, artistically etched, which completely conceal the cabinet. Many exclusive features of construction.

THE Morton Line of Steel Bathroom Cabinets is *complete!* Regardless of the type of bathroom, be it in a modest residence or a pretentious mansion, a hotel, apartment or club, there is a *Morton* Cabinet to satisfy every requirement.

There are 11 models from which the architect, builder, realtor and owner may choose the exact cabinet to fit any decorative scheme. While usually finished in a pure white enamel, permanently baked on, Morton Cabinets may be obtained in any selected color to harmonize with whatever artistic effect is desired in the bathroom.

Special finishes are made to order for a nominal extra charge. Write for catalog and prices.

MORTON MANUFACTURING COMPANY
5102 WEST LAKE STREET-CHICAGO, ILL. U.S.A.

Send the Coupon for a MORTON Catalog.

MORTON MANUFACTURING CO., 5102 West Lake St., Chicago, Ill.



Without obligation, please send me a catalog of the MORTON Line of Steel Bathroom Cabinets.

Name _____

Address _____

City _____ State _____

Architect _____ Builder _____ Contractor _____ Please check business or profession: _____ Realtor _____ Home Builder _____

In a Newport Garden

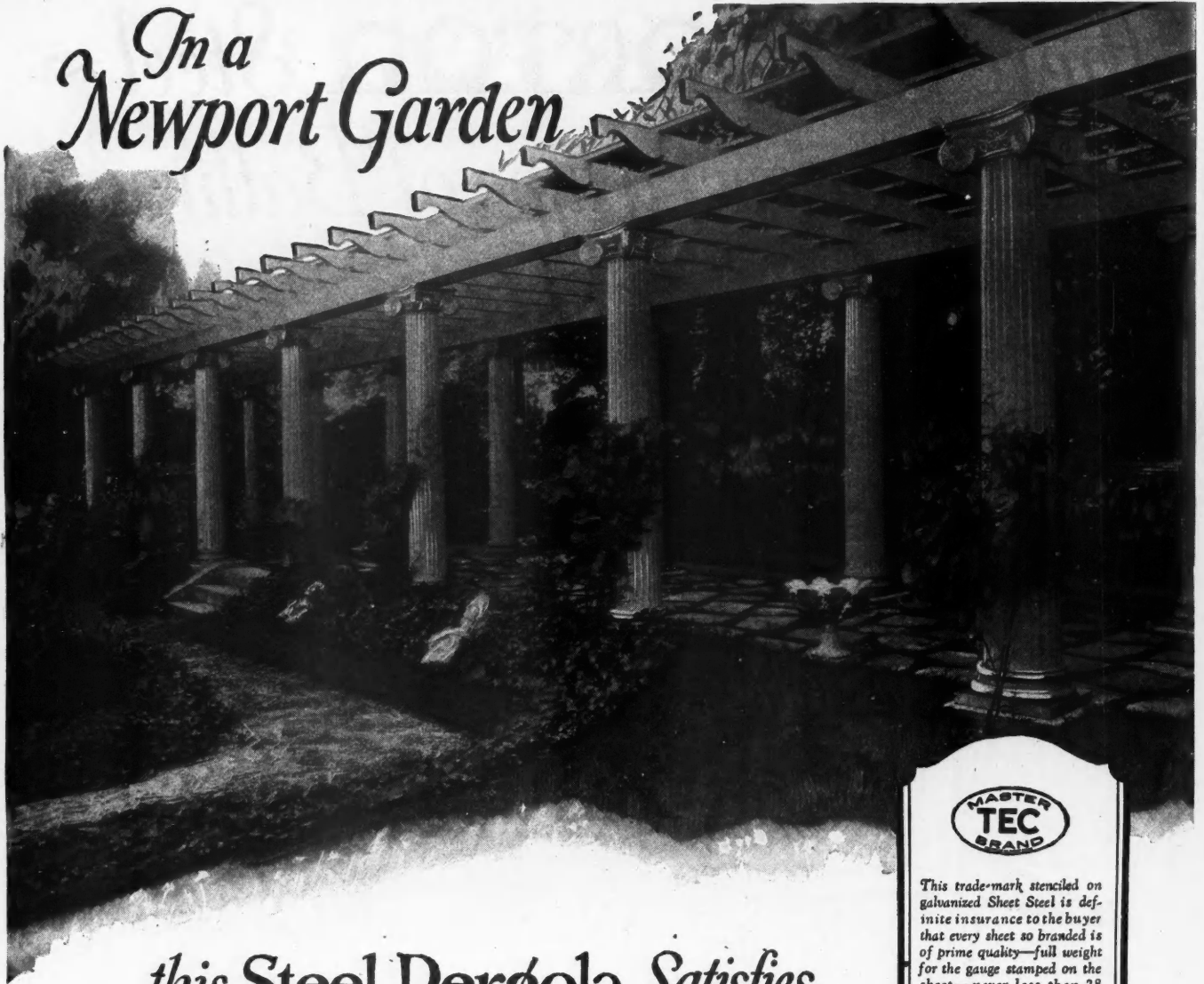

this Steel Pergola Satisfies the Demand for Lasting Beauty



This trade-mark stenciled on galvanized Sheet Steel is definite insurance to the buyer that every sheet so branded is of prime quality—full weight for the gauge stamped on the sheet—never less than 28 gauge—and that the galvanizing is of the full weight and quality established by the SHEET STEEL TRADE EXTENSION COMMITTEE specification.

And the demand was imperative. For this is the estate of Mrs. Herman Oelrichs, at Newport, and the garden embellishments must sustain the high ideal of beauty that pervades the entire place.

Sheet Steel pergolas are coming more and more into demand as people learn to appreciate their superiority. They do not become affected with rot resulting from the moisture and shade of the foliage they support. Bugs and ants do not infest them nor do "boring" birds such as woodpeckers. They never get that run-down appearance.

Because Sheet Steel makes possible pergolas of any degree of simplicity or elaborateness to suit both purse and surroundings, and because local sheet metal shops can fabricate specific designs, this beautiful garden feature can be economically added to any home.

And for roofing, trellises, tennis shelters, garages and many other garden fixtures as well as for kitchen and bedroom furniture sheet steel is the modern material for strength, beauty, safety and economy.

For particulars, write the SHEET STEEL TRADE EXTENSION COMMITTEE, OLIVER BUILDING, PITTSBURGH, PA.

SHEET STEEL

for Strength Safety Beauty and Economy

PLASTERING IS 90% OF THE VISIBLE INTERIOR OF THE HOME

Plastering

— 90% of what you see — *only* 10% of the cost

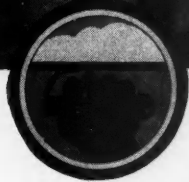

PLASTER with LIME

Plaster is a word too often used in a broad sense. There are many kinds of plaster. Specify LIME plaster for this very important building item.

No other factor in the entire building offers as much satisfaction at such comparatively small outlay as lime-plastered walls and ceilings. Lime lends itself ideally to the production of standard float finishes or vogueish period textures... Lime, the assured base for decorating or papering. Specify Gibsonburg, Ohio's Super-Finish... snow-white, pure, easily worked uniform—the perfect lime for plastering over wood or metal lath.

THE GIBSONBURG LIME PRODUCTS COMPANY : GIBSONBURG : OHIO

Gibsonburg

Finishing Lime

WHEN WRITING ADVERTISERS PLEASE MENTION THE AMERICAN BUILDER

PROGRESS

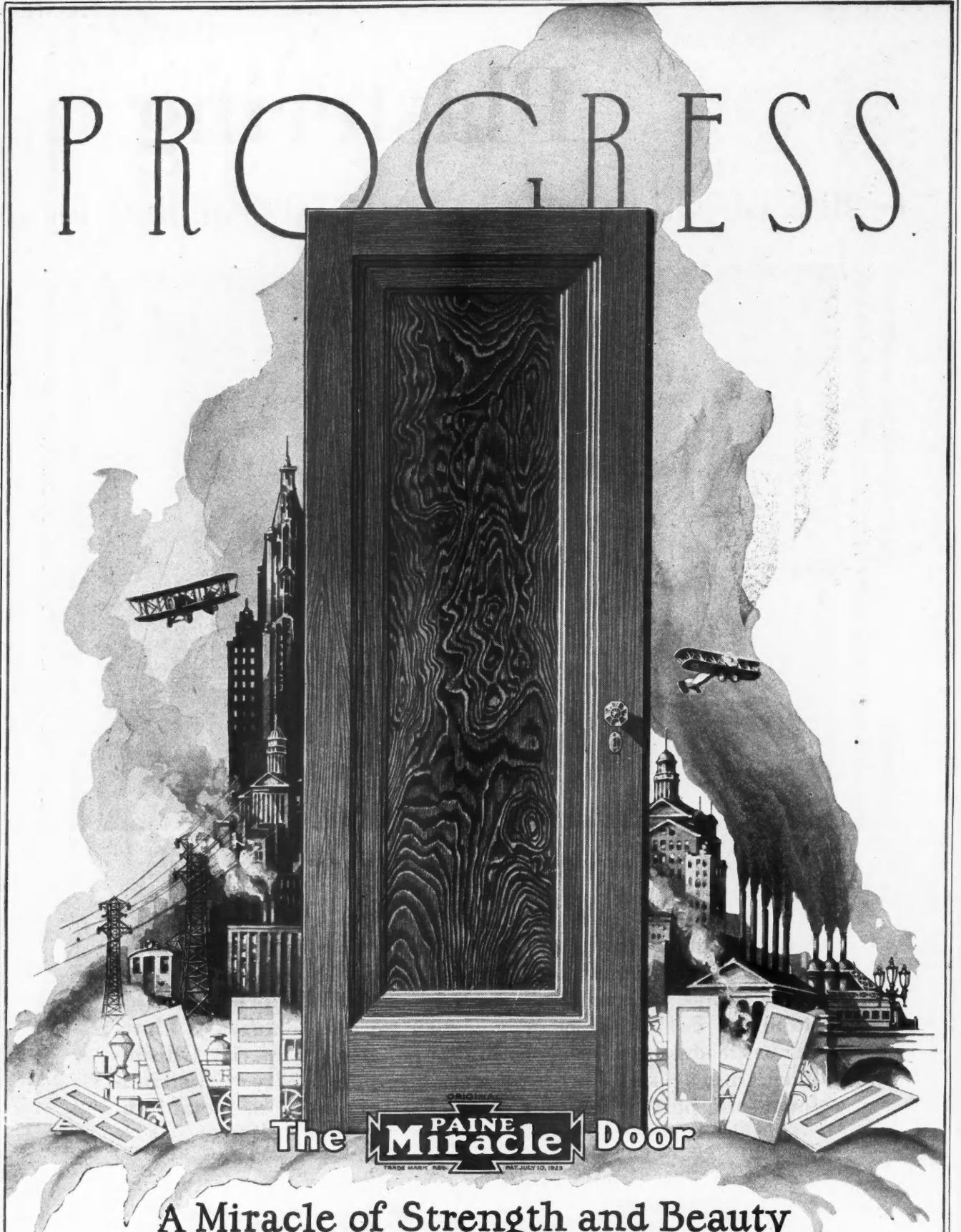

The **PAINÉ** Miracle Door

A Miracle of Strength and Beauty

PAINÉ LUMBER COMPANY, Ltd.

OSHKOSH, WISCONSIN.



Expanding Business Requires New and Improved Equipment

If you are interested in any kind of building materials, contractors' equipment and machinery, power shop equipment, heating systems, plumbing supplies, water supply systems, lighting systems, elevators, school, church or



theater equipment, farm building equipment, building hardware, home conveniences or anything that is used in constructing or equipping any kind of building—we will help you get all the information.

How to Compile Reference Data

A complete file of catalogs of the equipment and materials manufactured for the building field can be obtained by writing to us or to manufacturers advertising in the American Builder. Such a file will assist you in planning a new building—a difficult concrete job—visualizing special built-in equipment to your client or selecting machinery for increasing your output.

Read American Builder Advertisements

Manufacturers are constantly bringing out new or improved products. A close scrutiny of the advertisements appearing in the American Builder each month will be of great value to you. It not only lists the reliable product but is also a liberal education to you because many of the products advertised took years of study, toil and achievement to produce. By merely turning the pages, the information is yours.

Free Service to American Builder Readers

If there is some article which you want and lack the proper information regarding it, fill in the coupon below and we will gladly get it for you and co-operate in every way possible. Print or write your name plainly in the coupon below, list the articles and check your occupation.

Fill Out the Coupon Below — Be Sure to Write Plainly

AMERICAN BUILDER, 1901 Prairie Ave., Chicago, Ill.

A.B. 3

Gentlemen: I am in the market for the following items:

Please put me in touch with manufacturers whom you know to be reliable and can furnish goods promptly:

Name _____

Address _____

Please check your occupation: Building Contractor Dealer in Building Materials Prospective Home Builder Architect

CLINCH THE SALE WITH MODERN FLOORS BY SLOANE



Ask any merchant. He will tell you that style and color are the most important considerations in merchandising to-day. This is equally true with houses and apartments. Give your buildings "eye value" by installing modern linoleum floors by Sloane. They are nationally advertised. For full information communicate with Contractors Service Department, 577 Fifth Avenue, New York. W. & J. Sloane Mfg. Co., Trenton, N. J.

W. & J. SLOANE LINOLEUM

Around the Family Table

Next Month— Our Reference Number for 1928

THE APRIL American Builder will be our Special Reference Edition for 1928. It will follow closely the style of last year's book; and will be one of the largest, most comprehensive and best illustrated magazines ever offered the building industry.

There will be no increase in subscription price—extra copies 35 cents each; by the year 12 monthly issues \$2.00.

Invite your friends to share in this. Send us your order now.

Don't miss this big April Reference Number.

Editor American Builder.

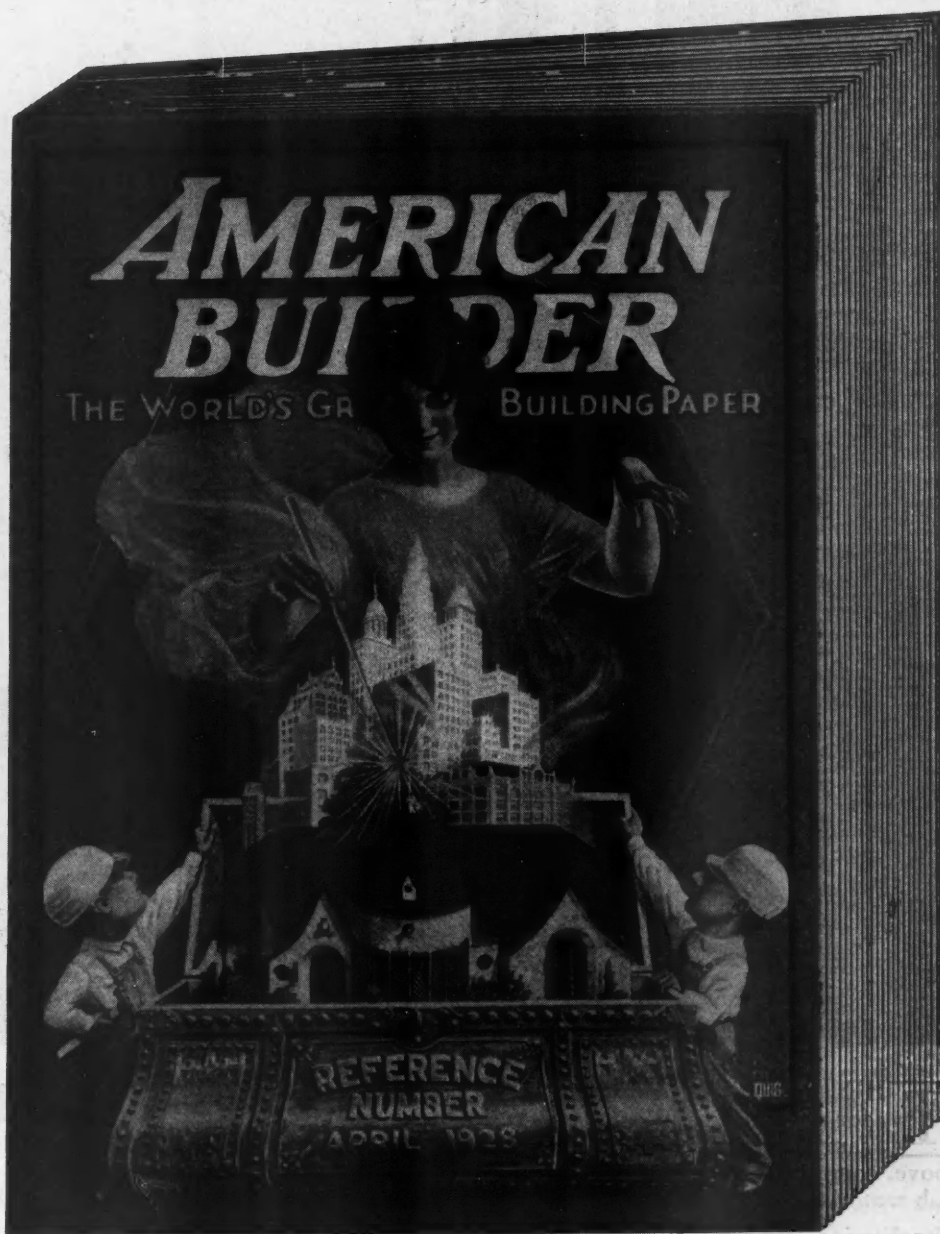

The April Cover Is Beautifully Lithographed in Four Colors and Gold. Our famous GREEN PAPER Directory of Building Materials and Supplies is one of the features of this book.

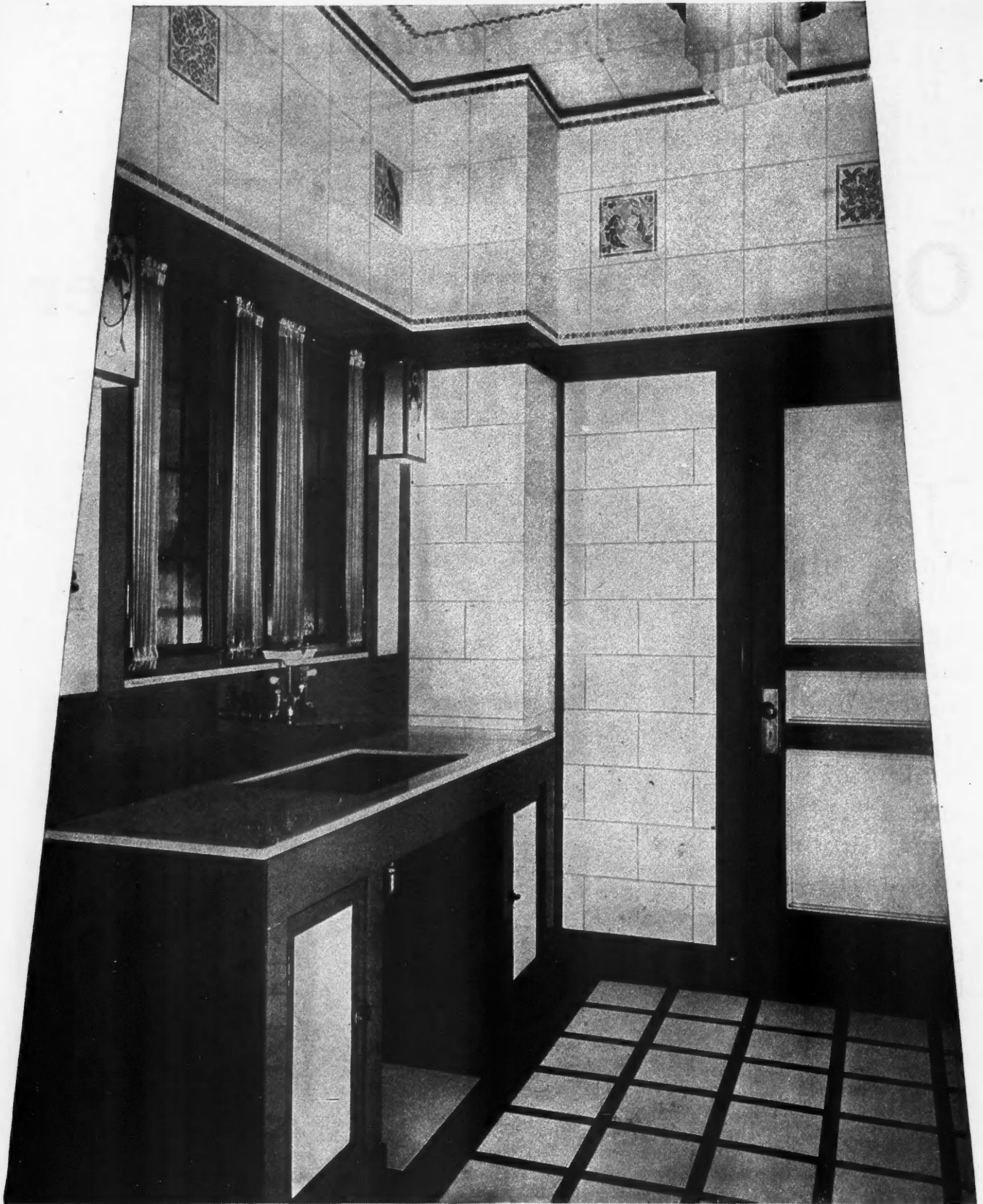

THE adaptability of Vitrolite—its possibilities for decorative and color effects, its beauty and sanitation—are vividly shown in the kitchen above, completely finished with this modern vitreous slab material.

Vitrolite is permanent. Its fire-polished surface defies dirt, grease, stains and scratches. A damp cloth keeps it clean. Send for booklet issued by our Architects Service Department on its construction details and uses.

VITROLITE

THE VITROLITE COMPANY

Suit. 624, 133 W. Washington St., Chicago

Factory: Parkersburg, W. Va.

SALES REPRESENTATIVES

Atlanta	Dallas	New Orleans	Providence	Colombia,	Mexico City
Baltimore	Denver	New York	San Francisco	S. A.	Montreal
Boston	Detroit	Omaha	Seattle	Copenhagen	Osaka
Brooklyn	Kansas City	Philadelphia	St. Louis	Havana	San Juan
Buffalo	Los Angeles	Pittsburgh	Tampa	Johannesburg	Shanghai
Cincinnati	Miami	Portland	Washington	London	Vancouver,
Cleveland	Minneapolis			Melbourne	B. C.



AMERICAN BUILDER

Formerly AMERICAN CARPENTER AND BUILDER

1827 Prairie Ave., Chicago—250 Park Ave., New York City

January Contracts Run High

TOTAL construction contracts awarded during January in 37 states amounted to \$427,168,700, according to the F. W. Dodge Corporation. These states include about 91 per cent of the total construction volume of the country. This was next to the largest January total on record and represented an increase of 11 per cent over January of last year. Compared with December, the past month showed a decline of 11 per cent.

Three districts made new high totals for the month of January, the new records being reached by New England, the Central West and Texas. Three other districts, New York State and Northern New Jersey, the Southeastern States and the Middle Atlantic States reached totals which were next to the highest ever recorded for January.

The more important items in the January building and engineering record were: \$193,189,200, or 45 per cent of all construction, for residential buildings; \$72,038,700, or 17 per cent, for public works and utilities; \$68,851,400, or 16 per cent, for commercial buildings; \$37,970,300, or nine per cent, for industrial buildings; \$23,369,400, or five per cent, for educational buildings; \$11,182,400, or three per cent, for hospitals and institutions; \$9,189,700, or two per cent, for social and recreational projects; \$5,612,300, or one per cent, for public buildings; and \$5,532,900, or one per cent, for religious and memorial buildings.

Contemplated construction projects were reported for these 37 states to the amount of \$904,674,900 during January. This was a 20 per cent increase over the amount reported for January of last year, though it represented a decrease of nine per cent from the December figure.

N. L. M. A. to Guarantee Lumber

THE National Lumber Manufacturers Association has recently taken a step toward the better merchandising of lumber and lumber products which is of basic importance and for which the association is deserving of great credit. A determined effort to create a nation-wide consumer preference for lumber of guaranteed quality has been launched by the Executive Committee of the Board of Directors of the National Lumber Manufacturers Association through its Trade Extension Department. At its recent meeting in Washington, the committee unanimously recommended to the Trade Extension Committee a sweeping program for grade-marking and trade-marking the lumber made by members of the National Lumber Trade Extension group.

It is intended to draw a clear line of distinction for the mutual benefit of users and manufacturers of lumber, between good lumber, well manufactured, carefully graded and accurately sized under American Lumber Standard rules, on the one hand, and inferior lumber, poorly manufactured, unseasoned and carelessly graded, on the other.

It is definitely proposed to put the financial guarantee of the National Lumber Manufacturers Association behind every stick of grade-marked lumber from the mills authorized to use the Association trade-mark.

In the opinion of the committee, no greater service can be rendered to the buyers and users of lumber and to the cause of practical conservation.



More Work for the Builder

IN response to requests for aid in combating the outbreaks of hog flu which have occurred every year for the past decade, veterinarians of the Bureau of Animal Industry, of the U. S. Department of Agriculture, have pointed out the importance of proper housing for farm stock.

These outbreaks of hog flu, or infectious bronchitis, which have been especially prevalent in the Middle West, commonly begin late in the fall when the weather becomes cold and stormy. Exposure is a contributing cause and hogs affected with the flu sometimes die through the development of pneumonia. Hog flu resembles in its symptoms what is known among people as colds.

The application of proper hygienic measures, says the experts, is the most important procedure in treating the disease. Hogs that are provided with clean, dry, well-ventilated quarters, free from drafts and dust, usually recover promptly. Plenty of dry bedding, a reduced ration of easily digested feed, and a constant supply of good drinking water are likewise beneficial in hastening recovery.

Prostrated herds with all the symptoms of flu sometimes recover in a few days when housing conditions have been made favorable, and hog owners are reminded that proper housing and care of their herds, especially during cold, stormy weather, is known to be a dependable practical treatment for this disease.



Financing to be Centralized

"DURING the past year mortgage bond houses have been taking notice of the fact that seldom if ever do first mortgages, well made, get into difficulties," said W. J. Moore, President of the American Bond and Mortgage Company recently. "It is the secondary financing which has nearly always been responsible in the past for any difficulties which may have arisen in the financing of city real estate."

"Now progressive mortgage houses throughout the country are proposing to see that this secondary financing is solidly accomplished and have acted upon the old adage 'If you want a thing well done, do it yourself.'"

"In former years it has been necessary for first mortgage bond houses to intrust one of the most important sides of financing to other houses which have been comparative strangers to them. Fortunately that situation is fast changing. To accomplish this change progressive first mortgage houses are adopting the same type of corporate financing for buildings which is used by public utilities and industrials for their plants and equipment."

"First mortgage bond houses have been slow to recognize the great value of this type of financing, but are now convinced I believe. Thus the next five years will see the stability and solidity of the first mortgage bond business."



“We Wanted Both Early Use and an Extra-Strong Pavement

“High-Early-Strength Universal Concrete Gave Us Both

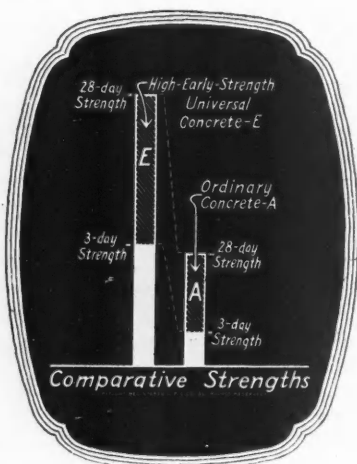

“Because our driveway is used every day,” writes the B. F. Hoffman Coal & Supply Co., Harrisburg, Pa., “we couldn’t afford to tie it up a moment longer than necessary. Because five-ton trucks are continually thundering over it, we wanted the concrete to be extra strong.

“High-Early-Strength Universal Concrete solved our problem. Three and a half days after placing the concrete, the driveway was opened. Since then, it has been subjected to continuous heavy truck traffic without damage to the concrete.”

High-Early-Strength Universal Concrete is made according to approved methods with the usual materials, usual equipment, usual labor and usual Universal cement. It not only is as strong at 3 days as ordinary concrete at 28 days but because it has a higher ultimate strength in addition to a higher early strength (see diagram) it is permanently better and stronger concrete. For full details send in the accompanying coupon.

UNIVERSAL PORTLAND CEMENT CO.
208 South La Salle Street, Chicago.

Without obligation, please send me detailed information on methods of securing strong concrete in 3 days with the usual materials and equipment.

Name _____

Address _____

AB 3-28

Universal Portland Cement Co.

Chicago Pittsburgh Minneapolis Duluth Cleveland Columbus New York

Concrete for Permanence

EVERYBODY'S BUSINESS



Fakirs and Fallacies

By FLOYD W. PARSONS

MAN himself is dropping behind in the mad dash to a higher civilization. He is not keeping up with the amazing developments in the mechanical field. This is true notwithstanding our talk about how sophisticated we have become, how hard-hearted we are in business, how quick we can recognize bunk, and how difficult it is for any one to pull the wool over our eyes and get us interested in ideas or articles of doubtful value.

The other day at a crowded resort I saw a fellow working the old shell game with as much success as was ever attained in the past. It brought back memories of the time when I was a freshman in college and went out to the county fair and met this game for the first time. That was my first experience with the "cappers" who work in partnership with the fakirs themselves. My chum and myself saw these strangers picking up shells and walking away with what seemed to be easy money, and our only fear was that the fellow running the game would lose all he had before we could get some of it.

One would think that people in this modern age would have profited sufficiently from the experiences of others to at least make it necessary for unscrupulous schemers to employ new methods and devices in fooling the public. But one does not need to investigate far to discover that Barnum was right. Street vendors still find no trouble in selling their dancing dolls while a confederate lounges unconcernedly against a wall or other dark background, stares vacantly in the opposite direction and slyly manipulates the dolls by pulling a thread that is practically invisible. Thousands of people buy these devices believing they are getting an automatic toy for ten cents.

The work of freeing ourselves of follies and superstitions proceeds with painful slowness. A multitude of folks believe it is unlucky to walk under a ladder; that the screeching of an owl portends misfortune; a dog howling at night indicates somebody is going to die; the appearance of a black cat or a crow foretells misfortune; breaking a mirror is seven years' bad luck; a wart will disappear if you wash it with a stolen dishrag; a potato in the pocket will cure rheumatism; never light three cigars or cigarettes with the same match; don't pick up a pin when

the point is toward you; thirteen is unlucky; so is Friday. On and on goes the bunk.

The origin of superstition is found in early man's effort to explain nature and his own existence. The average person has always been inclined to attribute most of the happenings he doesn't understand to

supernatural causes. Even today many more business men than any one could imagine consult clairvoyants in the hope of procuring additional light on future happenings with respect to an important deal. Dream books still have a large sale and precious stones continue to be subject to

a multitude of superstitions, and as for lucky talismen, one will hardly find a person but secretly has faith in the efficacy of some

prized possession which he links up in affection or association with a person or event.

One reason for the continuance of superstitious beliefs is the everlasting truth that "men mark when they hit and seldom when they miss." When the result happens just as the belief prescribes, it is human nature to remark: "See? I told you so!"

For instance, we meet a friend and he says: "It rained Monday, so it is going to rain four days this week." If it does rain four days he reminds us of his prediction. If it doesn't, he forgets the incident. Thirteen people sit at a table and six months later one of them dies. "Do you remember 'the dinner we had when thirteen were present?" says one of the party months afterward. "Well, I suppose you know that Jones cashed in last week. Strange how true these old sayings," he adds.

Notwithstanding that this and many other similar superstitions are purely cases of mathematics and form nothing more than matters to be solved by the formulas of probability and chance, we are so possessed of such delusions that many hotels find it unprofitable to have a thirteenth floor. In many cities there is no thirteenth street, and a real estate dealer will tell you that a house or building marked number thirteen is not the easiest kind of property to sell.

Just for a moment consider the widespread belief that Friday is unlucky. Shipping returns indicate that fewer vessels leave port on Friday than on any other day, and yet the records show that in the matter of ocean accidents,



© Brown Bros.

it is one of the luckiest days of the week. Columbus sailed upon his first great voyage of adventure on Friday, discovered land on Friday, started back on Friday and again landed in Spain on Friday. Later he started his second voyage on Friday, and finally discovered the Isle of Pines not only on Friday but on the thirteenth day of the month of June, 1494. The Mayflower made the harbor of Provincetown on Friday, and the Pilgrims made their final landing on Plymouth Rock on Friday.

It was also on a Friday that Richard Lee moved in Congress that the United Colonies be free and independent, and it was on another Friday that the first Masonic lodge in America was organized. The list of people born on Friday includes such eminent figures as Washington, Gladstone and Disraeli. What more evidence is necessary to prove that the idea of Friday being unlucky is pure bunk? How easy it is to put the stamp of untruth on a multitude of common beliefs. Mad dogs do not avoid water. Diamonds do wear out—when employed for cutting glass they become practically useless in ten weeks. The ocean is not actually blue, but appears so because sea water absorbs blue less freely than other colors. A red rag waved before a bull will not excite him any more than a rag of any other bright color. It is the strangeness of the moving object, not the redness of the rag, that bothers the bull. In actual experiments, the bull paid more attention to white rags than red ones.

Dozens of delusions are capitalized for profit by individuals or groups. Many Frenchmen continue to shun the luscious blackberry because they are the victims of a long-existing fallacy which says that the blackberry will give you fever. As a result the people of Great Britain and other nearby countries get the bulk of the French blackberry crop, and greatly relish the savory jams and jellies made from this fruit. Our own ancestors, for no better reason, avoided eating the tempting tomato or love apple, as it was called in Colonial days.

Widely advertised fallacies are blessed with remarkable longevity. A Tory preacher who was driven out of the Colonies to England was largely responsible for the notion that New England was cursed with blue laws. In his resentment, this clergyman published a long list of absurd enactments for the purpose of slurring the intelligence and character of the American patriots. He even went so far in his fabrications as to say that no woman was even permitted to kiss her child on the Sabbath Day.

The truth is that the Colonial Acts were no more intolerant nor bigoted than the laws of the rest of the Colonies and even of England and other countries at that time. But the Tory preacher's libel of early American customs still perpetuates the fallacy that New England was in a class all by itself in restricting personal liberty.

We ridicule the methods of the medicine men of savage tribes, forgetting that many kinds of modern heating include procedures no less fantastic. Such physical benefits as may accrue from an optimistic mental posture could have been secured by early healers even if their methods did differ from those of modern times. Recently I wandered into a crowded health-and-power meeting. In response to the leader's greeting, "How are we all tonight?" the audience chanted in unison, "Fine and dandy. Why shouldn't we be?" The lecturer told how to obtain physical and financial success and then distributed circulars.

How strange it is that practically all of the people who claim to be endowed with the power to obtain wisdom and advice from the other world never seem to be able to profit themselves from their superhuman ability. Invariably they are diligent seekers after the dollars of their clients in order to overcome the usual scantiness of their own financial resources.

I might go on and present an endless array of fallacious notions now current in the public mind. The common sayings about ground-hog day, a showery Easter Sunday, a rainy St. Swithin's Day, and a supposed equinoctial storm are all silly fabrications. Nine people out of ten are sure that all of the brain is sensitive, whereas important parts are as insensitive as shoe leather and one portion could be touched or even cut off without stopping the patient in a sentence he might be uttering. Night air does not differ from day air except that it contains a slightly increased percentage of carbon dioxide. And as for the notion that lightning never strikes twice in the same place, the Eiffel Tower, which is amply protected, was struck six times during one storm.

A lot of people still hold the notion that business depressions come at definite time intervals—most of them say seven years. Since 1812, the intervals elapsing between important recessions in industry, expressed in years, have been as follows: 6, 7, 12, 10, 10, 16, 11, 6, 3, 10, 4, 3, 3, 7. If any one can find an existing relationship between these figures, he is some mathematician.

Life is but a never-ending succession of puzzles and paradoxes. Our important work is to pick the facts from the fallacies. We have passed the age of witchcraft because we are able to understand and explain far more of life's phenomena than could our forefathers. But it is time we turned the light of truth on a multitude of illogical notions that exercise an adverse effect upon our lives and pocket-books.



Annual Oil Burner Convention

PLANS for co-operation by the oil producers, and the electric light and power companies in serving the users of oil heating apparatus will be one of the important topics discussed at the Fifth Annual Convention of the American Oil Burner Association at the Hotel Stevens, Chicago, on April 3, 4 and 5, 1928.



Store Fronts Offer an Opportunity Not to Be Overlooked. With abundant data on the sales effectiveness of good window display it should not be difficult to sell many owners on the advantage of such remodeling.

Chicago Civic Opera to Have Magnificent New Building

Graham, Anderson, Probst and White, Architects

FOR years, the Chicago Civic Opera has been housed in the old Auditorium Theater, but has now secured an exceptionally fine site for a magnificent new 42-story building of its own, with 662,000 feet of rentable store and office space which is expected ultimately to yield sufficient revenue to maintain the opera without financial support other than the box office receipts. Wrecking of the old buildings occupying the site is now under way.

The site selected, after careful study, is that bounded by Wacker Drive, Madison Street, Washington Street and the Chicago River. This site was selected because of nearby railway terminals, good transportation, favorable commercial surroundings for stores and offices, but, more than all else, because of the wide, plaza-like frontage procurable on Wacker Drive.

On this site will be erected a monumental building which will be 42 stories—550 feet—from the street level to the top of the tower and 21 stories—270 feet—as the height of the main building. The illustration on this page shows the admirable design developed by the architects, Graham, Anderson, Probst & White, for this building which will be one of Chicago's most notable structures costing, for land and building, up-

wards of \$20,000,000. Half of this amount is being advanced as a loan by one of the large life insurance companies and is, evidently, regarded as a good investment for its funds.

Besides the large opera auditorium, which will be enclosed between the wings of the building and extended back almost to the river, the building will contain a smaller theater seating an audience of 1,000. The new opera house will have about the same seating capacity as the former leased auditorium, viz., 3,600, but the arrangement and acoustics will be greatly improved. On the main floor, instead of some 900 seats, as in the old Auditorium, there will be approximately 1,700. Instead of the 58 boxes of the former Auditorium, there will be 36 boxes, none of which will be along the sides. Each box of the double tier will offer a perfect view of the stage. Thus, the old "horseshoe" of boxes, with its occupants and costumes on display, will be done away with and box patrons will have a thorough and satisfying view of the stage.

The vision problem and the acoustical problem have been studied together and solved with the aid of the world's leading experts. Adequate mechanical ventilation with tempered, washed air will be provided in both theater and opera auditorium, which will be changed to artificially cooled air in the warm weather.

The stage facilities have been most carefully planned with the object of making the new home of the Chicago Civic Opera the most modern and best equipped in the world. A special committee representing the architects and technical directors of the opera made a

(Continued to page 139)

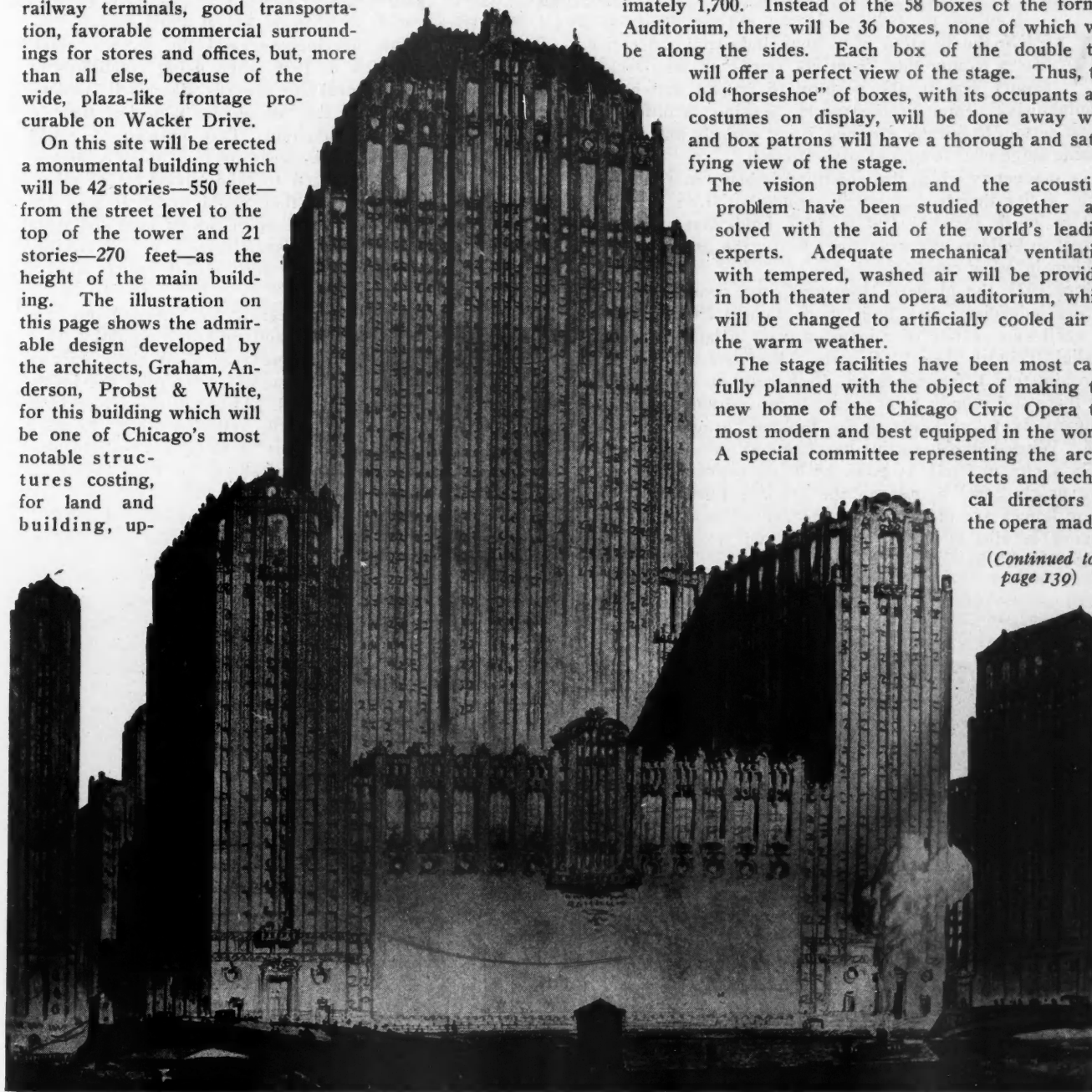

Magnificent New Home for Chicago Civic Opera Company Now Under Construction on the Banks of the Chicago River Directly Across from Two Large Railway Terminals. The opera house will be "the last word" in mechanical stage equipment, lighting, seating and acoustics and the office building is expected to provide a permanent revenue which will assure the future of grand opera in Chicago.

How GENERAL MOTORS *Builds* HOMES

The Exploits of the Modern Housing Corporation

WHEN the location of a huge industrial enterprise lifts a community from its status as an obscure county seat to the position of second automobile manufacturing center of the world, housing facilities are almost certain to become strained, if not entirely inadequate, at some stage of that community's growth.

The manner in which this condition is being met in Flint, Mich., a city that has grown in population from 13,000 in 1910 to more than 140,000 in 1927 holds out particular interest to builders and developers facing the group housing problem in other cities.

Since 1925, the Modern Housing Corporation, a General Motors subsidiary, has built more than 1,250 houses in the northwest section of Flint on a tract of land consisting of slightly more than 1,000 acres. Previous to that time approximately 1,200 houses had been built on the property and there still remain 1,500 vacant improved lots, where the company is to concentrate its building program during 1928. When completed, this development, constituting virtually a city in itself, in point of living conveniences, will have nearly 5,000 homes on the original 1,000-acre tract. These homes are of standard type and of modern design, ranging in size from five to eight and nine rooms, all equipped with bath.

The story of this development and the factors which influenced it goes back to 1919 when living conditions in Flint were almost unspeakable for the thousands swarming to Flint to work in the automobile factories, then in the fever heat of war production. Poor persons were not the only sufferers. Skilled workers, many of them comparatively well-to-do, were forced to take advantage of whatever living accommodations they could find. It was not an uncommon sight to see row upon row of huts and tents stretching along the Flint River, housing entire families under the most unsanitary and pitiful circumstances imaginable.

In 1919, the Dupont Engineering Co. stepped into the building field in Flint to try and relieve a condition that had become acute. In that one year alone the company built 950 houses on a tract that a few months previously had been unimproved farm land. Although the project was successful in point of temporarily relieving Flint's housing shortage, it fell somewhat short of being an entirely successful venture, as the industrial slump hit Flint before all of the 950 houses were sold.

Later when automobile production began to return to a normal state the houses, left vacant when the city's industries slackened, were disposed of.



These English Shingle Type of Houses Have Met with Great Favor Among the Modern Housing Corporation's Customers in Flint. They may be bought with a down payment of \$300 and upward.



This Row of Houses Is Located Within a Block of the Entrance to the Mott Golf Course Within Easy Access of Transportation Units to the Downtown Area. Less than a year ago there was not a single building on this land.

Once more, however, lack of housing facilities developed and the Modern Housing Corporation began to sponsor and finance a huge development program in territory adjacent to the site of the earlier Dupont enterprise.

In 1924 thirty-five high-grade houses were constructed. The company from the time of its organization adopted the policy of building the house according to the order of the purchaser and then selling the house and lot for an amount agreed upon at the time the order was placed.

During 1925 the development program began to hit its stride and in that year 167 houses were built. In 1926 the activity was continued and 450 families were provided with first-class living accommodations. This year the company set a new mark by the construction and sale of 600 homes. Every year the value of the development has been increased, not only by the building of a greater number of homes, but by the company's gradual branching into the construction of higher priced houses.

Although an important factor in the economic life of Flint, this area, viewed from the standpoint of owner and real estate dealer, is a city in itself.

This development constitutes a large area uniformly well developed and restricted as to quality and price of buildings and nothing that would make for ideal living conditions has been omitted from the program.

The Modern Housing Corporation area contains between 50 and 60 streets with 35 miles of surface. Ten miles of street surface have been paved already. Paving plans

to include all of the remaining 25 miles, with the Modern Housing Corporation bearing the greater part of the cost, have been accepted as a program by the city council recently, and individually the house owners are signifying their consent to the proposal by approximately 100 per cent signature of the circulated petitions.

The property is two and a half miles long and one mile wide at its widest point. The greater number of lots have a frontage of 50 feet with sufficient depth to take care of construction of standard type garages at the rear. On Nolen Drive, where building activity is to be confined to the building of higher priced houses, the lots have a frontage of 120 feet and a depth of 145 feet.

Through the co-operation of city officials, transportation service, equally as efficient as that serving much older sections of the city, has been obtained. It includes street car service running through to the main centers of the development, augmented by buses carrying passengers to and from the more outlying points. Highways leading to many principal Michigan points pass through this area.

From a resale standpoint a house and lot in this development have great resale value. There is no section of Flint where quality in building can be obtained at such low cost. In other words, the purchasers realize that their profit in the event of resale of their property, will be the amount that the Modern Housing Corporation was able to save them by its policy of mass production, when the original transaction was made.



One of the Nine Business Districts Developed by the Modern Housing Corporation for the Purpose of Taking Care of Its Customers' Light Store Needs. These stores are restricted to one-half block structures and any enterprise that might be defined as even semi-industrial is barred from these locations.

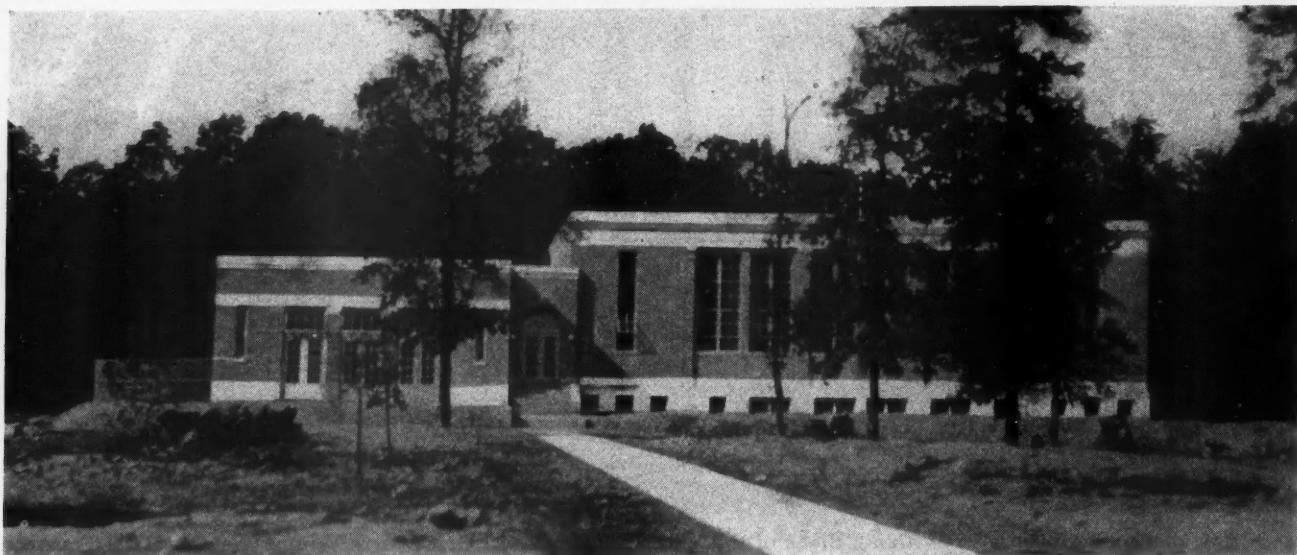

This Building, Known as the Haskell Community House, Was Built by the Modern Housing Corporation as a Recreational Unit of Its Housing Project, and the Building Was Deeded to the City for Municipal Use. It contains a swimming pool, gymnasium, bowling alleys and club rooms for women's organizations.

There is probably no group housing project of similar size in America today that has attained greater variety in architectural design than this development in Flint. This may be explained in several ways.

First, contracts for the construction of houses, while invariably going to Flint builders, are not confined to any particular group of contractors. All sound building companies are eligible to submit bids, providing they are willing to conform to certain specifications, which have been approved by the Modern Housing Corporation. In this manner, with several builders often erecting their typical styles of houses in the same block, variety is certain to result.

The company uses another scheme in relieving the effect of sameness by having many types of houses with identical standard interiors, yet with the exteriors so entirely different that similarity of any kind cannot be detected.

Unlike many group housing projects, these houses are in no way connected with each other. On all of the lots there is ample ground space between the houses. The value of the property improvements, including sewers, water, lights, sidewalks and pavement is augmented by the attention that has been paid to the interior. Standard equipment in the interior of all the homes, from the lowest priced to

the most expensive, consists of solid oak floors in every room, complete bathroom fixtures and choice oak or red gum trim. In many types of homes, fireplaces are standard features.

Purchasers of these houses are extended unusually liberal terms. The less costly type of house and lot may be bought for as low as \$300 down with subsequent payments amounting to one per cent of the remainder each month. This is the smallest type of house the company builds, a home of five rooms with bath. A similar payment scale is maintained in the sale of higher priced homes, the prices of which have ranged as high as \$25,000 or as high as the prospective purchaser wants to pay. The number of rooms that the house is to contain is also governed by the buyer's wishes.

Another feature, which the company has developed, is the policy of occasionally leaving the upstairs of a house unfinished when requested to do so, and deducting the finishing cost from the price of the property. In this manner, many persons who cannot afford the luxury of a completely finished home, may finish the house to suit themselves when their finances will permit.

Construction of the higher-priced types of homes on Nolen Drive during 1928 will probably be one of the outstanding building activities of the year in Flint. This piece of land, facing the Mott Golf course, and overlooking the Flint River, affords a sweeping view across the Flint River valley into the depths of a wooded parkland.

Playground and recreational facilities have not been forgotten in this housing project. Situated in easily accessible locations on the property are two parks, Bassett and Mott parks, containing more than 100 acres, and both developed by the Modern Housing Corporation. In these parks the company has spent large sums in improvements and has installed concrete tennis courts and other recreational facilities where children may enjoy themselves in safety. In Mott Park is situated the Mott Golf course, which the company developed and deeded to the city for municipal use. Recently an up-to-date clubhouse was erected and present plans call for enlargement of the course.



One of the Higher Priced Homes of the Modern Housing Corporation Development Located on Nolen Drive. On this street, restricted to the more expensive type of homes, the company plans to concentrate a large share of its building program in 1928.

(Continued to page 125)

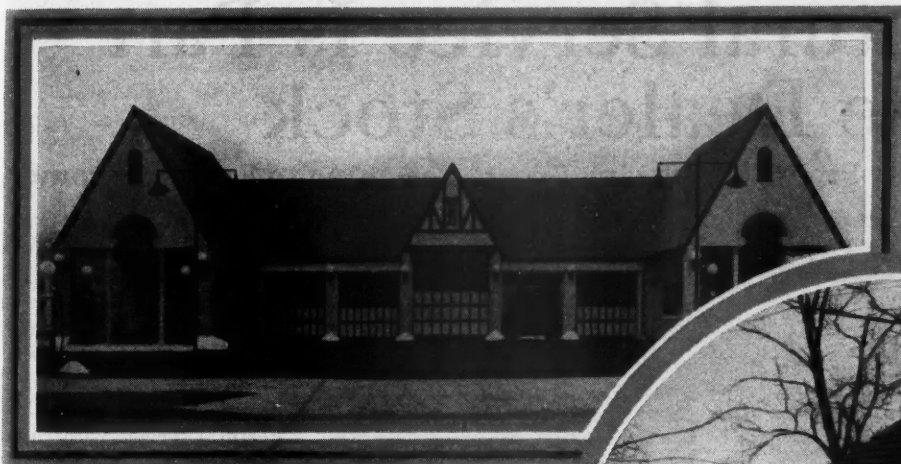

A Chicago "Greasing Palace" Equipped with Large Upward Sliding Doors.

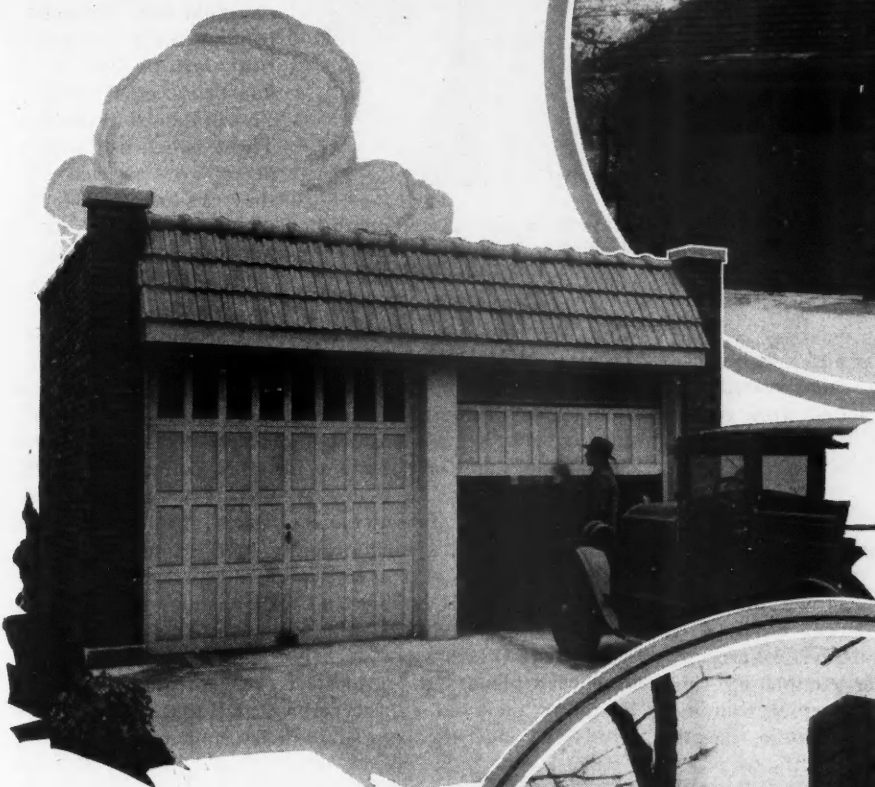
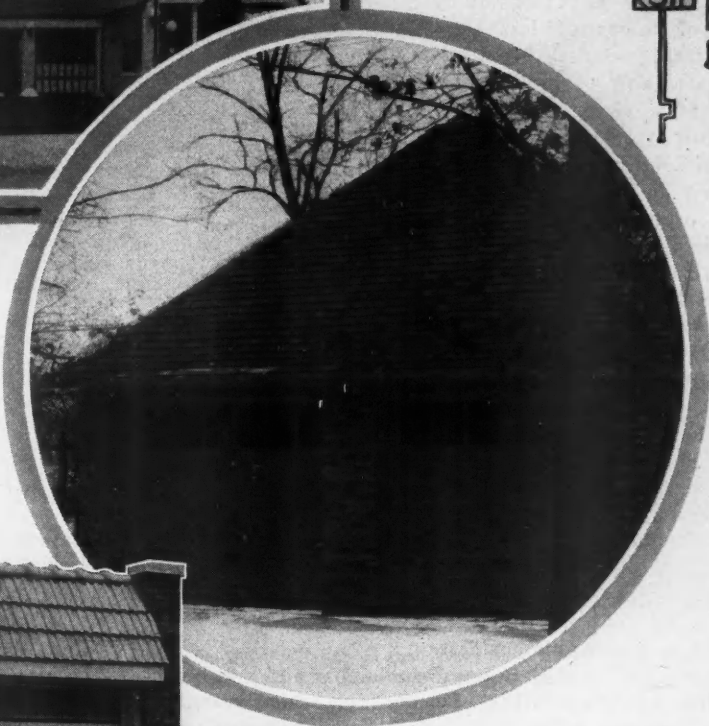

Doors That Slide Up and Out of the Way Add Not Only to the Convenience of These Buildings but Also to Their Appearance.

Whether It Be a Public Service Station or a Private Garage a Well Designed Building Harmonizing with Neighboring Buildings Means Much to Community Values.



Home with Garage in Harmony in Palmer Woods, Detroit; Frazier Couzens Building Co., Builders.

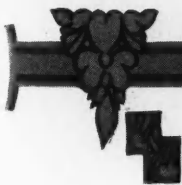

Architectural Service Is Part of the Dealer's Stock

The Stein Lumber Company Profits by Offering Expert Designing to Every Customer

ALTHOUGH many lumber retailers of towns of less than 4,000 population give little attention to architectural services, Stein Lumber Company of Fredericksburg, Texas, is marking up some additional profits through stressing such a service. This retail firm, which is owned by Joe and Ed Stein, was established in 1892 by their father, who came from Germany as a cabinet maker. He found that the demand for his trade did not keep him fully occupied; therefore he opened a small retail yard, later adding a planing mill. In 1925 he was ready to retire and turn over to his two sons, Joe and Ed, a prosperous business.

Joe and Ed Stein grew up in the lumber and mill business established by their father. During high school years, each of the boys was active in the retail and actual work of the planing mill and on finishing high school they decided they had enough training in the business to know that they liked it better than any other.

They decided that Joe should stay with the retail end of the business and learn it from the ground up, while Ed should learn to be an architect. They would then be in position to give the public of their small town the same building service that could be had in larger cities.

Ed Stein completed the course in architecture offered by the Armour Institute of Chicago. After completing this course, he still believed he needed some further training. He joined an architectural firm of San Antonio, Texas,



Joe Stein, Left, Is the Retail Expert of the Stein Lumber Company, While His Brother, Ed, Right, Trained Himself as an Architect, so That the Firm Might Furnish Architectural Service.

after their building needs with no extra cost for this added service.

According to the Stein brothers, even the prospects for building small homes are giving much more detailed attention to their home plans than formerly. Just such a tendency has made it possible for this company to build increased sales by its policy of offering a complete architectural service. This service is made all the more valuable by Mr. Stein's early training in the lumber business. Ed Stein believes that every young man should spend two years in the retail lumber and mill business before studying to be an architect.

Of course, Mr. Stein does not attempt to dominate his prospect's plans, but he does let every prospect know that he offers them an expert service and that he is glad to co-operate and help them solve their problems.

the largest city of Texas. Here he worked for five years on every type of building job. At the end of this time, he returned to Fredericksburg and the Stein Lumber Company inaugurated free architectural service with each building sold from the yard.

Prospects are furnished the services of an architect that has had special training as well as practical work on some of the finest city homes and business buildings of the state. These small town prospects are assured that they can have just as well designed homes as are to be found in the larger centers and that they can let Stein brothers look



The Stein Brothers Believe That One Way to Persuade People to Repair and Rebuild Is to Set a High Standard Example so This Attractive New Office and Display Room Was Added to Their Yard Not Long Ago.

A brief survey of the plans that have been figured out by the prospect often shows glaring faults and handicaps that are quickly noticed by Stein, who in turn tells his prospect of these faults. In getting across this information, he does so in a diplomatic way, suggesting changes, additions and various items that are quickly seen to be practical by the prospect.

By pointing out desirable changes and arrangements that mean a saving of money, work and future convenience, this architect is able to gain the confidence and appreciation of a wider list of prospects. When they see that he has made suggestions that they had overlooked, they reason that he can be safely depended upon to furnish quality building materials.

No building job is too small or too large for this firm to apply this architectural service to a prospect's plans. Even in building small cottages Mr. Stein makes it a special point to keep a close check on the workmanship and quality of materials that go into them.

The public is informed that there is nothing compulsory about buying building material from Stein brothers in order to obtain the services of Ed Stein as architect, for he accepts contracts for any building regardless of who furnishes the material, but as this material is at the usual rates, a large majority of the prospects profit by the system of buying from the firm where they obtain this added service free.

There are many other factors in the business policies of this yard that contribute to the success of the firm. The ability to extend their service over an unusually large trade territory is one thing that has made it possible for them to realize better sales. Three trucks are operated. One of these is a small yard truck for general work about the town, while the others are heavy duty trucks equipped with trailers. One of these trucks is equipped with a cab in the form of a model bungalow which was built in the Stein yard.

The delivery service of the yard is operated on a one-cent-per-mile basis with the first two miles as free delivery. At this rate, a seven-mile delivery would be charged for at five cents per 100 pounds and so on up to the 50-mile deliveries. Over 50 miles is charged for at a straight rate of 50 cents a hundred. Although it might appear that there would be little need for a 50-mile-or-more special



The New Nimitz Hotel, in Fredericksburg, was Remodeled by the Stein Lumber Company, Which Furnished the Architectural Service as Well as the Building Service, from the Old Building Shown Below.

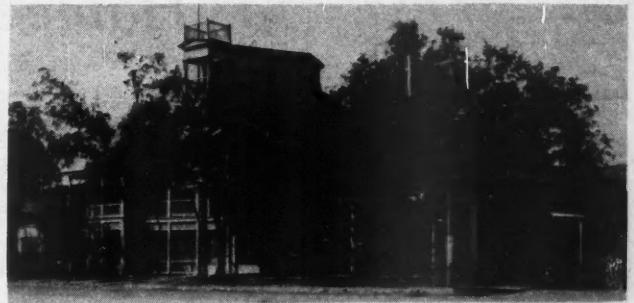

The Old Nimitz Hotel Was, if Not an Eyesore, at Least a Freak and the Remodeling Job Was a Real Community Improvement.

rate, this firm has been successful in selling a number of large jobs to customers over this distance.

Every trucking job must be made to pay a profit for the firm. Small items are not hauled a long distance unless the customer wishes to pay at the rate of a full load. When small orders are received by telephone, the Steins explain in a diplomatic way that the trucks must pay expenses of operation and upkeep and they find that a vast majority of these customers are willing to pay for the service they get.

By featuring built-in equipment for the average home of their trade territory, extra sales have been made by the Stein brothers. Prospects are approached by suggesting the fact that this firm will supply them the best grades of building lumber and other materials for building many built-in fixtures that mean the saving of several hundred dollars in furniture as well as the enjoyment of the most convenient arrangements.

These prospects do not have to depend upon mere suggestions, for members of this firm always have in mind some friend that they have previously served along this line. The prospect is driven to some home where the owner is pleased to show the conveniences and economy of this type of equipment. At the same time, this customer is ready to boost the firm that helped him to plan these modern conveniences.

The 35 years that this lumber company has been established have been years of progress. Of course, there have been ups and downs, but, regardless of local conditions, the Stein brothers and their father have found ways of meeting new friends, and ways of keeping the old customers satisfied with the increasing service extended by the firm. Old settlers of the section, who were customers of the firm in the early days of the business have been shown the practical economy of keeping their buildings repaired, repainted

(Continued to page 120)



This Neat Display Room in the Stein Lumber Company Building Has Helped the Firm to Build Up Its Paint Sales to an Envious Point.



FREE INFORMATION SERVICE

for

Home Planners and *Home Builders*

THE ColorKeed Home Plans presented in this magazine have many special points of excellence which are of particular importance and timeliness to those of our readers who right now are facing the home building question—with its joys and its problems.

We illustrate these home designs and show the room arrangements, but our space for description is so limited that we are not able to cover all points. We know there is much additional information desired by subscribers about to build, which would be very valuable to them. Since, we have all data pertaining to these ColorKeed Homes, both in this current issue and in previous issues of the AMERICAN BUILDER, we are glad to offer our readers a free service of information, whether questions pertain to the estimated cost, the method of construction, suitable materials to use, special equipment or features, or any other information whatsoever.

Limited space in the magazine prevents publishing all this information; but if you will write American Builder Home Planning Service, 1827 Prairie Ave., Chicago, we will be very glad to give you direct by mail any information desired.

COLORKEED HOMES

FOR STYLE AND VALUE

TRADE MARK
 Registered in U. S. Patent Office.

*"It is Timely now to Plan the Home
 and Its Garden"*

—William A. Radford

HOME! There is magic in that word. It brings thoughts of a place that is your own—a place where you and yours are happy—a place where you forget your cares and business problems—where

your wife may rear your children, and where, as they grow into young manhood and womanhood, they may have their friends. Home at once brings to mind the comfort and companionship that only is found at one's own fireside.

Then, too, there is the mental picture of the grounds surrounding the home. The lawn is smooth and velvety—there are flowers in beds, along the walk and the driveway—at the back is the garden where you may grow vegetables for the family table, and perhaps may have a few chickens to supply the family with that greatest of breakfast delicacies—really fresh eggs.

Thoughts of home may be turned into a realization of a home of your own by firmly resolving that you will have a home, and a lawn, and flowers and a garden. Building a home is a considerable undertaking, but millions of other American families have achieved homes of their own, and what millions have done those who have not yet secured homes of their own may do also.

It is to help those who would have homes of their own—those who have the moral stamina to make a resolve to build and then carry that resolve to completion that this department is dedicated. Here are a number of home building designs, shown in their natural colors—just as the homes will be after they are finished and the lawn and gardens and flowers have been secured. These home building designs are accurate in every detail—they were built from proven plans. They are popular homes, quick, ready sellers.

When planning and building, either for your own use or for sale, always remember **marketability**. The home that is designed along customary, approved lines but with graceful attractiveness will sell much more readily and at a better price than the "freak" house.

Certain things about the setting and surroundings of a home have a universal appeal also, adding much to the sales value. The flower garden, the smooth green lawn, the entrance walk edged with blooms—all of these add to home value, and it is timely now to think and plan for them.

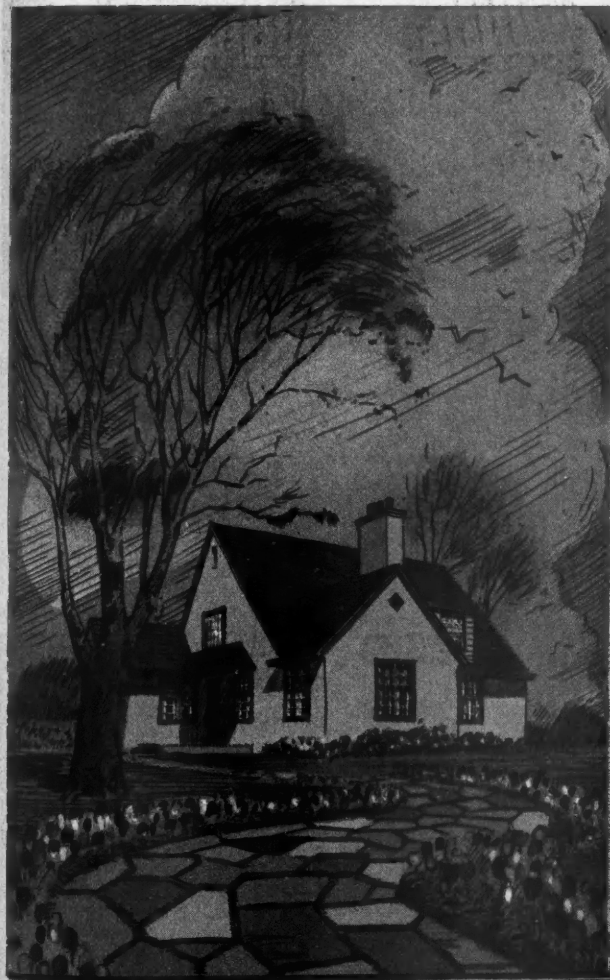

**Comfort Inside and Sunshine
 Outside Dwell In
 COLORKEED TOWN**





The PIERPONT

THIS English cottage has the reputation of being the best selling home in the New York Suburban area. Six rooms, bath and large sun parlor are provided.

COLORKEY HOME PLANS TRADE MARK

	Living Room		Closet
	Dining Room		Bed Room
	Kitchen		Bath and Lav.
	Pantry		Porch
	Halls		Roof

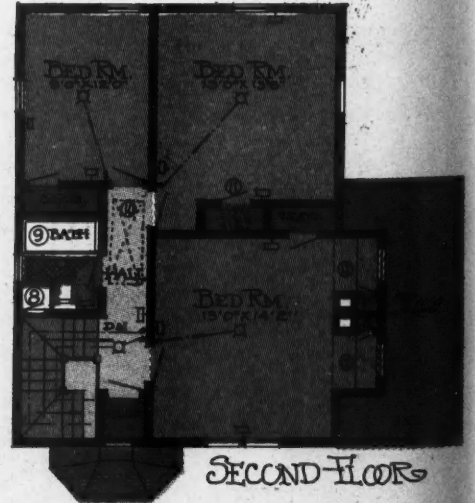
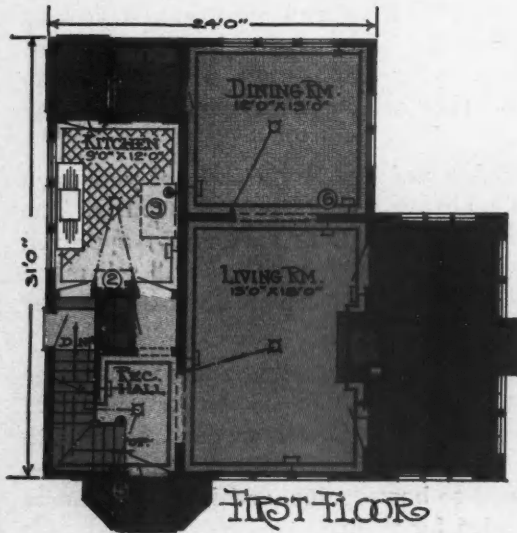

Key to Equipment

- | | | |
|-------------------------------|-------------------------|--------------------------|
| ① Kitchen Cabinet | ⑩ Disappearing Stairs | Coal Chute |
| ② Refrigerator | ⑪ Space-Saving Wardrobe | Heating Plant |
| ③ Gas or Electric Range | ⑫ Hinged Seat | Oil Burner |
| ④ Clothes Closet | Weatherstrips | Water Supply System |
| ⑤ Built-in Mail Box | Storm Sash | Hot Water Supply |
| ⑥ Thermostat | Screens | Water Softener |
| ⑦ Fireplace Throat and Damper | Lighting Fixtures | Radiant Gas Heaters |
| ⑧ Medicine Case | Convenience Outlets | Casement Windows |
| ⑨ Shower Bath | Electric Panel | Dishwashing Sink |
| | Washing Machine | Automatic Cellar Drainer |
| | Ironing Machine | Garbage Incinerator |
| | Clothes Drier | |

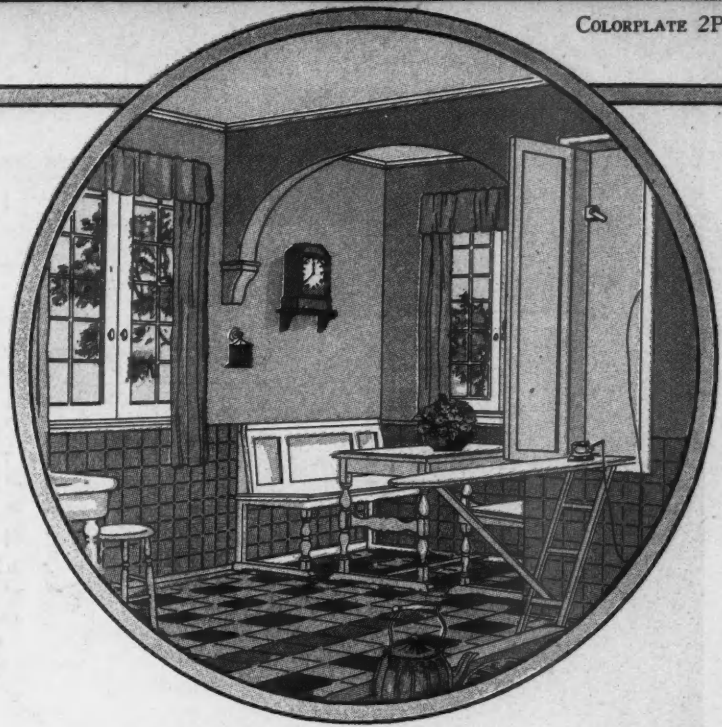
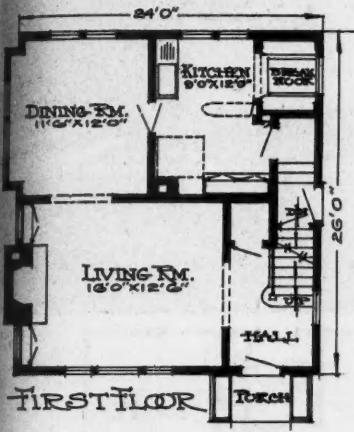
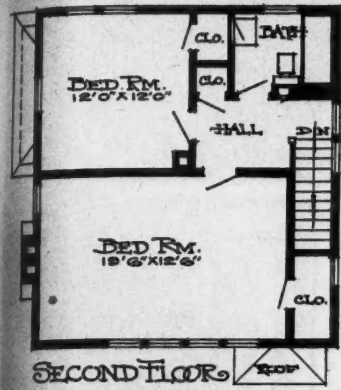

The PILOT HILL

A LOW cost home well designed and well constructed is presented here. There are five rooms, reception hall, breakfast nook and bath arranged compactly in 24x26 feet. The hall, living room and dining room opening freely together give a spacious interior effect; and the charming, cheerful kitchen is revealed in the circle sketch above.

On the second floor there is a very large front bedroom with lighted clothes closet, also another bedroom 12x12 feet, which is a large size.

In exterior design this home follows the popular Dutch Colonial and can be built either in stucco as illustrated or with wide siding or shingles for the outside finish.

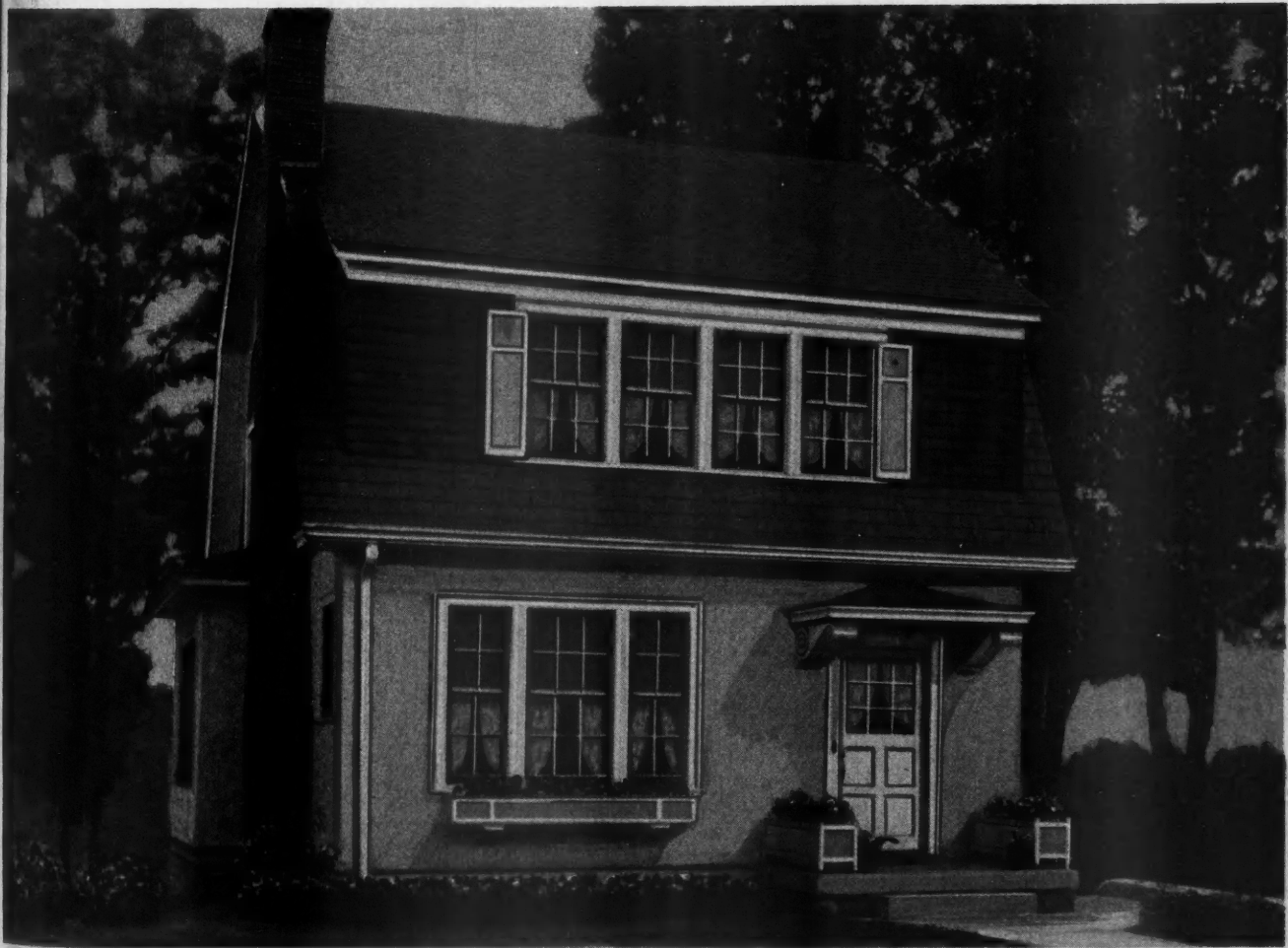

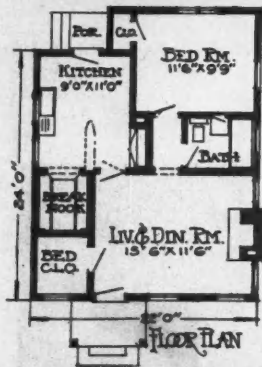
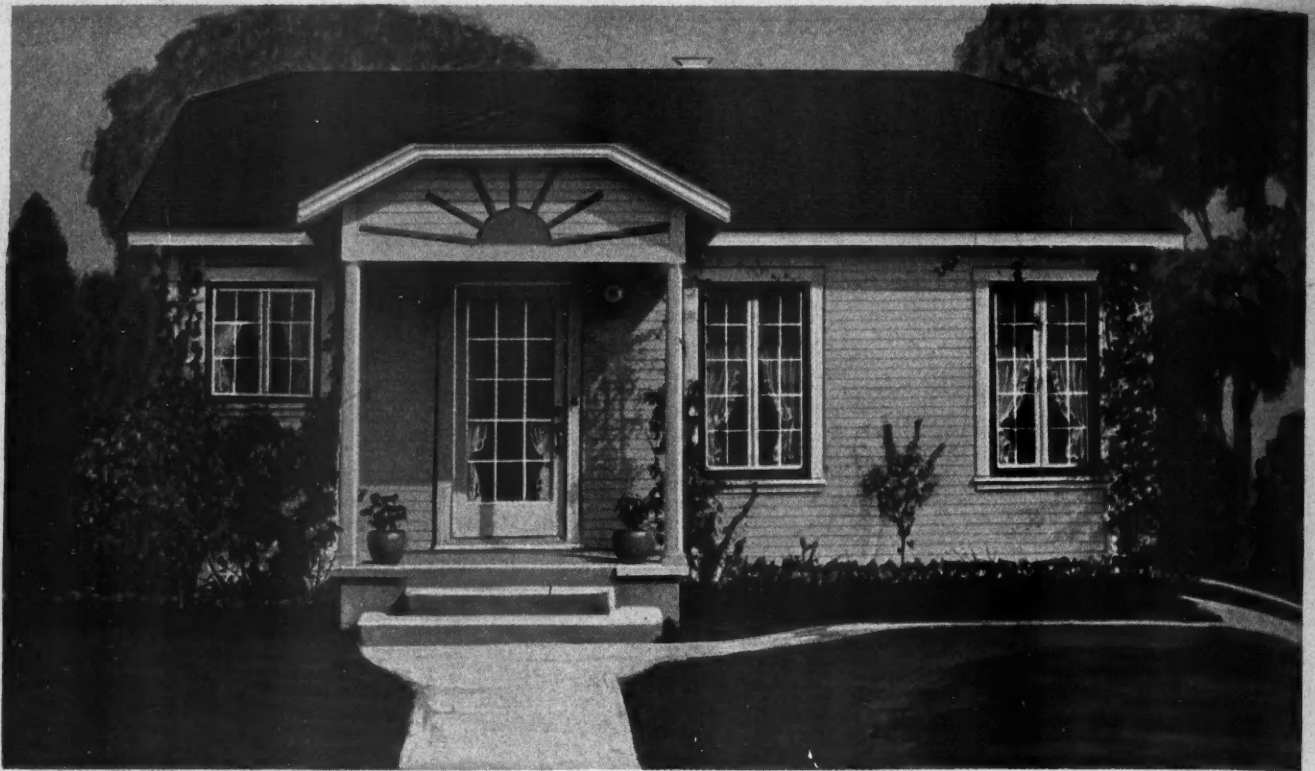

The PLACID
Above and to the left is a little home 22x24 feet containing three rooms, breakfast nook and bath—really a five-room efficiency home.

The POPLAR
Below and to the right is a four-room home 24x32 feet.

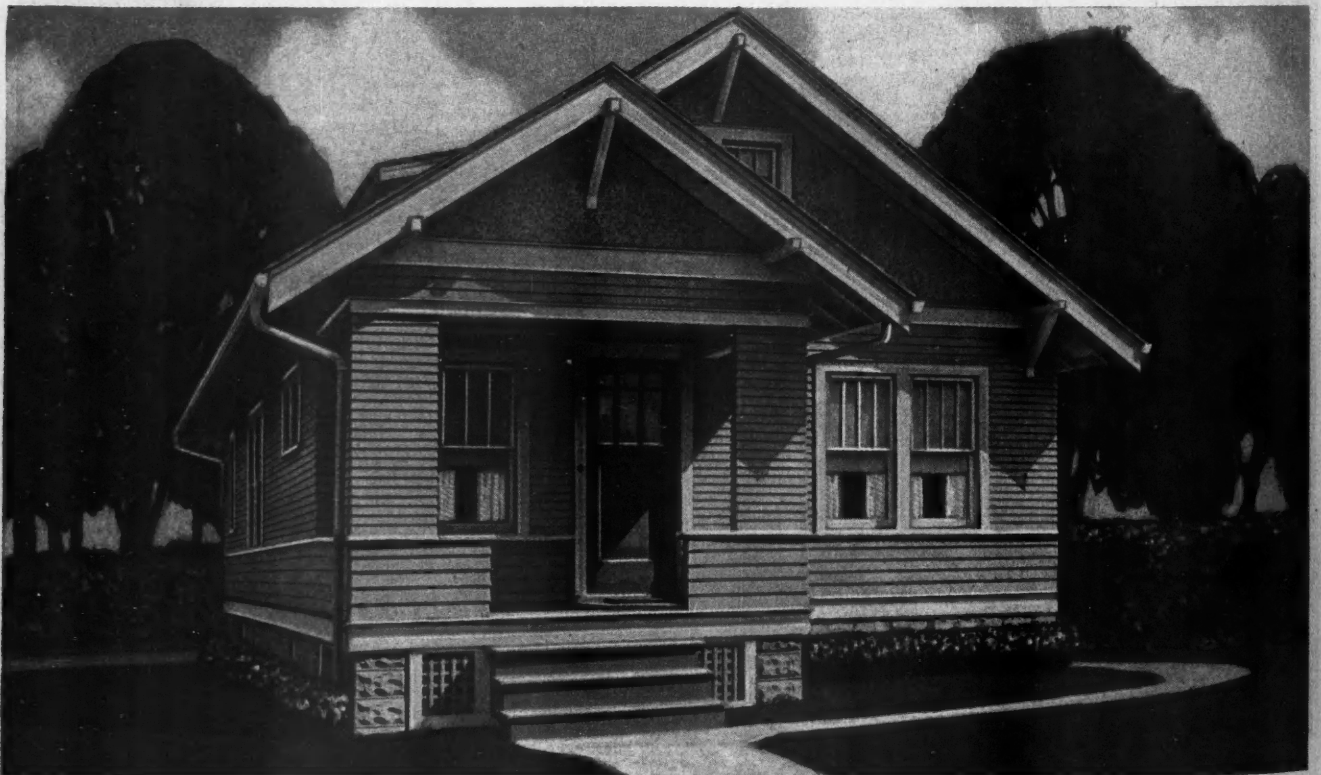
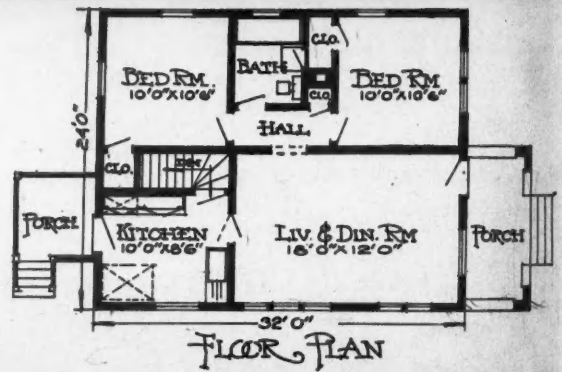

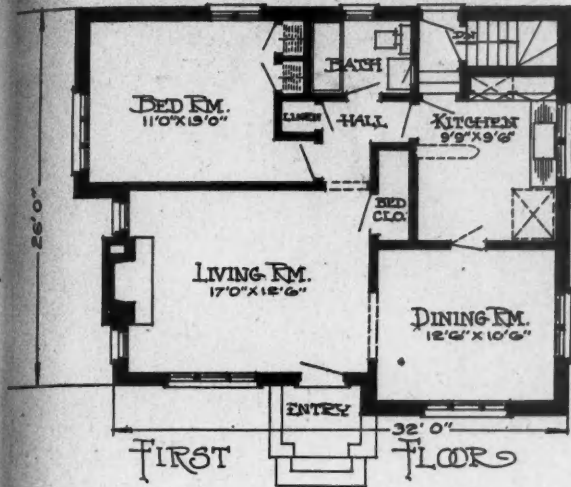

There is a world of homelike convenience in this four-room plan with its large well lighted and cross ventilated rooms.

The PIONEER

A SUBSTANTIAL home of brick and tile construction is illustrated below. The floor plan shows four large rooms and bath, however, the bed closet opening off the living room gives opportunity for extra sleeping accommodations making this equivalent to a five-room arrangement.

A suggestion for furnishing the living room is presented in the color sketch above.



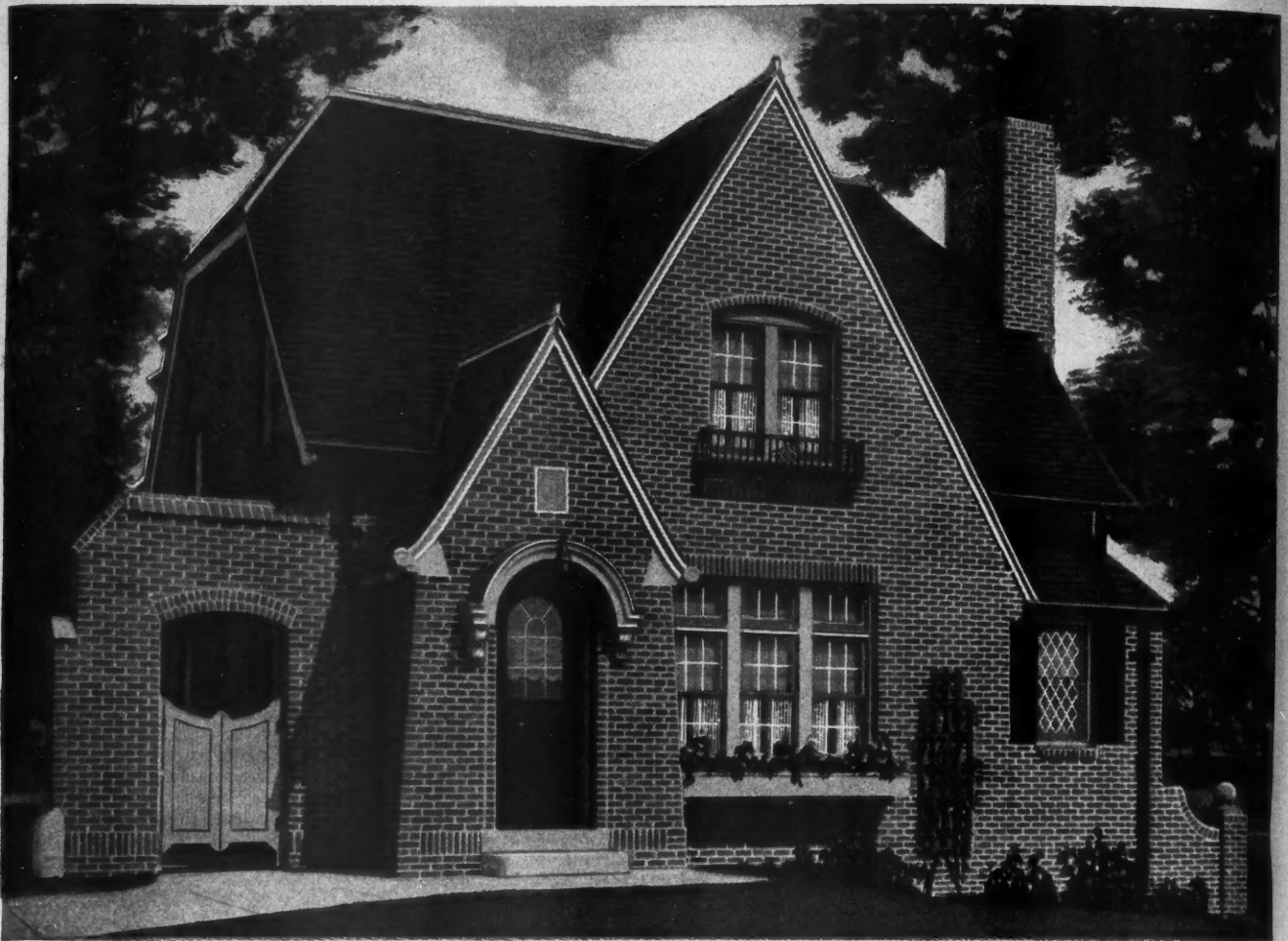

Size 28' 6" x 26' 0"

5 Rooms, Bath, Nook, Alcove and Sewing Room

The CANTWELL

A SMALL English type home with exterior of face brick. The two front gables give individuality without eccentricity to the exterior. Built in seat and bookcases in the nook, and a built in linen chest in the sewing room are conveniences of the interior. Stable construction, attractive interior arrangement, and a distinctive architectural style mark the "Cantwell."

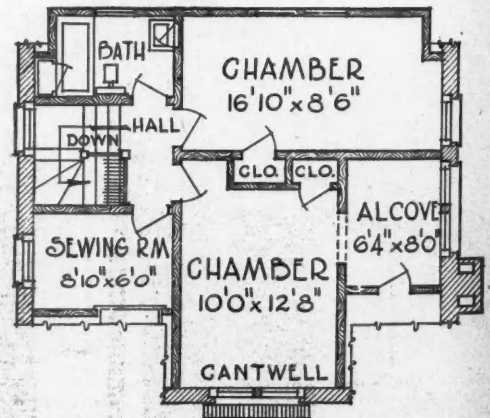
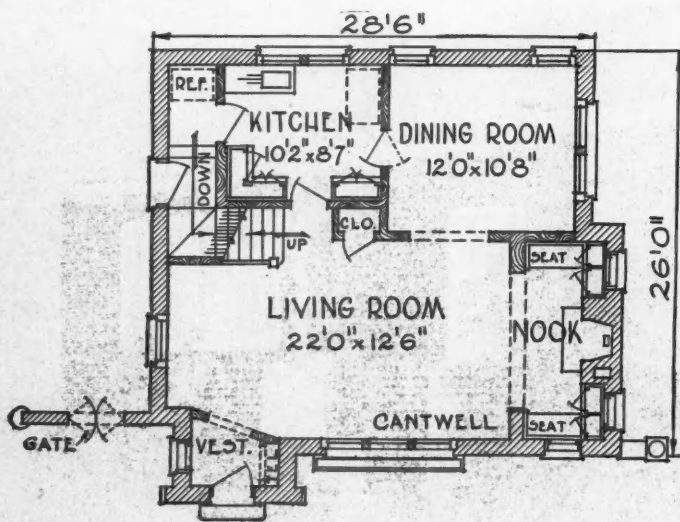

DIMENSIONS

Width over all	42' 3"
Depth over all	32' 3"
Ceiling Height, 1st floor	8' 6"
Ceiling height, 2nd floor	8' 0"
Height of basement	7' 0"



The POTOMAC

A RESIDENTIAL type two-flat or duplex is illustrated, five rooms, bath and sleeping porch on each floor. Service stairs are entirely enclosed, making this an attractive design for residential neighborhoods.

COLORKEED HOME PLANS

	Living Room		Closet
	Dining Room		Bed Room
	Kitchen		Bath and Lav.
	Pantry		Porch
	Halls		Roof

Key to Equipment

- | | |
|-------------------------------|--------------------------|
| ① Package Receivers | Lighting Fixtures |
| ② Ventilating Fans | Convenience Outlets |
| ③ Kitchen Cabinets | Electric Panel |
| ④ Built-in Ironing Boards | Washing Machine |
| ⑤ Gas or Electric Ranges | Ironing Machine |
| ⑥ Refrigerators | Clothes Drier |
| ⑦ Thermostats | Coal Chute |
| ⑧ Medicine Cases | Heating Plant |
| ⑨ Fireplace Throat and Damper | Oil Burner |
| ⑩ Built-in Mail Box | Water Supply System |
| ⑪ Book Shelves | Hot Water Supply |
| ⑫ Seat with Hinged Top | Water Softener |
| Weatherstrips | Radiant Gas Heaters |
| Storm Sash | Casement Windows |
| Screens | Dishwashing Sink |
| | Automatic Cellar Drainer |
| | Garbage Incinerator |
| | Disappearing Stairs |

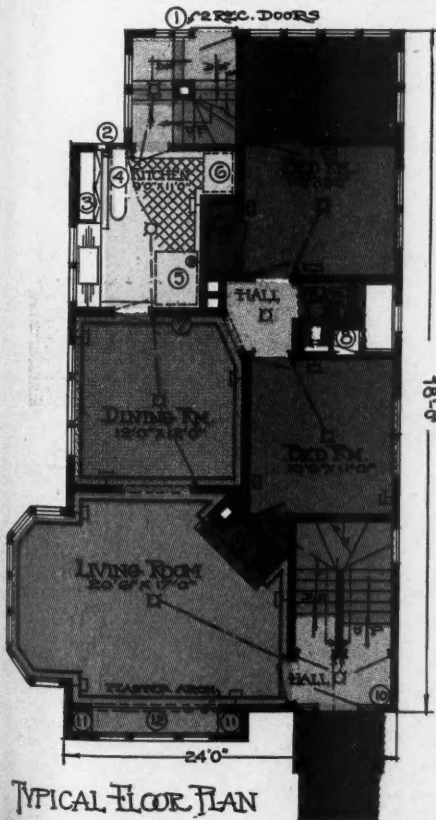

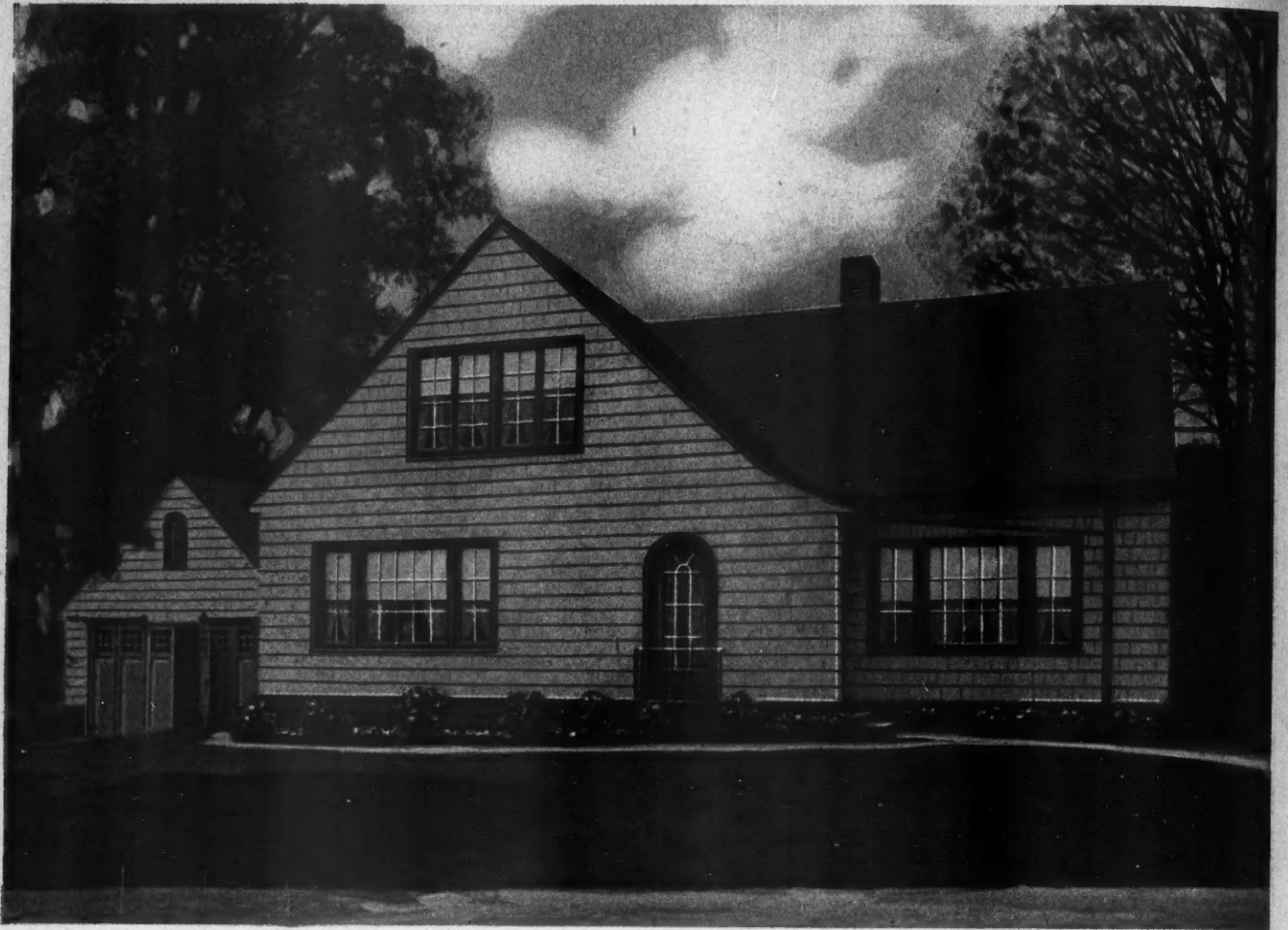

The PRICHARD

A HOME of graceful English lines is illustrated, six rooms, bath, pantry, breakfast nook and reception hall being provided.

COLORKEY HOME PLANS

- | | | | |
|--|-------------|--|---------------|
| | Living Room | | Closet |
| | Dining Room | | Bed Room |
| | Kitchen | | Bath and Lav. |
| | Pantry | | Porch |
| | Halls | | Roof |

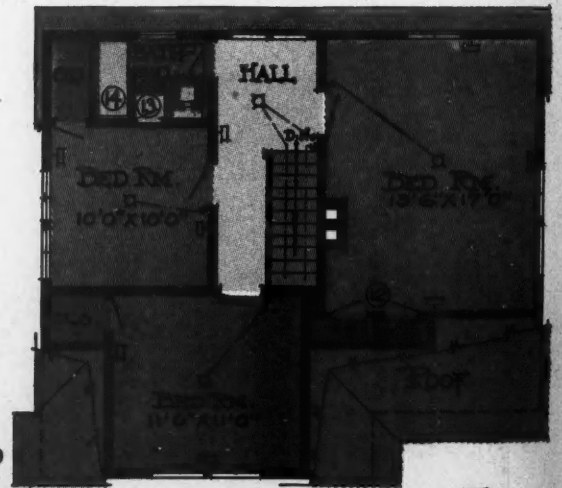
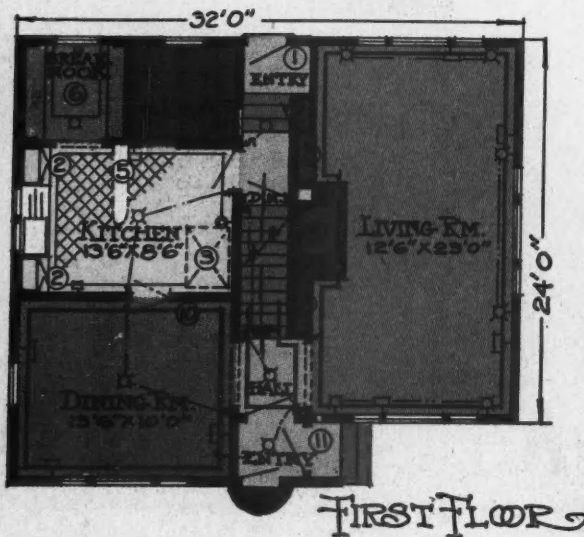

Key to Equipment

- | | | |
|-------------------------------|---------------------------|--------------------------|
| ① Package Receiver | ⑬ Space - Saving Wardrobe | Coal Chute |
| ② Kitchen Cases | ⑭ Medicine Case | Heating Plant |
| ③ Gas or Electric Range | ⑮ Tub Shower | Oil Burner |
| ④ Refrigerator | Weatherstrips | Water Supply System |
| ⑤ Built-in Ironing Board | Storm Sash | Hat Water Supply |
| ⑥ Breakfast Nook | Screens | Water Softener |
| ⑦ Broom Closet | Lighting Fixtures | Radiant Gas Heaters |
| ⑧ Book Cases | Convenience Outlets | Casement Windows |
| ⑨ Fireplace Throat and Damper | Electric Panel | Dishwashing Sink |
| ⑩ Thermostat | Washing Machine | Automatic Cellar Drainer |
| ⑪ Built-in Mail Box | Ironing Machine | Garbage Incinerator |
| | Clothes Drier | Disappearing Stairs |

SECOND FLOOR

OUR FRONT COVER HOME



A Thoroughly Modern, Six Room Home Adapted from the Attractive English Cottage Style of Architecture

THIS month Our Front Cover Home is a design suggested by the English cottage type of architecture which has been thoroughly adapted to the modern American requirements. It is a six room house compactly designed and offering a multitude of conveniences and ample space for the average family.

These six rooms include a bed room on the first floor, a feature which is becoming increasingly popular these days. It is especially convenient for the housewife who has a young baby to care for along with the household duties of the day and makes it possible for her to avoid

much running up and down stairs.

The upstairs bed rooms, it will be noted, are provided with an unusual amount of closet and storage space. In addition to a large closet for each room there is a storage closet almost as large as a small room and this will be welcome particularly in view of the fact that this type of home has no attic.

All this may be seen from the floor plans reproduced on the page which follows this. On other following pages are other plans, all drawn to scale so the builder is provided with complete working plans.



An English Cottage Type of Home Incorporating Every Modern Convenience. The compact arrangement of rooms may be seen by referring to the plans, drawn to scale, which are shown on the pages following this.

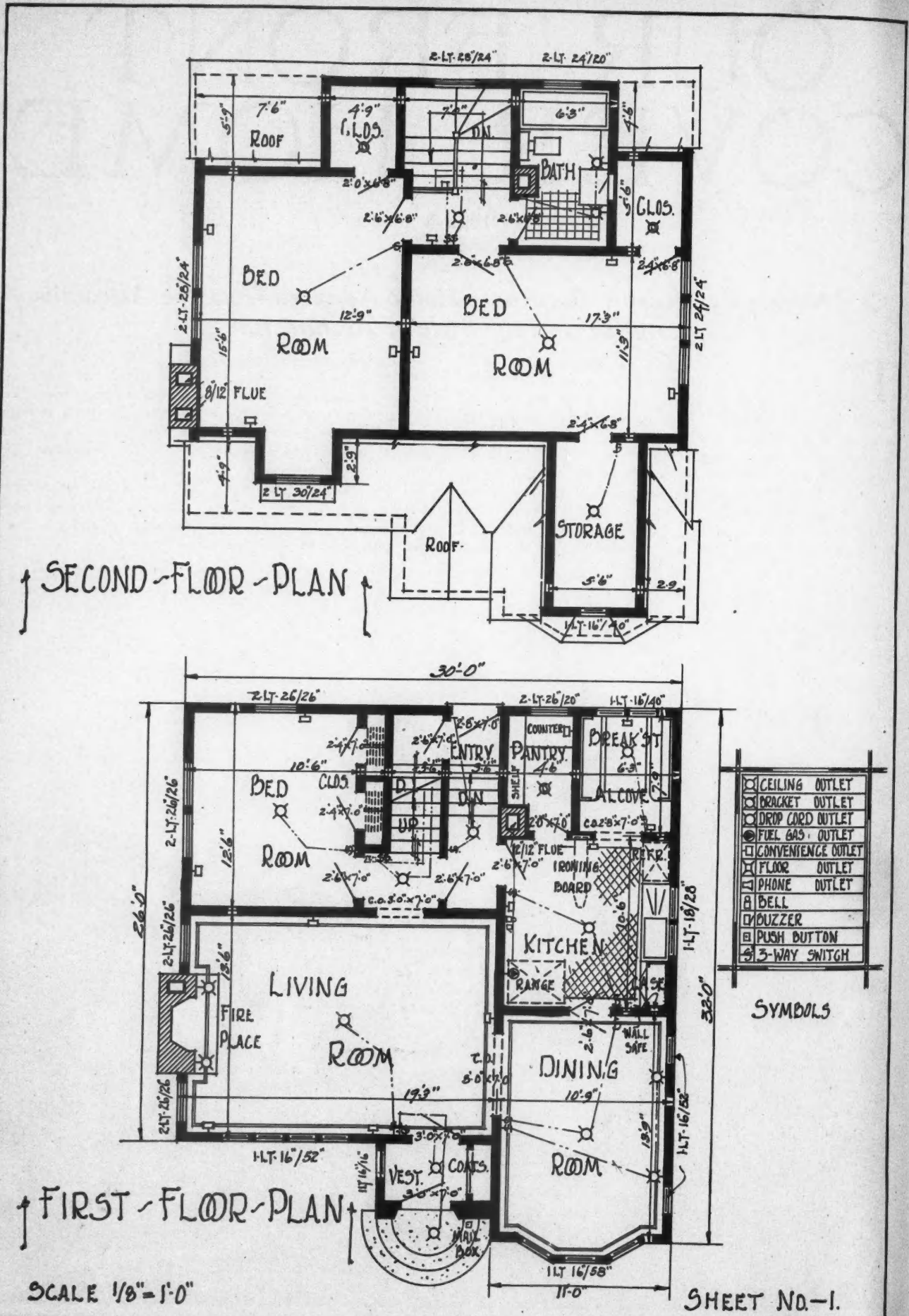

These First and Second Floor Plans of Our Front Cover Home Should Appeal to the Housewife by Reason of Their Convenience.

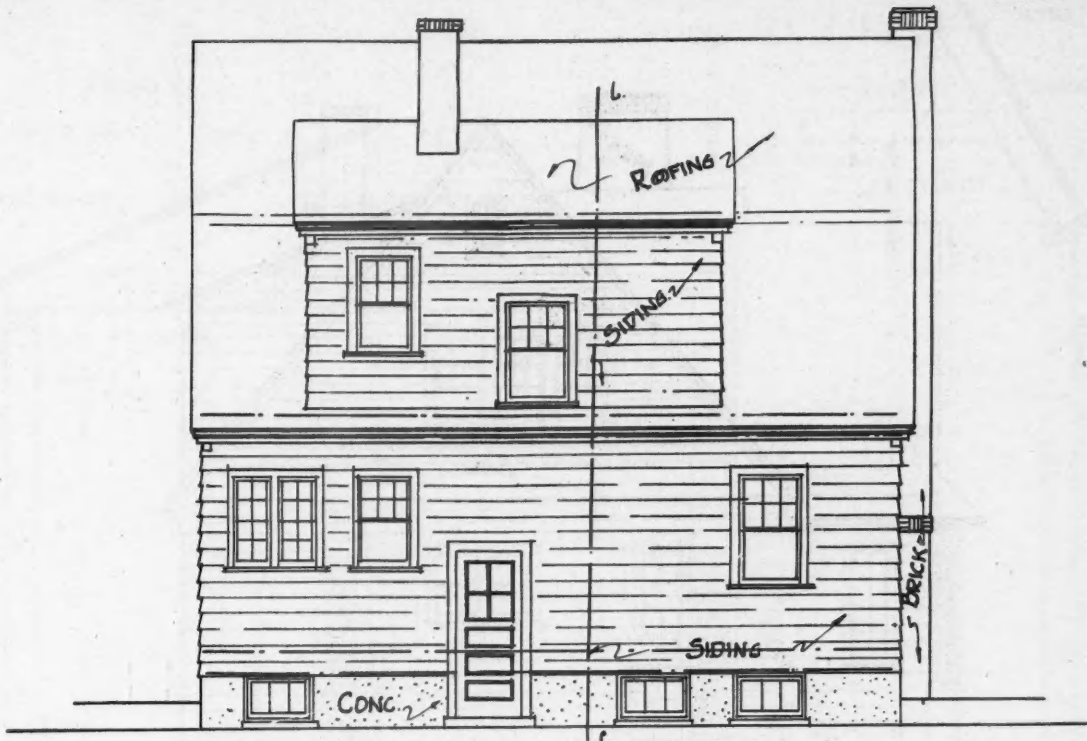

REAR - ELEVATION

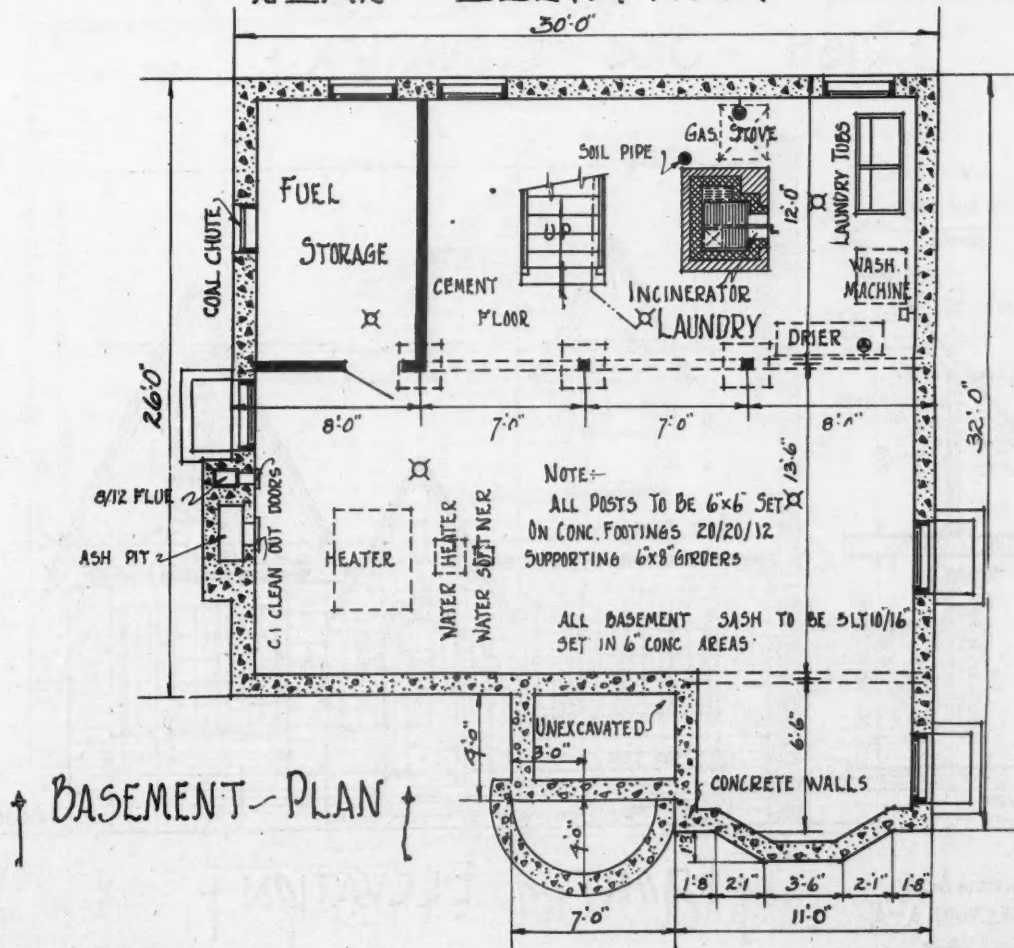

BASEMENT - PLAN

SCALE 1/8" = 1'-0"

SHEET NO. - 2.

The Rear Elevation Will Aid the Builder While the Basement Plan Shows a Really Modern Basement. Other plans follow.

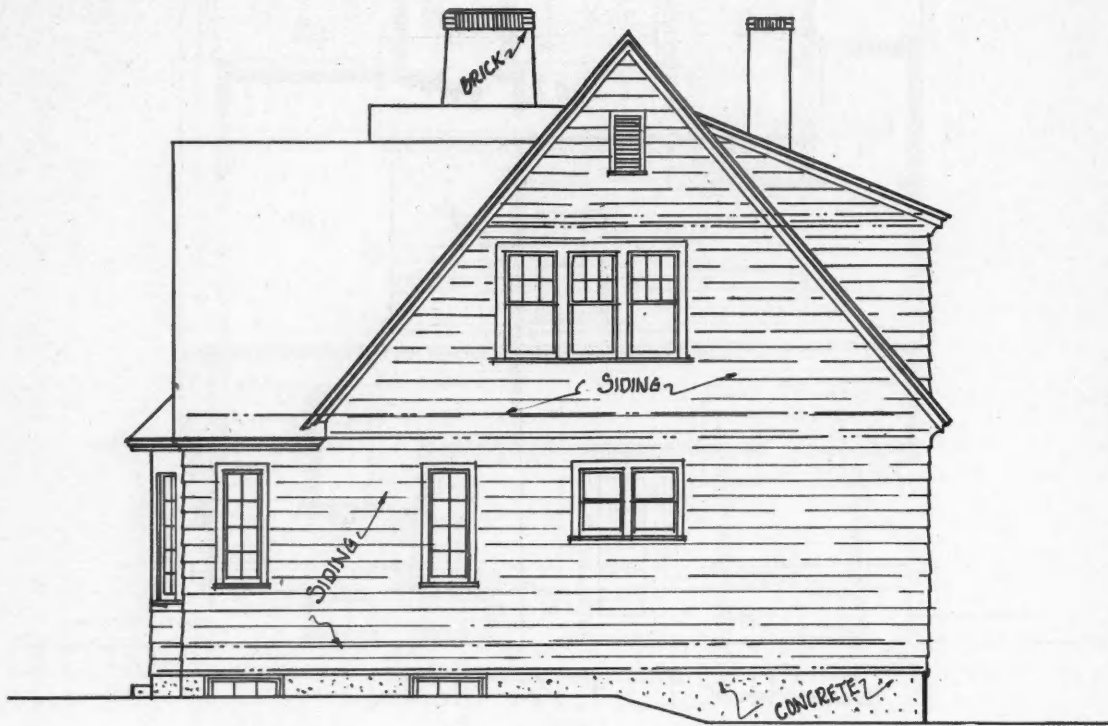

↑ RIGHT - SIDE - ELEVATION ↓

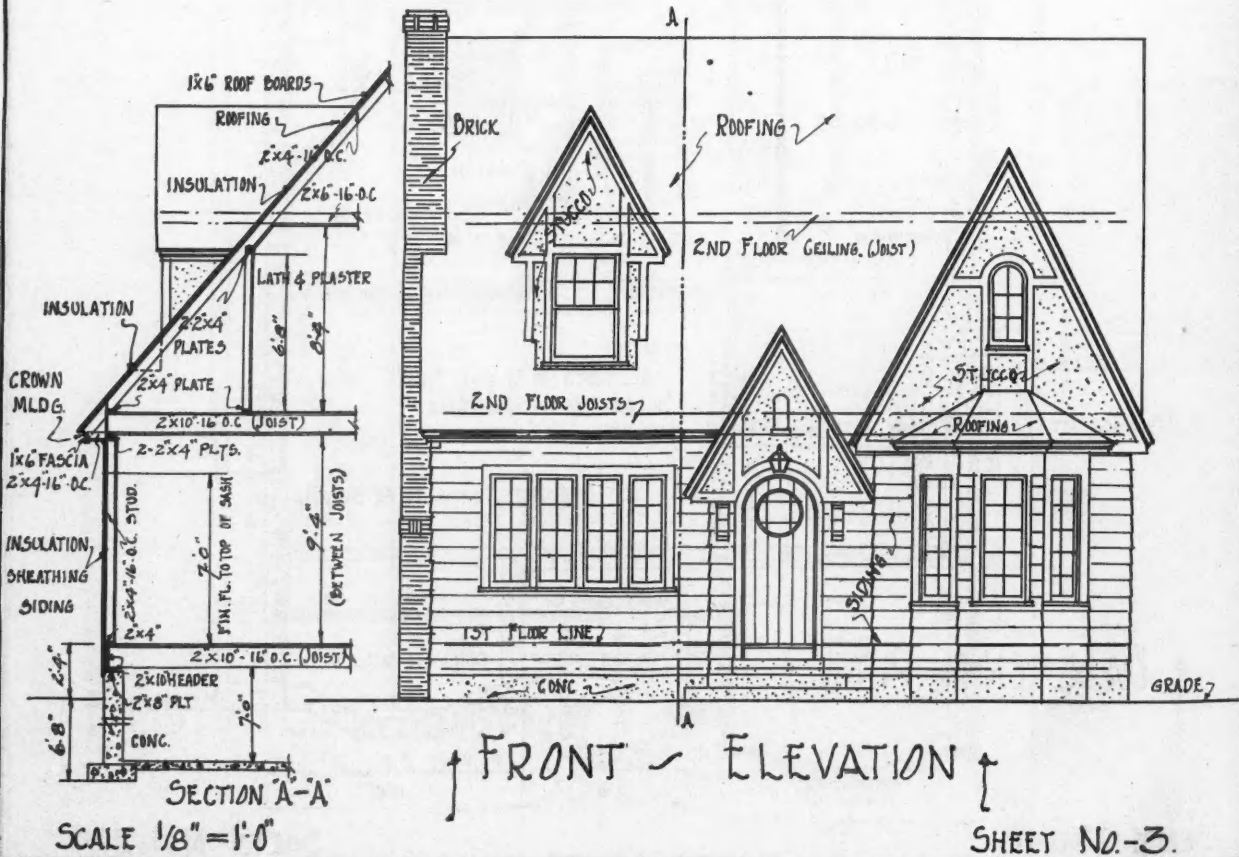

↑ FRONT - ELEVATION ↓

SHEET No.-3.

Two More Elevations of Our Front Cover Home and Section Indicating the General Construction.

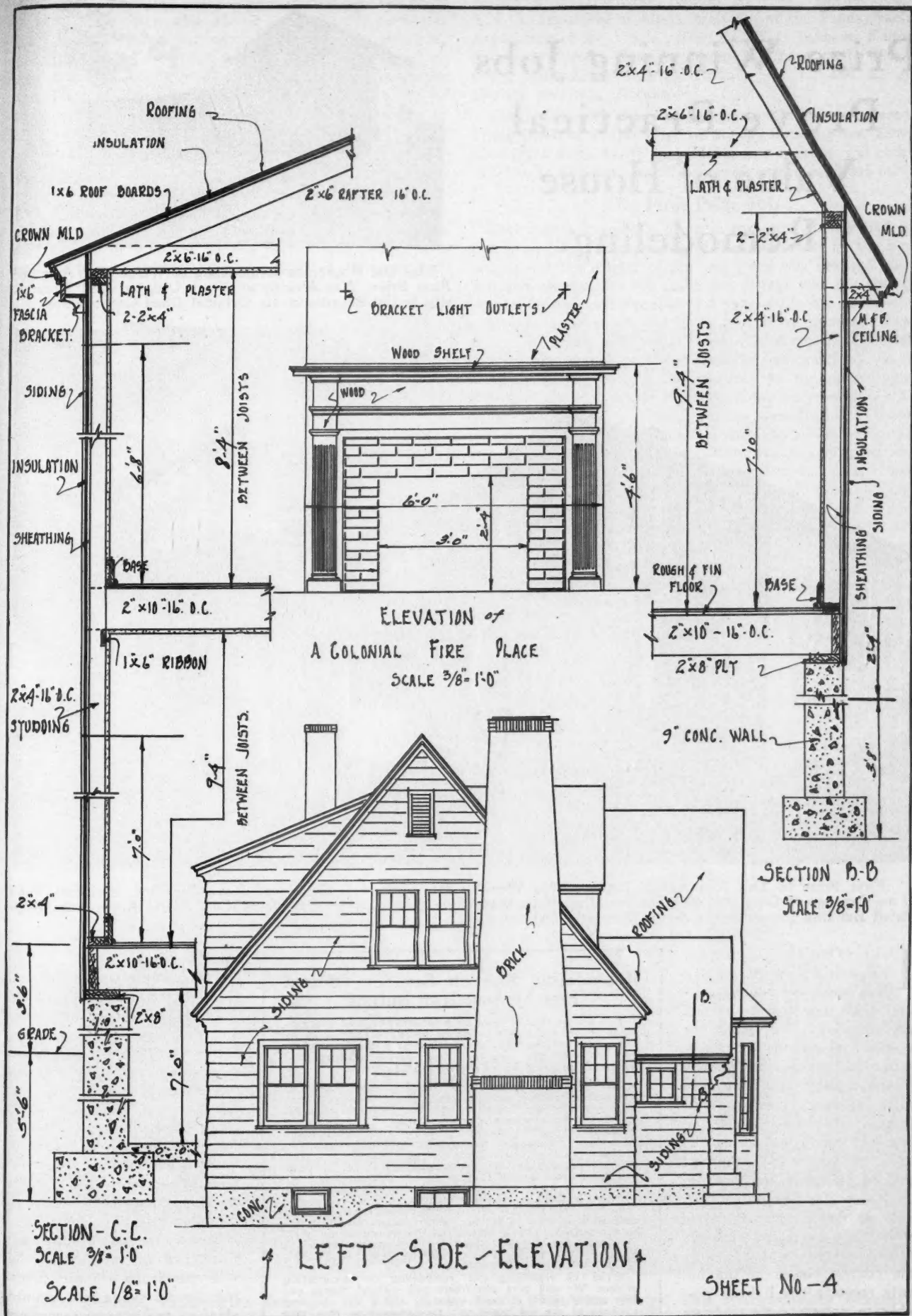

Here, in Addition to One Elevation Drawing, We Have Sections and Details Necessary as a Building Guide to Our Front Cover Home.

Prize Winning Jobs Prove Practical Value of House Remodeling



This Old House, the Remodeling of Which Was Awarded First Prize, Was Already 83 Years Old, but Still Structurally Sound Because of Its Original Good Construction.



First Prize in This Remodeling Contest Was Won by Mr. Clifford J. Foster, of Rives Junction, Michigan, Who at an Expense of Only \$801.49 Made for Himself the Attractive Home Shown Here from the Old and Apparently Dilapidated Building Shown in the Small Illustration Above.

ILLUSTRATED here are the four first prize winners in a house remodeling contest which demonstrate beyond any question of a doubt the practical possibilities of rejuvenating old houses and thereby creating new and enhanced values far in excess of the cost of such remodeling. This contest was conducted during the past year by the Weatherbest Stained Shingle Company, Inc., of North Tonawanda, N. Y., and so much interest did it arouse and so many were the entries submitted that though the contest closed in the fall only recently has it been possible to complete the judging of entries and announce the

Remodeling Sketch Service Offered Free by American Builder

You are invited to send in photographs and descriptions of any old home or other building that is to be remodeled or modernized, telling us what is wanted, and we will give you our best advice accompanied whenever possible by an architectural sketch.

ALL signs now point to a much greater volume of remodeling than ever before. There are more than twenty million old homes in the United States that fall far short of the present-day standards. Their structural members are sound, but their style is wrong and the lack of modern conveniences make them no longer satisfactory to their owners and occupants.

Thousands of these old homes are going to be remodeled and modernized during 1928.

Here is a great opportunity and a great responsibility for AMERICAN BUILDER readers.

So the AMERICAN BUILDER comes forward at this time with an offer of service, which we are confident will be appreciated. Our Architectural Department in co-operation with the Editorial Staff has generously offered its facilities to form THE AMERICAN BUILDER REMODELING SERVICE.

Write us regarding any remodeling or modernizing project. We will give you freely and without charge our best expert advice in every instance; and if you can send a photo of the old house our recommendation may take the form of an architectural sketch.

prize winners.

This contest was announced through extensive advertising in various national magazines and thousands of requests for entry blanks and information were received. Before the contest closed several hundred entries had been submitted. Many other owners who were unable to go forward with plans in time to enter have become interested and will carry out remodeling plans during the coming year.

The contest was run in open form, that is, any person who was remodeling a house, covering the old siding with stained shingles, might enter regardless of what brand of material was

being used. The advertising which carried the announcements of the contest also offered the impartial service of the company's remodeling service department in supplying ideas, suggestions and sketches to those who wished to avail themselves of the service. Many calls for such service were received from contestants and a large number of sketches were prepared. The same service is available at all times to any contractor or dealer who wishes to offer suggestions to his prospects for remodeling old houses.

In order that there should be no possibility of partiality in judging, each entry in this contest was assigned a number and only the number was available to the judges so that none of the judges knew where any of the entries were located or who the owners were. The judges who made the final awards were: C. M. Caldwell, vice-president,

Kinsey Realty Company, Buffalo, N. Y.; C. Paxton Cody, A. I. A., registered architect, president of the Pennsylvania Association of the A. I. A., Erie, Pa.; B. L. Johnson, Editor AMERICAN BUILDER, Chicago; Jerome B. Chase, of the Moss-Chase Advertising Agency, Buffalo, N. Y., and E. A. Martini, architect, Chicago.

Thirty-nine cash prizes amounting to \$2,750 were offered. These included a first prize of \$1,000; second prize, \$500; third prize, \$300; fourth prize, \$100; five prizes of \$50 each; 10 prizes of \$30 each, and 20 honorable mentions of \$15 each.

The First Prize Job

Each house winning a place in the prize money had to receive at least three out of the five votes cast by the five judges, but the winner of the first prize was selected with hardly a question by the entire five judges who felt that it was by far the best example of a very old house made into a modern and presentable home and at an unusually low cost. The owner, Clifford J. Foster, stated that he did most of the work himself, working evenings and holidays. As is instantly apparent from the pictures on the page opposite, a really remarkable transformation was made in this house, and it serves to show, possibly more than any of the others, just what can be done at a reasonable expense, in the way of making a very old homestead livable and attractive.

This house is located at Rives Junction, Mich., and was bought for remodeling by Mr. and Mrs. Clifford J. Foster, who saw the possibilities which the original good sound construction offered as a base for remodeling, even though the building was already about 83 years old. The stained shingles used in remodeling this house were furnished by the Holaday Lumber Company, of Leslie, Mich., and they were applied by Mr. Foster himself, who estimated his labor at \$50.00 in figuring the total cost of remodeling. The cost of the shingles was \$135.00, 14 squares of 16-inch gray stained shingles being used.



Before Remodeling This House Which Took Second Prize in the Contest Was Classed as an Architectural Atrocity, but a Remarkable Change Was Wrought.



From a Crude, Inhospitable Structure, as Seen in the Small Illustration Above, This Architecturally Beautiful Country Home Was Created by the Addition of Two Wings and the Application of Wide Colonial White Shingles Over the Original Narrow Siding.



The Third Prize Winner, a Thoroughly Modern and Attractive Home Created at a Cost of Less Than \$1,000.00 from an Old "L" Type House Such as Is a Familiar Sight in Every Community. After remodeling this house was valued at \$2,000.00 more than the top market value before remodeling.



Many Such "L" Type Houses Are to Be Found in Every Community and Afford a Profitable Field for the Contractor Who Appreciates the Possibilities of Remodeling.

In addition to these expenses the interior remodeling, which included plastering, a new furnace, hardware, paint, etc., amounted to \$397.69. The exterior remodeling, other than covering the walls with shingles, cost \$219.75 and included new trim, porches, painting the trim and various miscellaneous items. This brought the total cost of remodeling this house to \$801.49. The increase in valuation of the house after remodeling was placed at \$3,700.00. On this basis the remodeling was a remarkably profitable investment.

The Second Prize Job

The remodeling job to which second prize was awarded was selected as a fine example of a crude, inhospitable house changed into a home of warmth and architectural beauty. Mr. William M. Miller, of Paterson, N. J., the owner of this home, spent \$6,600.00 for its remodeling. The shingles

used in covering the old narrow siding cost \$260 and the labor of applying them amounted to \$280.00, making a total of \$540.00 for this part of the remodeling expense. It is interesting to note a statement made by Mr. Miller in a letter accompanying his entry: "The actual cost of stained shingles and labor was only slightly more than the cost of repainting the old siding would have been and the slight difference will be more than offset by the saving in fuel (due to better insulation), repairs and repainting."

No itemized account of the interior remodeling is available, but the "before and after" photographs give a very good idea of what was done. The addition of two wings, together with the shingle over-coating remade an architectural atrocity into a very handsome country home and the added valuation which has been estimated as resulting from this remodeling is double the cost of the work.

The Third Prize Job

The third prize winning house is an excellent example of what can be done with an old "L" type house at a comparatively small expense. There are many houses of this type in every community which are structurally in good condition, but, because of their appearance and lack of modern interior equipment, have little sales or rental value in their present condition. Here, then, is a proven field in which the builder is assured a substantial profit.

The owner of this house, Mr. Madison Gilbert, of Owosso, Mich., secured his suggestions for remodeling from the Weatherbest Remodeling Service Department and followed these suggestions almost to the letter. The stained shingles, felt, nails and labor for applying the shingles over the old siding and on the roof of the new section, was only \$322.06. Other work amounting to \$598.85 brought the total cost of this remodeling up to \$920.91, but the increased valuation ascribed to the remodeling has been placed at \$2,000.00. The materials for remodeling were furnished by Sturtevant & Blood, lumber dealers of Owosso, Mich.



Fourth Prize Went to the Syracuse Land & Development Company, of Syracuse, New York, Which Completed the Remodeling of an Old Run Down Building on Its Franklin Park Tract, at a Cost of \$1,500.00, and Produced This Attractive and Livable Home Covered with Wide Colonial White Shingles.

The Fourth Prize Job

The Syracuse Land & Development Company, of Syracuse, N. Y., was the winner of the fourth prize. This company spent a total of \$1,500.00 in reclaiming an old but sturdily built house which was located on their Franklin Park tract in Syracuse. Colonial white shingles were used to brighten up the side walls to very good effect. The shingles and labor of applying them cost \$175.00.

One of the most interesting pieces of data gathered from the results of this contest was the low cost of remodeling old homes. It was found, in checking over the data furnished with many hundreds of entries, that the average cost of remodeling was less than \$1,000.00 per house. This should be good news to those who have been under the impression that remodeling costs always run into a large amount of money.

Another sidelight on the contest is found in the fact that quite a number of replies to a questionnaire filled out by the owners advised that the contractor who did the work had been very skeptical about the idea of placing stained shingles over old siding but, after completing the job, was turned into an enthusiastic booster for this method of remodeling.

It was found that 9 per cent of the homes entered in the contests were less than 10 years old, 7½ per cent were 10 to 25 years old, 30 percent were 25 to 50 years old, 45½ per cent were 51 to 100 years old and 8 per cent were over 100 years old.

After the completion of this contest, E. B. Allen, advertising manager of the Weatherbest Stained Shingle Company, Inc., made the following statement: "We feel that the contractors who will go after this remodeling business can make it into a volume that will keep them busy throughout the year. Remodeling by laying stained shingles over old siding is work that can be done in nice weather through the winter months while the inside work can be saved for stormy days. There is no question but what the remodeling of old houses has helped us immensely in keeping our sales ahead of those of 1926 and we have many cases of the contractor taking off his coat, rolling up his sleeves and going in for remodeling business and coming out with both hands full of work that would not otherwise have materialized."



Before Remodeling This Old House Held Little Attraction, but Its Sturdy Construction Offered an Ample Base for Producing the Modern Home Shown in the Larger Illustration.



City Planning Gains in Favor

THE growing practice of fitting American cities to a definite pattern rather than allowing them to grow as they will is disclosed in a forthcoming report of the Civic Development Department of the Chamber of Commerce of the United States on City Planning and Zoning Accomplishments. This practice which originated 20 or more years ago has steadily grown until at the present time more than 600 American cities have adopted some form of city planning.

"City Planning," the report explains, "is the proper co-ordination of civic development, to the end that a city may grow in a more orderly way and provide adequate facilities for living, working and recreation."

"To serve the community best a comprehensive city plan must co-ordinate all physical improvements, even at the possible expense of subordinating individual desires. City planning applies the fundamental principles of business corporations to civic development. It means the budgeting of future improvements to secure an orderly and uniform growth for the entire community and prevent over-expansion of one phase of development at the expense of others."

Common Brick Is Supreme in Mass Textures

Under the Play of Light and Shadow on the Varying Color Tones the Wall Takes on the Tapestryed Appearance of a Well-Worn Oriental Rug

TEXTURAL effects, and their possibilities from the use of common brick, have seldom been more strikingly demonstrated than in the wonderful collection of photographs submitted in a recent architectural photo contest conducted by the Common Brick Manufacturers Association and presented in their well-edited monthly publication, "Building Economy."

These show the brick laid in every type of bond, in natural and colored mortars, and with all the different mortar joints. Decorative effects display a wide variety of pattern designs and while most of the walls have been either solid, or with a hollow tile back-up, there are some excellent examples of the all-rolok Ideal hollow wall in Flemish bond.

Generally the brick used have been the run of the kiln although in some instances the lighter shades have been thrown out to intensify the color scheme and clinkers have been used liberally for headers. Some of the houses have been built entirely of over-burned brick and clinkers while from New England come some interesting examples of the swelled brick, a variety as distinctive to that region as the clinker is to Chicago. Unfortunately photographs do not reproduce color effects so much of the merit of these examples is lost.

The paramount message of this contest and these photographs is that the architects of the country are coming to realize what can be done with common brick by carefully adapting the brick to the design, mixing the colors with an artistic appreciation of tone values, and giving due consideration to bond and mortar joint. All of these features enter inescapably into the production of the mass poly-



Running Bond, Flush Cut Joint, and a Wide Variety of Colors. Howell Gilbert, owner; Louise M. Gilleo, architect, Grand Rapids.



Note the Play of Shadows in This Deeply Raked Joint. Darrah Corbet, owner; A. L. Loveless, architect, Seattle.

chrome effects which are coming so fast into popular favor and for which the common brick is so peculiarly and admirably adapted. No other material can duplicate it.

Variety is the supreme quality that places the common brick in a niche all its own. No two bricks are alike. Each individual unit differs as well in its color, and frequently one brick will display on a single face a quartet of shades, due to fire flashing. All are uneven in their lines to just that degree necessary to pleasing variety and irregularity in the wall. There is no monotony either of line or color; no sameness; nothing mechanical. Above all the common brick is natural and being so exerts an unfailing appeal upon the lover of beauty in the rough.

Good architecture is imperative to a beautiful home. Proportion and line must be true. But design is not



A Variety of Reds in a Pressed Joint with Natural Mortar. J. J. Cromwell, architect and owner, Woodmere, L. I.



An Over-Burned Brick Laid in Flemish Bond and a Natural Mortar. J. M. Haynes, owner; Parks & Baxter, architects, Washington, D. C.

everything, and attractiveness may not only be insured, but immeasurably enhanced, by a facade which catches and holds the eye from its sheer beauty of softened and harmonious color tones. Color is playing more and more an important part in the work of the best designers of present-day homes. "Lay the brick roughly and mix the colors," is the advice of the architect who best appreciates the possibilities of common brick and works to a definite end in decorative effects. For in its wide range of colorings, and an irregularity that precludes all possibility of monotonous lines in the wall surface, the common brick is without a peer in the field of exterior materials. And architects are making the most of this fact.

New interest is being added to the masonry wall of late by the introduction of skintled brickwork, purely a common brick development and about the only radical departure in solid wall masonry in the last 500 years. Much longer ago than that the Romans introduced the arch and various forms of pattern brickwork together with a variety of bonds when their legions ran wild over Southern Europe



Dark Reds and Browns, Semi-Skintled, with Unusual Fireflashings. Dr. J. A. Fordyce, owner; R. G. Dixon, architect, Pittsburgh.

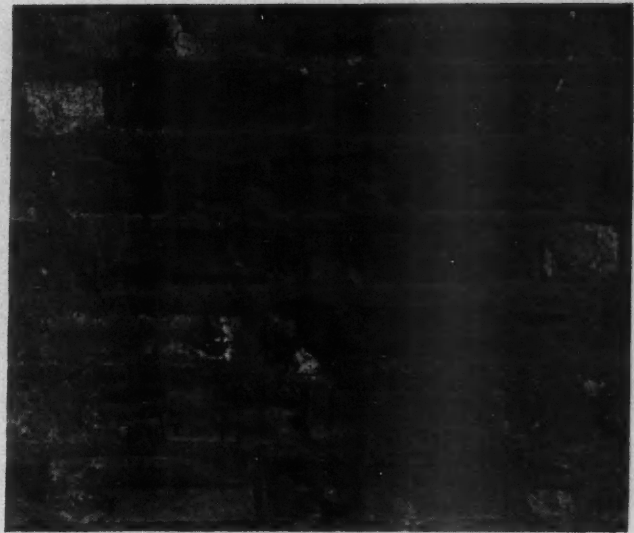

Clinkers with Mudball Headers Laid in a Specially Heavy-Colored Mortar. L. R. Hurley, owner; Howard E. Hall, architect, Camden, N. J.

and invaded the British Isles. Virtually all the later innovations have been merely elaborations of principles the Romans established.

But skintled brickwork seemingly had no precedent. In fact it broke all precedent, so much so that when it was first introduced bricklayers refused to lay it. The old rule of thumb, the idea that each brick on the exterior surface must be laid to the exactness of almost a hair's breadth, was rudely tossed aside. The exterior brick were tossed in irregularly, producing a surface as rough as a nutmeg grater, and withal a wonderful textural effect.

Using the run of the kiln, skintled, a common brick wall becomes a medley of colors. The skintling brings out the tones with striking boldness and the constantly changing

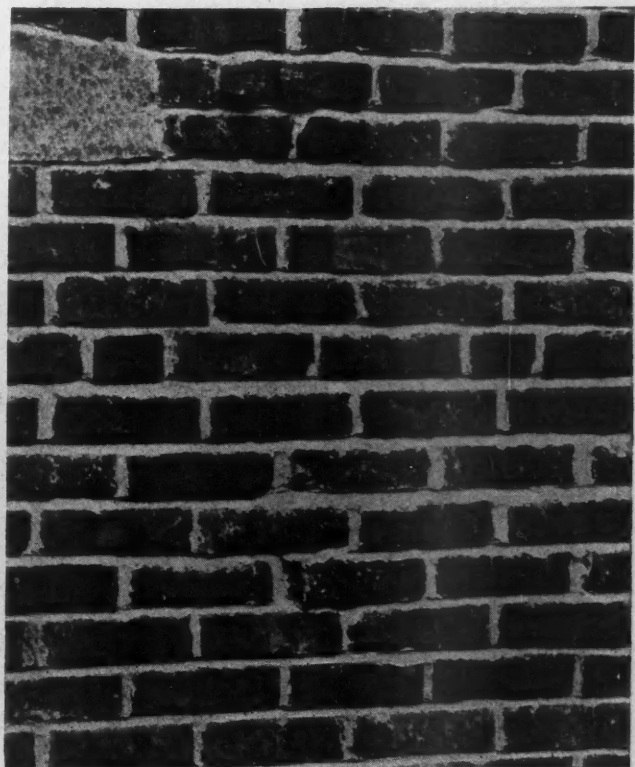

An Exceptional Variety of Colors Laid in White Mortar, Weathered Joint. C. W. Lundberg, owner; Lundberg & Ekball, architects, Tacoma.

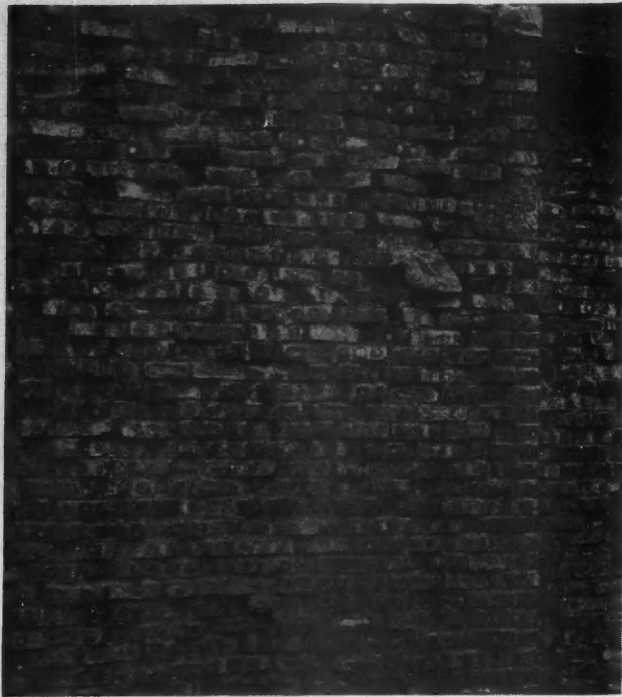

Over-Burned Half Clinkers, Skintled, Laid in a Dark-Colored Mortar. Albert B. Lewis, owner; Wm. T. Braun, architect, Chicago.

play of the sunshine, deepening the richness of the reds, and yellows, and browns, glinting on the hard head clinkers and accentuating the shadows under the projecting headers, produces a tapestried effect not approached in any other type.



Architectural Service

(Continued from page 99)

and up to standards in all respects, while many of these old time customers have been shown the advisability of erecting new buildings with more thought to the arrangement which has been made possible through the architectural service extended by Ed Stein to customers of the firm.

Sales by demonstration is the plan carried out by these retailers. They are constantly stressing repairing and rebuilding for appearance and convenience to their pros-



Projected Stretchers Which Furnish an Interesting Play of Shadow. T. S. Etheridge, Jr., owner; Louise M. Gilleo, architect.

pects; therefore they have taken the lead by applying the system to their own business. The planing mill is now a large feature with the firm and is equipped with modern machinery to handle every need. In 1925, the yard which had been remodeled at times to take care of the growing business was thoroughly remodeled and rebuilt.

The sheds, warehouses and bins of the firm are built on either side of an archway. An attractive office and a front storage house, on either side of the arched driveway, are set on a heavy reinforced concrete foundation. These buildings are frame construction, finished in stucco and neatly painted. A plate-glass front on two sides of the office is used to a fine advantage in displaying paints, builder's hardware, hardwood flooring, roofings, wallboards and other merchandise.

There is a great deal of personality linked up with the retail sales made from this firm. Stein brothers demonstrate that they believe in cultivating friends, for friends often become customers. Every person, regardless of whether he is a prospect or not at that time, is assured of the service extended by this firm and informed that his visits to the yard are always appreciated. These facts, together with the architectural service extended by the firm, have built a business from a one-man-part-time affair to one that commands more than \$125,000 in annual sales.

CHAS. N. TUNNELL.



Another Type of Skintling, Pressed Joint with Mortar Overhang. J. E. Plant, owner; Bohnard & Parsson, architects, Cleveland.



Mixed Clinkers and Swelled Brick, Laid All-Rolok, Headers Projecting. Mrs. M. G. Thompson, owner; Van Belt, Thompson & Churchill, architects, New York.

The Lead Mattress

How Foundation Vibration Is Eliminated in the Skyscraper Type of Construction

LEAD plays many strange roles, but probably none more unique than its use as a shock absorber for buildings in what is known as a vibration plate or mattress, says an article in a recent issue of the "Dutch Boy Quarterly," published by the National Lead Co.

The vibration mattress is used in the skyscraper type of construction where the elimination of foundation vibration is found necessary. This condition sometimes occurs where a tall building rests on solid rock such as that which forms the geological structure of Manhattan Island. It was discovered that under some circumstances vibration was transmitted from the bed rock up through the foundation piers to the building itself.

This factor of vibration became of such importance to structural engineers that an investigation was made to determine just how the problem might be solved. They finally adopted the lead vibration mattress as a corrective.

This mattress is a huge sandwich composed of two sheets of lead between which are an asbestos sheet, a galvanized steel sheet and another asbestos sheet in that order.

One mattress is laid on each foundation pier of a building. The piers are constructed to support the required weight per square foot, and are topped with cement, leveled off. On this is put a thick sheet of tar paper, large enough to cover the whole surface. Next, a sheet of 8-pound lead is placed on the tar paper. This lead sheet is larger by about 3 inches all around than the subsequent plates. The reason for this overlap will be seen presently.

On top of the lead is placed a sheet of asbestos, $\frac{3}{8}$ inch thick, then a 20-gauge galvanized steel sheet. Next comes another sheet of asbestos, $\frac{3}{8}$ inch thick, and finally another sheet of 8-pound lead, the same size as the asbestos and steel sheets.

The bottom lead sheet is now turned up and lapped over the top lead sheet, thereby encasing the asbestos and steel entirely in lead. Completed, the mattress measures one inch in thickness.

After a sheet of heavy tar paper is placed on top of the mattress, a grillage is laid, consisting of I-beams arranged side by side and imbedded in concrete. Holes are drilled in the I-beams to permit the passage of tie rods which hold the beams in place. When inserting the tie rods, collars are slipped over them between each pair of I-beams so that when the rods are finally secured each beam is equidistant from its neighbor. A form is now set around and grout run in to a depth of approximately 3 inches. This is followed by concrete, the grillage beams being entirely covered with it. Before the grout and concrete are run in, anchor bolts for the column are set in the grillage.

It is sometimes necessary, especially where foundations of adjacent structures are within four inches of the pier under construction, to insulate the sides of the grillage with a filler of cork. This practice so isolates the grillage that there is little chance of any vibration waves being transmitted to the building horizontally.

On top of the grillage a steel slab is placed which covers

the entire surface. On this slab rests the base plate and column.

When the load is placed on the pier, it is thought that the mattress compresses to about half its original thickness. Although no mattress has as yet been removed to prove this assumption, allowance for a 50 per cent settling is always made.

The first set of lead mattresses was installed in 1917 and it probably will be many years before their life can be reckoned. There is little doubt, however, that the mattress will last longer than the buildings erected under prevailing construction practice, because lead which forms the entire covering is the most durable of all building metals. It will outlast, many times

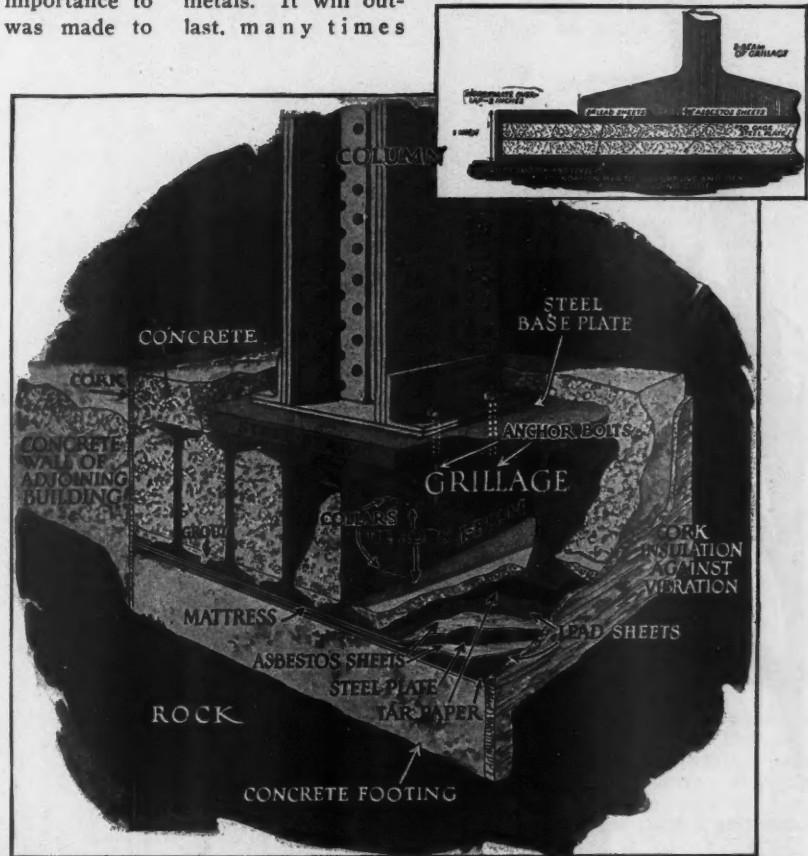

A Typical Installation Showing Lead Mattresses in Position with Grillage, Slab and Column. Insert shows cross section of lead mattress drawn to a larger scale.

over, the steel that constitutes the very framework of the building.

There is, of course, another reason for the choice of lead; that is because it does not carry vibration waves. As every one knows, lead does not vibrate when struck. These two all-important qualities make lead the ideal material for use in the vibration plate.

Since the satisfactory proving of the first lead mattresses which were laid in the Grand Central Terminal area, many new buildings including the Graybar Building, in New York, have been equipped with them. The specifications for the new Union Station at Buffalo also provide for lead vibration plates. The day may come when every large building erected in thickly populated sections is resting on a set of lead cushions.

Detroit's Finest Apartment Hotel

Charles Noble, Architect—Otto Misch Company, Contractors—
Ralph T. Lee, Owner and Builder

DETROIT'S finest apartment hotel, the Lee Plaza, is the latest achievement of Ralph T. Lee, American builder subscriber, whose million dollar Lee Crest Apartment Hotel was illustrated and described in the October, 1926, American Builder.

The new building has many attractive features of design, material, finish and equipment which give it unusual interest. Italian architecture lends grace to the structure. It is 17 stories high, built of concrete and steel, faced with brick and stone. Its arched entrance is adorned with marble



The Lee Plaza Apartment Hotel, Detroit, Owned and Built by an American Builder Subscriber, Mr. Ralph T. Lee, Is Said To Be Detroit's Finest Building of This Type. Among other innovations, it has an airplane beacon on the roof which throws a nine million candle power light into the sky and has been recognized by the government as Detroit's official airline beacon.

columns and the lobby is finished in Italian marble. The

entrance and lobby elevator doors are of heavy, cast bronze. A powerful beacon light of 9,000,000 candle power throws its beams into the sky and this light has been recognized by the Department of Commerce as the official airplane beacon for the city of Detroit.

The building contains 200 apartment suites ranging in size from one to four rooms and each suite will have loud speaker connections from three radio receiving sets on the roof.

In addition to the spacious lobby and adjoining lounge, the most noteworthy features of the ground floor are the large main dining room which seats 125 guests, the beautifully decorated ball room and the spacious corridor promenade between them known as "Peacock Alley." The dining room is paneled in American Walnut and both dining and ball rooms have high ceilings with beautiful plaster decorations.

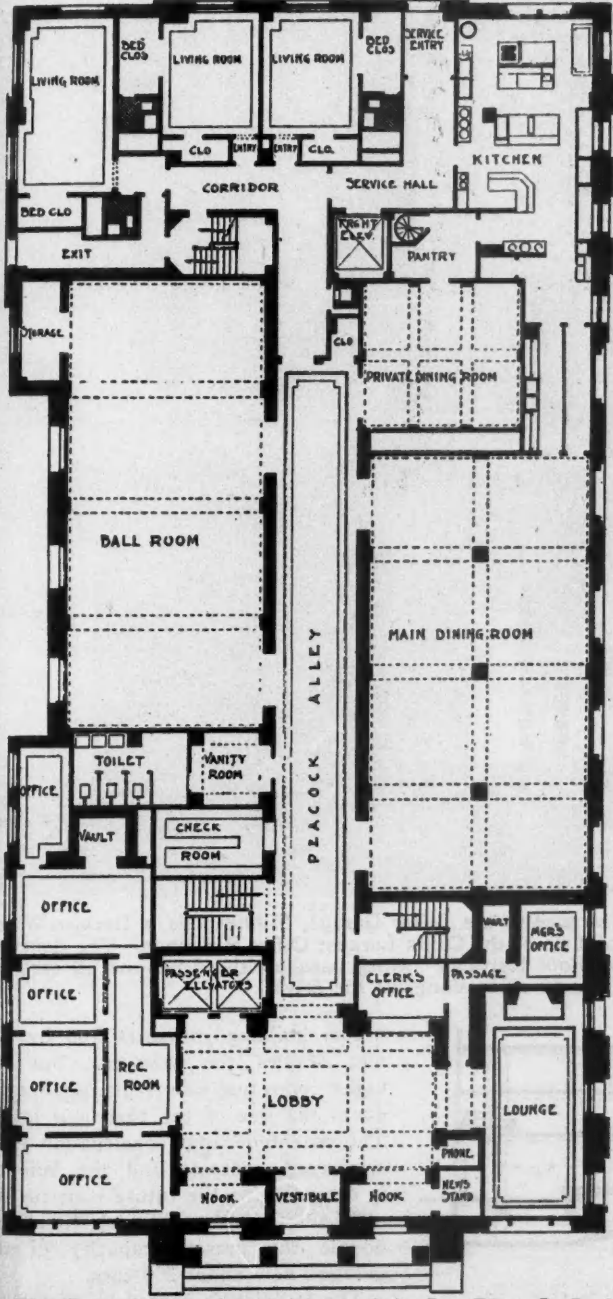

The Ground Floor Arrangement of the Lee Plaza is Such as to Assure the Maximum of Comfort to Guests and Efficiency in the Operation of the Hotel. The lobby and adjoining lounge are spacious and a long corridor known as "Peacock Alley" leads to the main dining room on one side and the ball room on the other.

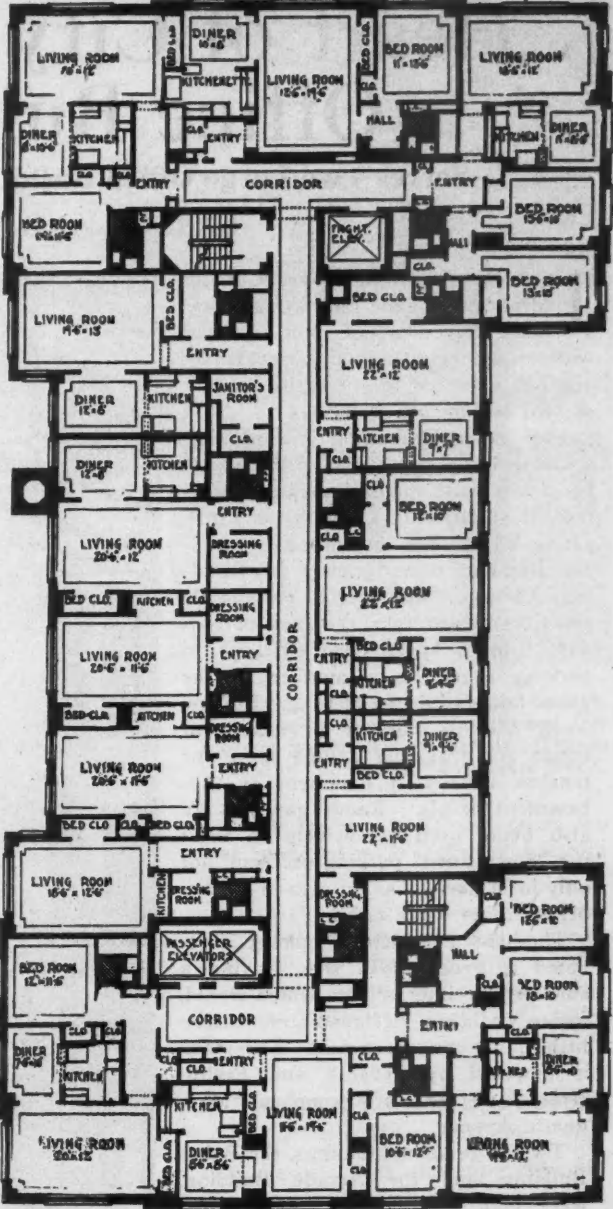

Typical Floor Plan of the Lee Plaza Shows Suites on Both Sides of a Central Corridor with Ample Light and Air in All Rooms. Living rooms have disappearing beds and adjoining bed closets providing extra sleeping accommodation. Kitchenettes and diners are small but conveniently arranged and equipped with gas ranges and automatic refrigeration.

The building is heated by three 79-inch boilers fired by automatic stokers of the domestic type which use motors for fan draft and for carrying coal to the burners which are operated by thermostats.

The kitchenettes throughout the building are equipped with automatic refrigeration, each having its separate control but arranged on the multiple unit plan, 12 to 14 being supplied from one compressor.

More than 200 disappearing beds are installed in the various hotel suites, bed closets being provided off the living rooms. A special type of treated oak flooring is used throughout the building which is laid in asphalt mastic on the concrete floors without nails. This type of flooring, it is claimed, will not warp or shrink.

The clock system consists of a master clock in the office of the building operating clocks in every suite.

Each suite has automatic dumbwaiter service replacing bell boys for practically every service required. Three electric elevators of the gearless traction type serve the tenants of the building.

Heart of City Block Used for Office Building Garage

Serves Two Large Office Buildings Which Are Connected by Arcade

LARSON AND McLAREN, Architects

IN the design of the Baker Garage, Minneapolis, the architects have made clever use of interior space without sacrificing rentable street frontage for a garage to serve the tenants of two large office buildings.

The problem of automobile parking space in large city business districts is becoming acute and designers are meeting the situation in a number of interesting ways. For instance, the Jewelers' Building, now the Pure Oil Building, Chicago, has special automobile elevators which take the cars of tenants from a lower level entrance to parking space on a number of the upper floors of a special wing. In New York City, a number of apartment hotels are providing garage space for tenants, usually at basement or sub-basement levels. Ramp garages are also being used extensively to meet the "down-town" parking problem, not only in Minneapolis, but also in a number of other large cities.

The block in which this garage is situated is generous in size, leaving a considerable interior area which would, under ordinary circumstances, return little or no rental revenue. The block is bounded by Seventh and Eighth streets and Second Avenue and Marquette Avenue.

Two large office buildings, the Baker Building and the Arcade Building, were built on opposite sides of the block and the architects planned an arcade connecting them, running diagonally through the block and connecting also with an intersecting arcade, with the office building lobbies and the Baker Garage.

This garage is of the staggered floor type with connecting ramps, equivalent to five full floors, the lower three levels being beneath the sidewalk level.

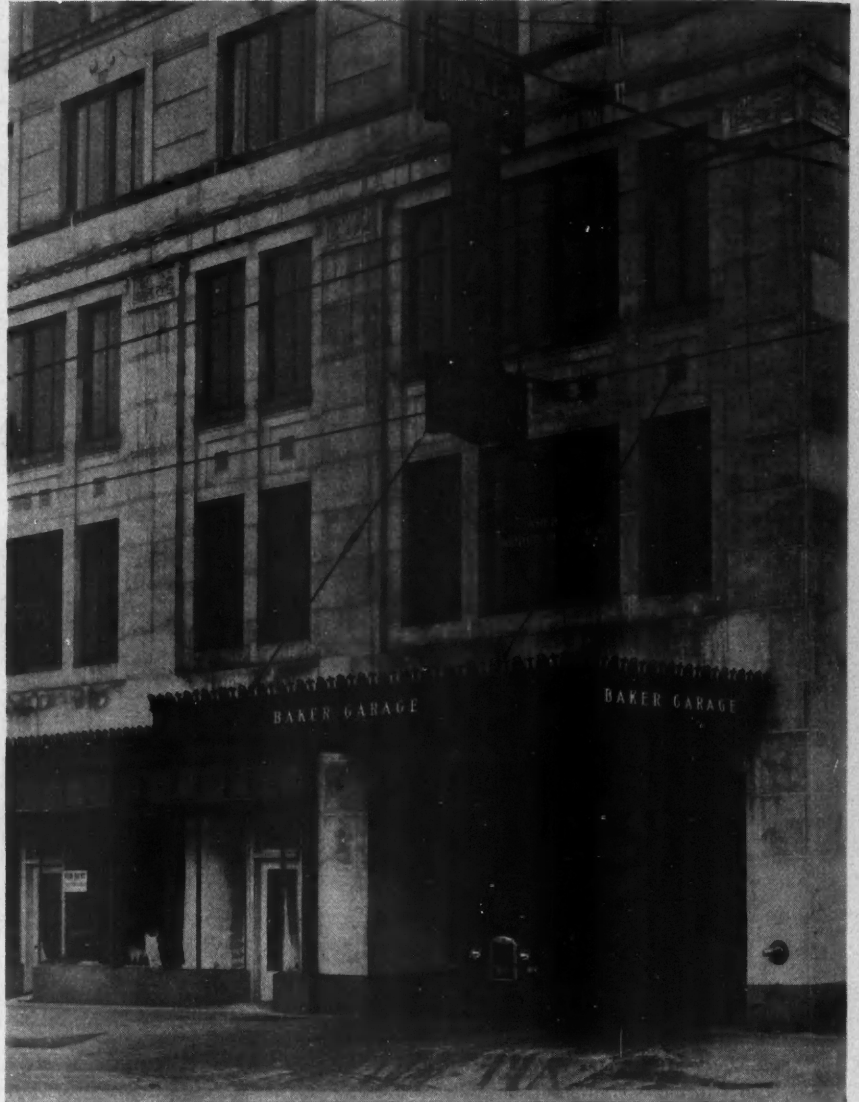

Eighth Street Entrance to the Baker Garage, Minneapolis, a Garage Which Serves the Tenants of Two of the City's Largest Office Buildings. The doorway to the left leads to a "Foot Entrance" which parallels the drive and all cars are checked in and out from an office alongside the drive.

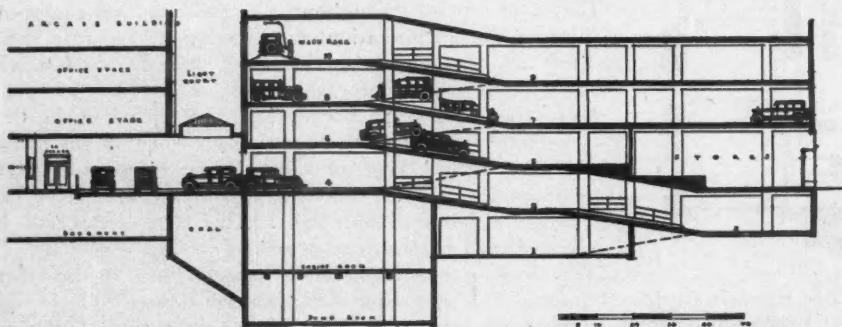

Cross-Section Showing Staggered Floors and Ramps of the Baker Garage with Parking Space on Ten Levels. Provision has been made for the addition of eighteen additional levels.

The building measures 100 by 155 feet besides the approach, but the boiler room and power plant space reduces the size of the basement levels. The patented ramp construction is of reinforced concrete and the building is designed for the future construction of 18 additional levels which will almost double the present capacity of the garage—now about 260 cars.

The building is heated by unit heaters, one of which shows in the illustration of the entrance driveway. The garage is provided with a women's waiting room. Very little heating is

required, as a rule, for the upper floors of ramp garages on account of heat finding its way quite easily up the ramps from floor to floor. Care has been taken in this garage, as should always be done, to place the unit heaters high enough so that there can be no interference with, or damage to cars being driven to and from parking locations.

Illumination is quite simple, being provided by rows of lights from 15 to 20 feet apart in the main aisles and ramps. Generous illumination at the entrance is advisable and this is provided under the marquee and in the approach drive of the Baker Garage.



Interior View of the Baker Garage, Minneapolis, Showing Ramps and Car Storage Space on Two Levels. This is typical of all but the basement levels.



Entrance Driveway to the Baker Garage Showing Office Where Cars Are Checked In and Out, Also Doorway to "Foot Entrance." One of the unit heaters which heats the building shows in the immediate foreground.

There are two greasing pits on the first floor and wash racks on the tenth level.

The architects, Larson and McLaren, have made ingenious use of the interior space of this site, not only by the arcades and shops, but no less in the location and design of the Baker Garage.



A Modern Housing Project

(Continued from page 96)

In Bassett Park the company built the elaborate Haskell community house, which was deeded to the city upon completion. Situated on one of the best pieces of land in the development with a beautiful stretch of woodland for background, this building has drawn interest and favorable comment from the heads of many building firms from other cities. Its interior equipment includes a swimming pool, gymnasium, bowling alleys and club rooms for women's organizations.

The development contains nine small business districts designed to take care of light store needs of property owners. These districts have been restricted by the company to half-block structures and any enterprise that might be described as even semi-industrial is barred from these locations.

The Modern Housing Corporation is carrying on similar projects in other cities, including Pontiac, Mich., where 650 houses were built in 1926 and 150 in 1927; Janesville, Wis., 160 in 1926 and 15 in 1927; Lansing, Mich., where 28 houses were built in 1926.

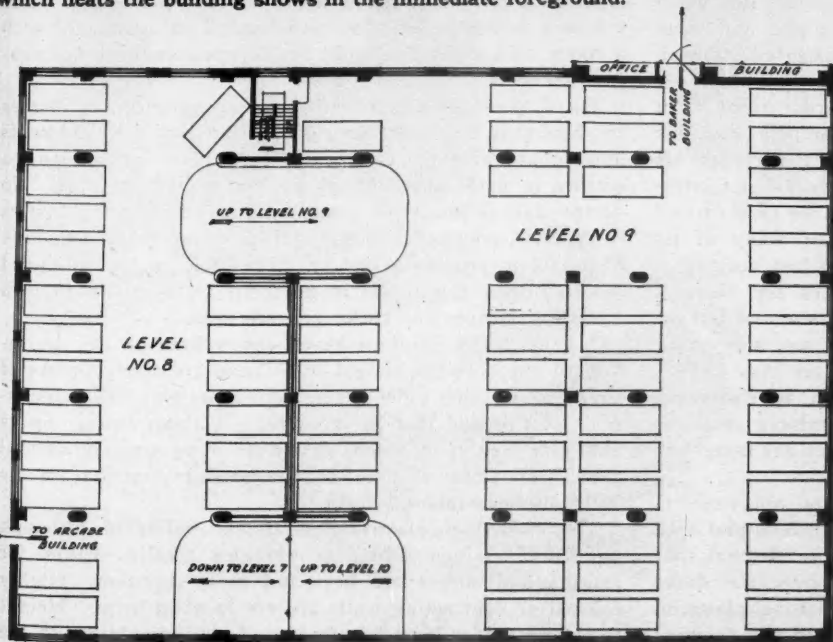

Typical Floor Plan of Baker Garage Which Shows Car Storage and Ramps Leading from One Level to Another of the Staggered Floor Construction. On each of the upper floors there is space for parking about 65 cars.

DETAILS *f* HOME BUILDING



The Western Bungalow

By V. L. SHERMAN,
Lewis Institute of Technology

TOO great stress is laid in architecture on the lines of various imported fashions, on their influence, and their inherent beauty. The writer admits the fault and with only one excuse, that is, because the majority of the better types of homes being adapted from old country studies show more variety than native designs. But there are a few types of strictly American lines which in his opinion outdo any of the foreign. One of these is the Western or California bungalow.

In the cities and larger towns there is ever an aim toward the imposing building. Size must show and what we have come to call "front." There is so little background and the want of background is so little realized that street after street grows up of conglomerate designs. This fact is less apparant in America than in Europe, but it leads many architects into proclaiming most of the cities ugly. And they are, to certain minds.

At the other extreme there is the work of the pioneering American. He forsook the cities for other than architectural dislikes but when he came to build he wanted to get even further away. Through the central states his marks of 1850 and later invariably show outskirts colonial types both from the north and south. As he crossed the plains material wants decided his style for him. But when he reached the mountains and the Pacific slope, and especially southern California, his cunning reasserted itself in the luxury of material and location.

The pioneer was always modest as regards "front." In his architecture he never attempted to compete with his surroundings, but he had a way of putting them to his best uses. The bungalow type became them, did not interfere in any way, took every advantage. So the type carried back east, changing and, some say, losing many of its beauties. But I recall many cases where it lost nothing.

Through the northern woods where lakes are plentiful and hills are thick with timber, you will often find bungalows, small and large, some enormous ones, and many built of logs. The air is bright in summer, the sun may be hot, and distances great. The natural tendency to shade the eyes with the hand makes for the great overhung roof, the broad covered porches and the desire to perch the bungalow on a rise of ground.

In Fig. 1, we have a bungalow of a type not western, except in line. There it stands on fair flat ground and with features built in to attract. Still there is no element that is disturbing. The eaves are very broad over the shake sides and the chimney rises from a base of stone, plastered brick with small brick trim. To the right of the chimney and under the shade of the roof and tree is a row of tall casement windows. Perhaps the place is more than necessarily decorative, but in flat territory it is less noticeable.

Fig. 2, is the top-side of a studio built in New York. The point is that, being at the edge of a crest, no better style could have been chosen than this. No heavy rafters are visible, but the long hips and the heavy saddle back of the stone chimney bring out the beauty of a great roof. And here is one of the instances where an outside chimney of rugged size and structure should be used. While this building is not a bungalow the particular appearance makes it an excellent study.

In Fig. 3, we go back to California. It is quite apparent that these homes are up the hill. While California has no patent on hills they have the privilege of telling us what to make of a house when we place one on a hill. Can you think of any style, save a Swiss chalet or an Asiatic bangla, that could sit contentedly and so well.

In Fig. 4, there is shown the large porch which, with its show of rafters, may, in a bungalow, be anything from a living room to a vine covered pergola. One of the great points in favor of bungalows is their easy adaption of porch and garden framing. For instance, in Fig. 5 is the corner of a bungalow porch that is really covered with wistaria. And in Fig. 9, is a glassed room-end over which there is to be a trailing curtain of vine. Fig. 6 again shows the possibilities in windows under a proper roof protection. The curtains, however, look too nice for full enjoyment of such a room. There is, or should be, an openness about bungalow windows.

Fig. 7, presents a more cultivated appearance but it goes to show that long, overhung gables, hip roofs, decked roofs and squat chimneys can combine to make as pleasing a picture in park surroundings as can any other style. No better style is found for park buildings, community houses in grounds, or country club buildings where there is enough of nature to provide a setting. The style seems descended at times from the slopes in northern Italy and to fit well groomed terraces and rocky grounds alike.

A great many opinions have been written on the derivation of the western bungalow. There are many points of similarity to other older types, some quite plausible explanations of this and that in the style. Without setting up as authority we are inclined to believe it an entirely natural growth of American type, drawing possibly most from the early Mexican mission style.

The choice of materials is almost unlimited although unfinished stained siding or shingles (really shakes for length) and stones are best and most common. Highly colored or contrasting walls are not in good form. Height to the first floor level is a matter of accommodation to the building site. The arrangement of ground plans is controlled entirely by taking every advantage of the building site for sun, trees, outlook and domestic accommodation.

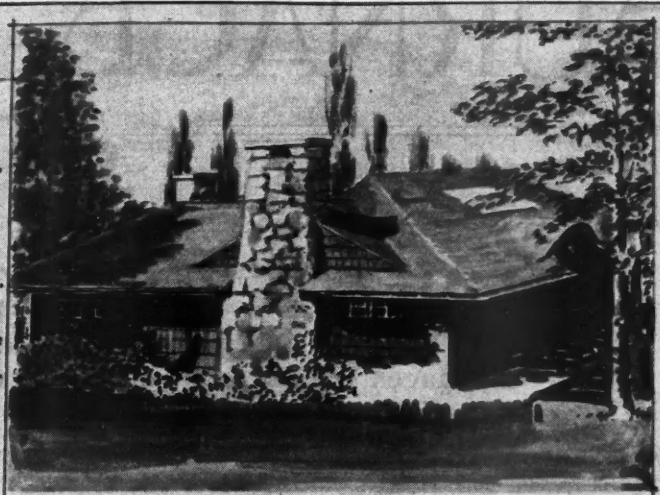

FIG. 2. AT THE TOP OF THE HILL. ONE SIDE OF AN EASTERN STUDIO.

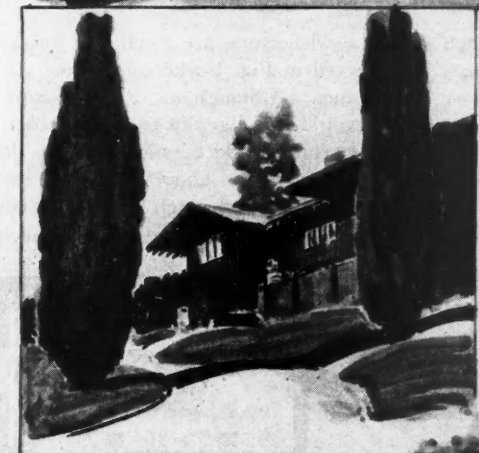
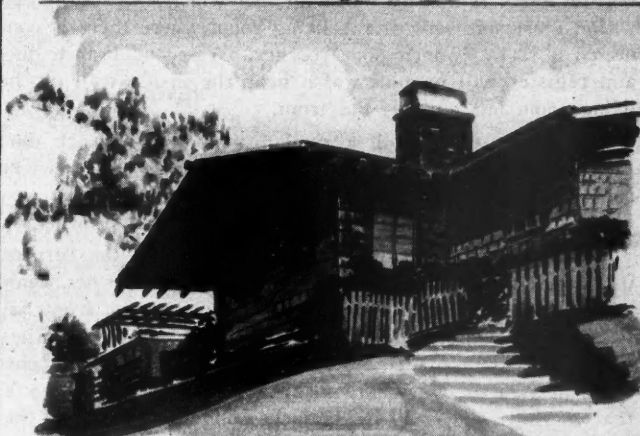

FIG. 3.

FIG. 7.
FLAT HIP AND
GABLE ANGLES
COMBINE WELL
WITH CURVED
TERRACES.



FIG. 8. NOT VERY MANY POINTS, BUT SOME LINES.



FIG. 9.
J. R. Sherman 1-28-28.

Some Examples of the Western Bungalow and Its Variations.

FURNACE HEATING



Warm-Air for Cellarless Houses

How Houses Without Basements May Be Successfully Heated with Warm-Air Furnaces When Recirculation and Mechanical Fans Are Used

This Department by R. C. Nason, Heating Expert, appears every month in American Builder.

ABSENCE of free area below the first floor, as in the increasing popular basementless home, has occasioned some little anxiety among heating installers who favor the warm air method. Accustomed as these men are to plenty of space for extension of heat and air supply ducts, not a few needlessly have fought shy of the furnace for such buildings and readily given up to other methods.

Getting back to fundamentals, it is generally understood that where there is a furnace there must be a cellar. There is the more or less old-fashioned notion that without basement space warm air ducts cannot properly be installed with sufficient pitch to give the heat a good upward start. We say "old fashioned" because those who still feel this way about warm air heating have overlooked one important piece of equipment, namely, the mechanical fan. With the introduction of this appliance Ante- and Post-Civil War ideas as to warm air heating have had to be changed for heat leaders may now be rectangular as well as round, horizontal as efficiently as pitched, run underground or between rafters with little loss in temperature or effectiveness.

Cellarless houses, to be sure, cannot well be heated by gravity air flow, wherein the heat supply is delivered to the rooms under its own head. Fans must be used and if they are included in the plans almost any size and design of cellarless building, be it residence or factory, club or theatre, can be heated with warm air. The heating system thus becomes an ordinary air handling problem such as has been satisfactorily met in material conveying systems and hot blast heating work during the past half century.

A brief description of the warm air plant recently installed in a 15-room Massachusetts home should prove instructive as the cardinal features involved apply equally well to almost any basementless residence. The ground beneath is unexcavated, with the exception of a small area at the rear which contains the furnace, coal bin, closet and storeroom.

The first-floor plan appears in Fig. 1 and most of the desired information is here revealed. The heat supply main is of cement and extends underground directly from the back to the front of the building. There is also shown the direct-connected fan, the recirculating duct, piping connections, alternate fresh air inlet and the furnace. Although the heat leader runs straight down the center, yet only the laundry and front hall registers are without branch ducts.

The pantry and kitchen, for example, are six feet off the supply line, which necessitates a 12 by 12-inch branch duct in each case. To these branches there is connected an 8 by 12-inch floor register in the pantry and a 10 by 12-inch register in the kitchen. The branch duct to the dining room, about

three feet distant from the main, is 10 by 12 inches, to which there is connected a 14 by 16-inch black-japanned, lattice design, floor register. The short connections from the heat main to the front hall register is 10 by 12 inch and its register 14 by 16 inch.

At a point opposite the dining room branch duct and its register there is a 9 by 9-inch branch which extends to just within the inside wall of the living room where there is connected a 12 by 15-inch floor register. A second branch duct and register will be noted also near the inside wall of the living room but towards the front.

The den is warmed in a similar manner, its branch duct forming one leg of a Y, having for its other leg a riser which runs to the second floor. Attention is directed to the easy bends in the duct and the graduation of the Y branches.

Whereas the heat main is 20 by 45 inches at the furnace, its size is diminished at the pantry to 20 by 40 inches, again at the hall to 20 by 36 inches, further along at the front hall to 20 by 26 inches, and a little further on to 12 by 20 inches. Here the main contains 240 square inches while its branches have an area of 200 square inches. The right leg of the Y, that to the riser, is 10 by 12 inches and the other leg, that to the den, is 8 by 10 inches.

The duct branch scoops, or deflectors, are worthy of special notice. These may be observed in Fig. 1 where branches take off from the heat leader duct. Although a certain quantity of warm air in any event would find its way to the rooms to be heated if there were no branch duct reflectors, yet the insertion of these galvanized iron pieces about six inches into the path of air flow insures filling the branch pipes with the quantity of warmth needed to heat the rooms which they serve.

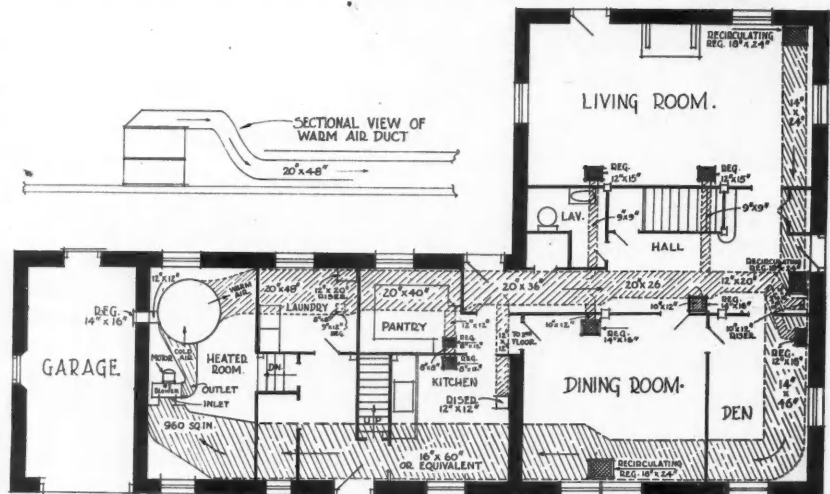

Fig. 1. First Floor Plan of a 15-Room, Basementless Residence Which Was Successfully Heated with a Warm Air Furnace. In this plan the warm air ducts are fully indicated.

The recirculating duct also has deflectors but of a different pattern, as is shown in Fig. 2. Were these not included in the duct the influx of air from the different recirculating registers might interfere with the flow of air already within the duct. It need not be reminded that unless a furnace can secure an adequate supply of air, there will be insufficient heat as a natural consequence. No furnace can make its own air supply but must depend on outside sources which include either a connection outdoors, interior air passed back to the heater for re-warming, or both.

The second floor of the residence here discussed has a total of eight rooms and a bath room all to be warmed by the heat forced along by the mechanical fan and within the cement underground duct. Reference to the plan (Fig. 1) demonstrates that the first heat riser stack to branch off from the main duct extends through the laundry and is 12x20 in. Another riser passes through the kitchen and is 12x12 in., and a third is concealed within the panelling of the front hall. This is 10 by 12 inches in size. All risers are of galvanized iron, insulated with several thicknesses of asbestos paper.

The amount of heating duty placed on the rear, or laundry, second floor duct is considerable but the rooms are small, hence are easily warmed. The laundry riser branches in opposite directions. Although it emerges as 12 by 20 inches, the branch extending to the rear is 10 by 12 inches at its beginning and is reduced to 8 by 8 inches at its end. Two chambers are warmed from this branch, the first having an 8 by 12-inch wall register, located about two feet above the floor, and the second a 10 by 14-inch register of the same kind.

The opposite branch duct passes to the front of the building and although it starts as 10 by 12 inches, it is graduated to 9 by 9 inches. This branch serves three rooms, two chambers and a bath room. Registers here, as is likewise true all through the second floor, are of the convex type, finished in white japan and are of lattice design. Although the bed room registers are placed two feet above the floor, that in the bath room, 8 by 10 inches, is located two feet above the tub.

The heat riser which runs through the kitchen supplies heat to two chambers, one of them a master, and the riser extending through the front hall serves two front master chambers.

It previously has been pointed out in other articles that the air supplied to a furnace for warming must be pure, hence should be taken from rooms where cooking, laundry and other odors are absent; also it is customary to take air to be rotated from halls, living or dining rooms. This has been done in the basementless Massachusetts home.

There is an 18 by 24-inch floor register in the remote, or outside, corner of the living room, another of the same size in the front hall and a third, also of the same size, in the dining room. These are placed where the air is likely to be coldest hence heaviest. Beneath windows is the preferred location.

Although the gross area of the recirculating registers is 1,296 square inches the free area is only about 960 square inches which is the size of the recirculating duct near the inlet of the fan. The location of the fan and ducts in the building shown represent what is known as a draw-through system, in contrast to a blow-through arrangement wherein the fan is placed on the other side of the heater, that is, on

the heat delivery main. Note also the careful graduation of the duct from small, at its end, to a gradually increased size until it reaches its maximum of 16 by 60 inches near the fan inlet.

The most remote recirculation register is that at the corner of the living room where the duct is 14 by 24 inches. As the duct adds the branch from the den its size is increased to 14 by 46 inches. At the end of the dining room, where the third and last register is located, it is 16 by 60 inches. Air current interference, as successive branches are connected to the duct, is prevented by diaphragms, or deflectors, patterned as in Fig. 2. These protrude into but parallel with the top of the duct, the distance between the duct and the deflector being 6 inches.

If a skeleton outline of the duct system in its entirety were

to be studied, it would be noted that there are some 20 elbows in the line. These all result in internal friction which acts as a back pressure. Straight duct has similar friction loss but this is substantially less in proportion. Re-

sistance of this sort must be compensated for in estimating the air supply and its temperature and the speed at which the air must travel within the duct to overcome loss of pressure due to friction. Size and revolutions of the fan per minute are directly dependent on the resistance within the duct line.

Friction loss charts are rather common yet for the benefit of readers who are unfamiliar with this phase of forced fan heating it might be stated that loss of head is usually calculated in inches of water, measured by a U shaped tube. Charts based on experiment express the loss per 100 linear feet of pipe of various sizes when air at various velocities passes through such pipes. Elbow loss is taken as equivalent to that lost in about 10 diameters of pipe of the same size. The electric fan installed in the residence shown here has an inlet permitting the use of an 18 by 18-inch square collar. The volume of air handled is 2,350 cubic feet per minute and the frictional loss within the system, including that lost in supply duct, recirculating duct, fittings and furnace casing, was estimated as $\frac{3}{8}$ -in water gauge.

The smoke pipe is of 24-gauge galvanized iron, 10 inches in diameter and the top of the pipe extends 15 inches from the ceiling. There is a cleanout pocket in the base of the flue, its bottom being 6 inches below the point where the smoke pipe enters.

How supplementary air supply is obtained will be noted in Fig. 1. The register in the outside wall is 14 by 16 inches and the duct connected to it is 12 by 12 inches, as it joins the heater casing. Such auxiliary inlets are excellent in providing circulation balance and for use in mild weather. It is during cold weather that recirculation is most keenly enjoyed, for this method provides quick warm-up, a warmed home with less expenditure of fuel and eases the load on the plant, thus lengthening its life.

The mechanical furnace fan has silenced to a large extent the criticism of adherents of other methods that warm air heating must be confined to small homes. The plant installed in the New England residence here shown demonstrates further that if a 15-room residence of the basementless type located in western Massachusetts, where sub-zero weather recurs frequently, can be satisfactorily warmed, other larger-than-average homes, not to mention small industrial buildings, also may be similarly served.

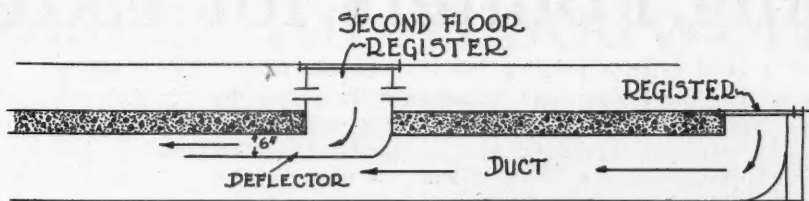

Fig. 2. A Sectional View of the System Shown on the Opposite Page, Showing the Arrangement of Sheet Metal Deflectors in the Recirculating Duct to Prevent Cross Air Currents.

PAINING *and* DECORATING



Painting Pointers for Exteriors

THE importance of a good exterior painting job is difficult to estimate. For the builder who wants a house to serve as a standing example of good workmanship, for the dealer who wants to sell it, and most of all, for the home owner who must live in it, no one item is of more importance. For paint is not only the greatest single contributing factor to beauty, but it is the preserver of structural property as well. To get the best in economy, preservation, and beauty the paint must be of good quality and it must be well applied.

If the surface is not properly prepared, care in actual painting will be of no avail. However, the process is entirely simple when the wood, either old or new, is in good condition. A thorough dusting to remove loose particles of dirt and possibly the scraping or sand papering of a few rough places will suffice.

But for a house that has been neglected the case is quite different. An exterior painted surface, if not renewed, will eventually become cracked and scaly. Where this condition occurs the old coating must be burned off before the

new can be successfully applied. This should be done on a day when there is little wind or it will be difficult to get enough heat on the paint to blister it. When the surface coating has thus been loosened a knife scraper should be used to remove the paint while it is hot. The process is both tedious and expensive but it is absolutely necessary for a scaly surface. It should be done only by an experienced painter. Anyone who has been so neglectful as to allow himself to become confronted with this condition is not likely to do so a second time.

When the surface is carefully prepared the painting job can go right ahead, providing weather conditions are favorable. The importance of this factor cannot be over-emphasized. Moisture, a blistering sun, or excessive cold or frost will ruin any job. For the surface to be quite dry does not suffice, since condensed moisture, the result of frosts, fogs, snow, or rain may be hidden beneath. If paint is applied under these conditions it will eventually become blistered when the sun draws the moisture to the surface.

Another point to be considered is the type of wood used,



Here Is an Example of Exterior Painting Where All Precautions Have Been Carefully Observed. It is only such careful work that can give results which are both entirely satisfactory and of lasting quality.

whether it is hard or soft, close grain or open grain; whether it is generally spongy or compact and solid. For absorption varies and paint must be mixed or chosen accordingly. The proportion of oil should be larger when absorption is great. Again, if wood is kiln dried the paint must be mixed to a thin consistency to assure penetration to the vital wood beneath. The surface area may have become brittle and lifeless, in which case the dead fibres will break away by contraction and expansion with temperature changes if this caution has not been taken. Air seasoned wood, however, does not involve any such danger as it affords a firm footing for paint.

This question of penetration also explains the necessity

of a three coat job for new work, and its desirability even for renovation. Since the first coat must be quite thin its hiding properties are not great. Any attempt to economize by getting along with two coats will be a complete failure both as regards perfect finish and preservation. Skimping on paint is too expensive an economy for the man of moderate means.

For the builder who wants his construction to stand the test of time these points are worth remembering. Surface protection saves the whole. True, it must be periodically renewed—and this should be explained to the purchaser—but the first painting is the most important of all and this task belongs to the builder.

Finishes for Woodwork

WOODWORK can lend the distinctive touch to the simple charm of plain walls. It can furnish the builder's final contribution to an effective, interior setting.

Each detail of a house should be planned in relation to every other detail and to the whole. Before deciding on the woodwork to be used the general architecture must be considered, the wall finishes, the color schemes of individual rooms. Since the finish of the woodwork must be partially determined by the type of lumber, each of these details must be thought out in advance.

Where a stain finish is desired, a mahogany, walnut, chestnut, oak, ash, cherry, selected birch or redwood may be used. For a natural finish, gumwood, red wood, mahogany, American and Circassian walnut, white and red oak, cherry and chestnut. For a painted or enameled finish, white and yellow pine, fir, bass, cottonwood, gumwood, birch and redwood. If either of the first two of these is chosen, the wood should be carefully selected for grain, or the figure and color will necessitate painting or enameling to present an attractive appearance.

If you have a hardwood trim, several interesting effects may be obtained. By coating the wood with a light brown stain that has been grayed slightly by the addition of a black stain, a weathered or silvered finish is produced. This stain dries very quickly and should then be treated with a coat of paste filler which has had either white or aluminum paint added to it in generous quantity. This should be allowed to set for thirty minutes, and the wood then wiped across the grain. After twelve hours the surface may be varnished or waxed or rubbed.

Another artistic effect may be procured on hardwoods such as oak, by the use of a stain and contrasting color in the filler—russet stain, for instance, with white filler, a dark mission oak stain with a filler tinted with Venetian red; golden oak stain with very dark blue filler; or olive green stain with neutral gray filler. These finishes are most attractive for dining rooms.

Painted woodwork makes a bright, cheerful appearance, and is particularly well adapted to the average type house of moderate dimensions and simple style, now being widely constructed. Many combinations which do not adhere to conventional decoration are gaining increasing popularity—jade green woodwork with light buff or ecru walls; tan with



Here Woodwork of a Rich Ebony Finish Is Attractively Combined with Walls of Deep Cream, Giving an Effect to be Long Remembered.

mauve; burnt orange with blue gray; Chinese gold with French blue, and countless other combinations.

A charming effect of rich ebony, which is attractively combined with a number of shades and colors, may be obtained by applying a coat of vermilion flat paint, followed by two coats of black paint slightly tinted with Chinese blue.

The finish coats are of rubbing varnish. Stippled finishes, too, are artistic, and simple to achieve. After the woodwork has been painted the desired ground color—for which two or three coats will be required if the wood is new—a thin glaze coat of contrasting color is applied, which is stippled with a large stippling brush. The brush should be kept fairly clean and dry by frequent wiping.

Good color combinations are light buff ground with olive green glaze; Venetian red ground with mahogany glaze; white ground with orange glaze; silver ground with blue black glaze, ivory ground with raw sienna glaze. Due to the extreme thinness of the color glaze, the durability of these finishes will be greatly enhanced if a coat of varnish is applied when the glaze is dry. In fact, varnish is very desirable to preserve woodwork painted in any manner.

The builder should give due consideration to this problem of woodwork. By finishing it in an appropriate manner, he can give an artistic note that will make the setting of a house complete for an artistic interior.

HOW DAN DOES IT



A Department for Passing "Life Savers" along to other Builders

\$2 for an Idea

Dan is an ingenious cuss. Nothing ever stumps him. He always knows the way out when he runs into a tough problem out on the job or in the office. Dan is editor of this Department and will pay \$2.00 each for every good idea he can use here to show and tell other builders "how to do it." Send him a rough sketch and a short description of what the tough job was and how you handled it. Address Dan-Do-It, care of American Builder, 1827 Prairie Avenue, Chicago, Ill.

A Sliding Door Idea

IN installing sliding doors in a garage a great deal of cold air and snow can be kept out by the method illustrated in the sketch. An angle iron is screwed onto the bottom edge of the door with the drop edge outside. Other angle irons are placed in the concrete on each side of the door, with about 3/16 inch play, as shown in the diagram.

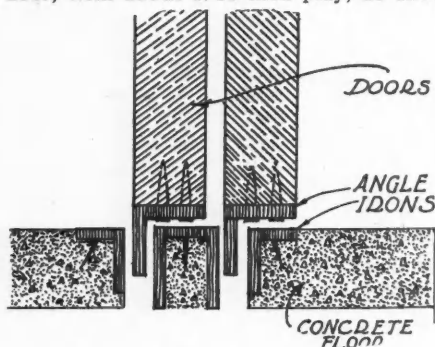

This Sketch Shows a Method of Using Angle Irons to Keep Snow and Cold Out of the Garage.

other, the same method can be used. It is this type which is shown in the sketch.

NICHOLAS L. BINEER, JR., 207 Elm St., Trenton, N. J.

To Keep Files Sharp

SOME carpenters seem to have difficulty keeping files from wearing out. I have even seen some use two files to file one saw. They think that when a file gets full of steel dust it is worn out. If you will always oil the teeth of a saw before starting to file it your file will last two or three times as long. After filing a saw take a piece of hardwood charcoal, as maple, rub it over the file and you will find that it will then cut almost as well as a new file. These two things are all that are necessary to get real service out of files.

EMANUEL BURKMAN, Architect, 803 Federal St., Camden, N. J.

Laying Out Arches

IN forming arched openings for windows and doors it is frequently necessary to strike an arc of a circle. There is a quick and easy way to do this without any calculations

or instruments. Suppose you have an opening 3 feet wide and want an arch with a rise of 7 inches. Take a board 3 feet long. Put a nail in each lower corner. Mark a point 7 inches from the lower edge and in the center of the board and drive another nail at this point.

Now take 2 laths, place one of them against two of the nails and the other against the nail at the 7-inch mark and

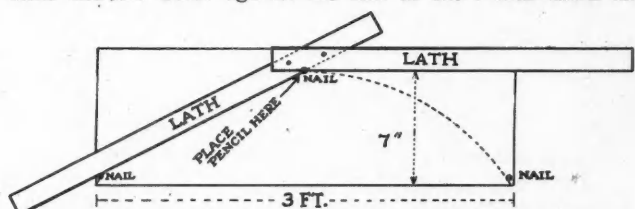

A Simple and Accurate Method of Describing a Perfect Arc Without Instruments or Calculations.

parallel with the bottom edge of the board. Nail these two laths together. Place your pencil in the angle formed by the 2 lath and slide the laths around the nails keeping them snug against the nails. The pencil in the angle of the laths will describe a perfect arc.

JOHN BRERETON, Route 3, Walworth County, Elkhorn, Wis.

Keeping Out Cold and Dust

HERE is an idea which will add to the warmth and dustproof qualities of any room. Take an 8-inch strip of building paper. The tough, water-proof paper now on the market is best for this purpose as it is less liable to creep and consequently open up after a few years service. Place this strip of paper in the angle formed by the floor and side wall. It should extend up against the wall under the baseboard and should project out along the floor between the sub-floor and finish flooring.

L. W. PIKE, 17 Brattle St., Brattleboro, Vt.

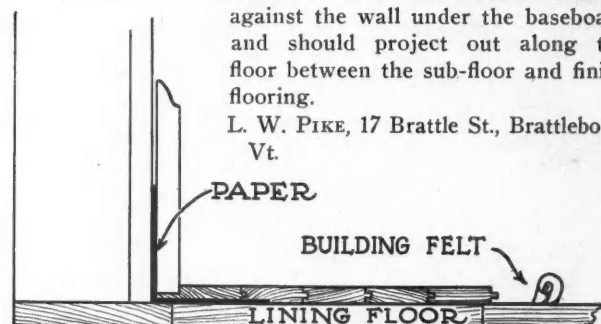

Building Paper Placed as Shown Here Will Make the Room Warmer and Keep Out Much Dust.

To Form Curved Wall Board

RECENTLY placed plasterboard to form a curve at the head of a wall, where it meets the ceiling, without using a curved back or brackets. The method is quite simple and will be found useful by others, I believe.

Place the sheet to be curved against any wall, with the part to be curved down. Use clean water and, with a white-wash brush, wet both sides of the board at the place where it is to be curved. Place a strip of wood horizontally across the center of the curve and lean another piece on this strip, the other end resting on the floor, forming a "T." On the last piece place a weight, about 10 pounds, and you will be surprised to see how quickly the curve is formed. Moving the weight backwards and forward on the strip helps to form the curve more quickly.

One additional wetting will be found sufficient. Allow the board to partially dry and, when placing, nail the head, marked "A" in the sketch, placing nails about 3 inches apart. Use a board lever at the foot of the sheet to pry it upward to get the required curve.

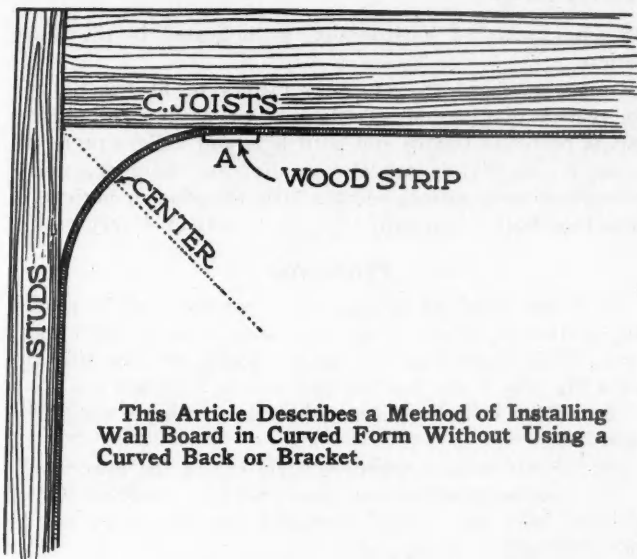

This Article Describes a Method of Installing Wall Board in Curved Form Without Using a Curved Back or Bracket.

In the first operation of forming the curve do not form a curve that is sharper than required, in fact make it somewhat less sharp and you will find it surprisingly easy to form your curve in place and meet the next sheet laid. The balance of the sheet can be nailed in the usual way.

JAMES C. WAREOP, 120 Wabash Ave., Kenmore, N. Y.

Mending a Cracked Boiler

WE had just completed alterations to a residence in the country and the owner suggested that an inspection be made of the heating boilers and hot water heating system. This inspection disclosed a large crack about one-eighth of an inch in width and six inches long in the boiler. The heating contractor was called on for advice and he suggested the use of boiler compound; we obtained, and used according to the manufacturer's directions, one of the several boiler compounds that are on the market, but without success, the heating contractor stating that the crack was so large that the compound was not retarded long enough for it to set. He advised dismantling the boiler and taking the part to a shop for welding. Instead of doing this I decided to experiment along lines suggested by his theory of the failure of the compound.

I procured a small quantity of straw and bran, cut the straw into very small pieces and mixed together about two buckets of equal parts of straw and bran. I poured this into the boiler and then proceeded to use the compound as before. This time it was entirely successful, completely

closing the crack and stopping the leak. The small particles of bran and straw worked into the crack and closed the leak sufficiently long for the compound to set.—LINCOLN H. SMITH, McNeill Construction Co., 1505 Race St., Philadelphia, Pa.

Nail Box Stops Waste

THERE is much waste in the handling of nails, especially small sizes, as they become mixed and the workman either throws them away or re-sorts them. The latter is just about as wasteful as throwing them away because the time taken for sorting is expensive. The box shown in

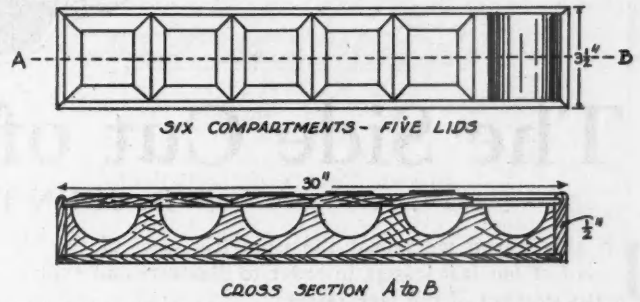

A Nail Box Made Like This Eliminates the Mixing of Nails and Will Be Found Convenient.

the sketch will prevent the mixing of nails by anyone who is not extremely careless, and, if the box happens to be dropped only one compartment will be emptied.

This box has six compartments which offer separate spaces for a wide variety of nails. More compartments can be provided if desired. There are five sliding lids which make it impossible for more than one compartment to be open at a time. If the box is properly constructed the lids will slide easily when desired but will ordinarily stay in place. The rounded bottoms of the nail compartments make it easier to get nails out than would be the case with squared compartments. Such a box is particularly suitable for bench work, where fine finish is done and in schools.

C. J. FERGUSON, 827 112th Ave., Edmonton, Alberta, Canada.

Lumber Handling Made Easier

NOT long ago we were working on a house and because of the snow and ice on the ground, which made it very slippery, had a difficult job standing our lumber against the building. I have also had the same difficulty when it got very muddy. An idea occurred to me which I tried out and found very useful. I took a piece of shiplap and nailed a piece of 4 by 6 at one end of it. I laid this on the ground with the 4 by 6 block up and with that end toward the house. It was then easy to place the end of a board against the block and push it up against the house walking along the strip of shiplap. This way the lumber could not slip away and the men did not slip on the ice.

CHAS. S. RAIA, 60 Sampson St., Garfield, N. J.

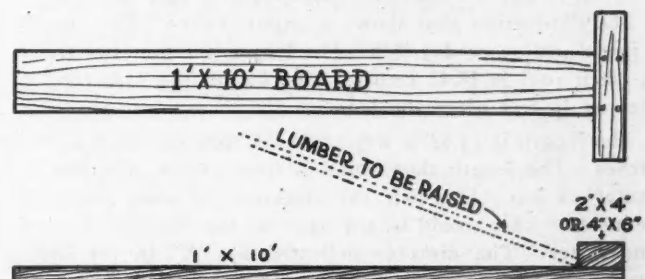

Simple but Very Handy When the Ground by a New Building Is Slippery from Ice, Snow or Mud.

INSTRUCTIONS *in* ROOF FRAMING



The Side Cut of the Jack Rafter

By JOHN T. NEUFELD

IN this lesson we repeat the isometric view of the hip roof of our last lesson, in order to illustrate and explain the side cut of the jack rafter.

There are various ways of obtaining the side cut. If the roof were flat then cut would be a 45-degree cut. As the roof takes on a pitch the side cut changes. Some carpenters will use the numbers 10 and $10\frac{1}{2}$ on the square, marking along that arm of the square on which the $10\frac{1}{2}$ is taken. These numbers will be fairly accurate for the lower pitches, but for the steep pitches this bevel will not be enough.

Fig. 2 is given in order to illustrate the rule for the side cut. The body of the square lies along the length of the common rafter, and the tongue lies along the plate, or as might be termed along the tangent to the common rafter. The length of the plate from the foot of the common rafter to the foot of the hip is the same as the length of the run of the common rafter. Therefore, if we take the length of the common rafter on one arm of the square and the run of the common rafter on the other arm of the square we have the right numbers for the side cut of the jack rafter. Or if we wish we may express the rule as follows: Take the length of the jack rafter on the body of the square and the run on the other arm of the square and mark along the body.

This same rule may be changed as follows: Take the length per foot run on the body of the square, and 12 inches on the tongue and mark along the body of the square.

From this rule we may compile a table as follows:

Rise per foot run	Length per foot run	Side cut of jack
6 inches.....	13.42 inches	$13\frac{1}{2}$ and 12
8 inches.....	14.42 inches	$14\frac{1}{2}$ and 12
9 inches.....	15.00 inches	15 and 12
10 inches.....	15.62 inches	$15\frac{1}{2}$ and 12
11 inches.....	16.28 inches	$16\frac{1}{4}$ and 12
12 inches.....	16.97 inches	17 and 12

Note that the numbers for the side cut are to the nearest $\frac{1}{4}$ inch, as this is accurate enough for this work.

The illustration also shows a cripple rafter. The run is 2 feet 8 inches, or $2\frac{2}{3}$ feet. The length per foot run for a $\frac{1}{3}$ pitch roof is 14.42 inches. The length per foot run \times the run in feet gives the length.

The length is $14.42 \times 2\frac{2}{3} = 38.458$ feet, or 3 feet $27\frac{16}{100}$ inches. The length thus found is from center of valley to center of hip. One-half the thickness of each must be deducted. This would be the same as the full thickness of one rafter. The distance indicated by "X" in the illustration is the distance that must be deducted from the length of this jack. If the valley and hip rafters are each $1\frac{1}{2}$ inches then this distance will be $2\frac{1}{4}$ inches. This

must be measured horizontally, as indicated in the illustration.

It is very hard to get these rafters to fit exactly for the reason that in our calculations we assume a building that is perfectly square and with hips and valleys perfectly straight. As this is not always the case there are many chances of some rafters being a little too long or perhaps a little too short. Generally this can be adjusted very easily.

Problems

- (1) What numbers on the square would give the plumb cut for the upper end of a valley jack for a $\frac{1}{3}$ pitch roof.
- (2) What figures on the square would give the side cut for a hip jack if the rise per foot run is 7 inches?
- (3) Which rafter requires a side cut or a bevel cut at the upper end?
- (4) Which rafter requires a bevel cut at the lower end?
- (5) The length of the common rafter for a building 30 feet wide is $16\frac{1}{2}$ feet. What numbers on the square would give this cut?
- (6) What numbers give the side cut for a jack rafter if the length per foot run is 18 inches?

Answers

- (1) The rise is 9 inches per foot run, therefore the plumb cut would be 12 and 9.
- (2) If the rise per foot run is 7 inches the length per foot run is 13.89 inches. The numbers 14 and 12 will give the side cut.
- (3) The hip rafter, the hip jack and the cripple jack, also valley.
- (4) The valley jack and cripple jack.
- (5) The numbers $16\frac{1}{2}$ and 12 will give the side cut.
- (6) The numbers 18 and 12 give the side cut.



Grade-Marked Lumber in Demand

AN increasing demand for grade-marked Southern Pine Lumber is reflected by reports received by the Southern Pine Association from its inspector who travels among mills to supervise the grade-marking practice. In commenting on these reports and other information reaching the association, Secretary-Manager Berckes, states: "For a long time buyers of lumber apparently did not fully realize the benefits grade-marking afforded them and they did not particularly specify grade-marked lumber in their purchases. The tendency now seems to be swinging in the other direction and it is a general feeling among our mills which are grade-marking that they will benefit by giving this added protection to their customers."

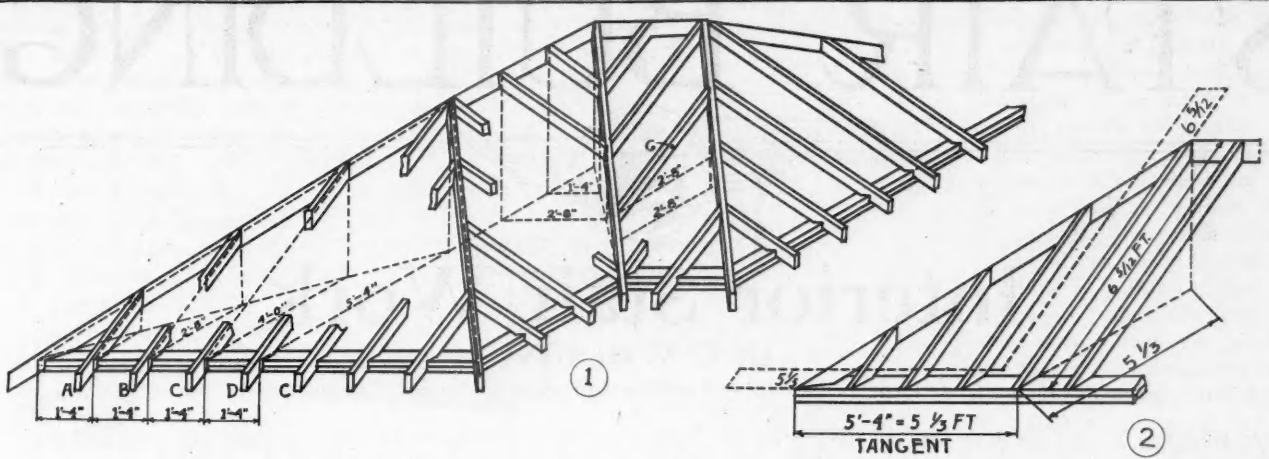

Illustrating Rule for Side Cut

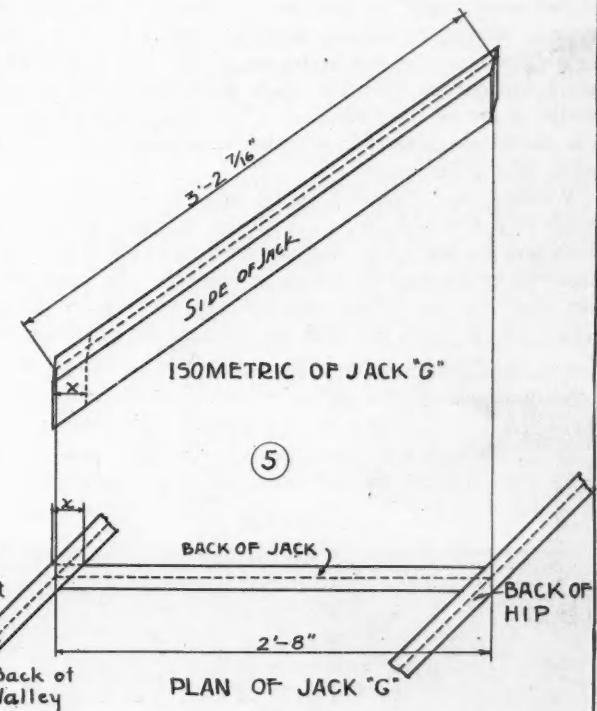
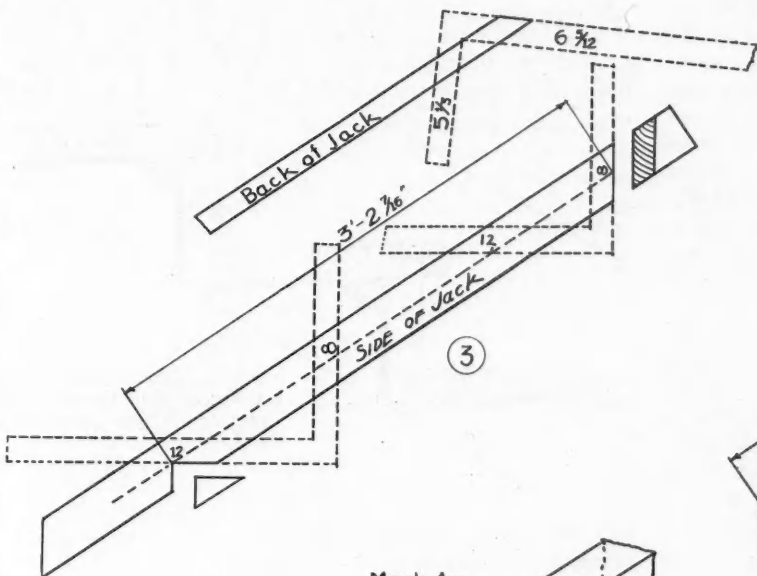

RULE For SIDE-CUT
 Take Length of Jack on Body,
 Run of Jack on Tongue of Square
 Mark along Body Or take
 Length of Common Rafter on Body
 and Run of Common Rafter on Tongue
 of Square

RULE 2
 Length per Foot Run on Body
 12" on Tongue of Square
 Mark along Body

Diagrams Illustrating the Method of Obtaining the Side Cuts for Jack Rafters.

STAIR BUILDING



Interior Stair Work

By C. V. OLSON

Instructor in Carpentry Lane Technical High School, Chicago

IN preceding articles we have outlined method of construction and the principles for laying out outside stairs. Interior stairs must be considered in the same way for the difference lies in the construction only. The terms applied to exterior stairs also apply to interior stairs but we have additional terms such as stair case which is the whole set of stairs, including the landings, and where they are several stories high, the term applies to the whole series.

The term "flight" is that part of the stair case built from floor to landing or landing to floor, or floor to floor. Newel is the main post at the beginning of the stair and is usually more ornamented than the angle posts which are the posts at the angle of the stair case. The term "newel," however, has become so general in use that it usually is applied to all posts in a stair case.

Winders, as in outside stairs, are the steps forming the angle in a flight of stairs. A closed stairway is one that is built between walls requiring no balusters as the rail is usually fastened to the wall by means of brackets. An open stair is one that has one stringer housed and fastened to the wall. The other is open, allowing the nosing and mouldings to be

and allow a wedge to be driven in under the tread and another behind the riser, thereby forcing the faces to the routed edge forming a strong and complete unit.

Routing of the stringer is shown in Fig. 1. Section A-A illustrates the routed section and shows that the sides are undercut, thereby assuring a close fit to the upper surface. When the wedge is driven under the tread it forces the sharp

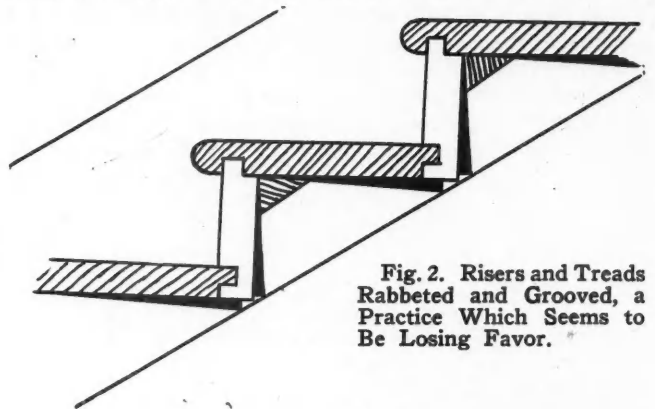

Fig. 2. Risers and Treads Rabbeted and Grooved, a Practice Which Seems to Be Losing Favor.

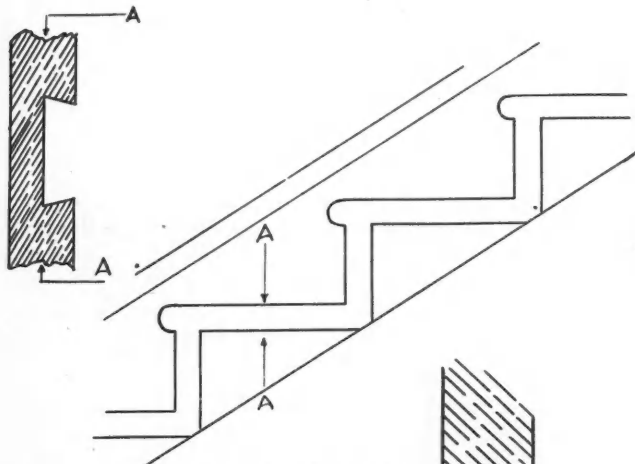

Fig. 1. Showing the Routing of the Stringer, the Routed Section Illustrated at A-A.

returned across the ends of the treads. A rail and balusters form a decorative as well as essential feature of this stair.

In interior stairs the common practice is to house the stringers wherever the ends of the treads and riser are hidden from view. In this method the stringers are cut so as to allow the treads and risers to be supported by about half the thickness of the stringer. This is done by routing out a shape which would conform to the shape of the tread and riser

edge into the surface of the stock, and as the wedge is also glued on both edges, a joint similar to a dovetail is formed, making a joint that is sure to stay out. See Fig. 3.

In Fig. 2 you will note that the riser is rabbeted and grooved so as to fit into the under edge of the tread, and allows the back edge of the tread to fit into the riser. This is a practice that has been used by good stair builders for a century or more, but seems to be losing favor for a more simple and perhaps just as good a system. A desire for economical methods of construction may have caused stair builders to eliminate this groove and rabbet, but they stoutly defend a system as shown in Fig. 4, claiming not only a more economical but also a more rigid construction.

Note that this system is practically the same as used on outside stair work excepting for the housed string and glue blocks. We are all inclined to stick to old methods if they are apparently better, but when the larger majority of stair builders are adopting this new system, it must be recognized for its worth.

It must be kept in mind that when the older system was adopted the materials used were air seasoned with a far greater moisture content than lumber treated by the kiln. Kiln dried lumber does not shrink to a degree which requires a give and take space as the tongue and groove allowed. As the kiln has eliminated great shrinkage, the real reason for having the tongue and groove is thereby eliminated.

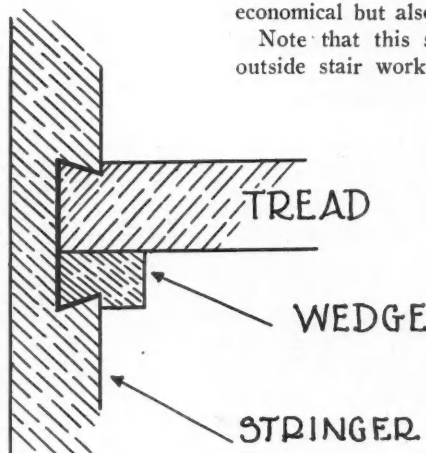

Fig. 3. When the Wedge Is Driven Under the Tread It Forms a Joint Similar to a Dovetail.

A great disadvantage of the tongue and groove was that it was found difficult to assemble the tread and riser without allowing too much play in the joint. The result was a loose joint which allowed the two surfaces to rub against each other. As this caused the squeak when the tread was stepped upon it was a great annoyance not only to the owner, but also to the stair builder, who was called upon to repair it.

In this latter system we need not think of shrinkage, as it would not be great enough to affect the stair, if the lumber used were kiln dried. It permits the riser to be fit perfectly to the underside of the tread so when nailed and glue blocked there can be no chance of rubbing. With proper nailing the riser can be fastened to the back of the tread just as effectively as the tongue and groove would make it.

Another deviation from an old practice is the method of assembling the stringer and the newel. The old practice is to mortise the newel enough to receive a tenon, the stringer having a shoulder which would fit firmly against the newel. The common practice today is to cut a slot in the newel large enough to fit the entire cross section of the stringer. That this has its advantage, especially in the assembly, is obvious.



Cement Cells Found to Have Special Acoustic Values

EMILE BERLINER, the well-known Washington inventor, has been commissioned to change the Trading Hall of the New York Stock Exchange room, which was noted for its babel of voices, into a room where the human voice could be used distinctly and easily and understood by all. The commission to alter this noted building followed the successful demonstration in Washington, D. C., of Mr. Berliner's latest invention. Here the acoustical qualities of an assembly room, long considered valueless, have been corrected.

The change in the room was achieved by covering portions of the inner walls, consisting in the present instance of hard glazed bricks, with cement acoustical cells, applied in large oblong sections. As finished the room appears to consist mostly of large smooth cement panels which, however, are vibratory like piano soundboards and highly responsive to a tuning fork, and therefore to every kind of sound that strikes against them.

A school assembly room of the James F. Oyster School in Washington, D. C., was used by Mr. Berliner in a practical demonstration of his new device. Government officials witnessed the results. The room measures 84 by 44 feet, including the stage and seats about 600 people. Previously this room was considered very bad and speakers found it almost impossible to make themselves understood. A jumble of noises was the result of any attempt.

The change brought about by Mr. Berliner was striking. Two persons standing at opposite corners of the hall, about 80 feet apart, may now converse with each other in an ordinary speaking voice; every word is now easily understood and no

impurity in the acoustics can be noticed.

Until recently, when acoustical plaster was brought out, very little had been achieved with halls having bad acoustics. Covering them with some sound-absorbing material like felt or padded cloth was the usual method. This would weaken the reverberation or other interfering sounds, but would at the same time reduce the loudness of the original speaking or playing of instruments. Besides, such coverings absorb dust and germs and cannot be cleaned, as walls in public buildings should be at stated intervals.

This new invention by the scientist who perfected the microphone is really very simple.

This tile is made of cement that is porous, yet hard like stone and having the resonance of wood. It can be cemented to the walls to cover a sufficiently large area to give the desired results. This special tile combines the hardness and dignity of stone with the resonance of wooden panels.

It is possible to make acoustical tile in various molded ornamental designs to suit the architecture and form the final finish of the walls, or they may be painted without reducing their efficiency.

Another method, designed specially for buildings that have already been completed, consists of attaching flat acoustic cells of wire netting to rough finished walls and spreading acoustic cement over them. This is as efficient acoustically and it lends itself to any treatment that is applicable to plain cement walls. This device can readily be installed after a building has been completed, although it is wiser to construct the acoustic cells while the wall is under construction. The demonstration at the New York Stock Exchange and in the Washington public school followed the method of adding cement cell walls.

Mr. Berliner emphasizes that these cells may be painted over, or grained and otherwise treated without affecting their resonance.

U. V. WILCOX.

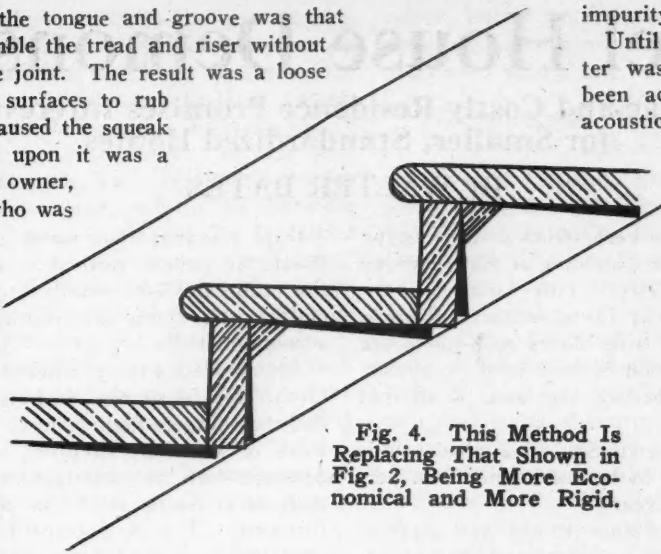
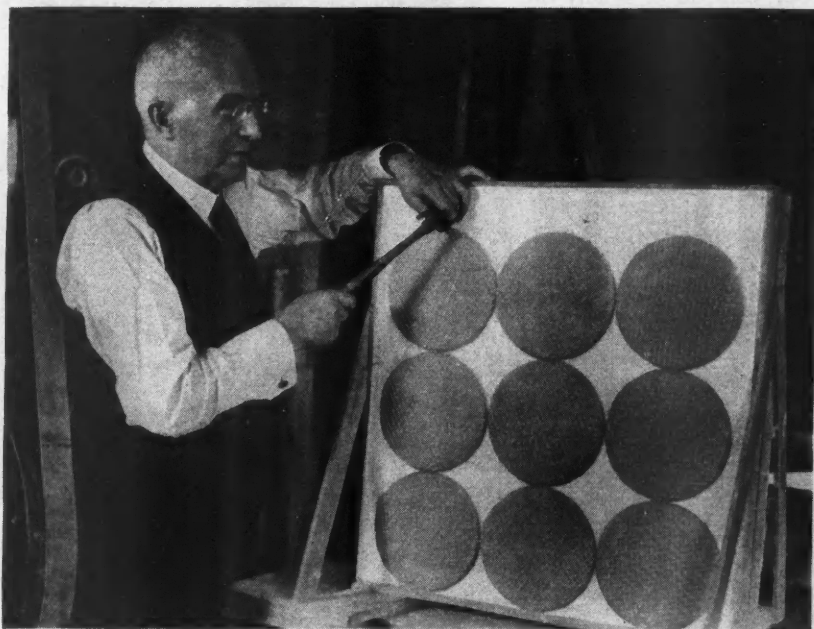

Fig. 4. This Method Is Replacing That Shown in Fig. 2, Being More Economical and More Rigid.



Mr. Emile Berliner Fastening in Place the Wire Used in the Making of the Acoustical Cells Which He Has Recently Devised and Demonstrated by Actual Installations.

All-Steel House Demonstrated

Success in Large and Costly Residence Promises Interesting Results for Smaller, Standardized Homes

By WALTER BATES

ENTIRELY new notes have been struck in a new type of construction which we are building at Sixth Avenue and Roosevelt Street, Gary. This home is constructed entirely of steel except for a veneer of brick. Studding, roof, shingles, sash, trim, doors and joists are all of steel. Not a stick of wood is used in its construction, and yet, in architectural beauty, the home is all that could be asked for.

The use of steel in the construction of a residence is not new. Steel has been used in homes in increased percentages for a period of several years.

It has been the custom, for instance, to use steel columns in the basement and steel beams for supporting floor joists so that there would be no possibility of the center construction of the house settling. We have been using materials of steel for many years.

In the progress of steel in the residence the next step was the use of steel window sash, which at the time of introduction was considered quite revolutionary and, as is generally true in progressive moves, was criticized. Now it is quite universally accepted as an established item of construction. From that the builders progressed to the use of steel floor joists, which has also become customary.

Now we have come to the all-steel frame house with a veneer of brick or stucco, as the builder may desire.

When one builds a steel frame house with steel window sash, concrete floors laid over steel floor joists and these concrete floors either covered with a wood floor, cork tile or solidly carpeted, we then have our home construction on a sanitary and fireproof basis.

It is essential that water pipes, electric conduits, etc., should be passed vertically through all exterior and interior walls and horizontally through the floor joist, without cutting the frame members. These factors have been accommodated.

After the steel frame work is in place, the steel floor joists in, the steel fabric stretched across the top of the floor joists and the concrete floor poured, one has obtained the skeleton work of a strictly fireproof home, but it is preferable to continue with the same factors of safety, using steel window sash, steel doors, steel trim and, insofar as possible, steel furniture. The roof construction is of steel. The steel roof trusses should be covered with a sheet steel roofing made for the purpose and this in turn covered with insulating material and the insulating material in turn covered with fireproof shingles.

The steel home will not settle unless the ground gives way. Assuming that your foundation is good, then you do not have any settling of the house and the cracking of plaster.

It is a known fact that in the earthquake of Santa Barbara, and the tornadoes in Florida and St. Louis, steel frame buildings were not seriously affected. We recommend that these steel frame houses be anchored to the foundations, i. e., foundation bolts should be cast in the foundation and extend above the concrete in such a manner as to suitably bolt the steel frame work to the concrete, thus making the house safe against tornadoes.

The second floor of concrete creates a perfect diaphragm approximately half up on the frame work and this stiffens the house against twisters.

Steel frame work is eco-

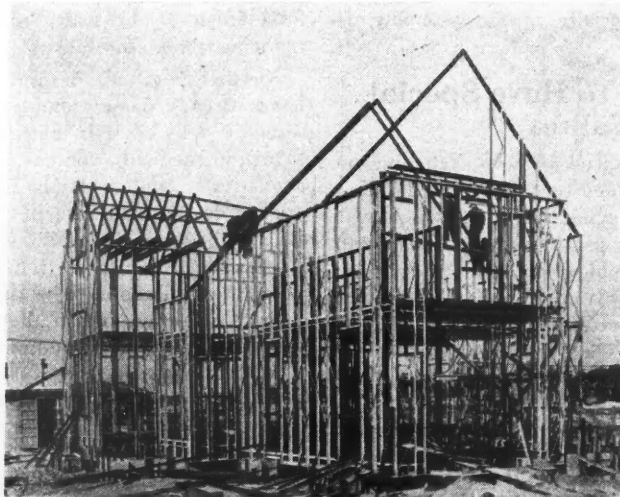

The All-Steel Frame Work of the Walter Bates Home, Sixth and Roosevelt, Gary, Ind.

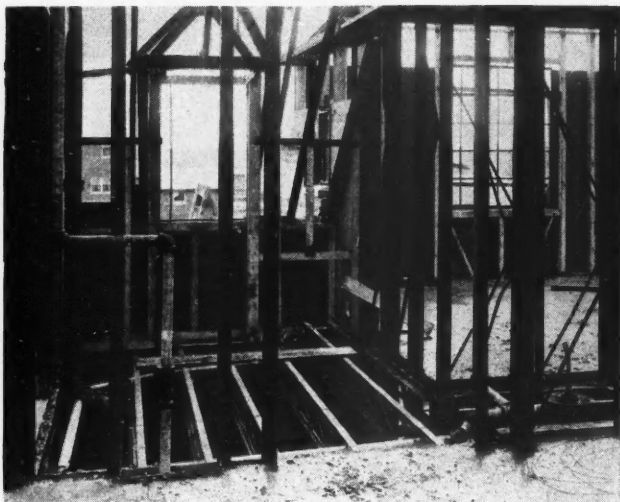

Partition Studs Are Steel. Note how the piping runs through the expanded steel floor joists without cutting.

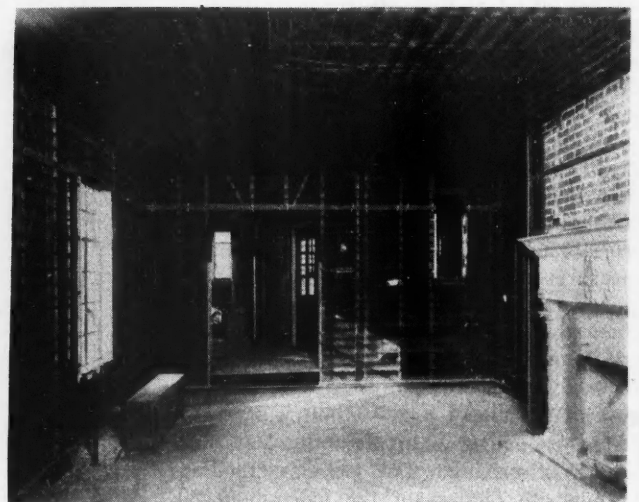

Ribbed Metal Lath in Place Ready for Plastering.

nomical. It can be made completely in the factory, shipped and assembled at low cost without any waste. When unit construction is used, the large quantities cut down the cost. They can be made in periods of depression and stored, or they can be made in off seasons, all of which tends to keep the cost down. In our particular type of construction, our units are so made that they thoroughly brace the house, which we consider extremely important. A house should not be dependent upon other materials such as brick or stucco for bracing.

The American Institute of Steel Construction in their Bulletin 197, dated June 22, 1927, state that on a \$45,000.00 steel frame residence completed in Cleveland the claim is made that the use of the steel frame was \$300.00 less than the cost of the lumber, and a saving of \$3,500.00 on the labor because of the erection. This is a saving of 8.45 per cent.

We maintain that on any type of house designed we can put up the steel frame erected in place at approximately the same cost as a wood frame.

However, assume that a steel frame cost 10 per cent more than a wood frame. Let us take a case of, say, a \$15,000.00 home. It is roughly estimated that the framework for this house would cost \$1,500.00 for all the steel erected in place and that this would be the cost of the wood frame erected in place. Let us assume then that instead of charging \$1,500.00 for the steel frame erection, we charge 10 per cent additional, which sounds like quite a high extra charge. In other words, made our charge \$1,650.00 or \$150.00 over the wood frame construction. It will readily be seen that this \$150.00 or 10 per cent of the frame work is only 1 per cent additional on the total cost of the \$15,000.00 house. No one would object to this extra 1 per cent. They pay much larger percentages for fuel oil burners instead of coal, for electric refrigeration instead of ice, and such other luxuries, so that it can be readily visualized that the cost of a steel frame house is entirely practical.

As for the method of distribution. The lumber yards would store standard units in their yards and sell them to the contractors or owners against any house plan that they might care to build. There is very little possibility of variations in dimensions which would seriously affect a house plan. We might find it economical to move a window a few inches one way or the other, which would not be objectionable. In other words, we can adopt the steel frame to the present designs very easily. A lumber dealer would store these units and quickly become accustomed, through the aid of the architect, as to the method by which these units are adaptable to any house. The units for the non-bearing partition are put in position after the steel joist has been placed and the concrete floors poured. They are set directly on top of the concrete floor and are held in position by wires or clips which have previously been attached to the steel mesh stretching across top of floor joists and brought up through the concrete, these wires or clips are of sufficient length to wrap around the bottom chord angle of the non-bearing partition unit.

The top of these partitions are wired into place in a similar manner by wires which have been securely attached to the ceiling joist, after which the metal lath is stretched on all walls and ceilings, making the house a complete unit.

Units are marked and the erection plan for a particular set of house plans is marked to show the constructor where the various units go, making for very simple erection.

The dealer or the contractor can assemble from the architect's drawings very easily and cheaply. For portable building construction the units can be taken down and moved at any time.

The loan companies are anxious to make loans on houses of this permanent type of construction, less hazard, less depreciation. The public should think of steel in home construction not only in terms of strength, safety and sani-

tation, but of beauty, and we venture to predict that in a very few years from now there will be many times as much steel used in building construction as there is used today.

Suppliers of Material and Equipment for the All-Steel Home

Universal Portland Cement Co., cement; Illinois Steel Co., steel; Bates Expanded Steel Truss Co., steel joists; Wheeling Metal & Mfg. Co., Leadclad steel shingles; Woodbridge Ornamental Iron Co., Presteel stairs; Heggie-Simplex Boiler Co., steel boiler, electrically welded; Mason Fibre Co., Masonite insulation; Detroit Steel Products Co., steel windows; National Steel Fabric Co., Steeltex for concrete floors; Associated Metal Lath Mfrs., metal lath; Metal Door & Trim Co., steel doors and trim; Holorib, Inc., steel roof deck units; American Window Glass Co., Quartz-Lite glass; Standard Sanitary Mfg. Co., plumbing fixtures; Frigidaire, electric refrigerator; Walker Dishwasher Corp., electric sink; Gary Boiler Repair Co., electric welding; Eduard M. Pripps, plumbing and heating; I. M. Cohen, architect; The Kitchen Aid Mfg. Co., electric kitchen aid; The Edward M. Riddle Co., lighting fixtures; Graver Corporation, oil storage tank; Calumet-Harding Co., Hardinge oil burner; W. R. Baker Co., Heimbach incinerator; P. & F. Corbin, hardware; Rolscreen Co., screens; The National Lime & Stone Co., plaster; Robert Rossman Co., glazed tiles; National Fire Proofing Co., hollow building tile; Morton Manufacturing Co., steel bathroom cabinets; Tuttle & Bailey Mfg. Co., steel radiator cabinets; Safety Water Heater Co., electric water heater; Horton Manufacturing Co., electric washer and ironer; Henry Weiss Mfg. Co., steel shower stall; Sangamo Electric Co., electric clocks; General Insulating & Mfg. Co., Gimco garage insulation; Meyer Light Co., electrical contractor; General Construction Co., general contractor.



Chicago Civic Opera to Have Magnificent New Building

(Continued from page 93)

trip through England, Germany, France, Italy and Austria to inspect the facilities provided in foreign opera houses in lighting, scenics and mechanical equipment, such as hydraulic trap doors, revolving stages, etc. However, very little was found which equaled the hydraulic trap door equipment of the old Auditorium.

A noteworthy feature of the new Opera Building is to be a wide colonnade along Wacker Drive leading to the entrances, where 40 automobiles may be loaded or unloaded under shelter at one time.

Unusually complete rehearsal facilities are to be provided, so that soloists, groups, choruses, ballet, orchestra, etc., may rehearse separately or together. In fact, there will be stage facilities so that, while an actual opera performance is being given, a separate cast may be at work rehearsing a different opera on another stage. Entrance to the opera auditorium will be at the southern end of the colonnade on Wacker Drive; to the theater at the north end and to the office building midway of this colonnade.

From the grand foyer at the level of the parquet, a grand staircase will lead to the mezzanine lounge at the rear of the boxes. Separate stairs will rise from the main lounge to the balconies and there will be additional stairways for convenient and ample access from all parts of the auditorium. There will also be special elevator service to the balconies and galleries. There will be 26 high speed elevators serving the tenants of the office building.

The building is to be owned and operated by a corporation to be known as the 20 Wacker Drive Building Corporation, headed by Samuel Insull, president; Stanley Field, vice-president; Herbert M. Johnson, treasurer, and John W. Evers, secretary.

WHAT'S NEW ?



EDITOR'S NOTE: *The AMERICAN BUILDER does not accept payment in any form for what appears in our reading pages. In order to avoid any appearance of doing so, we omit the name of the maker or seller of any article we describe. This information is, however, kept on file and will be mailed to anyone interested; address AMERICAN BUILDER Information Exchange, 1827 Prairie Ave., Chicago, Ill.*

Forced Draft Blower for Homes

THERE has recently been placed on the market a new forced draft blower, especially designed for use with small furnaces of the residence type. The new blower supplies sufficient forced draft to burn buckwheat coal in furnaces having up to five or six square feet of grate area. It has the same general design as this company's larger forced draft units. It is small and compact and may be directly bolted to the floor.

Any kind of furnace, steam—hot water or warm air—can be readily equipped. The blower is fitted directly into the furnace base, without ducts. The motor is fully enclosed and dustproof, to protect the windings, commutator and bearings from dust and grit. It requires only 1/20 horse-

power and can be plugged into any light socket. The motor is so quiet that it hardly can be heard.

With automatic control, by means of a thermostat, the blower may be turned off and on in order to maintain a constant steam pressure or temperature. The intensity of the draft from the blower can be

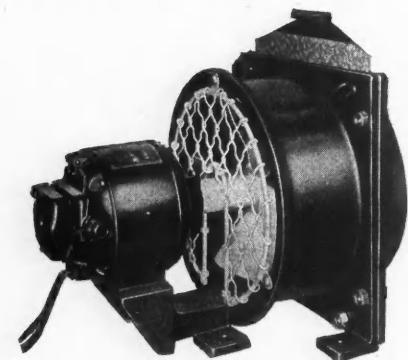

Here Is a Forced Draft Blower Which Makes It Possible to Burn Buckwheat Coal in the Home Furnace.

varied by adjusting a sliding damper.

Because of the large number of furnaces which can advantageously burn low cost buckwheat instead of the expensive domestic sizes, this new forced draft unit has a wide field of application. Owners who burn eight to ten tons of coal a year can now burn buckwheat coal with a surprising reduction in the annual coal bill.



Novel Steel Bar Clamp

A WELL-KNOWN manufacturer is introducing the novel form of carpenters' steel bar clamp shown in the illustration. These clamps consist of a set of parts that when applied to any piece of 3/4-inch water or gas pipe, either standard weight, extra heavy or double extra heavy, make an excellent steel-bar clamp of such length as the pipe may be.

The head of the clamp is screwed fast to the threads at one end of the pipe and the foot or tail piece is slipped over the other end. No holes, notches, rivets or other preparation of the pipe are required, nor are any tools required to make the assembly or to take the clamp apart. The foot contains a set of special, heat treated, steel, multiple clutch rings, which automatically engage the pipe at any point

to which it may be moved to fit the work to be clamped, and hold it firm against the pressure applied through the crank and screw in the head. No time is lost in finding a suitable spot to fasten the foot nor in running the screw forward or back to fit the work. This makes the clamp fast in operation.

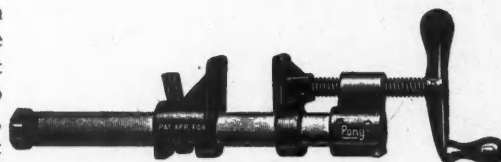

This Clamp Set Can Be Applied to Any 3/4-Inch Pipe and Gives Fast Operation.

The limit of strength in the clamp is the stiffness of the pipe used and it is stated that ordinary "standard black iron pipe" is stiff enough for all but very heavy work or extra long clamps. The material and workmanship in these clamp fixtures are high grade in every respect and include all the most desirable and up-to-date features of clamp construction, it is said, together with many advantages not obtainable in other types of clamps.



Buck Anchor for Hollow Tile

A NEW buck anchor for anchoring door bucks to hollow tile has recently been announced by a manufacturer of building specialties. These buck anchors are manufactured from No. 22 gauge galvanized metal and are made up in pairs, a pair consisting of one right, and one left anchor, which makes them much easier to handle and assures the two anchors being together when needed. The

two are separated by a slit down the middle which breaks in two by a slight twist. The anchor has a bent piece which fits over the side of the tile and a straight piece with three nail holes punched one inch apart, which is nailed to the wood buck as shown in the illustration. This anchor is designed to be used with any size of tile.

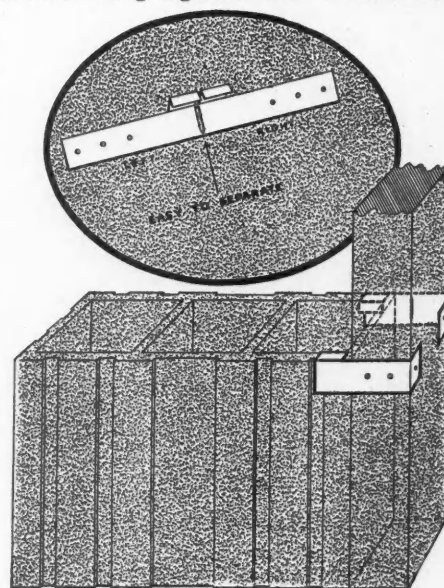

For Anchoring Door Bucks to Hollow Tile These Anchors Are Easily Handled and Dependable.

Use the Advantages of Johnson's Liquid Wax Glaze

To Help Increase Your Business and Prestige

The art of carrying colors in wax, practiced thousands of years ago by the ancient Egyptians, has been modernized and made commercially useful in Johnson's Liquid Wax Glaze for textured and sand finished walls.

This new product has many outstanding advantages and offers an opportunity to you for greater prestige and increased profit. It gives your customers superior decorating, more beautiful color effects and endless satisfaction.

Study the following advantages and cash in on the opportunity this exceptional new product offers you in new business and in greater profit on the decorating work you always have in connection with your building work.

Liquid Wax Glaze Advantages

Every desired color effect can be obtained.

Color-combinations can be tested on the wall to be finished, and changed if desired.

Colors mixed in Johnson's Liquid Wax Glaze do not fade, nor are they affected by room temperatures and dampness.

A wall finished with Johnson's Liquid Wax Glaze can be washed with soap and water.

Johnson's Liquid Wax Glaze has great covering capacity—700 square feet to the gallon.

It is extremely simple to apply—and there is no danger of laps, streaks or brush marks.

Multi-color effects can be produced with a single setting of ladders and scaffolds.

The finish can be entirely removed by washing with Johnson's Natural Wax. The surface is left in ideal condition for refinishing.

An Unlimited Range of Artistic Treatment

Liquid Wax Glaze is the latest and is fast becoming the most popular finish for textured walls. Beautiful mottled and tinted tones with a richness to match the most elaborate surroundings are easily and quickly obtained. Walls finished in colors with Johnson's Liquid Wax Glaze become an artistic background for modern tapestries, paintings and beautiful furniture.

The very simplicity of this latest development opens new opportunities to you, especially on remodeling work where the interior decorating is the part of the job that shows the most. When Johnson's Liquid Wax Glaze is used you know the finished job will exceed the fondest expectations of your customers.

Beautiful multi-color effects are easily secured with a little practice by anyone familiar with the handling of ordinary paint brushes. Your regular decorator has men who can obtain really artistic results, easily and quickly with Johnson's Liquid Wax Glaze.

This new product is rich in possibilities. If you are not yet familiar with it, mail the coupon today for a FREE sample quart. It is your opportunity to capitalize in a big way on the artistic finish the painter and decorator can give your building work.

JOHNSON'S LIQUID WAX GLAZE

FACTORY BRANCHES AT

ATLANTA 16 West Peachtree Pl.	KANSAS CITY 2433 McGee Trafficway	OMAHA 1407 Harney St.
BOSTON 852 Summer St.	LOS ANGELES 1151 Santee St.	PHILADELPHIA 410-412 Commerce St.
CLEVELAND 1645 Superior Ave.	LOUISVILLE 115 South 6th St.	PITTSBURGH 926 Duquesne Way
DALLAS 2900 Main St.	MILWAUKEE 936 Third St.	SAN FRANCISCO 1250 Folsom St.
DENVER 1846 Arapahoe St.	NEW ORLEANS 500-506 Magazine St.	ST. LOUIS 2116 Locust St.
DETROIT 5432 Grand River Ave.	NEW YORK 270-276 Lafayette St.	ST. PAUL 1930 St. Anthony Ave.
		SEATTLE 314 Bell St.

Clip to your letter-head or business card

S. C. JOHNSON & SON, Dept. A. B. 3, RACINE, WIS.
"The Wax Finishing Authorities"

I am interested in the use of Johnson's Liquid Wax Glaze for decorating textured and sand finished walls.

Please send me one quart sample FREE together with complete specifications and instructions for use.

Name.....

Address.....

City..... State.....

Pine is the Tested Building



SINCE the earliest days of American history and down through all the years to the present day, Pine construction has withstood the tests of time and the elements.

The early settlers soon realized that the huge Pine forests offered a material with which to build a nation. The log cabins and later the homes of the colonists were built of Pine—homes that today are considered models of architectural beauty and enduring construction.

The Eldridge House pictured above is an example. For over a century it has been in continuous use. Built in 1806 by Daniel Conkling at Rensselaerville, New York, it is now the summer home of the great granddaughter of the original owners.

Still Holds First Place

Practically all the homes in this country over two hundred years old are of Pine and even today with all the varied materials available, Pine still

SHEVLIN PINE

Material of Our Ancestors

holds first place in building construction of all kinds.

Down through the years, Pine has proven itself like no other material has—proven its beauty, its workability and its staunchness against time and the elements.

Shevlin Pine is Pine at Its Best

For more than forty years the Shevlin interests have specialized in Pine and have selected the best Pine stands on the continent. There is a sufficient supply to furnish the nation with the tested lumber of our ancestors for centuries ahead. When Shevlin Pine reaches the construction job you will find it thoroughly seasoned, rigidly graded and smoothly milled—ready to give years of economical service.

Leading lumber dealers throughout the nation can supply you with Shevlin Pine in five varieties:—Shevlin California White Pine, Shevlin Norway Pine, Shevlin California Sugar Pine, Shevlin Northern White Pine and Shevlin Ponderosa Pine.

Get More Information About Pine

As Pine is one of the most important building materials today, you should

have all the information available about it. The booklet, "Specify Shevlin Pine," you will find contains a raft of

interesting data on Pine—characteristics, physical properties, allowable stresses in small homes, uses and other information.

It also shows many illustrations of lumbering methods in the Pine forests of the North and West.

Use the Coupon

Simply mail us the coupon below and we will send you this book.

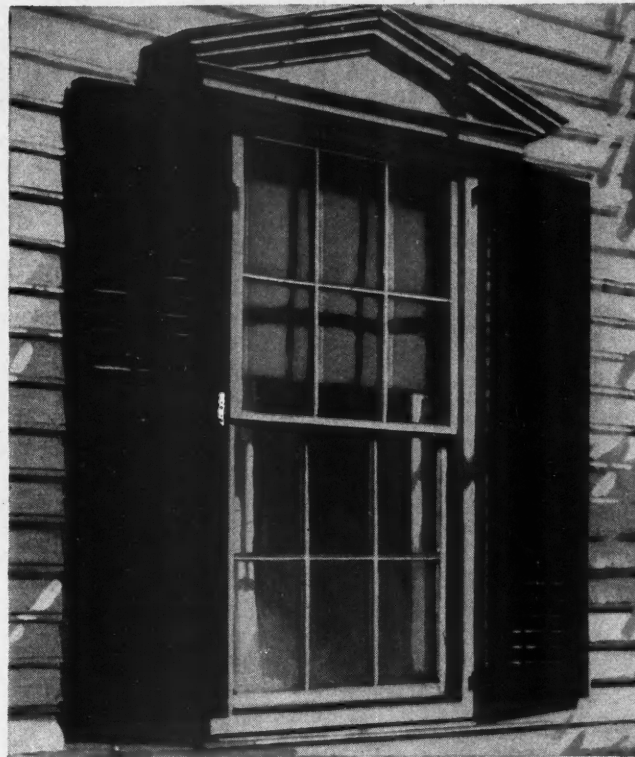

Pine moulding detail of a first story window of the Governor Wolcott House built at Litchfield, Conn. in 1753. The mitered break was a favorite device of early American woodworkers.

Shevlin, Carpenter & Clarke Company
 903 First National Soo Line Bldg., Minneapolis, Minn.
 Chicago Sales Office: 1866 Continental and Commercial Bank Bldg.
 San Francisco Sales Office: 1028 Monadnock Building
 Sold in New York by N. H. Morgan, 1205 Graybar Building

SHEVLIN, CARPENTER & CLARKE COMPANY
 903 First National-Soo Line Bldg. Minneapolis, Minn.
 Please send me the booklet, "Specify Shevlin Pine."

NAME.....
 BUSINESS.....
 ADDRESS.....
 CITY.....

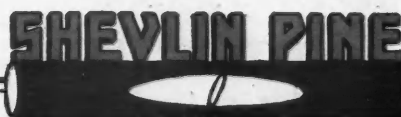

Solid Rolled Steel Windows

THE window illustrated here is one of a line which is built on principles that produce positive results in operation and in overcoming air leakage. They may be obtained in groups of one or more pairs of sash as desired. The frames of the sash are of solid, rolled steel and the sash are firmly hinged together to open outwardly and shut under symmetrical control of hinged arms attached to a stationary vertical bar. The arms are forged steel and afford absolutely rigid support. A simple catch lock fastens the sash when the window is closed.

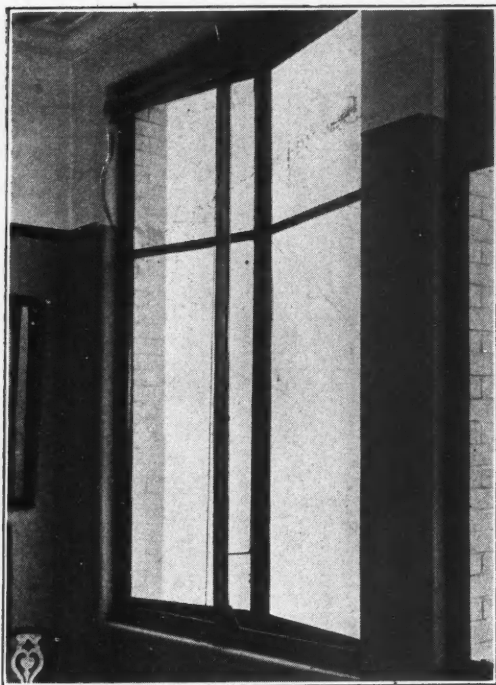

Windows of Solid, Rolled Steel with Many Excellent Features.

Heavy felt weatherstripping is an integral part of the construction. Every window is assembled at the factory, tested for accuracy and shipped as a complete unit, including hardware and weatherstrips. They require no special skill for setting and are readily glazed after installation.

The sash are continuous from sill to head with no obstruction from horizontal meeting rails. The sash control forms a flue that draws out all impure air which is automatically replaced with fresh air. The airtight and dustproof qualities of these windows have been established under a laboratory test of a 140-mile wind velocity. Thick felt contact cushions practically shut out street noises when the window is closed.



A Home Gas System

UNTIL comparatively recently the growth of suburban residence construction has been limited by the development of public utilities, water supply, electricity, gas and transportation for those who wished to live in suburban surroundings, but also wished modern comforts and conveniences. That condition has been changed with the development of the automobile for transportation, the home electric plant, the pressure water system and the radio for

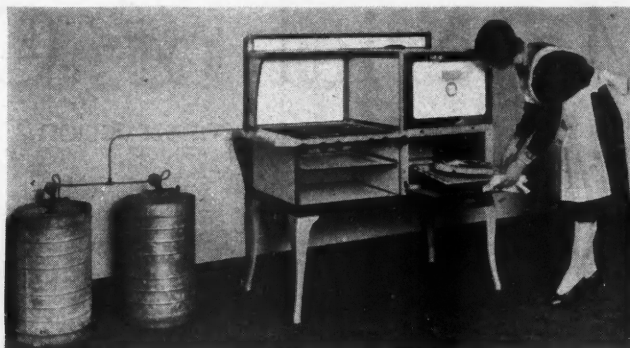

With This System, Gas Is Available to the Home Beyond the City Gas Supply.

entertainment. Now, too, private gas systems are made available.

Such a system presents no construction difficulties for its installation involves nothing more than connecting the fuel drums with the cooking appliance by means of a supply pipe. In the plant illustrated, bottled gas is made from the vapors from oil wells. These vapors are refined and condensed until they form a colorless low-pressure liquid.

In operation the bottled gas is almost identical with city gas. It burns with an intense hot flame and without soot or odor. It is non-poisonous and will not asphyxiate. The cost of operation averages about the same as for city gas and the fuel and apparatus is listed as standard by the Board of Fire Underwriters.

Each system is equipped with two drums of gas one of which is in use and the second held in reserve. When the first drum is used up the reserve drum is put into use by opening a valve, the service man is notified and he replaces the empty drum with a full one.



Complete Electric Tool Set

THE illustration shows a complete workshop suitable for installation in the small shop or home. The set, which is completely portable, consists of an electric drill, lathe, electric power tools, jig saw, band saw. The capacity of the lathe is 9 by 38 inches, the bench saw has depth and side gauges, scroll and jig saw and all accessories for both stationary and portable power drilling, buffing, grinding and cleaning.

The equipment attaches to any light socket and converts the work bench into a complete private tool and machine shop, it is stated. This set is sold on very easy time payments.

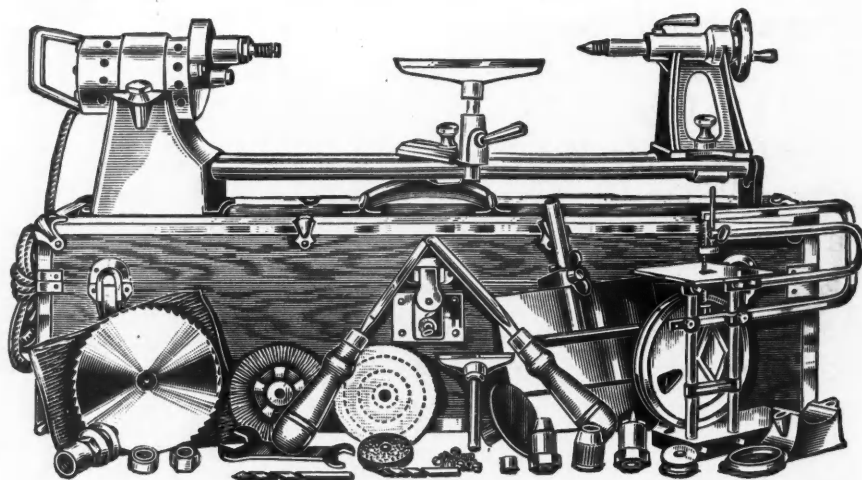

Here Is a Complete Electric Tool Set for the Home Shop.

A special base makes the Reid-Way easily convertible to a Jointer. It can be carried anywhere—connected to any light socket. The floor sanding device is instantly attached without tools.

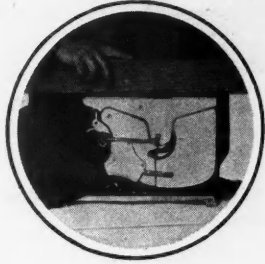

**LIGHT
STRONG
DURABLE**

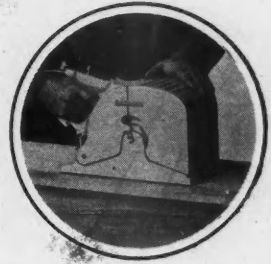
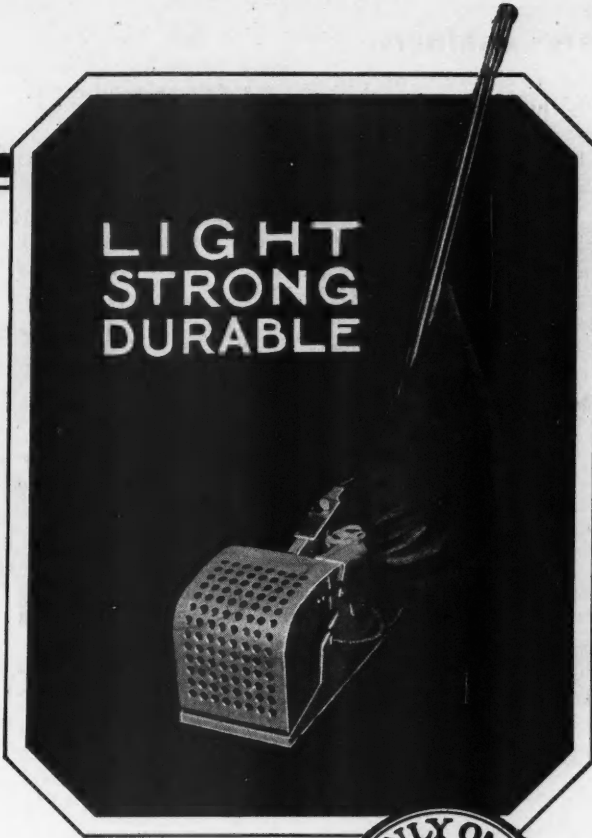

As a bench sander, the light Reid-Way has become an indispensable machine tool to many craftsmen. It cuts sanding costs to a minimum and speeds up production.

The Reid-Way



Vacuum Convertible SANDER

Still the outstanding value in the light sanding machine field. Devoid of frills and complicated driving mechanism, the Reid-Way is preferred because of its remarkable simplicity. It has an amazing capacity for hard work because the entire power of the motor is utilized for sanding. The revolving field motor, which is the sanding drum, is the **ONLY** moving part. No friction losses—nothing to wear out. New vacuum principle eliminates dust. Sold strictly on its merits, hundreds of satisfied users endorse the Reid-Way. Send coupon for free circulars.

The REID-WAY Co.

706 North 16th Street

Cedar Rapids, Iowa

REID-WAY Co.,
706 No. 16th St.,
Cedar Rapids, Iowa

With no obligation on my part you may send circular describing the new Reid-Way Vacuum Sander.

Name.....

Address.....

Just clip this to your letterhead if more convenient.

Humidifying Radiator Cabinets

PHYSICIANS everywhere strive to impress on their clients the necessity of properly humidified air in the home. Diseases of the nose, throat and lungs are encouraged, and often directly caused by excessively dry heat. Proper humidity will prevent many of these diseases. As



These Radiator Cabinets Greatly Improve the Appearance of the Room and Also Humidify the Air.

closely as can be ascertained, correctly humidified air contains about 45 to 50 per cent moisture. The radiator cabinets illustrated here help to maintain this correct humidity in the home.

By reducing the amount of dust in the air these cabinets also eliminate much unnecessary cleaning of drapes and curtains. Smudges do not form on the walls when the radiators are enclosed with these cabinets and you are saved the expense and worry of frequent redecoration.

These cabinets are finished in any color, or grained in mahogany, oak or walnut to match the wood trim or furniture. They may have cane or square rod grills with paralleled fronts.



New Improved Metal Lath

THE illustration shows a new type of metal lath which has recently been perfected and placed on the market. It is a $\frac{3}{8}$ -inch rib lath, the "V"-shaped ribs of full $\frac{3}{8}$ -inch depth giving exceptional rigidity. The steel is so expanded that it develops the greatest possible tensile strength and assures maximum reinforcement.

This lath is made from heavy gauge sheet, giving increased rigidity and durability. It is said to be easier for the lather to handle on the job. There are no ragged projections in the mesh to catch the hands or clothes which makes for faster work and less installation time.

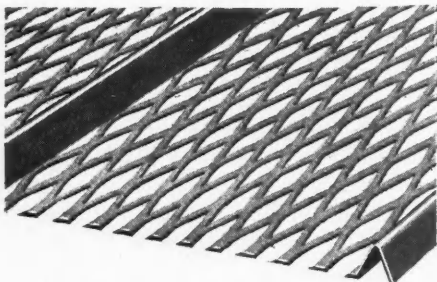

A New Type of Metal Lath with Several Improved Features.

The mesh is large enough to give the hands or clothes which makes for faster work and less installation time. The mesh is large enough to give the hands or clothes which makes for faster work and less installation time. The mesh is large enough to give the hands or clothes which makes for faster work and less installation time.

For light weight concrete slab construction this lath is superior to any other type, it is claimed, because of its flat strands and small mesh.



Inexpensive Combination Saw

HERE is pictured a combination bench saw which is designed for all types of work from delicate pattern work on wood or metal to sawing up lumber for framing, etc. It is a sturdily built machine and simple to operate,

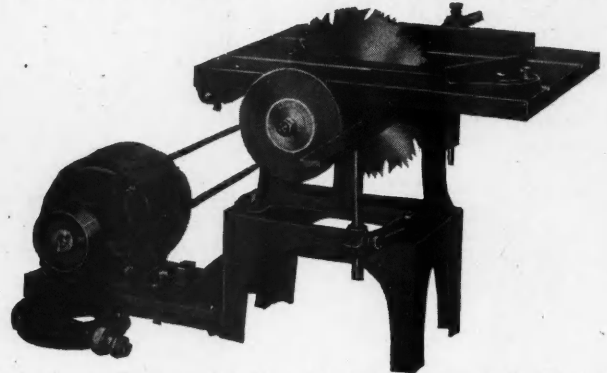

Here Is an Inexpensive Saw That Serves a Wide Variety of Purposes.

taking its power from any lamp socket. It will cross cut, route, plough, bore, grind, dado, rabbit, rip, drill, buff, mold, sand polish, bevel or miter.

The saw table is 12 by 16 inches. The equipment includes a saw table base; a $\frac{1}{3}$ H.P. motor, A.C., 1,750 R.P.M., 60 cycle; a motor base; an eight-inch combination saw; iron pulley; 10-inch ripping fence; adjustable cut-off miter gauge; saw guard; $1\frac{1}{4}$ -inch endless belt; 6-inch buffing wheel; 8-foot cord and plug; $\frac{1}{4}$ -inch, three-jaw drill chuck; 5-inch emery wheel; 6-inch sander.



Outdoor Incinerator

WITH this incinerator installed there need be no fear of fire hazard. There are no flying sparks, no open flames, no fire visible, the contents are always out of sight and the burning is not affected by either wind or rain. It burns the garbage satisfactorily when the contents mixture is about 20 per cent garbage to 80 per cent dry rubbish. It is made of non-rusting, non-corroding patented steel.

Rubbish and garbage are deposited in it as they originate and when the incinerator is filled it is lighted at the top with a match and no further attention whatever is required during the burning. Each burning sterilizes the interior. The perforated inner flue, an exclusive patented feature insures perfect combustion at all times, makes clogging of the draft impossible and develops burning from the top downward, it is stated.



This Incinerator Is for Outdoor Use and Is Completely Fire Safe.

The
Best
Buy

In All
Mixer
History

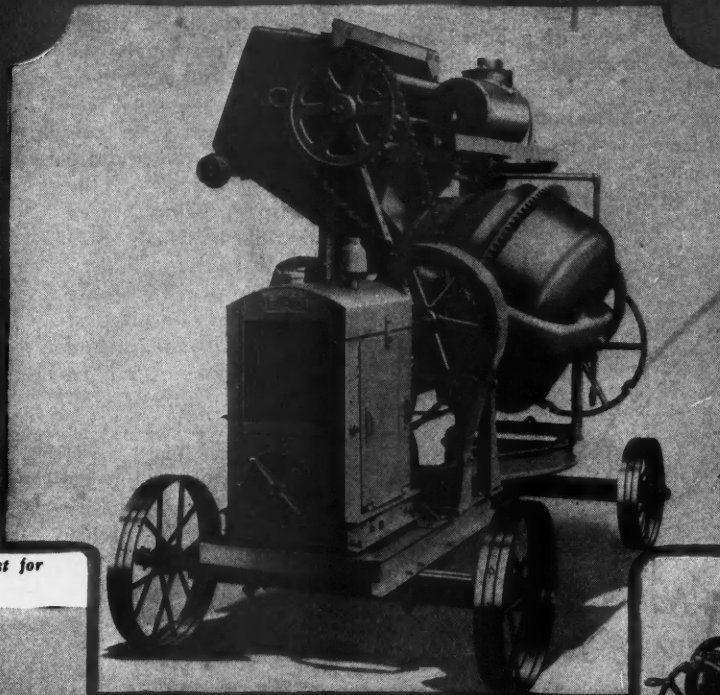

WONDER 5-S

Shown with auxiliary hoist for plaster work.

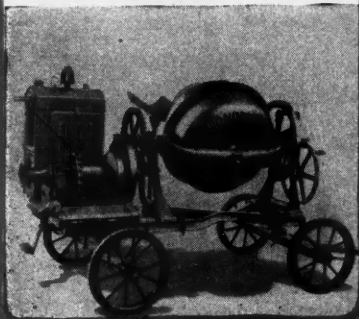

WONDER 3 1/2-S



You Can't Afford to
Work Any Mixer But

WANDER

It looks as if 1928 is going to be a mighty good year for construction, but good only for those contractors who are equipped to battle for the business. It is going to be one of those years when you have to be up on your toes and on the job every minute. It is going to be one of those years when to prosper you must have equipment that will enable you to complete the job on time.

Wonder, as usual, heads the procession again with a complete line of concrete mixers, re-designed to add many labor saving features, coupled with all the time savers that only a Wonder mixer has.

Fast mixing—longer life—a brand new water supply—easy tilting—roller bearings for easy travel, the best power plant on the market—alemite lubrication, and a drum bearing that is guaranteed for the life of the mixer.

The wise contractor works Wonders—it is more important that he use them in 1928 than ever before.

A catalog, brand new from cover to cover, beautifully illustrated, describing in detail the many exclusive time and labor saving Wonder features is now ready. A copy is yours for the asking. Just return the convenient coupon at the right. We will appreciate you checking the size or model in which you are interested.

Construction Machinery Co.
103 Vinton Street
Waterloo, Iowa

WANDER
THE BEST TILTING
MIXERS

Mail it Today

For Bigger Profits

Construction Mch. Co., 103 Vinton St. Waterloo, Ia.
I'm certainly interested in bigger profits this year. Please send me catalog and prices on machine checked below.

LOADER MODELS	TRAILERS
<input type="checkbox"/> 3 1/2-S <input type="checkbox"/> 5-S <input type="checkbox"/> 7-S	<input type="checkbox"/> 3-S <input type="checkbox"/> 3 1/2-S
<input type="checkbox"/> 10-S <input type="checkbox"/> 14-S	<input type="checkbox"/> 5-S With Auxiliary Hoist for plaster.

Name _____
City _____ State _____

These Nails Do Not Split Wood

THE fibres of wood run lengthwise of a board and a nail with any kind of an entering point spreads these fibres and wedges them apart, often causing the board to split. The new nail shown in the illustration has been especially designed to avoid splitting. It does not, in entering the wood, work on the principle of an ax, as does the ordinary nail, but is designed to spread the tension around the nail instead of in just two directions.

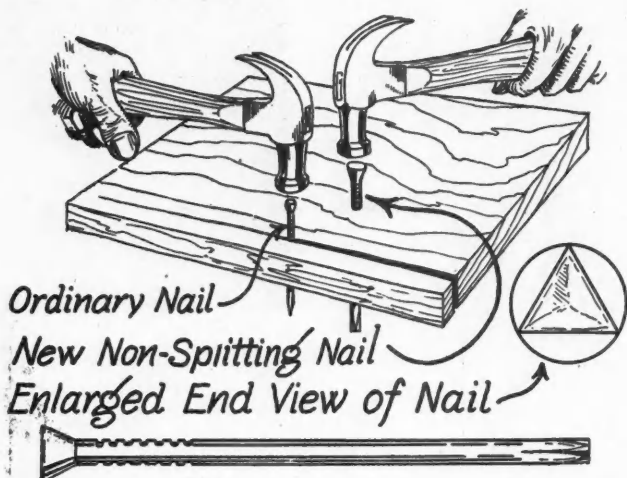

Here Is a Special Nail so Designed That It Will Not Split the Wood.

With the use of this nail, splitting is reduced to a minimum and the holding power is greatly increased, it is stated. This nail cuts the fibers of the wood and punches a triangular hole ahead of the body of the nail. The size of the triangular hole is always proportioned to the size of the body of the nail.



Automatic Stairway Switch

A DARK stairway is always a dangerous place and this is especially true of the basement stair. All too often when one starts for the basement carrying packages or other things the hands are too full to turn on the basement light. In such a case an accident is not at all unlikely. This can be avoided, however, by the simple expedient of installing a stairway switch.



Automatic Control of Basement, Attic or Other Lights with a Switch in the Stair Tread.

The switch, as shown in the illustration, is a simple device which can be installed quickly at small expense. Attached to the top step of the basement stair, it automatically turns on the basement light when one steps on the tread. In returning, stepping on the tread turns off the light.

The switch can also be installed on the lower step of the attic stairs or, for that matter, on any stair way and saves much inconvenience and neglect of lights.



Improved Screw Jacks

A NEW line of screw jacks with ingenious improvements in design and finish has been announced by a well-known manufacturer. Instead of the solid frame, these

jacks are built with an open manhole, permitting the screw of the jack to be visible at all times. This informs the operator how high the screw may run out, which is a practical safety feature. The carrying handle is an ingeniously formed portion of the manhole, being braced and ribbed, which adds strength to the jack.

The screw and head are forged from one piece of steel. The standard and cap are made of refined gray iron, which safeguards against cracking or chipping. The base is formed with an extra ribbing, providing stability and strength. Another novel feature is the Duco finish which insures a clear and permanent color that will not rust or corrode. As an aid to more effective handling, each distinct size is finished in a different color. There are 32 sizes comprising this line of jacks and they embrace only the styles that are universally in demand. Included in these sizes is one special size for farm, house, garage and shop use.



These Screw Jacks Are Completely Visible in Operation.



Devices for Better Heating

FOR the larger buildings, hotels, apartments, office buildings and certain residences, vapor or vacuum heating systems are particularly applicable due to their small maintenance cost and also to their rapid heating characteristics. With the use of specialties such as described here, steam circulation throughout the heating system of the largest building is an easy matter.

The supply valve shown here, for use on the supply end of the radiator, is of a particularly interesting design. No packing at all is used. A seamless bellows, spirally corrugated, separates the steam side of the valve from that of the inlet or control side. An easy moving handle with a packless feature makes a combination valve which, at all times, will be free from sticking and will not require repacking. "On" and "Off" positions are definitely marked on an exceptionally good looking dial.

The radiator traps, for use on the return end of the radiator, either vacuum or vapor systems, consist of a sensitive element formed from a seamless tube, corrugated spirally. This element is charged with a volatile liquid which vaporizes when coming in contact with steam. As soon as air or water condensation collects in the radiator it is automatically discharged.

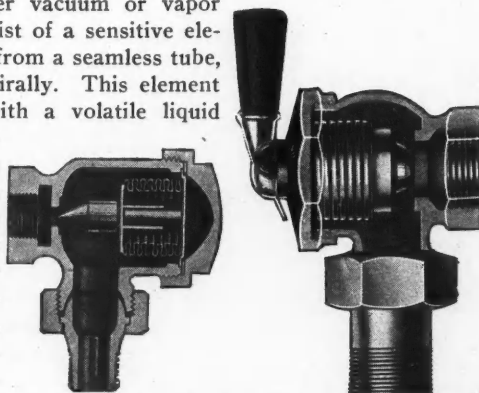

Two Heating Devices That Add Efficiency to the System.



“no wonder
they used CARNEY CEMENT!”

HALLBAUER-LABAHN, INC., originally planned to use four laborers for every 50 masons, to mix the mortar on the Lake Shore Drive Hotel, Chicago.

Instead, they used Carney Cement and three laborers for their entire crew of 90 bricklayers.

It's easy to see how Carney saves this tremendous amount of labor when you know how it works. It doesn't need lime or soaking. All the mixers have to do is add water and sand.

The mortar box is not the only place where Carney Cement saves money on a job. Watch a crew of bricklayers using Carney mortar. You'll see another, and even bigger saving.

Carney is so smooth and plastic that it rarely needs tamping or re-tempering. Which means that 60 minutes of every mason's hour are spent doing just one thing—laying brick.

No wonder builders are swinging to Carney Cement!

T H E C A R N E Y C O M P A N Y

DISTRICT SALES OFFICES: CLEVELAND, CHICAGO, DETROIT, ST. LOUIS, MINNEAPOLIS

Cement Makers



Since 1883

Specifications:

1 part Carney Cement
to 3 or 4 parts sand de-
pending upon quality of
sand.

CARNEY CEMENT
for Brick and Tile Mortar

For Small Tenoning Work

A TENON guide has recently been invented which fills a real need in the small woodworking shop which is not equipped with box-making machinery. It is used to replace

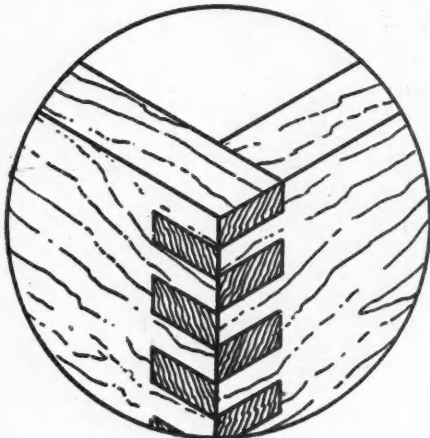

For All Kinds of Small Tenoning Work This Machine Will Be Valuable.

hand dovetailing on small work and is found particularly useful on novelty work such as lamp shades, drawers, cabinets and boxes of various sorts. On actual test a box five by seven by three inches deep was tenoned with this guide in 2½ minutes, time taken in setting up the saw being included. This makes an interesting comparison with the time required for hand work. It also makes a neat, strong job and can be used on angular work where dovetailing would be impractical. It will pay for itself, it is claimed, on the first job for which it is used besides opening up new fields of work.



Pivoted Built-in Ironing Board

HERE is illustrated a pivoted ironing board which offers unusual convenience. The builder can place this ironing board in any location he wishes and its usefulness cannot be obstructed. It can be placed in a corner or before an obstruction where other boards could not be used. It is especially adapted to apartments where wall



A Built-In Ironing Board Which Takes Very Little Space Because of Being Pivoted.

space is at a premium and to homes where the greatest convenience is desired. All working parts are of iron with the exception of two maple blocks that slide in a groove for smooth operation. After the board is lowered by loosening one wing nut, it may be swung to any angle up to 45 degrees and then clamped rigidly for use. To fold the board it is brought back to the right angle and clamped and then folded into place.

It is especially adapted to apartments where wall space is at a premium and to homes where the greatest convenience is desired.

All working parts are of iron with the exception of two maple blocks that slide in a groove for smooth operation. After the board is lowered by loosening one wing nut, it may be swung to any angle up to 45 degrees and then clamped rigidly for use. To fold the board it is brought back to the right angle and clamped and then folded into place.

This board is made in two

sizes, the standard size, 13¾ inches by 6 feet 9 inches, to be fastened to the wall. A second size, 17 inches by 6 feet 9 inches is designed to be hung as a door.

Ornamental Commercial Lighting

THE demand for ornamental commercial lighting units has resulted in a new type of unit which combines the totally enclosed and exposed ball lamps in an unusually attractive manner. These units are obtainable in a great variety of sizes and styles with almost 100 different ornamental variations to choose from. These stock units are available where special lighting would be too costly.

It is stated that the long curves in these designs are responsible for the highest degree of efficiency ever attained in an enclosed globe and that tests on all five sizes show an average of 90 per cent light output. They produce no shadows on the ceiling, whether ceiling fitted or pendant type is used. This is due to the light distribution being general. No shadows appear on the glass itself, nor does the ornamental ring cast a shadow. More light, however, is thrown in the bottom plane by this unit than by a bare lamp, amounting in some sizes to 6 per cent more downward light.

While thus flooding the space beneath with an efficient light plenty of light is provided in all directions. The light thrown downward brings out the height of the room in which it is used without producing the usual objectionable ceiling shadows. Because of the perfection of the glass mixture used, these units are unusually good for color matching, especially when equipped with the daylight lamp.



Here Is a New Ornamental Fixture Suitable for Commercial Installations.



Built-In Tie and Collar Case

HERE is, a handsome and convenient tie and collar cupboard which can be built into any home to good advantage. It is equipped with nickeled racks, hinged to swing freely in and out and equipped with patent clips to prevent ties from slipping off. At the bottom is a round collar hanger with folding wings which keep the collars from dropping down and becoming soiled. A small drawer provides space for collar buttons and cuff links. In the door is a 5½ by 24-inch beveled plate glass mirror.

Quality is built into this appliance. It is made of seasoned, best grade fir throughout and the interior is enameled white. The outside is left in the natural wood so that it may be painted to conform to any room color scheme. The interior measures 8 by 3¼ by 32 inches, extending into the wall about 3½ inches. Ordinarily it is made without casing but, if so desired, it may be obtained with suitable casing at slight extra cost.

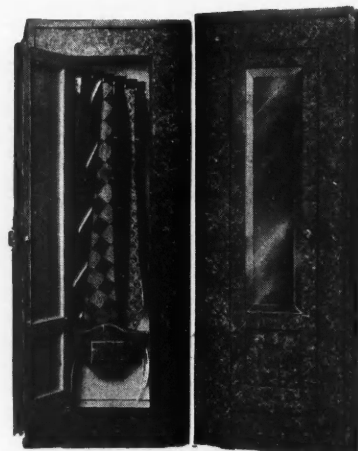

A Convenient Built-In Case for Ties and Collars.



Colorful Walls--Permanent--Sanitary at Substantial Savings

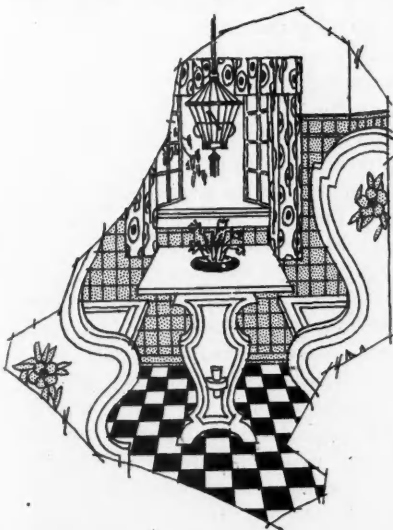

MIAMI TILE—the new tile—is a finished wall surface so constructed that you can install A COMPLETE WALL AS A UNIT, with savings of 30% to 50%!

MIAMI TILE combines cement and asbestos into a fireproof sheet as strong as a rock and just as durable . . . it's the one tile that leaves all worries behind when once installed. It won't crack, craze, peel or chip and can be washed with ease. Simply apply it to furring strips or shiplap with screws and cement—and the job is done.

To meet the popular demand for color in home decoration, Miami Tile is finished in delicate shades of blue, green, gray, tan, orchid and white. Steel or wood mouldings are furnished in contrasting or harmonizing colors so you can produce original effects. Special mouldings cover the corners.

MIAMI TILE is the ideal wall for homes, apartments, hotels, barber shops, cafeterias, restaurants, meat markets—anywhere a finished wall surface is desired.

For a BETTER wall—at LOWER cost—you need MIAMI TILE.

Mail the coupon for full details about the tile, prices, installation methods, colors, etc.

Note the details of Miami Tile

Tile in Sheet Form for Ease and Economy of Application

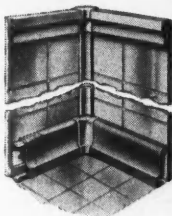

Bull nose moulding and clip.
 Inside corner cap for bull nose.
 Inside corner moulding.
 Base moulding and clip.
 Inside corner cap for base moulding.

THE MIAMI CABINET CO.
 MIDDLETOWN, OHIO

Distributors. . . .
 EXCLUSIVE territory for live distributors still available. You can profit by the low price . . . the growing demand . . . and our leads and selling aids. Write us TODAY for full details.

THE MIAMI CABINET CO. Middletown, Ohio
 Please send me full particulars about MIAMI TILE.

Name.....
 Address.....
 City.....

Check here:
 Architect
 Contractor
 Owner
 Dealer

A Keyless Door Lock

THE lock illustrated is a keyless lock, designed with the idea of greater convenience and of eliminating the difficulties involved in losing or forgetting the key to one's home. Almost everyone has had some such experience and oftentimes it proves not only inconvenient but really serious.

With this lock entrance is gained by pressing the correct combination of buttons. The lock has 12 buttons in a circle, the arrangement corresponding to the numbers on a clock dial. With it in use there is no hunting through pockets or purse for a key and this will especially be appreciated in cold weather when one is anxious to get indoors where it is warm.

Thousands of combinations are possible with the 12 buttons provided on this lock and the owner may change the combination to suit himself in five minutes' time. This assures that security which is the most essential feature of a lock. The general design is standard. The working mechanism is inside of a metal box which is mortised into the edge of the door. There is nothing difficult about the

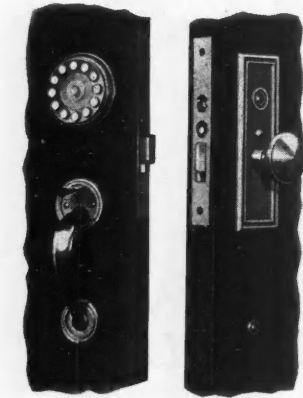

Inside and Outside Views of the Keyless Door Lock with Its Combination Buttons.

installation and it may be done by any carpenter who can install other locks.

There are two push pins in the edge of the door. With the upper pin pushed in the door is locked until the lock is operated by pushing the combination buttons. When locked the latch bolt is transformed into a dead locking bolt which cannot be forced back. After unlocking the door, closing it again will automatically lock it. With the lower pin pushed in the door remains unlocked. There is also a positive locking button on the inner side of the door. Even though an intruder happened to know the combination, it would not be possible for him to unlock the door when this button is down.

The lock is a high grade, ornamental piece of hardware that adds to the appearance of the home where it is installed. The door plates, handles and knobs are of solid brass, neatly finished. The 12 buttons are tipped with pearl which will not discolor or show signs of wear and will last a lifetime. Each lock is thoroughly tested to assure its reliability and only the best materials are used in its construction. The box containing the mechanism is of heavy steel and a rust-resisting plate. The working parts are of brass and bronze, which permanently protects them against rust and corrosion.



Clip for Ribbed Metal Lath

A NEW metal lath clip has recently been developed by a prominent manufacturer of metal lath and similar building materials and is designed to secure this company's ribbed metal lath to flanged structural supporting and framing members such as I-beams. This clip is made in two parts, a flat metal strap and strong U shaped tie wire. The metal strap is of No. 16 gauge, one-inch band iron and is hook shaped at one end, being designed to slip over one flange of an I-beam or any other type of flanged supporting member. The other end of the strap is straight and remains so until the clip is placed in position, then this end is hammered or clinched around the opposite flange of the beam. This makes the strap adjustable to any size of flanged metal lumber.

The U shaped tie wire is made of No. 12 gauge steel wire and when the clip is assembled the two legs project up $2\frac{1}{2}$ inches, at right angles, through holes punched in the strap for this purpose. When the lath is applied the two legs of the tie wire extend up through the lath, straddling the rib, and are clinched or twisted tightly on the upper side, thus holding the lath securely.

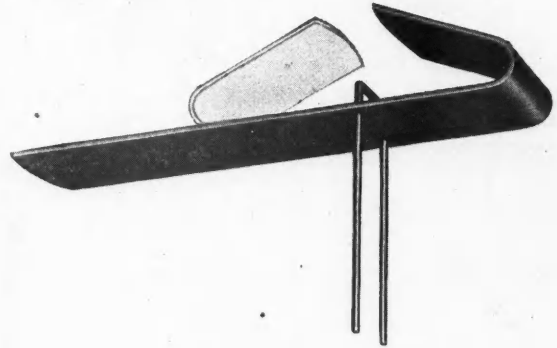

Here Is a Clip Designed for the Purpose of Attaching Ribbed Metal Lath to Supporting Members.

The position of the strap may be adjusted along the flange after the lath has been laid. This makes it possible to fit the wire legs so that they project through the lath without distorting the lath or the clip. This clip will hold the lath at any angle whether for floors, ceilings or walls. Its design simplifies the manufacture reducing its expense and the straps and wires are easily assembled on the job without loss of time.



Combined Rule, Level, Protractor

A NOVEL and handy tool has been placed on the market by a well known manufacturer of measuring tapes, rules and precision tools. It is a combination rule, level and protractor. The four-fold genuine boxwood, two-foot rule of good weight, marked in eighths and sixteenth inches and drafting scales is suitable for all general measuring work. Into one leg or section of this rule is fitted a metal tube containing a spirit level. The center joint of the rule has a securely attached brass degree or protractor plate so that the rule may be opened to any desired degree or angle and the friction in the joint will hold the sections at the point to which they are opened.

This tool is made in two types, one with plain edges and the other having the outer edges brass bound their entire length. Both types have the substantial arch joint.

The level and protractor plates makes these rules serve many purposes other than those served by the ordinary rule. For common and quick leveling the spirit level is most convenient, making it unnecessary to carry a separate level. The rule section into which the level is mounted is six inches long and the rule is so constructed that when closed the level glass is fully protected. With the degree markings angles are readily measured or laid out. The whole rule is neat, strong and because of its compact design can be carried in a pocket where it is always at hand when wanted.

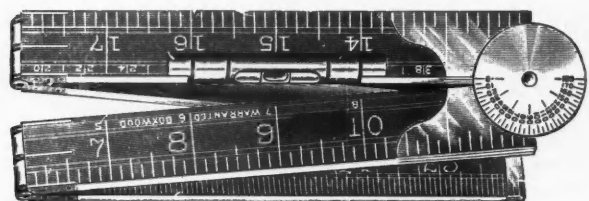

This Neat, Handy Tool Combines a Rule, Protractor and Spirit Level in Most Compact Form.

FIREPLACE CHARM WITH FURNACE-LIKE HEAT



Now—the hidden Heatilator
We now have ready for delivery a new type of Heatilator which gives much wider latitude for fireplace design. With this model there can be two or more warm-air outlets—for example, one on each side of the fireplace, invisible from the front, or one at any height in the mantel—and cold air intakes on each side of the fireplace, drawing cold air off the floor.

NOW—A BIG SAVING IN COST!

YOU CAN'T AFFORD NOT TO PUT HEATILATORS INTO YOUR FIREPLACES

Heatilators are widely advertised in all the great national magazines that are edited particularly for people interested in new homes. People are looking for Heatilator Fireplaces in homes they buy or rent. We guarantee complete satisfaction or will refund the full purchase price plus up to \$20 extra to cover bona fide cost of removal and return. Your bank or Dun's or Bradstreet's will tell you that this guarantee is good!

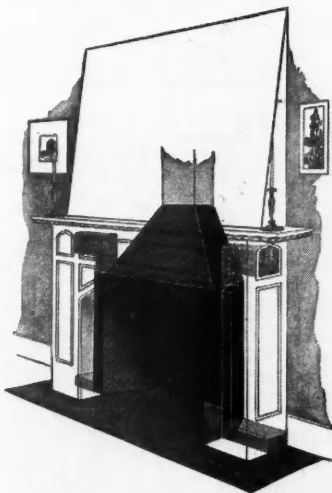

Above phantom view shows a Heatilator with cold air intakes and warm air outlets on each side of the fireplace. Intake and outlet boxes may be of any shape or any length, so that openings will fit into the design of the mantel. Openings may be covered with open masonry or grilles.

THE Heatilator is a boiler-plate form built into the fireplace, a complete unit up to the chimney flue. Its scientific design assures absolutely perfect, smokeless operation, and completely eliminates uncertainty about how a fireplace will draw. We fully guarantee it.

In addition, it creates a new source of heat and ventilation. Its double walls act as a heating chamber over and around the fire. Cold air from off the floor comes into this chamber, is heated and delivered into the room. Thus heat is utilized which in the ordinary fireplace is wasted—equal in volume to that of a warm-air furnace register.

The new Heatilator is so simple and produced in such quantity, that the price has been reduced to \$58 delivered (U. S. A.). Any mason can install it in a new or old

fireplace in a few hours. Enough material, time and labor are saved to pay more than half the cost of the Heatilator, and the balance is quickly saved in fuel, not only because the Heatilator gives double heat from the same fuel but because its extra heat makes a furnace fire unnecessary in unseasonable weather.

Write for this booklet FREE!

For free inspection, let us send a Heatilator at our expense, direct to you; or write for our new booklet, "The Heatilator Plan-book of Modern Fireplaces"—sent free and without obligation. Mail coupon, indicating your wishes, to

THE HEATILATOR COMPANY
621 Glen Avenue Colvin Station
Syracuse, New York

Heatilator Fireplace Unit

Dealers and Agents: Write for our special proposition to representatives—NOW!

HEATILATOR COMPANY,
621 Glen Avenue, Colvin Station, Syracuse, N. Y.

- Please send me full information without charge.
- Enclosed find \$58.00 for which send Heatilator subject to your guarantee of complete satisfaction with extra payment in case of return, or \$25.00 deposit, balance C. O. D., plus collection cost.
- Please send Heatilator on open account. I attach dealer's name or bank reference.

Name.....Address.....

Bru-CELL-ized flooring is damp-proof and insect proof. It is easier to lay, scrape and sand. More durable, and takes a superior finish



Y You can now furnish

real plank floors of Solid Oak at a cost no longer Prohibitive for Average Homes

EXTRA sales—extra profits are yours, in this opportunity to supply distinctive Colonial floors, at reasonable cost. People want plank floors, because they are different, but the expense has been too great for any but the most pretentious homes. This is due to costly methods of manufacture, such as laminating or veneering, and other precautions needed to prevent shrinking or swelling.

Bru-CELL-izing, a remarkable chemical process perfected in the Bruce laboratories, now makes possible the use of solid oak planks, because it stabilizes the wood and prevents cupping, buckling, or shrinking. Laminating or veneering is unnecessary.

As a result, Bru-CELL-ized planks may be laid without extra precautions. They may be blind-nailed like strip flooring, and need no screws, plugs, or

butterfly keys to hold them in place. Solid oak planks are the most profitable flooring item a dealer can handle.

E.L. Bruce Co.
MEMPHIS, TENNESSEE
Largest makers of oak flooring in the world

Write today for full details and illustrated literature.

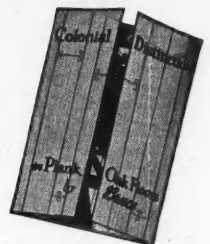

Write for this book *How Bru-CELL-izing solves the plank floor problem is fully explained in this book: "Colonial Distinction in Plank Floors." It is free.*

Bru CELL ized Oak Flooring
PLANK • FABRICATED BLOCK • DESIGN • STRIP

Bru
are
floor
fact
or n
geth
(Ba
wo
As
eve
in l
req
in i
F
rem
lev
CE
wh
swe

Extra Sales - Extra Profits

Bruce FabriCELLized blocks are the newest idea in distinctive flooring. Each square is manufactured in a complete unit, three or more oak strips, splined together. Ready to lay in mastic (Barrett XC) over subfloors of wood or cement, without nails. As a result, the blocks are laid even faster than strip flooring, and in less than one-third the time required to lay the same pattern in individual pieces.

FabriCELLized blocks will remain permanently firm and level, because each square is BruCELLized, a chemical process which prevents shrinking or swelling and increases durability.



Laid quickly in mastic, over subfloors of wood or cement. Nonnailing.

E. L. Bruce Co.
MEMPHIS, TENNESSEE
Largest manufacturers of oak flooring in the world

In no other way can more be offered for less money. Here is a beautiful design floor at a cost very little higher than strip flooring. It will not squeak, or show cracks. It is sound-deadening, quiet under foot, and has a "feel" unique in a wood floor.

Builders today are selecting blocks for the best residences and for remodeling jobs over old, worn floors. Complete information for laying this new type of floor in mastic, will be supplied by our service department.



FabriCELLized Flooring Blocks

BruCELLized

Now being laid extensively in hotels, apartments, public buildings, offices, churches, as well as residences. Easier to lay, scrape and sand, and takes a superior finish. Insect proof; moisture proof.

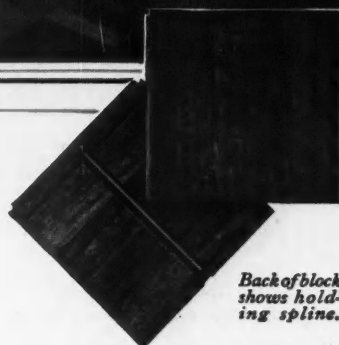

Back of block shows holding spline.

Bruce FabriCELLized blocks of either three or more oak strips may be laid in diagonal, half center or regular square patterns. Three sizes, 6", 9", and 11½" in. squares; in all grades.

For Pulling Electric Plugs

IF you pull out electric plugs by the wire, as shown at the upper portion of the illustration, the wire will soon break and you are likely to be bothered with burned-out fuses. And that is the way most people do pull plugs out.

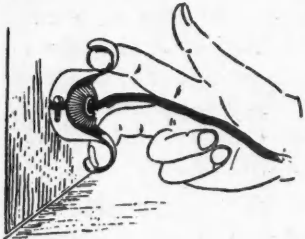
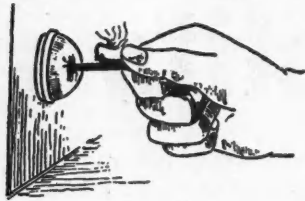

A Simple Attachment for Electric Plugs Which Prevents the Cord Getting Pulled Loose.

Now you can obtain a simple little attachment for the plug which gives you a really convenient handle by which to pull it, as shown in the lower portion of the illustration. This attachment is readily slipped onto standard plug caps of any size, style or make and is fastened by merely tightening a screw. It will not slip off and nothing need be done to the wiring. The two curved arms form a convenient grip for the fingers and no one will be tempted to grasp the wire to pull the plug as the arms are more convenient. The attachment also acts as a shield, protecting the plug-cap against breakage. It is finished in black japan to match the hard rubber or composition plug and is neat, safe, durable, inexpensive and a real convenience. Equipping the various plugs used in a house with this device will appeal to the prospective buyer.



New Three Gang Tumbler Switch

THE illustration shows a new tumbler switch for two and three circuit connection, three switches in a single gang. They are miniature switches in a porcelain base, designed with this manufacturer's precision mechanism and are said to have the smoothest, easiest action yet devised for a tumbler switch. An entirely new principle in switch mechanics has been employed in these tumbler switches which gives an exceptionally easy, quiet snap, hardly noticeable. The use of this three gang switch effects a saving in material compared with the use of a large three gang unit. There is a common feed for each tumbler switch which saves wiring time and only one main connection. The leads to each circuit are quickly hooked up, making a simple installation.

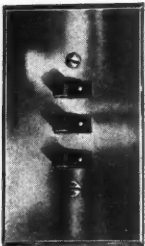

New Tumbler Switch with Three Switches in a Single Gang.



Clean Convenient Garbage Receiver

THE old fashioned garbage can has always been unsightly and really unsanitary, because it is always being knocked over by dogs and cats and becomes a breeding place for flies. The nuisance of such a garbage receptacle can be done away with simply and inexpensively by installing a receiver of the type illustrated here.

This garbage receiver is made in three parts, a copper steel, rust resisting, outer casing to which is attached a cast iron lid and a galvanized iron pail in which the garbage is placed. It is made in four sizes with can capacities of 8, 12, 15 and 20 gallons.

With this receiver it is simply necessary to dig a hole in the ground at the point you wish to place the receiver, near the kitchen door or back by the alley, insert the outer casing in the hole and pack the earth around it

then place the galvanized pail in the casing and it is ready for use. In use it is not necessary to lift a soiled lid, just press the foot trip which raises the lid, dump the garbage into the pail and shut the lid with your foot. The pail is easily removed by the garbage collector, the can is always out of sight, nothing but the neat, cast iron lid being visible and it cannot be knocked over or opened by dogs or cats, nor reached by flies or rats. There are no odors of fermenting garbage on hot days.

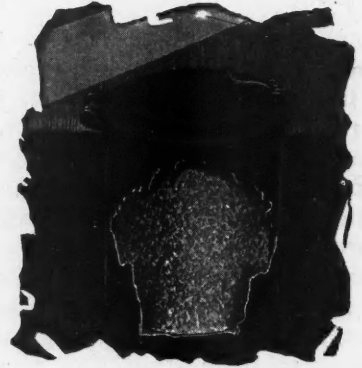

A Garbage Receiver of This Type Eliminates the Disagreeable Features of the Old Fashioned Garbage Can.

New One Bag Mixer

A NEW 5-S standard building mixer has recently been placed on the market as an addition to a leading line of concrete mixers. This machine is a one-bagger and, according to the manufacturer, is designed especially for the smaller contractors who want a one-bag mixer built up to the standards of large mixers and for the large contractors who are not satisfied with a small mixer built to lower standards.

The drum of this mixer is 42 inches by 30 inches with unusually large, rounded corners to facilitate quick mixing and easy cleaning. It has ample room to handle a one-bag batch of 1-2½-4 concrete. The charging chute is large and shaped to give rapid charging with wheelbarrows. The power loader takes a full load without crowding and goes up in five seconds, while the discharge takes place in six to seven seconds.

This mixer is described as being exceedingly simple to operate for all the control levers are at the drum end and the operator sees both the power loader and the discharge. The gears are unusually quiet in operation. An Alemite system of lubrication is used. The frame is simple and rugged and the whole machine is easy to move, the front wheels turning under the frame.

A choice of single or two-cylinder engines, of two well known makes, or an electrical motor is offered. Actual use in the field, it is stated, has demonstrated that this new mixer fulfills the rigid requirements set for it by the manufacturer's engineering department, so that it can be counted on for dependable service.



A Standard, One Bag, Building Mixer Which Has Recently Been Added to a Well Known Line Is a Quality Product.

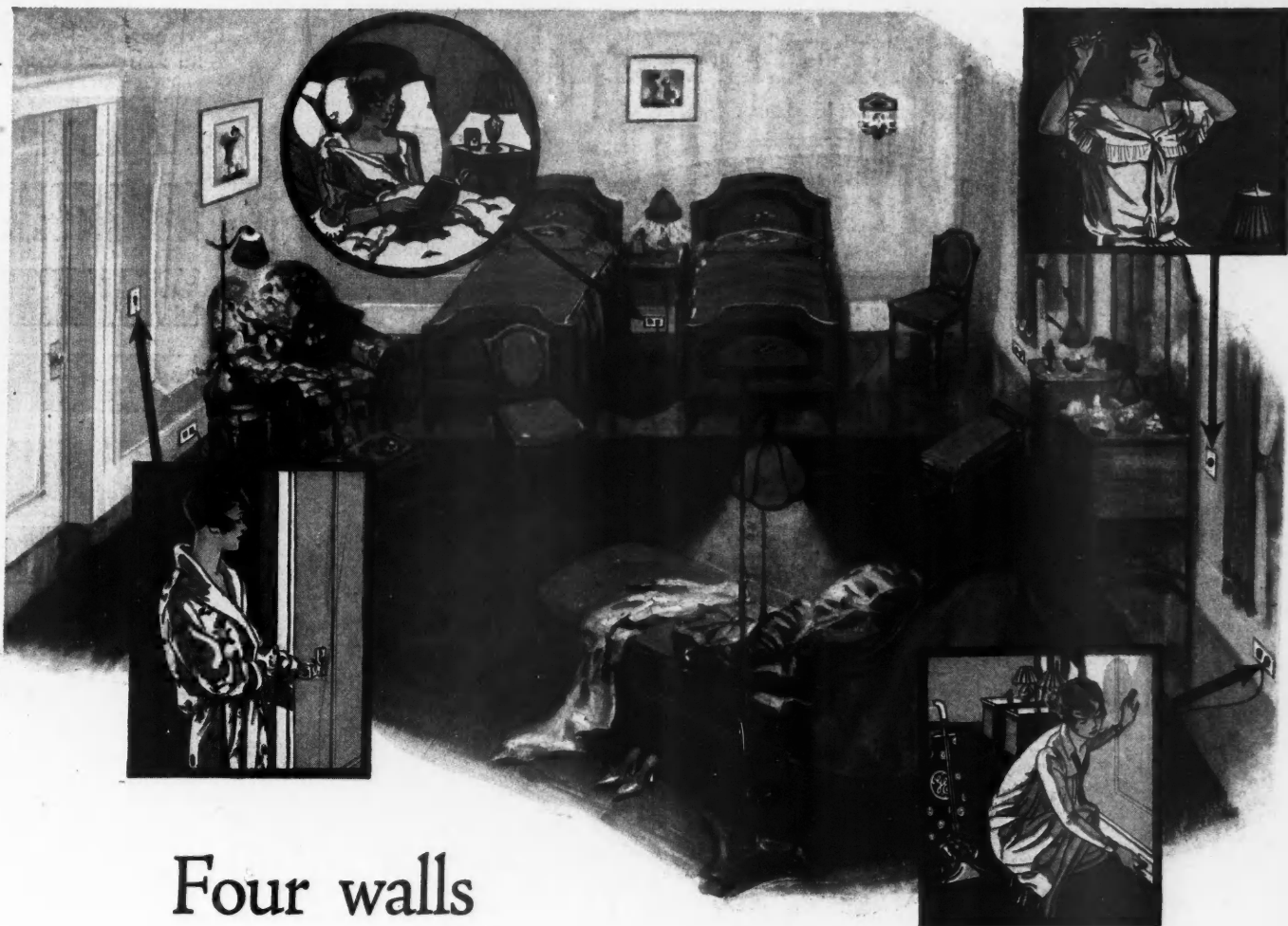

Four walls no longer make a house!

You must *wire* selling points
into every room you build

*Write for this
helpful booklet
you should have it
in your files*

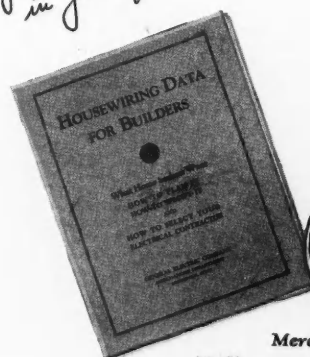

Gone are the days when large airy rooms were all you needed to sell a house! These days women (and men, too) look for the comforts that can be theirs only if the house they choose has adequate wiring.

The nationally advertised General Electric Wiring System is

the *complete* wiring system. It provides for plenty of outlets and switches. It provides electrical comfort for every room and a mighty forceful sales argument for any house. General Electric's name and endorsement are instantly recognized as symbols of satisfactory and lasting service.



Merchandise Department
Section 33
General Electric Company
Bridgeport, Connecticut

WIRING SYSTEM







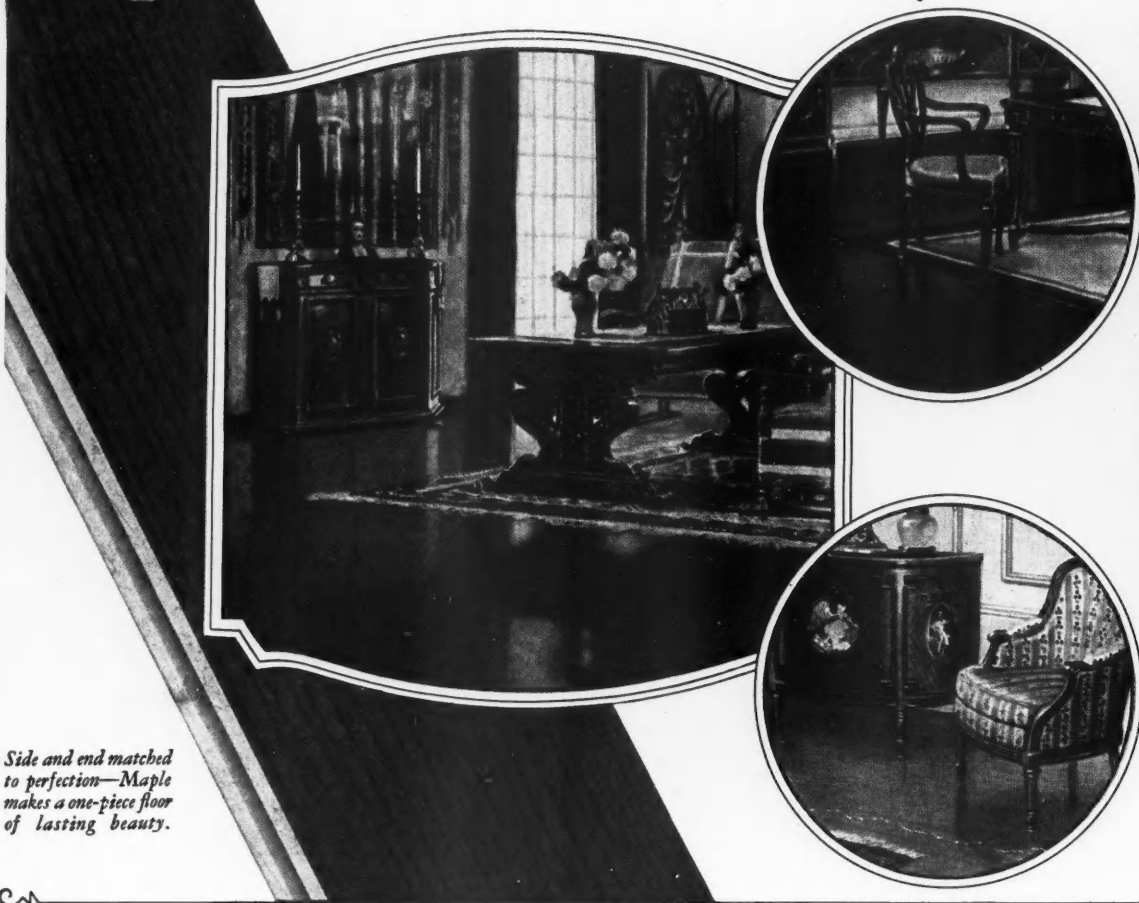

—for lifetime service

GENERAL ELECTRIC

Maple Floors in Color!



Side and end matched to perfection—Maple makes a one-piece floor of lasting beauty.

-  MFMA No. 108—Orchid
-  MFMA No. 107—Pastel Green
-  MFMA No. 104—Silver Gray
-  MFMA No. 101—Early American
-  MFMA No. 106—Royal Blue
-  MFMA No. 105—Dove Gray
-  MFMA No. 102—Spanish Brown
-  MFMA No. 103—Autumn Brown

Standard finishes shown, made only by the Marietta Paint & Color Co., Marietta, Ohio.

THE charm of color . . . combined with the lasting comfort and homelike atmosphere that only a fine hardwood floor can bring . . . this is the marvelous new opportunity Northern Hard Maple Flooring offers you for every room in the modern home or apartment.

With fadeless penetrating stains recently developed, which you, yourself, or any painter or decorator can apply, it is now possible to produce permanent colors in Northern Hard Maple floors.

Any tone you choose! From light, cool green to deep, mellow brown . . . from delicate blue to rich, rare ebony. And with this coloring, the subtle grain of the wood develops a distinctive beauty never before seen in any floor.

Maple has long been known to be the smoothest, most resilient and most enduring of all the better flooring materials. With this new element of color

added, it becomes at once the outstanding flooring for residential use.

Think, then, of the comfort and cheer you will create by flooring bedrooms, living room, dining room, kitchen and hallway with Northern Hard Maple. Think, too, of the value modern Maple floors in color will add to a home in future years.

Why not learn the many advantages of this new flooring opportunity? Write for the free illustrated booklet, "The New Color Enchantment in Hard Maple Floors."

MAPLE FLOORING MANUFACTURERS ASSOCIATION
1798 McCormick Building, Chicago, Illinois

Guaranteed Floorings

MFMA The letters MFMA on Maple, Beech or Birch flooring signify that the flooring is standardized and guaranteed by the Maple Flooring Manufacturers Association, whose members must attain and maintain the highest standards of manufacture, and adhere to manufacturing and grading rules which economically conserve these remarkable woods. This trade mark is for your protection. Look for it on the flooring you use.

Floor with Maple

Improved Paint Spray Gun

A NEW paint spray gun is illustrated here featuring a new and important development in the adjustable spray head with positive, accurate control of type and width of spray. It is described by the makers as offering the best in spray gun design that could be produced out of their long years of experience and enlarged engineering and manufacturing facilities.

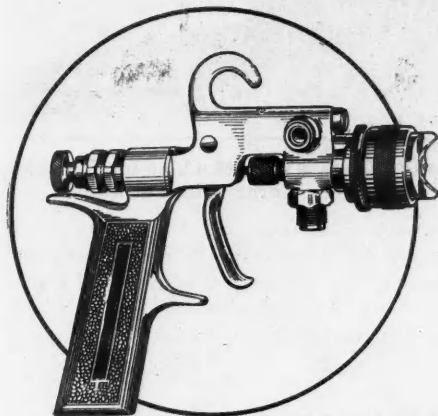

This Paint Spray Gun Features Positive and Accurate Control of the Spray.

The new spray head has a graduated adjustment controlling both the character and width of the fan spray. This graduated adjustment makes possible a quick return to a previous setting for producing any desired spray. The air can also be cut off, producing a round spray. This adjustable head eliminates split sprays and "overspray" and insures proper balance between the amount of material used, nature of work and speed of operation.

Another outstanding feature is the positive self-centering of the nozzle parts, based on an absolutely correct mechanical principle which, it is said, makes it impossible for these parts ever to get out of alignment. These and other features combine to bring the adaptability of this spray gun, for doing a greater variety of work and for using every kind of material, to a higher point than ever before reached. The greatest practicable speed can be attained without affecting in any way the high quality of the work.



Mixer Wheels Improved

A NEW type of roller bearing wheel, for portable concrete mixers, which is designed to give a wide tread for soft footings and a rubber tire for easy towing, has been announced as standard equipment on a well known line of mixers. This new wheel is equipped with a steel rim eight inches wide and 20 inches in diameter which is the proper size to receive a standard 3½-inch solid rubber tire 24 inches in diameter, pressed on in the usual way.

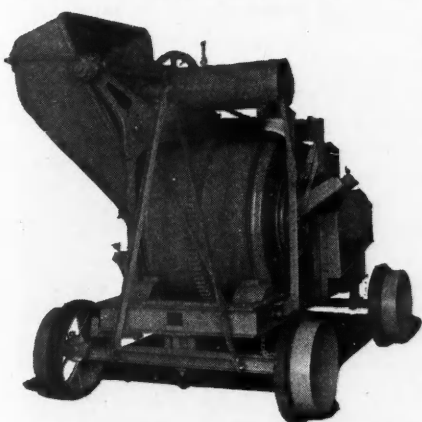

Roller Bearing Wheels with Wide Tread for Soft Footing Have Been Placed on a Well-Known Line of Mixers.

The steel spokes are set to one side of this rim and the rubber tire is pressed on this side so that some 4½ inches of rim project out beyond the tire. This permits the mixer to run on the rubber tires for towing or where there is firm footing. When soft footing is encountered the tire sinks in until the full width bears on the ground and gives an effective wheel width of eight inches.

The hub has also been completely redesigned in order to receive a set of Timken bearings which give added ease

of rolling and assure long life and true running wheels. Before being adopted as standard the new wheel underwent extensive tests on the type of work for which it is particularly adapted, where bad footing was the rule on the job. It proved to be a valuable time saver in moving as well as being effective in keeping the wheels from sinking into the ground while working on soft footing.



Four New Engines Announced

A NEW single, a new two and two new four cylinder engines are being added to a well known line of industrial engines in 1928. This line has included three sizes of two cylinder engines, 6, 9, and 12 h. p., available either in hopper or radiator cooled types. The new two cylinder will be an 8 h. p. unit and will be similar to 6 h. p. engine. The line of two cylinder engines will then include 6, 8, 10, and 12 h. p. units. Steel housing is standard equipment on the radiator cooled types and is offered as extra on hopper cooled engines.



A Leading Manufacturer of Gas Engines Has Brought Out Four New Models.

With the addition of the new single cylinder unit the line will include two single engines similar to the two cylinder units. These will be a 3 and a 4 h. p. unit.

The two new four cylinder units will closely resemble, in construction, the two cylinder units, in fact, they will be "doubled-up" two's. They will be of 12 and 16 h. p. and will incorporate advanced practices such as are found in no other four cylinder power units, it is claimed. At the same time these developments are practical since they have been in general use on all this company's two cylinder engines for two years.



Home Ventilating Unit

THE fixture illustrated here is a handy ventilating unit for the home, particularly for ventilating kitchens and removing the hot stuffy air and cooking odors. By ejecting to the outside the hot air and odors given off by cooking the rest of the house is kept sweet and clean. Not only is the kitchen ventilated, but the other rooms as well, because the device creates a gentle circulation of air, withdrawing air from the rooms into the kitchen and thence outside.

This fixture is easily installed, usually the whole installation can be made in 15 minutes. It is installed in line with the lower sash. When not in use the upper sash is entirely closed, thus protecting the whole ventilating unit from the outside elements. To put in use, the upper sash is pulled down so that the top of it is in line with the bottom of the ventilator.

The motor requires only one oiling a year. It is furnished with an eight-foot extension cord and attachment plug, so that it can be fitted into any ordinary light socket. It uses no more current than an ordinary bulb, so that its operating cost is practically negligible. The frame in which the ventilator is mounted is fitted with opaque prismatic glass, so that the sun light is not obscured.

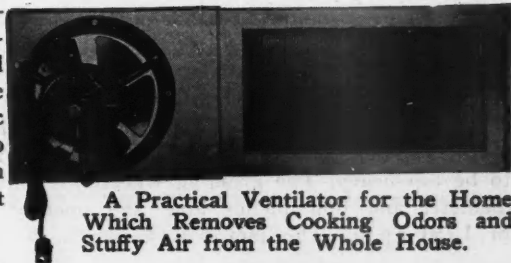

A Practical Ventilator for the Home Which Removes Cooking Odors and Stuffy Air from the Whole House.

Line of Mixers Improved

THE influence of the growing acceptance of the water-cement ratio theory for concrete control is definitely reflected in the new models of a line of mixers which have been developed during the past 18 months and are now being added to this well-known line. During this 18 months the company engineers have worked in the field with construction organizations to determine the exact type of mixer required for economical operation by the contractor.

As a result of this experimenting, important design changes have been made. The drums are higher and not so long. This permits more thorough mixing in any given length of time because it makes possible better arrangement of paddles and buckets. This new drum handles efficiently the concrete of "sticky" consistency that is now so often specified.

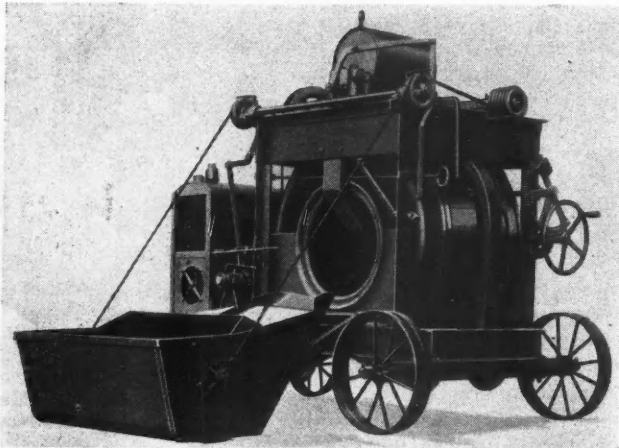

The Line of Mixers of Which This Is One Has Been Improved with Special Reference to the Use of the Water-Cement Ratio.

A water measuring tank of new design provides accurate water measurement within less than $\frac{1}{2}$ pint and assures the right amount of water for every batch. The high drum makes possible larger drum openings, making it possible for the contractor, faced with specifications requiring minute or minute and a half mixing, to cut charging time. The larger discharge opening, with steep and deep semi-round discharge chute, effects a discharge as fast as a tilter, it is said, while retaining all the advantages of the non-tilting drum.

All control levers have been brought to the drum end of the machine and once the engine is started the operator puts it through all its functions while standing at the discharge side. This means barrows and buggies are uniformly filled and a minimum time is lost in getting the batch on the way to the forms.



New Toggle Joint Base Grinder

BUILDING the finest and most efficient terrazzo grinding machinery made has been the aim of a leading company in this field for over 16 years and it has produced a complete line of machines and supplies which are widely used. Now comes another machine which has been added to the line which the makers describe as "the finest toggle joint base machine ever built," and claim that every disadvantage and weak point common to toggle joint base machines has been overcome in this machine.

It is constructed of steel and aluminum practically throughout and is mounted on a pressed steel stand with a truck and casters so designed that there is no tendency to be top heavy. The grinding wheels are three inches in diameter and four inches long and operate at a speed of 1,750 r.p.m. The motor is a one h. p. ball bearing

type operating at the same speed as the grinding wheel.

Ball bearings are used throughout the entire machine and all moving parts are packed in grease and fully protected against dust and grit.

The over-all dimensions, with shafts in the most compact form, are 41 inches high, 45 inches long and 21 inches wide. The machine weighs 300 pounds and comes complete ready for use and equipped with one straight wheel, one cone wheel and 100 feet of trailing wire.



Air-Cooled Stationary Engines

WHILE the air-cooled gasoline engine is well known as dominating the airplane field, it is perhaps not so well known as a recognized factor in the stationary engine field. It has, however, reached the highest standards of efficiency in this field, especially in the five to eight horsepower class. A leading manufacturer of this type of engine has been developing it for the past 20 years and has produced thousands of engines which are now operating with high efficiency in all types of stationary engine work.

This engine is standard equipment on a large variety of machine tools and implements. In the building field it is used for sawing, pumping, temping, mixing, hoisting, grading, conveying, loading, paint spraying, compressing and many other purposes. It is built with the same care and precision and to the same standards which are found in the automobile industry. It is simple and compact and the air-cooling system eliminates water and all its attendant troubles and permits heavy duty service in any temperature.

Every working part can be removed and replaced in a few minutes, in the field, with ordinary tools. Unit construction permits removing the crankshaft without disturbing the ignition, governor, valves or gears and the connecting rod bearings can be adjusted in five minutes. This unusual accessibility means much saving of time and money to the user.

The engine is entirely enclosed and dustproof and every working part runs in a bath of oil. Speed is regulated instantly and a convenient lever controls the mechanism of the implement being operated.

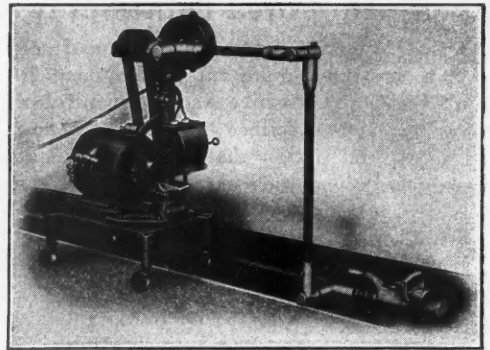

Here Is a Toggle Base Machine for Finishing Rounding Corners in Terrazzo.

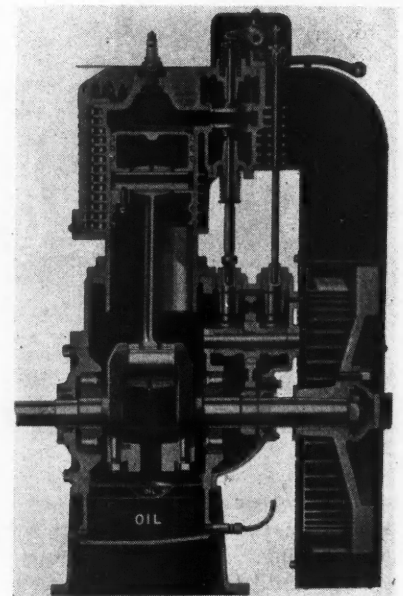

This Line of Air Cooled Engines Has Demonstrated Its Efficiency in the Stationary Engine Field.

You can get
 Dependable Materials
 and Service from
**Andersen
 Dealers!**



A Frame for Every
 Kind of Building

IF you are building houses for particular customers, you will want frames for a variety of window opening styles and sizes. You may need frames for double hung windows in a studding wall and others for casements in a stucco or brick veneer wall or perhaps you will want box frames for solid masonry. Surely you will have immediate need for cellar, garage and door frames.

In each frame of whatever assortment you order you will want wood that cannot warp or split or rot.

You will want to save time and money by having frames that are accurately milled, finely finished, and that can be set up quickly.

Right? Then order from a dealer who carries Andersen Frames*. That dealer can fill your order promptly because of the standardized assortment and convertibility of Andersen Frames. You have positive assurance that an Andersen dealer can give you variety, quality and service.

For further information fill out and mail the coupon below.



Distinctive Features

- 1 Patented, noiseless, long wearing *Anderson* pulleys used exclusively.
- 2 Genuine soft *White Pine* sills and casings—last a lifetime.
- 3 Patented, exclusive *weather-tight* features including groove for wide blind stop.
- 4 Absolute accuracy of milling.
- 5 A Frame up in 10 minutes.
- 6 Standardized styles and sizes, convertible for all architectural needs.
- 7 Nationally known and distributed.
- 8 Dependable because guaranteed by a reliable manufacturer.

Sold by Leading Building Material Dealers

**Andersen
 FRAMES**

*Look for the Andersen Trade Mark on every frame.

ANDERSEN LUMBER COMPANY

Box 2103, Bayport, Minnesota.

Please send me without cost or obligation the material checked in squares on this coupon.

Set of illustrated folders describing construction and uses of various Andersen Frames.

"How to Make Your New Home More Comfortable"—an illustrated booklet of interest to all home builders.

Name _____ Business _____ Street Address _____
 City _____ State _____ Name Lumber Dealer _____

Overhead Rolling Steel Doors

THE illustration shows an application of rolling steel doors which afford a number of features that recommend them for a multitude of installations. These doors roll up out of the way overhead and waste no floor space. They are weatherproof, burglarproof and fireproof. The door proper is built up of a series of interlocking mouldings, called slats, and though it is stiff against pressure it is flexible in its ability to roll up.



Strong Steel Doors that Roll Up Out of the Way Overhead and Are Furnished in All Sizes.

The door is retained at the sides in guides and rolls up on an overhead, steel, pipe roller or shaft. The shaft is supported at each end in a steel bracket, which is fastened to the heavy steel side guide. The shaft contains springs which counterbalance the door at any point in its travel.

The smaller doors push up and pull down with handles on the bottom. This is called the self-coiling type. Larger doors have geared operators, the gears furnishing the leverage to revolve the shaft which raises and lowers the door. They are turned by a sprocket wheel and an endless hand chain. This is called the chain gear type. The gears may be turned by an upright shaft leading to a hand crank attachment near the floor. Very large doors can be rapidly and economically operated by electric motors.

These doors can be used for practically any opening and the manufacturer maintains an engineering department which offers consulting service for layouts of special openings.

Luminous House Numbers

A HOUSE number that can be seen easily in the dark saves trouble for both the owner of the house and the passerby. Ordinarily numbers can be seen only in the day time. The house number shown here, however, can be seen perfectly in the dark. The figure is 2½ inches high and the overall size of the number plate is 3½ inches. The plaque is of very heavy gauge aluminum with a deeply recessed figure, having a secondary recess for holding a good grade of radium compound. This gives one figure inside of another.



These Luminous House Numbers Save Trouble for Both Owner and Caller.

The luminous figure can, relatively, so much more readily be seen because of the better contrast, that the larger figure is provided for day time use, thus the double figure. The plaque is treated with a high grade bitu-

mastic enamel and baked hard. After treatment with the luminous compound it is enclosed in a curved top and bottom rectangular frame and closed together as a unit.

These numbers are attached by two small nickel-plated brass screws and may be mounted on a separate board



Copper Steel Boilers

THE boiler illustrated here is the residence size of a line of copper steel boilers which are known for their quality. Structurally these boilers are described as the strongest boilers built. They are made of uniformly thick, rust resisting, copper steel. There is no cast iron part to hold water and no weak spot anywhere. They conform with the A. S. M. E. Boiler Code requirements.

These boilers are constructed in one piece and can be set up in a few minutes' time without special equipment. There are no sections to be bolted together and no joints to putty. They are easy of access both inside and out and the heating surfaces can be cleaned in two minutes. They are very compact requiring a minimum of floor space and the upkeep cost is said to be practically nothing. This boiler is made for steam, vapor and hot water and burns oil or any kind or size of coal. It is made in sizes to heat any building from the smallest residence to the largest skyscraper.

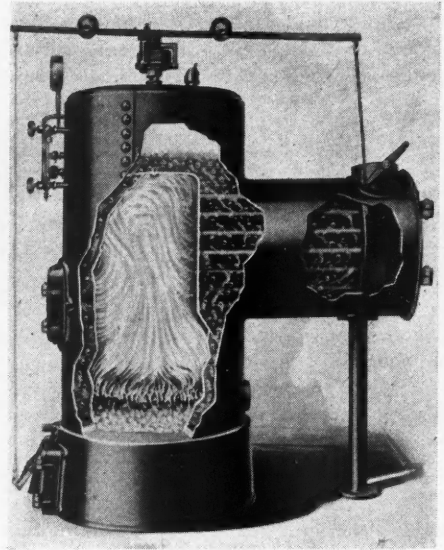

Boilers of Copper Steel, in All Sizes That Will Give a Considerable Fuel Economy.

The really outstanding feature of these boilers, however, is described as being their fuel economy. It is stated that, with nine tons of coal, one of these boilers will heat a house that previously used 15 tons with an ordinary boiler.

The really outstanding feature of these boilers, however, is described as being their fuel economy. It is stated that, with nine tons of coal, one of these boilers will heat a house that previously used 15 tons with an ordinary boiler.



A Handy Motor Attachment

THE electric motor attachment illustrated here is described as "the handy tool which makes a complete machine shop." It is an attachment which may be used on any motor shaft of ⅜, ½ or ⅝-inch size. The size of shaft must be stated when ordering, however. It holds attachments for polishing, sawing, drilling, grinding, a grooved pulley and many other applications. It fastens directly to the motor shaft and can be quickly attached. No belts or pulleys are necessary. It is made of the highest grade, cold rolled steel, with machined, cast flanges and a three-jaw, 0 to ¼-inch drill chuck.

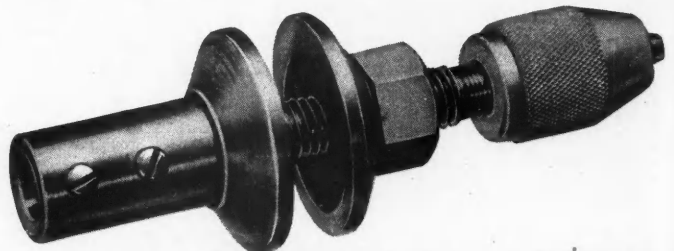

This Attachment Adapts the Electric Motor to a Multitude of Uses.

Only Genuine
High Class Performance

Pays Big Money!

YOU GET THAT WITH THE

AMERICAN UNIVERSAL FLOOR SURFACING MACHINE

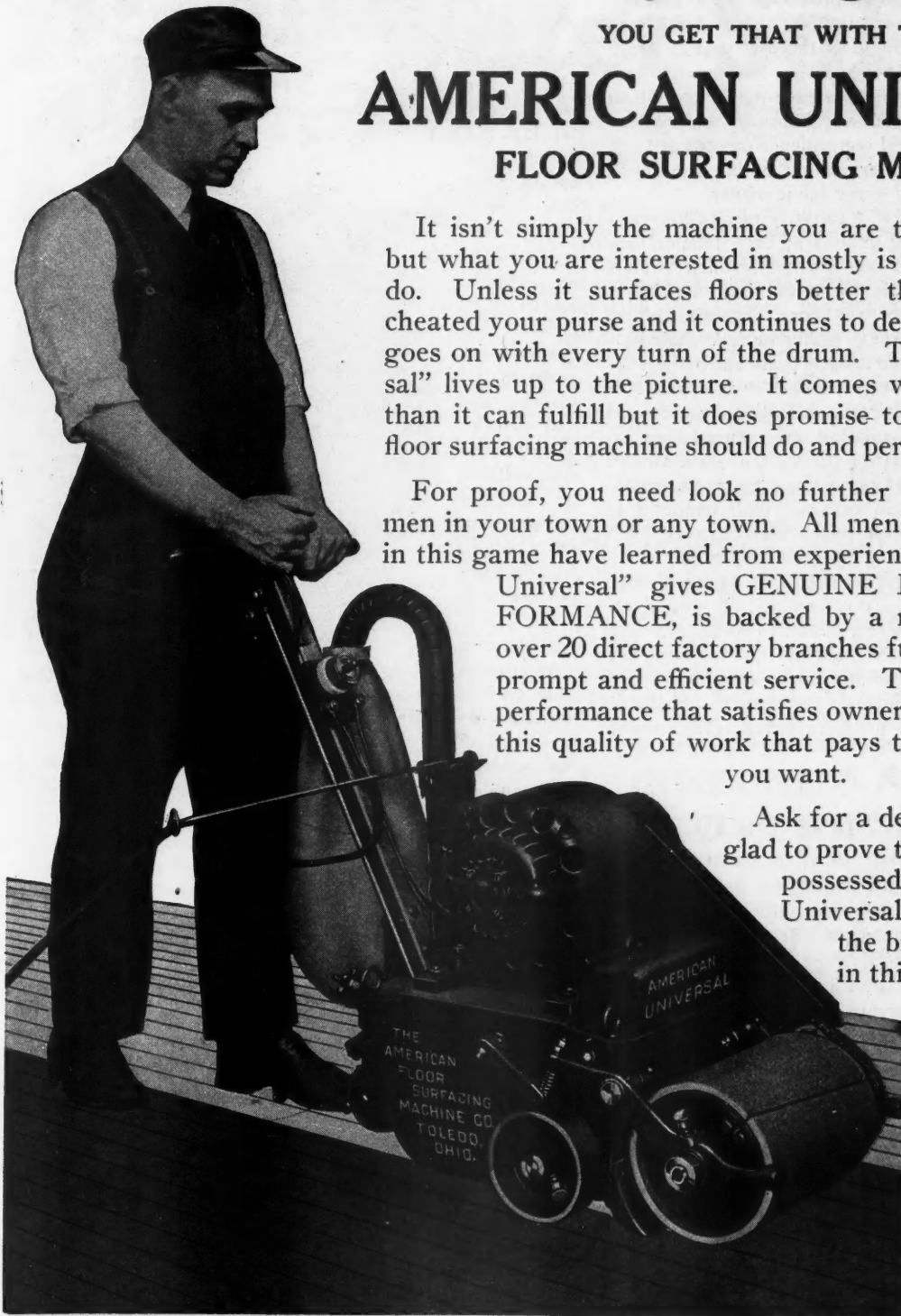

It isn't simply the machine you are thinking of possessing, but what you are interested in mostly is what the machine will do. Unless it surfaces floors better than any other, it has cheated your purse and it continues to defraud because cheating goes on with every turn of the drum. The "American Universal" lives up to the picture. It comes with no more promises than it can fulfill but it does promise to do all those things a floor surfacing machine should do and perform its service better.

For proof, you need look no further than the leading floor men in your town or any town. All men who make their living in this game have learned from experience that the "American Universal" gives GENUINE HIGH CLASS PERFORMANCE, is backed by a reliable company with over 20 direct factory branches fully equipped to render prompt and efficient service. This is the only kind of performance that satisfies owner and builder alike. It's this quality of work that pays the BIG MONEY that you want.

Ask for a demonstration. We are glad to prove to you the real qualities possessed by the "American Universal" and tell you about the big income to be earned in this ever increasing business.

**SIGN
COUPON
BELOW
and
MAIL
AT ONCE**

THE AMERICAN FLOOR SURFACING MACHINE CO.
515 So. St. Clair St., Toledo, Ohio

Without obligation, send complete information at once about the "American Universal" floor surfacing machine.

- I am a building contractor.
- I am interested in floor surfacing as a business.

Name.....
Address.....
City..... State.....

WHEN WRITING ADVERTISERS PLEASE MENTION THE AMERICAN BUILDER

Perfect Automatic Water Heater

A PROMINENT manufacturer of private water systems has recently announced an addition to their line which makes their service to the home owner complete. This is an electric water heater which is the culmination of a long series of investigations intended to produce a more efficient and more dependably controlled, automatic, hot water heater at a reasonable price. It is offered as the best that 25 years

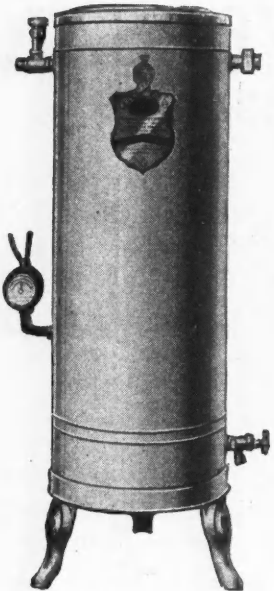

A Highly Perfected Heater That Brings Controlled Hot Water Within the Reach of All.

of engineering and manufacturing experience has been able to produce. It brings the comfort and convenience of constant hot water supply within the reach of every home owner.

The capacity of this heater is 30 gallons at bath temperature at one draw-off, which is suitable for a two-bath residence, doctor's or dentist's office, beauty parlor or four-chair barber shop. Tests show the lowest heat loss ever achieved, it is claimed. Scientifically arranged insulation has reduced heat radiation to such a point that it takes no more current to maintain constant bath temperature with this heater than an ordinary 50-watt lamp bulb.

The heater is equipped with a cut-off switch, all completely wired, ready to hook up. The base legs and top are rustproof and the heavy sheet steel case is gayly lacquered in brilliant orange. A temperature and pressure relief valve provide absolute safety.

❖

Portable Paint Spray Outfit

HERE is a portable spray painting outfit which is specially adapted to a situation where it is desired to have the advantages of spray painting without setting aside a definite space for doing the work. It can be used anywhere within reach of the electric line. This outfit supplies plenty of air for one spray gun in continuous operation and gives just the right pressure for painting with Duco, lacquer or paint.

The outfit is very compact being 31 inches high, 33 inches long and 19 inches wide, with a 32-inch handle. The total weight is only 375 pounds. It is mounted on a special steel truck with sturdy steel wheels and balloon tread rubber tires. The handle is convenient for moving the outfit and for holding the hose when not in use.



Here Is a Spray Paint Outfit That Is Completely Portable.

Equipment includes an accurate pressure gauge, air filter, oil filter, oil gauge, check and safety valves, latest type toggle joint switch, steel reserve tank maintaining balanced air supply and 25 feet of rubber covered electric extension cable with plug. There is an automatic unloader

which releases the load when the maximum pressure is attained, saving power and wear on the motor.



Improved Electric Hand Saw

A WELL known manufacturer of electric hand saws has just perfected a new model of saw which is described as a very light, powerful and efficient electrically operated hand saw. This saw weighs only 11 pounds, yet develops ½ H.P. It is designed for cutting

up to two-inch dressed lumber and is said to be ideally adapted to industrial purposes, literally supplanting the old-fashioned hand saw as it can be used in any position, in either hand, with perfect ease.

This saw sells at a very reasonable price and combines all of

the superior construction and workmanship for which this company's saws are known. Simplicity of design and neatness of appearance are outstanding features of the new saw, as well as economy of operation, speedy working ability and safety in handling. With it smooth, accurate sawing is assured, and it will cut a piece from a board as thin as a plane shaving.



The Latest and Most Highly Perfect Model Brought Out by a Leading Manufacturer of Electric Hand Saws.



Complete Line of Wheelbarrows

THE wheelbarrow illustrated here is one of a line which the long experience of the manufacturer has shown contains the styles which are in constant demand and which cover all the common needs. In the manufacture of these wheelbarrows careful attention is given to every detail of construction with the idea of maintaining the highest quality in every respect. The wheelbarrow line contains 20 different models. In addition this company also manufactures hand trucks, mortar tubs, drag scrapers and fertilizer carts.



One of a Complete Line of High Class Wheelbarrows Designed to Meet All the Usual Requirements.

At Last an All-AUTOMATIC Water Softener



EASE OF INSTALLATION

The Bazark Auto Water Softener is easily installed in less than an hour. Its design is so simple, its construction so sturdy that with ordinary use no servicing is required.

© 1928 Bazark Corp.

THE oldest principle of water softening is modernized successfully in the Bazark Water Softener. It is safe, sure and efficient. Mechanical construction is simple, durable and reliable. It is simple in operation; compound is replenished in two minutes or less without muss, fuss or bother. No backwashing or reconditioning required. Safe! Mixture of the softening compound with the water is completely and rigidly controlled. The *only* way compound can get out of the reservoir is by operation of the mechanism.

Sanitary—has purifying action on water. Bazark softened water can be used for drinking, shaving, bathing, washing fabrics, or other articles with the same implicit confidence that is placed in naturally soft water. —and the price is within the reach of everybody.

No Home, Apartment, or Public Building Need Be Without One—NOW

BAZARK softened water flows at full pressure without interruption the instant a faucet is opened. Sizes for every need. First cost is *low*—lower than that of any other water softener on the market. Easily installed in less than an hour by any good plumber. With ordinary care no expensive servicing is required. Less than *half a thousandth* of a cent per gallon keeps the Bazark in operation.

GUARANTEED FOR ONE YEAR

BAZARK Water Softeners are guaranteed against defects in materials or workmanship for a period of one year from date of sale.

We will replace any part or parts which are found to be defective upon examination by our service department at Rockford, Illinois. This guarantee becomes void if article claimed as defective has been altered or repaired in any way; or when instructions for installing or operating have been disregarded; or when anything except Bazark Water Softening compound has been used in the Softener; or when the article has been subject to misuse, neglect or accident.



Mail to-Day

BAZARK CORPORATION
Rockford, Illinois

Gentlemen—We are interested in knowing all the facts about the NEW BAZARK AUTO WATER SOFTENER. Send us your proposition by return mail today with the understanding that there is NO OBLIGATION attached.

Dept. 31

Name _____

Firm _____

Address _____

City _____ State _____

PLUMBER HOUSE OWNER HOME BUILDER
 ARCHITECT CONTRACTOR

BAZARK Corporation ROCKFORD-ILLINOIS

A Sheet Steel Laundry Tray

AN announcement from one manufacturer states that, for the first time, stamped sheet steel has been used, successfully, in the manufacture of domestic equipment of sizeable dimensions, with the placing on the market of this company's new porcelain laundry tray. This company manufactures a brand of porcelain enamel which has for more than two decades been used in the white parts of a number of well known makes of kitchen ranges, work tops of kitchen cabinets and tables and linings of refrigerators.

After two years of research and experiment, 20-gauge

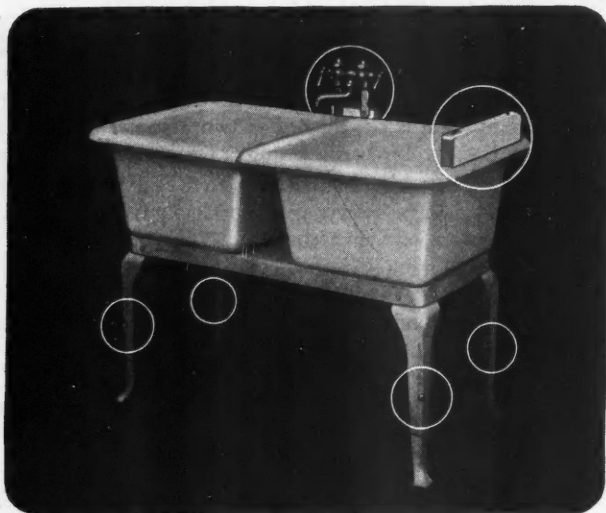

Laundry Trays Have for the First Time Been Stamped Successfully from Sheet Metal and Produce a Much Improved Fixture.

metal was successfully stamped to a depth of 14 inches, 25 inches wide and 26 inches long at the top, with a 2½-inch rolled rim all around. These dimensions are the standard dimensions for laundry tubs and constitute a complete unit which can be used either independently as a one-compartment laundry tray for small homes or combined with a similar unit for a two-compartment tray.

The importance of the development of this tray is expressed primarily in the fact that for the first time so-called "wet" enamel has been used for large household units. There are, of course, plenty of castings coated with dry enamel on the market, such as bath tubs, lavatories, etc. The successful development of this tray, however, is the first instance whereby the toughness of "wet" enamel has been combined with the lightness and ease of handling of a steel stamping.



A Simple Washing Machine

THE manufacturers of the washing machine shown here point out three features which distinguish it from other machines. You can use your own tubs, it takes up little space and it is inexpensive because you do not have to pay for the extra tub which is a part of most washing machines.

By using your own tubs for washing, rinsing and bluing, the entire washing process, you have an instant and easy supply of water from the faucet and can empty the tubs by merely pulling the stopper. You can change the water as often as you wish without labor or inconvenience and therefore are not tempted to use dirty water too long. You do not have the task of scalding and drying the inside of a wash machine tub. The wringer and cups are easily dried and the regular tub can be rinsed in a few minutes with running water.

Washing is done on the compression cup principle which has been proved most satisfactory and is the same as washing with the hands in its effect. As a result you can wash the finest materials without damage as well as the heaviest blankets.

With the wringer there can be no tangling of clothes. A patented device makes it possible to disengage the wringer from the power with a slight push or pull and this assures absolute safety. The standard which held the motor and to which the wringer is attached can be swung around easily so that wringer can be placed in position to wring out of or into either tub.

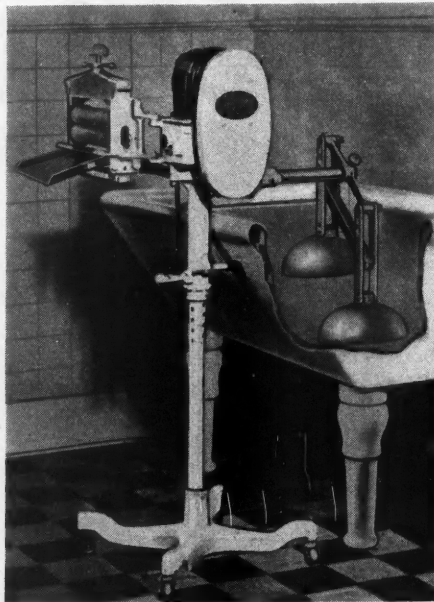

The Simplest and, It Is Said, Most Economical Type of Washing Machine.

When through washing it is merely necessary to lift off the wringer and compression cups, put them away in the tubs or closet and roll the standard out of the way into a corner or broom closet.



A Simple Practical Saw Set

THE saw set shown in the illustration is the product of a company manufacturing a variety of saw sets, punches and similar products. This particular tool is for hand, band, jig, butcher and fret saws ½ inch or more in width and not over 16 gauge. It is 6 inches long, weighs 10 ounces and has a frame and handle of semi-steel and working parts of tool steel. It is furnished in both cast finish and full polish.

It is stated that anyone can use this saw set with perfect results as it has an adjustable, rotatable anvil, beveled to give both the correct angle and depth of set and is so plainly indexed that all the operator has to know is the number of saw tooth points to the inch of his saw.

In use the number is set to the arrow, on the anvil, corresponding to the number of saw tooth points to the inch of saw, the gauge screw is run up until the saw goes through easily, then locked and the operator proceeds to set the saw.



This Saw Set Can Be Used by Anyone With Perfect Results.

A Combination Bath Tub

*Regular Bath, Shower Bath, Seat Bath, Foot Bath, Child's Bath
All in one piece, Patented*

Semi-Vitreous Porcelain and Enameled Iron Ware



PLATE 10-E

Enameled Iron Ware, 44x30 inches to tile in recess, only. Enameled white front. Waste in foot section either right or left hand end. Only one size made.

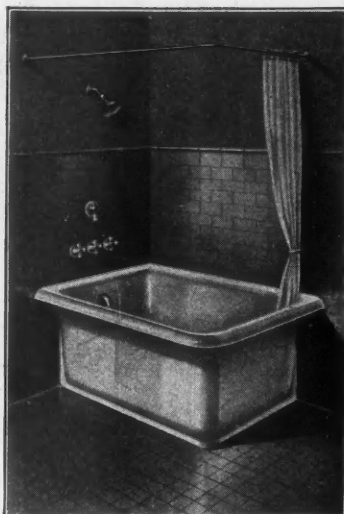

PLATE 11-E

Enameled Iron Ware, 44x30 inches to tile in right or left hand corner. Enameled white all exposed parts. Only one size made.



PLATE 30-E

Semi-Vitreous Porcelain Ware, 44x30 inches to tile in right or left hand corner, or in recess. Glazed white all sides. Only one size made.

The COMBINATION BATH is an entirely new departure in the development of modern sanitary comfort, comprising, as it does, a SEAT, FOOT, SHOWER and CHILD'S bath, all in one.

It possesses many essential common sense features not found in any other types. For instance, it is more comfortable and less wasteful of water; it is possible to bathe and treat the feet without the removal of all clothing, by having only a small amount of water in the foot section. The ledges on the end and both sides of the foot section enable one to treat the feet conveniently, while the dimensions of the foot section allow ample space for the feet when standing or sitting. The Mother or maid can bathe a child in comfort under ideal conditions. The child can be bathed on the seat section, and then, if desired, dipped in the water filled foot section.

Remember, when you are considering the length of the COMBINATION BATH in comparison with other kinds or styles, that you do not assume a half reclining position when using the COMBINATION BATH, but instead a sitting position; so that your length from the knee down does not count in the length of the space required as it does when using the ordinary bath; also that the uncomfortable, cramped position assumed in the latter case is entirely removed and supplanted by a natural, comfortable posture, such as experienced when sitting in an easy, comfortable chair with just as much room in every direction as a person would have in using the ordinary bath of greater length.

Furthermore, when the COMBINATION BATH is used as a shower bath it is equal to any standard type shower receptor.

The arrangement of the seat and foot bath permits the taking of a head or body shower bath, the latter without wetting the hair. This commends it, and is a feature which should not be too lightly regarded; in fact, we strongly recommend installation of showers in connection with the COMBINATION BATH.

When one desires to get out of the COMBINATION BATH, he can do so without the aid of grip-rails or even the use of his hands, by merely standing up—just like arising from a chair.

Water can be turned on and off or discharged without changing from a sitting position, instead of being obliged to slide along the bottom of the tub, in order to reach the valve, as is necessary when using any other type bath.

In planning bath rooms, space saving is oftentimes a most important problem, which can be readily and satisfactorily solved by the adoption of the COMBINATION BATH. This is all accomplished without encroaching on the space required for persons weighing as much as 250 pounds to an extent that comfort is sacrificed in any degree.

There will be given the bath room wherein such a distinctly attractive and meritorious fixture as the COMBINATION BATH has been installed—an added attraction fully appreciated and not likely to be overlooked by your guests.

We furnish plans for installing the COMBINATION BATH, avoiding the necessity for having any part of the waste fittings extended through the ceiling below the bath room, requiring a suspended ceiling; which, in many cases, would prove undesirable.

These plans provide for raising the bath about four inches above the floor level, and filling in the open space with tile. This increases the extreme height of the tub from floor to top to about twenty-one inches, which is slightly less than the height of a staple bath on legs or base.

Many of the COMBINATION BATHS have been installed in this manner, and have proven entirely satisfactory.

WRITE US FOR DESCRIPTIVE BOOKLET GIVING MEASUREMENTS AND OTHER DETAILS

WHEELING SANITARY MFG. CO., Wheeling, W. Va.

VITREOUS CHINA—Water Closet Bowls, Flush Tanks, Lavatories. **SEMI-VITREOUS PORCELAIN**—Bath Tubs, Lavatories, Drinking Fountains, Kitchen Sinks, Laundry Trays, Urinal Stalls. **ENAMELED IRON**—Bath Tubs on feet and on base, Lavatories and Kitchen Sinks.



Thousands of "Jim Stewarts" agree with you

when you specify SWP House Paint



Trade-Mark Registered

The "Jim Stewart" ad is *another* powerful SWP "quality" argument. These double-page thunderbolts are creating hundreds of thousands of "Jim Stewarts"—men who have learned that "cheap" paint isn't cheap at all . . . who *know* that they get better results *at much less cost* by using *fine old SWP House Paint*.

Naturally, they agree with the architect, contractor, or builder who specifies and uses fine old SWP House Paint.

SWP House Paint not only gives the house a better looking and longer lasting finish

at *less* cost but it adds a valuable sales feature.

Our present advertising campaign has made SWP more popular than at any time during the past 50 years. Its wonderful quality and economy are the topic of the hour. And its use is almost a guaranty that all other materials used in the house were selected on a "quality" basis. Thus it aids the sale.

Sherwin-Williams makes a "quality" finish for every surface inside or out. Our technical staff will be glad to help you plan specifications. Address Dept. 450.

THE SHERWIN-WILLIAMS CO.
CLEVELAND, OHIO

SHERWIN-WILLIAMS SWP HOUSE PAINT

FOR ADVERTISERS' INDEX SEE NEXT TO LAST PAGE

HoltBid

THE MOST PRACTICAL METHOD
IN THE BUILDING FIELD

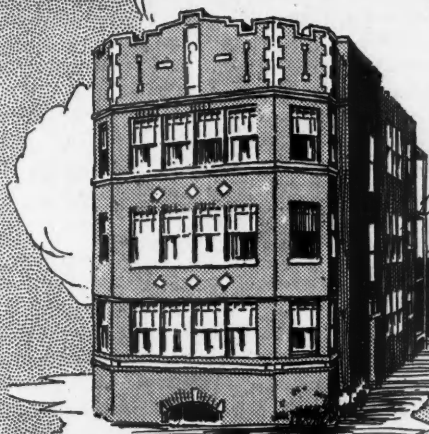

For pricing and de-
veloping sales of—

HOMES
APARTMENTS
STORES
GARAGES
OTHER
BUILDINGS

for

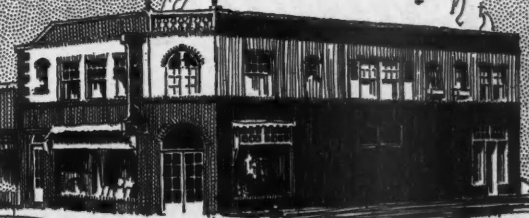
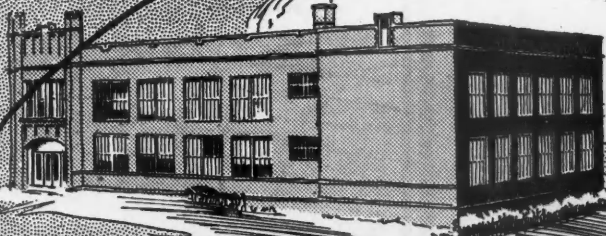
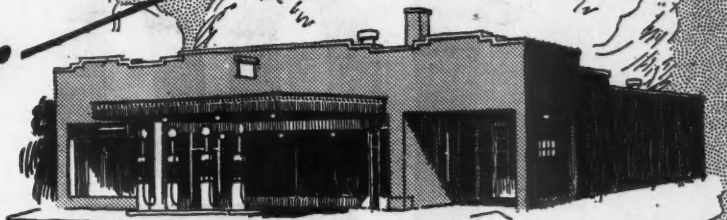

ACCURATELY FIGURING
BUILDING COSTS

\$100

Brings HoltBid for your Examination

HoltBid Is Easy To Learn

You Can Learn This Accurate and Practical Method In 8 Hours

HoltBid is easy to learn because it deals with the ordinary terms familiar to every one. There are no problems in mathematics. You can learn to HoltBid in eight hours or less—so that you can get the cost on the first plan outlined in Part Six at your own local prices. Thereafter it is only a matter of practice.

100

Brings HoltBid

Besides Homes, HoltBidders can estimate Apartments, Stores, Factories, Garages, certain types of Schools and Churches, Barns, Granaries, Cribs, Machine Sheds, Chicken Houses and all other such buildings.

HoltBid is equally helpful in finding costs on remodel and repair jobs, additions, alterations, adjustments on fire or storm losses.

Every unit cost table in HoltBid is based on actual figures. No guessing, approximating or averaging was done in making up these factors.

The HoltBidder's Key covers 864 different wall framing, each one based on actual material required.

Job No. _____
 For Mr. _____ ft.; Depth _____ ft.;
 (facing front entrance) _____ ft.;
 cornice and other construction as specified and checked in details.

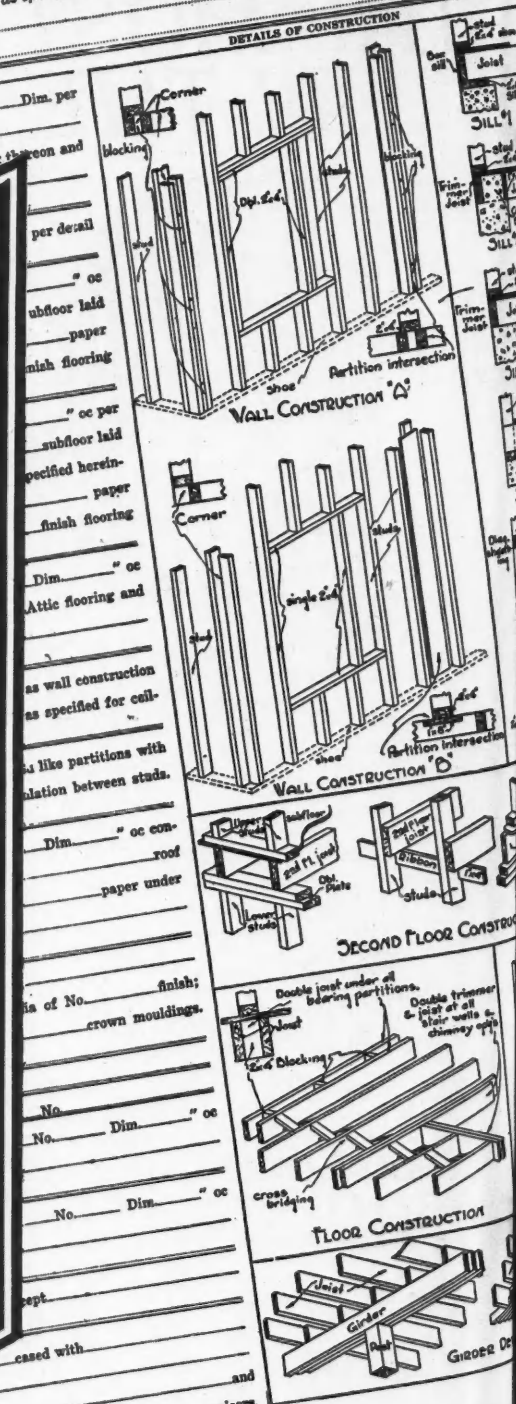

RAIL to be of _____ sets to have _____ treads and _____ risers.

STEPS (_____ sets) to have _____ treads and _____ risers.

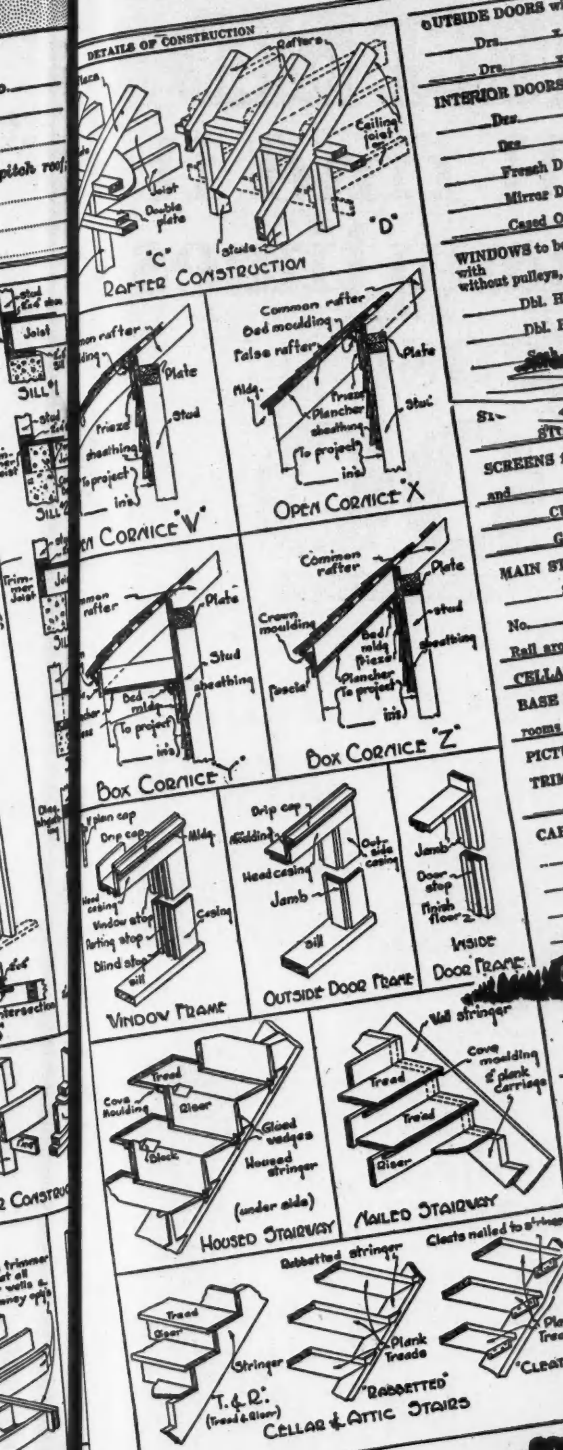

SPECIFICATIONS.

OUTSIDE DOORS with frames as detailed, " casg. _____ No. _____

Dr. _____ No. _____

INTERIOR DOORS with _____ No. _____

Dr. _____ No. _____

Fresh Drs. _____

Mirror Drs. _____

Cased Ovr. _____

WINDOWS to be _____ thick, with _____ with _____ without pulleys, weights, sash cord and _____

Dbl. Hung _____

Dbl. Hung _____

SCREENS for _____ doors, all with _____

and _____

CELLAR SASH _____

GABLE SASH _____

MAIN STAIRS as ch. _____

St'g New _____

No. _____

Rail around Stair _____

CELLAR STAIRS _____

BASE BOARDS to be _____

rooms except _____

PICTURE MLDG. _____

TRIM. All inside _____

CABINET WORK _____

COAL CHUTE _____

SHEET METAL _____

EAVE GUTTER _____

FIRE _____

CELLAR _____

with _____

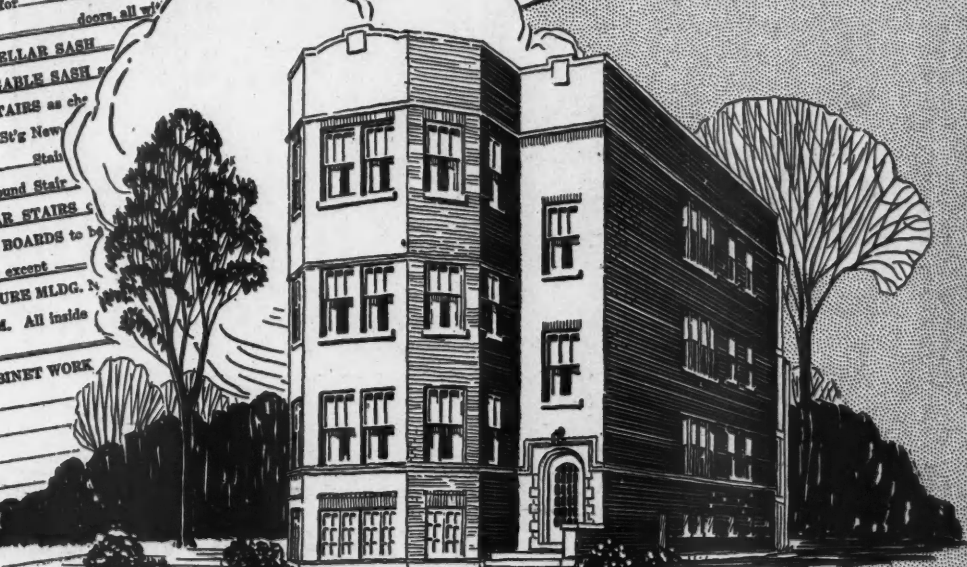

The Holt Bidder Gets
The Contract
\$100
Puts Holt Bid in Your Hands



I WANT YOU TO SEE HOLT BID

You will find it
worth many times
its cost

\$ 100

Brings this Remarkable
System for your approval

MY PERSONAL GUARANTEE

I GUARANTEE that the HoltBid Method of Estimate Building Costs will be satisfactory to you in every respect. All I ask is that you give it a fair trial, and that is the only condition. If at the end of thirty days you do not find the HoltBid Method exactly as represented, I will refund the small down payment you have made. During the thirty days of free examination it is understood that our corps of expert HoltBidders will hold themselves in readiness to answer any question, and to give you true appreciation of the great value of the HoltBid Method. In accepting your order I place my full confidence in your intentions to give the HoltBid Method a fair trial.

WILLIAM A. RADFORD, President,
The HoltBid Service Company.

PIN A DOLLAR BILL TO THIS COUPON MAIL IT—AND RECEIVE HOLT BID

WILLIAM A. RADFORD, President,
HOLT BID SERVICE CO.,
1827 to 1901 Prairie Ave., Chicago, Ill.

Please send at once HOLT BID SERVICE of accurately estimating building costs. Enclosed find \$1.00. If I keep HOLT BID more than thirty days, it is understood that I wish to keep the service and I will pay you \$5.00 per month until the balance of the SPECIAL INTRODUCTORY Price of \$85 has been paid. The HOLT BID SERVICE includes all units, as well as a year's subscription to American Builder, the World's Greatest Building Paper.

Name

Town State

Street Address Occupation

Note:—The service must be entered in the name of the individual and not the firm.

(Without the American Builder, we shall deduct \$1.00 from the total purchase price. If you already are a subscriber, we can readily extend your subscription for a year.)





Automatic Skip Shaker
(Patented)

Stops that man from pounding your skip out of shape. More batches a day with this exclusive JAEGER feature. Only skip vibrates. Simple! Troubleproof!



JAEGER'S TIMKEN BEARING FULL ONE BAG TILTER

—at the usual half bag price!

DEPENDABILITY, that's why Jaeger is the world's largest selling line of mixers—We try to eliminate break downs by using steel and forgings—semi-steel gears—Timken bearings—saving weight yet 50% stronger.

SPEED, Jaeger Patd. "Flat Spot" Drum discharges batch clean in 5 seconds—mixes better—easy automatic discharge—fast accurate measure water tank—automatic skip shaker. Get more batches a day with Jaegers.

THE JAEGER MACHINE COMPANY

521 Dublin Avenue

COLUMBUS, OHIO

Over 100 Jaeger service stations, distributors and branches are located in all principal cities—no delays—standardize on Jaeger and profit by our quick service.

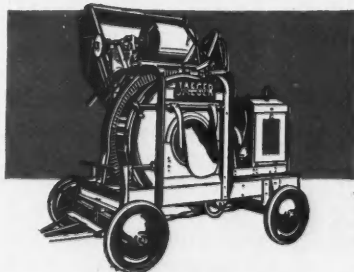
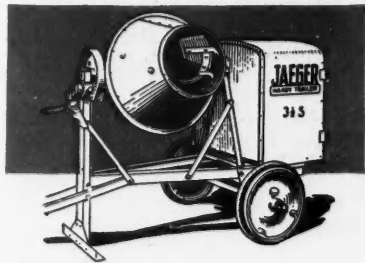

\$179.50
NET
F.O.B.
Factory

buys the Handy Trailer—full half bag size—complete with engine.

HEAVY DUTY NON TILT MIXERS

7-10-14-21-28 ft. sizes
Ask about 7-S Speed King for \$200 less.

Mail this Slip Today for Prices and Convenient Terms

THIS JAEGER MACHINE CO. Date _____
521 Dublin Avenue, Columbus, Ohio
Please send catalog, prices and terms on
 NON-TILT MIXERS PLASTER MIXER TILTING MIXERS
Name _____ Address _____ City _____ State _____

BRADLEY-MILLER
MICHIGAN WHITE PINE
Frames

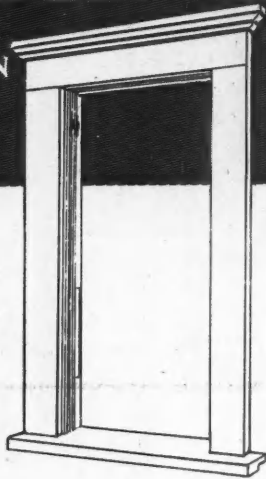

for Dealers who
Believe in Quality

The dealer who believes in giving his customers a product that will deliver the utmost in service finds Bradley-Miller the ideal frames to sell.

He knows that his trade will gladly pay him an extra margin of profit if his product is right and they can depend on it.

And Bradley-Miller frames are right. In materials, design and workmanship, they are unsurpassed. Genuine Michigan White Pine insures durability and freedom from splitting, warping and rotting.

By all means Bradley-Miller Frames are the ideal frames for the dealer who stands for quality.

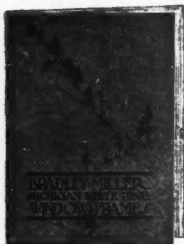

Write for our free booklet.

BRADLEY, MILLER & CO.
Marquette Street
BAY CITY, MICH.



This Clock Tends the Furnace

ALL the inconvenience and discomfort of getting up in the cold of early morning to start the furnace and warm up the house can be eliminated simply by the installation of a furnace clock such as the one illustrated here. It can be used on either steam, hot water, warm air or warm air pipeless furnaces. The illustrations show the installation for the hot water and warm air type of furnace.

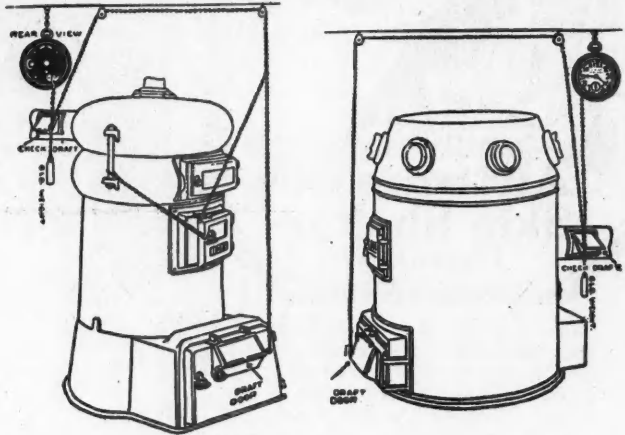

Here Is a Clock Attachment for All Types of Furnaces Which Automatically Controls the Heat.

The clock itself is built for basement use. It is encased in a solid steel housing, appropriate to its location in the basement. It is thoroughly rust-proof and dust-proof, every crevice and opening being ingeniously covered to protect the works of the clock.

Such a furnace clock is useful not only in the morning but also at any time of day when you wish to let the heat go down for a time and then to have the house warmed promptly at a certain time without further attention. For example, if you are to be away most of the day, simply set the clock for an hour before the time you plan to return, close up the house and when you return the house will be comfortably warm while, in the meantime, the fire will have remained low with no waste of fuel.



Illuminated House Numbers

EVERY city requires all buildings to be numbered. This is all right, but mere numbering can be improved upon. This improvement has appeared in the form of an illuminated house number which can be identified on the darkest night. The new lighted numbers are available in a variety of styles and forms to meet all requirements and with interchangeable numbers.

This new development is particularly useful since the development of the automobile. With the old style of number it is not uncommon to see an automobile pull up to the curb and the driver get out several times and walk up to the houses in the effort to locate a number. With the luminous numbers all the bother is done away with.



House Numbers Illuminated at Night Will Be Found Most Convenient for All Concerned.

The General Electric Company, Schenectady, N. Y., offers a pamphlet on the new Novalux ornamental units for decorative street lighting.



for Economical Transportation

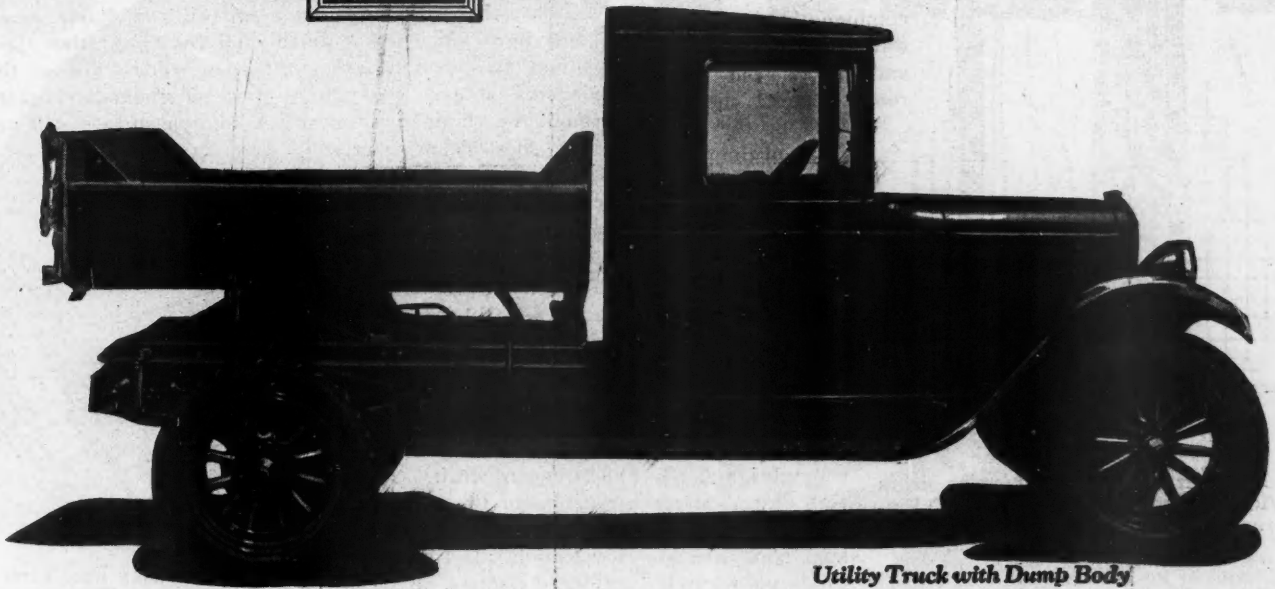

Utility Truck with Dump Body

The World's Lowest Ton-Mile Cost —at Amazing Low Prices!

Whether you need a truck for fast, dependable delivery over city streets . . . whether your problem is the transportation of heavier loads over all types of highways . . . or whether you need a haulage unit for any sort of special purpose—Chevrolet trucks will give you the world's lowest ton-mile cost, plus a type of performance never equalled in a low-priced commercial car!

This matchless economy has been experienced in every line of business and under every condition of usage. You will find that this truck will meet the haulage requirements of *your* business. Thousands of owners have found that no other truck does the job so satisfactorily, at such low cost.

Your Chevrolet dealer can provide a body type designed especially for your business. See him today—and arrange for a trial-load demonstration.

UTILITY TRUCK
\$495

(Chassis Only)

f. o. b. Flint, Mich.

This price now includes 30 x 5 balloon tires on all four wheels.

Also
Light Delivery
\$375

(Chassis Only)

f. o. b. Flint, Mich.

CHEVROLET MOTOR COMPANY, DETROIT, MICHIGAN
Division of General Motors Corporation

Q U A L I T Y A T L O W C O S T

WHEN WRITING ADVERTISERS PLEASE MENTION THE AMERICAN BUILDER

Colorful Shower Curtains

NOT very long ago the bath room was a cold and cheerless place of white sanitary tile and porcelain with at best but a touch of blue in the bath mat or window

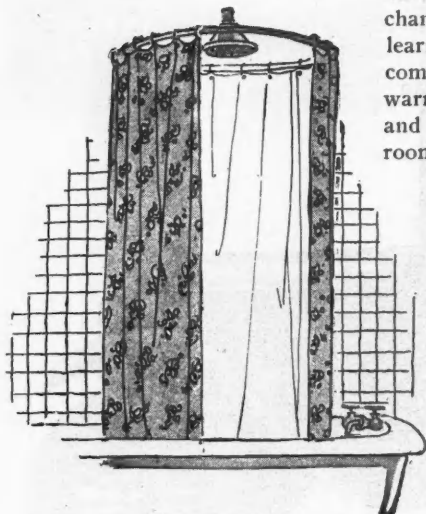

Rubberized Shower Curtains in a Wide Variety of Materials and Patterns Add Color to the Bath Room.

curtains. That is all changed now. We have learned that we can combine hygiene with warm color and beauty and make our bath rooms more cheerful. One of the most pleasant improvements is in the matter of shower curtains. Dull grayish white has been replaced with gay colored cretonnes and rich solid shades in rubberized curtains. The same fabrics which brighten the rest of the house have been rubberized and made waterproof by a process in which all the seams are securely cemented and each curtain is equipped with sturdy eyelets. The fabrics used are chosen as those favored by decorators and home makers and include gorgeously patterned cretonnes, luxurious silk moires, frosty plain silks, serviceable gingham and novelties in solid shades, stripes, checks or prints. These materials are made up by the yard also so

that one may carry out a color scheme in screens, hampers and other accessories in materials which will retain their color and freshness even in the steaming atmosphere of the bath room.

Waterproof by a process in which all the seams are securely cemented and each curtain is equipped with sturdy eyelets. The fabrics used are chosen as those favored by decorators and home makers and include gorgeously patterned cretonnes, luxurious silk moires, frosty plain silks, serviceable gingham and novelties in solid shades, stripes, checks or prints. These materials are made up by the yard also so

that one may carry out a color scheme in screens, hampers and other accessories in materials which will retain their color and freshness even in the steaming atmosphere of the bath room.

that one may carry out a color scheme in screens, hampers and other accessories in materials which will retain their color and freshness even in the steaming atmosphere of the bath room.

Square-Round Flue Lining

IT is a well known fact that a smooth, round flue is not only more efficient but much safer than any other type. A round flue is more efficient than a square flue of the same area because the natural flow of smoke and gases through the chimney is spiral. A smooth surface will not collect soot which interferes with the flow of the gases and creates a fire hazard. For this reason smooth flue lining should be used in chimneys.

Recently there has been placed on the market a flue lining which has a square, or rectangular, exterior to simplify the laying up of the brick chimney and a round interior to obtain the greatest efficiency of draft. The construction of this flue lining is shown in the accompanying illustration. It is actually an ordinary square lining with the addition of clay webs across the corners. These webs merge into the outer walls forming the necessary roundness and also adding considerable strength. The dead corners become open cells between the round and square walls.

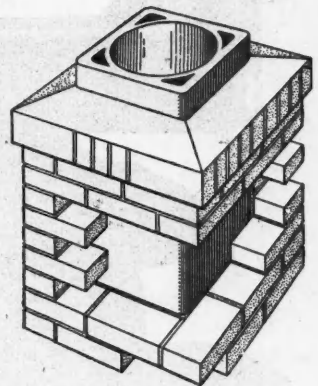

Burned Clay Flue Lining with a Square Exterior and Round Interior Gives Greater Efficiency.

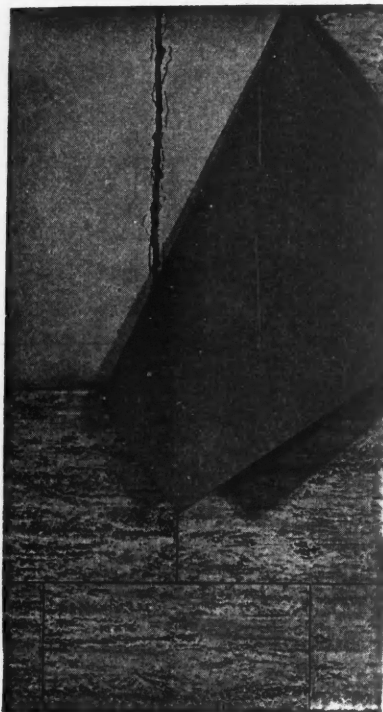

Italian Travertine

rock, in preference to metal ceilings—Travrtile applied on the side-walls over plaster—Produced a perfect insulation against heat and cold and also deadened sound. Lincrusta-Walton wall coverings are made in a great variety of patterns appropriate for private homes and public places.

This New Wall Covering Applied to Plaster or Wall Board Makes a Permanent Wall

*Inexpensive—Easily Applied—Washable—Decorative
Built Up in Linseed Oil—No Surface Cracks*

Travrtile fabric—imitation Italian Travertine Marble—made in any color, satisfying every taste. Applied like wall paper.

Non-repeating pattern of blocks removes the usual mechanical effect. Duplication of line on both sides of sheet saves labor and worry in application.

Travrtile on all walls assures permanency and beauty. Desirable for hotels, apartment houses, banks, public halls, stores, offices, etc.

Contractors and Builders, investigate Travrtile.

Send at once for samples and free literature. Also name of your wall paper supplier.

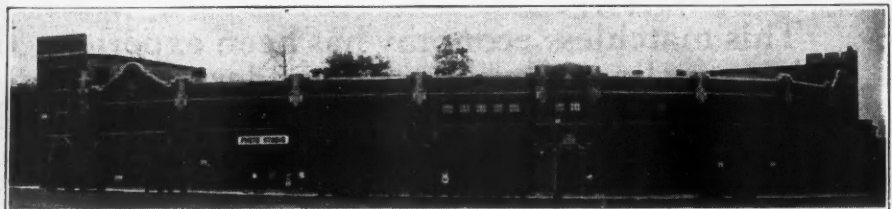

Nelson M. Ayres, Owner, West Englewood, N. J., 18 Stores with offices and corridors. Travrtile was used on all side walls, and Lincrusta-Walton pattern No. 290 for ceilings.

What Mr. Ayres says about Lincrusta-Walton:—"It is the most decorative, most economical and satisfactory decoration I have ever seen. The tenants are well pleased and have had many favorable comments. Have specified Lincrusta-Walton on several business blocks and a 300-family apartment house about to be started."

Signed: Nelson M. Ayres.



Ceiling Pattern No. 290

LINCRUSTA-WALTON COMPANY

Hackensack, New Jersey

Division Tait Paper and Color Industries, Inc.

STAMINA

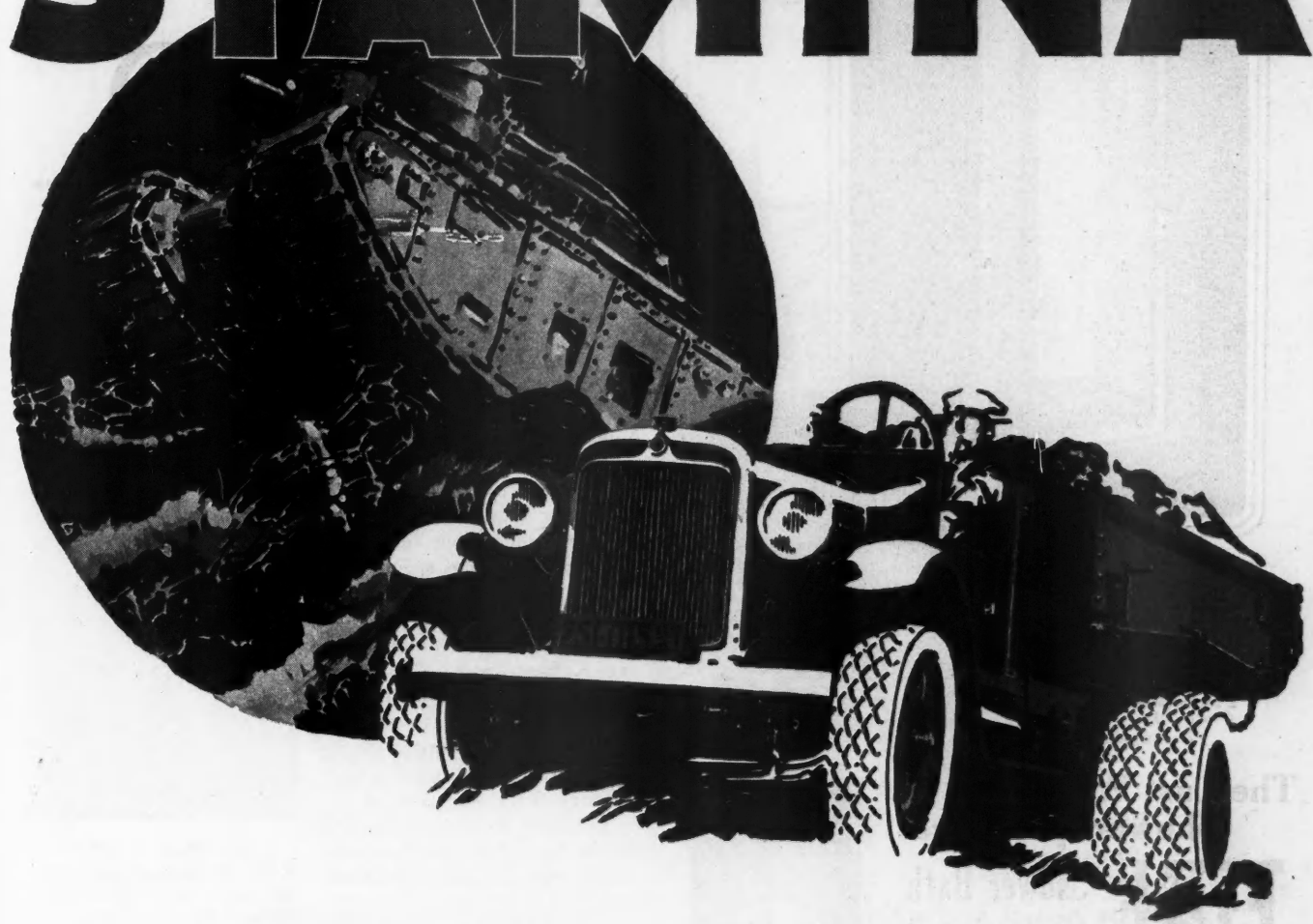

TO go on working mile on mile, day after day, capacity loads, all roads, all weathers to do this with sunrise certainty year upon year requires unusual stamina.

That sort of stamina in Graham Brothers Trucks and Commercial Cars—all sizes, from 1/2-Ton to 2-Ton—is being proved constantly on the roadways of the world by just such performance. Combine with this stamina the

power, the speed and the operating economy to which hundreds of thousands of owners bear witness.

Know that service, though seldom needed, is available from Dodge Brothers dealers—always and everywhere.

Know that the prices are extremely low, due to great volume production. Then let your local dealer show you the right type—body and chassis—for your business.

2-TON \$1595
6-cylinder engine, 4-speed transmission, 4-wheel brakes (Lockheed Hydraulic)

1 1/2 TON \$1245
4-cylinder engine, 4-speed transmission, 4-wheel brakes (Lockheed Hydraulic)

1-TON (G-BOY) - \$895
1/2-TON COMMERCIAL - \$670
Chassis Prices f.o.b. Detroit

1/2-TON Panel DELIVERY CAR \$770
(Complete with body f. o. b. Detroit)

GRAHAM BROTHERS TRUCKS

Sold and Serviced by
Dodge Brothers
Dealers Everywhere

Built by
Truck Division of
Dodge Brothers, Inc.

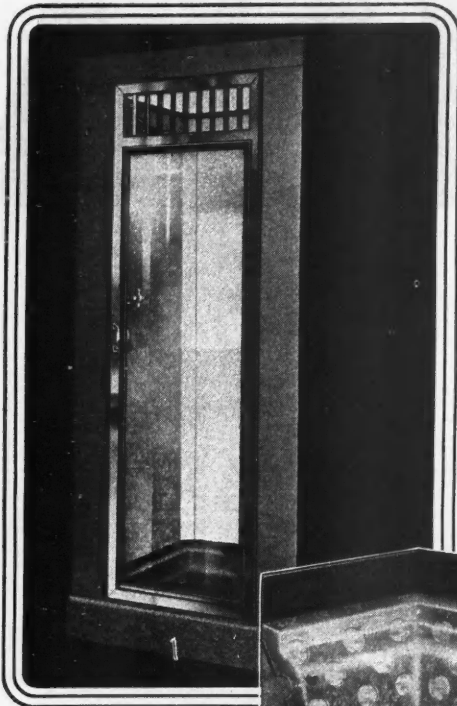

The "Admiral," with "Nautilus" Door.

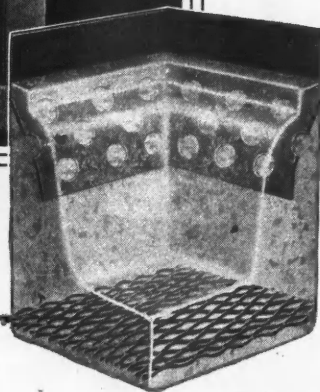

Corner section, Fiat Receptor. Integral with Compartment. Leakproof Construction. (Patent applied for.)

The Last Word in Shower Enclosures

Fiat Shower Bath Compartment

The Popular Bath Made Practical

FIAT—the last word in shower bath compartments—meets the public demand for an enclosure that will remain permanently leak-proof under all conditions. A complete unit within itself, "rides" the building, not affected by shrinkage, settlement, expansion or contraction. Greatly simplifies the problems of installation and cost—a wonderful investment for residences, apartments, summer homes, etc.

Doubles the Bathing Facilities of the Home

Because it occupies such small space—merely a corner or closet room—a FIAT is a boon to every home owner. No tearing up floors or mixing mortar in new or old homes—the plumber does the complete job without fuss or muss. No home complete without one. Today thousands of home owners are enjoying this outstanding improvement in shower bath compartments.

Learn more about the desirable features of FIAT Shower Bath Compartments by sending the coupon for a 32-page illustrated catalog.

FIAT METAL MFG. CO.
1201 Roscoe St., Chicago, Ill.

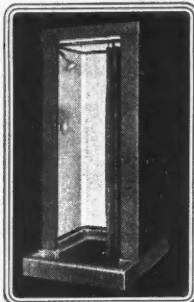

The "Admiral" with Extended Receptor.

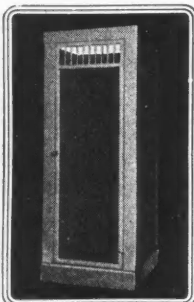

The "Ensign" with "Marine" Door.

FIAT METAL MANUFACTURING CO.
1201 Roscoe St., Chicago, Ill.

Please send me full information regarding Fiat Shower Bath Compartments.

Name.....

Street.....

City..... State.....

Please check—I am a Contractor , Plumber , Architect , Dealer , Realtor , Home Owner

NEWS of the FIELD



Kalman Buys Sykes Plant

AN announcement has been made that the Kalman Steel Company, Wrigley Bldg., Chicago, has purchased the Sykes Metal Lath Company of Niles, Ohio. The Sykes organization will be consolidated with that of the Kalman Steel Company in the distribution of a complete line of metal lath and building specialties. It is also announced that J. W. Gleason has been made assistant sales manager of the Kalman Steel Company. Mr. Gleason was connected with the Northwestern Expanded Metal Company from 1915 until the entrance of this country in the war. He served in the army for 2½ years after which he joined the organization of the General Fireproofing Company, with which he remained till 1926. Since then he has been devoting his time to the development of patents on lath machinery.



J. W. Gleason, Who Has Been Made Assistant Sales Manager of the Kalman Steel Company.

Ryerson Officers Elected

JOSEPH T. RYERSON & SON, Inc., has announced the election of Donald M. Ryerson, formerly vice-president and general manager, to the position of chairman of the board of directors, to succeed his father, Edward L. Ryerson, Sr., who died January 19, 1928. Edward L. Ryerson, Jr., vice-president in charge of plant operations and several sales divisions, succeeds his brother, Donald Ryerson, as vice-president and general manager. Everett D. Graff has been elected a vice-president.

S. P. A. Annual Meeting

ANNOUNCEMENT has just been made by Secretary-Manager H. C. Berckes, of the Southern Pine Association, that the dates of the annual meeting of the subscribers to the association will be held March 26 to 28, all sessions to be held at the Roosevelt Hotel, New Orleans, La.

Appoint New Managers

KEASBEY & MATTISON CO., Ambler, Pa., has announced the appointment of O. C. Ferens as manager of its New York office and R. C. Nelson as manager of its Chicago office.

“YES, This Complete Thor Laundry is Included”



“Jim, I want this house.”

Wise builders know that even a very small amount, invested where it will appeal most strongly to the wife, helps swing the sale.

And it needn't cost you a penny!

The small cost, added to the down payment, will never be noticed.

Our Remarkable Offer

WE have a wonderful offer to make to builders and realtors who are putting up single units or quantities of homes in subdivisions or suburban developments. This offer will help you make *more* sales—and *faster* sales. All we ask in turn is a reasonable amount of local publicity featuring that fact that “Each home is equipped with the most MODERN time and labor saving home laundry in the

world—the *fast* Professional Type New Thor Cylinder Washer and the New Thor Folding Ironer.” And this publicity, as you can realize, will be mighty profitable to *you*, too.

Just tell us, on your letterhead about how many homes you build a year (to sell) and get the details of our remarkable co-operative offer.

HURLEY MACHINE COMPANY
22nd St. and 54 Ave. Chicago, Ill.

Thor

Home Laundry Equipment

WHEN WRITING ADVERTISERS PLEASE MENTION THE AMERICAN BUILDER

Colonel Greeley to Manage Douglas Fir Industry

OFFICIAL announcement has been made that Col. W. B. Greeley, chief of the United States Forestry Service, has accepted the management of the West Coast Lumbermen's Association. Commenting on this announcement, Wilson Compton, secretary and manager of the National Lumber Manufacturers' Association, said: "This is good news, wonderful news for the lumber industry. In the first place it demonstrates the essential unity of the science of forestry and the lumber industry. Col. Greeley would not, I am sure, have accepted the leadership of the Douglas Fir industry if he had not been convinced that he had a broad and favorable field in which to follow his chosen profession.

"In the second place, his appointment signifies the beginning of a new and better period in the organization of the fir industry. I am sure that the prestige, the executive ability, the comprehensive and sympathetic knowledge of the lumber industry Col. Greeley will bring to his task will quickly have a stimulating effect on the lumber industry in the Northwest.

"Col. Greeley has the confidence and respect of lumbermen everywhere. While he has never forgotten his ideals as a forester, and has never neglected his ultimate goal of converting the American lumber industry into a self-perpetuating one, he has never lost touch with the realities. He has kept his ideals but he has not forgotten the ledger.

"Also, throughout his career in the government service the Colonel has firmly held the

belief that if the United States is to be perpetually a forested country it must be such mainly through industrial reforestation, by individual initiative."



Publish Concrete Calculator

THE Northwestern Cement Corporation, 285 Madison Ave., New York City, has published a really unique concrete calculator which is patented by the company. It is in the form of a small disc which will fit into the vest pocket, providing a convenient and quick method of computing the quantities of cement, sand and gravel required for various concrete mixtures. It also makes it possible to compute quickly the number of board feet of lumber in various size boards. This company states that it will be glad to supply one of these calculators to anyone who writes to them on his business letterhead.



Daniel Kees Elected

AT the annual meeting of the F. D. Kees Mfg. Co., held at the company offices in Beatrice, Neb., on February 6, Daniel Kees was elected president to succeed the late F. D. Kees, who died October 20, 1927.



Pfeiffer Joins Milcor

AN announcement that Julius A. Pfeiffer well known throughout the building material industry, has become director of sales of the fireproof materials division of the Milwaukee Corrugating Company, with headquarters at the main Milwaukee plant.



Julius A. Pfeiffer, New Director of Sales of Fireproof Materials for Milwaukee Corrugating Company.

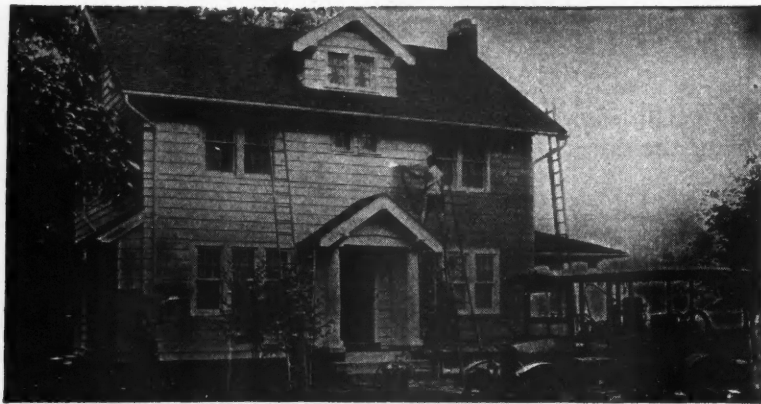

Your Profits Increased painting the improved DeVilbiss way

Faster painting, more jobs done in present working time, less cleaning up—that's one way your profits are increased painting with the DeVilbiss Spray-painting System.

The greater satisfaction of your customers with the improved quality of painting, as well as with the short time required for the different jobs, brings increased profits through widespread endorsement of your work and methods.

DeVilbiss equipment is practical, complete and reliable. Its operation and upkeep costs are negligible items. Your men will like to paint with it and you'll like the DeVilbiss service.

We'll gladly mail you further FACTS regarding DeVilbiss equipment and how painting with it will increase your profits. Address—

THE DEVILBISS CO. 238 Phillips Ave. TOLEDO, OHIO

New York
Chicago
Detroit
Philadelphia
Indianapolis
San Francisco

DeVilbiss
Spray-painting System

Pittsburgh
Cleveland
Cincinnati
Milwaukee
St. Louis
Minneapolis
Windsor, Ontario

New DeVilbiss Spray Gun Type AV

One new and unparalleled feature of this Gun is the spray head with graduated adjustment controlling both character and width of spray. The graduated adjustment control makes possible a quick return to a previous setting for producing any desired spray. The air can also be cut off, producing a round spray. This adjustable spray head eliminates split sprays and "overspray."

Among the many other outstanding features of the AV Gun is the positive self-centering of the nozzle parts—these parts are always in perfect alignment.

This new Spray Gun is a DeVilbiss quality product throughout. *Let us send you the complete story.*

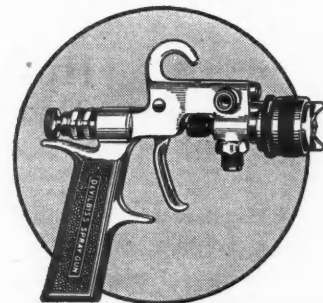

These Real Blue Prints and two Books Sent FREE



Just mail the coupon below! Send no money!

Every builder can get these real blue print plans and our book "How To Read Blue Prints" without sending us a penny. Just send the coupon. Lots of valuable and interesting information—all free. Yes, and we'll send along another book on building; it tells why "the big money goes to the man who *knows*." It explains the practical Chicago Tech. easy method of home-training for men in the building trades. Learn how to get the jobs that pay most money or how to get into your own business as a building contractor.

Plan Reading—Estimating—Superintending, etc. Train at Home to **MAKE MORE MONEY** No Schooling Necessary

Learn how to read plans, lay out work and run jobs. Your spare time is enough. Wherever you may be—whatever your job—we can help you quickly to fill a higher place and have a bigger income. Age does not matter. Previous school training is not needed. This is a practical course for practical men, prepared by practical instructors who have been through every branch of the building game themselves. You owe it to yourself to find out how to make more money.

To Builders Living in or Near Chicago

Visit our Day or Evening School for builders and see with your own eyes the work we do. 1000 builders attend each year. You can get the same training *at home*. Same lessons—same blue prints—same practical instructors—same successful results.

Get the Facts Find out how little time it takes to make more money—much more money—in building. Write today. The coupon brings all *Free*.

Chicago Technical SCHOOL for BUILDERS

Dept. C-121, 118 East 26th St., Chicago, Ill.

Mail the Coupon—NOW

Chicago Technical SCHOOL for BUILDERS

Dept. C-121, 118 East 26th St., Chicago, Ill.

Please send me without obligation, Free and Postpaid, your two Books and Blue Prints for Builders. It is understood that no salesman will call on me.

(Please Write or Print Name Plainly)

Name

Address

City.....State.....

Age.....Occupation.....

Architects for Civil Service

THE United States Civil Service Commission, Washington, D. C., announces open competitive examinations for the positions of architect, salary \$3,800; associate architect, salary \$3,000; and assistant architect, Salary \$2,400. Applications for positions of architects must be on file with the Civil Service Commission at Washington, D. C., not later than March 27, 1928. The examinations are to fill vacancies in the office of the Supervising Architect, Treasury Department, Washington, D. C., in connection with the construction of public buildings in Washington and elsewhere and vacancies in the Federal classified service throughout the country.

Will Coordinate Air Ports

ANNOUNCEMENT has recently been made of the organization of the American Airport Corporation, with offices at 527 Fifth Ave., New York City. This announcement is of unusual interest in that this is the first company organized in this country to operate a chain of airports. It is the purpose to locate sites, plan and design leading fields and supervise and manage airports throughout the country. This company, which has been organized and backed by a group of prominent men, comes as the result of the new recognition of the importance of air

transportation and the need for co-ordinating airplane operation.

Announce New Officers

THE Asbestos Shingle, Slate & Sheathing Company, Ambler, Pa., announces the election of Ralph E. Frey and J. E. Ledebuer as vice-presidents. Mr. Frey, who has been secretary and sales manager, will continue in charge of the company's products. Mr. H. R. Weaver has been elected secretary.

Ryerson Makes Fast Delivery

JOSEPH T. RYERSON & SON, Inc., of Chicago, which takes particular pride in its quick delivery of emergency orders, has announced a new record in this line. Probably the first delivery of steel by airplane has been made by this company. Recently the Iowa City Iron Works, Iowa City, Iowa, wired for five pounds of seven pound rivets. It was late afternoon when the wire was received but the order was made up, rushed to the American Railway Express air station and placed on the 7.50 p. m. airplane express. An hour and fifty minutes later the plane landed at Iowa City, 236 miles from Chicago, the rivets were thrown out and were on the job, in use, that night.

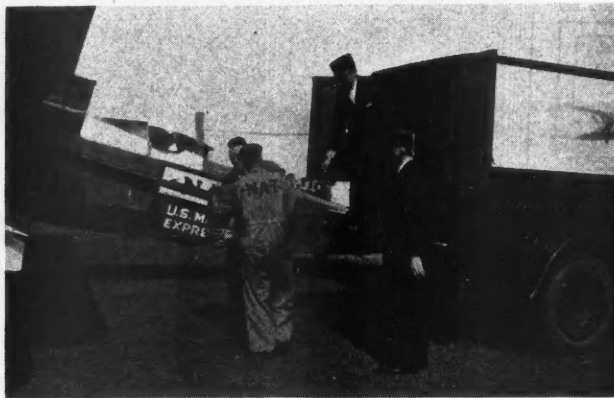

Loading the First Shipment of Steel to Be Delivered by Air Express, Shipped by Joseph T. Ryerson & Son, Inc.

Unusual Service for the Contractor

Ryerson combined service on all steel products saves time, money and trouble

The Special Contractors and Builders Division of Ryerson Steel-Service is without parallel in the building fields.

This department has its own warehouses and provides complete service on all reinforcing for concrete, Steel Joist, Metal Lath, Steel Sash, and all the various steel building products are also included.

In addition, structurals, bars, plates, sheets, rivets, bolts, wire, etc., are furnished from the general steel departments. Trench braces, jacks, electric drills, and hundreds of other tools needed on every job are supplied by the machinery and small tool departments.

Contractors use the Ryerson Warehouses as if they were their own. Reinforcing steel, lath, sash and other miscellaneous materials are kept under cover until they are ready to use each item. Delivery is according to their schedule.

Large fleets of trucks and private switch tracks help provide service unequalled by any other source of supply.

All types of jobs are figured and lump sum or pound price quotations prepared.

Write for Complete Information.

JOSEPH T. RYERSON & SON INC.

CHICAGO
CINCINNATI
BUFFALO

MILWAUKEE
DETROIT
JERSEY CITY

ST. LOUIS
CLEVELAND
BOSTON

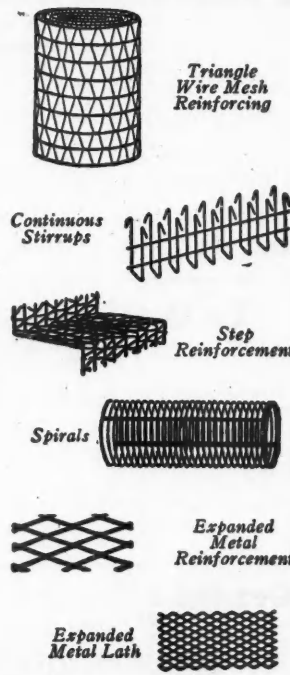
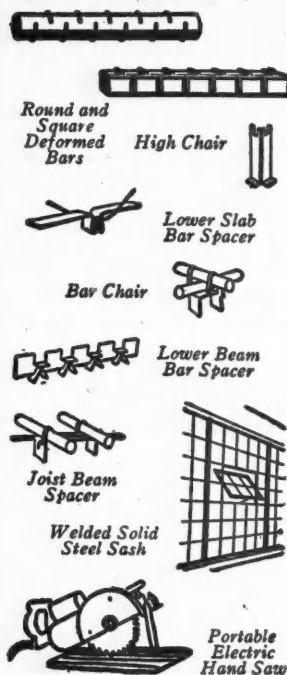

RYERSON REINFORCING-SERVICE



Opposite is brick home design T104. It is a six-room house with sun parlor and sleeping porch. This home was designed and built by Leland Lyon, Architect, for his own personal use. It is one of many in "Homes of Lasting Charm" offered in the coupon below. Complete plans for this home at very moderate cost.

In no other way can a builder offer so much for so little!

THE builder who concentrates on common brick construction has no bug-a-boo of excessive costs to burden his sales program.

No building material, that offers the permanence and stability of common brick, even approaches it in low first-cost of construction.

As a creator of home values, common brick has no equal. Its complete cost is approximately only 5% more than frame. It contributes an age-proof stability and a time-proof beauty that can be neither matched nor equalled by any sub-

stitute material. It is an open certain road to the popular favor of the buying public.

The builder who studies the cost of his resale values knows the dominating economy of common brick. Not a penny wise and pound foolish economy—but a cost economy that walks hand in hand with the highest forms of architectural artistry.

Haven't you a great deal to gain by looking into the possibilities of this material? Write the Association to learn how our service helps the dealer and the builder.



Are you taking advantage of the service behind Brick?

Back of common brick is a trade service of important cooperation. Make use of it. Below we list a group of valuable brick books. These are distributed at cost. Send today for those you are interested in.

COMMON BRICK MANUFACTURERS ASSOCIATION OF AMERICA
2131 GUARANTEE TITLE BLDG., CLEVELAND, OHIO

BRICK forever

PREFERRED BY ARCHITECTS

These District Association Offices and Brick Manufacturers Everywhere Are AT YOUR SERVICE

Boston 11 Beacon Street
Chicago 605 Builders Bldg.
Cleveland—Ohio Association
2124 Guarantee Title Bldg.
Denver 1735 Stout Street
Detroit ... 400 U. S. Mortgage Trust Bldg.
Hartford 226 Pearl Street
New York City ... 1716 Grand Cent. Term.

New York State District
Post Office, Box 773, Rochester, N. Y.
Norfolk 112 West Plume Street
Philadelphia 1420 Walnut Street
Pittsburgh... 702 First National Bank Bldg.
Raleigh, N. C.
508 Commercial National Bank Bldg.
Salt Lake City 301 Atlas Block
Seattle, Wash. 913 Arctic Bldg.

CHECK COUPON BELOW
—SEND CASH OR STAMPS
TO NEAREST OFFICE —

- "Homes of Lasting Charm"—25c
- "Skintled Brickwork"—15c
- "Multiple Dwellings of Brick"—10c
- "Farm Homes of Brick"—5c
- "Brick, How to Build and Estimate"—25c
- "The Heart of the Home (Fireplaces)"—25c

Check above books wanted or send \$1.00 for all of these books.

What Do You Offer?



Group of Duplex Apartments, Tarrytown, N. Y. Insulated with Double-ply Waterproof Quilt. Architects & Builders, King-Walsh Corp., New York.

When you tell a prospective customer about one of your houses, what do you offer him? Do you want to offer him more for the money than your competitors?

Then offer An Insulated Home, with increased health, increased comfort, winter and summer, and increased savings.

Insulate with Cabot's Quilt, and actually save in your costs through reduced heating plant and plastering.

Cut the coupon below (Roll of Quilt) and send it in today for full Quilt Information and U. S. Bureau of Standards Home Insulation Tests.

The Home Insulation That Pays for Itself

Cabot's Quilt

IN SUCCESSFUL USE FOR OVER 30 YEARS



Books, Bulletins and Catalogs for You

THE literature and publications listed here are available to the readers of American Builder. They may be obtained from the firms mentioned and will be forwarded without cost except where a price is noted.

The American Institute of Steel Construction, 285 Madison Ave., New York City, has published a "Standard Handbook of Steel Construction," containing 384 pages of data indispensable to the designer and specification writer, including the A. I. S. C. Standard Specification for Structural Steel for Buildings, the A. I. S. C. Standard Specification for Fireproofing Structural Steel Buildings and the A. I. S. C. Code of Standard Practice. Price \$1.50.

"Builders' Book-Keeping and Costing," by C. G. Dobson, published by Oxford University Press, American Branch, New York City, is a first textbook for students and builders' assistants, with examples for practice. Price \$4.00.

"The A B C of Plastering," by A. H. Telling, published by the Oxford University Press, American Branch, New York City, is intended to provide an elementary book for handy reference for the apprentice and craftsman. It is very complete. Price \$2.85.

"Real Estate Titles and Conveyance," by Nelson L. North and DeWitt Van Buren, published by Prentice-Hall, Inc., 70 Fifth Ave., New York City, is of special interest to all who are now or may be confronted with problems on titles. It is complete, up-to-date and thoroughly practical. Price \$6.00.

The Grand Rapids Public Library, Grand Rapids, Mich., has published a "List of Books on Furniture," with descriptive notes which has gotten out in connection with the Hundredth Furniture Market, held in Grand Rapids. Price on application.

They
are
the best

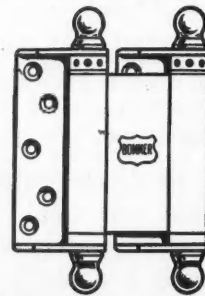

They
are
the best

Millions and Millions

of People are Pushing
BOMMER SPRING HINGES
Whenever They Open a Door

Follow the line of least resistance
Your Dealer handles them

Copyright 1927 by Bommer Spring Hinge Co., Factory and Offices, Brooklyn, N. Y., U. S. A. Established 1876

Big Work Ahead?—

Perhaps Our Service Can Help You



HAVE you heard about the latest American Builder service now offered to builders absolutely without charge?

It puts you in touch with leading manufacturers of building material, equipment and supplies whenever you want to know about the latest developments or any information as to products, prices or deliveries.

You may need a hoist, a derrick, a crane, pumps, trucks, tractors, concrete mixers, woodworkers, electric hand saws, unloaders, scaffolding or a steam shovel.

We have left a space below for you to describe any important jobs you have in prospect where you might use better equipment to reduce costs. Be sure and fill this in—it may be the most profitable thing you ever did.

AMERICAN BUILDER MARKETING SERVICE, 1901 Prairie Ave., Chicago, Ill. (1)

Gentlemen:

Please put me in touch with all interested manufacturers in regard to the following items, for which I am in the market or expect to be in the market shortly: (state exactly what you want—prices, literature, nearest point of distribution, etc., as well as the nature of the material required).

.....

Describe any important job you have in prospect or contracted for where labor-saving contractors' equipment might reduce your costs—

.....

Name.....
 Street and Number.....
 City.....
 State.....

Please check your occupation: Building Contractor Dealer in Building Materials
 Prospective Home Builder Architect

Helps to Sell or Rent the Building



The WHITEHOUSE Clothes Vault

Installed in new or old buildings, the WHITEHOUSE Clothes Vault is a great sales factor. It enables you to sell or rent the home, apartment, etc., more quickly and at a higher price. WHITEHOUSE Clothes Vaults are absolutely moth and vermin-proof and make an ideal burglar-proof vault for jewelry, silverware and personal papers. Reduce insurance premiums 66% per cent. Every family is entitled to this protection. Fur Stores, Ladies' Tailor Shops, Dress Shops and Cleaners and Dyers include a partial list of the various other uses for WHITEHOUSE Clothes Vaults.

The WHITEHOUSE Clothes Vault is cedar lined. Has steel walls, top, sides and bottom. Convenient roller-bearing pull hanger at top. Anti-dynamite four tumbler bank-style Yale combination lock.

Write for complete information

WEBER-BUSSE COMPANY
308 North Michigan Ave., Chicago, Ill.

Burglar & Fireproof Safes & Vaults for Every Purpose.

The New HOOSIER FOR BETTER WATER SERVICE!

NEW refrigeration type motor runs cool and smooth; NEW rubber motor mounting for quiet operation; NEW "V" type belt does away with noisy idlers; plus GalVAZink coating inside and out, pump design that keeps oil from water supply and other HOOSIER features.

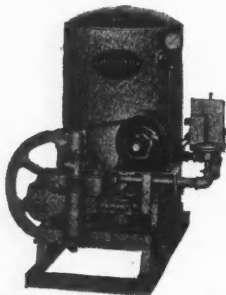

FLINT AND WALLING MFG. CO.
65 Oak Street KENDALLVILLE, IND.

Books, Bulletins and Catalogs for You

THE literature and publications listed here are available to the readers of American Builder. They may be obtained from the firms mentioned and will be forwarded without cost except where a price is noted.

"Architecture and Rust Proofing" is a booklet published by the Parker Rust-proof Company, Detroit, Mich., on "The Parker Process as Applied to Building Materials."

Harvey Hubbell, Inc., Bridgeport, Conn., has issued a loose-leaf booklet cataloging its switch plates and other electric fixtures.

The Automatic Electric Heater Co., 1505 Race St., Philadelphia, Pa., has issued a pamphlet giving some interesting data on its automatic electric water heaters.

The Burke-Stone Co., 1237-47 West 47th St., Chicago, offers a booklet, handsomely illustrated in colors descriptive of its marble-like product and its use of floors, cove base, wainscoting, door and window trim, ashlars and similar purposes.

"Gypsum Partition Tile" is the title of a pamphlet by Henry J. Schweim and published by the Gypsum Industries, 844 Rush St., Chicago. It contains complete information, specifications and other data.

The Lorillard Refrigerator Company, Kensington, N. Y., has issued a new catalog, No. 28, descriptive of its refrigerators for hotels, restaurants, hospitals, clubs and similar establishments, and sold by Albert Pick & Company, L. Barth & Company and the John Van Range Co.

The Weatherbest Stained Shingle Co., Inc., 135 Main St., North Tonawanda, N. Y., has prepared a poster illustrating some of the prize-winning remodeling jobs entered in its remodeling contest held in 1927.

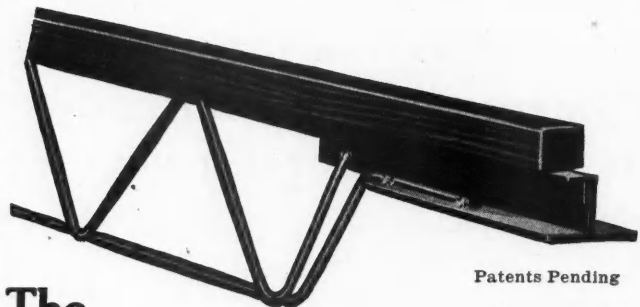

Patents Pending

The Massillon Nailer Joist

is a steel joist designed for nailing wood flooring or roof decking directly to the wood nailing screed forming part of the top member of the joist. Normal shipments are made from stock and the joists rapidly placed without cutting or fitting on the job. Metal lath and plaster, plaster board, or other standard ceilings are readily attached to the bottom bars.

Strength, elimination of shrinkage and warping, open web for piping and a high degree of fire resistance are features of the construction—all at a cost approaching and at times less than the cost of wood joist floors.

Construction details and loading tables will be mailed on request. Send us your plans in asking for quotation.

THE MACOMBER STEEL CO.
909 Belden Ave., Canton, Ohio

Manufacturers of
Massillon Bar Joists, Massillon Steel Roof Trusses and
other Standardized Steel Building Products

Women Like Them

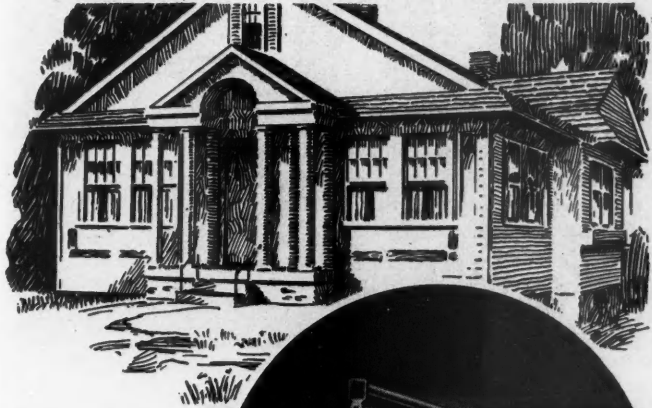

Build this Sales Feature in Your Homes



The demand for economy and home convenience is greater than ever. The K-V Clothes Closet Fixture helps make the small closet more livable. Equipped with K-V Fixtures it presents a powerful and influencing sales appeal.

K-V Fixtures make the small closet do double duty in closet capacity. For the builder, they save money in construction costs by saving space. In addition they help sell homes, and increase turnover.

Know more about these possibilities—quicker sales and better profits. Use the coupon.

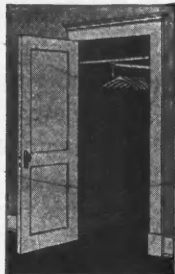

Liberal Discounts to Contractors

Knapé & Vogt Manufacturing Co.
654 Richmond St. Grand Rapids, Mich.

Also Manufacturers of K-V Adjustable Shelf Supports

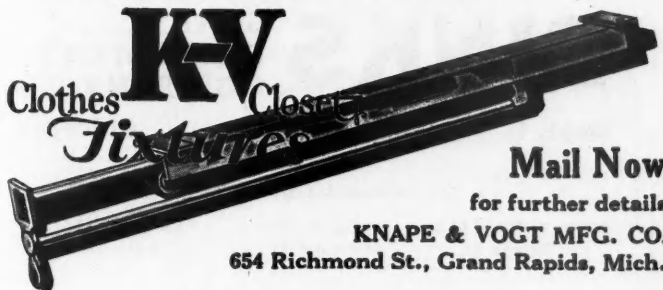

Mail Now
for further details

KNAPÉ & VOGT MFG. CO.
654 Richmond St., Grand Rapids, Mich.

Name

Address



4th Prize Winner
WEATHERBEST
1927 Remodeling Contest
Syracuse Land Development, Franklin Park Tract, East Syracuse, resingled over old siding with WEATHERBEST Colonial White at big profit.

To Remodel Old Houses



IF you own or can buy old houses in desirable locations, you can remodel and improve their value by putting WEATHERBEST Stained Shingles right over the old sidewalls. An old porch badly in need of repair can be enclosed effectively and a "cleaning up" of out-of-date "gingerbread" will help you sell the old house at a nice profit.

In every community there are old houses of excellent construction which can be modernized easily . . . to increase their sales value immediately . . . to save re-painting cost and insulate against heat and cold . . . to make more business of the same kind in the same neighborhood.

Our Remodeling Service Dept. will help you without charge. Send a snapshot or photograph any size and give general dimensions and floor plans of an old house and we will submit free sketch showing practical changes. WEATHERBEST STAINED SHINGLE Co., Inc., 136 Main St., North Tonawanda, N. Y. Western Plant—St. Paul, Minn. Distributing Warehouses in Leading Centers.



WEATHERBEST STAINED SHINGLE Co., Inc.,
Remodeling Service Dept.
136 Main St., North Tonawanda, N. Y.

- Send Free Booklet, "Making Old Houses Into Charming Homes," with Broadside showing 1927 WEATHERBEST Remodeling Contest Prize Winners.
- From enclosed photograph and data, submit free sketch showing suggestions for exterior remodeling.

Name.....

Address.....

If not convenient to send picture, write for free book, "Making Old Houses Into Charming Homes," and Broadside showing WEATHERBEST 1927 Remodeling Contest Prize Winners, with actual results and costs.

American Steel & Wire Company's

WIRE FABRIC

"The Steel Backbone for Concrete"

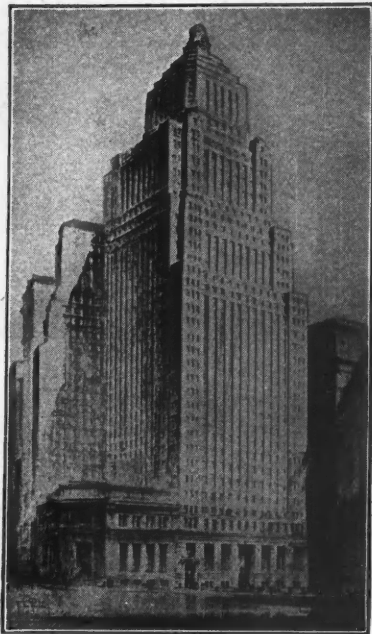

823,000 sq. ft. of Wire Fabric reinforces the Concrete floor slabs in the new Equitable Trust Building, New York City

THE Equitable Trust Building in the heart of New York's Financial District is built to endure for all time. Each construction feature represents the best available in the special field.

The short span concrete floor arch, **WIRE FABRIC REINFORCED**, is positive protection against fire, load and quake.

Wire Fabric is produced from high strength cold drawn steel which insures absolute safety. Being furnished in rolls it provides continuous reinforcement, properly distributed, and is easily and quickly installed. There is a style or weight for every floor load. **WIRE FABRIC** is also furnished in light weights for beam wrapping or temperature reinforcement. Write for complete information.

SALES OFFICES

- | | |
|---|--------------------------------------|
| CHICAGO.....208 So. La Salle Street | NEW YORK.....30 Church Street |
| CLEVELAND.....Rockefeller Bldg. | BOSTON.....Statler Bldg. |
| DETROIT.....Foot of First Street | PITTSBURGH.....Frick Bldg. |
| CINCINNATI.....Union Trust Building | PHILADELPHIA.....Widener Bldg. |
| MINNEAPOLIS-ST. PAUL..... | ATLANTA.....101 Marietta Street |
|Merchants Nat'l Bank Bldg., St. Paul | WORCESTER.....94 Grove Street |
| ST. LOUIS.....506 Olive St. | BALTIMORE.....32 So. Charles Street |
| KANSAS CITY.....417 Grand Avenue | BUFFALO.....670 Ellcott Street |
| OKLAHOMA CITY.....First Nat'l Bank Bldg. | WILKES-BARRE..... |
| BIRMINGHAM.....Brown-Mark Bldg. |Miners Bank Bldg. |
| MEMPHIS.....Union and Planters Bank Bldg. | *SAN FRANCISCO.....Russ Bldg. |
| DALLAS.....Praetorian Building | *LOS ANGELES, 2057 E. Slauson Av. |
| DENVER.....First National Bank Bldg. | *PORTLAND.....777 Nicolai St. |
| SALT LAKE CITY.....Walker Bank Bldg. | *SEATTLE.....4th Ave. So. & Conn St. |
- *United States Steel Products Co.

The Binks Spray Gun applies paint 60% to 80% faster than Hand Work!



BUILDERS

Paint by Machine

Pocket the Difference!

Builders should not lose time in acquainting themselves with the speed and economy of Spray Painting.

If you turn your painting jobs over to a painting contractor, by all means try one with a Binks Portable Spray Painting Outfit. Buildings are completed for earlier returns; the work is mechanically even and mechanically better. The spray forces paint into surfaces. The speed is the same regardless of surface texture. One man does the work of four or five hand painters. Binks—Spray interiors, exteriors, equipment—everything!

A-C-T N-O-W

If you operate your own painting crew, get busy with a Binks Portable Spray Painting Outfit at once. The big season is ahead. The outfit quickly pays for itself—after that bigger, quicker profits! Write us for details today.

BINKS SPRAY EQUIPMENT COMPANY

Dept. C. 3121 Carroll Ave. Chicago

Branch Offices

- | | | |
|--------------------------------|---------------------------|---------------------------------|
| NEW YORK CITY
56 Warren St. | DETROIT
4456 Cass Ave. | SAN FRANCISCO
371 5th Street |
|--------------------------------|---------------------------|---------------------------------|

Representatives in Principal Cities



Colorful tints make stucco houses sell

A brilliant red tile roof, brown weather wood-work and salmon colored stucco highlighted with cream. No wonder the Snell Isle Gardens apartment at St. Petersburg, Florida, is considered one of the most attractive apartments on the west coast.

Bondex does help wonderfully to complete the picture and make a stucco job an outstanding success. Builders, contractors and real estate developers have been quick to realize how important a beautiful coat of Bondex is in making a satisfied client or a quick sale.

The waterproofing ability of Bondex, in addition to its beautifying effect, is another reason why this paint is ideal for stucco, concrete, brick, stone or hollow tile. It makes no difference whether the surface is damp or dry, for Bondex is used successfully in tunnels and breweries where the walls are always wet. Outside walls, foundations, basements, garages and even swimming pools can be painted economically with Bondex. Use a brush or spray, whichever you prefer.

Send for a liberal free sample and give Bondex any tests you want.

THE REARDON COMPANY
ST. LOUIS CHICAGO LOS ANGELES

Reardon's

BONDEX

WATERPROOF CEMENT PAINT

Other Reardon Products:
Solarite, Cresto, Lumnite, Alfresco,
Wall Size



The Reardon Co.,
103 Clinton Street, St. Louis, Mo.

Please send me your FREE booklet and a sample of BONDEX.

Name.....
Street.....
City..... State.....
Business.....

Everlasting Money Makers



Trouble Saver Steel Brackets

*You don't make your own ladders
—Why manufacture scaffolding?*

Trouble Savers turn scaffolding into tools which, like ladders, can be used on hundreds of jobs without extra expense for each job.

Trouble Saver Steel Brackets Pay for Themselves On Every Job

Trouble Saver Steel Brackets are put up and taken down so much faster than wood scaffolding can be erected or dismantled, that they save enough money to pay for themselves on every job.

Trouble Savers are practically everlasting. Their replacement cost doesn't have to be reckoned with, whereas scaffold lumber quickly becomes scrap lumber and is a constant item of expense.

Full information on our 30-day trial offer sent on request

Trouble Saver Studding Brackets

Support a ton. Will not bend. Hook around studding and are firmly braced by 2 legs. Fold for cartage or storage.



Nail Attached Brackets

Support a ton weight. Held by four nails. Braced by two legs. Fold for cartage or storage.



Trouble Saver Bolt Brackets

Approved by State Industrial Commissions. Detachable. Ball Standards. Held by 1/2" bolts. Fold for storage or cartage.



Trouble Saver Steel Products

Bolt Brackets with Safety Railing
Studding Brackets
Nail-Attached Brackets
Adjustable Trestles
Ladder Jacks
Wood Shinglers
Asphalt Shinglers
Mortar Board Stands
Sectional Steel Scaffolding

THE STEEL SCAFFOLDING CO.

1101 Governor St.

Evansville, Indiana

THE STEEL SCAFFOLDING COMPANY
1101 Governor Street - - - Evansville, Ind.

Gentlemen: Please send me prices and full information on Trouble Savers—also details of your 30-day Trial Offer.

Name.....
Address.....
City..... State.....



Beautiful!
But Will It
WORK
?

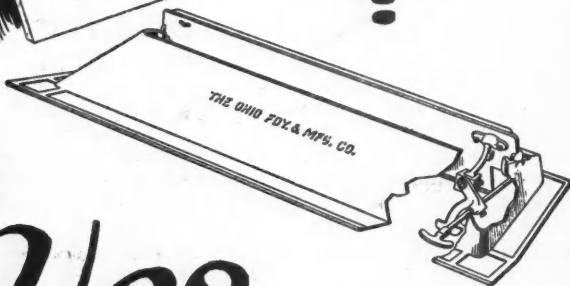

Yes

That is the answer to the prospective home owner's query. A fireplace that actually functions as a heating unit presents a great appeal to all home lovers. We manufacture a complete line of fireplace equipment, from gas logs, gas heaters, andirons, portable fireplace baskets to dome dampers, etc. All are fully guaranteed. We invite you to inspect our line. Coupon below brings our illustrated catalog.

The Ohio Foundry & Mfg. Co.
Stuebenville, Ohio

Established 1846

THE OHIO FOUNDRY & MFG. CO.
Stuebenville, Ohio.

Gentlemen: Please send me your catalog.

My Dealer's name is

Name

Street

City State

Nature's Permanent Mineral Colors

*Of Course
It Helps the Sale!*

Made Since 1887

ANY investment builder will tell you that the house brightened and beautified with color is the easy one to sell these days. Why shouldn't it be? Color is in demand today as never before. It's used on everything from parasols to skyscrapers—and houses are no exception.

The wide variety of shades available in Clinton Mortar Colors assures the builder of obtaining the exact color combinations in brick and mortar which he wants. Made since 1887, these colors have proved themselves color fast throughout the years. They are heartily endorsed by architects and builders throughout the country.

Complete information regarding Clinton Mortar and Cement Colors and their use will be sent upon request.

Clinton Metallic Paint Co.
538 CLINTON ROAD
CLINTON, NEW YORK

Clinton Mortar Colors

CLINTON METALLIC PAINT COMPANY CLINTON N. Y.

Representative Bargains from Our New Catalog

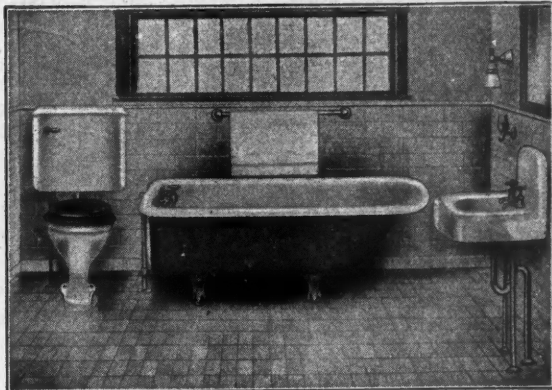

on Quality
Plumbing &
Heating
Material

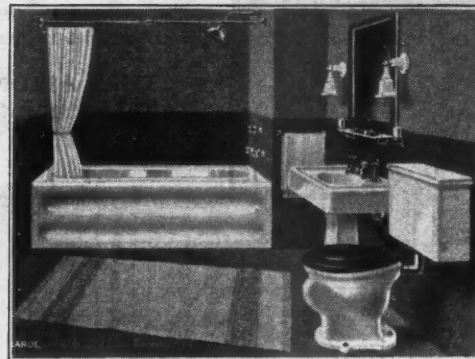

The Jewell An inexpensive high grade outfit of latest style that carries the stamp of perfection, priced very low at..... **\$56**
Bath Tub and Lavatory are cast iron, heavy porcelain and fully equipped. Tub lengths to 5 ft. same price, with 26 or 30 in. wide. Closet has deep seal syphon action wash-down bowl.



The Peerless Beautiful Complete **\$102**
Highest type of Bathroom. Fixtures are solid and massive. Tub, Closet and Lavatory, heavily enameled inside and out. Closet is deep seal syphon action, wash-down type with jet. Solid porcelain tank. Shower equipment shown \$11 extra.

WHOLESALE PRICES
on the best plumbing and heating supplies. Everything **GUARANTEED**, or we refund your money. Only high class goods sold and prices always lowest.

CATALOG FREE

Hot Water Heating Plant Complete For 6 Rooms
and bath with 900 ft. Boiler and 275 ft. Radiation of your own choice for only **\$275**
Larger systems equally as low. Send your plans for estimate — No Charge.

YOU CAN ALWAYS SAVE MONEY AT KAROLS
and be assured of the best quality of goods and fast service. We carry a big stock and can make immediate shipment. Try us!
ESTIMATES FREE

B. Karol & Sons Co., 800-10 So. Kedzie Avenue, CHICAGO, U. S. A.

Simplicity, Economy and Accuracy

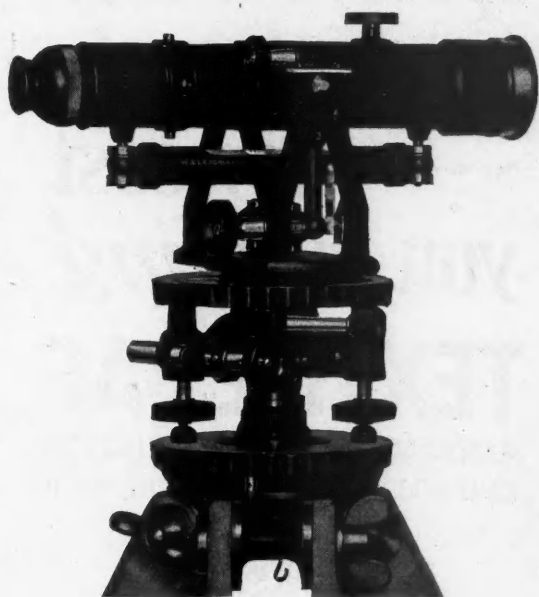

by use of the
Gurley Tilting Level

Any workman who can level with a carpenter's spirit level, can use the Gurley Tilting Level. By simply turning a slow motion screw, the bubble can be brought to the center before each reading.

"Line and Grade" can be given without removing the telescope from its bearings. The Tilting Level is thus instantly ready for either Transit or Level work.

The Gurley Tilting Level is made by the oldest American makers of fine instruments for Engineers and Surveyors, and brings the same instrument precision to Contractors and Builders in a simplified form.

No. 385 Gurley Tilting Level
Send for Illustrated Bulletin

W. & L. E. Gurley, Troy, N. Y.

W. & L. E. GURLEY
514 Fulton St.
TROY, N. Y.

Send me at once descriptive bulletin on the new Gurley Tilting Level.

Name.....
Address.....

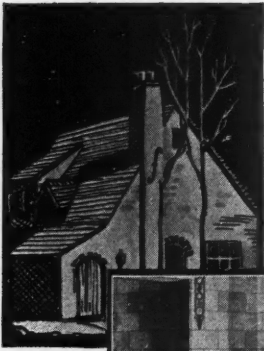

THAT ASTONISHING
NEW WALL MATERIAL

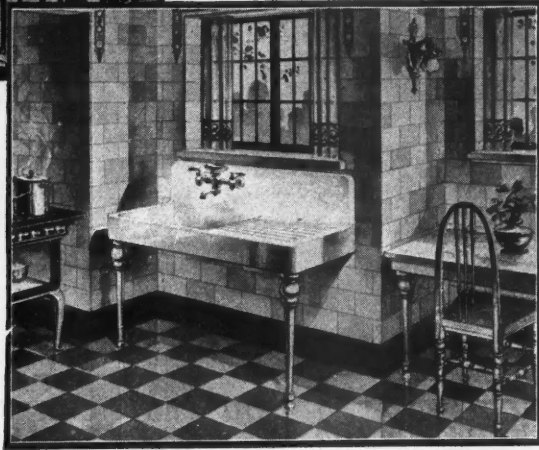

One Room Sells the Whole House—

“SALES are made—or lost—on hunches,” a wise old builder once remarked. “Let a woman find one or two things about a place that truly appeal to her—an attractive kitchen or a beautiful bathroom—and the sale is made.”

Practical builders have found that it *pays* to use Sani Onyx in those two important rooms. This new wall material, made from *melted rock*, brings surface textures and color combinations never before possible.

You may have Sani Onyx in plain sheets or tile pattern slabs. Easily and quickly installed by our construction houses in principal cities. Sani Onyx doesn't crack, chip, check or discolor—and it really outlasts the building itself.

MARIETTA MANUFACTURING COMPANY
80 Brookside, Indianapolis



Have you received a copy of the beautiful Sani Onyx book, picturing actual kitchen, bathroom and breakfast room nooks in full color? We shall be glad to send one on request. No cost—and no obligation, of course.

Beautiful **SANI ONYX**
A VITREOUS MARBLE

Cloth the economical
cement package

Why pay for the
bags when you
buy cement?
specify delivery
in *cloth sacks*
--- they cost
you *nothing*

TEXTILE BAG
MANUFACTURERS ASSOCIATION
7310 WOODWARD AVE., DETROIT, MICH



40 years' experience endorses Oak Floors

Quality-construction pays. The experience of Mills & Sons, Chicago Realtors and Builders, in erecting thousands of homes and apartments over four decades of time, has amply demonstrated the selling value of good materials in home construction.

Today, 800 bungalows more, in the Westwood suburban development alone, creating a veritable city of 1800 Mills-built homes, is further evidence of the fact that quality-construction pays. All have Oak Floors, affording substantial, permanent value in one of the most important features of room decoration.

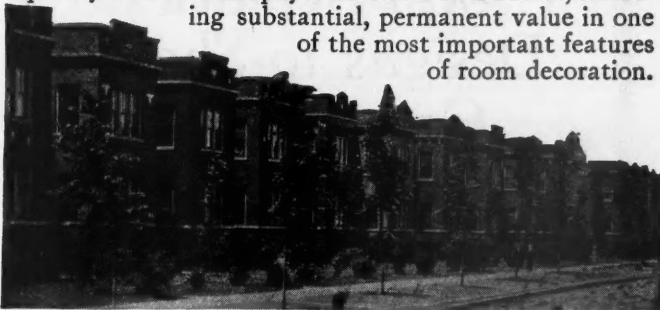

OAK displays Nature's beauty in grain and coloration, blending over the entire lustrous floor expanse.

OAK lends dignity to any room; it harmonizes with woodwork and with furniture of whatever period. It is the proper background for rugs.

OAK is permanent. Time only improves its mellowness. It is easily kept in perfect condition; is cleanly and saves housework. The cost is negligible compared with temporary floor coverings.

Mail coupon for free literature

To assist in solving flooring problems, we prepare technical literature mailed on request, and maintain a staff of experts who will serve you without obligation.

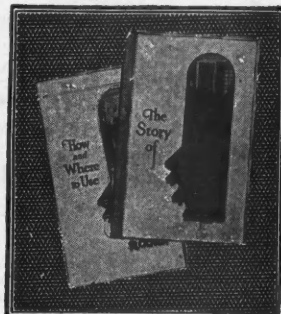

OAK FLOORING BUREAU
1238 Builders' Building, Chicago
Please send me "The Story of Oak Floors" and "How and Where to Use Oak Floors."

Name

Address

City State



PEERLESS

Dome Dampers

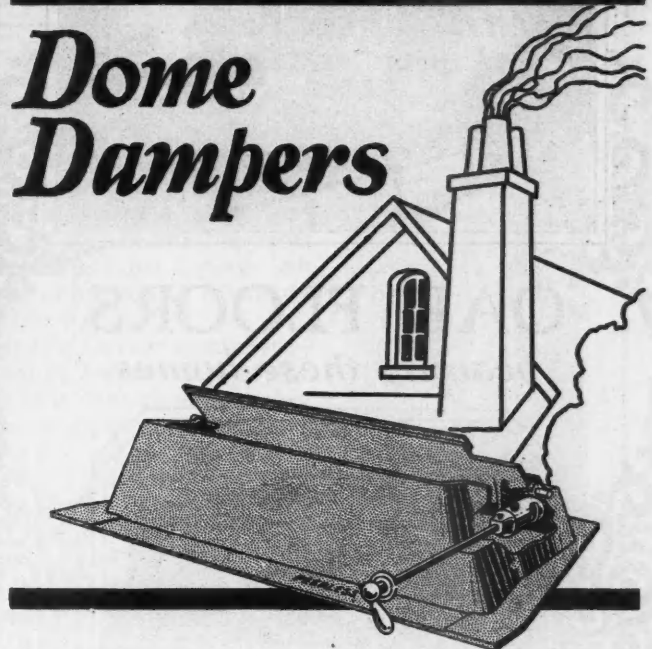

7 Features of Peerless Superiority

1. The front flange is made sufficiently strong to support the fireplace arch without the use of angle iron or lintel.
2. Time and labor saved; eliminates necessity of building up brick throat.
3. The Peerless Dome assures correct throat shape and size.
4. Perfect regulation of draft.
5. Elimination of smoky fireplace.
6. Damper leaf is removable, permitting access to the flue for cleaning.
7. Operating mechanism is such that it may be adjusted either before or after the damper is installed.

We guarantee complete fireplace satisfaction for the contractor, architect, home owner and dealer. Install the Peerless Dome Damper in homes you build. There will be no falling soot to clean up on the hearth, and there is perfect control of the draft.

Send for literature on our complete line of Ash-Pit Doors—Ash Dumps—Coal Windows and other Building Specialties.

Let us help you with your fireplace problems

MAIL THE COUPON

PEERLESS MFG. CO.

324 W. Main St.

Louisville, Ky.

PEERLESS MFG. CO.,
324 W. Main St.,
Louisville, Ky. 3-28

Kindly Check

- | | |
|-------------------------------------|------------------------------------|
| <input type="checkbox"/> Contractor | <input type="checkbox"/> Architect |
| <input type="checkbox"/> Home Owner | <input type="checkbox"/> Dealer |

I am interested in Peerless Dome Dampers and other Building Specialties. Please send me complete information.

Name

Address

Town State



OAK FLOORS

beautify these homes

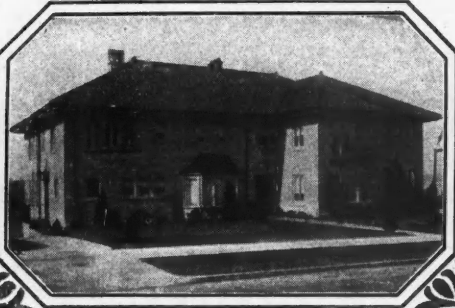

The texture and pattern of "Perfection" Brand Oak flooring make possible a finish that is seldom found on any other flooring.

You can depend upon "Perfection". In two modern plants operated by skilled lumbermen, only the finest oak is selected. After proper seasoning and kiln-drying, it is perfectly milled and matched so that it lays smooth and stays smooth. It is graded and handled so carefully that upon arrival anywhere, it is always in perfect condition. Leading lumber dealers gladly feature this nationally advertised brand.

ARKANSAS OAK FLOORING CO., PINE BLUFF, ARK.

PERFECTION

BRAND OAK FLOORING



There's a size and grade for every structure, new or old. Write today for full particulars.

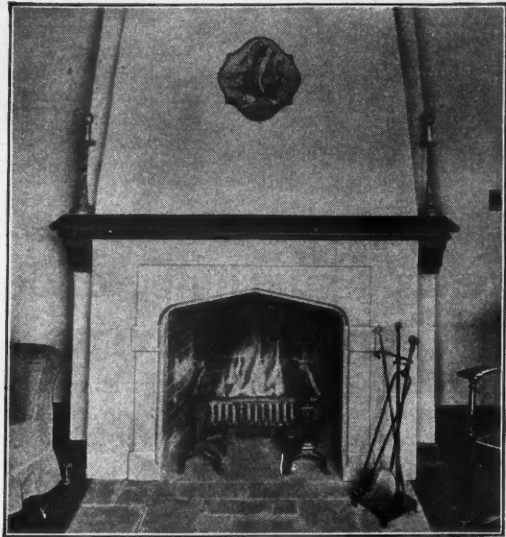
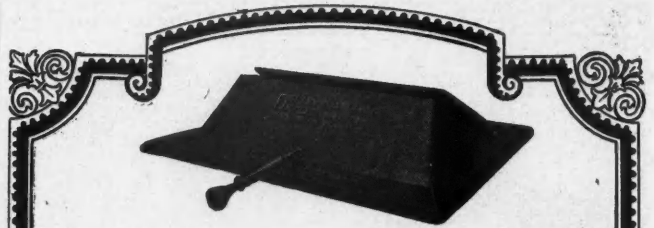
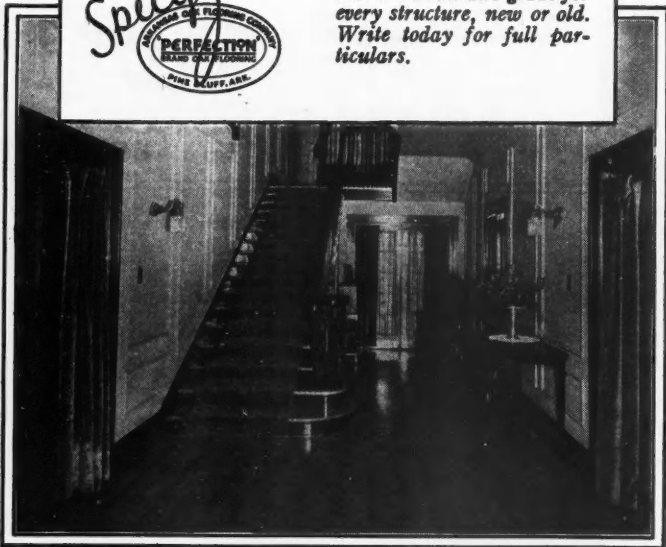

60 Fireplace Designs to Show Customers

EVERY BUILDER has need of a reliable book of beautiful up-to-date fireplace designs to show his customers. The Donley Book of Successful Fireplaces, is, we believe, the finest book on fireplaces published today. It contains the latest designs in brick, wood, stone and combinations of these materials—fireplaces for almost any room in the house—and with a range in prices that will fit any pocket-book.

Designs are but a part of this invaluable fireplace reference book. It also contains tried and proven construction details on interior design of the fireplace. It describes the Donley Fireplace Equipment necessary to building a completely successful fireplace. A copy of this book will be sent to any builder who will send 25 cents in stamps or coin to cover cost of postage, mailing, etc.

The Donley Brothers co.
13926 Miles Avenue • • Cleveland, Ohio

REG. U. S. PAT. OFFICE



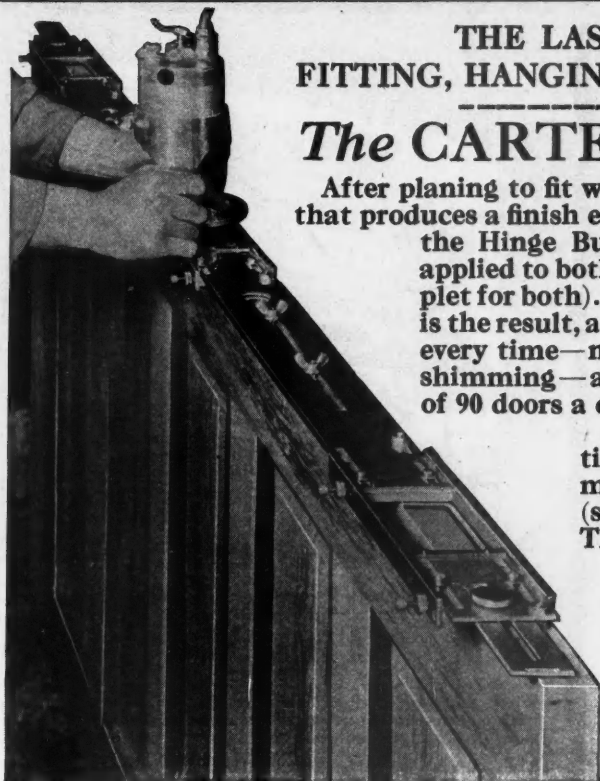

Hinge Butt Router and Templet on Door

THE LAST WORD IN FITTING, HANGING, LOCKING—DOORS

The CARTER DOOR SET

After planing to fit with the Carter Super Plane that produces a finish equal to sanding or scraping, the Hinge Butt Templet and Router is applied to both door and jamb (same templet for both). A perfectly smooth cut out is the result, and exact to size and location every time—no mistakes—no trying—no shimming—and you can swing upwards of 90 doors a day this way.

Then the Carter Lock Mortiser (next issue) will easily mortise 300 doors a day (shorter runs proportionate). The fully adjustable Lock Face Templet will finish the job in a few seconds—and a perfect job always.

Can you afford to overlook this tremendous saving? Hundreds of the world's largest builders are now Carterized—when will you be?



Hinge Butt Router and Templet on Jamb

THE R. L. CARTER CO., INC.
PHOENIX, NEW YORK

SEND FOR
FOLDER 9-A

Originators and sole manufacturers of the Door Set

You Can Mix a Batch a Minute WITH THE "Magic" Mixer



"Little Giant" Gasoline Engine—the "Magic's" power plant—a powerful 2½-h. p., 4-cycle gasoline engine, hopper cooled—a marvel of simplicity and dependability.

Actual tests right on the job prove that, due to the special arrangement of paddles, a thorough mix can be made in one minute with this sturdy Magic Mixer—every batch thoroughly mixed and absolutely uniform. Compare this with the old shovel method where the best two men can do is four batches an hour. Think of the saving in time, money and labor.

On an average house of six rooms with concrete foundations, sidewalks, basement and garage, costing \$650.00—a positive saving of \$200.00 in time and labor is assured—and proportionate savings on all other types of concrete work.

You need the Magic Mixer on your work. It is a marvel for hard service. Equipped with Little Giant Oversize Engine that provides ample power for any mix—at the cost of a single gallon of gasoline a day. Has extra large drum, gear-driven and gear-dumping—loads and discharges on either side. Trailer type—hooks on behind truck—equipped with steel disc wheels and solid cushion tires. Can be taken anywhere—always ready for hard and continual service—the best possible investment you could make.



Learn About Our Liberal Terms—and about our trial offer. Our Easy Ownership Plan requires only an extremely small first payment and almost a year to pay. The Magic Mixer will earn the payments before they come due.

Get This Free Booklet It tells you what the Magic Mixer will do for you—how it will help you get bigger jobs, do better work and make more money. Sign and mail the coupon now and let us mail you the facts.

A. S. ALOE CO., 1810 Olive Street ST. LOUIS, MO.

MAIL COUPON TO-DAY

A. S. ALOE COMPANY,
1810 Olive Street, St. Louis, Mo.

Send me FREE booklet, "The Concrete Road to Success," full description of the Magic Mixer and particulars of your Easy Ownership Plan.

Name.....

Address.....

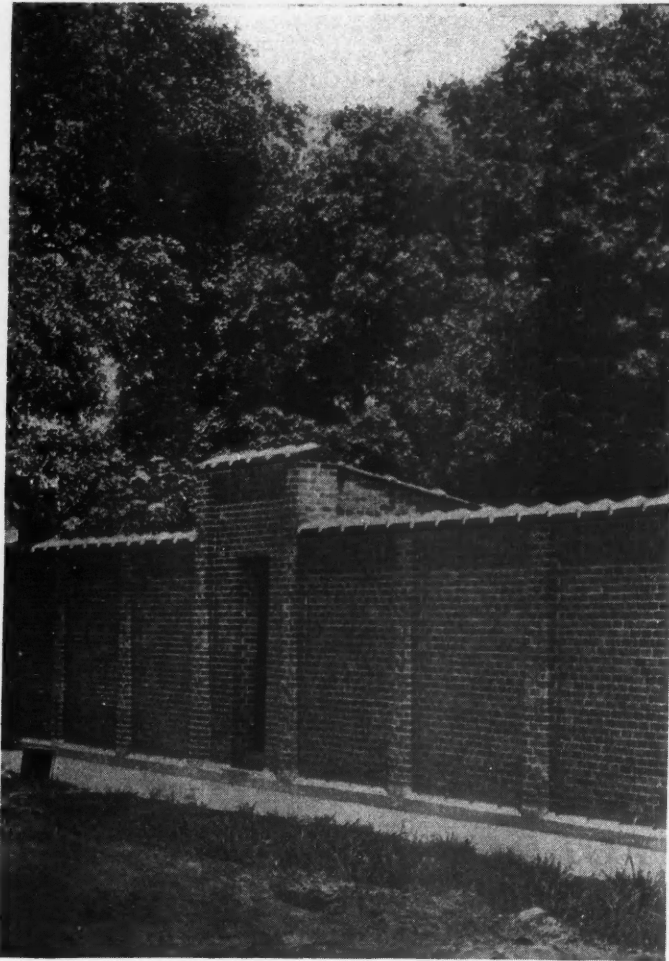

Put clay wall coping on the top bricks and the rest will take care of themselves

CLAY PRODUCTS ASSOCIATION
CHAMBER of COMMERCE BLDG.
Chicago

VITRIFIED ^{Salt Glazed} CLAY
Wall Coping

AB3—Gray

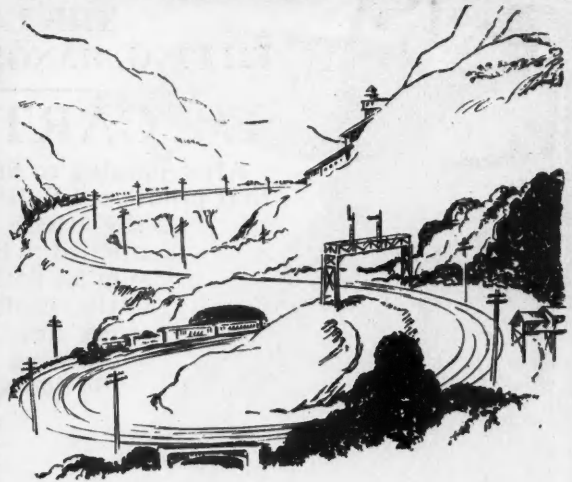

You Can Meet the Heating Grade This Way Also

When you have a fixed amount of radiation to supply, with a strict limit put on boiler space and fuel consumption, do what the railroad engineers do.

They curl up six miles of track into one mile as the crow flies, using the familiar loop construction to do it.

A Burnham Boiler loops up *three times its own length* of fire travel between the front and the back.

As you know, its the long fire travel that makes the short fuel bills.

Every Burnham Boiler has that fuel thrifty fire travel, and there's a Burnham built for every heating purpose you may have to put up to it.

You'll find them all in Catalog 67.

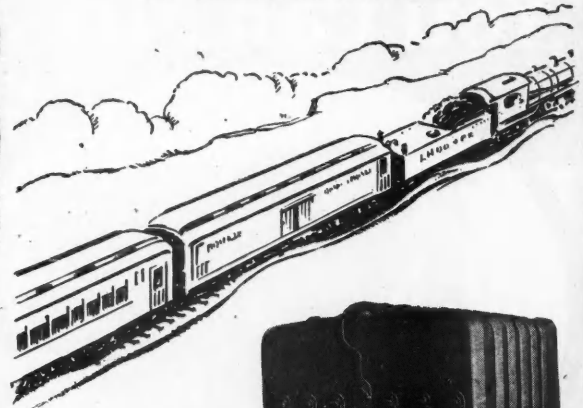

Here's the Big Twin, ready to undertake the heating of a church or a school house, apartment or office building, and do it fuel-thriftly.



Burnham Boiler Corporation

Irvington, New York

Representatives in all principal cities of the United States and Canada

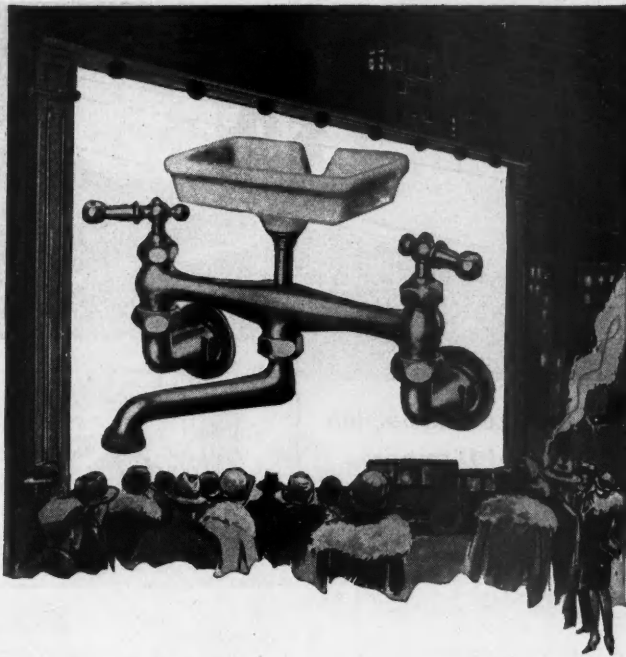

A New Faucet Design

Illustrated is the new Hays Excel Double Sink Faucet. Finished in the new chromium plating, a finish that will not tarnish and lasts forever.

Hays Faucets are in step with all the newer building ideas, refined, more beautiful and improved in accordance with present day home building and design.

The foregoing and all other facts about Hays faucets are being advertised every month to more than a million families who either now own a home or contemplate building one.

All of which means that the families interested in the homes you build are likewise interested in the new faucets being shown, they will more readily buy homes that are equipped with the latest and most improved products.

The Hays line includes several styles in every type of faucet. All furnished either in the new chromium plating or nickel plating finish. Send for folder illustrating and describing our new and improved faucets and our built-in bathroom equipment.

WHEN YOUR FAUCETS ARE MARKED
HAYS YOU CAN FIND NONE BETTER

THE HAYS MFG. CO., Liberty & 12th Sts., Erie, Pa.

HAYS FAUCETS



You can use these Starretts!

Here are only a few of the scores in the big Starrett Catalog—the No. 108 Aluminum Line Level, No. 132 Iron Level with Double Plumbs, No. 50 Improved Trammel Points, No. 194 Universal Scraper, No. 800 Square Head Nail Sets, and No. 810 Burnisher for turning scraper cutting edge.

Every one of them of Starrett quality and enduring value. It pays to ask for Starrett's. Your dealer has the genuine. Write us for free copy of the new Starrett Catalog No. 24-6.

THE L. S. STARRETT CO.

*World's Greatest Toolmakers
Manufacturers of Hacksaws Unexcelled
Steel Tapes—Standard for Accuracy
ATHOL, MASS., U. S. A.*

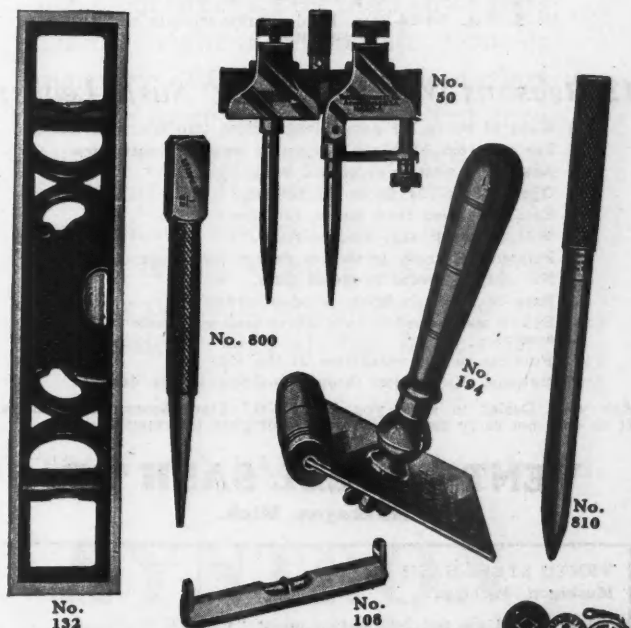

Use Starrett Tools

1663

Vento

PUTTYLESS STEEL SASH

Cuts Costs

INCREASES THE VALUE

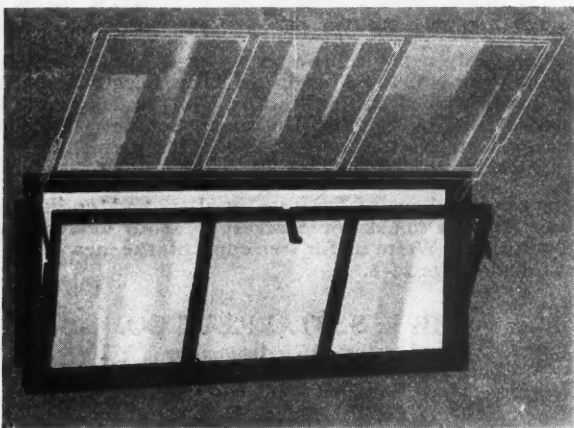

U. S. Pat. 3-4-24-Pats. Pend. Infringements will be Prosecuted.

12 Reasons Why "VENTO" Sash Leads:

- (1) Made of heavy, 12 gauge steel welded into one solid frame.
- (2) Tee bar stock 1"x1"x $\frac{1}{4}$ " welded in its sash construction.
- (3) Absolutely weather-proof and water-tight.
- (4) Opens easily—Locks at the bottom.
- (5) Easily removed from frame, full opening.
- (6) Will not warp, sag, bind or stick.
- (7) Painted and ready to ship or deliver from your dealer.
- (8) No putty is needed to install glass.
- (9) Easy to install in brick, wood or cement.
- (10) Drilled and tapped to take storm sash or outside "VENTO" screens.
- (11) Provides proper ventilation at the top.
- (12) National distribution through building supply dealers.

Ask your Dealer to show you "VENTO" Steel Basement Windows. If he does not carry them write us for complete information.

VENTO STEEL SASH CO.
Muskegon, Mich.

VENTO STEEL SASH CO.
Muskegon, Michigan

Please send me full information about "VENTO."

Name.....
Address.....
City..... State.....



For Fireplace Satisfaction Colonial Damper

The new style "G" of the reliable Colonial Damper can be set two or three courses of brick above the opening where best results are obtained. Operating handle slides out of sight under the opening. Pulls forward and moves right or left to open or close. Controls draft perfectly.

Colonial Damper, Ash Traps, Ash Pit Doors, etc., at your dealers.

Write for details of fireplace construction FREE



GLO-HOT GRATE ELECTRIC-HEATS

Fits any fireplace, looks like live coals, heats from concealed "Glo-Bar" under hood.



Send 10c for "The Best of Pals" The Wonder Instrument. Gives Plumb, Angle, Level, Square—Many other uses.

Colonial Fireplace Company
4604 Roosevelt Rd. Chicago, Illinois

Colonial ^{Head-Throat and} Damper

Adamston

Vertically Drawn Flat Glass



No curvature to flatten out or strain from the drawing process.

Vertically drawn in continuous sheets. Uniform in thickness and perfectly flat.

A brand you can depend upon.



ADAMSTON FLAT GLASS COMPANY
CLARKSBURG, W. VA.

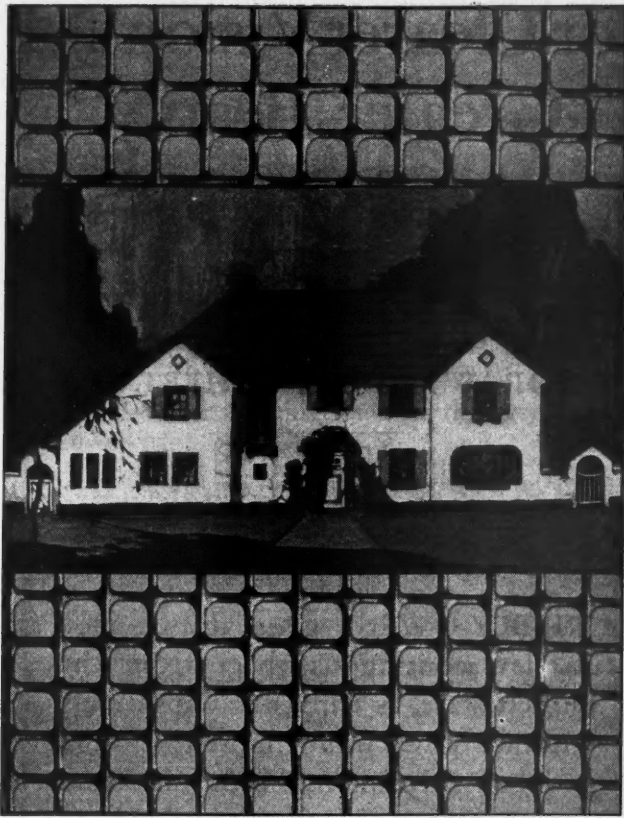

*After you deliver
a house*

The new owner will have you up on the carpet as sure as cracks appear.

This is as true of contract work as it is of speculative building. It is why so many architects are specifying and so many builders are using Clinton Wire Lath.

For Clinton Lath is woven of finely tempered steel wire into a close even mesh. It provides a vertical and horizontal key. When the lath is strong and the key is there it is up to the plasterer to make a perfect job. This is why a job on Clinton Lath comes through.

After the owner pays his bill he soon forgets the very few dollars he would have saved by using wood lath. But he never forgets cracked walls.

Let us send you further information.

WICKWIRE SPENCER STEEL CO.

General Offices

49 East 42nd St., New York, N. Y.

208 South LaSalle St., Chicago, Ill.



CLINTON WIRE LATH

*“Paid for itself
10 times
or more”*

—says a well-known contractor in Texas *

* Name on request

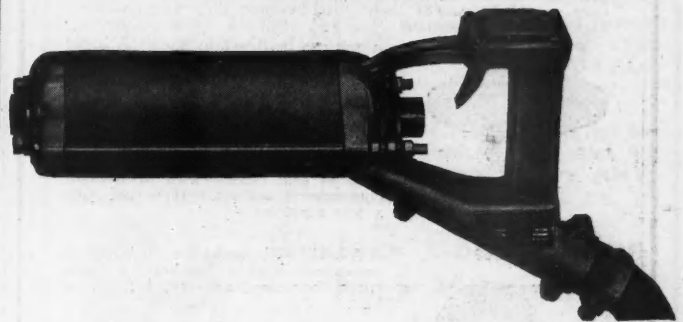

RUN a Syntron for an hour and you'll never go back to hand drilling, chipping or channeling. Smooth, steady blows—3600 a minute—ten times faster than any hands can do—right into concrete, stone or masonry. With a Syntron motorless electric hammer, hours are cut into minutes, labor costs reduced to a fraction and perfect workmanship assured. It operates from any light socket, is easy to hold, has only one moving part and cannot be stalled or overloaded. Get all the facts now.

Address

SYNTRON COMPANY, Pittsburgh, Pa.

SYNTRON
Electric Hammer

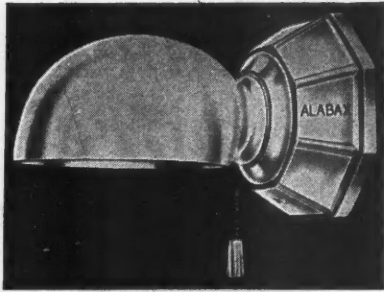

AL-923 Alabax

Lighting Fixtures Count with Women Buyers

HOME, to a woman buyer, is made up of smaller items, one of the most important being the lighting fixtures.

Many times a sale has been closed because the brackets and receptacles suggested the quality that she was looking for, but she could not judge in paint, beams, joists, etc.

Even if P & S Alabax porcelain brackets and receptacles had to be sold at higher prices than competitive products they would be worth their cost because they are quality—high grade and beautiful.

P & S Alabax porcelain fixtures will retain their beautiful finish because it is fired in—just like fine china. They will not crack or peel, nor will they rust or age in any way. And a damp cloth cleans them perfectly.

For every lighting purpose there is a P & S Alabax unit, with or without pull chain; with or without convenience outlets. Here are just a few numbers—



AL-1200

AL-923—Shown above. A beautiful hexagonal Alabax bracket for bathroom, bedroom, nursery, kitchen or hall.



AL-990

AL-1200—An attractive Alabax ceiling receptacle that is strong and lasting, but is neat and graceful in appearance when installed. Similar fixture units can be arranged for use with three conductor cord to allow for pendant-convenience outlet and switch.



AL-2846

AL-990—This is another Alabax bracket that may also be used in kitchen, bathroom, bedroom, nursery and hall. The convenience outlet is of the same fine quality that is in every P & S product.

AL-2846—An Alabax bracket of exceptionally fine design for use in kitchen, bathroom, etc. Also for hospitals, beauty parlors or wherever quality is desired.

P & S Alabax porcelain brackets, receptacles and other approved devices are described in our 1928 catalog.

Write for your copy. Please give us your Electrical Contractor's name and address.

PASS & SEYMOUR, INC.

Solvay Station, Syracuse, N. Y.

NEW YORK, 71-73 Murray St. CHICAGO, 730-32 W. Monroe St.

WEST COAST SALES REPRESENTATIVES
C. R. BACH CO., 252 Fifth St., San Francisco, Calif.

NEW ENGLAND SALES REPRESENTATIVE
ALVA D. STEIN, 156 Purchase St., Boston, Mass.

P&S ALABAX

REGISTERED U.S. PATENT OFFICE

"THOSE WHO KNOW THE FACTS INSIST ON ALABAX"

For Clearer Vision and Greater Beauty

Specify

Libbey-Owens

FLAT-DRAWN CLEAR SHEET GLASS



LIBBEY-OWENS glass, drawn in a flat, continuous sheet from the molten state, is truly flat—absolutely without bow—uniform in thickness, and has a brilliant, beautiful lustre.

These unusual superiorities are inducing architects and builders everywhere to specify LIBBEY-OWENS flat-drawn clear sheet glass for windows for they know these qualifications mean clearer vision and greater beauty.

Twice inspected and twice graded to insure its meeting our exacting standards, LIBBEY-OWENS "A" quality glass is ideal for all fine windows.

LIBBEY-OWENS "A" quality glass is packed with water-marked paper between the lights to protect its high lustre, and to further identify this superior glass, each individual light bears the LIBBEY-OWENS label.

Specify LIBBEY-OWENS labelled glass for all fine windows everywhere.

Aided by a national advertising campaign in the Saturday Evening Post, a definite demand is being created for quality glass—and likewise a definite prestige and preference for Libbey-Owens flat-drawn clear sheet glass for windows.

THE LIBBEY-OWENS SHEET GLASS CO.
TOLEDO, OHIO

Libbey-Owens Flat-Drawn Clear Sheet Glass for Windows
Distributed Through Representative Glass Jobbers and Used by Sash and Door Manufacturers Everywhere

A Profitable Line

Bayley-Springfield Steel Windows

DEALERS are making money in handling Bayley-Springfield Steel Windows. Designed for all types of buildings. Bayley construction features make for great strength and economical installation. Carried in stock so that a dealer's turnover makes the Bayley line an attractive proposition.

RESIDENCE CASEMENTS

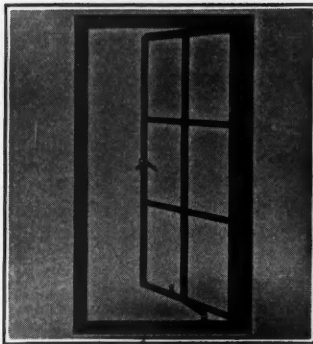

Bailey-Springfield residence casements meet the demand for steel windows in residences, apartments, and many other buildings.

Many units of standard sizes and layouts carried in stock. Send for catalog.

BASEMENT WINDOWS

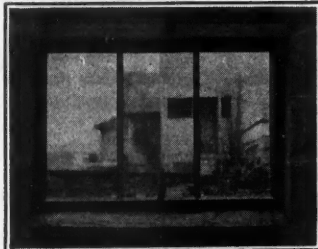

For basements in residences, apartments and other buildings. Just the window for side-walls in garages and other small buildings. Holes in steel jamba for screens. Made in four standard sizes. Special hinge construction permits ventilator to be easily and quickly removed and replaced. Not removable from outside.

UTILITY WINDOWS

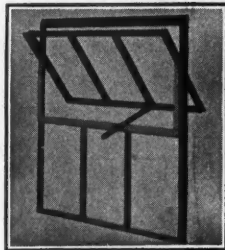

The utility window, because of quantity production, is moderate in cost. Usable in buildings of many types and for many purposes. Ideal for garages and similar small structures. Ventilators center pivoted. Each unit has 4 lights 12 x 20 and 2 lights 13 x 20.

WRITE AT ONCE FOR PRICES

The Wm. Bayley Company

128 W. North St., Springfield, Ohio
Sales Offices and Warehouses in Principal Cities

Send proposition on

CASEMENT BASEMENT UTILITY

Name.....

Address.....

CONTRACTOR DEALER OWNER

WODACK TOOLS

Are Real Money Savers on Every Job

Built to "Stand Up"

Model C

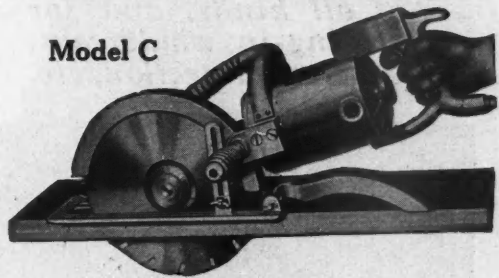

Wodack Saw

The Wodack Electric Hand Saw, which cuts up to 4 1/8" lumber, saves \$20.00 over hand sawing in just one day's use. Is the only electric saw on the market that combines big capacity with easy portability. Weighs only 24 lbs. 3/4 h.p. G. E. Universal Motor for A.C. and D.C., 110 or 220 volts. 11" and 8" saw blades furnished. PERFECT SAFETY GUARD.

Model B

Model B features a swivel base for bevel cuts up to 60°, and a rip gauge. 3/4 h.p. motor. 11" and 9" blades. Capacity to cut jack-rafters. Saws ANY lumber from 0" to 4" thick, in ONE cut.

Wodack Combination Lock Mortiser and Router

2 Tools in 1

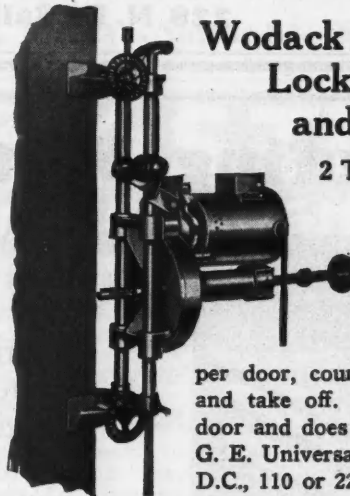

Cuts both face plate and barrel in ONE OPERATION in an average time of less than one minute

per door, counting time to put on and take off. Saves 50c on every door and does better work. 1/2 h.p. G. E. Universal Motor for A.C. and D.C., 110 or 220 volts.

Wodack Router

Remove the Motor and have complete Router with straight edge attachment. Saves a big labor cost on all grooving, routing stair stringers, etc. Router sold separately, if desired. Unparalleled low price.



ALL ATTACH TO LIGHT SOCKET

F. L. ROGERS & CO.

23 S. Jefferson St.
Chicago

Also
New York

-----MAIL COUPON TODAY-----

Send me literature on the Wodack Saw Wodack Combination Lock Mortiser and Router and name of nearest demonstrator.

Name.....

Address.....

City..... State.....

Try SISALKRAFT Now

*for covering storage piles,
machinery, materials
of all kinds, and for
closing-in windbreaks,
concrete protection, etc.*

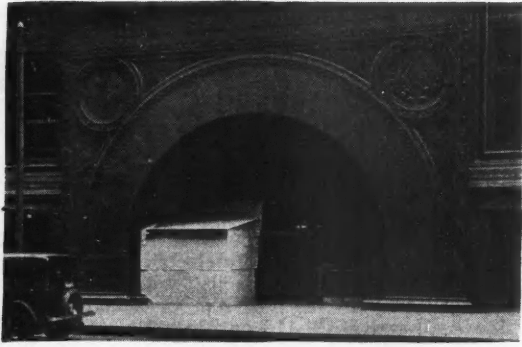

*Sisalkraft makes an economical, weather tight protection
for remodeling jobs.*

CONTRACTORS who have used Sisalkraft, as a waterproof covering, say it's the best means of protecting a job from the weather, and costs far less than old methods.

Sisalkraft is tough, permanent, always pliable and easily handled, besides being waterproof. It can be used to cover newly laid concrete and will stand the traffic of workmen and even wheelbarrows, without damage either to the Sisalkraft or the concrete surface.

Send for a sample of this new material and see for yourself how strong, waterproof and easy to handle it is.

*There is no other waterproof paper
like Sisalkraft*

The Sisalkraft Company
228 N. La Salle St., Chicago, Ill.

A. B. S-Gray

Re-Roofing With Natural Slate



EVERYWHERE, a common sight, is warning the public of this eventual necessity if they buy a home roofed with anything but material that is *known* to be durable. And what roofing material is better known to have withstood the test of time than Genuine Natural Slate?

Would not, therefore, the very sight of "A Slate Roofed House" invoke exceptional interest in the mind of your prospective buyer?

Literature on our special Quarry Cleft Slate as well as standard varieties will be mailed upon request, or return of this advertisement.



VENDOR SLATE CO.
INCORPORATED
EASTON, PENNSYLVANIA



Faster Sanding-Bigger Profits

There are two kinds of builders. Those of the "old school" who work hard for long hours—and up-to-date builders who snap into the modern way of doing things profitably.

Why should any builder waste time in the back-breaking work of scraping, planing or sanding by hand when the work can be done 5 times faster with even a better finish by means of the

IMPROVED TAKE- ABOUT Sander

It's made right—light of weight for greater ease of operation—but strong enough to live up to its job.

A new insulated handle and a larger roller for easy handling and perfect balance.

Long slits let in plenty of air to cool the motor. Detachable cap makes the motor very accessible. Sands slightly curved surfaces—sands right up to the base board. Many added features in the Improved Model at no added cost.

Write today for printed matter or a free demonstration—no obligation

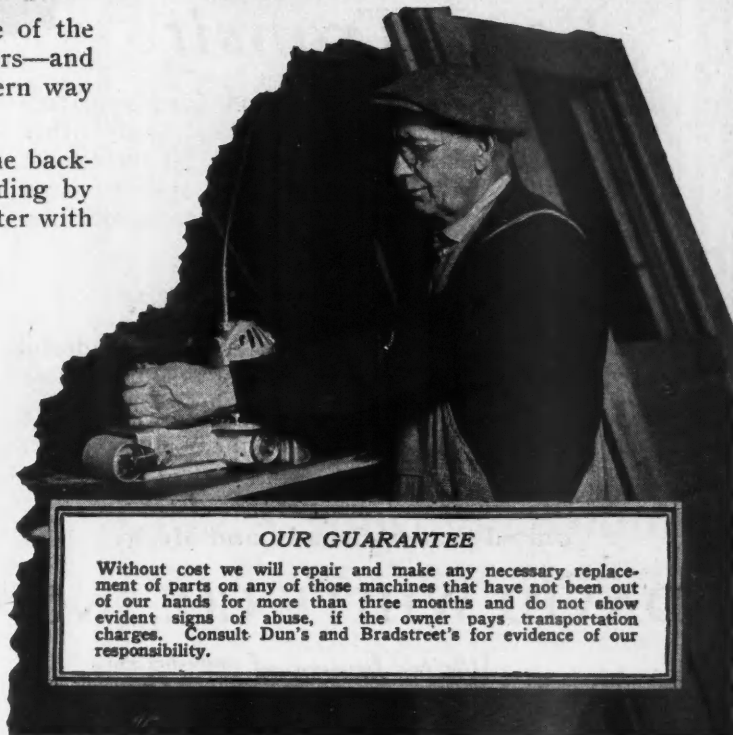

OUR GUARANTEE

Without cost we will repair and make any necessary replacement of parts on any of those machines that have not been out of our hands for more than three months and do not show evident signs of abuse, if the owner pays transportation charges. Consult Dun's and Bradstreet's for evidence of our responsibility.

PORTER-CABLE MACHINE COMPANY, 1721 No. Salina St., Syracuse, N. Y.

AREALLY The HIGH GRADE MIXER AT AN AMAZINGLY LOW PRICE

BOSS 3 1/2 S TILTER

LOW CHARGING TYPE

Just the right size. Big enough for an average foundation a day, yet small enough to be easily handled about the job or towed behind touring car or truck. Makes small jobs pay big profits. Quickly pays for itself in saving over hand labor costs.

New low prices will amaze you. Investigate! Mail coupon now for details.

Built of Steel



Mixes mortar as well as concrete. Mixing always in plain sight.

Specifications

Capacity based on crushed 1 1/2 inch stone in aggregate, dry 5 cu. ft., wet 3 1/2 cu. ft. Average daily 30 to 40 cu. yards. 29 x 27 inch bowl with 19 inch opening. Loading height 40 inches. Frame 4 in. steel, 14 x 3 in. steel wheels or 24 x 3 rubber tire. Alemite lubrication.

Adopted by Contractors in U. S. and Foreign Countries.

U. S. Govt. [100]; Clough, Bourne Corp., N. Y. [40]; Tokio Elec. Bureau, Japan [80]; Cameron, Joyce & Co., Iowa [25]; Stone & Webster, Mass. [13]; State Highway Departments of Illinois, Iowa, Missouri, Massachusetts, Pennsylvania, Michigan, Montana, Kansas, Georgia and other states.

Gear Driven—Gear Dump!

The Boss 3 1/2 S Tilter is a marvel of fast, easy operation. With it two men can turn out as much work as six men using old-fashioned, back-breaking methods. Equipped with 5 second "Easy Dump" arrangement. High speed mixing action. Batch mixed 60 times a minute—produces more uniform aggregate. Water gaps make blade and bowl self cleaning.

Full 1 Year Guarantee!

BOSS Mixers are noted for their long life. They are built almost entirely of steel and forgings. Materials and workmanship guaranteed for 1 year. The 3 1/2 S Tilter is driven by powerful 2 H. P. motor requiring the minimum of gasoline a day.

Investigate!

Before you decide on what mixer to get, send for full particulars. Note the unusually low prices. Compare the superior quality. The complete line of BOSS Mixers and Hoists is backed by 17 years of manufacturing experience and is endorsed by over 17,500 users.

CLIP AND MAIL THIS COUPON NOW

AMERICAN CEMENT MACHINE COMPANY

216 S. Fourth St. Keokuk, Iowa

Please send me complete details and prices on the BOSS 3 1/2 S Tilter

Name

Address

City State

The "Universal" Level-Transit

Due to an entirely new patented standards construction, this new instrument supersedes all other known builders' levelling devices in all their most vital points. Has twin release lever system. Used at will as level or transit without changing position of telescope.

New, Different, Better

This is a heavy-duty instrument, sturdy, wonderful precision, utmost simplicity, perfect results without any previous knowledge of operation.

Write for detailed information and name of dealer near you.

Dealers in all important cities in
United States, Canada and Mexico.

DAVID WHITE CO., INC.

Manufacturers of *White's Improved* Surveying and
Drawing Instruments

Home Office and Works:
315-319 Court St., Milwaukee, Wis.

Chicago Office:
West Van Buren St., At Hoyne Ave.

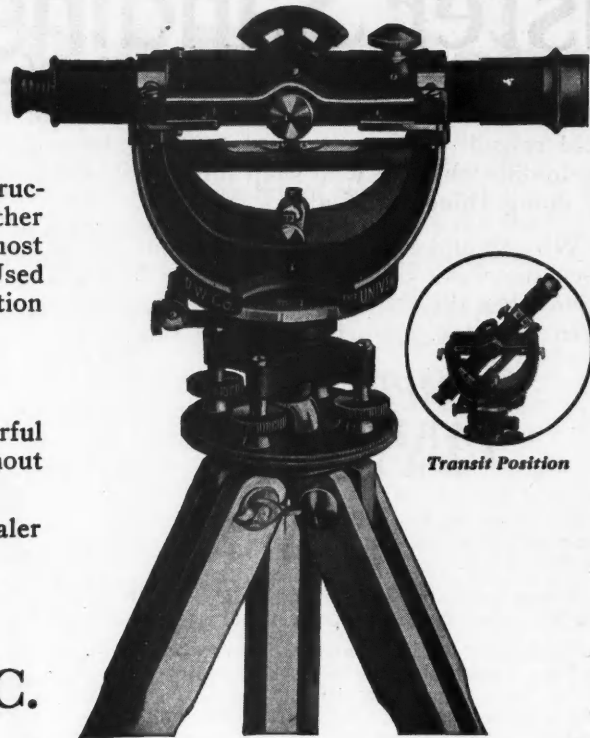

The New "Universal" Level-Transit

Level Position

150 Pounds Pressure



CRANE VALVES



2500 Pounds Pressure

For cottage as well as for estate

It is true that Crane materials have won preference in town houses, estates, luxurious apartments, where the demand is for beauty, with cost secondary. It is true that Crane

fixtures have been chosen to adorn bathrooms breathing the spirit of a Florentine palace or a Spanish estancia. But it is just as true that Crane materials are favored by builders who are erecting bungalows of the simplest kind. Because they have learned that Crane quality pleases buyers and adds value, and that a complete Crane installation costs no more than a substitute, hundreds of builders of low-priced homes exclusively specify Crane plumbing and heating materials.

CRANE

Address all inquiries to Crane Co., Chicago

GENERAL OFFICES: CRANE BUILDING, 836 S. MICHIGAN AVENUE, CHICAGO

Branches and Sales Offices in One Hundred and Sixty-two Cities

National Exhibit Rooms: Chicago, New York, Atlantic City, San Francisco, and Montreal

Works: Chicago, Bridgeport, Birmingham, Chattanooga, Trenton; Montreal, and St. John, Quebec; Ipswich, England

CRANE EXPORT CORPORATION: NEW YORK, SAN FRANCISCO, MEXICO CITY, HAVANA

CRANE LIMITED: CRANE BUILDING, 1170 BEAVER HALL SQUARE, MONTREAL

CRANE-BENNETT, Ltd., LONDON

CIE CRANE: PARIS, BRUSSELS

Get These Booklets



and a free Sample of **KUHLS** ELASTIC GLAZING COMPOSITION

Find out for yourself the superior qualities of this perfect glazing composition.

UNEQUALLED

for bedding and glazing sash, skylights, conservatories and glass construction work, tile setting, etc. May also be used for pointing stone or terra cotta work. Is ideal for calking window frames on new work as well as old.

Kuhls' composition is elastic, never sets hard, adheres strongly to wood, metal, glass, concrete, etc., and never cracks nor crumbles. Stands heat and cold and is not affected by moisture, nor changing weather. Beds perfectly and makes an absolutely tight joint under all conditions. Keeps out the driving storms.

Kuhls' Elastic Glazing Composition can be economically and efficiently used in all construction work—from a four-room cottage to a 25-story building. It is now used by the best builders, contractors, architects and greenhouse builders in the country.

Write today for your free sample, prices and booklets. Or go to your dealer. See our list of distributors in October, 1927, American Builder for your nearest dealer.

H. B. FRED KUHL'S

6415-21 Third Avenue, Brooklyn, N. Y.



H. B. FRED KUHL'S,
6415-21 Third Ave.,
Brooklyn, N. Y.

Please send me free of charge your literature and a sample of KUHL'S Elastic Glazing Composition.

Name.....
Street.....
City..... State.....

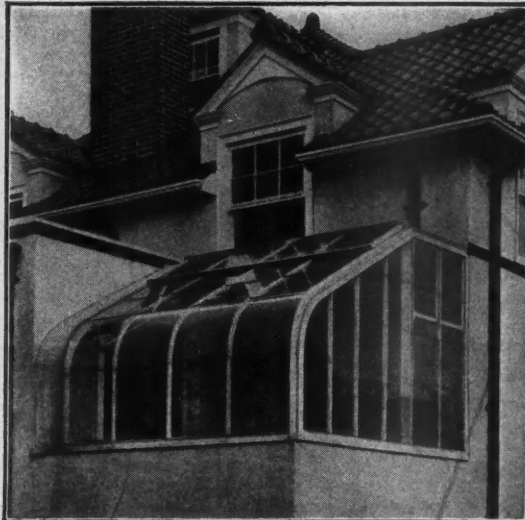

Put A Sunshine Room on Your Next House

A SUNSHINE room like this takes a house right out of the made-to-sell class, and turns it into a real home.

It fits snugly into any odd corner having a sunny exposure. For instance, this one over the garage opens off the breakfast room.

Wouldn't you say that such an indoor garden spot would add more than twice what it costs to the selling value of your house?

Your own workman can erect it, or we will quote on the whole job.

This one cost the builder who was within 35 miles of our factory, \$625. Other types for less or more.

Ask us to tell you about greenhouses as selling features.

We go anywhere for business, or to talk business.

Hitchings Company

General Offices and Factory:
ELIZABETH, N. J.

New York 136 Liberty St.	Oak Lane, Philadelphia 6709 North Broad Street
Wilkes-Barre 402 Coal Exchange Bldg.	Boston 161 Massachusetts Ave.
Albany, N. Y. Postoffice Box 921	

The Cellar Walls In This Model Home Are Damp-proofed with "ANTI-HYDRO"

A cold water paint made by mixing "ANTI-HYDRO" with water and white portland cement was applied with an ordinary brush on the cellar walls of this model home. In addition to making the concrete permanently damp-proof it made the walls permanently bright and white. They can be washed with a sponge or hose and will always retain their whiteness.

Cold water paint made with "ANTI-HYDRO" bonds securely to any clean surface made of concrete, brick, cement block, stone or tile. This method of damp-proofing is very economical and is far less expensive than repeatedly whitewashing walls.

"ANTI-HYDRO" is extensively used in white damp-proofing paint by factories, warehouses and industrial plants. Saves continual painting of walls and ceiling. Can be applied by anyone with an ordinary brush on any clean masonry surface.

Always use "ANTI-HYDRO." It is guaranteed by a 24 year reputation.

ANTI-HYDRO WATERPROOFING Co.

265-269 Badger Ave.

Newark, N. J.



NEW YORK HERALD-TRIBUNE
MODEL COMFORT HOME, TEANECK, N.J.

BUILT BY
COMFORT COAL
LUMBER CO.

There's more profit in a HUTHER SAW

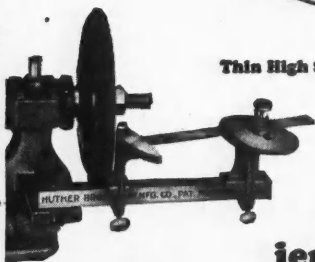

Thin High Speed Steel Knives

Grinding Attachment

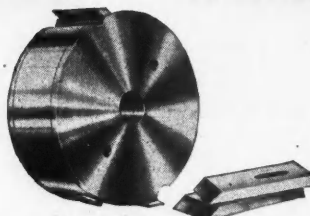

Cylinder Cutter Head

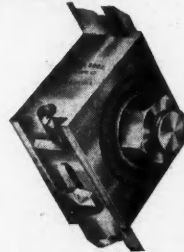

Cutter Head

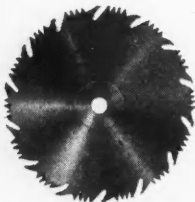

Circular Mitre Saw
with Cleaner Teeth

Backed by fifty years experience in the making of highest grade saws, each Huther Saw has a quality built into it that insures maximum length of service.

Huther Bros. Saw Mfg. Co.
ROCHESTER, N. Y.

Makers of Better Saws for More Than Fifty Years

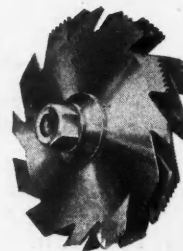

Cado Head



*Requires
No Mortising
Simply
Bore 4
Holes*

**A Worthy Addition
to America's Most Pop-
ular Line of Locks and
Latches**

THIS new Dexter front door lockset is in every way an ideal lockset, and worthy of a place in America's most popular line of locks and latches. Its pleasing design wrought in cast bronze, pebble finished, renders it unusually attractive. Its tubular construction, as in all Dexter locks and latches, assures positive action, many years of trouble-proof service, and, above all, it saves approximately 4/5 of the cost of installing the ordinary mortise latch.

A five pin tumbler lock mechanism offers perfect security. Plain glass, cut glass, or brass interior knobs are optional. The price is surprisingly moderate.

There's a time and money-saving Dexter tubular lock and latch for every door in the house, including French Window latches and cupboard door turns. If you haven't tried them as yet, don't delay further. They will save you money and do a better job. Examine them at your dealers' or if he doesn't handle them, write us for name of dealer who does.

Illustrated literature on request.

NATIONAL BRASS CO.
1601-9 Madison Ave.
GRAND RAPIDS, MICH.
Manufacturers of

DEXTER
Tubular Locks and Latches

**Faster
Handier** **New
No 3 1/2
KWIK-MIX
TRAILER**
**Now
Ready**

New 1928
Model com-
plete with
high grade
engine \$150
and up

Patented
Nov. 8, 1927

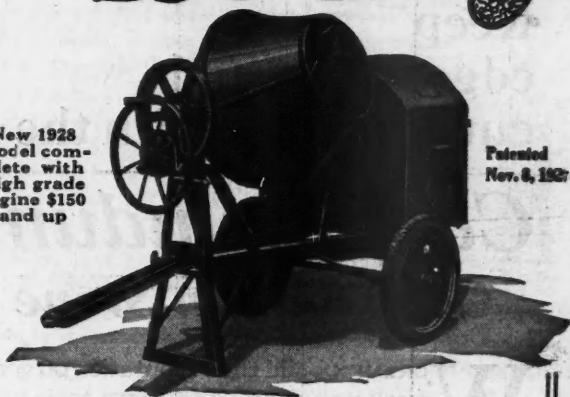

**Featuring the New
Friction Tilting Device**

An astounding improvement found exclusively on the new Kwik-Mix Trailer. Gives more speed, greater ease, better work. This and other exclusive improvements places the Kwik-Mix far in advance of any other mixer made.

"Greatest improvements I ever saw on any Mixer," say contractors who have seen our new 1928 line.

Write Today for New Catalogue

This remarkably interesting catalogue gives full details regarding the new Kwik-Mix Trailers. Page after page describes this high quality, low priced line of tilting mixers, plaster mortar mixers and pumps, products of Pioneer Makers of Mixers. No contractor can afford to pass this opportunity by.

Write TODAY.

Kwik-Mix
Concrete Mixer Co.
Dept. 40
Port Washington, Wis.

**Most Complete Catalog
of
Late Model
Low Priced
MIXERS
Ever Published**

Kwik-Mix
CONCRETE MIXER

Kwik-Mix Concrete Mixer Co.
Dept. 40
Port Washington, Wis.

Please send me catalogue and terms on the
Kwik-Mix Line.

Name.....
Street.....
City..... State.....

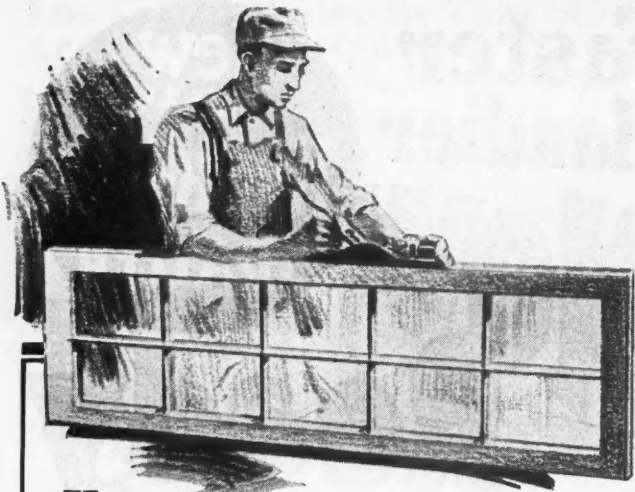

Keep edges keen and cutting clean with the

Carborundum Combination Stone

WORKMEN build their reputation on good work well done. And sharp tools help a lot to do better work quicker.

Use this "double duty" sharpening stone to put smooth, keen edges on plane bits, chisels, scraper knives—on all edge tools in your kit. The coarse grit side removes nicks and starts your edge quickly. Then finish off on the fine grit side, and you have an edge that will take a clean, deep bite and will hold its edge through the day's work.

Carborundum is a manufactured abrasive—harder, sharper, faster-cutting than any other material. Every stone uniform in grit and grade; wears evenly. Use dry or better with oil.

Carried by Hardware Dealers Everywhere
SEND FOR CATALOG C-2

THE CARBORUNDUM COMPANY
Niagara Falls, N. Y.
CANADIAN CARBORUNDUM CO. LIMITED
Niagara Falls, Ont.

Carborundum is the Registered Trade Name used by The Carborundum Company for Silicon Carbide. This Trade Mark is the exclusive property of the Carborundum Company.

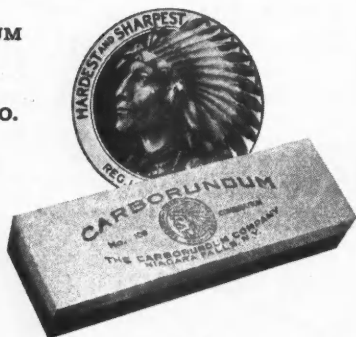

Carborundum

ABRASIVE PRODUCTS

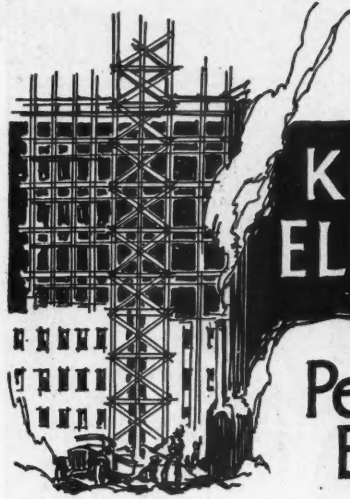

KIMBALL ELEVATORS

for Permanent Building!

SAFETY---SERVICE
---and ECONOMY

LONG life and good service are two outstanding characteristics of Kimball Straight Line Drive Elevators. Nearly half a century of such service has brought many complimentary letters to us. Mr. F. D. Higginbotham, Manager of the Dooly Block in Salt Lake City, writes:

"In the month of October, 1914, Kimball Passenger Elevators were installed in this building. They have a capacity of 2500 pounds and a speed of 300' per minute. We have not been without service a single day during thirteen years."---This is just one example of Kimball Superiority.

Inquire about Kimball Straight Line Drive passenger and freight elevators---motor and machine assembled as an integral unit. Permanent alignment of motor and machine guaranteed.

Valuable descriptive pamphlets sent free upon request.

KIMBALL BROS. CO.
989-97 Ninth St., Council Bluffs, Ia.

Elevator Builders for 45 Years



1883

RELCO CONCRETE GARBAGE RECEPTACLE



New PROFITS, SALES!

Now you can make new profits from concrete. Relco Concrete Garbage Receptacles are necessities in modern life. Health authorities and good citizens demand methods of garbage handling which are sanitary. The Relco offers an underground concrete garbage container that is permanent, durable, efficient and neat. You make them easily with the Relco Concrete Molds.



Lasts Forever COSTS LESS

Millions of Homes Prospects

You can install a Relco in any home anywhere—they want and will buy this inexpensive but highly necessary equipment. Builders, contractors and hardware dealers will bring you business too.

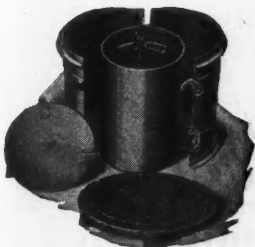

Relco Molds are clean cut and efficient

Made Easily With These Perfect Working Molds

The Relco Molds are very simple to operate and any laborer without previous instruction can do perfect work. We also furnish castings necessary at very reasonable prices. The only competition is the all metal type and concrete is much more durable, satisfactory, permanent and economical. Your sales will be easy too, for we furnish advertising helps.

R & L Concrete Machinery Company

Kendallville, Indiana

Successors to RABER & LANG MFG. CO.

R & L Concrete Machinery Co.
1828 Mill Street
Kendallville, Indiana _____ 19__

Send your folder about Relco Concrete Garbage Receptacle Molds and prices. I am interested in this new service for home owners.

Name _____
Address _____



BUILDING TRADES NEED TRAINED MEN



THE building trades are still booming. Trained men are in demand at good salaries. Government experts estimate that billions of dollars will be spent for construction this year.

Today the most vital need of this great building program is men—trained men—men who can step right in and do the skilled work that building construction requires.

There is a simple, easy, practical way by which you can prepare for a better position, at a bigger salary. You can do it right at home, in spare time, no matter where you live, through the International Correspondence Schools.

A recent investigation of 13,298 students enrolled in I. C. S. Building Trades Courses showed that 1291 had become Architects; 246 had become Designers; 494 had become Chief Draftsmen; 2827 had become Draftsmen; 1845 had become Contractors; 211 had become Assistant Foremen; 4030 had become Foremen; 2354 had become Superintendents.



In every instance these students reported salaries or independent incomes far greater than when they took up their studies. Many have shown increases of 300 per cent to 500 per cent. Some have incomes as high as \$25,000 per year.



You, too, can have the position you want in the work you like best, an income that will give you and your family the home, the comforts, the luxuries you would like them to have. No matter what your age, your present occupation, or your means, you can do it!

All we ask is the chance to prove it. That's fair, isn't it? Then, mark and mail this coupon.

INTERNATIONAL CORRESPONDENCE SCHOOLS

"The Universal University"

BOX 8167-C SCRANTON, PA.

Without cost or obligation, please send me a copy of your booklet, "Who Wins and Why," and full particulars on the subject before which I have marked X:

- | | |
|---|---|
| <input type="checkbox"/> Architect | <input type="checkbox"/> Pharmacy |
| <input type="checkbox"/> Architectural Draftsman | <input type="checkbox"/> Navigation |
| <input type="checkbox"/> Architects' Blueprints | <input type="checkbox"/> Salesmanship |
| <input type="checkbox"/> Contractor and Builder | <input type="checkbox"/> Advertising |
| <input type="checkbox"/> Building Foreman | <input type="checkbox"/> Window Display |
| <input type="checkbox"/> Concrete Builder | <input type="checkbox"/> Show Card and Sign Lettering |
| <input type="checkbox"/> Structural Engineer | <input type="checkbox"/> Industrial Management |
| <input type="checkbox"/> Structural Draftsman | <input type="checkbox"/> Secretarial Work |
| <input type="checkbox"/> Plumber and Steam Fitter | <input type="checkbox"/> Business Correspondence |
| <input type="checkbox"/> Heating and Ventilation | <input type="checkbox"/> Bookkeeper |
| <input type="checkbox"/> Plumbing Inspector | <input type="checkbox"/> Stenographer and Typist |
| <input type="checkbox"/> Foreman Plumber | <input type="checkbox"/> Higher Accounting |
| <input type="checkbox"/> Sheet Metal Worker | <input type="checkbox"/> Common School Subjects |
| <input type="checkbox"/> Civil Engineer | <input type="checkbox"/> Mathematics |
| <input type="checkbox"/> Surveying and Mapping | <input type="checkbox"/> English |
| <input type="checkbox"/> Electrical Engineer | <input type="checkbox"/> Illustrating |
| <input type="checkbox"/> Electric Lighting | <input type="checkbox"/> Railway Mail Clerk |
| <input type="checkbox"/> Electric Wiring | <input type="checkbox"/> Civil Service |
| <input type="checkbox"/> Telegraph Engineer | <input type="checkbox"/> Mining Engineer |
| <input type="checkbox"/> Practical Telephony | <input type="checkbox"/> Gas Engine Operating |
| <input type="checkbox"/> Mechanical Engineer | <input type="checkbox"/> Textile Overseer or Supt. |
| <input type="checkbox"/> Mechanical Draftsman | <input type="checkbox"/> Traffic Manager |
| <input type="checkbox"/> Toolmaker | <input type="checkbox"/> Airplane Engines |
| <input type="checkbox"/> Machine Shop Practice | <input type="checkbox"/> Automobiles |
| <input type="checkbox"/> Stationary Engineer | <input type="checkbox"/> Agriculture |
| <input type="checkbox"/> Chemist | <input type="checkbox"/> Poultry Raising |
| | <input type="checkbox"/> Spanish |
| | <input type="checkbox"/> French |
| | <input type="checkbox"/> Radio |

Name _____
Street and No. _____
City _____ State _____
Occupation _____

If you reside in Canada, please send this coupon to International Correspondence Schools Canadian, Limited, Montreal, Canada



For walls and ceilings, Wall-Tex offers strength as well as decoration



THIS attractive living-room by a prominent interior decorator reveals the practicality of Wall-Tex. Back of its beauty in design and color is all the strength of a remarkably flexible and durable fabric . . . to hide cracks in old walls and especially in ceilings . . . to prevent new plaster from cracking . . . to insure against repairs and replacements. No other wall-covering can possibly give such all-around satisfaction as Wall-Tex.

The 1928 Wall-Tex line includes handsome patterns to meet any requirement of color and decoration. Glossy finishes as well as dull. Plain patterns for painting, stenciling or frescoing. An ideal foundation for rough-cast plaster. Wall-Tex is hung just like wallpaper. It can be wiped clean with a damp cloth—it is built to stand years of service.

Architects, builders, decorators should write for full information on their particular requirements. The Columbus-Union Oilcloth Company, Columbus, Ohio.

WALL-TEX
PERMANENT
WALL-COVERING

With the name that's easy to say and hard to forget

Throw away the Shears



"No cutting, no trimming on Willis skylights and ventilators. They always fit."

"Just think what this saves—trouble, time, labor, temper."

"And they give maximum light with perfect ventilation. There is a lot of glass without sacrificing strength. They are water tight without the use of putty. Gutters carry away the condensation."

"Rigid construction makes impossible any sagging, buckling or bending. We make them up in sections, assemble and test them at the factory—then ship them knocked down to you. You can erect them with no more tools than a screw driver and a hammer."

"We can make any size, any style. Catalog shows the standard models and our engineering department is at the service of our customers, without charge, for designing special jobs."

"Send us your specifications. Quotations and our new Catalog No. 9 are yours for the asking."

Willie Willis

WILLIS MANUFACTURING CO.
Dept. 128
Galesburg, Ill.



Ask for new
Catalog No. 9.

The Elusive Charm of Color in Woodwork

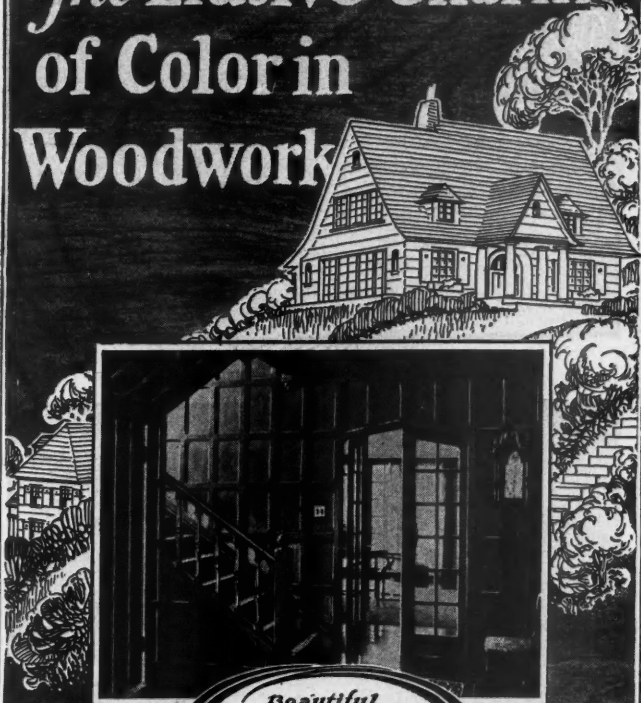

interior woodwork in new color finishes Makes "Easy To Sell" Homes

Color is the most potent selling force today and progressive builders are "cashing-in" upon the amazingly beautiful effects to be secured with the marvelous new stains developed especially for this northern cabinet wood.

These new transparent penetrating stain finishes bring out the full richness and enthralling beauty of the attractively figured birch grain. Available in a wide selection of colors and tones—from a delicate orchid to a rich, rare ebony—they permit a range of color effects that will satisfy the most conservative or ultra-modern taste.

Wisconsin-Michigan birch is a preferred wood for trim, doors and veneer paneled walls—hard, durable floors, too. And the wondrous beauty of these new "in the wood" finishes inspire a steady volume of profitable business.

May we present you with all the facts? Also, send you a copy of our new "Beautiful Birch" brochure with illustrations of fine interiors by eminent architects.

THE BIRCH MANUFACTURERS
201 F. R. A. Building, Oshkosh, Wis.

"Beautiful Birch for Beautiful Woodwork"

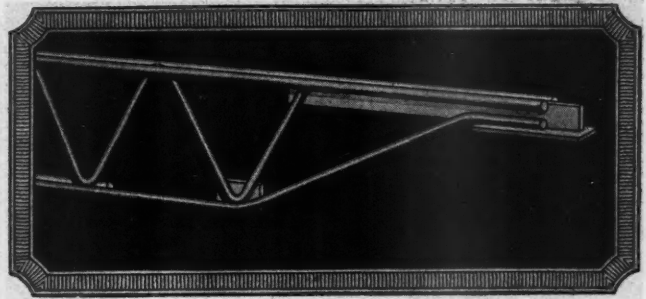

Construction Features with Massillon Bar Joists

THESE steel joists designed for building fire-proof floors and roofs in all types of buildings, have manifest advantages for contractors.

Built in Standard Stock Sizes: Massillon representatives or our engineers at Canton give prompt service in submitting quotations or recommendations. Shipments are normally made from stock.

No Cutting or Fitting in the Field: The joists are rapidly placed without cutting or fitting. The smaller floor openings are framed with standard Massillon headers. Stair wells and larger openings are framed in the usual manner.

Ease of Erection: The depth at the end is standard for all joists with center of gravity below the line of support. Joists are placed by the usual building trades in their natural position, ends clipped with simple clips to beams or bricked into masonry walls. The end joists in each panel are anchored with simple anchors to parallel wall or beam, intervening joists braced laterally with wire bridging and joists are ready to carry their load.

Floor Lath: Self-centering rib floor lath is rapidly and securely fastened to the joists by driving a simple wood lath wedge through the lath between the top bars of the joists. Where wood floor finish is laid on the concrete sub-floor wood nailing strips are carried on simple screed clips.

Piping Features: Conduits, piping and plumbing are handled in direct lines through as well as parallel to the joists. These building trades work after the concrete floor slab is poured and the building enclosed and do not delay the building operation.

Ceiling Lath: Rib ceiling lath or pencil channels for carrying flat lath is rapidly wired to the bottom bars of the joists. A simple ceiling extension carries the ceiling support to the walls at the ends of the joists.

Cost: It has been demonstrated time and again that the Bar Joist floors can be built into strictly fireproof buildings at a cost between that of wood joist construction and other types of approved fireproof floor construction.

We solicit opportunities of quoting on work under your control. Where redesigns may be used to advantage our recommendations will be furnished without obligation. Pamphlets sent on request.

THE MACOMBER STEEL CO.

909 Belden Ave., Canton, Ohio

Manufacturers of

MAS SILLON

BAR JOISTS

U.S. PATENTS NO. 1,610,121, NO. 1,610,248, NO. 1,610,249, NO. 1,610,250



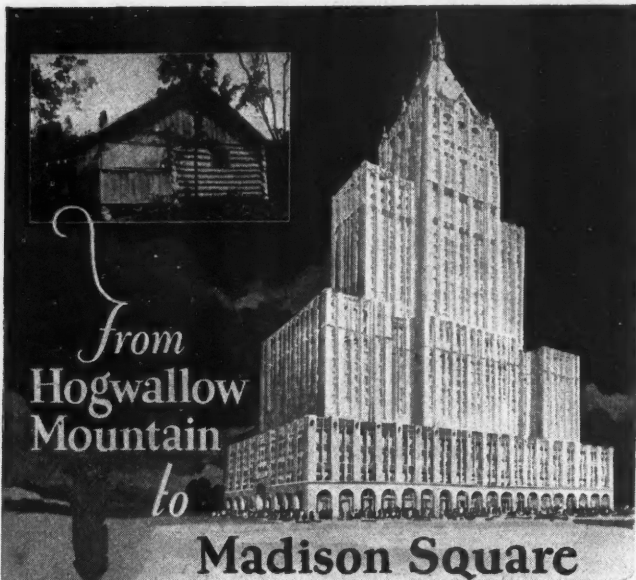

A TOP Hogwallow Mountain, in the hills of North Carolina, there is a lonely cabin built with native logs—and CEL-O-GLASS. In the huge New York Life Insurance Company building, now in course of construction at Madison Square in New York, CEL-O-GLASS is being used for healthful, comfortable winter work enclosures.

Wherever and whatever you build, there is a need for CEL-O-GLASS. It is unbreakable, highly translucent, extremely light in weight, weatherproof and durable. It comes in rolls—you can install it anywhere with a hammer and tacks.

Ultra-Violet Rays Penetrate CEL-O-GLASS

The health rays of the sun pass freely through CEL-O-GLASS, making it ideal for sun porch enclosures, sleeping and living room windows, cellar doors and windows—any place where pure sunlight is desirable. Better than glass for temporary enclosures and field offices, because it cannot break.

Try CEL-O-GLASS

See how economical it is—no breakage, no repair bills. You'll find many money-saving uses for this remarkable utility material. If your supply dealer does not carry genuine CEL-O-GLASS, write us for samples, prices and descriptive folder No. 60.

ACETOL PRODUCTS, INC.
21 Spruce Street New York, N. Y.

© 1928 Acetol Products, Inc.

CELO-O-GLASS
REG. U.S. PAT. OFF.
WON'T BREAK
AN UNBREAKABLE TRANSLUCENT

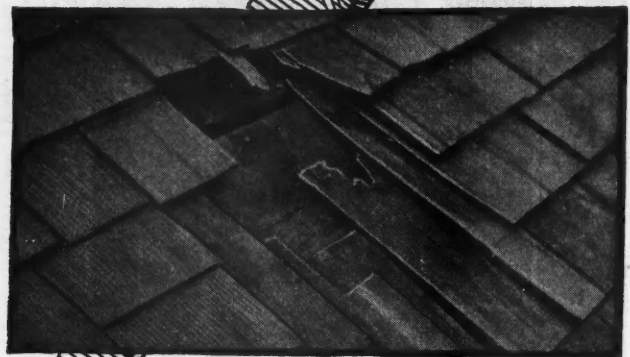

Because of the
GOOD NAILS

The top illustration shows a roof laid 35 years ago with RUST PROOF NAILS. The lower one was laid only 10 years ago with ORDINARY CHEAP NAILS. The condition of the shingles speak volumes. By paying a few dollars more for good nails the far sighted owner saved \$12 per year depreciation cost, not to mention annual repairs the other owner had to make because of the rusting of nails.

Reading Cut Nails in addition have extraordinary holding power—72 per cent greater than the common round wire nail. The wedge shape of Reading Cut Nails grip at every point, spreading the wood without splitting it. If you want to insure first class jobs and win the everlasting goodwill of your customers use Reading Cut Nails at all times.

READING IRON COMPANY
READING, PENNA.

**READING
CUT NAILS**



What Better Talking Point

Can \$95 Buy?

HOW much does it cost you to make a rental? To sell a home? Time after time the Kernerator has proved to be the best extra inducement to close new tenants and hold them. Time after time it has proved itself a selling feature that enhances the property's sales value far beyond the Kernerator's moderate cost.

How It Helps Rent and Sell

Kernerator residence models cost as low as \$95 and the masonry adds but little more when regular chimney is used. The most modest home can afford it. For here is what the Kernerator offers:

First—It can be advertised as an outstanding convenience to attract more prospects.

Second—It banishes the fire hazard of the basement rubbish pile—accountable for three out of every four fires in residences and apartments.

Third—It does away with the unsightly garbage can, the filthy job of cleaning it and the expense of buying and replacing it.

Fourth—Saves the housewife miles of steps in trips to these nuisances.

Fifth—Without expense other than an occasional match, it disposes of all waste—not only garbage, but sweepings, old magazines, broken crockery and tin cans. Non-combustibles are flame-sterilized for removal with the ashes.

Should Be Built-in

Only rarely can the Kernerator be installed in existing buildings. It should be in the plans. Over 2,500 architects and contractors use and recommend it. Selected for Home Owners Institute Model Homes in thirty principal cities.

See Sweet's: write for catalogs or phone nearest representative. Offices in 89 cities.

KERNER INCINERATOR COMPANY
753 East Water St. Milwaukee, Wis.

KERNERATOR

REG. U.S. PAT. OFF.

THE CHIMNEY-FED INCINERATOR

*Garbage and Waste Disposal
without Leaving the Kitchen.*

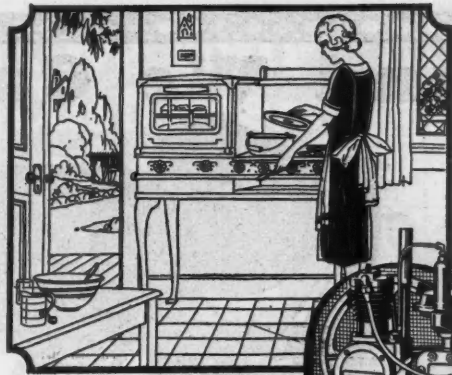
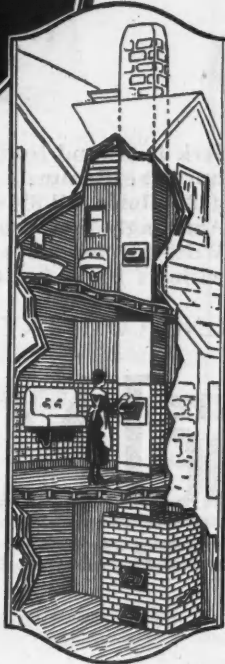

Provides a hot oven for baking and roasting—constant pressure for all burners of your range.

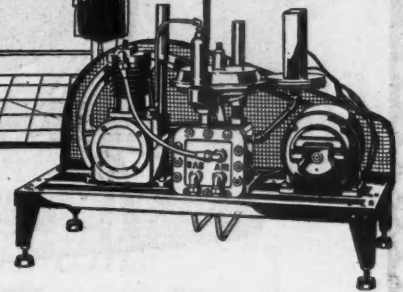

BURN GAS

Cheap, Clean Fuel, No Matter Where You Build

Now you can include gas in you home plans, no matter where your lot is.

GAS-O-MATIC makes you independent of gas mains. Gives you all the gas you want, for every household purpose—and it costs no more than city users pay.

No special connections or other equipment. Works with all standard gas ranges, auxiliary and hot water heaters. Efficient. Reliable.

Mail coupon for descriptive literature, statements by satisfied users and details of easy purchase plan.

GAS-O-MATIC time payment plan makes ownership easy. Mail coupon for detailed information.

GAS-O-MATIC

Enjoy the Convenience of Gas in Your Home—Any Time—Anywhere

GAS-O-MATIC CORPORATION
Dept. B, 500 Fassett St.,
TOLEDO, OHIO

Gentlemen: I am interested in GAS-O-MATIC for my home _____ . I am interested in dealership _____ .

Name _____

Street Address _____

Post Office _____

And We Can Prove It!

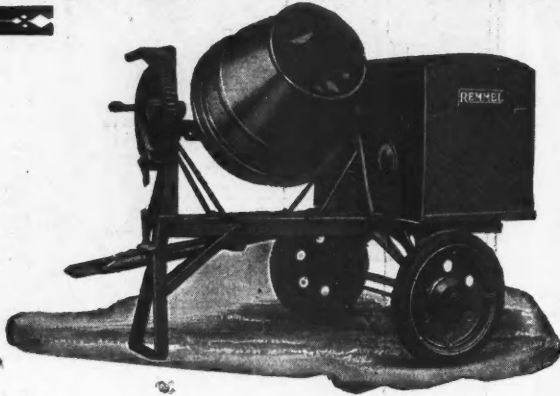

Here's the Biggest Value You Were Ever Offered in a Mixer—

IN this Remmel 3½ S Trailer Mixer you have the finest construction—Timken bearing drive shaft, roller bearing wheels, all-steel frame, direct gear drive, fast mixing, quick, clean discharge—and low price.

Jerk it around from job to job. You won't hurt the Remmel. It's made to stand the gaff. Holds full 3½ cu. ft. of mixed material. Amazingly free from trouble and repairs. Write for full details—and prices with or without power loader.

Manufactured by REMMEL MANUFACTURING COMPANY, Kewaskum, Wisconsin

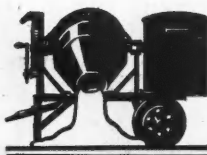

Direct Drive Remmel Mixers



To Serve You Even Better than Before!

WE are building a new addition to our already extensive plant—new storage space, new factory assembly room. And in the same proportion we are increasing our facilities to help you sell bigger building contracts! International Service includes FREE plans and estimates to reliable contractors. For information—and for a copy of our new big Steel Catalog—please address Department 18.

INTERNATIONAL STEEL & IRON CO., **Evansville, Indiana**

Store Fronts
Steel Columns
Steel Ceilings

— **PRODUCTS of INTERNATIONAL** —
Sidewalk Lights Airplane Hangars Steel Windows
Public Garages Roof Ventilators Coal Chutes

Skylights
Steel Girders
Steel Trusses

KEWANEE

Copper Steel BASEMENT WINDOWS

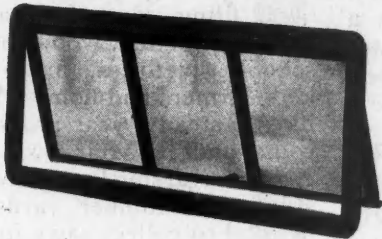

The basement will be far more attractive and usable if you install Kewanee Copper Steel Basement Windows because, for a given size of wall opening, they afford 75% more light and ventilation. These rugged windows also embody features of design which make them more durable and efficient than the old-fashioned bulky wood construction. They are readily installed in any type of foundation wall.

KEWANEE Copper Steel Basement Chutes



The unsightliness of the battered wall and broken frame and sash will be avoided if you install a Kewanee Copper Steel Coal Chute. It costs little more than a wood basement window and soon pays for itself by saving repair bills. Kewanee heavy pressed Copper Steel construction can be absolutely depended upon to withstand the hard knocks of coal delivery and protect the building from damage and defacement.

Kewanee Basement Chutes and Windows are a good investment not only for the home owner, but also for the builder who installs them or the architect who specifies them. They guarantee satisfaction—assure good will—and provide the utmost in permanence, attractiveness and convenience at low cost. That they improve the value of any property goes without saying. Be sure you have the latest Kewanee catalog.

DEALERS: You will find profit and satisfaction in handling these Kewanee building products. Send for our Agency Proposition and Liberal Discounts.

KEWANEE MFG. COMPANY

307 Tremont St.

Kewanee, Ill.

MAIL THIS COUPON

KEWANEE MFG. CO.
307 Tremont St., Kewanee, Ill.

Please send me full information regarding
Kewanee Building Products.

I am a
 Builder
 Architect
 Property Owner
 Dealer

Name.....

Address.....

City.....State.....

Give Your Customers a Better Tile Finish



*but charge
them less and
make a Bigger Profit
for Yourself*

It is not only possible to accomplish all of this, but it is being done every day in the week with

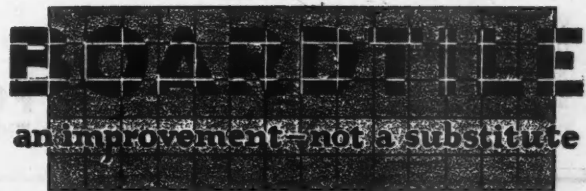

Boardtile is the modern, sanitary wall tile finish for Bathrooms, Kitchens, Doctors' and Dentists' offices, Nurseries, Chapels, Churches, Halls, etc. Boardtile

**Costs Less—Looks Better—Wears
Longer—Holds Color Indefinitely.**

Boardtile is just as easy to install as wall-board. It is glued or nailed to the plaster. Any carpenter can do a professional job.

Investigate and learn the profit possibilities of this important building material.

GIBBS BOARDTILE CORP.
344-350 N. Ogden Ave., Chicago, Ill.

USE COUPON FOR CONVENIENCE

Gibbs Boardtile Corp.,
344-350 N. Ogden Ave., Chicago, Ill.

Without obligation send us full information regarding Boardtile.

Name

Address

City and State.....

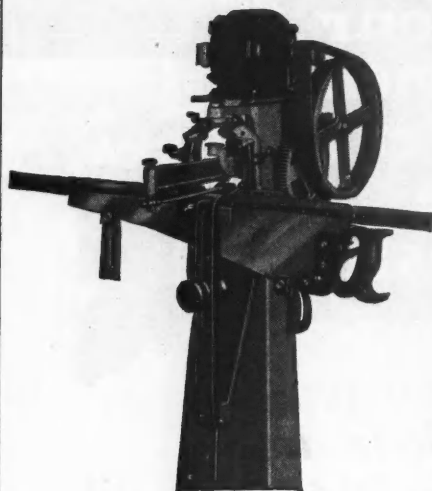

FOLEY Automatic SAW FILER

Files and joints in one operation. Entirely automatic. Files all kinds of hand saws, band saws $\frac{1}{8}$ " to $4\frac{1}{2}$ " wide, cross-cut circular saws 3" to 24" in diameter. Retoots old hand saws. Made in motor-driven, and hand-drive portable models.

? Which Do You Want ?

Better-Cutting Saws—

You just ought to see how slick and clean your saws will cut when you file them on a Foley. One old-time carpenter says, "I never knew what good cutting saws were before!"

File Your Saws by Machine

Run your saws through a Foley and every tooth is brought down to exactly the same size so every one cuts. Bevels and pitches are uniform. The Foley files a saw far better than possible by hand, and more than twice as fast! No eyestrain, either! You'll have faster, cleaner, truer cutting saws to work with if you own a Foley. Let us prove it by filing one of your own saws. No obligation!

Write today for demonstration offer, FREE plan, and full information about the Foley. Ask for them now. Address—

FOLEY SAW TOOL CO., Inc.

127 Foley Bldg., 9 Main St. N. E.

MINNEAPOLIS, MINN.

A Business of Your Own—

Get a Foley and you can build up a big business of your own, filing saws for carpenters, contractors, woodworkers, schools, factories, meat markets, farmers and homes. You'll have a steady, year around income and be your own boss. No canvassing! Hardware stores and lumber yards will be glad to collect saws for you on a percentage basis.

Make Your Time Worth \$2.00 to \$3.00 an Hour

Good money—"I filed 6 saws in 40 minutes at 50c each."—Chris. Fuller, Lima, Ohio. Keep on with your present work while you get your business started and make big extra money. We'll help you get your saw filing business started with a FREE plan.

You Gain 5% Coverage WITH E. E. JACKSON FLOORING

A premium value to your customers—because our 1 x 3" Flooring is manufactured 13-16 x 2 1-2" face giving the user 5% extra on each strip over 25-32 x 2 3-8" face which also counts as 1 x 3".

Not only is this a material saving in coverage but the extra standard thickness gives a finished floor of greater rigidity and wearing qualities.

Featuring Edge Grain Flooring in our production we offer the highest standard of flooring values based upon choice Long Leaf Yellow Pine timber from which our flooring stock is especially selected.

Manufactured in End-Matched and Plain End



E. E. JACKSON LUMBER COMPANY

Sales Office: Citizens Bank Bldg., Baltimore, Md.

Plant: Riderwood, Ala.



SAMSON SPOT

Sash
Trade Mark

Cord
Reg. U. S. Pat Off.



"There IS a Difference in Sash Cord"

It is the Most Durable Material for Hanging Windows

Outwears metal substitutes many times over. Noiseless operation—easily installed. Solid braided cotton, guaranteed to contain no adulterants, and to be free from imperfection of braid or finish.

Glazed and fully stretched: weights do not drop down after hanging. No bad places to be cut out. Saves time and money for you, and insures better satisfaction.

Send for samples and chart showing proper cord, pulley and weight sizes—free.

Made by
SAMSON CORDAGE WORKS
88 BROAD STREET BOSTON, MASS.

Premier Telephone Cabinet, No. 25. Revolving doors, opening at a touch, expose telephone at right height. Hinged drawer accommodates directory and provides shelf for phone when sitting. Bell box and wires completely hidden but readily accessible.

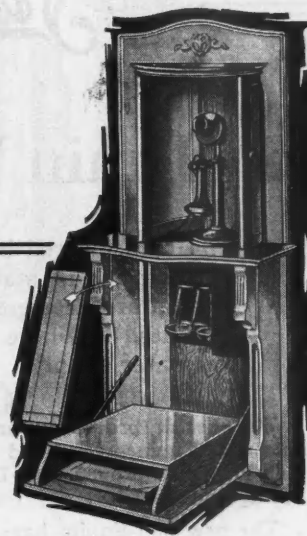
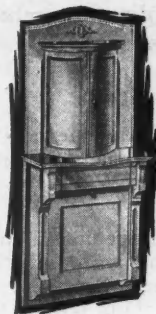

EVERY designer and builder should have a copy of the 1928 catalog of Premier Built-In Conveniences. Consider this telephone cabinet: It adds many dollars in value to the home, yet it costs only a few dollars. It is convenient, practical, handsome, one of those tricky, appealing, clever little conveniences that make you think "why hadn't someone thought of *that* before?" Yet this is only one of the famous Premier family. Others are a folding breakfast nook, ironing boards, a seat that disappears into the wall, divider or buttress cabinets, a flexible unit-built kitchen cabinet, and every one comes *complete*, in a carton, ready to install and finish. You should know more about Premier Built-In Conveniences. *May we send you catalog and specifications.*



PREMIER Standardized WOODWORK

2207 Mills Street



El Paso Texas

Premier Built-In Conveniences are stocked by jobbers in principal cities and sold by leading retail lumber dealers. There is probably a dealer near you.

San-Equip

Improved

Self-Drain Waterless Toilets

For unsewered homes, summer camps, farms, roadside inns, gas stations, rural schools and factories located in unsewered districts where the water supply is limited or where disposal of sewage might endanger the water supply.

The health protection and conveniences of an inside toilet for the unsewered homes you build adds many dollars to property values. Install San-Equip Improved Self-Drain Waterless Toilets for dependable, safe sewage disposal.

The new San-Equips have all openings liquid sealed to prevent offensive odors. Sewage is sterilized and automatically discharged. No disagreeable care or attention required. Complete with rust-proofed copperoid iron storage tank and vitreous china bowl. Easily installed at a low cost. Write today for complete details to

CHEMICAL TOILET CORPORATION

721 East Brighton Ave.

SYRACUSE, N. Y.

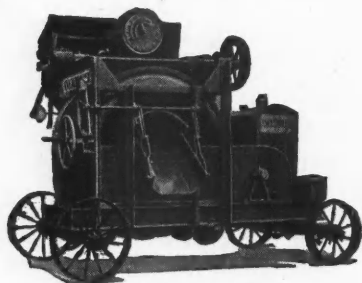
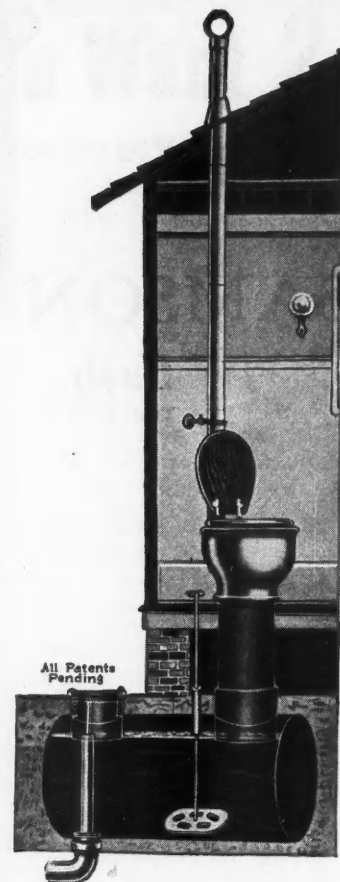

10-S with Power Loader

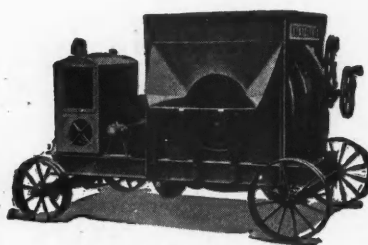

7-S Low Charger

KNICKERBOCKER Concrete Mixers

Designed to enable the contractor to meet the constantly tightening concrete specifications as they refer to longer mixing, sticky concrete and the observance of the water-cement ratio.

Higher drums, larger drum openings and an accurate water-measuring tank of new design

help the contractor to maintain his customary daily output.

Built in 5-S, 7-S, 10-S, 14-S, 21-S and 28-S sizes, with various mountings, hopper and power equipment.

Ask for our catalog of concrete, mortar, mastic and plaster mixers and saw rigs.

The Knickerbocker Company, Jackson, Mich.



Matot

Full Diameter Lift Wheel — Hobbed Gear Automatic Brake

DUMB WAITER

Matot machines are roller-bearing throughout, easy of operation, noiseless, and guaranteed for five years.

LARGE STOCK
PROMPT SHIPMENTS

[Catalog]
On Request

D. A. MATOT CO.
Manufacturers of Hand Power Dumb Waiters and Elevators
1539 Montana St., Chicago



OVER 10,000

Contractors and Builders have sent in to us for sample pairs of the

AUSTRAL SASH SUSTAINER

Join the Crowd . . .

- Costs Less
- No More Weights
- No More Pulleys
- No More Cords to Break
- No More Spring Bolts

The Austral Window Co.

101 Park Ave.,
New York

AUSTRAL WINDOW CO.
101 Park Ave.,
New York

Gentlemen:

Please send me a sample pair of AUSTRAL SASH SUSTAINERS for which I am enclosing fifty cents (this covers actual production cost, postage and handling).

Send for a Sample Pair—Tear along this line.

Name

Concern

Address



BUILDERS take advantage of this wonderful opportunity for greater profits and satisfied customers by installing Perfection Window Ventilators.

They are not only beautiful but are practical, giving perfect ventilation without draft. Many of the largest contractors and architects are now recognizing them as a standard Building Commodity.

Furnished in clear polished plate and all kinds of obscure glass. Brackets are made of a non-corrosive metal and are finished in all standard colors, including grained walnut and oak to match window sash.

Brackets are adapted to both steel and wood sash. The complete installation requires but a few minutes.

Write for prices and information.

The PERFECTION COMPANY

2500-22 W. 21st Street,
Chicago, Ill., U. S. A.

Established 1917 *Cable Address "Curwinco"*

**A RECENT INSTALLATION
OF A PAIR OF BRONZE DOORS**

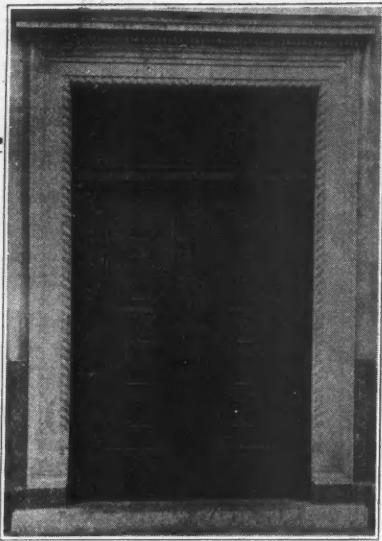

Better Building at Less Cost

Builders and Contractors know Leonard Products to be of the highest quality. Bronze Store Fronts, metal covered doors and windows, high grade bronze covered doors for office buildings and banks, rolled steel door frames, kalamein work and Leonard steel windows are building equipment known to every builder. Let our engineering department help you in your problems.

LEONARD SHEET METAL WORKS, Hoboken, N. J.
Established 1900

Branch Offices:

New York City Washington, D. C. Atlanta, Ga.
Jersey City New Haven, Conn. Miami, Fla.

Our reputation since 1900 is your guarantee of high grade work.

**THE Fire That Heats
the Home
Heats a Plentiful Supply of
HOT WATER**

when the Excelso is connected to the steam or vapor heating boiler. It eliminates leaky fire pot coils; requires no attention.

In all sizes to supply hot water for one family or one hundred families.

Excelso Products Corporation
DIVISION OF AMERICAN RADIATOR COMPANY
79 Clyde Ave. Buffalo, N. Y.

*Nationally Distributed by Leading Wholesalers
and Boiler and Radiator Manufacturers*

*Sold and
installed by
plumbing
and heating
contractors
everywhere.*

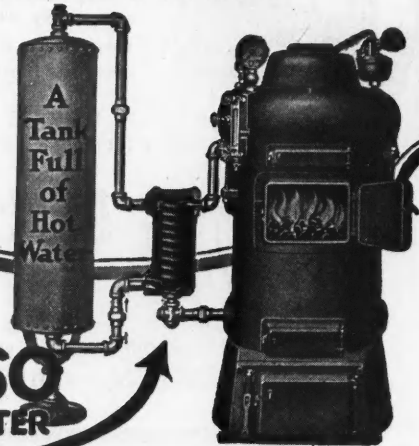

**EXCELSO
WATER HEATER**

Safety - Saw

**RIPS - CROSS CUTS - MITERS - JOINTS
GROOVES - RABBETS - TENONS - BORES
MORTISES - DADOES - BEVELS - SANDS**

Ball Bearing

Runs from light socket



Cuts any angle.

Table tilts to 45° and raises for any depth of cut or Dado

Handles 2 1/2" Material with 8" Saw

Do your work on this machine and save many hours hard labor. The Safety Saw will handle 80% of your inside trim, closets, shelving, cabinets, etc., and will pay for itself on the first job.

**WITHOUT MOTOR \$35.00
WITH 1/2 H. P. MOTOR \$67.00**

SAFE TOOL MFG. CO., Bridgeport, Pa.

**Metal Table
14' x 17'**

\$48⁵⁰

Including 1/2 H. P. - A. C. Motor, Belt, Pulley, 8 in. Saw, 2 Guides, Aluminum Guard.

Free Trial
Write for Folder A.B.N.



**DURABLE
EVERLASTING
ARTISTIC
PERMANENT
ECONOMICAL**

**USE
SLATE**

It is the ideal material for Toilet Enclosures, Shower Stalls, Stairways, Caps, Bases, Wainscots, Floors, Fireplaces, etc.

Sales offices in all principal cities.

**THE STRUCTURAL
SLATE CO.
304 Robinson Ave.,
PEN ARGYL, PA.**

STRUCTURAL SLATE

WHY THE V TRACK TREAD?

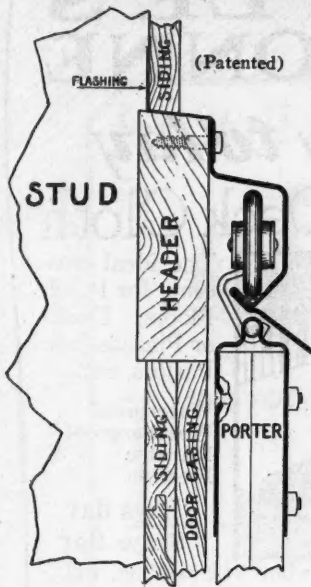

IT PROVIDES—

1. An absolutely uniform straight track.
2. Self-centering alignment for the hanger wheel.
3. Two point contact, with minimum friction.
4. Dirt and scale cannot interfere with wheel.
5. Absolute satisfaction for owner and operator.

What do these facts mean to you as a builder—Simply this—When you specify Porter HUMMER track and hangers, you insure a correct and satisfactory job for your customer; furthermore, being a one-piece track, the labor and skill required to install is a minimum—something else of interest to you, the contractor.

Remember the name—HUMMER—the track with the V tread.

If unable to secure locally, write us direct.

J. E. PORTER CORPORATION, Mfrs. Ottawa, Ill.

Lower Prices—Easy Terms

3-3 1/2-5
7 & 10
SIZES



NEW
HYATT
ROLLER
BEARING
MIXERS

The Finest of Fine Mixers

Hyatt roller bearings throughout, roller-drive chain, Dot high-pressure lubrication, malleable wheels, divided type mixing blades, automatic return—everything provided to make it the fastest, easiest operated, most durable mixer built.

Republic

Republic Concrete Mixers are built in all sizes from half bag up, in both tilting and non-tilting types.

Dealers carry complete stock for quick delivery.

Write for Catalog



REPUBLIC IRON WORKS, Tecumseh, Mich.

Prompt Shipments of Speed-grits



*A Corner of the
Shipping Room at Troy*



*Let us send you
the address of the
nearest dealer or
branch Warehouse*

MANNING ABRASIVE CO., Inc., TROY, N.Y.

GARNET and DURUNDUM FLOOR PAPERS

assured by the hundreds of dealer stocks throughout the country, served by 14 complete branch warehouse and factory stocks in important centers.

MANNING ABRASIVE CO., Inc.
Troy, N. Y.

Gentlemen: Please send me the address of the nearest stock of Speed-grits Floor Sanding Papers.

NAME
ADDRESS
CITY

Big Profits for YOU- We Tell You How

**INVESTED \$53
CLEARED \$1334**

Mr. Le Doux of Louisiana made \$1334 clear profit in spare time on an investment of only \$53 in Utility molds. H. G. Young of New Jersey invested \$67 in two molds and in spare time cleared \$2700. A contractor in Colorado cleared \$333. A building supply dealer in Ohio cleared \$590. An Indiana man says, "We had to turn down business this year—couldn't make them fast enough." Either spare time, part time or full time, here's big profits for you. Write for Utility catalog. Explains all.

PORCH MAKING OUTFITS—All sizes



A BIG MARKET YOU SUPPLY IT

The growing demand for ornamental permanent products by home owners, schools, parks, libraries, cemeteries and estates, represents a vast waiting market to the man who supplies it. Easy to make. Complete instructions furnished. Send for catalog.



LUXOR
Materials cost 24c;
Selling price \$5.00.



CLARE-MONT

Materials cost 44c;
Selling price, \$5.00.



MADEIRA

Materials cost 24c;
Selling price, \$4.00.



AVON-DALE

Materials cost 45c;
Selling price, \$6.00.



SUNTYME

Materials cost 40c;
Selling price, \$17.00.



ARDMORE

Materials cost 15c;
Selling price, \$3.00.



WREN

Materials cost 58c;
Selling price, \$21.00.

CONCRETE EQUIPMENT CO.
500 Ottawa Ave., Holland, Mich.



Send for Catalog



The Modern System for Handling Concrete Construction

The Metaform idea is so simple that it does away with the need for high priced skilled labor for erecting forms. It consists of reinforced metal sheets of various standard sizes which can be quickly locked together to form one smooth continuous form of any size or shape. More speedy than wood form construction—no spoilage as when wood is used.

A Metaform outfit will more than save its cost in one season. The savings after that are sheer net profit for year after year.

Tell us what classes of concrete work you do and we will send you complete Metaform information.

Metal Forms Corporation
Milwaukee, Wisconsin

BOYLE'S BAYONNE

ready to lay Roof and Deck Cloth



The ideal covering for Porch Floors, Decks or Piazzas, Sun Parlors, etc.

Waterproof
Weatherproof
Durable
Flexible

Lays flat
Stays flat

Ready to lay—Requires no white lead bedding; will not buckle, crack or peel.

Write today for our Sample Booklet "P."

JOHN BOYLE & CO. Inc.

Established 1860

112-114 Duane St.,
1317-1319 Pine St.,

New York
St. Louis, Mo.

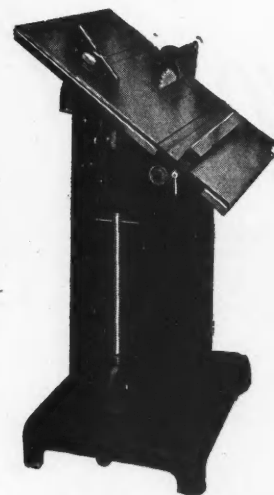

Motor
Driven

No
Noisy
Gears

A Big Profit Maker--

Here is just the machine for contractors. Compact, rugged, and speedy—easily moved from one job to another—will attach to any light socket. Will do your work at much lower cost. Cuts costs in many ways. It's a woodworking machine no contractor can afford to be without. Get the facts, and our catalog illustrating and describing the complete Gallmeyer & Livingston Union line.

Gallmeyer & Livingston Co.
206 Straight Ave. Grand Rapids, Mich.

for Stall Floors ~

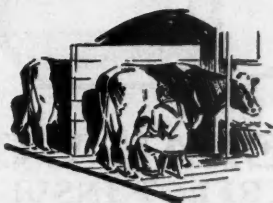

use rot-resisting
Larch

ANIMAL acids that make short work of most stall floors cannot harm *Larch*. It has its own natural oils that resist rot and the action of acids.

Larch floors are warm—keep cows comfortable—increasing milk production.

Larch from the great Inland Empire is slow growing. The grain is close-knit. *Larch* is tough and strong yet moderately light and easily worked.

Use *Larch* inside your house for its deep russet color. Use it wherever wood comes in contact with the soil, or wherever there is dampness, for its resistance to rot.

Do not confuse *Larch* from the Inland Empire with the small larch called "Tamarack." *Larch* is reasonable in price—the finest low-cost lumber. Ask for *Larch* by name. It comes to you thoroughly seasoned, rigidly graded and carefully milled.

For complete information address

**Western
Pine Manufacturers Assn.**
PORTLAND, OREGON

Manufacturers of
Pondosa Pine Idaho White Pine *Larch*
Red Fir White Fir Cedar Spruce



**The Owner
of the Building**

—what *he* thinks of
concrete wall units

THE building owner—the ultimate consumer—the fellow who pays all the bills—is your customer.

He wants the best structure he can get for the money. But he has long since ceased to be penny-wise and pound-foolish. He no longer thinks in terms of first cost alone.

He knows that concrete block, brick and tile represent maximum economy—in first cost and ultimate cost. He knows they give him a permanent building—fire-proof, weatherproof, perfectly insulated.

And he knows the difference between good concrete and bad concrete. He's asking for good concrete units—asking louder every day.

Live builders are equipping themselves to meet the demand for concrete block, brick and tile. May we tell you how YOU can meet it—at a profit?





The Money Making Possibilities
—
WRIGHT RUBBER TILE
—
In Your Town
—
Directions For Laying



WRIGHT RUBBER PRODUCTS CO., Dept. A. B. J., RACINE, WIS.

A New Department In Your Business

Contractors, builders and floor layers all over the country have found Wright Rubber Tile an excellent source of increased income for them.

Opportunity Outlined

The ease of laying and the outstanding advantages of this modern flooring are outlined in our book, illustrated at the left.

A postcard in the mail today will bring you a Free copy. Write.

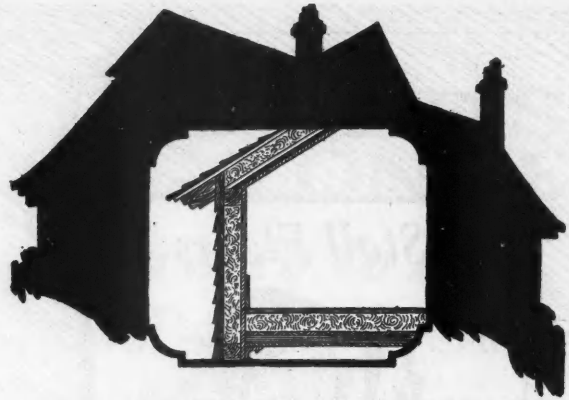

MINERAL WOOL THE PERFECT INSULATOR

Adds Value Beyond all Proportion to Cost

This entirely mineral material is cold-proof, heat-proof, fire-proof, vermin-proof and sound-proof.

The saving alone in winter fuel in buildings lined with Mineral Wool will quickly pay for its installation, and the comfort to the occupant is immeasurable.

It also supplies one of the best arguments in case of sale of building as Mineral Wool is rated by the U. S. Bureau of Standards as a most efficient insulating material.

Send for your sample and illustrated booklet.

U. S. MINERAL WOOL COMPANY
280 MADISON AVENUE NEW YORK, N. Y.

Western Connection: Insulating Products Co., 1653 W. Madison St., Chicago, Ill.

POST'S Norwood Drawing Table



If you are looking for a *serviceable* and *substantial* Drawing Table that is not prohibitive in price, order a **NORWOOD**, a *sturdy* table at *low cost*.

The top is raised easily and maintained at any height by clamps at the sides; the angle desired is obtained by releasing clamp screws and moving the curved arches until the required position is reached.

Top is made of selected pine wood, and the stand of well seasoned oak, shellac-finish. Comes in seven (7) sizes ranging from 23 x 31 inches to 48 x 72 inches top.

Ask for **FREE CATALOG**, giving full description and prices of our entire line of **DRAWING STANDS, BUILDERS' LEVELS and TRANSITS, BLUEPRINT, DRAWING and TRACING PAPERS and DRAFTING ROOM SUPPLIES.**

THE FREDERICK POST COMPANY

P. O. Box 803

CHICAGO, ILL.



The Great Northern is in Chicago's central business section, within one block of State Street, the great shopping thoroughfare; close to theater, financial and wholesale districts. Field Museum, Art Institute and Soldier Field Stadium are within walking distance.

Great Northern Hotel

Dearborn Street, from Jackson to Quincy . . . Chicago

Men in the building lines have long favored this hotel, not only for its convenient location, but also for its accommodations of comfort here enjoyed without extravagance.

**400 Large, Bright Livable Rooms,
\$2.50 a day and up.**

Exhibit Rooms . . . \$4, \$5, \$6, \$8.

For two persons in any room the additional charge is only \$1.00 a day. No extra charge over main restaurant prices for meals sent to guest rooms.

Garage near. Tourists' cars delivered without service charge.

"They Keep a-Running"

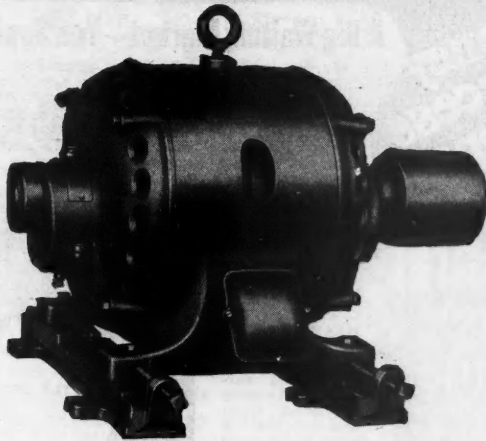

10 Horse Power, 3 Phase Squirrel Cage Motor

**A BEARING
for
EVERY PURPOSE**

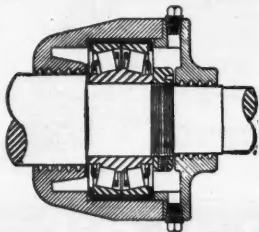

TIMKEN

Double Row Self Contained Roller Bearing.

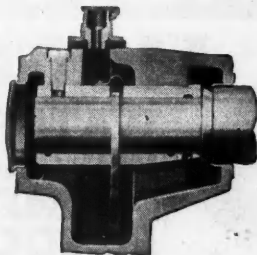

Century

Phosphor Bronze Bearing—Ring Oil Lubrication

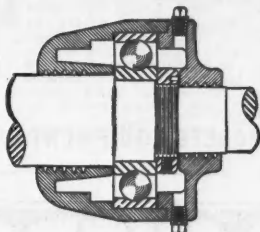

New Departure

Self Contained Ball Bearing

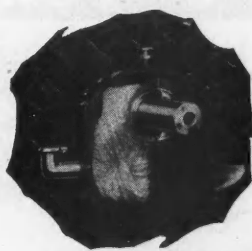

Century

Phosphor Bronze Bearing with Century Wool Yarn System of Lubrication.

CENTURY ELECTRIC COMPANY
1806 Pine Street St. Louis, Mo.



THERE IS A DECIDED DIFFERENCE

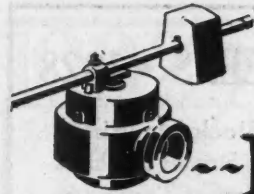

Hot Water Heating, Thrush Equipped, keeps on Selling for years!



A GOOD heating plant has more to do with the satisfaction of the people who live in the homes you build than almost any other one thing. Mere quality in the heating plant is not enough, for satisfaction comes only from dependable performance and fuel economy.

Install Hot Water Heating, Thrush Equipped, and your reputation will be safe. Every home you build will bring you another customer, for Thrush System satisfies. Ask about it.

**THRUSH SYSTEM
of HOT WATER HEATING**

MAIL THIS NOW!

H. A. THRUSH & CO., Dept. B.
Peru, Indiana Date _____ 19__

Please send your booklet about Home Heating.

Name _____

Address _____

My Heating Contractor is _____



Thrush System is nationally advertised and we are telling thousands of interested home builders about it monthly.



There is a real interest in Better Home Heating. Adding Thrush Equipment will add sales value to any home.



1898 • PIONEERS • 1928

**Face Down Block Machines
Hand and Power Stripper Machines
Automatic Power Tampers
Elevators and Feeders**

A complete line of concrete block making machinery which has proven its value in thousands of concrete products plants in all parts of the world, we being pioneer manufacturers, all of our equipment being built for service and fully guaranteed. Complete catalog gladly sent free on request.



Dept. 5

The Miles Manufacturing Co.
Jackson, Mich., U. S. A.

**Write your own Pay Check
in a business of your own**

**Money
Success
Independence**

A Big Waiting Market—You Supply It!

Either for your own building operations or as a business, prepare now to supply the demand for concrete block, brick or tile. A small investment will equip you to start. As your business grows, you can add more machines, either hand or power. Investigate. The Success Book tells all. See for yourself. Write for your copy.



HEAVY DUTY TAMPER

Assures greater density and uniform high quality in making block, brick and tile. A marvel of simplicity and automatic action. The one tamper may be used with any one or all three machines, which doubles output. Priced low. Fully described in Success catalog.



TILE MACHINE

Builders are turning towards lighter building units that are easy to handle, lay up quickly and cost less. This machine makes two tile at each operation. With Success tamper output is doubled. With a small investment you can supply this expanding market. Fully described in Success catalog.

This Book Tells HOW



SUCCESS BLOCK MACHINE

Gives extra years of high speed, dependable service. Mold box accurately machined and cannot be fanned out of alignment. Every block produced is of true dimensions. Makes approved three-core block in five sizes, all designs. Output doubled by using power Tamper. See Success catalog for low prices.



**WIN LEADERSHIP
MANUFACTURING
SUCCEED ON
THE SUCCESS
ROUTE!**

550 Ottawa Ave.
Holland, Mich.

CONCRETE EQUIPMENT CO.,

Value that Sells



With popular demand centering on **quality construction**, it is good business to build homes that show their superiority at first glance—and prove it in lasting service. There is no mistaking the sterling worth of houses made of

**Louisiana Red Cypress
"the Wood Eternal"**

The fine clear boards display an unblemished surface. The perfect painting properties yield an alabaster finish. Its reputation for durability creates **value that sells**.

Consistent use of this enduring lumber for all exterior woodwork enables you to avoid profitless competition and to secure a **paying monopoly** on quality homes.

If you want practical building information on this subject, write for a copy of SPECIFICATION DATA for STRUCTURAL USES of TIDEWATER RED CYPRESS. Supplied FREE in handy filing form.

LOUISIANA RED CYPRESS BUREAU
502 Carondelet Street New Orleans, Louisiana

**MYERS Self-Oiling
BULLDOZER &
POWER PUMPS**

**A 100%
WATER
POWER
PUMP
for YOU**

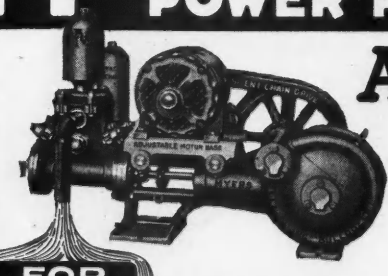

FOR

- Farms and Plantations
- Private Residences
- Dairies and Creameries
- Hospitals and Sanitariums
- Apartment Houses
- Hotels and Laundries
- Railway Tanks and Stations
- Summer Resorts
- Power Plants
- Mills and Factories
- Mines, Oil and Gas Fields
- Road Building
- Irrigation and Drainage
- Etc. Etc.

Dependable, low cost power water facilities for home, farm or factory—have them with Myers Self-Oiling Bulldozer Power Pumps. Positive self-lubrication, housed working parts, improved method of power application, larger valves, higher speed, provide larger capacity at lower cost. There is a style and size for every service up to ten thousand gallons per hour. Catalog and complete information to those who are interested. Dealers, supply houses, contractors, builders, write us for catalog and prices.

THE F.E. MYERS & BRO. CO. ASHLAND, OHIO.

MANUFACTURERS FOR OVER FIFTY YEARS OF MYERS "HONOR-BILT" PUMPS FOR EVERY PURPOSE WATER SYSTEMS HAY AND GRAIN UNLOADING TOOLS—BARN, FACTORY AND GARAGE DOOR HANGERS—STORE LADDERS, ETC.



Paul Water Service Makes Easier Sales..

BETTER homes will bring better prices. A Paul Water System or a Paul Soft Water Generator is a real selling feature in any home.

Paul Soft Water

Modern woman demands modern conveniences and a home is not complete without softened water, available at full city pressure at every faucet. The Paul Soft Water Generator provides this economically. Hand-operated or electrically-operated types, priced right.

Ask for Bulletins

FORT WAYNE ENGINEERING AND MANUFACTURING CO.
FORT WAYNE, INDIANA
1718 N. Harrison St.



100% of Home Owners Want SLAM-PROOF and PROP-FREE Garage Doors



Slamming wears out doors. Smashes fenders. Props are clumsy and hard to keep. Home owners order "Cyclone" Door Stop Hinges on sight. Every Garage and Barn owner is a prospect. They make doors stay put where set. For hanging new doors or reinforcing hinges on old doors.

CYCLONE Door-Stop HINGE

A 2-in-1 hinge. A husky, easy swinging hinge that holds doors rigid and swings them true. A high friction door stop that never fails but is flexible to touch of the hand. Friction instantly adjustable to any tension desired. Built for a heavy job. Outlasts garage or barn and will not get out of order. Heavy enough for any door. One used in center straightens sagging, makes old doors swing true and when it blows, it holds. Only a trifle more expensive than an ordinary heavy well made hinge. Write direct to factory for circular, prices and special dealer's agency introducing offer.



Northfield Iron Company
400 Nico Street
NORTHFIELD, MINNESOTA, U. S. A.

FREE

This 9" Torpedo Level



With Each Order for the **MAYES 28" LEVEL**

This 28" Mayes Carpenters' Aluminum Level at the special price of \$5.75 with the 9" Torpedo Level, not a toy but a real, pocket size level, given FREE, is a bargain no carpenter or builder can afford to pass up.

The coupon below is worth \$1.10, the price of the Torpedo Level alone. Clip this coupon, mail together with money order (\$5.75, our special price for the carpenters' level) and we will mail to you immediately both levels. Order on approval, examine each level and see for yourself that they are the bargain we advertise.

The coupon below, worth \$1.10, will bring both levels to you. Examine them carefully. If you are not fully satisfied, send them back to us.

THIS COUPON WORTH \$1.10
30-DAY SPECIAL FREE OFFER

MAYES BROS. TOOL MFG. CO.
Port Austin, Michigan

Gentlemen:—I am enclosing \$5.75 for which please send me Carpenters' Aluminum Level illustrated above. I understand that the 9" Torpedo Level is given FREE with each order. If these levels are not fully satisfactory, I will return both within 5 days.

Name.....
Address.....
City..... State.....
Your Dealer's Name.....

INVESTIGATE the SUPER WOODWORKER

This gasoline engine or electric motor driven saw table, equipped with swinging arbor and tilting table, is saving time and money for thousands of contractors.

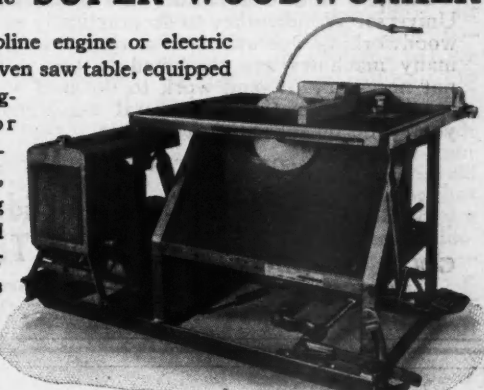

THE SUPER WOODWORKER will increase your profit on every job. One man operating this machine can saw as much lumber in an hour as ten men could by hand.

ALL WOODWORKING OPERATIONS such as cutting off, ripping, bevel ripping, mitring, double mitring, grooving, rabbeting, tenoning, etc., are easily and quickly accomplished on the Super Woodworker and changing from one operation to another is a matter of a few seconds.

ALL STEEL CONSTRUCTION combines great strength and light weight. This machine will last for years and save you real money every day you use it.

It will pay you to investigate the SUPER WOODWORKER

Jones Superior Machine Co.
1260 W. North Ave., Chicago, Ill.

Send coupon today for Bulletin giving complete information

JONES SUPERIOR MACHINE CO.
1260 W. North Ave., Chicago, Ill.

Gentlemen: Please send full details and Bulletin on Super Woodworker.

Name.....
Address.....
City..... State.....

WHY SAW LUMBER BY HAND?

When You Can Take A Power Saw Out On Every Job
The Saving You Make With Its Use Is A Real Profit

Here is a Powerful, Portable, Carpenter, Sawing Machine not dependent on electric service or skill of the operator. Will cut rafters, studs, stairhorses and bridging; square long dimensions as fast as you can handle the lumber. For trimming sash, doors, screens, fitting casing and flooring. Will do those smooth, accurate jobs with 50% of the cost of hand fitting.

Cross Cuts, Rips, Miters, Dados

Furnished with either gasoline or electric power, or both. Gasoline equipment weighs 300 pounds and is positively without vibration. Runs all day long on a couple of gallons of gas and a little oil. Will saw as much lumber as a crew with hand saws. Build 1928 buildings 1928 way.

If you will write, we will make you a trial offer that will interest you. Delivery from stock or warehouse near you.

Manufactured by

4444 Royalston Ave., D. W. ONAN & SONS, Minneapolis, Minn.

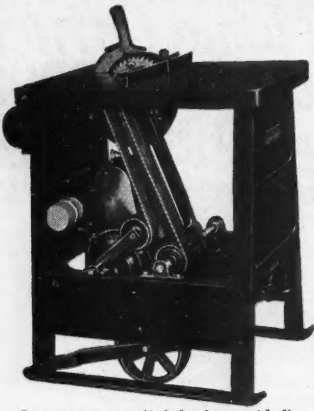

One man moves it (wheels provided).



Starter Provided



Two men load it.

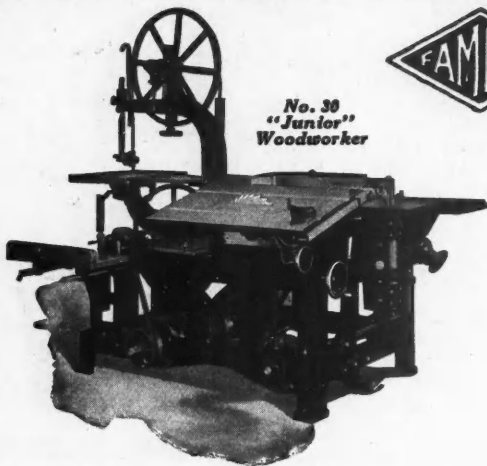

No. 39
"Junior"
Woodworker



A Whole Shop in One Unit

Builders and Contractors are enabled by this Universal Woodworker to do practically all of their woodworking operations in a time-saving way, as many machines are combined in this one. It is not necessary to send work to the mill work shop as this combination of several machines enables you to do 30 different operations.

WRITE FOR ILLUSTRATED BULLETIN

BUILDERS
of
GOOD MACHINERY
SINCE 1904

The Sidney
Machine Tool Co.

857 Highland Ave.
Sidney, Ohio

How Good is Your Work?

If you are satisfied only when your work is best you will want to use the Improved Schlueter to surface and resurface floors.

Note these features which make the Schlueter unequalled: 1. Roller adjusts itself to floor irregularities by patented suspension features. 2. No levers to manipulate. 3. No weights to lift. 4. Link belt chain drive. 5. Surfaces right up to quarter round. 6. Positive suction gathers all dust. 7. Five year guarantee.

Write for details of Five Days' Free Trial.

LINCOLN-SCHLUETER
MACHINERY CO.

222 W. Grand Ave.
Chicago, Illinois

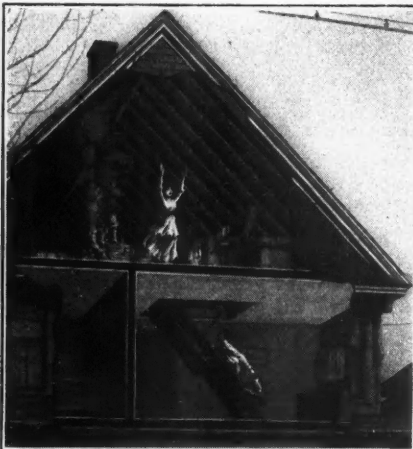
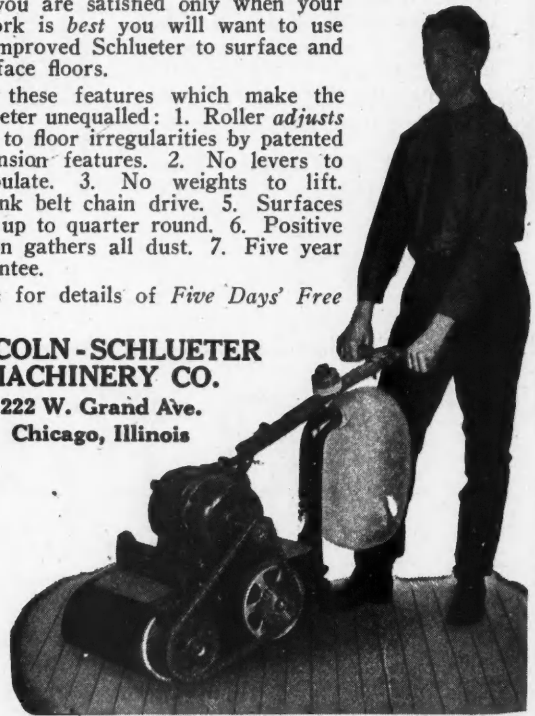

FIRE starts in the attic more often than in any other part of the house. A Bessler Disappearing Stairway, as a safe and convenient way of reaching the attic, greatly reduces the fire hazard. A Bessler occupies no space on the floor below when not in use. Its cost is low and it will last as long as the house.

Write for particulars.

The Bessler Disappearing Stairway Co.
AKRON, OHIO

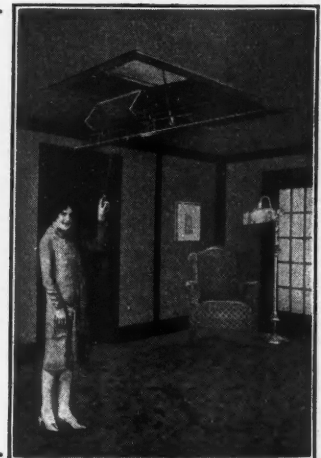

Clothes Closets



that take less space, hold more clothes, save construction costs, and prove

A REAL SELLING POINT

You can make them with these inexpensive "Garcy" clothes closet fixtures.

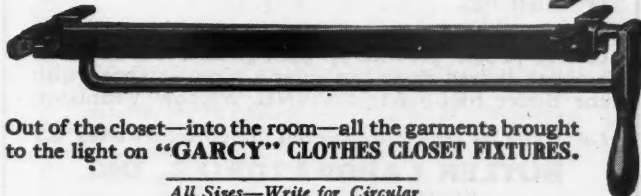

Out of the closet—into the room—all the garments brought to the light on "GARCY" CLOTHES CLOSET FIXTURES.

All Sizes—Write for Circular

GARDEN CITY PLATING & MFG. CO.
1430 South Talman Avenue CHICAGO, ILLINOIS

SAVE MONEY ON YOUR LIGHTING FIXTURES



HOME OWNERS! BUILDERS!

Send for Our BIG New FREE Catalog

Containing hundreds of fixtures for every purpose and every taste. Our selection is the finest and most complete. Be sure you have our catalog before buying. Our prices save you money and our MONEY BACK GUARANTEE gives you 30 DAYS TRIAL.

Contractors, Builders and Electricians are invited to write for our proposition

MAIL COUPON

PARAMOUNT ELECTRIC CO.
930 Z ARCH ST., PHILA., PA.
Send me FREE your Big Bargain Catalog—

Name _____
Address _____
P. O. _____ State _____
Occupation _____

PARAMOUNT ELECTRIC CO.
930 Z ARCH ST., PHILA., PA.



Expansive Screw Anchors



Expansion Bolts

Ackerman-Johnson

What are the compelling reasons why ACKERMAN-JOHNSON Expansive Screw Anchors have become the most popular type with Electricians and the various Trades Mechanics everywhere?

Because in comparison with the work and uncertainty in setting the older type Expansion Bolts for making fastenings to concrete and masonry generally, it becomes an actual pleasure to set the ACKERMAN-JOHNSON.

Because there is distinct fascination in so easily setting so small a device with a realization of the tremendous load it can hold.

Because there is great satisfaction in leaving a job knowing it could not have been better done.

Ackerman-Johnson Co.

625 W. Jackson Blvd.
CHICAGO



One-Hole Pipe Straps

53 Park Place,
New York City

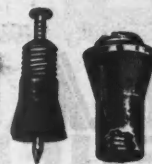

Concrete Inserts

Boosting Profits Higher



Cross Cutting

Any reasonably good combination woodworker, in the skilled hands of a mechanic, will perhaps justify its cost. Few manufacturers fail to give good value. But:

The 20th Century Woodworker dominates the combination-woodworker field by performing functions that other machines will not—by being either gasoline or electric driven and portable—by being ball bearing throughout—and by being beautifully finished, fast, and accurate.

These things boost your profits higher—and the cost of the machine is modest.

20th Century Wood Worker

Can be equipped with 1 H. P. to 5 H. P., A. C. or D. C. electric motors, or 1 1/4 H. P. air-cooled gas motor. Information on motors cheerfully furnished. This is the best combination woodworker that can be driven by either electricity or gasoline.

Excellent territory still available for agents.

MAIL THIS COUPON NOW
Please send me, without obligation, details concerning ownership and operation of the 20th Century Woodworker. P
Twentieth Century Sales Agency, 1321 Arch St., Philadelphia, Pa.
Name _____
Firm _____
S. I. No. _____
City _____
State _____

10 Brief Reasons Why HARDINGE FUEL OIL HEAT SELLS And Why You Should Buy HARDINGE

1. Because thousands of satisfied users have found it dependable season-after-season, and don't hesitate to tell their neighbors about it.
2. Because it is the only oil burner with a **Ten-Year Factory Guarantee**—a real bond of confidence.
3. Because, built by a financially strong company with 37-years' experience in manufacturing precision-built machines and forcefully advertised, buyers' investment protection is assured.
4. Because it is listed as standard by Underwriters Laboratories and approved by Board of Standards and Appeals of New York.
5. Because it is quiet—automatic—durable—easily understood—economical, completely burning cheaper grades of oil efficiently.
6. Because all bearings are submerged in lubricating oil, and require a minimum of attention.
7. Because there are twelve different sizes and combinations—all parts standard and interchangeable—providing individual treatment to fit the needs of any heating plant.
8. Because scientific distribution of flame over grate area of boiler and numerous exclusive, patented features assure economy and dependability unobtainable elsewhere.
9. Because it is endorsed and specified by leading architects and heating engineers regularly for installation in the finest buildings in America from bungalow to skyscraper.
10. Because it is sold only by dealers equipped to render prompt day and night service—a service demanded by Hardinge policy, seldom found necessary, but nevertheless a reassurance to the layman.

Call on the dealer in your city or write direct to us.

Hardinge Brothers, Inc.

Factory and General Offices:
4149 Ravenswood Avenue, Chicago, Ill.

Factory Branches:
CHICAGO **BOSTON**
Michigan Ave. at Ohio St. 839 Beacon St.



You can safely have confidence in

HARDINGE FUEL OIL HEAT

*Consider
the
BATES-TRUSS
JOIST
It
pays!*



Bates-Truss Joists

THE expanded, one-piece Bates-Truss Joist has many advantages over either the assembled or the solid web types of joist. The expanded truss has no joints and therefore has no welds or rivets in shear or tension. The open web permits piping to be run through the joists at any desired point.

LOW COST—Because of the simple method of manufacture, Bates-Truss Joists are exceedingly low priced. Write for our catalog.

The Expanded

BATES-TRUSS JOIST
A Sound Engineering Product

B E S T
Bates Expanded-Steel Truss Co.
EAST CHICAGO, INDIANA

*for Homes
Apartments
Offices and
Public Bldgs.*



**Draft-Proof
—
Rain-Proof
—
Snow-Proof**

*Fits Any
Window*

Low-Priced

The Butler Self Adjusting Window Ventilator

THE healthiest and handsomest ventilator obtainable. It closes and opens with the window. No rain or snow can enter and destroy furniture or drapes, because when open it drops down over sill. No dangerous drafts. No wind to blow about papers or trimmings.

Frames are made of weatherproof metal finished or colored to suit; set with 3/4" plate glass. Fresh air to the amount desired alone can enter a room equipped with the Butler SELF-ADJUSTING Window Ventilator.

Write us regarding special introductory offer

BUTLER LABORATORIES, INC.
Makers of Butler Metal Ceiling Dryer

Executive Offices and Factory
4201-17 Avenue H, Brooklyn, N. Y.
Exclusive Territories Open for High Grade Distributors

*...here's the
extra help
you need!*



Cabinet Shop
Special No. 10
\$290.00
including motor

A seven-billion-dollar building year is estimated for 1928. That's \$70 each for every man, woman and child in the average town or city! This Parks will help you handle your share without extra payroll cost. Put it in your shop or haul it from job to job and speed up your finishing. Save five men's pay. Send for catalog.

PARKS WOODWORKING MACHINES

THE PARKS WOODWORKING MACHINE CO.
FERGUS & C. H. & D. CINCINNATI, O.
Canadian Factory: 208 Notre Dame East, Montreal, Can.

HESS CABINETS
and MIRRORS
Snow-White Steel



Still Another De Luxe Cabinet
THE PARISIAN

THE door frame is of drawn steel moulding (not sheet steel) welded and finished at the corners. The mirror conceals the spacious cabinet, which is fitted with adjustable polished plate glass shelves. Suitable for the finest bath room, at a moderate price.

Write for description of this and of six other styles, in five sizes.

HESS WARMING & VENTILATING CO.
Makers of Hess Welded Steel Furnaces
1220 S. Western Avenue, Chicago.

The
FREE-O-DUST SUPER SURFACER
The World's Fastest
Floor Sanding and Resurfacing Machine

The Free-O-Dust is also the smoothest running machine. The new ERMCO V-BELT drive is superior to all chains and gears and gives far better results. We will gladly ship a machine for your five days' trial so you can decide for yourself. We have a liberal term payment plan. Mail the coupon for complete details. You will not be obligated to buy.

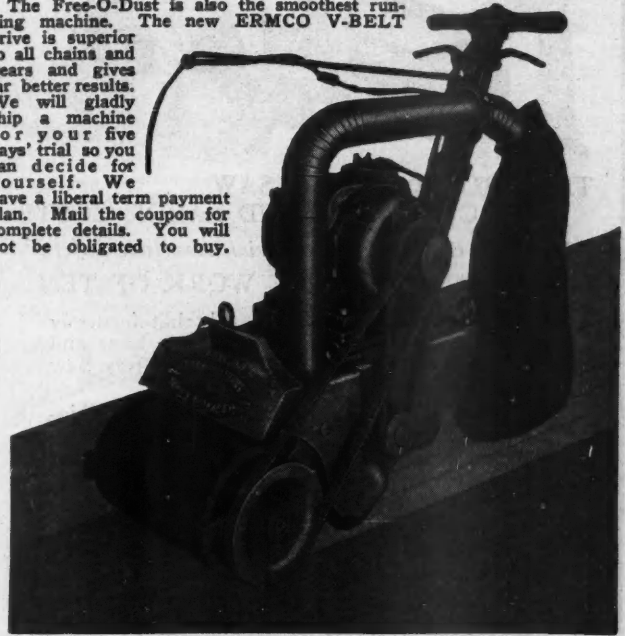

ELECTRIC ROTARY MACHINE CO.
3824 W. Lake Street, Chicago, Ill.

Please send your free booklet, "A DAY'S WORK," on your Free-O-Dust Sanding Machine; also information on your Long-life Abrasive Paper, with prices on both.

Name.....
Address.....

For **SIMPLER MORTISES**
and **QUICKEST FASTENING!**

MOREOVER, "Grand Rapids" All-Steel Sash Pulleys are the strongest yet lightest pulleys made—capable of carrying any weight a cord or chain will support.

And the fact that they are more widely sold and used than any other sash pulley proves how sweepingly their superiorities appeal to everyone.

In spite of their advantages and exclusive features "Grand Rapids" Pulleys cost no more than common pulleys made of cast iron.

Sold By All Distributors Everywhere

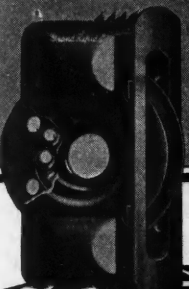

No. 10 Ball-Bearing
No. 110 Cone Bearing
(2-inch wheel)

2 popular numbers from a complete line of Ball Bearing, Cone Bearing and Axle Bearing pulleys.

GRAND RAPIDS
HARDWARE COMPANY
ALL-STEEL
SASH PULLEYS

MAIL COUPON
for FREE
SAMPLE

Grand Rapids Hardware Co.
556 Eleventh St.
Grand Rapids,
Michigan
U. S. A.

Grand Rapids Hardware Co.,
556 Eleventh St., Grand Rapids, Mich.
I am interested in the pulley illustrated.
Please send sample.

Name.....
Address.....
City..... State.....

G & B MODEL 45
The Reliable Wye Level Type
A CONVERTIBLE LEVEL
FOR UNIVERSAL SERVICE

Approved by
Thousands of Satisfied Users

CASH OR TERMS
Free Trial

FREE
Illustrated Booklet
"How to Select, Test and
Care for Convertible Levels."



Mail
Coupon

GEIER & BLUHM, Inc. 670 River St., Troy, N.Y. A.B. Mar. '28

Please send me free Valuable Information.

Name.....
Address.....

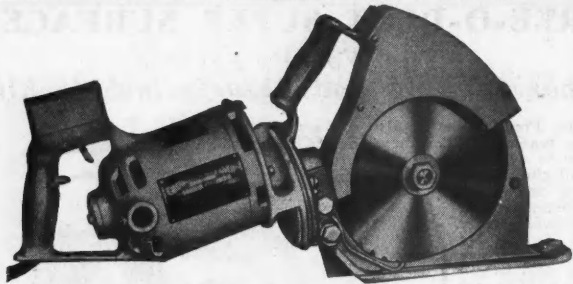

**THE CROWE SAFETY SAW
CUTS TIME AND LABOR COSTS**

Works at Lightning Speed with Absolute Safety
ONE MAN DOES THE WORK OF TEN

One contractor says: "On a job that formerly required a man with a hand saw one hour and ten minutes to complete, the Crowe Safety Saw now does the work in 20 minutes."

Contractors, concrete workers, engineers, shipping departments, railroad yards, lumber yards—wherever a saw is necessary—the Crowe Safety Saw is cutting time and labor costs.

Contractors and workmen prefer it. Officially approved for safety by some of the most critical authorities in the country.

Saw blades are made in three sizes: CC-6, CC-8 and CC-12, and cut 1½, 2½ and 4½ inches deep, respectively.

For full description and interesting details write for the folder, "Safety Approved by Many States." Send for it today.

THE CROWE MANUFACTURING CORP.

Dept. A, 226 E. THIRD ST., CINCINNATI, OHIO, U. S. A.

Cut Your Mortising Hours to Minutes!

You can do it with the Champion Mortiser. It will cut more mortises in thirty minutes than a carpenter can cut in three hours with brace and chisel. Think of the saving that means in labor, time and MONEY. If you pay \$1 an hour for labor it means a saving of 42c on every mortise over the old way or \$42 saved on each one hundred mortises. And the Champion will easily cut that many a day!



2 mortises an hour this way.

Get a Champion and get this saving. Cuts any size mortise in any hard, knotty, cross-grained or end wood. Carried anywhere. Eliminates risk of damaging the job.



12 mortises an hour this way.

The CHAMPION MORTISER

Try it on our 15-day trial offer. Year's guarantee. Money back if not satisfied.

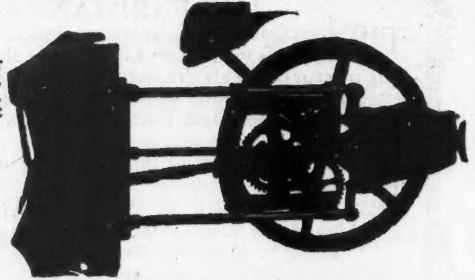

Colgan Machinery & Supply Co.
403 Hayden Bldg.
Columbus, Ohio

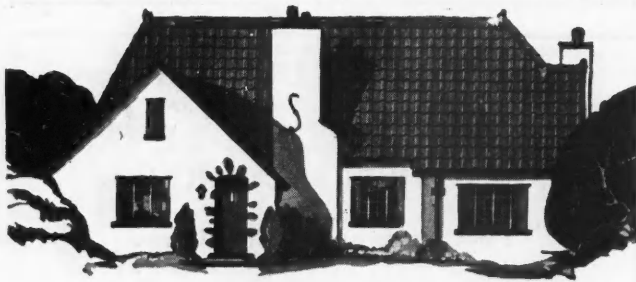

LEADCLAD Spanish Tiles
Long Life and Beauty

Since time immemorial, enduring lead has played a leading role in roofing fine buildings. Through the Leadcloth process, lead is now made available, at very moderate cost, in the form of Spanish Tiles, Shingles, or as flat and standing seam roofing, for buildings of every type and style of architecture. Leadcloth Spanish Tiles afford perfect protection against lightning, fire, breakage, or the ravages of time. Furnished red or green; look exactly like clay tiles, but are much lighter and stronger. Send for free book "Defying Age and Time."

WHEELING METAL & MFG. CO.
Dept. 1-C Wheeling, W. Va.

VALLEYS GUTTERS



SPANISH TILES

Get Into the Floor Surfacing Business While the Field is Fresh

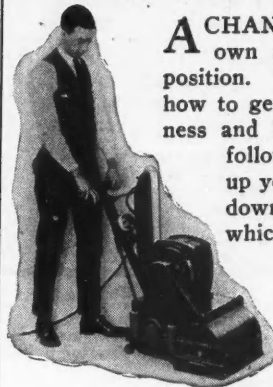

A CHANCE to have a business of your own and still retain your present position. Write today—let us tell you how to get started in this Paying Business and how you can make good by following our method in working up your business. Free Trial. Part down—balance easy payments, which machine will earn for you.

\$40 to \$50 a day easily earned with the AUTOMATIC—the result of 16 years' manufacturing experience. Will save the wages of 5 men and do

work that will stand inspection against the light. SKF ball bearings, carefully protected from dust—Whitney Silent Chain—Roller Pressure Regulator—Force Feed Lubrication—Edge Roller Border Work Eliminated—Steel, not cast iron construction—all dust taken up on forward operation with New Vacuum Nozzle—all working parts inclosed.

The Little Automatic Surfacing Machine is a wonder for removing varnish from desk tops, counters, etc., or for all sorts of new work.

WAYVELL CHAPPELL & CO.
38-40 Jackson St., Dept. Z WAUKEGAN, ILL.



This **FA** Panelboard Catalog
will help contractors make
more money

Send for Your Copy **FREE**

Frank Adam
ELECTRIC COMPANY
ST. LOUIS
Offices in Twenty-five Cities

FA Panelboards Are the Sign of a Better Job



Make more
by serving more

Do your leveling and plumbing the modern, accurate way. Mistakes are always costly. By actual experience you can save an average of \$2.00 a day or more on every job as a result of the speed and accuracy possible with this specially designed Beckmann level and transit.

A Genuine Beckmann
More Cannot Be Said

Beckmann instruments are known the world over. They are noted for precision and accuracy—for their sturdy construction and long life.

This model is designed for the use of builders and contractors. It cuts time and mistakes in leveling buildings, floors, walls

and foundations—in running lines for fences, streets and ditches—in surveying lots and locations.

Easy to learn to use. Big volume makes the price very low.

Write for our booklet "Low Priced Precision"

The L. Beckmann Co.,
538 Jackson St.,
Toledo, Ohio.

Please send me your book, "Low Priced Precision."

Name.....
Address.....
City.....



"EDWARDS"
EMBOSSED
METAL CEILINGS & WALLS

Sanitary, Durable, Fire-proof, Germ-proof. Made from sheets of specially prepared steel and stamped into ornamental designs.

Send us a rough sketch of rooms showing all offsets, etc., and we will prepare, without any charge, a drawing showing how the ceiling will look when erected, and forward same together with a lump price for material delivered f.o.b. your railroad station.

Our large Catalog showing our complete line of Ceilings and Walls sent free on request.

THE EDWARDS MANUFACTURING CO.
401-417 Eggleston Avenue CINCINNATI, OHIO
The World's Largest Manufacturers of Metal Roofing, Metal Sinks, Metal Garages, Portable Buildings, Rolling Steel Doors, etc.

Frazier
Self-Balanced
Stairs

The Simplified Disappearing Attic Stairway
PRICE \$35.00
F. O. B. Pittsburgh, Pa.

Shipped completely assembled, including Jamb, weight 125 lbs. These stairs cannot get out of order.

No Weights—Springs or Cable are Used. Installed by anybody in one-half hour.

OUR GUARANTEE—In event stairs are not as represented return to us at our expense.
Attractive Specialty Salesman Arrangements

Send this Coupon for information

FRAZIER STAIR COMPANY
2615 West Liberty Avenue, Pittsburgh, Pa.
Gentlemen: I am an Architect Builder Dealer
Please send Details on Frazier Stairs.

Name.....
Address.....

**A PERMANENT PROFITABLE YEAR ROUND BUSINESS
METAL WEATHER STRIPPING**

SOME FINE TERRITORY STILL OPEN

THE **DIAMOND** LINE

THE **CAPITOL** LINE

THE "QUALITY" KIND FOR USE
IN BUILDINGS WHERE QUALITY, EFFICIENCY
AND SERVICE ARE CONSIDERED FIRST

WHEN PRICE SELLS THE JOB THIS LINE GETS
THE BUSINESS ON COMPARATIVE MERITS

SEND FULL PARTICULARS

Name _____
Street _____
City _____ State _____

Address

The Diamond Metal Weatherstrip Co.

Box 7—Station "H"

COLUMBUS, OHIO, U. S. A.

**Cardinal Toggery Racks
Multiply Closet Space**

.....So important to women renting or buying a home.... keep hats, shoes and toggery clean, orderly and within instant reach. A tremendous help to the housewife.

Cardinal Toggery Racks are indispensable in clubs, hotels or schools—a cardinal necessity in the small apartment.



A small investment but a big talking point for the renting agent. All metal, nickled, strong, fit any door. Get price and quantity discount today



Write to

Charles Fischer Spring Co.
244 Kent Ave., Brooklyn, N. Y.
Telephone Greenpoint 10000

FLEXOSTAY ADJUSTER
Opens closes and LOCKS the Casement
through the screen in one continuous movement
EASY TO INSTALL - EASY TO OPERATE - DISTINCTIVE IN APPEARANCE.



THE FLEXOSTAY WITH ITS SCROLLED HANDLE IS AS WELL MADE AS IT IS GOOD LOOKING. EMBODIED IN ITS DESIGN ARE EXCLUSIVE FEATURES WHICH INSURE FREEDOM FROM RATTLES AND LONG YEARS OF STEADY RELIABLE SERVICE.

UNITED SPECIALTIES MFG CO. LTD.
RICHMOND HILL, NEW YORK CITY.
Makers of casement hardware since 1910.

SEND FOR CATALOG

**Write or Wire for
TILE Samples**

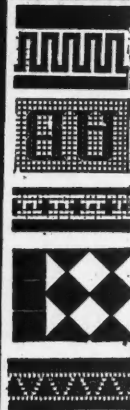

- Assortment No. 1. Encaustic White Floor and Glazed Wall Tiles
- " " 2. Encaustic White and Colored Floor and Glazed Wall Tiles
- " " 3. White Glazed Wall Tile Trim-mers
- " " 4. Color Wall Tiles
- " " 5. Colored Mantel and Hearth Tiles
- " " 6. Red Quarry Tiles

Direct to you at wholesale prices. Here is a chance for you to make plenty of money. Let us tell you how. Any mason, tile-setter or enterprising carpenter can install tile. We furnish instructions.

Write or wire for catalog.
LLOYD FLOOR & WALL TILE CO.
P. O. Box 5064, A-B Kansas City, Missouri



Steel and Woven Tapes of all patterns, Folding Aluminum and Steel Rules.

LUFKIN

MEASURING TAPES AND RULES



Send for Catalog

New York Windsor, Ont.

THE LUFKIN RULE CO.

Saginaw, Mich.

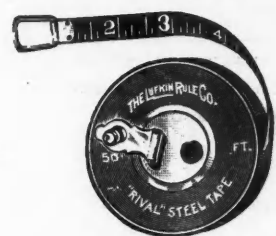

Spring Joint Rules with or without hook; Box-wood, Caliper, and Extension Rules.

CAN YOU DO THIS

With A Wooden Rule?

Both Rigid and Flexible

THE FARRAND RAPID RULE



You Can Measure Circumferences with the FARRAND RAPID RULE

Is a six-foot measuring stick of nicked steel—not a limp tape. Coiled in a neat nickel-plated cup about the size of a watch. Instantly available for any purpose where TAPE or RULE can be used. Figures large and dark, imposed on slightly concave, light-reflecting surface, and are easily read in dim corners.

A MODERN TOOL FOR MODERN CRAFTSMEN

Price \$5.00

Ask Your Dealer or Write

HIRAM A. FARRAND, Mfr.
Room 639A, 149 Broadway
New York City

Or You Can Measure Straight-Away With One Hand

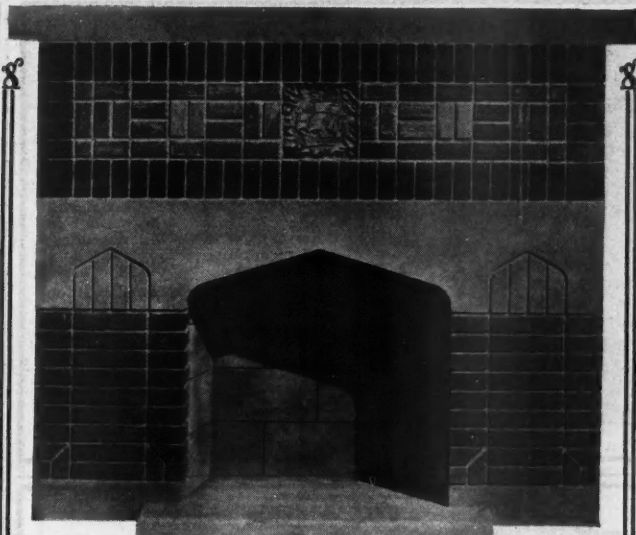

JUST OFF THE PRESS—Yours for the Asking
Our latest catalog showing a new and complete line of **READYBUILT FIREPLACES** in Brick—Stone—Tile. Also Electric Grates.

(UNION MADE) MANUFACTURED IN CHICAGO ONLY

“YOU HAVE TRIED THE REST —NOW TRY THE BEST”

“PIONEER MADE—MADE PIONEER”

PIONEER FIREPLACE AND SUPPLY CO., 5327 W. Lake St., Chicago, Ill.

Originators of Readybuilt Fireplaces. Ask for Dealers' Proposition—Coast to Coast

Please send catalog

Name.....
Address.....
Occupation.....

Cut Your Costs —

Do More Work

with this Wonderful

CRESCENT



Universal Cut-Off Saw

Send for **FREE** Illustrated Circular

Here's a machine every building contractor needs to speed up his jobs, cut his costs and do more and better work. Cuts every conceivable angle—performs 11 operations from straight sawing to stair routing. Compact, self-contained, easy to operate and readily portable from job to job wherever needed. Does the work more quickly and accurately than by hand. Does away with flying sawdust, universal in adjustment.

MAIL THIS COUPON

THE CRESCENT MACHINE CO.
224 Main Street, Leontia, Ohio

Please send free circular on your Universal Cut-Off Saw.

Name.....
Address.....
Occupation.....

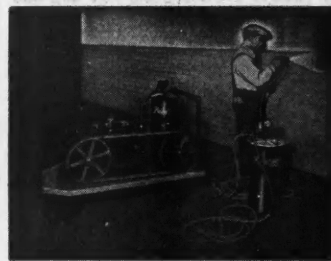

Paintair

BRUSH

MACHINE

and

Pneu-Gun

Paint by Machine and Do a Week's Work in One Day
\$100.00 DOWN

Immediate Delivery on Your Own Terms

We show our confidence in the Paintair Machine with Pneu-Gun Atomization by sending it to you on the recommendation of your banker or on part payment, because we depend on the utility and efficiency of the equipment to sell itself after you get it. Motor driven, \$299.00 Complete. Gas engine driven, \$315.00 complete.

Further information page 227 Sweet's Engineering Catalog.

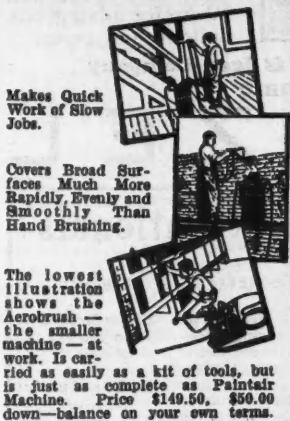

Makes Quick Work of Slow Jobs.

Covers Broad Surfaces Much More Rapidly, Evenly and Smoothly Than Hand Brushing.

The lowest illustration shows the Aerobrush—the smaller machine—at work. Is carried as easily as a kit of tools, but is just as complete as Paintair Machine. Price \$149.50, \$50.00 down—balance on your own terms.

The MELLISH-HAYWARD Co.
Manufacturers *Established 1894*
211 W. AUSTIN AVE. CHICAGO, ILLINOIS

Please send me Catalog 105 and full details on cutting painting costs with the Paintair Machine and Pneu-Gun.

Name.....
Address.....

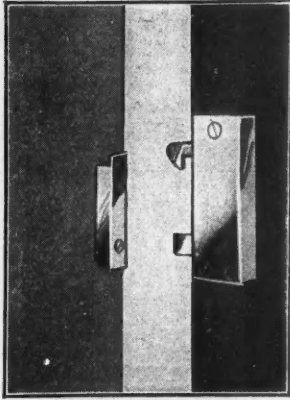

HAGSTROM SECRET DOOR LATCH

A brand new Hagstrom product designed especially for concealed panels. May also be used on other doors, instead of ordinary latch. When door is closed no hardware is visible. To close push lightly on door—to open push hard. Door moves less than 1/4". Shrinking or swelling of door will not affect this latch as long as door swings free.

Latch may be screwed right on door jamb. Built in five sizes. Strike screwed on door without cutting. Anyone can apply this latch in less than ten minutes. If your jobber cannot supply you address Dept. A for further particulars and prices.

Hagstrom Mfg. Co., Glen Cove, N. Y.

Patent Applied For



THE MAILO-BOX WRITE US TODAY!

for liberal dealer proposition on this practical built-in feature. Every new home a good prospect. Eight styles and many finishes. The most complete line on the market. We want to talk business if your territory is open.

Penn-Greg Mfg. Co.
809 University Ave. St. Paul, Minn.

Build a Fire to Keep the Mortar Warm

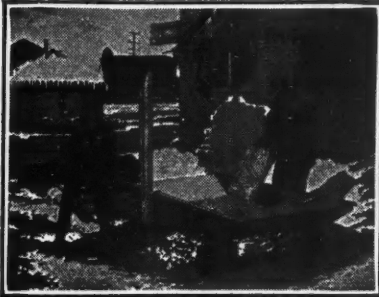

With HELTZEL steel mixing boxes, cold weather won't hold up your work. Simply fire up and let the work go on. Three sizes. Low prices. Outlast a dozen wood boxes. Nothing to catch the mixing tools. Water tight after first use. Write for mixing box bulletin and prices.

The Heltzel Steel Form & Iron Company
WARREN, OHIO

HELTZEL

Why Contractors Prefer "Nationals"

The "National" Electric Floor Surfacing Machine.



1. Beautiful Finishes
2. Surfaces Up to Quarter Round.
3. Absolutely Dustless.
4. Completely Enclosed.
5. Sturdily Built.
6. Sold on Approval.

National Sanding Machine Company
4567 Diversey Ave., Chicago, Ill.

SLIDE—

This Rule for **INSIDE MEASUREMENTS**

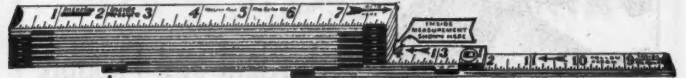

Cut out "guesswork"—use the MASTER SLIDE RULE and always be accurate—exact—safe! This scientific measuring device is the last word in rules. No rule supersedes the MASTER SLIDE RULE for accuracy and simplicity.

For taking inside measurements order a MASTER SLIDE RULE from your dealer, or if he does not carry them, write directly to us. MASTER RULE CO., 815 East 136th St., New York City

Let us **SHOW YOU**
The Way to **Start Your Own Business**

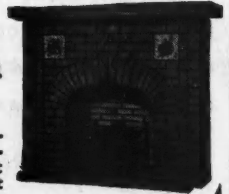

We sell you the complete forms, moulds, formulas and full instructions on how to build fireplaces. Excellent opportunities now for alert contractors of fireplaces. Build a product that costs less—sells quickly and nets you large profits. Unskilled labor can build these fireplaces with our full instructions.

Let us show you. It costs nothing to get the facts, how to start your own business. Terms. Write today.

NATIONAL FIREPLACE SUPPLY CO.
2743 Osgood Street, Chicago, Ill.

The Kennedy Utility Saw

Diameter of Saw 8"

Pat. No. 1622327



Without motor **\$25**

Will cross-cut, rip, plane, groove and tongue, plough, bevel, bore, sand, rabbet, tenon, mortise joint, make mouldings, etc.

RALPH M. KENNEDY
111 North 7th St.
PHILADELPHIA, PA.

Ball Bearing table tilts to 45°

OLD EUROPEAN SLATE ROOFS

Exactly duplicate the old slate roofs of Europe with their rich colorings and strong natural texture.



Roof Suggestions on Request.

KNICKERBOCKER SLATE CORP.
E. J. Johnson, President
355 West 26th St. New York

Do You Build HOMES

Here's an added feature which appeals to men

"Every Home Can Have Its Own Gymnasium"



GYM JUNIOR

Patented in U. S. and Foreign Countries

is a strong malleable iron apparatus, combining in 7½x9 ft. floor space, a Rowing Machine, Chest Weights, Punching Bag, Parallel Bars, Wrist Developer, Chinning Bar, and other standard gymnasium equipment. Three persons can use it simultaneously.

Put it in attic, basement, sleeping porch or small room next to shower. Advertise your homes as **HEALTH-HOMES** — "equipped with a complete gymnasium." Then you will have a selling angle to men, just as built-in kitchen fixtures influence women buyers.

Write for illustrated literature and special discounts to builders.

GYM JUNIOR COMPANY
540 Gregory Avenue, Weehawken, N. J.

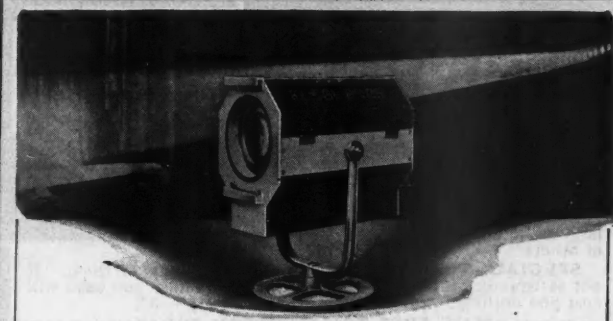

that STAGE LIGHTING job

THE safest and easiest way to handle it is—ask Kliegl Bros to check your plans and make suggestions—being specialists in theatrical lighting we can help you get the best results at the least expense—and our products are dependable, easily installed, approved, and priced right.

OTHER KLIEGL LIGHTING SPECIALTIES

Footlights	Exit Signs	Floor Pockets	Floodlights
Borderlights	Aisle Lights	Wall Pockets	Spotlights
Cove Lights	Step Lights	Panel Boards	Music Stands
Color Lighting	Auto-Calls	Dimmers	Scenic Effects

for Descriptive Literature write:

KLIEGL BROS

UNIVERSAL ELECTRIC STAGE LIGHTING CO., INC.
ESTABLISHED 1896
321 WEST 50th STREET
NEW YORK, N. Y.

One Sure Way to Make Money On Any Construction Job

Use the
SAFE, SAVING, STURDY
Reliable Scaffold Brackets

No holes to plug after they are removed



Stronger and cheaper than costly wooden scaffolding — quickly erected and quickly taken down, they are time and money savers on any job—wood, brick, stucco.

Thousands of other wise builders are using them—have used them for years. What they will save you will surprise you.

Figure on using them on that next job. Send for our catalog showing the various types and styles. Glad to ship C.O.D. with privilege of inspection, before you pay a penny. We wouldn't make this offer if we didn't know they are good.

ELITE MANUFACTURING CO., - Ashland, Ohio

If you want to know

- the amount of labor required for the various operations of a building construction job.
- the prices of labor and materials as a check on your estimates.
- the cost of replacing various types of existing buildings.

See this book

Barnes'

ESTIMATING BUILDING COSTS and APPRAISING BUILDINGS

A THOROUGH, up-to-date cost handbook for the building contractor, estimator and appraiser. The book covers all types of building. The data in the book are arranged for quick, easy reference. Wherever possible they are presented in the form of tables.

From excavation and foundation work right through to the wiring and painting of the finished buildings, the book gives exactly the information needed to insure safety in the estimate from every point of view. It tells you how to calculate the cost of materials, of labor, of haulage, of overhead, of equipment, and so on. It gives valuable information on installations and material strengths.

By
Frank E. Barnes
Supervising
Bldg. Valuation
Engineer
N. Y. C. Lines

818 pages
4½x7, flexible,
\$5 net,
postpaid

McGraw-Hill Book Company, Inc.
370 Seventh Ave.
New York City

You may send me for 10 days' free examination Barnes' *Estimating Building Costs and Appraising Buildings*, \$5 net, postpaid. I agree to remit for the book or to return it, postpaid, within 10 days of receipt.

Name.....
Address.....
Position.....
Company.....

**See your copy free—
MAIL THIS COUPON!**

A. B. 3-1-28

Self Clinching
JAMB NAILS



Set your door jambs with this new Universal Jamb Nail. It makes a perfect job, saves time, leaves no hammer marks or nail holes to putty up. They are easy to use. These Jamb Nails hold jamb squarely when building settles.

Used by Mills & Sons (the world's largest home builders) and hundreds of others.

SPECIAL—Try 1000 at our expense. Use some of them. If not satisfactory return what you have left. Those you used will cost you nothing. **THREE SIZES: 1 1/4" - 2 1/4" - 3"**

-----**MAIL FREE TRIAL COUPON TODAY**-----

Strand Mfg. Co.
 644 West Randolph St., Chicago, Ill. AB 3-28

Send 1000 Universal Jamb Nails on approval.

Name.....
 Address.....



Real Heat in the Electric Fireplace

Our Ruby Coal Electric Grate fits into any of our ready-made fireplaces and adds the finishing touch together with real heat to the room. The Electric Fireplace eliminates odors and dirt and leaves more space in your living room.

Let us send you full details of ready-made fireplaces and Ruby Coal Electric Grates.

WRITE TODAY

ELECTRIC FIREPLACE MFG. COMPANY
 400-8 N. Union Ave. Chicago, Ill.

The CABINET STAIRWAY



Slides Up in the Ceiling When Not In Use

USE YOUR ATTIC

Non-collapsible; the stair stringers are all one piece, rigid and neat in appearance. Strong enough to carry a person on each step. Perfectly counterpoised by highly resilient springs enclosed in well finished drums.

Send for particulars

THE STAIRWAY MANUFACTURING CO.
 Akron, Ohio

The Contractor's Delight

Specially Designed for Contractors



WRITING up specifications on the L. C. SMITH SPECIAL CONTRACTOR'S model is easy. All the symbols and extra keys contractors and architects need. Time-saving, convenient specification tabulator. Equally good for business correspondence. The world's only ball-bearing typewriter; longest wearing; easiest running; turns out best appearing letters, specifications, carbons.

\$3 DOWN

Special Contractors Keyboard & Specification Tabulator

Yours for 10 Days FREE

To show you what a difference this specially designed contractor's model makes, we'll send you a Re-Newed L. C. Smith for a 10-day trial. You can save \$40 by buying now. Write today for details.

SMITH TYPEWRITER SALES CORP.
 293-360 East Grand Avenue Chicago

Universal All-Metal Built-In Mail Chutes

Improve Your Houses

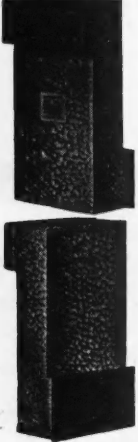

The handsome, dull finished, wrought brass face plate of the Universal All-Metal Built-In Mail Chute always draws a favorable comment from home buyers.

The door on the interior wall is of dull ornamental brass and the chute of galvanized iron.

Specially made for easy installation in frame or stucco walled houses and built to last as long as the wall itself, this mail box is a great asset to any house.

The exterior and interior doors of Model F-4 are illustrated at the left.

Very reasonably priced at **\$4.50**

Send for our illustrated folder showing different models.

AMERICAN DEVICE MFG. CO.
 4527 Shaw Ave. St. Louis, Mo.

BEST FOR GARAGES, WAREHOUSES, AUDITORIUMS, FAIR BUILDINGS, ETC.



Lamella (Patented)

Lamella Roofs are safe, economical and attractive in appearance. Lamella construction eliminates interior columns and trusses. Write for folder and address of nearest agent.

for **LAMELLA ROOF SYNDICATE, Inc.**
 45 W. 45th St., New York, N. Y.

TRUSSLESS ARCH ROOFS

THE GROWING DEMAND FOR FIRE-SAFE ROOFING

of Permanent Beauty and Service at Reasonable Cost can only be met by **CONCRETE ROOF TILE**.

Our **U. S. CHAMPION TILE MACHINES** turn out Light-Weight French and Spanish Concrete Tile Roofing at minimum cost. Anyone can make it and lay it profitably. Proof of 34 years of successful practice is there.

These machines are simple to operate, turn out perfect tile, are speedy, and cost comparatively little. A surprisingly small amount of money purchases our complete tile making outfit.

A Well-Built house needs a concrete tile roof for being perfect. You can supply it profitably by using our machine.

Write for our illustrated Circular and Prices

L. HANSEN CO., 2311 Ward Ave., Kansas City, Mo.



The Only Wall Board with the 4-ply Nailing Edge

White Rock Fireproof Gypsum Wall Board

THE AMERICAN GYPSUM CO.
 White Rock Wall Board—Anchor Gypsum Lath-Plasters—Hydrated Finishing Lime—Anchor Gypsum Partition Tile
 Anchor Roof Tile—Stucco—Plaster Paris
 General Offices, Mines and Mills
PORT CLINTON, OHIO

State Portable Saw & Jointer

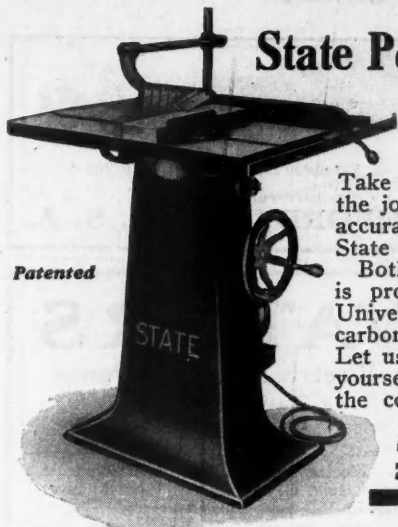

Patented

Save Time and Power by the Use of these Machines. Learn how you may own them Yourself at a Small Cost.

Take the State Universal Saw or Jointer to the job with you. See how economical and accurate you can finish a job by the use of State machines.

Both machines are easy to operate; a guard is provided assuring perfect safety. The Universal Saw will cut wood fibre, asbestos, carbon, soft metal, etc.

Let us tell you how to own these machines yourself at a small cost. Write today using the convenient coupon attached.

STATE MFG. & ENG. CO.
2756 W. Fulton St., Chicago, Ill.



Mail this Coupon

STATE MFG. & ENG. CO.
2756 W. Fulton St., Chicago, Ill.

Gentlemen: I am interested in your State Universal Saw and also your Jointer. Send me complete information.

Name.....
Address.....
City.....
State.....

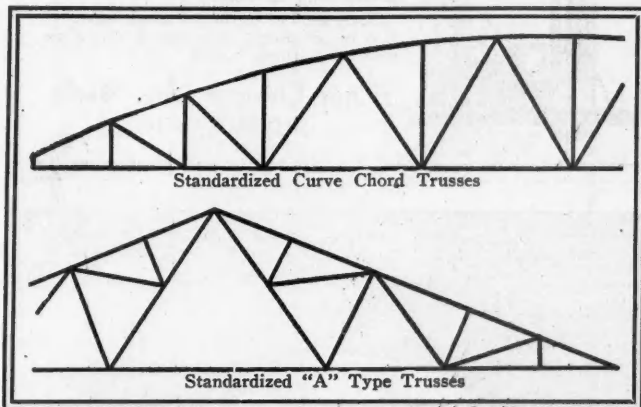

Standardized Steel Roof Trusses

Massillon Steel Roof Trusses are built from regular structural shapes in standard stock sizes for all roof truss spans. No metal is less than 1/4 inch thick. All shop connections are arc welded. The longer trusses are shipped in sections with turned bolts for assembly in the field. Massillon Bar Joist Purlins and Nailor Joist Purlins provide the most economical purlin construction. Send for designing data and safe loading tables.

The Macomber Steel Co.
909 Belden Ave. CANTON, OHIO

MASSILLON
ROOF TRUSSES

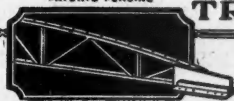

THE USE OF Bogalusa "edge-grain" Long Leaf Yellow Pine Flooring results in a beautiful, smooth, even surface—famous for its wearing qualities. Once nailed down, it stays flat and immovable through years of service.

Makes a fine floor when used over old floors in old houses. Brightens up and enriches the entire house.

We offer prompt shipment on any size order.
Write or wire for quotations.

GREAT SOUTHERN LUMBER CO., Bogalusa, La.

BOGALUSA

TRADE MARK REGISTERED U.S. PATENT OFFICE

Look for the Name Stamped on Every Foot of Cord

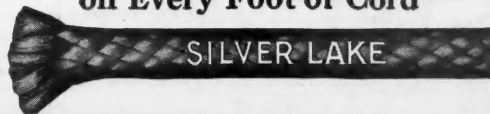

SILVER LAKE

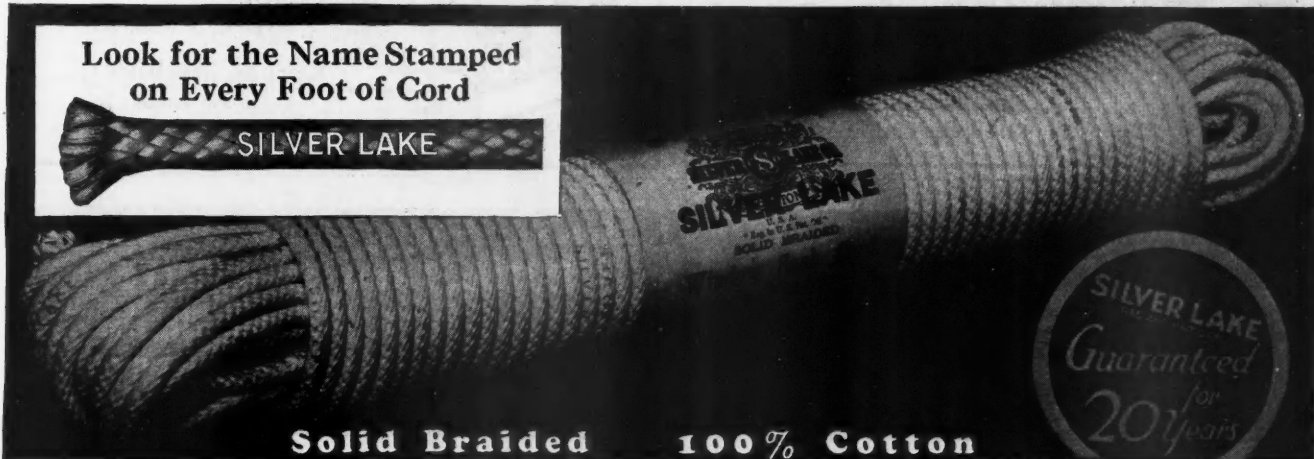

Solid Braided 100% Cotton

WHEN WRITING ADVERTISERS PLEASE MENTION THE AMERICAN BUILDER



Adjustable Countersink No. 124
Registered Trade Mark "FOREST CITY"
FOREST CITY BIT & TOOL CO.



Extension Lip Machine Bit No. 102
Incorporated 1890
ROCKFORD, ILL., U. S. A.

FOREST CITY BIT & TOOL CO.

Stanco One Piece Wall Tile for Kitchens and Baths

ERECTION AGENTS WANTED



Stanco One Piece Wall Tile is a Ready Finished Porcelain-like Tile Substitute at half the cost — It is easy to install and never needs refinishing — It sells itself.

Good exclusive sales territories are still open for Erection Agents for those who can qualify.

STANDARD WALL COVERING CO.
1821 North Ninth Street Philadelphia, Pa.



ELEVATORS

**Electric and Hand Power
Dumbwaiters
Builders Hoists
Material Elevators**



Electric Power Units, or Attachments, for Hand elevators. Don't fail to investigate this most efficient device.

Our Elevators are time and labor savers, easy to install.

State kind of elevator wanted, capacity, size of Platform, and overall height as well as platform travel.

Sidney Elevator Mfg. Works
SIDNEY, OHIO

Beautiful Brick Effects

deserve

**Anchor Brand
Mortar Colors**



C. K. Williams & Co.
634 North 13th St.
EASTON, PA.

for
Stores Offices
and Homes

Hopson Metal Ceilings and Sides

Tasty, dignified designs, characterize Hopson Metal Ceilings and Sides. They're all easy to match and install. Our pictorial catalogue will show what we have to offer in original designs. Get a copy today.

W. C. HOPSON CO.
704 Ellsworth Ave. Grand Rapids, Mich.



Something Finer!

*A Hidden Medicine Cabinet
—A Fine Venetian Mirror*



Here you have the elegance of a decorative mirror. The medicine cabinet is hidden. No hinges visible. The back of the mirror is of steel finished in hand-rubbed walnut. The cabinet is of electrically welded steel, white enameled. Every builder should have the complete Bulletin of our comprehensive De Luxe line on hand. Write for it today.

Majestic Steel Cabinet Co.
Household Steel Cabinet Headquarters
4211 Belle Plaine Ave. Chicago

A TOOL FOR EVERY JOB



This Combination Woodworker takes care of all your work. No other equipment is needed. Detachable lathe makes it portable. Get this complete workshop equipment and watch your PROFITS RISE.

Write for Particulars.

Kornau Machine Co.
Gulow and Vandalia Sts.
Cincinnati, : : Ohio

"READY" STEEL BRIDGING



Made of rust-resisting TERNE PLATE STEEL

See this Bridging at your **DEALERS**
INITIAL TRIAL SHIPMENTS
To contractors at 2 3/4 cts per strip F.O.B. Muncie Ind
FREE SAMPLE ON REQUEST
MID-WEST METAL PRODUCTS CO · MUNCIE IND.

IT'S NEW

PORTER-CABLE

PORTER-CABLE GRAM

SYRACUSE, NEW YORK

THE PORTER-CABLE MACHINE CO.

FLOOR SANDING CONTRACTORS - SOMETHING BIG COMING! AMAZING IMPROVEMENT IN FLOOR SANDING MACHINES WATCH FOR APRIL ANNOUNCEMENT PORTER-CABLE MACHINE CO. SYRACUSE, N. Y.

WAIT

CLASS OF SERVICE
LATHES
GRINDERS
SANDERS

Patrons are cautioned to order greater capacity and profits through the adoption of PORTER-CABLE PRODUCTS

SYRACUSE Sanders are Built Like Machine Tools!

BEAVER

COMBINATION WOODWORKER

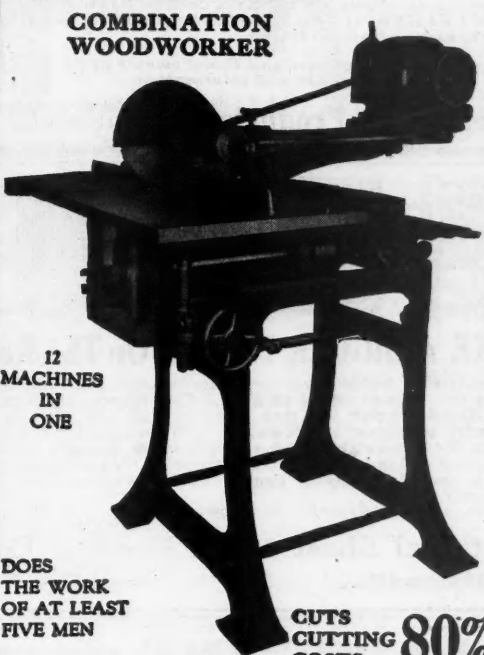

12 MACHINES IN ONE

DOES THE WORK OF AT LEAST FIVE MEN

CUTS CUTTING COSTS 80%

Write for Free Folder AB-9

HUTCHINSON MFG. CO., INC.
 MAIN OFFICE AND FACTORY, NORRISTOWN, PA.

Weather stripping is profitable work

Contractors, builders and representatives are making real money by handling and installing Kuhlmann's Metal Weather Stripping.

You can often weather strip a house or building between larger jobs and thus keep busy all the time.

Kuhlmann's Metal Weather Stripping is made in zinc, bronze and brass in various styles for double hung and casement windows and doors, etc. (Note cross sections.) It can easily be installed with ordinary tools.

Write for our proposition and samples and get in on this profitable work.

KUHLMANN METAL WEATHER STRIP COMPANY

3805 Forest Park Blvd. St. Louis, Mo.



THE ECONOMY INCINERATOR

Safe! --- And Costs Nothing to Operate

The "double-door" feature of the Economy Incinerator is real fire protection. No flames, gas, soot or smoke can come into the room.

And remember, the Economy costs *nothing* to operate. No fuel of any kind is required. Complete combustion is secured by strong drafts and correct design.

First cost, too, is astonishingly low --- and the first cost is the last. Once installed, there is nothing to be replaced.

Write for full details---now

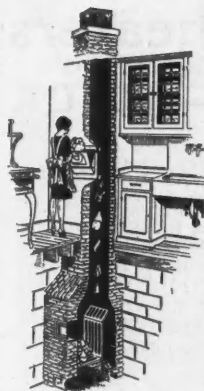

This is the type of installation constructed at the time the building is erected.

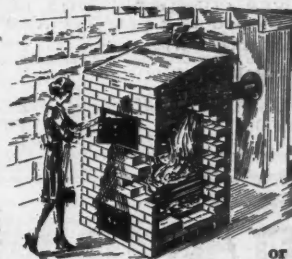

This model is for houses already built. Can be installed at low cost in any home or other type of building.

ECONOMY INCINERATOR CO., INC.
 Milwaukee, Wis.



KOLSTAD
 Built-In MAIL BOX

Why Kolstad Boxes are Better

Absolutely Weather Proof—Snow, sleet or rain cannot drive in.

Permanently Trouble Proof—No springs or wearing parts to get out of order.

All Metal—No wood parts to warp or crack.

Easily Installed—Inside door insertable after plastering. Harmonize with the handsomest home. Manufactured under original Kolstad Patents.

Three sizes: \$8.50, \$6.75, \$3.50. Send for data.

KOLSTAD MAIL BOX CO.
 318 West 1st Street
 Duluth, Minn.



LIGNINE (WOOD) CARVINGS—UNBREAKABLE

Their USE will Save You—BIG MONEY. Beautiful, Attractive, Dependable. Can be Carried in stock Without Loss. Capitals, Pilasters, Drops, Scrolls, Corners, Heads, Period Designs. Supplied in Oak, Mahogany and Walnut.

NUMBER 9 CATALOG—FREE

ORNAMENTAL PRODUCTS COMPANY
14th Ave. and La Fayette Blvd., Detroit, Mich.

**Faster . . . Cheaper . . . Better
with H & A Bench Saw Table**

Portable . . . Electric

SAVE nine-tenths of the time and labor of hand sawing. Cut your payroll. Get better and more accurate work. Plug into the nearest lamp socket. Write for information and prices.

Heston & Anderson
203 Western Ave.
Fairfield, Iowa

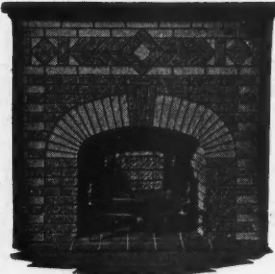
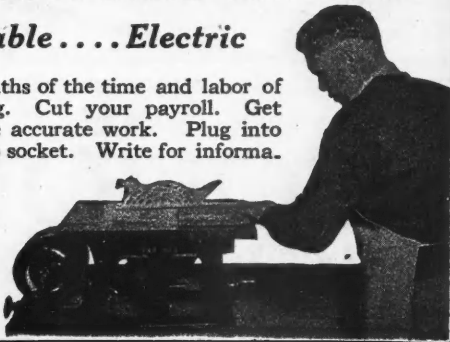

READYBUILT
(Reg. U. S. Pat. Off.)
FIREPLACES

Adds Cheer—Beauty—Comfort
and
Selling Value to Your Houses

The soft romantic appeal of the READYBUILT fireplaces is irresistible to the home buyers. Made in a variety of designs, styles, sizes and colors. The sides of READYBUILT fireplaces finished similar to facing. Shipped complete anywhere—ready to install.

Dealers, Builders and Home owners write for prices and information.

The Readybuilt Products Co. 2404 Frederick Ave. Baltimore, Md.

Sepeco flameless
water heaters
HOT WATER—QUICK

THE NEW METHOD—WITHOUT FLAMES OR FIRE HAZARD. WITHOUT FUMES, MUSS OR FUSS, WITH THE SAME EASE AS DONE IN OVER 30,000 OF HOMES IN THE UNITED STATES. THE SEPCO ELECTRIC ENDORSED BY POWER COMPANIES WILL BE A REVELATION TO YOU IN COMFORT AND ECONOMY.

We will mail full details on equipping any home with SEPCO. You'll want to know the cost, conveniences, etc., so write us today for more information.

AUTOMATIC ELECTRIC HEATER CO.
1505 Race St. Philadelphia, Pa.

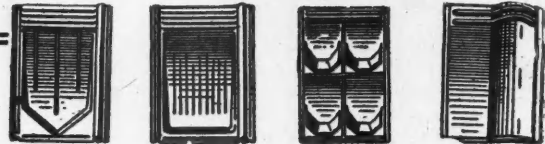

MAKE A BIGGER PROFIT On The Roof

Wise, thrifty builders will appreciate the saving in putting on Walters and Coopers Metal Shingles. The Walters and Coopers Metal Shingles weigh less than wood or slate and takes lighter frame work to support it. Moreover, it is permanent. This roofing does not require skilled labor to put it on, carries a low rate of insurance and is storm, wind and fireproof. We manufacture a complete line of designs in Painted Tin, Galvanized Sheet Zinc and Copper.

Write for full size samples and prices

National Sheet Metal Roofing Co.
339-345 Grand St., Jersey City, N. J.

HEY ALWAYS HOLD

Mitred Joints are the best Joints

Clamp Nails make them so. Guaranteed Everlasting Mitred Joints

DURABLE-DEPENDABLE-ECONOMICAL

Ask us for samples.

CLAMP NAIL CO.
4540 PALMER ST.
CHICAGO, ILLINOIS

CLAMP NAILS

750 LBS

MARSCHKE

Folding Stairs

Make better use of your attic

Ask for Booklet "A"

The Marschke Co.
St. Paul, Minnesota Columbus, Ohio

Electric Capstan Winch— for all purposes.

WINCHES

Manufacturers of winches for all purposes. Power, Electric and Hand Winches. For Motor Trucks, Tractors and general purposes. Also Lifting Jacks and Rollers for Lumber Trucks.

Safety Worm Geared Winches —made in eight sizes, 100 to 6000 pounds capacities.

Write for Bulletins and prices. State for what purpose winch is to be used, and weight of load to be lifted.

Manufactured by

Stimmel Winch & Machine Works
Works and Offices: 562-66 W. 22nd St. New York City

SIGN OF STABILITY

MESKER

STANDARD BOWSTRING STEEL ROOF TRUSSES WRITE FOR CATALOG
BETTER TRUSSES FOR LESS MONEY GEO. L. MESKER & CO. EVANSVILLE IND.

TAYLOR COLLAPSIBLE HORSES

Taylor Collapsible Horses are easily taken apart or assembled. Can be carried or delivered to different jobs conveniently.



Can be made any size, length or height.

Will carry 8,600 pounds without a creak. No nails or braces.

Send for Complete information

TAYLOR COLLAPSIBLE HORSE CO.
730 West Harrison St. Chicago, Ill.

Sawing Jobs Simplified

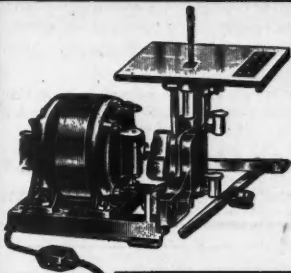

The International MOTOR SAW

does everything a bench saw should do. Cross cutting, mitering, ripping, beveling, scroll work—inside and outside—all are accomplished without changing blades or parts. Press the button and start sawing. Ideal for carpenters, builders, shop and home owners, manual training, etc. Portable, weighing less than 50 pounds.

Write for particulars.

The International Stamping Company
Dept. B
400 North Leavitt Street, Chicago, Illinois

WEATHERSTRIP MEN WANTED— \$5000 TO \$7500 PER YEAR

Ceco is making an unusual proposition to one good weatherstrip man in each of 15 cities. The profits should run well over \$5,000 the first year. You work under a plan utterly different from anything you've known in the weatherstrip business. You own your own business. Yet you get more support than ever before offered. Write at once for full details. Address Sales Manager,



Ceco Weatherstrip Co.
1926 So. 52nd Ave., Chicago, Ill.

METAL WEATHERSTRIPS

—For permanence specify the famous

Hodell Sash Chain



Hodell No. 75 Apartment Sash Chain offers the most modest home or apartment building all the advantages of noiseless, permanent, smooth-running sash chain at no greater cost than for cord. Formed from a cold-drawn ribbon of polished steel, NOT STAMPED FROM SHEET; every link is uniform. See Sweet's. Ask for A. I. A. Specification File, Class 27-A1, and No. 75 folder.

We have some open territory on an exclusive basis for reliable resident agents handling several builders specialties.

THE CHAIN PRODUCTS CO.
Established 1888
CLEVELAND, OHIO

Why Buy a Big Machine—



with its big first cost and upkeep when a Boice-Crane Bench machine will do the job accurately and speedily at a fraction of the cost? Whether you want a band saw, circular saw, jointer, mortiser, jig saw, or lathe you'll find it listed among

Boice-Crane Bench Machines

Jointer shown cuts all kinds of mouldings. Has 4 1/2" knives and table length of 36". Safety head and safety guard. Full ball-bearing. Easily operated by 1/4 h.p. motor.

Universal Handisaw shown has table 15"x17". Elevates for grooving—tilts 45° for bevelling. Swings 8" saw, cuts 2 1/2" stock. Insert takes dado head 6"x1", cope heads and 8" sand disc. Also has insert providing opening for 3" jointer head. Jointer attachment fits on right of table. Guides always remain parallel to saw regardless of elevation or tilt of table. No other saw of equal cost has this feature.

All Boice machines operate from light socket. Sold with or without motor. Send for illustrated catalog showing complete line of Boice-Crane Bench Machines. Send today!

W. B. & J. E. BOICE, Dept. A. B. 3-D, Toledo, Ohio

Iron Railings for Every Purpose

Plain and ornamental iron fence—entrance gates, wire and iron window guards, folding gates, gratings, cellar doors, etc. *Catalog on request—estimates cheerfully given—orders filled promptly*



CINCINNATI IRON FENCE CO., Inc., 3331 Spring Grove Ave. CINCINNATI, OHIO

PULLMANIZE YOUR WINDOWS!

From Mills & Sons—Home Builders—5558 W. North Ave., Chicago, Ill.

"One of the most outstanding improvements in our building construction has been the adoption of Pullman UNIT Sash Balances. When all economies made possible by your device are given proper credit we find them more economical, even in speculative building operations, than the old sash weight box window frame plan. It is also the last word in satisfactory window balancing equipment and we believe you have the best window control available."

Write for New Folder Today

PULLMAN MFG. CO., INC. 47 SOUTH FORD ST. ROCHESTER, N. Y., U. S. A.



The ZAGELMEYER SYSTEM Is the only one that produces perfect concrete blocks. **ELIMINATES COMPETITION — INCREASES PROFITS.** No other block made like it, therefore you have no competition. **PRODUCTION COST LOW — PROFITS BIG.** Produces block, brick and tile for less than any other. Your locality may still be open. Write today.

MULTIPLE MOLDS FOR CASTING BLOCK -- BRICK -- TILE

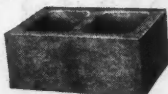

5x8x12 Tile

Send for Free Catalog

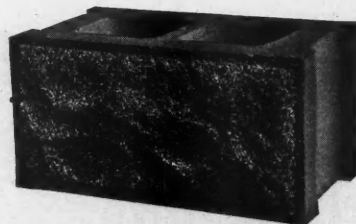

Waterproof Block with Beautiful Face

1101 S. Henry St. ZAGELMEYER CAST STONE BLOCK MACHINERY CO. Bay City, Mich.

Increase Your Income During 1928



You can make more money—selling and installing Federal Metal Weatherstrips. Other contractors are cashing in on our attractive agency proposition. Economy and protection are easy to sell and every home, office building, school, apartment house and church is a prospect for Federal Metal Weatherstrips.

Writing for our agency proposition puts you under no obligation. Let us tell you how it is done.

Federal Metal Weather Strip Co.
4538-58 Fullerton Avenue - Chicago, Illinois

SAVE 1/2 ON YOUR MILLWORK

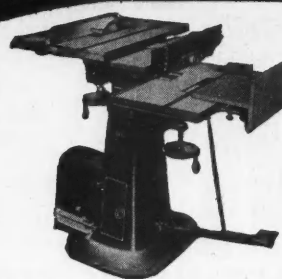

SIMPLICITY
Combination Woodworker

Performs 28 different, practical operations. 8 machines in one. Makes all kinds of wooden articles, including lawn, garden and built-in furniture way below usual cost.

1000 Useful Salable, Big Profit Designs Illustrated in Our Plan Books. Write for money-making information.

COMBINATION WOODWORKING MACHINE CO.
551 W. Randolph St. Chicago, Ill.

Hoosier HOLLOW Structural Tile for all **PERMANENT BUILDING**

HOOSIER Building Tile offers you durability, fire-resistance, beauty, adaptability to any kind of building, economy of labor cost in construction and the elimination of upkeep expense for interior and exterior finished wall construction. Smooth glazed or wire-cut finish furnished. Write for literature. Send plans for estimate. ADDRESS DEPT. B 5.

Hoosier BUILDING TILE COMPANY
Albany, Indiana

Just Completed and the Outstanding Success of the City

The Belvedere Hotel
48th Street, West of Broadway — Times Square's Finest Hotel

Within convenient walking distance to important business centers and theatres. Ideal transit facilities; 450 rooms, 450 baths. Every room an outside room—with two large windows. Large single rooms, size 11' 6" by 20' with bath, \$4.00 per day. For two, \$5.00—twin beds, \$6.00. Large double rooms, twin beds, bath, \$6.00 per day. Special weekly rates. Furnished or unfurnished suites with serving pantries \$95 to \$150 per month. Moderately priced restaurant featuring a peerless cuisine.

Illustrated booklet free on request.

CURTIS A. HALE, Managing Director.

INTERNATIONAL CASEMENTS

OTSWOLD CASEMENTS of solid rolled steel with muntins for sheet glass or prepared to receive leaded glass. Standard sizes and designs. Write for catalog containing full details and photographs.

INTERNATIONAL CASEMENT CO. INC.
90 HOPKINS AVENUE - JAMESTOWN, NEW YORK

Now!! only \$70 cash, f. o. b. factory complete with 60 cycle electric motor

Biggest capacity for price

Due to quantity production, world wide distribution, long experience in water plant building and F-M manufacturing efficiency, this modern 210-gallon-per-hour home water system can be offered at the lowest price ever placed on a unit of this capacity. Enclosed and fully protected. Automatic. Built with F-M dependability—and unmistakably the greatest water system value ever offered! There's a size and type F-M water system for every purse and purpose. Write for new catalog—just published.

FAIRBANKS, MORSE & CO.
Manufacturers Chicago, U. S. A. Dept. H-3

FAIRBANKS-MORSE HOME WATER SYSTEMS

A Selling Feature — Worth 5 Times Its Cost

GAS-GARD Water Heater Control is a system for lighting and turning off any gas water heater from bath, kitchen and laundry by merely touching an electric button. No matter where the heater is located. Red indicator lights in the switches tell you when the heater is lighted. A safety device shuts off the gas when the water is hot, should you forget it. **Backed by an Unconditional Guarantee.** Simple to install, convenient, economical and safe. **GAS-GARD** attracts more attention in your houses than features costing many times more. **GAS-GARD** will earn money for you. Write for folder. Dealers wanted in unassigned territories.

The GAS-GARD COMPANY, 375 Main St. East, Rochester, N. Y.

ZIMMERMAN PATENT IRON BASE

**NO MORE
WATER SOAKED
BASES**

The Zimmerman Patent Iron Base prevents rotting of wood columns.

The Zimmerman is the only base having center bearings. Lifts the column from 1 1/4 to 6 inches off the floor, allowing the air to circulate between the column and the floor. Water runs off without wetting the bottom of column. Specify this base by name.

S. CHENEY & SON, Manlius, N. Y.

HEINZ COPPER CORNER FOR STUCCO CORNERS

No
More
Wood
Strip-
ping

Copper
Nose
Corrosion
Proof

We Man-
ufacture
All Types
of
Corner
Beads

Church Appliance Mfg. Co.
935 Hennepin St.
LA SALLE : ILLINOIS

**WRITE FOR SAMPLES
AND PRICES**

PERMAROC

The Perfect Blackboard Surface

PERMAROC gives more dollar for dollar value than can be obtained in any other blackboard regardless of price. The surface is composed of ground slate and carborundum which provides the finest writing surface obtainable—a writing surface which meets every school room requirement—a blackboard surface which the teachers and pupils delight in using. PERMAROC is as permanent as slate, brick, concrete or any other building materials. It will outlast the life of any school building.

Write today for complete information, sizes, samples, etc.

E. W. A. ROWLES COMPANY
2347 South La Salle Street CHICAGO, ILLINOIS

A Strong Man~ can stand on it— a child can operate it

Slides Up
Into Ceiling
When
Not In Use

Here is a disappearing stairway that beats the world for convenience, appearance and ease of operation. Moderate in price, too.

Send for all
the facts
and figures

**THE DISAPPEARING
STAIRWAY CO.** AKRON OHIO

FORSTNER BITS

BRACE & MACHINE

THE FINEST Tool Manufactured
for important wood work.

Specially adapted for Hardwood operations;
indispensable to the High Class Carpenter
and for Cabinet and Pattern Works.

Manufactured by
THE PROGRESSIVE MFG. CO.
TORRINGTON, CONN.

Special Offer

A sample bit up to 1 inch in diameter will be mailed postage prepaid, upon receipt of 75c to any woodworker or carpenter.

BUILT-IN WOODWORK

Adds the touch of Refinement. Beauty that increases renting and selling values.

SEE OUR OFFERS

Bookcase Colonnades—Sideboards, Medicine Cabinets, etc., are of Distinctive Design and give living comfort to any home.

STEPHEN BILEK CO.
2119 South Troy Street : CHICAGO

Send for
Free
Catalog

The New Automatic Control ELECTRIC

GUARANTEED TO SAVE GLUE
AND TIME — WRITE FOR
FREE TRIAL OFFER
J. D. WALLACE & CO.
2809 ADAMS ST.
CHICAGO, U.S.A.

GLUE POT

HEATING BOOK

Ask for Agency Offer and Catalog

All Kinds of Heating—Hot Water—Steam—Hot Air—Pipeless—Pipe—Sewage Disposal—Water Supply—Plumbing—Low Prices.

ANDREWS HEATING CO.
1900 Healy Bldg.
MINNEAPOLIS, MINN.

ANDREWS HEATING COMPANY
Please Send Catalog and Agency Offer
Name.....
Address.....
Town.....
State.....

quality lighting fixtures

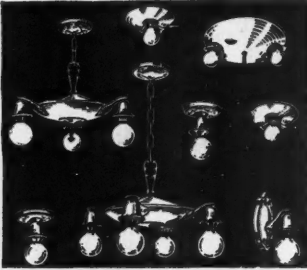

Complete Outfit for 5-Room House \$10

Living Room, Dining Room, Porches, Kitchen and Bathroom; all fixtures completely wired and assembled; we furnish tape, wood screws, fasteners and solderless connection. Every fixture guaranteed and tested. Artistic design; beautifully finished. Direct sale to you from factory makes this low price possible. We save you 1/3 to 1/2 on lighting fixtures.

Write for complete catalog.
BAB'S LIGHTING FIXTURE MFG. CO.
 4204 Hastings Street Detroit, Michigan

RUBBER TILE FLOORING

A profitable business with **"REAL RUBBER"** tile is open to contractors, builders and floor layers. The field is new and unlimited. Best season now starting. Our product has many superior features and price is right. Our full cooperation makes success assured. Sell from samples.

Write today for particulars, samples and choice of territory.

J. D. STRUTZEL RUBBER CO.
 Joliet, Illinois Dept. A.

\$35 COMPLETE WITH MOTOR

F. O. R. CHICAGO

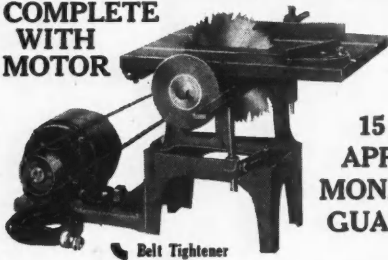

15 DAYS APPROVAL MONEY BACK GUARANTEE

18 TOOLS IN ONE
Greatest Machine You Ever Saw

The S&B 8-in. Combination Saw (18 tools in one) is the ideal machine for the shop, factory or the home; will rip, cross cut, bevel, miter, mortise, groove, drill, tenon, grind, rabbet, buff and polish. Motor is mounted on a base that is a part of the machine proper. Complete with attachments and price includes 1/3-H.P. Motor, 60-Cycle, 110-volt A. C., run from any light socket. Shipping weight 100 lbs.

(Planer attachment to fit on table top will smooth pieces up to 2 inches wide, \$12.00 extra.) Write for Complete Illustrated Folder.

SCOTT-BANSBACH MACHINERY CO., 130 So. Clinton St., Dept. 69, Chicago, Ill.

JOIN TO-DAY thousands who use MILLER DRIP EDGE

They like it. You will enjoy it's results when laying prepared roofings or shingles. Samples and particulars free. Send a card.

MILLER & GLEASON, Div. 1, Olean, N. Y.

PROFITABLE SPARE TIME WORK

BUILD YOUR OWN GRANDFATHER'S CLOCK WITH OUR HELP
 We furnish blue prints, finishing material and instructions. Buy the works, dial, weights and pendulum from us at surprisingly low prices. You make a fine profit building artistic clocks for your friends. Complete Works \$5.00. Others with Chimes at all prices. Ask for our attractive Free Offers

AMERICAN CLOCK CO., 1643 D Ruffner St., Philadelphia, Pa.



BE INDEPENDENT

Start a Business of Your Own

Atlas Weatherstrips are in Great Demand

Every home, apartment house, school, office buildings, etc., is a prospect for Atlas Metal Weatherstrips. Just a little effort on your part will assure you a handsome income. Write us today for agency proposition.

ATLAS WEATHERSTRIP CO.
 3943 W. 16th St. Chicago, Ill.

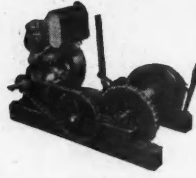

PROFITS With IDEAL HOISTS

Save money wherever there is a rope or cable to pull. Made in two sizes, 1,200 to 2,000 lbs. capacity. Reversible and non-reversible—single and double drum, with or without engine. Write today for complete information.

UNIVERSAL HOIST & MFG. CO.
 196 East 14th St. Cedar Falls, Iowa

Banks (Patented) Removable Steel Clothes Posts for Wash Day

We have added to our factory a PARKERIZING PLANT, making our clothes posts and flag poles, absolutely RUST PROOF. Known by their "Ace of Clubs Top."

If dealer or jobber can't supply, write for descriptive folder.

BANKS STEEL POST COMPANY
 128 Wakeman Ave., Newark, New Jersey



CONCRETE FORM TIE CORPORATION

134 SIXTH AVENUE
 HOMESTEAD, PA.

MAKERS OF CONCRETE FORM TIES (See reproduction above) and **LOCKTITE STEEL BRIDGING**

Let Tillery Fire Your Furnace!



Tillery's Little Janitor Clock will start your fires going before you get up. Works while you sleep. Contractors and Builders install this necessity at a very slight extra cost. Sells homes faster. Send for folder with prices.

TILLERY'S LITTLE JANITOR CLOCK CO.
 55 Orchard St. Newark, N. J.

INDESTRUCTO CARPENTER'S TOOL CASES

Made of three-ply Veneer with canvas, painted and varnished, waterproof, light and strong. Secure locks, strong handle, place for every tool, carried like suitcase.

Write for booklet and prices.

WEDELL & BOERS
 28 West Jefferson Ave. Detroit, Mich.

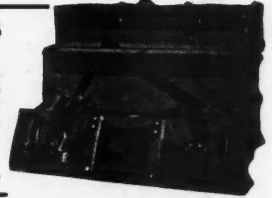

Stop "Guesstimating"—avoid Errors and Omissions

Our BUILDERS' ESTIMATE SHEETS

will SAVE Time and MONEY—
 100 leaves in a book, 4x9 1/2 inches. { 1 Book, \$1.00 }
 via Ins. Parcel Post same day we get order { 3 Books, \$2.50 }
 { 5 Books, \$4.00 }

LOUIS FINK & SONS CO., Printers

Time Sheets, Job Tickets, Letter Heads, etc.

Elm Ave., Laurel Springs, N. J.
In Business Thirty Years Noted for Quick Service

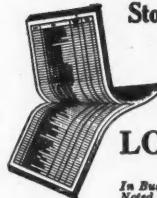

THE SLATINGTON-BANGOR SLATE SYNDICATE, Inc.

SLATINGTON, PENNA.

Miners and Shippers of

Black Roofing Slate **Natural Blackboard**
Structural Slate **Electrical Slate**
and Slate Products

Write us for prices

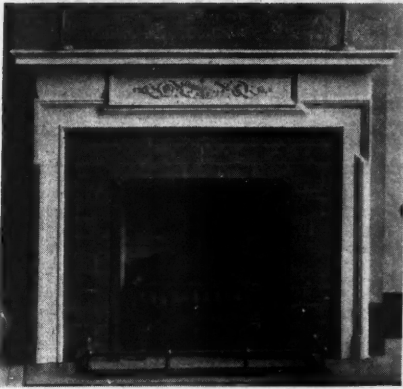

55 Designs in Wood Mantel-Pieces

Classical and Period designs in finishes to harmonize with any scheme of interior decoration.

Write for literature and descriptive folder showing mantel-pieces that will meet the requirements of any room in the home.

THE BRECHER COMPANY
443 W. Jefferson St.
Louisville, Ky.

INVISIBLE SASH PULLEYS OFFER MANY VITAL ADVANTAGES



OUTLASTS THE BUILDING

Produce a Tailored Frame with no Breaks in Weatherstrip

Free Sample On Request

VELGUTH METAL PARTS, INC.
418 4th STREET MILWAUKEE, WIS.

- OUT OF SIGHT
- DUST PROOF
- NOISELESS
- CAN'T CUT CORDS
- WEIGHTS WON'T JAM OR BANG
- RUSTLESS
- TROUBLE PROOF

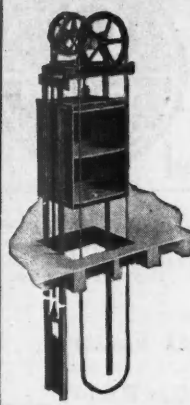

SEDGWICK DUMB WAITERS and ELEVATORS for All Purposes

A full line of Hand Power Outfits excelling in material, design and workmanship and including Trunk Lifts, Fuel Lifts, Ash Hoists, Gravity Drops, Invalid Elevators, etc.

Standard Sizes Ready to Ship

Write for Catalog
SEDGWICK MACHINE WORKS
154 West 15th Street New York
"Sedgwick Service Satisfies"

Builders Realize the Importance of Proper Humidity

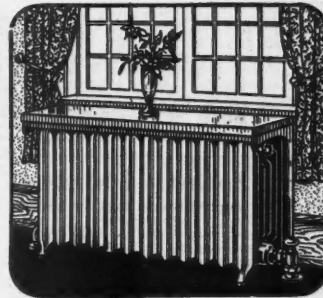

Winchester Cabinets and Covers should be installed in every home. Salient features are:

Saves unnecessary cleaning of drapes and curtains—prevents wall smudge.

Makes a useful window seat or table of your uncovered radiator.

Baked enamel finished to match any decorative scheme.

Made of auto-body steel; lasts a lifetime.

Provides proper humidity—makes for better health conditions.

Point out these features to prospective buyers. Write for information.
WINCHESTER RADIATOR CABINET CO., 551 W. Monroe St., Chicago, Ill.

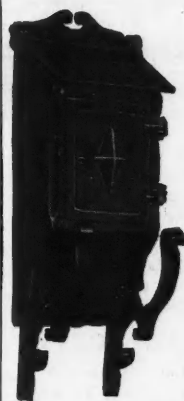

"CONSOLE" MAIL BOXES DESIGN "C"

CONSOLE MAIL BOXES lend a touch of artistic charm and individuality to the home. They are constructed of cast metal in various styles and finishes to suit the most exacting taste. Serves as a permanent utility.

We have other designs and finishes.

Write for information and prices

Colonial Hardware Manufacturers
128 N. Clinton Street Chicago, Illinois

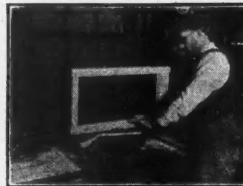

Do 1/2 Day's Work In 1/2 Hour with the "Oliver Portable" Jointer

Take it to the job. It operates from a light socket. Use it in place of hand planes for jointing and fitting. It saves time. Will make money for you.

Made in 4-in. and 6-in. sizes, this machine is thoroughly guarded, efficient and accurate. It handles any type of work within its capacity that a larger machine can. One user says, "It handles frames, fittings and a surprisingly wide range of work, and we have found it to be a real economy."

Ask for the new "Oliver" Junior Line Catalog, which describes this and other "Oliver" Portable Machines.



Oliver Machinery Co.
1009 Coldbrook St.
Grand Rapids, Michigan

We Mfg. A COMPLETE LINE OF BUILDERS' DERRICKS and Winches

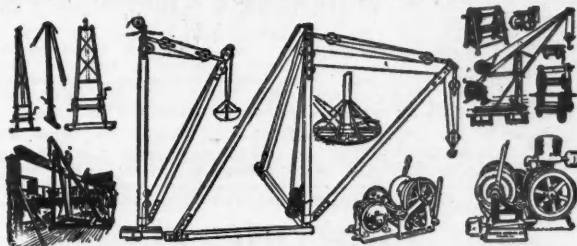

WE SEND DERRICKS ON TRIAL TO RELIABLE CONTRACTORS
OUR MOTTO IS SATISFACTION OR DERRICK RETURNED

Write for Circular No. 2 with illustrations, descriptions and best prices on our complete line. Sagen Builders' Derricks are built of the best Crucible Steel and Malleable Iron Fittings which makes them light, strong, safe and durable. The derricks will please you, and probably more than pay for themselves on the first job. Get one on trial.

SAGEN DERRICK CO., 3101-3125 W. GRAND AVE. CHICAGO, ILL.
NEW YORK OFFICE—130 West 42nd St.

ALLMETAL WEATHERSTRIP

BUY IT LIKE LUMBER
INSTALL IT YOURSELF
SAVE ABOUT 50%

-----RETURN COUPON TODAY FOR SAMPLES-----

ALLMETAL WEATHERSTRIP CO.
231 West Illinois Street, Chicago, Ill.

Name.....

Address.....

City.....State.....

Genuine By this Mark Genuine Franklin Tunnel



REG. U. S. PAT. OFF.

This work of excellence in Slate Roofing guarantees you to the absolute uniformity in quality found only in this roofing of the ages. Slate will outlast the building upon which they are laid. Their unexcelled beauty and quiet dignity are at once apparent in the home.

Will give you full information about
Genuine Franklin Tunnel Slate

Write to us for samples
SLATINGTON SLATE COMPANY
SLATINGTON PENNSYLVANIA

Athey Weatherstrip AGENTS

set the big business. The finest of Hotels, Office Buildings, Hospitals and private homes all over the U. S. A. are ATHEYZED. Installation Contractors who believe in selling the very best at a reasonable price with good profits, are making Big Money as exclusive agents for this high grade Weatherstrip. It makes any rattling, loose window or door of wood or steel, airtight, yet works smoothly without sticking. Some territory open in cities up to 50,000. We help you succeed. Write for details.
ATHEY COMPANY, 6100 W. 65th St. CHICAGO

Building Plans for Modern Homes



The most comprehensive book of homes ever published by any architect, size 8 1/2 inches, heavy board covers, 224 pages, 214 different designs for colonial homes, cottages, bungalows and two-family dwellings. Contains floor plans and all dimensions, photo of each design and approximate cost to build. You cannot afford to build until you have seen this book. Postpaid only \$3.00. A new book of 1928 edition containing fifty-eight snappy designs of medium-cost English and American colonial homes, postpaid only \$1.00. These books may save you hundreds of dollars in extras. Both books postpaid for \$3.50.

Frederick H. Gowing, Architect — 101 Tremont Street, BOSTON, MASS.

PATENTS

Time counts in applying for patents. Don't risk delay in protecting your ideas. Send sketch or model for instructions or write for FREE book, "How to Obtain a Patent" and "Record of Invention"

form. No charge for information on how to proceed. Communications strictly confidential. Prompt, careful, efficient service. Clarence A. O'Brien, Registered Patent Attorney, 189-E Security Bank Building (directly across street from Patent Office), Washington, D. C.



The Perfect Bond for Concrete

Contains no acid. Therefore cannot injure concrete or steel. Forms a bond stronger than the concrete itself.

Catalog on request
LIVING-STONE CO.
1 E. Lee Street, Baltimore, Md.

OUR TRADE MARK SINCE 1905

C. A. SNOW & CO.
PATENTS & TRADEMARKS
SUCCESSFUL PRACTICE SINCE 1875
716 8th St., Washington, D. C.

A Real Home Comfort
Mallory Shutter Workers
MALLORY MFG. CO.
700 BROAD STREET FLEMINGTON, N. J.

Classified Advertising

RATES:
Small letters 25c per word.
Capital letters 50c per word.
Minimum twenty words.

Business Opportunities
For Sale and Exchange
Help and Situations Wanted

To insure insertion remittance must accompany order

PATENT PROCURED. Prompt service. **PERSONAL, CAREFUL AND EFFICIENT SERVICE.** Highest references. Moderate fees. Send sketch and model for actual search and advice. **GEORGE P. KIMMEL**, Master of Patent Law, 94-C, Legal Bldg., Washington, D. C.

PATENTS—Booklet free. Highest references. Best results. Promptness assured. **WATSON E. COLEMAN**, Patent Lawyer, 724 Ninth St., Washington, D. C.

USED TRANSITS and LEVELS, BUFF, Hudson Terminal Building, New York City.

CARPENTERS, CONTRACTORS, BUILDERS, ETC.—Send for our Free Booklet, "How to Read Blue Prints." Tells how to make most money in the building trades. Every builder should have this information. Write today. Address: Dept. 2346, **CHICAGO TECH.**, 118 East 26th St., Chicago, Ill.

ATTENTION—Home Mechanics. We sell unusual cabinet hardware, chest trimmings, tea wagon wheels and casters, big line small hinges, locks, etc. Upholstering supplies, electrical hardware, knocked down cedar chests, etc. Send ten cents stamps for catalog. **THURSTON MANUAL TRAINING SUPPLY COMPANY**, Jobbers and Manufacturers, Anoka, Minnesota.

LIGHTNING RODS, "DIDDIE BLITZEN," approved by Underwriters. Write for territory and free samples. **L. W. DIDDIE COMPANY**, Marshfield, Wis.

Why have rusty tools??? **"KILRUST"** removes rust from chest of tools (few minutes) resisting future rust. Trial 35c—3 bottles for \$1. **DEEDERA PRODUCTS**, Winter Haven, Fla.

SALESMEN to sell side line nationally known cabinet ironing boards to dealers. Prefer salesmen now selling lumber. Exclusive territories given. **NATIONAL MILL & LUMBER COMPANY**, Oakland, California.

FOR SALE: One Houston Hollow Chisel Mortiser at a bargain. Write for particulars to **SCHMID & LEHRER CO.**, Springfield, Minn.

REPAIRING TRANSITS & LEVELS



NOW is the time to have your instruments repaired. Fully equipped repair plant at both Chicago and New York. All work guaranteed.

Ask for list of used transits and levels. Large stock of all makes at low prices.

CHARLES BRUNING CO., INC.
445 Plymouth Court, Chicago
102 Reade Street, New York



Waterston's Aluminum Vise

The handiest and most practical vise made for the Carpenter. Weight, only 2 lbs. Easily attached to end of Bench or Horse by tightening thumb screw. Holds boards, windows or doors plumb or horizontal. Both Screws work in Steel Bushings, making a strong, serviceable vise.

J. M. WATERSTON—424 Woodward Ave., Detroit, Mich.
Send for our No. 25 Catalog showing a complete line of Carpenters' Tools.

\$3.75 Postpaid



LIGHTING FIXTURES READY TO HANG

Direct from the manufacturer. Completely wired, including glassware. Send for new catalog No. 29. Just reduced prices.

Special Proposition to Dealers
ERIE FIXTURE SUPPLY COMPANY, Inc.
Station B Erie, Pa.



Expansion Nail

Send for Samples

The new Chicago Expansion Nail was developed primarily for holding wooden strips in place for fastening carpet in the new Stevens Hotel, Chicago. In only one operation the nail becomes an integral part of the concrete. Cheaper and better than driving in wooden plugs.

The Chicago CONCRETE Nail is practical and efficient. To be used only as a temporary fastening and later replaced with Chicago expansion products. We also manufacture Expansion Bolts, Nuts, Bridle Rings, Conduit Hangers and Toggle Bolts of all kinds.

Let us send you a sample Expansion Nail and Concrete Nail. Write for Catalog and Samples today.

Chicago Expansion Bolt Co.

126½ South Clinton Street, Chicago, Ill.



Concrete Nail



AJAX folding metal SHEATHING AND ROOFING BRACKETS

Take planks or boards up to 12-inches wide. The quickest ever, safe as the earth under your feet.

Send for descriptive literature to

Ajax Building Bracket Co.

1551 Rydal-Mount Rd., Cleveland Heights, Ohio



INTERNATIONAL HARVESTER TRUCKS COMPANY

Trucks: ¾-ton "Special Delivery", 1¼, 1½ and 2-ton Speed Trucks and Heavy-Duty Trucks up to 5-ton. Also McCormick-Deering Industrial Tractors. Write for information.

Service: Through our justly famous Company-owned truck service organization. 142 branches in the United States safeguard International Trucks.

At your service.

INTERNATIONAL HARVESTER COMPANY OF AMERICA (Incorporated)

606 S. Michigan Ave.

Chicago, Ill.

ORIGINATORS OF SASH CHAINS



SEND FOR OUR A 1 SASH CHAIN CATALOG DESCRIBING OUR FULL LINE OF SASH CHAINS

THE SMITH & EGGE MFG. CO. BRIDGEPORT, CONN.

QUICK ACTING *The Taylor* SELF LOCKING

CLAMPS An Investment Not An Expense

Quickest and strongest clamps made. Standard in U. S. Government Works and in such concerns as General Electric Co., Singer Sewing Machine Co., Victor Talking Machine Co., etc. We can prove it in your own shop. Write today.

JAMES L. TAYLOR MFG. CO., 110 Parker Avenue Poughkeepsie, N. Y.

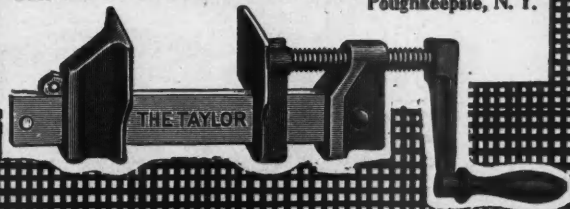

Good Reasons to Stock KEES PRODUCTS Quality Price

Detachable Spring Hinges

Screen doors put up or taken down without removing a single screw. For storm doors, too. Unbreakable; simple and substantial. Tempered steel; torsion spring; steel pin. A new product in the superior KEES line. Write for prices and catalogs.



F. D. KEES MFG. CO.

Box 93

Beatrice, Neb.

BETTER CONCRETE WALL'S



Low in Price, High in Efficiency USE THE LATEST

TRUE to line all steel MOLDS that build concrete buildings any design with speed and accuracy. Perfect tools mean better workmanship and more profit.

Send for literature.

GREENE'S STEEL MOLDS NORTH MILWAUKEE, WIS., U. S. A.

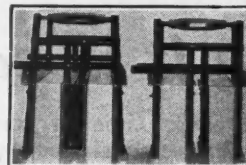

Open Closed

What Type Level to Select

Unless you know the advantages of Wye Level Construction as used in the

"STERLING" CONVERTIBLE LEVEL, PHILA. MODEL No. 40.

write for our "Helpful Hints" giving valuable information about levels which you should have BEFORE making your selection.

Better still—TRY a "Sterling" for 10 days at our expense, and note the sturdy design and special time and money saving features.

Return this coupon with your letterhead.



"Sterling" Convertible Level for use as a Transit.

WARREN-KNIGHT CO.

136 N. 12th Street. Philadelphia, Pa.

Send me "Helpful Hints"—free.

Send me folder FL-23, giving full information about the "Sterling"—including free trial offer and easy terms on which I can purchase it.

Name

Address

Business

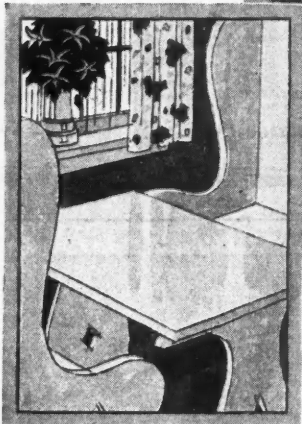

A bright, sunny breakfast nook—there's a place to start the day! Interior trim of Pondsosa Pine always stays snug and trim looking, too.

Excellent for all inside work. Pondsosa is a particularly happy choice for built-in features, such as a cozy little window seat.

Why should I use Pondsosa Pine?

Because it is easy to work with

Pondsosa Pine saves time in construction and that means money. Carefully milled, rigidly graded, and thoroughly seasoned, it is ready for the saw and hammer the minute it arrives on the job. Pondsosa Pine takes a clean mortise. It does not split readily, causing waste of material, botchy jobs or time-out for remakes. Pondsosa takes paint and varnish quickly and beautifully. The grain stays flat and ages without raising.

Use Pondsosa where a dependable soft wood is required and know the satisfaction of a quick-going, profitable job and pleased clients.

Lumber dealers everywhere carry Pondsosa—"The Pick o' the Pines"—it is trade-marked for identification and your protection with the Pondsosa brand.

Western Pine Manufacturers Association, Portland, Oregon.

Pondsosa Pine

The Pick o' the Pines

FOR ADVERTISERS' INDEX SEE NEXT TO LAST PAGE

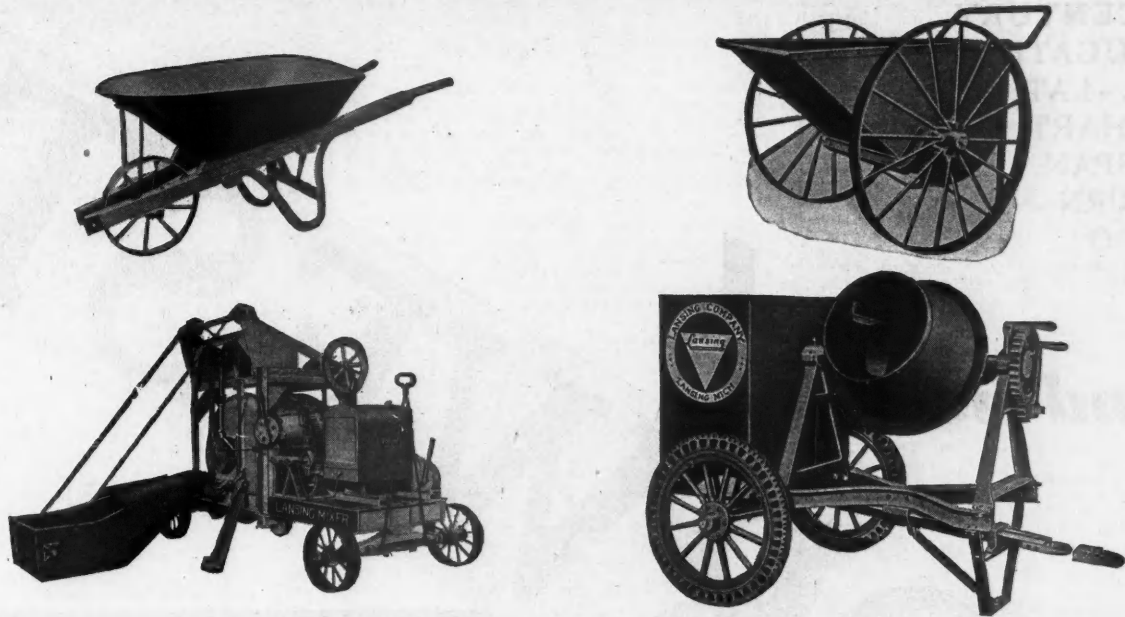

Nearly half a century of manufacturing and distributing experience is back of Lansing Products. Buyers of Lansing equipment are assured of prompt shipment, efficient repair service and low freight rates. Send for our General Catalog.

"There is a Lansing Dealer in your vicinity"

LANSING - COMPANY

Factory: LANSING, MICHIGAN

Branches: Boston, Kansas City, Minneapolis, Chicago, New York, Philadelphia

ADVERTISERS' INDEX



March, 1928

	Page		Page		Page
Acetol Products, Inc.	212	Bates Valve Bag Corp.	51	Chappell & Co., Wayvell.	232
Ackerman-Johnson Co.	229	Bayley Co., The Wm.	201	Chase Companies, Inc.	52
Adam Electric Co., Frank	233	Bazark Corp., The.	165	Chemical Toilet Corp.	218
Adamston Flat Glass Co.	198	Beaver Products Co.	56	Cheney & Son, S.	245
Ajax Building Bracket Co.	249	Beckman-Dawson Roofing Co.	60	Chevrolet Motor Co.	175
Allmetal Weatherstrip Co.	247	Beckmann Co., L.	233	Chicago Expansion Bolt Co.	249
Aloe Co., A. S.	195	Bessler Disappearing Stairway Co.	228	Chicago Technical College.	181-248
Alpha Portland Cement Co.	42	Bilek, Stephen.	245	Church Appliance Mfg. Co.	245
American Cement Machine Co., Inc.	203	Binks Spray Equipment Co.	188	Cincinnati Iron Fence Co.	243
American Chain Co., Inc.	60	Birch Mfrs. Assn.	211	Clamp Nail Co.	242
American Chime Clock Co.	246	Black and Decker Mfg. Co.	41	Clarke Sanding Machine Co.	17
American Device Mfg. Co.	238	Boice, W. B. & J. E.	243	Clay Products Assn.	196
American Face Brick Assn.	77	Bommer Spring Hinge Co.	184	Clinton Metallic Paint Co.	190
American Floor Surfacing Machine Co.	163	Boyle & Co., Inc., John.	222	Coleman, Watson E.	248
American Gypsum Co.	238	Bradley-Miller Co.	174	Colgan Machinery & Supply Co.	232
American Saw Mill Machinery Co.	43	Bruce Co., E. L.	154-155	Colonial Fireplace Co.	246
American Steel & Wire Co.	188	Brecher Co.	247	Colonial Hardware Mfrs.	198
Andersen Lumber Co.	161	Brunning Co., Inc., Charles.	248	Columbus Union Oil Cloth Co.	210
Andrews Heating Co.	245	Buff & Buff.	248	Combination Woodworking Machinery Co.	244
Anti-Hydro Waterproofing Co.	206	Burnham Boiler Corp.	196	Common Brick Mfrs. Assn.	183
Arkansas Oak Flooring Co.	194	Butler Laboratories, Inc.	230	Concrete Equipment Co.	222-226
Asbestos Shingle, Slate & Sheathing Co.	80			Concrete Form Tie Corp.	246
Athey Company	248	Cabot, Inc., Samuel.	184	Consolidated Conc. Machy. Corp.	223
Atlas Weatherstrip Co.	246	Carborundum Co., The.	208	Construction Machinery Co.	25-147
Austral Window Co.	219	Carey Co., The Phillip.	24	Coppes Bros. & Zook.	22
Automatic Electric Heater Co.	242	Carney Co., The.	149	Crane Company	204
Babs Lighting Fixture Mfg. Co.	246	Carter Co. Inc., R. L.	195	Crescent Machine Co.	235
Banks Steel Post Co.	246	Ceco Weatherstrip Co.	243	Cromar Co., The.	35-36
Bates Expanded Steel Truss Co.	230	Century Electric Co.	225	Crowe Mfg. Corp.	232
		Chain Belt Co.	2	Curtis Companies, Inc.	39
		Chain Products Co.	243		

(ADVERTISERS' INDEX CONTINUED TO PAGE 253)

PLASTA - SAVER
 20th CENTURY
 CORRUGATED
 CORNA - LATH
 STEELHART
 LONGSPAN
 KNO-BURN
 ECONO

-and now



METAL LATH—NEW! DISTINCTIVE!
 Just what you've needed to meet the competition of plaster board or ordinary lath for residences, etc.—FIRE-RESISTIVE—CRACK-RETARDING—STIFF—EASILY HANDLED—A 3.0 lb., 1/8" flat rib steel plastering lath and reinforcing North Western NORWEST is so economical that you'll want to use it in all your low cost work.

NORTH WESTERN
EXPANDED METAL CO.
 1203 Old Colony Building CHICAGO, U. S. A.

MAIL THIS COUPON NOW

The new NORWEST Metal Lath interests us. Send samples and literature.

AB

NAME.....STREET.....CITY and STATE.....

Copyright 1928, North Western Expanded Metal Co.

FOR ADVERTISERS' INDEX SEE NEXT TO LAST PAGE

Page	Page	Page
Deeders Products Co.....248	Kimball Brothers Co.....208	Rowles Co., E. W. A.....245
Detroit Steel Products Co.....74	Kimmel, George P.....248	Ruberoid Co., The.....68
De Vilbiss Co., The.....180	Kliegl Brothers.....237	Ryerson & Son, Joseph T.....182
DeWalt Products Co.....83	Knape & Vogt Mfg. Co.....187	
Diamond Metal Weatherstrip Co.....234	Knickerbocker Co.....218	Safe Tool Mfg. Co.....220
Diddle Co., L. W.....248	Knickerbocker Slate Corp.....236	Samson Cordage Works.....217
Disappearing Stairway Co.....245	Koehring Co.....49	Sanitary Equipment Co.....15
Donley Brothers Co., The.....194	Kolstad Mail Box Co.....241	Sargent & Co.....57
Dunn Mfg. Co.....29	Kornau Machine Co.....240	Sasgen Derrick Co.....247
Duro Co., The.....47	Kuhlman Metal Weather Strip Co.....241	Schlage Lock Co.....54
	Kuhls, H. B. Fred.....205	Schmid & Lehrer.....248
	Kwik-Mix Concrete Mixer Co.....207	Scott-Bansbach Co.....246
Economy Incinerator Co.....241		Sedgwick Machine Works.....247
Edwards Mfg. Co., The.....235	Lamella Roof Syndicate.....238	Sellstrom Mfg. Co.....215
Electric Fireplace Mfg. Co.....238	Lansing Co.....251	Sheet Steel Trade Extension Committee.....82
Electric Rotary Machine Co.....231	Leach Company.....27	Sherwin-Williams Co.....108
Elite Manufacturing Co.....237	Leonard Sheet Metal Works.....220	Shevlin, Carpenter & Clarke Co.....142-143
El Paso Sash & Door Co.....217	Libbey-Owens Sheet Glass Co.....207	Sidney Elevator Mfg Co.....240
Erie Fixture Supply Co.....248	Lincoln-Schlueter Machinery Co.....228	Sidney Machine Tool Co.....239
Eternit, Inc.....16	Lincrusta-Walton Co.....176	Silver Lake Co.....228
Excelsio Products Corp.....221	Living Stone Co.....248	Sisalkraft Co., The.....202
	Lloyd Floor & Wall Tile Co.....234	Skillsaw, Inc.....88
Fairbanks, Morse & Co.....244	Louisiana Red Cypress Bureau.....226	Slatington Bangor Slate Syndicate.....246
Farrand, Hiram A.....235	Lufkin Rule Co., The.....234	Slatington Slate Company.....248
Federal Metal Weatherstrip Co.....244		Sloane Mfg. Co., W. & J.....86
Fiat Metal Mfg. Co.....178	McGraw-Hill Book Co.....237	Smith Co., The T. L.....255
Fink & Sons Co., Louis.....246	McKinney Mfg. Co.....73	Smith & Egge Mfg. Co.....249
Finzer Brothers Clay Co.....76	Macomber Steel Co., The.....186-211-239	Smith Typewriter Sales Corp.....238
Fischer Spring Co., Charles.....234	Majestic Steel Cabinet Co.....240	Snow & Co., C. A.....248
Flint & Walling Mfg. Co.....186	Mallory Mfg. Co.....248	Southern Cypress Mfrs. Assn.....46
Foley Saw Tool Co.....216	Manning Abrasive Co., Inc.....221	Stairway Mfg. Co.....238
Forest City Bit & Tool Co.....240	Maple Flooring Mfrs. Assn.....158	Standard Sanitary Mfg. Co.....10-11
Fort Wayne Engineering & Mfg. Co.....227	Marietta Manufacturing Co.....240	Standard Textile Products Co.....70
Frantz Mfg. Co., The.....3	Marschke Co., The.....242	Standard Wall Covering Co.....240
Frazier Stair Co.....233	Mason Fibre Co.....78	Stanley Works.....23
	Master Rule Mfg. Co., Inc.....236	Star Expansion Bolt Co.....26
Gallmeyer & Livingston Co.....222	Matot, D. A.....219	Starrett Co., L. S.....197
Garden City Plating & Mfg. Co.....229	Maves Bros. Tool Mfg. Co.....227	State Mfg. & Engineering Co.....239
Gas-Gard Co.....244	Mellish-Hayward Co.....235	Steel Scaffolding Co., The.....189
Gas-O-Matic Corp.....218	Mesker & Co., George L.....243	Sterling Wheelbarrow Co.....31
Geier & Bluhm, Inc.....231	Metal Forms Corp.....222	Stimmel Winch & Machine Works.....242
General Electric Co.....157	Miami Cabinet Co., The.....151	Strand Mfg. Co., Eric J.....238
Gibbs Boardtile Co.....215	Mid-West Metal Products Co.....240	Structural Slate Co.....235
Gibsonburg Lime Products Co.....83	Miles Mfg. Co.....224	Strutzel Rubber Co., J. D.....246
Gilbert & Bennet Co.....75	Miller & Gleason.....246	Superior Sheet Steel Co.....55
Gowing, F. H.....248	Milwaukee Corrugating Co.....254	Synton Co.....199
Graham Brothers.....177	Morton Mfg. Co.....81	
Grand Rapids Hardware Co.....231	Murphy DoorBed Co.....45	Taylor Mfg. Co., James L.....249
Great Northern Hotel.....224	Myers & Bro. Co., The F. E.....226	Taylor Collapsible Horse Co.....243
Great Southern Lumber Co.....239		Textile Bag Mfrs. Assn.....192
Greene's Steel Molds.....249	National Brass Co.....200	Thrush & Co., H. A.....225
Gurley, W. & L.....191	National Fireplace Supply Co.....236	Thurston Manual Training Supply Co.....248
Gym Junior Company.....222	National Lumber Mfrs. Assn.....18	Tillery's Little Janitor Clock Co.....246
	National Mfg. Co.....256	Trane Company, The.....37
Hagstrom Mfg. Co.....236	National Mill & Lumber Co.....248	Trimpak Corp.....19
Hansen Co., L.....238	National Radiator Corp.....14	Truscon Steel Co.....5-72
Hardin-Lavin Co.....71	National Sanding Machine Co.....236	Twentieth Century Sales Agency.....229
Harding Brothers Co.....230	National Sheet Metal Roofing Co.....242	
Hart & Hegeman Mfg. Co.....30	North Western Expanded Metal Co.....252	United Specialties Mfg. Co.....234
Hays Mfg. Co.....197	Northfield Iron Co.....227	U. S. Gypsum Co.....64
Heattilator Co.....153	Novo Engine Co.....32	U. S. Mineral Wool Co.....226
Heltzel Steel Form & Iron Co.....236		Universal Hoist & Mfg. Co.....246
Hess Warming & Ventilating Co.....231	Oak Flooring Bureau.....193	Universal Portland Cement Co.....90
Heston & Anderson.....242	O'Brien, Clarence A.....248	
Hitchings & Co.....205	Ohio Foundry & Mfg. Co.....190	Veiguth Metal Parts, Inc.....247
Holland Furnace Co.....79	Oliver Machinery Co.....247	Vendor Slate Co.....202
HoltBid Service Co.....169-170-171-172	Overhead Door Corp.....28	Vento Steel Sash Co.....198
Hoosier Bldg. Tile & Silo Co.....244	Ornamental Products Co.....242	Vitrolite Co.....88
Hopson Co., W. C.....240	Onan & Sons, D. W.....228	
Hotel Belvedere.....244		Wallace & Co., J. D.....12-13-245
Hunt, Helm, Ferris Co.....20	Paine Lumber Co.....84	Warren-Knight Co.....249
Hurley Machine Co.....179	Paramount Electric Co.....229	Waterson, J. M.....248
Hutchinson Mfg. Co.....241	Parks Woodworking Machine Co.....230	Weatherbest Stained Shingle Co.....187
Huther Bros. Saw Mfg. Co.....206	Pass & Seymour.....200	Weber-Busse Co.....186
	Peerless Mfg. Co.....193	Wedell & Boers.....246
Indiana Limestone Co.....8-9	Penn-Greg Co.....236	West Coast Lumber Trade Extension Bureau.....44
Ingram Richardson Mfg. Co.....21	Perfection Co., The.....219	Western Pine Mfrs. Assn.....223-250
Insulite Co., The.....53	Pioneer Fireplace Co.....235	Weyerhaeuser Forest Products.....61
International Casement Co., Inc.....244	Porter Corp., J. E.....221	Wheeler, Osgood Co.....58
International Correspondence Schools.....209	Porter Cable Machine Co.....203-241	Wheeling Corrugating Co.....40
International Harvester Co.....249	Post Co., The Frederick.....224	Wheeling Metal & Mfg. Co.....232
International Steel & Iron Co.....214	Progressive Mfg. Co.....245	Wheeling Sanitary Mfg. Co.....167
International Stamping Co.....243	Pullman Mfg. Co., Inc.....243	White Co., Inc. David.....204
		Wickwire Spencer Steel Co.....199
Jackson Lumber Co., E. E.....216	Radford Architectural Co.....65-66-67-68	Williams & Co., C. K.....240
Jaeger Machine Co.....173	Reading Iron Co.....212	Willis Mfg. Co.....210
Johnson & Son, S. C.....141	Readybuilt Products Co.....242	Winchester Radiator Cabinet Co.....247
Jones Superior Machine Co.....227	Reardon Co.....189	Wood Conversion Co.....61
	Reid-Way Co., The.....145	Wright Rubber Products Co.....224
Kalman Steel Co.....34	Remmel Mfg. Co.....214	
Karol & Sons, B.....191	Republic Iron Works.....221	Zagelmeyer Cast Stone Block Machin-ery Co.....244
Kawneer Co., The.....59	Richards-Wilcox Mfg Co.....6-7	Zouri Drawn Metals Co.....48
Kees Mfg. Co., F. D.....249	R. & L. Concrete Machinery Co.....209	
Keith Corporation.....62	Rogers & Co., F. L.....201	
Kennedy, Ralph M.....236		
Kerner Incinerator Co.....213		
Kewanee Mfg. Co.....215		

NOTICE TO ADVERTISERS

Forms for the April number of the American Builder will close promptly on March 10. New Copy, changes and orders for omissions of advertisements must reach our business office, 1827 Prairie Ave., Chicago, not later than the above date. If new copy is not received by the 10th of the month preceding date of publication the publishers reserve the right to repeat last advertisements on all unexpired contracts.

AMERICAN BUILDER.

Residence of L. L. Dougan, Architect, Portland, Ore. Milcor "Expansion" Casings for interior and exterior door-and-window trim.

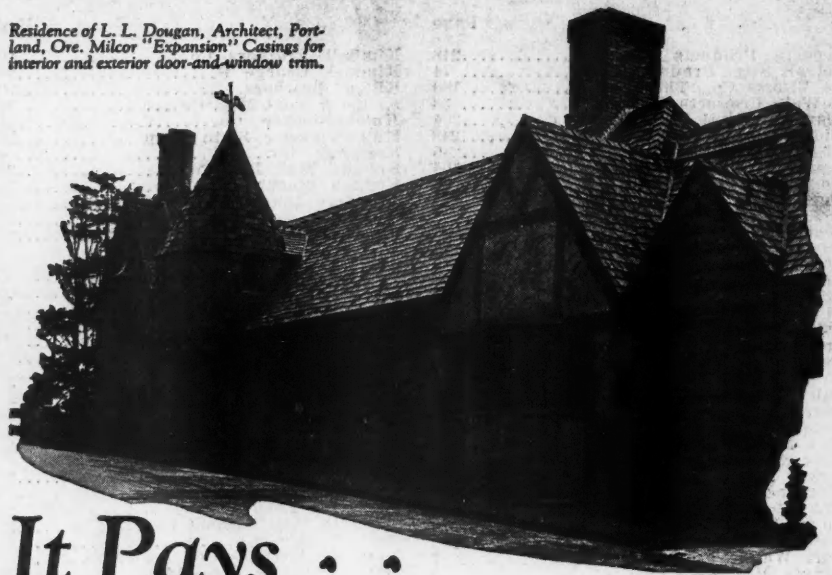

It Pays to build this way!

The foreman who superintended the installation of Milcor "Expansion" Casings in the home shown above, was surprised to find that this superior type of door-and-window-trim actually showed a big saving. He wrote us a mighty enthusiastic letter — here is part of it:

"Comparative costs of wood casings and Milcor "Expansion" Metal Casings showed that a considerable saving resulted wherever Milcor Casings are used. Wood here is very cheap (in Oregon). In other sections where wood is expensive, the saving would be still greater".

THE fine thing about these Milcor Products is that they not only improve the appearance of any home or building, but they also insure permanence and firesafety—all at a price that will satisfy the most conservative builder.

People are inclined to balk at much of this talk about quality construction. It may be very fine, they think, but they can't afford it! Here are products, however, that will save money not only in first cost but principally in maintenance expense. It is no longer a question of whether the builder can afford these modern Milcor products, but rather, *can he afford to build without them!*

By all means investigate Milcor "Expansion" Casings—get samples and prices; install them on one job; then you'll appreciate the reasons for their success and growing popularity.

Investigate also the many other products made by Milcor—Stay-Rib Metal Lath, Netmesh Metal Lath, "Expansion" Corner Bead, Base Screed, Concealed Metal Picture Molding, Metal Tile Roofing, Architectural Sheet Metal, etc. Getting acquainted will cost you nothing and will obligate you not one bit.

Would you like to have a copy of our now-famous book on "Modern Modes in Better Plastering" and "The Milcor Manual", a technical data book on Milcor Metal Lath and allied products? We'll gladly send you both. Yours for the asking. The coupon, a Post Card, or a letter will do.

Member of
National Council
for Better Plastering



Member of
Associated Metal Lath
Manufacturers

MILWAUKEE CORRUGATING COMPANY, Milwaukee, Wisconsin
Chicago, Ill. Kansas City, Mo. La Crosse, Wis.

MILCOR

Metal Lath and Roofing
in Steel, Zinc,
Copper and



MILWAUKEE CORRUGATING CO., Milwaukee, Wisconsin
Please send "Modern Modes in Better Plastering" and
"The Milcor Manual", without cost or obligation.

INGOT IRON

Name..... Address.....

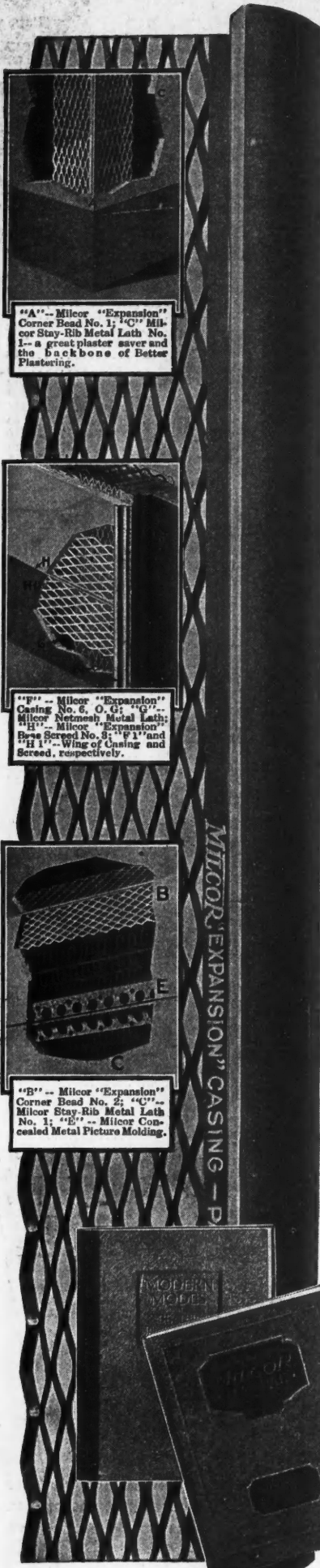

"A" -- Milcor "Expansion" Corner Bead No. 1; "C" Milcor Stay-Rib Metal Lath No. 1 -- a great plaster saver and the backbone of Better Plastering.

"B" -- Milcor "Expansion" Casings No. 6, O. G.; "G" -- Milcor Netmesh Metal Lath; "H" -- Milcor "Expansion" Base Screed No. 3; "F 1" and "H 1" -- Wing of Casings and Screed, respectively.

"B" -- Milcor "Expansion" Corner Bead No. 2; "C" -- Milcor Stay-Rib Metal Lath No. 1; "E" -- Milcor Concealed Metal Picture Molding.

