

AMERICAN BUILDER

A SIMMONS-BOARDMAN PUBLICATION

Vol. 47.

CONTENTS FOR JUNE, 1929

No. 3.

COPYRIGHT, 1929, BY AMERICAN BUILDER PUBLISHING CORPORATION

Page	Page
Around the Family Table..... 51 Where Readers and Editors Get Together.	AMERICAN BUILDER'S EXHIBIT OF GOOD BUILDINGS69-76
Editorial Page 53 Looking Forward—April Building Activity Shows Increase—What the People Want and What They Can Afford.	A Shingled Home of True Comfort.....Plate I This Home from Portland, Oregon, "Has Everything"Plate II A Home of Dignity and Grace.....Plate III Dutch Colonial with Pressed Metal ColumnsPlate IV Two Small Homes of Character.....Plate V A Three-House Row at Washington, D. C..Plate VI The Downtown Parking Garage.....Plate VII Five-Apartment Building of Indiana LimestonePlate VIII
First Steel Found Good..... 55 Examination of Tacoma Building Now Being Wrecked—Shows No Deterioration of Structural Steel.	Good Design—Modern Equipment.....77-81 Home of Unusual Interest Presented with Complete Working Plans to Eighth-Inch Scale.
A Living Room by T. H. Maenner Com- pany, Omaha..... 56 A Full Page Photographic Plate.	Question and Answer Department..... 82 A Valuable New Service for Readers.
Suppose I Should Die—Before the Mort- gage Is Paid?..... 57 A Home Financing Article by James O. Cobb.	How Dan Does It..... 84 Trimming Board Ends—It Holds Door Firmly— Resetting Door Locks—To Plumb Door Jambs— Hanging Double Action Doors—An Aid in Stair Work—Repairing Cracked Cistern.
Art Moderne in Store Fronts.....58-59 Photographs of Unusual Entrance and Display Win- dows, Alexander-Oviatt Building, Los Angeles.	Building Thatched Roofs.....86-87 How to Get Good Results in This Popular Style with Details by John T. Neufeld.
Wrecking by Truck Crane.....60-61 Unusual Method Successfully Used by A. W. Bowie, Inc., Binghamton, N. Y.	Color in Roofs..... 88 A New Colored Cement Shingle Described by Glen Stewart.
Oklahoma Builds Tall.....62-63 The Ambassador Apartments, Tulsa; N. E. Peters, Architect.	Bright Colors for Bathrooms..... 89
Etched and Tinted Douglas Fir..... 64 A New Decorative Material.	Can You Afford to Make Window Frames by Hand? 90
First Baptist Church, Jackson, Miss..... 65 Americanized Gothic Design by Ferrand & Ferris, Architects.	Care of Oak Floors.....'91
More Glass, More Sunshine..... 66 Remodeling for Better Health.	What's New.....92 to 116
For the Women Customers..... 67 Downtown Display by the Dix Lumber Company, North Cambridge, Mass.	ADVERTISERS' INDEX171-173
Service to Home Builders..... 68	

Published on the first day of each month by American Builder Publishing Corporation. *Chairman of Board*, Edward A. Simmons; *President*, William A. Radford; *Treasurer*, John T. De Mott; *Secretary*, Roland D. Radford; *Editor*, Bernard L. Johnson; *Eastern Editor*, Charles G. Paker; *Associate Editors*: P. W. Hanna, E. B. Quigley, L. E. Arent; *Advertising Staff*: Delbert W. Smith, C. R. W. Edgcumbe, L. H. Reich, O. H. Sutter, Cecil W. Blashill, J. J. Dubro, R. E. Clement, Sam Campagna, R. H. Morris.

Publication Office:

Bankers Building, 105 W. Adams St., Chicago

Telephone: Randolph 0794

Branch Offices:

New York—30 Church Street.
Cleveland—Terminal Tower.
Washington—17th and H Streets, N. W.
San Francisco—215 Market Street.

Entered as second-class matter July 1, 1905, at the post office at Chicago, Ill., under the Act of March 3, 1879. Additional entry as second-class matter at Binghamton, N. Y.

SUBSCRIPTION RATES—One year, United States, Canada, Mexico, and U. S. Possessions, \$2.00; six months, \$1.00; single copy, 35 cents. Foreign countries, \$4.00.

PROTECTION FOR OUR READERS—The publishers of the AMERICAN BUILDER reserve the right to decline any advertising they believe is detrimental to the interest of its readers; to edit advertising copy and to change or eliminate any statements that reflect injuriously or cast discredit upon other building products, machinery, equipment, supplies or tools.

Be sure in writing to advertisers to say: "I saw your advertisement in the AMERICAN BUILDER."

ADVERTISING RATES—Furnished on application. Advertising forms close on the 10th of the month preceding date of publication.

MEMBER OF THE AUDIT BUREAU OF CIRCULATIONS
AND OF THE ASSOCIATED BUSINESS PAPERS

AMERICAN BUILDER

A SIMMONS-BOARDMAN PUBLICATION

Vol. 47.

CONTENTS FOR JUNE, 1929

No. 3.

COPYRIGHT, 1929, BY AMERICAN BUILDER PUBLISHING CORPORATION

Page	Page
Around the Family Table..... 51 Where Readers and Editors Get Together.	AMERICAN BUILDER'S EXHIBIT OF GOOD BUILDINGS69-76
Editorial Page 53 Looking Forward—April Building Activity Shows Increase—What the People Want and What They Can Afford.	A Shingled Home of True Comfort.....Plate I This Home from Portland, Oregon, "Has Everything"Plate II A Home of Dignity and Grace.....Plate III Dutch Colonial with Pressed Metal ColumnsPlate IV Two Small Homes of Character.....Plate V A Three-House Row at Washington, D. C..Plate VI The Downtown Parking Garage.....Plate VII Five-Apartment Building of Indiana LimestonePlate VIII
First Steel Found Good..... 55 Examination of Tacoma Building Now Being Wrecked—Shows No Deterioration of Structural Steel.	Good Design—Modern Equipment.....77-81 Home of Unusual Interest Presented with Complete Working Plans to Eighth-Inch Scale.
A Living Room by T. H. Maenner Com- pany, Omaha..... 56 A Full Page Photographic Plate.	Question and Answer Department..... 82 A Valuable New Service for Readers.
Suppose I Should Die—Before the Mort- gage Is Paid?..... 57 A Home Financing Article by James O. Cobb.	How Dan Does It..... 84 Trimming Board Ends—It Holds Door Firmly— Resetting Door Locks—To Plumb Door Jambs— Hanging Double Action Doors—An Aid in Stair Work—Repairing Cracked Cistern.
Art Moderne in Store Fronts.....58-59 Photographs of Unusual Entrance and Display Win- dows, Alexander-Oviatt Building, Los Angeles.	Building Thatched Roofs.....86-87 How to Get Good Results in This Popular Style with Details by John T. Neufeld.
Wrecking by Truck Crane.....60-61 Unusual Method Successfully Used by A. W. Bowie, Inc., Binghamton, N. Y.	Color in Roofs..... 88 A New Colored Cement Shingle Described by Glen Stewart.
Oklahoma Builds Tall.....62-63 The Ambassador Apartments, Tulsa; N. E. Peters, Architect.	Bright Colors for Bathrooms..... 89
Etched and Tinted Douglas Fir..... 64 A New Decorative Material.	Can You Afford to Make Window Frames by Hand? 90
First Baptist Church, Jackson, Miss..... 65 Americanized Gothic Design by Ferrand & Ferris, Architects.	Care of Oak Floors.....'91
More Glass, More Sunshine..... 66 Remodeling for Better Health.	What's New.....92 to 116
For the Women Customers..... 67 Downtown Display by the Dix Lumber Company, North Cambridge, Mass.	ADVERTISERS' INDEX171-173
Service to Home Builders..... 68	

Published on the first day of each month by American Builder Publishing Corporation. *Chairman of Board*, Edward A. Simmons; *President*, William A. Radford; *Treasurer*, John T. De Mott; *Secretary*, Roland D. Radford; *Editor*, Bernard L. Johnson; *Eastern Editor*, Charles G. Paker; *Associate Editors*: P. W. Hanna, E. B. Quigley, L. E. Arent; *Advertising Staff*: Delbert W. Smith, C. R. W. Edgcumbe, L. H. Reich, O. H. Sutter, Cecil W. Blashill, J. J. Dubro, R. E. Clement, Sam Campagna, R. H. Morris.

Publication Office:

Bankers Building, 105 W. Adams St., Chicago

Telephone: Randolph 0794

Branch Offices:

New York—30 Church Street.
Cleveland—Terminal Tower.
Washington—17th and H Streets, N. W.
San Francisco—215 Market Street.

Entered as second-class matter July 1, 1905, at the post office at Chicago, Ill., under the Act of March 3, 1879. Additional entry as second-class matter at Binghamton, N. Y.

SUBSCRIPTION RATES—One year, United States, Canada, Mexico, and U. S. Possessions, \$2.00; six months, \$1.00; single copy, 35 cents. Foreign countries, \$4.00.

PROTECTION FOR OUR READERS—The publishers of the AMERICAN BUILDER reserve the right to decline any advertising they believe is detrimental to the interest of its readers; to edit advertising copy and to change or eliminate any statements that reflect injuriously or cast discredit upon other building products, machinery, equipment, supplies or tools.

Be sure in writing to advertisers to say: "I saw your advertisement in the AMERICAN BUILDER."

ADVERTISING RATES—Furnished on application. Advertising forms close on the 10th of the month preceding date of publication.

MEMBER OF THE AUDIT BUREAU OF CIRCULATIONS
AND OF THE ASSOCIATED BUSINESS PAPERS

Coons
CLOTHIER
LOWELL, MICHIGAN

July 23, 1928.

Keasbey & Mattison Co.
222-224 West Lake St.,
Chicago Ills.

Dear Sirs:-

Twenty one years ago I roofed my home with your Asbestos Slate Shingles. It is in fine condition today but I am enlarging a porch and need a few more of the 12 x 12 Gray shingles. Are they on sale in Grand Rapids Michigan where it would be convenient for me to get a few more?

Very truly yours,

Harvey J. Coons.

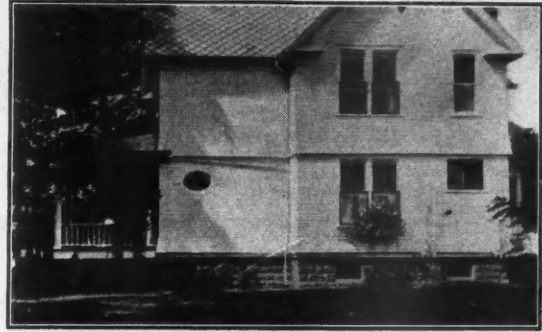

Here's Your Proof—
There is a Roof
That Will Endure!

Ambler Asbestos Shingles Will Add Value To The Homes You Build

THE above letter is not a solicited endorsement but an inquiry for more shingles. Mr. Coons wanted the same quality that had lasted for 22 years, so he wrote our parent company which in those days sold Ambler shingles; of course we furnished them.

Ambler has always claimed that its asbestos shingles "wear forever". An authority on building materials recently estimated that they would improve with age during the first 150 years, then begin to depreciate during the next century. Is that long enough life?

As a builder of good houses you will be able to sell "resale value" to the purchaser if you use Ambler Asbestos Shingles. Some day that buyer may want to sell. An enduring, fire-safe, attractive roof will increase the value, and give comfort during the years he lives beneath it.

Impress that on your customer and he'll pay the few dollars extra to have a lasting roof of beauty.

Ask
About
"DUOFACE"
SHINGLES

Have
You
Seen
WALTILE?

**ASBESTOS
SHINGLE, SLATE & SHEATHING
COMPANY**

AMBLER, PENNA. - - ST. LOUIS, MO.

BRANCHES: Boston, Buffalo, Chicago, Cleveland, Detroit, Minneapolis, New York City
Philadelphia, Pittsburgh, Washington, Wilkes-Barre

WHEN WRITING ADVERTISERS PLEASE MENTION THE AMERICAN BUILDER

"I'm Out of the Beaten Path Now"

"I find that Indiana Limestone Random Ashlar is a profitable field for the contractor who wants to get ahead. I consider that I'm out of the beaten path now on account of having used it and sincerely recommend it to any one."

(Signed)
H. M. SCHELL



Writes Contractor H. M. Schell, of Mansfield, Ohio, who is using Indiana Limestone Random Ashlar. Send for free booklets giving all the facts about using this beautiful natural stone for residences.

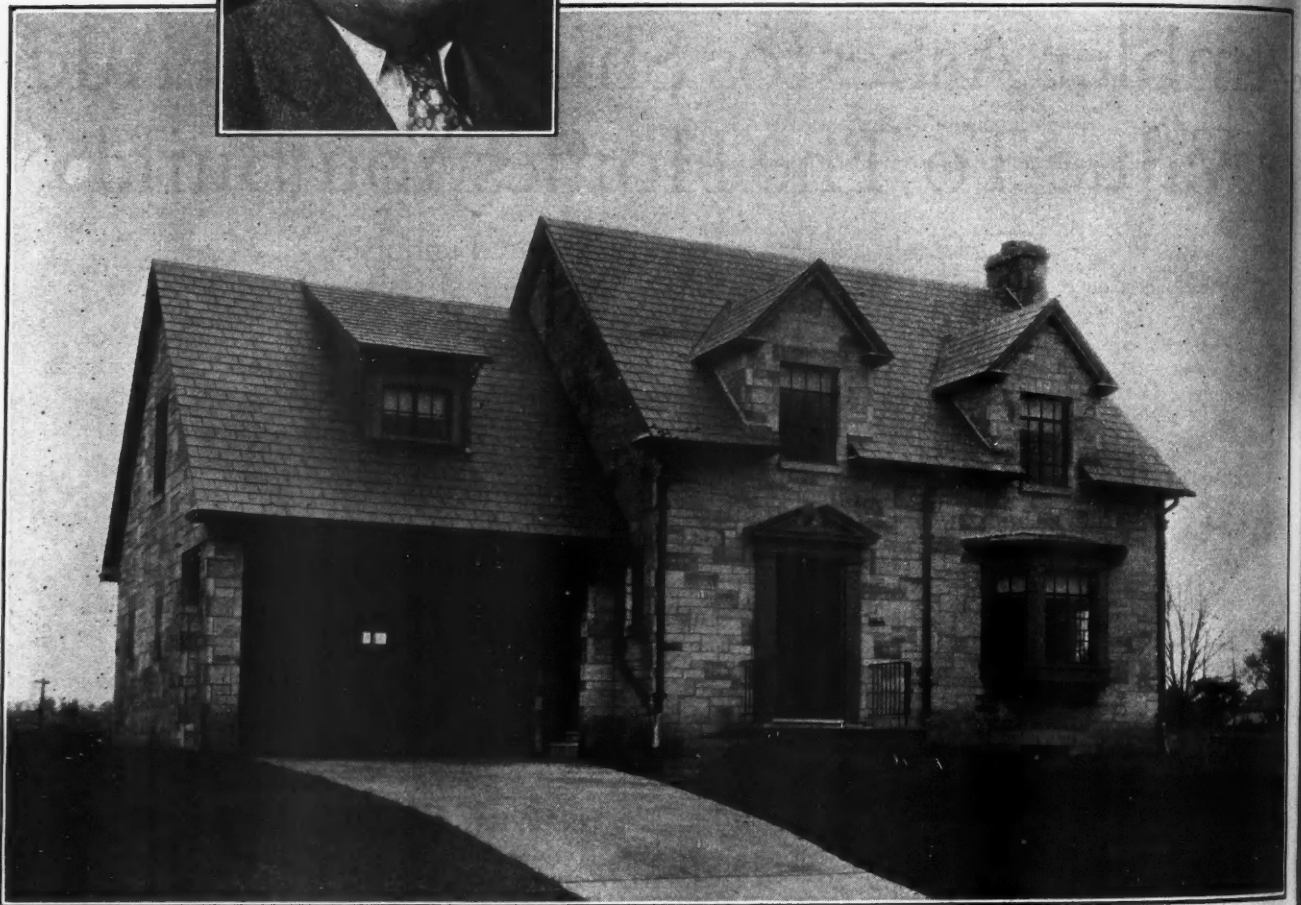

Residence, Mansfield, Ohio. Oberlin & Newlon, Architects. H. M. Schell, Builder. Shot sawed Old Gothic Indiana Limestone Random Ashlar.

HUNDREDS of contractors in the past year or two have written us for the facts about the sawed Indiana Limestone for Random Ashlar.

Now many have tested out this new form of stone construction. Mr. Schell of Mansfield, Ohio, is one. Read what he says. Like other builders, he is enthusiastic, as you also will be when you try it.

"Indiana Limestone makes \$10,000 look like \$20,000," is the way another contractor expresses it. Certainly no other facing material gives the same rich appearance of beauty and permanence as you get in this beautiful natural stone.

Shot-sawed Old Gothic Random Ashlar is used like any other facing material. The stone is sawed

INDIANA LIMESTONE COMPANY, General Offices:

FOR ADVERTISERS' INDEX SEE NEXT TO LAST PAGE



In breaking Indiana Limestone Random Ashlar, a shallow groove is made on one side of the stone strip by means of an electric portable saw or ordinary hand saw. The stone is then turned over and a tap with a mallet breaks it clean on a line with the groove.

into strips four inches thick and of several heights required, at the quarries. It is then shipped direct to the building site and there is broken to length by an ordinary workman, using either an electric saw as shown above, or an ordinary hand saw. One man with the aid of an electric saw keeps six stone masons or bricklayers busy laying up the stone in the wall.

This construction is both speedy and economical, and gives most satisfactory results. Your stone masons or bricklayers spend their entire time on the wall laying up stone, not on the ground breaking it. No setting drawings are needed when you use Indiana Limestone in the new, modern way. Cut stone may be used as trim or may be omitted entirely.

Indiana Limestone Random Ashlar homes have durable beauty and therefore possess high resale values. One such home will advertise your business as nothing else will do.

Why not write now for full information about this attractive proposition? Home owners the country over are looking for something new. The beauty and permanence of Indiana Limestone will appeal to

them. The shot-sawed Old Gothic stone gives to such homes an old world charm.

The coupon will bring you full information about this modern building material and its use. Fill it in, clip it and mail it today.

The volume at the left contains many fine plans. People have gladly paid 50c a copy for it. Here we offer it to you FREE.

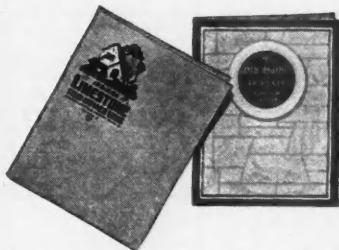

Box 757, Service Bureau,
Indiana Limestone Company, Bedford, Indiana.

Please send booklets and other information regarding Indiana Limestone Random Ashlar for residences.

Name

Street

City..... State.....

Bedford, Indiana Executive Offices: Tribune Tower, Chicago

WHEN WRITING ADVERTISERS PLEASE MENTION THE AMERICAN BUILDER

To Increase Your Profits Build Homes To Sell

What Speculative and Investment Builders did in just one year— 1928

According to Dodge Reports, they erected 70,141 single family dwellings, 17,552 two family dwellings and 17,726 apartments in 1928. The total valuation of this business is \$1,813,791,900.

Dodge covers only those sections of 38 Eastern States in which it is necessary to file building permits. Actually developers did much more building than the report shows. In the territory covered by Dodge Reports, developers did 65% of the residential building.

There were two magazines that the contractor could read to secure the new merchandising angle toward successful merchant building. These two papers were **BUILDING DEVELOPER**, which is published in New York and is the leading publication serving developers, and **HOME BUILDING**, a close second to **BUILDING DEVELOPER**, published in Chicago. These two have now been combined to form one large magazine—

BUILDING DEVELOPER
with which is incorporated
HOME BUILDING

*AMERICAN BUILDER tells
How to Build.*

***BUILDING DEVELOPER with
HOME BUILDING**
tells what to Build and
How to Sell.*

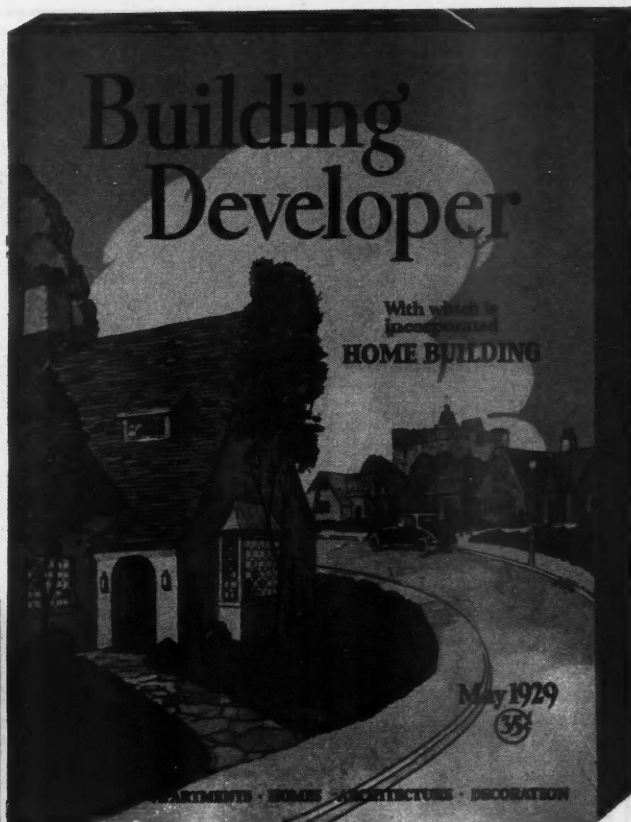

M a y
 1 9 2 9
 has found
HOME BUILDING
 Incorporated with
BUILDING DEVELOPER
 Write for a sample copy
 of the first combined issue.
 Alive and interesting, it covers
 Real Estate, Architecture, Decora-
 tion, Construction and Developing.

BUILDING DEVELOPER (with which is incorporated **HOME BUILDING**)
 30 Church Street, New York

DATE.....

1. I am doing Speculative Building, so send me **BUILDING DEVELOPER** for One Year for \$2. It is understood that if I do not like my first issue the \$2 will be returned upon request.
2. Please send me a sample copy.

<i>Fill out if you please</i>	
IN 1928 I BUILT FOR RE-SALE	HOMES
IN 1929 I EXPECT TO BUILD FOR SALE HOMES

Name.....

Address.....

City..... State.....

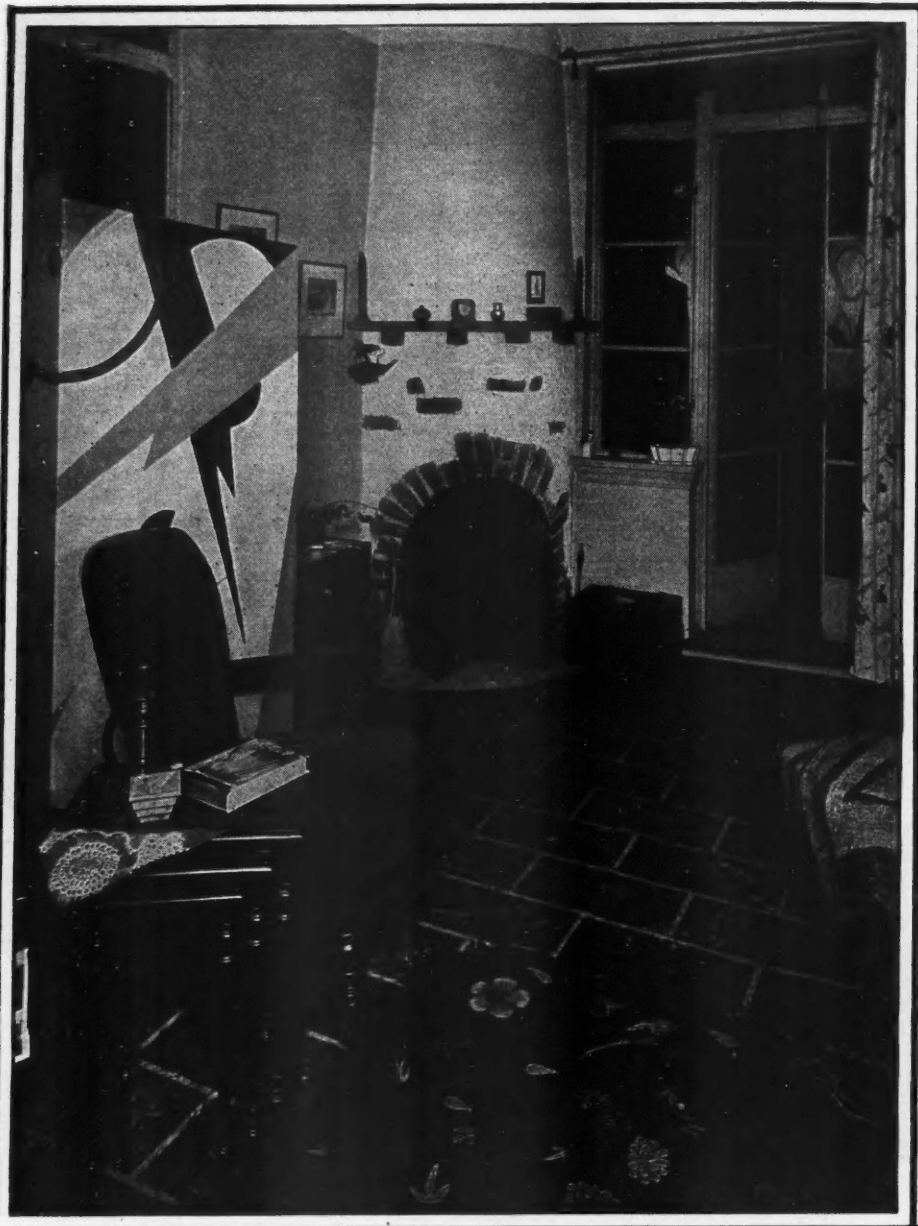

IN exactly nine cases out of ten you must please the woman if you wish to sell or rent. What you tell her means little. What she sees means everything. Today, be sure that she sees *color*. Floors of W. & J. Sloane Linoleum, for example. They brighten a room and make it look lived-in. Yet they cost you no more. If included in the original plans they actually effect a saving. W. & J. Sloane Mfg. Co., Trenton, N. J.

**W. & J. SLOANE
L I N O L E U M**

FOR ADVERTISERS' INDEX SEE NEXT TO LAST PAGE



**“92%
of All Houses
Are Bought
On the Word of
A Woman”**

*Write for
Free Portfolio
of Ideas*

Our Contractors Service Division has prepared a portfolio of interesting ideas on floors for investment builders. A copy of this portfolio is yours for the asking. You may call on this Division at any time for practical cooperation on specific flooring problems. This service includes selection of patterns, specifications, securing of estimates, etc. Write: Contractors Service Division, W. & J. Sloane, 577 Fifth Avenue, New York City.

r
b
v
y
Yo
floor
easi
wher
whom
wom
appe
Oft
Yet,
Vact
floor
No
sell
othe

P
Tod
abou
men
mak
ante
in w
you
as r
will
That
clain
clear
thou
sand
unde
If th
Sanc
this
busi

Mc
The
a va
easily



You may not read this Advertisement but the whole world will read yours in your FLOORS



YOUR jobs with smooth beautiful floors can be yours even more easily and at lower cost than where the floors just get by. You who have showed your homes to women know how they prize floor appearance.

Often it makes or breaks a sale. Yet, sanded with the Clarke Vacuum Portable Sander, your floors will actually cost you less. No wonder Clarke makes and sells more Sanders today than any other manufacturer in America!

Performance Talks

Today there's no need to gamble about what your sanding equipment will do. Clarke, pioneer maker of Portable Sanders, guarantees every claim of performance in writing. If, within sixty days, you find the Clarke is not exactly as represented, then your money will be refunded.

That's taking the bunk out of claims for sanders. That's the clean-cut kind of guarantee that thousands of these remarkable sanders by Clarke have been sold under.

If the Clarke Vacuum Portable Sander didn't do as we say in this ad, Clarke couldn't stay in business six months.

The

Money Saving Facts

The 31-pound Clarke handles like a vacuum cleaner, and almost as easily. Fast cutting, powerful, it



surfaces 800 to 2,000 square feet of new floor to velvet smoothness in 8 hours. On old floors it knocks off 2 to 20 coats of varnish, shellac, wax or oil at the rate of 300 to 1,000 square feet a day, and leaves a smooth perfect surface all ready for the painter. No varnish remover or neutralizer is needed.

Try and match this performance in any other sanding machine. Try and get these facts guaranteed, definitely in writing, with a money back clause, by any maker but Clarke.

Write for Details

Don't spend a cent on any sander 'till you get the full facts about the Clarke. Sold on easy time payments if desired. Clarke has a book—not a word of bunk in it—of hard-boiled facts for hard-boiled contractors. Write for it. No cost or obligation. Use the coupon here.

Clarke Sanding Machine Co.

Dept. A-36, 3815 Cortland Street

Chicago, Illinois

MAIL THIS FOR FULL INFORMATION

	CLARKE SANDING MACHINE CO.
	Dept. A-36, 3815 Cortland St., Chicago, Illinois
	Please send me, without obligation, full facts about the Clarke Vacuum Portable Sander.
	Name
	Address
City	State

Without floor handle the Clarke sands interior trim, doors, cabinet work.

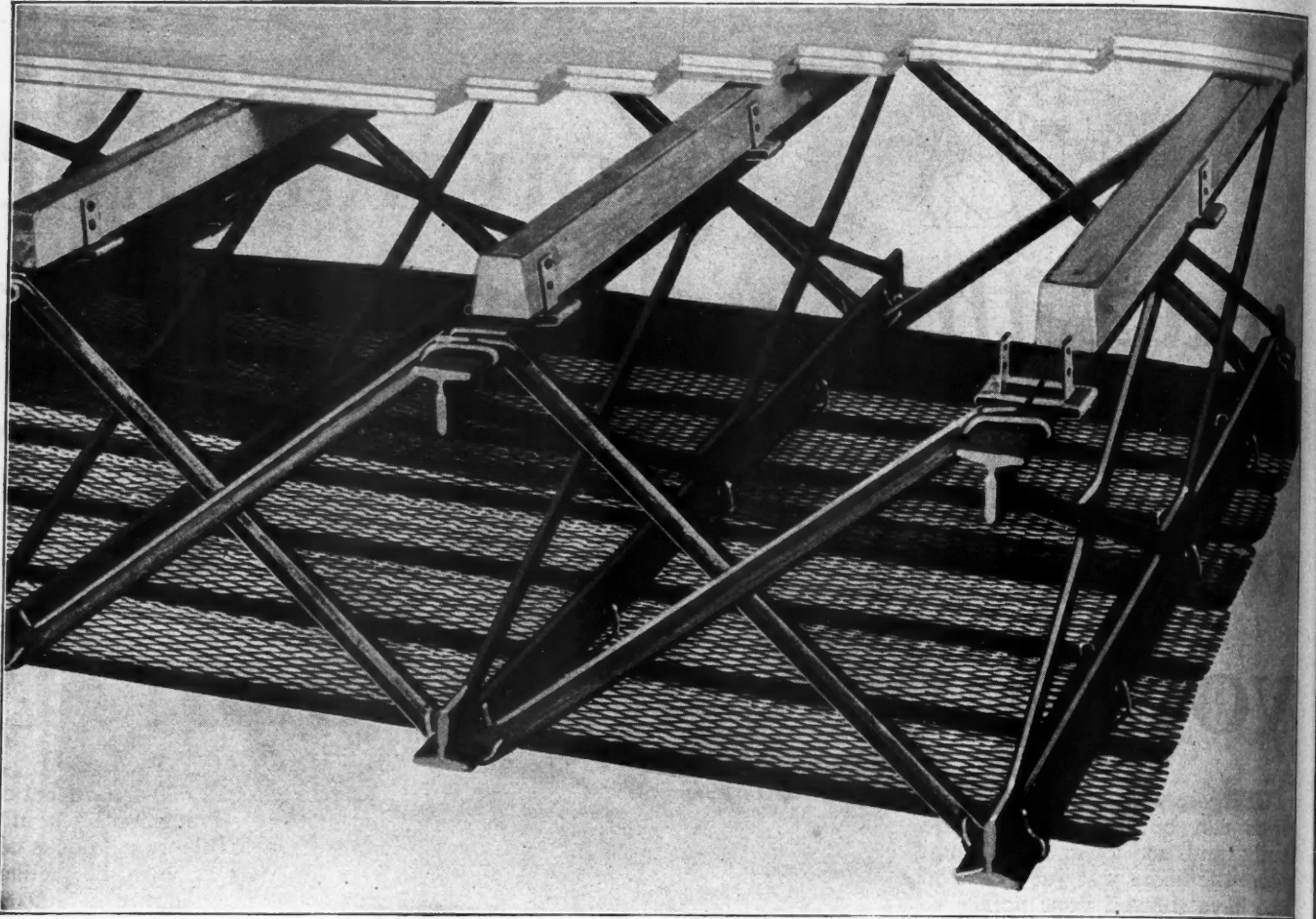

The Floor and Roof Construction of Tomorrow

Through engineering genius and modern manufacturing methods Kalman provides you with a new and improved method for building fire-safe floors and roofs.

The principle of the old wood floor and roof construction is maintained—but the materials used are greatly improved.

Kalmantruss Steel Joists are made by a new and different method—a rolling process. As a result, joints are one-piece and you get unusual dependability.

Kalmantruss Rigid Bridging possesses the bracing qualities of wood cross bridging but it is fire-safe. In addition, Kalmanlath and the distinctive line of Kalman accessory products, such as ceiling and floor lath clips, result in producing the improved fire-safe floor and roof construction of tomorrow.

This construction is easy to erect—resulting in speed and economy for the builder.

KALMAN STEEL COMPANY

KALMAN STEEL

**MODERN. FIRE-SAFE
BUILDING PRODUCTS**

Atlanta
Baltimore
Boston
Buffalo

Charlotte
Chicago
Columbus
Dayton

Detroit
Houston
Kansas City

Milwaukee
Minneapolis
Newark

New York
(Export Office—New York)

New Haven
Niles
Philadelphia
Pittsburgh

St. Paul
Syracuse
Youngstown
Washington, D. C.

STARTLING

NEW "Built in Wardrobe" CLOSET



PAT. PEND.

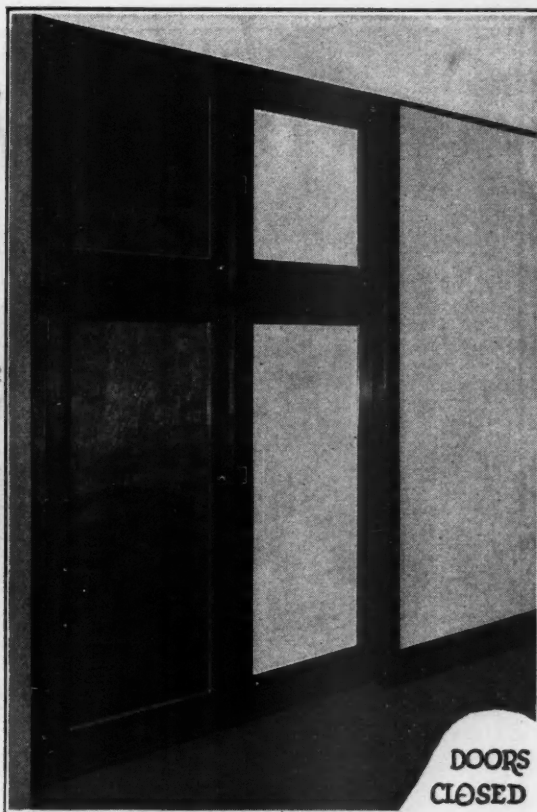

for

New Homes and Apartments

Every garment in sight. Space for shoes, hats, blankets when and where needed.

Cedar space for out of season clothes. Saves floor space.

Two Treiber "BUILT IN WARDROBE" closets completely installed cost less than building two regular closets.

Makes homes or apartments more attractive to buyer or renter.

Investigate this new and long wanted development.

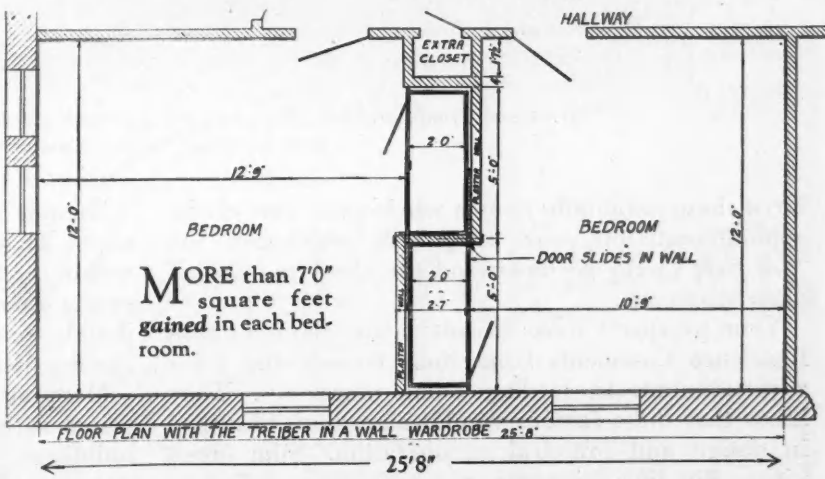
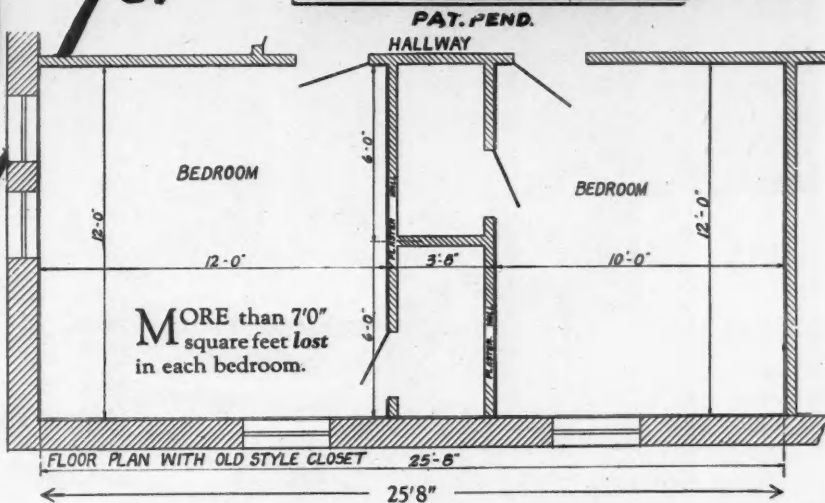

Treiber Company, 629AB
506 S. Wabash Ave., Chicago, Ill.
Please send me blue prints and full information on layout, dimensions and prices.
I am Architect Builder

Name.....
Address.....

TREIBER COMPANY

506 S. Wabash Ave. Chicago, Ill.

WHEN WRITING ADVERTISERS PLEASE MENTION THE AMERICAN BUILDER

LUPTON WINDOWS HELP PUT NAMES ON THE AGREEMENT-OF-SALE

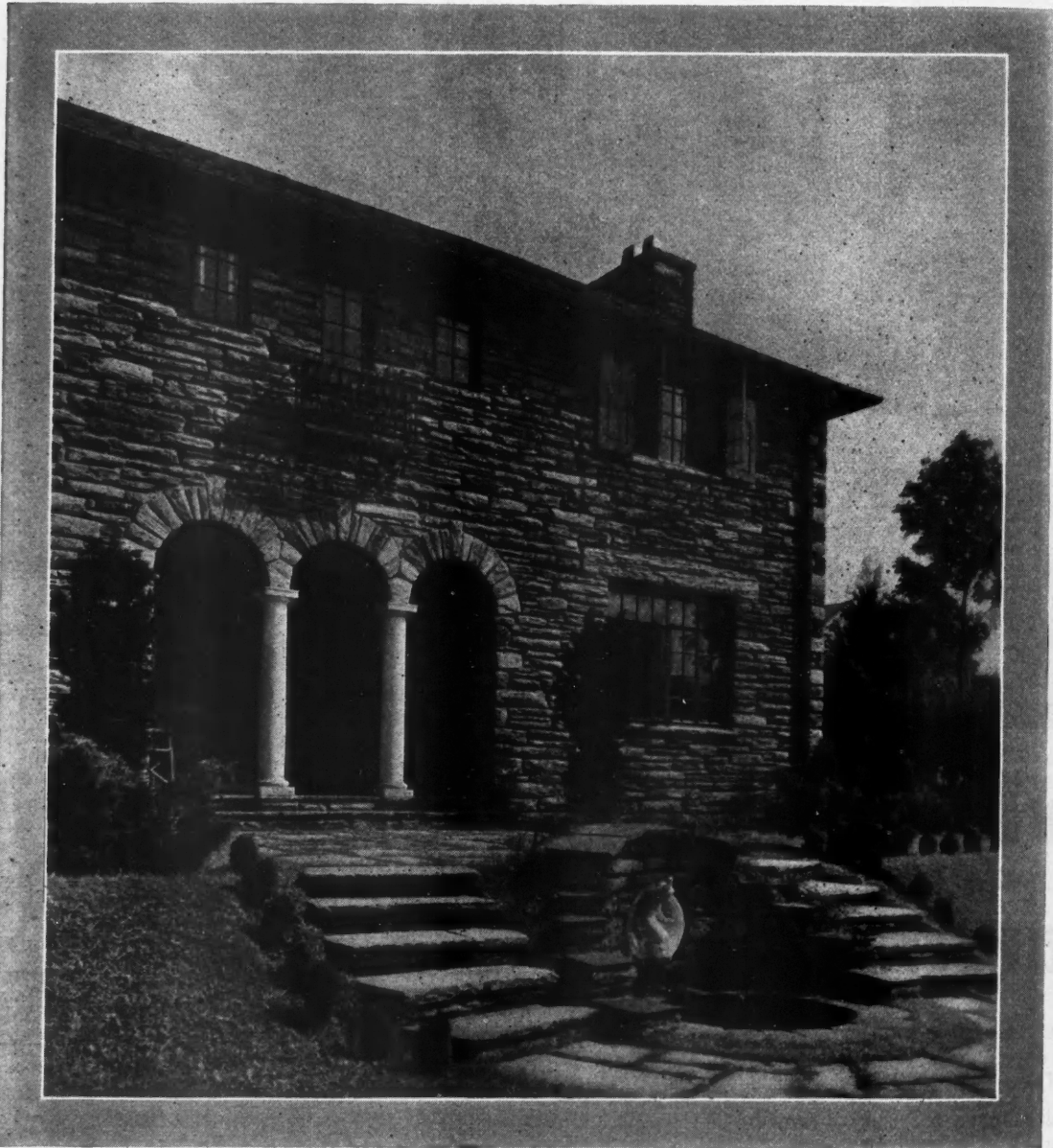

Mr. Aaron Traub, architect, has equipped his residence at Elkins Park, Pennsylvania, with Lupton Residence Casements

WITH these nationally known windows as part of the appointments of your investment residences, the "For Sale" signs go down and the satisfying "Sold" placards go up.

Your prospects have already heard about Lupton Residence Casements from their friends and from advertisements in leading home magazines. They know that these famous windows are both beautiful in design and practical in operation. Slim cross-pieces, dividing the panes, give windows an effect of daintiness. Enduring steel construction prevents warping or jamming at any season of the year.

Lupton Casements have other household advantages. They can be cleaned easily on both sides from within the room. In summer, their ventilators can be swung open to catch the faintest breeze. In winter, a double contact of steel on steel makes them snug against dampness and penetrating cold.

Manufacture in standardized sizes has brought prices within range of even the smaller investment buildings. Have us send you the full story. Mention the type of building you plan to erect, and we will mail you the exact details. DAVID LUPTON'S SONS Co., 2203 E. Allegheny Avenue, Philadelphia, Pa.

LUPTON
WHERE STEEL IS FUSED WITH SINCERITY

LE

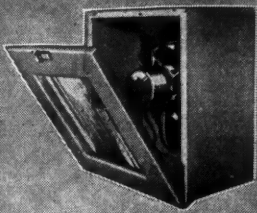

away
with
Cooking
Odors
and
Greasy
Fumes

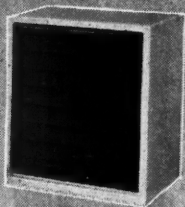

Ventilate the Kitchen with an **ILG AIR** Electric Ventilator

THE day is here when no home or apartment is truly modern without an Ilgair Electric Ventilator installed in the Kitchen for removing cooking odors, greasy fumes, and excessive heat. The Ilgair is an electrical feature that adds to the sales and rental values of cottage or mansion, and costs little. Be sure you buy and specify the Ilgair — the only electric ventilator with a *fully enclosed, self-cooled motor* — made, tested, sold and guaranteed as a complete unit. Clip, sign and mail the coupon for new illustrated bulletin.

ILG ELECTRIC VENTILATING CO. 2852 No. CRAWFORD AVENUE CHICAGO, ILLINOIS



For Offices, Stores, Restaurants,
Factories, Public Buildings,
Homes, Theatres, etc., etc.

Ventilation

ILG ELECTRIC VENTILATING CO.
2852 NORTH CRAWFORD AVENUE, CHICAGO, ILL.

Gentlemen— Without obligation please send me your new illustrated Ilgair Electric Ventilator Bulletin, also specific information on the subjects checked.

Name _____

Address _____

Home Kitchen Office Store Public Building Factory

WHEN WRITING ADVERTISERS PLEASE MENTION THE AMERICAN BUILDER

WHEN YOU BUILD OR REMODEL INSULATE YOUR HOUSE WITH

INSULITE

the Wood-Fiber Insulating Board

*The Luxurious Comfort of
an Insulated Home Is Within
the Reach of the Most Modest Income*

At very low cost your customers may have homes insulated with INSULITE. This cost is more than paid back in greater structural strength and reduced fuel bills, to say nothing of the all-year comfort that the occupants will enjoy.

INSULITE Building Board is ideal for use as sheathing and wall board. INSULITE Plaster Base enjoys a fine record of successful service. INSULITE in roof insu-

lation—for lining attics and garages—for sound control and acoustical correction—and various other uses—has won the commendation of thousands of builders, architects and owners.

Please write for samples and booklets telling about the uses of this *all-wood* insulating board.

THE INSULITE COMPANY

(A Backus-Brooks Industry)

1202 Builders Exchange, Dept. 10
MINNEAPOLIS, MINN.

ALL WOOD
1/2" THICK
RESISTS
HEAT, COLD
AND
NOISE

**THE
NATION'S
PROTECTION
AGAINST HEAT AND COLD**

A New and Improved DEWALT WONDER-WORKER

MODEL D

Times change—and call for speed—more speed. Without sacrificing any of the wonderful merits of the DeWalt Wood-working Machine we have developed improvements on this Model D which meet the needs of modern business.

Tests made show the Model D is 50% faster in cutting and the motor equally cool. The motor design, in 2 or 3 phase 5 H. P. has been changed to make this speed practical.

The Dial Plate now directly faces the user and measures by exact degrees with a pitch scale as well as the degree scale. The Snap Switch is attached to the table.

For any cutting service, this speedy, flexible, accurate DeWalt Wonder-Worker, with its ability to make so many and so varied cuts, stands as the greatest recent development in wood cutting machinery.

Write for descriptive literature on this and other models of DeWalt Wonder-Workers, Jointers and Band Saws.

DEWALT PRODUCTS CORP.

762 New Holland Ave., Leola, Pa.

Factory in Canada also

PRICES

DeWalt Wonder-Workers are priced at \$195.00 and up F. O. B. Factory. Model D costs \$425.00. Each unit is complete with motor, table, saw blade, safety guard, switch and connecting cord.

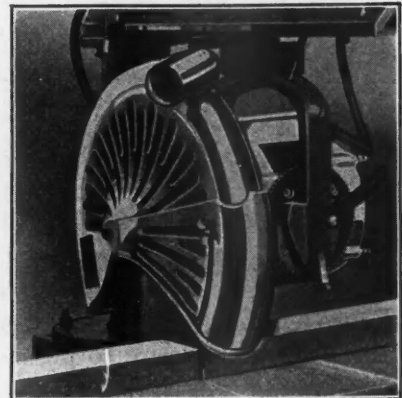

THE Type H. Mandrel Guard prevents cloth becoming entangled in Revolving Mandrel. Note adjustment possible. If this Type H is desired in place of standard guard furnished so specify and add to cost of machine \$8.35.



Real Tiles *change prospect* *into purchaser* more quickly

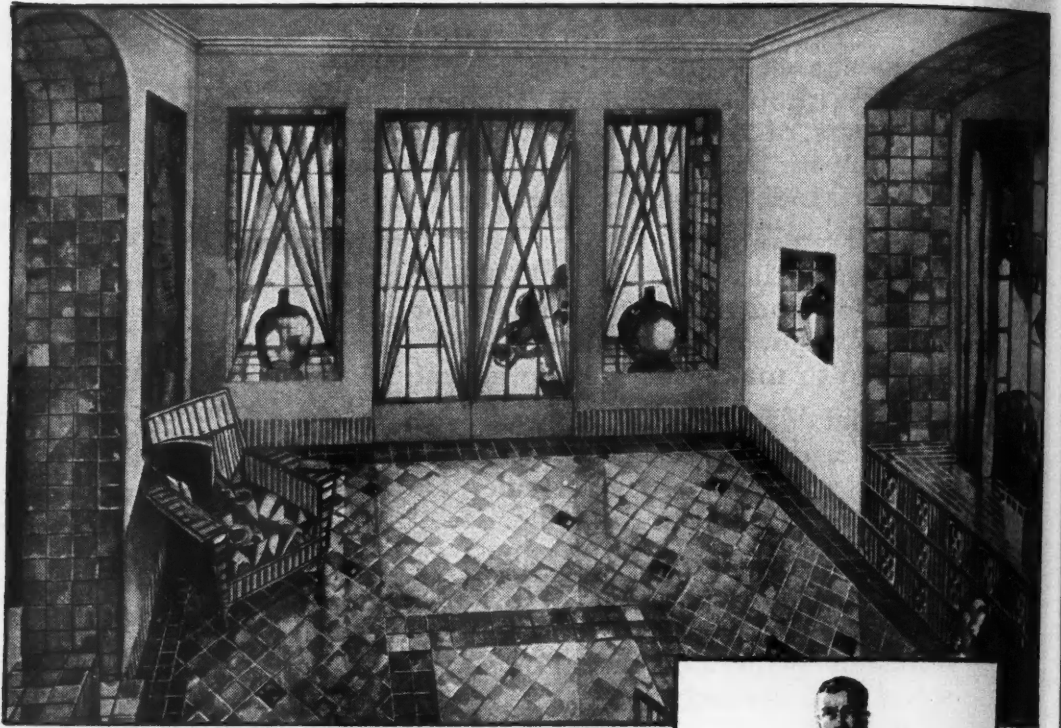

JULIUS GREGORY has designed this attractive sun room. Ceramic Tiles in rich blues and greens heighten the cheerful spirit of the room

YOU want to release the money you have invested in the house as soon as possible. The quick sale means a greater gain for you. And so you build into the house features that at once arouse the prospect's desire to possess.

Keramic Tiles—real tiles—attract people instantly. Noted equally for their beauty and endurance, real tiles make the prospect willing to sign the sales contract.

With Ceramic Tiles you have innumerable opportunities to create the original color harmonies that are now in great

demand. This versatile material gives to rooms the rare distinction that draws immediate approval.

Tiles add to the life of the building. That part of the house built with tiles will never deteriorate.

The remarkable ease with which tiles are cleaned gives you another strong point on which to sell the house.

Put the permanence and delightful charm of Ceramic Tiles into all the homes you are building. Let real tiles endear kitchen and pantry to the woman prospect. Try real tiles for the

floors of sun porches and you will never use any other material.

Call in your local tiling contractor. He will show you how to use Ceramic Tiles to make the house a *quicker seller*.



YOU DERIVE the greatest benefit from Ceramic Tiles when the tiles are set by experts. Their skilled workmanship is instantly apparent. Select your tiling contractor on the quality of his work.

ASSOCIATED TILE MANUFACTURERS : 420 Lexington Ave., New York, N. Y.

ALHAMBRA TILE CO.
AMERICAN ENCAUSTIC TILING CO., Ltd.
CAMBRIDGE TILE MANUFACTURING CO.
FEDERAL TILE COMPANY
FRANKLIN POTTERY
GRUEBY FAIENCE & TILE CO;

MATAWAN TILE CO.
THE MOSAIC TILE CO.
NATIONAL TILE CO.
OLEAN TILE CO.
THE C. PARDEE WORKS
ROSSMAN CORPORATION

STANDARD TILE CO.
THE SPARTA CERAMIC CO.
UNITED STATES ENCAUSTIC TILE WORKS
UNITED STATES QUARRY TILE CO.
WHEATLEY TILE & POTTERY CO.
WHEELING TILE CO.

K E R A M I C T I L E S

ly

ou will
ial.
g con-
how to
ke the

N. Y.

WORKS
CO.
CO.



THE error in the belief of some novices that color decoration requires matched shades is shown in this Crane bathroom, where a charming result has been obtained through sharply contrasted fixture colors. The bathtub, blending into the deep water effect of the floor, is the *Corwith* in Lisbon blue. The *Corwith* lavatory and *Saneto* closet are in citrus yellow, a part of the sunlight effect of the walls. Pale blue and white in the

ceiling complete the motif of water, sun, and sky. Tasteful decorative ideas are a part of the good measure given with the beauty and quality of Crane fixtures, valves, and fittings. For a new book of twelve other such beautiful rooms, containing many suggestions for contractors, write for *Bathrooms for Out-of-the-Ordinary Homes*. It is illustrated, with color schemes, floor plans, decorating and equipment information.

150
Pounds Pressure



CRANE



2500
Pounds Pressure

FIXTURES, VALVES, FITTINGS, AND PIPING, FOR DOMESTIC AND INDUSTRIAL USE
Crane Co., General Offices, 836 S. Michigan Ave., Chicago + 23 W. 44th St., New York + Branches and sales offices in one hundred and eighty cities



In this pine home built at Litchfield, Conn., in 1771, architects and builders may find inspiration for modern residences.



Pine is Always Good Taste

A RCHITECTS and builders who specify pine for modern homes, have their judgment verified by centuries of satisfactory service. Through all the changes in architecture and modes of living, the dignified home of pine has remained perennially "in style."

Modern designers are using pine not only for exteriors of enduring charm but for hospitable pine-paneled living and recreation rooms.

The five varieties of Shevlin Pine make possible a wide range of treatments satisfying to the discriminating builder. Pine of Shevlin quality may be obtained from leading lumber dealers in your town.

The five selected varieties of Shevlin Pine are Shevlin Northern White Pine, Shevlin Pondosa Pine, Shevlin Norway Pine, Shevlin California White Pine, Shevlin California Sugar Pine.

You will have no trouble getting Shevlin Pine as there is a plentiful supply. Through a thrifty policy of selective logging, this enduring material has been safeguarded for generations to come.

For further data write for the booklet, "Specify Shevlin Pine."

Shevlin, Carpenter & Clarke Company

903 First National-Soo Line Building, Minneapolis, Minn.
 Chicago Sales Office: 1866 Continental & Commercial Bank Bldg.; San Francisco
 Sales Office: 1030 Monadnock Bldg.; Toronto, Ontario, Sales Office: 606 Royal
 Bank Bldg.; Sold in New York by N. H. Morgan, 1205 Graybar Building

This Roof of Winthrops *STILL A MODEL*

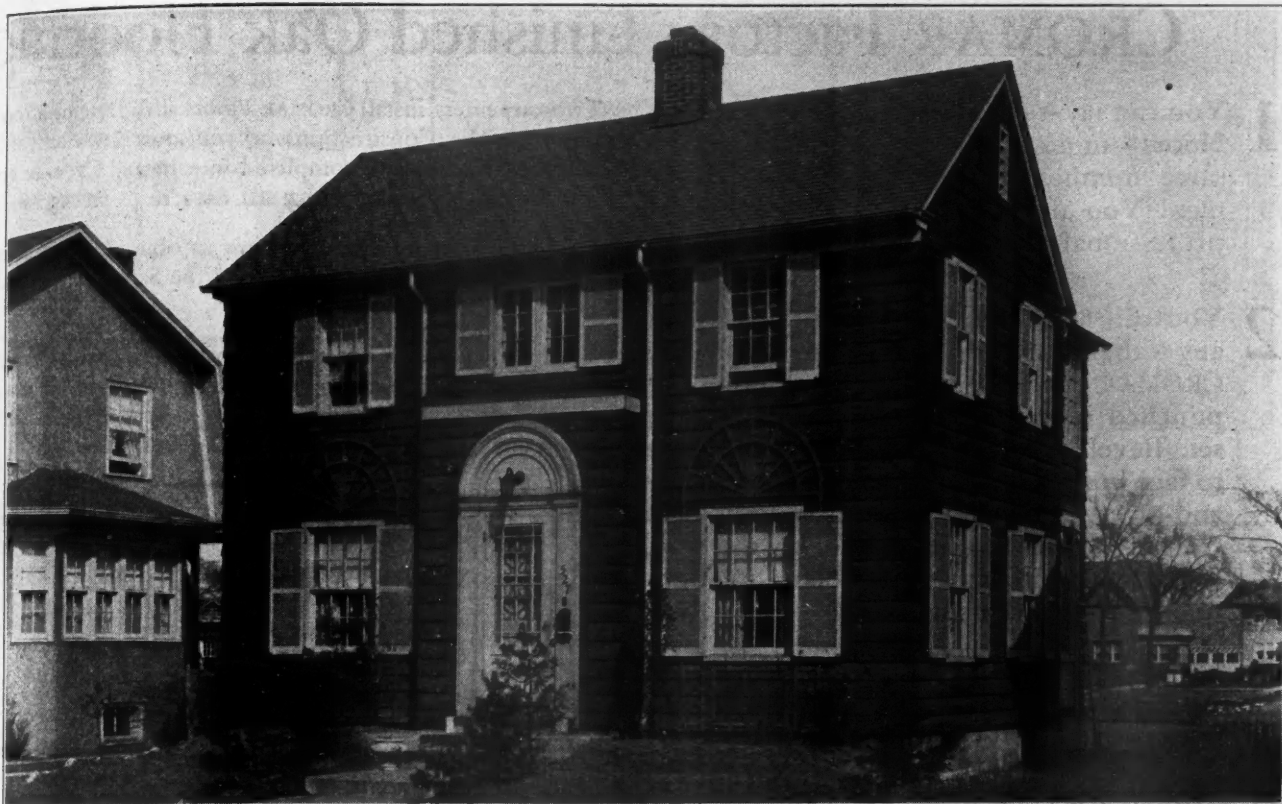

Five years ago, this Model Home, built by the Chicago Daily News in suburban River Forest, Ill., was roofed with Winthrops, selected without solicitation by the supervising architect.

This recent illustration can not show the unfaded sea green color of this five year old roof, but it does show that the thick-butted Winthrops have not curled, that this is still a weather-sealed roof, good for many, many years to come.

Winthrops are the only tapered asphalt shingles with thick butts, that double the wearing thickness, built up of extra coats of everlasting asphalt on both sides the heavy felt cores.



With twenty superb, non-fading natural slate colors at your command you can fit any roof to its structure and to its surroundings

with Winthrops. Winthrops do not rot, crack, split nor catch fire from sparks and brands. They bear the Class C Label of Underwriters Laboratories.

Write for Sample

Let us send you a sample of this Model Shingle, the Winthrop, and a sample, too, of Argotex Building Felt, noted for insulating value. Most lumber dealers carry Winthrops, but get this sample, free, for yourself.

BECKMAN-DAWSON ROOFING COMPANY
1032 Brooks Building, 223 W. Jackson Boulevard, Chicago, Illinois
Factories at Chicago, Detroit and Lockport, N. Y.

Winthrop
Tapered Asphalt Shingles

Argotile (slate surfaced) Roofing, Supreme (mica surfaced) Roofing, Wearproof (talc surfaced) Roofing, Argotex Insulation

WHEN WRITING ADVERTISERS PLEASE MENTION THE AMERICAN BUILDER

Here are the two principal reasons why Building Contractors like CROMAR Factory Finished Oak Flooring

- 1 You can lay a greater number of CROMAR Floors—in new buildings or old—with the same number of men. And they're *your* men. You are completely independent of professional floor-layers.
- 2 You can nail a CROMAR strip faster than any other hardwood flooring strip. The CROMAR tongue is beveled; nail-holes are punched in the tongue; nails need not be set. Beveled tongue also prevents damage to face in nailing. And the V-shape tongue-and-groove fits easily, quickly, snugly. That CROMAR tongue-and-groove, by the way, forms a flexible joint, which takes up slight unevenness in the subfloor.

What makes it possible for you to accomplish these two important short-cuts to bigger profits is this: CROMAR is the only wood-flooring in the world which is completely finished at the factory—milled, filled, double-varnished and even treated to resist moisture! When the completely finished CROMAR strips reach you, all there's left for you to do is **NAIL THEM DOWN.** *That's all.*

CROMAR FACTORY FINISHED Oak FLOORING



Two carpenters install CROMAR Floors at the rate of a room per day. In New Construction work you know how vital it often is to get the building completed in a hurry. CROMAR gets a house ready for occupancy 10 days to 2 weeks earlier.

The advantages of speed are just as obvious in re-laying work. Our slogan "Laid and Used the Same Day" means exactly what it says.

Let the CROMAR Dealer in your territory show you CROMAR Flooring the next time you're in his lumber yard. Write us for complete details and tell us to clear up your doubts about any of the exclusive features of CROMAR.

THE CROMAR COMPANY WILLIAMSPORT, PA.

Pacific Greater West Distributor:
THE C. L. THOMPSON COMPANY
Offices and Warehouses:
200 Davis Street, San Francisco, California
324 N. San Pedro Street, Los Angeles, California

CROMAR Strips Are CRATED

CROMAR Strips are packed face to face, 18 or 24 pieces to a bundle. Bundles are clamped in a press, edges protected with crating, and bound with strap iron to prevent rubbing. Fastened so tightly together, it is impossible for strips to work loose. Thus they are made light-proof, dirt- and dust-proof. Each bundle is stenciled with grade and quantity, so that the material can be stored, without uncrating, until ready for use. Loss from broken tongues and grooves, split ends and damaged faces, is completely eliminated.



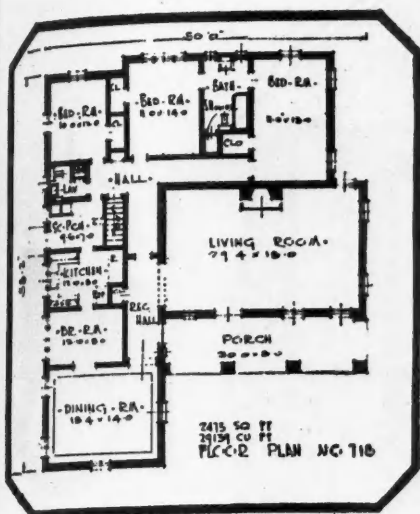

A Brick Bungalow of the Spanish Type

(Brushed with a coating of white cement)

THE Spanish Type Home is increasingly in demand. The San Bernardino model pictured above was a prize winner in last year's competition of this Association. It takes but a glance to agree that this recognition was merited.

Through the service of the Common Brick Manufacturers' Association these plans and specifications are available to you at \$18.00, just their cost.

We have a booklet, recently completed, entitled "Spanish Homes." It is filled with charming homes of the Spanish or Mission type. The price is 25 cents. Additional booklets will be found listed on the coupon and the cost is so nominal that we suggest you send for them today.

COMMON BRICK MANUFACTURERS ASSOCIATION OF AMERICA
 J2131 GUARANTEE TITLE BUILDING CLEVELAND, OHIO

Clip and Mail This TODAY

Without charge, please send me a copy of "Common Brick."
 I am enclosing cash or stamps for the booklets checked.

- "Homes of Lasting Charm" 25c.
- "Farm Homes of Brick" 5c.
- "Beautiful Homes" (1 story) 25c.
- "Brick, How to Build and Estimate" 25c.
- "Skintled Brickwork" 15c.
- "The Heart of the Home (Fireplaces)" 25c.
- "Spanish Book" 25c.

(Enclose \$1.40 if you want all the books)

BRICK

beauty forever

These District Association Offices and
 Brick Manufacturers Everywhere
 Are at Your Service:

- Boston 11 Beacon Street
- Chicago 228 No. La Salle Street
- Cleveland—Ohio Assoc., 2124 Guar. Title Bldg.
- Detroit 400 U. S. Mortgage Trust Bldg.
- Hartford 226 Pearl Street
- New Orleans, La. 727 Canal Bank Building
- New York City 1716 Grand Central Terminal
- Philadelphia 1420 Walnut Street
- Pittsburgh 524 Fourth Avenue
- Raleigh, N. C. 508 Com. National Bank Bldg.
- Richmond, Va. Builders Exchange
- Seattle, Wash. 913 Arctic Building

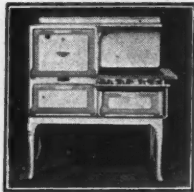
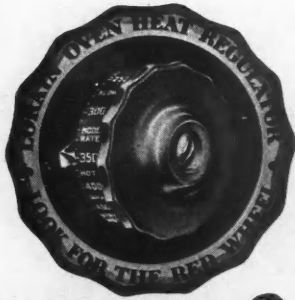

NEW PROCESS
New Process Stove Co.
Div., Cleveland, Ohio

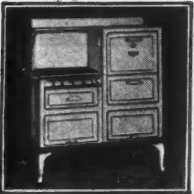

RELIABLE
Reliable Stove Co.
Div., Cleveland, Ohio

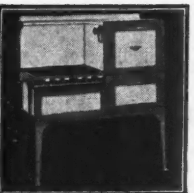

DANGLER
Dangler Stove Co.
Div., Cleveland, Ohio

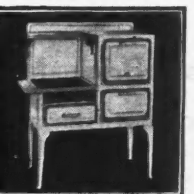

CLARK JEWEL
George M. Clark & Co.
Div., Chicago, Ill.

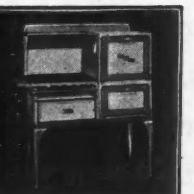

QUICK MEAL
Quick Meal Stove Co.
Div., St. Louis, Mo.

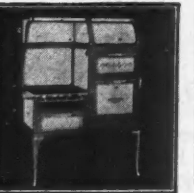

DIRECT ACTION
Direct Action Stove Co.
Div., Lorain, Ohio.



Apartment Building at 47 Plaza Street, Brooklyn, N. Y. Each of the fifty suites has a Reliable Red Wheel Range. Owner: Jacob Mark, New York City. Builder: 47 Plaza Street Corporation, New York City. Architect: Rosario Candela, New York City.

SKIMP.. on Something Else!

If the apartment home is to grow in popularity it must grow in utility and comfort. The equipment that people use most should be of the best, the beds, the bathroom fixtures and—the cook stove.

The apartment house owner or builder can select no item of home-furnishings that will please a prospective tenant more than a handsome Red Wheel Gas Range with automatic oven heat control.

The bride finds it easy, the experienced housewife easier, to cook with a Red Wheel Gas Range. All-enamel finishes are attractive, durable and easy to keep clean. Capacious ovens and efficient broilers produce food that is deliciously cooked, thereby making tenants more contented.

Rather than install cheap, undersize, inefficient cookery appliances, better skimp on something else! Ten years of continuous advertising in well-known magazines have made women the country over prefer Red Wheel Gas Ranges. They'll exclaim their pleasure when you show them a kitchen equipped with a Red Wheel Gas Range. Over 2800 schools and colleges use these ranges to instruct classes in cookery.

There are six different lines to choose from: *Direct Action, Reliable, Clark Jewel, Quick Meal, Dangler and New Process* (see illustrations). All are made by American Stove Company. All popular sizes, styles and finishes. See Sweet's Catalog 23rd Edition, Pages C4009-4018 incl.

For data regarding models to meet unusual requirements write to

AMERICAN STOVE COMPANY, 233 Chouteau Avenue, St. Louis, Mo.
LARGEST MAKERS OF GAS RANGES IN THE WORLD

**UNLESS THE GAS RANGE HAS A
RED WHEEL
IT IS NOT A
LORAIN**

In modernizing
houses and apartments
include



OUTSIDE ICING

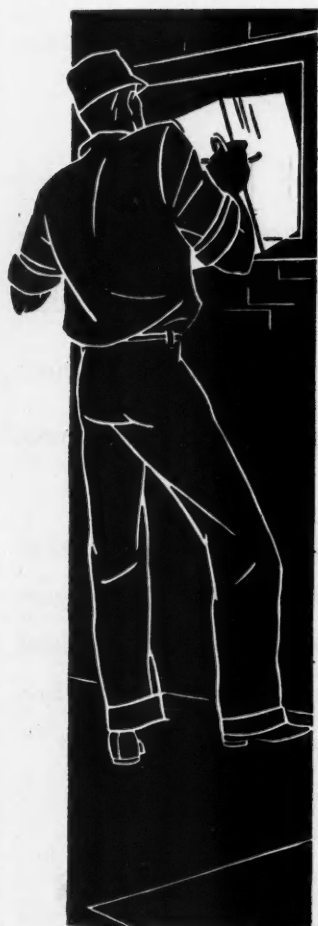

WHEN clients remodel, it is naturally for the sake of securing extra conveniences. That is why it is so important to include OUTSIDE ICING in all plans for modernization. The up-to-date housewife regards it as a necessary convenience. Her refrigerator can be kept constantly well iced without any bother or worry to her.

If a client should fail to ask you to make provision for outside icing, he will appreciate your reminding him about it. It is, of course, much better to provide outside icing while other remodeling is being done than to wait and have it done separately. In building new houses and apartments, it is now quite essential that outside icing be provided—renters and owners demand it.

It is very easy to provide for outside icing. Write for free illustrated folder, "Inside Facts on Outside Icing."

SAVE WITH ICE



NATIONAL ASSOCIATION
OF ICE INDUSTRIES

163 W. WASHINGTON ST. CHICAGO, ILL.

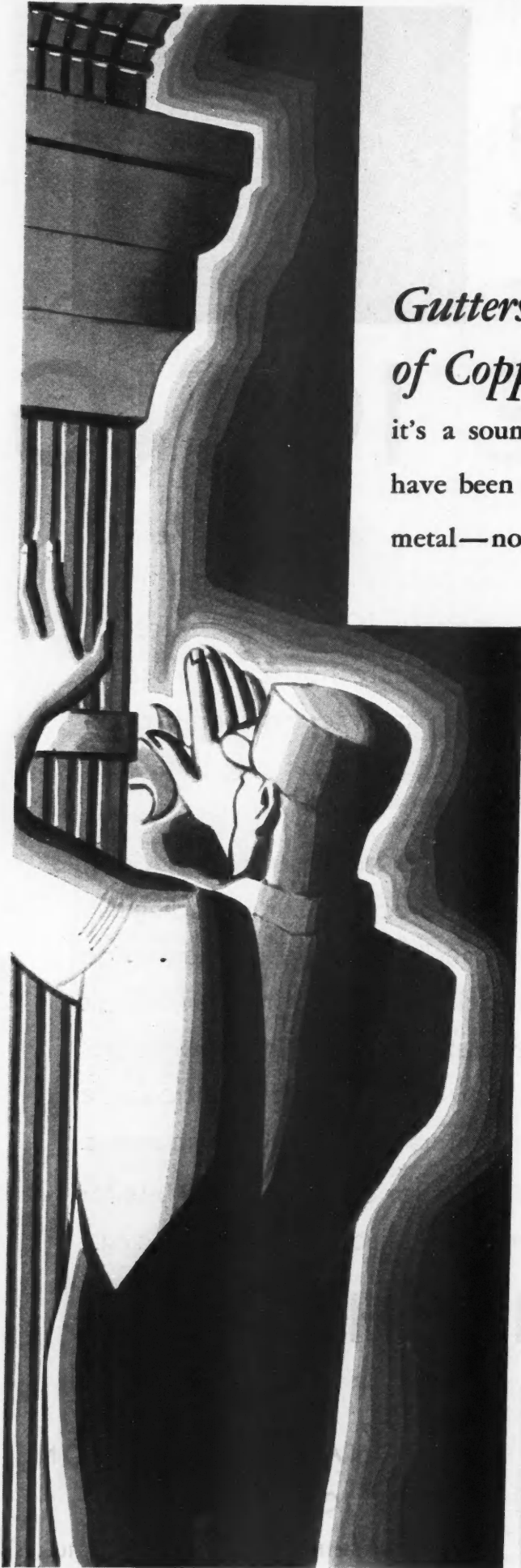

*The mark that identifies good
brass and copper products.*

*Gutters, Leaders and Downspouts
of Copper**—evidence to the prospective buyer that
it's a sound, well-built house — that the best materials
have been used throughout. For Copper is a *permanent*
metal—no leaks to stain walls . . . no costly repairs
later on.

The home-buying public *expect* the
protection of *rustless* materials — plumbing
of Brass, screen cloth of Bronze, leaders
and gutters of Copper—all *rustless* products
which are made and guaranteed by Chase.



* Chase Copper leaders and gutters are
made from full weight, honest-gage,
pure Chase Copper. Each length is plainly
stamped "16 oz. Copper"—and the Chase-
mark guarantees satisfactory quality.



CHASE LEADERS AND GUTTERS

*Chase Brass & Copper Co., Incorporated, at
Waterbury, Conn.* And thirteen complete Warehouse
stocks in the following cities: New York, Boston,
Newark, Philadelphia, Baltimore, Cincinnati, Cleve-
land, Detroit, Chicago, St. Louis, New Orleans, Los
Angeles, San Francisco. (Also Branch Offices in Roch-
ester, Pittsburgh and Dallas.)

THIS QUESTION OF PRICE

as it applies to doorways

MAYBE you have wondered why price appears to be a secondary consideration with R-W engineers.

The simple obvious answer is that Richards-Wilcox prefers not to compete for your favor on the price basis, but on service and responsibility.

Nothing is more deceptive than a low first cost . . . it's the final cost and performance that determine price and should govern the selection of doorway equipment.

The building itself is stationary, but its doors must always be readily, easily movable. Their efficient operation depends on both the doors and the proper hardware. When final cost and correct equipment are the chief considerations, R-W doors and hardware invariably win.

This has been proved throughout twenty-five years of making the right kind of equipment for every type and size of doorway.

Consult an R-W engineer and you'll discover what we mean by "R-W Service and Responsibility."



Richards-Wilcox Mfg. Co.

A Hanger for any Door that Slides.

New York AURORA, ILLINOIS, U.S.A. Chicago
Boston Philadelphia Cleveland Cincinnati Indianapolis St. Louis New Orleans Des Moines
Minneapolis Kansas City Atlanta Los Angeles San Francisco Omaha Seattle Detroit
Montreal • RICHARDS-WILCOX CANADIAN CO., LTD., LONDON, ONT. • Winnipeg

TRUSCON STEEL WINDOWS





DONOVAN AWNING
PIVOTED
CASEMENTS

TRUSCON STEEL DOORS





STOCK TYPE
SLIDE DOORS
ROLLING TYPE

TRUSCON STEEL JOISTS





O-T (OPEN TRUSS)
P-G (PLATE GIRDER)
NAILOR

TRUSCON ROOFDECKS
INSULATED AND WATERPROOFED





I-PLATES
FERRODECK
FERROBOARD

QUALITY STEEL PRODUCTS at ECONOMICAL COST

Truscon Steel Building Products enable the contractor to do a better job at lower cost. The complete lines include individual products exactly suited to any structural condition. Large manufacturing facilities to insure fine workmanship, local warehouses to guarantee prompt deliveries, and a nation-wide engineering organization to render direct personal service supplement the inherent merits and distinctiveness of these products. We desire to cooperate in every way by furnishing detailed suggestions, complete information and useful literature.

TRUSCON STEEL COMPANY, YOUNGSTOWN, OHIO
Trussed Concrete Steel Company of Canada, Limited, Walkerville, Ont.
Offices in Principal Cities of the United States and the Dominion of Canada

TRUSCON STEEL BUILDING PRODUCTS

STEEL WINDOWS—STEEL DOORS—ROOFDECKS—METAL LATH—STEEL JOISTS—REINFORCING STEEL—ROAD REINFORCEMENT—ENGINEERING SERVICE

FOR ADVERTISERS' INDEX SEE NEXT TO LAST PAGE

R-W
Doors
rail
heavy
by the
groove
comb
sturdy
free j

Bot
Fo
door
bras



FOLDER-WAY

utilizes idle floor space

Several small rooms quickly converted into one large assembly hall



"Quality leaves its imprint"

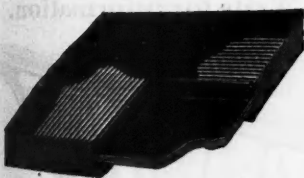

R-W Compound Key Veneered Doors have laminated stile and rail core construction. Extra heavy sawed veneer is applied by the exclusive tongue and groove method. The result is a combination of beauty and sturdiness that lasts for decades, free from warping, swelling, shrinking, etc.

Additional space for extra large gatherings is a frequent and urgent need in churches, community centers, auditoriums, lodge halls and clubs. But the cost of idle floor space prevents reserving a room exclusively for such occasions. Several smaller rooms must be thrown into a single large assembly hall.

This problem is adequately met by R-W Folder-Way partition

door equipment, engineered to fill any and all requirements.

Rapid, noiseless operation of the doors was an essential feature specified by the architect of the Denver Y.W.C.A. Folder-Way filled the bill with complete satisfaction, as illustrated. Perfect alignment and smooth, silent, easy moving, trouble-free operation are assured by Folder-Way.

Write for R-W Catalog No. 43.

Richards-Wilcox Mfg. Co.

A Hanger for any Door that Slides

New York AURORA, ILLINOIS, U.S.A. Chicago
 Boston Philadelphia Cleveland Cincinnati Indianapolis St. Louis New Orleans Des Moines
 Minneapolis Kansas City Atlanta Los Angeles San Francisco Omaha Seattle Detroit
 Montreal • RICHARDS-WILCOX CANADIAN CO., LTD., LONDON, ONT. • Winnipeg

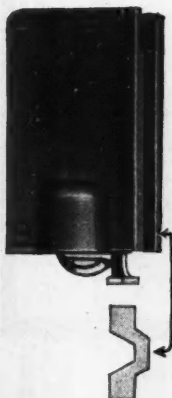

Bottom roller for Folder-Way doors, beautiful brass finish or dull black.

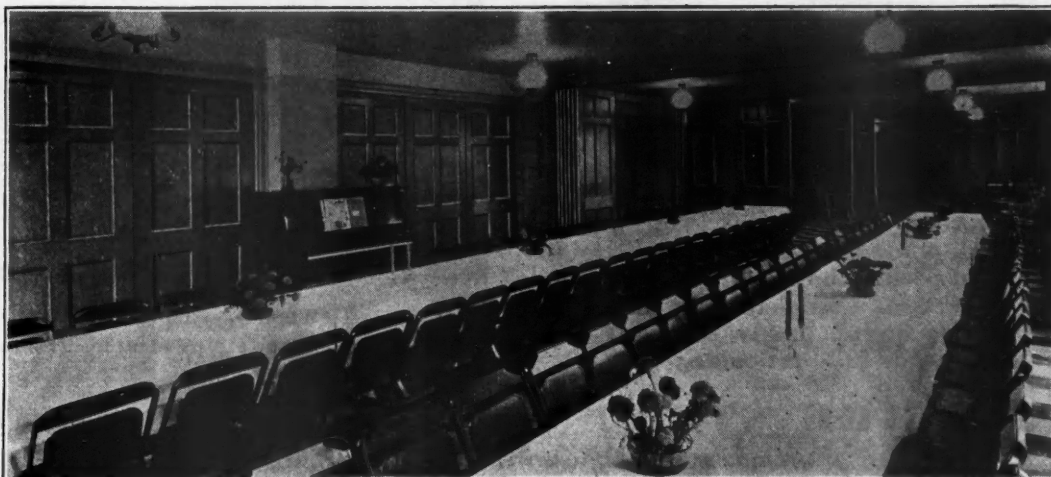

GENFIRE *Announces* 2 New FIRESAFE BUILDING PRODUCTS

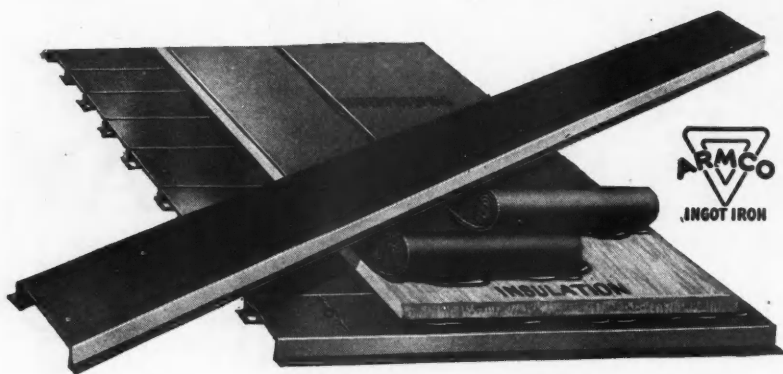

Furnished in 6' wide units of either 18 or 20 gauge Armco Ingot Iron with 1 1/4" or 1 3/4" depth of ribs and in lengths up to 30'.

RIGIDECK FOR ROOFS

Insulated to any Degree and Waterproofed

A high quality Roof Deck consisting of Armco Ingot Iron units 6' wide, which interlock throughout their length forming rigid reinforcing ribs and a smooth continuous roof surface. Quickly installed at low cost, Rigideck forms a permanent, firesafe roof for any shape of roof and any kind of building. Its light weight effects economies both in field labor and supporting framework. Write for information.

NAILER JOISTS

for any Light Occupancy Building

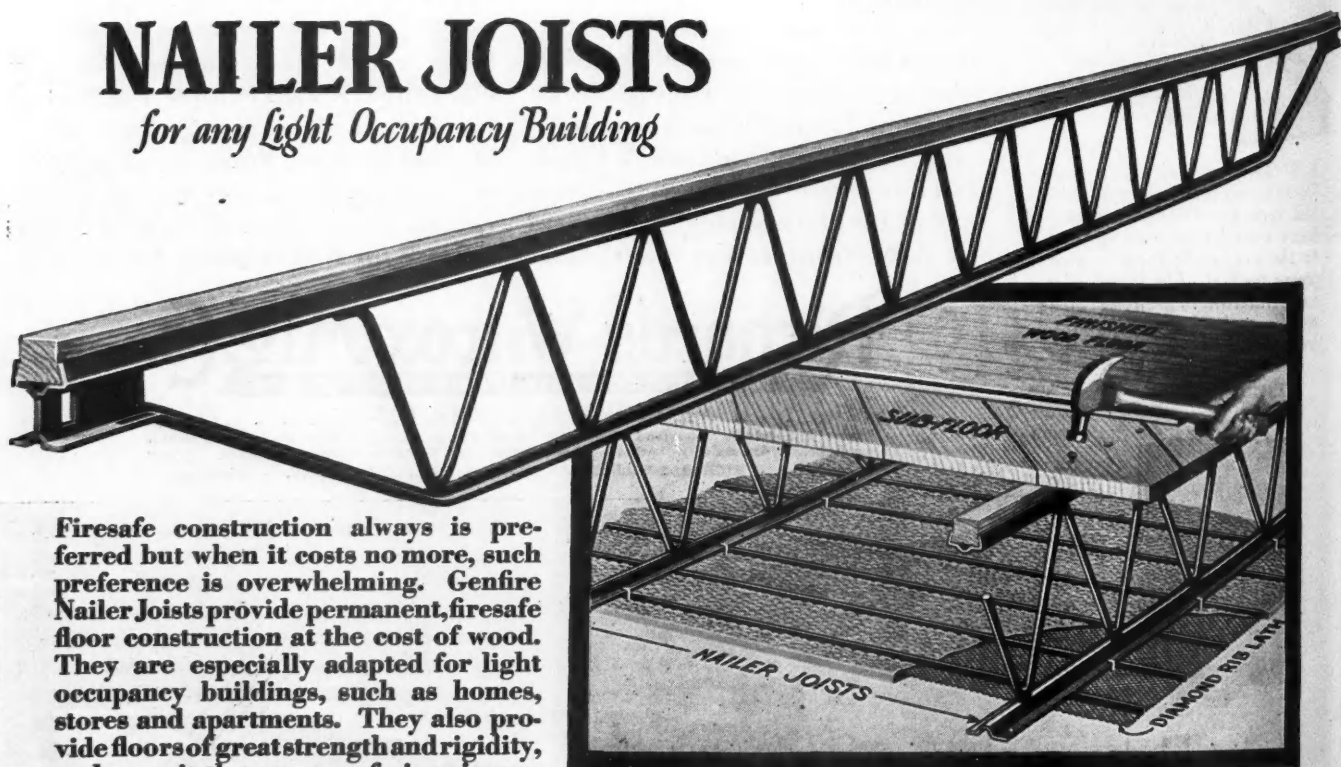

Firesafe construction always is preferred but when it costs no more, such preference is overwhelming. Genfire Nailer Joists provide permanent, firesafe floor construction at the cost of wood. They are especially adapted for light occupancy buildings, such as homes, stores and apartments. They also provide floors of great strength and rigidity, and permit the passage of pipes in any direction. Complete shop fabrication and painting makes erection simple. Write for full particulars.

Wood flooring is nailed directly to the wood strips attached to the joists.

GENFIRE STEEL COMPANY, YOUNGSTOWN, OHIO

Warehouses and Offices in all Principal Cities.

Dealers Everywhere

FOR ADVERTISERS' INDEX SEE NEXT TO LAST PAGE

"Yes we bought the DURO equipped home!"

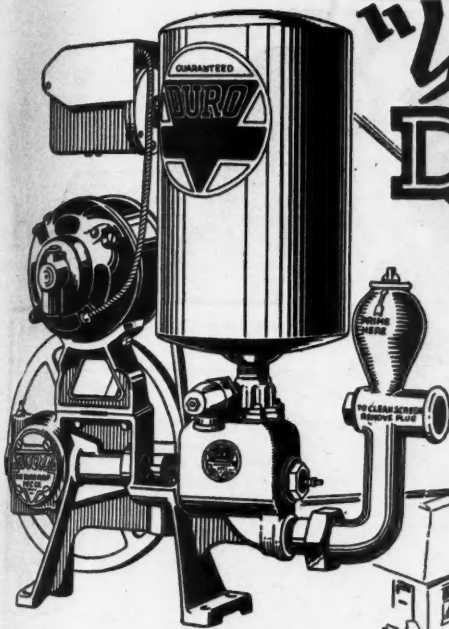

Duro Fresh Flow Water System

\$69⁵⁰

Only Duro could give you such value as this. The No. 250 Duro Fresh Flow Water System is automatic, electric with a big capacity of 250 gals. per hour List f. o. b. factory price:



"TED smiles when I call it the 'Duro house' but that's what stood out in my mind as the difference. It was hard to decide among so many nice homes. But I know what a comfort it will be to have an unfailing water supply. I know that Duro is dependable. And, really, that decided it."

Home buyers everywhere appreciate the equipment which makes for greater comfort and convenience and are impressed by known quality in that equipment. More often than you realize, perhaps, just such a thing as the installation of a DURO Water System or Water Softener swings the sale.

To suburban and country homes, DURO Water Systems bring the priceless convenience of fresh, running water under uniform pressure. And in hard water cities, homes are made truly modern with either an auxiliary DURO Water System or a DURO Water Softener.

DURO quality shows itself in quiet, care-free, long-life performance and low operating cost. Write for new Duro catalogs of Water Systems and Water Softeners.

THE DURO COMPANY , , , Dayton, Ohio

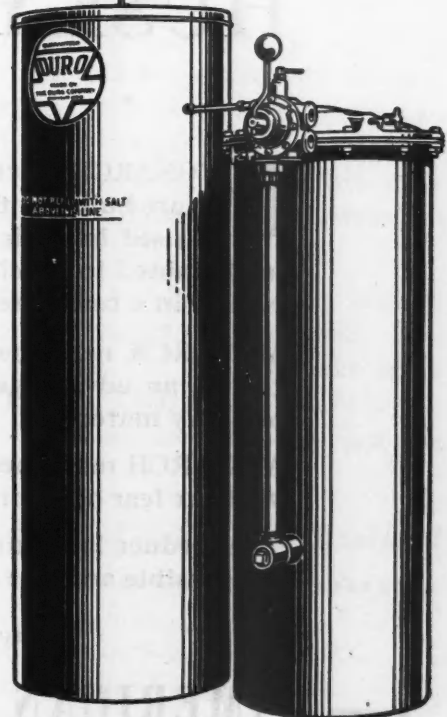

Duro Water Softeners

Duro Softeners are made in 3 types . . . the Automatic, the Semi-Automatic (here illustrated) and the Hand Operated. The f. o. b. factory price of the latter is

\$76⁵⁰

DURO
Water Systems - Water Softeners

WHEN WRITING ADVERTISERS PLEASE MENTION THE AMERICAN BUILDER



Fig. 690—Four men can use this Variety Wood Worker at the same time. A Rip and Cut-Off Saw Bench, with Boring Attachment, Mortiser, and Jointer all in one. Send for Booklet No. 82.

No. 65—Variety Tilting Table Saw—with motor on arbor; with motor on base; with counter shaft. Each machine furnished with one saw, ripping gauge, and one cut-off gauge with reach rod and stop.

No. X-24—A revolutionary new machine. Tilting Arbor Saw Bench—Sturdy, compact, self-contained. Motor built in; saw completely guarded.

Monarch

HUSKY and HANDY

... and HOUNDS FOR WORK!

MONARCH machines will never object to continued hard usage! They are built for that very thing. Only tested and proved materials are used in their making. The men who build them are craftsmen long trained in precision. Every part is inspected and approved before it is used in a complete machine. Every machine is guaranteed.

MONARCH machines are portable—they can easily be moved from job to job, an advantage which saves endless time and difficulty in the case of bulky materials.

MONARCH machines are well guarded. Your operators can work steadily without fear of injury.

They reduce labor to its minimum, and enable you to turn out the greatest possible amount of work at the least possible cost.

Write for descriptive circular and low prices

AMERICAN SAW MILL MACHINERY CO.
60 MAIN STREET HACKETTSTOWN, N. J.

Bigger Profits . .

by building with "NATIONAL TREE" LUMBER



Look for the Tree Symbol

*
Construction economies,
quicker sales on houses built
of advertised "National
Tree" lumber.

Beautiful interiors of wood
bring more money to you
when "National Tree"
lumber is used.



*.. because you can GUARANTEE this lumber
in the
Houses
you Build*

EVERY builder is interested in bigger profits . . . quicker sales . . . ways to get rapid turnover on the houses he builds.

When you build with "National Tree" lumber it is possible to make bigger profits. The National Lumber Manufacturers Association guarantees, to your dealer, that the lumber bearing its trade mark—the Tree Symbol—is of the quality indicated thereon by the official marks of the expert grader . . . that it is carefully manufactured "American Standard Lumber from America's Best Mills."

"National Tree" built houses give you quicker sales because you can *guarantee* the lumber to prospective purchasers. You can get more for the houses you build . . . you can make many construction economies. The Lumber Consultants can help you with your building problems. Their services are free—just use the convenient coupon.



*
The National Lumber
Manufacturers Association
guarantees to the dealer that
lumber bearing its Tree Sym-
bol is of the quality indicated
thereon by the official marks.
He can pass on to you the
benefits of this guarantee

Clip and Mail—Valuable Free Booklets!

National Lumber Manufacturers Association
Dept. 4754, Transportation Bldg., Washington, D. C.

Gentlemen: Send me free the following booklets:

- "Taking the Mystery out of Lumber Buying" ()
- "Modern Home Interiors" ()

Name

Address

NATIONAL LUMBER
MANUFACTURERS ASSOCIATION
WASHINGTON, D. C.

The Easiest Homes to Sell are those
with Walls and Ceilings of
ARCH LATH



Residence, Winston Salem, N. C.—H. W. Nash, Contractor & Designer

Years ago it made little difference what type of plaster base was used. But that day has passed. Today, the home owner not only demands a metal lath plaster base but one that is made of *known* material. Witness the growing demand for Arch Lath which is fabricated from solid sheets of the nationally advertised and universally used

COP-R-LOY

Reg. U. S. Pat. Off.

THE COPPER ALLOYED SHEET STEEL

Always economical in cost because of design and rigidity which save plaster, time and labor. Arch Lath now offers still greater economy through increased durability. The use of COP-R-LOY for this distinctive plaster base marks another step forward in building progress.

Whether you build on contract or build to sell, it will pay you to use Arch Lath. Costs no more to use than inflammable material—saves money in the end. Write to us for samples and prices.

WHEELING CORRUGATING COMPANY, Wheeling, W. Virginia
Branches: New York Buffalo Philadelphia Chicago Kansas City
St. Louis Richmond Chattanooga Minneapolis Des Moines Columbus, Ohio



Arch Lath is a plaster saver not a plaster "skimper." Only the correct amount of plaster to insure perfect key can squeeze through the arches. One sheet of Arch Lath (27 x 96) grips the plaster at 8064 points.



Reg. U. S.

Pat. Off.

Wheeling Sheet Steel

The better and more durable steel, COP-R-LOY, is also available in building materials such as Spanish Metal Tile, Roofing Ternes, Diamond Lath, Corner Bead, Picture Mold, Base Screed, Wall Ties and other building essentials

Spanish
Metal
Tile



to LOCK
press the button
to UNLOCK
turn the knob

Here's the way the women are getting better acquainted with Schlage Locks. Every month House and Garden, and the American Home are carrying the message to over 300,000 prospective home-owners.

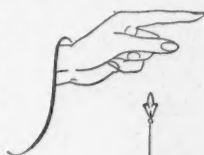

After fussing with keys all these years. Now

WHAT A GREAT SELLING FEATURE

yet it doesn't add to the cost

Tastes have certainly changed! People just won't have ordinary homes and apartments any more. They want convenience and beauty. They want attractive features. Hundreds of building developers install Schlage Locks exclusively. They have found that this one feature alone frequently sells a home or rents an apartment.*

Yet, Schlage Locks cost no more than any good mortise lock. Besides!— you save about 70% on installation cost — you can install four Schlages to one mortise.

Easiest lock to install—drill two holes

You merely drill two holes, insert latch bolt and lock unit, then tighten-up on two screws — and the Schlage Lock is installed. A ten-minute job. Often done in five. No expensive mortising. No weakening of the door.

There is no other lock so easy to install, because the Schlage is an entirely new principle. It's a unit-type lock. Factory assembled.

Parts don't come in contact with wood. They are protected by a steel housing. And they don't fracture, because there are no "cast" parts. They are all made of cold-drawn, sheet steel.

It takes a catalogue to cover all of the many new, outstanding features of Schlage Locks. Mail the coupon. When you get the facts you'll install Schlage Locks exclusively.

* Heyman Brothers, subdividers and builders, of San Francisco, state,— "Our salesmen, in pointing out the different features of the homes, look upon the advantages of the Schlage Lock, and the purchasers have found them superior to all other locks of different design".

This stunning new principle in locks

We honestly don't know why such a delightful lock as the new Schlage waited so long to be born. At a guess, it just had to have the right sort of houses, apartments and furniture, so it wouldn't be lonesome.

Now, Schlage is here! In the smartest designs and finishes! Some are really irresistible. Yes,— in colors, too! . . . And isn't it strange? So ingenious, yet one of the simplest locks made. It's installed by merely drilling two holes.

No danger of getting out of order. No wobbly knobs or loose screws. Built on a new principle. The parts are held together permanently. They stay put!

Millions of Schlage Locks are already in use. Even in the palaces of kings. Actually! Surely you'll want them in your new home. They cost less than other high-class locks. Talk to your architect or contractor about them (say Slay-g).

SCHLAGE

Say Slay-g

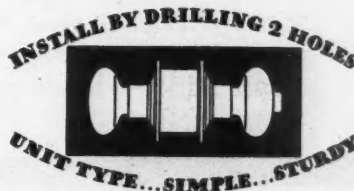

SCHLAGE LOCK COMPANY • SAN FRANCISCO, CALIFORNIA { Name _____
 Please mail me information Company _____ Address _____

KOEHRING DANDIE

with Batchmeter

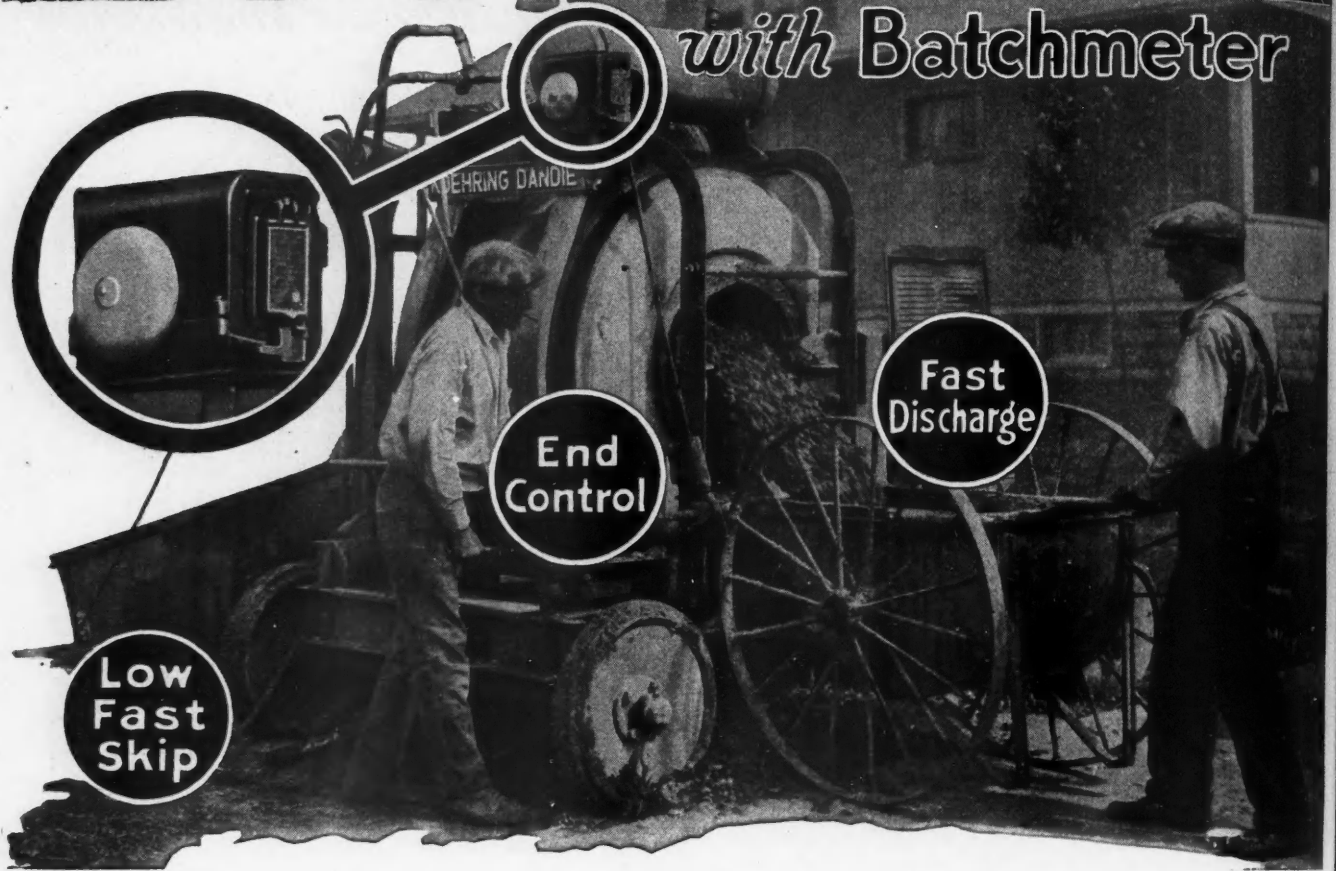

A Two Bagger that Meets Specifications

AN adequate sized drum to hold 10 cu. ft. with liberal, generous room for proper mixing action, this Dandie, with batchmeter, and accurate, automatic water measuring safeguards the contractor on strict specification jobs, bridges, retaining walls, etc.

Fast! Fast because of low, high-speed charging skip that chutes material into the drum in a swift clean slide — because of high,

narrow drum that pours a big volume down on discharge chute — because of discharge that starts instantly, cuts off instantly! Enclosed worm drive in oil bath!

Get the Dandie Catalog

Mechanically this is the outstanding mixer in its class—light, easily handled, short turning, compact—but with long distance durability. At its price a remarkable value! Send for catalog.

Dandie Mixers: 5-S, 7-S, 10-S

5-S single or four cylinder, 7-S two or four cylinder, 10-S four cylinder gasoline engine. Charging skip or low charging hopper and platform. Rubber tired or steel rimmed wheels. Comply with A. G. C. standards.

KOEHRING COMPANY MILWAUKEE, WISCONSIN
PAVERS, MIXERS — GASOLINE SHOVELS, PULL SHOVELS, CRANES AND DRAGLINES

Sales Offices and Service Warehouses in all principal cities
Foreign Department, Room 579, 50 Church Street, New York City
Mexico, F. S. Lapum, Cinco De Mayo 21, Mexico, D. F.
Division of National Equipment Corporation



Certainty

of square dealing
is the
greatest
business
builder



This sign of CONFIDENCE identifies the 4-SQUARE DEALER

4-Square Lumber from the 4-Square Dealer helps you establish confidence

AFTER all a builder, whether he operates on contract only or builds for sale, has only one thing to sell—confidence in the integrity of his materials and workmanship.

And, now, for the first time he has lumber that helps him prove his right to this confidence.

4-Square Lumber—trade-marked, species marked and grade marked. Known to the public as the lumber of definite and unmistakable quality. What better means

could the reliable contractor desire for demonstrating the *soundness* with which he builds—the honest basis for his estimates? What better means to prove the value of the house he offers for sale?

Progressive lumber dealers everywhere are hanging out the 4-Square sign. If yours is not yet ready to supply you, write us.

**WEYERHAEUSER FOREST PRODUCTS
ST. PAUL, MINNESOTA**

Weyerhaeuser Sales Co., Distributors, Spokane, Washington
District Offices: Minneapolis, Kansas City, Chicago, Toledo,
Pittsburgh, Philadelphia, New York

4 SQUARE LUMBER

Species and Grade are Marked and Guaranteed

TRIMMED SQUARE.. PACKAGED.. READY TO USE.. GUARANTEED

SOLD BY 4 SQUARE DEALERS

WHEN WRITING ADVERTISERS PLEASE MENTION THE AMERICAN BUILDER

This is the Saw You've Waited for

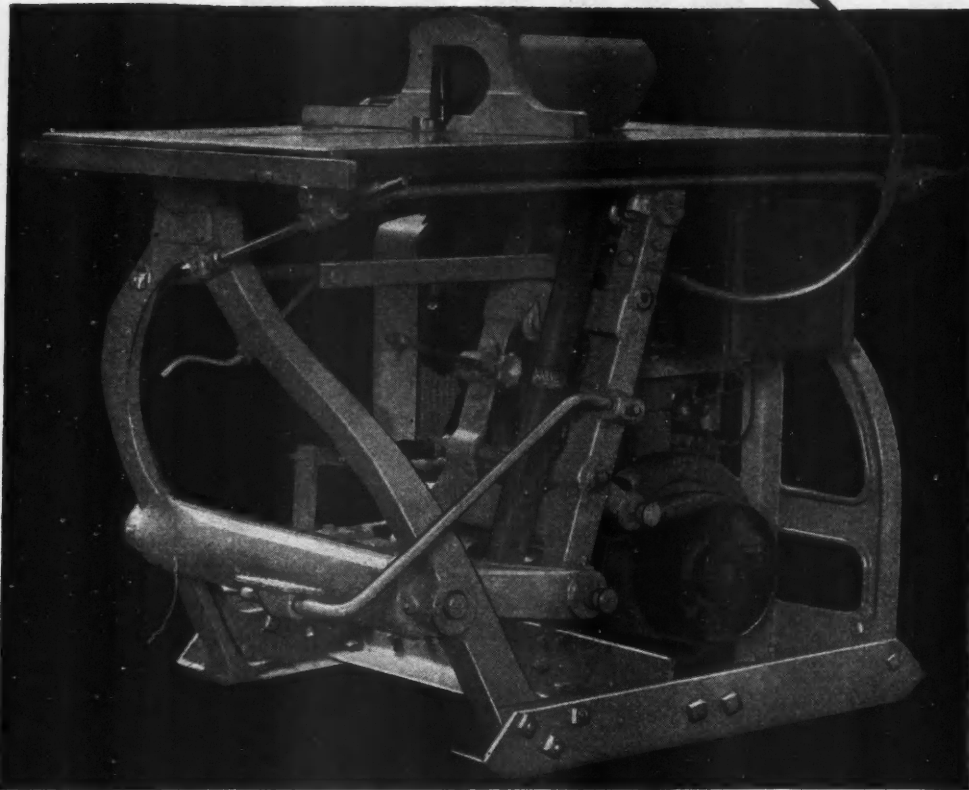

In 2 Sizes: No. 3 and No. 5
 Tilting Table
 Straight-Line Cut-Off
 Cut-Under Frame
 Radiator-Cooled Engine
 Engine Under Table
 Efficient Saw-Guards
 Hand or Foot Operation
 Easily Adjustable Gauges
 Adjustable Arbor Shaft
 Self-Oiling Arbor Bearings

It makes Hand Labor Expensive on Practically any Cutting

Either of the two new Rex Portable Saws make cutting so easy, fast, and cheap that hand labor is out.

For these Rex Saws handle cuts ordinary rigs can't manage: dadoing, mitering, and double-mitering. And the exclusive Straight-Line Cut-Off cuts larger pieces of lumber, ranging up to 5" x 10", 4" x 12", and 2" x 14"—and handles all cuts far faster.

Check these and other important details with the Rex Saw Catalog—if you are interested in getting faster, cheaper lumber cutting than ordinary rigs or hand labor can give you.

Coupon brings the book.

CHAIN BELT COMPANY
 721 Park Street, Milwaukee, Wisc.

REX SAW RIGS

(Reg. U. S. Pat. Office)

Just fill in and send this coupon if you're interested in cutting costs on any job—

Name.....

Address.....

City..... State.....

Type of work.....

Send to Chain Belt Company
 721 Park Street, Milwaukee, Wisconsin

The Rex Saw is made in two sizes — No. 3 and No. 5—the former for lighter work such as home building—the latter for heavy work where large cuts are common—both Saws with either gas or electric power. No. 3 is only 28" wide for easy passage through any standard door.



Permanently beautiful exteriors depend upon the material under the surface. The stucco in these exquisite homes is reinforced by rustproofed steel. They are part of a recent development designed and built by Deal Gables, Inc., Deal, N. J. STEELTEX for Stucco is also an effective and economical base for stucco overcoating of old houses.

How Steeltex speeds sales of homes like these

Walk through the unusually beautiful development at Deal, N. J., pictured above, built by Deal Gables, Inc. Your prospects, like theirs, are sure to appreciate the strength that is added to stucco by the rust-proofed steel reinforcing of STEELTEX.

Or walk down Winchester Boulevard in Queens Village, Long Island. The photograph at the right shows a few of the 350 attractive STEELTEX homes now being built—and promptly sold—in this choice residential section by Mezick Homes, Inc. STEELTEX reinforces the stucco with rigid steel fabric and insulates with a tough, fibrous backing.

Successful builders find that buyers want reinforced homes—houses and apartments built with STEELTEX in place of lath—because reinforced homes keep their good looks and comfort and save upkeep dollars. Your prospects are looking for this under-the-surface strength.

Send the coupon below and get complete details about this new material which has proved its advantages over a quarter of a million times.

National Steel Fabric Company

DIVISION OF
Pittsburgh Steel Co.

3106 Union Trust Bldg. Pittsburgh, Penna.

The world's largest manufacturers of welded steel fabric

STEELTEX

Four types . . . same principle . . . same protection for plaster . . . for stucco . . . for floors and roofs (concrete and gypsum) . . . for stone or brick facing.

National Steel Fabric Company, 3106 Union Trust Building, Pittsburgh, Pa. Without obligation send information about material I have checked.

- STEELTEX for Floors
- STEELTEX for Stucco
- STEELTEX for Plaster
- STEELTEX for Stone or Brick Facing

Name _____
 Business _____
 Street _____ City _____

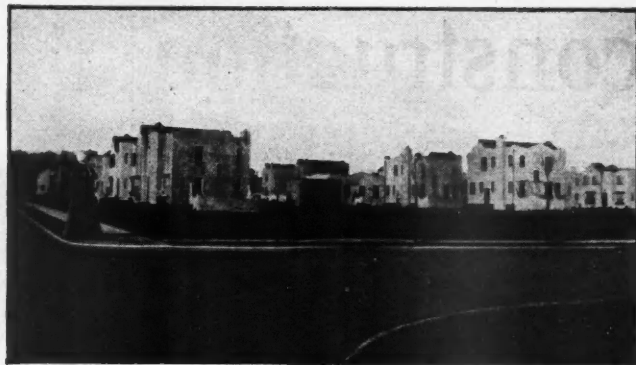

(above) STEELTEX for Stucco puts completely embedded steel reinforcing into the stucco exteriors of Mezick Homes, Inc., Queens Village, Long Island. Its double waterproofed backing shuts out dangerous dampness, making homes dry and healthful—in addition to its insulating and sound-deadening properties.

(below) STEELTEX safeguards the plaster walls and ceilings of this beautiful, modern apartment house at Harrison, N. Y., Gerry Beschello & Sons, Harrison, N. Y., owners and builders. Reinforced protected plaster is an increasingly strong selling point today because of the newer trends in interior decoration.

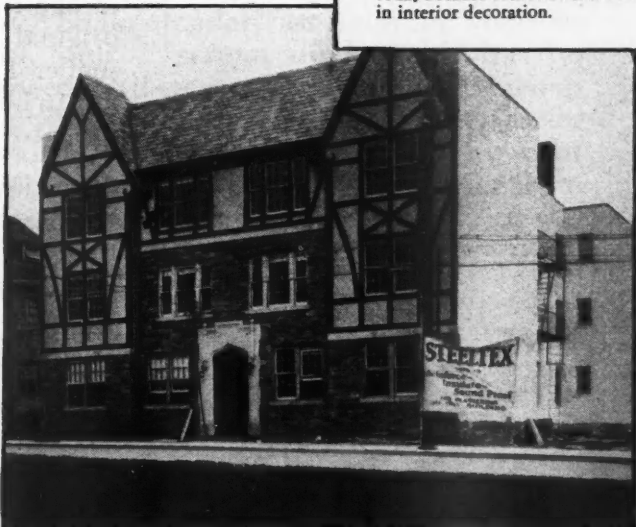

HOMES with STEEL FRAME skyscraper construction

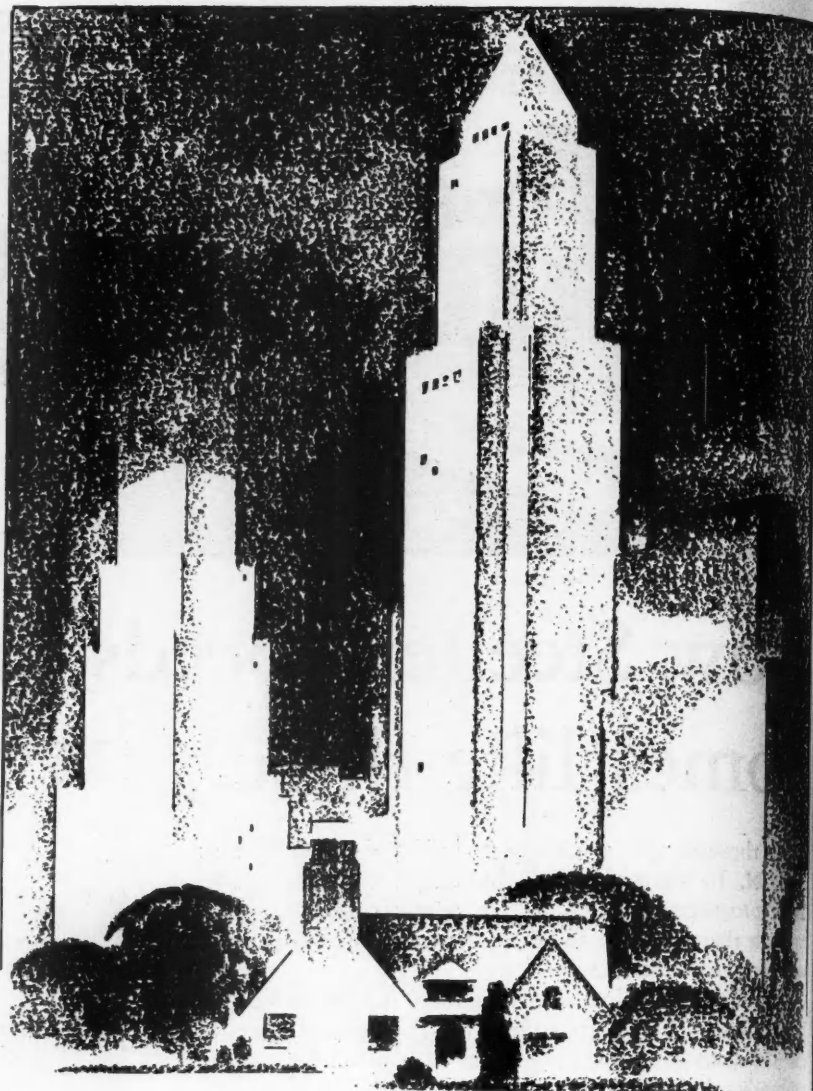
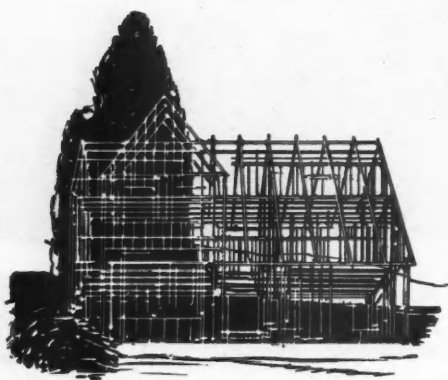

Why shouldn't steel be best for building homes, too? It provides the strongest and most rigid framework known in the building industry. Steel means permanent construction—a framework that is both fireproof and windproof, and will never warp or shrink to cause settling or plaster cracks.

And with Steel Framing you are not limited in architectural design in any way. Specifications are taken direct from the original architect's plans—no special provisions need be made. The complete framework arrives at the building site cut to fit and ready for quick and easy erection with ordinary tools by home-building workmen.

Steel Framing provides modern homes—better homes, of increased value—by bringing to home building all the advantages of skyscraper construction at a cost comparable to that of ordinary construction.

Many different plans of standardized homes are available to building developers. Write for complete information.

STEEL FRAME HOUSE CO., OLIVER BLDG., PITTSBURGH, PA.

STEEL FRAMING

THE MODERN METHOD OF HOUSE CONSTRUCTION



Spring Shock Absorbers
 save wear on both tires and mixer



Automatic Skip Shaker Loader
 Shakes out every ounce of aggregate without pounding bucket. Speeds up loading operation.



Timken Bearing, One Bag Jaeger Tilter - FASTEST 7S BUILT... USUAL 1/2 BAG PRICE!

(3 1/2 S - 5 S - 10 S Sizes Proportionately Low Priced)

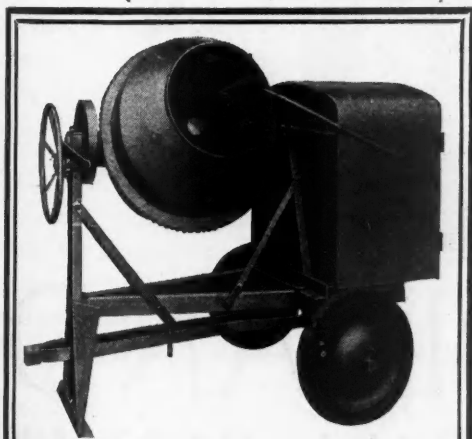

ENGINEERED and built for fast, low cost mixing by the world's largest makers of concrete mixers. With Skip Shaker loader, fast Accurate Measure Water Tank and 5 second discharge it has no equal for speed. All-steel, with Timken Bearings and Spring Shock Absorbers, it's lighter, easier handled and 50% stronger. Endorsed by over 75,000 Jaeger users. Backed by quick service from over 100 Jaeger stations in U. S.

Mail slip below for prices, specifications, terms on Jaeger mixers—all sizes, types.

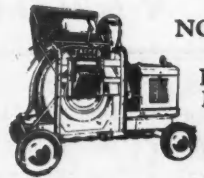

NON-TILTERS up to 28 ft. Sizes
 PLASTER MIXERS

THE JAEGER MACHINE CO.,
 521 Dublin Avenue, COLUMBUS, OHIO

Please send catalog, prices, terms on ... Non-Tilt Mixers
 Tilting Mixers Plaster Mixers

Name _____ Date _____
 Address _____
 City _____ State _____

TRAILERS - \$169 up
 Full 1/2 bag trailers, built of steel with "Flat Spot" Drum, roller bearings, husky power plants. Jaeger Heavy Duty Trailer, illustrated, rides on springs, Timken bearings, cushion tires—outlasts any other half-bag trailer built.

The Smith family

*comes out of
the huddle*



THE SMITHS, the Browns and the Jones' are equipping their new homes with modern Holland Vaporaire systems. Everywhere today you hear new terms used in connection with home heating—proper humidity, air circulation, automatic control, forced warmth and summer cooling service—things that only a Holland can give. Three out of every four Hollands replace heating systems of other types that have failed. Here is the permanent solution of the home-heating problem—a lifetime investment for the home owner and a convincing sales point and advertisement for the builder. Every Holland is installed under direct factory supervision and backed by an ironclad written bond of satisfaction that protects both you and the home buyer. Get the facts. Learn how Holland co-operates with builders, helping them reduce sales costs, increase profits and sell more homes.



HOLLAND

VAPORAIRE HEATING

USE THIS **COUPON**
HOLLAND MEN KNOW WHO PLANS TO
BUILD OR BUY IN YOUR COMMUNITY.
Get the facts. There's no obligation.



HOLLAND FURNACE COMPANY, HOLLAND, MICH.

Without obligation on my part, please

Have a Holland man call

Send me literature

Name _____ Address _____

City _____ State _____

HB-1



Does Competition Cut Your Profits ?

Do you run your own business? Fix your own prices? Or does competition hedge you about and force your prices down?

In your building business, just suppose, for a moment, you had a superior building material. An exclusive material. A material that built better buildings than you have ever built before, yet a material that you could manufacture in a plant of your own at a profit of from 30 to 60%, and then use in your wall construction at a saving of 30% or more.

To have the exclusive right to make such a product in your community could mean only one thing—manufacturing independence—a secure future—a position of real prominence. You would have the whip hand over competition. Your goal would be limited only by your own desires.

Do you know that such a material and such an opportunity exists and that it has been tried and tested for more than seven years? That hundreds of homes and other buildings in this and other countries attest to the superiority of the material and its inherent money-saving qualities?

Over \$100,000 worth of homes in St. Louis provided by one firm alone in 1928. An investment multiplied 33 times in Kansas City, with their output absorbed by a large chain of supply yards. Garage specialists in Altoona who have refused \$85,000 for their four-year business. \$4000 saved in walls alone for a small Cincinnati factory. Great apartments, factories and a stadium in Montreal

that have effected big savings to the contractors and profits to the manufacturer.

These are facts about men and savings which you can duplicate. A great market is at your door, eager for your product because it costs less, and is better than anything you have ever known before. With such a product and such a market, the money-making opportunity is limited only by your ambition.

Why not investigate the opportunity? Someone in your city is going to grasp the advantages that this material offers. It may as well be you. Facts and figures are awaiting you. A postage stamp will bring them. They're in a book called "Basic Facts." Use the coupon if it's more convenient.

W. E. Dunn Mfg. Co.

415 W. 23rd Street,

Holland, Michigan



**THIS BOOK DESCRIBES
A NON-COMPETITIVE
BUSINESS—SEND FOR
IT!**

W. E. Dunn Mfg. Co.
415 W. 23rd St.
Holland, Michigan

Send me your book, "Basic Facts," describing this material that reduces costs and offers a plan leading to manufacturing independence.

Name.....

Address.....

You Get This Big New Book

Absolutely Free!

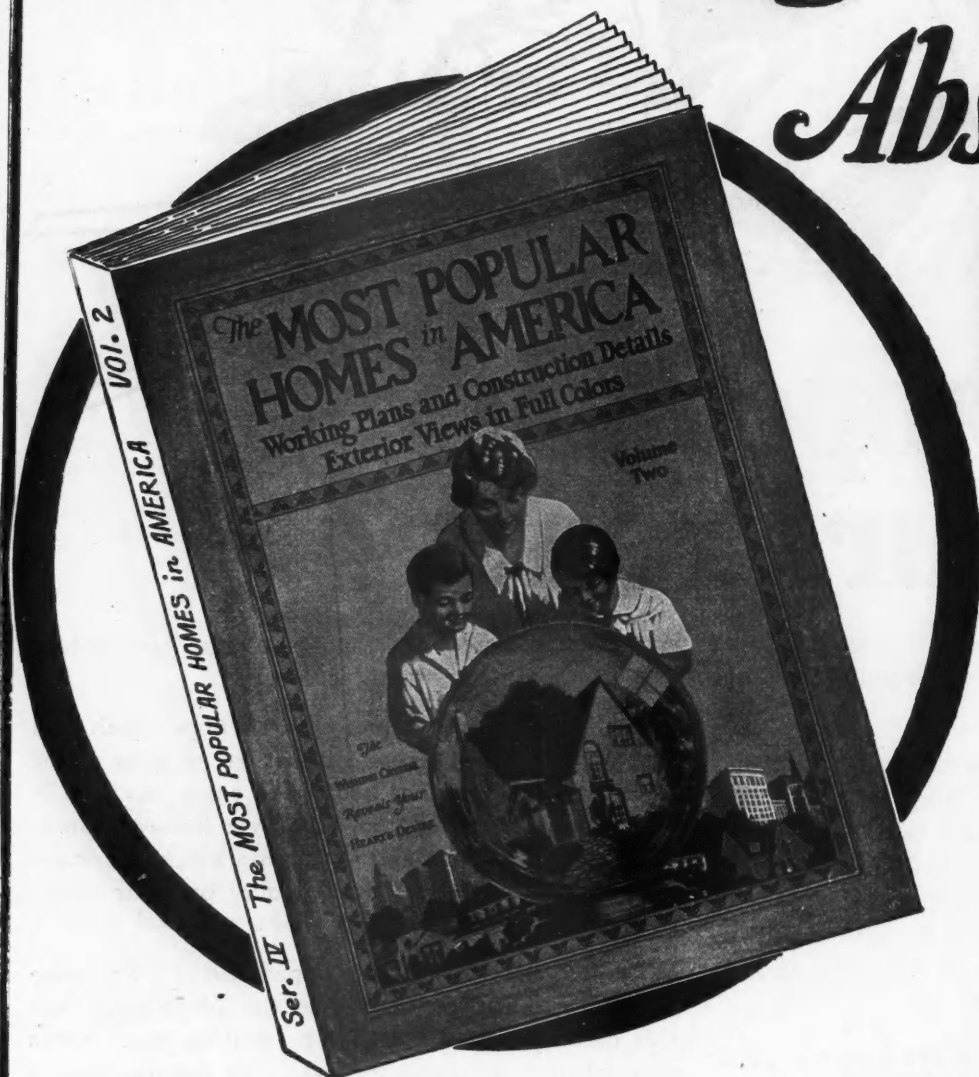

“Most Popular Homes In America —VOLUME TWO”

is a companion book to *Volume One*, which has had a phenomenal sale in the past year. *Volume One* has been repeatedly called the most beautiful and useful home design book ever printed.

The new book, “*Volume Two*”, is even more beautiful in appearance and contains 20 more full color plates than *Volume One*. If you already have *Volume One*, you will certainly be delighted with *Volume Two*.

We have on hand only a limited number of this new book—they are going rapidly. If you want yours, send for it now, *today*, before the supply is exhausted.

15 Sets of Complete Building Plans

FIFTEEN of the home designs in this wonderful book have complete working drawings, scale one-eighth inch and larger. You can build direct from these drawings, thus giving you an architectural service worth a neat sum of money, yet we include them in this wonderful book and send it to you absolutely free of cost.

These working drawings are only one of the many valuable features of this remarkable book. In addition, there are *Twenty Pages* of designs printed in four colors. Many pages of high-class half-tones reproduce actual photographs of beautiful interiors, furnishings, modern home conveniences, etc., etc.

Clip and Mail This Coupon—NOW!

THE AMERICAN BUILDER AB 6-29
 105 W. Adams St., Chicago, Ill.,.....1929

Enclosed find \$2.00 for which **ENTER RENEW** my subscription to The American Builder for one year and send me free and postpaid a copy of your book “**MOST POPULAR HOMES IN AMERICA**”—Vol. 2.

NAME.....

ADDRESS.....

POST OFFICE.....STATE.....

My occupation is (Check Only One)

Dealer Builder Architect Real Estate Miscellaneous

How to Get Your Free Book

This useful and handsome book will be sent you Free and Postpaid with a new or renewal subscription to “*American Builder*” at the regular subscription rate, \$2.00 for one year. \$2.00 pays for the subscription—the book is a gift.

The subscription may be new or renewal, or it can be an extension of present subscription, but in all cases *must be sent direct to “American Builder” and be accompanied by check, money order or currency for \$2.00.* Subscriptions sent in any other way will not entitle sender to free book.

OFFER GOOD IN U. S. AND CANADA
 Add \$2.00 to Foreign Countries

KWIK-MIX

THE T. L. SMITH COMPANY

A Model for Every Type of Mixing Job!

PUT a Kwik-Mix to work for you. It'll speed up the mixing job and add dollars to your pockets — a good low price mixer built to stand the gaff of hard everyday service.

Concrete — Plaster — Mortar Mixers

The line is complete—a model for every type of mixing job—From the 2½-S up, there's a Kwik-Mix to do the work faster, better and more economically.

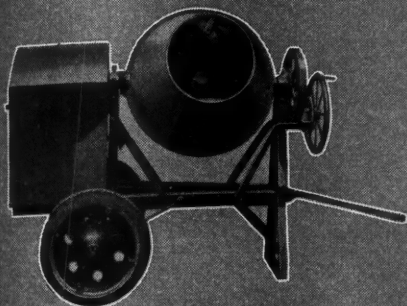

3-S Trailer

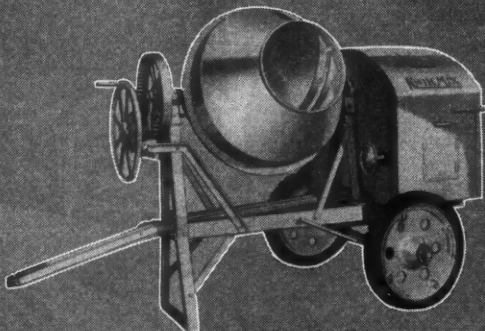

3½-S Trailer

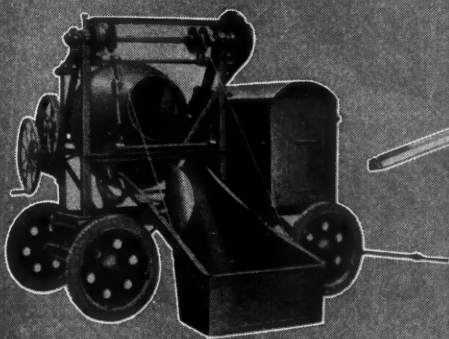

3½-S 4-Wheel Power Loader



7-S 4-Wheel Power Loader

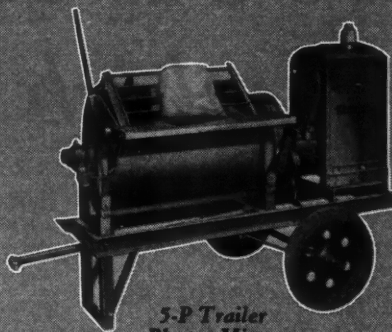

5-P Trailer Plaster Mixer

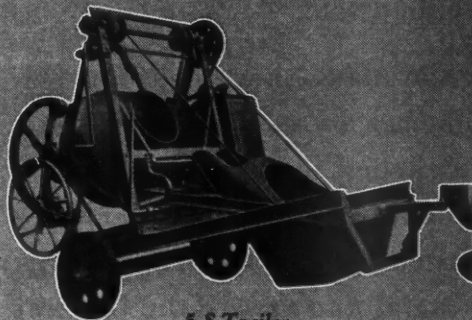

5-S Trailer Power Loader

Kwik-Mix Mixers are available in trailer type or with 4-wheel trucks equipped with steel wheels or cushion tires — either side or end discharge. Size 3½-S and up have power loaders.

You'll like the Kwik-Mix—the All Roller Bearing Mixer—with extra large Counter-balanced Drum — Easy Tilting Mechanism—Quick-acting Friction Brake—Shock-Absorbing Spring-Mounted Axle—Roller Bearing Disc Wheels—and easy fast portability. A bear for punishment—just the mixer you're looking for.

Mail the Coupon for your copy of the New KWIK-MIX Catalog No. 92 — There's no obligation involved.

THE T. L. SMITH COMPANY (Division of National Equipment Corp.)
1026 .32nd Street, Milwaukee, Wisconsin
Please send me a copy of the KWIK-MIX Catalog No 92.

Name.....
Address.....
City..... State.....

A5253-1-KM

WHEN WRITING ADVERTISERS PLEASE MENTION THE AMERICAN BUILDER

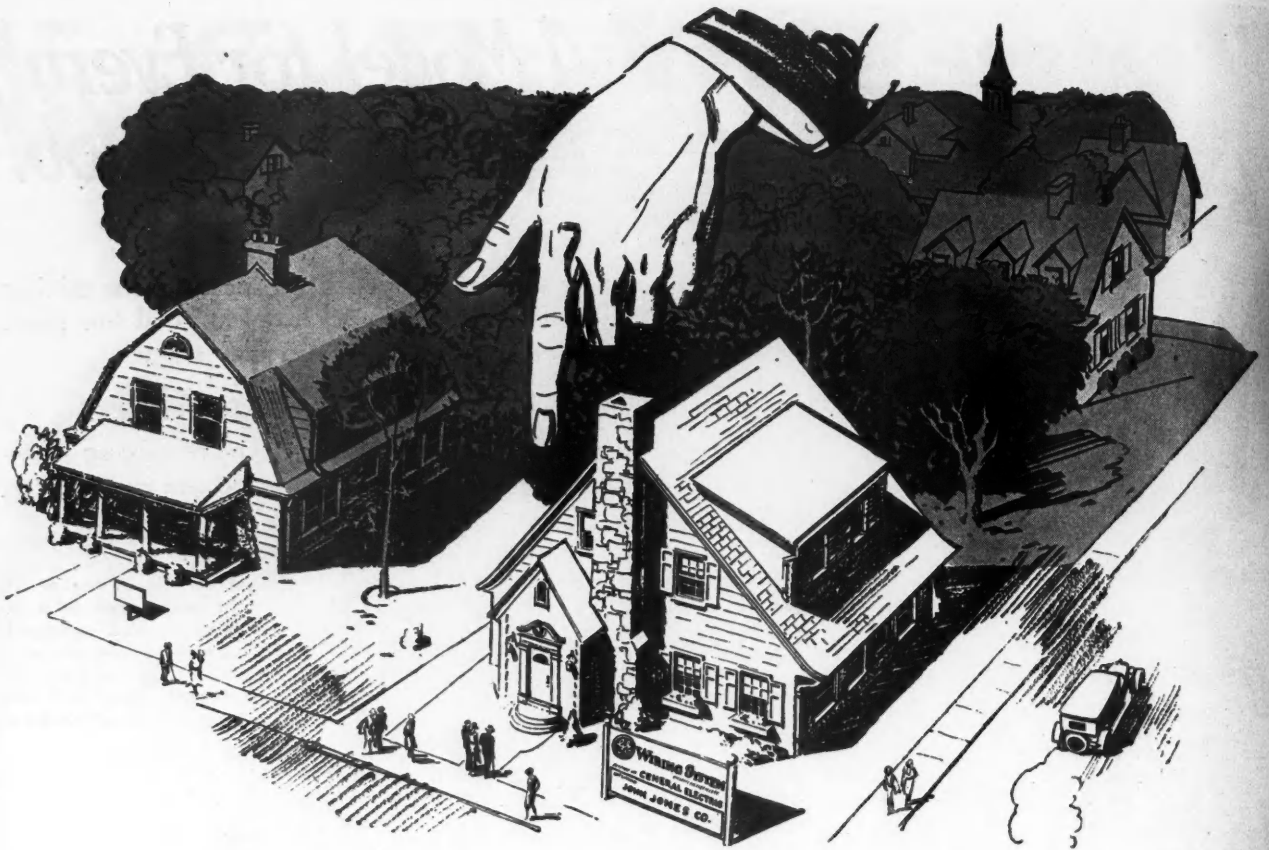

Indoor Appeal..

which house has it?

Equally attractive outside, yes. But home buyers look *indoors* for those little evidences of comfort and convenience that so often decide a sale.

Nowadays they look for evidences of adequate wiring—switches that are handy . . . plenty of outlets properly located for lamps and appliances—and *find them* if the General

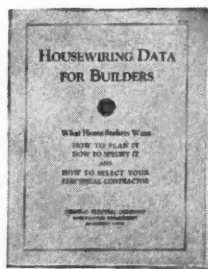

Send to Section W-166 for a copy of the booklet, "Housewiring Data for Builders."

Electric Wiring System has been used. It not only helps to sell homes; it provides a large element of future satisfaction for those who buy.

The General Electric Wiring System designed by experts familiar with builders' problems and executed with G-E quality materials simplifies house planning and adds value and appeal to a dwelling.

GENERAL  ELECTRIC
WIRING SYSTEM

MERCHANDISE DEPARTMENT • GENERAL ELECTRIC COMPANY • BRIDGEPORT, CONNECTICUT

FOR ADVERTISERS' INDEX SEE NEXT TO LAST PAGE

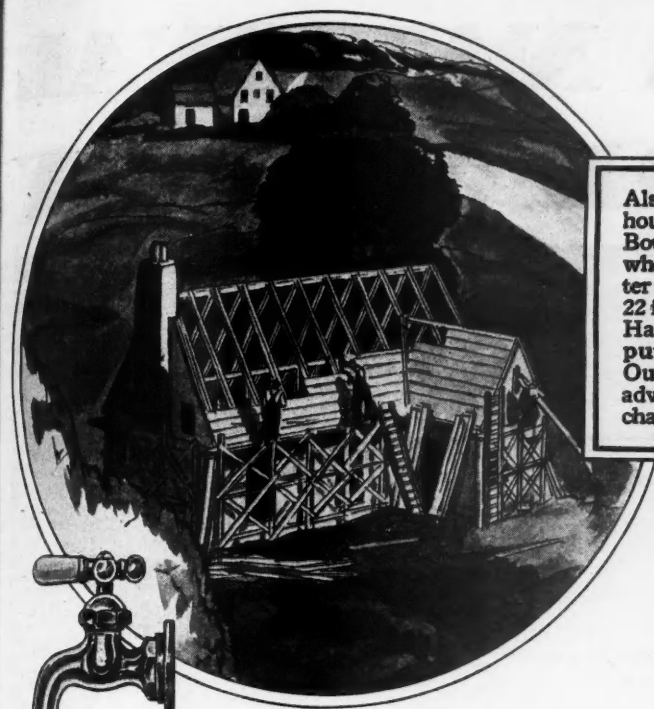

Also a 420 gal. per hour system at \$100. Both sizes for use where source of water is not more than 22 feet below the unit. Have you a water pumping problem? Our engineers will advise you free of charge.



ONLY \$70
 cash f.o.b. factory, complete with 60 cycle A.C. or direct current motor

Note these unmatched F-M features

Increase its value with running water

Even if the house you are building or living in is located beyond the city water mains—it can still have low-cost running water. With this wonderful new type F-M Home Water System, it can have a perfect running water service with all the comfort, convenience and additional property value that go with it. It will make your house a better place to live in—an easier place to sell at your own figure.

Here is unquestionably the most outstanding home water system on the market. Unusually low price with high quality and easy terms are making it irresistible to thousands. Think of it! A system with a 210 gallon an hour pumping capacity—ample for all family needs. And with all the best features developed by Fairbanks-Morse's years of research and experience, and absolutely guaranteed. Fully enclosed. Compact. Complete with 60-cycle A. C. or direct current motor. Easy to install—with only two simple pipe connections ready to go on the job. And the cash price is only SEVENTY DOLLARS, f. o. b. factory.

Easy terms—only \$20 down with small payments monthly. Any Fairbanks-Morse dealer will be glad to give you all the details. Meanwhile, send the coupon.

- 1 Completely enclosed. All parts fully protected.
- 2 Compact—19" in diameter, 21" high.
- 3 Big capacity—210 and 420 gallons per hour.
- 4 Entirely automatic—starts itself—stops itself.
- 5 Easy to install—only two pipe connections.
- 6 Completely equipped, including electric motor, automatic switch, pump and tank.
- 7 Quickly accessible—simply lift hood. The removal of one stud bolt exposes valves.
- 8 Quiet and exceptionally smooth running.
- 9 Self-oiling.
- 10 Supplies steady, full stream without pulsation.
- 11 Can be used with large storage tank when desired.
- 12 Genuine F-M unit throughout. Fully guaranteed—the biggest home water system value ever offered.

FAIRBANKS-MORSE Home Water Systems

Manufacturers: FAIRBANKS, MORSE & CO., Chicago, U. S. A.
 Branches and Service Stations Covering Every State in the Union

Fairbanks-Morse Products



"Every Line a Leader"

MAIL COUPON TODAY

Send your FREE Home Water Service Booklet and information about the F.M. Home Water Systems.

Name R.F.D.
 Address State
 County My source of water supply is:
 Shallow Well Deep Well Lake
 Spring Stream Cistern

WHEN WRITING ADVERTISERS PLEASE MENTION THE AMERICAN BUILDER

THERE'S A NATIONAL FOR EVERY

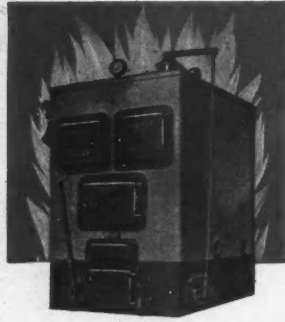

**National Jacketed Boiler
No. 4 Series**

Brings a new conception of what a boiler can offer in outstanding attractiveness, full-saving efficiency, and upstanding service; a striking and colorful jacket, and contrasting trim.

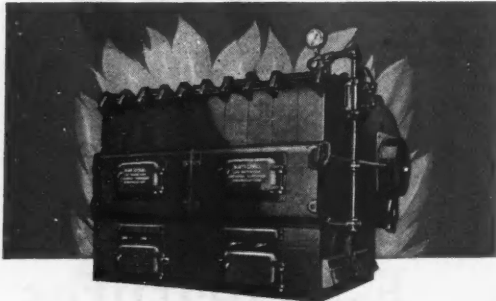

National Low Water Line Boiler

Where lack of head room is the problem, this boiler is always the best, often the only, solution; highly efficient.

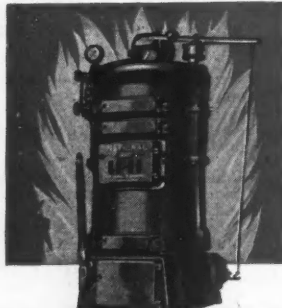

National Round Boiler

In residential and small building heating, its staggered fire travel leads straight to efficiency, economy, and complete and permanent user satisfaction.

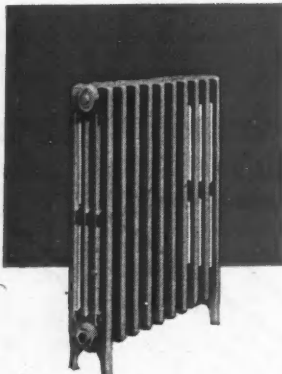

Aero Radiation

Aero Radiators pioneered the way to new heating efficiency, were the first to supply beauty for every setting and utility for every heating purpose.



For all Structures

For large homes or small ones, for theatres, churches, or schools, for apartments or office buildings—for every structure, everywhere, there's a National *Made-to-Measure* Heating System that can be expertly installed, efficiently and economically operated.

The systems embody outstanding equipment which enjoys unusual prestige won in years of demonstrated dependability. Aero Radiators, that pioneered the way to new heating efficiency and beauty, and National Bonded Boilers, renowned for honest ratings and dependable performance, have long been synonymous with complete heating satisfaction.

For all Conditions

Perhaps the problem is the lack of boiler head room so frequently encountered in theatre buildings, and in structures in tide-water country; or perhaps it is a combustion problem in some locality with a rigid smoke-ordinance.

In either case, there's a National Bonded Boiler to solve it efficiently and completely. Perhaps the problem is the selection of radiation to harmonize with certain finishes or furnishings. There's an Aero Radiator that will fit in perfectly. Whatever the requirements, National *Made-to-Measure* Heating Systems will meet them completely, efficiently, and with permanent dependability.

NATIONAL *Made-to-Measure* HEATING SYSTEMS

HEATING SYSTEM

Building Need

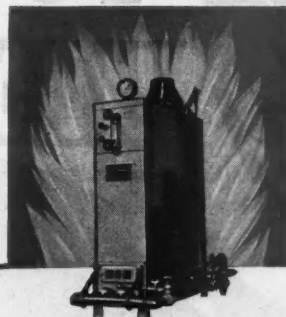
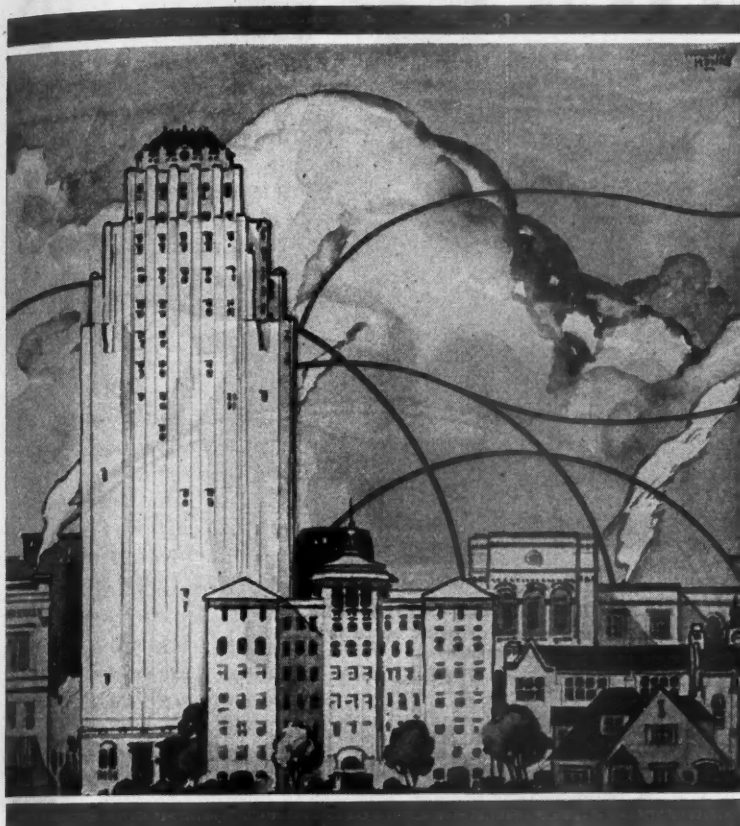

National Jacketed Gas Boiler No. 1

Cleanliness, convenience, accurate maintenance of any desired degree of warmth—are the contributions of this strikingly attractive, highly efficient boiler.

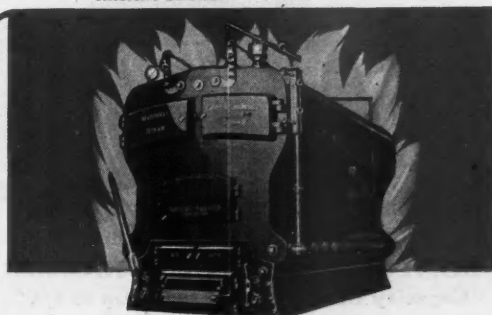

National Super-Smokeless Boiler

Specifically designed for the efficient and smokeless combustion of all grades of fuel. Distinguished for its swirling scarlet flame, and balanced secondary air supply.

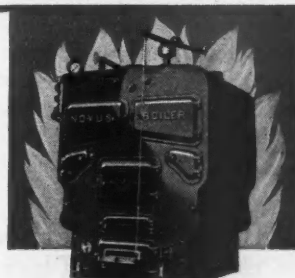

National Novus Boilers

These businesslike, dependable, effective boilers have for 18 years been demonstrating their worth in all types of applications, all over the country.



National Boilers are backed by a bond, issued by a great surety company, which guarantees performance, assures satisfaction.

National Radiator Corporation,
55 West 42d Street, New York, N. Y.

Please send me full information concerning National *Made-to-Measure* Heating Systems, and the services behind them.

Name.....

Street.....

City..... State.....

For all Types of Fuel

National Boilers are Bonded to deliver their published ratings, and are designed to perform efficiently with leading types of fuels, such as all domestic sizes of anthracite, bituminous coal, oil, gas and coke. They can be converted on the ground to meet the individual characteristics of the fuel selected. The engineering design of the grate surfaces, air spaces, sizes and shapes of combustion chambers, design of fire travels, waterways, and the systems of air intake and damper control combine to set up a balanced condition resulting in economical combustion and satisfactory heating performance.

For all Purposes

The National Protective Payment Plan permits the installation of a National *Made-to-Measure* Heating System on a low down payment, the balance being retired in easy monthly installments. A fire, disability, and death insurance clause protects the purchaser during the period of payment.

One Source of Supply — One Responsibility

All heating needs can now be filled from a single source of supply, backed by a responsibility that does not quibble or compromise, that positively assures satisfaction to the user. Fill out the coupon, and receive full information.

Copyright 1929
N. R. Corp.

NATIONAL RADIATOR CORPORATION

Executive Offices : 55 West 42nd Street, NEW YORK

ARE YOU HAMMERING *By* ELECTRICITY?



NO. 4 PORTABLE ELECTRIC HAMMER
Capacity in concrete or brick up to 1 1/8"
Weight - 15 1/2 lbs.
Price - \$185.00

NO. 2 PORTABLE ELECTRIC HAMMER
Capacity in concrete or brick up to 3/4"
Weight - 10 lbs.
Price - \$145.00

NO. 6 PORTABLE ELECTRIC HAMMER
Capacity in concrete or brick up to 1/2"
Weight - 23 lbs.
Price - \$245.00

THIS is the method used in the majority of industries today, regardless of their size. There is no industry so small that "hand hammering" methods will suffice when electric tools are available which will hammer at the rate of from 2,300 to 3,300 blows per minute.

Black & Decker Portable Electric Hammers are manufactured in three sizes with a range from 1/4 to 1 1/2 inches in concrete or brick. They can be plugged into any electric socket, making them instantly available. A complete line of star drills, diamond point drills, chisels, seam tools etc., are manufactured for these Hammers, doubling their usefulness.

If you have holes to drill in concrete or brick it will pay you to investigate these powerful, labor saving tools.

Write for our new 8 page Hammer Booklet - also for details regarding our Time Payment Plan.

The BLACK & DECKER MFG. CO.
Towson, Maryland

Gentlemen:

I am interested in your Portable Electric Hammers and will be glad to have further information regarding them.

NAME _____

ADDRESS _____

Around the Family Table

Where Readers and Editors Get Together

THE other day in our morning's mail we received a letter showing a fine spirit of helpfulness between interests that are sometimes thought of as competitors, namely, the lumber manufacturers and the brick manufacturers. We had turned over to one of the prominent lumber manufacturing associations an inquiry from a housing engineer who wanted ideas for a corporation housing project of inexpensive homes. The carbon copy of their letter to this housing engineer came through to us, and we were interested to see that, in addition to sending their own plan booklet, this lumber association Secretary added, "We suggest you write also, to the American Face Brick Association, 130 N. Wells Street, Chicago, for further plan books."

This is good teamwork among these big and influential producers of building materials. While they may be in competition at some points, they know that every brick home put up is a market for some lumber and every house of wood erected makes a market for a certain amount of brick.

The Building Industry is so complex and so varied that many trades and crafts must work together to produce the finished structure. Teamwork is very important and we see many evidences of it.

Service to Readers

Service is said to be an over-worked word; often it's a thing easier to promise than to deliver. However, when we received an air mail letter recently from a California subscriber, asking for immediate advice as to the address of the President of the American Institute of Quantity Surveyors—the urgency being that this subscriber was just about to sail for South America, we telegraphed back the information. We didn't think much about this, for such things are not at all unusual in this office. However, we are just human enough to relish this thank-you note, which came back, "Your telegram received and I wish to express my grateful thanks for the same. This is what I call SERVICE, and was more than I expected. It will not be forgotten in a hurry. Wishing you continued success in all of your work."

Growing Interest in Home Designs of Architectural Merit

During the past six months we have been illustrating home designs in duotone on fine enamel stock, and it has been very interesting to note the reaction of our readers to these designs. Some small homes have been illustrated, and some more expensive. The conservative old favorites have been shown along with the newer smart and unusual designs.

Somewhat to our surprise the greatest interest has not been in the low cost houses, but in the designs to cost up to twenty-five thousand dollars. Exteriors of real charm and plans containing novel and unusual features have brought most inquiries.

The AMERICAN BUILDER desires to cooperate with all architects, and will welcome the opportunity of publishing with proper credit interesting and meritorious designs by professional architects everywhere. Our builder and dealer subscribers often want blue print service on designs we illustrate and these inquiries we are happy to turn over to the architects. We want to serve the great building field by illustrating the best designs, and then by helping bring together the authors of these designs and those who want the working plans.

Questions and Answers

A new department makes its appearance this month—QUESTIONS AND ANSWERS, conducted by V. L. Sherman of the Engineering Department of Lewis Institute. In addition to the large number of questions we are constantly answering by mail from this office, Mr. Sherman will select questions and answers of general interest for publication in this department.

So give us your questions. Also give us your answers to the other fellow's question—if it is something that you know. In other words, make this department a practical give and take. Ask questions and share your experience with others. All answers published will be paid for at regular rates.

Trade Papers for Education

Among our readers are thousands of ambitious men who have worked into better positions and bigger responsibilities through home study. A survey of industry in general has recently been made by the Carnegie Foundation, and the fact has been brought out that between 80 and 85 per cent of the executives in charge of seven of our great American industries have never received college or technical education, but are self-trained; and that the basis of this self-training is in part the business press. In this survey-report the statement is made that the business and technical publications are a far greater force for the education of industry and trade than the engineering and trade schools.

This is interesting to us as publishers of the AMERICAN BUILDER and only goes to bear out our own experience with AMERICAN BUILDER readers as to their enterprise, ambition and ability to profit from the pages of this publication.

Our Front Cover

HOW do you like our front cover this month? We think it is one of the best we have ever had. It is just a little different from the old style—more modern, we believe, more attractive and interesting from an architectural standpoint. It is a water color by Quigley of the residence of J. B. Green, Esq., Flintridge, Calif., Paul R. Williams, Architect.

A series in this style for the next few months will present close-up views of important building details, entrances, etc., painted in full colors. Red (our trade mark) is used but sparingly. This is a series of cover paintings which many of our architect and builder readers will want to file and preserve.

Lack of Drainage is no Obstacle in Speculative Building

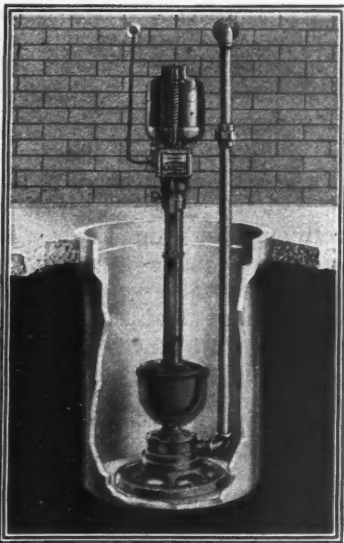
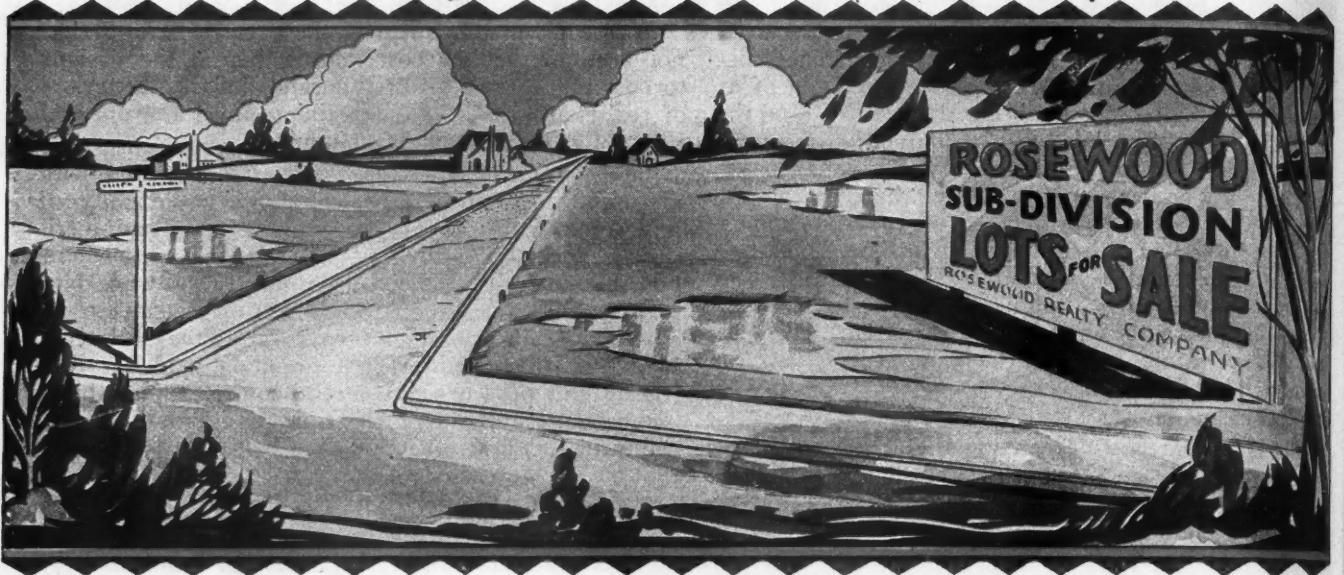

Penberthy Automatic Electric
Sump Pump

THE builder who operates in the newer subdivisions where there are no sewers, can offer his prospects all the advantages found in the older districts. A dry basement is no longer dependent on a sewerage system.

A Penberthy Pump automatically removes all seepage and drainage from the basement as soon as it accumulates. It is inexpensive, dependable in operation and requires no attention.

Your plumbing contractor can quickly supply and install either the electric or hydraulic Penberthy Pump. There is a size for every condition.

PENBERTHY INJECTOR CO.
Established in 1886 DETROIT Canadian Plant Windsor, Ont.

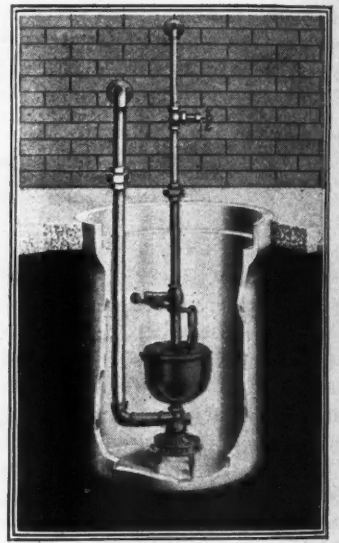

Penberthy Automatic Cellar
Drainer (water operated)

PENBERTHY PUMPS
PREVENT FLOODED BASEMENTS

Established
in 1886



Canadian Plant
Windsor, Ont.



BERNARD L. JOHNSON, *Editor*

105 West Adams St., Chicago—30 Church St., New York City

Looking Forward

BECAUSE of the trend in the building field toward better built and equipped residences and apartments and, indeed, structures of all kinds; and of changed conditions and ways of operating, the AMERICAN BUILDER, long recognized as the leading publication in the building field, finds it necessary to revamp its makeup to the end that it shall not only maintain that lead but also better serve its subscribers by anticipating their increased demands for information.

First, effective with the next issue, the size of the paper will be enlarged to 9 in. x 12 in., a standard that is followed by most of the leading business papers. There are two advantages—better typography, which means easier reading and quicker comprehension; and larger and clearer illustrations, especially of plans. Then, the scope will be widened and the tone highered. While the AMERICAN BUILDER has always included in its coverage homes little and big, apartments, office buildings and other structures which form the composite of any community, town or city, it is now the purpose of the editor to delve deeper into certain phases of construction than has heretofore seemed necessary. The higher tone is but the natural outcome of the trend in residential building; but since the tendency upward does not mean the elimination of inexpensive houses, for which there will always be a certain demand, it is not the intention of the AMERICAN BUILDER to overlook the need for the same kind of facts about that class of homes that it has presented in the past. In short, our intention is to make a still bigger and better AMERICAN BUILDER and in so doing uphold the Simmons-Boardman motto—"Be a motor; not a trailer."

CHAIRMAN OF BOARD.

April Had Large Construction Record

NEW construction work contracted for in the territory east of the Rocky Mountains during the past month, reached the second highest April contract total on record and was the largest monthly construction total that has been recorded since June, 1928, according to F. W. Dodge Corporation. Building and engineering work contracted for during the month of April in these 37 states amounted to \$642,060,500. This figure was almost equal the April, 1928, total and it was 32 per cent ahead of the March, 1929, total.

Analysis of the April building and engineering record showed the following important classes of work: \$256,779,700, or 40 per cent of all construction, for residential buildings; \$152,126,000, or 24 per cent, for public works, and utilities; \$77,988,400, or 12 per cent, for commercial buildings; and \$68,229,500, or 11 per cent, for industrial projects.

During the past four months there was \$1,897,889,800 worth of new construction work contracted for in the 37 states east of the Rocky Mountains, which was a loss of 11 per cent from the amount contracted for during the corresponding period last year.

New work reported in contemplation in April reached a total of \$940,249,100. This figure was 6 per cent in excess of the amount reported in the preceding month and it was 13 per cent ahead of the amount reported during the corresponding month of a year ago.



What They Want—and Can Afford

THE Junior Class in a Port Huron, (Michigan) high school, was asked recently to list the items it considered necessary for a home. When these students finished their modest calculations, it was found that the kind of homes they thought they required would cost not less than \$35,000,—a figure by the way that was out of reach of the entire group.

Some people, like the Michigan high school students contemplating home ownership, think they must have sunken baths, frescoed ceilings, and expensive outlooks. Although they live in modest quarters when they start their figuring, such folks get a total on pretentious dream homes, and are frightened out of home ownership, sometimes forever.

The U. S. Division of Building and Housing is now making a survey of home "essentials," so as better to advise home builders.

When the Port Huron high school class turned in lists that contained items they could not possibly afford, the instructor who evolved this problem then had the students go over their papers and eliminate items until they had brought the cost of their homes down to a figure they might be able to pay. This weighing of items certainly gave these young people training that many prospective home builders should have. It gave them judgment in evaluating the essentials for home construction from the individual point of view.

Base Your Choice on Results!

Test Cylinders
from Driveway Pavement,
Consolidated Co., Chicago

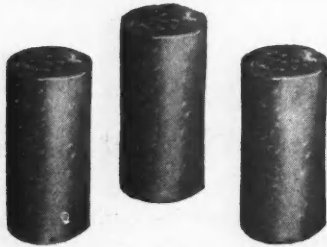

Average of 3-day tests*
3140 lb. per sq. inch

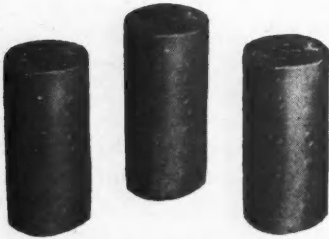

Average of 7-day tests*
4183 lb. per sq. inch

*Concrete as ordinarily mixed and placed reaches a compressive strength of about 2,000 lb. per sq. in. in 28 days.



Send
for the methods!

Heavy-Duty Concrete Ready for Use in 3 Days

Ready to begin a long service under heavy traffic 3 days after placing—sufficiently strong and wear-resistant in 3 days to permit operation of a heavy yard-crane upon it—that's the kind of pavement the Consolidated Co., coal and building material dealer, Chicago, obtained with *High-Early-Strength Universal Concrete* (see tests at left). Nor was early use the only advantage obtained.

Heavy-duty pavements placed with *High-Early-Strength Universal Concrete* in 1926, with compressive strengths of over 2,000 lb. per sq. in. at 3 days (the same strength as ordinary concrete attains in 28 days) and of over 6,000 lb. per sq. in. at 28 days, have successfully withstood the punishment of heavy trucking for 3 years. Both high ultimate strength and durability in addition to high 3-day strength, are thus assured to users of *High-Early-Strength Universal Concrete*.

Standard Universal cement, used according to methods fully described in either of the booklets shown below, was the choice on this job because of results obtained elsewhere on many different kinds of work. You can profit also by basing YOUR choice on these known results.

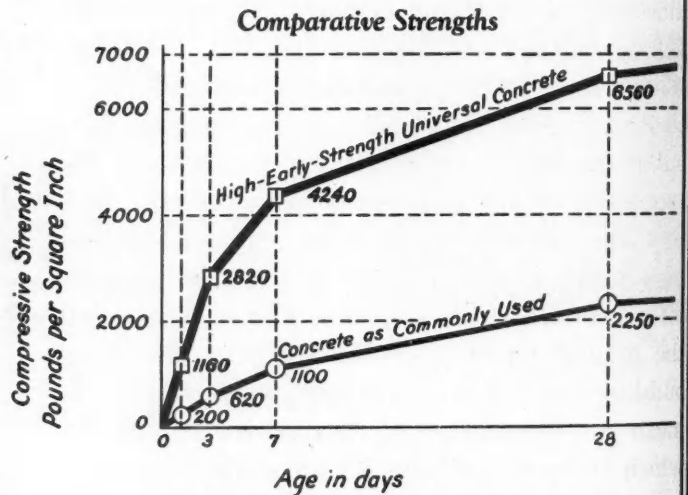

Name _____

Address _____

Universal Portland Cement Co.
208 So. La Salle Street, Chicago

Without obligation, please send me the following booklet:

High-Early-Strength Concrete

General Building Edition

Paving Edition

AB 6-29

One Standard Cement for All Concretes and Mortars
Universal Portland Cement Co.
Subsidiary of United States Steel Corporation
Chicago Pittsburgh Minneapolis Duluth Cleveland Columbus New York
Concrete for Permanence

First Steel Found Good

Experts Study Structural Members of Original Skyscraper, Now Being Wrecked

AFTER 31 years of service the steel beams and cast iron columns of the old Tacoma Building, in Chicago, the first skyscraper ever built, are in as good condition as the day they were erected. That is the report of experts who made an examination of the building which is now being wrecked to make way for a large and more modern structure, the One La Salle Building.

The Tacoma Building, erected in 1887, was designed by Holabird & Roche, architects, in collaboration with Purdy & Henderson. The structure was recently examined by a group of three experts to determine the condition of the metal frame. One was W. P. Ruppert, job superintendent for the W. J. Newman Company, which is razing the building. Mr. Ruppert has superintended the wrecking of numerous important buildings, among them many of steel skeleton construction. A second was T. C. Fredericks, a structural engineer with the engineering office of James B. Black. The third was J. W. Rittenhouse, construction superintendent for John Griffiths & Son, builders of the new structure.

In inspecting the old building a stop was made at the second floor where a massive cast iron column was exposed for examination. This column was rib reinforced, with two inch webs. There was not the slightest trace of crystallization or rust. "It's as good as it was the day it went in," Mr. Ruppert remarked. The column examined was typical of others in the building, except that the higher up in the building the columns were placed the smaller they were in diameter.

On the 13th floor, the top story, workmen were engaged in cutting away the metal work by means of acetylene torches. And here, with a considerable amount of metal skeleton work laid bare, was a good opportunity to note the effects of time on cast iron and steel. But so far as could be seen time's effects were nil—the metal skeleton work was in perfect condition.

Some of the steel beams supporting the roof were somewhat rusted, but this was due to recent rains. The roof covering was torn away and the beams had been exposed to the elements for some days. On many of the steel beams the old code numbers put on them by their fabricators were plainly legible.

Cast iron columns were bolted together at flanges. Beams, too, were generally bolted to the columns, though there were some that had been hand riveted. One exterior rectangular column occasioned some comment from the experts by reason of lugs cast with the column. These lugs probably were for the convenience of workmen in carrying the column.

Railroad rails entered into the skeleton through use as a framework for the balconies. Outside cast iron columns were protected by a heavy terra cotta covering.

Observation was made of one of the huge columns at the base of the building. This column was rectangular in shape, roughly two feet nine inches by a foot, while the thickness of the metal was $1\frac{3}{8}$ inches. This column also was in perfect condition, without any trace of deterioration.

This column would probably be typical of all others at the base, Mr. Ruppert said, inasmuch as there was even less likelihood of any ill effects in them than those at the

top of the building for the lower columns were less subject to temperature changes than the upper ones.

The new One La Salle Street Building will be erected from plans by K. M. Vitzthum & Co., Inc., Architects. It will be a 49-story bank, store and office building and will have the distinction of being Chicago's tallest commercial stone shaft, rising to a height of 530 feet above the street level.

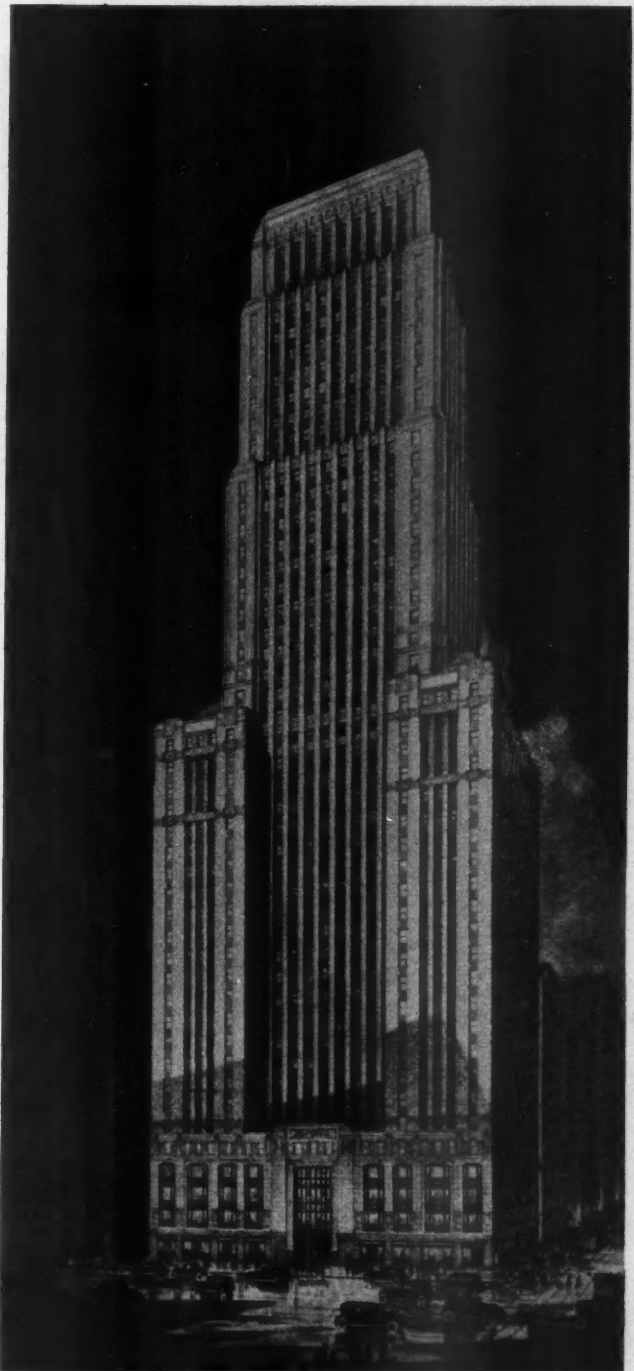

THIS NEW BUILDING, ONE LA SALLE ST., Chicago, Will Occupy the Site of the Old Tacoma Building, Said to Be the Original Skyscraper.

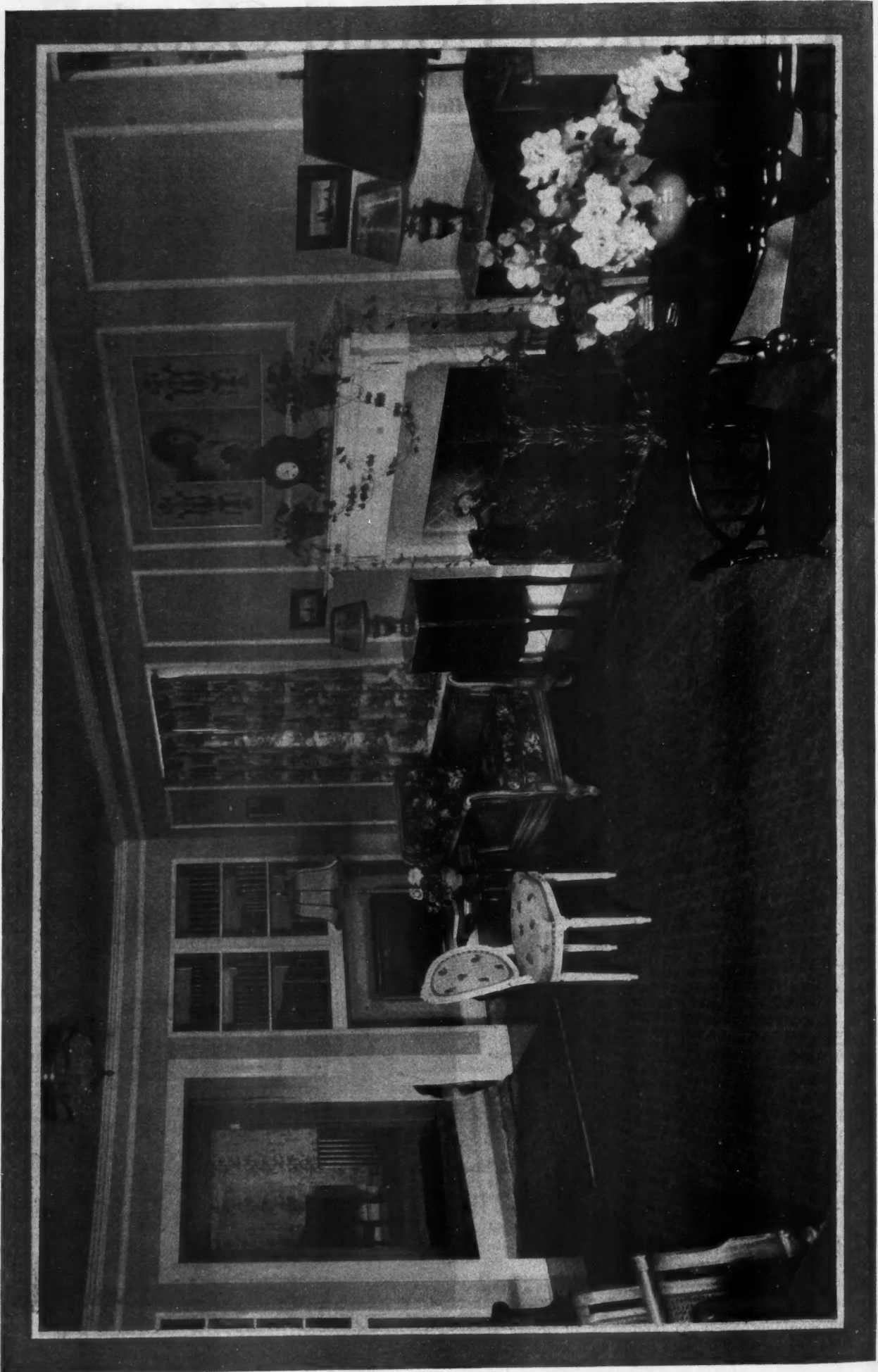

A LIVING ROOM Designed and built by the T. H. Maeneer Co. of Omaha, Neb. Walls canvased, paneled and painted, white enamel trim and gracefully carved mantel provide a favorable setting for the home furnisher.

S
L
vest
hav
mot
con
attr
I
alto
star
fail
of t
V
sec
rest
has
A
clos
ther
it.
inte
its
Me
V
a r
due
an
the
tha
pro
cip
dea
T
or
row
side
har
the
hea
seq
ce
wh
adv
dea
cia
lea
dis
der
mu
T
ing
gag
M
ad
saf
has
qua
bor
T
dor
by

Suppose I Should Die—Before the Mortgage is Paid?

By J. O. COBB

President Home Mortgage Co., Durham, N. C.

LOANS on real estate and buildings are one of the earliest types of investment. For hundreds of years they have been an invaluable factor in promoting home ownership and building construction and at the same time have offered to investors attractive income with reasonable security of principal.

In their old form, however, mortgage bonds were not an altogether perfect form of investment, either from the standpoint of the borrower or the investor, in that they failed to provide for one important contingency—the death of the borrower.

When the investor has had only the mortgage as his security, the death of the borrower has not infrequently resulted in a partial loss of the principal and quite often has involved a loss of income.

Anyone who is familiar with the usual course of foreclosure proceedings knows that it takes a long time to bring them to a conclusion and that it costs a lot of money to do it. In the first place, foreclosure cannot be started until interest payments have been defaulted. From then on to its conclusion the cost is heavy in both time and money. Meanwhile the invested principal is earning no return.

Where the investor has purchased a mortgage bond from a reliable institution, this danger is of course minimized, due to the fact that the financial strength of the company is an added safeguard. Nevertheless, the fact remains that it is highly desirable to provide protection of principal in the event of the death of the borrower.

The welfare of the family or dependents of the borrower is also worthy of consideration. The economic hardships imposed upon them by the death of the head of the family and subsequent foreclosure proceedings is something which, in our present age of advancement, we should endeavor to avoid. Commercial progress should not leave in its wake individual distress and additional burdens of charity for the community to bear.

Through its plan of linking life insurance to mortgage bonds the Home Mortgage Company has added a new factor of safety to its security and has also established adequate protection for its borrowers.

The way in which this is done can best be made clear by the following explanation

How Insurance Linked to Home Buying Contract Protects All Parties

of how our mortgage loans were originally handled and the way in which they are handled today.

In the beginning of our business our mortgage loans were based on a twelve year period. Amortization of these loans was provided for by 144 equal monthly payments, which, when completed, paid the principal and interest in full. Now that our life insurance plan is in effect, the period is extended to twelve and one-half years, and the number of monthly amortization payments increased to 150. The extra six months of the loan pays for the life insurance.

We buy a decreasing term policy, which means that the amount of the policy decreases each year, but is always sufficient to pay off the balance of the mortgage in case of death. We pay for this insurance a single cash-in-advance premium covering the full period. As it is a participating policy, the dividends on it amount to a little more than enough to pay the interest on the amount we advance for it. Due to the fact that the borrower repays the loan in monthly payments, the average life of a loan is actually only seven years, and the insurance company bases the cost of the business on seven years, though written for a twelve and a half-year period.

If the borrower dies at any time during the life of the loan, the insurance company pays us enough to cancel the mortgage, and we give the widow or the estate of the deceased a clear title to the property.

Within the last three months a case in point was that of a young man in Fayetteville, North Carolina, who had a mortgage with us on his home and who died suddenly, leaving a wife and infant child. We immediately cancelled the mortgage, and the young wife can face the world with a home free of debt.

We have come to believe so thoroughly in the soundness of our insurance feature that in the first instance no loan is considered until an application for insurance is attached to it.

S. W. Straus & Company have bought from us three collateral trust Home Mortgage Company bond issues of one million dollars each, secured by small mortgages averaging less than \$3,000 each, the mortgage and notes of the borrower being deposited by us with the First National Bank of Durham, North Carolina, as trustee.



J. O. COBB,
President Home Mortgage Co.

LIVING ROOM Designed and built by the T. H. Maeneer Co. of Omaha, Neb. Walls canvased, paneled and painted, white enamel trim and gracefully carved mantel provide a favorable setting for the home furnisher.

In Step with Progress



ART MODERNE Entrance Retail Shops of Alexander-Oviatt, Los Angeles; Feit & Paradise, Los Angeles, Designers. Daylight Illumination secured through the Art Glass Canopy.



Photos by Mott Studios

THERE'S WELCOME in This Wide Entrance and an Atmosphere of Quality and Style.

BUILDERS Are Helping Business by Providing Store Fronts in Line with These Modern Times.

TRUCK CRANE on the Job, Taking Down the Old Six-Story Phelps Building at Binghamton.

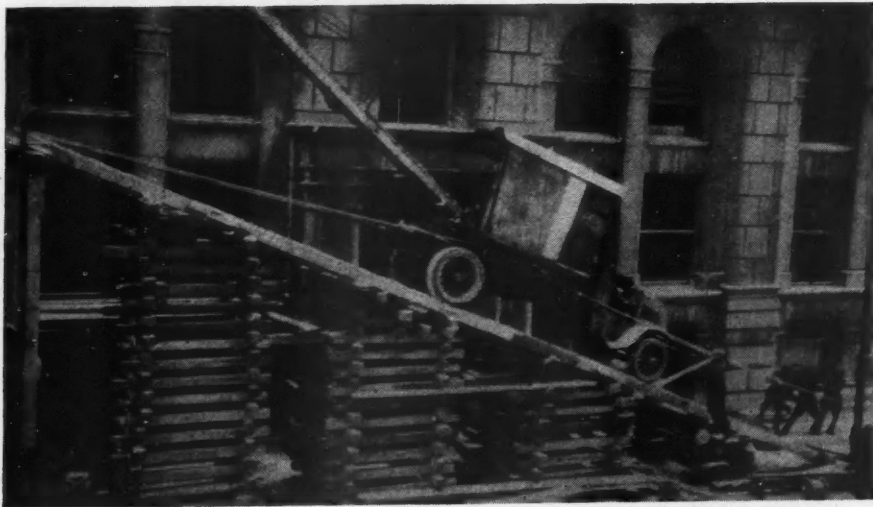
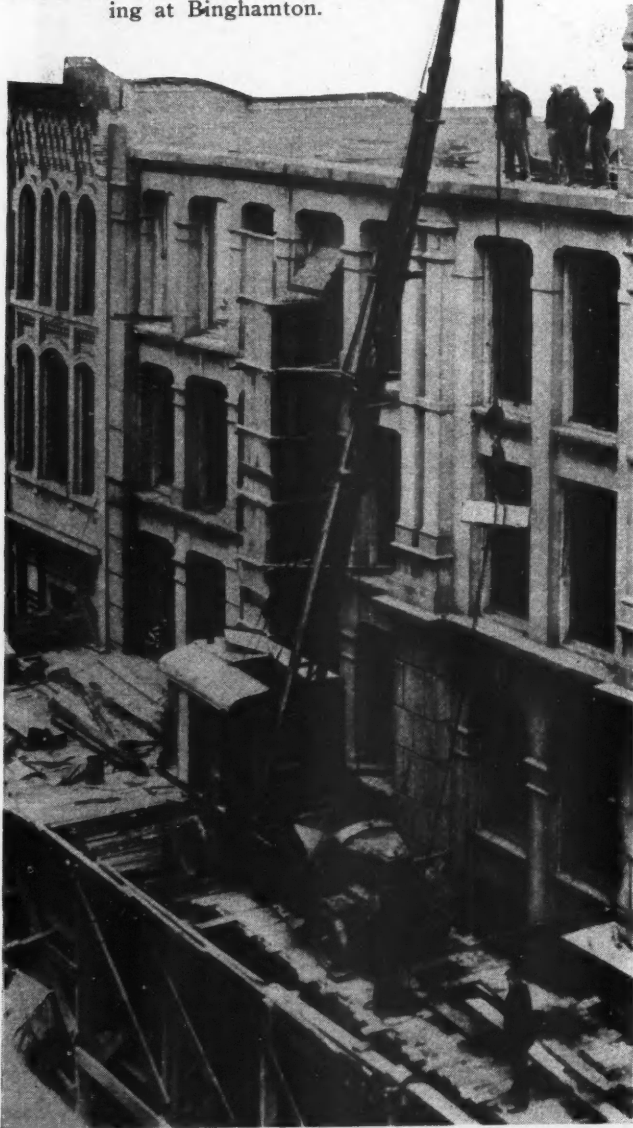

GOING UP the Timber Ramp, 60 Feet Long, 20 Feet High.

Wrecking

Unusual Method Successfully Used by A. W. Bowie, Inc., Binghamton, N. Y.

UNUSUAL use of equipment and commendable engineering ingenuity characterize the methods used by A. W. Bowie, Inc., Binghamton, N. Y., in wrecking the six-story Phelps Building, Court House Square, Binghamton, to make way for the new First National Bank Building.

The Phelps Building was a six-story building built in 1863, of a wall bearing type with stone exterior walls, but with few interior bearing walls. All in all, there was approximately 1,700 tons of face stone in the building, varying in size from one-half ton to three tons, with a large number of the larger stones. All the face stone had to be removed and loaded, together with other debris into trucks for hauling to the city dump.

It was the method of handling the removal of the cut face stone which had to be removed and loaded into trucks standing at the curb, that presented a real problem in the demolition of the building. Plainly a derrick or crane, or some other type of lifting device with a swinging boom was required.

Mr. A. W. Bowie first considered the use of a "stiff-leg" derrick, but found that this required spotting trucks for loading on one spot, which was an impossible condition due to traffic conditions on Chenango Street. Also the contract called for removing a story a week, which would have required setting up and dismantling a derrick at least six times in six weeks at a rather high cost.

To simplify his method and to keep his costs down, Mr. Bowie made a study of his present equipment, which convinced him that his universal crane, mounted on a truck chassis, would be most suitable; and plans were made accordingly.

This was accomplished by building a timber platform about 20 feet high above the sidewalk and placing the crane, truck and all up on it. First the crane itself erected the first two bays of the timber trestle on Chenango Street. Then the crane was run up on to them by means of a 60 foot timber ramp, leading up to it. The accompanying photograph shows how the crane was elevated under its own power by using a system of double snatch blocks reeved up with the crane hoist line. Further, a 1¼ inch manila rope around the crane winches in the sub-frame of the truck mounting was also used. In this manner, the ascent was made in about 15 minutes.

From its position on the trestle, the crane built additional bays to the trestle as required, as the work progressed, until it enclosed the outside perimeter of the Phelps Building. The total cost of erecting the sidewalk bridge was about \$1,200.00. The bridge, however, is an essential part of the necessary falsework in constructing the new bank building so that the only additional expense required was to make it heavy enough to support the universal crane. Mr. Bowie estimates this required between \$400.00 and \$500.00, which is the actual trestle cost chargeable to using the truck crane method of demolition.

The contract price for the demoli-

tion
week
and
cost
From
a 65
tions
back
cient
its fl
beam
to the
All
fixtur
lower
the b
As
mater
on the
The
contai
the b
60 ya
a har
best e
dynam
cess.
handle
Mr.
wreck
tive as
footing
tributin

Perce

Below
of the
finishe
from r
vision
does n
financi
taxes.

General
Structur
Brick an
Plumbing
Electric
Marble T
Elevators
Stone
Ornament
Metal W
Lathing
Roofing
Metal St
Kalsomine
Painting
Mail Chu
Special D
Excavatio
Foundatio
Hardware
Fireproof
Vault Do
Linoleum
Overhead

By Truck Crane

tion of the building was \$8,000.00, with a time limit of six weeks, or a floor a week. This schedule was met easily and due to the methods used, Mr. Bowie states that final cost figures are "substantially below the estimate."

From its position on the trestle, the crane, equipped with a 65 foot boom, handled all stones directly from their positions in the walls into trucks at the sidewalk. It traveled back and forth on the trestle as necessary to most efficiently handle the work, resembling a locomotive crane in its flexibility of operation. Flooring, floor joists, steel beams and miscellaneous bulky material were also lowered to the ground by the crane.

All doors, trim, radiators and miscellaneous fittings and fixtures were stripped from each floor in advance and lowered through elevators and stairways to the interior of the building.

As the work progressed, brick, plaster, lath and similar materials were wheelbarrowed to chutes which discharged on the outside of the trestle into trucks at the street level.

The Phelps Building was erected as a bank and contained a series of brick vaults extending from the basement to the fourth floor. They were built 60 years ago of soft brick and lime mortar and proved a hard proposition to handle as they refused the best efforts of bars and pavement breakers. Light dynamite charges finally were resorted to with success. The vault doors and other heavy portions were handled from each floor to trucks by the crane.

Mr. Bowie avers that his universal crane is a real wrecking tool but just to show that it is constructive as well, he points to its usual jobs of digging footings for new buildings and for unloading, distributing and erecting structural steel.

J. H. BELTZ.

Contractors:

You are invited to send in photos and data on interesting work you are doing. When you strike a good idea pass it along to others through AMERICAN BUILDER.

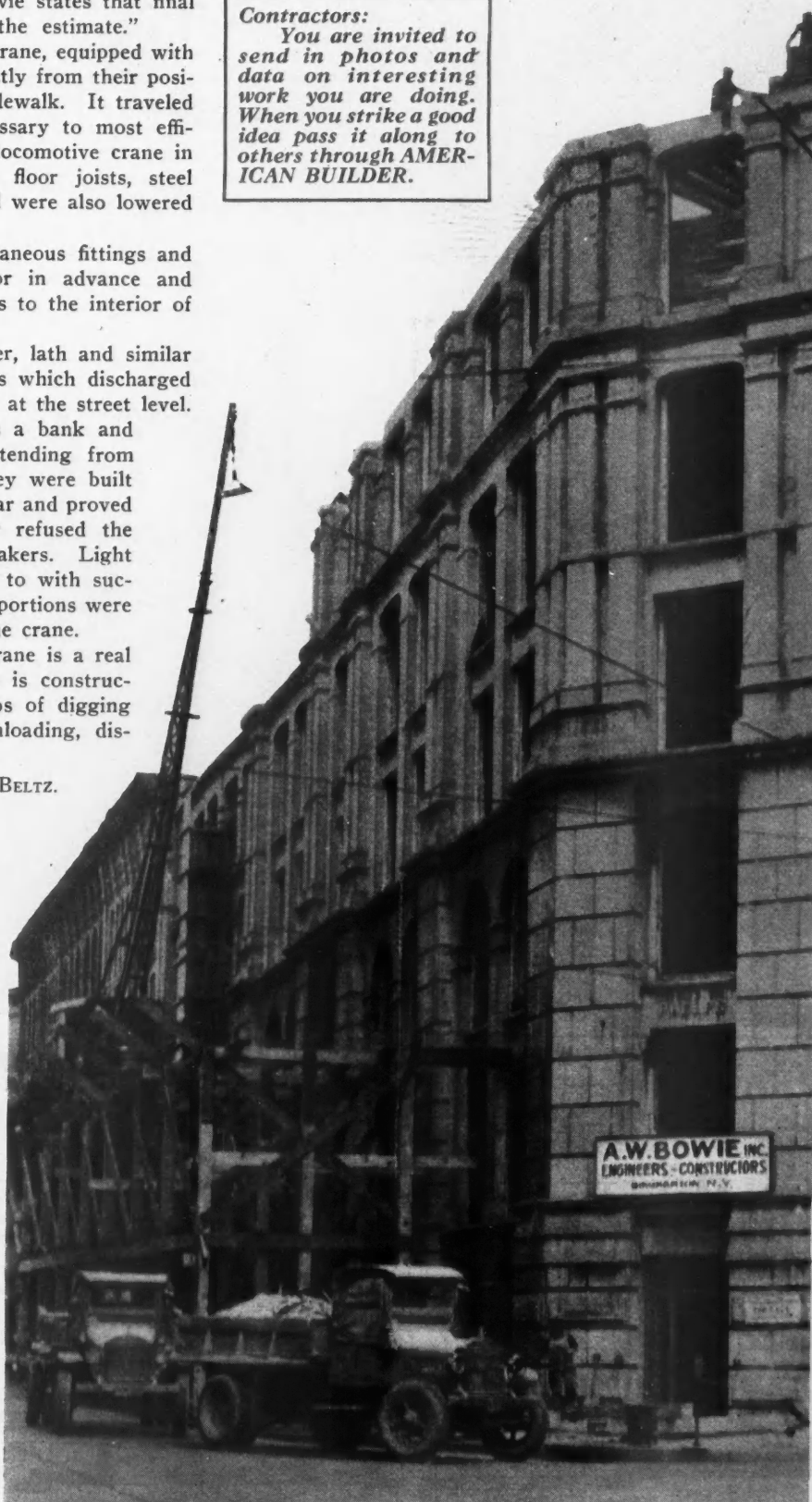

CRANE with 65 Foot Boom Handled All Stones Directly from Walls to Trucks in Street.

Percentage Cost of Modern Office Building

Below is given the apportionment of the cost of a 15-story office building, finished in the last year, and obtained from reliable sources. It is a subdivision of the actual contract price and does not include such expenses as financing cost, architectural fees or taxes.

	Per Cent
General Conditions	5.25
Structural Frame	22.00
Brick and Masonry	15.00
Plumbing, Heating and Ventilation	10.00
Electric Wiring and Fixtures	2.25
Marble Tile and Terrazzo	1.75
Elevators	7.50
Stone	3.00
Ornamental Iron	2.25
Metal Windows	2.25
Lathing and Plastering	4.00
Roofing and Sheet Metal75
Metal Store Fronts, Glass and Glazing	1.00
Kalsomine Work and Fire Doors	2.50
Painting	1.75
Mail Chutes75
Special Decoration Allowance50
Excavation	1.00
Foundations	1.75
Hardware	1.25
Fireproof Partitions	2.50
Rough and Finished Carpentry	3.00
Vault Doors50
Linoleum Floors	1.50
Overhead and Profit	6.00
	100.00%

Oklahoma Builds Tall

New Fire-proof Apartment Building at Tulsa Contains 96 Efficiency Units

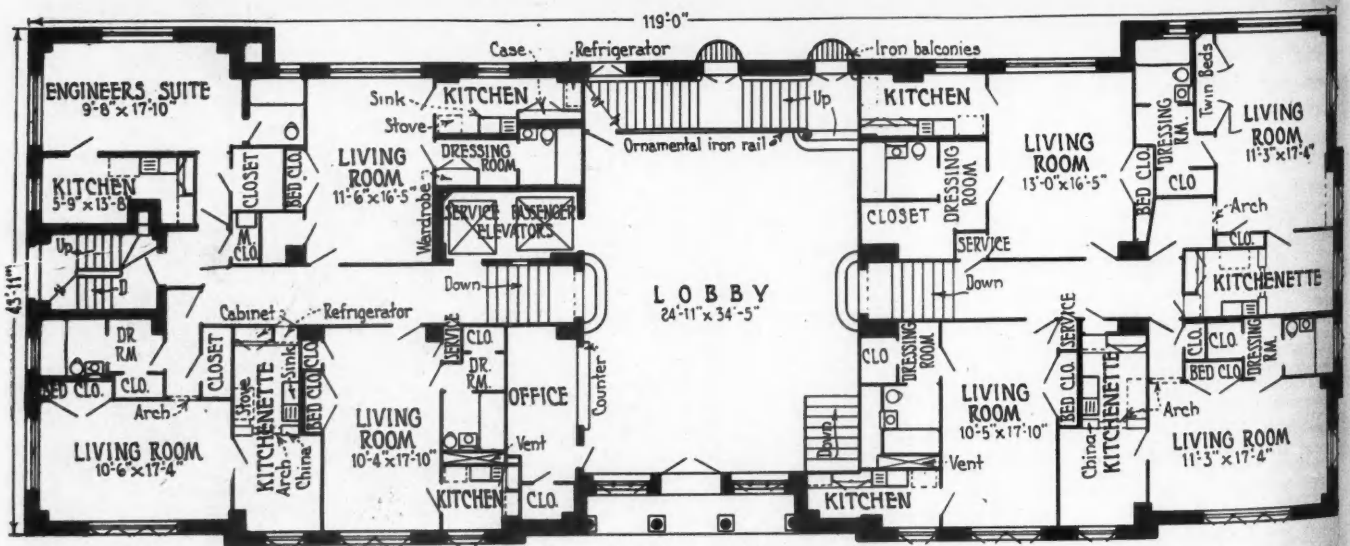
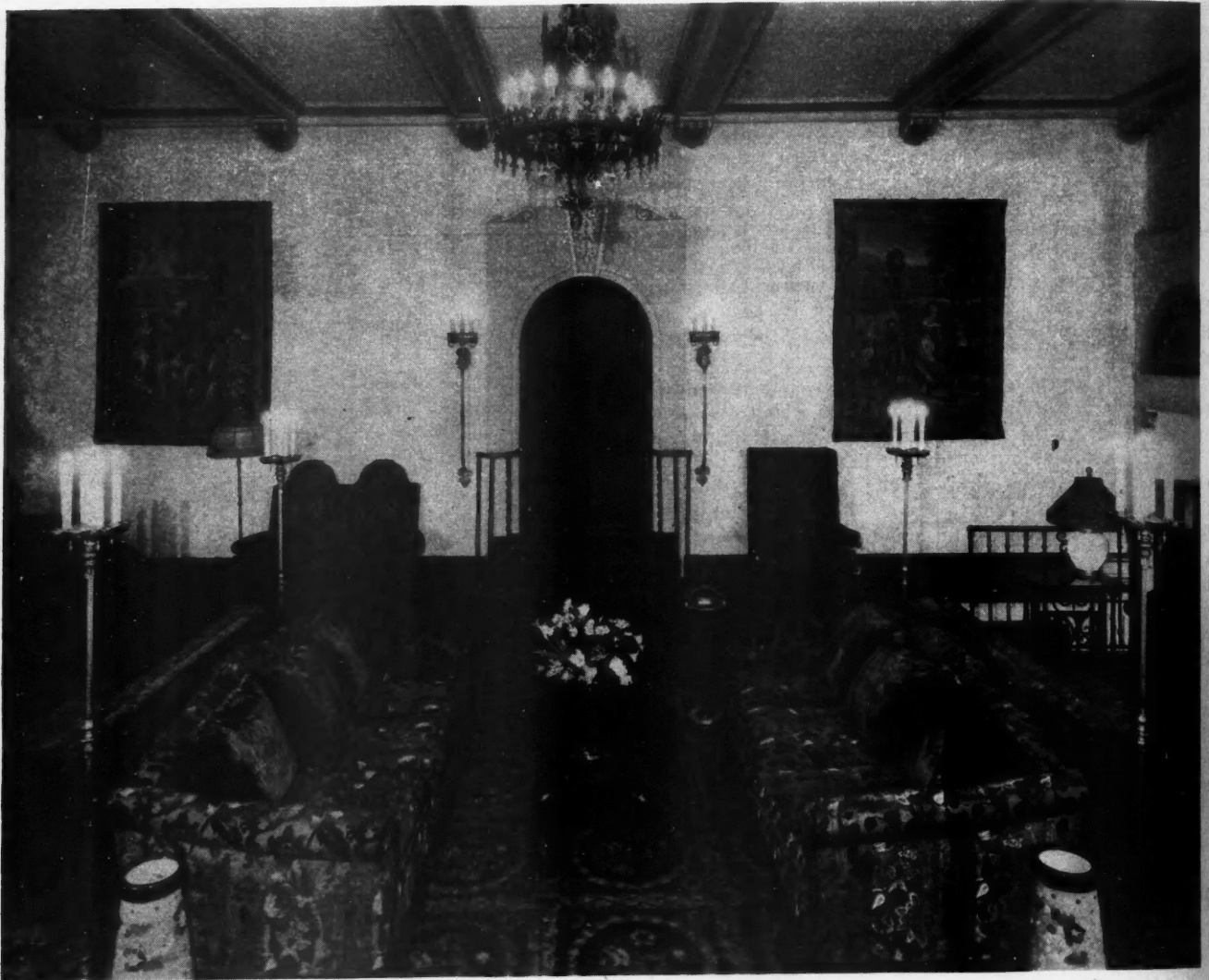

FIRST FLOOR PLAN

THE AMBASSADOR APARTMENTS, Tulsa, Okla.,
 Built by the Hurley-Park Investment Co., Cost \$450,000.
 Nelle E. Peters, Kansas City, Architect.

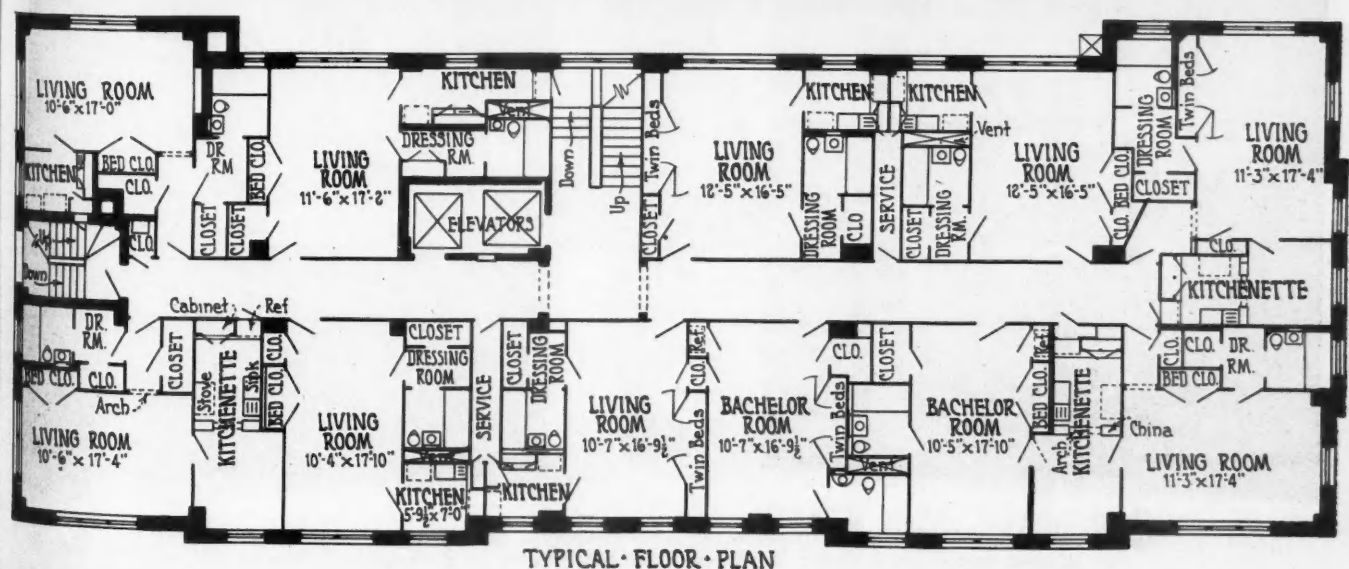

TYPICAL FLOOR PLAN



Etched and Tinted Douglas Fir

New Decorative Material Offered Builders



A NEW conception of the use of wood in interior decoration is now available to the home builder in Grainart—a process of wood etching developed by one of the largest producers of fir lumber in the Northwest.

Experiments revealed that when the surface of Douglas fir was subjected to a sand-blasting process, the sand ate away the soft grain, leaving the harder sections intact, and creating a raised and lowered grain of unusual beauty. The next development was the placing of stencils of pictures and elaborate scroll work on panels which were then subjected to the etching process.

The sharp sand, forced against the wood at heavy pressure, etches away the exposed parts of the stencilled design, leaving the covered portions smooth and standing out in bas-relief against a delicate background of raised and lowered grain. The stencils are drawn and cut by an artist, who, after the etching, adds stain to the wood to deepen

the perspective and give life and color to the panel. Wax, hand-rubbed, is applied as the final touch. This gives the panel a mellowed, antique appearance of unusual charm and distinction.

Another development of the sand-blasting process is the etching of figured grain lumber without the use of a stencil. All interior finish, window and door frames, baseboards, ceiling, moulding, beams, doors and paneling is well adapted to the etching process.

The producing company is not offering grainart picture panels in quantities of stock sizes and designs. Instead, the company is catering to the individual tastes of each customer, creating for him the picture panels or the etched figured grain lumber which he wants for his specific purpose. A staff of trained etchers and artists is maintained to work in co-operation with the architect, the decorator or the individual builder.



MISS LOUISE WENTWORTH, of Longview, Wash., Displays Two Etched and Tinted Panels to Be Placed in the New Great Northern Railroad Station at Bellingham, Wash.

T
Sunda
in its
Mo.,
of Jac
superv
Bec
section
rium i
devote
itself i
Gothic
famous
balanc
As
seating
balcon
addition
floors,
various
openin
The
rooms.
ity and
arrange
minor
the ma
through
ejected

"Americanized Gothic"

*A Church Design That Provides a Modern Building
But Retains the Old World Effect*

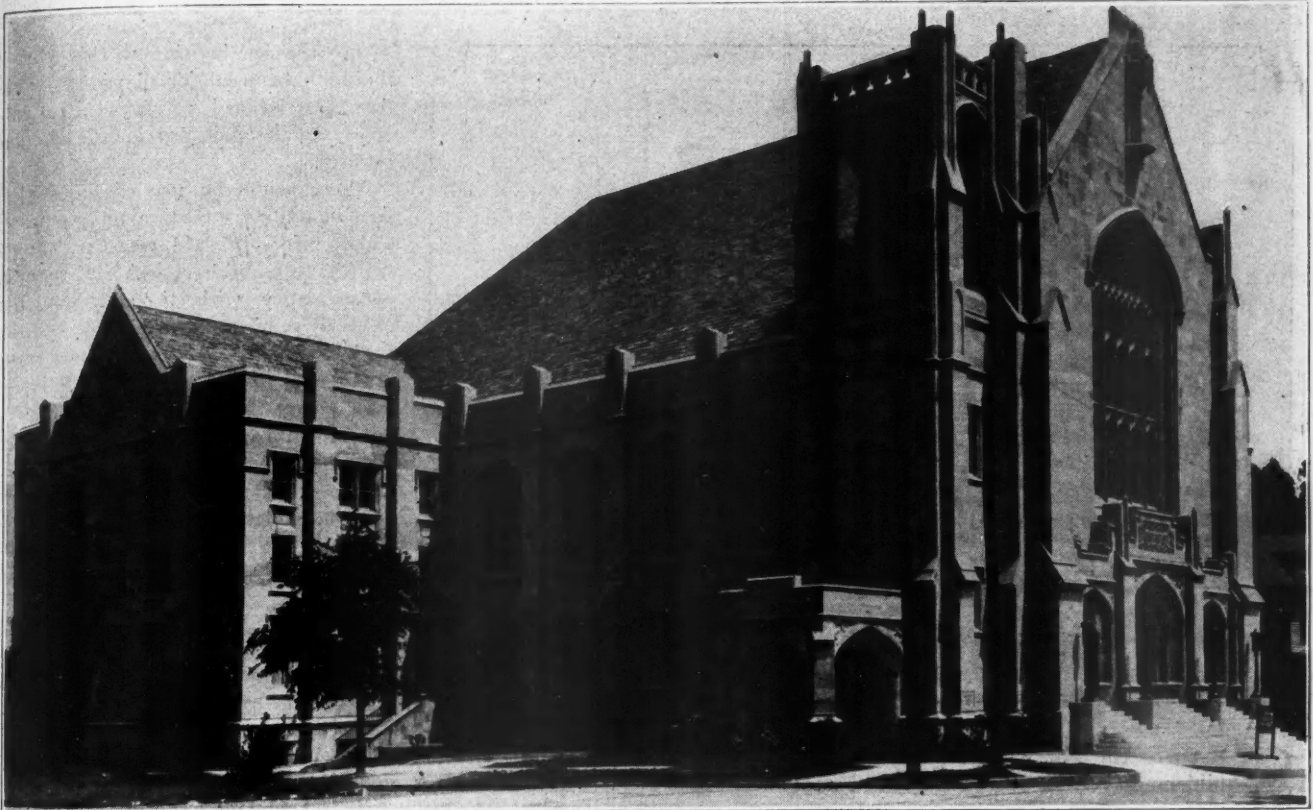

FIRST BAPTIST CHURCH of Jackson, Miss., Ferrand & Ferris and N. W. Overstreet, Associated Architects.

THE First Baptist Church, of Jackson, Miss., is a real achievement in church architecture designed to meet the requirements of a church with a large Sunday school section. Two architectural firms collaborated in its design and erection, Ferrand & Ferris, of St. Louis, Mo., executing the exterior design, and N. W. Overstreet, of Jackson, Miss., handling the plan design, engineering and supervision.

Because of the requirement for a large Sunday school section a "T" shaped plan was used with the church auditorium in the stem of the "T" and the cross arms of the "T" devoted to the Sunday school. The exterior design resolved itself into a style termed, by the architects, "Americanized Gothic," a style plainer than the original Gothic of the famous Old World cathedrals, but retaining their beautiful balance and upward soaring effect.

As already stated, the main auditorium of the church, seating 1,000 people, occupies the stem of the "T," while a balcony, at the second floor level, provides seating for an additional 600 persons. The basement, first and second floors, of the cross arms of the "T" are occupied by the various Sunday school departments with ample class rooms opening off the department rooms.

The sub-basement houses the heating equipment and fuel rooms. The building is equipped with an automatic humidity and temperature control system. Heating is by an arrangement using steam radiation in all classrooms and minor auditoriums and a circulating, warm air system for the main auditorium. Cold fresh air from outdoors passes through heating coils and is transferred by ducts to be ejected through grilles under the pulpit platform and in

the face of the balcony. The air is returned through grilles under the pulpit platform and reheated with a mixture of fresh air. Forced ventilation may be used in hot weather and ample space is provided for auxiliary fans.

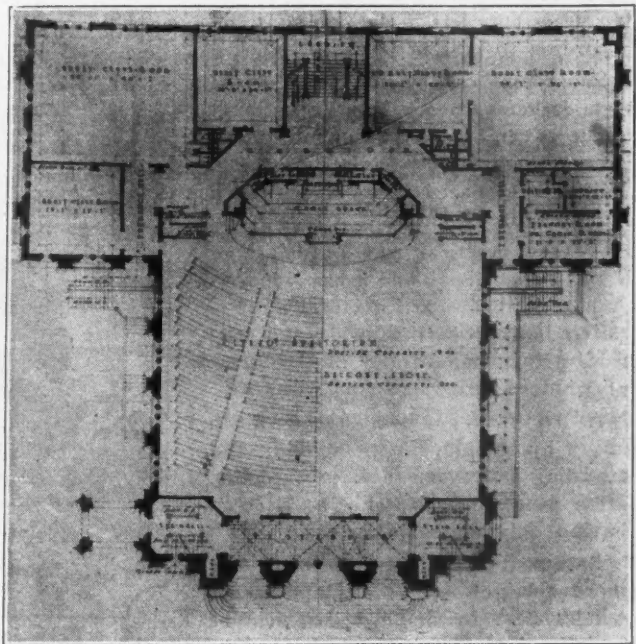

CHURCH PLAN Designed to Provide for a Sunday School Section of Unusually Large Proportions.

More Glass, More Sunshine

*Remodeling or Building New
for Better Health*

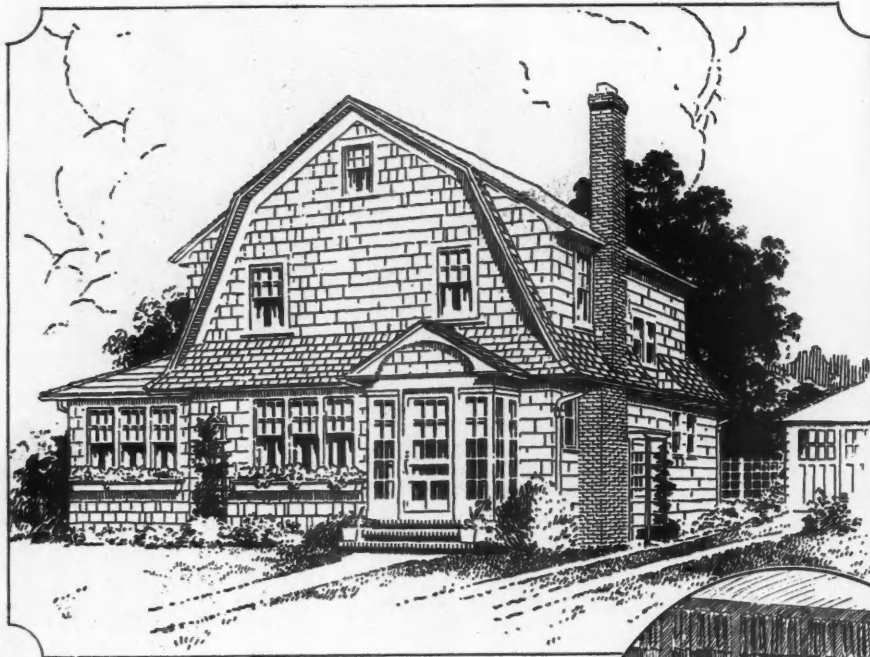

is no reason in the world why it shouldn't be used for playroom, workshop, or billiard room. Extra windows will keep it dry and bright and healthy.

Along with the use of more glass area has come attention to heat losses and comfort in cold weather. Storm sash have come back. A sun room or conservatory with three sides glass, properly equipped with storm sash for cold weather, is just as snug and warm as the most sheltered part of the house.

Both outside and inside the appearance is improved by plenty of well designed modern windows. The doctors are prescribing sunlight and those who set the styles are calling for tan, so the next move is up to the builders—provide more glass, build in more sunshine.

SUN tan is the smart color this season and builders have discovered that the more glass they put into homes—admitting cheerfulness and the healthful rays of the sun, the more popular they and their houses are.

Here is a keynote idea for the home modernizing campaigns that are sweeping the country and producing so much profitable work for builders. Scarcely a home built twenty years ago, yes, even ten years ago, lets in enough sunshine according to present ideas.

Sun rooms can be built on and old style darkening porches torn off. Small windows can be enlarged or interesting group windows or bays substituted. Full length glazed doors and French windows are wanted.

A very practical way of enlarging a small room is to add a bay window. A bay is always architecturally interesting both from the inside and outside. It is one of the oldest forms of windows.

A bay makes a room seem much larger by bringing in the sunlight and affording a broader view of outdoors. It is especially adaptable to a room having only one exposure.

Basements, too, can be made far more cheerful with more and larger windows. Why should a basement be a dark, damp, mouldy place for furnaces and coal and wash tubs? There

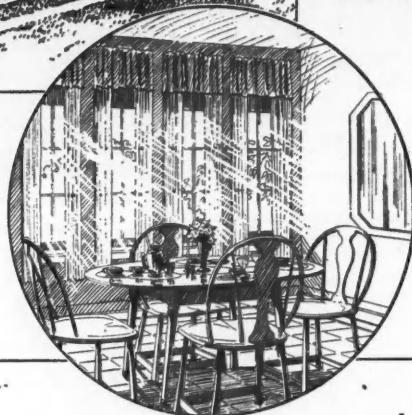

SUNSHINE Drenches Every Corner of This Added Breakfast Room and Solarium.

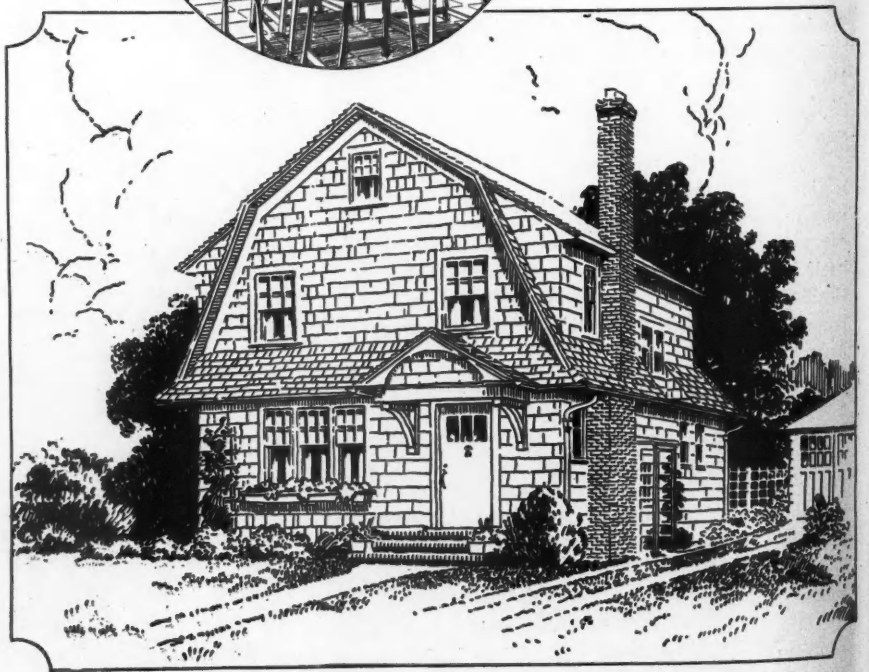

THE SUN ROOM Addition Pictured Above Increased Threefold Over What it Cost the Comfort and Healthfulness of This Little Home.

M

of this
Dix L
compar
or less
women
decided
glad to
bring t
The
of Mis
compar
might
is the s
"We
Publici
ment a
Boston
that of
is a bit
exact, i
from M
is a ma
one wh
go the
interfer
business
hired a
floor, r
which,
call a D



For the Women Customers

Display Department with Publicity Bureau on Main Thoroughfare Is Effective

MUCH is being said these days about the importance of selling the women on home building materials and equipment, but no more practical application of this new idea has been made than that instituted by the Dix Lumber Company, North Cambridge, Mass. This company realized that the out-of-the-way location and more or less rough atmosphere of the average lumber yard kept women customers away instead of attracting them. It was decided to establish a display room where women would be glad to drop in and where contractor customers might bring their women prospects to demonstrate materials.

The new display room was put under the management of Miss Marguerite Stoddard, publicity manager for the company, and her assistant, so that the women visitors might deal with representatives of their own sex. Here is the story in Miss Stoddard's own words:

"We have recently opened a Display Department and Publicity Bureau which is exciting a good deal of comment and interest in and around Boston. Like most lumber yards, that of the Dix Lumber Company is a bit off the line of travel. To be exact, it is about seven minutes' walk from Massachusetts Avenue, which is a main thoroughfare. While anyone who actually wants to buy will go the little distance required, it does interfere with the so-called 'drop-in' business. For this reason we have hired a corner office, on the street floor, right on Massachusetts Avenue which, as the picture indicates, we call a Display and Publicity Bureau.

"We have some 40 feet of window display space which gives us ample opportunity for effective window displays and these are kept lighted every evening. Our opening displays were given over to the line of paints and varnishes which we carry, materials for textured wall finishes and composition roofing shingles.

"We felt that the interior walls were too valuable as demonstration space to be finished in the conventional manner, so, instead of having the entire wall done in some one material, we panelled it, using different panels to display different gypsum and fiber boards finished in textured finishes and flat paints. Each panel is done in a different color, but all are sufficiently subdued shades so that the effect is not too startling. It is difficult for the average person to tell how a wall is going to look from the small samples which are usually shown, but a full size panel makes it a simple matter to visualize an entire room.

"We have on display such things as built-in breakfast nooks, folding breakfast nooks, built-in ironing boards, telephone cabinet, medicine closets and doors, ranging all the way from the combination screen and storm door to the French door. These doors are erected on a movable, swinging stand and occupy one corner. Good sized samples of floors, not just flooring materials, are arranged in the same way.

"While we have the usual, conventional office furniture for the use

RIGHT on a main thoroughfare of North Cambridge, Mass., this corner store space has proved a profitable investment to the Dix Lumber Company as an accessible display department and publicity bureau where women customers are welcome and feel perfectly at home.

of my assistant and myself, we have brightly upholstered wicker chairs for our customers. This lends color to the room and takes away any unduly business-like appearance. A library table is kept constantly supplied with literature which is descriptive not only of the products which we actually carry, but of other articles which will interest the home builder. We are prepared to take orders for the main office, accept payments on bills and to give advice on building, remodeling, furnishing or decorating.

"Our first idea was that we would cater particularly to women, for they are naturally hesitant about going to a lumber yard and asking questions. This has worked out exactly as we hoped it might, for we find the women dropping in quite comfortably for information on all sorts of subjects. These conferences are, pleasingly often, followed by orders.

"A careful analysis has convinced us that the modern woman has a great deal to say about the building of a home, and certainly she is a member of the family to whom you should appeal when you want to sell conveniences such as the built-in products mentioned."

In line with this policy the Dix Lumber Company, in corresponding with these women customers, has abandoned the conventional business letterhead. Social size stationery in a deep peach tint, with mottled finish, is used with a texture similar to a dull linen.

The letterhead is tastefully printed in three colors. There is a cut of an attractive country home labeled "This Is the House That Dix Built."

Probably the Only Grindstone Road

AND now we have a grindstone road. The picture shows it in the making. After the grindstones were laid in position the interstices were filled with small pieces of grindstone, cement and sand, and then a thin layer of sand spread over the entire bed. Results: A neat, smooth, substantial road which is standing up well under heavy truck traffic. This road was built by Henry Disston & Sons, Inc., Philadelphia, Pa., the well-known saw, tool, and file makers, and was another move by the firm to conserve waste material.

It is estimated that from 1,500,000 to 2,000,000 tons of grindstones have been used by Disston during the company's 88 years of continuous operation. The stones range from 48 to 72 inches in diameter, and from five to 15 inches in thickness. A stone 72 inches by 15 inches weighs approximately 5,000 pounds.

After a grindstone is worn to about 2½ feet in diameter, it becomes necessary to revolve it at too high a speed to give the best results, so it is replaced by a larger stone. This is why this company has furnished thousands of cast-off grindstones for walks and walls, and one church building. However, this is the first time they have been used for road building.

There are several miles of cement roads and sidewalks running here, there, and everywhere throughout the 65 acre tract upon which the Disston plant is built. Recently when an additional strip of road became necessary the engineers decided to use castoff grindstones.

Service to Home Builders

ON the eight pages following we present some very interesting designs in duotone on special enamel stock. A variety of home designs are included, selected from many parts of the United States and designed by various architects of standing.

The "American Builder" will gladly serve its readers by bringing them together with these architects if any further information or plans are desired for any of these designs. Address the American Builder Home Planning Service, 105 West Adams Street, Chicago.



A GRINDSTONE ROAD Built of Stones Worn Down Making Hand Saws. The spaces between stones are filled with concrete. The road is standing up well under heavy truck traffic.



A Shingled Home of True Comfort

Built in Minneapolis—MAINE & BROWN, Architects

Key to Recommended Specialties of Equipment

The small numbered circles on the plans represent the following:

- 1—Package Receiver
- 2—Broom Closet
- 3—Ironing Board
- 4—Kitchen Cabinet
- 5—Range
- 6—Refrigerator
- 7—Space-Saving Closets
- 8—Medicine Cabinet
- 9—Thermostat
- 10—Mirror Door
- 11—Phone Cabinet
- 12—Fireplace Throat & Damper
- 13—Shower
- 14—Moth-Proof Closets
- 15—Disappearing Stair to Attic

Is It Modern?

That is the first question asked of a home builder, and in order to qualify, the house should include:

- Weatherstrips
- Storm Sash
- Screens
- Lighting Fixtures
- Convenience Outlets
- Electric Panel
- Washing Machine
- Ironing Machine
- Clothes Dryer
- Coal Chute
- Heating Plant
- Oil Burner
- Incinerator
- Water Supply System
- Hot Water Supply
- Water Softener
- Radiant Gas Heaters
- Electric Wall Type Heaters
- Casement Windows
- Dishwashing Sink
- Automatic Cellar Drainer
- Radiator Covers or Furniture

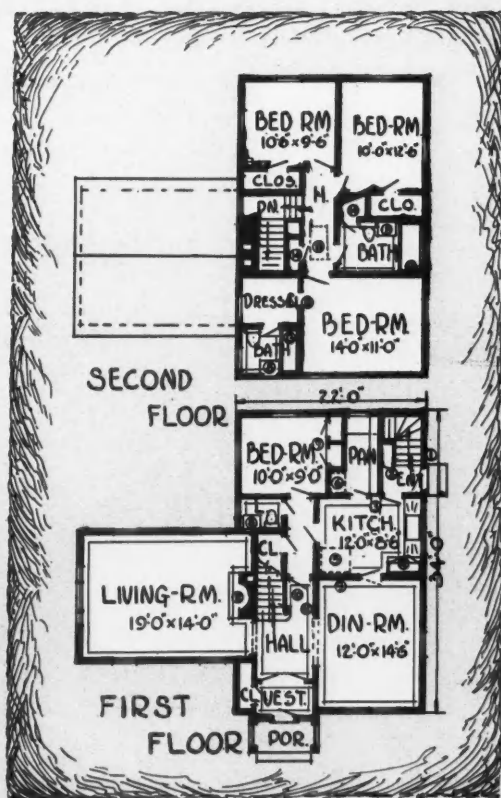



This Home from Portland, Ore., "Has Everything"—
Style, Convenience, Thrift

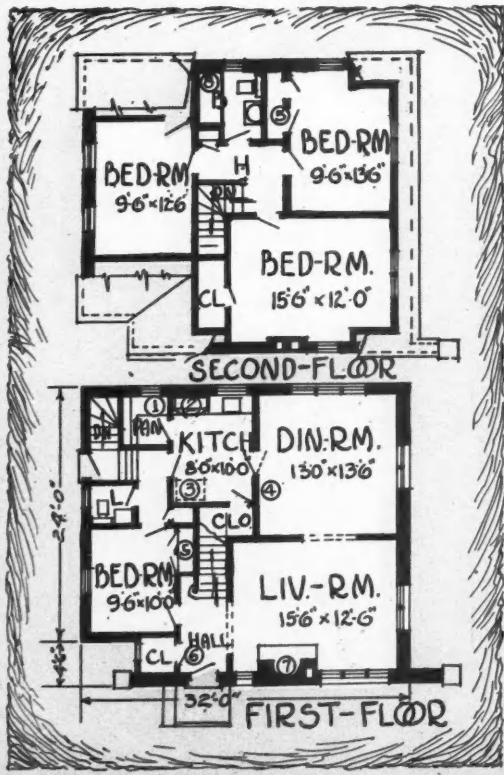

Key to Recommended Specialties of Equipment

- The small numbered circles on the plans represent the following:
- 1—Refrigerator
 - 2—Kitchen Cabinets
 - 3—Range
 - 4—Thermostat
 - 5—Space-Saving Closet
 - 6—Mirror Door
 - 7—Fireplace Throat & Damper

In addition to the above many other items of modern equipment must be considered:

- Weatherstrips
- Storm Sash
- Screens
- Lighting Fixtures
- Convenience Outlets
- Electric Panel
- Washing Machine
- Ironing Machine
- Clothes Dryer
- Coal Chute
- Heating Plant
- Oil Burner
- Incinerator
- Water Supply System
- Hot Water Supply
- Water Softener
- Radiant Gas Heaters
- Electric Wall Type Heaters
- Casement Windows
- Dishwashing Sink
- Automatic Cellar Drainer
- Radiator Covers or Furniture
- Disappearing Stair to Attic



Tile, wrought iron and cement
keep the interior in harmony
with the exterior.

K
T
1—
2—
3—
4—
5—
6—
7—
8—
In
sider
Wea
Stor
Scre
Ligh
Conv
Elect
Wash
Iron
Clo
Coal
Heat
Oil
Inc
Wat
Hot
Wat

The
room



A Home of Dignity and Grace Built at River Forest, Ill.

Key to Recommended Specialties of Equipment

The small numbered circles on the plans represent the following:

- | | |
|---------------------------|--------------------------------|
| 1—Kitchen Ventilating Fan | 9—Built-in Mail Box |
| 2—Kitchen Cabinets | 10—Book Cases |
| 3—Broom Cabinet | 11—Fireplace Throat & Damper |
| 4—Incinerator | 12—Tub Shower |
| 5—Refrigerator | 13—Medicine Cabinet |
| 6—Range | 14—Disappearing Stair to Attic |
| 7—Thermostat | 15—Linen Cabinet |
| 8—Phone Cabinet | 16—Mirror Door |

In addition to the above many items of modern equipment must be considered:

- | | |
|---------------------|------------------------------|
| Weatherstrips | Radiant Gas Heaters |
| Storm Sash | Electric Wall Type Heaters |
| Screens | Casement Windows |
| Lighting Fixtures | Dishwashing Sink |
| Convenience Outlets | Automatic Cellar Drainer |
| Electric Panel | Radiator Covers or Furniture |
| Washing Machine | |
| Ironing Machine | |
| Clothes Dryer | |
| Coal Chute | |
| Heating Plant | |
| Oil Burner | |
| Incinerator | |
| Water Supply System | |
| Hot Water Supply | |
| Water Softener | |

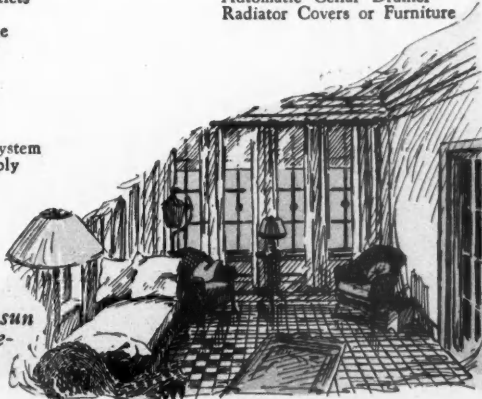

These big sun rooms are delightful.

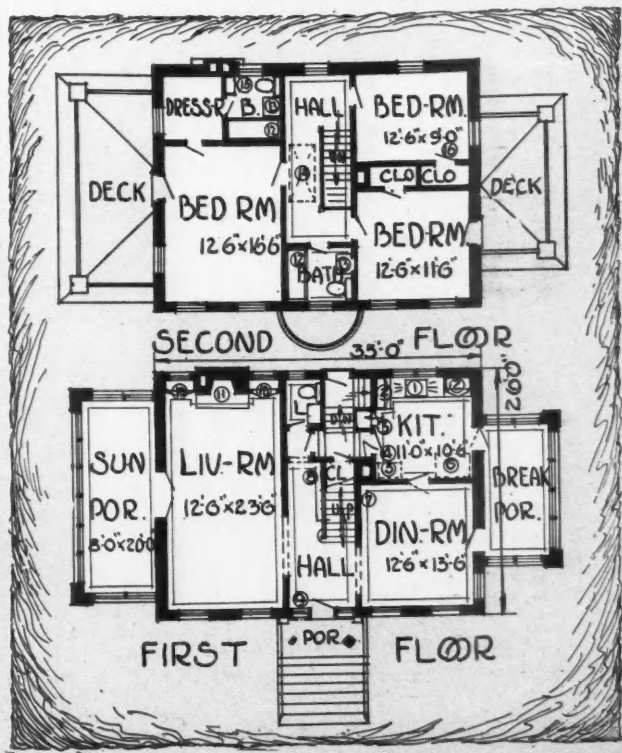



The Vogue for Pressed Metal Porch Columns is Exemplified in This Residence of C. L. Eshleman, Esq., Canton, O.

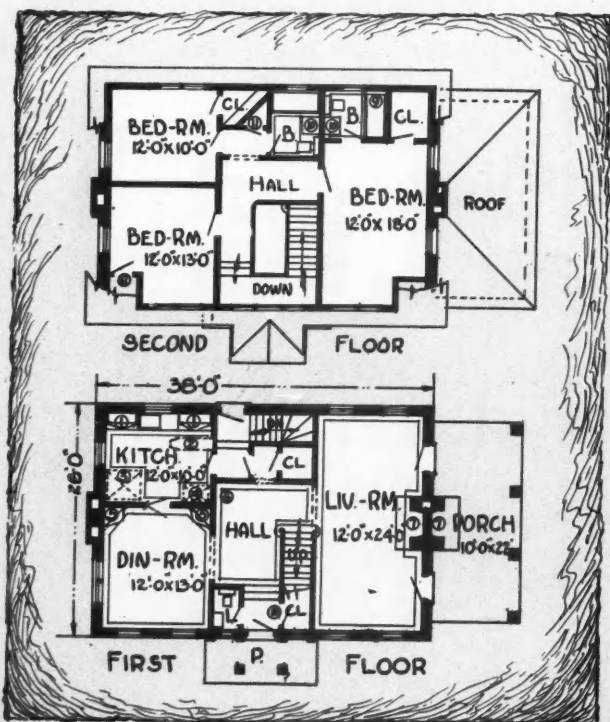

Key to Recommended Specialties of Equipment

- The small numbered circles on the plans represent the following:
- 1—Kitchen Cabinets
 - 2—Ironing Board
 - 3—Range
 - 4—Refrigerator
 - 5—China Cabinets
 - 6—Thermostat
 - 7—Fireplace Throat & Damper
 - 8—Mirror Door
 - 9—Tub Shower
 - 10—Medicine Cabinets
 - 11—Moth-Proof Closet
 - 12—Space-Saving Closet Equipment

In addition to the above many items of modern equipment must be considered:

- Weatherstrips
- Storm Sash
- Screens
- Lighting Fixtures
- Convenience Outlets
- Electric Panel
- Washing Machine
- Ironing Machine
- Clothes Dryer
- Coal Chute
- Heating Plant
- Oil Burner
- Incinerator
- Water Supply System
- Hot Water Supply
- Water Softener
- Radiant Gas Heaters
- Electric Wall Type Heaters
- Casement Windows
- Dishwashing Sink
- Automatic Cellar Drainer
- Radiator Covers or Furniture
- Disappearing Attic Stairs

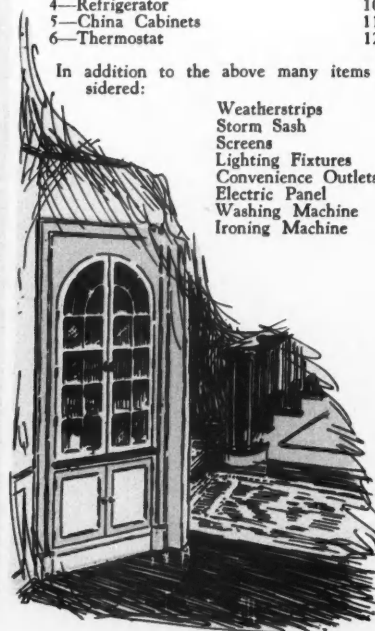

Glimpse of hall from dining room, showing corner cupboard.

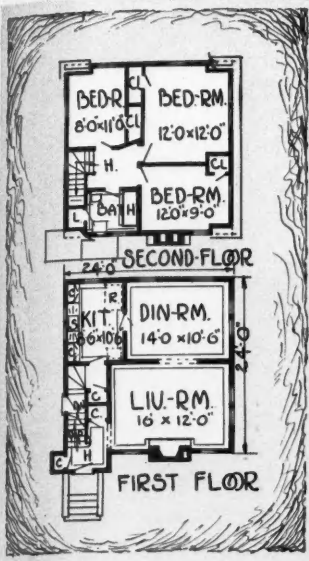

Beauty at a Low Price in These Two Sweet Little Homes

It's a joy to plan a small house, putting style into the outside appearance, and convenience and hominess into the inside. Above is an artistic little English home 24 feet square, containing six rooms and bath. Below is another type of English, 29x26 feet, with four rooms and bath downstairs and two rooms and bath upstairs.

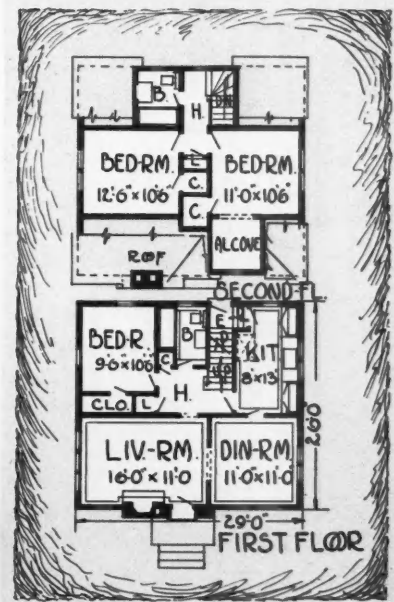



A Three-House Row at Washington, D. C.

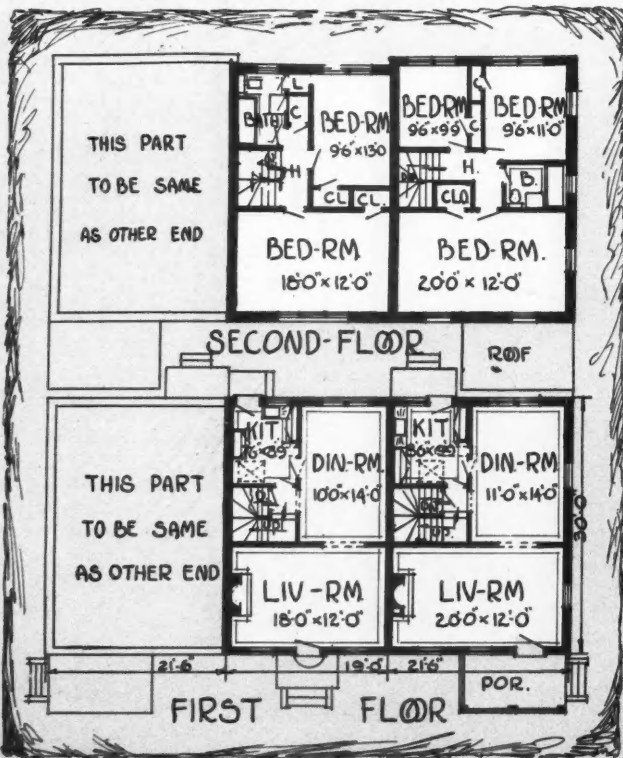

Houses with party walls in common meet the demand for economy, at the same time offering many of the advantages of the detached, private home. The group illustrated consists of three separate homes; the end units containing six rooms and the middle or inside unit, five rooms. This building measures 30' in depth, by 62' across the front. Of this frontage the end units require 21½', the inside unit, 19'. Each unit has its own separate front entrance and rear entrance, and its private garden plot.

Where land is high priced, the row houses compactly built solve the problem, proving popular and desirable either for sale or to rent. Sometimes the site to be developed is longer than required for this three-house row, and in that case this same layout can be expanded to four, five and six houses by repeating the inside unit arrangement. This, however, should not be overdone to the point of making a monotonous appearing street frontage.

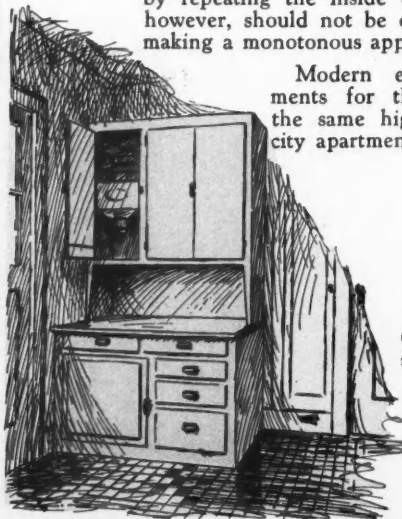

Modern equipment and appointments for these row houses follow the same high standards as used in city apartments generally.

Convenience packed into small space in these kitchens.

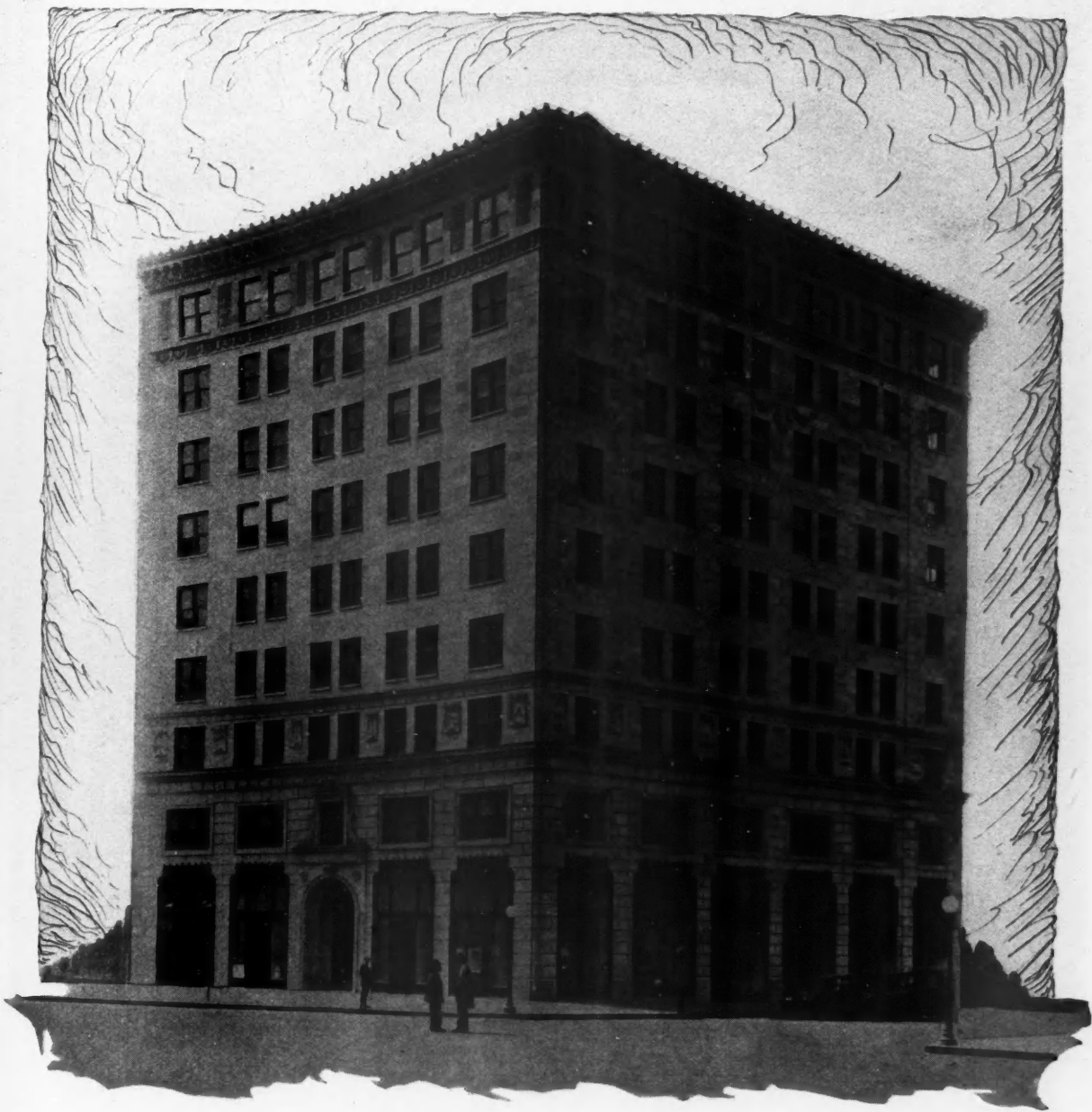

The Down-Town Parking Garage, an Urgent Need in Every City

**Illustrating The Circle Motor Inn
Indianapolis, Ind.**

Bass, Knowlton & Co., Architects

The Ramp Buildings Corp., New York City

Patentee of Ramp Type Garages

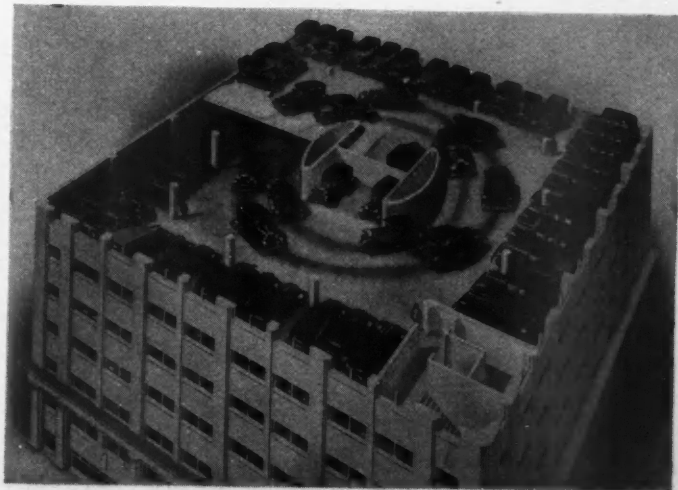

Building cut open to show operation of motor ramp.

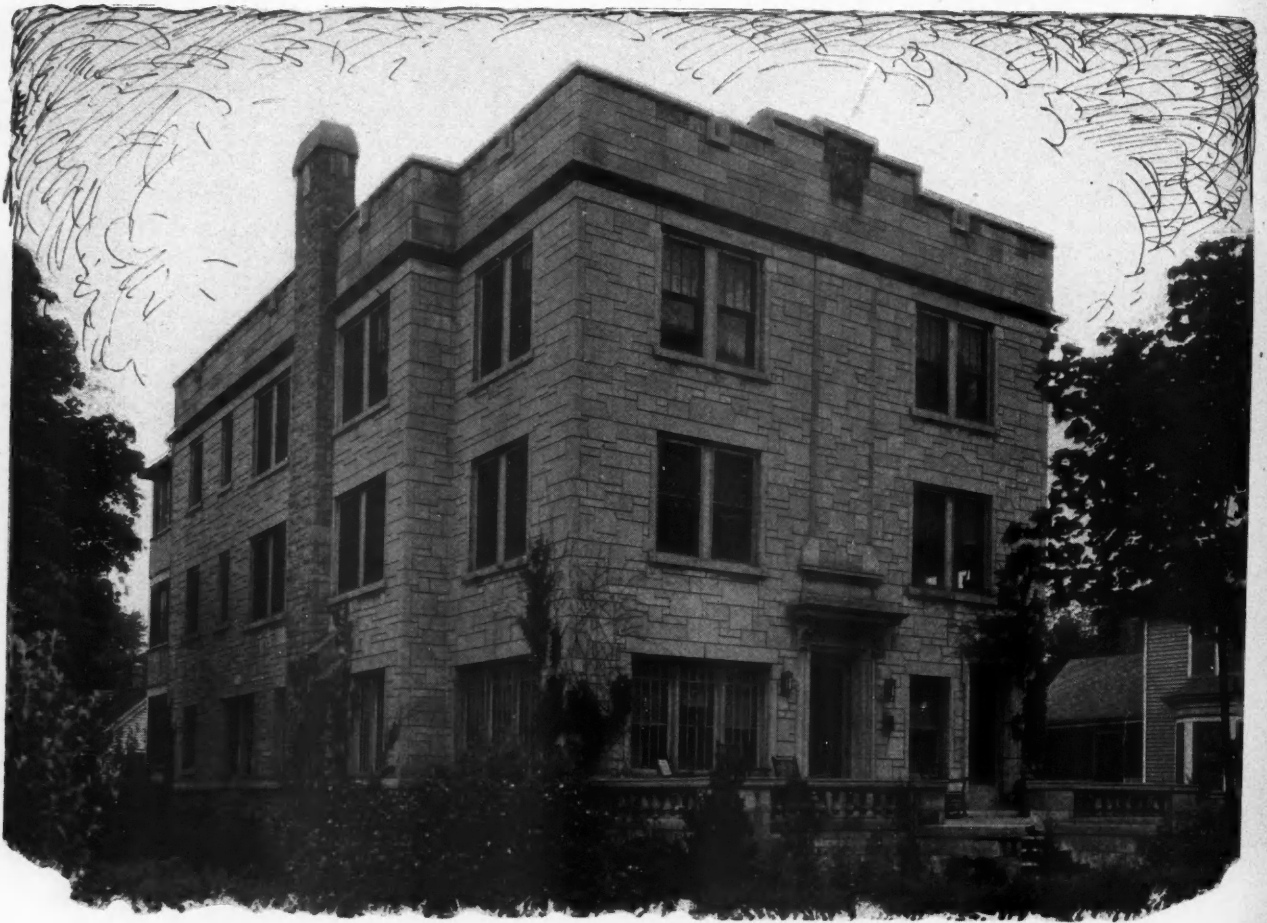

Five Apartments in This Building of Indiana Limestone at Champaign, Ill.

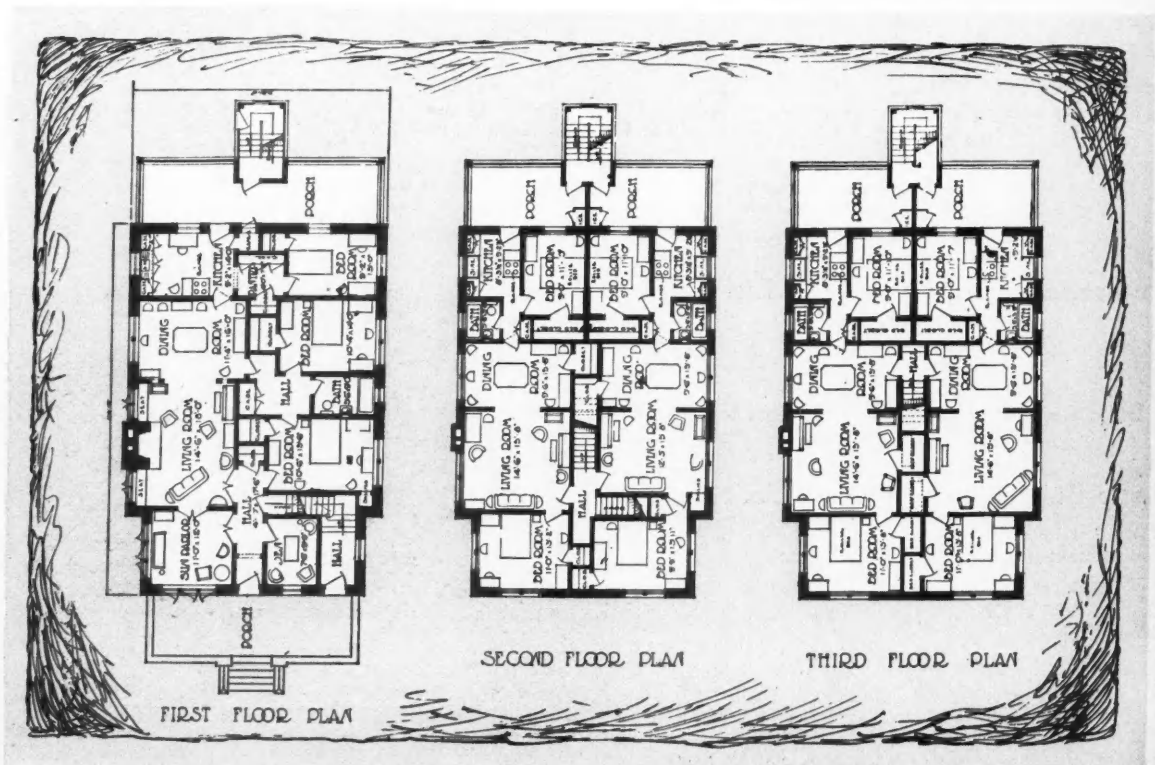

D
 who
 routi
 manu
 know
 thing
 matic
 and a
 buyer
 Th
 fully
 use.
 which

Good Design—Modern Equipment

Featured in This House for Which Complete Working Plans, Drawn to Scale Are Presented

DESIGN and equipment, those are the two problems which confront every builder of homes. We take it for granted, of course, that the progressive builder who will read this makes good workmanship a matter of routine and that, with the aid of the advertising pages and manufacturers' literature, he has obtained a very accurate knowledge of standard materials. Design, however, is something more illusive. Design is not a question of mere information or craftsmanship. It demands a high grade of skill and a knowledge of the ever-changing demands of home buyers.

The wide-awake builder is always on the lookout for skillfully handled home designs which he may adapt to his own use. For this reason we are presenting, on the four pages which follow this, the complete working plans, drawn to

scale, of the attractive and well designed, small home pictured on this page.

A close study of these plans will show that the designer has, on foundation dimensions of only 30 by 28 feet, developed a home providing six rooms, a breakfast alcove, a sewing room or nursery, bathroom and extra lavatory, and that none of these rooms are cramped either as to size or arrangement. This is the sort of plan which is so often sought but seldom found.

In the matter of equipment, the problem is really one of selection. Modern inventive genius has provided specialties of every sort to meet the space and cost requirements of every type of home. The builder who uses these to produce completely equipped homes will establish a reputation on which he may depend for much future business.



GOOD DESIGN Is Seen Here in Intelligent Selection of Materials and the Method of Using Them, in the Restrained Use of Ornament and the Balanced Proportions and Lines. Good design as it affects the interior may be seen on the next four pages.

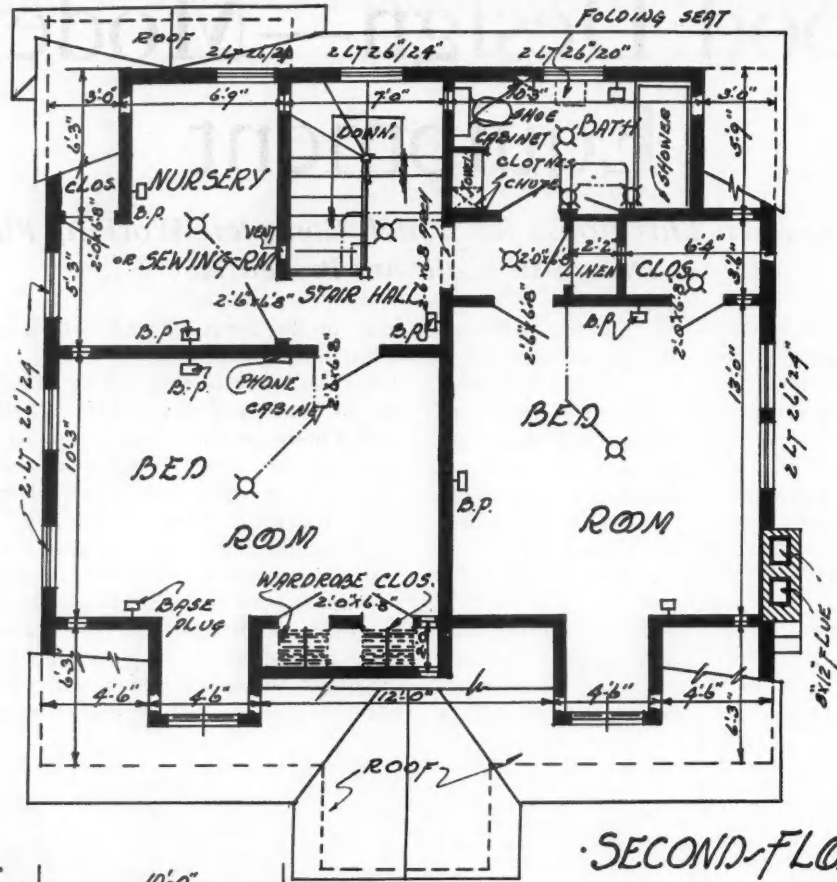

SECOND-FLOOR-PLAN.

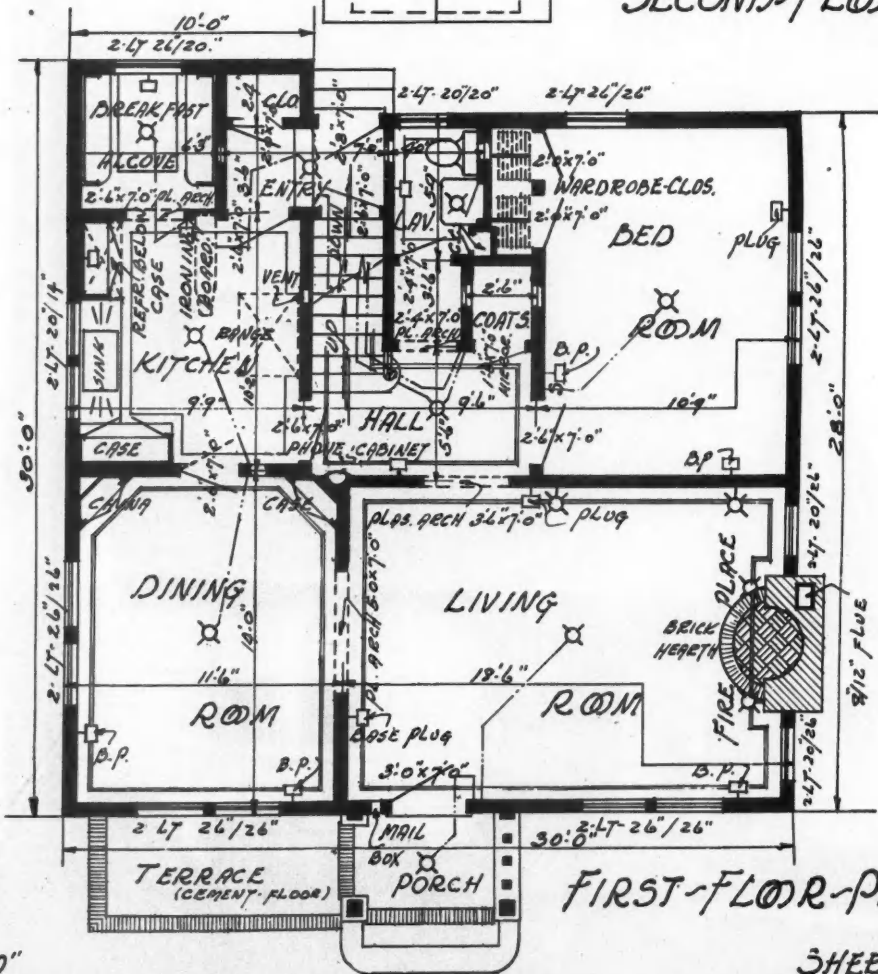

FIRST-FLOOR-PLAN.

SCALE 1/8"=1'-0"

SHEET NO. 1.

STEP-SAVING ARRANGEMENT Makes Its Appearance in This Compact Layout of Rooms and Complete Utilization of Space. Modern equipment appears in every room, from the built-in mail box at the entrance to complete electric wiring and the telephone cabinets.

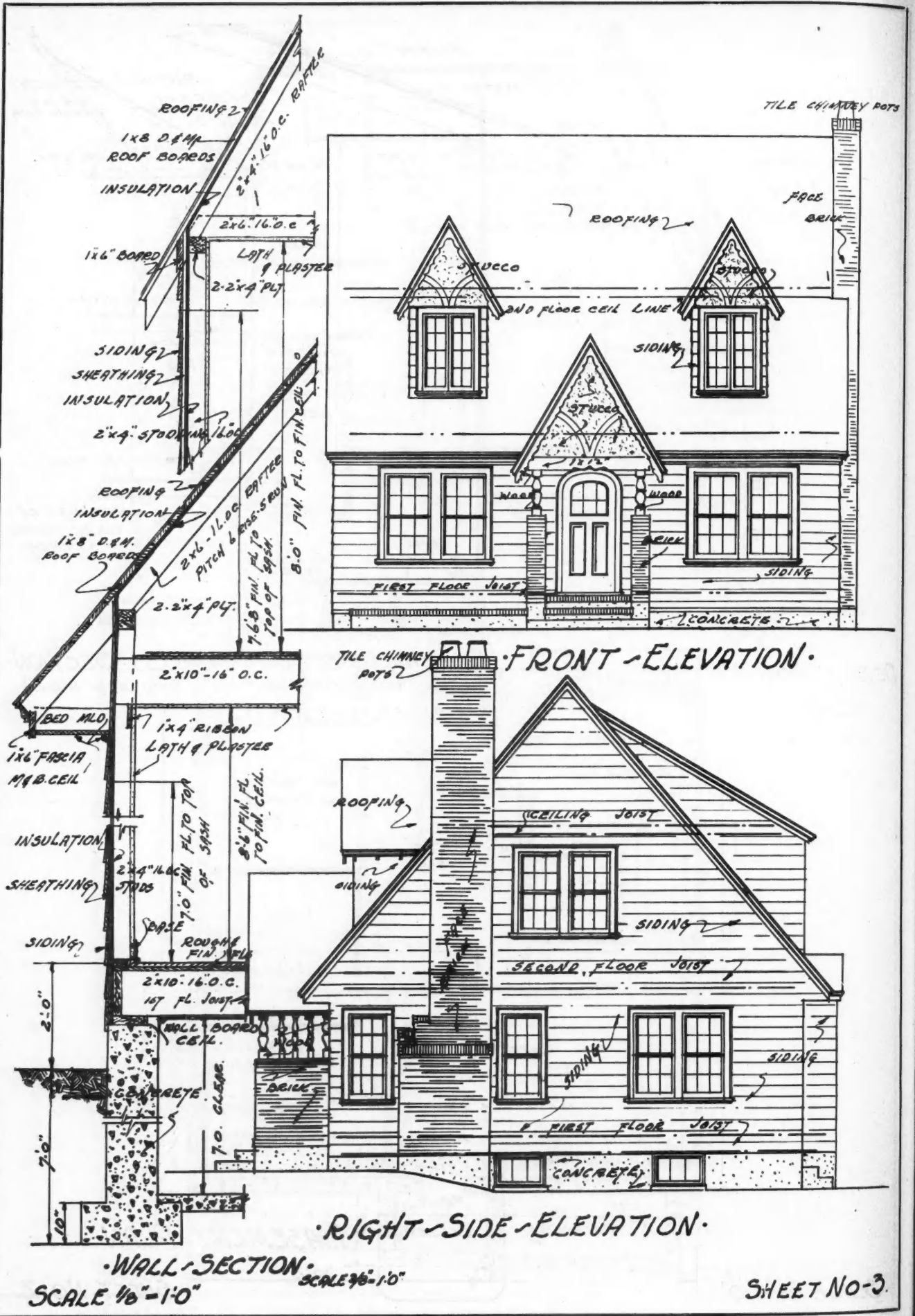

INSULATION, in Side Walls and Roofs, Has Rapidly Been Recognized as an Essential Feature of Modern Well Built Homes. Provision for such insulation is indicated in the wall sections.

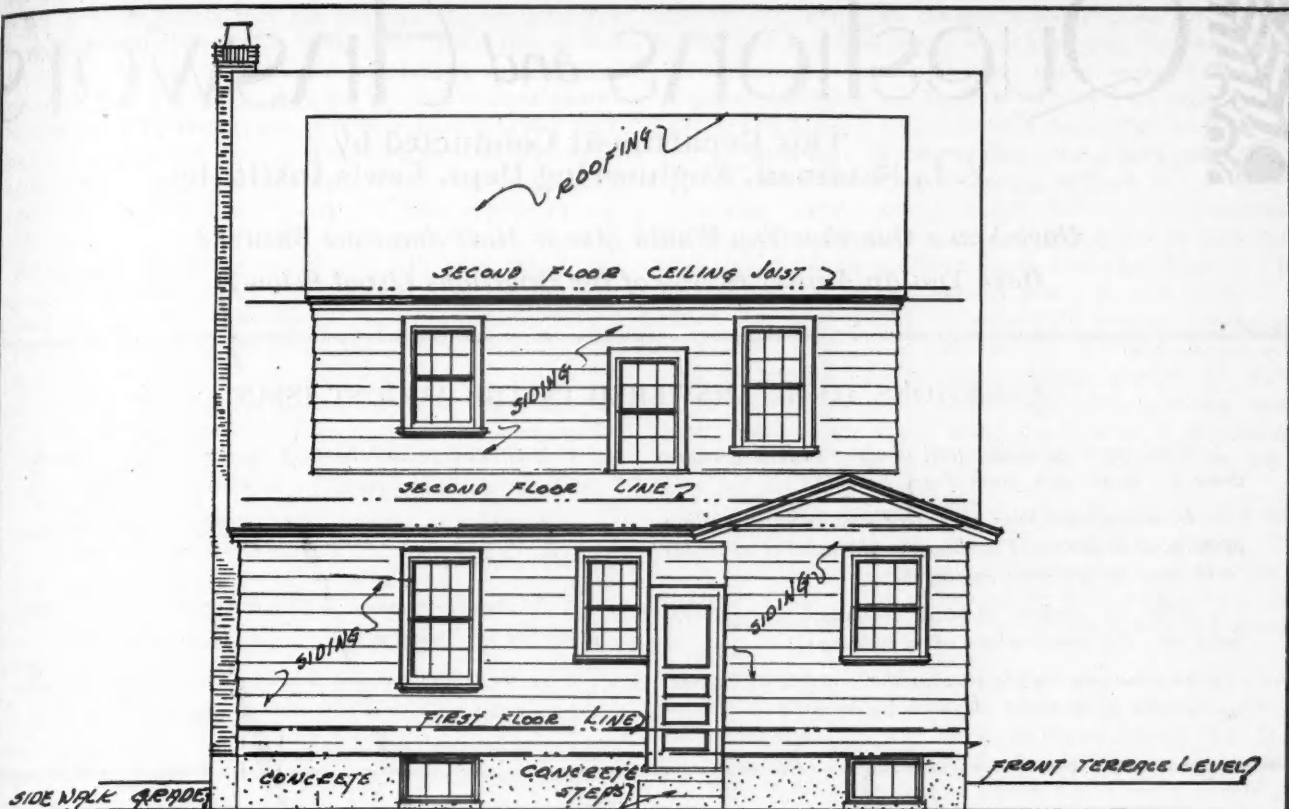

REAR - ELEVATION.

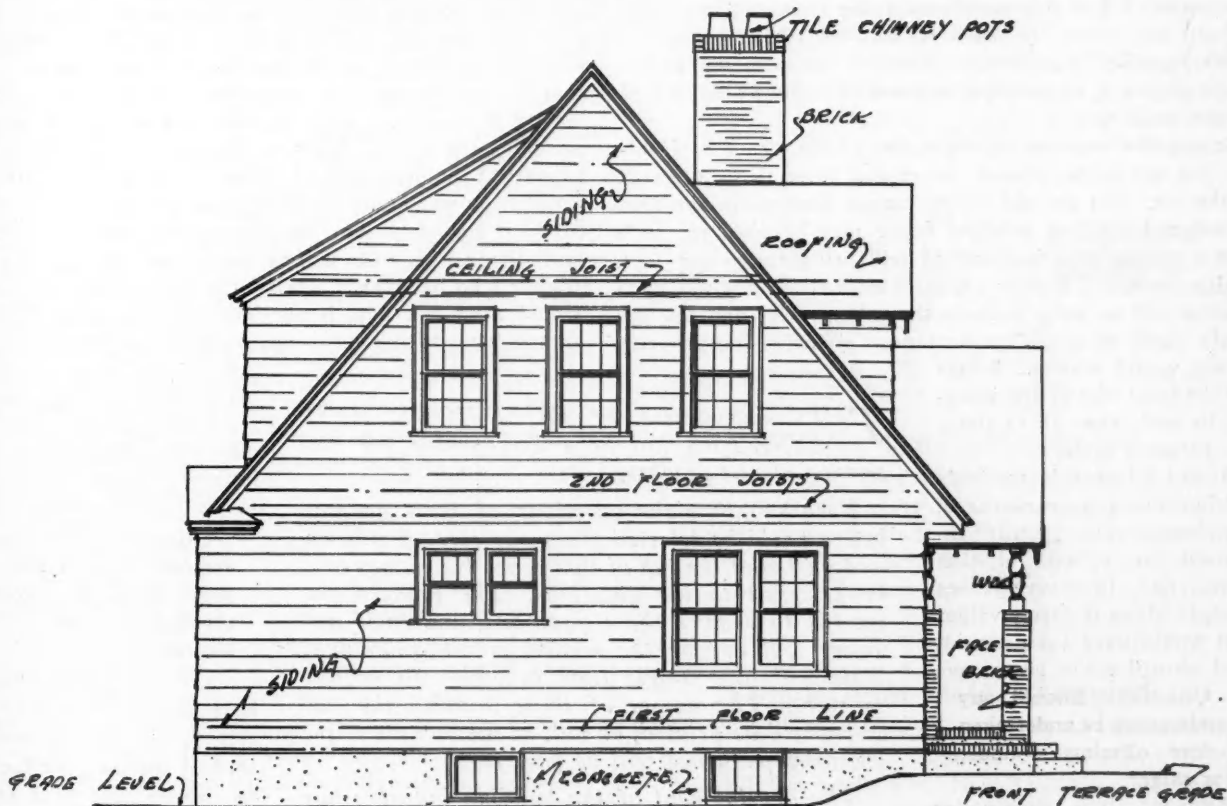

LEFT - SIDE - ELEVATION.

SCALE 1/8"=1'-0"

SHEET NO-4.

THESE ELEVATIONS Not Only Indicate the Grade and Floor Levels and Types of Construction Materials, but Also Call Attention to Small Refinements Like Chimney Pots.



Questions and Answers

This Department Conducted by
V. L. Sherman, Engineering Dept. Lewis Institute

Have You a Question You Would Like to Have Someone Answer?

Have You An Answer to Any of the Questions Listed Below?

QUESTIONS TO BE ANSWERED IN THE AUGUST ISSUE

1. How can a retaining wall along a sunken garage-drive be made safe from frost heaving?
2. In arranging stairs are there any rules regarding landings or locations of landings, or the number of treads to be used to approach landings?
3. Why are bankers disposed to examine very carefully into the construction of new homes?
4. Is there any way to prevent the contents of backed-up sewers from rising through basement drains?
5. Must any regard be paid to the location of soil-stack outlets in the roof?
6. In what way are power hand-tools a benefit to the smaller contractor?
7. Are ready-installed mechanical refrigeration units attractive to home buyers?
8. Is there any type of window glass through which more of the sun's rays pass than ordinary?

Question: What expense is warranted in rebuilding or remodeling an old house, and how can it be figured?

ANSWER: While this question may be answered in a cold-blooded way there are some reasons for taking exception. There may be neighborhood interests, investments in adjacent property, or perhaps, increase of loans to be secured on the property.

Basing the expense on the value of the property frontage, the house-cost should not exceed three times the cost of the lot. But an old house cannot always be rated at its original cost. A nominal figure may be used for such improvements or rebuilding as will bring the house to a salable state, and further expenses allowed only where such expense will actually increase the selling price and procure a sale. Only reasonable expectations of increasing property values would warrant bringing the total cost of the building to more than three times the property value.

Recent advance in methods for improving appearances of old houses has greatly increased the volume of that work, and in many cases brought along property values that would have been considered absurd some years ago.

Question: Should any landscaping be undertaken before offering a house for sale?

ANSWER: It is much easier to sell a finished house than a thoroughly practical and attractive plan for a home. The reason is that relatively few people have any gift for picturing a house from the drawing. It is just as true that a handsome home will remain

unattractive to some people so long as its surroundings produce an unfinished picture. A framed picture is more attractive. There is another side. It is part of every day's work for a contractor to see that material is moved, arranged, used, disposed of and so on. What looks to him like a small job of leveling, trenching, shrub planting, sowing of grass, a job that he might suppose a green buyer would take to in the way of recreation, is quite as often as not a serious obstacle in selling the house. When the buyer sees that he will have to start at the beginning of things and work up, the chances are that he will figure in the cost of having to hire someone to do it for him. And he knows that when he hires as an individual his costs will be more than the costs to a contractor who has steady work for such unskilled labor as he would need. A new house before being offered for sale should have such improvements about the grounds as will

relieve the buyer from the need of immediate improvements, and enough planting to offer encouragement, provoke interest, and set off the house to its best advantage.

Question: How can I estimate the amount of heat which is absorbed through a roof in hot weather?

ANSWER: The amount of heat absorbed depends on the type of roof and the temperature of the air over the roof. In winter the heat escapes to the outside, and in hot weather the heat imprisons itself. The heat is measured in B.t.u. (British Thermal unit) per hour, per square foot, per degree difference in temperature between the air inside and outside.

THIS department of **QUESTIONS AND ANSWERS** has been inaugurated for the service of our readers.

Each month eight questions of most general interest will be selected from our correspondence and posted at the top of this page. No names will be attached to the questions. The readers are invited to answer these questions, and their answers will appear the second month following. This will give ample time in which to submit answers. The names of those sending the answers will be printed, or not, as the writers wish. Answers published will be paid for.

The development of the building industry has been such that none of us is familiar with all of its branches or specialties. We are all asking questions if we mean to get ahead. At the same time each of us is in a position to answer some question from his own experience. We open these pages, then, to all of the readers for questions, answers, suggestions, or criticisms.

Give us the pleasure of your company.—L.V.S.

A pitched roof with unceiled rafters will average one-half B. t. u. per square foot, per hour, per degree difference in temperature. It requires about two hundredths of one B. t. u. (.02 B. t. u.) to raise the temperature of one cubic foot of air one degree Fahrenheit. When you have figured the volume of your attic, the time of exposure to the heat, and the temperature next to the shingles, the amount is available as a numerical value. However, it is much more important to know what part of the heat can be further excluded.

By ceiling the rafters with wood lath and plaster, the unit of absorption is cut to one-quarter of a B. t. u. per square foot, per hour, per degree difference in temperature.

By further insulation between the rafters, such as quilt, felt, fiber, or cellular or powdered fill, the unit of heat admission may drop to .14 B. t. u. In some cases as low as .10 B. t. u. This last is only one-fifth of first given value.

Bare members are promising but not nearly so convincing as experience with insulated attics and the other kind.

Question: Does pine possess any special advantages as interior trim?

ANSWER: The answer to this one is relayed from a man who has a special liking for pine as trim. Whether or not you think him biased, his fondness for pine cannot be ascribed to business reasons.

"With the gradual return to more homelike homes after a period of one hundred years or so, we have come to the stage again where interiors are more quietly disposed. Naturally that leads to more wood trim and along simpler lines. I have found pine as trim acceptable in more ways than any wood I know. Pine is reliable, of handsome grain, when selected, easily worked, and less likely to contrast badly with walls, ceilings, and floors. As to the first point. Only three pieces of trim were discarded on the last two jobs where all of the trim was yellow pine. Perhaps that speaks well for the mill as well as for the pine. Part of the trim was enameled over two coats of paint. Some of it was flat paint. Some of it, and this was a new one on me, was washed with a solution of verdigris crystals and water, allowed to dry, given a coat of varnish and then rubbed with wax. There were batten doors and casements in two rooms in which this was used and the whole thing gave a mellow old style look that I have never seen before. This came in part from the varying grain densities absorbing more or less of crystal.

"After what experience I have had it does not seem that pine trim is more subject to marred spots than other woods. Where narrow trim is demanded it is exceptional. There is a softness in the straight lines if it is painted, and if stained it can be matched with any wall, even the most radical of the modern plaster coats."

Question: Is forged hardware for exterior trim profitable to the builder?

ANSWER: If the increasing market for exterior hardware in hand-forged patterns is any index it would seem that it was quite profitable to the builder. One large retail hardware firm operates a shop of its own where special work is designed and made up. The best of the original pieces are kept for reference and display, and the increase in business indicates profits all the way to the buyer.

To get some conception as to the difference in hardware for exterior trim during the last twenty years compare the illustrated catalogs of the old days and the present. If the larger firms were not devoting time and money to the adaptation of the hand-forged styles many of the present day improvements in exteriors would hardly be acceptable to the buyer. The adaptations from the hand-forged styles have led to distinct changes in the designs for finished fittings, such as thumb-latches and levers replacing knobs. Present day hardware is not what it was a few years ago,

and it is distinctly better in use and appearance. (Did you ever have to polish up the old brass fireplace set and the andirons? And how many time have your knuckles been skinned when the door-knob came too close too the jamb?)

Forged hardware for exterior trim is profitable to the builder, and lack of it may cause a perceptible loss.

Question: Is an overhung second story good construction or just a passing fashion?

ANSWER: Without going into the history of this method of construction from the architect's side it can be said that this type is always good if treated with consideration. It is not a passing fashion, nor is it a very popular style.

Many old Colonial houses were built with an overhanging second story. The construction then was simple because of heavier framing, the overhang gave some relief to the front of the house which might otherwise have been rather blank, and added floor space without increasing foundation size. There is also some protection for the windows and doors.

Builders and architects have returned to many of the old time features in building, and with very good reason. It has been shown that simple roofs and otherwise plain lines in the exteriors can be turned to excellent design by some simple changes in the form of the structure, and this is one of them.

But the overhung second story must be treated with care. There is the case of an architect and builder who completed a beautiful specimen and went his way satisfied. But the client was not. The front of the house was too simple for him, and, besides, he had no front porch from which to view the street. So a porch was built across the whole front with the porch roof below the overhang. It became the horrible example of the town.

Question: Of what advantage is a fan or blower in warm-air heating?

ANSWER: A forced feed in a warm-air heating system first provides a more uniform temperature of air about the heating surface and at a lower temperature. The absorption of heat by the air is increased because of the greater

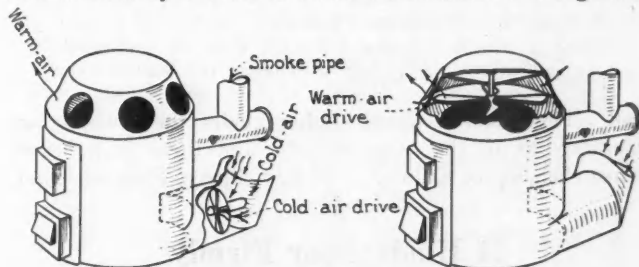

WARM AIR PLANTS USING FORCED FEED

difference of temperatures within and outside of the firepot. A forced feed also provides a more uniform temperature throughout the air ducts and rooms, maintaining room temperatures at lower duct temperatures. A fan will also bring up the room temperatures more quickly on starting the plant.



Competition Date Extended

THE closing date of the National Better Homes Architectural Competition, conducted by the Home Owners Institute, 441 Lexington Ave., New York City, and thirteen co-operating newspapers, has been set forward to midnight of Sunday, June 20, 1929, according to an announcement by L. Porter Moore, President of the institute. This gives competitors an additional month, beyond the time set in the original announcement in which to submit their entries.

The announcement also states that a 13th Region has been added and that 39 regional prizes of \$500 each will be awarded, increasing the total prize money from \$27,500 to \$29,000.

How Dan Does It

A Department for Passing "Life Savers"
along to other Builders

\$2 for an Idea

Dan is an ingenious cuss. Nothing ever stumps him. He always knows the way out when he runs into a tough problem out on the job or in the office. Dan is editor of this Department and will pay \$2.00 each for every good idea he can use here to show and tell other builders "how to do it." Send him a rough sketch and a short description of what the tough job was and how you handled it.

Address Dan-Do-It, care of American Builder, 105 W. Adams St., Chicago, Ill.

Trimming Board Ends

A METHOD of trimming the end of a piece of lumber that is only a trifle too long, which is quicker and simpler than the one shown in the January issue, is illustrated by the sketch. Just lay a piece of waste lumber under the piece to be trimmed, holding the edges with one

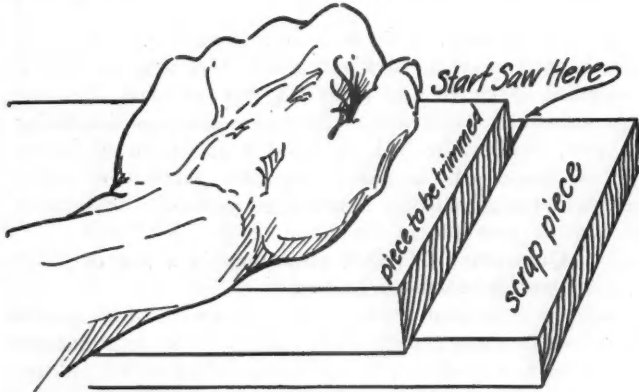

A SIMPLE AND ACCURATE WAY of Trimming a Small Excess Off the End of a Board Without Stopping to Clamp or Nail.

hand. The piece of waste lumber guides the saw just as accurately as in the other method and there is no time wasted clamping or nailing. C. J. Royce, Fremont, Ohio.



It Holds Door Firmly

I AM sending a sketch of a door holder which, I find, holds a door more firmly to the regular horse with a "V" cut, when putting on butts, etc. The wedge must

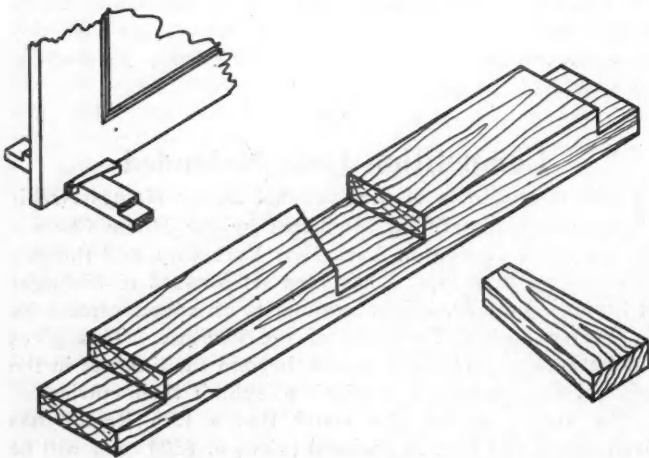

THIS SIMPLE TWO BY FOUR and Wedge Holds a Door Firmly While Putting on the Butts.

be left blunt on the small end so that it can be tapped out easily. The block is made from a piece of two by four. The notch in the two by four is square across the piece on one side and at an angle on the other side. The wedge is cut to fit this angle. The notches at each end of the two by four are simply intended to make it easier to nail the piece down, without using large nails.

E. W. Lyster, Box 251, Newport, Vt.



Resetting Door Locks

I AM offering a description and sketch of a method I have found very satisfactory in fastening a rim door lock where the holes for the screws that hold the lock in place are worn out so that screws will no longer hold and plug no longer remedies the trouble. I bored two $\frac{1}{2}$ or $\frac{3}{8}$ -inch holes in the lock stile from the edge of the face as shown in the sketch, boring through the center of the worn screw holes, about 2 to $2\frac{1}{2}$ inches deep. I use a sharp bit to make sure that the wood does not splinter.

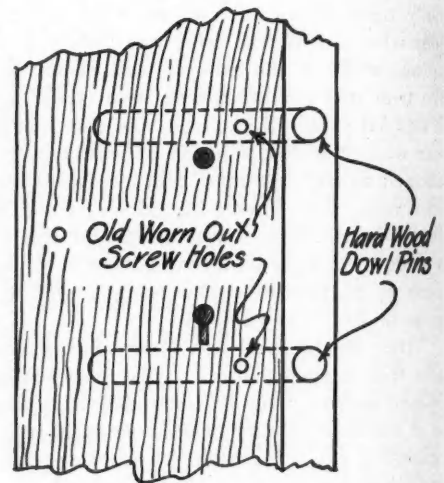

I next drive a hardwood dowel into the full depth of each hole and cut it off smooth on the edge of the stile, sandpaper and finish it. I then put the lock back on and use a little longer screw than originally so that it will reach through the dowels. In this way the new screws will hold satisfactorily.

DOWELS SUNK Into a Door Like This Make It Possible to Reset a Lock When the Screw Holes Are Worn Out.

On a fine job I cut the dowels about $\frac{1}{4}$ inch shorter than the depth of the holes, so that I can use veneer finish on top of the dowels to finish the door. The lock screw hole seldom wears to any extent and can be easily fixed with a plug from the face of the stile. One should be careful not to use too thick a dowel as it is liable to split the stile and make a very unsatisfactory job. Dowels can be bought any thickness desired. The new screws usually split the dowels, which tightens them in the holes so that they will never come out.

RICHARD BARR, R. No. 2, Pine Grove, Pa.

To Plumb Door Jambs

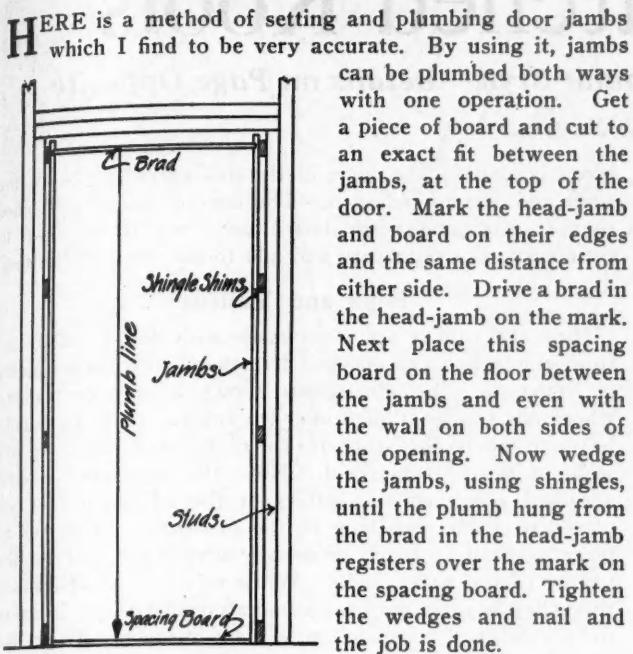

HERE IS a Simple Method of Setting a Door Quickly and Accurately.

I also plumb outside door frames the same way except that I mark the sill of the door frame and do not use wedges but nail the casing.

C. M. CARPENTER, Poland, N. Y.



Hanging Double Action Doors

A METHOD of hanging double action doors was described in the January, 1929, issue. I believe that the method I use is a quicker one. I first fit the door for top and sides, then place it in the jamb and put a four penny finish nail on the top edge of each corner of the door.

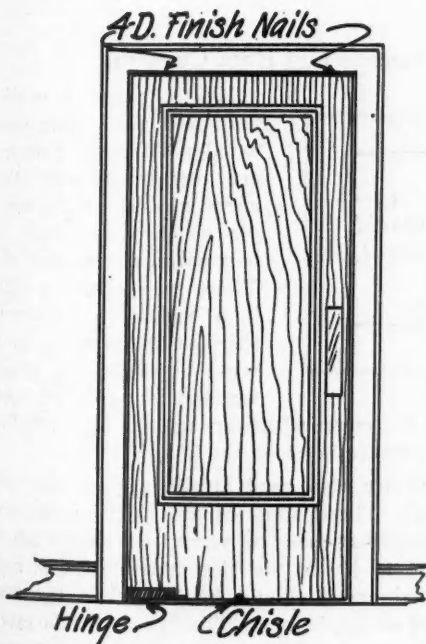

A QUICK WAY to Hang Double Action Doors as Described Here.

I then take a chisel and, while holding the door in position kick the chisel under it till the four penny finish nails are tight against the casing. This gives the proper clearance on top.

L. S. WORLEY, 5320 Webster St., Downers Grove, Ill.



The Delco-Light Company, Dayton, Ohio, offers an interesting pamphlet on "Power Education by Isolated Plants."

An Aid in Stair Work

HERE is a little gauge that can be carried in the pocket and will be found very helpful in stair work. This is a piece of soft wood about three inches long and 1 1/2 inches wide, with a 7/8 inch slot cut into nearly half its length. The top horn is 1/8 inch longer than the bottom one so that, when applied to the tread as shown in the sketch, the nails will not split the surface of the riser but will drive straight down through the center where they belong. I make the top horn 1/8 inch longer because, in this region, all our material comes either 1/4 or 3/8 thick.

The left hand side of the sketch shows the same idea applied to the stool cap. I should add that, in this work, I always cut two sticks a little longer than the distance between the floor and the bottom of the sub-base and drive

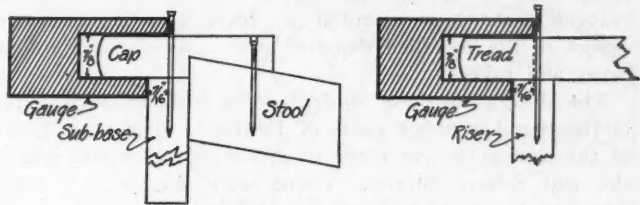

A HANDY LITTLE GAUGE Which Can Be Used in Stair Work or Nailing Stool Caps.

them under the sub-base to hold it from sagging while nailing in place.

N. W. COLE, Hampden Highlands, Maine.



Repairing Cracked Cistern

CISTERNs that have been plastered on the clay, and are badly cracked are hard to fix so that they will be permanently repaired. My way of fixing them, shown in the sketch, has proved very satisfactory. Take sheets of metal lath and apply to the walls of the cistern, running them up and down. Use 16 or 20 penny nails to fasten them. A 20d nail can be driven right through the old cement plastering. If necessary, apply the metal lath up as far as the brick arch.

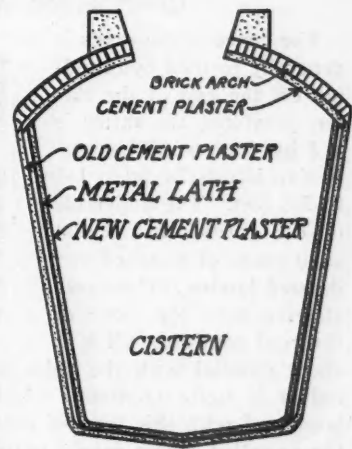

A BADLY CRACKED Cistern Can Be Made Watertight by This Method.

When the metal lath is in place, cover it with a coat of good portland cement mortar. Let it stand for a few hours, or until it has set up enough to apply a second coat. Let the second coat stand for a couple of days and apply a coat of clear cement and water, mixed thin enough to apply freely with a brush. Last of all, if preferred, apply, a few days later, a coat of water glaze to keep water from becoming hard when first put into the cistern.

V. A. ANDERSON, Box 352, Elbow Lake, Minn.



The Lone Star Cement Co., National Bank of Commerce Bldg., Norfolk, Va., has just issued a circular, "Solving the Time Problem for the Highway Builder," which describes its "Incor,"

The Pittsburgh Reflector Co., Bowman Bldg., Pittsburgh, Pa., offers a package of forty-one photographs illustrating its Permafecter lighting installations.

Building Thatched Roofs

How to Get Good Results in This Popular Style—Details on Page Opposite

By JOHN T. NEUFELD

ROOFS with rolling eaves and rakes are becoming more popular again. They present quite a problem for the carpenter. The important point to bear in mind in the construction of these roofs is to carry out the general effect that the architect tried to bring out and not so much the details given for the construction. In fact, the carpenter will find plenty of points of framing that he will have to figure out himself on the job in order to carry out the general feeling of the design. For the reasons given it is essential we learn a little about the design of the so-called thatched roof or roofs with rolling eaves and rakes.

The design of these roofs has its historic background in the thatched straw roofs of England. The very nature of the roof as it was made of straw naturally was one of the soft rolling curves. There were no sharp corners. The thatch seemed to cover the building like a soft blanket and harmonize with the rolling curves of the surrounding landscape. It is hardly possible to imitate the thatch effect to a very marked degree; however, we may borrow the suggestion of the soft rolling curves and do what we can with the materials at our disposal. A roof of this kind lends itself to a cold climate. The extra curve at the eaves will do much to shed the snow from this point where it otherwise has a tendency to settle down to rest; and the gutter placed well below the sweep of the roof will not be ruined by the snow and ice.

Constructing these roofs we must, therefore, try to frame in such a way that sharp curves and angles are avoided. This may be accomplished in different ways. The methods illustrated here are only suggestive.

Construction at the Eaves

The curve at the eaves is generally formed by rounding off the end of the rafter, providing the rafter is a 2 by 6 piece. The projection is usually from 1½ to 2½ feet. The underside of the cornice has a flat soffit made of matched and dressed lumber. The curve starting with the slope of the roof continues till it is about parallel with the sides of the building. A 20 inch radius is quite common. A half round hanging gutter goes well with this type of roof. Sharp angled gutters or the so-called crown mould gutter should not be used, as it does not harmonize with the soft curves of the roof.

Construction of the Ridge

The curve of the ridge is also formed by rounding off the ends of the rafters, usually to the same radius as the eaves. Sometimes strips are nailed to the upper edge of the rafter to make a wider rafter and a more gradual curve. The ridge, too, is very often made irregular in its horizontal line. It is therefore, in either case, not so essential that the curves of all the rafters be exactly alike. Irregularities will help to emphasize the rolling curves.

The Rolling Rake

The curve at the rake is usually made the greatest at the ridge, that is the widest as is shown in the illustration. A wide verge board is usually used. Sometimes the verge

board is omitted, the curve of the roof extending below the soffit and sort of hiding it. The curved brackets attached to the rafter and verge board need not all be exact in their curve as irregularity will add to the effect of the roof.

Hips and Valleys

Hips and valleys are often made with double rafters set from one to one and one-half feet apart, with curved pieces in between. The illustration shows a way of framing where one roof is framed over the other. This can usually be done where the space in the roof is not used. It will make a very strong roof. Note that one roof is first sheathed and then the rafters of the adjoining roof are placed over the sheathing of the first roof. It is well to place a board or plank diagonally across the roof for the nailing of the valley jacks. While this method of framing the valley to some may seem uncraftsman-like, yet it makes for a very good construction in many respects. To get the curved effect a wide board is nailed into the valley. The valley tin or roofing is then applied over this.

Dormer Construction

In the second illustration the framing of a dormer for this type of roof is illustrated. The brackets shown to form the curves for the side of the dormer could be made to extend farther beyond the side of the dormer so as to form a more gradual curve. Sometimes the eyebrow effect is desired in which case the upper part of the dormer is also curved. The brackets shown should not be too exact in their likeness, a freehand sawn method will give the best results.

Roof Boards and Roof Covering

Most of the roofs of this kind are now made with wooden shingles. Shingles are furnished with the curve already in the shingle so that no trouble is encountered on the job. These curves are to a 20 inch radius. If wooden shingles are used this curve must be followed. When wooden shingles are used

the roof boards at the curve which are usually narrow strips may be laid with a space between the boards.

Asphalt shingles are also used at the present time for roofs of this kind. These shingles are bent on the job, but it may be advisable at times to warm the shingles before bending so as not to break the slate coating. The roof boards for the main roof should be laid close together, preferably matched or shiplapped. The boards for the eaves and rake may be narrow strips placed as close together as possible. As shingles may overlap a little more at the curves it will not be so essential that an altogether tight sheathing job be made.

The small illustration to the left of the dormer shows a method of applying the shingles to the sides of the dormer and at the rake. In this method, which is known as the *stayput method*, the shingle overlaps the one to the side of it. The one side of the shingle is nailed close to the butt end of the shingle, thus making a very good nailing job and giving it the name *stayput*.

If there are any special problems of carpentry construction which readers would like Mr. Neufeld to discuss in this department, just drop the Editor a line.

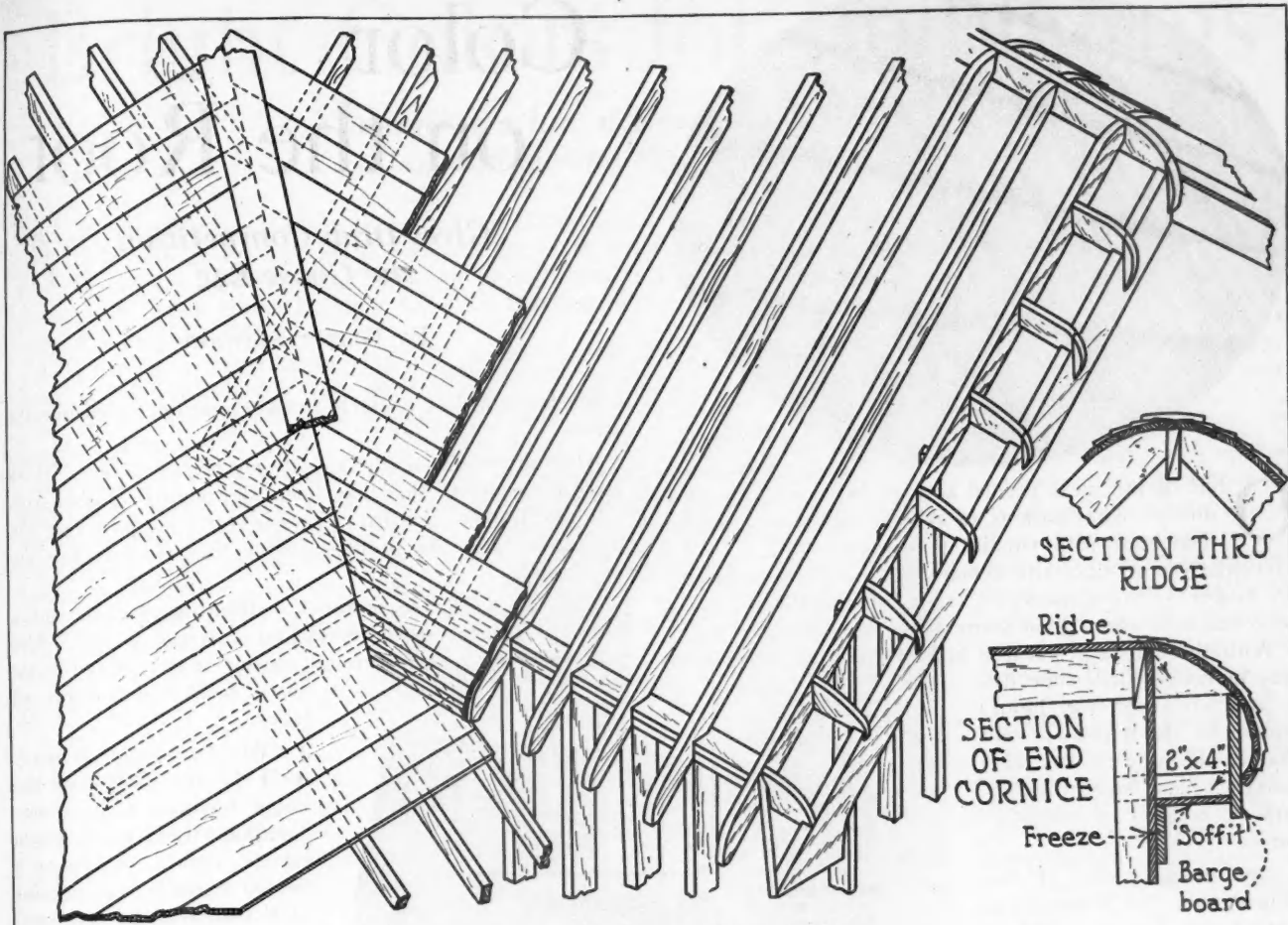

DETAIL OF THATCHED ROOF FRAMING

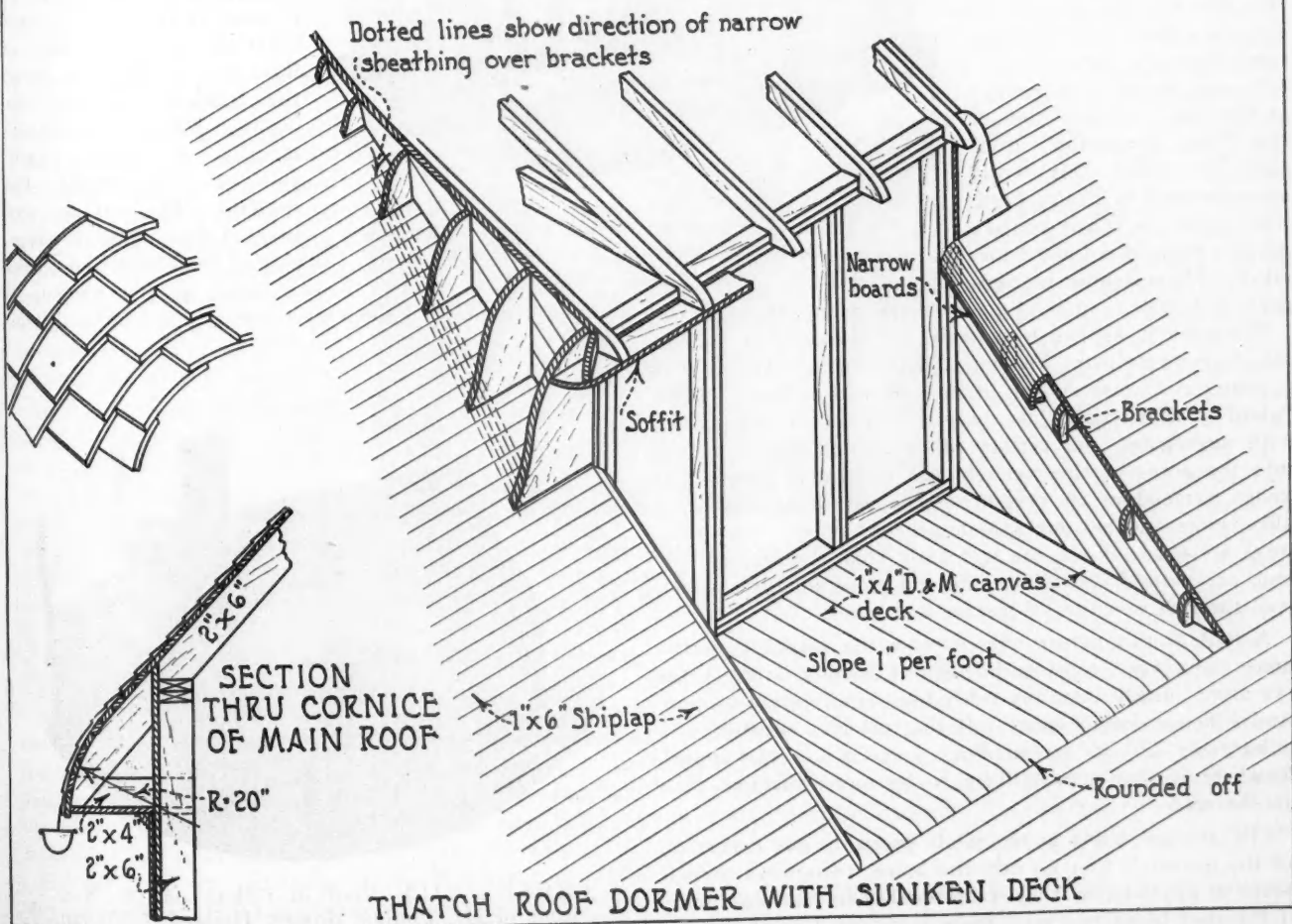

THATCH ROOF DORMER WITH SUNKEN DECK

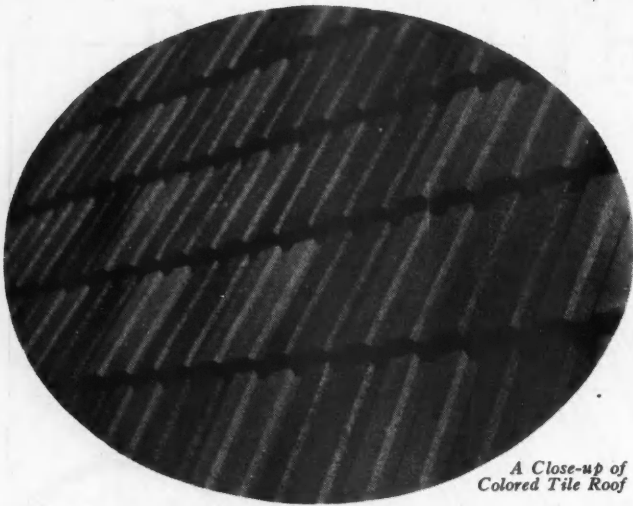

A Close-up of
Colored Tile Roof

ONE of the most needed and at the same time most difficult combinations to achieve has been a permanent roof with equally permanent color. This is particularly true since the demand for color in everything no longer seems a passing "craze," but a factor to be reckoned with for a good many years to come.

With the constant research behind concrete products, it was inevitable that some day a concrete roof for homes would be developed—a roof that would in every way meet today's needs, both in quality and in method of manufacture.

One manufacturer of machinery who for 25 years has contributed a great deal to the concrete products industry, has solved the problem. His tile making machine is entirely automatic. Ordinary raw materials enter at one end and perfect tile emerge at the other—a perfection of the "line production" principle for which this world owes so much to Henry Ford. The mix is thoroughly packed, compressed and trowelled. The machine is compact, fast, and a marvel of mechanical ingenuity.

The color is applied by a truly revolutionary process in the concrete industry known as mat-glazing. This is not a paint or a wash, nor is it applied with a brush. The "glaze" is a material whose base is portland cement. This, with aggregates and certain other ingredients, is forced into the pores of the concrete tile by a dual action gun under tremendous air pressure. The two materials, being alike, unite and become a homogeneous mass. Two mixtures are used. First, the wet basic color aggregate; second, dry natural colored granite and stone mixtures which lend the rich variation of texture and tones.

A roof of this nature will increase the salability of the house to a very considerable degree. Color attracts the eye more quickly than any other one thing, except motion. And a house doesn't move. If that color is beautiful and in harmony with its surroundings, it has a powerful appeal. Nowhere is that appeal likely to be more effective than on the roof.

The average home buyer, while probably not expert on all the materials that go into the home, recognizes permanence in anything as a desirable quality in his new house. If the roof be of concrete, there is no need to explain to him that it is permanent. He knows that already, and the

Color on the Roof

*Gives Drab Competition
the Goose Egg*

BY GLENN STEWART

seller has one less obstacle to overcome in completing the sale.

Although this roof tile is relatively new, it is one of those unusual products that has been thoroughly reliable from the beginning, so great was the care in perfecting the machinery and the process before the tile was first announced.

The tile will have national distribution, but through a chain of plants rather than from a single factory. This plan will reduce costs through saving in freight and by the use of local raw products and labor.

While "economy" is apparently the key-word in modern home buying, it is an outstanding trait of American human nature that when a person is really sold on some particular material or piece of equipment for his home, the price makes no great difference. He is determined to have what he wants. Shrewd builders take advantage of this characteristic to speed their sales and increase their profits. Hundreds of refinements for the home are available to help them. But something like this new roof tile has the additional advantage of being seen and desired as soon as the building is

sighted. It makes known its value at a glance, and it invites inspection within.

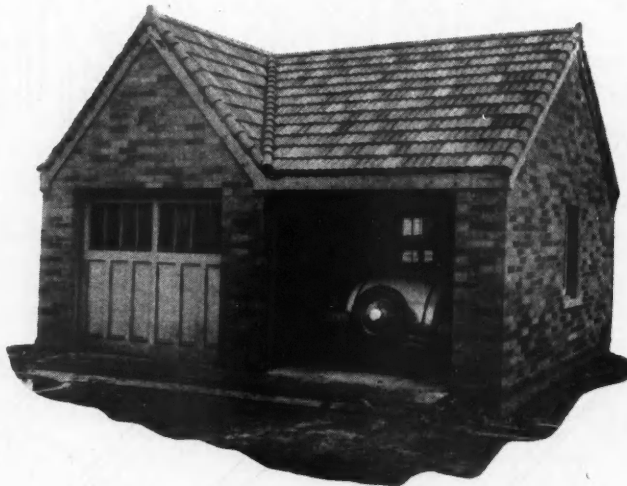

MINGLED Blues and Greens Makes This Roof
Stand Out on This Attractive Garage, Blending
Perfectly With the Duntile Walls.

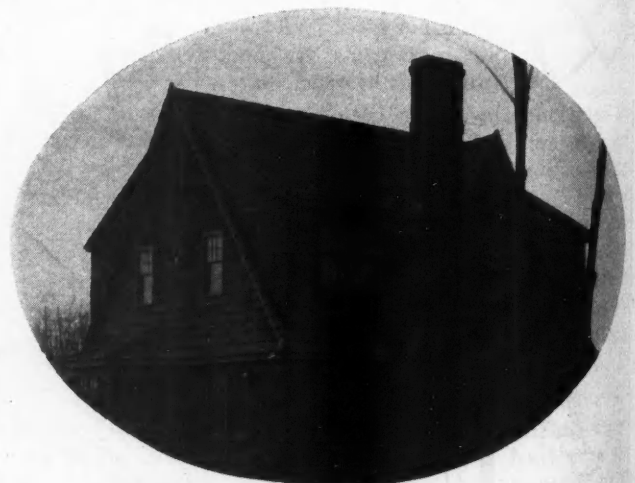

CEMENT TILE Roof in Colors on the New
Home of Mr. Phillips Brooks, Holland, Michigan,
Blending With the Natural Weather Color of the
Side Wall Shingles.

Bright Colors for Bathrooms

A Demonstration of How Color Was Used to Camouflage the Size of a Bathroom

A PROPER use of the new craze for color in the bathroom will go a long way to overcome the disadvantages of a small space. This was vividly demonstrated at a recent Home Building Show in Philadelphia, where a 4 by 8-foot space was transformed into a model up-to-date bath which brought the "Ohs" and "Ahs" from the passing crowds.

It was done by a plumbing supply house which has an exhibit every year a step or two ahead of general run of installations. The idea was to show what the large closet, small hall or stolen slice from a larger room would look like when properly dressed for its new use.

Of course, if it was not that the manufacturers of practically all things which go into the bathroom are now offering a wide choice of colors it might be hard to duplicate the striking results obtained in this exhibit. As it is, however, color can be put with telling effect in even the medium priced jobs and will far repay the small additional cost.

The textile industry is one of the most recent converts to color for the bathroom and is offering a wide variety of waterproofed fabrics. This makes it possible to add a touch of color in the shower curtains where for a long time a lifeless white canvas, looking too often like a wet furled sail, has struck the eye as a thing of utility rather than beauty.

Rubberized silk, satine, chintz and lower priced prints in great variety may now be used for their decorative value as well as their usefulness. They are also not subject to mildew and retain their attractiveness for a long time. Window shades and curtains may be made from the same material and add other touches of lasting and beautiful color.

The possibilities of tile, linoleum and wall coverings are too well known to need mentioning but all of them and a few other things were used by the plumbing firm at the builders' show to obtain its results. Black and white was the background of the room but a bright rich red was introduced into it so as to make it a thing of beauty.

On the floor was linoleum of 4-inch black and white checker board design and the lower sidewalls were black tile outlined in squares with white cement. Above the tiles

was wall paper in a white tile effect with every other block showing a black gondola. Without the red the room would have looked only like a cross-word puzzle and been as hard to sell as some of those puzzles were to solve.

In the rear was a 4-foot tub which stretched from wall to wall. To give the full benefit of its length the fixtures were placed in the back wall. The shower curtain was a vivid red rubber and hung from an arch giving the tub the appearance of being in an alcove.

On the right hand wall near the door was the pedestal wash basin and on the other side nearer the tub was the toilet. A bright red seat gave a dash of color never obtained from the old line of white, oak or mahogany but was not too vivid surrounded as it was by considerable black. Of course you know manufacturers now carry seats in 20 different colors so red is not the only choice possible.

All of the fittings were black but were brightened by the red of the articles used with them. The tooth brushes had red handles, the towels red borders and the drinking glass was red, so they all added to the picture instead of being merely in it. Red soap in the black dish carried out the same idea far better than if it had been white or any other color.

A wooden stool in one corner of the room had its excuse for being there by its shiny red legs and rounds and a coal black seat. The wall mirror instead of its usual white frame was bordered in bright red and added a spot of life to an otherwise large colorless area.

The size of the room was never noticed or at least not mentioned by the thousands who saw it. They were so attracted by its novelty that all else appeared of little value. It stood not only as an example of what a little color can do but as a good pattern for a Spanish type house.

With the rainbow to choose from for nearly all its contents there is no longer any excuse for the old time expressionless white bathroom. A little color well applied will give it an individuality and the builder a dividend beyond his farthest hopes.

THOMAS H. WITKORN.

The General Electric Co., Schenectady, N. Y., has issued a number of booklets illustrating its electrical products.

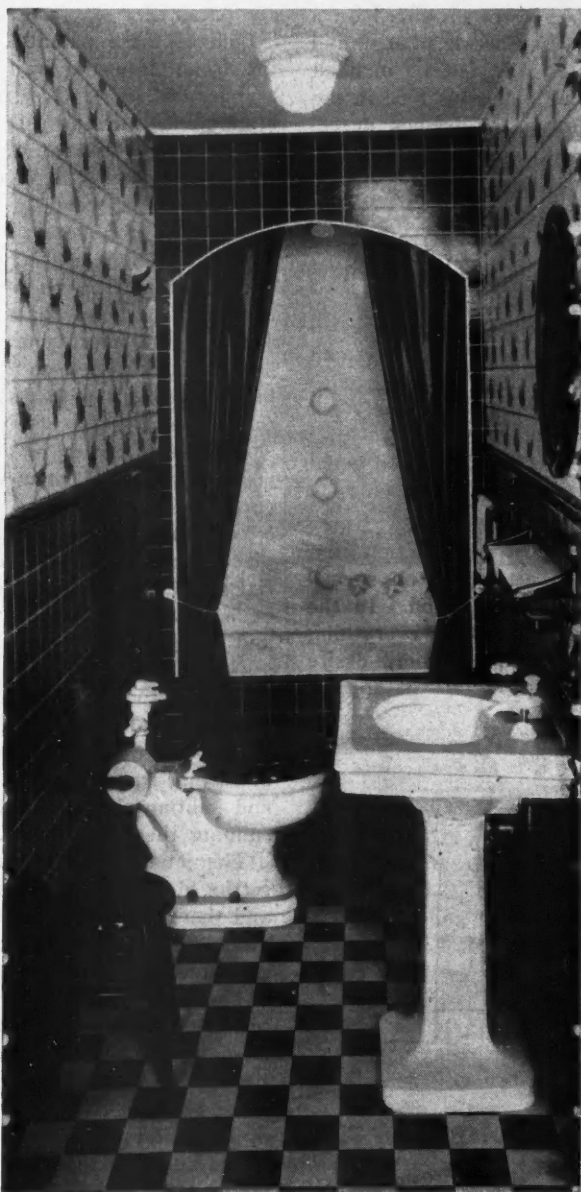

STRIKING COLORS Used in the Decoration of This Exhibition Bathroom Made it Attractive in Spite of Its Small Size, Only 4x8 Feet.

Can You Afford to Make Window Frames by Hand?

BY FRED C. ANDERSEN,
President Andersen Frame Corporation

BEFORE the days of specialized production of stock frames all factory made frames were produced on a special order basis in general millwork plants, and it was not difficult for the carpenter who felt so inclined to compete, as the equipment and methods employed in the factories making these small quantities of frames necessarily held little advantage over hand manufacture.

However, it seems to me that the open-minded progressive carpenter will now frankly admit that he can spend his time to much better advantage at something else than competing with stock frames which are made on special millwork machines.

For instance, one of the specially designed machines in a frame plant will do all the cross milling on a thousand window sills in one hour, and another will do in one operation at a good speed what, for a carpenter, would be fourteen operations on a triple head jamb! All of the other work on these stock frames is performed with speed equal to that indicated by these two illustrations.

One other marked accomplishment in the stock frame field is the improvement in design and construction that would add materially to the cost if attempted on special order factory frames or on those made by hand. In the best of the stock frames of today is embodied everything that the most particular builder or architect could desire to make a frame weather-tight and attractive in appear-

ance. Included in these frame features are several that are patented.

One of these patented features makes it easy to build the frame into the wall in a manner that stops leakage around the frame. This is accomplished by the use of wide blind stops of ordinary D & M lumber fitted into a patented groove in the frame. A recent laboratory test conducted at the University of Wisconsin shows that air leakage is reduced 55 per cent by this one feature. Formerly, this wide blind stop construction has been available only on expensively built special frames. Attention to such details is in keeping with the present trend toward the use of wall insulation in good construction.

All of the improvements in construction and design of stock frames have been accomplished by the use of specially built machinery without appreciably adding to the cost of the frame.

As to the matter of accuracy, I contend that it is impractical for the best mechanic to produce as true and accurate a frame by hand as we find it possible to produce by our methods on specially built machinery. In the first place, every carpenter knows that in any lot of frame material which is run to pattern in the long lengths there will be a number of pieces which are not perfectly straight; and the fact that the material was run before the carpenter got it prevents him from jointing this material straight. It, perhaps, is not bad enough in this particular to justify discarding it, and yet it will not produce the absolutely accurate and true frame that results from machine methods of cutting frame parts to approximate lengths in the rough, and jointing all parts that are not absolutely straight before running them to pattern.

Then, too, by having all machinery equipped with steel setting devices the accuracy of cross milling is 100 per cent and therefore greater than it is practical for a carpenter to attain by ordinary methods of measuring and cutting with hand tools.

The extreme accuracy of the best stock frames is attested by the fact that many builders who are using such frames have found it unnecessary to do a separate and distinct job of fitting of each window to each frame on a more or less "cut and try basis." They fit at a bench all of the windows of a given size that there may be in a house and find that any window of this given size fits any frame of that size on the job perfectly. There is a definite time-saving in being able to fit the windows all to one set of measurements at a bench rather than employing the "cut and try" method necessary with less accurate frames. This saving is doubled by having the same advantage in cutting the trim. Thus the total saving in the use of accurate frames runs into considerable money.

Those contractors who have discarded the practice of making their frames by hand and are using stock frames will be glad to note the growth of the stock frame business as the best possible indication that they are merely keeping up with the trend of the times in adapting stock frames to their purposes. This growth is indicated, partially at least, by the production figures of one of the stock frame companies. In 1907 they sold 41,462 frames and in 1928 almost a round million, 970,798 to be exact.

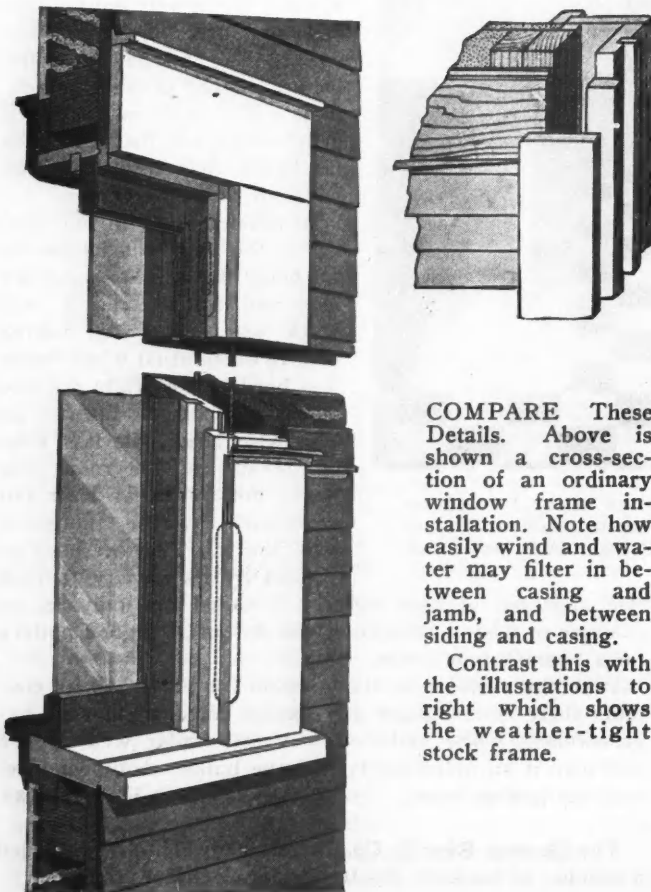

COMPARE These Details. Above is shown a cross-section of an ordinary window frame installation. Note how easily wind and water may filter in between casing and jamb, and between siding and casing.

Contrast this with the illustrations to right which shows the weather-tight stock frame.



Your Oak Floors Are Lovely

How Home Owners Can Maintain Permanently Beautiful Floors

BY LEMIRA BEALE,
Interior Decorator

OAK floors so beautify the interior of any home that in many of the great estates they are treated with the care of a family heirloom. In the famous palaces of Fontainebleau and Versailles, in the White House at Washington, in many of the great art galleries of this country and Europe, oak floors enrich the interiors.

The same floors may be laid in the average home at hardly any greater cost than inferior substitutes. Better still, the average housewife can perpetuate the beauty of her oak floors easily, if she knows how.

In searching for the simplest way of caring for oak floors many housewives have adopted methods that experts on floor finishes know are ruinous to the rich gloss that characterizes these floors. The care of oak floors is simple if all the wrong methods be avoided. Never use water, oil, kerosene, turpentine, soap or alkaline cleansing agents.

If water has been spilled upon the floor and it has turned white in places, moisten a soft cloth with a little alcohol and lightly rub the spots, which should immediately disappear. Do not repeat this operation too often, however, or the finish will be entirely removed. Shellacked floors sometimes take on a clouded or grayish appearance due to dampness in the air. This condition can usually be greatly improved by the same treatment described above.

If the finish has become so dirty that it is necessary to remove it entirely, first scrub the floor with wood alcohol and then bleach it with oxalic acid—never use lye, as it turns the wood black and ruins the surface permanently.

After all moisture has evaporated the original finish may be applied.

If the finish has become badly worn, thoroughly scrub it with a brush and sapolio and water (never flood the floor). After it has dried out, apply a thin coat of varnish; or in case time cannot be allowed for the varnish to dry, wax may be substituted. Do not use shellac on top of old varnish or varnish on top of old shellac.

Waxed floors should be dusted daily with a broom covered with canton flannel. Keep a can of wax on hand and should the finish become worn in the doorways or elsewhere, apply a thin coat, rubbing well into the wood. Allow the wax to dry for one hour and then polish thoroughly. Before rewaxing the floor, scrub it thoroughly with turpentine and a piece of cheese cloth.

In finishing the floor, either wax or varnish may be used. The wax finish is preferred by many, due to its economy and ease in renewing spots that show wear.

The best method of applying the wax is to take cheesecloth and double it, then fold it into a sort of bag. Put a handful of wax inside and go over the floor thoroughly. The wax works through the meshes of the cheesecloth and coats the floor evenly. After drying for about 20 minutes, it is ready for polishing. Rub to a polish with a weighted floor brush, first across the grain of the wood, then with it. Then place a piece of woolen felt under the brush to give the finishing gloss. After waiting an hour a second coat of wax should be applied in the same manner.

What's New in Equipment for Buildings

For further information in regard to any item described in the "What's New" Departments address, American Builder Information Exchange, 105 W. Adams St., Chicago

An Indirect Water Heating System

A NEW device for heating water with hot-air furnaces has recently been announced. This is an indirect system and is an adaptation of another device, manufactured by the same firm, which is used in conjunction with steam boilers. No scale will form in these water tubes.

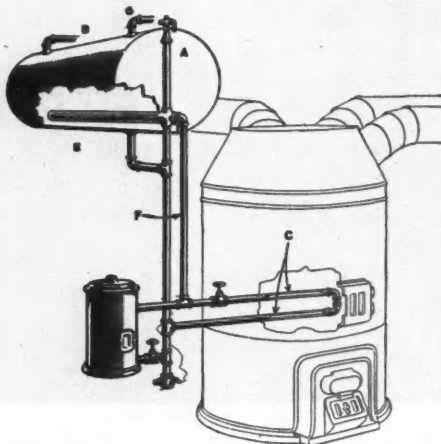

THIS DIAGRAM Shows the Operation of This New Water Heating System as Described Here.

Water, when heated, rises; and when cooled, it sinks. Therefore, if water is introduced in the pipes running across the fire in the hot air furnace (indicated by C in the illustration), it will rise through pipe F to the tubes (E) in the bottom of the reserve tank.

It is plain to see that the reserve tank (A), being full of

cold water supplied by city pressure through pipe B, will derive heat for its water from this now-heated tube, and at the same time, the water in the tube, losing its heat, will sink.

This tube (E) is in reality two tubes, one running within the other. The outer is made of copper, and the inner of brass. The inner tube ends a few inches away from the sealed end of the outer tube. The water, when heated in the pipes in the furnace (C) rises through pipe F and enters the inner tube. Through this it flows until reaching the end, when it reverses its flow and travels back through the outer tube. On coming to the end of the outer tube nearest the furnace, it is returned through the pipe to the left of pipe F to the furnace, where it is reheated and returned to the tube, by the same process.



Space Saving Built-In Closets

THE builder who is awake to the demands of his customers realizes the importance of closets in the houses which he builds. A shortage of closet space makes a house less desirable. Ample closet space makes it readily salable. Yet the ordinary closet takes up a large amount of very valuable space, especially in this day of small homes and bungalows. The closet illustrated here has been designed to take care of this problem. It is a specialty on which patents have been applied for and which has now been placed on the market.

This closet takes but 10 inches off of each room yet has the capacity of two, five-foot closets, of the old style, which take three feet or more from each room. As may be seen

from the plan illustration, it is placed between two rooms and can be used from bath rooms, yet each room retains complete privacy. When the swinging door is opened the sliding door slides into its place, as in the illustration, to give access to the space closed by the sliding door. When the swinging door is closed, that side of the closet is locked against the other room.

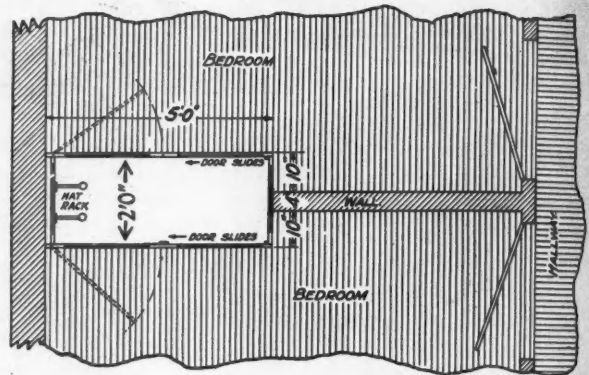

WARDROBE PLAN Showing Installation Between Two Rooms.

This wardrobe will hold 10 men's suits, 15 women's dresses, shoes, hats, blankets and boxes. It also has a cedar shelf for the storage of out-of-season clothing. The cost, it is stated, is less than for a single plaster walled closet of the old style.

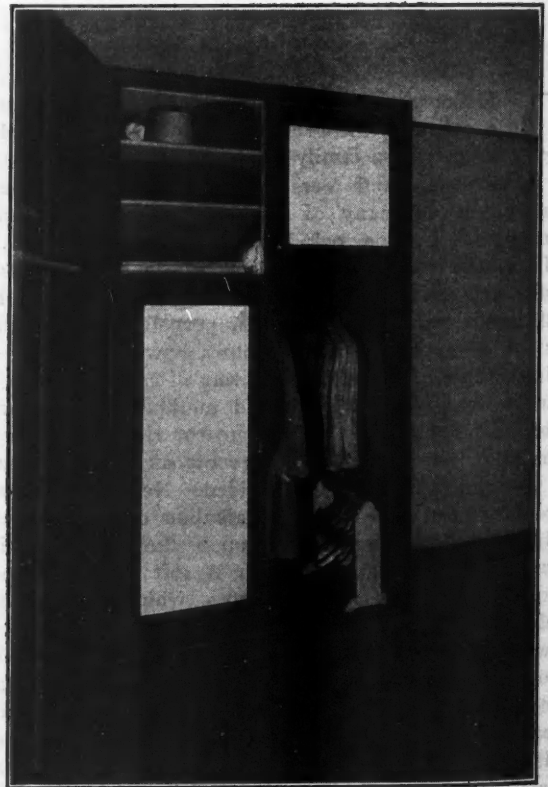

WARDROBE CLOSET Which Requires a Minimum of Space for Large Capacity.



250 Andersen Frames used in this apartment building at Albuquerque, New Mexico, built by T. W. Plunkett.

Weather-tight Frames of White Pine make any building more Marketable

Builders who recognize quality and use nationally known, trade-marked *quality* products like Andersen Frames find a readier market for their projects.

When superior building material can be used without increase in cost, there is a double benefit to the builder. The builder who uses Andersen Frames gets this double benefit.

T. W. Plunkett, Contractor and Apartment Builder at Albuquerque, New Mexico, maintains that he *saves money* by using Andersen Frames. "Never before" he writes, "have we used K. D. frames of such high quality in both workmanship and material, every piece fitting perfectly. In consideration of these qualifications, we feel we realized a great saving by installing these frames."

Andersen Frame quality is available to every builder. There are over three thousand Andersen dealers and one is no doubt convenient to you. If you do not know him, write us for his name.

SUPERIORITY
GUARANTEED
by this trade mark

Genuine
White Pine
Sills and Casings

- 1 White Pine for PERMANENCE
- 2 Styles and Sizes for BEAUTY
- 3 Weather-tight for HOME COMFORT
- 4 Available at dealers for CONVENIENCE

5 Standardized Quantity Production for ECONOMY

See Home Builders' Sweet's Architectural Catalog for complete details.



Why...

Andersen FRAMES
add Sales Value

- (1) Patented, noiseless, long wearing Andersen pulleys used exclusively.
- (2) Genuine soft White Pine sills and casings—last a lifetime.
- (3) Patented, exclusive weather-tight features for home comfort.
- (4) Absolute accuracy of milling insures tight-fitting joints.
- (5) Dependable because guaranteed by a reliable manufacturer.
- (6) Andersen Trade Mark is on every frame.

Andersen FRAMES

Andersen FRAME CORPORATION., Bayport, Minn.

An Oil Burner for Any Furnace

AUTOMATIC oil heat can be installed in any home without the slightest discomfort or inconvenience and without discarding the existing heating system, according to the manufacturers of the oil burner shown here, a company which has been a pioneer in the oil burner business. It is only necessary to remove the grates from the present furnace and install, in their place, the automatic oil burner.

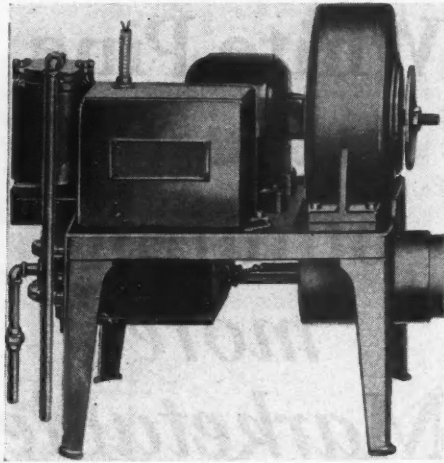

OIL BURNERS Adapted to Any Type of Heating System Give Automatic Temperature Control.

The installation is not limited to a single type of burner which may not be adapted to the conditions or present heating equipment as this company makes models to fit all conditions. They can be used with either steam, hot water, vapor or warm air systems. This range of models permits the use of different grades of oils so that the owner can take advantage of the market at any particular time to secure the lowest cost fuel.



A Convenient Kitchen Sink

DISH pans are awkward, they scratch and mar the fine porcelain finish of a sink and must be scoured inside and out frequently to keep them clean and sanitary. They take up precious cupboard space and much time is wasted with them in getting ready to wash dishes.

The built-in washing bowl of the sink illustrated here is always in place, ready for any washing purpose, just like the lavatory bowl in the bathroom.



THE SINK Itself Takes the Place of Awkward Dishpans Which Are Hard to Keep Clean.

Its smooth porcelain finish can be cleaned instantly without scouring and is self-draining. It is round and the dishes and cooking utensils fit with ample room for thorough washing. After washing you simply pull the plug and you are through.

Vegetables, fruits and meats can be prepared easily in these sinks. You simply have to wash and pare in the dish pan, place in the draining compartment, flush and freshen with a cold water spray and the job is done, there are no extra kettles and pans, and no cleaning up to be done. The removable strainer stops all refuse from entering and clogging the waste pipe.

Inexpensive Incinerators

THIS new garbage and rubbish incinerator, for inside installation, is described as being efficient, simple and low in price and, since it requires no fuel other than the rubbish which it burns, involves no operating cost. The top and base are of special grade, heavy castings. The body consists of two shells with a one inch, insulating air space between them. These shells are of a special steel which is highly resistant to heat and to rust. The inside shell is of 14 gauge and the outside shell of 16 gauge material.

A patented feature of this incinerator is a perforated inner flue and grate bottom which, it is stated, produce a constant air circulation which dries out the moisture in the garbage, eliminates odors during the filling period, produces complete combustion, burning from the top downward. Each burning sterilizes the interior of this incinerator, it requires no attention during burning, it has no parts to get out of order, and it has a self-closing receiving door.

Its installation is simple, and inexpensive as it is merely connected to the chimney with a standard, five inch stove pipe, the first section of pipe being furnished with the incinerator. It comes in two sizes, one with a capacity of 1¼ bushels, the other with a capacity of 3½ bushels.

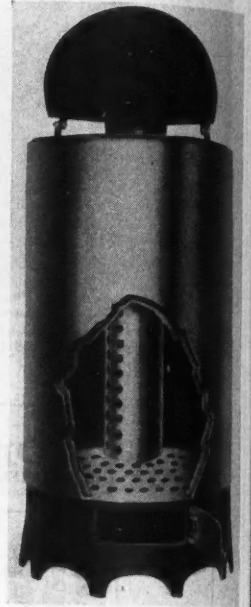

INCINERATOR, for Inside Installation, Is Simple and Efficient.



Steel Built-In Laundry Cabinet

FOR the builder who would produce up-to-date homes and apartments which will appeal to prospective owners, the built-in, steel, laundry cabinet illustrated here will be a welcome piece of equipment. It is ruggedly made of heavy furniture steel and will last indefinitely. It is beautifully finished and is an inconspicuous and attractive addition to the bathroom, where it is usually installed. It can be installed, however, in the wall of any room or hallway.

The standard sizes are designed to give a maximum capacity, yet will fit into the smallest, two-inch wall space. Builders who wish special sizes to fit special requirements, can obtain them. Each cabinet has two doors which provides for easy insertion and removal of soiled clothing and does away with reaching and dumping necessary with the old fashioned clothes receptacles.

The cost of these cabinets is moderate and the manufacturers point out that the saving on wall tile brings the cost of their installation down to a small figure.



A CABINET for Soiled Clothing Built Into the Bath Room Wall.

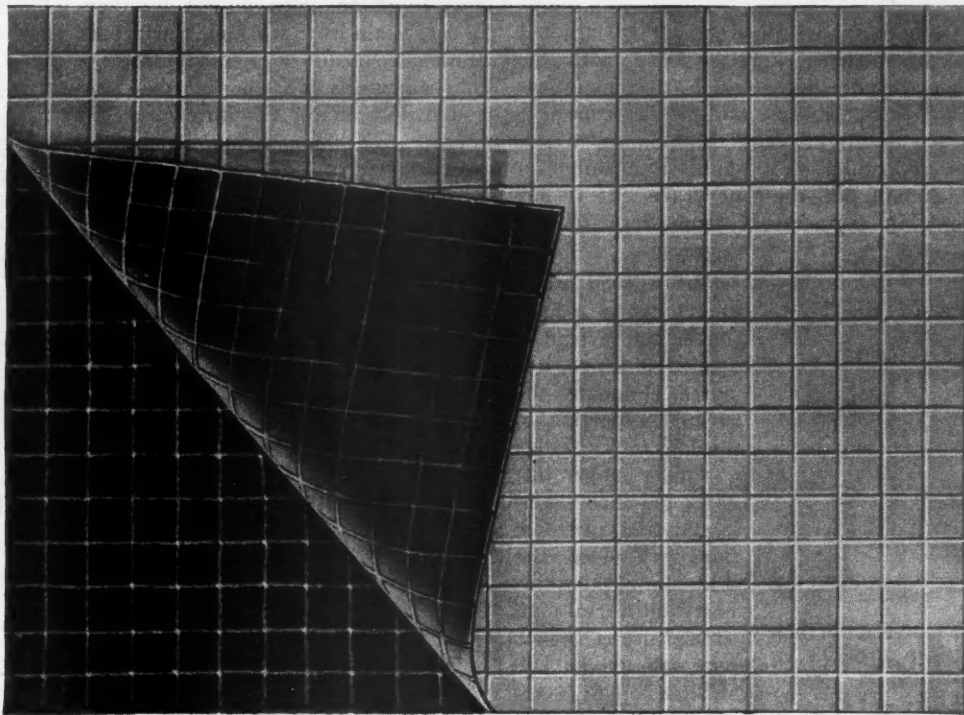

EXTRAORDINARY - NEW - BUILDING PAPER

Safe-n-dry

"A Non-Tearable Protective Asphalt Blanket"

Safe-n-dry commends itself on sight to Architects, Contractors and Builders, who appreciate that in *Safe-n-dry* is found a paper of greater protective efficiency than the Building-world ever before conceived.

Safe-n-dry is composed of two strong sheets of strong Kraft paper with a layer of tough woven jute fabric between, the three being cemented together with an abundance of asphalt, forming a single sheet of extraordinary strength and weatherproofing value.

The extra thick layer of asphalt, forming a veritable blanket, is an outstanding feature of *Safe-n-dry*, and in no other building paper is found such a strong reinforcing material as woven jute fabric.

A building properly sheathed in *Safe-n-dry* is, therefore, more efficiently protected than if the entire exterior was coated with asphalt; and asphalt is the greatest waterproofing material known.

Safe-n-dry is impenetrable to every destructive element of wind, weather or climate known to mankind. No form of moisture or vermin can penetrate its surface.

Safe-n-dry is everlasting. Will not rot or dry out. Bends and creases without cracking. Handles easily on the job. Requires no cleats to hold it in place.

Safe-n-dry was made, not to meet a price, but to give a greater service than has ever before been rendered by any other building paper.

Generous Sample test sheets are yours on request— with prices and literature. Mail the coupon NOW

Safepack Mills Inc.
 Millis Massachusetts

Safepack Mills, Inc.
 Millis, Mass.

Gentlemen:

Kindly send complete information on your extraordinary new *Safe-n-dry* Building Paper.

A. B. 6

Firm Name _____

Street _____

City _____

Attention of _____

WHEN WRITING ADVERTISERS PLEASE MENTION THE AMERICAN BUILDER

A Quiet Low Price Tank

THE tank shown here is described as an exceptional quality in low priced tanks, and is fitted with the special valve, ball cock and lever which this manufacturer has perfected. Each tank is said to be a perfect "A" tank. There is a lift of only 39 pounds which makes a quick and easy action. The tank has a buffed-on celluloid finish which will not color or craze. It is not affected by extremes in temperature from zero to 205 degrees.

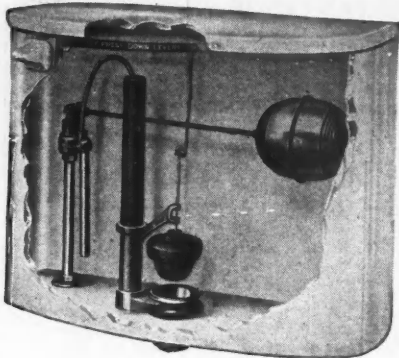

A LOW COST TANK Which Is a Real Quality Product in Mechanism.

The special valve makes use of a hard rubber ball instead of a soft one which, it is stated, eliminates the greatest objection to the low tank. It has a copper upper lift wire; $1\frac{1}{2}$ inch seamless copper overflow tube; one piece cast brass, integral guide post; a universal joint attachment which prevents the ball sticking open; a removable flat leather washer; a ball shaped to form a positive guide into the valve and an unrestricted waterway.

The ball cock gives, at any pressure, the maximum volume of water silence. The principle used is the creating of a back pressure on the seat by means of a spiral waterway, regulated by a tapered plug with a thumb screw. This plug can be regulated to suit any pressure.

The lever has an all china handle and no exposed metal parts. It uses a simple press down action, is sturdy in construction, fits snugly any size lever hole, will not twist or turn in the tank.



Modern Units for the Kitchen

AS competition becomes keener, and women become an increasingly important factor in the sale of every home, kitchen equipment becomes increasingly important to the builder. The modern woman knows what she wants—and builders must supply it if they expect to sell her.

To the modern woman, the most important room in the house is the kitchen. This is her work shop and the rambling kitchen of her mother's day will not satisfy her.



KITCHEN UNITS Beautifully Enamelled in Period Designs and Scientifically Designed Attract the Women Home Buyers.

Designed by kitchen experts, unit kitchen furniture offers a maximum in convenience and compactness. One well known line, for example, has a base shelf that extends automatically when the door is opened, bringing pots and pans within easy reach. Special

She wants convenience and compactness, everything at her finger tips so that her work can be done in the shortest time.

Designed by kitchen experts, unit kitchen furniture offers a maximum in convenience and compactness.

patented 3-point suspension drawers insure the smooth drawer action, even in wet weather. The broad expanse of porcelain-iron working surface is easy to keep clean. Built in a furniture factory entirely of kiln dried hardwood, unit furniture has the sturdy, non-warping construction found only in fine furniture.

This new kitchen equipment comes in sections beautifully enameled and ready to set in place. The largest or smallest kitchen can be equipped with it. Another thing the modern woman insists upon is beauty, color in her kitchen. She is tired of bleak monotonous kitchens. She wants a cheerful, colorful room to work in and she knows she can have it at no greater cost. These units are even available in period styles to meet the new demand for beauty and harmony.

Make the kitchen a convenient room compactly arranged, finish it in gay colors, then watch how the women are attracted to it.



Low Cost Water Systems

OPPORTUNITIES for the sale and installation of home water supply systems are an important item to the builder doing considerable work in rural or suburban communities beyond the range of municipal water supply. These opportunities are not confined, however, to new construction as statistics indicate that scarcely one farm home in 10 has running water piped into the house or other farm buildings.



WATER SYSTEMS of This Type Make Running Water Available for Any Home.

The type of water system illustrated here is available at such a low cost that there is no reason why practically every home should not have running water available. The simplicity of design and construction, there being only two moving parts, gears, and no valves, belts, valve leathers, pulleys, etc., provides low upkeep cost and long life. The servicing by the dealer is practically eliminated as, after a long time, if the pump should need repairing, an entirely new pump head, costing only a few dollars and making practically a new pump, can be installed.

This is a complete water system, automatically controlled, supplying water under pressure and having a capacity of 250 or 500 gallons per hour. All the working parts are fully enclosed and the system is delivered complete ready to install to well pipe and house piping. It is furnished with either black or galvanized tank, and the $\frac{1}{4}$ horse power motor is moisture-proof.



The Stone & Tar Products Co., 97 S. Sixth St., Brooklyn, N. Y., has published a booklet and a number of circulars which fully describe its line of products,

T
A
Faction
home
taste
dema
dissip
keepi
Build
thickness
And th
transfer
trim bea
Send co
Airmaste

THE AIRMASTER

REG. U. S. PAT. OFF.

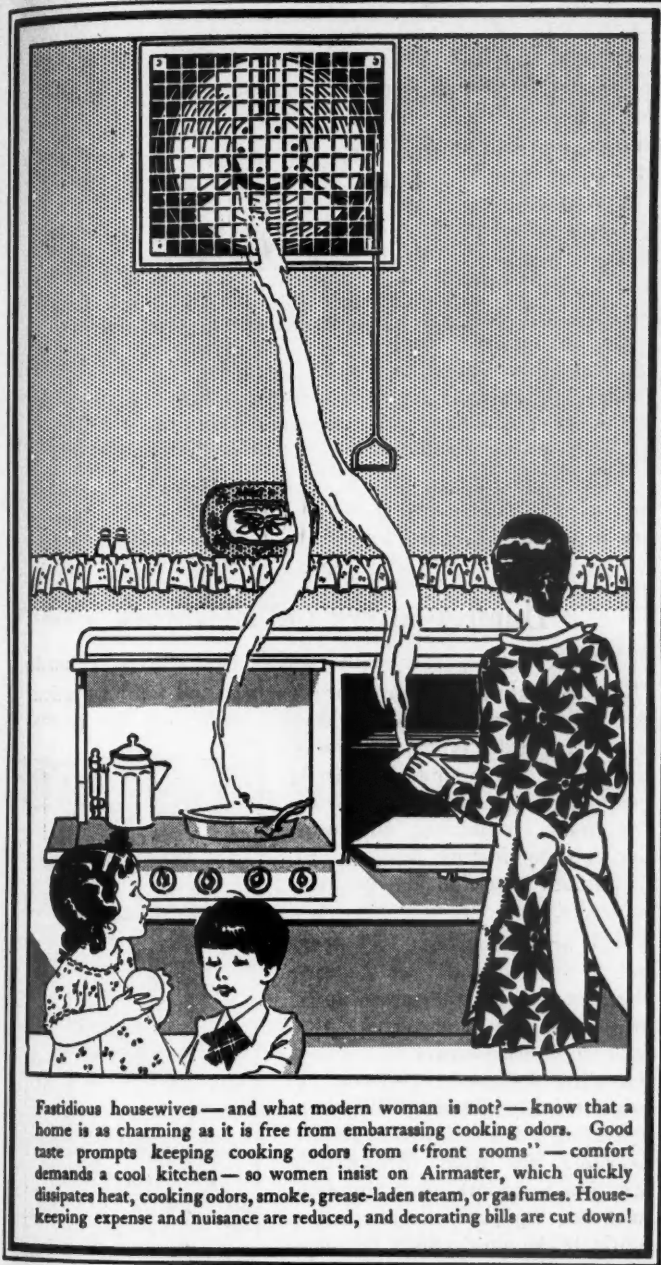

Fastidious housewives—and what modern woman is not?—know that a home is as charming as it is free from embarrassing cooking odors. Good taste prompts keeping cooking odors from “front rooms”—comfort demands a cool kitchen—so women insist on Airmaster, which quickly dissipates heat, cooking odors, smoke, grease-laden steam, or gas fumes. House-keeping expense and nuisance are reduced, and decorating bills are cut down!

costs so little and helps you sell-

It's the little things that make a home livable—and turn your partially-interested prospects into buyers. Home owners appreciate these refinements and tell their friends what you have provided.

Make it a definite policy to install Airmaster in every home. You'll be well rewarded for helping solve the housewife's vexing problem.

Send at once for complete details of this highly efficient ventilating fan. Use the coupon now.



Built-In or Portable Install wall cabinet Airmasters when you build; compact and beautifully finished, highly efficient; suitable for any thickness of wall. One-piece, weatherproof outside shutter operates automatically with fan. ¶ And there's a portable Airmaster to fit any standard size window. Easy to install—easy to transfer from one window to another—moderate in price. ¶ Women are proud of Airmaster's trim beauty and pleased with its silent operation. Men appreciate the efficiency and economy of the high-volume “eagle wing” propeller.*

*Airmaster propellers are fully protected by patents

AIRMASTER CORPORATION, 140 S. Dearborn Street, CHICAGO

Send complete information about Airmaster, without obligation to me.

Name _____

Company _____

Address _____

AB6

A Glass Enamelled Clothes Chute

ONE of the specialties which has been designed for the production of better equipped homes is a glass enamelled clothes chute. This means a chute which is made of welded Armco ingot iron, with no rivets to catch and tear the clothes, with enamel fused into the surface of the metal, making a permanent, glass-like surface. This surface is always sanitary.

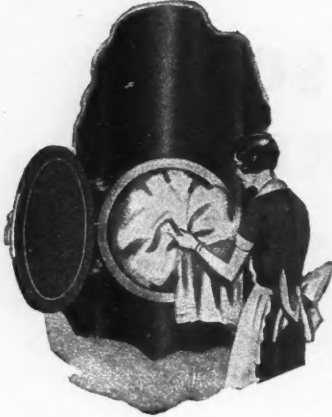

CHUTES That Are Neat and Sanitary and Will Never Damage Clothes Placed in Them.

These chutes are made in sections of the required length, flanged at the ends and bolted together with rubber gaskets between. After each section has been ground smooth it is hand dipped and the enamel fused into the metal in the furnaces, not baked on. They are made in a standard diameter of 12 inches, inside, cylindrical shape, but can also be furnished in rectangular shapes 10 by 12 and 12 by 12 inches, if desired.

These chutes terminate in any of three ways, in the basement; either six inches below the basement ceiling with open end; with an elbow discharge 42 inches above the basement floor, or with a straight run six inches below the ceiling, closed by an automatic fire door operated by a counter-weight.



Kitchen Ventilating Fan

WHEN the modern family buys a home it buys something more than a mere house of attractive appearance. The modern buyer demands living comfort and convenience developed to a high degree. The public is awake to the importance of good ventilation and the house which is properly ventilated will sell far more easily than one in which the smoke, steam and odors of cooking are always conspicuous when meals are being prepared. When a hostess can ask a guest into the kitchen while a meal is being cooked that is a good sign that an efficient ventilating fan is at work.

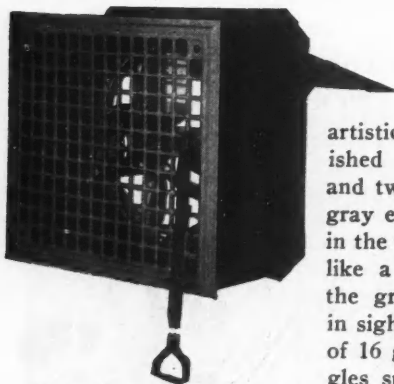

VENTILATING FAN Especially Designed for the Home and Easily Installed.

The ventilating fan shown here has been especially designed for the home. It is artistic in proportion and finished in polished aluminum and two coats of baked, pearl gray enamel. When installed in the wall, it looks very much like a hot air register, only the grill being unobtrusively in sight. The cabinet is made of 16 gauge steel with all angles spot welded. It is fully protected against rust. All electrical connections are made inside the cabinet and the only electrical work required in installation is one connection to the switch and a solder joint on the wire.

The motor is a special design by one of the foremost manufacturers. The construction of the motor insures quiet operation and its simplicity makes for cheap, dependable operation. It is packed in vaseline lubricant and will

last indefinitely with little attention. The fan is a special design, 10 inches in diameter, which produces air thrust at the hub as well as at the tips of the blades and has a capacity of 800 feet per minute. A similar unit for window installation is made for houses already built where the labor of wall installation is to be avoided.



Garment Hanger Saves Space

THERE has recently been placed on the market an extension garment hanger, illustrated here, which appears to be an article that will assist the builder to equip his houses in the most modern style.



GARMENT HANGERS Like This Increase the Usefulness of Closet Space.

This device has a place for 15 clothes hangers and when fully loaded will collapse into an area of less than 10 inches. It extends to 32 inches and, when extended, all garments are evenly distributed, making it possible to detach any one without disturbing or wrinkling the others.

The manufacturer claims that closet capacity can be increased to three times normal capacity when these hangers are installed.



Dumb Waiters and Elevators

THESE hand power, dumb waiter equipments are made in several types each being well adapted for its particular requirements. The automatic brake or the geared automatic brake types in capacities up to 500 pounds are most generally used, and are practical equipment combining an automatic brake feature designed to be smooth in action and positive in brake.

The brake does not lock fast, but is applied and regulated by the load, holding the car securely at any point. The heavier the load the more positive the brake. They are designed to release the brake quickly and smoothly when operating the hand rope. Roller bearings are used throughout, assuring a smooth, easy running, long life equipment. The automatic brake mechanism requires no adjustment of any kind, and is guaranteed for five years against defects.

The band brake and geared band brake outfits, in capacities up to 500 pounds, are most practical for use in high hatchways, where an exceptionally strong, reliable, rapid running dumb waiter for hard service is required. The speed in lowering and the positive stops are regulated by a partial application or a final pull on the brake cord. This is most practical for lowering loads, as it does not require the operation of the hand rope, the speed being regulated by the brake cord.

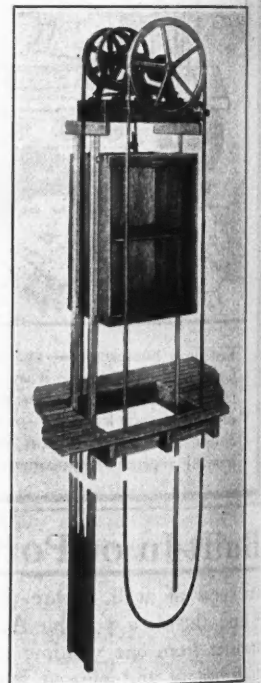

DUMB WAITERS of a Line That Saves Labor in Homes, Apartments and Other Buildings.

th
Spr
a
Pre
a
Spr
a
fi
Air
Air
c
Air
c
Com
sn
us
tr

THE

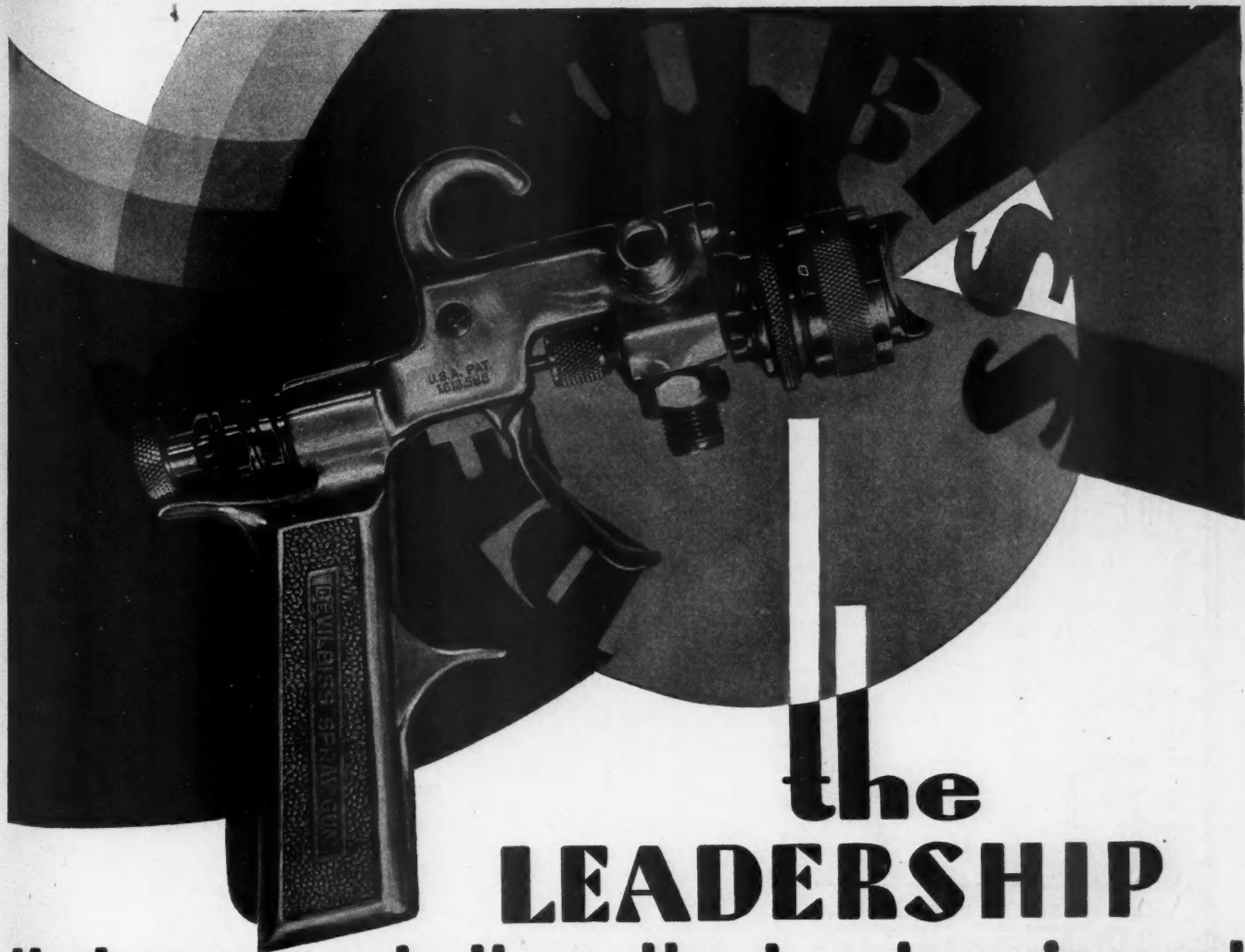

the LEADERSHIP

that provides both method and equipment

THIS organization renders a constant service to all classes applying paints and finishes, helping the users determine the most economical and efficient ways to use spray systems. Many, many times DeVilbiss engineers have rendered an installation service that was far more valuable than the cost of the equipment.

Changing times and the modern popular preference for color have brought painting and finishing problems into occupations and industries that never before have been confronted by such necessities. All these new and old problems demand vast experience, tremendous resources, and established responsibility. DeVilbiss alone brings to them a full measure of competence, knowledge and equipment.

Those who want to inaugurate spray painting or finishing into their operations, and those who seek a quicker and better way to paint a house or a product, are invited to use the knowledge and resources of this organization. Improvements come with startling rapidity today. Is your painting or finishing method really up-to-date?

Spray guns of various types and sizes.

Pressure feed paint tanks and containers.

Spray booths, exhaust fans, and approved lighting fixtures.

Air compressing equipment.

Air transformers and accessories.

Air and fluid hose and connections.

Complete outfits from the smallest hand-operated units to the largest industrial installations.

DeVilbiss

Spray-PAINTING FINISHING System

THE DEVILBISS COMPANY / 238 PHILLIPS AVENUE / TOLEDO, OHIO

Sales and Service Branches

NEW YORK PHILADELPHIA CLEVELAND DETROIT INDIANAPOLIS CHICAGO
ST. LOUIS SAN FRANCISCO WINDSOR, ONT.

Direct factory representatives in all other territories

WHEN WRITING ADVERTISERS PLEASE MENTION THE AMERICAN BUILDER

What's New in Construction Materials

For further information in regard to any item described in the "What's New" Departments address, American Builder Information Exchange, 105 W. Adams St., Chicago

A Distinctly New Insulation

A RECENTLY announced insulating material is a distinctly new type of product and has a number of characteristics to recommend it to the builder. Among these are ease and economy of installation and high insulation efficiency. It consists of units which can be installed without tools, except a sharp knife or saw, and require no nailing or strips.

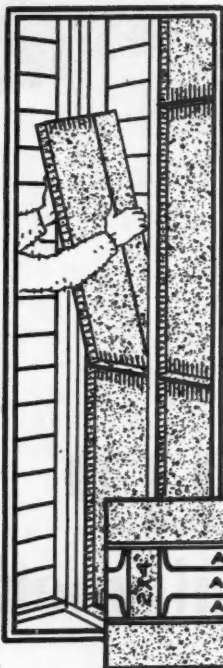

THESE UNITS Placed Between the Studding Form Three Insulating Air Spaces.

Each unit consists of a piece of corrugated board folded double in the center of the sheet with the two loose ends fastened together. This results in flat sections which are easily and compactly bundled for shipping or storage. The corrugated board is scored so that a simple twist of the section forces it into a tube three feet long, of the proper width to fit between studding or joists and having the form of an "I" beam.

When this unit is placed between the studs it forms three air spaces, one between the outside sheathing and the unit, another within the unit itself, and the third be-

tween the unit and the lath and plaster. Horizontal header plates seal each three-foot unit at top and bottom and prevent vertical circulation of air within the walls.

Steel Deck Roofing Announced

ENTRANCE of one of the leading manufacturers of structural steel into the steeldeck roofing field has been announced and a catalog showing the company's products in this field is being issued. Addition of the steeldeck roof to this line of building products is in keeping with the long established policy of the company to meet new demands for modern building materials by extending its manufacturing facilities to include new items.

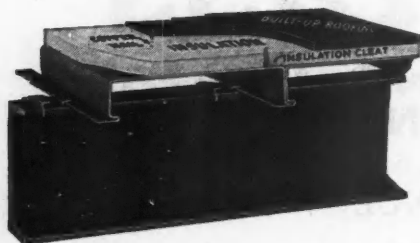

A SECTION of the New Steeldeck Roof with Insulation Applied.

The first roof design offered by this company is made in six-inch widths of Armco ingot iron, each

of which hooks rigidly to those adjacent to it.

The distinctive feature of this roof is that it presents an unbroken smooth surface to receive insulating materials, and that it can be erected without any perforations of the steel. Each section is formed by the pressing of a patented self-locking rib section into a strip of Armco iron, giving rigidity to the section and providing bearing points to rest on the purlins of the building. Each rib is an I-section, and it is contended that from an engineering viewpoint it is an ideal structure.

Cost of installing either type of roofing on any kind of building is said to compare favorably with any other roof construction.

Distinctive New Building Stone

ONLY a few years ago a natural travertine stone was discovered on the west coast of Florida. Quarries have now been developed and this stone is being placed on

the market by a company long known in the building field. It is a building stone of unusual individuality and charm and, though a genuine travertine possesses distinctive qualities and differs desirably from the imported stone of the same name.

This stone ranges, in color, from a light creamy buff

to darker shades of cool grayish cast, with soft and interesting mottlings. The intermediate tints and shades admit unusual latitude for successful combinations with other materials. It is suitable for any of the uses such as wainscoting, interior trim, vestibules, etc., for which imported travertine, French limestone and foreign and domestic marbles are employed and is adaptable either alone or in combination with these or with tile, brick and other materials.

The cost is well within the limits of the better class building operations, it is stated, comparing favorably with other stones used for corresponding purposes. Carved ornaments and delicacy of detail are freely possible without excessive expense due to the uniformity of grain.

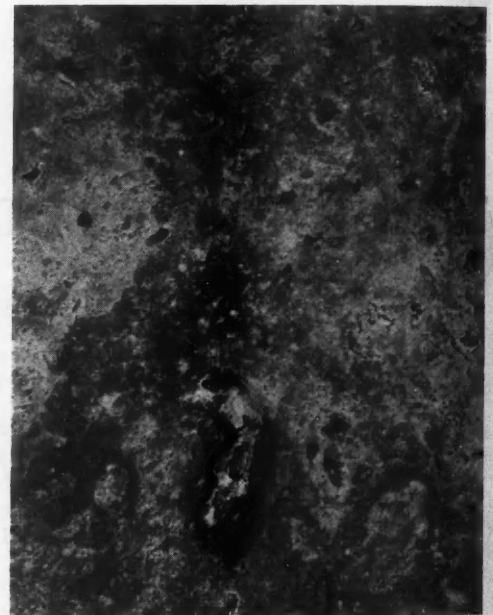

TRAVERTINE STONE from Florida Offers a Number of Distinctive Characteristics.

THE
T come
improved
These
with less
... stay
saws ever
They h
ance, bett
give you
They ar
yet stiff,
first achie
ble only b
And you
is, if it is
easier it is

The new Dis
7 on. in 26-in
for you. Than
all the fourteen

Now, for faster, easier cutting New-Model Disston Hand Saws



- 1—Lighter Blades
—for easier cutting
- 2—Narrower Blades
—save strength
- 3—True-Taper Grind
—for faster cutting
- 4—Thin, yet Stiff
—for true running
- 5—New Handles
—give better balance
- 6—Disston Steel
—stays sharp longer



Disston Hand Saws are ground with a true double taper and run smoother in the cut. This true taper graduates uniformly from cutting edge to back and from handle to point. Tooth edge is of even thickness from end to end.

Never until now could you get blades so thin, so stiff, so light, to cut fast and run true.

Handles of new design,

with larger handholes, for a more comfortable grip, give perfect balance and new ease in using. These handles have a new and finer finish, weatherproofed to prevent warping.

There is no strain on the wrist, no drag on the arm. Every blade "follows through" as never a hand saw could before.

Whatever style of saw you want, you will find it in the new line of Disston Hand Saws.

Get This Helpful Book

Every saw user will enjoy reading "The Disston Saw, Tool and File Book," an illustrated manual on the selection, care and use of tools. It tells how to file and set saws and contains much other helpful information. The coupon below will bring it.

File your saws with the new Disston Special Extra-Slim Blunt Saw Files

DISSTON Files were first made for Disston saw makers. These men must have files that cut fast, cut true, save time and stand up to the job. Files that are sharp! . . . accurate! . . . dependable! . . . lasting! These are the qualities that Disston Steel makes possible in a file and in all cutting tools.

NEW

Now Disston has a new saw file for you: the Disston Special Extra-Slim Blunt. You can get it at good hardware stores.

This new Disston File gives you these advantages:

- 1—Special cut, with plenty of bite. Cuts smoothly and lasts longer.
- 2—Extra slim, so you can see just where and how it is cutting.
- 3—It is blunt (all sides parallel). There is no taper to require a "rocking" motion. Easier to use.
- 4—Made of Disston Steel, hard, tough, and strong. Outlasts two ordinary files.

If you don't see it on display, in the case shown below, ask your dealer for it.



THE Saw Most Carpenters Use now comes to you in entirely new models, improved in every feature.

These new Disston Hand Saws will run with less set . . . cut faster . . . cut easier . . . stay sharp longer, than any other hand saws ever made.

They have better clearance, better balance, better steel, better temper, and will give you better service.

They are lighter, with blades thinner, yet stiff, always the goal of saw makers, first achieved by Disston. Now made possible only by Disston Steel.

And you know this: *The thinner a blade is, if it is stiff, the better it cuts and the easier it is to use.*

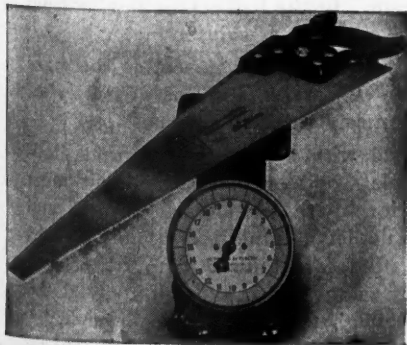

The new Disston D-8 Lightweight Saw weighs only 1 lb., 7 oz. in 26-inch length. Less weight to push; less work for you. Thinner, yet stiff, it cuts faster and easier, like all the fourteen other hand saws in the new Disston line.

DISSTON

Makers of "THE SAW MOST CARPENTERS USE"

Henry Disston & Sons, Inc. (Desk 2), Philadelphia, U. S. A.

(In Canada, address Henry Disston & Sons, Ltd., Toronto)

Please send me "The Disston Saw, Tool and File Book."

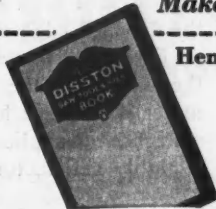

Name

Address

Acoustical Interior Finish

A LEADING manufacturer of building products is marketing a sound-absorbing interior finish which has a remarkably high acoustical rating among commercial finishes. This finish consists of a bevel-edged, perforated,



METAL TILE, Filled with Sound-Absorbing Material Have a High Acoustical Rating.

"T's" which may be economically fastened to any type of structural support. When installed in buildings during erection all metal lath and plaster may be omitted back of the tile. In existing buildings an entire installation can be made easily and quickly, with very little inconvenience to the occupants of a room. Once the "T's" are correctly lined up, the tile, filled with sound absorbing material, are snapped into place and the work is finished save for any further decoration that may be desired.



Hangar Construction Materials

ONE of the best known companies producing steel for building construction has recently published a booklet on the subject of hangar design for airports. This booklet is based upon the economic and efficient use of this company's standardized steel building products to meet the individual requirements of all such projects.

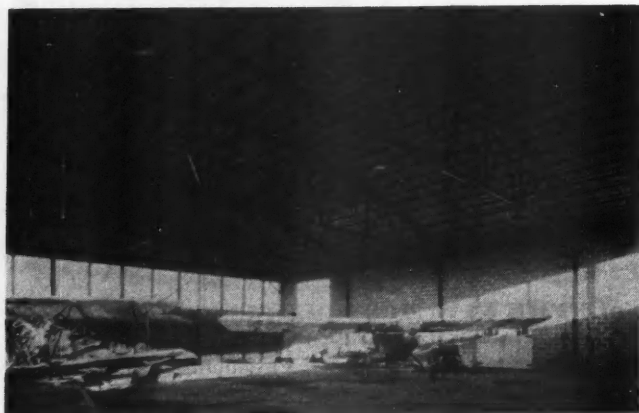

STEEL TRUSSES and Purlins as Used in Hangar Construction Are Standardized Products.

metal container, utilizing this company's acoustical felt or acoustical mineral wool as the sound absorbing element to fill the container. These tile-like containers are made in six standard sizes and styles, permitting a great variety of patterns.

The tiles are supported by steel furring

The booklet states that extensive experience in hangar construction has proved that there is no place for a standard hangar but that standardized products, such as trusses, purlins, windows, doors, columns and structural details can be readily adapted to hangar construction. It also states that the local general contractor with his knowledge of local conditions is the logical man to handle airport construction and this company's policy is to co-operate with the contractor.

With the standardized products described in this booklet it is possible to obtain a maximum of individuality of design, permanence and economy in hangar construction. Except for the doors and door details all of these products are wily specified and used by architects, engineers and contractors in industrial buildings, garages, apartments, schools, hotels, office and commercial buildings. The prompt and competent service offered with their use is already well known. A staff of engineers who specialize in hangar construction is also maintained and this service is available for definite recommendations on airport projects.



Linoleum for Wainscoting

LINOLEUM for floors, for bathroom and kitchen and other rooms as well, is well established in favor and well known everywhere. Linoleum for walls of bathrooms

and kitchens is just as appropriate and just as practical, though not yet so widely known. A bathroom or kitchen with the floor linoleum run about half way up the walls makes an attractively finished room and one in which the walls are well protected and easily kept clean.

The photograph reproduced here shows a bathroom in Fort Dearborn Lodge, a large apartment building in Dearborn,

Michigan. In this building 90 kitchens and 89 bathrooms were floored with linoleum. In the bathrooms the linoleum was run half way up the walls as a wainscoting.

When linoleum is used on walls as wainscoting there are certain precautions to be observed. If these are observed the job will prove an entirely satisfactory one.

The linoleum is applied with a special waterproof linoleum cement. A suitable wood or metal moulding must be provided as a trim for inside and outside corners and the exposed edge of the linoleum. Only the thinnest gauges of linoleum should be used for wainscoting. Because of the weight of the heavy gauges, it is difficult to hold the material in place long enough to obtain good adhesion. A wainscoting applied in accordance with these rules will be a highly satisfactory and permanent installation.

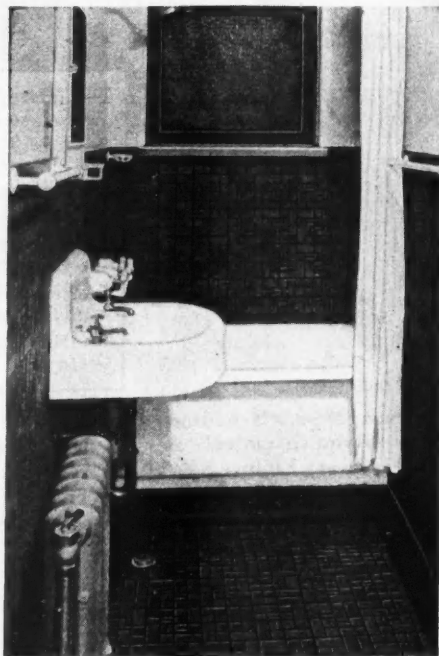

EIGHTY-NINE BATHROOMS in the Fort Dearborn Lodge Apartment Building Have Linoleum Wainscoting.

STU
Sev
tos Shi
be used
telling
consta
magazi
Asbesto
that the
wish to
about t
Henc
Shingle
force fo
of its co
The
Asbesto

These roofs advertise . . .

GOOD FAITH

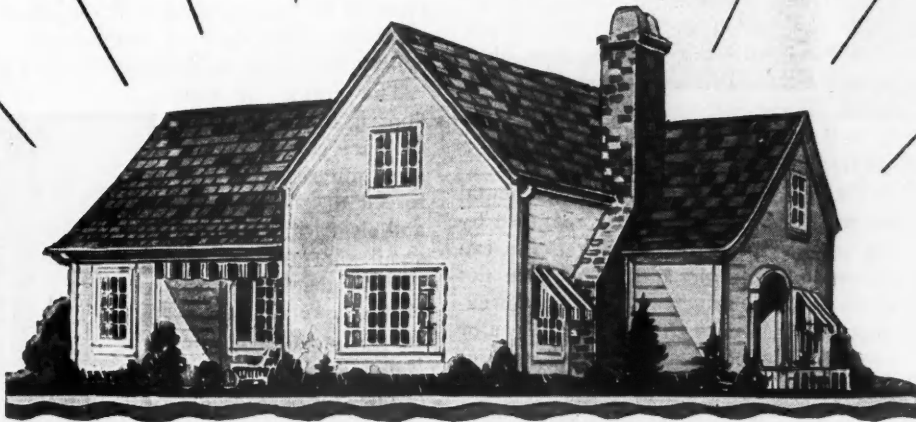

The obvious quality of J-M Asbestos Shingles puts a stamp of superiority on the house they cover

STURDY, good-looking, fireproof, everlasting Johns-Manville Asbestos Shingles are a covering worthy to be used on the finest homes. We are telling this fact to millions of persons constantly. Color pages in leading magazines advertise the merits of J-M Asbestos Shingles to so many readers that the very prospects to whom you wish to sell homes already know about these shingles.

Hence a roof of J-M Asbestos Shingles is an advertisement of real force for your house and the quality of its construction.

The attractive appearance of J-M Asbestos Shingles makes certain that

all-important favorable first impression, which often decides a sale. The fact that the roof is of J-M Asbestos Shingles gives the home buyer a feeling of confidence in the whole job. In some developments hundreds of houses have been roofed with J-M Asbestos Shingles because experiment showed the slight extra cost to be more than justified by the advertising value of the roofs.

Let us tell you in person or by letter about the use of J-M Asbestos Shingles on houses built for resale and how little more they cost.

Johns-Manville

RIGID ASBESTOS SHINGLES



JOHNS-MANVILLE CORPORATION
 New York Chicago Cleveland San Francisco Toronto
(Branches in all large cities)

I should like to have further information about Johns-Manville Asbestos Shingles for speculatively built houses.

Name _____

Address _____

RB-26

WHEN WRITING ADVERTISERS PLEASE MENTION THE AMERICAN BUILDER

Removable Steel Clothes Posts

ANY yard can be made more attractive with a set of removable steel clothes posts. These posts are painted with high grade lawn green enamel and the sockets are black. The tops, which are made of malleable iron and hold the clothes line, are finished with black enamel finish which is patented process, making them absolutely rustproof.

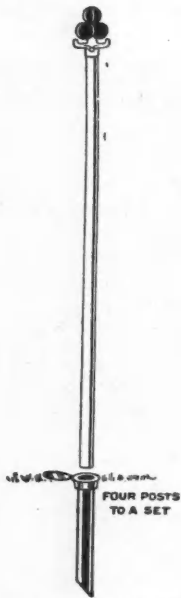

THIS POST
Can Be Re-
moved When
Not in Use—
Leaves Yard
Entirely Clear.

These clothes posts are sturdily constructed of high carbon steel tubing, 1½ inches in diameter and stand 6 feet above ground when installed and are strong enough to hold any necessary weight. The steel socket base is 24 inches long and is easy to install. All you do is dig a hole about eight inches square, drive the socket in the center of the hole level with the ground, then place stones around the socket and jam down solid. If the hole is filled with concrete, it will stand up and give even better service.

The clothes posts are ornamental when in use, and are easily removed by merely lifting out of the socket, and can be put out of sight and away when not in use. This leaves the yard clear except on wash day. The lawn mower or auto may be run over the lawn without obstruction.



Plywood with Fiberboard Core

A NEW plywood panel board using a well known fiber board, a semi-rigid cane fiber building material of high insulating value, as a core stock, in place of wood, has been developed and placed on the market. Plywood panels, finished in walnut, oak, mahogany or any wood desired, are used extensively for interior decoration such as paneled walls for executive offices or homes, in ocean going steamships and private yachts, railroad coaches and airplane cabins. In addition they are extremely useful for industrial applications such as desk tops, sound-proof paneled doors, furniture, radio cabinets and a great variety of similar work.



A ROOM Paneled with Plywood Having a Fiber Board Core is Also Insulated.

The ordinary core for plywood panels is made of wood. One of the first objections to core wood is that it must be thoroughly seasoned and kiln dried before use or the panel will warp out of shape. With the fiber board core this disadvantage is entirely eliminated and a much lighter panel results.

Not only is the panel with this cane fiber core lighter in weight and easy to handle but, because of the nature of the material, it gives the important factor of thermal and sound insulation. The core may be of any thickness from ¼ inch up, making possible any desired coefficient of insulation. In other words, a room paneled with this new plywood panel board has the added quality of the ordinary panel over an insulated base. The cane fiber board resists the passage of heat and absorbs a high percentage of sound, keeping the room at an even temperature and to a great extent sound-proof.



Steel Doors for Any Hangar

A SPECIAL door, for airplane hangars in which limited space is available for operation of the door units in opening and closing, has been developed and is being manufactured by a company producing all kinds of steel building products. This door is applicable to any kind of hangar construction and may be used on any size of door opening.

The frame of the door is of heavy gage tubular copper alloy steel, mitered and reinforced at the corners and electrically welded at all joints, or, if preferred, structural steel shapes may be substituted for tubes in the frame.

The lower sections are solid steel panels. Any desired area may be built of standard steel window sections to permit adequate daylighting of the hangar. The door design is in harmony with recognized architectural practice, thus giving to the building a unified and effective exterior.

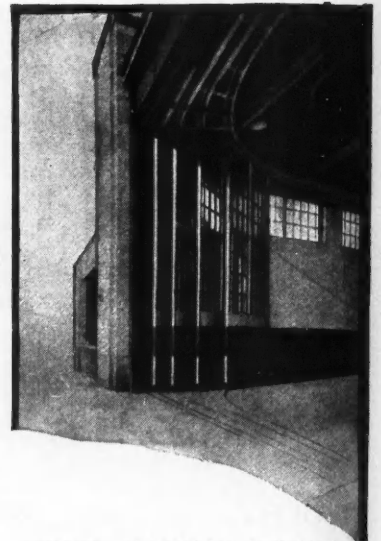

STEEL HANGAR DOORS of the Round-the-Corner Type as Installed in the Ford Hangar at Lansing, Ill.

These hangar doors are not suspended from overhead tracks, but are equipped with Timken roller bearing trucks operating on tracks embedded in the concrete floor. Alemite lubrication maintains the trucks in easy operation. Even the heaviest leaves, weighing up to seven tons, are easily and quickly opened or closed by one man. This is made possible by a special operating device incorporated in each door.

These doors are made to operate in either of two manners. Many of the most modern hangars use straight slide doors which, when opened disappear into towers or other auxiliary portions of the hangar structure. This arrangement is popular because it leaves the entire hangar opening unobstructed, admitting a 100-foot ship to a 100-foot hangar.

Round-the-corner doors, which fit snugly against the sides of the hangar near the opening, are also used. They are preferred where the plan of the building does not provide a space for the opening of the straight slide doors and where there is no objection to narrowing, slightly, the door opening by storing opened doors at the sides.

An attractive feature of these new doors is their comparatively low first cost. This results from large quantity production of the standardized parts from which individual sets of doors are built up to meet individual requirements.

Special literature on the new hangar doors has been prepared and will be mailed to anyone asking for information.

REID-WAY
736 North
Gentl
Reid-

Name
Address

THE SANDER WITH ONLY ONE MOVING PART



THE REID-WAY WHIRLWIND

SIMPLICITY
SAFETY
LOW COST

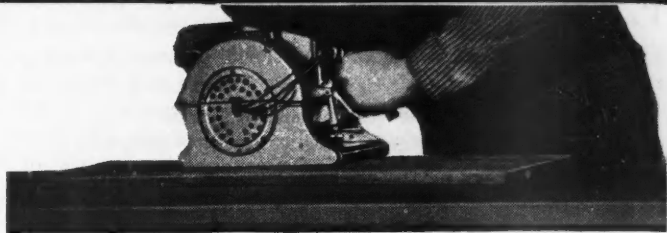

As a bench sander, the dustless Reid-Way is handled as easily as a smoothing plane.

ONLY the Reid-Way combines such remarkable simplicity with an almost unbelievable capacity for hard, continuous work. The powerful Reid-Way revolving-field, induction motor is built for long life. Its simplicity makes for low first cost. Its direct drive---no belts, chains, gears, insures low operating cost. Its convertibility and wide application to all classes of sanding, speed up production and produce profits for the contractor. Use the coupon for descriptive circular.

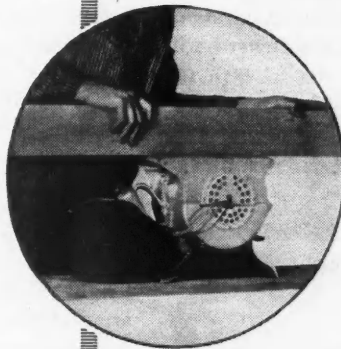

Inverted in a special base, the Reid-Way Whirlwind becomes an efficient jointer.

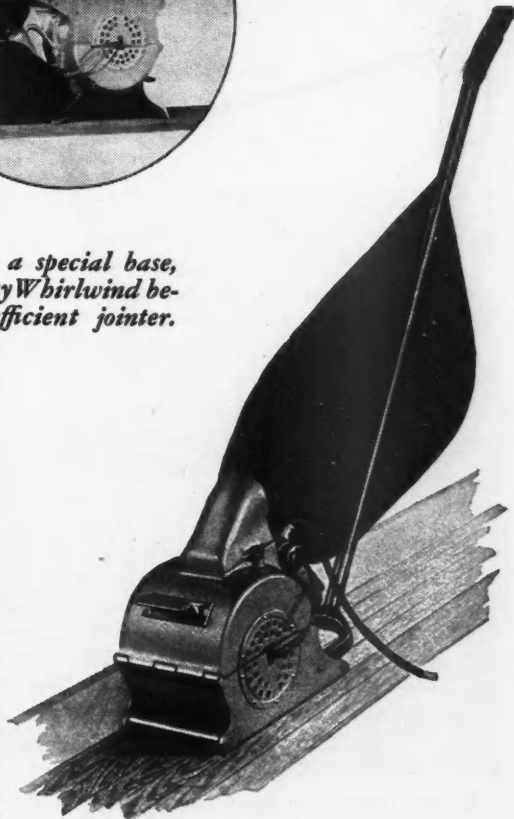

Floor surfacing attachments and large dust bag quickly applied without tools. Depth of cut under positive control.

THE REID-WAY CO.

736 North 16th Street
Cedar Rapids, Iowa

REID-WAY COMPANY
736 North 16th Street, Cedar Rapids, Iowa
Gentlemen: Please send free circular describing the new Reid-Way Whirlwind Sander.

Name

Address

What's New in Contractors' Equipment

For further information in regard to any item described in the "What's New" Departments address, American Builder Information Exchange, 105 W. Adams St., Chicago

Hoisting and Spouting Equipment

EVERY feature of design and workmanship which increases speed, ease and accuracy of operation, which lengthens wear and which reduces repair expense has been embodied in the line of hoist tower outfits and spouting equipment illustrated here, according to the manufacturers. These towers are available in three sizes having bucket capacities of nine, 18.4 and 25 cubic feet of mixed concrete.

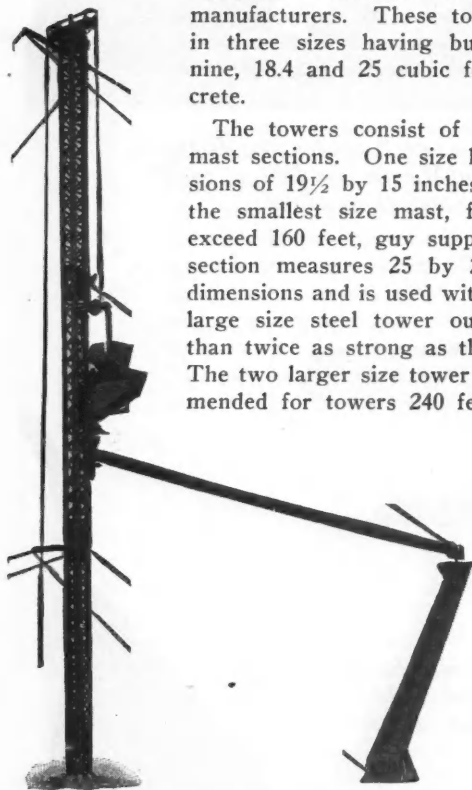

THESE TOWERS Are Made in Two Sizes of Mast Section to Adapt Them to Various Construction Needs.

The towers consist of two sizes of steel mast sections. One size has outside dimensions of 19½ by 15 inches and is used with the smallest size mast, for towers not to exceed 160 feet, guy supported. The other section measures 25 by 21 inches, outside dimensions and is used with the medium and large size steel tower outfits. It is more than twice as strong as the smaller section. The two larger size tower outfits are recommended for towers 240 feet high, guy supported. Both these towers can be furnished to any height if they are fastened to a building or to the skeleton work of a steel fabricated building. The mast sections are made in 20 foot lengths, are interchangeable and made to template.

Cross arm brackets are furnished for bolting to the mast at 40 foot intervals. Steel tower buckets, made in the three sizes already mentioned, are heavily constructed and waterproof. They travel on one face of the mast and, if raised too high, will automatically empty into the hopper, right themselves and come down in upright position. The hopper carries dumping guides so that no matter where the bucket is located it will empty into the hopper. A splash plate prevents any splashing.

Boom chutes are made in 30 and 40 foot lengths, the smaller size for the small outfit with which two spouts can be supported from the mast. The larger size outfits use 40 foot, trussed spouts and three of these may be hung from the mast before the first support is required at the end of the third spout.

A particular feature of these outfits is the combination of a material elevator in connection with the mast for hoisting and spouting concrete. This elevator complete with a wood platform has a capacity of three wheelbarrows.

Wheelbarrows for Construction Work

ON many construction jobs there are narrow places, sharp corners, and unusual jobs where a narrow nose tray barrow that will pour accurately is needed. The new measuring tray barrows illustrated here, take care of such troublesome jobs. The trays are especially adapted to charging mixers and pouring concrete. They concentrate the flow of materials and place them exactly where wanted.

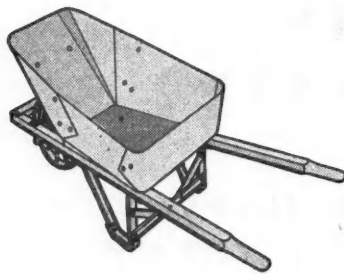

ONE OF A LINE of Wheelbarrows Specially Adapted to Handling Concrete.

The back and sides of the measuring trays are vertical; there is less possibility of spilling material, and they hold their shape better than shallow trays. The measuring trays are made in two, 2½, three, 3½ and four cubic feet level capacities, with capacities guaranteed. They are interchangeable on either standard wood or steel tubular frames.



New Electric Hand Saw Announced

THE manufacturers of a well known line of portable electric tools announce three sizes of electric hand saws. The sizes are six inch, eight inch and 10 inch designating the diameter of the circular saw that each size will use. These saws will cross cut and rip lumber up to 3½ inches thick and in addition can be used with a special metal cutting saw for cutting light gauge metal or with an abrasive disc for cutting slate, marble, tile, porcelain, etc.

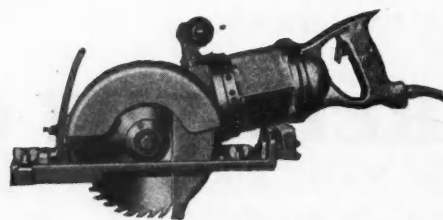

A SAW Especially Designed to Take Out on the Job and Operate Continuously.

tirely covering the saw blade.

These saws are provided with universal motors which will operate on direct or alternating current and are shipped in a substantial carrying case as a convenience for men who take them out on the job. They are unusually light in weight and are equipped with a pistol grip and trigger switch which afford ease in handling and controlling. These tools are full ball-bearing with chrome nickel gears and shafts throughout. They are air cooled and will operate continuously without overheating. Gears run in grease in grease tight compartment.

The saw blades are enclosed in telescopic guards so that as the saw progresses in the work the guard automatically telescopes and when cut is finished the guard snaps back, en-

ATTRACT THE PASSER-BY

with the NEW Fenestra Screen Casements

They'll help sell your houses

ROBERT A. FERGUSON, Jr.
Operative Builder

Gentlemen:

Fenestra Casements afford a saving in wall space and our customers seem to like them for the extra light and cozy, homey atmosphere which they give to the houses. Another feature which the men like as well as the women is the fact that your windows screen on the inside. There is no material difference between your casements and the cost of double hung wood windows. Formerly we used some wood casements but found them unsatisfactory as they warped and split.

Very truly yours,

RAF:R

These beautiful modern NEW windows of steel, easily seen from the street, will bring prospects into your houses—give you an opportunity to sell ALL of the modern features you have built into your homes.

And now you may have Fenestra Steel Casements and SCREENS built in a single unit by *one* manufacturer. Metal screens fit snugly against the inside of the casement frame. Swing leaves easily open *through* the screens which need not be touched. Screens are easily removed or replaced.

Fenestra Casements increase both the appearance and convenience of your houses—have a greater appeal to the home-buying public than any building specialty perfected in the last decade. They're homey, decorative, modern and surprisingly low in cost. Write for details.

DETROIT STEEL PRODUCTS COMPANY
2281 East Grand Boulevard, Detroit, Michigan
Factories: Detroit, Michigan, and Oakland, Calif.
Convenient Warehouse Stocks

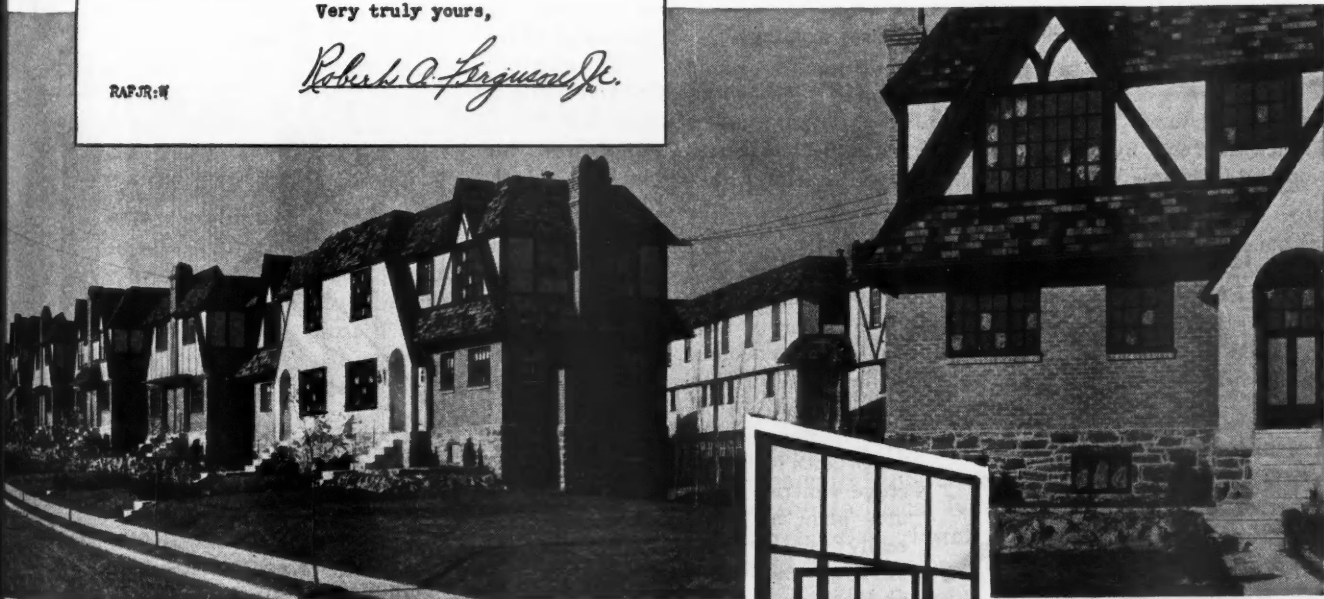

Above—Part of Wynnewood Park Development, Wynnewood Park, Pa. Robert A. Ferguson, Jr., Ardmore Park, Pa., Builder.

Left—Fenestra Casement Type 4416 VCR-L. Dimensions: 3' 1 1/2" wide x 4' 3 3/4" high. Over 50 types are carried in local stocks for quick delivery. Catalog free.

Fenestra

screen casement windows

WHEN WRITING ADVERTISERS PLEASE MENTION THE AMERICAN BUILDER

Woodworker Handles Many Jobs

A NEW combination woodworking device which is described by the makers as "seven machines in one" has just appeared. An outstanding feature is the fact that it is ball bearing throughout. Because of this, unusual ease of operation is obtained. The machine is operated by a ½ h. p. motor from any light socket, and will perform heavy

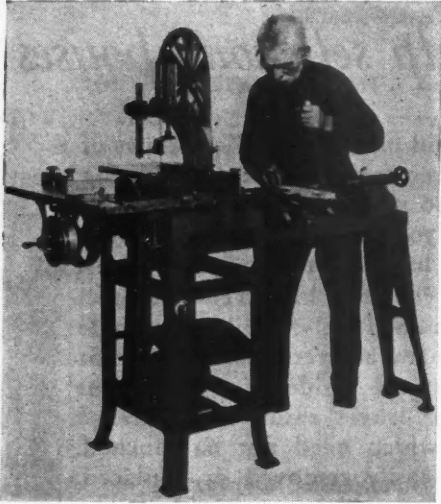

THIS WOODWORKER Is Ball Bearing Throughout, Making for Easy Operation.

duty work with a minimum of power. It is claimed that the frictionless ball bearings eliminate the oil can, so that lubricating and greasing are required only once a year.

Included in the device are a saw table, jointer, band saw, shaper, speed spindle, mortiser and lathe. With this equipment, 35 woodworking operations may be performed

with speed and accuracy. All the power of the motor is delivered direct to the cutting tool. Each tool can be operated independently and two tools may be operated at the same time when desired. Changing operations can be effected quickly and simply, without the necessity of adding or removing machine parts with bolts or screws.

The device is supported by a one-piece, solid iron ribbed frame, accurately machined. This, it is asserted, prevents twisting, warping, or vibration, and increases accuracy.

The saw table, band saw table and jointer top are ground to true surfaces for delicate cabinet work. The whole machine is readily portable and may be passed through a 30-inch doorway by simply removing the lathe bed extension and band saw table top.



Improves Concrete Block Making

WHEN straight concrete blocks are used as back-up for brick, it is necessary for the contractor to have a special shaped header block for use when occasional header brick courses are to be provided for. The production of header block is a matter of vital importance in the average concrete products plant and generally represents a serious mechanical problem.

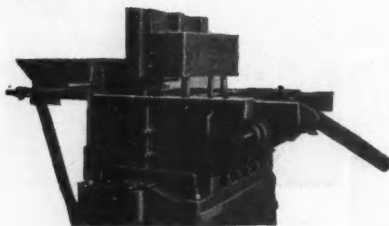

A NEW ATTACHMENT for the Stripper Block Machine for Producing Header Blocks.

An attachment has been introduced for use with a well-known type of stripper block machine, which makes the production of these special units a simple and profitable operation. The attachment has these three advantages, it is stated: It reduces the cost of making header blocks to less than the cost of full blocks because it makes them at exactly the same speed, with the same

labor and with less material; the header block has clean-cut angles and true edges; the header block has exactly the same texture and strength as a standard block because a standard block is first made and then part of it is taken away.



Gas Engine Drive Paint Spray

THE new portable paint spray outfit illustrated here is equipped with gas engine drive. It has plenty of air capacity for the largest jobs without worrying about sloppy work. Portable features allow it to be used on any kind of work and it is especially adapted for maintenance painting, house painting, barn painting, greasing forms and other such heavy duty work. This is one of a complete line of portable electric and gas engine drive paint sprays made by one of the leading manufacturers in this field.

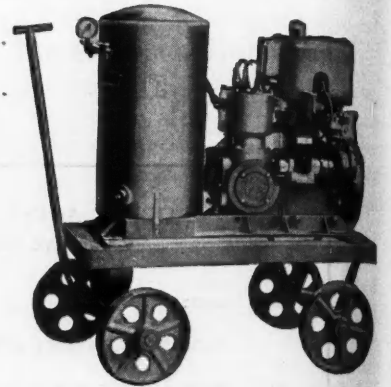

NEW PAINTING OUTFIT, Gas Engine Powered, Suitable for House and Barn Painting and Similar Heavy Work.



Melting Pot with Bottom Spout

THE illustration shows a new electric metal melting pot with a bottom pouring spout. The bottom pouring feature is particularly applicable in cases where it is impractical to ladle and where large quantities of metal are handled. It is designed for melting lead, babbitt, tin, solder, type metal and similar alloys or metals, except spelter or zinc, at temperatures not exceeding 950 degrees Fahrenheit.

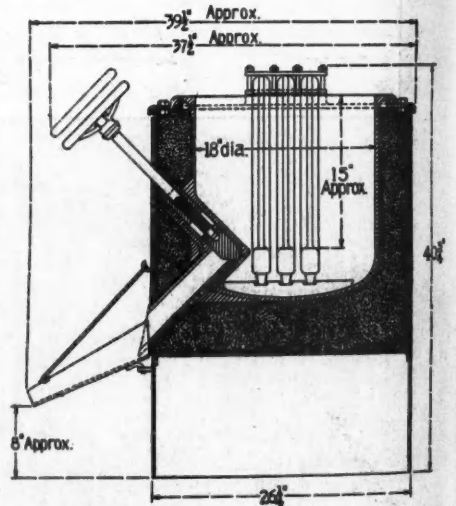

A MELTING POT Suitable for Handling Large Amounts of Metal at Temperatures Up to 950 Degrees.

The automatic control consists of an automatic control panel and a temperature control instrument. Manual control is not recommended. The advantages of the redesigned pot, as pointed out by the manufacturer, are: Heat is generated right in the metal, affording quick heating and low radiation loss; heating units are easily replaceable without interrupting production; the maximum rate of heating is obtained without overheating; the pots are reliable, safe and economical.

Manual control is not recommended. The advantages of the redesigned pot, as pointed out by the manufacturer, are: Heat is generated right in the metal, affording quick heating and low radiation loss; heating units are easily replaceable without interrupting production; the maximum rate of heating is obtained without overheating; the pots are reliable, safe and economical.

can-cut
ly the
ause a
taken

T-
d,
rn
vy

sprays
ld.

ng pot
ouring
is im-

or
al
es.

is not
ot, as
erated
iation
rrupt-
tained
and



Choosing a colored sink for someone

WHO that someone will be you don't know when you build the house and install the sink. But you do know that everyone has an individual taste and preference in this matter of color. So you won't select the color just because it is the color you like best. You will want a color that, you can be reasonably certain, will appeal to all who come to see the house you are trying to rent or sell.

Ming Green, one of the new "Standard" colors, is recommended, because of its proven popularity. It has a positiveness and beauty not to be expected in other shades of green. With Ming Green as the starting point a beautiful color scheme can be worked out for the kitchen.

It is important to recognize that color, beautiful as it is, is not a substitute for good design. There must be both beauty of form and color. The ideal combination is realized in the "Three 8's" Sink in color. The 8 inch back of this design fits under deep-set windows; the 8 inch

sink compartment is roomier and prevents over-the-rim splashing; the 8 inch front gives the whole unit the beauty of correct proportion. This beauty is enhanced by the Mastercraft Fitting in tarnish-proof Chromard Finish.

The "Three 8's" Sink is available in both regular enamel and "Standard" A-R (Acid-Resisting Enamel) which cannot be roughened or discolored by fruit and vegetable acids. And, like all "Standard" Plumbing Fixtures, both vitreous china and enameled it is made in Ming Green, T'ang Red, Clair de Lune Blue, Ionian Black, Ivoire de Medici, Royal Copenhagen Blue, St. Porchaire Brown, Rose du Barry, Orchid of Vincennes and Meissen White.

"Standard" has not only created these beautiful colors but has published a book which shows how to combine them correctly with other colors. A copy of this book, "Color and Style in Bathroom Furnishing and Decoration", will be mailed on request.

Standard Sanitary Mfg. Co.
PITTSBURGH
"Standard"
PLUMBING FIXTURES

THIS PRIMING COAT *insures enduring*



THE best of paint cannot resist the warping and checking of wood, caused by alternating moisture and dryness. Unless the finished coating of paint is moisture proof or the finish coats are applied over a priming coat of moisture-proof paint.

Aluminum Paint is moisture-proof. Used as a priming coat it will prolong the freshness and beauty of finish coats of paint long after an ordinary paint job would have begun to peel, chip and discolor.

Aluminum Paint is opaque, too. It is impermeable to the bleeding through of stains.

By using an Aluminum priming coat you prolong for the owner the original beauty of his newly painted home—and you insure for yourself his enthusiastic approval of the finished paint job.

We will gladly send you complete information about the use of Aluminum Paint as a priming coat. Write to Aluminum Company of America, 2411 Oliver Bldg., Pittsburgh, Pa. (Offices in 18 principal American cities.)



The pigment base for the better grades of Aluminum Paint is ALBRON, made from pure ALCOA Aluminum. To use ALBRON as the pigment for a priming coat is to assure the quality of the pigment. Most paint manufacturers, dealers and painting contractors are prepared to furnish ALBRON with a suitable vehicle for priming coat use.

OF SPECIAL INTEREST *to the* MERCHANT BUILDER

Home buyers are coming to realize the importance of an Aluminum Priming Coat in preserving the beauty of their homes and in saving repaint-

ing expense. You will find an Aluminum priming coat a very definite aid in selling your finished houses... an excellent "plus" talking point.

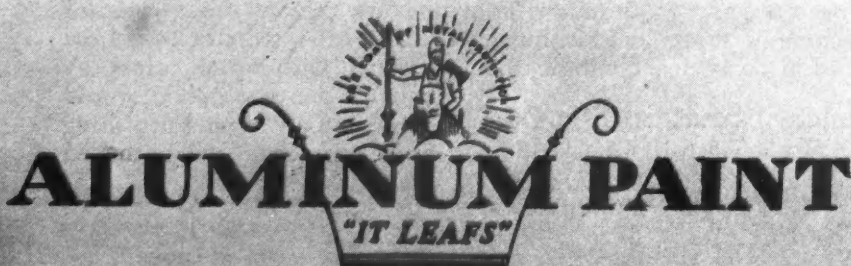

BEAUTY

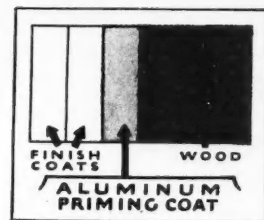
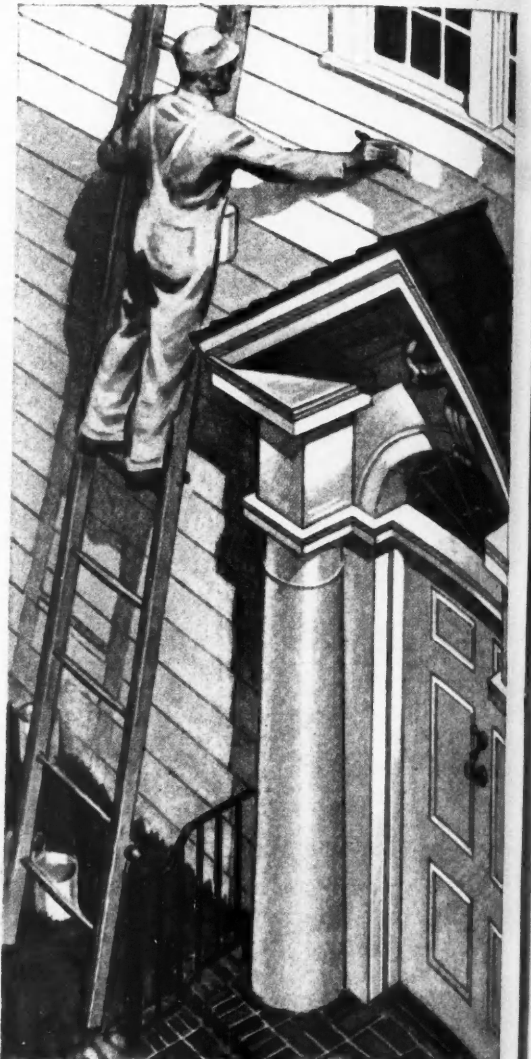

This Aluminum priming coat seals the surface of the wood keeping out moisture and preventing the warping and checking that ordinarily would break down the finishing coats of paint.

B
ne

M

MED

NEW
Venetian
at the top
type hin
and door
ment of
type door
A beautif
roomy sl
etching a
glass she
white en

The new
Cabinets
bathroom
black, wi
the design
graceful c
harmonio
spicuous
combine t
cabinet fo
standard s
Venetian.

Morton M
such well
Post, Lite
Housekee
icine Cabi
priced. Sh
into the w
illustrated

2 Beautiful new designs in **MORTON** MEDICINE CABINETS

NEW Style—New Etching—New Construction . . . all are now available in the improved Venetian, Model F, Morton Medicine Cabinet, shown at the top of this page. New features include a piano type hinge with a special arrangement of the hinge and door which permits easy removal and replacement of door whenever necessary. A new cushion-type door renders the mirror virtually unbreakable. A beautiful cabinet, made in four standard sizes, four roomy shelves five in. deep, finest mirrors, artistic etching and metal rosettes, special bulb-edge plate glass shelves, steel construction throughout with white enamel permanently baked on.

The New Modernistic

The new Modernistic model in Morton Medicine Cabinets meets the popular demand for color in the bathroom. The mirror is decorated in green and black, with silver flowers delicately interwoven in the designs at the top and bottom of the mirror. The graceful contour of the mirror, the beveled edge, the harmonious color scheme, the attractive yet inconspicuous metal rosettes, the large clear vision, all combine to make an exceptionally beautiful medicine cabinet for modern bathrooms. Available in four standard sizes at slight additional cost over the new Venetian.

Nationally Advertised

Morton Medicine Cabinets are widely advertised in such well known magazines as Saturday Evening Post, Literary Digest, American Magazine, Good Housekeeping and House and Garden. Morton Medicine Cabinets are made in 11 models, all reasonably priced. Shipped ready to install, "Out of the carton into the wall." Mail the coupon for FREE 24-page illustrated catalog.

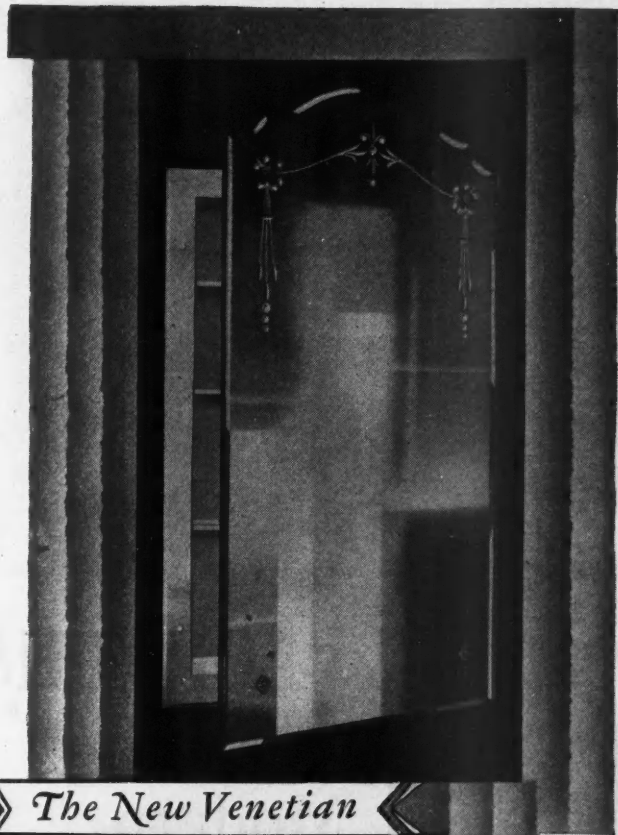

» *The New Venetian* «

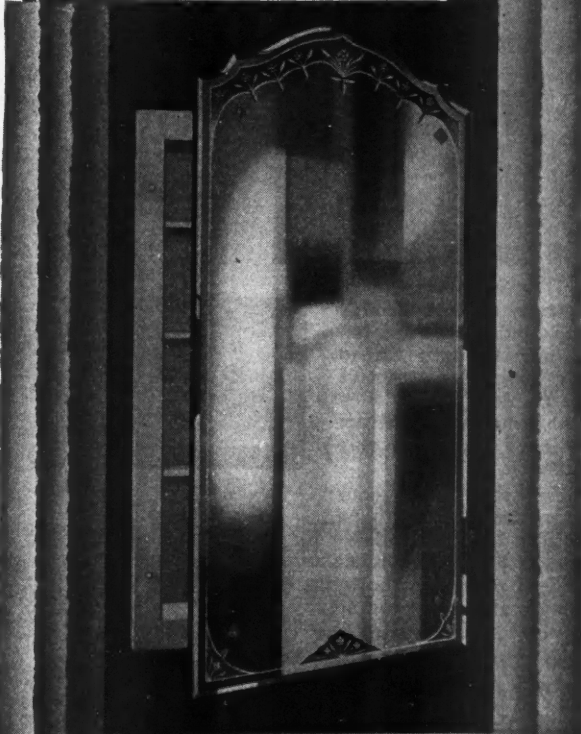

» *The New Modernistic* «



**THIS
BEAUTIFUL
CATALOG
FREE**
including
installation
details.
Mail the
coupon.

MORTON MANUFACTURING CO., 5190 West Lake St., Chicago, Ill.

Without obligation, please send me your latest catalog of Morton Medicine Cabinets.



Name.....

Address.....

City..... State.....

Please Check: Architect Builder Contractor Realtor Home Builder



Why not put in attractive store fronts like this for merchants and make more money?

New Profits FOR YOU!

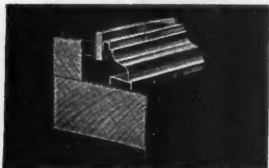

PERMAWITE

THIS IS THE TIME!

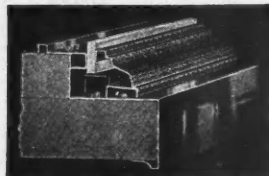

ART BRONZE

Right now, new store buildings are going up—old stores are being altered and brought up to date with bright, attractive fronts. Merchants know they need brilliant windows to attract customers—they must display their merchandise to sell it.

Here's where you have your biggest opportunity! With a beautiful Brasco design available for every kind of store—with the most stylish store front constructions ever offered—with excellent profits on both material and erection—you can keep busy and make good steady money right along. Ask us for the details. Mail the coupon below and get started NOW while the big season is on!

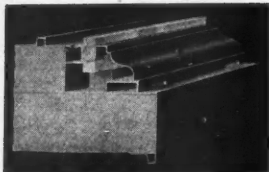

COPPER

Brasco Mfg. Co.
5029 Wabash Ave.
Chicago



Mail Coupon

BRASCO MFG. CO., 5029 Wabash Ave., Chicago
Send me your free information on profitable store front work.

Name.....(AB 6-29)
Address.....

Portable Rip and Cross-Cut Saw

SEVERAL outstanding advantages are claimed for a new portable combination rip and cross-cut saw which has just been placed on the market. In cross-cutting or mitering, the saw travels through the work—gliding on two polished steel rods beneath the table. Since the saw travels in a straight line, the cut is of uniform depth throughout the stroke. This not only gives the saw greater cutting capacity, but also permits the use of dado heads on rapid cross-cut work.

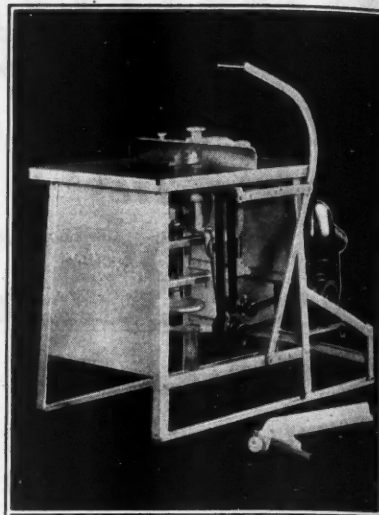

GREAT CUTTING CAPACITY and Accuracy Are Two of the Features of This Saw.

Unusual accuracy in mitering is secured through the use of the miter fence which extends the full width of the table. This is clamped solid to the table when in use and cannot get out of adjustment. Provision made for maintaining perfect alignment of the ballbearing saw arbor, also makes for cleaner and more accurate work.

With the exception of the hardwood throat around the saw, the machine is built entirely of steel, with a reinforced steel table. An 8-inch saw is used and power is provided either by a 3/4 hp. repulsion-induction motor, or a 1 1/2 hp. 4-cycle gas engine.



For Better Floor Polishing.

THE compact little floor polishing machine shown here weighs only 14 pounds, which makes it easy to carry about and also to operate on stair treads and similar places where a larger and heavier machine would be difficult to handle. It is so proportioned as to weight, size and speed as to produce the best results and it can be operated right up to the baseboard, under low furniture and around the legs of furniture. This is made possible by the two brush arrangement.

It is equipped with two soft bristle brushes instead of one. It is very simple in construction, having no belts or chains, and all moving parts are packed in grease. It is smaller than the average vacuum cleaner and is equipped with a ball bearing universal motor to work equally well on direct or alternating current. A convenient pistol grip and trigger control make for ease of operation.

This machine produces an even, uniform polish over an entire floor without effort and can be used by anyone, without experience. It is stated that it will do the work of four men giving smooth surface with a high luster to which dust and dirt does not adhere. With it is supplied a wax applicator which is used to apply a special wax prepared by this manufacturer. This wax contains, besides the advantages of wax, the lasting qualities of varnish, it is claimed, and produces a beautiful, hard finish floor with a high luster, but not slippery.



FLOORS Can Be Polished Quickly and Well with this Light, Compact Machine.

C. A. R...
around I...
many of...
he is, an...
Because...
J. J., use...
doors ev...
recently...
famous d...
Specula...
us that...
houses m...
contracto...
Laminex...
to repair...
C. A. R...
Said he:...
"Many...
life can b...
'warped'...
building...
who const...
"Our ex...
ever, tha...

Many a grievance in a contractor's life can be traced to this . . .



Contractor C. A. Reed maintains



C. A. Reed, a veteran builder in Long Beach, California. Read what he says about door troubles and their threat

C. A. REED has been building houses around Long Beach since the days when many of us were kids. A shrewd builder he is, and a bit of a philosopher, too. Because Contractor Reed and his son, J. J., use quite a quantity of Laminex doors every year, we sought him out recently to get his opinion of these famous doors.

Speculative builders have been telling us that advertised Laminex doors in houses make them easier to sell. General contractors have praised them because Laminex doors do away with going back to repair doors that stick or warp. C. A. Reed has another reason, too. Said he:

"Many a grievance in a contractor's life can be traced to a faulty door that 'warped' an owner's confidence in the building, and his judgment of the men who constructed it.

"Our experience has taught us, however, that the owner of a Laminex-

In new buildings, doors all too often swell and stick, or warp and fail to latch. And the contractor gets the blame that isn't his; stands the cost of making the doors right!

equipped building will never be annoyed by a warped door that will not latch—that Laminex doors don't have the common failings of cheaper doors."

Perhaps you can't understand how builders everywhere can be so enthusiastic about a door. Perhaps you haven't tried Laminex? Mail the coupon and we will send you the information you want, including a new catalog on the strikingly beautiful Philippine Laminex doors and carton trim.

LAMINEX DOORS

Will not shrink, swell, or warp

The Wheeler, Osgood Company, Dept. E-69 Tacoma, Washington.

Please tell me more about Laminex doors, and from whom they can be bought locally.

Name.....

Address.....

City..... State.....

WHEN WRITING ADVERTISERS PLEASE MENTION THE AMERICAN BUILDER

A Show Building That Shows!

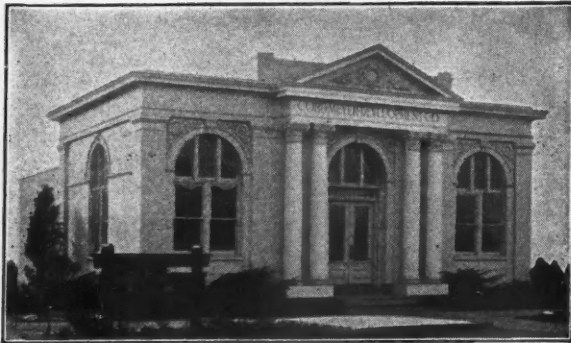

Photo Samuel H. Gottscho

THIS beautiful office building of the Cord Meyer Company is naturally in keeping with the high standards of development in Forest Hills, Long Island.

Here is its picture—a building of limestone, brick and stucco, finished with Cabot's DOUBLE-WHITE Collopakes tinted light cream.

Cabot's Collopakes do all paint will and more. The tints last, and because of the patented process employed in their manufacture, they *bond* themselves into the texture of the material.

Cabot's Collopakes

Send in the coupon below for full details

COUPON

Samuel Cabot Inc.

141 Milk Street
Boston

Please send me full information on

CABOT'S COLLOPAKES

Name

Address

AB-6-29

Something New in Woodworkers

A WELL known manufacturer is placing on the market a new style of woodworking tool. This new tool consists of a uniquely arranged ribbon or band saw. By the combination of special steel and process, saws of unusual strength and flexibility have been developed, and it is possible for any workman to have a small, light, portable band saw that will do a great variety of work at a low price. The cost of the whole outfit will be very low, the power used will be but a few cents a day and the saw blades, though of special construction, will be so cheap in price that a number may be purchased and a new one used to replace the dull one in the same manner as razor blades are. Saws may be sent to the factory for repairs and returned by parcel post.

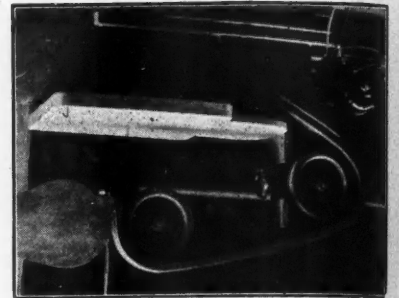

SMALL BAND SAWS with Unusual Features Have Recently Been Placed on the Market.

The larger size will have a cutting capacity of 10 to 18 inches and a clearance of 30 to 50 inches. In the smaller size the clearance will be 21 inches and cutting capacity will be eight inches of oak. With special metal cutting blades, it may be used to cut light metal. All this done with a one-quarter horse motor on the smaller machine.

The small machine measures 40 inches in length, 30 inches in height. The width is governed by the size of the table, which is generally 20 inches square, with an apron running from table to frame.



Large Capacity Portable Pump

WITH a capacity of 8,000 gallons an hour, yet easily portable, as shown in the illustration, and selling at a surprisingly low price, this pump is described by the company manufacturing it as its most popular model. It is equipped with a two h.p., four cycle, high speed engine, with a foot starter which makes starting easy. This engine is an air cooled unit of well known make which will stand up for years under constant heavy pumping. The engine is direct coupled with a non-clogging, big volume pump with an open type, brass impeller which handles 25 to 28 per cent solid matter, like sand, mud or small stones, it is stated. The brass impeller of the new, open type, will not cog nor will it rust or stick. It can be pulled about on the job on the wheels, as illustrated, and can be easily placed on a truck for moving.



ONE MAN Can Move This Pump Wherever Needed as Shown Here.

The manufacturer states that they have discarded primers on small pumps as they reduce the volume of the pump approximately 20 per cent.

25 Years

... or an afternoon



BEAR this in mind when you are looking toward motor truck purchase and want the facts before you: Any Harvester branch or truck dealer will demonstrate an International for you at any time, right in your everyday work.

Whatever the nature of your hauling and your loads, we will put at your disposal an International of the size you need and let you compare its all-around performance with anything you are doing now or want to do.

Take that as the evidence of an *afternoon*, or a day or two, if longer time may be necessary. And take with it the evidence of the *twenty-five years* that the Harvester Company has been building trucks to do a truck's work as it should be done.

You owe it to your business to know International trucks. You'll find in these trucks the speed and stamina that cut operating costs right down to where they show a strong profit. You'll find appearance, reliability, performance, service facilities . . . everything you expect, and more.

Accept our invitation to *prove* this product of 25 years of progress in truck manufacture. Visit the nearest International Truck branch or dealer. In the meantime write for literature on trucks for your business.

INTERNATIONAL HARVESTER COMPANY
 606 So. Michigan Ave. of America Chicago, Illinois
(Incorporated)

THE INTERNATIONAL LINE consists of a variety of models of different size, capacity, wheelbase, and power, including the Special Delivery, $\frac{3}{4}$ -tons; the Six-Speed Special, 1-ton; 4 and 6-cylinder Speed trucks for $1\frac{1}{4}$, $1\frac{1}{2}$, and 2-ton loads; and Heavy-Duty trucks, double reduction and chain drive, for $2\frac{1}{2}$, $3\frac{1}{2}$ and 5-ton loads. SERVICE . . . 172 company-owned branches in the United States and Canada.

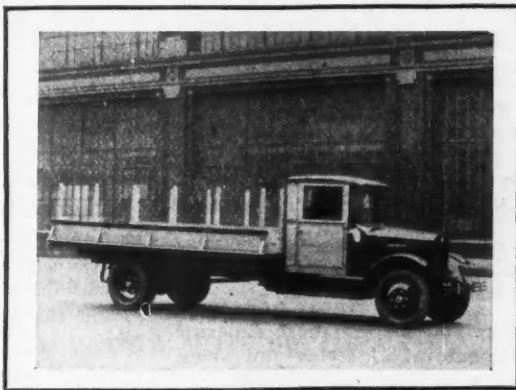

The International line is the most complete line of speed trucks in the country. There are many distinct chassis designs. This view shows one of the typically good-looking models.



INTERNATIONAL TRUCKS

WHEN WRITING ADVERTISERS PLEASE MENTION THE AMERICAN BUILDER

Michigan White Pine

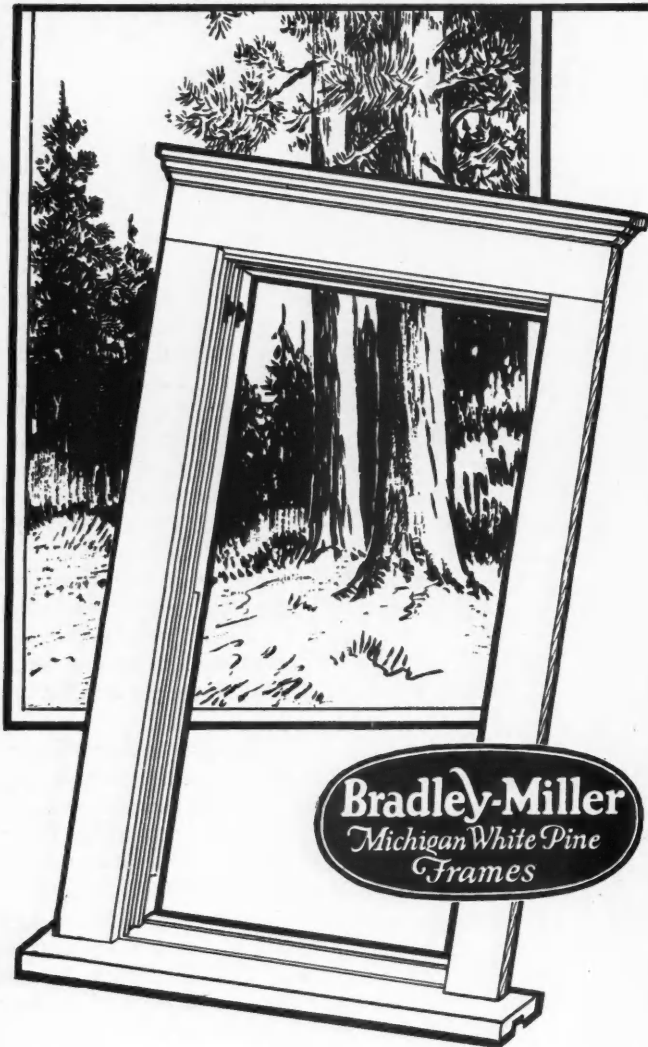

Bradley-Miller
Michigan White Pine
Frames

for a Quality Job

Bradley-Miller Michigan White Pine Window Frames will always give you a quality job.

All exposed parts of Bradley-Millers are made out of that finest of all frame woods, Michigan White Pine, (*Pinus Strobus*). This assures you of a time-lasting job; no warping, swelling, splitting, shrinking or rotting. The windows will always run easily and the scientific design combined with the expert workmanship make them weather-tight.

They come in two bundles, tied with mar-proof cord, and can be nailed up in less than ten minutes.

Go to your Dealers today and inspect these superior frames. You will find them in all styles and sizes; there's one that will meet with your requirements.

Let us send you the Bradley-Miller Construction Booklet and Catalog Free. Drop us a line today.

BRADLEY-MILLER & CO.
1200 MARQUETTE ST.
BAY CITY, MICHIGAN

A Portable Material Hoist

THE portable steel hoist shown here was designed by a company specializing in hoisting equipment, as a time and labor saver for builders. It hoists brick, mortar and similar construction materials, in wheelbarrows or concrete buggies and can be moved from job to job without loss of material. It can be erected by two men, to a height of 36 feet, in 2½ hours. When a job is finished, it can be dismantled even more quickly, loaded on a truck and moved to the next location. Some jobs require an elevator at more than one point during construction. This elevator can be moved on rollers, while erected, the upper sections being held securely with guy ropes.

This elevator consists of a steel base section on which the hoisting mechanism is mounted, and upright steel carriage guides. The platform travels entirely clear of the guides so that the load may be extended over the platform sides, if necessary, with no interference. Up to 26 feet the elevator is self contained and requires no bracing or attaching to the building. This includes the six-foot base section and two 10-foot sections above. Provision is made for tying additional sections above this height, to the building for rigidity and safety. These sections come in five and 10-foot lengths and are easily attached.

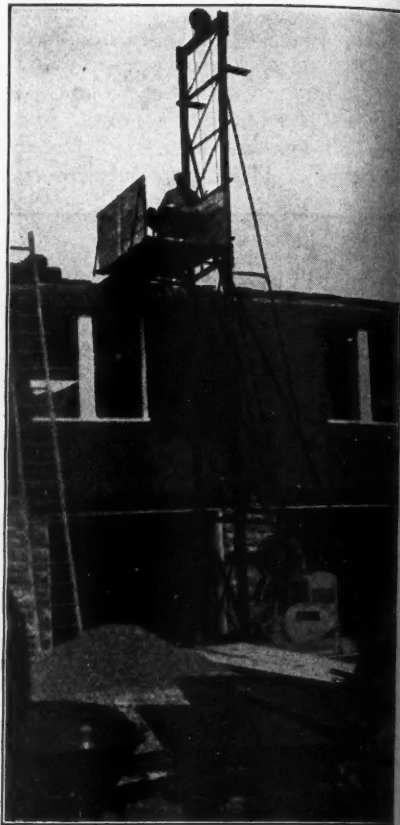

STEEL HOISTS That Are Designed to Save Time, Labor and Materials.

Hollis Joins Triple Insulaire

THE Triple Insulaire Company, of Milwaukee, Wis., which has recently developed and placed on the market a new insulating material providing a high degree of insulation by means of air spaces enclosed by corrugated board, announces that H. G. Hollis has become associated with the company as vice-president. Mr. Hollis was formerly joint secretary-manager of the Northwestern Lumbermen's Association and the Retail Lumbermen's Insurance Association, and has for many years been well known throughout the lumber and building industries.

"Facts About the Structural Steel Industry" is the title of a 128-page book published by the American Institute of Steel Construction, Inc., 200 Madison Ave., New York, N. Y., and presents a statistical outline of the progress of steel construction in the country. Price 50c.

The National Fire Protection Association, 60 Battery-march St., Boston, Mass., offers a number of advance copies of its 1929 committee reports.



FEDERAL has YOUR JOB in Mind . . .

In the great Federal line of 43 chassis and more than 100 body-and-chassis combinations, there is one *exactly* fitted to *your* job. If there isn't, we'll work one out. That's the way we do business . . . by meeting the definite and exact needs of each and every particular haulage task. We

don't try to fit a few trucks to all jobs.

Furthermore, the truck will be ALL-TRUCK. Whether a light package delivery or a seven-ton monster, the basic construction will be the same . . . every part a TRUCK part . . . every unit a TRUCK unit.

Naturally Federal Trucks last longer and earn more. They are built that way. And the fact that seven out of every ten Federals built go to previous owners of Federals certainly bears this out.

THE FEDERAL MOTOR TRUCK CO.
5842 Federal Avenue
DETROIT, MICHIGAN, U. S. A.

FEDERAL TRUCKS

Write for "The Federal System of Truck Operation Control" (246)

WHEN WRITING ADVERTISERS PLEASE MENTION THE AMERICAN BUILDER

Outstanding Features of the Chevrolet Six Cylinder Trucks



1 SIX-CYLINDER PERFORMANCE

Powered by a rugged six-cylinder valve-in-head engine—Chevrolet trucks provide remarkable smoothness, flexibility and acceleration—even when hauling a capacity load.

2 AMPLE CAPACITY

A longer, stronger, heavier frame makes possible the mounting of any body type, with loading space up to 9 feet in length and a gross load limit of 7000 lbs.

3 OUTSTANDING ECONOMY

Improved carburetion and a new high-compression, non-detonating cylinder head provide gasoline economy which is actually as great as that of a four-cylinder truck.

4 DAY-AFTER-DAY DEPENDABILITY

Numerous notable mechanical advancements, combined with extraordinary staunchness of construction, make the new Chevrolet six-cylinder trucks unusually dependable.

5 SMART APPEARANCE

A wide array of body types not only meets every haulage and delivery requirement—but provides unusually smart appearance and the utmost convenience.



Builders know—

—that the swift pace of today's traffic conditions demands the increased power, speed, flexibility and acceleration of a six-cylinder engine. And because the new Chevrolet trucks provide this six-cylinder performance with the economy of the four, their popularity is growing by leaps and bounds in every section of the country.

Visit your Chevrolet dealer today and see how completely the new Chevrolet trucks meet the requirements of your business. In performance, in convenience and in handling ease—they will prove a revelation. And they are as economical, both to own and to operate, as any truck you could buy.

CHEVROLET MOTOR COMPANY, DETROIT, MICH.
Division of General Motors Corporation

The Sedan \$ 595 The Light De- \$ 400 The 1½ Ton \$ 545 The 1½ Ton \$ 650
Delivery.. livery Chassis Chassis..... Chassis with Cab

All prices f. o. b. factory, Flint, Michigan

- A SIX IN THE PRICE RANGE OF THE FOUR



Builders Transfer Company, Heavy Hauling Contractors, Omaha, Neb., have used Goodyear Tires for nine years

3 years of road-building without replacement

"We purchased a fleet of new trucks three years ago and had them equipped with Goodyear Pneumatic Tires for Iowa road work. We are just beginning to make replacements—a record we think exceptional, and one much better than reported by any of our competitors." (From a letter written by F. W. Currey, Owner.)



Three years of road-building is a test of stamina which demonstrates two important facts about Goodyear Tires.

It shows the superb vitality of SUPERTWIST cord, used in the body of every Goodyear pneumatic tire. Because this cord can stretch and recover with least fatigue, it fortifies the tire against the shocks of bumping through unmade roads.

It shows, also, the stubborn traction of the famous All-Weather Tread—which grips,

holds, and pulls through under heavy loads in soft and treacherous footing—and the economical mileage which this slow-wearing tread delivers.

For hauling operations and excavation work which demand unusually great traction, there is the Goodyear Dump-Truck Pneumatic. Extra breadth of tread—and traction flanges extending far up the sidewalls—enable this mighty Goodyear to walk away from anything ever put on wheels.

Goodyear Super Heavy Duty Cushions and Super Cushions (hollow center) supply generous cushion and All-Weather traction in hauling operations where absolute reliability is the uppermost requirement.

Goodyear Truck Tire Service Station Dealers are equipped and ready to show you how the right Goodyear equipment can reduce your hauling costs.

More Tons Are Hauled on Goodyears Than on Any Other Tires

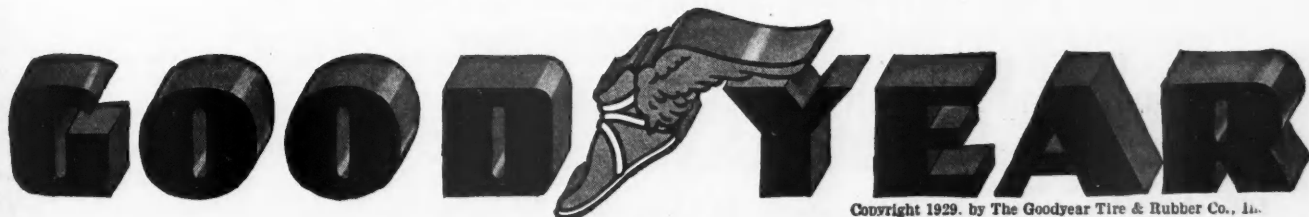

Copyright 1929. by The Goodyear Tire & Rubber Co., Inc.

WHEN WRITING ADVERTISERS PLEASE MENTION THE AMERICAN BUILDER

Books, Bulletins and Catalogs for You

THE literature and publications listed here are available to the readers of *American Builder*. They may be obtained from the firms mentioned and will be forwarded without cost except where a price is noted.

The Cornell Wood Products Company, 190 N. State St., Chicago, Ill., has issued a circular on the use of Cornell tile boards to produce beautiful effects at low cost.

The W. E. Dunn Mfg. Co., Holland, Mich., offers a book on its new product, "Duntex" roof tile, with illustrations in colors.

The James B. Clow & Sons, 201-99 No. Talman Ave., Chicago, Ill., has just published a data book on "Clow Gasteam Heating Systems" which thoroughly covers this system of heating.

The Metropolitan Life Insurance Co., New York, N. Y., offers two booklets, "Safety in Welding," which is based upon the study of welding practices, and "The Foreman's Part in Safety," which emphasizes the need for safety supervision in industry.

The Reading Iron Co., Reading, Penna., has issued a catalog which gives some interesting and valuable facts about the Reading galvanized cut nails.

The Truscon Steel Co., Youngstown, Ohio, has published a circular which illustrates and describes its Truscon steel casements.

The E. L. Bruce Co., Memphis, Tenn., has published a small booklet, entitled "White Ants—Destroyers of Floors and Interior Woodwork," pointing out the damage done by these insects and the means of preventing this damage.

The Kalman Steel Company, Wrigley Bldg., Chicago, offers a pamphlet on "The Improved, Fire-safe Floor and Roof Construction" obtained by using Kalman steel building materials.

The Atlas Portland Cement Company, 25 Broadway, New York City, has issued a new booklet, entitled "To Help the Dealer Sell Everything He Handles." It is an "Outline of the Application of Modern Merchandising Methods to the Building Material Dealer's Business."

The Harvey Hubbell, Inc., Bridgeport, Conn., offers a new catalogue No. 19 covering its line of electrical specialties.

The Marschke Co., St. Paul, Minn., offers a new catalog No. 7 on its disappearing stairs and other Marco specialties.

The De Vilbiss Co., Toledo, Ohio, has issued a book on its portable spray painting equipment which fully illustrates this line of equipment.

The Graver Corporation, East Chicago, Ind., offers a new bulletin No. 5049 on the "Graver Hot Process Water Softener."

The Cornell Wood Products Co., 190 N. State St., Chicago, Ill., offers a pamphlet on profits from farm home improvements which illustrates the use of Cornell boards in farm homes.

The Consolidated Expanded Metal Companies, Steelcrete Bldg., Wheeling, W. Va., has issued a folder on "Steelcrete," the proper reinforcement for concrete floors laid on the ground.

The University of Illinois, Urbana, Ill., has published a Bulletin No. 189, "Investigation of Warm Air Furnaces and Heating Systems," The Research Residence, Part 4 by Arthur O. Willard, Alonzo P. Kratz and Vincent S. Day and Bulletin No. 190, "The Failure of Plain and Spirally Reinforced Concrete in Compression," by Frank E. Richart, Anton Brandtzaeg and Rex L. Brown.

"House Painting," by A. H. Sabin, is a book published by the John Wiley & Sons, Inc., New York, N. Y. This is a book for the householder on glazing, paper hanging and whitewashing. Price \$1.80.



1340 Square Feet of Sanded Floors — In 2³/₄ hours

With the New AMERICAN HIGH PRODUCTION Sander

The Same Time It Took To Sand 460 sq. ft. With Old Machine

For a quarter of a century, American Floor Sanders have set the standards for floor surfacing, both in area finished hourly and quality of the work.

Now the AMERICAN HIGH PRODUCTION Sander, by sanding from two to four times faster, raises that standard, gives you still higher production, makes you a greater and quicker profit and reduces your costs for abrasive paper as much as \$8.50 a roll.

Investigate this new HIGH PRODUCTION SANDER—learn how it will fit into your work. Increase your profits by handling more contracts. We will be glad to tell you — just use the coupon.

COUPON

The American Floor Surfacing Machine Co.
514 So. St. Clair St., Toledo, Ohio

Gentlemen: Please mail me full information on the AMERICAN HIGH PRODUCTION Sander, and how it will help me increase my earning power.

Name

Address

City..... State.....

**The American
Floor Surfacing Machine Co.**
514 So. St. Clair St. Toledo, Ohio

Branch service stations in principal cities

Canadian Representatives

THE A. R. WILLIAMS MACHINERY CO., Ltd., Toronto

You wouldn't leave openings in siding—

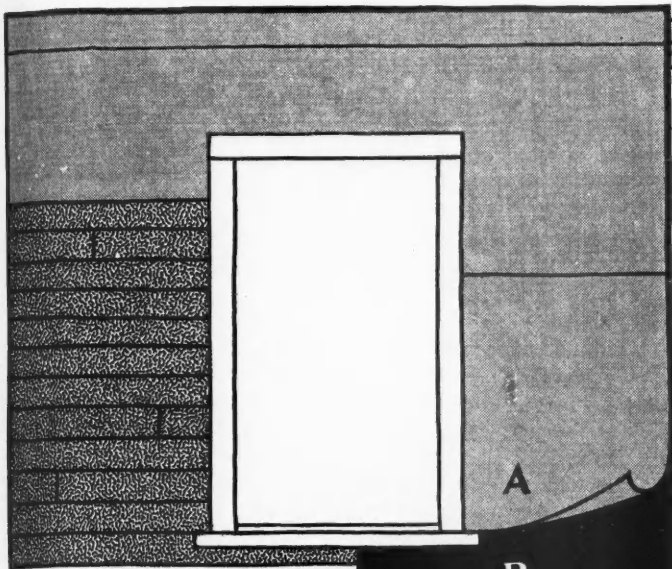

Then why not apply building paper without tears or holes?

Before Sisalkraft came on the market torn building paper was accepted as inevitable on almost every job. But Sisalkraft does not tear in application and therefore presents an entirely new standard of protection. As shown in the sectional view, it has crossed sisal fibres. This non-elastic reinforcement gives it unbelievable strength in both directions.

The asphaltum provides an absolutely water and air-tight membrane.

The kraft surfaces make the paper clean and easy to handle, and permanently protect the asphalt from drying out.

Sisalkraft saves expensive labor for application. One man can apply it with ease and without rips even in a high wind. No battens needed when paper is to be covered promptly. No patching required.

Sold through lumber dealers. Rolls 36 to 84 inches in width. Samples free on request.

Sisalkraft Uses

Walls—In all types of walls, Sisalkraft not only stops moisture but also air, dust and smoke. Saves fuel cost since it can be used to create dead air space or to cover insulating material, thereby preventing moisture and air infiltration from impairing its efficiency.

Roofs—Sisalkraft applied under the roofing eliminates a lot of worries about leaks.

Floors—Creaking and warping in floors is prevented by Sisalkraft which stops moisture coming up from below.

Covering—Sisalkraft will do anything that canvas will do in protecting stock piles, machinery, unfinished masonry, etc. Costs one tenth as much. Can be used over and over for covering purposes or applied permanently in a building after serving a temporary use.

(A) Kraft Paper
(B) Asphaltum
(C) Crossed Sisal Fibres

THE SISALKRAFT CO
205 West Wacker Drive (Canal Station)
Chicago, Illinois

In Canada—Alexander Murray & Company, Limited, Montreal, Toronto, St. John, N. B., Halifax, Winnipeg and Vancouver
In East—55 West 42nd Street, New York City
In Northwest—The John Leslie Paper Co., Minneapolis, Minnesota

SISALKRAFT

“More than a building paper”

Reg. U. S. Pat. Off.

AB6-Gray

WHEN WRITING ADVERTISERS PLEASE MENTION THE AMERICAN BUILDER

Books, Bulletins and Catalogs for You

THE literature and publications listed here are available to the readers of American Builder. They may be obtained from the firms mentioned and will be forwarded without cost except where a price is noted.

The Structural Slate Co., Pen Argyl, Pa., has prepared a number of booklets on the application of slate in building. These are made up in three handy volumes to fit the A. I. A. file size and are mailed free upon request, together with a sample paper weight, to architects and others actively connected with the building industry. They are free from advertising matter. They deal only with the geological history of slate and present many pages of drawings and specifications which are constantly used by architects and specification writers.

The Kolesch & Co., 138 Fulton St., New York, N. Y., has just published a little book about sand and the Universal sand tester which also describes the Kolesch builders' level and the Kolesch construction transit.

"Sanitation and Health" is the title of a handsome book published by the National Association of Master Plumbers, Inc., 317 N. Eleventh St., St. Louis, Mo., which particularly emphasizes importance of the master plumber.

The Wm. Bayley Co., Springfield, Ohio, offers two circulars on its Bayley-Springfield tubular steel doors and Bayley-Springfield pivoted windows screened.

The Knickerbocker Co., Jackson, Mich., offers a booklet, "Knickerbocker Mixers," which illustrates its concrete, mortar, plaster and mastic mixers and contractors' saw rigs.

"Built-In Conveniences" is the title of a handsomely illustrated book in colors published by the El Paso Sash & Door Company, El Paso, Texas, and which completely covers its line of Premier built-in conveniences.

The General Wheelbarrow Co., Cleveland, Ohio, has just

published a General Wheelbarrow Handbook, Catalog No. 108, which fully describes and illustrates its line of wheelbarrows.

The Gorton Heating Corporation, 96 Liberty St., New York, N. Y., offers Catalog No. 94, on the Gorton single pipe vapor heating system and Gorton quarter turn packing lock valves.

The Consolidated Expanded Metal Companies, Wheeling, W. Va., have published a booklet under the title, "Steelcrete Industrial Mesh Handbook," which is, as the name implies, a complete handbook of this product and its application in building.

"Taking the Mystery Out of Lumber Buying," is a new booklet published by the National Lumber Manufacturers' Association, Washington, D. C., explaining this association's "National Tree" symbol and its significance as a guarantee of American Standard lumber.

The "Massachusetts Building Laws Manual" has been published by the Massachusetts Building Officials Conference, 80 Boylston St., Boston, Mass. This is the first, 1929, edition of a volume which will be compiled and published annually by this organization.

"Blueprint Reading—A Problem Text" is the title of a book by W. W. Sturtevant, published by the McGraw-Hill Book Co., Inc., 370 Seventh Ave., New York, N. Y. Price, \$1.90.

The Winslow Boiler & Engineering Co., Chicago, has published a handsomely illustrated booklet on its Kleen-Heat boilers, under the title "The New Developments in Oil Heat and Some Modern Ideas of House Heating in General."

The Cornell Wood Products Co., 190 N. State St., Chicago, Ill., has issued a pamphlet illustrating the use of Cornell Wood Boards.

WHO GETS THE WEATHERSTRIP PROFITS

YOU or the Sub-Contractor?

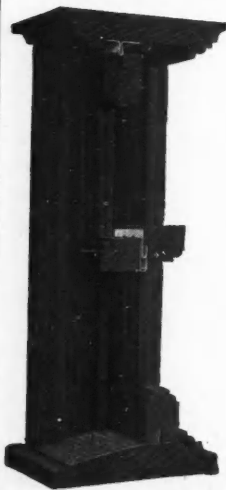

Some one is going to install weatherstrip for your customers—*why don't you?*

Thousands of other contractors and builders are making their own weatherstrip installations and are saving the sub-contractor's profit. They are buying ALLMETAL Weatherstrip *direct from the factory* cut to size required for each job as needed.

YOUR men can install weatherstrip too—it is carpenter work. Make your own weatherstrip installations and get the weatherstrip profit.

We Loan Necessary Tools

ALLMETAL WEATHERSTRIP CO.,
231 West Illinois St., Chicago, Ill.

Gentlemen: Send literature and samples.

Name.....

Address.....

City.....State.....

I am a

Builder Contractor Carpenter

Bommer Spring Hinges

are the best

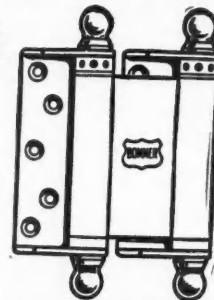

are the best

Millions and Millions

of People are Pushing

Them

whenever they open a door

Follow the line of least resistance

Use **Bommer** Always

They are the best

Bommer Spring Hinge Co., Brooklyn, N.Y.

"LARGER LOANS for LONGER PERIODS on Face Brick Houses"

The Canton Bank & Trust Co.

Canton, Ohio.

C. A. HANNER, PRESIDENT
WM. H. MILLER, VICE PRES.
G. H. ROBERTSON, CASHIER
CARL H. SCHICKER, ASST. CASHIER

March 1st
1929

American Face Brick Association,
130 North Wells Street,
Chicago, Illinois.

Gentlemen:

Referring to your recent letter regarding loans on face brick residences:

We very much prefer placing insurance mortgage loans on face brick residences because we find that the insurance companies are willing to make larger loans and for longer periods of time on face brick houses.

When a customer approaches us for advice in building a residence, it is our practice to point out to him the many advantages of face brick construction. We refer to permanence, security against fire and the beautiful effects that can be obtained with the many handsome blends of color available in face brick.

We have it on good authority from leading architects and builders that face brick houses can be erected in the newest stylish designs and that face brick houses are easier to sell, owing to their lasting beauty and value. These facts further increase loan values and we mention them to our clients.

In case of necessity, a face brick house can always be resold to advantage.

Yours respectfully,

C. A. Hanner, Pres.
CAH/WMF

*Show this letter
to your banker*

*Send for
Face Brick
plan books*

AMERICAN FACE BRICK ASSOCIATION,
2163 City State Bank Bldg., Chicago, Ill.

If you live in Canada, please write to 26 Queen Street East, Toronto, Ont.

Please send booklets I have checked:

- Up-to-date book on remodeling, free.
- Story of Brick, beautifully illustrated, free.
- Manual of Face Brick Construction, 116 pp., 50c.
- Designs and floor plans for 3 & 4 room houses, 25c. 5 room houses, 25c. 6 room houses, 25c. 7 & 8 room houses, 25c. 5 & 6 room duplexes and double houses, 25c.

Name.....

Address.....



FOUR SUMMERS A YEAR INSTEAD OF FOUR SEASONS

Doctor Johnson said that nobody ever read Robinson Crusoe without wishing it were longer...and everybody feels the same way about Summer...children dream of its arrival and poets deplore its departure...the face of the world is lifted to the sun and the hearts of young and old seem to blossom with the flowers!...outdoors, of course, Summer can never be anything but one season out of four...but indoors, an American Radiator plant makes life a perpetual Summer... keeps the house warm and the family well...lightens a woman's cares and a man's expenses...preserves health, promotes happiness, and caters to the human longing for continually finer living conditions in the home.

Not expensive...in fact...not an expense...but an investment in family welfare and property improvement.

I am interested in...

- receiving particulars of your convenient payment plan by which my home may be heated for less than \$75 a room.
- receiving interesting book with illustrations in color... "Heat and the Span of Life."
- receiving information on the Arco Vacuum Cleaner
The fuel I plan to use is: • Coal • Coke • Oil • Gas

MY NAME IS _____

MY ADDRESS IS _____

CITY _____ STATE _____

AMERICAN RADIATOR COMPANY

40 WEST 40th STREET, NEW YORK • AND ALL PRINCIPAL CITIES

This advertisement is one of many that are being published by the American Radiator Company as their contribution to the far-reaching campaign to "bring America back home."

FOR ADVERTISERS' INDEX SEE NEXT TO LAST PAGE

ACCO No. 8 SASH CHAIN

costs less per window

ACCO No. 8 Sash Chain is the best window suspension material obtainable. It outwears and outlasts. It will not stretch, shrink, fray, tear or rot. It gives many years of trouble-free service, and *costs less to install.*

ACCO No. 8 Sash Chain costs more per foot *but costs less per window* so that the material saving alone more than offsets the difference in cost. There is also a big saving in labor cost.

Material Saving

With cord, there are eight knots per window, which means a waste of four or five feet of material. With ACCO No. 8 Sash Chain simple attachments are used instead of wasteful knots and not one inch of material is wasted.

This means that 100 feet of ACCO No. 8 Sash Chain will hang on an average 2 more windows than cord; seven windows per 100 feet with chain as against 5 windows with cord.

Labor Saving

A coil spring is first slipped into the end link of the chain. The other end of the chain is then fed over the pulley; it drops into the casing of its own weight—no "carpenter's mouse" is needed.

The weight is hooked to the other end of the chain, and the coil spring inserted into the sash, as shown in the photos at the right.

ACCO No. 8 Sash Chain operates over any cord pulley

It is not necessary to install special pulleys. ACCO No. 8 Sash Chain is made to operate perfectly over ordinary cord pulleys. Ask your hardware or builders' supply dealer for ACCO No. 8 Sash Chain.

AMERICAN CHAIN COMPANY, INC.
Bridgeport, Connecticut

*World's Largest Manufacturer of Welded
and Weldless Chains.*



The above illustration shows how ACCO No. 8 Sash Chain is attached to the weight.

The Chain is then laid into the groove of the sash and the coil spring inserted into bore of the sash, as shown at the right.

Both ends of the chain are thus securely and permanently fastened.



Up Go 1-Bag Mixer Standards

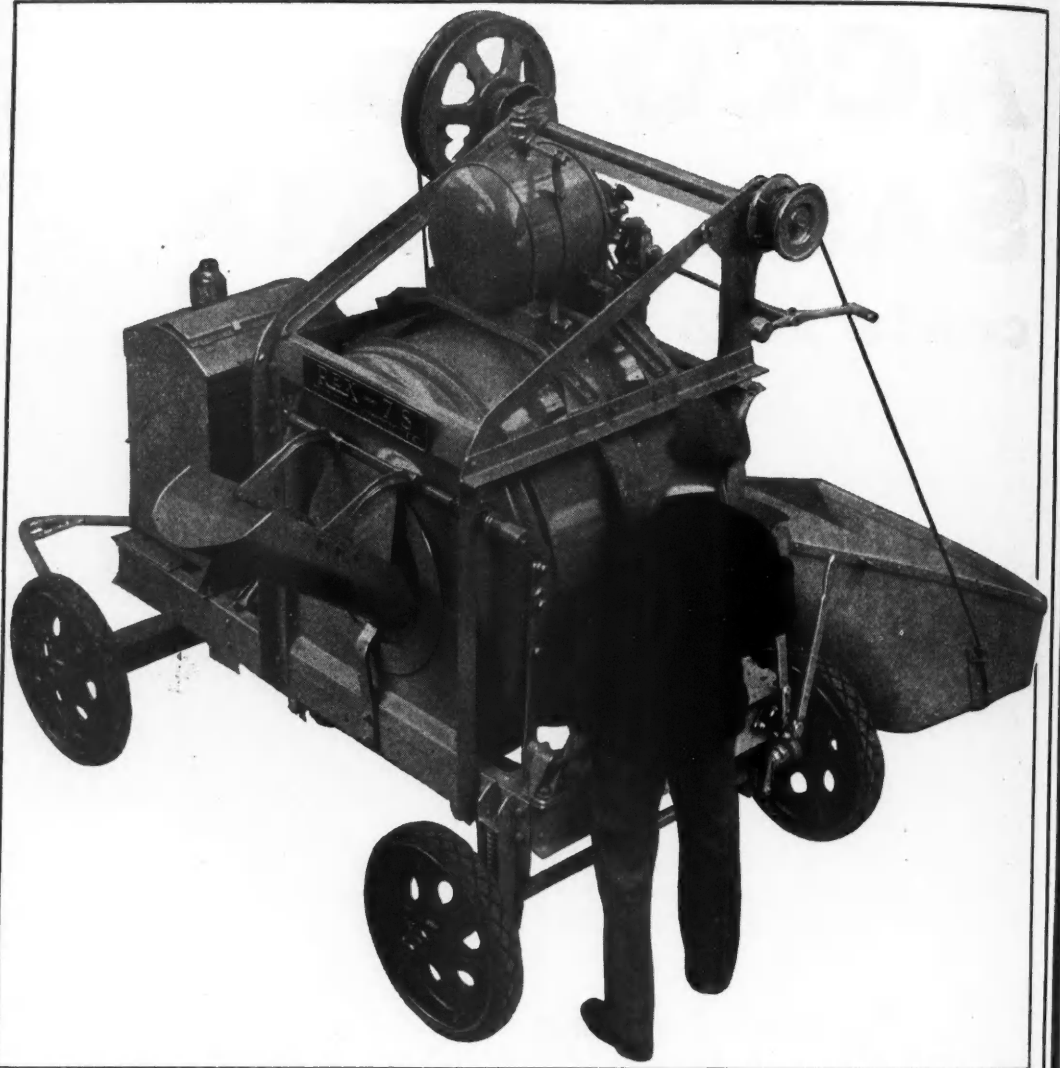

One man end controls—easy to handle—and spring hung axles.

Up Goes the Value of Your Dollar

CHAIN BELT CO.,
721 Park St., Milwaukee, Wis.

Send me Catalogs on the mixers I've checked.

- 1/2-bag tilter
- 1/2- to 1-bag 5-S
- 1-bag 7-S
- 1- to 2-bag 10-S
- 2- to 3-bag 14-S
- 6-bag 28-S
- 12-bag 56-S
- 27-E Paver

Name _____

Address _____

City _____

State _____

To build a radically new 1-bag mixer that is a sweeter, smoother, faster performer than anything in the industry is not enough for Rex.

For Rex insists that this mixer be made available to contractors at prices that actually set new standards for mixer buying dollars.

Broad and complete facilities make a practical reality of this demand that more ordinary manufacturing would consider hopeless.

The result is the New Rex 7-S, a year or more ahead of the design and performance to which you contractors are accustomed—at a price which represents that greatest dollar for dollar value ever offered in the 1-bag class.

CHAIN BELT COMPANY, 721 Park Street, Milwaukee, Wis.

REX MIXERS

(Reg. U. S. Pat. Off.)

FOR ADVERTISERS' INDEX SEE NEXT TO LAST PAGE

Why Blame *the* Carpenter?

DON'T blame the carpenter for the time he takes on a job. He brings to a job a certain amount of experience and a good set of tools. Before he starts he must be a pretty good workman or he wouldn't be on your payroll.

Did you ever stop to think that the result he gets depends on *you*? In other words, what he *does* and the *time* he takes doing it depends a lot on the materials he has to use.

Do you want to prove this? It's very simple. Have the same man install a cheap, poorly constructed lock and then a Corbin lock. What a difference when he is working with Good Hardware—Corbin! No fumbling around. No trying to make screws catch in the edge of a mortise put so near the screw hole that the wood won't hold. No filing. No time wasted experimenting.

Corbin locks are built to be installed. Naturally we want to do everything at our end to save time on your end. Which is just common sense, isn't it? Yes, it takes us a little longer—but nothing like the time it would take your carpenter if we did not take this extra care.

Which explains why Corbin locks may cost a little more to buy but a whole lot less to install. And this goes for the whole Corbin line. Contracting builders who are handling big developments watch every cent of expense. They must if they are going to profit.

But they save money scientifically. They know how labor costs vary. So they concentrate on keeping these costs down by using material that saves installation time. That is why Corbin Hardware is being specified throughout for many of the country's biggest building projects. Corbin bought on a price basis? You bet your life it is! And it must be

the *best* buy to close contract after contract, year after year, from the same builders.

So don't blame the carpenter when he takes an extra forty cents worth of your time installing a lock you saved (?) ten cents on.

Bolts! Butts! Locks! Catches! Hinges! Turns! These are the pieces the carpenter has to attach and make work. And how Corbin helps him do his job right and quickly! No coaxing. No geeing them around. No makeshift, patch-work jobs. Not with Corbin, because Corbin quality means easy instal-

lations, just as much as it means long life and permanent satisfaction.

Competition is pretty stiff these days. So it's a fine thing to know that Corbin actually will save you money.

And more important, it's a valuable name to remember, because a Corbin equipped house adds to a builder's reputation and *you* know how valuable that is.

Good Buildings Deserve Good Hardware

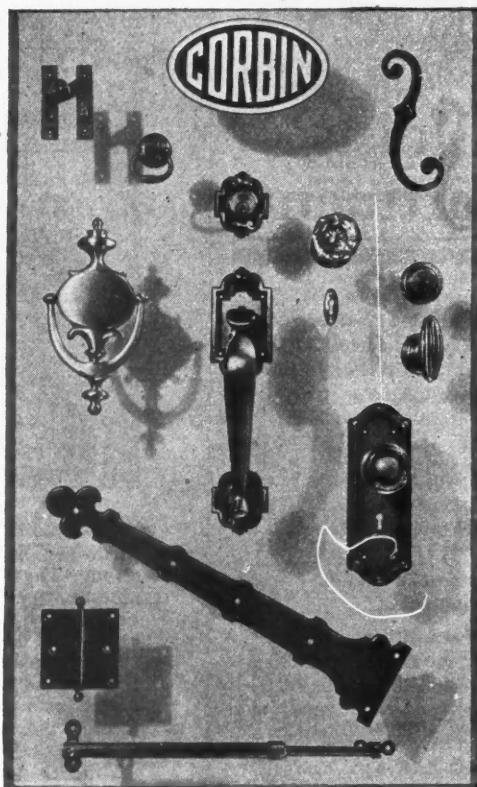

P. & F. CORBIN SINCE 1849 NEW BRITAIN CONNECTICUT

The American Hardware Corporation, Successor

New York

Chicago

Philadelphia

WHEN WRITING ADVERTISERS PLEASE MENTION THE AMERICAN BUILDER



Why Nailer Joists In This Fine Apartment?

ABRAM ROSEN, far-sighted real estate operator of Rochester, N.Y., expected to pay a premium for the use of Massillon Nailer Joists in his modern \$500,000 Roosevelt Apartments at Utica, N. Y. The Utica Code permitted wood joists, then why a premium for Nailer Joists?

To eliminate warping and unsightly shrinkage cracks.

To secure the strength and permanence of steel.

To provide a fire resistance that is firesafe for this occupancy.

The ease and simplicity of erecting these steel joists—"Put 'em up, nail down the floor"—resulted in savings in labor that made the completed cost approach that of wood.

You will like these steel joists with wood nailing strip attached to the top chord. See the nearest Massillon representative or send us your plans for quotation.

THE MACOMBER STEEL COMPANY

909 Belden Avenue,
Canton, Ohio



MASSILLON NAILER JOISTS

Massillon Products are manufactured and distributed in Canada by the Sarnia Bridge Co., Ltd., Sarnia, Ont.

FOR ADVERTISERS' INDEX SEE NEXT TO LAST PAGE

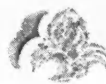
 A dingy house
 becomes a cheerful home
*when there's Wall-Tex
 on the walls*



DECORATORS AND BUILDERS are fast learning that Wall-Tex has many fine selling points. That it is strong. That the surface is water-proof and that spots may be wiped off with a cloth. That, because of these two facts, it is as bright and clean after ten years' service as the day it was put on the walls. Furthermore, that new patterns, beautiful designs, are being added to the list every year. Finally, that Wall-Tex is thoroughly economical and pleases their clientele.

Wall-Tex is obtainable in many designs. There are bright gay patterns for children's rooms. There are distinctive wall coverings for dining-rooms. Somber motifs for imposing hallways and many unusual designs for bedrooms, living-rooms and formal drawing-rooms. Wall-Tex is prepared in white, dull, and glossy finishes. It acts as a splendid base for modern finishes and can be utilized for the most bizarre, as well as the most conventional, interior schemes.

Architects, builders, and decorators: Write your name and address on the margin of this page and send for samples, full information and name of nearest Wall-Tex distributor.

THE COLUMBUS-UNION OIL CLOTH CO.
Dept. D-6 Columbus, Ohio



From PAUL REVERE'S HOUSE - Comes This Staunch Old Nail



The nail pictured above has seen more than two hundred years of service in the historic house of Paul Revere at Canton, Mass. Notice that this nail has four sides—four gripping surfaces. That's the secret of its remarkable holding power!

Today, Reading Cut Nails embody the same ideals of craftsmanship and endurance. They are wedge-shaped for a permanent grip. Generations of experience have proved their superior durability and economy. And there's a size of Reading Cut Nail for practically every building need.

Write for our new illustrated catalog—get the profitable facts about Reading Cut Nails.

READING IRON COMPANY

Reading, Pennsylvania

- | | | | |
|-----------|-------------|---------------|--------------|
| Atlanta | Cincinnati | Pittsburgh | Fort Worth |
| Baltimore | Detroit | Cleveland | Seattle |
| Boston | Houston | St. Louis | Philadelphia |
| Buffalo | Los Angeles | Tulsa | New Orleans |
| Chicago | New York | San Francisco | Kansas City |

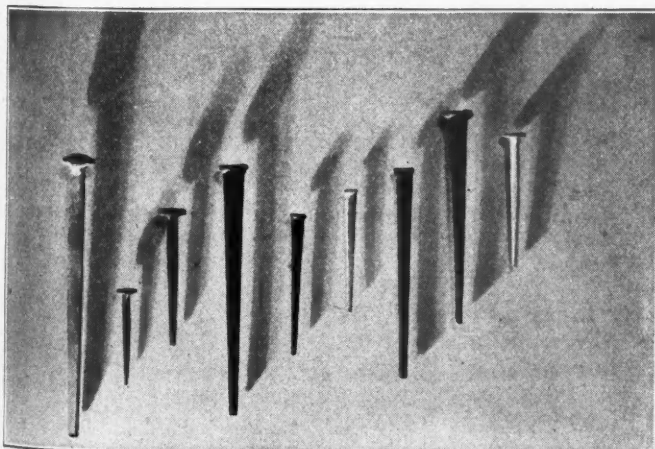

READING CUT NAILS

WHEN WRITING ADVERTISERS PLEASE MENTION THE AMERICAN BUILDER

A Frantic Call For Men

Who Can Read Blue-Prints

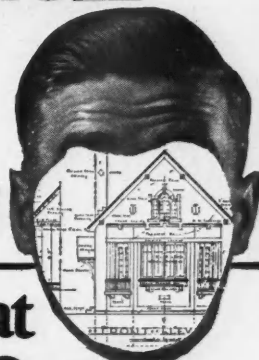

..and Run Jobs at \$4,000 to \$12,000 A YEAR

See how easy it now is for any man to get ahead in the building game. Nowhere else does such simple training count for so much. Nowhere else are there so many thousands of openings as there are with contractors, builders and real estate firms, who are constantly calling for practical men who can read blue prints. Seven billion dollars will be spent this year for building. Trained men are at a premium in this gigantic industry. Untold thousands are needed at steady salaries far above the wage scale.

90 DAYS' TRAINING PUTS YOU ON THE WAY TO A BIG-PAY BLUE PRINT JOB

NO longer is it necessary for building tradesmen to spend years learning the "mysteries" of plan reading. For now you can get blue print training in three months that has taken others years to "pick up on the job." We train you at home by the fascinating "blue-print method" with lessons that are as easy to read as your newspaper. You do not need more than a common school education.

Simple and Easy as A. B. C.

There is no hard, grinding study—the whole course is just like playing some interesting new game. Plans and lessons come to you from this old and approved school for men in the building trades. This is the kind of training that puts men quickly into \$4,000 to \$12,000 a year jobs and into contracting businesses of their own. You learn from actual working plans—to estimate all the costs—and to supervise the construction of a building.

A Big-Pay Job or Your Own Business

With this quick easy training, the building field is wide open to building tradesmen who want to become foremen and superintendents—or to get into business for themselves. Burgess, Ill., stepped into a foremanship at a 200% increase in salary. Marchand, La., writes, "My salary is now increased 196%." After finishing his training, Baker, Ohio, made \$3,800 clear profit in three months as a contractor.

If you really want more money—if you hope to have a business of your own—if you want quick advancement in the building trades—decide now to get this training you must have for a real success. Simply mail the coupon below. It will bring real blue prints and a fascinating book, "How to Read Blue Prints"—ABSOLUTELY FREE. See what amazing opportunities are open to you in this billion dollar field. But don't delay!

IF YOU LIVE NEARBY
Visit our big day or evening school attended by over 1,000 Builders. You can get the same training at home by mail—same plans, lessons and instructors. Your spare time is enough.

**FREE
Blue Prints
and Book**



CHICAGO TECHNICAL SCHOOL FOR BUILDERS

Dept. G-122,
Chicago Tech Building,
118 E. 26th St., Chicago, Ill.

Chicago Technical School for Builders,
Dept. G-122, Chicago Tech Building,
118 E. 26th St., Chicago, Ill.

Send me free blue prints and your book without obligation. It is understood that I may keep these without cost to me. It is also understood that no salesman will call on me.

Name.....
Address.....
Town..... State.....

HERE'S ANOTHER OF MORE THAN 2500 USERS OF THE CARTER DOOR SET

The Steuben Building, Chicago, is one of the most modern buildings in the country—and Carter Tools played a prominent part in fitting and hanging the doors—*better—easier—faster—and on time.*

The man at the left is cutting for the butts—he makes no mistakes the CARTER WAY—every door hangs perfect.

The man in the center is planing to fit—fast and smooth, without effort.

The man at the right is just about to mortise for the lock—another minute and he'll be on the next door.

IT COSTS LITTLE TO BE MODERN IT SAVES MUCH

The Plane, complete with Cutter and Grinding attachment \$118.00
C. O. D. or check with order price, \$112.00

The Hinge Butt Router and Templet (For doors and jambs) \$105.00
C. O. D. or check with order price, \$98.00

The Lock Mortiser (2 cutters) \$105.00
C. O. D. or check with order price, \$98.00

All Prices F. O. B. Factory.

YOU PAY FOR THE DOOR SET ANYWAY—
WHY NOT USE IT?

Full Description in Folder "A"

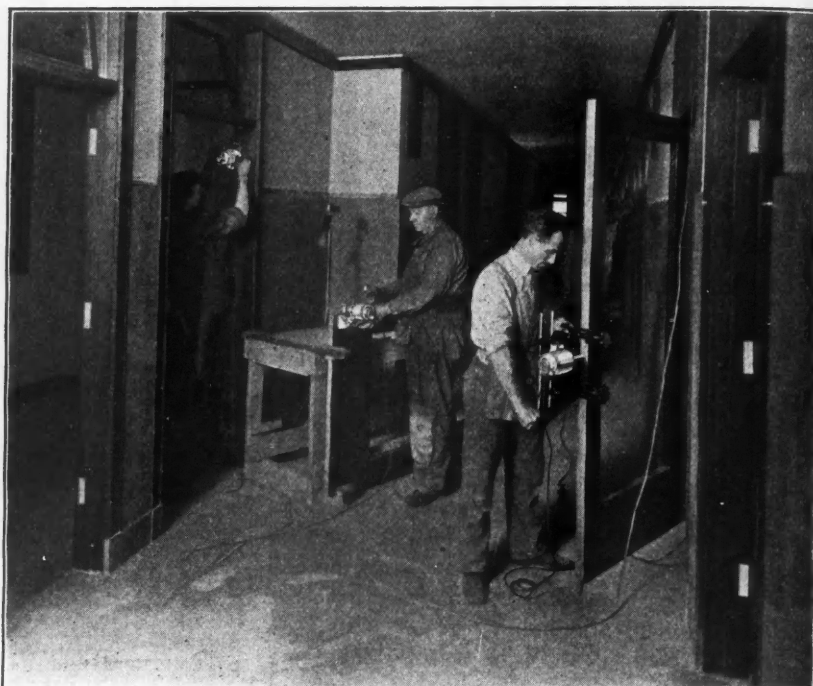

COURTESY—W. L. ANDERSON—CHICAGO, ILL.

THE R. L. CARTER CO. Inc. 1303 CHESTNUT STREET, PHOENIX, N. Y.

The National "Little Brute"

is the biggest value ever offered in floor surfacing equipment.

Simplicity of design—plus mass production—makes possible this unheard of low price.

Built on the same plan as the big Nationals, the "LITTLE BRUTE" is a high speed, big production machine, equipped with 7-inch high-speed sanding drum—does as much work as five hand scrapers.

Lowest in Price Lightest in Weight

The "LITTLE BRUTE" will remove ten coats of varnish from floors, without neutralizers. It's dustless all the time. The separate vacuum dust collector motor always operates at maximum speed. Suction never fails even if main motor is slowed down by heavy pull.

A Fast Powerful Floor Surfacer for Only

\$147.50

The National Little Brute

A woman can run it. A man can carry it. But it's sturdy and strong. Guaranteed for five years.

Weights only 115 pounds

Descriptive literature on the "Little Brute" and our new booklet, *Floor Finishing Solved*, sent on request.

The National Sanding Machine Company
4567 Diversey Ave., Chicago, Ill.

COMPARE PRICES

You can buy almost two "Little Brutes" for the price of any other Floor Surfacer.



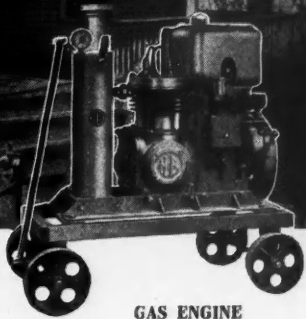

GAS ENGINE

A New Source of EXTRA PROFIT

No longer need you pay out profits to outside painters. One man with an HB Spray outfit enables you to do the work of 4 to 5 brush painters—you keep all the profit. HB does the highest quality work, both inside or out.

The first one or two jobs will pay for the outfit from additional profits.

Only \$25 Monthly
—easily paid out of increased profits



ELECTRIC

HB costs less because built in complete in HB factories, not assembled—that's why hundreds of painters and building contractors say "HB is the outstanding value in the paint spray field today."

Ball bearing motor, spiral drive, gives a really portable outfit and eliminates noisy, breaking belts.

30 Days Trial
—at our risk on your job

We welcome comparative tests. That's why you can have HB on 30 Days' Trial. We know what your choice will be when you compare HB's quality and HB's performance.

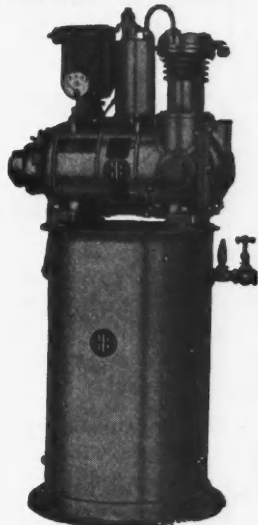

ELECTRIC STATIONARY

HOBART BROS.
Box V69 Troy, Ohio

Tear Off and Mail Today

HOBART BROS., Box V69, Troy, Ohio
Without obligation please send me complete details on the paint spray equipment I've checked below, together with liberal Trial offer and easy monthly terms.

- Gas Engine Paint Spray
- Electric Drive Paint Spray

Name.....
Address.....



Door Knobs of Bakelite Molded do not get shabby

THROUGH years of use, the color and finish of Bakelite Molded door knobs remain unchanged. There is neither lacquer nor plating to wear off. Polishing is never required. With knob and shank molded in one piece, they are very strong, and even a sharp blow cannot separate the knob from the shank.

Made in walnut brown, and black it is possible to match almost any trim finish with Bakelite Molded door knobs. Their appearance always attracts favorable comment.

Notwithstanding their many advantages, Bakelite Molded door knobs are inexpensive. They cost a little more than hollow metal, but less than glass. It will pay you to consider Bakelite Molded door knobs for any houses you are building—for their use is an indication of superior construction and equipment. These knobs are made by the National Brass Co., Grand Rapids, Mich., and may be obtained through your regular supply house.

BAKELITE CORPORATION
247 Park Avenue . . New York, N. Y.
Chicago Office . . . 635 W. 22nd St.
BAKELITE CORP. OF CANADA, LIMITED
163 Dufferin Street . . Toronto, Ontario

BAKELITE

THE MATERIAL OF  A THOUSAND USES

The registered Trade Mark and Symbol shown above may be used only on products made from material manufactured by Bakelite Corporation. Under its control. It is the registered sign for Bakelite or Bakeloid. In connection with the name number of process and former use of Bakelite Corporation's products.

The Master Builder says
 "Play Safe~
 Buy a
MASTER;
 It's the Best
 Machine on
 the Market"



MASTER WOODWORKER

Builders long in the business know that the "Master" always has been and still is the world's leading woodworking machine. For 13 years it has been constantly improved; and now the New Master, with its many new features, stands still farther in the lead. It's big, strong, sturdy and reliable. It will give you years and years of dependable, trouble-free service. Rips, crosscuts, bevel rips, dadoes, routs, bores and does a dozen other operations with wonderful speed and accuracy. It's a remarkable time and labor saver. Its cost is negligible when you consider the added profits it brings. Made by an old, reliable company who has built woodworking machines exclusively for more than a dozen years. Investigate the Master thoroughly and you'll buy no other.

*Gasoline or
Electric Drive.*

6 Models



*Overhead
crosscut;
underslung
rip.*

**MAIL
COUPON**

MASTER WOODWORKER
 Congress and Brush Sts.
 Detroit, Mich.

(D)

Send me new catalog, prices and easy payment plan.

NAME.....

ADDRESS.....

*You can use
the
cheaper woods
with*

Stronach Nails
 NON-SPLITTING, SURE HOLDING



The use of many of the low grades of woods—desirable except for their readiness to split—is made possible by non-splitting Stronach Nails. This economy is especially important in packing and in box making.

The splitting of redwood, fir, yellow pine, chestnut, oak, white poplar, cypress, cedar and other woods is reduced to a minimum through the use of Stronach Nails. *All woods give greater satisfaction when Stronachs are used.*

We have assisted in solving many wood problems involving splitting, loosening, material costs and labor costs. Our services are at your disposal. Write for further information.

Non-Splitting

Sure-Holding

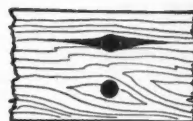

The triangular end cuts the wood fibers, punching a hole ahead of the nail body. There is no splitting as with the diamond pointed nail, which wedges the fibers apart.

The hole punched is smaller than the nail body, giving the wood a tight grip *all around* the nail. This increases holding power tremendously.

STRONACH NAIL COMPANY

2008 Union National Bank Bldg.

Pittsburgh, Pa.



It's O.K. Because it's Portable

**HEIGHT
CHANGED
AT WILL**

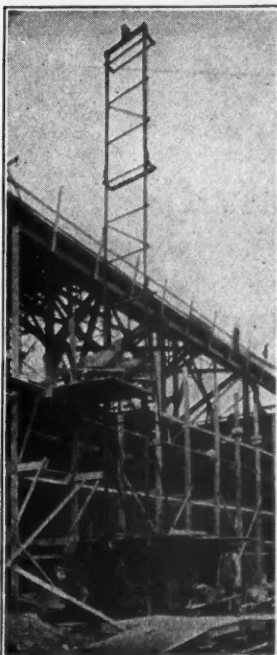

We manufacture a complete line of Hoisting Machinery and Air Compressors, Gasoline Power, Electric Power, Belt Power. Consult us before you buy.



**LET O-K
GIVE YOU
A LIFT**

An O. K. Portable Elevator is the best investment you can make in contractors' equipment. It will save you more time, labor and material than any other piece of equipment on the market. The O. K. is especially designed for hoisting materials in wheelbarrows or concrete buggies. It is all steel construction, electric welded, equipped with single drum O. K. Hoist and 8 or 12 H. P. gasoline engine. It is delivered to you complete, ready to set up and run. Nothing else to buy.

Write for catalog containing full information and specifications. The coupon is for your convenience.

O. K. Clutch & Machinery Co.
COLUMBIA, PENNSYLVANIA

O. K. CLUTCH & MACHINERY CO.
Columbia, Pa.

Please send your latest catalogs of equipment as checked.

PORTABLE ELEVATORS HOISTS PORTABLE AIR COMPRESSORS

Name.....
Address..... State.....
City.....

MULTI-VIDER

Multiplies—Divides

*Instantly and
Accurately*

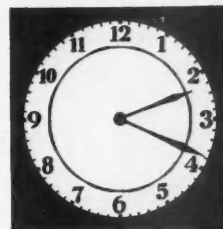

As easy to read as a clock

HOW many times each day do you have to figure unit costs, rates, yardage, percentages and many other common mathematical qualities?

The Multi-Vider does your figuring *instantly*. It is a pocket rapid-calculator and automatic pencil combined. All you do is set the accurate bakelite scale—and the answer is before you, as easy to read as the hands of a clock. You eliminate tedious figuring, and save many dollars' worth of valuable time.

And the Multi-Vider sets the answer down, as well. It's as fine an automatic pencil as money can buy. Makes a unique, useful gift for engineers, students or any business man.

Act today, to equip yourself with one of the practical business time-savers. The price is reasonable — \$10.00 for the Executive model finished with 14 kt. gold-filled metal parts—\$5.00 for the Standard model with silver-filled metal parts. If your dealer can't supply you, mail the coupon direct to us.

RUXTON MULTI-VIDER CORPORATION
4057 Graybar Building, New York City

I enclose \$..... Please send me.....
Executive Multi-Viders at \$10.00 each (.....Standard models at \$5.00 each).

Name.....
Address.....



This Mark
on a frame
is recognized as an emblem of supreme quality

To the thousands upon thousands of builders who during the past thirty years have learned that there is practically no limit to the perfect service given by Grand Rapids pulleys, there is nothing that so definitely establishes the quality of a frame as the above insignia—a potent, powerful selling factor.

Grand Rapids Hardware pulleys are guaranteed trouble-proof. Perfectly uniform, they always fit the mortise. They never break. Furnished in Ball Bearing, Cone Bearing, Axle Bearing types and made of heavy wrought steel in various weatherproof finishes.

Catalog, samples and prices gladly furnished on request.

Grand Rapids Hardware Co.
 556 Eleventh St.
 Grand Rapids, Michigan



KIMBALL STRAIGHT LINE DRIVE ELEVATORS

**CHIEFTAIN---A
 New Eppley Hotel
 at Council Bluffs,
 Iowa**

*Equipped with Kimball
 Elevators*



Passenger Elevators

In the office building, where the absolute certainty of elevator service is an essential, it is interesting to note that the type of elevator construction is pointing towards the Kimball Straight Line Drive Elevator Machine, as the most practical solution for the builder who figures the upkeep, as well as initial cost.

The simplicity of Kimball Straight Line Drive construction, its fewer parts to get out of order, forms a sane contrast to older style double unit type, still much in use.

If you are interested in Kimball efficient elevator installations you can secure valuable information and literature on the Kimball Straight Line Drive Elevators by writing to this address:



KIMBALL BROS. CO.
 COUNCIL BLUFFS IOWA

989-97 Ninth Street Council Bluffs, Iowa

Elevator Builders for 45 Years

PEERLESS

Building Specialties

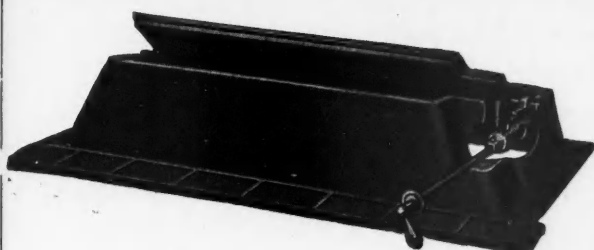

THE PEERLESS FIREPLACE DAMPER

Its Absence May Cause A Smoky Fireplace

In spite of the architect's and builder's efforts fireplaces are frequently more ornamental than useful. Contractors are not usually fireplace experts and with all the many possibilities of going wrong in building the fireplace throat the builder should take every precaution to insure correct construction. The use of a Peerless Fireplace Damper automatically gives the correct width, height and taper to the throat and permits draft control which is essential for an even burning fire. When the fireplace is not in use the closed damper door keeps out falling soot, rain and insects. A fireplace necessity.

Other Peerless Home Conveniences

- COAL WINDOWS ASH DUMPS
 ASH PIT DOORS
 PACKAGE and GARBAGE RECEIVERS

PEERLESS MFG. CO.,
 14th & Ormsby 6-29
 Louisville, Ky.

Kindly Check

- Contractor Architect
 Home Owner Dealer

Please send Peerless Fireplace Damper Information.
 Other Building Specialties.

Name.....
 Address.....
 Town..... State.....

You can *guarantee* real heating comfort-



with Thrush System!

DURING many months of the year, home comfort and heating comfort are synonymous. People who buy the homes you build can be comfortable—can be satisfied boosters for your service—only when the heating plant provides *uniform, healthful temperatures* with little attention and at a reasonable cost for fuel.

By installing Thrush System of Hot Water Heating in every home you build, you can assure the *enthusiastic, boosting, good-will* of every purchaser—and that increases your business.

H. A. THRUSH & COMPANY
 PERU, INDIANA



H. A. THRUSH & CO.,
 Dept. B, Peru, Indiana. _____ 19____
 Please send me your booklet "Which Heating Plant for My Home?" I am interested.

Name.....
 Address.....
 My Htg. Contr.....



. . . Durundum Floor Paper Keeps Pace with construction schedules

MODERN construction moves fast, and the floor surfer of today has to get his job done and move out for the next man just as all other contractors do. His abrasive paper determines his success in meeting his schedule. To finish up on time he requires the fastest cutting paper; to have his job pass inspection, he must use a fine finishing paper; and to make his profit, he

needs an economical high production paper. Behr-Manning Durundum Paper, as thousands of floor surfacers have found, combines all these qualities. Its rugged electric furnace grain is the fastest cutting abrasive obtainable. The careful grading of the grain insures an extremely fine finishing paper, and this, combined with the tough paper backing, gives it a long production life.

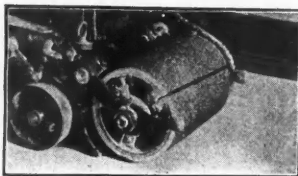

**BEHR-MANNING
TROY . NEW YORK**

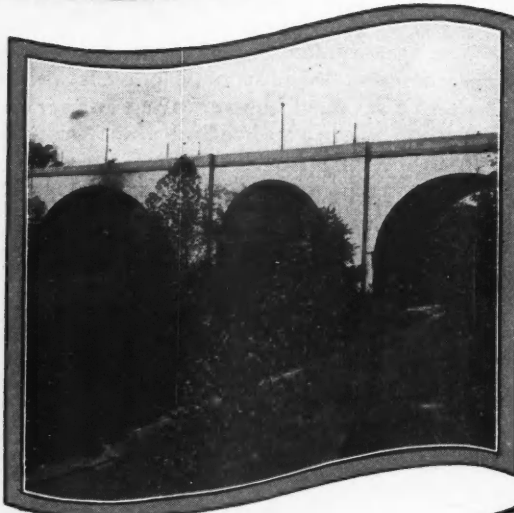

View taken late in 1928 of Edmondson Avenue Bridge, Baltimore, Md.

The test of time

The Edmondson Avenue Bridge of Baltimore, Md., was built in 1906. 10,000 barrels of ALPHA CEMENT of standard quality used. The accompanying view shows its fine condition after 23 years of service.

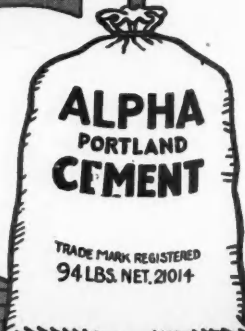

Alpha Portland Cement Company

- Baltimore
- Battle Creek, Mich.
- Birmingham, Ala.
- Boston
- Chicago
- Easton, Pa.
- Ironton, Ohio
- New York
- Philadelphia
- Pittsburgh
- St. Louis

use **ALPHA** cement

NEW! A Complete Planing Mill

Brings you extra profits and speeds up your shop work

Make more money by turning out your own doors, windows, trim, etc., the WAY you want them, WHEN you want them. Get more contracts by bidding low and giving quick service. You can do it with this new, practical device.



Ball Bearing Throughout

The Electric Carpenter

Runs from any Light Socket

7

Machines in One

- 8" Circular Saw
- 14" Band Saw
- 36" Lathe, 10" Swing
- 4" Jointer
- 1/2" Hollow Chisel Mortiser
- Reversible Shaper Sander

Designed expressly to meet today's demand for speed, accuracy, and economy. Miter, panels, routs, dados, rabbets, bevels, mortises, shapes, etc. Does 35 woodworking operations. Takes little floor space. Rugged cast-iron frame; no warping, twisting or vibration. Handles heavy work rapidly. Direct drive. Frictionless. NOT a toy. Weight 520 pounds.

Low Price!

Most devices in this field cost at least \$100 more. Easy terms if you desire. A journeyman can build his own business in spare time with this machine.

MAIL THIS COUPON TODAY →

We also make a complete line of single purpose machines.

THE WOODWORKING MACHINERY CO., INC.
250 N. Eleventh St., Philadelphia, Pa.

Send folder describing The Electric Carpenter and telling how it will add to my profits. No obligation, of course.

Name
Address



Join the Crowd...

- Costs Less
- No More Weights
- No More Pulleys
- No More Cords to Break
- No More Spring Bolts

Over 10,000 Contractors and Builders save 2/3 of Window Costs They Sent 50c for a Sample pair of the THE AUSTRAL SASH SUSTAINER

Send 50c and this Coupon for Sample

AUSTRAL WINDOW CO., 101 Park Ave., New York

Gentlemen: Please send me a sample pair of AUSTRAL SASH SUSTAINERS, for which I am enclosing fifty cents (this covers actual production cost, postage and handling).

Name _____ Company _____
Address _____

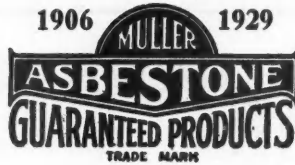

ASBESTONE *Flooring*

for Lasting Service *Plus* Distinctive Beauty

Hygienic, Fireproof, Easy to the Tread

ASBESTONE plastic magnesia flooring—durable, beautiful, comfortable, economical, is decidedly appropriate for hospitals, schools, churches, office buildings, hotels, apartments and residences.

ASBESTONE affords a jointless, smooth, sanitary surface that is easy to the tread, non-slippery, and noiseless, giving maximum comfort. First cost is moderate, the upkeep practically nil. It will withstand years of severe wear. ASBESTONE flooring preserves its fresh new appearance for years; it is fire-proof and waterproof; easy to clean and may be waxed and polished. Easily applied over any old or new sub-floors, at any angle, over and around any irregularities.

Descriptive literature upon request

FRANKLYN R. MULLER, INC.

ESTABLISHED
1906

Manufacturers of Asbestone Flooring and Sana-bestos Tiles

206 MADISON STREET, WAUKEGAN, ILLINOIS

"THE BEST MODERATE PRICED FLOORING KNOWN TO SCIENCE"

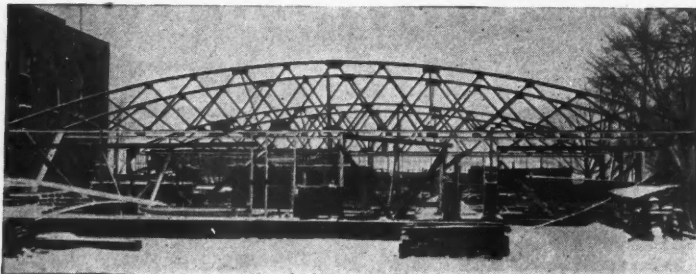
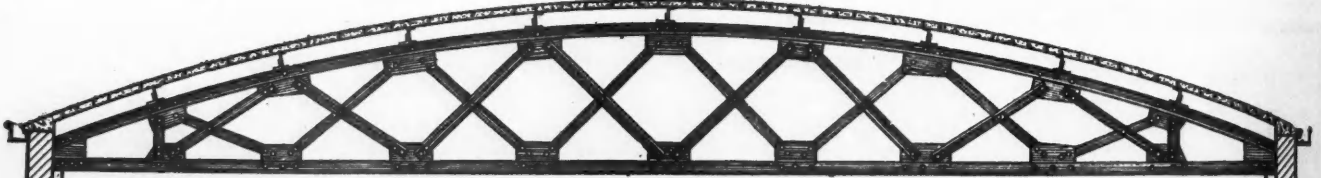

STANDARDIZED BOWSTRING TRUSSES

STRENGTH, economy, appearance—these are some of the reasons why International Standardized Bowstring Trusses have won many jobs for aggressive contractors all over the country. When you use this construction, you can offer, (1) maximum economy without sacrifice of strength, (2) graceful appearance, (3) a great saving in wall and roof materials, (4) easy erection, (5) superior lighting and ventilating possibilities, (6) minimum fire risk, (7) highest quality and lowest ultimate cost. The International Engineering Department will be glad to cooperate with you in designing plans and figuring estimates. Just write us the details of your construction problems and we'll work closely with you to help you land those profitable contracts in which International Steel is used. There is no obligation for this service, of course. Ask for our new Steel Catalog. It is free.

PRODUCTS of INTERNATIONAL
Store Fronts - Steel Columns
Steel Ceilings - Skylights
Steel Windows
Steel Girders - Steel Trusses

**INTERNATIONAL STEEL
& IRON COMPANY**
DEPARTMENT 18
EVANSVILLE INDIANA

PRODUCTS of INTERNATIONAL
Sidewalk Lights - Coal Chutes
Public Garages - Roof Ventilators
Airplane Hangars
—and many more listed in our Catalog!

**Now--59
Contractors
in Cincinnati
Use
WEATHERBEST**



Above—U. C. Ewing, Arch., and Builder, 24-inch WEATHERBEST Hand Rived Shakes in Brown and Black variegations on roof.

Bottom — Myers Y. Cooper, Builder; Ward Franklin, Arch. WEATHERBEST 24-inch Colonial White side-walls. Roof variegated shades of green.

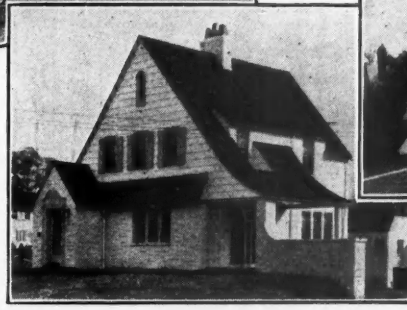

Above—W. Cordes & Sons, Architects and Builders. Upper sidewalls 18" Thatch Effect WEATHERBEST Colonial White. Roof variegated shades, Brown to Gray, laid staggered.

WEATHERBEST Stained Shingles have earned their leadership in the Cincinnati market through the strict adherence of the seventeen year old WEATHERBEST manufacturing policy. "Not to cheapen materials or process to meet price competition."

There is much being said today about staining shingles. WEATHERBEST process has kept in advance of present day practice, not only through laboratory test of staining, but through im-

proving processes and careful inspection.

Our Service Department is rendering valuable assistance with special color schemes and suggestions to builders. Not only in the use of different WEATHERBEST treatments, but in the pleasing variety of effects in groups of homes with a repetition of designs. Send for Color Chart and Portfolio of Photogravures in full colors showing a wide range of WEATHERBEST Stained Shingles for sidewalls and roofs. WEATHERBEST STAINED SHINGLE Co., Inc., 151 Main St., North Tonawanda, N. Y. Western Plant — St. Paul, Minn. Distributing Warehouses in Leading Centers.



Another Triumph In a Portable Electric Saw



The Crowe Safety Beveling Saw cuts angles with the speed of cross-cuts—ten times as fast as an ordinary saw, and twice as fast as any other portable saw on the market.

Saw is operated by a trigger switch and is absolutely foolproof. Just rest the front guide flat on the material to be cut, press the trigger, and feed the blade into the lumber. The safety guard automatically returns and locks in position.

With ordinary care, a Crowe Safety Beveling Saw can be used almost continuously for months without servicing. If a movable part does wear, it can be easily replaced and at low cost.

Body of saw is aluminum alloy, blades are standard, and power is supplied by a G.E. motor plugged into a 110 or 220-volt electric socket. For trimming flooring, making window frames, cutting joints, studding, sills, frames or rafters at an angle, it is the biggest time saver on the market.

For interesting details, clip the coupon and mail it today.

"CROWE SAFETY SAW"
CUTS THE COST

Standard Blades Used
Made In Four Sizes

Crowe Manufacturing Corporation
317-321 Sycamore Street
CINCINNATI, OHIO, U. S. A.
Dealers in all principal cities

Crowe Mfg. Corp.
Dept. A, Cincinnati, Ohio

Gentlemen:
I am interested in a saw of this type. Send further information.

Name

Address

City....., State.....

**Never a Drop of Water in This Basement
- It's Waterproofed with "ANTI-HYDRO"**

The concrete basement in this building had to be absolutely dry because it contains a restaurant, also the equipment and storage rooms for the theater. In order to eliminate the slightest possibility of dampness the entire basement was waterproofed with a plaster coat mixed with "ANTI-HYDRO." It is permanently dry and free from the slightest suggestion of moisture.

You will find "ANTI-HYDRO" extremely easy to use. Being a liquid integral compound it mixes easily with water without the aid of skilled labor. It waterproofs, hardens and dustproofs concrete in one operation—accelerates the set of concrete, increases its strength and actually saves you money.

For twenty-five years "ANTI-HYDRO" has proved its merit on every type of concrete work. Results are *guaranteed permanent*. Use it on your next job.

ANTI-HYDRO WATERPROOFING &

265-295 Badger Ave.

Newark, N. J.



APOLLO THEATRE, INDIANAPOLIS, IND.



VONNEGUT, BOHN & MUELLER, ARCHTS.
BEDFORD STONE & CONSTR. CO., CONTRS.

And **PRESTO...** *Your Screen*
Appears like Magic!



That's the beauty of the new Higgin Rolling Screens. They're permanently in place, concealed in the top of the window frame until you want them. Simply pull them down or push them up—they work like magic. And every opening is fully screened, from top to bottom!

The new Higgin Rolling Screen combines ultra-convenience with practical construction **plus** durability. All exposed parts are of copper-coated steel with statuary bronze finish. The mesh is Anaconda bronze cloth—almost invisible.

It is as outstanding in its class as Higgin **Sliding** and **Hinged** Screens are in theirs!

What a selling point for the homes you build. Mail the coupon now for our illustrated booklet and complete information.

THE HIGGIN MANUFACTURING COMPANY
SCREEN SPECIALISTS SINCE 1893

Home Office
Washington Avenue
NEWPORT, KY.

Branches at:
Kansas City, Mo. Toronto, Ont.

HIGGIN
ALL METAL
SCREENS

The Higgin Mfg. Co.
502 Washington Ave.
Newport, Ky.

Please send complete information
regarding your new rolling screen.

Name _____

Street _____

City _____ State _____

Now offered AT LOWEST PRICE



faster handling ... lower cost per batch

HERE'S Real Value! A Trailer Tilter with Speed, Capacity and All-Steel Construction at still lower Prices. Never before has Leach offered a Mixer at so low a price.

ALL-STEEL—LONGER LIFE

Besides, this Trailer Tilter never before had the features of this model. It has the famous Leach All-Steel Construction, which means longer years of service, it has large drum opening; the arrangement of blades makes for faster, a more thorough mixing action.

This Trailer can now be had at a surprisingly low price. If you want Mixer value, here it is! Send back Coupon today.

LEACH COMPANY, Oshkosh, Wis.

LEACH MIXERS

LEACH COMPANY, 10 So. Main Street, Oshkosh, Wis. Kindly send me details and prices covering your Tilter Mixers.

Name Address

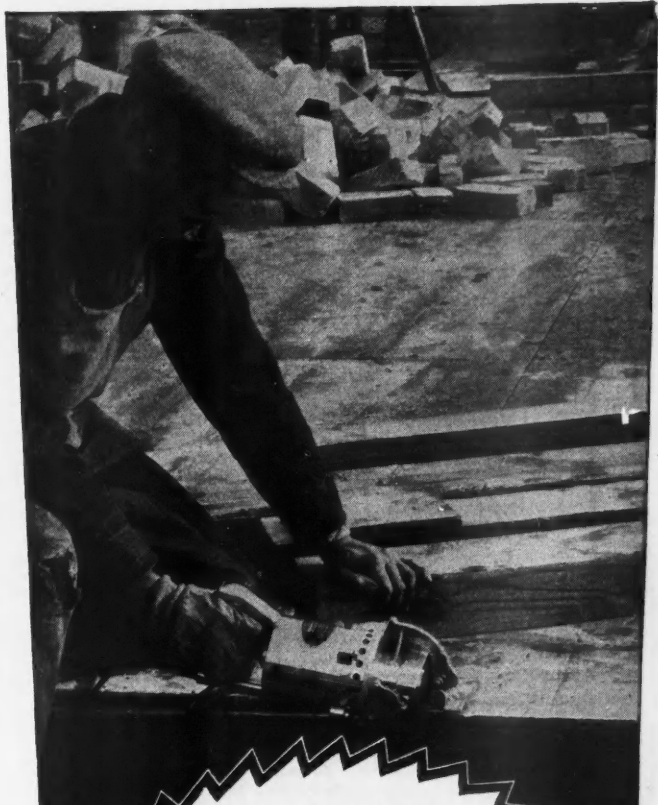

HERE

is SKILSAW, the original electric hand saw that has proven itself to be a profitable investment to thousands of contractors and carpenters who demand speed in sawing and want to lower construction costs.

This 10 lb., 1/2 H.P., portable saw will do all your sawing -- and do it 10 times faster than the old fashioned hand saw. That's why SKILSAW saves time and money, every time you put the blade to the wood -- and it is a muscle saver.

The SKILSAW, illustrated above, cuts 2" dressed lumber -- ZIP -- just like that -- in a matter of seconds.

There are three other sizes.

Let us show you, free of charge, what any model SKILSAW can do right on your own work.

Just fill out the coupon below and mail it to us.

Show me how SKILSAW will save me time and money in sawing.

Name

Address

City State

SKILSAW INC Dept. F.

3310 Elston Ave., CHICAGO, ILL.

BOYLE'S BAYONNE

ready to lay
Roof and Deck Cloth



The ideal covering for Porch Floors, Decks or Piazzas, Sun Parlors, etc.

Waterproof
Weatherproof
Durable
Flexible

Lays flat
Stays flat

Ready to lay—Requires no white lead bedding; will not buckle, crack or peel.

Write today for our Sample Booklet "P."



JOHN BOYLE & CO. Inc.
Established 1860

112-114 Duane St., New York
1317-1319 Pine St., St. Louis, Mo.



KUHLS'

Elastic Waterproofing Compositions

Kuhls compositions are unequalled for calking around windows, pointing up terra-cotta and all other stone work, waterproofing the joints between the roof and walls, all kinds of glass construction work and tile setting, etc., in fact, any place where a watertight joint is required. These compositions adhere strongly to wood, metal, glass, concrete, etc. They never dry, crack or crumble, always remaining elastic under any conditions. Any color to match.

Try Kuhls on your next job.
Write today for prices.

H. B. FRED KUHL'S
6415-21 Third Ave., Brooklyn, N. Y.



Get These Booklets

LAMELLA ROOF—50' x 155'

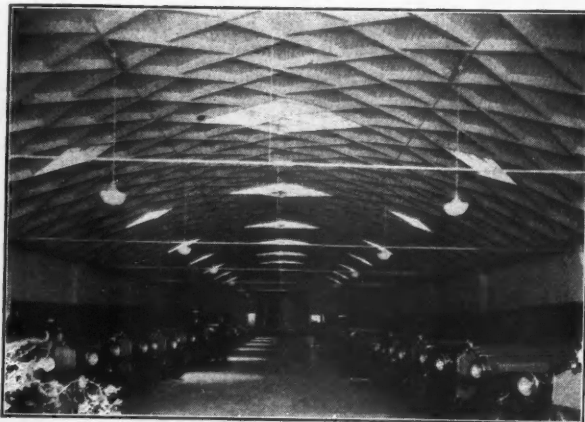

"LAMELLA" (PATENTED)

Trussless ARCH ROOFS

Quickly and Economically Erected
Thoroughly Safe—Very Attractive

Good distribution of light, excellent acoustical conditions. Adopted for auditoriums, dance halls, garages, warehouses, factories, etc., in all parts of the country. Spans up to 150'.

Write nearest office for descriptive folder

- | | |
|--|--|
| Lamella Roof Syndicate, Inc.
45 W. 45th St., New York City | Lamella Trussless Roof Co.
201 Kirby Bldg., Houston, Texas |
| Lamella Constructions, Inc.
201 Norris Bldg., Atlanta, Ga. | Missouri Lamella Roof Co.
904 Bank of Commerce Bldg.,
St. Louis, Mo. |
| The Trussless Roof Co.,
754 East 29th Street, Los Angeles, Cal. | |

PERFECT
VISIBILITY
THROUGH
ADAMSTON
VERTICALLY
DRAWN
FLAT GLASS

ADAMSTON FLAT GLASS COMPANY
CLARKSBURG, WEST VIRGINIA



A brand you can depend upon.

Satisfaction known beforehand!

Farmington, Missouri, March 13, 1929.

Willis Mfg. Company,
Galesburg, Illinois.

Gentlemen:

We are building an addition to our plant and want another skylight the same as we purchased from you two years ago. If you have the size and price on your records and can furnish another at somewhere near the same figures, you may enter our order without further notice from us.

B. T. GENTGES.



Style No. 708

Specify WILLIS SKYLIGHTS and know YOUR PROFIT beforehand!

WILLIS manufacturing methods take all the guess work out of the job. Finest materials, sound design, the result of over 30 years' engineering practice—but the biggest point that guarantees satisfaction is the fact that every skylight job is made complete, assembled complete and inspected complete—before it is taken apart and shipped to you.

Consequently, you won't have to do any trimming or cutting. You won't have to pay high-priced, skilled labor—an ordinary workman using screw driver and hammer can do the whole job. And your profit won't be eaten into by future servicing. WILLIS skylights, while admitting all light and affording perfect ventilation, have strength far in excess of service demands. They won't buckle, bend or sag. They won't leak.

Get the whole story—find out what made Mr. Gentges send a repeat order "without further notice from us." Send for our big catalog on sheet metal products. It's FREE!

WILLIS

Manufacturing Company
Dept. 128 Galesburg, Ill.

WILLIS products make more profit by saving on installation costs.

BUY DIRECT FROM FACTORY

BOSS MIXERS and HOISTS

YOU GET SALESMAN'S & JOBBER'S PROFIT!

SAVE \$42 to \$384 ON EACH MACHINE

Every manufacturer is trying to reduce his selling costs. We have found the way and are going to give the difference to our customers in order to increase our sales. We have done away with all our salesmen and jobbers and are now selling direct to users. We have deducted the salesman's and jobber's commission from each machine and the difference is our price to you. This is the most astonishing news in the construction industry and it is certainly paying us as sales are jumping by leaps and bounds. Get the new catalogue with new confidential wholesale prices on each machine. It shows the most popular types and combinations, describing each fully—with new price. The coupon will bring it.

SAME HIGH QUALITY

Regardless of this drastic price cut, the quality of BOSS Mixers and Hoists remains the same. They have always been noted for their heavy duty construction and materials. Under no consideration will we ever sacrifice this reputation. Get the catalogue. Note the specifications and compare the prices. You get the same patented Re-Mixing Action and other exclusive features that have made BOSS preferred wherever used. Hundreds of BOSS machines have ten, twelve and fifteen years of continuous service behind them and still going strong. For quality of design, materials and construction we defy anyone to find a better built machine than a BOSS. You can now get all this for less.



BOSS 108 NON-TILTER
"One-Two Bagger" patented re-mixing action, steel construction, high speed performance with one man control.

Get Our Prices Send Coupon for New Catalogue

With Confidential Wholesale Prices

The new BOSS Catalogue gives complete information on all the BOSS Mixers, Pavers and Hoists along with the new confidential wholesale prices. Even if you do not want to order now, get this new catalogue and keep it on hand for future use. Fill in the coupon and mail today. It will save you money.

Though you may have bought direct from a manufacturer before you have never been able to buy at these prices because no salesman's or jobber's commission is figured in. Prices on every machine are greatly reduced. Get the new catalogue with wholesale prices.

A COMPLETE LINE

We make over 75 various sizes, combinations and types of BOSS Mixers, Hoists and Pavers. There is a type for every conceivable use. Get the new catalogue first, then decide. Often our customers find that they can use a much lower priced machine after studying this catalogue. There is no need of going elsewhere for a certain machine when it is in the BOSS line. Write for catalogue and confidential wholesale prices; also give us information on kind of work you want the machine for. We can probably be of help to you.

1 YEAR GUARANTEE

GUARANTEE—All BOSS equipment is guaranteed for one year against defective materials and inferior workmanship. Any parts proving defective will be replaced free of charge (electrical or engine equipment excepted, as this equipment is guaranteed by the respective engine manufacturers) upon return to us of defective parts, carrier charges prepaid for our inspection. American Cement Mach. Co., Inc.

5 DAYS' FREE TRIAL

So confident are we that every BOSS Mixer and Hoist will give complete satisfaction, that we offer you five days' free trial. Order a BOSS. Use it in the field. If within five days you do not find it exactly as represented in every way, send for return instructions and refund of purchase price. This protects you; you can't go wrong on a BOSS. As long as we have sold on this basis, we have never had a customer demand his money. This proves BOSS quality. Every BOSS machine is backed up with an iron clad guarantee. Read it above.

NEW CATALOG WITH WHOLESALE PRICES TELLS ALL

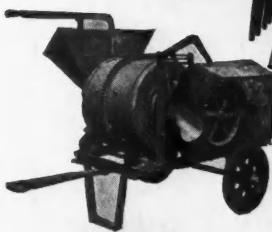

THE BOSS 3 1/4 S NON-TILTER. One half bag drum type trailer mixer with 2 disc wheels, cushion rubber tires, batch hopper, 2 HP Stover engine, magnet, steel engine housing.



GET OUR PRICES

CLIP AND MAIL THIS COUPON

AMERICAN CEMENT MACHINE CO.,
218 S. Fourth St., Keokuk, Iowa.

Send me your new catalogue showing complete line of BOSS Mixers, Pavers and Hoists with confidential wholesale prices.

Name _____

Address _____

Town _____ State _____

CLIP AND MAIL THIS COUPON NOW!

Strong Enough to hold a horse "EVER LASTING" Nail Brackets are



Safe as the ground under your feet.
Easy to put up or take down.
Ten times faster than scaffolding.
Sturdy enough to last a lifetime.
Guaranteed to give satisfaction.

Descriptive folder on request

For Sale at all Leading Lumber and Builders' Supply Dealers

DEALERS!!

Our offer will interest you. Write for details.

Manufactured by
HUBENY BROS., Inc.
600 First Ave., Roselle, N. J.



Compact Rugged Speedy

**20" Band Saw
Every Contractor Needs It**

You can save time and money with Gallmeyer and Livingston Union Woodworking machines. The work you are now turning out on bulkier, more expensive machines can be done with greater speed, and more economically with Unions.

Union Woodworking Machines are compact, and easily moved from one job to another. They will attach to any light socket. In this day of keen competition, every contractor needs Gallmeyer and Livingston machines. They cut costs in many ways. They help you land more jobs. They cost less to buy and to operate. Insurance is less. There is less depreciation. You should know about the many advantages of Gallmeyer and Livingston Union Machines.

Send today for catalog and complete information. Free.

GALLMEYER & LIVINGSTON CO.

206 Straight Ave.

Grand Rapids, Mich.

Crofoot SCREEN TACKER



Wonderfully
Improved
TACKER

AND 1000

STAPLES
ON A
5 DAY TRIAL
\$5.75
CASH
WITH
ORDER

MONEY PROMPTLY REFUNDED
IF YOU ARE NOT SATISFIED

Crofoot Perf-O-Matic A New Era in Screen Tacking

Thousands were enthusiastic over the former Crofoot Screen Tacker, but the new Perf-O-Matic is 100% more efficient. 100% easier to use—absolutely no clogging or jamming. No wasted staples—no damaged screen cloth. Fully guaranteed. 4 times faster than hammer tacking—saves its cost in a hurry. Send us your order today! Money back if you're not perfectly satisfied, BUT YOU WILL BE.

J. B. CROFOOT CO.
Dept. A P. O. Box 783 Chicago, Illinois

Copyrighted, 1929, by J. B. Crofoot Co.

MYERS WATER SYSTEMS

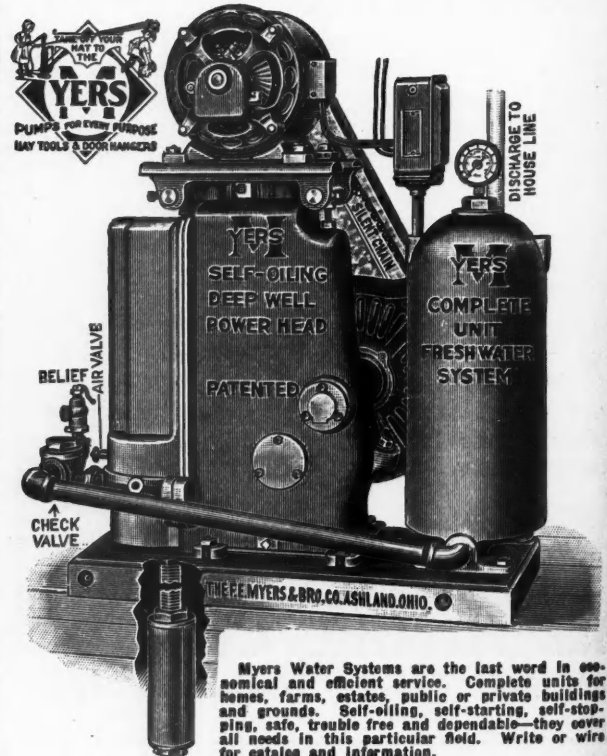

SAVE UP YOUR MONEY BY BUYING THE
MYERS
PUMPS FOR EVERY PURPOSE
HAY TOOLS & DOOR HANGERS

RELIEF AIR VALVE
CHECK VALVE

SELF-OILING
DEEP WELL
POWER HEAD
PATENTED

DISCHARGE TO HOUSE LINE
COMPLETE UNIT
FRESH WATER
SYSTEM

THE F. E. MYERS & BRO. CO. ASHLAND, OHIO

Myers Water Systems are the last word in economical and efficient service. Complete units for homes, farms, estates, public or private buildings and grounds. Self-oiling, self-starting, self-stopping, safe, trouble free and dependable—they cover all needs in this particular field. Write or wire for catalog and information.

THE F. E. MYERS & BRO. CO., Ashland, Ohio
Pumps—Water Systems—Hay Tools—Door Hangers

Hard Jobs made easy with the



Hand-sanding and scraping floor edges, for instance, is slow, tedious work—but the SUPER TAKE-ABOUT Sander makes it easy. It's a real production machine—saves time, labor and does a better job on the edges than is possible by any other method.

Many contractors report big savings in using the SUPER TAKE-ABOUT for sanding door casings, bases, sash, closets, stairs, bench work, etc.

The powerful 1 H. P. Motor gives the 4 inch wide belt a smooth, even action that insures a perfect finish. Let us show you how it works.

Also, ask about the Porter-Cable Portable Electric Saw, ideal for contractors' requirements.

THE PORTER-CABLE MACHINE CO.

1721 North Salina Street
SYRACUSE, . . . N. Y.

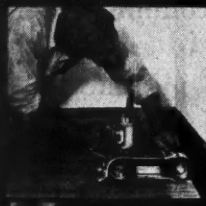

Above, sanding butt ends of floor with grain with the edging attachment. Below, using SUPER TAKE-ABOUT for sanding stairs.

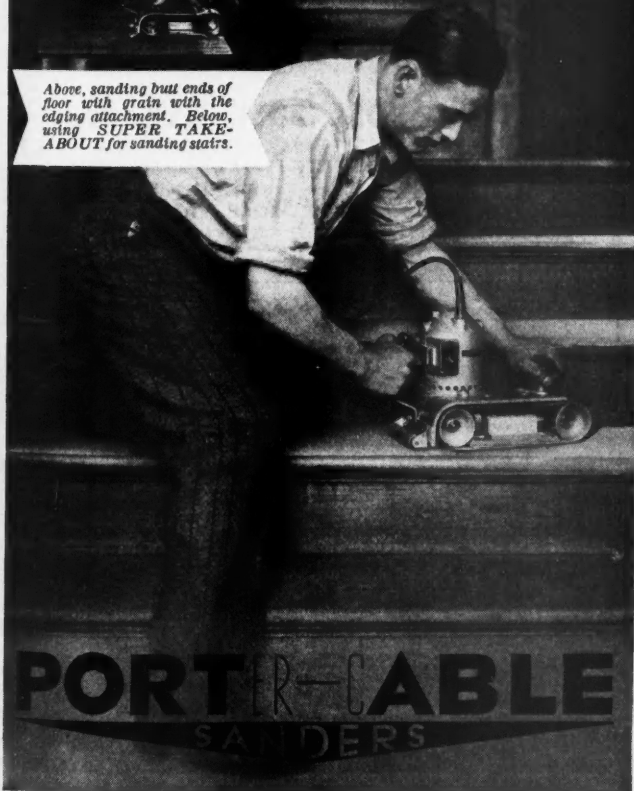

PORTER-CABLE
SANDERS



Only 28 years old and earning \$15,000 a year

W. T. Carson left school at an early age to take a "job" in a shoe factory in Huntington, W. Va., at \$12 a week.

He worked hard and long and he had greater handicaps than you will ever have. But he refused to quit. He made up his mind that he was going to get ahead in a big way and nothing could swerve him from that resolve.

Today W. T. Carson is owner and manager of one of the largest battery service stations in West Virginia with an income of \$15,000 a year.

He gives full credit for his success to the International Correspondence Schools and says he still refers to the I. C. S. text-books. Just a few months ago the faculty of a large college in West Virginia called him in to demonstrate the principles of battery construction to a class in electricity. That shows how thoroughly he understands the technical as well as the practical side of his work.

If the I. C. S. can smooth the way to success for men like W. T. Carson, it can help you. If it can help other men to win promotion and larger salaries, it can help you.

At least find out by marking and mailing the coupon printed below. It won't cost you a penny or obligate you in any way to ask for full particulars, but that one simple little act may be the means of changing your entire life.

Surely, W. T. Carson wouldn't be earning \$15,000 a year today if he hadn't found out about the I. C. S. when he did.

Mail the Coupon for Free Booklet

INTERNATIONAL CORRESPONDENCE SCHOOLS

"The Universal University"

BOX 8132-D

SCRANTON, PA.

Without cost or obligation, please send me a copy of your booklet, "Who Wins and Why," and full particulars on the subject before which I have marked X:

- | | |
|---|---|
| <input type="checkbox"/> Architect | <input type="checkbox"/> Business Management |
| <input type="checkbox"/> Architectural Draftsman | <input type="checkbox"/> Navigation |
| <input type="checkbox"/> Architects' Blueprints | <input type="checkbox"/> Salesmanship |
| <input type="checkbox"/> Contractor and Builder | <input type="checkbox"/> Advertising |
| <input type="checkbox"/> Building Foreman | <input type="checkbox"/> Cost Accountant |
| <input type="checkbox"/> Concrete Builder | <input type="checkbox"/> Show Card and Sign Lettering |
| <input type="checkbox"/> Structural Engineer | <input type="checkbox"/> Industrial Management |
| <input type="checkbox"/> Structural Draftsman | <input type="checkbox"/> Secretarial Work |
| <input type="checkbox"/> Plumber and Steam Fitter | <input type="checkbox"/> Business Correspondence |
| <input type="checkbox"/> Heating and Ventilation | <input type="checkbox"/> Bookkeeper |
| <input type="checkbox"/> Plumbing Inspector | <input type="checkbox"/> Stenographer and Typist |
| <input type="checkbox"/> Foreman Plumber | <input type="checkbox"/> Higher Accounting |
| <input type="checkbox"/> Sheet Metal Worker | <input type="checkbox"/> Grade School Subjects |
| <input type="checkbox"/> Civil Engineer | <input type="checkbox"/> Mathematics |
| <input type="checkbox"/> Surveying and Mapping | <input type="checkbox"/> English |
| <input type="checkbox"/> Electrical Engineer | <input type="checkbox"/> Illustrating |
| <input type="checkbox"/> Electric Lighting | <input type="checkbox"/> Railway Mail Clerk |
| <input type="checkbox"/> Electric Wiring | <input type="checkbox"/> Civil Service |
| <input type="checkbox"/> Telegraph Engineer | <input type="checkbox"/> Coal Mining Engineer |
| <input type="checkbox"/> Practical Telephony | <input type="checkbox"/> Gas Engine Operating |
| <input type="checkbox"/> Mechanical Engineer | <input type="checkbox"/> Textile Overseer or Supt. |
| <input type="checkbox"/> Mechanical Draftsman | <input type="checkbox"/> Traffic Manager |
| <input type="checkbox"/> Toolmaker | <input type="checkbox"/> Aviation Engines |
| <input type="checkbox"/> Machine Shop Practice | <input type="checkbox"/> Automobiles |
| <input type="checkbox"/> Stationary Engineer | <input type="checkbox"/> Agriculture |
| <input type="checkbox"/> Chemist | <input type="checkbox"/> Pharmacy |
| | <input type="checkbox"/> Poultry Raising |
| | <input type="checkbox"/> Spanish |
| | <input type="checkbox"/> French |
| | <input type="checkbox"/> Radio |

Name.....

Street.....

and No.....

City..... State.....

Occupation.....

If you reside in Canada, please send this coupon to International Correspondence Schools Canadian, Limited, Montreal, Canada

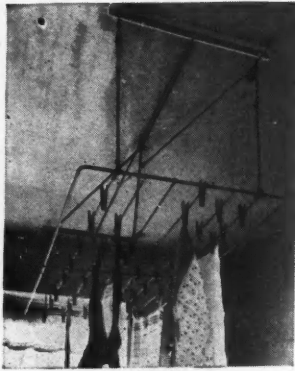

Style 00B

An all metal dryer, 1/2 in. steel; white enameled outside frame; 8 galvanized wire lines with supporting cross-piece and 48 spring clothes-pins. Dimension, 24 in. x 55 in.

Add A New Renting Feature To Your Apartments and Homes

INSTALL

ROYAL INDOOR CLOTHES DRYERS

Here is an innovation which the average home buyer and apartment seeker will be quick to appreciate. Does away with the old-fashioned clothes lines. Can be used rain or shine.

Shipped in individual cartons ready for easy hanging. Write us immediately for literature and special quantity prices.

Distributors Wanted in all Territories

Royal Manufacturing Co. 190 Southern Blvd. New York City, N.Y.

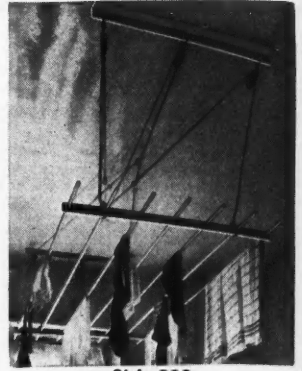

Style 00C

An all-aluminum dryer, with De Luxe appearance for the better class house. Dimensions 24 in. x 55 in. This type dryer also made in all wood at lower prices.



Expansive Screw Anchors



Expansion Bolts

Ackerman-Johnson

What are the compelling reasons why ACKERMAN-JOHNSON Expansive Screw Anchors have become the most popular type with Electricians and the various Trades Mechanics everywhere?

Because in comparison with the work and uncertainty in setting the older type Expansion Bolts for making fastenings to concrete and masonry generally, it becomes an actual pleasure to set the ACKERMAN-JOHNSON.

Because there is distinct fascination in so easily setting so small a device with a realization of the tremendous load it can hold.

Because there is great satisfaction in leaving a job knowing it could not have been better done.

Ackerman-Johnson Co.

625 W. Jackson Blvd.

CHICAGO



One-hole Pipe Straps

53 Park Place,
New York City



Concrete Inserts

You need a

HUTHER Dado head

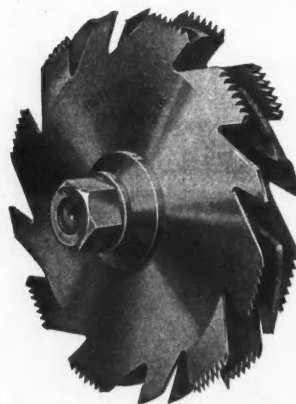

Developed from our own patents, this adjustable groover cuts either with or across the grain. Cutters may be used singly, in pairs or in any combination necessary for desired cut.

Send for one on approval. It may be returned at our expense if unsatisfactory.

Huther Bros. Saw Mfg. Co.

Rochester, N. Y.

Makers of Better Saws for More than Fifty Years

LOOK FOR THE NAME STAMPED
ON EVERY FOOT OF CORD



SILVER LAKE CO.
NEWTONVILLE, MASS.

SILVER LAKE
SOLID BRAIDED

Window Sash Cord
100 Feet No. 10



Solid Braided 100% Cotton



SAFE-UNDER FOOT

*non-wearing
surfaces
treated with*

Carborundum

REG. U.S. PAT. OFF.

GRAIN

HERE is a form of Liability Insurance that costs little and pays big. The use of Carborundum Grain in any concrete surface subject to foot traffic—sidewalks, floors, ramps, gives the public a safe, sure footing. And adds years of wear resistance.

Thus you can safeguard the footsteps of millions, and get back dividends in avoidance of accidents and in longer life of the surface itself.

[Write for complete details and instructions]

The CARBORUNDUM Company

REG. U. S. PAT. OFF.

NIAGARA FALLS, N. Y.

CANADIAN CARBORUNDUM CO., LTD., NIAGARA FALLS, ONT.

Sales Offices and Warehouses in

New York Chicago	Boston Philadelphia	Cleveland Detroit	Cincinnati Pittsburgh	Milwaukee Grand Rapids
---------------------	------------------------	----------------------	--------------------------	---------------------------

The Carborundum Co., Ltd.
Manchester, England

Deutsche Carborundum Werke
Dusseldorf, Germany

(Carborundum is the Registered Trade Mark of The Carborundum Company for its Products.)

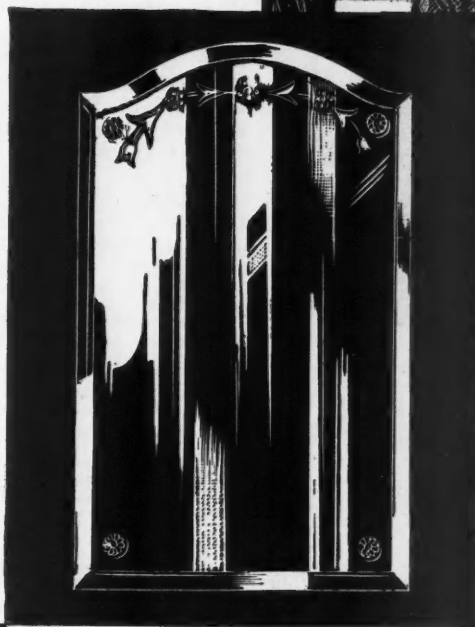

BATHROOMS SELL HOMES—Hess Mirrored Cabinets sell bathrooms—in your new construction—in remodeling—a Hess Steel Mirrored Cabinet in the bathroom, concealed behind a large mirror of fine beveled plate glass, will give that feeling of comfort and luxury that far offsets the price. A wide variety of styles and sizes to meet any service. Mail the coupon below for catalog and prices on Hess Mirrored Cabinets.

HESS WARMING & VENTILATING COMPANY
1220 South Western Ave., Chicago



HESS WARMING & VENTILATING CO.
1220 S. Western Ave., Chicago, Ill.

I am interested in Hess Mirrored Cabinets. Send me your complete catalog.

Name.....

Address.....

**Add the Mill-Man's Profit
to Your Profit on Every Job**

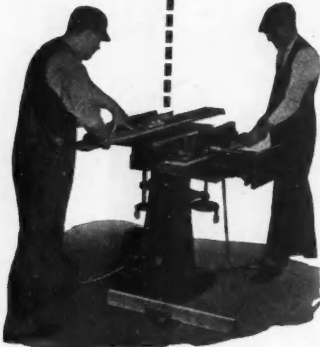

**"Buy One
Machine
Instead of
Eight"**

Every time you buy mill work you're paying someone else a profit that you could make for yourself.

Hundreds of contractors have realized this and have equipped themselves with a SIMPLICITY woodworker, *one machine* that performs practically every woodworking operation the contractor has use for—28 in all.

The SIMPLICITY combines *eight machines in one*: Saw Table, Jointer, *Practical Thickness Planer*, Speed Spindle, Borer and Mortiser, Band Saw Attachment, Upright Spindle Shaper Attachment, Lathe Attachment. Does real work—not a toy. Each operation done in the usual and ordinary way.

Keep your shop busy in rainy weather.

Our customers get expert advice free on what to make, how to make it and how to sell it.

Combination Woodworking Machine Co.
551 W. Randolph St. Chicago, Ill.

**VENTO Puttyless
STEEL WINDOWS**

ARE THE ONLY *PUTTYLESS STEEL WINDOWS* THAT HAVE TWO DISTINCT OPENINGS—
—Don't Be Misled by Cheap Imitations
Infringements Will Be Prosecuted

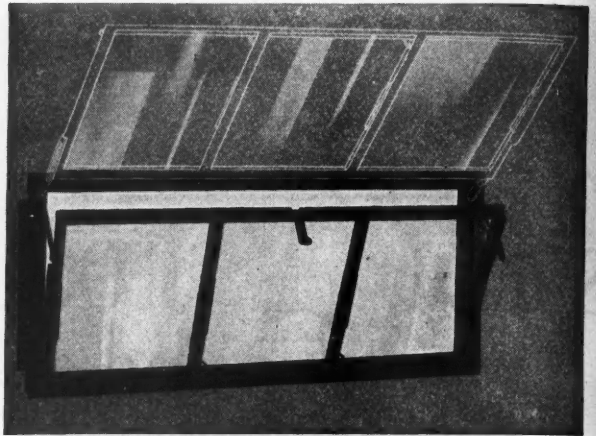

Pat. U. S. Pat. Office (3-4-24), (12-11-28). Other pats. pend.

VENTO can be opened full wide from the bottom, same as any other window, and that is all you get in any other window on the market, just one way opening, while *Vento* also opens in at the top, giving overhead ventilation—"When it rains it runs out." Can be locked when open and basement is safe from intrusion. The one window with proper ventilation and that will keep the basement dry.

GLAZE WITHOUT PUTTY
Write for new two-color broadsides and price lists
VENTO STEEL SASH CO.
MUSKEGON : MICHIGAN

**CARDINAL
Toggery Racks**

**SELL HOMES EASIER
RENT THEM FASTER**

A small investment but a big talking point the minute you swing open any closet door. The housewife appreciates this modern convenience that gives her the space of two closets in one. Equally indispensable as standard equipment in hotels, clubs and dormitories, new or remodeled.

Make Every Door an Extra Closet

Keep toggery smooth. Hats in shape. Shoes off floor. All in plain sight and instant reach. Lighten the woman's work.

Beautiful Duco finish. Jade Green—Old Rose and Silver Color Cadmium. All metal. Strong. Easily attached on the inside of any closet door. Write us for price and quantity discount.

**CHAS. FISCHER SPRING
COMPANY**
244 Kent Ave. Brooklyn, N. Y.



**The FARRAND
Rapid Rule**

**Greater Value In Present Model
New Model at Lower Price**

Unceasing effort on the part of the manufacturer to provide craftsmen with a measuring tool of the highest quality and greatest value makes possible the following announcement.

Two Models Are Now Available

MODEL A is an eight foot rule of finely tempered steel, highly polished and nickel plated. The container is a hand finished, nickel plated cup, approximately two inches in diameter.

MODEL B is a six foot rule of exactly the same quality as Model A. The container is the same except that it is furnished with a plain brass finish.

RUST RESISTANT Rule Blades. Where rule is to be used for outdoor work we recommend a rust resistant blade, now available, at no extra charge.

The same high quality steel is used in this rule blade as in the nickel plated type, but it has a different finish. Order should specify type of rule blade desired.

*A
Modern
Tool for
Modern Craftsmen*

**Model A Complete with 8 ft.
rule, Price \$5.00**

**Model B Complete with 6 ft. rule,
Price \$3.75**

Ask your Dealer or write

Hiram A. Farrand, Berlin, N. H.



Trouble Savers

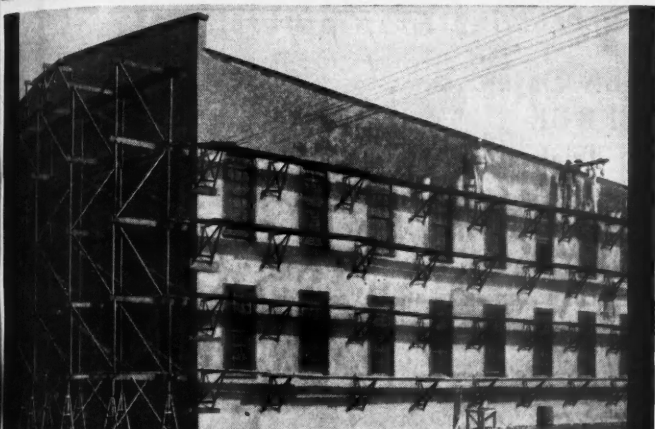

TROUBLE SAVER Steel Trestles form first tier of scaffolding on left side of building; sectional steel scaffolding above. TROUBLE SAVER Brackets on right side.

are
Everlasting Money Makers

Steel vs. lumber - and-nail Scaffolding

Trouble Savers save their cost on every job.

Trouble Savers are erected and taken down in about one-tenth of the time of wood scaffold.

Trouble Savers give a lifetime of use, whereas scaffold lumber soon becomes kindling.

Trouble Savers are 100 times safer, reduce fire-hazards, and aren't blown down by heavy winds.

That's Why They're Used ALL OVER THE WORLD

Mail coupon today for 30-day trial offer



Trouble Saver Studding Brackets support a ton. Will not bend.



Trouble Saver Nail Attached Brackets support a ton. Held by four nails.



Trouble Saver Adjustable Steel Trestles (patented).

Quickly adjusted to desired height, 8 sizes. Each size adjustable from 4 to 15 different heights, giving a range from 16 inches to 12 feet by 3 inch lifts.

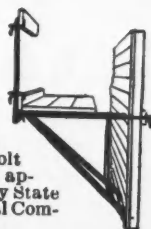

Trouble Saver Bolt Brackets approved by State Industrial Commissions.

The Steel Scaffolding Company

1101 N. Governor St., Evansville, Ind.

(Check items on which you wish particulars, fill out coupon and mail today.)

Trouble Saver Steel Products

- | | | |
|-----------------------------------|---------------------|-----------------------------|
| Studding Brackets | Adjustable Trestles | Mortar Board Stands |
| Nail Attached Brackets | Ladder Jacks | Sectional Steel Scaffolding |
| Bolt Brackets with Safety Railing | Wood Shinglers | |

Name.....
Address.....

WHEN WRITING ADVERTISERS PLEASE MENTION THE AMERICAN BUILDER

**A
P
P
R
O
V
E
D**



CORCORAN

one piece
Steel Bathroom

CABINETS

Instant approval! . . . instant acceptance! . . . from jobber and consumer alike! Corcoran Cabinets are right . . . more than right . . . they meet the demand for modern bathroom equipment. Sales indicate that they have "gone over" . . . passed the most critical examination. Complete stocks now carried at Corcoran offices at 1820 McCormick Building, Chicago; 1228 Locust Street, Philadelphia; 11 West 42nd Street, New York; and Beaudette and Graham Company, 915 Boylston Street, Boston, Mass.

If you haven't seen the line . . . write today for descriptive catalogue.

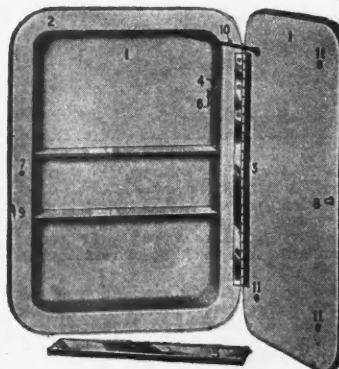

6 POINTS OF SUPERIORITY

Cabinet body and flange drawn from one continuous piece of steel.

Round corners inside and outside harmonize with all bathroom fixtures.

Continuous piano type brass hinge will not sag or warp. Bulb edge glass shelves cannot slip forward.

Improved door catch — press button — door springs open instantly.

Special pad prevents mirror breakage.

Corcoran Cabinets are sold through Jobbers only

WRITE for CATALOG

THE CORCORAN MFG. COMPANY NORWOOD CINCINNATI, OHIO

CORCORAN MFG. COMPANY, Dept. AB-6

Gentlemen: We are interested in Corcoran One-Piece Steel Bathroom Cabinets. Kindly send catalogue and full details.

NAME.....
ADDRESS.....
CITY.....
Contractor . . . Dealer . . . Architect . . .

Know Perfect Incineration!
Investigate
SECO
Improvements

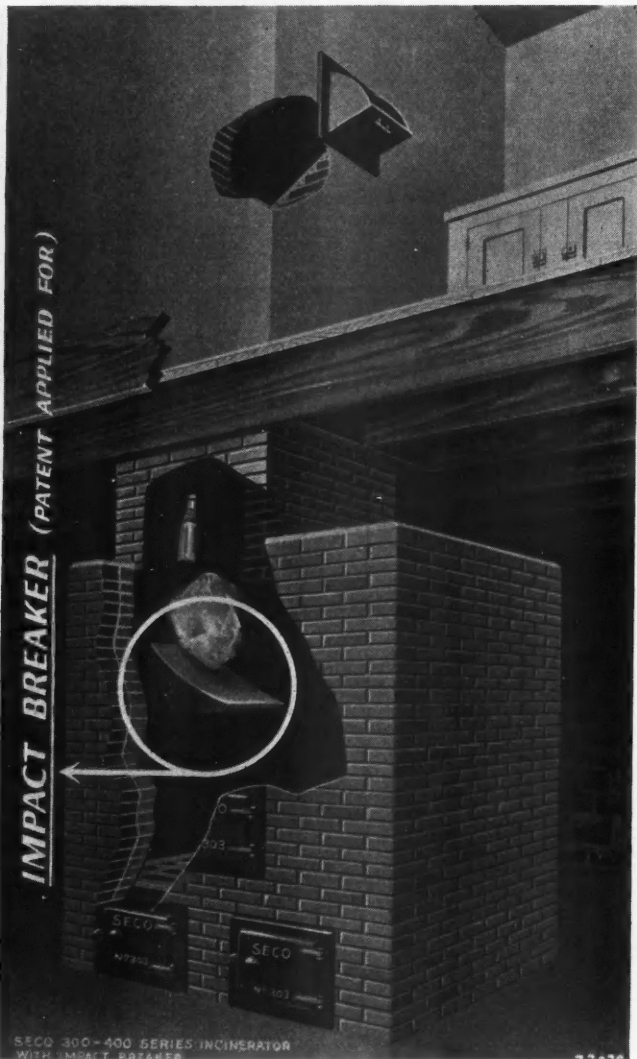

Exhaustive research and experiments evolved the features which make SECO the outstanding incinerator for modern construction. No other incinerator can offer all the practical features of SECO. It's special "Impact Breaker" (Patent applied for) and "Secondary Air Supply" are revolutionizing incineration. The Impact Breaker deposits the refuse lightly and loosely—it eliminates hammering and packing of refuse upon the grates.

The Secondary Air feature provides a strong steady circulation of air around and through the garbage and insures its rapid and complete reduction. The fact that it is designed to obtain very high temperature is responsible for perfect combustion—but the SECO Incinerator is the best obtainable even without these improvements.

No matter whether you are building a modest home or a gigantic structure there is a SECO to fit your needs. Write us today for illustrated literature giving complete details about our various models—you'll find both pleasure and profit in installing a SECO.

[Consult your telephone directory (under listing Seco Incinerators) for the name of your local Seco dealer.]

SECO INCINERATORS

Division
Sanitary Equipment Company

3714 Main St. Kansas City, Mo.

(Bricked-up types, portable metal types, ranging in price from \$55 up.)

The NEW
"Universal" Level-Transit
Superseding the Convertible Level

TEN Days
FREE
Trial



The new "Universal" is the highest development in combination Levels and Transits. It is superior to and displaces the convertible level FOR ANY USE OR NEED.

No previous experience required for perfect success in operation—this is the ideal instrument for any builder or contractor. Instantly changeable to level or transit, it is the most scientific development of its kind available. Only a slight touch of the finger changes it to either need. An indispensable instrument for the up-to-date builder.

This combination level-transit is exceptionally accurate, strongly built, with 3-point support, assuring perfect optical and mechanical alignment; 43-degree tilt above or below. Trade in your old instrument for a New Universal. We manufacture surveying and drawing instruments for every need.

Sold by first-class supply houses throughout the country, or directly by the manufacturer. Write for information and free trial offer.

DAVID WHITE COMPANY

317-319 Court St., Milwaukee, Wis.
Branch Office, 2101 West Van Buren St., Chicago, Ill.

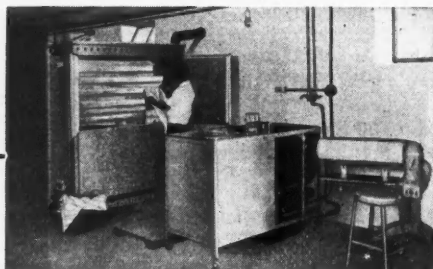

Lamneck Dryers Installed in Woodford Apartments, Highland Park, Detroit, Mich.

For Washday Convenience!

WHETHER you build large or small homes, clubs or apartments, some provision must be made for washing, drying and ironing clothes. Numerous good washers and ironers are available, but safe, dependable, mechanical dryers are still comparatively new.

Colored Grey and Green

Two colors of heat-treated enamel paint cover the Lamneck—inside and out—making a beautiful, yet durable finish.

The LAMNECK Laundry Dryer

is the logical solution to the drying problem. It dries the clothes quickly, clean and white, on every washday. It protects them from dust, soot, whipping winds and sagging lines. It dries one tubful of clothes while the next is being washed and wrung. It has an indirect heating system—thermostatic temperature control—drying capacity equal to 60 ft. of line, and it occupies but 10 sq. ft. of floor space.

Call your local gas company for detailed information—or write us direct

The W. E. Lamneck Co., 447 Dublin Avenue COLUMBUS, OHIO

"I never had better filed saws in all my 20 years of carpentry—

in fact, they cut better than new saws. The Foley Filer is perfect in every way," writes Mr. T. Hafner, of Illinois. Mr. Hafner is one of the thousands who couldn't be hired to go back to hand filing—he knows from experience that saw filing has been revolutionized by the Foley Automatic Saw Filer.

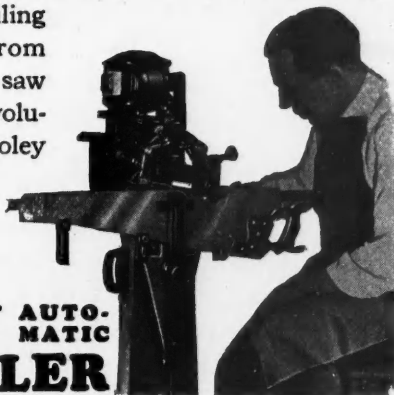

FOLEY AUTO-MATIC SAW FILER

It makes a perfect-cutting saw in a fraction of the time required by the most expert hand filer. Will also retooth hand saws. Not only saves the saws and time filing, but insures faster, better work—enables you to give service the other fellow can't. Files hand saws, band saws, and cross-cut circular saws. The Foley pays for itself and then goes on paying you **BIG PROFITS** year after year.

Read What These Men Say

"I have filed saws for 40 years, but the Foley has me beat, both as to better work and speed. I am very highly pleased with it."
S. J. Bottomley,
Conn.

"I am greatly pleased with the work my Model F-5 Foley Automatic Saw Filer is doing. Our saws now cut perfectly."
V. A. Russell,
California

"I am very much satisfied with the performance of my Foley Filer. It is very easy to pick up enough work to pay for the machine in a short time."
Frank Huber,
New York

Make EXTRA MONEY, Too

Besides keeping your own saws in perfect cutting condition, you can make **EXTRA MONEY** filing saws for others on your Foley. They will be glad to have you do it when they find out how much better it will make their saws cut. Send coupon for complete information and **FREE PLAN** telling you how to get this business and make **EXTRA MONEY!**

MAIL THIS COUPON For FREE PLAN

FOLEY SAW TOOL CO., Inc.
342 Foley Bldg.
11 Main St. N. E., Minneapolis, Minn.
Please send me complete information and **FREE PLAN** for making **EXTRA MONEY** with the Foley Filer.

Name.....
Street.....
City..... State.....

What Kind of an Assistant would you choose—



a Husky Man or a Weakling?

Think of your floor surfacing machine as your assistant, for that is what it is. You wouldn't choose a weakling to work with you. You'd want a husky man who could work hour after hour all day long—and do the work right.

The Improved Schlueter—

You want a surfacer like the Improved Schlueter with the **weight, power, and guts** to eat away the surface of any floor hour after hour without a stop—and do it right.

Works for You!

You want the Improved Schlueter because you don't have to run it like you'd drive a horse. No levers or weights. The Schlueter is entirely automatic. The steel roller has a patented suspension feature and adjusts itself to floor irregularities.

5 o'clock Blues—

In other words, the machine does the work for you and when 5 o'clock comes around, instead of singing the "I'm too tired" blues, you have plenty of pep left to enjoy your evening.

MAIL COUPON FOR FREE TRAIL OFFER

LINCOLN-SCHLUETER F.L.R. MACHINERY CO.,
221 W. Grand Ave. (Dept. AM6), Chicago, Ill.
Gentlemen: Send me full details about the Improved Schlueter with details of **FREE TRIAL OFFER** and Easy Payment Plan.
Name.....
Address.....
City..... State.....
Lumber Dealer.....

Cuts 4 inch Lumber - Weighs only 24 lbs Stands Up Under Heavy Work



Model C Wodack is the lightest weight, and lowest priced saw ever made to cut full 4 inches.

Model B is the most complete hand saw on the market. It has the power to cut up to 4 3/8 inches, with the ability to make bevel cuts up to 60°. Weighs only 28 lbs.

Model K is the great little saw. It cuts up to 2 3/8 inches. Weighs only 15 lbs. \$95.00 at Chicago.

Wodack Saws have the original patented swing guard and are known all over the world for their power and ability to give steady service.

All models have G. E. Universal Motors.

Ask us about our other Labor Savers:
Lock Mortiser. Electric Hammer. 3/8 and 1/2" Drills.

Demonstration without obligation
F. L. ROGERS & CO.
23 South Jefferson St., Chicago, Ill.

Also New York City



MODEL "B"



GAS
Now Available Anywhere — Cheap
GAS for the Kitchen



GAS
GAS for the Restaurant Hotel etc.

GAS-O-GEN

No Carbide—Kerosene—Gasolene—nor Oil of Any Kind

The easiest, cleanest, cheapest and safest method of producing gas for cooking. No other kind of heat can compare with it. Ample supply of gas at all times for any standard gas range. Abundance of hot water at very low cost. **POTS WILL NOT BLACKEN.**

No carbide, no kerosene, no gasoline, no oil of any kind. Materials used so inexpensive that gas is produced for less than city gas. Write for name of nearest representative. Larger units for heating homes, hotels and institutions. Industrial units for all purposes.

Quick Heat, Odorless, Noiseless, Foolproof, Safe
DISTRIBUTORS WANTED



The comforts of civilization

Exclusive Franchise
WRITE FOR OUR SALES PLAN



GAS-O-GEN CORPORATION
165 W. Wacker Drive Chicago



Why-

not get your share?

THERE are worth-while profits in concrete block construction as any builder will tell you who has Multiplex Machines in his plant. Whether your need is for a hand stripper or a power stripper, whether you want plain or face blocks, concrete building tile or chimney blocks, there's a Multiplex Machine that will exactly suit you. Why not get your share of the profits that others are making by manufacturing their own concrete blocks on Multiplex Machines?

Write today for a complete catalog showing every type of Multiplex Machine.

The
Multiplex Concrete Machinery Co.
ELMORE, OHIO

KEES BUILDING CORNERS SAVE CARPENTER'S TIME

Give the effect of a butt-mitered corner, but are tight and weather-proof. Made of galvanized iron treated for painting without weathering. Sizes for lap siding 3 inches to 12 inches wide; any thickness. If your hardware or lumber dealer does not have KEES corners, write for free sample.



KEES

F. D. KEES MFG. CO.
Box 93
Beatrice, Nebr.

Saves 42 Hours' Labor on 100 Mortises

ONE man with the Champion Mortiser can easily cut twelve mortises an hour or ten more than a skilled mortise cutter can cut with brace and chisel in the same time. On a hundred mortise job that's a saving of 42 hours' labor or \$42 at \$1 an hour.

The CHAMPION MORTISER

And the Champion will easily cut 100 mortises a day! Why continue to lose time and money on mortising? Try the Champion on our 15-day trial offer. Money back guarantee.

Literature sent on request

Colgan Machinery & Supply Co.
406 Hayden Building Columbus, Ohio





Steel Sash Pulleys

"They Cost No More"

Every builder should at least know where he can get the best—even if he doesn't use the best in the homes he builds.

Every builder will be particularly interested in K-V Steel Sash Pulleys, especially when he realizes that they cost no more.

K-V Sash Pulleys are made of steel, finished in rust resisting amber bronze. They are cone bearing, with free running wheels, electrically welded at three points. The steel is heavier gauge. They are made in styles, sizes and types to meet requirements in various parts of the country. If you haven't received a free sample, write today.

Other K-V Products for the Builders of Homes that Sell

Every builder knows K-V Clothes Closet Fixtures. No new home is complete without properly equipped modern clothes closets. They actually help sell homes, and aid turnover. K-V adjustable Shelf Supports—adjustable every quarter inch with perfect alignment are needed wherever shelving is used. Installed without grooving side panels. Find out about this. It's a money saver.

KNAPE & VOGT MFG. CO.

660 Richmond Avenue Grand Rapids, Mich.

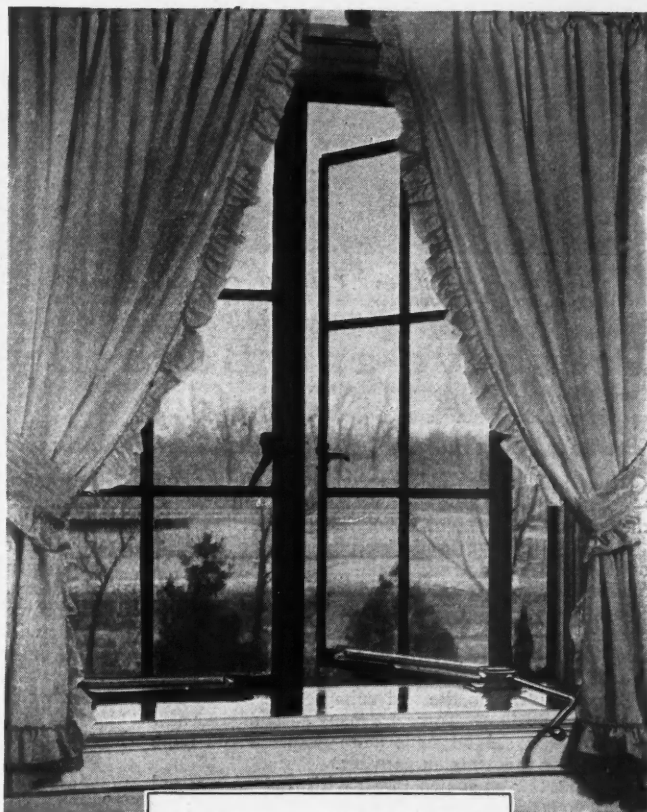

SERIES 26
CASEMENT
OPERATOR

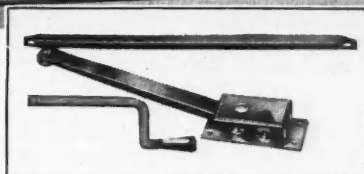

FOR WOOD
OR STEEL
WINDOWS

Such conveniences as these SELL HOUSES FAST!

The quick, easy operation of casement windows through inside screens makes a strong appeal—particularly to women.

Put these inexpensive Win-Dor Casement Operators on your next houses and see!

The picture above shows the new Series 26 Operator which can be installed on either wood or steel sash, equipped with any kind of inside screens. It is reversible so that it can be used on both right and left hand sash. All steel, rust-proof, \$2.90 list, complete.

Send for literature describing latest WIN-DOR devices

Win-Dor

CASEMENT HARDWARE

THE CASEMENT HARDWARE CO.

402-A North Wood Street, Chicago, Illinois

Casement Hardware Headquarters

Please mail me your catalog and booklet "Setting the Stage for Easier Selling."

Name _____

Address _____

AB



The residence of Mr. Charles F. Colbert, Jr., Colbert Acres, Delafield Heights, Pa. F. C. Sauer, Architect, 625 Center Ave., Aspinwall, Pa. Woodwork treated thruout with Ligni-Salvor.

Preserve and Beautify All Wood

Beautiful English and Rustic Effects Easily Obtainable

SHINGLES, doors and woodwork, inside and out, treated more than a quarter of a century ago, are still as solid and pleasing to the eye as the day Ligni-Salvor was applied.

Ligni-Salvor is a liquid preparation that penetrates into the heart of the wood, kills all the wood-destroying fungi, prevents the growth of new fungi-spores, and thus protects the wood from all rot and decay. It brings out the grain of the wood and renders that natural brown tone so desirable in English and Rustic interiors and exteriors. It will take either a dull or glossy finish, and as it ages, the wood becomes even more lovely. Hence the name, "Best Wood Preserver."

To multiply the life and enhance the beauty of your woodwork apply Ligni-Salvor. There are many parts of your new building that can be made more beautiful and more enduring by this simple treatment.

Clip out this ad and enclose it with your address and that of your supply dealer. We will see that you get our new booklet, and that he has samples to show you of various kinds of wood treated with

DEALERS!

We are looking for Distributors of this wood preserver

LIGNI-SALVOR

PFALTZ & BAUER, INC., 298 Pearl Street, New York, N. Y.

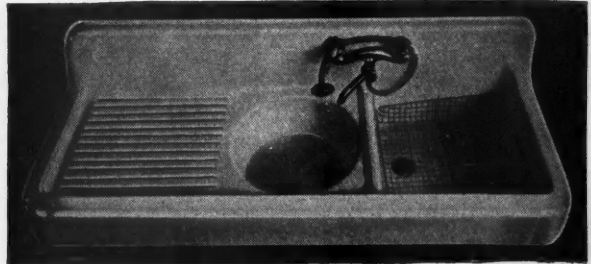

"EBCO" DISHWASHING SINK

with dish pan built integral

A beautiful porcelain enamel sink in white, gray, Nile green or blue with distinctive features that add substantially to the value of home or apartment. The dish pan is self-draining, deep and round. Featured by builders everywhere.

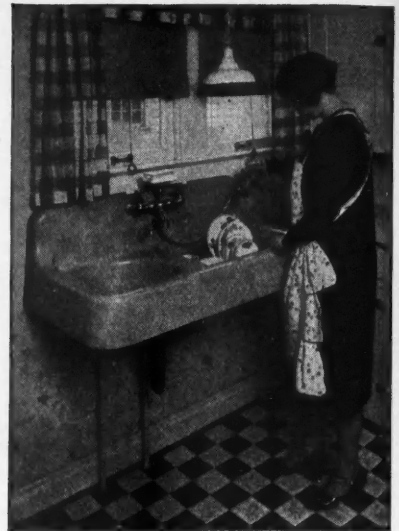

Write for full details and prices

The D. A. Ebinger Sanitary Mfg. Co. 407 W. Town St. Columbus, Ohio
Manufacturers also of Ventilated Closets, Urinals, Wash Sinks, Drinking Fountains and Steel Partitions for Toilet Rooms.

TRADE **(CHICAGO)** MARK

SPRING HINGES

A Type for Every Requirement



"Triplex" Spring Hinges

for Lavatory Doors

Adjustable Clamp Flange

Type 2242

Adjustable Clamp Flanges offer a protection against variations in the thickness of marble partitions.

Cutting of marble involves the danger of breaking or defacing it and also means unnecessary expense which can be avoided by the use of Triplex Lavatory Spring Hinges, Type 2242.

Your Dealer Can Supply These Hinges

Chicago Spring Hinge Company.

CHICAGO

NEW YORK

U. S. A.

MODERN METHODS DEMAND ECONOMY

That is why nearly all block men specify



Manufactured in quantities by a pioneer builder of over 30 years successful experience. Miles equipment has been and is doing a good job in all parts of the world.

A Miles machine was recently found in Pennsylvania that after 28 years of daily operation is still going strong.

The line is complete. It includes face down block machines, hand strippers, power strippers, power tampers, elevators and feeders. See a Miles plant in operation before you buy.

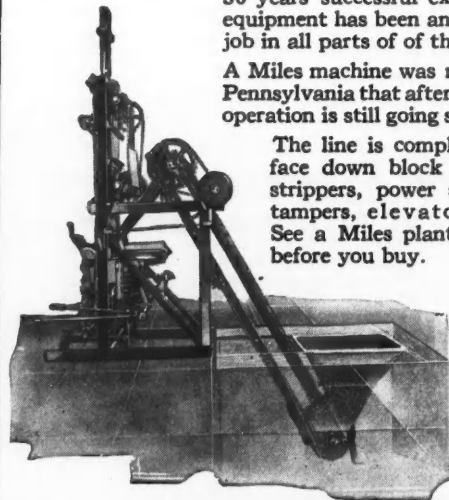

The **MILES** Manufacturing Company
JACKSON, MICH.

Write for catalogue Dept. 8



Kernerator Equipped Home Designed by
M. D. Hetherington, Chicago Architect

Architect M. D. Hetherington explains why

Kernerator is Biggest Sales Feature in Moderate Priced Home

"INCINERATION is now a necessity that most clients naturally expect", says Mr. Hetherington, noted Chicago architect. "The sanitary advantages, together with the conveniences, are readily recognized and insisted upon by the modern housewife.

"I have observed that the inclusion of a Kernerator is an outstanding selling advantage. This is particularly true in the more moderate priced homes. While incineration is expected as a matter of course in the higher price class, it is distinctly an innovation in the lower price brackets. Innovations, with as much to recommend them as incineration has, are outstanding selling arguments.

"Builders of small homes who adopt incineration as a feature of their homes will find little difficulty in selling their prospects".

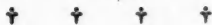

There is probably no other selling feature you can put into a home that costs as little and means as much as a Kernerator.

Write for complete information and prices or phone your nearest Kernerator representative.

KERNER INCINERATOR CO.

753 East Water St., Milwaukee, Wis. Offices in over 100 cities.

KERNERATOR

REG. U.S. PAT. OFF.

INCINERATION

*Garbage and Waste Disposal
for New and Existing Buildings.*



Hydro Proof Plaster Bond Saves Your Walls

AND then — down comes the plaster! How often this happens, in a comparatively new building. All because moisture—the deadly foe of all construction—has worked its way through to the vitals of the walls and partitions. Decomposition sets in. Gaping cracks appear. And then—down comes the plaster!

You can prevent these conditions in the structures you build—by using for your bonding, "Hydro Proof" Plaster Bond.

Hydro Proof Liquid Plaster Bond is one of the most effective and economical water-proofing agents on the market, for interior walls. Applied to concrete, brick, tile, gypsum or similar types of partitions, it makes a perfect adhesive bond for plaster or stucco, and does away with the older and more expensive method of using furring and lath.

Its asphalt base, by means of capillary attraction, permanently seals the walls against dampness or moisture. It forms a perfect insulation against heat or cold. It expands or contracts under varying climatic and atmospheric conditions, and will not re-emulsify, crack or check.

Hydro Proof Plaster Bond is easily applied to any surface—like paint. It coalesces quickly and becomes practically indestructible.

Insure the walls of the structures you build against moisture for all time by coating them with Hydro Proof Plaster Bond.

The coupon below will bring you our Hydro Proof Plaster Bond specification sheet, together with further information and prices.

THE ASPHALT PRODUCTS CO., Inc.
703 Free Street Syracuse, N. Y.

-----Mail This Coupon-----

THE ASPHALT PRODUCTS CO., Inc.
703 Free Street, Syracuse, N. Y.

Without obligation, please send me complete information, specification sheet and sample of Hydro Proof Plaster Bond.

Name.....
Address.....
City.....State.....

P. S. Why not ask \$125 for your saw? It would still be a big bargain!

BECAUSE, brother, because—

we take our own medicine. We practice what we preach regarding the savings to be made by the use of machine instead of hand labor. In building our machines we use every means to reduce hand labor, and a big part of our savings are passed on to you in this remarkable machine at a low price.

**MODEL-N
Safety-Saw**

A practical combination Saw Table built to handle builders' work from rough rafters to the finest interior trim.

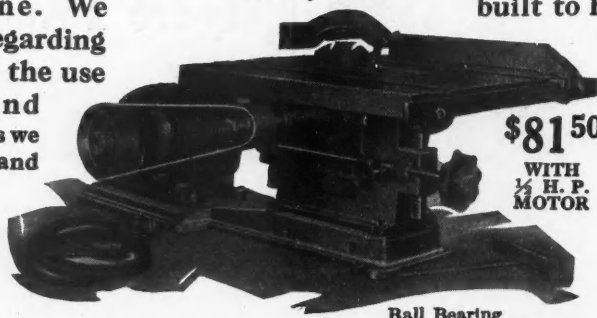

\$81.50

WITH
1/2 H. P.
MOTOR

Table raises and lowers ON A LEVEL and tilts to a full 45 degree angle.

Rips, cross cuts, miters, bev-els, rabbets, dadoes, grooves, bores, sands, grinds, etc.

It will do more woodworking than any five men using hand tools. Ask about our free trial and time payment plan.

YOU TOO
can reduce your costs by using this machine!

Ball Bearing
We also manufacture a complete line of other woodworking machines, selling from \$35.00 up. Write for free folder

**SAFE TOOL MFG. CO.
BRIDGEPORT, PA.**

Double Your Income! We Tell You How

LUXOR
Materials cost 24c;
Selling price, \$5.00.

CLARE-MONT
Materials cost 44c;
Selling price, \$5.00.

MADEIRA
Materials cost 24c;
Selling price, \$4.00.

AVON-DALE
Materials cost 45c;
Selling price, \$6.00.

SUNTYME
Materials cost 40c;
Selling price, \$17.00.

ARDMORE
Materials cost 13c;
Selling price, \$3.00.

WREN BATH
Materials cost 58c;
Selling price, \$21.00.

Invest \$23.00—Clear \$1334.00
Yes, Mr. Ledoux did just that. Mr. Young of N. J. invested \$97.00 in molds and cleared \$2700.00. Big profits? Certainly! No experience necessary. Put your spare time to work on this side line. Soon you will devote full time to it.

Molds \$14.80 Up
The Utility line includes complete molds for making vases, flower boxes, bird baths, sun dials, ornamental porches, chimneys, etc., etc.
Write for big Utility Catalog giving full information and prices.
CONCRETE EQUIPMENT CO.
500 Ottawa Ave., Holland, Mich.

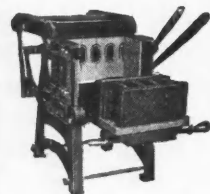

MACHINERY CATALOG
describing power and hand machines for making block, brick and tile. Send now for free catalog.



Send for Catalogs

ALUMINUM GENERAL PURPOSE (90 lb.) FLOOR SANDER



*Latest Model—
Just Out!*

Built for
**GREAT SPEED and
HIGHEST QUALITY
of work**

No vibrations—no dust—no chains—no belts. Roller sands even with wall on either side of machine. 9" long roller 1-3/4 HP AC & DC motor.

Write for price

WAYVELL CHAPPELL & CO.
36 Jackson St., Dept. Z., Waukegan, Ill.

LUFKIN TAPES and RULES

The "Universal" is an Accurate Steel Tape at a popular price. Line is 3/8" wide, standard weight. Case is sturdy, and of good appearance.



Send for Catalog

Our Folding Aluminum Rules are furnished with or without hook. All joints and fittings are solid brass, making the rule rust-proof throughout.

THE LUFKIN RULE CO. SAGINAW, MICH.
New York - Windsor, Ont.



Paul
Products Help Sell the Homes You Build!

HOMES beyond the water mains can be modernized inexpensively with a dependable Paul Private Water System. City homes sell easier when equipped with Paul Water Softeners [Dual flow or Automatic]. A Paul Electric Hot Water Heater adds the final touch of comfort that clinches the sale.

DEALERS: Contractors and dealers will be interested in our sales proposition. Write while your territory is still open.

The Fort Wayne Engineering & Mfg. Co.
 1713 North Harrison St. Fort Wayne Indiana



"EDWARDS"

METAL Spanish
TILE ROOF
 Beautiful - Durable
 Economical

Write for
 Beautifully
 Illustrated
 Catalogue
 It Explains



A remarkable transformation takes place when an "Edwards" Metal roof is properly applied to a house—all of the charm of the old Spanish Terra Cotta Roofing Tile is preserved, even to the color.

An Edwards Metal or Tile Roof is a real commercial asset and will bring a better return in rent or sale.

Edwards Metal Roofings made to have the appearance of wood shingles, tile, slate, or any other roofing effect, and none of these fine artistic effects will cost any more than a plain, commonplace roof.

All Edwards Metal Roofing is easy to lay—no big expense for skilled labor—storms and winds will not wrench it loose. It is lightning-proof and fire-proof—Reduces Insurance Rates.

When an Edwards Roof is laid, it is there to stay.

THE EDWARDS MFG. CO., 401-417 EGGLESTON AVE., CINCINNATI, OHIO
 The World's Largest Manufacturers of Metal Roofing, Metal Ceilings, Metal Garages, Portable Buildings, Rolling Steel Doors, etc.

MAKES ANY BUILDING MORE ATTRACTIVE

Shady-way

ROLLER
AWNINGS



for

HOMES
 OFFICES
 STORES
 APARTMENTS
 FACTORIES
 HOTELS
 HOSPITALS
 and
 PUBLIC BUILDINGS

HERE'S the latest double-purpose awning, serving both as an awning and a shade. It rolls up and down like a roller curtain, controlled from the inside and does not need to be taken down in winter.

Easy and economical to install. Makes any home, apartment or building more desirable in comfort and appearance and easier to sell or to rent. It adds the final touch of color to your work as a builder. Get the facts now by sending for FREE awning book.

Shady-way Awning Division
SHANKLIN MANUFACTURING CO., Inc.
 2745 S. Eleventh Street - Springfield, Illinois

Without obligation on my part, please send me FREE Awning Booklet of 9 special features. 2745

Name.....
 Street and Number.....
 City.....State.....



MAIL COUPON Gives You **CRESCENT Universal Wood Worker**

the Edge on Competition

THIS is just the machine a contractor needs to put him on the inside track in bidding. With it he can work out his interior trim, make odd sash and frames, make special built-in features to his customers' exact specifications, at a handsome profit to himself. Efficiently does band sawing, ripping, cutting off, boring, makes moulding; attachments adapt it for sanding, panel raising, resawing, mortising, grinding knives and tenoning. Add this Crescent Universal Wood Worker to your equipment and you will be all set to do a bigger business than ever before, at less cost and make more money. Investigate now before the season opens. Write today.

WE BUILD:
 Band Saws
 Saw Tables
 Self Feed Rip Saw
 Shapers—Jointers
 Variety Woodworkers
 Planers
 Planers and Matchers
 Disk Grinders
 Cut-off Table

Swing Saws
 Borers—Tenoners
 Hollow Chisel Mortisers
 Universal Cut-off Saw



FILL OUT AND MAIL COUPON

THE CRESCENT MACHINE CO., 224 Main St., Leestonia, Ohio
 Send booklet showing the many uses of the Crescent Universal Wood Worker

Name..... Street..... Town and State..... Business.....



Master Metal Weatherstrips

Weatherstrip installers throughout the country have found that it pays to use high grade weatherstripping material. Master Weatherstrips are easier to install because they are accurately made of finest materials, yet

THEY COST NO MORE

Write Us Today for Samples and Illustrated Catalog

MASTER METAL STRIP SERVICE
1720 N. KILBOURN AVENUE
CHICAGO, ILLINOIS

ONE QUALITY ONE PRICE

BECKMANN INSTRUMENTS

THE
L. BECKMANN CO.
ESTABLISHED 1874
500 JACKSON ST.
TOLEDO, O.



SEND FOR CATALOG

—For permanence specify the famous

Hodell Sash Chain



Hodell No. 75 Apartment Sash Chain offers the most modest home or apartment building all the advantages of noiseless, permanent, smooth-running sash chain at no greater cost than for cord. Formed from a cold-drawn ribbon of polished steel, NOT STAMPED FROM SHEET; every link is uniform. See Sweet's. Ask for A. I. A. Specification File, Class 27-A1, and No. 75 folder.

We have some open territory on an exclusive basis for reliable resident agents handling several builders specialties.

Address
THE CHAIN PRODUCTS CO.
Established 1888
CLEVELAND, OHIO



MAKE A BIGGER PROFIT On The Roof

Wise, thrifty builders will appreciate the saving in putting on Walters and Coopers Metal Shingles. The Walters and Coopers Metal Shingles weigh less than wood, or slate and take lighter frame work to support it. Moreover, it is permanent. This roofing does not require skilled labor to put it on, carries a low rate of insurance and is storm, wind and fireproof. We manufacture a complete line of designs in Painted Tin, Galvanized Tight Coat, Sheet Zinc and Copper.

Write for full size samples and prices

National Sheet Metal Roofing Co.
339-345 Grand St., - Jersey City, N. J.

PARKS
WOODWORKING MACHINES



Contractors' Special
Portable Saw Rig
\$190
with 3 h. p. engine
Without engine \$90.
Send for catalog

THE PARKS WOODWORKING MACHINE CO.
Builders of quality woodworking machines since 1887
Fergus & C. H. & D. CINCINNATI, OHIO
Canadian Factory: 338 Notre Dame East, Montreal

Are You Losing Any Tools or Scaffolding?

Brand all your equipment and prevent thieves and "borrowers" from helping themselves.

Then when you replace tools or scaffold lumber you will have the satisfaction of knowing that you wore them out yourself and got your money's worth—and that you are not replacing perfectly good equipment that somebody else is still using.

Write today for full details on the Everhot Special Branding Outfit for Builders.

EVERHOT
America's Brand Makers
MANUFACTURING CO.
619 S. 10th Ave.

FREE-O-DUST

THE ONE SURFACER THAT MAKES FLOORS PERFECT
FASTER—CLEANER—BETTER

Greatest production in square feet per hour.
ERMCO V-Belt eliminates vibration.
No chains or gears to oil, grease or wear.
Portable—may be carried by one man.



Full information and details of our **FREE TRIAL OFFER**
Sent on request

Electric Rotary Machine Co.
3924 W. Lake St., Chicago, Ill.

We Mfg. A COMPLETE LINE OF BUILDERS' DERRICKS and Winches

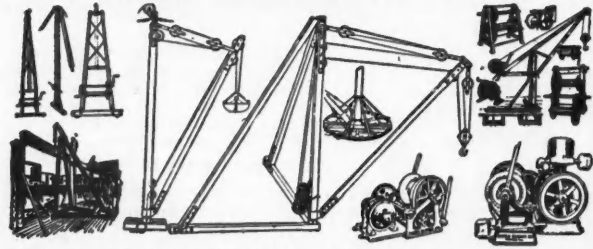

**WE SEND DERRICKS ON TRIAL TO RELIABLE CONTRACTORS
OUR MOTTO IS SATISFACTION OR DERRICK RETURNED**

Write for Circular No. 2 with illustrations, descriptions and best prices on our complete line. Sagen Builders' Derricks are built of the best Crucible Steel and Malleable Iron Fittings which makes them light, strong, safe and durable. The derricks will please you, and probably more than pay for themselves on the first job. Get one on trial.

SAGEN DERRICK CO., 3101-3125 W. GRAND AVE.
CHICAGO, ILL.
NEW YORK OFFICE—130 West 42nd St.

A *Parsons*
Pureaire

CABINET
(PATENTS PENDING)

due to scientific design,
eliminates all cooking odors, heat, grease and smoke from Apartment

New method of keeping Apartments rented, by obtaining Pure Air through direct Outside Ventilation

Beautiful cabinets. Staunchly constructed. Price is right.

Attractive proposition to dealers

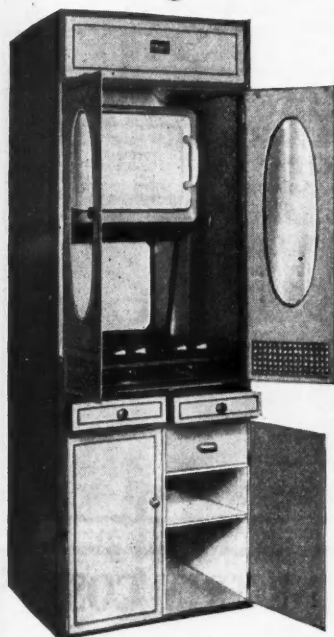

No. 500

The Parsons Co.

603 MILWAUKEE EAST - - - DETROIT

HINGE CONTROL

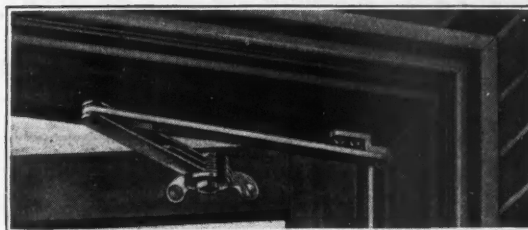

Rixson Friction Stay

There are a hundred and one cases where added convenience and satisfaction are given at the most moderate cost by use of the Rixson Friction Stay. Without it, doors and hinged in-swinging

windows are free to swing in every breeze. With it, safe adjustment at any point is assured. Six friction discs afford ample friction surface. Construction is remarkably simple.

Write, or see Sweets for details

THE OSCAR C. RIXSON COMPANY
4450 Carroll Avenue Chicago, Ill.

New York Office: 101 Park Ave., N. Y. C.
Philadelphia Atlanta New Orleans Los Angeles Winnipeg

RIXSON
Builders' Hardware

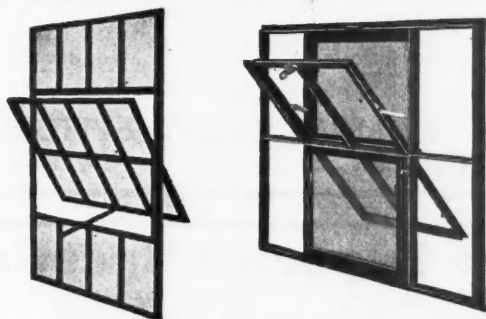

**SATISFACTION FOR OWNER
GOOD PROFIT FOR DEALER**

BAYLEY-SPRINGFIELD windows are the last word in steel window construction. Designs for all types of buildings. Two popular designs shown here. **Pivoted Window**—39 layouts and sizes; deep horizontals and verticals. **Pivoted Window Screened**—made for efficient and economical screening. Ventilators operate independently of screens. Screens removable.

Full line Casement, Utility and Basement Windows carried in stock. Attractive prices—Good profit to dealer.

Write today for prices and full information.

THE WILLIAM BAYLEY COMPANY
128 North Street Springfield, Ohio

Warehouses in Principal Cities

**Bayley-Springfield
Steel Windows**

MAUK Shingles

**STAINED TWICE
UNDER
PRESSURE**

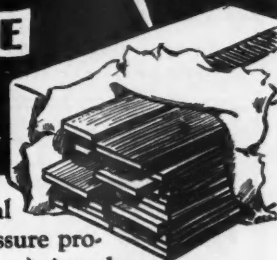

ONE application of a special stain under the MAUK pressure process (in use, now, for three years) gives these shingles a 37 per cent heavier coating. But this is not enough to meet MAUK standards. The shingles are treated, dried and then submitted to another bath, using the same pressure — 32 tons per bundle—and the same color mix. MAUK shingle-clad homes hold their color longer—look better and sell quicker.

**Valuable Manual
FREE**



The C. A. Mauk Lumber Co., 2
Toledo, Ohio
Send me your shingle manual and special portfolio of homes.
Name _____
Address _____
City _____ State _____

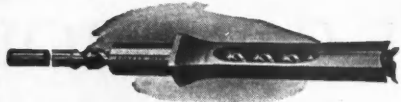

Improved Hollow Mortising Chisel No. 28
Registered Trade Mark "FOREST CITY"

**FOREST CITY BIT & TOOL COMPANY
MANUFACTURING**

High Quality Hollow Mortising and Wood Boring Tools that give service and satisfaction. Write for new catalog No. 25 illustrating and describing our complete line of FOREST CITY tools.

Incorporated 1890

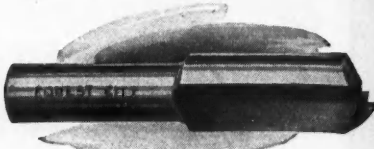

Router Bit No. 400

FOREST CITY BIT & TOOL CO., ROCKFORD, ILL., U. S. A.

**"EVER READY" FOLDING TYPE
ROOFERS' BRACKET**

Pat. Sept. 7, 1926



Speed up your work and make it safe with our dependable heavy gauge brackets.

EVER-READY BRACKETS
pay for themselves

Send for descriptive circular and prices.

CASHMAN EQUIPMENT CO.
14 Winslow St. Providence, R. I.

The Machine for Many Uses
H & A PORTABLE, MOTOR-DRIVEN RIP SAW



A STURDY, heavy-duty machine that you can use in your shop or on the job—profitably—because it does the work of 8 or 10 men using hand tools, and does it better. Use it for ripping, cross-cutting, mitering, dadoing, grooving or rabbetting. Just the machine for off-season shop work—for making cabinet work, sash, screens, trellises and many other profitable items. Costs little to own and operate. Write for full information.

HESTON & ANDERSON
206 Market St., Fairfield, Iowa
Write for catalog showing complete line of H & A portable motor-driven tools.

Make Blocks, Brick & Tile for Less! Money!



THE ZAGELMEYER SYSTEM

Make Blocks, Brick and Tile for less money

Cut down your building costs by making your own concrete blocks, brick and tile with

ZAGELMEYER MULTIPLE MOLDS in your own plant. You, too, can grow to manufacturing independence from a moderate start, the same as many others have done. Get started now. Send today for free booklet.

Zagelmeyer Cast Stone Block Machinery Co.
3000 So. Henry St., Bay City, Michigan

CUT DOWN YOUR TRIM COSTS



With TRIMPAK three carpenters can completely trim a 6-Room house in one day. TRIMPAK, the interior trim for doors and windows, comes packed in 2 cartons—one for the horizontal members and one for the verticals. All ready to fit. Made in every wood.

Write for further information.

TRIMPAK CORPORATION
44 Whitehall St. New York City

THE SHEBEL FILER



MAKE MONEY

filing saws. It's easy. Get a Shebel Filer and you at once become an expert filer. Nothing to it. Any one can get a high class job of filing with it. It's a brand new idea in a Saw Filer. Send for full particulars. Some say it is worth \$100.00. The price is only \$5.00.

ANTHONY P. SHEBEL
326 REED STREET Milwaukee, Wis.

The Superior Speedster

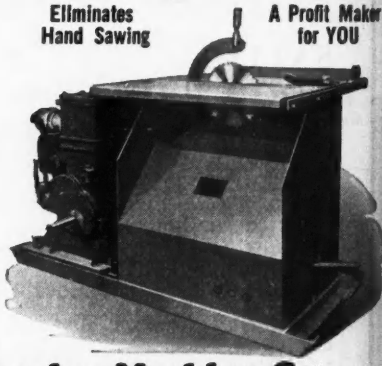

Should save you \$100 on every job **Why?**

- Because it is built with swinging arbor and tilting table.
- Because it may be powered with gasoline engine or electric motor.
- Because it is light in weight and yet has enough power to saw lumber in one-tenth the time required by hand.
- Because it saves time and labor, thereby producing greater profits.

Eliminates Hand Sawing

A Profit Maker for YOU

New bulletin describing the SPEEDSTER is ready—send for your copy today.

Jones Superior Machine Co.
1240 West North Ave., Chicago, Ill.

Malleable Asphalt (Mastic)

The Roofing and Flooring compositions that are creating a sensation. We want Salesmen to act as district Sales Supervisors—also local Salesmen.

Contractors make a two-way profit... one on the sale and one on the application.

Write today for free Information

MALLEABLE ASPHALT CO.
6355 Broadway, Chicago, Ill.

THE SLATINGTON-BANGOR SLATE SYNDICATE, Inc.
SLATINGTON, PENNA.

Miners and Shippers of

Black Roofing Slate **Natural Blackboard**
Structural Slate **Electrical Slate**
and Slate Products

WRITE US FOR PRICES

Thousands of Contractors
Have Found a Way to Save Money on
Their Bridging Costs by Using

Lane's "3-Ty" Steel Bridging

Why Spend 4 Hours of Skilled Labor
in Installing Bridging When "3-Ty" May
Be Installed in 1 Hour?

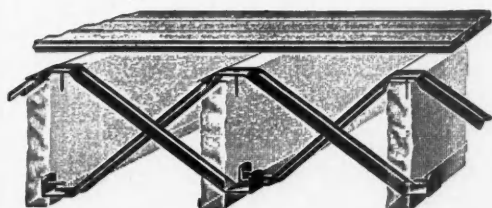

"3-Ty" Eliminates All Expense of Preparation
and Misfits, Will Not Split, Warp or Dry Out,
and Makes a Stronger and Neater Job

Write for information and prices

LANEBRO MANUFACTURING CO., INC.
WEST POUGHKEEPSIE NEW YORK
Also Door Hangers and Track, Automatic Lock Tackle Blocks

The Quickest Way To Cut a Stair Horse

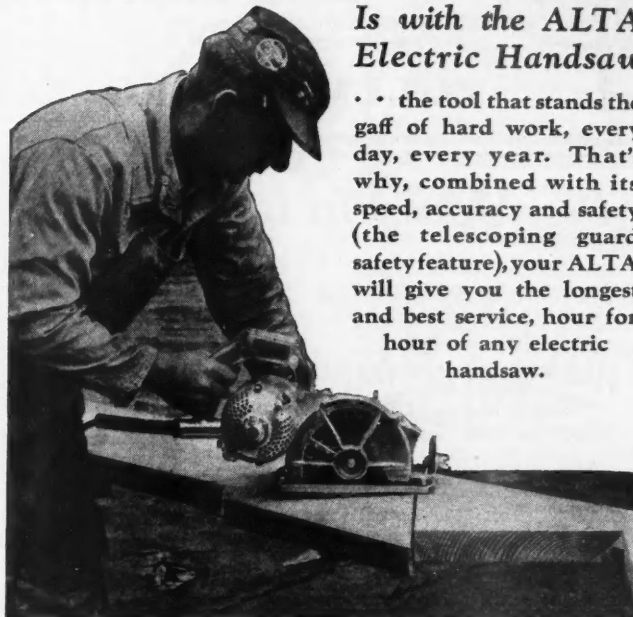

Is with the ALTA
Electric Handsaw

• • the tool that stands the
gaff of hard work, every
day, every year. That's
why, combined with its
speed, accuracy and safety
(the telescoping guard
safety feature), your ALTA
will give you the longest
and best service, hour for
hour of any electric
handsaw.

Write for Catalog

WAPPAT
GEAR WORKS, INC.

Division of
SIMONDS SAW & STEEL CO.
7526 Meade Street
Pittsburgh, Pa.

Name _____
Address _____
City _____

Nature's Permanent Mineral Colors

None but the Best!

NO matter what you buy
in building materials it
pays to buy the best. For
years to come you are assured
of reliable service.

If you are using color in
your mortar—surely it is im-
portant to select a brand
that insures permanency,
uniformity and long life.
Consequently all builders
look to Clinton Mortar and
Cement Colors as the out-
standing product of merit in
its field.

Complete information
on Clinton Mortar and
Cement Colors and
their use will be sent
upon request.

CLINTON METALLIC PAINT CO.
569 Clinton Road, Clinton, N. Y.

Clinton Mortar Colors

FRAZIER Self-Balanced DISAPPEARING STAIRS

The Only Fully
Assembled
COMPLETE
Disappearing
Stairs Made
(Jamb Included)

Save attic or closet
space and enhance
selling value by in-
stalling a FRA-
ZIER—shipped
ready to install!

Highest in Quality
and Lowest in Price

See Your Dealer or Write

F. O. B. Pittsburgh, Pa.
(Shipping weight 125 lbs.)

FULLY GUARANTEED

Attractive proposition for
specialty men—write



No
mechanical
features to
get out of
order

No Springs,
Weights or
Pulleys

24-Hour
Service

FRAZIER STAIR COMPANY, 2615 West Liberty Ave., Pittsburgh, Pa.

Gentlemen: I am an Architect , Builder , Dealer . Please
send details on Frazier Stairs.

Name.....
Address.....

PULLMANIZE YOUR WINDOWS!

Mills & Sons, 5558 W. North Ave., Chicago, Ill., are erecting and **completely Pullmanizing 1478 bungalows** at Westwood, within 26 minutes of the Chicago Loop. They have already used and ordered **20,331 sets of Pullman UNIT Sash Balances** and expect to install **over 30,000 sets**. Mr. Mills writes us Pullman is more economical even in speculative building than weights and cords and believes we have the best window control available.

Write for New Folder Today

PULLMAN MFG. CO., INC. —47 SOUTH FORD ST.—
ROCHESTER, N. Y., U. S. A.

Big Money In It For You

Every home-owner and home-builder in your town is a prospect for Diamond Weatherstrips. With profits averaging 33 1/2 to 50%, without any investment until the actual contract's made, there's big money to be made with this quality line.



PRACTICAL METAL THE DIAMOND WEATHER WAY STRIPPING

Valuable territory remains open to your enterprise and initiative. Write now for complete information about this money-maker.

THE DIAMOND METAL WEATHERSTRIP CO., Columbus, Ohio

IRON FENCE FOR EVERY PURPOSE

Plain and ornamental iron fence—entrance gates, wire and iron window guards, balcony railings, grilles, folding gates, gratings, cellar doors, etc. Catalog on request—estimates cheerfully given—orders filled promptly.



CINCINNATI IRON FENCE CO., Inc., 3331 Spring Grove Ave. CINCINNATI, OHIO.



Mail This Ad with your name and address for circular and special price on this fine

Bearcat Electric Mortiser
It's a Money Maker

THE PAXSON COMPANY
DOWAGIAC, MICHIGAN

SAW RIGS—SANDERS—
MORTISERS

HAGSTROM SECRET DOOR LATCH

Designed especially for concealed panels. May also be used on doors, instead of ordinary latch. When door is closed no hardware is visible. To close push lightly on door—to open push hard. Door moves less than 1/4". Shrinking or swelling will not affect this latch as long as door swings free. Latch may be screwed right on door jamb. Strike screwed on door without cutting. Built in five sizes. Anyone can apply this latch in less than ten minutes. If your jobber cannot supply you address Dept. A for literature and prices.



Patent Applied For

Hagstrom Mfg. Co., Glen Cove, N. Y.



MAILO-BOX
PAT. U.S. AND CANADA

Attracts Home Buyers

Because of its beauty and convenience, the Mailo-Box makes a hit with women. It saves many steps and protects mail. Costs little. Easily and quickly installed. Adjustable to any wall thicknesses. Lasts as long as the house. Price \$4.75 to \$12.00. Beautifully finished.

Write for circular and our proposition.

Penn-Greg Mfg. Co.
809 University Ave. St. Paul, Minn.



KNICKERBOCKER MIXERS

All sizes 3 1/2-S to 28-S—each built as only Knickerbocker builds mixers.

Ask for Catalog
KNICKERBOCKER COMPANY
Jackson, Michigan

WINCHES

Electric Capstan Winch—for all purposes.

Manufacturers of winches for all purposes. Power, Electric and Hand Winches. For Motor Trucks, Tractors and general purposes. Also Lifting Jacks, and Rollers for Lumber Trucks.

Safety Worm Geared Winches—made in eight sizes, 100 to 6000 pounds capacities.

Write for Bulletins and prices. State for what purpose winch is to be used, and weight of load to be lifted.

Manufactured by
Stimmel Winch & Machine Works
Works and Offices: 562-66 W. 22nd St. New York City

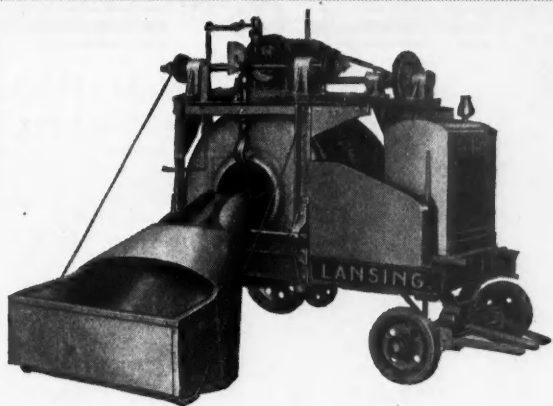

Lansing 10-S Mixer

SPECIFICATIONS:

Powered with a 4-cylinder, 12 H.P. LeRoi gasoline engine, 8 seconds to elevate skip from ground and 15 seconds to empty. Automatic clutch knockout bar holds skip in charging position. Operating levers arranged on drum end, making effective one-man control.

Thirteen Heavy Duty Hyatts mean long life and easy running. Rubber tired wheels. Capacity: Mixed concrete per batch 10 cu. ft. Drum heads shaped to throw material towards center, away from openings. Alemite Pressure Lubrication gives quick, thorough greasing. GET THE COMPLETE SPECIFICATIONS ON THIS FAMOUS MIXER.

Have YOU the latest Lansing Catalog?

LANSING COMPANY
LANSING, MICH., U. S. A.

An Exclusive Crescent Feature



Operator only pulls saw toward him.



Saw returns to position of itself.

CRESCENT Universal Cut Off Saw

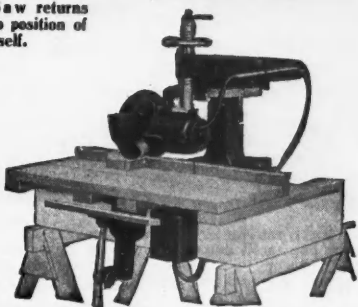

SAFETY that develops Speed

USERS appreciate the carefully guarded saw, essential for ripping, equally valuable for cross-cutting. It inspires confidence so that the operator can work faster, better, and with less fatigue. Guard is easily adjusted, quickly removed. Spout that carries off sawdust is a great convenience.

These and many other up-to-the-minute features make the Crescent Universal Cut Off Saw the most efficient machine available for doing a multitude of sawing operations out on the job. It is easily carried from place to place, saving hours of time in cutting joists, rafters, sheeting, siding, flooring, etc., routing stair stringers, making mouldings, dadoing, cutting tenons.

This machine has proved to be such a big time saver and money maker that no alert contractor would think of getting along without it.

- | | | |
|--------------------|---------------|-------------------------|
| We Build: | Planers and | Hollow Chisel Mortisers |
| Band Saws | Matchers | Borers—Tenoners |
| Saw Table | Disk Grinders | Universal Wood |
| Self Feed Rip Saw | Cut-off Table | Worker |
| Shapers—Jointers | Swing Saws | |
| Variety Woodworker | | |
| Planers | | |

FILL OUT AND MAIL COUPON

THE CRESCENT MACHINE CO., 224 Main St., Leontonia, Ohio
Send booklet showing the many uses of the Crescent Universal Cut-off Saw

Name _____ Street _____ Town and State _____ Business _____

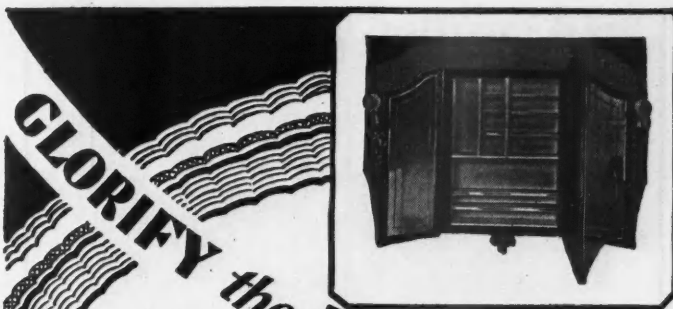

GLORIFY the BATHROOM with Colorful MIAMI STEEL Bathroom Cabinets

THE nation has become "bathroom conscious!" Color in the bathroom is an important part of the building scheme . . . in new or modernized homes.

Miami Steel Bathroom Cabinets set the pace for colorful style . . . dependable construction . . . economical installation. Learn more about the Miami Line for homes, apartments, office buildings, hotels and institutions.

Send for CATALOG No. 7

The MIAMI CABINET CO.
MIDDLETOWN OHIO

THE MIAMI CABINET CO.
Middletown, Ohio
I'd like to know about your new line of cabinets.
Please send full particulars.

Name _____
Address _____
City _____
 Owner Contractor Architect Dealer

How crack construction men get things done

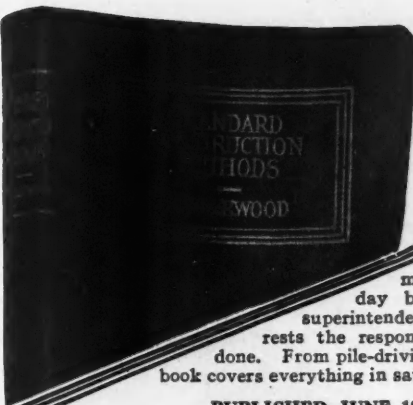

A manual of actual construction methods; methods that are used every day by practical construction superintendents and others upon whom rests the responsibility of getting things done. From pile-driving to scaffolding, this new book covers everything in satisfying detail.

PUBLISHED JUNE 1927

STANDARD CONSTRUCTION METHODS

By G. UNDERWOOD
Construction Engineer

408 pages, 6x9, 327 illustrations, flexible
\$5.00 net, postpaid

A real chapter on rigging and erection work. Tables of safe capacities for tackle—a new simple formula for strengths of manilla and wire rope—figuring the strength of hooks and shackles—how to rig a gin pole and shears, etc., etc.

McGRAW-HILL BOOK COMPANY, Inc.
370 Seventh Ave.
New York City

- CONTENTS**
- I.—Organization and Equipment;
 - II.—Excavation;
 - III.—Pile-Driving;
 - IV.—Concrete Construction;
 - V.—Wood Construction;
 - VI.—Brick Construction;
 - VII.—Steel Construction;
 - VIII.—Roofing and Flashing;
 - IX.—Lathing and Plastering;
 - X.—Scaffolds;
 - XI.—Erection and Rigging;
 - XII.—Pipework;
 - XIII.—Painting;
 - XIV.—Construction Schedules.

You may send me for 10 days' free examination Underwood's Standard Construction Methods, \$5.00 net, postpaid. I agree to remit for the book or to return it, postpaid, within 10 days of receipt.

Name _____
Address _____
Position _____
Company _____

Send your copy—free
MAIL THIS COUPON!

AB-6-29

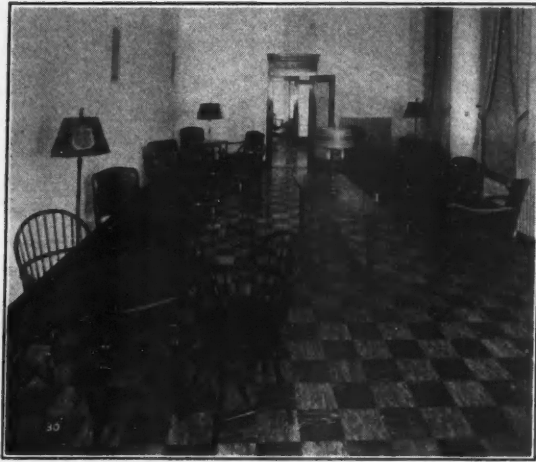

LOUNGE ROOM AND OFFICES
ROSEHILL MASONIC LODGE, ST. LOUIS, MO.
E. Christopher, Architect

WRIGHT RUBBER TILE FOR ALL FLOOR COVERINGS

Our Installation Instruction Booklet has been instrumental in starting many men in a profitable business. Write for a copy today.

WRIGHT RUBBER PRODUCTS CO.,
Dept. A. B. 6, RACINE, WIS.

WRIGHT RUBBER TILE
Rubber Only Material That Withstands Tire Road Wear

Send for yours *today*

If you would like to receive a set of books describing the use of slate with sizes and complete information on Stracco Slate describing its beautiful highly polished and colorful surface and illustrating its many uses, address your request today to

THE STRUCTURAL SLATE CO.
630 Robinson Ave., Fox Argt., Pennsylvania

New FREE CATALOG!

HOME OWNERS! BUILDERS!
Send for Our **BIG New FREE Catalog**

Containing hundreds of fixtures for every purpose and every taste. Our selection is the finest and most complete. Be sure you have our catalog before buying. Our prices save you money and our **MONEY BACK GUARANTEE** gives you 30 DAYS TRIAL.

Also describes fixtures for Churches, Theatres, Auditoriums and Public Buildings
Contractors, Builders, Electricians are invited to write for our proposition

PARAMOUNT ELECTRIC CO.
930 Z ARCH ST., PHILA., PA.

Send for it *today!*



Sepco

Sepco Flameless Water Heater
a Revelation to the Building Trade

Installed at a good profit to Builders and a great comfort, convenience and economy to home owners or tenants. No soot, smoke, danger or worry. The only hot water heater that prevents waste of hot water when user forgets to close faucet tightly.

Power companies grant low rates—lower than lights—to make this service available to everyone.

See this wonderful Sepco Automatic Heater at your dealer's or write us for information. You will want to install Sepco Flameless Water Heaters on every job.

AUTOMATIC ELECTRIC HEATER CO.
1706 Race Street Philadelphia, Pa.



2 WAYS TO IDENTIFY

PEARL WIRE CLOTH

Due to its metallic coating, a secret process exclusive with G. & B. PEARL is an exceptional rust resister. Because of its long life, smooth finish and even mesh PEARL is and has been for over 30 years the most satisfactory screen wire cloth.

Our round red tag and two copper wires in the selvage identify PEARL.

Address Dept. "A"

The Gilbert & Bennett Mfg. Co.
New York Georgetown, Conn. Chicago Kansas City
PEARL is made in Regular Grade (12x13 mesh) and 14, 16, 18, 20, 24 and 30 mesh; also Extra Heavy Grade (14 mesh only)
The best hardware dealer in your city sells "PEARL"



PROFITS With IDEAL HOISTS

Save money wherever there is a rope or cable to pull. Made in two sizes, 1,200 to 2,000 lbs. capacity. Reversible and non-reversible—single and double drum, with or without engine. Write today for complete information.

UNIVERSAL HOIST & MFG. CO.
196 East 14th St. Cedar Falls, Iowa



Build Your Own Jointer Frame

Buy your Jointer head or saw mandrel from us. Build your own frame and you can make a big saving. Our machines are guaranteed to give perfect satisfaction. *Circulars and Prices on Request.*

WHISLER MFG. CO. - - Ottumwa, Iowa

INDESTRUCTO TOOL CASES

Handy, light, and very strong separate space for saws, level, planes, square, miter box, chisels, bits, etc. Every tool easy to get at and carried like a suit case.

Write for catalog and prices

WEDELL & BOERS
125 W. Jefferson Ave., Detroit, Michigan

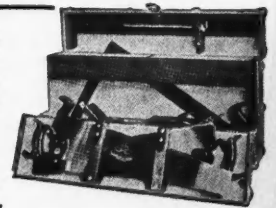

AMERICAN BUILDER

The Open Door to a Great Market
COVERS THE ENTIRE BUILDING INDUSTRY

MODEL 29

FOR big value, this new Bessler is unmatched anywhere. It is efficient, well made of best materials. Panel hinged at side is great space saving feature.

Ask Your Dealer

\$29⁵⁰

The lowest priced disappearing stairway in the world!



BESSLER
DISAPPEARING STAIRWAYS

The Bessler Disappearing Stairway Co.
Akron - - Ohio

Make money bottling heat!

Keep the cold outside
With
A new scientific
Weatherstrips

You save fuel and energy—when your house is Pyramid protected.

Factory Agents Wanted **Twelve Hour Service**

Now, for the first time, you can show home owners how to save 25% to 40% on their fuel bills. Big cash profits, quick sales. Supply the popular demand for this newly invented weather-strip.

Keeps cold draughts out—warm air in.

Quickly and easily installed around windows at nominal cost. Get details. Excellent money-making side-line for dealers. Quick cash profit-taker for sales representatives. Write today for confidential information and price list by return mail.

PYRAMID METALS COMPANY
2014 Wabansia Ave. - - - CHICAGO, ILL.

You Can Chalk up the Profits on any Slate

BUT You Want

Genuine By this Mark



Clear Black Slate

To Give LASTING ROOFS and PROFITS Worth "Chalking" About

First Quality, Reasonable Prices, Good Profits

Write for Samples and Information

SLATINGTON SLATE CO., SLATINGTON, PENN.

AJAX folding metal SHEATHING AND ROOFING BRACKETS



Enable you to work right up into the hard-to-get-at corners. The quickest ever, safe as the earth under your feet.

Send for descriptive literature

Ajax Building Bracket Co.
1551 Rydal-Mount Rd., Cleveland Heights, Ohio

KEWANEE

Copper Steel Basement Chutes



Install Kewanee Coal Chutes in the homes you build. They save repair bills for the owner and reflect credit on the builder.

A Kewanee Chute protects the building during coal delivery and adds to appearance, and increases value, at low cost.

Dealers: Write for our attractive offer.

KEWANEE MANUFACTURING CO., 609 TREMONT ST., KEWANEE, ILL.

NEW

BISMARCK HOTEL-CHICAGO

RANDOLPH AT LA SALLE

The hotel with a history, where good food is a tradition—where superior service is a creed—and where the cheerful comfort of the guest is an accepted obligation.

All outside rooms; restful beds.

Rooms \$2.50 and up.
With bath \$3.50 and up.

"Handy as Their Name"

\$30

—say contractors and users of Boice-Crane Handi-Saws and Handi-Jointers. Not only handy, but low-priced and economical in operation. Operated anywhere there's a light socket. Save steps, time and money.

Handi-Jointer

Tables 20" long, ground and polished. Planes 1/4" by 4". Fence tilts 45 deg. both ways. Improved rabbet arm. Bronze bearings. Safety guard, \$3 additional.

Handi-Saw

Our Universal type. Table 15" by 17". Tilts 45 deg. 8" saw cuts 2" stock. Elevates for dadoing. Always accurate. Pulley between bronze bearings. Attachments for dadoing, jointing, disc and drum sanding, boring, grinding, etc. Wgt. 60 lbs.

Send for free, new 80-page catalog describing 15 different Boice-Crane machines.

W. B. & J. E. Boice, Dept. A.B. 6-E, Toledo, Ohio



\$25 Without Motor

KNO-BURN, JR.

Small Mesh
METAL LATH

"Makes Good Plastering Cost Less"

Sample and circular gladly sent

NORTH WESTERN EXPANDED METAL CO.
1203 Old Colony Bldg.
CHICAGO

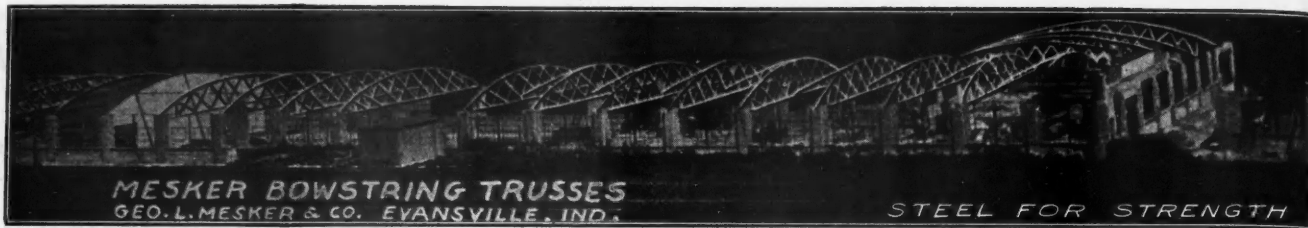

MESKER BOWSTRING TRUSSES
GEO. L. MESKER & CO. EVANSVILLE, IND.

STEEL FOR STRENGTH

Beautiful Brick Effects



deserve

Anchor Brand
Mortar Colors

C. K. Williams & Co.
634 North 13th St.
EASTON, PA.

MITERED CASINGS ARE THE BEST CASINGS



This is all the extra equipment that is required for making the finest mitered casings.

CLAMP NAIL CO. 4540 Palmer St., Cragin Station CHICAGO, ILL.

CLAMP NAILS

MAKE THEM SO

The Best, Fastest
and most
Economic
METHOD

Write us for information
and samples.

\$15.00

YEAR 'ROUND PROFITS



You'll find that weatherstrip is not just a cold weather item. Buildings of all kinds in your town—homes, schools, churches, hotels, apartments, office buildings, etc., look for protection against alternate flying dust and dashing rain. Each one of these buildings is a prospect for Federal Metal Weatherstrip. You can become our agent in your town. Write today for details of our proposition.

Federal Metal Weather Strip Co.
4538-58 Fullerton Ave. Chicago, Ill.

THE MASTER SLIDE RULE

For all inside and outside measurements the Master Slide Rule is preferred. Its accuracy is never questioned, and it eliminates all guess work.

Order one from your dealer today. If he does not carry them write us

MASTER RULE COMPANY
815 EAST 136th ST. NEW YORK

Matot

Full Diameter Lift Wheel—Hobbed
Gear Automatic Brake

DUMB WAITER

Matot machines are roller-bearing throughout, and guaranteed for five years.

PROMPT SHIPMENTS
Catalog on Request

D. A. MATOT CO., 1545 Montana St., Chicago
Manufacturers of Hand Power Dumb Waiters and Elevators

Blackboards for all requirements

Duroplate, Permaroc, Enduraroc, Natural Slate
Tackboard, Corkboards and Bulletin Boards

Highest quality guaranteed. Let our service department help you with your problems. It costs you nothing.

Samples sent free on request. We can save you money; write today for prices.

E. W. A. ROWLES CO.

2345 So. La Salle Street Chicago, Illinois

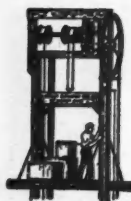

ELEVATORS DUMBWAITERS and HOISTS

(Electric and Hand Power)

Electric Attachments for hand power elevators. Our product unsurpassed. Have been elevator builders for nearly fifty years. When inquiring for estimate, state kind of elevator wanted, capacity, size, platform travel and height of hatch.

Sidney Elevator Mfg. Works (Miami St. Plant), Sidney, Ohio



Fully Enjoy MILLER DRIP EDGE

It easily re-inforces, protects, supports and finishes prepared roofing or shingles at the roof edges. Millions of feet sold, from Eastport, Maine, to Honolulu, Hawaii.

Free sample and folder

MILLER & GLEASON, Div. D, OLEAN, N. Y.

TAYLOR COLLAPSIBLE HORSES

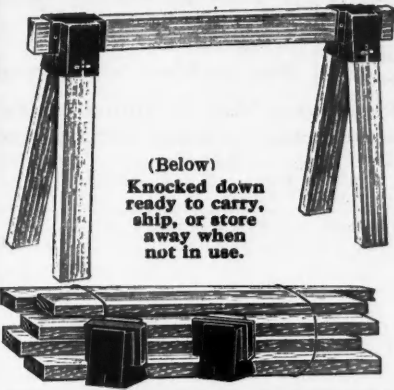

(Below)
Knocked down
ready to carry,
ship, or store
away when
not in use.

Quickly assembled or taken apart. Easily carried from job to job. Hold 8600 lbs. without a creak. No nails or braces.

Write for Complete Information
EVERHOT MANUFACTURING COMPANY
620 S. 10th Ave.,
MAYWOOD ILLINOIS

QUICK ACTING *The Taylor* SELF LOCKING

CLAMPS An Investment Not An Expense

Quickest and strongest clamps made. Standard in U. S. Government Works and in such concerns as General Electric Co., Singer Sewing Machine Co., Victor Talking Machine Co., etc. We can prove it in your own shop. Write today.
JAMES L. TAYLOR MFG. CO., 110 Parker Avenue, Poughkeepsie, N. Y.

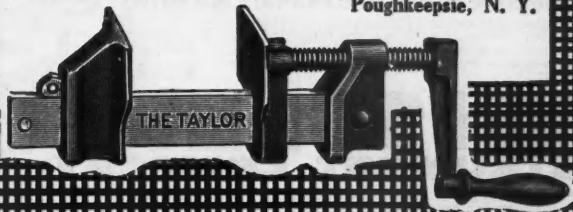

METAFORM

The Best Investment A Contractor Can Make

The Metaform system of shifting molds ahead, allows continuous pouring of concrete with a surprisingly small amount of equipment. A Metaform outfit will more than save its cost in one season. The savings after that are sheer net profit for year after year.

Tell us what classes of concrete work you do and we will send you complete Metaform information.

METAL FORMS CORPORATION
Milwaukee, Wisconsin

METAL FORM OUTFITS

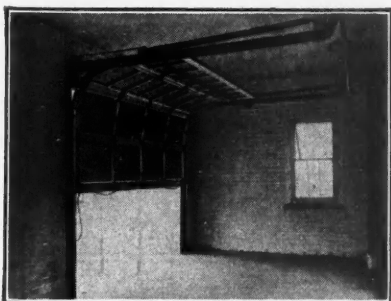

THE "OVERHEAD DOOR"

Opens Up—Completely Out of the Way.
For Garage—Factory—Warehouse. Send for Catalog.
Overhead Door Corporation Hartford City, Ind.

QUICKER SALES . . . BETTER PRICES

You get both when your houses are floored upstairs and down with oak. The floors are the first thing a home buyer looks at. If they are of oak, the house makes a good first impression. You can sell it *today*—not months from now. And you can get more for it by hundreds of dollars. Check these advantages against the few dollars extra that oak flooring costs and you'll *always* floor with oak. Ask your lumber dealer for the figures today. Or write direct to the **OAK FLOORING MANUFACTURERS' ASSOCIATION of the United States, 1238 Builders' Building, Chicago.** A bureau maintained by the oak flooring industry for the benefit of home owners and builders.

Oak Flooring advertising is being carried on during 1929 on an increased scale. Look for the advertisements in "House and Garden," "House Beautiful," "Good Housekeeping," "Better Homes and Gardens" and "The Literary Digest."

Install Your Own PLUMBING-HEATING!



Send Sketch—FREE Estimate
Now you can buy Highest Quality Grade "A" goods at lowest wholesale prices. Have the best—at a price. Our New Easy Method makes it quick and easy for any handy man to install his own.

BOOK FREE

New bargain catalog just off press. Get our rock-bottom prices and special terms. Our new cut-to-fit plan saves waste material and high labor cost. Fifty years successful service to builders, home owners, farmers, mechanics. Your FREE copy of our New Book gives you complete instructions. Write for it TODAY.

Million Dollar Bonded Guarantee—Protects You
Hardin-Lavin Co. Est. 1876. 142-52 W. Pershing Road, Chicago, Ill.

FORSTNER BITS BRACE & MACHINE

THE FINEST Tool Manufactured for important wood work.

Specially adapted for Hardwood operations; indispensable to the High Class Carpenter and for Cabinet and Pattern Works.

Manufactured by
THE PROGRESSIVE MFG. CO.
TORRINGTON, CONN.

Special Offer

A sample bit up to 1 inch in diameter will be mailed postage prepaid, upon receipt of 75c to any woodworker or carpenter.

NO DEPOSIT! Use a "STERLING" 10 Days

Get first-hand facts on what the "STERLING" Convertible Wye Level can do for you. Test it 10 days. No cost. No risk. No obligation. Easy terms if you buy.



(PATENTED)
Model No. 40

Gold Medal Sesqui-Centennial Exposition, 1926

Pin this coupon to your letterhead and mail today

WARREN-KNIGHT CO.
136 N. 12th Street PHILADELPHIA, PA.
Send new Free Bulletin F-36, explaining free trial offer and easy purchase plan.
Name.....
Firm.....
Address.....

IDEAL MANUFACTURING PLANT
 in Milwaukee, Wisconsin, consisting of two large manufacturing buildings, several small buildings; 150,000 feet floor space; Sprinkler System; Generator and power plant; switch track; 7½ acres ground; employee's auto shed. Buildings have daylight on all sides. For immediate sale this complete plant can be had at a real bargain price. Terms over a period of ten years on practically a rental basis if desired. Write for information.
Owners, SMITH BARNES & STROHBER CO.
 105 N. Clark Street, Chicago, Ill.

AMAZING NEW COMPLETE TRANSIT \$45.00
 Levels and plumbs from same set-up. Has everything; shifting center, vertical arc, clamp and tangent. No shifting or locking of 'scope. Control level prevents error. A complete transit, fully guaranteed. Write for Folder 172.
Compass Extra \$5.00

WISSLER INSTRUMENT COMPANY WRITE FOR FOLDER
 627 No. Broadway St. Louis, Mo. 172

Build for Pleasure-PROFIT!
CLOCKS
 with our Plans Parts and Help
 WOULD a set full of Extra Dollars look good to you? BUILD CLOCKS!—Simple Clocks, Mantel Clocks, Grandfather's Clocks. Big demand, plenty of profit. We furnish plans, work, parts. Small work \$1.65; others with chimes all prices. Write NOW for FREE Book—FREE Blueprint offer—all the money-making details!
American Chime Clock Company
 1643-F Ruffin St. Philadelphia, Pa.
 Send for FREE BOOK

Stop "Guesstimating"—avoid Errors and Omissions
Our BUILDERS' ESTIMATE SHEETS
 Will SAVE Time and MONEY—{ 1 Book, \$1.00 }
 100 leaves in a book, 4x9½ inches. { 3 Books, \$2.50 }
 via Ins. Parcel Post same day we get order. { 5 Books, \$4.50 }
LOUIS FINK & SONS CO., Printers
 Time Sheets, Job Tickets, Letter Heads, etc.
 In Business Thirty Years Noted for Quick Service
 Elm Ave., Laurel Springs, N. J.

A FREE TRIAL
 will sell you on the G. & B. Model 45 Convertible Y Level. A Regular Level and Transit Combined. Fully equipped. Honest value and a low price. Ask for circular. (June, 1929)
GEIER & BLUHM, INC.
 670 River Street : : TROY, N. Y.

DE LUXE EDITION. The most wonderful book of home plans ever published. 224 pages, nearly 600 illustrations of floor plans, photos and approximate cost to build—of medium cost Colonial homes, cottages, bungalows and two-family dwellings, an ideal reference book showing size o' rooms, buildings and a description of each postpaid for \$3. New book of 60 nifty plans of medium-cost English and American Colonial homes \$1. or both books for \$3.50 Complete plans and specifications as low as \$10 You cannot afford to build until you have seen this book. It may save you hundreds of dollars.
FREDERICK H. GOWING, Architect
 101 Fremont Street Boston, Mass.

for **SCRUBBING WAXING POLISHING ALL FLOORS**
Investigate Before You Buy A Floor Machine
 The simplest, most practical electrically operated floor machine for home, office, store, church, school, hospital, showroom, garage, factory, etc. Finishes old or new floors; waxes, scrubs, polishes.
 Write today for OUR LOW PRICES and complete information.
HILD FLOOR MACHINE CO.
 108 West Lake Street, CHICAGO, ILL.

The Most Economical Sash Holder
 It Is Automatic
 No Sash weights, cords, pulleys or balances necessary.
 Write for Prices
 Send For Trial Set \$1.25 Prepaid
HARDWARE SALES CO., 30 Church St., Room 446E, NEW YORK CITY

Classified Advertising

RATES:
 Small letters 25c per word
 Capital letters 50c per word.
 Minimum twenty words.
 Business Opportunities For Sale and Exchange Help and Situations Wanted
 To Insure Insertion Remittance Must Accompany Order

ASBESTOS SLATE ROOFERS, save labor and slate by using the Duplex Punch and Brake. Made by the CARROLLTON SHEET METAL WORKS, Carrollton, Mo.

LIGHTNING RODS, "DIDDIE BLITZEN," approved by Underwriters. Write for territory and free samples. L. W. DIDDIE COMPANY, Marshfield, Wis.

PATENTS PROCURED. Prompt service. PERSONAL CAREFUL AND EFFICIENT SERVICE. Highest references. Moderate fee. Send sketch and model for actual search and advice. GEORGE P. KIMMEL, Master of Patent Law, 94F, Legal Bldg., Washington, D. C.

ATTENTION—Home Mechanics. We sell unusual cabinet hardware, chest trimmings, tea wagon wheels and casters, big line small hinges, locks, etc. Upholstering supplies, electrical hardware, knocked down cedar chests, etc. Send ten cents stamps for catalog. THURSTON MANUAL TRAINING SUPPLY COMPANY, Jobbers and Manufacturers, Anoka, Minnesota.

USED TRANSITS and LEVELS. BUFF, Hudson Terminal Building, New York City.

CARPENTERS, CONTRACTORS, BUILDERS, ETC.—Send for our Free Booklet, "How to Read Blue Prints." Tells how to make most money in the building trades. Every builder should have this information. Write today. Address: Dept. 2346, CHICAGO TECH., 118 East 26th St., Chicago, Ill.

PATENTS—Booklet free. Highest references. Best results. Promptness assured. WATSON E. COLEMAN, Patent Lawyer, 724 Ninth St., Washington, D. C.



MAKE WASH DAY EASIER
 Banks (Patented) Removable Green Enameled Steel Clothes Post and Flag Poles.
 They carry a money back guarantee. To guard against inferior imitations, be sure to look for the "ACE OF CLUBS SHAPED TOP" which has the name and date of (Patent) "The Ace of Clubs Top" that holds the clothes lines is PARKERIZED, making them absolutely rust-proof. Will last as long as your house. Why buy anything but the best—quality will tell.
 All progressive Department and Hardware stores and supply dealers sell them. Write for Descriptive folder.
BANKS STEEL POST COMPANY
 128 Wakeman Ave., Newark, New Jersey

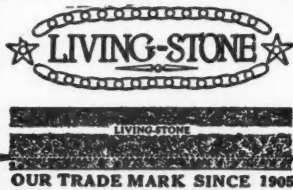

LIVING-STONE
 The Perfect Bond for Concrete
 Contains no acid. Therefore cannot injure concrete or steel. Forms a bond stronger than the concrete itself.
 Catalog on request
LIVING-STONE CO.
 1 E. Lee Street, Baltimore, Md.



SAVE 1/2
 on plumbing, heating, hardware, paint, roofing. Large quantity buying enables us to offer Grade "A" merchandise at great savings.
 Send today for free catalog—over 120 pages of enormous bargains
Stanley Plumbing Supply Co., Inc., 412 North 12th St. Philadelphia, Pa.





A Real Home Comfort
Mallory Shutter Workers
MALLORY MFG. CO.
 700 BROAD STREET FLEMINGTON, N. J.

AMERICAN BUILDER
 The Open Door to a Great Market
 COVERS THE ENTIRE BUILDING INDUSTRY

SPECIFY the Hoosier

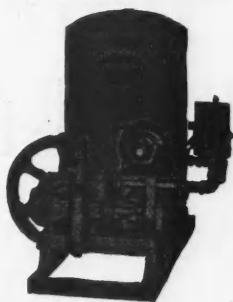
If you want life-time, un failing service, a sure and plentiful supply of running water—then specify the Hoosier Water System. It runs absolutely silent, due to special Hoosier features. Motor is capable of running under heavy loads for long periods without heating. Protected outside and inside by the GalVAZink process which makes the outfit absolutely rust-proof. No oil can get into your water supply. Many other Hoosier features that will appeal to you.



FLINT AND WALLING MFG. CO.
44 Oak Street - - - KENDALLVILLE, IND.

SEDGWICK ELEVATORS and DUMB WAITERS

Sedgwick Hand Power Trunk Lifts protect walls, stair and floors in up-to-date homes.

Also Invalid Elevators and Fuel Lifts.

Standard Sizes Ready to Ship
WRITE for Complete Catalog

SEDGWICK MACHINE WORKS
154 West 15th Street New York

"Sedgwick Service Satisfies"

The **WEHRLE** **WATCHMAN**

CONVENIENCE

Isn't that what every buyer as well as owner is looking for in a home? Sure is—and the Wehrle Watchman will add that very thing to every home as well as a nice profit to you Mr. Contractor.

Investigate this sturdy little fellow today and let it prove itself on your next job.

THE WEHRLE CO., Newark, Ohio

No Cracks—No Leaks LUCKE-LEAK-PROOF BATHTUB HANGER

Prevent Built-in Bathtubs from settling and cracking the walls. Easy to install and guaranteed.

Let us send you free descriptive literature. It's yours for the asking.

Write Today.
WILLIAM B. LUCKE
Manufacturer
Wilmette, Illinois
Box 130 Dept. "C"

Folding Stairs \$35.00

adds a **STORY** to your **HOME**

Make *better* use of your attic

WRITE FOR FREE BOOKLET "A"

THE MARSCHKE CO.,
551 University Ave. -:- St. Paul, Minn.

Something Finer!

A Hidden Medicine Cabinet — A Fine Venetian Mirror

Here you have the elegance of a decorative mirror. The medicine cabinet is hidden. No hinges visible. The back of the mirror is of steel finished in hand-rubbed walnut. The cabinet is of electrically welded steel, white enameled. Every builder should have the complete Bulletin of our comprehensive De Luxe line on hand. Write for it today.

Majestic Steel Cabinet Co.
Household Steel Cabinet Headquarters
4211 Belle Plaine Ave. Chicago

TILE AT WHOLESALE Sold Direct to

Builders, Tile Setters, Bricklayers, Contractors, Home Builders.

Only \$25.00 The Tile for a bathroom can be purchased for as little as \$25.00.

SEND US YOUR SKETCHES
We will estimate the cost free of charge on Bathrooms, Kitchens, Vestibules, Mantels, Store Rooms, Entrances, Store Fronts, Bulkheads or any kind of Tile work.

PROMPT SHIPMENTS
We ship promptly White and Colored Ceramic Floor Tile and Borders in Plain or Designs—White Glazed Wall Tiles, many shades and colors of colored Wall Tiles, Faience, Tiles, Mantel Tiles, Tile Mantels, Red, Buff, Travertine and Copper Colored Quarry Tiles, Decorated Glazed Strips, Recess Tile, and China Bathroom Fixtures, both in White and to match our various colors of Wall Tile.

Free Catalog illustrates our complete line in colors. Send today.

LLOYD FLOOR & WALL TILE COMPANY
Box 5964-AB KANSAS CITY, MO.

KORNAU No. 551 (Ballbearing) WOODWORKER

The Saw Supreme

Does everything that a **GOOD WOODWORKER** should do.

Easily taken from one job to the next. This fine value complete including saw and stand... **\$195.00**

Write for catalog.
KORNAU MACHINE CO.
Vandalia St. Cincinnati, Ohio

"Harris Built for Builders"

TENONERS AND HOLLOW CHISEL MORTISERS

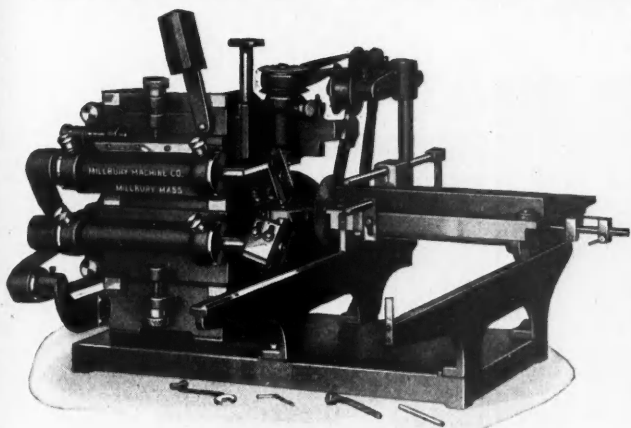

BENCH TENONER

The Tenoner completely equipped with ball bearings on spindles and motor, has ample capacity for small tenon and cope work.

Made by the manufacturers of the Enterprise Ball Bearing Window Frame Machinery. *Write for Circulars.*

This easily operated Mortiser has a capacity for Hollow Chisel Mortising and Vertical Boring, up to 5/8 inch. The tilting table is an added feature for special work.

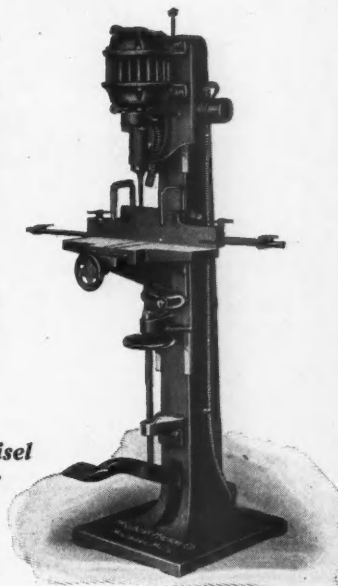

Hollow Chisel Mortiser

MILLBURY MACHINE COMPANY : MILLBURY MASSACHUSETTS

ADVERTISERS' INDEX



JUNE, 1929

	Page
Ackerman-Johnson Co.	146
Adamston Flat Glass Co.	142
Airmaster Corp.	97
Ajax Building Bracket Co.	165
Allmetal Weatherstrip Co.	122
Alpha Portland Cement Co.	136
Aluminum Company of America.	110
American Cement Machine Co.	143
American Chain Co.	125
American Chime Clock Co.	168
American Face Brack Assn.	123
American Floor Surfacing Machine Co.	120
American Saw Mill Machinery Co.	32
American Stove Co.	24
American Telephone & Telegraph Co.	170
Andersen Frame Corp.	93
Anti-Hydro Waterproofing Co.	140
Asbestos Shingle, Slate & Sheathing Co.	5
Asphalt Products Co., The.	155
Associated Tile Mfrs.	18
Austral Window Co.	137
Automatic Electric Heater Co.	164

B

Bakelite Corp.	131
Banks Steel Post Co.	168
Bayley Co., Wm.	159
Beckman-Dawson Roofing Co.	21

	Page
Beckmann Co., L.	158
Behr-Manning Co.	136
Bessler Disappearing Stair Co.	165
Bismark Hotel	165
Black & Decker Mfg. Co.	50
Boice Co., W. B. & J. E.	165
Bommer Spring Hinge Co.	122
Boyle & Co., Inc., John.	142
Bradley, Miller & Co.	116
Brasco Mfg. Co.	112
Buff & Buff.	168
Building Developer	8-9

C

Cabot, Inc., Samuel.	114
Carborundum Co., The.	147
Carter Co., R. L.	130
Casement Hardware Co.	153
Cashman Equipment Co., W. E.	160
Chain Belt Co.	38-126
Chain Products Co.	158
Chappell & Co., Wayvell.	156
Chase Brass & Copper Co., Inc.	26
Chevrolet Motor Co.	118
Chicago Spring Hinge Co.	154
Chicago Technical College.	120-168

D

	Page
Cincinnati Iron Fence Co.	162
Clamp Nail Co.	166
Clarke Sanding Machine Co.	11
Clinton Metallic Paint Co.	161
Coleman, Watson E.	168
Colgan Machinery & Supply Co.	152
Columbus Union Oil Cloth Co.	128
Combination Woodworking Machine Co.	148
Common Brick Mfrs. Assn.	23
Concrete Equipment Co.	156
Corbin, P. & F.	127
Corcoran Mfg. Co.	149
Crane Co.	19
Crescent Machine Co.	157-163
Crofoot Co., J. B.	144
Cromas Co., The.	22
Crowe Mfg. Corp.	130
Detroit Steel Products Co.	107
De Vilbiss Company, The.	99
DeWalt Products Co.	17
Diamond Metal Weatherstrip Co.	162
Diddle Co., L. F.	168
Disston & Sons, Inc., Henry.	101
Dunn Mfg. Co., W. E.	43
Duro Co., The.	31

ADVERTISERS' INDEX CONTINUED TO PAGE 173



HUNDREDS OF PROSPECTS

... yet a field for the contractor that is uncrowded—lacking in capable men who can render satisfactory service. Why not, for your own good, investigate this new field of opportunity—

STORE FRONT CONSTRUCTION

Merchants in your city could use the services of a capable store front builder.

Kawneer

BRONZE

STORE FRONTS

THE KAWNEER COMPANY
1526 FRONT ST., NILES, MICHIGAN
Send more information about the opportunity of store front specialization. I'm interested.

Name _____
Address _____
City _____ State _____

Hbinger
Edward
Electric
Everho

Fairban
Farran
Federal
Fink &
Fischer
Flint &
Foley S
Forest
Fort W
Frantz
Frazier

Gallmey
Gas-O-C
Gefer &
General
Genfire
Gilbert
Goodyea
Gowing
Grand I

Hagstro
Hardin-
Hardwa
Hart &
Hess W
Heston
Higgin
Hild Fl
Hobart
Holland
Hubeny
Huther

Ilg Elect
Indiana
Insulte
Internati
Internati

Jaeger M
Johns-M
Jones S

Kalman
Kawneer
Kees Mf
Kerner I
Kewanee
Kimball
Kimmel
Knap &
Knickerb
Koehring
Kornau
Kulis Co
Kwik-Mis

Form

for omis

new copy

last adve

ADVERTISERS' INDEX

June, 1929 (Continued)

Page	Page	Page	Page
E	L		
Eblinger Sanitary Mfg. Co., D. A.154	Lamella Roof Syndicate, Inc.142	Rogers Co., F. L.152	
Edwards Mfg. Co., The.157	Lamneck Co., W. E.150	Rowles Co., E. W. A.166	
Electric Rotary Machine Co.158	Lanebro Mfg. Co.161	Royal Mfg. Co.146	
Everhot Mfg. Co.158-167	Lansing Co.163	Ruxton Multi-Vider Corp.133	
	Leach Co.141		S
F	Lincoln-Schlueter Machinery Co.151	Safepack Mills95	
Fairbanks-Morse Co.46	Living Stone Co.168	Safe Tool Mfg. Co.156	
Farrand, Hiram A.148	Lloyd Floor & Wall Tile Co.169	Sanitary Equipment Co.150	
Federal Metal Weatherstrip Co.166	Lucke, W. B.169	Sasgen Derrick Co.158	
Federal Motor Truck Co.117	Lufkin Rule Co.156	Schlage Lock Co.35	
Fink & Sons Co., Inc., Louis.168	Lupton's Sons Co., David.14	Sedgwick Machine Works.169	
Fischer Spring Co., Chas.148		Shanklin Mfg. Co.157	
Flint & Walling Mfg. Co.169	M	Shebel, Anthony P.160	
Foley Saw Tool Co.151	McGraw-Hill Book Co.163	Shevlin, Carpenter & Clarke.29	
Forest City Bit & Tool Co.160	Macomber Steel Co.128	Sidney Elevator Mfg. Co.166	
Fort Wayne Engineering & Mfg. Co.157	Majestic Steel Cabinet Co.169	Silver Lake Co., The.146	
Frantz Mfg. Co.3	Malleable Asphalt Co.160	Sisalkraft Co.121	
Frazier Stair Co.161	Mallory Mfg. Co.168	Skillsaw, Inc.141	
	Marschke Co.169	Slatington Bangor Slate Syn.160	
G	Master Metal Strip Service.158	Slatington Slate Co.165	
Gallmeyer & Livingston Co.144	Master Rule Mfg. Co.166	Sloane Mfg. Co., W. & J.10	
Gas-O-Gen Corp.152	Master Woodworker Mfg. Co.132	Smith Co., T. L.45	
Geier & Bluhm, Inc.168	Matot Co., D. A.166	Smith, Barnes & Strohber Co.168	
General Electric Co.46	Mauk Lumber Co., The C. A.159	Standard Sanitary Mfg Co.109	
Genfire Steel Co.30	Mesker & Co., George L.166	Stanley Plumbing Supply Co.168	
Gilbert & Bennett Mfg. Co.164	Metal Forms Corp.167	Steel Frame House Co.40	
Goodyear Tire & Rubber Co.119	Miami Cabinet Co.163	Steel Scaffolding Co.149	
Gowing, F. H.168	Miles Mfg. Co.154	Stimmel Winch & Machine Works.162	
Grand Rapids Hardware Co.154	Millbury Machine Co.171	Stronach Nail Co.132	
	Miller & Gleason Co.166	Structural Clay Tile Assn.175	
H	Milwaukee Corrugating Co.174	Structural Slate Co.164	
Hagstrom Mfg. Co.162	Morton Mfg. Co.111		T
Hardin-Lavin Co.167	Muller, Inc., Franklyn R.138	Taylor Mfg. Co., James L.167	
Hardware Sales Co., Inc.168	Multiplex Concrete Machinery Co.152	Thrush Co., H. A.135	
Hart & Hegeman Mfg. Co.2	Myers & Bro. Co., The F. E.144	Thurston Manual Training Supply Co.168	
Hess Warming & Ventilating Co.147		Treiber Co.13	
Heston & Anderson.160	N	Trimpak Corp.160	
Higgin Mfg. Co., The.140	National Assn. of Ice Industries.25	Truscon Steel Co.28	
Hild Floor Machine Co.168	National Lumber Mfrs. Assn.33		U
Hobart Brothers.131	National Mfg. Co.176	Universal Hoist & Mfg. Co.164	
Holland Furnace Co.42	National Radiator Corp.48-49	Universal Portland Cement Co.54	
Hubeny Brothers, Inc.144	National Sanding Machine Co.130		V
Huther Brothers Saw Mfg. Co.146	National Sheet Metal Roofing Co.158	Vento Steel Sash Co.148	
	National Steel Fabric Co.39		W
I	North Western Expanded Metal Co.165	Wappat Gear Works, Inc.161	
Ilg Electric Ventilating Co.15		Warren-Knight Co.167	
Indiana Limestone Co.6-7	O	Weatherbest Stained Shingle Co.139	
Insulite Co., The.16	Oak Flooring Bureau.167	Wedell & Boers.164	
International Correspondence Schools.145	O. K. Clutch & Machinery Co.133	Wehrle Co.169	
International Harvester Co.115	Overhead Door Corp.167	Weyerhaeuser Forest Products.37	
International Steel & Iron Co.138		Wheeler, Osgood Co., The.113	
	J	Wheeler Corrugating Co.34	
Jaeger Machine Co., The.41	Jaeger Machine Co., The.41	Whisler Mfg. Co.164	
Johns-Manville Corp.103	Johns-Manville Corp.103	White Co., Inc., David.150	
Jones Superior Machine Co.160	Jones Superior Machine Co.160	William & Co., C. K.166	
	K	Willis Mfg. Co.143	
Kalman Steel Co.12	Kalman Steel Co.12	Wissler Instrument Co.168	
Kawneer Co., The.172	Kawneer Co., The.172	Woodworking Machinery Co., Inc.137	
Kees Mfg. Co., F. D.152	Kees Mfg. Co., F. D.152	Wright Rubber Products Co.152	
Kerner Incinerator Co.155	Kerner Incinerator Co.155		Z
Kewanee Mfg. Co.165	Kewanee Mfg. Co.165	Zagelmeyer Cast Stone Block Machinery Co.160	
Kimball Brothers Co.134	Kimball Brothers Co.134		
Kimmel, George P.168	Kimmel, George P.168		
Knape & Vogt Mfg. Co.153	Knape & Vogt Mfg. Co.153		
Knickerbocker Co.162	Knickerbocker Co.162		
Koehring Co.36	Koehring Co.36		
Kornau Machine Co.169	Kornau Machine Co.169		
Kuhls Co., H. B. Fred.142	Kuhls Co., H. B. Fred.142		
Kwik-Mix Concrete Mixer Co.45	Kwik-Mix Concrete Mixer Co.45		
	P		
	Paramount Electric Co.164		
	Parks Woodworking Machine Co.158		
	Parsons Co., The.159		
	Paxson Co., The.162		
	Peerless Mfg. Co.135		
	Penberthy Injector Co.52		
	Penn-Greg Co.162		
	Pfaltz & Bauer, Inc.154		
	Porter-Cable Machine Co.145		
	Progressive Mfg. Co.167		
	Pullman Mfg. Co.162		
	Pyramid Metals Co.165		
	R		
	Reading Iron Co.129		
	Reid-Way Co.105		
	Richards-Wilcox Mfg. Co.27-29		
	Rixson Co., Oscar C.159		

NOTICE TO ADVERTISERS

Forms in the July Number of the American Builder will close promptly on June 10. New copy, changes and orders for omissions of advertisements must reach our business office, 105 W. Adams St., Chicago, not later than the above date. If new copy is not received by the 10th of the month preceding date of publication the publishers reserve the right to repeat last advertisement on all unexpired contracts.

MILCOR Expansion Corner Bead

is unusually easy to work ...
and form

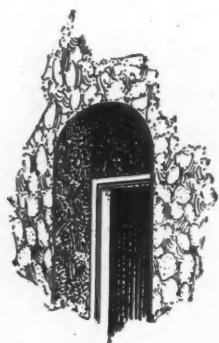

BESIDES supplying an ideal key for the plaster . . . *Milcor* Expansion Corner Bead with expanded metal wings . . . simplifies the entire erection. It is easier to handle . . . effects big labor savings.

Milcor Expansion Corner Bead can be wired, nailed, stapled or "stuck" to any type of wall construction. Its many openings provide more "nailing-spots" . . . important when working over tile or concrete.

Standardize on *Milcor* Products . . . Expansion Corner Bead . . . Expansion Metal Casing . . . and Stay-Rib Metal Lath. For complete information write for a copy of the "*Milcor* Manual".

Milwaukee Corrugating Co.
1409 Burnham Street MILWAUKEE, WIS.

Branches: Chicago, Ill., Kansas City, Mo., La Crosse, Wis.
Sales Offices: Boston, Mass., Detroit, Mich., Atlanta, Ga., Little Rock, Ark., Minneapolis, Minn.
Eastern Plant: The Eller Manufacturing Co., Canton, Ohio

MILCOR PRODUCTS

FOR ADVERTISERS' INDEX SEE NEXT TO LAST PAGE

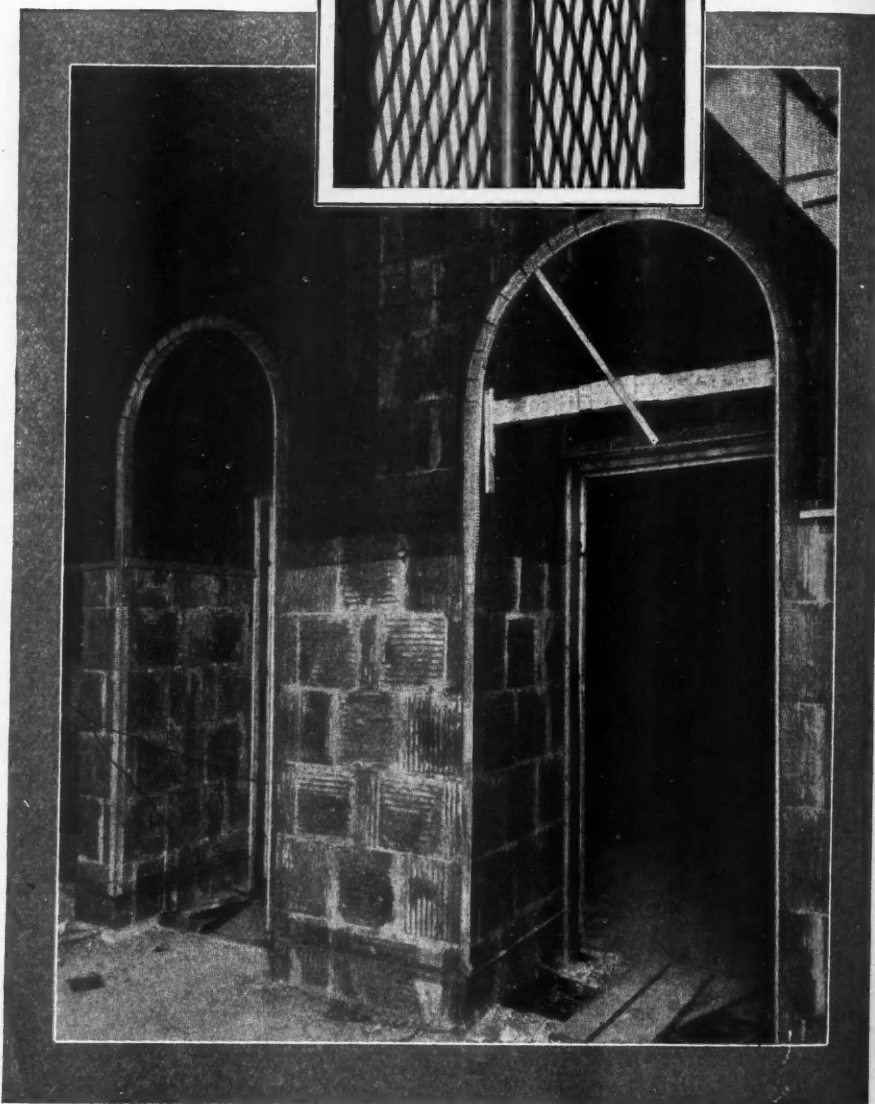
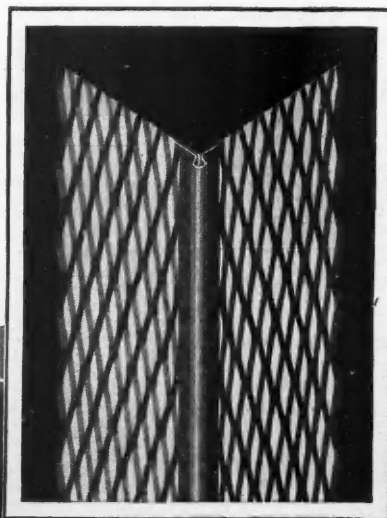

INSIST UPON QUALITY SCREEN HARDWARE

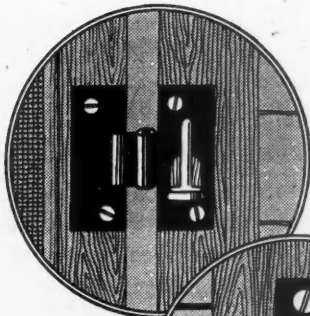

Easily and quickly detached for cleaning screens or changing with storm windows.

Brass pin eliminates possibility of hinges rusting tight from exposure to the elements.

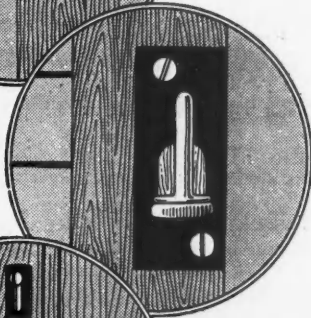

Handle automatically slides up and down over a pin to fasten screen or storm window shut. Makes opening and closing easy.

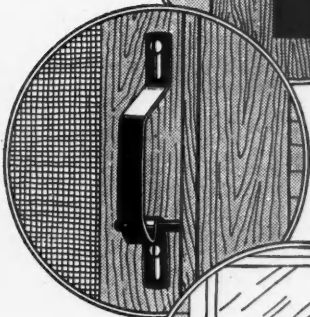

Works equally as well on half screens as on full length because hinges fasten at the side.

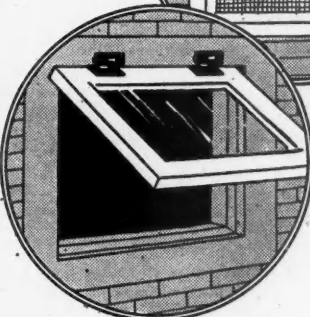
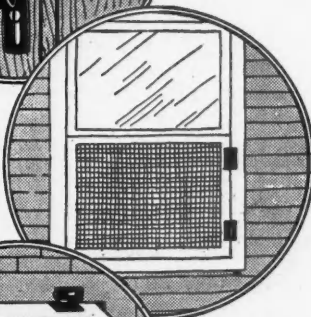

Cellar windows can be removed entirely or the hinges slid half off their pins to hold sash half open, by bracing against the casing.

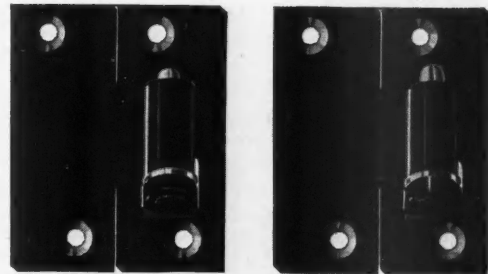

Frantz Screen Set No. 450

You can buy Frantz Screen Hardware just as you would buy a stove or any other type of equipment for a home—by seeing a demonstration of the convenience and labor-saving features of its construction and selecting the set best suited to your needs.

The No. 450 Screen Set (above) is one of the many in the Frantz Line. Its unique construction assures unusual convenience. For example, the No. 450 Set is designed so as to permit screens to be swung around against the side of the building for cleaning sills and washing windows.

Frantz Screen Hardware not only is made of the highest quality materials but also is designed to provide convenience and long, satisfactory service. Write today for full information on the Line. Dept. A-729, Frantz Mfg. Co., Sterling, Illinois.

FRANTZ

TRADE MARK

Guaranteed Builders Hardware

No Hardware is Genuine FRANTZ QUALITY Without the Red Label

WHEN WRITING ADVERTISERS PLEASE MENTION THE AMERICAN BUILDER