

690.5 v. 52-53



AMERICAN BUILDER and BUILDING AGE

(A Simmons-Boardman Publication)

53rd Year Vol. 52—No. 1
WINTER BUILDING NUMBER—OCTOBER, 1931

Front Cover.....	Oil Painting by L. E. Arent	1
Looking Ahead with the Editors.....	November Forecast	7
Subject Sign-Post.....	Editorial Contents Classified	27
Editorials		29, 30
Prepare Now for Better Times. Divided Sentiment on Central Mortgage Bank. A Tax on Ideas.		
Frontispiece—Winter Building Brings Profit.....		31
We've Got to Capitalize on Low Costs Now.....		32-35
Opportunities for Winter Building Because of Present Low Building Costs.		
Exploding the Winter Building Slump Myth.....		36-38
How to Secure Winter Contracts and Handle Them at a Profit.		
Fall Selling Campaign by Mail.....		39, 40
Part II—How to Write Selling Letters That Get Business.		
Sidelines Can Be Profitable.....		41
The Small Woodworking and Jobbing Shop for Winter Work.		
Shop Work for Rough Weather Is Better Than "Snow Balls".....		42, 43
Shops Big and Little According to Local Needs Look Good at This Season.		
Boost the Twin Fuel Savers—Storm Sash and Entrance Enclosures....		44, 45
Some New Ideas in Winter Windows and Storm Enclosures—Business Here for Enterprising Men.		
Frozen Radiators Sell Garages.....		46, 47
Cold Snaps Demonstrate Economy of Proper Housing for Automobiles.		
Insulation for Comfort.....		48-50
Insulation Saves Its Own Cost and Makes Ideal Inside Work for Winter.		
Home Design Department		51-59
Ten Home Designs Styled High But Priced Low for the Fall Market.		
Is a Central Mortgage Bank for Urban Real Estate Necessary?.....		60, 61
Marcus Nadler Discusses Recent Developments in the Central Mortgage Bank Campaign.		
New Styles in Apartment Houses		62
What People Are Looking for and Builders Are Providing.		
The Modern Multi-Family Dwelling.....		63-66
Illustrating Hawthorne Court, Bayside, L. I. Benjamin Braumstein, Architect; Neisloos Bros., Inc., Builders.		
The House of the Month.....		67-71
Working Drawings to One-Eighth Inch Scale of Six-Room Brick and Stone English Cottage.		
The Latest Outstanding Development in Home Building Construction		72, 73
L. Brandt, Housing Engineer, Describes an Improved Form of Insulated Brick Veneer Construction.		
Practical Job Pointers.....		74, 76
A Readers' Exchange of Tested Ideas and Methods Taken from Their Own Building Experience.		
News of the Industry.....		78-84
The Builder's Library.....		86
What's New in Building Materials and Equipment.....		88-96
Advertiser's Index		105

**AMERICAN BUILDER
and
BUILDING AGE**

**IS THE BUSINESS
JOURNAL OF THE
ACTIVE MEN OF THE
BUILDING INDUSTRY**

SUBSCRIPTION RATES — One year, United States, Mexico and U. S. Possessions. \$2.00; six months, \$1.00; single copy, 35 cents. Canada, one year, including duty, \$2.50; other foreign countries, \$4.00. **ADVERTISING RATES** — Furnished on application. Advertising forms close on the 10th of the month preceding date of publication. Entire contents copyright, 1931, by American Builder Publishing Corporation.

MEMBER OF THE AUDIT BUREAU OF CIRCULATIONS
AND OF THE ASSOCIATED BUSINESS PAPERS

AMERICAN BUILDER AND BUILDING AGE, with which are incorporated Building Developer, Home Building, National Builder, Permanent Builder, and the Builder's Journal, is published on the first day of each month by the American Builder Publishing Corporation.

President, EDWARD A. SIMMONS; Vice-Presidents, Henry Lee and Samuel O. Dunn; Secretary, Elmer T. Howson; Treasurer, John T. DeMott.

BERNARD L. JOHNSON, Editor; Joseph B. Mason, Managing Editor; R. H. Mathewson, Eastern Editor; H. F. Lane, Washington Editor; P. W. Hanna, L. E. Arent, Associate Editors; Robert H. Morris, Business Manager.

EDITORIAL AND PUBLICATION OFFICE: 105 W. Adams St., Chicago; Telephone, Randolph 0794. Branch Offices: New York, 30 Church St.; Cleveland, Terminal Tower; Washington, 17th and H Sts., N. W.; San Francisco, 215 Market St.

No COMEBACKS No COMPLAINTS

WHY should you, the contractor, stand all the gaff? Why should service expense come out of YOUR pocket? What good are profits that don't stick?

Doors are mechanical, and like everything mechanical, they have to be looked after. Somebody's GOT to service them. If the maker won't—you MUST—and servicing doors costs money.

When you specify The "Overhead Door" your responsibility ends. We stand responsible for every "Overhead Door" everywhere, all the time. We watch it. We service it. We keep it in perfect working order.

That's what our nation wide sales and service organization is for. That's ALL it's for—just YOUR benefit.

OVERHEAD DOOR CORPORATION

Dept. 319

Hartford City, Indiana, U. S. A.

Made In Canada By

Overhead Door Company of Canada, Ltd., Toronto 3, Ont.

*Specify
The*
"OVERHEAD DOOR"
REG. U.S. PAT. OFFICE
FOR GARAGE - FACTORY - WAREHOUSE



© O. H. D. Corp. 1931

FOR ADVERTISERS' INDEX SEE NEXT TO LAST PAGE

ADVERTISING PAGES REMOVED

SUBJECT SIGN-POST

A Quick Guide to the Business Articles and Designs Presented in This Issue

BUSINESS MANAGEMENT

Editorials29, 30
 Capitalizing on Low Costs Now.....32-35
 Sidelines Can Be Profitable..... 41
 Shop Work for Rough Weather.....42, 43
 Central Mortgage Bank Developments.....60, 61

DESIGNS AND PLATES

Homes of Popular Size.....52, 53, 54, 55, 58, 59
 Homes of Larger Size.....56, 57, 67
 House Plans, Complete Set.....67-71
 Garage Designs46, 47
 Details of Construction.....44, 45, 68-71
 Apartment Design63-66
 Interior Detail Photographs.....45, 47, 48, 50
 Exterior Detail Photographs....1, 44, 45, 49, 51, 63

MERCHANDISING AND ADVERTISING

How to Secure Winter Building Contracts....36-38
 Fall Selling Campaign by Mail.....39, 40
 Sales Appeal of Storm Sash and Entrance Enclosures44, 45
 Frozen Radiators Sell Garages.....46, 47

Insulation for Comfort.....48-50
 New Styles in Apartment Houses..... 62

TECHNICAL AND CRAFT PROBLEMS

How to Handle Building Work in Cold Weather36-38
 How to Write Sales Letters.....39, 40
 How to Insulate for Comfort.....48-50
 Improved, Insulated and Reinforced Brick Veneer Construction72, 73
 Practical Job Pointers.....74, 76

DEPARTMENTS

Editorials29, 30
 House Designs51-59
 "The House of the Month," Complete Plans..67-71
 Contractors' Equipment42, 43
 News of the Industry.....78-84
 August Building Figures..... 82
 Calendar of Coming Events..... 78
 New Materials and Devices.....88-96
 Masthead Page 5
 Forecast of November Issue..... 7
 Index to Advertisers.....105

This Classified Index is Presented for the Convenience of Readers Who Are Seeking Features and Designs of a Particular Sort. An Index by Pages in Regular Order Appears on Page 5.

WINTER WINDS — STORM SASH — AND INCREASED PROFITS



COLD weather has no regard for heating systems or insulated houses. There is no type of house that could not be made more comfortable and be better protected with Winter Windows or Storm Sash. Government statistics show that this type of protection will save from 10% to 15% of fuel costs in houses with no other insulation. The better the house insulation, the greater the fuel savings and comfort with Winter Windows or Storm Sash.

This fall and winter offer a better and quicker market for Storm Sash for the builder and sash and door manufacturer, than any before, because the house owner is willing and anxious to talk economy.

Libbey·Owens·Ford Quality Glass is known and preferred by the public—through the

message of Libbey·Owens·Ford advertising in leading home and building magazines. Offer your customers L·O·F Quality Glass in the Storm Sash you install for them.

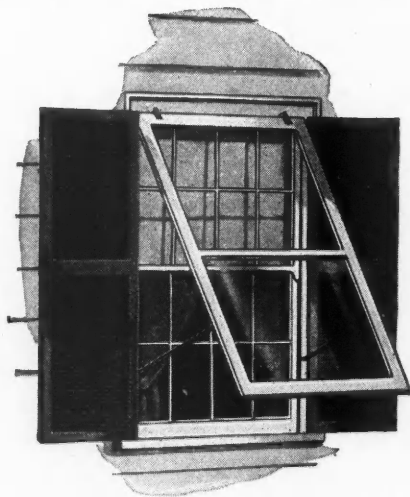

LIBBEY·OWENS·FORD GLASS COMPANY
TOLEDO, OHIO



Manufacturers of Highest Quality Flat Drawn Window Glass, Polished Plate Glass and Safety Glass; also distributors of Figured and Wire Glass manufactured by the Blue Ridge Glass Corp. of Kingsport, Tennessee.

LIBBEY·OWENS·FORD QUALITY GLASS

FOR ADVERTISERS' INDEX SEE NEXT TO LAST PAGE



AMERICAN BUILDER AND BUILDING AGE

PREPARE NOW FOR BETTER TIMES

PRESENT prices offer an unusual opportunity for contractors to bring their construction plants and equipment thoroughly up to date. A glance backward over the history of other depressions and the periods immediately following them will show that such action is highly desirable at this time.

During a depression contractors tend to let their equipment deteriorate. New purchases are put off and in many cases even nominal repair and upkeep are neglected. Stocks of materials are allowed to dwindle almost to the vanishing point. This has happened in other depressions and is true of this one. In fact because of the length and severity of the present building slump conditions are worse than usual. Obsolescence and disrepair are building up a costly trap into which unwary builders will fall if they do not watch out.

History shows that when a depression ends, building booms develop rapidly. In 1922, for example, construction volume increased 225 per cent in three months. In 1925, it jumped more than 100 per cent in three months. In 1928, it climbed 75 per cent in the first ten months of the year. The worse the depression, the bigger the building volume that follows is likely to be.

Don't Be "Caught Short"

In the rush to get in on the ground floor of a building boom that seemingly developed over night, contractors who have let their plants deteriorate pay dearly for their neglect. They find themselves with fine contracts but inefficient or out of date equipment to handle them. There is a demand for speed, and the man who can deliver rapid work is preferred. A sudden rush of buying overtakes manufacturers causing delays in delivery. Prices of materials and equipment tend to skyrocket. Many men have been caught short in this fashion in previous times of recovery, who might have been in a position to make big profits if they had prepared in advance.

We do not attempt to predict a date when business will turn the long-deferred prosperity corner. But we

do say that the time has come to prepare for such a turn. Do not wait for the construction volume curve to go up; it moves too fast. Prepare for better business now. Manufacturers' stocks of construction equipment and building materials are badly depleted. Hand to mouth buying has been common for many months, and small inventories are being kept. Any perceptible building increase at all will cause a rise in prices.

Manufacturers are about done with selling at cost or below cost prices. The attitude is being taken that materials furnished for a legitimate purpose are worthy of a legitimate price, and that regardless of price, work will not proceed without a proper need. Further price reductions seem out of the question. What is more, it is probable that rises will take place at the first sign of returning normal building volume.

Investigate for Future Needs

These conditions call for a careful stock-taking and inventory by contractors and building supply men at this time. Is your equipment in good condition, modern, able to handle considerable new work? Does it meet the present requirements of speed, durability, mobility, stamina? Will it stand up over a long period of hard use? Will it resist breakdowns and handle a large volume of business easily? Would it not pay to stock up now with basic commodities which you will need in large volume later?

Present prices offer an opportunity not only to bring the construction plant and equipment up to date but to build up material stocks. Purchase can be made at considerable saving over what may be expected later:

As a second course of action, where financial condition makes purchases at this time impossible, preparation for future buying should be carried on by making a study of recent developments in construction materials and equipment. Then when the need comes, purchases can be made wisely and quickly. Wise buying must be based on a thorough knowledge of modern construction products especially suited to the peculiar and

special needs of the individual concern. Such knowledge cannot be gained over night but should be built up from extensive examination of the claims of manufacturers as put forth in advertisements, trade literature, and technical publications.

Past experience is a helpful guide for future plans. Builders and supply men will do well to avoid the mistakes of previous depressions by preparing NOW for the building boom that is ahead. Our recommendations are: *First*, make a careful inventory of equipment and materials; *Second*, estimate the probable needs of the future to see whether you are fully prepared; *Third*, make all purchases possible at this time while prices are down; *Fourth*, prepare for future buying by reading up on developments in materials and equipment.

DIVIDED SENTIMENT ON CENTRAL MORTGAGE BANK

THE Mortgage and Finance Division of the National Association of Real Estate Boards evidently does not see eye to eye with President Kissell and the Board of Directors in the matter of the central federal mortgage bank. At the Baltimore convention, when this new home financing proposal was announced and hailed by practically all of the delegates and by the building industry in general as the most interesting and important project of the year, an ominous rumble of discontent was heard from certain members of the Mortgage and Finance Division.

Since the convention, President Kissell, with members of his committee, has been working at Washington to perfect this proposal so as to have it ready to introduce when Congress convenes next December. Evidently the men of the Mortgage and Finance Division of the realtor boards have also been busy consolidating opinion hostile to this proposed legislation. At any rate, on August 31, the Executive Committee of the Mortgage and Finance Division of the National Real Estate Boards met in Chicago and issued a resolution to the effect that the proposed central mortgage bank plan would not solve the problems of home owners, and recommended further study of long term amortized loans.

The text of the resolution follows:

"RESOLVED

"1. That the Mortgage and Finance Division of the National Association of Real Estate Boards is heartily in accord with the efforts of the President's Conference on Home Building and Home Ownership to assist and encourage home ownership in this country and pledges its full support to this endeavor.

"2. We believe that excessive taxation of real estate and excessive special assessments for local improvements are the foremost problems confronting the home owner.

"3. After full and careful consideration of the proposed central mortgage bank plan, we are of the opinion that it will not solve the problems of the present and prospective home owner for the following reasons:

- "(a) Ample funds are now available for all first mortgage loans that are safe.
- "(b) Any plan that may lead to excessive loans is unsound and will result in dangerous inflation of real estate credit.
- "(c) The serious judgment of this country recognizes the dangers and inadvisability of government sponsorship of private business.

It is a matter of record that very few bankers were in favor of the Federal Reserve System *before it was created*. They predicted dire results; but now they are all for it, many even claiming to be the fathers of the plan. Perhaps bankers and mortgage men will find that their present opposition to the proposed central federal mortgage bank is equally unwise, and that if and when it is created, it will work to their advantage and that of builders and home owners.

Professor Marcus Nadler of New York University, who has made a very thorough study of central mortgage banks abroad, and understands perhaps better than any other the details of this proposed federal mortgage institution, presents elsewhere in this issue an article summarizing the objections that have been brought up during the past few months. This article, however, was written prior to the announcement of the Mortgage and Finance Division's resolution.

A TAX ON IDEAS

BUILDING practice in America has developed along identical lines, both north and south of the line that joins Canada and the United States. The builders "across the border" have been one with those on this side. They have been largely trained in the same traditions and make use of the same building methods; the problems that they encounter are practically the same in all respects as those confronting builders on this side of the International boundary. A free interchange of ideas and information has, in the past, been very beneficial to both groups.

In order to promote this interchange of ideas, this publication has always gone to Canadian subscribers at the same rate as domestic. However, we are now confronted with a new problem for, on September 1, a duty was imposed by the Dominion on all business papers entering Canada. For this publication this tax amounts to five cents per copy.

It has been necessary to pass part of this increased cost along to our Canadian subscribers, increasing their rate to \$2.50 per year. This will be the rate when present subscriptions are renewed, the publisher absorbing this tax on the balance of all present unexpired subscriptions.

While it would not be proper for us to question the propriety for a neighboring nation to impose such an import duty on business publications, we nevertheless regret the fact and look forward to the time when we will be able again to serve our Canadian readers without this added burden.

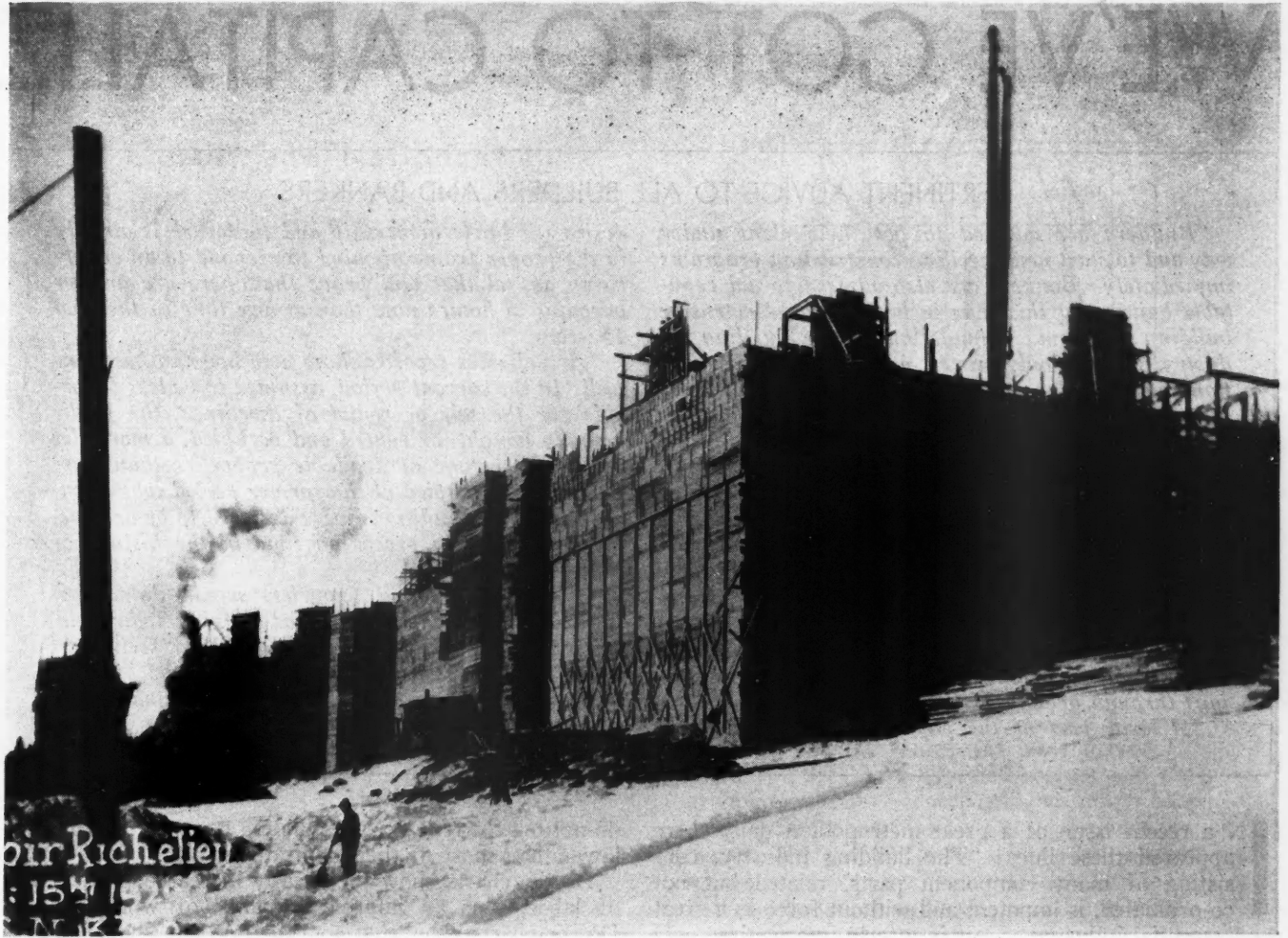

WINTER BUILDING BRINGS PROFIT



New methods, materials and equipment make cold weather construction more easily possible than ever before. As in the case of the Manoir Richelieu Hotel, Quebec, shown above, it can be done profitably in spite of sub-zero temperatures. Builders were Wilde & Brydon of Toronto.

WE'VE GOT TO CAPITALIZE

PERTINENT ADVICE TO ALL BUILDERS AND BANKERS

"Builders are advised to get their plans under way and to start new dwelling construction programs immediately. Bankers are also advised to aid reputable builders at this time in launching an extensive building program. Stimulation of the building industry will not only hasten normal business conditions but will also provide essential dwelling accommodations for a steadily increasing population. Builders heeding this advice will be ready for the appreciable increase in the demand for dwellings which will be felt six to nine months from today. We base our recommendations on extensive data which has been assembled in regard to new construction by construction cost, sales price range, absorption, buying power capacity by income ranges, demolitions, conversions, rental changes, vacancies, tenant mobility, population changes and trends, and the causes that contribute to the obsolescence of dwellings through growth of the slums.

"A large part of the population has an inherent

desire for home ownership and therefore is already in the proper frame of mind to respond to an advertising appeal that will prove that there are greater bargains in homes now than at any time in the past 15 years.

"Actual sales records show new housing has gone well. In the current period, assumed to be less favorable for the sale or rental of dwellings, the public actually bought, or rented and occupied, a markedly larger percentage of available properties than were bought and occupied at the former period when general economic conditions were declared to be as prosperous as at any preceding time in the history of the country.

"Wise builders and financiers would do well if they recognized the situation as it exists today and, instead of subscribing to the prevailing feeling of panic and depression, set the whole of the building industry in motion against the certain demands for new housing."

—Philadelphia Housing Association

IN a recent issue of a great metropolitan daily there appeared these lines: "The building industry, consisting of many component parts, related but not co-ordinated, is impotent and without force as a great and essential industry . . . it is utterly unorganized. Is the industry taking any steps to solve fundamental financing and marketing problems or is it awaiting supinely the return of a prosperity which it has done little to bring about?"

How would you answer this challenge?

Locally, men say that national and international forces are at work which they cannot control. Nationally, men say that local conditions, with which they cannot cope, are responsible for the building depression. Everywhere, you will hear the same story: "The situation is very complex. It will have to work itself out." Everyone you meet has a different idea of what is wrong and what should be done.

One fact, however, stands out stark and clear above all the welter of opinion:

Building costs are now down so low that construction today is being erected at bargain prices—prices that may last only a short time. Now, if ever, is the economic time to build.

Every builder knows this. But does the public know it sufficiently well?

Study the charts shown in this article. They depict an amazing decline in building costs. The building dollar is now worth more than \$1.31 compared to its previous worth in 1926, and it would be tragic if the public did not take advantage of these prices during the coming months.

Dozens of charts and statistical tables like the ones shown here, have been compiled by various organizations to show the astonishing decline in building prices. We have studied them all—or most of them—and as graphically as some of them reveal the present condition of bargain prices, yet there is much that these charts can in no way depict. Statistics and charts on building costs

do not tell the true story. Building costs are down much lower than most of them indicate.

Do the charts show the greatly increased productivity of labor, plus an improved quality of workmanship? Do the charts show that contractors have shaved profits to the bone? That manufacturers are selling products

LOWEST BUILDING COSTS IN 10 YEARS

See how building costs have fallen from the peak of 1920 to the lowest level in 10 years. The heavy line shows frame construction; the dotted line shows brick construction with wood frame. This curve is based on index numbers of The American Appraisal Company and includes the first seven months of 1931.

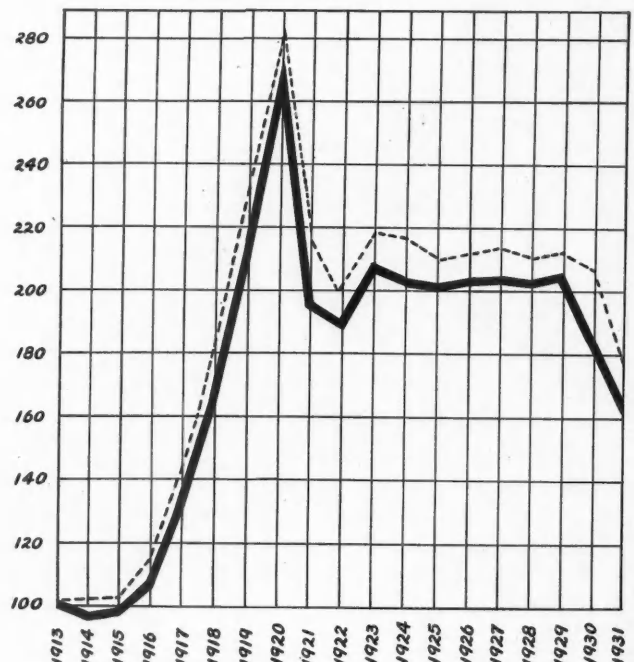

ZEON LOW COSTS ... NOW!

Locally and Nationally,
The Building Industry
Must Fight Its Own
Economic Battles and
Win Them

ROCK-BOTTOM PRICES

The following figures have been taken from a survey recently made public by Paul S. Collier, secretary-manager of the Northwestern Retail Lumbermen's Assn.:

Items	July 1, 1929	July 1, 1931
Douglas Fir No. 2 Common 2 x 4	\$48.00	\$38.00
Douglas Fir No. 1 Common 2 x 12	54.00	44.00
Yellow Pine, Shiplap, No. 2 Common 1 x 8	41.00	33.00
Yellow Pine, Matched No. 2 Common 1 x 6	41.00	35.00
Yellow Pine Roofers No. 2 Common 1 x 6 Square Edge	40.00	33.00
Douglas Fir Boards No. 2 Common 1 x 6	40.00	31.00
Cove Siding, B and Better Fir 1 x 6	68.00	55.00
Beaded B and Better Fir 1 x 6	70.00	57.00
16" 5X Red Cedar Shingles.....	7.20	5.60

at rock-bottom prices? That dealers are selling products so low that only distressed merchandise is any lower? Do the charts show that mechanics are working for what they can get?

All these tremendous sacrifices that the building industry is making will be in vain, *unless we capitalize on these low costs this fall and winter!*

Upturn From Low Levels Likely

A short time ago AMERICAN BUILDER AND BUILDING AGE made a survey of actual conditions as they are today and found that prices had fallen much lower than most people believe. From builders and dealers in many sections, we received reports that prices of materials were down 20 per cent at least, and that labor costs had been cut drastically, in some places as much as 50 per cent! Whether we believe this to be a good condition or not, it is a condition that actually exists.

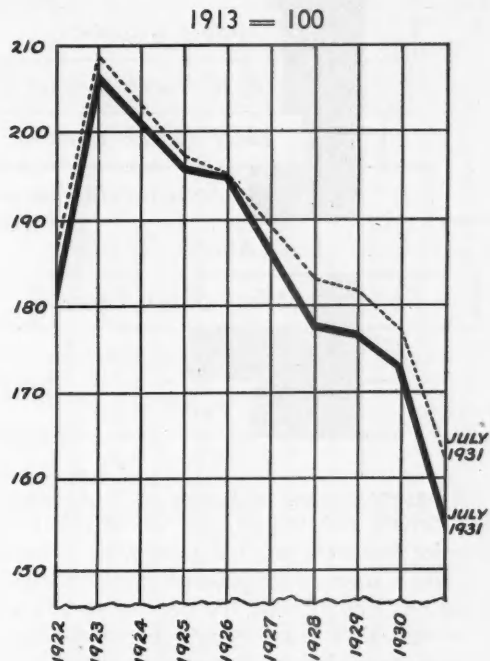

MATERIAL PRICES ARE 'WAY DOWN

Material prices have dropped sharply and are now at very low levels, according to this graph based on index numbers compiled by the Department of Commerce. Material prices for a frame house are shown by the heavy curve while the dotted line represents the prices of materials for a brick house.

Now that prices have reached bottom, the logical assumption is that the next movement must be upward. Already, wholesale commodity prices in general have stopped declining. For the past several weeks these prices have run along on a level. Those who want to build at the lowest level must do so in the next few months because these low construction costs may not stay low! Next spring building costs may be up 10 to 15 per cent.

No Longer Any Reason To Wait

A survey recently completed by the Northeastern Retail Lumbermen's Association shows that there is no longer any reason for builders of homes to wait for lower material costs. This survey reveals reductions of building material prices amounting to approximately 25 per cent since 1929.

It was found on one house job, for which prices of building materials were compared, that the figure in April, 1929, was \$3,075 as against \$1,618 in July, 1931. In many instances, the survey shows, current prices barely include the cost of the raw materials, to say nothing of manufacturing and selling costs. Will such a condition continue long?

Among the items covered in this survey were Douglas fir dimension lumber showing a decline of 29 per cent between July 1, 1929 and July 1, 1931; yellow pine roofers with a reduction of 24.4 per cent; cove siding, 23.7 per cent; 5X red cedar shingles, 25 per cent; white pine lath, 36 per cent; spruce lath, 50 per cent; select oak flooring, 27 per cent; insulating wall board, 18 per cent.

The reductions cited above are all the more striking in face of the fact that freight rates have not declined during this period, the survey says.

Country As a Whole

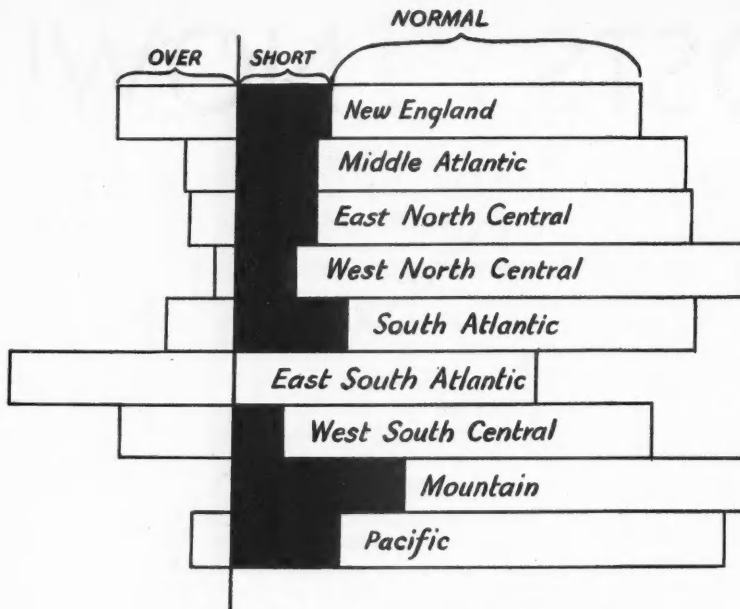

PREPONDERANT NUMBER OF COMMUNITIES SHOW NO CONDITION OF OVERBUILDING

Communities having a normal supply, or even a shortage of single family houses, are represented to the right of the vertical line by columns showing the percentage of cities reporting. These far outweigh the percentages of overbuilding. Shortages of apartment houses are also reported in many sections.

ductions as evidenced by newspaper reports in cities where organized labor controls the situation to a greater or lesser extent. The competition indicates the trend to normalcy in wage rates, consistent with the cost of living and conditions in respect to construction work."

Tremendous Back Log of Construction

There can be no question of the fact that there is need for new construction all over the nation. Two charts are reproduced on these pages which show the tremendous backlog of construction that exists in the country today. For the past two years we have been building far below a ten-year average as shown by the chart and such a condition is bound to result in a damming-up of building needs. Contrary to the prevalent belief that an overbuilt condition exists in most communities, a survey of the National Association of Real Estate Boards taken earlier in the year proves conclusively that a preponderant number of communities throughout the country are either in a normal condition or have an actual shortage of houses. This fact is graphically brought out in an accompanying chart.

Wages Are Down

That building material prices have fallen drastically is a fact borne out all along the line by figures from various sources. The Weekly Commodity Index prepared for the National Association of Purchasing Agents shows an index of 71.9 on August 28th for building materials. The figure on January 5th was 96.0 and in 1926 it was 100!

The Annalist Weekly Index of Wholesale Commodity Prices shows an index number of 137 for building materials on August 26, 1930. A year later it had dropped to 114.

The cry has heretofore been that wages have not kept step with the prices of products in the decline, but this can no longer be said. Carpenters that have been getting \$12.00 a day are now getting \$8.00, and in some localities lower than that. The monthly bulletin of the National Association of Building Trades Employers reports: "The annual wage rate schedule in the building trades published by the Builders Association of Chicago and now on the press, discloses the fact that notwithstanding the opposition to a reduction of wages by the building trades, there are many trades in various cities throughout the country whose wages have either arbitrarily or by mutual consent been reduced from the figures reported as of July 1, 1930. It may be possible that many of the trades reported as receiving a reduction are in what are called open shop cities, but there are undoubtedly many re-

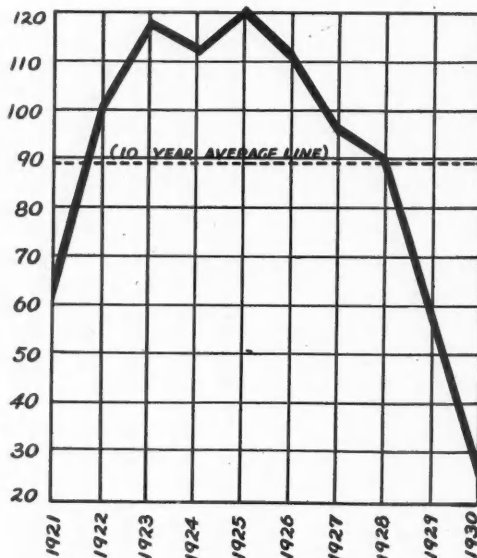

POPULATION NEEDS MUST BE MET

We are far below our normal average in providing for our population. This curve shows the families provided for per 10,000 population in new single family and two-family dwellings and apartments.

of the present business impasse, is the notable response generally accorded by the public to offers of goods for sale at real bargain prices. *Where real values are available there appears to be little hesitancy in buying.*"

Performance Needed

Whatever may be developed in the way of a national plan for stimulating building construction, something must be done locally in the way of performance. Today the local builder can in no way depend on what is being done for him nationally, either by his own trade associa-

Is Not Overbuilt

tion or by any other group. Valiantly as these organizations may be trying to relieve the situation, time must elapse before any national constructive program can be worked. Meanwhile, if the builder is to profit by the demand for low-cost houses at the present time, he must do what he can locally to help his own business.

Many communities today have a surplus of mortgage funds. Strange as it may seem, there are some banks actually advertising mortgage money! Other communities are not so fortunate. But in spite of mortgage foreclosures, repossessed homes, frozen conditions, these facts remain:

1. Many banks have surplus funds that could legitimately and safely be utilized in construction.
2. Many people want new homes, could use them, have money to build them.
3. Economically this is the best time to build.
4. Building construction is one of the best and most legitimate ways to stimulate business and provide employment.

This is the great fact: That it is not necessary to wait for any national plan to stimulate construction when such local conditions prevail. Enterprising individual builders are already succeeding in fighting the slump single-handed but community co-operation among building elements would help much more.

The greatest hope for the building field in the coming months would seem to lie in co-operative effort in local communities to create a local psychology to stimulate building construction. "Build up public confidence locally," should be the watchword. Some people don't believe prices are down. Convince them with the facts on these pages. Convince wealthier people, who are hanging back, that they should build now. They will lose nothing. On the contrary, they will get new structures at less money and will provide employment for men this winter.

Many Communities Active

The strange thing about this building slump is that some communities have been active right straight along. Houses and other structures have been erected and curiously enough people have rushed to buy! In these communities it has seemingly been much easier for buyers to put down first payments than ever before! This means that people have money and that they are willing to spend it for what they want.

But it takes local effort along co-operative lines to

A TYPICAL REPORT OF CONDITIONS

In the preparation of this article on economic conditions in the building industry, American Builder and Building Age made an editorial survey of actual conditions in the field in order to present to our readers as true a picture as possible of the situation in the country as a whole. From the data received in this survey we have selected the following report from a builder in the middle west as being typical:

How much have prices gone down on material you buy?

As compared to last year?.....15%.

As compared to 1929?.....25%.

Likely to go lower?.....No, except distressed mdse.

Which products have shown the greatest drop? *Cement, common and hardwood lumber, sash and doors and glass.*

What has been the drop in fixture and equipment prices? 15%.

Is building active in your locality? No.

What is main reason for inactivity? *Inability to finance.*

Is mortgage money available in your section? No.

If not, what is the reason? *All building and loans have suspended payments.*

Is there any co-operative effort in your community to stimulate building? No.

How do you think construction can best be stimulated in your community? *Available financing*

What type of house is popular in your section now?

Description	Price
1. Frame.....	\$5,000 to \$ 8,000
2. Brick.....	7,000 to 12,000
3. Doubles or duplexes.....	8,500 to 15,000

Are labor costs down? Yes. How much? 10%.

Remarks: "About 100 residential units, practically all single houses, will be built in our city this year, as compared with a normal of 400. The city was not overbuilt at the beginning of the depression period, consequently there is a house shortage here now. In my opinion, the situation will not be adjusted until a new source of primary financing is developed or the Central Residential Mortgage Bank, as your publication has suggested, is authorized by Congress."

This report is typical of those received from various builders and dealers. Those closest in touch with actual conditions cannot see how prices can go lower except for distressed merchandise. Note that, in this city, homes in the lower price ranges are now most popular. This is true of the whole country.

effectively release this buying power. Let us cite a few of the principles and methods that are pre-requisites to any improvement in the building situation as it stands today. These pre-requisites are four in number:

1. Local organization of building men.
2. Arousing of the public by local promotion.
3. Securing co-operation of local banking interests.
4. Establishment of some kind of effective supervision of construction to guarantee values to the public.

Out of the depression these four principles have emerged as pointing up the road of progress in the building field. Whatever happens, these four principles will eventually have to be followed, no matter what is accomplished nationally. The key to the situation is the local program. By establishing a smooth-working local organization of building men following the above principles, the building industry could capitalize on low costs this fall and winter.

EXPLODING THE WINTER B



Home building done profitably in spite of snow on this Massachusetts project. F. T. Foley & Co., contractors.



Preparing to heat sand for concrete by building fire under pan. Adams Const'n Co., Hinsdale, Ill.

No Sound Reason for Inactivity, Study of Cold Weather Methods Shows

It takes facts to explode such a myth as the one that causes builders to shut up shop in winter. A nationwide survey of the facts concerning winter building has revealed some surprising contradictions to commonly accepted ideas. For example:

Excavation can be done from 25 to 40 per cent cheaper in winter than in summer. Reason: a small charge of dynamite breaks the frozen crust, and after that progress of a steam shovel is rapid. Excavation equipment, which reaches its peak use in summer highway work, can be rented in the winter dirt cheap. Most owners of such equipment figure their overhead on the basis of summer work only, and anything they can get in winter is clear profit for them. Another reason

REBUILDING SLUMP MYTH

why winter excavation is cheaper is that the earth is more firm, permitting a sharper cut with fewer cave-ins.

Labor productivity is just as great in winter as in summer. Reason: any slowing up caused by cold weather is more than equaled by the slowing up caused by hot weather. There are just as many rainy days in the summer that stop work as there are cold or snowy days in the winter when work is inadvisable. Actually the number of winter days when work cannot be done are very few.

Prospective home buyers would rather be able to move into a new house in the spring than the fall, hence construction should go ahead during the winter. Reason: in the spring the new owner can get his garden in, work on the lawn and attend to planting of trees, shrubbery, etc. The "urge" for new things, and for moving, is greatest in the spring.

The additional cost of concrete or brick work at zero temperatures is more than offset by lower material prices, lower overhead, and increased productivity of men anxious to retain their jobs all year. There is reason to believe that winter construction, even in such cold regions as northern Canada, can be carried on slightly cheaper in winter than summer when the builder knows how to proceed in a scientific, efficient manner.

Big city builders have led the way in showing that winter work is as practical to do as summer work. City statistics show the winter slump on the basis of normal operations is now less than 6 per cent. These builders were forced to do winter work by demand for speed and for *immediate action* regardless of weather conditions. Once the habit was broken and the winter building myth dispelled it became clear that cold weather work was perfectly feasible.

Home building presents less of a problem for winter work than skyscraper construction. Progress has been less because habit is stronger in the rural regions and until now builders have not been *forced* into winter work in the same way city builders were. The habit is now being overcome.

Some builders are doing all of their solicitation of business and are running their advertising in the fall and winter. They rely on regular sources of business to keep them busy in summer, and confine their promotion to winter work. In this way they keep their construction volume almost constant and give year around employment to their men.

The fact that it is habit more than anything else that creates a winter building slump is shown in the South and Southwest where the winter recession is practically as bad as in the North. Actually, work in the warmer parts of the country can be done *better* in the winter, yet most building work is carried on in the sweltering heat of summer.

* * *

The foregoing facts indicate that the great majority of the builders of the country have been neglecting a fruitful field for profitable operation. Instead of accepting a winter slump, they should redouble their selling and promotion efforts with the coming of fall. By doing this, construction can be put on a twelve months' basis, which will do more to stabilize the industry than any other single factor. Construction employees should



Heat supplied by salamanders and temperature checked by thermometer until concrete and mortar has fully set. Hinsdale Memorial building, Hinsdale, Ill.

be employed on a year-around basis, and the only way contractors can do this is to promote winter building.

The biggest field for new work, especially among the smaller organizations, is the building up of a home-building and modernizing business for fall and winter. The public must be convinced that home-building can be done satisfactorily during the cold months. Once that is done, there will be a big increase, for there are many advantages connected with moving into a new house in the spring.

Modernizing and interior alterations can, of course, be done just as well in winter as in summer, and the reason that more of such work is not done during the cold months is sufficient evidence that builders have been falling down in their selling work. A growing volume of statistics indicates what a large, potential need for home-modernizing and improvements has grown up during the inactivity of the past few years.

This winter as never before builders should find it worthwhile to make a definite sales drive for modernizing work. They have probably the strongest talking point that can be mustered, namely, *low building costs*. It should be possible to convince the homeowner that on every hundred dollars spent in improvements this winter he will save twenty-five to thirty-five



Heater made of concrete block and old tank to warm water and sand for concrete work.

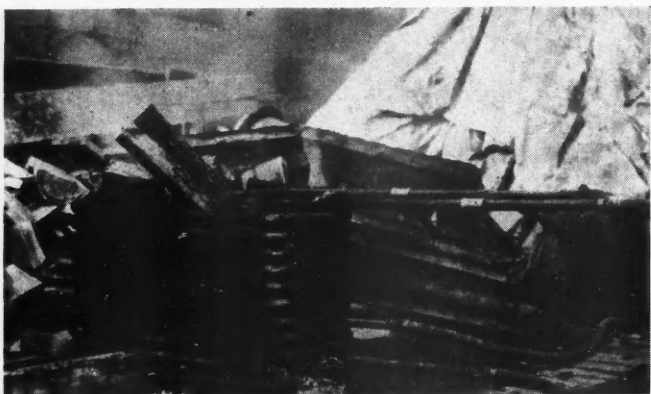

Wood fire in the center of this pipe coil is used to heat water for concrete mixer.

dollars over what the same work in all probability will cost a year or two hence.

Another big factor working in favor of the builder is the enormous national agitation over unemployment and the closely connected fact that construction work will not only relieve local unemployment but will operate to the national advantage of the whole nation's business.

Architects, contractors, building supply dealers and

realtors should all be actively preaching the business benefit of building. They should point out that every dollar spent in construction starts a long train of business operations. It puts architects, contractors, and craftsmen to work. It starts the cement and brick plants, lumber mills, and manufacturing of building specialties. It can be pointed out that the building dollar is respent many times, sending orders for products to every corner of the country and stimulating trade along the line. In no other field are the values of money expenditures so great.

Our study of new equipment, new materials, and new methods for building operations during cold weather shows what tremendous advances have been made in this field. Numerous carefully and scientifically prepared textbooks on the subject are available, so it will only be necessary here to present a few of the outstanding facts.

Our previous statement about excavation costs may be modified by varying conditions. It serves, however, forcibly to call to our attention a mistaken notion that many builders have never even taken the trouble to investigate. Where the ground is frozen extremely hard and deep, there is a slight additional cost at the start of excavation for dynamite or use of skull-crackers to make an opening. Such an opening need not be large, in fact just enough to permit the shovel to reach below the frost line and get a start. The chief saving is made possible by the fact that excavating contractors can well afford to quote prices 20 to 35 per cent less than their regular summer scale.

Twenty years ago contractors experienced difficulty in laying concrete during cold weather. Such difficulties have long ago been solved, and any builder who has any doubts about the subject should hasten to consult with the nearest concrete engineer or specialist. The latest technical data on making and placing concrete may also be secured free of charge from the Portland Cement Association, Chicago. A partial list of equipment to facilitate cold weather concreting would include a boiler, either new or old, for heating water; pans or a steam grille for heating sand and aggregates; tarpaulins or heavy building paper for protection against cold; salamanders or other equipment to heat newly placed

(Continued to page 100)



Laying up a concrete masonry wall for small home in Illinois, middle of January. Chas. Arbogart, builder.

HOW TO CONDUCT A FALL SELLING CAMPAIGN BY MAIL

PART 2

LAST month we outlined some of the basic requirements for successful business-getting letters and promised to follow up this month with a few concrete examples. Before doing so, however, let us repeat that letters should not try to cover too wide a territory or be too general in nature. Take a specific subject, such as *Save Money by Building this Fall* or *Build A New Home Before Christmas*. Or develop a single home improvement proposal like *Add a Sun Porch While Prices Are Low*, or *Transform the Basement into a Playroom*.

The following letters illustrate many points made in last month's article. A formula is followed because we feel it helps eliminate unnecessary or distracting items. With slight changes to meet local needs, some of these letters may be put to work at once in a campaign for fall building business.

The first letter goes to a selected list of apartment dwellers paying \$50 to \$100 a month rent. We wish to persuade them to build a home this fall.

Greeting Dear Mr. & Mrs. Merrick:

Contact Sentence You have probably heard that building costs are the lowest they have been in many years and that this is an ideal time to switch from rent paying to home owning.

Reason for Writing It is a fact: you can build a \$10,000 house now for \$2500 less than you could have two years ago, or will be able to two years hence. That is why I am writing. I want you to consider building a home while you can profit by bottom prices. You can do so with a down payment as small as \$500 and monthly payments as low as \$50. Isn't that less than you pay now for rent?

Description of Service I have an organization especially equipped to build fine homes, and a record of many years of careful, reliable work in this city. We design, construct and finance completely, taking care of all details. Under our plan building a home is a simple, easily accomplished matter and yet we work understandingly with our clients to produce a home that exactly meets their needs or desires.

Argument or Persuasion If you have ever dreamed of owning a home that is all yours, now is the time to make that dream come true. We are anxious to keep our best workmen employed all winter, and will make special concessions to get business. We can give better service now than at any other time of the year.

Request for Action By starting work this month you can have a new home ready to move into before Christmas. Or by starting a little later we can have it ready for early spring, enabling you to start a garden. Fill in and mail the enclosed card NOW and we will send an architect around to discuss plans.

Friendly Wind-up After all there's no reason why you should go on paying rent when that same money might be going into a permanent home investment. Let us help you save money by building now.

Signature Yours very truly
Johnathon Jones

Firm Name American Building Company

Note that there is a definite request for a reply. This is an extremely important part of every letter: make a request and enclose a reply card.

Business reply cards are designed by the post office department for the especial use of mail advertisers. When they are used, postage payment is made only when the card is returned to you. You should secure a permit and use these cards for they save money.

To arrange for a permit, go to your local post office and ask for a bulletin "Conditions Governing Distribution of Business Reply Cards." Also ask for Form No. 3614 entitled "Application for Privilege of Sending Out Business Reply Cards." Full instructions tell you how to arrange all details.

On the back of the reply cards have a proper form printed with your name. Something like the following is suggested:

I AM INTERESTED IN BUILDING A
HOME AND WOULD LIKE TO SEE YOUR
NEW FLOOR PLANS AND DESIGNS

Name

Address Tel.....

It may be wise to alternate letters on home construction with others on modernizing and improvements. The letter that follows is intended to sell a sun porch to a selected list of housewives.

Greeting Dear Mrs. Pierson:

Contact Sentence Will you have enough warm, energizing sunshine in your home this winter? Wouldn't you like to add a small comfortable room which would be flooded with healthy rays all day?

Reason for Writing I am writing to suggest that this fall is an especially opportune time to add a sun porch to your house. With building prices way down we can do it very inexpensively and produce such a sun-room as you have always wanted.

Description of Product We have a fine lot of sun porch designs—cozy, warm and healthy—bright spots on even rainy days. And on sunny days these porches enable you to make the most of Old Sol's healthy rays.

Argument or Persuasion You know how important sunlight is to health. We are now able to provide sections of glass that let all the health-giving rays through. You and your children can absorb energy and bask in the sunshine in warmth and comfort.

Request for Action I have a crew of expert builders whom I am anxious to keep employed all winter. I am willing to make you a "thrifty" price to do so. Won't you let me send an architect over to discuss the matter with you? Just drop the enclosed card in the mailbox. No stamp is needed.

Friendly Wind-up If you want healthy sunshine in your home we can give it to you. But send the card now!

Signature Yours very truly,
Johnathon Jones

Firm Name American Building Company

A good letter is nearly always made better by the addition of a well gotten up stuffer or folder. If you can arrange to print your own stuffers, your message can be tied in with the letter. Much time and effort can be spent in making the folders interesting, colorful, and full of sales appeal. You can also get many valuable stuffer pieces from building material manufacturers or their local representatives, the supply men. Have your name printed on them and enclose them in all your correspondence, bills, statements, etc.

When a stuffer is enclosed with a selling letter the two should work together. But never leave the message in your letter incomplete on the grounds that it will be finished by the stuffer. You can refer to the enclosure but always make the letter complete in itself.

Odd jobs of carpenter work around the house may bring in much worthwhile work in the fall and winter if it is properly promoted. The letter that follows is suggested for wide distribution.

Greeting Dear Mrs. Alfred:

Contact Sentence No doubt you have been reading about the Unemployment Problem this fall, and how home building and improvement can do much to keep men from going hungry.

Reason for Writing I am writing to suggest a plan that will not only put men to work, but will give you a better and more comfortable house. I have a large crew of carpenters and craftsmen anxious to do something. My plan is to have some of them go to work in your home.

Description of Service Under my supervision these men can build new shelves, bookcases, closets or other needed fixtures. They might cut in a needed door, add a bay window, fix up floors or woodwork or modernize your kitchen or bathroom. They are well trained, efficient men, specialists in their lines. Because most of them have families they need work more than the itinerant drifter that so often claims the money of local charities. My men do not want charity, they want work.

Argument or Persuasion If there was ever a time when home improvements are justified, it is NOW. Building materials as well as labor are at extremely low cost, and you can have work done at from 25 to 35 percent below normal.

Request for Action The cold days are coming rapidly. Won't you look about and see whether there is not work you would like to have done at once?

Then fill in and mail the enclosed card.

Friendly Wind-up It's a pleasant form of Unemployment Relief and we can really do a lot to make your home nicer.

Signature Yours very truly,
Johnathon Jones

Firm Name American Building Company

The time for mailing letters is an important matter. Between the 18th and 25th of the month is considered good because there is less competition from bills, statements, etc. Tuesdays, Wednesdays and Fridays are considered the best days for arrival of letters. For housewives, afternoon arrival is preferred to morning.

A good letter is always worth following up, whether you get a reply or not. It can be done by telephone, personal visit, or by another letter. Possibly all three should be used. If your mailing list is good the prospect is worth keeping after vigorously. Frequently selling letters are sent out on schedule, one following the other at regular intervals. Selling effect can be built up by letter after letter until a sale is made.

As this article is written there is more and more evidence of the need this fall for more aggressive selling by builders. We cannot repeat too strongly the statement that *there is business waiting for those who are able to sell*. For further data to help conduct a fall campaign refer to March issue, p. 52, "Showmanship"; April issue, p. 63, "Building a Prospect File," and Sept. issue, p. 42, on letter writing.

Save Money By Building This Fall Or Winter



Make Your Mailings Do Double Duty by Enclosing Stuffers Specially Prepared or Received from Building Material Manufacturers.

SIDE LINES Can Be Profitable

One Stunt Is To Establish A Small Woodworking Shop

In It You Can Make Articles for Your Own Houses and Then Sell the Same Products to Others in Your Town

TAKE storm sash or screen windows and doors, for example. Many families in your locality may be in need of winter windows at this moment. With a comparatively small outlay for machinery equipment, you can put yourself in a position to give your neighbors estimates on storm protection for the coming winter or on rescreening their windows for next spring. Your figures may surprise them, yet bring you in a profit.

It has been done. One team of brothers in Harrisburg, Pennsylvania, have developed a nice business in this line. Last fall they sent around cheaply printed circulars to drum up screen trade. It worked.

Many people, every year, consider the possibility of adding a screened porch or putting in new screen windows; and a circular like the following may come in at just the right time:

**If You Want
NEW SCREENS**

Let Us Estimate the Job

The Low Figure May Surprise You

We make our screens by machinery so they are tight-fitting and well-made but the cost is relatively low. We can screen any type of door and window with any kind of screen cloth. Let us give you an idea of how low the cost will be for rescreening.

We Also Make

**GARDEN FURNITURE, BOOKCASES,
CABINETS, LATTICE WORK, ETC.**

**Just Let Us Know Your Needs and We Will Give
You An Estimate Without Obligation**



Window screening is but one of the dozens of possibilities in the woodworking line. One of the bulletins issued by the Wood Utilization Bureau of the U. S. government, tells how to make things from wood. In this book, scores of ideas are presented that can be turned into money in almost any locality.

Repairing and replacing broken sash, repairing sun porches and verandas, steps, and other parts of residences,—all offer a good market in which to establish a profitable side line. Some builders hesitate to do the necessary selling work in connection with enterprises of this kind but in reality it is much easier than they believe. People are suspicious of high pressure selling and this type of salesmanship is not needed. Home owners do not fail to respond to a frank approach and an honest proposition.

One man started in slowly with a small radio cabinet business. With just one inexpensive, combination electric machine he is now putting out radio cabinets and other furniture that sell to metropolitan department stores. Another builder gets wood from old crates and boxes to make his products.

The possibilities in the woodworking business for the builder are many, because he can not only supply interior and exterior pieces for his own houses but he can also make these products for sale to other builders and home owners in his locality.

The latest advances in woodworking machinery now makes it possible for the local builder to handle practically any sort of woodworking job. Machines of low cost that are capable of performing a number of different operations are already on the market.

For the builder now wishing to carry on woodworking as a sideline there is available, for example, a com-
(Continued to page 98)

SHOP WORK FOR ROUGH WEATHER



The Volume of
Work in Many
Places Justifies
a Larger Shop.

A
me
Equi
Wi

R IS BETTER THAN "SNOW BALLS"

IN SPITE OF the fact that cold weather construction is on the increase, there are still many hours during the long winter months when most builders would welcome some sort of work to keep them busy. The best answer to this problem is the home power workshop.

Most builders are especially suited to develop a winter business of this kind which they can carry on in a warm workroom while the winter blasts rage outside. Recent years have brought about the development of power machinery for the home workshop that makes it possible to turn out a big volume with little labor cost. There was a time when it cost so much to outfit a complete shop that it was difficult to get started. This is no longer the case, for with increased efficiency manufacturers have also given lower prices.

Machines may be bought singly or in combinations that save space and original cost too. Combination woodworkers are extremely efficient, combining as they do many machines in one. They combine cross-cut and rip saw, band saw, jointer, lathe, shaper, etc. With such machines it is possible to set up a complete workshop in a very small area.

Once the decision has been made to go into work of this kind it should be gone about in a business-like way. The first step is to determine on salable products. Lists of such products with instructions in making them may be secured from manufacturers of the equipment. They may include cabinets, bookcases, chests, wood novelties,

lamps, ashtrays, checker boards, stools, etc. A big new field for the enterprising man lies in *moderne* furniture. This furniture has become a popular and up-to-the-minute thing, and most of the styles are carried out in straight line proportions that are easy to make. Money may be made by originating a small piece of modern furniture such as a table, a bookcase or a cabinet and pushing it exclusively. The biggest profit, of course, comes where volume production is possible.

The first step, then, is to make a survey of possible products and select the most likely one. A few models should then be made and photographed. With these photographs made up into an attractive folder (the work can all be done by yourself or wife) start out to interview all the business establishments in your community. Explain your proposition, being sure to give the merchant a chance to make a good profit on sales. Get him to display some of your products.

By co-operating with business men in this way, an outlet may be built up. Your selling may be done in furniture stores, general merchandise stores, radio shops, specialty shops and a host of other places. Supposing you have developed an especially attractive modern bookcase. See that that bookcase is on display everywhere in town. Distribute photographs widely.

One product forcibly pushed is better than a whole line that is sold only haphazardly. You may engage in
(Continued to page 98)



A Home Basement Well Equipped for Winter Shop Work.

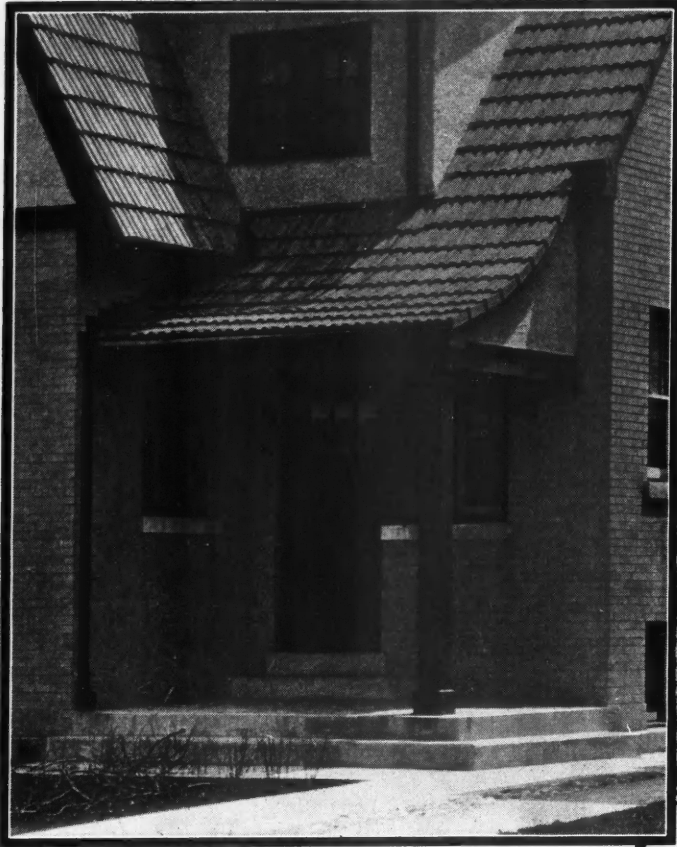

This Type of Modern Porch Lends Itself Readily to a Winter Enclosure Which May Become a Permanent Feature of the Home.

The Sketch Suggests How This Entrance May Be Enclosed to Afford Ample Weather Protection Without Cutting Off the Light.

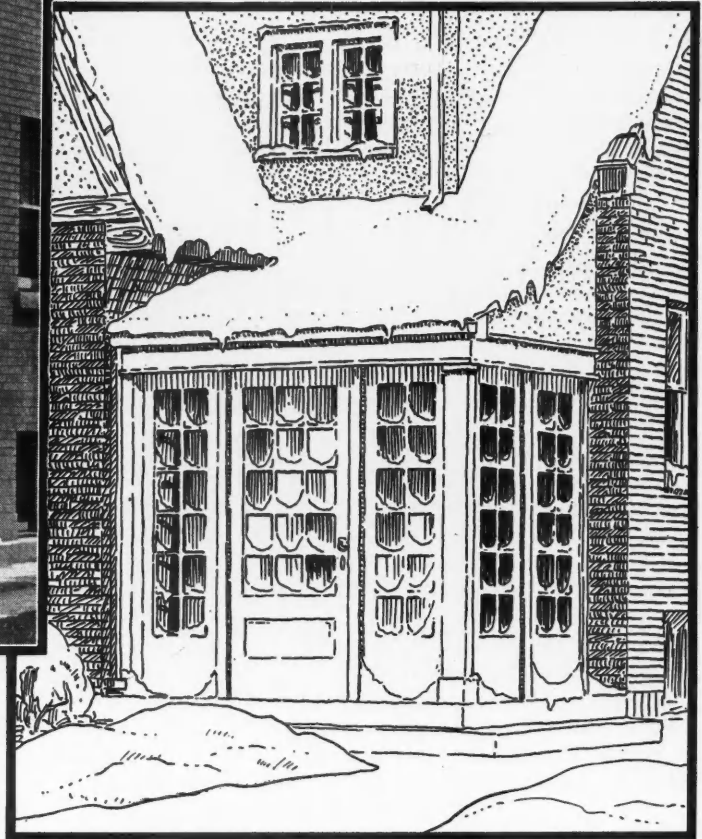

Boost the Twin Fuel-Savers— Storm Sash and Entrance Enclosures

IN these unusual times every possible source of added income is worthy of serious consideration on the part of the contractor or builder. This is especially true of the normally slack autumn months. During October and November, and even in December, many wide-awake contractors find it possible to turn a highly profitable volume of business by interesting home owners in storm windows, porch enclosures and storm vestibules.

This year, more than at any time in a number of years, people are thinking in terms of economy. This public state of mind plays right into the hands of the contractor who is actively selling winter enclosures for it can be proved that such protection quickly pays for itself through fuel economy; and from then on shows an actual saving in fuel costs. The added comfort gained is an extra which costs nothing.

But this added comfort is a big factor in selling winter enclosures. Health and comfort are of vital interest to the American people. We need only turn the pages of any current magazine to see that the appeals of health and comfort are the main theme of many of the most successful advertisers. The vast increase in the sale of insulating materials and more efficient heating equipment is conclusive proof that the American public is

willing to spend its money for greater home comfort.

While the sales of insulating materials have been mounting rapidly during the past ten years, the supplementary protection of winter windows and entrance enclosures has been largely neglected. In cold weather, heat is lost from the house, and cold air enters, both through the walls and at the wall openings. Insulation reduces heat loss and infiltration through the walls and roof to a minimum. The wall openings, on the other hand, remain unguarded unless storm sash and door enclosures are provided.

There are few houses today which can not be equipped with storm windows if the owner is shown the advantage to be gained from such equipment. Regardless of the insulation used in the original construction, there is a tremendous heat loss through and around the glassed openings, as well as cold air infiltration on the windward side of the house. Winter windows are the most effective means of reducing this heat loss and infiltration. The dead air space created by the winter window is a poor conductor of heat and the well fitted storm sash largely eliminates drafts.

With such drafts eliminated the entire room is comfortable for use even in the coldest weather. This does

Well Designed Storm Sash Do Not Detract from the Appearance of the House but Seal It Against Winter's Cold.

not mean, however, that ventilation is sacrificed. The improved hardware of today, especially adapted to storm sash, makes it possible to open and close the winter windows with the greatest ease.

Of course it is possible for the home owner to buy cheap, ready made sash, from the department stores in the larger cities, or from the mail order catalog, but that is poor economy. Such sash require trimming and fitting before they can be installed. Once installed they seldom fit as well as storm sash made by the contractor for that particular house and they detract sadly from the appearance of the home.

With only a slightly greater outlay of money the owner can obtain sash especially made for his windows. They will be efficient in weather protection and if the contractor knows his job will actually add to the appearance of the home instead of detracting from it.

French windows and doors are highly popular these days, especially for living rooms and dining rooms. The use of such long length windows greatly increases the area of leakage and indicates an even greater need for storm sash. Storm sash for such an installation should be especially designed if they are not to spoil the whole effect of the original design. If designed with rounded tops to fit the fan light of the window and with vertical or horizontal stiles to match those of the regular windows, they will be appreciated by the owner who prides himself on the appearance of his home.

The same is true of entrance enclosures. They should be designed to match the style of the house and give the impression of being a part of it. They should be largely of glass, to avoid the cutting off of light as well as for appearance. The shed-like vestibule of boards sometimes seen may offer protection to the entrance but it should be out of the question for the modern home.

Entrance enclosures are seriously needed for modern homes, those built within the last few years. The tendency of late years has been to eliminate the old time porch, frequently to omit any sort of vestibule and still further to permit the entrance to open directly into the living room. Such an entrance actually demands pro-



tection in any stormy weather and especially in winter.

Experience has demonstrated this need. Owners who have provided their homes with entrance enclosures which were well designed and constructed, have frequently refused to take them down at the end of the winter season and have permitted them to become a permanent feature of the house.

By the same token, porch enclosures are also a fertile field for the enterprising contractor. Porches are rare on the more recently built homes, but where they do exist glass enclosures increase their usefulness many times over, as sleeping porches and as additional living space. Then, too, many owners who have followed the vogue and built porchless homes have already felt the lack. A proportion of them have houses so designed that a porch can be easily added. They are good prospects for fall and early winter work with the idea of the glassed-in porch enclosure emphasized.

When it can be pointed out to the home owner that this storm enclosure work can be paid for by savings in fuel bills, there is certainly an opportunity for the contractor to build up a profitable business in such work.

And it can be demonstrated. The United States Bureau of Standards has issued a tabulation of fuel savings through the use of storm windows. This impartial bureau states that the use of storm windows will effect a savings of from 10 to 20 per cent in the amount of fuel required to maintain comfortable temperatures. From personal experience we would say that the gain in comfort is even greater than these percentages.



The Glassed-in Porch Is an Ideal Winter Playground for the Children, Fully Protected Against Drafts.



Frozen Radiators Sell Garages

Cold Snaps Demonstrate the Economy of Proper Housing for Automobiles as Builders Cash in on Garage Building and Improvement

It is a pretty safe bet that sometime, before many weeks now, there is going to be a sudden, overnight drop in temperature. When it comes, a lot of home owners who have been parking their cars at the curb or in the vacant lot all summer will wake up to discover frozen radiators and cracked cylinders. Their repair bills will amount to many dollars—totally wasted money—and the first enterprising builder who comes along to talk garage building will find some easily sold prospects.

But why wait till cold weather to sell garage jobs? Plenty of those car owners know what a frozen radiator means. The reason why they have not already provided housing for their cars is that queer twist of human nature which makes them wait.

It is a simple matter to locate the prospects in your territory. Just get up early some morning, before the sun is really up and while the rest of the population is getting that last few minutes of sleep. Drive around and note the addresses where cars are parked outdoors, left there all night. Those addresses will form your prospect list and it is not too early in the season to get to work on it.

None of these people who are leaving their cars out every night would think of treating any of their other valuable property that way. The automobile may be worth anywhere from five hundred dollars up into the thousands, more than any other single item the family owns. It certainly deserves proper care and protection from the elements, as well as from thieves.

There is a big market for new garages. Automobile registrations had mounted, in 1930, to a total of over 23,000,000 for the United States. Existing private garages, as authoritatively estimated, numbered only about 9,000,000 in 1930. Here is a difference of 14,000,000 between the number of automobiles to be housed and the private garages provided to house them. Of

course some of these garages are of the two car type and a large number of cars are kept in public garages, but allowing for all that there still remains a margin of several million cars for which no housing has been provided.

But new garage building is not the only profitable opportunity open to the builder in connection with the housing of automobiles. There are, also, several million private garages in this country which are in need of modernizing. Fully half of the private garages in use at the present time were built ten years or more ago. Most of these, and many of the more recently built ones, need repairs, insulation, modern doors, and other equipment.

The outstanding item in garage modernizing is, of course, modern garage doors. Garage doors have been remarkably improved in the last ten years with the introduction of upward-acting doors and the sliding-folding type. Within less than two years a large number of such doors have been perfected and placed on the market by various manufacturers so that today modern doors are available at prices to fit every pocket book. It is even possible to obtain hardware which can be applied to the old type of swinging doors to convert them into the modern upward-acting type.

The big advantage of these modern doors, both upward-acting and sliding-folding, is that they can be opened easily without first clearing the snow or ice from the driveway. Snow and ice do not affect them, and neither does wind. When these doors are opened they stay open and there is no danger of the wind slapping them against the car and crumpling a fender.

For prospects who want still greater convenience in garage door equipment there are a number of mechanical opening devices. With such a device installed the owner need only stop in the driveway long enough to

Reinforced Building Paper Applied Inside the Garage Keeps Out the Wind and Protects the Car at Small Cost to the Owner.



insert a key in a lock which is installed on a post beside the driveway, without getting out of his car. This automatically opens the garage doors and he drives in. There also is a type of opener which is operated by the weight of the car driven onto a platform approach, and even a radio control operating from the dashboard of the car itself.

Most of these mechanical operators also control the garage lights, automatically switching them on as the doors are opened, so the owner need not run the risk of approaching a dark garage. A switch inside the house turns off the lights and closes the doors so that the garage and driveway are well lighted until the owner is actually in the house and safe from the danger of holdups.

Besides modern doors, garage insulation is a subject of importance to the owner which offers a fertile field to builders and contractors. Sell the prospect on the fuel economy obtained by insulating the heated garage, or the convenience, and protection to the car, from insulating the unheated garage.

The fuel economy of insulation for houses is already

well known. The same applies with equal force to garages. In the unheated garage, insulation also serves an important need. Even in a garage radiators may be frozen in extreme cold weather, and there is the very familiar difficulty of starting the cold car in winter which can be overcome by insulation.

With the prospect who wants protection against cold but is not able to invest in a complete insulating job there is still a chance for business. Suitable building paper applied inside the garage will go a long way to cut down the infiltration of cold wind and conserve the heat inside. There are now several reinforced building papers on the market and these are especially adapted to this purpose because they are exceedingly tough and not easily torn.

With all these possibilities for garage building and improvement, there is little reason for the wide-awake builder to resign himself to a slack fall and winter season. A survey of local garage needs, followed by some intensive selling, will produce enough garage work during October, November and December to show a mighty attractive profit when the year's total is figured up.

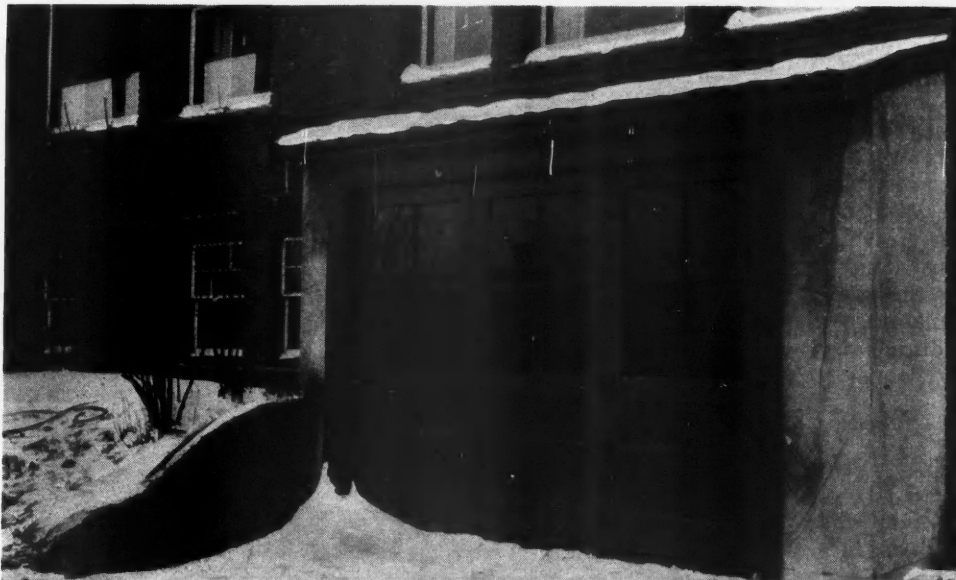

With Modern Garage Doors Snow Need Not Be Shovelled Away Before Opening, and Wind-Slammed Doors No Longer Damage Fenders.

Insulation for Comfort

Comfort, in Both Summer and Winter, as Produced by Insulation, Is Now Demanded by Home Owners



Demonstrate the Comfort Effect of Insulation by Showing the Home Owners How a Blanket of Insulation Can Be Tucked in around the House Just as the Blankets Are Tucked in around a Bed.

THE SUMMER of 1931, the most prolonged period of hot weather in the history of the weather bureau, has started thousands of home owners thinking seriously of insulation as they never did before.

Although the period when insulation will be in demand as comfort insurance against heat is about over for this year, the other side of the insulation question, comfort in cold weather, will soon be making itself felt. The same insulation which will assure comfortable homes during future hot summers will also assure comfortable homes during the coming winter.

Even though new building should not greatly increase before next spring, there is still a big field for insulation work. There are several million homes in this country, as well as thousands of other buildings, which are uninsulated but can be insulated without excessive cost.

Such improvement work consists of applying a fiber board to the rafters or attic floor, a flexible blanket material between the rafters or attic floor joists, or a loose fill material in the attic over the ceiling plaster. If the building is of frame construction, loose fill material can be blown into the walls to produce a complete job of insulation.

This sort of work can be done during the fall and early winter. It is largely inside

work which does not call for special cold weather methods. It is to the owner's advantage to have it done during the usually slack building period at this time of year, and a campaign for insulation work for fall and early winter will help the contractor or builder to keep profitably busy when other work may be falling off.

Nor is the expense of insulation excessive, even in these days when everyone is thinking of economy. In fact insulation of any building is, in the long run, an actual economy. The annual fuel saving made possible

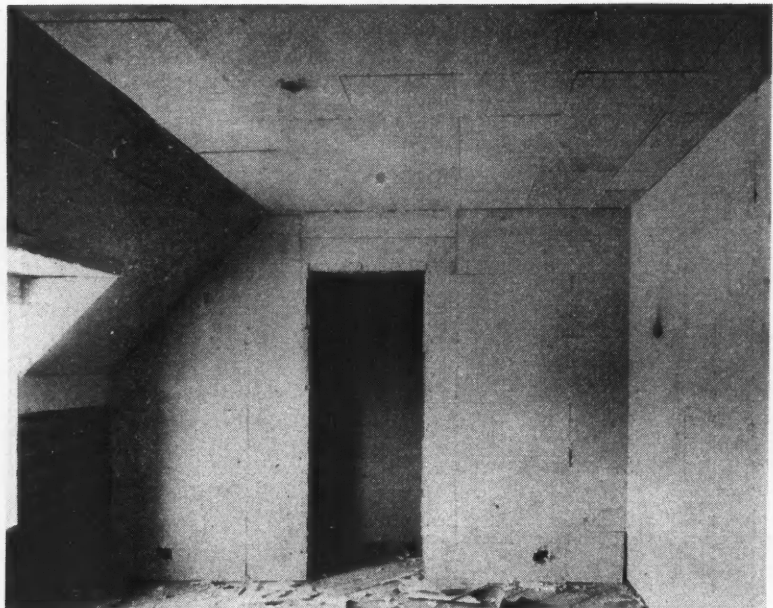

Insulating Board Not Only Makes the House More Comfortable But Also Provides Extra Usable Space in the Attic.

Economy, in Fuel Cost, Made Possible by Insulation, Pays an Excellent Rate of Interest on the Investment

IT PAYS FOR ITSELF

Comparative table of total fuel costs of heating a home 45' long x 25' wide x 20', uninsulated and insulated, with the savings in fuel effected by insulation

Types of Fuel	Cost of Fuel per Year		Annual Savings in Fuel	Gross Return on Insulation Cost	Net Return on Insulation Cost
	Uninsulated House	With Loose Fill Insulation		% per Year	% per Year*
Anthracite Coal @ \$13.00 ton	\$176.20	\$117.60	\$58.60	9.16	8.5
@ \$15.00 ton	203.40	135.70	67.70	10.58	9.81
Fuel Oil @ 7½c gal.	142.50	95.00	47.50	7.42	6.75
@ 10c gal.	190.00	126.80	63.20	9.88	8.98

*This net return percentage corrects the gross return for 4 percent depreciation charge on the insulation investment and also 6 percent interest on the insulation cost. In the returns on coal fuel a counter correction is made amounting to three quarters of 6 percent interest for a period of six months on the saving in fuel cost. This is done because house owners nearly always lay in not less than 75 percent of their fuel requirements for the year before the heating season starts. This is not true of oil, and no counter correction is made for it.

The above yearly fuel costs are based on the consumption of various types of fuels in a two-story house 45' x 25' and 20' high to the eaves, with 8' 4" above the eaves to the peak of the roof. The attic is occupied. This house costs approximately \$640.00 to insulate with Loose Fill. The annual saving in fuel amounts to 33¼ percent and the net return on the investment, less depreciation and interest charges, ranges from 9.81 percent to 22.35 percent depending on the type and cost of fuel used.

by insulation pays an excellent return on the investment and eventually pays for the entire cost of the work.

A typical example of fuel saving through insulation is found in the computation of fuel requirements, made by the engineering department of one of the manufacturers of insulating materials, on a residence erected in 1926 in St. Paul. This is not an exceptional case but merely typical of thousands of cases, records of which are in the hands of all the insulation manufacturers and available for the information of both owners and contractors. The details of this computation follow:

"The fuel and radiation requirements here given are

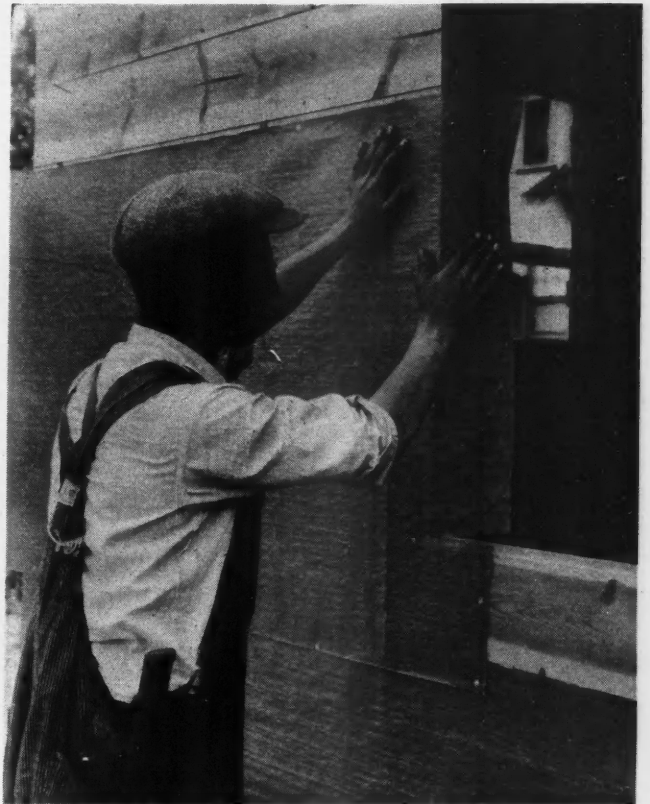

Building Paper Supplements the Insulating Materials by Cutting Down Infiltration. The reinforced type will not tear.

the figures as applied to this residence, without insulation, and with 1" of flexible blanket insulating material in the side walls and 1½" in the ceiling.

"Before construction was begun on this job the engineering department worked out the transmission on the walls and ceiling, and applying these known values to the plans arrived at the following figures:

Wall area	3,039 sq. ft.
Ceiling area	1,136 sq. ft.
Glass area	673 sq. ft.
Volume of air	20,108 sq. ft.

	Uninsulated	Insulated
Kw (Transmission thru walls)24	.107
KG (Transmission thru glass) (1)620	.620
Kc (Transmission thru ceiling)179	.076
Hw (Total Heat Loss thru walls)	66,150	29,295
Hg (Total Heat Loss thru glass)	36,333	36,333
Hc (Total Heat Loss thru ceiling)	18,315	5,985
Hv (Total Heat Loss in Infiltration and Ventilation)	32,571	32,571
Total Heat Loss per hour	153,369	104,184
Plus 10% for exposure.	15,336	10,418

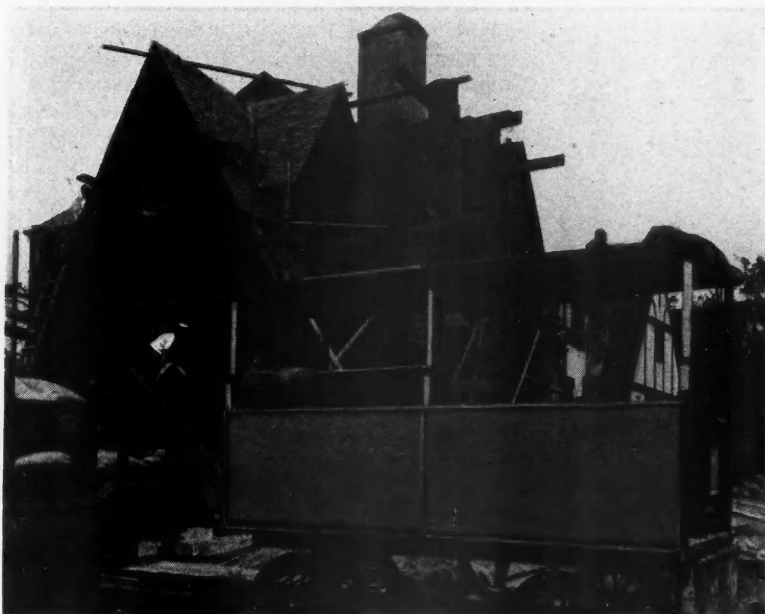

Loose Fill Insulating Materials Can Be Blown into the Walls of New Houses or Those Already Built.

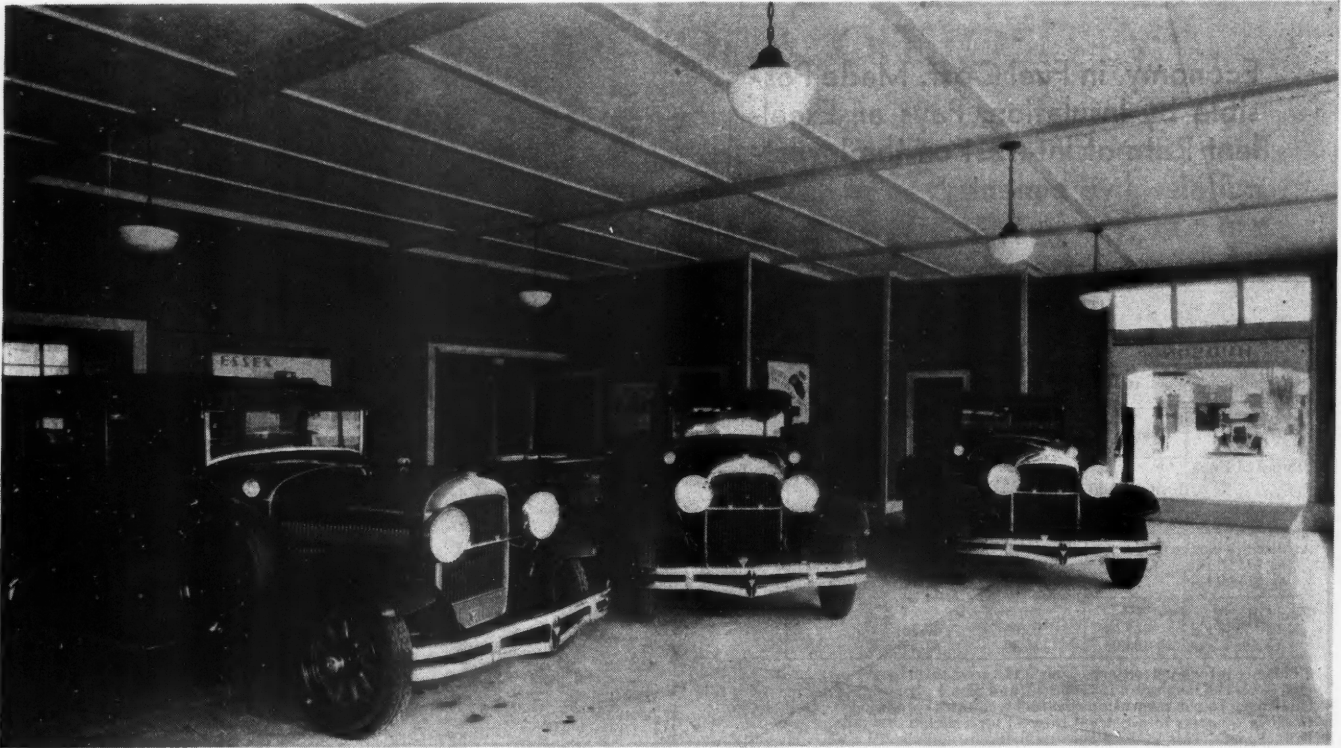

Public Garages Are Also Excellent Prospects for Insulation Which Reduces the Cost of Heating Both Showrooms and Car Storage Space and, in the Showroom Supplies an Attractive Wall Finish.

	Uninsulated	Insulated
Total Loss per hour	168,705	114,602
Total Radiation Required (2) ..	1125 sq. ft.	765 sq. ft.
Gas Required (3)	799,000	543,000
Less 10% (4)	79,900	54,300
Net Total Fuel	719,100	488,700

"The actual fuel consumption in this home during the heating seasons of 1926-27 and 1927-28 is given below:

Season 1926-27		Season 1927-28	
September } 1926	28,700 cu. ft.	September } 1927	31,500 cu. ft.
October }		October }	
November	57,400 cu. ft.	November	41,100 cu. ft.
December	75,000 cu. ft.	December	86,800 cu. ft.
January, 1927	82,000 cu. ft.	January, 1928	95,100 cu. ft.
February	87,000 cu. ft.	February	79,300 cu. ft.
March	61,000 cu. ft.	March	77,300 cu. ft.
April	47,400 cu. ft.	April	45,300 cu. ft.
May }		May }	
June }	29,600 cu. ft.	June }	39,400 cu. ft.
Total for season.....	468,100 cu. ft.	Total for season.....	495,800 cu. ft.

"The estimate for fuel required was 488,700 cu. ft. For the season 1926-27 the actual consumption of gas was 468,100 cu. ft. or a reduction from the estimate of 4¼ per cent. For the season of 1927-28 the actual consumption of gas was 495,800 cu. ft. or an excess over the estimate of 1½ per cent. The variation in total fuel consumption can be accounted for by the human element, in its requirements applying to temperature and ventilation."

It should be noted that the fuel saving effected by insulation of this house amounted to 32 per cent. What this represents, in dollars and cents, can be readily figured by using the fuel rates in effect in any community.

The tabulation at the top of this page shows another typical set of figures on the saving affected by insulation. In this case the figures are carried still further to show the net return on the insulation investment, effected through fuel saving. A return of 6.75 to nearly 10 per cent can be considered very good on any investment.

In this case the insulation, loose fill rock wool, was applied to an existing house. If this had been a new house, and the insulation had been applied at the time of construction, there would have been a saving in the cost of the heating plant and radiation, due to the fact that a smaller heater will serve an insulated house than will be required for an uninsulated house. This saving varies with the size of the house, ranging from 20 per cent to 35 per cent and sometimes possibly as much as 40 per cent. It is sufficient to pay at least a large part of the cost of insulation.

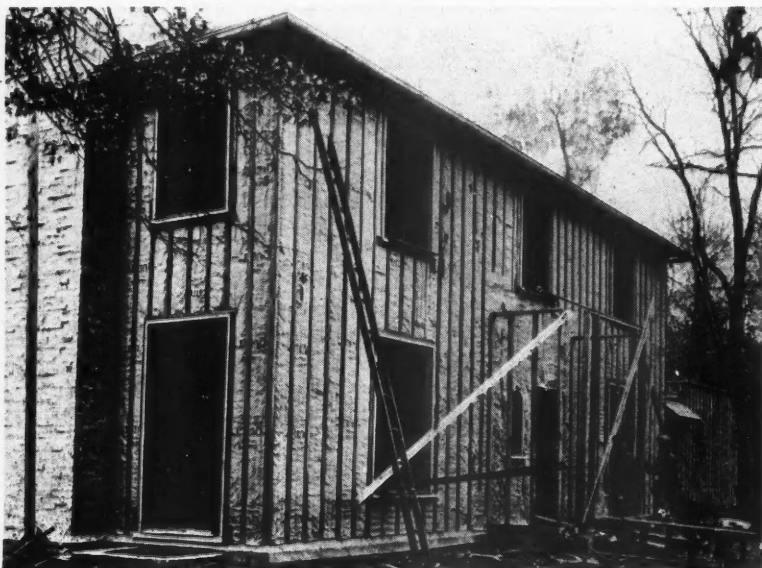

An Overcoat of Insulating Material Serves the House Just as a Winter Overcoat Serves Its Owner.

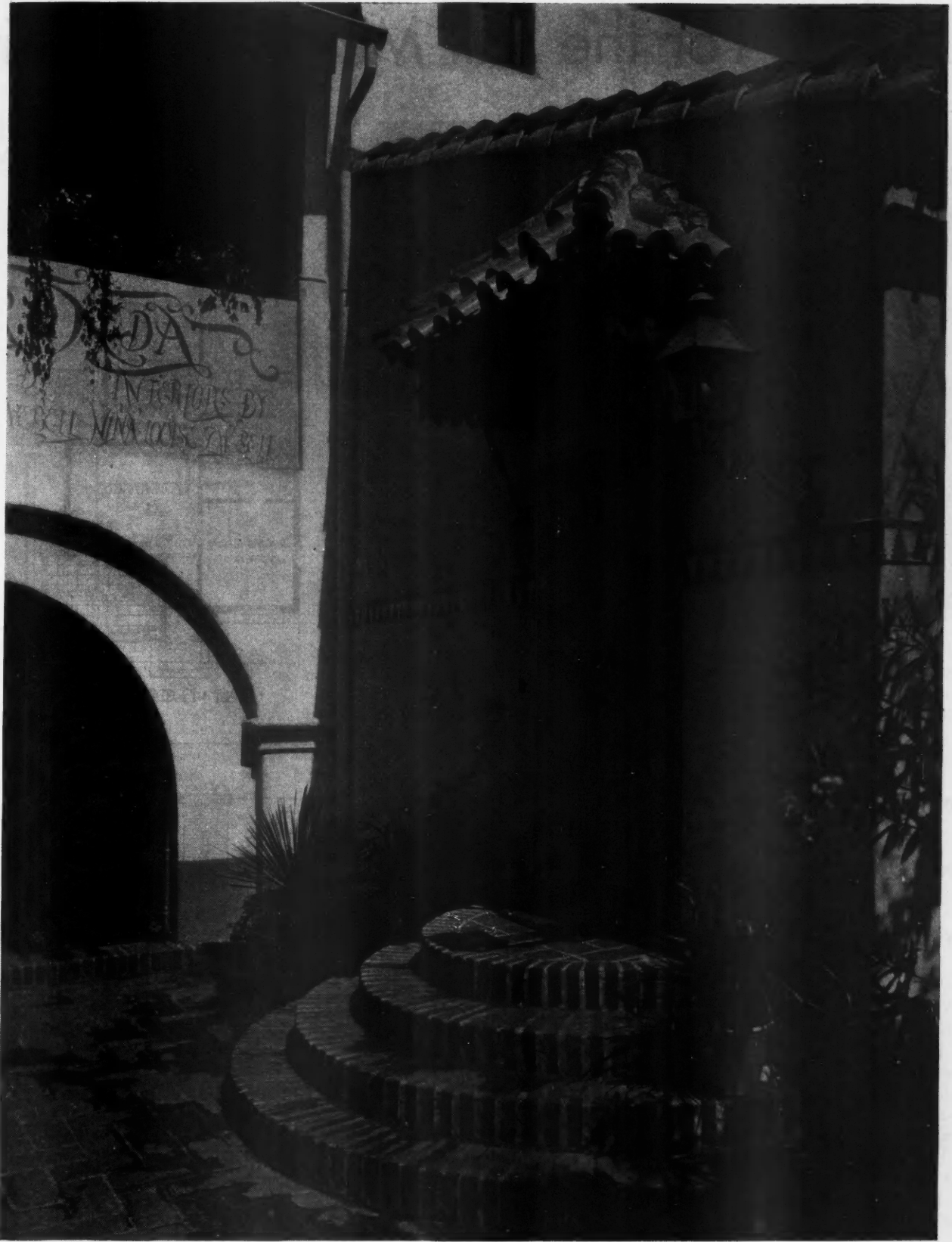

Homes for Winter Building

Designs of Timely Size
and Character — Tuned
to the Season's Demand.

For the Fall Market: Attractive

Build Your Homes In



ARTHUR FAHR, Architect

Brick, stone, stucco and wood have been combined in this bungalow. The walls are brick veneer and the roof of Bangor slate. Four other possible treatments of this attractive design are shown here.

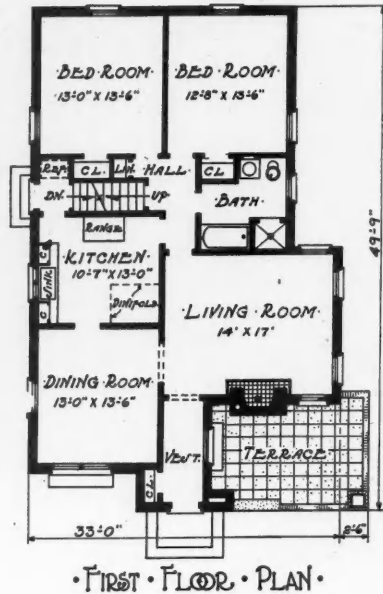

The Fall Buyer Demands
 Good Design — Convenient
 Layout—Modern Equipment

SEVENTY-FIVE houses built from one basic plan! That is the record of the fast-selling bungalow illustrated on these pages. In one Eastern residential locality, it has been built to sell for as low as \$8,990 and this included the finishing of the three extra rooms in the attic. The basic design is such as to permit both exterior and interior variations that can be employed to cut the cost considerably. The interior of this bungalow has proved to have a strong popular appeal particularly when fitted up with such equipment as refrigerators, tile in kitchen and bathrooms, cabinets, brass pipe, concealed radiators and other modern fittings.

Steam heat has been commonly used in houses built from this design.

Elevations Can Be
 Varied as Shown Here



Bungalow Styles...Priced Low

Popular Price Ranges

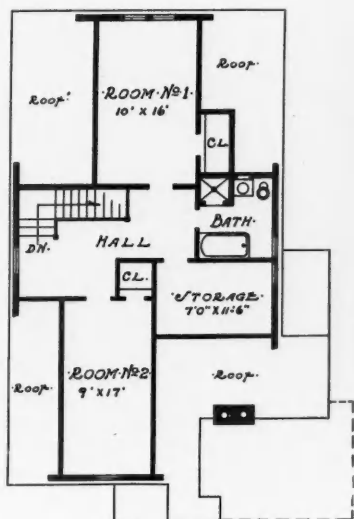

• SECOND FLOOR •



This is a side view of the same bungalow shown on opposite page. Here is revealed the attractive chimney and wall treatment of one elevation. Builders make their own variations in this design.

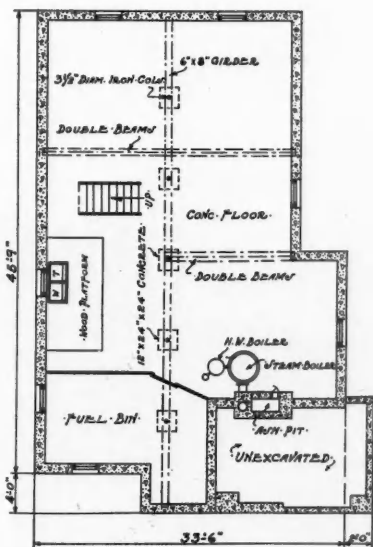

• CELLAR PLAN •

The basic floor plans of this bungalow style are shown above. From these can be worked out the different elevations, four of which are given here. Note that in two cases the chimney is in front while in the other two it is on the side. Popular features are the dining room, fireplace, terrace, upstairs bedrooms and extra bath.



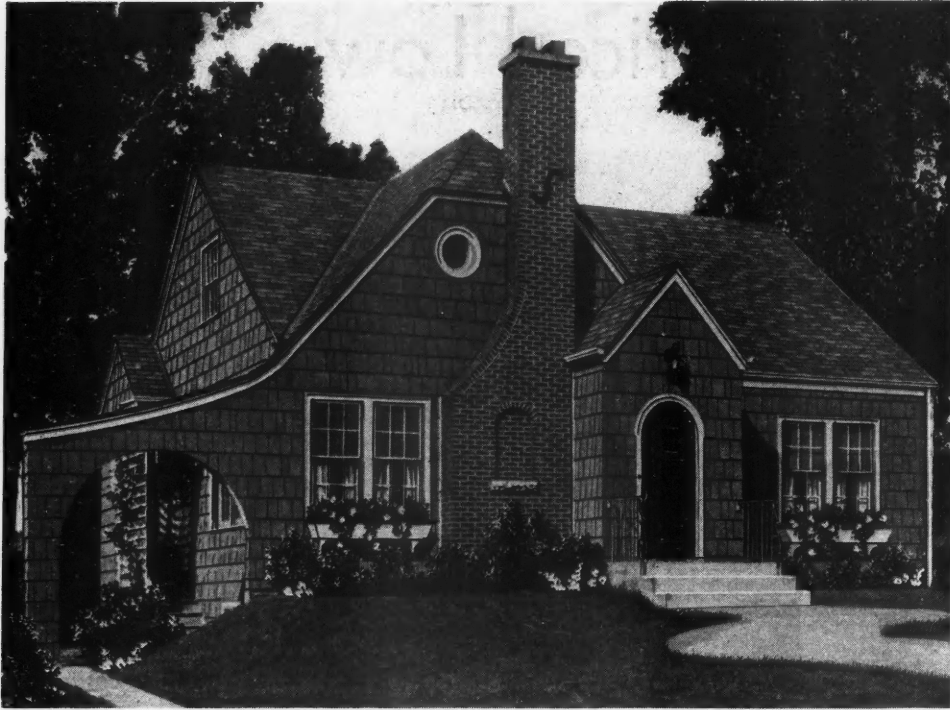

For Those of Thrifty Purse

Two Slightly Different Room Layouts Are Illustrated to the Right for the Interesting English Shingled Cottage Shown Above. Below is a smartly decorated plot bungalow for a narrow plot.

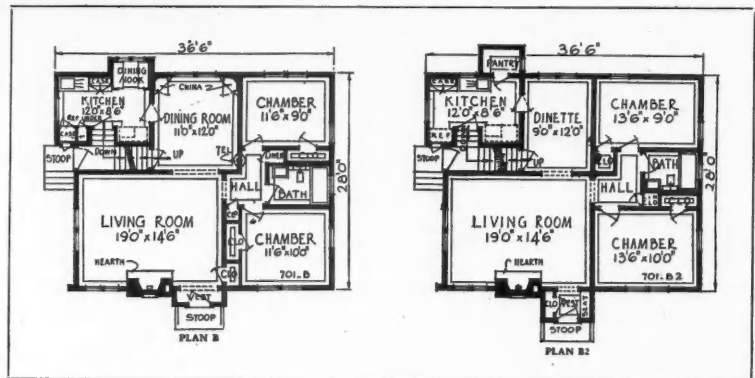

NATIONAL PLAN SERVICE Designs

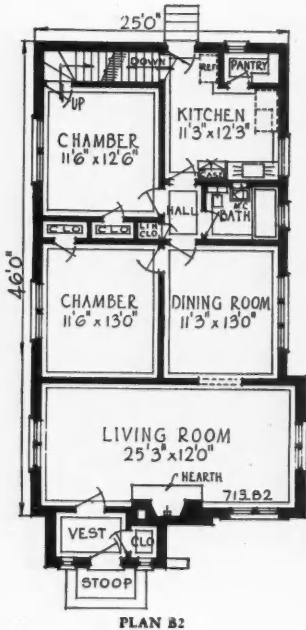

**Small of Size
Large in Quality**

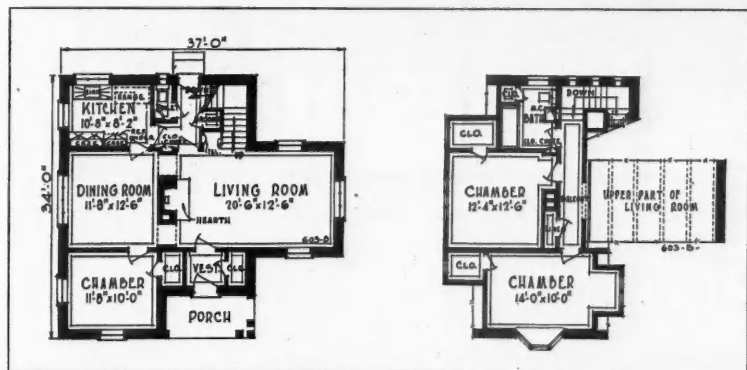

The Quest for Something Different in Small House Design Finds Encouragement in These Modernized Examples of English Planning. Convenient in room arrangement, their exteriors are intriguing.

NATIONAL PLAN SERVICE Designs

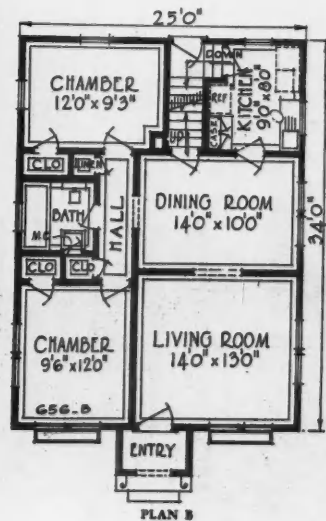

Early American Style

WILLIAM C. HALBERT, JR.

Architect

MAHAFFEY CONSTRUCTION COMPANY

Builders

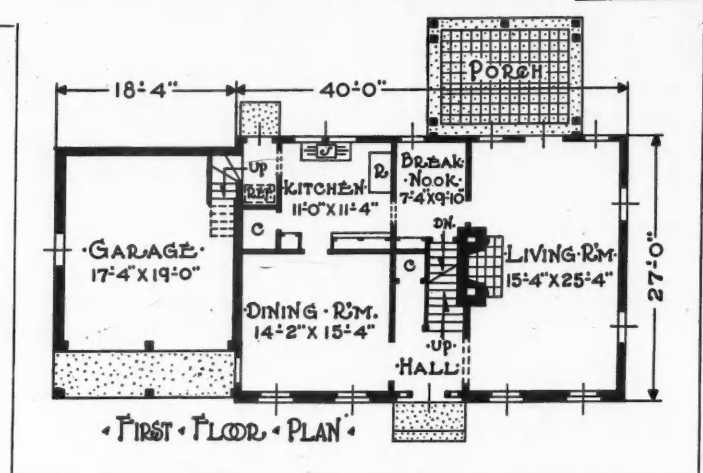
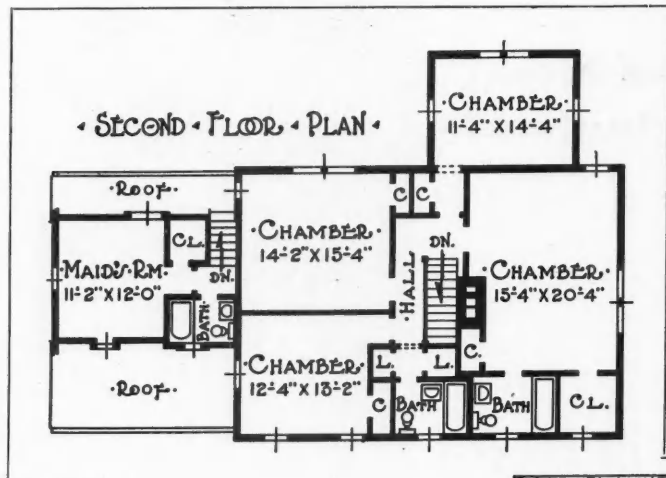

THE Colonial styles are becoming more popular than ever nowadays and they are very attractive when properly carried out. The Early American style is often handled in too severe a manner but here is an example of the style in which the architect's conception is true yet not harsh nor repellent in tone. The stone facing is effectively used and the dormered wing, housing the garage and maid's room overhead, helps to add to the attractiveness of the place. A porch is provided in the rear which permits the inclusion of an additional bedroom on the second floor which might become a sleeping porch if desired.



An Architect's Own Home

Residence of
JAMES J. BEVAN

Tuckahoe,
New York

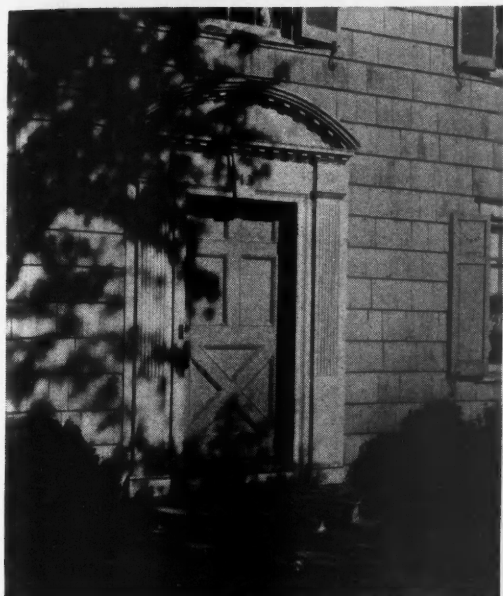

SERENELY and beautifully, this doorway marks the entrance to the Colonial home. With its dentilled arch and fluted pilasters, the treatment is appropriate and attractively ornamental. Note the panelling on the door and the numbered keystone above the door.

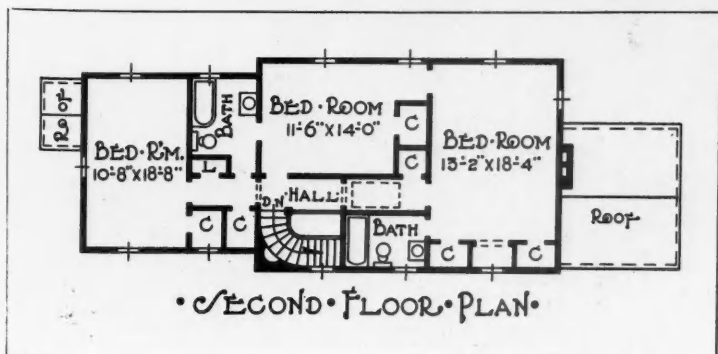
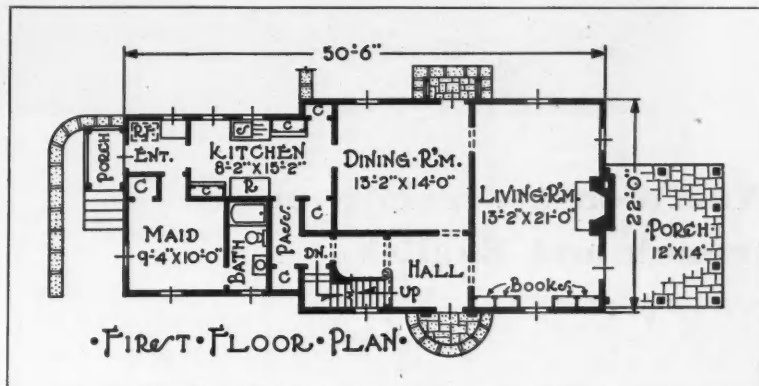

THE good architect or builder never "overdoes" his own residence. Here is an example of a perfectly conceived and executed Colonial house, dignified and handsome because it is simple and true. The dormered wing on the left and open porch on the right are pleasing additions to this design. The bird holes in the porch gable are to be noted and the slender columns that support the porch roof.

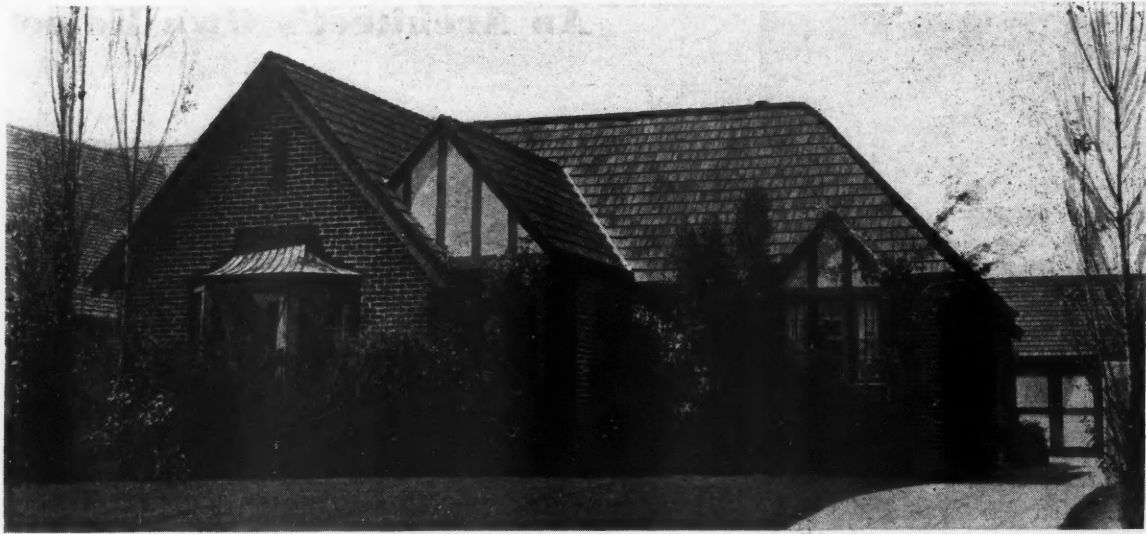

West Coast Versions of French and English

Out in sunny California home builders have perfected the idea of the small home—carefully planned, well built and equipped with every modern convenience. Here are two examples; the upper design in brick having a French cast, while the lower in stucco was derived from the English.

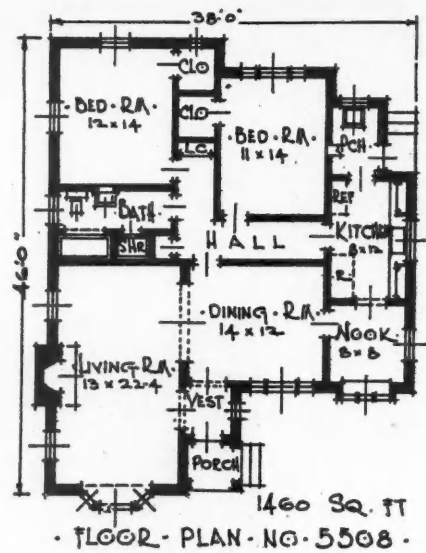

A. B. CLEVELAND Designs

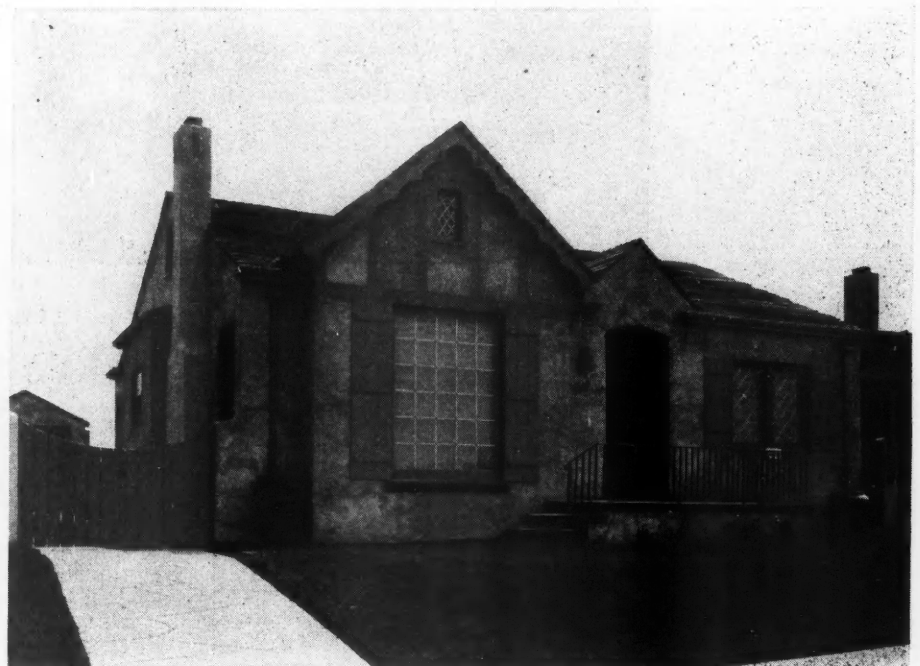
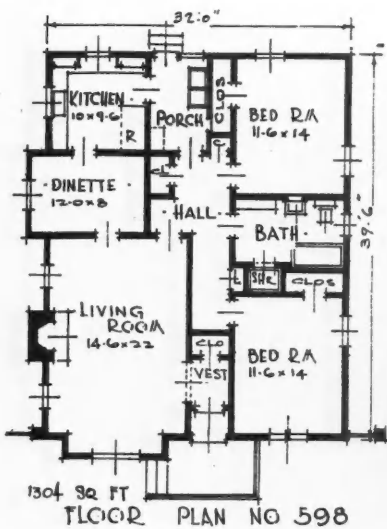



HOUSES FOR LESS THAN \$3,000

OFFERED BY RESIDENTIAL CORPORATION OPENING ITS FALL CAMPAIGN

CONVINCED that the present building market offers an ideal opportunity for the erection of low-priced homes in the suburbs, the Harmon National Real Estate Corporation of New York, have just launched a campaign for the building of attractive cottages for prices as low as \$2,785.

A number of experimental cottages at a base price of \$2,785 will be built. Harmon architects have designed a basic plan containing a 23-foot living room, a huge porch, a modern bath, a complete kitchen, and a bedroom large enough for twin beds, which can be built complete with its plot for this low figure. An extra bedroom may be added at an additional cost of only \$210. A third bedroom may be provided for by adding still another wing. Everything is included in these price schedules except furnace heating and insulation which will be provided as extra if the buyer desires.

Monthly payments, designed to pay for the cottage entirely in 52 months, are as low as \$50, with an initial cash payment of \$750. The monthly payment includes all interest, amortization and taxes.

The architecture of the cottages is formal New England Colonial, one of the few architectural styles permitting extensive reduplication of floor plan and design without wearying the eye. It was for this reason that this style was selected and all others

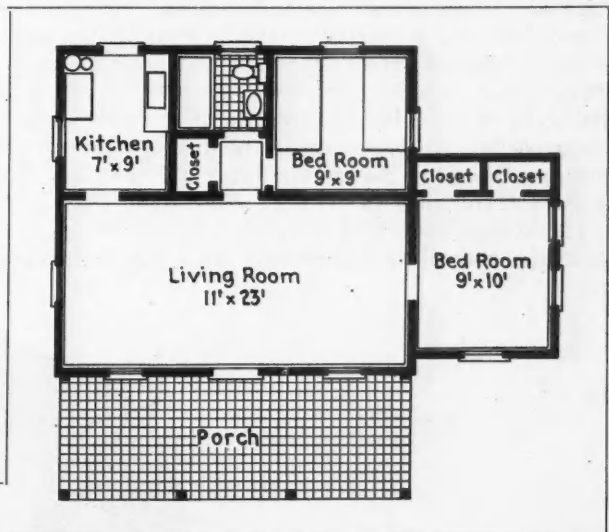
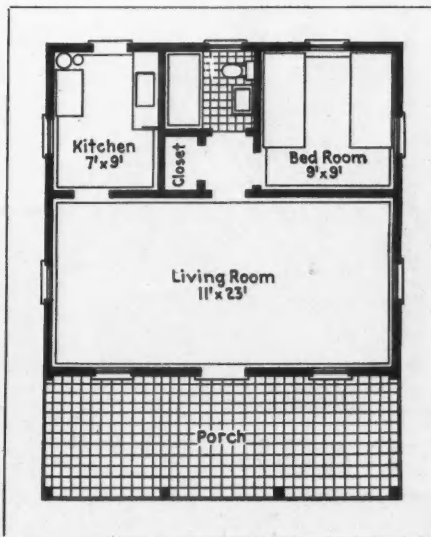

The basic floor plan of the Harmon house is shown to the left. Built on this plan, the cost is \$2,785, including a plot 40 x 100 feet, landscaped. When another bedroom is installed, as shown in the floor plan above, the price is \$210 extra or \$2,995 in all.

discarded, after extensive study.

The decision to undertake an immediate campaign in the low-priced housing field, followed an extensive survey, which disclosed these facts, according to the Harmon experts: (1) White collar workers do want inexpensive homes, of small size and good location, in
(Continued to page 100)

Is a Central Mortgage Bank for Urban Real Estate Necessary?

By MARCUS NADLER

Associate Professor, New York University

SINCE the proposal was first made to establish a central mortgage bank for urban real estate in the United States, considerable discussion pro and con has taken place. It is not within the scope of this article to analyze the arguments in favor of this institution. It is rather intended to deal briefly with some of the arguments against the establishment of such an institution.

One of the most common arguments is, that in spite of the fact that European countries have central mortgage banks, the rate of interest on mortgages is very high, ranging from 6 to 8 per cent, and that the bonds floated in the United States are selling as low as 50 per cent of par.

These critics are referred to a comparison of current quotations on foreign government bonds with those on United States government bonds. Whereas the United States government is able to sell bonds at 3 per cent, European countries have to pay 8 and 10 per cent and even then it is impossible to float new issues. The low price of European and South American mortgage bonds is not due to the merits of the institution but reflects primarily the uncertain economic and political situation prevailing in those countries. It is somewhat remarkable that those critics who point out the high yield on foreign mortgage bonds always forget to mention the fact that mortgage bonds in Switzerland and in France are selling at the present time to yield not more than 4 per cent.

The second argument presented against the establishment of a central mortgage bank for urban real estate, is

At the National Realtor Convention last June in Baltimore, Professor Nadler played a key role in the launching of the Central Mortgage Bank idea. His paper on Central Mortgage Banks Abroad and Their Lesson for Us stirred the Convention. In his present article he answers some of the questions that have been raised regarding the proposed Central Mortgage Bank.

that there is plenty of money available in this country and that real estate operators as well as home builders can at any time obtain the necessary accommodations. While it is true that mortgage money can be obtained for first class properties, money for small homes, particularly in smaller amounts, cannot be obtained as liberally as is generally contended. Furthermore, mortgage loans in smaller amounts still bear 6 per cent interest at a time when high grade bonds yield around 4 per cent or less. If an institution were in existence which would link up the small mortgage with the national capital market, small mortgages at the present time should be selling at not more than 4½ per cent or a maximum of 5 per cent.

Another argument usually found is that foreign mortgage banks usually lend up to a maximum of 55 per cent of the assessed value of the property. This argument, too, does not take into consideration the actual conditions. In Europe and in most countries of Europe individual home owners are very anxious to have their

Lower
Interest Rate

Funds Available
Everywhere



property free and clear of mortgages, in contrast to the United States where even those who could afford to liquidate their mortgages prefer to have a first mortgage. The entire method of home financing in Europe and in South America differs so greatly from that of the United States that no actual comparison can be made. If properly handled there is no reason why mortgages of a central bank should not comprise 75 per cent of the actual value of a small home. Certainly no person familiar with mortgage banking would advocate such a large percentage for larger properties but for homes owned by the occupant a mortgage up to 75 per cent would not be, in many cases, excessive.

The general discussion on the central mortgage bank has clearly revealed that many do not understand its real purpose. *Its purpose is not to compete with existing agencies.* Everybody admits that there are plenty of agencies in this country engaged in the financing of realty. The real purpose of this institution is not so much to provide an additional means of such financing but to make the mortgages more liquid and marketable. At the present time, a mortgage company or a building and loan association, if it wishes to sell or to discount some of the mortgages held in its portfolio, either finds it very difficult or is forced to take a substantial discount. The purpose of a central mortgage bank for urban real estate is to make it possible for these institutions to sell or to discount their mortgages and thereby to obtain cash whenever they need it. It is a known fact that a number of small banks located in rural communities and a few larger metropolitan banks were forced to close their doors because of the inability to liquidate or to convert some of their mortgages into cash.

The purpose of a central mortgage bank for urban real estate is, therefore, not to compete with existing agencies but on the contrary, to co-ordinate their activities, to provide a ready market for existing mortgages and to link up the individual mortgages with the national capital market. Urban real estate as a general rule is income producing. Furthermore, this income is steady and provides the owner of the real estate with sufficient funds to pay principal and interest on the

outstanding mortgages. In this respect they are not unlike large corporations which have mortgage bonds outstanding; but whereas the bonds of corporations whose power is steady are selling at the present time at a low yield, the cost of mortgage money has not decreased greatly in recent years.

Another factor generally overlooked by those who criticize the project is that such an institution would greatly diversify the risk on real estate. The central mortgage bank would collect mortgages from all over the country, and on the basis of these mortgages it would then issue its own bonds. The bonds, therefore, would be secured by the assets of the central mortgage bank and by mortgages scattered all over the country. If one or the other mortgage would have to be foreclosed this would not in any way affect the merits of the bonds. In this connection it is worth while mentioning the fact that although such institutions have existed in Europe for many decades not a single holder of a bond lost any money on it up to the outbreak of the European War in 1914. With the risk diversified, a well managed institution should be able to discount mortgages of savings banks, mortgage companies and other financial institutions engaged in the mortgage business at a low rate of interest which in turn would result in a low rate of interest to be paid by the mortgagors.

There are also many who believe that such a central institution would buy or discount all classes of mortgages. This is a mistaken notion. The purpose of a central mortgage institution is merely to help home owners or to cheapen the financing of multiple dwelling houses. It does not include the financing of business property nor does it include financing of apartment houses in which the rent is very high.

In conclusion, one may say that the criticisms levelled at the central mortgage bank for urban real estate are about the same which were raised against the establishment of the Federal Reserve Banks. It was only after the latter had been in existence for a number of years and only after the banks realized, that instead of competing with them, the Federal Reserve Banks strengthened their own positions, that they began to support the system whole-heartedly.

Popular
with Investors

Secure as
The Nation Itself



New Styles in Apartment Houses

What People Are Looking For and Builders Are Providing

IN today's market one must give real value or forget about trying to rent or sell," an experienced apartment man said recently. "In order to sell our project we must provide innovations," he declared, "we must kindle a desire for a home in the woman and furnish comforts for the man."

All successful apartment builders now realize that in the model suites of today, even those offered for low rents, facilities must be furnished that were in the category of luxuries twenty-five years ago.

In a large Eastern city there has recently been completed a large apartment structure to provide homes for wage earners at moderate rentals. Each apartment has cross ventilation and most of them three exposures. Kitchens are supplied with gas-burning refrigerators, combination sinks and tubs, the latest type gas ranges, and ample cupboards, tiled bathrooms with tubs and showers, medicine cabinets and modern plumbing fixtures in color. Radio outlets will be furnished in each living room. In the basement, space will be provided for baby carriage rooms, trunk rooms, meter rooms, incinerators, paint and carpenter shops, and a playroom. There will be attractive planting in the central court. Automatic elevators will carry tenants up and down.

This is what is being provided for wage earners and when wage earners are furnished with living accommodations of this kind, then it is not difficult to gauge what will be the demands of families with salaries or incomes.

More Comfort—Fewer Rooms

As inducement to apartment life, multi-family dwelling must now be equipped with the latest and best devices for comfort and convenience. And this must be done without increase in cost and, if possible, a decrease in cost. Rental scales in some localities are falling; people cannot afford to pay out large sums for rent.

The answer in many cases has been a demand for apartment suites with fewer and smaller rooms. Tenants seem inclined to take less space than sacrifice ease of living.

A recently completed apartment house, erected by one of the largest organizations in this country engaged in apartment construction and rental contains a preponderance of small unit suites. Out of 110 apartments, 46 are 2's, 42 are 3's, 12 are 4's, and 10 are 5's. This is indicative of the trend toward fewer rooms and more compact units.

Children's Play Rooms

More and more, apartment designers and builders are coming to realize that they must make ample provision for resident children. The most recent apartment houses erected in 1931 have provided splendid accommodations in this respect.

One new apartment contains a large, light, and airy playroom for children which will be under experienced

supervision; and here the youngsters who live in the building may enjoy themselves on rainy days.

This same building is equipped with automatic elevators of the latest type, has bathrooms in color, and kitchens equipped with electric refrigerators and with the latest model gas stoves.

These apartments are painted or papered as desired by tenants, where advance rentals are made.

The "Human Angle" in Apartment Life

Painting and papering walls to suit tenants is just one example of the new principle that has entered apartment house development and promotion, the idea of making apartments fit the whims, humors, and habits of the average person. "Men whose business it is to manage successfully modern apartment structures are now studying the subject, not from the brick and mortar, but from the human angle," said a Chicago realtor recently. "Emotions, foibles, customs, and humors must be accommodated in the proportion as they are important to individual families. We can no longer hand out the same set of rooms to fifty families and tell them to live in them. The apartment building is no longer a temporary abode for such families; it will be a permanent home, and should be made as nearly like a suburban home as possible.

"Humanized design and humanized, day-by-day, management are the answers," was his conclusion.

Light and Air

Recent emphasis in apartment design and construction has been with the dominant idea of supplying as much light and air as possible to the interiors. In some cases, zig-zag effects, along the lines of German apartment design, have been resorted to in an effort to secure the utmost light and air.

This is where the suburban garden apartment, such as is described and illustrated in this number, gives greatest satisfaction to a large number of people. Large inner courts, well landscaped, satisfy the demand for a garden and also provide a means of getting cross ventilation and additional exposure.

Recent developments in suburban apartment construction point toward an increased use of land around apartments for lawns, gardens, and recreational areas. Playgrounds, tennis courts, miniature golf courses are all in high demand by apartment house tenants.

Design and Construction

Yet with all the modern appurtenances and accessories which go with apartment life today, design and construction cannot be made to suffer. The desire to obtain a maximum of attractiveness at a minimum of expense has forced designers to cut out over-elaboration and ornamentation and today some of the best designing in America is done on apartment structures. Construction, too, has been made stronger and better;

(Continued to page 98)



The Modern Multi-Family Dwelling

With Separate Entrances for Each Apartment, It Retains the Privacy of a Single Family Dwelling, Yet Provides Apartment Accessories and Conveniences

●

HAWTHORNE COURT

BAYSIDE . LOND ISLAND
New York

BENJAMIN BRAUMSTEIN
Architect

NEISLOSS BROTHERS, INC.
Builders

This is the type of suburban apartment most likely to appeal to renters of the white collar class today. It combines a maximum of attractiveness with moderate construction cost. The utilization of interior space is ingenious; studio living rooms have been made possible on the second floor by the use of attic space, which has also been broken up into bedrooms for the duplex apartments below. Complete floor plans are shown on the next pages.

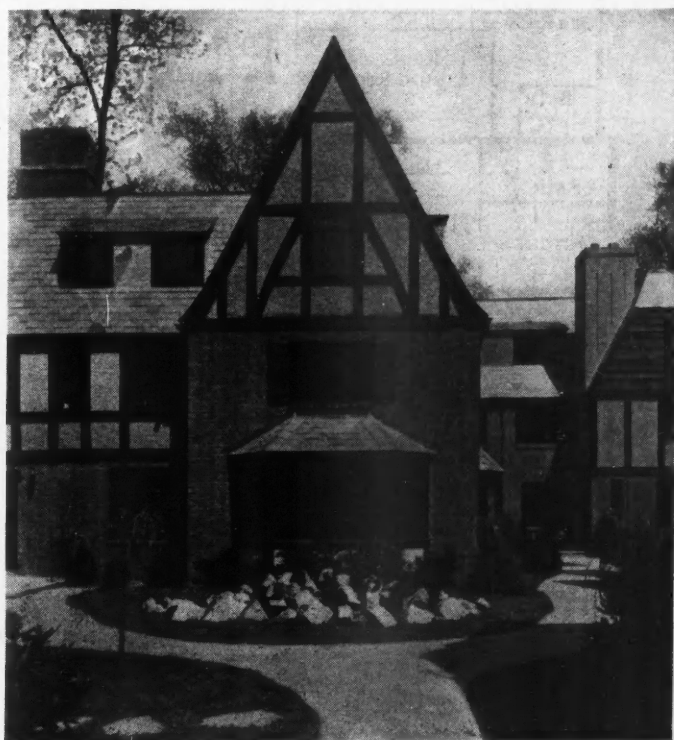

A Suburban Garden Apartment Offering Many Rental Choices

At Hawthorne Court, all first floor apartments are of 1, 2 and 3 rooms, as shown by the floor plan reproduced below. All upper apartments are duplex and are of 3, 4 and 5 rooms (see floor plans on opposite and following pages). Eight apartments on the second floor contain studio living rooms, the upper parts of these living rooms extending into the attic as shown on floor plan of third floor.

The scale of rentals at Hawthorne Court apartments is as follows: One-room apartment, \$50; two-room, \$65; three-room, \$85; four-room, \$110 to \$125; five-room, \$135.

Some of the duplex apartments have two baths. Smaller apartments contain disappearing beds.

Descriptive Data

Date of completion: May 15, 1931
 Cost of construction: \$150,000
 Total number of apartments: 32
 Total number of apartments per floor: 16
 Number of rooms per apartment: 1, 2, 3, 4, 5
 Total number of rooms: 101
 Apportionment of rooms throughout building:

1's:	1	4's:	10
2's:	8	5's:	4
3's:	9	Total:	32

FIRST FLOOR PLAN

Hawthorne Court Apartments

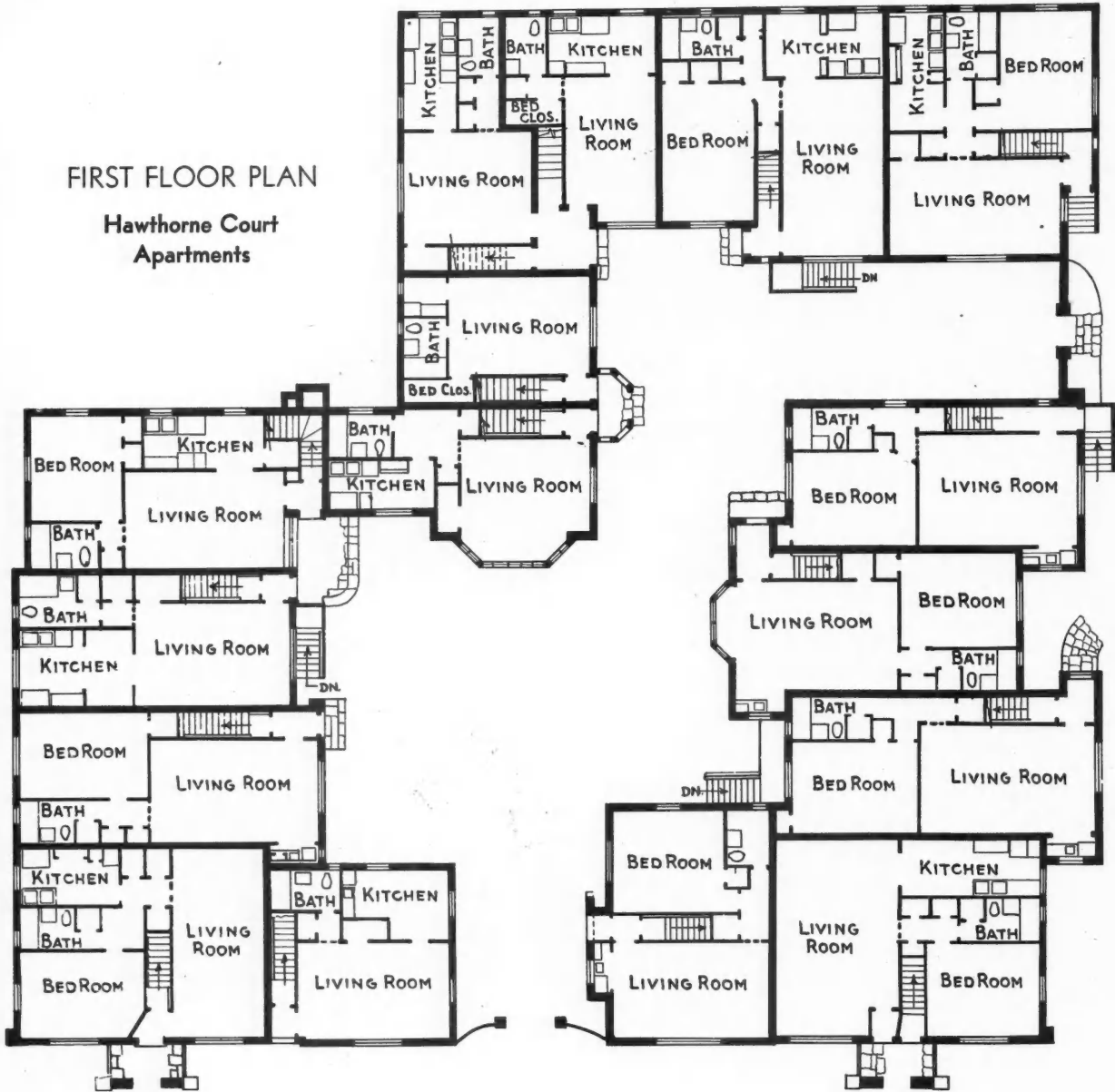

SECOND FLOOR PLAN

Hawthorne Court
Apartments



GENERAL OUTLINE SPECIFICATIONS

FOUNDATION: Concrete.

FRAMING: Floor framing 3" x 10"—16" o.c.
2" x 10"—16" o.c.

EXTERIOR WALLS: 8" brick, cypress timbering and stucco.

ROOFING: Sloping roofs, slate. Flat roofs, tar and gravel.

LEADERS, GUTTERS AND FLASHINGS: 16 oz. copper.

INTERIOR FINISH: Fiber insulating lath with wire lath on corners and angles. Three coat plaster job, Venetian finish in different textures.

PLUMBING: Brass pipe throughout for hot and cold water.

HEATING: Dunham vapor system.

CLOSETS: Ample closets, shoe shelves, shelves, rods.

KITCHENS: Cabinet gas ranges, electric refrigerators, combination sinks and tubs, kitchen cabinets, linoleum, colored tile.

BATHROOMS: Stall showers with glass doors, porcelain basin lavatories, tubs, chromium fixtures, colored tile, clothes hampers, Venetian medicine cabinets.

ELECTRIC FIXTURES: Hammered iron and Swedish brass.

INCINERATORS: Built-in.

Hawthorne Court Apartments

The floor plans below show the third floor room arrangement of Hawthorne Court apartments, indicating how the attic space is utilized to provide bedrooms and studio living rooms for the duplex apartments below. Fiber insulating lath provides the insulation that is necessary for these rooms underneath the tar and gravel and slate roofs.

SOME OF THE POPULAR FEATURES

- Sound-proof floors and ceilings.
- Studio living rooms with balconies and beamed ceilings.
- Steel casement windows.
- Hardwood trim, floors and doors.
- Textured walls.
- Chromium plumbing fixtures.
- Colored tile kitchens with kitchen cabinet equipment of special design.
- Colored tile baths, with set-in tub, standing shower, glass doors.
- Concealed set-in laundry hamper.
- Roomy dinettes.
- Inlaid linoleum in kitchen and dinette; enameled kitchen stoves.
- Laundry tubs and dryers in basement.
- Constant hot water supply.
- Incinerators on premises.
- Garage facilities arranged.
- Spacious courts, lawns, shrubs, floors, rock gardens.

THIRD FLOOR PLAN
Hawthorne Court
Apartments

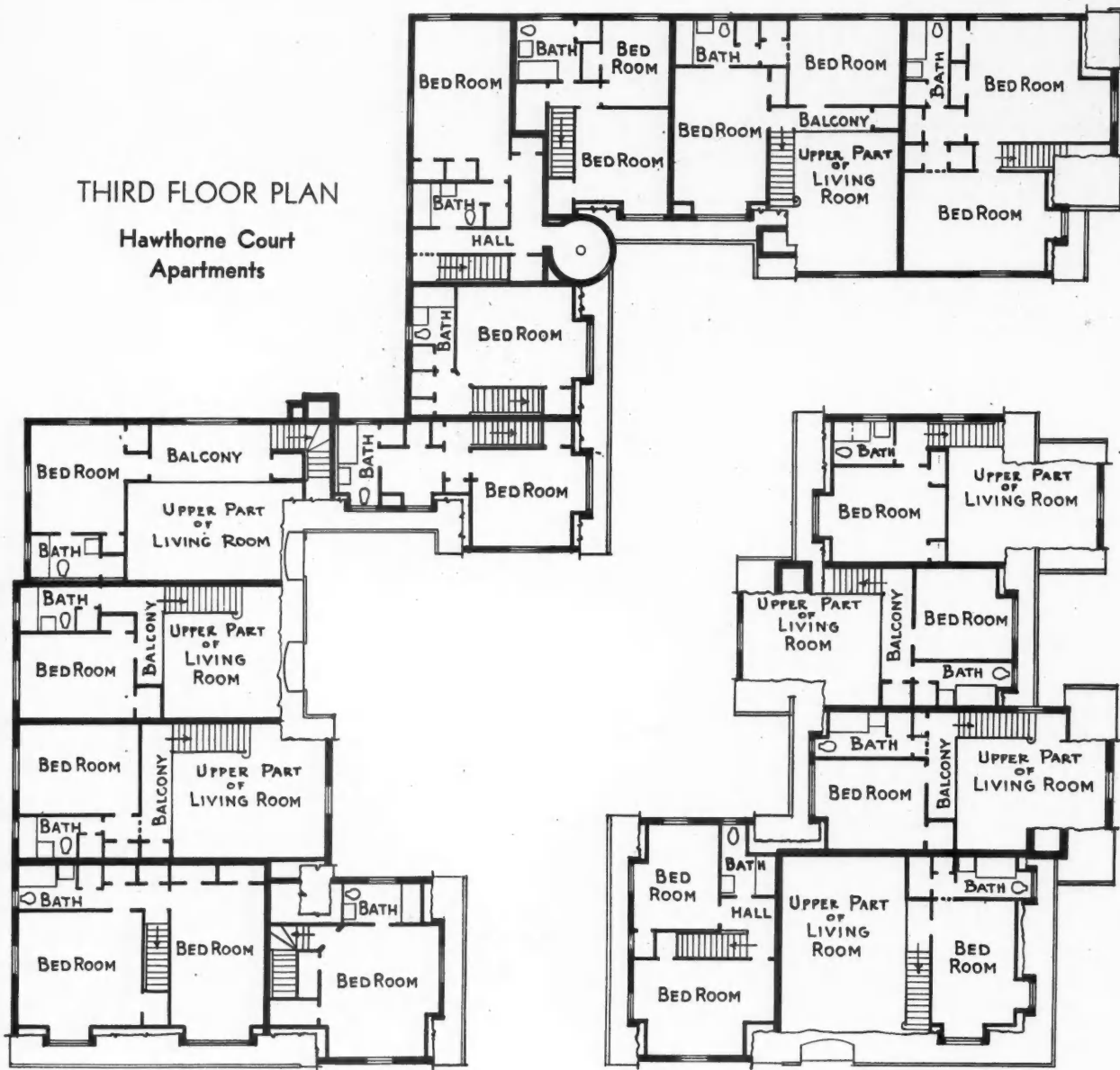



The House of the Month

Quaint Lines and Medley of Materials Produce a Unique and Charming Home—Eighth-Inch Scale Drawings Show Construction

THE versatility of the architect has run riot in this little home. A combination of brick reinforced with stone, shingles and stucco and all capped with an antique slate roof of mingled colors produces a decidedly interesting result. One would naturally label this "English" although it is doubtful if one could find its counterpart abroad. The broad, low lines and the sloping buttressed corners tie the house into its site, making it seem like a natural growth from the earth itself. Such a house will weather well and grow in beauty and in harmony with its surroundings.

Analyzing the interior arrangement, we find an L-shaped plan with five rooms and bath on the first floor and one large bedroom and bath, together with considerable storage space, on the floor above. The plan is fifty-two feet deep with a principal width of twenty-eight and a half feet. Across the front, the ell formed by the projecting living room makes the width thirty-six and a half feet, and this is still further augmented by the stone arch leading to the service entrance. The roof of the front gable is brought down over this arch so that the front has the very impressive width of about forty-six feet. Heavy random ashlar stone is used for the arch and also at the other corners of the front gable, as well as around the porch and at the base of the chimney. In fact, the masonry work at all of the corners is

built out in stone, producing an exceptionally massive effect.

Entering through the open porch and vestibule, you step into the studio living room—a room fifteen by twenty-two feet. To the left is the dining room with the kitchen directly back of it. The space in the rear wing is taken by two chambers, each about twelve by fifteen feet. A central hall connects them with bathroom, kitchen and living room; and the stairs to the second floor go up out of this hall. The bathroom is of extra large size with a completely enclosed shower stall in addition to the tub and other fixtures.

Up under the roof on the second floor, there is one large bedroom at the rear, thirteen by eighteen feet, and an adjacent bathroom. The space at the front could be used as an upstairs sitting room, recreation room or den, besides providing storage space. By building plenty of insulation into the roof, these upstairs rooms, although low, can be made entirely comfortable, even in hot weather.

The basement or cellar plan shows a neat arrangement with the heating plant and other basement apparatus back in the ell where they can be easily partitioned off. This leaves most of the basement space free for use as a home workshop, play room and laundry, the modern way of utilizing space formerly wasted in homes.

WORKING DRAWINGS OF THIS HOME ON THE NEXT FOUR PAGES

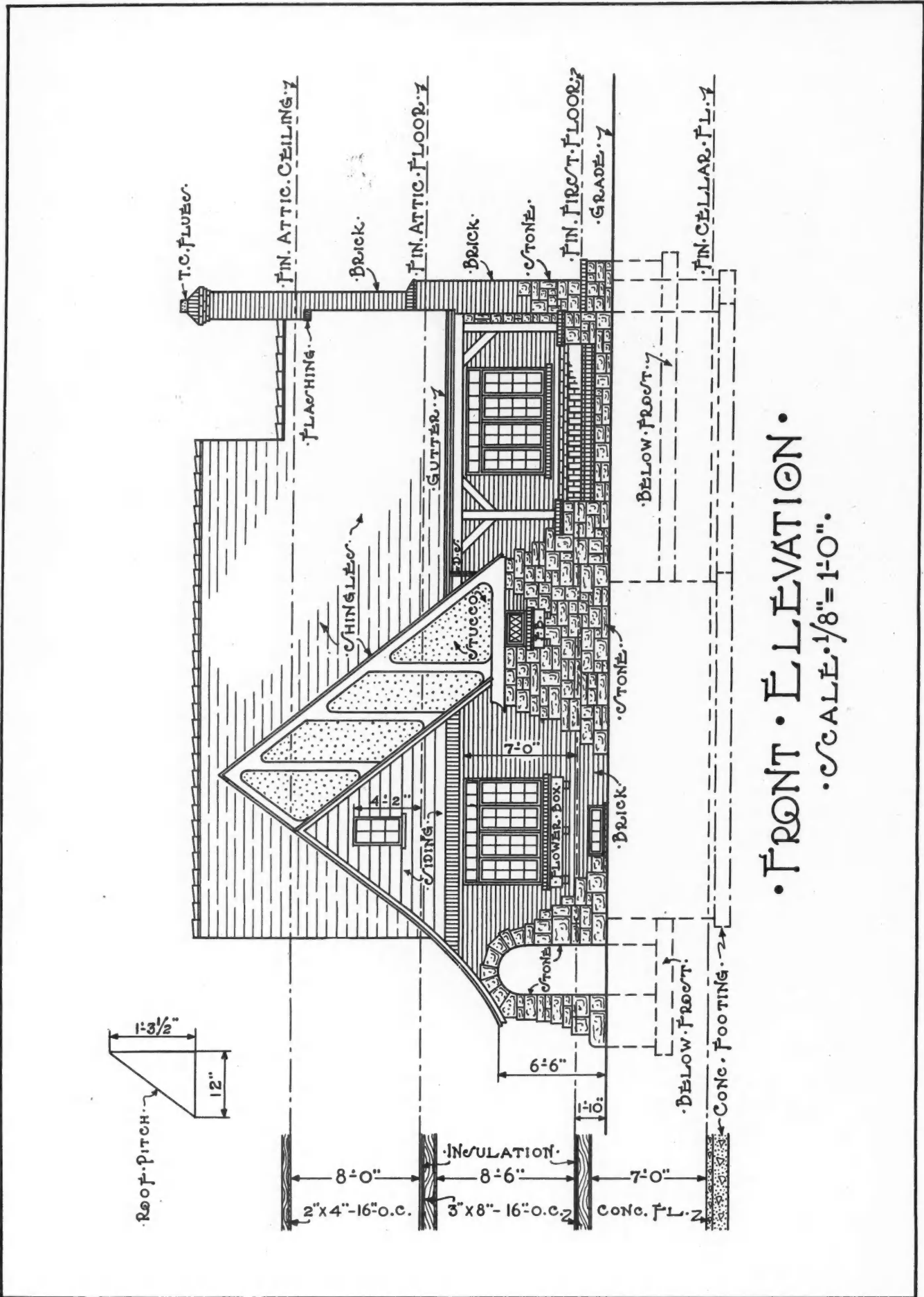

FRONT ELEVATION.
SCALE 1/8" = 1'-0"

The Front Elevation of the House of the Month Shows in Detail How Brick, Stone, Stucco and Siding Have Been Combined in an Interesting Way.

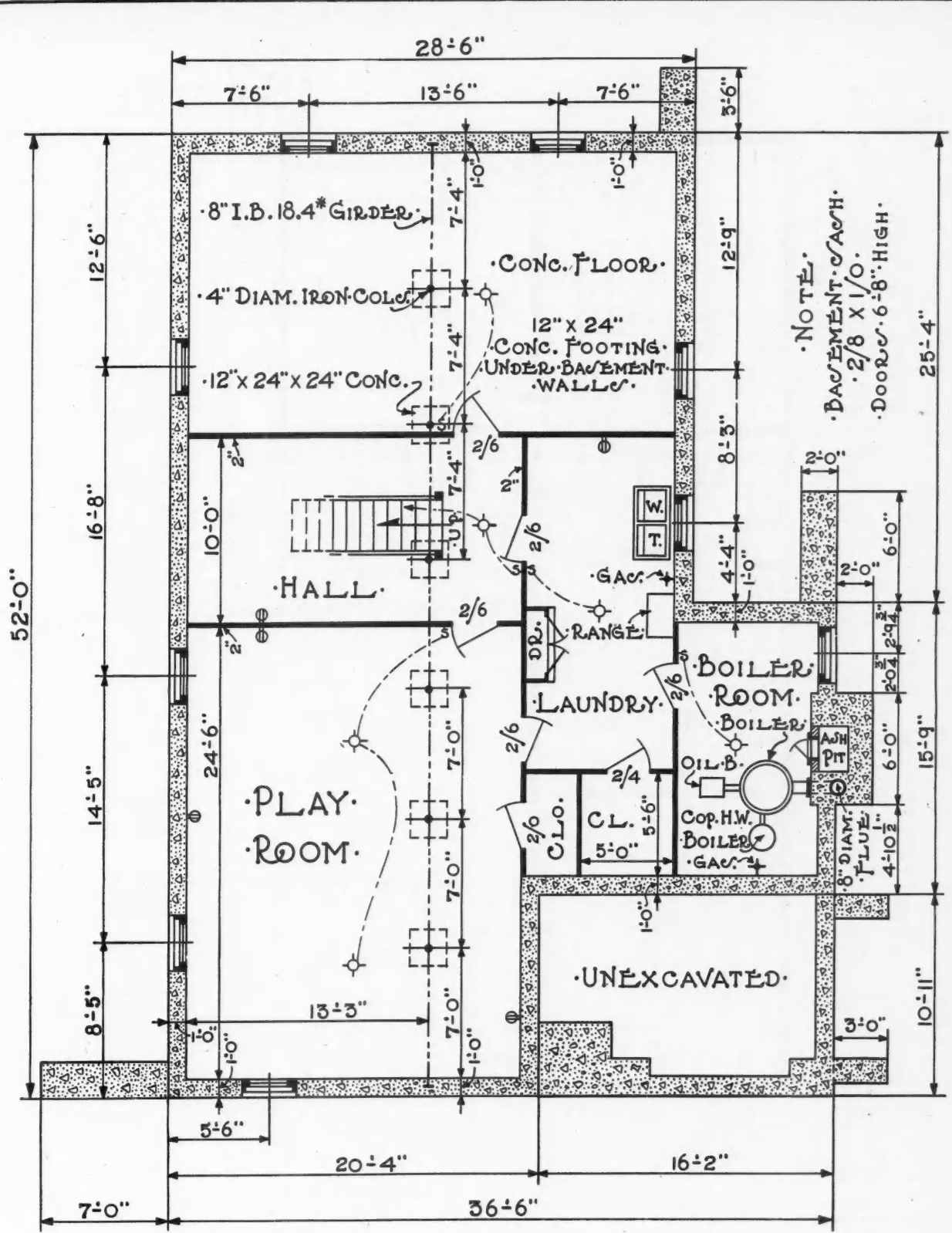

• CELLAR PLAN •
 • SCALE 1/8" = 1'-0" •

This Basement Layout Shows the Space Partitioned Off in an Interesting Way. Some no doubt would prefer a more open arrangement, walling off only the boiler room.

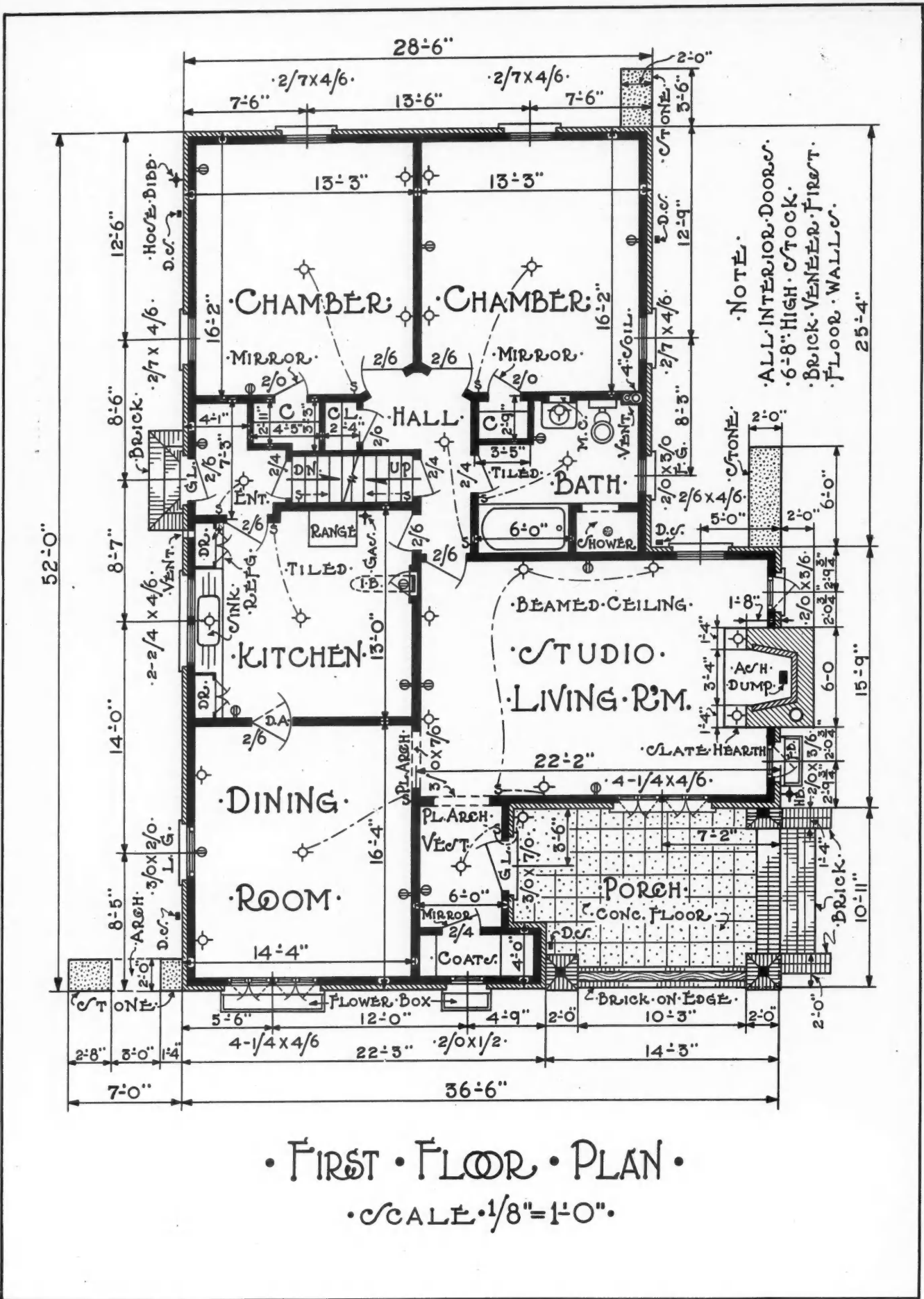

The First Floor of This House of the Month Is a Perfect Five-Room Bungalow. Every convenience has been thought of and built into this plan.

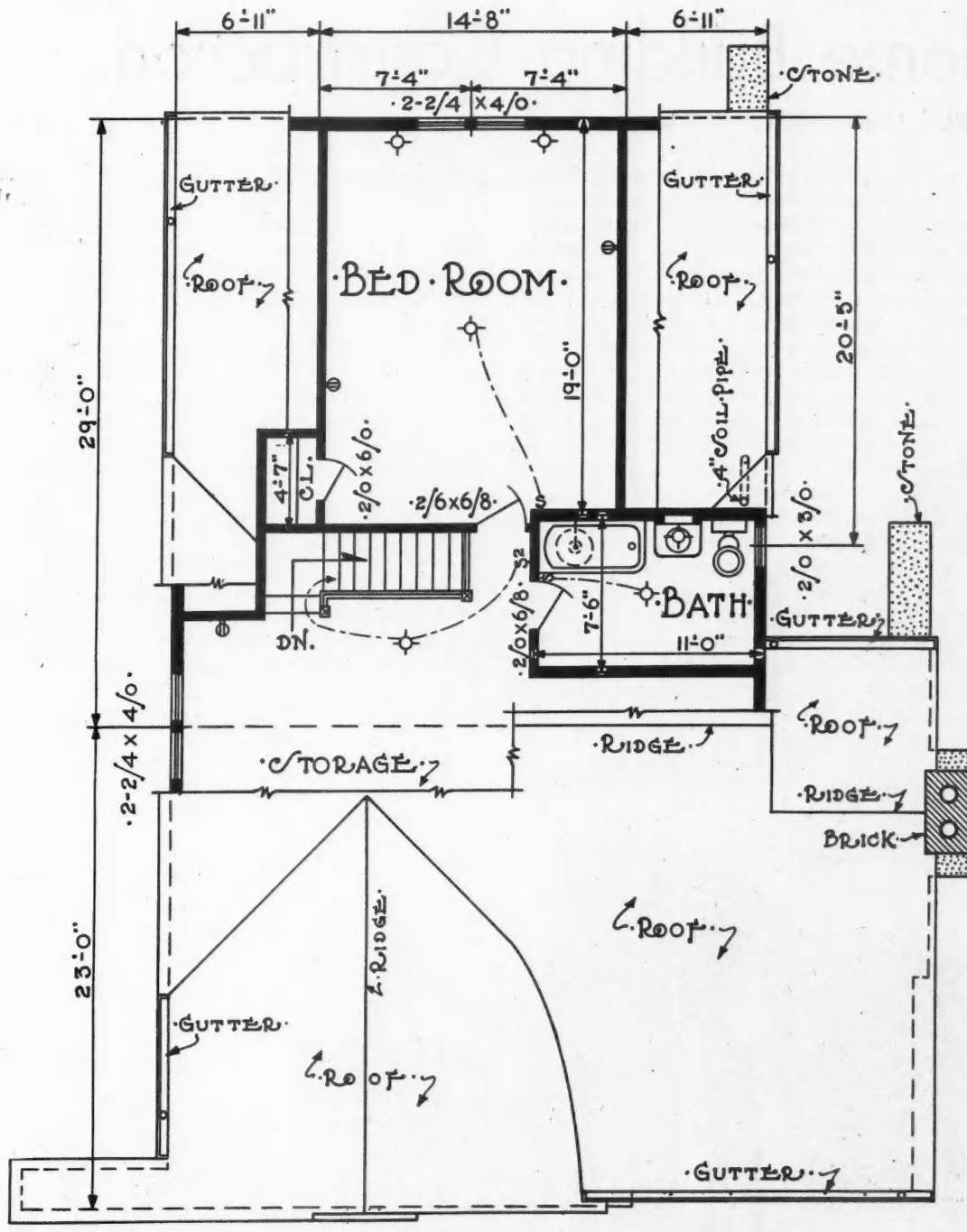

• ATTIC • PLAN •
 • SCALE • 1/8" = 1'-0" •

An Additional Large Bedroom and Bath, and an Abundance of Storage Space Are Provided on the Upper Floor. If plenty of heat-stop insulation is built into the roof this second floor space will be just as comfortable as downstairs.

The Latest Outstanding Development in Home Building Construction

By L. BRANDT Housing Engineer, Pittsburgh

BRICK veneer construction for the building of medium and low priced homes, is being widely used, and is gaining in popular acceptance. How to improve this type of home construction, overcome its known defects, and still keep construction costs low, were the problems confronting building experts and authorities. Now those problems are solved. Research has shown the right way to construct the walls and ceilings of the home—inside and outside. This latest, worth-while improvement in home building construction is known as a reinforced super-wall construction system. It is a proved system which gives reinforced brick construction for the outside walls, and reinforced plaster construction for the inside walls. And, in addition, provides water proofing—damp proofing—positive insulation—is vermin proof—fire resistive—has high sound resistance—is practical and economical in construction costs—and yet only standard builders' methods and building materials are employed.

Ordinary brick veneer construction leaves an open space, so-called dead air space, between the brick work and the sheathing. It was generally believed that this open air space provided the needed insulating qualities. Experience has proved that this open air space instead of being a dead air space, forms a flue that causes a draft or constant movement of air which actually con-

ducts heat and cold. To overcome this defect, it would be necessary to lay the brick tightly against the sheathing. This is impractical because brick cannot be laid in that manner for proper handling and alignment.

Another known defect, usually found in ordinary brick veneer construction, is the lack of sufficient mortar in the vertical joints of the brick work. These partially filled vertical joints are the cause of considerable infiltration of air and penetration of moisture.

Substantiating the statement just made, our attention was recently called to a brick veneer house that had been almost completely destroyed by fire originating on the inside. There was enough of the structure remaining to show quite clearly that decided improvements are needed in this popular type of construction.

Photographs of this fire, one of which is reproduced herein, tell a complete story within themselves. The picture shows exposed portions on the back of the brick work where plenty of mortar had been used in the bed joints but none shown at all in the vertical joints. Alongside of the door a brace acted as a fire-stop, indicating the value of firestopping between studing. It will be noticed even the wood lath did not burn. This was a good brick laying job from exterior appearance, but on the inside of the wall we see a surplus of mortar, improperly placed.

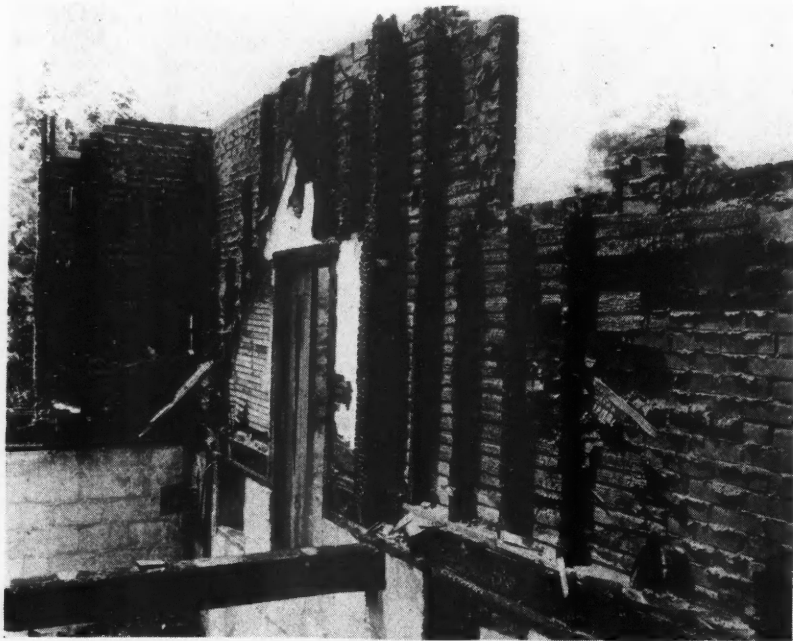

Above, Fire Reveals Flue Action and Poor Vertical Mortar Joints Typical of Ordinary Construction.

Below, Workmen Laying Brick for Reinforced Super-wall Slush the 1" Back Space Full of Mortar.



A great many attempts have been made in the last few years to develop an improved house construction but in most instances the actuating motive has been to introduce into the housing industry a specific material without considering its proper relation to the production of the economical house. In the development of any new construction, one must keep in mind that the real problem is to provide a well-built, desirable, economical house by the correct use of the proper materials.

The reinforced super-wall construction system which actually weather proofs and strengthens the home, does away with all known defects in ordinary brick veneer construction. This wall system consists of frame work studding erected in the usual manner. On the outside, an electric welded 2" x 2" wire mesh reinforced with a heavy paper backing is wrapped around the building and nailed to the studding. The brick is laid with a 1-inch space between reinforcement and the brick. This space is filled with mortar which becomes reinforced automatically with the paper-backed wire mesh. The heavy water resistant backing of the wire mesh prevents the infiltration of air and moisture. The outside wall, when completed, becomes a monolithic steel reinforced slab—a slab consisting of brick reinforced mortar, and water proof membrane backing all bonded together to give reinforced masonry construction. The brick is built into the slab, and the mortar works thoroughly into all joints—vertical and horizontal.

The reinforced super-wall is the same thickness as an ordinary brick veneer wall over wood frame construction. The structural value of the super-wall is proved through rigid laboratory tests and through actual use during hurricane, earthquake and every kind of weather conditions.

After the outside walls are finished, a mineral wool, loose-fill insulation is rapidly placed from the inside by pressing it between the wood studding. This loose-fill insulation does not settle, sift out, decay or disintegrate—is as permanent as rock and will outlast the home in which it is used. It is also vermin proof—rats, mice or destructive insects cannot eat it nor nest in it. This insulation material is likewise placed between joists at the top floor. Low in cost loose-fill insulation acts as a fire-stop by filling up all spaces (eliminating air currents)

and further protects the wood frame studding from fire attack. In fact, the studframing is completely surrounded with fire resistive materials.

The interior walls and ceilings are lathed with 2" wire mesh paper-backed lath, a base and reinforcement for interior plaster. This modern plaster lath, when plastered, eliminates all lath, joint and stud marks—retards sound—prevents infiltration of moisture and air—greatly reduces the tendency of plaster cracking—and adds structural strength. The entire home, inside and outside, is wrapped, not only with sufficient insulating materials, but is also encased with a complete network of steel wires which act to take up all strains and stresses in every direction. This method of wall reinforcement gives the home walls and the entire structure much greater strength than the ordinary method of brick veneer construction.

This latest reinforced wall development with its unusual strengthening and weather-proofing characteristics and qualities, compares favorably in cost with the ordinary method of brick veneer construction.

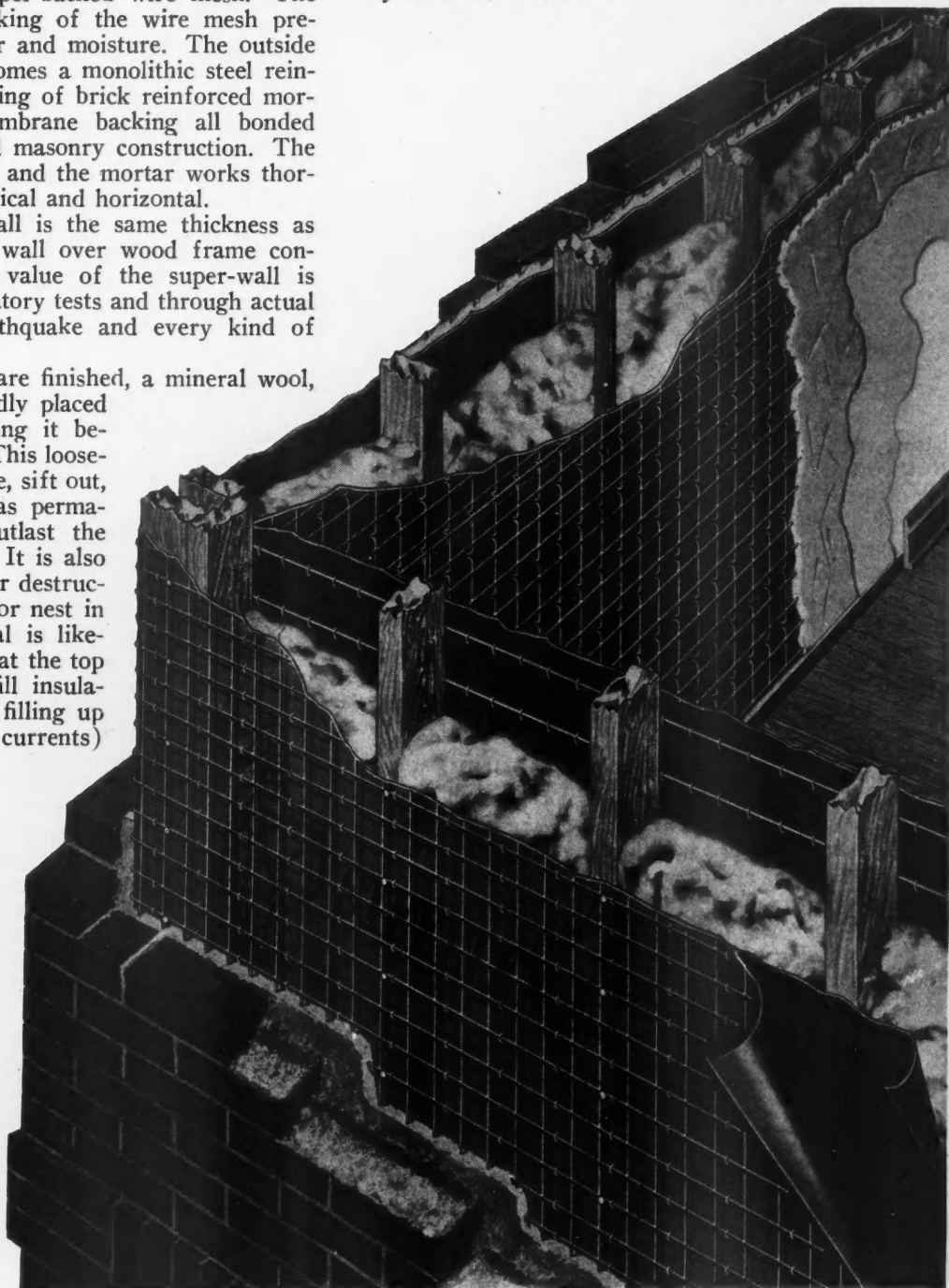

Diagrammatic View of Reinforced Super-wall in Which Interstud Spaces Are Filled with Mineral Wool Insulation and Ceiled Both Sides with Waterproofed, Steel Reinforced Plaster or Masonry.

Practical Job Pointers

Practical Stair Building

RECENTLY built a stairway up an 80-foot terrace. My plan for work provided an easy way to lay out stairs up a high terrace where the distances are too great for regular stair methods. First establish both top and bottom landings and stretch a line between them. Next set up a stringer bringing the bottom of the stringer to line.

Hold the level on the side of this stringer and make a level mark. Clamp a stair gauge on the blade of the square at the desired width of tread and place it on the stringer,

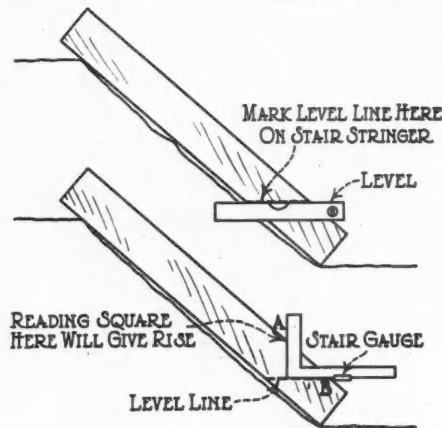

This Is a Handy, Practical Method of Laying Out Stairs Up an Unusually High Terrace.

letting the heel of the square come down to the level line. Now reading the square at the point where it intersects the top of the stringer, the point marked A in the sketch, gives the rise.

By measuring the total run, from the top to the bottom landing, with a steel tape, and dividing this by the diagonal of the square, the distance from A to B in the sketch, gives the number of risers required. Changing the width of tread a fraction of an inch either way will make the division come out exactly even.

HIRAM L. BANE, R. R. 1, Charleroi, Pa.

Laying Short Length Flooring

WHEN laying short length, butt-end flooring over a sub-floor, as is often done in the second story of small houses, time and labor can be saved and the quality of work improved by using a pattern as shown in the sketch.

The ends of each length of flooring are squared, any defects are cut out, and the pieces are laid on the pattern end to end. The pattern is the exact length of the floor, so the end marked A is sawed off and used to start the next course.

ELDRED SMITH, Modena, N. Y.

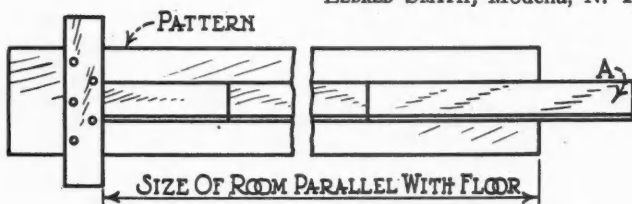

A Flooring Pattern of the Proper Length Used on Saw Horses Speeds Up the Work.

A Reader's Exchange of Tested Ideas and Methods, Taken from Their Own Building Experience. Two Dollars Will Be Paid for Each Contribution Published in This Department.

Stopping Cracks in Saws

THROUGH improper filing usually, and other causes sometimes, circular saws often develop cracks on the rim. Such cracks will continue to grow and render the saw useless unless something is done to stop them. About the best thing to do is to drill a hole

directly through the saw in such a position that the crack will grow into it. A $\frac{1}{8}$ or $\frac{3}{16}$ -inch hole is large enough.

When this is done the crack will go as far as the hole and stop. The reason is that the leverage exerted by the crack is distributed over the rounded side of the hole, instead of localizing on one point. Thus the steel is enabled to withstand the strain without further breaking.

This remedy also suggests the logical means of preventing such cracks. That is to avoid sharp bottomed gullets between teeth, and make rounded ones. A few strokes of a small file will serve to do this if a wheel is not handy, but using a wheel is quicker. If a wheel is used, however, care must

DRILL $\frac{1}{8}$ " OR $\frac{3}{16}$ " HOLE TO PREVENT CRACK FROM EXTENDING ANY FARTHER

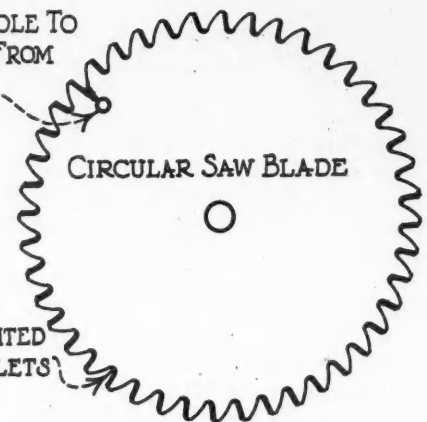

CRACKING PREVENTED BY ROUNDED GULETS

How a Hole Will Stop a Crack in a Saw and How Proper Filing Prevents Cracks.

be taken not to grind too fast or the temper of the saw blade will be disturbed. If the saw shows any tendency to "blue" in the grinding the safety limit is being approached.

JOHN E. HYLER, 501 Broadway Ave., Peoria, Ill.

Editor's Note—This "Pointer" was submitted to one of the large saw manufacturers for approval as it seemed that accidents might result from trying such a method if it was not good practice. The following comment was received:

"This is a common practice and is in general use throughout the country and usually prevents the crack from extending any farther into the blade. However, we do not recommend using circular saws which are cracked even though a hole be drilled at the bottom of the crack.

"We believe that you will agree with us that a circular saw which is cracked is a dangerous tool to operate, considering that it is running at a speed of anywhere from 10,000 to 15,000 feet rim motion per minute and if this slightly excess side pressure is brought to bear on this saw, or if it is permitted to operate with an insufficient amount of set or the teeth are dull, or it is not properly tensioned it is very difficult to say just what will happen. The saw is liable to fly to pieces, possibly injure the operator, and damage the machine.

"We always advocate keeping the teeth gullets well rounded and free from case-hardening at all times, then if the saw is kept sharp and with the proper amount of set on the teeth for clearance and it carries the right amount of

(Continued on page 76)

A YEAR FROM NOW YOUR CLIENT CAN SAY
*"I'm glad we spent that penny for
 Temlok"*



DO you want to give your clients lifetime comfort? Then insulate the houses you build (or remodel) with Armstrong's Temlok. They'll be warm in the dead of winter, because Temlok Insulation keeps furnace-made heat inside—and cuts fuel bills one fourth. They'll be cool in the hot summer months, because Temlok Insulation keeps out sun-made heat.

All this added comfort—all this real saving of money—your clients get for an average investment of only *one extra penny on each building dollar*. Those pennies come back quickly. And they keep right on coming back, piling up as hundreds of dollars of fuel savings, for the life of the house, for Armstrong's

... ONE PER CENT ...

little enough for insulation that provides permanent fuel saving and life-long comfort.

Temlok retains its insulating efficiency permanently.

Temlok, the new, low-cost insulating board is made from the heartwood fibres of the long-leaf southern yellow pine. It has high insulating efficiency; is light in weight; rigid and structurally strong; is odorless; and does not promote mold or bacterial growth. Made by Armstrong, Temlok has behind it the prestige and manu-

facturing experience of a company known nationally as the maker of fine linoleum and high grade insulation products.

Armstrong's Temlok may be used as a plaster base, or to replace sheathing, or as a wall board. Supplied one full inch or full half-inch in thickness, it is made as Temlok Insulating Board, 4' wide, 6' to 12' long; and as Temlok Insulating Lath, 18" wide, 48" long, long edges shiplapped.

We'll be glad to send you the Temlok booklet and samples of these new Temlok products. Mail the coupon below to the Armstrong Cork & Insulation Com-
 pany, 964 Concord Street, Lancaster, Pennsylvania. 

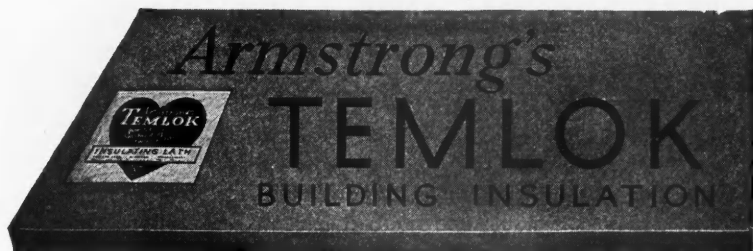

ARMSTRONG CORK & INSULATION CO.
 964 Concord St., Lancaster, Pa.

Please send me information regarding Armstrong's Temlok, the new fibreboard insulation fabricated from the heartwood of the long leaf southern yellow pine.

Please send sample.

Name.....

Street.....

City..... State.....

(Continued from page 74)

tension for the speed at which it is being operated, the chances are not one in a hundred that it will develop cracks.

"What we endeavor to do is to guard against the breakage by suggesting the proper means of fitting the teeth and keeping the saw in order rather than to recommend the drilling of holes at the bottom of a crack after breakage has taken place, but to answer your question, many cracked saws today are being operated satisfactorily with holes drilled at the bottom of the crack."

Setting Angles with a Clock

HERE is a tip given by a friend in the building trade when I had to lay off a 30 degree angle without the ordinary tools. I was making some alterations on a shed and did not have the tools with me so my friend took an alarm clock from the kitchen and set it up in such a position



Using an Ordinary Alarm Clock to Lay Off a Thirty Degree Angle When Tools Are Not at Hand.

that the face of a rule held vertically was in line with the center and the five minute to twelve mark, as shown in the accompanying illustration.

One minute on the clock face equals six degrees, so five minutes equals 30 degrees. Any angle can be measured in this way. It is, of course, an amateur sort of method, but will often prove satisfactory in an emergency when tools are not at hand.

W. H. MOORE, 349 Fairfield Ave, Hamilton, Ontario, Canada.

Case Protects Level

THE problem of caring for the level is an ever-present one with all building mechanics. Not only is a good level the most expensive tool in the kit, but it is the one most easily damaged. When even slightly damaged it is an aggravation and a liability to its owner. I have recently hit upon an easily made device which seems to provide effective protection for the level.

This device is a sleeve-like case, made of sheet metal—preferably copper—and fitted with tension spring to hold the instrument in place. It keeps the level clean and bright and protects it from all sorts of jams and bumps. The accompanying sketch shows a sheet of metal cut to shape for

this case and marked for bending.

It will be seen that the member "A" passes out through the slot "a" and is clinched to hold the bottom in place. The spring at "B" is preferably made of a short section of spring bronze weatherstrip but almost any flat spring will

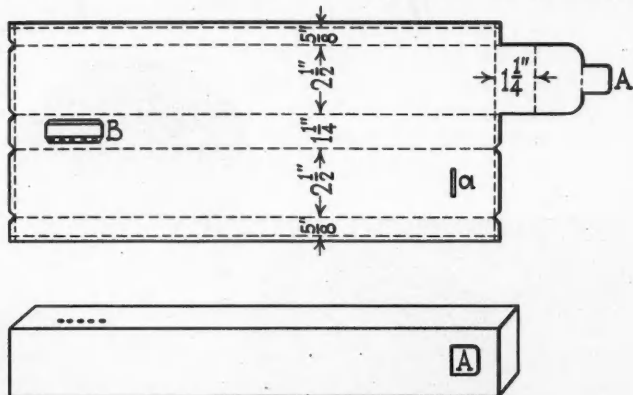

Sheet Metal Cut and Marked, and Formed into Case to Protect the Level.

serve and needs only sufficient tension to hold the level snugly in place.

The dotted lines around the edges indicate where bends are to be made to produce the rolled edges and a rolled joint when the metal is folded into shape. In case there is no sheet metal shop handy, two straight pieces and a vise can be used as a breaker, in which case it is advisable to solder the one joint to prevent its opening up.

WALTER KATELEY, 661 E. 126th St., Cleveland, Ohio.

Practical Paint Scraper

A THOROUGHLY practical and convenient scraper for paint or glue can be made with a block of wood and an old firmer chisel, as shown in the sketch. A hole is cut through the block for the chisel to pass through. This hole is slightly enlarged at the bottom so that the paint or shavings will not clog up around the chisel and keep it from scraping properly. The chisel point can be put in front for use on hard materials such as enamel.

WILLIAM WEITLAUF, JR., 1914 Kinney Ave., Cincinnati, Ohio.

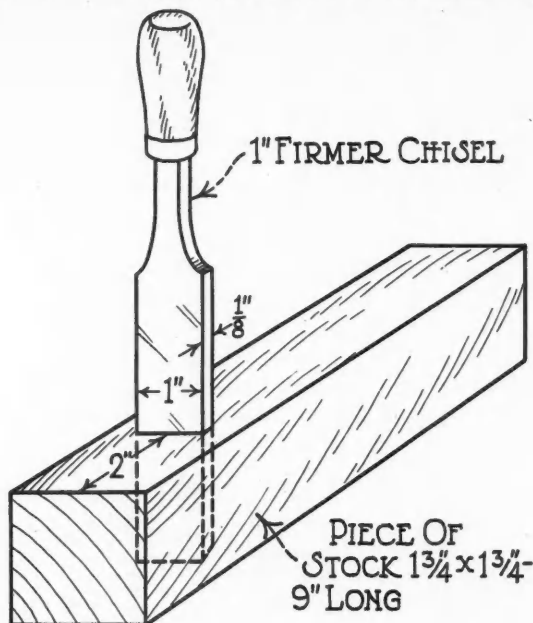

A Simple Scraper Made of a Block of Wood and an Old Chisel Is an Exceedingly Handy Tool.

THE NEW REO ^{BIG} 4 TONNER

A Truck Built to Do YOUR Job

The new Reo Big Four-Tonner is a heavy truck for heavy work, massively constructed at all vital points. It is engineered for *safe* and *profitable* high-speed travel. The Big 4-Tonner engine develops 101 h. p. at the low speed of 2600 R. P. M., has seven big main bearings, full force feed lubrication even to piston pins. The cylinder block of chrome nickel iron increases valve seat and cylinder wall life *seven times*. Built in three wheelbase lengths, from tractor to van types — offered at the lowest price ever placed on a comparably heavy 4-ton truck of equal specifications!



1. Powerful heavy duty, 101 H. P. Six Cylinder Engine.
2. Heavy Duty 4-speed Transmission.
3. Brake Booster standard equipment.
4. Chrome nickel cylinders—wearing 7 times longer than grey iron. Seven bearing crankshaft.
5. Dual wheels standard equipment.
6. Extra long springs; helpersprings, standard equipment.
7. Frame reinforced by 7 heavy cross members.
8. Powerful 4-wheel hydraulic brakes.
9. Heavy duty full-floating rear axle.
10. Extra heavy frames. Side channels 10" deep ¼" thick, with constant flange width of 3 inches.
11. Available in three wheelbase lengths from tractor to van type.

REO

BIG 4 TONNER

REO MOTOR CAR COMPANY
LANSING - TORONTO

150-inch wheelbase chassis . . . \$2800
170-inch wheelbase chassis . . . \$2875
190-inch wheelbase chassis . . . \$2950
f. o. b. Lansing

\$ 2800

WHEN WRITING ADVERTISERS PLEASE MENTION THE AMERICAN BUILDER AND BUILDING AGE

Building Activities

The Month's News of the Industry

President Hoover Calls National Housing Conference

THE National Conference on Home Building and Home Ownership will be held in Washington, D. C., December 2 to 5, 1931. After a year of preliminary research, by twenty-five committees consisting of experts in each phase of the housing problem, President Hoover has set the date for this joint meeting at which the reports of the committees will be presented. In his announcement the President said:

"About 400 persons have assisted in the preparatory work and 1,000 representative citizens from the forty-eight states, associated with building and housing activities, are expected to participate in the conference. The conference has been organized under the chairmanship of Secretary Lamont of the Department of Commerce. Dr. John M. Gries is the executive secretary.

"A planning committee, comprising representatives of some twenty voluntary associations, was created to make the study and set up a national conference for consideration of the data and recommendations of expert committees. The plan is somewhat similar to that of the White House conference on child health and protection, held in Washington in November, 1930. Funds have been provided privately to cover research and other activities of the committees of the housing conference.

"The forthcoming conference was initiated to deal with the question of housing under long-range plan. It will be doubly fortunate if it should result not only in a sounder permanent policy but in some degree of relief of current unemployment and in stimulation of the industries upon which building depends.

"The question touches many phases of both public and private activity. One of the important questions is finance. The present depression has given emphasis to the fact that the credit system in home building is not as satisfactorily organized as other branches of credit.

"First mortgages, carried so largely by the savings banks and insurance companies, have been affected by competition with bonds and other forms of investment. Second mortgages are also necessary to many people. In the period of expansion pre-

Coming Events

Oct. 12-16, 1931—American Gas Association, Annual, Atlantic City, N. J.

Oct. 13-16, 1931—Illuminating Engineering Society, Annual, William Penn Hotel, Pittsburgh, Pa.

Oct. 27-30, 1931—National Retail Lumber Dealers Association, Annual, Book-Cadillac Hotel, Detroit.

Oct. 27-31, 1931—American Institute of Steel Construction, Annual, Greenbrier Hotel, White Sulphur Springs, W. Va.

Nov. 10-12, 1931—American Petroleum Institute, Annual, Stevens Hotel, Chicago.

Dec. 7, 1931—National Homes Finance Corporation, First Annual Stockholders Meeting, Congress Hotel, Chicago.

Dec. 7-9, 1931—Associated Leaders of Lumber and Fuel Dealers of America, Annual, Congress Hotel, Chicago.

Jan. 18, 1932—National Association of Real Estate Boards, Annual Mid-Winter Meeting, Jefferson Hotel, St. Louis, Mo.

Jan. 25, 1932—United Roofing Contractors Association, Annual, Louisville, Ky.

Jan. 25, 1932—National Association of Sheet Metal Contractors, Annual, Louisville, Ky.

Jan. 25, 1932—Roofing Contractors Division of the National Slate Association, Annual, Louisville, Ky.

Jan. 25-29, 1932—International Heating and Ventilating Exposition, Cleveland, Ohio.

Jan. 25-29, 1932—American Society of Heating and Ventilating Engineers, Annual, Cleveland, Ohio.

Jan. 25-29, 1932—American Society of Refrigerating Engineers, Annual, Cleveland, Ohio.

ceding the current depression rates for second mortgages, including commissions, discounts and other charges, rose in many cities to the equivalent of 20 or 25 per cent per annum. This not only stifled home ownership, but led to the loss of many homes through the trades involved."

Pond Made Vice President

THE Truscon Steel Company, Youngstown, Ohio, announces the appointment of Clark P. Pond, as vice president, engineering and sales, in which position he will interest himself in engineering sales work.

Insurance Funds Available for Real Estate Loans

MILLIONS of dollars are held by insurance companies ready to be placed on well selected real estate, according to the fourth annual outline of the real estate loan policies of 131 risk concerns recently completed by the National Association of Real Estate Boards.

"There has been no change in the policies of these companies during the past year that would show any lessening interest in real estate," the survey states. "The majority continue to loan up to 50 per cent of the value of almost any type of property, including farms, and the table of maximum amounts loaned shows some larger totals than appeared on last year's survey."

Twenty-three more companies reported this year than last. All but a few lend on all usual types of properties which include detached single family homes, duplex homes, two apartments, larger apartments, combination apartment and store buildings, office buildings and farms.

Of the 131 companies reporting, 118 will use their funds for loans on single family homes. The next most popular investment is the duplex, or two family dwelling. Ninety-two place loans on this kind of structure. Seventy-nine of the companies loan on "two apartments"; sixty on larger apartments; sixty-five on combination store and flat buildings; eighty-seven on commercial buildings, and sixty-nine take farm loans.

The amounts loaned vary from \$3,000 accepted by one company on single family detached houses to the million dollar figure on office buildings listed by one company. Ten thousand dollars for single detached homes is listed most often as the maximum advanced for this class of property.

The length of the loans varies from one year, under which one company operates, to sixteen years, given by one company. Five year loans are listed by the greatest number of the companies, seventy of them extending credit for that time. Thirty-four give ten years; three give twelve years and three give fifteen years.

New Insulation Announced

ANNOUNCEMENT has just been made by The Insulite Co., Minneapolis, Minn., of two new insulating boards known as Insulite Fire-Proofed Board and Insulite Termite Board. The first offers a high resistance to the passage of flame while the second has proved its efficiency in areas which are affected by termites.



Safe-n-dry

BEHIND BRICK VENEER KEEPS DAMPNESS OUT

YOU need Safe-n-dry Building Paper behind every brick veneer job. It economically keeps dampness out and prevents costly deterioration and needless repairs.

The heavy layer of asphalt in which the jute reinforcing and two sheets of kraft paper are imbedded makes Safe-n-dry impervious to moisture. It water-proofs as it insulates.

Safe-n-dry has other qualities that both you and your customers will appreciate. It is clean, tough, strong, flexible and air-tight. It never becomes

sticky in summer or brittle in winter. It is almost impossible to tear.

Safe-n-dry is inexpensive. It pays for itself over and over again in comfort and in fuel saved regardless of whether you use it behind brick veneer, stucco, clapboards or shingles.

Safe-n-dry comes in 36, 48, 60, 72 and 84 in. widths. The wider widths are recommended for use between floors. Users of Safe-n-dry are enthusiastic about it. Send to the nearest office for samples. You will appreciate Safe-n-dry too!

The RUBEROID Co.

ROOFING MANUFACTURERS FOR OVER FORTY YEARS

Sales Divisions: RUBEROID MILLS—CONTINENTAL ROOFING MILLS
SAFEPACK MILLS—H. F. WATSON MILLS—ETERNIT

ASPHALT SHINGLES AND ROLL ROOFINGS—ASBESTOS-CEMENT SHINGLES AND CORRUGATED SHEETS—ASBESTOS, ASPHALT, COAL TAR PITCH AND FELT BUILT-UP ROOFS—ASBESTOS: SHEATHINGS, FELTS, MILL BOARD, PIPE COVERINGS—KRAFT WATERPROOF PAPERS—COAL TAR AND ASPHALT FELTS AND SHEATHINGS—ASPHALT WATERPROOFING PAINTS AND CEMENTS—DRY FELTS AND SHEATHINGS

Offices & Factories: New York, N. Y.—Chicago, Ill.—Millis, Mass.—Eric, Pa.—Baltimore, Md.—Mobile, Ala.

MANY PROPOSALS MADE TO EASE MORTGAGE MONEY

Central Mortgage Bank Scheme Being Studied by Financing Committee of President's Committee on Home Building and Home Ownership

LEADING the list of proposals that have been made this year to relieve the situation in the mortgage market, is the scheme for a central mortgage bank, discussed at the Baltimore convention of the National Association of Real Estate Boards and later brought to the attention of the financing committee of the President's Conference on Home Building and Ownership. In this issue of the *AMERICAN BUILDER AND BUILDING AGE*, there is an article by Professor Nadler of New York University, summarizing the pros and cons of the central mortgage bank idea. It is understood that the finance committee of the President's Conference on Home Building, headed by Frederick H. Ecker, president of the Metropolitan Life Insurance Company, will study this proposal closely at its next meeting.

Meanwhile, other students of the financing situation in the home building and ownership field are offering remedies for what they believe to be sorry conditions that are obstructing economic recovery.

Presidential Conference on Realty

A few weeks ago, it was reported from Washington that President Hoover and fiscal leaders of the Administration had discussed with New York bankers the possibility of undertaking a far-reaching plan to lift frozen real estate off the market until there has been a revival of economic conditions. In effect, the plan would be to establish a corporation or corporations which would finance distressed property and hold it off the market for a period of years. The scheme would be made effective in all sections of the country, most likely through a string of corporations under the control of some central authority which, though in private hands, would be approved and encouraged by the Federal government.

If this project eventually goes through, it will probably be as a private enterprise, financed by private interests, and not a government undertaking. Banking interests are now studying and discussing the proposal but nothing definite has emerged from council. One of the serious difficulties confronting the scheme is the huge investment that would be necessary to hold the real estate assets. In addition,

there is the question of disposing of the assets after they had once been acquired.

The fact that the realty situation, however, is receiving attention from such high government and banking officials is an indication that some sort of action is contemplated to alleviate conditions brought about by frozen realty assets. Undoubtedly, this is one of the major factors of the depression that must be dealt with.

The proposal considered in Washington is thought to embody the idea of avoiding foreclosure wherever possible because of the eventual sacrifice of existing values that it brings about.

Asks Help of Savings Banks and Insurance Companies

Joseph P. Day of New York City, one of the best known real estate men in the country, has recently drawn interest and attention by his proposal that savings banks and insurance companies get together and sponsor a home owners acceptance corporation that could arrange home buying on the installment plan, eliminate second mortgage practices, and encourage home seekers to save for their first down payment.

Mr. Day is reported to be arranging a conference with savings banks and insurance officials to consider such a plan. Says Mr. Day: "The biggest obstacle to home ownership is the initial down payment. Why can't banks persuade people to tie themselves up to saving this amount on the installment plan if they have nothing to start with?"

"In selling real estate at auction we have proved time and again that it is easy to sell well located real estate if the first payment requirement is small and liberal installment terms are provided. It seems to me that many more moderate and low-priced homes could be sold if prospective purchasers were not confused with talk of first and second mortgages, but had the proposition put up to them on the same basis as if they were to buy a set of furniture.

"My contention is that our savings banks and life insurance companies can become actively instrumental in making this secondary financing easier and less costly to the home owner.

"While the savings banks cannot legally invest their own money in such

financing, I believe they could lend their prestige and sponsorship to a home owners acceptance corporation, privately financed, but operated as a quasi-public institution. Under such splendid sponsorship, and with carefully chosen management, there should be no difficulty in raising funds.

"Certainly it would be ideal," agrees Mr. Day, "if every family would save up in cash 40 per cent of the purchase price of a home and then buy it subject only to a savings bank first mortgage. The trouble is that the average American family can't or won't do this. Furthermore, the time a man wants to obtain his home is when his children are young, not when he is old and gray and the young birds have left the nest.

"I have suggested that our savings banks should operate Own Your Home Clubs, which members would use to accumulate the initial cash payment for a home and thereafter to maintain a fund from which to pay taxes, interest and amortization payments. However, the requirement for the initial payment should be much less than 40 per cent of the investment."

National Second Mortgage Bank

Another proposal that has come out of recent discussion on realty finance conditions is one to establish a national second mortgage bank. This suggestion was made in a recent issue of the *New York Herald Tribune* by Edmund J. Donegan, vice-president of the State Title and Mortgage Company. "If it were up to me to suggest a plan by which the financing of home purchasing and home construction might be improved," said Mr. Donegan in the *Tribune*, "I would ask for the establishment of a national second mortgage bank, with local affiliated second mortgage banks in the principal centers of population. These local banks would be supervised by the national institution, and subject to its periodical inspection. They would be properly capitalized and officered, by some such legislative provisions as are in force in the establishment and conduct of national banks.

"These local banks, in lending money on second mortgages, would lend not only on the property as collateral, but on the personal credit of the borrower, adapting to their purpose the credit investigation methods of the small 'Personal Loan' banks, which are now operating so successfully. The paper on these second mortgages would be written partly as a property risk and partly as a credit risk.

"Such paper, I believe, plus the guarantee of the parent bank, could be

(Continued on page 82)

Revere Products

... that help sell homes

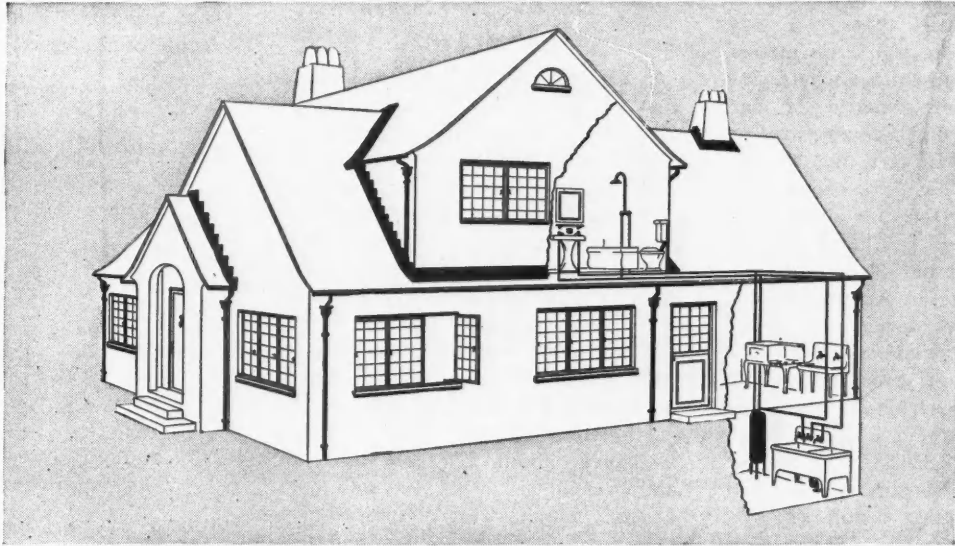

Plumbing that's rustless and trouble-free . . . a roof that's lasting and good-looking too . . . gutters and downspouts that are permanent as well as ornamental . . . here are features which not only make a home desirable but actually help the builder and realtor sell more homes and sell them faster.

Providing these features means using the right material of the highest grade for each part of the job. Revere manufactures a complete line of copper and brass products for these building requirements:

PLUMBING . . .

P R Pipe, a 99.9% pure copper pipe available in two tempers. No. 1 Soft for concealed work. No. 2 Hard for long, straight runs in exposed work. Used in connection with compression fittings. Also Revere Brass Pipe, Revere Red Brass Pipe and Revere Copper Pipe (SPS size) . . . using threaded fittings. A Revere pipe for every plumbing need and every local condition.

ROOFING . . .

Revere Sheet Copper or Revere Leadtex (lead-coated sheet copper). Permanent, weather-proof. Selection depends on color effect desired.

OTHER SHEET METAL WORK . . .

Valleys, Flashings, Gutters, Downspouts, Leaderheads: Revere Sheet Copper or Revere Leadtex, according to the architectural style and decorative requirements. Both are trouble-free, repair-proof, permanent. Both will add to the attractiveness of the home.

OIL HEATER INSTALLATIONS . . .

P R Pipe has proven its suitability and economy for this exacting service.

These Revere products will help you sell more houses. Why not begin specifying them? For further information, address Revere Copper and Brass Incorporated, 230 Park Ave., New York City.

Revere Copper and Brass

INCORPORATED



Baltimore Division, Baltimore, Md.

Michigan Division, Detroit, Mich.

Higgins Division, Detroit, Mich.

Dallas Division, Chicago, Ill.

Taunton-New Bedford Division, Taunton, Mass.

Rome Division, Rome, N. Y.

EXECUTIVE OFFICES: NEW YORK CITY

GENERAL OFFICES: ROME, N. Y.

WHEN WRITING ADVERTISERS PLEASE MENTION THE AMERICAN BUILDER AND BUILDING AGE

CURRENT CONSTRUCTION FIGURES

August Shows Gain in Development Projects

THE month of August showed a gain in contracts for single family dwellings erected by housing developers. This, encouraging as it is to those who look to residential construction to lead the way back to normal in the building industry, was not great enough to offset losses in the remaining residential types. It was most conspicuous in the large metropolitan centers of the East where single family dwelling construction has been going forward at a lively pace for some time now. In fact, the Metropolitan Area of New York shows residential contracts for the first eight months of 1931 greater than those for the corresponding period of 1930.

Total contracts for August showed a loss of slightly more than 19 per cent from July, while the loss for residential contracts was only slightly over 13 per cent, from July of this year. Total contracts for the month amounted to \$320,520,887, which was divided between the various important classes of construction as follows:

Residential Buildings\$130,327,257
Commercial Buildings 21,359,030
Factories 5,224,780
Educational Buildings 21,193,370
Hospitals and Institutions	11,848,650
Public Buildings 37,905,780
Religious and Memorial..	4,446,530
Social and Recreational...	7,955,640
Public Works and Utilities	80,259,850

Total\$320,520,887

These figures cover total volume of contract awards for the entire United States, as estimated by the AMERICAN BUILDER AND BUILDING AGE. They are based on the figures for contracts awarded in the 37 states east of the Rocky Mountains, as reported by the F. W. Dodge Corporation, together with factors to provide for contracts in the 11 states west of the Rocky Mountains and for the smaller unreported work not covered by the Dodge organization.

Construction in the states west of the Rocky Mountains normally amounts to about 10 per cent of the total of the other 37 states. During July this volume was running slightly above normal but during August there was a greater decrease in the western states than in the East so the normal factor of 10 per cent is used for this month.

The Dodge reports cover only a portion of the new building, modernizing and repair work of less than \$5,000. This work, a large portion of which is rural, has been running at

about the normal level, 25 per cent of the total reported construction, and this 25 per cent factor is used in accounting for it. Since practically all this work is home building and remodeling, it is classified under the heading Residential Buildings, in the tabulation.

Contract Awarded for Forest Products Laboratory

A CONTRACT has been awarded by authorities of the U. S. Department of Agriculture, Washington, providing for the construction, in Madison, Wis., of the largest and most complete establishment in the world devoted to research on wood, for the Forest Products Laboratory, to be completed in one year. This contract is the principal award under a \$900,000 Congressional appropriation to provide the Laboratory with adequate quarters and equipment.

In general plan the building will be U-shaped, about 275 feet in length and over-all breadth. It is of modern design, emphasizing "stepped-back" construction, vertical lines, and large areas of glass in the external walls and of fireproof construction throughout. C. B. Fritz & Co., of Madison, Wis., was the successful bidder. Holabird and Root, Chicago, are the architects. Davidson and Constable, Stamford, Conn., assisted in the landscaping design.

Loans Now Being Made

ANNOUNCEMENT is made from the offices of the organization in the Wrigley Building, Chicago, that the National Homes Finance Corporation is now prepared to make loans and already these facilities are being utilized by dealers who are entitled to the service.

The office of chairman of the board has been abolished and Al. J. Hager, of Lansing, Mich., has been elected president and will devote considerable time to the affairs of the corporation.

Frank Miller, who has been actively connected with the development of the organization of the company, has been elected assistant to the president and will have charge of much of the detail work of the executive department. Don McNeill, formerly of Denver, Colo., and nationally known as a merchandising and financing expert, is director of the mortgage department.

Many Proposals Made

(Continued from page 80)

rediscounted favorably with national and other banks. The investigations and handling of this business would be fairly expensive, but I believe 2 per cent would cover all expenses, and 6 per cent would be a fair return. An 8 per cent mortgage note, under such auspices would be an acceptable short term security."

Long Term Financing Thought Essential

Many students of the real estate financing situation agree that long term financing is necessary. Edward A. MacDougall, president of the Queensboro Corporation in Jackson Heights, New York, is quoted in the New York Herald Tribune as saying that "the earning power from housing will no more enable the capitalization of the cost in ten or twelve years than it would in the case of a railroad, public utility or other security financed on long term securities. Some form of mortgage security must be found, particularly for the small home owner, that will safeguard his interest until he has paid a substantial part of his capital debt. Europe is ahead of us in this respect."

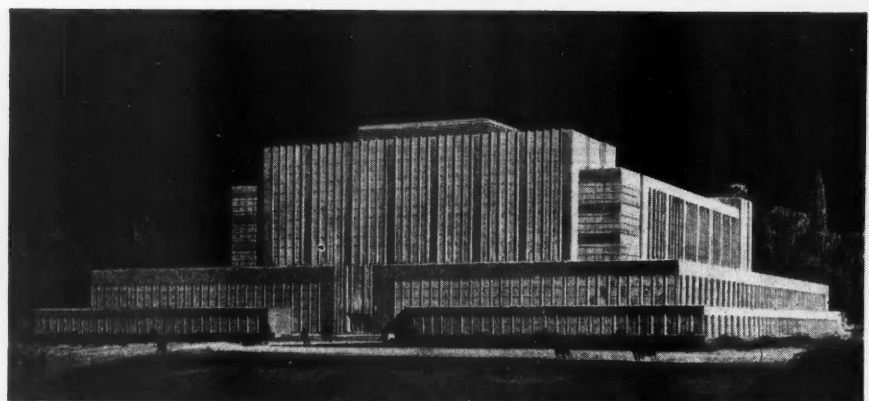

This New Building, to House the U. S. Forest Products Laboratory, at Madison, Wis., Is to Be Completed within One Year. Holabird and Root, Architects.

Firestone

TRUCK BALLOONS

"Guarantee Prompt Service

» » Anywhere"

TWO years ago the Red Star Transfer Company of Pittsburgh, Pa., equipped their entire fleet with Firestone Truck Balloons and signed up for Firestone Service. O. R. Weinert, president of this company, writes:

"Our fleet of 35 trucks give 24-hour service—must travel in all weather—over all types of roads—including the gruelling travel over mountain passes—and they must be on schedule!"

"With Firestone Tires and Firestone Service we have been able to cut our operating costs to a minimum—guarantee on-time service anywhere."

Such results are the daily experience of Firestone-equipped fleets the country over. That's because Firestone Gum-Dipped Tires give these Extra Values:

26% Greater Protection against punctures and blowouts

58% Longer Flexing life in Every Cord

56% Stronger Bond between tread and cord body

25% Longer Non-Skid Wear

which gives you 25% to 40% Longer Tire Life

Whether your trucks are light or heavy—used for inter-city deliveries or long hauls, a changeover to Firestone Truck Balloons will save you time and money. See your nearest Firestone dealer today!



One of the refrigerated trucks owned and operated by the RED STAR TRANSFER COMPANY of Pittsburgh.



Copyright, 1931, The Firestone Tire & Rubber Co.

Listen to the Voice of Firestone every Monday night over N. B. C. Nationwide Network

WHEN WRITING ADVERTISERS PLEASE MENTION THE AMERICAN BUILDER AND BUILDING AGE

BUHL FAVORS BUILDING NOW

\$2,000,000 Development of 300 Garden Homes at Pittsburgh Shows Economic Advantage of Building Now

Buhl Foundation Behind Project to Provide Model Housing

GROUND has been broken at Pittsburgh for a community of 300 garden homes which will be erected on 45 acres of wooded land on Mount Washington near the Pittsburgh business district by the Buhl Foundation, a philanthropic organization which has already financed many educational and scientific projects. The first unit of 125 homes is to be ready for occupancy by May 1, 1932. The second unit, it is expected, will be completed as rapidly as possible after that date.

The Buhl Foundation gives as its reasons for starting this \$2,000,000 project in the housing field: (1) To provide modern and desirable homes within easy access and at nominal rental especially for junior executives and clerical workers in the downtown business district of Pittsburgh, (2) to develop new ideas and higher standards in rental housing, (3) to help stimulate industry by showing the economic advantage of building now, (4) to help reduce the unemployment situation, particularly among higher paid skilled laborers.

How They Will Cut Costs

The Foundation expects that the contributing factors to low rentals in their project will be large scale operation, the present low level of material and construction costs, low financing costs, intelligent planning, and efficient construction methods.

Less than 30 per cent of the entire tract will be occupied by homes, it is said, the remainder will be landscaped to provide large central parks running through the property, wide lawns and gardens around each dwelling and

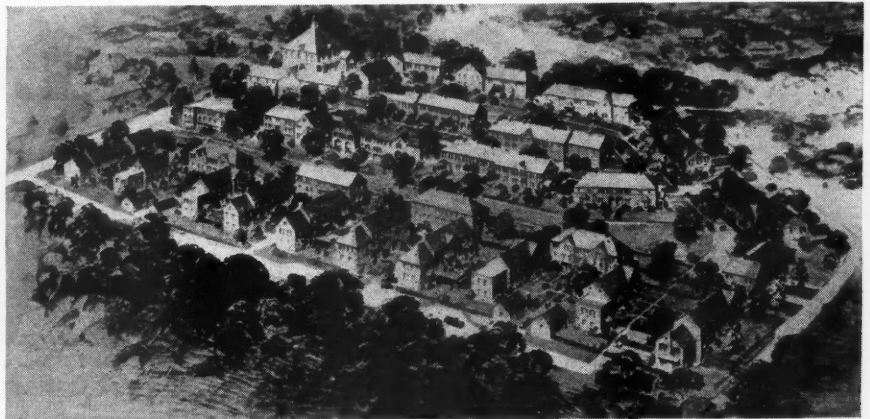

How the First Million Dollar Unit of the Buhl Foundation Housing Unit Will Look. Houses will be arranged in courts and will front on central gardens.

for playgrounds equipped for young children.

Plans provide that homes will face away from the public streets toward the central parks. The rear of each home is to have much the same appearance as the front. The same materials and design will be used and rear grounds also will be landscaped for lawns and gardens.

Each building is to be individual in design but in harmony with all others. Homes will be of five and six rooms with a ground and second floor. They will be built in units of from two to eight houses with sound-proof party wall between. All floors are to be of hardwood. Baths will be finished in modern colors with built-in tubs and showers. Kitchens will be equipped with permanent fixtures, including electric refrigeration. Each house will have a finished basement with laundry

and an independent heating plant. Fireplaces of practical construction will be provided in living rooms. Many of the homes will have sun parlors or private garages. Garages for smaller homes will be built in groups at convenient places.

Homes in the Buhl project will be offered for rental only. It is thought

that permanent management will preserve and assure benefits that could be maintained in no other way. Exact rentals will not be determined until actual cost of construction has been definitely estimated.

In addition to professional assistance the Foundation is enlisting a national advisory council composed of persons of prominence in the fields of town, community and home planning. A year-long study was made of housing needs in Pittsburgh, of advanced community planning developments in the east, and organization of policies of service and management before the site was selected and the type of housing.

Morgan Will Furnish Speakers

ARCHITECTS' clubs, leagues, societies, and chapters of the A. I. A., or other groups of architects will be furnished prominent speakers for their winter meetings by the Morgan Woodwork Organization, to tell of the national program now being conducted by that organization under the slogan, "Build Your Home Architecturally Correct—Consult an Architect." Organizations desiring to engage a Morgan speaker for this purpose should advise the Department of Public Information, Morgan Woodwork Organization, 2287 Blue Island Ave., Chicago, as quickly as possible. There is no charge for this service.

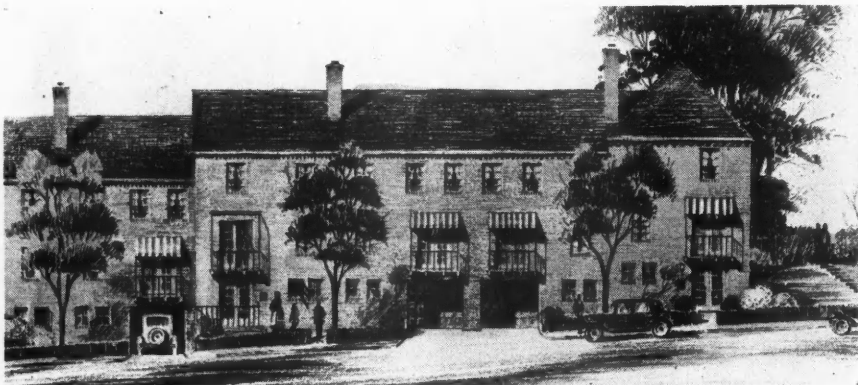

Type of Housing That Will Be Erected in \$2,000,000 Development by Buhl Foundation in Pittsburgh. The first million dollar unit has already been started.

What type hauling-unit do you need?

YOU WILL FIND IT IN THE STANDARD FORD LINE

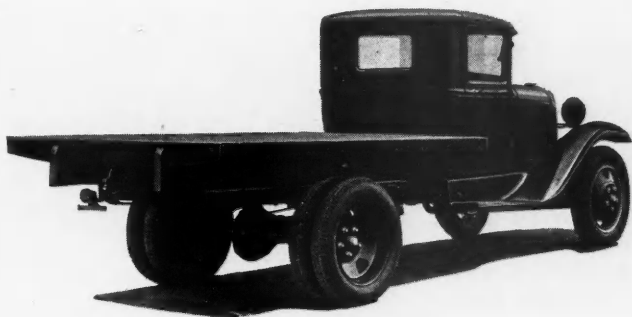

PLATFORM TRUCK with 131½-inch wheelbase. Also available with 157-inch wheelbase. There is a choice of open or closed cabs, single or dual rear wheels, and high or low rear-axle gear-ratios.

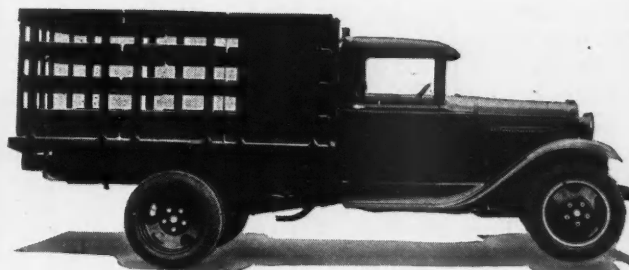

STAKE TRUCK with 131½-inch wheelbase. Also available with 157-inch wheelbase. Stake racks are 42 inches high, and are in nine sections, making them easily removable for loading and unloading.

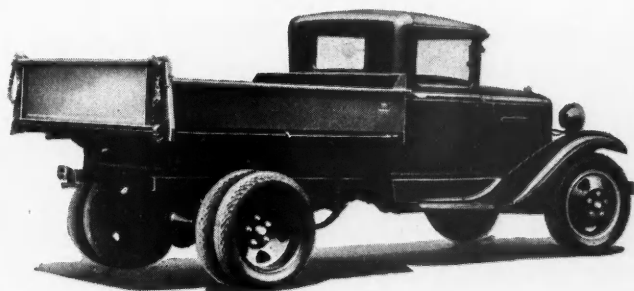

HEAVY HYDRAULIC DUMP TRUCK. One of five dump types. Capacity 1½ cubic yards. The body is a single piece of 10-gage steel, and has no center or bottom seams. The hydraulic hoist has an ample margin over its normal operating capacity of 1½ tons.

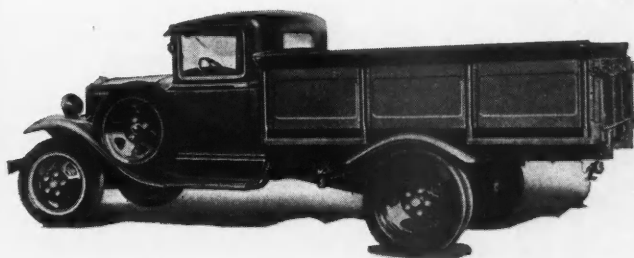

HEAVY-DUTY EXPRESS—131½-inch wheelbase. This strong, rugged body is built of steel over wood, and has unusually sturdy floor-boards. Sides are 18 inches high, with wide flare-boards. There is also an open express on either wheelbase.

NO LONGER is it necessary to have special truck bodies built, to meet your particular hauling needs. Now, at low cost, you can find exactly the units you need, in the standard Ford line. More than forty different types are available, with two different chassis, three different wheelbases, and in a choice of forty attractive color-combinations. Among these types are many especially designed for hauling building materials and supplies of all kinds. A few are illustrated here. All are available through any Ford dealer. In most principal cities, there are centralized exhibits of Ford commercial units.



WHEN WRITING ADVERTISERS PLEASE MENTION THE AMERICAN BUILDER AND BUILDING AGE

The Builder's Library

Equipment for Buildings

Woodworking Machines

An illustrated folder has been prepared by the American Floor Surfacing Machine Company, 545 S. St. Clair St., Toledo, Ohio, showing how large buildings can materially reduce maintenance costs with this company's Electric Carpenter.

Lighted Bathroom Cabinets

An illustrated and descriptive folder on the Edge-Lite Aplakay, the latest addition to the Edge-Lite cabinet line, has recently been issued by the Henkel Edge-Lite Corp., 900 N. Franklin St., Chicago.

Welded Steel Boilers

The Burnham Boiler Corporation, Irvington, N. Y., has published a new booklet on "Burnham Low Pressure Welded Steel Boilers—Steel Breechings, Steel Stacks, Riveted Tanks," which contains a table of ratings and measurements for Burnham Boilers.

Air Conditioning Equipment

A catalog on the new Surface Combustion Heatmaster, one of the most recent developments in air conditioning for the home, has been issued by the Surface Combustion Corporation, Toledo, Ohio. It is fully illustrated and contains charts and data on air conditioning problems.

Construction Materials

Woodwork

The Morgan Woodwork Organization, 2287 Blue Island Ave., Chicago, offers a folder devoted to architectural harmony obtained through the use of Morgan woodwork.

Hardwood Flooring

Uni-Box, a new and improved type of hardwood flooring, especially designed for use with concrete floor construction, is presented in a booklet offered by the manufacturers, the Wisconsin Land & Lumber Company, Hermansville, Mich.

Steel Double Hung Windows

David Lupton's Sons Company, 2203 E. Allegheny Ave., Philadelphia, Pa., has published a booklet illustrating and describing its new Georgian steel window, a low cost unit designed to reproduce the graceful pattern of the Georgian period.

Waterproof Concrete

"How to Make Good Waterproof Concrete," is the title of a booklet prepared by the Medusa Portland Cement Company, 1002 Engineers Bldg., Cleveland, Ohio. It contains methods, specifications, tests and much other valuable material.

Check These Items Every Month and Write for Those You Need to Keep Your Files Up to Date. Any Item Listed Will Be Sent Free on Request Except Where a Price Is Noted. The American Builder and Building Age Should Be Mentioned When Writing for These Publications.

Limestone Houses

Under the title "Distinctive Homes of Ilco Ripstone," the Architects Service Bureau of the Indiana Limestone Company, Bedford, Ind., offers a beautifully illustrated presentation of the use of Indiana limestone on residential construction.

Ornamental Iron Work

"Good Practice in Ornamental Iron Work" is the title of a portfolio of details published by the J. G. Braun Company, 537 W. 35th St., New York City.

"Tall Building Economy"

This booklet, prepared by the Concrete Reinforcing Steel Institute, Tribune Tower, Chicago, presents the economy of reinforced concrete construction in all types of building and particularly in tall buildings.

Aluminum Paint

The Aluminum Company of America, Pittsburgh, Pa., has just published a booklet on "Aluminum Paint—Its Uses, Utility and Application," which contains much interesting and valuable information on this important and comparatively new product.

Oak Flooring

The Oak Flooring Manufacturers' Association, 1812 St. Rick Bldg., Memphis, Tenn., has issued a pamphlet on the economy of oak flooring pointing out that prices are now lower than they have been since 1914, and including data for the specification writer.

Built-up Roofing

"Built-up Roofing," Number 4, of the Johns-Manville series of architectural monographs has recently been published by the Johns-Manville Corporation, 292 Madison Ave., New York City. It includes details and specifications.

Waterproof Lime

The Rockland & Rockport Lime Corp., Rockland, Me., has issued a folder on its new product, waterproof lime, which has been developed to enable the contractor to produce low priced mortar and at the same time prevent leaky walls and efflorescence.

Haydite Building Units

The Haydite Manufacturers' Association, Kansas City, Mo., has recently published a booklet on "Haydite—The Lightweight Aggregate—Building Units—The Modern System of Cost Reduc-

ing 'Multiple-Utility' Masonry Construction." It is fully illustrated and contains complete data on the various characteristics of Haydite units, roof tile, and specialties.

Miscellaneous Publications

"The House of the Growing Income"

This is the title of a new booklet that has been prepared by Eldred Mowry, A.I.A. and published by the National Lumber Manufacturers Association, Transportation Bldg., Washington, D. C. It contains plans, sketches, and text showing the development of a three room cottage, by means of additions, to meet the growing requirements of the family.

Bracing Buildings

Leaflet No. 77-L of the U. S. Department of Agriculture, is devoted to such subjects as taking the bulge out of granary walls, and straightening leaning barns, and points out the economy of proper original bracing as compared with later repairs. It can be obtained free, from the Office of Information, U. S. Department of Agriculture, Washington, D. C.

"History of Building and Loan"

The United States Building and Loan League, 59 E. Van Buren St., Chicago, has published the "History of Building and Loan in the United States". It contains statistical facts on building and loan, a bibliography, and directory of associations, as well as historical matter. Price, \$6.00.

Better Home Architecture

The Morgan Woodwork Organization, 2287 Blue Island Ave., Chicago, has issued a pamphlet presenting the endorsement by architects of its campaign, "Build Your Home Architecturally Correct."

Contractors' Equipment

Floor Finishing Profit

The American Floor Surfacing Machine Company, 545 S. St. Clair St., Toledo, Ohio, is offering a new booklet of information entitled "The American Method of Floor Finishing," for contractors and builders who want to make extra profits even in dull seasons, by adding floor surfacing, waxing, and polishing service.

Truck Loading Scale

A celluloid slide rule, which tells accurately the number of gross pounds that the Reo Gold Crown engine is capable of pulling under varying conditions, noting tire sizes and rear axle ratios required, has been made available to all owners of Reo Speed Wagons and prospective owners, by the Reo Motor Car Company, Lansing, Mich.



**FOR
INFORMATION**

ASK US

THE AMERICAN BUILDER and BUILDING AGE Service Department is ready at all times to co-operate with its readers in securing information regarding all kinds of building materials, contractors' equipment, special products used in the building field—in fact, any information of this nature which may be desired. This department will gladly place its readers in touch with reliable manufacturers of equipment, appliances, machinery, tools

and building products of every description. Just fill out the coupon below—please print or write your name and address plainly and check your occupation—and mail to AMERICAN BUILDER and BUILDING AGE. The Service Department will give your inquiry attention at once, and ask reliable manufacturers to send you their catalogs, price lists, and any other information you desire. This service is absolutely free to readers.

AMERICAN BUILDER AND BUILDING AGE
105 WEST ADAMS ST., CHICAGO, ILLINOIS

AMERICAN BUILDER AND BUILDING AGE, 105 W. Adams St., Chicago, Ill.

Gentlemen: I am in the market for the following items: Please put me in touch with manufacturers whom you know to be reliable and can furnish goods promptly:

.....
.....

Name

Address

Please check your occupation: Building Contractor ; Dealer in Building Materials ;
Prospective Home Builder ; Architect

10-31

Products for Better Building

Recently Announced Materials and Equipment Will Add to the Quality and Convenience of Buildings in Which They Are Used

CONSTANT improvement of products is one of the secrets of successful selling. Recognizing this fact, manufacturers of building products are constantly developing new and improved building materials and equipment. In doing so, they are making it possible for the builder who keeps himself well-informed to constantly improve his product, the buildings he erects. Many of the new products also make it possible to improve the older buildings and bring them up to date.

Porcelain Sinks in All Colors

A great many homes built recently have been made brighter and more attractive by the use of colored porcelain enamel in kitchens and bathrooms and the vogue for color has struck a responsive chord in the public mind. Now even the homes built before the days of colored enamel may have colored kitchen sinks to match any desired decorative treatment.

One-piece sink tops, of Armco ingot iron, can be obtained in any dimensions or mechanical layout to fit any kitchen cabinet installation whether new or old. One or more sink compartments may be located anywhere in these tops which are available in sizes up to 132 inches. They are available in any color of the rainbow to match a color scheme or to afford a contrasting color. And this wide range of colors costs no more than white.

The porcelain enamel is a stainless type which is highly durable and retains its beauty indefinitely. Since these tops

For further information on any of the products mentioned on these pages write American Builder and Building Age, Information Exchange, 105 W. Adams St., Chicago.

are made in one piece, there are no cracks, crevices or sharp edges to hold dirt or mar their beauty. They may be obtained with back and end splashers to fit the installation, as desired.

The illustration below shows an installation of one of these sink tops with a popular type of kitchen cabinet

layout, while the inset shows the same top by itself before being installed on the cabinet. The illustration, however, can give little if any idea of the attractiveness of the colored enamel. It has to be seen to be appreciated.

It is a far cry from enamel sink tops to insulating materials, but we must make that jump for one of the other outstanding developments of recent weeks is an improved type of insulating material.

A Fire-Proofed Insulating Board

The new fire-proofed material is the product of a well known manufacturer of insulating board. After several years of experiment the fire-proofing process has been perfected and the new board has met severe tests. One of these is shown in the illustration on page 90.

The test building was constructed half of the new board and half of plaster board, to afford a comparison. After 20 minutes of intense fire exposure, the new board was entirely undamaged while the plaster board had been destroyed.

This board, which is offered through dealers, in ½-inch thickness, 4 feet wide, and 6 to 12 feet long, lends itself to any decorative treatment, lacquer, oil enamel or plastic

(Continued on page 90)

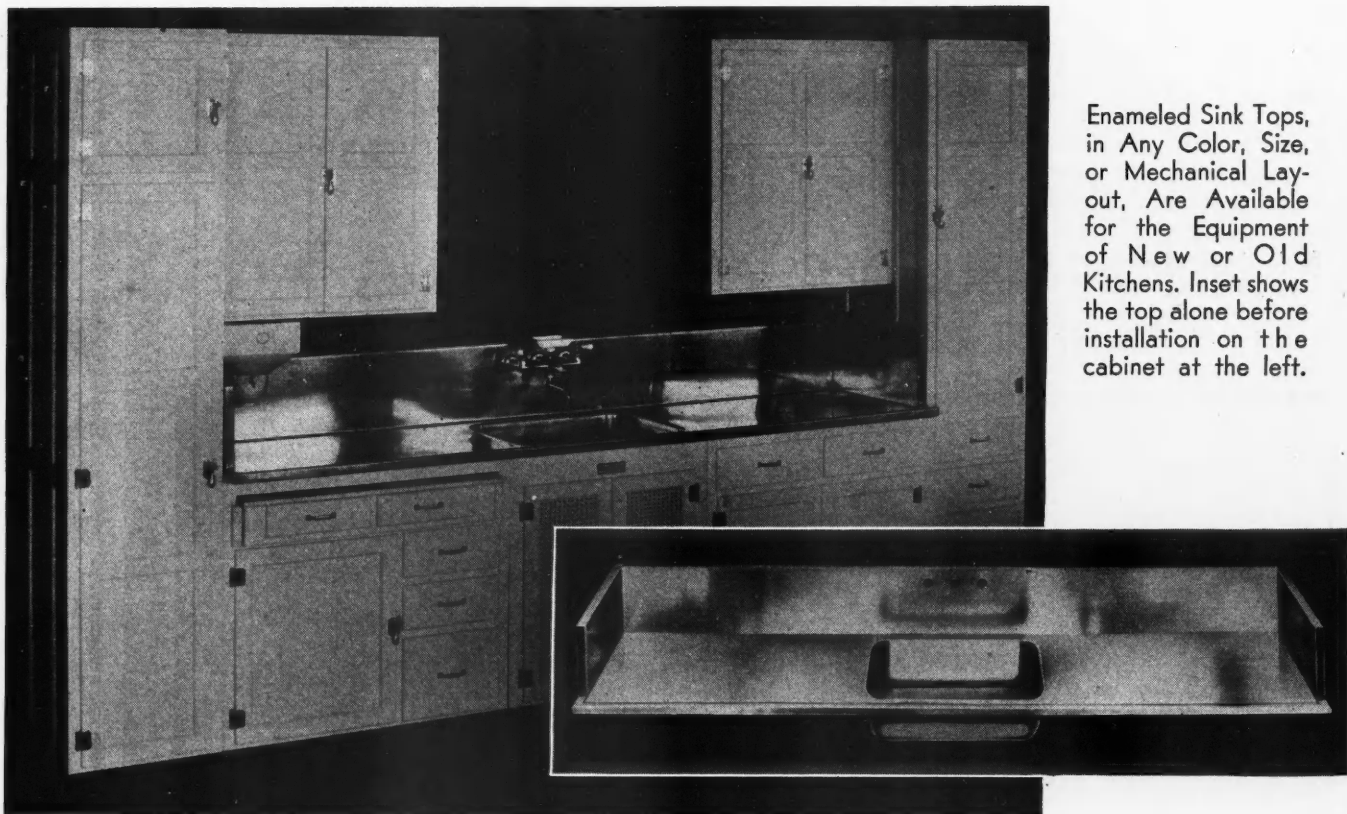

Enameled Sink Tops, in Any Color, Size, or Mechanical Layout, Are Available for the Equipment of New or Old Kitchens. Inset shows the top alone before installation on the cabinet at the left.



-hard floors need hard nails

PIANOS aren't dropped on hardwood floors very often. But ordinary, day-in-and-day-out wear will loosen floor boards and age the floor just as surely—unless Rico Flooring Nails have been used!

Rico Flooring Nails are HARD—they go straight into the hardest wood without splitting or bending. And they STAY FIRMLY ANCHORED as long as the floor lasts, because their wedge-shape gives them 72% greater holding power.

Rico Flooring Nails will make your next flooring job EASIER—and more permanent. Order Rico Flooring Nails today!

For information and quotations address

READING IRON COMPANY

General Offices: 401 N. Broad St., Philadelphia, Pa.
Mills: Reading, Pa.

Atlanta, Baltimore, Boston, Buffalo, Pittsburgh, Cincinnati,
New York, Detroit, Houston, St. Louis, San Francisco, Seattle,
Chicago, Tulsa, Los Angeles, Kansas City

R I C O

**SPECIALLY HARDENED AND TEMPERED
FLOORING NAILS**

CUT FROM SOLID PLATE

WHEN WRITING ADVERTISERS PLEASE MENTION THE AMERICAN BUILDER AND BUILDING AGE

PRIZE

Everyone interested in artistic homes that will sell at good prices should study this prize-winner of the \$29,000 National Better Homes Competition of 1930.

Master Model Home "Cheelcroft"

Erected by Harold W. Cheel, at Cheelcroft, N. J., under the auspices of the Home Owners Institute of America, this house is built of clinker brick, roofed with hand-made tile, and insulated with genuine sound-deadening and heat-insulating Cabot's Quilt. Thirty other houses at Cheelcroft have this most economical form of insulation.



We'd like you to know more about Cabot's Quilt—why it is rot-proof, fire-resistant and can never lose its insulating power. Just sign your name below for a free copy of our book on house insulation.

Cabot's "Quilt"

Send this to Samuel Cabot, Inc., 142 Milk Street, Boston, Mass., for "Build Warm Houses" and Laboratory Bulletin No. 5.

Name

Address



In a Fire Test the Portion of the Building Made of the New Fire-proofed Insulating Board Was Undamaged, but the Plaster Board Was Completely Destroyed.

finish, after being sized with glue or oil size.

In addition to this fire-proofed board, the same company has also developed a process to render its insulating board proof against the attacks of termites. The termite-proof board was perfected in 1928 but, before being placed on the market, was subjected to a field test. It was used to build a structure in Singapore, Straits Settlements, an area disastrously infested with termites. When dismantled and carefully examined in 1930 the termite-proof board showed no mark of termite attack and, in addition, had not been affected by the torrential tropic rains and excessive humidity to which it was subjected. This board is distributed in the same manner as the fire-proofed board and is made in both $\frac{1}{2}$ - and 1-inch thickness, 4 feet wide, and 6 to 12 feet long.

The development of these two new products marks an important step in the manufacture of insulation, greatly increasing the scope of its application and usefulness.

Bath Tubs Made Leak-Proof

It is one thing to make a bathroom attractive with colored equipment and fixtures, and quite another thing to keep it attractive, and free from cracks around the tub, when settling gets in its work. And those all too familiar cracks around the tub are bad, too, because they permit moisture to get into the wall.

But cracks and moisture in the wall can be eliminated easily by the use of

a cleverly designed bath tub hanger which is quite clearly shown in the illustration. It is made of heavy, galvanized steel, perforated to form a base for the plaster, and can be fastened to any wall construction. It is tested to support a weight of 8,550 pounds and it certainly does the work.

This Board Is Adjustable

In all kinds of working equipment, the height of the working surface is of the utmost importance, according to authorities who have studied the effect of incorrect posture in work, on the health of workers. And when it comes to comfort, almost any housewife can tell you how she has wished for an ironing board of the right height, or one which would permit her to sit down part of the time while ironing.

Such an ironing board can now be obtained. It is readily adjustable to any height, for adult or child, sitting or stand-

(Continued on page 92)

Decoration for Entrance Doors carved with a



The full line of
Carter Electric Tools
includes:

Planes
Butt Mortisers
Lock Mortisers
Weather Strip Equipment
Routers
Shapers
Stair Sets
Drills
Screw Drivers
Aerial Grinders
Bench Grinders
Saws

Carter Electric Hand Router

THE beautifully carved panels and attractive finish of these entrance doors of the Tau Kappa Epsilon Fraternity House at Corvallis, Oregon, were turned out with a Carter Electric Hand Router.

This is a typical illustration of the type of craftsmanship in wood which is being done every day with these versatile tools.

From the list of Carter Electric Tools shown here, select the ones which interest you. We shall be glad to supply you with complete information and prices.

THE R. L. CARTER CO., INC.
116 ELM STREET :: :: NEW BRITAIN, CONN.



Carter Type R-4 Electric Router

Proud of her WALLS

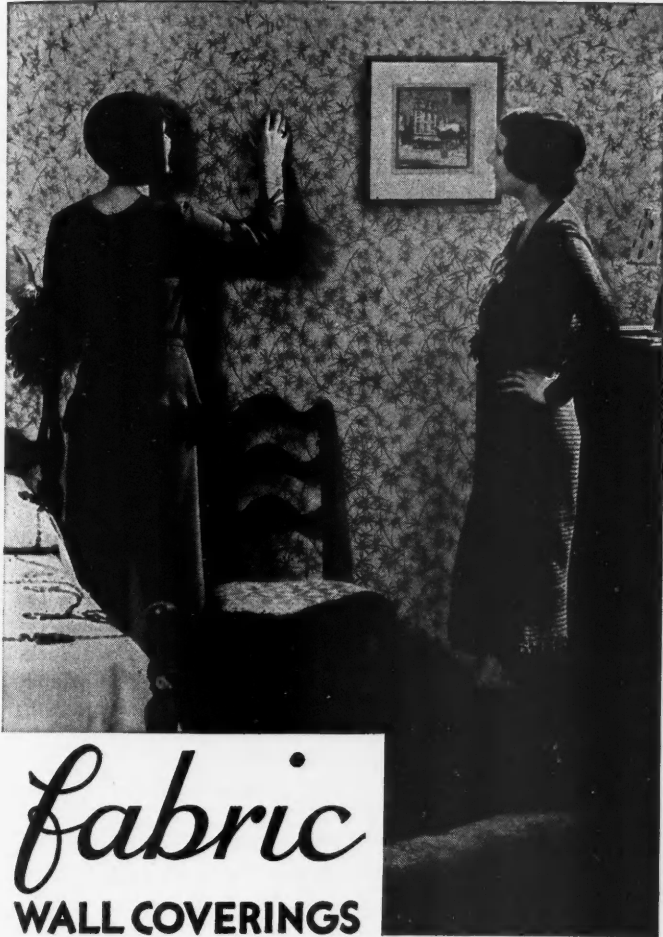

Fabric
WALL COVERINGS

*give the home greater beauty
and greater value!*

AS every builder knows, it takes the unusual to interest people today. In their homes they want more beauty, more quality, more of everything for their money.

Those big wall spaces are of first importance. Make the walls distinctive. Make them beautiful. The ideal material is Wall-Tex. At a glance people note the rich, quality-appearance of its *fabric texture*. The beautiful patterns and colorings also tell a quality story. And you can explain that Wall-Tex is washable. The colors are non-fading. The fabric is tough and durable — it conceals ordinary cracks, reinforces the plaster and prevents new cracks from forming.

Wall-Tex adds value to the home, makes it easier to sell. Write for samples of newest patterns and interesting folders on interior decoration.

COLUMBUS COATED FABRICS CORPORATION
Makers of Fine Coated Fabrics for a Third of a Century
Department C-10 Columbus, Ohio

WALL-TEX

fabric wall coverings of enduring beauty

WHEN WRITING ADVERTISERS PLEASE MENTION THE AMERICAN BUILDER AND BUILDING AGE

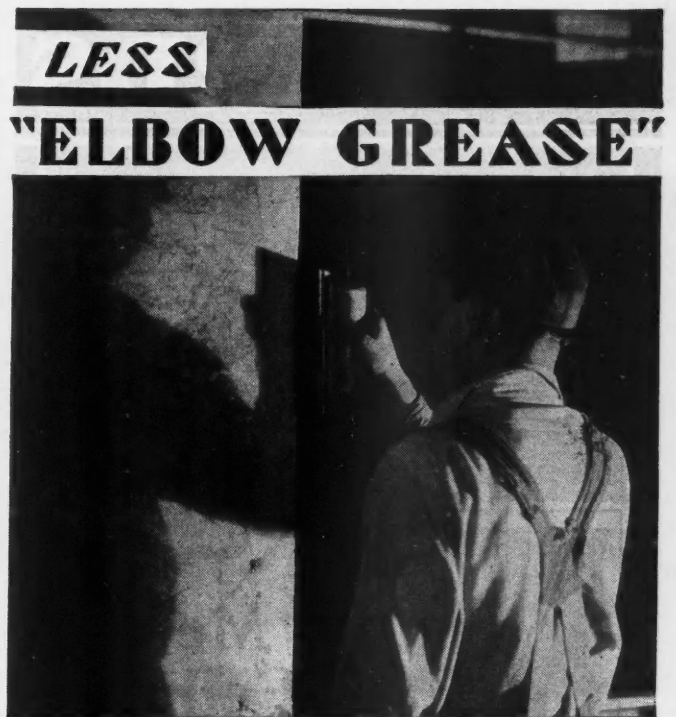

LESS
"ELBOW GREASE"

WITH THE
Carborundum
BRAND
Rubbing Brick

It's astonishing how quickly and easily form and mould marks—all such imperfections on concrete work—disappear under the fast, clean cutting, action of this remarkable abrasive brick.

Here is a brick that is fluted so as to give it a shear cut—enabling it to quickly free itself from surplus material—to retain its sharpness.

Concrete workers and contractors find it the most effective tool they have ever had for smoothing up all sorts of concrete work.

It's made from Carborundum Brand Silicon Carbide—a manufactured abrasive—that's why it cuts so fast—lasts so long. Sold by your hardware or supply dealer.

THE CARBORUNDUM COMPANY, NIAGARA FALLS, N. Y.
Canadian Carborundum Co., Ltd., Niagara Falls, Ont.

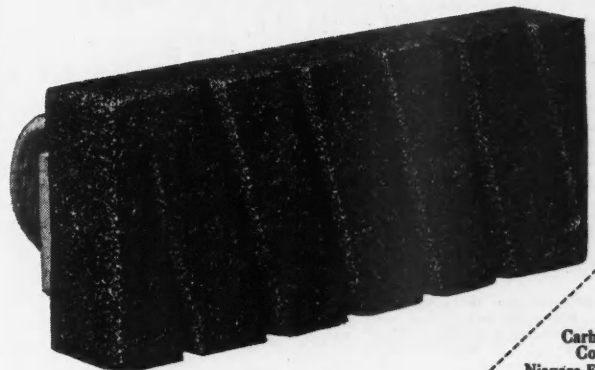

Made in 5 sizes with
and without handle

[CARBORUNDUM IS THE REGISTERED TRADE
MARK OF THE CARBORUNDUM COMPANY]

The
Carborundum
Company
Niagara Falls, N. Y.
Send me your leaflet C-2:
"Handler with the
Handle"

Name _____

Street _____

City _____ State _____

EDWARDS

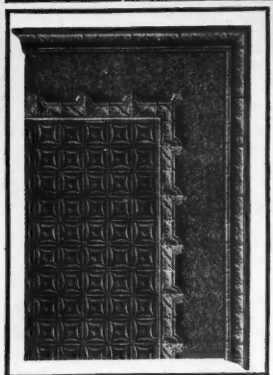

Metal Ceilings

Make floor space of waste space!

Finish cellars and attics . . . make permanent satisfied customers and profits for yourself by installing

beautiful, low cost Edwards Metal Ceilings and Sidewalls. Transform waste space quickly, easily and economically into valuable floor space.

Hundreds of beautiful, modern and period designs deeply embossed in permanent metal, insuring lasting beauty. Always clean, neat, sanitary and fire-proof. Beads are repressed and nail holes die-cut for quick application and perfect alignment.

Edwards Metal Ceilings and Sidewalls have been in use for more than thirty years in many of the world's finest buildings. Write for illustrated catalogue.

EDWARDS Metal

Spanish Tile and Shingles

The most beautiful roofing in the world reproduced in Edwards Metal Spanish Tile . . . all the massiveness of clay tile at a fraction of the weight and cost.

Edwards Metal Shingles in plain and ornamental designs match the architectural theme of the building. Thousands of installations in all parts of the country attest their lasting beauty and protection.

Edwards Metal Spanish Tile and Shingles cost less to buy and to lay . . . give you a better profit and your customers more satisfaction. They require no heavy roof structure. Joints interlock, insuring leak-tight roof and perfect alignment. Cannot curl, break, bend or blow off.

Made in galvanized steel or terne plate (tin), copper bearing steel, sheet zinc or pure copper. Proof against fire, lightning, wind and weather. Write for book showing typical installations.

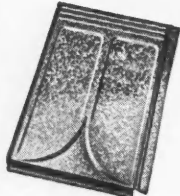

Complete working instructions furnished from your measurements. Get our proposition for ceilings, sidewalls and roofings. We save you money.

The EDWARDS MANUFACTURING CO.

542-562 Eggleston Avenue CINCINNATI, OHIO

World's largest manufacturers of Sheet Metal Building Materials.

ing. It is installed in an attractive cabinet designed to fit between the studs, and may be painted or stained to match the finish of the trim, making it inconspicuous. A wall design which is simply placed against the wall, and fastened with nails or screws, is also available. It occupies little room, being only three inches deep.

Speaking of the products of woodworking companies, a new window frame, designed to be completely weather-tight, is one of the interesting items that has recently been offered the building industry.

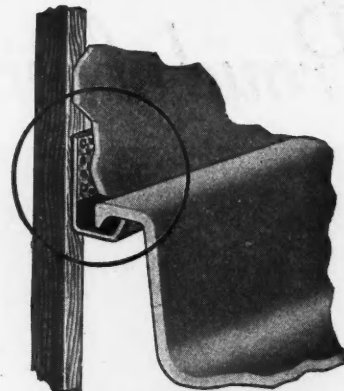

This Galvanized Metal Hanger Entirely Prevents Cracks and Leakage.

Frames That Are Weather-Tight

This new window frame has been especially designed to prevent the leakage of air and water. Leakage is caused by the opening of the joints between the blind stop and the jambs, due to the absorption of moisture during plastering and subsequent shrinkage. It is practically impossible to drive the members together after they have once opened.

In this new frame a lock joint, between blind stop and jambs, has been incorporated, as indicated at the point 1, in the illustration. With this joint, when the blind stop is nailed in place, it becomes practically an integral part of the jamb. The joint cannot pull open and leakage is prevented.

(Continued on page 94)

Here Is New Ironing Board Which Is Adjustable to Any Height.

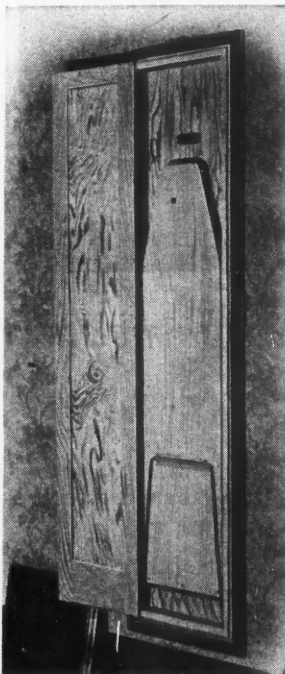

Here It Is!

The New American

LIGHT EIGHT



EASILY CARRIED ANYWHERE

Floor Sander

The last word in floor sanding machines. An 8 inch drum sander featuring speed and capacity without the penalty of excess weight. At a price anyone can afford to pay.

Lightest Weight

One piece aluminum frame. One man can easily carry it anywhere.

Greatest Capacity

New revolutionary principle applies full weight of machine on sanding drum while in operation. Automatic pressure control guarantees maximum capacity without necessity of added weights.

Lowest Price

Despite the many de luxe features ordinarily found only in our highest priced machines, the American Light Eight is priced lower than ordinary floor sanders which might possibly be compared to it. Quantity production, world-wide distribution and up-to-the-minute factory methods permit a record low price. Easy terms.

New Exclusive Features

24 exclusive American features make the American LIGHT EIGHT the best value ever offered in a floor surfacing machine. An illustrated circular describing these features in detail will be sent without obligation. Mail the coupon today.

Do YOU Want to Earn Big, Steady Profits? This Fall and Winter.

American Machines are real money makers. Thos. J. Crowley of Missouri writes: "I just finished a job that I got \$300 from. I am figuring on another job that will bring me \$650." Hundreds of new floors everywhere to be surfaced. Thousands of old ones to be resurfaced, wax, polish. We teach you and furnish FREE advertising, cards, folders, to help you get business.

Get Started Now. Send the Coupon Today.

Here's How You Can Earn
EXTRA PROFITS
with the American
SANDERPLANE

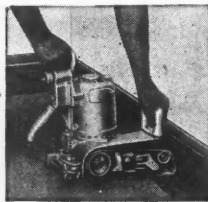

No more hand scraping along floor edges. The Improved American Sanderplane is a light weight portable belt sander with exceptional speed and power. Sands along edges, across butt ends, stair landings, table tops, cabinet work, etc. No floorman should be without it. Send coupon for free illustrated folder.

The **AMERICAN** FLOOR SURFACING MACHINE COMPANY

511 S. St. Clair St.

Toledo, Ohio

Please rush illustrated folder and price of new American LIGHT EIGHT Floor Sander.

NAME.....

ADDRESS.....

City..... State.....

Tell me how to earn Extra Profits with the Improved American SANDERPLANE.

Business or Occupation.....

10-31

Chutes for the Well Equipped Home

Features which make for conveniences and save the time and effort of the housewife, have a strong appeal to prospective home owners. Among these are classed laundry chutes and dust chutes which are so easily built into the walls, between studs.

The chute illustrated here is a new product which is available at small cost. It is of all metal construction with a smooth inside finish which cannot damage clothes when it is used as a laundry chute. A well ventilated receptacle for the soiled clothes is attached to the lower end in laundry and the top opening is built into the wall of the bathroom or wherever most convenient.

When used as a dust chute, a floor plate opening is placed in the hall or other handy place. This floor plate is opened by stepping on a pedal. A removable bag is attached to the lower end of the chute, in the basement to catch the dirt.

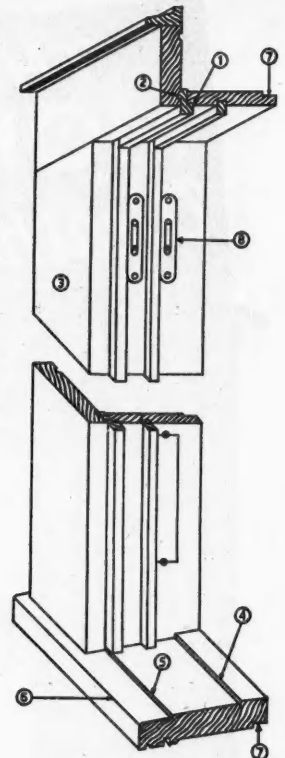

There Is a Lock Joint at the Point Marked 1.

This bag is placed at a convenient height to reach for removal. It only need be removed, and emptied, every four or five weeks, just as the bag of a vacuum cleaner is emptied. When this dust chute is installed in the kitchen, or anywhere in the floor directly over the basement, its installation is quite simple. A 6 by 12-inch hole is cut through the floor. The assembled chute is dropped into the hole and fastened with four screws. The bag is attached in the basement and the chute is ready for use.

The tube part of the laundry chute is the same as that of the dust chute. It is provided with a metal hamper, in the basement end, however, which is suspended from the basement ceiling at the right height for emptying. The ventilating holes in this hamper are of a size which will not

(Continued on page 96)

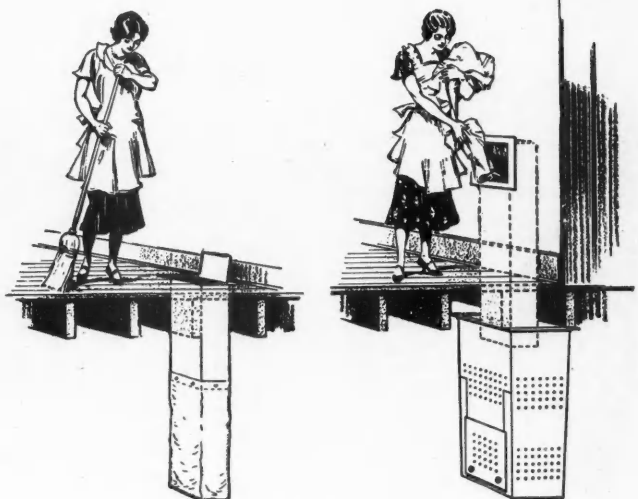

These Chutes Can Be Equipped for Use as Laundry Chutes or as Dust Chutes and Are a Real Household Convenience.

Eliminate Columns! Build Wide Spans Economically!

Large unobstructed floor areas make any building more useful. You can provide clear spans of fifty feet at moderate cost with Truscon Clerespan Trusses and save the expense of objectionable columns. These electrically welded box girders combine ample strength with maximum economy of materials. They are light in weight and easily installed.

Write for prices, suggestions and catalog.

TRUSCON STEEL COMPANY **YOUNGSTOWN, OHIO**
Engineering and Sales Offices in Principal Cities

TRUSCON *Clerespan* TRUSSES

TRADE MARK REG.
AND PAT. APPLIED FOR

with double web
system

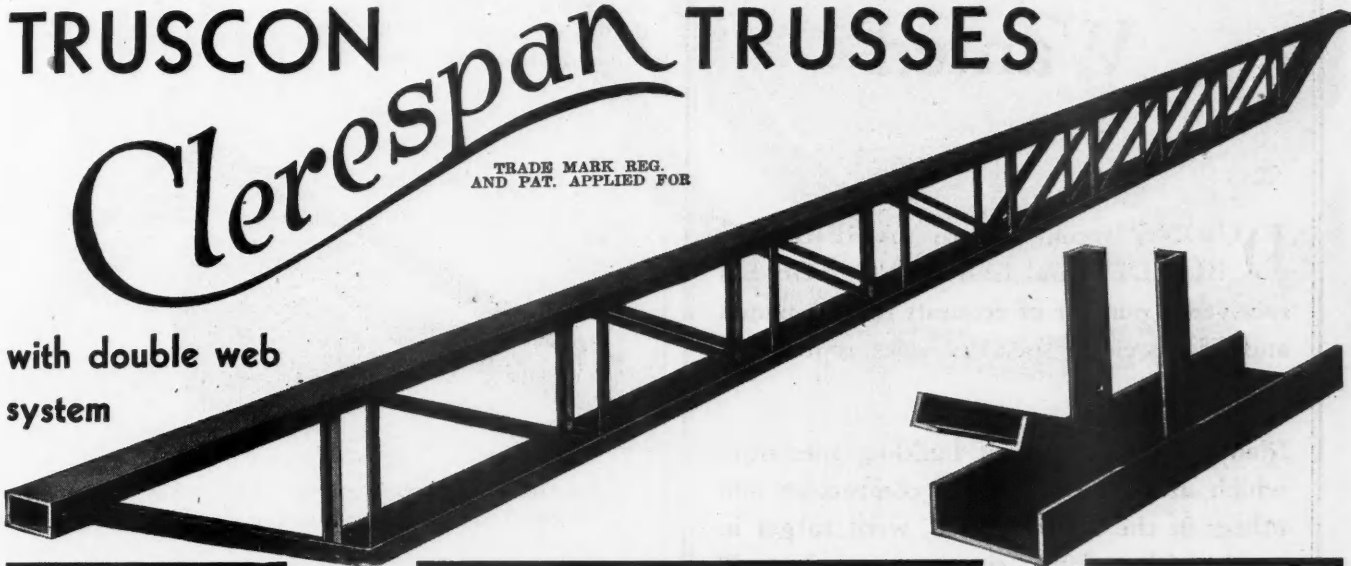

Variety WOODWORKER

**4 men
can use this
one machine
..... at once!**

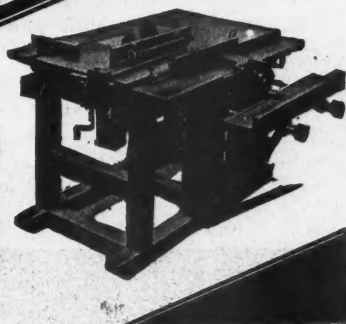

Four men can use the Variety Woodworker at one time . . . and turn out as much work and as good work as four machines! That's why users of this remarkable machine can bid lower and make more money. Cut-off Saw, Rip Saw with Boring Attachment, Mortiser and Jointer all in one. Made of better materials for longer service at lower maintenance cost. Every machine guaranteed. Write for literature and prices today. Ask, also, for booklets of other woodworking and saw mill machinery.

**AMERICAN
SAW MILL MACHINERY CO.**
60 Main Street Hackettstown, N. J.

"ANTI-HYDRO"

For Waterproofing
and Quick Hardening

For 27 years "Anti-Hydro" has been recognized as the one dependable integral water-proofer for all concrete and masonry operations. It also quickens the hardening . . . an invaluable time-saving feature. It prevents retarding of the set of concrete during a sudden drop in temperature. Use the coupon below for further facts.

Anti-Hydro Waterproofing Co.
295 Badger Avenue, Newark, N. J.
Please give me complete information regarding "Anti-Hydro" and your 25-year guarantee.
Name

Address

Specialty Sales Representatives Wanted



DURING recent months AMERICAN BUILDER and BUILDING AGE has received a number of requests for the names and addresses of specialty sales representatives.

Many manufacturers of building specialties which are readily sold to contractors and others in the building field, want to get in touch with reliable, sincere men who will act as local sales representatives.

The Research and Marketing Division of AMERICAN BUILDER and BUILDING AGE is compiling a more complete list of such specialty men.

Send your name and address, together with a brief description of the kinds of specialties you would like to handle, and tell us what territory you cover. This will not obligate you, but may bring to you a number of very good propositions.



Please address your reply to the Research and Marketing Division, AMERICAN BUILDER and BUILDING AGE, 105 West Adams St., Chicago, Ill.

catch buttons or hooks and the clothing is quite safe when dropped into it.

A Blower Is a Time Saver

So far the discussion has all been of materials and equipment which go into the construction of the building, but equipment used by the contractor to save time, labor, and expense should not be overlooked. In this line, the small portable blower shown in the illustration is a highly useful device.

Compressed air and various blowers are extensively used in many mechanical trades, notably the automobile repair shops. More and more, their usefulness in the building trades is being recognized. They are especially applicable in keeping the work clear in sawing and drilling and when drilling in stone, concrete and other masonry value is quickly demonstrated.



In Drilling Masonry and in Various Other Work, a Small Electric Blower Is a Time Saver to the Builder.

This blower can be plugged into any light socket as it operates on either direct or alternating current. It is equipped with eight feet of rubber covered cord. It has a handy pistol grip and weighs only five pounds.

Weatherstrip Grooving

Along with the electric blower should be mentioned another new, portable electric tool, a weatherstrip groover. It is light but ruggedly built and will give long and efficient service on heavy duty work. The handle is adjustable, to facilitate easy working; the machine is perfectly balanced and there is an automatic safety switch which releases when the grip is relaxed. There is a depth adjustment of $\frac{1}{4}$ to $\frac{1}{2}$ inch and a lateral cutting adjustment of $1\frac{1}{4}$ inches. The entire machine weighs only 7 pounds.

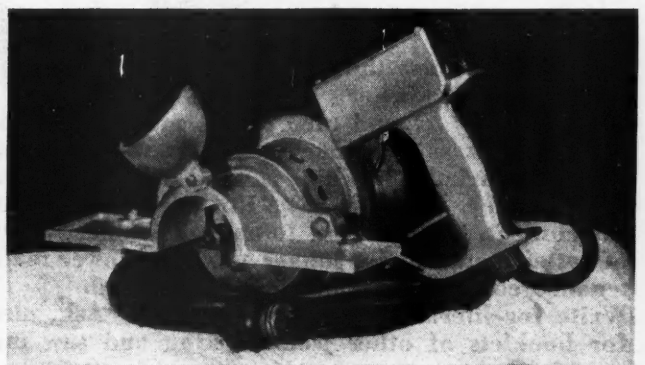

Light but Efficient on Heavy Duty Work, This Weatherstrip Groover Is a Valuable New Item of Power Construction Equipment.

a **BULLSEYE!**

for Fall Builders

PINE CRAFT
WEDGE-JOINT • WEATHER PROOF
FRAMES

Buyers inspect the frames more closely when Autumn winds begin to blow. Speed your work and your sales by using PINE CRAFT—the life-time frame with the weather-proof wedge joints.



..... *Ask
YOUR
Dealer*

PINE CRAFT Frames have double wedge-joints between pulley stile and blind stop, and a single wedge-joint between blind stop and casing.

Wauwaha County Court House, Wautoma, Wis.
E. A. Stubenrauch, Architect, Sheboygan, Wis.
New or existing buildings are prospects for Wright Rubber Tile floors.
Our Installation Instruction Booklet has been instrumental in starting many men in a profitable business. Write for a copy today.

Wright Rubber Products Co.
Racine, Wisconsin
P. O. Box A-696

WRIGHT RUBBER TILE
Rubber Only Material That Withstands Tire Road Wear

**There's Always Work
for the man who has
a REID-WAY**

The Reid-Way Whirlwind Sander offers a real money making opportunity for men who would like to increase their income. More repair work and remodeling is being done this year than ever before. You can get your share of this business with a Whirlwind. Floor surfacing and refinishing work pays good profits. The Reid-Way Whirlwind is a light weight, high speed sander at a very reasonable price. Let us show you how to increase your income with a Reid-Way. Write—



The Reid-Way Sander makes an easy job of sanding and floor surfacing. Positive control insures perfect results.

THE REID-WAY CORPORATION
2943 First Avenue
CEDAR RAPIDS, IOWA

BARCOL OVERdoor



The door opening is unobstructed

This garage, equipped with a BARCOL OVERdoor, has a free, clear entrance when the door is raised. Not one inch of door opening is taken up by the door itself when open. Other types of doors may be damaged through being struck by the car entering or leaving the garage. With the BARCOL OVERdoor this is quite impossible. In addition, neither wind, ice nor sleet can interfere with the opening or closing of this superior type of door.

An important feature of the BARCOL OVERdoor is its perfect balance. This is accomplished by the two individually "tailored" counterbalancing coil springs placed above the upper corner of each door. These springs compensate for the varying weight of the door. They can be ad-

STOCK SIZES of BARCOL OVERdoors

8'-0" x 7'-0"
8'-0" x 7'-6"
8'-0" x 8'-0"
8'-0" x 10'-0"

justed with great accuracy so that they will properly counterbalance the weight of the door at every point of its vertical travel.

The BARCOL OVERdoor is easy running, positive in closing. It is characterized by high grade hardware and millwork. Long service is built into these fine doors.

Coupon brings further information

Further information about the BARCOL OVERdoor will be sent promptly upon receipt of coupon below filled out with your name and address. Mail the coupon to us today.

BARBER-COLMAN COMPANY
ROCKFORD, ILLINOIS, U. S. A.

Also distributed by Carr, Ryder & Adams Company and affiliated houses

BARBER-COLMAN COMPANY
ROCKFORD, ILLINOIS

AB-10-31

Please send me further information about the BARCOL OVERdoor as advertised in American Builder.

Name.....
Address.....
City..... State.....

Shop Work for Rough Weather

(Continued from page 43)

mail selling, enclosing in each letter a photo or drawing of the product.

In spite of all that is said about depression and hard times, you can't get away from the fact that people will buy a product that catches their eye and is sold at a fair price. The modern woodworking machinery will enable you to do work cheaply. When the volume has increased your purchases of lumber can be done on a quantity basis that will lower costs still more.

The well equipped home workshop, power cabinet shop or manufacturing plant has worked out well for many enterprising men connected with the building industry. This winter such work will be especially appreciated and there will be a large demand for inexpensive wood products that can be given at Christmas time.

New Styles in Apartment Homes

(Continued from page 62)

sound-proofing has been one of the advances made in the past few years.

Commenting on the trend in design and equipment of the modern suburban apartment house, a well-known Eastern apartment developer recently said: "In planning and erecting our latest building, we were guided by the firm belief that the renting public has just as keen an appreciation for beauty in design, soundness in construction, and intelligent layout in apartments, as has the man or woman buying a single-family residence, and we have backed this belief with thousands of dollars, in providing features that we believe will add much to the comfort and ease of all residents."

Side Lines Can Be Profitable

(Continued from page 41)

bination electric machine which is really seven machines in one that can perform 35 different woodworking operations. This machine requires no complicated set-up; it operates from a light socket yet is strong enough to rip a 2" plank. Its compactness makes it easily installed and the favorable financial terms on which it is offered, allow almost any one to buy it.

Other woodworking machines for mortising, moulding, shaping, jointing, dadoing, sawing, etc., are now available on the market. Manufacturers are not only willing to install machines at low rates but they have gone to considerable lengths in advising buyers what can be produced in the way of marketable articles.*

More and more the successful builder is seeing the wisdom of applying machinery to his operations wherever and whenever he can. It not only cuts costs on his own work but, in the case of an electric woodworking machine, allows him to conduct such a profitable side line that it may in time become as important as his regular business. When times are slack, it is essential to develop new lines and nowhere is there a better market than in residential communities where there is a continuous demand for repairs, remodeling, and new articles and equipment of wood construction which machines can produce at a low cost.

*One manufacturer names 500 things that can be made with his combination woodworking machine, and lists the following publishers who provide books showing plans of articles that can be manufactured of wood: Popular Science Monthly, 381 4th Ave., New York City, a book costing 25c; Popular Mechanics, 200 East Ontario St., Chicago, Ill., book costing 25c; Popular Homecraft, 737 N. Michigan Ave., Chicago, Ill., book costing 35c; LePage's Craft League, 725 Essex St., Gloucester, Mass., 10c book; Wood Utilization Commission, U. S. Department of Commerce, Washington, D. C., 10c bulletin; National Lumber Manufacturers Association, 702 Transportation Bldg., Washington, D. C., free book; Science and Invention, 381 Fourth Ave., New York City, 25c book; Modern Mechanics, Robbinsdale, Minn., 25c book; American Clock Company, 1659 Ruffner St., Philadelphia, Pa., free book; Southern Pine Association, New Orleans, La., free book showing 500 articles.

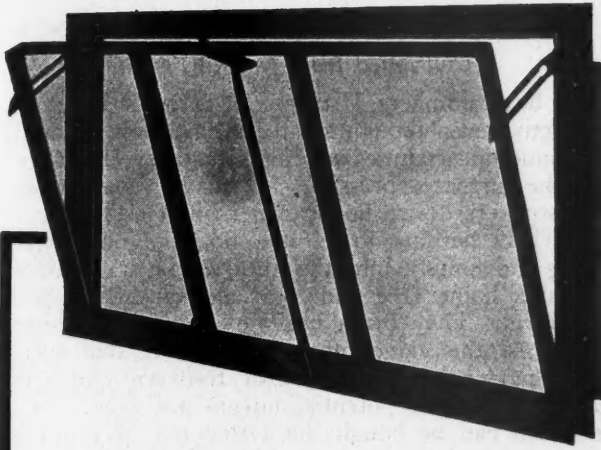

TEN CHANCES TO ONE YOU, TOO, WILL STANDARDIZE ON THE VENTO PREMIER BASEMENT WINDOW ONCE YOU HAVE INSPECTED IT AND MADE COMPARISONS

Hundreds of builders know from experience that its many practical features of convenience are a real asset in selling a home. From every angle, it's a superior product—a greater value, for it costs less installed than most well-made windows.

See the PREMIER at your building supply or lumber dealer. If he doesn't as yet have it write for name of nearby dealer who does.

VENTO STEEL SASH CO.
Puttyless Windows for Basements, Garages, Factories, Barns, etc. MUSKEGON MICHIGAN

And when it comes to the question of Glass—use A Brand You Can Depend Upon—Adamston!

PERFECTLY FLAT - - BEAUTIFUL LUSTRE -
 CLEAR VISION - GREAT TENSILE STRENGTH



ADAMSTON FLAT GLASS CO., — Clarksburg, West Va.
 Branch Sales Offices
 1 Madison Ave., NEW YORK CITY—11 So. La Salle St., CHICAGO, ILL.

Insulate
 with
**U. S.
 MINERAL WOOL**

The perfect insulator

**COLD PROOF . . HEAT PROOF . . FIRE PROOF
 SOUND PROOF VERMIN PROOF**

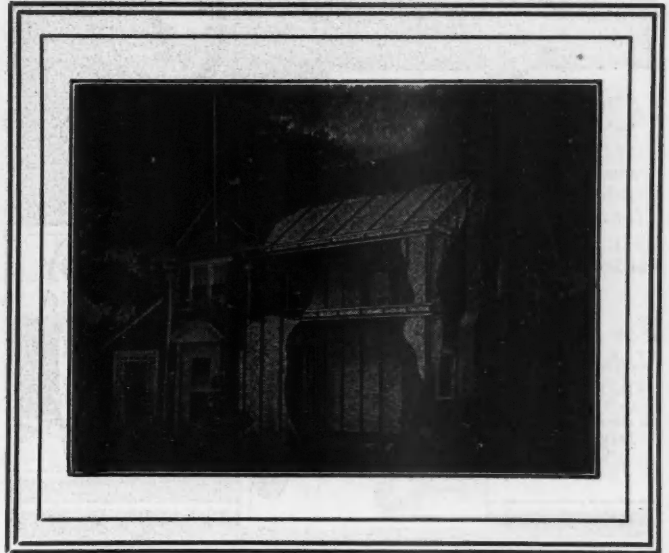

**An Unfailing, Continuous
 Money Saver**

Insulating a building with U. S. Mineral Wool is a constant source of saving, year after year. Not only does it protect from cold, heat, sound, fire and vermin, but it actually reduces annual fuel bills by about one third. This saving continues as long as the building lasts—U. S. Mineral Wool is indestructible and never requires renewing.

The first nominal cost is the last cost which will be saved many times over in the years following installation.

It is not an added building expense but a practice of real economy. It supplies the greatest living comfort obtainable in a home and protection from the elements.

Send for our FREE booklet which describes in detail the saving, protection and comfort supplied by U. S. Mineral Wool. Free sample accompanies booklet.

U. S. Mineral Wool Company
 280 Madison Avenue, New York

Western Connection

Columbia Mineral Wool Co., South Milwaukee, Wis.

U. S. MINERAL WOOL CO., DEPT. B.
 280 Madison Ave., New York.

Send FREE sample and illustrated booklet to

Name.....
 Address.....
 City.....State.....

Only \$169 F.O.B. Columbus
\$179.50 on
Rubber Tires

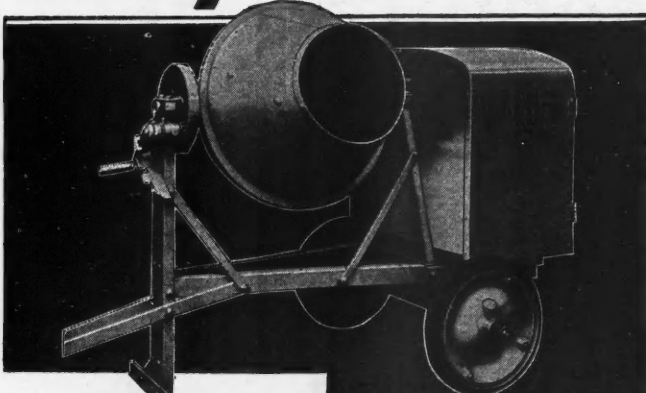

COMplete with engine and 100% Jaeger quality throughout. Only Jaeger world leadership makes possible values like this. Write for catalog, prices and terms.

THE JAEGER MACHINE CO.
521 Dublin Ave. Columbus, Ohio

For Biggest Values—

On Tilters and Non-Tilt Mixers, all sizes, let us send Jaeger's New Catalog.

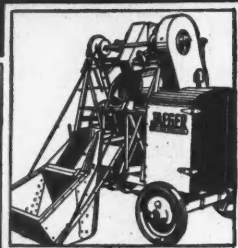
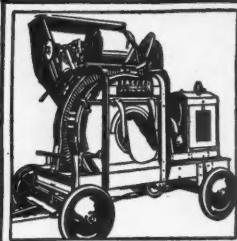

You need a

HUTHER Dado head

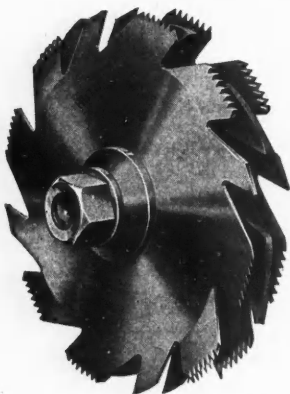

Developed from our own patents, this adjustable groover cuts either with or across the grain. Cutters may be used singly, in pairs or in any combination necessary for desired cut.

Send for one on approval. It may be returned at our expense if unsatisfactory.

Huther Bros. Saw Mfg. Co.
Rochester, N. Y.

Makers of Better Saws for More than Fifty Years

Houses for Less Than \$3,000

(Continued from page 59)

relatively large numbers, if these can be made beautiful and attractive even though small in dimension. Indeed, the economic uncertainties and fears that have been created by the current depression have made a great many salaried workers desire home ownership. (2) Most of these workers hesitate to assume financial obligations extending indefinitely into the future. Their ambition is to own a home free and clear at the earliest possible moment. They often hesitate to buy any home, regardless of the value offered, on terms that mean mortgage payments over twelve or fourteen years; on the other hand these potential buyers are eager for a home which can be bought on terms that pay out in a comparatively few months, and yet are small enough to be within the scope of a limited salary.

Exploding the Winter Building Slump Myth

(Continued from page 38)

concrete. A thermometer is also considered an important accessory, for a close check must be kept on temperature.

Steel, brick, lumber, paint and building specialties can all be handled efficiently and without undue cost during cold weather. The editors of AMERICAN BUILDER AND BUILDING AGE will be glad to supply information on winter use of any of these materials. The human element in cold weather work is one that should not be neglected, but it is also one that should not be considered an obstacle. Building workmen, just as truck drivers, railroad employees, trappers, mail men or any one of a great many trades that carry on in spite of climate, can do efficient work in winter. This has been amply proved, and some contractors claim that they get even better results from their workmen in winter than in summer.

Possibly the greatest need of the industry is a better recording of comparative costs of various winter operations. As experience is acquired, efficiency increases, costs go down. An adequate file of cost data and well-tried methods invariably put the contractor who operates in winter in a position to make more than average profit.

How They Grew

Nationwide wage scale data taken from the records of the Builders Association of Chicago on the hourly wages of certain building trades in New York, Chicago and San Francisco, during intervals of five years apart shows quite an upward trend in wage rates. 1915, 1920, 1925, and 1930 are the years taken as a basis and New York, Chicago and San Francisco are selected because they represent the extreme east, middle west and far west. The wage comparisons in condensed form follow:

BRICKLAYERS

Year	Rate per hour		
	Chicago	New York	San Francisco
1915	.75	.75	.87½
1920	1.25	1.25	1.25
1925	1.50	1.50	1.37½
1930	1.70	1.92½	1.37½

CARPENTERS

Year	Rate per hour		
	Chicago	New York	San Francisco
1915	.65	.65¼	.62½
1920	1.25	1.12½	1.06
1925	1.25	1.31	1.04
1930	1.62½	1.65	1.12½