

AMERICAN BUILDER and BUILDING AGE

(A Simmons-Boardman Publication)

54th Year FEBRUARY, 1932 Vol. 52—No. 5

Front Cover.....	Oil Painting by L. E. Arent	1
Editorials.....		22, 23
Hoover Home Loan Bill Needs Your Support. The Struggle for Reduction of Taxes.		
"Spend for the Home in 1932".....		25
Builders and Dealers Endorse Slogan Offered by Building Industry Publications.		
How Initiative and Co-operation Brought New Life to an Old Street		26-28
Oak Park's English Village Shopping Center Achieved by the Joint Efforts of Contractors, Building Owners and Financing Interests.		
Electric Refrigeration's Part in Home Modernizing.....		29
By Howard E. Blood, President Norge Corporation.		
Colonial Homes of Solid Brick for Only 6,490 Dollars.....		30-33
Philadelphia Builder Finds One Solution to the Problem of Providing a High Standard of Design, Permanent Construction and Modern Equipment at a Low Price.		
Co-ordination Increases Profits.....		34
By H. W. Lohmann, Vice-President James Stewart & Co., Inc.		
Home Design Section.....		35-40
Eight Charming Homes of Popular Size by Leading Architects.		
Four-Unit Apartment of Residential Lines.....		41
A Clever Apartment Design for a Residential Community.		
"How Can I Improve My Construction Methods,".....		42, 43
Analysis of Facts and Recommendations Contained in the Report of the Committee on Construction of The President's Conference.		
Estimating and Cost Reducing Methods of a One-Man Contracting Business.....		44, 45
By George A. Malmstedt, Building Contractor of Los Angeles.		
Air Conditioning Outstanding Innovation in the Home Moderne.....		46, 47
By A. W. Wrieden, Secretary Holland Institute of Thermology.		
Cost Analysis of the "House of the Month".....		48
The House of the Month.....		49-53
Pen and Ink Perspective and One-Eighth Inch Scale Drawings of Colonial Home of Stone and Wood, to Cost About \$24,000.		
Master Specifications for Good Carpentry Construction.....		54-57
Part II of the Weyerhaeuser Model Specifications (With Details of Construction) Begun in the January Issue.		
"Build Now," Advises John McSorley.....		58-59
Pittsburgh Builder Finds it Profitable to Take Advantage of Lowered Building Costs and Modern Building Systems.		
Modernizing Transforms Old Store to Rent Producer.....		60
How Builders Are Helping Merchants to Revive Business.		
Now in Business for Himself.....		61
Philadelphia Cabinet Maker Finds Profits in Machine Wood Working.		
Revolutionary Improvements in Double Hung Windows.....		62, 63
New Window is Supported by Coil Spring, Is Metal Weatherstripped and Completely Fitted at the Factory.		
What's New in Building Materials and Equipment.....		64-68
Practical Job Pointers.....		70-72
News of the Industry.....		74-76
Advertisers' Index.....		87

AMERICAN BUILDER and BUILDING AGE

IS THE BUSINESS
JOURNAL OF THE
ACTIVE MEN OF THE
BUILDING INDUSTRY

SUBSCRIPTION RATES— One year, United States, Mexico and U. S. Possessions, \$2.00; six months, \$1.00; single copy, 35 cents. Canada, one year, including duty, \$2.50; other foreign countries, \$4.00. **ADVERTISING RATES**—Furnished on application. Advertising forms close on the 10th of the month preceding date of publication. Entire contents copyright, 1932, by American Builder Publishing Corporation.

MEMBER OF THE AUDIT BUREAU OF CIRCULATIONS
AND OF THE ASSOCIATED BUSINESS PAPERS

AMERICAN BUILDER AND BUILDING AGE, with which are incorporated Building Developer, Home Building, National Builder, Permanent Builder, and the Builder's Journal, is published on the first day of each month by the American Builder Publishing Corporation.

Henry Lee, Chairman of Board; Samuel O. Dunn, President; Bernard L. Johnson, Robert H. Morris and Delbert W. Smith, Vice Presidents; Elmer T. Howson, Secretary; John T. De Mott, Treasurer.

Bernard L. Johnson, Editor; Joseph B. Mason, Managing Editor; R. H. Mathewson, Eastern Editor; H. F. Lane, Washington Editor; P. W. Hanna, L. E. Arent, Associate Editors; Robert H. Morris, Business Manager.

EDITORIAL AND PUBLICATION OFFICE: 105 W. Adams St., Chicago; Telephone, Randolph 0794. Branch Offices: New York, 30 Church St.; Cleveland, Terminal Tower; Washington, 17th and H Sts., N. W.; San Francisco, 215 Market St.



1932 MODEL "OVERHEAD DOOR"

Evidence

AFTER MANY YEARS of unremitting daily service in summer's heat and winter's icy blasts, the doors pictured on this page, like "Overhead Doors" everywhere, are in perfect operation. All over the world, in all climates, under all sorts of conditions, their smoothly perfect functioning is convincing testimony of their correctness of design and construction, as well as the alertness, thoroughness and efficiency of our sales and service organization. More than ten years of such service, better now than ever, is insurance to builders and owners that we assume all of the responsibility for the continuous satisfactory operation of every door bearing our name. Behind The "Overhead Door," every owner and every contractor builder who specifies it, stands this guarantee of service.

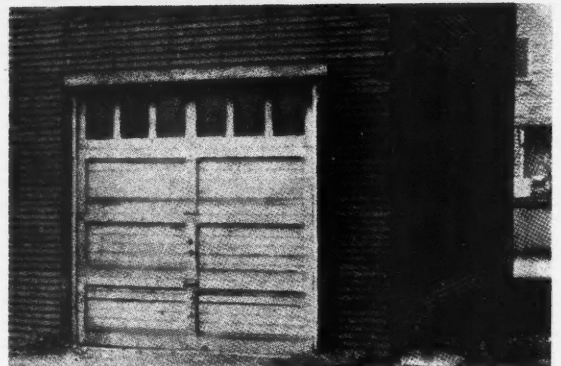

Installed in 1921. Still operating satisfactorily. Particulars on request.



Installed in 1924. Still working smoothly. Particulars on request.



Installed in 1927. In daily satisfactory use. Particulars on request.

Specify
The
"OVERHEAD DOOR"
REG. U.S. PAT. OFFICE
for
GARAGE-FACORY-WAREHOUSE
OVERHEAD DOOR CORPORATION
Dept. 322
Hartford City, Indiana, U. S. A.
Made in Canada by
Overhead Door Company of Canada, Limited, Toronto 3, Ontario

Copyright 1932
O. D. Corp.



AMERICAN BUILDER AND BUILDING AGE

HOOVER HOME LOAN BILL NEEDS YOUR SUPPORT!

OPPOSITION to the administration program for home financing has developed; and those favoring it should lose no time in rallying to its support.

The mortgage bankers are against the proposition. They have come out into the open and are denouncing the Hoover home loan proposal as dangerous, not needed and unworkable. They charge that it will stimulate home building and so tend to depreciate the value of all existing homes and the mortgages thereon. They maintain that there is at present an over-supply of housing, and are suggesting that the home building industry should take a five-year vacation until the demand catches up with the present supply.

Hiram S. Cody, president of the Mortgage Bankers Association of America, appeared on January 19 before the Senate sub-committee conducting public hearings on the pending Watson federal home loan bank bill, and presented the mortgage bankers' arguments against the passage of this act setting up a "federal reserve system" for home financing as advocated by President Hoover and endorsed unanimously by the recent national Conference on Home Building and Home Ownership.

Some Fear It Will, Some Fear It Won't

The mortgage bankers' apprehension that this act, if passed, will unduly stimulate new home building balances nicely the only other objection to the plan that this publication has so far encountered—namely, that it *will not* stimulate additional home building, but will only relieve the frozen condition of many loaning institutions and the embarrassment of many present home owners who are threatened with the loss of their homes because of the inability or unwillingness of the present home loan system to refinance their mortgages.

The President's plan was first opposed by those who felt that it would not stimulate new home building, and now it is opposed by those who fear that it will stimulate new home building! Mr. Cody referred to the

present housing situation as "over-built." That is not the right word. A truer characterization would be that housing is *doubled-up*. Tens of thousands of families—much against their will—have been forced to give up their independent homes and apartments because of unemployment and are now living with relatives or neighbors. A revival of general business, such as home building activity will help to bring about, will quickly put these families back into separate domiciles, with the result that any present over-supply of housing would soon become a shortage.

Are Mortgage Funds Ample in Your Town?

Mr. Cody, in his statement to Senator Watson's committee, maintains that the mortgage bankers are able, and in fact at the present time, are taking care of all proper home loan requirements. Many others, however, appearing before the committee, including prominent building and loan association officials, have testified that from one-third to one-half of all the home mortgages in certain communities are now in default largely because no funds are available under present conditions for mortgage extensions and refinancing. Also the testimony shows that a great many loaning agencies will certainly break down if not promptly assisted.

While the men active in the building industry are primarily interested in the encouragement of new construction, it is evident that the distress among present owners must be relieved before much can be done to induce additional families to become home buyers. The first step toward normal home building is to re-establish the public's confidence in home owning; and the provisions of this home loan bill are admirably designed to accomplish this, not only as an emergency measure but also as a greatly needed permanent institution for the service and guidance of the home building industry.

The opposition of the mortgage bankers to this pending legislation should call to its active support all builders, dealers, manufacturers, architects, building and loan men and realtors—also all home owners who are worried about their mortgage renewals. Write your

senators and your congressmen; let them understand in no uncertain terms that you want this home loan bill passed and passed promptly.

The sub-committee of the senate committee on Banking and Currency which is now holding public hearings on the Watson home loan bank bill (S. 2959) consists of Senators James E. Watson (Indiana), P. Lee Goldsborough (Maryland), Cameron Morrison (North Carolina), James Couzens (Michigan) and Robert J. Bulkley (Ohio). They are offering those interested every opportunity to express their views on this important piece of constructive legislation.

THE STRUGGLE FOR REDUCTION OF TAXES

A CONDITION which is affecting all industries adversely, and the building industry, perhaps, more than any other, is the enormous burden of taxation which has been loaded upon the backs of the American people. Attention repeatedly has been called in these columns to this situation. From 1924 to 1930 the expenditures of our federal government increased \$487,500,000 annually. From 1923 to 1928 the expenditures of our local and state governments increased \$2,261,000,000 annually. In other words, within a period of some seven years the total burden of taxation was increased about three billion dollars annually.

Four-fifths of this increase was made by the local and state governments. These governments derive most of their revenues from general property taxes, and, because real estate cannot escape the eye of the assessor, every increase in general property taxes results in a disproportionately greater increase in the taxation of real estate. An increase in the taxes upon any kind of property, like any other increase in the cost of owning it, reduces the desirability of owning it, and therefore it is not surprising that the first major decline in business which marked the beginning of the end of our prosperity was the decline in residential construction.

But the Turn Has Come

There is now an almost universal movement by property owners throughout the nation for sweeping reduction of all government expenditures and of taxation, and real progress is beginning to be made. The AMERICAN BUILDER AND BUILDING AGE has the satisfaction of being able to call the attention of its readers to the fact that it largely helped to start this movement, because it was one of the first publications in the United States to declare and support with conclusive evidence, in an editorial that was widely quoted, the proposition that the enormous increase in taxes was one of the main causes of the depression and probably the main cause of its prolongation and deepening.

As the enormous increase in taxation contributed

largely toward reducing residential construction, so it has contributed largely toward preventing a revival of it. The taxes paid by the American people in 1929 amounted to about 14½ per cent of the total national income. Because the incomes of every class, and therefore the total national income, have greatly declined since then, while government expenditures have not, the total taxes paid in 1931 are probably not far from 25 per cent of the total national income.

We have no disposition to indulge in captious criticism of the efforts of public men to reduce unemployment and revive business; but in the opinion of this publication, most recent efforts of this kind have been misdirected. We cannot increase expenditures upon public works without increasing taxes and thereby taking from private business and the owners of private property the means of giving employment. What we should do is to reverse this process. We should reduce government expenditures and taxes, and especially taxes upon real estate, and thus help to make it possible for private business in general, and the great building industry in particular, to give more employment.

Secretary Hurley Spots the Fallacy

It is highly significant, as indicating the attitude of the Hoover administration, that Secretary of War Hurley, in an address in Chicago on January 22, expressed exactly this view; and denounced numerous efforts that are being made to increase present government expenditures upon public works. How necessary is the strongest opposition to government expenditures that will increase taxes is indicated by the fact that Secretary Hurley made the startling statement that bills already introduced during this session of Congress to "revive" prosperity would, if passed, actually cause bond issues by the federal government aggregating *twenty-nine billion dollars*.

Will taxes actually be reduced and made more equitable? Not unless those who recognize the need for these changes put such pressure upon every class of public officials as will force them to be made. Unfortunately some of the strongest opposition will come from business interests that profess to want government in business and government expenditures reduced. No matter what kind of government expenditures you attack, or what changes in taxation you advocate, you will immediately meet with opposition; but one important fact we must all recognize. This is, that the total amount of taxes must be reduced. Our local and state governments are heading straight for bankruptcy, and even our federal government will have a deficit this year of \$2,000,000,000. Meantime, the enormous burden of taxation is affecting adversely our entire industry and commerce. Business will revive owing to other changes in conditions that are occurring, but our new prosperity will be brief unless we compel our governments to reduce their expenditures to a much more reasonable basis.

"SPEND FOR THE HOME IN 1932"

Business Slogan Offered by
Building Industry Publications

Use it to Mold Public Sentiment
in Your Community Toward
Sane Thrift and Investment

IN 1932, the building industry is called upon to face the tremendous pressure of inter-industry competition with a united front. In the preparations for merchandising supremacy in 1932 among the industries, some leading business papers of the building industry have adopted and are recommending to dealers, builders and manufacturers a slogan: "Spend for the Home in 1932!" The plan is spreading.

At a meeting of a group of men, representing various building journals, held in Chicago on December 29, this slogan was proposed by the publishers of "Domestic Engineering" and accepted by all of the building industry publications as one behind which the entire industry might unite; each unit in the industry working on its own method of bringing the idea—"Spend for the Home in 1932!"—to the public.

At the annual convention of the Illinois Builders League, held in Chicago on Jan. 11 to 13, a resolution was unanimously adopted, endorsing this slogan, on its presentation by a representative of AMERICAN BUILDER AND BUILDING AGE. This slogan is not copyrighted nor patented; and there is no restriction of any sort on its use. It is free for your use in any way you desire.

Among all of the industries interested in the American home, there are powerful organizations which, in their respective fields, can make this idea so prominent during 1932 that a far greater portion of American earnings will go into the home than has ever before been the case.

Every movement of this kind, if it is to succeed, must be based upon an idea that will meet with sympathetic public response. Good organization and aggressiveness will give any movement some success; but good organization and aggressiveness, put back of a movement that actually meshes with the state of mind of the general public, will be irresistible. The "Own Your Home" and the "Keep Your Home in Good Repair" movements of recent years were splendid examples.

It may be stated without qualification that the public is today ready to catch at the idea of "spending for the home." Perhaps no more striking way of stating this fact can be found than the remark, made by a man whose experience in advertising and promotional work makes it possible for him to speak with authority: "The American people have come home."

That is true. There is hardly a man or woman in America who has not been affected by the conditions through which we have been passing. Reduced earnings, whether from salaries or investments, uncertainty as to the future course of things, and a realization that there was something fundamentally unsound in the frenzied spending of recent years, have given men and women a more sober viewpoint.

Hundreds of thousands of families have been thrown back on their homes for their entertainment. And what was "good enough" when people didn't spend a great deal of time in the home is now seen as second-rate; and people who have begun to center their social lives about their homes are also beginning to realize a need for making those homes more beautiful and more convenient.

Thus, psychologically, and under economic pressure, the American public is ready to hearken to the message: "Spend for the Home in 1932." Perhaps in the years when it seemed easy to make money in the market, the idea that investment in the home paid good dividends had a difficult time to secure a hearing. But time has taught the American people a lesson—and no doubt the most powerful of all of the arguments that may be brought to bear in putting over the idea of spending for the home will be just that one—money invested in the home does pay big dividends in comfort, convenience, added value and added prestige.

The "Spend for the Home in 1932" movement will unquestionably be a powerful factor in the early revival of business. This publication recommends its wide use by builders, dealers and manufacturers, in their advertising and sales work throughout 1932.—THE EDITORS.

**SPEND
FOR THE
HOME
IN
1932**

**YOUR SAFEST
AND BEST
INVESTMENT**

How Initiative and Co-operation

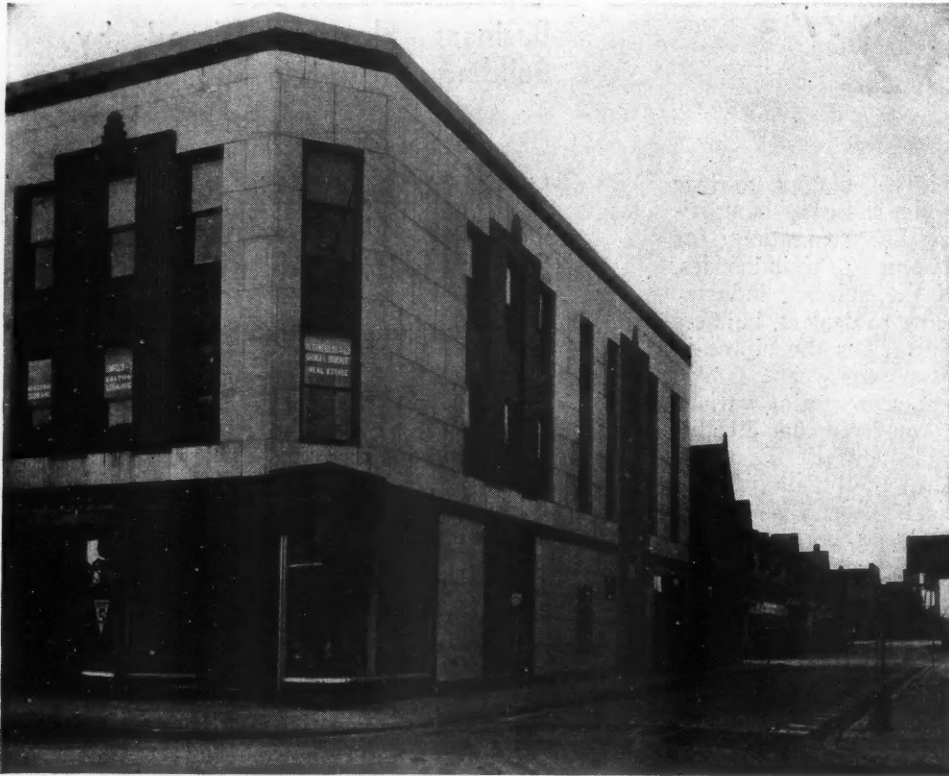

A Modernizing and Building Program Which Was Carried through by the Joint Efforts of Contractors and Building Owners of the Community.

Looking Down Westgate from Marion Street Showing the Old Buildings Now Remodeled Into "English Village" Shops.

THERE is no building depression in the principal business district of Oak Park, Ill., and the activity there is all due to co-operative effort on the part of contractors, owners, financing interests and business men. This co-operative effort has resulted in the rebuilding of an entire street, once known as William Street, but now renamed Westgate.

Most of the business in Oak Park, a suburban community adjoining Chicago, is located on Lake and Marion Streets. Their intersection is the business center not only of Oak Park but of the neighboring communities of River Forest and Forest Park. Half a block south of Lake Street was William Street, just one block long and extending parallel with Lake Street from Marion Street to Harlem Avenue.

For years William Street never amounted to much and, since the days of the automobile, has been given over largely to garages. It was a narrow street, little more than an alley, and no one ever expected much from it till a certain young contractor, Paul F. Desmond, conceived the idea of remodeling it into an old English Village, lined with shops of appropriate architectural style.

Three years ago, Mr. Desmond, junior partner in the firm of Desmond and Son, contractors, first realized the possibilities of William Street. Desmond is not only a contractor but also a skillful designer. He set to work to develop his idea and produced a sketch of William Street as it would look if his plan was carried out.

Armed with this sketch he gathered together a group of the principal owners of property in the neighborhood and presented the plan. It was received with enthusiasm; and a committee, with Desmond as chairman, was named to work it out.

Because of other extensive activity at the time the project was not undertaken immediately but later when building began to go from bad to worse the idea was revived. A promotional committee was appointed to carry it forward. The new committee was headed by R. E. Nickolas, head of a local financing organization who had already developed much of the business prop-



Looking Down William Street from Marion Street Before the Remodeling Project Converted It Into Westgate.

Brought New Life to an Old Street

The Story of Westgate an "English Village" Community Shopping Center in Oak Park, Ill.

Construction Work Is Under Way on the \$800,000 Goldberg Building Which, With 185 Feet Front on Westgate, Becomes a Part of the English Village Project.

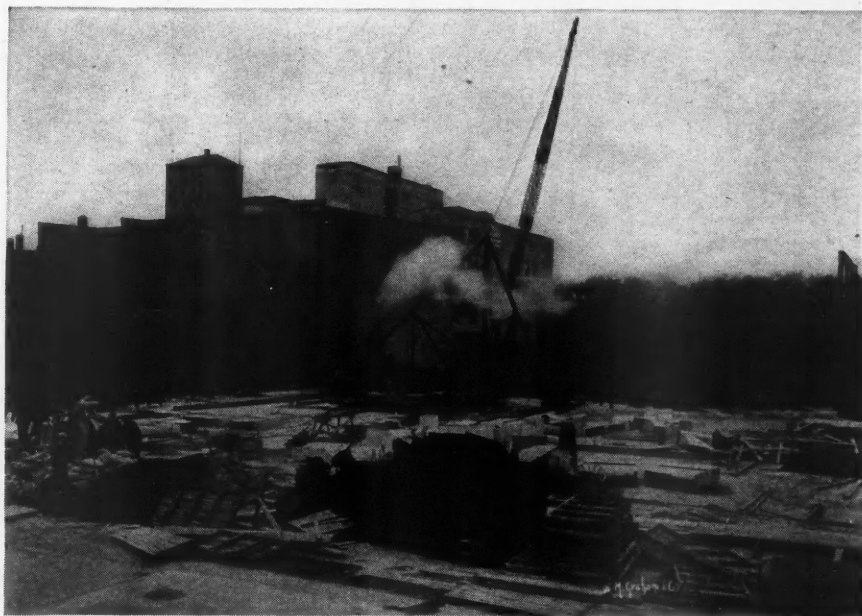

erty in the surrounding business community.

This time it was decided to widen the street before undertaking the remodeling of buildings. Quite a number of property owners were involved but Mr. Nickolas, with the co-operation of other business men in the community, secured the necessary consents for the widening. Every property owner on the street also subscribed to a "gentlemen's agreement" to remodel his building in English style. Then the actual work began and it has gone far toward maintaining a normal building volume for Oak Park. In addition it has played a part in an unusual situation which is described by Mr. Nickolas as follows:

"This Oak Park business district has probably suffered less from business conditions than any other in the country. In fact, there has been no decrease in property value, not a single sale or lease has been made in this district at a reduced price in the last two years of business stringency. A careful survey of the district will show that there is practically no vacant store property.

"What we are doing in this Westgate development

could just as well be done in many other communities," Mr. Nickolas continued. "There are many business streets, laid out in the old days before the automobile, that are too narrow under present day conditions. The congestion that results retards the development of business along the street. A program of widening and remodeling would put new life into every business.

"Then too, it is natural for a group of small stores and shops to grow up around a main business district. They supplement the larger establishments and each helps the other. This has been recognized by Oak Park merchants along Lake Street who willingly agreed to pay a small, proportionate share of the street widening assessment."

When work was begun on William Street, the fronts of the old garage buildings were torn away to allow for street widening. New fronts in English style were built and the old buildings were converted into shops, studio apartments, offices and tea rooms. Property values on the street, now called Westgate in keeping with its new

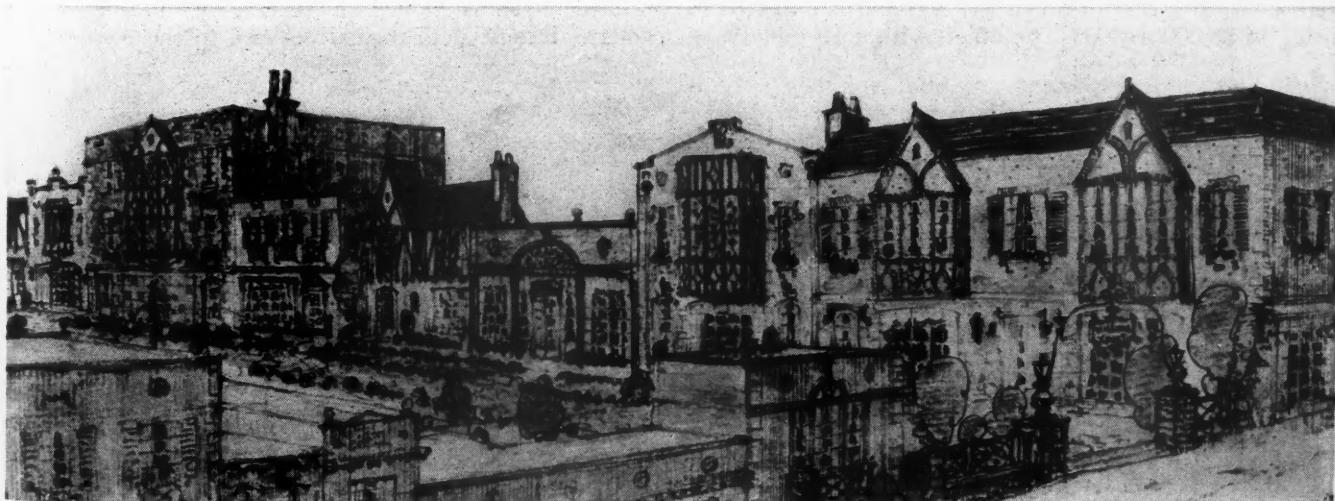

The Original Sketch Made by Paul F. Desmond, of Desmond & Son, Contractors, Showing the Plan Which Has Developed Into a Big Co-operative Project and Has Maintained Building Activity and Increased Property Values in Oak Park's Principal Business District.



At the Left: The Westgate Front of the New Goldberg Building as It Will Look When Completed.

Below: The Lake Street Front of the Goldberg Building with Westgate Visible at the Far End of the Court. Leichenko & Esser, Architects.

character, jumped amazingly.

On the corner of Marion Street a three story building had already been remodeled in a modern style satisfactory to the new plan, but just to the rear of it was a one story garage. This was remodeled at a cost of \$12,500 into a shop and office building with an expected income of \$3,500 a year.

A 50-foot garage was remodeled at a cost of \$35,000 into three shops with three studio apartments above. It will bring an income of \$9,000 a year. A 65-foot shop and loft building was next in line. About \$20,000 was spent on converting it into three stores with offices above. The expected income is about \$7,000 a year.

Beyond this building was the Wieland dairy barn. While the dairy company perhaps would not profit so directly from remodeling, nevertheless it joined in on the plan and put an English front on its building.

The next building was a 50-foot shop owned by Desmond and Son, the contractors. It too was remodeled at a cost of about \$7,500 and is expected to produce an income of \$3,000 a year.

On the opposite side of the street there were two adjoining garage buildings. Each of these was producing an income of about \$150 to \$200 a month. One was remodeled at a cost of about \$17,500 and is expected to bring in \$6,000 a year. The other, with a 50-foot front,



was remodeled at a cost of \$22,000 into stores and, on the second floor a tea room. The expected income for the next five years is \$7,500 a year.

The skeptical might say that expected income means little; but in this case they would be wrong. In spite of the fact that these remodeling jobs were complete in December and January, a decidedly off season for renting, most of the space has already been rented.

The biggest job in the whole project is a new, two-story, store and office building which is being erected by Sol H. Goldberg on the north side of Westgate.

All told, the enterprise and co-operative effort of this group of builders, architects and property owners has created business valued at several hundred thousand dollars, beneficial to themselves and to the community.



Two Views Showing the Actual Work of Remodeling the Old William Street Buildings in the Westgate "English Village" Project in Which the Entire Business Community Has Co-operated to Maintain Normal Conditions and Normal Values in a Period of Business Stringency.

Electric Refrigeration's Part in Home Modernizing

By HOWARD E. BLOOD

President, Norge Corporation

TODAY'S markets are every bit as much the product of psychology as they are of product-ability. As a matter of fact, the element of psychology plays a primary role. A very powerful illustration of this fact recently came to my personal attention.

Not every long ago a certain family installed a new electric refrigerator. The older one had been in use for a number of years; it was dilapidated in appearance, undependable and anything but economical in use. The new refrigerator was styled in the modern manner; it offered an entirely new concept of food preservation; more, it was equipped with those accepted and standard devices such as cold control, freezing compartment, defrosting switch and hydrating tray, which were quite new and altogether novel to the purchaser who had used the old type refrigerator for so long. All in all, the new appliance was a source of joy to the housewife and interest to her entire family. Like all women, this purchaser was proud of her new refrigerator. She asked a few neighbors in to see it and then—she saw the new refrigerator had made her kitchen look somehow "different." The room that had sufficed her family for years was found inadequate. The size and arrangement were all right but the painted walls now looked tawdry, the old linoleum was an eyesore, the kitchen cabinet needed painting, the range was ancient as the ice-box which had just been displaced—the whole room was anything but pleasing to its owner.

This kitchen had to be completely re-styled. A new gas range was installed, a new kitchen cabinet secured, new linoleum laid, the walls and ceiling were redecorated. In a word, the kitchen was completely done over. And it was the new electric refrigerator which started the realization that here in the kitchen was a much-used room totally out of keeping with all that is desirable according to the modern idea as promulgated by women's magazinees, women's pages of newspapers, the department and house-furnishing stores, and in advertisements of home wares; in fact, in the homes of this woman's own friends. The home modernization did not stop there with the kitchen. The purchase of the electric refrigerator was the motivating urge to step-up the plane of the entire home. Purchases of new appliances, furniture and furnishings, chiefly for the replacement of obsolete items, cost hundreds of dollars. And this one case, cited from my own observation, is typical of what is going on in thousands and thousands of homes through the United States.

It is perfectly understandable, this phenomenon which calls for a single purchase and ends only when the entire home has been changed to meet the stimulated desire for betterment of existing furnishings. Consider: a brand new electric refrigerator is installed in the home, somewhere in the kitchen. Immediately, that kitchen becomes the center of attraction. The woman of the house pridefully shows it to her visitors. It is some-



HOWARD E. BLOOD

thing new; something only 21 per cent of American families have as yet. And, because she is constantly alert to the newness of her refrigerator, the housewife comes to look upon other furniture in the kitchen much as do her visitors. She sees the kitchen through newly critical eyes.

Thereupon she goes about refurbishing that kitchen. When that is done the rest of her home takes on a new significance. It, too, must be stepped-up to conform with the bright spot of the house, the kitchen. So the process continues and is completed only when milady of the household has what is virtually a new home.

So much for the refurbishing of homes that are standing; homes that have been lived in for a period of, let us say, ten years. What about the brand new home which is planned or building? How can the electric refrigerator be called a factor in the development of the modern new home?

Look at any newspaper offering of small homes. Note the features listed. Prominent is the statement, "Electric Refrigeration." For this is one of the definite appliances which the prospective tenant or purchaser has come to expect. Electric refrigeration is an accepted fact. More, it is an *expected* fact. That is why the builder is vitally interested in tying-in with the merit of a well-known manufacturer.

Then there is the problem of the apartment house owner. Countless instances have been reported to show the increased percentage of rentals due to the instal-

(Continued to page 78)

Colonial Homes of S

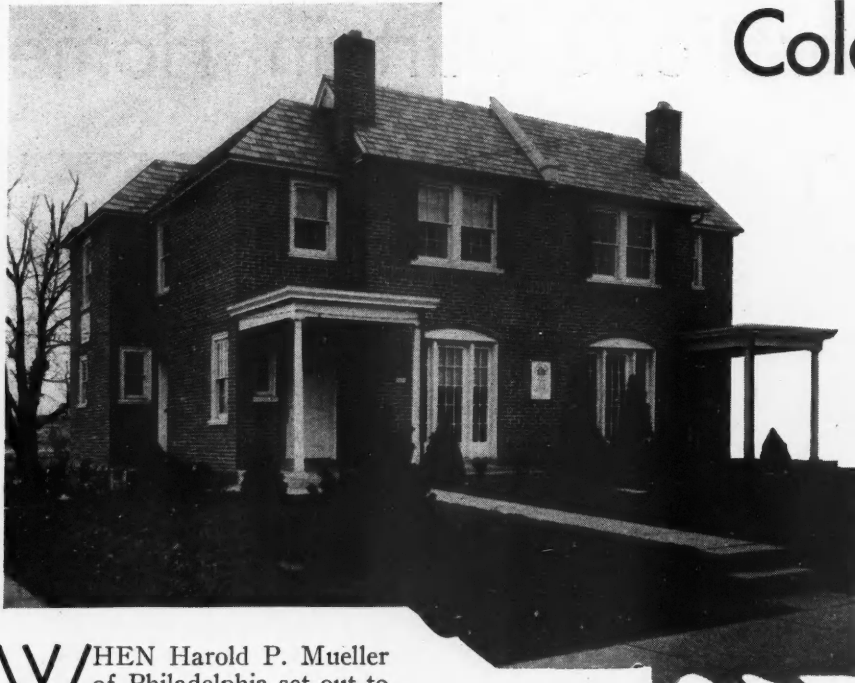

One of the three distinct duplex Colonial types of solid brick that Harold P. Mueller of Philadelphia has built to sell for \$6,490. Each half contains a house of six rooms and a bath as shown in the plans below. Every home receives plenty of air and light and there is an abundance of individual yard space. Features of equipment include first floor construction of steel and concrete, copper piping, and recessed radiation.

WHEN Harold P. Mueller of Philadelphia set out to build a solid brick house with a high standard of design, permanent construction, roomy interiors, the best of modern equipment, adequate air and light at all times and wholesome surroundings, for a price the average family could afford to pay, he was undertaking a feat concerning which there has been a great deal of fine talk but not much in the way of performance. Frankly, his fellow builders were a little skeptical about some of his ideas and questioned his ability to construct the house he talked about for the price he set—\$6,500 or under.

But Mueller had heard about the investigations of President Hoover's Conference on Home Building and Home Ownership. Was it possible to build a house, containing five or six rooms and all modern conveniences, of attractive architecture and permanent construction for a low price? This was the ideal. Could it be reached? Mueller thought so and he was willing to try.

He had had a wide construction experience in industrial and commercial, as well as residential building. He had worked his way through Purdue University and come out as a full-fledged engineer. His residential work had given him a keen eye for design, an expert knowledge of interior layout, a shrewd appraisal of equipment and material, and his experience in the handling of labor topped off these other valuable qualifications.

First he laid down six objectives toward which all his plans had to lead:

1. Permanent construction with a minimum of upkeep cost and a minimum of obsolescence.
2. Roomy, well-lighted and ventilated interiors.
3. First-class complete modern equipment of the latest type thoroughly tested and proven.
4. Plenty of air and light.
5. Adequate yard space.
6. An absolute maximum price of \$6,500.

These have all been the major aims of the residential building in the low price field for some time, but many have hitherto believed it impossible to accomplish all of these objectives for the price stipulated.

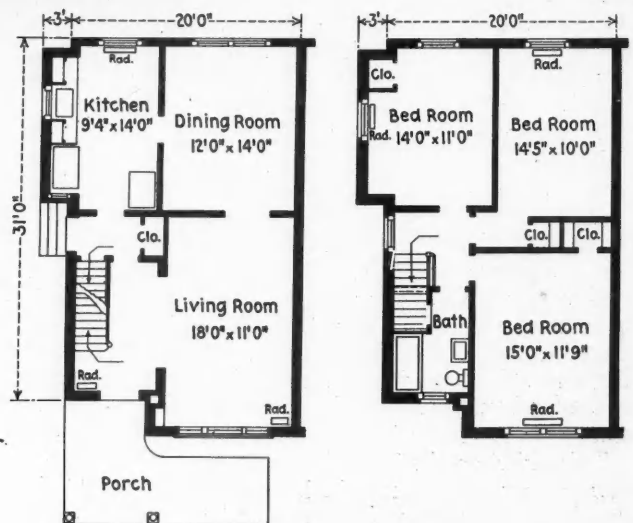

A rear yard of more than forty feet in depth is provided. The cellar garages are reached over driveways of concrete.

Solid Brick for Only 6490 Dollars

Philadelphia Builder Finds One Solution to the Problem of Providing a High Standard of Design, Permanent Construction and Complete Modern Equipment at a Low Price

Mueller did it by working out three distinct twin or duplex designs, that enabled him to combine the elements of mass production with the advantages of detached design. Into these handsomely designed, solid brick homes he put several advanced construction and equipment features, often not found in homes costing \$25,000: Steel and concrete first-floor construction, recessed radiation, copper plumbing, latest type of kitchen conveniences, and other features. The illustrations on these pages, combined with the plot and interior layouts, as well as the list of specification features, tell the story of his accomplishment. But the question immediately asked is: "How did he do it?"

Mueller himself says it was accomplished only after months of continuous effort, along with the co-operation of contractors and manufacturers of nationally known products, who sold their products and services at the lowest possible prices. Such well-known products as

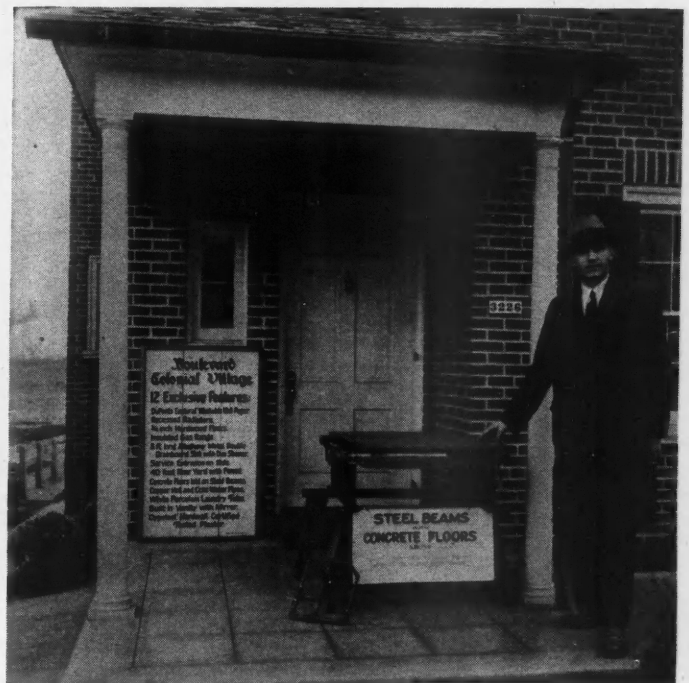

Harold P. Mueller applied big construction methods to the building of fine residences.

A street of 36 fine Colonial homes, semi-detached, with plenty of ground space. (Floor plans shown in plot plan below were somewhat changed in construction.)

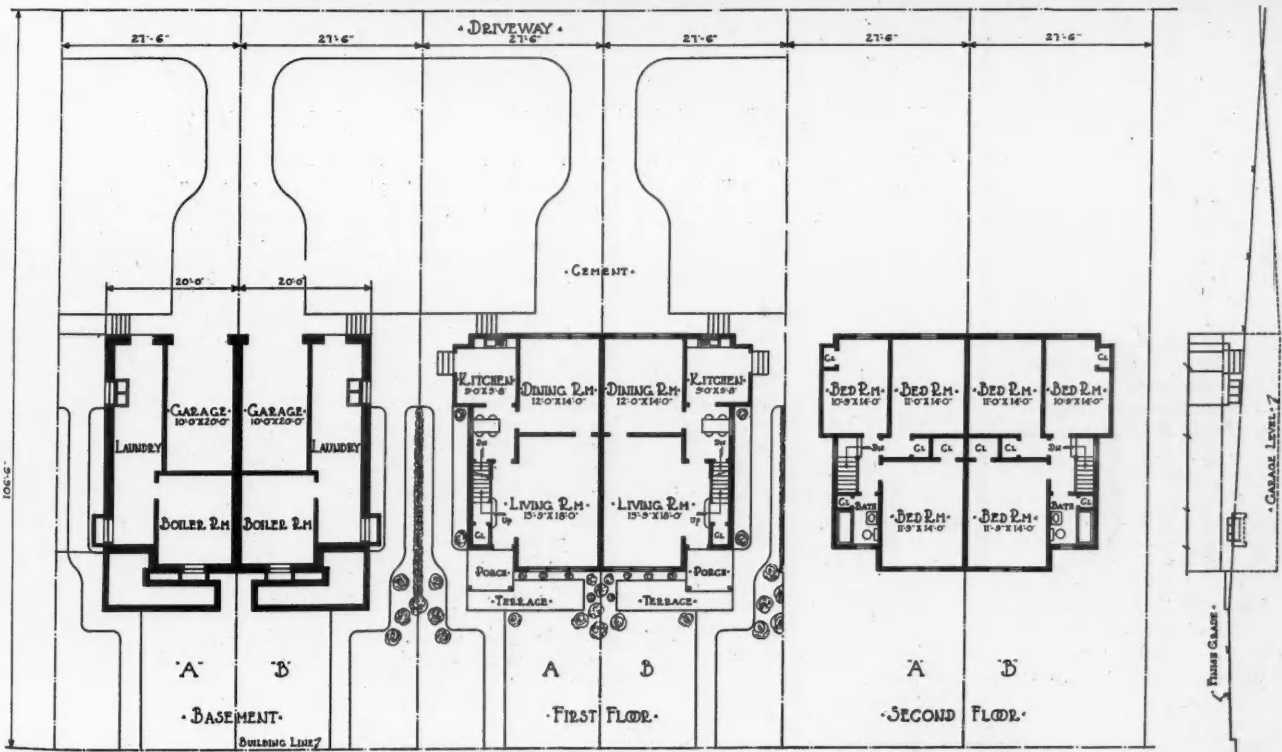

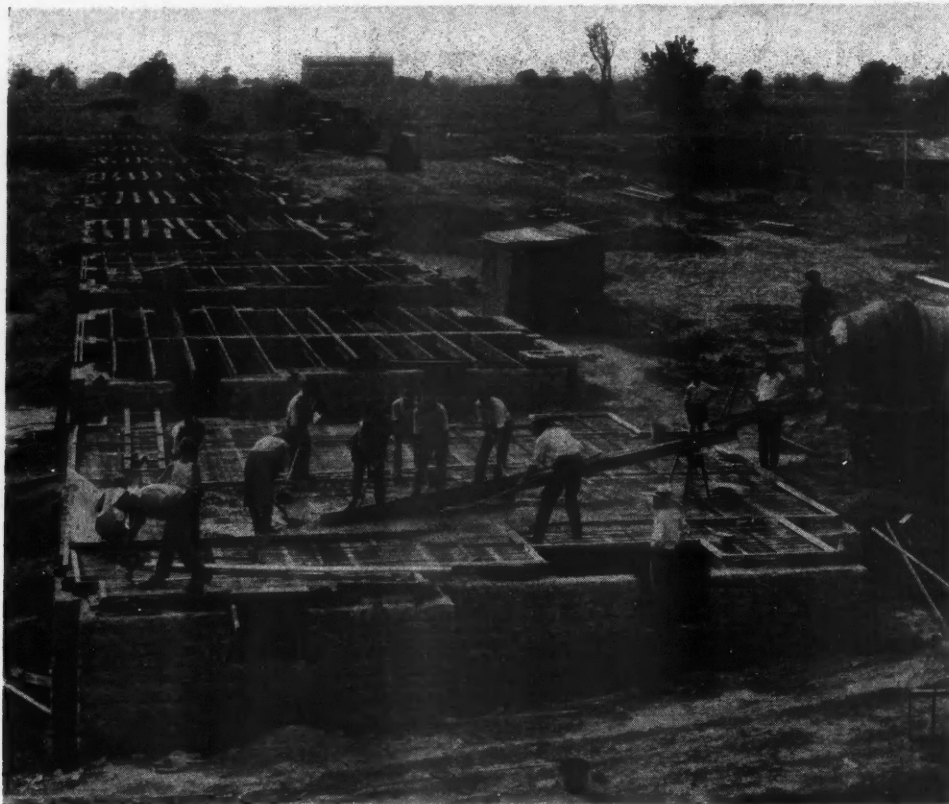

Concrete was poured around steel beams and reinforcing rods, with an under-support of wood forms, to a thickness of 2 1/2 inches. The resulting first floor construction is not only strong but makes a fireproof basement.

Jones & Laughlin copper bearing open hearth Junior Steel Beams, Warner Co.'s Central Mixed Certified Concrete, Kohler of Kohler Plumbing Fixtures, Mueller Streamline Copper Pipe, U. S. Radiator Co.'s Recessed Mural Radiators, Wood Mosaic Mastic Hardwood Flooring, Structural Gypsum Corp.'s Gypsteel Plaster and many others, were used.

In building a group of 36, solid brick houses, for a price of \$6,490, Mr. Mueller has endeavored to follow out what he believes are the aims of President Hoover's Conference on Home Building and Home Ownership.

His semi-detached homes are placed on lots 27 1/2 feet wide by 106 1/2 feet deep and are set back 42 feet from

the curb. There is a space of fifteen feet between houses and between halves of each house there is a brick party wall. Each house measures 32 1/2 feet by 23 feet and is of solid brick construction with a foundation of stone. The open front porch is a feature appreciated by many Philadelphians and this looks out upon a front lawn much larger than the average. The 42-foot yard in the rear is large enough to permit plantings. The builder has placed a neat, open fence between each plot in the rear and a trellis for roses is provided. A concrete driveway runs the length of the street in the rear, with individual driveways of concrete leading into cellar garages.

The twin house design gives three wall exposures. Face brick is used on front, side and rear. Roofs are of variegated slate. Copper gutters and spoutings have been used throughout.

The first floor construction consists of steel beams, supporting a reinforced concrete slab. The steel beams are 9 inches deep, spaced on 30-inch centers. The reinforced concrete slab is 2 1/2" thick, with reinforcing spaced 6-inch centers across the steel beams. The operation of pouring the floor is shown in one of the illustrations. The cost of putting in this fireproof cellar for thirty-six houses is said not to have exceeded ordinary construction because of the saving in labor.

The flooring placed on this steel and concrete construction consists of wooden blocks of oak 1 3/8" thick, tongued and grooved, which are embedded in a special mastic adhesive laid directly on the concrete.

The interiors of these Colonial brick homes bear

SPECIFICATIONS AND FEATURES OF MUELLER HOMES

EXTERIOR

Colonial architecture (3 distinctive types).

Open porch and terrace.

Three exposures.

Face brick-front, side and rear.

Variiegated slate roof and Philip Carey 10-year guaranteed roof.

Copper gutter and spoutings. Schlage brass unit locks throughout.

Individual sidewalks, front and rear.

Colonial fence separating rear yards with rose arbor. Ample space for flower gardens in 40-ft. rear yard.

Majestic, in-the-ground, garbage receiver.

FIRST FLOOR

Concrete floors laid on steel beams.

Recessed U. S. Radiation (Capital mural cabinet design).

Hall direct from front door to kitchen.

13/16" tongue and grooved hardwood floors laid in mastic on concrete.

Red Seal Electric Home.

Bakelite switch plates and duplex receptacles.

Cove moulding around living and dining room.

Inside radio aerial and ground.

Gypsteel hard wall plaster.

All brass sash lifts and fasteners.

All windows hung with sash chain and weatherstripped.

DuPont's "Endural" washable paper.

Six-panel interior Colonial

doors with veneered stiles and rails (no shrinkage). Best quality white pine wood trim, jambs, baseboards, and mouldings.

KITCHEN

8-ft. long kitchen cabinet in colors with stainless steel sink, double drainboard and Duo strainer.

Insulated gas range.

Chromium-plated solid metal spigots.

Linoleum of attractive design.

SECOND FLOOR

Three large sleeping chambers, two of which will accommodate twin beds.

Closet in each room.

Well-proportioned colored tile bathroom with "Mueller Streamline Copper

pip ing" and chromium plated all-metal handles and escutcheons.

Built-in vanity with mirror.

Vitreous china pedestal lavatory with medicine cabinet and mirror door.

Built-in tub with shower over. Large linen closet in bath.

BASEMENT

Concrete floors laid on steel beams.

Mueller streamline copper hot and cold water plumbing pipe.

White porcelain laundry tubs.

Cement painted ceiling and side walls.

Automatic gas hot water heater.

U. S. jacketed boiler.

One-car garage with brick partitions.

evidence of careful planning, with roominess, convenience and comfort as objectives. A downstairs hall permits entry into the kitchen without going through the living room. The bedrooms are commodious.

Special effort has been made to plan and equip the kitchen for the most efficient use. A kitchen sink of stainless steel (Enduro), has been combined with a kitchen cabinet (Oxford) to give a unit eight feet in length, with double drainboard. This sink is amply large and its surface is said to be rust-proof, unstaining, untarnishing and durable. The drain boards are backed up with insulating material to deaden sound and to keep them resilient.

One noticeable feature of the interiors is the presence of recessed radiators under the windows. The radiators are recessed flush with the finished wall as shown in one of the accompanying illustrations. The face of the radiator has a solid sculptured front, the tubes are concealed and act as flues, facilitating the circulation of warmed air. The extra surface is said to increase heat radiation through the lower part of the room. Thus there is a combination of direct radiant heat with convected, circulating heat.

Copper piping for hot and cold water is another feature that the builder is advertising extensively. The service pipe to the street connection is also of copper. Electric devices of Bakelite have been used all through the house and duplex receptacles have been installed. The radio antenna wires that disfigure so many homes are absent, each house being fitted with inside radio reception. All windows are weather-stripped and hung with sash chain. A durable, washable paper has been put on the walls of every room. Six panel Colonial doors have been hung throughout and pine trim of

The well-tiled bathroom is provided with a vanity, mirror, bath with overhead shower, high quality fixtures and chromium fittings. All radiators are recessed, as shown below.

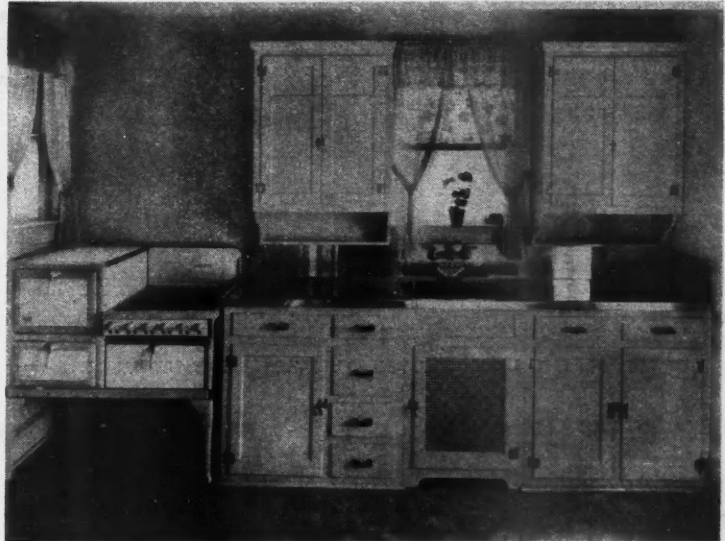

The kitchens are equipped with eight-foot cabinets containing a sink and drainboards of stainless metal. The gas range is insulated. Two windows provide ventilation.

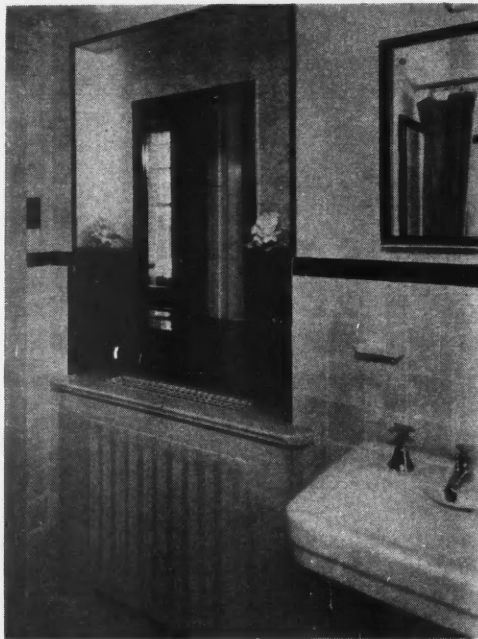

best quality has been put in.

The bedrooms on the second floor are roomy, two of them can accommodate twin beds and there is good closet space in each. The bathroom is well tiled and the color combinations are in good taste. A built-in vanity cabinet with mirror is supplied. The lavatory pedestal is of vitreous china with medicine cabinet and mirror door and a built-in tub contains an overhead shower with curtains. The fixtures in the bathroom are chromium-plated.

"Cost and value are terms often used synonymously when applied to homes," says Mr. Mueller, "but the cost of a home has no relation whatever to the value of a home. The cost of a home includes all expenditures of money for

financing, cost of construction, all equipment necessary to complete the home, ready for occupancy, and the cost of the land with all street improvements. The value of a home is the aggregate properties that render it useful or desirable, its durability, strength, elasticity of construction materials, the neighborhood, its future and restriction against industry to depreciate the neighborhood. Depreciation due to cheap first construction often places additional maintenance costs and reduces the value. The discriminating buyer of a home considers the first cost of the different features and types of construction along with their strength, durability, adaptability and cost of physical maintenance, with the assurance of permanent value."

Mueller's methods and the man himself are the chief reasons why he achieved what many believed impossible. They have enabled Mueller to plan and build what is probably one of the most outstanding low-price projects in the United States. Careful planning, close buying, courage to pioneer and to keep labor costs down are the Mueller success formula.



AT HEADQUARTERS

"One of our executives can sit at the telephone and get more done in a few hours than an executive who relies on slower means of communication can accomplish in a week. We know this because we have tried both ways."

IN the contracting business the executive who has charge of a particular job is never given an opportunity to forget the importance of time as a factor in determining whether the profit is to be large or small. There is an overall time schedule for the completion of the job, separate schedules for each of the sub-contractors, material men, and the various trades. Delay in one schedule may mean loss of time in a dozen others, so that from the time the contract is signed until the project is turned over to the owner, the job in many ways is a series of battles against time.

If modern contractors and builders followed the practice of trades in the Middle Ages, when a particular occupation was designated by an appropriate symbol—a bunch of grapes for the wineshop keeper or a boot for the cobbler—it is not unlikely that they would pass by the steel girder, the pneumatic riveter, or the steam crane, as the token of their vocation, and select the clock as symbolic of one of the most important elements entering into every phase of contracting work today.

Why is the time element so important in contracting? First of all, there is the matter of executive overhead. Throughout a job, this remains practically the same. The sooner a job is completed, the sooner the executives in charge can turn their efforts to another. And next, in most contracts there is a penalty provision. Extra days clipped from the construction period mean extra profits in the treasury. The margin of profit depends largely on time saved.

Perhaps the biggest factor in saving time is that of proper co-ordination among the various forces working on the job, the allotment of time schedules to the various groups, and the control of these groups to see that they meet their schedules. The dovetailing of schedules is largely a mathematical procedure. Given a certain amount of work to do, every contracting executive knows he can calculate how many men and how much time it will take to do it.

After detailed plans for the dovetailing of the various activities on a job have been completed, mathematical

Co-Ordination Increases Profits

By H. W. LOHMANN

Vice-President, James Stewart & Co., Inc.

elements are forced aside by the human element which then enters. It is one problem to make the correct schedules, but it is still another, and I think a more difficult one, to see that the various units meet their schedules on time. Even the best laid plans more than often go awry, and the contracting executive's duties increase. When things do not go smoothly, he often wishes that he had seven-league boots, so that he could be in the office one minute, the brickyard, the foundry or the factory the next.

In our organization we have found that the free use of modern means of communication—the telephone in particular—has been the greatest aid to co-ordinating the activities which combine to make the contracting job. We have jobs throughout the country, but the

(Continued to page 78)



ON THE JOB

There is rarely a day during the working week that the superintendent on the job is not in communication by telephone with his executive in the home office. . . . The telephone helps get things done. . . . "

FEBRUARY, 1932

A Residence in
Beverly Hills, Cal.



Homes for the Spring Building Season

A variety of home designs are collected here as suggestions for the new building season of 1932. Variety, not only of style but also of size and arrangement, is offered for the benefit of those who serve future home owners by seeking out ideas that will help them in the realization of their hopes and dreams of a home of their own.

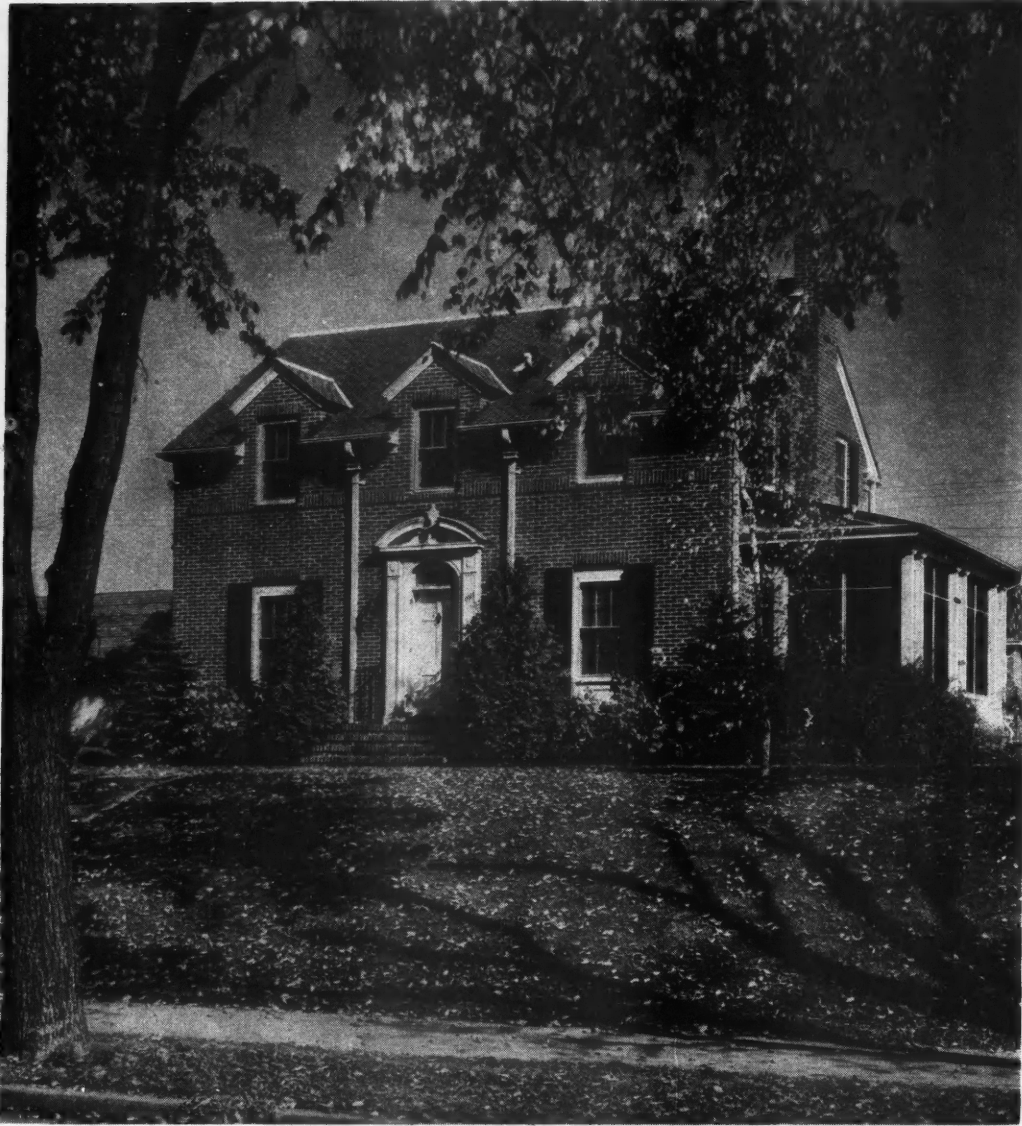

Design No. 6-A-45, Copyright Architects Small House Service Bureau, Inc.

A Colonial Home of Distinction

The beauty and distinction of this brick Colonial are dependent upon such details as the proportions of roof and walls, the spacing of windows, the width of eaves, and the entrance. In addition to its aristocratic appearance, this home is planned for many economies in construction.

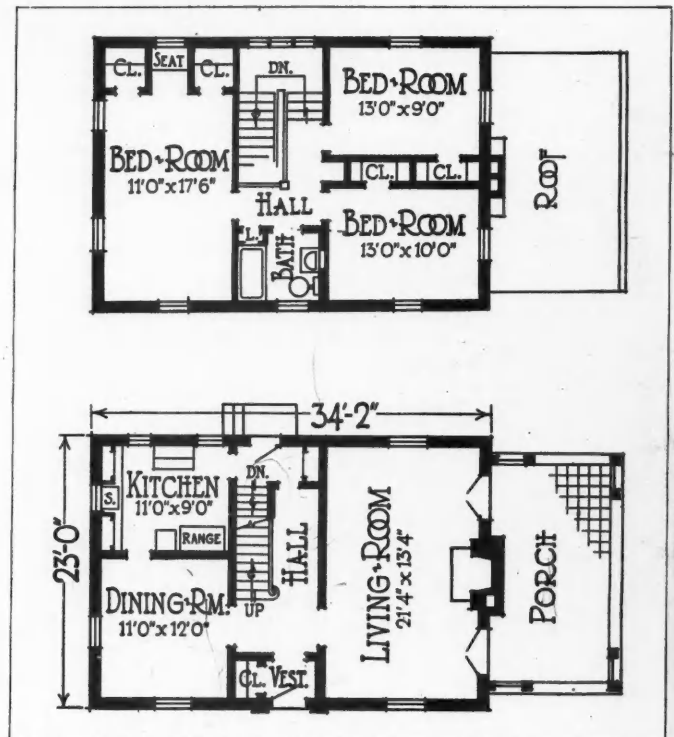



© A. S. H. S. B. Inc. Design No. 6-B-13

Two Charming Small Homes

These two small houses from Bureau plans seem to radiate that warmth and friendliness which is always associated with the word "Home."

© A. S. H. S. B. Inc. Design No. 6-B-30

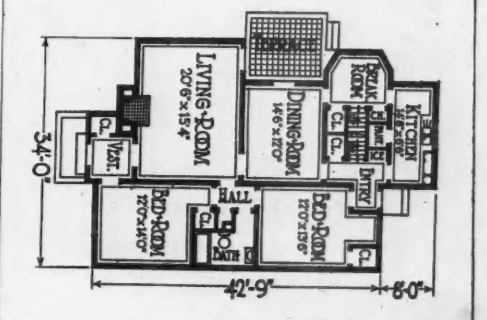
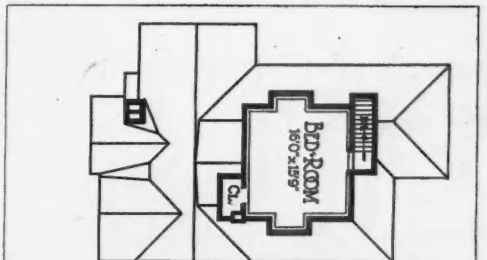
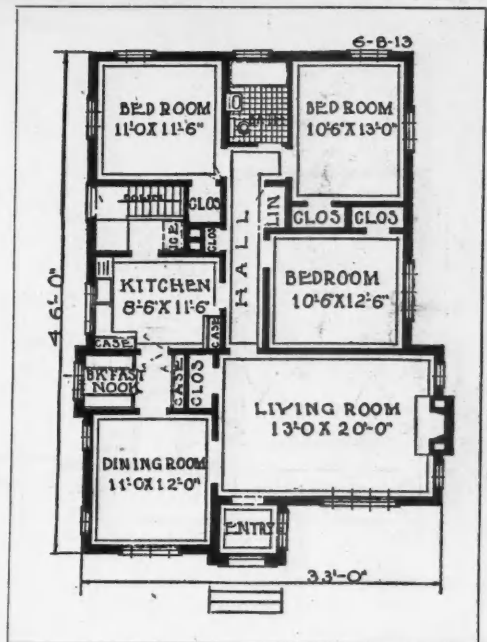
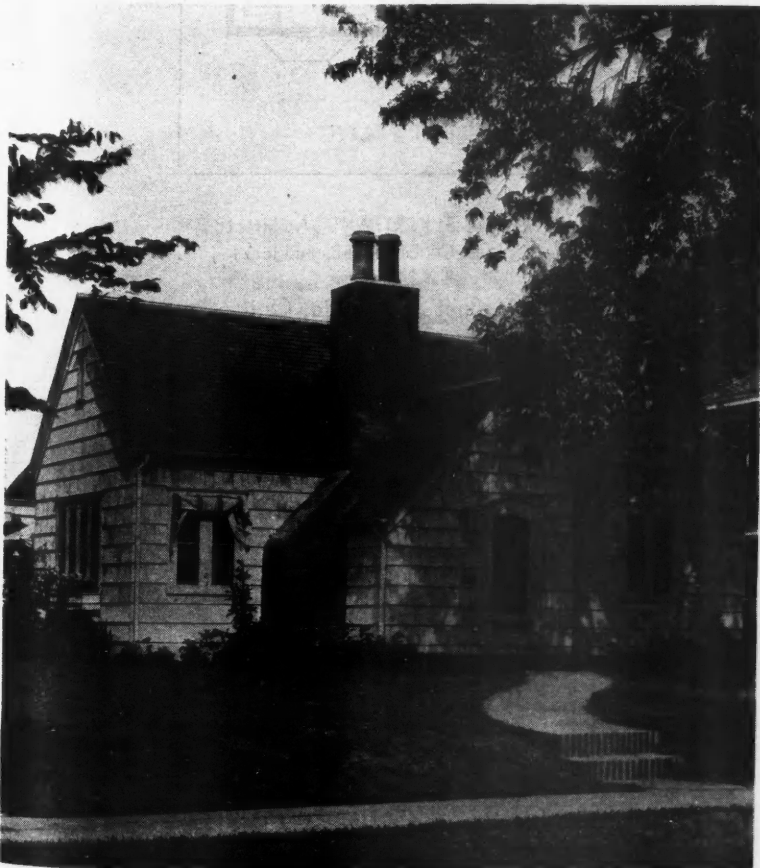



OBERLIN AND NEWLAN, Architects, OLSEN AND URBAIN, Associates

R. M. SCHELL, Builder

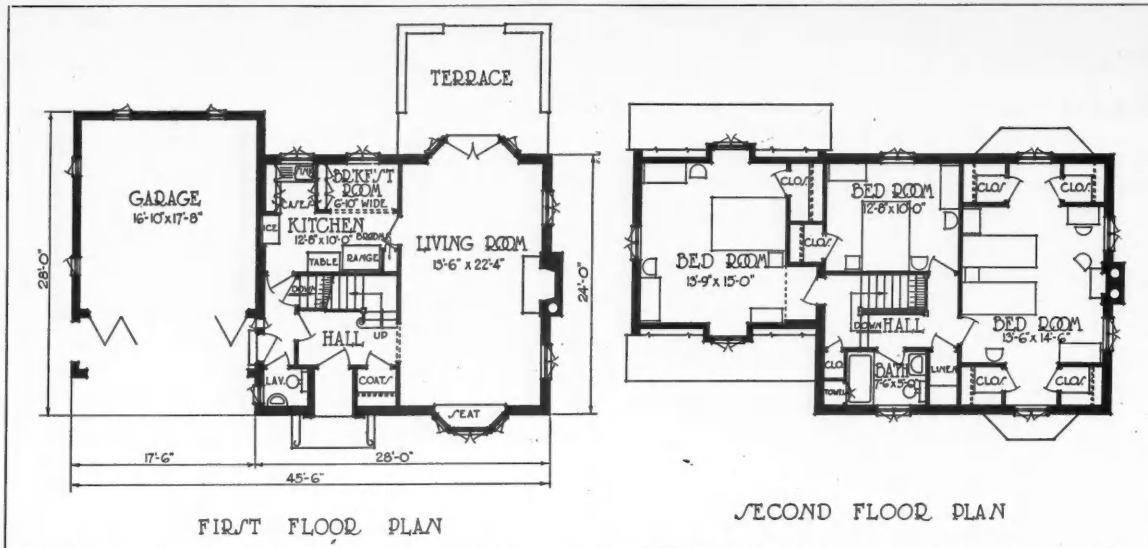

Built at Mansfield, Ohio.



D. E. KERTLAND, Architect
GEORGE WEBB, Builder

Built at Toronto, Ont.

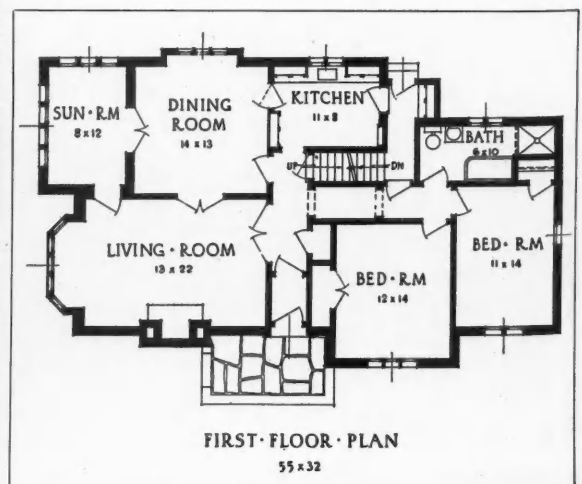



OLSEN AND URBAIN, Architects
MARTIN, ORR AND MARTIN, Builders

Built at Columbus, Ohio

Houses of Stone

There is a certain dignity and grace about a house of stone, a richness which makes it an outstanding feature of any community. All too often this feeling is accompanied by an impression of costliness which eliminates the stone house from consideration by the prospective owner. That impression, however, is a mistaken one for the extra cost of building with cut stone is not so great as often supposed. Homes of Indiana limestone can frequently be built at a cost within the limitations of the prospective owner's budget and once built they become a thing of permanent satisfaction.

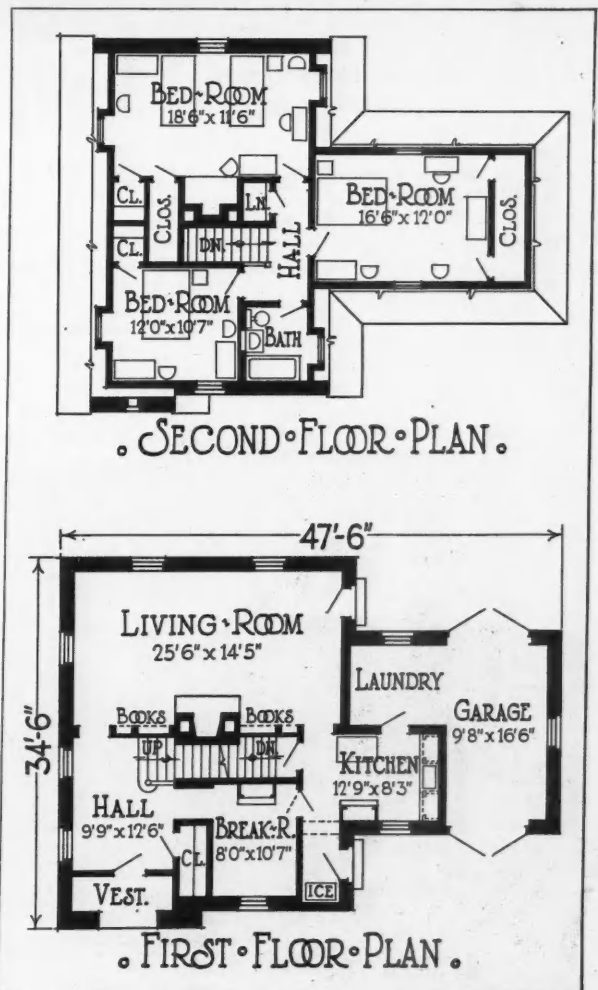



NATIONAL PLAN SERVICE Design

Colonial and English Cottage

The Ever Popular New England Colonial to Which a Modern Sun Room and Garage Are Harmoniously Added.

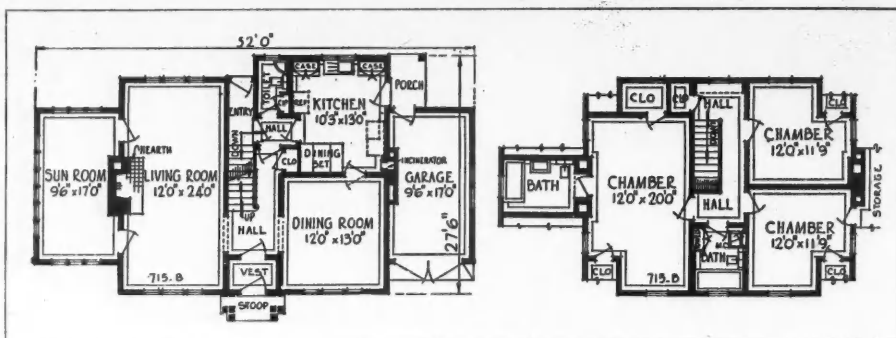

A. B. CLEVELAND Design

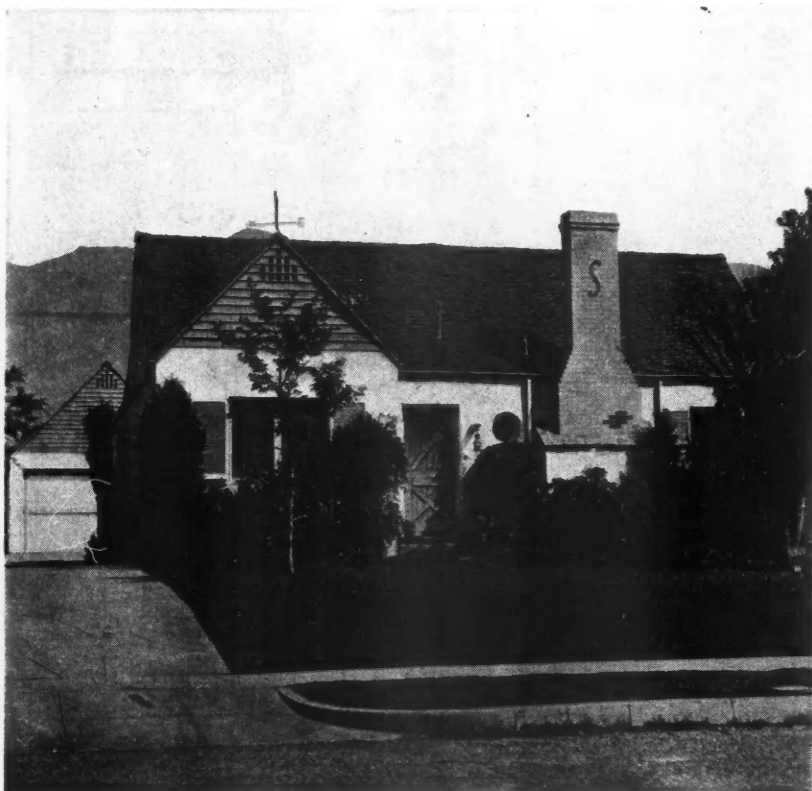

This Five Room English Cottage is a "Big Little Home" Affording Much of Comfort in Limited Space.

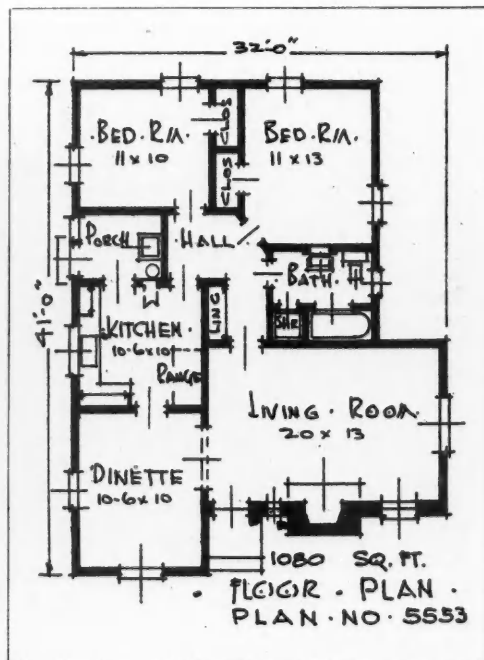



WM. G. KRIEG, Architect

Four Apartments in Single House

The convenience and economy of the small modern apartment in a neighborhood of single residences seems almost too much to expect, yet it is entirely within the range of practicability, as may be seen from this design. Here, to all appearances is a residence, in the Spanish style, which could not be out of place in any home community. But within there are two complete apartment dwellings on each floor. It is all a matter of design and is a subject to which the architects have given particular study.

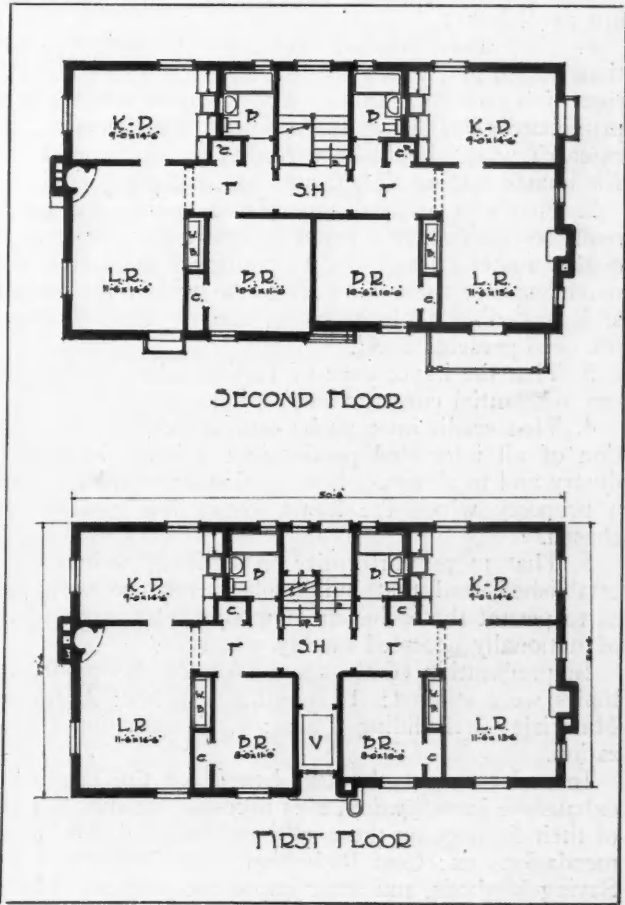

"HOW CAN I IMPROVE

By R. H. MATHEWSON

Eastern Editor, American Builder and Building Age

MASS PRODUCTION vs. SMALL SCALE OPERATION

BY far the most important fact in the field of home construction today is the presence in the field of methods and products associated with mass production, large scale operation and factory methods of fabrication. In this connection we have seen the rapid and tremendous growth of big housing companies that have founded whole communities, the construction of huge apartment projects and lately, the experimental development of pre-fabricated units.

It is too early to say how well radical developments in housing construction will succeed. At a time when the industry is in a state of flux, old methods and new trends exist side by side. Both will continue to operate and in the end those methods that are economically justified will prevail. Meanwhile, each builder must adapt his construction practices as far as he is able to the needs of the hour. The committee's report should help him to do this.

LOOKING at the problem from the standpoint of the small scale as well as the large scale builder, the Committee on Construction of the President's Conference on Home Building and Home Ownership conducted a survey of existing conditions throughout the country and on the basis of this survey has made recommendations as to the improved construction of new dwellings.

The general conclusions reached by this committee are as follows:

1. That there are too few home building organizations which give much needed attention to the construction of homes for families whose annual income is approximately \$2,000 or less per year. Further study and research work should be extended to meet the demand for homes costing \$5,000 and less, including land.

2. That co-operative supervision and inspection bureaus be established in order to insure the proper use of quality materials and quality construction in return for money spent; these bureaus to be within the industry and located in all large cities, and in smaller cities as the need presents itself.

3. That the importance of further education on modern substantial construction is vital.

4. That credit bureaus be established for the protection of all interested parties in the home building industry and to eliminate liens or double payments against a property which the home owner has recently purchased.

5. That more uniformity in building ordinances be established, and that building codes be so formulated as to permit the inclusion of modern methods and uses of nationally accepted quality materials.

In preparation of the main body of the report four topics were studied: 1. Building Practice; 2. Building Materials; 3. Building Codes; 4. Construction Organization.

In order to get the full benefit of the committee's exhaustive investigation, it is necessary to dip into some of their findings on these subjects and read their recommendations on: Cost Reduction, Cost Keeping, Labor-Saving Methods, and other important subjects. The fol-

lowing paragraphs give summaries of the committee's findings in which readers will find many valuable tips and suggestions.

1. Building Practice

If builders will follow the many good practice recommendations already available through publications and take advantage of every approved method which has been developed through scientific research, the cost of dwelling house construction can be materially reduced in a great many cases, the Construction Committee contends.

Construction failures can often be traced to one or more of the following causes, the committee points out:

- Insufficient footings.
- Poorly constructed foundations.
- Lack of drainage facilities.
- Poor mortar joints.
- Inadequate sizes and wide spacing of joists or rafters.
- Improper nailing throughout.
- Failure to provide full bearing areas.
- Lack of proper bridging and bracing.
- Omission of fire stops.
- Lack of, or improper flashings around openings.
- Frail construction over openings.
- Careless nailing of floors.
- Unseasoned lumber.
- Inaccurate cutting and improper fitting.
- Faulty construction around chimneys.
- Improperly designed gutters.
- Wrong kind of nails for roofing.
- Use of building papers of inferior quality.

The committee emphasized the necessity for further research on construction standards by impartial groups.

Comparatively few builders use regular standardized forms for detailed estimating, cost accounting and job scheduling, the committee found. The builder can establish an intelligent sale price only if he uses complete standardization forms to record original estimates and actual detailed costs, the committee maintains. A good standard form of contract is advised and it is emphasized that specifications be clear and definite so that the

MY CONSTRUCTION METHODS?"

Whether You Are a Small Residential Builder or a Large Scale Operator You Will Find Answers to Your Questions in This Article Summarizing The Report on "Construction" Submitted to the President's Conference on Home Building and Home Ownership

margin allowed for contingencies need not be excessive. "The various trades should move along in sequence without interruption, and all necessary materials should be on hand at the proper time to avoid delays," says the committee's report. All concealed features, such as piping and wiring, should be placed at the proper time so as to avoid subsequent cutting and fitting and each trade should complete its work, if possible, the first time on the job in order to avoid disrupting the schedule and to save the expense of returning."

Reducing Construction Costs

"Costs of construction can be materially reduced as new developments, which at first may appear to be somewhat radical, are adopted," the committee believes. "It is impractical to expect to include the obsolete features in a modern home and obtain a moderate cost."

Declaring that the original needs for portions of the house like the basement and attic may have disappeared, the committee points to the introduction of improved types of heating, laundry facilities, and insulating materials as making possible new types of layout and room arrangement.

Group construction operations have been shown to be more economical per house than single operations, the committee reports, and the large scale operative builder may be able to effect economies in the development of site, quantity purchase, and architectural services and supervision.

The use of power excavators in group house construction saves money, the committee believes. It further recommends that the following items should be especially considered from the point of view of effecting economies: "The simple plan versus the complicated plan or design, co-ordinated with materials; elimination of cellars and attics; type of foundation; room dimension to meet stock sizes of lumber; standard framing, doors and windows; location of bath and kitchen so that short length of pipe may be used; efficient placing of heater; lath and plaster versus wall board; spray painting; prefabricated construction units and interior fixtures; elimination of back stairs; a smaller number of interior partitions; possibilities provided by central heating plants; elimination of false appurtenances including false fireplaces and gables; and the use of well-seasoned lumber throughout."

The committee concludes its treatment of this subject by these words: "If it were possible to get away from custom and tradition with regard to many features of house building, cost of production could be materially reduced and the completed house turned over to the owner in at least one-third less time than has formerly been required. As more low-priced quality homes are built, sales will increase."

Although "the use of labor-saving equipment and devices is more practicable on large scale operations than on small ones", according to the committee's report, machines like floor sanders have been used to effect sav-

ings of 10 to 15 per cent, it reports. In about one-half the cases investigated, power saws were used at a saving of 10 to 50 per cent, the committee found. Power excavators effect a saving of 50 to 75 per cent when used on large volume jobs, it is said.

"Contrary to general opinion," the report reads, "portable forms, ready-mixed concrete, plaster mixers, power drills and paint-spraying equipment are used comparatively little, even on large-scale building operations."

The committee recommends that builders study costs and results of the use of labor-saving equipment, especially for large group operations.

That the building industry should carry on more extensive educational campaigns in which the qualities of construction are particularly stressed is the belief of the committee, which recommends that impartial home information centers be encouraged in all communities, where reliable information can be obtained locally.

To encourage better craftsmanship, the committee suggests that some form of recognition be given to workers on the job. It may be in the form of a prize or a bonus.

(Continued to page 80)

IMPORTANT FACTS CONCERNING IMPROVED CONSTRUCTION PRACTICE

(From the Committee's Report)

1. Sound and durable construction may be obtained by using current valuable information available in various publications covering recommended building practice.
2. Reduction of cost may be effected by accurate estimating and cost accounting; best methods in the use of standardized quality materials; proper use of labor saving devices and equipment; and proper job organization.
3. A more extensive development of group construction of houses with better arrangement is advocated in order to appeal to a greater number of prospective home buyers.
4. More prefabricated units of construction may be obtained by a continued investigation of the possibilities of standardization.
5. Best possible results may be secured only through co-operation between construction groups, architects, and manufacturers.
6. Quality construction, as well as the special features of attractive house equipment, may be secured only by education of the home buyer regarding fundamentals.
7. Modern merchandising methods now used to create a public demand for home equipment and furnishings should be studied and applied to the sale of houses as a whole, coupled with scientific research in order to avoid saturation of demand.

Estimating and Cost Reducing Methods of a One-Man Contracting Business

By GEORGE A. MALMSTEDT, Los Angeles Builder

There is an old saying that "he travels fastest who travels alone." I believe that holds for a man in the contracting business. I tried working with someone else several times; but it never paid.

A small organization that you can keep right under your finger-tips has the lowest overhead. I pay \$30 a month for my office in the business district of Los Angeles by sub-letting rear portion. I superintend all

work personally, driving out to the jobs in my automobile. I charge \$50 to every house for overhead and mileage, and that covers expenses fully.

There are other advantages to running your own business alone. I have absolute, first-hand knowledge about every detail in connection with my business. Every customer has my own personal service, and I think they like it. When I build a house for a client it is the kind of a house he (or more often she) really wants. For example, when the electrician is about to install convenience outlets I call the housewife up and ask her if she doesn't want to come out and select their location. She always does, and is tickled to death at the chance to do something. Together we put chalk marks where she wants the outlets, and that's where they go.

Low costs are necessary to sell houses in this market, and so I give my customers rock-bottom prices. I can do this because I keep a close check on current building costs, materials, and sub-contract prices. I keep a record of all jobs done, and as a result of continuous practical experience can figure an estimate within a few dollars. I call for bids on all operations and get the lowest competitive price commensurate with good work, and I see that I get good work by inspecting it myself.

For example, I go out on the job with the sub-contractor who is doing the concrete work. I always insist on having a complete plot plan. Together we lay out the work and decide just how it is to be done. It is the same way with the other sub-contractors. Each man is responsible to me and to no one else. We work things out together and he knows that I will see that he does a good job.

Right now the only thing that is holding up work is the financing situation. We have plenty of jobs ready to go; conservative homes for responsible people who can make a part payment but cannot carry the whole load. As soon as mortgage money is available, which I think is not far away, there will be a big increase in building.

Estimating the cost of a house is a matter of sound experience plus knowledge of present conditions. To help in making a quick estimate I use the form shown herewith. I have filled in the estimate on this form just as I would for a client, having in mind a house similar to one of those shown on the page opposite—five-room stucco, with floor area of about 1000 sq. ft. For most houses of this type the present average cost is approximately \$2.50 a square foot. This one runs a little higher due to the electric refrigerator, fireplace, and a few other items that can be included or

APARTMENTS FLATS INCOME		HOMES STORES COMMERCIAL	
GEO. A. MALMSTEDT BUILDING CONTRACTOR 623 WEST NINTH STREET LOS ANGELES Tucker 2647			
ESTIMATE SHEET			
Location <i>840 S. Calabazas</i>	Lot <i>5</i> Blk <i>12</i> Tract <i>23571</i>	Phone _____	
Owner <i>G. Thorge</i>	Address _____	Phone _____	
Architect _____	Address _____	Phone _____	
Description <i>5-Room Stucco</i>	Size <i>32 x 33</i> Sq Ft. <i>1056</i>	Started <i>Oct 1</i>	Comp. <i>Dec 7</i>
ARCHITECTURAL	HEATING		
Plans & Specifications \$ <i>25.00</i>	Gas _____		
Engineering \$ <i>3.00</i>	Miscel <i>Wall Heater @ 8.00</i> \$ <i>40.00</i>		
PRELIMINARY	MILL WORK - (CSCO)		
Survey _____	Frames _____		
Wrecking _____	Interior Finish _____		
LEGAL	Sash & Doors <i>(Included in labor)</i> _____		
Building Permit \$ <i>10.00</i>	Cabinets _____		
Water Tap _____	Stair Work _____		
Street Deposit _____	Ironing Boards _____		
Construction Water _____	Miscel _____		
EXCAVATING	GLAZING - (CSCO)		
Exc. yds @ _____	Miscel Glass _____		
Grading & Filling <i>level lot</i> _____	Plate Glass <i>Martin's Ord. 8.00</i> \$ <i>8.00</i>		
Hauling _____	Mirrors _____		
CONCRETE - (CSCO)	Corner Bends _____		
Walls etc. cu. ft. @ _____	Weather Strips _____		
Rainforcing Steel _____	TILE - (CSCO)		
Walks etc. sq. ft. @ _____	Tile Work _____		
Floors sq. ft. @ _____	Mantels _____		
Steps lin. ft. @ _____	Miscel _____		
Curbs lin. ft. @ _____	PAINTING & DECORATING		
Miscel _____	Paint Material - (CSCO) _____		
MASONRY	Paint Labor _____		
Common Brick M @ _____	Wall Paper & Labor _____		
Hollow Tile M @ _____	Special Decorating _____		
Chimneys & Fireplace _____	Waterproofing _____		
Mantels _____	FLOORS - (CSCO)		
Stone Work _____	Hardwood yds. @ _____		
Face Brick M @ _____	Linoleum yds. @ _____		
LUMBER - (CSCO)	Composition _____		
Rough M @ _____	MISCELLANEOUS		
Finish M @ _____	Window Shades - (CSCO) _____		
CARPENTRY	Curtain Rods _____		
Rough _____	Awnings _____		
Finish \$ <i>200.00</i>	Wall Beds _____		
SANITATION - (CSCO)	Incinerator _____		
Plumbing _____	Refrigeration <i>4-Door Elec.</i> \$ <i>115.00</i>		
Sewer _____	Insulation & Deadening _____		
Cesspool \$ <i>265.00</i>	Cleaning Windows etc. _____		
METAL WORK	Removing Debris _____		
Structural Steel _____	LANDSCAPING		
Sheet Metal - (CSCO) _____	Lawn _____		
Ornamental Iron _____	Shrubbery _____		
Steel Sash _____	Sprinkler System _____		
ROOF - (CSCO)	Fence _____		
Composition _____	Drainage _____		
Tile _____	INSURANCE - (CSCO)		
Miscel _____	Compensation _____		
Trusses _____	Liability _____		
LATH & PLASTERING - (CSCO)	Fire _____		
Exterior yds. @ _____	Bond _____		
Interior yds. @ _____	EXTRAS		
Staff Work _____	<i>Overhead & Mileage</i> \$ <i>50.00</i>		
Miscel _____	TOTAL COST \$ <i>2434.00</i>		
HARDWARE - (CSCO)	PROFIT \$ <i>316.00</i>		
Rough _____	COMPLETE BID \$ <i>2750.00</i>		
Finish \$ <i>40.00</i>			
Miscel _____			
ELECTRICAL			
Wiring \$ <i>155 per outlet</i> \$ <i>45.00</i>			
Fixtures \$ <i>30.00</i>			

Form Used by G. A. Malmstedt in Making Preliminary Cost of Estimate of House. Items as entered apply to typical 5-room stucco house with floor space of about 1,000 sq. ft. at current prices.

Houses Under \$3,500

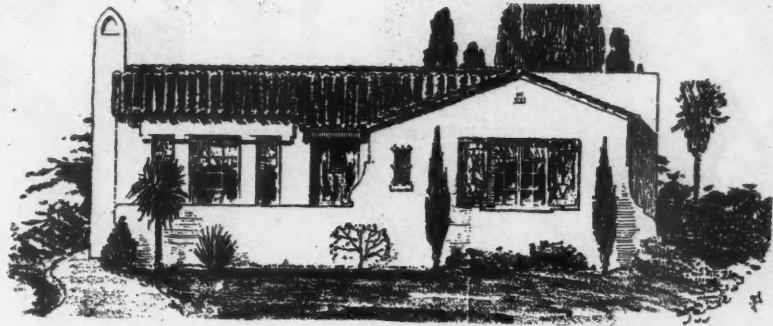
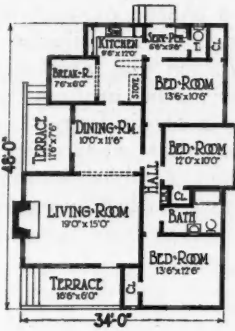

Attractive Tile and Stucco Spanish Design That Mr. Malmstedt Builds for About \$3,500.

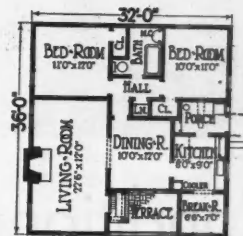

Two Exteriors for Same Floor Plan (at right) Which is Compact and Livable. Costs About \$2,500 Without Lot.

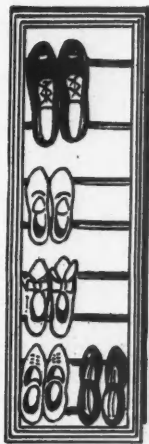
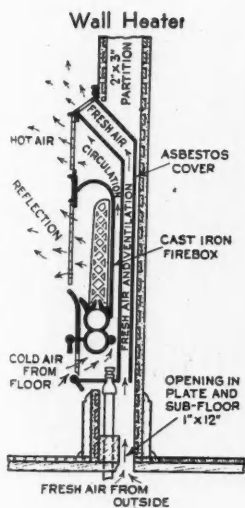
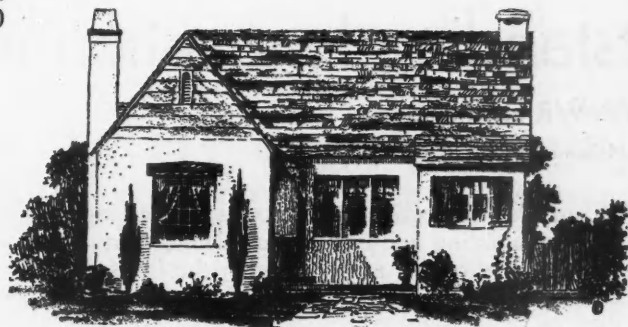

Shoe Cabinet

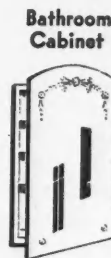

Bathroom Cabinet



Mail Box

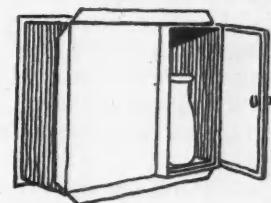

Milk Receiver

not, as the customer wishes. Taking up some of the individual items on the estimate sheet:

Architectural: I get architectural service at a cost of about one per cent. This includes an attractively gotten up colored drawing of the house, floor plans with all details well shown, and a plot plan. This helps to visualize the project in the customer's mind.

Concrete: Our concrete work is being done at low cost out here; and another item that reduces the total expense is that we do not put in full basements and do not require footings protected against frost. I figure footings for one-story houses at 30 cents per lineal foot; for two-story houses, 45 cents per lineal foot. I figure flat concrete work at 11 cents per square foot, which

may seem surprisingly low, but we can get all we want at that price here. I figure porches at 40 cents per square foot, including fill, and steps at 50 cents per lineal foot. Concrete foundation work costs us \$8 per cubic yard, complete. The \$275 I have estimated under this item includes concrete floor in garage, walks, an 8x80 foot driveway with apron at both ends, and cost of cutting curb for driveway entrance.

Masonry: The \$60 I have entered on the estimate sheet includes chimney, fireplace, and damper.

Lumber: I figure lumber costs at 35 cents per square foot of floor area. The \$350 estimated here includes a double garage, 18 by 18 feet, all doors, sash, and finished lumber.

(Continued to page 84)



Ninety-eight percent of dust and other impurities are removed from air by modern air conditioning systems. Lady at the left is injecting a charge of dust into the air over an air-conditioning unit. Dr. E. Vernon Hill, aerologist, who is shown with dust-counter taking sample of air from home heater, states that air-filtering and air-washing combine to remove 98.2 percent of dust and other impurities from home air.

Air-Conditioning Is the Outstanding Innovation in the Home Moderne

By A. W. WRIEDEN

Secretary Holland Institute of Thermalogy

OUT of the depression there issues a challenge to the building industry, a challenge that is especially directed at the mighty business of home building. It raises the question of whether the powers that be will countenance the haphazard construction that in all too many instances, in the past, has yielded the typical home builder or buyer a poor return on his one big investment; or, whether contractors, commercial builders, architects, and those who finance home building will lead the public out of the muddle of poor construction and tawdry equipment into an era of sound construction and practical, enduring equipment that will encourage more extensive building of individually owned homes.

There is no excuse for poor construction; for materials are available at reasonable prices as never before for quality work. And it is encouraging to note that farsighted men who have to do with financing are no longer content to finance just a house. Their financing is contingent upon the use of materials of known quality and the employment of contractors who can be depended upon to correctly fabricate these materials in accordance with known standards of good construction.

But the building industry must go further than this, for there is another factor that more adversely affects the stability of an investment than physical deterioration. That factor is obsolescence. Remarkable improvements have been made in structural materials and in equipment, providing comfort, economy and convenience in the home-making scheme never before enjoyed by home-owners.

Those who build new homes should be encouraged to include these new things in their building program

because of the benefits to be derived therefrom, and as a means of conserving the home investment. Not only should the material in the footings, the hardware, the glass in the windows, in fact, all materials from foundation to chimney-cap be of dependable service-giving quality, but new homes should be so equipped as to render the utmost in comfort and convenience made possible by things now comparatively new and which are found in but few homes.

More attention should be given to home designing. The bizarre architectural motifs that feature some homes are detrimental to maintenance of value. Let us adhere more closely to the attractive English and Dutch Colonials and Norman types which are ever beautiful in their multitudinous variations and which lend themselves ideally to fabrication in wood, stone, and brick.

An outstanding development in home-making is domestic air-conditioning. Air-conditioning systems have supplanted home heating plants and, incidentally, heating is but one phase of air-conditioning. Recently perfected equipment of moderate cost puts complete air-conditioning within the reach of every home-owner, giving him complete control of the weather within the walls of his home and assured comfort day in and day out regardless of what outdoor conditions may be.

This marks the most recent contribution of heating and ventilating science to home comfort. Varied types of domestic air-conditioning equipment are now available. In so equipping homes, however, it should be borne in mind that complete air-conditioning is contingent upon five factors—namely, winter heating, and humidification, summer cooling, air circulation and air cleaning by filtering and washing. Devices that do not

render all of these services obviously are not complete air-conditioning equipment.

Some of the equipment being introduced includes oil or gas heaters. A most recent innovation is a compact conditioning unit designed for attachment to any type of warm air heater regardless of kind of fuel used. In combination therewith it constitutes a complete air-conditioning system that heats, humidifies, cleans and circulates the home air during winter, and washes, cools and circulates it during summer. It may be installed independent of the heater, thus being adapted for auxiliary use with radiator heating systems.

Its operation is simple. By means of high-speed, noiselessly operating fans the indoor air is maintained in constant circulation through a modern filtering device and thence forced through a series of fine, swirling water sprays. This filtering and washing process removes, according to tests, 98 per cent or more of the dust and impurities that may be in the home air. The washing process is the means for humidifying the air during the heating season and the principal means for air-cooling during summer. In conjunction with the latter use the cool air of the basement is utilized as an auxiliary cooling agent.

Thermostatically controlled air-conditioning systems, especially where oil or gas may be used as fuel, or automatic stokers used for hard fuels, forever bann the drudgery of "tending the fire."

Equipment that makes for indoor comfort winter and summer is the most important of all household equipment and it is safe to assume that the house that is not air-conditioned will in the near future be regarded as obsolete. And this factor of obsolescence is positive of development because equipment for conditioning the home air is now within the reach of every purse.



The home air is forced through a series of fine swirling water sprays which wash out practically all of the dust and impurities. The water sprays not only clean the air but are a means for winter humidification and summer cooling.

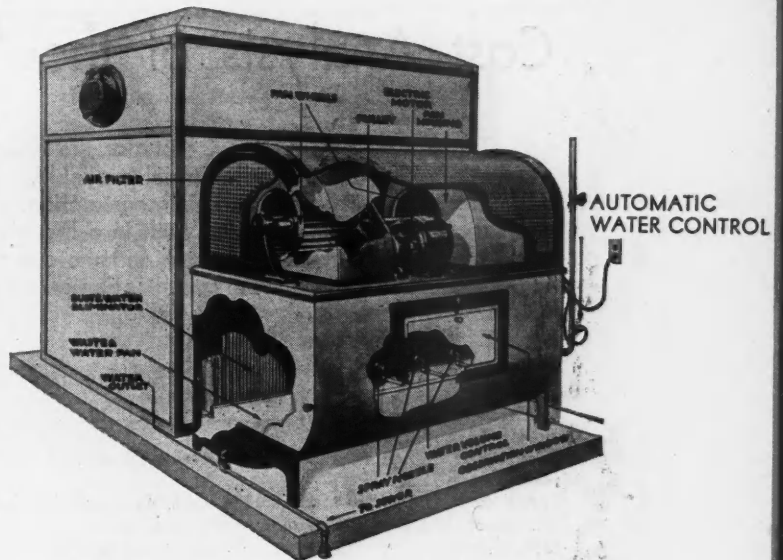

Phantom view showing operating details of new air-conditioning unit, attached to square-type warm-air heater. In combination with a household heating plant, it constitutes a complete air-conditioning system which warms and humidifies the home air in winter, cools it in summer, and washes and circulates it the year round.

Conversion of the basement area into practical living quarters is brought to the fore by air-conditioning, for air-conditioning comfortably tempers the basement air during winter and in summer eliminates that coolness and dampness characteristics of basements. The old bogey that basement air is unhealthful is definitely banished and the protection afforded by modern construction, plus the benefits of air-conditioning, make the basement available for living quarters.

Another improvement of importance is house insulation which is now recognized as being indispensable to good construction. Its benefits will be more manifest in homes that are air-conditioned, for it will conserve the warmed and adequately humidified air during the heating season, protect the home against the heat of sun and hot winds during summer and preserve the coolness begot of air-conditioning. As a further protection, windows and doors should be weather-stripped and the former should be equipped with double glass or with storm sash.

Furthermore, complete insulation and the cleaned, washed air developed by air-conditioning will immeasurably reduce the damage to walls and ceiling and interior decoration that are largely traceable to the dirt in outdoor air and usually manifested by grimy smudges or "lath mark" striations on walls and ceilings, especially those of wood lath construction.

In the foregoing are listed but a few of the major factors that should be given consideration by all who have to do with designing, furnishing materials, and constructing homes. The list of small things and big things that go into home building is comprehensive. All demand conscientious attention, and especial consideration should be given to such radical improvements as air-conditioning as it is of far reaching importance in the general plan of home making. As is now apparent, lenders will in future be more careful in advancing loans, and the size of the loan they make will be governed entirely by the quality of the materials, the equipment and the construction work that features the new home. In making their loan appraisals they will give due consideration to the factor of potential obsolescence.

Cost Analysis of the "House of the Month"

The following estimate of costs for the February House of the Month is based on prices of the best labor and material available. Thus the costs, as shown, are those of the highest quality of residential construction. With certain changes in material and labor costs, this house might be built in a first-class manner at the present time for \$20,000 complete. Between this cost and the one shown below there is a flexible range for reasonable variation in the specification of materials and products.

	Material	Labor	Total
1. Excavations (Excavating and backfilling)	\$ 508.20
2. Cement work (Cellar and garage floor, sidewalk, driveway, footings).....	\$ 391.00	\$ 177.00	\$ 568.00
3. Masonry work (Brick, hollow tile, stone and stucco work, flues and flue lining, clean-out doors, ash dump, retaining walls, masonry window sills, chimney caps, flue rings, wall ties, arch bars, flagging, steel windows).....	\$ 992.17	\$1,513.00	\$ 2,505.17
4. Carpentry and millwork (Frame lumber and sheathing, posts, girders, sills, joists, plates, rafters, wall studs, bridging, furring, sheathing, rough flooring, shingles, exterior and interior trim, flooring, doors, sash, glazed, window frames, stairs, sanding, kitchen cabinets, blinds).....	\$5,616.00	\$2,460.10	\$ 8,076.10
5. Hardware	\$ 250.00
6. Insulation	\$ 138.00	\$ 20.00	\$ 158.00
7. Roofing and sheet metal (Flashings, gutters, rainpipes).....	\$ 400.00
8. Lathing	\$ 312.50	\$ 133.00	\$ 445.50
9. Plastering	\$ 926.28	\$ 580.32	\$ 1,506.60
10. Electrical work (Fixture and wiring).....	\$ 420.90
11. Plumbing (Piping, fixtures and fittings).....	\$ 2,716.00
12. Heating (Equipment and installation).....	\$1,249.70	\$ 528.00	\$ 1,777.70
13. Painting and decorating.....	\$1,440.00	\$ 960.00	\$ 2,400.00
14. Tile work	\$ 612.00	\$ 335.20	\$ 947.20
15. Mantels	\$ 210.00
16. Special equipment and items			
Linoleum:	\$ 42.50	\$ 4.25	\$ 46.75
Weatherstripping:	\$ 148.00
Structural steel:	\$ 161.00
17. Landscaping and grading.....	\$ 340.00
18. Permits	\$ 72.00
TOTAL	\$23,657.12

Approximate Cubic Footage: 47,300 cu. ft.
Cost per cubic foot: 50c

GENERAL OUTLINE SPECIFICATIONS

FOUNDATION: Rubble stone.

FRAMING: 2 x 4 studs and sheathing.

EXTERIOR WALLS: 12" veneer of selected native stone over stud frame on first story front and ends. Flush ship-lap boarding between second story windows of main portion. 24" hand-split cedar shakes on walls of remaining portions.

ROOFING: 18" random width Washington red cedar shingle dipped in creosote stain—color black.

GUTTERS AND LEADER: Half round stock gutters and plain rectangular leaders of copper.

FLOORING: Clear, straight-grained, white oak strips.

INTERIOR FINISH: White wood trim with special band moulds. Oil painted plaster walls and ceilings.

PLUMBING: Brass water supply piping. Storage gas water heater. "Standard" plumbing fixtures and fittings.

HEATING: Hot water system; American Radiator Co.'s Red Flash oil-burning boiler and Corto radiators.

ELECTRIC OUTLETS & FIXTURES: 100 outlets on BX armored cable wiring. Door bells, buzzers, and telephone wiring. Service and power meters. Fixtures of Colonial design.

FIRST FLOOR: Walls finished with 3 coats lead and oil paint, stippled. Oil paint and enamel finish on woodwork. Dining room wainscoted to sill height with wood mouldings, 1" wide. Kitchen has tile panel behind range, 6'6" high. Linoleum on kitchen and pantry floor.

BATHROOMS: Tile wainscots, 4'6" high—6'6" high behind tubs. Ceramic tile on floors.

BASEMENT: Basement play room with plaster finish.

OTHER FEATURES: Flax-li-num insulation on sides and above second story and wing. Garage ceiling, cement plastered.



THE HOUSE OF THE MONTH

With All The Dignity of Stone and The Mellow Charm of Wood

HUNTER McDONNELL, Architect

ROUKEN GLEN, INC., Builders

IN its beautiful suburban setting in famous Westchester County, New York, this Colonial residence represents a type of distinctive design, quite appealing to the cultivated taste of the modern suburban family. Far removed from the commonplace, it carries an attractive dignity of its own that is a blend of perfect proportion, excellent but restrained treatment of detail and harmonious combination of materials. The unity of this design is complete and its marvelous integration with the site is not a small part of its charm. The terracing and landscaping further enhance the attractiveness of this fine place. Departure from the ordinary has characterized the architectural treatment of detail and has influenced the selection of exterior and interior trim. The complete floor plans and the cost estimate which follow will reveal in greater detail the high quality of this residence.

WORKING DRAWINGS OF THIS HOME ON THE NEXT FOUR PAGES

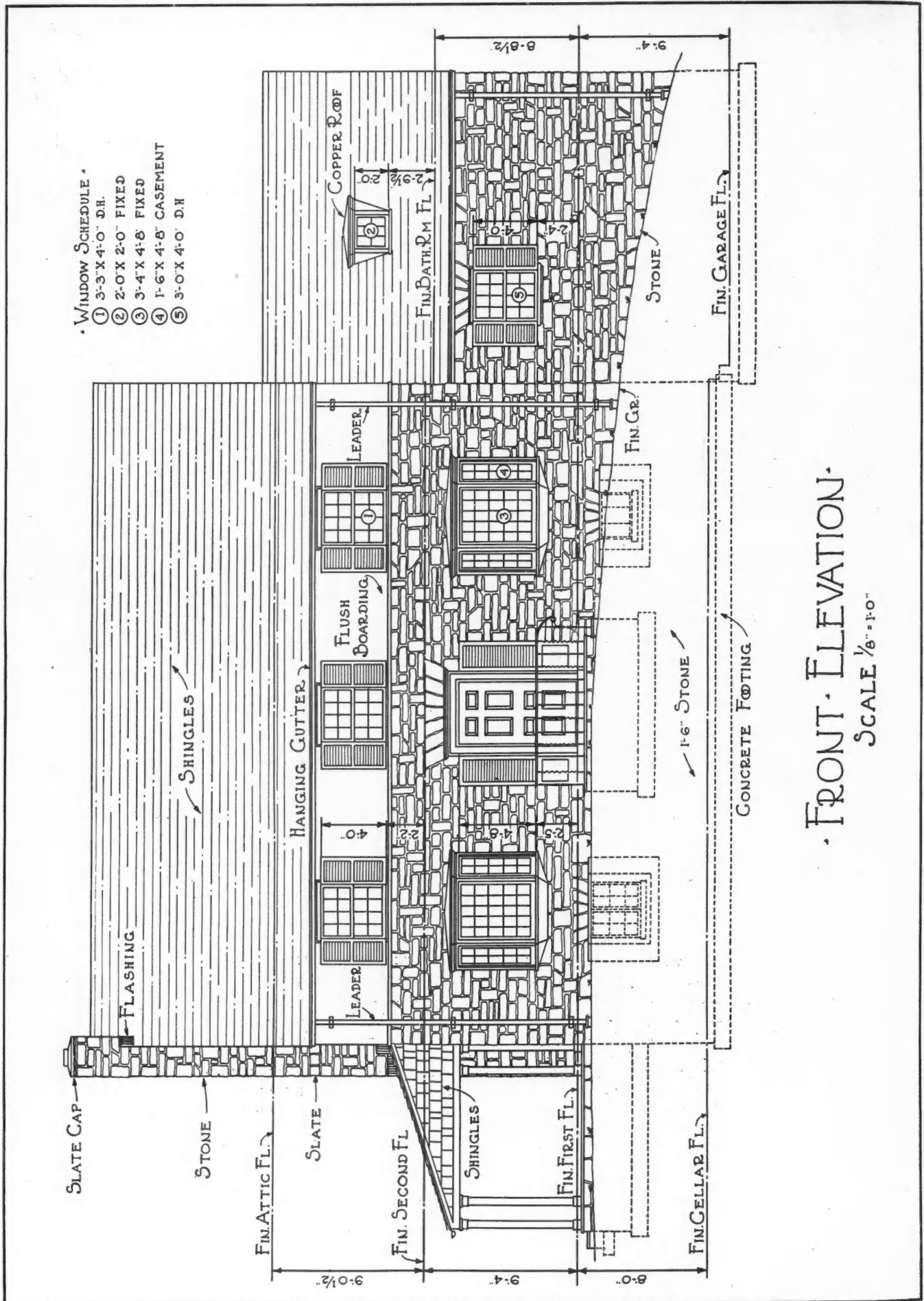

FRONT ELEVATION
SCALE 1/8" = 1'-0"

The Fine Balance and Proportion of the February House of the Month is Revealed in This Front Elevation. The entrance and window treatment are distinctive features of this design.

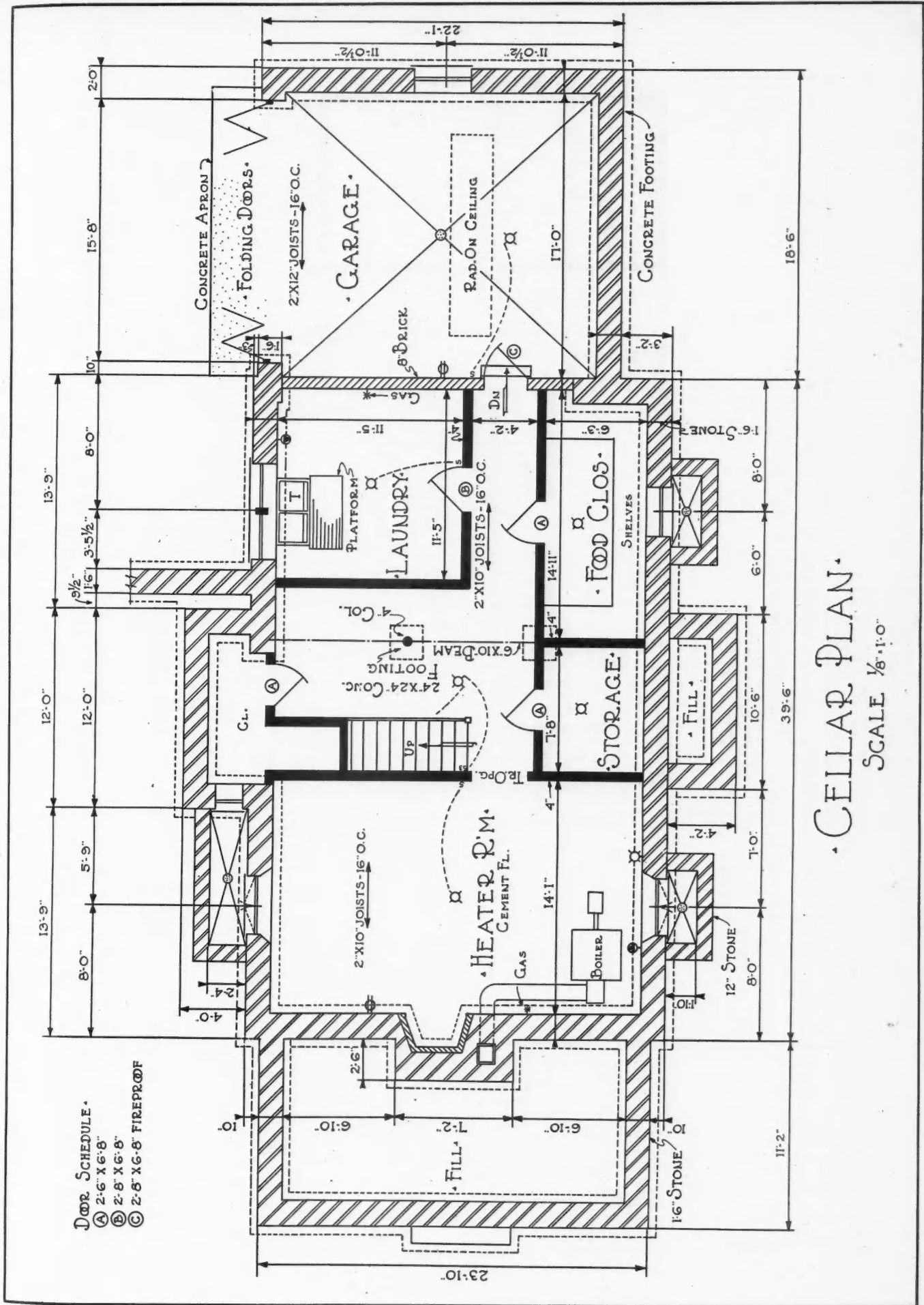

In This Commodious Basement the Laundry is Partitioned Off and a Platform Provided for the Tubs. Two storage rooms are provided and the heater room gives ample space for use as a play room.

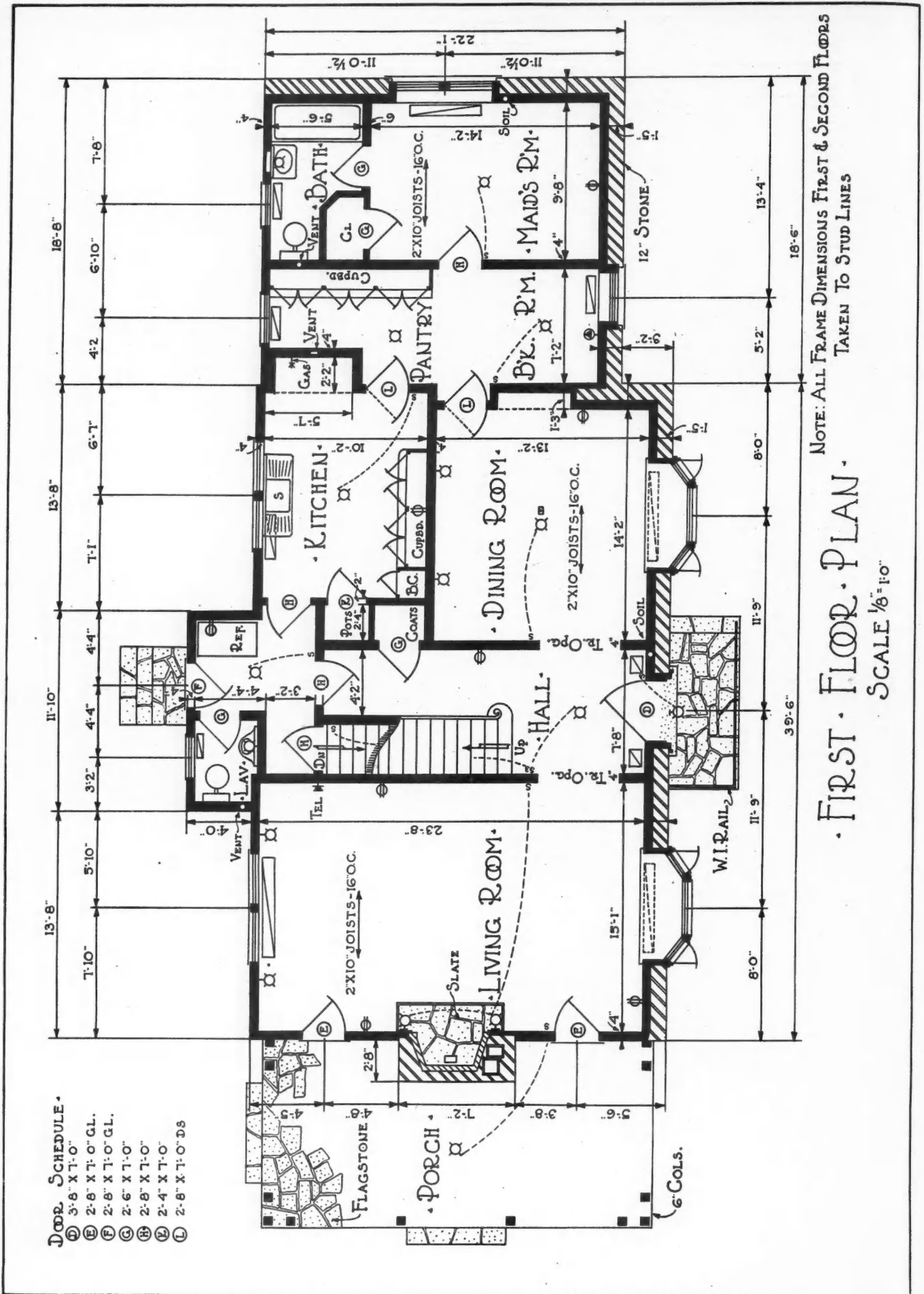

The Arrangement of the Housekeeping Unit In This Plan is Interesting. Provision is made over the garage for a maid's room and bath, breakfast room and pantry. There is a downstairs lavatory off the rear hall. Drawings by Polak and Sullivan, Architects.

- DOOR SCHEDULE •
- (M) 2'-8" X 6'-8"
 - (N) 2'-6" X 6'-8"
 - (P) 2'-6" X 6'-8" MIRROR
 - (R) 2'-6" X 6'-6"
 - (S) 2'-2" X 4'-0"
 - (T) 2'-8" X 6'-8" MIRROR

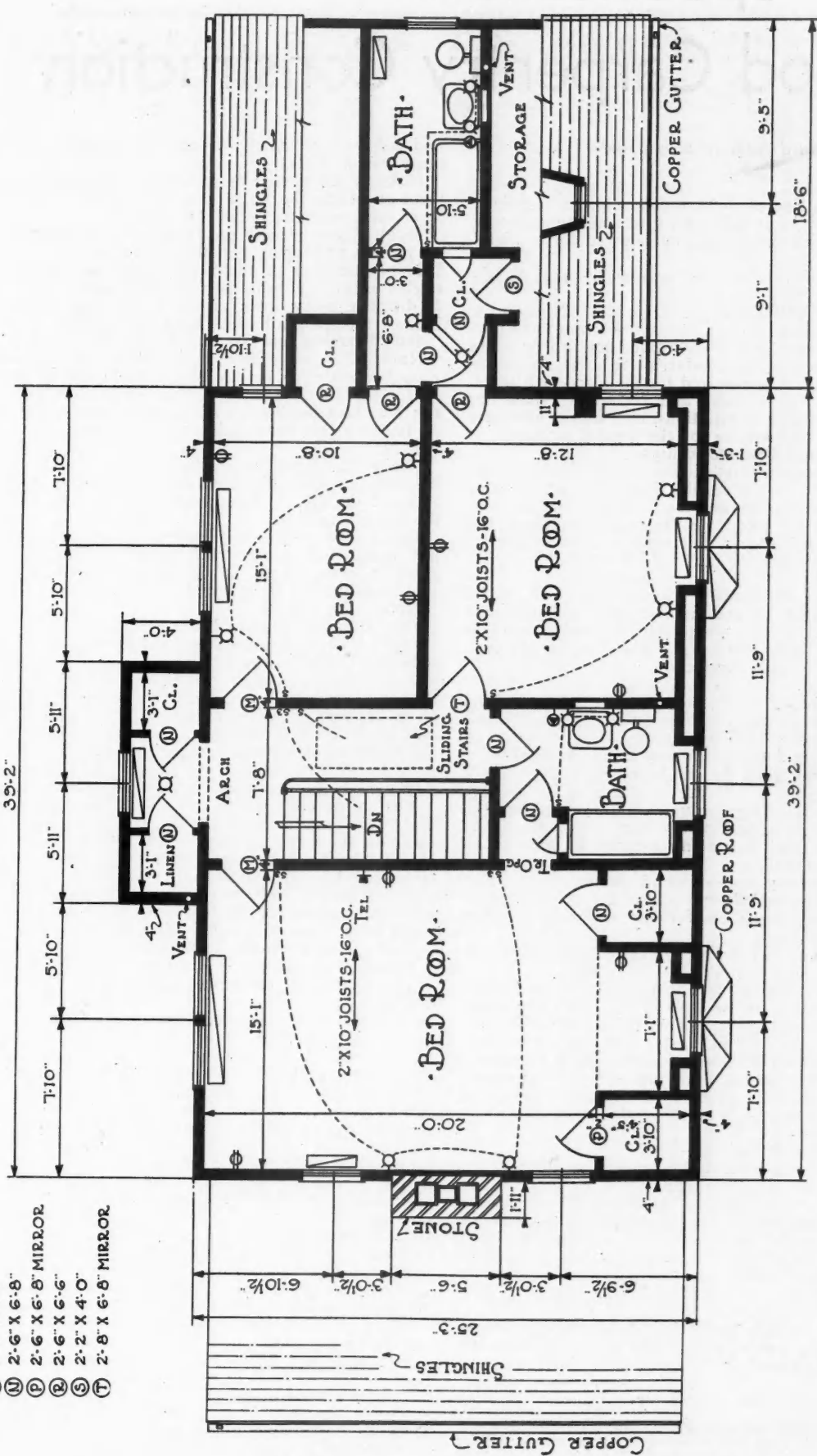

1. SECOND-FLOOR PLAN.
SCALE 1/8" = 1'-0"

This Plan Reveals a Large Master Bedroom and Two Smaller Bedrooms Together with Two Bathrooms, One of Which is Connected with the Master Bedroom. Note the utilization of space in the rear hall for closets. Drawings by Polak and Sullivan, Architects.

Master Specifications (continued) for Good Carpentry Construction*

(Continued from January issue)

(8) Joists

(8a) General—

(8a1) All joists shall be set with crown edge up, carefully leveled with full bearings at ends and intermediate supports. All headers and starting joists shall be selected for straightness.

(8a2) All butted joints shall be square cut and closely fitted.

(8a3) Space joists uniformly 16 in. o. c. (12 in. o. c. where so shown). Where required for added strength of particular floor areas, as hereinafter indicated, doubled or extra joists shall be set between the regular joists so as not to interrupt the uniform spacing required for standard lath units.

(8a4) Joists (including headers and trimmers) shall not be cut away to permit pipe installations, etc., unless adequate provision is made to compensate for the loss of strength.

(8b) Framing Around Floor Openings—

(8b1) Provide accurately fitted double header and trimmer joists of the same size as the regular joists around all floor openings. If the header is longer than six (6) feet and set back more than three (3) feet from the ends of trimmer, the trimmer shall be tripled, unless it is supported by a bearing partition column or girder.

Note: See Fig. 22.

(8b2) The ends of all headers longer than 3 ft. 6 in. (except when supported by columns or bearing partitions) shall be carried in steel stirrups, supported by and secured to the trimmer. Counter sink stirrups above and below the tops and bottoms of headers and trimmers.

Note: See Fig. 22.

(8b3) Wherever a trimmer is cut away at the header line, (as at an open stairway) the trimmer end shall be supported at the corner by a partition or post extending down to a girder or to a concrete footing. Where impossible to use a post, the construction shall be cantilevered and strongly braced.

(8b4) Trimmers and headers around chimneys and hearths shall be set at least two (2) inches from the face of the masonry. In no case shall a framing member be allowed to sit in or on a chimney wall.

(8b5) Provide correctly turned wood centers with outer ends supported on header ledger strips and butts supported on brick chimney-breast corbels for the support of rough brick hearth-arches.

Note: Omit (8b5) if reinforced concrete cantilever hearth slabs are provided.

(8b6) In fabricating headers and trimmers, a single header joist shall first be nailed to the ends of all joists supported with 20 penny nails two (2) for 2x6 in., three (3) for 2x8 in., four (4) for 2x10 in. and 2x12 in. joists. The second member shall then be nailed to the first with 16 penny nails staggered and spaced 16 in. apart along both top and bottom edges. The trimmer joists shall be nailed in a similar manner and with the same size nails, first to the ends of header joists and then to each other.

(8c) Framing Under Partitions—

(8c1) Double the joists under non-bearing partitions running parallel with the joists for spans 10 ft. or less. When span exceeds 10 ft. or partition height exceeds 9 ft. 6 in., the supporting joists shall be tripled. Doubled joists shall be separated a distance equal to the width of the supported partition sole and bridged every 18 in. with solid blocks the full joist depth (cut from joists) set with the grain running horizontally.

Note: See Fig. 26.

Where joists are tripled, first fabricate doubled joists as above and then secure a third joist at one side with 16 penny nails staggered and spaced 16 in. apart along both top and bottom edges.

Note: This provides solid nailing for the finished flooring

*As developed by architects and engineers for the Weyerhaeuser Forest Products Organization, St. Paul, and published in a new manual entitled "Standard Specifications for House Framing." The first half of these specifications was presented in our January issue, and the concluding section will be presented in March. In reproducing these we have omitted the Weyerhaeuser recommendations as to grade, species and qualities of materials.—Editor.

and allows pipe space through to partition without cutting away the supports.

(8c2) When one or more non-bearing partitions are set at right angles to the joists near the center of spans exceeding 10 ft., alternate joists shall be doubled.

(8c3) When bearing partitions are not directly supported on girders or bearing partitions, but are offset not to exceed 1/20 of the span of the supporting joists running at right angles to the partition, then alternate joists shall be doubled. If distance away from girder or bearing partition exceeds 1/20 of the span, all joists shall be doubled.

(8d) Framing for Tile and Similar Floors—

Note: The joists under toilet, bathroom and similar floors should provide for an additional dead load of 30 lbs. per sq. ft. for tile floors. Provide for an additional 20 lbs. per sq. ft. for plumbing fixtures. This often requires that joist be set 12 in. o. c. or extra joists set between regular joists. See Fig. 23.

(8d1) Where tile or similar floors are to be installed, the top edges of joists directly under these floors shall be tapered and 1x2 in. ledger plates nailed along each side to support the cut-in sub-floor.

(8d2) Joists shall be arranged, wherever possible, to permit installation of pipes with a minimum amount of cutting away of joists. If this is not possible, headers and trimmers shall be provided to compensate for the loss of strength.

Note: See Fig. 23.

(8g) Framing Second Floor Joists—

(8g1) Balloon Frame Construction—

Note: This method is illustrated by Fig. 18.

The ribbands shall be let into studs their full thickness. Ribbands shall be selected for straightness and leveled-up so as to support all joists evenly, and shall be nailed to each stud with two 8 penny nails.

The joists shall be placed against sides of studs and nailed to them with three 16 penny nails. The starting joists shall be nailed to each end wall stud with two 16 penny nails.

The inside ends of all joists shall be supported on partitions having a double 2x4 in. plate with the studs in this partition set as nearly under each joist as is possible. Joists shall lap each other directly over bearing partitions for a distance equal to the width of the partition plate and shall be nailed together with two 10 penny nails driven from each side. All joists shall be toe-nailed, each side of laps, to the bearing partition plates with one 10 penny nail.

(8g2) Braced Frame Construction—

Note: This method is illustrated by Fig. 19.

The joists shall be placed 16 in. o. c. (12 in. o. c. where studding is 12 in. o. c.) measured along the false girt and shall be toe-nailed to it with two 10 penny nails on each side.

The joists shall be placed against sides of studs and nailed to them with three 16 penny nails. The starting joists shall be nailed to each end wall stud with two 16 penny nails.

The inside ends of all joists shall be supported on partitions having a double 2x4 in. plate with the studs in this partition set as nearly under each joist as is possible. Joists shall lap each other directly over bearing partitions for a distance equal to the width of the partition plate and shall be nailed together with two 10 penny nails driven from each side. All joists shall be toe-nailed, each side of laps, to the bearing partition plates with one 10 penny nail.

(8g3) Platform Frame Construction—

Note: This method is illustrated by Fig. 20.

Both headers and starting joists shall be set flush with the outside edge of false girt and shall be toe-nailed to it with 10 penny nails set 20 in. apart.

All joists shall be toe-nailed, each side, to false girt with one 10 penny nail.

Headers shall be nailed to the joist ends with three 16 penny nails for 2x8 in. joists, and four 16 penny nails for 2x10 in. and 2x12 in. joists.

The inside ends of all joists shall be supported on partitions having a double 2x4 in. plate with the studs in this partition set as nearly under each joist as is possible. Joists shall lap each other directly over bearing partitions for a distance equal to the width of the partition plate and shall be nailed together with two 10 penny nails driven from each

STANDARD DETAILS FOR HOUSE FRAMING

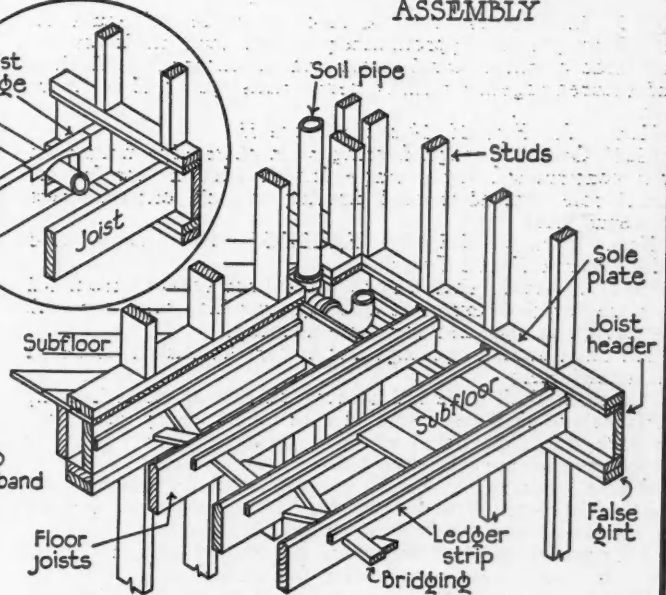
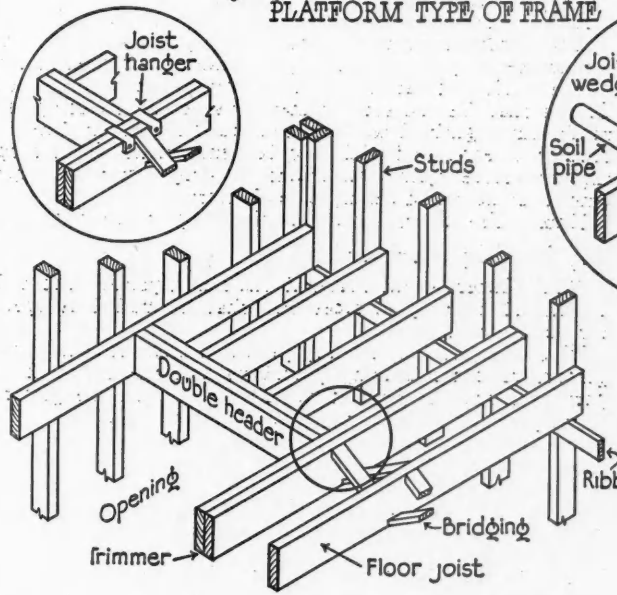
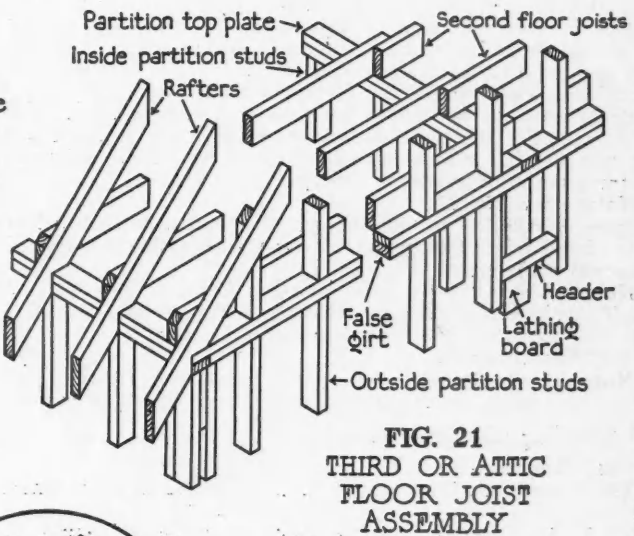
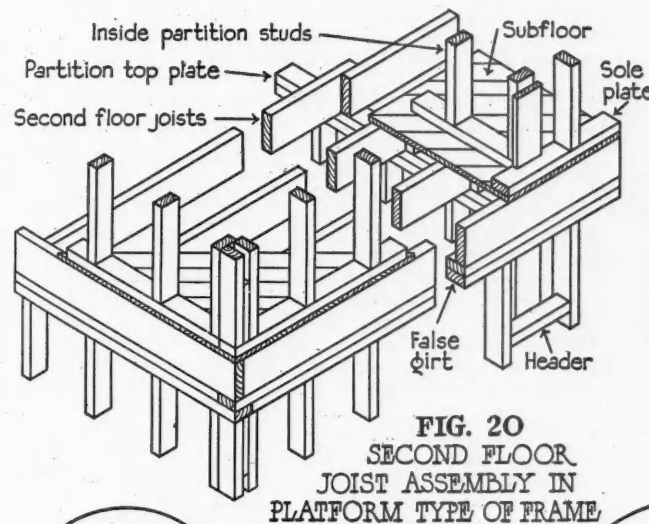
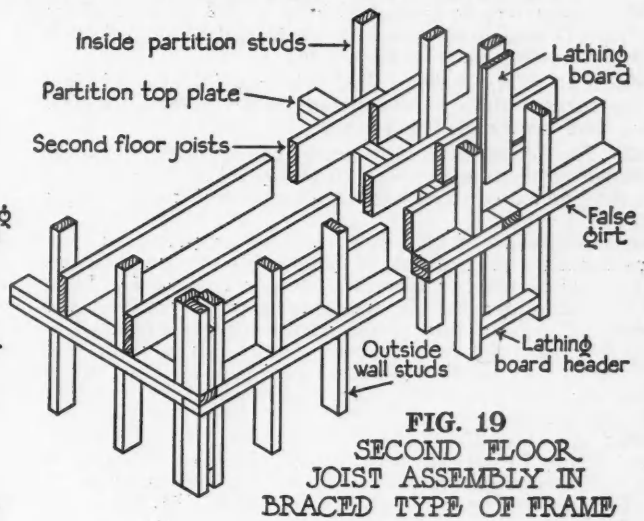
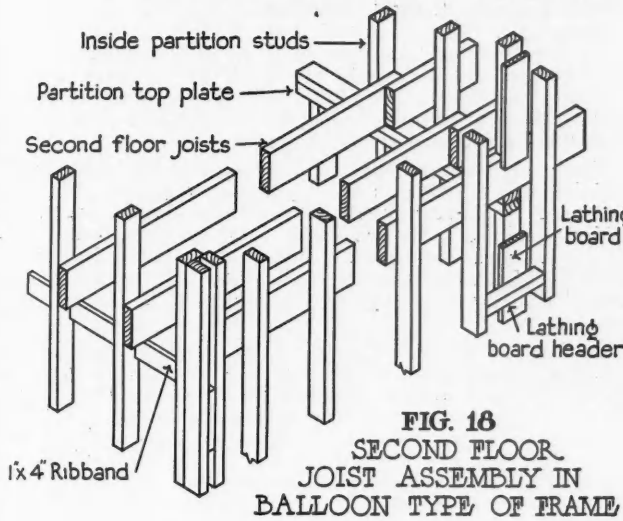

FIG. 22 FRAMING AROUND FLOOR OPENING

FIG. 23 FRAMING JOIST UNDER BATHROOM

Recommended Details of Timber Construction—House Framing; They Make Clear Many of the Paragraphs of the Accompanying Specifications.

side. All joists shall be toe-nailed, each side of laps, to the bearing partition plates with one 10 penny nail.

(8h) Framing Third or Attic Floor Joists—

Note: The method illustrated by Fig. 21 for supporting outer ends of the third or attic floor joist is adapted to either the BRACED, BALLOON or PLATFORM types of frame.

(8h1) Joists shall be spaced 16 in. o. c. (12 in. o. c. where so indicated) measured along the plate and toe-nailed to it with two 10 penny nails on each side.

Ends of all joists shall set flush with outside edge of plate and top corners shall be chamfered (when necessary) after rafters have been nailed in place.

(8h2) The joists shall be placed against sides of rafters and nailed to them with three 16 penny nails. The starting joists shall be nailed to each end wall stud with two 16 penny nails.

The inside ends of all joists shall be supported on partitions having a double 2x4 in. plate with the studs in this partition set as nearly under each joist as is possible. Joists shall lap each other directly over bearing partitions for a distance equal to the width of the partition plate and shall be nailed together with two 10 penny nails driven from each side. All joists shall be toe-nailed, each side of laps, to the bearing partition plates with one 10 penny nail.

(8i) Bridging—

Note: See Fig. 27.

(8i1) Cross bridge all floor joists with one (1) row of bridging for spans from six (6) ft. to ten (10) ft.; two (2) rows for all spans from ten (10) ft. to twenty (20) ft.

Bridging shall divide the spans into equal parts and shall be nailed at both ends with two 8 penny nails driven at right angles to face of joists. All nails shall be started before members are set in place. Bridging shall be put in and the top ends nailed before laying the sub-floor. The bottom ends shall be nailed after the sub-floors have been laid.

Bridging shall be put in between the first three or four joists opposite the ends of headers when these headers are set two (2) ft. or more away from the end of the trimmer or from the regular row of bridging.

Note: See Fig. 22.

(8i2) Add a 1x4 in. continuous strip nailed to the underside of the joists (when not plastered) beneath each line of diagonal bridging.

Note: On first story floors carrying heavy or concentrated loads this provision adds considerably to the strength in assisting in distributing the load over several joists.

(8j) Miscellaneous.

Note: Here include any special structural features not ordinarily encountered, but necessary in the particular work.

(9) Studding (Outside Walls)

(9a) General—

(9a1) Studs shall be spaced 16 in. o. c. (12 in. o. c. where so designated).

(9a2) All corners shall be made of three (3) studs so set as to provide approximately a full stud thickness on each side of the internal angle and all thoroughly blocked and secured together with 16 penny nails spaced 12 in. apart o. c.

Note: See Figs. 18, 19 and 20, page 55.

(9a3) Over the rough flooring, with outer edge flush with joist construction, lay a single 2x4 in. (2x6 in. for 2x6 in. studs) sole, secured through flooring to each joist with two 16 penny nails.

Note: Include (9a3) for BALLOON with box sill and PLATFORM Frame Construction.

(9a4) All studs shall be one piece (not spliced) from sill to plate (or girt) except at openings, in which case they shall be framed as specified for these openings.

All studs around openings and at corners shall be selected for straightness.

All studs shall have full bearing on sills or other bearing surfaces and shall be toe-nailed with four 8 penny nails (two on each side), except where these studs sit against joists in which case secure with two nails on the one side.

Where studs sit against joists, they shall be nailed to the joist with 16 penny nails, two for 2x6 in. and three for 2x8 in. joists and four for 2x10 in. or 2x12 in. joists.

All main studs shall be square cut and of uniform length so as to furnish uniform bearing for wall plates.

Studding at chimney shall be set at least (one (1) inch) (specify) from the face of masonry.

Plates shall consist of two pieces of the same size material as the studs. They shall be lapped at the corners and at all joints. All joints shall be made directly over the studs.

Plates shall be nailed to top ends of each stud, one thickness at a time, with two 16 penny nails and to each other

with 10 penny nails staggered and spaced 16 in. along each edge.

(9a5) All (gable) (and) (dormer) studs shall be notched and beveled to receive end rafters and rafters nailed to each stud with two 10 penny nails.

Note: See Fig. 24.

(9b) Framing Around Openings—

Note: See Figs. 28 and 29, page 57.

Double studs and headers shall be used around all openings (where 2x6 in. studs are used, the headers shall be tripled). All header members shall be securely nailed together, those at opening heads set on edge and secured flush with the outside face of studding.

For openings three (3) ft. wide or less in bearing walls and four (4) ft. wide or less in non-bearing walls, the material used for headers shall be the same size as studs. For wider openings up to five (5) ft. in bearing walls and seven (7) ft. in non-bearing walls, the material used for headers shall be of same thickness, but at least 2 in. wider than the studs. For wider openings the headers shall be symmetrically trussed.

In bearing walls the ends of the bottom headers in all window openings shall be supported by short studs nailed to the regular studs and extending down to the sill or second floor joists. Where a window opening in second floor comes above a first floor opening, studs at both sides of the openings shall be reinforced all the way up to the roof plate by short studs cut-in between all headers and nailed to them.

Double studs and bottom header members shall be nailed together with 16 penny nails staggered and spaced 16 in. apart along both edges. 2x4 in. headers shall be fastened to studs with two 16 penny nails driven through the studs into each end. The ends of all short studs fitted between the headers shall be toe-nailed to the headers with four 8 penny nails.

At windows, allow the dimensions detailed between finished jambs, sills and heads to rough framing for weight boxes, casement jambs, head jambs, etc.

Over the figured door sizes, allow (3 in.) (specify) in width and (2½ in.) (specify) in height for rough framing.

(9c) Bracing—

Note: Bracing is essential in all frame construction, because it provides rigidity, resistance to wind pressure and assists to prevent plaster cracks. The three methods following are given in the order of effectiveness. Specify one.

(9c1) Apply the sheathing diagonally.

(9c2) Provide let-in diagonal bracing at each story at all corners, set approximately at 45°, with upper ends on opposite side of corner studs and approximately full story height. Bracing shall be 1x4 in. accurately let-in the full thickness, flush with the outside face of studs and nailed to each stud with two 8 penny nails. Thoroughly brace at corners with two braces running in opposite direction where openings close to corners interfere with standard bracing.

Note: Use where horizontal sheathing is specified.

(9c3) Provide cut-in diagonal bracing at each story at all corners set at 45° with the upper ends on adjacent sides of corner studs and carried the full story height when possible. Braces shall be the same dimensions as the studding, accurately cut, tightly fitted between studding and in line. Nail bracing at each stud with two 10 penny nails. Where openings interfere with continuous bracing apply in shorter lengths at floor and ceiling of each story.

Note: Use where horizontal sheathing is specified.

(10) Studding (Partitions)

(10a) General—All material shall fit squarely and tightly against all bearing surfaces and shall be nailed as specified for outside wall studs.

Wherever possible, bearing partitions shall set directly over girders or other bearing partitions and the studs in these partitions shall be framed to rest directly on the girders or bearing wall plates (except that when the platform type of frame is used, then the second story partition studs shall sit on a single sole of the same size material as the stud nailed to the sub-floor).

Note: See Fig. 25, page 57, and Fig. 19, page 55. Omit bracketed clause in italics if PLATFORM type of construction is not used.

All non-bearing partition studs shall be set on a single plate nailed to the sub-floor except where a double plate permits use of standard length materials.

All bearing partitions shall be capped with a double plate and all non-bearing partitions with a single plate except where a double plate permits the use of standard length materials.

To be concluded in the March Builder.—Editor.

STANDARD DETAILS FOR HOUSE FRAMING

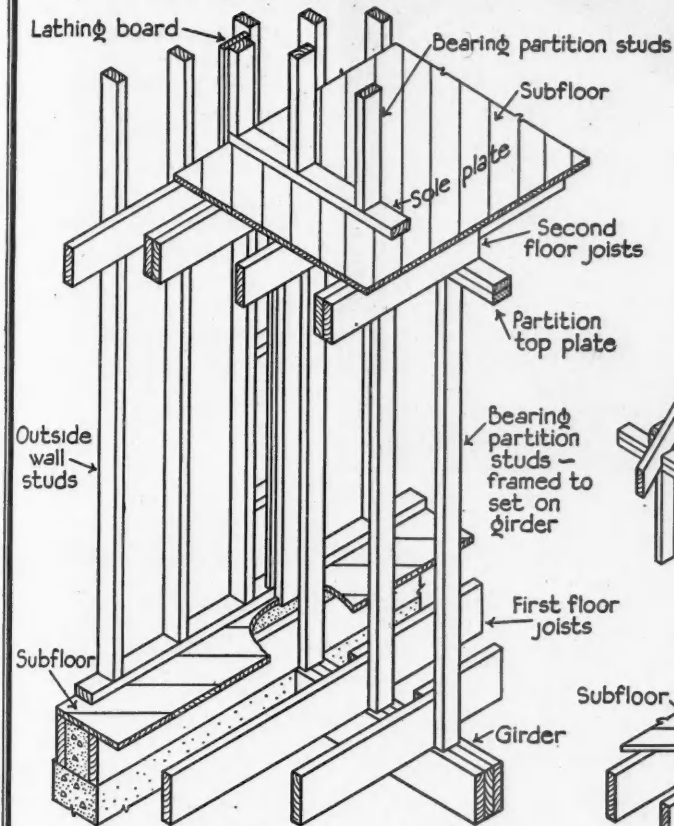

FIG. 25
FRAMING FOR BEARING PARTITION

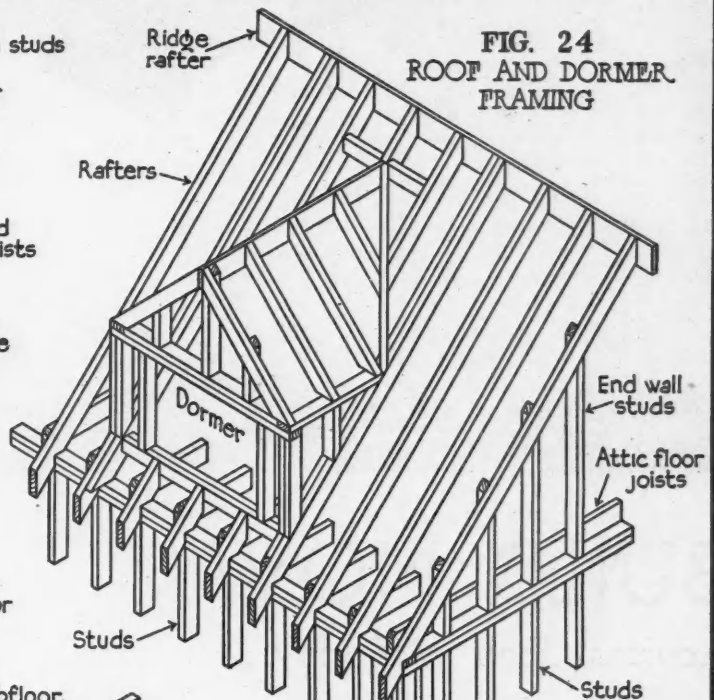

FIG. 24
ROOF AND DORMER FRAMING

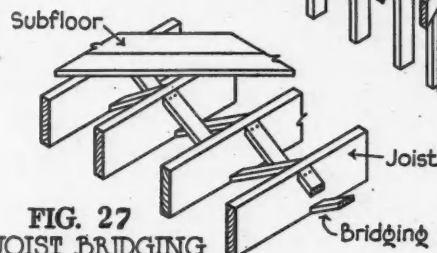

FIG. 27
JOIST BRIDGING
Note: Bridging should be nailed at top only until after subflooring is laid.

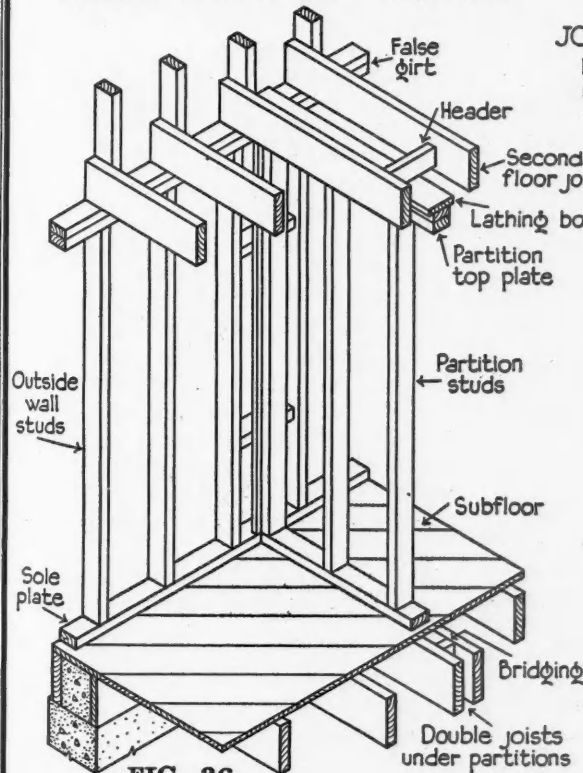

FIG. 26
FRAMING FOR NON-BEARING PARTITION

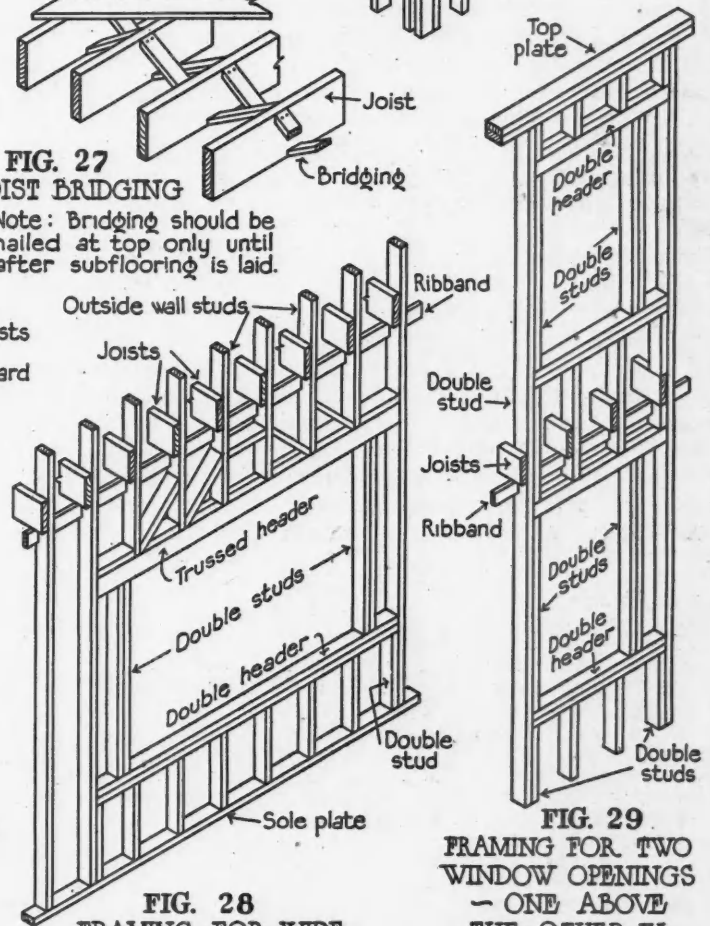

FIG. 28
FRAMING FOR WIDE WINDOW OPENINGS

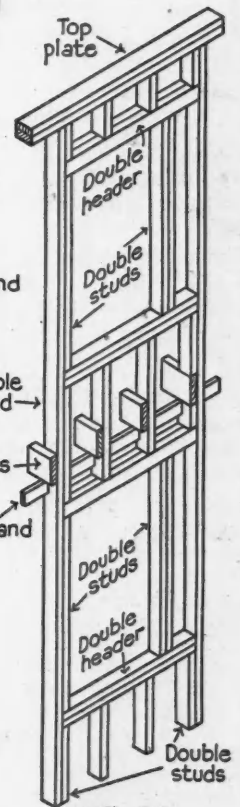

FIG. 29
FRAMING FOR TWO WINDOW OPENINGS - ONE ABOVE THE OTHER IN BEARING WALL

Partition, Roof and Wall Framing Details, Exemplifying the Principles Recommended in the Accompanying Specifications.



The Royal Yorke
Apartments
Bigelow Boulevard,
Pittsburgh

FREDERICK STANTON
Architect

JOHN McSORLEY
Builder and Owner

"BUILD NOW"

Advises John McSorley

DURING the past two years many of the nation's leading builders have been somewhat hesitant in going ahead with their building programs as they would have done had conditions been more normal. Perhaps this attitude on their part was due to the so-called element of fear which for some time has apparently gripped the minds of builders everywhere. In reality, prevailing conditions today give the builder an excellent opportunity to take advantage of lowered construction costs.

There is one outstanding builder in Pittsburgh, Pennsylvania, who has cashed in during a time when most others have rested, idly waiting for better times to come. That builder is John McSorley. To his credit now stand many buildings of the major type, erected during what is termed the "depression period." One building in particular, now in process of completion, is the Royal Yorke Apartments. This highly modern structure, consisting of 161 apartments of two, three, four and five rooms, represents the largest apartment building project to be undertaken in the Pittsburgh district the past

Pittsburgh Builder Finds It Profitable to Take Advantage of Lowered Building Costs and Modern Building Systems

year—a time when most builders would not consider attempting such a large undertaking.

It is a magnificent, fire-proof building situated on a commanding site overlooking the beautiful East End district of Pittsburgh.

In discussing construction details of this apartment, Arthur McSorley, oldest son of John McSorley and general manager in charge of construction, made a particular point of the partition system used, a new development in the industry! In his opinion, partitions are of vital importance in an apartment building since they afford comfort and privacy to the tenants. From his point of view, as a builder, the deciding factors of a partition material or method are the costs for both material and labor, and the effectiveness of the finished partition as to sound resistance, acoustical properties and insulating characteristics.

After considering various systems of partitions and using a conventional type in part of his building, Mr. McSorley decided to complete his building with the new steeltex partition system which consists of a steel

stud composed of two hot rolled channel members formed into a single stud by welding 12½ gauge galvanized annealed wire across the legs of the channels on 5 inch centers. The channels are placed one inch apart, giving an over-all depth of 2½ inches. The cross wires have an overhang of 1½ inches on both sides of the stud. After these partition studs are placed and fastened, the ribbed steel fabric lath for interior plaster is pushed against the extending prongs, which puncture the fibrous backing and are then simply bent back holding the lath securely. Plaster is then rapidly applied and the partition takes its complete form.

Mr. McSorley used this new partition system after compiling costs in comparison with other conventional

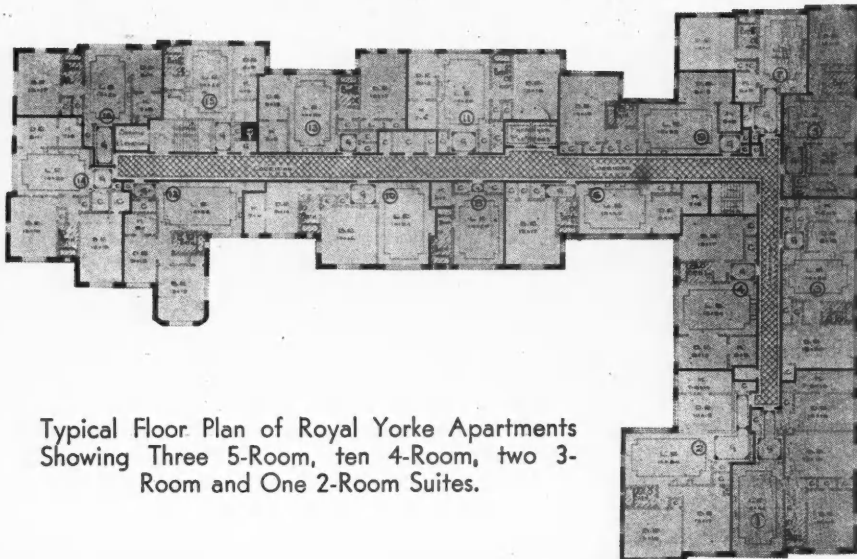

Typical Floor Plan of Royal Yorke Apartments
Showing Three 5-Room, ten 4-Room, two 3-Room and One 2-Room Suites.

types of partitions, including clay tile and gypsum (which he already had on the job). The costs of materials were practically the same, based on a square yard of partition. In other words, two yards of the steel fabric lath, plus the channel, cost as much as one yard of clay tile or gypsum. However, McSorley's experience in application was that the new type partition could be erected at a rate of 55 to 60 square yards per lather per day, on the average. This figure included erecting the channel studs and attaching the ribbed lath on both sides. In making a comparison of his labor costs, he found that when he included the breakage of clay tile and the labor involved in cleaning up and removing debris from the building, the erection costs on the new partition system were just about one-third of the erection costs of other types.

Another item of importance was sound-proofness. Here again the new partition system was found to possess a greater sound-proof quality than that obtained

through the use of tile partitions. Sounds emanating from corridors were not as easily detected or heard in the apartments with the steel and plaster partition as in those apartments where other partitions were used.

It has been the study of such conditions and the grasping of such opportunities that have enabled Mr. McSorley during the past year to cut considerably the costs in his extensive building operations in the Pittsburgh district and still erect imposing structures that meet the most exacting demands of high-grade apartment clientele.

When completed in May of this year, the Royal Yorke Apartments will stand as a monument to the confidence and business acumen of the builder in erecting a large apartment building during a period when building generally was at a low point of activity. At this writing over half of the apartments are rented and indications point to a full rental by the time the building is ready for occupancy.



New Type Partition Studs Erected, Ready for Steeltex Plaster Lath, in U. S. Naval Air Corps Barrack at Anacostia, D. C. Above is shown closeup view of partition in Royal Yorke Apartments, Pittsburgh, with some of the lath removed to show construction.

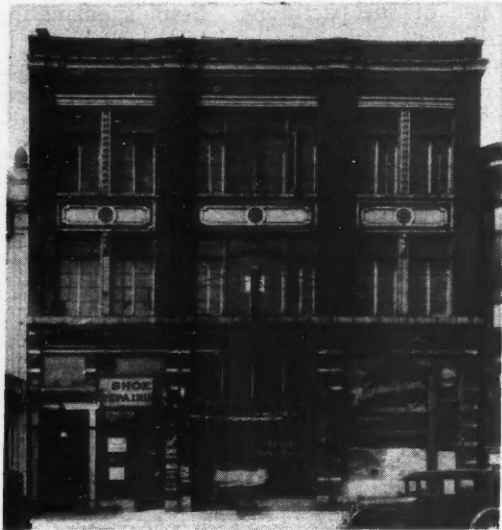

Before Modernizing—a Liability

THE accompanying pictures of a Chicago modernizing job performed by the Sanders Store Service Company speak for themselves. At a total cost of only \$5,500 this building was transformed from a liability to a live asset. It illustrates what can be done with a little money these days to get a big return through modernizing.

This remodelling is especially interesting because of the smart modern treatment of the store front, aluminum and formica being employed to give the desired effects. The sign is sand-blasted 1/16" deep on the front and filled with aluminum bronze which is protected by a surface coating.

Details of the construction include: double polished

aluminum entrance doors; concealed, double acting floor checks; traverteen plaster show window background; oriental walnut base, doors and trim; tempered composition flooring 6" x 8" alternate light and dark blocks; terrazzo entrance floor of red and yellow.

Front of building is of 3/8" black formica, asbestos filled. Upper panels are of textured stucco.

Aluminum self-supporting sash are used, and upper display windows and side windows are also of aluminum. The awning box is recessed and is of aluminum. It is estimated that use of the modern materials saved a considerable sum, as preliminary estimates showed cost of terrazzo to be 16 per cent and marble 53 per cent above that of the material finally accepted.

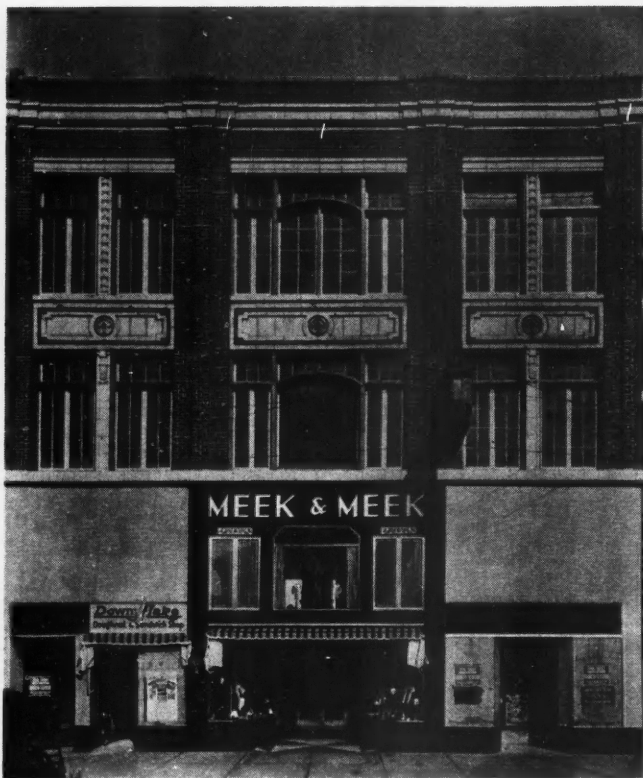

After modernizing—a modern, rent-producing structure that is an asset to its owners and to the community.

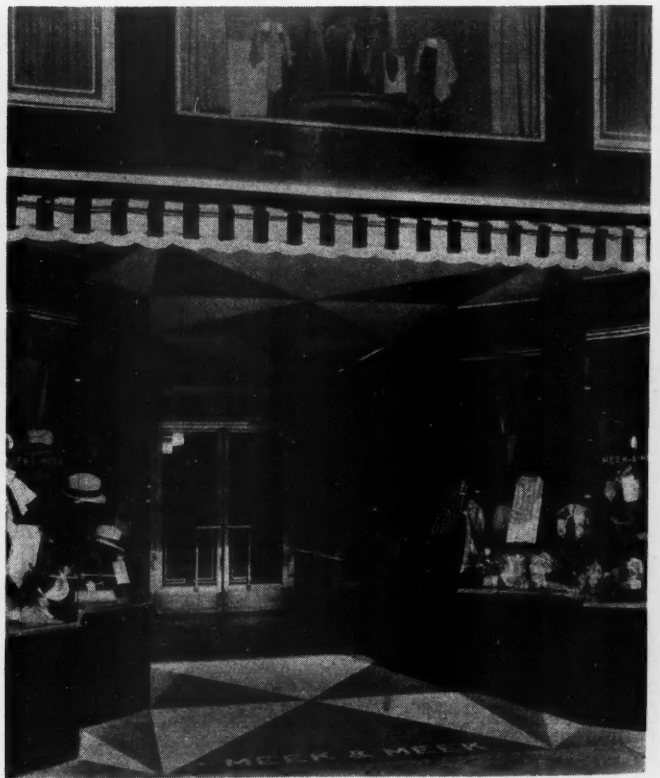

Interesting Modern Treatment of Store Front with Window and Door Arrangement That Provides Maximum Display.

Now in Business for Himself!

Philadelphia Cabinet Maker Finds Profits in Machine Woodworking

ABOUT a year ago, Louis Dickman, a Philadelphia cabinet maker, chanced on a power woodworker advertisement suggesting "Get Into Business for Yourself." He visited the showroom and examined the outfit. Later, he brought his wife and son to see the machine and, after a family conference, bought it, paying \$65.00 cash and the balance on time. He first set up the machine in his cellar, figuring that he would have a very small overhead or fixed expense, and so should be able to compete with larger factories.

He made up some samples of furniture and took them to the leading department stores. They gave him some small trial orders and the business grew. Mr. Dickman's cellar was soon too small to accommodate his business, so he rented a nearby store at \$17.00 per month, his electric power costing \$3.00 per month. One of his recent orders was for twelve breakfast room china cabinets. These were to be sold at retail by a local department store at \$45.00 each.

The question that will naturally come to the mind of every reader is whether or not, in these days of large unit production, an independent workman with limited manufacturing facilities can compete as regards cost and quality on work of this sort. In order that this

report might be of real helpfulness to others interested in embarking on a similar enterprise, Mr. Dickman has supplied his cost data. He states that he bought the lumber required for these cabinets from a local lumber yard for 5½ cents per foot average. It requires about 45 board feet to make a cabinet; and \$3.50 is the cost of all material, including hardware. With help of his boy, Mr. Dickman can cut out and assemble 20 cabinets in 5 days. Working 9 hours per day, they put 45 hours of labor on the 20 cabinets. According to his cost records, the cabinets cost about \$6.00 each. He sells them for \$12.00 each.

Another natural question concerns the source of the design for these cabinets. Many men who may feel themselves to be skilled craftsmen are not expert creative designers. In this instance, Mr. Dickman copied the design of the cabinet from a sample supplied.



Revolutionary Improvements in Double Hung Windows

AFTER more than two years of testing in scientific laboratories and in actual construction, one of the leading manufacturers of millwork is now offering through its dealers a factory-fitted window assembly consisting of frame, glazed and metal weatherstripped sash, full-length screen, and storm sash. The sash are double hung; yet weights and weight boxes, pulleys and cord are entirely absent in this new window. Instead, a simple arrangement of coil springs counterbalances the sash, and a bronze to bronze weatherstrip contact insures perfect weathertightness and freedom from rattle. Accurately machined at the factory, there is a saving of time on the job when installing these windows which fully pays for the metal weatherstripping and the other quality features. The enthusiastic commendation of those homeowners, builders, contractors and dealers who have become familiar with this new window on the numerous test job indicates that it merits the consideration of everyone in the home building industry.

The remarkable airtightness of this improved frame and weatherstripped sash is proved by a long series of tests by the Pittsburgh Testing Laboratories. These tests gave the following air leakage data:

With air directed against the new frame and sash at a pressure equal to a wind velocity of 30 miles per hour, it was found that in comparison, the regular weight-box quality frame, weatherstripped, had a 50 per cent greater leakage; another quality frame, not weatherstripped, had a 350 per cent greater leakage; an ordinary standard frame, weatherstripped, had a 500 per cent greater leakage.

The accompanying details illustrate the outstanding features of this new window. The single jamb (1½ inches net instead of ¾ inch as usual) replacing weight boxes, pulleys, and jamb pockets removes a major source of air leakage.

The jamb, blind stop and outside casing are membered together with heavy square shoulders to reduce air infiltration. The blind stop is rabbeted for the insertion of building paper. The carpenter inserts a strip of paper 6 to 8 inches wide and tacks it to the back of the outside casing before the frame is installed. Even though the single jamb construction had substantially reduced air leakage in comparison to the box frame, tests of the new window with and without this paper showed that the paper insertion pro-

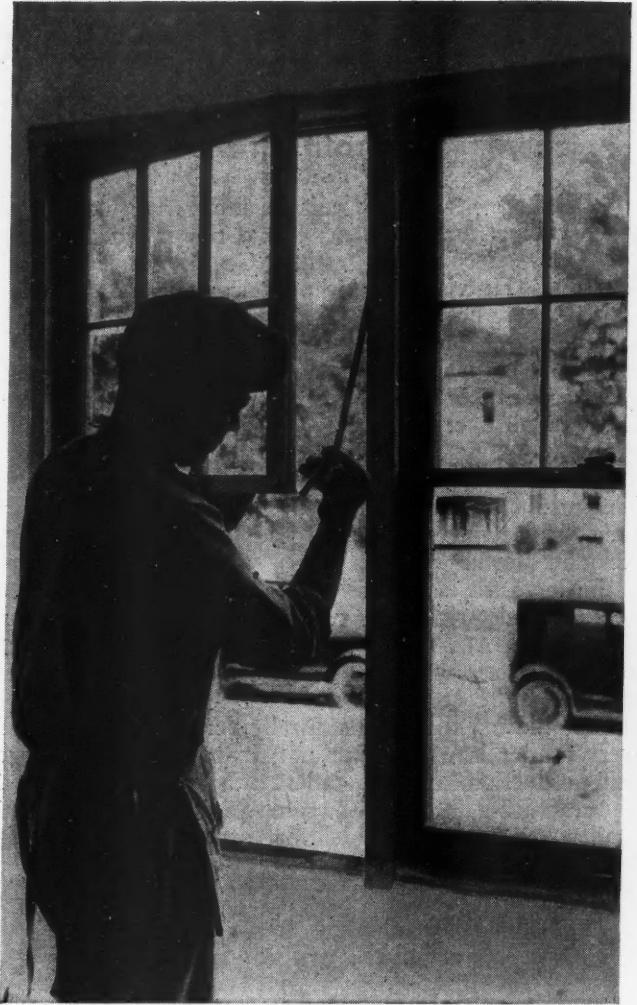

duced an added reduction of frame leakage (not total opening leakage) of approximately 50 per cent.

The window slides on resilient interfitting bronze weatherstrips which prevent rattling. There is a double contact of metal-to-metal which is extra assurance against air leakage. This so effectively seals the joint that wood contact is unnecessary. The sash may shrink or swell without affecting the easy operation or weather-resisting qualities. Paint binding is easily broken.

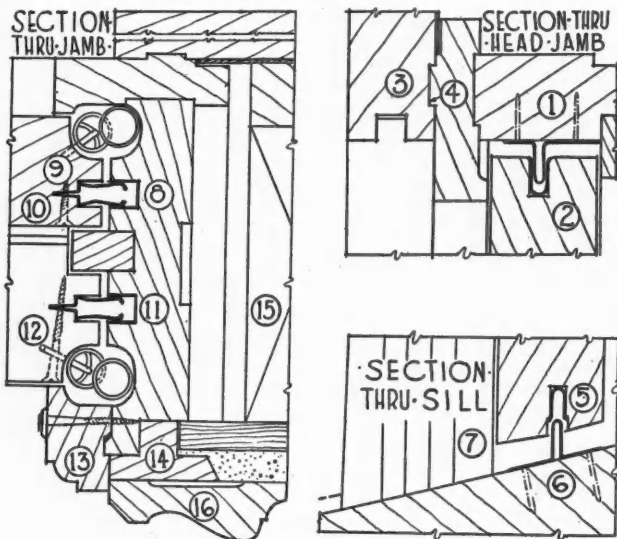

Frame, Sash and Screen Installed in Frame Wall	Cost Comparison—Retail Prices	
	Old Style DH Window	New Style DH Window
Frame KD.....	\$3.72	\$4.70
Set-up charge72	.48
Glazed sash (2).....	2.54	4.74
Carpenter labor fitting window.....	.50	none
Weights and cords90	none
Weatherstripping applied	2.75	included
Pine trim, 2¼"91	.91
Preparing opening for narrow trim, ground strips and metal lath.....	.75	none
Full length screen	1.77	1.77
Fitting and hanging screen.....	.60	none
Screen hardware15	.08
Totals	\$15.31	\$12.68

Details of new double hung window assembly: (1) head jamb with zinc rib; (2) top rail with zinc lined channel; (3) head casing grooved for screen and storm sash; (4) blind stop rabbeted; (5) bottom rail with zinc lined channel; (6) zinc weatherstripped sill; (7) parting stop; (8) bronze channel upper sash; (9) coiled spring upper sash; (10) retaining screw for weatherstrip; (11) bronze channel lower sash; (12) coiled spring lower sash; (13) stop; (14) jamb liner; (15) stud.



same for any wall thickness. Different outside moulding and plaster ground liner adapt the frame to any wall.

The new frame embodies a new principle of fitting screens and storm sash. The newly developed simple fastener makes the installation of either easily and quickly accomplished. The new vented storm sash permits adequate ventilation without opening the storm sash itself.

To the owner, this new window means more attractive narrow trimmed windows, more wall space or more glass area or both, a more comfortable home, lower heating costs, cleaner draperies and quiet windows which are easily operated.



The narrow mullions give improved appearance both inside and out.

If a defect in the wire should cause a spring to break, it may easily be replaced by anyone without the removal of the stop.

With this new arrangement narrow mullions are now possible on double hung windows. Narrow trim may be nailed directly to the studs assuring the same permanent, secure railing and freedom from plaster cracks previously attained with wide trim without the expense of installing additional grounds and metal lath around the window openings.

The new frame is easily adjusted to any type of wall construction. The head and sill of frame are packed in one carton and the side jambs in another. The jamb, blind stop and outside casing come nailed together, as they are the

The architect may now design homes using double hung windows and at the same time retain the beauty of narrow mullions, narrow trim and narrow outside casings previously associated only with casement windows.

In the majority of test jobs, it was found that contractors saved on installation costs because of the simpler construction and the factory pre-fitted sash. Reduced servicing charges are also an advantage. The speculative builder has found that these windows are an impressive sales point.

These new and revolutionary window assemblies are now in production in a full range of sizes at the factory and are on display in the sales offices of many lumber dealers. Examine them there or write for further particulars.

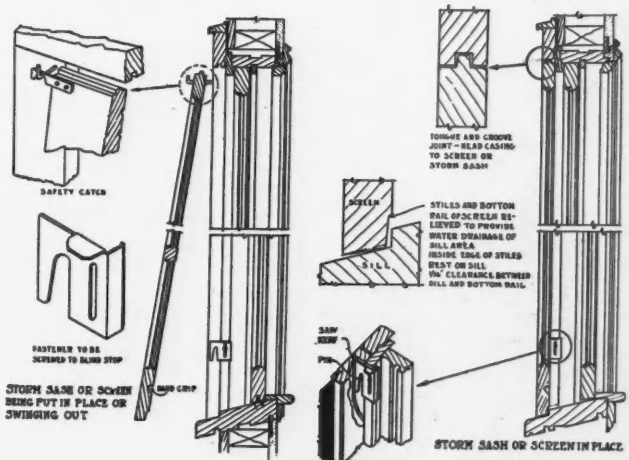
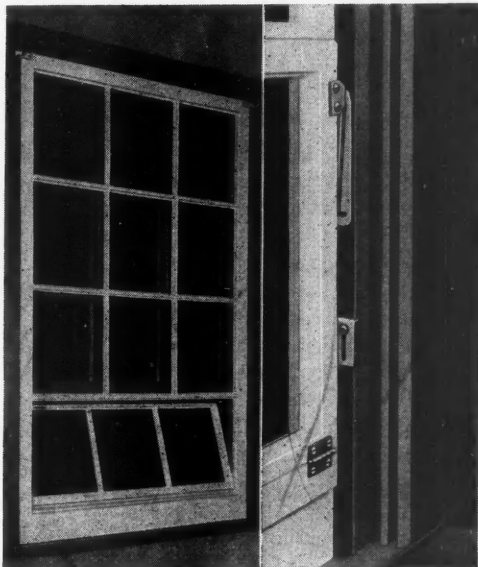

Full length screens and storm sash are provided in this new window assembly. Sketch to left shows ingenious storm sash vent, outside view and inside hardware.

Builders Offered New Products

Manufacturers of Materials and Equipment Are Announcing
New and Improved Products for the 1932 Building Season

For further information on any of the products mentioned on these pages write American Builder and Building Age, Information Exchange, 105 W. Adams St., Chicago.

ALWAYS something new, seems to apply with particular force to the building industry; and recent weeks have been no exception to the rule. Manufacturers' announcements of new and improved products run through a wide range, from roofing materials to floor machines, and from heating equipment to blue print cabinets. One of the most interesting is a roofing material which is an excellent reproduction of wooden shakes and shingles, in permanent form.

Permanent Roofs of Character

Protection, insulation, beauty and workability are combined in this new type of roofing material, in a most interesting and effective manner. Each shingle, or shake, is composed of a fiber board insulating material, dipped in hot asphalt, chemically treated for increased life, and surfaced with cement. In manufacture, the

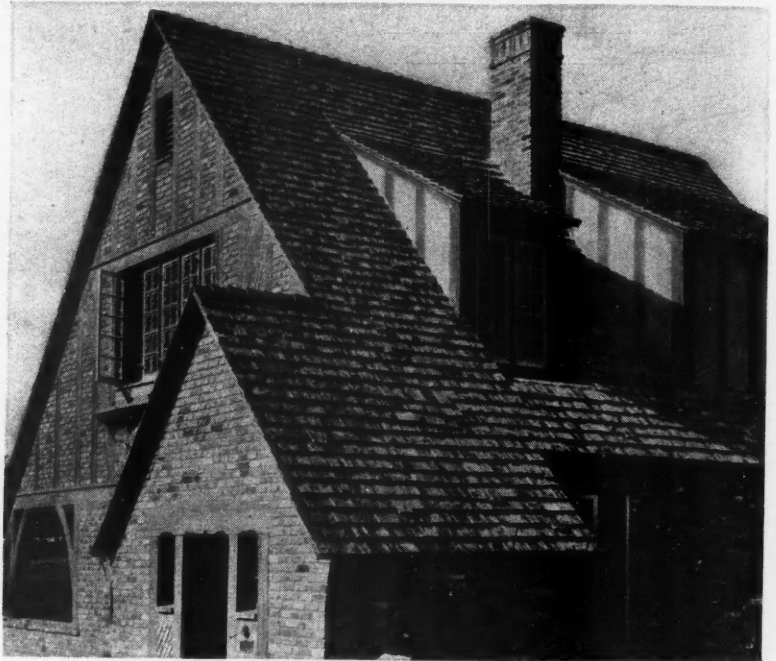

Permanent Composition Shingles Which Perfectly Reproduced Weathered Wood Make Roofs of Great Beauty and Also Provide Insulation.

cement surface is given a real wood texture with the result that the shingle actually looks like an old, long weathered shingle.

These shingles being offered in several patterns and colors, and in widths from four to eleven inches, make possible an interesting variety of architectural effects. Their thick butts produce deep shadow lines.

Being light in weight they can be applied over old roofs and their rigidity makes for easy application as well as durability. They are not brittle and will stand a lot of rough handling without breaking, both in transit and on the job. They are easily cut and mitered on the job for hips, valleys and dormer cheeks. They are fire resistant to a high degree as they will not burn and fire will not break through them. In addition they will not explode under extreme heat and so give maximum fire safety, as well as weather protection.

Modern Carved Mouldings

To be modern in decoration yet not "moderne" is the aim of many builders and architects today. The grotesque, freakish or extreme modern style has no place in everyday modern life, but really artistic modern decoration is greatly in demand. In keeping with the time, one company has put out a new series of carved mouldings for decorating residences and other buildings.

While entirely modern in treatment, these mouldings are, nevertheless, dignified, restrained and artistic in detail. In addition to the conventional uses of carved mouldings this line contains a number of patterns for decorating ordinary millwork. Special patterns are shown for the edges of shelves, one of these, which is illustrated on this page, shows how an ordinary cabinet can be beautified by a few feet of inexpensive moulding.

All of these mouldings are designed so that no dust or



Handsome Carved Mouldings in Modern Design Can Be Applied to Ordinary Millwork to Produce an Attractive Decorative Effect.

See it Today

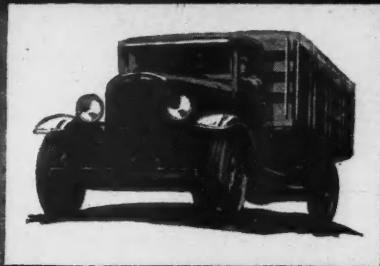

1 1/2 - 2 TON GENERAL MOTORS TRUCK

\$595

CHASSIS F. O. B. PONTIAC

It's every inch a truck—the product of an organization that builds commercial vehicles exclusively. See it today! Examine its sturdy "truck" frame, its truck-type clutch, its rugged axles. Note that it has a 65-horsepower six-cylinder engine, a truck-type radiator of generous cooling capacity, a heavy-duty 4-speed transmission and a full complement of other "truck" features—features that mean long life, operating economy and low upkeep, and dependable performance. Standard bodies are available for every need. Dual rear-wheel equipment and a 157-inch chassis are optional at correspondingly low prices.

GENERAL MOTORS TRUCK COMPANY, PONTIAC, MICH.
(A Subsidiary of Yellow Truck & Coach Bldg. Co.)

6 CYLINDERS

65 HORSEPOWER

Send me full information about your new line of 1 1/2-ton trucks:

Name _____

Address _____

City _____

dirt can collect in the members and, as a result they are sanitary and easy to keep clean. They are furnished either in random lengths of six to twelve feet or in specified lengths and are available in gum, maple, oak, mahogany and walnut. They are reasonably priced so that they may be used in inexpensive homes.

Lighting the Service Station

Automobile service stations seem to be constantly increasing in number and improving as to planning and equipment. Better equipment for such stations is strongly in demand so one of the leading manufacturers of electric equipment has developed a small and inexpensive floodlight which is particularly adapted to the lighting of greasing pits.

This company first put out a 100-watt light. A common installation with these is, one light at each end of the pit. This provides an abundance of illumination of all the under parts of the automobile. These lights are much smaller and less expensive than the standard floodlights.

Another light, almost identical in design but of 200-watts, has since been announced to provide for installation where more illumination is required but the large expensive standard light is not needed.

Both of these floodlights have numerous other applications besides that in greasing pits. In fact they can be used wherever floodlighting of that power is required. One of the popular uses is for lighting gardens and in such cases exceedingly beautiful effects can be obtained at comparatively small cost.

Electricity for Auxiliary Heat

It's been prophesied that at some future time all buildings will be heated by electricity. That day probably will not come immediately, though definite steps are being taken toward it now. In the meantime, however, electricity has a definite place as a medium for auxiliary heating, to supplement the regular heating plant. All of us are familiar with the electric glow heater so commonly used in bathrooms. Recently an electric auxiliary heater for industrial use has been developed.

This heater consists of a number of strip heaters mounted in a black japanned, perforated, steel case. It is made in

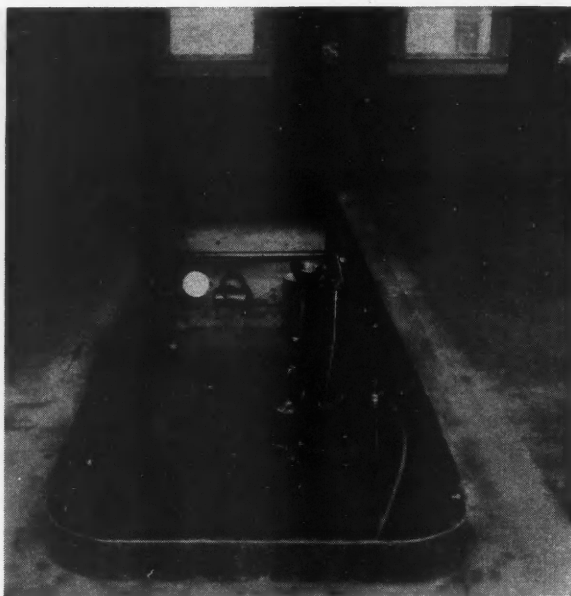

Two of These Small Floodlights Make Perfect Illumination in the Greasing Pit of an Automobile Service Station.

four ratings: 1,000 watts at 115 volts; and 1,000—2,000—3,000 and 4,500 watts at 230 volts. It is equipped with three feet of armored cable and a three heat snap switch mounted on a standard conduit base. It is designed for wall mounting or for horizontal floor mounting and is easily installed at any point in a plant, where extra heat is required.

This heater provides maximum heat because of free air circulation, and easy regulation of heat by means of the three-heat switch. It is easily moved from one job to another and is always ready to provide heat at the turn of the switch. Its use involves no soot, dirt, dust, odors, or gas.

Inexpensive Garage Door Operators

Another item of garage equipment which is of much interest these days is the electric door operator which eliminates service calls for opening and closing doors to admit customers. One manufacturer has recently perfected a new low priced operator for upward acting doors as an addition to its line. This device, while designed to meet the low price demand is substantial and dependable.

The operator is simple, and easily installed on practically any type of door. It is controlled by means of either a self-restoring switch, with which the door will not open unless the switch is held closed throughout the entire stroke, or by a three-position, snap switch with "open", "close" and "off" positions. The mechanism is so designed that the door automatically stops when completely open and just before it reaches the ground in closing. This prevents slamming and injury to the door.

The clutch is set to slip automatically when a force of

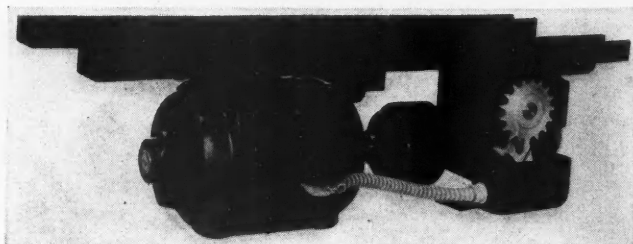
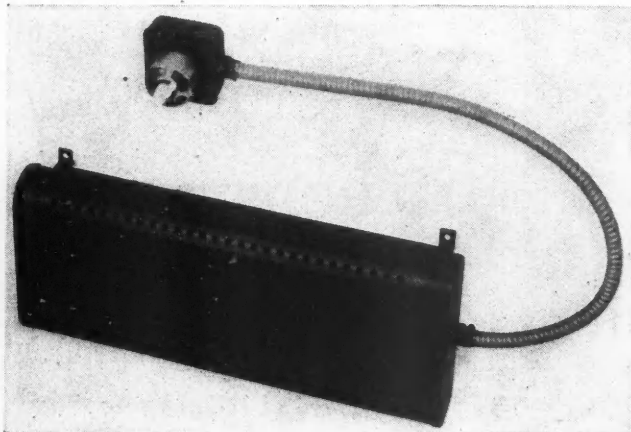

Left: An Auxiliary Electric Heater for Industrial Installation Provides Extra Heat Where Needed, Below: A Low Priced Operator for Upward Acting Garage Doors Will Be Welcomed by Owners and Builders.



Two-family dwelling before and after modernization with Carey Siding. This job was completed in four days.



Make profits now by modernizing old houses with *Carey* SIDING

Carey Siding

Carey Siding is made of stone cemented to waterproof felt. The material is supplied in three attractive finishes—red, buff and blended tapestry and resembles high-grade face brick.

Carey Stone-tex Siding

Carey Stone-tex Siding is made of asbestos and cement formed into shingles under tremendous pressure. It is applied the same as wood shingles and is produced in five colors—gray, red, green, brown and blue-black.

Carey Scotch Method Siding

This material is also made of asbestos and cement. It is particularly adapted for flat roof buildings and is supplied in gray, green and brown.

Why wait for new building to improve? Profitable business on Carey Siding is to be had in every community—business on which there is practically no competition. This statement is based on proven facts, for hundreds of Carey Siding jobs like that shown above were sold in 1931. Every owner of a frame or stucco building is a prospect, for Carey Siding actually saves its cost by ending painting expense.

We have a successful plan for developing Carey Siding business and we will be glad to give complete information to any builder or building material dealer. Write for samples, prices and complete information.

THE PHILIP CAREY COMPANY • Lockland, Cincinnati, Ohio
Branches in Principal Cities

BUILT-UP ROOFS
ASPHALT PRODUCTS
ELASTITE EXPANSION JOINT
WATERPROOFINGS
ROOF PAINTS



HEAT INSULATIONS
ASBESTOS MATERIALS
CAREYSTONE CORRUGATED SIDING
ASBESTOS SHINGLES
BUILDING PAPERS

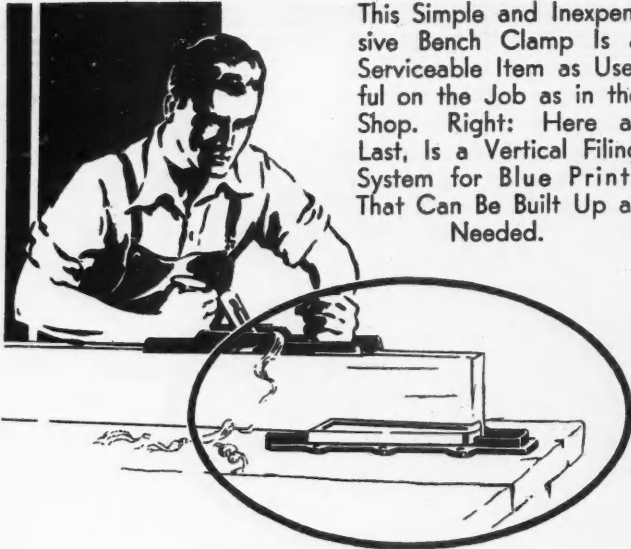

This Simple and Inexpensive Bench Clamp Is a Serviceable Item as Useful on the Job as in the Shop. Right: Here at Last, Is a Vertical Filing System for Blue Prints That Can Be Built Up as Needed.

25 pounds more than that required to open or close the door is applied. The result is that, if the door is started down while a car or person is under it, the clutch will slip and so prevent injury to the obstacle.

A Simple Effective Bench Clamp

Turning from those items which become a part of the building itself, we come to a group of products which are used by the builder in his work and are generally classed as "contractors' equipment." They are just as important in producing high grade, economical construction as are the building materials.

One of the new items of equipment is a bench clamp. It is quite simple and inexpensive but its value is much greater than its cost. It can be attached to any workbench in a few moments time, only four screws or nails, being required to hold it securely. Because of this it can be moved from place to place and many carpenters carry it with them to be attached to a plank, to form a workbench right on the job.

This clamp consists of a metal frame which is attached to the bench and a metal slide which clamps the piece to be worked. It locks and holds stock securely for planing, sawing, laying out work and gluing. It will hold anything up to two inches in width. For work on the flat side of the stock the two ends of the clamp are used as a bench stop.

Filing Drawings and Blue Prints

In caring for correspondence and other small papers and cards, the advantages of vertical filing have long been recognized, but large sheets, such as drawing and blue prints have been stuffed into drawers or piled on shelves in a most inconvenient manner. Recently, however, the vertical system has been adapted to the handling of such material.

By using interchangeable units it is possible to start at a small cost with a single holder for blue prints. This holder has a capacity of 200 sheets and it can be added to indefinitely as requirements demand. The holders can be placed on walls, tables, desks, in cabinets

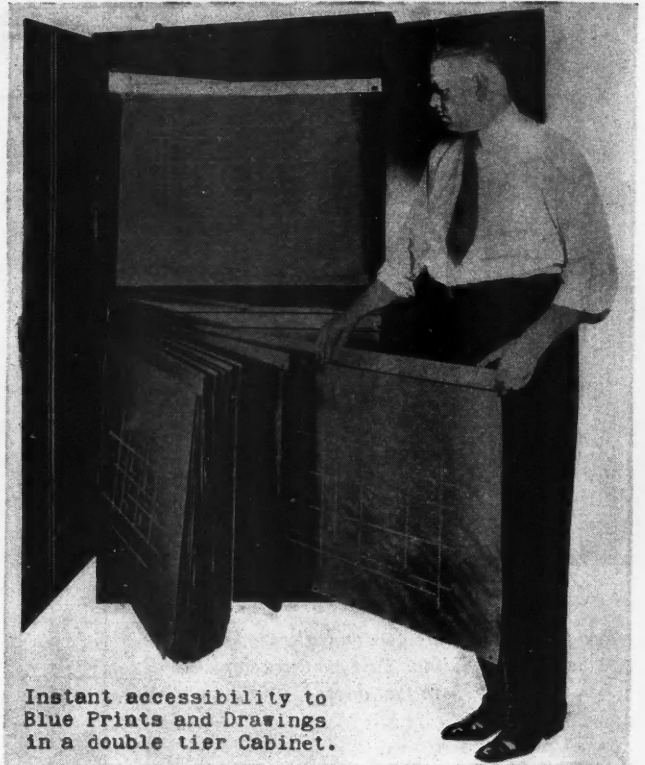

Instant accessibility to Blue Prints and Drawings in a double tier Cabinet.

or closets. A steel cabinet for the purpose as well as a vault is also available, and vault trucks are furnished.

The system consists of a metal channel having holes in the two flanges, a hanger arm that is supported in the channel with a pin, and a sheet holder that slides on the track of the hanger and onto which the sheets are secured.

After being punched, or gummed to strips that are already punched, the sheets are attached to the sheet holder with double pronged paper fasteners and the sheets of various sizes can thus be filed together.

Up-to-date Floor Surfacing

Something new also applies to floor surfacing machines. A recent new model incorporates a number of improved features which add to its efficiency, and ease of handling. Due to a new type of drum suspension the operator has absolute control of the drum at all times and adjustments can be made in a few seconds without the use of tools.

Unlike previous models, the drum is suspended by two arms which are independent of each other, mounted in a bracket in front of the motor. By an ingenious arrangement of springs, the flexibility and leveling of the drum is easily adjusted, by simply turning two knobs on the top of the bracket. It can be adjusted to follow the contours of the floor or, where required, so that it is rigid and cuts level.

Drum pressure is applied through a control rod by hand or by means of a drum pressure device attached to the handle. By means of a screw the amount of pressure can be exactly regulated. This means constant pressure for even cutting.

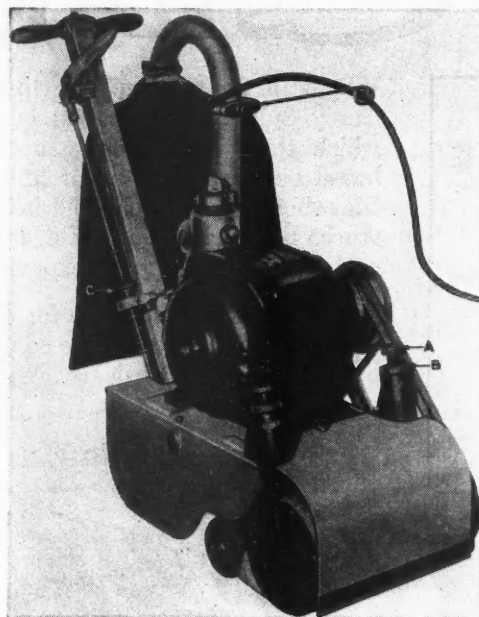

A New Floor Sander with Features Which Make for Greater Efficiency and Ease of Operation

These Heavy RU-BER-OID Shingles

STRONGLY APPEAL TO HOME SEEKERS

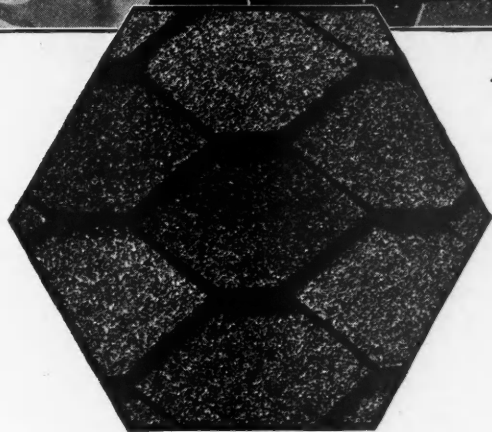

**RU-BER-OID Copper Green Tone
Heavy Weight Hex Shingles**

**RU-BER-OID Natural
Slatetone Heavy
Weight Shingles**

For roofing new houses or remodeling old homes, these two RU-BER-OID Asphalt Shingles are today's outstanding leaders. Massive and colorful in appearance, durable, fire-resisting and inexpensive to lay, these roofs offer the *extra value* in property that frequently clinches the sale.

Home seekers marvel at Ruberoid's new, beautiful, scientifically blended colors. The soft, harmonious tones of warm reds, blended browns, rich purples, bright greens and shaded greys lend lasting charm to modern architectures' graceful roof lines.

Regardless of the type or price home to be roofed RU-BER-OID Asphalt or Asbestos Shingles offer a style, design, weight and color to please every taste and every purse. All are designed to give both the builder and home

owner the most for their roofing dollar in beauty quality and economy. All are fire-resisting and bear the Underwriters' label of approval.

Write for samples of these two heavy RU-BER-OID Shingles illustrated. You will be surprised at their comparatively low cost and will appreciate their *extra value* on the homes you build or remodel. Your inquiry addressed to the nearest Ruberoid office will have prompt attention.

The RUBEROID Co.

ROOFING MANUFACTURERS FOR OVER FORTY YEARS

Sales Divisions: RUBEROID MILLS—CONTINENTAL ROOFING MILLS
SAFEPAK MILLS—H. F. WATSON MILLS—ETERNIT

ASPHALT SHINGLES AND ROLL ROOFINGS—ASBESTOS-CEMENT SHINGLES AND CORRUGATED SHEETS—ASBESTOS, ASPHALT, COAL TAR
FITCH AND FELT BUILT-UP ROOFS—ASBESTOS: SHEATHINGS, FELTS, MILL BOARD, PIPE COVERINGS—KRAFT WATERPROOF PAPERS
—COAL TAR AND ASPHALT FELTS AND SHEATHINGS—ASPHALT WATERPROOFING PAINTS AND CEMENTS—DRY FELTS AND SHEATHINGS

Offices & Factories: New York, N. Y.—Chicago, Ill.—Millis, Mass.—Eric, Pa.—Baltimore, Md.—Mobile, Ala.

Practical Job Pointers

Laying Out an Ellipse

HERE is one of the simplest and most accurate ways of laying out an ellipse. First make a trammel equal in length to one-half the width of the desired opening and cut a notch in it equal to the desired rise. For example, the sketch illustrates this method used for a 36-inch ellipse with a 10-inch rise. The small figure at the top shows the trammel.

After the trammel is made, nail a piece of board at right angles to the board to be marked, with one edge at the center of the board. The letter A indicates the board to be cut, B is the piece nailed at right angles, and C is the trammel. A pencil is placed at the upper end of the trammel to mark the dotted line of the ellipse as the trammel is slid along. The lower end of the trammel is held against the piece B and the notch against the lower edge of the board A, as the trammel is moved. This marks one-half the ellipse.

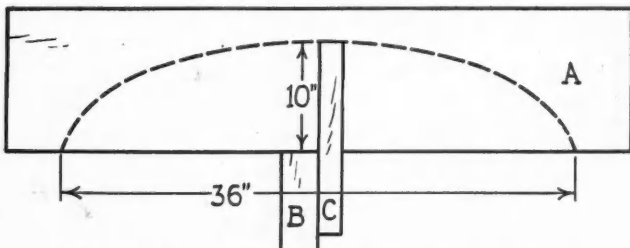
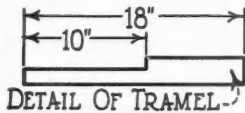

A Trammel Used in This Way Provides a Simple and Accurate Means of Marking an Ellipse.

To complete the ellipse, move the piece B so that the other edge is at the center point. Place the trammel on the other side of B and mark as before.

CLAUDE WILLEY, Widener Memorial School, Broad & Olney Ave., Philadelphia, Pa.

The Radius of an Arc

IN estimating millwork for one of the millwork survey bureaus here I frequently have to figure the radius of arched openings, cornices, bent porch rails, soffits and porch lintels. Because of the construction it is not possible to do this by measuring so it must be estimated. The following rule for doing this might be of use to others in the same sort of work.

Take half the width of the arc and square it. Divide the answer by the rise. Add the rise to this figure and then divide by two. The result is the required radius.

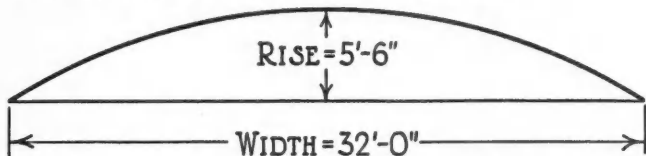

The Radius of the Circle of Which This Arc Is a Part Is Found by the Rule Given Here.

Applying this to the arch shown in the sketch, half the width is 16 feet. Sixteen squared equals 256, divided by the rise, which is 5½ feet, gives 46½. Adding the rise, 5½, gives 52, and dividing this by 2 gives 26 feet as the radius of the circle of which the arc shown is a part.

C. G. H. ENGEL, Box 96, Rossmoyne, Ohio.

A Readers' Exchange of Tested Ideas and Methods, Taken from Their Own Building Experience. Two Dollars Will Be Paid for Each Contribution Published in This Department

Handy in Painting

WHEN standing on a scaffold, a paint bucket which is set on the scaffold is inconvenient to reach. A simple holder, such as shown in the sketch, will be found very handy. It consists of a rod with a bracket arrangement at the top in which the paint bucket sits. The lower end of the rod fits into a hole in the scaffold plank and is prevented from slipping through by a bolt placed a few inches from the bottom of the rod. A

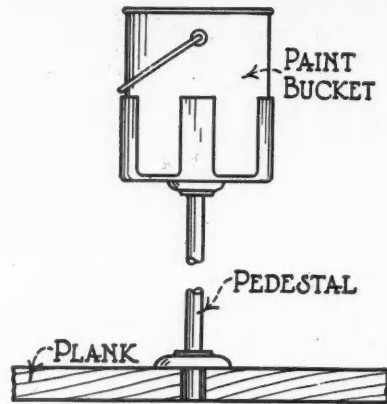

A Pedestal Like This Saves a Lot of Tiresome Stooping When Painting from a Scaffold.

series of holes can be provided at convenient intervals along the scaffold plank so that pedestal can be moved to the handiest point as the work progresses.

H. H. SIEGLE, 222 S. Constitution St., Emporia, Kan.

An Aid in Boring Large Holes

WHEN boring large holes in end wood, it is often difficult to make the bit cut. This difficulty is easily overcome, however, by first boring a small hole at one side of the diameter of the large one. The sketch shows how the small hole should be placed to make the bit take hold.

S. R. STARKEY, 545 Prospect Ave., Hartford, Conn.

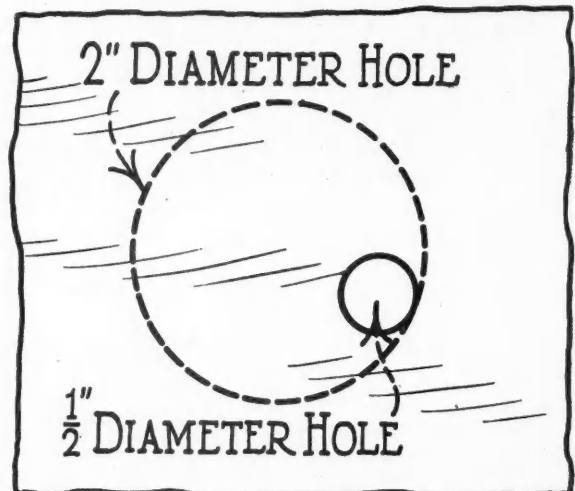

A Small Hole, Placed as Shown Here, Will Make the Bit Take Hold in End Wood When a Large Hole Is Bored.

after 280 Years A NEW WINDOW!



[PATENTS PENDING]

Originating in Holland, the weight-balanced window came into use in England in about 1650. Since that time no major changes in operating principle have been made.

Now Curtis makes available, nationally, a new window, spring balanced, weather-tight, easily operated, and most economically installed.

The Silentite Pre-Fit Window Unit is a new but proved product. The Pittsburgh Testing Laboratory spent thousands of dollars and months of time in exhaustively testing every feature.

More than 100 builders paid the regular price for 2,500 units, installed them in homes in 23 states and furnished written reports which brought out savings in installation costs.

Stronger • Superior • More Economical • •

If you will add up the costs of doing with materials heretofore available, all that the complete Silentite Pre-Fit Unit will do, you will find this new improved product more economical.

If you will compare the frame, feature by feature, with any now offered, you will find it more substantial — with many additional points of superiority.

If you will compare the ease of operation of each sash, the weather-tightness, the ventilating features of the storm sash, the several features of the screen and the advantages of the screen and storm sash hardware—you will use this new Unit complete in the next house you build.

NOW Consider these Advantages

No weights • cords • pulleys, sash fitted at factory • reduces labor costs.

Sticking • binding • rattle eliminated • weather-stripped with double contact metal • a sturdier frame • carton packed • adapted for narrow trim • — Weather-tight • Silent • Narrow Mullions • Lustra Glass especially primed glazing • Fits any type wall construction • Installed economically • operates most easily • springs of exceptionally long life • easily replaced without moving stop • one piece jamb, no air leaks • sill slopes 1" and 4" • Sill drainage under screens • storm, sash delivering ventilation without direct draft • Screen and storm sash hardware • simple • costs less • operates easily.

Examine a sample • "get the feel" of the window itself • only then can you know what this greatest forward step in the woodwork industry can mean to you and to your customers.

A PRODUCT of CURTIS COMPANIES

- | | |
|---|--|
| Curtis Bros. & Co.,
Clinton, Iowa. | Curtis Door & Sash Co.,
Chicago, Ill. |
| Curtis & Yale Co.,
Wausau, Wis. | Curtis-Yale-Purvis Co.,
Minneapolis, Minn. |
| Curtis Sash & Door Co.,
Sioux City, Iowa. | Curtis Companies Inc.,
Clinton, Iowa. |
| Curtis, Towle & Paine Co.,
Lincoln, Nebr.
Topeka, Kansas. | Curtis Woodwork Inc.,
New York City
(Empire State Bldg.) |



The exterior beauty of narrow mullions is apparent. The same narrow outside casings are used in all types of walls. More light or more wall space as desired. Narrow trim applied without expensive preparation of back of pulley box.

CONSTANT MAIL TODAY FOR FULL PARTICULARS

Unlike any other weather-stripped window, Silentite Pre-Fit efficiency against infiltration does not change. The ordinary window varies as high as 40% between wet and dry seasons. Silentite Pre-Fit—0.4%. Think of the fuel saving.

It is 5.26 times as weather-tight as a non-weather-stripped window, and in some markets costs little if any more.



CURTIS COMPANIES SERVICE BUREAU
120 Curtis Building, Clinton, Iowa

Please send me complete information on Silentite Pre-Fit Window Unit and the name of the dealer best situated to furnish me Curtis Woodwork.

Name.....

Address.....

City.....State.....

Repairing Sunken Floor Boards

FREQUENTLY a sunken place will appear in an otherwise sound floor. This may be confined to a single board, a defect or poor workmanship in the sub-floor beneath which has allowed one edge to drop. It is not necessary to rip the whole floor or make a big job of repairing this.

Drive wood screws into the sunken piece as near the bad edge as possible, screwing these in only far enough to have a good hold. Take a wrecking bar and, using a small piece of wood, placed back on the sound part of the floor, as a fulcrum, hook the bar under the screw head and lift the board edge into place.

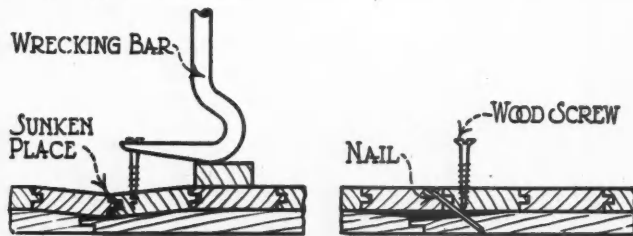

A Sunken Floor Board Can Be Lifted and Secured in Place by This Method Without Making a Big Job of the Repair.

While the board is held in this position, holes may be drilled and 8-penny nails driven in at an angle along the sunken edge so that they hold the board up in its proper position regardless of the defects below. Both nail and screw holes can, afterward, be puttied and stained to match the floor color.

MORRIS A. HALL, White Plains, N. Y.

Handy Sandpaper Block

IN my work I am constantly looking for and working out short cuts and better ways of working. In this line the sandpaper block shown in the sketch has proved most convenient. I cut the sheet of sandpaper in two or more strips, lengthwise. I take a block of wood, a little shorter than these strips and the same width, and round off one side of it, slightly, both ways.

I nail about a dozen strips of sandpaper to the rounded surface of this block, driving the nails into the end of the block. When one sheet wears out I simply tear it off and go right ahead with the work.

A. T. MONTGOMERY, 1011 N. Yale Ave., Wichita, Kan.

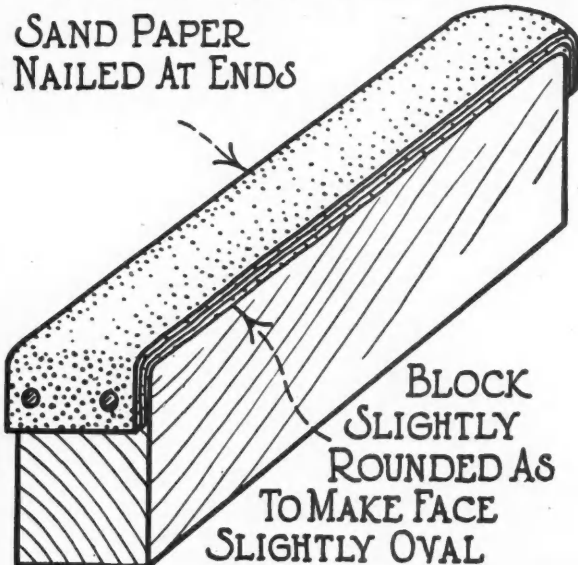

This Block with Strips of Sandpaper Nailed to a Rounded Surface Saves Time and Also Sandpaper.

Concealed Ties

FLOWER boxes that are rather long or wide have a tendency to spread, especially if they have sloping sides, unless they are tied. Sometimes the ties are so conspicuous that they spoil the appearance of the box, a cleat across the top being a common method of tying. The box can be effectively tied with the tie entirely concealed.

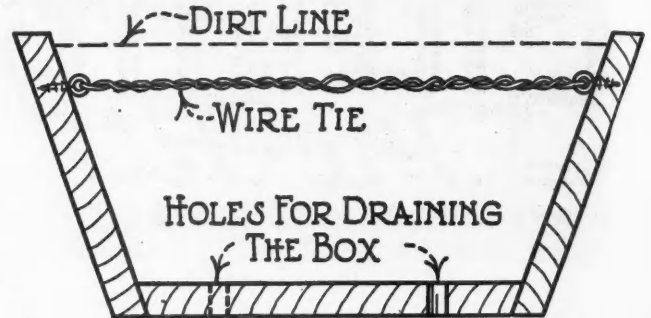

Flower Boxes Must Have the Sides Tied to Prevent Spreading, and Concealed Ties Do Not Mar the Appearance

The concealed tie consists of a piece of twisted wire attached to screw-eyes into the sides of the box about two inches below the upper edges. The wire is simply passed through these eyes and then twisted until it is tight and the sides of the box in perfect alignment.

H. H. SIEGLE, Emporia, Kan.

To Clean Drill Holes

THE usual way of removing dust from holes while drilling in stone or concrete is to pour water into the hole. This carries out the dust but is objectionable because the water spatters not only the driller but everything nearby and makes a messy job.

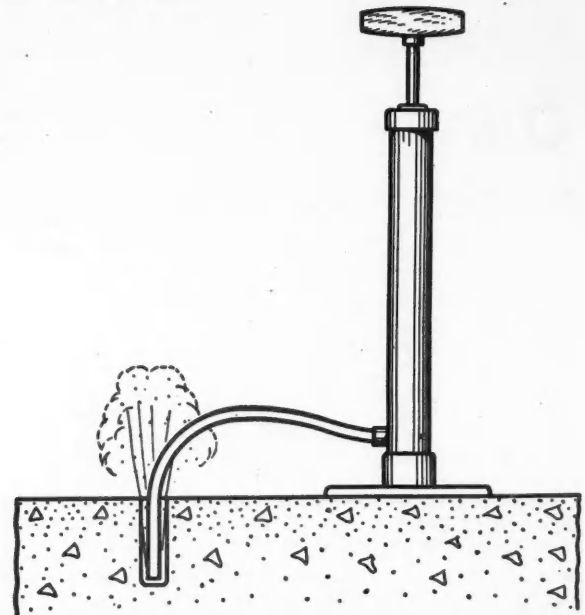

An Automobile Pump Clears the Dust from the Hole When Drilling.

There is a better way which is both clean and simple. I use it every time I am called on to do any such drilling, in concrete or stone, something which frequently falls to the lot of the carpenter. I simply use an automobile tire pump. Place the rubber tube in the hole and work the pump till all the dust is blown out, then proceed to drill again. When too much dust has again accumulated use the pump again as often as necessary.

H. H. SIEGLE, Emporia, Kan.

THE FORD TRUCK

paves the road to profits



THE low first cost, low maintenance cost and economical operation of Ford trucks helped the Hillding Construction Company of Bay City, Michigan, turn a profit on a road-building contract that was awarded only after much keen bidding by competitors.

Equipped with trailers, ten of these Fords gave quick and reliable service over the nine-mile stretch between Adrian and Hudson, Michigan, which was being converted into a modern concrete highway. These Fords handled with ease and

speed three "six bag" dry batches of material and were also used to haul heavy equipment from place to place.

Thus they replaced the miniature railway first thought necessary and represented a considerable saving in both time and money.

Every day Ford commercial units are serving profitably on such tasks as these by cutting the costs of transportation. It will repay you to consult with your Ford dealer and have him show you how the Ford can meet your hauling needs.



Building Activities

The Month's News of the Industry

Grading Rules Adopted by Face Brick Ass'n.

AT its recent annual meeting, the American Face Brick Association formally adopted standard grading rules that had been in process of preparation for more than a year and that will henceforth be used as the basis on which face brick are sold.

Four classifications are given in the rules which have been published in a booklet, and can be obtained from the association office at 205 W. Wacker Drive, Chicago. These classes are Uniform Shade, Mingled Shade, Substandard, and Cull. All first quality brick are placed in the first two classifications, which have stringent requirements as to dimensional variations, chippage, color and warpage.

The rules as adopted are based upon the standardized sizes of brick which were established in 1923. It was recognized then, as now, that it is impossible to manufacture brick conforming exactly to these sizes, but no limitations as to the variation in sizes were worked out. The new rules cover this point thoroughly. The small permissible variation in maximum and minimum dimensions will insure brick that will lay up well in the wall.

Building and Loan Savings Held Tax Exempt

THE dividend or cash settlement made to a building and loan association withdrawing member has been ruled by the Board of Tax Appeals as not subject to the normal income tax, in an important decision handed down recently in the Aaron Ward case. This decision is important to the more than twelve million members of building and loan associations, assuring them that when their shares mature, they do not have to report as income, subject both to normal tax and surtax, the amount which they receive over and above the amounts paid in.

The Board, in passing upon the Aaron Ward case, ruled that the payment received by the member from the building and loan association in excess of the amounts paid in by him was a dividend received from a domestic corporation and, as such, should not be included in determining the member's taxable income. The contention of the Commissioner of Internal Revenue that such payment simply represents interest on invested funds and

Coming Events

- Feb. 2-4, 1932—Iowa Lumber & Material Dealers Association, Annual, Coliseum, Des Moines.
- Feb. 2-5, 1932—Ohio Association of Retail Lumber Dealers, Annual, Columbus.
- Feb. 2-5, 1932—Michigan Retail Lumber Dealers Association, Annual, Pantlind Hotel, Grand Rapids.
- Feb. 9-11, 1932—Illinois Lumber and Material Dealers Association, Annual, Stevens Hotel, Chicago.
- Feb. 10-12, 1932—Retail Lumber Dealers Association of Western Pennsylvania, Annual, Wm. Penn Hotel, Pittsburgh.
- Feb. 12-13, 1932—Virginia Lumber & Builders Supply Dealers Association, Annual, John Marshall Hotel, Richmond.
- Feb. 16-17, 1932—Carolina Retail Lumber & Building Material Dealers' Association, Annual, Charlotte.
- Feb. 16-18, 1932—Wisconsin Retail Lumbermen's Association, Annual, Milwaukee Auditorium, Milwaukee.
- Feb. 18-20, 1932—Western Retail Lumbermen's Association, Annual, Davenport Hotel, Spokane, Wash.
- Feb. 22-24, 1932—Kentucky Retail Lumber Dealers' Association, Annual, Brown Hotel, Louisville.
- Feb. 24-25, 1932—North Dakota Retail Lumbermen's Association, Annual, City Auditorium, Fargo.
- Feb. 24-26, 1932—Nebraska Lumber Merchants' Association, Annual, Lincoln Hotel, Lincoln.
- Feb. 25-26, 1932—Mississippi Retail Lumber Dealers Association, Annual, Robert E. Lee Hotel, Jackson.

would therefore be taxable was not sustained by the Board.

District Manager Named

S. L. BENEDICT, Vice President, S. National Steel Fabric Company, Pittsburgh, Pa., manufacturers of Steeltex and National Reinforcing for concrete and plastic materials, has announced the following appointments, effective January 1, 1932: C. B. Dugan, district manager of the Los Angeles office at 607 Richfield Bldg., 555 So. Flower St., Los Angeles, Calif.; and H. M. Wilson, district manager of the Chicago office at 1118 Straus Bldg., Chicago, Ill.

Plan Co-operative Advertising

THE Builder's Hardware Division of the National Hardware Manufacturers Association is sponsoring a co-operative advertising program built around the slogan "Your House Is as Good as Its Hardware," which is being used in the form illustrated here.



This Slogan Sticker Is Being Used in a Campaign to Sell Better Hardware.

This campaign and slogan were proposed by P. F. King, general sales manager of the hardware division of The Stanley Works, at the recent convention of the association. Already hundreds of requests for cuts and other co-operation in the campaign have been received from dealers who are supporting enthusiastically the plan to sell better hardware.

Plan Permanent Exhibit

AN elaborate Permanent Architectural and Building Exhibition, illustrating design and showing construction materials and equipment for building, will occupy the first floor of the 20-story, \$5,000,000 St. Louis Mart Building, which was completed December 1. The exhibition is being sponsored by the St. Louis Chapter, American Institute of Architects.

A garden court forms a background for the showing of building materials such as brick, terra cotta and tile. A winding display avenue is lined with architecturally correct fronts, while through doors, the observer may pass from the street into completely furnished rooms. Booths show manufacturers' products as they appear in actual construction.

A model bungalow will be a part of the exhibit. Displays will be changed from time to time to keep abreast of new developments, new materials, and new uses for old materials. Efforts will be made to maintain equal interest among builders, realtors, architects and the general public.

This magnificent building has Floors Constructed with



Mermont Apartments, Bryn Mawr, Pa. Shubin Building Co., Builders. Charles F. Schaef, Architect.

KALMANTRUSS STEEL JOISTS

The Mermont Apartments, located in one of Philadelphia's exclusive residential suburbs, is an excellent example of one of the many types of modern, light-occupancy structures in which Kalmantruss Steel Joists and Accessories have been used to build better floors at lower cost.

Steel joists are widely accepted by contractors and builders. They provide a standardized method of constructing light, strong, rigid, and fire-resisting floors in light-occupancy structures of all types and sizes. Further, costs are lower when Kalmantruss Joists and Accessories are used, because of the ease and speed of erection and the elimination of expensive form work.

Kalmantruss construction for floors



Section of typical floor in course of construction showing use of Kalmantruss Steel Joists laterally braced with Kalmantruss Rigid Bridging.



Kalman Steel Corporation

Subsidiary of Bethlehem Steel Corporation
General Offices: Bethlehem, Pa.

District Offices: Albany, Atlanta, Baltimore, Boston, Buffalo, Chicago, Cleveland, Columbus, Dallas, Dayton, Detroit, Houston, Milwaukee, Minneapolis, Newark, New Haven, New York, Niles, Philadelphia, Pittsburgh, St. Louis, St. Paul, Syracuse, Washington, D. C., Youngstown.
Export Distributor: Bethlehem Steel Export Corporation, 25 Broadway, New York City.

consists of the proper combination of Kalmantruss Open-Web Joists—each joist made from a single piece of rolled steel—and Rigid Steel Bridging, Metal Lath, and secondary items such as special anchors and clips, and concrete slabs.

Further information regarding the many advantages of using these Kalman products and the methods employed will gladly be furnished by any of the District Offices listed below.

CURRENT CONSTRUCTION FIGURES

December Building Contracts Show Marked Decrease from Totals for Preceding Month

ANOTHER sharp decline in building contract awards was registered in December which showed a decrease of about nine per cent from November. This loss was felt in both residential and non-residential groups while public works and utilities were somewhat ahead of the preceding month. The actual figures for the three groups were as follows:

Residential Buildings\$78,117,804
Non-Residential Buildings.. 55,923,243
Public Works and Utilities. 55,840,548

Total.....\$189,881,595

These figures are for total contracts awarded in the entire United States, as estimated by the AMERICAN BUILDER AND BUILDING AGE. They are based on the contract figures for the 37 eastern states as reported by the F. W. Dodge Corporation, to which factors have been added to account for contracts in the 11 western states, and for the smaller, unreported work not covered by the Dodge reports.

The construction volume for the 11

western states normally amounts to about 10 per cent of that for the rest of the country. In December losses in these western states were not as heavy as in the east and a factor of 11 per cent was necessary to account for this work.

Only a portion of the new building, modernizing and repair work of less than \$5,000 is covered by the Dodge reports. A large portion of this work is carried on in the rural districts and small towns. It normally amounts to about 25 per cent of the reported volume.

Though the proportion frequently drops below this percentage during December, due to the difficulty of winter building in rural districts, the unusually mild weather this year has permitted rural building to continue at a normal rate and a factor of 25 per cent has been used to account for this unreported work. Practically all of this work is residential and farm building and has, therefore, been classified under Residential Building in the tabulation.

Pyrene Demonstrates Fire Control Equipment

AT A test field in Newark, New Jersey, the Pyrene Manufacturing Company recently presented a series of "problem" fires and demonstrated their extinguishing with a variety of chemicals. More than 30 fires, including motor truck, cabin motor boat, electrical switchboard, oil and gasoline pit, rubbish pile, oil barrel and other difficult hazards, were ignited.

The demonstrators not only showed the correct manner to attack such fires, but also explained to visitors the effects on the burning materials of the chemicals used.

Among the most spectacular fires was that of a large delivery truck, the motor of which was thoroughly saturated with gasoline, the gasoline feed line broken to provide a running stream, and a match applied. The blaze was quickly subdued with a hand extinguisher carried on the truck.

As the final climax to the afternoon, a 500 square foot area of oil in a tank pit was fired and put out, while flames actually swept over an adjacent 200 foot area of gasoline without igniting it. A protecting blanket foam had previously been laid over this gasoline to show how modern chemicals successfully protect highly flammable liquids.

Norge Increases Facilities

THE Norge Corporation, Detroit, Mich., announces that it has greatly increased its facilities through the acquisition of the Alaska Refrigerator Corporation, Muskegon Heights, Mich., and has also enlarged its plant operation in the Detroit factory as a part of its expansion program for the coming year.

A.G.C. Holds Annual Convention

THE Thirteenth Annual Convention of the Associated General Contractors of America was held in Milwaukee, Wis., on January 18 to 21. The principal subject of discussion concerned the more than 200 bills and resolutions of direct bearing on the building industry, which were introduced to Congress during the first month of its new session. Foremost among these were several bills relating to centralized control of all government construction work and uniform requirements affecting government contracts. President A. P. Greensfelder, of St. Louis, Mo., turned over his office to Colonel William A. Starrett, of New York City, the incoming president for 1932.

Fireproof Materials Gain

ASURVEY, recently completed by the Continental Insurance Company, purports to show a marked increase in the use of concrete, stone, brick and other fire-resistive materials in building construction in many leading cities during the last decade.

In the ten years from 1920 to 1930, according to this survey, the increase in the number of non-frame structures averaged 73.4 per cent while the increase in the number of frame buildings averaged only 26.5 per cent.

Builders League Meets

THE Illinois Builders League held its annual convention at the Sherman Hotel, Chicago, on January 11 to 13, inclusive. All of the executive officers of the organization were re-elected to serve for another year.

A New Showroom in Modernistic Style

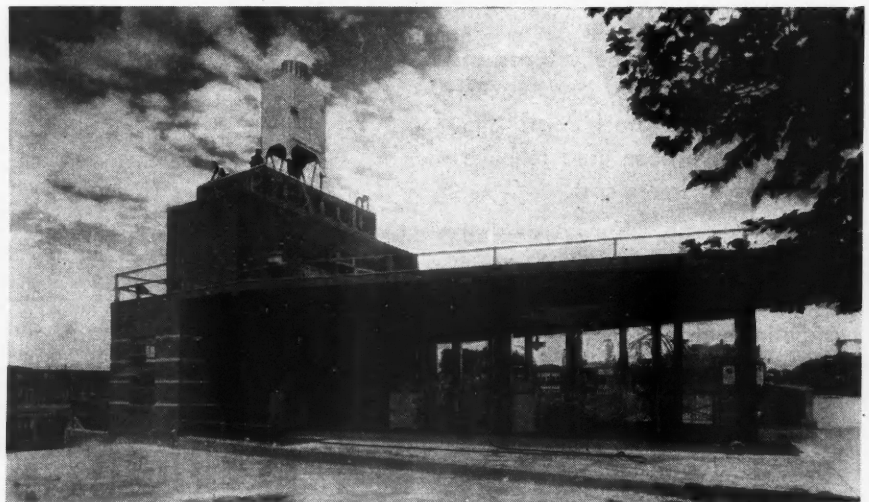

This Modernistic Showroom Was Designed by Raymond Hood and Foulhou, Architects, of New York, for Rex Cole, Distributor of General Electric Refrigerators. It occupies one of the busiest intersections in Brooklyn, New York.

MAGIC CHEF . . .

*here's a gas range you really
can get excited about*

Artyle

THE NEW
appealing finish

MILLIONS of women will see Magic Chef in Artyle finish advertised extensively in national magazines and displayed in leading stores throughout the country this Spring. This advertising will stimulate a new interest in gas range style and beauty and advance a new standard for present day kitchen decoration.



Patents Pending

MAGIC CHEF Series 600
in the ARTYLE Finish

To equip your kitchen with Magic Chef is to impress your properties as thoroughly modern and to make them immeasurably more attractive to discriminating home hunters.

Magic Chef, the most advanced cooking appliance you can buy, is likewise



(Look for this Trade Mark)

the most profitable for you to install because it attracts the most desirable class of buyers and renters.



Look for the **RED WHEEL**
When You Buy a **MAGIC CHEF**

A M E R I C A N S T O V E C O M P A N Y

World's Largest Manufacturer of Gas Ranges

NEW YORK • PHILADELPHIA • ATLANTA • CLEVELAND
CHICAGO • ST. LOUIS • SAN FRANCISCO • LOS ANGELES

WHEN WRITING ADVERTISERS PLEASE MENTION THE AMERICAN BUILDER AND BUILDING AGE



The Heatilator Fireplace shown below, by C. A. Ziegler, A.I.A., Philadelphia architect.

Architects Approve *this Modern Fireplace* Guaranteed Smokeless . . . *Now at New Low Prices*

LEADING architects over the country are recommending this modern fireplace. For now it is possible to build a fireplace of any design you like and have the assurance that it will never smoke. It CIRCULATES the heat throughout the living room and connecting rooms, giving the advantages of a living room uniformly heated—NO COLD FLOORS—NO CHILLING DRAUGHTS.

These advantages in fireplace construction are made possible by the development of the Heatilator—a double walled metal form, around which any style of fireplace can easily be built. This unit takes cold air from the room, passes it around the fire, and sends it out warm and healthful, to circulate over the entire room. Saves furnace operation during cool spring and fall weather. Only heat required for homes in mild climates. Ideal for summer cottages, cabins and camps.

A perfect fireplace is guaranteed; there will be no disappointments, no smoking with the scientifically constructed Heatilator. The small additional investment is offset by savings in labor, materials and fuel. We'll gladly send you full details of this modern fireplace. Just fill in and mail the coupon today. THE HEATILATOR CO., 632 E. Brighton Ave., Syracuse, N. Y.

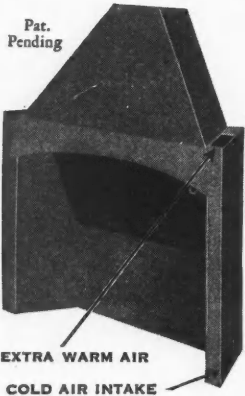

Heatilator Fireplace

HEATILATOR COMPANY, 632 East Brighton Ave., Syracuse, N. Y.
Send me without obligation full details of Heatilator. Also send me the nearest dealer's name. I plan to build...remodel... (which?). No...fireplaces.

Name.....Position.....
Company.....
Address.....

Electric Refrigeration's Part in Home Modernizing

(Continued from page 29)

lation of the expected appliance; electric refrigeration. In my own experience, a certain Detroit investor found his 38-family apartment house practically empty. Overheads were eating up the place. The problem was not one of location, for the building was in a very desirable section. It was not a question of newness for the building was but seven years old. The agent had no difficulty in getting prospective renters to come in and look at the apartments, but the number of leases signed was pitifully small. This owner remedied the entire situation by simply installing an accepted electric refrigerator in each kitchen. Rentals were easy after that and the renewals were consistent; the building is kept occupied without difficulty. So, we have an instance of the part which electric refrigeration plays in the business of keeping apartments rented.

In the fifteen years from 1910 to 1925 there were about 85,000 electric refrigerators made and sold. In 1930, over 700,00 were placed and the industry's outlook for 1931 exceeded 900,000 at the time this was written.

Co-Ordination Increases Profits

(Continued from page 34)

executives of the organization for the most part remain in the district offices. There are periodic visits to the various jobs, but the main contact between the superintendent on the job and the executive in charge is maintained chiefly by telephone. There is rarely a day during the working week that the superintendent on the job is not in communication by telephone with his executive.

The value of the telephone to our organization can be summed up in very few words—it helps us to get things done. Not all the difficulties on a contracting job can be anticipated. Usually they are things which come up from day to day and must be dealt with accordingly. One of our executives can sit at the telephone and get more done in a few hours than an executive who relies on slower means of communication can accomplish in a week. We know this because we have tried both ways. With a properly drawn progress chart brought down to date in one hand and a telephone instrument in the other, the job executive in one talk with his superintendent can take as much slack out of a job as if he made a personal visit.

Generally, the telephone provides a ready link between the superintendent on the job, the executive, who has charge of the broader co-ordination, and the sources of material supply, or the sub-contractors. The general plans are very seldom changed, but from day to day minor problems of administration develop and the superintendent saves time when time means money by straightening them out with his chief by telephone.

In business there are many persons whose first thought is, "It can't be done." They seem to have a natural resistance to almost any kind of proposal. It is quite true that contractors are probably called upon more than almost any other kind of business men to "do the impossible", and they encounter plenty of opposition when they try to carry out their intentions of rushing a job along here and there. This resistance is usually overcome by telephone. It provides the most effective means that we have found for carrying on long distance arguments.

Proper co-ordination undoubtedly makes for greater profits in the contracting business, but it is a difficult task unless we take advantage of the modern means of communication at our disposal to eliminate waste and make the work of our executives more effective.

TRUDEAU TRIUMPHS OVER PRESENT CONDITIONS thru DUNBRIK MANUFACTURING

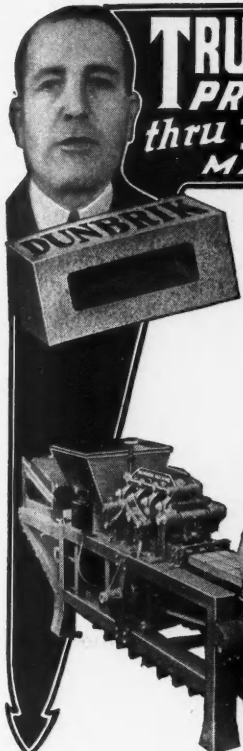

AGAIN TRADITIONS CRUMBLE. The STATE OF NEW JERSEY APPROVES and SELECTS DUNBRIK as the PREFERRED building material for a State Dormitory. Like a flash,—Trudeau of Bridgeton is deluged with three separate Dunbrik orders, totaling nearly 5 million units. Certainly a triumph!—A reward for his foresight and wise judgment in selecting the manufacture of Dunbrik for his territory.

WHIPS COMPETITION

Lies in his low production cost of a staple SUPERIOR building unit, giving him the "whip-hand" over competition. Actual operating Dunbrik plants now show an unprecedented low production cost of less than \$6.00 per thousand.

Added Advantages

Tinted and Face Dunbrik are furnished at an unheard of low price,—any color, shade, or texture,—meeting present conditions. More,—the investment required is but a fraction of what would be necessary in any other brick plant of equal capacity. Again,—this investment is protected and safe-guarded by an EXCLUSIVE FRANCHISE, at NO COST.

LEARN MORE—

About the progress being made by other Dunbrik plants under present conditions, and,—what an exclusive money-making opportunity is offered YOU for YOUR territory. Send for the DUNBRIK MANUFACTURING DIGEST,—a complete treatise on this growing industry.

CAPACITY
24,000
PER DAY

W. E. DUNN MANUFACTURING CO.

450 W. 23rd St.

HOLLAND, MICHIGAN



Variety WOODWORKER

4 men can use this one machine at once!

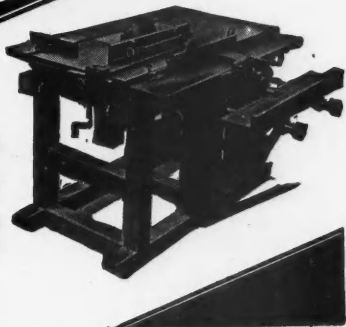

Four men can use the Variety Woodworker at one time . . . and turn out as much work and as good work as four machines! That's why users of this remarkable machine can bid lower and make more money. Cut-off Saw, Rip Saw with Boring Attachment, Mortiser and Jointer all in one. Made of better materials for longer service at lower maintenance cost. Every machine guaranteed. Write for literature and prices today. Ask, also, for booklets of other woodworking and saw mill machinery.

AMERICAN SAW MILL MACHINERY CO.
60 Main Street Hackettstown, N. J.

WHEN WRITING ADVERTISERS PLEASE MENTION THE AMERICAN BUILDER AND BUILDING AGE



THROUGH 93,000,000 MILES OF SPACE only to be stopped by ordinary window glass

Speeding through space—186,300 miles per second, the shorter (more valuable) ultra-violet rays of sunlight reach the earth in about eight minutes, yet a piece of ordinary window glass will stop them . . . Lustraglass, however, transmits a substantial amount of these all important rays of sunlight, yet costs no more than any good window glass.

Lustraglass can and should be used for all glazing purposes . . . It is a clearer, flatter, more lustrous window glass, the "whitest" of all glass made for windows—an obviously superior product even to the eye of the casual observer. Lustraglass, the ultra-violet ray window glass, will make a building more rentable, salable and . . . livable. It has no "equal." Write for Booklet A-430. AMERICAN WINDOW GLASS CO., Fifth Avenue, Pittsburgh, Penna.

Also makers of Lustrewhite Picture Glass • Armor-Lite Safety Glass and Bullet-Proof Glass • Tintaglass • Photographic Dry Plate Glass • 3/16" and 7/32" Crystal Sheet Glass • Ground and Chipped Glass • Bulb Edge Glass.

L USTRAGLASS
FLAT-DRAWN

IT COSTS NO MORE



INSULATE with U. S. MINERAL WOOL

COLD
PROOF

•

HEAT
PROOF

•

FIRE
PROOF

•

SOUND
PROOF

•

VERMIN
PROOF

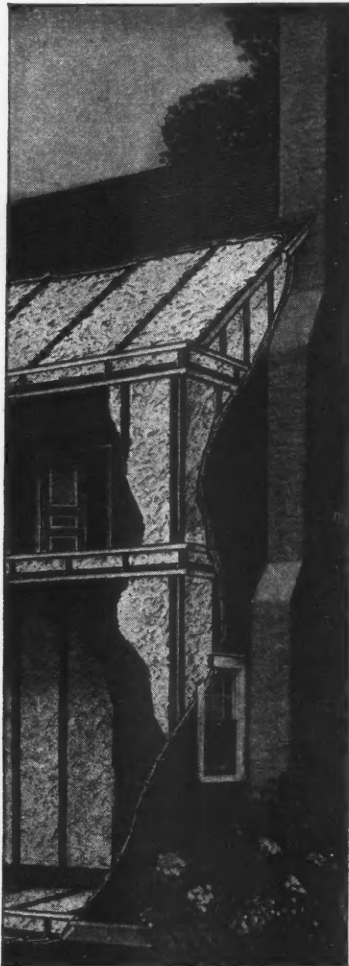

THE most effective insulating material is one which by reason of low conductivity prevents the passage of heat or cold.

U. S. Mineral Wool as determined by the United States Bureau of Standards is rated the lowest in thermal conductivity of all insulating materials (6.3 B. T. U.).

As a non-conductor it has no equal.

Send for sample and descriptive folder

U. S. MINERAL WOOL COMPANY
280 Madison Avenue New York

*Western Connection
Columbia Mineral Wool Co., South Milwaukee, Wisc.*

U. S. MINERAL WOOL CO., DEPT. B.
280 Madison Ave., New York

Send FREE sample and illustrated booklet to

Name.....

Address.....

City..... State.....

"How Can I Improve My Construction Methods?"

(Continued from page 43)

"It has been found that the men prize such awards very highly," the committee reports, "and are grateful for recognition of their ability. The introduction of competition between workers not only produced better construction but resulted in greater output."

Apprenticeship training is also suggested as a means of insuring future good workmanship.

2. Building Materials and Their Application

On the important subject of building materials and their application, the report of the Construction Committee has a number of recommendations to make on such phases of the subject as the economies of pre-fabrication, elimination of waste in distribution, new materials and methods.

"Grade-marking, trade-marking and other means of identifying good grades of materials are of commercial value to both buyers and sellers," the committee declares, and points out that when these are more widely adopted they will constitute an important factor in insuring quality construction at reduced cost. Says the committee: "The use of nationally known material and equipment increases the prestige of homes and is an outstanding factor in promoting their sale."

It seems obvious, the committee declares that much manufacturing is still being done on the job, which could now be done more advantageously in a mill or factory at less cost. But in order to establish prefabrication on a paying basis, the dimensions of parts of the house where such units are to be used will have to be standardized, the committee points out. A few builders reporting in the committee survey stated they were using prefabricated windows, doors and stairs and in so doing were able to save labor and complete the job in reduced time. A number agreed that material of this kind is too costly at present, but thought that under mass production it might be turned out at a lower figure.

Although shop fabrication of whole houses is now being studied extensively, no definite practical units have been developed as yet, the committee reports, and adds the comment that "the present tendency toward individuality would limit the sale of shop fabricated houses, except in industrial centers." Nevertheless, the committee recommends that further attention and study be given this subject by all concerned in the hope that prefabrication may become more practical and more economical to the builder.

3. Building Codes

Uniformity in building codes is both desirable and possible, the committee declares and states that it should be the purpose of good building regulations to recognize new developments when they prove themselves desirable. "Unless these worthy new materials are introduced, the public will be deprived of the economy which would result from their use," the committee contends. "Delay in progress involves an unnecessary cost to the public."

The committee makes the following recommendations:

That the arrangement prepared by the Building Code Committee of the Department of Commerce be followed.

That provisions of building codes be uniform as far as possible and that provisions be sufficiently broad to permit the use of any materials or methods of construction that make for public safety.

That the greatest possible freedom of design be permitted within the limits of safety and that there be the least practicable interference with new developments. Building codes should not be hard and fast specifications, it is pointed out.

(Continued to page 82)

EDWARDS

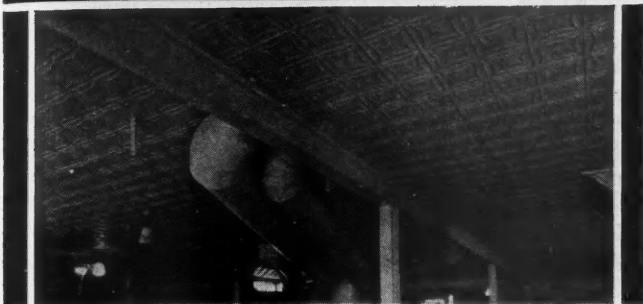

Metal Ceilings

Make Floor Space of Waste Space

Beautiful, economic, sanitary, verminproof and fireproof. Hundreds of beautiful patterns deeply embossed in permanent metal. Die cut nail holes for easy alignment. Get our prices for this profitable work.

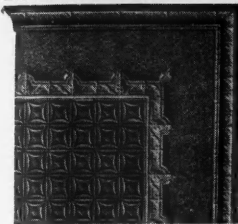

Edwards Metal Spanish Tile and Shingles

All the massive beauty of tile or slate at a fraction of the weight and cost. Made in galvanized steel, terne plate (tin), sheet zinc and pure copper. Roofing Book AB shows installations 25 years old. Send roof dimensions for low prices.



THE EDWARDS MANUFACTURING CO.

542-562 Eggleston Ave. Cincinnati, O.
World's leading manufacturers of Sheet Metal Building Materials

REID-WAY

A Complete Sanding Outfit

The man who wants to make money with a sander can use a Reid-Way. One compact, complete unit, easily adaptable for floor sanding and surfacing, edging and bench sanding. Nothing to break down—only one moving part. A simple dependable unit at a reasonable price—why pay more.

WHIRLWIND SANDER



THE REID-WAY CORPORATION
2945 First Avenue CEDAR RAPIDS, IOWA

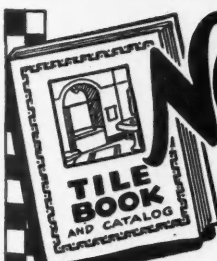

New! AUTHORITY TILE BOOK AND CATALOG

Months of time and thousands of dollars spent in compiling this 4-color, highly illustrated book. Solves all plans and specification problems for tile bath rooms, kitchens and drain boards, stairways, floors, mantels and hearths, store fronts, etc. Hundreds of newest patterns in natural colors. A valuable book for every contractor and tile setter. This book costs us \$1.00 to produce. We'll send it to you for 50c and refund on your first order of tile from us.

PROMPT SHIPMENTS

to builders, tile setters and brick layers, contractors, home builders, on White and Colored ceramic floor tile, borders in plain or designs—White Glazed wall tile, Colored wall tile, Falcone, Tile mantels, Red, Buff, Travertine and Copper colored quarry tiles, decorated strips, recess bathroom fixtures in White or to match various colors of wall tile. SEND US SKETCHES on any type of tile work. We will estimate cost free of charge. Tile circulars free. Tile Book as described above, 50c.

LLOYD FLOOR & WALL TILE CO.
BOX 5064 - - - KANSAS CITY, MO.

"The Prettiest Wood Shingle Roof in these parts"



Four Houses in the Charles Armstrong Development, Philadelphia, Pa. Roofed with Cabot's Stained Shingles, Stained with Cabot's Creosote Shingle and Wood Stains and laid in variegated patterns.

Mr. Charles Armstrong, well known builder in Philadelphia, says the second of the handsome group of houses in the picture above has "the prettiest wood shingle roof in these parts". It has a variegated gray roof, stained with Cabot's Creosote Shingle and Wood Stains. One advantage of these stains is the way that shingles or siding treated with them keep their beautiful clear colors. And their pure refined Creosote usually doubles the life of the wood. Send the coupon below for color card and full description of Cabot's Creosote Shingle and Wood Stains.

Cabot's Creosote Shingle and Wood Stains

Standard for nearly 50 years.

Made by the makers of Cabot's Heat-Insulating, Sound-Deadening "Quilt"

Samuel Cabot Inc. 141 Milk Street, Boston, Mass.

Gentlemen: Please send me your Color Card and full description of Cabot's Creosote Shingle and Wood Stains.

Name

Address

INSULMESH

the Plaster Base that Reinforces and Insulates and Deadens Sound



This inexpensive plaster base combines strength, permanence, fireproofness and insulation. The overlapping steel mesh is backed by a waterproofed corrugated board with $\frac{3}{8}$ " air cell insulation. Insulmesh saves plaster, labor and material, and is practical for the most economical installation.

Write for sample and price.

TRUSCON STEEL COMPANY
Youngstown, Ohio
Warehouses and Offices in
Principal Cities
Dealers Everywhere

Shipping
carton to pro-
tect Insulmesh

TRUSCON The Most Complete Line

The
VENTO PREMIER

The Basement Window that Sells Itself to American Housewives - - - - -

Provides correct overhead ventilation or full opening. Locks or unlocks at sill level. Requires no puttying. Easily fitted with outside screens or storm sash. Absolutely weathertight. Easy to install in new or old construction. Inexpensive.

See it at Your Dealer
Catalog on request

VENTO STEEL SASH CO.
Puttyless Windows for Basements, Garages, Factories, Barns, etc. MUSKOGON MICHIGAN

(Continued from page 80)

4. Construction Organization

"In most large cities," the committee finds, "a great proportion of houses are constructed by operative and speculative builders." Contracting, operative and speculative builders all have a place in the home building field, the committee believes, but the so-called "jerry builder," who produces inferior structures and takes advantage of the home-buying public, should be eliminated.

The committee recommends that more careful attention be given by builders and architects to the subdivision of land and group planning of houses.

"In some cases," the committee reports, "large operative builders make yearly contracts for labor only with various subcontractors, guaranteeing them steady work from year to year. In this way they develop a strong and efficient craftsman organization because of their desire to have steady work; and the builder himself obtains lower prices than if each job were subcontracted. In this case the builder also purchases all materials and relieves subcontractors of financial responsibilities."

"In fairness to the contracting business and its best interests, a general contractor should not be engaged in any other business which will give him an unfair advantage," the committee declares. "Material distributors should render their best service to builders and thereby secure sufficient volume to return a profit. Price discrimination by manufacturers, even on quantity purchases, is not the best practice and tends to create an unstable market for building. Duplication of sales effort on the part of manufacturers and distributors adds to general overhead and should, therefore, be minimized as much as possible, without conflicting with the fundamental business policies of either group."

According to the committee's report, the present methods used by some surety companies in bonding contractors does not insure against irresponsible ones securing jobs. The character, experience and responsibility of the builder are the best criteria of performance.

The subject of advertising in connection with selling is an individual problem for every builder, the committee believes.

The report emphasizes the belief that "the whole problem of construction merchandising should receive the earnest and immediate attention of not only all the various constituent elements of construction groups but the whole integrated industry. "Construction, as such, necessarily competes with all other industries for the consumer's dollar," the committee points out, "and it therefore behooves the progressive groups and leaders with vision to initiate research into adequate markets, publicity and finance."

The committee urges that a closer relationship be established between builders and architects in order to give the home owner the benefits of the knowledge of each and that there be periodical conferences of all or various groups in the industry to promote interest and better efficiency.

"During the past decade," the committee reports, "steady progress has been made in the development and use of good standards of construction, but the committee feels that there is still room for further improvement and extension in this direction. The more progressive type of builders, especially in large cities, is availing himself of every opportunity to produce improved houses at decreased costs."

The committee mentions the successful operation of construction supervisory bureaus operating in connection with building and loan associations in certain sections of the country and recommends that additional local central inspections bureaus be established and supported by financial agencies. "These bureaus should include representatives from the various groups concerned with financing, designing and constructing homes, in order that a well-balanced organization be obtained," the committee believes.



1 You Enter the Garage in the Usual Manner

For more than 25 years Majestic Building Products have been the choice of architects, contractors, and owners. The Majestic trade-mark is your assurance of quality and value.



2 The Touch of a Finger and the Door Rises

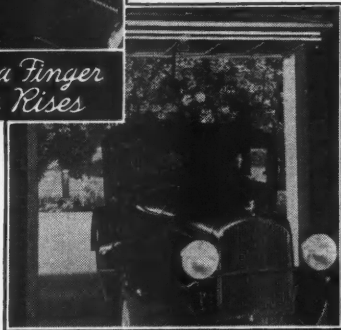

3 The Opening is Cleared Instantly Effortlessly

Now Automatic opening at no additional cost!!

« « « the newest home convenience

Modern home owners demand modern improvements and conveniences. The Majestic Roll-N-Fold garage door offers the newest in garage door operation—Automatic Opening—at no additional cost. Just the touch of a finger and the door rises instantly and quietly without further effort.

Its compactness and simplicity are distinct advantages in installation and operation. No tracks or equipment on the ceiling—no complicated machinery to get out of order.

Door guides and balances are enclosed in slender steel casings just inside the door jambs. The Majestic Roll-N-Fold door will operate easily and efficiently.

Majestic Roll-N-Fold doors are adaptable to any type building—new or old. A minimum clearance required above and inside of opening. Available in sizes to fit standard openings from 7' 6" to 10' 0" wide. See page C-3145 Sweets Architectural Catalogue (1932) for complete data and details or write us.

THE MAJESTIC COMPANY
HUNTINGTON, INDIANA



Majestic ROLL-N-FOLD DOORS

Save Time and Money
PLANE
By Power

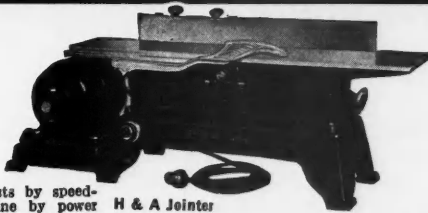

Now you can cut your costs by speeding up production. Plane by power on every job with this portable, electric H. & A. Jointer. Handles 97% of your work. Heaviest and toughest jobs. Planing, rabbeting, beveling, and jointing. Fast and highly accurate. Take it with you on the job. Plug in the nearest light-socket. Specially equipped with safety features. Built of highest grade materials. Perfectly machined and balanced. Priced reasonably. Send at once for complete information.

H & A Jointer

Send for NEW FREE CATALOG

We manufacture a complete line of powerful, fast, accurate portable electric woodworking equipment for busy builders. Completely described in NEW FREE Catalog. Band Saws, Rip Saws, Cut-Off Saws, Wood Lathes, Bench Jointers, Shapers, etc.

HESTON & ANDERSON
202 Park Avenue Fairfield, Iowa



If

**YOU DO NOT FIND
WHAT YOU WANT**

in the **AMERICAN BUILDER AND
BUILDING AGE**, write us and we
will try to get it for you.

**THERE IS
MONEY IN
Weatherstripping**

**When You Use a
Dependable Product**

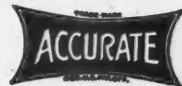

METAL WEATHER STRIPS

have for many years been recognized for perfect reliability and low price.

Many highly profitable independent businesses have been established through their use.

You, too, can build a money making business all your own—we will show you how and help you.

**ACCURATE METAL
WEATHERSTRIP CO.**

208 E. 26th St., New York

Established Weatherstrippers are invited to send for samples for comparison of quality and prices.



The
**AMERICAN METHOD
PAYS BIG PROFITS**

In addition to sanding newly laid floors and resurfacing old floors . . . the American Method enables you to wax, polish and finish the floor completely. This gives you two profits—one for the surfacing, another for the finishing.

Don't lay around idle this Winter. Get into this profitable business. We help you get started with free advertising matter that brings in the business. Small down payment starts you. Experience unnecessary. Write today to

THE AMERICAN FLOOR SURFACING MACHINE CO.
511 South St. Clair St. Toledo, Ohio

More **MIXER** for
Your **MONEY**

\$169.00

F. O. B. Columbus
On Steel
Wheels

Get latest catalog on Jaeger all-steel, roller-bearing 3 1/2 S trailers with "Dual-Mix" high speed drum.

POWER LOADER TILTERS:
3 1/2, 7, 10S sizes.

NON-TILTERS: 7S to 56S sizes.
Write for prices and details.

**THE JAEGER
MACHINE COMPANY**
521 Dublin Avenue, Columbus, Ohio

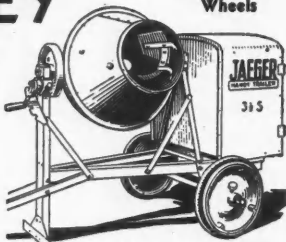

On Rubber
Tires \$179.50

"ANTI-HYDRO"

**A 25-Year
Guarantee**

. . . goes with every supervised job. "Anti-Hydro" is the recognized integral waterproofer for all concrete masonry. In addition, it increases strength, hastens hardening and prevents freezing.

Anti-Hydro Waterproofing Co.,
295 Badger Avenue, Newark, N. J.

A2

Please give me full details regarding "Anti-Hydro" and your 25-year guarantee on supervised jobs.

Name.....

Address.....

FOR ADVERTISERS' INDEX SEE NEXT TO LAST PAGE

One-Man Contracting Business

(Continued from page 45)

Carpentry: For a house of this type I figure carpenter cost at 20 cents per square foot of ground floor.

Sanitation: The price estimated here includes a good quality of tub and shower, lavatory, toilet, double sink, automatic water heater, and wash trays located on service porch. Fixtures are chromium plated. Sewer and gas connections, gas outlets and water connections are included.

Metal Work: Includes flashing, down-spouts, etc.; also lining of two lower drawers of kitchen cabinet.

Roof: This is a good mission tile roof laid over a ten-year guaranteed composition—three layers of 15 pound felt mopped with hot asphalt between layers. Tile is nailed with copper nails. We use two by six rafters to carry the extra load. Before stuccoing the exterior, we always haul the tile up upon the roof, distributing its weight evenly. Then if any settling takes place, due to its weight, it will occur before stucco is on. I figure cost of tile at \$16 per square (10x10) laid. Composition is figured at \$4.75 per square up to \$6.00.

Lath and plaster: Our exterior stucco work costs us 70 cents per square yard applied. Interior plastering or stucco costs 35 cents per square yard applied.

Electrical: Outlets cost us \$1.55 each. I figure electric fixture allowance at 1 1/2 per cent of the cost of the house.

Heating: Our heating problem is different from up north, but the idea is one that might be more widely used. We install ventilating wall heaters operated by gas in each room. I get these for \$8 each; sometimes an electric wall heater is placed in the bathroom; the cost is a little more. These heaters take up no floor space and because they draw their oxygen from outside (see sketch) do not foul the air of the house.

Millwork: The cost of sash and doors, about \$80 for this house, is included under lumber. We do practically all other work, such as frames, kitchen cabinets, stairwork, etc., on the job. I figure cost of screens at \$1 each.

Glazing: Under miscellaneous glass I include such items as shoe racks, bathroom cabinet with glass door, milk receptacle, mail-box, ironing board, and door grill—all of which are inexpensive and easy to install and yet mean a lot to the customer. We install one full-length plate glass door in the master bedroom, which costs us about \$8.

Tile: The \$150 includes an attractive tile floor in bathroom with six-foot tile wainscot. I figure 70 cents per square foot for tiling.

Painting: This is a difficult figure to break down, and my estimate is based on experience with a number of houses of this type, cost of painting the kitchen including the cupboard is about \$18; bathroom, \$10. All outside as well as inside work is given three coats.

Floors: Floors are of 1/2-inch oak, first grade, over good sub-flooring, laid diagonally. The oak costs us \$1.30 per sq. yd. laid. Linoleum costs us \$1.50 per sq. yd., laid. This is a good quality inlaid, glued to the floor which has been previously scraped and sanded. It is a permanent job.

The total price, \$2434, is a conservative estimate with material prices and general building conditions as they now are. It could be reduced still more by eliminating the fireplace. We always build in coolers, which are popular and inexpensive. Such a house as this is well built, comfortable, attractive, and a good investment for people of low income.