

AMERICAN BUILDER
AND BUILDING AGE

IS THE BUSINESS
JOURNAL OF THE
ACTIVE MEN OF THE
BUILDING INDUSTRY

SUBSCRIPTION PRICE in the United States and Possessions, 1 year, \$2.00, 2 years, \$3.00, 3 years, \$4.00; Canada, including duty, 1 year, \$2.50, 2 years, \$4.00, 3 years, \$5.00; foreign countries, 1 year, \$4.00, 2 years, \$7.00, 3 years, \$10.00. Single copies, 25 cents each. ADVERTISING RATES—Furnished on application. Advertising forms close on the 10th of the month preceding date of publication. Entire contents copyright, 1932, by American Builder Publishing Corporation.

AMERICAN BUILDER AND BUILDING AGE

(A Simmons-Boardman Publication)
Name Registered U. S. Patent Office

54th Year

JUNE, 1932

Vol. 53—No. 3

Front Cover.....	Painting by L. E. Arent	1
Editorials.....		17, 18
Home Construction and the Modernizing of All Buildings Best Unemployment Relief.		
Selling—Not Order-Taking—Will Revive Business.		
Frontispiece.....		19
Look for Business in the Houses Next Door.		
Modern "Minute Men" Out Fighting for Sales.....		20, 21
Describing Methods Used to Get Repair Business.		
Builders and Dealers Co-operate to Figure Fair Price on Houses.....	by A. W. Holt	22
New Plan Provides Way to Get Quick Estimates on Houses Shown in American Builder and Building Age.		
Homes—Garages—Gardens.....		23-28
A Group of Fine Homes, Each of Which Has "Cost Key" Enabling Readers to Estimate Exact Cost in Their Community.		
Garage Modernizing Increases.....		29
Demand for Weathertight, Convenient "Motor Homes" Opens Big Field for Builder Activity.		
Modern Garages.....		30-31
Eight Popular Types of Well Equipped "Motor Homes."		
War Declared on Shoddy Construction!.....		32
Builders and Dealers Fight to Overcome Public's Ignorance of Construction Standards.		
What Results from Demonstration?.....		33
A Record of Results from Modernizing.		
New Sun Porches Add Value to Old Houses.....		34
Insulation Plays Large Part in Modernizing.....		35
Modernizing and Repairs Needed in Basement.....		35
Built to Please Modern Rent Seekers.....		36-39
Brooklyn Apartment Has Unusual Combination of Residential and Business Design.		
Give Added Value by Improving the Electric Convenience of Dwellings.....		40, 41
The House of the Month.....		42-44
A Quality Small House of Charming Design for Which Complete Working Drawings and Cost Estimates Are Given.		
Good Architecture Pays.....		45
New Greasing Service Front for Old-Style Public Garage.....		46, 47
How a Chicago Builder Took an Old, Unprofitable Public Garage and Turned It Into a Modern Money-Maker.		
Profit in Making Old Kitchens New.....		48
Reconditioning Old Floors Develops Profitable Business.....		48
Porcelain Enamel for House Exteriors.....		49
Application of Raised Mouldings.....	by W. E. Griffiee	49
News of the Building Industry.....		50-52
Architects Will Investigate Small House Service Bureau.		
April Building Awards Show Slight Gain		
Realtors to Study U. S. Housing Needs.		
National Homes Finance Corporation Adds Members.		
New Catalogs Offered to Builders.		
Practical Job Pointers.....		53
What's New in Builder's Equipment.....		54, 56
What's New in Building Products.....		58, 60
Letters from Our Readers.....		62, 64
Advertiser's Index.....		67

MEMBER OF THE AUDIT BUREAU OF CIRCULATIONS
AND OF THE ASSOCIATED BUSINESS PAPERS

AMERICAN BUILDER AND BUILDING AGE, with which are incorporated National Builder, Permanent Builder, and the Builder's Journal, is published on the first day of each month by the American Builder Publishing Corporation.

Henry Lee, Chairman of Board; Samuel O. Dunn, President; Bernard L. Johnson, Robert H. Morris and Delbert W. Smith, Vice Presidents; Elmer T. Howson, Secretary; John T. De Mott, Treasurer.

Bernard L. Johnson, Editor; Joseph B. Mason, Managing Editor; E. L. Gilbert, Eastern Editor; H. F. Lane, Washington Editor; L. E. Arent, Art Director; Robert H. Morris, Business Manager.

EDITORIAL AND PUBLICATION OFFICE: 105 W. Adams St., Chicago; Telephone, Randolph 0794. Branch Offices: New York, 30 Church St.; Cleveland, Terminal Tower; Washington, 17th and H Sts., N. W.; San Francisco, 215 Market St.

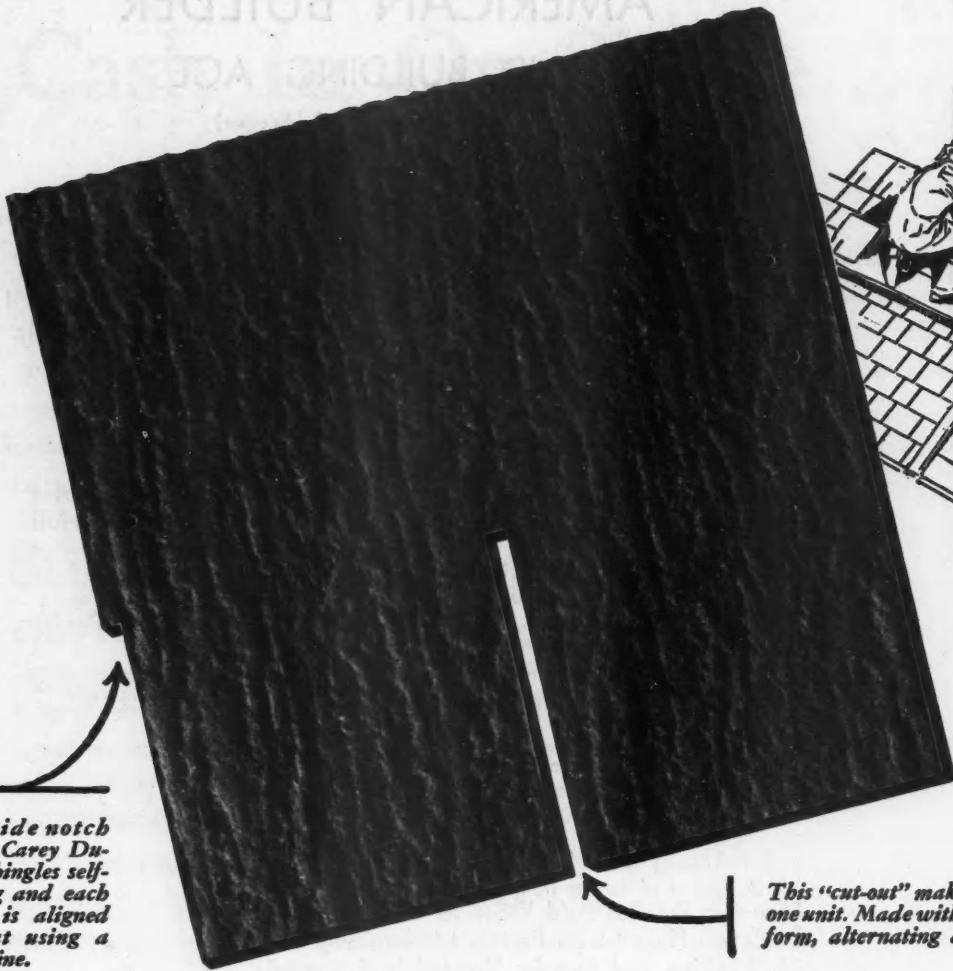

This side notch makes Carey Duplex Shingles self-spacing and each course is aligned without using a chalk line.

This "cut-out" makes two shingles out of one unit. Made with three style tabs: uniform, alternating and random width.

Carey Duplex Asbestos Shingles

APPLY 40% TO 50% FASTER

Carey Duplex Asbestos Shingles create extra business and extra profits. Fireproof, permanent and possessing an artistic rough textured surface, they nevertheless enable you to meet competition and still make a fair profit, because the double units and self-spacing side notch cut application costs 40% to 50%.

Carey Duplex Asbestos Shingles are produced in five attractive colors—Georgian Red, Windsor Gray, Tudor Black, Bristol Green and Weathered Brown. Write today for prices and complete information, and also for the details of the Carey Sales Plan for securing profitable re-roofing business.

THE PHILIP CAREY COMPANY • Lockland, Cincinnati, Ohio
Branches in Principal Cities

BUILT-UP ROOFS
ASPHALT PRODUCTS
ELASTITE EXPANSION JOINT
WATERPROOFINGS
ROOF PAINTS

Carey
PRODUCTS
EST. 1875

HEAT INSULATIONS
ASBESTOS MATERIALS
CORRUGATED ASBESTOS SIDING
ASFALSLATE SHINGLES
ROLL ROOFINGS

Look what we're doing TO HELP KEEP YOU BUSY!

Free Plans . . . Post advertising
. . . and a bigger profit when
you use Douglas Fir Plywood!

POWERFUL *Saturday Evening Post* advertising like this is making your prospects want—now—the extra comfort that Fir Plywood remodeling will give them!

It's showing them, too, how Douglas Fir Plywood builds *damage-proof* construction at low cost! This advertising is featuring especially the new 1/4" Fir Plywood Wallboard—real lumber that won't crack, crumble, buckle or sag! It retails for around 4c to 7c a sq. ft., depending on quantity and the dealer's freight cost.

Cabinet grades of this split-proof, warp-resistant lumber will give you more profit on built-ins, store fixtures, cabinets, etc. — because they cost less per surface foot than ordinary lumber and speed up your work 20 to 60%.

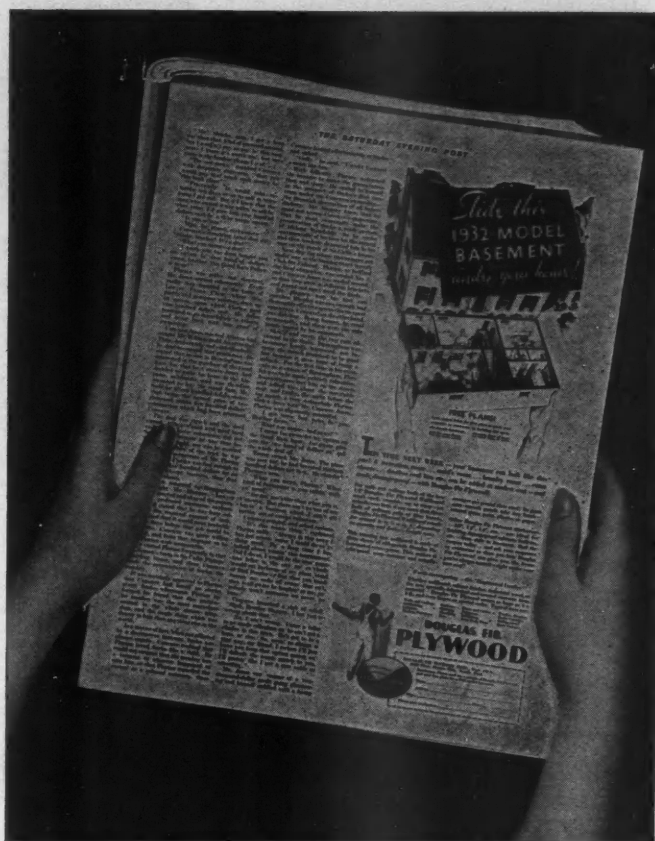

\$5000.00 for IDEAS!

Not a contest, but an outright purchase offer for practical designs using Douglas Fir Plywood. \$25.00 for every "idea sketch" we can use! For details, see our advertisement in the March, April or May issue of *American Builder & Building Age*—or write to Douglas Fir Plywood Manufacturers, Dept. 632-B, Sixth Floor, Skinner Bldg., Seattle, Wash.

Nearly 3,000,000 families will see this job-creating ad in the June 18 *Saturday Evening Post* (on newsstands June 14). It shows them how to modernize old-fashioned basements—urging them to send for free plans, and to call in a carpenter or contractor!

Mail the coupon for these plans, and show them to prospects in your own community.

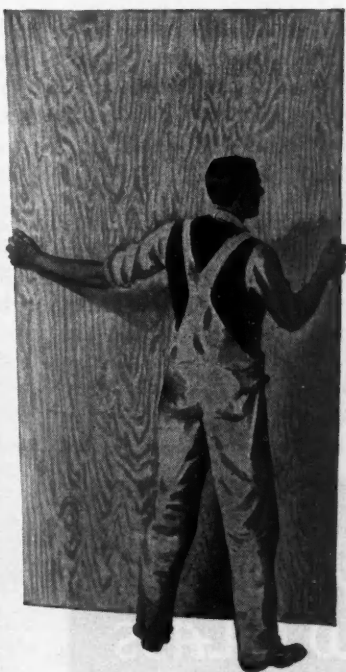

DOUGLAS FIR PLYWOOD

DOUGLAS FIR PLYWOOD MFRS., Dept. 632-B, Sixth Floor, Skinner Bldg., Seattle, Wash.

Gentlemen: Please send me free working plans, helpful literature, and sample of Douglas Fir Plywood.

Name _____

Address _____

City _____ State _____

Check here if you are a Contractor , Carpenter , Building Supply Retailer , Architect , or Realtor , and additional material will be sent you.

WHEN WRITING ADVERTISERS PLEASE MENTION THE AMERICAN BUILDER AND BUILDING AGE

Pennvernon
Windows
 bring the
 outdoors
 into the
 home

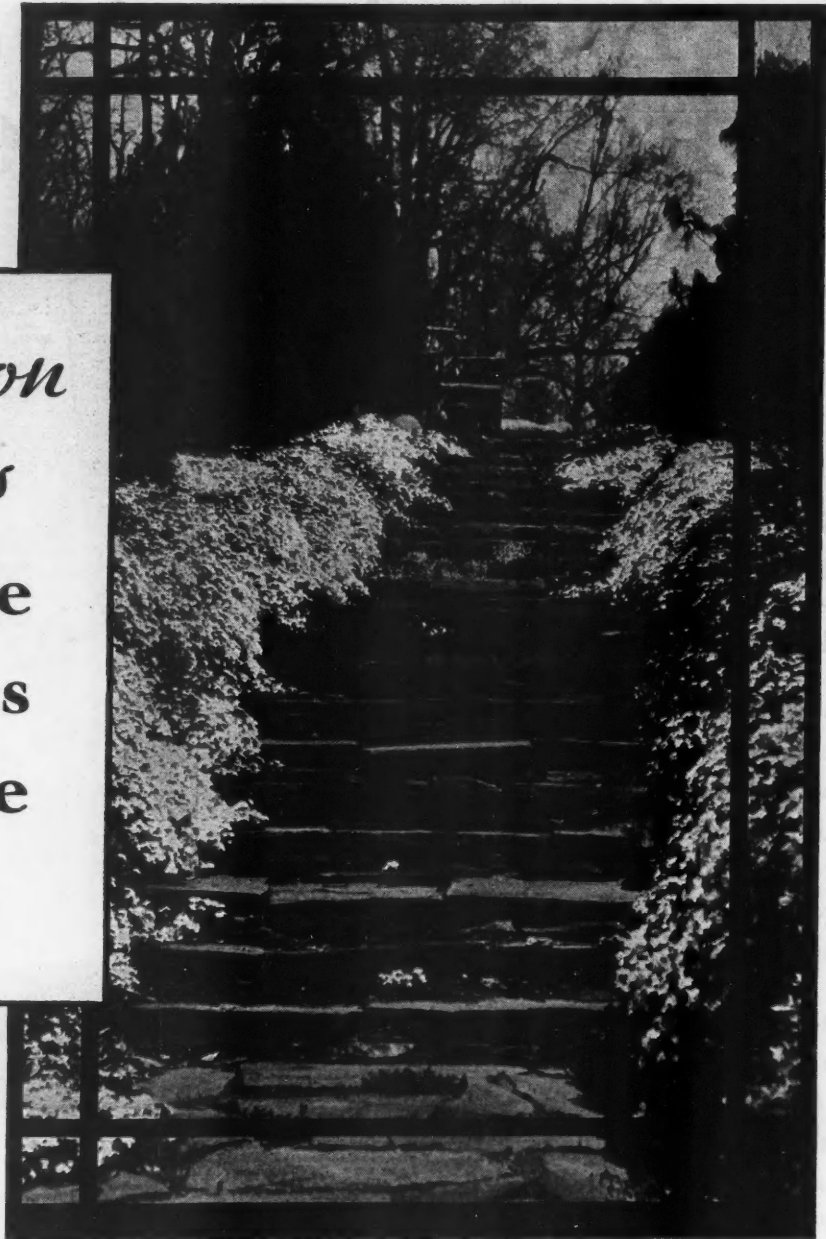

ONE of the major reasons for the increasing popularity of Pennvernon Window Glass with architects, builders and homeowners, is the ability of this glass to transmit clearly and truthfully the varied beauties of Nature's scenes. Windows glazed with Pennvernon make the outdoor views beyond them integral parts of the building. They literally bring the outdoors into the home.

The exclusive patented process of flat drawing by which Pennvernon is made gives to the glass a new transparency and a remarkable freedom from distortion. This manufacturing method, combined with the purity of the ingredients used in Pennvernon, accounts for Pennvernon's power to transmit Nature in all its fine detail and its bright, natural colors.

Another far-reaching effect of the Pennvernon manufacturing process is to endow the glass with surfaces of a fire-finished brilliance and luster never before equalled in window glass making. These surfaces are so smooth and so dense in structure that they not only provide unprecedented reflective

qualities in Pennvernon, but also resist wear and abrasion unusually well and give the glass longer lasting beauty. In addition, both surfaces of Pennvernon are alike in brilliance, which means that the glass may be glazed either side out.

Pennvernon Window Glass is well worth investigation. Ask us for samples and examine them. See for yourself why Pennvernon has become such a fast, steady seller everywhere. This glass is available in single or double strength, and in thicknesses of $\frac{3}{16}$ " and $\frac{7}{16}$ ", at the warehouses of the Pittsburgh Plate Glass Company in all leading cities and through progressive glass jobbers. For samples and our booklet on the Pennvernon manufacturing process, address Pittsburgh Plate Glass Company, Grant Building, Pittsburgh, Pa.



PENNVERNON
 WINDOW GLASS

"I smell smoke!"

(23% of all residential
fires start on the roof!)

*Give your houses the permanent
fire protection of Asbestos at Low Cost*

... J-M DUTCH LAP SHINGLES

EVERY home owner today is fully aware of the ever-present menace that an inflammable roof presents. He wants the assured safety that a fireproof, imperishable roof gives a home. He is quite right in expecting the roof to last as long as the house itself.



GOOD LOOKING . . . FIREPROOF
... the Johns-Manville No. 30 Dutch Lap
Roof on this home will never wear out.

Now Johns-Manville enables you to capitalize on this universal desire . . . allows you to offer home owners the complete and permanent protection of an asbestos roof at a cost within the reach of the most modest budget.

For J-M No. 30 Dutch Lap Shingles cost less today than even the old familiar "grey hexagonal." Their application moreover is so rapid and simple that labor costs are reduced to an absolute minimum.

These fireproof Johns-Manville Dutch Lap Shingles have a rich, colorful beauty and the charm of American Method lines. They are obtainable in 8 attractive colors to blend harmoniously with any architectural scheme.

No wonder that builders and dealers everywhere agree that J-M No. 30 Dutch Lap Shingles give them everything they want in a roof. Certainly they are *the shingles for 1932.*

For full particulars, inquire at your nearest Johns-Manville dealer or write to Johns-Manville, 292 Madison Avenue, New York City.

Johns-Manville



ASBESTOS
SHINGLES

KALMANTRUSS STEEL JOISTS

for Light-occupancy Structures of any type

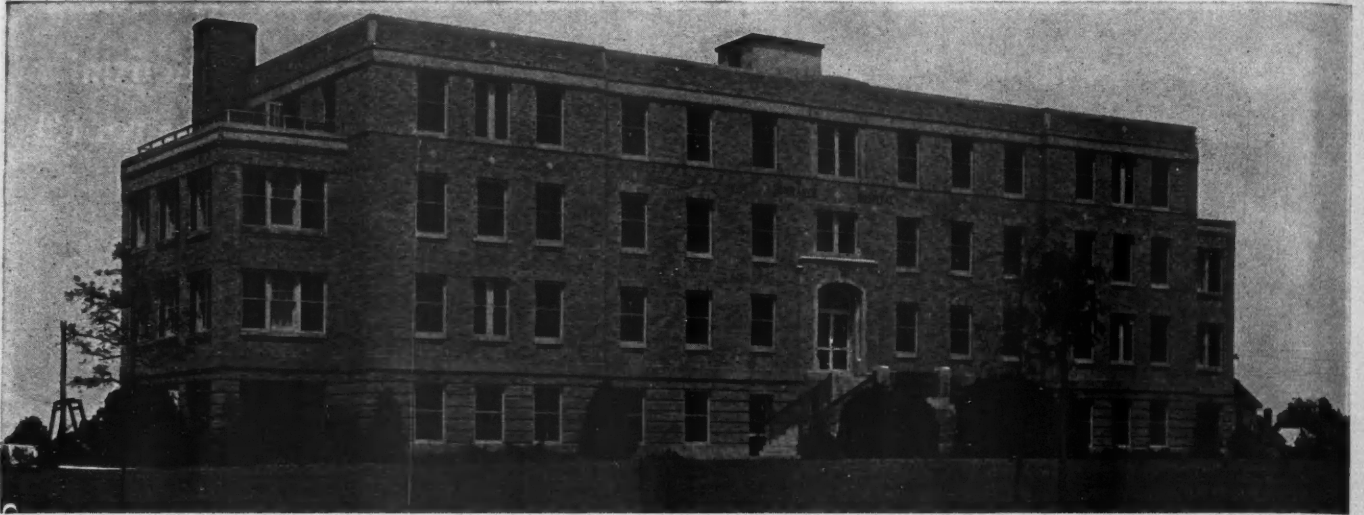

Lowrance Hospital, Mooresville, N. C. Architects: Chas. C. & Walter W. Hook, Charlotte, N. C. Contractors: C. A. Morrison & Son, Shelby, N. C.

KALMANTRUSS STEEL JOISTS and related specialties are suitable for use in all types of light-occupancy buildings. The Lowrance Hospital, illustrated above, is one of many attractive, modern structures built with Kalmantruss Steel Joists. Other examples are found among apartment buildings, office buildings, schools, hotels and residences.

Kalman materials, widely accepted by contractors and builders, provide a standardized method of constructing light, strong, rigid and fire-resisting floors which meet every demand of modern design. At the same time lower costs are made possible by the ease and speed of erection and the elimination of expensive form work.

Kalmantruss floor and roof construction consists of a combination of Kalmantruss Steel Joists, Rigid Bridging, Kalman Metal Lath, and necessary anchors and clips.

In addition to Kalmantruss Joists, Concrete Reinforcing Bars and Steel Door Frames furnished by Kalman Steel Corporation were used in the construction of the Lowrance Hos-



Showing the floor construction in the Lowrance Hospital. Note the use of Kalmantruss Steel Joists, Kalmanlath, and accessories.

pital. Detailed information will gladly be furnished regarding the many advantages obtained by using Kalmantruss Steel Joists and other Kalman Products. Address any of the district offices listed at the right.



KALMAN STEEL CORPORATION
Subsidiary of Bethlehem Steel Corporation
General Offices: Bethlehem, Pa.

District Offices: Albany, Atlanta, Baltimore, Boston, Buffalo, Chicago, Columbus, Detroit, Houston, Milwaukee, Minneapolis, New York, Philadelphia, Pittsburgh, St. Louis, St. Paul, Syracuse, Washington. Export Distributor: Bethlehem Steel Export Corporation, New York.

ALUMINUM PAINT—THE COAT OF METAL PROTECTION



Millions of advertisements are telling prospects of Aluminum-Primed lumber products today

Your prospects are reading millions of advertisements in leading publications about the many specific advantages of siding, trim and numerous other lumber products which have been "primed at the mill with aluminum paint". Incorporated in your building projects, the aluminum paint-protected products mark your work with distinct points of superiority on which you can pin a forceful selling story.

Lumber products that have been primed at the mill with aluminum paint are protected from the harmful effects of rapid changes in moisture content. They're sealed, front, back and ends, by millions of tiny flat flakes of pure aluminum which overlap like falling leaves, forming a continuous moisture-resisting coat of metal protection.

Today you can buy siding, mouldings, window frames and sash, shingles, roof sheathing, sub-flooring, ceiling, porch flooring that have been primed at the mill with aluminum paint, the pigment portion of which is Alcoa Albrón Powder, made by Aluminum Company of America.

If your dealer does not handle this ready-primed material, we will direct you to a source of supply. Address ALUMINUM COMPANY of AMERICA; 2420 Oliver Building, PITTSBURGH, PENNA.

ALCOA ALBRON
POWDER FOR
ALUMINUM PAINT

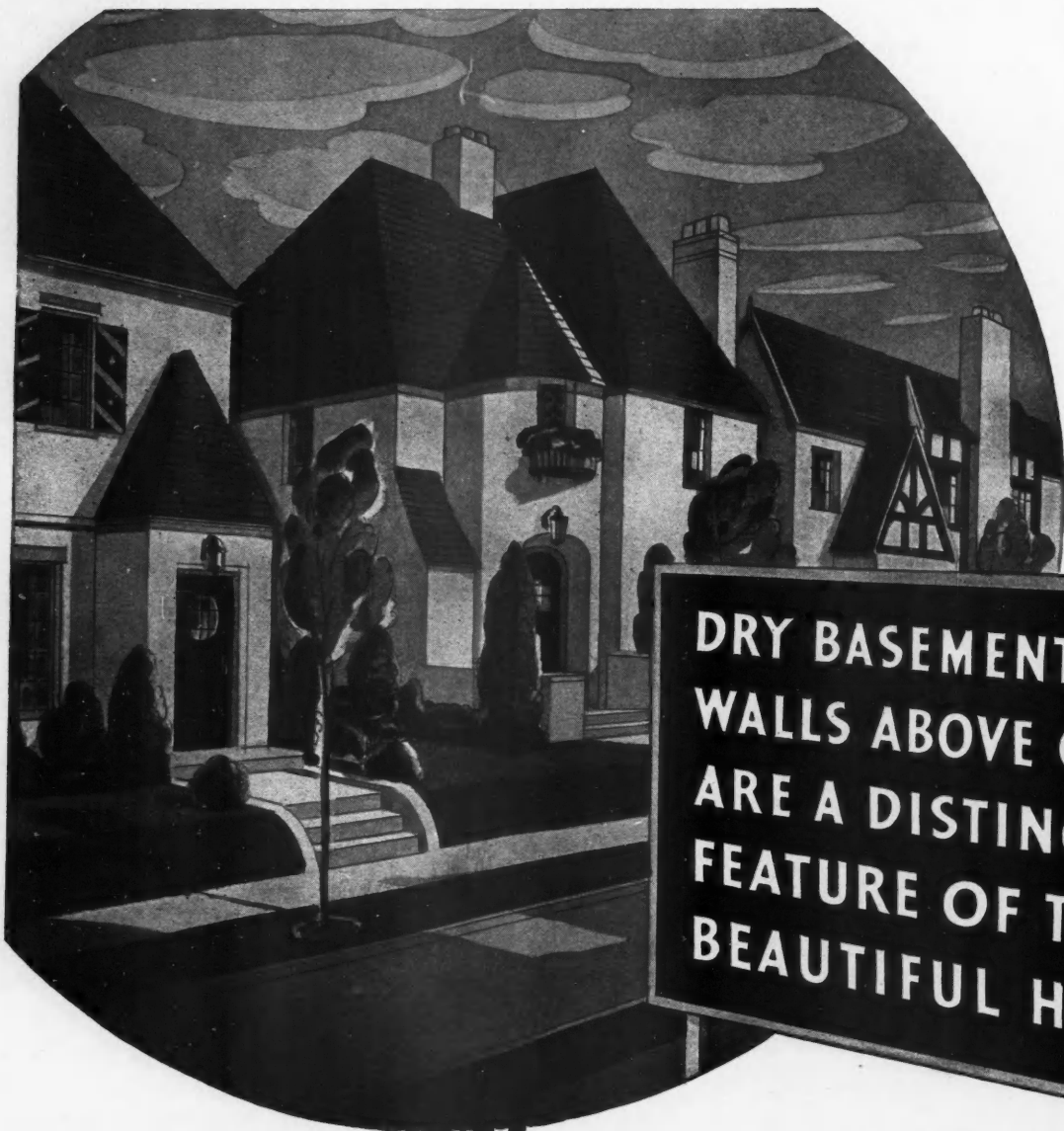

this sign WOULD HELP SELL YOUR HOMES



MEDUSA

WATERPROOFED PORTLAND CEMENTS
White and Gray
Originated by Medusa—Proved by Time

• Home seekers look critically at the basement these days. They want to be sure that it is dry and that *it will stay dry*. Builders also realize the added sales value of the home that has a recreation room in the basement. The most practical and economical way to assure dry walls above and below grade is to use Medusa *Waterproofed* Portland Cements, white or gray, in all concrete, stucco and mortar. The cost is negligible. These Waterproofed Portland Cements—*Successful for 22 Years*—contain Medusa Waterproofing Powder ground in at the mill. Write for the Medusa Stucco Book and the book on “*How To Make Good Waterproofed Concrete.*” The books will be sent to you without obligation or cost.

MEDUSA PORTLAND CEMENT COMPANY
 1002 Engineers Bldg. Dept. Z Cleveland, Ohio

And now "STRAITLINE" Monel Metal Sinks...

**PRICED LOW
ENOUGH FOR
ANY HOME!**

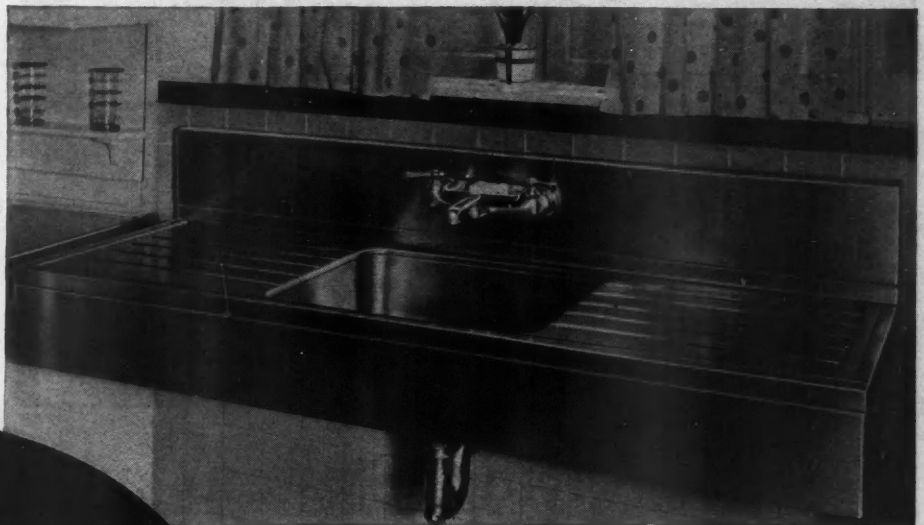

● ABOVE: Double drain board Monel Metal "Straitline" kitchen sinks are available in both 72- and 60-inch lengths.

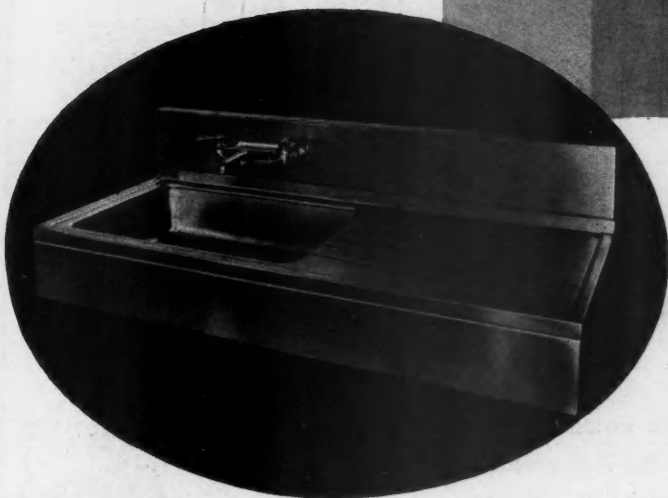

● AT LEFT: Single drain board Monel Metal "Straitline" kitchen sink. Available with drain board on either right or left side, in both 41- and 50-inch lengths.

● NOW...any home you build can have a beautiful kitchen...the kind of kitchen that every prospect wants. The sink is the key to kitchen attractiveness and...the new Monel Metal "Straitline"* Sinks are priced about 50% lower than any previous price for a Monel Metal sink.

Designed and styled on the most modern lines, Monel Metal "Straitline" Sinks are fitting companions to the more expensive "Streamline"* models. They offer the beauty and durability of Monel Metal kitchen sinks at a cost practically no more than for the better grade of ordinary sinks of comparable working area.

Women who inspect your homes will admire the new "Straitline" design. They will

also see how lustrous Monel Metal gives modern, harmonizing beauty that blends with kitchen color schemes. They will accept the presence of these silvery sinks as proof of the quality construction of your houses.

National advertising is now telling the story of Monel Metal "Straitline" Sinks as well as Monel Metal "Streamline" Sinks to more than 5,000,000 families. This widespread activity is creating a demand for modern metal sinks and making it easier for progressive builders to sell Monel Metal equipped homes in every price class. Let us send you complete information about Monel Metal "Straitline" Sinks. Meanwhile, inspect them at your local plumber's showroom.

The only kitchen sinks that offer all these advantages

- 1 Rich, lustrous beauty...with a satiny, glass-smooth surface.
- 2 Neutral silver tone that harmonizes with any kitchen color scheme. Eliminates problem of finding colors that please.
- 3 Rust-proof...highly resistant to corrosion...easy to clean.
- 4 Solid metal...no coating to chip, crack or wear off...strong as steel.
- 5 Surfaces give cushioning effect that protects dishes against breakage.
- 6 31% more work space than ordinary sinks of same nominal sizes. No space-wasting curves or bulges.
- 7 Standard sizes and models for every kitchen.
- 8 Prices within easy reach of the most modest building budget.

THE INTERNATIONAL NICKEL CO., INC., 67 WALL ST., NEW YORK, N. Y.

* Trade-mark.



Monel Metal is a registered trademark applied to an alloy containing approximately two-thirds Nickel and one-third copper. Monel Metal is mined, smelted, refined, rolled and marketed solely by International Nickel.



WHEN WRITING ADVERTISERS PLEASE MENTION THE AMERICAN BUILDER AND BUILDING AGE

The cost of Inadequate Wiring is Premature Obsolescence

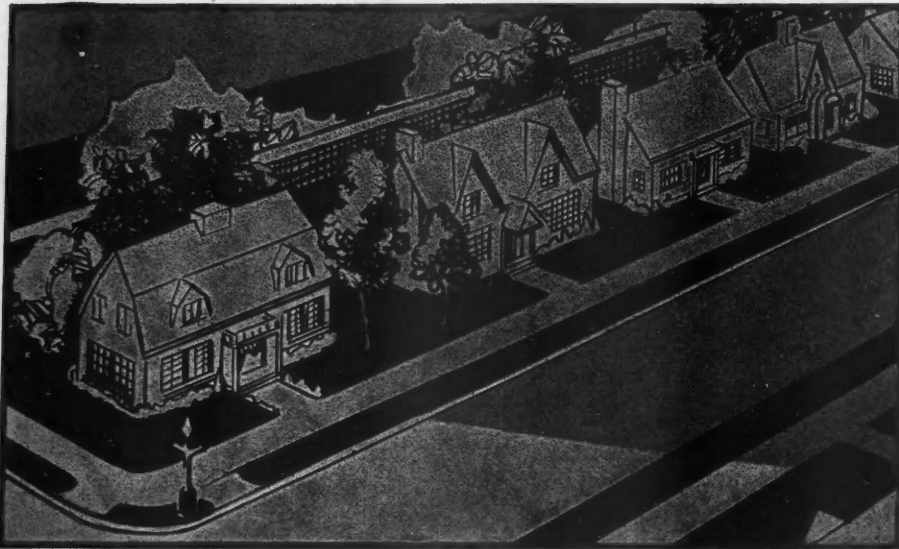

A G-E Wiring System adds value and safeguards your building investment

The ever-increasing uses of electricity and electrical servants in the modern home compel the 1932 builder to protect his investment by installing a wiring system of sufficient capacity to meet possible future requirements as well as present day demands.

Insure continued satisfaction with the building you are planning by installing a G-E Wiring System, of adequate capacity and with an ample number of outlets. A G-E Wiring System adds value to your building and increases its saleability.

Economical, the installation of a G-E Wiring System is a protection against any depreciation or premature obsolescence caused by inadequacy of wiring capacities. It is your guarantee that only wiring materials with the General Electric reputation for quality will be used.

Ask your nearest G-E Merchandise Distributor about the General Electric Wiring System and what it will do for you or write to Section G-1066, Merchandise Department, General Electric Company, Bridgeport, Connecticut.

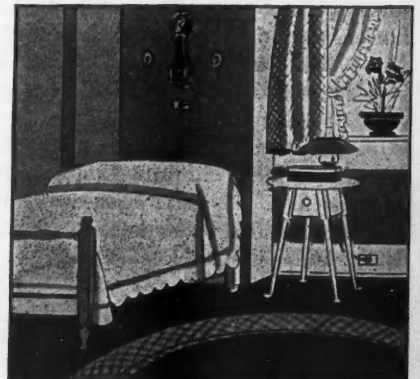
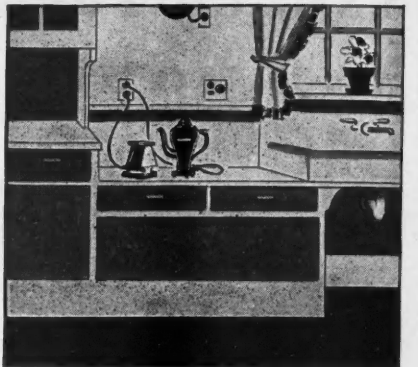
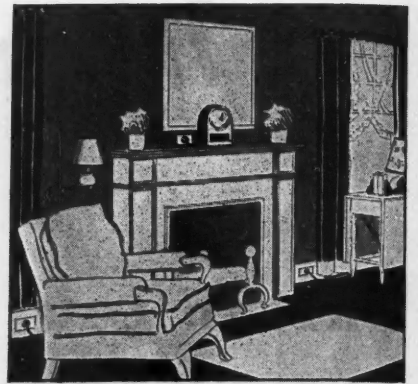

GENERAL ELECTRIC

WIRING SYSTEM

MERCHANDISE DEPARTMENT, GENERAL ELECTRIC COMPANY, BRIDGEPORT, CONNECTICUT

The BARCOL

OVERdoor

This is an *improved* overhead type door for use on residence garages, public garages, filling and service stations, warehouses, terminals, loading platforms, etc., etc. It is distinguished by unique features including: special, weathertight closing means—tailored, twin-torsion counterbalancing springs—heavy, durable hardware—easy operation—and many others. The illustration shows a standard Barcol OVERdoor used on a remodeling job on a built-in residence garage.

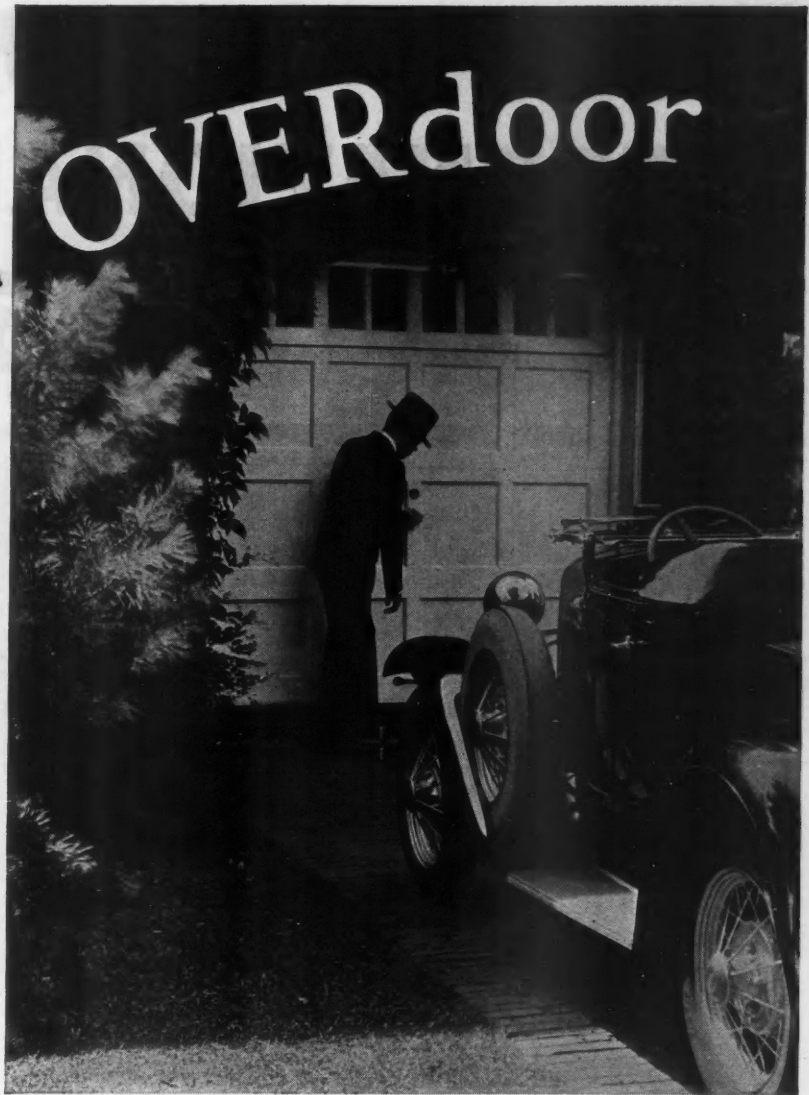

SATISFIED Customers..SATISFIED Contractors



Most customers would like to have this type of door — and will gladly pay for its extra quality and service.

Cultivate the satisfaction of your customers if you value your own. Show them the Barcol OVERdoor — a better door that will give them more for their money. Install the Barcol OVERdoor to eliminate garage door difficulties. The wise contractor makes every installation a guarantee of future business, because he leaves a customer that will “come back”. Use the coupon below to ask for further information.

BARBER-COLMAN COMPANY, Rockford, Ill., U.S.A.

BARBER-COLMAN COMPANY,
ROCKFORD, ILLINOIS

AB 6-32

Please send me further information concerning the Barcol OVERdoor. I am particularly interested in the following:

Residences. Service Stations. Standard Designs. Specials.

NAME _____

ADDRESS _____

CITY _____ STATE _____

NOW—Lower Prices for INTERNATIONAL TRUCKS

**The Popular 1½-Ton
4-Speed Model A-2
Reduced to**

\$615

**136-inch wheel-
base chassis
f. o. b. factory**



THE tremendous demand for International Trucks and their reputation in every kind of hauling work has been built on *quality*—not on price. Users learned that Internationals mean *long truck life, minimum up-keep, lowest costs, and hauling satisfaction.*

But during 1930, **LOW PRICE** became a factor, too. And now again we are announcing reductions on International Trucks. Think of what it means to get the popular International Model A-2 for \$615, and without any

sacrifice of quality. Similar reductions apply on other models in the line.

Put your faith in International transportation. And be guided by the experience of owners everywhere reporting hauling costs as low as 4, 5, and 6 cents a mile. Quality, low price, and low cost of operation—you get them all in International Trucks. Sizes from ¾-ton to 7½-ton. Ask the nearest of 183 Company-owned branches in the United States and Canada, or an International Truck dealer, for a demonstration.

Model A-2 Features

- 4 forward speeds.
- 22 ball and roller bearings.
- Powerful engine, L-head type; 3⅝-in. bore, 4½-in. stroke; ample power with unusual fuel economy.
- Cam-and-lever steering gear.
- Vibration-dampened clutch.
- 2 wheelbases: 136 and 160 inches.

INTERNATIONAL HARVESTER COMPANY
OF AMERICA
606 So. Michigan Ave. (Incorporated) Chicago, Illinois

INTERNATIONAL TRUCKS

AMERICAN BUILDER AND BUILDING AGE

HOME CONSTRUCTION AND THE MODERNIZING OF ALL BUILDINGS BEST UNEMPLOYMENT RELIEF

CONGRESS and the President have opened the 1932-33 unemployment relief discussion with proposals to loan federal funds in huge amounts to the States for charitable relief, and to corporations for use in projects that will employ much labor and will be "income producing."

This publication is not in favor of any measure that will increase the tax burdens which home owners, farmers and industrial concerns are now staggering under; but it does favor policies and programs that will produce widespread employment and will be paid for, voluntarily, by those benefited and not out of tax funds.

Repairs and improvements on homes, farm buildings, retail stores, hotels and apartments, together with needed new construction, offer the greatest available field for a general increase of business activity and employment at this time.

There is a real need today for building improvements, very little having been done for three years by home owners and business property owners to maintain their structures or to put them in line with changing styles and with present-day exacting standards. We estimate that building activity totaling fully eight billion dollars per year can be achieved, provided the credit problem can be solved. This amount of construction activity would put about five million men back to work. It would apply the unemployment relief right at the root of unemployment, namely, the building trades; and from that center, on the construction job, employment would spread back through all the fabric of American industry.

Just two things are needed to bring about this surge of building in the small construction field—credit and salesmanship.

Money for Improvements

Funds are almost totally lacking today for home building or for extensive home modernizing. No financial relief is in sight for the home owner and the builder except through the establishment of the system of Federal Home Loan Discount Banks as proposed by President Hoover last fall. Congress has been dilly-dallying with this urgently needed legislation for six months. All the other features of the Administration's program



Back to Work—
at Home Con-
struction and
Repairs.

have been enacted into law. But this Home Loan Bill to give the rank and file of home owners a fair deal has dragged along and, according to the present outlook in Congress, will be allowed to die. Everyone favors it except the mortgage bankers; and their selfish interest in maintaining the old expensive system of mortgage lending with its fat fees, commissions and bonuses, is so evident that their objection ought to be the final prod to stir Congress to action in behalf of this measure, which assures lower financing costs and a better organized mortgage loan market for home owners and builders.

Congress should pass the Home Loan Bill without further delay. It would do more to stimulate repairs, remodeling and new building, and to remove the need for unemployment relief, than any of the emergency relief projects proposed.

Organize for Selling

Aggressive salesmanship on the part of builders, dealers, and the entire building industry, is also needed if home and other building repairs and new construction are to lead the nation back into productive employment. In spite of financing difficulties, some very gratifying results have been secured in certain cities and towns, such as Muncie, Lansing, Danville and Minneapolis, where thoroughly organized drives have been made on the basis of an every-house canvass and inspection for repair and modernizing work. The men of the building industry have taken a leading part in these campaigns,

and the best results have been secured by those community drives which have centered around the upkeep, repairs and modernizing of homes and other buildings.

The home owners and building owners of America would rather give jobs than doles; and it is sounder economics to put millions of tradesmen back to work for individuals who will derive personal benefit from their labor, than it is for federal, state or local governments to create public works jobs to be paid for out of tax money.

If Congress will set up promptly the Home Loan Banks, so that reasonable credit can be secured for home improvements and for needed home building; and if the entire country can be so organized that the men of the building industry will go out and, in an energetic, thorough-going way, tackle this job of selling better buildings to the public and of getting the men back to work, it is certain that we will have at last found a cure for unemployment—productive work that needs to be done and that is paid for directly by those who benefit from it.

SELLING—NOT ORDER-TAKING— WILL REVIVE BUSINESS

THE one influence most needed to start a revival of business in this country—the one influence without which it never will be started—is better and more effective selling to the consuming public. To say the public can not buy more than it is buying now is absurd, and is equivalent to saying that business never can be revived, because it never will be revived until the public does buy more.

Take home owners and the building industry, for example. There are about 24,000,000 detached houses in this country. It would obviously be ridiculous to say, after all the deterioration of buildings which has occurred within the last three years, that there is not needed an expenditure for repairs upon at least 40 per cent of these houses, or, say, 10,000,000 of them, averaging \$100 each. It would be equally ridiculous to say that their owners could not afford to spend an average of \$100 upon them, when they are spending at least five to ten times that much annually in running their automobiles. At this average of \$100 per house the aggregate expenditure for repairs alone upon this many houses would be \$1,000,000,000.

What a Billion Extra Would Do

Consider the increases in the purchase of materials and in employment of labor that would result if, through effective salesmanship, this large an increase in expenditures for repairs of houses should be brought about. The effects produced would not end, however, with the increased purchase of materials and employment of labor that would be directly caused by the expenditure of one billion dollars. The additional men

employed would increase their purchases of all kinds of goods, and this increase of purchases would increase employment for those who make and sell the kinds of things they bought. The direct increase in purchases of materials caused would increase employment by those who make the materials, and this increase of employment would again indirectly increase purchases.

Thus the effects of this increased expenditure of one billion dollars would ramify throughout the entire industry and commerce of the country, and indirectly cause an increase of general business running into several billions of dollars annually. Indirectly, and in the long run, the increase of general business that would be started if the building industry could this year get an extra billion dollars spent upon repairs to houses, would cause an increase of billions of dollars in expenditures upon buildings.

Work, Not Waiting, Will "Improve Conditions"

There is more buncombe being talked about the present depression and ways of ending it than ever was talked before about any economic problem in the history of mankind. Our so-called statesmen down in Washington think, and have succeeded in getting millions of other people to think, that business can be revived only by some kind of governmental legerdemain which will "improve conditions". In consequence millions of men are sitting around "waiting for conditions to improve" in order that they may be able to go out and get some business. It isn't the people on Pennsylvania avenue or Wall street that are going to "improve conditions" when they are improved. It is the people on Main street—the people in every city and town and on every farm—that are going to improve conditions. They are not going to bring back business by improving conditions, but they are going to improve conditions by bringing back business. Government can either help or hinder business, and it usually does the latter. Nine-tenths of what must be done to increase business must and will be done, when it is done, by the people themselves back home. The way to revive business is for each business man, each farmer, each worker to do his best in his own way to revive it.

More Salesmanship Needed

The greatest weakness of the home building industry is its weakness in selling. That, as a matter of fact, is true of every business today. Too many of our business men became accustomed in the recent period of prosperity to sitting in their offices and taking orders instead of going out and finding customers and selling to them. This is not a time to take orders, but a time to go and get them. The building industry will be revived, when it is revived, principally by those manufacturers, builders and material dealers who persistently advertise what they have to sell, and who go out and call upon the people of their communities, find out what they need, arouse a desire to have it, and then sell it to them.

to uncover
repair
jobs—

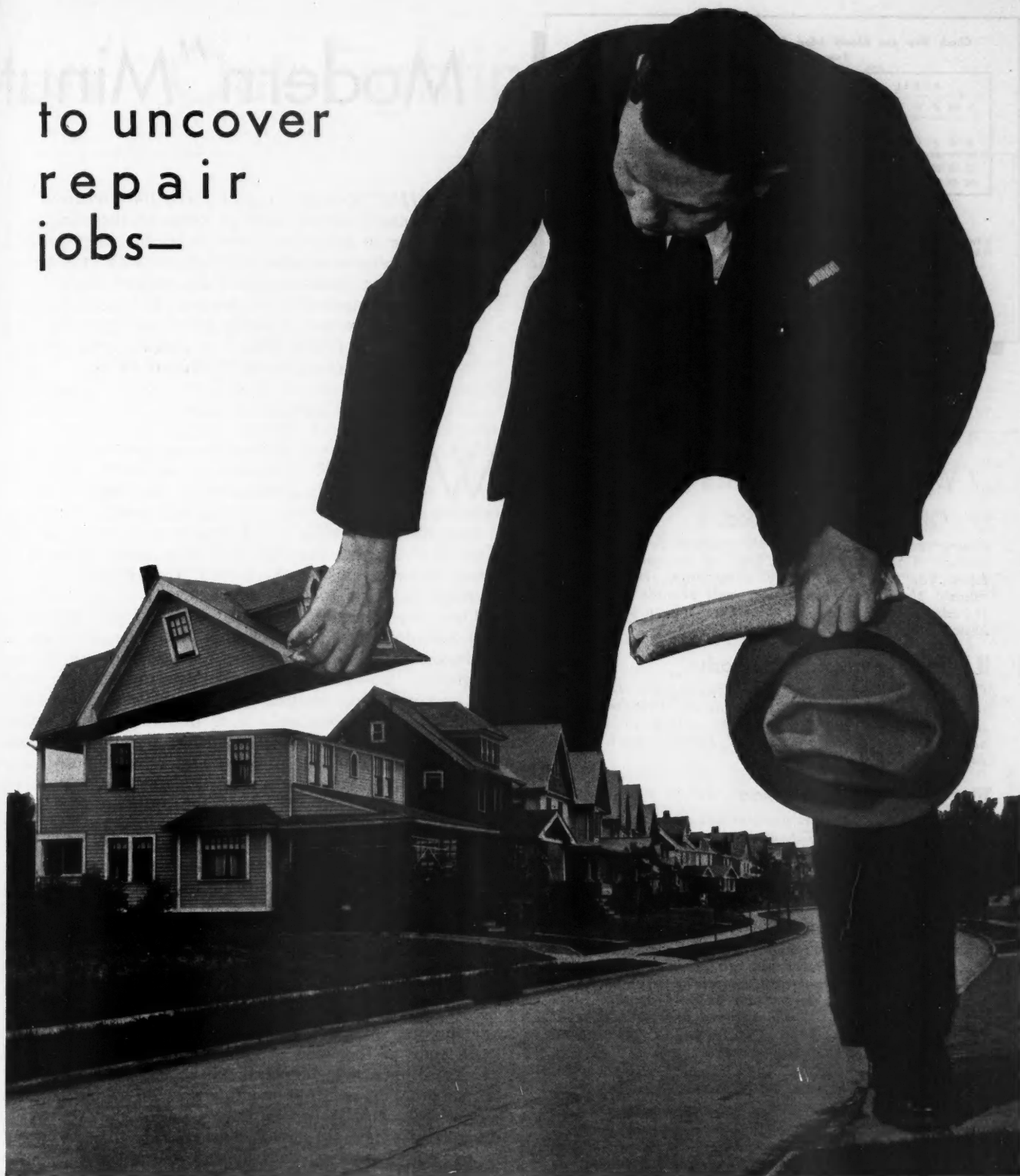

Look for business in the houses next door

Before any man can say "there is no modernizing business here" he must know the condition of every house in his neighborhood. Nine out of every ten houses need repairs or improvements. The builder is the man to seek out these needs and turn them into profitable business. A good place to start is on your own street.

Check Day and Month Most Convenient For Us To Make A
Free Service Inspection

APRIL							MAY							JUNE							
S	M	T	W	T	F	S	S	M	T	W	T	F	S	S	M	T	W	T	F	S	
				1	2		1	2	3	4	5	6	7					1	2	3	4
3	4	5	6	7	8	9	8	9	10	11	12	13	14	5	6	7	8	9	10	11	
10	11	12	13	14	15	16	15	16	17	18	19	20	21	12	13	14	15	16	17	18	
17	18	19	20	21	22	23	22	23	24	25	26	27	28	19	20	21	22	23	24	25	
24	25	26	27	28	29	30	29	30	31					26	27	28	29	30			

PLEASE INSPECT ROOF—SIDE WALLS—PILLARS—INSULATION—
FLOORS AND OTHER VITAL PARTS OF OUR HOME

If repairs are needed give recommendations that will put our home in proper condition.
It is understood this does not obligate us in any way.

Name.....

Address.....

Copy of reply card asking for appointment
to inspect house.

Modern "Minute

"NINETY-NINE out of every 100 dwellings are in actual need of some of the things you have to sell. On every street the need for building service is manifest to those with eyes to see and with minds to think. In most of the districts every home is a passive but thoroughly live prospect for modern building service ranging anywhere from a few shelves to a complete modernization job."—Instructions to Minute Men.

7 WAYS TO LOCATE PROSPECTS

I. Old Customer Method:

Every old customer is in the market for additional service. Call back often. Check up on your last job. Look for trouble. Rectify complaints. When thoroughly pleased, old customers will provide names of friends, relatives and acquaintances whom they know have spoken about modernizing.

II. Free Inspection Method:

Offer home owners a free inspection service. Don't try to sell on inspection call. Examine every room. Keep idea of service uppermost. Keep record of repairs, additions needed. Later call back, submit report. Make suggestions. Get a job.

III. Shirt Sleeve Method:

An intensive house-to-house canvass in your neighborhood. Take in every home, every property without skipping. Ask everyone for business. It means finding prospects that are ordinarily passed up. Business follows, by keeping on working, walking and talking.

IV. Peeled-Eye Method:

Watch local newspaper and publications with an eagle eye. A local man comes into an inheritance . . . an attorney wins important case, and earns a fat fee . . . a widow receives a large sum from insurance . . . newcomers arrive . . . all are good prospects. Should receive literature and be seen frequently. People buying old houses cheap, or foreclosures.

V. Back-Scratching Method:

Arrange with insurance men, furniture salesmen and others to tip them off to prospects in their lines, if they will do the same for you. Get 20 to 30 men recommending your services and turning over to you names of likely prospects. Alert business men are quick to act on this "you scratch my back and I'll scratch yours" idea.

VI. Bird-Dog Method:

Junior salesmen, precede the senior salesmen . . . locate a "hot" prospect . . . make an appointment for the senior salesman to follow up later. The junior ferrets out the prospect . . . builds up a service background and confidence in the man that follows.

VII. Spotting Method:

Spotting the home that's in need of repair, on one street or another. Recording it. Spotters for roofing, painting and exterior jobs build up valuable lists of prospects that can be cultivated by effective direct mail.

WAR has been declared on run-down, worn-out, and obsolete structures of all kinds, and men of the building industry are fighting for modernizing business as they never have before.

Reports from builders and dealers in all parts of the country show that for the first time modernization is being taken seriously, and a vigorous attempt made to increase this type of building business.

One very important aspect of this war on depression and idle dollars is that for the first time contractors, dealers, and building specialists are co-operating wholeheartedly. Co-operation between contractors and dealers in conducting business-getting drives is becoming more and more common. It is one form of progress that perhaps nothing short of such a situation as exists in the building industry today could bring about.

Lumber and building supply dealers in communities too numerous to list are taking the initiative in a campaign to develop modernizing "fix-up" and repairs. An excellent example is the H. M. Iltis Lumber Company of Des Moines, Iowa, which organized a drive early in January, and at the close of April had made \$16,900 of modernizing sales directly traceable to this drive.

Dealers are being backed up by large manufacturers who have worked out organization and sales campaigns for them to use. Many large manufacturers have launched such plans and to them may be credited much of the present nation-wide interest in modernizing by the building industry itself.

In spite of the wide publicity given to the subject of modernizing, it has been difficult to get a large number of the practical men of the industry, who should be most interested, actually out selling. Under the aggressive leadership of supply dealers backed by well worked out sales plans, however, real progress is being made.

One of the most successful drives is the "minute-men" campaign sponsored by the Masonite Corporation, of Chicago. At this writing 1,250 lumber and building supply dealers are carrying on this campaign and more than 65,000 "minute-men" have enrolled and are out on the line of battle fighting for more building business.

Each community drive is started off by a meeting called by the dealer in which all his contractor friends as well as local financing and other building interests are brought together.

A packet of sales ammunition is given to each one present and he is instructed in the art of salesmanship. Following are some of the sales tactics reported:

A contractor in a middle western city took to the road early in March. He started to call on the homes in the

Men" Out Fighting for Sales

middle class residential sections. He made 261 calls, and brought in the following prospects: new homes, 1; reroofing jobs, 22; new floors, 9; sleeping porch, 1.

Another contractor sells homes from samples; in his spare time he makes what to the casual observer might look like playhouses. In reality they are miniature designs of houses that he builds, and their purpose is to show prospective owners just what sort of a house they will have. These miniature homes are later placed around the city in vacant store windows.

A prospect considering a \$3,000 modernizing program said, "I'll let you know in a few days. I want to think it over." The contractor replied, "I am glad you want to think this over very carefully. I want you to be absolutely sure these are the improvements your home requires. There is only one sure way to tell, and that is to check each item with your wants and needs. First . . ." and then he went all over the advantages again, thus intensifying the buyer's desire, making it easy for him to decide then.

One minute man singled out the professional men of his vicinity. Practically none of the doctors, the dentists, lawyers and others in his community had ever been approached by the various contractors in the city regarding making home repairs to their property. This minute man found almost a virgin field in the midst of a highly competitive locality. He won the good will and got into the good graces of several of these professional men, which has kept him busy on repair work for the last eight months.

Another enterprising minute man with a 17-year old daughter gave her 5c a call for all telephone calls she would make to get business for him. She called up all kinds of people, school acquaintances, friends of friends, and any others she could think of or get leads on. She started out by saying that her father was a contractor and was looking for a chance to help improve this person's home. She tried to make an appointment for her father with the home owner, and succeeded in many cases. Whenever she succeeded in making an appointment, her father paid her 25c.

In a Buffalo suburb, there was a badly run down, unsightly house, the only one among a group of some 30 or 40 prosperous homes. A contractor purchased this house at a foreclosure sale and prepared to thoroughly remodel and modernize it. When he started this work, he sent letters to all the home owners in that community, telling them that he had bought the house, that he intended to put it in excellent condition that would make it a benefit instead of a detriment to the neighbors, and asked their help in securing a tenant whom they should like to have as a neighbor in that house. He had planned to rent the house but, as a result of this letter, was able to sell it before modernizing operations were complete to a friend that one of the neighbors recommended.

One of the best points about the drive for modernizing and repairs is that a large amount of present and potential new work is uncovered. In fact, it is possible that the contacts and friendships built up in seeking modernizing may in the end produce a still larger volume of new construction.

SOMETHING NEW-

a free home inspection service

Now it is possible to have your home inspected and repaired by our new service station method. You can't take your home to a service station as you do an automobile, so we bring the service station to your home.

Without charge we offer a free home inspection service to help determine what is needed and how best to do it. This service includes estimates on labor and materials—work done complete. We help in selecting the best and most economical materials to use.

You get the advantage of present low material costs and the services of competent workmen.

There is no obligation connected with the Home Inspection Service. We suggest no unneeded work. We have the inspection made by a man who knows and we recommend only such repairs or alterations as are needed and can be economically installed now.

NORTON LUMBER COMPANY
PHONE 2342 1123 EAST MAIN

How one firm announced beginning of an inspection and repair service.

CAPTAIN'S REPORT OF MINUTE MEN ACTIVITIES

Date	AWARD NO. 1	AWARD NO. 2	AWARD NO. 3	AWARD NO. 4
2/22/32				
<small>All occupations and awards by Minute Men Handicrafters are based on frequent reports from you. Minute Men you want cited for unusual sales service should be reported below and on reverse side.</small>				
NAMES OF MINUTE MEN				
	List No. of Proposals Turned In	List No. of Sales Calls Reported	List No. of Orders Closed	List Dollars Worth of Orders
1 D.R. Yeager	2	4	1	60.00
2 J. R. McDaniel	1	3	1	165.00
3 Axel Gustafson	1	2	1	485.00
4 John Cross	2	3	1	425.00
5 H. O. Ellis	1	10	1	900.00
6 Jim Patton	1	3	1	82.40
7 B. F. Roscoe	1	2	1	72.50
8 Tom Cooper	1	1	1	12.25
9 W. J. Racena	1	3	1	15.00
10 Geo. Reed (Livingston add.)	1	2	1	210.00
11 P. W. Lench	1	0	1	255.00
12 E. J.	1	1	1	42.50
13 Carl	1	2	1	451.00
14				148.65
15				
16				
17				
18				
19				
20				

SALES RECORD
Business from Modernizing
JANUARY \$ 500
FEBRUARY \$ 4,200
MARCH \$ 5,500
APRIL \$ 6,700

SALES Campaign Began early in January

E. H. JAMES LUM. CO.
HEAD OF DRIVE
R. H. Kenworthy Mgr.

Here is the actual report of "minute men" who went out and made numerous calls, many of which resulted in sales. The business of the company showed a sharp increase as a result of this drive.

Builders and Dealers Co-operate to Figure Fair Price on Houses

It was four-thirty in the afternoon when a contractor dashed into a lumber yard in Wisconsin, slapped a roll of blue prints down on the dealer's desk, and exclaimed, rather breathlessly,

"Charley, I'm in a tight jam. The last man I built for just tipped me off that a friend of his is going to build a mail order house. He thinks I can land the business, but I gotta have my bid in by seven-thirty tonight and I haven't even started to take off a material list yet. What'll I do? Can you do anything for me?"

"Sure," answered the dealer. "Sit down while I figure it for you. Seven-thirty, you said."

"Yes, and I haven't started——"

"That's all right, you got plenty of time. You remember a while ago I showed you the figures on a little one-story house?"

"Sure I remember."

"Well, that's part of a new service called the House Valuator that I got from the Merchandising Council of the National Retail Lumber Dealers Association, so that you and I can work together and make some money. You can get your plumbing, lighting and heating bids in a hurry, can't you?"

"Sure, I can, and I know what the foundations and basement costs will be. The lumber and millwork is what bothers me."

"Yes, and you probably have sat up nights working out lists for me to figure, and I've sat up nights transferring your list to my books, figuring footage, pricing, extending, checking and adding. And even then you lost jobs. If you are too high you lose the job. If you are too low we both lose money. But from now on we don't have to do that any more, because we're going to work together."

As he talked, the dealer counted the number of rooms, ascertained the dimensions, determined the roof pitch with a pocket roof gauge, then took out a small, blue covered book of actuarial tables, thumbed the pages, selected some figures, and in less than thirty minutes furnished the contractor with a complete, accurate price on the superstructure of the proposed house.

The happy windup of this true story is that the contractor and dealer went together that evening to visit the pros-

(Continued to page 68)

New plan provides tested way for readers of American Builder and Building Age to get quick cost estimates on houses shown in each issue

By A. W. HOLT

Director of Service,
Merchandising Council of National Retail
Lumber Dealers Association

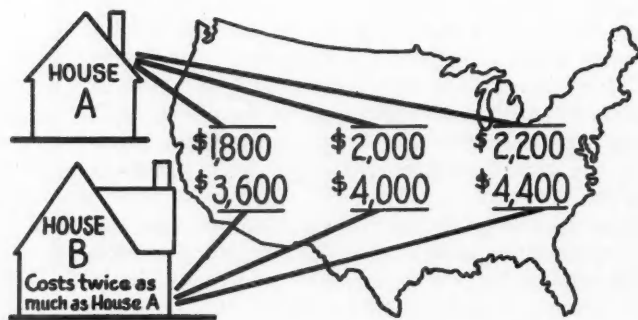

HOW COSTS ARE FIGURED

Cost of any house is quickly figured by comparing it with a simple Basic House which has been carefully worked out for each locality. Dealers and contractors work together to get the cost of this Basic House.

For example, here's how the cost of the frame Colonial, top of page 24, would be figured.

Note the Cost Key (1.445) given under design. This indicates it would cost 44½ per cent more than the basic house figured in your own town.

To be specific: a dealer in an Ohio town of 100,000 population has figured the materials for the Basic House cost at \$1,133. To figure our frame Colonial he multiplies this amount by the Cost Key, 1.445, and immediately knows that materials for this house will cost \$1,637.19.

To this the contractor adds cost of the foundation (figured

according to site, frost line or other local factors), built-in cabinets, fireplace, plumbing, heating, etc., besides labor and contractor's profit.

In Indiana a dealer who has figured the Basic House cost at \$1,280 would quote a price of \$1,849.60 for the frame Colonial without labor, foundations and other variables.

Dealers and contractors working together can also figure the cost of the Basic House including labor. In a Montana town, for example, a dealer and a contractor have figured material and labor for the Basic House at \$2,140. Using the Cost Key of 1.445 they would quickly quote a price on this frame Colonial of \$3,092.30 for the house proper. Adding foundation and other variable items they are ready to close the deal in only a few minutes.

EVERY HOME DESIGN WE ILLUSTRATE NOW GIVES ITS "COST KEY" ENABLING YOU TO ESTIMATE ITS EXACT COST BUILT IN YOUR OWN COMMUNITY

**Homes—
Garages—
Gardens—**

At this time of year people are thinking of homes and gardens, and such designs and details as are shown on this and following pages will interest them. Modern garages, which play an important part in today's houses, are also featured.

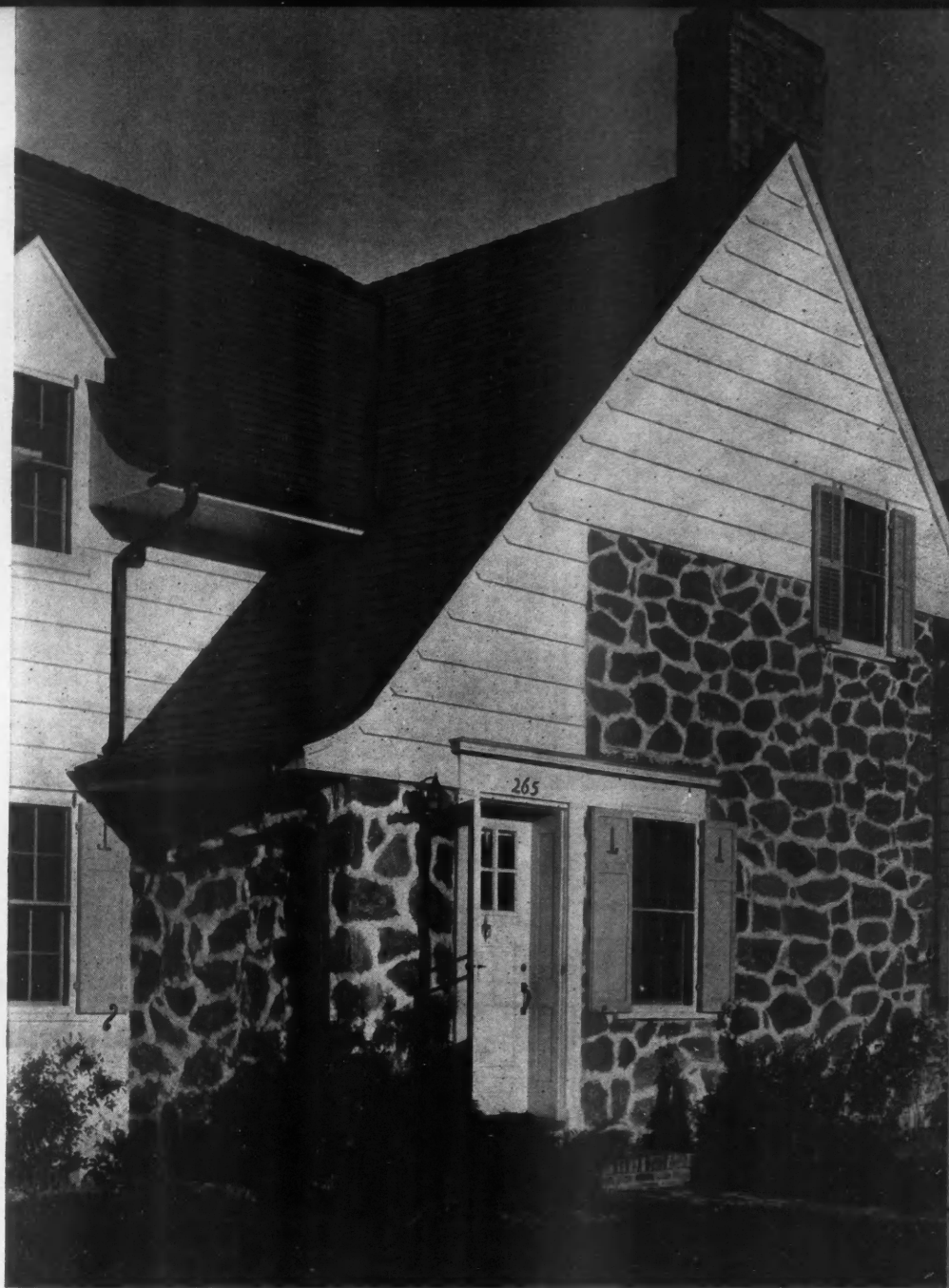
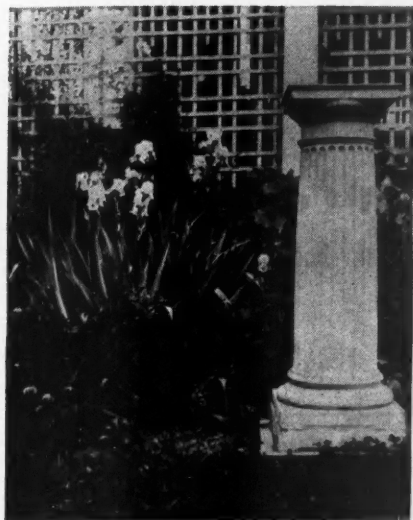

Above — Interesting detail of a New England house designed by R. C. Hunter. Stone and wide siding are effectively combined. Below—At a touch of the button the garage doors open. H. K. Nicewanner was the contractor and H. F. Smenner the architect. Doors supplied by the Overhead Door Corporation.

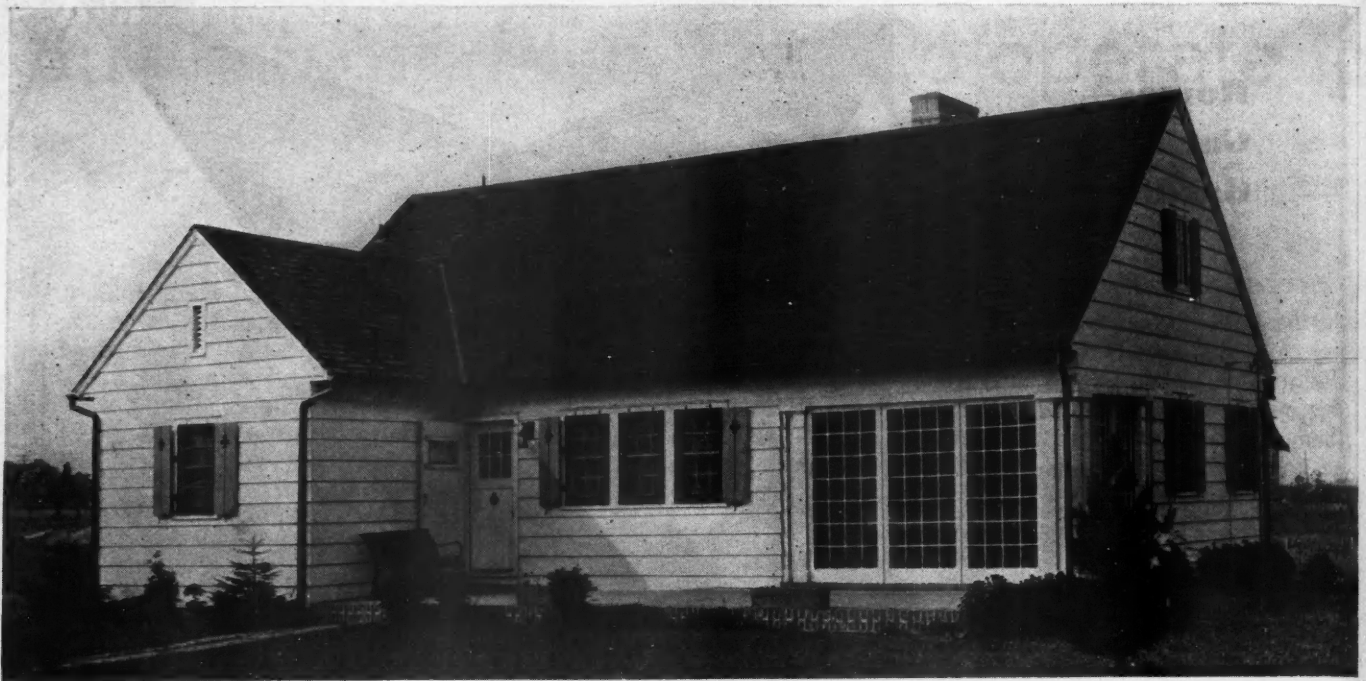

Cost Key 1.445—158—1065—45—19—20

Otto Preis, Architect

A Colonial Cottage Broad and Low

Plenty of character in Mr. Hunter's design below—The stone face is for ruggedness.

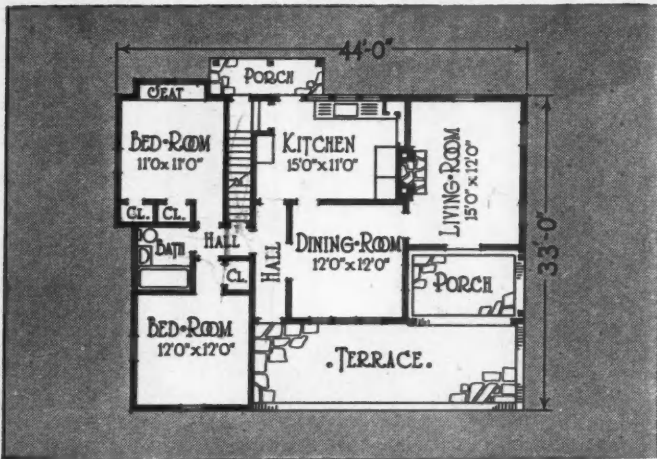

R. C. Hunter
Architect

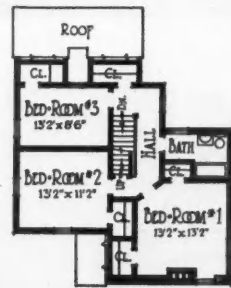

SECOND-FLOOR PLAN

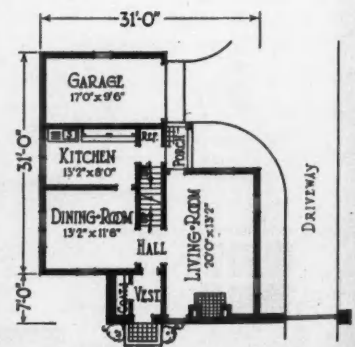

Cost Key 1.725—140
—756—33—24—15.



Popular In California

A. B. Cleveland
Design

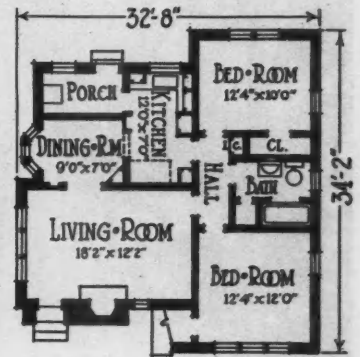

Cost Key 1.153—138
—980—41—16—15

Popular Eastern Type

R. C. Hunter
Architect

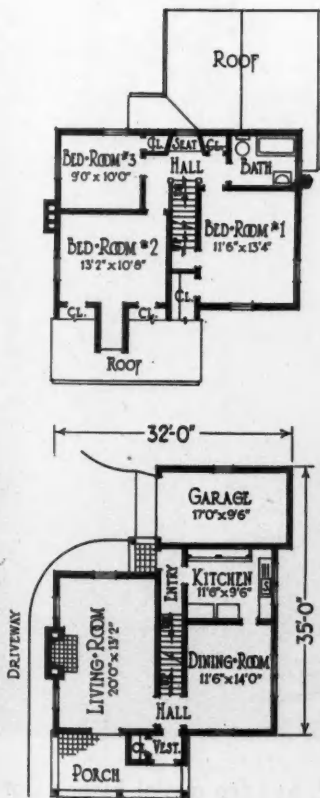

Cost Key 1.732—142
—694—31—25—16

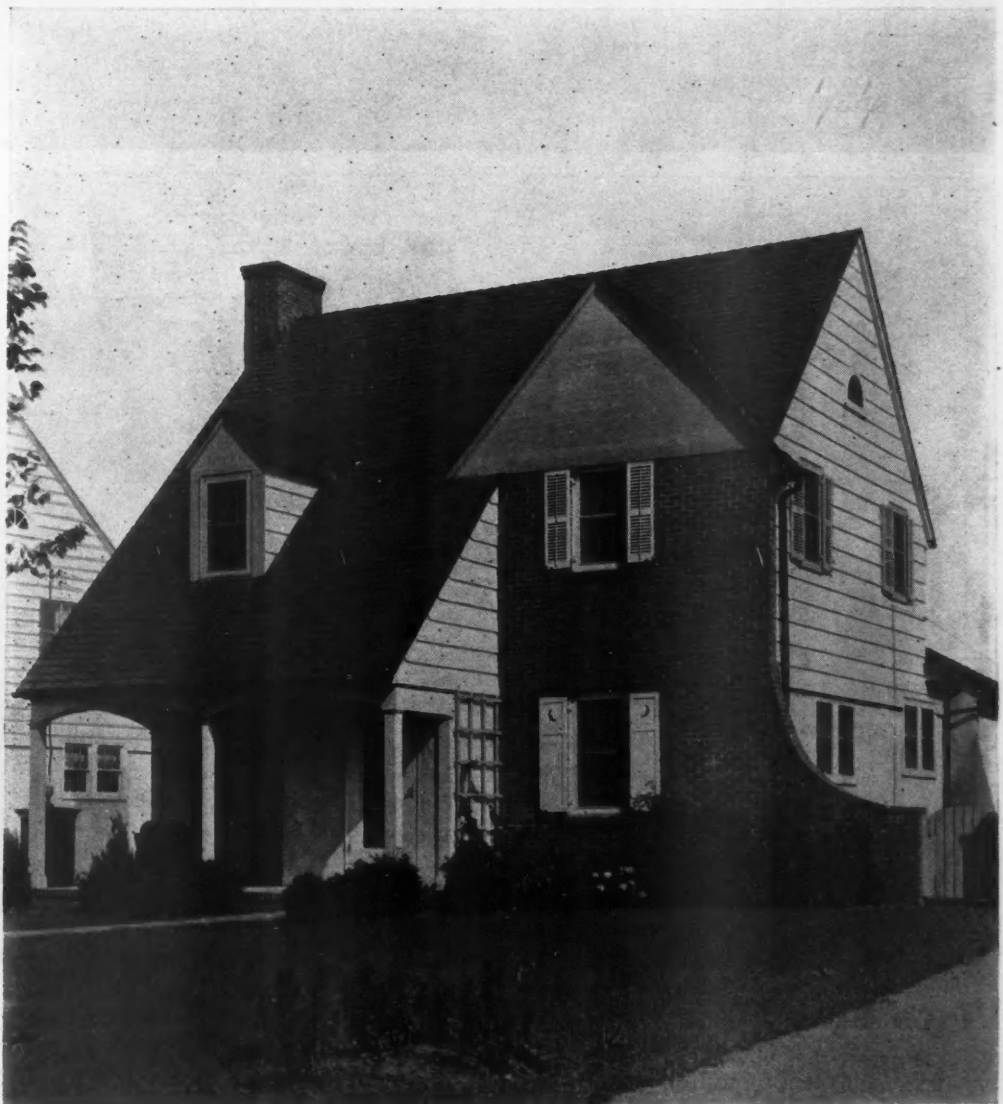



Two Fine Homes

(Floor plans opposite)

The Colonial Home above, No. 6-F-7, and the quaint French Cottage below, No. 6-D-12, were designed by The Architects' Small House Service Bureau, Inc. Floor plans and cost rates to build are shown opposite.

English or Spanish

Each is charming

J. C. Walsh
Architect
Plan to right, top.



A. B. Cleveland
Design No. 5563
Plan to right, below.

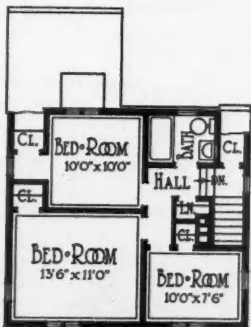
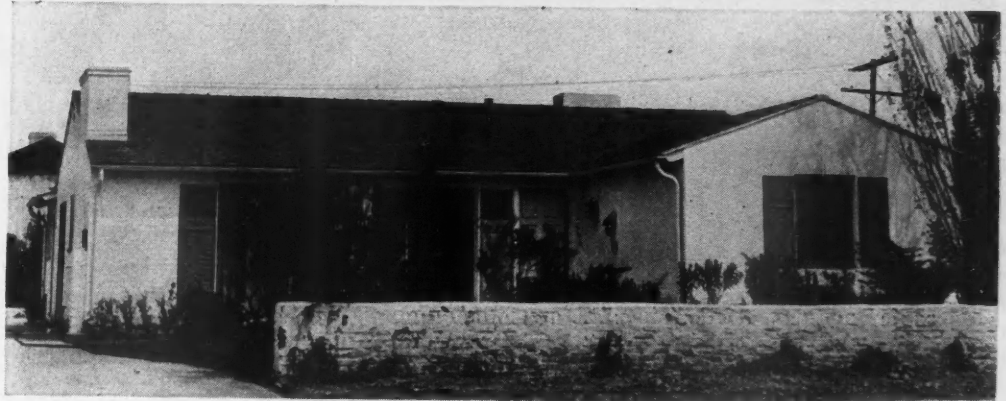

• SECOND-FLOOR-PLAN.

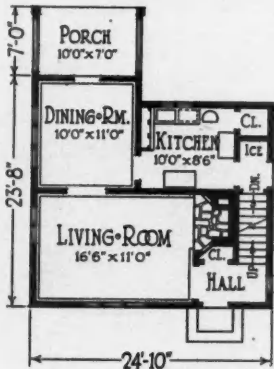

• FIRST-FLOOR-PLAN.

Cost Key 1.520—112
—583—26—22—11

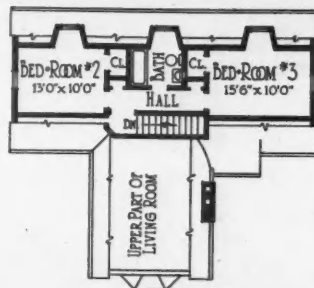

• SECOND-FLOOR-PLAN.

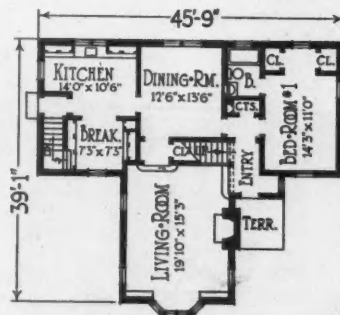

• FIRST-FLOOR-PLAN.

Cost Key 1.984—174
—1280—54—24—24

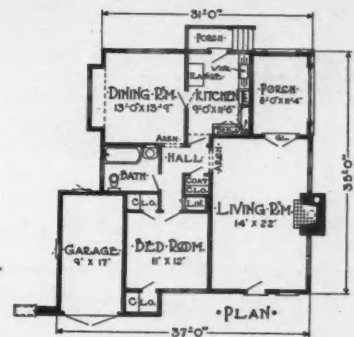

Cost Key 1.434—154
—1113—47—17—21

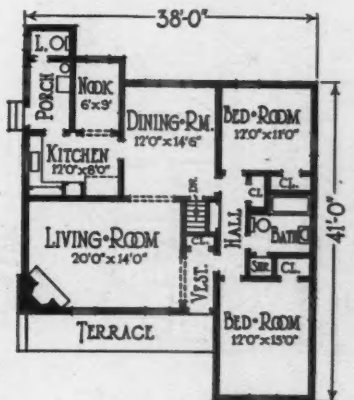

Cost Key 1.426—170
—1348—56—17—16

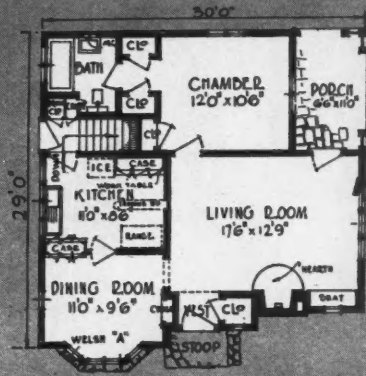

The "Welsh" is 810 square feet of comfort.

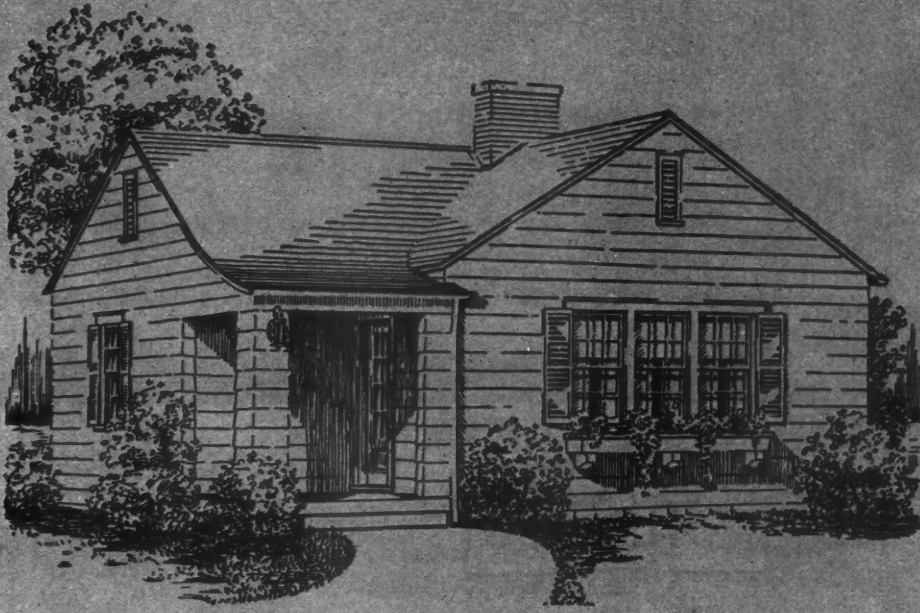
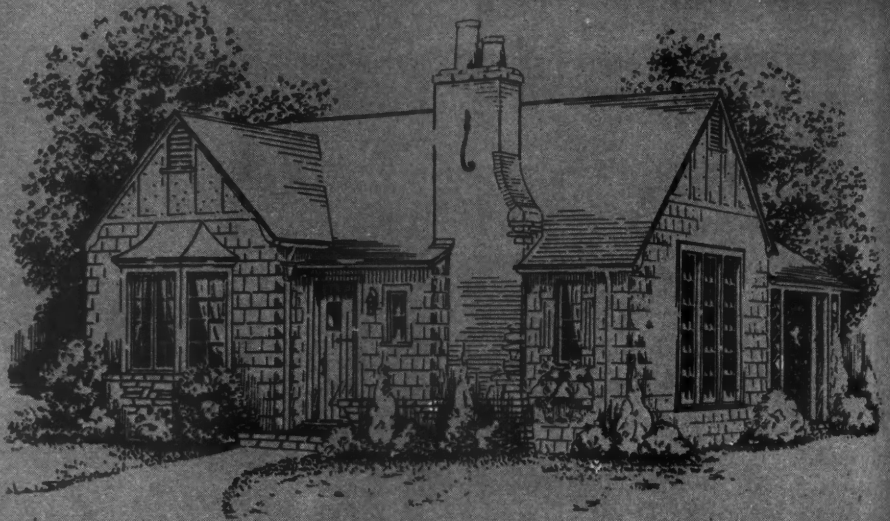

Small Homes in Good Taste

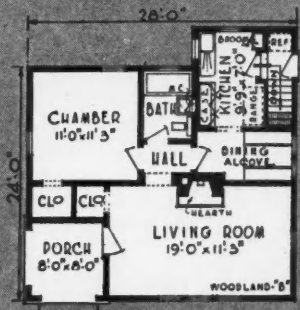

The "Woodland" is really small.

Cost-Keys

Welsh "A"	1.107	—122	—838	—33	—15	—14
Woodland	.890	—112	—756	—32	—13	—11
Wade "A"	.882	—108	—644	—28	—12	—11

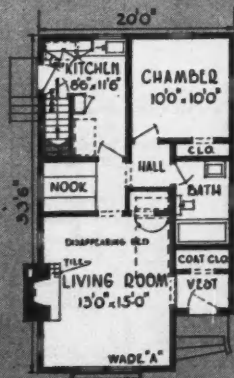

The "Wade" is charming for a narrow lot.



Garage Modernizing Increases

Demand for Weathertight, Convenient "Motor Homes" Opens Big Field for Builder Activity

Making Them Modern

New roofing and siding. Insulated, weathertight interiors. Plenty of windows and lights. Improved modern door equipment. Concrete floor, properly drained. Storage shelves and cupboards.

REPORTS from the many modernizing drives being carried on in various parts of the country show that garage modernization and repairs play an important part in the volume of work done.

There is a reason for this: the country is in need of modern, weather-tight, attractive and permanent residential garages. People are tired of struggling with sagging, sticking garage doors, and are interested in the new and improved garage doors and hardware now available at such reasonable prices.

An increase in automobile insurance rates for protection against theft is predicted by the insurance companies if more cars are not placed in safe garages. This means that a vast new field is open for builders to go after this type of work.

Modernization of garages is a work that is of interest to every builder in a time like this. A survey of the neighborhood should be made to determine the number of garages that need fixing up, and then a determined drive conducted to get the business.

The individual job requires careful study and analysis. A thorough knowledge should be had concerning

the upward-acting, overhead, over-the-top, sliding, folding and rolling garage doors as well as the modern garage door hardware on the market. Location of the garage with respect to the easy entrance and exit of the garage should be carefully considered in selecting the type of door.

In modernizing the garage especial attention should also be paid to the exterior appearance. People want the garage to be architecturally correct and to harmonize with the house. A new exterior of brick, stucco, shingle or siding may be called for. The roof will perhaps need to be replaced.

The attached garage or garage built into the basement of the house is very popular. One smart modernizing practice is to build an attached garage on one side of the house and balance it with a sun porch at the other. This works especially well for colonial or English-type homes.

Many garages are so flimsily built that the wind blows right through them. Modernization calls for lining such garages with reinforced building paper, insulating board, or other weather-tight material. Windows and ventilators should be installed and adequate electric lights provided.

There are thousands of car owners who have long wanted a concrete floor put in their garages, but who have never gotten around to do it. Now is the time to approach them and at the same time sell them on the idea of modern automatic door equipment. Concrete floors should be properly drained and well-constructed. A permanent driveway or approach of concrete, brick, or flagstone may also be sold as part of the garage modernizing plan.

SEE DISPLAY OF LATEST TYPES OF GARAGES ON NEXT TWO PAGES FOR FURTHER MODERNIZING IDEAS



Modern upward acting garage doors by Farley and Loetscher Co. Installed in an old house. The modernized basement garage is a popular type.



An old garage modernized and equipped with Stanley "Swing-Up" hardware. Before change doors sagged so badly they would not close.



Interesting semi-detached garage in Tudor style equipped with Majestic Roll-N-Fold doors. At left—garage is an attractive part of house. Doors operate with Frantz "Over the Top" equipment.

Modern Garages

Left below—inexpensive small garage with structural insulating board used under siding. Right—How a garage can be attached to house in pleasing fashion. Door equipment is by Farley and Loetscher.





A charming residential garage with shingle exterior. Barcol Overdoors, stained a dark shade, are used.

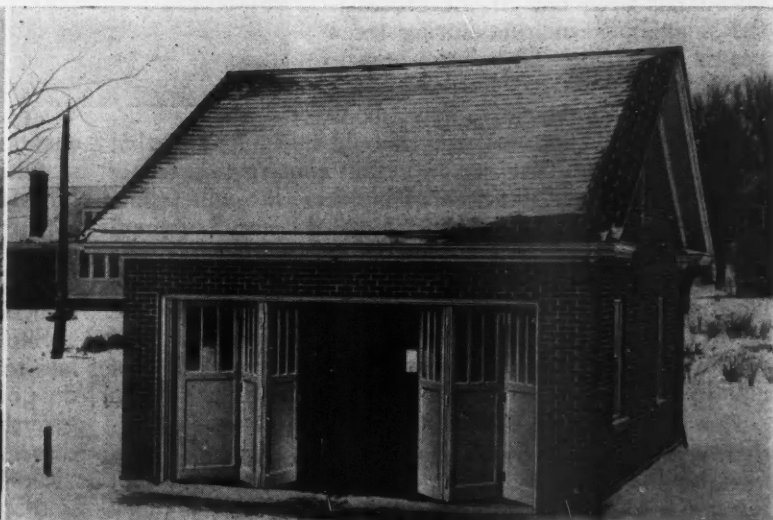
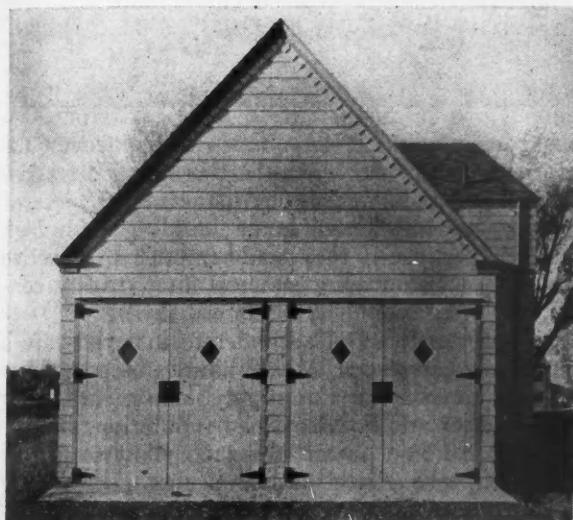

Left above—Colonial attached garage with inexpensive door hardware by Stanley Co. Right above—permanent construction in a roomy two-car garage with "Slidetite" doors by Richards Wilcox Co. Below—two views of a fine 4-car garage which owner demanded "should not look like a garage." Architects were Garrard & Keely; contractor, A. J. Glaser Co. "Overhead Doors" especially designed of solid white oak by Overhead Door Corporation are used.

EASY TO USE—ATTRACTIVE—PERMANENT CONSTRUCTION

WAR DECLARED On Shoddy Construction!

**Builders and Dealers Fight to
Overcome Public's Ignorance
of Construction Standards by
Using Sales-Room Displays of
Quality Framing**

BELIEVING that the shoddy construction indulged in by amateur bunglers who try to build their own homes with their own hands, without skilled assistance, or who try to handle homebuilding on a day-labor basis without adequate or skilled supervision has been one of the curses of the small house market during recent years, the Wilbur Lumber Company of West Allis, Wis., has undertaken to educate the public as to how a house of lumber construction really should be built, and that it pays well to entrust any important construction enterprise to skilled and experienced builders who will follow the best construction practice. So-called "jerry building" is more often than not the result of ignorance on the part of home seekers as to what really constitutes good construction, and why it pays in the long run to use plenty of framing lumber of adequate dimensions and proper quality, instead of skinning the job until it just gets by.

Having often observed how curious and interested is the average man in any piece of construction and how men, and women too for that matter, will stop and inspect any new house that is being built, Mr. Hawley Wilbur, president of the organization, decided to turn this natural curiosity to his account as a lesson in really good construction by setting up in his lumber yard display room a real piece of construction, exemplifying in full size dimensions the house construction which he recommends and which is followed by all the better carpenters and builders in his community.

Other exhibits were also set up showing the entire range of building material and home equipment which this progressive firm carries in stock.

When all was ready, the contractors, builders, carpenters and other building trades men were invited in to look over the display and make themselves familiar with it.

In explaining this phase of the campaign for better building and better construction practice, Mr. Small, Sales Manager of the company, said, "We invited in the contractors and told them that this 'customers' room' was theirs. We wanted them to act just as though they owned the place, and to feel free to bring in their



clients and customers at any time to look over the materials we carry in stock for their benefit. We asked them to pay particular attention to the model piece of construction showing better home building with high grade lumber, because if they could interest prospective home owners in authorizing staunch, first quality construction, everyone would be better satisfied."

Shoddy construction and second-rate materials are a loss to everyone concerned, Mr. Wilbur contends. They do not pay their way in the supply man's yard; they give the carpenter and builder a bad reputation, and for the unfortunate home owner are a constant source of "grief" and expense. Good lumber dealers co-operating with good contractors and skilled mechanics in every community can put flimsy materials and shoddy construction into the discard by working together to interest and educate the home owners and the home seeking public in the extra value which comes from using just a little more material and framing it with greater attention to detail.

Here are some of the points which the sales-office model display brings out clearly:

The corner posts are solid 4 x 6's; the lintels over door and window openings are double 2 x 8's; the headers are doubled below all windows; the ridge board is a 2 x 8; the sill is a double member; the plate is double; diagonal sheathing is featured for rigidity; diagonal sub-flooring is recommended; partition studs are doubled around door openings.

The material used in the construction of this demonstration model is all four-square guide line framing, straight, smooth, non-warping. Such a convincing example of quality construction hammers home its own lesson. The better builders of West Allis and the Wilbur Lumber Company are finding that it pays.



The Austin Daily Herald modernized home opened to the public June 21, 1931.

What Results from Demonstration?

One Year Ago the Building Industry of Austin, Minn., Staged a Modernized Home Display—Here Is the Record of Results

IN June, 1931, the building fraternity of Austin, Minn., got together under the leadership of Ralph Crane and put on a demonstration of what could be done fixing up an old, dilapidated house. Like many such efforts, it made a fine show. Five thousand people passed in at the door of this modernized home during the ten days it was open to public inspection. A local newspaper sponsored the enterprise and gave it liberal publicity. The public schools, the churches and the local clubs gave it their endorsement.

Do such demonstrations pay? Do they create business? What are the real, tangible results?

These are fair questions of special interest to builders in many communities this year when everyone is turning to modernizing as the cure for unemployment.

A survey of Austin one year after the demonstration shows very encouraging results. The demonstration house itself cost the sponsors of the movement \$1,500. The modernizing expense complete was \$2,400, making a total of \$3,900. The place was sold immediately after the demonstration for \$4,600, showing a nice profit on the investment and work involved.

Four other modernizing jobs were started immediately in the neighborhood of the demonstration, running

The old house, a very ordinary type, partially gutted by fire, was bought for \$1,500. It was sold for \$4,600 after \$3,900 spent in repairs.

from \$1,200 to \$3,500 each. Fred Nelson, general contractor on the demonstration house, has had ten other projects of a similar sort during the year and is an enthusiastic supporter of the modernizing idea.

The F. I. Crane Lumber Company, which was the prime mover in organizing the demonstration, reports innumerable small orders for repair materials, besides orders for the more extensive projects already mentioned. Free sketch plans showing the possibilities of modernizing old homes and illustrating them most attractively are a part of the service of this company.

Interestingly enough, a number of new home jobs have resulted from the demonstration, some visitors having concluded that, for them, the sensible way to modernize was to start at the beginning and build new.

The Austin campaign was modeled along the lines of the successful Minneapolis "home re-creation" campaign organized by J. A. Edgecumbe. Other cities where similar demonstrations have been held are Madison, Joliet, Grand Forks and Wisconsin Rapids. In each of these cities, the sponsoring lumber dealer has had no difficulty in securing the co-operation of the newspapers, the contractors and other factors necessary to assure the success of the venture.

Sketch showing proposed alterations. Outside finished with stained shingles, inside rearranged, refinished, and supplied with modern equipment.



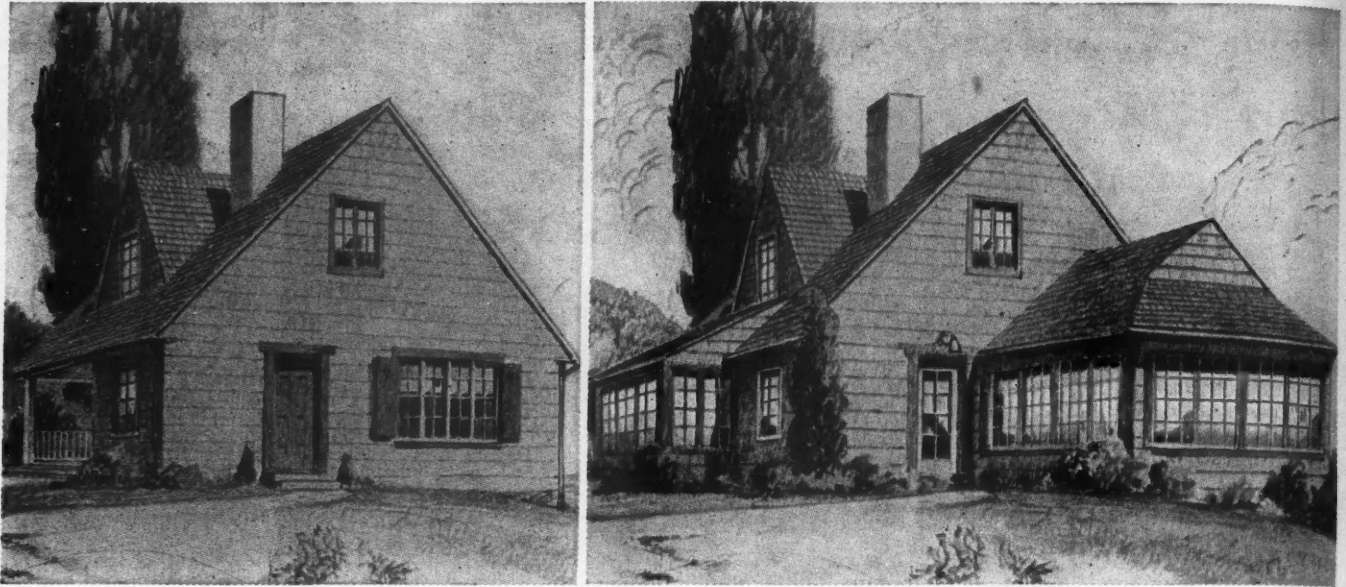

An example of modernizing a house by addition of two sun porches and an all-glass door. The plain cottage becomes a spacious home through these improvements at very small cost. Illustrations courtesy of American Window Glass Co.

New Sun Porches Add Value To Old Houses

NOTHING brightens up and cheers up a house more than letting in the sunshine. This can be done by addition of sun porches, bay windows, glass doors, and large well placed windows in various rooms throughout the structure.

This type of modernizing work is one of the biggest, most lucrative to the builder and satisfactory for the householder.

A good example is the house shown above. Simply by the addition of two sun rooms and an all-glass door (no other changes are indicated), this plain looking cottage was transformed into a handsome, roomy house. A good way to get work of this type is first to discuss with the housewife the type of arrangement she would like and then prepare a sketch such as this to picture for her how attractive the job really would be.

The present tendency in American life is undoubtedly toward the use of more glass area. All of the new homes are being built with more and bigger windows, French doors, sun porches and solariums. The public is becoming more and more "sun-conscious." They want to get every bit of sunshine they possibly can into their houses where it will bring health and cheer.

In homes where there is a sun parlor it is usually the most popular room in the house. Bright, cheerful, and informal, it is a delightful place to spend idle moments basking, sewing, or reading. It provides an ideal place for children to play when the weather does not permit them to be outside.

When building a sun parlor, make as much of its wall area of glass as possible. Let the glass extend all the way to the floor, and on three full sides if possible.

Addition of a sun porch adds another room to the house at a very low cost. It can be used as a place to rest, play, eat or sleep, as the needs may dictate.

Glass for the modern sun porch should be selected

with care. It should be of a type that permits as much of the invisible, ultra-violet rays of sunlight to enter as possible. New types of glass are now available that allow a large portion of these vital, health-giving rays to pass through, and since these are the rays which have a therapeutic, beneficial effect it is important that such glass is provided.

The health-giving qualities of modern types of window glass that permit passage of the ultra-violet rays is one of the biggest modernizing talking points available. How sun-baths made possible by such glass reduce colds, strengthen the body, and promote well-being should be forcibly brought out in sales talks with housewives.

In addition to modernization work involving sun porches, a considerable volume is being done through providing bay windows, French doors and windows, extra dormers, larger basement windows, conservatories. All of these call for a profitable volume of work that is of especial interest to builders. The extent of this work runs from small jobs costing \$15 to \$25 to ones running up into the thousands. Very often a job that starts out as a small task cutting in a new window will lead to other work that runs into more money. And there is always the possibility that the contact established by a modernizing job, no matter how small, may uncover a prospect for a new home in the near future.

It is almost possible to trace the progress of humanity by studying the amount of sunlight in homes. The cave-man, crouching in a dark, damp hole, was afraid of sunlight. With civilizing influences came windows, more sunlight. It is frequently predicted that the houses of the future will be largely of glass. From the builder's standpoint today, therefore, addition of sun porches and windows is a practical step right in line with current trends, and the work involves a wide range of materials and construction labor.

Insulation Plays Large Part in Modernizing

MANY builders are specializing in insulation work in connection with modernizing at the present time and finding it a large and profitable field. Most every modernizing job, large or small, calls for a considerable use of some insulation material, wall board, or composition product from the wide range included in this field.

A young man in Detroit who knew the building field is an especially good example of success in promoting and selling insulation and allied materials. He tied up with another energetic builder and together they canvassed prospects in their section, featuring insulation almost entirely. They were able to build up a business that keeps them both busy.

The public is pretty well sold on the value of insulating materials. Through extensive advertising they have been shown how important a part it plays in reducing heating costs, producing greater comfort, and insuring better health. All that is needed now is the definite house-to-house contacts that lead to sales. Carpenters and builders are especially qualified to do this type of work. They know how to handle the material and can act as both salesmen and installation experts.

The following procedure is recommended for installation selling.

Intensive canvas of a given community is conducted in which every house owner is contacted. The approach is on a service basis, offering to help the home owner to reduce his operating and upkeep costs.

Make a careful analysis of the house to see how much insulation is called for to do a thorough job, and what type is best suited for the work—whether rigid, flexible, cellular, large pieces or small. It would be well to arrange with a building supply dealer to secure samples of the various types, so that you can demonstrate to the housewife how it is applied and why it is effective in keeping out both heat and cold.

A salesman should be familiar enough with his cost figures to quote a price on the complete job in a very short time so that if possible he can close a contract in one visit.

In the allied fields of insulation which include the many interesting new wood and composition boards on

the market there are many possibilities for extra sales. The new wall boards and plywoods ranging in thickness from $\frac{1}{8}$ " to 2" and available in any size or shape desired offer a versatile field for home improvement.

Some of the sales possibilities include: building new coal bins, making new rooms in basements, building fruit cellars, installing shelves in pantries, applying new panelling for walls or ceilings, kitchen cupboards,

Selling insulation and such improvements as these very often go hand in hand. For example, in insulating the attic the owner is often willing to go a step further and build a playroom for the children or an extra bedroom. A job that starts out as a straight insulation proposition may be expanded to include many other home improvements. The important thing is to lay out a definite program of selling, backed up by all the contacts that can possibly be made.

Modernizing and Repairs Needed in Basement

A CLEAN, safe place for the children to play—a handy workshop—room for a billiard table, gymnastic apparatus or ping-pong outfit—a cozy den—an extra bedroom—how many people would be very happy to have one of these in their house! Yet by far the great majority could have any one of these by doing a little inexpensive basement modernizing.

This is a field on which builders may well do some intensive work at this time. The demand for usable, livable space in houses is greater than ever. During the depression people have been doubling up, with two or more families in one house. Extra space in the basement is therefore especially desirable.

Rapid advances in heating equipment and in modernizing materials now make it possible for builders to provide basements that are entirely dry, clean, and comfortable.

The work involves use of a large variety of materials, including many of the popular new insulating boards and panelling products. It calls for the application of considerable good, clean paint, which after all is one of the most important items in brightening up any part of the house.

Waterproofing of a basement may be called for as one of the first steps in its transformation. An article on this subject was carried in last month's *AMERICAN BUILDER AND BUILDING AGE*. It is enough to say that it is perfectly possible to guarantee an absolutely dry basement without getting into excessive costs.

The thorough modernization of the residential basement calls for careful planning and study. The present or future needs of the family should be considered. If considerable space is needed, the entire area should be carefully laid out and subdivided into the necessary rooms. To secure an absolutely dry and comfortable environment, it may be necessary to insulate all the exterior walls and also the floor. By using the rigid board type of insulation it is possible to secure at the same time a panel effect that is cheerful and good looking. Partitions erected between the various rooms should be strong and permanent. A fireplace in some of the rooms may give just the necessary touch of comfort needed to secure a livable room. This does not necessarily need to be of the regulation wood-burning type, but may be a gas or an electric one that can be quickly and inexpensively installed.

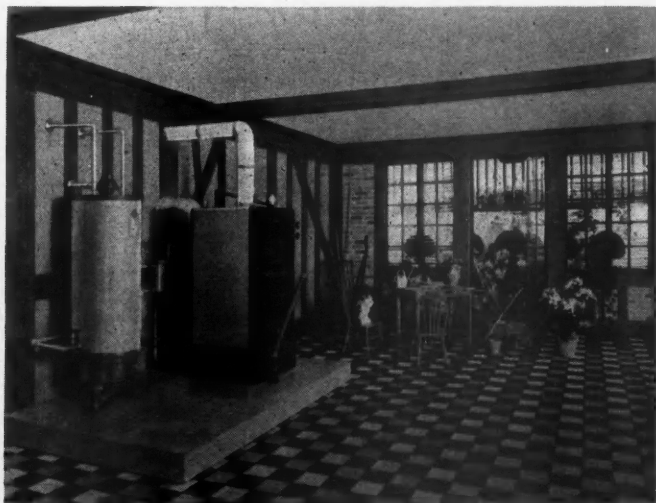

A clean heating plant, windows, a cheerful floor, attractive interior panelling make this basement livable and usable.



Built to Please Modern Rent Seekers

An-Unusual Combination of Residential and Business Design

GEORGIAN HALL is a six-story, elevator apartment at Jackson Heights, Brooklyn, N. Y. The building has several unusual features. A set-back of 12 feet over the stores affords privacy to the apartments above and at the same time makes possible shops of a uniform depth of 50 feet to meet all needs of certain lines of merchandising. This set-back also has the effect of adding 12 feet to the width of the street in front of the building and at the same time it capitalizes the unusual plottage depth by putting it to its maximum utility in combination of store and apartment house development.

Among the unique features of Georgian Hall are a large reception hall on the ground floor overlooking the rear garden, furnished in the style of the period and with a large fireplace, and a large, light and airy playroom for children which will be under experienced supervision and will be used by the children of tenants of the building.

Of the apartments, forty-six are two-room apartments, forty-two are three-room apartments, twelve are four-room apartments, and ten are five-room apartments.

The new building is in Georgian or "Colonial" style, the English adaptation of the Italian Renaissance arch-

GEORGIAN HALL JACKSON HEIGHTS, BROOKLYN

New York

JACKSON HEIGHTS APARTMENT CORPORATION
Builders

EDWARD M. ADELSON
Architect

itecture made popular in Italy by Palladio and introduced into England by Inigo Jones and Wrenn.

The style of architecture is an adaptation to modern use of classical details and the formal and balanced design of the buildings of antiquity. In Georgian Hall are included the cornices, pediments, pilasters, and other features so frequently seen in the buildings of old Rome, modernized from the point of view of the Eighteenth Century into buildings of a formal and dignified character.

Georgian Hall is constructed of limestone and brick.

DESCRIPTIVE DATA AND SPACE APPORTIONMENT

Name of Apartment: Georgian Hall.
 Location: Jackson Heights, L. I., N. Y.
 Date of Completion: June, 1931.
 Total number of apartments: 110.
 Total number of apartments per floor: 20.
 Number of rooms per apartment: 2, 3, 4, 5*.
 Total number of rooms: 316.
 Apportionment of apartments throughout building:

2's—46—41.8%
 3's—42—38.2%
 4's—12—10.9%
 5's—10— 9.1%

*Kitchen and dining alcoves designated as one room.

Average area of living rooms: 248 sq. ft.
 Average area of chambers: 173 sq. ft.
 Average area of kitchens (including dining alcoves): 126 sq. ft.
 Total number of stores: 14.
 Area of stores: 690 sq. ft. each (average).
 Elevators: 2 push-button automatic A.B. See.
 Ground Coverage: 78% (1st floor) 65% (2nd to 6th floor).
 Average area per room of building area: 305 sq. ft. (2nd to 6th floor).
 Average area per room of lot area: 465 sq. ft. (2nd to 6th floor).
 Height of ceilings: 9 ft.

The limestone balustrades, string courses, doorways, etc., are set off by brick known as Updraft Jersey brick, which has the slight irregularity which adds charms to the Eighteenth Century work. The pilasters are of brick with stone bases and caps. The cornices, mouldings and pediments on the roof are of copper with stone finish.

The building has several attractive and new features, the most notable of which, perhaps, is the reception room with bay window on the garden court. This reception room lies between two entrance lobbies and is connected directly to them. It affords an attractive place for entertainment of guests and is attractively furnished.

The decoration of the entrance lobbies and reception halls is in the style of the exterior, the floor being laid out in border and squares of black Belgian and cream-colored Bottecino terrazzo, starting from a base course of black Belgian marble. The walls are decorated and

painted, with paneled walls, classic cornices and ornamental doors treatment and mantelpieces.

The foyers, as well as the reception room, are furnished with furniture of the period. This ornamental treatment is carried through the entire first floor of the building; fully encased marble stairs go from the first to second floors.

In the basement, in addition to the usual carriage rooms, store rooms, and other public facilities, is a large well-lighted and ventilated play room, where children of the residents in the building may enjoy themselves on rainy days.

The building is equipped with two automatic elevators of the latest type, with especially ornamented cabs, having wood linings of American walnut, especially designed for this operation.

An added feature is the provision of ten bathrooms in color in the corner five-room apartments, these apartments having two bathrooms, one of which is white

This large reception hall on the ground floor overlooks the garden in the rear court of Georgian Hall. The bay window affords a fine view of the garden. This room is furnished in period style and contains a large fireplace. The floor is laid out in border and squares of black and cream-colored terrazzo from a base course of black marble. The reception room lies between entrance lobbies and is connected with them.

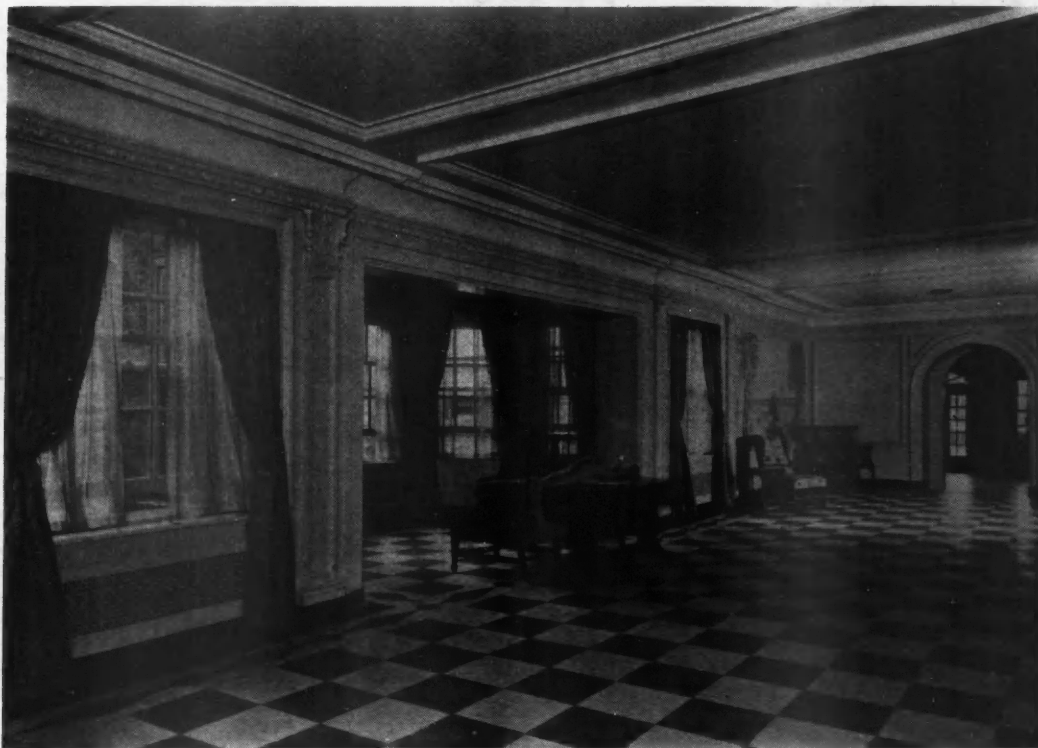

Interiors Planned for



In the entrance lobby of Georgian Hall

and the other an ivory-cream finish, and, in some cases, a Ming green.

Kitchenettes are equipped with electric refrigerators of latest model, and gas stoves approved by the American Gas Association.

Ample shelving space is provided throughout the apartments and glass closets separating the kitchenette from dinettes are of special design with twelve light panes, recalling the small muntin windows of the Eighteenth Century.

Apartments are to be painted or papered as desired by tenants where advance rentals are made.

In the two-room apartments there are dinette and kitchenette, large living room, and adjoining bath and dressing closet. The dressing closet has twin disappearing door-beds of metal, finished in American walnut to harmonize with the character of the building.

Two incinerators are provided, enclosed in specially designed closets with sinks, so as to provide the utmost privacy in disposal of waste.

A pressure tank with automatic pumping machinery is provided in the basement to insure adequate water pressure throughout the entire building at all times, regardless of city pressure.

The fourteen stores on Polk Avenue front are unusual in regard to depth. The main line of the building is set back ten feet from the building line, making the store approximately fifty feet in depth. This is an

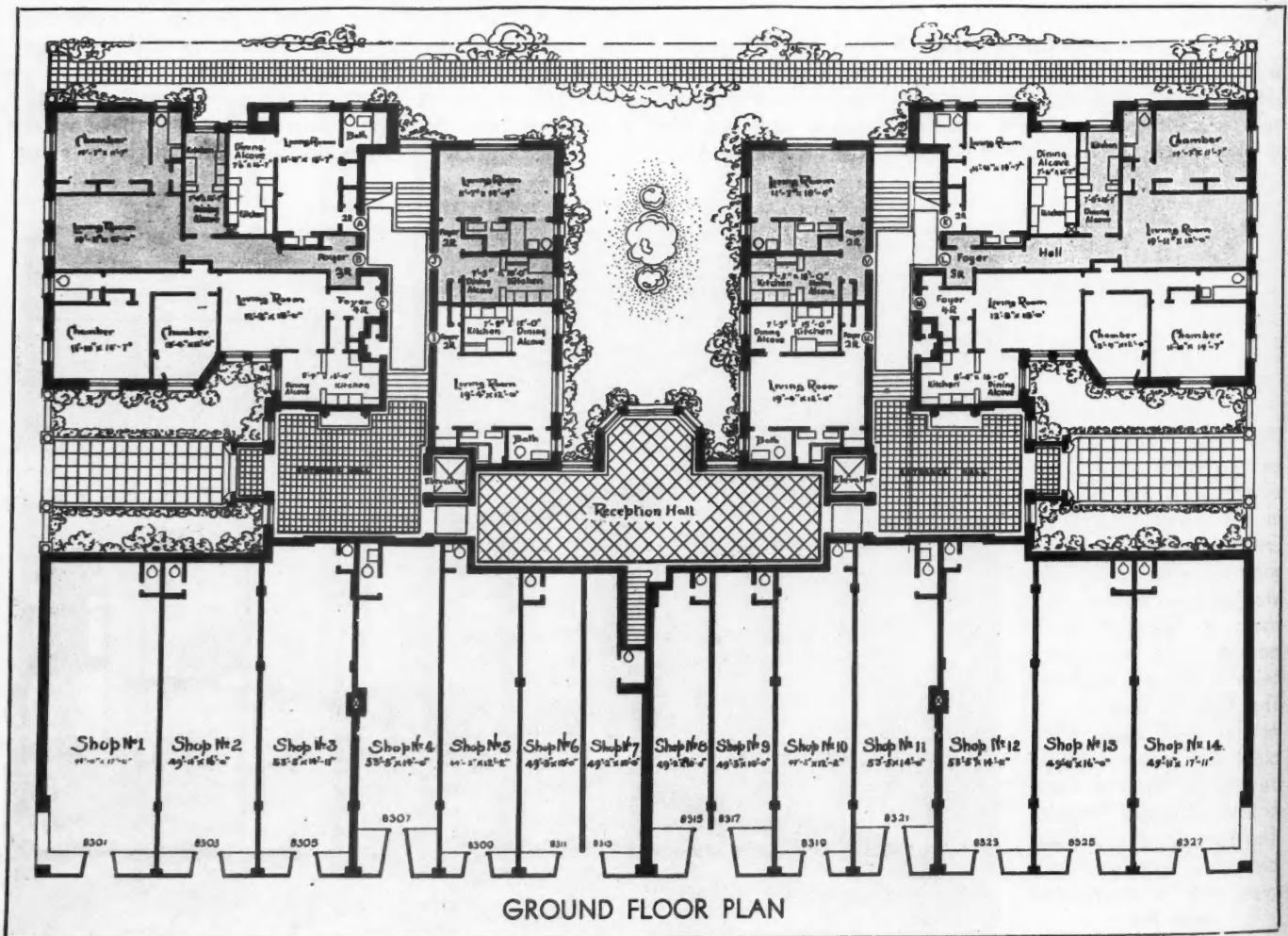

GROUND FLOOR PLAN

Privacy and Comfort

unusual feature and the only one so far at Jackson Heights.

The store fronts are set back and ornamented by a limestone balustrade and cornice. The plate glass windows of the stores are trimmed with bronze metal and the exterior entrances of the stores match. These stores are of varying width, and also varying depth of show windows, so as to accommodate the different types of business which will occupy them.

The entire surroundings of the building, except the store fronts, are planted with attractive ornamental planting, as are also the rear courts and yards.

GENERAL OUTLINE SPECIFICATIONS

FOUNDATION: Footings poured concrete; poured concrete foundation walls.

FRAMING: Structural steel wall bearing. Floor framing 3x 10-12" o.c.

EXTERIOR WALLS: Brick walls. All exterior walls face brick with limestone trim, 20" x 12", furred and damp-proofed.

ROOFING: Ornamental copper balustrade and pediments. Copper flashings and Ruberoid roof.

LEADERS: 16 oz. copper leaders.

FLOORING: Double floors. Rough floors 7/8" n. c. pine. Finished floors No. 1 White Oak. Felt between floors.

INTERIOR FINISH: Walls and ceilings, 3 coats plaster on wire lath. In halls, white coat given decorative finish.

PLUMBING: Brass supply pipes, hot and cold throughout. Fixtures, A-quality Standard Sanitary Mfg. Co., chromard finish.

HEATING: Coal with vacuum system. "Corto" radiators. Inspected and approved by the Certified Heating Ass'n.

CLOSETS: Ample closets with shelving, clothes rods.

KITCHENS: Gas ranges with heat regulators, G. E. refrigeration, sink, laundry, linoleum floors.

BATHROOMS: Wall finish, tinted tile wainscots with ceramic tile floors. White Standard fixtures and steel medicine cabinet. Built-in recessed tile accessories.

ELECTRIC FIXTURES: Of varying design in brass and enamel. Ample switches of Duplex type. All wiring in rigid conduit, and installation approved by National Board of Fire Underwriters.

INCINERATORS: 2 Kernerators with hopper door for each floor to combustion chamber in basement.

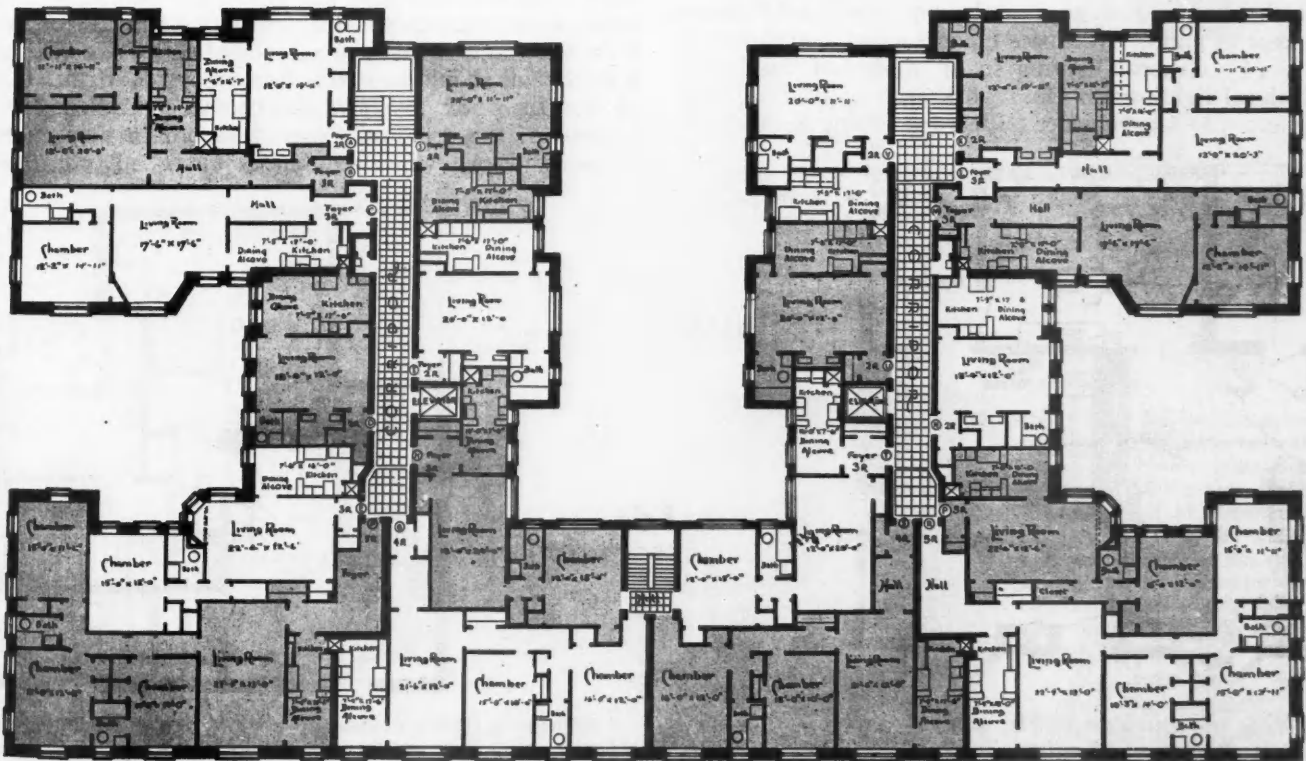

TYPICAL FLOOR PLAN

Give Added Value by Improving the Electric Convenience of Dwellings



BUILDERS who are now giving more careful consideration to the electric equipment of their homes are finding, on analysis, that high-class electrical equipment is a very important feature of the dwelling. The convenience and intrinsic quality which such equipment adds to the home, at comparatively low cost, increases its selling appeal many times. Many successful builders have discovered that the "electric home" carries an irresistible appeal to housewives and if the plates, outlets, switches, and other devices that appear on the walls are themselves an attractive part of the interior, are the latest types on the market and of high quality, then the builder is prepared to make the electrical part of the job one of his major selling points. Many builders have done this with a surprising response from clients and prospects.

Any builder can familiarize himself with the latest advances in home lighting and electric equipment with a little study. A few general principles should always be kept in mind. Adequate home wiring should provide for: (1) General lighting in all rooms of the house, (2) local lighting for close work such as reading, sewing, etc. (3) Convenience outlets for utilitarian and dec-

This picture shows at a glance the defects of poor lighting.

orative lighting, as well as other electrical uses such as the radio, fans, etc. A sufficient number should be installed to permit flexibility in furniture arrangement. (4) Special outlets for heavy duty appliances. (5) Switches that enable one to have light upon entering a room and to turn off the light upon leaving.

In talking with home seekers, impress on them the fact that the need for additional convenience outlets is always felt and that an adequately wired house is worth more than one inadequately wired. For a complete wiring system, at least 3 per cent of the building cost of the house should be allotted, and at least the same amount for lighting fixtures.

In checking the wiring of the home, keep in mind that current losses through the use of appliances may be kept down by following accepted wiring practice. A No. 12 wire is preferable with a 15 ampere fuse and appliances using more than 660 watts necessitate the use of No. 10 wire. Each room should be supplied by two circuits. Each circuit should be marked on the inside of the cover of the fuse box to show the rooms controlled by it. Instead of the commonly used fuse box, a new circuit breaking device which eliminates fuses may be used.

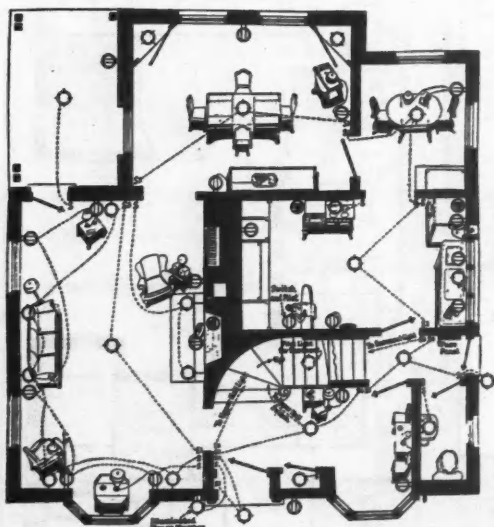

Left
FIRST FLOOR

Note the entrance lights; switch control of two-circuit convenience outlets in the living room; switch with pilot light in kitchen and basement stairs; fuse panel in back hall and the adequate number of switches and outlets throughout the whole floor.

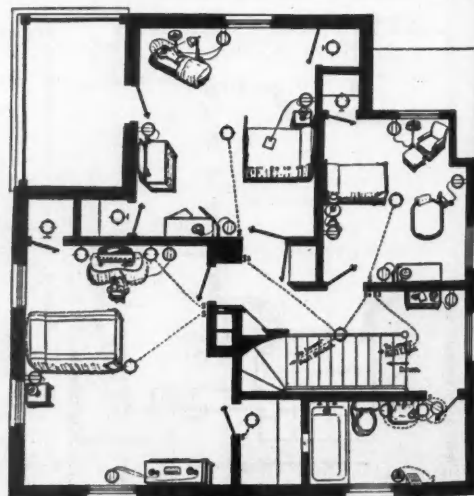

Right
SECOND FLOOR

Two lights on each side of mirror are necessary in bathrooms, and outlets for lights at beds are convenient. It is important to have adequate closet illumination and to have control of downstairs lights by switches at the stairs.



To please women, emphasize the electric conveniences.

This consists of a box containing a number of automatic switches, controlling the various circuits of the house, and may be placed in a convenient place in the kitchen.

Every room in the house should be wired for a ceiling fixture, even if it is not installed. There should be plenty of convenience outlets so that lamps and appliances can be properly attached without unsightly cord dangling from fixtures. Duplex convenience outlets give double the usefulness of single ones and cost very little more. Duplex convenience outlets should be placed every 12 feet around the room. Every wall space large enough for a piece of furniture should have its corresponding outlet.

In selecting the location of switches, never place them behind a door, but always on the lock side, 4 feet from the floor. The toggle switch is now commonly used. Switch plates are made in many different finishes. Switches of bakelite are often the least conspicuous. One of the latest improvements is to put the convenience outlets in the living room on a switch to save the tiresome trip around the room turning each portable on or off separately.

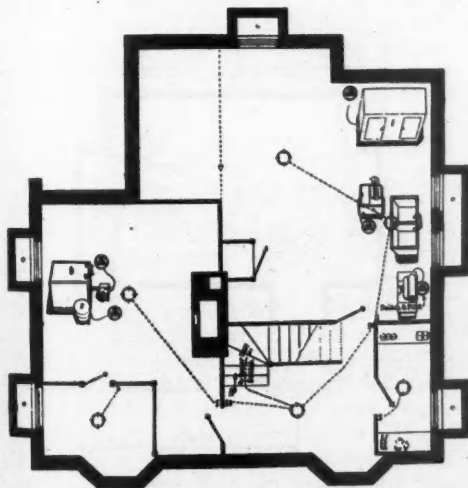

BASEMENT PLAN

The new popularity of basement rooms makes proper wiring and lighting essential in this part of the house. Where no recreation room is provided, as in the above plan, the furnace and laundry areas must be adequately equipped with lights and outlets.

NEW DEVICES FOR THE MODERN HOME

Electric Clock Hanger Outlet

This double-service unit provides a mechanical support for electric wall clocks and an electrical connection at the same time. When the clock is hung over this outlet, the whole unit with wire connection is entirely concealed.



Receptacle and Pilot Light

The bull's eye glows red when the current is "on" in the iron or other appliance that may be connected to this receptacle. It removes the hazard of current left on in curling irons, flat irons, and other appliances.

Radio Outlet

This newly developed device eliminates objectionable surface wires in connection with the installation of radio. Aerial-ground and power circuits are kept separate and plug terminals are marked. The grooves guide the plug prongs into the slots, making correct contacts with each plug.



Floor Outlets

Floor outlets are important. One should be placed under the dining room table and one or two in the living room.

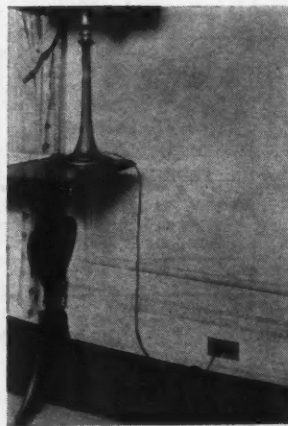
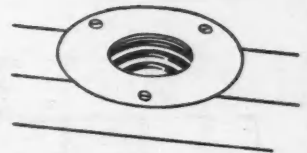

Two-Circuit Duplex Receptacle

One side of the two-circuit receptacle may be controlled with a wall switch—the other side may be on all the time. With this new type of receptacle, heavier loads may be drawn from both outlets at the same time so that a refrigerator can be placed on one outlet and a plate warmer from the other, without blowing fuses.

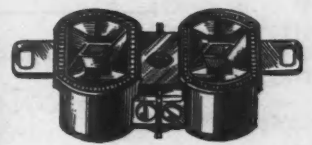



D. WENTWORTH WRIGHT, Architect

THE HOUSE OF THE MONTH

Cost Key 1.410-140-1310-49-15-18

A Quality Small House for \$8800.

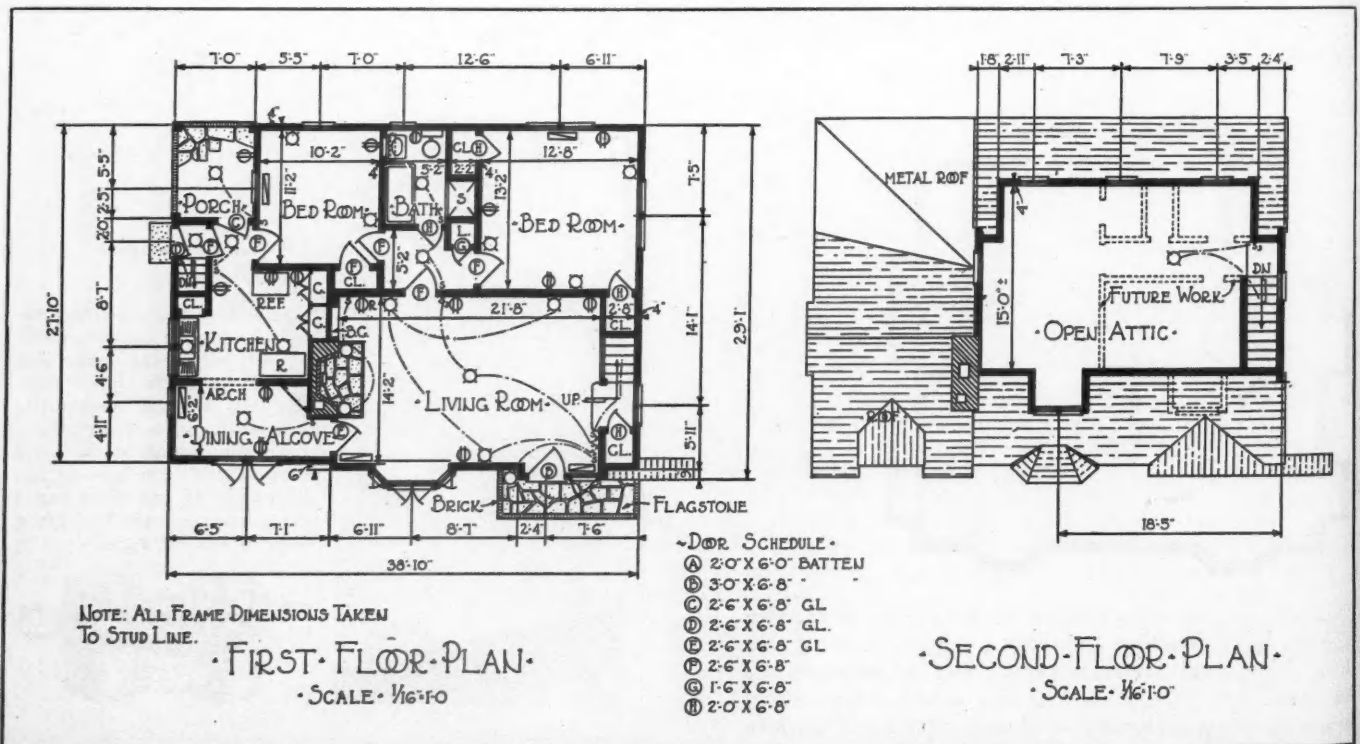

How to Save \$1755 Without Cutting the Quality

By G. William Bailey

SOMEONE has asked how a good speculative builder under Estimate "B" can possibly reduce his costs \$1755 or approximately 20 per cent by slightly revising the standard specification.

As briefly as possible, I will attempt to outline in detail the various items on which savings are made by quantity production and mass buying and by changes in methods of construction without in any material way reducing the quality or useful purposes and life of this June "House of the Month."

CHANGES IN SPECIFICATION AND METHOD

	Labor Savings	Material Savings
Excavating the cellar to neat dimensions, pouring 10" concrete foundation walls against earth banks, inside forms of stock lumber used subsequently in the frame of the house, under cutting banks to form footings, omitting waterproofing, and footing drains	\$150	\$ 172
Omitting area copings, finishing off concrete walls only	3	6
Monolithic cement finished for cellar floor	7	5
Reduction in number of electric outlets and in equipment	28	20
Reduction in number and quality of electric fixtures	2	65
White bath fixtures in place of colored fixtures	53
Omit smoothing between paint coats ..	50
Heating system changed from hot water to one-pipe steam with wet returns	35	68
Bathroom tiled 4' 6" high except around shower and tub, using white tile in place of colored	40	50
Omitting screened porch	8	37
Reduction in quality of weatherstripping	11	11
Direct saving in labor cost on account of carefully standardized and efficient operations, strict and continuous supervision, training of specialized workmen under piece work or sub-contract methods, wage advantage under present conditions where practically continuous employment is possible. Lack of contingencies and extras	\$375
Savings in material costs on account of buying in large quantities which under present conditions are offered to this class of builder as low or lower than quoted wholesale prices	\$ 567
Totals	\$701	\$1054
Total Savings, Estimate "B"	\$1755	

STANDARD SPECIFICATIONS

Foundation:—12" Concrete blocks on 12" thick poured concrete footings around cellar. Cellar walls against earth banks waterproofed with one heavy trowel coat of mastic on the exterior surfaces and on interior surfaces with hydrolithic plaster. Cellar frames and sills pointed and caulked with mastic. All exposed concrete block surfaces to have two coats of waterproofed cement plaster, rough cast trowelled finish, natural grey cement color.

Framing:—All No. 1 Fir lumber. 4" x 6" sills and corner posts. Sills anchored to foundation walls. Exterior and interior studding 2" x 4", spaced 16" centers and doubled at all openings. All studding bridged at least once in height. 6" x 8" Yellow pine girder. 2" x 10" first and second floor joists 16" centers, double bridged with 1 1/4" x 3". 2" x 6" second floor ceiling beams, 16" centers and bridged. 2" x 8" roof rafters, 16" centers, framed to 2" ridge and collar beamed. Porch posts of rough, hand hewn oak. All trim grounded throughout.

Flooring:—Rough under-flooring throughout 7/8" square edge No. 2 N. C. pine, laid diagonal on first floor and longitudinally for a temporary finished floor in second floor. Rosin sized paper well lapped under finished flooring. Living room, dining alcove, bedrooms and hall 7/8" clear oak strip flooring. Kitchen floor, 7/8" rift pine on which is applied "A" grade inlaid linoleum over felt lining.

	COST ESTIMATES by Mr. Bailey			
	Estimate "A"		Estimate "B"	
	Labor	Material	Labor	Material
1. EXCAVATIONS				
180 CY. General Earth	90	60
20 CY. Pier and Trench	15	12
38 CY. Backfilling	30
2. CEMENT WORK				
445 CF. Footings	45	111	32	84
578 PCS. 12" Blocks	93	138	42	86
274 PCS. 10" Blocks	44	60	20	40
306 PCS. 8" Blocks	46	61	22	44
19 LF. Area Coping	3	6
216 SF. Cellar Floor	22	22	15	17
96 SF. Rough Porch Slab	5	10	5	10
7 SF. Finished Porch Slab	2	1	2	1
1 CY. Firestops and Hearths	2	2	2	2
3. MASONRY WORK				
34 LF. Brick Borders and Sills	17	9	12	9
96 SF. Flagstone Paving	20	20	15	18
1100 PCS. Brick in Solid Walls	33	33	28	30
Brick Chimney and Fireplace	167	152	140	130
500 PCS. Brick Veneer	25	15	20	15
4. CARPENTRY AND MILLWORK				
Concrete Forms	75
8000 FBM Framing and Grounds	240	240	200	186
5250 FBM. Sheathing	131	131	105	108
17 SQS. Antique Asbestos Roof Shingles	85	204	68	177
List of Exterior Trim	40	135	30	107
List of Sash, Door and Frames	128	287	109	263
List of Rough Hardware	55	55
36 SF. Hand Split Shingle Siding	5	10	5	10
186 SF. Oak Bevel Siding	10	12	10	9
List of Interior Trim and Doors	205	430	178	382
Stairwork	40	70	34	52
718 SF. 7/8" No. 1 Oak Flooring	65	65	50	50
122 SF. 7/8" Rift Pine Flooring	6	13	6	13
W. I. Weathervane	5	45	5	35
5. ELECTRIC WORK				
52 Outlets. Wiring only	75	60	47	40
24 PCS. Fixture and Hanging	20	125	18	60
6. PLUMBING				
Piping, Fixtures and Fittings	270	365	207	312
Gas, Water and Sewer Connections	75	60	75	60
100 LF. Footing Drains	50	50
7. HEATING				
Boiler, Piping and Radiation	155	285	120	207
Oil Burner Equipment	75	475	75	400
8. SHEET METAL				
9. LATHING AND PLASTERING				
Copper Roofing, Flashings and Window Pans ..	74	115	67	97
25 SY. Scratch Coat on Wire	15	10	13	10
475 SY. 3-Coat Plaster on Wood	313	214	285	190
150 SY. Stucco on Galv. Wire Mesh	120	90	98	75
10. TILEWORK				
.....	125	195	85	145
11. PAINTING AND DECORATING				
.....	250	150	175	125
12. EQUIPMENT				
Screens	18	82	10	45
Weatherstripping	33	33	22	22
Medicine Cabinets	2	17	2	14
Built-in Ironing Board	1	9	1	7
List of Finished Hardware	85	50
Gas Range	70	60
Refrigerator	325	275
Shower Curtain	15	10
Window Shades	5	20	4	15
Kitchen Linoleum	8	22	6	18
INSULATION	75	225	65	210
TOTALS	\$3378	\$5434	\$2677	\$4380
		3378		2677
TOTAL—Labor and Material		\$8812		\$7057
Approximate Cubic Footage: 18040				
Cost Per Cubic Foot49		.39

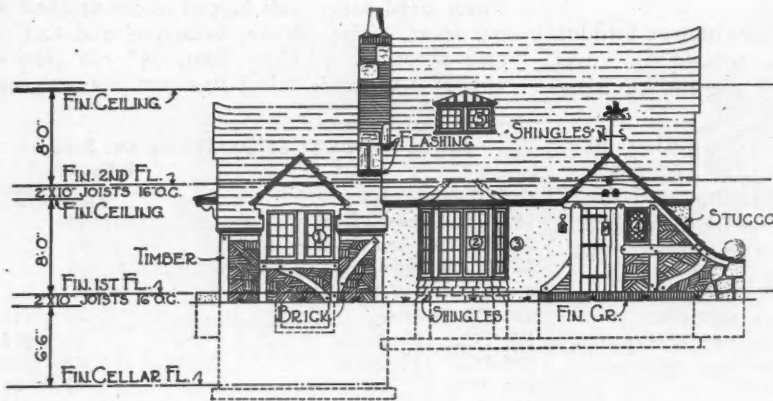

FRONT ELEVATION
SCALE 1/16"=1'-0"

- WINDOW SCHEDULE-
- ① 2'-6" X 4'-6" CASEMENT
 - ② 2'-0" X 5'-6" "
 - ③ 1'-0" X 5'-6" "
 - ④ 2'-0" X 2'-6" "
 - ⑤ 2'-0" X 2'-0" "

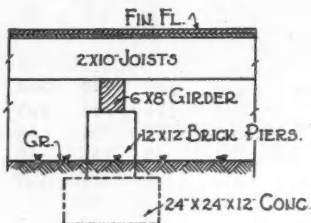

SECTION AA
SCALE 1/4"=1'-0"



DETAIL OF LIVING ROOM END
SCALE 1/8"=1'-0"

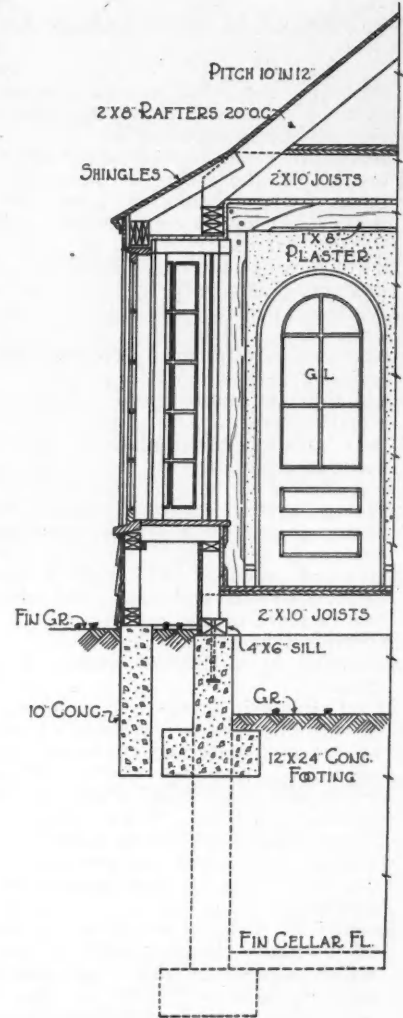

SECTION BB
SCALE 1/4"=1'-0"

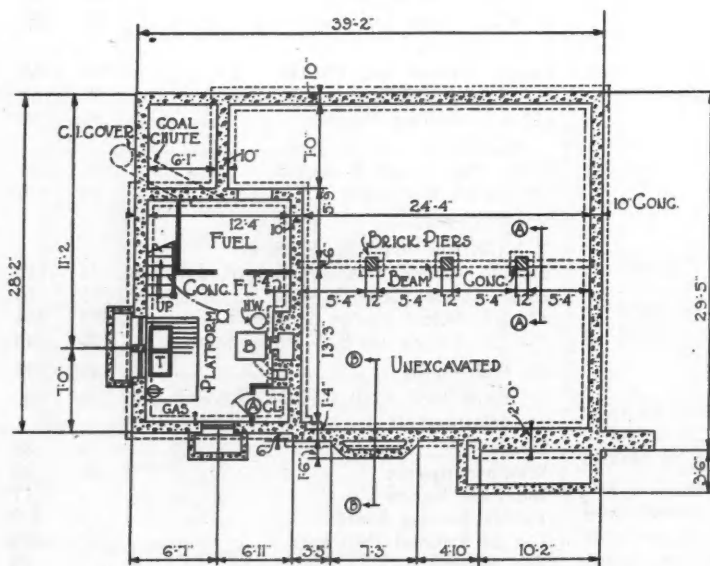

CELLAR PLAN
SCALE 1/16"=1'-0"

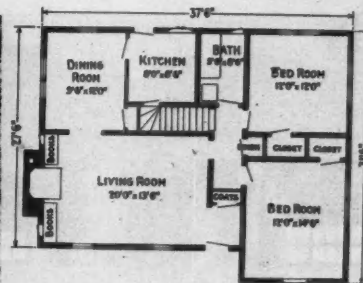

This Connecticut cottage is charming in design, low in cost, yet with plenty of room inside. Owner, Robert Ketting. Builder, William Guyaz. Architect, Frazur Forman Peters

Cost Key I.256-138-1078-45-16-17



William Guyaz pays attention to architectural detail.

Good Architecture Pays

Connecticut Builder Specializes in Homes of Good Design, Keeps Costs Down and Arranges Land Purchase and Financing for His Prospects

BILL GUYAZ, contractor-builder of Westport, Connecticut, has kept busy throughout the building slump. Since starting in business for himself a few years ago he has never been idle. This creator of good houses knows that the day of the smaller builder is not past, because he shows convincingly that he has a valuable function to perform. In Westport and nearby towns, Mr. Guyaz is proving that his service is very much in demand by home seekers. He gets work because he produces homes with real architectural appeal at rock bottom cost and with necessary financing arrangements all fixed for the prospective owner.

Very often Mr. Guyaz receives a job from a friend of a satisfied owner. With his intimate knowledge of local real estate, he often knows where he can pick up a good piece of land at a reasonable price. Likely as not, he will close this deal for the prospect. In soliciting business, he offers the home seeker a complete house. It is his experience that people do not want to bother with details. A beautiful, complete home at so much per month is the product that this contractor-builder offers to prospects and it has proved to be a successful method of solicitation.

Close co-operation with the lumber and building material dealer is one secret of Bill's success. Backed by the 15-year finance plan of one of the local supply houses, he approaches prospects with a complete financing arrangement, one which they usually welcome because it allows them a loan of 75 per cent of the value of both house and land, with reasonable down payment and monthly payments thereafter, provided they are passed

as good credit risks. And the people he chooses are always good credit risks. Until the house is finished the owner makes no payments although he is already on contract. As the builder, Mr. Guyaz receives three payments during the course of construction from the dealer handling the financing. Following completion of the house, the owner starts monthly payments on his mortgage note, the payments covering insurance, interest, and amortization.

With such a financing plan in his kit, this Westport builder does not fail to interest prospects, especially since he offers them unusually good design at low cost. As the small local builder should, Mr. Guyaz operates with an extremely low overhead. Building from his own or from architect's plans, he watches architectural detail closely and incorporates in his Colonial homes authentic reproductions of Colonial exterior and interior details, many of which he secures from stock. He does the carpentry work himself, letting the remaining jobs out on sub-contract. Realizing that the high cost of building homes has kept many people from living in their own houses, Mr. Guyaz strives to keep his costs so low, and offers such a good and attractive house for the price, that prospects will have a hard time to resist the appeal. He has been successful in this. Labor costs is one of the items which he watches very closely but he has saved money on other items of the building budget, for example, in land purchase.

Because he is thoroughly familiar with all local conditions and is on the job at all times, he is able to give an individualized service to each home seeker that cannot be duplicated by the mail order man.



New Greasing Service Front For Old-Style Public Garage

THE old-style public garage built from 10 to 15 years ago, although situated in a fairly good location, has been gradually losing its business. The owners of these outmoded structures have seen their properties slip back from good income producers to forlorn and dreary liabilities. The big and convenient gasoline filling station, the "greasing palaces," brake service shops and the auto laundries have taken away all of the extra cash-money business, leaving only storage for the old-style public garage.

It is estimated that there are 10,000 of these old wide-front storage garages on prosperous business streets which ought to be modernized.

E. J. Biggs, of the E. J. Biggs Construction Company out on West 83rd Street, Chicago, has devised a scheme for putting life into these old dead properties by a fairly simple remodeling procedure. The way his plan has worked out for the old garage at 79th Street and Engleside Avenue, Chicago, is illustrated herewith.

The old front was torn out completely and set back 25 feet so as to permit cars to drive in off the street to be served at the 8 new gasoline pumps installed there in front. The entrance to the storage garage was moved over from its old central position to the extreme left hand side, leaving the center for greasing pits and brake service department. Four wide upward-acting doors serve this central portion, each entrance being two cars wide and having a graceful brick arch at the top. The greasing pit section is 22 feet 10 inches deep, and back

of that is the public garage storage space. A convenient, all-glass office for the gasoline, greasing and brake service is to the left alongside the garage entrance. Over at the extreme right is a store space 25 by 26 feet for the display and sale of tires and accessories.

If later on additional storage space is needed, a second floor will be built, which will be reached by a concrete ramp straight ahead from the main garage entrance.

The results of this remodeling were immediately apparent on the books of the operating company. The average monthly income per car on the old basis had been \$7.00. In the remodeled garage, it is \$10.00. The sale of gasoline has increased from 2,000 gallons per month to 12,000 gallons per month.

This building has a frontage on the street of 125 feet. Its original depth was 130 feet. No structural difficulties were encountered in making the changes to convert this old-style, money-losing proposition into a present-day profit maker.

The construction of the greasing pits, the installation of the large upward-acting doors, the arrangement of the brake service equipment and of the gasoline pumps with underground storage, were all matters on which special consulting service is available from the manufacturers of such equipment.

An attractive modern business front, with plenty of illumination, has brought back once more to this old-style public garage a profitable volume of business.

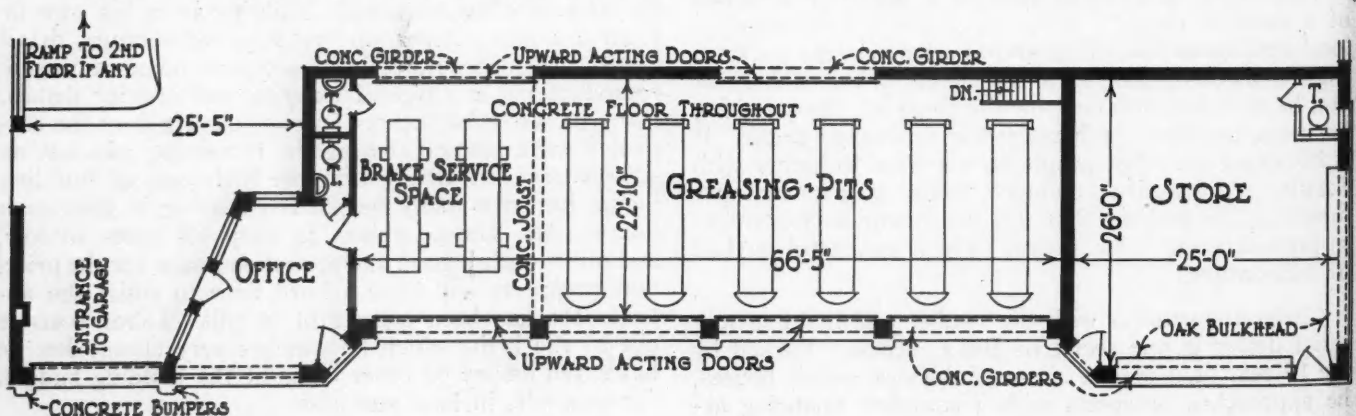

Plan of remodeled front of old-style public garage showing garage entrance moved to extreme left, with modern greasing pit and brake service department in the central location. The entire front is set back 25 feet so as to accommodate drive-in gasoline business.

PUBLIC GARAGE DESIGN DATA

The unit of design in a garage building is the parking section—two rows of cars and an aisle between them. If the parking of cars is properly supervised this unit section may be a minimum of 50 feet wide. But because of the growing popularity of the longer cars, a slightly wider section is desirable.

For passenger cars and most delivery cars, a clear headroom of 8 feet is sufficient. For better light and ventilation, usual practice is to provide 8½ feet. With average floor construction, the typical story height ranges from 10 to 11 feet. The first story is usually made higher for the sake of appearance and for the storage of medium size trucks.

In most buildings, column spacing is arbitrary to a large extent, but in a garage it spells the difference between a good and a bad layout. The car arrangement should be carefully determined before locating the columns. It is not economy to save two per cent of the building cost with structurally ideal column locations only to cut down the car storage twenty per cent. Many existing buildings suffer such loss because of adverse column spacing.

Three-car-bays require a practical minimum number of columns. Careful calculation demonstrates that two-car-bay construction costs nearly the same as three-car-bay construction because of the increase in columns

and the space they take from the storage areas.

The minimum net frontage per car space for the driver's freedom to enter and leave the car must exceed 6½ feet. Six feet 9 inches has been proven commercially practical by long trial.

Long experience has shown the 15 per cent grade satisfactory for ramps. The surface of the concrete ramp should receive a wood float finish. No grooving or other process requiring the steel trowel should be employed because better traction is obtained with the fine irregularities in the floor surface, rather than with large ones with smooth surfaces between.

The U. S. Dept. of Commerce has published a bulletin on the live load ratings for designing multi-floor garage buildings, containing the findings in a survey by the Building Code Committee. It shows a wide variation in the live load factors for garage floors specified by the various building codes. They range from 50 to 250 pounds per square foot, with most calling for from 100 to 125 pounds per square foot.

Concrete guides between stalls are rarely used. The objections to them are numerous. If the guides restrict the movement of the car sufficiently to prevent damage to adjacent cars, the movement of the cars in or out of the space is equally restricted. In many garages the use of projections above the floor surface destroys the flexibility of car and truck arrangement. The existence of guides makes it difficult to keep the floor clean and dry.



Interior view of greasing pit and brake service section at the front of old-style public garage on 79th Street, remodeled by E. J. Biggs Construction Co., Chicago.

Profit in Making Old Kitchens New

MODERNIZING of kitchens is one of the most popular types of work builders are performing, reports from various communities show. Much of this work starts from comparatively little things. For example, a woman decides to have new linoleum floors put down. When she really goes into the matter, she discovers she will have to move the old kitchen cabinet, and in doing so, decides it isn't worth moving; a new one is the best. Very often, a builder is called in to do a small job, and ends up by thoroughly remodeling the entire room.

The biggest field at present lies in old houses built in the days when they thought kitchens should be large enough to hold a barn dance. A careful survey by architect or builder immediately shows how a breakfast nook, closet, or even an extra bedroom may be partitioned off, and the remaining space converted into a practical, efficient, modern kitchen.

By concentrating on kitchen modernization and thereby becoming an expert in this work, much good business can be secured. One contractor called on fifty women in his community and got their ideas as to what would be a perfect kitchen. He then prepared what he called a "dream kitchen" and worked up sketches in colors. His next step was to call on the husband and point out just how his wife's kitchen could be improved at a low cost. In many cases, he arranged to do the work while the wife was away and it was presented by the husband as an anniversary or birthday gift.

In modernizing kitchens, the following important points concerning arrangement of units should be considered:

The dining room is the only room, except the kitchen, that must be considered in the process of preparing a meal. Therefore, in arranging the kitchen, the units most frequently used in connection with the dining room should be placed as close to the dining room door as possible, thus saving a maximum number of steps in kitchen work.

The butlery or storage cabinet should be near the dining room door because it is used as a serving table to the dining room, the base stores, linen and electrical

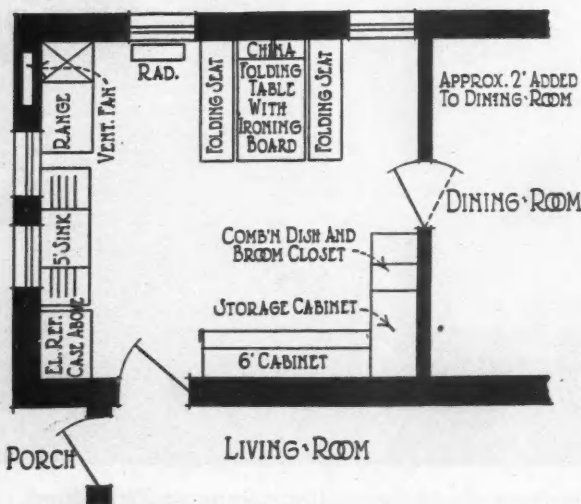

An ideal plan for a corner kitchen of square shape.

equipment such as percolators, toasters, waffle irons, etc. The top cupboard is for serving dishes, etc., and is deep enough for large dinner plates and platters.

All units used for dish storage should be as close as possible to the dining room. Several types of dish cupboards are available to meet any requirement in storage space.

The refrigerator should be as close to the sink as possible and not too far from the dining room door. Almost everything stored in this unit is partially prepared at the sink. The top cupboard should contain groceries that need not be kept cool.

The sink should be under a window, if possible. Good light is necessary for cleaning dishes, vegetables, etc. The drainboard should be toward the units that store the dishes.

The kitchen cabinet is the heart of the kitchen. It has the main work table and should be as large as possible. This unit contains cutlery, pots and pans, flour, sugar, spices, and all small supplies necessary for cook-

Reconditioning Old Floors Develops Profitable Business

A CERTAIN young engineer, recently finding himself out of a job, looked around for some opening where hard work and aggressiveness and a knowledge of construction practice might develop something worth while. As this happened to be in Chicago, he was struck by the number of old-style apartments standing vacant. Looking them over with a practiced eye, he found that the floors in many had been neglected until they were in bad shape. Reporting back to renting agents and owners, he found some of them ready to listen to a proposition for refinishing these old floors.

In addition to these apartment building floors, he also hunted out several store buildings that needed floor surfacing, also a number of homes where the style of floor finish was to be changed, in line with present-day ideas.

After three days of canvassing, he found he had enough orders booked to keep himself, a machine and a helper busy for three weeks.

In negotiating for power equipment to handle this work, he ran onto several interesting possibilities. He could rent a machine, or he could buy one outright, with a small payment down. The rental charge seemed high, especially in view of the fact that he would have practically continuous use for a machine. However, the fact that machines are rented gave him the idea that he could probably rent out his machine to others any time he had a lull in the work, so that he didn't need it himself. He found that builders and dealers who are well identified with the floor surfacing and floor finishing business often keep several extra machines on hand to supply the rental demand. He learned that, in numerous instances, men who had started in by renting a machine from time to time had later on developed enough steady business so that they finally invested in regular equipment of their own.

Smoothing and finishing of floors in new construction, supplemented by the reconditioning of old floors in times like these, proved to be the chance to get into business for himself, which this enterprising young fellow had been hoping for. Like many another, he boosted himself into a better paying line when he lost his old routine position. Floor surfacing by modern machine power is one of the big opportunities in connection with this season's drive for the modernizing and reconditioning of old buildings.

Porcelain Enamel for House Exteriors

AN experiment in all-metal home construction which architects and builders are watching with much interest is in process at Cleveland, O. at the present moment. Methods and materials developed by the White Castle Hamburger people and found so satisfactory for their numerous little eating houses are being tried out here for fine residential construction.

Charles Bacon Rowley is the architect, George L. Dubin, Inc., the building contractor, and the Ferro Enamel Corp., the sponsors of this \$16,000, seven room and attached garage residence, located on Campus Drive in the Cedar-Green sub-division, Cleveland.

The perspective sketch shows typical construction of the walls of this new-style house. The exterior porcelain enameled sheets are in the form of panels $\frac{1}{2}$ " deep. In these a fibre insulating board is held by a waterproof glue. The panels vary in size up to about 30" square. Special steel studs are fabricated and provided with bolts, which in turn are attached to an outside strip of sheet steel. This outside steel strip is covered by a porcelain enameled batten which slips down over the steel strip. A waterproof felt washer is then placed back of the porcelain batten. As the bolts are drawn up from the inside the batten is tightened against the washer and porcelain enameled panels which form the surface of the outside wall. The horizontal joints have a slight ship-lap, so that nothing is exposed to the weather but the porcelain enamel finish.

This porcelain-enamel faced residence will have exterior walls of a color resembling rich, buff limestone. A band of silver green will be under the parapet and

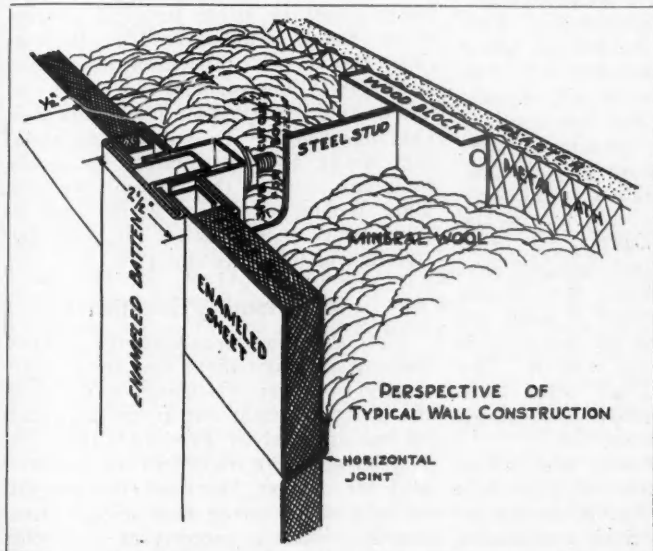

Porcelain enameled steel sheets make an impervious exterior; Fibre Board and mineral wool assure good insulation for this novel form of home construction.

form a belt course above the first story. The porcelain enameled roof shingles will be in three shades of russet or rust color. A dull, or "Matte" finish enamel will be used, *not the usual glossy finish*. Rustless steel will be used in the entrance detail, windows and doors.

Porcelain enamel is available in all colors and shades, as well as in simulated finishes such as wood, marble, stone, stucco, etc.

The floors in this house will be steel deck on metal joists, will be concrete fill and wood or tile.

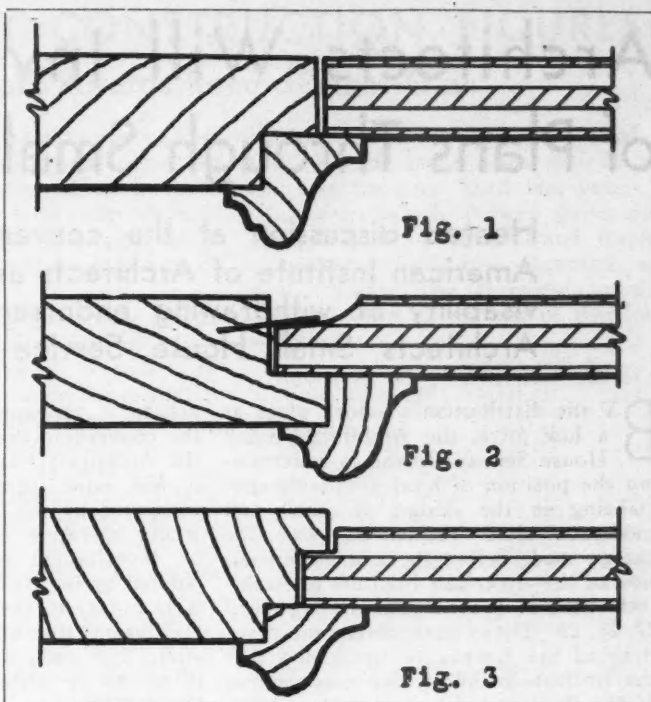

Application of Raised Mouldings to Good Paneling

By W. E. GRIFFEE

THERE are several methods of joining the panels to the stiles and rails and applying the mouldings to paneling. The designer in making his details, will wish to consider the cost and effectiveness of the various methods.

Figure 1 shows a simple method which is often used when paneling is to be built by the carpenter on the job. It should never be used for a cabinet job of paneling, however, because it prevents the assembling of the paneling for finishing. The joint is such that the panels drop out unless they are assembled against a wall.

The panels are held against the stiles and rails by metal pins or nails in Figure 2. This is all right while the paneling is being built, except perhaps for the final installation, but it makes repairs very difficult. A marred panel cannot be removed without wrecking an adjoining stile, and then the new or repaired panel cannot be readily put in place. Such a joint should never be used for paneling in which the back side is not readily accessible.

The preferred construction shown in Figure 3 holds the panel firmly in place but permits its easy removal. The lip against which the panel rests should be not less than $\frac{1}{4}$ " thick. The back of heavy panels may be rabbeted out as much as necessary to set the face back to the desired position. Panels are free to shrink or swell slightly as they need not be fitted tightly into the openings. This construction also is a little less expensive than that in Figure 2.

It is suggested that details show the bottom rail of paneling raised at least an inch above the floor, with the stiles running on down to the floor. Then the paneling can be fitted to the floor where necessary, merely by sawing off the stiles a little, rather than by ripping the full length of the bottom rails. A base moulding of some sort always covers the joint between the floor and the paneling anyway, so it is not necessary that the bottom rails rest directly on the floor.

Architects Will Investigate Distribution of Plans Through Small House Service Bureau

Heated discussion at the convention of American Institute of Architects as to advisability of withdrawing endorsement of Architects Small House Service Bureau

BY the distribution of stock plans at a low price, the Architect's Small House Service Bureau is undermining the position of local architects specializing in the design of small and moderate sized residences, was the charge made before the annual convention of the American Institute of Architects held in Washington, D. C., April 27, 28, 29. Those condemning the practices of the Bureau recommended that the Institute withdraw the endorsement of the Bureau which it started and has sponsored for many years. Robert D. Kohn, president of the Institute, presided over a debate on the subject of endorsement which brought in both proponents and opponents of the Small House Service Bureau.

Small house architects contended that the Bureau planned to distribute plans through local lumber dealers at low prices, consequently endangering their own practices. W. Stanley Parker, head of the Bureau, emphasized the importance of the new willingness to co-operate, evidenced by associated lumber dealers, who are anxious to work with the Bureau in connection with the program for financing house construction launched by their National Homes Finance Corporation. Donald H. McNeil, representing this corporation, outlined the financing scheme by which a fund of \$1,500,000, pooled by 100 dealers and 30 manufacturers, had been placed behind a national program permitting the borrowing of money for homes up to 75 per cent of their value. Other speakers pointed out the educational value of the Bureau and the manner in which it had helped improve the quality of small house design in those classes of residential building where architects function very little, if at all. One speaker quoted figures from the F. W. Dodge Corporation to prove that the great volume of the work in the small house field does not go through architectural hands at all.

The Institute should not encourage the use of stock plans by home builders, opponents of the Bureau argued, but should try to stimulate people to demand competent architectural service. The issue before the convention, according to these speakers, was whether the Institute should continue to endorse a Bureau which was not only operating against the specific interests of the Institute's members but whose methods were not in line with the ethics or principles professed by the Institute.

When a vote was taken, following the

debate, it appeared to be the sense of the convention that the endorsement of the Architects Small House Bureau, as it was now operating, should not be continued by the Institute but that the whole operation of the Bureau should be investigated by a committee appointed by the Board of Directors which is to report to the next convention any conclusions that may be reached. Meanwhile, the endorsement of the Bureau is not to be withdrawn. A number of the delegates seemed to be in favor of the plan of distributing the material prepared by the Small House Service Bureau through architects only.

Economist Advocates House Building As a Way Out of the Depression

Speaking at one of the convention luncheons, Paul M. Mazur of New York, member of an investment banking concern, advocated the immediate stimulation of residential construction to the extent of \$1,500,000,000 as an effective blow to end the depression. Residential construction is behind about \$3,000,000,000, said Mr. Mazur. This potential and vast volume of business might be released to the benefit of all classes of business by the simple rediscussing of mortgages for new residential construction through a credit association, backed by the government and capitalized at \$500,000,000. All other depressions in economic history have eventually been broken, Mr. Mazur declared, by the emergence of some one factor strong enough in its operation to pull other factors along with it. This factor, unfortunately, has often been war, he said, but in other cases single industries have led the way out.

In the present situation, Mr. Mazur believes, we must synthetically produce a stimulant to break the vicious declining spiral of business. Such a stimulant, Mr. Mazur feels, might most quickly and effectively be applied to residential construction because the ramifications of active residential building would spread benefits throughout the entire economic body of the nation and because the present lag in residential construction makes it absolutely economic and feasible to stimulate this field.

The present reconstruction measures which the government has put into effect, or is advocating, offer no guarantee, in Mr. Mazur's opinion, that the credit which is released to banks and other lending institutions will be actually made use of, by them, in loans for productive purposes. Credit is not credit

at all until it is used, he pointed out, and then it is only useful when applied to useful activity. Such an activity, in Mr. Mazur's belief, is residential construction. "Millions of American dollars financed homes for German workmen," he said, "yet we are not willing to lend money to finance homes for our own people on American soil."

Taking a fling at high taxation, Mr. Mazur made the statement that we had not advanced in this respect since the Middle Ages. If business is to pick up we must have a better guarantee than we have yet had that available credit will be used, he said. "Bankers are among the best hoarders we have," he declared.

Wants Construction Loans

Francis Lee Stuart, Past-President of the American Society of Civil Engineers, presented to the convention a plan for the stimulation of public works. Declaring that the construction industry has shrunk from an eight, nine, and ten billion dollar industry to a three-billion-dollar-a-year industry, Mr. Stuart voiced the imperative need for constructive measures. He advocated a reconstruction work corporation, capitalized at \$1,500,000,000 out of which loans might be made to local governments for construction work. He outlined the possible distribution of loans as follows: One-quarter for slum rehabilitation, one-quarter for public utilities, one-quarter for public transportation needs and one-quarter for public buildings. Under this scheme, he said, loans would be secured in the community and be paid back by the communities in which it was spent.

The Housing Situation

That there is a real shortage of good housing although there may be an oversupply of inferior housing, was one of the points brought out in the discussion on housing, led by Frederick Bigger of Pittsburgh. "We must find the balance," said Mr. Bigger, "between the financial interest of the owner as a private citizen and his financial interest as a member of the community." The cycle of public improvement has, up to this time, been as follows, said Mr. Bigger: First, public improvements, then high land values, higher taxes, more congested use of the land, more public improvements, higher taxes, greater congestion on the land, demand for public improvements and so on. Distinction must be made between the large and small property owner, Mr. Bigger declared, and between owner-occupied land and land occupied by buildings that are rented or sold.

Eugene Klaber of Chicago thought that the unserved two-family flat, constructed in rows, might be one possible solution of inexpensive housing. Some

sort of assistance from the state will probably be necessary in housing, he thought.

The fact that 70 per cent of the population is living in small communities has a strong bearing on the whole housing question, declared Harland Bartholomew, past-president of the American City Planning Institute. The question of what size of structure will produce the maximum economy has to be answered from the standpoint of land cost, building cost, and possible rental ranges. The fact that individual units may succumb to the neighborhood environment means that the whole environment must be stabilized and given a degree of permanence. Housing must therefore be conceived, in Mr. Bartholomew's opinion, as a fundamental part of a larger city plan.

Architecture During a Depression

In a symposium on the practice of architecture during a depression, a number of architects gave their ideas on how to make a living.

Arthur B. Holmes of New Jersey suggested the possibility of going into the modernizing business and helping people to repair, alter, or renovize their homes.

Merritt Harrison of Muncie, Indiana, spoke of the success of the Muncie plan, a modernizing campaign, inspired by an article published in AMERICAN BUILDER AND BUILDING AGE, which had resulted in a great deal of business for men of the building professions.

Home Loan Bill Forges Ahead

PROGRESS of the Home Loan Bank bill during the latter part of May was rapid and encouraging to all those in the building industry who are watching this important piece of legislation.

On May 20 the House Committee on Banking and Currency brought out a favorable report on the bill (now called the Reilly bill, H.R. 12280) and urged its immediate passage.

A request was made to the House Committee on Rules May 24 for a special rule to expedite action on the bill in the House.

The administration is strongly supporting the measure. President Hoover again urged its passage as a part of a program of government aid toward "breaking" the depression in a letter to the American Society of Civil Engineers made public May 23. He declared it "would protect home owners from foreclosure and would furnish millions of dollars of employment in home improvements without cost to the treasury."

The fact that the system of Federal Home Loan Banks called for would be entirely self supporting and independent is emphasized. Certain mortgage bankers, who are viciously opposing the measure, have declared that it would

CURRENT CONSTRUCTION FIGURES

April Awards Record Slight Gain

BUILDING construction throughout the United States as represented by contracts awarded showed an increase of about eight per cent over March. The increase was due to a pick up in public works, largely highway construction.

Residential building gains over March were shown in the New England, Chicago, Central Northwest, Kansas City and New Orleans areas. Residential volume for the entire country, however, was slightly less than in March.

AMERICAN BUILDER AND BUILDING AGE estimate of April construction volume based on F. W. Dodge reports modified to include all states and all types of work including modernizing and repairs are as follows:

Residential buildings ...\$65,252,990
 Non-residential 50,066,500
 Public wks. and utilities. 52,024,610

Total\$167,344,100

City building showed a greater increase, according to S. W. Straus figures. These report a gain of 19.7 per cent over March for building permits

in 568 cities and towns. The total of 52,079,621 for these cities was 30 per cent less than for April last year.

Six cities which showed gains over April, 1930, are Austin, Grand Rapids, Sacramento, Rockford, Scranton and New Orleans. The 25 cities reporting largest volume of permits of April are as follows:

	April, 1932	April, 1931
1. New York, N. Y.	\$10,101,158	\$58,221,281
2. Philadelphia, Pa.	4,041,695	7,662,135
3. Los Angeles, Calif.	1,531,814	3,413,850
4. Baltimore, Md.	1,484,280	5,869,440
5. Austin, Texas	1,467,566	228,518
6. Washington, D. C.	1,085,145	2,206,680
7. San Francisco, Calif.	1,041,906	1,837,433
8. Grand Rapids, Mich.	1,020,145	136,680
9. Sacramento, Calif.	1,017,797	478,230
10. Detroit, Mich.	944,749	2,709,488
11. Boston, Mass.	837,574	2,669,297
*Montgomery, Ala.	798,532	71,265
12. St. Paul, Minn.	684,204	1,229,658
13. Rockford, Ill.	579,270	86,415
14. Cincinnati, Ohio	574,070	1,711,485
15. Cleveland, Ohio	512,850	792,500
16. Milwaukee, Wisc.	486,973	2,957,772
17. Kansas City, Mo.	480,000	1,032,400
18. Dallas, Texas	468,449	540,273
19. St. Louis, Mo.	443,481	4,568,665
20. Portland, Ore.	404,395	527,290
21. Minneapolis, Minn.	380,525	1,707,855
22. Scranton, Pa.	370,843	109,060
23. New Orleans, La.	362,394	2,674,204
24. Houston, Texas.	333,730	1,430,782
25. Newark, N. J.	320,274	881,114

TOTALS\$30,975,287 \$105,682,505

increase taxes and governmental expenses. This is not the truth, as sums advanced by the Reconstruction Finance Corporation are in the form of subscriptions to the capital stock and are to be retired at an early date.

In its revised form, the bill provides for the creation of a Federal Home Loan Board of five members to be named by the President, which board would establish a system of from eight to 12 banks having an initial capital of \$125,000,000.

Membership in the system would be open to building and loan associations, co-operative banks, homestead associations, savings banks, trust companies, State banks and insurance companies. National banks are excluded since they already have access to the Corporation and Federal Reserve System. The members must subscribe 1 per cent of their mortgages that are eligible for collateral but not less than \$1,500.

Representative Luce (Rep.), of Waltham, Mass., author of the bill, stated orally that he does not believe more than \$60,000,000 of the Reconstruction Finance Corporation funds will be called for under the bill.

He declared, however, that it will, if enacted into law, prove the greatest of all the business relief measures suggested to date, since it affects so many people.

The agency proposed in the home loan bank bill is sound, conservative and built upon existing institutions, which are subject to inspection and regulation by the States. It is noninflationary and is planned to give financial support to existing home-financing, thrift or sav-

ings institutions.

It will fill an immediate need, as financial institutions have millions of dollars of preferred first mortgages on homes, upon which they can not raise a dollar to pay withdrawing depositors and shareholders, or to make loans either upon property that is unencumbered at the present time, or to re-finance existing mortgages.

Each of the Home Loan Banks will start with a minimum capital of at least \$5,000,000. Subscriptions are to be opened and at the end of 30 days the subscriptions are to be totalled and the Government subscriptions to stock bring the total initial capital for all banks to \$125,000,000. The Government subscription is merely an advance and is to be repaid as additional institutions join the system. An early retirement of the Government capital is anticipated by the provisions of the bill. It provides that the sum to be advanced by the Reconstruction Finance Corporation is not to exceed \$125,000,000 and interest is to be paid the government at the rate of 2 per cent.

Provision is made whereby, after the amount of capital of a Federal home loan bank paid in by the members equals the amount paid in by the Secretary of the Treasury, the bank is required to apply annually to the payment and retirement of the capital stock held by the United States 50 per cent of all sums thereafter paid in as capital, until all the stock held by the United States is retired at par. The Federal Board has full power to retire Government capital earlier, if conditions warrant such action.

National Homes Finance Corporation Adds Members

THIRTY new dealer members and fifteen leading manufacturers have been added to the list of stockholders and preferred stockholders of the National Homes Finance Corporation within the past few months, it was announced at a recent meeting of the Board of Directors.

General Manager Donald H. McNeal reported the company's position with respect to both first and second mortgages as excellent. He said loan commitments can now be made on a 48 to 72 hour basis.

The finance company's policy relating to monthly payment financing of modernization work was altered to limit such service to participating dealers only. The Unit Plan of subscription provides for dealer participation upon an investment of \$100.00. A considerable increase in modernizing loans was reported.

In closing, President Alton J. Hager commented on unfounded rumors concerning the corporation and its policies and position. He said the company was making commitments on all qualified loans and still had a large bank balance and plenty of money available for meeting all service demands.

"You can pick up any of our trade magazines," he said, "and read whole pages of letters and reports by dealers stating that lack of home financing is holding small construction at a standstill. They talk about their inventories, about their collections, and about their reduced operating expenses. They say they cannot afford to do any selling until there is financing available to take care of their prospects.

"Well, I say, gentlemen, that here is the financing service, and it is here in plenty. It is operating, and it is made ridiculously easy for any dealer to take advantage of. I say to you that the dealer who complains and belly-aches about his local conditions, and tries to alibi himself on the lack of local financing, is refusing to think and refusing to act because this company now can give him exactly what he needs and wants if he has any sincere ambition to go ahead and develop some profitable business instead of just sitting around howling about his hard luck."

Slum Clearance Advocated

EXPENDITURE of twenty billion dollars to modernize existing buildings and obsolete plants and to rehabilitate cities and towns in the quickest and soundest way of restoring prosperity and of meeting the needs of the American nation, according to Francis Lee Stuart, member of the Public Affairs Committee of the American Engineering Council.

"The outstanding disgrace of America is the unhealthy and indecent housing

and sanitary conditions of our slums and of many of our homes," he declares. "It is a governmental function of cities and states and nation to correct this abuse. The people have a right to ask them to act and at once."

Long Island Builders Declare Open Shop

BUILDERS on Long Island, New York, which is a very active residential area under normal conditions, have declared an open shop on the basis of a cut in wages which amounts to approximately one-third in practically all trades. No difficulty has been experienced in securing sufficient help, according to reports from the active sections of the Island.

That Feminine Touch

MODERN architecture is in need of the feminine touch, according to Dean Bossange, of the Department of Architecture of New York University. "I am convinced that women properly

trained could design and execute many types of small buildings very well, and very few women are doing this at the present time," he declared. "It is perfectly evident that women, because of their good taste, imagination, ingenuity and intimate knowledge of home life, certainly have something to contribute to architecture."

A new course for women leading to the degree of Bachelor of Architecture is to be started which will include not only the design of buildings of a domestic character but also the decoration and interior of those buildings, simple landscaping of the entourage and training in the selection of the materials of decoration.

Servicing Furnaces Uncovers Jobs

HOW home service develops business was shown by a recent survey of a vacuum cleaner manufacturer of users of his machines doing furnace cleaning.

He found that out of 5,700 cleaning jobs performed the cleaners secured the following business: 1,938 smoke pipes installed, 624 grates, 693 new fire boxes, 116 new furnaces.

What if builders would really develop their sales ability along the same line!

New Catalogs Offered to Builders

79—"Which Wallpaper and Why;" a popular treatise on wallpaper and modern home decoration, by The Wallpaper Assn., New York City.

80—"Asbestos Hygienic Fireproof Flooring"; installation data from Franklin R. Muller, Inc., Waukegan, Ill.

81—"Quality from Stone to Finish," a portfolio showing the modern trend in decorative plaster walls, offered by The Woodville Lime Products Co., Toledo, O.

86—"The Architect's Green Book"; the opinion of American architects on the merits of Cabot's Collopakes; Samuel Cabot, Inc., Boston, Mass.

87—"How to Paint Concrete and Masonry Surfaces," 16 pages of practical information from Medusa Portland Cement Co., Cleveland, O.

88—"Builders' Hardware—General Catalog," presenting the complete line of the National Manufacturing Co., Sterling, Ill.

89—"Modern Hardware for Your Home" featuring the window, door and garage hardware of the Richards-Wilcox Mfg. Co., Aurora, Ill.

107—"A Portfolio on Modern Window Shading," featuring Tontine window shades; E. I. du Pont de Nemours & Co., Inc., Newburgh, N. Y.

108—"How to Drape Your Windows," a complete handbook on window drapes

and rods, by the Kirsch Co., Sturgis, Mich.

109—"Color Creations in Shower Curtains"; samples of the latest in waterproof fabric from C. A. Boyle & Co., Inc., New York City.

110—"A Real Home" equipped with non-rusting, copper and brass products; a 48-page handbook by the Copper and Brass Research Assn., New York City.

111—"Wolverine Indoor Toilet System"; sanitation information for rural homes, by The Dail Steel Products Co., Lansing, Mich.

121—"General Electric Refrigerators"; a full line of General Electric domestic and commercial electric refrigeration, by the General Electric Co., Cleveland, O.

139—"How to Use a Surveyor's Level," a 52-page handbook on the "Sterling," Convertible Wye Level and Transit and how to use it; the Warren-Knight Co., Philadelphia, Pa.

140—"Alpha Cement and How to Use It," an illustrated handbook of 112 pages by the Alpha Portland Cement Co., Easton, Pa.

141—"Ro-Way Garage Doors," presenting the six improvements offered by the Rowe Manufacturing Co., Galesburg, Ill.

142—"Victor Ventilator Specifications and Installation Instructions," how to get complete built-in kitchen ventilation at low cost, as recommended by Victor Electric Products, Inc., Cincinnati, O.

To get any of the above catalogs put down number or title and send this coupon to American Builder and Building Age, 105 West Adams Street, Chicago, Illinois.

.....

Name..... Business.....

Address

PRACTICAL JOB POINTERS

A reader's exchange of tested ideas and methods, taken from their own building experience. Two dollars will be paid for each contribution published.

Uses 2x12 Ridge Board

IN erecting Spanish type houses having tile roofs, a 1x6 board is usually placed between and flush with the backs of the rafters at the ridge and sheathed over as for a shingled roof. Then a 2x6 is set edgewise on the ridge and toe-nailed to the points of the rafters to support the ridge course of tile.

A very much easier method is to use a 2x12 s.l.s. for the ridge, allowing it to project the desired height above the roof to receive the ridge tile, and let the sheathing lie against its sides, as shown in the accompanying sketch.

As these roofs are usually a low pitch, this heavy ridge adds much to their strength, the rafters being well spiked into it, and insures a straight, excellent job.

L. M. HODGE, 4039 Edenhurst Ave., Los Angeles, Calif.

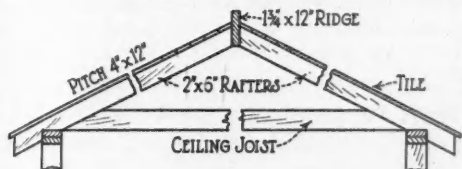

Extra size ridge board supports Spanish tile.

Tight Sheathing Joint

AM enclosing a drawing that shows how sheathing should be nailed on, so as to stop the draft from entering the cracks when put on a 45 degree angle.

I use a 1 inch by 2 inch strip, nail this on the sill even with the bottom, then fit the sheathing on to the top. This stops the cold air from entering between the walls. I have used this plan away back in the "eighties." All those I built for say it makes a much warmer house.

C. R. SCHULTZ, Menahga, Wadena Co., Minn.

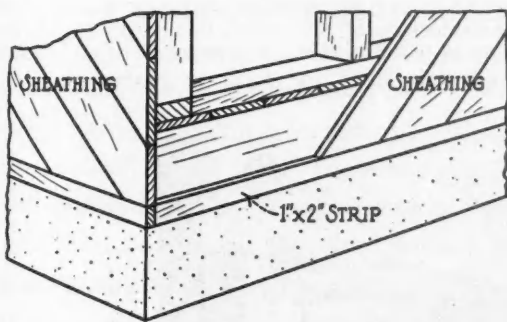

To make a tight joint at foundation line.

A Woman's Viewpoint

ALL mothers enjoy the use of a small balcony on the second floor, for instance, over your back porch where you can give "Junior" a sun bath or sun and air heavy bedding after he has had the measles. This is better than to carry things down stairs into the yard to sun.

Such a balcony adds very little extra cost, using a practically flat roof and a door instead of a window to enter.

Another important point is a permanent attic stairway, even though you say we can't spare the room in such a tiny house. By planning carefully, putting it directly over the main stairway to the second floor, it doesn't take up much room. Certainly it is worth it to the housewife.

After children have grown up and left a home, we often

would like larger rooms and wish we could take out a partition here and there. It is well to lay floors first and plaster walls, then put in the partition so it can be easily torn out and then the two rooms thrown together.

Mrs. E. F. SMITH, Abingdon, Va.

A Good Bin Idea

WHERE the owner has specified a recreation room in his cellar plans or where the builder in planning to construct his house with the added feature of a recreation room in the cellar, he can use to great advantage space underneath the enclosed or open porch for cold storage.

In an idea I used for an owner I excavated but half of the depth under the porch to that of the house, and graded this depth to meet the floor level of the house cellar floor. This graduation of the floor under the porch was funnel-shaped so as to provide a gravity slide for the coal. The doorway from the porch excavation to the cellar was provided when setting concrete forms for the house foundation. This doorway is divided, the upper part being on hinges and the lower part loose boards in a slide that can be lifted out if necessary. The lowest board which is provided for the slide merely needs to be lifted when coal is needed.

The advantages are obvious. More room in the cellar is provided for the recreation room, laundry or for any purpose. The funnel shaped floor of the coal bin forces the coal as it is used to slide toward the door hopper. Likewise, when coal is delivered, coal dust will not filter through the cellar or house.

HENRY D. NELSON, Queens, N. Y.

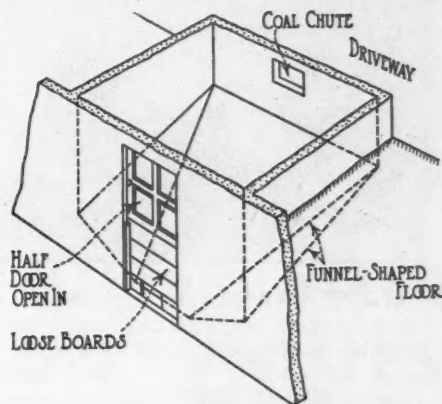

Gravity does the work in this sloping floor coal bin.

For Removing Flooring

ENCLOSED is a sketch of a very handy tool for removing old flooring, especially so when the old floor is to be used again for sub floor; it can be removed with very little breakage.

C. M. HUDSON, Eatonton, Georgia.

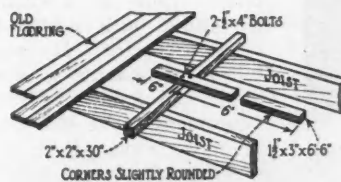

Wooden pry bar for floor work.

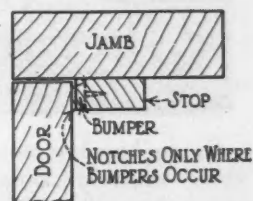

Rubber bumper for screens.

Deadens Screen Door Noise

A VERY cheap and effective method of sound deadening slamming screen doors is to use 3 or 4 ordinary small round rubber toilet seat bumpers. Cut notches into the door stop and drive the bumpers into these notches so that only the very tip comes into contact with the door, as the sketch indicates. Tools required are only a chisel and hammer and the total cost about two cents, with about ten minutes of time consumed for each door.

PHILIP KUTZ, 2548 S. Bronson Ave., Los Angeles, Calif.

What's New In Builder's Equipment

Brief reviews that help you keep up to date. For further data about any of these items write American Builder Information Exchange, 105 West Adams Street, Chicago.

DUSTLESS EDGERS—Two new dustless edgers—a belt-type and a disc type—have been announced by one company that are an important step forward in sanding equipment.

It is now possible with machines such as these to edge floors by electricity without getting dust in your face. An in-built vacuum system picks up all dust and makes the sanding operation clean and safe.

The disc sander-grinder is a fast, rugged machine that will smooth the edges of floors to a fine finish as fast as the sander can be moved. The 7 inch abrasive disc travels at 3200 r.p.m.

The belt type dustless edger consists of a 1½ inch front pulley covered with flexible rubber, idler arm support, and adjustable bumper to prevent marring. Use of a belt running over a soft roller is a new and important feature.



Machine works close up to wall. Absolutely no dust.

LIGHT CRANE—An improved crane that should prove useful in many ways on building jobs has recently been announced, and is of especial interest at this time when there is so much discussion of the use of heavy pre-fabricated units in home construction.

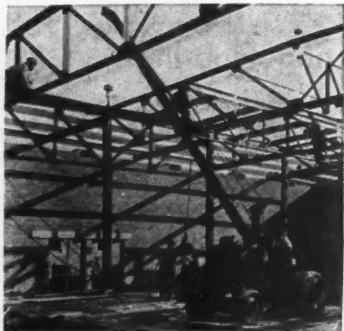

Crane handles materials on building job easily.

This crane, which has a capacity of 4500 lbs., has a wide variety of uses. It can be used as a stationary, revolving-boom crane, as a crane travelling with its load, or as a tractor. Its mobility, compactness, and ability to handle special equipment make it useful in many ways. It materially speeds up the building job and lowers labor costs.

It lifts and swings or carries loads to points where needed. It will load and unload trucks and cars, sort and pile stored material, lift rock, pipe, and heavy building materials. It is furnished with either a wheel or power mountings.

HIGH LIFT BULLDOZER—A new bulldozer with many important improvements of interest to contractors has been announced by a well-known manufacturer of this type of equipment. Outstanding features of the machine include the following:

An extra high 30" lift of the blade above the ground level.

A newly designed main frame and jack which enables the blade to be forced 16" below the ground level.

A double acting jack which forces the blade into the ground, or raises it out, in the hardest going.

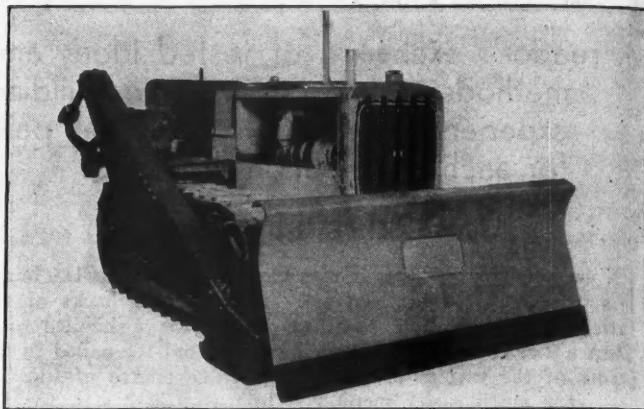

Improved bulldozer has extra high lift.

A unit with the blade placed close to the front of the tractor, and pump and controls all placed within the rear track line enabling the tractors to be used in close quarters with wagons, tampers, scrapers, etc.

A design which leaves the tractor drawbar entirely in the clear enabling the tractor to be used for hauling wagons.

A complete ground clearance when the blade is raised preventing the unit from high centering on the bulldozer frame.

NEW TYPE HANDY SAW—For those who prefer a direct drive saw to the belt driven unit, an old time manufacturer of combination woodworking machines has brought out a moderate priced, really portable machine capable of making any straight cut in wood cutting. It is also adaptable for cutting tile, brick, etc.

Saw is mounted directly on ball bearing motor, which travels on 3 tube slide, making for more perfect alignment and assuring absolute absence of vibration, while maintaining accuracy. Slide travels on ball bearings, making operation extremely easy and felt washers clean rods at every stroke. This construction eliminates all chances of dust collecting and hardening.

Crosscutting is done by the overhead method and ripping with saw beneath the table. Change from cross cutting to ripping or vice versa takes about 40 seconds. Saw or cutters can be placed at any angle either above or below table.

Two locking devices enable all angles, miters, double miters and adjustments to be easily and quickly made from in front of machine and dials allow for accurate gauging for any degree angle.

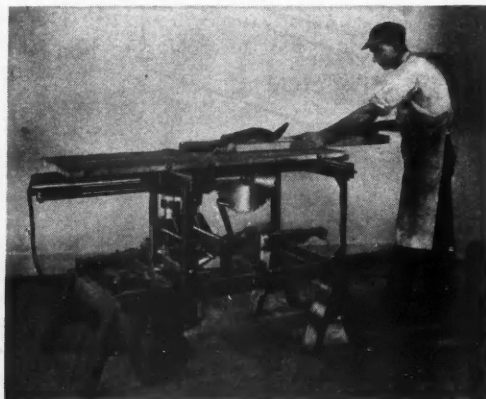

New portable woodworker has direct drive.

FAST MIXER—A higher speed truck mixer for both the contractor and the commercial concrete plant is being offered in 1 and 1½ cubic yard units mounted on a 1932 Ford chassis. The 1 yard unit is furnished for 132" wheel base and is driven direct from the truck engine. The 1½ yard unit is furnished with separate engine drive for 157" wheel base chassis. With the greater speed provided, these truck mixer units are ideal for express service use.

**NOW WITH
PRICES
ADJUSTED
TO THE
TIMES**



GENERAL MOTORS TRUCKS OFFER STILL GREATER TRANSPORTATION VALUES

Prices of practically all General Motors Trucks and Trailers—covering the whole range of transportation equipment—have now been completely adjusted in keeping with the present-day value of the dollar. Truck users in every line of business will instantly recognize the unusual significance of this fact. For years, General Motors Trucks have been established in every industry as outstanding values. Built to the most rigid standards, and embodying the latest mechanical developments, they have won the most enviable reputation for service, performance and over-all operating economy. And now, at these newly adjusted prices, General Motors Trucks and Trailers offer you an unusual opportunity to modernize your fleet with units which will decrease your costs and increase your profits from the day they are placed in service.

GENERAL MOTORS TRUCK CO., PONTIAC, MICH.
(A subsidiary of Yellow Truck & Coach Mfg. Company)

Time Payments Available Through Our Own Y. M. A. C.

Send booklet, "Cutting Distribution Costs with Motor Trucks"

Name _____

Address _____

Business _____ 20-F

FOR THE LIBRARY

**GENERAL
MOTORS
TRUCKS
AND TRAILERS**

THE RIGHT TRUCK FOR EVERY RUN—1½ TO 20 TON

True Silvery Grays Like Old Weathered Shingles in a Few Months With these Stains



New residences at Devon, Pa. Owners and builders, Schroder & Wood. Architects, Tilden & Register. Cabot's Creosote Shingle and Wood Stains on roofs and sidings.

YOU can secure the beautiful silvery gray tones seen on very old shingles at the seashore on new shingles, and in a few months. Cabot's Creosote Bleaching Oil No. 241 Shingle and Wood Stains produce this effect. The first results are a variegated warm gray color, which gradually turns to a permanent silver sheen. . . . Whatever color you wish in a natural wood finish, Cabot Creosote Shingle and Wood Stains will give it to you, without painty surface film, and at low cost. The refined creosote vehicle, best wood preservative known, preserves the wood from decay and makes it last years longer.

Send coupon below for color card and full information.

Cabot's Creosote Shingle and Wood Stains

Made by the makers of Cabot's Creosote Stained Shingles and Cabot's Collophane—Modern Scientific Colors for all Paint Uses.

Samuel Cabot
INC.

141 Milk St., Boston, Mass.

Gentlemen:

Please send me Color card of Cabot's Creosote Shingle and Wood Stains.

Name

Address

Am.B. 6-32

What's New in Builder's Equipment

HOME WORKSHOP—A well-known manufacturer of woodworking machinery, in announcing new products in his line, describes the popularity of the home workshop, such as is illustrated below. Such workshops are of special interest to builders at this time because they offer an opportunity for making of handicraft articles of various kinds that will enable him to develop a side-line while regular building work is slack. This interest is being reflected by the fact that many lumber dealers are now acting as distributors of such machines.

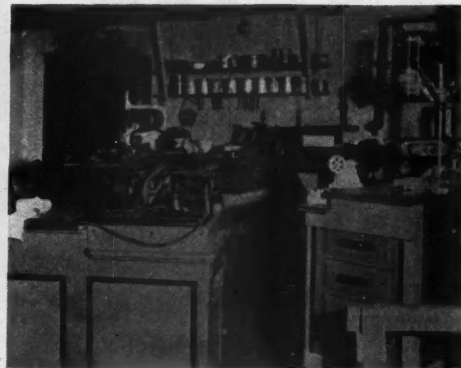

New additions to woodworking line make home workshops like this popular.

MIXER WITH HOIST—A new hoist for truck mixers which raises the mixer eight feet from the ground for a greater delivery and spouting range is interesting builders. It is a hydraulic hoist fitted to the rear end of the truck chassis. The lifting effort is exerted directly against the load to raise the drum the desired height. The cost of the concrete in the forms is often cut from 25 to 50%.

From the height of eight feet the concrete can be spouted over an area approximately 75% greater than heretofore. Sidewalks can be poured across parkways without wheeling. Building foundations and walls can be chuted even when the truck cannot get within ten to twenty feet of the hole. The hoist raises the drum high enough to discharge into a three-yard hopper. The flow of concrete can be regulated easily by the operator from a slow trickle to a full discharge by a simple turn of a handwheel. Though the mixer is raised at a considerable angle, the drum empties itself cleanly and thoroughly.

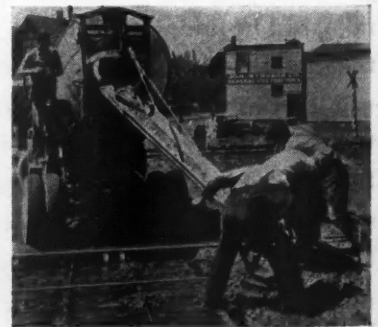

Hoisting attachment lifts mixer 8 feet and greatly increases spouting range. Usefulness of machine in building work is greatly increased.

REMOVES AIR MOISTURE—A new chemical product that extracts moisture from the air rapidly and efficiently is of interest in connection with air conditioning. Warm, moist air, laden with dust and obnoxious odors, is drawn through a fine spray of water, where it is washed and cooled, and then passed over a bed of this chemical, which delivers it cooled, dry, and odorless.

It is said that with a small unit designed to serve only one room in a house it will be possible to relieve sufferers from asthma and hay fever by insuring them a night of restful sleep in air free from dust and bacteria.



LOOK AT THE DIFFERENCE

Recognizing that an integral water-proofing material in the mortar helps prevent leaky walls, efflorescence and fading of colors, a compound of the highest water-resisting quality is mixed with Brixment during manufacture—thoroughly, intimately and in the most effective proportion. So when Brixment is used for mortar, it saves the expense of buying a water-proofing compound and eliminates the necessity of constant supervision at the mortar box to see that it is added in correct proportion. The above picture shows the unusual water-repellent quality of Brixment in comparison with other cements.

LOUISVILLE CEMENT COMPANY, *Incorporated*, LOUISVILLE, KY.
District Sales Offices: 1610 Builders Bldg., Chicago; 600 Murphy Bldg., Detroit; 101 Park Ave., New York
Mills: Brixment, N. Y. and Speed, Ind.

BRIXMENT

A Cement for Masonry and Stucco



WHEN WRITING ADVERTISERS PLEASE MENTION THE AMERICAN BUILDER AND BUILDING AGE

What's New In Building Products

For further data about any of these items write American Builder Information Exchange, 105 West Adams Street, Chicago.

INSULATION GLASS—The increasing use of large areas of glass in homes, apartments, and other buildings has brought about a demand for glass that will not allow passage of heat. Such a glass has been recently announced. This new product consists of two layers of glass separated by $\frac{1}{8}$ to $\frac{1}{4}$ inch air space, which is occupied by dehydrated air. It is claimed that this form of construction reduces heat loss through glass 40 to 63 per cent.

The possibilities of the new product are readily apparent. It produces a frost and moisture-proof window and permits a higher humidity inside the house with less condensation on the inside of the glass. It will play an especially important part in air conditioned homes and buildings by preventing passage of either heat or cold.

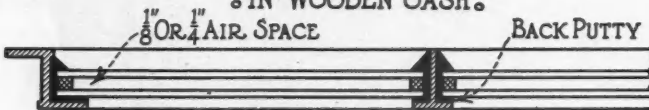

How insulation glass is installed in frames.

METAL-FACED CONCRETE—One of the most interesting of new building products is a light-weight, concrete building unit faced with metal which is coming into wide use for spandrels, pilasters, belt-courses, coping, and inserts.



Attractive use of light-weight units faced with metal.

the facilities for handling on the job. Weight is about 100 lbs. to the cubic foot.

GLASS-WOOL AIR FILTER—An important contribution to clean homes is a new air filter of glass wool recently announced for use with air conditioning appliances. It is a complete, self-contained air filter unit, in which the scientifically treated glass wool serves as the filtering medium. The device is simple of design and so low in price as to make replacement possible when dirty.

This air filter unit is of unique design in several respects. The container is of paper, which adds to its lightness and renders it readily disposable. While it weighs but two

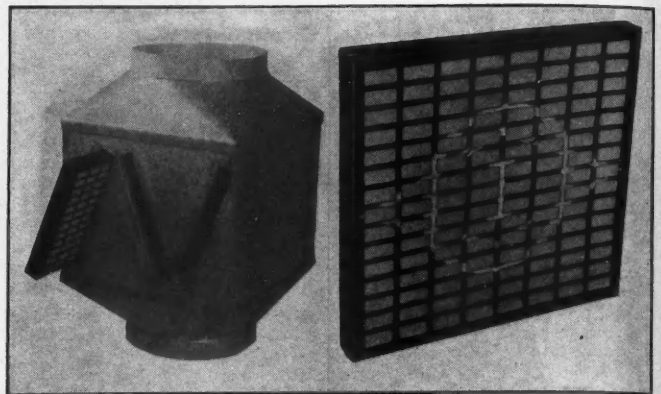

This glass-wool air filter absorbs dust in excess of its own weight.

pounds, it will absorb dust in excess of its own weight. The flexibility of the paper container establishes a tight seal between the filter and the metal frame into which it fits, thus preventing the passage of any unfiltered air around the unit.

The filter is 2" thick. When a standard 4" pack is established by using two units in tandem, or two units placed face to face, it is only necessary to change one-half the thickness of the total pack at one time. It is of very low resistance and is efficient. Two units in tandem will remove 99 per cent and more of the dust from the air.

AUTOMATIC STOKER—Rated at 950 square feet of steam radiation and with a maximum coal feed capacity of 40 pounds an hour, a new automatic household stoker is being offered at the lowest price ever placed on underfeed stokers by the company.

A thermostat and stokerswitch are included as standard equipment. The latter control is of special advantage in mild weather and is actuated by the chimney temperature to prevent the fire from going out regardless of the action of the thermostat.

Multiple feed control is provided, giving the user the advantage of being able to vary the amount of coal in any degree from one pound to the maximum of 40 pounds an hour. The air likewise can be regulated to comply with the requirements of the fuel. The construction of the fan damper automatically shuts off all air when the stoker is not running, yet resumes its correct position when the flow of air again begins.

An auxiliary air inlet to the feed tube prevents the possibility of gas, fumes or smoke coming from the hopper into the basement. In addition, the hopper has a fitted cover for further cleanliness. The overall height of the hopper is only 34 inches, while the mouth is four inches lower for convenient filling. All moving parts are fully enclosed.

Special care has been devoted to providing for easy and rapid installation. In the average warm-air furnace the installation can be completed in three to four hours' time. The air chamber is an integral casting with the fire-box parts, giving an air-tight installation without the necessity of sealing the fire-bowl and casing. The installation can be made from either the front or side of the furnace.

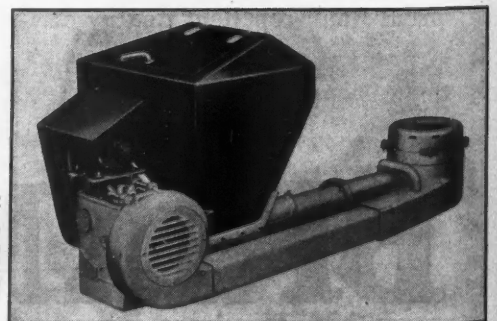

New automatic stoker especially designed for household use.

The **END**
of an Eclipse that lasted
HUNDREDS of YEARS

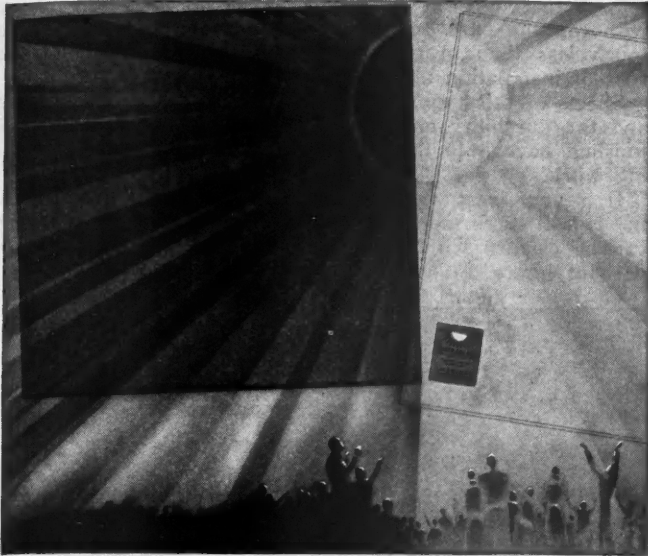

NO longer need you tolerate that greenish cast which is characteristic of ordinary window glass.

For centuries, scientists realized that the greenish cast in glass for windows impeded the transmission of sunlight. Now, after hundreds of years of unsuccessful attempts to remove this very objectionable color comes Lustraglass—practically free from green—the whitest of all glass made for windows. It transmits more daylight and a substantial amount of the shorter (more valuable) ultra-violet rays of sunlight, yet, with all its many extra advantages, it costs no more than ordinary window glass. Naturally, Lustraglass has the preference of architects and builders everywhere. If higher quality, more brilliant lustre, and increased transparency are important factors to be considered... if they can be had at no extra cost... Then there can be no reason for writing anything less than Lustraglass into a specification... You will be interested in our booklet A-430... it's yours for the asking. Write today for your copy.

AMERICAN WINDOW GLASS COMPANY
 FARMERS BANK BUILDING PITTSBURGH, PENNA.

Also makers of Lustrawhite Picture Glass, Armor-Lite Safety and Bullet-Proof Glass, Tintaglass, Photographic Dry Plate Glass, 1/16" and 1/32" Crystal Sheet Glass, Ground, Chipped, Bulb Edge Glass.

L U S T R A G L A S S
the ultra violet ray window glass

FOR ADVERTISERS' INDEX SEE NEXT TO LAST PAGE

INSULATE
with
U. S.
MINERAL WOOL

- COLD PROOF
-
- HEAT PROOF
-
- FIRE PROOF
-
- SOUND PROOF
-
- VERMIN PROOF
-



The roof of a dwelling, as a general rule, is the most poorly protected part of the building.

In Winter a large percentage of expensive heating escapes through it and in Summer the sun rays beating down on its slight protection causes hot, stuffy, almost unliveable top floor rooms.

Insulation with U. S. Mineral Wool repels outside Summer heat as strongly as it retains inside Winter heat.

By lining the attic of a building with it you not only save approximately 25 to 35% on Winter fuel expense but have the comfort of livable upper rooms made many degrees cooler by this most effective of insulating materials.

The nominal installation cost will be saved on fuel expense alone in a short period and delightful living comfort added to your home.

Sample and illustrated folder on request.

U. S. MINERAL WOOL COMPANY
 280 Madison Avenue New York

*Western Connection
 Columbia Mineral Wool Co., South Milwaukee, Wisc.*

U. S. MINERAL WOOL CO., DEPT. B.
 280 Madison Ave., New York

Send FREE sample and illustrated booklet to

Name.....
 Address.....
 City..... State.....

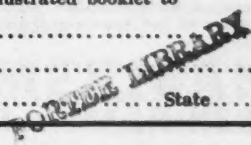

CONTRACTORS and LUMBER DEALERS

*Dont Miss a Single Word
of this Ad!*

An entirely new field for generous profits is now open for the lumber dealer. A host of good paying jobs are now available for the contractor. All made possible by a unique plan created by the Clarke Sanding Machine Company—a plan that has proved phenomenally successful throughout the country.

The big "push" for remodeling is on. And there'll be thousands of floor sanding jobs—jobs that will bring in generous profits for every lumber dealer and good pay for every contractor that follows the Clarke plan.

In this day of lowered sales and small margins no dealer can afford to overlook this unique and remarkable source of attractive extra profits. And get this, contractors—you can handle these jobs *without investing one cent in equipment.*



Contractors and Dealers—

Write for complete details without a moment's delay. Use the Coupon.



Clarke Sanding Machine Co., Dept. A16, Muskegon, Michigan.
Please forward at once complete details regarding your plan advertised in the June issue of the American Builder.

Name.....
St. Address..... City.....
Firm Name..... State.....

What's New in Building Products

WAINSCOT MATERIAL—A new type of laminated phenolic sheet is available for wainscot in which the base-board and cap moulding are integral with the sheet. The wainscot shown below was produced by cementing 1/16 sheet directly to smooth plaster. The sheets were made for this purpose with borders of various widths in black.

In actual use this produces the effect of wall paneling with cap and base. The cost of the material is said to be much less than in the conventional construction and the cost of installation also less.

Sheets of this type, because of the many attractive colors and the durability and beauty of the high gloss and satin finishes, have been finding a wider and wider use in building work.

It is very inert, and very few liquids have any effect on it. It will stand mopping and washing for long periods and can be cleaned with alcohol, gasoline and similar solvents without injury.

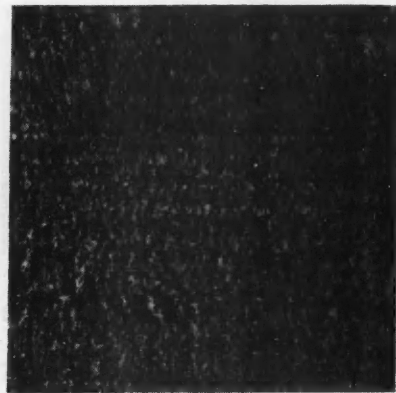

New composition product has wide range of building uses. Is strong, attractive and resists wear, acids, abrasions.

NEW CLEANING VALVE—Announcement is made of a new positive, two-way cleaning valve, designed for installation in connection with any hot water supply system to make easy the important job of keeping tank, piping, and heater clean.

Unlike the usual drain cock, this two-way valve cleans first one side of the system and then the other. Turn the handle a square turn to the right and then to the left, and all loose sediment and rust will be washed out. When the valve handle is pointed straight up and down, a full flow through circulating lines is provided.

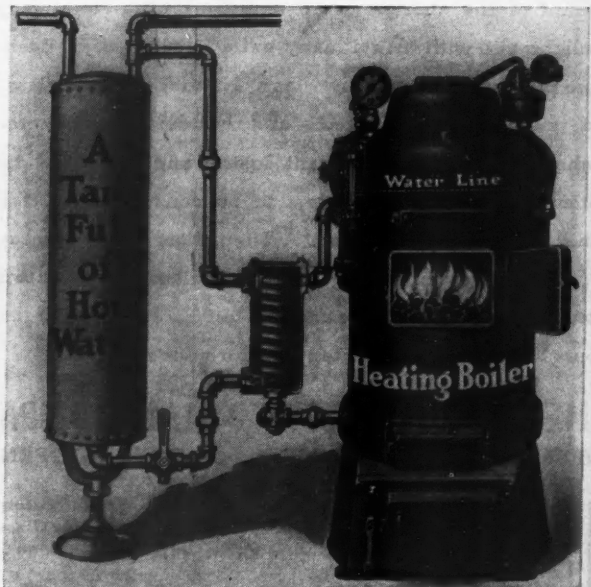

The cleaning valve is the important point of this picture. It simplifies an old and troublesome problem for homeowners.

AMERICAN

STEEL SHEETS for EVERY PURPOSE



High Grade Sheets and Terne Plates adapted to all modern Building Construction Uses—
Roofing and Siding, Gutters, Spouts, Eaves Trough, Flashings, Ventilators, Terne Roofs,
Heating and Ventilating Systems, and all general sheet metal work.

KEYSTONE COPPER STEEL gives Maximum Service and Rust Resistance

This Company manufactures a complete line of Black Sheets, APOLLO Best Bloom Galvanized Sheets, Galvannealed Sheets, Heavy-Coated Galvanized Sheets, and Sheets for Special Purposes; also KEYSTONE Rust Resisting Copper Steel Sheets.

USS
STAINLESS
Steel Sheets and Light Plates

AMERICAN Roofing Terne Plates and Long Terne Sheets are widely and favorably known to the building and roofing industries. Leading metal merchants sell these products, or can procure them for you. Write for literature and information.



American Sheet and Tin Plate Company

GENERAL OFFICES; Frick Building, PITTSBURGH, PA.

SUBSIDIARY OF UNITED STATES STEEL CORPORATION



AMERICAN BRIDGE COMPANY
AMERICAN SHEET AND TIN PLATE COMPANY
AMERICAN STEEL & WIRE COMPANY
CARNEGIE STEEL COMPANY
Pacific Coast Distributors—Columbia Steel Company, San Francisco, Calif.

PRINCIPAL SUBSIDIARY MANUFACTURING COMPANIES:
COLUMBIA STEEL COMPANY
CYLONNE FENCE COMPANY
FEDERAL SHEET PILING & DRILL PIPE CO.

ILLINOIS STEEL COMPANY
MINNESOTA STEEL COMPANY
NATIONAL TUBE COMPANY
Export Distributors—United States Steel Products Company, New York, N. Y.

OP. WELL SUPPLY COMPANY
THE LORAIN STEEL COMPANY
TENNESSEE COAL, IRON & R.R. COMPANY
UNIVERSAL ATLAS CEMENT COMPANY

EDWARDS



Metal Spanish Tile and Shingles

FROM first glimpse to last look Edwards Metal Spanish Tile and Shingle Roofs make favorable selling impressions. Cost less to buy and to lay. Lower insurance rate and upkeep. No extra roof structure needed. Fire, lightning, wind and weather proof. Made in galvanized steel or terne plate (tin), copper bearing steel, zinc or copper.

Get our quotation on your next job.

THE EDWARDS MANUFACTURING CO.

642-662 Eggleston Ave.

CINCINNATI, O.

World's leading manufacturer of sheet metal building materials.

MONARCH VARIETY WOODWORKER

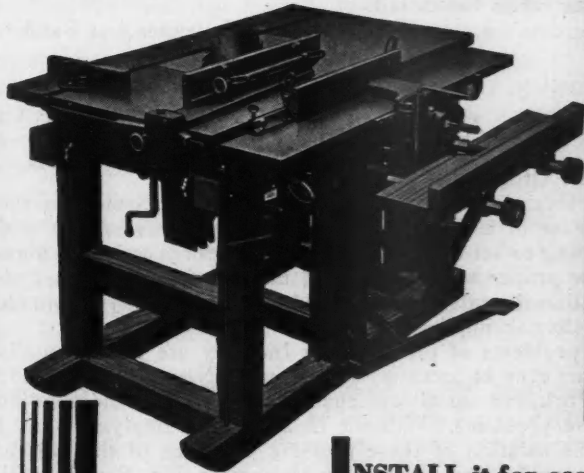

INSTALL it for economy and efficiency. Does the work of four ordinary machines—cut off and rip saw with boring attachment, mortiser and jointer. Enjoy the benefits of this famous machine which four men can use at once.

Send for descriptive booklet and 1932 prices on our complete line of woodworking and saw mill machinery.

AMERICAN
SAW MILL MACHINERY CO.
60 Main Street Hackettstown, N. J.

LETTERS from Our Readers

You are invited to write your views on any subject of interest to the building industry. 300 words should be enough!

Endorses "Joy Riding" Editorial

Warren, Minn.

To the Editor:

The scales shown on page 19 of your May issue (contrasting home owning and auto driving) caught my attention and caused me to read that article first. When reading papers and magazines I underline with a red pencil any statements that coincide with my views and also statements that contain information useful for future reference. After reading this article, I found that there had been so many things that agreed with my views that I decided to read it again and continued to mark as before. By the time the second reading was done the pencil marks on pages 19, 20 and 21 were so numerous that they showed up as much as the printer's ink.

I have been at housebuilding since 1899. In the small towns and adjacent country the work is mostly done by small contractors. When you state that "the automobile has become the fetish of the American people" you express my views to the dot, and I have seen too often how money has been used up for autos when the auto-fiend could not pay his grocery bills or his house rent, much less build a home of his own.

Small contractors seldom make enough money to afford an auto, though most of them have one or more. On one of my jobs I had a man to help me who had also done some contract work, and he said that the auto he then had was his ninth!

This part of the country would have been prosperous today if the auto and tractor had never been invented, and I have often so expressed myself. It was during the war that so many dealers lost their heads and sold goods right and left on credit to people that never should have been trusted; and now both dealer and customer are broke. Business people have gone broke because their customers are unable to pay, banks go broke because the business people fail, depositors go broke when banks fail.

C. H. LINDBERG, Carpenter and Builder.

A Complete Answer

Saint John, N. B., Canada.

To the Editor:

The seven questions proposed by Mr. G. Szmak in the April issue of the AMERICAN BUILDER AND BUILDING AGE and purporting to set forth what the public desires to know, hints that the proper answer may end the depression. 'Tis a consummation devoutly to be wished. If it were only as simple as Mr. Szmak implies.

The problems of the Building Industry are fundamentally the same even in localities as remote as New Brunswick and New York and we all are equally interested in the solution of these problems. Without in any sense implying that I have the solution of these pressing problems of the present time I would like to attempt to answer Mr. Szmak, with apologies, for the lack of brevity involved.

(1) Why should we build while radical fluctuations in market values exist?

It is obvious that on a rising market the builder is not handicapped by the enhancement in value which occurs even in the relatively brief period of construction. There never was a fundamental problem, for the builder, created by rising market values, but, the protracted decline in values such as we have experienced in the past few years has created problems in building and building financing just as it has created problems in all other businesses. Building during the decline in values must be on a sound basis as far as return from the property is concerned—and this requirement covers demand for the particular construction, desirability, per-

manence and other factors. Speculative building has probably suffered most and it is not strange that it should, when the abuses practiced are submitted to analysis in the cold light of fact rather than through the rose colored spectacles of the speculator. Anticipating the sane requirements of the next decade, it is patent that the prevailing low costs of construction would indicate the present as the opportune time to do much construction with ultimate profit far greater than that made on work done a few years ago. The fact that little or no profit is being made on commodities at prevailing commodity prices indicates that the current level of costs is the lowest that can be "maintained" and therefore the next swing of the pendulum will be upward.

Disregarding certain theories currently advocated it remains axiomatic that prosperity is founded broadly on the need of business to be profitable to those who carry it on—and this applies equally to the individual or the group, the workman and the business man—and the right of adequate security and return on invested capital.

(2) What is being done to stabilize construction values?

The answer here I think is—little or nothing—and I believe that little or nothing of a constructive nature can be done to "artificially" stabilize values which are dependent on a multitude of elements which in turn are affected by factors which are not conceivably subject to stabilization.

The writer presumes that Mr. Szmak's plea for stability implies regulation to prevent shrinkage of value (but not of cost if he is a builder); but does he go so far as to suggest regulation to prevent enhancement of value which is what makes the purchase or construction of property attractive? Mr. Szmak is rather naive if this interpretation is correct.

An explanation of the functions of a "Construction Survey Co." might assist in an analysis of the problems which appear to be consuming Mr. Szmak.

(3) What assurance do the buyer and investor have that they will receive the right economic value for the money if they do buy?

A proper answer to this question would apply equally to building buyers and to the buyers of any other commodity. If an individual purchases a home he does so influenced by his taste, his requirements and his purse. If he wants technical advice as to the intrinsic value of the structure, he can purchase such advice but his decision will probably be based on the first three rather than on the intrinsic value.

If the transaction is considered from the viewpoint of investment only the buyer or investor is guided by factors of cost and return which he analyzes or has analyzed for him and the cost or investment is regulated by the indicated return.

The question constitutes a suggestion of the need of regulation which would be entirely contrary to usages on which all business is founded.

(4) What is the sound basis on which to buy construction?

This has already been answered in the reply to question No. 3. It might be pointed out, however, that the unduly high construction costs of a few years ago constituted of themselves an unsound condition the folly of which has been adequately demonstrated since. The prevailing low costs create the opposite condition and, with the return of sanity in our outlook the factor of low cost will furnish the needed stimulus to construction activity.

(5) Is there a positive yard stick for the construction buyer and investor, and what neutral source of cost information concerning the relative value of construction work is available?

There is no such positive yard stick and if such an instrument is ever devised its application to any business would create chaos, inasmuch as it would be attempting to circumvent the law of supply and demand. I believe such a

(Continued to page 64)

Can YOU figure houses like this

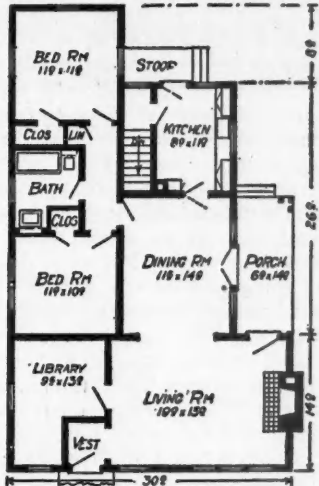
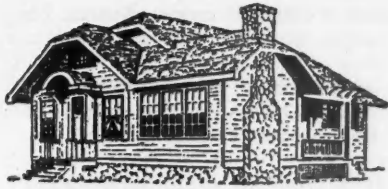

IN **5** MINUTES
and then answer ANY ?
question almost instantly ?

Questions like these—

How much more if the front bedroom projects 2' so it is 13' x 10'?—if it projects 3'?—if the rear bedroom projects 10' instead of 8'? What will be the difference in cost if the living room projects 2' more or less?—if the whole house is made 2' wider?—in fact, ANY QUESTION about ANY HOUSE.

YOU CAN—

When you have "Holt's Rapid Estimator," the new vest-pocket edition of "Automatic Building Costs," which has been proved to be *absolutely reliable* in every state by more than 4,000 live-wire men who know that this is the age of speed—shortcuts—keen competition.

BE THE BUILDING AUTHORITY IN YOUR COMMUNITY

Get this little "wonder" book—read it ONE evening—use it the next day—no more study required—simply use it to get PROFITABLE business every day at YOUR prices for ANY material and ANY wage scale NOW or at ANY time the rest of your life.

AMERICAN BUILDER AND BUILDING AGE
30 Church Street, New York

Send me "Holt's Rapid Estimator" AT ONCE and I will pay the postman its FULL price of \$3.00 on your promise to refund every penny if I am not fully satisfied.

Name

Address

(Please print or write plainly)

PERFECT CURVED ARCHES

made easier—quicker this new inexpensive way



The No. 11 True Circle Arch. Two pieces to the set.

Red Top Metal Arches are easily and quickly erected over any type of lath. They provide perfect curves economically in True Circle, Gothic and Elliptic designs.

FORM perfect curved arches with an ease and speed you never thought possible. That's exactly what Red Top Metal Arches now permit you to do. Builders who use them once rarely go back to slow, troublesome methods.

Red Top Metal Arches are ready-formed. You simply nail them over any type of lath and your arch is perfect, symmetrical, ready for the plasterer. You save the bother of constructing curved wood forms and forming corner beads. The result is an arch that is far more satisfactory and less expensive than one built-in-place on the job.

Made from "Galvannealed" steel, Red Top Metal Arches come in True Circle, Gothic or Elliptic designs. Six standard sizes permit you to form arched openings up to 6 ft. wide. Where necessary you may combine different units to meet special architectural requirements.

Your dealer in lumber or building supplies will gladly show you how these ready-formed arches will help you. See him today. Or write to us for free booklet that contains complete details. Please address the United States Gypsum Company, Dept. AB-6, 300 W. Adams St., Chicago.



FREE BOOKLET Mail Coupon Today

UNITED STATES GYPSUM CO.,
Dept. AB-6, 300 W. Adams Street, Chicago.

Without charge or obligation please send me your free descriptive booklet on Red Top Metal Arches.

Name

Address

City

RED TOP METAL ARCHES

Manufactured under license of Merryweather patent No. 1782147 granted November 18, 1930

WHEN WRITING ADVERTISERS PLEASE MENTION THE AMERICAN BUILDER AND BUILDING AGE

8 REASONS WHY!

"Over-the-Top" Door Equipment offers the most revolutionary improvement in garage door operation since garages came into existence.

- Lifts the doors, up out of the way.
- Easily operated by women and children.
- Applicable to OLD or new doors.
- Quickly installed—no costly fitting.
- Never needs adjustment or servicing.
- Weather-tight—no snow or ice worries.
- For doors varying from 8' to 18' in width and 7' to 12' in height.
- Priced within the reach of every purse.

Contractors — Builders! The dealer in your community will gladly share profits with you on equipment you sell. Write for more information.

FRANTZ MFG. CO.
Sterling, Ill. Dept. AB



Over-the-Top Door Equipment

Contractors MAKE REAL MONEY AGAIN

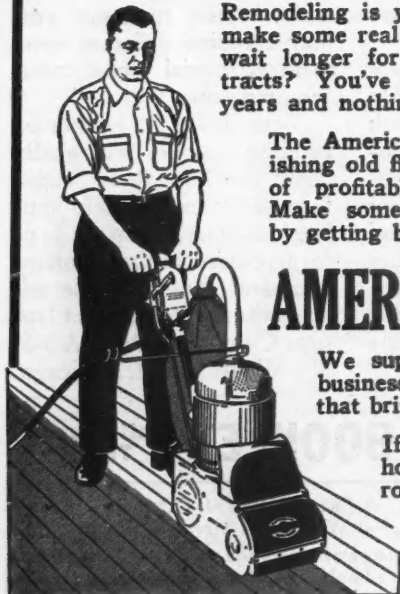

Remodeling is your only chance to make some real money again. Why wait longer for new building contracts? You've already waited two years and nothing has happened.

The American Method of refinishing old floors opens up a lot of profitable work for you. Make some real money again by getting behind an

AMERICAN Floor Sander

We supply free cards and business getting circulars that bring you the business.

If you want to learn how to get the money rolling in again—fill out and return coupon below. No obligation.

The American Floor Surfacing Machine Co.
511 South St. Clair St., Toledo, Ohio.

Without obligation tell me how I can make some real money.

Name

Street

City State

LETTERS from Our Readers

(Continued from page 64)

"stick" has been evolved in Soviet Russia, but it necessarily disrupts the usages to which we have become accustomed in business affairs.

There can be no really "neutral source of cost information" as the most authoritative cost data is secured by competitive bidding on ordinary construction. For the uninitiated prospective purchaser it is suggested that he must rely largely on advice from an authoritative and reliable builder to whom he can submit his problem. This species is not yet extinct, all opinions to the contrary.

(6) Will the taxes continue to soar to uneconomic heights?

Irrespective of what taxes are referred to by Mr. Szmak, the answer is yes, as long as Governmental expenditure continues to mount. We have arrived at the unhappy stage wherein we demand things we are not willing to pay for; we subsidize, in one way and another our transportation systems, our agriculture, our industry, yes, even our artificial scale of living and then groan aloud when the cost of the subsidy comes home to roost. We were insane to imagine any one else was going to bear our share of it. The temptation to moralize is almost irresistible but let us pass on to the next question.

(7) Why can't we borrow money without being crucified with unreasonable guarantees and high finance rates if the construction involved has sound economic value?

If the sound economic value can be vouched for evidently Mr. Szmak had answered No. 3 and No. 4 to his own satisfaction and had found the yard stick which he mentions in question No. 5. Permit me to be skeptical and to point out that money and, more fundamentally, credit are the shyest and most timid of commodities. If both had not been repeatedly crucified (I prefer the term abused) they would not be in hiding at the present time. Even the candied proposals of well meaning and highly organized propaganda fails to entice them out of their retirement. When the readjustment is complete, or goes as far as it may, the opportunity for adequate return with security will operate to put credit in circulation again and building construction, together with all other business, will start the long climb to normalcy.

I probably have given Mr. Szmak nothing which will directly "enable us to help encourage construction activities," but, if there is anything of value in the writer's analysis, the answers given may bring us a little closer to a true appreciation of just what does ail the construction industry in common with all industry and this, after all, is perhaps "what the public desires to know."

JOHN N. FLOOD,
Contractor and Engineer.

Wants Column and Stair Details

New Kensington, Pa.

To the Editor:

It would please me to see the old time lessons on the construction of columns and their details, and followed by modern stair rails. There are few of the old carpenters that have the proper knowledge to set columns, and the younger men must depend on the journals to teach them. Of late I have seen some awful bumbles in both columns and stairs by those who are would-be carpenters, and the best to be had. The architect either is negligent or lacking in knowledge of the proper detailing of these structural parts. There is nothing that so disfigures a building as a bungle in the trim.

The old "Noon Hour Talks" on stress and strain and figuring structural members was also a good subject. It is the technical end that interests young builders, more so than the older ones. Many a good lesson have I learned from a builders' journal, or some technical journal.

M. J. ZELLEFRON.

Qualitybilt DISAPPEARING STAIRWAY

You can make many profitable sales installing this quick, sure selling convenience in old or new homes. Guaranteed construction—strong—safe—rigid. Nicely balanced for quick, easy operation. Highest quality materials. Lifetime service. Low cost. Gives full use of attic without taking up valuable room below. Stored in attic when not in use.

Ask your lumber dealer or write us for complete details.

2 MODELS
AB 532

FARLEY & LOETSCHER MFG. CO.
DUBUQUE IOWA ESTABLISHED 1875

Edge Floors Faster

NEW Porter-Cable Dustless (96%) Edger revolutionizes floor edging. No longer necessary to hand scrape. Finishes right up to baseboard faster and leaves better finish. Varnish no handicap. One floor contractor says, "Very well satisfied with your E-7, for sturdiness and dependability it can't be beat. Every floor man ought to own one." (He is making money on jobs others won't touch.) This is what you have been looking for. Make us prove it by demonstrating. Write today!

Also New Speedmatic Floor Sanders, Electric Saws, Belt Sanders, Woodworkers, etc.



PORTER-CABLE-HUTCHINSON CORP.
1721 North Salina Street Syracuse, New York

Beautiful Brick Effects

deserve

Anchor Brand Mortar Colors

C. K. Williams & Co.
634 No. 13th St. EASTON, PA.
88 Kent Ave. BROOKLYN, N. Y.
and
1500 So. Western Ave. CHICAGO, ILL.

"DAHLQUIST"

NOW—
Clean fresh hot water
for DRINKING—COOKING
The TURBO-AQUATHERM
U. S. Patent No. 1768215

A Dahlquist automatic storage system equipped with this device offers the buyer something entirely new. A water heater that quickly supplies hot water which is always as fresh and clean as that in the cold water lines and which may be safely used for drinking and cooking as well as for every other household purpose.

Accumulation of sediment or stale water in the boiler is automatically prevented and the danger of burnouts as with other systems completely eliminated. The thermal efficiency is greatly increased and the expense for fuel as a result is lessened. Write for complete details.

DAHLQUIST MFG. COMPANY
10 West 3rd Street, So. Boston, Mass.

KAUBLE of IOWA

made \$1,980
In Spare Time

IF YOU WANT TO TURN YOUR SPARE TIME INTO PROFIT—start a mfg. business of your own or add to your present line—investigate Colorcrete. In addition to Kauble learn how O'Shea of Pa. made \$780 with 2 molds, and Crockett of Texas \$1231, etc.

WITH A FEW MOLDS you can supply your territory with smart permanent Pottery, Vases, Flower Boxes, Bird Baths, Garden Seats, Flagstones, Porches, Fireplaces, Brick and Tile. Colorcrete makes them in 30 colors, tints, and shades,—beautiful pieces of art that sell on sight.

THERE'S BIG MONEY FOR YOU making these attractive designs. Most of them sell for 6 times cost to make. Start in basement, garage, or any vacant space.

EQUIPMENT SHIPPED ON 15 DAYS' FREE TRIAL with complete Manual of Instruction on ornamental products manufacture. Send for catalog and data to-day. Big introductory discount for limited time.

COLORCRETE INDUSTRIES INC.
500 Ottawa Ave. Holland, Mich.

for Range!

29 distinct cutting operations in lumber, tile, brick and metal.

Write for full particulars of the most modern development in power cutting methods.

DEWALT

MACHINES CUT WOOD—METAL—STONE

Products Corp.
216 Fountain Ave., Lancaster, Pa.

Classified Advertising

RATES:
Small letters 50c per word.
Capital letters \$1 per word.
Minimum twenty words.

Business Opportunities
For Sale and Exchange
Help and Situations Wanted

To Insure Insertion Remittance Must Accompany Order

WE MAKE A SPECIALTY OF JOB TICKETS, TIME SHEETS, Letter Heads, Envelopes, etc., for Builders. Prices include delivery to Eastern Points. Samples mailed. Address LOUIS FINK & SONS, Elm Avenue, Laurel Springs, New Jersey.

Period Mantels Bring Profit

THERE are more than 60 different Period designs of Columbia Wood Mantels with which you can make extra profits in both new and modernization work. The fine cabinet work of these mantels adds more charm to your fireplace treatments and they cost very little more than makeshift imitations.

Write us today for the Columbia Wood Mantel book—in it you will find authentic designs for every requirement.

The BRECHER CO. Inc., 443 W. Jefferson St., Louisville, Ky.

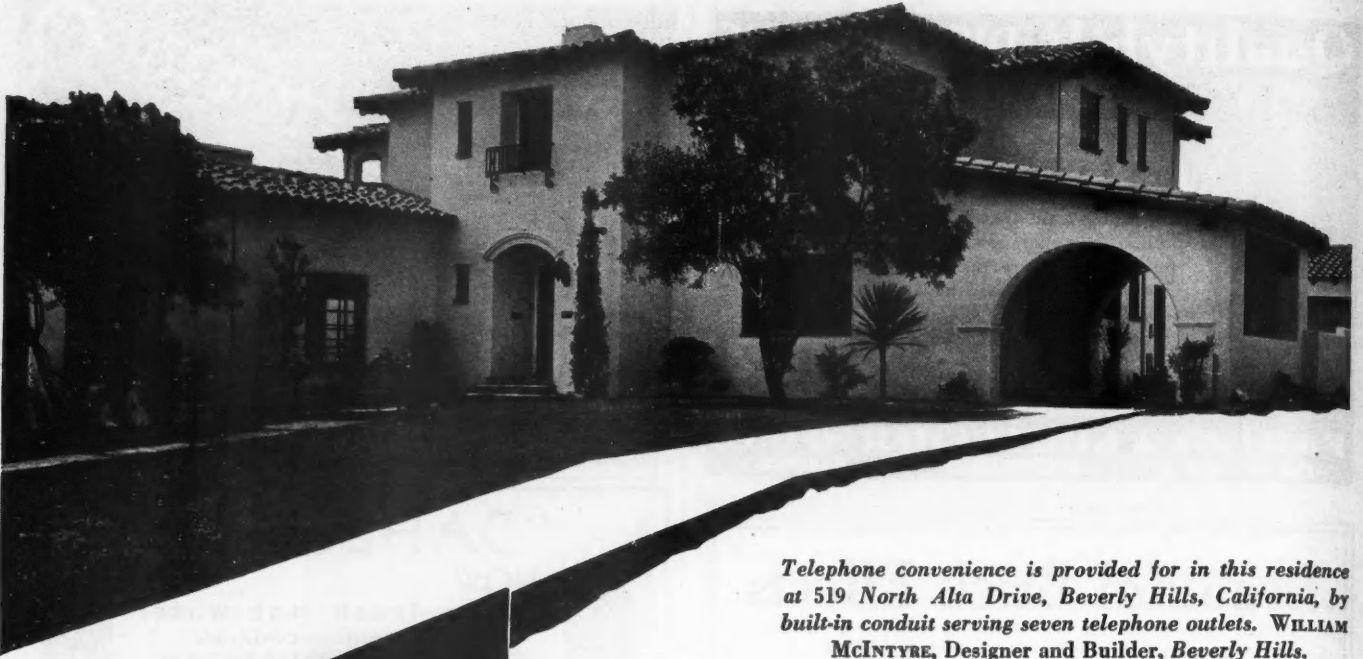

Telephone convenience is provided for in this residence at 519 North Alta Drive, Beverly Hills, California, by built-in conduit serving seven telephone outlets. WILLIAM McINTYRE, Designer and Builder, Beverly Hills.

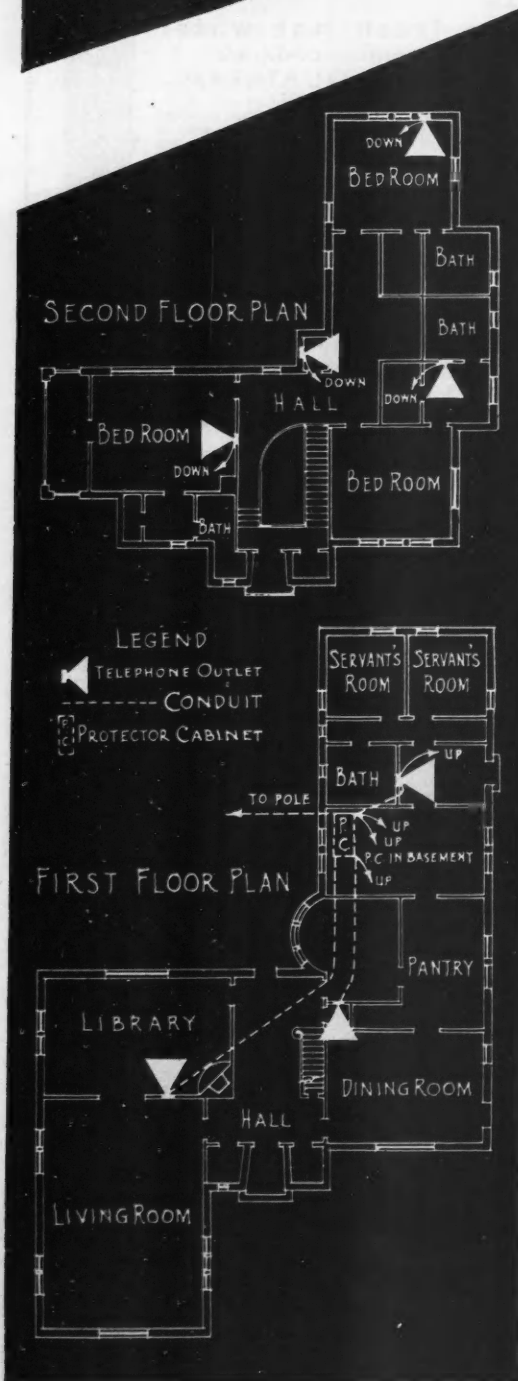

IT'S EASY, ECONOMICAL AND PROFITABLE TO PROVIDE FOR TELEPHONE CONVENIENCE

IN EVERY CORNER of the country, in every kind and size of residence, alert builders have demonstrated that telephone convenience adds little to construction costs and pays for itself many times over.

Telephone convenience is provided for simply by including telephone conduit in walls and floors. The conduit conceals all wiring, protects against most types of service interruptions, and allows telephone outlets to be located throughout the house — in all the important rooms — wherever they'll save time and steps.

Prospects are impressed by built-in telephone convenience. Houses move more quickly, bring better prices. Purchasers are more comfortable for having *enough* telephones. And from every angle, the builder benefits.

Let the local telephone company help you plan the telephone arrangements for new or remodeled residences. There is no charge. Just call the Business Office and ask for "Architects' and Builders' Service."



Index to Advertisers

June, 1932

A	Page
Aluminum Co. of America.....	11
American Floor Surfacing Machine Co..	64
American Saw Mill Machinery Co.....	61
American Sheet and Tin Plate Co.....	61
American Telephone & Telegraph Co....	66
American Window Glass Co.....	59
B	
Barber-Colman Co.....	15
Brecher Co., Inc., The.....	65
C	
Cabot, Inc., Samuel.....	56
Carey Co., The Phillip.....	6
Clarke Sanding Machine Co.....	60
Colorcreta Industries.....	65
D	
Dahlquist Mfg. Co.....	65
DeWalt Products Corp.....	65
Douglas Fir Plywood Mfrs.....	7
Dunn Mfg. Co., W. E.....	67
E	
Edwards Mfg. Co.....	61

F	Page
Farley & Loetscher Mfg. Co.....	65
Fink & Sons, Inc., Louis.....	65
Formica Insulation Co., The.....	69
Frants Mfg. Co.....	64
G	
General Electric Co.....	4-14
General Motors Truck Co.....	55
General Timber Service, Inc.....	67
I	
International Harvester Co.....	16
International Nickel Co., Inc.....	13
J	
Jaeger Machine Co.....	68
Johns-Manville Corp.....	9
K	
Kalman Steel Corp.....	10
L	
Louisville Cement Co.....	57
M	
Medusa Portland Cement Co.....	12

N	Page
National Mfg. Co.....	70
Norge Corp.....	2
O	
Overhead Door Corp.....	3
P	
Parks Woodworking Machine Co.....	67
Pittsburgh Plate Glass Co.....	8
Porter-Cable-Hutchinson Corp.....	65
R	
Reid-Way Corp.....	68
U	
U. S. Mineral Wool Co.....	59
U. S. Gypsum Co.....	68
W	
Weyerhaeuser Forest Products.....	67
Williams & Co., C. K.....	65
Wood Conversion Co.....	67

NOTICE TO ADVERTISERS

Forms for the July Number of the American Builder and Building Age will close promptly on June 15. New copy, changes, orders for omissions of advertisements must reach our business office, 105 W. Adams St., Chicago, not later than the above date. If new copy is not received by the 15th of the month preceding date of publication the publishers reserve the right to repeat last advertisement on all unexpired contracts. **AMERICAN BUILDER AND BUILDING AGE.**

Get Your Share!

FOUR IN ONE
\$260



With a Parks modern woodworker you can put in the low bid and still come out with a good profit. A Parks is your "best buy" because of low cost, low operating expense, and the long, reliable and accurate service it gives.

Send today for complete catalog.

THE PARKS WOODWORKING MACHINE COMPANY
Dept. AB-6, 1524 Knowlton St., Cincinnati, Ohio
Canadian Factory: 325 Notre Dame East, Montreal



PARKS
WOODWORKING MACHINES

Includes 22" hand saw, 12" jointer, circular rip and crosscut saw and boring machine.

LET THIS MACHINE BRING YOU PROSPERITY



CAPACITY 10 TO 24,000 PER DAY

Modest capital starts you

Val Berry's Business in Kalamazoo made profitable manufacturing. DUNBRIK. Another million order again proves its merit over all competition.

Joe Trudeau of New Jersey doubled capacity within year. Why? Better product. Lower cost. Lighter weight. Big savings in construction. Controls market.

TODAY'S GREATEST MFG. OPPORTUNITY

Learn why this automatic machine makes brick for 1-3 less--Why you, too, can control this growing market--How to utilize low cost local raw materials and labor.

Send for booklet "Four Keys to Prosperity." Write today.

W. E. DUNN MFG. CO.
450 W. 23rd St. Holland, Michigan

WANT MONEY? Get into this New Business

Quick pay if you act NOW. Ask your Lumber Dealer.

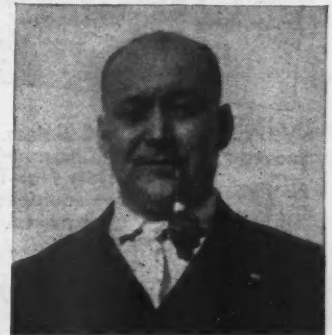

YOUR PLAN KEEPS ME BUSY SAYS BERT BAKER

"During the past 18 months contracting jobs have been scarce," says Bert Baker of Kansas City, Mo., "but I have found it possible to use my time very profitably in insulating old houses with Balsam-Wool. Your plan is making money for me."

Don't let present business conditions lick you! Get busy and cash in on a new business that is making real money—right now—for hundreds of wide awake contractors and carpenters.

Sixty per cent of home owners are prospects—they need and want the service you can give. You can cut their fuel bills way down! Make their houses more comfortable, healthful.

Become an insulation expert! Get these insulation jobs in your district for yourself. Your lumber dealer will show you how. Then—pocket the sure, quick dollars they bring!

No special training is necessary. Simply ask your lumber dealer for the tested plan that lines up, clinches these money-making contracts. This plan is backed by Weyerhaeuser, world's largest manufacturers of home building materials.

Don't pass up this live opportunity. See your lumber dealer—today. Mail coupon—now.

It tucks in

Balsam-Wool

Blanket

THICK... FLEXIBLE INSULATION... EFFICIENT

Wood Conversion Co.
Dept. H-10
Cloquet, Minn.

Send me details on your plan that clinches money-making jobs.

Name.....

Address.....

THE REID-WAY FLOOR ACE

Offers Every Advantage
For less than a
hundred dollars.

Full size—plenty of power—only one moving part—a 12-month guarantee! The Reid-Way Floor Ace offers everything you want in a light floor sander. A high production, sturdy outfit that will give years of trouble-free service. Why pay more—you can't get more. We've made it easy to own a Reid-Way Floor Ace.

Good
Profit on
Rentals

20 to 30 days rental
pays for your Floor
Ace. No maintenance
cost to eat up profits.



WHY
PAY
MORE?

THE REID-WAY CORPORATION
2953 FIRST AVENUE CEDAR RAPIDS, IOWA

JAEGER EQUIPMENT offers More for your Money

MIXERS: 3½S to 84S sizes. Improved "Dual-Mix" Tilters. Heavy Duty Non-Tilters—equipped for every need.



TRAILERS, \$169 Up, f.o.b. Factory

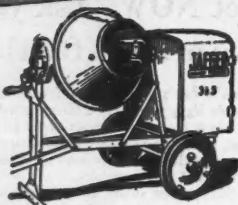

PUMPS: More capacity and power, less weight, lower prices. All sizes, types, 10,000 gal., 2" Self-Prime Centrifugal, complete with 4 cycle engine and strainer. \$181.00 f.o.b. factory.

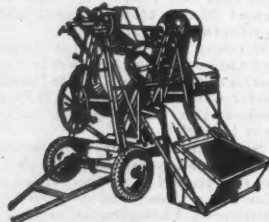

HOISTS: Timken Screw Thrust, powerful, fast, easy to operate.

All sizes.

THE JAEGER
521 Dublin Ave.

MACHINE CO.
Columbus, Ohio

GET OUR PRICES ON MIXERS, PUMPS AND HOISTS

(Continued from page 22)

pect and landed the order; furthermore, when the detailed cost figures and material list were made up for delivery purposes, it was found that the House Valuator estimate was within \$54.00 of the actual cost—\$54.00 on the high side of a \$6,500 house!

The foregoing is a true story, and is related here to illustrate the usefulness of a new service for home owners in which dealer-contractor co-operation is supported by AMERICAN BUILDER AND BUILDING AGE, together with leading home magazines of national circulation, and the Merchandising Council of National Retail Lumber Dealers Association.

Heretofore no publication of national circulation publishing pictures and floor plans of homes has ever been able to answer the inevitable question, "How much will it cost me to build this house here in my town?" The best that any of them could say was, "from \$5,000 to \$8,000," or "\$12,337 in Sometown, N. Y.," which means nothing to Mr. and Mrs. Homewanter in any other town or state.

Now, through this new service, any of these publications can tell its readers, "Ask your lumber dealer. He can tell you the exact price of this house in YOUR town or refer you to a reliable contractor who can."

Think what this means to dealers and contractors alike! Today the leading home magazines are boosting home ownership as they never have boosted before. It seems as though everyone is pulling for the building industry today, because it is one of the key industries that can bring us out of depression.

Here is a service that enables your lumber dealer to furnish a reliable price on any plan in any town without drudgery and hours of hard work. This means that you can take the plans from AMERICAN BUILDER AND BUILDING AGE, and have a wonderful plan book, more complete and effective than those in any mail order catalog because of a definite price on each home illustrated.

Determining reliable building costs by this new method is like opening a safety deposit box in a bank. It takes two keys. The lumber dealer's "key" consists of certain basic information involving local factors of construction, materials and prices. The publication "key" is a "cost coefficient" that will be determined for each published plan. These coefficients will be published under each plan published in AMERICAN BUILDER AND BUILDING AGE each month. This Cost Key when combined with the dealer's information will immediately open the door to reliable material costs anywhere.

Given the costs of all materials, any contractor can quickly determine his labor costs; can add his plumbing, lighting, heating and other variables and profit. He then can quote a complete price without delay, while the prospect is in the mood for buying.

In the past many a sale has been lost because the prospect cooled off while the contractor was getting his cost figures together. Guessing at the cost of a job is unsafe. A delayed answer indicates indifference, and undermines confidence.

Here is a new service that is being placed in the hands of 16,000 retail lumber dealers throughout the country for their information and for their reliable contractors. The fact that the basic principles of this plan have survived every test that actual use could apply in every state in the union for the past five years; that it is backed by leading manufacturers of building materials; that outstanding lumber dealers who are members of their national association and twenty-one affiliated state and regional associations have proved its merit. These facts are assurance that it will continue to work successfully for readers of AMERICAN BUILDER AND BUILDING AGE.

Houses must be SOLD in the future. Your ability to sell will depend largely on your ability to quote accurate prices, quickly, and in terms that interest the buyer—prices that he can understand, prices that are complete.

Anyone who continues to make a detailed list of materials to get a price on a house job is using a scythe, instead of a binder or a combine to harvest his sales. Take this issue of AMERICAN BUILDER AND BUILDING AGE and ask your lumber dealer about this new service. Arrange to make use of it now. Also watch for future articles telling how dealers and contractors are working together and proving that dealer-contractor teamwork wins.

t
e
s
e
t
y
y
e
e
t
s
d
s
r
t
st
or
-
s
-
is
o
n
ll
s,
ne
ls
of
er
it
d
r-

(Continued from page 22)

pect and landed the order; furthermore, when the detailed cost figures and material list were made up for delivery purposes, it was found that the House Valuator estimate was within \$54.00 of the actual cost—\$54.00 on the high side of a \$6,500 house!

The foregoing is a true story, and is related here to illustrate the usefulness of a new service for home owners in which dealer-contractor co-operation is supported by AMERICAN BUILDER AND BUILDING AGE, together with leading home magazines of national circulation, and the Merchandising Council of National Retail Lumber Dealers Association.

Heretofore no publication of national circulation publishing pictures and floor plans of homes has ever been able to answer the inevitable question, "How much will it cost me to build this house here in my town?" The best that any of them could say was, "from \$5,000 to \$8,000," or "\$12,337 in Sometown, N. Y.," which means nothing to Mr. and Mrs. Homewanter in any other town or state.

Now, through this new service, any of these publications can tell its readers, "Ask your lumber dealer. He can tell you the exact price of this house in YOUR town or refer you to a reliable contractor who can."

Think what this means to dealers and contractors alike! Today the leading home magazines are boosting home ownership as they never have boosted before. It seems as though everyone is pulling for the building industry today, because it is one of the key industries that can bring us out of depression.

Here is a service that enables your lumber dealer to furnish a reliable price on any plan in any town without drudgery and hours of hard work. This means that you can take the plans from AMERICAN BUILDER AND BUILDING AGE, and have a wonderful plan book, more complete and effective than those in any mail order catalog because of a definite price on each home illustrated.

Determining reliable building costs by this new method is like opening a safety deposit box in a bank. It takes two keys. The lumber dealer's "key" consists of certain basic information involving local factors of construction, materials and prices. The publication "key" is a "cost coefficient" that will be determined for each published plan. The coefficients will be published under each plan published in AMERICAN BUILDER AND BUILDING AGE each month. The Cost Key when combined with the dealer's information will immediately open the door to reliable material costs wherever.

Given the costs of all materials, any contractor can quickly determine his labor costs; can add his costs for painting, lighting, heating and other variables and profit. He can quote a complete price without delay, while the prospect is in the mood for buying.

In the past many a sale has been lost because the prospect cooled off while the contractor was getting the cost figures together. Guessing at the cost of a job is a waste. A delayed answer indicates indifference, and undermines confidence.

Here is a new service that is being placed in the hands of 16,000 retail lumber dealers throughout the country for their information and for their reliable contractor. The fact that the basic principles of this plan have survived every test that actual use could apply in every town in the union for the past five years; that it is backed by leading manufacturers of building materials; that outstanding lumber dealers who are members of their national association and twenty-one affiliated state and regional associations have proved its merit. These facts are assurance that we will continue to work successfully for readers of AMERICAN BUILDER AND BUILDING AGE.

Houses must be SOLD in the future. The ability to sell accurately prices, quickly, and in terms that interest the prospect—prices that he can understand, prices that are complete.

Anyone who continues to make a detour of materials to get a price on a house job is using the wrong method. Instead of making a binder or a combine to harvest his sales, he should make this issue of AMERICAN BUILDER AND BUILDING AGE a part of his work. Ask your lumber dealer about this new service. Arrange to make use of it now. Also watch for future articles telling how dealers and contractors are working together and proving that dealer-contractor teamwork wins.



WHY
PAY
MORE?

INATION
PIDS, IOWA

ER
ers
ney



b. Factory



: Timken
powerful,
operate.

yes.

CO.

HOISTS