

[A Simmons-Boardman Publication]

AMERICAN BUILDER

and Building Age

NAME REGISTERED U. S. PATENT OFFICE AND CANADIAN REGISTRAR OF TRADE MARKS

FEBRUARY, 1935

57th Year

Vol. 57—No. 2

BETTER HOMES

BETTER BUSINESS

BETTER HOMES MEAN BETTER BUSINESS. THE AMERICAN BUILDER ENDORSES A VIGOROUS HOME BUILDING AND REPAIR DRIVE IN EVERY COMMUNITY TO CREATE THE DESIRE FOR BETTER HOMES. BUILDERS, DEALERS, ARCHITECTS, REAL ESTATE MEN AND THE LOCAL DEPARTMENT STORES AND NEWSPAPERS SHOULD CO-OPERATE TO POPULARIZE BETTER HOMES.

AMERICAN BUILDER and BUILDING AGE, with which are incorporated National Builder, Permanent Builder, and the Builder's Journal, is published on the first day of each month by the

AMERICAN BUILDER PUBLISHING CORPORATION
105 West Adams Street,
Chicago, Ill.

NEW YORK
30 Church Street

CLEVELAND
Terminal Tower

WASHINGTON, D.C.
National Press Building

SAN FRANCISCO
58 Main Street



Samuel O. Dunn, *Chairman of Board*; Henry Lee, *President*; Bernard L. Johnson, Robert H. Morris, Delbert W. Smith, L. R. Putman, and R. E. Clement, *Vice Presidents*; Elmer T. Howson, *Secretary*; John T. De Mott, *Treasurer*.

Subscription price in the United States and Possessions, 1 year, \$2.00, 2 years, \$3.00, 3 years, \$4; Canada, including duty, 1 year, \$2.50, 2 years, \$4.00, 3 years, \$5.00; foreign countries, 1 year, \$4.00, 2 years, \$7.00, 3 years, \$10.00. Single copies, 25 cents each.

Member of the Associated Business Papers (A. B. P.) and of the Audit Bureau of Circulations (A. B. C.)

Shall Recovery Again Be Arrested? By Samuel O. Dunn.....	15
Editorials	17
"Speak for Yourself, John" Building Upturn Is Here	
Operative Builders' Department.....	19
The Operative Builder's Part in Home Building.....	20
FHA Rulings Assure Recognition, Financing and Supervision for Builders Erecting Houses for Sale	
Laurelton Homes, Inc., Quick to Use FHA Plan.....	22
Commercial Banks—A New Source of Building Money.....	23
Ohio Builders Organize.....	24
Richard F. Goodnow Tells of Nine-Point Program Adopted to Improve Building Business	
Modernization Department.....	25
Spring FHA Repair Prospects Bright	
Do Not Fear Elevator Modernization.....	26
An Authority Outlines a Simple Procedure	
Basement Recreation Rooms, How to Plan and Sell Them.....	28
Home Equipment Department.....	29
V. L. Sherman Outlines New Opportunities for Home Building Contractors Under FHA Financing	
The House of the Month.....	32
Photograph and Plans of Design Built Three Thousand Times—a True Economy Home	
Home Design Section.....	36
Practical Suggestions for Popular Priced Home	
Big Barn Is Problem for Builders.....	44
H. A. Heimbeck Describes a Model General Purpose Barn	
Timber Connectors Used in Big Highway Bridge.....	47
What's New Department.....	48
News of the Month.....	49
Practical Job Pointers.....	50
Letters from Readers.....	54
Selected List of Manufacturers' Literature.....	64
Advertisers' Index.....	66

BERNARD L. JOHNSON

Editor

JOSEPH B. MASON

Managing Editor

H. F. LANE

Washington Editor

E. L. GILBERT

Eastern Editor

L. R. PUTMAN

Marketing Editor

ROBERT H. MORRIS

Business Manager

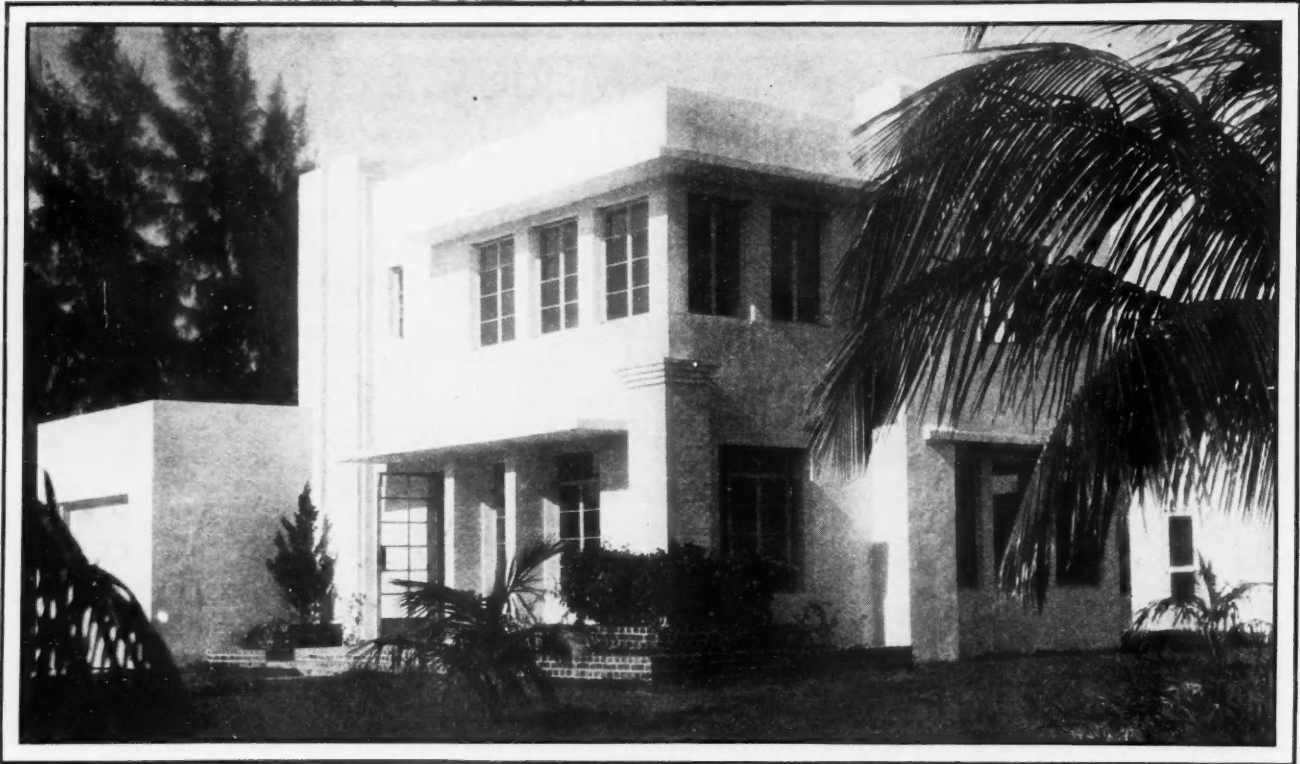

Concrete home of \$5,000 class, Miami Beach, Florida. Floors and roof slab of reinforced concrete with precast concrete joists. Walls of concrete masonry with portland cement stucco. Architect: R. E. Collins, Miami. Contractor: C. R. Clark, Miami Beach

In every price range

CONCRETE *helps sell houses*

There's no guess work about the *extra* sales appeal of fireproof Concrete construction. Authentic "case histories" of houses erected in various parts of the country prove the point. Here are a few facts:

MIAMI, FLORIDA

Over 200 all-concrete houses built in this area in 1934; 6 by one builder; prices from \$5,000 to \$100,000. Construction included both concrete masonry and reinforced concrete walls; both solid and precast concrete floors and portland cement stucco.

POUGHKEEPSIE, NEW YORK

Modern concrete masonry house built by Simmons & Simmons to sell for \$8,200 visited by thousands of people. Requests for plans received from every northeastern state.

KANSAS CITY, MISSOURI

Five-room concrete masonry demonstration house erected by Breyfogle Realty Company sold at large profit on first day of inspection. Attracted 15,600 visitors in three weeks resulting in 150 direct leads and 4 actual contracts.

NEW YORK CITY

The concrete-floored, concrete masonry *Woman's Home Companion* "Home-Keeping House" described in that magazine last year brought a flood of inquiries and over 100 cash orders for complete plans.

People *like* concrete—its modern appearance, economy, rigidity, durability and fire safety. Build with concrete and you build salable homes. A free booklet "It Pays to Own a Fireproof Home—Here's How It's Built," gives some of the reasons why. Let us send you a copy.

PORTLAND CEMENT ASSOCIATION

Room 152, 33 W. Grand Ave., Chicago, Ill.

Please send, free, "It Pays to Own a Fireproof Home—Here's How It's Built."

Name

Address

City.....State.....

Shall Recovery Again Be Arrested?

THREE times there has begun a *real* and *natural* recovery—the first in the last one-third of 1932; the second in April-July, 1933. The third, which began late in October, 1934, is still continuing. These have been *real* improvements because they have been due to readjustments in prices and other conditions that created a better *balance* between the purchasing powers of different industries and classes.

This sounds like deep, theoretical, economic stuff, but it relates to the most vital problems of every day life. How to get more business at a profit. How to get employment at fair wages. These are the vital problems. They have remained so long unsolved because government, business and labor have been trying to solve them by harmful *artificial* means.

WILL the improvement again occurring also be stopped? Unnecessarily huge government spending for bonuses, relief and public works would hinder it. Prices higher than most buyers can pay would hinder it.

Organized labor is demanding legislation to establish a six-hour day. This would mean approximately a *33 per cent advance in present hourly wages*. It would not reduce, but *increase and perpetuate unemployment by making the cost of transportation and industrial products higher than farmers and others not employed in industry could pay*.

The demand for reduction of hours is based upon the assumption that the depression and unemployment were caused by general overproduction, and that if we all went to work eight hours a day we would again produce more than we could consume, resulting again in unemployment.

This assumption has been made in every past depression. It is as false now as then. Even in 1929 the value of our total production was only \$2,800 per family, or *\$62 a month per inhabitant*. The Brookings Institution has demonstrated that, with a six-hour day, we could not produce anywhere near as much as in 1929.

FOR an "abundant life" the American people need to provide themselves much better housing, much more of all necessities, comforts and luxuries, than ever before. *To do this they must produce much more than ever before.*

Recovery and re-employment have been halted twice already within three years by *artificial* measures that arrested increase of production. Labor, in its own interest, should not be trying to again *curtail production* by increasing its cost. It should be helping to *increase production*. There is *no other way to reduce relief rolls and increase pay-rolls*.

Samuel O. Drun,

CHAIRMAN,
AMERICAN BUILDER PUBLISHING CORPORATION
SIMMONS-BOARDMAN PUBLISHING CORPORATION

WHEN IT'S DECORATIVE CONCRETE—

(Like Stucco or Terrazzo or Cast Stone)



You're Sitting Pretty with ATLAS WHITE!

For economical, durable remodeling work and new construction, when appearance is a factor, Atlas White portland cement serves many purposes:

STUCCO —made with Atlas White—provides a finish in any color, and for any texture.

CAST STONE —made with Atlas White—in interesting colors; in simple or ornamental design, permanent, beautiful.

FINE TERRAZZO —made with Atlas White—provides floors that are colorful and individual and easily maintained.

NON-STAINING MORTAR —made with Atlas White—for backing, setting and pointing fine building stones without danger of discoloration from staining.

WHITE MONOLITHIC CONCRETE —made with Atlas White—for swimming pools, for walls and for any structural use.

FOR COLOR AND BEAUTY AND DURABILITY IN ALL TYPES
OF DECORATIVE CONCRETE WORK

ATLAS WHITE PORTLAND CEMENT

Plain and Waterproofed

PRODUCTS OF

Universal Atlas Cement Co.

United States Steel Corporation Subsidiary

208 South La Salle Street • Chicago

AMERICAN BUILDER AND BUILDING AGE

"Speak for Yourself, John"

IN the daily newspapers, in Code meetings, FHA meetings and public discussions of housing, there is always someone to speak for the home building industry except a genuine residential contractor.

Everyone is anxious to represent the man who builds houses; but his own voice is seldom heard. The reason is that he lacks organization.

Whose fault is it if a local chamber of commerce appoints a "mortician" as head of the local FHA modernizing drive?

Whose fault is it if the Construction Code Authority, which is supposed to represent the entire building industry, is made up entirely of public works contractors, skyscraper architects, and labor leaders who think only of big city construction practices?

Whose fault is it if the Federal Housing Administration thinks speculative builders—whom they have now dubbed "operative builders"—are mostly realtors engaged in big suburban operations, when, as a matter of fact, the average speculative builder puts up only a few houses at a time and operates in numerous small communities, cities, suburbs and small towns?

The fault lies, of course, with residential builders themselves, who fail to organize and fail to speak for themselves in tones that can be heard across the land.

AMERICAN BUILDER believes residential builders in every city, town, village and rural section should be organized. They should have local community associations, state associations, and one strong national association that can speak with authority.

Residential Builders Forgotten

Residential builders know that their problems are not the same as those of the public works contractor, the highway builder or the realtor developer. And yet, whenever some local, state or national official is appointed to represent the home building industry, he invariably turns out to be from one of these groups.

As we said at the start—practically anyone can be found to represent the home building industry except a genuine home builder.

There are pressing problems and policies of greatest importance crying for the attention of an organized, powerful and militant residential builders' association. The Federal Housing Administration is making rules and regulations as to architectural services, home building practices and standards, and job control that will vitally affect the work of the builder of homes. Yet

where can the government officials turn to find men who can truly be said to represent the many thousands of the rank and file of contractors, builders and small operators whose projects, beyond the slightest question, represent the greatest single division of the construction industry?

No program involving the home building industry can succeed until the thousands of small operators in small towns, outlying areas and rural communities throughout the country are organized, represented and included in the plan. They can make or break any plan, and the sum total of the work they perform in normal years amounts to the enormous total that makes the nation's industries hum.

The Ohio Plan

AMERICAN BUILDER is proud to report that real progress in organizing residential contractors and builders is being made. On page 26 of this issue, an article by Richard F. Goodnow gives an illuminating picture of the formation of the General Building Contractors' Council of Ohio. In an extremely interesting letter in the correspondence section Samuel Anderson, president of the Seattle Master Builders Association, describes what is being done in that coast city, and tells of plans for a state association. Numerous other builder groups in cities and towns are getting organized.

Certain broad principles and purposes have been brought forward which residential contractors should consider in making a sound organization. The first of these is: *make no little plan*. In organizing an association, keep it on a broad, constructive level. Avoid petty rules, regulations and retaliations. Keep the membership cost high enough to make those who are members appreciate its value, and keep the objectives worthy enough to justify the organization.

Some Organization Objectives

Let us see what some of these objectives might be. Local conditions affect local organizations, but in general it seems that certain broad objectives may be set up. AMERICAN BUILDER will be glad to have suggestions from its readers as to additions and improvements in these objectives, which will be passed on as new associations are formed. As a starter, however, let us consider the following:

1. Establishment of high professional standards.

2. Elimination of unfair or discriminatory practices against residential contractors.
3. Raising qualifications for residential contractors and keeping out untrained, unreliable or fly-by-night operators. Adoption of a state license law similar to the California Contractors' License Law should be an important objective.
4. Co-operation and leadership in local, state and national movements (such as FHA) beneficial to home building.
5. Recommendations and political action regarding legislation that affects the business of home building.
6. Establishing sound trade and bidding practices, labor conditions, prices, relations with other branches of the building industry.
7. Co-operative home building advertising to create public confidence and good will, and to increase the home market.

Residential contractors may well pause to consider that every other division of the construction industry is well organized—architects, realtors, heavy construction contractors, lumber dealers and sub-contract groups. What is more, most of the other divisions maintain a licensing or control system which keeps out the unqualified, dishonest or irresponsible persons. One of the first objectives of a residential contractors' association should be, therefore, the securing of a state license law for contractors. The most effective law of this type is the California law, of which—and this is encouraging—California contractors are the strongest supporters.

This publication, as has been repeatedly stated, believes the good of the industry calls for a national organization of residential contractors. It will continue to assist in every way possible, and urges its readers to get together in their communities at once. The residential building industry has bumped along too long without organization or spokesmen. It is time it should speak for itself.

BUILDING UPTURN IS HERE

PREDICTIONS of a bigger year in building in 1935 than came to pass in 1934 are well justified. The pressure of demand for more shelter of all kinds has built up over a period of more than five long years; this alone is sufficient to bring about a great increase in all divisions of building during 1935. In addition, passage of the National Housing Act by the 73rd Congress set the stage for a prompt recovery in residential and small jobbing work, thus bringing valuable assistance to the most badly crippled division of the entire building and construction industry.

Residential building, which showed but a slight increase in dollar volume for 1934 over 1933, nevertheless promises to make a long awaited comeback in 1935. Existing structures require billions of dollars in work and materials to place them in proper repair and bring them up to the true American standard of living. Titles II and III of the Housing Act, even though they should not result in the writing of a dollar in mortgage insurance, have rebuilt the confidence of bankers, investors and others in the basic worth of home property; this return of confidence will serve to stimulate new home building in many ways. Predictions of a 200 per cent increase in residential building in 1935 (over 1934 figures), as shown in the chart below, are quite conservative when consideration is given to favorable conditions of the residential market at this time.

Alterations, repairs, modernization, etc., mounted to considerable volume in 1934, with Title I of the Housing Act in operation but little more than one-third of the year. So far the nationwide modernization drive by the Federal Housing Administration has shown progressive improvement with constantly mounting dollar volume results per average day, and there is every reason to believe that this activity will not be permitted to slacken in 1935. Predictions of not less than 100 per cent increase in the total dollar volume of this type of work in 1935 is therefore very conservative.

Non-residential building, which may be somewhat stimulated if owners of plants and factories find an improvement in their businesses, cannot be expected to show much more than the increase recorded in 1934 over 1933; 1935 volume will be higher, however, it is felt, in view of the generally increasing pressure of demand and need for this type of shelter and accommodation.

The chart presented at left is a graphic demonstration of the reasonableness of the building industry's hopes for 40 per cent better business in 1935, covering all four major divisions of the private building market.

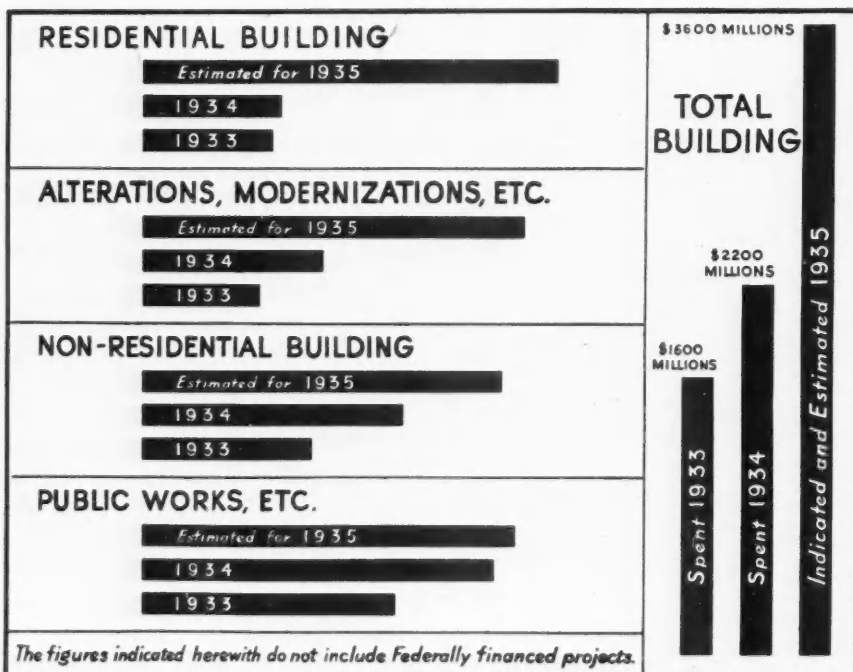

OPERATIVE BUILDERS

A monthly department for the men who plan, erect and equip homes for sale



CONTRACTOR ANTON DUOOS and many other operative builders in Minneapolis are not waiting until spring to start work. The \$12,000 house above is one of nine in one subdivision being built for sale NOW despite snow and cold. Operative Building has again become possible and profitable, this good example shows. On the following pages are more facts about operative builders and the opportunities for this work under FHA.

The Operative Builder's Part

THE revival of home building has brought back into the spotlight that old question of the value of the man or organization that builds homes for sale. Under a new name—Operative Builder—is now classified that large number of contractors and builders who prefer to complete a good home building job without the interference of well-meaning but ill-advised persons who interrupt job progress; it also includes those who, a few years ago, were known as Speculative Builders or Merchant Builders, with the exception that the new name implies a higher quality of work and materials than in the old days, and more completely equipped homes to sell.

Our own definition of an Operative Builder is "one who prepares complete home units featuring quality products and workmanship, offering them for sale when they are ready for occupancy." Back in the boom days of a few years ago, many builders of homes for sale would not have qualified for classification under this definition; certainly the "jerry builder" would have been definitely eliminated. Producer of homes in all price ranges, the good Operative Builder caters to the desire of Mr. and Mrs. Average Folks to avoid all the perplexities and bother of building. "Ready to move right in and start living," is a standard phrase of the Operative Builder when describing the homes he has ready to sell.

Of course, thousands of contractors throughout this country build homes for sale as fast as they are able to finance such new ventures, and as fast as the public in their communities can absorb the new home offerings. These active men of the building industry are Operative Builders part of the time, contractors otherwise. Just as high quality and fully as well equipped home properties are created by those who build for sale occasionally, as in the case of full time Operative Builders who offer complete new home units for sale.

FHA Recognizes Operative Builders

Commenting on the fact that Operative Builders were formerly responsible for a major share of the new homes built in this country each year, and voicing the expectation that Operative Builders will again become impor-

tant in the not distant future, the Federal Housing Administration has gone definitely on record as favorably inclined toward the producers of home properties for sale. This means, of course, that no serious obstacle will be placed in the path of those who desire FHA insurance on the mortgages placed against residential properties completed before the ultimate owner is definitely identified. In other words, the intent is plain, that private financing of homes constructed by the Operative Builder will not be subject to discrimination by the Government mortgage insuring agency.

The attitude of the Federal Housing Administration is important to all Operative Builders, as well as to those who plan to build homes for sale later; this ruling, in conjunction with the provisions of Title V of the National Housing Act (which makes it possible for builders to get construction money through 6-month notes at the regular going rate of interest on ordinary commercial paper), makes it possible for many experienced builders to undertake once again the building of one or more homes for sale, in addition to their current business under contract.

Pro and Con of Operative Building

The great number of organizations which erected homes for sale in the past have come in for considerable criticism. The "Mile Square Area of Brooklyn, N.Y." is pointed out as one example of the result of allowing "Speculative Builders" to operate without restraint; in this section of one of our great cities, there is almost universal evidence of great deterioration in less than a decade—the development of a new slum area. Unfortunately, although the "Mile Square Section" is not a typical development as regards the greater part of the United States, it has received a great deal of publicity and the enemies of operative building use it to clinch their arguments against building homes for sale. The answer, of course, is to refer to any of the many communities (Shaker Heights, Cleveland, or the Country Club District, Kansas City, for instance) which are acknowledged assets to their communities. The citation of specific examples of low-quality housing proves nothing; in the Real Property Inventory conducted by the Government last year, only 2.4 per cent of the more than 2,000,000 dwelling units investigated, were rated as "unfit for human habitation." In view of the fact that 65 to 80 per cent of the home units constructed each year during the last decade were built by Operative Builders, the Real Property Inventory provides evidence that by far the larger part of the structures so built were of good quality and have not depreciated at an unreasonable rate.

The basis for real complaint was the "jerry builder"; this type of builder, as we all know, did great harm to the entire building industry. The curious fact is that a majority of the so-called "jerry builders" were not builders at all; they were usually men or organizations that came into the "building game," as they called it, to make money while the making was good. Sometimes they came into the business with large sums of cash, with which they proceeded to buy both materials and labor at the lowest possible prices; *but they always tried to get the highest selling prices the traffic would bear!* Due to the depression, when profits in home building were practically nil, the moneyed groups thus classified



TYPICAL home property developed at Harbor Green, Long Island, by the Harmon National Real Estate Corporation. A good example of what the Operative Builder can do.

in Home Building

By E. L. GILBERT

have gone elsewhere and the unscrupulous builder has been forced out of business because his former exhibits have been proved poor values to the general public. The "jerry builder" is out; every contractor and builder with one iota of the sense of responsibility hopes, and will do everything possible to force, the boom time "jerry builder" to stay out of the home building field. FHA regulations covering new mortgages are intended to help in this.

Good Operative Builders are to be found in every section of the U. S., although they may not recognize themselves under their new name. In the past hundreds of fine neighborhoods have come into being and progressed, largely due to the wise development policies of these organizations. The Harmon National Real Estate Corporation has no need to be ashamed, for instance, of the many communities it has developed in the New York and Chicago areas. The same may be said without reservation of The Homeland Company of New York. The Arthur D. Crane Company's development at Lake Mohawk, Sparta, N. J., is another outstanding example of what a good Operative Builder can do. Reis-Allwood Homes at Allwood, N. J., started in the depression and has averaged 100 new homes per year ever since—built, sold and now occupied!—good homes which are a fine testimonial to the community. Miller

Brothers of Washington, Nichols of Kansas City, Potter of Houston—there are literally hundreds of other names which identify good Operative Builders who have nothing to fear from any investigation that anyone might want to make, with regard to original quality as manifested by the present day condition of the residential properties they produced in the past.

From the standpoint of community development control alone, the Operative Builder justifies his business existence; rigid insistence upon standards of quality in construction, upon maintenance of neighborhood quality, upon uniformity of general community treatment of physical features—these functions of the responsible Operative Builder make him a very valuable asset to any community. In addition, the good Operative Builder promotes the desire to own a home; without his shrewd sales efforts, thousands of young people might not buy a home with their first substantial savings, other thousands might never buy at all; causing the general public to be interested in good homes is certainly a community service of great worth.

ONE of the ready-to-live-in homes built and sold by The Arthur D. Crane Company in its development of Lake Mohawk, Sparta, N. J. Rustic charm for \$2900!



Laurelton Homes Inc. Quick to Use FHA Finance Plan

Prominent New York Firm of
Operative Builders Renews
Activity Building Homes
for Sale

Interesting Details of First
Home Built and Sold Under
FHA Insured Mortgage Rules



NEW YORK CITY'S first home mortgage to meet the standards of new construction and terms of government insurance set down by the Federal Housing Administration under the National Housing Act, Title II, is located in Laurelton, Borough of Queens, in the established residential community of more than twenty-five hundred homes developed by Laurelton Homes, Inc.

Commitment for this loan was made the first week of January through the offices of Julian M. Gerard, New York State Director of the Federal Housing Administration upon completion of a one family detached colonial type brick bungalow located at 130-38 230th Street, Laurelton, Borough of Queens, New York City.

According to information given by George M. Gross, president of Laurelton Homes, construction of the home began on November 1, 1934, after architect's plans and specifications were submitted to the Federal Housing Administration officials in Washington.

The mortgage loan was made by the West Side Building & Loan Association, Empire State Building, to John J. and Mary Smith, both of New York City. Mr. Smith is employed by a firm of tree surgeons. An interesting sidelight is the fact that his employer suggested the Laurelton Homes builders because of his own experience in purchasing two homes from the founder of this organization; one twenty years ago, and the second twelve years ago.

This mortgage loan under the FHA insurance plan is typical of how the National Housing Act will bring out private capital for small home building loans, and provide a "healthy, steady and enormous market for new homes and all that goes into the furnishing and equipment of new homes."

The insured mortgage feature of the FHA plan was the motivating factor in the erection of this and thirty other houses in the same community by the builders of Laurelton Homes. The twenty-two sales made during the past ten weeks under the plan is definite proof that homeseekers are most eager to take advantage of it.

It is interesting to note how the financing was arranged on the Laurelton home. The total price was \$3998. The insured loan is for \$3,000 (which is 75 per cent of the

total property value) and the owner, if he prefers, can extend monthly payments for a period of twenty years, which in this instance would amount to \$29.50 and include interest, taxes, amortization, water and insurance. Under this plan, second mortgages are a thing of the past. It means that a man with a modest salary of even \$25 to \$30 weekly and about \$1,000 cash can take advantage of home ownership under the government plan.

The house was designed by Arthur E. Allen, registered architect, and contains large cathedral living room with exposed hand-hewn ceiling beams, scientifically arranged kitchen, table top gas range, inlaid linoleum floor, cheerful dinette, large bedrooms, colored tile bathroom with shower, steam heat, brass plumbing, oak floors throughout, metal weatherstrips, asphalt shingle roof and copper leaders and gutters.

Volume Activity Seen

The recovery of the building industry has received its greatest impetus from this new method of mortgage financing, this firm of operative builders declares. With mortgagees' loans insured by the FHA plan, private capital will have the safety it demands, and financial institutions everywhere cannot help but support this type of beneficial legislation.

Just as Greater New York City has led the country in effecting the first loan on a newly built home erected for sale under the FHA plan, so it can be expected to lead the country in the volume of small home construction for the days to follow. Operative builders are setting up their organizations to meet the rules and regulations laid down by the Federal Housing Administration. Compliance with the simple terms of the plan is within the scope of all and the benefits that will accrue in better business and employment augurs well for the prosperity of millions of people and the happy contentment of hundreds of thousands of families who will now find it possible to become home owners on an economical basis.

Commercial Banks—

A NEW SOURCE OF CONSTRUCTION AND MORTGAGE MONEY?

By JOHN T. McCLINTOCK, JR., Analyst,
Goodbody & Co., New York

THE commercial banker, long condemned for his tight-fisted, obstinate aversion to construction and real estate loans, may soon be in the market actively seeking them. This long-desired reversal of policy will not be merely a change of heart, but one of the results of the National Housing Act. Titles II, III and V of the Act presumably make sound mortgages 100 per cent liquid and guarantee the mortgagee against loss of principal. Just as soon as commercial banks become convinced of the efficacy of these provisions they may be expected to compete with other institutions for good loans. Until such time, however, they cannot be condemned for maintaining their past point of view toward this type of risk.

Well managed commercial banks have never, in recent years, favored real estate loans as a form of investment. This attitude is not the result of the cold selfishness often ascribed to them but rather to legal limitations and, even more, to well founded ideas of what constitutes sound banking practice.

The first limitation on making real estate loans is the Federal Reserve Act, which provides that no national bank shall, at any time, have invested in such loans over 25 per cent of its unimpaired capital and surplus or over one-half of its savings deposits. This means that a medium sized bank, with capital and surplus of, say, \$1,000,000, doing principally a commercial business, could make only 50 loans of \$5,000 average. Furthermore, the bank would hesitate to become committed up to the limit since it would be very poor business to have to refuse a loan to a good client who might later request one.

Good management principles often placed stricter limits on real estate loans than did the law. There are three types of monies which may be loaned by a bank, excluding its own capital and surplus: 1. Demand deposits, 2. Savings deposits, and 3. Trust funds. The investments into which each class of fund goes must suit its peculiar needs.

Demand deposits, as the name implies, are supposedly withdrawable on demand. Actually, of course, no bank could afford to do business if it kept in a position to pay off all deposits at any moment. The banking business is founded on the principle of a small fluctuation only in total deposits which requires a correspondingly small cash reserve. The possibility of a sudden large demand, a run, cannot be overlooked, however. It is this which dictates that demand deposits should be invested only in such loans as can be rapidly converted into cash. The principal ones are: 1. Commercial working capital loans which are rediscountable at the Federal Reserve, 2. Readily marketable securities, and 3. Secured loans whose collateral is marketable. These funds have no place in non-liquid capital investments, in which class fall real estate loans. The bank cannot

avoid some loans becoming non-liquid so it should not voluntarily buy too many loans in the form of real estate mortgages. The runs of 1932 and 1933 proved the soundness of these principles. In general, the banks which were hurt most were those which had permitted themselves to become too involved in real estate and other unmarketable loans and investments.

Savings deposits differ from demand in that since they are not used commercially or to pay for current expenses there is less daily and seasonal fluctuation. Also, there has proved to be less possibility of severe runs. In addition, the usual 30 or more day notice of withdrawal which the bank may require gives opportunity for liquidating even long term loans. For these reasons, a somewhat larger amount of slow assets may be bought with these funds. Actually, savings deposits were used to a large extent for real estate loans but there was always the legal limitation noted above and the ever present possibility of needing to convert a great percentage of the loans and investments into cash on relatively short notice.

Trust funds have also been a source of mortgage money, but the amount is limited by the investment principle of diversification. A peculiar situation has arisen in some accounts where the mortgages have remained good but other investments have not. This has resulted in increasing the percentage of funds invested in mortgages, thus necessitating disposing of some.

On the basis of all the above considerations, the bankers seem to have been well justified in their antipathy toward real estate mortgages, but the question still remains as to why they were so opposed to construction loans. The duration of these compared favorably with regular commercial loans and had none of the unfavorable characteristics inherent in mortgages. The obvious answer is that all too often construction loans turned into mortgages. If, on completion, the structure could not be sold, the bank's only recourse was to take over the property, which rarely could it sell later for cash. The only construction loans the banks felt justified in making were to those builders whose net worth was sufficient to assure payment regardless of the success of the venture in question. And even some of these resulted in mortgages which are still in the banks' portfolios.

In brief, the bankers' objection to real estate loans was that they did not satisfy the liquidity requirements. Could the one feature of marketability be added to the investment merits of mortgages, the banks' attitude toward them should be revised completely. This, the National Housing Act has attempted to do.

Despite the barriers yet to be overcome, the fact remains that the Administration is determined to make real estate loans a suitable form of investment for commercial banks.

Ohio Builders Organize

Adopt 9-Point Program to Improve the Building Business

By RICHARD F. GOODNOW

A LARGE GROUP of contractors from all over the State of Ohio convened on January 3, 1935 in Cleveland for the purpose of forming an Ohio State Builders Council; this Council is being created with definite objectives for the benefit of the Construction industry, particularly that section of the industry having to do with home building. A committee was chosen to draw up a suitable constitution and by-laws. This constitution was tentatively adopted as read, and referred to the various Ohio State Builders organizations for ratification. The objectives cited in the Constitution and By-Laws are briefly summarized in the following paragraphs. Membership in the Council will:

- (a) Assure the public of the skill and reliability of the contractor.
- (b) Elevate the standards of the business to a level comparable to that of other professions.
- (c) Provide methods whereby members may avail themselves of the greater power of combined effort through the Council acting as an authoritative body in securing just and honorable dealings from the public.
- (d) Promote a spirit of cooperation between the contractors and those with whom they have business relationships in the construction industry.
- (e) Seek to eliminate injurious, discriminatory or unethical business methods practised by or against contractors.
- (f) Protect the legitimate market for the services of building contractors as nearly as possible against encroachment by outside agencies, and those whose background and experience has not given them the necessary qualifications to carry on the business of construction work.
- (g) Eliminate waste and reduce construction costs.
- (h) Foster a reasonable and proper credit structure for the construction industry.
- (i) Sponsor legislation in Ohio and political sub-divisions thereof that will insure the proper safeguarding of the public interest in all matters pertaining to the business of general building contractors.

For the purpose of Code Administration in the State of Ohio, the counties that make up the State have been sub-divided into 11 districts. From each of these districts are to be chosen representatives who will act as an Executive Committee of the Council. There will be two types of members: active and associate. The active members will pay dues of three dollars per annum. Associate members will pay ten dollars per annum. The active member is to be an individual or firm engaged in the contracting business who belongs to a local association of contractors, which association will take out a membership as a whole in the General Builders Association of Ohio. This local association will pay into the Council, three dollars per capita, per annum. An associate member will be an individual or firm engaged in the constructing business, whose place of business is located in a community where there is no local organization. One of the first steps to be taken by the new organization will be the seeking from the Ohio Legislature of a License Law for contractors in the State of Ohio.

Temporary officers were chosen at the meeting of January 3. George Gall of Cleveland, three times winner of the Cleveland Chamber of Commerce medal

GEORGE GALL
Cleveland Builder
Elected Chairman



GOODNOW PHOTO

for meritorious construction work, was elected temporary chairman. Robert Gaiser, a prominent builder of Shaker Heights was elected temporary secretary.

During the general discussion of what the Council might plan to do for the residential builder, Mr. Gall told the following story: "At the outset of my career as a builder in Cleveland I had the following experience. I had started construction on a small seven room house in one of the suburbs of Cleveland. Some four months after the start on this house, when its completion and sale were near, great activities started directly across the street. A builder, whom I call "Jake", arrived with several teams of horses and foundation materials to take control of three lots, his intention of course being the erection of three single houses. In little less than two weeks this "Jake" had house number one roofed and lathing started. House number two was fully framed, and the third house had first floor joists set. On the Saturday of that week, he withdrew from the bank, \$3,500.00 on the first, \$2,500.00 on the second, and \$1,500.00 on the third house, making a total of \$7,500.00 in all. He had made a down payment of \$2,000.00 on the three lots, and had expended approximately \$500.00 for labor. That was all Jake paid. The following Monday morning he did not appear at the scene of construction, nor has anyone seen him since. The houses were left standing in the above condition for over a year before steps were taken to complete them."

Drawing a moral from this experience, Mr. Gall continued. "Now then, who was Jake and where did he come from? How many Jakes do we have running around the streets today, who at the earliest possible opportunity would start just this same sort of program over again? Who are the losers in a case of this type? A person buying any one of these three homes would discover that in winter no matter how much steam he had in the furnace, his house would continue to stay cold. There would be little use in redecorating the rooms for no matter how often the work was done, plaster would continue to crack. The cause is obvious. With every shift of the wind the house would sway differently due to lack of proper framing and nailing, permitting cold air to sweep in through the foundation and frame of the house. The basic reason for purchasing a home is protection against the elements. Houses that do not live up to this standard are not a talking point in favor of home ownership and until the building industry can raise construction standards to a point where they are permanent protection against the elements without continual repair the public will continue to rent and move on rather than buy or build for themselves.

(Continued to page 60)



MODERNIZATION

Spring FHA Repair Prospects Bright

Big increase in modernizing activities expected.
More than 12,000 financial institutions sign up.

PREDICTIONS that one of the biggest repair and modernizing booms of all time is getting under way are being made by building analysts and those acquainted with the way the construction industry works.

The easy payment, no-money-down features of the FHA modernizing program are just beginning to be widely realized and appreciated. Cold weather has held back thousands of jobs which, with the first lessening of frigid weather conditions, will get started.

The three clear-cut facts that are making contractors, lumber dealers and building men active in modernization work plans for the coming months are:

1. Banks and lending institutions have now had time to get acquainted with the FHA plan and are beginning to realize its profit possibilities. On Jan. 12 the Administrator reported that 12,073 financial institutions had signed up.

2. The general public is just beginning to become modernization conscious. Constant repetition of the subject is necessary to turn talk into building action. FHA reported on Jan. 12 that 5,078 community Better Housing campaigns have been organized. Experience has shown that the real volume of building work does not actually get under way until months after the peak of a community drive.

3. Contractors, builders, carpenters, dealers, sub-contractors and other building men are themselves just

becoming sufficiently sold on the FHA plan to make an effort to sell repairs to the public. They have had to learn a new technique—the installment selling method. They have just learned how to capitalize on the greatest selling help ever given an industry—*no down payment required*.

Like any great national movement involving the building industry which operates through thousands of individual communities, the FHA modernizing drive took time to get under way. In some places it got off to a bad start because practical building men who knew the ropes failed to come forward and take a directing part.

In hundreds of communities concrete results have proved the value of the FHA plan. Sales of lumber dealers have showed a sharp increase. The dollar value spent on repairs and modernization created directly by the Better Housing Program was estimated on Jan. 12 by FHA as \$224,325,299.

While builders are interested in what has happened, they are much more concerned with *what is going to happen in 1935*. All indices point to an enormous increase in home repair and modernization work. It is an accepted fact that the surface has barely been scratched. Indications definitely show that men are making plans to increase their modernizing work this spring and take advantage of the no-down-payment, easy credit FHA terms.



"Don't Fear Elevator Modernization"

IN these days of changing conditions, resulting in materially altering the viewpoints of many contractors with regard to the kind of work they do, these active men of the building industry sometimes find themselves concerned with unfamiliar apparatus and equipment. During periods of intense building activity such as we had a few years ago, contractors could specialize on one type of building; as building activity declines, however, competition increases and contractors must look around for jobs of every kind. In this way, a contractor often runs up against conditions today which are unusual for him, making him feel that he is almost just starting in the business again, because of his unfamiliarity with items not previously within the scope of his experience.

This may be particularly true with contractors who specialized in residential or small buildings in the past but have since gone into the field of larger construction, thereby taking over much greater responsibility for subcontractors. This field requires sub-letting of mechanical equipment not usually required in smaller buildings. One of the most frequent instances of this kind is in connection with elevator equipment. Here the contractor, especially if he lacks experience in this line, often feels lost because of the technical problems in connection with selection of the proper type of equipment. If an architect's specifications are very clear and set forth exactly what is wanted, the problem is not so difficult; it becomes merely a matter of determining which of several types of apparatus submitted may be best for the purpose, and the best value. Sometimes contractors are inclined to take the cheapest price they can get but they could produce a far better building modernization by considering quality

Writes J. C. Bebb,
of Otis Elevator Co.

as well as price and awarding the contract on that basis.

Where the specifications leave the entire question more or less to the general contractor, it becomes necessary for him to study the situation carefully in order that an adequate number of elevators may be installed to suit the requirements of the building. This is a very important point because the success of the building as a business venture depends, to a large extent, on how well the elevator plant is laid out, so that there will be adequate service but no more elevators than really necessary. With too many elevators valuable rental space throughout all floors of the building would be taken up by unnecessary elevator hatchways. This, however, is a point seldom encountered because the tendency is always to put in too few, rather than too many, elevators.

Careful consideration must be given to the types of tenants who are expected to occupy the building, with particular reference to whether or not there will be an unusual number of visitors to the offices, as in a building where there are a number of doctors' and dentists' offices.

The matter of determining the number of elevators required has been carefully and scientifically worked out by the leading elevator manufacturers and impartial advice can be obtained from them with complete data based on the probable number of stops on each round trip, the time interval between cars which would be considered adequate for buildings of various types, also whether or not the elevator should be of manual or automatic operation, types of signals to be used to



ABOVE: Old walk-up apartment building at 111 Division Street, New York, before modernization. Note general rundown condition; location of building did not indicate that modernization would be profitable. However, after modernization (right), including installation of an elevator, this building became an income producer.



prevent waiting by passengers and, in the larger buildings, information about automatic dispatching systems. This data serve as a basis for determining the proper number and types of elevators to put in. In the intermediate type of building, which does not have as intensive service requirements, there is not quite as much need for split-second schedules, as the tenants usually are content to wait a little longer for elevators. However, the question of how many elevators should be installed in apartments, small hotels, etc., is just as important as in the case of the tallest building. Then, when it comes down to a building having only one elevator, the question of uninterrupted service is even more important than for the large office building; if one of the elevators in a large group is shut down, the other can absorb the extra load thrown on them but with only one elevator in a building a shut-down is a very serious matter as tenants are notoriously opposed to climbing stairs—an attitude for which they cannot be censured.

In all types of buildings, therefore, particular attention should be given to the reputation of the elevator manufacturer for supplying not only the highest class of installation to start with, but apparatus which has been proved by experience to be practically free from annoying shut-downs. The maker should also be one that maintains a supply of parts readily available for

replacements and repairs without it being necessary to send a great distance in case of need.

While the question of maintenance of elevator equipment after installation is not a matter that vitally concerns the contractor, as far as his contract goes, yet for the sake of having a satisfied client he should give this matter consideration in awarding the contract for the elevator work.

While the elevator problem may appear complicated to one in his first contact with it, yet it has been so highly studied that the contractor should have no difficulty in obtaining reliable information which will assist him in selecting equipment of a reputable nature which will adequately fulfill the needs of the building. There is no need to fear modernization work which involves elevator problems.

BELOW: This old private house was modernized into small apartments, with automatic elevator as one of the features. A profitable modernization.

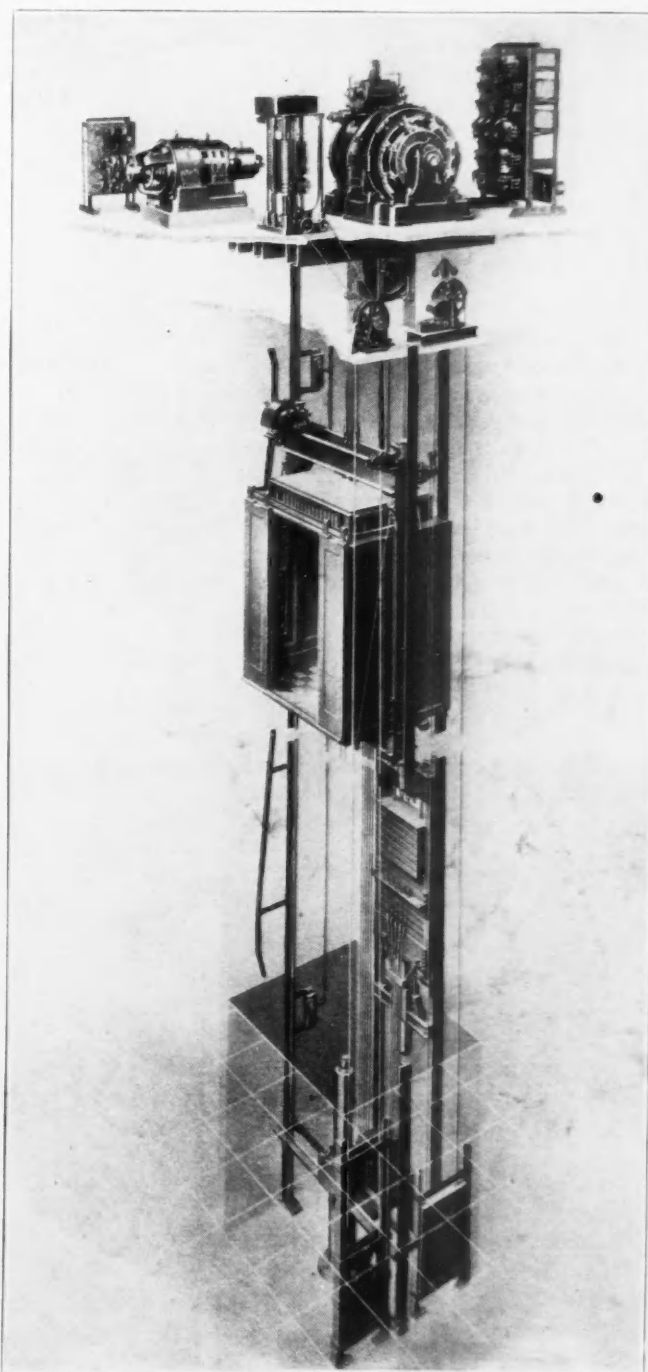

Drawing showing how a typical signal control elevator installation would look if it could be seen without enclosing hatchway walls.

BASEMENT

Recreation Rooms

How to Plan and Sell Them

By GEORGE J. BREKUS

Builder and Contractor, Wayne, N. J.



George J. Brekus

IN the little community in which I live we no longer play bridge, bunco, charades, and ping-pong in the living room. Our host proudly escorts us down to the basement recreation room while our hostess, greatly relieved, closes the living room door and gaily trips down the painted cellar stairs. No more burnt holes in the living room rug! No more glass "rings" on the new polished table. If the tenors in the crowd want to try out a new song (and invariably they do) there is the old piano down in the corner. The sleeping children needn't suffer. Two floors between deaden the shrill though sincere modeling of the aspiring musicians. Hurrah for the recreation room!

Most of the cellars which I have had the good fortune to remodel during the past year have been equipped with oil burners. This makes the problem of remodeling fairly simple as there is ample space available for the recreation room and little cutting up of this space is necessary. However, I have just transformed an old

type basement with its characteristic furnace, coal bin, ash can, and attendant clouds of dust into a charming room of old English design. This type job has its problems but they can be solved.

Every basement, whether of the old or new type, usually has its wash trays and furnace. These can be partitioned off into a neat, compact laundry and a furnace room. That space under the cellar stairs makes a dandy closet either for storing the children's toys or the golf clubs and fishing poles. The main problem centers around the recreation room proper. Here the treatment of ceiling, walls, and floors is to be considered.

I have found that the best way to cover the rough, dingy ceiling in a cellar is to use a good wall board, scored into panels. Where there are unsightly pipes overhead, (and there certainly will be if there is a bath room on the first floor) these can be hidden by dropping the ceiling at that particular point. The space under this will, of course, have a lower ceiling, but it makes a good cozy corner or a suitable spot for the refreshment bar. Steam pipes and heavy girders can be boxed in with wood to represent heavy beams. If preferred, the

(Continued on page 58)

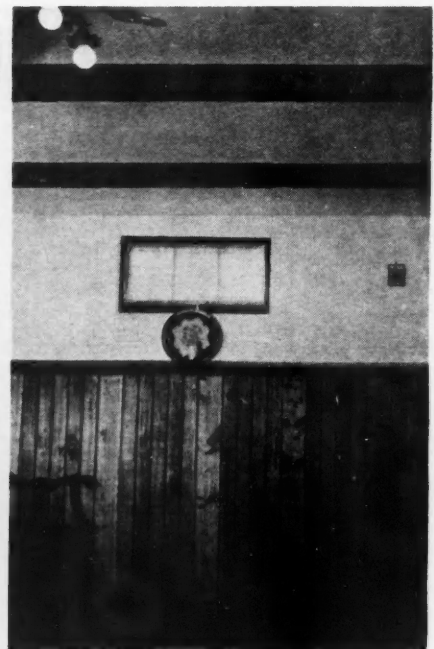
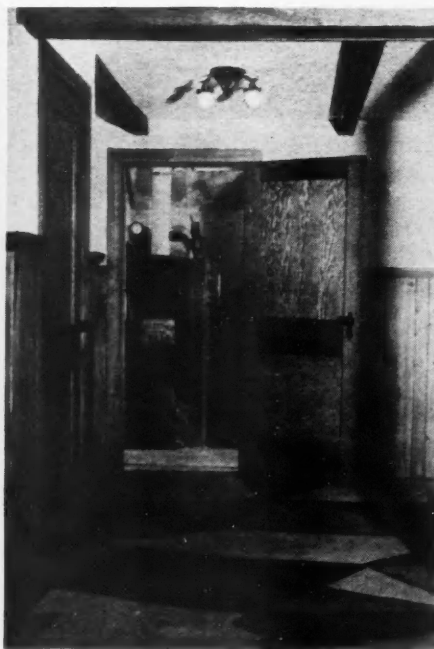
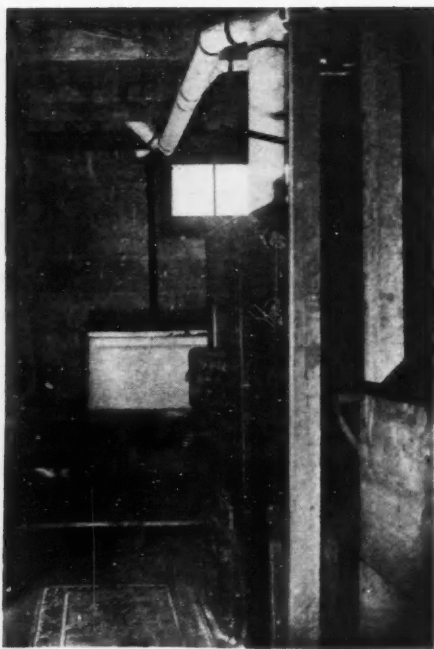

For \$450 Contractor Brekus transformed the tough looking basement at the left into the attractive paneled recreation room pictured above. Beamed ceiling, a built in bar, wall board, linoleum floor did the trick.

HOME EQUIPMENT

Nothing Down—5% Interest—Up to 20 Years to Pay

New opportunities for lower costs under FHA financing. Heating, plumbing, electrical, air conditioning planned in advance and included under one contract give added responsibility.

By V. L. SHERMAN

Department of Mechanical Engineering,
Lewis Institute of Technology, Chicago

COUPLED with the enthusiasm for the workings of the Federal Housing Administration comes the realization that, under it, every residential contractor must train himself for increased supervision of all sub-contractors. He must step far in advance of the old times when there seldom was anyone solely responsible for the entire job. And the residential contractor, being most responsible, must teach himself the worth and uses of all equipment which shall go toward making homes completely and enduringly satisfactory. The time has come when builders must be master builders—masters in every sense.

The word *depreciation* is going to be flung oftenest toward the builder who unfortunately, and possibly unconsciously, equips his building without knowing positively the character of the installations. Since all of the equipment which goes toward making a comfortable and enduring home is to be written into one mortgage alone—a mortgage that perhaps will last for twenty years—the need to include all elements of home-making in the best of qualities at the very outset is imperative.

Successful contractors will win out, nine times in ten, because they are completely informed concerning the mechanical equipment which they install.

It might seem that there is hard schooling ahead for many. Well, no schooling is hard when it is interesting. All real home building contractors are thoroughly interested in their buildings. Many of them have cursed and lain awake nights because they must cheapen their work to meet demands. Now the turn has come. It is no longer a competition in cost. It is a competition in competency.

I cannot too strongly emphasize that the new type of single mortgage contract which may extend over a period of twenty years is altogether inclusive. Not an item of expense is omitted to make it a secure investment for the owner, for the mortgagor and, certainly, for the community. No item of expense can safely be omitted which will make for convenience and comfort. And no item that makes for comfort and convenience can be less than durable and entirely reliable.

All general contractors know the great expense of "hiring and firing." What must the owner think of "buying and replacing"? With all of the contractors' proposals, plans and specifications on file, who will be the negligent one if the mechanical equipment proves to be faulty? Is equipment at a trifle higher cost which is to be paid for over a very extended period at an interest rate of five per cent not less expensive than cheaper



A NEW DEPARTMENT

AMERICAN BUILDER INAUGURATES this new department conducted by an expert in the field of home equipment at a time when reliable information on home equipment of all kinds is greatly needed by builders. Under FHA, responsibility is centered in the home building contractor—he must be able to advise and recommend items of home equipment more completely than ever before.

NEW OPPORTUNITIES

TO OBTAIN THE BENEFITS of low cost financing, all home equipment, services and costs should be included under one long term mortgage. While this increases the responsibility of the contractor, it increases his opportunities. It enables him to make sure that his houses are fully and substantially equipped, and that all items are fully specified in the FHA loan application.

equipment which through replacement may double or triple the cost? Is it less expensive to install less equipment than may be finally chosen, when the original cost may include all of the items at such low installment and interest rates? By all means the mechanical equipment must be complete, convenient and thoroughly reliable.

It is essential that the general contractor have at hand all possible means of acquainting himself with a building's mechanical equipment. He should more than become acquainted with these necessities. He should become familiar with them, with their uses, their proper design and installation, and with their characters. It will be the object of this department to present the essentials of modern mechanical equipment for buildings.

HEATING - AIR CONDITIONING - PLUMBING - WIRING - KITCHEN

There is no present promise of weaving the reader into technicalities concerning design and calculation. But we expect to meet his desire for readable information concerning the adoption of mechanical equipment, and to discuss features of the equipment which will lead him to wise choosing.

Take, for example, the question of heating. The writer has known numbers of instances where the same heating layouts were used for identical homes built in widely separated localities, where the weather conditions were entirely dissimilar. It seemed in each instance that the equipment was faulty, one underdone, the other overdone. But it was not so much the equipment as the unsuccessful application.

The question of heating is certainly one for some study, and that study does not become too technical.

Then there is plumbing. Plumbing layouts do not have to be expensive to be successful. The most expensive plumbing comes from haphazard layout in an effort to cheapen the cost, or through the use of cheap equipment. How about the bathroom? Right here in the town paper is a large photograph of a modern bathroom. Only careful examination by a practiced eye could lead to identification of the makers of the pieces of equipment, but every householder who does not possess a bathroom equal to it will be envious. It is well equipped, fully equipped, and well planned. The amount of housework necessary to keep it clean and bright is far less than that needed for one less well equipped and laid out.

Then there is the kitchen. This is one room in the house where your clients really must live. Is it convenient? Is it comfortable? Is it reliable? And there is one more thing to ask. Is it attractive? If the kitchen is well laid out with all of the modern requirements adequately answered, it is convenient. If it is warm or cool, as the case may be, and is well ventilated, and well lighted, it is comfortable. If the mechanical equipment is carefully selected and installed, it is reliable. If the design and proportions of the equipment

are the work of the best manufacturers there is no question as to attractiveness.

It has come to be accepted that the home shall be so completely wired that every room has its full supply of fixtures and outlets and switches. Quality here should equal abundance. Many an oversupplied room, that was, has come to a sad end, and that through cheapening the cost. The Russians are said to have a word, "kapoot," which describes the state of decrepitude arrived at when a single part's destruction leads them to discard the whole. There is nothing in modern mechanical equipment, or electrical, if you prefer, that will call forth more curses from the average man than cheap electrical construction.

Remember that the FHA terms for payment are long and the interest rate low. Is there any reason for depriving the owner from the start of equipment he will insist on later, meanwhile growling at the thoughtlessness of not including it under the one mortgage?

Then there is the question which is looming up so strongly now. It is that of proper illumination. Those whose experience has led them to the study of illumination have had their reward.

Now, we suppose that a number of readers will ask with a good deal of seriousness whether homes of the future will have to be air conditioned. That question has been asked of me repeatedly, in the last two years especially. Having had some experience with air conditioning and having had many years interest in it from many points of view, I will try to answer the question. Most homes will be air conditioned in the future. And to quite an extent many homes are already air conditioned.

It is essential to draw some distinctions in the meanings of air conditioning. A home is not a candy factory or a textile mill or a gold mine in Africa.

First of all a house is a home, and should be comfortable. There are some months of the year when heat is necessary, but no great effort is made to keep the win-

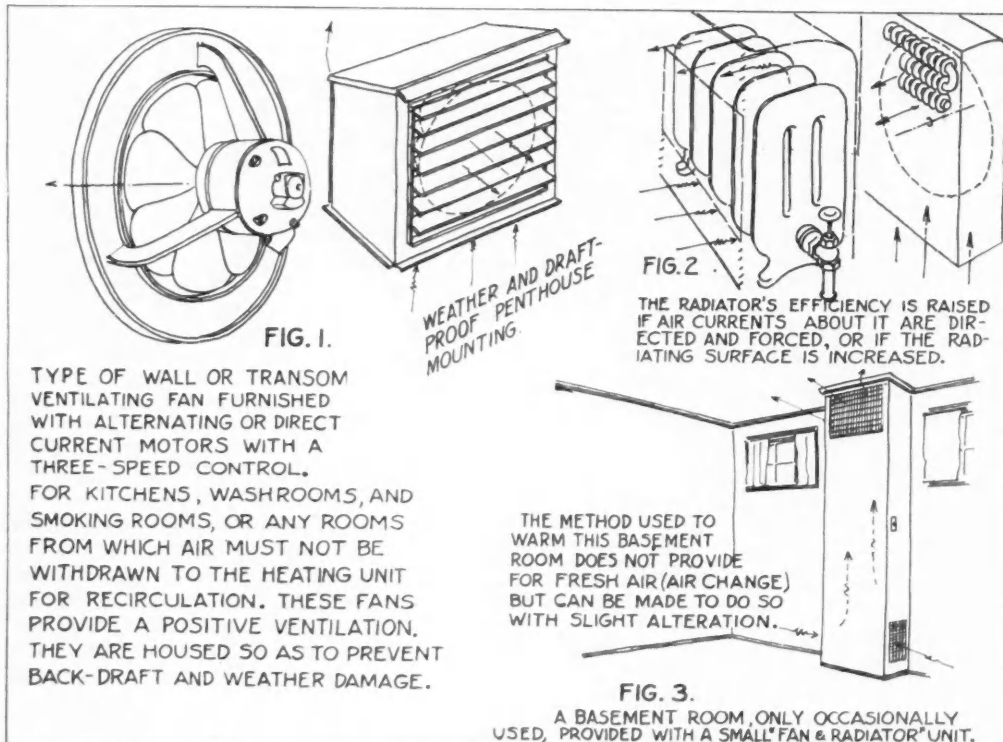

FIG. 1 SHOWS exhaust fan of effective type. **Fig. 2** illustrating how surface and circulation can increase heat supply from radiator. **Fig. 3** shows how a simple heating unit can be used to furnish an even heat supply in room used only occasionally.

AND BATHROOM EQUIPMENT FOR 20-YEAR FINANCED HOUSES

dows tight shut. Usually at these times there is enough moisture in the air to provide suitable humidity. Then there are the severe cold spells, when besides our effort to minimize the infiltration of cold air at jambs and sills there is an almost total absence of moisture in the outer air. Unless the air within the house is moistened by means of a humidifier, the excessive dryness of the air will lead to all sorts of trouble to the house and to the occupants, physical and mental.

Then perhaps there are some hot-waves in the summer, intervals of seeming eternity, when the air from outside is not only too hot but too wet. For comfort, the air within the house needs a stabilizer, but it does not need to have the stability of the air in a pharmaceutical laboratory. There are at present many firms which can furnish air conditioning equipment entirely adequate for home purposes, and at prices astonishingly low.

The question is often asked whether a house not equipped with ducts for supplying the air can be air conditioned. Certainly it can be.

At this "first starting" the subject cannot very well be taken up in detail. It may be stated, however, that air conditioning for homes is not the formidable project that many believe it to be. It is the efficient control of the air conditions throughout the house, a less expensive means because it obtains an evenness in temperature and humidity.

Before leaving the subject entirely, we wish to draw out one important element in the heating or cooling, and the ventilation of a modern home. For comfort and for efficiency of operation the air in any building should circulate properly. The correct circulation of air and its control have really more to do with comfort than any other factor. To bring this into more clearness we have sketched Figure 1 to show the uses of a fan of the exhaust type. Nothing adds more to positive exhaustion of doubtful air than does this little fan.

Figure 2 shows how surface and circulation can increase the heat supply from a radiator.

HEATING LAYOUT taken from recent installation by firm specializing in heating and air conditioning. Risers or stacks and return indicate how necessary the circulation of air is considered. Curtailment of air supply because of temperature differences is avoided.

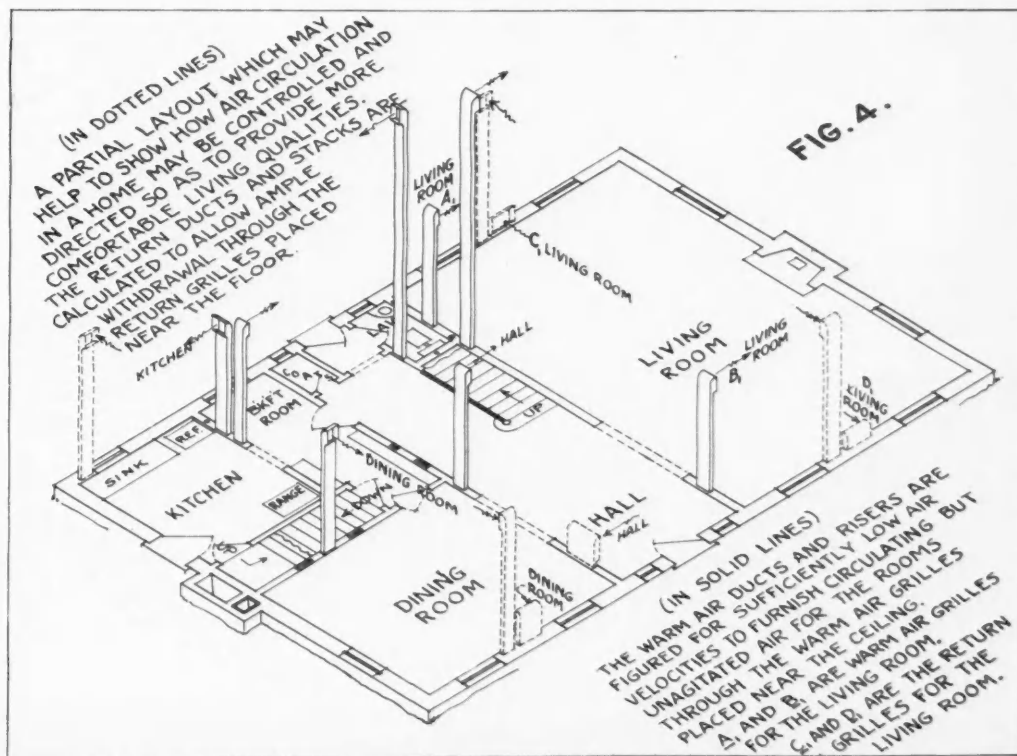

ADVISE AND RECOMMEND

HOMES MUST BE FULLY and carefully planned in advance, and details must be carefully specified in making application for FHA insured loans.

THE HOME BUILDING CONTRACTOR must be able to advise and recommend home equipment that will be substantial and satisfactory.

RESPONSIBILITY for the satisfactory service and operation of home equipment is placed upon the general contractor. He must select equipment that will outlast the long term financing.

Figure 3 is meant to show how a simple heating unit such as that shown at the right in Figure 2 may be used to furnish an even heat supply in a room that may be used only occasionally.

Figure 4 is taken from a layout recently installed by a firm which builds and installs heating and air conditioning equipment. The risers or stacks and the returns are shown to indicate how thoroughly they recognize the necessity of circulation of air. In this particular installation and unit there is no curtailment of air supply because of temperature differences, but a balancing in the heat absorption of the air passing through the unit. This feature is one of a number of improvements which have come about through the study of air conditioning carried on by the manufacturers. They have no secrets. Improvements in methods of manufacture are far ahead of what they were, with a consequent rise in quality, while the cost is declining.

The general contractor must realize the importance of mechanical equipment in the home, and be prepared to grasp the benefits to the home owner and to himself.

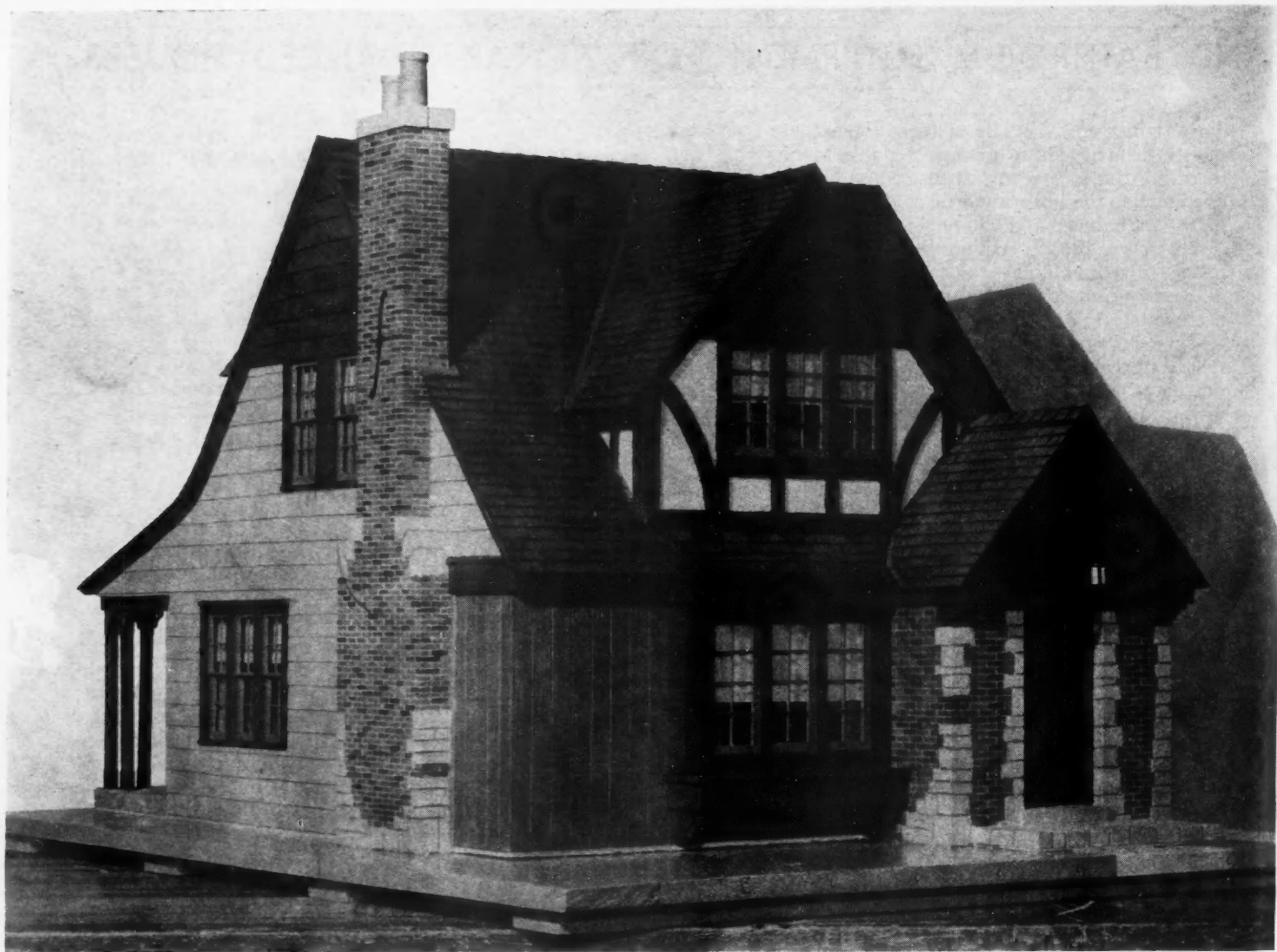

Popular "Economy House"

Stock sizes reduce building costs—English design most popular—thousands approve floor plans

SOME houses are designed to be built only once; others, because of the appeal of their floor plan, the popularity of the exterior and the *value* they give for the money, are built many times. Something about them appeals to small home lovers everywhere. The American Builder House of the Month pictured above, and with working plans on the three pages following, is such a house.

This is house design No. 234-A of the National Plan Service. Its over-all size is only 24 by 26 feet. When Western bungalow styles were popular, this same floor plan was used thousands of times. In fact, the National Plan Service reports that more than 3,000 sets of floor plans for this type of house have been sold by them.

Today, the house is restyled in the most popular type of the day—English architecture. It is compact, economical, homelike.

Best of all, this house is *economical*, because it uses stock lumber sizes carried by most retailers. The maximum economy of construction will be secured by dis-

cussing the plans in advance with your local lumber dealer to find out what stock sizes are most quickly and economically available. Most retailers have the material list for this house, or can secure it easily.

The photograph above is of a life-size model built by National Plan Service, which will be on display at many of the principal lumber dealer conventions this year. The model is perfect in every detail, and was built from complete working drawings prepared by the architects.

By adding 2 feet each way to the dimensions, the second floor could be re-arranged to include three bedrooms. In its present size, the design has been reduced to its most compact, economical form.

COST KEY OF THE HOUSE OF THE MONTH

1,427 Cost Rate	109 Lin. Ft. Founda- tion	665 Sq. Ft. Floor	29 Yds. Excav. Per Ft. Deep	18 Sqs. of W'l	13 Sqs. of Roof
-----------------------	------------------------------------	-------------------------	-----------------------------------	----------------------	-----------------------



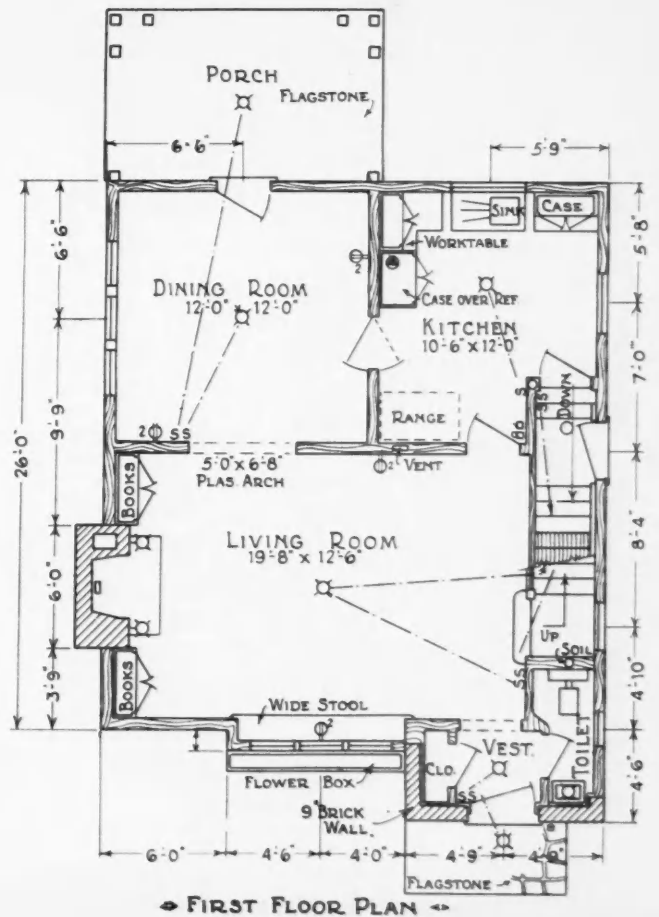
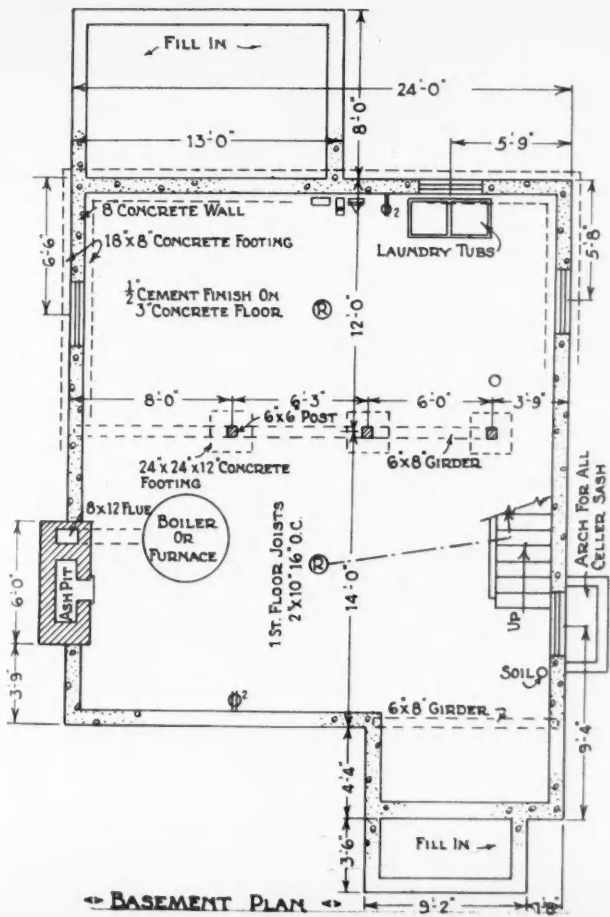
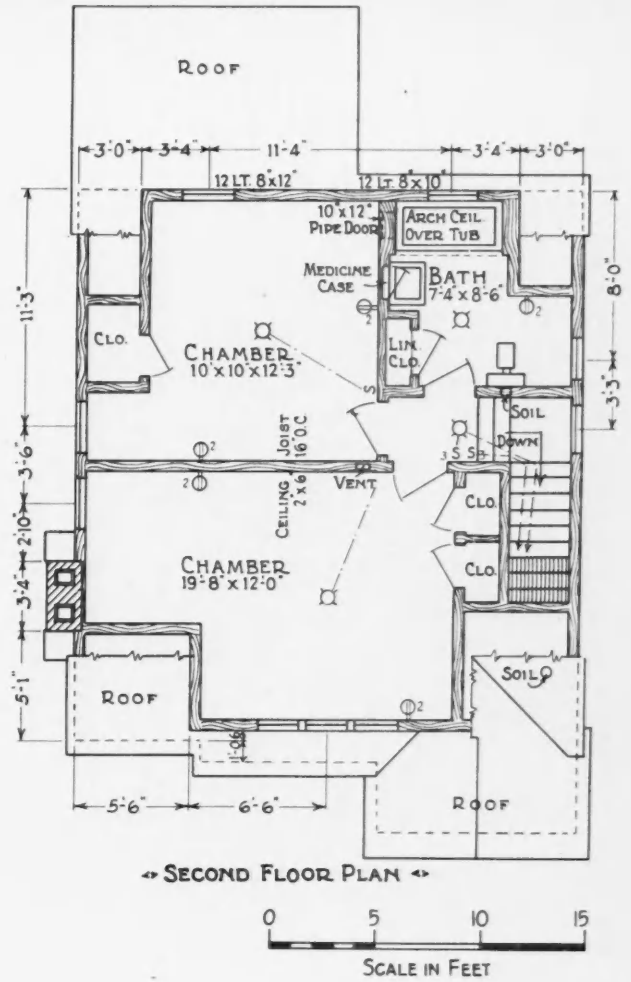
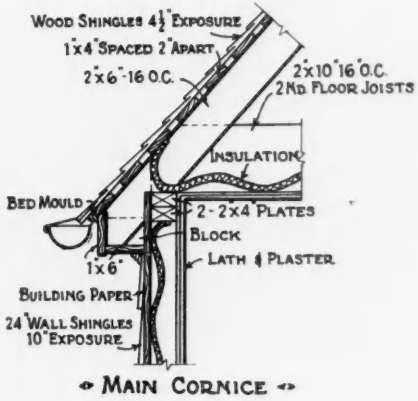
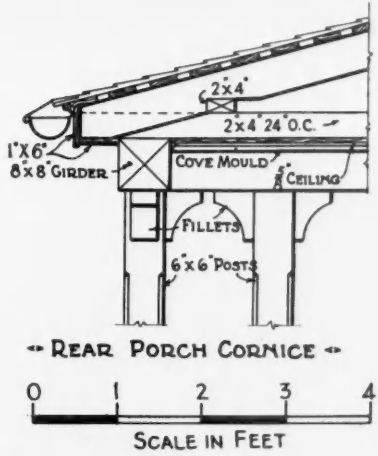

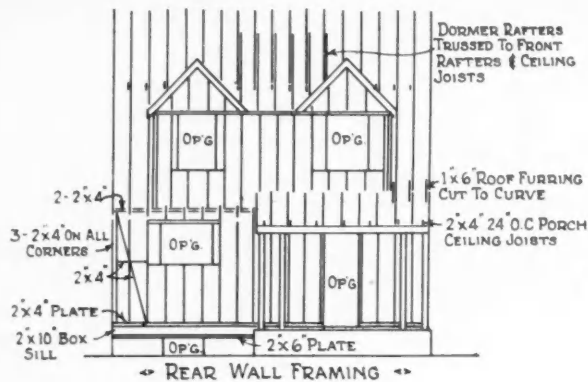

← REAR WALL FRAMING →

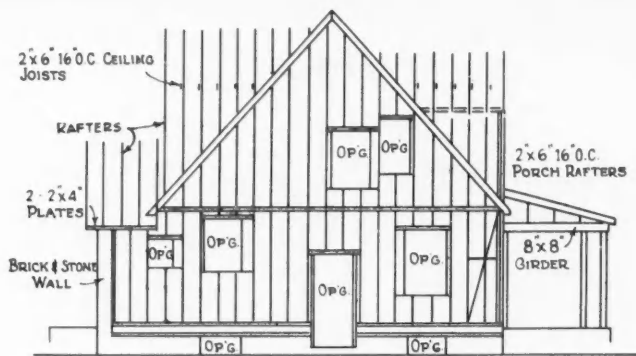

← RIGHT SIDE FRAMING →

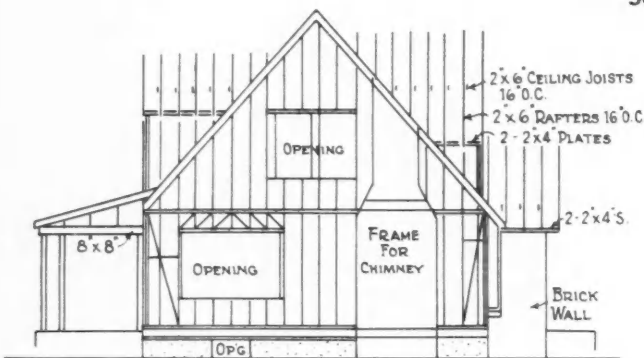

← LEFT SIDE FRAMING →

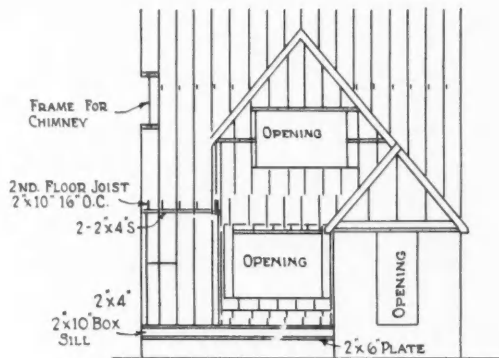

← FRONT WALL FRAMING →

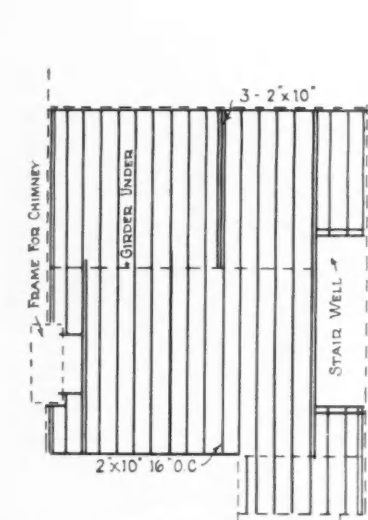

← 1ST. FLOOR JOIST FRAMING →

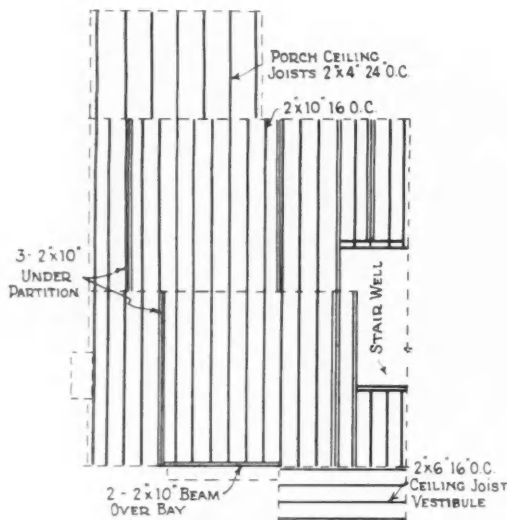

← 2ND. FLOOR JOIST FRAMING →

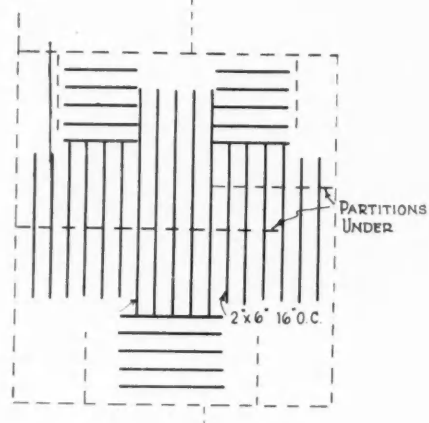

← CEILING JOIST FRAMING →

Framing Details for Maximum Economy

THE FRAMING DETAILS of the House of the Month given above are worthy of careful study. While the house is strongly and permanently constructed, it has been planned for economical construction. Long experience has taught the designers that the house most economical to build is the one in which maximum use of stock sizes from the local yard is possible. In this house there should be no delays or difficulties in getting materials from the local stock on short notice, because it was designed by an architect familiar with lumber practice.

There are many details shown in the elevations and architectural details on a preceding page that recommend the house to the builder and home buyer. Vertical boards with battens are used in the front wall, and the flower box built under the window harmonizes with the rustic siding is used over the door and in the gables. The rear porch is nicely handled, with its flagstone floor. An important feature of the floor plan is the extra toilet off the front entrance. The floor plan is one of the most popular arrangements ever made.

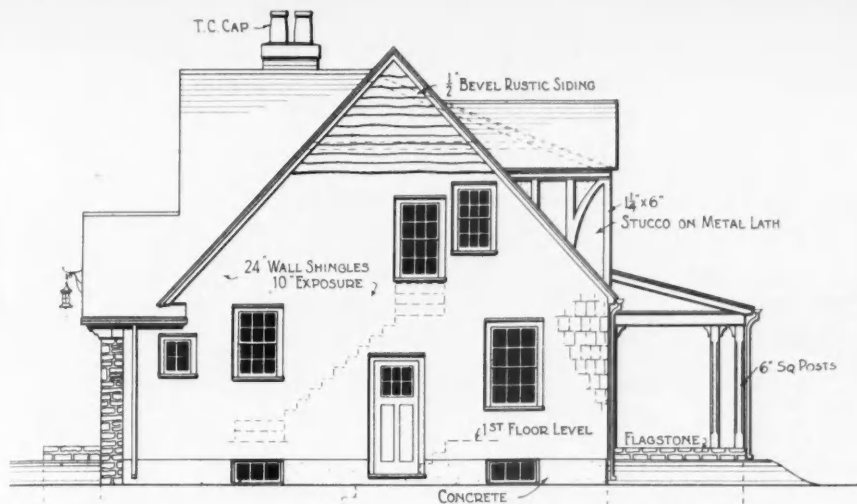

RIGHT SIDE ELEVATION

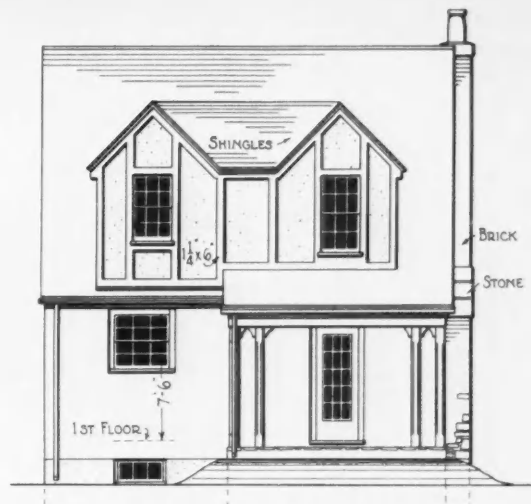

REAR ELEVATION



SCALE IN FEET



FRONT ELEVATION



LEFT SIDE ELEVATION

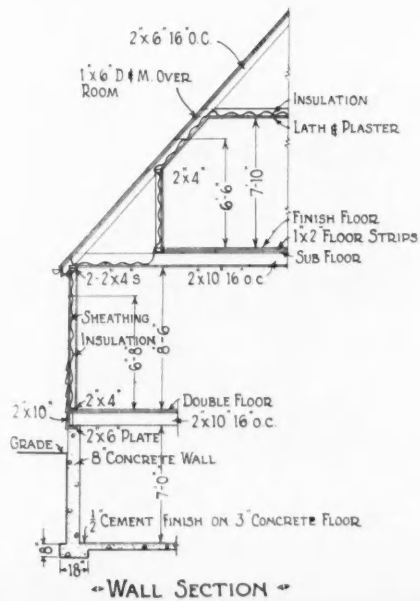

WALL SECTION

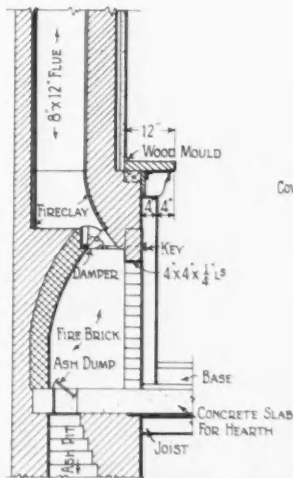

SECTION AT CENTER



HALF ELEVATION

FIREPLACE & BOOKCASES

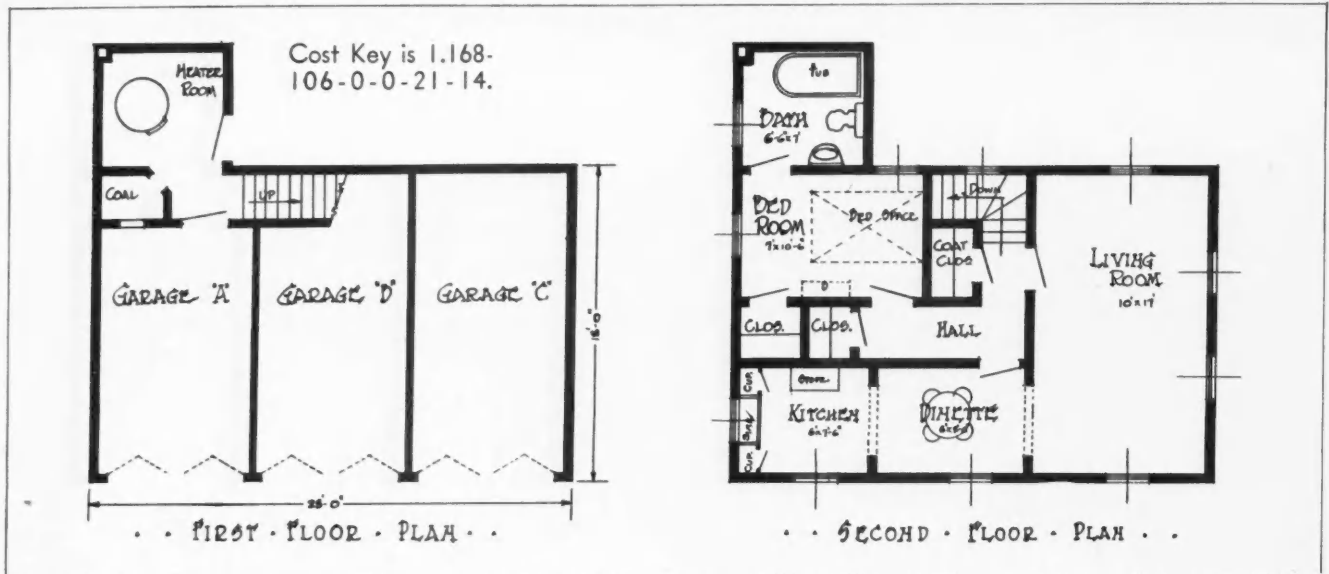

Home Above Garage

THIS THREE-CAR GARAGE has an attractive, well designed apartment above it which meets a need which is frequently encountered. It is located in Erie, Pa., and was designed by the architectural firm of Shutts and Morrison. Apartment is fairly spacious, with a 10 x 17 living room, ample closet space. Entrance is at rear.



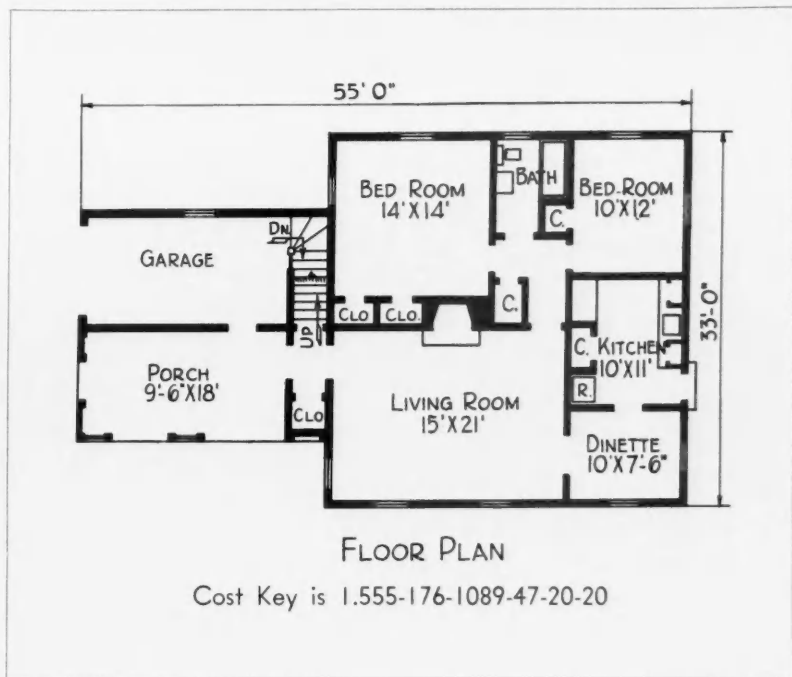

HOW A SMALL and inexpensive cottage can be built as a charming garden home is shown in this design by Randolph Evans, New York architect. It is located in the Harbor Green development of the Harmon National Real Estate Corp. on Long Island.

THE GARAGE AND PORCH extension at the left make an unusual combination which gives the appearance of size at small increase in cost. The main part of the house is compactly arranged, with a small center hall. In the exterior treatment Architect Evans has achieved charm by good proportioning, well designed cornice and window treatment. Another important feature is the way the house is located on the lot and properly landscaped.

Inexpensive Colonial- Well Designed



OLD HOUSE, Whiteparish, England. An interesting example of brick filled timbering; unfortunately, from an architectural viewpoint, the original leaded glass windows have been replaced by large pane sash.



QUEENS HEAD INN, Sedlescombe, England. A splendid inspiration for our wooded countryside.

Examples From Early English

EDITOR'S NOTE: The new home building to be done in the next decade will show, we believe, a much higher keynote of quality. This will tend to develop a stronger interest in true period work, the proper reproduction of which requires a sound first hand knowledge of the period styles as they were originally developed. This article by R. C. Hunter, New York Architect, presents many interesting features of authentic old English buildings.

OLD buildings are so interesting and have such far-reaching influence on current thinking about shelter, that it would seem most desirable to study them more thoroughly. This is particularly true in our domestic architecture, for the traditions associated with the wholesome home life of our ancestors are unseen ties which bind us strongly to these early examples.

Americans are a cosmopolitan people, which probably accounts in part for the many different styles in our domestic architecture; this tends to complicate matters for both architect and artisan when they attempt to produce authentic buildings with that warmth of feeling so necessary to the success of a particular style. In Eng-

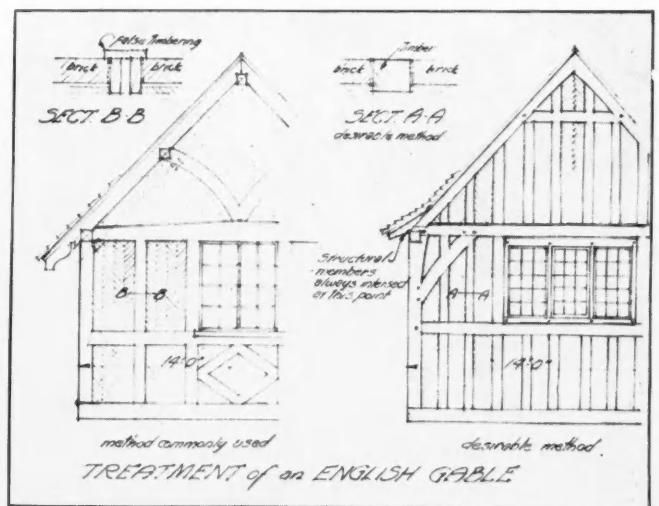

COMMONLY USED and desirable methods of treatment for an English gable.

FARM GROUP, (Cotswold Hills), Burford, England. Built all of one material, stone, simplicity rules supreme in this shed from the Cotswold Country.





OLD FARM GROUP near Battle, England. One of the few remaining early examples of wood houses in England. Note one brick end.



TO AN ARCHITECT the soft contours of stonework like this are pleasing as musical notes to a musician. Arch Entrance, Old Monastery on River, Maidstone, England.

Other Lands

Architecture

land, houses for generations have been built principally of materials at hand, by artisans whose skill is the result of long years of training. The result is that common things become noteworthy examples, with great warmth and charm.

We can do well by studying these examples, giving special attention to textures, materials and craftsmanship. The qualities we admire so greatly in these old buildings are not merely superficial surface effects, but are traceable often even to the skeleton framework.

All the accompanying photographs were taken by the writer and the sketches are from personal observations on the ground.—R. C. HUNTER, ARCHITECT, NEW YORK CITY.

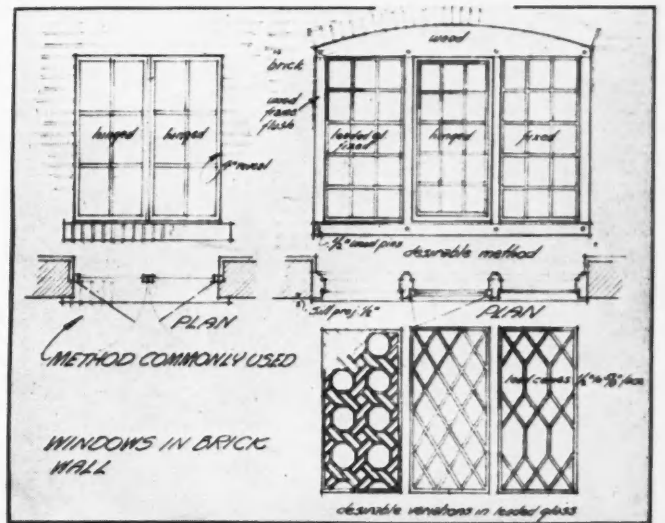

OLD FARMHOUSE near Peasenhall, England. Note placing of chimneys and dormer windows in this example below of the Queen Anne style

OLD COTTAGES, Hursley, England (below) which show a pleasing combination of brick, stucco and timbering. Above, details of casement windows.



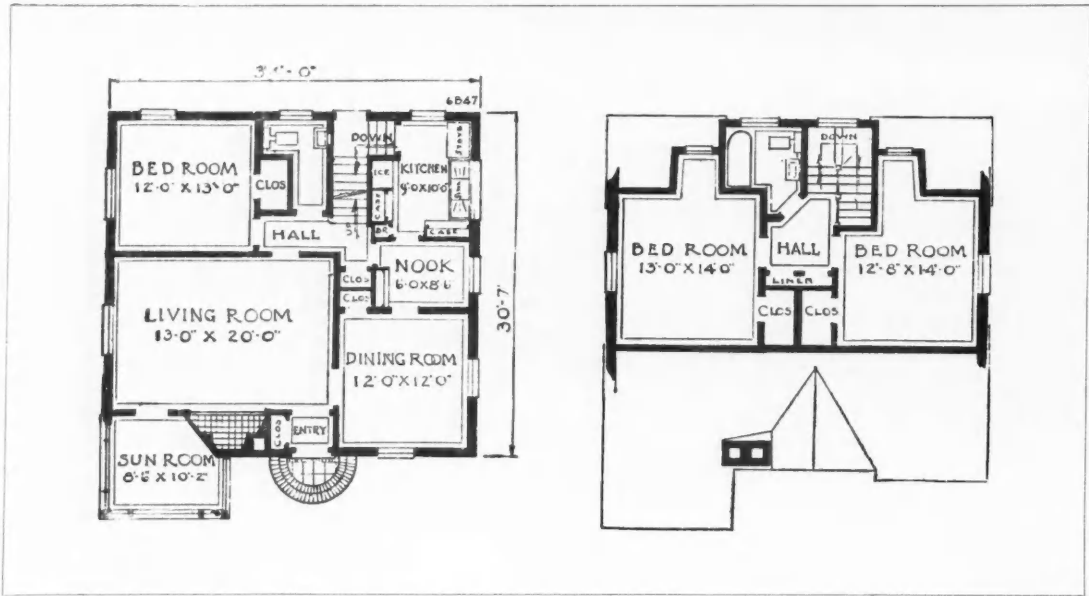

IN THE SOUTH AND SOUTHWEST this stucco home with tile roof, brick trim, casement windows and gabled entrance is very popular. Good features include the sun room, downstairs bedroom, good sized breakfast nook, downstairs lavatory, attractive fireplace in ingle nook. This is Design No. 6-B-47 of the Architects' Small House Service Bureau.

Planned for Family Comfort

Cost Key: 1.778-148-1139-48-21-18.

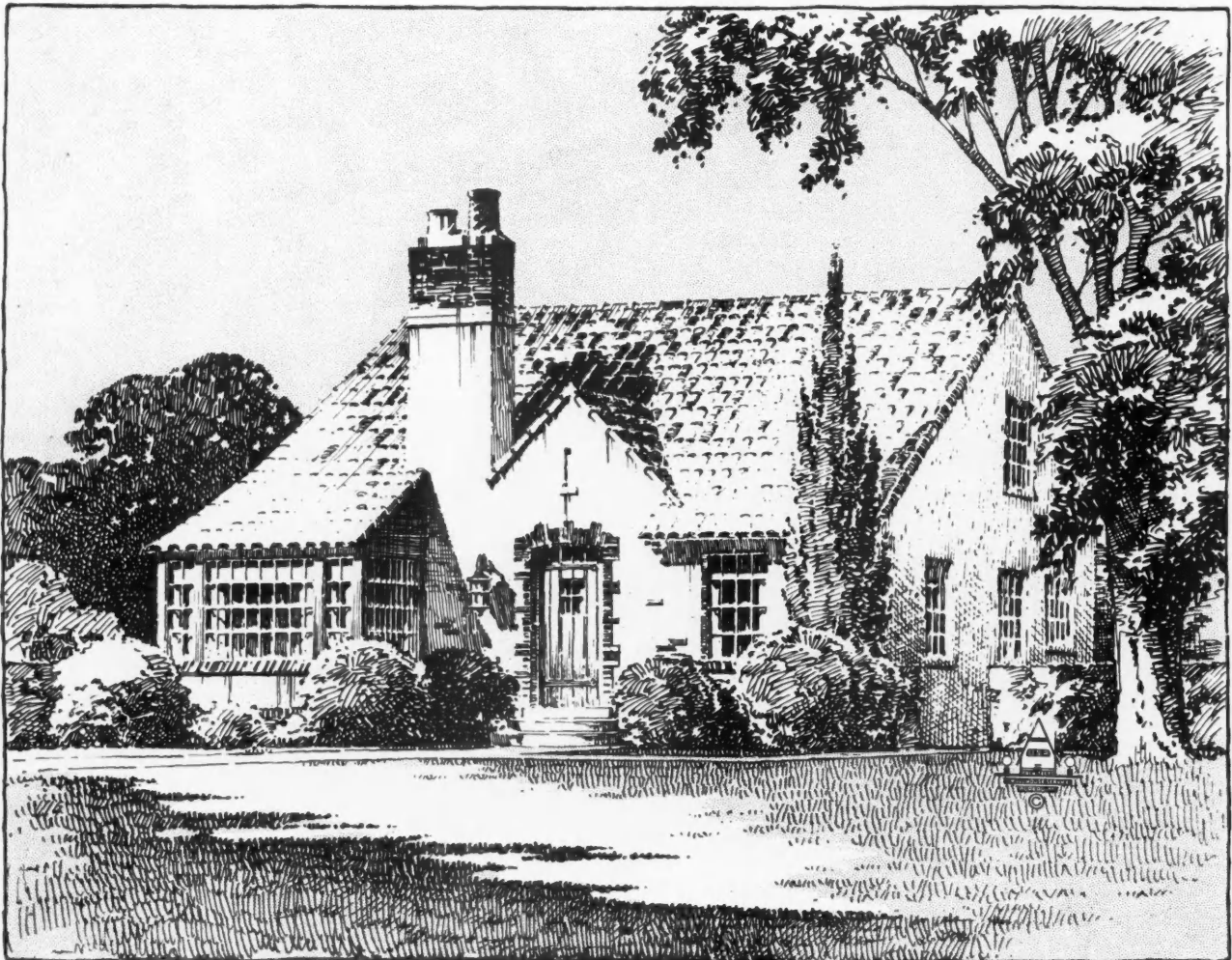

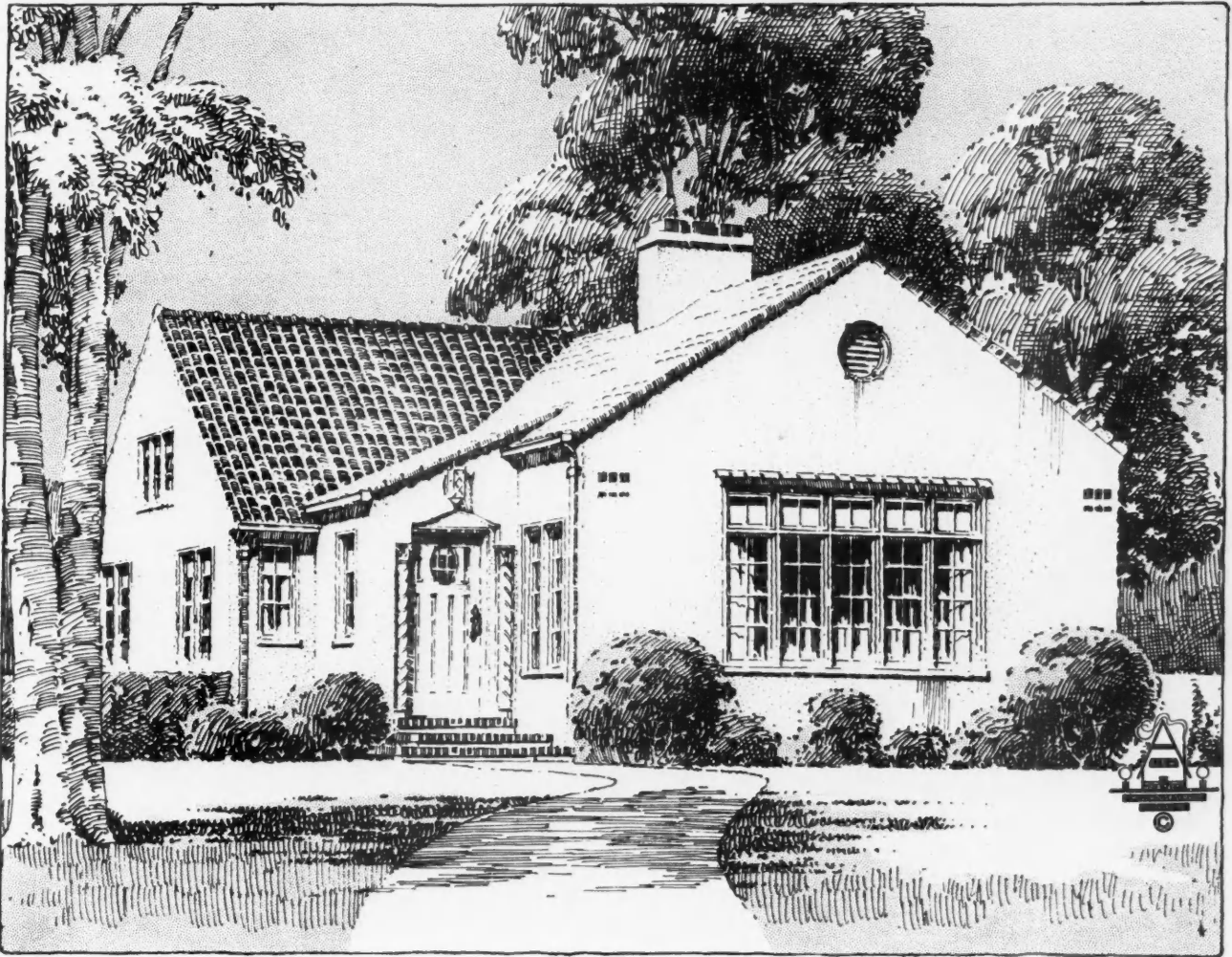

Pleasing Version of Spanish Bungalow

Cost Key: 1.384-152-1393-57-18-18.

THIS HOUSE is an improved and beautified Spanish type that is finding wide acceptance. It is well planned, with rooms of generous size, well lighted. Proportions of the roof are well done and account for the pleasing appearance. Stucco walls, tile roof, broad, high windows, grouped in front, and ornamental entrance contribute to the exterior design.

FEATURES OF THE INTERIOR are vestibule with coat closet, living room with windows on three sides, fireplace, storage in attic reached by stairway from hall, recreation room in basement with fireplace. This is Design No. 5-A-78 of the Architects' Small House Service Bureau.



Six-Family Building Spanish Architecture

WELL PLANNED INCOME PROPERTIES have withstood the depression, in many cases, better than other types of structures. The time may soon come when builders will be considering two, four, and six-family income properties that can be built to meet the growing demand in certain communities for apartment homes.

THE SIX-FAMILY BUILDING shown above is located in Leimert Park, a suburb of Los Angeles, and was built just before the depression. It is substantially constructed with concrete floors, tile baths, modern equipment, private garages. The record of rentals is reported as very good, one reason being the location of the building in a restricted community development where the architecture is harmonious and the project beautifully landscaped and taken care of.



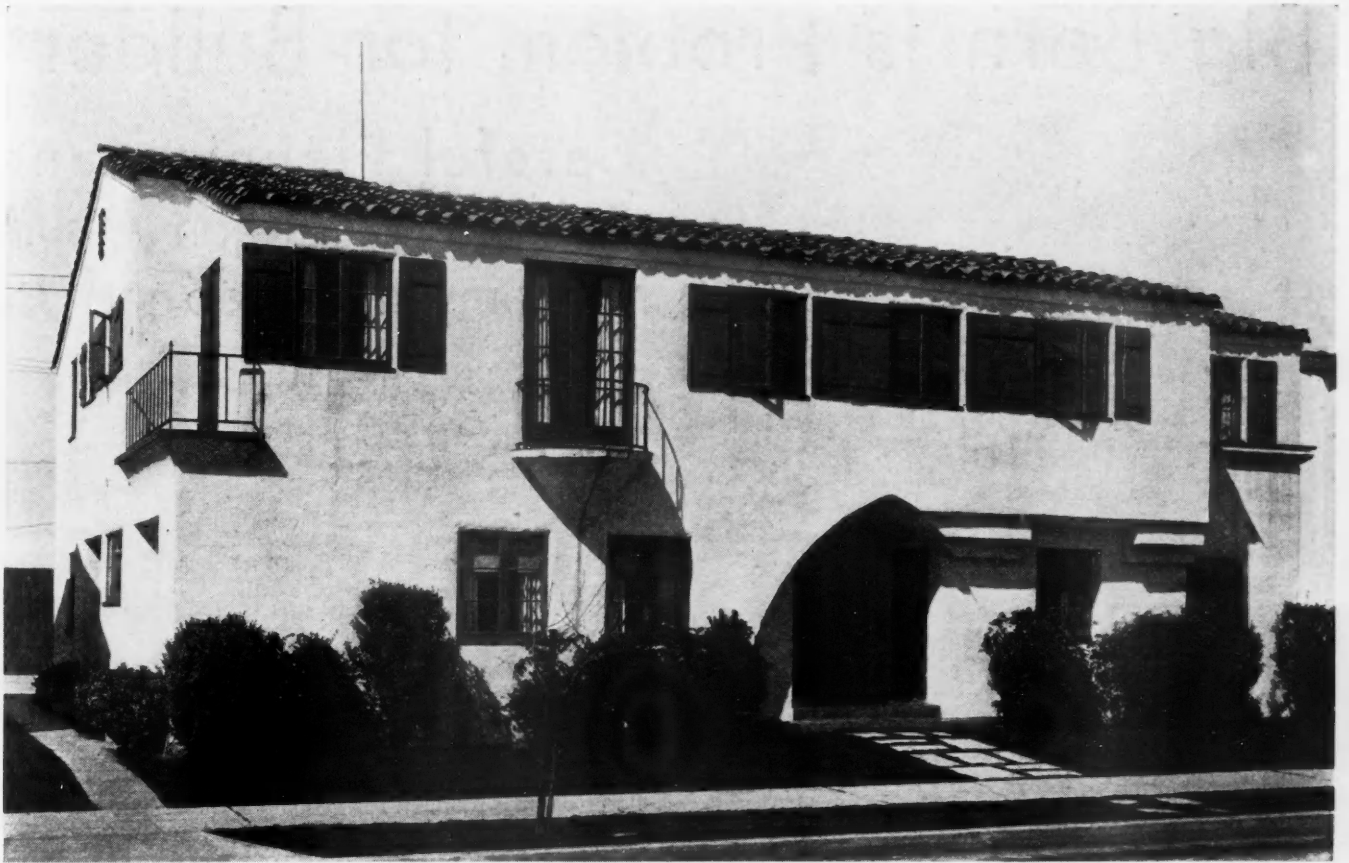

An Income Property 4-Family Building

FOUR GOOD-SIZED APARTMENTS are located in this building, and they surround a patio, or court, which is walled in and is attractive. The Spanish type architecture has been popular in California, although recent years have brought some changes in the style trend. This multi-family home was built prior to the depression, and was an example of careful planning and good layout.

THIS STRUCTURE, as well as a number of similar duplexes, four- and six-family buildings, located in a restricted area in Leimert Park, a suburb of Los Angeles, were sold on the basis of income. While rents have dropped, the record of occupancy has been good in Leimert Park. Indications are that many builders are laying plans for the smaller type income properties, duplexes and four-family buildings since these are eligible for financing under FHA.

Big Barn Is Problem for Builders



Careful Planning and Sturdy Construction Assure Economy in Upkeep and Use

Testifies H. A. HEIMBECK,

Designer and Construction Engineer,
Rock Island, Ill.

LAST MONTH I illustrated the general layout of the farm buildings designed for the purchaser of an old farm near Hamlet, Ill. The old buildings were so dilapidated that practically all had to be razed and the site cleared before the job could be started of providing a new and adequate equipment of buildings. This fact gave an unusual opportunity for planning the entire group in harmony and for efficiency.

The big general purpose barn was naturally the central unit in this layout; and this building I am illustrating herewith, with important construction details of roof framing, floors and stalls.

The type selected for the big barn has features common to all barns for diversified farming. Local regulations concerning production, handling and disposal of milk were considered. A new grade was established so the site is dry and well drained. The building is placed with the length extending north and south, providing greatest amount of light. Careful consideration was given for the location of the silo, feed bins and accessibility for loading hay and filling the silo. The size of the barn is 36 by 60 feet, and it was planned to accommodate twelve cows and seven horses. Except for a few details the size and arrangement of cow and horse stalls are standard for general practice.

The capacity of the hay mow is approximately fifty-five tons, of the small grain bins eleven hundred bushels and of the crib three hundred bushels of ear corn. The cows are located in the north end of the barn which is desirable with relation to the feed lots and convenient to the lane and fields. The horses are in the south end, nearest the farm court. The driveway and feed storage bins separate the two stables, which is required by state regulations.

The cow stable floor, alleys, driveways, gutters and mangers are concrete reinforced with salvage wire fencing. The horse stable floor is reinforced concrete covered with three inches of native oak nailed to two by four sleepers. The cow mangers and feed storage bins floors are troweled concrete. All other floors and driveways are rough surface concrete, all carefully pitched to drains.

All outside foundation walls are eight-inch reinforced concrete with footings below frost and poured eighteen inches above finished grade providing ample protection for the wood frame, which is an important factor in sanitation. The gambrel type of roof was selected for

the barn and other buildings in the farm court for attractiveness, larger mow room in the barn and better spouting facilities in the corn crib.

The vertical outside walls of the barn and other farm court buildings are framed with studding twenty-four inches on centers with drop siding for wall sheathing.

The supporting posts for the mow floor are four-inch outside diameter steel columns in the cow stall rows and six by six timbers in the granary and horse stable portion. The girders are continuous built up of two by twelve dimension. Mow floor joists are two by twelve twenty-four inches on center, bridged and lapped twelve inches at the girders for horizontal bracing and floored with one by eight ship-lap. At the corners and all door openings the studs are bolted to the two by six foundation plate with six by six clip angles. The main rafter plate is doubled two by eight with knee braces to the mow floor joists. The end walls are wind braced from the mow floor girder to the roof.

The outside walls of the cow stables are insulated with one inch of Balsam Wool. The interior walls and ceiling are sealed with five-eighths inch flooring. The interior of the outside walls in the horse stables has two-inch planking window high for protection. Cow stalls are arched tubular steel type with swinging stanchions. The cement manger is extra high type equipped with guard rail. The combination pen is stanchioned for two cows and six calves. Horse stalls are plank type partition and mangers have tubular steel guards.

The gambrel roof framing is the self supporting braced rafter type, built exceptionally strong and well braced at points of usual weakness. This type of roof offers large unobstructed mow capacity and can be erected economically without use of heavy timbers.

The silo is placed on the center line of the aisle leading to the main feed aisle with the outside of the barrel nine feet from the building line of the barn. The barrel is twelve feet in diameter extending three feet six below grade and forty-two feet high. The barrel and chute are laid up with rough textured five-inch hard burned tile with double inner and outer tile webs. The tile colors are deep buff and brown intermingled. The walls are insulated with built-in insulation strips and reinforced with wire in the bed joints for lateral pressure. The continuous concrete doorway has removable expanding doors. The chute is supported on concrete brackets six feet off the driveway floor providing accessibility for wagon loading. The round roof is laid up with brick covered with one inch of white waterproofed cement mortar. Capacity is ninety-four tons.

CONSTRUCTION DETAILS OF BIG BARN ON TWO PAGES FOLLOWING

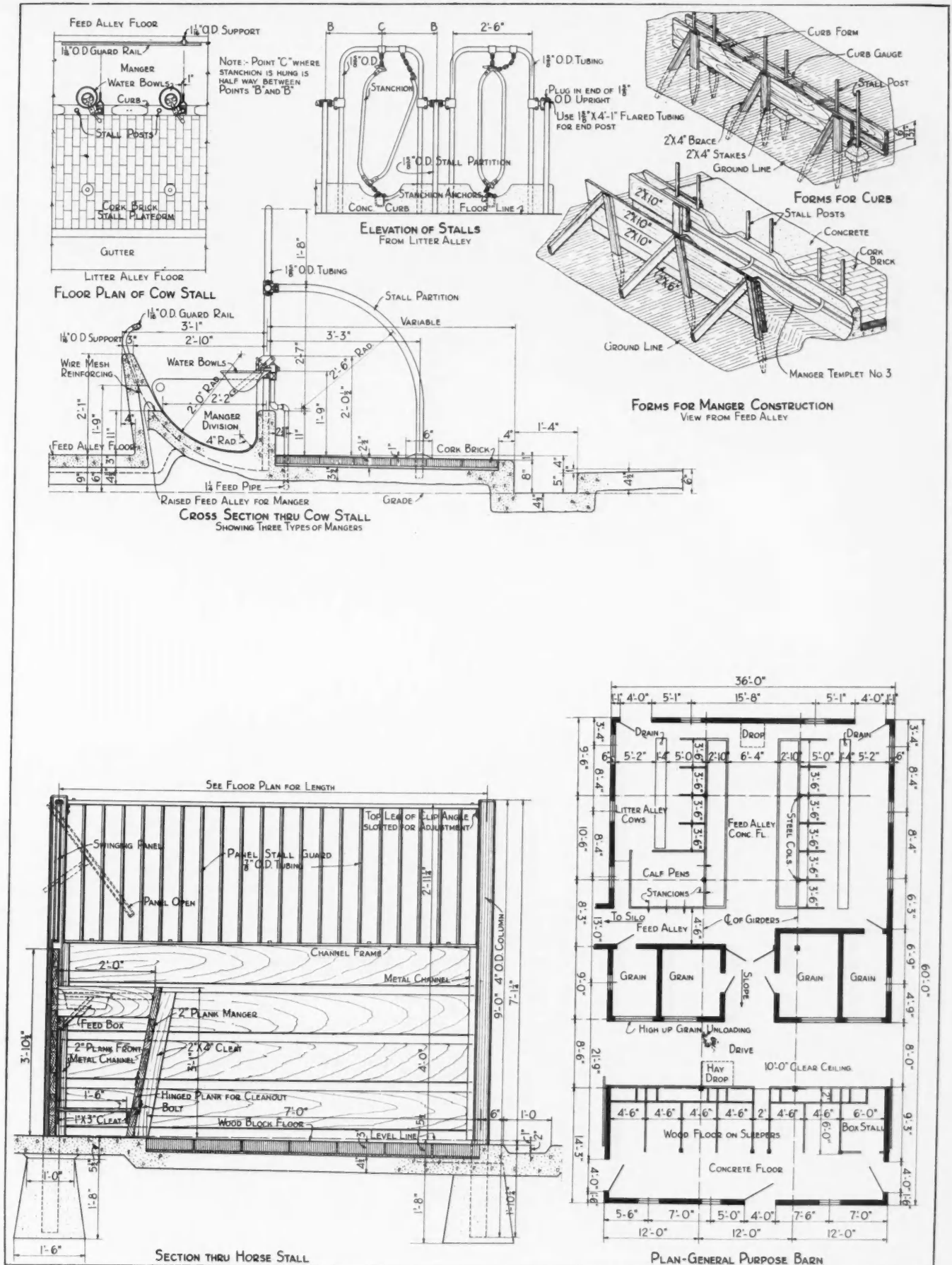

Layout and stall construction details of Big Barn for Horses, Cows and Storage as designed by H. A. Heimbeck

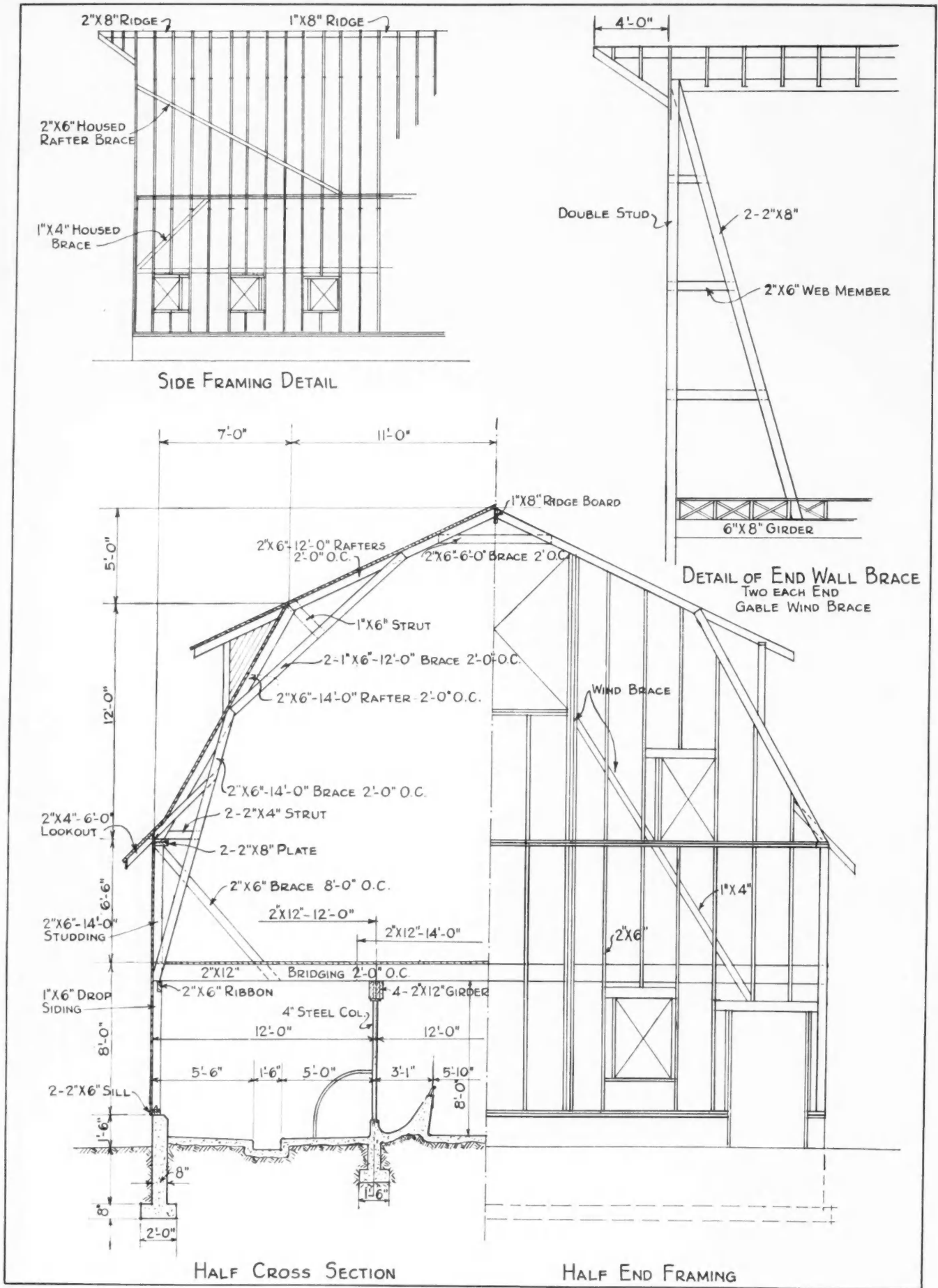

Section through Big Barn showing self-supporting plank-frame roof, also end bracing to resist wind pressure. See two preceding pages for photo and plan.

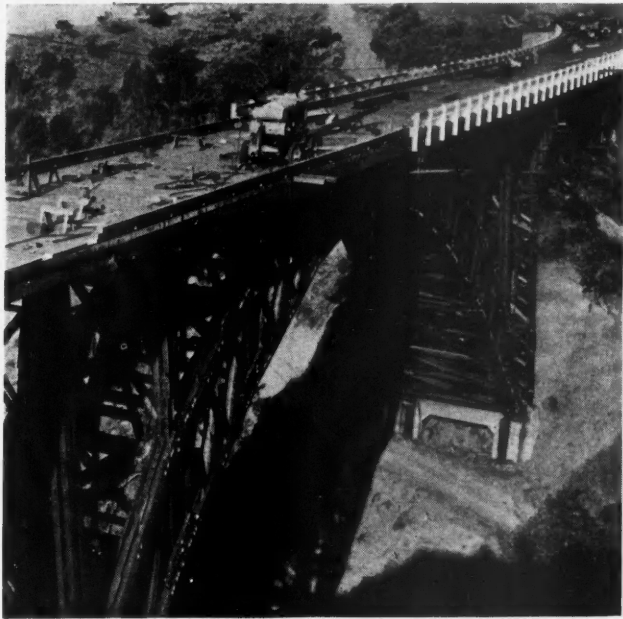

Timber Connectors Used in Big Highway Bridge

A SPECTACULAR illustration of a new development in wood construction is seen in the highway bridge designed by the California State Highway Commission and now nearing completion over Dolan Creek, about 50 miles south of Monterey, in Monterey County.

This structure is doubly in keeping with its setting. The sweeping arc of the approach and the majestic curve of the three-hinged arch, which spans 180 feet between abutments and rises 125 to 130 feet above the bed of the stream, complement the grandeur of the surroundings. The comparatively slender timbers in the lacey framework seem the ideal material to connect sparsely wooded hillsides.

The job was made possible through use of a simple contrivance called the modern timber connector. With the aid of this device State engineers were enabled not only to design with material suitable to the environment, but to effect a considerable saving as well.

Prior to the invention of these connectors, engineers were constantly confronted with the fact that bolted joints of timber-framed structures were not equal in strength to the cross section of the various members in an assembly. It was therefore a necessary practice, when designing for heavy timber construction, to use only 40 to 60 per cent of the allowable working stress for timbers, so that a large volume of wood for bearing area at joints would be available. Reduced to simplest terms this means that a joint formed by bolting two wooden pieces together in the old-fashioned way was not so strong as either of the pieces themselves. For that reason, in many instances twice as much structural timber as was actually needed between connections was employed to give necessary strength to the joints.

The connector is enabled to do its job because, when placed between the surfaces of timbers at contact points, more load is transmitted per square inch than is possible with bolts alone. The bearing area is enlarged and loads distributed more uniformly over the width of the pieces involved, thus reducing the unit stresses on bearing areas and strengthening the joint some times up to 100%.

There are several types of these connectors commercially available in this country. One, called the alligator

type, is a double-toothed ring of corrugated sheet steel. This is merely placed between the adjacent faces of timbers in such a way that the toothed ring centers on the bolt hole. As the faces of the timbers are drawn together by a bolt, the toothed rings are firmly imbedded in the wood, the teeth entering each timber to one-half the depth of the ring. It is the job of the bolt to hold the timbers and the ring together, but not to carry the load of the joint, as that is attended to by the toothed-ring connector, which transfers stresses from one timber to the other.

Another favored type of connector is the split ring variety, which is a plain, straight-edged, steel ring, with a tongue and groove break. Its position in a timber joint is similar to that of the toothed-ring or alligator-type connector, except that, instead of being self-embedded through pressure, it is placed in grooves pre-cut in the adjacent faces of the timbers to a depth in each timber equal to half the depth of the ring. The ring is placed in the groove of one timber, the other timber placed over it, and the two pieces drawn tightly together by a bolt. When under load, the split ring, being slightly flexible because of the break in the circumference, bears against both the outside rim of the groove in which it is placed as well as against the core of the wood encircled by the groove. The groove is made by a very simple tool which, because of the fact that it works from the center of the bolt hole, insures that the grooves in the adjacent timbers will be exactly opposite each other.

Both split ring and alligator-type connectors were used on the Dolan Creek bridge job. Still another type of connector, however, is the shear plate, which is a device for transferring load from steel to timber, or vice versa. It consists of a toothed plate with an annular hub. The plate is embedded in the wood somewhat after the manner of the alligator or toothed-ring connector, while the hub fits into a hole in the steel, the whole assembly being held together with a bolt.

Introduced here from Europe by the National Committee on Wood Utilization, (now a part of the Forest Products Division of the U.S. Department of Commerce), the timber connectors are handled in this country by the Timber Engineering Company, a subsidiary of the American Forest Products Industries, which is an affiliate of the National Lumber Manufacturers Association.

The Dolan Creek bridge is 514 feet long with a 24-foot roadway, designed for "H-15 loading," which means that the bridge will support a train of motor trucks led by a 12-ton truck, followed at a distance of 30 feet by one of 15 tons, and this by any number of 12-ton trucks at intervals of 30 feet. But the timber-connector principle is applicable to structures of far less heroic proportions. The several hundred structures in which the idea has been applied in this country, while including such spectacular construction jobs as radio and forest lookout towers, also include coal bunkers, tank platforms, roof trusses and innumerable other uses. The principle is particularly valuable for roof trusses in riding academies, auditoriums, skating rinks and other buildings where wide expanses of floor space, uninterrupted by columns, are necessary.

Favorite methods of construction provide for shop framing and, in the case of smaller built-up members, shop assembly. In the Dolan Creek bridge job, however, regulations imposed because of Federal aid necessitated both framing and assembly at the site and without the use of power tools. While this necessity for fabrication at the site operated to neutralize, to a limited extent, the economy factor, there are occasions when the readiness with which the material can be worked at the site enhances the economy factor.

NEW PRODUCTS

FOR FURTHER INFORMATION about any new product write the American Builder Information Exchange, 105 West Adams Street, Chicago, Ill.

New Speed Saw

A NEW six-inch Speedmatic saw with a cutting capacity of 1-7/8 inches, now offered by the Porter-Cable Machine Company, Syracuse, N.Y., includes the following features:

1. Light weight—12 lbs.;
2. Finger tip depth and angle adjustments; raises and lowers to desired depth and tilts to 45 degree angle.
3. Blade automatically guarded in every position.
4. Safety guard control for pocket cutting, etc.
5. Blade may be changed without removing any part of frame or guard.
6. Takes standard 6-inch blade, dado cutters, abrasive discs, etc., with round 1/2-inch diameter holes.
7. Special universal motor, developing 1/2HP at idle speed of 5000 RPM.
8. Cutting speed 4000 RPM.
9. Sturdy gear drive.
10. Ball bearing throughout. With proper abrasive wheels, stone, marble, slate and composite materials may be cut with the new saw.

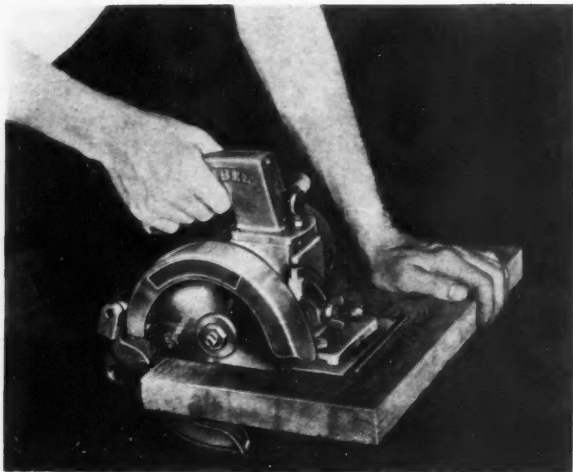

NEW SPEED SAW weighs only 12 pounds, takes 6-inch blade

New Holding Device

A ONE-PIECE device for holding or attaching anything to concrete, brick, stone and other materials has been placed on the market by The Rawlplug Company, Inc., 98 Lafayette Street, New York. It looks like a bolt and drives in like a nail, has gripping and holding power, and gives the user the advantage of a combination anchor and anchoring device in a single (one-piece) unit. A hole is drilled in the material, the fixture put in place, and by a few sharp blows with a hammer the Rawl-Drive is anchored permanently with a holding power heretofore considered impossible with any one-piece device. Tests show a 3/16-inch Rawl-Drive will withstand 12,000 lbs. direct pull when embedded in 1-2-4 concrete and a 1/2-inch Rawl-Drive in the same concrete will withstand 12,000 lbs. pull.

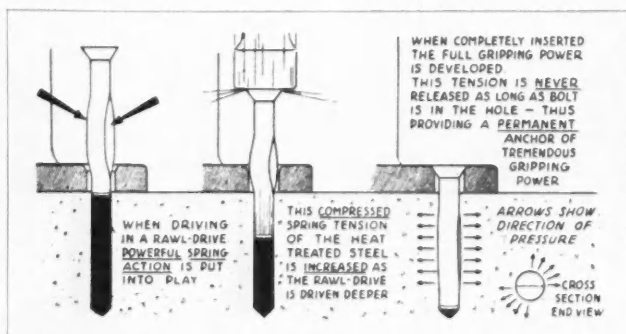

LOOKS LIKE A BOLT, drives like a nail; has strong holding power

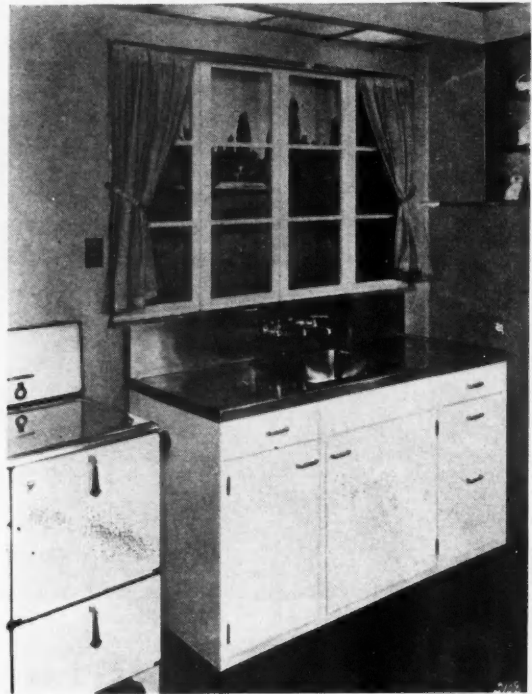

KITCHEN SINK has compact modern cabinet, 8-inch back-splasher.

Compact Kitchen Unit

A NEW "package unit" for the modern kitchen has been announced by the Whitehead Metal Products Company of New York, Inc., distributors of Monel Metal sinks. It includes a 60-inch, double-drainboard Monel Metal sink with an all-steel supporting cabinet available in different color schemes. It is designed primarily for the homes in the middle cost brackets and retails for \$99.50, with a 1 1/2 inch backsplasher. The cost of the unit with the 8-inch backsplasher as shown in the illustration is slightly more.

Cold Storage Insulation

ONE of the new items recently added to the line of The Insulite Company, Minneapolis, is Insulite Sealdslab. This product meets the demand for an insulating material suitable for cold storage insulation that can be obtained at a comparatively low cost and most economically installed. It is produced in various sizes and thicknesses.

The market for the new product includes: meat packers; public and private cold storage warehouses; ice manufacturers; ice cream and milk plants, creamery operators; brewers; manufacturers of brewery equipment; manufacturers of commercial refrigerator cabinets; citrus, apple, potato and vegetable growers and shippers; fruit jobbers and commission merchants; dry ice manufacturers; and a host of others.

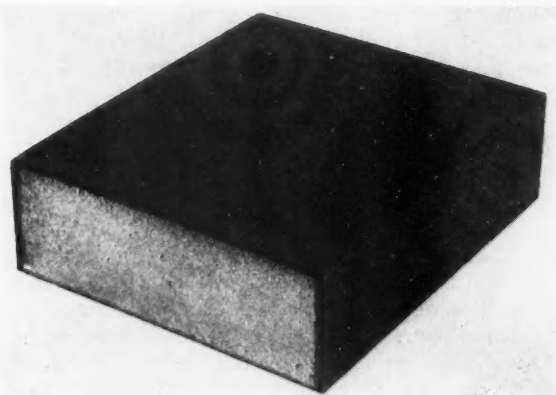

HEAVY INSULATION is made up to 4 inches thick in slabs up to 4 feet long.

NEWS OF THE MONTH

Building Activities

Ardrey Tells How to Get Loan

HOW a typical "Bill Jones" would go about getting an insured FHA loan to build a home was graphically told in a recent talk by J. Howard Ardrey, deputy administrator of FHA, as follows:

"He approaches a mortgage lending institution approved by the Federal Housing Administration. If the lending agency decides, after its appraisal, that the property represents sufficient collateral for a loan, and that Bill is a good credit risk, a request is made to the Federal Housing Administration for a commitment that the mortgage will be insured.

"The Federal Housing Administration then sends out two trained experts, one a competent appraiser and the other a competent architect. Their analysis not only safeguards the Federal Housing Administration, but also provides a valuable service to the lending agency in checking upon the nature of its investment.

"If all is well, Bill Jones can borrow up to 80 per cent of the appraised valuation. On a \$6,000 property, he lays down \$1,200 in cash and secures a mortgage for \$4,800, repayable in monthly installments on an amortized basis for a period not exceeding twenty years.

"Interest will be 5 per cent on the unpaid balance of his mortgage, since he is purchasing his home. On a twenty-year loan, Bill can refund his debt of \$4,800 by remitting \$35.02 a month. This amount does not include the approximate monthly cost of \$10.00 for taxes and other assessments, but it does include an annual insurance premium of one-half of one per cent on the face value of the mortgage."

"Super Plywood" Waterproof

THE Harbor Plywood Corporation of Hoquiam, Washington, has announced a new product called super plywood. It is fabricated by the use of a resin glue, hot pressed. Where ordinary plywood manufactured by the "wet" glue process requires about twelve hours under pressure to dry, the new plywood is glued, dried and ready for use in from three to five minutes.



E. W. Daniels, Vice-President and Salesmanager

The great advantage claimed for the new product is its resistance to moisture which makes it ideal for all outdoor uses, such as roofs, outdoor signs, sidewalks, etc., opening a field which has been practically closed to all except waterproof plywood.

The waterproof quality of super plywood has withstood every factory and laboratory test, according to A. R. Wuest, president of the Harbor Plywood Corporation. In one test he explains, a panel was boiled seven hours a day for fifteen consecutive days, letting the water cool between boilings, but keeping the plywood in the water. Other tests included boiling panels for seven hours, then redrying them and repeating this every day for fifty hours of boiling; also soaking panels continuously in water for several months. In none of these tests, it is declared, has there been any failure of the binder.

More Construction Equipment

THE Porter-Cable Machine Company of Syracuse, N.Y., whose products are used principally in the construction field, announced a 40 per cent increase in business for 1934, and the largest volume since 1931. Company representatives in all parts of the country report improved confidence among builders, because of increased activity in construction plans now in sight.

Appoint Assistant FHA Head

STEWART McDONALD was appointed Assistant Administrator by Federal Housing Administrator James A. Moffett on Jan. 20. Mr. McDonald has been a Special Assistant to the Administrator since his induction into office on Aug. 29, 1934. Mr. McDonald will be chief executive officer of the organization directly under Mr. Moffett.

Sweatt Made President

H. W. Sweatt, for the last eight years vice president and general manager of Minneapolis-Honeywell Regulator Company, has been made president of the company, according to an announcement made public by the board of directors. He succeeds M. C. Honeywell, who has served as president since the merger of the Minneapolis Heat Regulator Company and the Honeywell Heating Specialties Company in 1927. Mr. Honeywell becomes chairman of the Executive Committee.



H. W. Sweatt

Promotes New Type House

FOR the past several weeks there has been on display on the 9th floor of the Grand Central Palace, New York City, a new type of house that has aroused considerable interest. It is a pre-fabricated house of steel frame work and asbestos cement paneled exterior. It is equipped generously with electric apparatus for housekeeping convenience. Foster Gunnison, a former publisher of the Brooklyn Eagle, is sponsoring this demonstration as president of "Houses, Inc.," an organization affiliated with American Houses, Inc. Present plans call for the erection of three of these sample houses in the New York suburban area. A selection of designs is offered, ranging from a house for \$3800 consisting of three

rooms, kitchen and bath to a larger nine-room three-bath and two-car garage design priced at \$9900. All are strongly of the modernistic, reminiscent of the buildings at the Chicago Century of Progress.



Foster Gunnison
President
"Houses Inc."

PRACTICAL JOB POINTERS

A READERS' EXCHANGE of tested ideas and methods, taken from their own building experience. Two dollars or a year's subscription to American Builder is paid for each item published. State business connection or trade.

Matched Base and Baseshoe

THE base and baseshoe that I am showing in Fig. 1 below may not be new, but those who have worked at house-building for any length of time will agree that it is not commonly used, although it is much better.

The indicator at Fig. 1 points out the baseshoe, which has a groove worked into it in such a manner that the tongue of the base will fit tightly into it. How the base and baseshoe are nailed is shown by the shaded outline of nails. At "a" will be seen a heavy dotted line. This shows how the plastering is sometimes "dubbed off," which should never be permitted; nevertheless it happens occasionally, and when it does happen, the base must be blocked out unless a matched baseshoe and base are used, in which case the shoe will keep the base in proper alignment with the plaster-wall.

Fig. 2 shows an exaggerated fault of the commonly used baseshoe. And yet, I have seen some results that weren't much better. Another fault of the standard baseshoe is shown in Fig. 3. These faults are impossible with the matched base and baseshoe.—H. H. SIEGELE, Emporia, Kans.

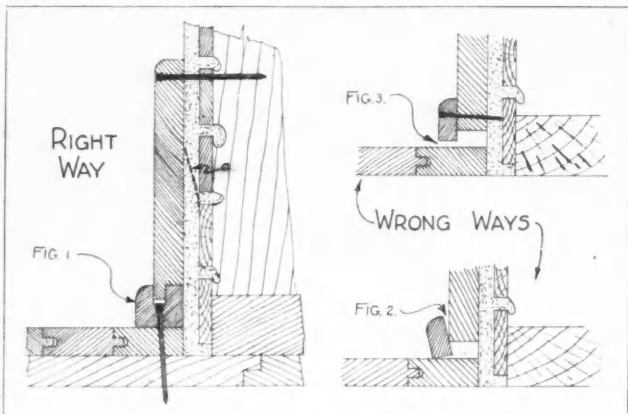

THE RIGHT WAY (at left) and two wrong ways of nailing base.

Staking Out A House

HERE is a short, simple method I use for staking out a house. No instruments are required. Two men can stake out a house in one-half hour.

Given: 4 corners of lot, A, B, C, D (Fig. 1); house to be 20' from front lot line, 3' from right side; size of house to be 24'x30'.

Stretch line BC and set stake E in line with proposed front house line—20' in this instance. If preferred, stake E can be set with tape line 20' from point B and sighted with C.

Sight F approximately in line AD 20' from A. Stretch line EF. Measure 3' from E; set stake at M. Then 3' plus width of house, 24', equals 27'. Put stake at N 27' from E. Put nails at exact points in top of stakes M and N.

Figure length of diagonal, which equals 38'5", as follows:

$$24' \times 24' = 576$$

$$30' \times 30' = 900$$

$$900 \times 576 = 1476$$

$$\text{sq. root of } 1476 = 38.419 \text{ or } 38'5''.$$

Use two tapes, one 38'5" from M and one 30' from N. Set stake at their intersection. Put nail in top of stake locating corner of house P. Duplicate procedure to locate corner of house O. Check work by measuring distance OP. If your

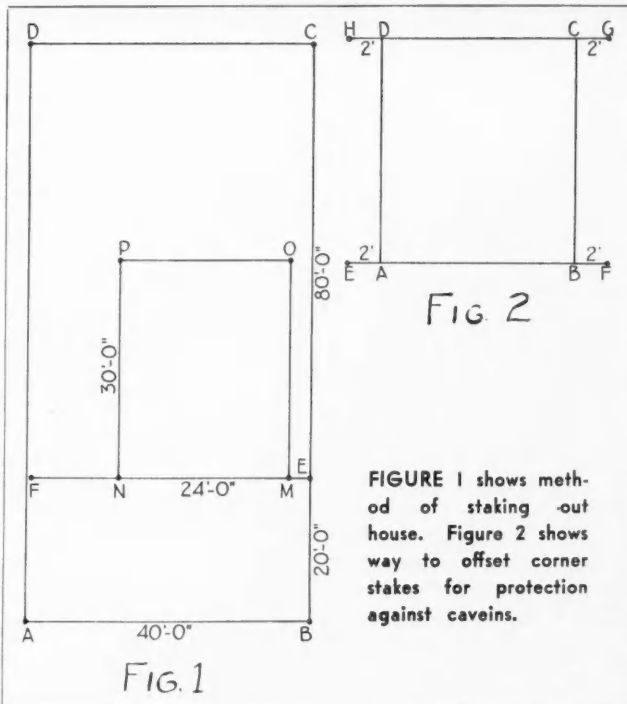

work has been accurate, the distance will be 24'0". I have laid out many houses by this rule and the distance has been within 1/8" of correct measurement.

In Fig. 2 I show my method of protecting corner locations. I stretch a line over AB far enough each way so I can locate a stake at F in line with AB and exactly 2' from B. This stake is driven flush with the ground and a nail is driven in top of stake. Locate points E, H and G in like manner 2' from their respective house corners. If desired, the distance can be increased but usually 2' is enough.

When building cellar wall, it is a simple matter to stretch line from nail to nail and measure 2' to cellar corner. These posts are safe against bumps or cave-ins.—EDWARD F. TREADWELL, Niagara Falls, N. Y.

* * *

Corners for Inside Forms

FIGURE B below shows how I make the corners when building inside forms. You will notice that instead of using one 2x4 stud in the corner, I use two—one set back the width of the corner stud, and the shiplap (4-3/8"). This stud is nailed to the corner stud with two or three 10d nails, not driving them home so that they can be caught with wrecking bar and pulled. This avoids nailing both ways into corner studs. When forms are for cistern or small rooms, corners should be beveled.

I also show sketch of a ladder (Fig. A) that I find useful when putting in floors in cisterns and for getting in and out of basements where there is no grade door, to avoid going through house. It is very handy.—ARTHUR HERRIMAN, Cement Finisher and Carpenter, Montpelier, Ohio.

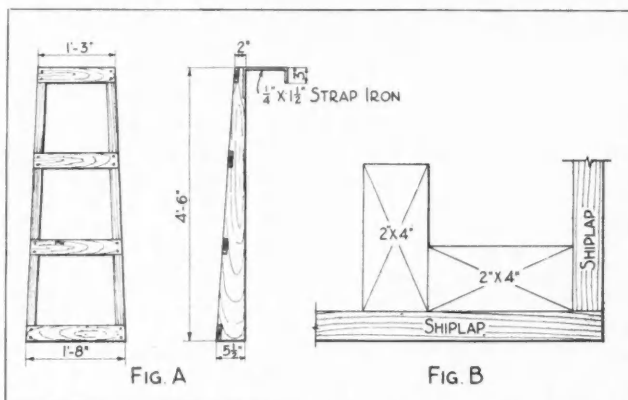

HANDY LADDER AT LEFT; corner form method at right.

A **FREE** BOOK OF MODERN STORE FRONT IDEAS FOR YOU

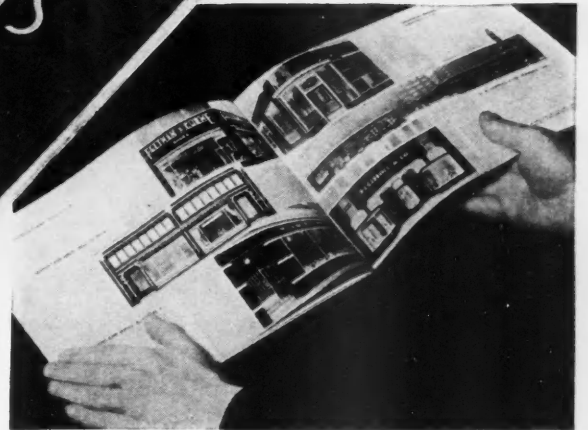

**SEND COUPON
TODAY FOR
YOUR COPY!**

THE National Housing Act, and the general trend toward the modernization of out-of-date properties, commercial as well as domestic, make this book a particularly timely one. We believe you will find it definitely valuable in your work for several reasons:

Because it will show you how, by sending this book to many prospective store remodelers in your district, we are attempting to build up and create more store front jobs for you.

Because it contains many photographs of actual profit-making store front installations

throughout the country which we think you will find interesting.

Because it provides accurate information concerning the qualities and proper application (with quarter-size details) of the store front products manufactured by the Pittsburgh Plate Glass Company.

And because of the original ideas for store front design and decoration which it is possible this book may inspire, and you elaborate, for use in your own store front remodeling work.

The supply of books is limited. So sign and mail the coupon now for your copy.

Carrara Structural Glass	PITTCO STORE FRONTS <i>glass...metal...paint</i>	Pittsburgh Paint Products
Pittco Store Front Metal		Polished Plate Glass
Pittsburgh Mirrors	PRODUCTS OF	Tapestry Glass
PITTSBURGH PLATE GLASS COMPANY		

Pittsburgh Plate Glass Company,
2292 Grant Bldg., Pittsburgh, Pa.

Please send me without obligation,
your new book entitled "How Modern
Store Fronts Work Profit Magic".

Name _____

Address _____

City _____ State _____

DEPENDABILITY

**Like the Mails
the Freight
Goes Thru**

neither rain nor snow nor heat nor gloom detains these carriers in the completion of their appointed routes

**MISSOURI
PACIFIC
LINES**

SHIP AND TRAVEL
Via the
ST. LOUIS GATEWAY

"A SERVICE INSTITUTION"

Inscription on the New York Postoffice

Be a Contractor— Make Big Money NOW

Uncle Sam will help you make money if you are ready.

Billions of dollars are being used to make jobs and the Home Modernization Program offers the biggest chance to make money carpenters have ever known. Are YOU Ready? Can you remodel from start to finish—do you know the tricks of estimating, laying out, etc.? Here's your chance to get these facts—quickly—easily, without study or work—just put your finger on what you want to know instantly.

5 Big Books Shipped FREE

2400 Pages, hundreds of diagrams, estimate sheets, etc., instructions on blueprint reading, estimating, framing, construction, architectural drawing, plumbing, heating, etc., make these books invaluable to any carpenter who wants to **Cash in NOW** on today's opportunities. This may be the chance of a lifetime. **Jiffy Index** makes these facts available in a few seconds. Remember these five big books all shipped to You **FREE** for examination. Send the coupon, there is no obligation. Get these books and be ready to bid on **ANY** building or modernizing job **NOW**.

Consulting Membership FREE!

Privilege of consulting experts of million-dollar American Technical Society on any building problem for one year without charge, if you mail coupon immediately.

----- For Free Offer Use Coupon -----

American Technical Society,
Drexel Ave. at 58th St., Dept. G-23, Chicago, Ill.

I would like to look at the five books described above. Send them on your free offer. I will examine them thoroughly and return them in ten days unless I like them in which case I will send you \$2.00 and after that \$3.00 per month until the total price of only \$19.80 is paid. You are also to send me your book, "Blueprint Reading," and consulting membership certificate without extra charge.

Name _____

Address _____

Attach letter stating age, employer's name and address and that of at least one business man as a reference.

Replacing Broken Slate

THE enclosed diagram shows an improved method of replacing slate or tile in a roof. The customary way is to fasten one end of a metal ribbon to the sheathing board and bring the other end of the ribbon down the roof and make a hook in the lower end to receive the slate to be replaced. The lower end of the ribbon is exposed to the weather and soon rusts away.

The method I advocate is to take strong wire and bend it as indicated by the diagram so the wire will go through the slate to be replaced and hook over the slate beneath the slate to be replaced. By this method all metal is covered. Slate and tile are intended to have a lap of three inches. In the roof the upper end of each slate should be covered for at least 3 inches by two slates.—D. W. DALEY, Parkersburg, W.Va.

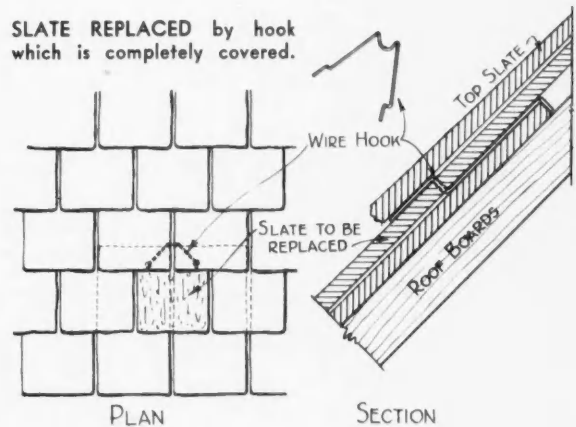

Locating Strike Plate

PROCURE a small container—a discarded brass shot gun shell is fine—get a cork that will fit the shell, place a small amount of lamp black in the container or shell, pour in about enough gasoline, turps or benzine to dissolve the lamp black. You are now all ready to locate strike plate.

Turn the lock bolt out with the key, use the cork for a brush, and give the end of the bolt a coating of lamp black. Do the same thing with the end of your latch, turn the door knob to draw the latch into the lock, draw the lock bolt into the lock with the key, and close the door. We assume that the stops are in place all around. Let the knob go, and turn the bolt out with the key. You now have a black mark for the latch and one for the bolt. Open the door, place the strike plate to member with the black marks, leaving an allowance for the door to sag, and scribe with your pocket knife to chisel out to set the plate flush.

Result—no measuring, no guess work, no taking off plates to file out to fit, and best of all in these hard times, the material costs practically nothing.—SAMUEL A. MATEER, General Contractor, Montclair, N.J.

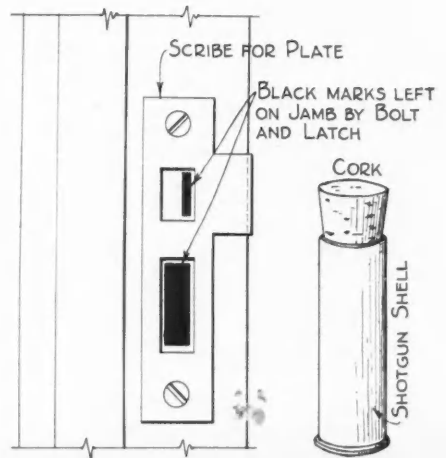

SHOT GUN SHELL filled with lamp black is used for locating strike plates.

BETWEEN THE WORLD AND THE WEATHER

SINCE 1854



The first essential to a Successful sale is the **RIGHT PRODUCT**

It is always easier to sell just the type of shingle your customer wants than it is to offer a substitute. It generates better feeling toward your business, too.

With a complete line of Barrett Shingles and Roll Roofings you can satisfy every roofing requirement and taste, whether for a new roof or for reroofing. There's a wide variety in types, colors, and weights, and the quality is always "Barrett"—finest grade materials made by processes developed during 81 years of successful manufacturing experience.

We will gladly send a representative to give you complete information about Barrett Asphalt Shingles and Roll Roofings. 'Phone. wire or write our nearest office.



THE BARRETT COMPANY, 40 RECTOR STREET, NEW YORK, N. Y.

2800 So. Sacramento Avenue, Chicago, Illinois

Birmingham, Alabama

Build your
FIREPLACES
this Improved Way

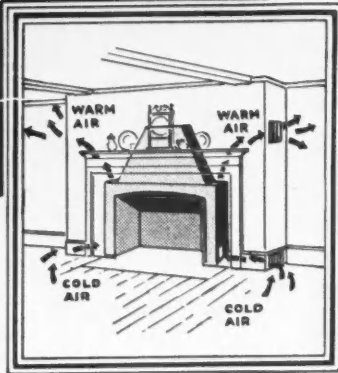

Insure

Smokeless Operation and Circulating Heat!

THE Heatilator operates on the warm-air furnace principle—takes the heat ordinarily wasted up the chimney and circulates it evenly to every corner of the room and to adjoining rooms. It cuts months off the heating season and dollars off the fuel bill—by providing living comfort during chilly spring and fall weather. In mild climates and for summer homes and camps it is the only heating equipment required.

The Heatilator is a correctly designed metal form around which the masonry is easily laid. Complete from floor to flue, it replaces firebrick, damper and other materials. Yet it does not limit the design of your fireplace or the type of masonry you wish to use.

There are now thousands of Heatilator Fireplaces in use throughout the country. The number is steadily increasing. Get complete Heatilator details now—facts that will prove valuable to you on every job, new or remodeling, that includes a fireplace.

Heatilator Fireplace

Heatilator Company
912 E. Brighton Ave., Syracuse, N. Y.
Please send complete Heatilator information.

Name.....
Company.....
Address.....

LETTERS from readers
on all subjects

Facts, opinions and advice welcomed here

Seattle Fiasco Shows Need of Builder Organization

Seattle, Washington.

To the Editor:

Your article, "Who Represents the Builder?", which appeared in your September, 1934, issue was read at the meeting of the Seattle Master Builders Association three weeks ago and at that time I was instructed to write you, offering our cooperation in a movement for national organization.

In answer to your "Call to Action" and also your request from building groups for information, I would like to tell you about our organization. The Seattle Master Builders was organized 10 years ago with 14 charter members. It has today 115 members and is growing rapidly and by 1936 we expect to have 200 members. All of the members are very active in the furtherance and betterment of the organization. Our membership is composed principally of home builders, both contracting and speculative, although we also have about ten general contracting members.

"Who Represents the Builder?" certainly hits the nail on the head. Everyone from the banker down has assumed that office and it is true when you state that the big construction interests have taken it for granted that they speak for the entire industry. Personally, I feel that the Home Builders, and by that I mean the rank and file of small contractors, have no one else to blame but themselves. They have never taken any interest in the promotion or betterment for their general good, but I do think that this attitude is changing. They realize that in organization lies their salvation. I am sure that they realize also that there are large organizations in the house building field, who are their competitors, and they know that competition of this calibre is unfair and to buy from them would be detrimental to their own interests. I certainly think that this is an opportune time for national organization of the builder.

We have an organization in Seattle called "Lumber Promotion." It is composed of 61 local retail yards. Many of these yards have installed Architects or Draftsmen and offer a complete building service to the consumer. You can readily see that this was a bad situation for the contractor in being unjust and unfair competition and hard to combat without organization. The Seattle Master Builders Association with the help of those yards who believe in fair business dealing have brought about a decided change in this condition. We have an agreement between the fair yards and ourselves, and as these yards sign up, they also give us their lists of registered contractors who, in their opinion, are eligible for membership in our organization and through these leads we find some of our membership prospects.

In your issue of December, 1934, and in your editorial headed, "Only \$7.00 per Month," in which you outline the many fine features of the FHA Modernizing Credit Plan and what the Contractor should tell the customer, I would like to tell you how this system has worked so far in Seattle, and I am sure you will see that through the mismanagement by political job holders and local publicity seekers the entire movement is a complete failure to date.

When orders were issued from Washington, D. C., to establish a local branch of the National Modernization Act and Publicity Headquarters, it was referred to the local Chamber of Commerce. They appointed a General Chairman, who has had no experience in the building business. He, in turn, appointed chairmen of the various committees as outlined on Page 7 of the "Federal Housing Act" Pamphlet No. 103 under date of August 24, 1934. These men were all from the Chamber of Commerce with the exception of one and he knows no

(Continued to page 56)

REO GUARANTEES TRUCK PERFORMANCE

IT IS a startling and unprecedented thing for a truck manufacturer to guarantee the performance of his product.

Since the origin of the industry it has been traditional among buyers to assume that there was no fixed measure of results—that some trucks might do the job claimed for them and others might fall far short of the glamorous preview.

Reo takes pleasure in wrecking this tradition.

We know so well that Reo trucks are built to last longer and perform better than the average, that we now GUARANTEE the performance of any Reo truck selected by the Reo Truck Performance Gage method and operated under the Reo Ability Rating System.

The Performance Gage is a simple slide rule by which factory-schooled Reo salesmen determine what power, axle ratio and tire sizes are required for any given operation. On this slide rule analysis they base their recommendation as to the type of truck to put in service.

On the Reo thus selected you will find an ABILITY RATING plate. On this plate you read exactly what may be expected of the

truck in terms of maximum gross load capacity, percent of grade it will climb in high gear, and the safe loaded speed on paved, level highways.

Reo GUARANTEES that any Reo truck so chosen will make good on every point on the rating plate!

What this means in arranging schedules, cutting costs and improving service is too apparent to require elaboration.

It is scarcely conceivable that any operator will continue listening to idle claims and optimistic guesswork about trucks when he can have Reo's ASSURANCE OF SATISFACTION IN ADVANCE OF THE PURCHASE.

Blindfolded buying is ended! Truck selection and operation are at last put on a SOUND and SCIENTIFIC basis!

Write Reo or see your Reo dealer for full details of this history-making guarantee!

Reo Speedwagons and Trucks range from ½ to 4-6 tons. New low prices—\$495 and up. 32 wheelbases, all with famous Reo-built Truck Engines—Hydraulic Brakes. Tractor-Trailer units and buses with correct load distribution and maximum pay load capacity. All prices chassis f. o. b. Lansing, plus tax.



See the brilliant new streamlined Reo Speedwagons. Lowest prices, greatest values in Reo history. Ask your dealer or write Reo for the "Extra Value Disc". Free! Shows you at a glance how much more truck you get for your money when you buy a Reo.

REO MOTOR CAR COMPANY
LANSING, MICHIGAN

How much is known about Termites?

Vulnerable points for Termite damage

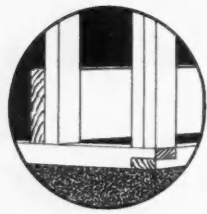

1. Plates and corner posts.

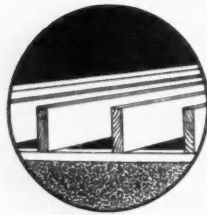

2. Sills.

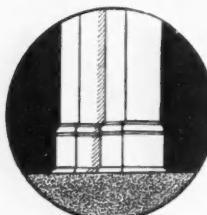

3. Porch columns.

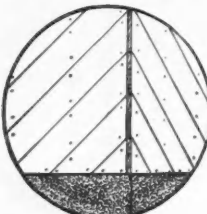

4. Sheathing.

IT is not easy for the ordinary man to find termites, or to be certain that any particular case of damage to wood has been caused by these insects.

But the habits of termites have long been known to scientists. The Bureau of Entomology has studied them exhaustively and has prepared numerous bulletins on the subject of controlling termite damage. There is adequate and authoritative knowledge back of the statement that two preservatives enable wood to resist the attacks of termites. These two are creosote and zinc chloride.

The art of timber preservation is a hundred years old. There is no mystery about protecting wood. It simply must be done according to the principles proven in generations of specialized work. This organization is engaged exclusively in the wood preserving industry and has for years offered wood properly treated to resist termites as well as decay and other fungi.

Letters Department

(Continued from page 54)

more about the building business than the General Chairman. This one exception was made Chairman of "Building Industry" as outlined in the Chart. He is Secretary of the local A. G. C., which is composed of 19 members, engaged in heavy construction. He has had no building experience; being an attorney by profession. Washington Federal Relief furnished 200 inexperienced men and women to canvass the field for prospects. They knew absolutely nothing about building; were sent out with very meagre instructions and less supervision. A downtown Information Bureau was established with four Relief Workers in charge; not one of whom had any construction experience of any kind with one exception; he being a plumber. In one month's time, the 200 in the field were withdrawn. Twenty-two per cent of the town had been covered, so we are informed. In this 22 per cent, they claim to have obtained 6,000 pledges. These pledges were then handed to the Chamber of Commerce, who is distributing them to anyone who will pay a registration fee of \$2.00 per month—this registration fee and the name of any material dealer, as a reference, being the only required qualification as to eligibility or capability to handle the prospect or job.

The Contractors who have registered from our organization are reporting to this office that the leads they are getting are absolutely without any merit or value; that in most cases where the report states work is needed that the tenants are renters or have no source of income and have no intention of doing any work or having any alterations made. One contractor reported that he had driven 105 miles in one day, following blind leads. At the Master Builders Meeting of January 7th, detailed reports were read by 10 builders, covering 50 jobs handed out to them by the Chamber of Commerce and not one lead was of any value.

The principle of the FHA Modernizing Credit Plan is undoubtedly sound and, if properly administered, there can be no question of its success, which brings us directly back to your September editorial, "Who Represents the Builder?"

It seems to me that you would be doing a lasting service to the builder if you would create a National Organization. The builder would then have representation by men who understand the problems of the builder instead of representation by publicity seekers and political job holders, who have no knowledge whatever of the building industry.

SAMUEL ANDERSON, President,
Seattle Master Builders Association, Republic Building,
Seattle, Washington.

Association Work Effective in Twin Cities

Minneapolis, Minn.

To the Editor:

This association, together with an organization of small builders and contractors which it has sponsored to bring the fullest benefits possible to our industry from the Modernizing Drive under the National Housing Act, has taken an active part in promoting the work of this drive in Minneapolis and St. Paul.

The Associated General Contractors of Minnesota, and in Minneapolis also the Minneapolis Contractors and Builders Association, are represented on the civic committees in charge of the Modernizing Drive of the local Better Housing Committees. In Minneapolis, the Better Housing Bureau turns over to our association the names of all prospects for property re-conditioning, as turned in by their solicitors. These prospects are distributed among the contractor subscribers to the campaign fund to contact with the idea of closing contracts for this work. While much of this work is either being done directly by the owner or by the owner employing his own labor, and in a large percentage of the remaining cases the owner insists upon postponing this work until spring, it is nevertheless true that quite a number of repair jobs for contractors have resulted from the campaign. Up to Nov. 1 the campaigns in Minneapolis and St. Paul have resulted in a total of \$363,459 in actual loans being made for various types of re-conditioning, modernizing, or equipment installation.

ASSOCIATED GENERAL CONTRACTORS OF
MINNESOTA,
by A. G. BEAUBIEN.

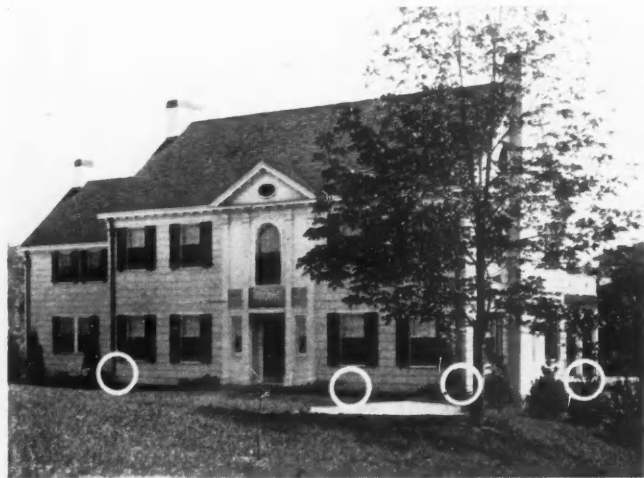

AMERICAN CREOSOTING COMPANY

COLONIAL
CREOSOTING
COMPANY
INCORPORATED



GEORGIA
CREOSOTING
COMPANY
INCORPORATED

LOUISVILLE — KENTUCKY

THE ONLY TRUCK AT ANY PRICE THAT GIVES YOU ALL THESE FEATURES

New Cab

Welded all-steel construction. Real passenger-car comfort for the driver. Adjustable driver's seat. Passenger-car-type instruments grouped directly in front of the driver. Safety Glass, standard equipment throughout. Triple ventilation includes: (1) Clear-Vision Ventilation in door windows; (2) easy-opening windshield; (3) large screened cowl ventilator. Seat width increased to 49 inches. Interior of cab completely lined.

New Brakes

Cast alloy iron drums with integral cooling ribs. Drums will not "bell-mouth." No "fading," even when making a series of quick stops in rapid succession. New brake mechanism makes stopping quicker and smoother with heavy loads. Longer life between adjustments.

New Clutch

New design assures much longer clutch life, minimizes slippage and permits smoother engagement. Lower pedal pressure at idling speed. Plate pressure increases as speed of engine increases. Improved ventilation makes clutch run cooler. Diameter increased to 11 inches. Larger frictional area.

Improved Cooling

Larger water pump impellers. Six-blade 15½-inch fan. Wider radiator, 15% more radiating area.

New Crankcase Ventilation System

Directed-flow crankcase ventilation reduces corrosion and oil dilution by removing fumes.

V-8 Performance with 4-cylinder Economy

The Ford V-8 Truck engine develops more than 80 horsepower. Uses no more fuel than a "four." Dual carburetor and dual intake manifold. Light-weight, cast alloy pistons. Exhaust valve seat inserts. Heavy-duty copper-lead connecting-rod bearings.

Low-cost Engine Exchange Plan . . . Full-floating Rear Axle with Straddle-mounted Driving Pinion . . . Full Torque-tube Drive Permits Free-shackling of Semi-elliptic Rear Springs...Deep, Rugged Frame with no "Kick-up" . . . Oilless Front Spring Shackles . . . Baked Enamel Finish . . . Deep-skirted Fenders Match Colors of Hood and Cab.

THE NEW 1935 FORD V-8 TRUCK



One hundred and twenty-five thousand Ford V-8 Trucks in use throughout the world have proved their right to the claim "America's great truck value." Because of this widespread acceptance, the entire production of Ford Truck engines is of the V-8 type.

To the proved design of the Ford V-8 Truck have been added many new features. But from your point of view, the most important question is: "What will this new truck do for me?" Your Ford dealer is ready to answer that question right NOW. He is so proud of this new truck . . . he is so confident of V-8 performance and V-8 economy that he will gladly arrange an "on-the-job" test for you if you are in the market for a new truck. Ask your Ford dealer to let you try a 1935 Ford V-8 Truck with your own loads . . . over your own routes . . . with your own driver at the wheel.

Then ask the price! Such performance and economy at a price so low will convince you once and for all that this 1935 Ford V-8 Truck is now more than ever AMERICA'S GREAT TRUCK VALUE!

PRICES

TRUCKS

131½-inch Chassis	\$500
131½-inch Chassis with Closed Cab	595
131½-inch Platform	650
131½-inch Stake	675
131½-inch Panel	760
131½-inch Dump Chassis	530
131½-inch Dump Chassis with Closed Cab	625
131½-inch Dump Truck	800
157-inch Chassis	525
157-inch Chassis with Closed Cab	620
157-inch Platform	690
157-inch Stake	735

COMMERCIAL CARS

112-inch Closed Cab and Chassis	\$435
Drive-away Chassis	360
112-inch Panel Delivery	565
112-inch De Duxe Panel Delivery	580
112-inch Sedan Delivery	585
112-inch Station Wagon	670
112-inch Pick-Up	480

(All prices f. o. b. Detroit. Convenient terms through facilities of Universal Credit Company.)

ALSO A NEW LINE OF SMART, FAST FORD V-8 COMMERCIAL CARS

ONLY ONE PAINT GAVE GOOD SERVICE

in this northern Indiana town



Mail coupon for
complete picture
story of sensation-
al paint test
made here

- No contractor can risk being careless over the paints he specifies. Too many people judge the houses you build only by the way they look.

A sensational paint test made by the real estate management of a community in northern Indiana is of vital interest to you. It determined, once and for all, what paint is most durable, most economical.

The 100 houses in the town were divided into 3 sections. Three different kinds of paint were used under identical conditions. Two of the paints cracked and peeled within two years. Only the third paint gave good service. Houses painted with it did not need repainting until five years later. This third paint — the only one that gave real, lasting protection — was Eagle Pure White Lead.

Mail the coupon below for the complete story of this sensational test. Then you'll understand why Eagle Pure White Lead is a safe specification for all your exterior painting jobs.

EAGLE *pure* WHITE LEAD



Boost the
Better Housing
Program in your
community

The Eagle-Picher Lead Company, Dept. AB2, Cincinnati, Ohio.

Please send me a copy of the picture-folder that tells the complete story of the Indiana Community Paint Test.

Name _____

Address _____

City _____

State _____

Basement Recreation Rooms

(Continued from page 30)

asbestos covering can be stripped from the steam pipes and they can be painted the same color as the ceiling. With the asbestos covering removed, the pipes will furnish more heat to the basement.

A most attractive treatment that lends character and dignity to any room can be had by the use of a beamed ceiling. Four by four timbers of fir are adzed and fastened over the joints in the wall board. These joints occur every four feet in the ceiling. Where an old English or early American design is required, this method proves to be particularly appropriate.

For the basement walls, wood panelling, in my experience, seems to be the most popular material. In addition to its attractive appearance it has valuable insulating qualities. Random width knotty cypress or pine about four or five feet high is nailed to a light framework of two by fours. This is capped off at the top by a piece of one-inch cypress. The space above this paneling can be covered with grooved wall board. This, likewise, has insulating qualities and is decorative as well. If the cement above the panelling is not too rough, however, it can be painted and the expense of the wall board eliminated.

Another treatment of the walls is effected by the use of wall board from the ceiling down to the floor. The board can be grooved to form panels and either painted, stained, or stenciled to conform with the general decorative scheme.

There are any number of ways in which the floor can be treated. If the cement is fairly smooth, it can be painted either a plain color or marked off with black into a charming broken tile pattern. In either treatment, I'd advise that the cement first be soaked with a solution of zinc sulphite, two pounds to a gallon of water. This solution is used to counteract the alkali and prevents the paint from flaking off. The solution will form white crystals on the cement. Brush the crystals off and the surface is then ready for three good coats of cement paint. In the broken tile pattern, I have used cement paint in tile red, gray green, and slate gray to give a gay and colorful effect. There are innumerable pleasing combinations of color that can be used. When thoroughly dry, a good coat of wax should be applied to the floor surface to give it a lustrous finish.

When it is desirable to cover the cement floor, an attractive linoleum can be cemented down or a wooden floor put down for dancing. The latter need not be expensive, for a cheap grade of pine flooring can be laid and finished with a stain and wax combination that is now on the market.

Probably the most important fixture in the glorified cellar is the refreshment bar. For this, I use the random width knotty cypress or pine, the same material used for panelling the walls. When finished, the bar is five feet long, forty-two inches high and thirty inches deep. The flat top is of one inch cypress with a trough grooved on it for setting up the glasses. Shelves can be put inside the bar and where practical, cabinets can be built into the wood panelling.

The wiring of the basement presents no problems since the wire can be slid behind the panelling. Be sure to have enough base plugs, and, in selecting electric fixtures, you will, no doubt, keep in mind the general design of the room and select accordingly. In my experience, hammered iron fixtures are inexpensive and there is a wide selection. I have come across many attractive lantern fixtures in this metal that are especially suitable when used in rooms of old English or early American design.

When it comes to the final painting and decorating of the room, I have discovered that waterpaints, paints mixed with water instead of oil, are excellent for painting wall board. They give a fine, even finish and there is a selection of eleven different colors. It is always advisable to paint the ceiling light while the wall board or the side-walls can be painted a darker shade or a contrasting color used, depending of course on the decorative scheme planned. If wood panelled walls and beamed ceilings have been used, the stain and wax combination previously mentioned will prove an ideal finish. Since it brings out the grain in the wood, giving it a rich lustre, it can also be used on the refreshment bar and any other fixtures made of wood. It can be obtained in natural and varying shades of brown.

(Continued to page 60)

DUNBRIK LOWERS BUILDING COSTS

GETS THE BUSINESS

DUNBRIK products made it possible for the contractors in the Lancaster, S. C., area to reach new, low-cost levels in permanent construction. This lower cost level stimulated building activity in that territory and again offers definite proof of the increased demand the country over for permanent, fire-safe building material when sold at prices that meet today's conditions.

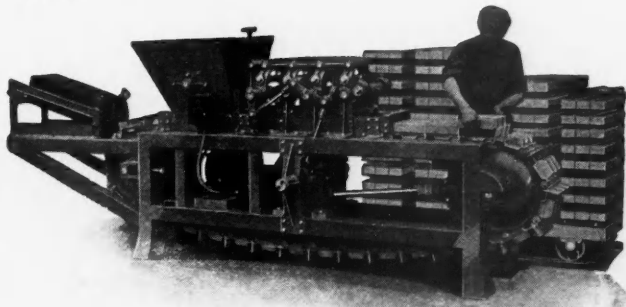

ORDERS EXCEED PRODUCTION

Tom Belk, a former contractor, equipped a plant to make DUNBRIK exclusively for this territory. Almost from the day he started, orders exceeded his production. The recognition accorded DUNBRIK'S superior qualities by Lancaster contractors and builders enabled Mr. Belk to sell 80% of the brick in his territory. In other localities where DUNBRIK is manufactured, similar records have been achieved.

YOUR OPPORTUNITY

Today with America's greatest building market approaching—with government finances available, the manufacture of DUNBRIK offers an outstanding opportunity for someone in each territory. Send for "4 Keys to Success" and let us show you how you too can lower building costs—Own a successful DUNBRIK business—With big future possibilities—Protected by exclusive franchise.

W. E. DUNN MFG. CO.
450 W. 24th St., Holland, Mich.



Vents, downspouts and waste lines should be Reading Genuine Puddled Wrought Iron Pipe everywhere in the country.

For the right pipe for other lines, write



READING IRON COMPANY
PHILADELPHIA

SCIENCE AND INVENTION HAVE NEVER FOUND A SATISFACTORY SUBSTITUTE FOR GENUINE PUDDED WROUGHT IRON

EDWARDS LOXSEAM ROOFING

Almost "Lays" Itself

You don't need special skill, tools or experience to apply Edwards LOXSEAM Steel Roofing. The seams are factory-made and self-locking. Sheets interlock with a full length, water-tight seal, as fast as you can nail and lock them together.

LOXSEAM Steel Roofing really clings to the roof. The harder the wind, the tighter the grip. Easily applied over old roofing. It's the most satisfactory roofing material available to the general contractor.



Write for LOXSEAM Literature and General Roofing Catalog 85.

THE EDWARDS MANUFACTURING CO.
542-562 Eggleston Ave. Cincinnati, Ohio

World's leading manufacturers of Metal Roofing, Siding, Ceilings and Sheet Metal Building Materials



Perfection BRAND OAK FLOORS

In old homes or new, whether for renting or selling, "PERFECTION" BRAND Oak Floors give service and satisfaction. The greatest value for the money.

Take advantage of the new Housing Administration Act and sell good Oak Floors on your modernizing jobs.

"PERFECTION" BRAND Oak Flooring as furnished by your local dealer is carefully manufactured from selected timber, scientifically seasoned and kiln dried, easily finished. Ask your dealer today to show you the "PERFECTION" BRAND.

Complete information is yours for the asking. Write us today. Sold only through retail lumber dealers.



ARKANSAS OAK FLOORING CO.
PINE BLUFF ARKANSAS

BIG MONEY FOR YOU AMERICAN FLOOR SANDER



Lots of old floors all around you need resurfacing and they offer you a chance to get into something for yourself. Big Government Housing program is creating greater field than ever. Income is practically unlimited.

WE GET YOU STARTED BY THE AMERICAN METHOD

No large capital or experience required. Investigate Now so you'll be ready to cash in on the big season just ahead. Write today for full particulars, sent without obligation.

THE AMERICAN FLOOR SURFACING MACHINE COMPANY
 511 South St. Clair St. Toledo, Ohio

FREE to BUILDERS and CONTRACTORS

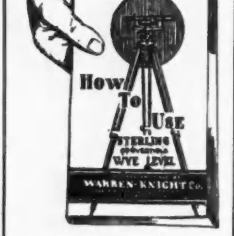

Handy 52 page INSTRUCTION BOOK on the USE and ADJUSTMENT of the Sterling Convertible Level, Model No. 40.

This book simplifies your building problems. Helps you make better use of any make Level.

Prepare NOW for more business in 1935.
 Pin this coupon to your letterhead and mail today.

Warren-Knight Co., 136 N. 12th St., Phila., Pa.

Send me Free Instruction Book, F-92, also send catalog of Warren-Knight Transits and levels List of Rebuilt Instruments Information about 10 day Free Trial without deposit.

Position.....
 Name.....
 Address.....

Basement Recreation Rooms

(Continued from page 58)

"How much will it cost?" is a question usually asked right away by a customer.

Well, as the saying goes, that depends. The cellar illustrated with this article, before remodeling was twenty-one by twenty-nine feet in size. The recreation room when finished was twenty by twenty, a good sized room. As you see, I used beamed ceilings, wood panelled walls, and the broken tile treatment of the floor. The total cost for this entire project was four hundred and fifty dollars. This included all labor, lumber, wall board, electric fixtures, and all materials for painting and decorating. Not much to spend for such a charming room! However, even this amount need not be spent. Last summer, I finished off a basement room simply by partitioning off the recreation room from the rest of the cellar, treating the walls and floor with cement paint in attractive colors and the total cost amounted to less than a hundred dollars. By all means, fix up that basement. It can be done.

Ohio Builders Organize

(Continued from page 26)

"The man who is your next door neighbor and who at present rents the house in which he lives nine times out of ten wants to build his own home. The problem before him is not always money, as many of us believe, but fear of poor construction. A building council set up to eradicate the injurious methods practised by and against building contractors will be an anchor to windward for the prospective home-owner. A man educated to the reliability of professional home builders is a man who will build reputations by word of mouth testimony."

Prominent building contractors at the organization meeting pointed out that there is always an element of waste on every job; however a great deal of this waste can be eliminated when the contractor is familiar with a perfected plan of attack made known to him through the Builders Council. The building contractor at the beginning of his career is often prey for the unethical business men, it was averred. An organization of this sort will without doubt raise the standards of residential building and close any possible loophole through which outside interests would be able to gain a "say" in the dealings. Poor construction ruins the reputation of the builder, undermines the mortgage companies and deters the progress of the nation. The only way to restore the confidence of the buyer is to give the buyer true value for the dollar that he expends. The building of homes is the backbone of the nation. Until the public is educated to permanent residency our heterogeneous population will be chaotic and the lives of the future generation blighted. One cannot give his offspring the advantages so necessary to the proper development of their mentality when moving from east side to west side or from town to town.

Quoting from FHA Circular No. 2 entitled "Property Standards and Requirements for Mortgage Insurance under Title II of the National Housing Act," page 3, "The Federal Housing Administration intends that mortgages insured under its program shall be upon dwellings which are substantial and durable in structure, convenient and efficient in arrangement, attractive in appearance, and appropriate in their neighborhood setting." This applies to new as well as existing buildings. Therefore the builder seeking for himself an opportunity to finance under the Housing Act as an operative builder or as a contractor for others, will be required to prove that he is capable from past experience as a builder, to conduct the business of residential building. This is the reason for Clause (f) in the Constitution of the General Builders Contractors Council of Ohio, and is the main reason why the builders of Ohio are seeking a License Law which will police and protect the interests of the legitimate and ethical contractor, and elevate the standards of his business to a level comparable to those maintained in other professions and businesses.

It is planned to hold a ratification and final organization convention of the Ohio builders in February, details of which will be reported in a later issue of this magazine. At the time of going to press, it was reported a large number of Contractors Associations in Ohio have approved this organization. An effort will be made immediately to carry the organization work into the States of Michigan, Kentucky, Pennsylvania, and West Virginia eventually making it a national movement.

AMERICAN STEEL SHEETS

FOR ALL KNOWN USES



KEYSTONE Copper Steel Sheets

Excel in the Building Field

Use sheets of recognized reputation and value. For roofing, siding, gutters, spouting, air conditioning systems, and general sheet metal work—Keystone Copper Steel gives maximum rust resistance.

Insist upon AMERICAN Black Sheets, Keystone Rust Resisting Copper Steel Sheets, Apollo Best Bloom Galvanized Sheets, Galvannealed Sheets, Heavy-Coated Galvanized Sheets, Formed Roofing and Siding Products, Terne Plates, etc. Write for information.

This Company also manufactures U S S STAINLESS and Heat Resisting Steel Sheets and Light Plates for all uses to which these products are adapted.

AMERICAN SHEET AND TIN PLATE COMPANY, Pittsburgh, Pa.

SUBSIDIARY of UNITED STATES STEEL CORPORATION

KWIK-MIX MIXERS

Full anti-friction bearing. Light weight. Skip shaker. Automatic water tank. Spring mounting. Sizes: 3½-S, 5-S, 7-S, 10-S.



3½-S Trailer — Roller Bearing — Spring Mounting.

DEALERS! ATTENTION!

Desirable territories are available to progressive Lumber and Materials Distributors

Kwik-Mix



Plaster and Mortar Mixers
Trailer and 4 Wheel Type.

Write for Catalog AB

KWIK-MIX CONCRETE MIXER CO.
PORT WASHINGTON . . . WISCONSIN

BUILT FOR SERVICE

Low initial and operating costs give Parks' owners the edge in meeting competition.

Write for complete catalog
THE PARKS WOODWORKING MACHINE CO.
Dept. BL-2, 1524 Knowlton St., Cincinnati, Ohio

Good woodworking machines since 1887





FOUR IN ONE \$260

BALL BEARING
Includes 22" band saw, 12" jointer, circular rip and crosscut saw and boring machine.

PARKS
WOODWORKING MACHINES

EARN EXTRA INCOME

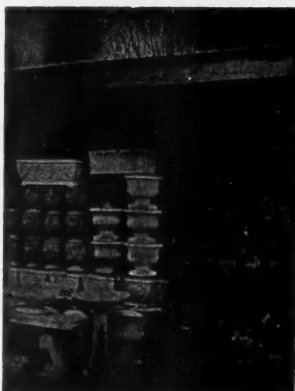

Make Colorcrete Products
Profitable. Sell for over 4 times cost to make. Offers quick returns and future growth. You have a growing market right in your own territory. Your materials cost little, obtained locally. With a few molds you can easily make beautiful porch, garden and house ornaments. Send for Catalog No. 22. Get ready for big spring demand.

Stucco Spraying Machine
Solves the problem of renovating masonry buildings, walls, etc. It fuses a plastic waterproofed mixture to any masonry surface—fills cracks—and can be applied in varying thicknesses and in 30 colors. Process proven by over six years actual use. The profit on one job often pays for machine. Write today for folder No. C-4.

COLORCRETE INDUSTRIES, INC.
500 Ottawa Ave. Holland, Mich.

A CALLING CARD TO NEW BUSINESS

EACH SALE MEANS MORE SALES



● LASTING
LUSTROUS
COLORFUL
INEXPENSIVE
AND EASY
TO INSTALL.
WRITE FOR
FOLDER AND
PRICES ●

MarshTile

MARSH WALL TILE COMPANY • DOVER, OHIO

★ ★ ★ ★ ★ ★ ★ ★

Selected List of Manufacturers' Literature

For the Service of Builders, Contractors, Architects and Dealers

THE publications listed on these pages may be obtained without charge either by using the coupon, listing the numbers of the catalogs desired and mailing to AMERICAN BUILDER, 105 West Adams Street, Chicago, or by applying on your business stationery to the manufacturers direct, in which case kindly mention this publication. Either the titles or the numbers may be used in ordering. This list is an editorial feature for convenience of our readers.

PLANS AND GUIDES

THE CELOTEX CO., 919 N. Michigan Ave., Chicago, Ill.

1148—**Tourist Camp Plans**—"Plan and Bill of Material for Tourist Cottage," a 6-page map plan drawn $\frac{3}{8}$ " to the foot of a well designed tourist cottage, well insulated with Celotex; bill of material and working details.

THE EDWARDS MANUFACTURING CO., Cincinnati, Ohio

1149—**Service Stations**—"Modernistic Daylight Service Stations," a 12-page portfolio presenting 9 different designs for gasoline service stations of glass and steel. All are modernistic in line.

MASONITE CORP., 111 W. Washington St., Chicago, Ill.

1150—**Home Workshop Projects**—"You Can Make These Useful Things," a pocket-size illustrated pamphlet giving designs and working drawings for cut out toys, ping pong table, writing desk, play house, bookcase, shoe rack and other interesting furniture pieces to be made of Presdwood.

MISSOURI PACIFIC LINES, St. Louis, Mo.

1151—**Perpetual Calendar and Wall Map**—Mr. E. H. McReynolds, Director of Publicity, states that he has a limited supply of perpetual calendars and wall maps of the Missouri Pacific System, which he will be glad to send to AMERICAN BUILDER readers on request.

BUILDERS' HARDWARE

TIMBER ENGINEERING CO., 1337 Connecticut Ave., Washington, D.C.

1152—**Strong Timber Joints**—"Blueprint Details of Typical Joints" illustrates the application of Teco connectors to general timber construction for greatest strength and important structural economy. General catalog of Teco timber joint connectors also offered.

THE KINNEAR MANUFACTURING CO., 1062 Fields Ave., Columbus, Ohio

1153—**Garage Hardware**—"Tip-Top Door Hardware" describes the new simplified design for converting any type garage door panels into a one-piece upward-acting door.

ROWE MANUFACTURING CO., Galesburg, Ill.

1154—**Garage Hardware**—"The Over-

head Door with Many Extra Features" is a 6-page data sheet illustrated with photographs and details of the Ro-Way garage door. Specifications and installation details included.

FRANTZ MANUFACTURING CO., Sterling, Ill.

1155—**Garage Door Equipment**—"Over-the-Top Door Equipment," a new 12-page catalog in two colors illustrating very completely how this hardware is installed and how the door operates. Photographs give numerous suggestions for garage design.

THE SHELBY SPRING HINGE CO., Shelby, Ohio

1156—**Builders' Hardware**—"General Catalog No. 35" presents double-acting and single-acting checking floor hinges and an extensive line of finishing hardware and hardware specialties; 52 pages illustrated; specifications and details.

PHENIX MANUFACTURING CO., Milwaukee, Wis.

1157—**Hardware Specialties**—"Catalog No. 30," a 48-page catalog illustrating the extensive line of Phenix hardware specialties of hangers, hinges and fasteners for doors, storm sash and window screens.

LUMBER PRODUCTS

BRADLEY LUMBER CO. OF ARKANSAS, Warren, Ark.

1158—**Block Design Flooring**—"Bradley Presents a New Creation in Block Design Flooring" is a spectacular illustrated broadside and wall hanger presenting Bradley's advanced nail seat flooring, and presenting numerous attractive flooring designs.

HUTTIG MFG. CO., Muscatine, Iowa

1159—**Improvement in Stock Windows**—"The First Big Idea" presents in a spectacular way the Huttig Red-E-Fit Rot-Proof windows which can be used in any standard frame; specification and installing data for architects, contractors and carpenters.

ARKANSAS SOFT PINE BUREAU, Little Rock, Ark.

1160—**Hand Book and Moulding List**—"Arkansas Soft Pine Hand Book," 64 pages and cover illustrating the 8000 Moulding List of wood mouldings and universal sizes—essential data for all who plan and specify with stock mould economy. How to use and finish Arkansas Soft Pine also included.

ARKANSAS OAK FLOORING CO., Pine Bluff, Ark.

1161—**Oak Floors**—"How to Lay and Finish SOFI Oak Floors" is a vest pocket manual of 36 pages packed full of practical information regarding the laying and finishing of oak floors.

THE CROMAR CO., Williamsport, Pa.

1162—**Factory-Finished Floors**—"Charter Oak Pre-Finished Flooring," a leaflet describing economical flooring which is sold to retail lumber dealers.

E. L. BRUCE CO., Memphis, Tenn.

1163—**Financing Oak Floors**—"Announcement of a new finance plan on block flooring which is said to remove the last barrier to increased sales is made by Bruce. Circular gives terms of loan and requirements, how to get flooring prospects, etc.

HASKELITE MANUFACTURING CORP., 208 W. Washington St., Chicago, Ill.

1164—**Waterproof Plywood**—"Phemaloid for Signs" features Phemaloid Compound Lumber for outdoor signs and other hard weather usage.

HARBOR PLYWOOD CORP., Hoquiam, Wash.

1165—**Plywood**—"Harbor data sheets three, four and five" give detailed information regarding Harbor Super Plywood for home building, concrete form work and industrial uses.

AMERICAN CREOSOTING CO., Louisville, Ky.

1166—**Wood Preservation**—Information regarding the American Creosoting method of preserving lumber for home building and other structural purposes.

BUILDING AND FINISHING MATERIALS

THE GLIDDEN CO., Cleveland, Ohio

1167—**Paint Specifications**—"Specifications on Painting and Varnishing Compiled Especially for Architects" is an 8-page portfolio of condensed information. A color card is included.

THE REARDON CO., 2200 N. Second St., St. Louis, Mo.

1168—**Waterproofing Cement Paint**—Bondex Waterproof Cement Paint is described in a new 4-page circular which features important questions and answers relative to cement painting.

THE FLINTKOTE Co., New York City

1169—Brick Siding—"New Homes for Old" is a little 12-page envelope stuffer in color illustrating "Setab Siding," "Thikbrik Siding" and siding strips in various color combinations available.

JOHNS-MANVILLE CORP., New York City

1170—Asbestos Flexboard—"The Revolutionary New Building Material" is a broadside in color presenting this new J-M product, a flexible asbestos cement sheet that can be sawed and nailed like wood. It comes in several decorative finishes.

THE TILE-TEX Co., Chicago Heights, Ill.

1171—Resilient Floor Tile—"Tile-Tex Book of Designs" is a portfolio of color cards, design cards and specification data on Tile-Tex resilient floor tile. Its uses in homes, hospitals and commercial buildings is illustrated.

UNITED STATES GYPSUM Co., Chicago, Ill.

1172—Insulation—"Demand Utmost Insulation Value" is a new 16-page brochure on Red Top insulating board, showing its uses in homes, commercial buildings and farm buildings.

MARSH WALL TILE Co., Dover, Ohio

1174—Marshmarble—A data sheet in full color showing the beauty and refinement of expensive marbles at a fraction of the cost; what Marshmarble is and how it is used, for counters, back bars, corridors, lobbies, bathrooms, kitchens, etc.

COLUMBUS COATED FABRICS CORP., Columbus, Ohio

1177—Washable Fabric Wall Coverings—"Questions and Answers About Wall-Tex" is a vest pocket size manual asking and answering all questions relative to wall coverings for homes and commercial buildings.

THE EDWARDS MANUFACTURING Co., Cincinnati, Ohio

1178—Steel Ceilings—A pocket size booklet on architectural sheet metal designs with data on estimating wall and ceiling areas and figuring costs is presented. A large number of popular, attractive designs are illustrated.

MILCOR STEEL Co., Milwaukee, Wis.

1179—Sheet Metal—"The Milcor Sheet Metal Handbook," a treasure house of 128 pages illustrating, indexing, specifying and describing the very complete line of sheet metal building products with data on steel, copper, zinc and tin sheets, and directions for applying various forms of sheet metal roofing.

LOUISVILLE CEMENT Co., Louisville, Ky.

1180—Stucco Work—"Brixment for Stucco," 5 pages of specifications and other data on durable exterior stucco work and materials.

MEDUSA PORTLAND CEMENT Co., Cleveland, Ohio

1181—Painting Cement—"How to Paint Portland Cement Stucco Concrete Floors and Other Masonry Surfaces" is a comprehensive handbook of 20 pages giving a quantity of valuable information on the subject indicated. Numerous illustrations enliven the specifications and technical directions.

HOME EQUIPMENT

PEERLESS MANUFACTURING CORP., Louisville, Ky.

1183—Fireplace Fittings—"Peerless Building Specialties" is a 6-page folder presenting fireplace dome dampers, ash dumps and ash pit doors, coal windows, garbage receivers, electric heaters, etc.

TRUPAR, INC., Dayton, Ohio

1184—Water Systems—"Trupar Pumps, Water Systems and Water Softeners" is a 20-page handbook on these subjects presenting much detailed information of interest to designers and estimators. An extensive line of equipment is illustrated.

GENERAL ELECTRIC Co., Air Conditioning Division, New York City

1185—Indoor Comfort—"How to Have a Home That Will Stay Modern" is an intriguing booklet of 12 pages attractively illustrated in 2 colors, featuring G-E air conditioning and oil burning equipment; an effective piece of literature for interesting the home owner in these modern features.

TEMPERATURE CORP., Division of Chrysler Motors, 405 Lexington Ave., New York City

1186—Air Conditioning—"The Airtemp Conditioner" is the first announcement of Walter P. Chrysler's air conditioner. A 4-page folder presents mechanical specifications and illustrates the equipment.

UTICA RADIATOR CORP., Utica, N.Y.

1187—Radiation—"Announcing the New Utica Convector," 6 pages of specifica-

tion data including dimensions, rating tables, etc., of this line of cast iron radiation units.

CONTRACTORS' EQUIPMENT

KWIK-MIX CONCRETE MIXER Co., Port Washington, Wis.

1188—Kwik-Mix Mixers—A 16-page catalog presents the Kwik-Mix line ranging from the small trailer mixer, size 3½-S, to the heavy duty two-bag 10-S mixer. Plaster mixers are both trailer and four-wheel type, and bituminous mixers are included in this catalog.

INTERNATIONAL HARVESTER Co., 606 S. Michigan Ave., Chicago, Ill.

1189—Half-Ton Truck—"International Half-Ton Six-Cylinder Model C-1," especially adapted for quick delivery and builders' pickup car is illustrated in a new 16-page catalog giving mechanical specifications and suggesting many body types.

BUCYRUS-ERIE Co., South Milwaukee, Wis.

1190—Excavators—"Profit from Modern Bucyrus-Erie Machines" is a vest pocket catalog of 64 pages presenting brief specifications of the complete Bucyrus-Erie line of contractors' equipment including shovels, draglines, clamshells, scoops, convertible cranes, etc.

JAEGER MACHINE Co., Columbus, Ohio

1191—Contractors' Equipment—"Jaeger Equipment, Construction and Road Machinery" is presented in a 36-page catalog covering construction machinery, truck mixers and road machinery in the entire range of sizes from small to large.

SKILSAW, INC., 3310 Elston Ave., Chicago, Ill.

1192—Power Saws—"Skilsaw Portable Electric Tools" is a 36-page handbook of modern labor-saving construction practice. It covers the entire Skilsaw line of electric handsaws, drills and sanders.

American Builder,
105 W. Adams St.,
Chicago, Ill.

(February, 1935)

Please have the following Catalogs listed in this issue sent me—

Numbers.....

I also desire further information about the following products advertised in this issue.....

Name.....

Street.....

City..... State.....

OCCUPATION*.....

*Please note that occupation must be stated if full service is to be given.

There's No Economy in Worn-Out—Out of Date Machinery

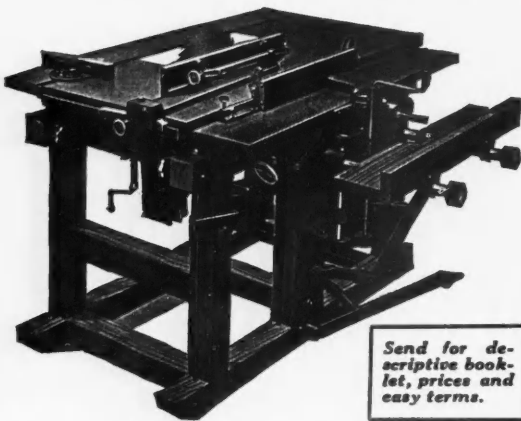

Send for descriptive booklet, prices and easy terms.

Modernize your equipment with Monarch machines on our present low price, easy term plan, an opportunity that may never come again.

Install a Monarch Variety Woodworker and enjoy the efficiency of this four-in-one machine—cut off and rip saw with boring attachment, mortiser and jointer.

Other big time and money-saving machines include jointers, band saws, lathes, and the marvelous 20th Century Woodworker.

AMERICAN SAW MILL MACHINERY CO.
60 Main Street Hackettstown, N. J.

STARLINE INC.

HARVARD, ILL. ALBANY, N.Y.

BARN EQUIPMENT

For Any Type Farm Building

We supply everything to equip any type barn—Door Hangers—Hay Carriers—Stalls—Stanchions—Pans—Water Bowls—Litter Carriers—Ventilators and Ventilating Systems—Poultry Equipment—also complete hardware for Garage Doors.

Before you remodel or build any farm building, ask our Architectural Department for free plans.

Write Department AB2

50 YEARS SERVING BARN BUILDERS

NEW!

TECO CONNECTORS

DOUBLE STRENGTH OF TIMBER JOINTS—ELIMINATE HEAVY HARDWARE

INCREASE THE STRENGTH OF YOUR ROOF TRUSSES, SUPPORTS, BRACING, FALSEWORK, ETC.—CUT COSTS—SAVE ON MATERIAL, LABOR, AND TIME—USE

TECO CONNECTORS.

EASY TO INSTALL—WRITE

TIMBER ENGINEERING CO.

1337 CONNECTICUT AVE. WASHINGTON, D. C.

Less MATERIAL Greater STRENGTH

Index to Advertisers

FEBRUARY, 1935

A		K	
Accurate Metal Weatherstrip Co.....	61	Kalman Steel Corp.....	6
Aluminum Co. of America.....	3rd Cover	Kwik-Mix Concrete Mixer Co.....	63
American Creosoting Co.....	56	L	
American Floor Surfacing Machine Co.....	60	Libbey-Owens-Ford Glass Co.....	10
American Gas Products Corp.....	62	M	
American Saw Mill Machinery Co.....	66	Maple Flooring Mfr's Ass'n.....	2
American Sheet & Tin Plate Co.....	63	Marsh Wall Tile Co.....	63
American Technical Society.....	52	Missouri Pacific Lines.....	52
Arkansas Oak Flooring Co.....	60	Mueller Furnace Co., L. J.....	3
B		N	
Barber Asphalt Co.....	9	National Manufacturing Co.....	4th Cover
Barrett Co., The.....	53	P	
C		Parks Woodworking Machine Co.....	63
Carey Co., The Philip.....	11	Peerless Manufacturing Corp.....	61
Celotex Co., The.....	61	Pittsburgh Plate Glass Co.....	51
Colorcrete Industries, Inc.....	63	Portland Cement Association.....	14
D		R	
De Walt Products Corp.....	62	Reo Motor Car Co.....	55
Dunn Mfg. Co., W. E.....	59	Reading Iron Co.....	59
E		Ruberoid Co., The.....	7
Eagle-Picher Lead Co.....	58	S	
Edwards Mfg. Co.....	59	Starline, Inc.....	66
F		T	
Ford Motor Co.....	57	Tile-Tex Co., The.....	61
G		Timber Engineering Co.....	66
General Electric Co.....	12	U	
H		Universal Atlas Cement Co.....	16
Harbor Plywood Corp.....	4-5	W	
Heatilator Co.....	54	Warren-Knight Co.....	60
J		Weyerhaeuser Sales Co.....	8
Jaeger Machine Co.....	62		

NOTICE TO ADVERTISERS

Forms for the March Number of the American Builder and Building Age will close promptly on February 15. New copy, changes, order for omissions of advertisements must reach our business office 105 W. Adams St., Chicago, not later than the above date. If new copy is not received by the 15th of the month preceding date of publication the publishers reserve the right to repeat last advertisement on all unexpired contracts.

AMERICAN BUILDER AND BUILDING AGE.