

(A Simmons-Boardman Publication)



AMERICAN BUILDER

and Building Age

NAME REGISTERED U. S. PATENT OFFICE AND CANADIAN REGISTRAR OF TRADE MARK

JULY, 1939

61st Year

Vol. 61, No. 7

AMERICAN BUILDER and BUILDING AGE, with which are incorporated National Builder, Permanent Builder and the Builder's Journal, is published on the first day of each month by the

SIMMONS-BOARDMAN PUBLISHING CORPORATION
105 West Adams Street
Chicago, Ill.

NEW YORK
30 Church Street

WASHINGTON, D. C.
National Press Building

SEATTLE
1038 Henry Building

SAN FRANCISCO
485 California St.

LOS ANGELES
530 West 6th St.



Samuel O. Dunn, *Chairman of Board*; Henry Lee, *President*; Bernard L. Johnson, Robert H. Morris and Delbert W. Smith, *Vice-Presidents*; J. S. Crane, *Eastern Manager*; Roy V. Wright, *Secretary*; Elmer T. Howson, *Assistant Secretary*; John T. De Mott, *Treasurer*.

Subscription price in the United States and Possessions and Canada, 1 year, \$2.00, 2 years, \$3.00, 3 years, \$4.00; foreign countries, 1 year, \$4.00, 2 years, \$7.00, 3 years, \$10.00. Single copies 25 cents each. Address H. E. McCandless, Circulation Manager, 30 Church Street, New York, N.Y.

Member of the Associated Business Papers (A. B. P.) and of the Audit Bureau of Circulation (A. B. C.)

PRINTED IN U.S.A.

Publisher's Page—Speaking of Monopolies—by Samuel O. Dunn.....	35
Editorial—"Special Assessments".....	37
How Detroit Home Builders Co-operate for Industry Progress— by W. J. Guinan.....	38
Part I—Organization and Experience of Greater Detroit Home Builders' Association Which Culminated in the Unique Duchess Project Described in Part II. In This Article, Detroit Builders Demonstrate How Building Industry Progress Can Be Made Through Model Associations Such As Theirs	
Presenting America's Greatest Home Show.....	43
Part II—How the Duchess Project Was Developed As 1939 Number One Accomplishment for Greater Detroit Home Builders Association	
Home Design Section Presenting Exteriors, Plans and Details on Eight of the Duchess Project Houses.....	44-53
Detroit Builders' Cape Cod Model	
Popular Detroit Colonial	
6 Rooms; Built-in Garage	
"All Electric Home"	
New England Colonial for Comfortable Living	
Compact 5-Room Plan	
High Value Planning	
Modern Colonial Design	
Stamford's "Double Lifetime" Home.....	54
Front Cover Home Analyzed Photographically for Such Typical Details As Lead Flashing, Paint, Plumbing, Plywood and Roof	
When Is an 80% Loan Not an 80% Loan?.....	58
TruCost Figures for Home Designs.....	60
Air Conditioning Today—by Harry M. Hitchcock.....	61
No. 1 of a Series, "Where Are We Now?"	
Largest Electric Housing Project Opened.....	62
Douglas Fir Plywood Paneling Details for a Modern Shop.....	64
How to Estimate Accurately.....	66
The Fifth Article in a Series by J. Douglas Wilson on Practical Estimating—Two Types of Framing Covered This Month	
The Plan's the Thing—Even for Barns!—by R. W. Louden.....	68
How to Build Split-Log Summer Cottages or Year 'Round Farm Homesteads—by S. A. Witzel.....	70
Shopcrafters' Corner—Building a Small Portable Boat.....	72
Construction and Recovery As Viewed by the Builders—by W. A. Klinger.....	74
New Products Department.....	78
Letters from Readers.....	82
News of the Month.....	86
New Information—Catalogs Offered.....	106
Index to Advertisers.....	113

JOSEPH B. MASON
Eastern Editor

R. E. SANGSTER
Managing Editor

DOLA PARR
Associate Editor

BERNARD L. JOHNSON
Editor

ROBERT H. MORRIS
Business Manager

LYMAN M. FORBES
Research Editor

L. E. ARENT
Art Editor

ADVERTISING: W. F. COLEMAN, L. B. CONAWAY, J. S. CRANE, J. C. JONES, E. J. REICH, GORDON SIMPSON, D. W. SMITH, C. J. WAGEMAN

FIELD STAFF: L. O. ANDERSON, V. L. ANDERSON, C. L. CONLEY, C. R. W. EDGCUMBE, J. H. FREE, CHARLES R. HARTUNG, DICK WHITTINGTON



DO YOU SEE EYE TO EYE WITH THE JONESES ON MODERN WALLS



MRS. JONES: "Here's all the evidence I need! This quiet, inviting living room with Insulite walls and ceiling, is proof that a home is as modern as the walls!"



MRS. JONES: "And the colorful appearance isn't all! Insulite walls give us cool rooms in the summer—and lower winter fuel bills!"

THEIR VIEWPOINT MEANS *Profits to You!*

Are you in a position to supply the Joneses in your town with Modern Walls? When they ask about The Insulite Wall of Protection, have you information to meet their increasing demands?

Give the Joneses the modern, comfortable homes they want, with inside and outside walls, ceilings, floors and roofs made of combinations of Lok-Joint Lath, the safe base for smooth plaster walls, Bildrite Sheathing, Insulating Brick Siding, the rigid mineral surfaced outside wall covering and other Insulite structural materials. *Their rapid turnover and wide acceptance mean more profits to you!*

Make the inquiring Joneses your profitable customers. Write today for samples and complete information. Have on file all necessary information about Insulite Materials. Because of them, homes have been more modern, comfortable and satisfying for 25 years. The Insulite Company, Dept. AB79, Minneapolis, Minnesota.



MR. JONES: "Modern homes need protection against wind and moisture. These Insulite outside walls fill the bill by saving fuel and speeding up building—and—they provide a second wall of INSULATION!"



INSULITE

Copyright 1939,
The Insulite Company



PUBLISHER'S PAGE

Speaking of Monopolies

THURMAN ARNOLD, official trust-buster of the New Deal, announces he is going to attack the building industry, nationally and locally, for monopoly practices which, he says, "have virtually ruined it." Among these practices that he alleges are the following:

"Producers of building materials have fixed prices by private arrangement * * * Owners of patents have used them to establish price control, control of sales methods and limits upon the quantities sold * * * Labor unions have frequently been used as the strong-arm squads for collusive agreements among contractors * * * In other cases the unions themselves have refused to permit the use of new products or processes."

THIS paper holds the old-fashioned view that a nation can prosper only under a system of *free private enterprise*, and that regulation of such a system by *supply and demand* is essential to its successful operation. We had it from the depression of the 90's until the Great War; and between 1896 and 1916 our national income—measured by the production of goods—increased 82 per cent, and average income per capita 30 per cent. We have had it only partially since the war; and in 1936 the national income was only 17 per cent larger than in 1916 and average income per capita was 8 per cent smaller; while in 1938 income per capita was as small as thirty-three years before in 1905.

Monopoly practices are incompatible with free and efficient private enterprise. But why did Mr. Arnold mention "price-fixing" and not "wage-fixing?" Why did he mention the use of labor unions "as strong-arm squads for collusive agreements among contractors," and not their use "as strong-arm squads" for maintaining ruinously expensive labor conditions and the rackets of gangster labor leaders?

ATTACKS by the present administration on monopoly practices have a strong odor of insincerity. For it established N. R. A. to start more monopolies and monopoly practices than ever were started in all other ways combined. Business dropped N. R. A. like a hot potato because business soon found its real aim was to create *labor monopolies backed by government*.

How can business be competitively conducted as *free private enterprise* when it is subjected to the dictation of government regulation and labor monopoly, both intended to restrict or prevent *profits*? It cannot be. If labor's wages and working conditions are to be determined by monopoly practices, then prices must be fixed high enough also by monopoly practices to pay the resulting excessive labor costs—or business can make little or no profits and *consequently cannot be carried on by private enterprise*.

PRESENT government policies are utterly inconsistent. They still promote *labor monopolies* in every industry to fix excessively expensive wages and working conditions. They even include the Guffey coal act authorizing and enforcing both *monopoly wages* and *monopoly prices* in the coal industry. And now they crack down on alleged monopoly practices in the building industry—but not on the *worst labor monopoly practices* in the industry.

Certainly monopoly practices should be stopped. But they should be *proved*—not merely alleged and an industry attacked for them without proof. And every form of *labor monopoly practice* should be included—for it is an economic impossibility to have *free competition in prices* and *monopolistic fixing of the labor costs that principally determine what prices should be*.

Samuel O. Dunn,



CONFIDENCE EARNED BY 12-YEAR PERFORMANCE

TWELVE YEARS have elapsed since Lone Star pioneered by introducing 'Incor' 24-Hour Cement—a true Portland cement with dependable high-early strength. It is a noteworthy fact that in a relatively short time, building regulations the country over now permit form stripping in 24 to 48 hours, instead of a week or longer.

This is due in no small measure to the consistent performance of 'Incor', which has earned the confidence of building departments as well as engineers and contractors, on the basis of its high-early and high-ultimate strengths.

Recently, T. A. Loving & Co., contractors of Goldsboro, N. C., having had previous successful experience with 'Incor', figured Maggie L. Walker School, Richmond, Va., with both Lone Star and 'Incor'. 'Incor' showed the lowest overall concreting cost for floor

slabs on this wall-bearing structure; repetitive wing-design permitted maximum form re-use.

But in this instance the City building code prohibited form stripping in time to take full advantage of the usual 24- to 48-hour 'Incor' stripping schedule, so Lone Star was used throughout. This exception highlights what is today an all but general rule—for seldom is it necessary to pass up the savings which 'Incor' makes possible.

So again we say—figure every job with both Lone Star and 'Incor'*—then let economy decide which cement to use. From the standpoint of ultimate quality it's a toss-up—because both of these high-quality Portland cements make better concrete. Write for new book, "Cutting Concrete Costs." Lone Star Cement Corporation, Room 2229, 342 Madison Avenue, New York.

*Reg. U. S. Pat. Off.

LONE STAR CEMENT CORPORATION

MAKERS OF LONE STAR CEMENT • • • 'INCOR' 24-HOUR CEMENT

Sales Offices: ALBANY, BIRMINGHAM, BOSTON, CHICAGO, DALLAS, HOUSTON, INDIANAPOLIS, JACKSON, MISS.; KANSAS CITY, NEW ORLEANS, NEW YORK, NORFOLK, PHILADELPHIA, ST. LOUIS, WASHINGTON, D. C.

AMERICAN BUILDER

AND BUILDING AGE

"Special Assessments"

LAST MONTH we pointed out that a fair and reasonable taxation of small homes and other building improvements is essential to building recovery; also that real estate taxes are levied *locally*, by city and county governments and, being local, can be directly controlled by local sentiment regarding tax assessments to pay for economical or extravagant local government.

Building industry men are usually active and influential in local civic affairs and so are ideally situated to lead public opinion to right conclusions in these tax matters. Realizing that the annual tax load is the first lien against all homes and other real estate, virtually a "first mortgage" that can never be paid off, building industry men naturally want to keep this burden as light as possible.

Along with the General Property Tax, most home buyers are also acutely conscious of another substantial burden—the Special Assessment. This is more particularly the case when buying in a new, or fairly recent, "subdivision." The Special Assessment is to pay for street improvements and underground utilities such as water, sewer, etc. These investments in behalf of future owners were made by the developer of the tract and by right are repaid by the individual home buyers as part of the purchase price or in the form of annual assessments by the municipality.

Formerly, before the days of heavy automobile and truck traffic, it was quite customary to assess highway repairs and maintenance in the same way against the adjacent home and property owners. More recently gasoline sales tax funds have largely taken care of street and highway repairs as well as new highway construction. This has seemed entirely fair from the point of view of the motoring public, both private and commercial, that uses and wears out the pavements, and also fair from the point of view of the farm owners, other home owners and the building industry.

The old theory was that the adjacent real estate would be benefited—increased in value—by highway paving, and that accordingly it should bear the cost.

Highways Today Are More for General Use Than Local Benefit

Today, however, with the ever-increasing use of our public streets and highways by commercial truckers, and with the increasing noise, loss of privacy and liability to accidents to those living on or near important highways, it is now realized that there is no increased "benefit" which can be fairly assessed against farms or homes that may happen to lie along these present-day avenues of commerce. To force farmers and other home owners to assume added tax or special assessment burdens to pay for these modern motor highway requirements would

obviously be most unfair. But farm and other home owners and the building industry will have to be more alert and active if they are to prevent an increasing burden of highway taxes from being, to their injury, imposed on real estate. Total expenditures on streets and highways are constantly and rapidly increasing, and apparently will continue to increase indefinitely. This raises a very important issue—viz., whether—and, if so, how—the increased taxes thereby being made necessary shall be divided between owners of real estate and users of the highways.

Who Shall Pay Highway Taxes?

All owners of real estate are also users of the highways; but there are millions of highway users who are not owners of real estate. Highway users include not only private motorists, but many individuals and companies operating large buses and trucks in carrying on their private business.

There is a nationwide controversy regarding whether the users should be required, through gasoline, vehicle and other taxes, to pay the total cost of providing and maintaining the highways, or most of it, or only a small part of it. It is a certainty, however, that the less of it the *users* pay, the more of it the *owners of real estate*—especially farmers and other home owners—will have to pay. And the heavier the taxes on real estate, for highway or any other purpose, are made the more they will hinder the full revival of home building. Therefore, it is plainly to the interest of all dependent on building for business or jobs, and all who desire to improve their homes or build new ones, to exert their utmost influence for local, state and federal government policies that will *increase the portion of total highway costs and taxes that must be paid by the users of the highways.*

There has recently been proposed a further extension of motor highway development on a grand scale; and surveys and studies preliminary to it are now being made by highway officials in Washington and throughout the states. If this immense construction project should be carried out, and a large part of the cost put on real estate, it would do the construction industry much more harm than good, in spite of the several billion dollars for highway construction service which would result. The blow to private home building and to private real estate improvements would prevent and destroy more building business by far than the highway work would amount to.

Proper tax policies, on the other hand, will permit the building industry to do an increasingly effective job not only of housing the "lower third" but also of improving the homes and the commercial buildings for the entire people, and thereby stimulating prosperity.

How Detroit Home Builders Co-operate for

By W. J. GUINAN

Editor, Greater Detroit Home Builders Association "Year Book" and Monthly Publication, "The Bildor"

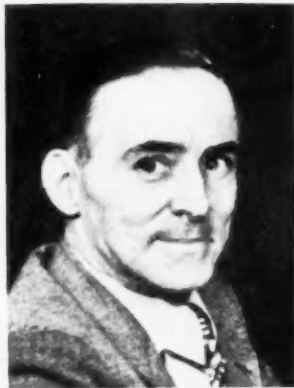

MEASURED in dollar volume, residential building ranks prominently among the nation's leading industries, measured by its host of critics, it outstrips all others, and easily assumes a number one ranking. These critical gentlemen will not be satisfied until a machine has been perfected, which accepts raw lumber, steel, cement, paint, varnish, etc., and ejects furnished houses at the other end. And in the meantime, with eyes closed, they will continue to spread their pompously inaccurate analysis of the building business.

There is no machine in prospect, which will take raw material, and at the turn of a switch, grind, shape and fabricate it into finished housing.

There is however a modern residential building technic, which originated in the early part of the last decade, and which is now developed to a high degree of efficiency. And the builder—or at least the Detroit builder—accepts full responsibility for the defects—if any—in this system; for good or bad, efficient or inefficient, it was originated, designed and developed solely and entirely by him.

Is this machine as obsolete and ineffective as its critics proclaim; or are these critics basing their premises in factual misinformation and faulty analysis? To arrive at a reasonably accurate decision it will be necessary to make at least a cursory inspection and examination; and to do so effectively, we shall have to delve briefly into the years of the last two decades. For the modern method of building and selling homes had its inception and early development in the decade immediately following the World War.

Prior to this period the prospective home owner had a choice of two methods of procedure. He might contract for a custom built home; or he might buy a home already built. If he chose the first, he was quite definitely a man of substance; for only a man who had a better than average share of worldly goods could afford this method; which involved the services of an architect to develop and draw plans, let the sub-contracts, and supervise construction. There was little, if any, standardization of either labor or material costs, and the size of the final total figure was dependent on the conscience, experience and ability of the architect in charge.

The second method represented the only one available to the man of average means; the man who buys 80 per cent or more of all the homes built. And his choice was usually between bad or worse, dependent as he was on the wares of the speculative builder. These consisted of houses which multiplied themselves row after row; as alike in their unpalatable sameness as they were in their inherent structural debility and lack of livable design

PART I—Organization and Experience Which Culminated in the Unique

and equipment. Built at a speed which precluded any attempt at precision workmanship, and at a price—and profit—which precluded quality materials, they began to sag the moment they felt the weight of the first mortgage; and depreciation worked a full twenty-four hour shift, starting the day the work was completed.

We believe the foregoing represents but an accurate outline of residential building, as it was conducted prior to 1920. And although the prospective home owner still has one of two methods of procedure in acquiring a new home, he may, even though he enjoys but average means and income, choose by inclination and not by necessity. For the custom built house is today available in all price brackets; an evolution in the building industry which was effected by the builder, and—unless evidence hitherto uncovered, is presented to confute this statement—by the Detroit builder.

In the early Twenties, a Detroit builder was erecting a large number of speculative homes in the northwest section of Detroit. His product was a standardized bungalow which represented a sound value for its day. However sales were necessarily limited to those who desired to live in the particular section in which the development was located, and it occurred to this builder that sales could be greatly increased if it were possible to offer this house sale in any location in the Detroit Metropolitan area.

"Duplicating" at a Price on Owner's Lot

Knowing that previous years' subdividing activities had provided thousands of persons with free and clear lots, he conceived the idea of building two models of this bungalow, one in frame and the other in brick veneer, specifying a definite duplication price for each model, and inviting inspection by means of newspaper space advertising. (The first instance—of which we have any record—of display newspaper space being used to solicit custom built homes.) Public response was immediate, and the early volume of business highly gratifying. Duplicates of these models began to appear over a wide-spread area; and the custom built housing in the lower price brackets made its initial bow.

The word "duplicate" is used in a broad sense; for even in those early jobs there was no exact duplication. Every job contracted for included at least a few minor changes; and in some the changes were so extensive that entirely new plans were developed.

It became necessary, therefore, for the builder to employ architects and draftsmen to redraft plans of existing models, incorporating the various changes and additions specified by the prospective home buyer. And gradually that service was broadened to include the development of any home plan which the customer desired, and which met with the requirements of his need and satisfied his taste and pocketbook. So that by 1926 many Detroit builders had architectural and drafting departments which employed a substantial personnel.

Naturally the pioneering builder in this field enjoyed a monopoly for but a short period, and as the other builders swung into the newly built road, models multi-

Industry Progress

Greater Detroit Home Builder's Association Business Project Described on Page 43

plied. The signs "Will Build on Your Lot—No Cash Required," began to dot the Metropolitan District, and occupy increasing space in the display sheets of the newspapers. And the design, equipment and appointment—at a price—began to occupy an ever increasing importance in the merchandising plans of the residential builder.

"BUILT ON YOUR LOT NO CASH REQUIRED"

Lured by this magic slogan, prospective customers by the thousands came to look, stayed to be convinced, and bought more and ever more homes, which were specifically designed and built to fit their individual housing needs. And thus there was formulated the primary structure of a new system of merchandising and selling custom built homes, which from 1923 to 1930 inclusive, produced approximately 140,000 residential units in the Detroit Metropolitan District.

Space does not permit us to enter into a detailed description of the technic employed. It was simple in theory, but somewhat complicated in the multiplicity of detail required in its practical application. And though it was similar in its broad outlines, it varied in detail with the individual builder.

Perhaps one of the most interesting by-products of this period included the development and standardization of the so-called "extra" list, which by 1928 had been more or less standardized to include several hundred items. The necessity for the extra list is understandable, when consideration is given to the fact that the early models represented merely skeleton construction; and provided little beyond the elemental needs required for adequate shelter, and offered little in the way of equipment, and practically nothing of refinement or luxury. So for those who could and would afford something better, the "extra" list was developed and built up through the years, to include practically every item in the way of construction, equipment and appointment, which the ingenuity of several hundred builders, architects and draftsmen could devise. It presented a series of accessory display tables, covered with merchandise; each complete with a tag giving price and description.

When the complete history of modern housing is written, this period will be assigned a position of importance, which will reflect its true measure of influence in shaping the housing trend of the Nation. For there is much evidence that the national desire for better homes which exists today, was largely created in the building wave which arose in the early twenties, reached its crest in 1926 and subsided in 1931. And it created a desire—and a market—not only for new homes, but also for the equipment and machinery which transforms a house from a mere shelter into a place which offers proper facilities to conduct the daily business of living.

For most of the modern home equipment of today had its first extensive and effective display in model homes. Under the spur of heavy competition, each succeeding model the builder produced incorporated the newest and latest in home equipment and appointment; and the display therein of mechanical refrigerators, oil burners,

ELEVEN OBJECTIVES OF THE GREATER DETROIT HOME BUILDERS ASSOCIATION

1. Elimination of dishonest building practices.
2. Promotion of more efficient construction methods.
3. The education of the home buying public to a degree which permits recognition of quality materials and workmanship, and wider acceptance of the fact that first quality means lower cost.
4. The improvement of merchandising and sales methods.
5. The co-ordination of effort of all parts of the industry to the end that intra-industrial differences and difficulties may be smoothed out or eliminated, and progress furthered.
6. To safeguard the interests of the home buyers.
7. To encourage and promote sound legislation relating to the industry and necessary to its orderly development and progress, and to oppose all legislation and enactment of which will serve special individuals or groups, or which is improperly restrictive.
8. To co-operate fully with all government agencies which center their activities in the building industry. To give the honest and efficient officials thereof all possible support and assistance; and to crack down on all those who are inefficient, incompetent, stupidly bureaucratic or dishonest.
9. To gather and disseminate valuable information relating to the industry and building practices.
10. To elevate individual builder standards.
11. To throw the spotlight of intelligent criticism on the self seeking "reformer"—public or private—who sees in the newly awakened national housing consciousness only a personal opportunity to "cash in."

ventilating fans, electric dishwashers, automatic water heaters, etc., created a market which went beyond the new house field, and stimulated a modernization movement which resulted in vastly increased sales.

The so-called boom period in residential construction in the Twenties attracted men of all types and character. As a result, the industry was burdened with promoters and racketeers, lured by the promise of easy money in large quantities, and abuses of various kinds crept in and spread throughout the industry.

Greater Detroit Home Builders Association

Recognizing this fact, and stimulated by a desire to curb existent abuses, and raise the standards of the industry, several reputable builders foregathered in the early part of 1926 to discuss the situation and formulate a definite plan of action. This gathering resulted in an informal organization, which in January 1929 was incorporated in accordance with the Laws of Michigan as The Greater Detroit Home Builders Association.

Broadly speaking, the Association exists for the sole purpose of improving the residential building business, and widening thereby the opportunity for home ownership on a sound basis. Because it has adhered strictly to a program designed to achieve this end, and has never initiated or promoted anything for the builder which has been contrary to the interests of the industry in general and the home buying public, it has constantly grown in size and strength, and year by year has widened its effective circle of influence.

Specifically the Association directs its effort toward the eleven objectives outlined in the box above and, to date, has made considerable progress in achieving them.



1939 BOARD OF DIRECTORS, Greater Detroit Home Builders Association, left to right: Henry Couvreur; W. J. Guinan; George Pastor; Charles Babcock, attorney; Milton Ratner; Robert Kitchen; A. C. Petersen; A. R. Vorys; Charles Gadd; Fred Garling, secretary; Bert C. Whitney, treasurer; (standing) Harry J. Durbin, president; Edmund Kuhlman, executive vice president; Wm. V. Seifert; Joseph Holtzman, Central vice president; Fred R. Cox, East Side vice president; Harvey Hohlfeldt; Clifton Woodry; A. R. Crow; Ralph Seiloff; Lester Waldo.

Somewhat further along in this article we shall set forth some of the accomplishments of the organization to date, outline what it hopes to accomplish in the future.

The Effects of the Depression

Very few builders—in Detroit—came out of the Depression with any appreciable assets. This was partly due to the widespread economic effects of the years from 1931 to 1934, and in part due to the type of men engaged in the business of building homes.

By 1930 the Association included within its membership, a great many builders who had painstakingly built up well rounded and complete organizations. Included therein were realty, architectural, financing, construction and servicing departments, each with its full personnel.

Many had built up finely seasoned construction crews; operating under competent foremen and superintendents; with very little sub-contract labor involved. One such firm, doing an annual business of approximately \$2,500,000 a year operated its own plumbing, heating and electrical departments, and did all of their own carpentry, masonry, roofing, flooring, sanding, tile work, lathing, plastering, painting and decorating. This firm also had a department which had for its sole function the free servicing of homes occupied by its customers. This firm had built up a fine personnel, including well paid satisfied craftsmen; and from 1925 to 1930 had practically no labor turnover.

It was possible to build up and maintain organizations of this type because of the sales and advertising tech-

nique used, and which had been perfected to a degree that enabled the sales and advertising department to do a job which was not exactly easy. For it was the function of the sales organization, not merely to sell a custom built housing volume in excess of \$2,000,000.00 annually, but to sell it so that construction might be spread with reasonable evenness over the year.

The job was so well done, that building operations from 1924 to 1930, in Detroit, were fairly well spaced throughout the year, with a consequent continuity of building mechanic wages, a condition of much benefit.

Then came the Depression!

The builder is a natural optimist. If he wasn't, he wouldn't be in the building business. And he believed the numerous gentlemen who spoke of the "rainbow just around the corner," and when he did not believe, he just shut his eyes and hoped.

Conscious of their obligation of those who were a part of his organization they carried on when common sense and their banker told them that it was time to abandon the ship while there was still hope of some salvage. But neither common sense nor the banker prevailed, and they carried on until there was nothing left to carry, over and above that which the sheriff had lugged away.

During these dark days, the Association's light became somewhat dimmed but never totally eclipsed and in the FHA initiated building Renaissance of 1935, its old members began to emerge from bomb proofs and dug-outs, and began the long trek along the road of recovery.

Most of these men had little in the way of material assets, but they possessed a great deal in an indestruc-

tible accumulated store of experience, and were all well fortified in the possession of those intangible assets which are the product of character and a sound past performance record. Such assets are non-transferable and depression proof.

And as building operations again got under way, other assets began to appear; singly, or in twos and threes they began to reappear out of the shadows of the Depression. Carpenters, masons, plumbers, excavators, electricians, lathers, plasterers and other craftsmen came back to greet their old bosses, and take up the jobs which they had left a few years previously.

Many of the substantial building organizations in Detroit today differ from the organizations of the twenties only in the matter of age. There are a few more wrinkles, a few more gray hairs and perhaps a more sober approach to the business of living, but otherwise the old gang is back, with the ranks thinned here and there, but generally intact.

The Great Detroit Building Association has been built strongly and solidly upon builders whose roots reach down and throughout organizations built upon mutual respect, forbearance and share of production.

Although Detroit has been an "open shop" town in so far as residential building is concerned, the Association is not opposed to unions. In fact it believes that the building craftsmen have not only the right to organize, but that it is their definite obligation to do so. It is the only way in which their mass thought can be transcribed into helpfulness to the industry. But it is opposed to the type of union whose leaders actions represent neither the thought nor conclusions of their membership; and who deny to members the voice in the management and direction of union activities to which their membership entitles them.

There is no difference of opinion between the intelligent Detroit building craftsman and the builders. The men know that the builder is paying the highest wage possible under present economic conditions, and that this wage represents a fair annual income and a fair share of the profits.

The Association maintains a definite wage scale, which is predicated upon first, the maintenance of a yearly income sufficient to maintain a decent standard of living; and second on the purchasing ability of the home buying public.

It is a recognized fact that labor receiving from 60c

to a \$1.00 per hour cannot long continue to buy products marketed on a cost of from \$1.50 to \$3.00 per hour. It is the practical application of this fact, which has maintained a steady volume of construction in the Detroit area, and thereby insured for the building craftsmen a steady livable annual wage. It is probably the reason why Detroit is building from 3 to 5 times the per capita volume of building over that being done in Chicago, Philadelphia, Cleveland, Boston, Milwaukee, and many other cities.

It is obviously unsound for wages in any industry to be such that they are completely out of line with the wages of industry in general; and any industry which so operates will sooner or later find itself completely idle.

During 1938, while providing 8,612 families with new homes, the builders in the Detroit metropolitan area paid out approximately \$23,000,000.00 in building labor. This is equivalent to approximately 32,000 man years of WPA labor. In the Detroit Area, approximately 11,000 men received an average wage of \$2,030.00 for the year 1938. We do not claim that this represents munificence; but it does compare very favorably with the annual average wage of the nation, and it represents purchasing power almost three times in excess of the annual individual WPA wage of \$720.00 per year.

When improved methods reflect still lower costs in building, those costs will be reflected in better values to the home buyer, and increased wages to the building mechanic. It is the responsibility of the union leader to cooperate with the industry to this end, which is the only sound economic basis upon which wages can be increased.

There is apparent at this time a movement which has acquired considerable momentum in the Detroit building mechanics field, which has for its objective the weeding out of irresponsible leaders, and their replacement by men who have a broadly intelligent conception of the residential building problems and are willing to cooperate with the rest of the industry in seeking their solution.

Accord Within the Industry Will Promote Continued Progress

With intelligent labor leaders working shoulder to shoulder with the builder, and they together cooperating with the other units of the industry toward a common purpose, it is the opinion of the Greater Detroit Home



STREET VIEW of the Association's successful model home demonstration for this year known as "Duchess Project."

Builders Association, that within a short time, the residential building business in Detroit, will be placed on a soundly stabilized basis.

The Association defines progress to mean a constantly widening opportunity for individual home ownership. But so effected that living standards of both the home buyer and the building mechanic will be constantly increased. This includes the building of increasingly better homes, with a steadily mounting building mechanic wage, but with no increase in cost to the buyer.

This will be accomplished by improved methods in the manufacture of building materials and equipment, and more efficient system of assembly at the building site. The comparison of costs of a house built in 1925 and 1939 indicates that a substantial degree of progress has already been effected.

Now let us examine the matter of comparative costs of today and yesterday. As a necessary preamble we will state that there is no central clearing house, either national or local, which can be depended upon for accurate residential costs. We won't go into detail on that statement, but its truth can be very easily proven.

Late in 1938 the Association made a comparison of 1925 and 1938 costs. As an example a bungalow having wide customer acceptance was used. Over a hundred duplicates of this particular job were built that year. The original cost sheets were used in making the computation.

It was found that this bungalow could be duplicated in 1938 for 11 per cent less, and would include the addi-

tional requirements set up by the FHA, the local Building Code, plus the Michigan Sales Tax, and the various Social Security Taxes; these latter items making a total of \$392.23. The savings effected were in costs of material and efficiency of assembly and application, as the wage scales used were practically identical.

And we might add that the entire savings effected by increased efficiency were not included; only those which could be definitely measured. As a matter of practical fact, any experienced local builder would duplicate that 1925 job, today, at a savings of at least 20 per cent. For if the house of 1925 were placed alongside the house of 1938, selling for the same price, the two would resemble each other about as closely as the car of 1919 resembles the streamline luxury model of today.

There has been progress in the building industry; but apparently the learned economists, analysts and commentators who cover this field are still consulting reference works published in the Post War Era.

The Association's Part

We doubt if there would have been a great deal of progress to date had there been no Builders Association, for progress in any industry is dependent upon the intelligent cooperation of those within its ranks.

The Association, by assembling the best thought within the industry and coordinately resultant action, has contributed a great deal to the common cause.

AMERICA'S BIGGEST HOME SHOW

One Home Given Away Free!



questionnaire shown on Page 150—of a reasonable favorite. Mail it and the questionnaire to the association's main office, 1501 Home Bank Building, or the association's temporary office at 1501 Home Bank Building. Each questionnaire is numbered. The lucky number will be drawn from a sealed container on the first floor of the model at 4:30 p. m., Saturday, April 15th.

**ALL ON ONE STREET
ON DUCHESSE—NORTH OF MORANG**

The great Home Exposition is easily accessible from all parts of the City. From the center of the City take Grand Avenue to Seven-Mile, east on Seven-Mile to Morang and south to Duchesse from Johnson, take Cadzow Road to Morang, Drive to Duchesse and east on Duchesse. A glance at map will set you right as to the correct route. You can't miss it—it's too big to miss.

**The Largest Group Display of Models Ever Shown in the United States.
Organized by the Greater Detroit Home Builders' Association
and Built Under Its Supervision**

**BUNGALOWS—
CAPE CODS—
COLONIALS—**

37 HOMES — ALL DIFFERENT — ALL NEW — ALL MODERN

**PRICED FOR DUPLICATION
AT**

**\$5800
and Less**



Map showing location of
Duchesse Road Homes.

**GREATER DETROIT
HOME BUILDERS' ASSOCIATION**

**IT'S EASY TO
SELECT AND BUILD
YOUR HOME
FROM THIS
GREAT**

**BOOK
Containing
36
Homes
AND
PLANS**

**A
\$5000 BOOK
for
50¢**

Its 164 pages are crammed full of information, not obtainable elsewhere, regarding home planning, financing and construction. The compilation and assembly of its contents has cost the association over

\$5,000.00

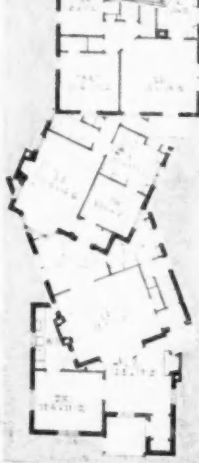

REPRODUCTION of one of the newspaper advertisements which announced "America's Biggest Home Show" presented by the Greater Detroit Home Builders Association to attract public attention to industry progress. The ads used in this campaign and similar to the one shown here appeared about twice this size and dominated newspaper pages. Illustration which shows street scene looking along Duchesse Avenue gives a good idea of how these "two show-cases of merchandise" consisting of 37 models cover 80 percent of the price range in the Detroit home market.

Presenting America's Greatest Home Show

PART II—How the Duchess Project Was Developed As 1939 Number One Accomplishment for Greater Detroit Home Builders Association. Details Are Presented on 8 of These 37 Outstanding Models.

IT MIGHT well be asked what justification there is for the super-billing claimed in the title of this article in which the facts are presented on the Greater Detroit Home Builders Association Demonstration Home Project. Here are the statistics as of the date the show closed, May 7—37 model homes built as a unit along Duchess Avenue; 500,000 visitors; 350 orders for duplicates or similar design; 2500 A-1 prospects for this year and 3500 more prospects who indicated desire to build in the near future! And there are the tangible accomplishments of the demonstration.

Beyond these, the Duchess Project has been of much educational value to the home buying public; it has attracted public attention upon progress made within the industry; it has been a dress rehearsal in intra-industry co-operation; it has resulted in progressive instruction and merchandising methods; and, in so doing, it has accomplished its principal purposes.

The Project was designed to serve as a practical classroom for the prospective home owner; the Annual Year Book of the Association to be the text book and the individual builders to serve as instructors. Each fulfilled its purpose in a capable manner; and we believe one of the outstanding results will be the thousands of dollars which this practical course will have effected in savings to individual home buyers during the coming year. Acclaimed nationally and locally as one of the most outstanding performances in the history of residential merchandising, it demonstrated very effectively the value of intelligent co-operative effort, and definitely proved the fallacious statements of lack of industry progress.

How the Project Got Under Way

We doubt very much that a project of this kind could be initiated and carried to a successful conclusion by any group which did not have a fair amount of co-operative experience. The Association has had this experience, which had included the publication of several annual year books with editorial content relating to the building industry. Even under these favorable conditions, there was some initial strain, due principally to the rigid regulatory measures, which considerably restricted the individual participating builder in the exercise of what, normally, he considered his own particular prerogatives.

These governing rules were as follows:

1. Any member of the Association in good standing is eligible to participate.
2. No member may build more than one house.
3. All materials, equipment and construction methods must have the approval of the Association.
4. All plans must be approved by a committee of architects, selected from the Detroit Chapter of the Michigan Society of Architects.
5. No builder may select his site. All houses will be placed on their proper site by the Architects' Committee, and this committee will determine the grade and set-back.
6. Only grade-marked lumber and wood shingles will be permitted.

7. Every house shall have a definite duplication price which shall be based on the house as shown, and shall include all equipment. This price may not exceed \$5800.

8. No frame houses permitted.

9. Only one identifying sign permitted for each house, carrying only the names of the builder and broker; these signs to be prepared by the Association.

10. All advertising to be done by the Association.

11. All houses to be kept open for inspection, and building jobs solicited only by licensed real estate brokers who have membership in any of the four realty organizations.

12. All houses to be kept open according to Association schedule.

13. No builder permitted to duplicate another builder's house without written permission.

14. One house—the 37th—to be built by the Association, and disposed of to the public on the last day of the Demonstration. (See next two pages for plans and details of this design.)

The original plan for the project was first outlined to the Association's Board of Directors during their regular July meeting in 1938, approved at that time, and authorization given to select a site and obtain the necessary lots. (The original plan contemplated 25 houses.)

Considerable time was consumed in selecting a site, for consideration had to be given to restrictions, location and suitable lot grouping. The location finally selected was Duchess Avenue off Morang Drive. Thirty-seven lots were purchased, 18 on one side of the street and 19 on the other. The Association House was located on an alley lot having 47 foot frontage on Duchess, and about 120 feet from the nearest other house in the project. Thus the Association Model was at the head of the row, and the other 36 houses were placed on adjacent lots, 18 to a side, stretching for a block and a half off Morang Drive—two huge parallel showcases, displaying in a wide range of style the latest and best in home construction. (Seven of the 36 individual houses are also shown with floor plans and construction outlines on pages 47 to 53.)

The site being selected, the Detroit Chapter of the Michigan Society of Architects was contacted, the plan explained to them and their co-operation invited. They assented, and a blanket fee of \$3075, plus incidentals, was agreed upon.

The procedure was as follows: Each of the participating builders submitted a plan. All means of identification were removed from the plans, each one being given a number. These plans were then turned over to the architects for study and recommended changes, they being given full authority to make such changes as they deemed expedient, even to the extent of complete redesign. After they had completed all preliminary work, their committee studied the houses as a group, and selected a site for each one, so that the group as a whole would present a pleasing and harmonious picture. They then drafted a plot plan, with exact location, side and front yards, and grade.

The architects were then given the participating builders' names, and each architect and builder working together completed each plan and its accompanying set of specifications.

Work was started in November, 1938, the Association,
(Continued to page 46)



DETROIT BUILDERS' CAPE COD MODEL

THE 37th Demonstration Home in the Greater Detroit Home Builders Association Duchess Project as shown above, with plans on these two pages, was built by the Association to represent its entire membership. It is worthy of careful study, because, in both exterior design and interior arrangement, it represents top value in its class.

AMERICAN BUILDER
The Cost FIGURES
FOR THIS HOUSE
ON PAGE
60

SPECIFICATION OUTLINE

FOOTINGS: 20" wide, 8" deep. Basement foundation 12" cinder blocks to grade; 8" cinder blocks first floor joists.

EXTERIOR: Face brick veneer. Open porch on front with flagstone floor; open platform porch on rear with concrete slab.

FIRST FLOOR JOISTS: 8" Stran-Steel, 20" on center.

SECOND FLOOR JOISTS: 2x10 yellow pine, 16" on center. All other framing lumber No. 2 yellow pine.

RAFTERS: 2x6 - 16" on center. Sub-floors and roof boards, 1x6 boards.

SHINGLES: Red cedar 5X, vertical grain, creosote dipped.

INTERIOR TRIM: Yellow pine and sap gum.

FLOORS: Select oak, manufactured by D. M. Rose & Co., Knoxville, Tenn.

WINDOWS: Fenestra casements by Detroit Steel Products Co.

KITCHEN EQUIPMENT: General Electric kitchen including all cabinets, sinks, electric dishwasher, Disposall, electric stove, electric refrigerator.

KITCHEN FLOOR: Armstrong linoleum.

BATHROOM: Floor, tile; side walls, Marlite.

INTERIOR DECORATIONS: All wood work enameled, and all walls papered.

ELECTRIC WIRING: Complete for any and all electric appliances; Square "D" Multibreaker. Lighting fixtures, Michigan Chandelier Co.

GARAGE DOOR: Tilt-A-Dor.

HEATING: Oil-burning air conditioning system, Nash-Kelvinator Co.

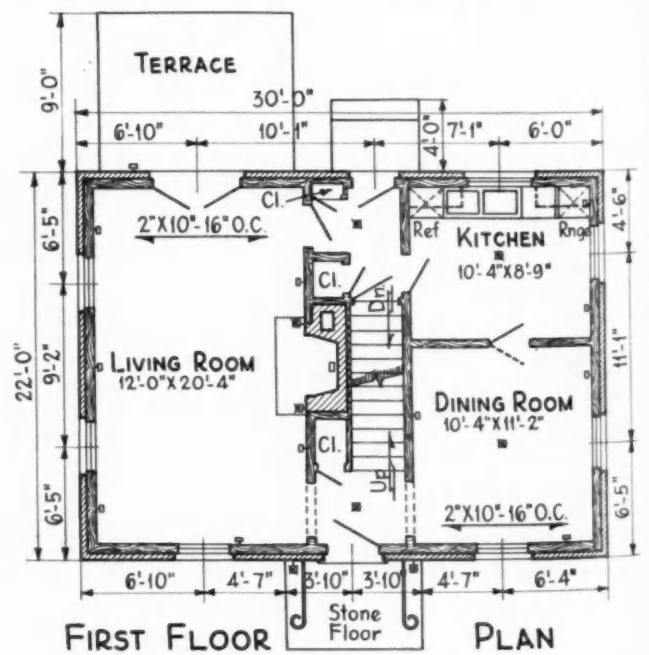
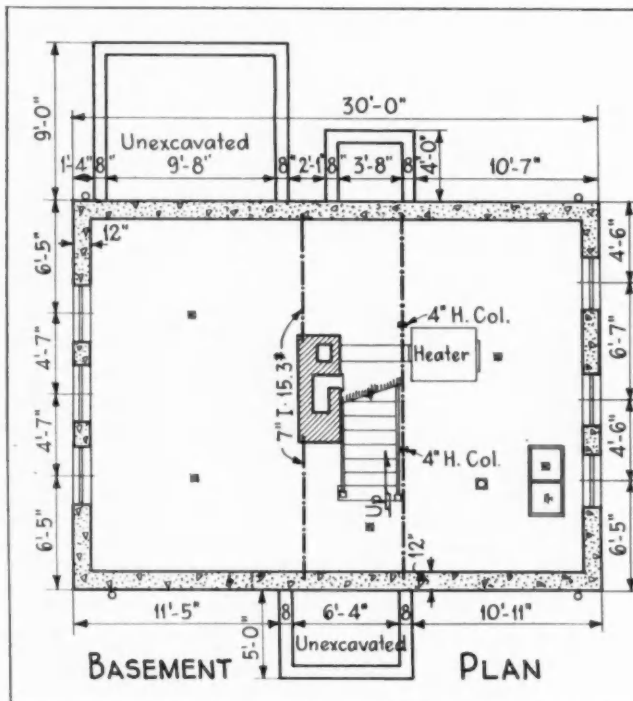

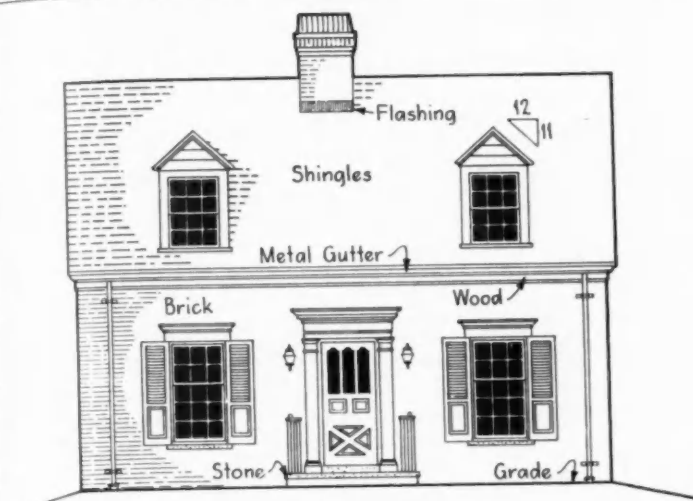

FRONT ELEVATION

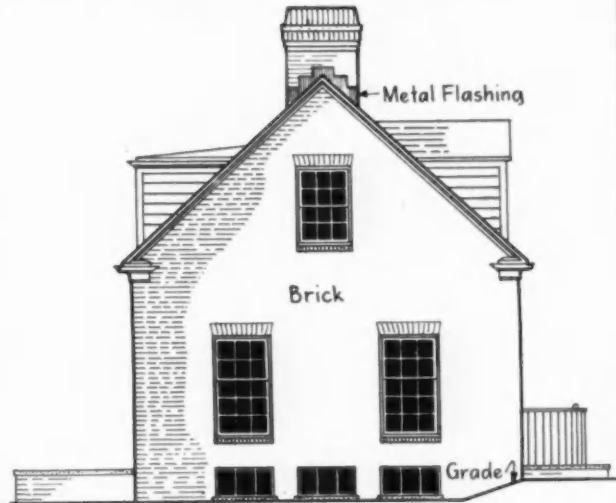

LEFT SIDE ELEVATION

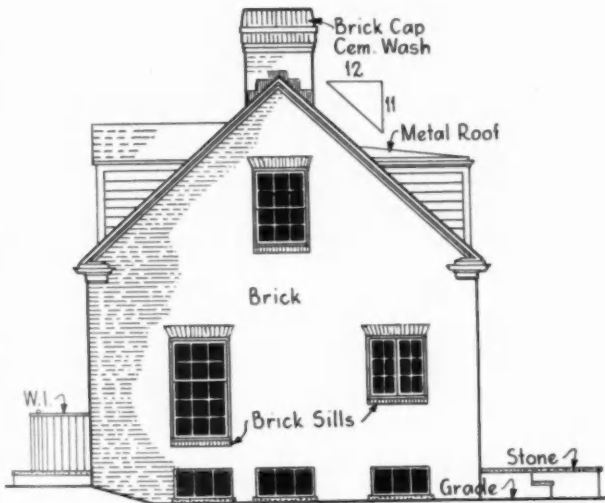

RIGHT SIDE ELEVATION

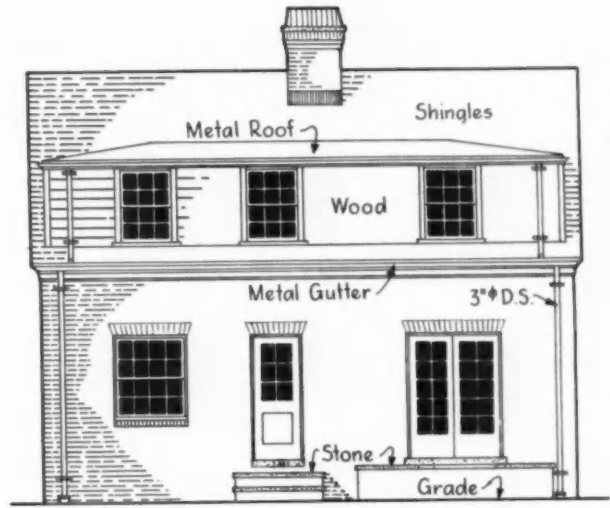

REAR ELEVATION

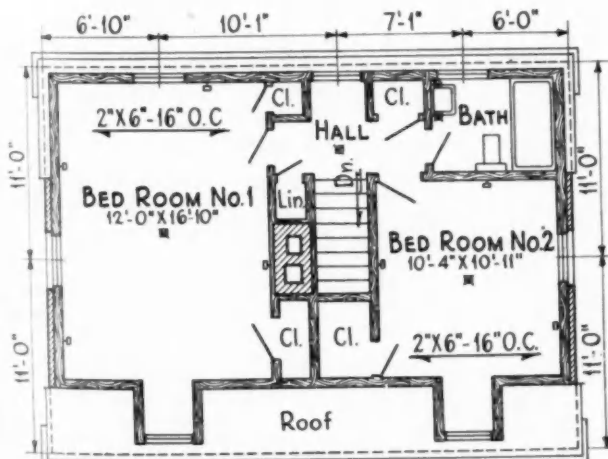
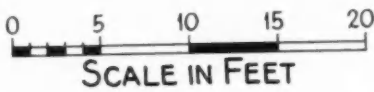

SECOND FLOOR PLAN

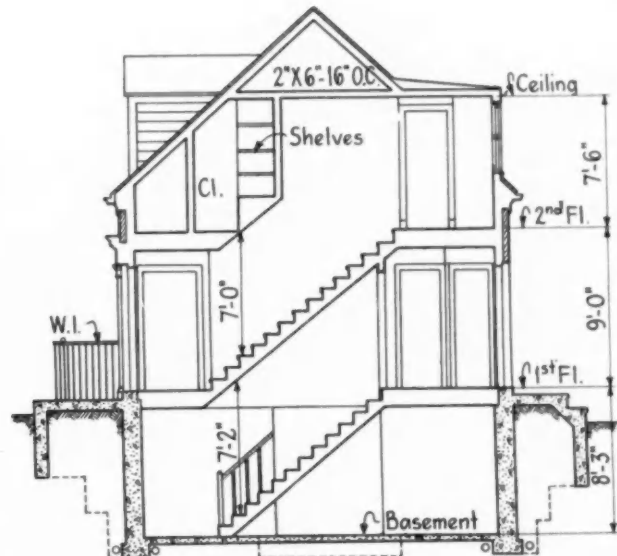

SECTION

FLOOR PLANS of Detroit Builders' house present compact livability and convenience; note proper stair planning in section.

(Continued from page 43)

for various reasons, digging all the basements. From that time on each builder was on his own, and completed his particular job in his usual manner, subject, however, to the fourteen rules governing the Project, as on page 43.

Detroit's 1939 Streamlined Home Show

The Demonstration officially opened February 15th in a heavy rainstorm which lasted all day. But despite this fact, from 10:00 A.M. until 10:00 P.M. Duchess Avenue was a thoroughly crowded street, and a steady stream of people milled in and out of the 37 models. Sample checks indicated that over 25,000 people visited the homes on the opening day.

The following Sunday Detroit experienced a heavy snowfall, sufficiently heavy to slow up traffic of all kinds; yet the crowd on Duchess Avenue seemed even bigger than opening day. The third Sunday, the worst sleet storm in the history of the local weather bureau descended on Detroit; but again there was no apparent lessening of crowd interest.

The original intention was to keep the houses open for two months; but due to public interest and demand this period was extended for five weeks; and the official demonstration closed on May 7th with an estimated attendance of 500,000 interested visitors, who came not only from Detroit and suburbs but also from practically all parts of the country.

During the period the Annual Year Book prepared to serve as a complete home buying guide was on sale at the Project office. Thousands of copies were sold from this office; mail orders numbering several hundred and originating in all parts of the country, were filled.

Through the Year Book, the Association conducted an Essay Contest. The subjects specified were: "The Value or Lack of Value of Government Subsidized Housing," and "The Contribution, If Any, Which Detroit's Streamlined Housing Had Given to the Cause of Better Housing." Limited to 200 words or less, over 5,000 people, representing every walk of life, sent in essays, indicating the degree of public interest in the matter of housing.

As we have stated before, the Project achieved to a certain degree its specified purposes. Being a project along uncharted lines, it was natural that many mistakes were made; but to counterbalance these, much experience was gained upon which to plan future projects.

Generally speaking, the primary object was not to promote the sale of home building jobs although the project did that particular job very effectively—a natural result, when it is considered that here were 37 models, within a price bracket which accounted for over 80 per cent of all sales, attractively designed and conveniently grouped for public inspection—37 houses which represented the best local building and architectural thought, and priced at the lowest possible figure consistent with sound construction. Hundreds of building jobs sales were effected, and thousands of future home buyers were developed.

Incidentally, thousands of names of persons who had indicated interest in modernization and equipment purchase were turned over to manufacturers and distributors for follow up campaigns. So results of this new type of home merchandising were very satisfactory.

However, the primary objective sought was the education of the home buying public to recognize quality in workmanship, material, design and equipment; and to appreciate their *VALUE IN A DOLLAR SAVING SENSE*. We desired to promote the idea that good construction was the *CHEAPEST* kind of construction; that good materials and equipment were the cheapest materials and equipment; that good construction could be

secured only from builders of sound reputation and experience; and that only materials and equipment manufactured by known and reputable manufacturers, distributed by reliable dealers, would give the service paid for and expected.

We desired to promote in the public mind the value of thoroughly investigating the prospective builder; and also to emphasize and call to their attention the expert staffs which reliable manufacturers and dealers had built up to serve in an advisory capacity, in the selection of materials and equipment. And to further this idea, the editorial content of the Year Book first warned of the pitfalls which might be encountered on the road toward home ownership, and then indicated the guide marks to follow in their successful evasion.

Naturally our interest in this was not entirely unselfish; but it was an objective which sought to protect the home buying public from its own carelessness, and to turn back into legitimate business channels the thousands of dollars which were annually mulched from the unwary home buyer. For during 1938 alone, the local police department averaged *THREE CALLS A WEEK* with reference to misappropriation of funds alone in the building field.

(During this period, the membership of the Greater Detroit Home Builders' Association, totalling 230, did approximately 80 per cent of all the residential building in the Detroit area. Despite this fact, there was only one complaint of this nature involving an Association member; and in this case the customer's money, under the direction of the Association, was refunded in full.)

Prior to our demonstration, demands upon the Association for information with reference to builders averaged about ten per week. For that period including March, April and May, builder inquiries addressed to the Association have averaged 15 *PER DAY*.

While only 36 builders out of the Association's 230 members directly participated in the Project, it had the unanimous enthusiastic endorsement of the entire group, and its beneficial results were enjoyed by the non-participating member as well. For it has resulted in sales which otherwise would have gone to one of that small minority in the building field, whose only ambition and purpose is to separate quick dollars from the unwary.

Co-ordination of Effort

It has been a subject of much comment, both locally and elsewhere, that 36 builders could be harnessed up for a project of this type, and work harmoniously. Well, the facts speak for themselves. These builders not only accepted the many restrictive checks in this multiple harness, but did so in a thoroughly co-operative spirit; and each one pulled his full load, and did everything possible to keep the project moving steadily and briskly forward. Fighting to the last ditch for individual business in a fiercely competitive market, they displayed unvarying sportsmanship of the highest type.

Each of the 36 builders in this Project sincerely believes that no one in the world builds a better house, or gives better value than he does. Each one fought for his share of business on this basis; but he fought cleanly. And if he lost the job, he was satisfied if it went to a competing builder of sound reputation, and not to a promoter.

For the builder knows that even in a fiercely competitive market, with the incompetent, dishonest and inefficient operator barred, he will get his share of the business, and that it will be business which will be good business—good for the man who is buying; good for the building industry; good for the builders; and good for the general economy.

THE Following Home Designs, As Shown on Pages 47-53, Were Selected from the 37 Demonstration Models in the Duchess Project Home Show.

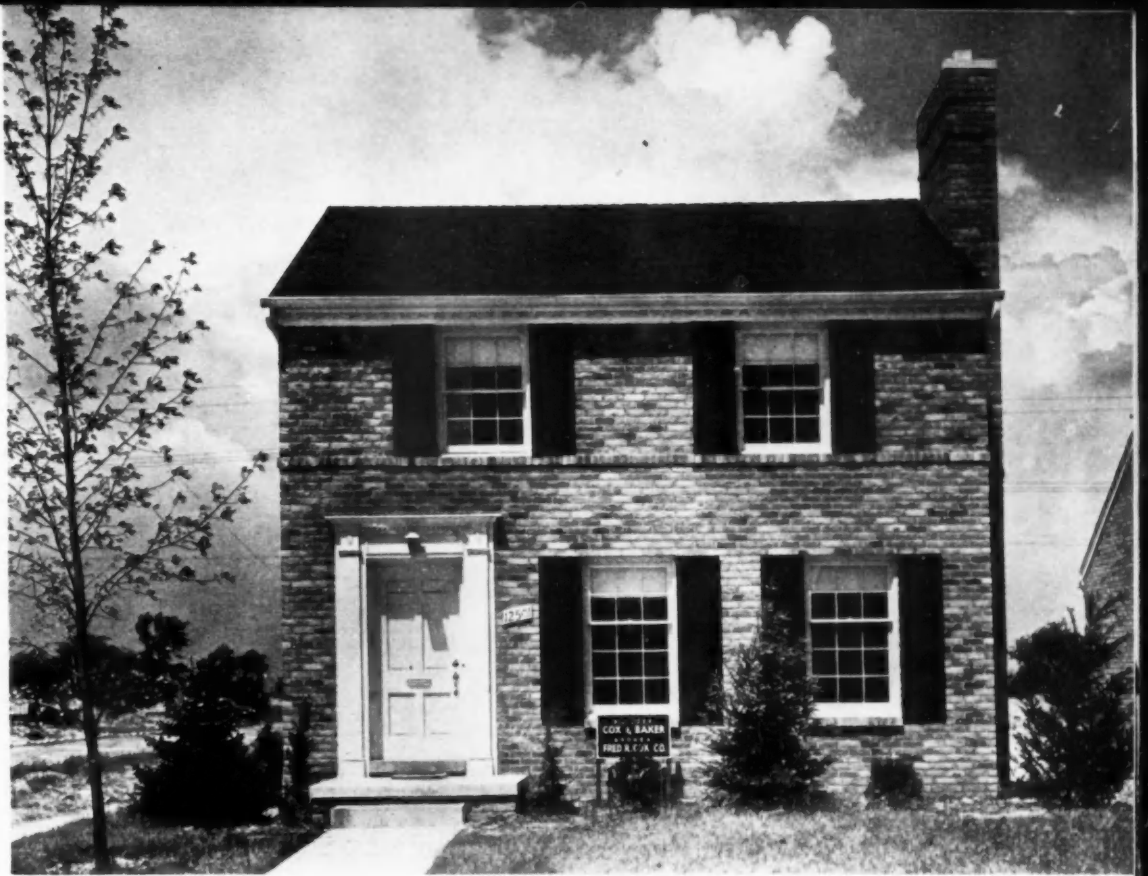

AMERICAN BUILDER
True Cost FIGURES
FOR THIS HOUSE
ON PAGE
60

POPULAR DETROIT COLONIAL

Cox & Baker, Detroit, Builders

ONE of the most popular demonstration homes in Detroit's Duchess Project was this attractive little five-room Colonial. The exterior, with its impressive entrance to one side, trim lines, dark blinds and divided sash, gives one the impression of modest livability in an up-to-date manner. In plan the layout offers maximum space utilization, while retaining the necessary convenience. Stair hall is lighted on both floors; grade entrance well placed for access to basement. The kitchen is fairly small but well arranged in an L-shaped plan. A rear terrace opens off the dining room. Second floor is equally compact and well laid out.

SPECIFICATION OUTLINE

FOOTINGS: 20" x 8" concrete.
EXTERIOR: Hard burned brick veneer laid in Peerless mortar. Walks, 4" thick; terraces, 5" thick.
BASEMENT WALLS: Cement block, waterproofed with coat of cement mortar covered with asphalt.
FRAMING LUMBER: Southern pine sub-floor 3/4" x 6" Y.P. laid diagonally; bridging 1" x 3" between joists of 1st and 2nd floors.
SHINGLES: Stained 5X vertical grain cedar.
LATH: Gold Bond Rocklath.
PLASTER: Two coat.
INSULATION: 4" rock wool above ceiling; 15 lb. felt over shiplap, Air-O-Cell between studs.
PLUMBING FIXTURES: Standard Sanitary.
ELECTRICAL FIXTURES: Michigan Chandelier; Wiring, Romex.
HEATING: Season-Aire gas-fired winter air conditioner, by Domestic Air Conditioning Co.
WINDOWS: "Sibley-All-Weather" sash; weatherstripped and caulked.
DECORATING: Wallpaper and paint.
EQUIPMENT: Kitchen ventilator, Victor "In-Bilt" electric model; Venetian medicine cabinet, Miami Cabinet Co.

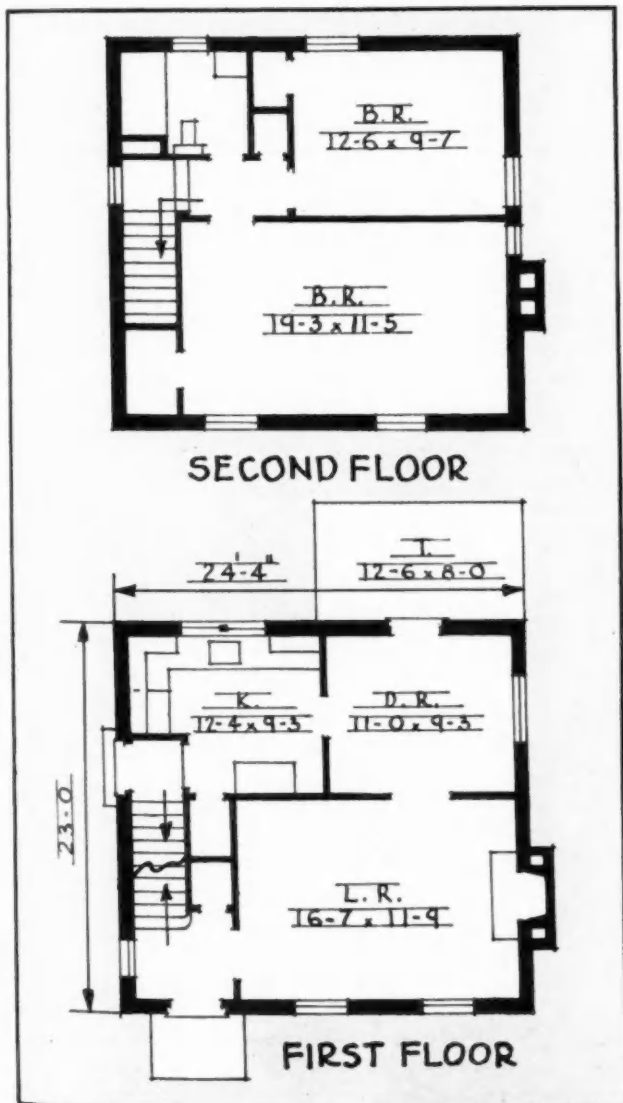



THIS HOME is one of the 6-room models in the Duchess Project and the only one with an attached garage. As such, it represents high value for the price. A covered rear porch and protecting hood over garage entrance are two of the extras resulting from economical planning.

6 ROOMS; BUILT-IN GARAGE

Harry Durbin, Detroit, Builder

SPECIFICATION OUTLINE—FOOTINGS: 8" x 18" poured concrete. Basement walls: 10" monolithic concrete.

FRAMING LUMBER: Grade marked No. 2 or better—1st floor joists, 2" x 10"—12" o.c.; 2nd floor joists, 2" x 8"—12" o.c.; roof rafters, 2" x 6"—16" o.c.; studs, 2" x 4"—16" o.c.; bracing, 1" x 4".

SHINGLES: 5X vertical grain, stained.

LATH: Rocklath—Cornerite, all corners and angles.

PLASTER: Two coat, rodged.

INSULATION: Side walls $\frac{3}{4}$ " Celotex Vapor Seal. Ceilings, 4" rock wool.

PLUMBING FIXTURES: Kohler.

ELECTRICAL FIXTURES: Madison Electric.

HEATING: Bard gas-fired air conditioned unit.

FRAMES & SASH: Wood, Sibley's S.A.W.

TILE: Bathroom floor and wainscot to height of 4'.

DECORATING: Walls and ceiling painted. Durax paper above tile in bathroom.

EQUIPMENT: Package receiver, mail box, G-E Disposall unit; built-in cupboards, linen closets, clothes hamper, fruit room.

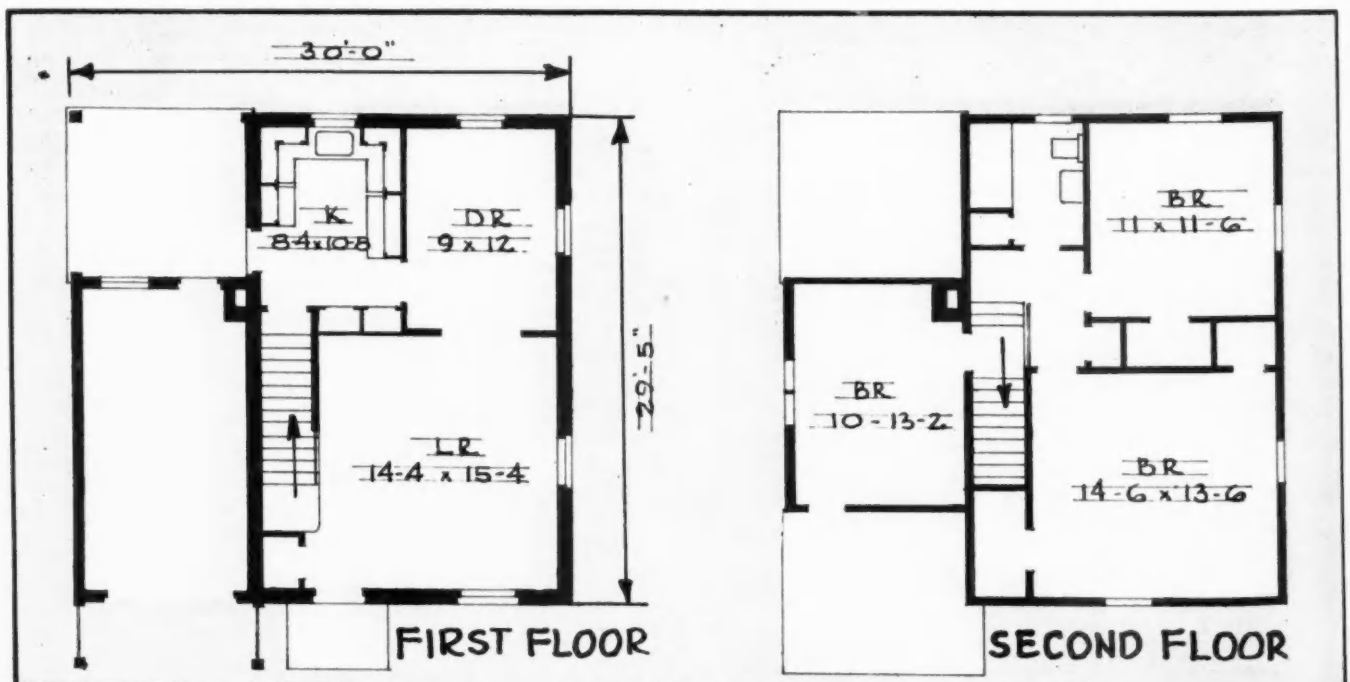

"ALL ELECTRIC HOME" IN DETROIT'S DUCHESS PROJECT

Gratiot Building Investment Co., Builders

SPECIFICATION OUTLINE—FOOTINGS: 20" x 8"—2000#
Transit mixed concrete. Basement wall: 12" sand lime block.
FRAMING LUMBER: Grade marked No. 2 or better—1st floor joists,
2" x 10"—16" o.c.; 2nd floor joists, 2" x 8"—16" o.c.; roof rafters,
2" x 6"—16" o.c.; studs, 2" x 4"—16" o.c.; bracing, 1" x 6".
LATH & PLASTER: U. S. Gypsum recess dry wall.

INSULATION: Side walls, Fir-Tex; ceilings, rock wool.
PLUMBING FIXTURES: Kohler.
ELECTRICAL FIXTURES: Michigan Chandelier.
FRAMES & SASH: Wood; Currier Three-in-One all-weather units.
HARDWARE: Corbin.
HEATING: Ideal gas-fired air conditioned unit.
EQUIPMENT: Detroit Incinerator Co.'s Fulmenator; Duplex ventilat-
ing fan; G-E electric range, garbage Disposall, hot water heater,
refrigerator, dishwasher and metal cabinets.

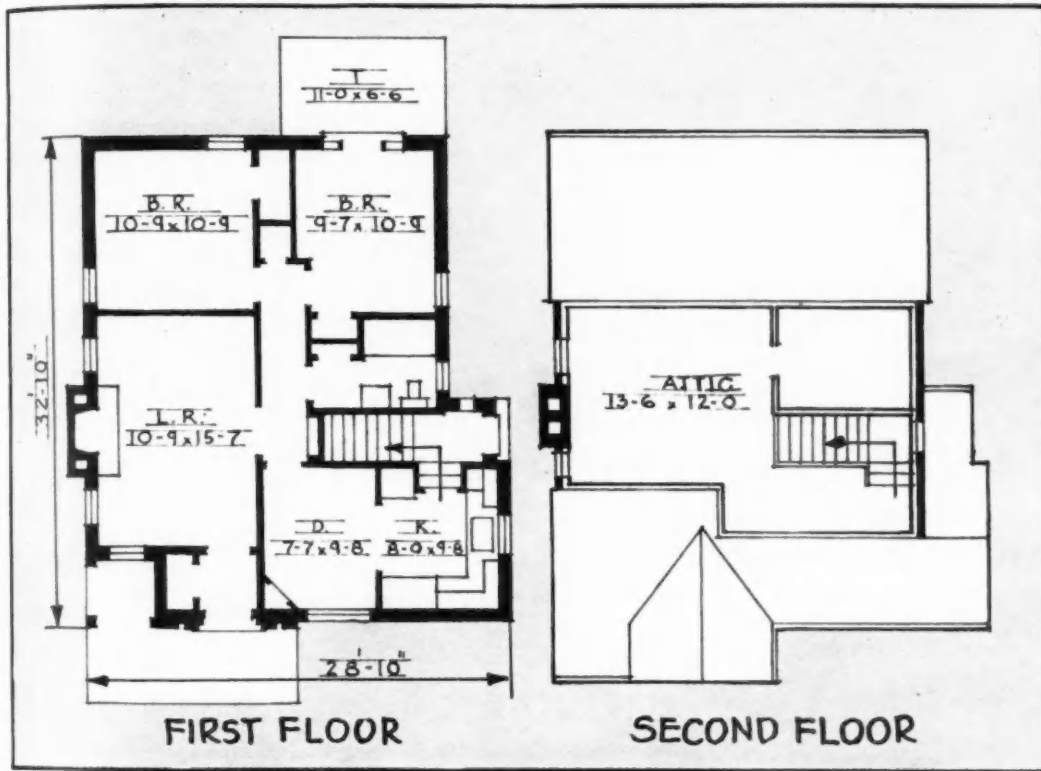

ONE of the features that made this five-room one-story design popular in the Greater Detroit Home Builders Assn. demonstration project was the compact, all-electric kitchen with equipment as listed in the specification outline above. Another feature is the possible use of attic space for an extra bedroom to be finished later.



"These High Value Homes Are the Result of Building Industry Progress and Co-operation Within the Detroit Builders Association"





The 37 Houses in the Duchess Demonstration Project, Detroit, Are Grouped Along Both Sides of the Street and Offer a Wide Range in Style.

AMERICAN BUILDER
The Cost FIGURES
 FOR THESE HOUSES
 ON PAGE
 60

NEW ENGLAND COLONIAL FOR COMFORTABLE LIVING

Waldo & Weller, Detroit, Builders

THIS is another of the two-story six-room homes in the Duchess Project, Detroit. It features good circulation from front to rear of the house, a symmetrical living room with inside fireplace, rear service hall with storage closet, breakfast space in a corner of the kitchen, equipment placed for recreation room in the basement, and ample closet space, linen closet and well lighted hall area on the second floor.

SPECIFICATION OUTLINE

FOOTINGS: 20" x 8"—2000# Transit mixed concrete.
BASEMENT WALL: Concrete blocks, R.I.W. waterproofing.
FRAMING LUMBER: Grade marked No. 2 or better—1st floor joists, 2" x 10"—16" o.c.; 2nd floor joists, 2" x 10"—16" o.c.; roof rafters, 2" x 6"—16" o.c.; studs, 2" x 4"—o.c.; bracing, 1" x 6".
SHINGLES: Creo-Dipt.
LATH & PLASTER: Rocklath with metal joints, 3-coat plaster.
INSULATION: Ceilings and walls, Ferro-Therm.
PLUMBING FIXTURES: Standard Sanitary.
ELECTRICAL FIXTURES: G-E.
HEATING: Bard gas-fired air conditioned unit.
FRAMES & SASH: N.S.W. wood.
HARDWARE: Schlage.
DECORATING: Paints, Pratt & Lambert; wallpaper, Fisher Wall Paper Co.
EQUIPMENT: Package receiver, Gabriel.

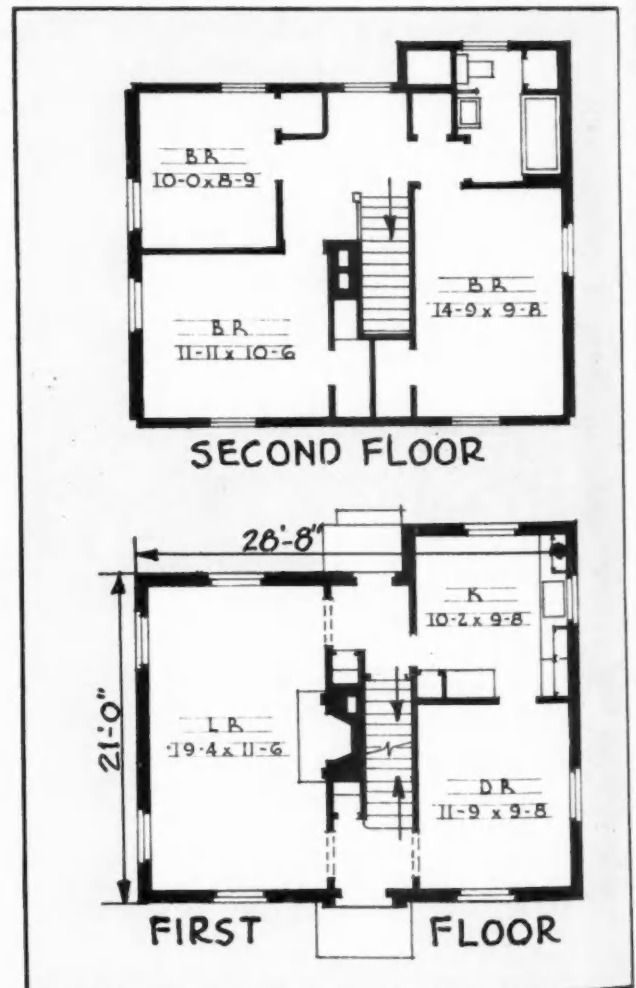



COMPACT 5-ROOM PLAN

Coe & Asselin Co., Detroit, Builders

THIS five-room model in the Duchess Project, like the one seen next to it, is styled in neat English design. The stairs have been worked out to give good access from the grade entrance and kitchen to the basement, and at the same time the stairs from the future room above lead down into the connecting hall to the bath.

SPECIFICATION OUTLINE

FOOTINGS: 20" x 8".
BASEMENT WALLS: Cement block plastered with portland cement and water-proofed with Truscon.
FRAMING LUMBER: 1st floor joists, 2" x 10"—12" and 16" o.c.; 2nd floor or attic, 2" x 8"—16" o.c.; rafters, 2" x 6"—16" o.c.
SHEATHING: 25/32" Celotex Vapor-Seal.
SHINGLES: Wood stained 5X.
LATH: Rocklath, metal over ceiling joints.
PLASTER: Two coat.
FLOORS: Select oak; random width oak plank, screwed and plugged in dining room.
INSULATION: Side walls, 25/32" Celotex Vapor-Seal; ceiling, 4" rock wool.
PLUMBING FIXTURES: Standard Sanitary.
HEATING: Capitolaire conditioning, U. S. Radiator Co.
DOORS & WINDOWS: Steel casements, Detroit Steel Products Co.; birch Rezo slab doors.
TILE: Robinson Tile Co.
LINOLEUM: Armstrong.
DECORATING: Painting, 3 coats; wall paper, Fisher Wall Paper Co. Floor finished with Duro Seal.

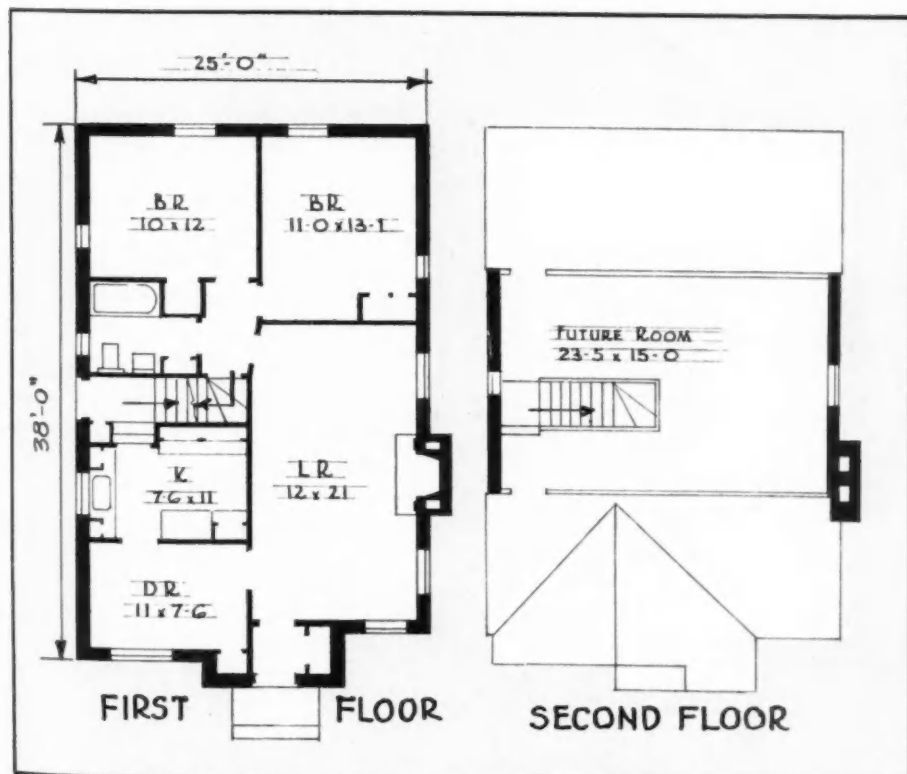

HIGH VALUE PLANNING

William V. Seifert, Detroit, Builder

THIS home in the Detroit builders' demonstration has extra features built into it which are not apparent from the street elevation. It has three bedrooms, 1½ baths, handy connecting rear hall, breakfast room off kitchen, large recreation room in basement, and ample closet space.

SPECIFICATION OUTLINE—FOOTINGS: 20" x 8"—2000# Transit mixed concrete. Basement wall: 12" cement block.
FRAMING LUMBER: All No. 2 or better, grade marked—1st floor joists, 2" x 8"—16" o.c.; 2nd floor joists, 2" x 8"—16" o.c.; roof rafters, 2" x 6"—16" o.c.; studs, 2" x 4"—16" o.c.; bracing, 1" x 4".
SHINGLES: 5X vertical grain, stained.
LATH: Rocklath with ¾" rods 10" o.c.
PLASTER: Standard X plaster, Gold Bond.
INSULATION: Ceilings, J-M rock wool; side walls, Air-O-Cell.
PLUMBING FIXTURES: Standard Sanitary.
HEATING: Gar Wood gas-fired winter conditioning unit.
FRAMES & SASH: Currier Never-Stick D. H.
TILE: Floor and wainscot in bath, backboard and drainboards in kitchen, Virginia tile.
HARDWARE: Corbin.
DECORATING: Walls of bath and kitchen painted; ceilings of all other rooms painted. All other walls papered.
EQUIPMENT: Duplex ventilating fan; Gabriel package receiver; General Electric refrigerator.
FEATURES: Attractive wood-burning Colonial fireplace and finished recreation room.

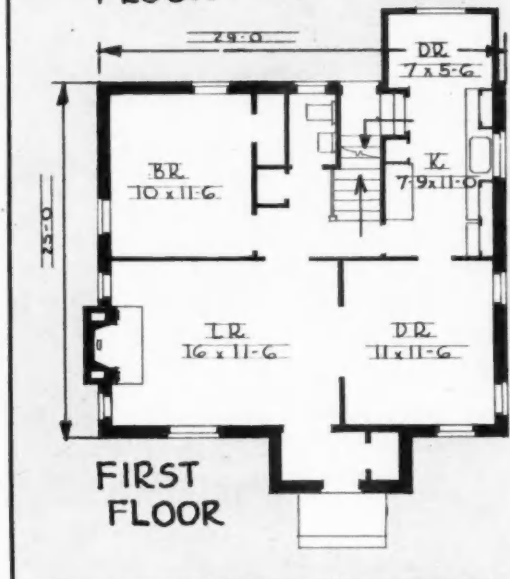

AMERICAN BUILDER
The Cost FIGURES
 FOR THESE HOUSES
 ON PAGE



MODERN COLONIAL DESIGN IN DETROIT HOME SHOW

Benton Construction Co., Detroit, Builders

SPECIFICATION OUTLINE—FOOTINGS: 20" x 8"—Transit mixed concrete. Basement walls: 12" concrete blocks.
 DAMPPROOFING: 2 coats black asphaltum on 1/2" cement plaster.
 FRAMING LUMBER: Grade marked—joists, 2" x 10"—16" o.c.; ceiling joists, 2" x 6"—16" o.c.; also 12" o.c. on long spans; rafters, 2" x 6"—16" o.c.; studs, 2" x 4"—16" o.c.
 SHINGLES: 5X, wood stained.

LATH: Rocklath.

INSULATION: Ceiling, 4" rock wool; in side walls, Air-O-Cell.

PLUMBING FIXTURES: Kohler and Standard Sanitary.

ELECTRICAL FIXTURES: Madison Electric; Wiring, Romex.

HEATING: Season-Aire gas-burning air conditioner.

FRAMES & SASH: Andersen casement and Currier Never-Stick D. H.

FLOORING: Select oak.

DECORATING: 3 coats; Du Pont.

EQUIPMENT: Coppes kitchen cabinets.

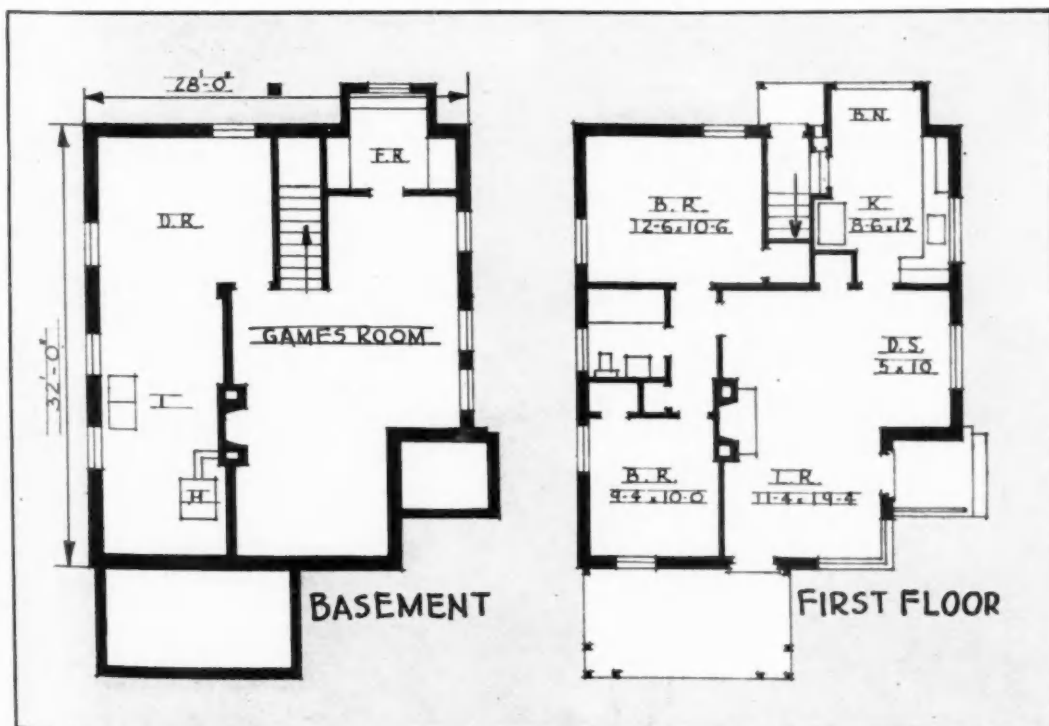

THE nearest approach to modern design in the Duchess Project is this one-story modified Colonial model. The interior, in plan and finish, is likewise modern, with a combined living room-dining alcove. Living porch is located to the front, breakfast nook to the rear. A large game room with fireplace is a feature of the finished basement.

AMERICAN BUILDER
The Cost FIGURES
 FOR THIS HOUSE
 ON PAGE
 60

RED CEDAR shingle exterior of the Edwards home at Stamford, Conn., given 3-coat finish of pure white lead and oil. Provoost and Everett, architects of Stamford.

Stamford's "Double Lifetime" Home

CONSTRUCTION methods employed in the R. B. Edwards home at Stamford, Conn., were carried out with unusual thought and attention to secure the long life so traditional with New England homes. The owner, an engineer, co-operated closely with architect, builder and subcontractors to demonstrate up-to-date but thoroughly sound quality methods.

Unusual interest is attached to the flashing, painting, plumbing, plywood and shingle construction, as follows:

FLASHING—All intersections which might allow destructive leakage were flashed with $2\frac{1}{2}$ lb. hard sheet lead. This type of lead flashing is formed by the addition of a small percentage of antimony which increases the tensile strength and permits the use of $2\frac{1}{2}$ lb. rather than 4 lb. soft lead. The owner felt that a frequent cause of paint failures is improper flashing which allows moisture to get in underneath the wood.

Window and door head flashings were run 3 in. up

COMPLETE ANALYSIS of lead flashing, paint, plumbing, plywood and red cedar shingle details and installation methods

FLOOR PLAN at left illustrates placing of living room at rear to take advantage of quiet garden view. Kitchen below is well laid out with compactly installed cabinets, painted a light grey.



The Story of a Quality Home Building Job. Construction Details and Methods Are Planned for an Enduring Life

VERY LITTLE separation between living room and dining room, which makes both rooms appear larger. Fireplace wall is done in knotty pine. Dining room walls above pine wainscot are cheerful blue paper.

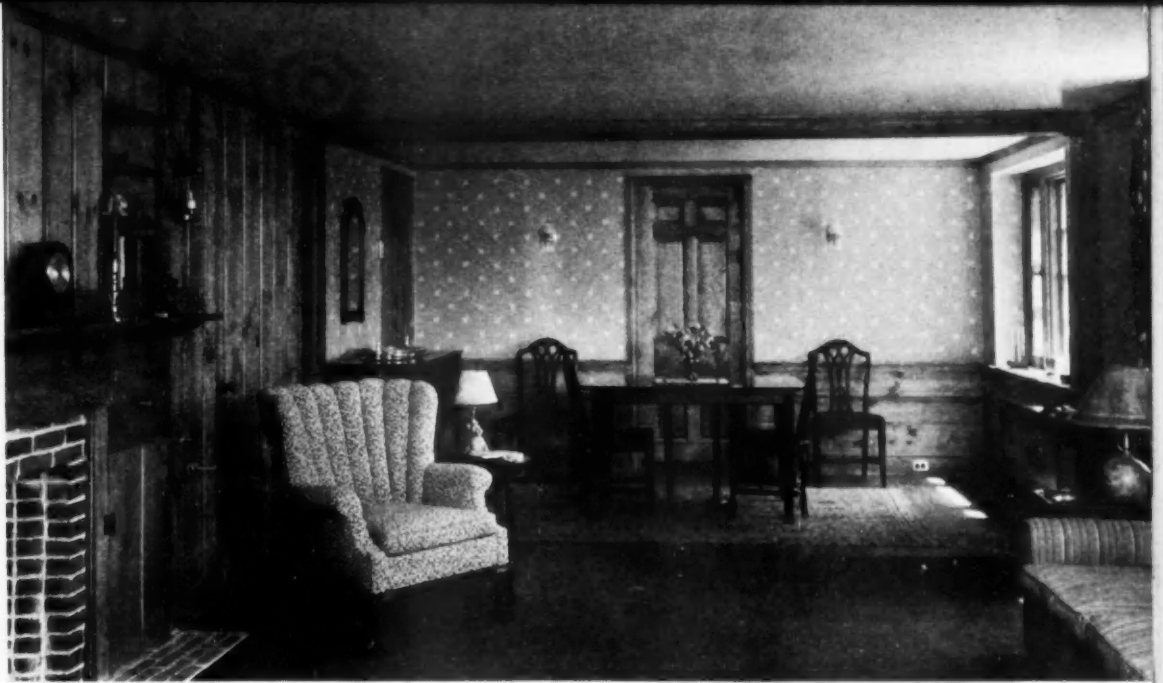

behind shingles and lower edge turned down $\frac{3}{8}$ in. over face of trim. Flashing extended 2 in. beyond trim on each side. Gusset pieces were soldered in at corners where lead turns back from face of trim.

On window sills a one-piece pan was formed, with dog-eared corners, which enclosed the sill and was turned up 1 in. on the sides and back. The sill flashing was turned down over the top of the siding, or in the case of dormers had an apron overlapping the top roofing course 4 in.

Chimney flashing consisted of lead step flashing built into the brickwork and turned up 1 in. against the flue lining, each piece overlapping the next by 3 in. Particular care was taken in flashing the chimney, as one of the causes of paint failures or other deterioration is moisture

penetrating the masonry joints. Base flashings at the sides of the chimney were in small pieces interwoven with the shingles. They extended 5 in. out upon the roof under the top shingle and were turned up 4 in. against the chimney and lapped at least 3 in.

A sheet lead chimney cap protects the top from moisture infiltration, with flashing extending down on the inside of the flues at least 2 in.

Valley soakers were extended 7 in. on each side of the valley and interwoven with the shingles. All intersections of roof surfaces and vertical walls were flashed with lead. The bay window roof was of 3-lb. hard lead installed in one piece, turned up 4 in. in back of the shingle siding and extending 2 in. beyond the edge of the roof.

NO. 1 Certigrade western red cedar shingles were nailed directly to the plywood sheathing (at right). A 20-lb. asphalt saturated kraft building paper was used. Below, plywood walls and ceiling of bathroom above tile were given 3 coats lead and oil paint which were finished with a stipple surface.

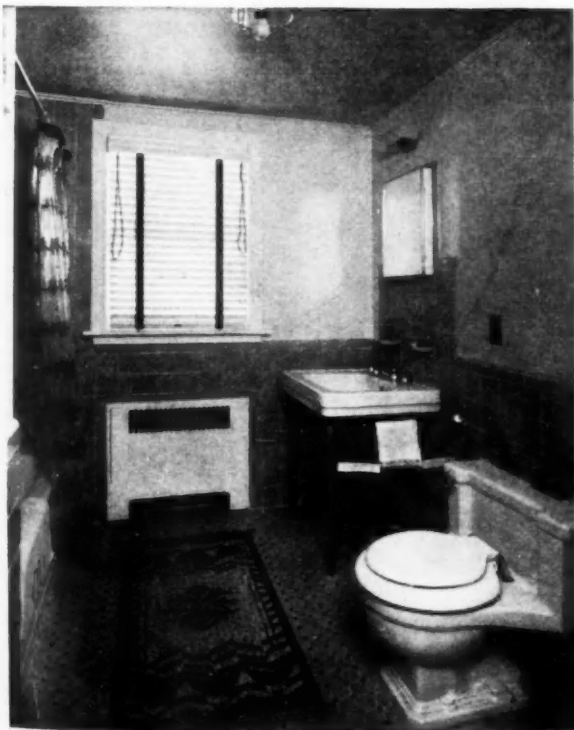

Long Life, New England Tradition Upheld by These Careful Construction Methods as Illustrated Here

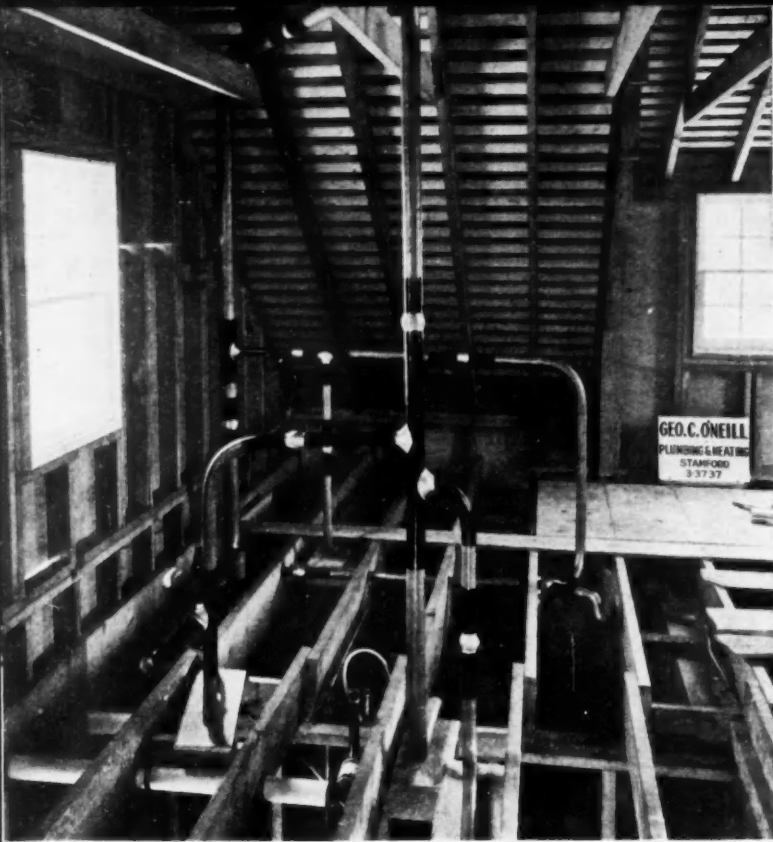

COMPLETE UPSTAIRS ROUGHING, showing easy sweep of lead pipe bends and small number of joints which have been necessary.



APPLYING LONG-LIFE red cedar roof. Arrow shows lead flashing installed at change of pitch above triple dormer at rear of house.



Gutters were lined with 2½-lb. hard sheet lead turned up under the shingle as far as possible without being punctured by nails in the first shingle course.

Sidewall flashings consisted of small pieces of sheet lead interwoven with roofing courses, a method considered superior to the use of one long piece.

PAINTING—Painting throughout consisted of pure white lead and oil. Volume formulas used on the outside were as follows:

Priming coat, 3 parts white lead and oil, 4 parts linseed oil, 2 parts turpentine. Body coat, 2 parts white lead, 1 part linseed oil, 1 part turpentine. Finishing coat, 1 part white lead, 1 part linseed oil. This type of paint job provides a long-lasting exterior that will wear smoothly and evenly and keep the surface in good condition.

INTERIOR PAINTING—Plywood interior finish and woodwork were painted with lead and oil according to the following formulas:

Priming coat, 3 parts white lead, 3 parts linseed oil, 2 parts turpentine. Add ¼ pt. drier to each gal. of paint if raw linseed oil is used. Finishing coats, 3 parts white lead, 4 parts lead mixing or reducing oil.

The brick chimney is also painted white with the following formula:

Priming coat, 3 parts white lead, 5 parts linseed oil, 1 part turpentine. Second coat, 3 parts white lead, 5

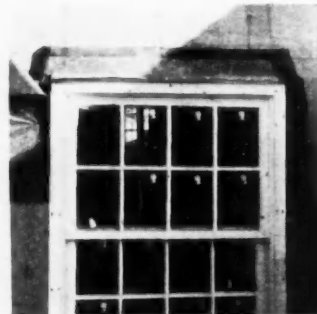

2½ LB. HARD SHEET lead flashing used at window head (left) and at dormer intersection with roof at the bottom and sides (right).

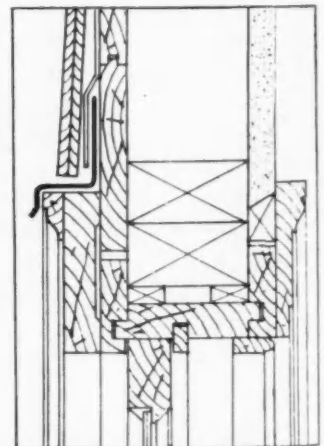
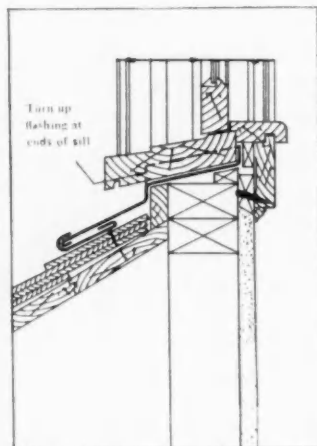

WINDOW SILL AND HEAD FLASHING DETAILS recommended to prevent leakage at these vital points, which frequently cause paint trouble. AT LEFT: Construction view of chimney showing hard lead step flashings which run all the way through to the tile flue lining.

parts liquid consisting of equal parts linseed oil and lead mixing or reducing oil. Third coat, 1 part white lead and 1 part lead mixing or reducing oil.

SHINGLES—Exterior walls and roof were shingled with No. 1 quality Certigrade western red cedar shingles, according to specifications, and given 3 coats of white lead and oil paint. They were placed over 20-lb. fibre reinforced kraft building paper and nailed directly to the 5/16 in. plywood exterior sheathing.

PLYWOOD CONSTRUCTION—A rigid, weathertight structure was assured by the use of Douglas fir plywood for subfloors, exterior wall sheathing and interior walls and ceilings. The "Uniwall" system for installing interior plywood over furring strips, developed by the I. F. Laucks Company, was used. Details of the plywood construction include:

SUBFLOORING—Subfloors are of $\frac{5}{8}$ in.
(Continued to page 92)



JOURNEYMAN PLUMBER preparing roof joint with tallow before wiping lead flashing to lead vent pipe.

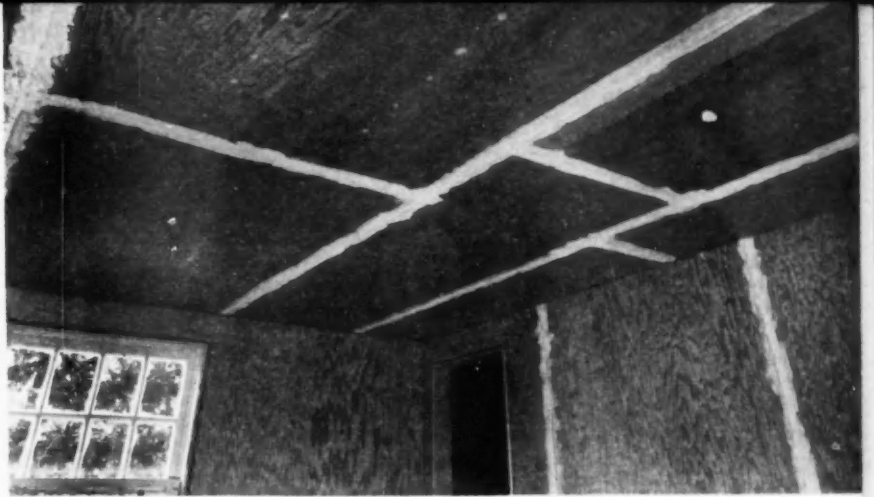

PANEL JOINTS of interior plywood finish were carefully filled and sanded. Ceiling given 3 coats white lead and oil paint. Walls papered over felt base.



DOUGLAS fir plywood subflooring, lengthwise across joists; nails, 6" apart.

INTERIOR PLYWOOD PANELS were back-primed with lead and oil paint, then glued and nailed in place. Furring strips (right, below) between panels and studs absorb any building movement and at the same time provide a proper base to which the plywood can be applied.



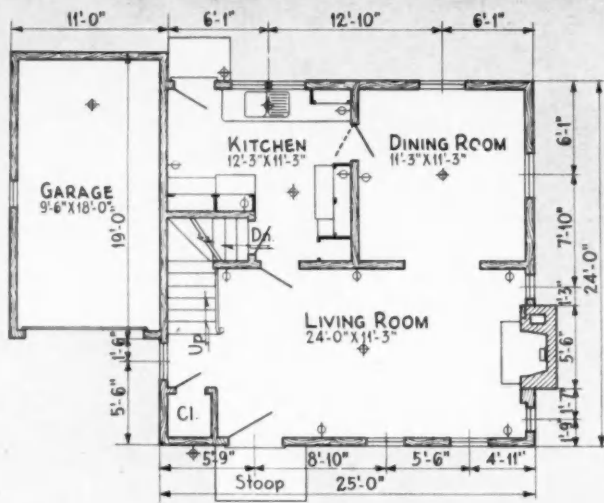

FIRST FLOOR PLAN

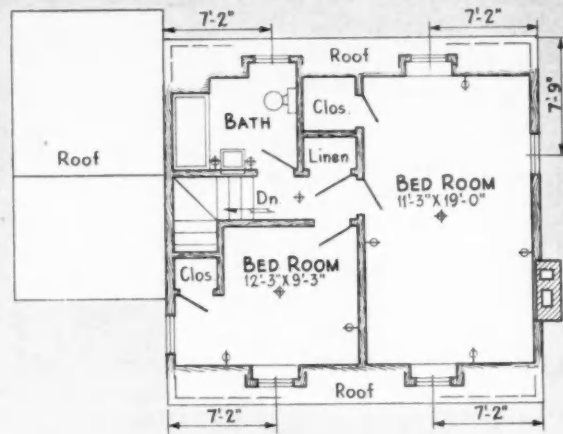

SECOND FLOOR PLAN

COMPACT PLAN provides 2 bedrooms and bath on second floor, kitchen, dining room and 11'-3" x 24' living room. Basement size is 25' x 24'.



THIS COMPACT little Dutch Colonial, designed by Norris F. Prentice of Elmwood, Conn., has a gambrel roof which gives a low, rambling appearance yet provides space for 2 good bedrooms and bath on second floor. It has good Colonial design which fits into its New England location.

AMERICAN BUILDER
The Cost FIGURES
 FOR THESE HOUSES
 ON PAGE
 60

SPECIFICATIONS include Chrysler Airtemp conditioning unit, U.S.G. Rocklath plaster base with metal foil back on outside walls, red cedar clapboards, Veos metal tile in bath, Morgan Colonial windows and trim. Cubage is about 16,400.

When Is an 80% Loan NOT an 80% Loan?

MUCH good has been done by the extensive national publicity on 80 percent FHA loans, and as a result many people who had never considered building because they thought they could not raise the down payment have become prospective buyers.

Indications are, however, that in many communities and in many instances "80 percent loans" is an empty phrase. It may be called an 80 percent loan, but on the basis of the below-cost appraisal used it is far less.

Conditions vary so in different parts of the country and even in different sections of the same town that no blanket criticism can or should be made. The complaint was put

in definite form recently, however, by Wallace B. Goodwin, home builder of Elmwood, near Hartford, Conn., who has built some 35 houses in his own developments in the past two and a half years.

The objective of FHA in regard to operative builders, he points out, is stated in its own literature as being "to encourage that type of operative builder who, preferably, assumes responsibility for the product from the plotting and development of the land to the disposal of the completed dwelling units. It seeks to encourage the creation of dwelling property, the stability of which will be assured by the protection afforded against inharmonious land uses,

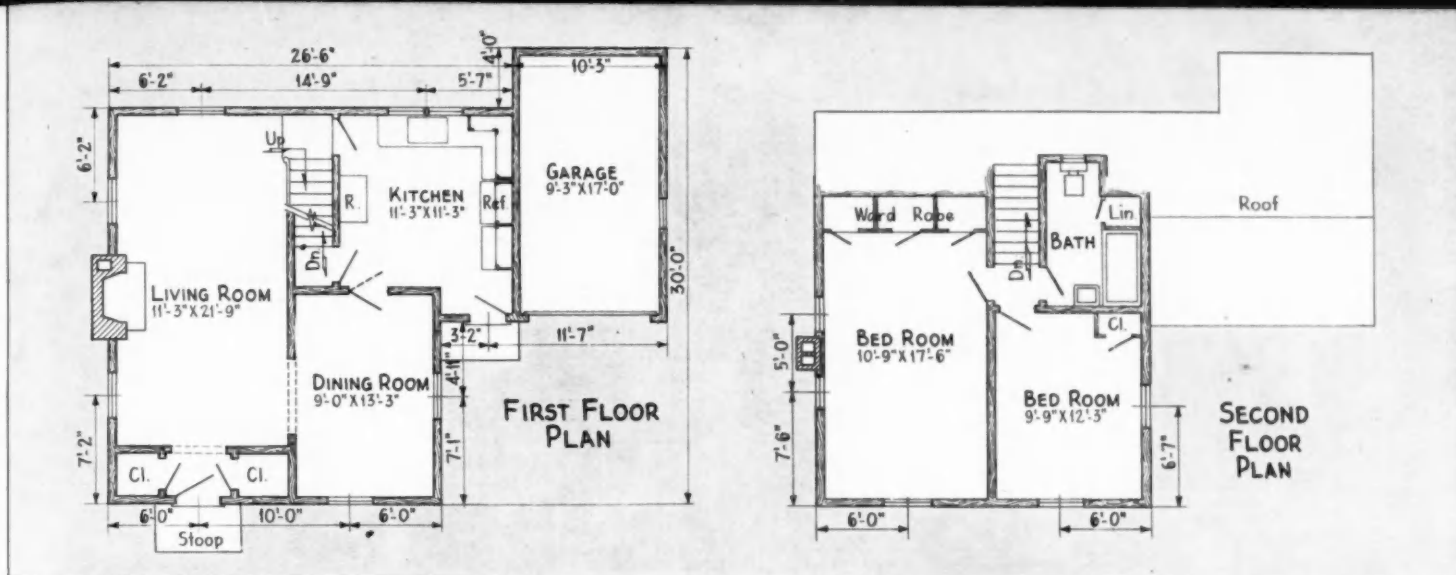

"THE GROVE" No. 1 is a 5-room New England Colonial type, with cubage of 16,200, living room 11' x 21' 9"; cost sheet shown below.

Builder's Cost Sheet "The Grove" No. 1

Building Permits.....	\$ 21.00
Blue Prints.....	5.00
Brick	54.40
Concrete	303.95
Cement Floors.....	58.95
Cleaning Windows.....	15.00
Carpenter Labor.....	674.91
Common Labor, including grading driveway, etc....	250.00
Engineer for surveying....	50.00
Excavation	60.00
Electrician	126.00
Electrical Fixtures.....	30.00
Grading (Seed & ferti- lizer)	15.00
(Stone for driveway)	20.00
(Flagstone)	20.21
(Shrubs)	50.00
(Loam)	20.15
(Fill)	25.00
Heating	660.00
Lumber Co. materials (Hardware) (Lath & plaster) (Insulation)	1,898.20
Legal Fees.....	25.00
Interest	150.00
Compensation Insurance, Social Sec. & Unem- ployment	110.00
Iron & Steel.....	22.39
Linoleum	51.00
Mason Labor.....	220.00
Plumber & Supplies.....	425.00
Painter	217.50
Painting Supplies.....	61.75
Tinning	33.50
Tile	97.75
Scraping Floors.....	12.00
Wallpaper	30.00
Weatherstripping	34.15
Shades	11.00
Screens	38.75
Stairs	60.00
Sand & Cinders.....	16.50
City Water connection....	95.00
FHA Appraisal.....	16.87
Fuel Oil.....	28.00
Electricity	5.00
Lot	1,200.00



by thoughtful group planning, and by sound, attractive and economical building. It desires to see the elimination of waste in housing production by organized construction, and by the installation of streets and utilities of a character suited to the calculable demands of planned neighborhoods."

Goodwin claims that is exactly what he is doing. He says, "We buy the land in the rough, provide streets and utilities, erect and sell the completed dwelling all within our own organization. We are qualified by the FHA to mortgage these properties up to at least \$50,000, but when we apply for commitments we are cut to 60 per cent of an appraisal that is way below actual cost."

In his latest development, "The Grove," he claims that FHA appraisals are so low that the project is endangered. He points out that a local insurance company has offered to make a direct first-mortgage loan on one of these houses of \$4,950, which is 60 per cent of the conservative valuation. But on the same house FHA will only recommend \$4,300. The project was planned to be sold to people requiring 80 percent loans based on fair appraisals, and the result is discouraging to further expansion. If the project is curtailed it will mean less work for the building trades and less sales of building products—things that Goodwin believes the FHA was conceived to assist rather than discourage.



Reg. U.S. Pat. Off.

Figures for American Builder Homes

HOME DESIGNS ON PAGES AS NUMBERED

Units of Construction	July 44	July 47	July 48	July 49	July 50	July 51
Basement Walls, lin. ft.	104	96	100	124	106	130
Trench Walls, lin. ft.	56	41	62	55	20	14
Basement Floor, sq. ft.	560	506	504	773	545	713
Garage Floor, sq. ft.	0	0	200	0	0	0
Excavation per ft. deep, cu. yds.	29	25	25	38	28	40
Outside Walls, squares	17.05	19.25	21.80	16.46	20.18	17.60
First Floor, squares	6.60	5.64	5.90	8.60	6.35	9.50
Second Floor, with Fin. Flg., sqs.	5.64	5.64	7.30	0	6.50	0
Second Floor, without Fin. Flg., sqs.	0	0	0	3.67	0	4.00
Ceiling, sqs.	6.60	5.64	7.90	8.60	6.50	9.50
Roof Pitch, inches rise per ft. run	11"	8"	7"	8"	8"	7"
Roof, squares	14.70	7.25	11.50	11.60	8.60	11.50
Hips and Valleys, lin. ft.	36	0	14	28	40	36
Cornice, type and lin. ft.	C & F-	C & F-60	C & F-102	C & F-133	C & F-144	C & F-153
Cornice, type and lin. ft.	6"-70	8"-50	6"-46	4"-20	0	0
Partition, lin. ft.	136	135	174	141	165	127
Inside Finish OS Walls, lin. ft.	206	192	219	124	200	130
Front and OS French Doors, opgs.	2	2	1	2	1	1
Rear and Grade Doors, opgs.	1	1	2	1	1	1
Garage Doors 8 ft. wide	0	0	1	0	0	0
Inside Doors and Cased Opgs., opgs.	17	12	16	15	17	17
Windows and Casements, opgs.	20	19	19	21	22	16
Gable Sash and Louvers, opgs.	0	2	3	0	2	3
Chimney, lin. ft.	35	36	34	30	35	30
Main Stairs	1	1	1	1	1	0
Porch Floor, sqs.	1.59	1.20	1.24	1.86	.67	.24
Porch Ceilings, sqs.	0	0	1.40	.20	0	0
Porch Beam, lin. ft.	0	0	38	10	0	0
Porch and Balcony Post and Newels, no.	0	0	7	3	0	0
Porch Roof, sqs.	0	0	0	0	0	0
Porch Cornice, lin. ft.	0	0	0	0	0	0
Porch and Deck Rail, lin. ft.	10	0	6	0	0	0

HOME DESIGNS ON PAGES AS NUMBERED

Units of Construction	July 52	July 53	July 54	July 58	July 59
Basement Walls, lin. ft.	126	128	140	98	106
Trench Walls, lin. ft.	0	45	100	50	60
Basement Floor, sq. ft.	684	771	1008	5.52	590
Garage Floor, sq. ft.	0	0	220	1.90	180
Excavation per ft. deep, cu. yds.	35	38	46	26	29
Outside Walls, squares	18.00	15.02	21.90	17.35	18.40
First Floor, squares	8.13	9.31	11.00	6.00	6.47
Second Floor, with Fin. Flg., sqs.	4.31	0	7.12	5.16	4.78
Second Floor, without Fin. Flg., sqs.	0	0	1.20	0	0
Ceiling, sqs.	8.13	9.31	13.20	7.90	8.27
Roof Pitch, inches rise per ft. run	13"	7"	12"	28" and 5"	12"
Roof, squares	11.52	11.06	15.90	12.94	12.30
Hips and Valleys, lin. ft.	36	52	36	36	0
Cornice, type and lin. ft.	C & F-204	C & F-111	C & F-168	C & F-192	C & F-165
Cornice, type and lin. ft.	0	0	6"-104	0	24"-15
Partition, lin. ft.	200	108	301	168	153
Inside Finish OS Walls, lin. ft.	222	132	262	192	198
Front and OS French Doors, opgs.	1	2	2	1	1
Rear and Grade Doors, opgs.	1	1	2	1	1
Garage Doors, 8 ft. wide	0	0	1	1	1
Inside Doors and Cased Opgs., opgs.	19	13	26	13	15
Windows and Casements, opgs.	22	25	28	22	20
Gable Sash and Louvers, opgs.	2	3	0	1	0
Chimney, lin. ft.	33	26	36	32	33
Main Stairs	1	0	1	1	1
Porch Floor, sqs.	.24	1.35	1.25	.30	.32
Porch Ceilings, sqs.	0	1.17	1.00	0	.15
Porch Beam, lin. ft.	0	40	20	0	12
Porch and Balcony Post and Newels, no.	0	9	8	0	4
Porch Roof, sqs.	0	1.80	1.60	0	.30
Porch Cornice, lin. ft.	0	44	20	0	16
Porch and Deck Rail, lin. ft.	0	5	8	0	0

Necessary Home Equipment, Fixtures, Accessories, Extras

Since the above surveyed items cover only the actual superstructure of the house, you should figure and add the following items as specified or wanted (and don't forget Overhead and Profit):

Areaways, Cellar Sash, Coal Chute, Basement Partitions & Doors, Attic Flooring, Attic Stairs, Blinds, Gutters & Downspouts, Fireplaces,

Built-in Cabinets, Rail & Newels for Stairs and Stair Well, Beamed Ceiling, Weatherstrips, Tile Work, Plumbing, Heating & Air Conditioning, Lighting, Terraces, Patio Walls or Fences, Sidewalks including Porch Steps, Driveways, Unattached Garages. Also add for painting and decorating if not included in Unit Costs.

Air Conditioning Today

By HARRY M. HITCHCOCK

Editor, Information Bureau,
National Warm Air Heating
and Air Conditioning Ass'n.

No. 1. Where Are We Now?

THIS is the first of four articles on the "brass tacks" of air conditioning. They deal with the problem in the home and the small commercial building—store or restaurant—where the big development is still to come; leaving at one side large industrial and special installations. They will combine a progress report on the state of the art, with a summary of today's best engineering opinion as to what to do and why and how to do it, from the viewpoint of architect, installation designer, builder and heating contractor.

Succeeding articles of this series will cover: "Where the Customers Are Now;" a discussion of the present marketing problem, its economic and geographical factors, and what has so far been learned as to the present customer attitude; "What To Do About It," dealing with sales tactics, service problems, etc.; and "The Real Possibilities of the Future," a summing-up and attempt at forecast of the probable line of development of air conditioning as an industry, and its possible influence on the building industry as a whole.—EDITOR

NINETEEN thirty-nine seems likely to become known as the year in which air conditioning finally got out from under the engineer's slip-stick, and proceeded in an urban direction, or—as the vulgar would put it—went to town.

Not all the bugs are completely eliminated, of course. They never are, in any new thing offered for universal public use, until after the public has had a good chance to use it. The public has a propensity for discovering, or inventing, bugs that the engineers, just because they are engineers, may not have dreamed of. But the basic engineering problems involved in universal air conditioning—that is, air conditioning capable of reasonably economical application to any enclosed space designed for human occupancy—are pretty well licked. We really do know, now, what we can do, how we can do it, what it will cost, and, closely enough for all practical purposes, what will happen afterwards.

More important still, neither Mr. nor Mrs. John H. Customer is any longer required, in order to have an air-conditioned home, to master any greater amount of engineering skill than will suffice to apply thumb pressure to a button or—at increasingly rare intervals we hope—pick up a telephone and dial the service man. Anybody who remembers what similar developments did to spread the camera, the automobile and the radio beyond the original circle of mechanically gifted enthusiasts to the mechanically helpless millions, will have no trouble appreciating what simplicity of control is also going to mean to air conditioning.

There is, of course, another extremely important point. Nobody engaged in the fascinating though occasionally precarious business of selling a new industry to the American public overlooks the lesson impressively taught by Henry Ford—that the wide market and the big money is in the low-priced models. But summer cooling is by far both the most expensive and, in the public's eyes, most important, element in universal year-'round air conditioning. Consequently, with thousands of homes already enjoying a fair degree of summer coolness on

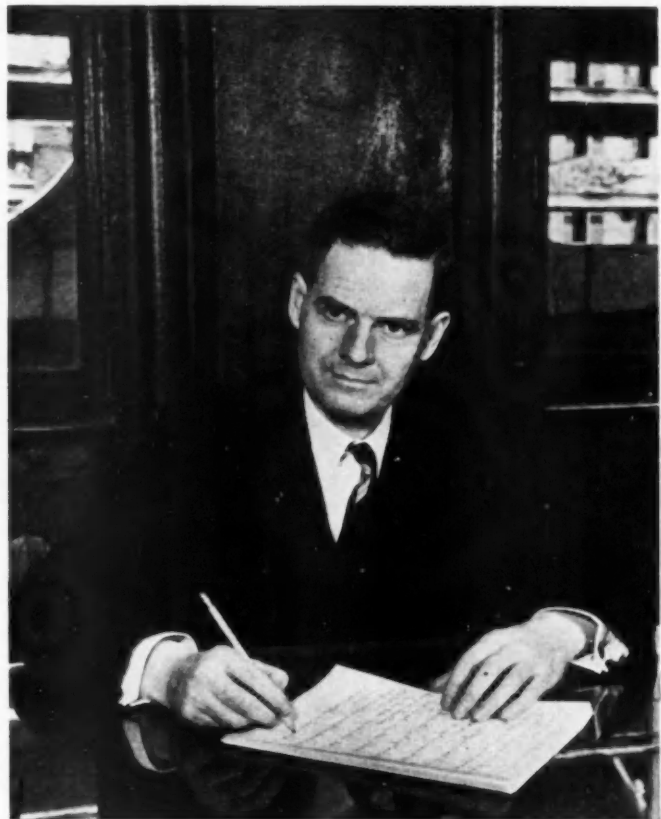

nothing more complicated or expensive than cool night air drawn into the house by an attic or furnace fan, it looks as though air conditioning's "Model T" had finally arrived.

As a matter of fact, there are definite indications that we have reached the stage where meticulous calculation of each installation as an individual engineering job are being replaced by the development of standard installations, including sufficient safety factors to guarantee satisfactory results over a fairly wide range of conditions as to climate, house design and so on. More will be said about this in another article.

Another sign that we are coming out of the scientific stage, and . . . let us hope . . . into the commercial-boom stage, is the extent to which everybody (including the engineers and scientists themselves) is abandoning the rigid performance standards which, up to now, have been pretty generally considered necessary for satisfactory air conditioning performance.

This doesn't mean that the four fundamentals of air conditioning—temperature, circulation, humidity and purity—don't stand right where they always stood. They do. But they have proved more flexible in their application than anybody realized at first. We'll come to the reason for that in a minute. The first point is that purification is the only one of the four where specific application, on a particular job, hasn't in practice been modified in all sorts of ways. (And there's reason for that, too.)

Let us, for a moment, consider the other three. We know quite a bit more today about the real significance of each of them than we did even as recently as a year ago. And practically all of this new knowledge might

(Continued to page 96)



Largest Electric Housing Project Opened

SAID to be the largest and most complete electrified housing project in the United States, the Olentangy Village development in Columbus, Ohio, was officially opened December 1, 1938. Occupancy in the thoroughly modern electrified project was started September 15th, only 125 days after the ground was broken and work began on it.

Built and operated by the L. L. LeVeque Company of Columbus, Ohio, this recently completed project will have a connected load of 750 kilowatts, with the Columbus and Southern Ohio Electric Company as the power source. Electricity will be re-metered to the 403 meters by the project maintenance operation.

The Olentangy Village project occupies a river-front tract of approximately 66 acres, of which about 10% is covered by buildings. The structures have been designed

in early American and Colonial by Raymond C. Snow, and as the housing units are so grouped that they follow the river front a most unusual and beautiful effect is secured. The general effect is heightened by the use of soft red colored bricks combined with white painted bricks for the exterior walls. A Williamsburg pattern roof, Ludowici Tile, completes the general scheme of Colonial treatment.

In the interior of the housing development one of the outstanding features is the exclusive use of electricity for the kitchens and laundries. The 403 kitchens, planned by Westinghouse, are completely electrified and will be the most modern in any housing project yet built. According to Sanders A. Frye, Chief Engineer of the LeVeque interests, the company's previous experience with using electrified kitchens prompted the exclusive adoption for

BELOW: Two typical three-room floor plans in Olentangy Village housing project at Columbus, O., and two dining-living 3 1/2-room layouts.

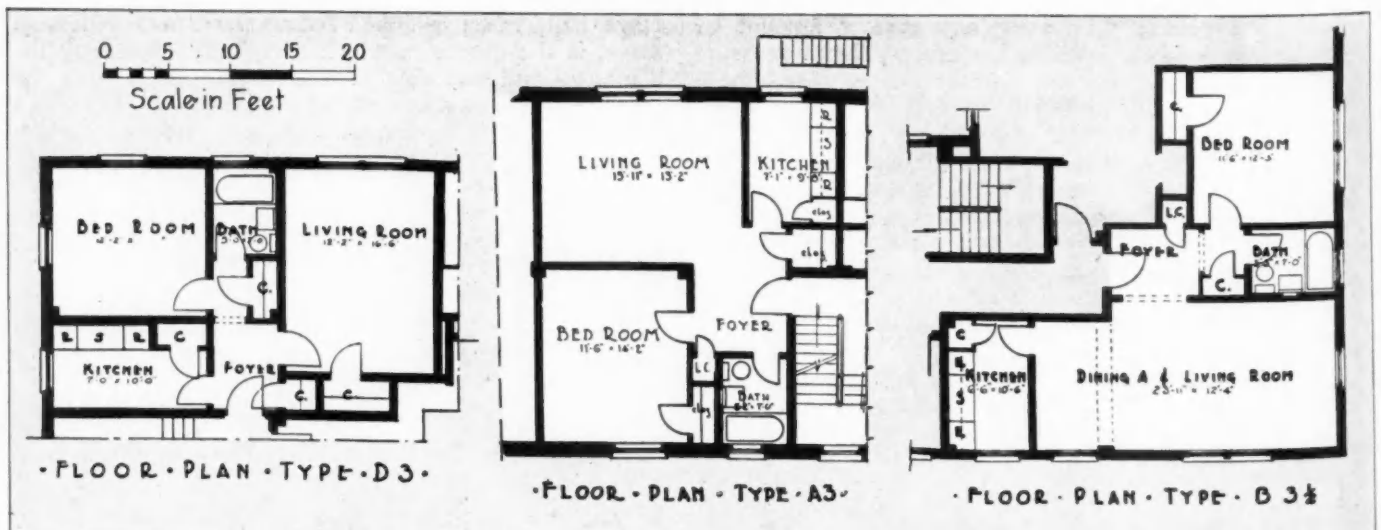

ON OPPOSITE PAGE: Aerial view of Olentangy Village at Columbus, O., shows its location along the river front and construction progress. Note the large proportion of garden area; only about 10 per cent of the 66-acre tract is covered with buildings.

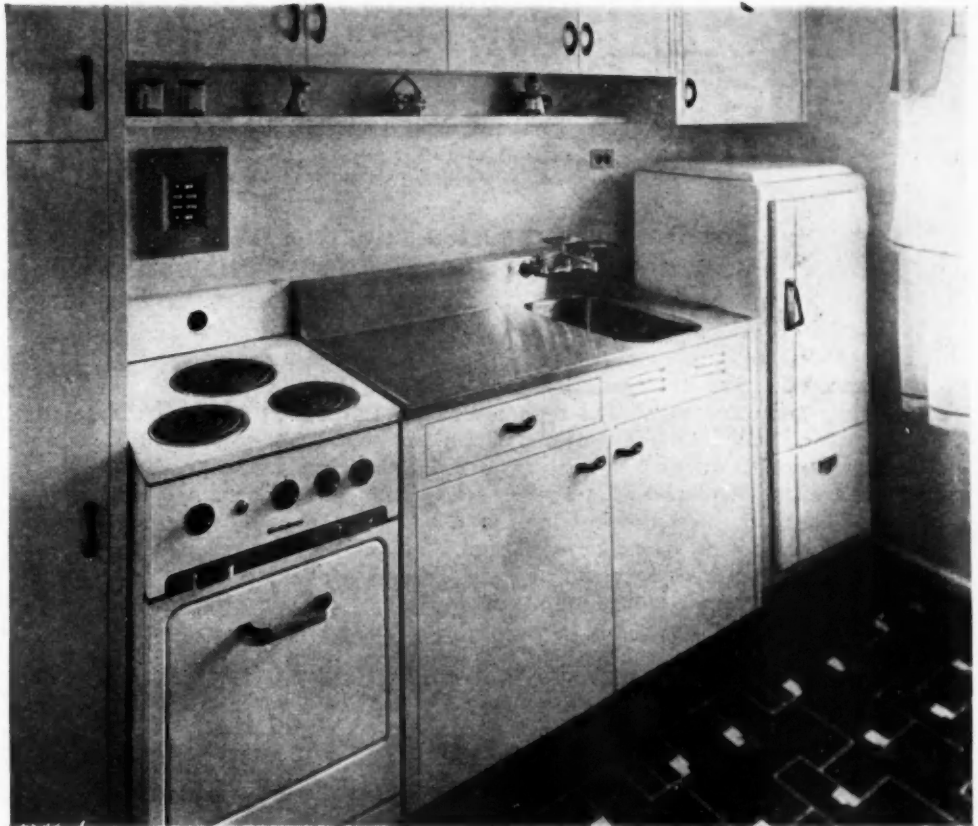

RIGHT: The kitchen equipment shown here is typical of that used throughout the project; 403 Westinghouse all-electric kitchens were installed, the largest number on record in a privately owned housing project.

the large Olentangy Village project at Columbus, Ohio.

"We have found," Frye reports, "that not only do the tenants appreciate the all-electric kitchen but in most cases it also has definite operating advantages. The cost of maintaining the kitchens is always a factor to be considered in planning and operating a multiple unit housing project and our past experience has convinced us that wherever possible we use the all-electric kitchen. It goes without saying that the completely automatic features and the general economy, convenience and use of these modern all-electric kitchens are appreciated by the tenants."

Laundry facilities are provided in the basements for the tenants who wish to use them. Planned by Westinghouse, these laundries will have the most modern Spinner Dryer electric washers to expedite the laundry processes.

Recreational and social facilities common to the development are tennis courts, a swimming pool, playgrounds, picnic grounds, and boating. A shopping center is conveniently located at the entrance to the village proper. The river is to be developed for boating.

A total of 1,374 rooms, divided into 58 units and seven buildings, comprise the 403-suite project. The rentals vary from \$30 to \$55 or average about \$14.50 per room. The average family rent, per unit, will be approximately \$48. A central heating system for each of the seven housing groups has been provided.

Assisting Raymond C. Snow, nationally known Washington, D.C., architect, were Merrill H. Hobbs, Structural Engineer, and William K. Karsunky, Mechanical Engineer, also of Washington, D.C.

The 4- and 4½-room sizes have an extra bedroom. Kitchens throughout have the same compact equipment and built-in storage space.

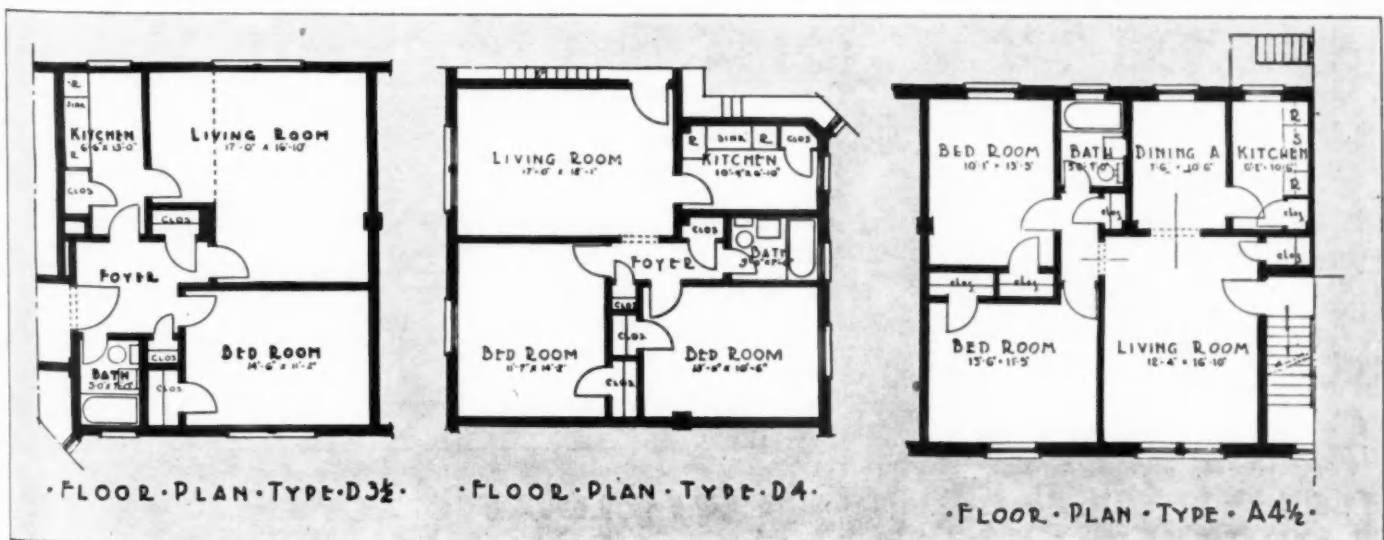

Portfolio of Architectural Plates of DOUGLAS FIR PLYWOOD PANELING

PREPARED BY CARL F. GOULD, F.A.I.A.

The fourth of a series intended as suggestions to the builder and architect as possible ways of using Douglas Fir Plywood for walls and equipment items in modern shop design.

A DESIGN for a modern shop or display room is shown on these pages. Douglas fir plywood is used for walls, balcony, facing, and showcases. This type of design requires careful cabinet work in its execution. The large radius portions of the semicircular niche can be faced with strips of plywood, either bent to radius or applied as segments. An ornamental sand-blasted frieze at the height of the recessed wall cases is a feature of the design. The recommended finish would be two coats of paint, in taupe or cafe-au-lait color, applied thinly enough to retain the

surface pattern of the underlying wood grain, and slightly stippled.

MATERIALS: The panels should be of a good 1-Side Grade Douglas fir plywood, unless the designer elects to cover the grain with paint; in such case $\frac{1}{4}$ " or $\frac{3}{8}$ " wall-board will be adequate. Fourpenny finishing nails carefully set and puttied are used. The V-jointing at edges of panels is readily accomplished with a plane. Additional scoring of panels is easily done with one of the portable electric saws fitted with a suitable bit.

DETAILS

$\frac{1}{2}$ FULL SIZE AND $1\frac{1}{2}$ " = 1'-0"

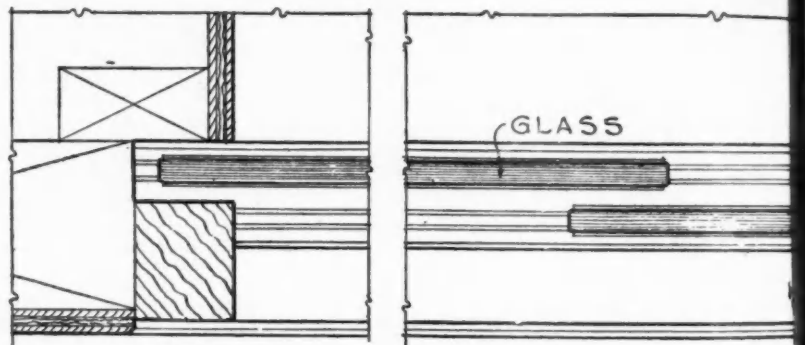
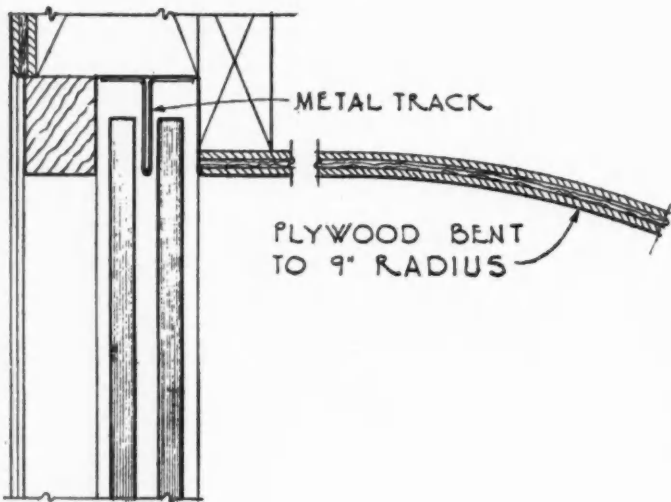

PLAN THROUGH DISPLAY SHELF

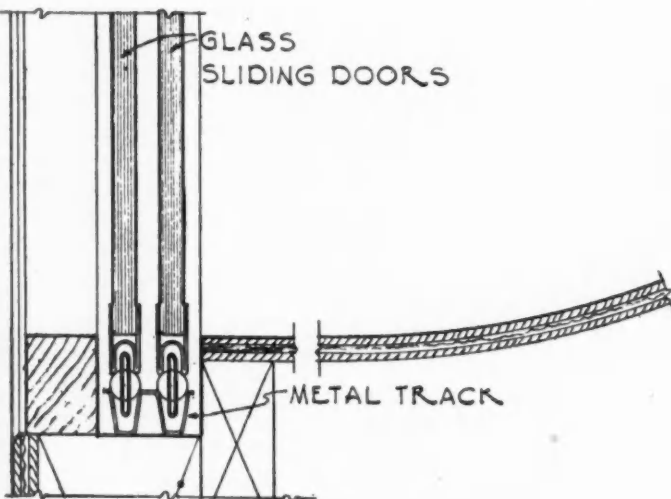

SECTION THROUGH DISPLAY SHELF

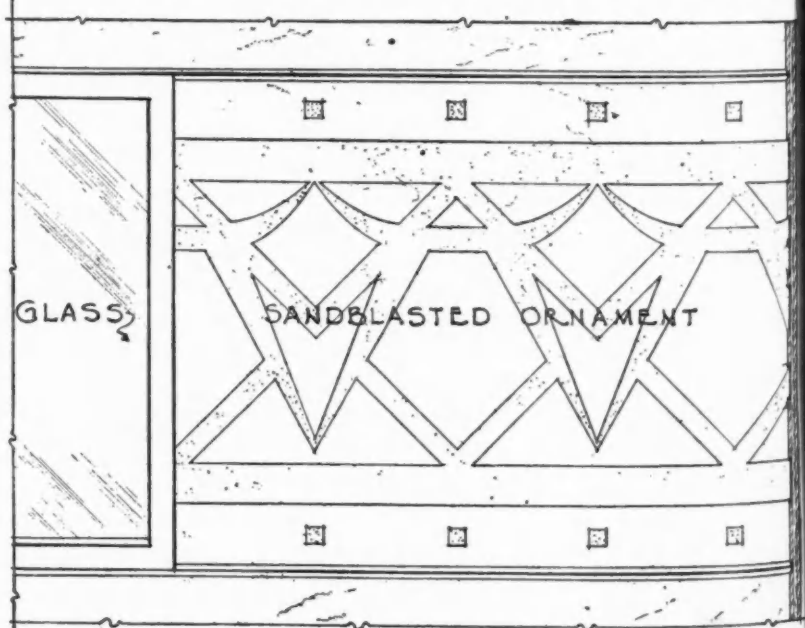

PART ELEVATION OF DISPLAY SHELF AND ORNAMENT

SCALE $1\frac{1}{2}$ " = 1'-0"

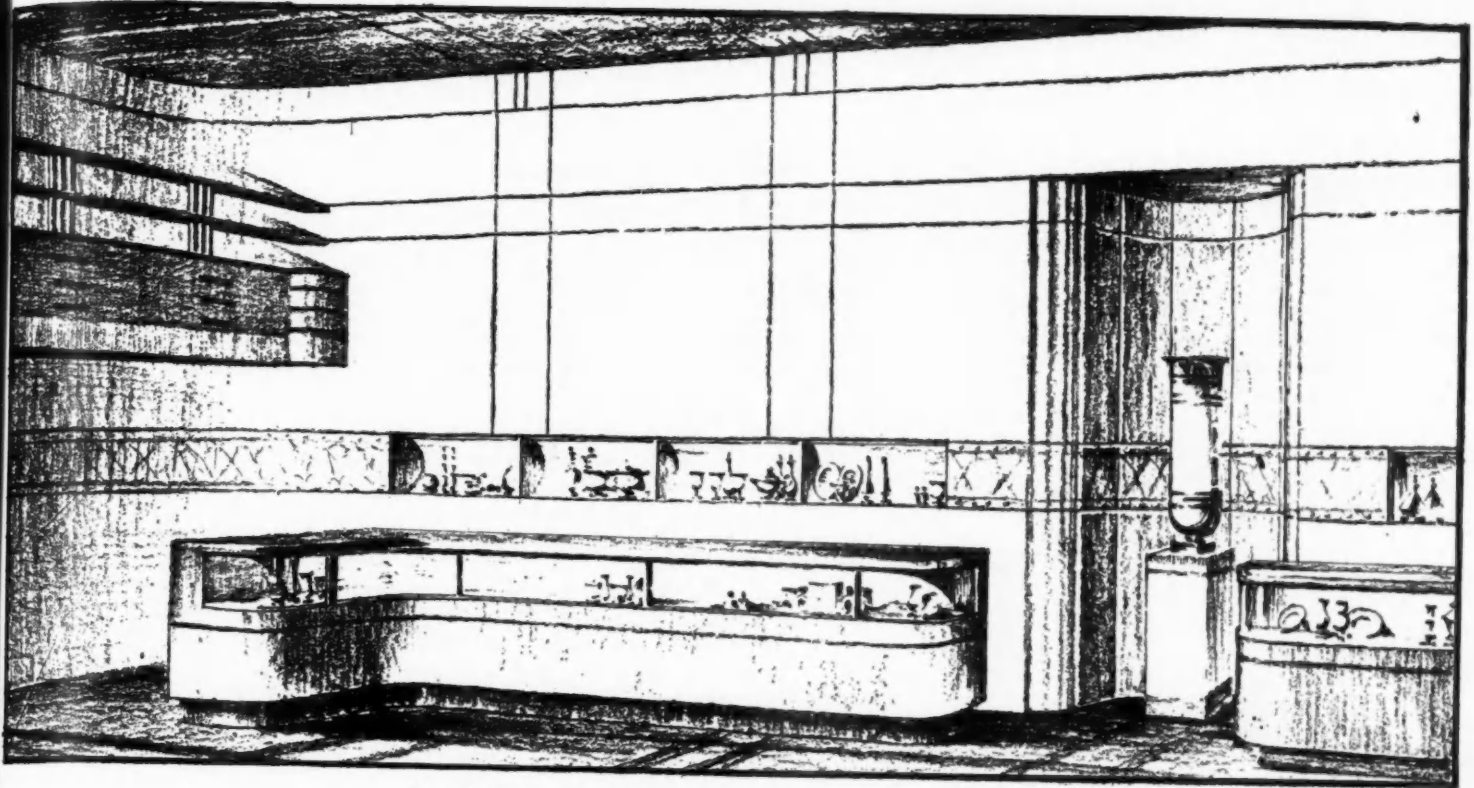

RETAIL DISPLAY ROOM

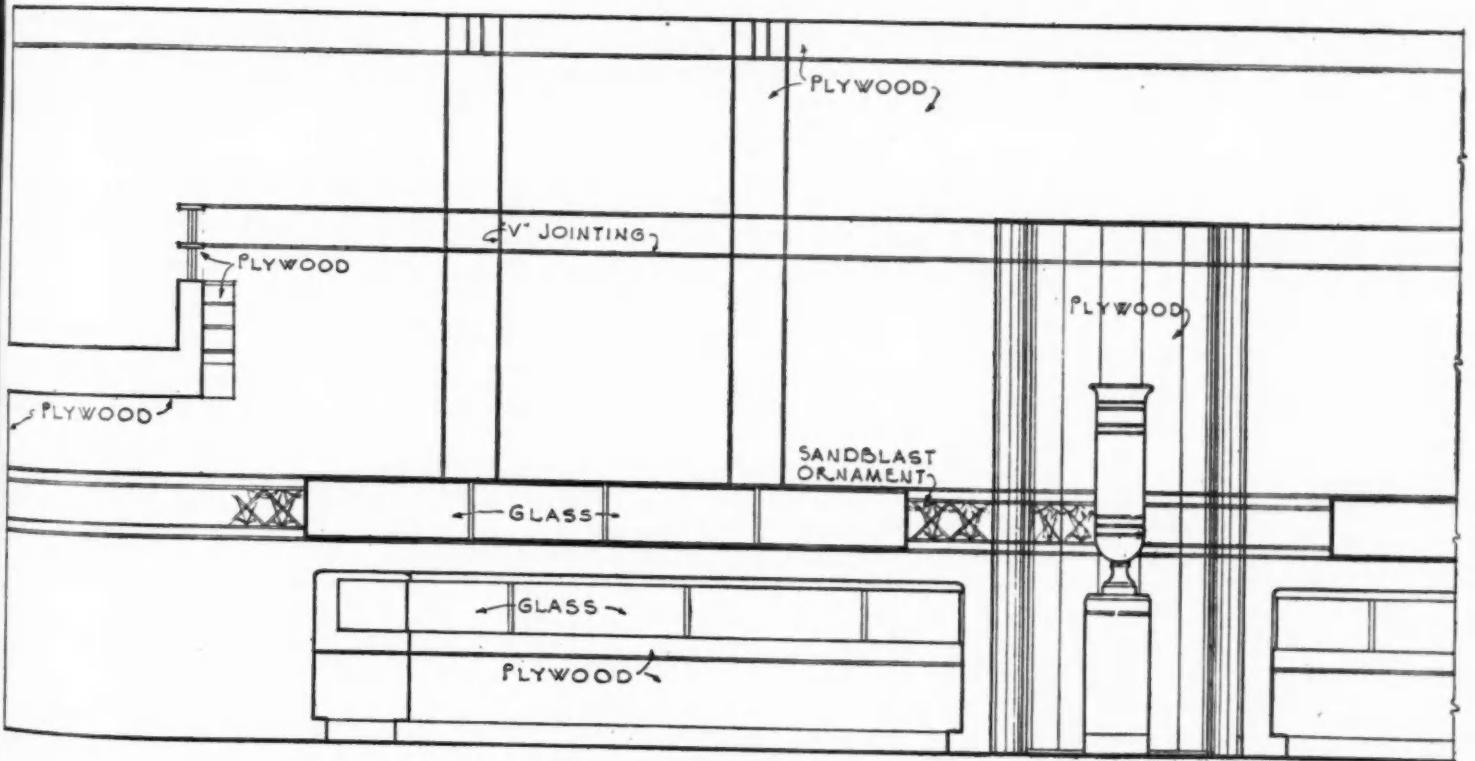

SIDE ELEVATION
SCALE 1/4" = 1'-0"

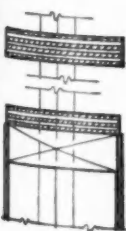

DETAIL OF
BALCONY RAIL
SCALE 1 1/2" = 1'-0"



PLAN
SCALE 1/4" = 1'-0"

How to Estimate Accurately

Two Types of Framing Are Covered in This Article of a Series on Estimating

By J. DOUGLAS WILSON

Head, Building Trades Dept., Wiggins Trade School, Los Angeles, Calif.

THE EXPERT carpenter experiences considerable satisfaction when laying out the walls and partitions of a house. The construction problems involved in cutting the framing materials, assembling and raising them are full of interest to him. Openings are not the same size and shape; the methods required to frame these openings vary according to the width of the window or door and the load to be carried over opening. Building ordinances also must be followed.

There are two types of construction which may be followed in the building of two-story houses; namely, balloon and Western framing. See Fig. 1. In balloon framing the studs on outside walls are full height from sill to top plate of the second story. In Western framing the first story is framed. Then the second story joists are placed and sub-floor laid, after which the second story is framed.

Due to the complexity of the layout and construction, an estimator must, of necessity, find some way to simplify the "take-off" work for this part of a building. Too much time would be consumed if each separate framing member of a wall or partition had to be listed. These framing members are top and bottom plates, studs, braces, and firestops. If only a single opening is considered, top and bottom cripples, top and bottom headers and trimmers must be estimated. See Fig. 2.

The number of pieces of lumber necessary for some framing members will vary with every wall. A long wall may have no partition backing while a short wall may require two or three pieces. A small opening will have the top header made of the same size stock as the studs, while a wide opening will require a special piece of lumber for the top header. Bracing will also vary in terms of the number of pieces required. Because of these variations, backing, top-headers, and brace materials are each figured separately when listing framing lumber for walls and partitions. The opening framing materials are allowed for by using a general rule which will provide enough material to make them without listing each piece.

The size of the framing lumber varies although 2" x 4" stock is most commonly used. To secure certain architectural effects a double wall is sometimes built. At least one wall of a bathroom will have 2" x 6" studs to provide a wall thick enough to contain the 4" stack which serves as the main vent for the plumbing system.

Each of the several framing members of a framed wall will be discussed separately and on the basis of either balloon or Western framing.

Western Framing

TOP AND BOTTOM PLATES: A plate is the horizontal framing member of a wall or partition at the top and bottom ends of the studs and to which each stud is nailed. Two plates are required at the top of

THE two types of framing ordinarily used in the construction of two-story houses are shown in Fig. 1 at the right. Western framing differs from balloon framing in that the first story is framed, joists and subfloor laid and then the second floor studs erected; in balloon framing the studs are full height of outside walls.

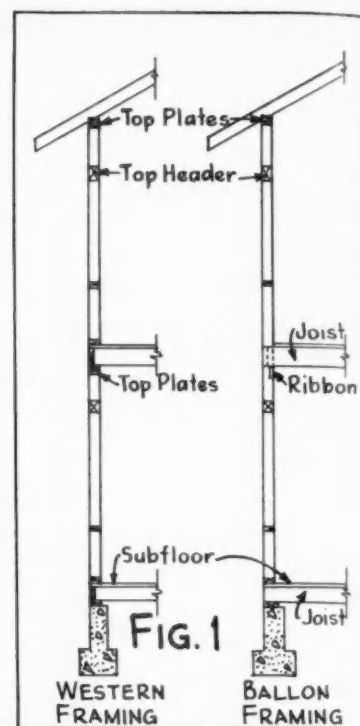

the wall, the second one being nailed to place before walls and partitions are plumbed and braced.

Plate stock must be sized to make it the same width throughout and is also surfaced on one side to make it an even thickness. The lumber term for this milling is "SISIE" (surfaced one side and one edge).

Rule: Multiply the linear feet of all walls and partitions by the number of plates required (usually three). The result equals the number of linear feet of plate stock required. On residential work the length of walls and partitions may vary so that random lengths of lumber can be ordered without causing much waste. For a small building such as a garage the rule is: Order lengths of lumber which are the same as the width and length dimensions of the building. Each wall will require two plates if a single top plate is used, or three if the top plate is doubled.

Note: When measuring walls and partitions on the blueprint it is a good plan to take the outside walls first and figure the perimeter of the building. Next measure all partitions that run in the same direction, that is, either across the building or else its length; then go across the floor plan in the other direction. This will insure against any partition being overlooked or missed.

STUDS: Studs are vertical members that form the frame work of a wall or partition. See Fig. 2. They are spaced 16" on centers (o.c.), to permit the lath to be put on without waste. Wood laths are 48" long and span four studs, and a piece of plasterboard lath is 32" long and spans three studs.

The length of a stud varies with the height of the ceiling. 8'-6" ceiling height is standard in many parts of the country, requiring an 8' stud to be used. On some two-story houses the first floor will have a 9' ceiling, requiring a stud 8'-6" which is cut from either a 9' or 18' piece of lumber. 9' lengths of lumber for studs are not carried by many lumber yards.

There are several framing situations to be considered when figuring studs such as walls without openings, walls with openings and circular work.

Rule (A), Walls Without Openings: Multiply the length of the wall or partition by $\frac{3}{4}$; then add one piece. Result equals number of pieces.

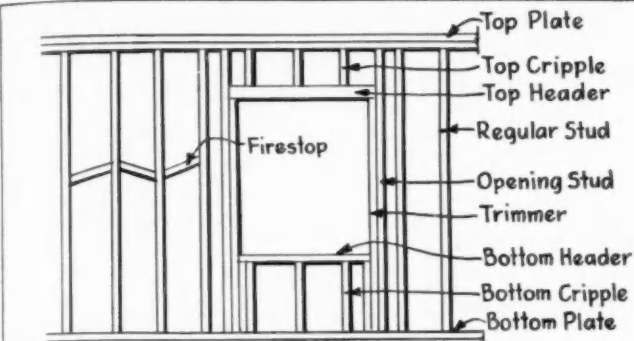

FIG. 2 FRAMING MEMBERS IN OPENING

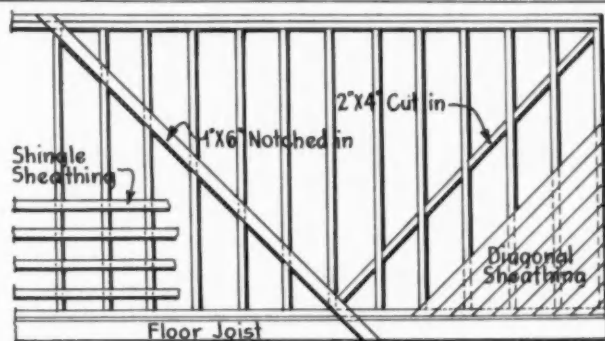

FIG. 3 BRACING AND SHEATHING

THE framing members used for openings and other framing details are shown in Fig. 2 above; bracing types and sheathing in Fig. 3.

Rule (B), Walls With Openings: Allow one stud for each linear foot of wall or partition; then add two studs for every opening. This will give enough material to allow for top and bottom cripple studs, bottom headers and trimmers.

Rule (C), Circular Walls: Studs are usually placed 12" on center on circular work. Allow one stud per foot of wall; then add three studs for every opening. To find the length of the wall multiply the diameter of the circle by 3.1416.

FIRESTOPS: A firestop is a piece of framing stock, the same size as the stud material, placed horizontally (or at a slight angle) about half way between the bottom and top plate. See Fig. 2. Its purpose is to prevent the creation of a draft in case of a fire between two studs. It also serves as a splendid wall stiffener.

Rule: Deduct from the total linear feet of walls and partitions the combined width of all openings. Result equals the linear feet of firestop required.

Firestops are also required on all rooms that have cove ceilings to close up the space behind the cove brackets. See Fig. 6.

Rule: Figure the perimeter of each room that has a cove ceiling and order that many linear feet of stock.

TOP HEADERS: Top headers are pieces of framing lumber placed horizontally over each opening. They vary in size according to the width of the opening and the load to be carried. Building ordinances usually give minimum requirements.

Rule: Make a list of all openings in the building; add one foot to each width dimension; then combine into lengths which will cut with the least waste. Care should be used when combining lengths to indicate how each is to be cut. This will enable the carpenter foreman to select the correct piece for any opening.

BRACES: A brace is a framing member, cut in as near a 45 degree angle as possible, which stiffens the walls and partitions of a building and prevents them from collapsing. There are several different ways to cut in a brace. A common method is to use lumber the same size as the studs and cut in a continuous row of braces between several studs. Occasionally a brace is nailed in place first and the studs cut to fit it. Another method now becoming popular and required in some building ordinances is to use a 1" x 4" or 1" x 6" piece of lumber and notch it into the outside face of the studs, making it continuous from the top plate to the mudsill line. See Fig. 3.

Rule: Irrespective of the method used to frame in the brace, the takeoff rule is the same. Find the diagonal of a right angle whose size is equal to the length of the studding. Then convert to a standard length of lumber. All braces are figured at the 45 degree angle even though the angle may have to be less on account of openings in the walls.

The number of braces will vary with the shape and size of the building. Allow two for each corner and two for each main partition. Walls longer than 25' should have one extra brace allowed. It may not be possible to always place two braces at every corner or in every main partition due to the openings; however, the extra brace stock will be used in minor partitions.

BACKING: Backing is framing material required at the intersection of every partition or wall so as to permit each room to be lathed separately. See Fig. 4. Improved construction demands additional studs be used for backing. These studs are nailed in place when the walls and partitions are framed. The lumber is the same size and length as the studding.

Rule: Allow eight pieces of stud material for each room and closet.

Balloon Framing

The preceding rules have been based on Western framing methods in which one story at a time is framed. In balloon framing the studding extends from mudsill to the top plate of the second story. Additional rules are necessary for the studding for all outside walls and for the ribbon used to support the second floor joists. For all inside partitions in balloon framing the above rules will apply.

STUDS: For balloon framing, allow one full length
(Continued to page 102)

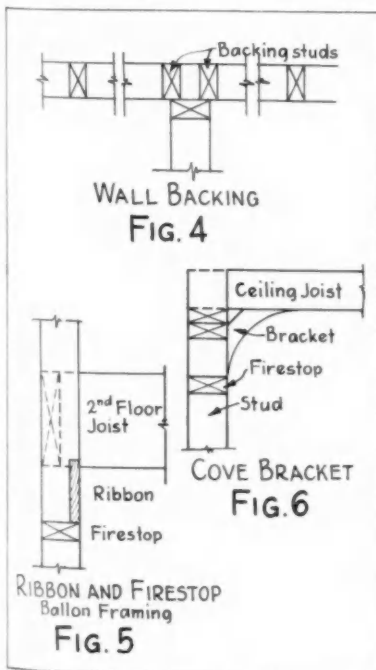

BACKING studs necessary at partition intersections are shown at the left in Fig. 4; ribbon and firestop details in Fig. 5; cove bracket framing details in Fig. 6.

The Plan's the Thing— Even for Barns!

By R. W. LOUDEN

IF barns could talk, too many of them would say, like Topsy, "I 'spect I jes' growed. Don't think nobody never made me!"

Substitute the word "planned" for "made" and you have a complete picture of the manner in which most barns are constructed today.

This is true in spite of the fact that excellent plan services for barns are available—and in most cases these services are free. Perhaps the most authentic, up-to-date information on barns can be obtained from the leading manufacturers of barn equipment who are in constant touch with the subject. And their information is undoubtedly more practical.

Although good barn plans are yours for the asking, still too many barns "jes' grow."

Why this should be is not clear.

You wouldn't consider building a house without first devoting much thought and study to it and putting your conclusions on paper in the form of plans, specifications, and a bill of materials. If this wasn't done, your client or prospective customer wouldn't think much of you as a builder or building materials dealer. And you'd probably lose the job to another

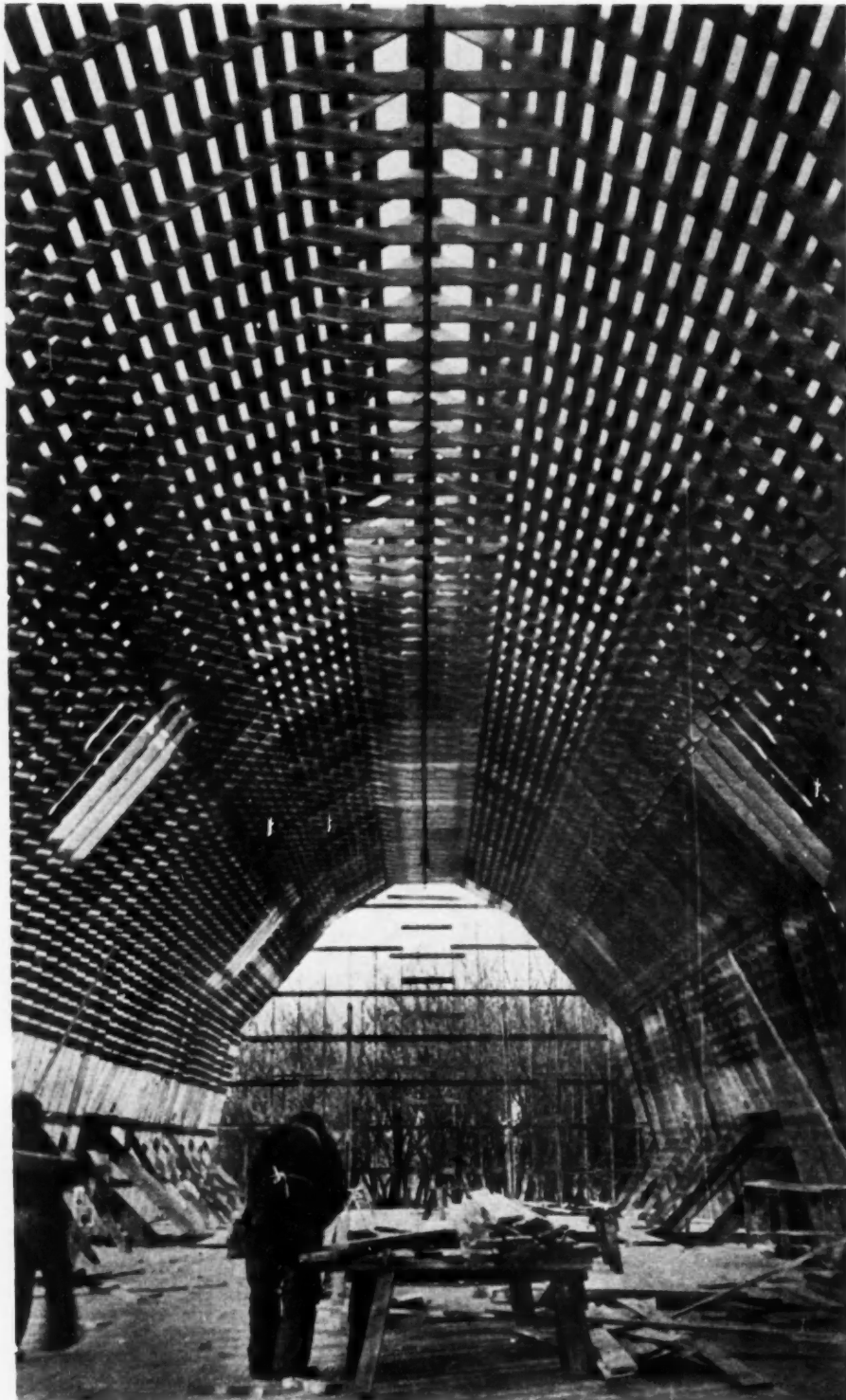

UNUSUAL view of a gambrel type plank frame roof under construction. This particular barn is 154 ft. long and 36 ft. wide. The construction is the strongest and best type for this kind of a roof. While more expensive than some of the commoner types, it will repay the builder in length of life and service and there will be no sagging or failure. Now will hold one ton of hay per running foot.



BARNs like this one near New Augusta, Ind., are the result of many hours of careful planning. Plans for barns like this are available to barn building contractor, and retail lumber dealers at no cost.

contractor or dealer who did present a good set of plans.

But, you say, barns are different!

Barns? Why, shucks, any intelligent carpenter can build a barn good enough for any farmer—why, that's as easy as falling off a log—you don't need plans for building a barn!

Time was when this sort of reasoning was accepted. But today is 1939.

Do not the reasons for planning a house apply equally to a barn? Let's see . . .

In the first place, houses are well planned so your client or prospective customer will have some idea of what he is getting for his money. Shouldn't the same reasoning apply to barns? No one doubts but that planning is more economical than just "going ahead." The same definitely applies to barns.

Times upon end I have seen sketches of barns that farmers propose to build that cost ten to twenty per cent more than a barn for their requirements should. And in too many cases, dealers and carpenters have helped draw the sketch. Imagine what the farmer must think of those who helped him draw up his sketch when we show him how to save many dollars by a simple re-arrangement of his proposed barn!

Not only have I seen sketches but actual barns whose cost was excessive. The farmer who discovers that the barn he recently built cost too much can't have much regard for the dealer and builder with whom he did business.

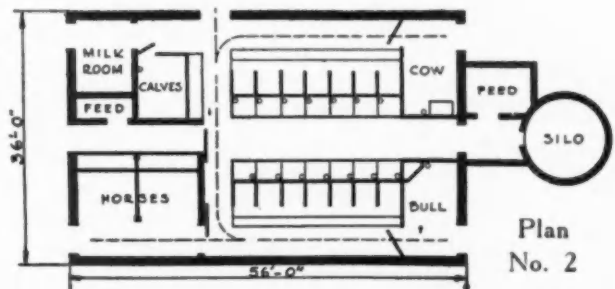
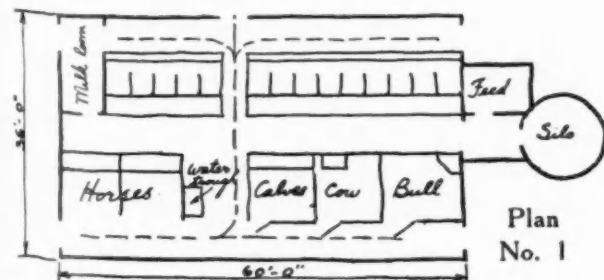

WHICH plan sold the job? The barn in plan No. 1 is 4 ft. too long—would cost \$200 to \$300 more and the milk inspector would never O.K. it. Plan No. 2 eliminates miles of walking and many hours of back-breaking drudgery every year.

Then, too, houses are planned and put on paper first so as to have good arrangement and save as many steps as possible. For those who spend much of their time in the barn this is of paramount importance.

I know of many cases where careful planning and arrangement has saved over a half hour of back-breaking drudgery every day. Multiply this by 365 days and I'm sure that a few hours of careful planning will pay, especially if your competitors do not offer plans that include this desirable feature.

Another reason why houses are so thoroughly planned is to eliminate waste space—space which is never used but which nevertheless costs money. With modern barns costing in the neighborhood of \$100.00 per running foot a difference of two feet might easily be the determining factor as to who will furnish the materials and who will do the work.

Purely from the standpoint of the dealer, a good barn plan eliminates both "left overs" and "extras", often a source of embarrassment to the dealer and sore point with the customer. With a good plan, you as a dealer can figure your bill accurately down to the last nail.

Anyway you look at it, barn planning is important. Farmers do business with those that offer them the best plans. 1939 farmers expect it and there's no need to disappoint them or lose their business.

After all, good barn plans are available and in most cases don't cost you a cent!

How to Build Split-Log Summer Cottages of Ye

Attractive Rustic Buildings Can Be Inexpensively Erected on Farm or Cottage Sites from Second Growth or Small Size Timber Using This Split Log System

A MARKED increase in applications for loans to build small summer homes has been reported and would indicate that a good volume of such building can be anticipated for the summer ahead. Since the rustic cottage type of structure is always a favorite with summer home owners, the split log type of construction described and shown in detail in this article will undoubtedly find wide application. The system was originally devised as a means of lowering costs of small farm homes in the rural sections of Wisconsin; trees not large enough to be of commercial value give the farmer the necessary material from his own land.

The design reproduced in rear elevation and floor plan on these pages from the booklet, "Log Buildings," is a pioneer homestead of minimum size for six people. With a few changes in the partition arrangements and with such additions as a screened porch, fireplace and bath, this little home would make an attractive summer cottage. The eight-sided shape and corner windows add to its unusualness.

The basic idea of the split log type of construction is the use of trees growing on cut-over land, which are usually too short and too crooked for horizontal log construction. To utilize these trees, logs are cut, divided in half lengthwise, and then edged on a saw. These split logs are put face to face with heavy waterproof building paper between them, the inside and outside vertical joints being staggered. By standing the logs vertically, they do not need to be more than 8 or 9 feet in length, and since they are edged, a tight wall can be obtained.

If a native wood such as cedar, which is resistant to insects and decay, is not used, the materials should be properly treated to give longer service. The first requirement is that the logs be peeled and air-dried for at least three to six months, depending upon the weather, before they are used in the building. With such seasoned lumber, there will be less trouble with shrinkage and cracks after the building is erected. By setting the split logs in a barrel of creosote or other good preserva-

*Mr. Witzel is Associate Professor in Agricultural Engineering at the University of Wisconsin and author of "Log Buildings" published by the Agricultural Extension Service.

THE drawings of the split log farm homestead shown in elevation at the right with plan and details on the opposite page indicate one of the types of buildings which can be economically assembled by the methods described in this article. The section and details do not necessarily apply to this design, but are shown to give highlights of these methods.

tive and letting stand overnight so that the lower 12 to 18 inches of the log become thoroughly impregnated, the first step is accomplished. Care should be taken to keep out moisture at all joints and provide a high and dry foundation. The rest of the split logs are painted on all sides with all of the creosote they will soak up before they are placed in the building. Care must be taken to prevent moisture from entering the ends of the logs. All exposed ends are given added creosote treatment or soaked overnight as outlined above. Split logs are erected in walls top side down so that the knots where branches have been cut do not hold water and conduct it into the inner portion of the wood.

An additional precaution which will be well worth the time and expense is the treatment of the sills with creosote before they are laid on the masonry foundations.

It is essential for any building intended for permanent use or occupancy in northern areas to have a good foundation. Foundation walls are extended slightly below frost line to prevent heaving and cracking. In sandy or gravelly soils which are well drained, these depths may be reduced by one-half foot, otherwise, they are followed except where solid rock is encountered. It is very good practice to remove weathered rock and expose the hard surface of the solid rock before the foundation is started. Where basements are excavated, the walls will normally go deeper than the minimum required for safety.

To prevent surface water from leaching the preservative out of the sills, extend the tops of the walls at least eight or ten inches above the grade line. For the same reason the surface of the ground is graded away from the building. Any effort expended to keep the wood sills dry will retard decay in these members, thereby lengthening the life of the structure.

Where stone is available, stone foundation walls are more practical than concrete. They will be found to be less expensive than concrete on most homestead construction projects. If basement is built, walls of stone are

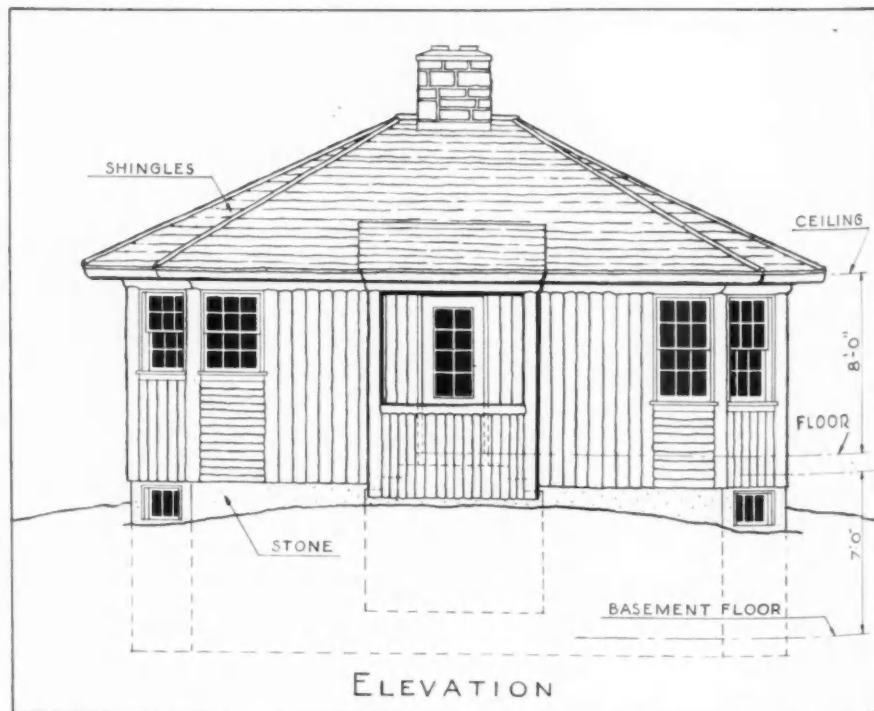

Year 'Round Farm Homesteads By S. A. WITZEL*

usually 20 to 24 inches in thickness and serve also as a support for the house. A lime mortar is used for laying it up. A satisfactory mortar mixture consists of two parts of slacked lime, one part of portland cement and nine parts of sharp, well graded sand. The center of the wall can be laid up without much mortar. Standard sacked, hydrated lime can be used in place of slacked lime if lump lime is not available.

Flue linings for chimneys are the best insurance against fire that can be devised. They prevent hot flue gases from leaking through unfilled masonry joints and igniting the nearest woodwork. Sections of flue lining are tightly butted against one another and extend the full length of the flue.

Many chimneys are built with flue linings surrounded by four inches of brick (see detail). This makes a serv-

iceable chimney provided the brick are good hard burned, clay brick. If stone is used for the construction of the chimney, the thickness of the masonry around the flue lining will necessarily be greater. Some sand or lime stones can be laid up successfully with as small a thickness as six inches. Most of the rough stone available will be difficult to lay less than eight inches in thickness. Be sure all joints are fully filled with mortar. It is dangerous construction to rest any chimney on wooden brackets. Well constructed chimneys are carried down to a good, solid foundation of concrete or rock, spread to about two and one-half to three times the area of the chimney above and bearing upon firm and level earth.

If fireplaces are used, the basement masonry is carried the full size of the fireplace, with a small ash pit left out
(Continued to page 90)

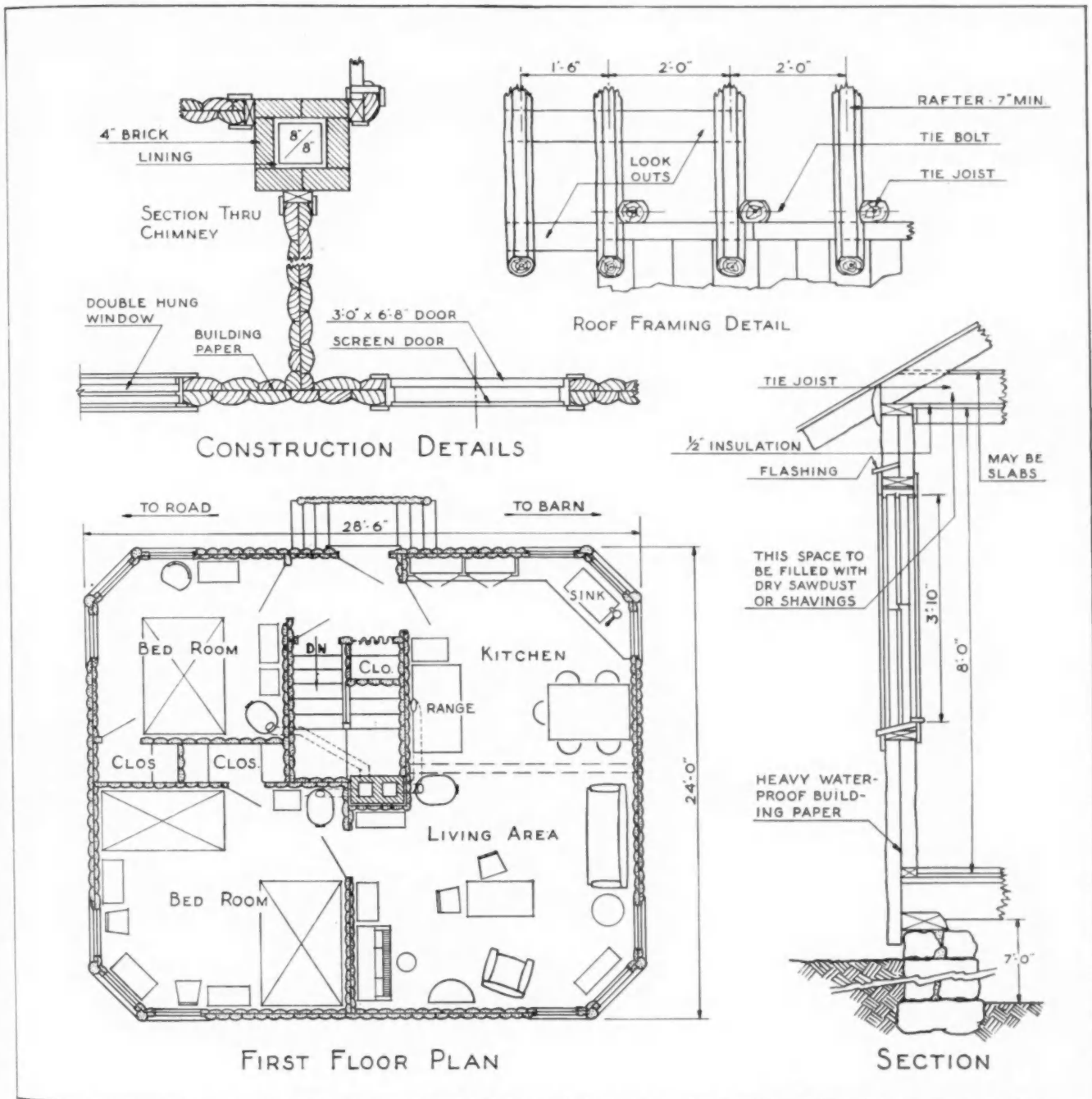

SHOPCRAFTER'S Corner

Things To Build for Profit or Pleasure

Building a SMALL PORTABLE BOAT

SUMMER days near lakes or rivers are more enjoyable if a good small boat is available, such as the one shown in detail on these pages. It is 9 feet 6 inches long by 3 feet 6 inches wide, will handle nicely with two people and may, in a pinch, be used by three. It is light and strong and may easily be carried upside down on top of an automobile.

The drawings are practically self-explanatory and the first step will be to make the three frames to the dimensions shown. These may be made from any scrap lumber, at least $\frac{3}{4}$ inch thick as indicated by the dotted lines in the section on the right hand side of the drawing. These frames should be as rigid as possible and it is advisable to put another piece across the tops of them so that they will not come together when the planking is put on. Later on these frames are taken out of the boat entirely so it would be advisable to put them together with screws.

Make the frames to the dimensions shown and also the stern board or transom. The transom should be of oak or mahogany but if these are not obtainable, a good piece of yellow pine may be used. These frames should be set up on the floor, upside down and securely braced in place so they cannot move. They are spaced 2 feet $4\frac{1}{4}$ inches apart. The stem may also be made and set up the same way and also the transom. Note in the top drawing the dimensions at bow and stern giving the exact angles at which these members are set.

Planking Is Bent and Glued On

The side planking is bent on, starting with the bow and working aft. Note the chine pieces set inside and allow a notch in each frame to take this. The planking is glued and screw-fastened into the stem and also at the stern. There is a little knee or triangular piece of wood joining the side pieces with the transom.

The bottom planking is glued and screwed to the chine pieces and will run across the bottom of the boat—not fore and aft. The edges of the chine should be rounded off so that the canvas will not be cut by the sharp edge. The canvas should be soaked in water and the excess water thoroughly wrung out; then copper tacked along one of the sheer or upper edges of the boat. Mix water-

proof glue in regular proportions (1 measure of glue powder and 1 measure of cold water). Apply a liberal coat to both wood and canvas and while still wet, stretch quickly into place and copper tack. It may be advisable to use two pieces of canvas, joining them down the centerline under the keel. The canvas may be waterproofed with protective coats as follows: 1 coat shellac, 1 coat of lead and oil, 2 coats of paint, 2 coats of spar varnish. All fastenings under the canvas should be countersunk a little and the holes filled with putty or plastic wood, otherwise these heads may, in time, work through and put a hole in the canvas.

Putting on the Keel and Keelsons

The keel and the keelsons are put on with screws, but they should be painted underneath before applying and fastened down while the paint is still wet. It is always advisable to increase the bonding power of screws by dipping them into a heavy solution of glue (Casco or equal) before screwing into place.

The hull is then turned over and the seat at the bow and stern fitted. Put some temporary braces across where the middle frame comes (No. 2) and take the frame out. Then fit the rowing thwart. Make sure that these seats are all glued and screw-fastened to the sides of the boat, and then remove all the frames. The seats will hold the boat in shape.

Cover the line of copper tacks holding the canvas in place, with a half or quarter round molding, and paint the boat inside and out in the colors you desire. Incidentally, in putting on the canvas, do not carry it up over the stern board, but leave this bright finished with a little stain and varnish. Ring bolts are added to the bow and stern as shown, the oar locks and sockets and the flooring. A section of this should be made so it can be taken out for sponging out rain water. A pair of 5 or 7 foot ash oars will be needed. There are two types of stem which may be used, both being shown in the drawing.

The sizes of the various types of materials needed are clearly shown in the plan and it would be best to take the drawing to a lumber yard and have them estimate on the amount of wood required. No widths are specified for the side and bottom planking and the sides may be

THE PORTABLE BOAT at the right with construction details on the opposite page is reproduced from a design furnished by Casein Co. of America, Inc., 350 Madison Ave., New York City. It is one of the 24 plans offered to Casco users in the Casein Free Project service.

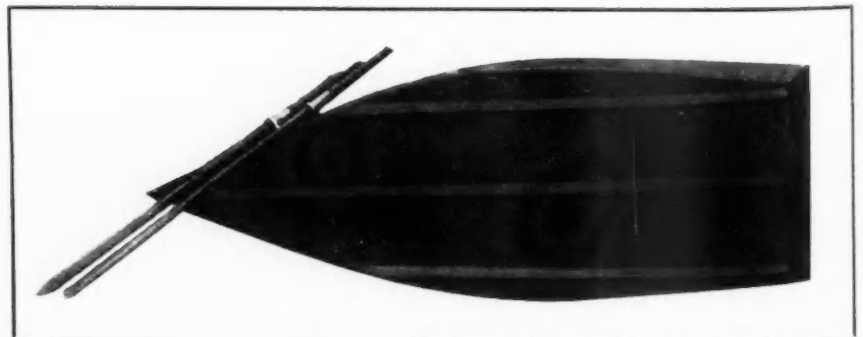

built up in two or three planks to suit the materials available. When the top side plank is put on, it will just about take the curve of the sheer but if it does not do this, plane it down and make a fair curve from bow to stern. By using three planks on each side the bending will be somewhat easier than with wider planks. The materials listed in the plan are those that are best suited for each part; if the particular material specified is not available, the next best can be used.

Note: Use waterproof glue (Grade A) throughout. When gluing end grain joints, apply to each side of joint a sizing coat of a standard mix (1 measure glue powder to 1 measure cold water) and let dry; then apply a second coat in usual way, clamping or pressing joints as directed.

Use a "heavy" mix (1 1/4 measures glue powder to 1 measure water) wherever joints do not fit exactly, or when pressure cannot be applied while glue is setting.

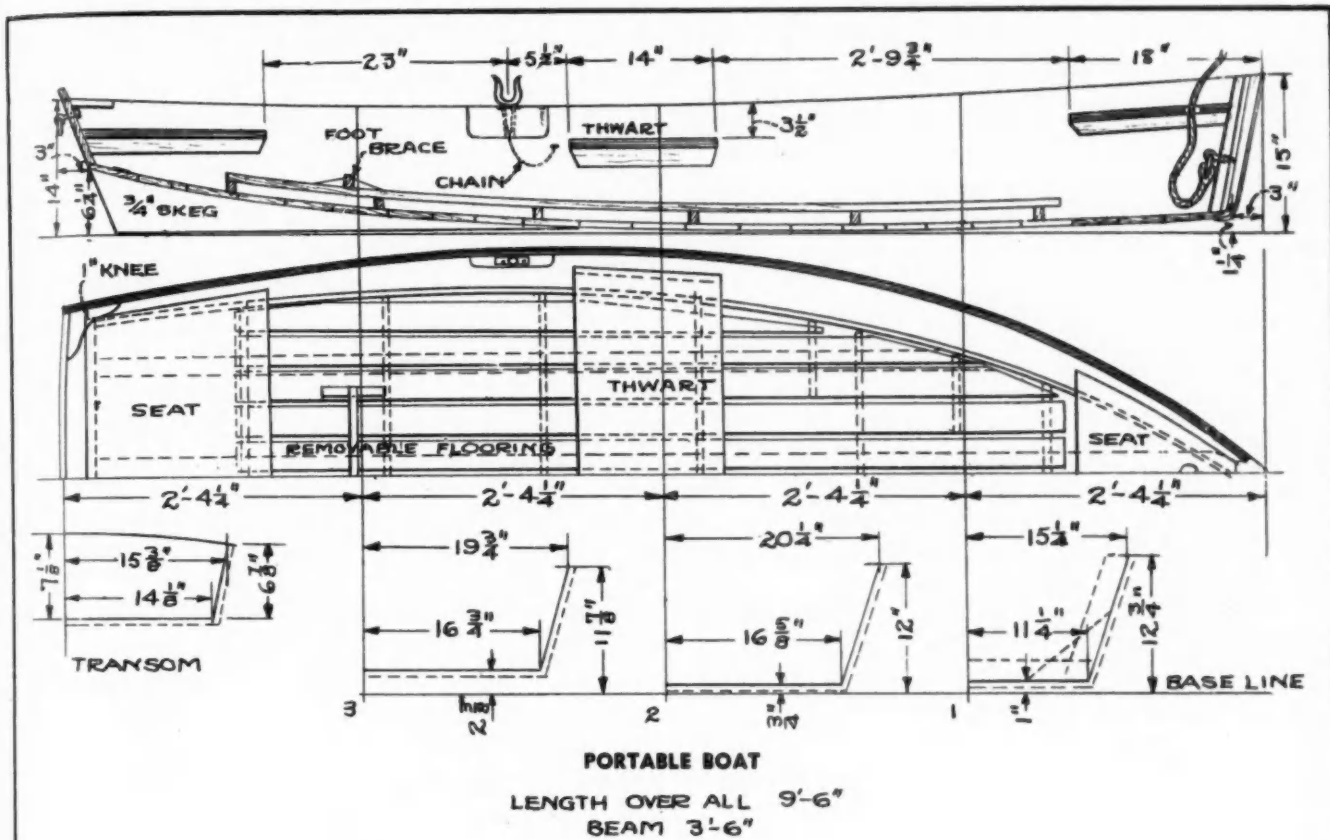

PORTABLE BOAT

LENGTH OVER ALL 9'-6"
BEAM 3'-6"

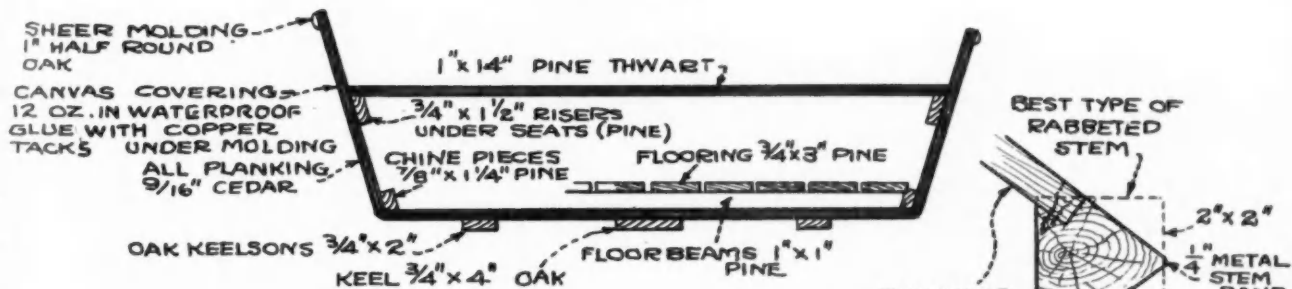

CONSTRUCTION DETAILS

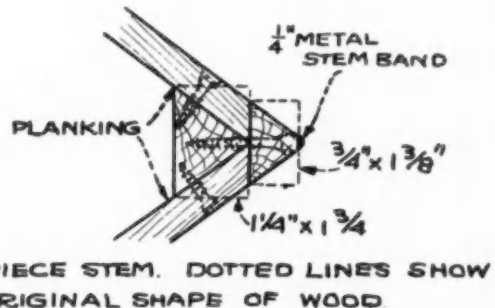
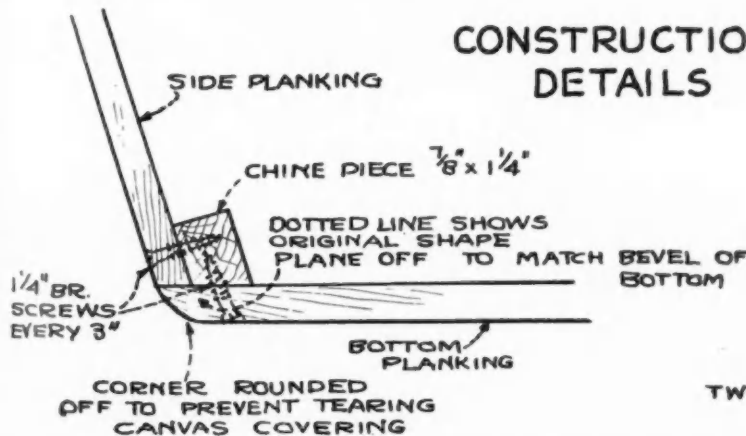

THE DRAWINGS as detailed above indicate dimensions and materials for building a portable boat; a list can be taken from them.

Construction and Recovery as Viewed by the Builders*

BY W. A. KLINGER

President, W. A. Klinger, Inc.,
Sioux City, Iowa

CONSTRUCTION, in normal years, filled more pay envelopes with more dollars than any other American industry. The first of our CHARTS, No. 1, shows construction employment compared with other key industries which statistically and in the public mind are the major employment factors in American industrial life. The figures are taken from the revelations of the last U. S. Census, taken in 1930. At the top is construction with 3,600,000 employees—2½ times as many as the next industry—the railroads, with 1,400,000. In order comes steel with 850,000; automobiles, 750,000; miscellaneous machinery, 750,000; coal, 750,000; lumber, 650,000; and so on. Construction as a direct employment leads all other industries.

with 10,300,000 out of a total of 30,800,000 employables in 1929, falling off to 3,200,000 out of a total of 21,400,000 in 1933 and slowly rising to 6,100,000 out of 26,300,000 employed in 1938.

On the chart, construction employment at the site is shown in solid black; construction employment in materials, preparation and transportation, in cross hatch; and all other industries, excluding only agriculture and domestic service, in diagonal shading. The purpose of the chart is to show how substantial construction is as an employment factor compared with the combined employment in all other industries.

CHART 3. Our third chart shows the national income from the period 1922 through 1937 from the best

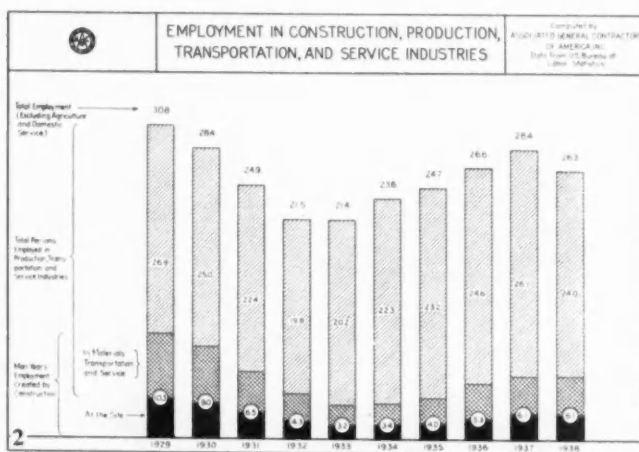
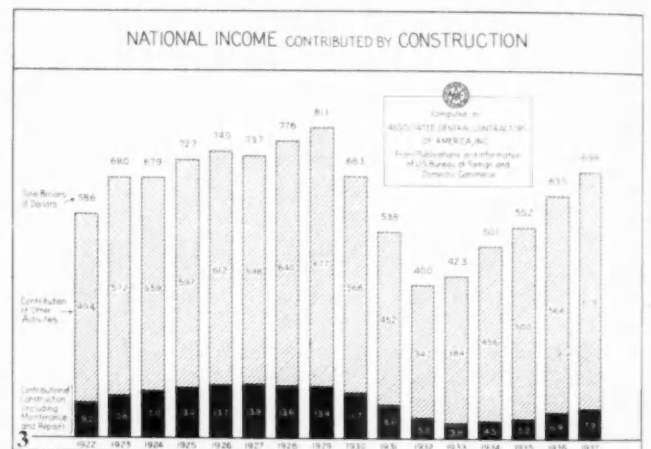
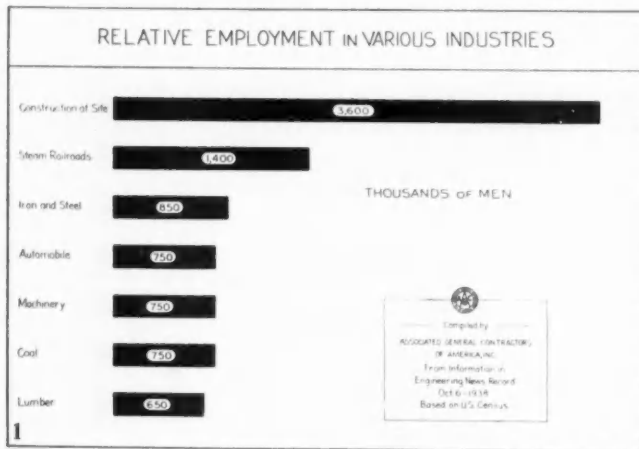

CHART 2. Construction, in normal years, provided jobs for 3½ million men on the site, and another seven to eight million in the production and transportation of materials to be used on the site; one out of every seven male employables at the site; one out of every 3½ of all male employables in the United States, excluding only agriculture and domestic service. 10,500,000 wage earners had jobs because of construction.

Our second chart shows graphically this employment in construction from the years 1929 to 1938. Starting

available figures. It shows that from 1922 to 1929 construction, shown in black, contributed from 16% to 19% of the national income, and that by 1933 it had fallen to less than 9%, at which figure it has remained.

One out of every five freight cars operating on American railroads carried construction materials in raw or finished form.

Thus, construction as an employer was second only to agriculture. It served the twofold purpose of putting men to work directly on the job site, and of extending its purchasing power into scores of other industries that supply construction with lumber, steel, lead, copper, cement, stone, glass, clay products, paints, power, tools, trucks, machinery and materials, all from the durable goods industries.

The products of the industry range from the single family house of John Doe, factory employee, or the concrete silo of Farmer Brown, to the 85 story Empire State Building, the 70 million dollar Boulder Dam, and the 4200 ft. span over the Golden Gate. Within these limits fall hundreds of thousands of projects in thousands of communities. So much for employment in construction.

But employment is not the only contribution construction makes to national well-being. Construction has been the Nation's No. 1 capital fixing industry, its primary investment creator. From the first beginnings of civilization, practically all of the permanent tangible wealth acquired by the human race is invested in construction. What else is there? Some precious jewels, some priceless documents of recorded thought, gold and silver

*Address before the General Session, U. S. Chamber of Commerce, Washington, D. C., May 4, 1939.

buried in the hills of Kentucky and West Point (both at present of questionable value), implements of death and destruction, and the works of the constructor. Practically all of the accumulated wealth of posterity is in construction. It takes the savings of our people and of our industries and converts them into forms of durable works, structures and facilities that serve modern community and rural life, shelters for processing and for people. More money finds its way into completed construction than all forms of investment combined.

Construction also plays its part in daily life. By and large the people of the nation are more constantly interested in the nation's construction than in any other single human endeavor. The progress of civilization has been led by construction. The civilized status of the dead races, their means of livelihood, their daily habits, even their thoughts and ideals, are indelibly left to posterity in their works of construction. So, today, the very standards of living of our time depend almost entirely upon the construction of our time. Both move backward or forward in accord.

To this point I have tried to impress upon you that construction has been in normal times:

1. The nation's greatest single employment force.
2. The nation's greatest single capital investment source.
3. The nation's greatest single force toward raising the standard of living of its citizens.

But I have been establishing the case for construction on a normal basis, as it existed in any decade previous to 1930. Let us now see what has happened to this most vital industry during the last decade. Because statistics are at best both boring and tiresome, I have attempted to tell the story in a series of charts which, I hope, will be understandable. The information pictured on the charts is from the most authentic data available. Unfortunately for the industry and for business as a whole there is no statistical fact finding agency in construction. Various governmental departments, especially the Construction Section of the Bureau of Foreign and Domestic Commerce, do the best they can with the funds available. In this great governmental hodgepodge of recovery effort, we have recounted all the pages in all the books of many public libraries as a useless white collar WPA project, and we have had a thorough research into and subsequent publishing of a brochure on "The Sex Life of the Bull Frog," but we have no comprehensive statistical study of construction, the nation's second greatest industry and its greatest re-employment hope. These charts are compiled mostly from the U. S. Bureau of Labor Statistics, Bureau of Foreign and Domestic Commerce, records of the F. W. Dodge Corporation, Engineering News-Record and Associated General Contractors of America. The charts generally cover the period from 1922 through 1938, eight years each way from 1930.

CHART 4 shows total of new construction, excluding relief, but including recovery expenditures. The total is made up of private and public construction, invested capital and tax money. Private construction is shown in black; public construction in cross hatch and diagonal shading.

In the decade prior to 1930, approximately 80% of all construction was privately financed and only 20% came from tax money, from county, municipal, state and federal funds. As the chart shows, since 1930 the proportion has changed materially, until in recent years almost one-half of all construction came from tax money.

Private construction, previous to 1930 consistently up to 8,000 million in volume, dropped to 1,100 million in 1933 and 1934, and has slowly risen to 2,800 million in 1938, a drop of 75% to one-quarter of its previous aver-

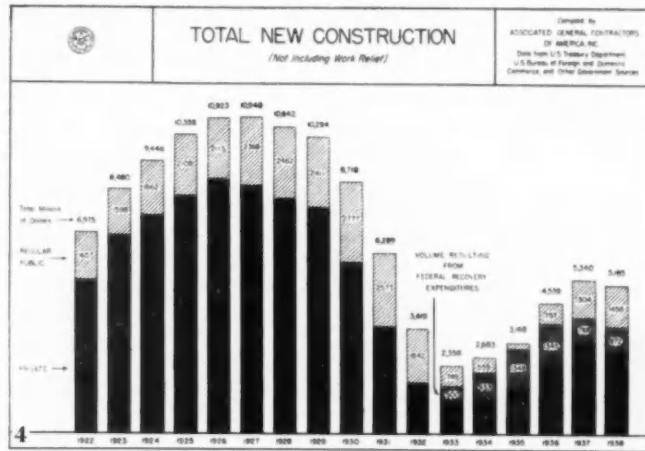

age, and then a recovery of 10%, but still only 35% of its previous normal. In private construction, therefore, lies a great potential employment recovery.

Also noted on this chart is the tremendous shrinkage in public construction between 1932 and 1935 because cities, counties and states stopped construction appropriations. Referring again to the chart, the diagonal shading designates the Public Works Administration program, carried out through the regular channels of the industry by the contract system, and shows very graphically how public works during the past six years has been saved from almost complete cessation by the Public Works Administration program under Secretary Ickes. The remarkably wholesome effect of PWA cannot be overestimated; neither can the debt construction owes Mr. Ickes and his PWA program be overestimated. It rescued an industry in its darkest hour. But the chart also shows that total public works construction in spite of the PWA lift, and including the tremendous projects such as Grand Coulee, is still 80% of its volume previous to 1930. This is shown more effectively on CHART 5.

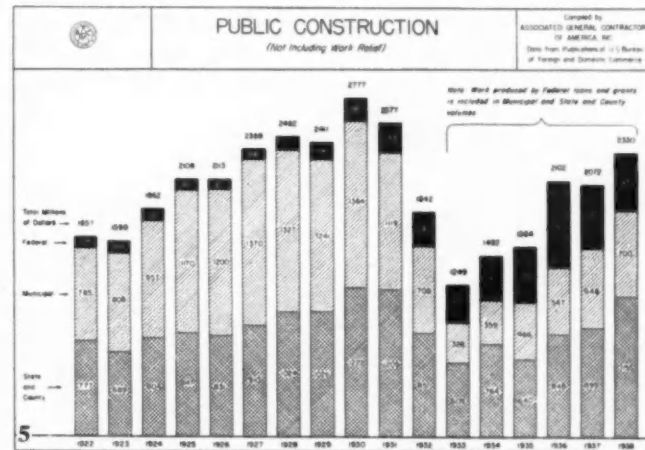

CHART 5. It may be well to say here that in the preparation of these charts the work of—wait a minute, work is the wrong word—the expenditures of WPA are not included.

Construction men are not considering WPA expenditures as construction any more than you businessmen would consider it good business to pay 25 cents for a 3-cent pencil. I will have more to say about WPA later.

Getting back to our chart on public construction. This shows total tax money construction—state and county in cross-hatch, municipal in diagonal shading, and federal in black. Contrary to popular belief, the total in recent years has not been as great as in the pre-depression years. Not as much tax money is going into construction as previous to 1932. Only federal construction expenditures,

shown in black, have increased. Counties, states and municipalities are not purchasing construction, unless subsidized by PWA loans and grants. The chart very readily shows that normally municipal construction contributed the greatest volume, but the cities, under the leadership of the Council of Mayors, inspired by LaGuardia of New York, Hoan of Milwaukee, and others, have reduced their normal construction programs to a mere fraction of former volume, contributed to unemployment in their communities by this procedure, and then bellowed for WPA to come to the rescue. Counties and states readily joined in the move and unloaded their burdens on WPA.

Here in public works also lies a potential employment recovery, though not as big as that in private construction.

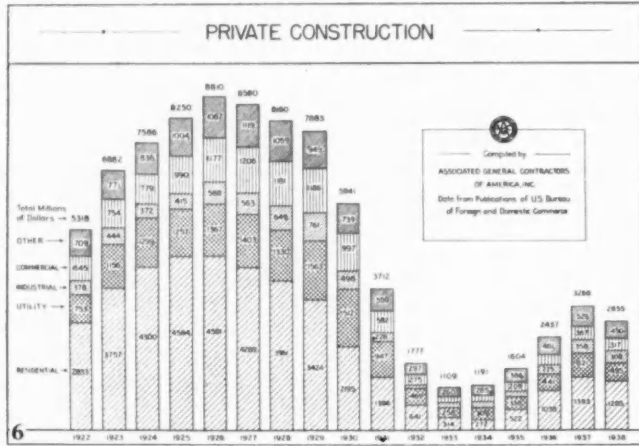

CHART 6 shows private construction volume broken down into Residential, in coarse diagonal shading; Utility and Railroad, in crosshatch; Industrial, in medium diagonal shading; Commercial, in vertical shading; and all other classes in fine diagonal shading. Each type of construction has shown a marked decline. No one type escaped the decline. Only residence construction shows a marked recovery. The chart shows vividly what has happened to our industry and, when you remember that it takes 2½ hours employment in supply industries for each employment hour at the construction site, the great white open space after 1930 also indicates a void in general industry; 1918, though more than twice as much in volume as 1933 or 1934, still produced but a small fraction of normal. Recent yearly percentage increases are extremely misleading; 1938 actually produced the following percentages of the 1922 to 1930 average: Residential 30%, utility 38%, industrial 55%, commercial 29%, resulting in an average recovery of 37% for private construction. One glance at this chart also shows the re-employment possibilities.

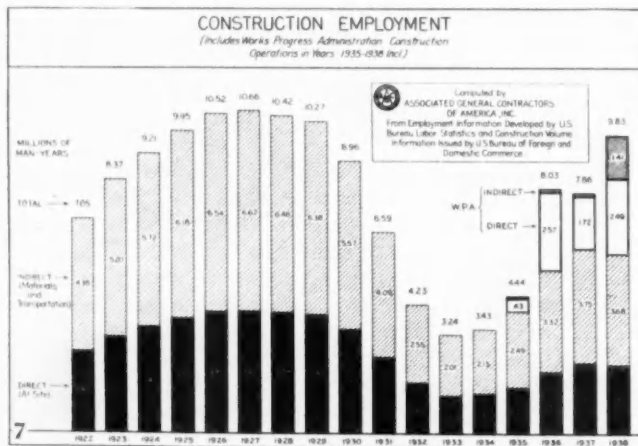

CHART 7 shows construction employment in millions of man-years divided into direct, at site, in black, and indirect, material and transportation, employment, in diagonal shading. It follows the curve of total construction volume. It shows in more understandable form than ten minutes of statistics, that in 1933 construction contributed more than seven million man-years to the unemployed, and that even in 1937 it was still contributing more than four million man-years to unemployment. Because it has been the greatest contributor to unemployment, it is now the greatest potential re-employment force.

This chart is also introduced here because superimposed on employment in private industry is the octopus of WPA shown on the upper bars of 1936, 7 and 8.

Before we leave this chart, I want to call your attention to two additional facts because I will refer to them later. WPA, in 1935, 1936 and 1937, confined itself largely to labor—pick and shovel and wheelbarrow stuff, much of it magnificently useless, but staying by the purpose of its inception, "made work." Its contribution to other industries was very small. But imbued with the Hopkins' philosophy as it was before February 24, 1939 (I mean antedating his Des Moines, Iowa, speech), imbued with that philosophy, convinced that it should establish itself as a permanent institution, and bent on self-preservation, WPA bought construction equipment, heavy tools, trucks, etc., to the extent shown by the shaded area at the top of the 1938 employment total.

The second fact worthy of notice on this chart is that the WPA personnel, when added to construction employment on private payrolls, produces a total almost exactly the 1923-30 average. Construction restored to normal volume could absorb the relief load and wipe out WPA.

Up to this point, I have devoted my time to 1. A picture of what the construction industry was in normal times—what it meant to the nation in the '20's.

2. The story of construction in recent years—or what happened to it in the '30's.

Let us lend our time now to the third phase of the subject. What can be done to promote construction recovery?

Construction volume is both the barometer of industry and its balance wheel. Economists are unanimously of the opinion that until construction recovers, general recovery cannot come. That construction is the key, is as necessary to recovery as is the much doped, much doctored, much subsidized agricultural industry. Restored construction volume would cause an immediate threefold bulge in the national income, would act as a tonic to all industries.

What retards recovery in construction? The answer can be divided into two classes—Minor and Major retarding influences. There are three minor influences.

1. Erroneous belief concerning construction costs. The popular belief, fostered by frequent Government pronouncements, is that completed construction costs have been definitely on the uptrend and are now excessive. Facts as shown on this Chart (No. 8) do not bear this out. True, the wage line has shown a strong uptrend since 1936, but materials have shown a down trend sufficient to counteract wages, and the construction cost line, in red, has remained fairly constant at a level below that preceding 1931. The chart is based on monthly surveys by the A. G. C.

2. A second minor deterrent is the inability of construction to function as an integrated industry and proceed along a well planned sales program. Efforts to correct this situation have been frequent but not decisive. It is a problem within the industry being worked upon by both the Construction League and the Construction and Civic Development Department of the U. S. Chamber. Progress is slow.

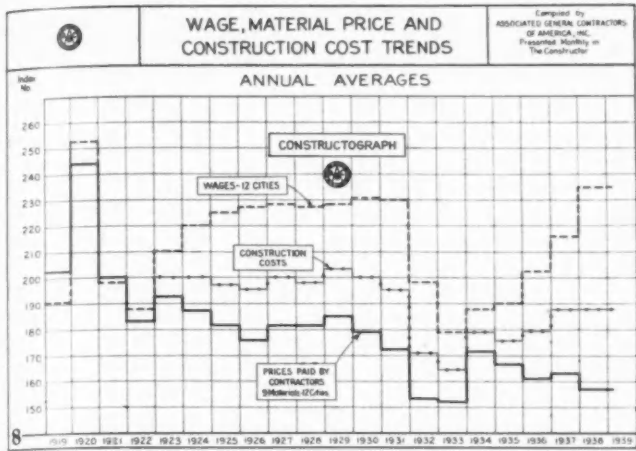

3. The third minor deterrent is Labor. Labor problems are not now as acute in construction as in other industries. Most construction work has been on a closed shop basis for many years. Wages and hours have generally been above labor legislation requirements. Increased activity of organized labor in smaller cities, and on large construction operations in the wide open spaces has been felt and costs affected. What will happen when organized labor extends its control to small residential units remains to be seen. This is a serious threat to the gently rising volume of residence construction which can only be checked by placing purely residential construction in a lower wage bracket. Strange but true, in a number of cities, organized labor has agreed to such an experiment because the more intelligent leaders realize that industry and white collar workers at 50 or 60 cents per hour, cannot afford to live in homes erected at \$1.50 per hour.

These three minor deterrents do not, however, greatly affect recovery in construction. They are problems inherent in the industry and solvable within the industry. They are brought out here merely because the public has had a tendency to magnify them.

Major retardants come in two classes.

1. Fear—investment fear.
2. Government Competition.

Because construction is the primary investment source, the curves of industrial, commercial and utility construction follow almost exactly the flow of capital into the securities of those industries. During this meeting of the National Chamber we have had addresses on "Taxation and Investment," "Taxation and Jobs," "Enterprise Capital," "Hindrances to Investment in Free Enterprise," all by economists and experts, all by men who know more about investment than does a contractor. We only know that as investments go, so goes construction; that those things, governmental restrictions, legislative enactments, administrative pronouncements, which produce investment chills keep millions in construction unemployed. Cyclone cellar money piled up in financial institutions, necessity for extreme liquidity, enforced or implied, in the banks; stringent bank examination practice which seemingly places its blessings only on the bank up to its neck in government securities and frowns on all others; undistributed profit taxes punishing those who would save for plant expansion; an inequitable tax structure and the certainty of more taxes to pay for the spending program, as pointed out by Senator Byrd in one of Tuesday's Round Table Conferences; all these produce investment chills which you as business men know more about than do I as a builder. I only know that everything we build is visible, tangible and assessable; that the fear of compounded taxes, local and national, on a fixed asset such as construction, is real, strong and a potent barrier to

more private construction. Everywhere real estate men note the tendency of the government to become a landlord and fear that tendency, fear to compete with it. Everywhere business men, average size business men, with a lurking fear of the future, postpone plant addition and plant renovation, follow the advice of the harrassed banker—"stay liquid." The great bulk of construction volume in America comes from small jobs, new stores, plant expansions, elbow room. That too is a fear postponed volume. Money that formerly went into construction is now idle "cyclone cellar money" or it is placed in the great competing investment—Government Securities. America was built on venture money. Until the flow of private capital into private investment is once more resumed, private construction volume has a definite barrier. To surmount it, we ask the help of just such men as you, just such men as have spoken on this program with that singular unanimity of thought to which Mr. Magill referred yesterday. That problem is of primary importance to general business as well as construction.

The second major barrier to construction recovery is that present in public construction. Here we as construction men are in our own sphere. Here we know the cure and, after pointing out the cure to you, we ask your help in effecting it. I refer to government competition in our industry, as typified by the grossly mis-named Works Progress Administration.

In practically every community in the United States, there is WPA activity centered on some imitation construction operations. More and more as the years have gone by since the first CWA appropriation, and then through ERA and WPA this program has taken on the air of permanency; more and more the tentacles of this octopus have taken a firm hold on the economic life of the nation; more and more the nation, once highly resentful of this organized loafing, has come to believe that WPA is a necessary evil and has unfortunately become tolerant of it; more and more the local politician, the Council of the Mayors, the Conference of the Governors, finding in WPA an opportunity to relieve their own charity loads, have become the strong advocates of increasing appropriations, and unfortunately for the construction industry and for the nation as a whole, they have found a willing ear. We have but to trace the relief appropriations of the last four years to see the growth of WPA and the decline of PWA; the growth of the makeshift and the abandonment of the worthwhile; the continuation of the WPA, and the cessation of the Ickes PWA.

The last of our charts is a graphic representation of this tendency. It shows the recovery expenditures in construction, that is, the expenditures made through the regular channels of the industry using the contract system. (Continued to page 94)

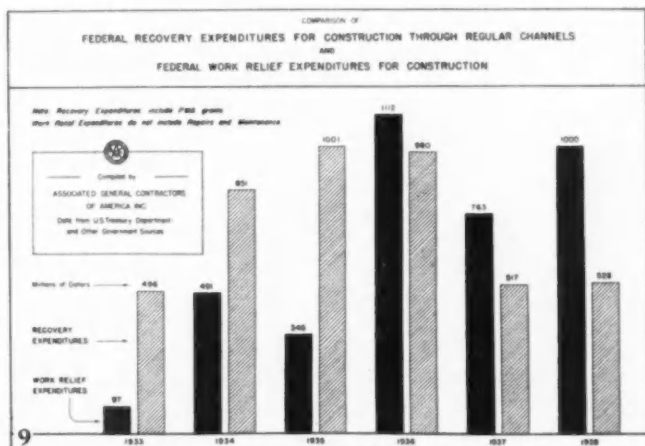

New, Improved Materials and Equipment

Improved Gas-Fired Conditioner

THE Henry Furnace & Foundry Company of Cleveland, Ohio, has recently made improvements and developments in its line of gas-fired winter air conditioners. The "Aristocrat" has been redesigned, finished in smooth gray enamel with large access doors in all four sides. All controls and other devices are very accessible at the front and the heating cabinet has a metal floor so that the casing becomes an air-tight, dust-tight compartment. This type is also equipped with a two-speed blower.

The "Special" is similar in construction to the "Aristocrat," finished in dark buff enamel, equipped with one-speed blower and of somewhat smaller dimensions. It is very favorably priced, which commends it for use in low-priced homes.

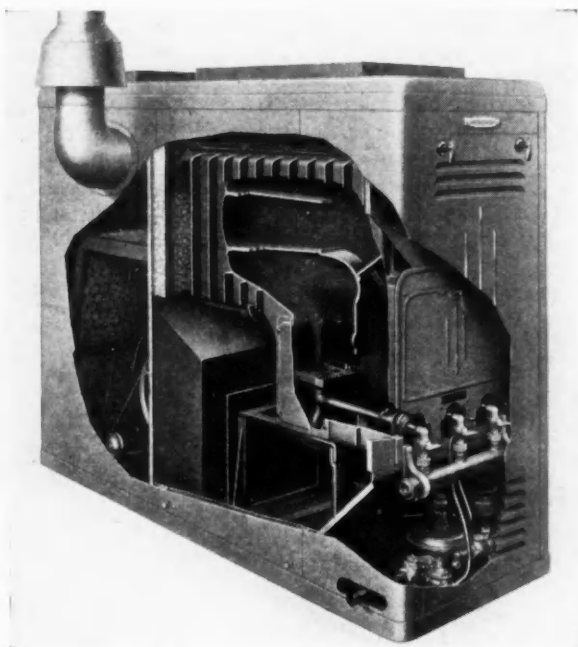

CUTAWAY view of new gas-fired winter conditioner.

Ventilating Fan Fits Steel Casements

ESPECIALLY designed for steel casements is a new ventilating fan, announced by Signal Electric Mfg. Co., Menominee, Mich. This fan is of the quiet type with 10-inch fan blades that move air at the rate of 600 c.f.m. It expels odors, steam, and smoke while at the same time it provides circulation of fresh air. Between the motor and the fan blades is a protective wire guard. The frame is made of steel and equipped with weatherproof shutters, operated easily and quickly from the inside by a latch from which extends a cord to the switch. A pull on one end of the cord operates the shutters, and a pull on its other end controls the one-way switch.

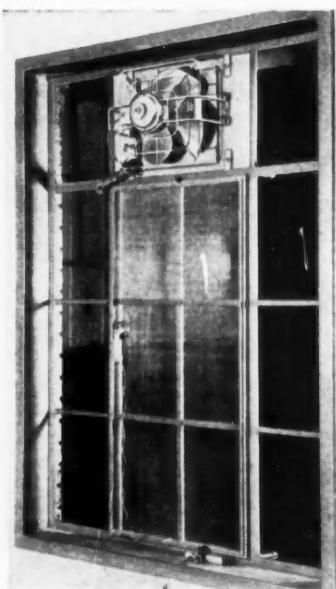

VENTILATING fan designed to fit upper section of steel casement windows.

Economy Dishwashing Type Sink

THE Kitchen Maid Corp., Andrews, Ind., has introduced Handideck, an exclusive new type of sink, designed and built to meet modern requirements.

In this smart sink are two compartments for the popular new method of dishwashing. All washing is done in one bowl; all scalding and draining is done in the other. The old style drain-board is completely eliminated. All top surfaces are kept smooth and level, in harmony with the cabinetry, and more top working space is assured.

Faucets are located on a horizontal deck at the sink-top level, convenient and easy to reach. A neat, swing-spout mixing faucet and a disappearing rinsing spray are also parts of this deck feature. Bowls are of cast iron with glossy, smooth white porcelain enamel finish and acid-resisting surfaces. Both drain openings are made especially for removable crumb cup strainers.

For economy, the water pipes for the Handideck sink come up through the bowl, not through the walls or counter work surface, resulting in much easier installation in old homes or new, and lower installation costs; piping is hidden and the complete sink unit harmonizes with all other cabinetry. This construction eliminates any need for recessing inlet pipes in the walls, for insulating inlet pipes, for unsightly holes and patching plaster, for cutting through counter work surface. Three simple holes in the floor do the job.



DOUBLE compartment dishwashing sink.

New 3-Inch Belt Sander

A NEW streamlined 3 inch belt sander has been announced by Skilsaw, Inc., Chicago. It is called the Skilsaw "Zephyrplane" and it incorporates many new features which give it outstanding performance and ease of operation. It has been developed particularly for those whose work does not justify the purchase of the usual larger and more expensive sanders. It is the ideal tool for woodworking shops, furniture factories, boat builders, manual training classrooms, and for general maintenance work in industrial plants.

The streamlined design results in a balanced tool that provides uniform pressure over the entire sanding surface. It is lighter in weight and much easier to handle.

The interchangeable knob handle can be moved from the top to the nose of the sander for greater convenience in sanding vertical surfaces. A "touch-control" lever instantly releases the tension on the sanding belt, so that changing belts becomes a simple and quick operation. The mounting of the motor permits straight-line ventilation that results in greater cooling efficiency.

Smooth running is assured by ball bearings on armature and transverse shaft; Oilite bearings on idler and driver pulley. A belt speed of 1200 sur. ft. per minute permits fast sanding and produces a smooth, even surface without ripples or ridges.

(Continued to page 80)

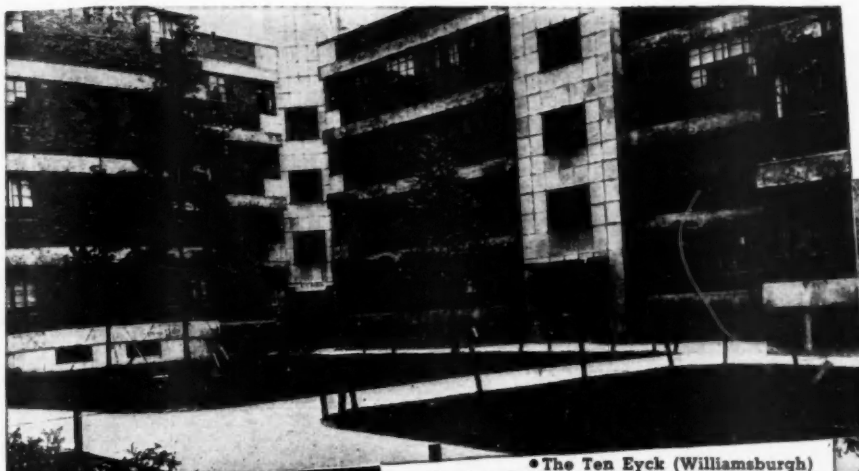

•Techwood Homes, Atlanta — 604 dwelling units. Milcor Metal Lath, Channel, and Corner Bead used. Architects: Burge & Stevens, Atlanta, Ga. Photo courtesy USHA.



•The Ten Eyck (Williamsburgh) Housing Project. A 50,000-yard installation, of Milcor Solid Plaster Partitions in Buildings 1, 2, 3, 4, 6, 7, 8. R. H. Schrebe, Chief Architect. Photo courtesy USHA.

Now housing, too, goes fireproof
 — at low costs never possible before
 — with the new

MILCOR Partition Systems

These new Milcor developments are of profound interest to your clients — especially to anybody who puts up money for building, public or private, residential or monumental.

When you can erect solid plaster partitions of full two-hour fire rating — knowing that low costs are possible, even below the cost of ordinary non-fireproof construction — that's real news. It is certain to have a far-reaching effect on building design.

Introduced a year ago, the Milcor Solid Partition and Furring System has set remarkable records for speed and economy. The average worker erects 150 channel studs per hour.

All the well known advantages of solid plaster partitions—(1) saving of floor space—1/3 sq. ft. per each foot of partition (compared with 2" x 4" stud partitions) . . . (2) increased strength, especially under impact . . . (3) reduced dead floor load — 2/3 less than some types . . . (4) reduced sound transmission — now are within reach of everybody, for almost any type of building.

The new Milcor Steel Stud makes a similar improvement in the mechanical efficiency of erecting fireproof hollow plaster partitions.

Write for the Milcor Solid Partition or Hollow Partition Bulletin, today. F-46A



Milcor Solid Partition and Furring System

This system makes erection a fast-running job. Only three simple pre-fabricated members.

The Milcor Steel Stud saves time on the job, for a single unit serves as studding, ceiling runner, and floor track.

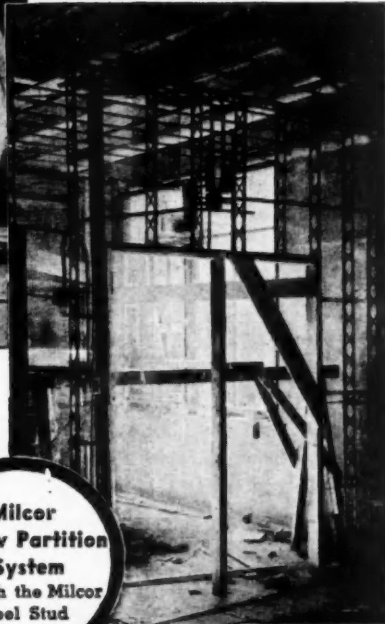

Milcor Hollow Partition System — with the Milcor Steel Stud



(Inset shows how metal shoe locks floor track and upright member firmly together)

MILCOR STEEL COMPANY
 MILWAUKEE, WISCONSIN CANTON, OHIO
 CHICAGO, ILL., KANSAS CITY, MO., LA CROSSE, WIS., ATLANTA, GA.,
 NEW YORK, N. Y., ROCHESTER, N. Y., BALTIMORE, MD.
 Sales Offices: Minneapolis, Minn., Little Rock, Ark., Dallas, Tex.,
 Denver, Colo., Washington, D. C., Boston, Mass.

(Continued from page 78)

The compact construction of the Skilsaw Zephyrplane is due to its die-cast aluminum frame which, while lighter in weight, is actually 50 per cent stronger than the usual sand-cast aluminum. The tool weighs 13¼ pounds.



NEW belt sander has trigger switch safety feature to prevent accidental starting.

Sealed Cold Storage Insulation

WOOD CONVERSION Company, St. Paul, Minn., has announced a new product—Nu-Wood sealed cold storage insulation—which is adaptable to all standard construction and will be sold through lumber dealers. It consists of units of Nu-Wood insulation board having a continuous double coating of waterproof asphalt on all surfaces and edges. This treatment renders Nu-Wood highly resistant to moisture or moisture vapor. In order to eliminate continuous joints through the insulation, this product is designed so that it can be placed in two or more separate staggered layers. The size conforms to standard construction 16 inches on center.

The first layer is placed between wood nailing strips, and the second layer is placed directly in contact with the first and is nailed to the strips. Each layer is set in emulsified asphalt adhesive. The entire insulation surface can then be finished with a trowel coat of emulsified asphalt mastic or metal lath and plaster.

Nu-Wood sealed cold storage insulation blocks are available 1½, 2, 3 and 4 inches thick, measuring 14¾ inches x 32 inches. Half-size blocks 14¾ x 16 inches and 7⅞ x 32 inches, can be furnished for staggered or broken joints.



SEALED cold storage insulation for locker and similar refrigerated construction to be built up from 3" to 8" in thickness.

Does Away with "Dead End" Cellars

THE "dead end" cellar may be defined as one which has an inside entrance only and is therefore less convenient, less safe and less well lighted and ventilated. In fact, it may truthfully be said that if a builder deliberately set out to add a point of irritation, trouble and discomfort to a home he could find

no better way than omitting the outside entrance to the basement.

There was a time when no one would think of building a house without an outside basement or cellar entrance. In recent times, however, quite a few builders, in an attempt to save a few dollars and believing that the city dweller would not appreciate this item, have been leaving them out. The result has been so much discomfort and inconvenience that the trend is now reversed and more outside entrances are now being installed.

One reason for the change is that with the development of the modern copper steel bulkhead, the outside entrance construction is greatly simplified. Such construction eliminates sagging or warping doors, is watertight, burglar-proof and easy to open.

Basement condensation—a problem that is frequently a serious one—is largely caused by lack of ventilation. By throwing open the modern outside basement doors, a maximum amount of light, air and ventilation is quickly introduced, which eliminates condensation and dampness.

Of course, it should be obvious that the home owner who has an assortment of garden tools, trunks and various and assorted items appreciates the outside entrance which makes their movement in and out of the basement so much more simple. If he has to haul out ashes it becomes of supreme importance.

There is danger too in the "dead end" cellar since, in case of fire, explosion or accident, anyone in the basement may be trapped.

Yes, the "dead end" cellar is a liability that should be done away with.

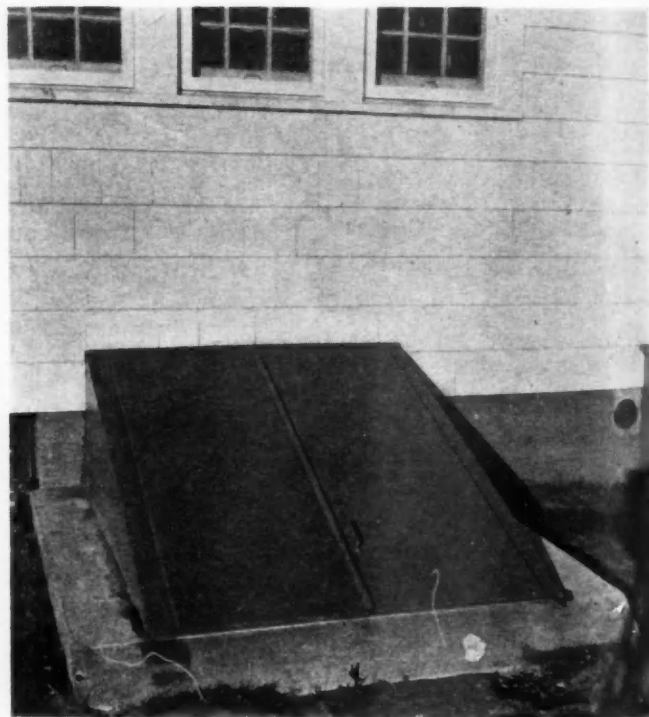

NEAT AND STURDY metal cellar bulkhead provides quick and convenient outside entrance to basements; made by Bilco Mfg. Co.

Non-Rising Pin in Door Butts

THE Stanley Works, New Britain, Conn., has recently announced a new development to insure the non-rising of the pin in door butts.

The new pin is secured by means of a split ring attached in a groove in the pin. This split ring fits into a pocket formed in the bottom of the top knuckle of the butt. When the pin, through action of the door, attempts to rise, the split ring comes in contact with the inside of the knuckles above the pocket and is prevented from further rising.

This improvement combines extreme simplicity, effectiveness in operation, and ease in setting and withdrawing.

SPOTLIGHT ON GAS!

BOSTON'S FIRST "LIFE HOME" ACCENTS EASE AND ECONOMY OF ALL-GAS HOUSEKEEPING

When a home draws as much attention as this one, it's just plain *good advertising* to equip it with the last word in modern housekeeping appliances. And that means *gas appliances for all four big jobs!*

For home-buyers recognize these handsome, automatic miracles as real labor-savers and money-savers. Each house you build this way enhances your reputation for homes that are easy to live in, economical to run.

Lower first cost, and lower installation cost mean more house for the money. See your local Gas Company for details of the new gas ranges, refrigerators, water heaters, and house heating equipment.

LIFE HOUSE, Chestnut Hill Colony, Brookline, Mass.
Builder: Homer T. Brown
Architect: Royal Barry Wills

AMERICAN GAS ASSOCIATION



STILL TIME TO ENTER \$10,000 ALL-GAS
HOME BUILDING COMPETITION

All types of homes, new or modernized are eligible
for big prizes. Simple rules. Worth your while.

MAIL ENTRY COUPON NOW!

Competition Director
American Gas Association, 420 Lexington Ave., N. Y. C.

Date.....

Last Name.....First.....

(Please Print)

Address.....City.....State.....

I wish to enter A.G.A. Builders' Competition. I am a builder

Note: Architects may enter homes in this contest with
the written permission of the builder. Architect

Kindly forward complete details.

B-9

Signature.....

LET
GAS
DO THE 4 BIG JOBS

COOKING
WATER HEATING
REFRIGERATION
HOUSE HEATING



Be sure the gas appliances you specify
bear the Approval Seal of the American
Gas Association Testing Laboratories.

LETTERS from Readers on All Subjects

Facts, opinions and advice
welcomed here

Name Plates for Houses

To the Editor:

Erie, Pennsylvania.

I would like to ask if name plates for homes have ever been suggested or considered. If not, why not advocate them? Name plates appear on appliances of all kinds—automobiles, electrical apparatus



METAL name plate identifies architect, builder and owner.

and on large buildings. I think they can, and should be included on homes also—not conspicuously, but perhaps inside the front door or so, as a means of recording for the life of the home, information pertinent to its origin and construction. I made up such a name plate for my home, and enclosed you will find snapshot.

J. W. ANDERSON.

Low Cost Homes in Demand

To the Editor:

Shelton, Wash.

In 1938 I built only one house and two garages, plus a few minor repair jobs. The house valued at \$2,000 was built to rent. One garage was worth \$250 and the other \$175.

Lumber and pulp are the principal products of Shelton, and the Orient is one of the large consumers. Japan alone is supposed to buy normally 60 per cent of the rayon pulp produced on this coast. When the Japanese government decreed rigid exchange restrictions, and put its importers on a quota basis, along with its war destroying the Chinese market, this business practically dried up. The logging camps went down, and Rayonier closed. The net result was that, during the last of '37 and most of '38, there were vacant houses all over the town. Rents took a vertical



LOW price house built by Lawrence Forck in Shelton, Wash.

tumble. Many property owners received no rent from their tenants. After being down several months the pulp mill began a sporadic operation. Since the sharp midsummer rally of the stock market, the mill has operated steadily, and now most of the logging camps have started again. There seems to be more domestic business, which is really the best business anyway. If

things continue to improve, I expect to build three houses in the \$2,000 price field this summer. On the other hand, if things turn black again, I won't build at all.

Your editorials calling attention to the need and wide possibilities of low priced houses are constructive and timely. As a result I have been surprised that you have not featured more pictures and plans of houses in that field, namely, between \$1,500 and \$3,000—houses that would be definite competition to automobiles. Certainly, houses are more necessary than cars, yet more people own cars. Possibly you are having difficulty securing satisfactory pictures and plans for this class of house. It is with this thought in mind that I am enclosing a snapshot of my last house.

LAWRENCE FORCK.

Good Service for Advertisers

To the Editor:

Pedro Miguel, Canal Zone.

Enclosed is check for \$4.00 in payment for a three year's subscription to *American Builder*; also two snapshots of my latest creation, "Fairdeal Annex," probably the first of this type of building in the city of Houston, Texas. (Not much of architectural art displayed, but convenient, and with plenty of light and ventilation.) Plans for this building were not copied from the

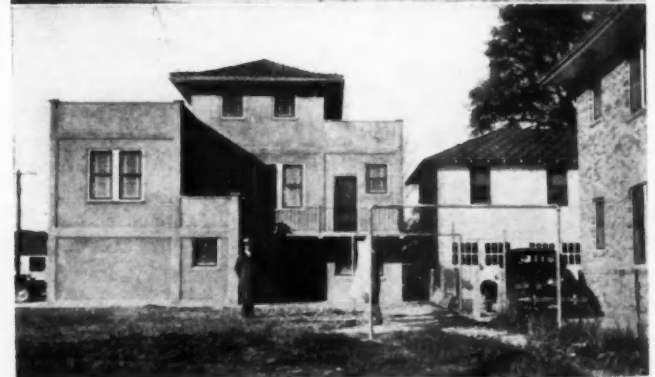

BUILDING in Houston, Texas, designed and built by G. U. Putcheck who writes from the Canal Zone.

American Builder nor any other plan book; however, a number of your advertisers rendered good services, either in prompt delivery or desired information which enabled me to finish my work in record time; in appreciation of their prompt service I mention their names:

Portland Cement Assn., Chicago, Ill.—for information on early strength cement.

Concrete Engineering Co., Omaha, Nebr.—open web steel joist.

Milcor Steel Co., Milwaukee, Wis.—roof deck.

Uvalde Rock Asphalt Co., San Antonio, Tex.—floor tile.

Owens-Illinois Glass Co.—glass blocks.

Victor Electric Products, Inc., Cincinnati, Ohio—kitchen ventilator.

Overhead Door Corp., Hartford, Ind.—three sets of doors.

G. U. PUTCHECK.

Chimney Tops; Attic Ventilators; Dormers

To the Editor:

Nashua, N.H.

Here is a snapshot of a house that I am building. Three items in the picture may make it worthy of your attention. This is the

(Continued to page 84)

Quality in Trucks Means Profits Through the Years



● Take stock of *your* truck needs—and then find out what International offers in size, body, price, and after-sale service for your loads. And remember this when it comes to trucks: International has been building *trucks* for 33 years. International gives you *more* for your truck dollar in operating economy and long truck life because it does not compromise truck con-

struction. *Every* International is *all-truck* in every detail.

Ask the International Truck dealer or nearby Company-owned branch to tell you how Internationals save money on loads like yours. Sizes range from Half-Ton units to powerful Six-Wheelers—42 models in 142 wheelbases—for every hauling need.

INTERNATIONAL HARVESTER COMPANY

(INCORPORATED)

180 North Michigan Avenue

Chicago, Illinois



Philan, Inc., New York City, depends on this International Truck to do its hauling.

INTERNATIONAL TRUCKS

Announcement:

Wyvernwood, the largest rental housing project in the United States, is heated by Payne.

WYVERNWOOD STATISTICS:

Wyvernwood is a 70 acre development within 10 minutes' drive from downtown Los Angeles.

When completed, it will comprise 143 residential buildings made up of 1102 units containing 4443 rooms.

It is a private enterprise erected under the National Housing Act, and privately financed by the largest single loan for which an F.H.A. insurance commitment has ever been issued. Total investment will be in excess of \$6,000,000.

The architects, David J. Witmer and Loyall F. Watson, designed this project for permanence and specified the finest materials to help maintain rental values and reduce up-keep costs.

The entire project is being heated by Payne Floor Furnaces, Payne Duplex Furnaces and Payne Console Heaters.



Payne has been a recognized leader in the gas heating field for more than a quarter of a century. The same facilities that have made it possible for Payne to meet Wyvernwood's rigid specifications are available to you for your next heating job. Whether you are planning another Wyvernwood project or a three room house, take advantage of Payne's scientifically designed precision-construction and feel free to call upon Payne's up-to-the-minute engineering staff for heating plans.



PAYNE FURNACE & SUPPLY Co., Inc.
BEVERLY HILLS, CALIFORNIA

Letters

(Continued from page 82)

fourth of a number of small homes built by myself in the past three years as a spare time occupation to supplement my small contracting business. Having no preconceived ideas as to chimney construction, there seemed no reason to me why chimney tops should not be arched so that shelter would be offered to the prevailing wind, and so, as you see, I have developed this particular type of chimney top. The harder the wind blows the better the chimney draws, and there is little or no water seepage into the



HOUSE Built to Sell at \$2700 to \$3000

chimney well and only a remote necessity of retopping after many years of use. Also note the placing of the ventilators almost at the gable end point; this assures rapid clearing of the air under the roof.

Dormer construction being slow and expensive, I puzzled for some time over a manner of construction that would produce large, well balanced dormer construction on the front without the necessity of repeating the same on the back of the house. Finally the roof plan that you see here was arrived at, which seems to give a balance to the roof line and eliminates construction and the consequent expense of dormers on the back of the house.

The house itself is 24 x 30, contains 6 rooms with garage, and recreation and boiler room in the basement, and when completed will sell for from \$2700 to \$3000 because of the fact that it is framed throughout with 3 x 4's cut from well dried used 3-inch mill planking and other good used framing material that was obtained at a cost of approximately \$15 a thousand.

Your magazine is a great help and inspiration for any builder.
ROBERT A. PEASE.

Local Master Plumbers Say "No"

To the Editor:

National City, Calif.

I have a copy of your home plan book, "American Builder Buyer-Approved Homes of Known Cost." Page 86 therein refers to the National Small Homes Demonstration for 1939. Above the picture in the lower left hand corner which is numbered 2B is the following: "... the ... electrical and plumbing industries are preparing to provide 'package use units' for each of (these) to allow further savings by means of standardization."

I am planning on building a few houses of this type and of the idea expressed on this page, with the kitchen and bath arrangement as given in the cut referred to. So I called the secretary of the Master Plumbers Association to find out what to call for when I went to a plumber.

Well, I was told it couldn't be done, there wasn't any such animal, no plumbing could be standardized, any idea of "pre-fabrication" in any plumbing was hokey, I had been misinformed, the national plumbing industry wouldn't do anything in any way but to send anyone right back to the local plumber, the only way anyone could get costs on any plumbing was to have plans and specifications written up on each job, etc.—and I was lectured on trying to get plumbing cheaper when the poor plumbers were working now for small day wages and the pipe and fixture manufacturers were broke and in the hands of the bankers.

So, what information can you give me that will enable one to take advantage of the real idea conveyed in the quotations from your pages and the idea of small home low-cost but quality housing, particularly from the plumbing and electrical angle.

E. MIRRILL HOWARD.



FOR 16" STUDDING

Barrett VB Batts are laid vertically. Batts measure 15" x 23".

FOR 24" STUDDING

VB Batts are laid horizontally. Waterproof Paper backing extends 1/2" beyond edges on all 4 sides. Double thickness of paper seals all joints.

**THE 1 BATT
THAT MEETS
ALL REQUIREMENTS**

A Tight Job on 16" or 24" Framing!

● It's that full overlapping barrier of waterproof paper that does the trick. Not just flanged on top and bottom, but *flanged on all four sides* to help build tighter, healthier homes.

Barrett VB *Batts are made in just the right size, so they can be laid either vertically or horizontally on both standard framing spacings. This means there's no need for you to carry rock wool batts in two widths! And Barrett VB Batts come in full and semi-thick styles.

Here is the *practical* way for builders to *apply* rock wool insulation ... the *profitable* way for you to *sell it!* Take advantage of public acceptance of the familiar Barrett trade mark, and cash in on the current demand for insulated homes.

THE BARRETT COMPANY

40 Rector Street, New York, N. Y.

2800 So. Sacramento Ave., Chicago, Ill.

Birmingham, Alabama

* Reg. U. S. Pat. Off.



**BATTS
BLOWING FIBRE
LOOSE WOOL**

NOW, MORE THAN EVER, IT'S **BARRETT** "BETWEEN THE WORLD AND THE WEATHER!"

NOW ON SALE ALL OVER NORTH AMERICA



Reardon's WASHABLE KALSOMINE Brings You

- 1 "Finger-Tip" MIXING
- 2 "Smooth-as-Velvet" FINISH

Here's real news! Reardon's Washable Kalsomine has been improved in two different ways—ease of mixing and smoothness of finish. Nothing else has been changed and R.W. K. again sets the pace offering these major improvements plus washability, self-sizing, uncanny "hide" and permanency at low cost. Reports from users of the improved product are full of enthusiasm for its "finger-tip" mixing and its "smooth-as-velvet" finish.

Mixes With Amazing Ease

R.W. K. was always easy to mix but now all you need for preparation is a few minutes of "finger-tip" stirring. The New R.W. K. has an even finer texture and achieves complete dispersion through effortless mixing.

Ends Bumpy, Sandy Finish

Inferior washable kalsomines fail to deliver the smooth hard effect that is so desirable. The New R.W.K., however, achieves a satin-like texture through an extra milling process which insures a uniform "soft-as-velvet" finish.

Try This New R. W. K. Today!

The improved R.W. K. will sell itself. Try it on a job soon. You'll be convinced that we have succeeded in making a fine product even finer.

Send for New R.W.K. Folder

THE REARDON COMPANY
St. Louis • Chicago • Los Angeles

Reardon's WASHABLE KALSOMINE

THE MICROSCOPE TELLS THE STORY OF R.W.K.'S NEW SMOOTHNESS



Photomicrograph of ordinary washable kalsomine — note roughness.



Photomicrograph of the New R. W. K. Note how much smoother it is.

183

News of the Month

Building Activities and Meetings

Expect Residential Building for First 6 Months to Show More Than A 55% Increase Over 1938 Period

RESIDENTIAL building for the first 22 days of June amounted to \$69,945,000, according to contract figures of F. W. Dodge Corporation. This compares with \$58,657,000 for the same period last year, and indicates that residential building for the first six months should amount to approximately \$630,000,000, representing an increase of about \$230,000,000 over the same period of 1938, or an increase of almost 58 per cent.

The statistics for the four classes of construction, as recorded during May, are as follows:

37 Eastern States	May, 1939	May, 1938	June 1-22, '39
Residential	\$133,818,000	\$ 83,153,000	\$ 69,945,000
Non-Residential	76,749,000	77,771,000	51,130,000
Public Works.....	76,141,000	78,533,000	44,209,000
Utilities	21,779,000	43,699,000	6,885,000
Total	\$308,487,000	\$283,156,000	\$172,169,000

Real Estate Survey Shows That Prices Lag, Activity Is Steady, and Outlook Is for General Rise in Home Building

DECIDED evidence of a new pattern in real estate capital supply, one that has grown up in the past few years, is seen in reports from 262 cities made to the National Association of Real Estate Boards in its 33rd semi-annual survey of the real estate market. Some of the findings are as follows:

1. The availability of mortgage money is coming to be a matter of the activities and investment opportunities of the various geographical sections of the country, rather than simply of their nearness to money centers.

2. Real estate sales activity is as high as last year at this time in more than three-quarters of the cities, higher than it was a year ago in almost 40 per cent of the cities. But prices have softened in 29 per cent of the cities. Outlook for the remainder of the year is for a higher sales volume in 48 per cent of the cities, while only 13 per cent look for declining volume.

3. New suburban development begins again to emerge. "Sub-division activity greater than last year" is the predominant report. This is the first time this has been the case in these surveys since midyear 1937.

Median Price Change Is 10 Per Cent; Interest Rates Lower

The median price rise is 10 per cent. Where prices have fallen off, the median decline is 10 per cent.

Interest rates are lower than last year, and the outlook in 25 per cent of the reporting cities is for still lower rates to come.

Business property sees prospect of price advance in 11 per cent of the cities, and of increasing construction in 22 per cent of the cities. Modernization is expected. Industrial property is very generally still static.

Outlook is for higher real estate taxes in 42 per cent of cities reporting, but in 9 per cent of the cities there is reasonable hope of lower taxes. High taxes are reported in one of the largest cities to be causing industries to leave the community. Projected U.S.H.A. construction is frequently reported as deterring new home and apartment building. In some cities FHA apartment projects are felt to have come too fast for best balance of the residential market. Geographically, the Great Lakes region makes the best report on market conditions, with 46 per cent of its cities showing a more active market and only 18 per cent a less active market than last year. But this region reports that in 42 per cent of its cities selling prices are lower than

(Continued to page 88)

THE AMERICAN HOME - THE SAFEGUARD
OF AMERICAN LIBERTIES



The Federal Home Loan Bank System Assures PROMPT MONEY FOR HOME LOANS



No longer can there be a shortage of home mortgage money, for now the Federal Home Loan Bank System makes reserve credit facilities available to member savings or building and loan associations. A flow of funds to finance local homes is assured at all times.

On July 22, 1932, seven years ago, the Federal Home Loan Bank Act was signed. Its passage created another national safeguard for community investors . . . helped more families finance homes locally through local home financing institutions.

This Act provides twelve regional Federal Home Loan Banks which maintain a permanent reservoir of credit for local home financing institutions. No longer can depressions or re-

cessions isolate member institutions.

In your own community, friendly savings or building and loan associations await the opportunity to serve you. Their service is without red tape and, therefore, easier to understand and faster to complete. And they utilize local dollars to finance home loans at home—a plan that builds your community and promotes your business.

Let a member of the United States

Building and Loan League in your community explain the function of the Federal Home Loan Bank System. It makes safe and prompt home financing possible for the people you serve.

BUILDERS—the map below shows the twelve Federal Home Loan Districts. Their geographical positions make convenient credit facilities available to 3944 local savings or building and loan associations which are members of this reserve system.

Your Local
SAVINGS OR BUILDING
AND LOAN ASSOCIATION

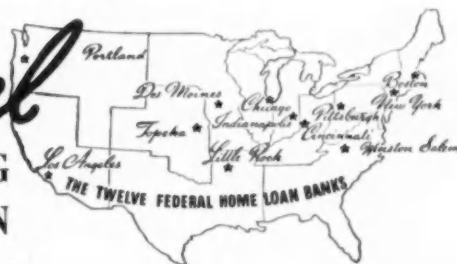

When you support Your Local Savings or Building
and Loan Association—You help local business!

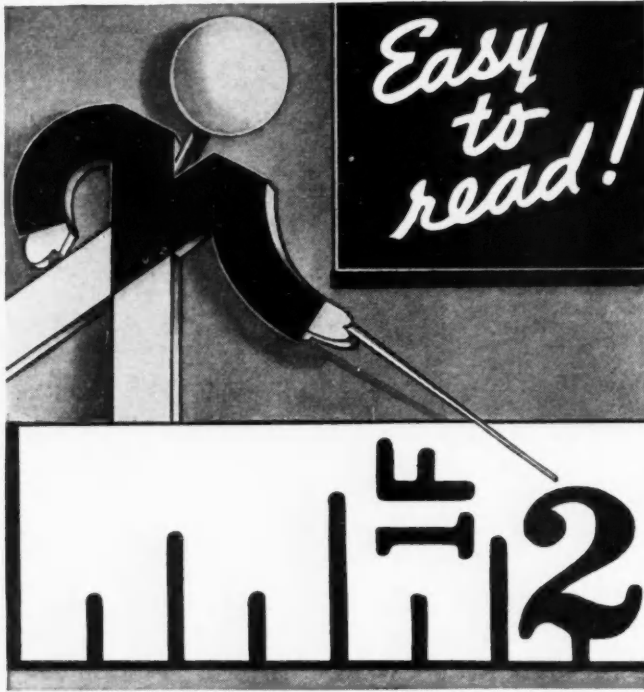

"MOST SENSIBLE STEEL TAPE MADE"

That is the verdict of thousands of users—in professions, in industries and in trades.

Black markings on a smooth white surface—as clean-cut as the face of your watch. Easy to read—even in poor light! Your chance for error is reduced to a minimum.

The full-strength steel in Favorite Wyteface makes it hard to kink, hard to curl. The crack-proof white surface protects the steel from corrosion and rust; it is easy to clean. This new,

popular-priced tape is built for a long life of hard usage.

Favorite Wyteface Tapes are sold by building material and hardware dealers. 25, 50, 75 and 100 ft. lengths; sturdy, leatherite case; nickel-plated mountings; simplified center; patented friction brake.

Mail us the coupon below for a free sample of tape and illustrated folder.

EST. 1867
KEUFFEL & ESSER CO.
 NEW YORK - HOBOKEN, N.J.
 CHICAGO - ST. LOUIS - SAN FRANCISCO - DETROIT - MONTREAL



K & E FAVORITE WYTEFACE
REG. U.S. PAT. OFF. TRADE MARK
STEEL MEASURING TAPES

LOOK FOR THIS DISPLAY



KEUFFEL & ESSER CO., Dept. 78, Hoboken, N.J.
 Send sample and folder on Favorite Wyteface.

Name.....

Address.....

NEWS

(Continued from page 86)

last year, indicating that lowered selling prices at this time may mean a more active market.

Other "up" sections: The Southeast, with 45 per cent of its cities showing a more active market and only 7 per cent a less active market; the North Central, with 45 per cent in the up column, and 22 per cent on the down side.

Plentiful Money Supply

Plentiful mortgage money supply is a common story. Some cities say, "Excess supply." Occasionally the report comes, "Loans are being made on a more conservative basis. In 82 per cent of the cities capital is seeking loans. In only 8 per cent are loans seeking capital.

NEWS BRIEFS—

SUCCESS has at last crowned years of research by glue engineers and machinery men for a method of manufacturing fir plywood panels of low moisture content in a practical, commercial operation. A new continuous mastic glue hot press operation is now in regular production at the West Coast Plywood Company, Hoquiam, Wash. I. F. Laucks, Inc., glue manufacturers and research engineers, have perfected this new mastic process to make a new kind of fir plywood one which is much flatter, is free from stain, can be better finished, has fewer checks, has a much nicer and smoother sanded surface, has the proper moisture content to meet average climatic conditions throughout the United States. . . . BERGER Manufacturing Division, Republic Steel Corp., is now making a complete line of steel cabinets consisting of wall, base and sink cabinets to fit all sinks now on the market. . . . INSULUX Glass Block Competition awards have been made in the first of four quarterly prize contests sponsored by Owens-Illinois Glass Company. Harris A. Kemp was named winner of the \$1,000 first prize by a jury of seven well known Chicago architects. More than 700 designs for small homes submitted by architects from 43 states were entered in this competition. . . . CARNEY ROCK WOOL Company, an affiliate of the Carney Cement Company, Mankato, Minn., has been formed. . . . NATIONAL GYPSUM Company has opened its recently completed \$1,500,000 plant in Savannah, Ga., to give improved manufacturing facilities to the Southeastern market. . . . P. Y. DANLEY, Westinghouse Electric & Mfg. Company, Springfield, Mass., was elected president of the Air Conditioning Manufacturers' Assn. at the recent annual meeting.

* * *

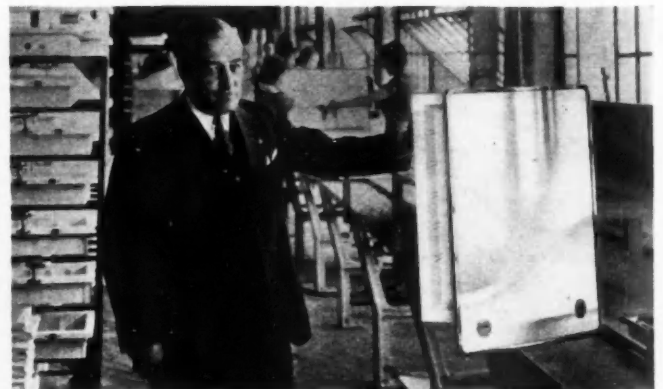

ABOVE: Martin V. Coffey, sales manager of Miami Cabinet Div., The Philip Carey Co., Middletown, Ohio, inspects No. 1 in a line of 12,300 all-metal medicine cabinets scheduled for installation in the Metropolitan Life Insurance Company's 50 million dollar apartment building project in New York City. The medicine cabinets will be standard equipment in all dwelling units. Size of the mirror is 18 x 24 inches. Cold rolled steel for the cabinets and stainless steel for mirror-trim are being supplied by The American Rolling Mill Company.



Revolutionary Bullets
**Stood on shelves
like these**

Pewter mugs and candlesticks might have gone from these shelves into bullets when the cry—"the Redcoats are coming!" rang out.



How to furnish Beautiful Woodwork AT LOW COST...

Equip your homes with stock Curtis Woodwork!

You know what special-made woodwork costs. But do you know that you can furnish high quality, beauty and correct design in all the woodwork for the modern home, at remarkably low prices?

Prominent architects design most of the items in the Curtis line. And Curtis has maintained the

highest quality of manufacture throughout its 73 years. This combination gives you unlimited opportunities to sell permanent satisfaction and good design at low prices.

Entrances, mantels, china cases, stairways—all the woodwork for the modern home—are available from your Curtis Dealer. See him or get complete details from Curtis. Use this coupon today.

CURTIS COMPANIES SERVICE BUREAU
CLINTON, IOWA

If you live in Canada, write to Edwards Curtis Limited, 991 Somerset Street West, Ottawa, Canada

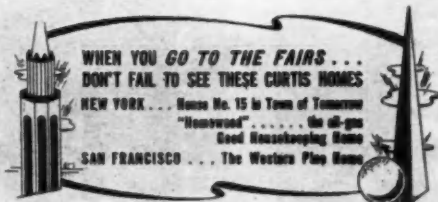

WHEN YOU GO TO THE FAIRS...
DON'T FAIL TO SEE THESE CURTIS HOMES
NEW YORK... House No. 15 in Town of Tomorrow
"Homewood"... the all-gas
Good Housekeeping Home
SAN FRANCISCO... The Western Play Home

CURTIS COMPANIES SERVICE BUREAU

Dept. AB-7W, Clinton, Iowa

Please send information on Curtis Woodwork

Name

Address

City..... State.....

Substantial
Economical
Adaptable . . .

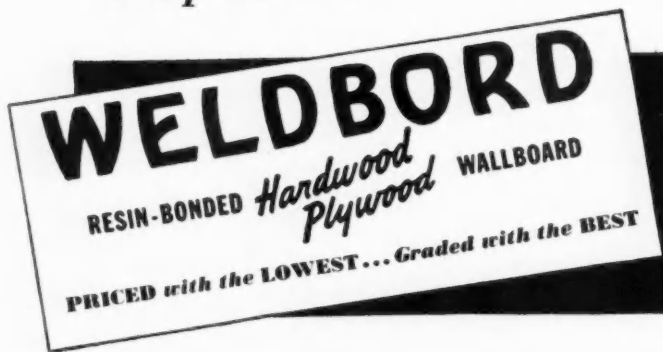

**Takes PAINT, STAIN or
WALLPAPER perfectly**

**7 1/2 ¢ PER
SQUARE
FOOT***

**Price varies slightly according
to location of lumber dealer*

Cross-grain construction gives extra stiffness
—no patches—no grain-raising—no checking

1/4" thick only

Panel Sizes: 96" x 48" • 84" x 48" • 72" x 48"

DELUXE
WELDBORD

Faced with WALNUT, OAK or MAHOGANY
48" x 96" x 1/4" only
grain runs long way of panel

The remarkable welcome given to WELDBORD stimulated a demand for something more ornate suited to finer installations. DeLuxe WELDBORD is the result. This new member of the "USP" family of plywood specialties is so inexpensive that the entire panelling for a

**12 x 15 LIVING ROOM
costs less than \$55**

Lumber Dealers!

*Write for details of our
"We-Stock-It" Selling plan.*

UNITED STATES PLYWOOD CORP.

EXECUTIVE OFFICES

616 WEST 46th STREET NEW YORK, N. Y.

Branch Offices and Warehouses in Principal Cities

Split-Log Cottages

(Continued from page 71)

below the hearth. A foundation three or four inches all around the spread of the basement masonry is then ample to carry the load. If a fireplace is built, it is most advisable to install a damper in the throat of the fireplace which may be closed when the fireplace is not in use, thus preventing the escape of heat up the unused flue. A small investment for a damper will save much fuel. It is also suggested that fireplace chimneys be provided with a thimble so a stove may be used in the room.

There are many types of roofing on the market, but the roof that presents the best appearance and gives the most durable and satisfactory service is the first quality, edge-grained, cedar shingle.

Before any roof is laid, it is desirable to cover the roof boards with waterproof paper lapping the sheets at least two and one-half to three inches. These sheets are run horizontally.

Select straight grained material for the posts and girders which support the floor and of such size as to provide ample strength to prevent the floors from sagging. The footing for the post may be a stone or a block of concrete sixteen inches square and nine inches thick, resting flatly on firm ground and extending two inches above the floor of the basement to keep the post dry. The joint between the sill and the masonry foundation can be made tighter by bedding the sill in mortar.

For joists, girders and sills, logs may be edged on a mill or with an adz. If straight logs are not available, regular two-inch lumber of proper widths could be used for the frame work, rafters and joists of the house. The use of sized lumber will save time in the construction of the buildings, but will probably require a greater cash outlay.

The details shown cover the most important points of construction. Although the section detail does not show it, a box sill and plate of lumber or split logs could be devised to make a tighter and warmer job. Notice also how the waterproof paper between the interior split logs and the outside split logs runs down over the sill and two or three inches of the foundation. This drains all water to a point where it can no longer seep under the sill. It also helps to make the house wind-tight.

In nailing the split log wall, use the largest nails possible which will not penetrate the opposite surface of the wall. Stagger the nails on each piece and space the nails 24 inches apart on each edge of the split log. Nail both the inside and outside of the wall.

The interior partitions may be of thinner or smaller pieces than the exterior. It is advisable to lay the roof boards tight for warmth, especially if the attic floor is not tight.

Ceilings may be made of insulation board, split logs with paper, or lath and plaster. Another satisfactory method is to expose the log ceiling joist by covering on the top side with split logs, smooth face down.

Where exterior logs are in any other position than vertical, the interior logs will still run vertically for support.

On the exterior of the buildings, it is desirable to use white pine trim. There is so little of this trim that the slight added initial expense of this durable material will be more than offset by its length of life. On the interior, the trim may be planed down from the aspen boards sawed on the job. On openings where doors are not used, the openings may be framed with small split logs and the casings omitted. Small cupboards and closet doors can be made of planed boards fastened with cross battens.

How to turn a white elephant into a gold mine!

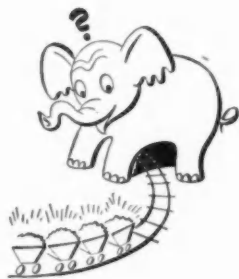

HOW can you make an old structure modern? How can you turn a hard-to-rent building into one that's attractive and easy to lease?

Read an answer to these questions in the apartment dwelling shown here. The owner decided on some structural changes... and on stucco for the new exterior. He used Terratone Stucco, made with Atlas White portland cement. And that gives the house its attractive, modern appearance today!

Here is just another example of the use you can make of Atlas White in producing a satisfactory stucco for modernization work. This fine white portland cement stucco—

- Provides a sturdy, fire-safe and weather-resisting exterior covering;
- Can be applied in a wide range of colors and textures;
- Is low in first cost and needs practically no upkeep;
- Endures in any climate.

Look around you for old, ugly buildings that are white elephants on their owners' hands. Go after the job of turning them into income-producers—and make a profit yourself—with an Atlas White stucco! Universal Atlas Cement Co. (United States Steel Corporation Subsidiary), Chrysler Building, New York City.

A FACTORY-PREPARED STUCCO IS PREFERABLE

AB-S-5



COMPARE THESE BEFORE-AND-AFTER PICTURES and decide which house you would prefer to live in. The owner, William Sullivan of Milwaukee, worked out the modernization plan with the Northwestern Plastic Art Company. The exterior of Terratone Stucco was made with Atlas White cement, by the Coddington Manufacturing Company, of Milwaukee.



STUCCO MADE WITH Atlas White PORTLAND CEMENT

Your COMMUNITY WANTS A MAN

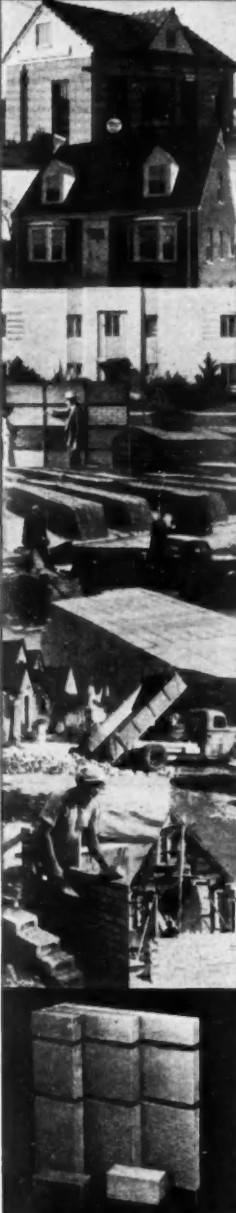

TO MANUFACTURE an improved building product of highest quality at lowest cost.

TO SUPPLY the entire building trade with more attractive and permanent construction that offers savings at every step. **TO ESTABLISH** new distribution methods whereby transportation and selling costs are reduced up to 25%.

YOUR COMMUNITY will welcome this man or firm to contribute materially to better buildings at lower cost. Your builders and prospective home owners are waiting for better, lower cost material which you will be able to supply.

If You Are the Man

WE WILL EQUIP YOU with exclusive line production machinery—Large production. Only one or two men. Equipment costs but fraction of other processes of equal capacity.

WE WILL SUPPLY YOU with processes to enable you to supply product in 40 colors, shades and textures. Your product will be capable of meeting all known building requirements and is now being used by Government-City Building Depts. throughout the country.

WE WILL GRANT YOU Manufacturing Franchise covering your locality—protecting your market, business and future, with available engineering and advertising service.

YOUR EARNING POWER AND FUTURE. Present manufacturers have pioneered the way for you. Some are selling at 100% over cost. Some are getting as high as 80% of the business in their territories.

YOUR OPPORTUNITY IS COMPLETE Ready made. One that is proven. Ready for you to cash in on the great building upturn under way.

YOU SHOULD INVESTIGATE while your territory is still open. Fill in and return coupon today. No obligation.

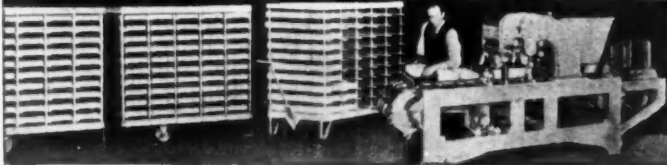

W. E. Dunn Mfg. Co., 450 W. 24th St., Holland, Michigan

7-39

Show me through your new books the earning power of an exclusive plant in this territory, and how I may WIN MANUFACTURING INDEPENDENCE.

How a contractor can BUILD BETTER BUILDINGS FOR LESS.

Name

Address

City State

"Double Lifetime" Home

(Continued from page 57)

"Plyscord" plywood of stock 48 by 96 in. panels applied lengthwise across the joists, fitted tightly together and nailed with 8d common nails 6 in. apart at all edges and 10 to 12 in. apart along intermediate joists.

WALL SHEATHING—Exterior sheathing is 5/16 in. "Plyscord" unsanded plywood sheathing applied horizontally, with face veneer at right angles to the studs, fitted tightly together and nailed with 6d common nails spaced 6 in. apart around all edges and 12 in. apart on intermediate studs. All joints were made directly over center of studs.

Wall sheathing was notched to fit closely around rafters at the eaves and fitted closely around all doors and window openings providing a rigid, weathertight, waterproof job.

"UNIWALL" INTERIOR PLYWOOD—Interior walls of the house consist of 3/8 in. "Plywall" plywood panels, sanded two sides, back-primed and laid over furring strips.

Backpriming was done to provide a moisture barrier and give added protection to panels. The priming formula consisted of 3 parts white lead, 4 parts linseed oil, 2 parts turpentine.

The interior wall panels were then installed according to the "Uniwall" system. Quarter-inch thick plywood furring strips 2 1/2 in. wide were tacked to all studding, headers and ceiling joists with 6d finish nails. A special self-bonding cold casein glue was then applied to the furring strips and the plywood panels immediately set in place and held in good contact with the glue with 6d finish nails. Panels were butted tightly together, forcing the glue along the facing of the adjacent panel and producing a solid glue joint. Since the furring strips are only lightly tacked to the studs, a normal amount of movement due to shrinkage or other causes is possible without affecting the finish joint.

All joints, nail holes and blemishes were rough-filled with Swedish putty or spackle which was allowed to dry and then brought to a perfect smooth finish which was sanded before the application of paint. Ceilings were given 3 coats white lead and oil according to the previously given formula, which was also used on kitchen and bathroom walls. Other walls were covered with wallpaper which was applied over a 3/4 lb. felt underlay. The felt was applied with butt joints rather than an overlay, and care was taken to see that no wallpaper joint fell exactly over the butt joint of the felt underlay.

Plumbing roughing throughout is of lead, with all lead pipe, traps, bends and caulking stamped with the Lead Industries seal of approval. Use of lead made possible a 3 in. stack or soil pipe which was easily enclosed in a normal 4 in. wall and which has the added advantage of sound deadening. An important advantage revealed in the use of lead for branch waste and vent pipes was that the 1 1/2 in. flexible lead pipe was easily reeved through holes bored in joists or studding. This eliminates notching and cutting that frequently weakens the structure. It was possible to bend the lead pipe in easy sweeps which permit maximum flow with fewer joints.

Where the 3 in. lead stack pierced the roof, the joint was made completely watertight with a 4-lb. sheet lead flashing which was wiped to the stack and extended 6 in. in all directions.

Through skillful planning of the work and use of flexible lead piping it was possible to do a large part of the work on the bench, increasing the efficiency and decreasing the cost. A further saving was made by the elimination of many joints and fittings.

Outstanding Features of Design

The design of the Edwards house is in good New England tradition, with a garage attached to main part of house by an attractive open porch. The floor plan is unusual in that the living room quarters are at the rear where they look out on an attractive garden and wooded area. There is very little separation between the large living room and the dining room, which adds to the apparent size of both rooms. In addition to the 2 bedrooms and bath downstairs, there is space for 2 or 3 additional bedrooms and a bath upstairs.

Specification and construction details include the following:

FOUNDATION—10 in. monolithic concrete.

INSULATION—4 in. mineral wool in attic floor.

KITCHEN CABINETS—Oxford mill-built stock cabinets, baked enamel finish.

(Continued to page 94)

MIAMI BATHROOM CABINETS Cut Installation Costs

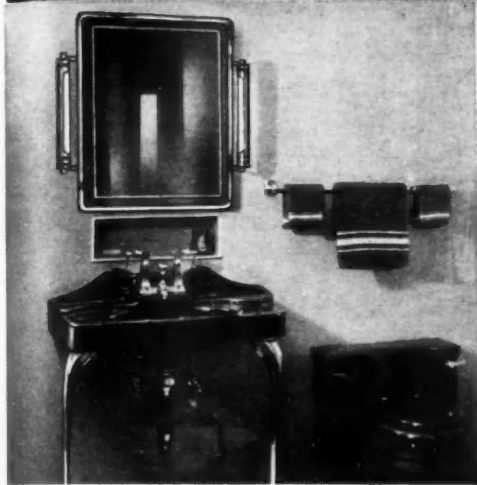

This attractive master bathroom in home designed by Architect H. L. Schwartz, New Kensington, Pa., for Leon D. Hansen, Pittsburgh, features Miami Cabinet model 1100 with tubular light brackets. The recessed shelf shown above the lavatory is model 410.

Miami Lighted Bathroom Cabinets are completely wired at the factory. With light fixtures, switch and electric convenience plug mounted on the cabinet, they require only one electric outlet—save installation costs.

Over 140 models . . . Modern Styles . . . Outstanding Quality . . . Nationally advertised. Write for catalog F.

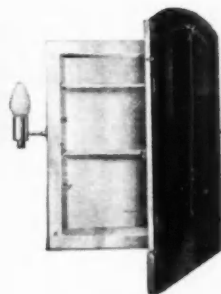

MODEL 401

MODEL 2010 (with Tubular Light Brackets No. 1) is a Gothic Top Cabinet with Full Mirror Door, Stainless steel frame. Selected No. 1 plate glass mirror guaranteed for five years against silver spoilage. Wired complete at factory.

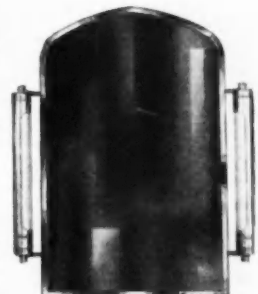

MODEL 2010

With Tubular Light Brackets No. 1

MODEL 401 . . . an inexpensive model for the modest bathroom. Colonial-type light fixtures, switch and convenience plug for electric appliances. Wired complete at the factory.

MIAMI CABINET DIVISION · The PHILIP CAREY COMPANY, Middletown, Ohio.

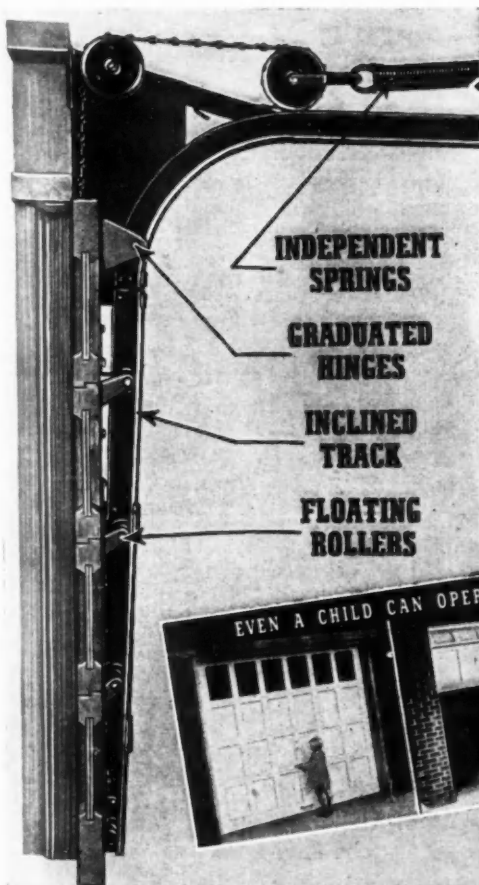

The "OVERHEAD DOOR" TRADE MARK

THE DOOR WITH THE
MIRACLE WEDGE
*Wedges Tightly—YET—
Opens Easily*

INSTALLED AND SERVICED
by our
NATION-WIDE SALES INSTALLATION SERVICE

MAIL COUPON TODAY!

Please send me literature and full information regarding your product. I am interested in doors for the particular purpose as checked.

Name

Address

City

State

PRIVATE GARAGE
PUBLIC GARAGE
WAREHOUSE
GREASING STATION
WOOD DOORS
STEEL DOORS
FACTORY DOORS
OTHER BUILDINGS
ELECTRIC OPERATORS

OVERHEAD DOOR CORPORATION • HARTFORD CITY, INDIANA U. S. A.

LONG ISLAND BUILDERS Step-up Home Sales



with
NOFMA
Certified
HARDWOOD
FLOORS

A Mott
Development Home,
Garden City,
Long Island



HARDWOOD FLOORS help sell homes. When they're NOFMA Certified Hardwood Floors their sales appeal doubles.

Why? Because NOFMA Hardwood Floors have beautiful natural color and texture; they're mirror-smooth and stay that way; they stay that way because shrinking and swelling, frequently glaring faults in unidentified flooring, are minimized in NOFMA floors. Again, why? Because NOFMA flooring material is first skillfully seasoned and then produced by tested methods which qualify under standards approved by the U. S. Department of Commerce.

Certifying those standards, flooring bundles are identified by the NOFMA copyrighted label, the maker's warranty mark which guarantees each grade specified and protects every user of NOFMA Hardwood Floors against sub-standard flooring.

No wonder then, that Mott Brothers, builders of the famous Garden City, Long Island homes development, are among the thousands of realtors and builders who rely on pedigreed NOFMA Hardwood Floors to help turn quicker sales.

Sold by local lumber dealers everywhere, NOFMA Hardwood Floors are immediately available in Oak, Beech, Birch and Maple. Write for these useful pieces giving you all the facts...then see your favorite dealer.

National Oak Flooring Manufacturers' Ass'n

777 Dermon Building, Memphis, Tenn.

WRITE FOR
YOUR COPIES



LOOK FOR THIS LABEL WHEN YOU BUY HARDWOOD FLOORS

"Double Lifetime" Home

(Continued from page 92)

HEATING—Burnham steam boiler, Electrol oil burner, American Radiator Co. concealed convector-type radiators.

OVERHEAD DOOR—Overhead Door Corp.

LIGHTING FIXTURES—Colonial fixtures by Lightolier and Chase Brass and Copper.

HARDWARE—Brass Colonial hardware by Corbin.

BUILDING PAPER—20-lb. Brownskin fibre-reinforced kraft asphalt paper by Angier Corp.

PLYWOOD GLUE—Self-bonding water-resistant Laucein glue by I. F. Laucks, Inc., Seattle.

INTERIOR TRIM—Idaho white pine.

WATER PIPES—American Brass Co. red brass piping.

KITCHEN RANGE—Universal electric range.

REFRIGERATOR—Frigidaire.

Architect, Richard Everett, Jr., 421 Main St., Stamford, Conn.; builder, Joseph Li Volsi, Stamford; plumbing contractor, George C. O'Neill, Stamford.

Construction and Recovery

(Continued from page 77)

tem, in black, and the work relief expenditures, or WPA, in diagonal shading. A glance will show a rapid increase in relief expenditures and the consequent decrease in recovery expenditures. The planned withdrawal of PWA will once more reduce public construction volume to a fraction of pre-depression level. The presidential request for \$1,477,000,000 to continue WPA, if granted, will enable that organization to slip into the breach and grab as much of this work as possible for its highly inefficient day-labor organization; an organization which is straining at the leash to build monuments, to do the nation's public works construction without the use of the regular channels of business, without any sense of economy, without the use of private construction organizations, but by the socialization of one of the nation's major industries. Each year through WPA history the character of the work it has done has changed. Each year its invasion into the legitimate field of private enterprise has become more pronounced until now, the volume of work taken away from private industry is the open boast of the organization. If WPA is permitted in the impending governmental reorganization plan presented to Congress by the President, and in the bill recommending an appropriation for the coming fiscal year, to become a permanent public works organization, as was so often predicted by Mr. Harry Hopkins, its former chief, then construction has a permanent barrier to recovery.

It has been my purpose in this discussion to convince you that in construction lies the greatest possible immediate re-employment recovery. New ideas, new industries, industrial progress, though an exceedingly welcome contribution to re-employment, will of necessity be slow. Construction, now at one-third of its normal volume, but still capable of an immediate expansion to its former employment leadership, is the present most potential re-employment possibility. Recovery in construction carries with it recovery in the capital goods industries. Fortunately the market is here. It doesn't have to be created. America's appetite for new construction will never be satiated. There is now on the horizon in America more construction that should be done than has been done in the last century. Super-highways, housing, lifting the face of Main Street, streamline construction, flood control, replacing the obsolescent, rebuilding American cities to fit modern transportation necessities—all these and many more present problems which challenge the construction imagination. All these remain to be done. All make for a happier, more contented citizenry. Give the construction industry its chance to serve.

CARPENTRY and JOINERY WORK

By Nelson L. Burbank

Formerly Instructor, Building Vocational High School, Cincinnati, Ohio

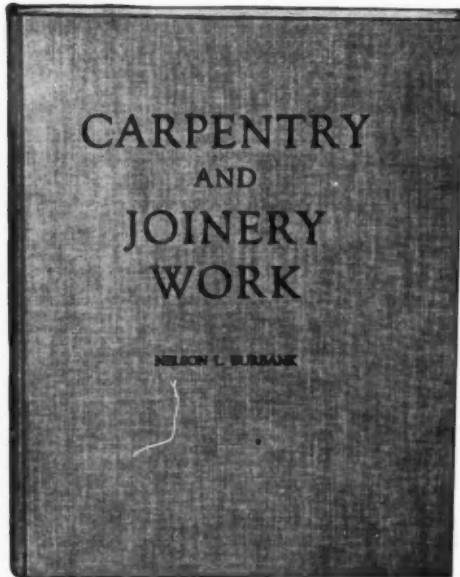

The new second edition has been thoroughly revised.

The manuscript was carefully checked by a former contractor and ex-editor so that this book combines the practical outlook with the author's trade teaching experience. The cardinal principles of modern residential construction are set forth simply and logically with the aid of many photographs and line drawings. The Second Edition contains 90 revised pages with new illustrations and descriptions of new methods and materials.

The program of study as presented in this latest textbook for students of carpentry work involves class discussion, practical job work and related studies. These include Architectural Drawing, Plan Reading, Carpentry Mathematics, Business English, Applied Science, Civics and First Aid.

280 pages, illustrated, 8 1/2 x 11 inches. Cloth Bound, \$3.00
Send for a Free Copy of our 1939 Book Guide

BOOK DEPARTMENT

American Builder and Building Age
30 Church Street New York, N. Y.

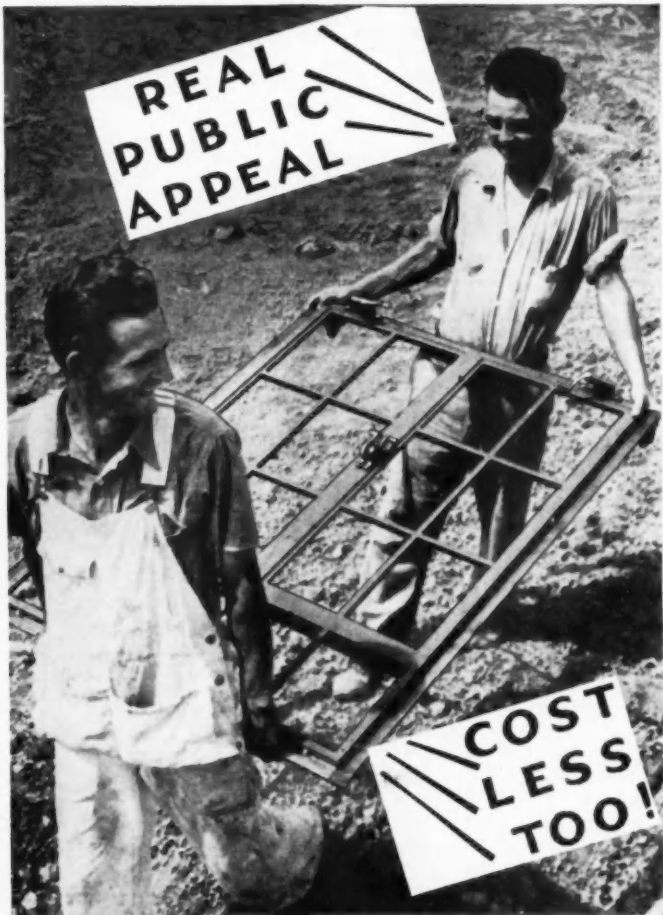

RIGHT YOU ARE GENTLEMEN!

Mesker steel casements lead in both of these important points.

The real public appeal so necessary today in selling houses... and the extra low cost that keeps your buildings within their budgets.

And think of this Mr. Contractor!

They're quicker to install... no wasted field labor and they're actually no more expensive than ordinary double hung sash although they always open easily, give up to 100% ventilation, have inside screens and storm sash and can be washed from the inside! Write for the 1939 Mesker Catalogue and see your nearest Mesker dealer for prices!

Mesker
SINCE 1879

MESKER BROS., 424 S. SEVENTH ST., ST. LOUIS, MO.



BY using lumber treated with Du Pont Chromated Zinc Chloride, you assure long life for your buildings, with low maintenance costs.

Lumber treated with this chemical lasts 3 to 5 times longer than untreated lumber and effectively resists decay and repels termites.

Builders everywhere will be interested in Chromated Zinc Chloride Treated Lumber because it has so many advantages as a building material.

It is clean, odorless, paintable, easily fabricated, resistant to abrasion, and fire retarding.

Write today for the names of suppliers, and for important facts about this cost saving lumber.

E. I. DU PONT DE NEMOURS & CO., INC.
GRASELLI CHEMICALS DEPARTMENT
WILMINGTON  DELAWARE

Air Conditioning Today

(Continued from page 61)

be summarized in a single statement. That statement would read something like this:

It isn't adherence to, or departure from, arbitrary performance standards which makes or breaks an air-conditioning installation. It is *its effect upon the comfort of the individual human beings* subjected to its influence. And their comfort is dependent, though *largely*, not *wholly* upon the condition of the air surrounding them. It is actually dependent upon the *rate of heat loss of their individual bodies*; and this is governed not merely by the temperature, humidity and motion of the surrounding air, but by the total effect of *all* the contributory factors—which are quite a bit more numerous and various than we realized.

For instance, there's wall temperature. More than one air-conditioning installation has disappointed its users because the arbitrary performance standards which it lived up to didn't take enough account of the fact that the human body radiates heat to cold walls a lot faster than it does to warm ones. Then there are individual preferences in clothing—some people, for reasons of fashion or personal taste, wear more heat-resistant clothing than others. And finally, there is the enormous field of individual physiological idiosyncrasies, which we can only glance at by remarking that some people produce more body heat than others, and moisture likewise; that there are equally striking variations in their bodies' capacities to throw off the heat they produce; and that even the same individual varies perceptibly from day to day and even from hour to hour in both his rate of production and his rate of throw-off of body heat.

When you once get really immersed in this maze of variables, all moving rapidly in opposing and usually unpredictable directions, you are not to be blamed for wondering who started it all in the first place, and why; and whether it wouldn't be a good idea to call the whole thing off. But in the meantime there are more and more people demanding more and more insistently to be made comfortable; and willing to pay more and more money for it.

That is the real point. People don't buy air conditioning; they buy comfort. Or if you insist, they only buy air conditioning because they believe it will give them comfort. If they find out, later, that they've been fooled . . . look out! And the great trouble up to now has been, that attempts have been made to make air conditioning conform to rigid theoretical engineering standards, ignoring the other and above all the human factors. With the result that, too often, it has not only failed to provide comfort, but has provided active *discomfort*.

Nobody, for instance, can ever tell you how many air conditioning jobs have been lost because of the splendid crop of snuffles, earaches and stiff necks harvested in some of the early air-conditioned trains and movies, operated on the noble thesis that the specifications called for air temperature 70°, humidity 40 per cent, and air motion pretty near anything you please, no matter what the outside temperature might be, or the amount of extruded moisture (perspiration, to you) on the noble brows of the entering victims. Let us turn to more cheerful themes.

Yes, there's a lot more to it than we thought a year or so ago; but once we grasped that one fundamental—that what we're really trying to provide is *comfort*, and that the real problem, always and everywhere, is not to maintain any particular set of theoretically perfect conditions, but to enable a certain more or less definitely known group of human beings, of more or less known or ascer-

(Continued to page 100)

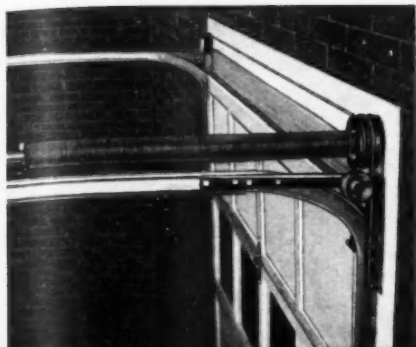

1 Ro-To Live Spring
No side-drift...no binding

Why Take **LESS** than **Ro-WAY** gives?

-No Extra Cost for All These Exclusive Features

Ro-Way Overhead Type Doors had to be *better* to make such giant strides against the whole field. They had to be more than *good* doors of the Overhead Type. They were not the *first* to be made, but we were determined that they should be the *best*. Today, they set the pace with three exclusive features; any one of them is sufficient to make your choice a "Ro-Way."

Consider what these three extra values mean . . .

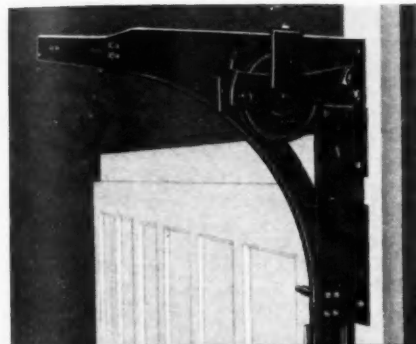

2 "Crow's Foot" Assembly
Gives Outer Bearing Support



3 Parkerized and Painted Hardware
... Very rust-resisting

1 Ro-To Live Spring, which eliminates all side-drift and binding.

2 "Crow's Foot" Assembly, which simplifies installation, gives more quiet, smoother operation, and freedom from bothersome mechanical troubles.

3 Parkerized and Painted Hardware, giving Garage Door hinges the same protection provided in fine motor cars, refrigerator cabinets, etc.

These extra refinements and improvements insure lasting satisfaction. They are yours now without any extra cost in a Ro-Way Door.

Ro-Way Doors of the Improved Overhead Type are available for every purpose . . . Residence, Commercial and Industrial . . . electrically operated if desired. Write for the Ro-Way Door Folder and Price List.

ROWE MFG. CO.
785 Holton St., Galesburg, Ill., U.S.A.

You Can Cut **EVERY** Rafter for Roofs of **EVERY** Pitch with **SKILSAW**

You'll never believe how simple cutting rafters can be until you try it with a Modern SKILSAW—adjust the base for bevel-cutting . . . draw only the plumb line . . . and, in a second, the job is done! With SKILSAW, you can bevel-cut jack, valley, hip and cripple rafters for roofs of ANY pitch, quicker and more conveniently than by any other method—you can cut all your joists, sub-flooring, sheathing, studs . . . notch rafters, cut stair stringers and trim doors 10 TIMES FASTER THAN BY HAND!

- easier!
- faster!
- cheaper!

Nothing less than Skilsaw can give you SKILSAW's time- and cost-cutting performance! 19 years of constant improvement have made this original portable electric handsaw THE BEST on the market today! It is lighter, more powerful, will do more sawing jobs. Cuts wood, metal, stone and compositions. Works from any light socket. 9 POWERFUL SIZES.

SKILSAW, INC., 5031 ELSTON AVE., CHICAGO
26 East 22nd St., New York—52 Brookline Ave., Boston—15 S. 21st, Philadelphia—2124 Main Street, Dallas—918 Union St., New Orleans—1253 South Flower Street, Los Angeles—2065 Webster Street, Oakland.
Canadian Branch: 85 Deloraine Ave., Toronto.



FREE BOOK!

SKILSAW, INC., 5031 Elston Ave., Chicago. Send us a free copy of "How to Cut Costs on Small Homes."

Name.....
Address.....
City..... State.....

96 Homes of Irresistible Charm and Appeal

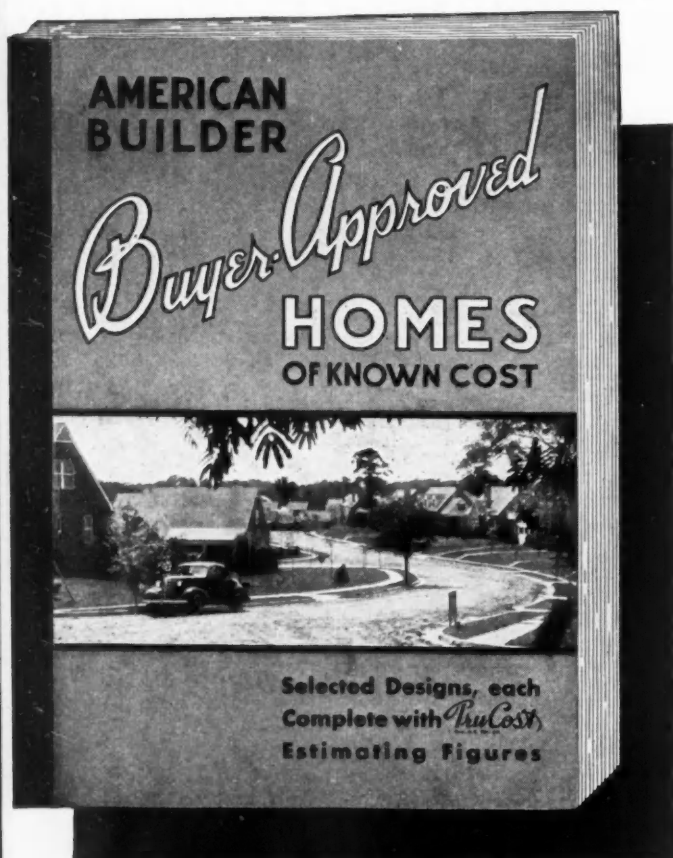

Modern, inexpensive, making the utmost use of cubage—yet neither bizarre or commonplace.

Just the sort of distinctive, sensible, liveable homes that the average man of today deep down in his heart craves for, and on which he can be easily sold.

These homes have been carefully selected from the best recent work of representative architects and builders in widely scattered communities.

For each home there are attractive exterior views, reproduced from actual photographs, and large dimensioned floor plans. Many of them have exquisite interior views, outline specifications of materials and equipment and striking construction details.

As evidenced by the partial summary of its contents, below and on the following page, this new Plan Book offers building professionals unrivalled helps in capturing captious clients and closing hard-to-get contracts.

For Gracious Living Out in the Open

with entrancing picture windows—all of them well within the means of clients with moderate incomes.

A Gem from the Old South fitting into its environment in a way that shows it was designed and built by men who know their business, for a client of unimpeachable good taste. . . . A Colonial Farmhouse near Chicago, built for a tenant, but which later will become the owner's house, future changes being outlined in dotted lines on the floor plans. . . . A brace of cozy Connecticut Country Homes that reach a new high in rural charm, and in which any former city-apartment dweller would feel quite at home. . . . Attractive "Sunset Ridge" Cape Cod Cottage, well styled and suggesting many new helpful ideas.

Other Sections

are devoted to new Double Houses and Apartments. . . . New Ideas in Interiors, Kitchens, Bathrooms, Basements, Adequate Wiring, Stair Halls, Economies in Modern Plumbing, etc.

Country Homes Thoroughly "Citified" in their Conveniences

Continued from preceding page.

Low Cost Homes That Win Approval

Homes of delightful charm—homes so expertly designed as to possess far more roominess than their appearance would indicate—homes that admirably fit into the 1939 market. Among them:

A Small Colonial Beauty at Glastonbury, Conn., with recreation room in basement . . . "Alden Estates" concrete masonry home built to last a lifetime. . . . Small Colonial for city lot, with grace in every line. . . . Dry-Wall Homes at \$43.85 per month. . . . Small Homes built by Large Job Methods at Clairton. . . .

Low Cost Home in Highclass Westchester. . . . \$40,000 Quality in a \$6,000 House, made possible by expert planning and quality materials. . . . The "Greenfield" 5-room Colonial. . . . The "Westminster" English Design House at White Plains. . . . A fine, hospitable looking six-room "Williamsburg" Colonial. . . .

"Florida's Largest Low Cost Home Development Meets with Immediate Success in the houses of the Lester F. Preu Organization that were eagerly grabbed up at \$16.80 a month over a period of 24 years."

AMERICAN BUILDER, New.....
 30 Church Street, Renewal.....
 New York.
 For the enclosed \$..... enter
 my subscription for 1 year, \$2.....
 2 years, \$3..... 3 years, \$4.....

**And Include AT NO EXTRA COST
 a copy of "AMERICAN BUILDER
 BUYER-APPROVED HOMES"**

Name.....
 Street.....
 City.....
 State.....
 Occupation.....

7-39

This offer good only in United States, its Possessions and Canada



copy of "American Builder Buyer Approved Homes" is included with a paid-in-advance new or renewal American Builder subscription order, accompanied by \$2 for one year, \$3 for two years, or \$4 for three years. To get YOUR copy use the form to the right, above.

180 pages, 8 1/2 x 11 1/2
 331 Illustrations—163 Exteriors,
 45 Interiors and 123 Plans, Elevations
 and Construction Details.

Beautifully covered with extra weight
 enameled paper stock, cloth-strip
 reinforced.

Some of the Other Homes Described and Illustrated

In the moderate price class and more pretentious homes—representing all the popular architectural styles—each a jewel of the purest ray serene:

Portland, Oregon, Model Home, triple insulated. . . . Carefully planned 5-room brick home in Indiana. . . . Two good Florida Bungalows in concrete. . . . 7-room Modern New Orleans Colonial at Miami Beach. . . . Two fine homes in Modified French, planned for light, air and view. . . . Chicago Modern Cottage with Plywood interior.

California Bungalow for 50-foot lot. . . . New England Colonial in Ohio. . . . Early California Ranch House. . . . Port Washington Home built on two levels. . . . "Comfort" Cottage overlooking Lake Candlewood. . . . Milwaukee compact 5-room house. . . . Montgomery All Hardwood Home built for 300 years.

Monterey Style at Blue Ridge, Wash. . . . Charming Colonials at Montford Hills, Teaneck, Evanston, Ill., etc. . . . Borough of Queens Prize Winner. . . . Five-Level House at Chicago. . . . "Orchard" House from Mississippi.

Dutch Colonial in a Chicago Suburb. . . . Pittsburgh Basementless Home outstanding for its economies. . . . Popular Detroit 6-room House with one bedroom downstairs. . . .

A nifty Cheel Colonial with attached garage. . . . A group of well planned "Plymouth Haven" Homes arranged about a court. . . . The "Faith Brewster" Home. . . . Home with garage, extra bedroom and bath in ell. . . . 5-room California Home on Hillside. . . . A Builder's Own Home in French Norman styling. . . . New England Colonial in Iowa.

English style Stucco Home. . . . Three Exteriors for one plan, built in Roland Park. . . . A Riverside 4-Level Home. . . . W. C. Tackett Modernistic Home near Chicago, with working plans. . . . Center Hall Colonial with attached garage. . . . Low Cost Firesafe Home. . . . House Put Together with Screw Nails.

A Cottage that "hugs the ground" . . . Stone and Old Brick Virginia Home. . . . 7-room Colonial at Cleveland. . . . "Modernism in Brick" at Chicago. . . . Franch Mansard Style at Kenilworth.

Each design presented has its "TruCost" figures for quick and accurate estimating. There are 10 pages of survey figures in some 30 units of construction on each of these 96 homes, and 27 pages fully explaining the "TruCost" system.



*Our dining-room
used to be gloomy*

BUT LOOK AT IT NOW!



RIGHT OVER OLD WALLS IN REMODELING—If prospects ask you to solve the problem of dingy walls and ceilings, Masonite Products will do the trick. These all-wood, grainless boards go on right over old walls—nailed or cemented. Look at this dining-room, for example, brightened up with marble-smooth wall panels of Masonite Presdwood. Can be painted or left in its natural warm-brown finish.

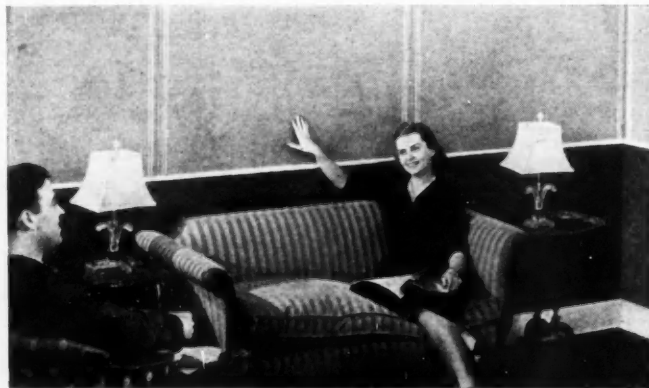

EYE-APPEALING EFFECTS—Masonite Products can provide any number of eye-appealing effects at very comfortable cost. In this living-room, Masonite Tempered Presdwood forms a durable, scuff-resisting wainscot, topped off with upper walls of Masonite Presdwood grooved vertically.

• MAIL COUPON TODAY FOR FREE SAMPLE OF MASONITE TEMPERED PRESWOOD AND DETAILS OF ITS USES IN NEW BUILDING, REMODELING.



COPYRIGHT 1939, MASONITE CORPORATION

FREE!

MASONITE

THE WONDER WOOD OF A THOUSAND USES

MASONITE CORPORATION, Department AB-19
111 West Washington Street, Chicago, Illinois

Please send free sample of Masonite Tempered Presdwood and Masonite De Luxe Quatrboard and information about these products in new and remodeled homes.

Name _____

Address _____

City _____ State _____

Air Conditioning Today

(Continued from page 96)

tainable personal characteristics and range of activities, to get rid of their own natural body heat production, neither so fast they'll feel chilly nor so slowly they'll feel hot, but just fast enough to be comfortable—why then, this slightly complicated sentence set out to say, you'll find all the seemingly contradictory pieces of the puzzle falling neatly into place.

Take temperature. It still, to most people, merely means a thermometer reading. But the thermometer only gives you the temperature of the air around it, at the particular point in the room where it is located. But that is not the air temperature that matters to you; it may or may not even be a good indication of *that* temperature. The temperature that matters to you is that of the air in actual contact with your skin; and less than in contact with your face than that in contact with the more sensitive areas of your body where heat transfer is freest—notably, with most people, the ankles and toes.

So not only does clothing come into it right away as an important element in what Dr. Sheard of the Mayo Foundation aptly calls "your private climate"; so does the not uncommon phenomenon called "stratification", in which cold air collects on the floor, and your feet and ankles may be immersed in a pool of 65° or even 61° air at the very time the wall thermometer blandly assures you the room temperature is 70°.

Then there's wall temperature, already referred to. Your body gets rid of its heat mainly in three ways—by convection to the air around it; by evaporation of perspiration; and by radiation to surrounding objects, of which the room walls are the most important. Radiation is actually the most important of these three; but convection is the only one with which room air temperature has much to do. There are other factors but the main point is that temperature standards should be taken less seriously than we used to take them.

The same thing applies to humidity. There are still too many die-hards around muttering darkly, "40 per cent., or else"; but sad experience has taught those who've had to wrestle with such things as condensation, and other untoward developments which seem to elude the laboratory and only turn up on the actual job, that there's much more to it than that.

There have been two extremely helpful experimental investigations into this phase of the problem; especially helpful because they attacked it from opposite directions—one from the point of view of apparatus and its results; the other from the physiological side. They are, respectively, the tests made at the famous "research residence" of the National Warm Air Heating and Air Conditioning Association, under the Association's research fellowship at the University of Illinois College of Engineering; and the experiments at the University of Minnesota conducted by Dr. Charles Sheard of the Mayo Foundation, already quoted.

The long and short of the whole thing has been proof that humidity is actually less important, both to health and comfort, than we thought. It mustn't be ignored of course. But its importance is chiefly in winter, when, in extremely cold weather, there is constant danger of its going too low, which means below 20 per cent. relative. Anything over 25 per cent. is good enough for health, comfort and furniture protection.

One of the points involved in this 40 per cent. humidity business that many have been overlooking is this; all the humidifiers and humidistats aimed at keeping 40 per cent. humidity in the home provide, not an *average* 40 per

(Continued to page 102)

Estimating Forms

Contractor's Record Book

Contains 21 2-page estimating forms listing 47 items and leaving 10 blank lines for extras. Columns for figuring the estimated cost and the actual cost, and 5 pages of handy estimating tables.

1939. 48 pages, 3 1/4 x 7, paper.....\$.25

Estimate for Suggested Home

A complete estimate form computed from plans, specifications and material list. There are two copies of Proposal for Complete Construction; and five copies of Estimate for Plumbing, Painting, Heating and Electrical Work.

1939. 14 pages, 9 x 12, loose leaf, paper.....\$.25

Material List Estimate for Suggested Home

A practical 8-column take-off form to help the estimator make up a complete list of every item that enters into the construction of a well built house. Each sheet deals with a definite part of the house.

1939. 32 pages, 9 x 12, loose leaf, paper.....\$.75

The Small Job Estimating Kit

A pocket-size, easy-to-use method for estimating 10 modernizing, repair, maintenance or other small jobs amounting to \$500 or less. The original bid figures covering labor, materials, work to be sublet, etc., are listed on the form which remains in the book. The figures are then transferred to the Letter of Proposal, which is detached and handed to the prospect.

1938. 4 1/4 x 8 1/2, 10 forms which open to 11 x 8 1/2, wrap-around cover, \$.35; 4 for \$1.00; 12 \$2.50

"Practical" Estimating Sheets

Quantity sheet for listing all classes of work from the plans. Space is provided for full and accurate description of all work estimated, allowing sufficient space for listing dimensions and quantities. Unit material prices with total cost of materials for each class of work and for the entire job can be entered in separate columns.

1938. Form 514. 100 sheets in a tablet, 8 1/2 x 11, green ink on white bond.....\$.75

"Practical" Summary of Estimate Sheets

The front side contains a complete list of the different classes of work encountered in residential construction. The back has a complete detailed list of every operation encountered in different branches of building.

Form 515. Pad of 50 sheets, 8 1/2 x 11, ruled green ink on white bond.....\$.75

Send for a Free Copy of our 1939 Book Guide

BOOK SERVICE DEPARTMENT

American Builder and Building Age

30 Church Street

New York, N. Y.

LESS
for heating
MORE
for other features
WITH
U. S. EQUIPMENT



Home of Mr. and Mrs. Henry C. Forster, Jr., Bingham Road, Birmingham, Michigan, heated by U. S. Equipment.

EFFICIENT and economical U. S. heating equipment leaves more in the building budget for other features that make houses easier to sell. This is especially important to the builder of moderate priced homes.

The home pictured above is equipped with a one-pipe Taco forced hot water system. This includes a Capitol Red Cap FS Series Boiler, with Biltin Taco heater for year-around domestic hot water.

Builders everywhere find U. S. equipment runs as little as 7% to 10% of the total building cost, depending on geographical location. Consult your heating contractor.

UNITED STATES RADIATOR CORPORATION

General Offices: Detroit, Michigan

Branches and Sales Offices in Principal Cities

BUILDERS Here's Great News GAR WOOD ANNOUNCES TWO NEW UNITS FOR SMALLER HOMES



**SALES
BUILDER 1**

Gas-Fired
Model 80
TEMPERED-
AIRE

Write today for illustrated literature describing Model 80 Tempered-Aire winter heating and air conditioning unit — Model B-120-W hot water Boiler-Burner heating unit. Both are sensationally new—Both are just what you need to build better homes for your clients.

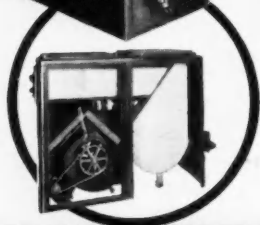

**SALES
BUILDER 2**

Oil-Fired
Model B-120-W
BOILER-
BURNER

AIR CONDITIONING DIVISION
GAR WOOD INDUSTRIES, INC.

7924 RIOPELLE ST., DETROIT, MICHIGAN
Canadian Distributors: Engineering Industries, Ltd., Leaside, Ontario

"Clean Up" BIG MONEY SURFACING FLOORS

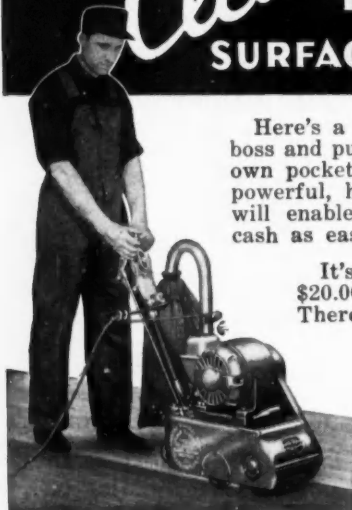

Here's a chance to be your own boss and put all the profits in your own pocket. Floor sanding with a powerful, high capacity American will enable you to clean up real cash as easy as ever in your life.

It's not unusual to clear \$20.00 for a day's work. There are no secrets—speed and quality work will do the trick every time the American Way. Sign and send coupon for more free details.

Return Coupon Today

The **AMERICAN** FLOOR SURFACING MACHINE COMPANY

511 SO. ST. CLAIR ST.

TOLEDO, OHIO

Gentlemen:

Send complete details and prices without cost.

I want to go into floor surfacing business.

I would use sander in my contracting business.

Name

Street

City State

Air Conditioning Today

(Continued from page 100)

cent. humidity, but a minimum of 40 per cent. The result usually is that every so often, when the temperature goes up rapidly as it occasionally does even in mid-winter, you get an absolute humidity . . . and even, for a time, a relative humidity . . . away above 40 per cent.; sometimes as high as 60 per cent. or over. With later results in the way of condensation, better imagined than experienced. Much better to have a minimum humidity of 25 per cent.; the resulting average will be manageable, healthy and comfortable.

Furthermore, humidity in summer is important only when the temperature is over your personal perspiration point. Its effect is, of course, upon your heat loss by evaporation; and when you are not actually perspiring, your heat loss from this factor varies so little with humidity changes that it may be said that a change from 30 per cent to 80 per cent humidity will have less effect upon comfort than a rise of only one or two degrees.

Finally, air motion . . . and just here is the point at which we are still sparring around a bit. The best authorities, however, now believe that air movement past the body of from 25 to 50 linear feet per minute . . . the less speed when the temperature and humidity are lower, and the higher speed to counteract the high temperatures . . . seems to be a pretty safe prescription.

But in this, and indeed in every aspect of the problem, our great gain in recent months has been in our better appreciation of the human factors. The human body is, after all, a fairly good automatic air-conditioning apparatus in its own right, and its powers of adjustment to widely varied conditions are really pretty wonderful . . . as was demonstrated in the classic example of the Cheyenne chief, who, when a much bundled-up white man asked how he could stroll abroad in breech-clout and moccasins in the snows of a Wyoming January, calmly pointed to the questioner's exposed features, and remarked, "Me, all face!"

How to Estimate Accurately

(Continued from page 67)

stud for every linear foot of outside wall. The perimeter of the building will usually give the linear feet of wall to be framed. The length of these studs will have to be scaled on the elevation sheet or wall section. Order the next even foot length of lumber. Then add two studs for every opening. The length of these opening studs will be the same as the stud height for each story.

RIBBON FOR BALLOON FRAMING: A ribbon (riband) is a piece of 1" stock notched into the inside face of the studs which are two stories in height and forms a support for the second floor joists. See Fig. 5. Ribbon material is sometimes used on a one story flat-roofed house. In this case the studs are long enough to form the firewall of the roof. The width of the ribbon will vary according to the plans and building ordinances. 1" x 4" and 1" x 6" are commonly used.

Rule: Order as many linear feet of ribbon stock as there are linear feet of outside supporting walls. The direction of the second floor or ceiling joists will determine which are the supporting walls as any wall parallel to the joists does not require a ribbon.

FIRESTOPS IN BALLOON FRAMING: Additional firestops are needed in the outside walls to close up the space behind the ribbon. See Fig. 5. The size is the same as the studs.

Rule: Linear feet of ribbon stock equals linear feet of firestop.

COVE BRACKETS: Cove brackets are required in any room that has a cove ceiling. Generally, the living room, dining room, or library only are specified to have a cove. Each bracket is made of 2" rough lumber bandsawed to the radius given on the plans, and nailed in angle formed by stud and ceiling joist. See Fig. 6.

Rule: Multiply the perimeter of the room by $\frac{3}{4}$; then add at least two extra brackets to allow for framing situations in which

(Continued to page 104)

A MAN BUILDS A HOME FOR A LIFETIME



Don't you think he would gladly pay a trifle extra to protect his woodwork? ASK HIM!

Just a few cents per door or window invested now gives lasting protection against decay, blue stain, swelling, warping and other common evils that attack wood.

Many architects now specify a WOOD-LIFE dip for trim, frames, windows, doors, etc.



WOODLIFE is not experimental. Countless houses throughout America offer daily testimony to WOOD-LIFE'S practical insurance for fine woodwork. (Get the facts on the WOODLIFE treatment.)

Typical Low-Cost Dipping Tank Used by Many Builders and Lumberyards To Treat and Prime Siding, Trim, Etc.

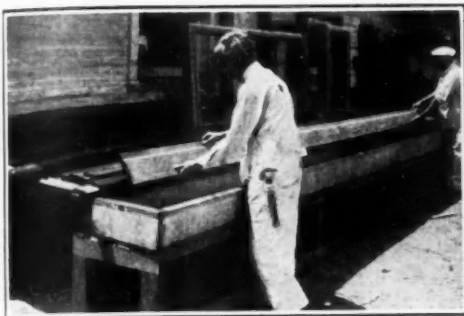

Protection Products Mfg. Co.

Mrs. of PRESERVATIVE SOLUTIONS for **18** Years
Research Laboratory and Plant KALAMAZOO, MICH.

Here's Help for Builders

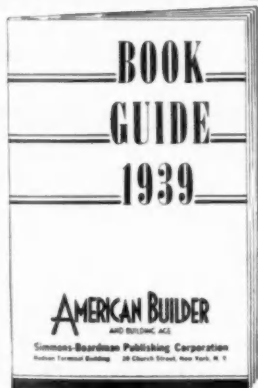

New 1939 Book Guide

of
American Builder and Building Age

A lot of the information you want is found in books. The problem of finding the right books is made a lot easier if you have a copy of this 1939 Book Guide on your desk. In its 64 pages are classified and described more than 500 building trades books. Year of publication or last revision is given so that you can find the latest book on the particular subject you are interested in.

Free on Request

BOOK SERVICE DEPARTMENT

American Builder and Building Age

30 CHURCH STREET

NEW YORK, N. Y.

EDWARDS FIREDAIRE OPEN FIREPLACE

The only open fireplace and mantel combined

F. H. A. APPROVED!

- NEW
- DIFFERENT
- PRACTICAL

Women enthuse about it!

Modern all-steel construction. Unlike anything ever offered before.

Installed in two hours without alteration to chimney or walls.

Burns any fuel—Holds fire over night—Heats 4 to 6 rooms on 1 or 2 Floors. For new construction and remodeling.

Seven Models, priced surprisingly low.

Write for Catalog and Special Introductory Offer

THE EDWARDS MANUFACTURING CO.
542-562 Eggleston Ave. Cincinnati, Ohio

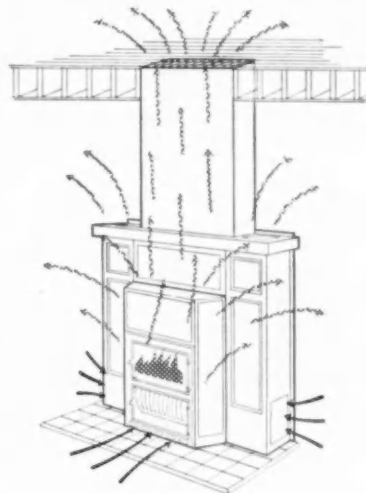

SEE this NEW LOW-PRICED DE WALT!

Watch it in demonstration! See for yourself how flexible it is—how quickly it can be changed for many different operations! This De Walt woodworker is designed for builders . . . an all-purpose woodworking tool that saves 20% to 30% in building jobs. It's light in weight—can be transported easily. It's fast . . . accurate . . . powerful . . . safe. And it's low-priced! Your savings pay for it quickly. Let us give you a demonstration. Write today.

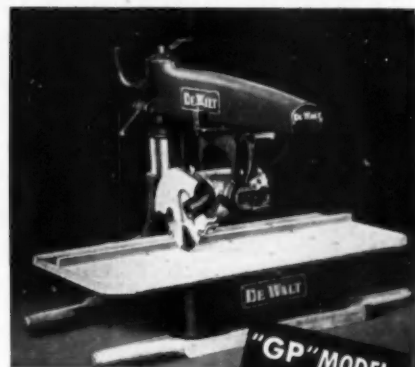

NEW 1/2 h.p. MODEL GP

Only \$175⁰⁰
F.O.B. FACTORY

"GP" MODEL
PORTABLE ✓
FAST ✓
ACCURATE ✓
FLEXIBLE ✓
POWERFUL ✓
SAFE ✓

DE WALT

425 Fountain Avenue, Lancaster, Pa.

"The Brute"

of Hand Saws . . . Model D 12" saw . . . with 4 1/2" cutting capacity Fast . . . Powerful . . . Accurate.

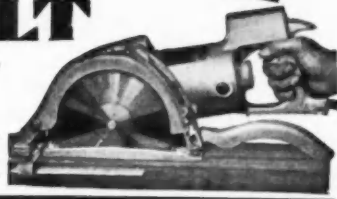

MONCRIEF

Furnaces and Winter Air Conditioners



Builders find in the complete Moncrief line a type and a size for every need—Winter Air Conditioners and Gravity Warm Air Furnaces in specialized types for gas, oil or coal. All quality built, moderately priced.

See a Moncrief Dealer Near You. Send for new literature.

THE HENRY FURNACE & FOUNDRY CO.

3479 E. 49th STREET, CLEVELAND, OHIO

BIGGEST NEWS IN SMALL MIXERS!

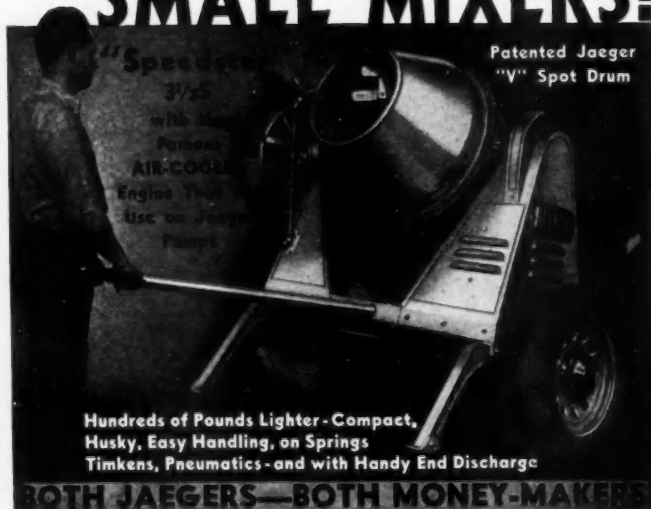

Hundreds of Pounds Lighter - Compact, Husky, Easy Handling, on Springs Timkens, Pneumatics - and with Handy End Discharge

BOTH JAEGER — BOTH MONEY-MAKERS



3 1/2 UTILITY WITH MEASURING BATCH HOPPER

Fast as a Power Loader—Up to 40 Yds. a Day Load next batch while you mix and discharge—no waiting—30% to 40% more yardage daily, all your job can handle. Saves you about half the cost of heavy 5S Non-Tilts. Get new catalog and prices.

THE JAEGER MACHINE COMPANY
521 Dublin Avenue Columbus, Ohio

How to Estimate Accurately

(Continued from page 102)

the studs may be closer than 16" o.c. If required, allow one hip cove for each corner or angle. Repeat for all coved ceiling rooms.

STORM SHEATHING: Storm sheathing, sometimes called diagonal boarding, is 1" x 6" lumber cut and nailed on the outside of exterior framed walls. It is also necessary on the inside face of the firewall studs. It is laid either straight or at a 45 degree angle. See Fig. 3. There are four framing situations to be considered: walls without openings, walls with openings, gables, and firewall areas. The manner of laying it affects the quantity of material as there is more waste when laying it diagonally than straight.

Rule for walls without openings: Multiply the wall height, from sill line to top plate, by the building perimeter. If sheathing is laid straight add 1/10; if laid diagonally add 1/6. Result equals board feet of sheathing required.

Rule for walls with openings: Laid straight, find the total wall area (as above); deduct all openings 20 sq. ft. or more. Result equals board feet of sheathing.

Laid diagonally, find the total wall area; deduct all openings 20 sq. ft. or more; then add 1/10. Result equals board feet of sheathing.

Rule for each gable area: Find gable area by multiplying roof rise by one-half the span. If sheathing is laid straight add 1/10 if laid diagonally add 1/5.

WALL SHEATHING FOR SHINGLES: Shingle sheathing is 1" x 4" laid horizontally on the outside face of the wall studs to form a nailing surface for wood shingles. See Fig. 3.

The spacing of the sheathing varies; some shingle manufacturers advocate the sheathing be spaced on centers the same as the shingle exposure. Trade practice in some parts of the country has been to space the sheathing from center to center twice the shingle exposure. The following table covers both situations:

SHINGLE SHEATHING TABLE

Spacing Center to Center	Shingle Manufacturer Recommendations			Trade Practice		
	4"	4 1/2"	5"	8"	9"	10"
Constant for 1" x 3"	.75	.7	.6	.4	.35	.3
Constant for 1" x 4"	1.0	.9	.8	.6	.5	.45

Rule: Figure total surface area to be covered. Deduct area of all openings. Multiply net area by constant selected on basis of shingle exposure. Add 5% to allow for waste. Result equals board feet of sheathing required.

FIREWALL SHEATHING: Firewall sheathing is only required on flat-roof houses when the outside walls project above the line of the roof. The sheathing is laid horizontally or sometimes follows the slope of the roof. There is considerable waste due to this slope which is allowed for by using the firewall dimensions as measured at the lowest part of the roof.

Rule: Multiply the perimeter of the roof by the height of the firewall at the lowest part of the roof. Result equals board feet of sheathing.

PLASTER GROUNDS FOR BASEBOARD: Plaster grounds are not really a part of the framework of a building but are considered in this unit so that they will not be overlooked. They are 3/8" x 3/8" strips of lumber nailed horizontally on the inside face of the studs a little below the top of the finish base line. If properly applied, they serve as a guide for the plasterer, so that a true and straight plastered surface can be obtained.

Rule: Figure the perimeter of each room, then deduct the width of each door or archway opening. Result equals linear feet of ground stock. Opening widths are reduced to the nearest foot. The exact size of the ground is determined by the specification or building ordinance requirements which give the thickness of the plaster.

Note: Trade practice now permits nailing on the baseboard before plastering. A piece of 1" x 4" flooring stock is often used. The base then becomes the ground for the plaster and is painted before the plastering is done. The rule given above will apply.



Wright Rubber Tile
Installation in Cook
County Nurses
Home, Chicago,
Illinois



MAKE MORE PROFITS WITH FLOORS OF LASTING BEAUTY



One Wright flooring job sells another. Wright floors have a tough impervious surface—keeps its beauty years longer—is less fatiguing on the feet—makes cleaning easy. Comes in gay colors and patterns for all decorative schemes. Easy to lay on new or old floors. Costs no more than good linoleum. A great profit builder. See Sweet's or write—

FOR HOMES
OFFICES
SCHOOLS
CHURCHES
HOSPITALS
ALL FLOORS

WRIGHT RUBBER PRODUCTS CO.
1603 Layard Ave. Racine, Wis.

WRIGHT RUBBER TILE



EVERYTHING about The Gotham bespeaks gracious living—its spacious rooms, its atmosphere of good taste, its superb cuisine . . . Elegance is apparent; economy not forgotten.

Under the same Management as

- The Drake
CHICAGO
 - The Blackstone
CHICAGO
 - The Evanshire
EVANSTON, ILL.
 - The Town House
LOS ANGELES
- A. S. Kirkeby
Managing Director

The Gotham

Fifth Avenue at 55th Street · NEW YORK CITY

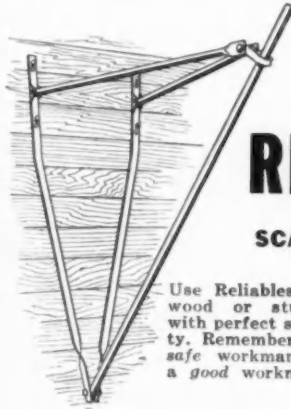

RELIABLE

SCAFFOLD BRACKETS

Use Reliables on wood or stucco with perfect safety. Remember: A safe workman is a good workman.

Reliables are easy to erect or remove to another job. Fold up compactly. Far less bulky to handle.



Speed Up BUILDING and PAINTING

Cut Scaffolding Cost 50%

In the last 25 years thousands of Builders and Painters have PROVED that RELIABLE Scaffold Brackets cut scaffolding costs in half, last for decades and are many times SAFER. RELIABLES are easy to erect and remove—leave no holes to be plugged.

Amazingly superior in every way to wooden scaffolding. You owe it to yourself to know all about these remarkable brackets.

WRITE TODAY for free literature

RELIABLE JACK CO., 1401 W. Second Street, Dayton, Ohio

RELIABLE

SCAFFOLDING BRACKETS

Something New FOR THE HOME BUILDER!



MALL 1 h.p. Jack-of-all-Trades gasoline engine with its many attachments.

An efficient, low priced gasoline engine for vibrating concrete in footings, foundations and concrete homes to get stronger, denser, and more durable concrete. Eliminate aggregate pockets and expensive patching, and get better jobs. You can rub the surfaces, too, to get a fine white Monolith finish. Attachments for PUMPING, SAWING, SANDING, DRILLING and WIRE BRUSHING available.

You profit in two ways—you make more money and get more satisfied home owners with this versatile tool. Write for descriptive circular—no cost or obligation!

MALL TOOL COMPANY

7737 South Chicago Ave.
Chicago, Illinois

Please send additional information on the 1 H.P. gas engine unit. Also, on MALL electric handsaws and other power tools.

Name.....
Street.....
City..... State.....



VICTOR In-Bilt VENTILATORS

If you want your homes to appeal to the most people, be sure to install Victor In-Bilt Ventilators. Cooking odors, greasy fumes smoke and steam have no place in the modern home and a Victor In-Bilt sees to it that they don't stay there. Look over the complete Victor line now—there's a model for every size and price of home and they are all built to give years of trouble-free performance.



FREE! WRITE TODAY!

Send today for Victor's Ventilation Data Book—contains valuable information every architect and builder should have. Write for your Free copy now.

VICTOR ELECTRIC PRODUCTS, INC.
3010 Robertson Avenue Cincinnati, Ohio



THE DE LUXE



THE STANDARD



THE MASTER

New 3 1/2-S KWIK-MIX non-till

Modern Rubber Roller Drum Drive



No ring gear—no pinion
—no countershaft, less wear—smooth running.

LOAD WHILE MIXING— INCREASES PRODUCTION 40 TO 50%

END DISCHARGE

Write For Bulletin 2X

KWIK-MIX CONCRETE MIXER CO.
PORT WASHINGTON . . . WISCONSIN

NEW INFORMATION— CATALOGS OFFERED

Readers Wanting to Receive Any of the Catalogs and Data Sheets Listed in This Department Should Write on Their Business Stationery Direct to the Manufacturer. When Writing, Mention This Department of American Builder and State Your Occupation or Business Connection.

JANITROL GAS-FIRED HEATING EQUIPMENT—New information regarding the Janitrolaire, a radio cabinet size self-contained heating unit for small basementless bungalows or apartments, the Janitrol CA winter conditioner for larger homes, and the Janitrol BC line of low-cost conditioners in both horizontal and vertical models. Illustrated data sheets give clear instructions for installation.—**SURFACE COMBUSTION CORP.**, Toledo, Ohio.

"HOW TO MAKE GOOD WATERPROOFED CONCRETE"—A 36-page book tells why concrete, stucco, masonry and mortar should be waterproofed during original construction. It explains the advantages of waterproofed cement in making concrete for above grade and below grade construction. Specifications are included for waterproofing all walls and floors; also specifications for waterproofing existing concrete work.—**MEDUSA PORTLAND CEMENT CO.**, 1000 Midland Bldg., Cleveland, Ohio.

"WIREMOLD SURFACE WIRING SYSTEM"—A 16-page handbook for builders and wiring contractors, showing the many new forms of hollow metal raceways and fittings. The new Wiremold "Plugmold" is clearly presented. A companion piece is the "Wiremold Catalog and Wiring Guide," 1938 edition, 100 pages, pocket size.—**THE WIREMOLD CO.**, Hartford, Conn.

"AUTOMATIC FLOOR FURNACES BY AGP"—An informative folder showing gas-burning floor furnaces with floor registers, single side wall registers, and double side wall registers. These inexpensive heating plants require no basement space.—**AMERICAN GAS PRODUCTS CO.**, Div. of American Radiator Co., 40 W. 40th St., New York City.

"PERMUTIT ZEOLITE WATER SOFTENING"—Bulletin No. 597 is a 32-page illustrated handbook on water conditioning. It describes this simple method of removing hardness from water supply, and illustrates the details of water softening equipment in many types of industrial buildings.—**THE PERMUTIT CO.**, 330 W. 42nd St., New York City.

"CHENEY FLASHING"—A new 16-page data sheet giving full details of two new Cheney flashing products, the Three-Way 10-oz. flashing, and the Cheney system of spandrel waterproofing, now available in plain copper and in lead coated copper. How \$500 worth of flashing could save \$25,000 is related.—**REVERE COPPER AND BRASS INCORPORATED**, 230 Park Ave., New York City.

"AMES MOULDINGS"—A 20-page fully illustrated catalog of metal mouldings and metal-covered wood mouldings, also snap-on mouldings, counter edgings, nosings, etc., in plated metal, stainless steel, aluminum, copper and brass. Price list is included.—**AMES METAL MOULDING CO., Inc.**, 225 E. 144th St., New York City.

"KITCHEN PLANNING WITH CURTIS"—A rich brochure in color, 32 pages, presenting the latest available kitchen planning information for those thinking of building or modernizing a home, as well as for architects, builders and dealers. An ingenious series of cut-out pages takes the average kitchen space without cabinets, and shows the results of adding one by one twelve different Curtis kitchen units. Dimensions and details of construction are clearly shown. Eighteen basic units in the Curtis kitchen cabinet line are included in this new book.—**CURTIS COMPANIES SERVICE BUREAU**, Clinton, Iowa.

(Continued to page 108)



*He makes a
P R O F I T
on Scaffolding!*

HE'S ONE OF THE 100's OF
CONTRACTORS WHO USE

**"TROUBLE SAVERS"
NAIL ATTACHED BRACKETS**

You can't bend them! You can't wear them out! You can't beat them for simplicity—safety—and savings! They can be erected and dismantled in a fraction of the time it takes to build even a make-shift scaffold! They fold compactly for carting and storage—and they give life-time service at steady savings in time and material!

"Just 4 Nails—That's All!"

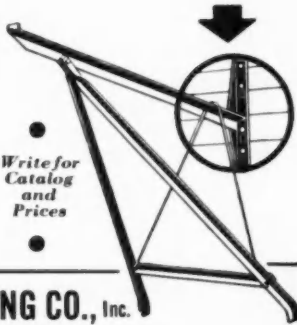

A Complete Line

includes "TROUBLE SAVER" Asphalt Singlers, Roofing Brackets, Studding Brackets, Ladder Jacks, Adjustable Steel Trestles, Single Pole Scaffolds, Mason's Steel Horses, etc.

Write for
Catalog
and
Prices

THE STEEL SCAFFOLDING CO., Inc.

Governor & Missouri Sts., Evansville, Ind.

**HOW TO ESTIMATE FOR THE
BUILDING TRADES**

By Gilbert Townsend, Ralph Dalzell and James McKinney

This new book gives complete information on the estimating of materials and labor for every phase of the building trades as related to residences and moderate sized buildings. It not only covers all formal estimating processes but includes a complete explanation of all the things a man needs to know to do a thorough job. Questions with answers worked out in detail refer to an actual set of full sized blueprint plans.

Contents

Mathematics Related to Estimating. Specifications and Contracts. Blueprint Reading. Surveying and Excavation. Footing. Foundations and Walls. Framing and Trim. Procedure of Construction and Check Lists. Cost Records. Estimating Forms. General Principles Relating to Estimating Materials and Labor for Excavations, Masonry, Carpentry, Electricity, Sheet Metal, Marble and Tile, Lath and Plaster, Painting, Linoleum, Window Shades and Curtain Rods, Plumbing, Furnaces, Heating and Air Conditioning, Hardware, Glass. Functions of Numbers. Index.

1939. 629 pages, 310 illustrations, 44 tables, 555 questions and answers, index, 5 1/2 x 8 1/2, cloth, \$4.75.

BOOK SERVICE DEPARTMENT

AMERICAN BUILDER AND BUILDING AGE

30 Church Street

New York, N. Y.

Specify

for **DURABILITY
EFFICIENCY
ECONOMY**

"Windows to be hung with Samson Spot Cord; size of cord and size of pulleys to agree with manufacturer's list...."

SAMSON SPOT CORD is made of extra quality cotton yarn, firmly braided, smoothly finished, carefully inspected and guaranteed to be free from the imperfections which cause inferior sash cords to wear out quickly. When used with proper weights and pulleys, Spot Cord will give more than 25 years of service.

Write for Samples and Specification Data.



SAMSON CORDAGE WORKS
BOSTON, MASSACHUSETTS

**SAVE
50% or More
of FINAL COSTS on
WOOD FLOOR
FINISHING
WITH
LIGNOPHOL**

LIGNOPHOL costs less than one cent per square foot. It is applied in one coat with a long handled brush—reducing labor to the minimum. The U.S. Forest Products Service says linseed oil does not even protect and—you know shellac and varnish are surface treatments that wear off.

When you use LIGNOPHOL there is nothing to wear off. Its ONE application gives smoother, harder, more attractive floors. Thousands of contractors are finding the LIGNOPHOL method of preserving and finishing floors (and trim) at 50% or more savings, the modern way to more profits and greater job satisfaction.

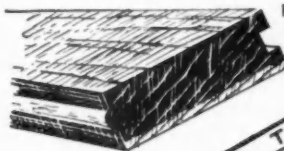

Find out more about advantages of LIGNOPHOL—

MAIL THIS COUPON TO-DAY!
Dept. B-7, L. Sonneborn Sons, Inc., 88 Lexington Ave., New York City

YOUR NAME _____
ADDRESS _____
CITY _____
STATE _____

Illustration shows how deeply LIGNOPHOL penetrates the wood.

Every Home Should be Calked
STOPS DRAFTS AND LEAKS—CUTS FUEL BILLS

Be Sure to Calk with Pecora

For 30 years, Pecora Calking Compound has been used by leading architects and builders. Many of the Nation's finest buildings are Pecora-calked. This material is absolutely dependable, for it will not dry out, crack or chip when properly applied. Available in bulk, or in non-refillable metal cartridges of approximately one quart size for use with the new improved Pecora High Pressure Calking Gun illustrated.



Write for illustrated folder



This Gun With 3 Nozzles and 4 Cartridges of approx. 1 qt. each Shipped Express Collect for **\$6.50**

Pecora Paint Company, Inc.
Member of Producers' Council, Inc.
Established 1862 by Smith Bowen
Fourth St. & Reading R. R. Philadelphia

ALSO MORTAR STAINS • SASH PUTTIES • ROOF COATING
• PECOMASTICS FOR STRUCTURAL GLASS INSTALLATION

SMITH 3½-S TILTER—the ONLY
Small Mixer equipped with a FEED CHUTE



31" wide and only waist high, the handy Smith feed chute provides the shovelman with a big target to shoot at. Prevents spilling. Speeds up charging. Saves time with every batch. Included as standard equipment on all small Smith Tilters.

Write for literature.
THE T. L. SMITH CO.
2849 N. 32nd St., Milwaukee, Wis.

SMITH MIXERS
THE BOULDER DAM MIXERS

Catalogs Offered

(Continued from page 106)

"CALCIUM CHLORIDE AND PORTLAND CEMENT"—52-page pocket-size handbook giving clearly and concisely the exact effects of calcium chloride on portland cement mixes, including setting time, early strength and ultimate strength. It shows how calcium chloride affects curing, and why the addition of calcium chloride permits the reduction in water cement ratio.—SOLVAY SALES CORP., 40 Rector St., New York City.

"COPPERSKIN—20 USES AND DIAGRAMS"—An 8-page detail sheet of damp-proofing, waterproofing, insect-proofing, flashing, drip pans, vapor-sealing and protecting insulation in commercial buildings, residences and public works. A companion piece features "Vapor-Seal with Copperskin or Brown-skin," an effective, permanent barrier against the passage and condensation of water vapor inside the wall and roof spaces of modern buildings.—ANGIER CORP., Framingham, Mass.

"FLINT SIDEWALL STAGING BRACKETS"—An interesting 4-page folder shows how to save \$15 to \$20 on every siding job through the use of the Flint system of staging and brackets. The well known Flint ladders are also catalogued.—A. W. FLINT CO., New Haven, Conn.

"HOW TO USE 'STERLING' CONVERTIBLE WYE LEVEL"—A valuable 52-page handbook, pocket size, telling all about the Sterling convertible level and how to use it. Six common problems in laying out buildings, land measurement and determining levels are given, illustrated and fully explained. The handy catalog section covers drawing instruments, tapes, scales, slide rules, etc.—WARREN-KNIGHT CO., 136 N. 12th St., Philadelphia, Pa.

"THE PLYWOOD CATALOG"—The May 1939 edition of this catalog is said to be the most elaborate work of its type ever produced in the plywood field—more detailed, even, than the previous issues. It is a 32-page illustrated handbook, and lists and prices the plywood of every description, both domestic and imported woods, carried in stock by this large manufacturer and distributor.—UNITED STATES PLYWOOD CORP., 616 W. 46th St., New York City.

"UNIQUIP ELECTRIC HAND TOOLS"—A 6-page folder gives illustrations and mechanical specifications of the new Uniquip router, power plane and door mortiser, and describes the automatically self centering templet for mortising for butt hinges and locks. Numerous special cutting heads are shown.—UNIT ELECTRIC TOOL CO., Inc., Syracuse, N.Y.

"AMTICO AND TRENT RUBBER FLOORING"—A 12-page de luxe brochure in full color illustrates the wide variety of patterns and colors now offered in the Amtico marbled rubber tile flooring. Illustrations show applications in numerous types of buildings.—AMERICAN TILE & RUBBER CO., Trenton, N.J.

"THE STORY OF AIR CONDITIONING"—A cleverly written popular explanation of air conditioning, what it is, and what it does. This is a 16-page booklet prepared and issued by the Bureau of Information—AIR CONDITIONING MANUFACTURERS ASSN., Southern Bldg., Washington, D.C.

"VITRA SEAL"—An interesting 6-page folder is entitled, "The Reason Why This Vitra Seal Licensed Contractor Should Get Your Floor Job." It tells about Vitra Seal floor finish and cites prominent users.—VITRA SEAL CO., Inc., 531 Church St., Ridgefield, N.J.

"PULLMAN UNIT SASH BALANCES"—A new general catalog No. 42 of 32 pages and covers presents the 14 sizes and styles of Pullman unit sash balances, shows how they are constructed, how installed, and illustrates many important buildings in which they are installed. Blueprint details and complete specifications give all necessary information.—PULLMAN MFG. CORP., Rochester, N.Y.

(Continued to page 110)

AS ESSENTIAL AS YOUR PENCIL



WRITE FOR YOUR COPY NOW



COMMERCIAL

HOMES

GARAGES

—The No. 39 CATALOG for Correct Door Selections

If you plan, specify or build residences, garages or commercial structures, you'll find the new WOCO and LAMINEX door catalog indispensable.

Entrance doors for modern, period or conventional homes—interior doors to meet every requirement—and garage doors that hit a new high in economy are described and illustrated—over 200 designs and layouts are included.

Just tell us where to send this time- and money-saving book of door facts and we'll mail it—no cost to you—no obligation.

WHEELER OSGOOD SALES CORPORATION

Factory and General Office: Tacoma, Washington

Branch Offices: Los Angeles, Dallas, Wichita, Tacoma, San Francisco

General Sales Offices: New York, Chicago

Stocks Carried in Principal Cities

The Country's Most Complete Line of Doors

WHO



SUCCEEDS IN THE BUILDING WORLD?

The TRAINED MAN succeeds! The untrained man is doomed to eternal failure—unless he ACQUIRES sound, practical knowledge.

Since 1891, nearly 5,000,000 men have enrolled with the I.C.S. More than 2000 progressive concerns have

employee-training agreements with these world-wide Schools. I. C. S. graduates hold leading executive positions in every industrial field.

We believe there is food for thought—for the employer and the employee—in these facts!

INTERNATIONAL CORRESPONDENCE SCHOOLS

BOX 9238. SCRANTON, PENNA.

Please furnish me with full particulars about the subject indicated:

TECHNICAL AND INDUSTRIAL SUBJECTS

- | | | |
|---|---|--|
| <input type="checkbox"/> Air Conditioning and Cooling | <input type="checkbox"/> Diesel Engineering | <input type="checkbox"/> Refrigeration |
| <input type="checkbox"/> Architecture | <input type="checkbox"/> Electrical Engineering | <input type="checkbox"/> Sanitary Engineering |
| <input type="checkbox"/> Bridge Engineering | <input type="checkbox"/> Electric Lighting | <input type="checkbox"/> Sheet Metal Work |
| <input type="checkbox"/> Building Estimating | <input type="checkbox"/> Foremanship | <input type="checkbox"/> Steam Engineering |
| <input type="checkbox"/> Chemistry | <input type="checkbox"/> Heating | <input type="checkbox"/> Steam Fitting |
| <input type="checkbox"/> Civil Engineering | <input type="checkbox"/> Machinist | <input type="checkbox"/> Structural Engineering |
| <input type="checkbox"/> Coal Mining | <input type="checkbox"/> Mechanical Drafting | <input type="checkbox"/> Surveying & Mapping |
| <input type="checkbox"/> Contracting and Building | <input type="checkbox"/> Mechanical Engineering | <input type="checkbox"/> Ventilation |
| | <input type="checkbox"/> Plumbing | <input type="checkbox"/> Welding, Electric and Gas |
| | <input type="checkbox"/> Radio | |

BUSINESS SUBJECTS

- | | | |
|--|--|---|
| <input type="checkbox"/> Accounting | <input type="checkbox"/> Civil Service | <input type="checkbox"/> High School Subjects |
| <input type="checkbox"/> Advertising | <input type="checkbox"/> College Preparatory | <input type="checkbox"/> Salesmanship |
| <input type="checkbox"/> Bookkeeping | <input type="checkbox"/> First Yr. Col. Subjects | <input type="checkbox"/> Secretarial Work |
| <input type="checkbox"/> Business Management | | |

Name..... Age.....

Address.....
Canadian residents send coupon to International Correspondence Schools Canadian, Limited, Montreal, Canada.

STERLING Balanced WHEELBARROWS HAVE THESE FEATURES

- | | |
|------------------------------|-----------------------------------|
| 1. 10 Spoke Whee's | 6. Interchangeable Parts |
| 2. Channel Steel Legs | 7. Square Bent Leg Shoes |
| 3. Self Lubricating Bearings | 8. V-Braces and Braces Supports |
| 4. Malleable Axle Brackets | 9. Clear Maple or Tubular Handles |
| 5. Malleable Wheel Guards | 10. Welded Trays |

Heavy Continuous Rod in Top Edge of Tray



No. S-18 BARROW

STERLING WHEELBARROW CO.

MILWAUKEE, WISCONSIN

Estimating Building Costs

By WILLIAM ARTHUR

THIRD EDITION—Revised and Enlarged

This concise and handy volume has been specially prepared for the use of building tradesmen, contractors, material men, technical students, instructors and all others interested in the construction of dwellings, barns, stores, and industrial buildings of moderate cost. It contains a collection of material data covering all classes of building construction and arranged for quick reference. There are ninety-one tables showing the actual number of hours of labor and quantities of material on work done. These examples are all worked out on the basis of \$1.00 per hour for mechanics, and 60 cents per hour for laborers. The quantities are given and any change of rates can easily be adjusted by simple proportion.

PRICE \$2.00 POSTPAID

AMERICAN BUILDER & BUILDING AGE

30 Church Street

New York, N. Y.

PATTERNED HARDWOOD

is the greatest floor news of this age!



Here is floor news you can't afford to miss! Here is a modern hardwood flooring with a scientific finish, enduring beauty, and a smart parquet design.

Write for FREE BOOK on Bruce Finished Blocks—fabricated units of genuine hardwood flooring that can be laid easily over wood or concrete.

E. L. BRUCE CO.

Memphis, Tenn.

Dept. AB-7

"The Handiest Saw Ever Made"

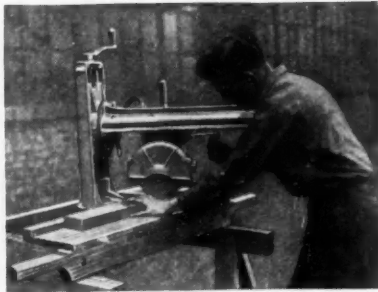

And the most profitable, too, for the builder!

The Wallace No. 1 Radial Saw is quickly and easily set up for cross-cutting, ripping, mitering, shaping, routing, fluting, dadoing, and many other jobs.

Portable and easy to handle. Write today for illustrated bulletins and prices.

J. D. WALLACE & COMPANY
136 S. California Ave. Chicago, Illinois

ORNAMENTAL WROUGHT IRON

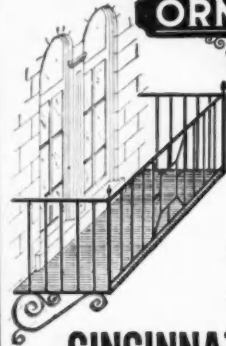

**FOR INTERIOR AND
EXTERIOR USE**
MADE TO SUIT
YOUR REQUIREMENTS

Also manufacture Iron Fence, Gates, Wire & Iron Window Guards, Grilles, Area Gratings, etc. Write for latest Folder. Send Measurements.

CINCINNATI IRON FENCE CO., INC.

3411 Spring Grove Ave.

CINCINNATI

OHIO

Get the Story of

REZ

TRADE MARK REG. U.S. PAT. OFF.

Synthetic resin sealer
—protects plywood, millwork—
saves paint—cuts finishing costs!

I. F. LAUCKS, Inc.,

Seattle, Wash.; Lockport, N.Y.

MR. KEES SAYS:

"THESE KEES GOSSETT SCREEN AND STORM SASH HANGERS ARE EASY ON YOUR NERVES. No fuss. No trouble!"



● Use Kees Gossett Hangers for screen and storm sash. One set of hooks serves for both. The quickest, easiest way to put up or take down sash . . . from inside the house or out. Mr. Kees will send you Free sample hangers on request, along with his new 1939 catalog of builders' hardware and hardware specialties. Write today.

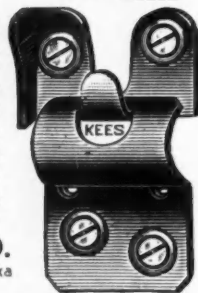

F. D. KEES MANUFACTURING CO.
Box 193 (Established 1874) Beatrice, Nebraska
Distributed Thru Wholesale Hardware Trade

Catalogs Offered

(Continued from page 108)

"PERMO DIP TOXIC"—An important little folder offers a line of quality wood sash guaranteed against dry rot, fungus decay and termite destruction since treated with Permo Dip Toxic.—E. & F. KING & CO., Inc., 399 Atlantic Ave., Boston, Mass.

"CATALOG OF NEW TRUFIT DOUGLAS FIR DOORS"—A 16-page portfolio illustrating the new line of factory-fitted, scuff-stripped, precision-made, trade marked, exact size, individually packaged stock fir doors. These are entrance doors of real distinction and lasting quality.—FIR DOOR INSTITUTE, Tacoma Bldg., Tacoma, Wash.

"HOW TO CUT COSTS ON SMALL HOMES"—An 8-page brochure showing how the Skilsaw (electric hand saw) brings savings in time and labor costs on specific jobs of house framing.—SKILSAW, Inc., 5033 Elston Ave., Chicago, Ill.

"MULTIPLEX SAWS"—The Red Star Multiplex saw in three models is described in a new circular. Illustrations show the various operations, such as cross-cutting, bevel cross-cutting, ripping, bevel ripping, shaping, mitering, bevel mitering, dadoing, ploughing and tenoning. Attractive prices are quoted. A companion piece features the Red Star pneumatic tire carts in three models and three capacities.—RED STAR PRODUCTS, Inc., 12910 Taft Ave., Cleveland, Ohio.

"GAR WOOD HOISTS AND DUMP BODIES"—Labor-saving dump bodies for Ford trucks and for other 1½ to 2 ton trucks are illustrated and described in new folders. Numerous types and sizes are offered. Several ingenious labor-saving features are of special interest to contractors and building supply dealers.—GAR WOOD INDUSTRIES, Inc., 7924 Riopelle St., Detroit, Mich.

"HOTSTREAM WATER HEATERS"—An elaborate series of data sheets, bound in portfolio, illustrate and describe the extensive line of Hotstream water heaters. Both gas and electric heaters are included, and many different models are offered.—THE HOTSTREAM HEATER CO., 8007 Grand Ave., Cleveland, Ohio.

"CLAY EQUIPMENT FOR DAIRY AND HORSE BARN"—A new handy pocket sized book of 232 pages with more than 600 illustrations, all pertaining to the planning and equipping of buildings to house cows, hogs, horses and poultry is now ready. Numerous farm building designs, blueprinted floor plans, and cross section details make this a valuable reference book. A quick reference index is a valuable feature also included with it.—CLAY EQUIPMENT CORP., Cedar Falls, Iowa.

"HIGGIN SCREEN"—A most satisfactory 16-page handbook of details and specifications of metal frame and rolling screens, screen doors, and metal and wood frame porch screens. The line is extensive and has many special features. Companion pieces offer the new Higgin Venetian blinds, Higgin light tight shades, metal frame storm sash, etc.—HIGGIN PRODUCTS, Inc., Newport, Ky.

"FLOWERHOUSE"—"Keep Your Garden Growing All Year Long in Your Own Flowerhouse" is the appealing title of a new 4-page circular offering a small greenhouse of radically new design. It is polygon-sided with a cupola top. Framework is Douglas fir, panels plastic-bonded plywood, and is shipped knock-down, fully glazed, in cardboard cartons. It is easily assembled and erected.—NATIONAL TANK & PIPE CO., Portland, Ore.

"TWO KITCHEN SINKS IN ONE"—The new Humphries two-compartment Sinkmaster is attractively presented in a new folder. This new style kitchen sink is supposed to make dishwashing twice as easy because there is one compartment for washing and one for rinsing, each with drainboard. The circular suggests various assortments of wall and base cabinets to go with this sink.—THE HUMPHRIES MFG. CO., Mansfield, Ohio.