

JANUARY, 1941 - 25 CENTS

AMERICAN BUILDER

PUBLIC LIBRARY
APR 1 1941

AND
BUILDING
AGE

THE WORLD'S GREATEST BUILDING PAPER



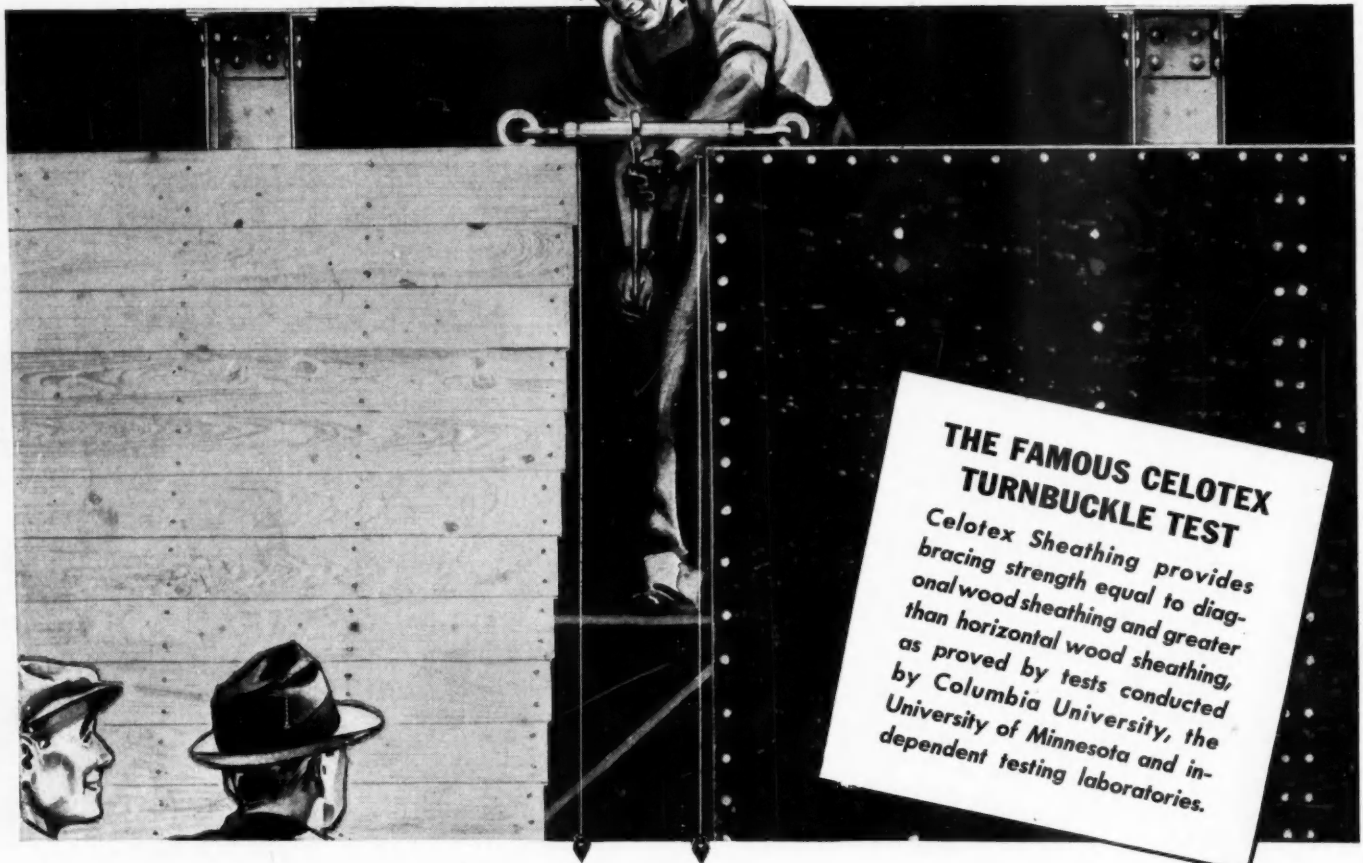
1940 BUILDING INDUSTRY TRENDS & FORECAST FOR 1941

Tech.

STRENGTH *plus* EFFICIENT INSULATION

... Enables Contractors to Give Today's Owners

EXTRA VALUE!



**THE FAMOUS CELOTEX
TURNBUCKLE TEST**
Celotex Sheathing provides
bracing strength equal to diagonal wood sheathing and greater
than horizontal wood sheathing,
as proved by tests conducted
by Columbia University, the
University of Minnesota and independent testing laboratories.

Contractors Who Use Celotex Vapor-seal Sheathing Avoid Delays— Give Owners Extra Strength—Plus Insulation—At No Extra Cost!

WHEN so many contractors meet the current sheathing lumber situation by using Celotex Vapor-seal Sheathing, they are doing more for owners than merely avoiding annoying delays. This material in large boards, by actual test, provides structural strength equal to that of diagonal wood sheathing. It provides three times the insulation of wood. It permits tight wall construction. It is permanently protected against termites and dry rot by the patented Ferox Process. And it is guaranteed in writing for the life of the building!*

*When issued, applies only within Continental United States.

Yet all these extra advantages represent, in most cases, practically no extra investment for the owner. For nineteen years Celotex Sheathing has provided structural strength, insulating efficiency, and all-around satisfaction in thousands of homes. Increasing numbers of architects are using Celotex Vapor-seal Sheathing today. Celotex is the brand preferred by 8 out of 10 insulation board buyers, according to a recent survey. Available in vertical boards 4' wide and in the new 2' x 8' horizontal center-matched units.

CELOTEX

REG. U. S. PAT. OFF.

BUILDING PRODUCTS
INSULATING SHEATHING, LATH, INTERIOR FINISHES
ASPHALT SHINGLES, SIDING, ROLL ROOFING
HARD BOARDS • ROCK WOOL BATTS, BLANKETS
GYPSUM PLASTERS, LATH, WALL BOARDS

Sales Distributors Throughout the World

★ WE FAVOR ADEQUATE PREPAREDNESS FOR NATIONAL DEFENSE ★

THE CELOTEX CORPORATION • 919 NORTH MICHIGAN AVENUE • CHICAGO, ILLINOIS

Published monthly by Simmons-Boardman Publishing Corporation, 105 W. Adams St., Chicago, Ill. Subscription price, United States, Possessions, and Canada 1 year \$2.00; 2 years, \$3.00; foreign countries: 1 year, \$4.00; 2 years, \$7.00. Single copies, 25 cents. Entered as second-class matter Oct. 11, 1930, at the Post Office at Chicago, Illinois, under the act of March 3, 1879, with additional entry as second-class matter at Mount Morris, Ill. Address communications to 105 W. Adams St., Chicago, Ill.

✓ R v.63 1941

(A Simmons-Boardman Publication)

AMERICAN BUILDER

and Building Age

NAME REGISTERED U. S. PATENT OFFICE AND CANADIAN REGISTERED TRADE MARK

CONTENTS FOR JANUARY, 1941

Publisher's Page—Economic Effects of Spending for Defense—by Samuel O. Dunn.....	29
Prospects for 1941: Everybody BUSY.....	31
<small>Private Home Building and Light Construction Expected to Increase Despite Higher Prices and Some Temporary Shortages of Materials. Defense Housing May Swell 1941 Total of 650,000 Dwellings.</small>	
One Building Boom We Hope Won't Happen Here.....	34
A Plan for Providing Industrial Defense Housing Without Government Subsidy.....	35
<small>Proposed by John E. McNamara, Certified Homes Bureau, Buffalo, N.Y.</small>	
Develops Basementless Concrete Designs.....	36
"Air Conditioned" Homes at \$22 a Month.....	38
Luxury Living Planned Into Country House.....	40
29'-3" x 27' Flush-Board Siding New England Colonial.....	42
One-Story Pennsylvania Dutch.....	43
Streamlined Cutting.....	44
Army and Navy Try Out "Demountable" Houses.....	46
"Pre-Sold" Small Houses Going Big!.....	48
USHA Offers Plans for Defense Housing.....	50
Bungalow Court Type 9-Unit Apartment.....	52
One Store Job That Led to 100 More.....	53
Service to Readers Department.....	56
On and Off the Record.....	64
Letters from Readers.....	69
Time-Saving Automatic Roof Framer and Mitre Box for Portable Electric Saw.....	76
How to Apply Wood Gutters on Various Roofs.....	78
Teamwork in Housing—by Jacob Crane.....	83
New Stainless Steel Gutters.....	86
News of the Month.....	89
TruCost Department.....	94
Advertisers' Index.....	96



63rd Year Vol. 63, No. 1

AMERICAN BUILDER and BUILDING AGE, with which are incorporated National Builder, Permanent Builder and the Builder's Journal, is published on the first day of each month by the

SIMMONS-BOARDMAN PUBLISHING CORPORATION, 105 West Adams Street, Chicago, Illinois.
New York Office: 30 Church Street

WASHINGTON, D. C.
National Press Building
SEATTLE, WASH.
1038 Henry Building
SAN FRANCISCO, CAL.
550 Montgomery Street
LOS ANGELES, CAL.
530 West Sixth Street

Samuel O. Dunn, *Chairman of Board*; Henry Lee, *President*; Bernard L. Johnson, Robert H. Morris and Delbert W. Smith, *Vice-Presidents*; J. S. Crane, *Eastern Manager*; Roy V. Wright, *Secretary*; Elmer T. Howson, *Assistant Secretary*; John T. De Mott, *Treasurer*.

Subscription price in the United States and Possessions and Canada, 1 year, \$2.00, 2 years, \$3.00; foreign countries, 1 year, \$4.00, 2 years, \$7.00. Single copies 25 cents each. Address H. E. McCandless, Circulation Manager, 30 Church Street, New York, N.Y.

Member of the Associated Business Papers (A. B. P.) and of the Audit Bureau of Circulations (A. B. C.) PRINTED IN U.S.A.

JOSEPH B. MASON Eastern Editor	BERNARD L. JOHNSON Editor	JOE SANDERS Marketing Editor
R. E. SANGSTER Managing Editor	ROBERT H. MORRIS Business Manager	LYMAN M. FORBES Research Editor
DOLA PARR Associate Editor		L. E. ARENT Art Editor

Advertising: W. F. COLEMAN, L. B. CONAWAY, J. S. CRANE, J. C. JONES, E. J. REICH, GORDON SIMPSON, D. W. SMITH, C. J. WAGEMAN
Field Staff: L. O. ANDERSON, V. L. ANDERSON, C. L. CONLEY, C. R. W. EDGCUMBE, J. H. FREE, CHARLES R. HARTUNG, DICK WHITTINGTON

HOW TO SPECIFY SOFT TEXTURED FINISH AND FRAMING LUMBER THAT PROTECTS GOOD WORKMANSHIP

Every builder likes to work wood of soft texture that cuts easily. When you find such texture in a wood which takes paints without bleeding, discoloration or raised grain, you have the exact qualities needed for beautiful interior woodwork and paneling and for well-groomed, exterior trim. When you find such texture in framing lumber, plus adequate strength, protected by correct drying and seasoning, you have the exact qualities for a workmanlike structure that stays plumb, free from shrinking and swelling.

ARKANSAS SOFT PINE

is your answer to finding each of these qualities in a single wood. Inherent in its natural growth are soft texture for ease in working; tough resilient fiber for resistance to splitting and wear; freedom from pitch or hard streaks for taking enamels and paints uniformly and holding their life and lustre with no discoloration or raised grain; attractive figure for decorative effects in stained woodwork or paneling . . . the sum of which is a superior wood of correctly balanced soft texture for framing, finishing and beautifying homes.

Identified for your protection by trade and grade-marks which warrant standard manufacture and correct seasoning to approved moisture content, ARKANSAS SOFT PINE supplies you with a thoroughly trustworthy building wood for every item from foundation plates to satin-like interior trim and mouldings.



Arkansas Soft Pine Bureau • 141 BOYLE BUILDING, LITTLE ROCK, ARKANSAS



"Arkansas Soft Pine cuts clean, matches up all even at each mitre and joint and stays put"

SENT ON REQUEST →

Complete information, including construction details, stress tables, grades to specify, trim and moulding patterns, etc., are included in this useful Builders' Handbook which is yours for the asking. Write for your copy today. Arkansas Soft Pine is sold by retail dealers and planing mills east of the Rockies.



PUBLISHER'S PAGE

Economic Effects of Spending for Defense

WE are entering our *twelfth* year of effort to regain prosperity. Many hopefully believe prosperity finally will be restored by the huge expenditures for defense we are beginning.

It is truly amazing how many believe huge government spending, regardless of what for, will cause prosperity, and nothing else will. How do they get that way? Don't they ever look up any *facts*? Or do they just wait to hear from their political or labor union leaders, and believe what they are told, regardless of *what* it is, or *why* they are told it?

At any rate, it is an irrefutable *fact* that never was any country made prosperous by its government's spending of its own people's money. The United States has had more prosperity than any other country; but even it has had numerous minor and four major depressions before this one. Did it pull itself out of them by government spending? Not once. It never even tried to. Apparently nobody ever suggested it. If anybody did, doubtless he was simply dismissed as "not all there," and no record made of it. Our country was always soon pulled out of previous depressions and raised to new heights of prosperity, by the *work, thrift and good sense of its people, unaided and uninterfered with by government.*

It remained for a lot of our present politicians and people to make the discovery that there was an easy way to create prosperity—not by *hard private work*, but by huge government spending. How do they explain how we recovered from previous depressions? And how do they explain such facts as the following?

IN the six years ending with 1921 expenditures of our federal government averaged 7 billion 700 million dollars a year; and our national income averaged 55 billion a year. In the six years ending with 1927 federal expenditures *declined* to an average of 3 billion 600 million a year; and national income *increased* to an average of 68 billion a year. In the six

years ending with 1933 federal expenditures *increased* to an average of over 4 billion a year; and national income *declined* to an average of only 63 billion a year. In the six years ending with 1939 federal expenditures *increased* to an average of 8 billion a year—and national income *declined* further to an average of 62 billion a year.

What these irrefutable *facts* illustrate is simply that the effect of *government* spending, like that of *private* spending, depends not on its amount, but on *how and for what it is done.* If it greatly exceeds the income of the spender, if it is not done to buy needed useful things or increase their *production*, if, in fact, it is done largely or mainly to cause the *destruction* of such things, then the bigger the spending the more it *tends* to *prevent*, not to cause, *prosperity.*

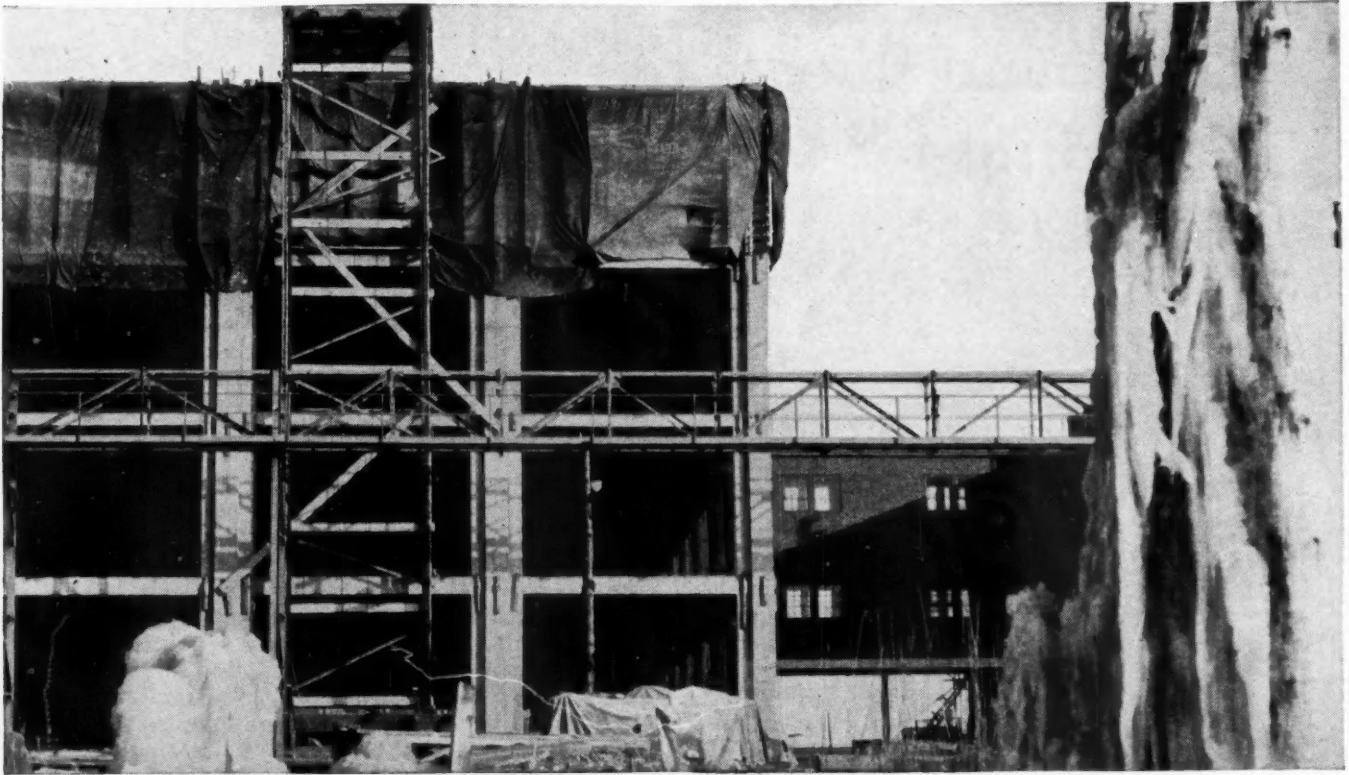
NOW, all spending for defense, however necessary, is obviously spending for *waste and destruction.* Therefore, its *natural* effects must be extremely harmful unless the people are protected by sound economic policies such as—(1) Making all preparedness expenditures with the utmost *economy* consistent with speed and effectiveness. (2) Reducing or *abolishing* other government expenditures. (3) Increasing taxes enough to reduce greatly or to abolish government deficits. (4) Paying both labor and capital enough—no more, no less—to *put all the labor and capital of the nation to work.* (5) Sparing no reasonable effort to prevent advances in prices *and their causes*—including advances in wages.

Expenditures for defense, however huge, won't cause prosperity. But they don't need to prevent it if we will adopt economic policies about the opposite of those by which we have succeeded in making this depression eleven years long.

Samuel O. Dunn,

SIMMONS-BOARDMAN PUBLISHING CORPORATION: SAMUEL O. DUNN, CHAIRMAN OF THE BOARD; HENRY LEE, PRESIDENT; BERNARD L. JOHNSON, ROBERT H. MORRIS, AND DELBERT W. SMITH, VICE-PRESIDENTS; ROY V. WRIGHT, SECRETARY; E. T. HOWSON, ASSISTANT SECRETARY; JOHN T. DE MOTT, TREASURER; EXECUTIVE AND EDITORIAL OFFICES: 105 WEST ADAMS STREET, CHICAGO; 30 CHURCH STREET, NEW YORK CITY.

'INCOR' 24-HOUR CEMENT SPEEDS WINTER WORK, REDUCES FREEZING RISK, CUTS HEATING COSTS



Cold-Weather Safety Factor



QUALITY PAYS . . . INSIST ON 'INCOR'—'Incor' 24-HOUR Cement means just what the name says—dependable 24-HOUR service strength. Plus long-time durability, proved by 13-year performance. Quality pays—because better cement makes better concrete.

WITH temperatures as low as 9° above zero, concreting proceeded at normal speed last winter, on 5-story addition to General Aniline Works' Building No. 48, Grasselli, N. J.—White Construction Co., New York, general contractor. The structure was designed for live loads of from 100 to 500 lb. per sq. ft. Economical 'Incor' concrete design mixes provided dependable high early strength, permitted form stripping in 2 days, without the use of reshores. 'Incor' saved \$1,150 on heating-fuel expense, alone.

'Incor' cures and hardens 5 times as fast, is safe from freezing that much sooner; that cuts heat-protection costs 50 to 60 percent, and permits normal stripping schedules with safety, even at sub-freezing temperatures.

Use 'Incor'* on work now in progress—it's a proven cold-weather safety-factor, sure enough. Write for copy of "Cold Weather Concreting." Lone Star Cement Corporation, Room 2229, 342 Madison Avenue, New York. *Reg. U. S. Pat. Off.

LONE STAR CEMENT CORPORATION
MAKERS OF LONE STAR CEMENT . . . 'INCOR' 24-HOUR CEMENT

Prospects for 1941:—Everybody BUSY

Private home building and light construction expected to increase despite higher prices and some temporary shortages of materials. Defense housing may swell 1941 total of 650,000 dwellings—a 19 per cent increase over 1940

NOT since 1928 have builders in the residential and light-load-bearing construction field had such good prospects for an active and busy year. Whatever else may be said of the present conditions, every indication is that there will be plenty of work ahead for everyone.

The year 1940 closed with construction volume at better levels than 1929 and with prospects that the momentum of the movement will carry on through 1941.

Let us first take a look at the residential field. Preliminary estimates made just before the close of the year indicate that approximately 545,000 dwelling units, omitting farm homes, were provided in the United States last year. This is a 17 per cent increase over 1939's 465,000 units, and is 36,000 units greater than the 1929 figure.

The value of the total nonfarm residential construction in 1940, as estimated by Herman B. Byer, chief of the Construction Division of the Bureau of Labor Statistics, was \$1,850,000,000. This estimate is based on building

permits recorded in more than 2,100 communities and in numerous rural and country areas.

The remarkable fact about the large volume of residential building that went ahead in 1940 is that it was apparently unaffected by war, blitzkrieg, the election, and economic uncertainty. These 545,000 homes were built by people in small towns as well as large cities, by rich and poor, despite all uncertainties.

It may be that there is a moral in this to the effect that in a world of change and confusion the American public is coming to realize that a "bit of good earth" and a home of your own are the best security.

At any rate, the residential building industry had the best year since 1928. Approximately 80 per cent of the dwelling units were one-family homes. Six per cent were two-family homes. The percentage of new apartment dwellings dropped sharply as it has been doing every year since 1929, and was this year only 14 per cent.

A study of Table I, below, shows some rather interesting facts about the trend of residential building in this country as applying to single-family homes and apartments. These estimates are by the United States Bureau of Labor Statistics:

Note that the number of single-family homes in 1940—436,000—equalled the number built in 1928. It is apparent that the percentage of apartment dwellings is on the decrease, and there are many factors in the present market that will tend to further this movement in 1941. For one thing, any shortages of materials that may develop will probably be in products involved in apartment building rather than the small home field.

Further analysis of the dwelling units built last year shows that there has been a continuation of the trend towards smaller and lower-priced homes. This is reflected

TOTAL DWELLING UNITS (EXCEPT FARMHOUSES) BUILT ANNUALLY IN U.S.

Year	by type of structure						In all Types of Structures
	In One-family Structures	% of Total	In Two-family Structures	% of Total	In Multi-family Structures	% of Total	
1920.....	202,000	81.8	24,000	9.7	21,000	8.5	247,000
1921.....	316,000	70.4	70,000	15.6	63,000	14.0	449,000
1922.....	437,000	61.0	146,000	20.4	133,000	18.6	716,000
1923.....	513,000	58.9	175,000	20.1	183,000	21.0	871,000
1924.....	534,000	59.8	173,000	19.4	186,000	20.8	893,000
1925.....	572,000	61.0	157,000	16.8	208,000	22.2	937,000
1926.....	491,000	57.8	117,000	13.8	241,000	28.4	849,000
1927.....	454,000	56.1	99,000	12.2	257,000	31.7	810,000
1928.....	436,000	57.9	78,000	10.4	239,000	31.7	753,000
1929.....	316,000	62.1	51,000	10.0	142,000	27.9	509,000
10-year average.....	427,100	60.7	109,000	15.5	167,300	23.8	703,400
1930.....	185,000	64.7	28,000	9.8	73,000	25.5	286,000
1931.....	147,000	69.3	21,000	9.9	44,000	20.8	212,000
1932.....	61,000	82.4	6,000	8.1	7,000	9.5	74,000
1933.....	39,000	72.2	4,000	7.4	11,000	20.4	54,000
1934.....	42,000	76.4	3,000	5.4	10,000	18.2	55,000
1935.....	110,000	76.4	6,000	4.2	28,000	19.4	144,000
1936.....	199,000	73.7	13,000	4.8	58,000	21.5	270,000
1937.....	220,000	76.9	15,400	5.4	50,800	17.7	286,200
1938.....	262,300	75.6	16,900	4.9	67,500	19.5	346,700
1939.....	351,000	75.5	21,300	4.6	92,500	19.9	464,800
1940.....	436,000	80.0	32,700	6.0	76,300	14.0	545,000

TABLE I. 21 year review of swing to multi-family living and back again to single, detached homes.

in the Federal Housing Administration's figures on mortgages, with the reservation, of course, that the higher priced homes are not usually FHA financed and so are not well represented in these figures. The average value of FHA mortgages accepted in the first ten months of 1940 was \$4,417. This compares with \$4,511 in 1939, \$4,601 in '38, \$4,638 in '37, \$4,711 in '36 and 4,824 in '35.

Further analysis of the home building market in 1940, as shown in Table III, indicates that the sharpest increases took place in towns of 10,000 to 25,000 (30 per cent) and 25,000 to 50,000 (38 per cent). Rural homes (non-farm) showed a 20.8 per cent increase to 148,300. Big city homes showed a 3 per cent decline.

Estimate 650,000 Homes Next Year

Not only did residential building gain in acceleration throughout 1940, but it maintained a high rate in the winter months, much greater than usual. Residential contract awards as reported by F. W. Dodge for November were 31 per cent ahead of 1939. Another barometer of building activity which has proved valuable in predicting future volume is the FHA report of new home mortgages selected for appraisal. In November the number of mortgages selected showed an increase of 13 per cent over 1939, and the value an 11 per cent increase. Still more striking was the FHA report on the average weekly number of homes started under its control during November, which was 3,137—a 13.5 per cent increase over November, 1939, when only 2,765 were started weekly. The following table shows the value of new FHA home mortgages selected for appraisal in 1939 and '40:

	1940	1939	% Increase
January	\$ 51,036,000	\$48,970,250	4
February	63,887,295	58,365,300	10
March	89,703,393	83,994,895	7
April	100,901,774	71,777,675	40

	1940	1939	% Increase
May	101,217,472	76,083,150	33
June	85,226,150	71,005,994	20
July	94,120,780	60,747,320	55
August	95,875,500	68,408,320	40
September	90,906,190	64,633,975	41
October	91,820,966	72,724,181	26
November	65,463,360	59,256,405	10
December	(1st 2 weeks)	48,759,340	18

While estimates for the coming year must be considered in the light of war uncertainties, the considered judgment of building analysts is that private home building should at least hold its own in 1941 as compared with 1940, and may go considerably ahead. A conservative estimate would be a 10 per cent increase in private home building in 1941. In addition to this increase in the normal residential market there must be added some 40,000 to 60,000 defense housing units to be built with government funds by the Army and Navy. Early in December 20,000 defense houses had been placed under contract and 25,000 more allocated and in process of planning. It is quite possible that the defense housing program will amount to some 60,000 units actually built in 1941. When these are added to the expected large private residential program it may swell the probable total to between 625,000 and 650,000 units for the year. Thus, as far as home building is concerned, 1941 should see a return to levels far ahead of 1929 and approaching 1928, which was a year of good business all around for the building industry.

Of course, any such estimate as has been given above must be qualified by the possibility that the United States may become involved in a war, or that building prices may rise so sharply as to scare off home buyers. There is also the possibility that government priorities in basic commodities and materials essential to national defense may interfere with production.

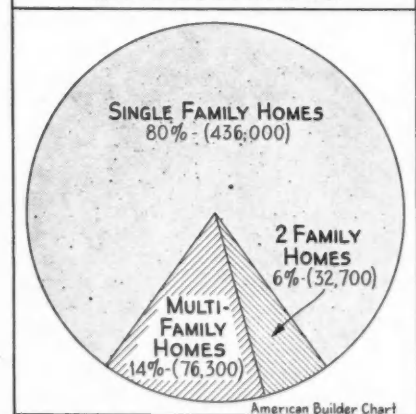
American Builder has thoroughly weighed the above possibilities, however, and feels that although some in-

**545,000 New Dwelling Units Built in 1940—
17 Per Cent Increase Over 1939**

Estimates by Construction Division, U. S. Bureau of Labor Statistics, Based on Building Permits in More than 2,100 Cities with Population of 60,500,000 (1940 Preliminary)

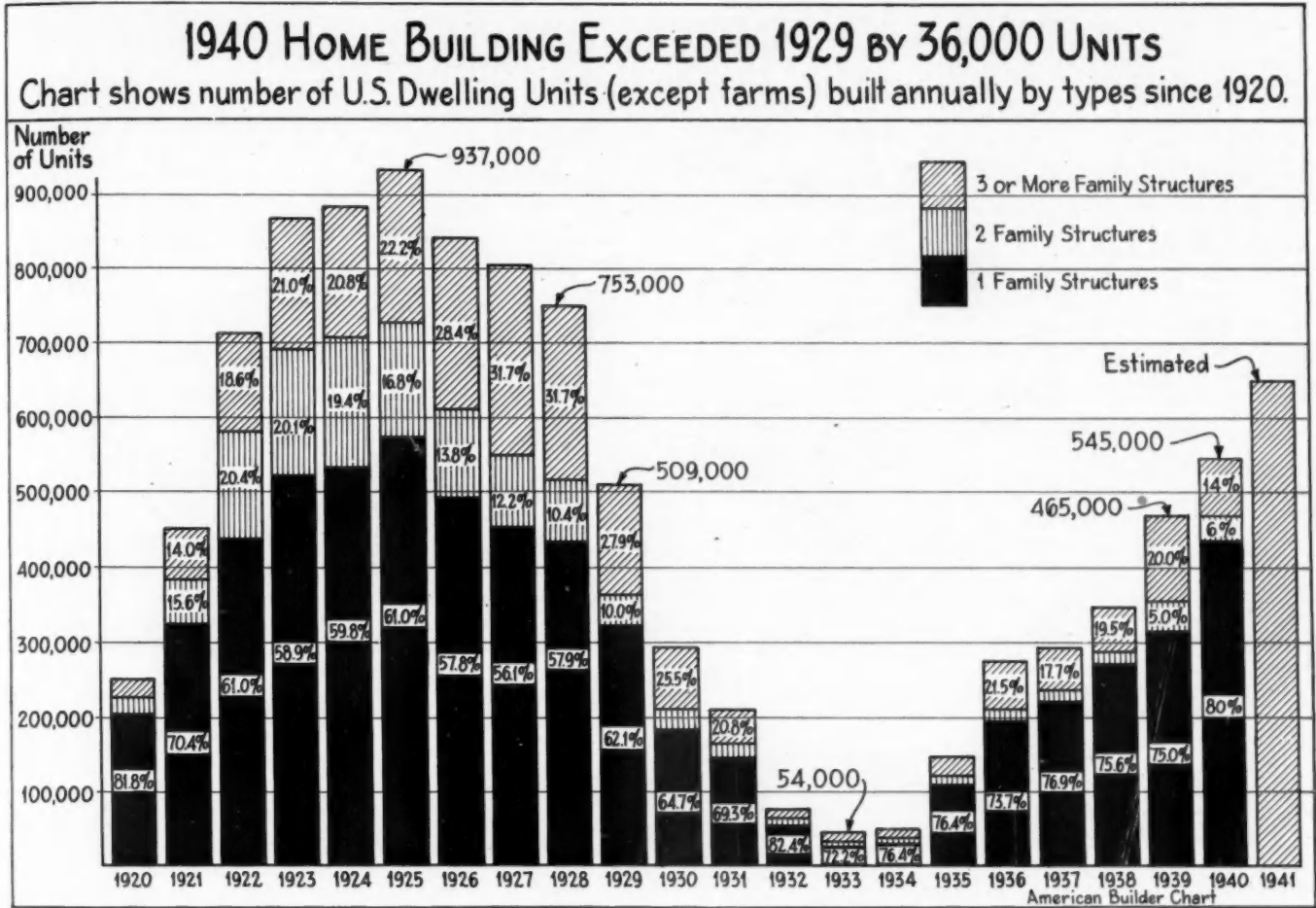
Size and Number of Places	Population (1930 Census)	New Dwelling Units		Percent Change	
		1940	1939		
1. Cities 500,000 and over.....	14	21,315,411	101,200	104,700	-3
2. Cities 500,000 to 100,000.....	79	15,010,325	88,100	72,200	+22
3. Cities 100,000 to 50,000.....	93	6,491,448	31,500	28,100	+12
4. Cities 50,000 to 25,000.....	185	6,425,693	43,300	31,400	+38
5. Towns 25,000 to 10,000.....	606	9,097,200	62,500	48,300	+30
6. Towns 10,000 to 5,000.....	851	5,897,156	39,700	32,000	+24
7. Villages 5,000 to 2,500.....	1,332	4,717,590	30,400	25,600	+19
Total URBAN	3,165	68,954,823	396,700	342,300	+16
8. Incorporated Places of Less than 2,500.....	13,433	9,183,453	148,300	122,700	+20.8
9. Rural Pop'n. Not on Farms or in Incorporated Places.....		14,191,420			
Total NONFARM.....		92,329,696	545,000	465,000	+17
10. Farm Population.....		30,445,350			
TOTAL U. S.....		122,775,046			

**SINGLE FAMILY HOMES MAKE UP
80% OF 545,000 DWELLING
UNITS BUILT IN 1940.**



No. II—Sharp decline in apartment building has taken place. Above chart, based on U. S. Bureau of Labor statistics for first nine months of 1940, shows that 86 per cent of dwelling units built were one or two-family.

No. III—A 17 per cent increase in 1940 to 545,000 dwelling units is shown in table at left. Largest increases were in towns of 10,000 to 25,000 and 25,000 to 50,000. The 1940 figures are preliminary, subject to later revision.



No. IV—Home building volume in the United States in 1940 went well above 1929, this chart shows. The 545,000 total for 1940 covers all residential construction except farms. Notice that SINGLE-FAMILY home total equalled 1928 and was slightly above the ten-year 1920-1929 single-family home average of 427,000 units. Data from the U. S. Bureau of Labor Statistics.

creases in prices may be unavoidable and some problems in material shortages may be expected, yet the industry will be able to surmount these obstacles. Experience has shown that usually where prospective purchasers have money to spend, a way will be found to supply their needs.

It is true that already shortages have appeared in certain building materials due to rush government orders. In most cases, these shortages are temporary and will pass as soon as the peak of the vast Army barrack and camp housing program is over, which should be early in the year. Careful study indicates that in practically every instance in the building industry where any material has become difficult to obtain or has gotten out of line in price, substitutes are found which quickly meet the need. Frequently such products establish a place in the market that is never fully regained by those displaced.

American Builder has already found numerous instances of builders who, when confronted with a delay in delivery or an undue increase in price, have switched to a different type of product or equipment. The building industry is so vast and its sources of material and equipment so widespread that there seems little danger that any serious bottleneck can develop that will retard the normal building operations that take place in thousands of separate communities and establishments.

\$2 Billion Defense Construction

National defense is, of course, a spectacular feature of the 1941 building program. The National Defense Advisory Commission has indicated that about \$2 billion will be spent in defense construction through 1941 and

the first half of 1942. The effect of government expenditures of this kind will be to create additional employment in the building field and keep many of the larger contracting firms busier than they have been in years. They may be so busy in fact that thousands of smaller contracting firms will have the residential and light-load-bearing field to themselves.

The National Defense Advisory Commission's analysis of its construction program shows that the largest chunk of money—\$631 million—is being spent for shelter for the Army, National Guard and Navy personnel. These barracks and buildings are largely of wooden construction and will be completed early in the year.

The second largest classification of direct government spending provides \$520 million for construction of airplane and engine plants, armor, tank, ammunition and loading plants, shipways and shipyard facilities.

In addition to the above, there are, of course, many plant expansions and new plant construction financed entirely with private funds. It is estimated that private factory construction may run from \$330 to \$500 million in 1941. Another \$337 million will be spent by the government for air bases, hangars, shops, administration buildings, etc. A fourth classification calls for the expenditure of \$258 million for seacoast defenses and construction at military and naval stations other than air bases.

Defense housing—that is, housing for defense workers and families of enlisted men, as has already been stated—is expected to total about 60,000 dwelling units. Some \$240 million, including land cost, is available for this purpose. The over-all cost per unit, including land, is limited by law to \$3,500. *(Continued to page 67)*



British Combine Photos, Ltd.

BRITISH demonstration air raid shelter with solid common brick walls to be built in the streets of residential sections.

One Building Boom We Hope Won't Happen Here

THE type of construction pictured on this page might be captioned, "Building against destruction." Shown is a current phase of intense building activity in England today—the provision of shelter against air raids. Gruesome though they are, they do represent improvements over some of the earlier makeshifts and crowded underground areas. In fact, the British source describes them as being "easily converted into comfortable sitting rooms."

Note that in all these shelters, solid brick walls and poured concrete construction have been used. The one above has had an opening left in the side walls, and the unit being demonstrated is not covered over, so that there will be enough light to show the bunks. It is proposed

that these continuous row units be built in the streets and each family in the adjacent houses will have a key to its own shelter and can furnish it as it pleases.

The two other types illustrated below are of similar construction but slightly different arrangement. The one at the left is a portion of the shelter facilities now being erected on the grounds of some dwellings in South-West London. Doors are provided with lock and key so that the quarters remain private. There are no windows, a minimum number of small openings having been left in the brick for ventilation (shown in upper and lower right photos). This view at the lower right is of the Stoke Newington demonstration of the first of these family shelters. Again, one wall is cut away to show interior.

BELOW at left: Brick and concrete row shelters being erected in South-West London; right: demonstration of shelter, wall removed.



A Plan for Providing Industrial Defense Housing Without Government Subsidy



Proposed by

John E. McNamara

Certified Homes Bureau,
Buffalo, N.Y.

DISLOCATING and Wasteful Effects of Last War's Housing Program: During the last war housing needs were ignored until a late date. The government then financed speedily built projects of various types, most of which were unfitted to the communities in which they were built.

Disadvantages: 1. They had a dislocating effect on local realty values by injecting in communities housing for well paid workers which were rented at rates below the true economic rent sought by other local residential real estate; 2. They were wastefully disposed of after the war. Real Estate speculators picked them up at a price 50 percent under government's cost. In most cases speculators sold them back to occupants or renting corporations at almost the cost the government paid to build them.

Nature of Present Industrial Defense Housing Problem: The principal need is not for segregated housing facilities for defense workers. The need rather is for an expansion of the present number of housing units in concentrated population areas where employment is increasing for execution of the rearmament program.

An analysis of the rearmament orders placed and being placed shows most of the work going to firms located in or near our present large industrial centers. These areas will then be the ones most in need of increased shelter facilities.

Likewise exists the fact that these same industrial centers are the very areas in which increased small-home building has been expected to take place in the next several years under normal conditions.

Speed and Decentralization are recognized as the primary requisites of needed housing. The reason for speed is obvious.

Decentralization, as against the segregation of defense workers in government-owned housing projects, is to be desired for these two reasons: 1, The workers will not be easily locatable for the concentrated efforts of radical and subversive elements. 2, Scattered throughout a community they will not be distinguishable from workers in normal production and will not therefore be a convenient group target for possible sabotage.

A Non-Subsidized Private Industry Solution

This plan calls for an expansion of the number of housing units in communities where needed by making possible an acceleration of the building of small homes by established home builders on already improved land.

It is not intended that the new houses added to a community would necessarily be occupied by those actually employed in defense work. The purpose served by the new houses would be to swell the total volume of available housing to a point sufficient to accommodate the increased shelter needs created by rearmament employment.

This can be accomplished by liberalizing present

FHA mortgage requirements to permit 5 percent down-payments where mortgages are not in excess of \$4,000.00.

To effect this, the following legislation is needed:

1. Eliminate Title 1, Class 3 loans.
2. Permit 5 percent down-payments (which means 95 percent mortgages) on houses built under Title 2 with twenty-five year amortization where mortgage is not in excess of \$4,000.
3. Set up a special risk fund to protect FHA against the greater risk incurred with the smaller down-payment.

Speed and decentralization, the primary requisites, are best served by this plan. In addition to the points already advanced in the interest of decentralization, it must be acknowledged also that speed itself is fostered by building to a decentralized plan.

While it is an accepted fact that small houses can be completed much faster than apartment houses, the building of a large number of small houses under a centralized plan might take as long or longer than the building of a large apartment. The delay would be caused by the lack of tracts of improved land large enough to accommodate such large scale projects. Months would be consumed acquiring and surveying land, installing sewer, water, gas and electric lines and laying new pavements before any actual construction of homes could begin.

Under a decentralized plan, on the other hand, the new houses would be built in several separate sections and subdivisions in which these land improvements have already been installed. Construction could thus be started immediately to provide the additional housing needed. The second factor of speed would be the employment of many established small house builders who are in a position quickly to double their present production schedules, as against the use of large contracting firms which are already overtaxed with the building of needed plant expansion.

In addition to best serving the primary requisites of speed and decentralization, the following six secondary but important benefits will also flow from the adoption of this plan:

1. Protects the stability of present residential real estate values; because it simply advances the date of building some houses which would likely be built at a slightly later date under normal conditions; because such houses are fair competition to

(Continued to page 75)



LIKE the front cover home, this design is the work of Architect Walter Wendland, Milwaukee, Wis.; it is an exact duplicate except for exterior color scheme. Built by A. C. Dallach in Western Springs, Ill., a suburb of Chicago. TruCost figures for these houses appear on page 94.

RIGH
utility
five-r

BELO
crete
arch

Develops Basementless Concrete Designs

AFTER several years of pros and cons on the subject of basementless houses, the building industry generally now has decided that because of certain advantages which can be weighed against their shortcomings, these designs do have a definite place in the field of home planning. One of the more important of these factors is the difficulty or impossibility of excavating on certain sites.

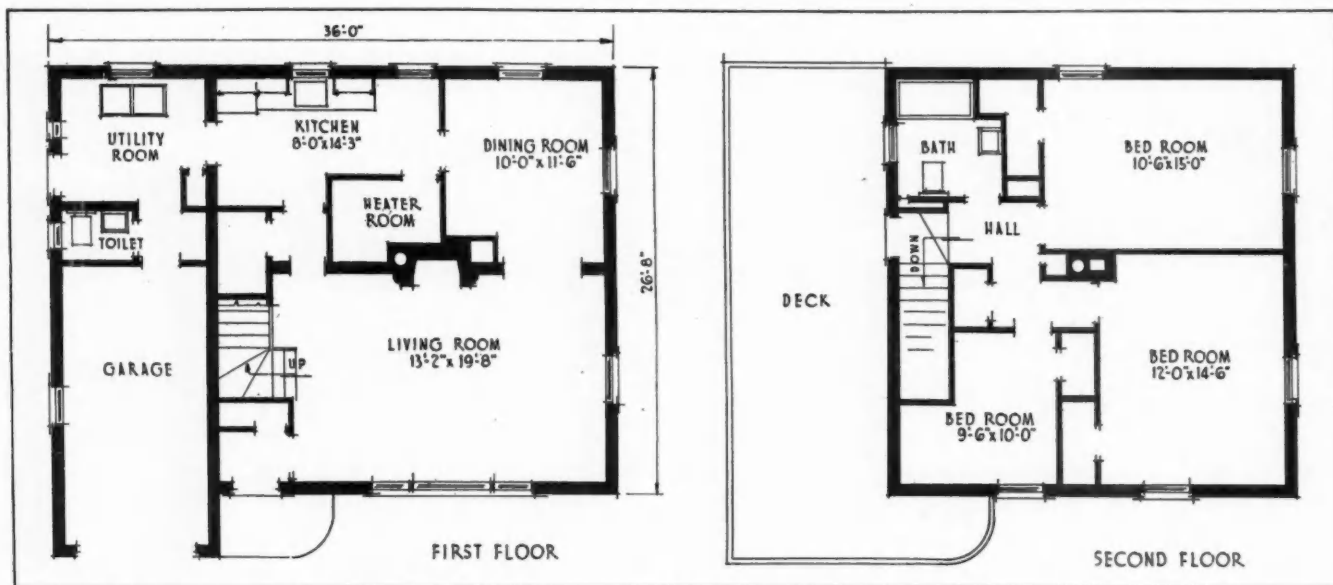
Two such homes are illustrated on these pages. They are the work of Architect Walter Wendland of Milwaukee, a recognized authority in the Midwest on small house design. They are basic in plan and capable of wide variation, both as to exterior treatment and change of arrangement. For example, the six-room design shown on the front cover and that above are identical except for color scheme and trim. Both of these and the five-room single-story type were built in Western Springs, Ill., by A. C. Dallach.

Economy has been a major consideration in their plan-

ning and construction; as shown in the plans, all floor area is utilized. Provision is made for a compact heating room which may be separate or incorporated in the utility room. Concrete construction consisting of Way-lite block exterior walls finished in 2 coats portland cement stucco, concrete floor and gypsum block partitions has been used in all these units, and an interesting heating method has been developed to take advantage of this type of planning and construction.

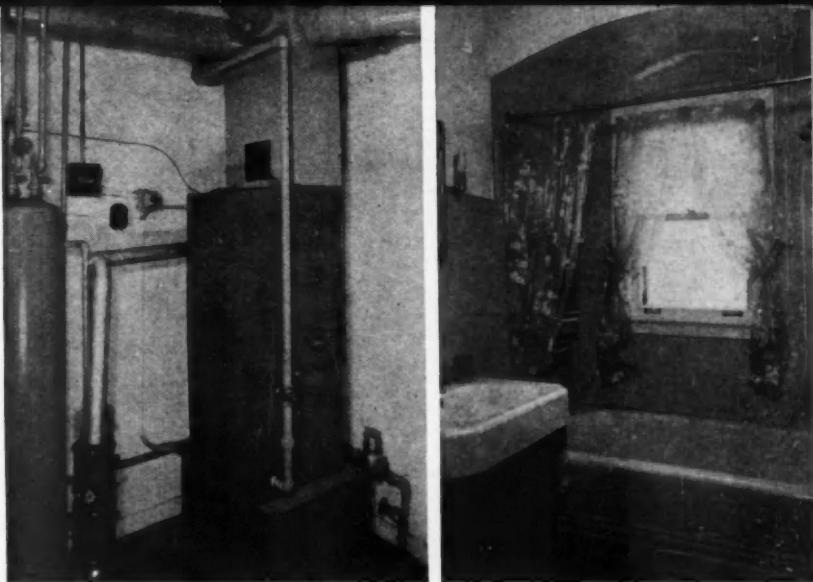
This gas-fired warm air heating system, illustrated at the top of the opposite page, has short overhead supply ducts out of the heating room. Return ducts are set in the 6-inch insulated concrete floor, keeping the floors warm and dry. Other insulation in the house includes sprayed-on insulating fibre under the plaster of exterior walls and 4 inches of rock wool over the ceilings. Thus, completely surrounded with insulation, the compactly arranged living area has been found most easily and economically heated.

THE floor plan below of the front cover house and the one shown above offers a compact arrangement of six rooms and attached garage, with utility and heater room space to replace conventional basement. Large deck above garage is accessible from stair landing.

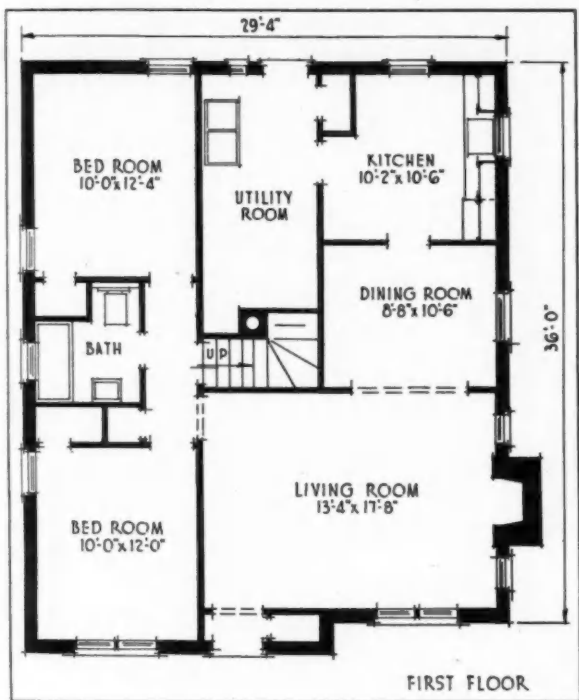


TI
w
le
li
S
c
e
r
u
d
e

RIGHT: Typical gas-fired heating system designed for utility room placement and view of bath in the compact five-room house shown below, built in Western Springs, Ill.



BELOW: Typical five-room floor plan of basementless concrete houses, designed by Walter Wendland, Milwaukee architect; good sized utility room is located off kitchen.



ABOVE: Plenty of cabinet space and flat top linoleum covered work surfaces arranged for efficiency are featured in the kitchens of these houses built as a group in a western Chicago suburban section.

THE first floor exterior walls of this basementless house are of Waylite block finished in Swedish type portland cement stucco. Gable ends are shingled with red cedar. TruCost figures for this and other designs will be found elsewhere in the issue.



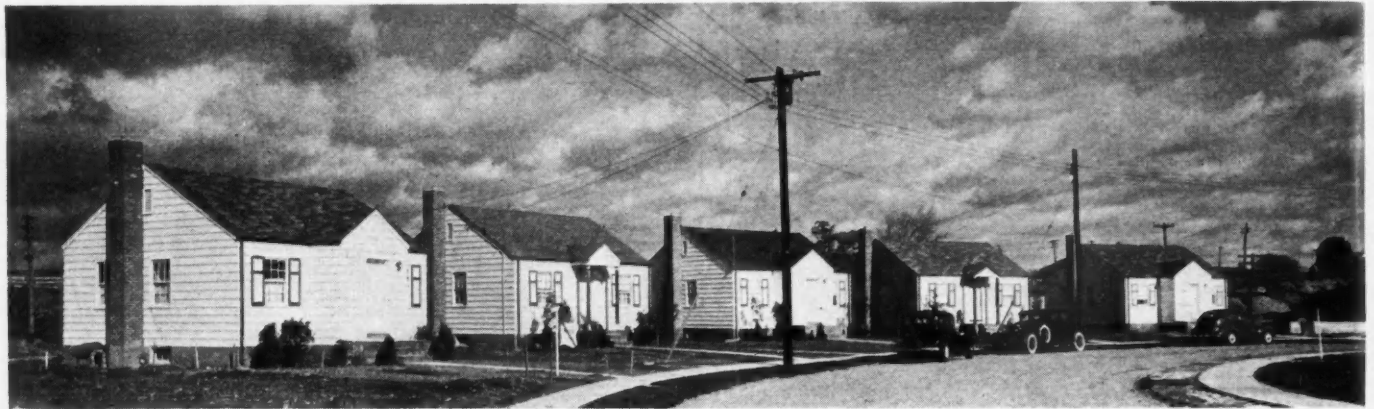


Photo by Lamplough

CURVED STREETS and sidewalks, 45' lots, are featured in Speedway Homes at Mineola, N.Y.

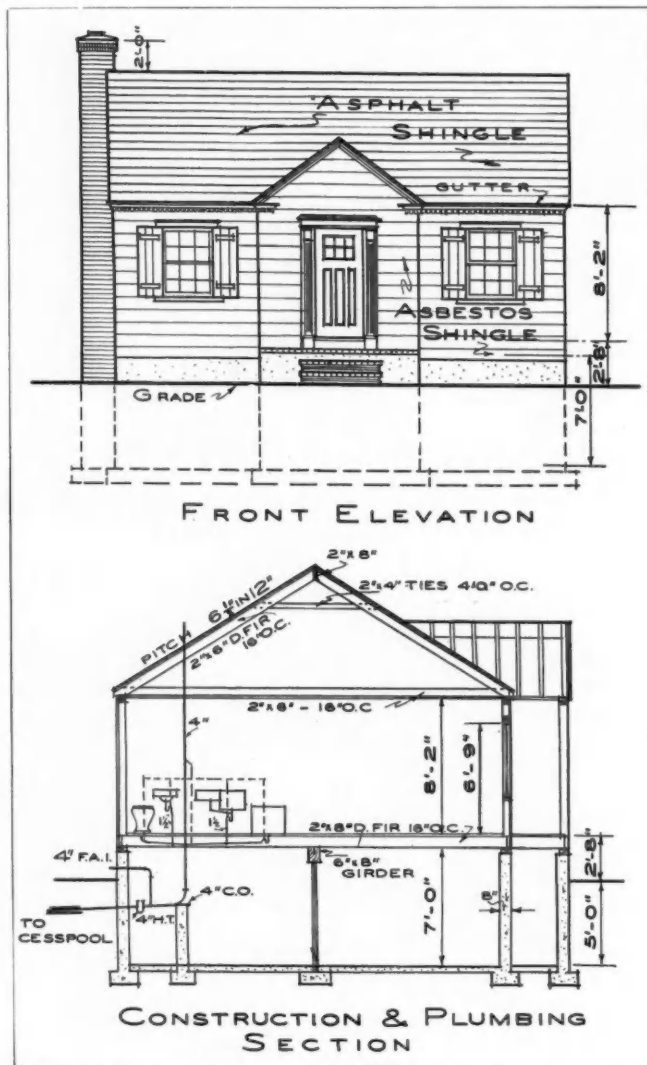
"Air Conditioned" Homes at \$22 a Month

EVEN the lowest cost homes today are being equipped with economical, completely automatic winter air conditioning systems. That the trend is in this direction is shown by the fact that a large number of Long Island operators are installing this type of heating in such houses.

One of the newest home developments on Long Island

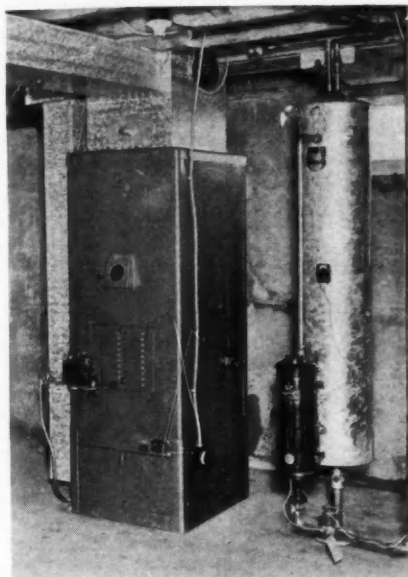
is Speedway Homes at Mineola, where 600 houses are planned by Emanuel Janos and Joseph Lester, builders of West Hempstead Manor homes. The new Speedway houses sell for only \$22 a month, placed on a 45' x 100' plot with attractive curved streets.

Janos-Lester are equipping these little houses with the latest model Lochinvar oil-fired winter air conditioning unit made by the Michigan Tank and Furnace Co. of Dearborn. The Model 60 unit being installed delivers 44,000 B.t.u. at the register and circulates, filters and humidifies the air. It has a Sirocco fan which insures a complete air change 7 times per hour. The unit has a 3-speed switch for various temperature conditions and operates very quietly. The firm that supplied the equipment has sold some 800 of these units on Long Island,



FLOOR PLAN of Type 1 Speedway Home, illustrated above, is 27' x 23' 6", with a 14' 8" x 11' living room. House has full 7' basement. Economical kitchen and bathroom plumbing layout is indicated at left.





LATEST MODEL Speedway Home, above, is equipped with oil-fired winter air conditioning system guaranteed to heat house all winter for \$45. Gas water heater is controlled by push-button in kitchen.

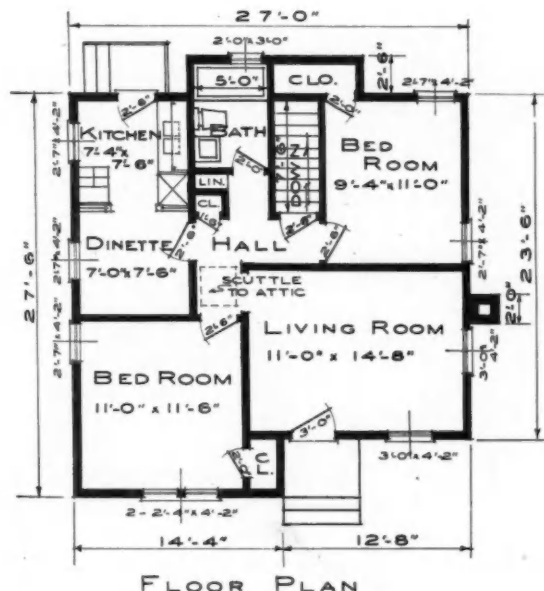
using a simplified duct system. The contractor guarantees the system to heat the house for \$45 a year in an average normal winter. Another item of equipment designed to reduce operating costs is the Savutime gas water heater control. A push-button installed in the kitchen turns the side-arm heater on or off, and a red light glows while the heater is in operation.

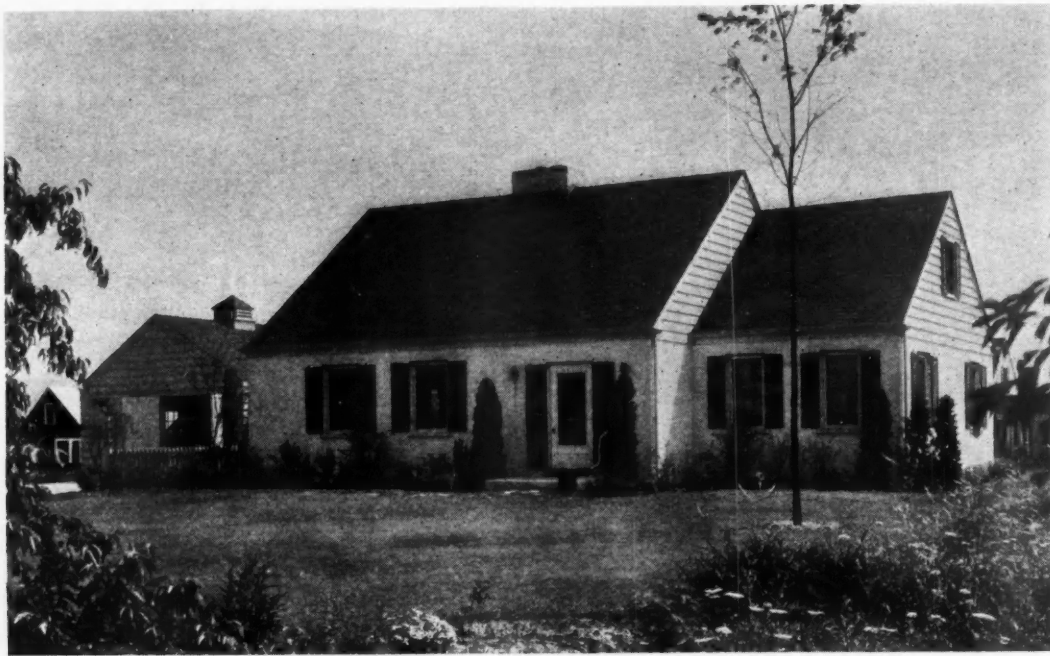
Speedway Homes have solid concrete foundations and a full basement, Barrett guaranteed roofs, cabinet-type sinks, tile bathrooms, double floors. Kitchens are

equipped with Victor In-Bilt ventilators which were supplied by Victor Electric Products Co., Cincinnati.

The latest model, Type 3 illustrated with plan, is approximately 27 feet square, and has a most attractive layout with unusual livability. All the houses are designed by O. R. Hamberg of 22 Bergen St., Floral Park, N. Y. The development is located on a large tract opposite Roosevelt Field, and the attractive features and equipment provided in a convenient site such as this are resulting in large sales.

TYPE 3 Speedway Home, illustrated above, is approximately 27' square, with 11' x 14' 8" living room. The kitchen-dinette arrangement is convenient, and the 2 bedrooms have good cross ventilation. Bath and kitchen plumbing are back to back for economy. Designed by O. R. Hamberg.





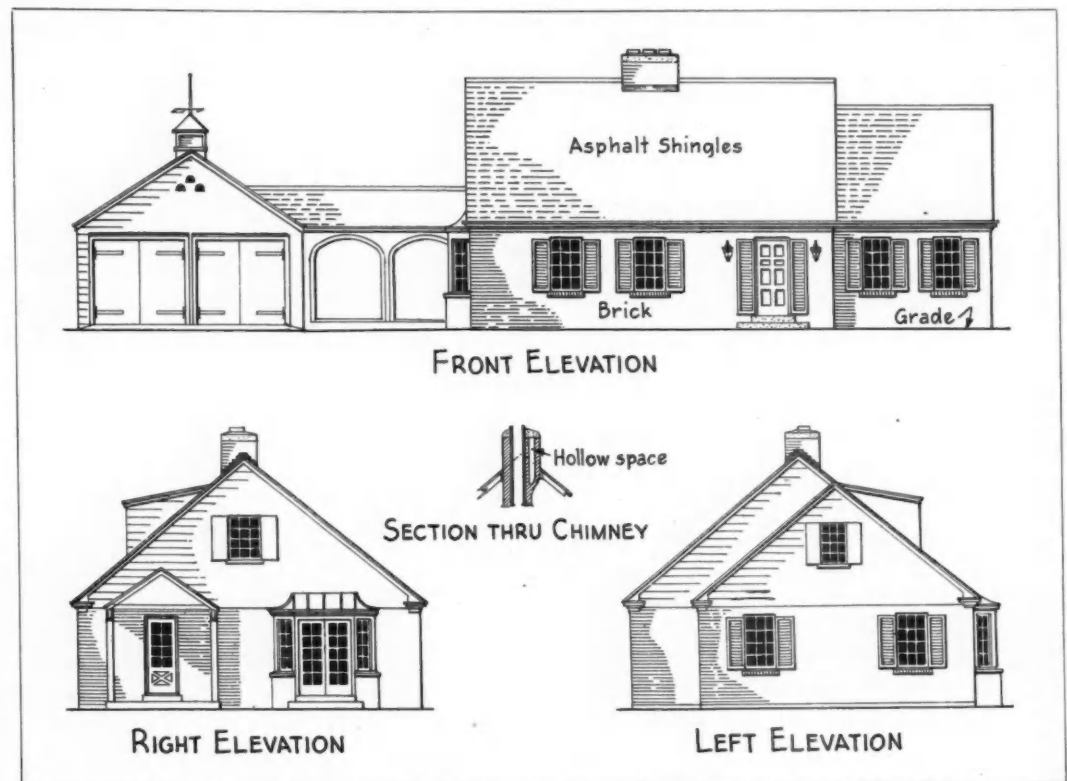
WIDE expanses of lawn, open views from three picture bays and plenty of air and sunshine are offered in this typical house built in Mills & Sons Glen Oak Acres. TruCost figures on page 95.

Luxury Living Planned Into Country House

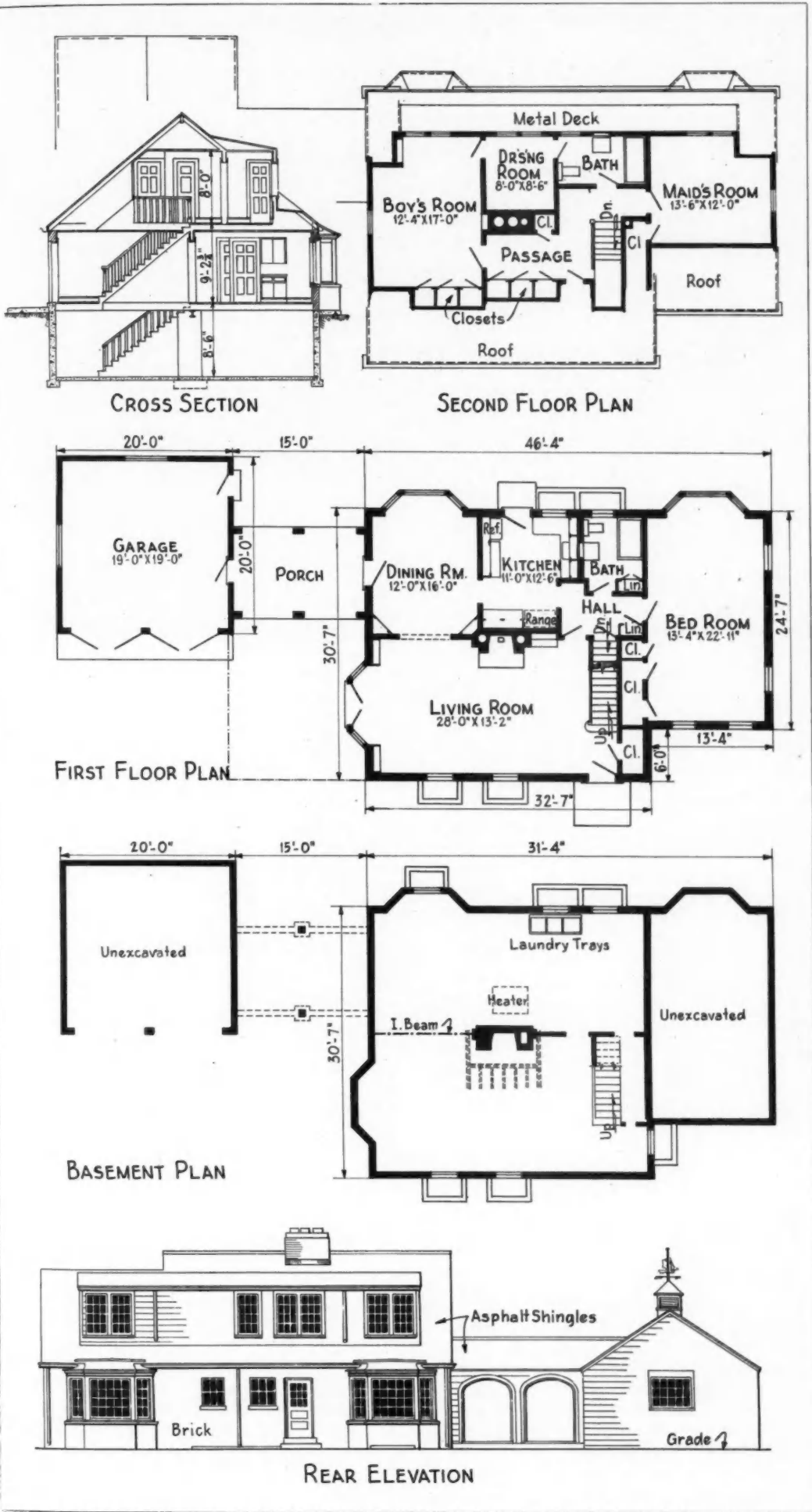
THE continued appeal of uncrowded quarters beyond the city limits where land costs are low and fresh air and sunshine abound is developing and refining a type of home such as the one shown above. This is another of the houses built by Mills & Sons of Chicago and designed by Frank M. Howard for their Glen Oak Acres section.

The emphasis is placed on quality building rather than pretentiousness of exterior. As shown in the floor plans opposite, the six good sized rooms, connecting porch and two-car garage are spread out to an over-all length of over 80 feet.

Construction materials and equipment include 10-inch poured concrete foundation, solid brick walls furred, insulated with Balsam-Wool, and finished with 3-coat plaster, kiln-dried precision framing lumber of certified moisture content, red cedar siding in gable ends, asphalt shingle roof, 4 inches rock wool above ceiling, Sunbeam gas-fired winter air conditioning, Standard plumbing fixtures, and Modern steel kitchen cabinets.



THE elevations are well handled in a most attractive manner, with many interesting details, one of which is the manner in which the chimney has been corbeled out to break better at the ridge.



CROSS section shows careful planning of the important stairway detail to provide proper headroom in this type house. Closets are exceptionally numerous.

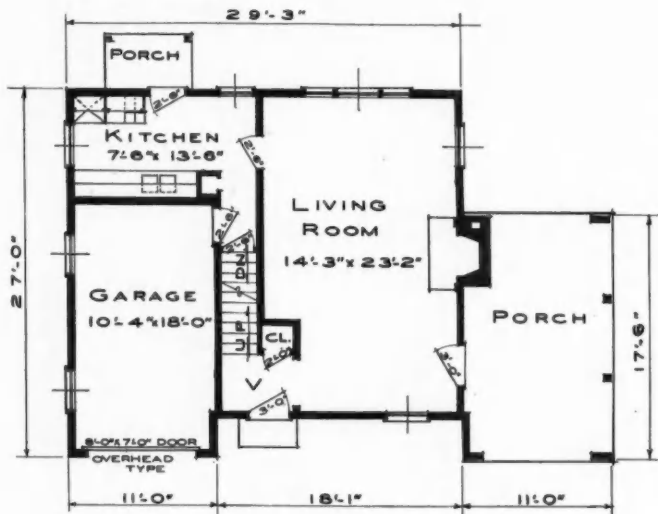
THE extra large first floor master bedroom is a new note in planning; the bay allows a sitting room arrangement at one end. Bath and kitchen back up for economy. Fenced in terrace is viewed through living room bay.

THE basement has been arranged for a large recreation room with natural fireplace and the balance to be used for the utilities and storage. Note careful planning of the rear elevation.

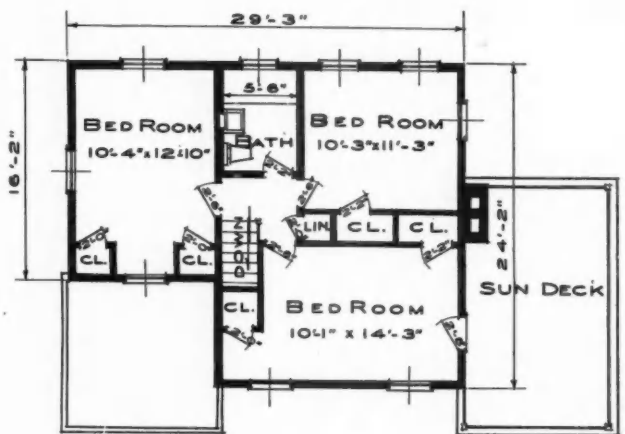


Photo by John Gass

SQUARE TYPE New England Colonial looks big but has very economical plan.



FIRST FLOOR PLAN



SECOND FLOOR PLAN

29'-3" x 27' Flush-Board Siding New England Colonial

NEW YORK architects Evans, Moore & Woodbridge, who designed the House of Wood at New York's late World's Fair, recently executed the above New England Colonial for Economy Planners, Inc., at Harmon-on-Hudson, N. Y. The house has an interesting exterior of flushboard siding accented by deep-tone shutters. This house has an economical, square layout and is only 29' 3" x 27' in size, including the garage. Yet considering the moderate floor area involved it appears to be fairly large and impressive. The size is increased by the open porch, which is balanced by the projecting garage.

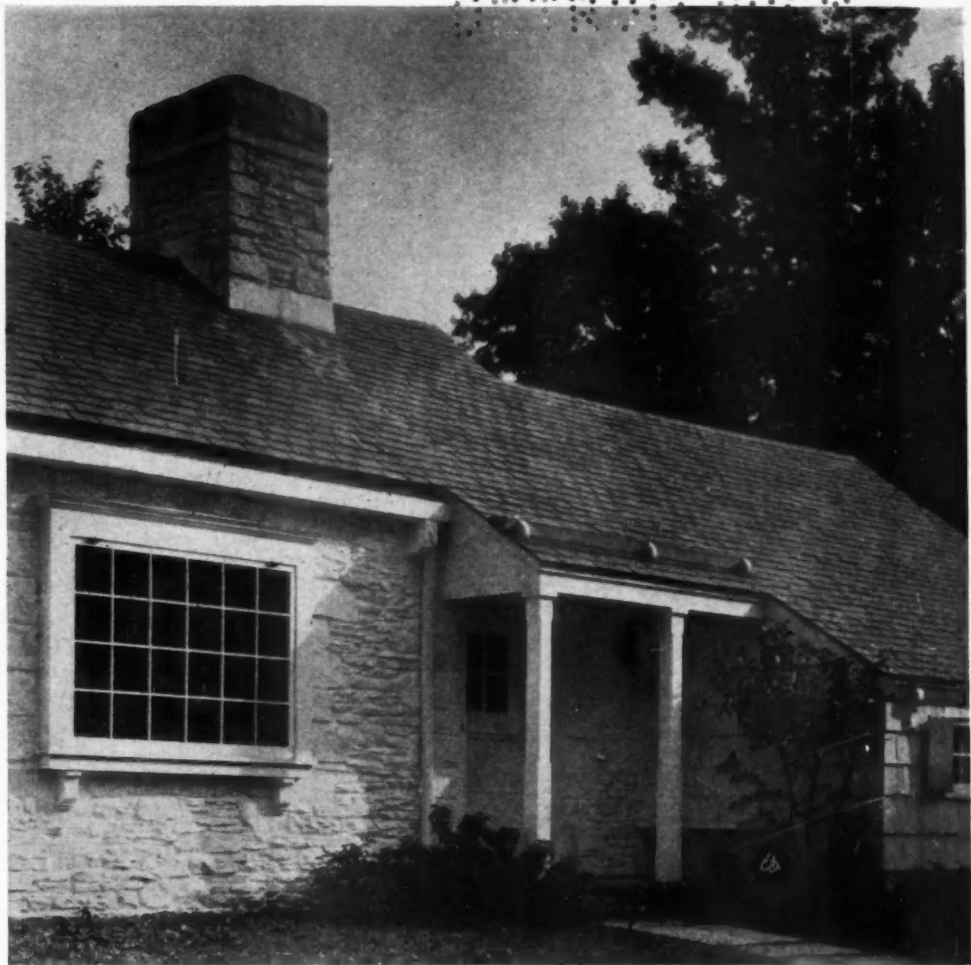
Living room of the house has been made unusually spacious—14' 3" x 23' 2"—and it is laid out so that one end would be used for dining purposes. However, the kitchen area has been made large enough and attractive enough for most of the everyday meals of the average family.

Construction materials include 12" concrete block foundation, Celotex Vapor-seal sheathing, 1/2" Kelley plaster board interior finish, strip oak flooring, Certi-grade red cedar shingle roof, Thatcher forced warm air heating system and conditioning unit. There are three good-sized bedrooms, ample windows and ample closets.

One-Story Pennsylvania Dutch

BENSON ESCHENBACH,
ARCHITECT; **GEORGE F.**
D'HUY, BUILDER

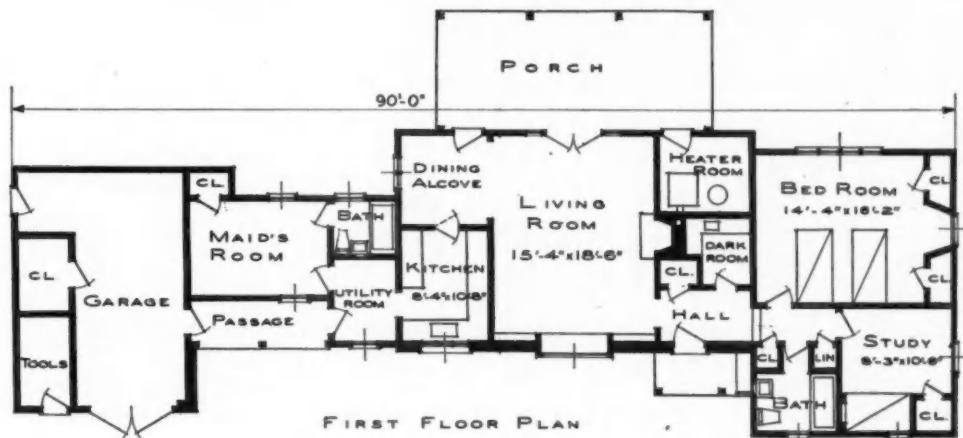
STONE WALLS painted white were used by Architect Eschenbach in this Scarsdale, N.Y., home. The stone has been placed with a flare for design, with large quoins surrounded by smaller field stone, laid with natural horizontal joints. The entrance has a friendly air with its two-part Dutch door and protected site. The large window bay is unusually attractive. Another interesting detail is the stone support for the wood eave.



LONG AND NARROW is this Scarsdale home atop a wooded hill. There is no basement. Heating unit is on first floor, and ample storage is provided in spacious garage. Hand-rived shingles on ell are painted white, with shutters a faded blue grey. Cubage 17,200.



SPECIFICATIONS include Curtis trim, Penn. Bangor black slate, Delco boiler-burner unit, Creodipt wall shingles, Sherwin-Williams paints, Wilson overhead doors, Congoleum-Nairn linoleum, General Electric refrigerator.



STREAMLINED CUTTING

"Roll Out the Barracks" is slogan of contractors on rush government jobs who are using multiple saw layouts and new mass production methods in pre-cutting

CONTRACTORS on the government's rush construction jobs have adopted new mass production cutting methods that have set some remarkable records. In other words, power saws are helping to "roll out the barracks" in a big way.

At Fort Meade, Md., for example, eleven saws have been set up under one roof by the Consolidated Engineering Co. Lumber moves from the freight car direct to the power saw and passes through a straight line cutting setup which delivers it to the carpenters, ready for nailing. The production setup for rafter cutting is remarkable. Four power saws are set in a row (see drawing below), connected by permanent extension tables equipped with stops for the different lengths of 16, 18 or 20 feet. Four cuts are required, and each saw makes one cut. The lumber comes to the first saw and is squared off. It then moves on to the second for the pitch or angle cut. Then to the third for the first heel cut, and finally to the fourth for the second heel cut. The minimum production on this four-saw hookup is 150 rafters an hour, and it has a capacity of more than 300.

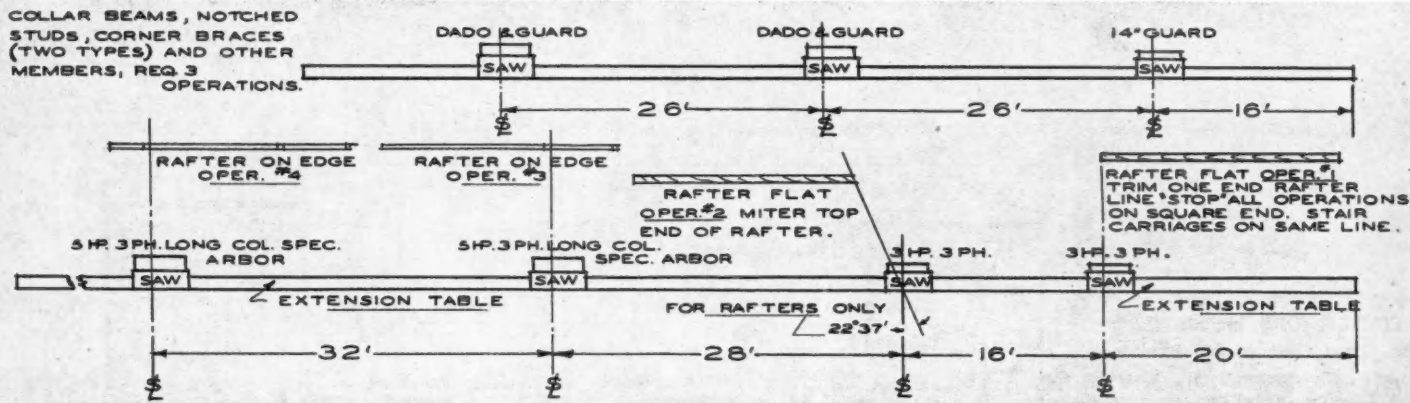
The system of pre-cutting used by Consolidated Engineering Co., as well as Coleman Brothers and John Bowen at Fort Devens, Mass.; J. A. Jones at Camp Jackson, S.C.; Sound Construction Co. at Fort Lewis, Wash., and numerous others, was developed by Paul Gardner, president of DeWalt Products Co. of Lancaster, Pa., who set up a specialized engineering service to work with con-



SPECIAL HEEL CUTTING HEAD on saw at Ellington Field, Texas. Multiple saw layout, arranged as in diagram below, speeds cutting.



DIRECT from freight car to saw is system used at Camp Peay, Tenn., where 24 saws are set up under one shed 600 feet long.



MULTIPLE SAW LAYOUT as used at cantonments. Four-saw hookup is used primarily for rafters and has capacity of 300 an hour, each saw doing one operation. Three-saw hookup, above in drawing, is used for collar beams, notched studs, etc., requiring three operations.



THIS FOUR-SAW straight line rafter cutting setup is used by Coleman Brothers and John Bowen, Inc., at Fort Devens, Mass. Lumber is squared off on first saw, moved on to second for the angle cut, then to the third for the first heel cut, then to the fourth for second heel cut.

tractors in organizing their power cutting methods.

Gardner realized the vast quantities of lumber to be handled and the short time schedule called for something special in the planning of the power saw setup.

In effect, what the engineers did was to set up for contractors straight-line mass production cutting methods that have formerly been used only in factories. Contractors on rush government jobs all over the country and in the Canal Zone have adopted the new production methods, and have not only reduced their expenses by a large amount but have been materially helped in meeting their time schedules.

At Fort Meade, the Consolidated Engineering Co. has been making pre-cutting history by rolling out 800 rafters per eight-hour working day, using a single line of four DeWalt machines, laid out as detailed in the accompanying sketch. On this job the contractor's schedule calls for a complete two-story barrack, 30 by 80 feet, to be turned out every 90 minutes.

Under the engineered pre-cutting system that has been perfected, blue prints supplied by the Quartermaster's Office are analyzed and all the important cuttings listed. Sketches are made showing the exact size of principal members and the angle of the cuts. Estimates are made as to the number of pieces required and the number of machines to cut the job in the required time. The location of the central cutting plant is scientifically worked out, and a straight-line production arrangement set up, usually taking the lumber direct from freight cars to the first saw.

Some remarkable cost-saving records have been made. At Fort Devens, for example, Coleman Brothers Corp. and the John Bowen Co., the general contractors, have reported the following specific savings on specialized cuts: 1. Canopy rafters—1,750 pieces cut, with a saving of \$135; 2. Canopy rafter braces—1,750 pieces cut at a saving of \$163; 3. Bridging—7,800 pieces cut at a saving of \$468; 4. Outside stair carriages, 48, at a \$50 saving.

On another government job the contractor made a saving of \$248 in cutting 1,500 rafters with two power saws, as compared with what it would have cost to be done by hand. He figured that cutting rafters by hand his average carpenter would cut six per hour. At \$1.25 an hour, this would have made the cost per rafter approximately 21 cents. Using two 5-HP DeWalt saws side by side, one of which was equipped with a four-inch dado head to make the notch cuts, and the other set at the

(Continued to page 74)



CUTTING CANOPY BRACES at Fort Devens. A saving of \$163 was made in this one operation; other savings are listed in article.



TWO-SAW HOOKUP at Fort Meade, Md., used by Consolidated Engineering Co., in the cutting of collar beams, knee braces, canopy braces and other items needed for this particular defense job.

Army and Navy Try Out "Demountable" Houses



10 A.M.: First sections of Precision-Built, Jr. house at Morrisville, Pa., are set into place. Henry Palmer of Langhorne, Pa., builder.



WALL SECTIONS of insulating board glued to 2-in. studs fit snugly together and are held in place by metal clips screwed to floor sections. Sections were built in nearby lumber yard.

Government orders stimulate building of prefabricated or shop-built houses which can be taken apart after present emergency

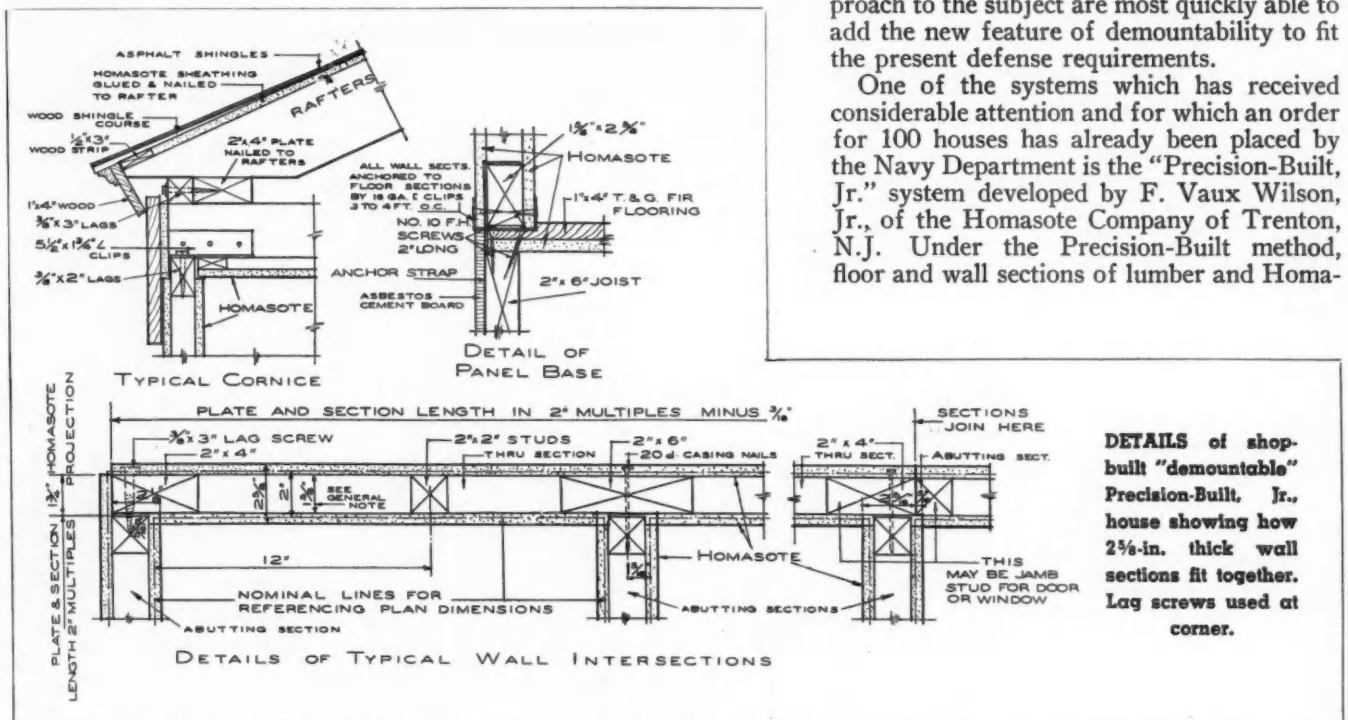
ONE of the significant developments coming out of the Army and Navy defense housing program, in which some 50,000 to 70,000 homes may be built next year, is the aid and assistance it is giving to a number of new types of house construction systems.

Some observers feel that this government defense housing program may give the prefabricated shop-built, or panel type house systems the boost they have long needed to make them an important factor in the national low-cost home picture.

Defense Housing Coordinator Charles F. Palmer and officials of the Army and Navy have definitely announced that educational orders are being placed for "demountable" and portable houses. Defense officials feel apparently that a large amount of housing must be built close to powder plants, naval or air bases and other defense projects that are temporary in nature. They feel that after the emergency they should be able to move or reclaim these houses and use them elsewhere. One suggestion is on farms.

This important development has given a new slant to the old topic of prefabrication, "packaging" or shop-building of low cost houses. It appears that persons who have been working along the shop-building approach to the subject are most quickly able to add the new feature of demountability to fit the present defense requirements.

One of the systems which has received considerable attention and for which an order for 100 houses has already been placed by the Navy Department is the "Precision-Built, Jr." system developed by F. Vaux Wilson, Jr., of the Homasote Company of Trenton, N.J. Under the Precision-Built method, floor and wall sections of lumber and Homa-



sote building board are constructed in the shop of a lumber dealer and sold to a local builder who handles the erection and sales.

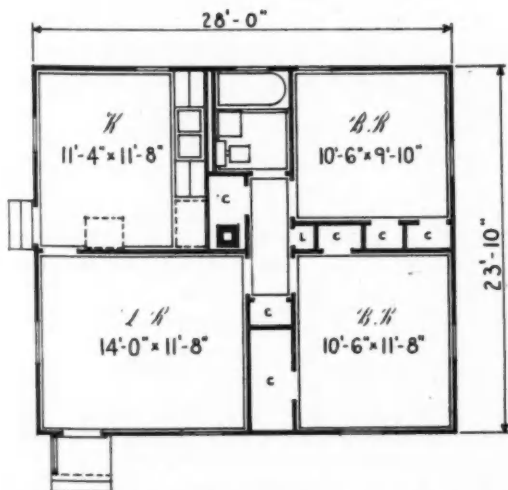
In the first order for 100 houses to be built at the New London, Conn., Navy base, the sections are being built by the City Lumber Company of Bridgeport. Construction of the houses is being carried out by Wadhams, Mays & Carey, building firm of Hartford, Conn. The City Lumber Company is to build the floor, wall and roof sections complete, ready for erection, at the rate of four houses a day.

About a month ago, your *American Builder* correspondent attended the demonstration erection of one of the Precision-Built, Jr. houses at Morrisville, Pa., and the pictures with this article were taken at that time. The floor, wall and roof sections of this house were built in the nearby lumber yard of the Henry Palmer Company at Langhorne, and were delivered by truck. With officials of FHA and interested observers from various branches of the building industry present, the 28' x 23'-10" house was completely enclosed in one day. Since that time, the system has been approved by FHA as well as by Army and Navy purchasers, and the 100 now under way at New London are duplicates, using the 28' x 23'-10" floor plan illustrated below.

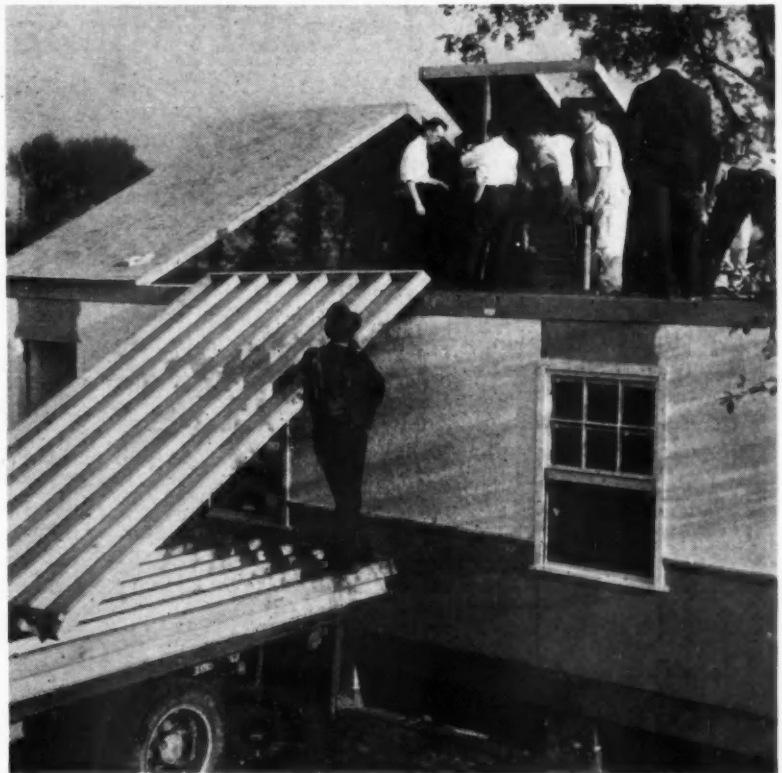
The Precision-Built, Jr. system makes use of large half-inch insulating board panels which are glued and nailed to wood joists, walls, studs and rafters, briefly as follows:

FLOOR SECTIONS—The floor sections for the standard house are 7' x 11'-11" in size, and eight are required. They consist of 2 x 6 joists, to which a layer of half-inch Homasote building board is first nailed and then a matched-pine surface flooring applied. Since the house rests on piers, the insulating board provides needed warmth to the floor. The floor sections fit tightly together and are firmly bolted in place.

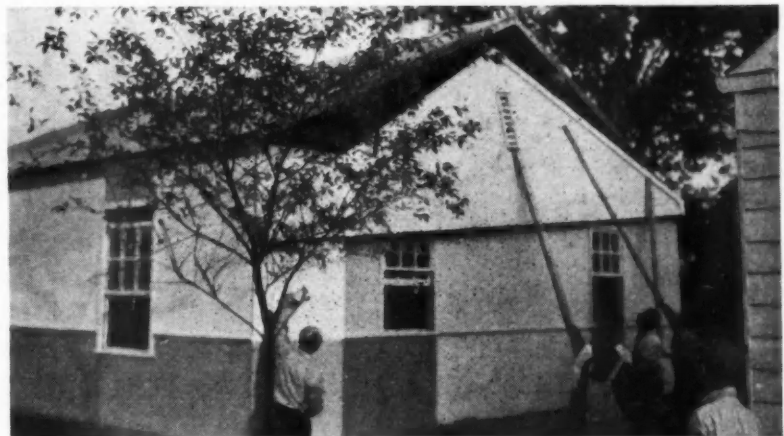
WALL SECTIONS—The wall sections are 7'-6" in height and come in various lengths, in two-inch multiples. The sections (Continued to page 75)



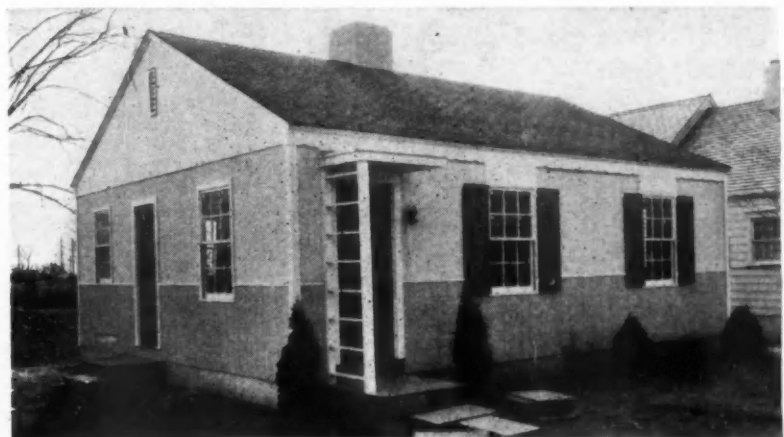
STANDARD defense housing floor plan is 28' x 23'-10". Has heating unit in center hall. Economic back-to-back kitchen-bath plumbing layout.



3 P.M. SAME DAY: 7' x 13'-6" roof sections of half inch insulating board glued and nailed to rafters are speedily set in place. Roof was completed in one hour.



4:15 SAME DAY: Shop-built end gable, 24' x 6'-6", is moved into place and attached by lag screws. House enclosed in one day.



COMPLETED PRECISION-BUILT, JR. house, which was approved for defense housing. Order for 100 duplicates for New London Navy Yard has been placed.

"Pre-Sold" Small Houses Going Big!

Nation-Wide Campaign Through Films and Radio on "Design for Happiness" Houses Is Creating Profitable Business for Builders and Dealers.

CONTRACTORS and lumber dealers enter the 1941 building year with one of the greatest opportunities ever offered to the industry, the opportunity to build pre-sold houses for a mass market that is waiting to buy.

Pre-selling has been accomplished by creating a new type of low-cost construction and built-in features that provide a dwelling far above the ordinary but at a selling price that enables the vast low-income group of prospects to obtain a well-built home at less than \$1 a day. Designed to satisfy the inherent yearning of millions ordinarily unable to acquire a home of their own, this revolutionary type of house has caught the public fancy.

Identified as "Design for Happiness" houses and approved by the Federal Housing Administration, the unusual attractiveness of the residences, combined with their low cost, have been and are arousing the interest of millions of potential purchasers through a campaign that includes a technicolor motion picture seen by nearly 15,000,000 people, a Sunday radio program on a national network of 79 stations, articles in national trade and consumer publications, and national advertising reaching 20,000,000 readers.

Incorporating a number of new low-cost construction methods made possible by erecting ten or more houses in a project, contractors and dealers, by utilizing the advantages of group buying of mirrors, decorative and structural glass for interiors, and by installing larger windows, are building "Design for Happiness" houses that are being sold in many cases before the roof is on.

Building experts believed that, by working out a basic plan which could be varied in exterior treatment and whose room arrangement could be reversed to get away from a "row house effect," they could build groups of dwellings at a lower outlay per home. This saving, they figured, could be put into the houses in the form of mirrors, larger windows, and other refinements not ordinarily found in residences costing less than \$10,000, and the homes could still be profitably sold at a price comparable to that asked for other places of the same size.

The idea was tried out in Toledo during the past fall by Sound Builders, Inc. Dale M. Garnsey, local contractor, was hired to build ten houses. The Kelsey & Freeman Lum-

ber Co. was lined up to supply the materials as they were needed so that there would be no delays during construction. Work got under way in mid-August, and the No. 1 house was sold about two weeks later.

When the first house was finished, it was furnished by a Toledo department store and opened to the public for three weeks. More than 10,000 visitors inspected it, and marveled at the increased cheeriness given the interior by larger window openings, the 42 square feet of polished plate glass mirrors, the colorful Vitrolite wainscot above the bathtub, and the decorative glass used in the kitchen cupboard doors.

It was instantly apparent to those checking the reactions of visitors that the answer to attractive low-cost housing had been found. It was a dwelling designed for greater beauty, convenience, and comfort through the carefully planned application of glass.

The real success of the "Design for Happiness" type of house was indicated by the quick sale of the other nine in the Toledo project. Most of them were sold from the blueprints! Their buyers had seen the completed first house and realized that at last something had been done to put charm and graciousness into small homes which they could afford to buy.



NEIL JONES of Kelsey & Freeman Lumber Co. price-tagged glass installations of "Design for Happiness" house.

How It Works Out

"I CAN'T afford to install a triple-view mirror like that, in a bedroom of the low-cost houses I'm going to build," R. G. Dunbar, Toledo contractor, told Neil Jones, sales manager for Kelsey & Freeman Lumber Co., a few days ago.

"How much do you think that unit of polished plate glass mirrors would cost you?" asked Mr. Jones.

"Oh, about \$35," replied the builder.

"You're 40 per cent too high; you can put that set in for \$21.25! If you build a lot of houses, they won't cost you quite that much," said Jones.

"Well, those mirrors are just what my little houses need to dress them up," agreed contractor Dunbar.

The above conversation occurred recently in Mr. Jones' office as he and the contractor were looking at pictures of glass installations in "Design for Happiness" houses. The photographs are thumb-tacked to the wall and each bears a price tag showing, the cost of the mirrors, Vitrolite, and Louvrex decorative glass. They instantly capture the attention of people coming to see Mr. Jones. All of the contractors who have talked over the installations with him have thought that the inclusion of glass was a great idea.

Mr. Jones, also, shows the pictures to prospective home owners. "They're pretty sure to insist that the plan for the house built for them contains some of these features," said Mr. Jones. "We're sowing now for harvest later."



MR. AND MRS. Robert Taylor of Toledo, the first couple in the nation to buy a "Design for Happiness" house, broadcast their appreciation of this new type of house over a network of 79 stations.

The "package of glass" in each Toledo "Happiness" house cost approximately \$50, but in the eyes of buyers it increased the appearance and value of the places two or three times that amount. They never before had seen so much appeal in a house selling with its 50 x 120-foot landscaped lot for \$400 down and monthly payments under the FHA of \$26.60.

The ball was rolling for the new type of house. Contractors in Washington, D.C., Houston, Tex., and Jacksonville, Fla., who had viewed the technicolor film, "Design for Happiness," which the FHA sponsored with the cooperation of Libbey-Owens-Ford, heard that in Toledo a builder had grasped the opportunity presented by the motion picture, national advertising, and the weekly radio broadcast. Some of them went to Toledo to see what a real "Design for Happiness" house was like, and others wrote to Sound Builders, Inc., seeking information.

The contractors in all instances were impressed by what they learned. Houses which they had under construction were changed where possible so that mirrors and other portions of the glass parcel could be included, and new plans were launched for "Design for Happiness" subdivisions. It is the intention of builders in the three above cities to erect more than 800 houses, and incorporate the sales-appeal glass items in each. In Washington, a \$44 "glass parcel" is being installed; in Jacksonville it amounts to \$55, and in Houston it is \$50. Each local application of the pre-planned "package of glass" idea varies to suit conditions.

Reports coming from the widely separated towns say that the public is responding to the houses with the same enthusiasm as did Toledoans. They are flocking to the building sites, and the houses are selling in many cases before the are enclosed.

Stimulating national interest in this new kind of house are such interviews as have been on the "Design for Happiness" radio program recently. On Nov. 24, millions of Americans heard Mr. and Mrs. Robert Taylor, who have the honor of buying the first "Design for Happiness" house in the nation, tell how they came to buy the place, what features in it they like so much, and why they recommend its architecture to others. The broadcast had added appeal since it came directly from the living room of the Taylor's new home. From Houston came an interview between the contractor and a prominent club woman during the Dec. 15 program. Again the air audience heard a woman's impression of this revolutionary type of small house. Her reaction may be

summed up with this one sentence: "It (the house) has great promise for all the couples who have the problem of building a home on an average income."

Theater managers probably get as accurate a pulse reading on human nature as do doctors. Typical comments from them, following the showing of the "Design for Happiness" film in which movie-goers watched the Bob Martins build this new kind of "glassical" home, are interesting:

"Moline (Illinois) is a town of a lot of 'Bob Martins' of the \$25 a week income group. They were all favorably impressed."

"An excellent reel which was very well received in this residential community (Manhasset, Long Island)."

"Audience reaction splendid. Many asked about obtaining FHA loans," Deming, N. Mex.

"Very good; it sold me the idea!" Greggton, Tex.

Hundreds of such reports have been received, and the film is still showing in many sections of the nation. It is educating millions of prospects to a new type of better housing. Up to now they have been reluctant to build because their incomes only permitted a plain little house. They are learning now through the powerful media of national advertising, radio and a motion picture that it is possible to buy a glamorous small house on payments less than rent.

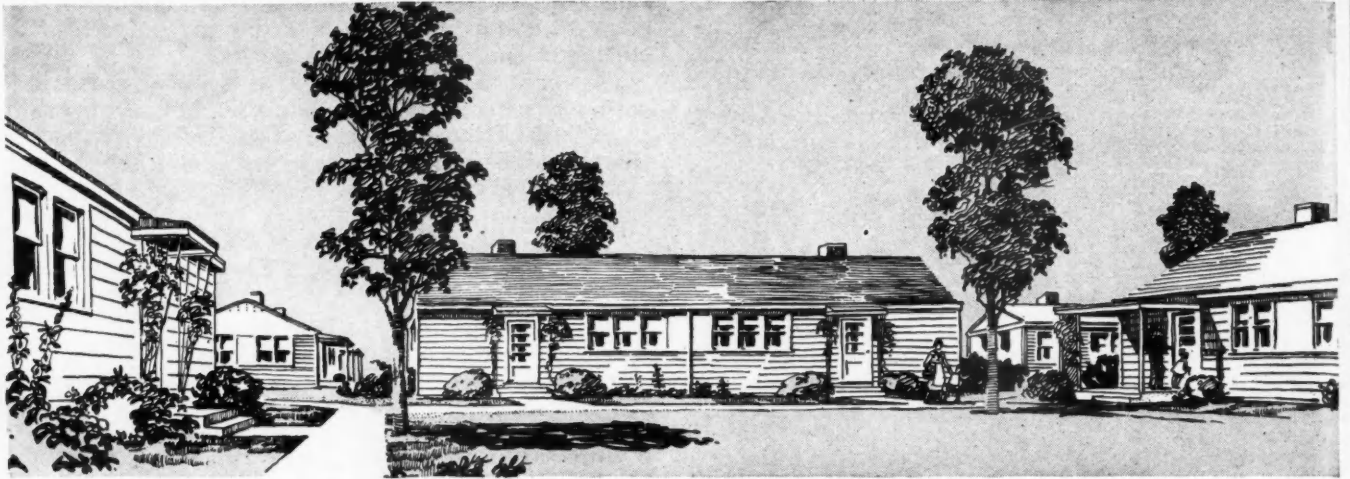
It is estimated that during the next five years four million houses will be built in the United States. Probably three-fourths of them will be bought by people in that market which owns 75 per cent of all savings accounts, 72 per cent of the nation's radios, and 68 per cent of all new automobiles. They are active prospects for homes of their own, and there is now a house designed for them and priced for them.

Added assurance to the public that these dwellings are soundly built and the answer to a long-felt desire is the seal which has been prepared for affixing to the glass in the front door. It announces that here is a "Design for Happiness" house which bears the approval of FHA. This seal will be the hallmark of quality—assurance to the prospective buyer of new beauty, permanence, convenience, and low maintenance and assurance to the contractor of ready consumer acceptance of a finished product.

The market is everywhere. Contractors and lumber dealers have a new type of approved house to talk about. It's the pre-sold "Design for Happiness" house for '41.



THIS SEAL goes on the front door of "Design for Happiness" houses.



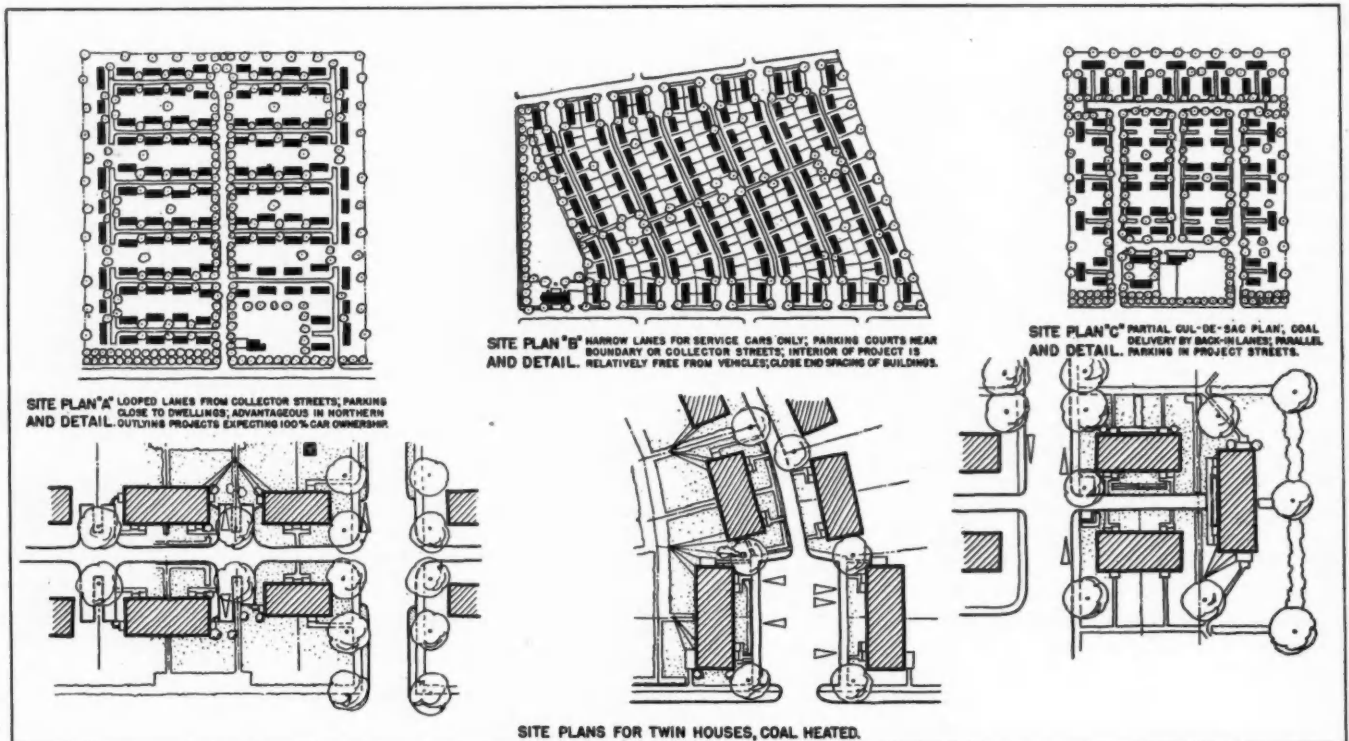
SKETCH showing how typical defense housing units of the twin type, detailed opposite, would appear when arranged in one of the suggested groupings similar to site plans appearing below.

USHA Offers Plans for Defense Housing

FOR the purpose of speeding defense housing, by giving local authorities all possible aid in preparing such plans, the USHA Technical Division has recently issued two series of working drawings which are basic and widely adaptable to this purpose. The first series, entitled "Defense Housing Projects," consists of 18 pages of drawings for the frame construction of one-bedroom, one-story twin dwellings (two houses);

two-bedroom, one-story twin dwellings (two houses); three-bedroom, one-story twin dwellings (two houses); four-bedroom, one-story single (one house); two-story building comprising eight one-bedroom flats. Included are construction details and heating diagrams.

These basic working drawings (some of which are shown on the opposite page at reduced scale) allow freedom of adaptation to local planners and architects that



REFERRING to the above drawings, it is suggested that site plan, dwelling unit plans and coal storage must be correlated. Pave access to all units for coal delivery and ash removal, for greatest economy, provide for chute delivery. (Chute distance to be determined locally.) Adapt auto parking to scheme of service drives. With moderate spacing of buildings as here shown, density is approximately ten dwelling units per acre, omitting playgrounds. Modifications and combinations, or specially designed types of arrangement, will be necessary to fit the conditions of each site. These basic plan types can be adapted to informal or curvilinear layouts.

the most suitable housing might be worked out according to such factors as arise in the community. A standard specification has also been prepared, and more recently similar plans and "specs" have been released for masonry construction of these units.

The last report available indicated that defense construction of this general type was under way or completed involving 6400 homes spread over 17 different communities. This indicates that adaptations of these basic designs will continue to be used in many sections, and will provide a considerable volume of this type building.

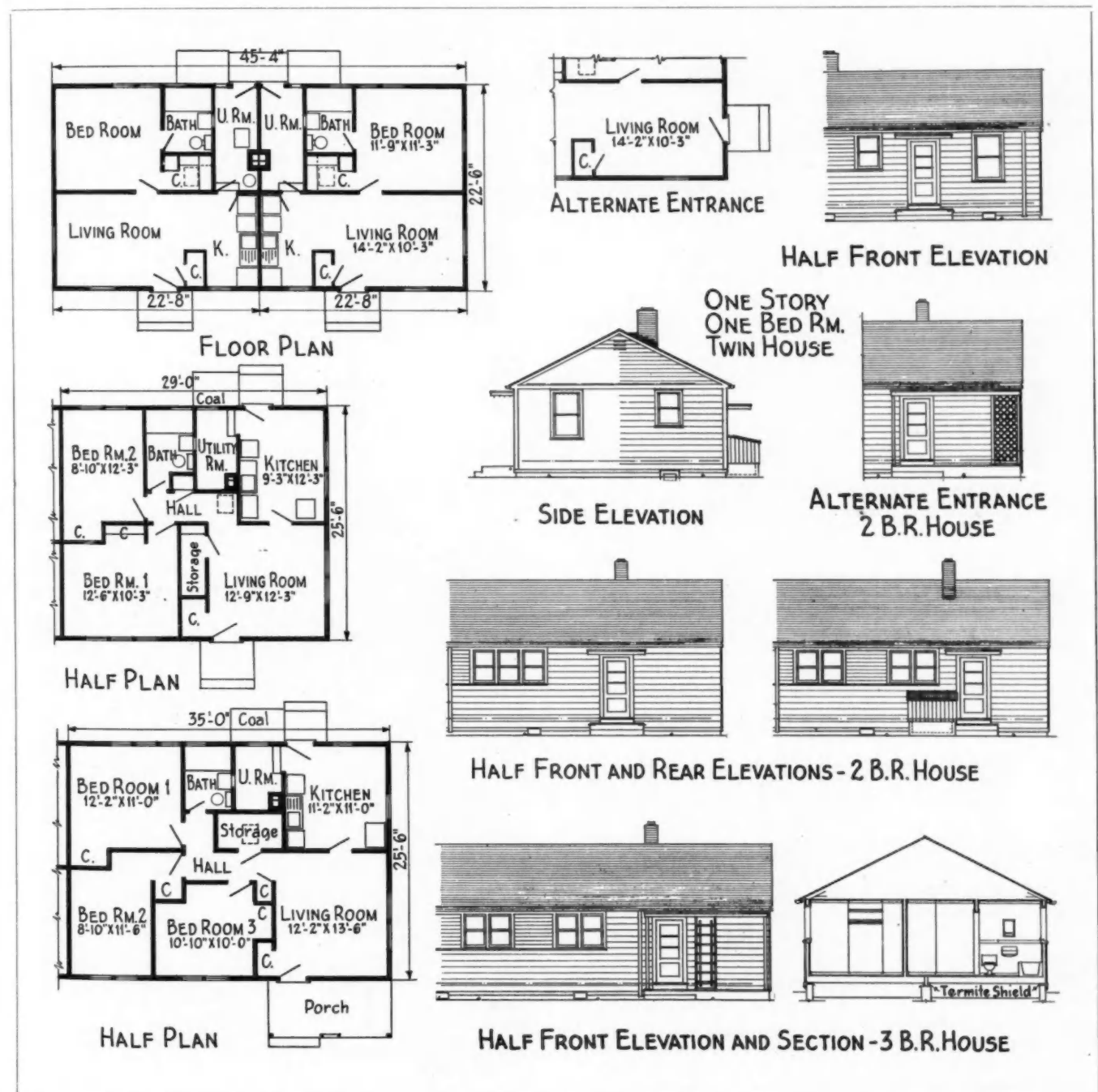
Site planning for these units, as shown here, suggests some of the possibilities of arranging the twin houses for the best utilization of land having various shapes and contours. It will be noted that with the exception of the flats (these were not included in the drawings selected for reproduction), all homes in these series were

designed for individual heating systems coal-fired.

To further assist in this work, complete directions for use of the plans and specifications are also supplied to local authorities. By utilizing these various types of aid, architects engaged on defense housing in every part of the country will be able to reduce their working time in preparing plans by at least 50 per cent. Since speed is a prime factor in defense housing, with the need for new homes in this category mounting more rapidly each week, any elimination of routine work is an essential contribution to the program. At the same time, it is highly important to safeguard against the relaxing of standards which often accompanies stepped-up production. These Technical Division plans were prepared with both these ends in view.

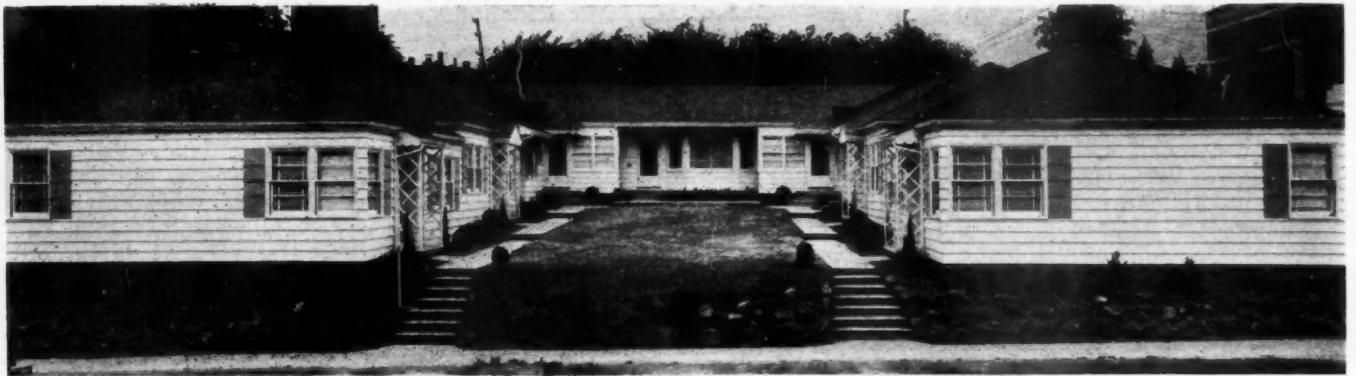
Distribution of this material follows drastic cutting by USHA and local authorities of the time required for many other stages of project planning and construction.

BELOW, Plans, elevations and details of one-, two- and three-bedroom twin defense housing units.



ises);
ises);
story
cluded
h are
free-
s that

COAL
PARALLEL
TS.
Pave
deter-
is ap-
rrange-
ayouts.



Bungalow Court Type 9-Unit Apartment

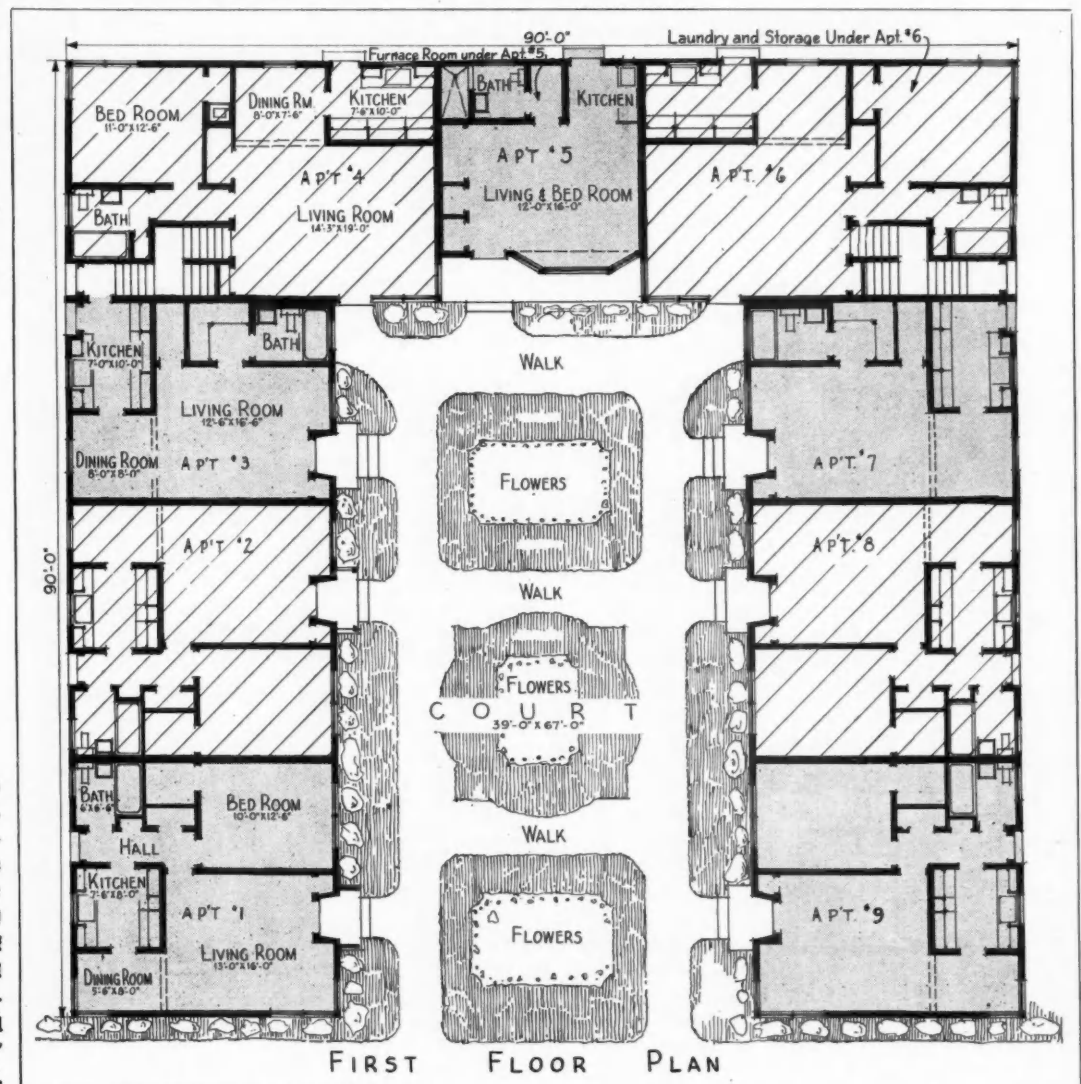
THIS attractive bungalow court nine-unit apartment building was erected in Portland, Ore., by Carl Illig, for thirty years a specialist in construction of houses and apartments. Clyde Simmons is the designer of this building which was put up at a total cost of \$25,000 on a 100 by 100 foot lot close to the heart of the city; this location near rental garages made further car storage accommodations unnecessary. There is basement space under a portion of the building where there is a furnace room, and where each tenant has his own storeroom.

The building contains the following units: Four bungalow

apartments, each having living room with rollaway bed, dinette, kitchen and bath; four apartments with the same room arrangement plus one bedroom; and one bachelor apartment of living room, kitchenette and bath. Exterior is finished with 1 x 10 red cedar siding, the roof with cedar shingles, and ceilings are insulated with Palco wool. Basmore hot water boiler system heating and Crane automatic gas water heaters are supplied.

Outstanding features of these Izzar apartments which are incorporated into every suite are separate front and rear entrances, cross ventilation, and soundproof partitions. Kitchens have tile work tops, Electrolux gas refrigerators, and 20 lineal feet of cupboard space. Bathrooms have Pembroke tubs with showers, tile floors and trim, and built-in cabinets.

THE nine units in this plan of the Izzar apartments, Portland, Ore., are arranged around three sides of an attractive court; apartments 6, 7, 8 and 9 are reversed duplicates of Nos. 1, 2, 3 and 4. Carl Illig, builder; Clyde Simmons, designer; over-all dimensions, 90' x 90' placed on lot 100' x 100'.

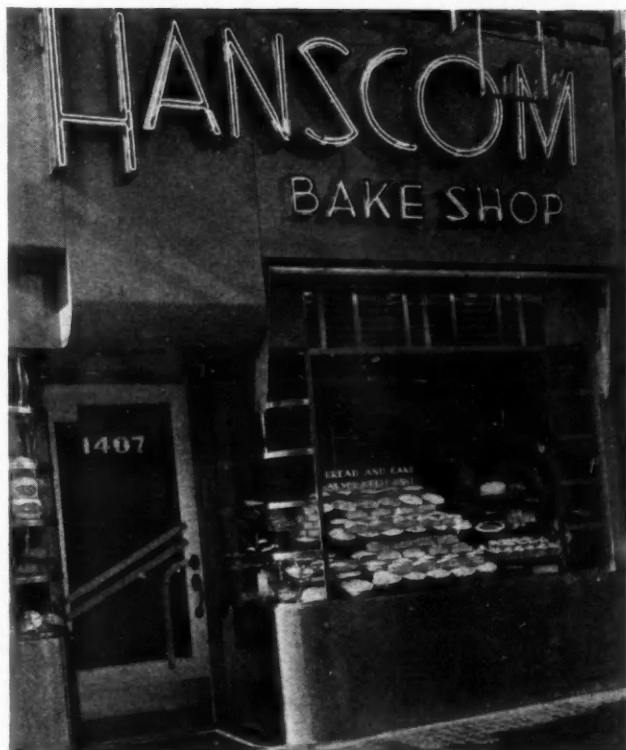




STAINLESS steel, glass and a porcelain metal sign make up the front of this typical Hanscom center-door bake shop, designed by Horace Ginsbern.

Photos by Robert M. Damora

One Store Job that Led to 100 More



POPULAR narrow-front, side door shop used by Hanscom.

"It Pays to Modernize" proved by New York bakery chain which "cast its bread upon the waters."

A FEW years ago when the Hanscom Baking Corp. of New York gingerly set out to remodel one store, it was in the nature of an experiment in which there was some feeling that they might be just throwing good money away.

But it turned out that these famous bakers were "casting bread upon the waters" in a way that brought back high returns. In fact, it may be said that there was "dough" in it for all concerned.

As a result of this first modernizing job, store sales showed a sharp increase, and New York Architect Horace Ginsbern, specialist in store front design, was commissioned to do several more. Ultimately, the entire chain of Hanscom stores was remodeled. Not only did Architect Ginsbern design all these jobs, but the precedent established resulted in the modernizing of numerous other shops and stores in similar lines.

The moral in this story for architects and builders is that the store modernizing market is one of the biggest sources of profitable new business for many people in



MODERN Hanscom bake shop interior features terrazzo floors, concealed lighting and walnut plywood paneling with snap-on mouldings.



OPEN DISPLAY shelves set at an angle.

the industry. There has been a sharp increase in modernizing work in this field in the past few years, and 1941 is expected to show still greater increases. The advent of air conditioning, indirect lighting, acoustical materials, new display techniques and new store front equipment has vastly expanded the potentialities in this field. Surveys show that the market is particularly inviting in the smaller cities and towns.

In setting out to create something new and distinctive in the bakery field, Architect Ginsbern made use of

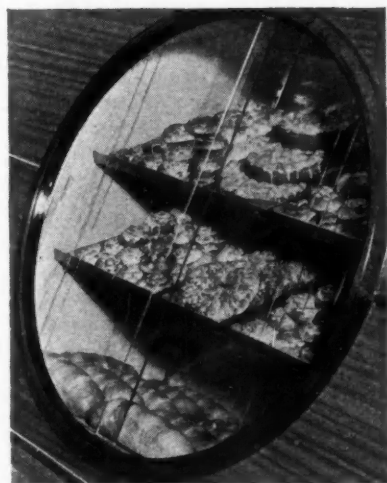
Modern store interiors with "self-selling" display features pay way in increased sales. Here is a profitable market for builders and contractors.

many of the newer materials available. He adopted stainless steel for his store fronts and devised a striking, modernistic front that has attracted wide attention. An important feature of the modernizing work as far as it concerns the typical Hanscom bake shop is that the materials used are screwed or bolted in place in such a fashion that they can be removed without loss, to another site. This salvage feature is an important one in the retail store market in a city like New York where there is a constant shift taking place.

The modernizing of stores and shops has become a specialized business of its own, and many of the tricks of the trade are well illustrated in the accompanying photographs of both exteriors and interiors. One feature of importance as concerns the exterior is the fact that the entire upper portion of the store front above the glass consists of a porcelain metal sign. The signs are fabricated in shops specializing in this work. Many of the Hanscom signs, with their distinctive modernistic Neon lettering, are made by the Serota Sign Co. Low maintenance cost as well as salvageability are



SMALL SHOP INTERIOR executed in modern design has display racks set in niches in wall; concealed lighting on bakery goods displayed.



ABOVE: oval niche with sliding doors.

Photos by Robert M. Damora



AIR conditioned Hanscom shop designed by Horace Ginsbern.

important features of the Hanscom fronts. The glass, stainless steel and porcelain metal are all easy and inexpensive to maintain in shining condition.

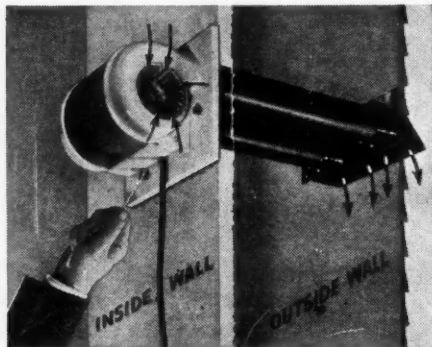
In the interiors the Hanscom stores feature colorful terrazzo floors of unusual design. Walls are finished in five-ply plywood with oriental walnut surface. The panels are standardized and the joints are covered with snap-on bronze mouldings. Niches or wall cases are widely used. These are lined with white Formica and well lighted by concealed reflectors. Open shelves set at an angle are widely used for the display of goods.

SERVICE TO READERS

EACH ITEM in this department is numbered for convenience of readers. Please use the coupon on page 62 for requesting further product information or new catalogs. Mail coupon to American Builder Reader Service, 105 W. Adams St., Chicago; or write direct to manufacturers at addresses given, mentioning your profession, occupation or business connection with building industry.

EQUIPMENT ITEMS FOR MODERN BUILDINGS

AB307 The Skuttle No. 100 ventilator (J. L. Skuttle Co., Detroit) is easily installed through the outside wall, anywhere. Two 2¼ adjustable flues connect the fan panel with the outside louvered plate. Toggle bolt fastenings attach the unit which weighs only 11 pounds. Twin blowers of the Sirocco type are silent in operation and deliver 90 c.f.m. Current consumption is same as a 25-watt electric light bulb.



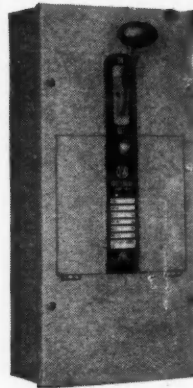
Skuttle Vent Goes Through the Wall.

AB308 Van Dyke Industries, Chicago, offer a new clamp-on adjustable fluorescent lamp, for drafting boards, office desks, work benches, and wherever fluorescent lighting is desirable. The lamp is completely adjustable in height, and comes in two sizes either for the 15 or 20 watt. Fluorescent lamps are the newest thing in eye-sight efficiency and operating economy—100 watt efficiency for 15 watt cost.



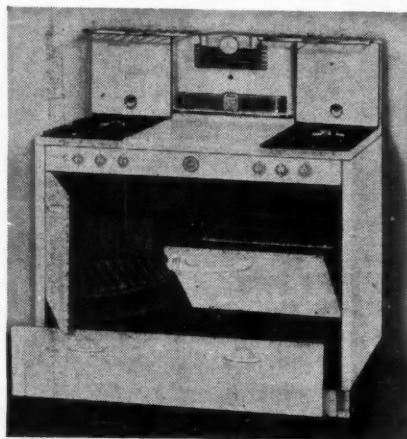
New Van Dyke Fluorescent Lamp Attaches to Desk, Table or Bench.

AB309 The (F-A) Shutlbrak Switch, developed by Frank Adam Electric Co., St. Louis, Mo., is a front-operated enclosed safety switch, for either surface or flush mounting. It is a high quality, heavy duty industrial switch with quick make and quick break connections held under compression. The line and load connections are enclosed in the completely insulated shuttle, which contains the movable contacts.



New Frank Adam Safety Switch.

AB310 New 1941 "All American" model Magic Chef gas range, offered by the American Stove Co., Cleveland, is a real family size range, 42" wide. Has roomy top surface, with divided cooking top, burners spaced sufficiently to take four 12" utensils at one time. Oven is 18" wide and 20" deep. Has large swing-out broiler with increased broiling area, high enough to broil chicken or barbecue meats, and has extra warming-compartment. Range fits flush to wall, with extra-high back-splash panel and disappearing back shelves. Base is solid at sides, open at front for easy cleaning. Streamline drawer at bottom provides easy access to gas adjustment mechanism. This range was designed on suggestions by home economists.



1941 "All American" Model Gas Range.

Readers Service Department Continued to Page 58

AB311 "Lead Lighting Fixtures" is the subject of a valuable 4-page folder by The Products Research Co., High Ridge Road, Stamford, Conn. Four designs of Ledlite, the modern ornamental lead lighting fixture, are illustrated. These standard models are five or six sided, made in attractive Gothic style with either a plain or ornamental beaten finish in genuine sheet lead—a luxury item reduced in cost to fit the average home.

AB312 "Youngstown Pressed Steel Kitchens," an 8-page catalog for general distribution to prospective home owners and a companion piece, "Youngstown Pressed Steel Kitchen Equipment and Service for Better Kitchens at a Lower Cost," a 24-page booklet for contractors and builders, have been prepared by the Youngstown Pressed Steel Div., Mullins Mfg. Corp., Warren, O.

AB313 The Dome-Turbo exhaust for kitchens, baths and amusement rooms is presented in a new 6-page folder from the Electric Specialty Co., 2936 4th Ave. S., Minneapolis, Minn. This electric ventilator is built into the ceiling connecting by an air duct to the outside.

AB314 Catalog E from The Deming Co., Salem, O., presents "Deming Water Systems." It is a handbook on shallow and deep well pumps and water systems—a very important subject in these days of modern country homes.

AB315 "Illustrated Steel Window Price List, 1940-1941" has been issued by Mesker Brothers, St. Louis, Mo. It is a valuable handbook of 32 pages presenting standard sizes and recommended construction details with list prices and discounts, making this a good estimator and buyers' guide.

AB316 "MetaLane Weatherstrip Doors" is a sales and installation portfolio prepared by the Monarch Metal Weatherstrip Corp., St. Louis, Mo. Numerous examples of Monarch installations are illustrated and 26 pages of detail drawings and text give installing guidance.

AB317 "The Phantom Doorman," an illustrated broadside from The Yale & Towne Mfg. Co., Stamford, Conn., illustrates and describes in detail the electric-eye-controlled automatic door opener-closer. It pictures this modern device applied to many entrance doors.

FOR QUICK, CONVENIENT SERVICE, USE COUPON, PAGE 62

The Springs
are
"POWER-
METERED"
on Every RoWay Door

* First, each Ro-Way Door is weighed ... then the springs are manufactured in our own plant for each particular door and carefully "metered" to insure the correct POWER for most perfect door operation



Ro-Way Garage Doors with curved top section, with interesting glass arrangement.



Garage of U. S. Government Marine Hospital, New Orleans, La.



Ro-Way Industrial Garage Doors are widely used



Modern Residence with attached Garage, equipped with Ro-Way "Two-Car" Overhead Type Door.

No "Stock Springs" Used

Ro-Way brings to Garage Door operation a new measure of lasting satisfaction. By developing a method of "power-metering" the springs for each Ro-Way Door, we are able to apply to each Door the power best suited to its weight. Each Ro-Way Door is weighed ... then the springs are manufactured in our own plant for use on a particular door, to insure absolutely correct spring balance. This is just one of the engineering refinements available to you without any extra cost when you specify ...

Ro-Way OVERHEAD TYPE DOORS

Four other worth while advantages developed by Ro-Way add immeasurably to overhead type door performance, ease of operation, and lasting "good looks." These are ...

"Crow's Foot" Outer Bearing Support

Rigidly holds the chain sheave wheel in permanent alignment. No twist ... no sag to cause friction.

"Ro-To Live" Spring

A powerful *Floating Torsion Spring* (used on some models) gives perfect balanced lifting power, and ends side-drift and binding.

"Zip-Lock" Adjustment

Used on Ro-Way Doors having Twin Torsion Spring Power. Permits instant easy adjustment of spring tension.

Parkerized and Painted Hardware

Ro-Way Hardware and Tracks are given finest known protection against rust and corrosion ... same method as used on fine motor cars, refrigerators, etc. Parkerizing and Painting process occurs AFTER all forming and/or other machine operations have been completed.

Ro-Way Service is Nationwide

Sales offices, with competent installation engineers, are located in principal cities. Write for name of one nearest you, or ask us for Free Ro-Way Door Folders, prices and complete information.

ROWE MANUFACTURING COMPANY

713 Holton Street, Galesburg, Ill., U. S. A.

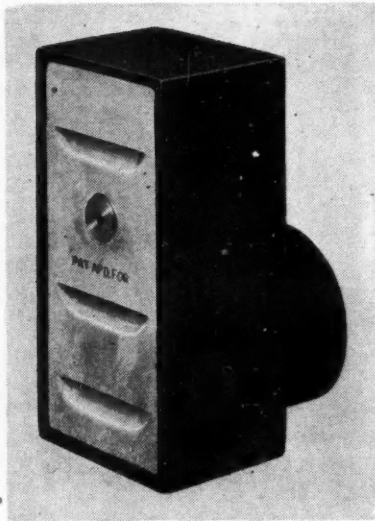
There's a RoWay for every Door way!

SERVICE TO READERS

EACH ITEM in this department is numbered for convenience of readers. Please use the coupon on page 62 for requesting further product information or new catalogs. Mail coupon to American Builder Reader Service, 105 W. Adams St., Chicago; or write direct to these manufacturers mentioning your profession, occupation or connection with building industry.

WHAT'S NEW IN BUILDING MATERIALS

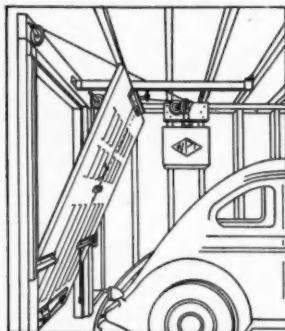
AB318 A useful refinement in building, where fuel oil is to be used, is the "Fill and Vent Box" offered by the Flush, Fill and Vent Co., Philadelphia. It is a fill and vent in one compact tamper-proof unit plus flush installation; a metal



Fill and Vent Box for Oil Service to be Built into Basement Wall.

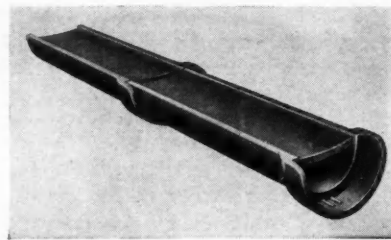
casting $2\frac{3}{4}$ " x $5\frac{5}{8}$ " x $2\frac{1}{2}$ ", having slotted removable plate and lock screw. Oil is received by putting extensions into threaded 45 degree fitting cast into box for $1\frac{1}{2}$ or 2-inch pipe. This is also threaded on rear for attachment of vent and filler pipes.

AB319 The Western Products, Inc., New Castle, Ind., has developed its No. 760 "Tip Top Float Over" garage door hardware in two types, Deluxe and Standard. As illustrated, this door is perfectly counterbalanced by small weight box filled with gravel.



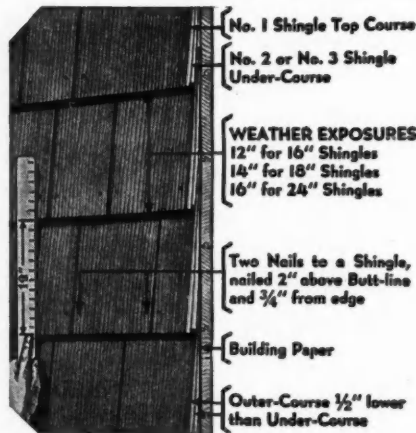
760 Standard "Float Over"

AB320 A recent arrival in the underdrainage field is vitrified clay "Skip-Pipe" developed by the Robinson Clay Products Co., Akron, O. Its special design assures high velocity flow equivalent to a much larger size of full-round pipe. It comes in sizes from 4" to 12", inclusive, all in 2-foot lengths.



Robinson "Skip-Pipe" for Underdrainage.

AB321 Double-Coursing is a method of red cedar shingle sidewall application which combines durability, beauty and economy. This simple construction calls for the placing of two layers of shingles on each course, at the same time materially increasing the exposure between courses. Economy is obtained through the use of a No. 1 grade shingle for the outer



Double-Coursed Sidewall Construction as Recommended by Red Cedar Shingle Bureau.

course and a No. 2 or No. 3 shingle for the inner and completely covered layer. In applying pre-stained or painted shingles, the under course can therefore be applied untreated. The use of No. 2 or No. 3 stock for the under course, plus the wide exposure, accounts for a strikingly low materials cost. The double course produces a deep and beautiful shadow line.

AB322 "Let's Decorate Your Home with Sunbeams" is the intriguing title of a 24-page brochure on Curtis Silentite insulated windows prepared by the Curtis Companies Service Bureau, Clinton, Ia. It contains a rich quantity of design material concerning windows and demonstrates with both photographs and working drawings the ease of installation and the efficiency of the Curtis window units.

AB323 "How Lumber and Paint Keep Your Home Always in Style" is a 4-page brochure for prospective home owners and builders concerning modern paint styling and how good paint helps to maintain permanent quality in good wood construction—Lead Industries Assn., 420 Lexington Ave., New York City.

AB324 "The Zinc Industry" is a 30-page brochure by the American Zinc Institute, Inc., 60 E. 42nd St., New York City. It is offered as "A Mine to Market Outline." Zinc for galvanizing and for paint pigment are sections of particular interest to builders.

AB325 "The Plywood Catalog," fall-1940 edition, is ready for distribution by the United States Plywood Corp., 616 W. 46th St., New York City. It is a handbook and buyers' guide of 32 pages listing the items in stock of every type of plywood, including many imported woods and specialties.

AB326 "Barber Genasco Built-up Roofing" is a new 20-page handbook prepared by the Barber Asphalt Corp., Barber, N. J. A companion piece of 12 pages is devoted specifically to shingles, sidings and roll roofings, these being illustrated in full natural colors.

AB327 Wire calculator free—a novel slide rule type of electric wire calculator giving pertinent information on the various types of building wire required under the new National Electric Code has been prepared by the General Cable Corp., 420 Lexington Ave., New York City.

AB328 "Transform Cracked Plaster" into walls and ceilings of lasting beauty easily and quickly at little cost, is the title theme of a new 8-page brochure by The Upson Co., Lockport, N. Y., presenting the Upson "Kuver-Krak" panels and illustrating how they are used.

AB329 "It's Different" is the intriguing title of a new 24-page 2-color brochure on "Eagle" insulation, the mineral wool wall-fill insulation of the Eagle-Picher Lead Co., Cincinnati, O. Comfort both winter and summer is proved.

AB330 "Blue Ox Series No. 1; Specimen Plans for Open and Covered Grandstands"—West Coast Lumbermen's Assn., Seattle, is offering a new series in loose leaf portfolio form detailing various structures "With Douglas Fir Timbers For Strength."

Readers Service Department Continued to Page 60

FOR QUICK, CONVENIENT SERVICE, USE COUPON, PAGE 62

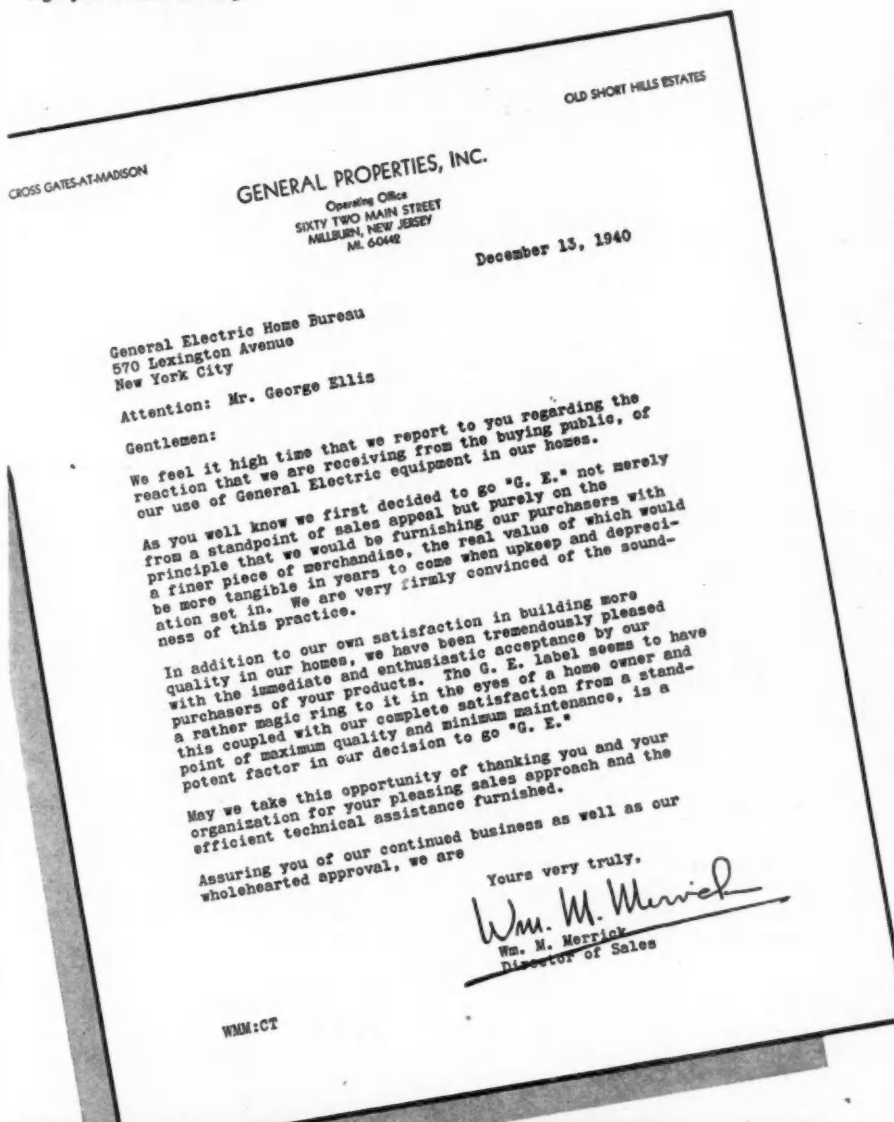
General Properties Drafts PUBLIC ACCEPTANCE

As An Additional Salesman



Marcel Villaneuva, Architect

Owner satisfaction is paramount in the selection of the materials and equipment for the fine homes built by General Properties, Inc., in Madison and Short Hills, N. J. This is one important reason for its continued success and high professional standing.



Public acceptance and owner satisfaction are assured when homes are equipped with G-E kitchens, wiring systems, and heating plants. In addition, alert builders are using G-E's tested House Merchandising Plan — a service that includes Architectural Engineering, Promotional, and Advertising aids.

This widely used plan is available to you, carefully fitted to your needs. If you are looking for increased sales, why not find out how General Electric's merchandising experience can be made to work for you? The coupon will bring complete information, without obligation.

General Electric Home Bureau
Dept. AB-411, 1285 Boston Avenue
Bridgeport, Conn.

Please send information on the G-E Home Bureau's House Merchandising Plan.

- I am building my own home
- I am building for resale
- I am an Architect

Name.....
Address.....
City.....State.....County.....

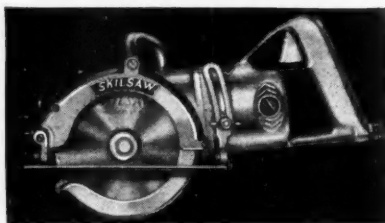
GENERAL ELECTRIC

SERVICE TO READERS

EACH ITEM in this department is numbered for convenience of readers. Please use the coupon on page 62 for requesting further product information of new catalogs. Mail coupon to American Builder Reader Service, 105 W. Adams St., Chicago; or write direct to these manufacturers mentioning your profession, occupation or connection with building industry.

NEW MODELS, POWER EQUIPMENT & TOOLS

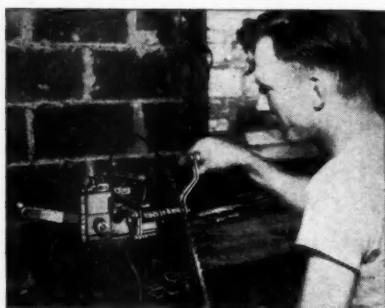
AB331 A new improved 6-inch saw, Model "67," has just been added to its line of portable electric saws by Skilsaw, Inc., Chicago. It is a powerful saw for heavy duty service, sturdy and compact. It is designed for the carpenter builder for general remodeling work. May also be used with abrasive discs for scoring



New 6 In. Saw Introduced by Skilsaw.

tile, concrete, etc., and for tuck-pointing. It cuts to a depth of $1\frac{7}{8}$ ". It will rip and cross-cut hard wood up to 1"; cross-cut dressed pine lumber up to 2"; bevel cut lumber $1\frac{3}{16}$ " thick at 45 degrees. The blade has a free speed of 3400 R.P.M. and is protected by an automatic telescopic guard that rotates on ball bearings.

AB332 K-B Devices Co., Geneseo, Ill., has developed the K-B bandsaw reset and filer. It is a compact, precision-built device, composed of few parts which are automatic in their operation. It is easily clamped in a bench vise



K-B Bandsaw Reset and Filer.

or set up on a work bench by using a malleable cast iron block included with each set. It is so designed that it may also be anchored to the bandsaw table and operated with no need for removal of blade from bandsaw. Expert workmen will no longer reset and file by hand after once using a K-B reset and filer. It works so easily that the user keeps his blades in tip-top shape.

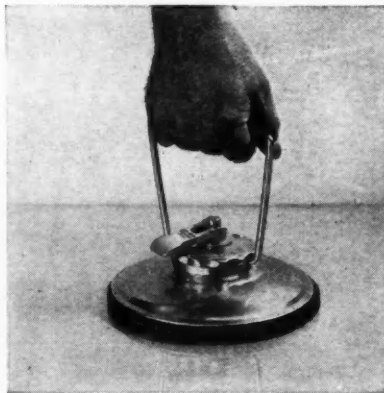
AB333 A new heavy blade chisel No. 58 for such work as easing up window sash, cleaning out old putty, and for smoothing sash for glass, is announced by Stanley Tools, New Britain, Conn. Blade and tang are forged in



Stanley Glaziers' Chisel No. 58.

one piece from finest chisel steel. Proper heat treatment and tempering insure full potentiality of steel. Heavy wings on tang lock blade in preshrunk hickory handle. Handle is capped with three leather washers.

AB334 A vacuum cup holder, or lifter, is now manufactured by Landon P. Smith, Inc., Irvington, N. J. It is a safe, sturdy lifting device capable of holding as much weight as a strong man can lift, and its uses are practically unlim-



New "Red Devil" Vacuum Holder for Lifting.

ited. The device literally puts a handle on all kinds of glass as well as marble, granite and various smooth-surfaced articles whose weight makes lifting awkward and difficult. These vacuum cup holders come in three models, 4, 6 and 7-inch diameter discs.

AB335 "Black & Decker Portable Electric Saws" is a convenient 8-page folder illustrating four of the current models, Nos. 35, 75, 85 and 95, electric saws of 5", 7", 8" and 9" diameter saw blades respectively. The B. & D. saw sliding arm, portable saw table and saw blades are also covered.—The Black & Decker Mfg. Co., Towson, Md.

AB336 "Speedmatics" is the title of a 6-page data sheet presenting four of the electric hand saws of The Porter-Cable Machine Co., Syracuse, N. Y. These are the K-66, 6" diameter saw; K-88, 8" diameter saw; K-10, $10\frac{1}{4}$ " diameter saw; and K-12, 12" diameter saw. Action photographs illustrate various types of work being performed with this equipment. The Speedmatic Radial Arm, Rotary Disc Edgers, Take-About Sanders and Floor Sanding Machines are included.

AB337 The Construction Machinery Co., Waterloo, Ia., has issued a deluxe catalog of 52 pages illustrating its complete new line of construction equipment including non-tilt concrete mixers, tilting concrete mixers, plaster and mortar mixers, bituminous mixers, dual prime pumps, power saw rigs, hoists, batching equipment, hoppers, buckets, etc., concrete carts and wheelbarrows. Tabulated specifications and large 2-color illustrations make this a good reference book.

AB338 The Foley Automatic Saw Filer, offered by the Foley Mfg. Co., Minneapolis, is illustrated and described in an 8-page folder. This machine files and joints hand, band and circular saws. Several different models are illustrated, some with power drives.

AB339 "How to Make More Money in the Floor Sander Rental Business" is a 12-page booklet prepared by the American Floor Surfacing Machine Co., Toledo, O. It is directed principally to dealers in building materials, hardware and paints and lists the numerous promotional and advertising helps which this company is offering dealers to help them make bigger profit out of their floor sander rentals. A companion piece "Renting Floor Sanders as a Business" tells some interesting stories of sander profits.

AB340 Aeroil winter construction equipment, including kerosene burners and heaters, is presented in a most timely 24-page spirally bound handbook from Aeroil Burner Co., Inc., West New York, N. J. This is known as "Winter Catalog A." It binds for convenient reference six helpful bulletins within one cover. How to carry on building construction in freezing weather at summer speed is fully explained in these bulletins.

AB341 The Sterling "Gyro-Electric" Sander developed by the Sterling Products Co., Detroit, Mich., is illustrated in an interesting 6-page folder. This is a convenient light weight tool replacing hand sanding on wood, metal, lacquer, varnish, leather and composition.

AB342 "Besser Concrete Products Plant Equipment" is illustrated and described in a 12-page 3-color portfolio with numerous supplementary sheets on Besser standard building units and the equipment to produce them; 35 years of experience and engineering progress are back of the Besser line.—Besser Mfg. Co., Alpena, Mich.

Readers Service Department Continued to Page 62

FOR QUICK, CONVENIENT SERVICE, USE COUPON, PAGE 62

title sheet saws, excuse, meter K-10, meter rious this Arm, nders dded.

Ma- , Ia., pages con- con- aster exers, oists, etc., 'abu- illus- ook.

Saw Foley and ma- cir- are

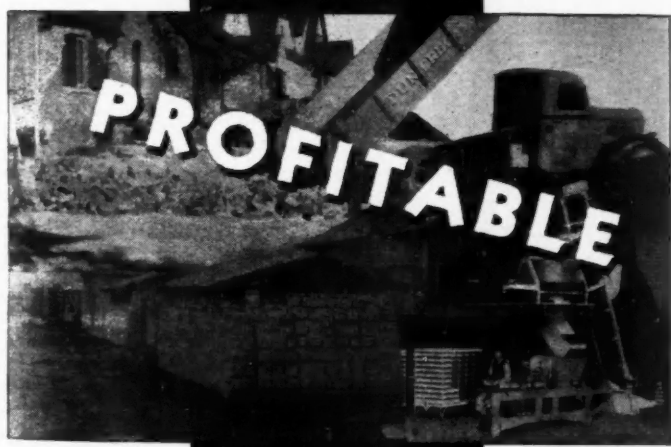
More nder pre- cing ected rials, ous hich help floor cent- tells ofits.

ction zero- in a and- West inter efer- ver. n in fully

Elec- by ich., page ight etal, tion.

rod- " is e 3- ple- mild- duce ngi- sser

Here is a MANUFACTURING BUSINESS for You



In your community wherever you may be located, the opportunity is yours to own an Exclusive, Profitable manufacturing business with a Big Future!

IN THIS BUSINESS you will be manufacturing a super quality masonry building material that is lighter in weight, lower in cost, has greater strength, keyed mortar bond, absolute accuracy in all dimensions. Besides standard and Jumbo size DUNBRIK, you can also produce DUNSTONE, a multiple size unit that is the most versatile masonry material in the market. With this material, builders are producing permanent, fire safe construction at cost level of frame.

YOU WILL BE EQUIPPED with the most modern manufacturing plant, automatic line-production that enables one or two men to displace large crews. You will independently own this business, yet benefit from the experience and prestige of a national chain of such individually owned plants, all maintaining a uniform standard of quality on a nationally advertised product.

YOU WILL BE SUPPLIED with new processes and formulas, enabling you to manufacture these products in over 40 beautiful colors, shades and textures. Products made by already established manufacturers are accepted by Government and City building departments.

YOU WILL BE GRANTED manufacturing franchise covering your locality, protecting your market, business and future, with available engineering and advertising service for further expansion of your business.

YOU SHOULD INVESTIGATE while your territory is still open. Let us tell you where you can visit the nearest manufacturer and talk to the owner about this outstanding opportunity. Fill in the coupon today. It may be the first step to a stable, profitable business of your own.

W. E. DUNN MFG. CO.,
450 W. 24th St., Holland, Michigan.

Mail me your free books telling all about this outstanding and complete manufacturing opportunity for me in this industry.

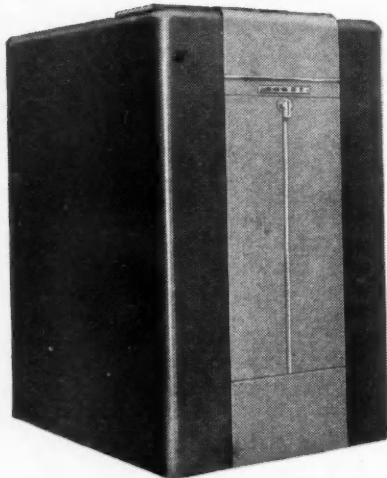
Name.....
Address.....
City..... State.....

SERVICE TO READERS

EACH ITEM in this department is numbered for convenience of readers. Please use the coupon on this page for requesting further product information or new catalogs. Mail coupon to American Builder Reader Service, 105 W. Adams St., Chicago; or write direct to these manufacturers mentioning your profession, occupation or connection with building industry.

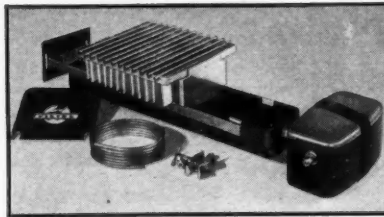
HEATING & AIR CONDITIONING PROGRESS

AB343 Four modern heating and air conditioning units, new in design and construction, are offered by Norge Heating and Conditioning Div., Detroit. They range in size from a small "below the floor" installation which requires no basement, to a completely automatic full-sized oil furnace with electric ignition, air filter and humidifier.



Norge "Fastemp" Air Conditioner.

AB344 Here is the new streamlined Plastic Float Tank recently developed by Viking Air Conditioning Corp., Cleveland, for use with two-unit humidifiers. The illustration shows this new float chamber as it is used on the Viking Series 1100-A Humidifier. Made of durable plastic material, this float tank is impervious to heat and corrosion.



Viking Plastic Tank Humidifier.

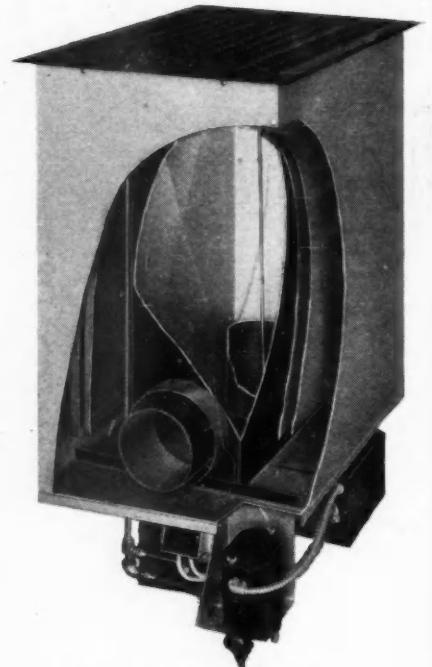
AB345 A new Fuel-Miser boiler for hot water installation is offered by the Copper Boiler & Heater Works, Manitowoc, Wis. These heaters make use of the well known superior ability of copper to transmit heat. Products of combustion rise inside a chamber with corrugated copper walls, rise to the top,



Outside and Cutaway Views of Copper "Fuel-Miser" Water Heater.

and out to flue connection. The chamber is water jacketed, employs copper for the material of construction in the outer wall also. Several sizes are available.

AB346 The H. C. Little Burner Co., San Rafael, Calif., announces an oil-burning floor furnace which allows inexpensive installation in the floor without ducts or sheet metal work. It is manufactured in two sizes, 70,000 B.T.U. and 105,000 B.T.U., with manual control



H. C. Little Burner Co. Floor Furnace.

or full automatic, thermostatic control. Added features are: burner with progressive low-temperature carburetion design; thermo-limit control valve to prevent overheating; and automatic, thermostatic control. Recently listed by the Underwriters' Laboratories, company officials say they introduced this oil-burning floor furnace over eight years ago and have thousands of successful installations now operating.

AB347 "Anchor-Aire," a complete winter air conditioning unit developed by the Anchor Stove & Range Co., New Albany, Ind., is presented in a new 6-page folder. Sturdy construction inside and streamlining outside make this a worth-while heating plant. Anchor-Aire is equipped with the Anchor coal stoker, full details of which are illustrated.

AB348 Airtemp heating systems perfected by Airtemp Div., Chrysler Corp., Detroit, Mich., are concisely presented in a 16-page pocket size catalog. They include oil, gas and coal burners and include much valuable data in handy form for the selection and installation of home heating plants.

AB349 "Dirt Is a Critical Hazard," remove it by Precipitron, are the message and title of a new 4-page folder by the Westinghouse Electric & Mfg. Co., East Pittsburgh, Pa., announcing the Precipitron electrostatic air cleaner.

CLIP AND MAIL TO CHICAGO

Reader Service Department,
American Builder,
105 W. Adams St., Chicago, Ill.

(Jan. 1941)

Please send me additional information on the following product items, or the catalogs, listed in this department:

Numbers

.....

Name

Street

City..... State

OCCUPATION*

*Please note that occupation must be stated if full service is to be given.

FOR BUILDING INSULATION

Armstrong's TEMLOK

LATH · SHEATHING · INTERIOR FINISH

ARMSTRONG'S TEMLOK is a structural insulating board made under controlled conditions which assure uniformity. It is rigid, light in weight, easily handled in large board sizes, and can be cut, sawed, and worked with ordinary tools. Temlok's qualities of high insulating value, low moisture absorption, and adequate structural strength make it adaptable to a wide variety of building uses. It is resistant to the destructive action of termites and other vermin, and because it is sterilized in the manufacturing process, it is strongly resistant to dry rot or fungus growth.

TEMLOK LATH

insulates and offers a firm plaster base

Builders save time and work, owners get the lasting satisfaction of a more efficient job when Temlok Lath is used. Conveniently-sized boards are easily handled and cut, quickly nailed in place. Temlok offers a smooth surface over which plaster is easily and quickly applied with a bond that exceeds the U. S. Commercial Standard.

For building owners, this means a smoother wall surface, lasting service, and the money saving that comes with efficient insulation. In addition, Temlok Lath helps prevent noise being transmitted through walls from one room to another.

TEMSEAL SHEATHING

is double-sealed against the infiltration of air and moisture

Armstrong's Temseal Sheathing is efficient Temlok Insulation, sealed with a double coating of asphalt and strong kraft paper. This double seal adds strength and protects against the infiltration of air and moisture, thus assuring longer service. Temseal is applied in the same manner as ordinary sheathing. Its large boards are easily cut and handled and quickly erected. Nailed in place over the studs, Temseal's bracing strength exceeds by 50% that of standard thickness wood sheathing laid horizontally, and is approximately equal to the bracing strength of wood sheathing laid on the diagonal.

TEMLOK DE LUXE

does three jobs at one time—one cost

Armstrong's Temlok De Luxe, the factory-colored insulating interior finish, performs three major services for building owners: It insulates efficiently; it decorates effectively; and it helps to quiet noise. In addition, scientific tests have shown that the excellent

Product	Widths	Lengths	Thick-nesses	Edges	Colors
Board	4'	6', 7', 8', 9', 10', and 12'	1/2"	Square	Cream
		8', 10', 12'	3/4"		
Panels	12"	12"	1/2"	V-Bevel on all edges	Cream White Green
	16"	16"			
	16"	32"			
	24"	24"			
	24"	48"			
Planks	8", 12", and 16"	8', 10', and 12'	1/2"	V-Bevel on long edges	Cream Green Ash
Structural Units	16"	16"	3/4"	V-Bevel on all edges	Cream White
	16"	32"			
	16"	48"			
	16"	8'		V-Bevel on long edges	Cream
	16"	10'			
	16"	12'			
Moldings	2 1/2"	9'	1/2"	Plain bevel on long edges	Cream White Green Ash
Temseal Sheathing	4'	8', 9', and 10'	2 5/8"	Square	Sealed with asphalt and heavy kraft paper
	2'	8'	2 5/8"	Ship-lap on long edges	
Insulating Lath (Plaster Base)	18"	4'	1/2" and 1"	Ship-lap on long edges and scoop bevel on all four edges	Natural screen surface

light reflecting qualities of factory-finished Temlok De Luxe permit a definite saving in lighting costs in many instances.

Temlok De Luxe saves time and money. It replaces plaster and paint or wallpaper. It is quickly and easily installed with either Temlok Adhesives or the newly developed Tem-Clips which "float" the insulation against furring strips or joists. And it eliminates the delay caused by waiting for plaster to dry: The interior is ready for occupancy immediately after the wall is finished.

Temlok De Luxe makes it easy to re-decorate old buildings and insulate at the same time. It can be installed over old plaster walls and ceilings, with a minimum of preparation and delay. Its pleasing colors give new life to dull interiors.

The table above shows the wide range of sizes, shapes, and colors in which Armstrong's Temlok De Luxe is available. These various shapes and colors may readily be combined in a number of different groupings or combinations to aid decorative effects.

ARMSTRONG CORK COMPANY

Building Materials Division



979 Concord St., Lancaster, Pa.

MONCRIEF

*Furnaces and Winter
Air Conditioners*



DELUXE LONG LIFE FURNACE

ARISTOCRAT WINTER
AIR CONDITIONER

HAVE GREAT FEATURES THAT SELL HOMES

ASK YOUR MONCRIEF DEALER He can show you why Moncrief Furnaces and Winter Air Conditioners help sell homes. Moncrief style appeals to the woman's eye, advanced engineering design and sturdy construction are points that look good to the man; priced to give outstanding values. The Moncrief line is most complete in every particular, units for small and large homes specially designed for burning oil, gas or coal, hand or stoker fired. Investigate the comfort efficiency features that Moncrief gives, and the attractive prices that enable you to give most for the money. Write for illustrated catalogs and get in touch with the Moncrief dealer near you.

THE HENRY FURNACE & FOUNDRY CO.

3479 E. 49th Street, Cleveland, Ohio

Send me complete literature as follows.

- Cast Furnaces Steel Furnaces Stoker-Fired Furnaces
 Winter Air Conditioners For Coal; Gas; Oil.
 Give me the name of Moncrief Dealer near me.

NAME _____

STREET _____

CITY _____

STATE _____

ON and OFF the RECORD

Views, News and Comment

ARMY vs. LABOR—Army, Navy and defense people who are trying to rush defense work to completion have their private opinion about union labor obstructions—and it can't be printed! The recent strike of carpenters working on the War Department Building in Washington put the spotlight on this subject. It was the old jurisdictional dispute about who should install metal plaster backing;—only a few involved, but a large and important job tied up.

Similar disputes have cropped up in many other government jobs. Contractors who have long suffered under restrictive and frequently ridiculous union regulations are glad to see the Army delays getting publicity. It may help clean up some bad situations.

PORTABLE HOUSES! WHAT NEXT?—Yes, sir, defense housing authorities are in the market for portable houses, trailers and other movable housing for defense workers. At one Navy base a popular excursion boat has been tied up at the dock and is being used for temporary housing. Maybe the French would be glad to unload the Normandie.

As another article in this issue describes, educational orders are already being given to a number of people for prefabricated and demountable houses. It looks like all the prefab promoters have been flocking to Washington—and some have come away with orders. With Uncle Sam passing out the millions it may give the prefabricated house builders the push they have never been able to get through normal public acceptance. It won't be a bed of roses, though—Army and Navy are limited by law to only \$3,500 per house—including land.

PIPE DREAM—We heard a prominent "spec" builder explaining why he was using iron pipe in his low-priced houses the other day. (Note: copper and brass prices are up.) "It's the water," he was saying; "we just can't use copper here—something in the water, so we're using iron now." (1)

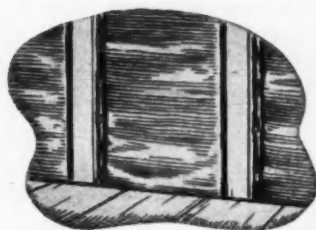
BROWN'S SPEECH—Lewis Brown, popular J-M president and building industry spokesman was scheduled to speak at a construction industry conference recently; but the plane he planned to fly was grounded due to bad weather and he missed the last train by three minutes. It looked for a while as though Art Hood would have to give the talk. Just in time one of Brown's smart young assistants, who was on the job in Washington, had an inspiration—a telephone hook-up. It took a corps of fast-working engineers right up to the last minute to arrange a direct wire hook-up from Brown's office in New York to the public address system of the Washington hotel banquet room; but it was done and the speech came in in a most impressive way. Science is wonderful!

NAVY STORY—A prominent Navy man in speaking before the Producers' Council in Washington, recently, told this one: A young tar asked for extended leave of absence saying he expected his wife was going to have a baby. He got a rather formal reply from the C.O. to the effect that it was taken for granted that the sailor should be on hand for the laying of the keel, but that the Navy did not feel his presence was necessary at the launching of the vessel. Leave refused.

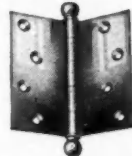
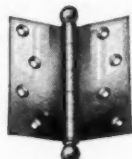
95% 30 YEAR LOANS—One of the objectives of the new National Home Builders Association described in last month's *American Builder* is said to be to persuade FHA to increase insurance of mortgages up to 95 percent and extend the loans to 30 years on low-priced houses. Certainly would make home ownership more easy for the low-income fellow. The FHA experience with mortgages of 80 to 90 percent of valuation has been remarkably good. Out of 250,000 financed, only 186 have been acquired by FHA after foreclosure by leading institutions. Still there will be much opposition to 95 percent, 30 year loans.

ARCHITECTS' COMPLAINT—Architects and plasterers are among those complaining that they are not getting enough
(Continued to page 66)

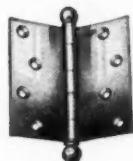
Good Construction Calls For Insulation



...And Three Butts on Every Door



VISIBLE MARK OF
GOOD CONSTRUCTION



Your prospect must take your word for the insulation and other elements of good construction that are hidden within the walls.

Here's a *visible* mark of good construction that anyone will be quick to appreciate: *Three Butts To A Door*. Remember, it can cost as much to repair a single warped door as to put the third butt on every door in the house. And remember this, too; thin doors are more apt to warp than thick ones. Give your homes this visible mark of good construction — it costs so little. The Stanley Works, New Britain, Conn.

STANLEY

Trade Mark

REMEMBER...THREE BUTTS TO A DOOR

EXCLUSIVE Stanley Non-Rising Pin



The simple solution to an annoying problem! Pin, fitted with a split ring, snaps into place as ring seats in pocket formed at the lower end of the butt's top knuckle. Exclusive, simple, trouble-free. Write for Stanley Catalog No. 61 and use it as your reference book on good hardware.

Mall Saw
TRADE MARK

HAS THE EDGE

For Power • Speed
• Safety and
Ease of
Operation

MODEL 85

BALANCED FOR SAFE ONE
HAND USE WITH GREATEST
WEIGHT ON LONG END OF BOARD

CAPACITY
2 3/4"

... and Its **LOW PRICE**
Challenges **EVERY Thrifty-Minded Builder**

NO other power saw—at any price—will give you the power, speed, safety, ease of operation and smooth cutting performance you get in this powerful, money-making, low priced MALLSAW.

The MALLSAW has so many outstanding advancements and indispensable features that to see it instantly inspires possession. But it's when you take this powerful saw in your hand . . . unleash its High Torque Universal Motor that operates on A. C. or D. C. . . . and watch it master every sawing job in house framing, at low cost, that you quickly realize it's the only power saw for you to own. And you can do this **AT OUR EXPENSE.**

SIMPLY MAIL COUPON BELOW FOR FREE DEMONSTRATION AND FULL INFORMATION

We want you to feel the ease and speed with which it cross cuts and rips dressed and rough lumber . . . cuts rafters for roofs of any pitch . . . notches studing and other framing members . . . makes compound mitre and pocket cuts . . . and does dadoing, grooving, ploughing and tenoning.

You'll like the MALLSAW'S lighter weight . . . convenient switch built in the operating handle . . . simple adjustment for depth, and bevel cuts to 45 degrees and the sawdust blower that keeps the cutting line clean. You'll welcome the safety guard that stops flying chips and the engineered balance that distributes most of the weight on the long end of the board for safe one-hand operation and to eliminate blade binding near end of each cut.

Don't Delay! **MAIL COUPON TODAY FOR FREE DEMONSTRATION.** Plan now to give yourself the advantage of this powerful money-making MALLSAW in 1941 that is priced so low it will pay for itself on the first two house framing jobs.

MAIL COUPON TODAY !

MALL TOOL COMPANY
7737 SOUTH CHICAGO AVE., CHICAGO, ILL.

Yes, I am interested in (✓ check items wanted) A FREE MALLSAW Demonstration; Descriptive Literature and prices. Also information on MALL Radial Saw Arm; MALL Door Mortiser; MALL Door Planes.

NAME _____

ADDRESS _____

CITY _____ STATE _____

ON and OFF the RECORD

Views, News and Comment

(Continued from page 64)

out of the defense housing program. At the recent C. of C. construction conference in Washington, the president of the A.I.A. stood up and made a strong complaint following a talk by defense housing coordinator, Palmer. Palmer's reply was right to the point: the government couldn't "make jobs" for architects on \$3,500 defense homes any more than they could make work for plasterers where plasterers weren't needed. That made both the plasterers and the A.I.A. mad.

UNIONS LOVE THIS—One effect of unreasonable labor requirements is that a growing number of speculative builders are sub-contracting all their work. One prominent eastern operator who builds several hundred homes a year has organized his entire building operations on the basis of crews of six or less, headed by one responsible man who takes the contract for a specific operation at a specific price.

One crew of carpenters does the framing on this basis. Another crew may do nothing but install interior trim. Even the odd jobs such as cleaning up and washing windows are handled on a strictly contract basis at so much per house. This builder knows before he starts exactly what his costs will be because every single operation is under definite contract. The faster the men work the more they get done and the more they earn. This system also solves some knotty little details in connection with social security and workmen's compensation.

BIG YEAR FOR FHA—Plenty of orchids to FHA for the job done in 1940. They insured loans on close to 175,000 new small homes compared with 142,000 in 1939. That's about 40 percent of all the new single-family homes built in 1940. Value of the FHA insured homes exclusive of owner's equity was more than \$750,000,000.

LOW-COST EQUIPMENT—Big government defense housing orders are enabling many manufacturers to develop important new low-cost home equipment under mass production methods. G.E., for example, has some new kitchen cabinet and sink combinations and range-water heater units in the works that get right down into the \$3,000 house market. The Army and Navy houses are limited to \$3,500 overall including land, so it takes some pretty smart production work for makers of quality products.

FRANK LLOYD WRIGHT LEVITT—Preview of some of Levitt & Sons new 1941 home models on Long Island shows influence of that famous old play-boy prodigy of architecture, Frank Lloyd Wright. Well, who compliments whom?

WRAPPED IN CELLOPHANE—Sumner Hersey of Certified Homes, Inc., of Boston, made news recently in opening his new home development at East Natick, Mass., by wrapping the entire house in cellophane, and persuading Diana Blythe Barrymore, daughter of the famous John, to cut the ribbon on this giant-size Christmas package at the formal opening. This is a striking new development in the \$40-a-month cost range. The houses are equipped with G-E electric kitchens, wiring and oil furnace. Certified Homes is sponsored by G. Fuller and Son Lumber Co.



CELLOPHANE WRAPPED small house at East Natick, Mass.

CONSENSUS HOUSE—George Hatley of Washington put on one of the most successful model homes of last year with his "Consensus House"—no, it didn't have anything to do with the U.S. Census. Hatley merely made a survey of what people want in their homes, covering a five-year period. Then he built this model home, featuring things that were the "consensus of the people of Washington." It may sound crazy; but it went over big. His latest model home is called, "The American Way Home." Hatley has a flare for names and for showmanship. His development in Chevy Chase is called, "The Hamlet."

CONSTIPATED—Plumbing manufacturers report a serious shortage in some lines of important bathroom items due to government orders. The worst shortage is in stools—and it is pretty serious.

SIX-HOUR DAY—The almost unbelievable wage, labor hours and labor restrictions in New York City got a good airing when the World's Fair was built. Now they are getting another airing as a result of a study by the National Industrial Conference Board of the effect of the six-hour day on building operations there. The six-hour day at \$12 has been in effect for some time in some trades, notably the electrical. The conference board report shows: (1) no increase in hourly production from the shortened work day, (2) a minimum 15 percent increase in construction costs, (3) increased costs have seriously diminished building volume, (4) shorter hours actually reduce the amount of employment in the industry, (5) if applied to home building, (now open shop, thank God) it would eliminate all low-priced home building.

Prospects for 1941

(Continued from page 33)

Store and Shop Building to Increase

The effect of the speeding up of the entire industrial system will be felt in various branches of the building industry. The building of shops and stores and improvements to existing retail establishments are expected to increase materially. According to preliminary estimates of the F. W. Dodge Corporation, this class of structure, under the division, "Commercial Buildings," is estimated to show a 16 per cent increase over 1940, or a total of some \$370 million. Other classifications, with the Dodge estimates for 1941, are as follows:

Manufacturing Buildings.....	\$440,000,000	16%	Increase
Educational Buildings.....	160,000,000	10	"
Hospital & Institutional....	90,000,000	20	"
Public Buildings.....	95,000,000	12	"
Religious Buildings.....	45,000,000	0	"
Social & Recreational.....	80,000,000	14	"
Misc. Nonresidential.....	120,000,000	50	"

One of the effects of the increased industrial activity throughout the nation is to create housing shortages in certain areas which are being partially met by the remodeling and rebuilding of old houses. The recent United States Census figures showed conclusively that in a great many of our cities there is a real housing shortage. This not only had an effect on new home construction but is a large stimulus to modernization. That the modernization market is a good one is at least somewhat indicated by the figures of the Federal Housing Administration, which shows that in the first 10½ months 570,000 modernization loans under Title 1 were made in an amount totaling \$240 million. This was a large increase over 1939. While adequate estimates of the modernization market are difficult to obtain, there is evidence to indicate that for the country as a whole the amount spent for modernization, repairs and improvements to all kinds of structures would approach a billion dollars. It should be pointed out that the \$240 million

(Continued to page 68)

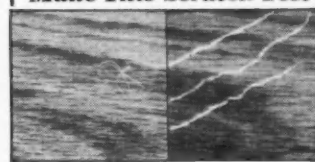
Question:
WHAT FLOORING GIVES "EXTRAS" AT NO EXTRA COST?



Answer:
STREAMLINE
FACTORY-FINISHED
For Beauty—Durability—Economy

● Clients always approve when you use Bruce Streamline Floors. And why wouldn't they! They're getting extra beauty, a superior finish—at no extra cost. Bruce STREAMLINE Flooring is finished at the factory by tested, scientific finishing methods. The famous "Bruce-Way" Finish penetrates the wood . . . doesn't scratch, chip or peel like ordinary surface finishes. Bruce STREAMLINE Flooring comes in wide strips with graceful beveled edges that give an expensive plank floor effect. Yet it costs no more—often less than ordinary hardwood flooring finished on the job.

Make This Scratch Test



"BRUCE-WAY" SURFACE FINISH

Bruce STREAMLINE Flooring comes in two sizes—25/32" x 3¼" and ½" x 2½" in Oak, Beech or Maple. Learn more about Bruce STREAMLINE . . . the modern hardwood flooring that's finished at the factory! Mail coupon for illustrated literature and free scratch test panel now.

Send for this scratch test panel. Half is finished the new "Bruce-Way" used on STREAMLINE flooring—other half finished the ordinary surface way. Scrape a coin across both finishes. See how the ordinary surface finish scratches and chips away, while the "Bruce-Way" finish is unharmed.

BRUCE **E. L. BRUCE CO.**
1406 Thomas Street, Memphis, Tennessee

FREE OFFER Mail Coupon

E. L. BRUCE CO., 1406 Thomas St., Memphis, Tenn.
GENTLEMEN: Please send FREE Scratch Test Panel and new illustrated literature on Bruce Streamline Flooring.

Name.....
Address.....
City..... State.....

SPEED UP DEFENSE BUILDING

with



INSULATION TACKER

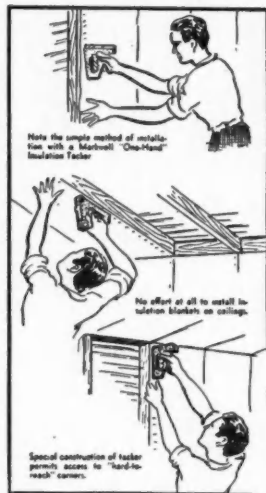
by MARKWELL

does the job

- FASTER
- CHEAPER
- more SECURELY

THE Markwell INSULATION Tacker has won universal acceptance by Builders and Contractors for speedy fastening of ALL TYPES of INSULATION, such as Balsam Wool, Hinde & Dauch, Insulite, Red Top Wool, Reynolds Metallation, Rockwool, Silvercote, Etc.

Its one-hand operation permits use of the other hand to hold insulation in place so that it can be tacked exactly in the position desired. No fussing, no fumbling, no "banged" fingers . . . just a trigger action and the insulation is tacked firmly. Staples driven flush . . . no tearing of the insulation.



Four Sizes
for one machine



The SAFE Way
To Tack Insulation

Used in Construction of
TENTS, BARRACKS, CAMPS, HOMES, OFFICES and
BUILDINGS of EVERY DESCRIPTION

Automatic Glaziers Point Drivers and Points, Screen Tackers, Moulding, Bead, Toe-Nailing, Automatic Tackers and Staples of every Description.

Clamping Benches—Wire Stretchers
Mitre Cutters

Write for FREE Catalog of MARKWELL Woodworking Equipment and Special Industrial Staples.

A. MARKWELL MFG. CO., Inc.

200 Hudson St.
New York, N.Y.

Prospects for 1941

(Continued from page 67)

of modernization loans, as reported above by FHA, is confined strictly to property improvements and does not include machinery and equipment.

Inventory of Building Material

A canvass of conditions in the building material and equipment producing fields as to the ability of producers to meet demand during the coming year is as follows:

Lumber—Shortage exists in many areas in certain types and sizes due to rush government orders. A national study of lumber inventories of 1,900 dealers, however, shows inventories only slightly below normal. Since peak of government orders is over, it is expected that shortages will be rapidly overcome early in the year.

Insulation Board—All plants working at capacity and temporary shortages in some products. Increased production capacity of industry expected to handle demand

Cement and Concrete Products—No shortage.

Heating Equipment—Production expanded but no widespread shortage.

Plumbing Equipment—Temporary shortage in some lines (lavatories and closets) where government demand has been great.

Wood Windows and Doors—Temporary shortage in some lines due to barracks orders.

Steel Windows—No shortages reported.

Steel Products—Entire steel industry working at top capacity. Demand being largely met and no shortage expected despite large national defense requirements.

Copper and Other Metals—Some shortages, higher prices.

Electrical Wiring and Equipment—No shortage.

Plywood—Considerable shortage, although production is being stepped up 50 per cent by plant improvements and additions.

Home Building Costs Up

The greatest fear expressed by analysts of the building industry is that a too sharp increase in building costs may choke off private construction. The United States Labor Bureau's index of wholesale building material prices rose from 93.1 in August to 96.3 in mid-November—a 3.4 per cent increase. A large part of the increase in this index was due to the rise in lumber prices. A considerably sharper increase in the cost of building a standard six-room frame residence is shown in a report by Real Estate Analysts of St. Louis. This shows a rise from \$6,004 in July to \$6,611 in November—a 10 per cent increase. A breakdown of the items accounting for the principal cost rise shows a \$122 increase in the cost of unfinished lumber, a \$154 increase in the cost of finished lumber, an \$80 increase in millwork, a \$30 increase in plumbing labor, a \$33 increase in overhead and profit of subcontractors and a \$24 increase in general contractor's overhead due to taxes, insurance, etc.

It appears certain that there will be unavoidable increases in the cost of home construction due principally to the rise in the cost of basic raw materials and in labor. However, there appears to be a growing appreciation in the industry that any very drastic price rise will have an adverse effect on volume and a disposition to get along with the very minimum price rise necessary to cover increased cost of production.

LETTERS from Readers on All Subjects

Facts, opinions and advice
welcomed here

Wants More American Products in S. A.

Santiago, Chile, S.A.

To the Editor:

As my subscription to the *American Builder* expires in December of this year I am requesting that the Board of Foreign Missions of the Methodist Church at 150 Fifth Ave., New York City, renew my subscription for two years more.

I am requesting that you send me a copy of the "American Builder Recommended Homes" in spite of the fact that you say "This offer is good in U.S., its possessions and Canada." It is a mighty short-sighted policy not to include these South American Republics in your offer. Postage to these South American Republics on magazines and publications is no greater than in the United States.

I have been building in these South American countries for over 25 years and it has been exasperating oftentimes to try to get building materials and equipment from the United States, and have the cheap German stuff shoved over all the time. Now that European products have been cut off by the war for over a year it is high time that North American manufacturers woke up and got their advertising across in these countries. The stock of European products is about exhausted and right now you ought to shove American-made goods and get the market. American goods are usually far superior to European but usually more expensive.

If your magazine and the "Recommended Homes" offer were placed in a number of the book stores selling American magazines in the principal cities of South America, I feel sure you would get a large number of subscriptions and get American advertisements across to a hungry market, especially now during war time.

Friendly relations often arise from satisfactory commercial relations, and heretofore Germany has gained many friends through satisfactory business dealings. Why cannot American Business get some of this trade?

Yours for better understanding and more business with the United States.

CHARLES ARTHUR IRLE, Missionary Architect,
Methodist Church, South America.

Australia Heard from on Asbestos

Melbourne, Australia.

To the Editor:

We have been very interested in your article in the *American Builder* for September on the Asbestos Industry, and would like to secure a copy of the reprint of the various articles in pamphlet form.

We are forwarding you, under separate cover, some of our own literature on asbestos cement sheeting.

WUNDERLICH LIMITED,
By S. J. Irwin, Secretary.

How to Reduce Local Taxes

Springfield, Mass.

To the Editor:

An anonymous constituent of mine has sent me your tax editorial, page 33 November issue.

The rightness of what you say is self-evident. People are moving into the suburbs in every city. The taxes are lower in the suburban areas. It is a very real national problem that you have put your finger on. The mayors of every big city would welcome your giving them some suggestive solution.

I have been Mayor of Springfield for three years but my real job is that of being president of the Package Machinery Company. We have offices in the same building that you do in New York. I have been able to bring some business experience, therefore, to

(Continued to page 70)

LIGHT AS A FEATHER



SNUG AS A DOWN QUILT



MASONITE* CELL-U-BLANKET

TODAY'S NEWEST HOME INSULATION



MASONITE's new Cell-U-Blanket is a highly efficient blanket insulation engineered for permanence. Yet it's so light in weight—and that means easy handling—that a 1-inch-thick roll sufficient to cover 125 feet of area weighs less than 30 pounds.

And that's, just the start of Cell-U-Blanket's many superior advantages. The core of the insulation is Cellufoam, today's most sensational insulating material . . . already adopted by many manufacturers of automobiles, refrigerators and other products which require the finest insulations.

Cell-U-Blanket is water and wind proof . . . provides a positive vapor barrier . . . does not shrink, sag or settle . . . is very inexpensive to apply. It is termite-treated, mould-proofed and rot-proofed, and low in first cost.

Cell-U-Blanket is offered in two types: Standard, which has a brown vapor barrier; Silver Sheen, which has a reflective vapor barrier. Available in rolls 1 inch thick, covering 125 square feet; and rolls 1/2 inch thick, covering 250 square feet. Let us send you a free sample and complete information. Mark and mail the coupon today.

MASONITE CELL-U-BLANKET
SOLD BY LUMBER DEALERS EVERYWHERE

*TRADE-MARK REG. U. S. PAT. OFF. "MASONITE" IDENTIFIES ALL PRODUCTS
MARKETED BY MASONITE CORPORATION. COPYRIGHT 1941, MASONITE CORPORATION



Cellufoam Products Division
MASONITE CORPORATION, Dept. AB-1
111 W. Washington St., Chicago, Ill.

Please send me FREE samples and all details about
Masonite Cell-U-Blanket Insulation.

Name _____

Address _____

City _____ State _____

If you live in Canada, write Masonite Company of
Canada, Ltd., Gatineau, Que.

Thousands of Builders say:
FASTER SAWING
with
Speedmatic

Because
11% More Cutting Power
Perfect Balance
Sturdy-Built



● Builders know why SPEEDMATIC gives them faster sawing day after day. Because its straight-line, helical gear drive delivers 11% more cutting power to the blade . . . assures power to spare, even on your toughest jobs . . . permits sturdier design to handle heavier cuts . . . and increases gear life practically 4 times over other drives.

With SPEEDMATIC's perfectly balanced light weight—plus Extra Wide Shoe—you get *One-Hand* operation . . . easy handling in any position . . . and true-line accuracy. Check SPEEDMATIC's faster, cleaner cutting . . . see why it gives you finer, easier work—larger profits job after job!

TODAY—Phone your local Porter-Cable man for FREE demonstration. WRITE for free copy of useful Saw Manual and complete information.

PORTER-CABLE REPRESENTATIVES
IN ALL PRINCIPAL CITIES

(see telephone directory)

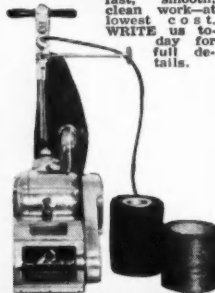
PORTER-CABLE MACHINE COMPANY

1721-1 No. Salina Street

Syracuse, N. Y.

Extra Profit in Floor Finishing

Many builders are using this new Porter-Cable TRI-CRAFT for making extra profits from original floor finishing jobs . . . PLUS re-conditioning floor work. 3-in-1 machine—Sander, Steel Wooler, Polisher—with simple drum change. Guaranteed fast, smooth, clean work—at lowest cost. WRITE us today for full details.



LETTERS— (Continued from page 69)

the office of Mayor and I have been reluctantly convinced that any major cutting of municipal expenditures is practically impossible. I do not mean there are no savings to be made, because there are in any business; but there is not enough to overcome the difference between the municipals and their suburbs.

The difference is caused almost wholly by welfare. The suburbs have comparatively little welfare expense. WPA has been a material help towards overcoming this difference. Welfare should be a state-wide burden so that the suburbs would bear their fair share. If this were the case, the real estate burden in the major cities would be eased at once.

I am writing you this letter, not in any spirit of criticism but in the hope that people like you will look more deeply into the problem and suggest an answer. Your editorial simply points out a self-evident truth to all who have studied the problem and suggests no possible answer.

Urging your readers to insist on economy is also no answer to this. You must point out to them that they must be specific in their suggestions. In other words, to have them urge a ten per cent cut in municipal expenses will mean nothing, but to have them urge the elimination of ash collections, for example, might mean a great deal.

ROGER L. PUTNAM, Mayor, City of Springfield.

ANSWER:

The *American Builder* editorial staff appreciates your writing as you have—demonstrating a very practical concern toward this problem of mounting real estate taxation and the flight of property owners from the city centers to the more lightly taxed suburbs.

Rather than to go into specific details as to what you or any other City Mayor might do to correct this condition of unfair and destructive taxation against homes and other city real estate, permit me to quote from a letter I have just received from Mr. J. I. Lyle, chairman of the Citizens Public Expenditure Survey of New York State. In his letter he tells me that through the activities of this Citizens Survey twenty-six and one-half million dollars were cut out of the New York State budget for 1939. How this was done he summarizes as follows:

"The taxpayer groups achieve their economies through research into government records, publication of surveys explaining where the tax dollar goes and recommending specific changes in practice and policy, publicity, attendance at budget hearings and personal contacts with public officials. The citizen organizations lend strength and support to the efficient, conscientious public official and use their influence to put the best citizens available into office and keep them there. In addition to improvements in local government the taxpayer organization has become a force for civic education and the building of an informed economic citizenship.

"Another important work of the movement is the uncovering and publicizing of a great variety of careless, wasteful and inefficient practices by government officials which tend to increase public expenditures and lower the standards of public services.

"The following examples, taken from the citizen surveys are typical:

"The signing of blank cheques against future expenditures; budget proposals presented to citizens give total departmental requests only; no public hearings called on proposed budgets for the coming year; county supervisors' reports give no specifications on expenditures, only amounts and names of recipients; amounts budgeted are not given with amounts spent by various departments; the citizen doesn't know where or how the budget was exceeded.

"Expenditures charged against appropriations with which they have no relations; no control exercised over the purchase of highway rights; no effort made to plan or check monthly expenditures in order to keep within the budget; no allowance made for reduction of funded debt, thus interest piles up, departments making their own purchases on a basis of favoritism and regardless of competitive bids; no independent audit made of public revenue and expenditures; one county in Missouri has two county seats, two court houses and jails; theft insurance bought on a fire truck; fire insurance issued on snow plows; hiring a truck at \$10 a day for three years; officials riding daily 140 yards in taxicabs from the capitol to a hotel for lunch at a charge to the taxpayers of \$1 apiece, etc. Amusing though these incidents may be, they represent a serious lack of concern on the part of public officials for spending the taxpayers' money."

In quoting to you these generalizations from the activities of

the New York State Survey, I do not imply at all that all of these, or perhaps any of them, apply to your city or to your administration of it. However, I think it is pretty generally agreed that governmental budgets can be reduced and substantial savings made provided there is a concerted will to such action.—EDITOR.

Help in Selling Quality Homes

Wilmette, Ill.

To the Editor:

Please send me two copies of the October, 1940, issue of *American Builder*. I am particularly interested in an article by Joseph B. Mason in this issue, concerning the use of quality products to "provide security against high upkeep." This is an idea we have been trying to put across for some time with varying degrees of success. Mr. Mason's article states the case for the use of high quality materials so clearly and convincingly that we would like to present copies of it to several of our clients who are being tempted by so-called "bargain" prices.

JAMES CRABB, Designer and Builder.

Flexibility in Working Hours Proposed

Chicago, Ill.

To the Editor:

Enclosed find copy of letter sent to Mr. Patrick Sullivan, president of the Chicago Building Trades.

JOHN J. MANGAN, Builder.

Mr. Patrick J. Sullivan, Pres.

Chicago Building Trades

130 North Wells Street

Chicago, Illinois

Dear Mr. Sullivan:

As you know, the recent extremely cold spell caused a tremendous loss in time and earning power to thousands of Chicago's building mechanics. In addition it created a building pile-up that will be impossible to unravel in the spring. Thousands of prospective home owners anticipating completion by April 15, 1941, will be placed under considerable expense in temporary quarters, waiting for completion of their home.

Under the present setup it is a physical impossibility for the building mechanics to pick up time recently lost. With the allotted hours of time—8:00 to 4:30—and the days—Monday to Friday, inclusive—you would have to control the rain, wind, sun, snow and all other elements that go towards making workable weather in order to produce a fair, annual income for building mechanics. I have a suggestion to make and if it meets with your approval, I wish you would submit same to the Executive Board of the Chicago Building Trades.

For a period of six months, in order to fairly test, permit all building mechanics to work 200 hours per month. Permit them to work during any hours they see fit on any day during the week with the exception of Sunday. This week we had only two working days. Today is Saturday and being fair and dry is ideal working weather, yet the mechanics cannot avail themselves of this workable time because of present restrictions.

Often in the spring I have seen it rain on Thursday and Friday and be clear and sunny on Saturday. In the spring when the days are long, if the men desire to put in ten or eleven hours on Monday or Tuesday, let them do so. The following days, Wednesday and Thursday, may be rainy and unworkable. Unquestionably this plan would step up, and I believe more than double, the annual income of the average building mechanic. It is my understanding that the average present amount is close to \$1300. It would also step up building volume. When you had the forty-four hour week some years back, we were building apartment buildings complete in ninety days. Today the average home requires five and one-half months to complete.

Increasing the working hours during the week not only helps the average building mechanic but is beneficial to the individual building his home. The period during which his invested capital remains idle is shortened. Where he now pays four months interest on his loan before occupancy, he would be paying only two months' interest. Watchman service, temporary heat, liability insurance, fire insurance and taxes all would be just one-half of the present cost. With expenses lessened, it would naturally be an inducement for many individuals to build their home.

I would like much to hear from you.

JOHN J. MANGAN.

(Continued to page 72)



**WANT AN
EXTRA PROFIT
ON FLOOR
FINISHING JOBS?**



SWITCH TO THE NEW "BRUCE-WAY" FINISH THAT COVERS IN ONE COAT

● Floor finishers everywhere are turning to the modern "Bruce-Way" Finish. It saves money because only one coat is needed, and a gallon covers 800 to 1000 sq. feet.

"Bruce-Way" Finish is better, too. It penetrates the pores of the wood . . . forms a tough, lustrous finish that doesn't scratch, chip or peel like ordinary surface finishes.

"Bruce-Way" Finish comes in the new, simplified "Bruce-Way" Floor Finishing Unit. Developed especially for hardwood floors, this unit contains "Bruce-Way" Finish, Filler, Solvent and Wax . . . all made to work together. Burlap, cotton waste and painter's cap are also included. One handy carton. Easy to buy. Easy to carry. 3 sizes: *large* for covering 1,000 square feet; *medium* for 500 square feet; *small* for 250 square feet.

Discover this new "one-coat" way to finish floors. Order a "Bruce-Way" Floor Finishing Unit from your distributor today. If he cannot supply you, order direct, giving distributor's name.



**Free SCRATCH TEST PANEL
MAKES "BRUCE-WAY" JOBS
EASY TO SELL!**

Send for this Scratch-Test Panel. Half is finished the new "Bruce-Way." Other half is finished the ordinary way. Scrape coin across both finishes. See how the ordinary finish scratches while the "Bruce-Way" finish is unharmed. Also FREE BOOK: "How to Finish and Maintain Wood Floors." Mail coupon.



E. L. BRUCE CO.

1622 Thomas Street, Memphis, Tennessee

E. L. BRUCE CO., 1622 Thomas Street, Memphis, Tennessee
GENTLEMEN: Please send Free Scratch Test Panel and booklet on "How to Finish and Maintain Wood Floors."

Name.....

Address.....

City..... State.....



IT'S POPULAR
Because
IT'S SIMPLE



10 SIZES MEET 95% OF ALL RESIDENTIAL REQUIREMENTS

Easy to order . . . 10 sizes meet 95% of the usual residential requirements. Easy to install . . . complete, easily understood instructions printed on carton. Easily adjusted . . . tension adjustment chart included with instructions. Builders acclaim the new "GRAND RAPIDS INVISIBLE" Sash Balance as the one really practical, perfected balance.

Simplified Design Guaranteed Performance

The result of 3 years of research and testing. Only one moving part. No exposed tape, tubes, or cables. Entire balance fits into grooved sash stile and moves with sash. No interference with painting. Actually invisible in all window positions. Can never get out of true. Unconditionally guaranteed for smooth, trouble-free, dependable performance when installed according to simple directions.



No. 155
Overhead 1 1/2" Wheel Pulley

No. 150
Covered 1 1/2" Wheel Pulley

No. 151
Open 1 1/2" Wheel Pulley

COMPLETES THE GREAT "GRAND RAPIDS" LINE

These most recent additions to the well known "GRAND RAPIDS" line of sash pulleys, make it the most complete in the world. Pulley types (overhead and standard) for narrow trim and conventional installations. All made to precision specifications and strictest quality standards.

Write for Detail drawings of unusual window designs with "GRAND RAPIDS INVISIBLE" Balance installations.

Also send for your 1941 copy of "GRAND RAPIDS INVISIBLE" CATALOG SECTION.

New 1941 catalog on standard and narrow trim "GRAND RAPIDS" SASH PULLEYS ALSO AVAILABLE.

GRAND RAPIDS HARDWARE CO.
GRAND RAPIDS, MICH.

"GRAND RAPIDS"

The Standard for 40 Years

LETTERS—

(Continued from page 71)

Believes Government Spending Helped Building

Knoxville, Tenn.

To the Editor:

I was much interested in your editorial in your December issue. You attribute the present low level of stock prices and the increase in the Republican vote, as compared with 1936, to government spending. I believe you to be mistaken in both cases.

If you will look back you will find that the big drop in the Dow Jones averages this year took place when the Germans overran Holland, Belgium and France. Since then stock prices have fluctuated very closely with British war prospects—up when they looked good, down when they looked bad. I think the activity of Mr. Hitler has much more to do with the present low level of stock prices than has government spending. In fact, I heard just as much denunciation of government spending and the size of the national debt in 1936 as I did in 1940. It is more logical to assume that the third term issue was the cause of the increased Republican vote. Mr. Willkie had the most effective issue (3rd term) that any candidate for President ever had, worked it for all it was worth and still didn't win.

As to building, how much building would there have been during the last seven years if it hadn't been for government spending and lending—FHA, USHA, WPA and PWA, and now army camps and defense construction?

JOHN BARR.

Remodeling Experiences Wanted

New York, N. Y.

To the Editor:

We are preparing for publication at the present time "The Remodeling Book," for which we need articles on the following subjects: (1) Adding rooms to a bungalow; (2) Adapting the old homestead to current needs; (3) Remodeling the derelict house; (4) Remodeling the farm house; (5) Turning a barn into a house; (6) Adding a sundeck; (7) Remodeling the kitchen; (8) Making a garage from a barn; (9) Building a recreation room in a dingy basement; (10) Selling the remodeled home, as well as filler articles on "easy jobs that you can do yourself" which will add to the beauty of the home.

These articles must be illustrated by suitable "before and after" pictures, as well as diagrams or sketches (if possible) and a complete itemized cost account must be attached.

We are wondering whether or not any of your readers may be able to supply such material. Articles should not exceed 1,500 words, and good rates will be paid upon acceptance.

ROBERT N. FARR, Remodeling Editor,
Fawcett Publications Incorporated.

Claims Handicap for the Builder

Pearl River, N. Y.

To the Editor:

After the building of some 1600 homes during the span of 52 years it seems to me that at 76 I am entitled to register my kick at the handicap the home builders of the country generally have had to face. I know I did. It is the failure of lenders in most cases to definitely aid good building by premium loans for premium jobs. The reason is that they know much too little in detail about the buildings they finance. So how could they favor quality?

It has cost the public and the lenders no end of money that we builders have not been given, and are not yet, the positive incentive of more money on the better jobs to put our heart into the effort to see to it that nothing is skimped, that we don't cut our costs by some of the short-cuts that are possible on every job; short-cuts mere inspection of FHA often fails to catch.

It was a matter of pride with me to build such houses as would bring customers back to me for another buy. That happened to me, many times. But there are mighty few home buyers who are qualified to judge either at time of purchase or later how good a structure is. Building is a technical job, and this and that can be omitted without that fact being known.

For example: I know well enough that it makes any structure more sturdy to withstand the storms of winter to have corner

braces. They cost something, not much, but it was one of the savings I used, since the lender didn't seem to care, to omit those corner braces.

The average home buyer doesn't dream that too-small flues in chimneys will cost them needless fuel—and fuel costs money—and a good deal of it, year after year. In the course of 30 years that extra fuel runs into a big sum of money. Yet how many builders have provided 96 square inches of flue area? Not many. Most chimneys have 64 inches, 8 by 8. The result is that drafts must be forced by opening dampers, thus burning, they tell me, something like 25 per cent more fuel yearly—unless oil or gas is used.

While I am thinking chimneys, there also is the question of flue liners to prevent sparks creeping through some mortar joint that comes loose or never was tight, creeping through and setting the house afire, perhaps to destroy it entirely. I have known of many builders who complied with the underwriters' requirements only to the extent of putting liners in at the bottom and top of chimneys, leaving the area in between unlined and, of course, dangerous. That was another kind of saving. A "jerry" trick.

Again, there are windows and windows. If the frame or sash are not dry, and frequently that was not the case, the shrinkage in one winter would be enough to set the sash to rattling, both letting in winter cold and letting out heat that has cost money to produce. If there are rattling windows all over a house, the cost in extra fuel of any kind—coal, oil or gas—runs into real money, sometimes enough to pay taxes. The "cheap" windows assess a big tax, but why would not most builders use them if lenders failed to encourage a better kind by liberal, intelligent lending? I did better than most builders, I believe, but I was in need of a profit. So were all other builders. Now, FHA properly has something to say about good window sash but at best FHA inspection fails to provide the protection that home buyers need.

I used a thin sort of copper flashings and the fact that they were copper was a selling point but if I had had more money on my loans I could have afforded and would have used heavier copper sheets that would not have been punctured by shoe nails of men working on roofs, important to home buyers.

I preferred to use sturdy roofing but if I substituted thin asphalt roofing or shingle there usually was no one to stop me. With mighty little inspection for the lenders, if any worthy the name, it was to my interest to cut the cost of the roofing all I decently could. And although I know of roofs I put on thirty years ago that are still there, I skimmed as I would not and could not if the lenders had required real evidence of what quality was in, in detail.

From my long years of experience I know that it would have been a God-send to buyers if the lenders had required such proofs, certificates based on supervision, that those very lenders required when they loaned on ships, and always had. Why should not the builder have the reward of better loans and better price—if he could prove the better grade?

I think the greatest benefit builders can look for is to have discrimination on the part of lenders, on the basis of grades known by supervision of honest and competent men of either the architectural or engineering profession. The FHA system is a step toward better building but it doesn't enlist the best the builder has to give, by any means. Period inspection can't catch the gypping that a builder will do out of necessity so long as his loan doesn't reward him. When most of the materials that go into buildings are graded, why should not the completed structures also be graded and be known by grades, with certificates of their rating first essential in the financing, then available in the selling and later available to aid the owner of a really good structure to refinance and resell without the losses that come from vagueness?

I have asked just that question a hundred times but lenders evade the question. I know the answer, however; all are grabbing for new loans with one eye shut to the sort of buildings they finance because so much money is being offered for mortgage investments, for which the interest rates are two or three times what money can get in the bond markets. However, I know that the plan of requiring certificates of structural ratings, first advocated by the biggest lender of them all, Walter Stabler, when comptroller of the biggest life insurance company, has been favored in powwows of the big lenders. He said that lenders should look to such certificates of grade as an agency sponsored by the architects, engineers, contractors and others is prepared to provide through the "Lloyd's register of buildings"—Certified

(Continued to page 74)

*Yes! you can get
Immediate Delivery*
**NEW 1941 DEWALT
Portable Builders' Saw**



- Exclusive!*
- ★ FIBERGLAS MOTOR INSULATION does not "burn" . . . gives double protection
 - ★ SEALED GREASE-PACKED MOTOR BEARINGS . . . need no lubrication on the job
 - ★ BRUSHLESS DIRECT DRIVE MOTOR . . . no armature or gears to worry about
 - ★ BALL BEARING ROLLER HEAD for tireless operation . . . gets more work done
 - ★ BALANCED POWER on every cutting operation . . . fast and accurate

Try this new 1941 DeWalt and you'll get a portable builders' power saw which surpasses all previous levels of performance in the lower-priced field. It gives you the fastest . . . most accurate . . . and lowest cost method of cutting material on your job!

Let us help you earn greater profits! Call in your local DeWalt dealer for a demonstration on your job . . . make a thorough test of the finest builders' saw we ever built . . . give it a real trial on your work without obligation. Write, wire or 'phone . . .

DEWALT PRODUCTS CORPORATION
440 FOUNTAIN AVE., LANCASTER, PA., U.S.A.

Please send more information on the 1941 DeWalt Builder's Saw.

Name _____

Address _____

Here's an overhead-type garage door that's equally popular with car owners, realtors, builders, dealers

It's the sturdy

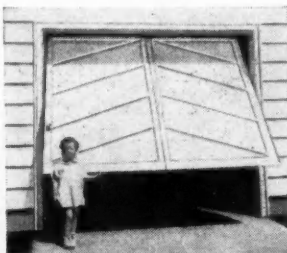
CRAW-FIR-DOR!



THIS 8-PANEL DESIGN SELLS FOR ONLY...

Learn today how this easy-opening door can speed your house sales!

● If you sell, build or modernize houses, Craw-Fir-Dors on the garages will make your work easier. This overhead-type garage door combines every feature a garage door should have. It operates with such amazing ease even a small child can open it. The tested, approved door is durable Douglas fir. The hardware is extra strength and includes an automobile trunk-type lock. The door is pre-fitted for 8' x 7' openings, weather-stripped, and complete instructions enable any carpenter to install a Craw-Fir-Dor in less than half a day.



NEW FLUSH TYPE . . . Comes with bundle of moulding that can be applied in any desired pattern. Retail for \$29.

This isn't all. The 8-panel design sells for only \$28 in any U.S.A. jobbing center, and the three other designs are just slightly higher. No wonder the Craw-Fir-Dor is the most popular overhead-type garage door in the country. Your dealer has Craw-Fir-Dors in stock or can quickly supply you. For more information, write Fir Door Institute, Tacoma, Washington.

Now nationally advertised in American Home and Better Homes & Gardens

Craw-Fir-Dor

SELF ENERGIZING • ONE PIECE • OVERHEAD TYPE

For special residential or industrial installations, write Crawford Door Co., Detroit, Mich., who make a complete line of sectional overhead-type doors.

LETTERS— (Continued from page 73)

Building Registry with a New York headquarters.

We builders have a grievance that lenders of "other peoples' money" fail to discriminate to give the edge to those of us who want to give full value to home buyers but can't get mortgage money to recognize the difference—because the lenders don't know the difference. Right there is the cause for stupendous losses not only to home buyers but to the lenders themselves, and the tax rolls.

GEORGE B. BERGKAMP.

Commends Courage

Paterson, N.J.

To the Editor:

Please allow me to congratulate you on your statement on the Publisher's Page, December, 1940, issue; you voiced the sentiment of all us 22 million good American citizens.

I surely admire any man who is unafraid to come out in the open and state the truth, as you did.

SIGFRED BECH,
Contractor, Builder, Real Estate.

Streamlined Cutting (Continued from page 45)

proper angle to make the ridge cut, he reduced the average cost to 3½ cents. The costs in this case were figured as two operators at \$1.25 per hour, two laborers at 75 cents per hour, and the cost of the power saws at 62½ cents per hour each. Thus, the cost of the power setup was \$5.25 per hour. At the minimum production of 150 rafters per hour, the average cutting cost per rafter was thus only 3½ cents. In cutting 1,500 rafters, the 16½ cent-saving on each amounted to \$248. In addition, the cuts fitted better, less time was used in getting the job done and less time was required to erect the members.

Another important angle is that the power saw was not subject to compensation insurance, social security benefits and similar costs.

The size of the cutting establishment setup depends, of course, on the amount of lumber to be handled. On the larger jobs a typical establishment is as follows:

1. A four-machine line for cutting rafters. The layout is shown in the detailed drawing with this article.
2. A three-machine line for cutting members requiring three operations. These include platform braces, inside stair carriages, certain types of rafters and canopy rafter braces. This line is also detailed in the accompanying drawing.
3. A two-machine line is set up for cutting members where two cuts are required, including such items as collar beams, knee braces, platform posts, outside step carriages, step rails and posts, stair jacks, roof ties.
4. In addition, a number of one-machine lines are set up to handle such items as bridging, collar box rafters, roof truss braces, bevel ripping, split 2 x 4's for knee wall, etc.

The result of experience contractors have gained on these numerous government jobs is to add a whole new chapter to the subject of pre-cutting methods that save both time and money on the job. While the average building operation does not permit any such setup as used on these big government jobs, there are many of the methods and principles developed in this kind of work that are applicable to smaller jobs. Probably, one of the most important lessons to be drawn is the fact that it is possible for the contractor or builder to arrive at an exact listing of the number of pieces of lumber required in a house or other building and to accurately detail the cut required on each piece. To do this calls for a thorough analysis of the job, which frequently throws new light on the spots where savings may be achieved.

A Plan for Industrial Defense Housing

(Continued from page 35)

existing privately owned homes in that they would pay all normal charges such as local realty taxes, interest and amortization; and because the dislocating effects of subsidized government-owned housing would be eliminated now and after the emergency has passed.

2. Eliminates the introduction of a new social and economic problem—the selection of a segment of defense workers who are to be favored with government rent subsidy, a problem which will attend any type of government-owned defense housing project with resulting dissatisfaction on the part of the majority defense workers.

3. Permits flexibility of expansion or contraction of the volume of home building to accommodate increased or decreased housing needs in any community by the simple exercise of administrative control over mortgage applications. If an industrial section appears to be well supplied with housing facilities, the FHA administrator could direct that the local office tighten up on risk requirements. If more housing is needed, the local office could likewise be instructed to loosen up on risk requirements.

4. Make possible "more house for the money" by the new economies of construction which increased volume will bring to the building of small homes.

5. Spread employment over a wider field which includes many men who are too old for the fast pace demanded in other types of defense work.

6. Relieve the government of both the responsibility and the cost of managing large housing projects at a time when all administrative energies are sorely needed in other phases of defense and when a strong need exists for all possible economy aside from spending for preparedness.

* * *

Army and Navy Houses

(Continued from page 47)

consist of half-inch Homasote sheathing glued to two-inch framing members. The corner members consist of 2 x 4's laid flat and interior members, 2 x 2's. The overall thickness of the wall is 2½ in. The exterior surface of the building board is given a sand, lead and oil finish, and the interior painted with Plasterez finish at the shop. Doors and windows are installed complete including glazing, weatherstripping and trim at the shop. All of the different types of sections are built on specially prepared jigs by the lumber dealer. The wall sections are attached to the floor by means of 16-gauge galvanized metal U-shaped clips 2½ inches wide, spaced three feet apart.

CEILING SECTIONS—Ceiling sections are 11'-11" long and are in varying widths from 2' to 5'-4". They consist of half-inch insulation board attached to a framework of 2 x 4's and 1 x 2's. The sections are bolted together with ¾" x 4" carriage bolts and are screwed to the wall sections with ¾" x 2" lag screws. The ceiling surface is painted at the shop and requires no further attention after erection.

ROOF SECTIONS—The roof sections also consist of Homasote sheathing glued and nailed to the 2 x 6 rafters with Lauxeim glue and 1¼" zinc-coated roofing nails. The sections are bolted together at the sides and also at the ridge. After the sections are in place 12" x 36" asphalt shingles are attached by nailing into the rafters with 1½" zinc coated roofing nails.

The demonstration house was designed by Architect W. Henry Neubeck, associated with the Homasote Company.

* * *

Dealer Contest Winners Announced

FIRST award in Johns-Manville's Cash Prize Contest for the best publicity and promotion campaign of 1940 by a J-M dealer went to C. A. Stuck & Sons, Jonesboro, Ark., H. M. Shackelford, J-M vice president and a Contest judge, announced. Dual awards for second place were made to Sawyer's of Worcester, Mass., and the Ramsey Lumber Co., Tampa, Fla., while duplicate third prizes were awarded to the following J-M dealers: Bristol Builders Supply Co., Bristol, Va.; Klipstine Lumber & Supply Co., Sidney, O.; Ed Von Tobel Lumber Co., Las Vegas, Nev.; N. T. Fox Co., Inc., Portland, Me.; Modern Materials, Inc., Los Angeles; Barney Stewart Lumber Co., Oklahoma City.

American HIGH SPEED Machines will make YOU MORE MONEY



1. AMERICAN FLOOR SANDER

Be your own boss and make big money with an American Floor Sanding Machine. As much as \$25.00 a day is not an unusual amount for the floor surfacing contractor to make. When "New Building" activity is slow, there are always hundreds of floors in older homes to be resurfaced and finished.

With the many outstanding time and money-saving features, American machines for years have been the favorites of floor surfacing men. Investigate the wonderful possibilities of this work today.

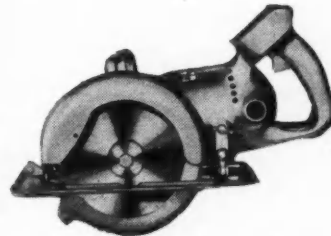
2. AMERICAN SPINNER EDGER

Here's a real money-maker and time-saver—the American Spinner for edging and matching the borders with the body of floor work. This is also an excellent machine for stair treads, halls, closets, landings, display windows and other hard-to-get-at places. The patented design and construction of this disc type edger makes it a favorite with the professional floor trade.



3. AMERICAN PORTABLE SAW

Slow hand methods on many jobs can be replaced by this speedy, electric portable American Saw. Labor saved by this saw will run into hundreds of dollars yearly.



SEND COUPON NOW

If you are at all interested in getting into something for yourself and getting out of the "old rut" or if you want to increase your profits in your present business, sign and send in the coupon below. There is no cost or obligation to you. Be sure to check the kind of machine you are most interested in on the coupon below.

THE AMERICAN

FLOOR SURFACING MACHINE COMPANY

511 So. St. Clair Street • Toledo, Ohio

Gentlemen: Without cost or obligation send complete prices on the following:

- American Floor Surfacing Machines.
- American Spinner Edger Machines.
- American Portable Saw.
- I want to get into something for myself.
- I already own one, quote trade in value (make and years old).....

Name

Street

City..... State.....



Above concrete-floored home in a St. Louis suburb designed by Architect Gay C. Weinel, Robert Hinkson, Contractor.

Over 1,000 St. Louis homes in 5 years built with firesafe CONCRETE FLOORS

Builders create large volume by offering superior concrete floors at costs comparable with ordinary construction

Louis Eisenschmidt, who built the row of attractive concrete homes pictured above, says:

"Many people appreciate the advantages of having a firesafe, rigid floor of concrete. When they learn that such a floor is also comfortable, can be given any desired covering and need cost little or no more, concrete is chosen."

Scores of St. Louis builders, contractors and architects have aggressively pushed various types of concrete floors. As a result, they have brought costs and prices down while adding a structural feature of immense value in any home.

Offer Concrete's Big Values

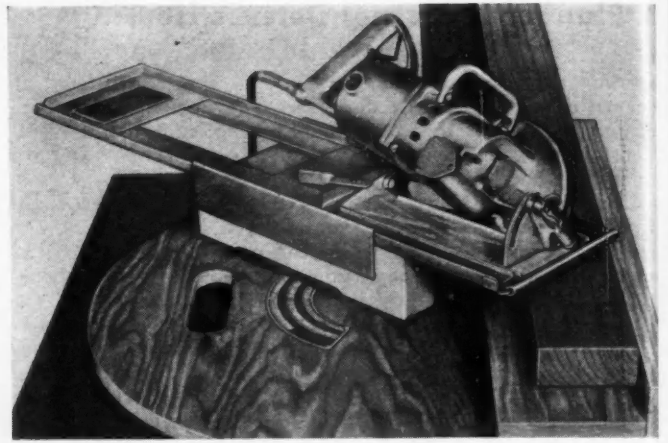
With concrete floors and walls, you can offer fire-safety; resistance to termites, storms and decay; all-year comfort; low upkeep through decades of service; higher resale value. Yet first cost, you'll find, is comparable with that of ordinary construction.

This Association is continuing national advertising of concrete homes and concrete floors. Get your share of the business by building concrete demonstration homes and featuring firesafe concrete walls, floors and foundations in your homes.

Suggested specifications and construction details sent on request (free in U. S. or Canada).

PORTLAND CEMENT ASSOCIATION
Dept. A1-3, 33 West Grand Ave., Chicago, Illinois

A national organization to improve and extend the uses of concrete . . . through scientific research and engineering field work



ABOVE: Skil saw in the Automatic Roof Framer, set for making a compound mitre cut with base of saw tilted, such as for jack rafter.

Time-Saving Automatic Roof Framer and Mitre Box for Portable Electric Saw

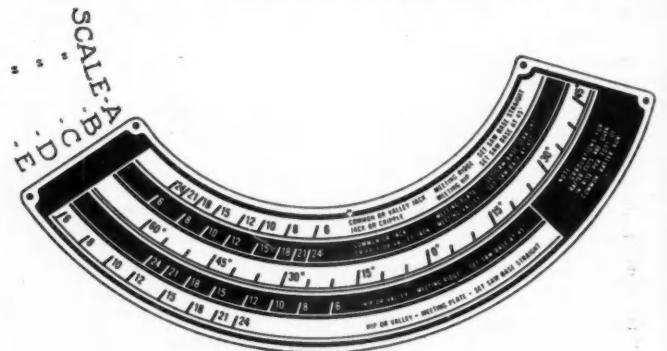
Skil saw Offers Helpful Device

DETERMINING the proper angle of a rafter cut, without calculations on a steel square or without marking the cutting line on the rafter, is possible on the new Automatic Roof Framer and Mitre Box, made by Skil saw, Inc., Chicago; this is done merely by setting the base of this device at the point indicated, and then cutting. It is easily handled, the framer weighing only 23 pounds, and it gives full benefit of savings possible with a portable electric saw.

The roof framer is made for either Models "77" or "87" Skil saw, and for all rafter cuts in 2 x 4 or 2 x 6 lumber up to full pitch. Construction is of sturdy pressed cold-rolled steel, mounted on a waterproofed, laminated plywood base, carefully fitted for smooth operation and accurate cutting. Simple clamping arrangement holds the electric saw securely in position at any desired angle and, when needed, can be easily released for use as a portable saw.

Two aids to simplify the use of the framer have been worked out and are mounted on the device—a protractor setting scale and a rafter length table similar to those on steel squares. The protractor is placed on the mitre box baseboard and is graduated in inches rise per foot of run; in the illustration below, the two top scales, "A" and "B," are used for common rafter cuts, jack, valley jack, or cripple rafter cuts. The upper of these two scales, "A," is used for the cut at the top of the rafter, and the lower of these two scales, "B," is used for the cut at the bottom of the rafter.

Two additional scales, "D" and "E," at the bottom are provided for hip or valley rafters; the upper scale, "D," of these



THIS etched protractor scale, mounted on the base of the Roof Framer, determines the position of the saw for making all rafter cuts on regular roofs, both at top and bottom, by setting the carriage at the proper mark and cutting. Another scale (opposite) contains all information needed to determine rafter length.

two scales is used for the cut at the top of the rafter, while the lower of these two scales, "E," is used for the cut at the bottom of the rafter. Separating these two sets of scales is an additional scale, "C," calibrated in degrees. This scale is used for special purposes only. The mitre box is set to the right pitch by gauging from the right side of the base and all rafter cuts are made with the saw moving to the right of the baseboard.

For example, when using the mitre box it is necessary to know only the rise per foot of common rafter run to set the guide to the proper rise number for the ridge or the plate cut. The ridge cut of a common rafter is shown on the first or top scale, "A," and is made with the foot or base of the saw set straight. The plate cut is shown in the second scale, "B," with the foot or base of the saw again set straight. If the box is set to the correct angle as indicated on the protractor, the result will be cuts which give perfect fits, both top and bottom. The same thing is true for hip rafters except that the bottom two scales are used, "D" and "E." However, ridge cuts of hip rafters are made with the foot or base of the saw set at 45 degrees. There is no need to calculate any angles or to use a carpenter's square.

After the ridge cut is made, the rafter length table (illustrated below and showing an example of use) will quickly determine the length required which is measured and marked. Then the rafter should be turned over and slid through so that it extends to the right of the box, and the angle of the cut changed to the common rafter cut at the plate by setting the mitre box to figure 10 on scale "B" of the protractor. After this cut is made, the rafter is completed. This description of use covers only one rafter, however, and it will be found that usually a number of pieces are the

MADE IN U.S.A. AT CHICAGO		SKILSAW INC.		PATENT APPLIED FOR								
RISE PER FT. OF RUN	PITCH	LENGTH OF COMMON RAFTER FOR GIVEN RUN										
1/4	1/2	3/4	1	1 1/4	1 1/2	1 3/4	2	2 1/4	2 1/2	2 3/4	3	
10	1/4	0-1-2	4-5-11	5-7-2	6-8-8	7-9-15	8-11-8	10-0-13	11-2-4			
10	1/2	0-1-3	4-9-11	6-0-2	7-2-8	8-4-15	9-7-6	10-9-13	12-0-4			
10	3/4	0-1-5	5-2-8	6-6-2	7-9-12	9-1-8	10-5-0	11-8-10	13-0-4			
10	1	0-1-7	5-7-14	7-0-14	8-5-13	9-10-13	11-3-12	12-8-12	14-1-11			
15	1/4	0-1-10	6-4-14	8-0-1	9-7-4	11-2-8	12-9-11	14-4-15	16-0-2			
15	1/2	0-1-13	7-2-9	9-0-3	10-9-13	12-7-7	14-5-1	16-2-11	18-0-5			
15	3/4	0-2-0	8-0-12	10-0-15	12-1-2	14-1-5	16-1-9	18-1-12	20-1-15			
15	1	0-2-4	8-1-5	11-2-3	13-5-0	15-7-13	17-10-10	20-1-8	22-4-5			

THE rafter length table is a simplified method of rapidly and accurately determining the rafter length required when the rise per foot of common rafter run is known and the length of common rafter run is determined. Any rafter length can be determined by using various combinations according to the example shown in the upper left-hand corner of the table.

same; consequently, the cuts are made only on one end, the rafters stacked, measured, turned, and then cuts at the opposite ends are made.

The Skilsaw mitre box used in conjunction with its protractor and its rafter length table provides a most rapid and accurate means of calculating and cutting rafters. Instructions are furnished to fully explain the use on all cuts in the framing of an entire roof, with calculations worked out for a sample problem.

New, Labor-Saving, Strap-on Flue Thimble

A NEW adjustable furnace thimble, available in two sizes and strapped in position on the flue lining before the foundation is built, to produce a stronger, longer lasting job at a lower cost, has been developed by The Wilson Building Materials Company, Cincinnati, Ohio. Under the usual method, a square wooden frame is placed in front of the flue lining during the construction of the foundation, to provide an opening for the furnace pipe; it must be chiseled out after the masonry has hardened. Then a round metal thimble is inserted and the excess space is pointed with mortar.

By using the new thimble, all this unnecessary labor is eliminated. It is adjusted to the proper diameter, held firmly in position on the flue lining with metal bands, and tightened. The foundation is poured or laid around the metal thimble which forms a perfect gauge to cut the thimble hole in the lining.

"I've used them for 18 years— and figure to keep right on building with Western Pines."

Western Pines bring a smile of satisfaction to contractor-builder Sam A. Harris, president of Hillside Park Oaks, New Hyde Park, L. I., N. Y.

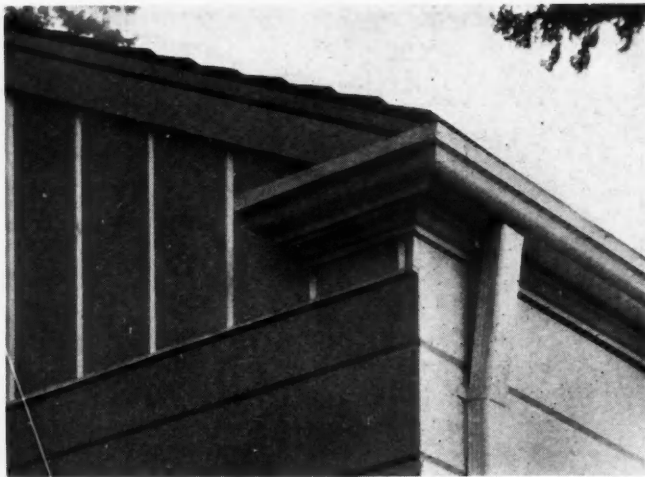


Many a carload of Western Pines Economy Siding protects the weather-side of Harris-built homes. "These woods work better, paint better, stand up better," writes Mr. Harris, who also uses these thoroughly-seasoned, soft-textured, even-grained woods for sash, window and door frames, interior and exterior trim, shutters, porch work, paneling, mouldings, built-in fixtures, mantels, and stairs . . .

THE WESTERN PINES WILL DO YOUR NEXT JOB BETTER—TRY THEM!

Western Pine Association Yeon Building Portland, Oregon

- *Idaho White Pine
- *Sugar Pine
- *Ponderosa Pine
- *THESE ARE THE WESTERN PINES**



How to Apply Wood Gutters on Various Roofs

Application Details

WOOD gutters have an extensive historical background in American construction, having been introduced to this country nearly 300 years ago. However, many craftsmen and builders are not familiar with installation details as their popularity has been greater in certain sections than in others.

The installation of Douglas fir gutters is easily accomplished by the carpenter. Gutter ends may be sealed with blocks, returned and mitred, or butted against the extended rake frieze. This latter method results in a very trim appearance, especially on the gable side of the house. In general, however, the gutter may be treated exactly as the cornice moulding it replaces and the following are general recommendations as made by the Weyerhaeuser Sales Co.

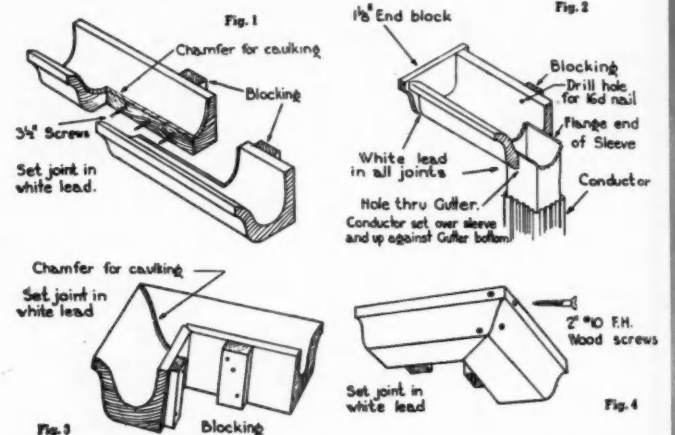
The gutter should be blocked out away from the fascia at least

$\frac{3}{8}$ of an inch. This is accomplished by nailing strips on the back, before erection, about 24 inches apart. The gutter may be placed squarely against the fascia provided flashing is carried from the inside of the gutter up over the edge of the roof sheathing to a point well up under the shingles.

The lip or front top edge of the gutter should not be lower than the top of the roof sheathing line extended. One to one and one-half inches is recommended for the shingle projecting beyond the eaves. Be sure that the gutter is set perfectly level.

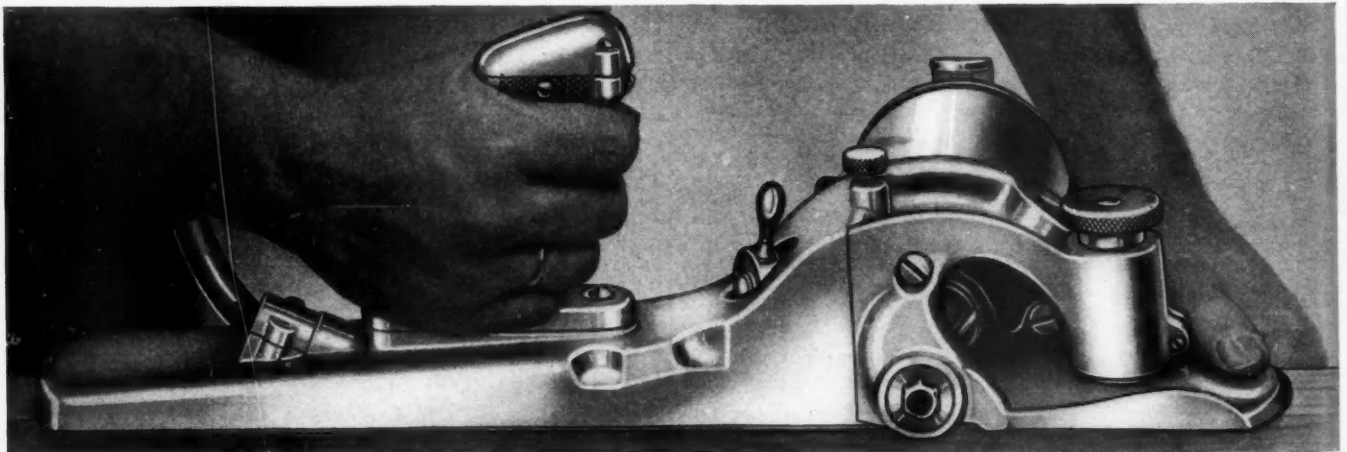
Joints and splices should be cut accurately and fitted tightly. In the accompanying drawings, Fig. 1 shows a typical splice. A permanently flexible caulking compound is recommended for application in joint chamfers.

Early craftsmen used strips of soft lead laid into rebates about 3 inches wide with navy pitch to seal the joints. Another method frequently used is to cut a caulking groove and fill it with flexible caulking compound. Long brass wood screws with countersunk heads are useful at joints and mitres to hold segments together.



FOUR installation details showing common recommended practice for the handling of mitres, joints, downspouts, etc., on wood gutters.

THE 16-POUND "MILLWORK PLANT"



**"Hog it off" - $\frac{3}{16}$ " at a stroke
- - or plane a paper-thin shaving straight and true!**

The Carter J-5 is the most powerful portable electric plane on the market - but that's only part of the story! With its 1 H.P., 18,000 R.P.M. motor it weighs only 16 pounds. And in addition to a satin-smooth planing job, up to 2½" wide, it makes a good jointer, right on the job, when mounted in the bench bracket furnished with it. Bevel cuts to 45°.

Use it as a plane to fit doors, sash, screens, stern windows, transoms. Use it as a jointer for inside trim and similar work. The high-speed spiral cutter is quickly adjustable for depth, leaves a smooth, waveless surface with or against the grain.

Get this time-saver on the job with you right now! Send the coupon today for catalog, or for Carter representative to meet you at your convenience and demonstrate the tool. R. L. Carter Division, The Stanley Works, New Britain, Conn.

SEND COUPON NOW FOR FULL FACTS!



R. L. Carter Div., The Stanley Works, New Britain, Conn.

Have your representative demonstrate the J-5 Power Plane.

Send catalog on Carter Money-Making Tools.

Name.....

Address..... (Please print)

CARTER MONEY-MAKING TOOLS

FIG. 5: Simple mitered splice of non-structural type gives neat appearance and assures alignment of sections. The joints should be carefully fitted on the ground and sections set in place separately, fastened with countersunk wood screws.

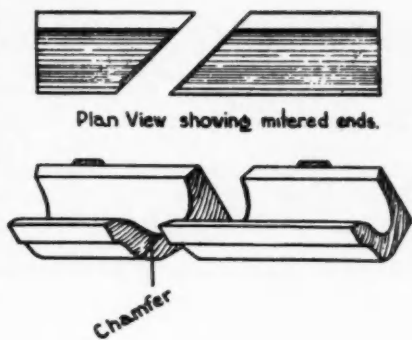
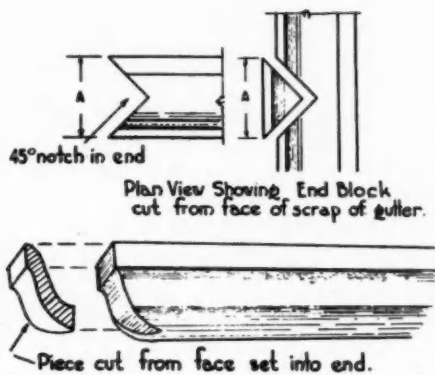


FIG. 6: Simple method (right) of closing end of gutter or return by cutting a 45° notch and fitting with segment cut from piece of scrap gutter of same size. Power saw helps in making these cuts and furnishing blocks for the job beforehand.



Downspout connections (Fig. 2) are simply made by cutting a hole through the gutter and inserting a sleeve which may be of sheet metal or lead, or a 1½-inch pipe nipple screwed into place, and should fit snugly. Flange the end of sheet metal or lead sleeves and caulk with compound. The sleeve fits into standard conductor.

There are many other good ways of making joints and connections, and carpenters soon become adept.

Figs. 3 and 4 show inside and outside views of a corner mitre. Note the use of screws and chamfered groove for caulking. Figs. 5 and 6 show two other useful fitting details. Gutters should be thoroughly primed before erection, with white lead and linseed oil. All cuts and raw ends should be saturated with pure linseed oil and the joints sealed together with white lead, roofing cement, or a commercial caulking compound.

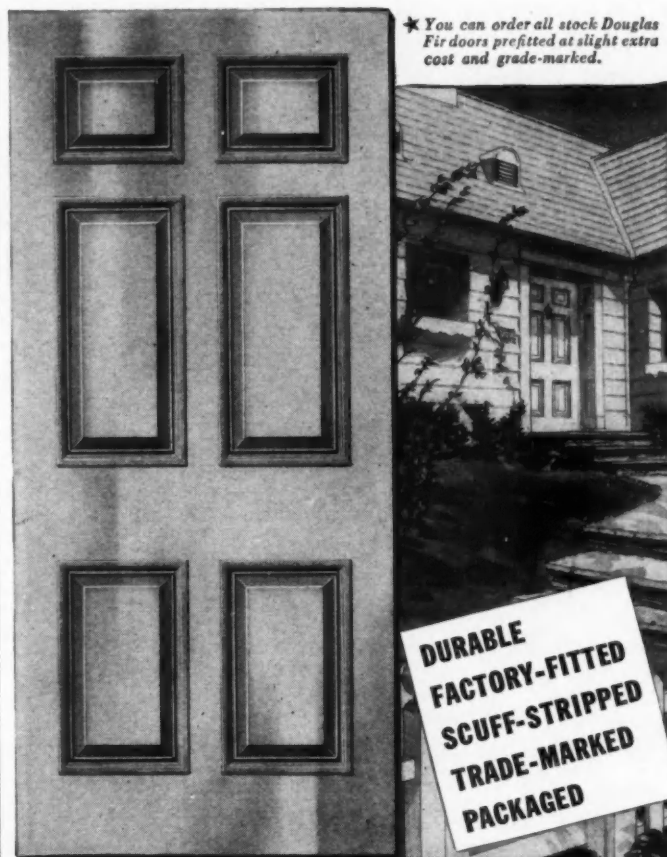
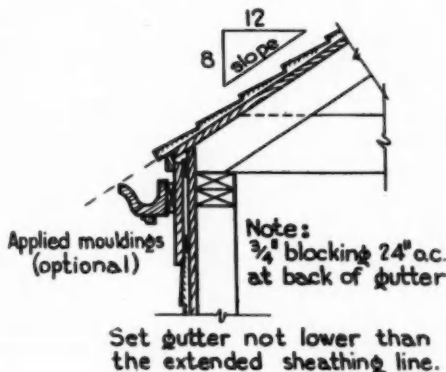
The best time to erect the gutter is while the scaffolding is still in place and before shingling is started; 16d nails should be used. All the above described cutting, fitting or jointing is done on the ground and the gutter is drilled for nailing before being lifted into place.

Blocking the gutter out away from the face of the building eliminates the need for apron flashing extending up under the shingles. This blocking is applied without being pitched in the direction of drainage, as there is no resistance if adequate conductors are provided and reasonable care is exercised in keeping the gutters clean; this maintenance operation is easily accomplished, as there are no cross straps.

The detail below (Fig. 7) shows how to determine the proper height of gutter under ordinary conditions. For very steep roof pitches, the gutter should be set higher so that all the water rushing off the roof will be caught.

(Continued to page 80)

FIG. 7: The detail at right shows how to determine proper height of gutter under ordinary conditions. This and other suggestions on these pages are recommended in Weyerhaeuser's booklet, entitled "4-Square Wood Gutters."



**DURABLE
FACTORY-FITTED
SCUFF-STRIPPED
TRADE-MARKED
PACKAGED**

TRU-FIT

Durable Douglas Fir Entrance Doors

Ideal for every home!

● No matter what the price range of the homes you build, you will add both to their appearance and their value if you use Tru-Fit Douglas Fir Entrance Doors. These marvelous doors cost no more than other good entrance doors, yet they give superior performance. They're made only from durable Douglas fir, *the wood that lasts longer*. They're built by skilled craftsmen and precision tools . . . pre-fitted at the mill to save you time and work . . . then scuff-stripped and packaged to assure the delivery of a perfect door to your job. The trademark on every door is a positive identification of a genuine Tru-Fit Entrance Door. One of the 27 distinctive designs is exactly right for every house you build. Keep a catalog on hand . . . order from your dealer soon.

SEND FOR FREE COLOR CATALOG

FIR DOOR INSTITUTE, Tacoma Building, Tacoma, Washington
Please send me your free catalog of Douglas Fir Doors, No. 2000.

Name _____
Address _____
City _____ State _____



A PROGRAM by BETTER HOMES & GARDENS to help you sell more houses built with ADVERTISED PRODUCTS.*

This program, to be announced in this magazine in February, is fresh, effective, packed with dramatic ideas. It

- ... WILL provide a means for tying-in every home you build during 1941 with many national advertising campaigns.
- ... WILL make your prospective customers conscious of value rather than price.
- ... WILL help you sell your houses faster at a greater profit.
- ... WILL provide a means of developing many new prospects for your houses.

* Back of this program to help you sell more houses built of nationally advertised building materials is the famous Better Homes & Gardens Guarantee.

This guarantee—read monthly by over 2,200,000 home-owning-minded American families—can be your guarantee to your prospects. You'll find it mighty good business to use it and business mighty good when you do.



BETTER HOMES & GARDENS

The publication voted "most useful" by three out of five families who built new homes during 1940

How to Apply Wood Gutters

(Continued from page 79)

Details on the Use of Wood Gutters for Various Roofs

THE drawings that follow illustrate common ways of applying wood gutters to various types of roofs as is determined by the framing involved; that is, with overhanging eaves, close-cropped eaves with and without return, extended rake board, etc.

For cottages, farm buildings and remodeling jobs with overhang-

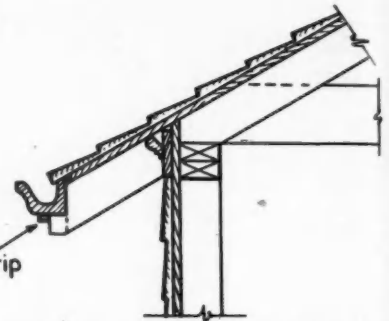
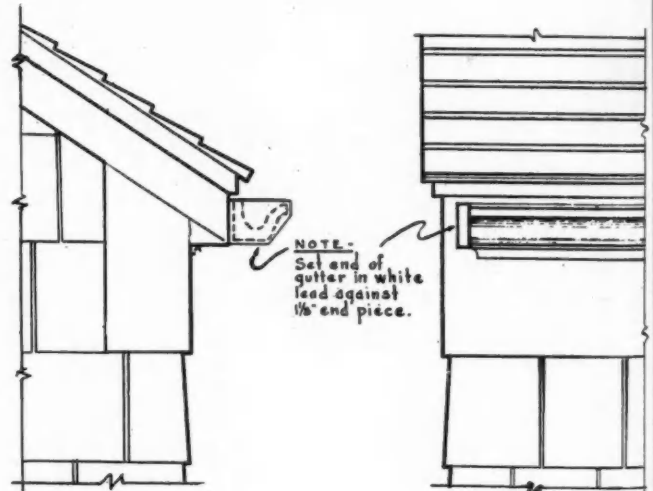


FIG. 8: Wood gutters can be applied to extended eaves or lookouts, as shown at the right.

1" strip
Notch end of rafter. Lay shingles directly on the gutter.

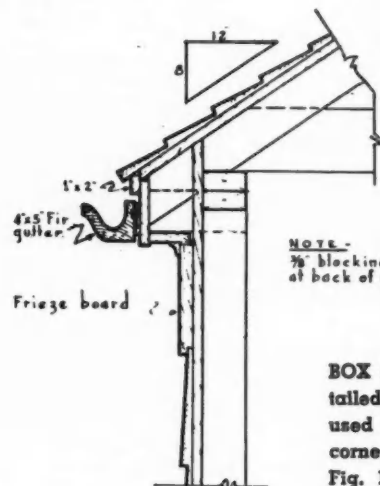
ing eaves, the gutter is frequently applied to the ends of the rafters, or lookouts, as shown in the sketch (Fig. 8) below. In remodeling jobs, where notching the rafter ends might be difficult, the gutters may be fastened directly against the rafter ends as shown by the dotted line.

The three details of Fig. 9 appearing below show a very simple way to apply the wood gutter to a box cornice. A mitered return



NOTE - Set end of gutter in white lead against 1/8" end piece.

FIG. 9: The group of three details above and at left shows method of applying gutter to a box cornice.



NOTE - 3/4" blocking 24" o.c. at back of gutter.

BOX cornice construction, as detailed above, in Fig. 9, can be used on hip roofs with mitered corners, as shown opposite in Fig. 11.

could be used if required as shown in the drawings of Fig. 12. A moulding could also be used on the bottom of the gutter if desired, especially if the face of the box cornice were higher.

This method could be applied to box cornices where hip roofs are used, in which case gutters should be mitered at the corners, caulked and set in white lead. The two details (Fig. 11) at the bottom of this column show a hip roof on which wood gutter is applied without the usual blocking at the back. It is raised up close under the shingles to offset the projection lost by the elimination of the blocking, and results in a very snug and attractive cornice. In very cold climates where ice will form, this application is not recommended. Note how the flashing is run from the inside of the gutter and up under the shingles. Many types of mouldings may be used below the gutter at the frieze board.

In the details at the right (Fig. 10), the manner of fastening the gutter to the wall results in a very neat and trim appearance, (Continued to page 82)

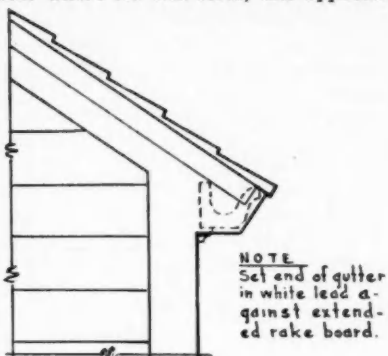


FIG. 10: The three details at the right indicate method of butting gutter against extended rake frieze for simple and trim appearance.

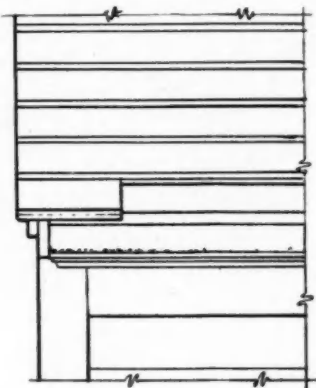
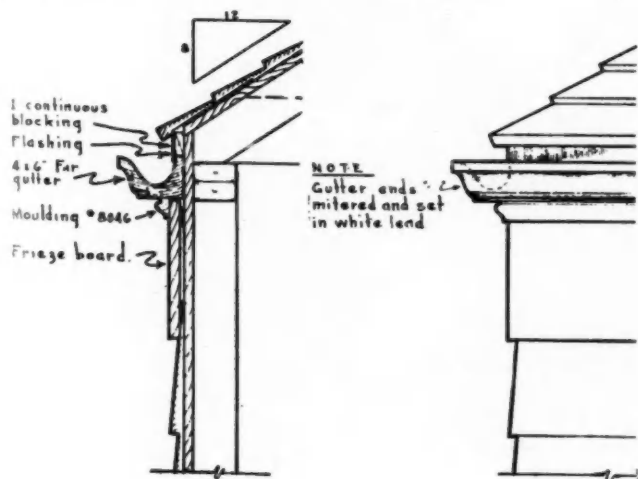
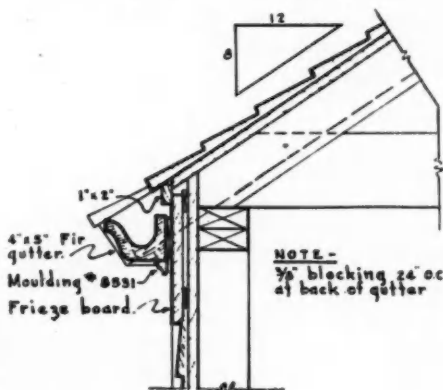


FIG. 11: Two details below show wood gutter on hip roof without blocking at back.



Wherever you turn
SKILSAW
 is on the job for
UNCLE SAM!

in building
FORT ORD
 in
CALIFORNIA

Top speed is the word . . . so builders of the world's biggest defense program turn to SKILSAW above all others to speed up every sawing job! That's why Fort Ord is being built with the help of SKILSAW...that's why so many orders we get call for SKILSAW in lots of 30 to 100...that's why more SKILSAWS are used by builders than all other makes combined! No other saw can give you SKILSAW'S time-saving, cost-cutting, profit-making features. 9 powerful models for wood, metal, stone and compositions.

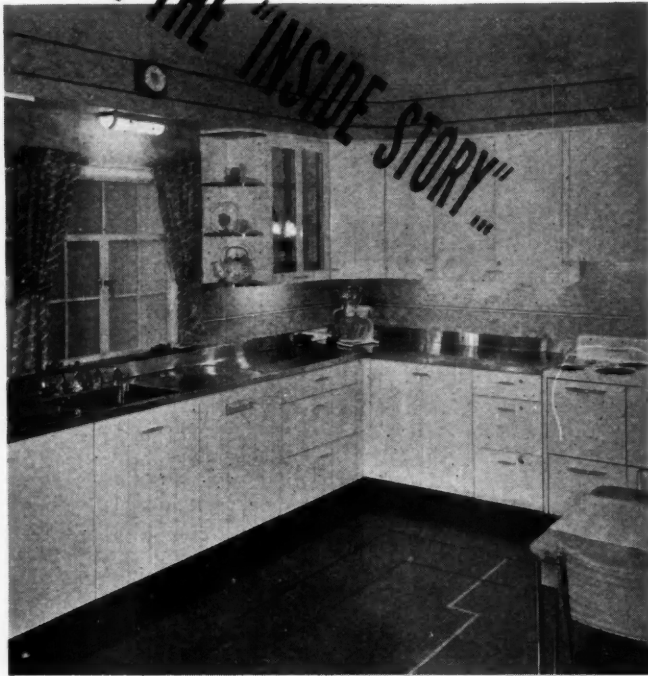
SKILSAW, INC.
 5031 Elston Avenue, Chicago
 36 East 22nd St., New York—52 Brookline Ave., Boston—182 Main St., Buffalo—15 S. 21st St., Philadelphia—2902 Euclid Ave., Cleveland—2124 Main St., Dallas—918 Union Street, New Orleans—29 North Ave., N. W., Atlanta—2645 Santa Fe Ave., Los Angeles—2065 Webster St., Oakland. Canadian Branch: 85 Deloraine Avenue, Toronto.

...148
SKILSAW TOOLS

SPEED CONSTRUCTION AND CUT COSTS

... say
FORD J. TWAITS CO.
 and
MORRISON-KNUTSEN COMPANY, INC.
 Joint Contractors

TELL THE "INSIDE STORY"



WITH TILE-TEX

IF you are building homes to sell, you know how important it is to make the interior of the home attractive and appealing to women. It is an accepted fact that women control the purchase of most homes, and to women interiors are vitally important.

Here, in Tile-TEX, is a material for both floors and walls that can be used to build modern, attractive interiors in the key rooms of today's home—the bathroom, the kitchen, and the basement playroom. And, in using Tile-TEX, you make important savings against outmoded and conventional materials.

Tile-TEX floors are low in first cost, easy to maintain, long-wearing, and eye-appealing. Kitchens, bathrooms, and recreation rooms are "natural" areas for this new, resilient flooring.

Tile-TEX walls are currently the sensation of the residential home building industry. Low initial cost, speed of installation, attractive color styling—all of these factors are making it the choice of progressive builders seeking to satisfy the public taste for a wall treatment that meets all present day requirements.

There is an approved Tile-TEX contractor near you who can show you Tile-TEX products now in service—show you how little they cost—and demonstrate how they can help you sell new homes. Write today for his address and for free copies of the new Tile-TEX booklets on floors and walls.



The Tile-TEX Company
Chicago Heights, Illinois

Send me complete literature on the following:

- "Floors That Endure" by Tile-TEX
- "Decorative Walls" by Tile-TEX
- "Flexachrome," an Exclusive Product

Name

Address

A-1

How to Apply Wood Gutters

(Continued from page 81)

especially on the gable side of the house. The ends of the gutter are butted against the extended rake frieze to make an unusual and simple method of stopping the gutter. These gutter ends may also be stopped as shown in the detail (Fig. 12) on this page, and also as shown in Fig. 9, if end shingles are not extended.

The four details below illustrate the most common way of applying a wood gutter; a photographic view of this method is shown at the beginning of this article. The mitered return should be cut accurately at the joints and set in white lead. Any type of flat moulding may be used on the bottom of the gutter and, if desired, it may be applied to the gutter as shown in Fig. 10. The same mitered return could also be used to terminate the gutters shown in Fig. 9. Note the clearance left between the end of the gutter return and the siding.

NOTE -
Gutter ends mitered and set in white lead

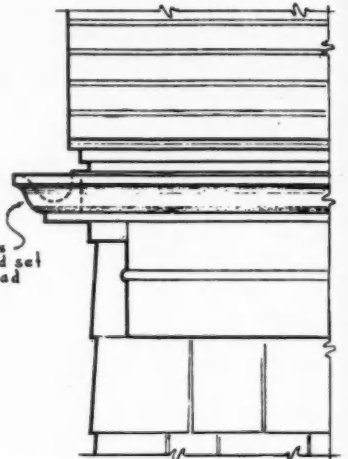
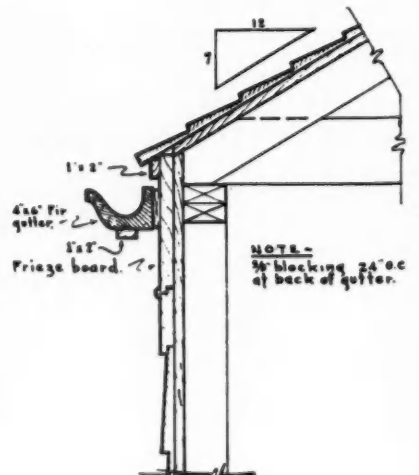
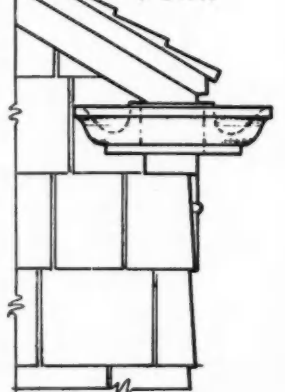
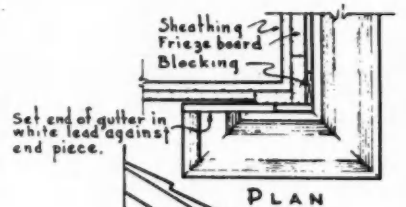


FIG. 12: Three details which illustrate the most common way of applying a wood gutter with mitered return. Any type of flat moulding may be applied on the bottom of the gutter.



NOTE -
3/4\"/>

THE section at the right shows method of blocking in applying gutter with mitered returns, as detailed above.

Teamwork in Housing

Address at Annual Public Meeting, Washington Housing Association, December 9, 1940, United States Chamber of Commerce.

by JACOB CRANE,

Assistant Defense Housing Coordinator
National Defense Advisory Commission

OUR vast program for national defense requires teamwork of a very high order. As a part of national defense, defense housing requires first-class teamwork. Furthermore, in its vital relationship to our huge peace-time national housing problem, defense housing requires organized team-play. In fact, it does not permit of disorganization.

Here we have a close analogy to the play of a football team. When a field goal is attempted, each player must know in advance and agree in advance on the precise part which he will take, and every move must be carried out by teamwork. Very few field goals would be completed if all eleven players tried to kick the ball. Of course, if there is a fumble and the ball goes loose, then every player scrambles to recover it. And, with so many interests involved, some people may have considered defense housing to be a loose ball, free for any one to grab and run with. Hence the need for co-ordination.

Let us set down some of the underlying principles for defense housing.

Preparations for national defense are now paramount in importance. Our national resources and energy must be devoted to this purpose. And the utmost speed is indispensable.

In meeting immediate requirements as a part of national defense, defense housing includes the provision of suitable shelter for the families of married Army and Navy enlisted personnel, and for single workers and families of civilian workers in Army and Navy establishments and in defense industry.

In a wider sense, however, total national defense requires a high level of national health and morale; and national health and morale require decent housing for all American families.

Thus the whole housing problem becomes part of the national defense problem. With millions of American families now badly housed, we must not permit the major housing programs to be retarded for long. If, in our preoccupation with what appear to be the most urgent phases of national defense, we were to neglect the over-all housing problem even for a few years, the vital necessity for providing decent civilian housing would have reached colossal proportions; and in a fundamental sense we should be ill prepared for total defense.

Hence defense housing must do all it can to stimulate and not interfere with the expansion of the other major housing programs; in fact, defense housing must be geared toward meeting the need for decent housing generally, toward city rebuilding, and toward the provision of essential community facilities.

Permanent Houses and Demountable Houses

In many localities defense activity is drawing in thousands of new families who require defense housing for only a temporary period. But this does not justify temporary housing of an inferior standard. Instead, in these localities, the defense housing should be programmed and designed to provide standards of livability and sanitation not lower than those for permanent housing. Furthermore, such housing should be planned either to become a part of the community's permanent housing after the emergency, or it should be designed so that it can later be moved to other localities where housing is badly needed. Thus, in some situations, permanent houses may be built for temporary defense needs and used to replace slums later on. In other instances *demountable* houses may be used, that is, houses built to decent standards now and constructed so that they can be taken down, transported, and re-erected at small cost. Such houses could be moved to other towns, to rural areas, or to places for special use in connection with recreation facilities or for housing of the families of migratory workers.

To obviate ghost towns or ghost developments, with their resultant waste and damage to public and private interests, it

(Continued to page 84)

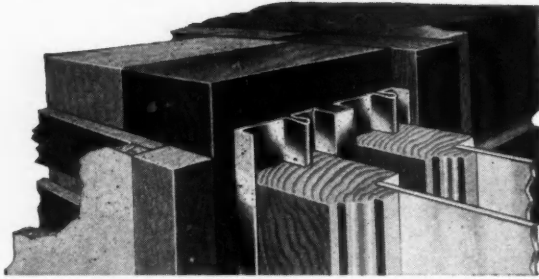
SAMPLE HOUSE
OPEN SOON

• All the most modern conveniences, including built-in telephone outlets—with permanent conduit to conceal wires inside the walls.

Have you ever used the "Architects' and Builders' Service" offered by your local telephone company? Call your nearest Bell Telephone Business Office and get acquainted with this time-saving service.

BELL TELEPHONE SYSTEM

THE BEST WINDOW ON THE MARKET!



- The Non-Stick Window is simplicity itself.
- The Non-Stick Window is provided with 2 x 4 Jamba; sturdy construction prevents weaving.
- One-piece Metal Sash Guides assure positive alignment of the sash.
- Wood-to-wood contact is eliminated by the metal sash guide, thus preventing paint stick.

See the Non-Stick Window at Your Dealer or Write Us.

N. S. W. CO., 2137 Gratiot, Detroit, Mich.

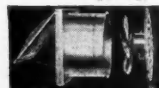
NON-STICK WINDOW

OPPORTUNITY—For home owners, realtors—Silent Partner ready to invest your homes with clean, fresh air—free from dirt, grease, grime—make it liveable and saleable at mighty little cost. Address Victor In-Bilt, Cincinnati, Ohio, U. S. A.

I sell homes because buyers appreciate me. I keep rooms fresh and clean, free from fumes, smoke, odors. I make homes more pleasant—make them easier to sell.

THE *Champion*

Victor In-Bilt's round silchrome-finished grille harmonizes with modern kitchen appliances. A beaded chain controls automatic operation. Fan blades perform quietly, efficiently.



TWO UNIT CONSTRUCTION

The Victor In-Bilt is made in two units for the builder's convenience. Makes it easy and quick to install.

For full information about Victor In-Bilt ventilators, write—

VICTOR ELECTRIC PRODUCTS, INC.

Dept. 18-211, 2950 Robertson Ave., Cincinnati, Ohio

SILENT PARTNER in HOME SALES

VICTOR *In-Bilt* VENTILATORS

Teamwork in Housing

(Continued from page 83)

is just as important that plans be made now for the co-ordinated disposition after the emergency of housing built now to meet what may turn out to be a temporary defense need as it is to agree upon organized defense programs in the first instance.

The impact of defense programs and of defense housing upon local interests and local governments must be recognized and reasonably handled. Schools must be provided; recreational facilities and other community services must be arranged; and all the problems having to do with the local governments must be worked out.

In programming defense housing, and in designing it, building it, and managing it, the existing agencies of federal, state, and local government should be utilized to the full, before attempting to set up new and separate agencies. Equally important, the facilities of private enterprise must be utilized to the limit of their capacity in providing defense housing.

Co-ordinating Private and Public Housing

To carry out this last named principle, the co-ordination of defense housing involves making a clear division of the field of operations, and assigning each portion to the agency and method best adapted to handling it. In other words, there must be assigned to private enterprise all that it can handle successfully; and to each of the several agencies of government the portion of each defense housing program best adapted to its statutory powers and methods of operation.

The last-named principle is of primary importance for general housing programs as well as in defense housing; and defense housing is making a demonstration of the way this can be done.

Public housing agencies and private developers have been waiting for this kind of co-ordination. Public housing and private housing are both greatly strengthened by knowledge that the division of the field is agreed upon in advance and announced to the public in advance, for each local program. For private housing (with FHA and HLBB assistance) there is reserved the job of providing dwellings for families with incomes ranging upward from about \$1500, where it is known that these houses will be used for more than ten or fifteen years. To the USHA and the local housing authorities there is assigned the low-income permanent housing, in places where responsible local authorities exist, and insofar as funds are available. And the defense housing of uncertain duration, plus the low-income defense housing where no local authorities exist, is assigned to the Army and the Navy, and to the Federal Works Agency and its constituents. The formula is simple. Defense housing offers an opportunity to apply it. The whole national housing business is clarified thereby.

Obviously, to make any headway under these principles requires co-ordination, clear agreements among the agencies, and highly systematized teamwork throughout.

Surveying Regional Housing Needs

Not all of these objectives have been reached as yet by any means. It has been said that everyone with a bicycle is now undertaking to make defense housing surveys; and there are situations where several agencies have made surveys in the same locality. But this is being straightened out by dividing the field and correlating the work; and the housing agencies and the WPA are cooperating wonderfully. With the assistance of the Consumer Division and the Division of State and Local Cooperation of the Defense Commission, vacancy registration is to be established in the more critical areas, to get a more accurate gauge of need for defense housing and of problems on housing standards. The Labor Division in the Defense Commission and its affiliates in the Department of Labor are furnishing the essential background information on the prospective number of incoming workers, their wage rates, etc., and this will help greatly to make the programming more efficient and realistic. Standards of space and sanitation seem relatively satisfactory thus far, but standards of community facilities have not in all cases been met. The Consumer Division of the Commission is studying this problem with the Office of Defense Housing Co-ordination. The use of demountable houses has not yet been fully clarified, and there are problems of materials, productive capacity, and labor to be

worked out. We have to systematize a method of establishing rents so that defense workers' families will be housed as intended, without gaps or duplication.

On the intricate problems of local planning and co-ordination, the Division of State and Local Cooperation, through state and local defense councils, the Bureau of Education, the National Resources Planning Board, and other agencies are aiding the Defense Housing Co-ordinator. In the localities the local governments, local housing authorities, local school boards and park boards, etc., are helping to work out co-ordinated programs. From the long range viewpoint, this local planning is perhaps most significant of all in the whole defense housing operation.

From what has been said, it is clear that for team-play we have not eleven but 111 players engaged in defense housing. In this situation, it is possible for any one of the 111 to fall on the ball and hide it, and virtually to stop the play altogether.

The Housing Co-ordinator

Foreseeing this problem of organizing for team-play in defense housing, the National Defense Advisory Commission created the office of Defense Housing Co-ordinator, naming Charles F. Palmer of Atlanta as the Co-ordinator. Working with this office are representatives from each of the federal housing agencies, and constant collaboration is carried on between the various branches of those agencies and the Co-ordinator's office. The Division of State and Local Cooperation furnishes liaison and co-ordination with local defense councils. The Division of Research and Statistics furnishes background data and a constant flow of other information. Purchase is arranged in the Procurement Division of the Treasury. And so on through many arrangements for co-ordinated planning and action.

Now, each local defense housing program takes form in our Locality Program Report; and each program reaches the public in the Locality Information Sheet. Behind each locality program there lie various reports on the need for defense housing, various surveys, numerous discussions, the use of certain formulae in dividing the field of operations, circulation of the Report among the parties at interest, and finally agreement and action.

To illustrate, I might take the Locality Program Report for the District of Columbia Locality. This Report will be prepared on the background of survey and discussion, and circulated to the Defense Commissioners and the housing agencies for comment and, we hope, for agreement.

Since workers now travel considerable distances between home and work, we have included within each locality the reasonable commuting area, so that, in this case, Arlington County as well as the District of Columbia and the immediately adjacent territory in Maryland are included in the Washington Locality.

The general housing situation and the need for new housing in Washington have been discussed by other speakers on this program. For defense housing in the narrower sense, we have not yet been able to determine whether or how much housing will be required for civilian employees of governmental agencies other than the Army and the Navy. But for the Army and the Navy, we find that nearly 2000 houses are needed soon, most of them immediately.

Several hundred of these dwellings are needed for the families of civilian employees of the Navy, at the Navy Yard, at the Naval Air Station, and at the torpedo station in Alexandria. While the period of defense activity for these civilian families is uncertain, it is considered that the houses will be needed permanently in the community. Since these families can generally pay from \$25 to \$45 shelter rent per month, the provision of this particular category is assigned in the main to private enterprise. It is believed that private agencies, with the aid of the FHA and the HLBB, can meet this portion of the need. Private developers are active, and thus it appears that the Defense Homes Corporation of the RFC will not be needed for this part of the program at least for the time being.

On the other hand, a large part of this need is for houses to shelter married enlisted personnel of the Army and the Navy and lower-paid civilian workers' families. These families cannot pay commercial rents for decent houses and hence cannot be served now by private housing. Therefore, this need is

(Continued to page 86)



EVERY HOME IS MORE LIVABLE

when equipped with the efficient auxiliary heat of the built-in

“ELECTRIC” QUIKHETER

It provides comfort on chilly days — adds its warmth to that of the furnace on exceptionally cold days. It is fully hot the minute the switch is turned on. The cold air, drawn in at the floor level, is quickly heated and forced out at the top — and immediately begins to circulate through the whole room. Bedrooms, dressingrooms and nurseries need this cheerful warmth.

In New Construction or Modernization

the built-in Electric QUIKHETER should be included in the plans. Installed now, it will be ready to go into immediate and effective service.

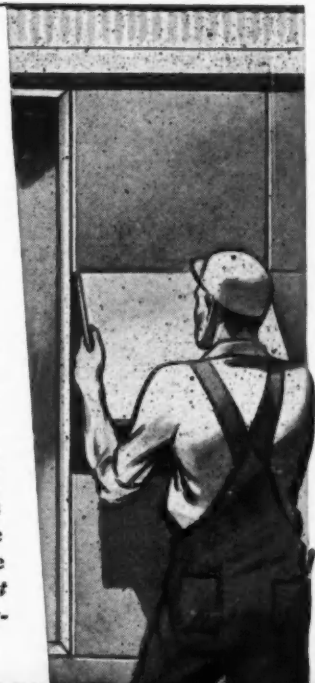
There is a Wholesaler near you

who will make quick delivery from stock — in either 1,000, 1,250 or 1,500 watt sizes. Write us for his name — and for descriptive circular.

Frank Adam
ELECTRIC COMPANY
ST. LOUIS

Don't pass up the PROFITS in Porcelain Enamel

• Smart contractors are making good profits RIGHT NOW on the rapidly growing trend to porcelain enamel store fronts. These attractive units are readily adaptable to new or modernization work. Quickly and easily installed. Your customers will like their wide range of colors, up-to-the-minute appearance and low-cost up-keep! Get the money-making facts today!



MAIL THIS COUPON NOW

THE AMERICAN ROLLING MILL CO.
61 Curtis Street, Middletown, Ohio

Without cost or obligation, tell me how I can make real money erecting porcelain enamel work.

Name _____
Firm _____
Address _____
City _____ State _____



**WHERE TERMITES
MAY ATTACK--
TURN THEM BACK**
Specify
**TECO TERMITE
SHIELDS**

TERMITE damage is permanently preventable in new building with TECO Termite Shields. Protect your reputation and property owner's investment—wherever termites are a problem.

**WRITE NOW FOR
FREE VALUABLE BOOKLET**

**TIMBER ENGINEERING
COMPANY, INC.**
Dept. H-1, 1337 Connecticut Avenue
WASHINGTON, D. C.

Teamwork in Housing

(Continued from page 85)

assigned to the Navy for construction under Public Act 781 and to the FWA under Public Act 849. We understand that the Alley Dwelling Authority will assist both the Navy and the FWA.

The relatively simple principle of co-ordination is illustrated. Private enterprise is given a chance to perform in its field, and it is given assurance that government housing will not encroach upon that field if private developers can meet the need in time. And the low-rental housing is to be provided by government funds—that is, the housing to be rented generally for \$11 to \$20 per family per month.

It is probable that the defense housing program for the Washington Locality will expand, both in the field of private enterprise and in the field of government housing; but the program will continue to be developed on the principles outlined here.

With all of this complexity, it may be justifiable to point out that during the past few months allocations have been made for nearly 50,000 dwelling units and construction has started on more than 20,000 dwelling units at various points.

The purpose of the Office of Defense Housing Co-ordinator is to put the ball in play by teamwork, through effective participation, agreement, and co-ordination among the great number of agencies and interests. We believe that this process constitutes the very essence of Democracy; and we believe that this process is essential to the success of Democracy. And, while the people of Europe seem to be headed toward reversion to something resembling cave dwellings, we want defense housing to work toward good housing and satisfactory communities for all Americans.

* * *

New Stainless Steel Gutters

Lower Cost to Bring Wider Use

BUILDING contractors will be interested to know that stainless steel, a relatively new metal, is now being used for one of the oldest applications for sheet metal—conductor pipe, gutter, flashing and accessories. Its general acceptance is being hastened by the fact that leading manufacturers are supplying stainless steel roof drainage products through the regular trade channels. Formed parts as well as sheets for flashing are stocked by a number of sheet metal distributors.

Since the use of stainless steel is comparatively new in the roof drainage field, there are misconceptions about its cost among contractors and their customers. Some still think of stainless as a luxury metal to be used only for decorative work, kitchen equipment and similar applications. Yet the grade of stainless steel most satisfactory for roof drainage work is cold-rolled and not polished; primarily it is the elimination of the polishing operation that brings the metal within the reach of builders and property owners. The recent standardization of stainless steel roof



TRAIL-SMITH
**7-S or
10-S**

Spring-mounted axle — Roller bearing auto type wheels — Oversize low pressure pneumatic tires — Automatic skip vibrator — Enclosed gear reduction — Multiple V-belt drive — Vertical siphon-type tank.

BUILT TO "TAKE IT" — either on the job or traveling between jobs. Compact. Lightweight. Roller bearings throughout. Also 4 wheel end or side discharge models. Other sizes 2½-S to 112-S. Write for literature.

THE T. L. SMITH COMPANY
2849 N. 32nd Street
Milwaukee, Wis.

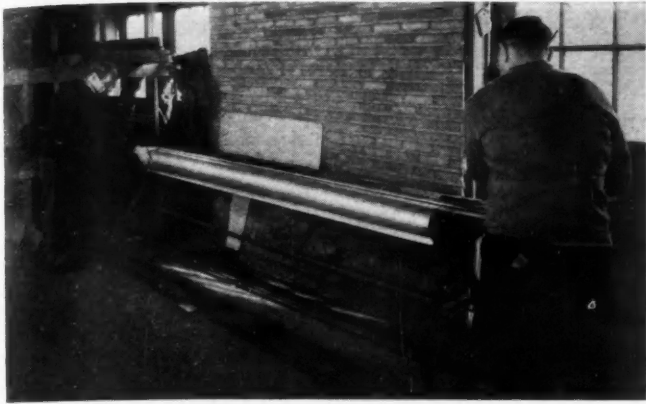
Tows behind car or truck at fast driving speeds!

SMITH

MIXER MANUFACTURERS FOR MORE THAN 40 YEARS



WORKMAN installing stainless steel gutters on new garage of Ohio



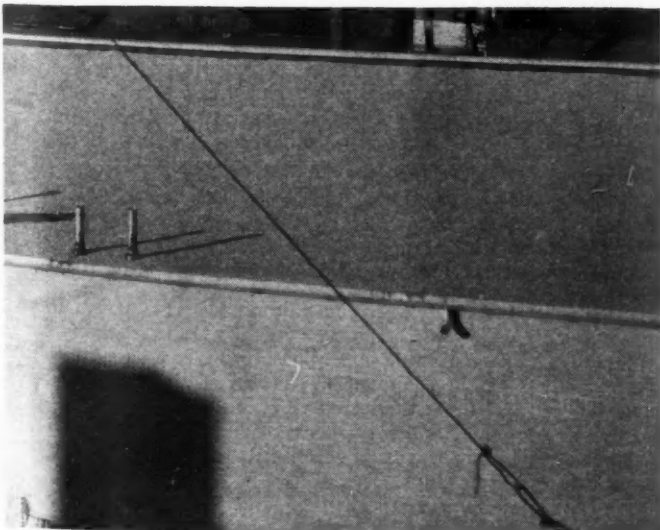
SHOWING how 28 gage stainless steel is easily made up as a section of gutter; bead is being rolled in this operation

drainage products has likewise helped to keep the cost of this rustless metal compatible with other of the so-called permanent roof-drainage materials. Then too, it is not necessary to use heavy gages for this application.

The recommended grade is 28-gage chromium-nickel stainless steel (type 301) and this is as easy to work as 26-gage galvanized iron or 16-ounce cold-rolled copper. Stainless steel nails, rivets, screws, cleats, and bolts are also recommended to make the job completely stainless. This is important; for the finest installation can be marred by unsightly discoloration from the rusting of common steel accessories. Hangers, hooks, circles, straps, shanks and other accessories should be stainless steel, but if these cannot be readily procured, lead-coated copper or lead-coated bronze may be substituted to preserve the color effect.

The soft natural color of stainless steel gutter, conductor pipe and accessories harmonizes nicely with practically any surrounding construction and color scheme. If the customer wants the metal painted this can readily be done and no special preparation is needed. The same primer and cover coats can be applied to stainless as to the rest of the building and of course it is not necessary to paint inside the gutter. Stainless steel makes an excellent base for paint, does not tend to dry it out, and, because there is no danger of undercoat corrosion, actually increases paint life.

The fact that stainless steel is rustless is a decided advantage on flat work as well as formed. When water collects in puddles on most painted metals it usually hastens peeling of paint, and the underlying metal is subject to rust-action. In many cases the trouble doesn't stop here. Not only does ordinary metal construction have to be repaired, but the structural and facing work as well. Frequently plaster is cracked, painted woodwork is defaced and wall paper ruined. It is reasonable to assume that these and other problems arising from roof drainage failures can be solved by the use of stainless steel, although lack of ordinary good care, such as keeping gutters free from debris, would work against any such assurance. (Continued to page 88)



Bell Telephone Building: downspouts and coping of same material.

Add Value to Every House You Build . . .

Build the fireplace around the Heatilator—the new-type fireplace that **CIRCULATES HEAT AND WILL NOT SMOKE.** Besides, it's easier to build.

Drop a postcard to-day for complete details

HEATILATOR CO.
711 E. Brighton Ave.
Syracuse, N. Y.



HEATILATOR Fireplace

SAVE
50% or More
of FINAL COSTS on
WOOD FLOOR FINISHING
WITH
LIGNOPHOL

LIGNOPHOL costs less than one cent per square foot. It is applied in one coat with a long handled brush—reducing labor to the minimum. The U. S. Forest Products Service says linseed oil does not even protect and—you know shellac and varnish are surface treatments that wear off.

**WHEN YOU USE LIGNOPHOL
THERE IS NOTHING TO WEAR OFF**

Its ONE application gives smoother, harder, more attractive floors. Thousands of contractors are finding the LIGNOPHOL method of preserving and finishing floors (and trim) at 50% or more savings, the modern way to more profits and greater job satisfaction.

Find out more about advantages of

LIGNOPHOL

MAIL THIS COUPON TO-DAY!
Dept. B-1-L. Sonneborn Sons, Inc., 88 Lexington Ave., New York City

YOUR NAME _____
ADDRESS _____
CITY _____
STATE _____



Sold

...by
**"Double Feature"
COMFORT APPEAL**



Quick sale of a small home at a good profit—the happy result of combining comfort appeal with economy. ¶ This double feature is provided by the gas-fired, vented **PAYNE Duplex Furnace**—which does double duty too: circulates warm air from both sides of wall. Carefully located, can heat an entire small home. ¶ For modern, streamlined heating equipment adapted to any size home, see your **PAYNE Dealer or Gas Company**. Write us for location of nearest salesroom.

All **PAYNE** equipment is twice-tested for reliability, efficiency, safety.



PAYNEHEAT Payne FURNACE & SUPPLY CO., INC.
BEVERLY HILLS • CALIFORNIA

**NON-TILTING PLASTER-MORTAR
KWIK-MIX 6-P**



Fast discharge — 7 seconds — no tilting necessary — weighs only 850 pounds — air-cooled engine — V-belt and worm drive.

WRITE FOR BULLETIN NP — AB

3½-S TILTING KWIK-MIX

Side discharge — anti-friction bearings — welded construction — discharge either side — spring mounting.



WRITE FOR BULLETIN SD — AB

KWIK-MIX CONCRETE MIXER CO.
PORT WASHINGTON WISCONSIN

New Stainless Steel Gutters

(Continued from page 87)

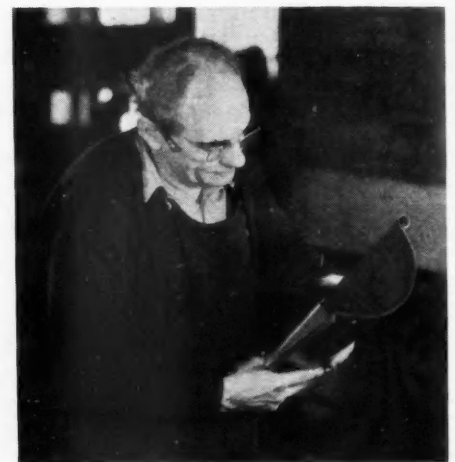
There are other important influences that contribute to the long life of stainless steel besides its rustless properties. Chromium-nickel stainless steel is at least twice as strong as other metals commonly used for this purpose. This is an important point to remember; for roof drainage systems are constantly subjected to contraction and expansion.

Every contractor knows that northern winters tax roof drainage systems to the limit and often beyond. Sharply changing temperatures and heavy loads of ice and snow must always be taken into consideration. Sagging is a common failure; however the yield point of chromium-nickel stainless steel is so high (45,000 pounds per square inch) that when properly installed there is little likelihood of sagging gutters.

Architects and contractors who have studied this new application for stainless steel say that these are the important advantages that impress them most:

(1) When properly installed a stainless steel roof drainage system should last indefinitely.

(2) Stainless steel is rustless and there can be no rust or patina to wash away and discolor adjacent building areas.



SHEET metal worker **George Wuchet** inspects a stainless steel gutter made in Dayton, O., shop.

(3) Gutters are stronger and therefore resist sagging. Stainless steel is a tough metal and elbows made of it better withstand the abrasive action of sedimented water. Cracking under expansion and contraction would be rare if it happened at all.

(4) Since stainless steel has an attractive finish, neutral in tone, it blends well with surrounding construction and color schemes. If a painted surface is desired, the metal is readily painted and there is no possibility of undercoat corrosion.

(5) Since stainless steel is considered a permanent material it is definitely economical in cost-per-year-service.—Fred Kehrer, The American Rolling Mill Co.

* * *

Concrete Contractors to Meet in Chicago

THE annual conference of concrete contractors is to be held in Chicago at the Hotel Sherman on Feb. 10, 11 and 12, sessions to take place concurrently with the Concrete Industries Exposition and the annual conventions of concrete products manufacturers and cast stone producers. The meetings will be devoted to an exhaustive study of the newest and most efficient methods of modern concrete construction practice—of particular interest at this time because of the large amount of concrete construction, both private and public, involved under the national defense program.

Tying in with these conventions, manufacturers of equipment and materials employed in concrete construction and the manufacture of concrete products are planning extensive exhibits of their products at the Exposition. To allow the thousands of concrete men attending their several conventions an ample opportunity to see the Exposition, convention sessions will be held in the mornings and the Exposition will be open in the afternoons and early evenings.

The cast stone manufacturers will hold their annual convention at the Bismarck Hotel on Feb. 10 and 11, and the American Concrete Pipe Association its annual meeting at the Edgewater Beach Hotel on the same days.

News of the Month

Building Activities and Meetings

November Building Contracts Show Big Gains

RESIDENTIAL building in 37 eastern states, according to F. W. Dodge Corporation, amounted to \$152,838,000 for the month of November 1940, as compared with \$116,588,000 for the same month in 1939. This represents a gain of over \$36,000,000, or an increase of about 31.1 per cent. Statistics for the four classes of construction in 37 eastern states are as follows:

37 Eastern States	November, 1940	November, 1939	October, 1940
Residential	\$152,838,000	\$116,588,000	\$148,469,000
Non-Residential	148,367,000	77,769,000	136,405,000
Public Works	51,430,000	81,584,000	73,220,000
Utilities	27,712,000	23,906,000	24,975,000
Total	\$380,347,000	\$299,847,000	\$383,069,000

Semi-Annual Real Estate Survey Shows Effect of Defense Program

THE Thirty-Sixth Semi-Annual Survey of the Real Estate Market, made by the National Association of Real Estate Boards, shows a favorable trend in every major factor of the real estate situation, advance in market activity and prices, and a surge throughout the country that is very generally expected to mean for 1941 accelerated business and a new rise in real estate demand. The survey, covering 237 cities, is made from confidential reports by the Association's member real estate boards.

For the individual American city, the one big factor which is affecting the pattern of its immediate real estate activity and coloring the whole outlook for its real estate market for the coming year is the relation of that city to large-scale activity in the national defense program. Effect of the defense effort as it is already pushing and pulling both general business and urban land use is an important part of the story running through the confidential reports, made by local member real estate boards, which make up the survey. By that same token, the new and large element of uncertainty in the outlook for individual cities is, necessarily, uncertainty as to the way the program may develop in their direction.

Present conditions shown by the survey are as follows:

A more active market than last year in 57 per cent of the cities, large and small, and a market at least as strong as last year in 89 per cent of the reporting cities.

Sales prices 5 to 10 per cent above last year's level in more than a third of the cities, and the same or higher than last year in 93 per cent of the cities.

Supply of single-family dwellings definitely on the short side in 45 per cent of all the reporting cities, which is approximately the same condition found by the like survey of a year ago, an indication that new home building is about balancing the expansion in home demand. Apartment shortage in 28 per cent of the cities, but 17 per cent still with an oversupply.

Rents for single-family dwellings, immobile through the years 1938 and 1939, are higher than last year in 45 per cent of the cities. Apartment rents have moved up also, but less generally.

Financing costs still dropping in 17 per cent of the cities, rising in only 3 per cent of the cities. Capital supply equal to or in excess of loans offering in 95 per cent of the cities.

There is a high degree of correlation shown in the reports between absorption of residential space and starching of the rent situation. But the survey asked specifically this key question: "Are residential rents in your community sufficient to justify investment in rental housing at present construction costs?" And only one-third of the cities replying said yes. Two-thirds of them said no.

Asked whether there will be need during the coming year for construction of an emergency nature for defense workers, 75 per cent of the cities replying said no. But 25 per cent of these typical cities look for emergency building to be required to house new population before the year is out. Some of them attempted to estimate the amount. Those communities, with a combined population of 7,782,954 people, estimated they would need as emergency housing a total of 49,545 family units. That would

(Continued to page 90)



This Useful Guide

TO HELP YOU SELECT THE RIGHT DUMB WAITER FOR THE JOB

Every builder and contractor should have a copy of this Reference Chart. It tells you at a glance the type of dumb waiter best suited to every kind of lifting job—when best to use electric or hand power.

This is but one of the many ways that Sedgwick helps buyers of its equipment. If you are not acquainted with Sedgwick Dumb Waiters and Elevators, this is a good time to write us. *Sedgwick Service Satisfies.*

SEDGWICK MACHINE WORKS

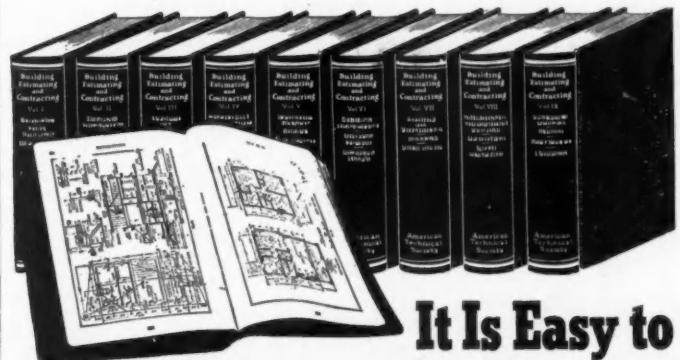
Established 1893

Member of Producers' Council, Inc.

154 WEST 15TH STREET

NEW YORK, N. Y.

Dumb Waiters & Elevators



It Is Easy to Be a CONTRACTOR

Learn to estimate, to plan buildings, to take contracting jobs, and make money on them. Here are 9 up-to-the-minute books on building, estimating, and contracting which cover in an interesting way, the subjects that carpenters, builders, and contractors should know to make the most out of their jobs. Roof Framing, The Steel Square, Architectural Drawing and Design, Estimating, Painting and Decorating, Heating, Air Conditioning, Building, Contracting, Concrete Forms, and other subjects are all well covered. A marvelous encyclopedia for general reference purposes in the building field.

Boss Carpenters in Demand

Vast public works jobs, immense projects, and the rapid growth of home building, are making jobs for MEN WHO KNOW HOW. These books give you quick training. With them you shouldn't be afraid to tackle any job, for needed facts can be found in a hurry.

Up-To-Date Edition

These books are the most up-to-date and the most complete books we have ever published for those interested in the Building Trades.

Coupon Brings Nine Books Free for Examination

American Technical Society, Publishers—Home Study Courses Dept. G133, Drexel at 58th Street, Chicago, Illinois.

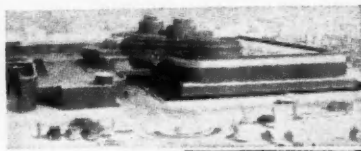
You may ship me the latest edition of your nine big books, "Building, Estimating, and Contracting" without any obligation to buy. I will pay the delivery charges only, and if fully satisfied in ten days, I will send you \$2.00, and after that only \$3.00 a month, until the price of only \$29.80 is paid. I am not obligated in any way unless I keep the books.

Name

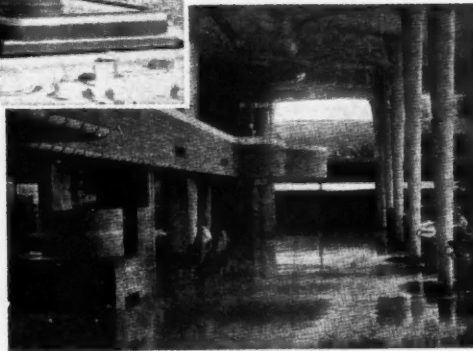
Address

City State

Please attach a letter stating your age, employer's name and address, and that of at least one business man as a reference.



New Famous Johnson's Wax Office Bldg., Racine, Wis., has 50,000 Sq. Ft. of Wright Flooring.



Flooring of Distinction

PRICED FOR EASY PROFITS

● Enjoy bigger profits installing Wright Rubber Tile on new or old floors in homes, schools, offices, churches, hospitals, etc. Wright Floors are quiet, comfortable, easy to clean, and resist years of heavy traffic. They come in gay colors and patterns to match all decorative schemes—yet they cost no more than good grade linoleum. See Sweet's or write for illustrated literature.

WRIGHT RUBBER PRODUCTS COMPANY
1603 Layard Ave. Racine, Wis.

WRIGHT RUBBER TILE

PROTECTS!



Also White Rez

TOUGH, SMOOTH AND HORNY! That's the kind of "hide" you can give to wood products when you use Laux REZ—amazing, synthetic resin sealer and primer. With REZ, fir plywood, sash, doors, floors, millwork, furniture are protected from weather, water and wear. And they're painted, enameled, or stained much easier, much more beautifully when they've first been REZ-treated. REZ controls moisture absorption, grain raise, checking and decay. Millions of gallons proven in use. Ask your dealer today.

LAUX SALES CO.

Seattle — Los Angeles — Minneapolis —
Chicago — Dallas — New Orleans —
Portsmouth, Va.

Real Estate Survey

(Continued from page 89)

be one family overflowing into emergency housing for every 40 families of present population.

As to industrial real estate the forecast is for increased demand during 1941 in not quite half the cities of the country. It is the prediction in 40 per cent of the surveyed cities. The demand will be powerful enough to cause a price rise in one-third of the cities, the local observers predict in their reports.

Real estate selling prices are higher than last year at this time in 36 per cent of the cities, lower in only 7 per cent, hold where they were in 57 per cent of the cities. The median rise is 10 per cent. A considerable number of cities report prices for new houses are up 10 per cent to 15 per cent, but prices of older dwellings have sagged lower than they were a year ago. The Association has pointed out that differentiation in FHA financing between existing houses and new construction is a potent cause for this split, that it is disintegrating values unnecessarily in established residential sections and that it calls for correction at the coming session of Congress.

While shortage of single-family dwellings is shown in 45 per cent of the cities, over-building is still felt in 5 per cent of the cities. Normal balance between supply and demand is today's condition in 50 per cent of the cities. Increase in dwelling rents, where it occurs, has in one city out of every two been a 5 per cent rise. In two cases out of five it averaged 10 per cent, and in one city out of twelve it went higher. The greater rise came in the smallest cities. Apartment rents rose less generally than house rents. They are up, however, in 34 per cent of the cities, while only 11 per cent show down trend; 55 per cent are stationary. Where they stiffened the rise, however, is oftener 10 per cent than 5 per cent. Cities of over 500,000 population show the highest percentage of residential oversupply. Few of them cite rent increase in either houses or apartments.

Location	Station or Establishment	No. of Units	Estimated Cost	Contractor
ARIZONA				
Ft. Hauchuca	Ft. Hauchuca	30	\$ 94,000	M. M. Sundt Const. Co., Tucson, Ariz.
Tucson	Municipal Airport	135		
CALIFORNIA				
Benicia	Benicia Arsenal	50		
Fort Ord	Fort Ord	550		
Fresno	Municipal Airport	150		
Riverside	March Field	150		
San Diego	San Diego	3,000	9,070,000	McNeil Const. Co. & Zoss Const. Co., Los Angeles, Calif. (both)
San Rafael	Hamilton Field	175		
Stockton	Municipal Airport	100		
Sunnyvale	Moffett Field	150		
Vallejo	Mare Island	950		
COLORADO				
Denver	Fort Logan	50	172,000	F. J. Kirchhof Const. Co., Denver, Colo.
Lowry Field	Lowry Field	125		
CONNECTICUT				
New London	Elec. Boat Co.	300		
DELAWARE				
Delaware City	Fort Dupont	20	67,000	J. George Benschel Co., Baltimore, Md.
FLORIDA				
Orlando	Municipal Airport	100		
Jacksonville	Navy Air Station	300		
Tallahassee	Municipal Airport	100		
Pensacola	Navy Air Base	100		
Tampa	MacDill Field	300	816,000	Paul Smith Const. Co. Tampa, Fla.
West Palm Beach	Municipal Airport	150		
GEORGIA				
Augusta	Municipal Airport	75		
Columbus	Ft. Benning	350	1,035,500	Murphy Pound, Columbus Ga.
Rossville	Ft. Oglethorpe	50		
Savannah	Municipal Airport	325		
IDAHO				
Boise	Municipal Airport	100		
ILLINOIS				
Belleville	Scott Field	100		
Rantoul	Chanute Field	200		
Savanna	Savanna Pro. Gd.	200		
KANSAS				
Ft. Riley	Ft. Riley	125		
KENTUCKY				
Fort Knox	Fort Knox	700	1,935,000	Fleisher Eng. & Const. Co. Lexington, Ky.
MAINE				
Bangor	Municipal Airport	150		
MARYLAND				
Aberdeen	Aberdeen Pr. Gd.	300		
Baltimore	Holabird QM De.	85		
Edgewood	Edgewood Arsenal	200		
Havre De Grace	Aberdeen Pr. Gd.	500		
Indian Head	Powder Plant	650		
Odenton	Ft. Ge. G. Meade	115	376,000	George Hyman Const. Co., Washington, D. C.
MASSACHUSETTS				
Boston	Aviation Base	1,050		

Defense Housing

THE office of the Defense Housing Coordinator working with the various agencies responsible for the development of the defense housing program is beginning to bring some order in the defense housing picture, and through this bulletin, prepared by H. R. Northup, secretary-manager of the National Retail Lumber Dealers Association, Washington, D.C., are summarized the defense housing developments so far as they had been released in Washington up to Dec. 16.

Under the Lanham Act and the Supplemental Defense Appropriation Bill, there was made available a fund of \$250,000,000 for defense housing projects, plus an additional fund available through the Reconstruction Finance Corporation, which has now set up the Defense Housing Corporation to develop defense housing projects in cooperation with the Federal Housing Administration.

Below, and in the column opposite, is presented the following information:

A list of defense housing projects assigned to the Public Buildings Administration by the Federal Works Administrator, to be constructed with funds provided by the U. S. Army and the Lanham Defense Housing Act. This list shows locations, the number of dwelling units to be built, and the awards made to date, with the contractors' names. It indicates approval of the construction of 22,083 dwelling units.

The list includes six defense housing projects approved for construction by the USHA through local housing authorities. These USHA jobs are at Jacksonville, Fla., 300 Units; Philadelphia, 500 Units; Pensacola, 100 Units; Boston, 1,050 Units; Charleston, S.C., 600 Units; and Bremerton, Wash., 800 Units. They total 3,350 Units.

Through the office of the Federal Works Administrator the project involving the construction of 500 dwelling units at Camden, N.J., is under way, but no contract awards have yet been made.

Location	Station or Establishment	No. of Units	Estimated Cost	Contractor
Chicopee.....	Westover Field.....	200		
Ft. Devens.....	Ft. Devens.....	300		
MICHIGAN				
Battle Creek.....	Ft. Custer.....	250		
Mt. Clemens.....	Selfridge Field.....	130		
MISSISSIPPI				
Jackson.....	Municipal Airport.....	50		
NEW JERSEY				
Camden.....	N. Y. Ship Yard.....	500		
Fort Dix.....	Fort Dix.....	100		
Long Branch.....	Ft. Monmouth.....	265		
NEW MEXICO				
Albuquerque.....	Municipal Airport.....	100	285,000	Lembke Const. Co., Albuquerque, N. M.
NEW YORK				
Fishers Island Village.....	Ft. M. G. Wright.....	20		
Hempstead, L. I.....	Mitchell Field.....	200		
NORTH CAROLINA				
Fayetteville.....	Fort Bragg.....	550		
OKLAHOMA				
Ft. Sill.....	Fort Sill.....	150		
PENNSYLVANIA				
Philadelphia.....	Navy Yard.....	500		
SOUTH CAROLINA				
Columbia.....	Ft. Jackson.....	400		
Charleston.....	Navy Yard.....	600		
SOUTH DAKOTA				
Fort Meade.....	Fort Meade.....	35		
TEXAS				
El Paso.....	Fort Bliss.....	200	\$12,000	H. T. Pensford & Sons, El Paso, Texas
Fort Clark.....	Fort Clark.....	50	153,500	Taylor & Byrnes, Ft. Worth, Texas
Houston.....	Ellington Field.....	200	296,000	Templeton & Cannon, San, Angelo, Texas
San Angelo.....	Army Flying Field.....	100		
San Antonio.....	Brooks and Kelly Fields and Ft. Sam Houston.....	717		
VIRGINIA				
Arlington.....	Arlington Cantonment.....	35		
Langley Field.....	Langley Field.....	350		
Phoebus.....	Ft. Monroe.....	90		
Virginia.....	Ft. Story.....	50		
WASHINGTON				
Bremerton.....	Navy Yard.....	800		
Ft. Lewis.....	Ft. Lewis.....	250		
So. Tacoma.....	McChord Field.....	150		
Spokane.....	Municipal Airport.....	250		
TERRITORY OF HAWAII				
Oahu, Hawaii.....	Navy Base.....	1000	\$1717000E.	E. Black, Ltd., Honolulu, Hawaii
Oahu, Island.....	Fort Kamehameha.....	550		
P. R.—				
Henry Barracks.....	Henry Barracks.....	30		
Ft. Buchanan.....	Ft. Buchanan.....	200		
Juan Diaz Air Base.....	Juan Diaz Air Base.....	200		
Borinquen Field.....	Borinquen Field.....	300		

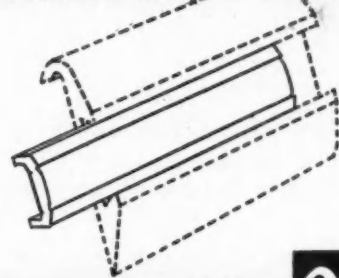


TIME Takes Little Toll of EDWARDS Metal Spanish Tile Roofs

The roof illustrated above, installed almost a quarter century ago, proves the superior value of Edwards Metal Spanish Tile. It has lasting beauty and protective efficiency without excessive weight. Requires no special roof reinforcement. The cost is moderate and the profit for supply dealers and contractors is unusually attractive. Write for Catalog No. 72.

THE EDWARDS MANUFACTURING CO.
542-562 Eggleston Avenue Cincinnati, Ohio

New WILSON ALUMINUM INSERT



Use of this exclusive new Wilson all-aluminum insert with standard half-inch, insert-type moldings, gives an easily installed, all-aluminum surface that is permanent and highly decorative.

Number 60-D insert fits all standard half-inch nosings, edgings and moldings. (Used alone, 60-D is an attractive decorative bar.)

Wilson
METAL PRODUCTS CO., COLUMBUS, O.

GIBBS BOARDTILE

means unlimited ceiling



on Your Profits!

INCREASE YOUR PROFITS by meeting new home and remodeling customer demand for modern, distinctive, low cost interior walls and ceilings with Gibbs Boardtile. Its gleaming beauty, unlimited color range, durability, mean more eye and buy-appeal to prospects for modernizing bathrooms and kitchens, and easier closing of complete room remodeling jobs. Gibbs Boardtiled rooms increase the saleability of model homes. Write for samples and color chart.



GIBBS BOARDTILE CORPORATION
624 North Aberdeen St. CHICAGO

BOOKS ABOUT BUILDING

Authoritative information about the designing, construction and financing of buildings can be found in up-to-date books. We will be glad to recommend suitable books on any subject you are interested in.

BOOK SERVICE DEPARTMENT

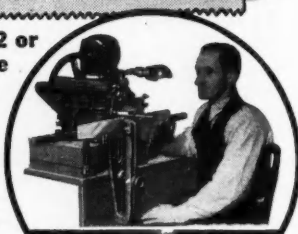
AMERICAN BUILDER AND BUILDING AGE
30 Church Street New York, N. Y.

SAW-FILING

Carpenters Make up to \$2 or \$3 an Hour in Spare Time

With a Foley Automatic Saw Filer you can file hand, band and circular saws better than the most expert hand filer. Cash business, no canvassing. No eyestrain, no experience needed. Louis P. Wadwick, Ohio, says: "I have filed 764 saws in spare time and have earned \$850.00 in carpenter work due directly to my saw filing contacts." Send coupon for FREE PLAN, no obligation.

Large Contractors and Builders who have many saws to file can increase production, do better work and reduce filing costs with a Foley Saw Filer. Soon pays its cost. Get the facts.



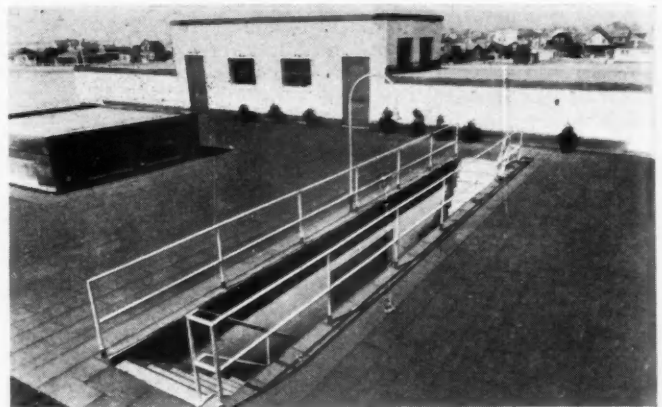
FOLEY MFG. CO., 124-1 Foley Bldg., Minneapolis, Minn.

Send Free Plan on Custom Saw Filing.
 I want to file saws for crew of about (10-25-50-100) men (Check No.)

Name
Address

Improved Carey Asphalt Tile

THE Philip Carey Manufacturing Co., Lockland, Cincinnati, has developed an improved asphalt tile with a smoother, more attractive surface for use both as an industrial flooring and for protection of roof areas which are used for recreational purposes. Marketed under the trade name, Elastite Asphalt Tile, it is a compound of asphalt and mineral filler, reinforced with asbestos fibres, densely compressed and die cut to size, and is now approved by the Underwriters' Laboratories for "Class A" built-up



ROOF of the Hampton Beach House, Hampton Beach, N. H. Covered with Carey Elastite Asphalt Tile.

roofing, when applied in accordance with their instructions, on slopes up to and including 1" to the horizontal foot. It should not be confused with asphalt paving blocks or asphalt floor mastics.

Carey Elastite Asphalt Tile is manufactured in standard black and standard red, in 1/2" thickness, and in sizes 12" x 12" and 12" x 24". This product is extremely dense, tough, highly resistant to compressive loads, dustless and quiet under wheel traffic. While relatively hard, it is not rigid or unyielding, thereby contributing to workers' efficiency. It may be applied to any properly prepared sub-base and is ready for use as soon as laid.

Five New International Trucks

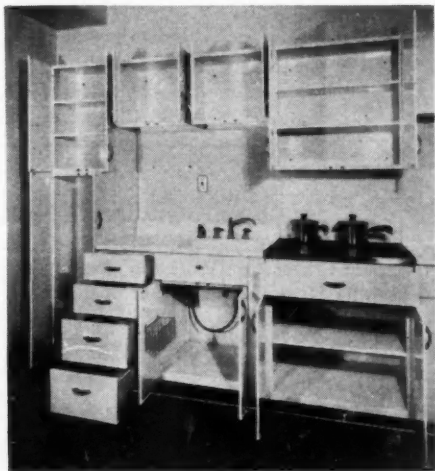
INTERNATIONAL Harvester's new line of trucks has five models in the 1/2 to 1 1/2 ton capacity range. These are: the 1/2-ton Model K-1, 3/4-ton Model K-2, 1-ton Model K-3, 1 1/4-ton Model K-4, and the 1 1/2-ton Model K-5. Wheelbases range from 113 to 177 inches and gross vehicle weight ratings from 4,400 to 13,500 pounds. Outstanding among many important mechanical features of the new Internationals is the new "Green Diamond" engine which, in three sizes, powers the five new models. Exhaustive research and an extensive and far-reaching testing program have proved the ability of these engines to provide more power with improved performance and remarkably greater fuel economy. International also announces new and highly efficient hydraulic brakes on all of these models. Two-shoe, double-anchor-type brakes provide greatly improved braking ability for trucks of the various sizes.



NEW International Model K-5 with all-steel welded dump body, ideally suited to the needs of contractors.

YPS Steel Kitchen Units

MUCH of the credit for developing the *planned* kitchen goes to the Youngstown Pressed Steel Division of the Mullins Manufacturing Corporation in Warren, Ohio. Housewives have long been receptive to such an idea; yet many had a notion that custom-built cabinets were required and that these would be too



RIGHT. Steel kitchen units for dish washing center; Below. Complete kitchen of YPS units.

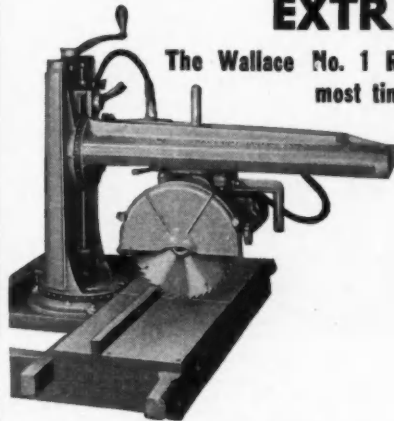


expensive for modest budgets. Buyers had tended to associate popular-priced steel cabinets with flimsy construction and tinny sounds. To answer this, Y.P.S. incorporated several noteworthy features: electrically welded "box-type" doors with rolled edges; drawers with brass runners on steel for quiet operation; semi-concealed hinges; all parts electrically spot welded; two coats of baked enamel over all steel surfaces; friction catches on doors; drawers and heads fully insulated and the drawers equipped with rubber bumpers; and cutlery drawers lined with linoleum. Mass production of steel cabinets meant revamping the factory layout. Taking a hint from the automotive industry the assembly line method was adopted. Now it is straight-line production, from the time the sheets of Armo cold-rolled steel are sheared and stamped till they arrive on the inspection table as finished cabinets.

Knowing full well that many budgets could not afford a complete planned kitchen, Y.P.S. designed its line around three ensembles: the dishwashing and cleaning center, food storage and preparation center, and the cooking and serving center.

To enable buyers to visualize how their new or remodeled kitchens will look, the Y.P.S. company offers miniature model kitchens of cardboard. These may be "juggled" and changed about until the one right combination of appliances and cabinets is attained. This works out very satisfactorily for the contractor or architect as well as for the owner, since it enables the housewife (the boss in this case) to give full expression to her individual ideas and desires.

FOR EXTRA PROFITS— EXTRA ACCURACY— EXTRA SPEED!



The Wallace No. 1 Radial Saw saves the most time on:

- X-CUTTING
- MITERING
- RIPPING
- DADOING
- ROUTING
- SHAPING
- FLUTING
- GROOVING
- CUTTING TILE

Safe, speedy, accurate in operation. Cuts up to 4" material. Saws rafters on a production basis, without marking! Also studs, joists, sheathing, cripples, flooring, wedges, etc.

After framing is up, machine is used for making and fitting cabinet work and trim.

Saves from \$75 to \$200 on small residential contracts,—proportionately more on heavy construction.

If you want to speed up your work,—make more money,—write today for bulletins on the Wallace No. 1 Radial Saw.


J. D. WALLACE & CO.

136 S. California Ave.

Chicago, Ill.

Set of Blue Prints and FREE BOOK

"HOW TO READ BLUE PRINTS"



This Free Trial Lesson on "How to Read Blue Prints," and a set of blue prints plans—sent to show you how this 37 year old School for Builders makes it easy for men in the building industry to lay out and run jobs, read blue prints, estimate costs, superintend construction, etc. Drawing of plans included if wanted.

LEARN AT HOME IN SPARE TIME

Men with this training are needed now to handle expanding business in building construction. This knowledge leads to promotion. Building contractors urge employees to get this training. For Free Trial Lesson address:

CHICAGO TECH COLLEGE

A-129 Tech Building,

118 East 26th St.

Chicago, Illinois

Profit by REDUCING COSTS THROUGH MANUFACTURING



Own a business. Build it by supplying more for less. Eliminate all unnecessary expenses. Manufacture and deliver direct to job, and profit by reducing costs. Learn how you can make your own materials or supply building trade in your territory. We supply machine and equipment for making any permanent material efficiently and at low cost. Write today for free catalog containing low factory prices and liberal terms. Act now and see how easily you can make this double profit.

CONCRETE EQUIPMENT CO.
514 Ottawa Ave. Holland, Mich.



BLOCK
BRICK
TILE
ROOF TILE
DRAIN TILE

Builders—Get Wise To SAVUTIME!

In Detroit alone twenty or more new homes are equipped with Savutime every day! In Rochester, N. Y., 75% of all new homes are Savutime equipped! Outstanding home developments the country over—like Long Island's Speedway Homes—are using Savutime. They realize that—Savutime is a worthy substitute for expensive automatic hot water heaters—a substitute with so much appeal that it actually helps to sell new homes. Get the facts. Write for literature and name of nearest distributor.

SAVUTIME SALES CO.
105 Manhattan St.,
Rochester, N. Y.

SAVUTIME
GAS WATER HEATER
PUSH-BUTTON CONTROL

BATH
KITCHEN
LAUNDRY

MR. KEES SAYS:

"USE KEES METAL SIDING BUILDING CORNERS"

SAVE THE TIME AND COST OF SAWING SIDING TO EXACT LENGTH. GET A BETTER JOB.

Free Catalog and Sample on request.

F. D. KEES MFG. CO.
Box 93, Beatrice, Nebraska
Distributed Thru Hardware Stores

Authoritative information about the designing, construction and financing of buildings can be found in up-to-date books. We will be glad to recommend suitable books on any subject you are interested in.

AMERICAN BUILDER—BOOK DEPT.
30 Church St. New York City

QUICK CHANGE Try it FREE
from Level to Transit

Two motions shift it from level to transit. One-piece standard casting gives great rigidity and strength. Built especially for contractors.

Try the Universal
Avoid Costly Errors

\$10 brings you the "Universal" Level-Transit. One hour teaches you how to accurately check up surveys, avoid costly errors. Money-back guarantee.

Easy Payments. Use instrument. If not satisfied, return and your money is refunded. Or keep on easy monthly payments. Particulars on request.

Ask for FREE booklet "How to lay out building lots"

DAVID WHITE CO.
311 W. Court Street,
Milwaukee, Wis.

We Do Expert Repairing

Tapes Rods Supplies

Only \$10 Down

"TrueCost" Estimating Figures for Home Designs in this Issue



The Editors have prepared a 28-PAGE EXPLANATION of American Builder's "TruCost" system of quick, accurate estimating and offer it to anyone interested at 25 cents per copy. Please enclose payment when ordering. Address American Builder, 30 Church St., New York City.

Page 36, January: Wendland, Archt.

"TRUCOST" ESTIMATING FIGURES FOR THIS HOUSE: Foundation Walls, 160 lin. ft.; Trench Walls, 10 lin. ft.; Utility and Heater Room Floor, 130 sq. ft.; Garage Floor, 190 sq. ft.; Excavation per ft. deep, 43 cu. yds.; Outside Walls, 20.00 sqs.; First Floor, 6.75 sqs.; Second Floor, with fin. fg., 6.75 sqs.; Ceiling, 16.50 sqs.; Roof Pitch, 7" rise per ft. run; Roof, 8.25 sqs.; Hips and Valleys, 60 lin. ft.; Cornice, C & F, 104 lin. ft.; Partitions, 250 lin. ft.; Inside Finish OS Walls, 230 lin. ft.; Front and OS French Doors, 2 opps.; Rear and Grade Doors, 1 opp.; Garage Door 8 ft. wide, 1; Inside Doors and Cased Opps., 22 opps.; Windows and Casements, 18 opps.; Gable Sash and Louvers, 1 opp.; Chimney, 34 lin. ft.; Main Stairs, 1; Porch Floor, .32 sqs.; Porch Ceilings, .32 sqs.; Porch Beam, 10 lin. ft.; Porch and Balcony Post and Newels, 0; Garage and Porch Roof, 3.50 sqs.; Garage and Porch Cornice, 62 lin. ft.; Porch and Deck Rail, 62 lin. ft.

Page 37, January: Wendland, Archt.

"TRUCOST" ESTIMATING FIGURES FOR THIS HOUSE: Foundation Walls, 172 lin. ft.; Utility Rm. Floor, 100 sq. ft.; Excavation per ft. deep, 40 cu. yds.; Outside Walls, 18.25 sqs.; First Floor, 9.50 sqs.; Second Floor, without fin. fg., 6.00 sqs.; Ceiling, 10.50 sqs.; Roof Pitch, 12" rise per ft. run; Roof, 11.75 sqs.; Hips and Valleys, 40 lin. ft.; Cornice, C & F, 150 lin. ft.; Cornice, 4", 44 lin. ft.; Partitions, 160 lin. ft.; Inside Finish OS Walls, 135 lin. ft.; Front and OS French Doors, 1 opp.; Rear and Grade Doors, 1 opp.; Inside Doors and Cased Opps., 13 opps.; Windows and Casements, 17 opps.; Chimney, 28 lin. ft. Main Stairs, 1.

Page 38, January: Janos-Lester, Bldrs.

"TRUCOST" ESTIMATING FIGURES FOR THIS HOUSE: Basement Walls, 120 lin. ft.; Trench Walls, 15 lin. ft.; Basement Floor, 620 sq. ft.; Excavation per ft. deep, 29 cu. yds.; Outside Walls, 12.65 sqs.; First Floor, 6.00 sqs.; Ceiling 6.20 sqs.; Roof Pitch, 6 1/2" rise per ft. run; Roof, 7.95 sqs.; Hips and Valleys, 16 lin. ft.; Cornice, C & F, 122 lin. ft.; Partitions, 106 lin. ft.; Inside Finish OS Walls, 120 lin. ft.; Front and OS French Doors, 1 opp.; Rear and Grade Doors, 1 opp.; Inside Doors and Cased Opps., 11 opps.; Windows and Casements, 15 opps.; Gable Sash and Louvers, 2 opps.; Chimney, 26 lin. ft.; Porch Floor, .30 sqs.

Page 39, January: Janos-Lester, Bldrs.

"TRUCOST" ESTIMATING FIGURES FOR THIS HOUSE: Basement Walls, 125 lin. ft.; Trench Walls, 10 lin. ft.; Basement Floor, 640 sq. ft.; Excavation per ft. deep, 31 cu. yds.; Outside Walls, 13.25 sqs.; First Floor, 6.50 sqs.; Ceiling, 6.70 sqs.; Roof Pitch, 7" rise per ft. run; Roof, 8.75 sqs.; Hips and Valleys,

EVERY BATHROOM NEEDS THIS Extra HEAT

You need this bathroom heat every day in the year. When it's too warm for unit heat or too cold for unit heat alone—Thermador Built-In Bathroom Heaters

are the answer. Just a flip of the switch and you are instantly blanketed from head to heels in flameless, fumeless, economical electric warmth.

Write to
Thermador Electrical Mfg. Co.
5119 So. Riverside Drive
Los Angeles, California



THERMADOR ELECTRIC BATHROOM HEATERS

16 lin. ft.; Cornice, C & F, 134 lin. ft.; Partitions, 100 lin. ft.; Inside Finish OS Walls, 125 lin. ft.; Front and OS French Doors, 1 opg.; Rear and Grade Doors, 1 opg.; Inside Doors and Cased Opps., 10 opps.; Windows and Casements, 10 opps.; Gable Sash and Louvers, 2 opps.; Chimney, 24 lin. ft.; Porch Floor, .50 sqs.; Porch and Balcony Post and Newels, 2; Porch and Deck Rail, 10 lin. ft.

Page 41, January; Mills & Sons, Bldrs.

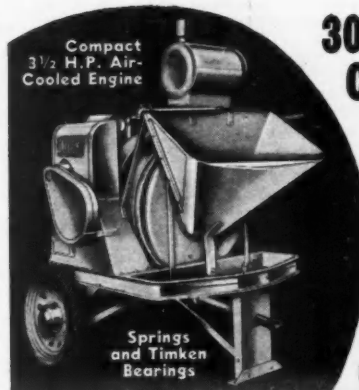
"TRUCOST" ESTIMATING FIGURES FOR THIS HOUSE: Basement Walls, 130 lin. ft.; Trench Walls, 162 lin. ft.; Basement Floor, 980 sq. ft.; Garage Floor, 380 sq. ft.; Excavation per ft. deep, 42 cu. yds.; Outside Walls, 30.00 sqs.; First Floor, 13.00 sqs.; Second Floor, with fin. fig., 7.36 sqs.; Second Floor, without fin. fig., 3.00 sqs.; Ceiling, 20.50 sqs.; Roof Pitch, 10" rise per ft. run; Roof, 22.50 sqs.; Hips and Valleys, 20 lin. ft.; Cornice, C & F, 230 lin. ft.; Partitions, 270 lin. ft.; Inside Finish OS Walls, 300 lin. ft.; Front and OS French Doors, 3 opps.; Rear and Grade Doors, 3 opps.; Garage Door 8 ft. wide, 2; Inside Doors and Cased Opps., 29 opps.; Windows and Casements, 31 opps.; Gable Sash and Louvers, 1 opg.; Chimney, 32 lin. ft.; Main Stairs, 1; Porch Floor, 1.92 sqs.; Porch Ceilings, 1.50 sqs.; Porch Beam, 30 lin. ft.; Porch and Balcony Post and Newels, 6; Porch Roof, 1.80 sqs.; Porch Cornice, 30 lin. ft.

Page 42, January; Evans, Moore & Woodbridge, Archts.

"TRUCOST" ESTIMATING FIGURES FOR THIS HOUSE: Basement Walls, 108 lin. ft.; Trench Walls, 88 lin. ft.; Basement Floor, 550 sq. ft.; Garage Floor, 258 sq. ft.; Excavation per ft. deep, 26 cu. yds.; Outside Walls, 19.50 sqs.; First Floor, 5.50 sqs.; Second Floor, with fin. fig., 5.92 sqs.; Ceiling, 12.42 sqs.; Roof Pitch, 7" rise per ft. run; Roof, 7.00 sqs.; Valleys, 24 lin. ft.; Cornice, C & F, 112 lin. ft.; Cornice, 8", 60 lin. ft.; Partitions, 130 lin. ft.; Inside Finish OS Walls, 212 lin. ft.; Front and OS French Doors, 3 opps.; Rear and Grade Doors, 1 opg.; Garage Door 8 ft. wide, 1; Inside Doors and Cased Opps., 15 opps.; Windows and Casements, 22 opps.; Chimney, 32 lin. ft.; Main Stairs, 1; Porch Floor, 2.25 sqs.; Porch Ceiling, 2.16 sqs.; Porch Beam, 54 lin. ft.; Porch and Balcony Post and Newels, 2; Porch & Garage Roofs, 3.10 sqs.; Porch & Garage Cornices, 66 lin. ft.

Page 43, January; Eschenbach, Archt.

"TRUCOST" ESTIMATING FIGURES FOR THIS HOUSE: Foundation Walls, 275 lin. ft.; Trench Walls, 64 lin. ft.; Heater Rm. Floor, 80 sq. ft.; Garage, Tool Rm. and Closet Floor, 300 sq. ft.; Excavation per ft. deep, 45 cu. yds.; Outside Walls, 26.00 sqs.; First Floor, 10.75 sqs.; Ceiling, 14.55 sqs.; Roof Pitch, 9" rise per ft. run; Roof, 23.00 sqs.; Hips and Valleys, 32 lin. ft.; Cornice, C & F, 300 lin. ft.; Cornice, 8", 30 lin. ft.; Partitions, 224 lin. ft.; Inside Finish OS Walls, 300 lin. ft.; Front and OS French Doors, 3 opps.; Rear and Grade Doors, 5 opps.; Garage Door 8 ft. wide, 1; Inside Doors and Cased Opps., 18 opps.; Windows and Casements, 20 opps.; Gable Sash and Louvers, 2 opps.; Chimney, 24 lin. ft.; Porch Floor, 3.00 sqs.; Porch Ceilings, 3.00 sqs.; Porch Beam, 68 lin. ft.; Porch and Balcony Post and Newels, 11; Porch Roof, 3.75 sqs.; Porch Cornice, 72 lin. ft.



30% to 40% MORE CONCRETE with this MIXER!

Load the Measuring Batch Hopper (12" lower) while you mix and discharge — fast as power loader. Criss-Cross "Re"-Mix Drum, Accurate Measuring Tank (siphon type). End discharge design. Get catalog, prices. The Jaeger Machine Co., 521 Dublin Ave., Columbus, Ohio.

JAEGER 3 1/2 SPEEDLINE

8 Machines in One!

And each of them is full-sized and independently operated. That is why you can do complete job, from rough lumber to finished product, with the

NEW MODEL "A" PLANING MILL SPECIAL

Like the whole Parks line, the New Model "A" is low in cost and in operating expense and will give years of long, hard service.

Complete line of individual and combination machines
Good Woodworking Machines Since 1887
THE PARKS WOODWORKING MACHINE CO.
 Dept. BL-1 1524 Knowlton Street, Cincinnati, Ohio

YOU CAN DEPEND ON THAT KINNEAR ROL-TOP DOOR FOR LASTING SATISFACTION

Contractors know they can rely on Kinnear Rol-TOP's rugged durability and smooth, easy action. And clients prefer Rol-TOP's exclusive weathertight "keystone seal" and other quality features. Any size, wood or all-steel. (Rol-TOP is made by the makers of the famous Kinnear Steel Rolling Doors.) Write for catalog today.

KINNEAR ROLLING DOORS **THE KINNEAR MFG. COMPANY**
 1560-80 FIELDS AVE., COLUMBUS, OHIO

10 STERLING Features

- 1 Perfect Balance.
- 2 10-spoke Wheels.
- 3 Self-Lubricating Bushings.
- 4 Welded Trays.
- 5 Heavy Continuous Tray Rod.
- 6 Malleable Wheel Guards.
- 7 Channel Steel Legs.
- 8 Square Bent Leg Shoes.
- 9 Clear Maple Handles.
- 10 Interchangeable Parts.

No. S-12 BARROW—FOR DRY MATERIAL. Furnished with Solid Rubber Tires if so desired.

STERLING WHEELBARROW CO.
 MILWAUKEE, WISCONSIN

ORNAMENTAL WROUGHT IRON



To suit your specifications or will gladly furnish suitable designs and suggestions.

Manufacture PLAIN or ORNAMENTAL RAILINGS, GATES, GRILLES, IRON FENCE, also all kinds of Wire Fence including Chain Link Fence, Iron and Wire Window Guards, Cellar Doors, Area Gratings, etc.

Send measurements

CINCINNATI IRON FENCE CO., INC.

3411 SPRING GROVE AVE. CINCINNATI, OHIO

Only \$28⁰⁰

For all Panel Style 16 Panels!
Glazed 4 Lights . . . Slightly Higher Priced!
Retail Prices any U. S. Jobbing Center
East of Rocky Mountains

FLOATING ACTION "UNI-ROL" GARAGE DOOR



Complete with Stanley "Swing Up" Hardware, Bronze Cylinder Lock and Metal Weather-strip.

Doors 1 3/4" thick. Fitted for 8-0 x 7-0 and 8-0 x 6-6 openings.

The popular price of this "QUALITYBILT" smooth operating door creates real sales volume. Easy to install. Only 1 3/4" headroom and 2 1/2" sideroom needed.

If your dealer can't supply you write us, Dept. AB-141

FARLEY & LOETSCHER MFG. COMPANY
"QUALITYBILT" WOODWORK DUBUQUE, IOWA

New C.M.C. KOSTKUTTER POWER SAWS

FOR HIGH SPEED PRECISION SAWING!



Left—Kost Kutter Jr. Fast, powerful, built to last. 3.6 H.P. Briggs & Stratton Engine. Cuts up to 3 1/4" stock.

Right — Kost Kutter Sr. Husky, streamlined, sawdust proofed. Cuts up to 4" stock. Has 6 H.P. air-cooled engine or electric motor.

Write for new CMC catalog of latest Mixers, Pumps, Saws, Hoists, Carts and Barrows.

CONSTRUCTION MACHINERY COMPANY—WATERLOO, IOWA

SPRAY WATERPROOFED COLORED STUCCO



Renew and beautify old buildings. Make new construction more permanent and attractive. Plastic Colorcrete fuses with any masonry surface. It fills all checks. It can be applied in any thickness and in 30 colors. Fully proven by over 13 years actual use under all conditions and every climate.

OFFERS BIG EARNINGS

Owners everywhere want to enhance present values. With this machine you can supply this big waiting market with permanent Colorcrete at amazingly low cost. Operators report cost of 2c and up per sq. ft. and sell up to 7c. Some have paid for their equipment from first few jobs. Machine capacity up to 1000 sq. ft. per hour.

Get the facts. Colorcrete books tell the whole story. Write today. It may mean business independence for you.

COLORCRETE INDUSTRIES, INC.
800 Ottawa Ave. Holland, Michigan



INDEX TO ADVERTISERS

JANUARY, 1941

A	
Adam Electric Company, Frank.....	85
Aluminum Company of America.....	6
American Builder Book Dept.....	16-17-22-92-94
American Floor Surfacing Machine Company.....	75
American Rolling Mill Co., The.....	85
American Technical Society.....	89
American Telephone & Telegraph Co.....	83
American Window Glass Co.....	20
Arkansas Soft Pine Bureau.....	28
Armstrong Cork Company.....	63
B	
Better Homes & Gardens.....	80
Bruce Co., E. L.....	67-71
C	
Carnegie-Illinois Steel Corporation.....	98
Carter Division, R. L.....	78
Celotex Corporation, The.....	2
Chicago Technical College.....	93
Cincinnati Iron Fence Co., Inc.....	96
Colorcrete Industries, Inc.....	96
Columbia Steel Company.....	98
Concrete Equipment Company.....	93
Construction Machinery Company.....	96
Crane Co.....	8
D	
Detroit Steel Products Company.....	3
De Walt Products Corporation.....	73
Douglas Fir Plywood Association.....	7
Dunn Mfg. Co., W. E.....	61
E	
Edwards Manufacturing Co., The.....	91
F	
Farley & Loetscher Mfg. Company.....	96
Fir Door Institute.....	74-79
Foley Mfg. Co.....	92
Ford Motor Company.....	4
G	
General Electric Company.....	10
General Electric Home Bureau.....	59
Gibbs Boardtile Corporation.....	92
Grand Rapids Hardware Co.....	72
H	
Heatilator Company.....	87
Henry Furnace & Foundry Co., The.....	64
J	
Jaeger Machine Co., The.....	95
Johns-Manville.....	19